

TREATISE ON INVERTEBRATE PALEONTOLOGY

*Prepared under the Guidance of the
Joint Committee on Invertebrate Paleontology*

*Paleontological
Society*

*Society of Economic
Paleontologists and
Mineralogists*

*Palaeontographical
Society*

Directed and Edited by

RAYMOND C. MOORE

Part O

ARTHROPODA 1

ARTHROPODA—GENERAL FEATURES
PROTARTHROPODA
EUARTHROPODA—GENERAL FEATURES
TRILOBITOMORPHA

By H. J. HARRINGTON, GUNNAR HENNINGSMOEN, B. F. HOWELL, VALDAR JAANUS-
SON, CHRISTINA LOCHMAN-BALK, R. C. MOORE, CHRISTIAN POULSEN, FRANCO
RASETTI, EMMA RICHTER, RUDOLF RICHTER, HERTA SCHMIDT, KLAUS SDZUY,
WOLFGANG STRUVE, LEIF STØRMER, C. J. STUBBLEFIELD, RONALD TRIPP, J. M.
WELLER, and H. B. WHITTINGTON

GEOLOGICAL SOCIETY OF AMERICA
and
UNIVERSITY OF KANSAS PRESS

1959

REPRINTED 1968, 1977

© 1959 BY THE UNIVERSITY OF KANSAS PRESS
AND THE GEOLOGICAL SOCIETY OF
AMERICA

ALL RIGHTS RESERVED

Library of Congress Catalogue Card
Number: 53-12913
ISBN 0-8137-3015-5

Composition by The University of Kansas Press
Lawrence, Kansas

Printing by The Meriden Gravure Company
Meriden, Connecticut

Address all communications to The Geological Society of America, 3300 Penrose Place, Boulder, CO 80301

Pau Martin

The *Treatise on Invertebrate Paleontology* has been made possible by (1) a grant of funds from The Geological Society of America through the bequest of Richard Alexander Fullerton Penrose, Jr., for preparation of illustrations and partial defrayment of organizational expense; (2) contribution of the knowledge and labor of specialists throughout the world, working in co-operation under sponsorship of The Palaeontographical Society, The Paleontological Society, and The Society of Economic Paleontologists and Mineralogists; and (3) acceptance by the University of Kansas Press of publication without cost to the Societies concerned and without any financial gain to the Press.

JOINT COMMITTEE ON INVERTEBRATE PALEONTOLOGY

RAYMOND C. MOORE, University of Kansas, *Chairman*

G. ARTHUR COOPER, United States National Museum, *Executive Member*

NORMAN D. NEWELL, Columbia University and American Museum of Natural History,
Executive Member

C. J. STUBBLEFIELD, Geological Survey of Great Britain, *Executive Member*

Representing THE PALAEOONTOGRAPHICAL SOCIETY

L. BAIRSTOW, British Museum (Natural History)

O. M. B. BULMAN, Sedgwick Museum, Cambridge University

C. P. CHATWIN, Geological Survey of Great Britain (retired)

L. R. COX, British Museum (Natural History)

T. NEVILLE GEORGE, Glasgow University

H. L. HAWKINS, University of Reading

R. V. MELVILLE, Geological Survey of Great Britain

H. M. MUIR-WOOD, British Museum (Natural History)

C. J. STUBBLEFIELD, Geological Survey of Great Britain

H. DIGHTON THOMAS, British Museum (Natural History)

Representing THE PALEONTOLOGICAL SOCIETY

G. ARTHUR COOPER, United States National Museum

CARL O. DUNBAR, Yale University

B. F. HOWELL, Princeton University

A. K. MILLER, State University of Iowa

R. R. SHROCK, Massachusetts Institute of Technology

F. M. SWARTZ, Pennsylvania State College

H. E. VOKES, Tulane University

A. SCOTT WARTHIN, JR., Vassar College

J. W. WELLS, Cornell University

W. P. WOODRING, United States Geological Survey

Representing THE SOCIETY OF ECONOMIC PALEONTOLOGISTS AND MINERALOGISTS

CARL C. BRANSON, University of Oklahoma

DON L. FRIZZELL, Missouri School of Mines

H. V. HOWE, Louisiana State University

J. BROOKES KNIGHT, Longboat Key, Florida

C. G. LALICKER, McAllen, Texas

STUART A. LEVINSON, Humble Oil & Refining Company

N. D. NEWELL, Columbia University;
American Museum of Natural History

F. W. ROLSHAUSEN, Humble Oil & Refining Company

H. B. STENZEL, Shell Development Co.

J. M. WELLER, University of Chicago

GEOLOGICAL SOCIETY OF AMERICA

H. R. ALDRICH, *Editor-in-Chief*

AGNES CREAGH, *Managing Editor*

UNIVERSITY OF KANSAS PRESS

CLYDE K. HYDER, *Editor*

TREATISE ON INVERTEBRATE PALEONTOLOGY

Directed and Edited by
RAYMOND C. MOORE

VOLUMES ALREADY PUBLISHED

(Previous to 1977)

- Part C. PROTISTA 2 (Sarcodina, chiefly "Thecamoebians" and Foraminiferida), xxxi+900 p., 5311 fig., 1964.
Part D. PROTISTA 3 (chiefly Radiolaria, Tintinnina), xii+195 p., 1050 fig., 1954.
Part E. ARCHAEOCYATHA, PORIFERA, xviii+122 p., 728 fig., 1955.
Part E, Volume 1. ARCHAEOCYATHA, second edition (revised and enlarged), xxx+158 p., 871 fig., 1972.
Part F. COELENTERATA, xvii+498 p., 2700 fig., 1956.
Part G. BRYOZOA, xii+253 p., 2000 fig., 1953.
Part H. BRACHIOPODA, xxxii+927 p., 5198 fig., 1965.
Part I. MOLLUSCA 1 (Mollusca General Features, Scaphopoda, Amphineura, Monoplacophora, Gastropoda General Features, Archaeogastropoda, mainly Paleozoic Caenogastropoda and Opisthobranchia), xxiii+351 p., 1732 fig., 1960.
Part K. MOLLUSCA 3 (Cephalopoda General Features, Endoceratoidea, Actinoceratoidea, Nautiloidea, Bactritoidea), xxviii+519 p., 2382 fig., 1964.
Part L. MOLLUSCA 4 (Ammonoidea), xxii+490 p., 3800 fig., 1957.
Part N. MOLLUSCA 6 (Bivalvia), Volumes 1 and 2 (of 3), xxxviii+952 p., 6198 fig., 1969; Volume 3, iv+272 p., 742 fig., 1971.
Part O. ARTHROPODA 1 (Arthropoda General Features, Protarthropoda, Euarthropoda General Features, Trilobitomorpha), xix+560 p., 2880 fig., 1959.
Part P. ARTHROPODA 2 (Chelicerata, Pycnogonida, Palaeoisopus), xvii+181 p., 565 fig., 1955.
Part Q. ARTHROPODA 3 (Crustacea, Ostracoda), xxiii+442 p., 3476 fig., 1961.
Part R. ARTHROPODA 4 (Crustacea exclusive of Ostracoda, Myriapoda, Hexapoda), Volumes 1 and 2 (of 3), xxxvi+651 p., 1762 fig., 1969.
Part S. ECHINODERMATA 1 (Echinodermata General Features, Homalozoa, Crinozoa, exclusive of Crinoidea), xxx+650 p., 2868 fig., 1967 [1968].
Part U. ECHINODERMATA 3 (Asterozoans, Echinozoans), xxx+695 p., 3485 fig., 1966.
Part V. GRAPTOLITHINA, xvii+101 p., 358 fig., 1955.
Part V. GRAPTOLITHINA, second edition (revised and enlarged), xxxii+163 p., 507 fig., 1970.
Part W. MISCELLANEA (Conodonts, Conoidal Shells of Uncertain Affinities, Worms, Trace Fossils, Problematica), xxv+259 p., 1058 fig., 1962.
Part W. MISCELLANEA (Supplement 1). Trace Fossils, second edition (revised and enlarged), xxi+269 p., 912 fig., 1975.

CONTRIBUTING AUTHORS

- | | |
|---|---|
| AGER, D. V., Imperial College of Science and Technology, London, England. | BASSLER, R. S., U.S. National Museum, Washington, D.C. |
| AMSDEN, T. W., Oklahoma Geological Survey, Norman, Okla. | BATTEN, ROGER, L., University of Wisconsin, Madison, Wisconsin. |
| †ARKELL, W. J., Sedgwick Museum, Cambridge University, Cambridge, Eng. | BAYER, FREDERICK M., U.S. National Museum, Washington, D.C. |
| BAIRSTOW, LESLIE, British Museum (Natural History), London, Eng. | BELL, W. CHARLES, University of Texas, Austin, Tex. |
| BARKER, R. WRIGHT, Shell Development Co., Houston, Tex. | BENSON, R. H., University of Kansas, Lawrence, Kans. |

- BERDAN, JEAN M., U.S. Geological Survey, Washington, D.C.
- BOARDMAN, R. S., U.S. Geological Survey, Washington, D.C.
- BOSCHMA, H., Rijksmuseum van Natuurlijke Historie, Leiden, Netherlands.
- BOWSER, ARTHUR L., Sinclair Oil & Gas Co., Tulsa, Okla.
- BRAMLETTE, M. N., Scripps Institution of Oceanography, La Jolla, California.
- BRANSON, CARL C., University of Oklahoma, Norman, Okla.
- BROWN, D. A., University of Otago, Dunedin, N.Z.
- BULMAN, O. M. B., Sedgwick Museum, Cambridge University, Cambridge, Eng.
- CAMPBELL, ARTHUR S., St. Mary's College, St. Mary's College, Calif.
- CARPENTER, FRANK M., Biological Laboratories, Harvard University, Cambridge, Mass.
- CASEY, RAYMOND, Geological Survey of Great Britain, London, Eng.
- CASTER, K. E., University of Cincinnati, Cincinnati, Ohio
- CHAVAN, ANDRÉ, Chantemerle à Seyssel (Ain), France.
- COLE, W. STORRS, Cornell University, Ithaca, N.Y.
- COOPER, G. ARTHUR, U.S. National Museum, Washington, D.C.
- COX, L. R., British Museum (Natural History), London, Eng.
- CURRY, DENNIS, Pinner, Middlesex, Eng.
- †DAVIES, L. M., Edinburgh, Scot.
- DECHASEAUX, C., Laboratoire de Paléontologie à la Sorbonne, Paris, France.
- DOUGLASS, R. C., U.S. National Museum, Washington, D.C.
- DURHAM, J. WYATT, Museum of Palaeontology, University of California, Berkeley, Calif.
- EAMES, F. E., Anglo-Iranian Oil Company, London, Eng.
- ELLIOTT, GRAHAM F., Iraq Petroleum Company, London, Eng.
- EMERSON, W. K., American Museum of Natural History, New York, N.Y.
- EXLINE, HARRIET, Rolla, Mo.
- FELL, H. BARRACLOUGH, Victoria University College, Wellington, N.Z.
- FISCHER, ALFRED G., Princeton University, Princeton, N.J.
- FISHER, D. W., New York State Museum, Albany, N.Y.
- FLOWER, ROUSSEAU H., New Mexico Institute of Mining and Technology, Socorro, N.Mex.
- FRIZZELL, DONALD L., Missouri School of Mines, Rolla, Mo.
- FURNISH, WILLIAM M., State University of Iowa, Iowa City, Iowa.
- GARDNER, JULIA, U.S. Geological Survey, Washington, D.C.
- GEORGE, T. NEVILLE, Glasgow University, Glasgow, Scot.
- HAAS, FRITZ, Chicago Natural History Museum, Chicago, Ill.
- HANNA, G. DALLAS, California Academy of Sciences, San Francisco, Calif.
- HÄNTZSCHEL, WALTER, Geologisches Staatsinstitut, Hamburg, Ger.
- HARRINGTON, H. J., Tennessee Gas Transmission Company, Houston, Tex.
- HASS, WILBERT H., U.S. Geological Survey, Washington, D.C.
- HATAI, KOTORI, Tohoku University, Sendai, Japan.
- HAWKINS, H. L., Reading University, Reading, Eng.
- HEDGPETH, JOEL, College of the Pacific, Dillon Beach, Calif.
- HENNINGSMOEN, GUNNAR, Paleontologisk Museum, University of Oslo, Oslo, Norway.
- HERTLEIN, L. G., California Academy of Sciences, San Francisco, Calif.
- HESSLAND, IVAR, Geologiska Institutet, University of Stockholm, Stockholm, Swed.
- HILL, DOROTHY, University of Queensland, Brisbane, Queensl.
- HOLTHUIS, L. B., Rijksmuseum van Natuurlijke Historie, Leiden, Netherlands.
- HOWE, HENRY V., Louisiana State University, Baton Rouge, La.
- HOWELL, B. F., Princeton University, Princeton, N.J.
- HYMAN, LIBBIE H., American Museum of Natural History, New York, N.Y.
- JAANUSSON, VALDAR, Paleontological Inst., Uppsala, Sweden.
- JELETZKY, J. A., Geological Survey of Canada, Ottawa, Can.
- KAMPTNER, ERWIN, Naturhistorisches Museum, Wien, Aus.
- KEEN, MYRA, Stanford University, Stanford, Calif.
- KESLING, ROBERT V., Paleontological Museum, University of Michigan, Ann Arbor, Mich.

- KIER, PORTER, U. S. National Museum, Washington, D.C.
- KNIGHT, J. BROOKES, Longboat Key, Fla.
- KUMMEL, BERNHARD, Museum of Comparative Zoology, Harvard University, Cambridge, Mass.
- LA ROCQUE, AURÈLE, Ohio State University, Columbus, Ohio.
- LAUBENFELS, M. W. DE, Oregon State College, Corvallis, Ore.
- LECOMPTE, MARIUS, Institut Royal des Sciences Naturelles, Bruxelles, Belg.
- LEONARD, A. BYRON, University of Kansas, Lawrence, Kans.
- LEVINSON, S. A., Humble Oil & Refining Company, Houston, Tex.
- LOCHMAN-BALK, CHRISTINA, New Mexico Institute of Mining and Geology, Socorro, N.Mex.
- LOEBLICH, A. R., JR., California Research Corporation, La Habra, Calif.
- LOEBLICH, HELEN TAPPAN, University of California, Los Angeles, Calif.
- LOHMAN, KENNETH E., U.S. Geological Survey, Washington, D.C.
- LOWENSTAMM, HEINZ A., California Institute of Technology, Pasadena, Calif.
- LUDBROOK, N. H., Department of Mines, Adelaide, S.Austral.
- MARWICK, J., New Zealand Geological Survey, Wellington, N.Z.
- MELVILLE, R. V., Geological Survey and Museum, London, Eng.
- MILLER, ARTHUR K., State University of Iowa, Iowa City, Iowa.
- MONTANARO-GALLITELLI, EUGENIA, Istituto di Geologia e Paleontologia, Università, Modena, Italy.
- MOORE, RAYMOND C., University of Kansas, Lawrence, Kans.
- MORRISON, J. P. E., U.S. National Museum, Washington, D.C.
- MUIR-WOOD, HELEN M., British Museum (National History), London, Eng.
- NEWELL, NORMAN D., American Museum of Natural History (and Columbia University), New York, N.Y.
- OKULITCH, VLADIMIR J., University of British Columbia, Vancouver, B.C.
- OLSSON, AXEL A., Coral Gables, Florida.
- PALMER, KATHERINE VAN WINKLE, Paleontological Research Institution, Ithaca, N.Y.
- PECK, RAYMOND E., University of Missouri, Columbia, Mo.
- PETRUNKEVITCH, ALEXANDER, Osborn Zoological Laboratory, Yale University, New Haven, Conn.
- POULSEN, CHR., Universitetets Mineralogisk-Geologiske Institut, København, Denm.
- POWELL, A. W. B., Auckland Institute and Museum, Auckland, N.Z.
- PURI, HARBANS, Florida State Geological Survey, Tallahassee, Fla.
- RASETTI, FRANCO, Johns Hopkins University, Baltimore, Md.
- RASMUSSEN, H. W., Universitets Mineralogisk—Geologiske Institut, København, Denm.
- REGNÉLL, GERHARD, Paleontologiska Institution, Lunds Universitets, Lund, Swed.
- REHDER, HARALD A., U.S. National Museum, Washington, D.C.
- REICHEL, M., Bernouillanum, Basel University, Basel, Switz.
- †RICHTER, EMMA, Senckenberg Natur-Museum, Frankfurt-a.-M., Ger.
- †RICHTER, RUDOLF, Universität Frankfurt-a.-M., Frankfurt-a.-M., Ger.
- ROBERTSON, ROBERT, Museum of Comparative Zoology, Harvard University, Cambridge, Mass.
- SCHINDEWOLF, O. H. Geologisch-paläontologisches Institut der Universität Tübingen, Tübingen, Ger.
- SCHMIDT, HERTA, Senckenbergische Naturforschende Gesellschaft, Frankfurt-a.-M., Ger.
- SCOTT, HAROLD W., University of Illinois, Urbana, Ill.
- SDZUY, KLAUS, Senckenbergische Naturforschende Gesellschaft, Frankfurt-a.-M., Ger.
- SHAVER, ROBERT, State Geological Survey, Bloomington, Indiana.
- SIEVERTS-DORECK, HERTHA, Stuttgart-Möhringen, Ger.
- SINCLAIR, G. W., Geological Survey of Canada, Ottawa, Can.
- SMITH, ALLYN G., California Academy of Sciences, San Francisco, Calif.
- SOHN, I. G., U.S. Geological Survey, Washington, D.C.
- †SPENCER, W. K., Crane Hill, Ipswich, Suffolk, Eng.
- †STAINBROOK, MERRILL A., Brandon, Iowa.
- STEHLI, F. G., Tulsa, Okla.
- STENZEL, H. B., Shell Development Co. Houston, Tex.
- STEPHENSON, LLOYD W., Dover, Ohio.

- STØRMER, LEIF, Paleontologisk Institutt, University of Oslo, Oslo, Nor.
- STRUVE, WOLFGANG, Senckenbergische Naturforschende Gesellschaft, Frankfurt-a.-M., Ger.
- STUBBLEFIELD, C. J., Geological Survey and Museum, London, Eng.
- STUMM, ERWIN C., Museum of Paleontology, University of Michigan, Ann Arbor, Mich.
- SWAIN, FREDERICK M., University of Minnesota, Minneapolis, Minn.
- SYLVESTER-BRADLEY, P. C., University of Sheffield, Sheffield, Eng.
- TASCH, PAUL, University of Wichita, Wichita, Kans.
- TEICHERT, CURT, U.S. Geological Survey, Federal Center, Denver, Colo.
- THOMPSON, M. L., Illinois Geological Survey, Urbana, Ill.
- THOMPSON, R. H., University of Kansas, Lawrence, Kans.
- †TIEGS, O. W., University of Melbourne, Melbourne, Victoria, Austral.
- TRIPP, RONALD P., Glasgow, Scot.
- UBAGHS, G., Université de Liège, Liège, Belg.
- VOKES, H. E., Johns Hopkins University, Baltimore, Md.
- †WANNER, J., Scheidegg (Allgäu), Bayern, Ger.
- WEIR, JOHN, Glasgow University, Glasgow, Scot.
- WELLER, J. MARVIN, University of Chicago, Chicago, Ill.
- WELLS, JOHN W., Cornell University, Ithaca, N.Y.
- WHITTINGTON, H. B., Museum of Comparative Zoology, Harvard University, Cambridge, Mass.
- WILLIAMS, ALWYN, Queens University of Belfast, Belfast, N.Ire.
- WILLS, L. J., Romsley, Eng.
- †WITHERS, T. H., Bournemouth, Eng.
- WRIGHT, C. W., Kensington, Eng.
- †WRIGLEY, ARTHUR, Norbury, London, Eng.
- YOCHELSON, ELLIS L., U.S. Geological Survey, Washington, D.C.
- YONGE, C. M., University of Glasgow, Glasgow, Scot.

†—Deceased.

EDITORIAL PREFACE

The aim of the *Treatise on Invertebrate Paleontology*, as originally conceived and consistently pursued, is to present the most comprehensive and authoritative, yet compact statement of knowledge concerning invertebrate fossil groups that can be formulated by collaboration of competent specialists in seeking to organize what has been learned of this subject up to the mid-point of the present century. Such work has value in providing a most useful summary of the collective results of multitudinous investigations and thus should constitute an indispensable text and reference book for all persons who wish to know about remains of invertebrate organisms preserved in rocks of the earth's crust. This applies to neozoologists as well as paleozoologists and to beginners in study of fossils as well as to thoroughly trained, long-experienced professional workers, including teachers, stratigraphical geologists, and individuals engaged in research on fossil invertebrates. The making of a reasonably complete inventory of present knowledge of invertebrate paleontology may be expected to yield needed foundation for future research and

it is hoped that the *Treatise* will serve this end.

The *Treatise* is divided into parts which bear index letters, each except the initial and concluding ones being defined to include designated groups of invertebrates. The chief purpose of this arrangement is to provide for independence of the several parts as regards date of publication, because it is judged desirable to print and distribute each segment as soon as possible after it is ready for press. Pages in each part will bear the assigned index letter joined with numbers beginning with 1 and running consecutively to the end of the part. When the parts ultimately are assembled into volumes, no renumbering of pages and figures is required.

The outline of subjects to be treated in connection with each large group of invertebrates includes (1) description of morphological features, with special reference to hard parts, (2) ontogeny, (3) classification, (4) geological distribution, (5) evolutionary trends and phylogeny, and (6) systematic description of genera, subgenera, and higher taxonomic units. In general,

paleoecological aspects of study are omitted or little emphasized because comprehensive treatment of this subject is being undertaken in a separate work, prepared under auspices of a committee of the United States National Research Council. A selected list of references is furnished in each part of the *Treatise*.

Features of style in the taxonomic portions of this work have been fixed by the Editor with aid furnished by advice from the Joint Committee on Invertebrate Paleontology representing the societies which have undertaken to sponsor the *Treatise*. It is the Editor's responsibility to consult with authors and co-ordinate their work, seeing that manuscript properly incorporates features of adopted style. Especially he has been called on to formulate policies in respect to many questions of nomenclature and procedure. The subject of family and subfamily names is reviewed briefly in a following section of this preface, and features of *Treatise* style in generic descriptions are explained.

A generous grant of \$35,000 has been made by the Geological Society of America for the purpose of preparing *Treatise* illustrations. Administration of expenditures has been in charge of the Editor and most of the work by photographers and artists has been done under his direction at the University of Kansas, but sizable parts of this program have also been carried forward in Washington and London.

FORM OF ZOOLOGICAL NAMES

Many questions arise in connection with the form of zoological names. These include such matters as adherence to stipulations concerning Latin or Latinized nature of words accepted as zoological names, gender of generic and subgeneric names, nominative or adjectival form of specific names, required endings for some family-group names, and numerous others. Regulation extends to capitalization, treatment of particles belonging to modern patronymics, use of neo-Latin letters, and approved methods for converting diacritical marks. The magnitude and complexities of nomenclature problems surely are enough to warrant the complaint of those who hold that zoology is the study of animals rather than of names applied to them.

CLASSIFICATION OF ZOOLOGICAL NAMES

In accordance with the "Copenhagen Decisions on Zoological Nomenclature" (London, 135 p., 1953), zoological names may be classified usefully in various ways. The subject is summarized here with introduction of designations for some categories which the *Treatise* proposes to distinguish in systematic parts of the text for the purpose of giving readers comprehension of the nature of various names together with authorship and dates attributed to them.

CO-ORDINATE NAMES OF TAXA GROUPS

Five groups of different-rank taxonomic units (termed *taxa*, sing., *taxon*) are discriminated, within each of which names are treated as co-ordinate, being transferrable from one category to another without change of authorship or date. These are: (1) Species Group (subspecies, species); (2) Genus Group (subgenus, genus); (3) Family Group (tribe, subfamily, family, superfamily); (4) Order/Class Group (suborder, order, subclass, class); and (5) Phylum Group (subphylum, phylum). In the first 3 of these groups, but not others, the author of the first-published valid name for any taxon is held to be the author of all other taxa in the group which are based on the same nominate type and the date of publication for purposes of priority is that of the first-published name. Thus, if author A in 1800 introduces the family name X-idae to include 3 genera, one of which is X-us; and if author B in 1850 divides the 20 genera then included in X-idae into subfamilies called X-inae and Y-inae; and if author C in 1950 combines X-idae with other later-formed families to make a superfamily X-acea (or X-oidea, X-icae, etc.); the author of X-inae, X-idae and X-acea is A, 1800, under the Rules. Because taxonomic concepts introduced by authors B and C along with appropriate names surely are not attributable to author A, some means of recording responsibility of B and C are needed. This is discussed later in explaining proposed use of "*nom. transl.*"

The co-ordinate status of zoological names belonging to the species group is stipulated in Art. 11 of the present Rules; genus group in Art. 6 of the present Rules;

family group in paragraph 46 of the Copenhagen Decisions; order/class group and phylum group in paragraphs 65 and 66 of the Copenhagen Decisions.

ORIGINAL AND SUBSEQUENT FORMS OF NAMES

Zoological names may be classified according to form (spelling) given in original publication and employed by subsequent authors. In one group are names which are entirely identical in original and subsequent usage. Another group comprises names which include with the original subsequently published variants of one sort or another. In this second group, it is important to distinguish names which are inadvertent changes from those constituting intentional emendations, for they have quite different status in nomenclature. Also, among intentional emendations, some are acceptable and some quite unacceptable under the Rules.

VALID AND INVALID NAMES

Valid names. A valid zoological name is one that conforms to all mandatory provisions of the Rules (Copenhagen Decisions, p. 43-57) but names of this group are divisible into subgroups as follows: (1) "*inviolable names*," which as originally published not only meet all mandatory requirements of the Rules but are not subject to any sort of alteration (most generic and subgeneric names); (2) "*perfect names*," which as they appear in original publication (with or without precise duplication by subsequent authors) meet all mandatory requirements and need no correction of any kind but which nevertheless are legally alterable under present Rules (as in changing the form of ending of a published class/order-group name); (3) "*imperfect names*," which as originally published and with or without subsequent duplication meet mandatory requirements but contain defects such as incorrect gender of an adjectival specific name (for example, *Spironema recta* instead of *Spironema rectum*) or incorrect stem or form of ending of a family-group name (for example, Spironemidae instead of Spironematidae); (4) "*transferred names*," which are derived by valid emendation from either of the 2nd or 3rd subgroups or from a pre-existing transferred

name (as illustrated by change of a family-group name from -inae to -idae or making of a superfamily name); (5) "*improved names*," which include necessary as well as somewhat arbitrarily made emendations allowable under the Rules for taxonomic categories not now covered by regulations as to name form and alterations that are distinct from changes that distinguish the 4th subgroup (including names derived from the 2nd and 3rd subgroups and possibly some alterations of 4th subgroup names). In addition, some zoological names included among those recognized as valid are classifiable in special categories, while at the same time belonging to one or more of the above-listed subgroups. These chiefly include (7) "*substitute names*," introduced to replace invalid names such as junior homonyms; and (8) "*conserved names*," which are names that would have to be rejected by application of the Rules except for saving them in their original or an altered spelling by action of the International Commission on Zoological Nomenclature in exercising its plenary powers to this end. Whenever a name requires replacement, any individual may publish a "new name" for it and the first one so introduced has priority over any others; since newness is temporary and relative, the replacement designation is better called substitute name rather than new name. Whenever it is considered desirable to save for usage an otherwise necessarily rejectable name, an individual cannot by himself accomplish the preservation, except by unchallenged action taken in accordance with certain provisions of the Copenhagen Decisions; otherwise he must seek validation through ICZN.

It is useful for convenience and brevity of distinction in recording these subgroups of valid zoological names to introduce Latin designations, following the pattern of *nomen nudum*, *nomen novum*, etc. Accordingly, the subgroups are (1) *nomina inviolata* (sing., *nomen inviolatum*, abbr., *nom. inviol.*); (2) *nomina perfecta* (sing., *nomen perfectum*, abbr., *nom. perf.*); (3) *nomina imperfecta* (sing., *nomen imperfectum*, abbr., *nom. imperf.*); (4) *nomina translata* (sing., *nomen translatum*, abbr., *nom. transl.*); (5) *nomina correcta* (sing., *nomen correctum*, abbr., *nom. correct.*); (6) *nom-*

ina substituta (sing., *nomen substitutum*, abbr., *nom. subst.*); (7) *nomina conservata* (sing., *nomen conservatum*, abbr., *nom. conserv.*).

Invalid names. Invalid zoological names consisting of originally published names that fail to comply with mandatory provisions of the Rules and consisting of inadvertent changes in spelling of names have no status in nomenclature. They are not available as replacement names and they do not preoccupy for purposes of the Law of Homonymy. In addition to *nomen nudum*, invalid names may be distinguished as follows: (1) "*denied names*," which consist of originally published names (with or without subsequent duplication) that do not meet mandatory requirements of the Rules; (2) "*null names*," which comprise unintentional alterations of names; and (3) "*vain or void names*," which consist of invalid emendations of previously published valid or invalid names. Void names do have status in nomenclature, being classified as junior synonyms of valid names.

Proposed Latin designations for the indicated kinds of invalid names are as follows: (1) *nomina negata* (sing., *nomen negatum*, abbr., *nom. neg.*); (2) *nomina nulla* (sing., *nomen nullum*, abbr., *nom. null.*); (3) *nomina vana* (sing., *nomen vanum*, abbr., *nom. van.*). It is desirable in the *Treatise* to identify invalid names, particularly in view of the fact that many of these names (*nom. neg.*, *nom. null.*) have been considered incorrectly to be junior objective synonyms (like *nom. van.*), which have status in nomenclature.

SUMMARY OF NAME CLASSES

Partly because only in such publications as the *Treatise* is special attention to classes of zoological names called for and partly because new designations are now introduced as means of recording distinctions explicitly as well as compactly, a summary may be useful. In the following tabulation valid classes of names are indicated in bold-face type, whereas invalid ones are printed in italics.

Definitions of Name Classes

nomen conservatum (*nom. conserv.*). Name otherwise unacceptable under application of the Rules which is made valid, either with original or

altered spelling, through procedures specified by the Copenhagen Decisions or by action of ICZN exercising its plenary powers.

nomen correctum (*nom. correct.*). Name with intentionally altered spelling of sort required or allowable under the Rules but not dependent on transfer from one taxonomic category to another ("improved name"). (See Copenhagen Decisions, paragraphs 50, 71-2-a-i, 74, 75, 79, 80, 87, 101; in addition, change of endings for categories not now fixed by Rules.)

nomen imperfectum (*nom. imperf.*). Name that as originally published (with or without subsequent identical spelling) meets all mandatory requirements of the Rules but contains defect needing correction ("imperfect name"). (See Copenhagen Decisions, paragraphs 50-1-b, 71-1-b-i, 71-1-b-ii, 79, 80, 87, 101.)

nomen inviolatum (*nom. inviol.*). Name that as originally published meets all mandatory requirements of the Rules and also is uncorrectable or alterable in any way ("inviolate name"). (See Copenhagen Decisions, paragraphs 152, 153, 155-157.)

nomen negatum (*nom. neg.*). Name that as originally published (with or without subsequent identical spelling) constitutes invalid original spelling and although possibly meeting all other mandatory requirements of the Rules, is not correctable to establish original authorship and date ("denied name"). (See Copenhagen Decisions, paragraph 71-1-b-iii.)

nomen nudum (*nom. nud.*). Name that as originally published (with or without subsequent identical spelling) fails to meet mandatory requirements of the Rules and having no status in nomenclature, is not correctable to establish original authorship and date ("naked name"). (See Copenhagen Decisions, paragraph 122.)

nomen nullum (*nom. null.*). Name consisting of an unintentional alteration in form (spelling) of a previously published name (either valid name, as *nom. inviol.*, *nom. perf.*, *nom. imperf.*, *nom. transl.*; or invalid name, as *nom. neg.*, *nom. nud.*, *nom. van.*, or another *nom. null.*) ("null name"). (See Copenhagen Decisions, paragraphs 71-2-b, 73-4.)

nomen perfectum (*nom. perf.*). Name that as originally published meets all mandatory requirements of the Rules and needs no correction of any kind but which nevertheless is validly alterable ("perfect name").

nomen substitutum (*nom. subst.*). Replacement name published as substitute for an invalid name, such as a junior homonym (equivalent to "new name").

nomen translatum (*nom. transl.*). Name that is derived by valid emendation of a previously published name as result of transfer from one taxonomic category to another within the group to which it belongs ("transferred name").

nomen vanum (*nom. van.*). Name consisting of an invalid intentional change in form (spelling) from a previously published name, such invalid emendations having status in nomenclature as junior objective synonyms ("vain or void name"). (See Copenhagen Decisions, paragraphs 71-2-a-ii, 73-3.)

Except as specified otherwise, zoological names accepted in the *Treatise* may be understood to be classifiable either as *nomina inviolata* or *nomina perfecta* (omitting from notice *nomina correcta* among specific names) and these are not discriminated. Names which are not accepted for one reason or another include junior homonyms, a few senior synonyms classifiable as *nomina negata* or *nomina nuda*, and numerous junior synonyms which include both objective (*nomina vana*) and subjective (all classes of valid names) types; effort to classify the invalid names as completely as possible is intended.

NAME CHANGES IN RELATION TO GROUP CATEGORIES

SPECIFIC AND SUBSPECIFIC NAMES

Detailed consideration of valid emendation of specific and subspecific names is unnecessary here because it is well understood and relatively inconsequential. When the form of adjectival specific names is changed to obtain agreement with the gender of a generic name in transferring a species from one genus to another, it is never needful to label the changed name as a *nom. transl.* Likewise, transliteration of a letter accompanied by a diacritical mark in manner now called for by the Rules (as in changing originally published *bröggeri* to *broeggeri*) or elimination of a hyphen (as in changing originally published *cornuoryx* to *cornuoryx* does not require "*nom. correct.*" with it. Revised provisions for emending specific and subspecific names are stated in the report on Copenhagen Decisions (p. 43-46, 51-57).

GENERIC AND SUBGENERIC NAMES

So rare are conditions warranting change of the originally published valid form of generic and subgeneric names that lengthy discussion may be omitted. Only elimination of diacritical marks of some names in this category seems to furnish basis for valid emendation. It is true that many

changes of generic and subgeneric names have been published, but virtually all of these are either *nomina vana* or *nomina nulla*. Various names which formerly were classed as homonyms are not now, for two names that differ only by a single letter (or in original publication by presence or absence of a diacritical mark) are construed to be entirely distinct. Revised provisions for emendation of generic and subgeneric names also are given in the report on Copenhagen Decisions (p. 43-47).

Examples in use of classificatory designations for generic names as previously given are the following, which also illustrate designation of type species, as explained later.

Kurnatiophyllum THOMSON, 1875 [**K. concentricum*; SD GREGORY, 1917] [= *Kumatiophyllum* THOMSON, 1876 (*nom. null.*); *Cymatiophyllum* THOMSON, 1901 (*nom. van.*); *Cymatiophyllum* LANG, SMITH & THOMAS, 1940 (*nom. van.*)].

Stichophyma POMEL, 1872 [**Manon turbinatum* RÖMER, 1841; SD RAUFF, 1893] [= *Stychophyma* VOSMAER, 1885 (*nom. null.*); *Sticophyma* MORET, 1924 (*nom. null.*)].

Stratophyllum SMYTH, 1933 [**S. tenue*] [= *Ethmoplax* SMYTH, 1939 (*nom. van. pro Stratophyllum*); *Stratiphyllum* LANG, SMITH & THOMAS, 1940 (*nom. van. pro Stratophyllum* SMYTH) (*non Stratiphyllum* SCHEFFEN, 1933)].

Placotelia OPPLIGER, 1907 [**Porostoma marconi* FROMENTEL, 1859; SD DELAUBENFELS, herein] [= *Plakotelia* OPPLIGER, 1907 (*nom. neg.*)].

Walcottella DELAUB., *nom. subst.*, 1955 [*pro Rhopalicus* SCHRAMM., 1936 (*non FÖRSTER*, 1856)].

Cyrtograptus CARRUTHERS, 1867 [*nom. correct.* LAPWORTH, 1873 (*pro Cyrtograpsus* CARRUTHERS, 1867), *nom. conserv.* proposed BULMAN, 1955 (ICZN pend.)]

FAMILY-GROUP NAMES; USE OF "NOM. TRANSL."

The Rules now specify the form of endings only for subfamily (-inae) and family (-idae) but decisions of the Copenhagen Congress direct classification of all family-group assemblages (taxa) as co-ordinate, signifying that for purposes of priority a name published for a unit in any category and based on a particular type genus shall date from its original publication for a unit in any category, retaining this priority (and authorship) when the unit is treated as belonging to a lower or higher category. By exclusion of -inae and -idae, respectively

reserved for subfamily and family, the endings of names used for tribes and superfamilies must be unspecified different letter combinations. These, if introduced subsequent to designation of a subfamily or family based on the same nominate genus, are *nomina translata*, as is also a subfamily that is elevated to family rank or a family reduced to subfamily rank. In the *Treatise* it is desirable to distinguish the valid emendation comprised in the changed ending of each transferred family group name by the abbreviation "*nom. transl.*" and record of the author and date belonging to this emendation. This is particularly important in the case of superfamilies, for it is the author who introduced this taxon that one wishes to know about rather than the author of the superfamily as defined by the Rules, for the latter is merely the individual who first defined some lower-rank family-group taxon that contains the nominate genus of the superfamily. The publication of the author containing introduction of the superfamily *nomen translatum* is likely to furnish the information on taxonomic considerations that support definition of the unit.

Examples of the use of "*nom. transl.*" are the following.

Subfamily **STYLININAE** d'Orbigny, 1851

[*nom. transl.* EDWARDS & HAIME, 1857 (ex Stylinidae D'ORBIGNY, 1851)]

Superfamily **ARCHAEOCTONOIDEA**

Petrunkévitch, 1949

[*nom. transl.* PETRUNKEVITCH, herein (ex Archaeoctonidae PETRUNKEVITCH, 1949)]

Superfamily **CRIOCERATITACEAE** Hyatt, 1900

[*nom. transl.* WRIGHT, 1952 (ex Crioceratitidae HYATT, 1900)]

FAMILY-GROUP NAMES; USE OF "*NOM. CORRECT.*"

Valid emendations classed as *nomina correctae* do not depend on transfer from one category of family-group units to another but most commonly involve correction of the stem of the nominate genus; in addition, they include somewhat arbitrarily chosen modification of ending for names of tribe or superfamily. Examples of the use of "*nom. correct.*" are the following.

Family **STREPTELASMATIDAE** Nicholson, 1889

[*nom. correct.* WEDEKIND, 1927 (ex Streptelasmidae NICHOLSON, 1889, *nom. imperf.*)]

Family **PALAEOSCORPIIDAE** Lehmann, 1944

[*nom. correct.* PETRUNKEVITCH, herein (ex Palaeoscorpionidae LEHMANN, 1944, *nom. imperf.*)]

Family **AGLASPIDIDAE** Miller, 1877

[*nom. correct.* STØRMER, herein (ex Aglaspidae MILLER, 1877, *nom. imperf.*)]

Superfamily **AGARICICAE** Gray, 1847

[*nom. correct.* WELLS, herein (ex Agaricioidae VAUGHAN & WELLS, 1943, *nom. transl.* ex Agariciidae GRAY, 1847)]

FAMILY-GROUP NAMES; USE OF "*NOM. CONSERV.*"

It may happen that long-used family-group names are invalid under strict application of the Rules. In order to retain the otherwise invalid name, appeal to ICZN is needful. Examples of use of *nom. conserv.* in this connection, as cited in the *Treatise*, are the following.

Family **ARIETITIDAE** Hyatt, 1874

[*nom. correct.* HAUG, 1885 (pro Arietidæ HYATT, 1875), *nom. conserv.* proposed ARKELL, 1955 (ICZN pend.)]

Family **STEPHANOCERATIDAE**

Neumayr, 1875

[*nom. correct.* FISCHER, 1882 (pro Stephanoceratinen NEUMAYR, 1875, invalid vernacular name), *nom. conserv.* proposed ARKELL, 1955 (ICZN pend.)]

FAMILY-GROUP NAMES; REPLACEMENTS

Family-group names are formed by adding letter combinations (prescribed for family and subfamily but not now for others) to the stem of the name belonging to genus (nominate genus) first chosen as type of the assemblage. The type genus need not be the oldest in terms of receiving its name and definition, but it must be the first-published as name-giver to a family-group taxon among all those included. Once fixed, the family-group name remains tied to the nominate genus even if its name is changed by reason of status as a junior homonym or junior synonym, either objective or subjective. According to the Copenhagen Decisions, the family-group name requires replacement only in the event that the nominate genus is found to be a junior homonym, and then a substitute family-group name is accepted if it is formed from the oldest available substitute name for the

nominate genus. Authorship and date attributed to the replacement family-group name are determined by first publication of the changed family-group name.

The aim of family-group nomenclature is greatest possible stability and uniformity, just as in case of other zoological names. Experience indicates the wisdom of sustaining family-group names based on junior subjective synonyms if they have priority of publication, for opinions of different workers as to the synonymy of generic names founded on different type species may not agree and opinions of the same worker may alter from time to time. The retention similarly of first-published family-group names which are found to be based on junior objective synonyms is less clearly desirable, especially if a replacement name derived from the senior objective synonym has been recognized very long and widely. To displace a much-used family-group name based on the senior objective synonym by disinterring a forgotten and virtually unused family-group name based on a junior objective synonym because the latter happens to have priority of publication is unsettling. Conversely, a long-used family-group name founded on a junior objective synonym and having priority of publication is better continued in nomenclature than a replacement name based on the senior objective synonym. The Copenhagen Decisions (paragraph 45) take account of these considerations by providing a relatively simple procedure for fixing the desired choice in stabilizing family-group names. In conformance with this, the *Treatise* assigns to contributing authors responsibility for adopting provisions of the Copenhagen Decisions.

Replacement of a family-group name may be needed if the former nominate genus is transferred to another family-group. Then the first-published name-giver of a family-group assemblage in the remnant taxon is to be recognized in forming a replacement name.

FAMILY-GROUP NAMES; AUTHORSHIP AND DATE

All family-group taxa having names based on the same type genus are attributed to the author who first published the name for any of these assemblages, whether tribe,

subfamily, or family (superfamily being almost inevitably a later-conceived taxon). Accordingly, if a family is divided into subfamilies or a subfamily into tribes, the name of no such subfamily or tribe can antedate the family name. Also, every family containing differentiated subfamilies must have a nominate (*sensu stricto*) subfamily, which is based on the same type genus as that for the family, and the author and date set down for the nominate subfamily invariably are identical with those of the family, without reference to whether the author of the family or some subsequent author introduced subdivisions.

Changes in the form of family-group names of the sort constituting *nomina correctae*, as previously discussed, do not affect authorship and date of the taxon concerned, but in publications such as the *Treatise* it is desirable to record the authorship and date of the correction.

ORDER/CLASS-GROUP NAMES; USE OF "NOM. CORRECT."

Because no stipulation concerning the form of order/class-group names is given yet by the Rules, emendation of all such names actually consists of arbitrarily devised changes in the form of endings. Nothing precludes substitution of a new name for an old one, but a change of this sort is not considered to be an emendation. Examples of the use of "*nom. correct.*" as applied to order/class-group names are the following.

Order DISPARIDA Moore & Laudon, 1943

[*nom. correct.* MOORE, 1952 (ex *Disparata* MOORE & LAUDON, 1943)]

Suborder FAVIINA Vaughan & Wells, 1943

[*nom. correct.* WELLS, herein (ex *Faviida* VAUGHAN & WELLS, 1943)]

Suborder FUNGIINA Verrill, 1865

[*nom. correct.* WELLS, herein (ex *Fungiida* DUNCAN, 1884, ex *Fungacea* VERRILL, 1865)]

TAXONOMIC EMENDATION

Emendation has two measurably distinct aspects as regards zoological nomenclature. These embrace (1) alteration of a name itself in various ways for various reasons, as has been reviewed, and (2) alteration of taxonomic scope or concept in application of a given zoological name, whatever its hierarchical rank. The latter type of emen-

dation primarily concerns classification and inherently is not associated with change of name, whereas the other type introduces change of name without necessary expansion, restriction, or other modification in applying the name. Little attention generally has been paid to this distinction in spite of its significance.

Most zoologists, including paleozoologists, who have signified emendation of zoological names refer to what they consider a material change in application of the name such as may be expressed by an importantly altered diagnosis of the assemblage covered by the name. The abbreviation "*emend.*" then may accompany the name, with statement of the author and date of the emendation. On the other hand, a multitude of workers concerned with systematic zoology think that publication of "*emend.*" with a zoological name is valueless because more or less alteration of taxonomic sort is introduced whenever a subspecies, species, genus, or other assemblage of animals is incorporated under or removed from the coverage of a given zoological name. Inevitably associated with such classificatory expansions and restrictions is some degree of emendation affecting diagnosis. Granting this, still it is true that now and then somewhat radical revisions are put forward, generally with published statement of reasons for changing the application of a name. To erect a signpost at such points of most significant change is worth while, both as aid to subsequent workers in taking account of the altered nomenclatural usage and as indication that not-to-be-overlooked discussion may be found at a particular place in the literature. Authors of contributions to the *Treatise* are encouraged to include records of all specially noteworthy emendations of this nature, using the abbreviation "*emend.*" with the name to which it refers and citing the author and date of the emendation.

In Part G (Bryozoa) and Part D (Protista 3) of the *Treatise*, the abbreviation "*emend.*" is employed to record various sorts of name emendations, thus conflicting with usage of "*emend.*" for change in taxonomic application of a name without alteration of the name itself. This is objectionable. In Part E (Archaeocyatha, Porifera) and later-issued divisions of the *Treatise*, use of "*emend.*" is restricted to its

customary sense, that is, significant alteration in taxonomic scope of a name such as calls for noteworthy modifications of a diagnosis. Other means of designating emendations that relate to form of a name are introduced.

STYLE IN GENERIC DESCRIPTIONS

DEFINITION OF NAMES

Most generic names are distinct from all others and are indicated without ambiguity by citing their originally published spelling accompanied by name of the author and date of first publication. If the same generic name has been applied to 2 or more distinct taxonomic units, however, it is necessary to differentiate such homonyms, and this calls for distinction between junior homonyms and senior homonyms. Because a junior homonym is invalid, it must be replaced by some other name. For example, *Callopora* HALL, 1851, introduced for Paleozoic trepostome bryozoans, is invalid because GRAY in 1848 published the same name for Cretaceous-to-Recent cheilostome bryozoans, and BASSLER in 1911 introduced the new name *Hallopora* to replace HALL's homonym. The *Treatise* style of entry is:

Hallopora BASSLER, 1911 [*pro Callopora* HALL, 1851 (*non* GRAY, 1848)].

In like manner, a needed replacement generic name may be introduced in the *Treatise* (even though first publication of generic names otherwise in this work is avoided). The requirement that an exact bibliographic reference must be given for the replaced name commonly can be met in the *Treatise* by citing a publication recorded in the list of references, using its assigned index number, as shown in the following example.

Mysterium DELAUBENFELS, *nom. subst.* [*pro Mysterium* SCHRAMMEN, 1936 (ref. 40, p. 60) (*non* ROGER, 1862)] [**Mysterium porosum* SCHRAMMEN, 1936].

For some replaced homonyms, a footnote reference to the literature is necessary. A senior homonym is valid, and in so far as the *Treatise* is concerned, such names are handled according to whether the junior homonym belongs to the same major taxonomic division (class or phylum) as the

senior homonym or to some other; in the former instance, the author and date of the junior homonym are cited as:

Diplophyllum HALL, 1851 [*non* SOSHKINA, 1939] [**D. caespitosum*].

Otherwise, no mention of the existence of a junior homonym is made.

CITATION OF TYPE SPECIES

The name of the type species of each genus and subgenus is given next following the generic name with its accompanying author and date, or after entries needed for definition of the name if it is involved in homonymy. The originally published combination of generic and trivial names for this species is cited, accompanied by an asterisk (*), with notation of the author and date of original publication. An exception in this procedure is made, however, if the species was first published in the same paper and by the same author as that containing definition of the genus which it serves as type; in such case, the initial letter of the generic name followed by the trivial name is given without repeating the name of the author and date, for this saves needed space. Examples of these 2 sorts of citations are as follows:

Diplotrypa NICHOLSON, 1879 [**Favosites petropoli-tanus* PANDER, 1830].

Chainodictyon FOERSTE, 1887 [**C. laxum*].

If the cited type species is a junior synonym of some other species, the name of this latter also is given, as follows:

Acerularia SCHWEIGGER, 1819 [**A. baltica* (= **Madrepora ananas* LINNÉ, 1758)].

It is judged desirable to record the manner of establishing the type species, whether by original designation or by subsequent designation, but various modes of original designation are not distinguished.

Original designation of type species. The Rules provide that the type species of a genus or subgenus may be recognized as an original designation if only a single species was assigned to the genus at the time of first publication (monotypy), if the author of a generic name employed this same name for one of the included species (tautonymy), if one of the species was named "*typus*," "*typicus*," or the like, if the original author explicitly indicated the species chosen as the type, or if some other stipulations were met.

According to convention adopted in the *Treatise*, the absence of any indication as to manner of fixing the type species is to be understood as signifying that it is established by original designation, the particular mode of original designation not being specified.

Subsequent designation of type species; use of "SD" and "SM." The type species of many genera are not determinable from the publication in which the generic name was introduced and therefore such genera can acquire a type species only by some manner of subsequent designation. Most commonly this is established by publishing a statement naming as type species one of the species originally included in the genus, and in the *Treatise* fixation of the type species in this manner is indicated by the letters "SD" accompanied by the name of the subsequent author (who may be the same person as the original author) and the date of publishing the subsequent designation. Some genera, as first described and named, included no mentioned species and these necessarily lack a type species until a date subsequent to that of the original publication when one or more species are assigned to such a genus. If only a single species is thus assigned, it automatically becomes the type species and in the *Treatise* this subsequent monotypy is indicated by the letters "SM." Of course, the first publication containing assignment of species to the genus which originally lacked any included species is the one concerned in fixation of the type species, and if this named 2 or more species as belonging to the genus but did not designate a type species, then a later "SD" designation is necessary. Examples of the use of "SD" and "SM" as employed in the *Treatise* follow.

Hexagonaria GÜRICH, 1896 [**Cyathophyllum hexagonum* GOLDFUSS, 1826; SD LANG, SMITH & THOMAS, 1940].

Muriceides STUDER, 1887 [**M. fragilis* WRIGHT & STUDER, 1889; SM WRIGHT & STUDER, 1889].

SYNONYMS

Citation of synonyms is given next following record of the type species and if 2 or more synonyms of differing date are recognized, these are arranged in chronological order. Objective synonyms are

indicated by accompanying designation "(obj.)," others being understood to constitute subjective synonyms. Examples showing *Treatise* style in listing synonyms follow.

Calapoecia BILLINGS, 1865 [**C. anticostiensis*; SD LINDSTRÖM, 1833] [= *Columnopora* NICHOLSON, 1874; *Houghtonia* ROMINGER, 1876].

Staurocyclia HAECKEL, 1882 [**S. cruciata* HAECKEL, 1887] [= *Coccostaurus* HAECKEL, 1882 (obj.); *Phacostaurus* HAECKEL, 1887 (obj.)].

A synonym which also constitutes a homonym is recorded as follows:

Lyopora NICHOLSON & ETHERIDGE, 1878 [**Palaeopora? favosa* M'COY, 1850] [= *Liopora* LANG, SMITH & THOMAS, 1940 (non GIRTY, 1915)].

Some junior synonyms of either objective or subjective sort may take precedence desirably over senior synonyms wherever uniformity and continuity of nomenclature are served by retaining a widely used but technically rejectable name for a generic assemblage. This requires action of ICZN using its plenary powers to set aside the unwanted

name and validate the wanted one, with placement of the concerned names on appropriate official lists. In the *Treatise* citation of such a conserved generic name is given in the manner shown by the following example.

Tetragraptus SALTER, 1863 [*nom. correct.* HALL, 1865 (pro *Tetragrapsus* SALTER, 1863), *nom. conserv.* proposed BULMAN, 1955, ICZN pend.] [**Fucoides serra* BRONGNIART, 1828 (= *Graptolithus bryonoides* HALL, 1858)].

ABBREVIATIONS

A few author's names and most stratigraphic and geographic names are abbreviated in order to save space. General principles for guidance in determining what names should be abbreviated are frequency of repetition, length of name, and avoidance of ambiguity. Abbreviations used in this division of the *Treatise* are explained in the following alphabetically arranged list.

Abbreviations

| | | |
|------------------------------------|--------------------------------|---|
| Abhandl., Abhandlungen | Boll., Bollettino | Dev., Devonian |
| Abt., Abteilung, -en | Braz., Brazil | dors., dorsal |
| Acad., Academia, Académie, Academy | Br.I., British Isles | Dresbach., Dresbachian |
| Acad., Acadian | Brit., Britain, British | E., East |
| afd., afdeling, afdeling | Bull., Bulletin | ed., edition, editor |
| Afr., Africa, -an | Bur., Bureau | Eden., Edenian |
| Akad., Akademie | C., Central | Eng., England |
| Ala., Alabama | Calif., California | Est., Estonia |
| Alba., Alberta | Cam., Cambrian | etc., et cetera |
| Am., America, -n | Can., Canada | Eu., Europe |
| Ann., Analen, Annals, Annual | Canad., Canadian | exoskel., exoskeleton |
| Appal., Appalachian | Caradoc., Caradocian | Exped., Expedition |
| Arct., Arctic | Carb., Carboniferous | exsag., exsagittal |
| Arenig., Arenigian | Centralbl., Centralblatt | f., för, für |
| Arg., Argentina | ceph., cephalon | F., Formation |
| Ariz., Arizona | Chazy., Chazyan | Fac., Facultad, Faculté, Faculty |
| Ark., Arkansas | Chester., Chesteran | fasc., fascicle |
| Årsskr., Årsskrift | Cienc., Ciencias | fig., figure, -s |
| Ashgill., Ashgillian | Coll., Collection, -s; College | Förhandl., Förhandlingar, -er |
| AsiaM., Asia Minor | Colo., Colorado | Foren., Forening, -ens |
| Assoc., Association | Colom., Colombia | Fr., France, Française, -e, French |
| Atl., Atlantic | Comp., Comparative | Francon., Franconian |
| Austral., Australia | Conn., Connecticut | Gasconad., Gasconadian |
| Balt., Baltic | Contr., Contribution, -s | G.Brit., Great Britain |
| B.C., British Columbia | cosmop., cosmopolitan | Geog., Geography |
| Beil., Beilage | Couvin., Couvinian | Geol., Geología, Geological, Geológico, Geologie, Geologisch, Geologiska, Geology |
| Beitr., Beitrag, Beiträge | cran., cranidium | Géol., Géologie, Géologique |
| Belg., Belgique, Belgium | Czech., Czechoslovakia | Ger., Germany |
| Biol., Biological, Biology | Danm., Danmarks | Gesell., Gesellschaft |
| Blackriv., Blackriveran | Dec., December | Givet., Givetian |
| Böhm., Böhmischen | Denm., Denmark | Gotl., Gotland |
| Boh., Bohemia | Dept., Department, Departments | |
| Bol., Bolivia | deutsch., deutschen | |

Greenl., Greenland
 Handl., Handlingar
 Hemis., Hemisphere
 Hist., Histoire, -ia, Historia,
 History
 Hung., Hungarica, Hungary
 I., Island, -s
 ICZN, International Commis-
 sion on Zoological Nomen-
 clature
 Ill., Illinois
 illus., illustration, -s
 Imp., Imperial, Impériale
 incompl., incomplete
 Inst., Institut, Institute, Insti-
 tutet, Institution, Instituto,
 Instituut
 Internat., International, -en
 Ire., Ireland
 Jaarb., Jaarboek
 Jahrb., Jahrbuch
 Jahresber., Jahresbericht
 Jahresh., Jahreshefte
 Jahrg., Jahrgang
 Japan., Japanese
 Jour., Journal
 K., Kaiserlich
 Kans., Kansas
 Kgl., Königlich
 K.K., Kaiserlich Königlich
 Kl., Klasse
 Ky., Kentucky
 L., Lower; Land
 Landesanst., Landesanstalt
 lat., lateral
 Lief., Lieferung, -en
 Linn., Linnean, Linnéenne
 Llandeil., Llandeilian
 Llandov., Llandoverian
 Llanvirn., Llanvirnian
 Low., Lower
 Ls., Limestone
 M., Middle
 Mag., Magazine
 Manch., Manchuria, -n
 Mass., Massachusetts
 Mat., Matimaticske, Matematik,
 Matematisk
 Math., Mathematische
 Med., Medicine
 Meddel., Meddelelser
 Medit., Mediterranean
 Mem., Memoir, -ia, -s
 Mém., Mémoire, -s
 Menev., Menevian
 Mex., Mexico
 Mich., Michigan
 Mineral., Mineralogical, Min-
 eralogue, Mineralogisch, -e
 Minéral., Minéralogique
 Minn., Minnesota
 Misc., Miscellaneous
 Miss., Mississippi, Mississippian
 Mo., Missouri
 Mon., Monograph
 Mongol., Mongolia
 Mont., Montana
 Moroc., Morocco

Mts., Mountains
 Mus., Musée, Museo, Museum
 N., North
 N.Am., North America
 Nat., Natural; Naturale, -s;
 Naturali; Naturelle, -s
 Natl., National
 Nat.-Med., Naturwissenschaft-
 lichen-Medizinischen
 Naturf., Naturforschende
 Naturh., Naturhistorie, -ischen
 Naturv., Naturvetenskap,
 Naturvidenskapelig
 N.B., New Brunswick
 NE., Northeast
 Nev., Nevada
 Newf., Newfoundland
 no., number, -s; numéro, -s;
 número, -s
 n.s., new series
 N.Scot., Nova Scotia
 N.S.W., New South Wales
 NW., Northwest
 N.Y., New York
 N.Z., New Zealand
 N.Zem., Novaya Zemlya
 obj., objective
 Okla., Oklahoma
 Ont., Ontario
 Ord., Ordovician
 p., page, -s
 Pa., Pennsylvania
 Pak., Pakistan
 Paläont., Paläontologie, Pal-
 äontologisch
 Palacont., Palaeontologia
 Palacontogr., Palaeontographia,
 Palaeontographica, Palaeonto-
 graphical
 Paleont., Paleontologia, Pale-
 ontologica, Paleontological,
 Paleontologiese, Paleontology
 Paléont., Paléontologie
 pend., pending
 Penn., Pennsylvania
 Perm., Permian
 Philos., Philosophical
 Phys., Physique, Physikalische
 pl., plates, -s
 Pleist., Pleistocene
 Pol., Poland
 Port., Portugal, Portuguese
 Preuss., Preussische
 Proc., Proceedings
 Prof., Professional
 Prov., Province
 pt., part, -s
 Pub., Publication
 pyg., pygidium
 Quart., Quarterly
 Que., Quebec
 Queensl., Queensland
 reconstr., reconstructed, -ion
 Rept., Report, -s
 Res., Research
 Rev., Review
 Roy., Royal, -c
 S., South; Sea

sag., sagittal
 S.Am., South America
 Sard., Sardinia
 Scand., Scandinavia
 Sci., Sciences, Scientifique
 Scot., Scotland
 SD, subsequent designation
 SE., Southeast
 sec., section, -s
 seg., segment
 Selsk., Selskabs
 Senckenberg., Senckenber-
 gischen
 ser., series, serial
 Serv., Serviço, Service
 Sh., Shale
 Shrops., Shropshire
 Sib., Siberia
 Sil., Silurian
 Skr., Skrifter
 Soc., Sociedad, Società,
 Société, Society
 Sp., Spain
 Spec., Special
 Ss., sandstone
 Sver., Sveriges
 Swed., Sweden, Swedish
 SW., Southwest
 t., tome, tomo, tomos
 Tasm., Tasmania
 Tenn., Tennessee
 Tex., Texas
 Tidsskr., Tidsskrift
 tr., transverse
 Trans., Transactions
 Tremadoc., Tremadocian
 Trempeal., Trempealeuan
 u., und
 U., Upper
 Undersøg., Undersøgelse
 Undersök., Undersökning
 Univ., Universidad, Università,
 Université, Universitets,
 University
 Up., Upper
 Ural., Uralian
 U.S., United States
 USA, United States (America)
 USSR, Union of Soviet Socialist
 Republics
 v., volume, -s
 Va., Virginia
 Venez., Venezuela
 Vict., Victoria
 Vidensk., Videnskabs
 Vt., Vermont
 W., West
 Wenlock., Wenlockian
 Wis., Wisconsin
 Wiss., Wissenschaften, Wis-
 senschaftliche, -en
 Wyo., Wyoming
 z., zone
 Zeitschr., Zeitschrift
 Zool., Zoologi, Zoologia,
 Zoological, Zoologie, Zoolo-
 gisch, Zoologiska

REFERENCES TO LITERATURE

Each part of the *Treatise* is accompanied by a selected list of references to paleontological literature consisting primarily of recent and comprehensive monographs available but also including some older works recognized as outstanding in importance. The purpose of giving these references is to aid users of the *Treatise* in finding detailed descriptions and illustrations of morphological features of fossil groups, discussions of classifications and distribution, and especially citations of more or less voluminous literature. Generally speaking, publications listed in the *Treatise* are not original sources of information concerning taxonomic units of various rank but they tell the student where he may find them; otherwise it is necessary to turn to such aids as the *Zoological Record* or NEAVE'S *Nomenclator Zoologicus*. References given in the *Treatise* are arranged alphabetically by authors and accompanied by index numbers which serve the purpose of permitting citation most concisely in various parts of the text; these citations of listed papers are inclosed invariably

in parentheses and are distinguishable from dates because the index numbers comprise no more than 3 digits. Ordinarily, index numbers for literature references are given at the end of generic or family diagnoses.

SOURCES OF ILLUSTRATIONS

At the end of figure captions an index number is given to supply record of the author of illustrations used in the *Treatise*, reference being made to an alphabetically arranged list of authors' names which follows. The names of authors, but generally not individual publications, are cited. Illustrations consisting of exact copies of previously published figures (except for possible change of scale) are distinguished by the use of an asterisk (*) with the index number, and previously unpublished illustrations are marked by the letter "n" (signifying "new") with the index number; all other indications of the sources of illustrations are construed to mean "after" the cited author or authors, that is, embodying some degree of change. Addition of the abbreviation "mod." denotes appreciable alteration of the source figure.

RAYMOND C. MOORE



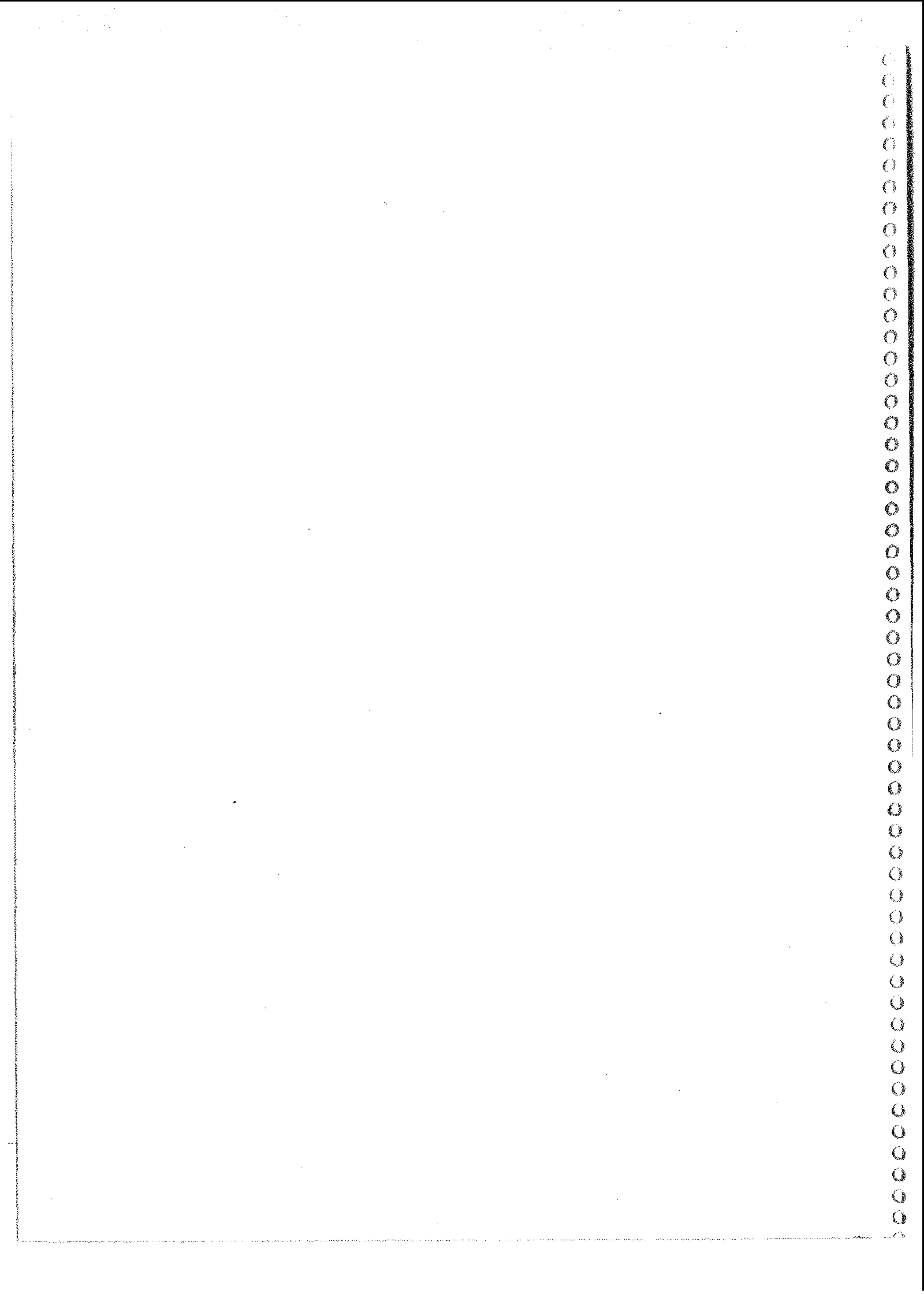

PART O ARTHROPODA 1

ARTHROPODA—GENERAL FEATURES PROTARTHROPODA EUARTHROPODA—GENERAL FEATURES TRILOBITOMORPHA

By H. J. HARRINGTON, GUNNAR HENNINGSMOEN, B. F. HOWELL, VALDAR JAANUS-
SON, CHRISTINA LOCHMAN-BALK, R. C. MOORE, CHRISTIAN POULSEN, FRANCO
RASETTI, EMMA RICHTER, RUDOLF RICHTER, HERTA SCHMIDT, KLAUS SDZUY,
WOLFGANG STRUVE, LEIF STØRMER, C. J. STUBBLEFIELD, RONALD TRIPP, J. M.
WELLER, and H. B. WHITTINGTON

CONTENTS

| | PAGE |
|---|------|
| INTRODUCTION (R. C. Moore) | 01 |
| ARTHROPODA—GENERAL FEATURES (Leif Størmer) | 03 |
| PROTARTHROPODA (R. C. Moore) | 016 |
| EUARTHROPODA—GENERAL FEATURES (R. C. Moore) | 020 |
| TRILOBITOMORPHA (Leif Størmer) | 022 |
| TRILOBITOIDEA (Leif Størmer) | 023 |
| TRILOBITA (H. J. Harrington <i>et al.</i>) | 038 |
| INDEX | 0541 |

INTRODUCTION

By RAYMOND C. MOORE

This volume of the *Treatise*, primarily concerned with the trilobites, is the product of collaboration of 18 specialists who represent 7 different nations, as follows: 6 from the United States of America, 5 from West Germany, 2 each from England and Norway, and one each from Argentina, Denmark, and Sweden. Harmonious joint effort of such an international group is unusual, especially when account is taken of voluminous correspondence exchanged, not only by

individual contributors and the Editor but by authors writing to each other. In this way many problems have been settled more or less definitely and satisfactorily, but it is natural that divergent viewpoints on some items of morphological terminology, interpretation of evolutionary trends, and especially taxonomic arrangement of trilobite genera should persist. Authors have been allowed greatest possible freedom to make determinations of the diagnostic characters

of genera allocated to them and to define familial groupings.

A great deal of work in organizing the assignments to authors and in dealing with problems of several kinds, especially during initial phases of effort, was done by C. J. STUBBLEFIELD, who at the beginning of the program and for some time thereafter was Chief Palaeontologist of the Geological Survey of Great Britain; his official duties then prevented him from accepting responsibility for an important share of writing on such themes as the nature and significance of morphological characters of trilobites or classification of these fossils, but he aided in preparing a first draft of definitions of morphological terms. Later, when Dr. STUBBLEFIELD was made Assistant Director of the Survey, he continued to help by giving counsel orally and through correspondence and by contributing editorial criticisms of typescripts referred to him. These services entitle him to special recognition and the expression of sincere thanks that I record here on behalf of each individual author and of users of the volume. Although Dr. STUBBLEFIELD'S name as a contributing author appears only in connection with the "Glossary of Morphological Terms" applicable to trilobites, actually he has shared in one way or another in shaping the content of various other sections.

In my capacity as general director of the organization of *Treatise* volumes, it is appropriate to acknowledge the co-operative attitude, patience, and especially the very great amount of painstaking labor that the numerous authors have provided. Without these things and teamwork of unusually high order, it would be impossible to accomplish our goal, particularly in view of the fact that no monetary compensation goes to anyone. Acknowledgment consists simply in publication of the names of authors. For some units, such as general descriptions and discussions prepared by H. J. HARRINGTON, LEIF STØRMER, and H. B. WHITTINGTON, no difficulty is encountered in specifying authorship, but the situation is otherwise in recording the authors of systematic descriptions. Because the allocations of taxonomic units to individual authors deviate widely from arrangement of these units in zoological order, the segregation of descriptions and

illustrations by authorship would be a most effective way to destroy utility, and the adoption of a zoological order requires a highly interspersed listing of authorship of taxonomic segments having diverse rank. Complications have been introduced by revisions of classification during the progress of work, transferring genera from one family assignment to another and revising familial classification; commonly, such changes have served to blur the distinctness of authorship boundaries. Accordingly, as the most practicable means of specifying the authors of intermingled taxonomic descriptions, record is given in connection with the tabular outline of classificatory divisions of the trilobites (p. O160). Reference should be made to this list in order to determine the author or authors of any given taxonomic description.

Some contributors to the volume on Trilobitomorpha were active in undertaking work on their assignments virtually from the time they were accepted in 1949 and 1950. In this group, along with C. J. STUBBLEFIELD, belong CHRISTINA LOCHMAN-BALK, CHRISTIAN POULSEN, FRANCO RASETTI, J. M. WELLER, and H. B. WHITTINGTON. When their work on systematic descriptions was finished, most of these paleontologists accepted an additional load and thus have aided importantly in completing the whole task. Meanwhile, death intervened to prevent ELSA WARBURG from doing much *Treatise* work and later (1956) both EMMA RICHTER and RUDOLF RICHTER died before more than a fraction of their important assignment on Phacopacea had been sent to the Editor. These were unhappy losses. Special acknowledgment and thanks are due to persons who have filled in the ranks, at relatively late dates accepting responsibility for organizing descriptions and illustrations of taxa in unfinished groups; these contributors are GUNNAR HENNINGSMOEN, VALDAR JAANUSSON, HERTA SCHMIDT, WOLFGANG STRUVE, KLAUS SDZUY, and RONALD TRIPP. In much the same way but for other reasons, important segments of the trilobitomorph volume still were lacking in 1956, which made the date of readiness for publication very doubtful; these segments included general description of the nature of Arthropoda, treatment of the Trilobitoidea, and discussion of the mor-

phology and classification of the Trilobita. LEIF STØRMER accepted the assignment to contribute materials on the first two mentioned segments, and H. J. HARRINGTON expressed willingness to grapple with the appreciably larger task of preparing introductory sections on the trilobites. It is almost superfluous for me to express thanks for this help. Also, I should not omit statement of appreciation to B. F. HOWELL for the efforts given by him to completion of a rather formidable assignment of systematic descriptions in time to permit organization of the typescript when other sections were ready.

It is appropriate here to record the valuable support furnished by Professor PER THORSLUND of the Paleontological Institution of Uppsala in authorizing work done

by VALDAR JAANUSSON for this volume and in furnishing highly competent services of an illustrator. Likewise, the Carlsberg Foundation financed illustrations needed by CHR. POULSEN. Thanks for this aid are expressed.

Special acknowledgments are made to CAROLE F. BAILEY, Editorial Assistant, for careful attention to innumerable tasks related to preparation of this volume, especially in dealing with complexities of rearrangements among various authors of work on systematic descriptions and in supervising parts of the organization of figures. Finally, the Editor has been aided greatly by GUNNAR HENNINGSMOEN in completion of the text on systematic descriptions and in dealing with some unsettled questions of trilobite classification. This was made possible by his visit at the University of Kansas in January and February, 1958.

ARTHROPODA—GENERAL FEATURES

By LEIF STØRMER

CONTENTS

| | PAGE |
|--|------|
| PHYLUM ARTHROPODA Siebold & Stannius, 1845 | 04 |
| MORPHOLOGY | 04 |
| Body wall | 04 |
| Body segments | 07 |
| Appendages | 07 |
| Relations of body segments and appendages | 08 |
| Sense organs | 012 |
| Feeding and digestive organs | 012 |
| Respiratory and circulatory systems | 013 |
| Ontogeny | 013 |
| GEOLOGICAL OCCURRENCE | 013 |
| PHYLOGENY | 014 |
| CLASSIFICATION | 015 |
| REFERENCES | 016 |

The joint-legged invertebrates grouped together in the phylum Arthropoda (Gr. *arthros*, joint; *podos*, foot) are an extremely numerous and varied assemblage that is represented by fossils of extreme antiquity. They include several kinds of complexly

organized trilobites found in lowermost fossil-bearing Paleozoic strata, and thus the origin of arthropods surely belongs to some part of Precambrian time. The nature of earliest ancestors classifiable as belonging to the Arthropoda, probably characterized by

close resemblance to annelids, is conjectural. Despite reasoning that supports conclusions as to great evolutionary development of arthropod stocks before the Paleozoic Era, none of the supposed Precambrian arthropods, such as *Beltina* (from Belt strata of Montana), *Xenusion* (? onychophoran from ? Precambrian quartzite erratic in Sweden), and *Protadelaidea* (from Precambrian rocks of Australia), are accepted as fossil representatives of the phylum demonstrating Precambrian age. Classification as arthropods is doubtful or age of the fossil-bearing rock is doubtful.

Phylum ARTHROPODA Siebold & Stannius, 1845

Aquatic, terrestrial, and aerial invertebrates with heteronomous segmentation and jointed legs; body covered with chitinous cuticula, each segment movably connected to adjoining ones by an articulating membrane. Segments ordinarily provided with one pair of jointed appendages. Growth takes place through molts. Nervous system with well-developed brain and ventral cord with ganglia in each segment; ocelli or compound eyes. Respiration by gills, tracheae, or body surface. Circulatory system lacunar. Coelome reduced in adults. Eggs with much yolk, cleavage superficial. *L. Cam.-Rec.*

Because the arthropod body is inclosed in a more or less solid exoskeleton, a great number of fossil forms have been found and described from all geological systems younger than Precambrian. Fossil arthropod remains—trilobites from early Paleozoic deposits, and eurypterids, crustaceans, and insects from later rocks—early attracted the attention of students in natural science.

The arthropods play a very dominant role in the Recent faunas. The number of living arthropods constitutes 75 to 80 per cent of the one million or more Recent animals described, among which the 700,000 species of insects form the greatly predominant part. Members of the arthropod phylum occupy the sea, land, and air, and occur from tropic to arctic regions. They have disclosed a most extraordinary ability to accommodate themselves to very different modes of life, for arthropods live both in cold and hot, light and dark environments. Very pronounced morphological changes are noticed

in connection with transition into a parasitic mode of life.

In Recent times certain groups occur in a great number of species, as for example some 350,000 species of the order Coleoptera among the insects, whereas others, such as the subclass Xiphosura, include only a few species. The groups with many species seem to be in a state of rapid evolution or radiation, and the same was true in earlier times. The rapid increase of trilobite species in the Middle and Late Cambrian and the sudden development of pterygote insects in the Late Carboniferous may be mentioned.

In segmentation of the body the arthropods demonstrate their relation to the annelids, and on this basis the two phyla were placed by CUVIER in a common major group called Articulata. The main difference between the Annelida and Arthropoda is found in the development of the appendages. The annelid parapodia, which consist of unjointed lateral outgrowths of the body wall are fundamentally different from the jointed arthropod appendages, which are structures only possible in a body with a solid exoskeleton.

The typical Arthropoda (Euarthropoda) comprise the following groups: Trilobitomorpha (Trilobita, Trilobitoidea), Chelicerata (Merostomata, Arachnida), Pycnogonida, Crustacea, Myriapoda, and Hexapoda (including Insecta). The Onychophora and the aberrant Tardigrada and Pentastomida have several characteristics common to both the Annelida and Arthropoda. The onychophoran legs have claws but no distinct articulation. The mentioned arthropod-like groups are generally regarded as arthropods different from the typical ones and in the *Treatise* are designated as Protarthropoda (LANKESTER, 1904); they have been classed together as Pararthropoda by VANDEL (1949).

MORPHOLOGY

BODY WALL

The arthropod body is incased in a more or less solid exoskeleton, which serves the purposes of forming an armor against enemies, a protection against desiccation, and a framework for support of the softer parts and for attachment of the muscles (Fig. 1). The body wall may be sclerotized

so as to form a rigid exoskeleton, with softer membranes occurring between the sclerotized parts (called sclerites), or remain flexible.

The outer integument (cuticula) is secreted from the cellular epidermis (Fig. 2).

In the stratified cuticula an endo- and exo-cuticula may be distinguished, the latter more dense and pigmented. The cuticula chiefly consists of chitin, a very characteristic substance that occurs in various invertebrate groups. It is a polyacetyl-glucosamin re-

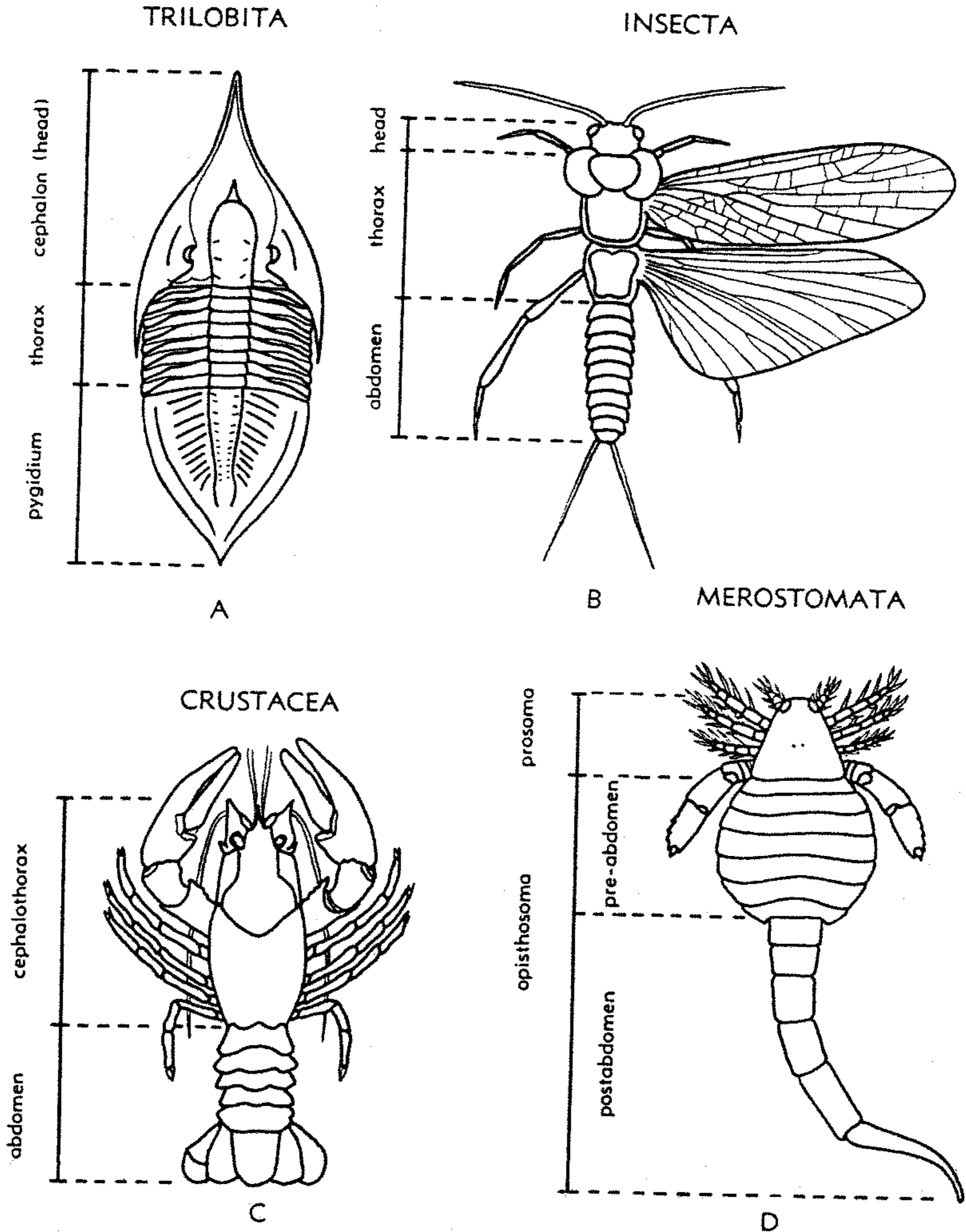

FIG. 1. Division of the arthropod body in representative types.

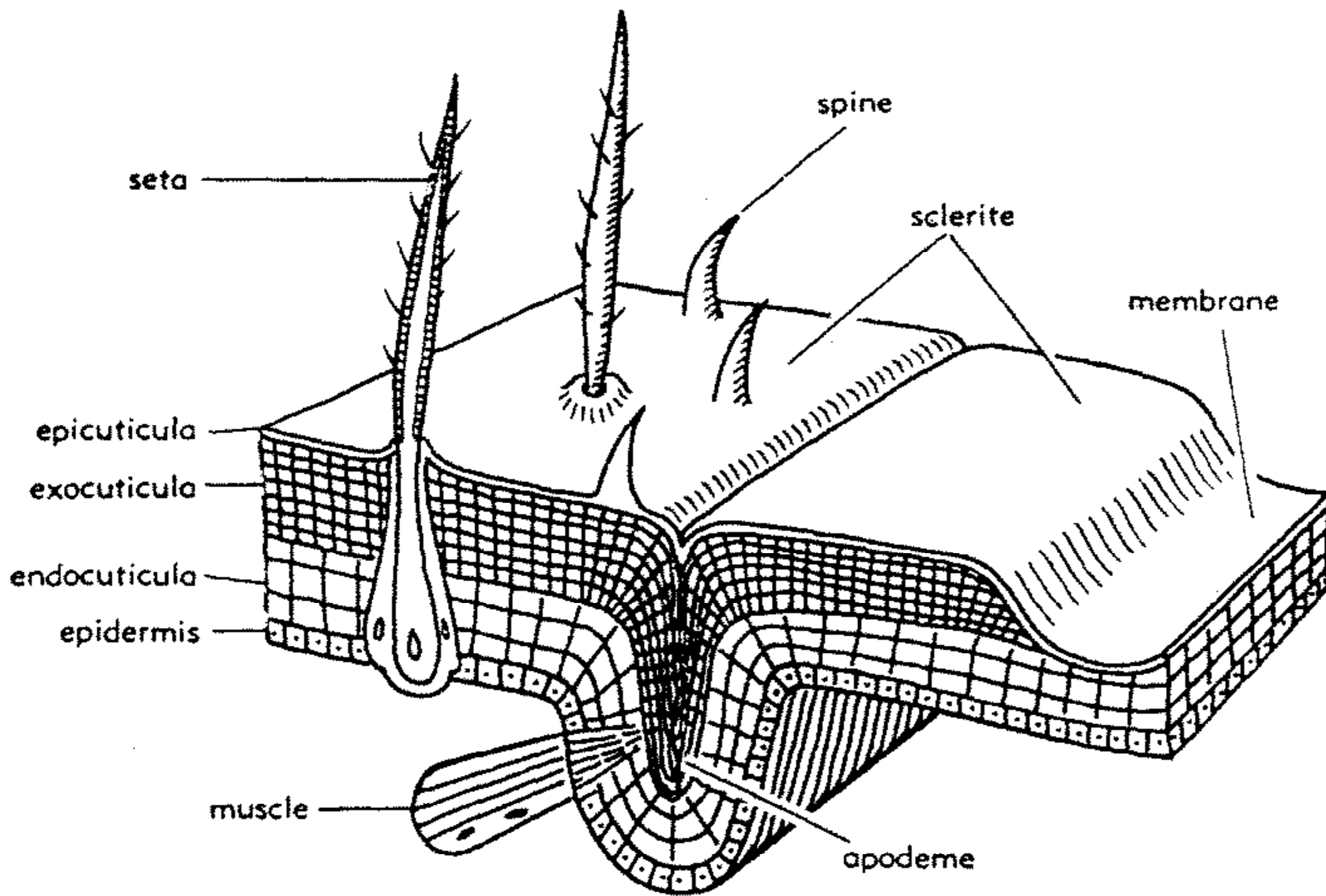

FIG. 2. Morphological features of the arthropod integument (diagrammatic).

lated in molecule structure to cellulose. The long molecular chains form the fibrillous micellae. Chitin is very resistant to chemical agencies, being insoluble in water, most acids, alcohol, and alkalis. The flexible chitin may be strengthened (sclerotized) by an impregnation of calcium carbonate and phosphate, but in most arthropods only the outer part of the cuticle (exocuticula) is sclerotized. The hard sclerotized parts contain much less chitin than the cuticula of soft membranes. The body wall is covered

by a thin epicuticula, which is not chitinous but contains a waxy substance that prevents water and acids from penetrating the cuticula.

The cuticula may be provided with spines or movable setae (hairs), with tubulae leading from the cells in the epidermis below. Invaginations of the sclerotized cuticula, called apodemes, serve as attachments for muscles (Figs. 2, 3).

Sclerotization of the body wall creates problems with regard to the growth and

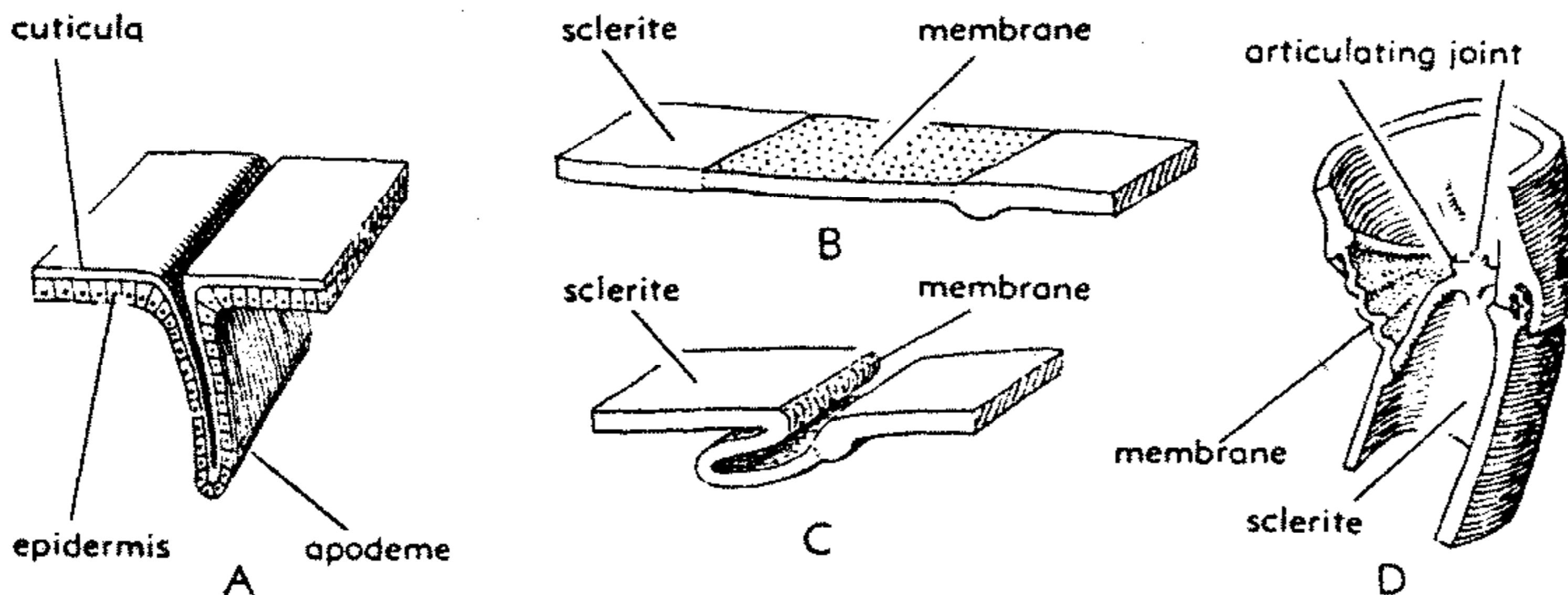

FIG. 3. Morphological features of the arthropod exoskeleton.—A. Formation of apodeme.—B. Flexible membrane between sclerites, membrane not infolded.—C. Same as B but showing infolded membrane. D. Articulation between segments of appendage. (All after Snodgrass and Weber.)

mobility of arthropods. Growth leads to increase of body volume that can be accommodated only by molting (ecdysis) of the hardened exoskeleton. Fluids dissolve the endocuticula so that the exocuticula peels off and splits along ecdysal nonsclerotized sutures. The ecdysal sutures have considerable taxonomic importance in certain groups. A solid exoskeleton impedes mobility of the body and appendages. Accordingly, the armor has to be divided into a number of sclerites separated by flexible membranes that permit bending or telescoping of the various parts (Figs. 3, 4). An articulation between adjoining sclerites (ball-and-socket joints) also may be provided.

BODY SEGMENTS

The body of annelids and arthropods is divided into a number of segments (somites or metameres) primarily alike. In the generalized annelid the cylindrical body has

transverse grooves marking the border of segments (Fig. 4a). Movements of the body are controlled by transverse and longitudinal muscles. Among arthropods the cylindrical body segments may be more or less sclerotized. A dorsal sclerite is called a tergite, and the ventral a sternite. The intermediate lateral parts, mostly membranous, are termed pleurites. The articulation between succeeding segments may not necessarily follow the primarily segmental borders, for each tergite commonly has a part of the frontal one incorporated in it (Fig. 4b).

APPENDAGES

In its typical development each body segment is provided with a pair of locomotor appendages. As expressed in the name of the group, jointed appendages are characteristic of the Arthropoda, each segment ordinarily bearing one pair of appendages. Throughout the phylum, as well as within

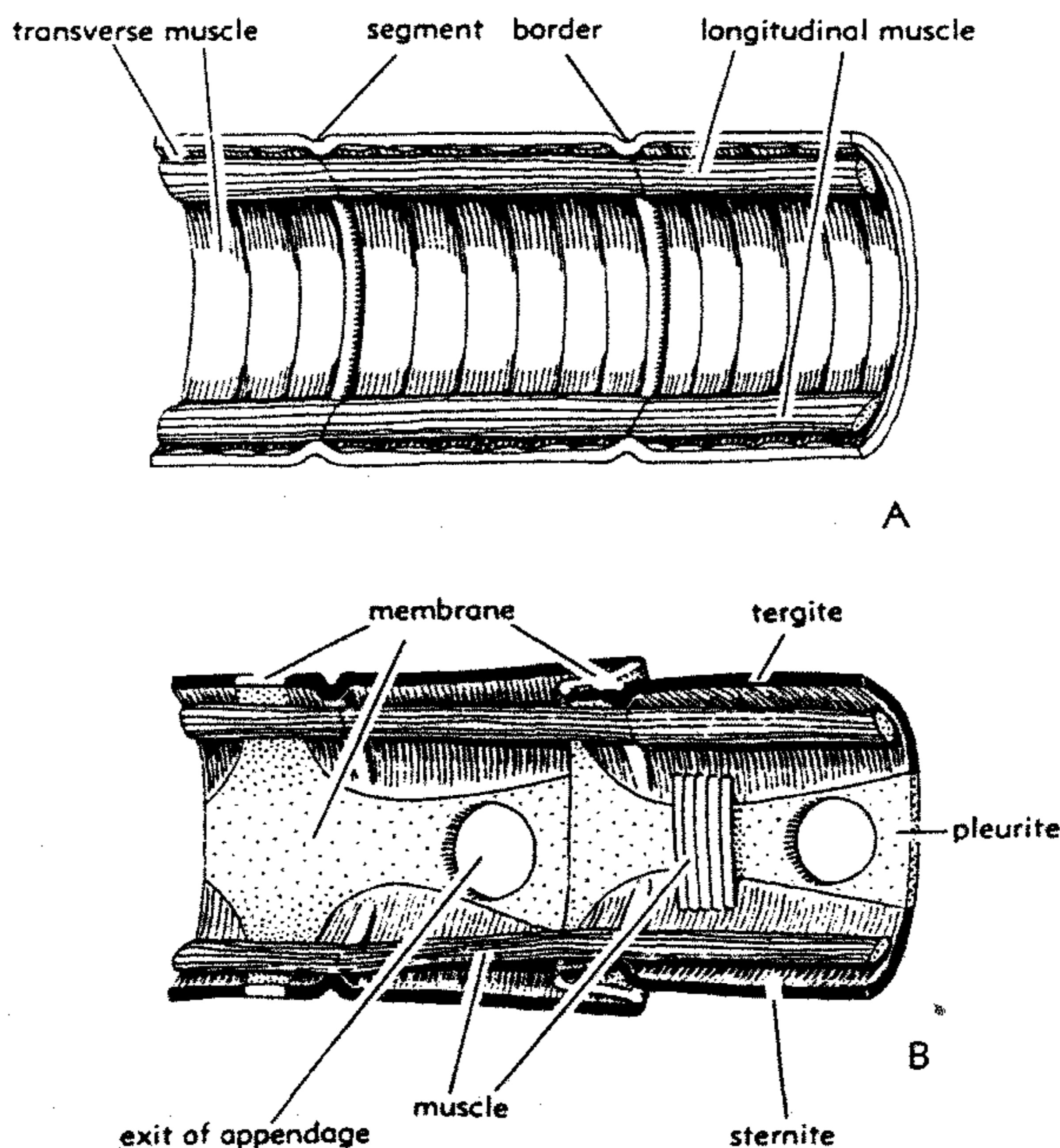

FIG. 4. Internal views of body segments of an annelid (A) and an arthropod (B), diagrammatic. (Mod. from Weber.)

a single individual, the appendages show a diversity in form that is unique in the animal kingdom. The limbs are adapted to the most different functions, some forming highly specialized tools needing a highly developed nervous system. The appendages are situated in the lateral (or ventrolateral) pleural part of the segment, between the tergite and sternite (Fig. 4*b*). The limbs form hollow outgrowths of the body wall, connected with the body by various muscles, chiefly promotor and remotor types. Each limb has several sclerotized cylindrical joints mutually connected by membranes or articulations (Fig. 3*d*), these joints being regarded as true joints only when they have separate muscles inserted at their bases. A secondary division into numerous separate rings does not mean appearance of new joints.

Much work and discussion have been devoted to the problem of homology of the arthropod appendages. Effort to homologize different joints of the limbs must take into account possible tendency of a limb to develop a more or less common type. Functionally, the simple cylindrical, locomotory limb is divided into coxal, femoral, tibial, and tarsal portions, according to position of the joints and their axis of articulation. The limbs of trilobites, eurypterids, and primitive arachnids (Fig. 5*c*) possess 8 or 9 joints: precoxa (doubtfully distinguished as a true separate joint), coxa, 1st trochanter, 2nd trochanter (prefemur), femur, patella, tibia, tarsus, and pretarsus. The patella (knee) occurs in Chelicerata, Pycnogonida, and probably Trilobita; since the musculature of trilobite legs is unknown, the joint here considered may represent the proximal half of a divided tibia, but this is rather improbable. In Crustacea, joints of the limb mostly have other names: pre-coxa (presence uncertain), coxopod (or coxopodite), basipod, ischiopod, meropod, cercopod, propod, and dactylopod. No joint corresponding to the patella is known in the Crustacea, Myriapoda, and Insecta.

The arthropod limb may have lateral lobes, either fixed or movable. The outer (lateral) ones are called exites and the inner (median) ones are endites (Fig. 5*c,g,i*). Exites of the pre-coxa, coxopod (coxa), and basis (1st trochanter) are called pre-epipodite, epipodite, and exopodite. The pre-

epipodites and epipodites are generally developed as a respiratory organ in the Crustacea (Fig. 5*d,g,i*). The exopodite forming the lateral branch of the biramous crustacean limb has mostly a natatory function. In Crustacea the basal uniramous part of the biramous appendage, the so-called sympod, may have 3 joints (precoxa, coxopod, and basipod or basis), 2 joints (coxopod and basipod), or a single joint (protopod consisting of an undivided coxopod and basipod). Although some authors (HANSEN, LANG) assume that the 3-jointed sympod is most primitive, others (CALMAN, HEEGAARD, VANDEL) regard the single-jointed (protopod) limb as the ancestral type. A correct assumption is important for interpretation of the trilobite limb, which has a characteristic structure that is found in various trilobites of different age and likewise in crustacean- and merostome-like arthropods of the Middle Cambrian. In biramous trilobite appendages (Fig. 5*c*) the lateral gill branch is attached to the very base of the limb, although uncertainty exists as to whether the attachment is to a short pre-coxa or the basal part of a large basal joint. According to the different interpretations mentioned, the lateral branch of the trilobite limb may be explained as a pre-epipodite or epipodite (SNODGRASS, STØRMER) or an exopodite (HEEGAARD, VANDEL). If the first view is correct, the trilobite and crustacean legs are fundamentally different, leaving little support for assumptions of a close relationship between these major groups, whereas if the second interpretation is true, the Trilobita and Crustacea are shown by this character to be closely related.

RELATIONS OF BODY SEGMENTS AND APPENDAGES

The number of arthropod somites varies considerably in primitive groups such as the trilobites but becomes fixed in advanced forms. During ontogeny the 1st segmentation, producing a small number of somites, seems to take place approximately simultaneously. To these segments (classed as primary by IVANOV) new secondary ones are added by teloblastic growth in a subterminal generative zone. A definite number (4) of postoral primary somites is indicated in the Trilobita and Xiphosura, but in the Crusta-

cea the number (?2) is uncertain; in the Myriapoda and Insecta it is unknown. Some Lower Cambrian trilobites exhibit characters suggesting the presence of more than 4 postoral segments in the head of their ancestors.

Unlike the body of annelids, which has a series of more or less uniform segments behind the head, that of arthropods reveals more complicated and specialized structures. The body generally is divided into groups of segments (*tagmata*), in which each segment and its appendages are somewhat closely alike. A tagma may comprise a number of fused segments forming a continuous shield, such as the *cephalon* (head) and *pygidium* of a trilobite (Fig. 1), or it may consist of several mutually similar movable segments, such as the *thorax* of a trilobite or *abdomen* of an insect. In the arthropod head

fusion of segments may be so complete that the borders of original segments have become quite obsolete. The naming of tagmata differs among the major groups of Arthropoda (Fig. 1) to such extent that the same names do not necessarily embrace corresponding segments (for example, *cephalothorax* in the Crustacea).

The homology of segments in the arthropod head presents a difficult problem, for interpretation of the segments must be based primarily on studies of early embryonic growth stages, and especially on the nerves leading from cephalic appendages to the brain or ventral nerve cord. The annelids have a mass of nerve tissue or brain (*archicerebrum*) in front and above the *stomodaeum* (fore-gut). Behind and below it comes a double ventral nerve cord with segmented ganglia and paired connectives.

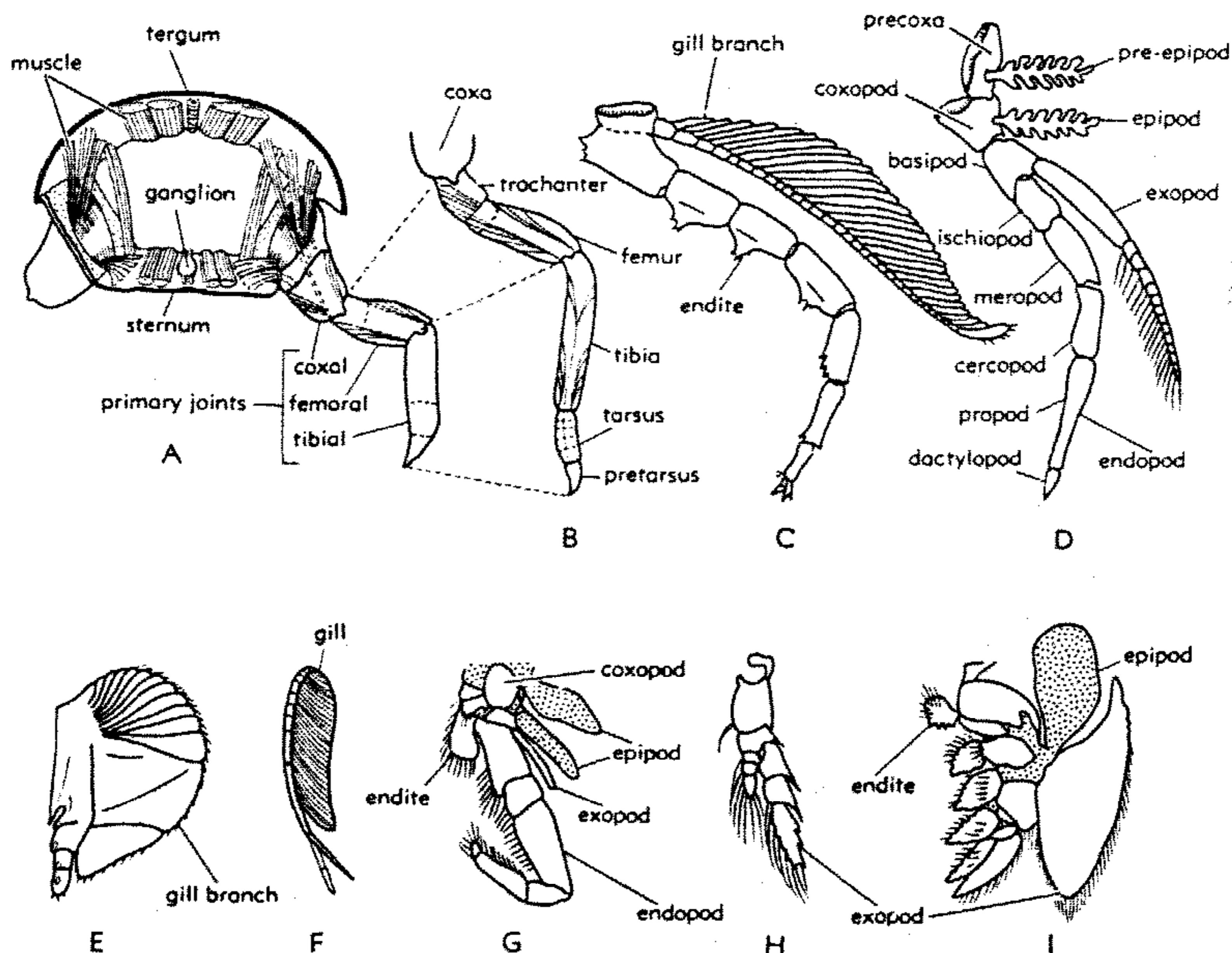

FIG. 5. Appendages of arthropods.—A. Transverse section of arthropod body segment and attached limb with primary joints (diagrammatic, hypothetical).—B. Limb of type belonging to insects and arachnids.—C. Biramous trilobite limb showing gill branch and walking leg.—D. Biramous limb of crustacean (Decapoda), diagrammatic.—E, F. Abdominal appendages of xiphosurans.—G. Crustacean maxilliped (Anaspidacea).—H. Crustacean thoracic appendage (Copepoda).—I. Crustacean thoracic leg (Branchiopoda). (A-B, after Weber; G-I, after Hansen.)

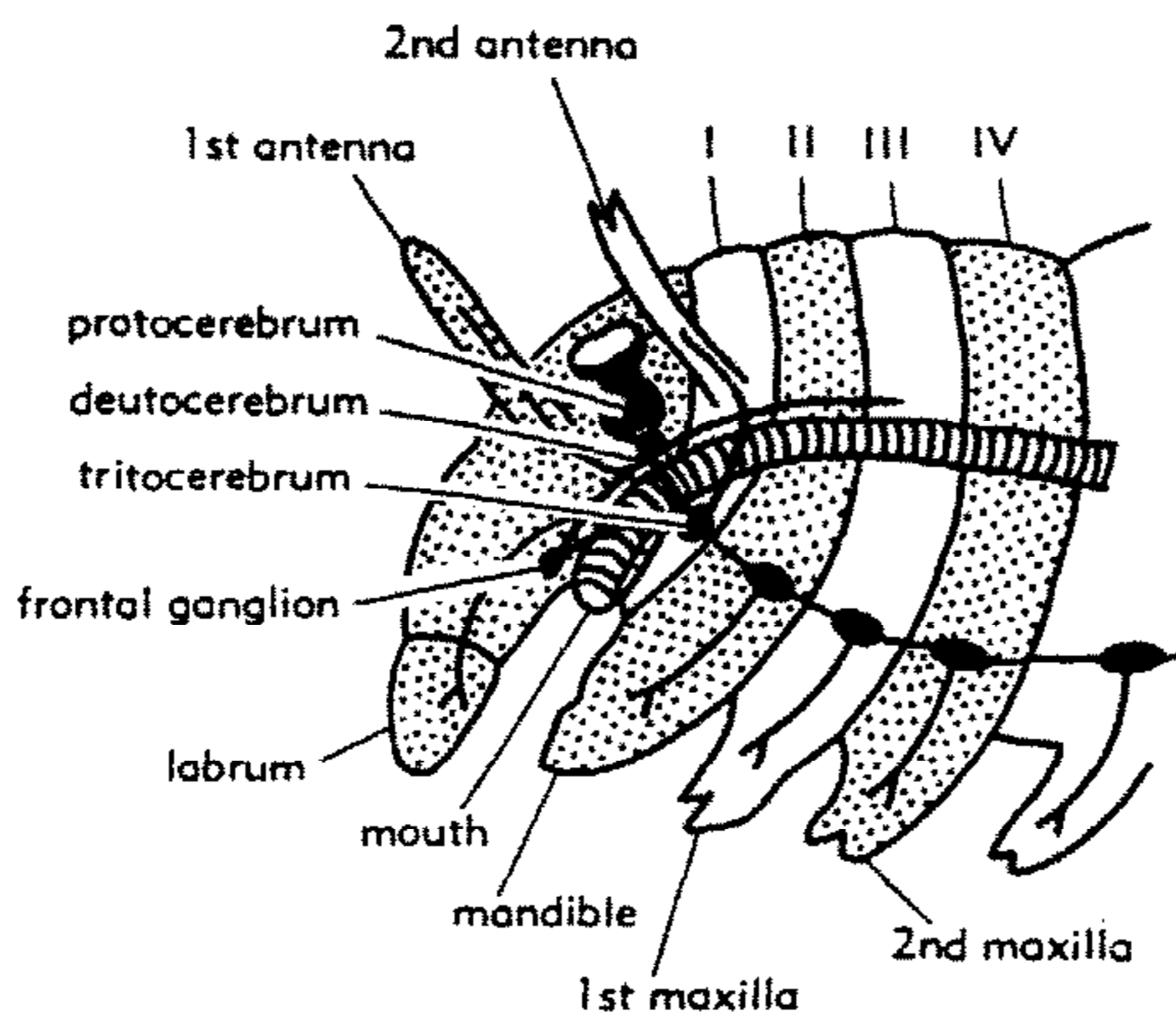

FIG. 6. Nervous system and segmentation of arthropod head (diagrammatic), showing undivided preoral portion (acron+antennal and preantennal segments). (After Weber.)

In the Arthropoda, the brain is normally divided into a protocerebrum, deutocerebrum, and tritocerebrum (Fig. 6).

The protocerebrum contains the optic centers and the centers of nerves leading to possible preantennae, which are appendages identified in the embryos of certain terrestrial forms (Chilopoda, Insecta). Vestigial coelomic sacs also suggest the presence of frontal segments.

The deutocerebrum contains the ganglia of the 1st antennae (antennules). These antennae are unique among arthropod appendages in usually having numerous articulations (although few are true joints) and in being uniramous (although branched in Pauropoda). The antennae of primitive trilobites differ markedly from the other appendages (except cerci in *Olenoides*). The deutocerebrum is strongly reduced in the Chelicerata, which is connected with complete reduction of the 1st antennae in members of this group. Traces of antenna-glomeruli, however, have been found, supporting the assumption of a secondary reduction of the appendages.

The 2nd antennae of crustaceans, belonging to the tritocerebral segment, have the structure of biramous "normal" appendages. The tritocerebral lobes are united by a commissure running below the esophagus (stomodaeum), thus indicating that the corresponding ganglia actually belong to the

ventral nerve cord, being secondarily incorporated in the brain complex. The tritocerebral somite has accordingly been called the 1st postoral segment (I).

The preoral portion of the brain was regarded as a primarily unsegmented acron by SNODGRASS and others (Fig. 6), the unique structure of the 1st antennae possibly serving to support this view. The occurrence of coelomic sacs and vestiges of preantennae in certain forms, however, rather favors the assumption that at least 2 more segments (deuto- and protocerebral) are to be incorporated. This means also that these 2 once were primarily postoral (Fig. 7). In the concept of TIEGS & WEBER the acron, corresponding to the prostomium of annelids, is restricted to the portion in front of these segments (Fig. 7). The possible occurrence of even more incorporated segments and a corresponding restriction of the acron, is suggested in the structure of certain lower Lower Cambrian trilobites (HUPÉ) (Fig. 7d). A secondary backward movement of the mouth (or corresponding forward movement of postoral segments) is characteristic of the Arthropoda. In the Chelicerata the chelicerae secondarily attain a pronounced preoral position. The probable homology of the segments and appendages in the anterior part of the arthropod body is indicated in the following tabulation.

Suggested Homology of Segments and Appendages in Anterior Part of Arthropod Body

| Preoral region and postoral segments (I-VI) | Appendages | | | |
|---|------------|-------------|--------------|----------------------|
| | TRILOBITA | CHELICERATA | CRUSTACEA | MYRIAPODA INSECTA |
| acron | | | | |
| preantennal | | | | |
| antennal | antennae | | 1st antennae | antennae |
| I | legs | chelicerae | 2nd antennae | |
| II | legs | pedipalpi | mandibles | mandibles |
| III | legs | legs | 1st maxillae | maxillae |
| IV | legs | legs | 2nd maxillae | labia |
| V | | legs | maxillipeds | |
| VI | | legs | | |

A distinct head, evidently comprising 4 (or primarily 6) postoral segments, is present in the Trilobita, Myriapoda, and Insecta (Fig. 1) (although Pauropoda have only 3 segments). In the Chelicerata the prosoma contains 6 postoral segments, a reduced 7th being incorporated in the Xiphosura. Among the Crustacea cephalization is less distinct. The "head" may include 1, 3, or 4 postoral segments.

As mentioned above, the deutocerebral appendages are developed as antennae (1st antennae or antennules). The tritocerebral appendages are lacking in Myriapoda and Insecta, but they form the biramous 2nd antennae in Crustacea, the characteristic chelicerae in the Chelicerata, and the undifferentiated limbs of Trilobita. The 2nd postoral appendages form the mandibles or jaws of Crustacea, Myriapoda, and Insecta, the pedi-

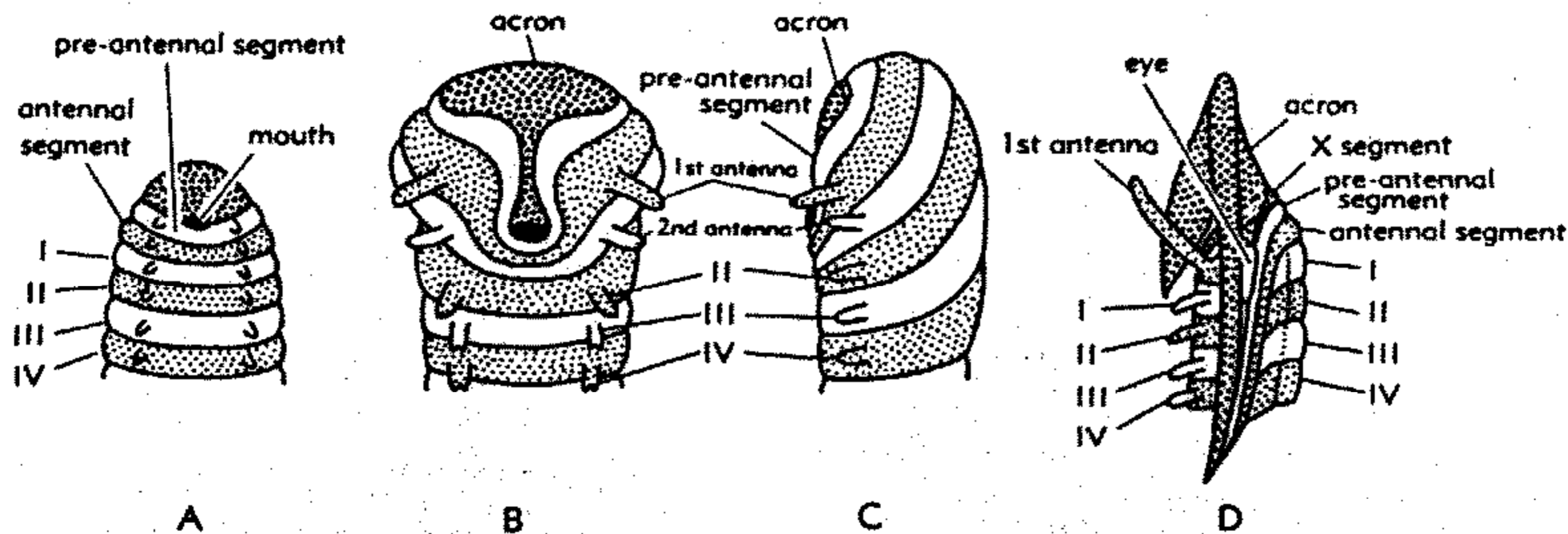

Fig. 7. Cephalic segmentation in an annelid-like arthropod prototype (A), generalized typical arthropod (B,C), and a trilobite (D). Ventral views in A,B; lateral views in C,D. The backward migration of the mouth is indicated in B,C. Traces of an "x segment" in trilobites (D) suggest that at least one segment is incorporated in the acron. (Mod. from Weber and Hupé.)

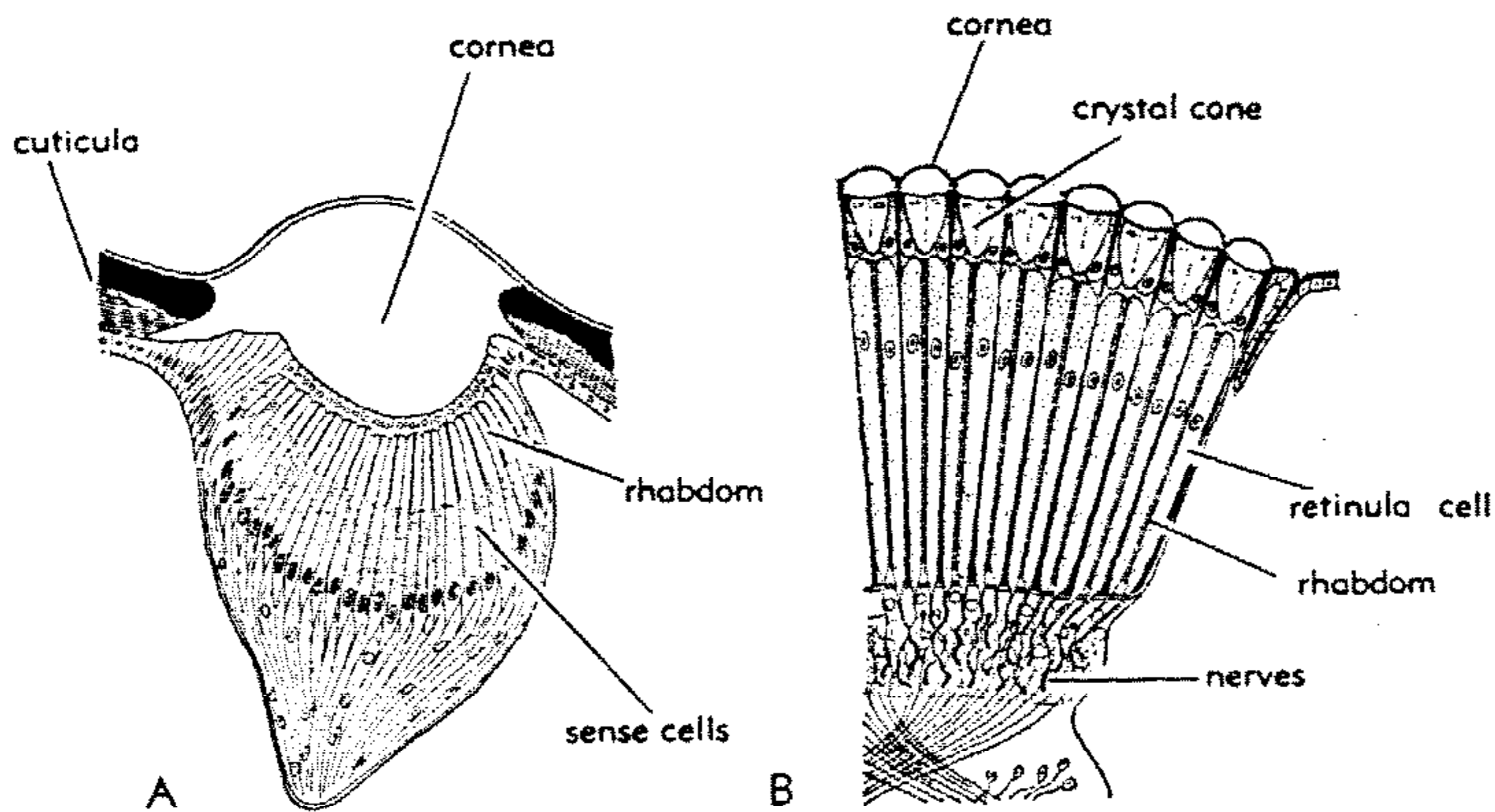

FIG. 8. Simple eye and part of compound eye of arthropods in section.—A. Median ocellus of an insect (*Formica*).—B. Diagrammatic section of compound eye normal to surface. (Both after Snodgrass.)

palpi of Arachnida, and the simple 2nd legs of Trilobita. The mandibles are limbs in which only the coxa has escaped reduction. Also the next-following appendages (maxillae borne by segments III and IV) take part in the masticatory functions. The 3 segments numbered II, III, and IV form a gnathocephalon. Jaws are lacking in trilobites and arachnids, but in the Merostomata the coxae of the well-developed prosomal legs serve to a certain extent as masticatory organs.

SENSE ORGANS

In connection with the nervous system mentioned above, the arthropods possess well-developed sense organs. Most characteristic are the sensory hairs (or setae) and eyes. Each of the movable setae (Fig. 2) has the extension of a nerve cell leading through a pore in the shell to the base of the body wall below. Fixed spines are only outgrowths of the outer cuticula.

The eyes, which are organs receptive to light, comprise the dorsal ocelli, lateral ocelli (or stemmata), and compound eyes. They are all connected with the optic centers in the frontal (protocerebral) part of the brain. Two main types of eyes are distinguished: simple eyes (or ocelli) and compound eyes (Fig. 8). Both have a similar ectodermal origin and are not fundamentally different. The simple eye consists of a trans-

parent cornea, that commonly is developed as a lens; a vitreous crystal body beneath the cornea, which takes over the function of the cornea when it is not lenticular; and a retina composed of elongate optic nerve cells. Adjacent retina cells unite so as to form a rodlike structure called rhabdom. Groups of simple eyes may replace the lateral compound eyes.

In typical development the compound eyes are composed of a large number of individual elements, termed ommatidia, each having a group of elongate retinal cells enclosing a long rhabdom with a crystal body and corneal lens above (Fig. 8b). Compound eyes occur in the earliest trilobites and are characteristic also of crustaceans, insects, and possibly extinct types of myriapods. In merostomes (xiphosurids and probably eurypterids) the primitive compound eyes have a common cornea with groups of rhabdom-forming sense cells below. The compound eyes, so very similar in crustaceans and insects, have evidently developed independently in several major arthropod groups.

FEEDING AND DIGESTIVE ORGANS

The crustaceans, insects, and myriapods, together comprising the so-called Mandibulata, have well-developed jaws that permit chewing of prey before digestion. The prosomal coxae of the merostomes partly

serve as jaws, but other chelicerates and trilobites have no masticatory organs. Arachnids suck out the liquids of the prey. The intestine has an ectodermal frontal part, the stomodaeum, which may be associated with a gizzard (in crustaceans and merostomes). An ectodermal hind part of the intestine is called the proctodaeum. The middle, mesodermal one, the mesentron, has numerous diverticular sacs in the Chelicerata, certain Crustacea, and evidently in the Trilobita. Excretion also takes place through special glands (coxal glands opening at the base of the 2nd antennae in crustaceans).

RESPIRATORY AND CIRCULATORY SYSTEMS

Very small arthropods, including both aquatic (Copepoda) and terrestrial (Paupoda) types, have cutaneous respiration. The gills or branchiae are the characteristic respiratory organs in aquatic forms. These generally form lateral lobes extending from the basal portion of the appendages (Figs. 5c,d,f). Terrestrial arthropods (Myriapoda, Insecta, Arachnida, Onychophora, and certain Crustacea) have tracheae, consisting of invaginated parts of the integument that form either branched tubuli or so-called book lungs (Fig. 9).

In contrast to conditions in annelids, the circulatory system is incomplete, the blood running from the dorsal heart into lacunae or sinuses.

ONTOGENY

The arthropod egg, which is rich in yolk, exhibits a discoidal cleavage. The 1st larva may be more or less developed when it is hatched. In several crustacean groups a small larva, called the nauplius, is very characteristic. It has a convex elliptical body with only 3 pairs of appendages (1st and 2nd antennae and maxillae). The corresponding 3 body segments, 2 of which are postoral, have been regarded as primary somites, suggesting development from an annelid with the same number of primary segments (IVANOV, 1933). This interpretation, however, is uncertain (VANDEL, 1949). In trilobites the small larva, called protaspis (pl., protaspides), has a circular outline with a segmented convex dorsal surface. The early trilobite larva seems to have had 4 postoral

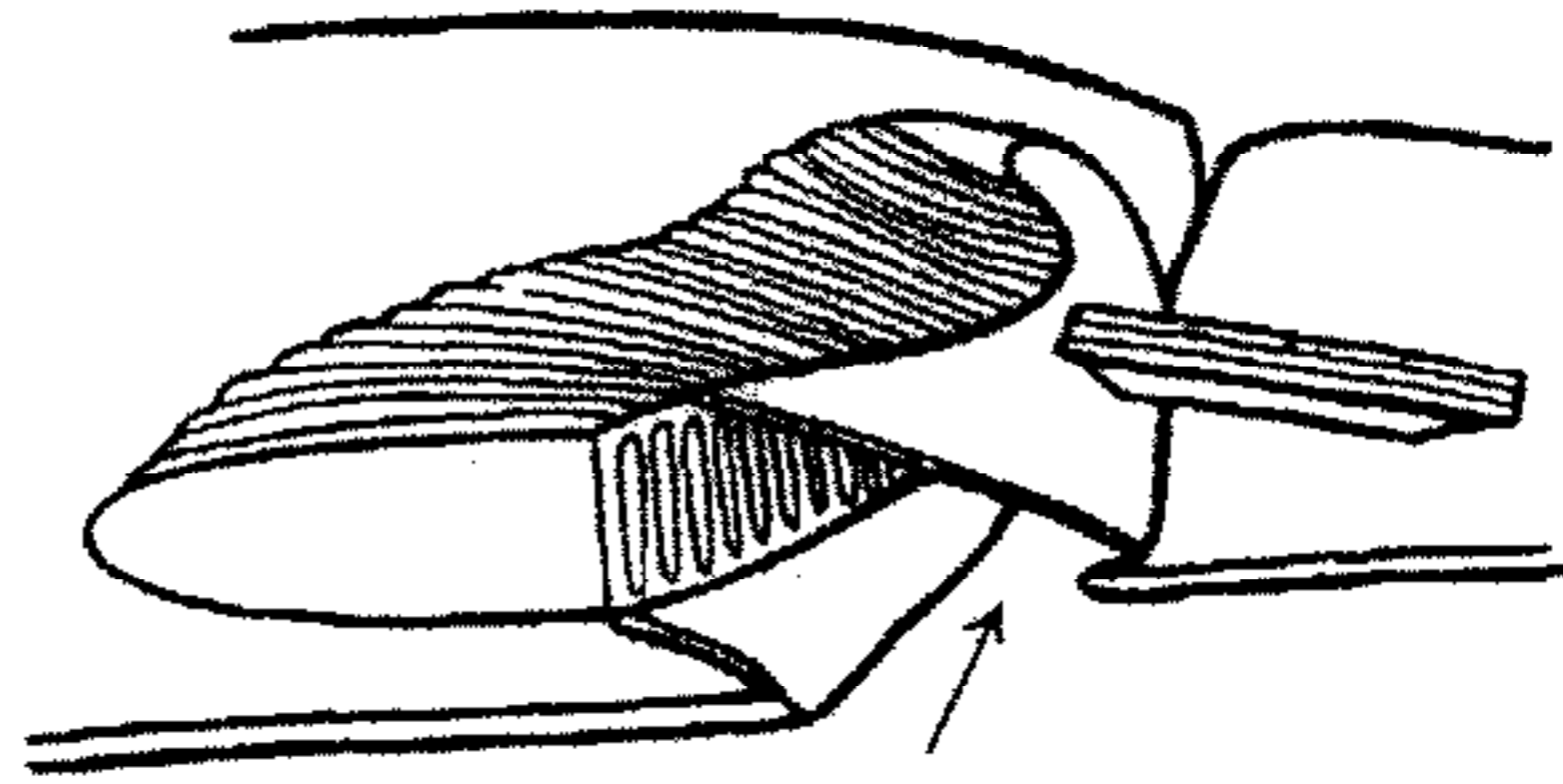

FIG. 9. Lung books of an arachnid (Phrynichida). (After Kästner.)

segments, a number also indicated in the embryo of the Xiphosura.

GEOLOGICAL OCCURRENCE

No arthropod remains are known certainly from Precambrian rocks. The so-called *Protadelaidea* of Australia (DAVID & TILLYARD, 1936) and *Beltina* (WALCOTT, 1911) are evidently inorganic formations (HUPÉ, 1952). The onychophoran-like fossil *Xenusion* (POMPECKJ, 1927) has been referred to the Precambrian but it may be younger.

The trilobites appeared near the beginning of Cambrian time. Although several groups of trilobites are represented in the Lower Cambrian, one need not expect a very long existence of typical trilobites (with solid exoskeleton) before the dawn of the Paleozoic. The trilobites had a very strong development and radiation through the Middle and Late Cambrian. Subsequently, they declined and became extinct in the Permian (Fig. 10).

The Crustacea probably existed in the Early Cambrian (identification being uncertain because appendages are unknown).

Primitive Merostomata (Aglaspida) also occur in the Lower Cambrian. The Eurypterida became extinct in the Permian but the Xiphosura still exist, the Recent representatives forming excellent examples of very long-enduring forms.

The Arachnida were well established in the Silurian and the first Myriapoda appear near the beginning of the Devonian.

The first insects (Apterygota) occur in the Middle Devonian. A sudden strong development of the Pterygota took place from Early to Late Carboniferous.

The Pycnogonida are represented in the Lower Devonian.

| | (MANDIBULATA) TRILOBITO- CHELI- (ANTENNATA) MORPHA CERATA | | | | | |
|--------|--|---------|-----------|-----------|-------------|--------------------------|
| | Myriapoda | Insecta | Crustacea | Trilobita | Merostomata | Arachnida Pycnogonida |
| Tert. | | | | | | |
| Cret. | | | | | | |
| Jur. | | | | | | |
| Trias. | | | | | | |
| Perm. | | | | | | |
| Carb. | | | | | | |
| Dev. | | | | | | |
| Sil. | | | | | | |
| Ord. | | | | | | |
| Cam. | | | | | | |

Pseudocrustacea
Merostomoidea
||

FIG. 10. Geological distribution of major arthropod groups. (For "Pseudocrustacea," read "Pseudonotostraca.")

PHYLOGENY

Among fossil arthropods, conclusions as to affinities have to be based on structure of the solid parts, the exoskeleton. Since the skeleton to a large extent serves functional purposes, phylogenetic conclusions may be misled by homeomorphy.

Primitive arthropod features are expressed by uniformity of the appendages of trilobites (only the antennae and in some forms a pair of cerci, differing from the common type). Another primitive feature is expressed in variation of the number of body segments. On the other hand, the development of compound eyes, known even in Lower

Cambrian forms, indicates advanced evolution at least as concerns the eyes.

The Xiphosura and Eurypterida of the Merostomata have many common characteristics, and the presence of an apparently more or less ancestral form (*Paleomerus*) in the Lower Cambrian suggests that division of the Merostomata into 2 separate branches took place at about that time.

The Arachnida probably branched off earlier. The Xiphosura, both earliest and Recent representatives, have features suggesting a relationship with trilobites.

The Pycnogonida commonly have been placed among the Chelicerata because of their chelicera-like appendages, but the presence of many particular and unique structures supported classification in a separate subphylum (HEDGPETH).

The Crustacea form a heterogeneous but still fairly well-defined group. They have been regarded as relatives (close or remote) of the Trilobita, because of the presence in both of antennae and biramous legs, although homology of the legs may be doubted.

With few exceptions, the Myriapoda and Insecta are terrestrial forms, their morphology showing many adaptations to this mode of life. The 2 groups are definitely related. The insects form a well-established, compact group (comparable to the trilobites), whereas the myriapods (Pauropoda, Diplopoda, Chilopoda, Symphyla) demonstrate a wide field of variation. The origin of the Myriapoda and Insecta is still unknown, their postulated derivation from trilobite- or crustacean-like forms being supported by little evidence. Affinities with the Onychophora have recently been pointed out by TIEGS (1947). Generally, however, the Onychophora have been regarded as having a more isolated position, being a kind of "arthropodan annelid," little related to the other arthropod groups.

In phylogenetic discussions of arthropods, certain Middle Cambrian fossils described by WALCOTT (1911, 1912, 1931) have played an important role. The specimens, though flattened to films in shale, show fine details of the exoskeleton, including minute setae. They vary considerably in general appearance. Some (*Pseudonotostraca*, including *Burgessia*, *Yohoia*, *Opabinia*, *Waptia*) are

very crustacean-like, whereas others (Marrellomorpha, containing *Marrella*) are trilobite-like or resemble merostomes (Merostomoidea, including *Emeraldella*, *Naraoia*, *Leancoilia*, *Sidneyia*). In development of the appendages, however, all these different arthropods seem to be linked together by their apparently common trilobitan appendages (or modifications of these structures). This points to existence of a mutual relationship of the forms mentioned and at the same time suggests definite affinities to trilobites. The Middle Cambrian arthropods discussed are mostly regarded as representatives of a primitive, more or less ancestral group called Trilobitomorpha by STØRMER (1944) and Proarthropoda by VANDEL (1949); it is from this group that the 2 stems, Crustacea and Chelicerata, are generally presumed to have been developed (RAYMOND, 1920, 1935). On the other hand, the crustacean-like features may be interpreted as indicating homeomorphy, the whole group including the trilobites (Trilobita) belonging to the trilobite-chelicerate stem (STØRMER, 1944). The problem is not settled. A monophyletic origin of the Arthropoda has been advocated among others by HEYMONDS, LANKESTER, CARPENTER, SNODGRASS, WATERLOT, and HEEGAARD. In recent years the idea of a polyphyletic origin has become more common (PACKARD, KINGSLEY, PLATE, FEDOTOV, IVANOV, STØRMER, VANDEL, TIEGS, WEBER).

CLASSIFICATION

A detailed classification of arthropod assemblages is given in the individual treatments of the various groups. Here only the major groups are considered.

The Pentastomida, Tardigrada, and Onychophora differ from the rest and have often been placed in a separate group (Protarthropoda LANKESTER, 1904; Pararthropoda VANDEL, 1949; Oncopoda WEBER, 1954).

The typical arthropoda (Euarthropoda LANKESTER, 1904) comprise 5 major groups. (1) The Trilobitomorpha (=Proarthropoda, VANDEL, 1949) comprehend the host of trilobites that together form the class Trilobita and the chiefly Middle Cambrian forms known as Marrellomorpha, Merostomoidea, and Pseudonotostraca. These latter are here ranked as subclasses of nontrilobite Trilobitomorpha collectively designated

as the class Trilobitoidea. (2) The Chelicerata is a well-defined group that includes xiphosurans and arachnids (*Treatise*, Part P). (3) The Pycnogonida (sea spiders), which in some respects seem comparable to the chelicerates and by many authors have been classified with them, are regarded as a distinct subphylum (*Treatise*, Part P). (4) The Crustacea are a very distinct assemblage consisting of the branchiopods, ostracodes, copepods, cirripeds, and malacostracans. (5) The myriapod-insect group comprises the Pauropoda, Diplopoda, Chilopoda, Symphyla, and Hexopoda (Collembola, Protura, Insecta).

The Crustacea with Myriapoda and Insecta have often been placed together in an assemblage called Mandibulata (or Antennata), a group that may be artificial in not being based on true relationships.

The main divisions of the Arthropoda may be given in tabular form as follows; in this outline the category "supersubphylum" is introduced so that divisions treated elsewhere (see *Treatise*, Part P) as subphyla may retain this assignment of rank.

Main Divisions of Arthropoda¹

- Protarthropoda (supersubphylum). ?Precam., Cam.-Rec.
- Pentastomida (subphylum). Rec.
- Tardigrada. Rec.
- Onychophora. ?Precam., Cam.-Rec.
- Euarthropoda (supersubphylum). Cam.-Rec.
- Trilobitomorpha (subphylum). Cam.-Perm.
- Trilobitoidea (class). Cam.-Dev.
- Merostomoidea (subclass). Cam.-Dev.
- Pseudonotostraca. Cam.
- Marrellomorpha. Cam.
- Trilobita (class). Cam.-Perm.
- Chelicerata (subphylum). Cam.-Rec.
- Merostomata (class). Cam.-Rec.
- Xiphosura (subclass). Cam.-Rec.
- Eurypterida. Ord.-Perm.
- Arachnida (class). Sil.-Rec.
- Latigastrea (subclass). Sil.-Rec.
- Stethostomata. Carb.(Penn.)
- Soluta. Dev.-Carb.(Penn.)
- Caulogastra. ?Dev., Carb.(Penn.)-Rec.
- Pycnogonida (subphylum). Dev.-Rec.
- Mandibulata. Cam.-Rec.

¹ The outline of classification given here conforms to views of the author of this section in recognizing the Protarthropoda (with their subdivisions) and Euarthropoda; also, the arrangement and taxonomic rank of the Trilobitomorpha (with their subdivisions) are adopted from STØRMER. The Editor is responsible for the portion of the table that follows Trilobitomorpha; this is based partly on consultation with other contributors to volumes of the *Treatise* allotted to arthropods.—R.C.M.

Crustacea (*class*). *Cam.-Rec.*
 Branchiopoda (*subclass*). *Cam.-Rec.*
 Cephalocarida. *Rec.*
 Ostracoda. *Ord.-Rec.*
 Copepoda. *Rec.*
 Cirripedia. *Ord.-Rec.*
 Malacostraca. *Perm.-Rec.*
 Myriapoda (*class*). *Penn.-Rec.*
 Chilopoda (*subclass*). *Penn.-Rec.*
 Diplopoda. *Penn.-Rec.*
 Symphyla. *Rec.*
 Pauropoda. *Rec.*
 Hexapoda (*class*). *Dev.-Rec.*
 Collembola (*subclass*). *Dev.-Rec.*
 Protura. *Rec.*
 Insecta. *Penn.-Rec.*

REFERENCES

Snodgrass, R. E.

- (1) 1952, *A textbook of arthropod anatomy*: Comstock Publishing Associates (Ithaca, New York), viii+363 p., 88 fig.

Stormer, Leif

- (2) 1951, *Studies on trilobite morphology. Part III. The ventral cephalic structures with remarks on the zoological position of the trilobites*. Norsk geol. Tidsskrift (Oslo), v. 29, p. 108-158, fig. 1-14, pl. 1-4.

Vandel, A.

- (3) 1949, *Embranchement des arthropodes. Généralités composition de l'embranchement*: in *Traité de Zoologie*, ed. P.-P. Grassé Masson (Paris), tome 6, p. 79-158, fig. 1-36.

Waterlot, G.

- (4) 1953, *Embranchement des arthropodes. Généralités sur les arthropodes*: in *Traité de Paléontologie*, ed. J. Piveteau, Masson (Paris), tome 3, p. 11-24, fig. 1-15.

Weber, H.

- (5) 1952, *Morphologie, Histologie und Entwicklungsgeschichte der Articulaten*: Fortschritte der Zoologie, Neue Folge (Jena), Band 9, p. 18-231, 24 fig.

PROTARTHROPODA

By RAYMOND C. MOORE

INTRODUCTION

The Protarthropoda (6) include invertebrates having subcylindrical, wormlike form and morphological characters intermediate between those of annelids and typical arthropods. No members of the group, however, are entitled to serious consideration as possible ancestors of the Arthropoda, for they possess obvious marks of evolutionary divergence that distinguish them as more or less aberrant stocks. Three assemblages, each classified as a subphylum, are recognized: Onychophora, Tardigrada, and Pentastomida. The onychophores are surely a very ancient group that exhibits hardly any perceptible change in external form during approximately 500 million years of their existence from Cambrian, or possibly Precambrian, time down to the present, although they have changed from originally marine habitats to a present exclusively terrestrial mode of life. The tardigrades (so-called "water bears") are very minute animals found on land, in fresh waters, and in the sea; they are unknown as fossils. The pentastomids are exclusively parasitic

protarthropods that also have no fossil record.

ONYCHOPHORA

Living Onychophora (*onychus*, claw; *phora*, bearing) are represented by 70 described species, distributed in a dozen genera (1). Except for reported occurrence in the West Indies, Mexico, Central America, northern South America, and southeastern Asia, they are restricted to widely scattered parts of the Southern Hemisphere. They are found most commonly in moist dark places, such as beneath leaves and stones, in rock crevices, and concealed by the loosened bark of rotting logs. Generally, they are adapted to lowland forests in warm temperate to tropical areas, but some species exist in mountains to an elevation of about 6,000 feet above sea level where a snow cover may persist 4 or 5 months, and at least one form has been observed in arid parts of central Australia. During unfavorable periods of cold and dryness, onychophores are relatively or entirely immobile.

The Onychophora are elongate cylindrical animals of wormlike appearance ranging

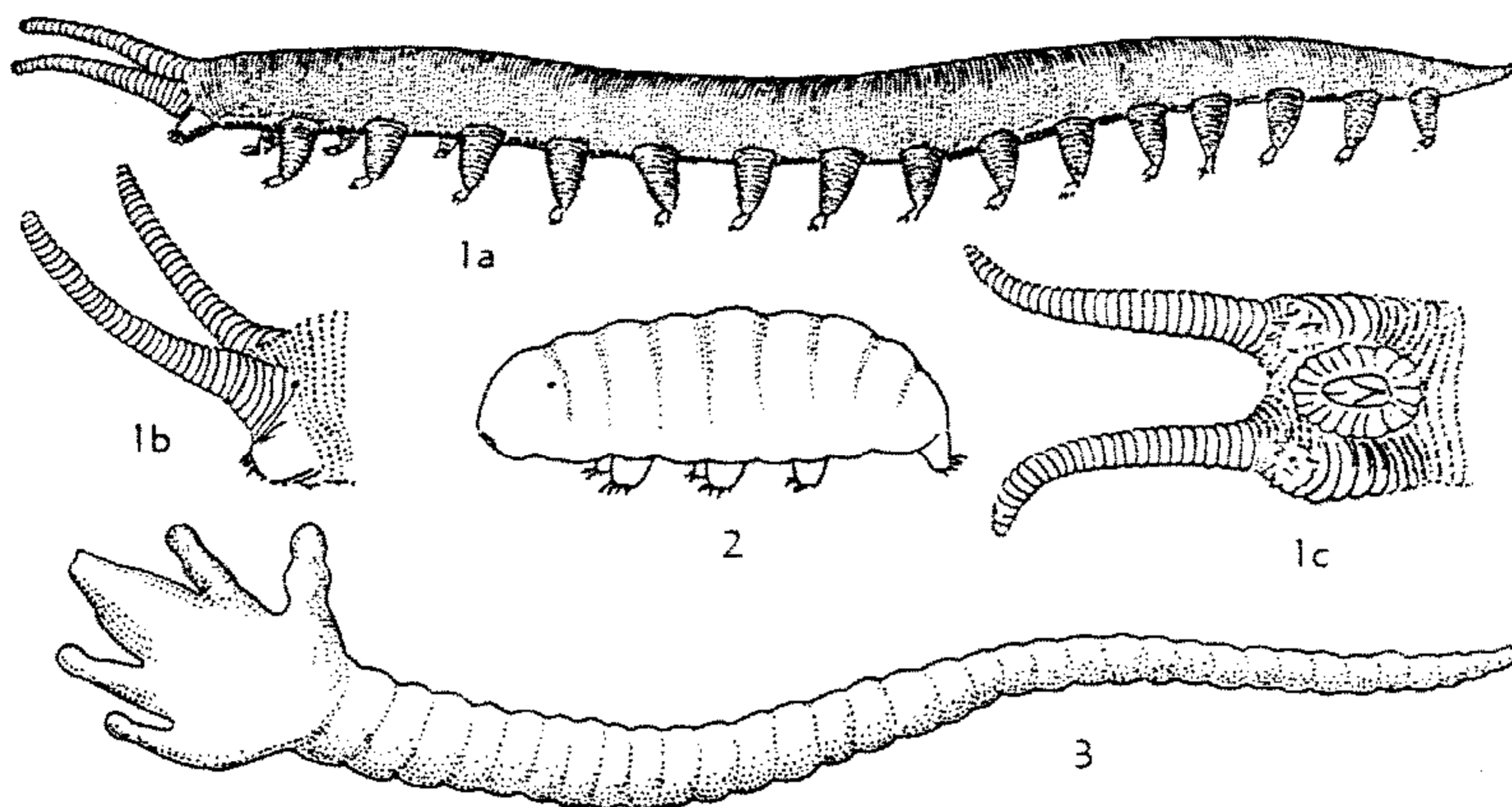

FIG. 11. Types of living Pararthropoda.—1. Onychophora; 1a, *Peripatus*, from South Africa, side view of whole animal, $\times 2$; 1b,c, side and ventral views of same, $\times 2.5$ (Mod. from Snodgrass).—2. Tardigrada; *Macrobiotus* from side, a cosmopolitan genus, $\times 60$ (Mod. from Cuenot).—3. Pentastomida; *Cephalobuena*, parasite in lungs of snakes, $\times 4$ (Mod. from Heymons).

in length from less than 1 inch (25 mm.) to a maximum of about 8 inches (200 mm.) (1). The body lacks evident marks of segmentation, but on its underside are regularly spaced pairs of thick and rather short stumpy legs, in different species (fossil and Recent) ranging in number from 10 to 43 pairs (Fig. 11,1). The anterior extremity bears 2 short antennae and a pair of small eyes, but there is no distinct head. The mouth, located between and just below the antennae, is bordered by a fleshy lip and provided with a pair of small horny jaws or mandibles laterally opposed to one another. On each side of the mouth is a blunt oral papilla that projects obliquely forward. The integument of the body is a flexible thin chitinous covering that bears numerous closely spaced transverse rings of fine papillae, each with a short hairlike spine. The fat rounded legs also carry transverse rings and lack division into joints such as characterize the limbs of typical arthropods; they are tapered toward their distal extremity, which is provided with a pair of claws (or in some extinct forms with 6 claws on each foot). The bluntly conical rear end of the body contains the anus and just ahead of it on the underside, a single genital opening (7).

Layers of longitudinal and transverse muscles immediately underlie the chitinous integument and in tubular manner inclose the undivided body cavity, digestive tract, excretory organs, and other soft parts. Special muscles control movement of the legs. The nervous system consists of a pair of ill-defined ganglia above the mouth, various nerves in the anterior part of the body, and a pair of ventral nerve cords (with many transverse connections) running the length of the body. Reproductive organs are paired and the sexes are separate. Most onychophores are viviparous. A large female may produce as many as 40 young in a year, each resembling the adult except in size and color.

Fossil onychophores are known only from Middle Cambrian rocks of British Columbia (*Aysheaia*) and possibly from Precambrian quartzite in Scandinavia (*Xenusion*) (4,5). They resemble modern species in external form but differ in some morphological characters and in being found (at least as regards *Aysheaia*) to occur in a marine habitat. The ancient onychophores are distinguished by their small number of body segments (10 in *Aysheaia* bearing limbs, as compared with 15 to 43 in living forms),

fewer and more widely spaced transverse rings of papillae, branched antennae instead of simple undivided antennae, presence of 6 terminal claws on the walking legs, and frontal rather than ventral position of the mouth. *Xenusion* is known only from a rather poorly preserved single specimen, which, however, clearly shows a pair of moderately large tubercles on the ventral side of each segment, their significance being quite unknown.

OTHER GROUPS

Protarthropoda unrepresented by fossils are included in the subphyla named Tardigrada and Pentastomida (2,3). For the purpose of completeness in survey of divisions of the Arthropoda, it is desirable to notice these even though discovery of them in the paleontological record is unlikely. Both have a cylindrical wormlike form, with a body that lacks distinct segmentation inclosed by a thin chitinous integument, and such locomotor appendages as are developed (4 pairs in tardigrades and a single pair in pentastomids) consist of rather stumpy unjointed limbs. The legs of Tardigrada, like those of Onychophora, are armed with terminal claws. The Pentastomida include only somewhat aberrantly specialized parasites that infest various mammals, snakes, and birds.

SYSTEMATIC DESCRIPTIONS

Supersubphylum PROTARTHRO- PODA Lankester, 1904

[=Pararthropoda, VANDEL, 1949; Oncopoda WEBER, 1954]
[Type—*Peripatus* GÜLDING, 1825]

Wormlike invertebrates having some characteristics of arthropods, which may include occurrence of molts, but lacking rigid or semirigid chitinous body covering and possession of jointed appendages; mouth with pair of modified appendages serving as mandibles. Includes some aberrant specialized forms, in part parasitic (6). ?*Precam.*, *Cam.-Rec.*

It is true that LANKESTER (1904, p. 565) assigned only the Onychophora to the "grade" Protarthropoda, but the lack of mention by him of the Tardigrada and Pentastomida (or Linguatulida) is not construed to be a significant omission, (1) because at the time of his writing these groups

had received little attention from the standpoint of general taxonomy, being unrecognized as entitled to rank correlative with the Onychophora, and (2) because modification of the assigned limits of the assemblage named Protarthropoda does not require rejection of the taxon itself since the essential concepts relating to it and its content of the Onychophora remain. Accordingly, designations proposed a half century after publication of Lankester's classification are here treated as synonyms; they are Pararthropoda (VANDEL, 1949) and Oncopoda (WEBER, 1954).

Subphylum ONYCHOPHORA Grube, 1853

Relatively slender, subcylindrical, wormlike body with anterior extremity not differentiated as a distinct head but bearing a pair of short antennae, small eyes, blunt oral papillae, and mouth opening with 2 laterally placed mandibles on underside; body unsegmented, marked by numerous transverse rings of small papillae and bearing 10 to 43 pairs of short, stout, unjointed walking legs that terminate in claws; body and legs covered by thin chitinous integument; anus at conical posterior extremity behind slitlike genital opening. ?*Precam.*, *Cam.-Rec.*

Order PROTONYCHOPHORA Hutchinson, 1930

Extinct marine Onychophora with terminal mouth, frontal papillae, and branched antennae, pairs of short walking legs provided with 6 terminal claws (5). ?*Precam.*, *Cam.*

Family AYSHEAIDAE Walcott, 1911

[*nom. correct.* MOORE, herein (*pro Aysheaidae* WALCOTT, 1911)]

Characters of the order. *M.Cam.*

Aysheia WALCOTT, 1911 [**A. pedunculata*]. Small (length 15-50 mm.), body unsegmented, but on basis of paired appendages divisible into 11 parts, each with 4 transverse rings of minute papillae; anterior pair of appendages antenniform, with 4 laterally diverging branchlets, attached above midline of sides and directed obliquely forward; other appendages consisting of short, blunt, tapered walking legs that are transversely annulated and provided with 6 terminal claws; unbranched alimentary canal extending length of body; obscure

ventral or internal organs, possibly respiratory in function, located near extremities of legs (4,5,9). Burgess Shale, W.Can.(B.C.).—FIG. 12,1. **A. pedunculata*; 1a,b, type specimen, $\times 2$, $\times 4$ (6); 1c, another specimen, $\times 1.5$ (5); 1d, reconstr., $\times 2.5$ (5). [Species known from 9 specimens.]

Family UNCERTAIN

Xenusion POMPECKY, 1927 [**X. auerswaldae*]. Body subcylindrical, moderately large (length more than 100 mm.), weakly segmented, with pair of rounded prominences on ventral side of each segment except at ?posterior extremity (opposite end

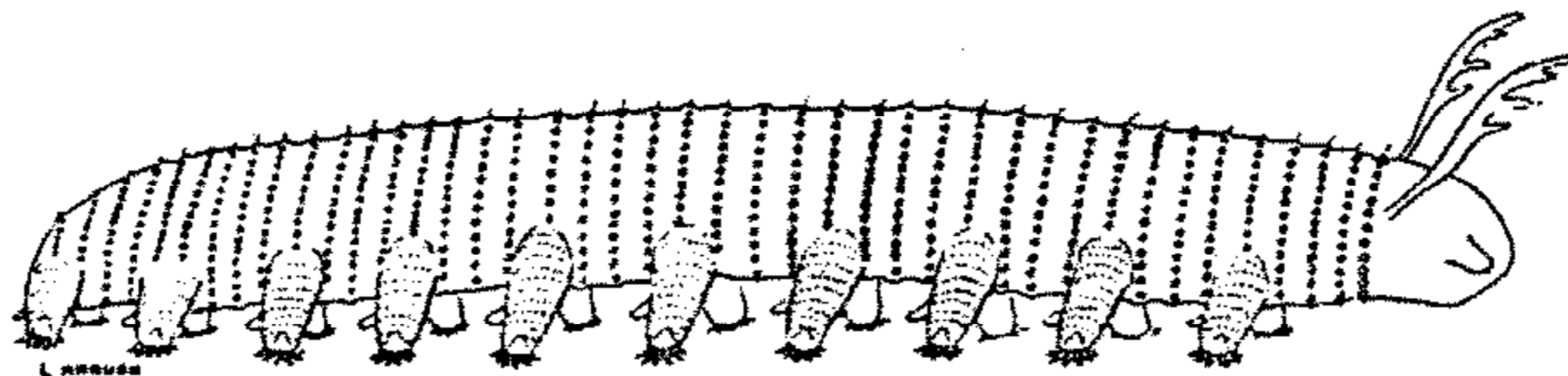
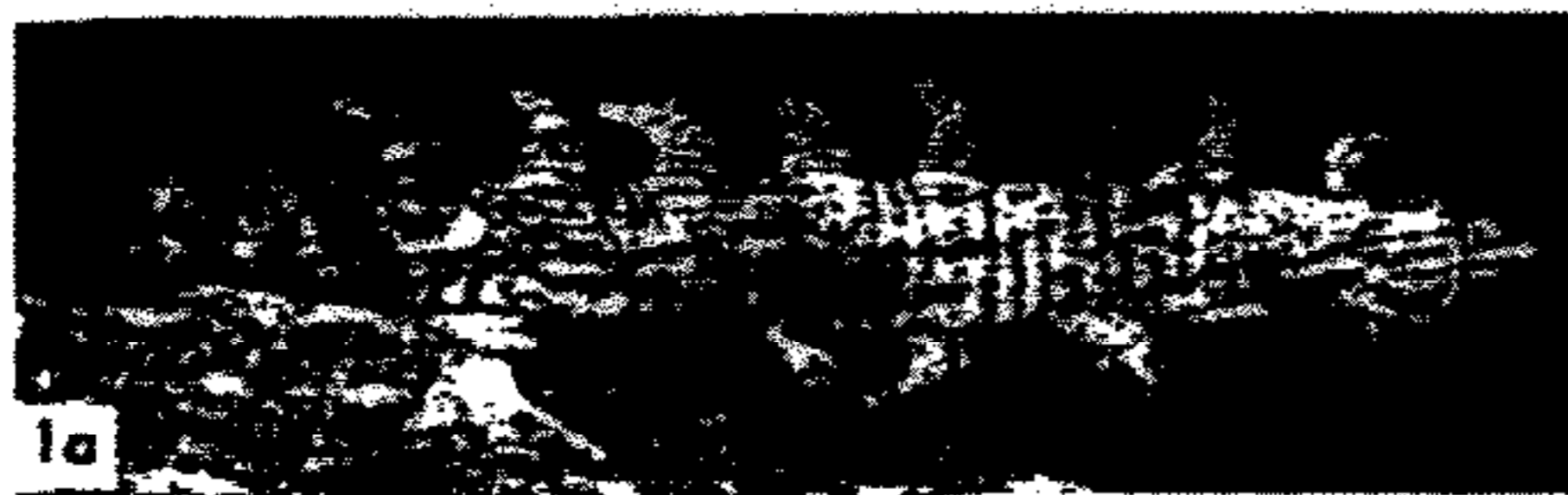

Aysheaia

1d



Xenusion

FIG. 12. Fossil Onychophora.—1. *Aysheaia pedunculata* WALCOTT, M.Cam., W.Can.(B.C.); 1a,b, type specimen, $\times 2$, $\times 4$ (6); 1c, another specimen, $\times 1.5$ (5); 1d, reconstr., $\times 2.5$ (5).—2. *Xenusion auerswaldae* POMPECKY, ?Precam., Swed.; ventral side, $\times 1$ (4).

unknown); legs thick, rounded and annulated, tapering distally, without observed claws; antenniform appendages unknown (4). ?*Precam.* (erratic in glacial drift), Swed.—FIG. 12.2. **X. auerswaldae*; cast made from type (only known specimen), which is a mold, ventral side, $\times 1$ (4).

Order EUONYCHOPHORA Hutchinson, 1930

Terrestrial Onychophora with tracheal respiratory system; anterior end with unbranched, moderately short antennae and blunt, laterally directed oral papillae; mouth anteroventral, with pair of horny mandibles; walking legs with terminal pair of claws (5). *Rec.*

Family PERIPATIDAE Evans, 1901

Reddish brown pigment altered by light and soluble in alcohol; with 22 to 43 pairs of legs; species tending to large size (length to 200 mm.). *Rec.*, distribution circum-tropical.

Family PERIPATOPSIDAE Bouvier, 1907

Blue to green pigment not altered by light or soluble in alcohol; with 14 to 25 pairs of legs; species tending to medium or small size. *Rec.*, distribution south of equator (Chile, C.Afr., S.Afr., Austral., Tasm., N.Z.).

REFERENCES

Cuénot, Lucien

- (1) 1949, *Les Onychophores: in Traité de Zoologie*, ed. P.-P. Grassé, Masson (Paris), tome 6 (971 p.), p. 3-37, fig. 1-37.
- (2) 1949a, *Les Tardigrades*: Same, p. 39-59, fig. 38-59.
- (3) 1949b, *Les Pentastomides*: Same, p. 61-75, fig. 60-77.

Dechaseaux, Colette

- (4) 1953, *Onychophores: in Traité de Paléontologie*, ed. J. Piveteau, Masson (Paris), tome 3 (1063 p.), p. 3-7, fig. 1-5.

Hutchinson, G. E.

- (5) 1930, *Restudy of some Burgess Shale fossils*: U.S. Natl. Mus., Proc., v. 78, art. 11, p. 1-24, pl. 1, fig. 1-5.

Lankester, E. R.

- (6) 1904, *The structure and classification of the Arthropoda*: Microscopical Soc. (London), Quart. Jour., n. ser., v. 47, no. 188, p. 523-582, pl. 42, fig. 1-11.

Storer, T. I., & Usinger, R. L.

- (7) 1957, *General zoology*: McGraw-Hill Book Co., Inc. (New York), 664 p., illus. [arthropoda, p. 385-461].

Vandel, A.

- (8) 1949, *Généralités [sur les arthropodes]*: in *Traité de Zoologie*, ed. P.-P., Grassé, Masson (Paris), tome 6, p. 79-158, fig. 1-36.

Walcott, C. D.

- (9) 1911, *Middle Cambrian annelids*: Smithsonian Misc. Coll., v. 57, no. 5 (Pub. 2014), p. 109-144, pl. 18-23.

EUARTHROPODA—GENERAL FEATURES

By RAYMOND C. MOORE

Determination of the classificatory limits of the phylum Arthropoda and the definition of first-rank divisions within the phylum are matters involving a large amount of subjective judgment. For example, the groups designated as Onychophora, Tardigrada, and Pentastomida are almost universally considered to stand sufficiently apart from one another and from other invertebrates to warrant treatment of them as subphyla, but if this is accepted, to what phylum do they belong? Obviously they possess characters denoting affinity with typical arthropods, yet lack jointed legs and well-chitinized exoskeleton such as basically distinguish the Arthropoda. Recognition of the Protarthropoda as an independent phylum

intermediate between Annelida and Arthropoda seems to be less satisfactory than stretching limits of the later enough to admit the Protarthropoda. This course is adopted in the *Treatise*.

LANKESTER (1904) introduced the "grade" Euarthropoda to contain all typical arthropods, including particularly the classes Diplopoda, Arachnida, Crustacea, Chilopoda, and Hexapoda (insects), as enumerated by him. Present classification calls for inclusion of the trilobites and related forms (here collectively designated as Trilobitomorpha) as a major division of the Euarthropoda, correlative in rank with Chelicerata, which is composed of the Arachnida and Merostomata; LANKESTER assigned the Trilobita and

merostomes such as *Limulus* to the Arachnida. Also, present judgment of most specialists on the arthropods supports a grouping together of the Crustacea, Myriapoda (Chilopoda, Diplopoda, Symphyla, Pauro-poda), and Hexapoda (Insecta, Collembola, Protura) in a subphylum designated Mandibulata. Entomologists commonly recognize the Insecta as including the Collembola and Protura, however.

The Euarthropoda are characterized by their segmented, externally jointed body that is covered by a hardened exoskeleton containing chitin. This covering firmly incloses the internal soft parts, allowing essentially no change of dimensions, expansion in growth being provided for by periodic molts. The body commonly is divided into a head, thorax, and abdomen, but these parts vary in distinctness and in some euarthropods the different regions may be fused together. Appendages consist basically of one pair to each somite and each appendage has few or many hinge joints that are moved by opposed sets of muscles; the appendages may be reduced in number, however, and generally they are differentiated to serve various functions. The digestive tract is a simple or complex tubular structure extending from the mouth, mostly located on the underside of the head, to the anus at the rear of the abdomen; elaborate diverticula may exist. The mouth commonly is provided with lateral jaws adapted for chewing or sucking. Respiration is effected by gills, air ducts (tracheae), so-called book lungs, or by the body surface. A dorsally placed heart forces blood through arteries to the various organs and body tissues, return of blood to the heart being through open body spaces. A well-developed nervous system consists of paired dorsal ganglia connected to ventral nerve cords leading to ganglia in each somite and branches serving the appendages. Eyes generally are present; they include both simple and compound types, although many euarthropods possess only one kind or the

other. Tactile and chemoreceptor hairs, antennae, statocysts, and auditory organs are widely occurring sensory equipment of these invertebrates. The sexes usually are separate, with fertilization of eggs inside of the female. After hatching, the young almost invariably pass through a series of larval stages that lead gradually or with abrupt metamorphosis to the adult form (7,8).

Taking account of the enormous number of different kinds of euarthropods, their effective adaptation to almost every conceivable environment, and their extremely long paleontological record, one must judge this group of animals supremely successful. The complex organization of their hard parts, found more or less abundantly and well preserved in rock formations throughout the geologic column, adapts them for purposes of stratigraphic correlation and age determination. As fossils, most of them are intrinsically of great interest to both specialists and laymen.

Supersubphylum EUARTHRO- PODA Lankester, 1904

Arthropoda distinguished by hardened body covering composed largely of chitin, body usually well segmented and jointed externally and commonly divisible into head, thorax, and abdomen (although with some of these parts fused together in many forms); with jointed appendages composed of few or several segments connected by hinges and moved by opposed sets of internal muscles; with rather highly developed sensory organs, circulatory and nervous systems, and modes of respiration; sexes usually separate; young mostly passing through a number of larval stages before gradual or abrupt attainment of adult form, growth accommodated by molts of exoskeleton (6-8). ?*Precam., Cam.-Rec.*

REFERENCES

For references see the preceding section on Protarthropoda.

TRILOBITOMORPHA

By LEIF STØRMER

INTRODUCTION

The name *Trilobitomorpha* was introduced (STØRMER, 1944)¹ to include the *Trilobita* and trilobite-like forms, particularly several peculiar Middle Cambrian arthropods found and described by WALCOTT (6-8). These forms, occurring in the Burgess Shale of British Columbia, are excellently preserved. Although flattened into films in the shale, the outlines, even of finest details such as bristles of the appendages, are very well preserved (Fig. 13). In spite of favorable preservation of these fossils, our knowledge of the various species represented is hardly sufficient to warrant definite determination of their taxonomic position. Whereas the trilobites apparently are very conservative as regards their basic structures, the nontrilobite members of the *Trilobitomorpha* exhibit a considerable variation both in development of the body and of the appendages. This suggests that the trilobites represent a well-established group, in contrast to the others that seem to be in a state of radiation, with ability to develop new and different groups.

The characteristic structure of appendages forms the connecting link between different members of the *Trilobitomorpha*. On its basic structure the trilobite appendage consists of a jointed, cylindrical walking leg with a lateral gill branch attached to its very base (Fig. 14). As far as can be ascertained from materials available, the nontrilobite forms have trilobitic appendages or derivations of this type. In some genera the walking leg is more or less reduced and in others the gill branch (certain appendages such as those interpreted as 2nd antennae) is too specialized to justify comparison with the trilobite limb.

The common features in development of the appendages seem to justify the establishment of a common group (*Trilobitomorpha*) for the different forms observed.

¹ Literature cited in this section is included in "References" at the end of the following section on *Trilobitoidea*.

Whether the structure of trilobite appendages is sufficiently unique to warrant recognition of trilobitomorpha as a separate subphylum of the Arthropoda, or whether it is so related to the biramous limb of Crustacea as to call for classification with this group remains an open question. The occurrence of the trilobite type of limb in several different trilobites from very different geological ages and its presence in several nontrilobite arthropods, apparently both benthonic and planktonic, are points favoring interpretation as a unique structure. The bifurcate nature of appendages in both trilobitomorpha and crustaceans has been considered to denote relationship. The characteristic gill branch of the trilobite limb, however, might be homologous with the gill-bearing epipodite (or pre-epipodite) of the crustaceans. The name *Trilobitomorpha* (4) is appropriate for segregation of the trilobites and trilobite-like arthropods as a group distinct from the Crustacea. The name *Proarthropoda*, suggested for the group by VANDEL (5) in 1949, seems to be less appropriate, especially if forms distinctly more primitive than the trilobitomorpha are found in future.

The *Trilobitomorpha* are here regarded as a subphylum comprising classes called *Trilobitoidea* (including the subclasses *Merostomoidea*, *Pseudonotostraca*, *Marrelomorpha*) and *Trilobita*. A diagnosis of the group follows.

SYSTEMATIC DESCRIPTIONS**Subphylum TRILOBITOMORPHA**
Størmer, 1944[=*Proarthropoda* VANDEL, 1949]

Aquatic Arthropoda with preoral antennae and remaining appendages of typical or modified trilobite type, biramous appendages characterized by presence of a lateral gill branch attached to very base of walking leg. *L.Cam.-M.Perm.*

TRILOBITOIDEA

By LEIF STØRMER

CONTENTS

| | PAGE |
|---|------|
| INTRODUCTION | 023 |
| MORPHOLOGY | 024 |
| Cephalic region | 024 |
| Postcephalic region | 025 |
| Appendages | 026 |
| Digestive tract | 026 |
| ONTOGENY | 026 |
| MODE OF LIFE | 026 |
| RELATIONSHIPS | 027 |
| CLASSIFICATION | 028 |
| SYSTEMATIC DESCRIPTIONS | 028 |
| Class Trilobitoidea Størmer, nov. | 028 |
| Subclass Marrellomorpha Beurlen, 1934 | 029 |
| Order Marrellida Raymond, 1935 | 029 |
| Subclass Merostomoidea Størmer, 1944 | 029 |
| Order Limulavida Walcott, 1911 | 029 |
| Order Emeraldellida Størmer, 1944 | 030 |
| Order Nectaspida Raymond, 1920 | 030 |
| Order Leanchoiliida Størmer, 1944 | 031 |
| Subclass Pseudonotostraca Raymond, 1935 | 031 |
| Order Burgessiiida Størmer, 1944 | 032 |
| Order Waptiida Størmer, 1944 | 032 |
| Subclass Uncertain | 032 |
| Order Opabiniida Størmer, 1944 | 032 |
| Order Cheloniellida Broili, 1933 | 035 |
| Subclass and order Uncertain | 035 |
| REFERENCES | 037 |

INTRODUCTION

Practically all forms referred to the Trilobitoidea come from the Middle Cambrian Burgess Shale of British Columbia. The fossils generally appear as thin films in the shale. Only in forms having a relatively solid exoskeleton is a certain relief preserved. Dark imprints of the intestine are seen in a number of specimens, signifying that they represent dead individuals rather than shed molts.

In the light of present knowledge it is difficult to establish a satisfactory taxonomy for the many different forms. WALCOTT (6), RAYMOND (3) and STØRMER (4) have suggested major classifications that contain features now considered unacceptable. The recognition of separate classes and subclasses for these arthropods as here outlined, similarly may be somewhat premature. For the following description of the morphology and relationships of the Trilobitoidea, all non-trilobite forms of the Trilobitomorpha are treated together.



FIG. 13. *Leanchoilia superlata* WALCOTT, M. Cam., W. Can. (B.C.); dorsolaterally compressed specimen (unretouched photo), $\times 1.5$ (3).

MORPHOLOGY

The body length of trilobitoids ranges from 1 to 16 cm., the most common length being 4 to 8 cm. The shape of the body varies from broad and dorsoventrally flattened (Fig. 16) to narrow and laterally compressed (Figs. 21, 24). Some have a pronounced merostome-like appearance, whereas others closely resemble crustaceans. Trilobite-like forms (*Marrella*) also occur. The body is divided into parts (tagmata) consisting of severally distinct sorts of more or less closely united segments (somites).

CEPHALIC REGION

A head shield is well defined, particularly in merostomoid forms but also in *Opabinia*. It is not possible to decide the number of postoral segments in the head. Only *Mollisonia* and *Yohoia* show traces of a dorsal segmentation of the head shield. In *Leanchoilia*, *Emeraldella*, *Burgessia*, and *Marrella*, the appendages suggest about 4 postoral segments (as compared with 4 such segments in trilobites). The Devonian *Cheloniellon* has a short "protocephalon" with only a single postoral segment, but the coxal development of the appendages indicates a functional cephalon having 5 postoral segments. In the trilobite-like *Marrella* the head shield is prolonged into 4 promi-

nent horns that evidently served as a floating organ in this small, probably planktonic, form (Fig. 15). The presence of supposed sutures at the base of the lateral horns suggests interpretation of them as "free cheeks." The posterior horns and their common base are prolonged backward as a sort of carapace. A typical carapace is developed in the most crustacean-like forms (*Burgessia*, *Waptia*) (Fig. 21). It extends backward so as to cover a small or large part of the trunk.

Eyes have not been distinguished in *Emeraldella* and *Sidneyia*, and they are identified only with doubt in *Leanchoilia* and *Helmetia*. WALCOTT thought that he could recognize small (sessile) eyes in

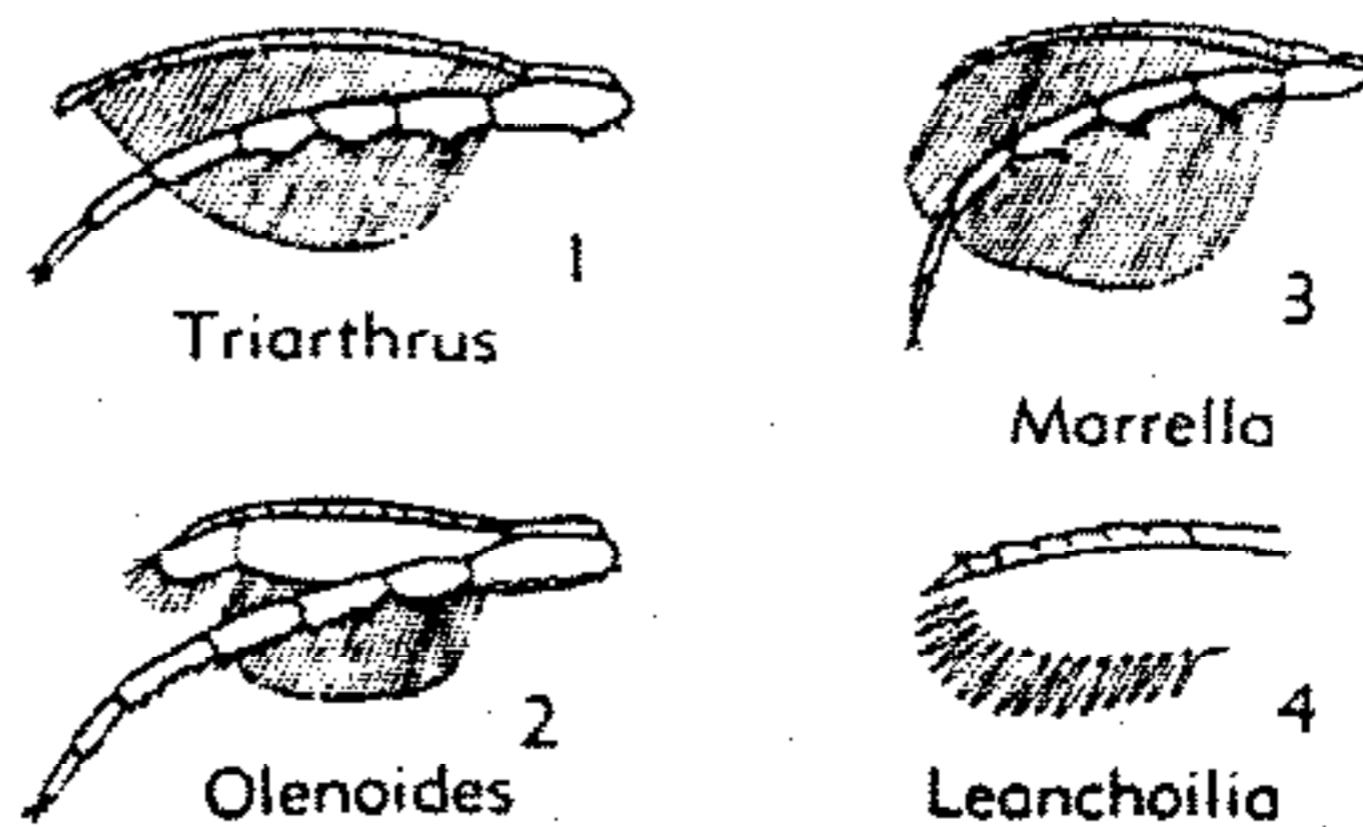

FIG. 14. Trilobite-type appendages of trilobitomorpha.—1, 2. Trilobites.—3. Marrellomorph.—4. Merostomoid. (All diagrammatic, not to scale.)

Naraoia and *Burgessia*. Well-developed sessile eyes occur in *Cheloniellon*. Of particular interest is the presence of apparently pedunculate eyes in *Opabinia* and *Waptia*. In other groups of arthropods, pedunculate eyes characterize the Malacostraca. Similar types of eyes, however, seem to develop independently in very different groups of the Arthropoda.

In *Opabinia* a peculiar frontal organ, possibly erectable, with a median canal, has been compared to structures in male Anostraca among the Branchiopoda (Fig. 22).

An upper-lip, resembling the hypostoma of trilobites, has been described in *Burgessia* and *Marrella*. A ventrally located plate in

Cheloniellon may represent a postoral plate or labium.

POSTCEPHALIC REGION

The trunk is generally elongate and divided into a number of movable segments. The number varies from 10 to 12 in the Merostomoidea to more than 12 in the other groups. A tagmatic division occurs. In *Naraoia* all the trunk segments are covered by a continuous abdominal shield (Fig. 18). In *Helmetia* the posterior segments are fused into a "pygidium" (Fig. 25). The last segment of the trunk carries a telson or lateral "fins," comprising either lateral outgrowth of the segments or modified appendages.

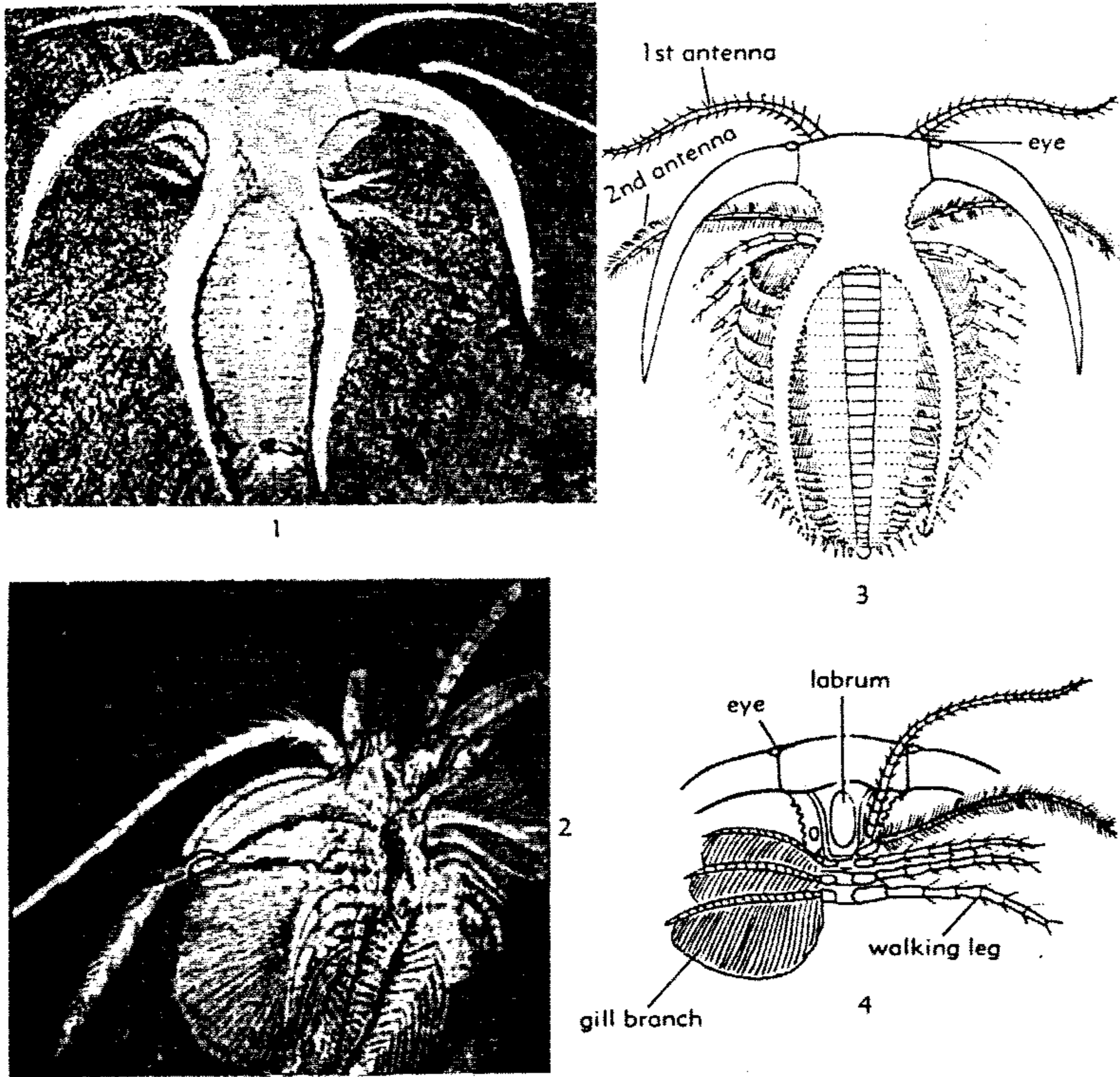

FIG. 15. *Marrella splendens* WALCOTT, M. Cam., W. Can. (B. C.); 1, 2, dorsal and ventral sides, X3, X4; 3, dorsal side (reconstr.), X3; 4, frontal appendages in ventral view showing one branch on either side (reconstr.) (4, 7).

The trunk may be fairly broad and flat, its pleural parts then forming a cover to the appendages. A trilobation is characteristic of many forms (*Leancoilia*, *Emeraldella*, *Naraoia*, *Molaria*, *Yohoia*, *Opabinia*, and to some extent in *Cheloniellon*) but is absent in *Sidneyia* and the typical crustacean-like forms in which the pronounced carapaces function as a protecting cover.

In crustacean-like and merostomoid forms (*Waptia*, *Emeraldella*, *Sidneyia*) the posterior trunk segments lack appendages, and the tergites and sternites unite to form solid cylindrical segments. A terminal lanceolate telson is characteristic of the Merostomoidea (except *Sidneyia*, in which the terminal segment has a transverse posterior border). The 2 long extensions from the dorsal side of the posterior segment in *Cheloniellon* may have the same origin as the ordinary single telson spines. A secondary jointing of the telson spine seems to have taken place in *Burgessia*.

APPENDAGES

The appendages are well preserved in many trilobitoids, but it is difficult to establish their number in the head and trunk and to decide on their homology. Generally, a pair of anterior uniramous, multijointed antennae are present. They are very characteristic of all 3 major groups. In *Leancoilia* vestiges of short appendages in front of the "great appendages" are possibly interpreted as 1st antennae. The flexible 1st antennae of all these members of the Trilobitomorpha are probably homologous with the antennae of trilobites and are thus preoral antennae (or antennules) corresponding to those of the Crustacea and Insecta. Whereas in trilobites all postoral appendages are practically alike (except for the antenniform last appendages in *Olenoides*), those of the nontrilobitic forms show considerable variation. Two pairs of antennae occur in *Marrella* (Fig. 15). The 2nd pair may correspond to the 2nd antennae in Crustacea. The "great appendages" of *Leancoilia* possibly belong to the same segment (Figs. 13, 20). In these appendages endites are prolonged into flexible multijointed tactile organs. The many blade-shaped endites of the powerful cephalic appendage in *Sidneyia* may be homologous structures.

In general, the appendages of the postoral segments of the Trilobitoidea seem to be more or less trilobite-like. Both *Naraoia* and *Marrella* have biramous appendages similar to those found in the trilobites *Triarthrus* and *Cryptolithus* (Fig. 14). The gill branch has a multijointed shaft with a fringe of gills. A similar development seems to be present in the Devonian *Cheloniellon*. In *Burgessia* the gill branch appears to be of the *Olenoides* type, with a broad unjointed shaft. The walking legs have endites like those of *Triarthrus*. In *Opabinia* and the thoracic region of the trunk in *Waptia*, gill branches occur, but the walking legs seem to be much reduced. In *Waptia* the abdominal part of the trunk lacks appendages other than flattened terminal ones (Fig. 21). Walking legs without gill branches possibly occur in the cephalic region of *Burgessia* and *Waptia*. The various nontrilobitic forms seem to bear appendages that are either of trilobite type or derivations of this type. The comparatively strong development of the gills, even in small forms like *Marrella*, may signify a low oxygen content of the sea.

DIGESTIVE TRACT

In some trilobitoid fossils, traces of the intestine appear as a dark staining along the median line of the body. In *Naraoia* and *Burgessia* beautifully distinct imprints of the anterior part of the intestine with diverticulae are preserved in many specimens (Figs. 18, 21).

ONTOGENY

Larval stages of described species of Trilobitoidea are unknown but certain fossils, such as those named *Mollisonia* and *Tontoia*, may actually represent larval forms (Fig. 26).

MODE OF LIFE

Among the Trilobitoidea flat forms with a length of more than 10 cm. (*Helmetia*, *Cheloniellon*) probably were benthonic animals. The tail of *Sidneyia* suggests that this species was a good swimmer. The middle-sized species, with a length of about 4 to 8 cm., probably were able swimmers also. The shrimplike nature of *Waptia* suggests a corresponding mode of life (Fig. 21). It

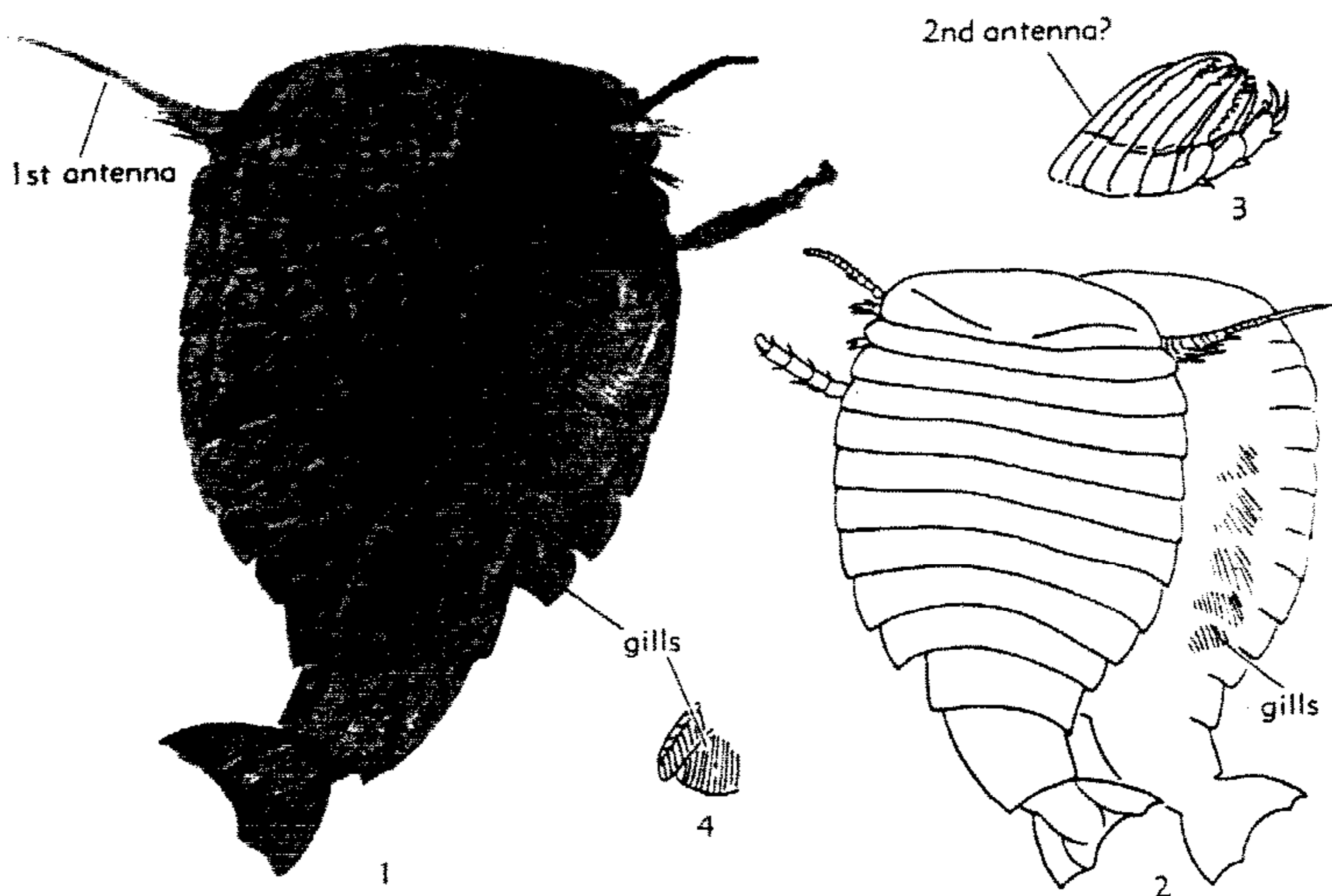

FIG. 16. *Sidneyia inexpectans* WALCOTT, M.Cam., W.Can.(B.C.); 1, dorsal side with impressions of ventral structures, $\times 0.7$; 2, dorsal and ventral sides, $\times 0.5$; 3, ?2nd antenna; 4, distal parts of trunk appendages (6).

is likely that the small trilobitoids, *Burgessia* and *Marrella* (1 to 1.5 cm. in length), characterized by their broad carapace and horned cephalon, belonged to the plankton (Figs. 15, 21).

RELATIONSHIPS

As pointed out previously, the Trilobitomorpha are linked together by the seemingly common basic structure of their appendages. Since the trilobite limb appears to be a characteristic and conservative structure, its presence in fossil arthropods may be interpreted as evidence of close relationship between the many different forms possessing it.

The Trilobitomorpha possess various morphological features that are characteristic of many members of the Chelicerata. Among these may be mentioned (1) trilobation, including development of broad pleural areas; (2) tendency to develop a styliform telson; (3) lack of true jaws; (4) structure of the appendages; (5) strong development of the intestinal diverticulae; and (6) probably like number of larval segments. The Merostomoidea resemble the Merostomata in

shape of the body. The lack of antennae and presence of chelicerae in the Chelicerata do not deny affinities. Indeed, it is probable that the Chelicerata developed from antennate forms.

Some of the characters mentioned above (1, 5), may occur, though less typically, in the Crustacea, but the affinities of Trilobitoidea with crustaceans are suggested especially by some very crustacean-like forms (*Burgessia*, *Waptia*, *Opabinia*). In addition to general appearance, features that suggest crustaceans are presence of a carapace, pedunculate nature of the eyes, and occurrence of a possible "branchiopod" frontal organ (*Opabinia*). If *Hymenocaris*, from the Burgess Shale, also belongs to the Trilobitoidea, it supports connection of this group with the Crustacea. The typical trilobite limb has not, however, been observed in crustaceans. It is possible, as held by most carcinologists, that this is of minor importance, and not denied is the possibility of deriving crustacean-type limbs from those of the Trilobitomorpha.

The Cambrian crustacean-like forms that here are assigned to the Trilobitoidea have

been regarded by WALCOTT, CALMAN, RAYMOND, HENRIKSEN, and others as true crustaceans belonging to an ancestral group from which Recent crustaceans evolved. On the other hand, merostome-like trilobitoids have been regarded as more or less definitely ancestral to Recent merostomes.

A few authors (STØRMER, SNODGRASS) have advocated a more fundamental difference between trilobitic and crustacean limbs, and consequently they have questioned close connection between the Trilobitomorpha (Trilobita and Trilobitoidea) and Crustacea.

According to divergent opinions, the Trilobitomorpha represent (1) an ancestral arthropod group from which both the Chelicerata and the Crustacea evolved, or (2) an ancestral arthropod group that gave rise to the Chelicerata, crustacean-like features of the Trilobitomorphs being due to homeomorphy. The present material is insufficient to solve the problem.

CLASSIFICATION

Taxonomic divisions may be based either on general morphological characteristics or on some particular element, such as development of the appendages. The latter here is employed for the group (Trilobitomorpha) as a whole. WALCOTT (6) regarded the Middle Cambrian trilobitoid forms as belonging to the Branchiopoda, Merostomata, and Trilobita (*Naraoia*). RAYMOND (2,3) established for them 2 subclasses (Homopoda, Xenopoda), chiefly distinguished by the presence of 2 pairs or a single pair of tactile organs (antennae). The degree of development (specialization) of the frontal appendage was also used by STØRMER in his classification, published in 1944. Since the development of the frontal appendages is not well known, taxonomy based on these structures may be uncertain. The general structure of the body has to be taken into account at the same time. Inasmuch as phylogeny of the Trilobitomorpha is uncertain, it is rather undesirable to use group names that express distinct phylogenetic concepts (for example, Palaeanostraca HUTCHINSON, 1930, and Prochelicera STØRMER, 1944). RAYMOND's major groups, Homopoda and Xenopoda, are difficult to maintain. The former includes such differ-

ent forms as *Aglaspis* (now assigned to the Merostomata), *Marrella*, and *Waptia*.

The evolutionary radiation of Middle Cambrian Trilobitoidea occurred at a "low level," that is, it yielded diverse groups of high taxonomic rank, seemingly almost correlative with the class Trilobita. To distinguish the Merostomoidea, Pseudonotostraca, Marrellomorpha, and possibly additional groups as independent classes associated with the class Trilobita seems ill-advised, or at least premature. In the present state of knowledge it is judged more appropriate to recognize assemblages of non-trilobites as subclasses, grouping them together under the name Trilobitoidea, defined as a class. The classification here adopted therefore deviates from that given by STØRMER (4) in 1944. Several forms are not definitely placed in named major groups. Numbers of genera belonging to each division are indicated by numerals inclosed by parentheses.

Divisions of Trilobitoidea (16 genera)

- Marrellomorpha (*subclass*) (1). *M.Cam.*
- Marrellida (*order*) (1). *M.Cam.*
- Marrellidae (1). *M.Cam.*
- Merostomoidea (*subclass*) (7). *M.Cam.*
- Limulavida (*order*) (2). *M.Cam.*
- Sidneyiidae (2). *M.Cam.*
- Emeraldellida (*order*) (1). *M.Cam.*
- Emeraldellidae (1). *M.Cam.*
- Nectaspida (*order*) (3). *M.Cam.*
- Naraoiidae (3). *M.Cam.*
- Leancoiliida (*order*) (1). *M.Cam.*
- Leancoiliidae (1). *M.Cam.*
- Pseudonotostraca (*subclass*) (2). *M.Cam.*
- Burgessiida (*order*) (1). *M.Cam.*
- Burgessiidae (1). *M.Cam.*
- Waptiida (*order*) (1). *M.Cam.*
- Waptiidae (1). *M.Cam.*
- Subclass uncertain (2). *M.Cam.-L.Dev.*
- Opabiniida (*order*) (1). *M.Cam.*
- Opabiniidae (1). *M.Cam.*
- Cheloniellida (*order*) (1). *L.Dev.*
- Cheloniellidae (1). *L.Dev.*
- Subclass and order uncertain (4). *M.Cam.*
- Yohoiidae (1). *M.Cam.*
- Family uncertain (3). *M.Cam.*

SYSTEMATIC DESCRIPTIONS

Class TRILOBITOIDEA

Størmer, nov.

Trilobitomorpha lacking distinctive morphologic characters of Trilobita and, in addition, exhibiting divergent structural pe-

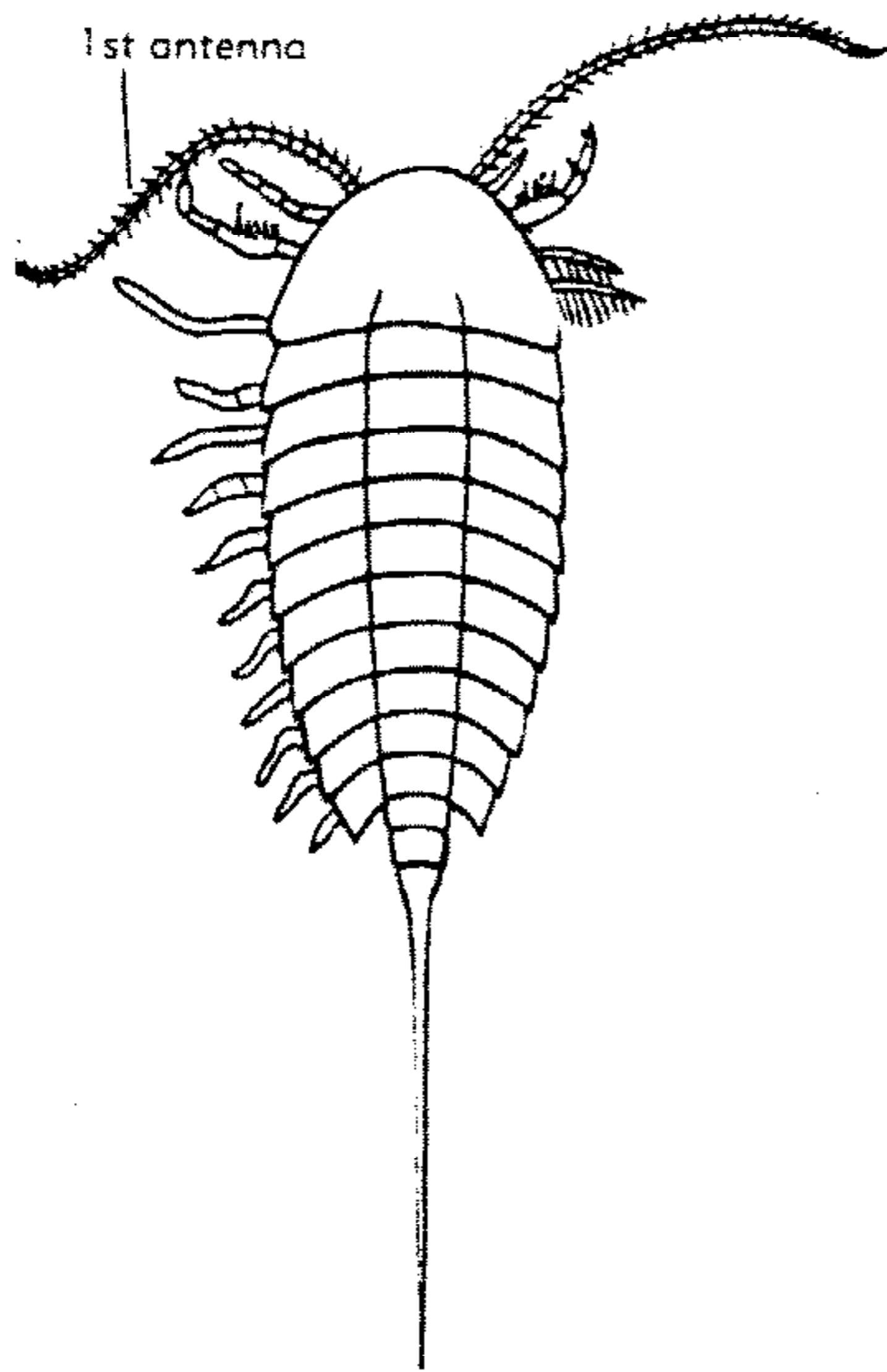

FIG. 17. *Emeraldella brooki* WALCOTT, M.Cam., W. Can.(B.C.); dorsal side, $\times 1.2$ (7).

cularities of their own, unlike those of trilobites (such as presence of eurypterid-like body, shield covering both cephalic and abdominal regions, laterally compressed carapace, widely divergent flat horns produced from cephalic shield, and others). Postoral appendages less uniform than in Trilobita. *M.Cam.-Dev.*

Subclass MARRELLOMORPHA
Beurlen, 1934

Trilobitomorpha with cephalic shield prolonged into flat horns; trunk with numerous free tergites and small telsonic plate; 2 pairs of antennae, other appendages of trilobitic type. *M.Cam.*

Order MARRELLIDA Raymond,
1935

[*nom. correct.* STÖRMER, herein (*pro* Marrellina RAYMOND, 1935)]

Characters of subclass (3). *M.Cam.*

Family MARRELLIDAE Walcott, 1912

Small Marrellida characterized by cephalon with 4 flat horns directed backward,

bearing facial sutures and sessile eyes; trunk elongate, composed of about 24 segments, probably with pleural areas; telson small, plate-shaped; elongate labrum attached to doublure; 1st pair of antennae uniramous with numerous joints, 2nd antennae with fewer joints, densely covered with setae, other appendages probably of *Triarthrus*-type; fringe of gills broad (7). *M.Cam.*

Marrella WALCOTT, 1912 [**M. splendens*]. Characters of family, order, and subclass. Burgess Sh., W.Can.(B.C.).—FIG. 15. **M. splendens*, Burgess Sh.; 15,1,2, dorsal and ventral sides, $\times 3$, $\times 4$; 15,3, dorsal side (reconstr.), $\times 3$; frontal appendages, in ventral view showing one branch on either side (reconstr.), $\times 3$ (4, 7).

Subclass MEROSTOMOIDEA
Störmer, 1944

[*nom. transl.* STÖRMER, herein (*ex class* Merostomoidea STÖRMER, 1944)]

Trilobitomorpha with eurypterid or xiphosurid type of body, trilobation more or less distinct; tergites of trunk free or ankylosed into continuous shield, telson mostly styliform; 1st and last pair of trilobitic appendages may be modified and others partly reduced (+). *M.Cam.*

Order LIMULAVIDA Walcott, 1911

[*nom. correct.* STÖRMER, herein (*pro order* Limulava WALCOTT, 1912, *nom. transl.* (*ex suborder* Limulava WALCOTT, 1911)) [=Subclass Prochelicerata STÖRMER, 1944 (*partim*)]

Merostomoidea with eurypterid-like body, ?2nd pair of appendages provided with numerous flat median spines; trunk appendages of trilobitic type, with walking legs reduced (4, 6). *M.Cam.*

Family SIDNEYIIDAE Walcott, 1911

[*nom. correct.* STÖRMER, herein (*pro* Sidneyidae WALCOTT, 1911)]

Limulavida with short cephalon provided with marginal ?eyes and ventral labrum; trunk divided into a preabdomen of 9 segments and postabdomen of 2 or 3 segments, with tail fin formed either by lateral outgrowth of last segment or by modified cerci; ?1st antennae (uniramous, with numerous setiferous joints; ?2nd antennae developed as powerful appendages of 9 to 10 joints provided with numerous long flat spines on their median sides; other cephalic appendages apparently resembling trilobitic walking legs, appendages on preabdomen probably consisting of jointed shafts with broad fringes of gills (6). *M.Cam.*

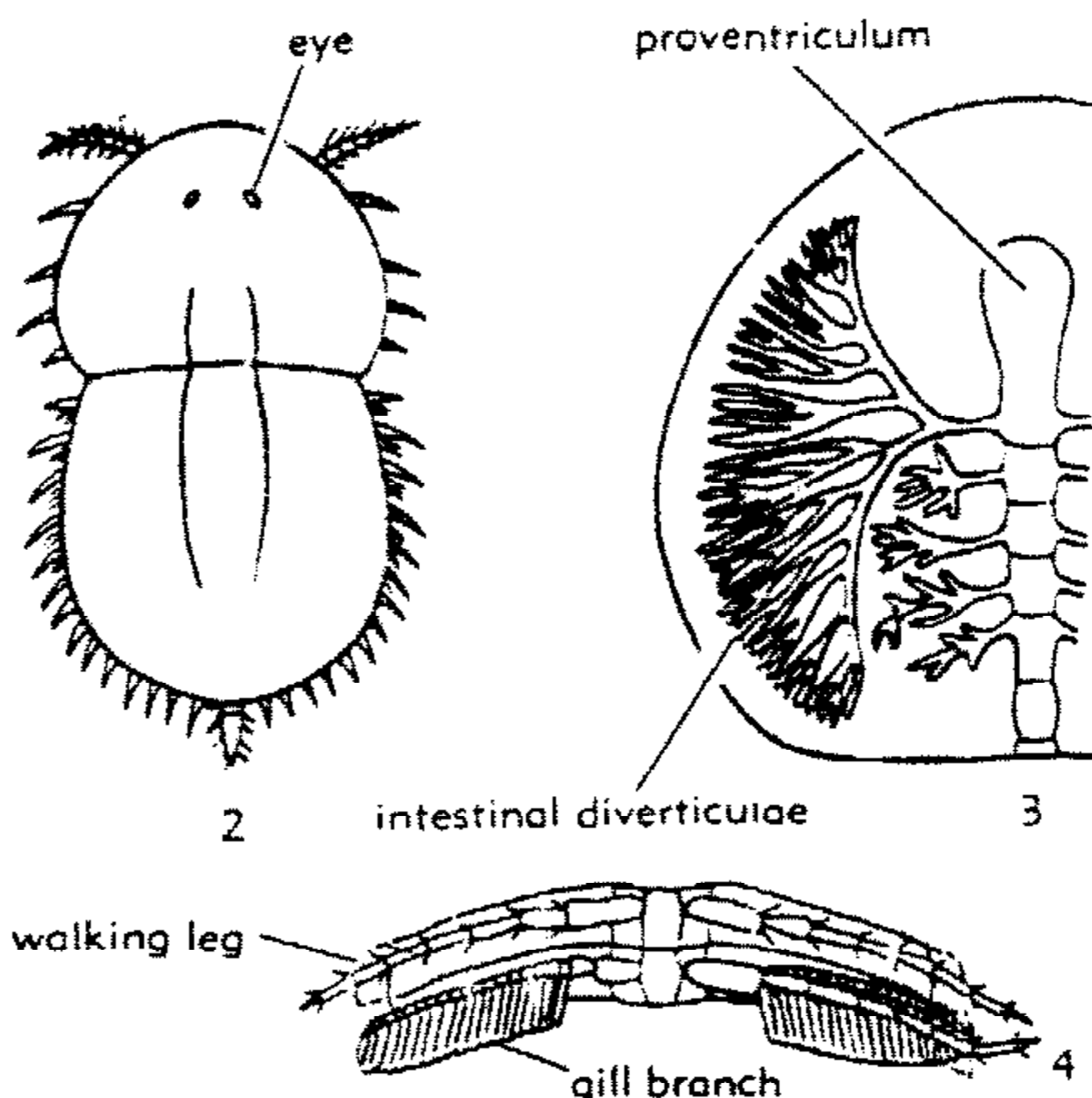

FIG. 18. *Naraoia compacta* WALCOTT, M.Cam., W.Can.(B.C.); 1, dorsal side, $\times 2$; 2, reconstr., $\times 1.5$; 3, intestinal diverticula, $\times 4.5$; 4, trunk appendages (reconstr.), $\times 4.5$ (4, 7).

Sidneyia WALCOTT, 1911 [**S. inexpectans*] [= *Sidneyia* STÖRMER, 1944]. Characters of family (4,6). Burgess Sh., W.Can.(B.C.).—FIG. 16. **S. inexpectans*, Burgess Sh.; 16,1, dorsal side with impressions of ventral structures, $\times 0.7$; 16,2, dorsal and ventral sides, $\times 0.5$; 16,3, antenna (?2nd), $\times 1$; 16,4, distal parts of trunk appendages, $\times 1$ (all 6).
Amiella WALCOTT, 1911 [**A. ornata*]. Little known, possibly synonym of *Sidneyia*. Burgess Sh., W.Can.(B.C.).

Order EMERALDELLIDA Størmer, 1944

[*nom. transl.* STÖRMER, herein (ex subclass Emeraldellida STÖRMER, 1944)]

Merostomoidea with elongate trilobed body, styliform telson, all appendages of practically unaltered trilobitic type (4). *M. Cam.*

Family EMERALDELLIDAE Raymond, 1935

Body narrow, divided into semicircular cephalon, preabdomen of 10 segments, and narrow, probably 2-segmented postabdomen bearing styliform telson expanded at base, postabdomen without appendages; eyes unknown; labrum elongate; 1st antennae long, uniramous, with many joints, other appendages probably biramous, of trilobitic type (3). *M. Cam.*

Emeraldella WALCOTT, 1912 [**E. brocki*]. Characters of family. Burgess Sh., W.Can.(B.C.).—FIG. 17. **E. brocki*; dorsal side, $\times 1.2$ (7).

Order NECTASPIDA Raymond, 1920

[*nom. correct.* STÖRMER, herein (pro order Nectaspida RAYMOND, 1920)]

Merostomoidea with body covered by cephalic and abdominal shield, postabdomen short and narrow, with telson; appendages of trilobitic (*Triarthrus*) type; intestinal diverticulae well developed (2,4,7). *M. Cam.*

Family NARAOIIDAE Walcott, 1912

[*nom. correct.* STÖRMER, herein (pro Naraoidae WALCOTT, 1912)]

Small Nectaspida with subelliptical, trilobate body, cephalon with small sessile eyes, postabdomen short and narrow with ?single segment and short lanceolate telson bearing lateral spines that protrude from below abdominal shield; 1st antennae short, with numerous setiferous joints, other appendages probably of trilobitic (*Triarthrus*) type; intestinal diverticulae with 5 pairs of basal branches (7). *M. Cam.*

Naraoia WALCOTT, 1912 [**N. compacta*]. Characters of family. Burgess Sh., W.Can.(B.C.).—FIG. 18. **N. compacta*; 18,1,2, dorsal side, photo, $\times 2$, and reconstr., $\times 1.5$; 18,3, intestinal diverti-

culae, $\times 4.5$; 18,4, trunk appendages (reconstr.), $\times 4.5$ (4,7).

?*Malaria* WALCOTT, 1912 [**M. spinifera*]. Body small, elongate, distinctly trilobate, with lanceolate telson. Cephalon semicircular, with median axis divided into ?3 transverse lobes, traces of intestinal diverticulae. Trunk 9-segmented, elongate last segment possibly representing about 3 fused segments; telson lanceolate; pleurae curved, quite narrow on last segment. Cephalic appendages little known, 1st antennae probably short and delicate; trunk appendages trilobitic, evidently with both branches present; last segment lacking appendages (7). [Genus probably related to *Emeraldella*, but whether it belongs to Emeraldellidae or a separate family is doubtful.] Burgess Sh., W.Can.(B.C.).—FIG. 19,1,2. **M. spinifera*; dorsal side and lateral view, $\times 3$ (7).

?*Habelia* WALCOTT, 1912 [**H. optata*]. Little known; body presumed to be similar to *Malaria* but with long styliform telson; appendages trilobitic (7). [Single known specimen is imperfectly preserved and may belong to another genus (e.g., *Burgessia* with carapace lost).] Burgess Sh., W.Can.(B.C.).—FIG. 19,3. **H. optata*; dorsolateral view, $\times 1.7$ (7).

Order LEANCHOILIIDA Størmer, 1944

[*nom. correct.* STØRMER, herein (*pro* order Leanchoilida STØRMER, 1944)] [=order Pseudonotostraca RAYMOND, 1935 (*partim*); subclass Prochelicerata STØRMER, 1944 (*partim*)]

Merostomoidea with elongate trilobate body (aglaspidid type), divided into cephalon and segmented trunk with lanceolate telson; 1st antennae considerably reduced or possibly absent, ?2nd antennae strongly developed and specialized, other appendages filamentous, walking legs (telopodites) missing (4). *M.Cam.*

Family LEANCHOILIIDAE Raymond, 1935

Body narrow, elongate, of medium size; cephalic shield subtriangular, with pointed rostrum, lateral eyes probably missing; trunk distinctly trilobate, with 10 curved tergites; telson short lanceolate, with marginal spines; presence of 1st antennae uncertain, probably reduced to short and delicate appendages, ?2nd appendages developed as powerful tripartite tactile organs; 2 distally jointed ?endites attached to distal portion of 5- or 6-jointed shaft, remaining appendages (2 or 3 pairs belonging to cephalic shield) developed as gill branches



Habelia

3



1



2

Malaria

FIG. 19. *Malaria* and *Habelia*, M.Cam., W.Can. (B.C.); 1,2, *M. spinifera* WALCOTT, dorsal and lateral views, $\times 3$ (7); 3, *H. optata* WALCOTT, dorsolateral view, $\times 1.7$ (7).

of *Olenoides* types, walking legs (telopodites) missing (3). *M.Cam.*

Leanchoilia WALCOTT, 1912 [**L. superlata*]. Characters of family. Burgess Sh., W.Can.(B.C.).—FIGS. 13,20. **L. superlata*; 13, dorsolaterally compressed specimen (unretouched photo), $\times 1.5$ (3); 20, dorsal and lateral views (reconstr., convexity probably exaggerated), $\times 0.7$ (4).

Subclass PSEUDONOTOSTRACA Raymond, 1935

[*nom. transl.* STØRMER, herein (*ex* order Pseudonotostraca RAYMOND, 1935)] [=Class Pseudocrustacea STØRMER, 1944]

Carapace well developed, eyes sessile or pedunculate; pleurae absent in trunk (at least beyond posterior border of carapace); styliform telson or tail fin formed by flat cerci; 1st antennae and other appendages of trilobitic type in postoral appendages with one branch reduced in some; postabdomen without appendages (except cerci) (3,4). *M.Cam.*

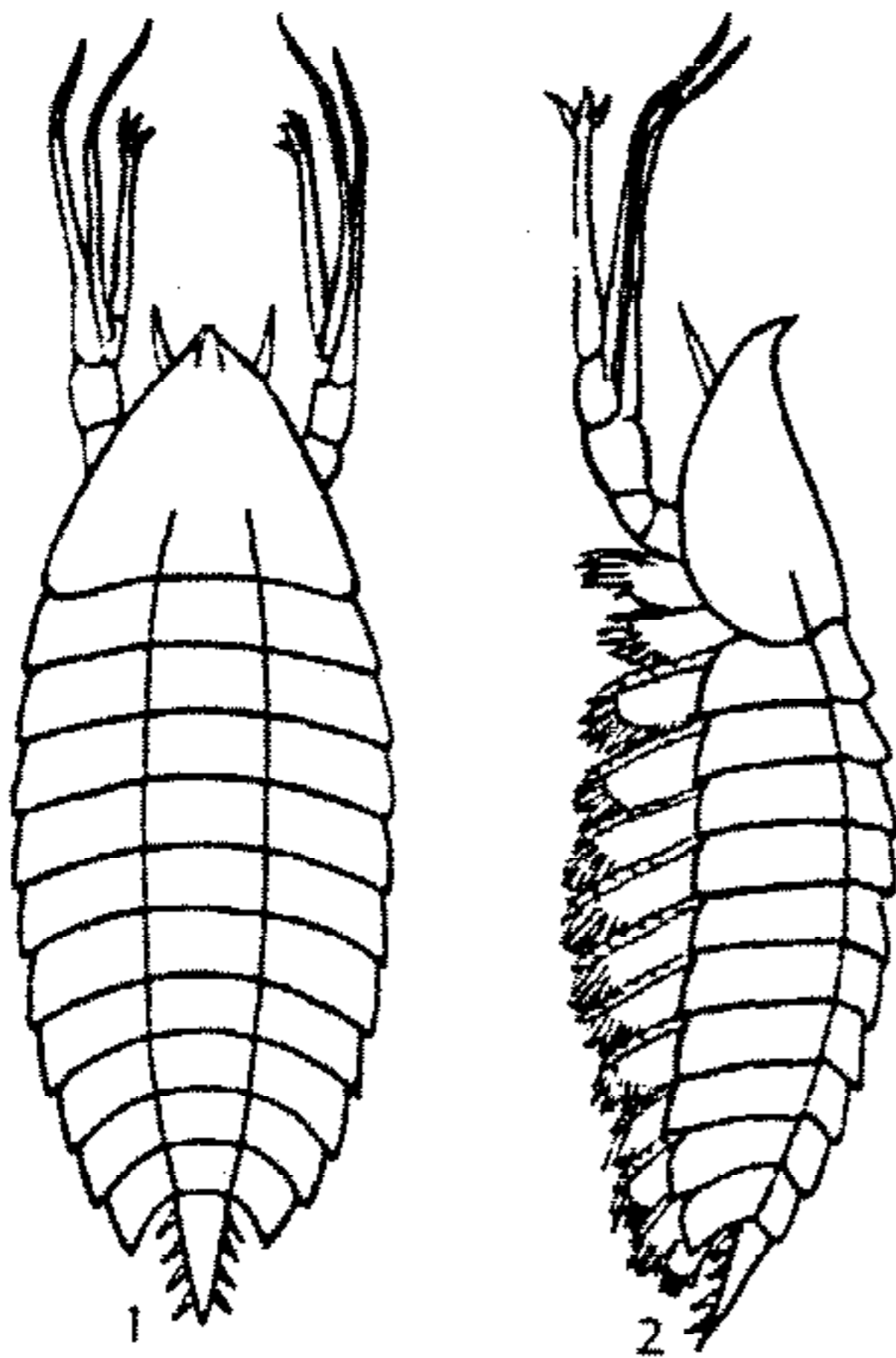

FIG. 20. *Leanchoilia superlata* WALCOTT, M.Cam., W.Can.(B.C.); 1,2, dorsal and lateral views (reconstr.), convexity probably exaggerated, $\times 0.7$ (4).

Order BURGESSIIDA Størmer, 1944

[*nom. correct.* STØRMER, herein (*pro* order Burgessida STØRMER, 1944)]

Carapace large subcircular, plate-shaped, with small sessile ?eyes and narrow labrum; postabdomen carrying long many-jointed telson; postoral cephalic appendages 3 to 4, of trilobitic type, with gill branch possibly reduced; trunk appendages of trilobitic (*Olenoides*) type; intestinal diverticulae well developed (4). *M.Cam.*

Family BURGESSIIDAE Walcott, 1912

[*nom. correct.* STØRMER, herein (*pro* Burgessidae WALCOTT, 1912)]

Body small, with trunk of 8 segments; walking legs with endites; intestinal diverticulae with single pair of basal branches. *M.Cam.*

Burgessia WALCOTT, 1912 [**B. bella*]. Characters of family and order. Burgess Sh., W.Can.(B.C.).—FIG. 21,1-5. **B. bella*; 21,1,2, dorsal and ventral sides, with one branch of appendages omitted on either side, $\times 4.5$ (4); 21,3, trunk appendages (endites not indicated), $\times 7.5$ (4); 21,4, intestinal diverticulae, $\times 4.5$ (4); 21,5, dorsal side with intestinal diverticulae visible below carapace, $\times 3$ (7).

Order WAPTIIDA Størmer, 1944

[*nom. correct.* STØRMER, herein (*pro* order Waptida STØRMER, 1944)]

Carapace laterally compressed, covering head, thorax, and part of ?preabdomen, with rostrum and pedunculate eyes; trunk lacking pleurae, postabdomen with 6 cylindrical segments; 1st antennae with comparatively long joints, cephalothoracic appendages little known, apparently trilobitic walking legs, preabdominal appendages filamentous, with jointed shaft (*Triarthrus* type); postabdomen with flat jointed cerci on distal segment (4). *M.Cam.*

Family WAPTIIDAE Walcott, 1912

[*nom. correct.* STØRMER, herein (*pro* Waptidae WALCOTT, 1912)]

Medium size, with thorax of 5 to 7 short segments, ?preabdomen with 5 to 7 segments. *M.Cam.*

Waptia WALCOTT, 1912 [**W. fieldensis*]. Characters of family and order. Burgess Sh., W.Can.(B.C.).—FIG. 21,6-8. **W. fieldensis*; 21,6, dorsal side (reconstr.), $\times 1.5$ (4); 21,7,8, dorsal and lateral views, $\times 1.5$ (7,8).

Subclass UNCERTAIN

Order OPABINIIDA Størmer, 1944

[*nom. correct.* STØRMER, herein (*pro* order Opabinida STØRMER, 1944)] [=Suborder Palaeanostraca HUTCHINSON, 1930; order Pseudanostraca RAYMOND, 1935 (*partim*)]

Body elongate, with small head bearing erectable frontal organ and pedunculate eyes; segmented trunk trilobate, with pleurae covering gill appendages of trilobitic type; postabdominal segment with telsonic plate (4). *M.Cam.*

Family OPABINIIDAE Walcott, 1912

[*nom. correct.* STØRMER, herein (*pro* Opabinidae WALCOTT, 1912)]

Body fairly large, narrowly elongate, with distinct trilobation; cephalon short and narrow, frontal organ long, with median canal and distal paired portion with spines; trilobitic cephalic limbs unknown; trunk with ?15 segments; postabdomen spatulate; trunk appendages trilobitic, consisting of gill branches of *Olenoides* type (7). *M.Cam.*

Opabinia WALCOTT, 1912 [**O. regalis*]. Characters of family and order. Burgess Sh., W.Can.(B.C.). [*Opabinia* generally has been regarded as belonging to the Branchiopoda division of the Anostraca (WALCOTT, 1912; FEDOTOV, 1924; HUTCHINSON,

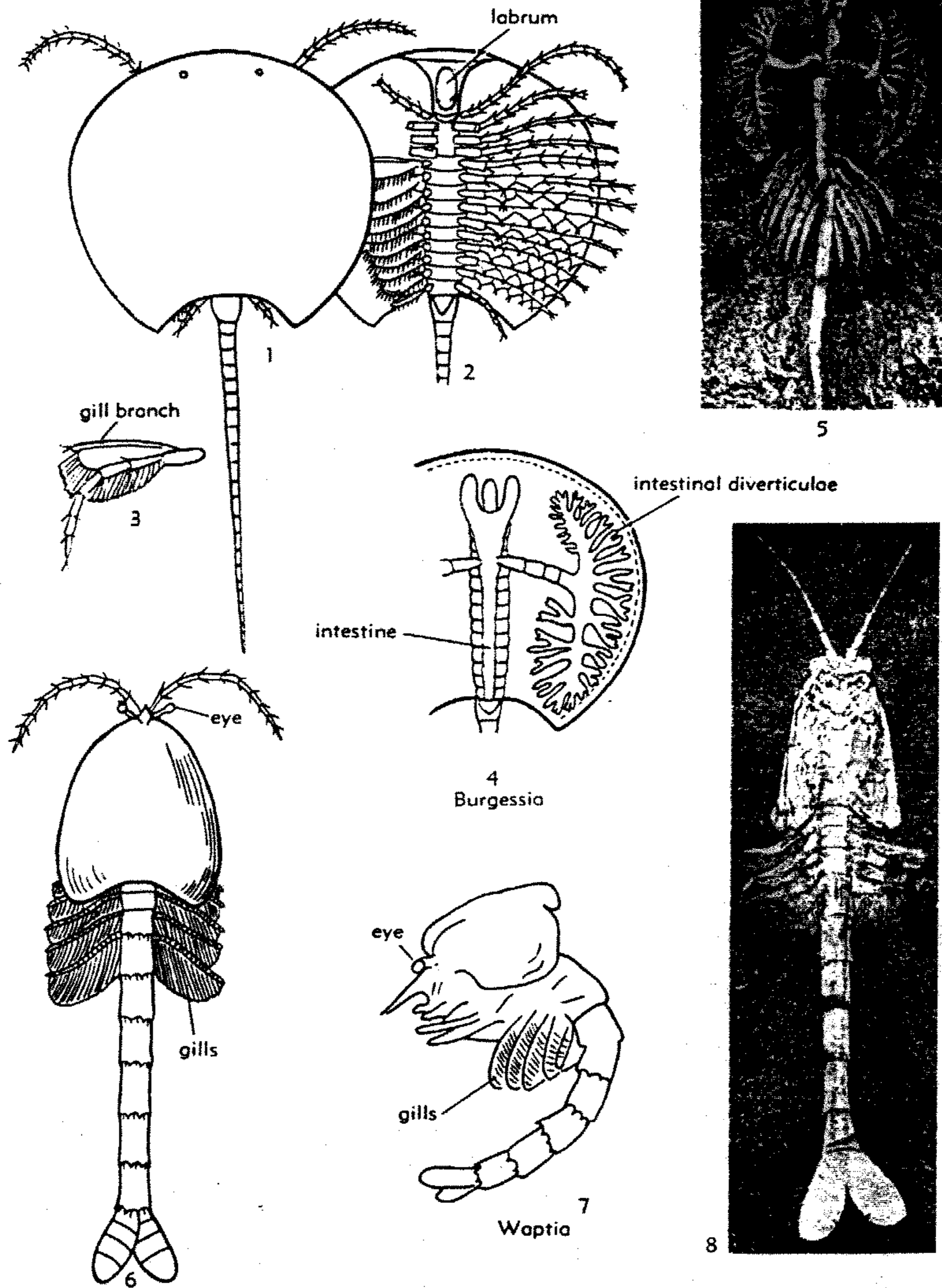

FIG. 21. *Burgessia* and *Waptia*, M. Cam., W. Can. (B. C.).—1-5, *B. bella* WALCOTT; 1, 2, dorsal and ventral sides, with one branch of appendages omitted on either side, $\times 4.5$ (4); 3, trunk appendages, with endites not shown, $\times 7.5$ (4); 4, intestinal diverticula, $\times 4.5$ (4); 5, dorsal side with intestinal diverticula visible below carapace, $\times 3$ (7).—6-8, *W. fieldensis* WALCOTT; 6, dorsal side (reconstr.), $\times 1.5$ (4); 7, 8, lateral and dorsal views, $\times 1.5$ (7, 8).

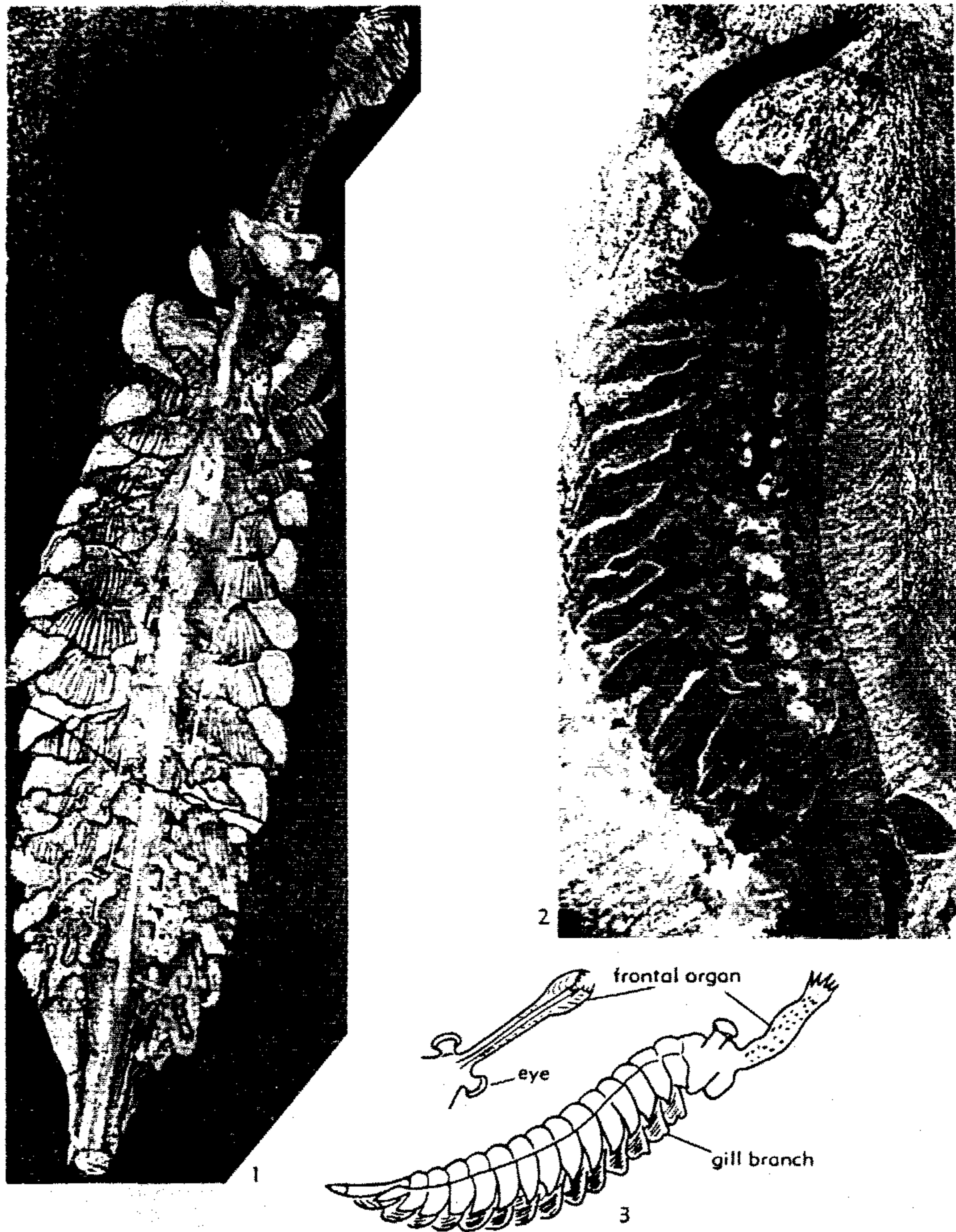

FIG. 22. *Opabinia regalis* WALCOTT, M. Cam., W. Can. (B.C.); 1, dorsal side with exoskeleton of trunk removed, $\times 2.5$ (7); 3, dorsolateral and lateral views showing frontal organ (reconstr.), $\times 1$ (7).

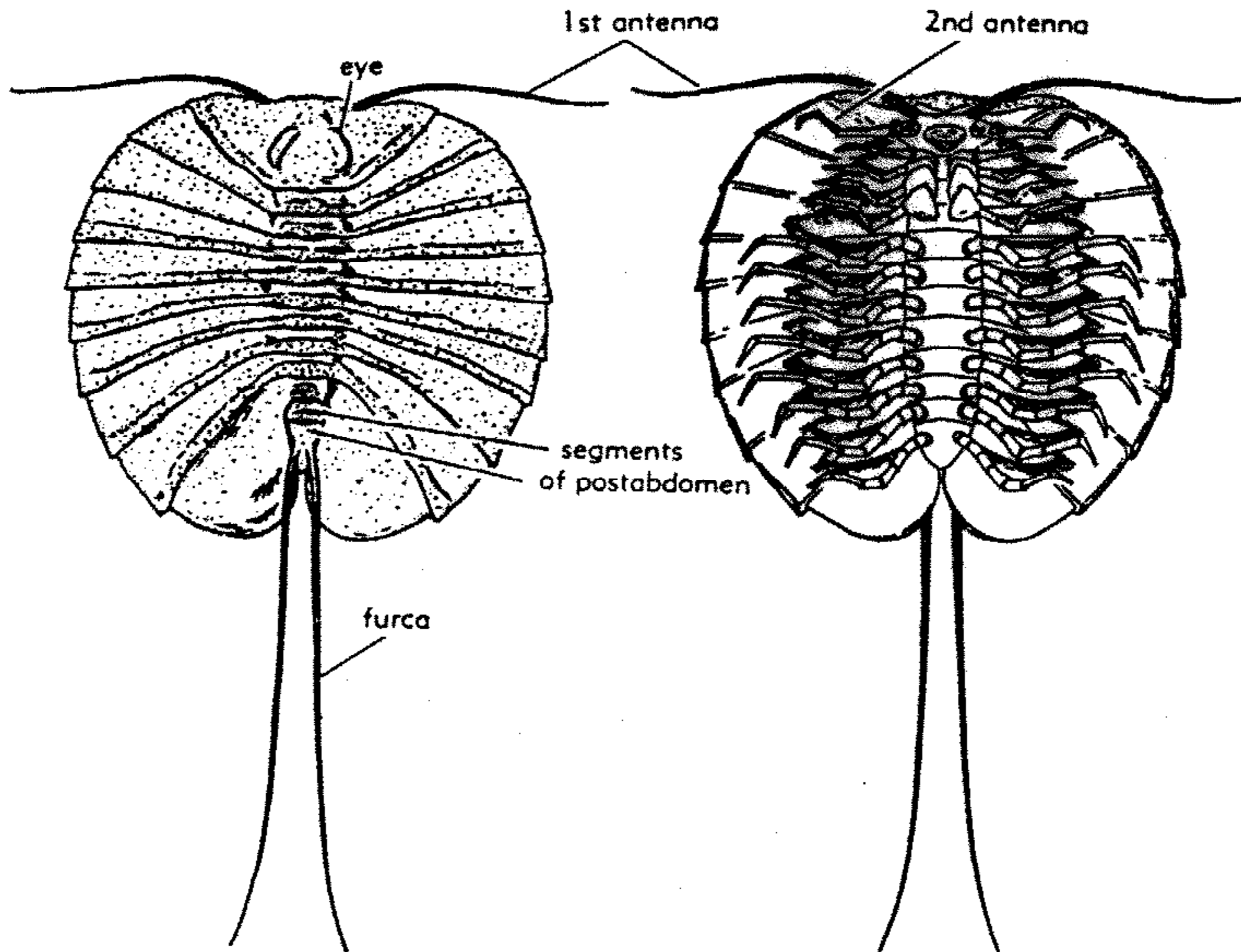

FIG. 23. *Cheloniellon calmani* BROILI, L.Dev., Ger.; dorsal and ventral views (reconstr.), $\times 0.4$ (7).

1930). RAYMOND (1935), however, placed it in a separate order (Pseudanostraca), interpreted as probably leading to the Anostraca. Since homology of the frontal organ with the fused and modified 2nd antennae in Anostraca is problematical and since trunk appendages are fundamentally different in the 2 forms, the taxonomic position of this genus remains an open question.]—FIG. 22. **O. regalis*; 22,1, dorsal side, exoskeleton of trunk removed, $\times 2.5$; 22,2, dorsolateral view, axis less distinct, $\times 2.5$; 22,3, lateral and dorsal views of frontal organ (reconstr.), $\times 1$ (7).

Order CHELONIELLIDA Broili, 1933

[*nom. transl.* STÖRMER, *herci* (ex subclass Cheloniellida BROILI, 1933)]

Body broad trilobate with short cephalon; trunk segmented, 1st segment double; narrow and short postabdomen with long furca; head short with lateral eyes and 2 pairs of antennae, trunk with trilobitic appendages, coxae of 4 first pairs enlarged. *L.Dev.*

Family CHELONIELLIDAE Broili, 1933

Body large, flat, subcircular, with narrow axis; head with centrally situated lateral eyes, ventral labrum or labium; 1st antennae

uniramous, many-jointed, 2nd antennae uniramous, with 4 or 5 joints, basal one with pit suggesting aperture of ?gland; trunk with 9 radiating segments, of which 1st is double; postabdomen narrow, 2-segmented, with furca inserted between pleurae of last pre-abdominal segments; trunk appendages trilobitic, with walking legs and delicate gill branches, anterior 4 pairs of coxae enlarged, probably forming gnathites. *L.Dev.*

Cheloniellon BROILI, 1932 [**C. calmani*]. Characters of family and order. Ger.—FIG. 23. **C. calmani*; dorsal and ventral sides (reconstr.), $\times 0.4$ (7).

Subclass and Order UNCERTAIN

Family YOHOIIDAE Henriksen, 1928

[=Order Pseudanostraca RAYMOND, 1935 (*partim*)]

Body small, narrowly elongate; head subtriangular, with 4 transverse lobes on axis, possibly with pedunculate eyes and small rostrum; trunk with 12 segments, 8 anterior ones with short pleurae, 4 posterior ones cylindrical without pleurae; telson spatulate (cerci described by WALCOTT not demon-

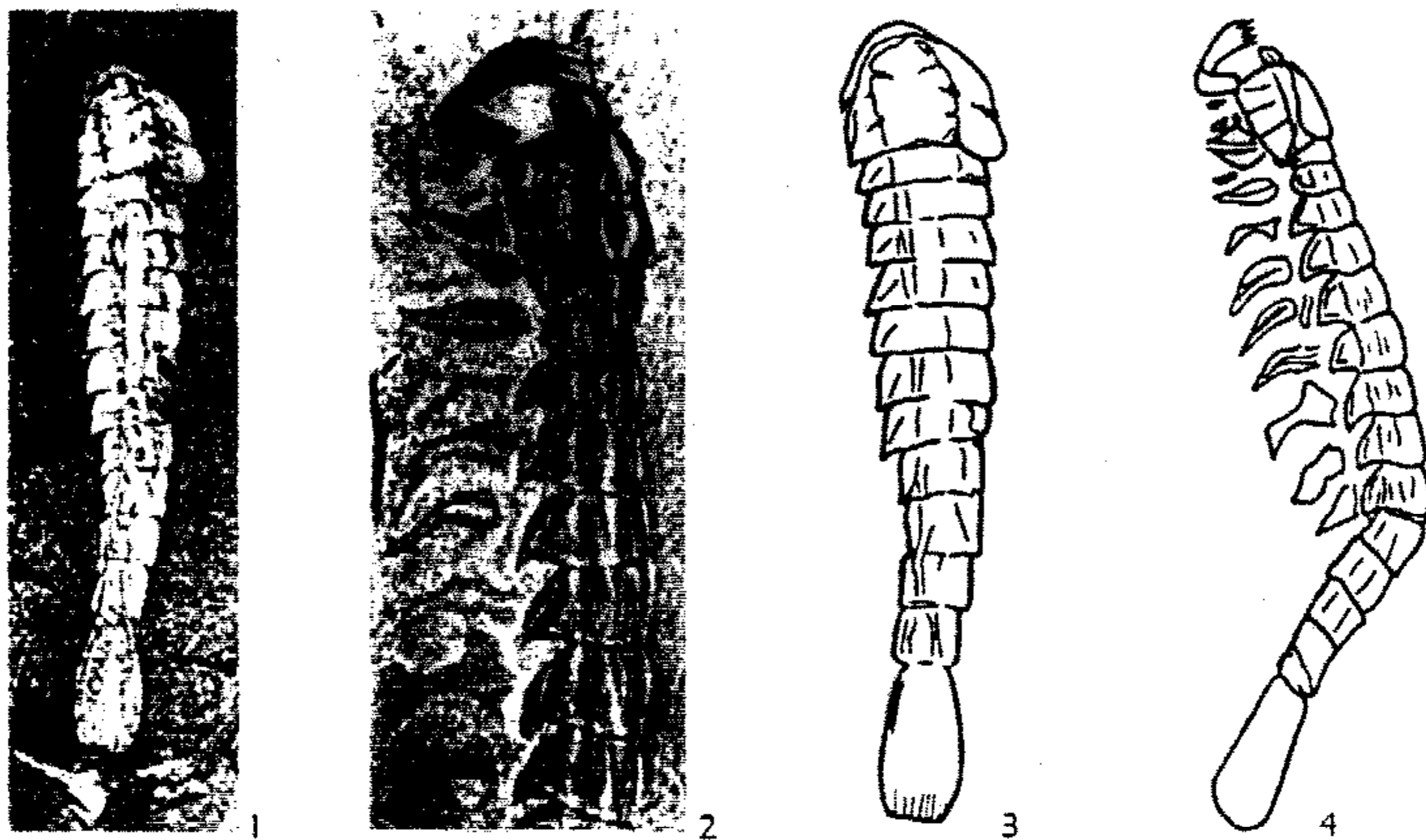

FIG. 24. *Yohoia tenuis* WALCOTT, M.Cam., W.Can.(B.C.); 1,3, dorsal side, $\times 3$, $\times 3.5$ (7); 2,4, lateral views, $\times 6$, $\times 4$ (7).

strated in illustrations of type species); appendages little known, indications of powerful cephalic limb with distal spines possibly representing 2nd antennae (or frontal organ similar to that of *Opabinia*), trunk appendages probably similar to gill branch of trilobitic appendages. *M.Cam.*

Yohoia WALCOTT, 1912 [**Y. tenuis*]. Characters of family (7). Burgess Sh., W.Can.(B.C.). [WALCOTT described *Y. plena* with bilobed telson or pair of flat cerci. This species may represent another

genus, possibly little related to *Yohoia*. The small size of *Yohoia* suggests that it may represent a larval stage of *Opabinia* or a related form. Taxonomically, *Yohoia* may belong in intermediate position between Merostomoidea and the Pseudonotostraca.]—FIG. 24. **Y. tenuis*; dorsal side, $\times 3$, $\times 3.5$ (7); 2,4, lateral views, $\times 6$, $\times 4$ (7).

Family UNCERTAIN

Helmetia WALCOTT, 1917 [**H. expansa*]. Body large, flat, divided into cephalic shield, thorax, and pygidium, trilobation faintly suggested; cephalic

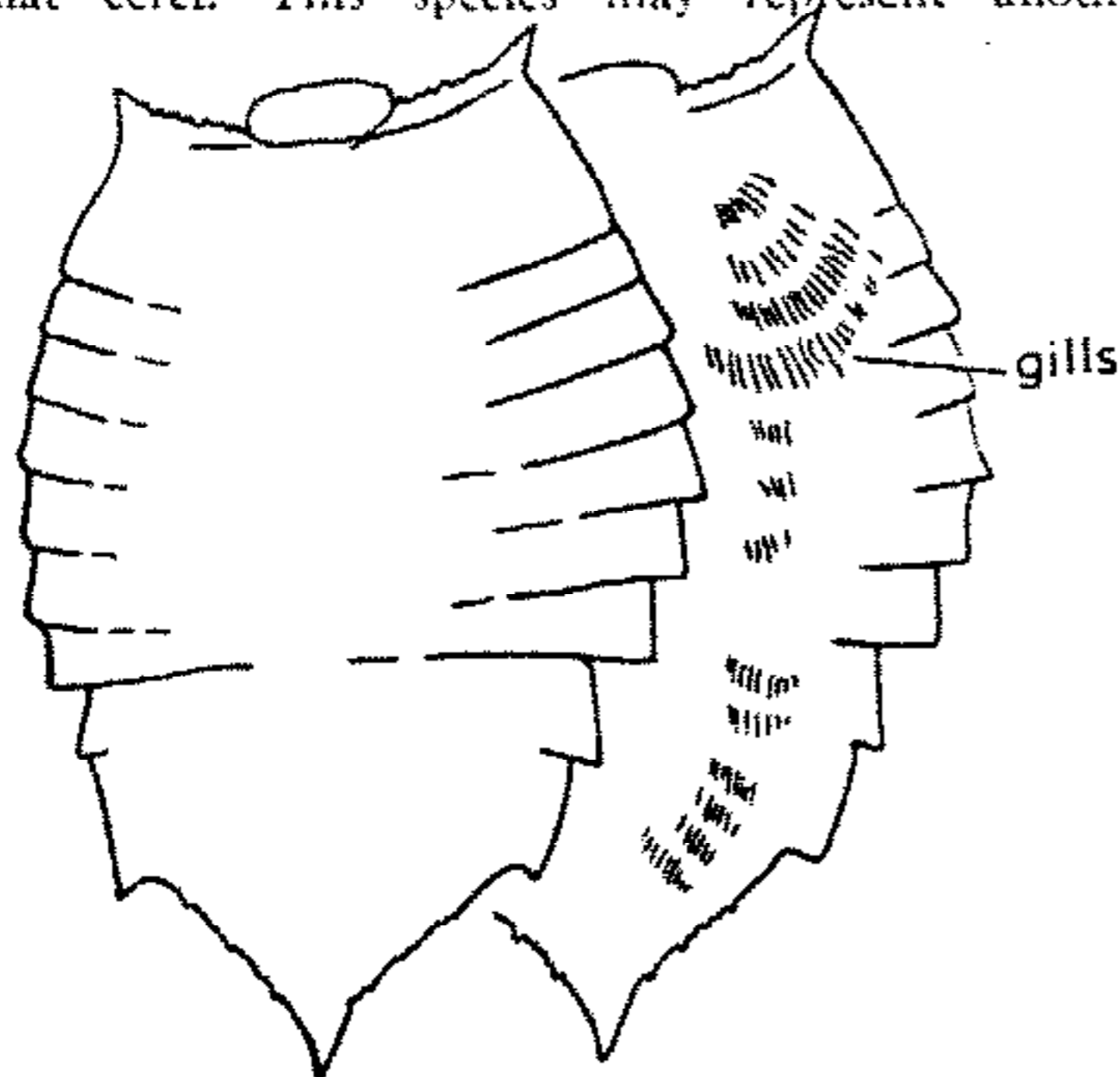

FIG. 25. *Helmetia expansa* WALCOTT, M.Cam., W.Can.(B.C.); dorsal side, with impressions of ventral gills at right, $\times 0.2$ (8).

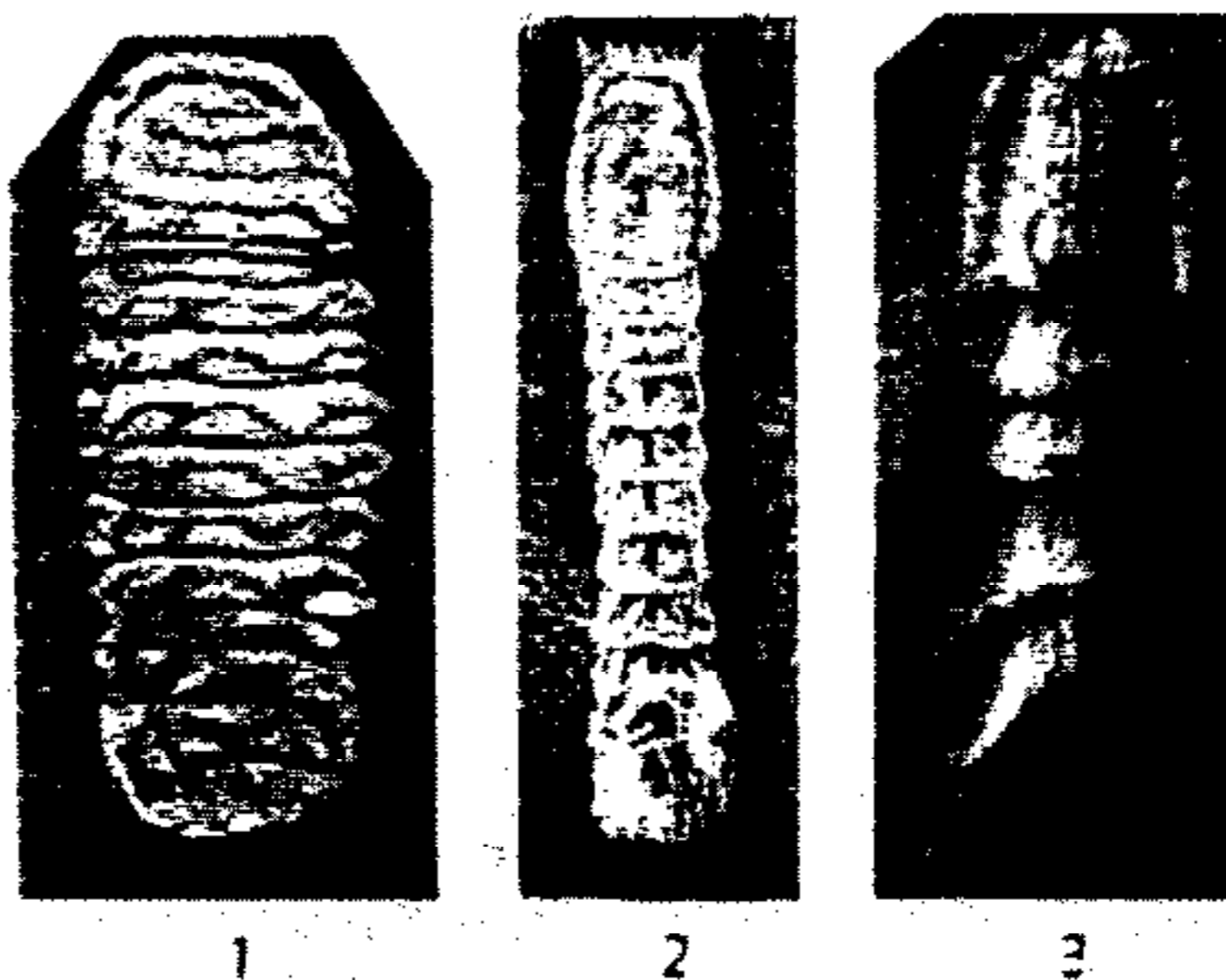

FIG. 26. Yohoiidae (*Mollisonia* and *Tontoia*), M.Cam.—1, *M. symmetrica* WALCOTT, W.Can.(B.C.), dorsal side, $\times 0.7$ (7).—2, *M. gracilis* WALCOTT, W.Can.(B.C.), dorsal side, $\times 1.8$ (7).—3, *T. kwaguntensis* WALCOTT, Tonto Ss., SW. USA(Ariz.), dorsal side, $\times 0.7$ (7).

shield trapezoid, with pointed anterolateral corners (median anterior lobe possibly representing displaced labrum); thorax with 6 segments; pygidium subtriangular, with 2 lateral and 1 median point; filamentous appendages probably of trilobitic type present in cephalic shield, thorax, and pygidium; antennae and walking legs unknown. *M.Cam.* (Burgess Sh.), *W.Can.(B.C.)*.—FIG. 25. **H. expansa*, dorsal side with impressions of ventral gills at right, $\times 0.2$ (8).

Mollisonia WALCOTT, 1912 [**M. symmetrica*]. Body small to medium in size, elongate, more or less narrow, divided into cephalic shield, thorax, and pygidium of equal width, trilobation faintly indicated; cephalic shield semicircular to elongate subovate, with 5 transverse lobes and marginal rim; thorax with narrow pleurae; pygidium subcircular, about equal to cephalic shield in size; appendages unknown (7). *M.Cam.* (Burgess Sh.), *W.Can.(B.C.)*.—FIG. 26,1. **M. symmetrica*; dorsal side, $\times 0.7$ (7).—FIG. 26,2. *M. gracilis* WALCOTT, dorsal side, $\times 1.8$ (7).

Tontoia WALCOTT, 1912 [**T. kwaguntensis*]. Body small, elongate, with convex somewhat indistinct axis, divided into cephalic shield, thorax, and pygidium; cephalic shield elongate subovate, with marginal rim; thorax 4-segmented, with concave-posterior margin; pygidium smaller than cephalic shield, with rounded posterior margin; appendages unknown. [Since appendages are unknown in *Mollisonia* and *Tontoia*, the subclass and order to which they belong cannot be decided with certainty. The development of a cephalic shield, thorax, and pygidium indicates, however, that they belong to the Trilobitomorpha.] *M.Cam.*, SW. USA (N. Ariz.).—FIG. 26,3. **T. kwaguntensis*, Tonto Ss.; dorsal side, $\times 0.7$ (7).

REFERENCES

Broili, F.

- (1) 1933, *Ein zweites Exemplar von Cheloniellon*: Sitzungsber. Bayrisch. Akad. Wiss. zu München, Math.-Naturwiss. Abt., p. 11-32, pl. 1-3.

Raymond, P. E.

- (2) 1920, *The appendages, anatomy, and relationships of trilobites*: Connecticut Acad. Arts Sci., Mem., v. 7, p. 1-169, pl. 1-11.
 (3) 1935, *Leancoilia and other Mid-Cambrian Arthropoda*: Harvard Mus. Comp. Zoology, v. 76, no. 6, p. 205-230, fig. 1-3.

Størmer, Leif

- (4) 1944, *On the relationships and phylogeny of fossil and recent Arachnomorpha*: Norske Videnskaps-Akad., Oslo, Skr. 1, Mat.-Naturvid. Kl., 1944, no. 5, 158 p., 29 fig.

Vandel, A.

- (5) 1949, *Embranchement des Arthropodes*: in *Traité de Zoologie*, ed. P. P. Grassé, Masson (Paris), tome 6, p. 79-158, fig. 1-36.

Walcott, C. D.

- (6) 1911, *Middle Cambrian Merostomata*: Smithsonian Misc. Coll., Pub. 2009, v. 57, no. 2, p. 17-40, pl. 2-7.
 (7) 1912, *Middle Cambrian Branchiopoda, Malacostraca, Trilobita, and Merostomata*: Same, Pub. 2051, v. 57, no. 6, p. 145-228, pl. 25-34, fig. 1-10.
 (8) 1931, *Addenda to description of Burgess Shale fossils*: Same, Pub. 3117, v. 85, no. 3, p. 1-46, pl. 1-23, fig. 1-11 (ed. C. E. Resser).

TRILOBITA

By H. J. HARRINGTON, GUNNAR HENNINGSMOEN, B. F. HOWELL, VALDAR JAANUS-
SON, CHRISTINA LOCHMAN-BALK, R. C. MOORE, CHRISTIAN POULSEN, FRANCO
RASETTI, EMMA RICHTER,¹ RUDOLF RICHTER,² HERTA SCHMIDT, KLAUS SDZUY,
WOLFGANG STRUVE, C. J. STUBBLEFIELD, RONALD TRIPP, J. M. WELLER, and H. B.
WHITTINGTON

CONTENTS

| | PAGE |
|---|------|
| GENERAL DESCRIPTION OF TRILOBITA (H. J. Harrington) | 038 |
| MORPHOLOGICAL TERMS APPLIED TO TRILOBITA (H. J. Harrington, R. C. Moore, and C. J. Stubblefield) | 0117 |
| ONTOGENY OF TRILOBITA (H. B. Whittington) | 0127 |
| CLASSIFICATION (H. J. Harrington) | 0145 |
| SYSTEMATIC DESCRIPTIONS (H. J. Harrington <i>et al.</i>) | 0170 |

GENERAL DESCRIPTION OF TRILOBITA

By H. J. HARRINGTON

CONTENTS

| | PAGE |
|---------------------------------|------|
| INTRODUCTION | 040 |
| Definition of class | 040 |
| Occurrence | 040 |
| Development of studies | 040 |
| Mode of preservation | 041 |
| MORPHOLOGY OF EXOSKELETON | 041 |
| Shape and size | 041 |
| Orientation | 042 |
| Structural elements | 043 |
| Cephalic region | 045 |
| Glabella | 046 |
| Occipital ring | 048 |
| Frontal area | 049 |
| Palpebral lobes | 050 |
| Fixigenae | 050 |
| Eye ridges | 050 |
| Librigenae | 051 |

¹ Deceased 15 November 1956. ² Deceased 5 January 1957.

Trilobita—General Features

039

| | |
|--|------|
| Cephalic spines | 051 |
| Doublure | 053 |
| Rostral plate | 054 |
| Hypostoma | 054 |
| Metastoma | 058 |
| Sutures | 058 |
| Facial sutures (p. 058); metaparian sutures (p. 062); rostral and perrostral sutures (p. 063); connective and median sutures (p. 065); marginal and submarginal sutures (p. 066); hypostomal suture (p. 066); cephalic types defined by sutural pattern (p. 066) | |
| Thoracic region | 070 |
| Axial rings | 070 |
| Pleurae | 071 |
| Pygidial region | 073 |
| Axis | 073 |
| Pleural regions | 073 |
| Ventral appendages | 076 |
| Antennae | 077 |
| Biramous appendages | 078 |
| Function of limbs | 082 |
| Antenniform cerci | 084 |
| Microstructure of exoskeleton | 085 |
| SENSORY ORGANS | 087 |
| Eyes | 087 |
| Holochoal eyes | 088 |
| Schizochroal eyes | 089 |
| Blindness | 091 |
| Median sensory organ | 092 |
| Maculae | 092 |
| Integumentary sensory organs | 094 |
| INTERNAL ANATOMY | 094 |
| Muscular system | 094 |
| Cephalic muscles | 094 |
| Thoracic and pygidial muscles | 097 |
| Digestive system | 098 |
| Genal caeca | 0100 |
| Circulatory, nervous, and respiratory systems | 0101 |
| Reproductive and excretory systems | 0101 |
| ENROLLMENT | 0102 |
| Mechanism of enrollment | 0102 |
| Spheroidal enrollment | 0102 |
| Double enrollment | 0104 |
| Discoidal enrollment | 0104 |
| Anatomic features related to enrollment | 0104 |
| Vincular furrows and notches | 0105 |

| | |
|--|------|
| Panderian organs | O105 |
| OTHER CHARACTERS | O107 |
| Color patterns | O107 |
| Cicatrization, regeneration, pathology, and teratology | O107 |
| Molting | O110 |
| Features of trinucleids and harpids | O114 |
| REFERENCES | O114 |
| SOURCES OF ILLUSTRATIONS | O117 |

INTRODUCTION

DEFINITION OF CLASS

The Trilobita are extinct Arthropoda distinguished by an exoskeleton that is trilobed longitudinally into axial and side regions and differentiated transversely into anterior, middle, and posterior areas. Tergites of the anterior and posterior areas are fused into rigid plates, whereas those of the middle area are movable upon each other, generally articulating freely. Compound eyes generally are present on the dorsal side of the head. Ventral appendages consist of an anterior pair of multijointed uniramous antennae and behind these a variable number of undifferentiated paired biramous appendages, 4 of which are cephalic, with a pair of appendages corresponding to each postcephalic somite. Caudal antenniform cerci occur in some forms. Respiration is by means of branchial fringes on the limbs called pre-pipodites. Ontogenetic development is marked by progressive metamorphoses proceeding from a free larva that shows only cephalic segments, although some authors claim the hindmost segment to be the anal.

OCCURRENCE

Trilobites are exclusively marine animals, remains of which are restricted to rocks of the Paleozoic Era. They first appeared in the Early Cambrian, already diversified in many families and genera, and attained maximum development in Late Cambrian time. They were still very numerous in the Ordovician but the Silurian witnessed the beginning of their decline, with disappearance of many "archaic" types. Still fairly abundant in the Devonian Period, where only a few families are represented, they dwindled rapidly during the late Paleozoic and completely disappeared by the close of Permian time.

Though they form a morphologically compact group, the trilobites diversified from the outset into different stocks which, during the 250-million-year life span of the class, gave rise to numerous genera and species. VOGDES, in 1923, estimated that about 450 genera and 3,970 species of trilobites had been described. Since then, the number of described forms has increased greatly, so that at present about 1,500 genera and a total of about 10,000 species are recognized.

DEVELOPMENT OF STUDIES

The first known descriptions and figures of trilobites were published by LHWYD in 1698, who called them Trinuclei. In 1745 LINNÉ described several species under the collective name of *Entomolithus paradoxus*, regarding them as a division of his Insecta (by modern standards, Arthropoda). The name Trilobitae was proposed by WALCH in 1771, and though WAHLENBERG (1821) preferred Entomostracites and DALMAN (1826) used Palaeades, WALCH's term (modified to "Trilobita"), alluding to the longitudinal trilobation of the exoskeleton, is now universally accepted.

The number of monographs dealing with description of trilobites is large, and during the last 130 years many paleontologists have added greatly to our knowledge of the class. Pioneers in the description of these fossils are BRONGNIART (1822), DALMAN (1827), GREEN (1832), EMMRICH (1839), MILNE EDWARDS (1840), BURMEISTER (1843), GOLDFUSS (1843), BEYRICH (1846), HAWLE & CORDA (1847), and M'COY (1849). Since the middle 1800's fundamental monographs have been published on trilobites of various regions: (1) Bohemia by BARRANDE, NOVÁK, and PRANTL & PŘIBYL; (2) Germany by

GÜRICH, POMPECKJ, and RUDOLF & EMMA RICHTER; (3) Scandinavia by ANGELIN, BRØGGER, WARBURG, STØRMER, and WESTERGÅRD; (4) Baltic region of Russia by NIESZKOWSKI, EICHWALD, SCHMIDT, ÖPIK, and LERMONTOVA; (5) Great Britain by SALTER, WOODWARD, HICKS, REED, COBBOLD, and LAKE; (6) France by ROUAULT, OEHLERT, BERGERON, BARROIS, and THORAL; (7) Italy by MENEGHINI; (8) North America by HALL, FORD, CLARKE, BILLINGS, MATTHEW, BEECHER, WALCOTT, RESSER, RASETTI, RAYMOND, WHITTINGTON, and POULSEN (Greenland); (9) South America by KAYSER, CLARKE, KOZLOWSKI, KNOD, ULRICH, KOBAYASHI, and HARRINGTON & LEANZA; (10) Asia by LORENZ, MANSUY, WALCOTT, RESSER, ENDO, REED, KOBAYASHI, and SUN; (11) Africa by SALTER and HUPÉ; and (12) Australia by WHITEHOUSE.

Up to 1870 only the hard exoskeleton of trilobites was known, and the zoological position of these organisms remained a matter of considerable uncertainty. They were variously regarded as related to quite different groups of Arthropoda, such as the Xiphosura, Branchiopoda, and Isopoda, and even to the Mollusca (Amphineura).

The ventral appendages were first described by BILLINGS in 1870 from North American Ordovician specimens of *Isotelus*. Between 1895 and 1920, excellently preserved specimens of several Cambrian and Ordovician species, showing all ventral appendages, were described by BEECHER, WALCOTT, and RAYMOND, and in 1930 BROILI described those of 2 species from Lower Devonian rocks. In recent years, our understanding of the trilobite appendages has

greatly increased, thanks largely to STØRMER's outstanding investigations.

Trilobite larvae were first described by BARRANDE (1852) and the name "protaspis" was given by BEECHER (1895) to the initial larval stage. The postembryonic development of some 50 species now is known, although only a few complete series of larval stages have been described.

MODE OF PRESERVATION

Trilobites are found in different types of marine sediments either (1) with their mineralized exoskeleton preserved, or (2) as external or internal molds. Fossils consisting of preserved hard parts may show little or no change in composition of the original exoskeleton, or alternatively, the substance of the exoskeleton may be replaced partly or wholly by silica, pyrite, or other mineral substances.

Complete specimens of trilobites are found frequently, either outstretched or enrolled, but commonly the remains consist of detached parts of the exoskeleton. These may represent exuviae shed during molting or the disarticulated parts of exoskeletons which became disjointed after death of the animals.

Exceptionally well-preserved complete specimens, with their fragile ventral appendages preserved, have been found both in black shales and in extremely fine-grained limestones. During recent years our knowledge of minute details of the exoskeleton of many species has grown through study of silicified specimens found in limestones, which can be completely detached from the matrix by dissolving away the limestone with hydrochloric, formic, or other acids.

MORPHOLOGY OF EXOSKELETON

SHAPE AND SIZE

Trilobites are typically ovoid to subelliptical in outline when seen in dorsal view, but this basic shape may be substantially modified in progressive and aberrant genera (*Deiphon*, *Ceratarges*, *Odontopleura*). The exoskeleton is usually moderately convex but in some (*Dionide*) it is almost flat, whereas in other (*Leiagnostus*) it is highly arched or globose.

The average length of trilobites ranges from 3 to 10 cm. Minute forms, however, are numerous, entire families (*Shumardiidae*, *Eodiscidae*) and even orders (*Agnostida*) being characterized by very small size. Some species of *Shumardia* are less than 5 mm. long, and many *Agnostida* measure less than 6 mm. The *Eodiscidae* are usually about 12 to 15 mm. long. Among the *Agnostida*, a species measuring 25 mm. in length is regarded as huge.

Truly gigantic forms, measuring more than 20 cm. in length, are scarce and restricted to a very few families. Outstanding examples are *Paradoxides harlani* (45 cm.), Paradoxididae, of Middle Cambrian age; *Megistaspis heros* (36 cm.), *Isotelus gigas* (44 cm.), and *Thysanopyge argentina* (45 cm.), all Asaphidae, of Ordovician age; *Illaenus giganteus* (40 cm.), Illaenidae, of Ordovician age; *Arctinurus boltoni* (30 cm.) and *Terataspis grandis* (60 cm.), Lichidae, from the Ordovician and Devonian, respectively; *Trimerus major* (38 cm.), Homalontidae, of Devonian age; and *Coronura myrmecophora* (40 cm.), Dalmanitidae, of Devonian age. The largest known trilobite is *Uralichas riberoi* (70 cm.), a lichid from Ordovician rocks of Portugal. The measurements given, representing recorded maxima, do not take account of appendages such as antennae and possibly caudal rami that projected beyond the front and rear margins of the exoskeleton.

ORIENTATION

Orientation of trilobites is self-evident, with exception of the Agnostina. In these small blind trilobites, having only 2 thoracic segments separating 2 subequal "shields," it is difficult to decide, on purely morphological grounds, which is the front and which is the rear part of the animal. Only 2 morphological features of the Agnostina furnish some indications in this regard but, unfortunately, they provide contradictory evidence. One is the direction of curvature of thoracic pleural extremities, and the other is the direction of paired marginal spines commonly carried by one of the "shields." These 2 directions are opposite. Since the earliest descriptions of agnostid trilobites, virtually all authors have accepted the conclusion that the marginal spines are carried by the "tail shield" and that, therefore, the spines are directed backward as posterolateral projections of the margin. RAYMOND, however, was an exception. Reasoning that in the Agnostina, as in all other trilobites, the pleural extremities should curve backward, he oriented the agnostid dorsal exoskeleton accordingly, regarding as rear extremity what all other authors consider to be the anterior end. He overlooked, however, the fact that the ontogenetic development of the Agnostina, as described by BAR-

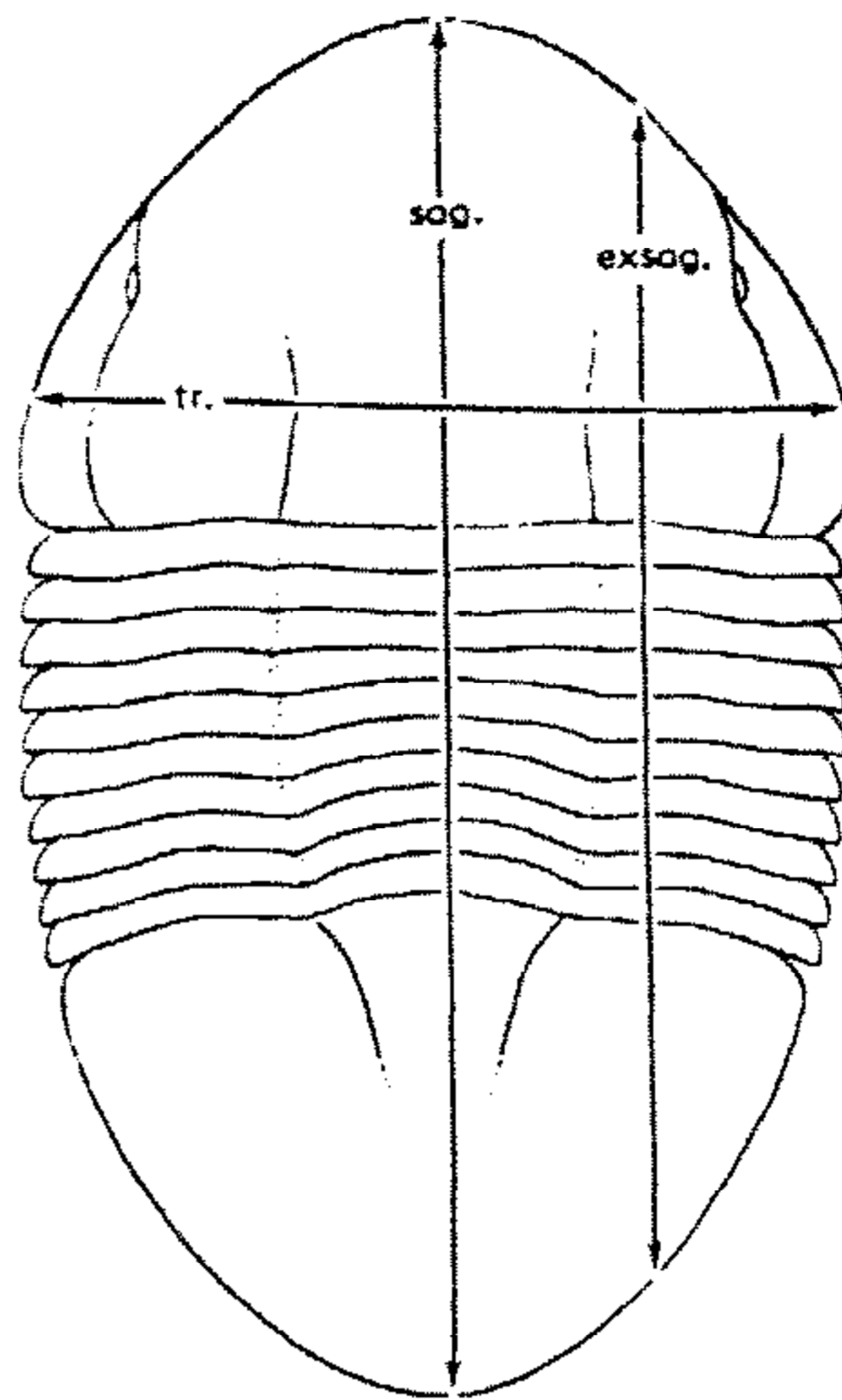

FIG. 27. Orientation of trilobite exoskeleton. *Ectillaenus katzeri* (BARRANDE) JAANUSSON, U.Ord., Boh., $\times 1$ (*sag.*, sagittal line; *exsag.*, exsagittal line; *tr.*, transverse line) (79, 1954).

RANDE as far back as 1852 for several Bohemian species, is opposed to this interpretation. If RAYMOND's views on orientation were to be accepted, this would imply admitting that the agnostids differ from all other known Arthropoda in the manner in which new thoracic segments are developed in the successive larval stages (see "Ontogeny of Trilobita"). Accordingly, the accepted orientation of these trilobites is such that when the animal faces forward, the pleural extremities also curve forward, the marginal spines (if present) being carried by the "tail shield" as backwardly directed projections of the posterolateral margins.

For the purpose of describing without ambiguity the length and width of trilobite parts, the descriptions are referred to the longitudinal and transverse directions of the whole animal (Fig. 27). Longitudinal measurements, however, can be taken either along the axial (sagittal) line of the body (abbreviated "*sag.*"), or along lines running parallel to it on either side and, therefore, "exsagittal" in position (abbreviated "*exsag.*"). When a given part, such as an axial

ring or occipital ring, is said to be "wide (*sag.*)," the meaning is that its width has been measured along the sagittal line of the body. When "*exsag.*" is used, as in referring to width of a pleural segment, this means that the measurement has been taken along an "exsagittal line," namely, along a line running parallel to the sagittal line on either side of the body. Transverse measurements (abbreviated "*tr.*") are always taken along lines transverse to the whole body.

For the purpose of describing directions away from or toward the line of symmetry of the body, the terms *abaxial* and *adaxial* are used, respectively, in preference to the ambiguous expressions "outer" and "inner." *Distal* and *proximal* are used almost in the same sense.

Ventral and *dorsal* are self-explanatory terms, but in description of exoskeletal parts of trilobites, the injudicious use of these terms may lead to confusion. The name "dorsal exoskeleton," for instance, is applied by some paleontologists to that part of the mineralized exoskeleton which other authors prefer to call "carapace." As the "dorsal exoskeleton" has a discrete thickness, it obviously has a dorsal or external, and a ventral or internal surface. Moreover, the so-called dorsal exoskeleton is not wholly dorsal in position, having a reflected rim (*doublure*) extending onto the ventral side of the animal. Clearly, the downwardly facing ventral side of the *doublure* is also its external surface, conditions being exactly the opposite to those obtaining in the truly dorsal part of the "dorsal exoskeleton." This may lead to descriptive expressions such as "dorsal side of the ventral extension of the dorsal exoskeleton" which, though perfectly correct, should be avoided as confusing, its far simpler equivalent "internal surface of the *doublure* of the carapace" being preferable. The term "dorsal exoskeleton" is not fortunate, since its reflected *doublure* is ventral in position. This would not be too objectionable if the *doublure* invariably were a very narrow rim, but in many trilobites it is actually a broad band extending a considerable distance *adaxially*. In some *Illaenidae*, for instance, the pygidial *doublure* covers more than 0.7 of the ventral side of the pygidial region. For these reasons, the term "carapace," despite its different connotation in crustacean morphology,

is preferred to "dorsal exoskeleton" by some authors, including me.

STRUCTURAL ELEMENTS

The exoskeleton of trilobites consists both of hard mineralized integument and comparatively soft chitinous parts. The mineralized integument covered the dorsal side of the body and parts of its ventral side, whereas the nonmineralized chitinous integument covered the ventral appendages. The remainder of the ventral side of the body was covered by a soft membrane. Most trilobites were capable of enrollment, and thus the vulnerable ventral side could be protected.

The chitinous covering of the appendages is very rarely preserved, all that usually remains of the trilobites being the hard mineralized exoskeleton that covered the dorsal side of the body and certain areas of the ventral side.

The *carapace* (dorsal exoskeleton) consists of the separate or fused areas of mineralized integument (*sclerites*) covering successive body segments. Each individual covering of this sort is a *tergite*. The tergites are longitudinally trilobed into an axial region (*mesotergite*) and 2 side regions (*pleurotergites*), which should be regarded as lateral extensions of the axial portion. The anterior tergites and their lateral extensions are fused together into a single rigid *tagma*, called the *cephalon*. Similarly, the posterior tergites normally are fused into a single plate called the *pygidium*. The part of the carapace interposed between *cephalon* and *pygidium* is termed *thorax*, being formed of individual tergites that are movable upon each other, articulating along their axial portions (Fig. 28).

Ventral *sclerites*, consisting of separate areas of mineralized integument (*sternites*), are restricted to the cephalic region. Trilobites have a maximum of 3 such *sternites*, which are known as *rostral plate*, *hypostoma*, and *metastoma*, the first 2 being preoral and the last postoral in position.

The external surface of the trilobite exoskeleton is usually smooth, but it may be sculptured by pits, granulations, tubercles, radial crests, and "terrace lines." The terrace lines, running subparallel to the margins of the exoskeleton and usually arranged in a Bertillon pattern, seem to represent

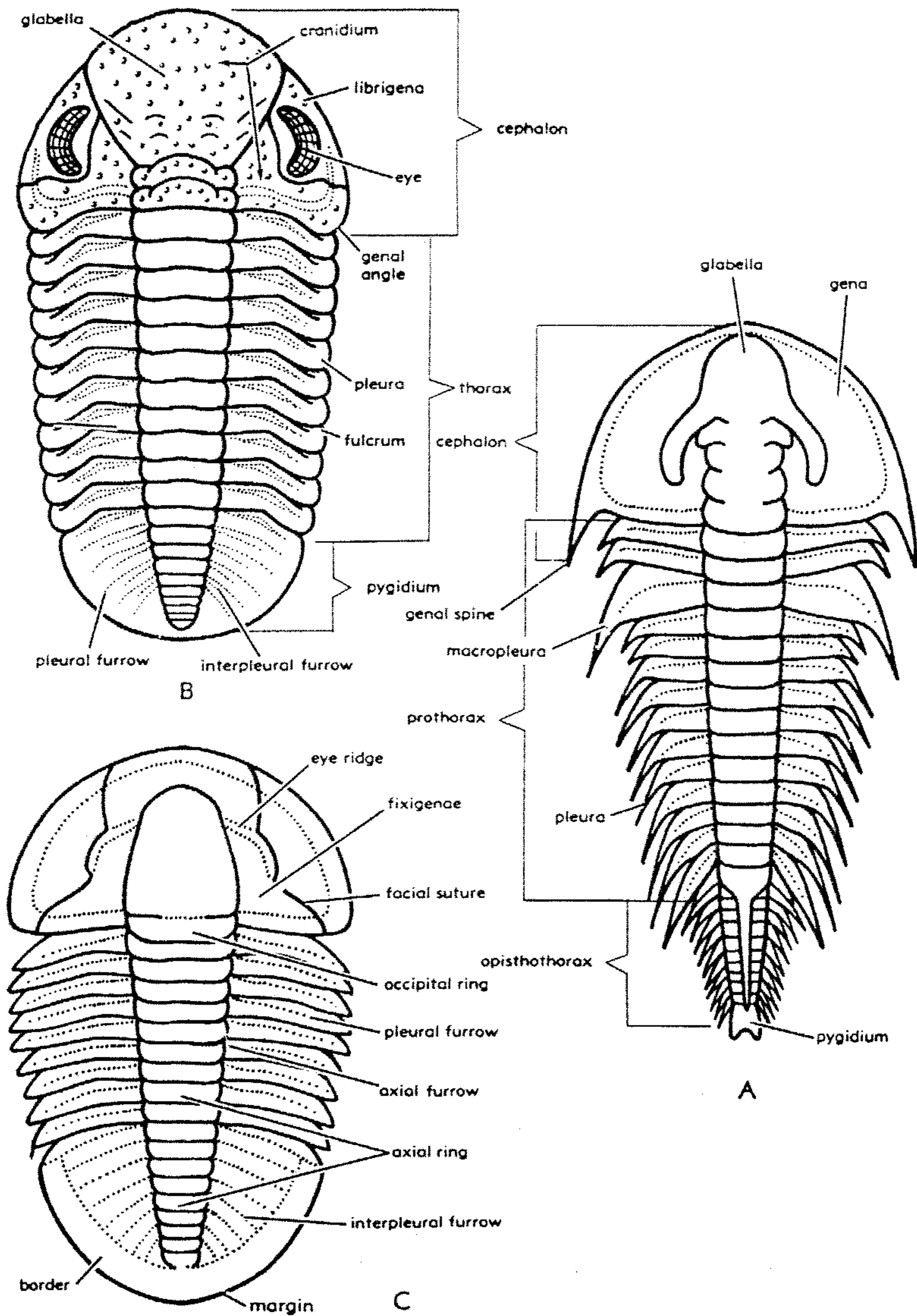

FIG. 28. Nomenclature of exoskeleton.—A. *Olenellus vermontanus* (HALL) HALL, L.Cam., USA (Vermont), $\times 1$ (64).—B. *Phacops fecundus* BARRANDE, Dev., Bohemia, $\times 1$ (2).—C. *Asaphiscus wheeleri* MEEK, U.Cam., USA (Utah), $\times 1$ (488).

folds of the integument comparable to those seen in living Arthropoda (SCHULZE, 1937). The granulations and tubercles may be perforated, as in some Calymenidae and Cheiruridae (noted in description of integumentary sensory organs).

CEPHALIC REGION

The term "cephalon" is properly applied to the rigid plate formed of fused anterior tergites of the trilobite exoskeleton.¹ However, the term is sometimes loosely extended to embrace the internal organs, appendages, and other parts located beneath the exoskeletal covering or "cephalon proper." This is a case of the name of a part being extended to designate the whole, being strictly comparable to the incorrect use of "skull" or "cranium" to designate the head of mammals, birds, and other vertebrates. To avoid confusion it is preferable to use different terms to designate the ensemble of fused anterior somites and the ensemble of their fused exoskeletal coverings.

The name cephalic region is here specifically applied to that area of the trilobite body formed by fusion of several anterior somites. The term embraces, by definition, the dorsal and ventral integuments (mineralized or not), internal organs, and ventral appendages borne by the somites. The term cephalon is here restricted, following common usage, to the rigid tagma formed of fused tergites of the cephalic region. It should be apparent that though the rostral plate, hypostoma, and metastoma are parts of the cephalic region, they are not parts of the cephalon.

The cephalon, being formed of fused tergites, is essentially dorsal in position, but it extends ventrally into a more or less wide reflected rim or doublure. Typically, it is semielliptical in outline, but considerable departure from this basic shape is seen frequently. In some Agnostida the cephalic outline is almost circular, whereas in other trilobites it may be semicircular, crescentic, subtrapezoidal, or subtriangular (Fig. 29). The size of the cephalon varies considerably in relation to that of the thorax and pygidium. Usually the cephalon is shorter than

¹ Noting that the rostral plate is commonly (though not invariably) part of the cephalic doublure and that the hypostoma almost universally is joined by suture or fusion to the rostral plate (as subsequently described), C. I. STUBBLEFIELD holds that these ventrally placed skeletal elements are correctly classed as parts of the cephalon.—R.C.M.

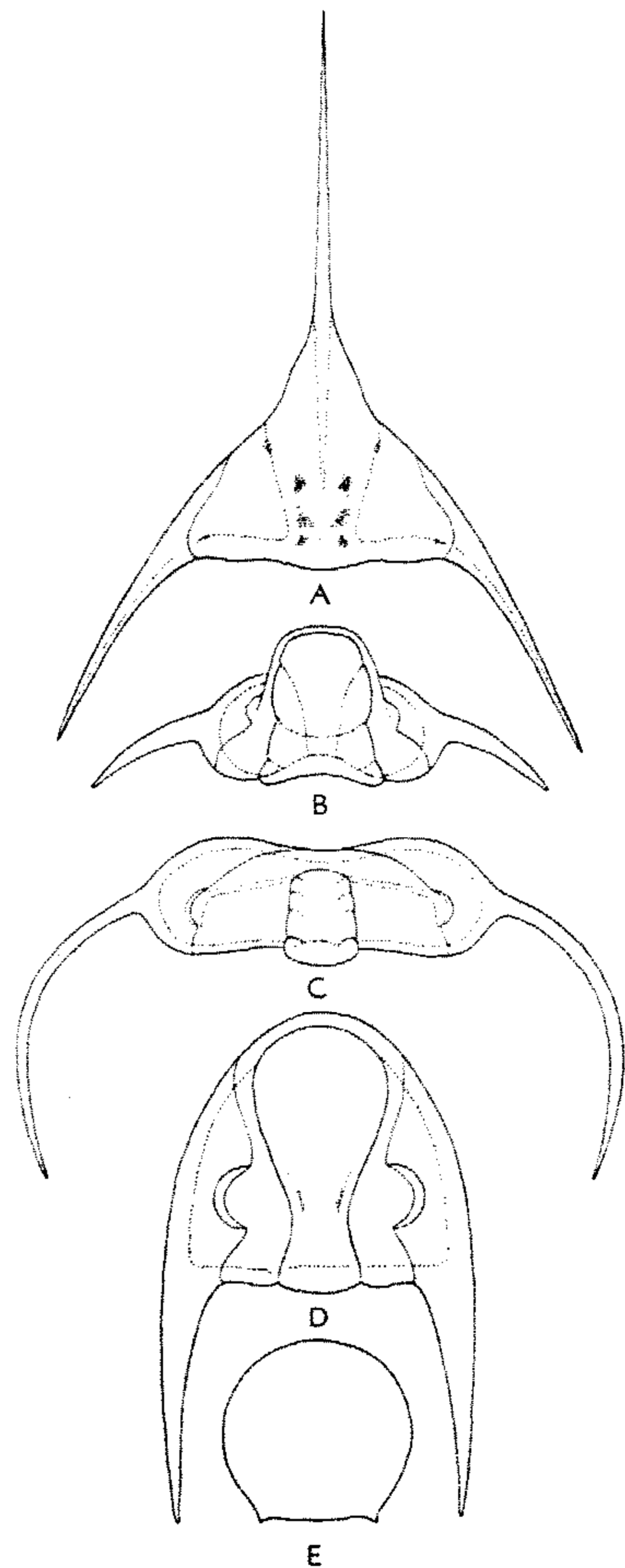

FIG. 29. Different cephalic shapes among trilobites. —A. *Lonchodomas rostratus* (SARS) ANGELIN, L. Ord., Norway, $\times 2.65$ (reconstr. from 99, 1950). —B. *Dicranopeltis scabra* (BEYRICH), Ord., Bohemia, $\times 0.65$ (after 2). —C. *Eurycare latum* (BOECK) ANGELIN, U.Cam., Swed., $\times 4$ (after 97, 1922). —D. *Phillipsinella parabola* (BARRANDE) NOVÁK, U.Ord., Scot., $\times 4$ (after 99, 1950). —E. *Ciceragnostus iruyensis* (KAYSER) HARRINGTON & LEANZA, L.Ord., Arg., $\times 4.8$ (after 19).

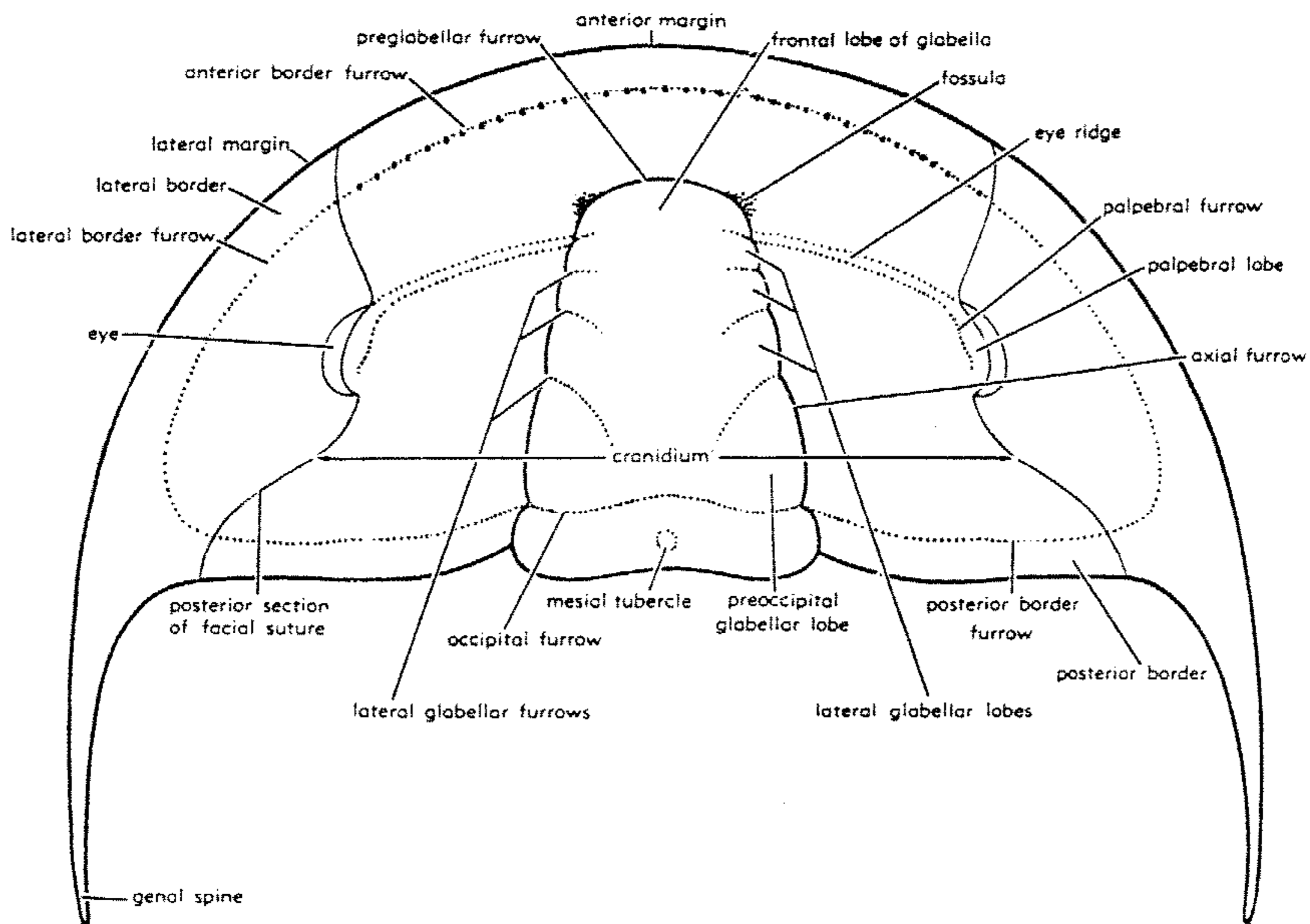

FIG. 30. Cephalic nomenclature of a typical psychopariid trilobite.

the thorax and longer than the pygidium, but in many genera cephalon and pygidium are of about equal size.

The cephalon is usually convex both longitudinally and transversely. The convexity ranges from very slight (*Dionide*) to exceptionally great (*Deiphon*, *Sphaerexochus*).

Longitudinal trilobation of the cephalon gives rise to an axial raised region (glabella and occipital ring) and 2 lateral (genal) regions which carry the compound eyes, if present. In some so-called smooth trilobites (*Leiagnostus*, *Iliaenus*) the trilobation is obsolete and the cephalon then appears as a single evenly convex structure. In the great majority of trilobites, the cephalon is transected by paired facial sutures that separate a middle portion (cranidium) from 2 side regions (librigenae, "free cheeks"), which carry the visual surface of the eyes (Fig. 30).

GLABELLA

Typically, the glabella forms a distinctly raised area along the axis of the cephalon, being bounded laterally by axial furrows.

These usually converge forward and grade into a transverse preglabellar furrow that bounds the anterior extremity of the glabella. In some genera, a pair of anterior pits (fossulae) are developed at the bottom of the axial furrows close to the anterolateral corners of the glabella. In "smooth" trilobites the axial and preglabellar furrows may be very shallow and indistinct. In extremely modified forms they disappear entirely, the glabella being then undifferentiated from the rest of the cephalon. The glabella is bounded posteriorly by the occipital furrow, which separates it from the occipital ring. In some trilobites (*Iliaenus*, *Ectillaenus*, *Stenopareia*, *Dysplanus*) the occipital furrow is obsolete, the occipital ring coalescing with the glabella proper (Fig. 27).

Size, shape, and convexity of the glabella are highly variable. In some genera, the glabella is moderately convex, usually extending along the posterior 0.7 of the cephalon. In progressive genera it may become inflated or globose and very large, even extending for a considerable distance beyond the anterior margin of the cephalon (*Lon-*

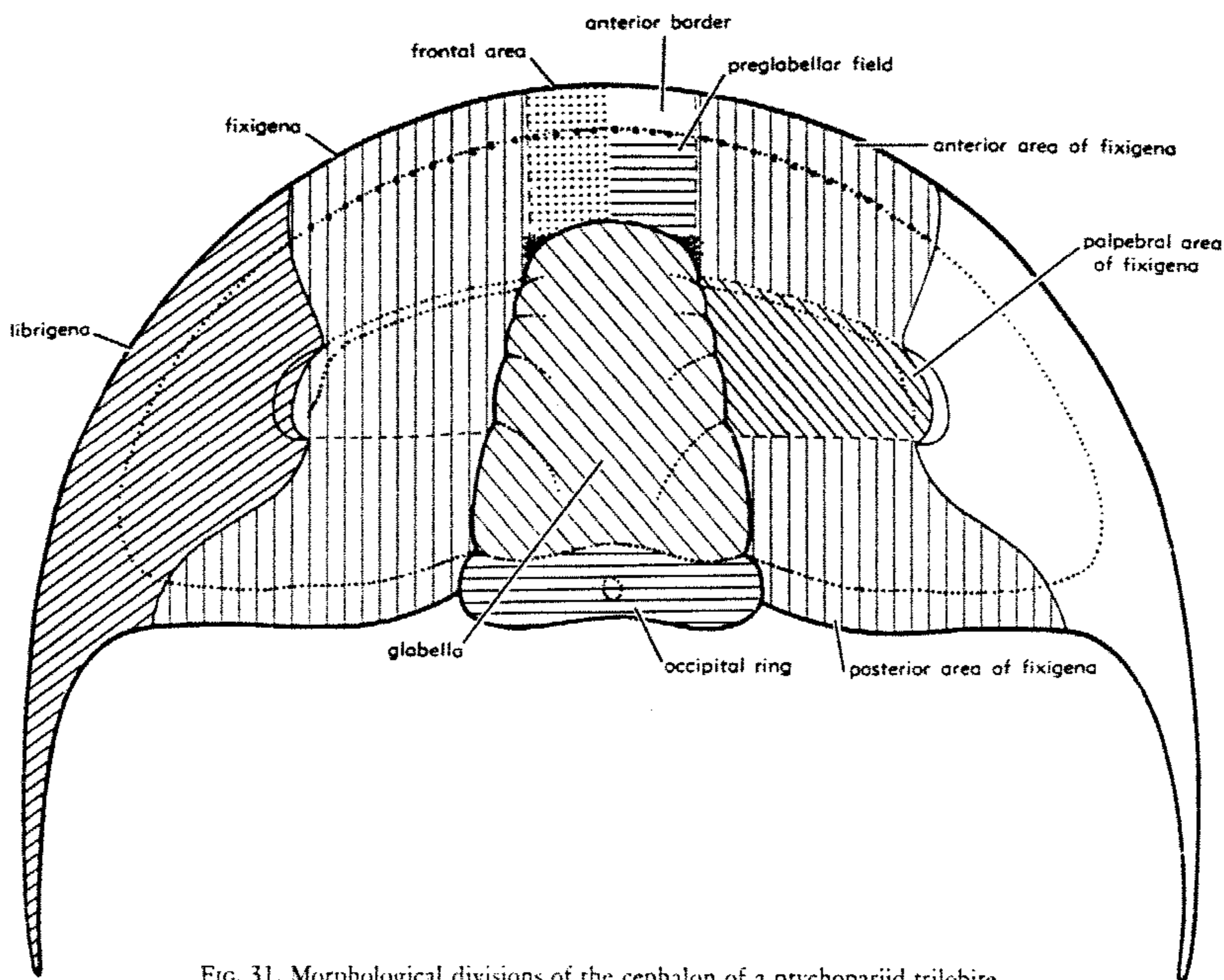

FIG. 31. Morphological divisions of the cephalon of a ptychopariid trilobite.

chodomas, Fig. 29A; *Raphiophorus*, Fig. 32R). The shapes of glabellae are commonly diagnostic characters of different genera (Fig. 32).

The glabella usually retains traces of the original cephalic segmentation. This is evidenced by paired lateral glabellar furrows which may vary in different genera from 5 pairs to a single pair (Fig. 33). In many trilobites, however, the glabella lacks furrows, being completely smooth. The lateral glabellar furrows may or may not reach the axial furrows. Their direction varies from inward-forward to inward-backward and their adaxial extremities may unite across the glabella so that a pair of furrows may form a single transglabellar furrow. For purposes of description, the lateral glabellar furrows are numbered by some paleontologists from front to back. When only 3 pairs are present they are termed anterior, middle, and preoccipital (or posterior). An alternative method is to number the furrows from back to front, in which case the preoccipital furrows are termed *1p* (1st from

the posterior extremity of the glabella), the next forward pair are designated as *2p*, and so on to the foremost furrows.

In some genera (*Parabolinella*) the preoccipital furrows may bifurcate at their abaxial extremities, whereas in others (*Hedinaspis*, *Hypermeaspis*) an intercalary pair may be present between the occipital and preoccipital furrows.

The paired side portions of the glabella between successive lateral glabellar furrows are called lateral glabellar lobes. They are numbered either from front to back or from back to front, much as the lateral glabellar furrows; using the latter method, *1p* corresponds to the preoccipital lobes. The portion of the glabella between the preglabellar furrow and the 1st (anterior) pair of lateral glabellar furrows is called frontal glabellar lobe. This may be continued backward along the axial line of the glabella into a central area delimited by the adaxial extremities of the lateral furrows. When frontal lobe and central area are confluent, they form a frontomedian lobe. In some special-

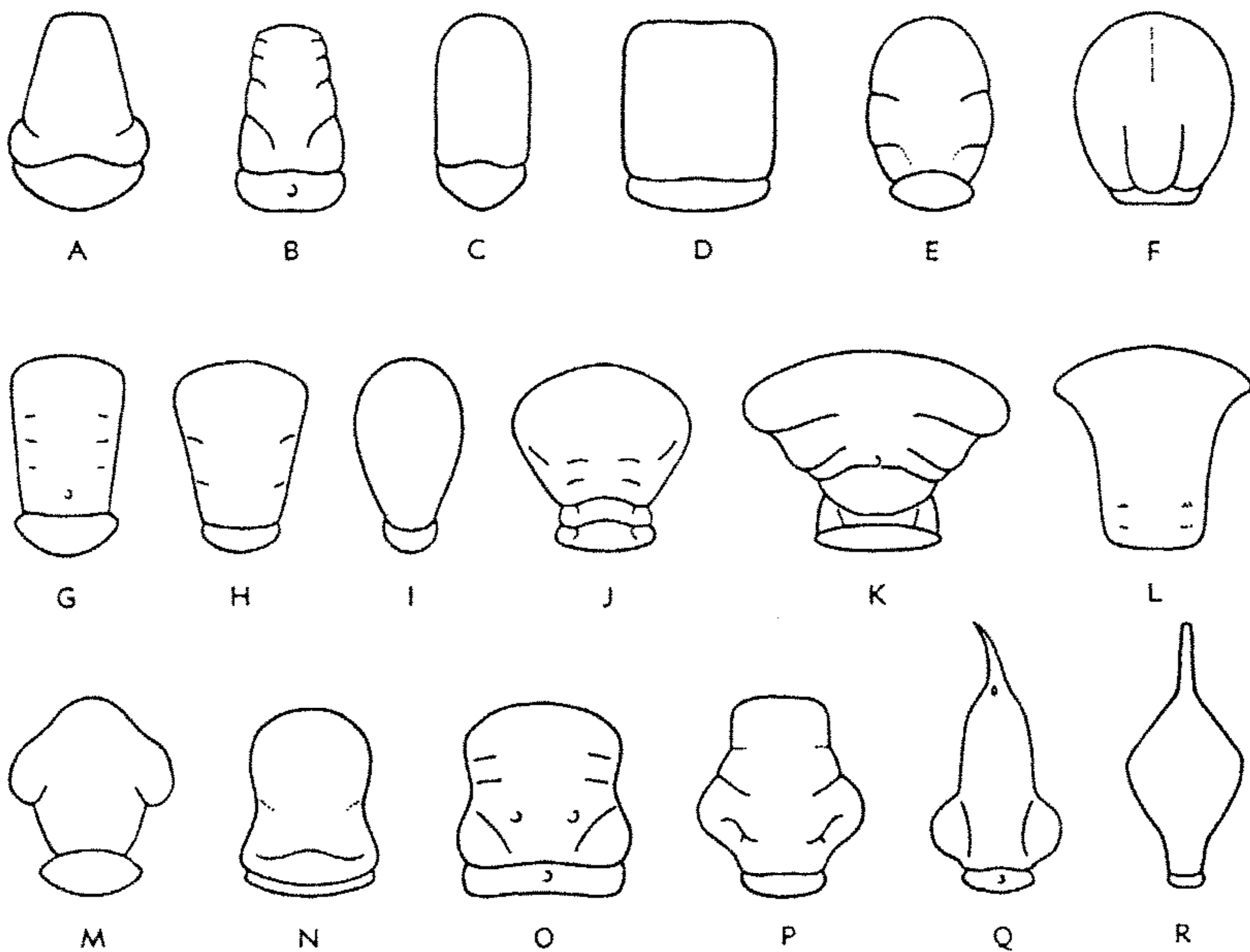

FIG. 32. Different outlines of trilobite glabella and occipital lobes.—A,B. Tapering forward; A, truncate anteriorly (*Harpides*); B, rounded anteriorly (*Ptychoparia*).—C. Parallel-sided, rounded anteriorly (*Brassicicephalus*).—D. Subquadrate (*Lloydia*).—E,F. Elliptical; E, *Isocolus*; F, *Seleneceme*.—G,H. Evenly expanded forward, axial furrows straight; G, *Ceratopyge*; H, *Theamataspis*.—I. Pyriform (*Famatinolithus*).—J-M. Expanded forward; J, *Phacops*; K, *Scutellum*; L, *Iliaenopsis*; M, *Shumardia*.—N,O. Contracted at middle; N, *Birmanites*; O, *Phaetonellus*.—P,Q. Bell-shaped; P, *Apatokephalus*; Q, *Teratorhynchus*.—R. Rhomboidal (*Raphiophorus*). (All diagrammatic, not to scale.)

ized genera (Lichidae, Odontopleuridae) the anterior lateral glabellar furrows are continued backward in longitudinal furrows more or less parallel to the axial furrows. Coincidentally, one or more of the lateral glabellar furrows may disappear, causing the lateral glabellar lobes to coalesce so as to form bicomposite and tricomposite glabellar lobes (Fig. 34).

The frontal glabellar lobe may carry a mesial spine, usually directed forward (*Lonchodomas*) or upward-forward (*Paracalmonia*). In some trilobites (*Telephina bicornis*, Fig. 37D) paired glabellar spines are developed. In many forms (Asaphidae, Ceratopygidae), the central area of the glabella bears a small mesial node that usually is located near the occipital furrow.

The paired preoccipital glabellar lobes may become a single preoccipital lobe when the preoccipital furrow becomes transglabellar. In some genera (*Ditomopyge*, Fig. 35A) the preoccipital lobe is longitudinally trisected into a median preoccipital and 2 lateral preoccipital lobes, whereas in others (*Schizoproetus*, Fig. 35B) a pair of small triangular lateral lobes may be developed close to the posterolateral corners of the glabella. These are termed basal glabellar lobes. In the Agnostida (Fig. 35C), which lack a differentiated occipital ring, the basal lobes reach the posterior margin of the cephalon.

OCCIPITAL RING

In most trilobites the rear part of the cephalic axis is differentiated into a distinct

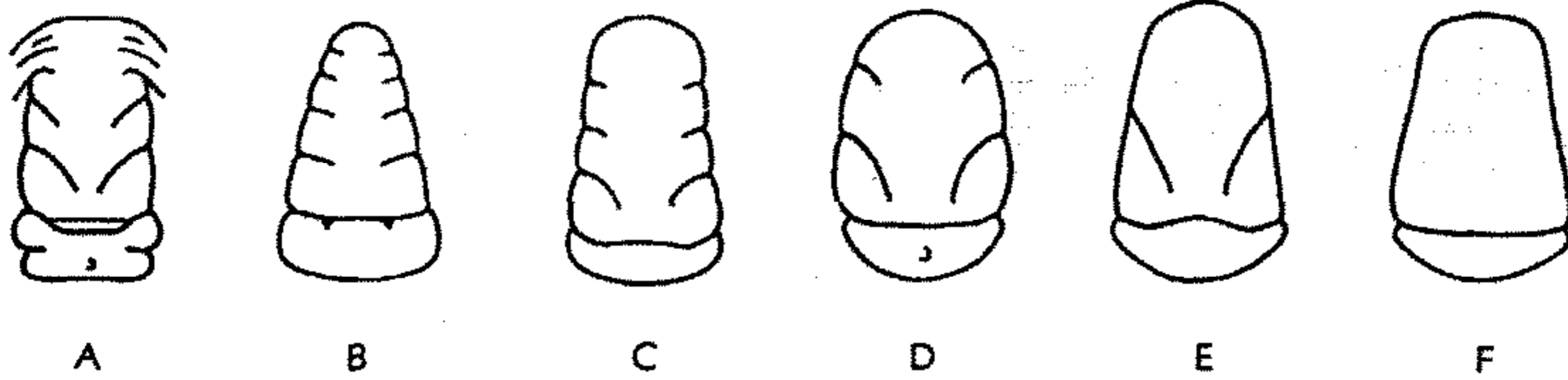

FIG. 33. Glabellar segmentation in different genera, showing decreasing number of lateral glabellar furrows from 5 pairs to none. *A*, *Fallotaspis*; *B*, *Daguinaspis*; *C*, *Latiredlichia*; *D*, *Talbotina*; *E*, *Elrathiella*; *F*, *Plethopeltis*.

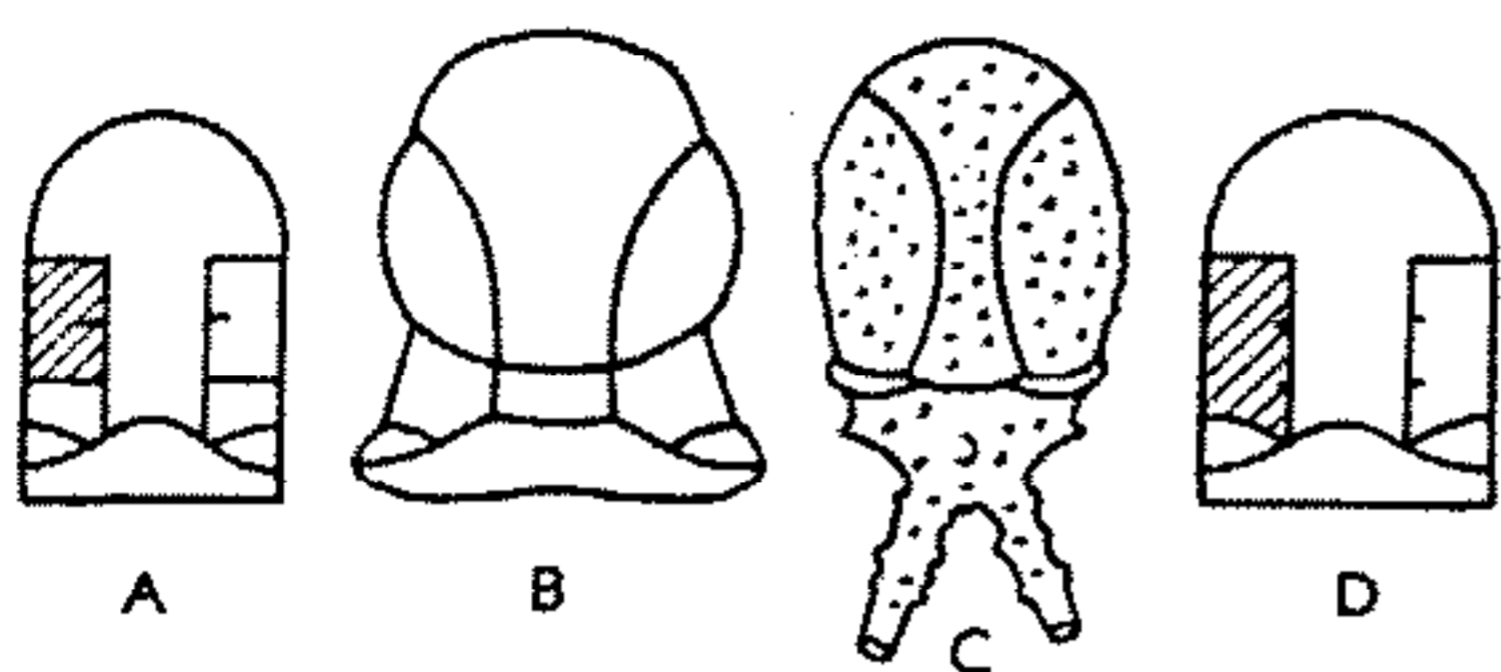

FIG. 34. Composite lateral glabellar lobes in the Lichidae.—*A, B*. Bicomposite lobes (*Dicranopeltis*); shaded area in schematic interpretation (*A*) represents bicomposite lateral lobe resulting from fusion of 1st ($4p$) and 2nd ($3p$) lateral glabellar lobes.—*C, D*. Tricomposite lobes (*Hoplolichas*); shaded area in schematic interpretation (*D*) represents tricomposite lateral lobe resulting from fusion of 1st ($4p$), 2nd ($3p$), and 3rd ($2p$) lateral glabellar lobes.

area called occipital ring, separated from the posterior extremity of the glabella by the occipital furrow. In many species, however, the furrow may be shallow and indistinct, disconnected at the middle or even effaced completely, in which condition (*Illaeidae*, Fig. 27) an occipital ring is not distinguished.

The occipital ring may be smooth or more or less trisected into a middle and 2 side portions (*Hypermeccaspis*). It may carry mesial or paired tubercles or spines and, in some genera (*Pagetia*), the whole ring may be drawn into a stout spine. In *Fallotaspis* (Fig. 45/) and some other forms, the ring may be more or less subdivided into anterior and posterior bands by short lateral intra-occipital furrows directed more or less at right angles to the sagittal line of the cephalon.

FRONTAL AREA

In most Cambrian trilobites and in many later genera, the glabella does not extend

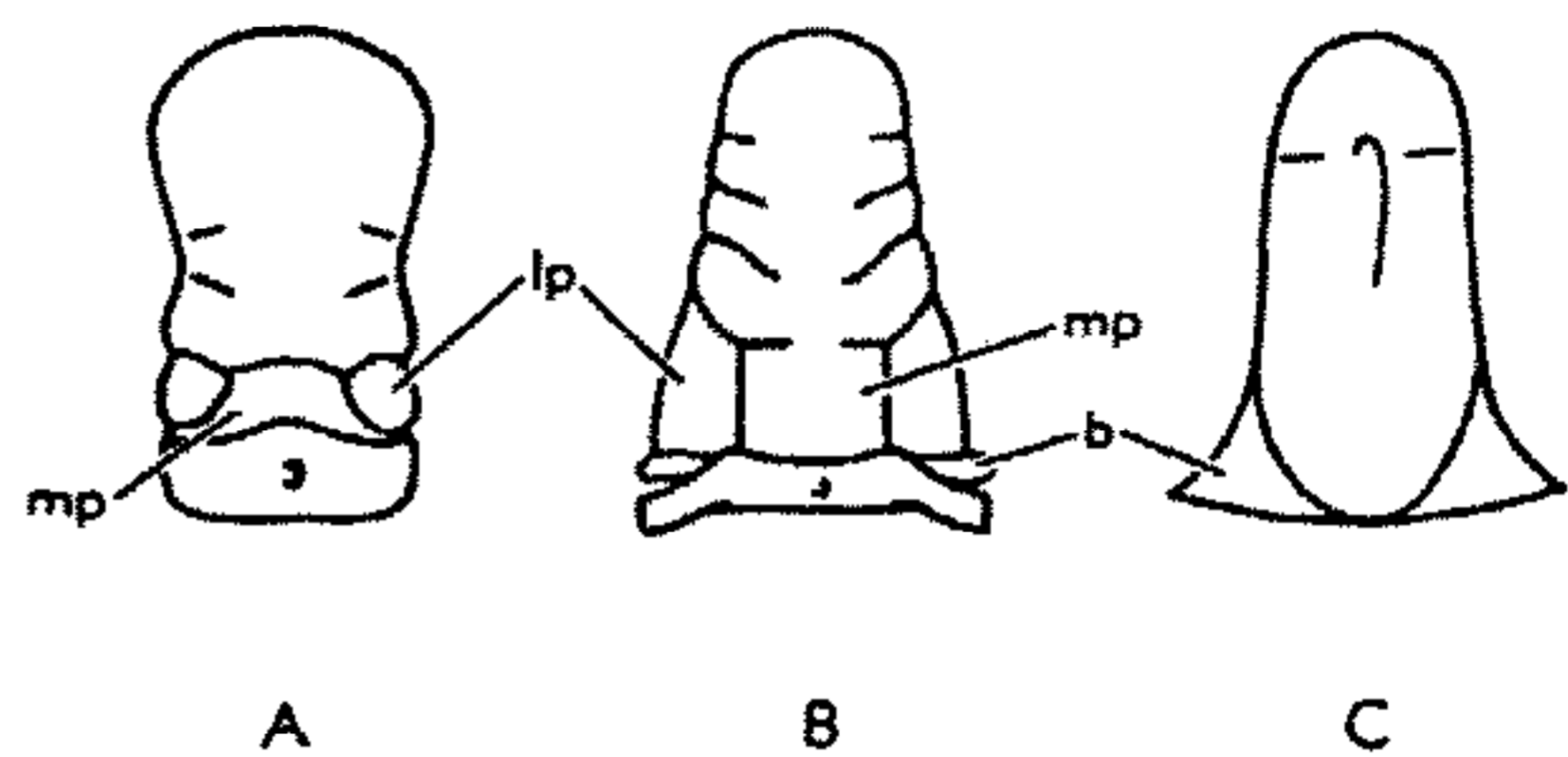

FIG. 35. Preoccipital and basal glabellar lobes. *A*, *Ditomopyge*; *B*, *Schizoproetus*; *C*, *Geragnostus*. (Explanation: *bl*, basal lobes; *mp*, median preoccipital lobes; *lp*, lateral preoccipital lobes).

to the anterior margin of the cephalon but ends in a depressed region called frontal area. The lateral and posterior boundaries of the frontal area are not always easy to define. In most Cambrian trilobites having a comparatively short glabella, submedian to subanterior eyes, and well-developed eye ridges, there is usually no difficulty in delineating the frontal-area boundaries. The area is bounded laterally by anterior sections of the facial sutures and posteriorly by the eye ridges (facial sutures and eye ridges described in subsequent paragraphs), or, if these are absent, by imaginary lines connecting the anterolateral corners of the glabella with the anterior extremities of the raised areas called palpebral lobes. In many other trilobites, particularly in those possessing a long glabella, submedian to posterior eyes, and no eye ridges, the boundaries are difficult to define. In these the frontal area is reduced to the part of the cranidium directly in front of the preglabellar furrow and bounded laterally by imaginary lines parallel to the cephalic axis extending from the anterolateral corners of the glabella to the anterior margin. Sides of the cranidium lying between these imaginary lines and an-

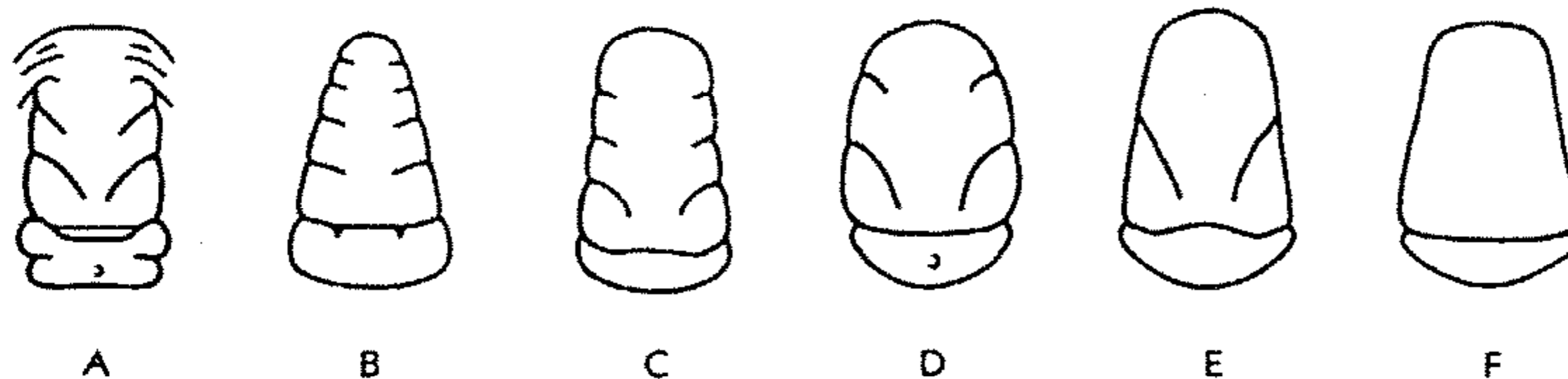

FIG. 33. Glabellar segmentation in different genera, showing decreasing number of lateral glabellar furrows from 5 pairs to none. A, *Fallotaspis*; B, *Daguinaspis*; C, *Latiredlichia*; D, *Talbotina*; E, *Elrathiella*; F, *Plethopeltis*.

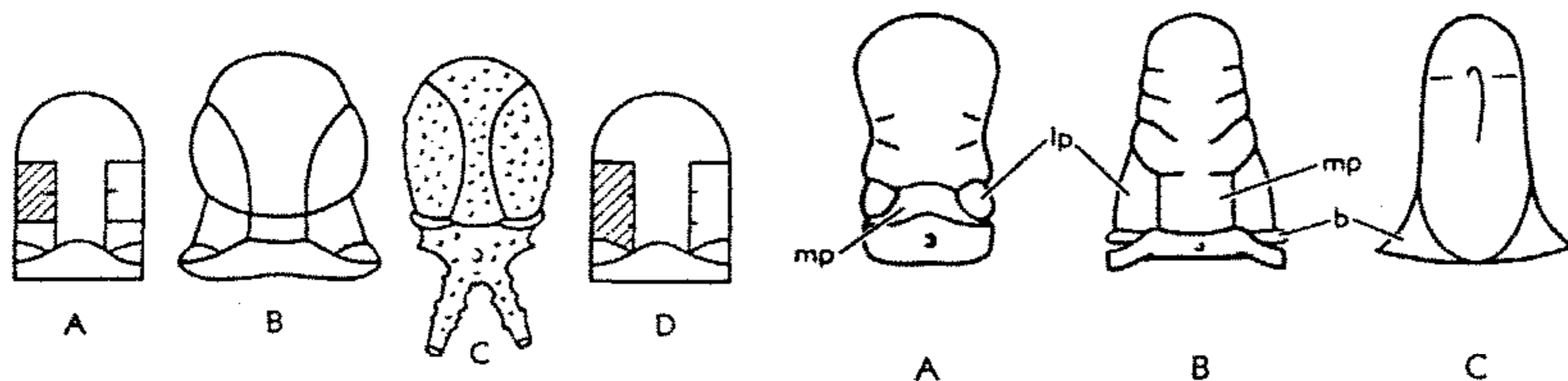

FIG. 34. Composite lateral glabellar lobes in the Lichidae.—A, B. Bicomposite lobes (*Dicranopeltis*): shaded area in schematic interpretation (A) represents bicomposite lateral lobe resulting from fusion of 1st (4p) and 2nd (3p) lateral glabellar lobes.—C, D. Tricomposite lobes (*Hoplolichus*): shaded area in schematic interpretation (D) represents tricomposite lateral lobe resulting from fusion of 1st (4p), 2nd (3p), and 3rd (2p) lateral glabellar lobes.

FIG. 35. Preoccipital and basal glabellar lobes. A, *Ditomopyge*; B, *Schizoproetus*; C, *Geragnostus*. (Explanation: *bl*, basal lobes; *mp*, median preoccipital lobes; *lp*, lateral preoccipital lobes).

area called occipital ring, separated from the posterior extremity of the glabella by the occipital furrow. In many species, however, the furrow may be shallow and indistinct, disconnected at the middle or even effaced completely, in which condition (*Illaenidae*, Fig. 27) an occipital ring is not distinguished.

The occipital ring may be smooth or more or less trisected into a middle and 2 side portions (*Hypermeccaspis*). It may carry mesial or paired tubercles or spines and, in some genera (*Pagetia*), the whole ring may be drawn into a stout spine. In *Fallotaspis* (Fig. 45) and some other forms, the ring may be more or less subdivided into anterior and posterior bands by short lateral intra-occipital furrows directed more or less at right angles to the sagittal line of the cephalon.

FRONTAL AREA

In most Cambrian trilobites and in many later genera, the glabella does not extend

to the anterior margin of the cephalon but ends in a depressed region called frontal area. The lateral and posterior boundaries of the frontal area are not always easy to define. In most Cambrian trilobites having a comparatively short glabella, submedian to subanterior eyes, and well-developed eye ridges, there is usually no difficulty in delineating the frontal-area boundaries. The area is bounded laterally by anterior sections of the facial sutures and posteriorly by the eye ridges (facial sutures and eye ridges described in subsequent paragraphs), or, if these are absent, by imaginary lines connecting the anterolateral corners of the glabella with the anterior extremities of the raised areas called palpebral lobes. In many other trilobites, particularly in those possessing a long glabella, submedian to posterior eyes, and no eye ridges, the boundaries are difficult to define. In these the frontal area is reduced to the part of the cranidium directly in front of the preglabellar furrow and bounded laterally by imaginary lines parallel to the cephalic axis extending from the anterolateral corners of the glabella to the anterior margin. Sides of the cranidium lying between these imaginary lines and an-

terior sections of the facial sutures and situated in front of the anterior extremities of the palpebral lobes must be regarded as parts of the lateral areas of the cranium called *fixigenae*. In trilobites devoid of facial sutures, such as the agnostids and olenellids, the frontal area is also reduced to the cephalic portion lying directly in front of the glabella between the preglabellar furrow and anterior margin.

In trilobites having an anterior border furrow, the frontal area is subdivided into a preglabellar field, between the preglabellar and anterior border furrows, and an anterior cephalic border, between the border furrow and cephalic margin. Typically, the preglabellar field is depressed and flat, but in some genera it may be strongly curved forward-downward, globose, or concave. The width (*sag.*) of the preglabellar field ranges from very wide to quite narrow. In many trilobites it is wholly absent, the preglabellar furrow becoming part of the anterior border furrow.

The preglabellar field may be transected by a mesial longitudinal ridge or furrow. In some genera it is crossed by raised radiating ridges that bifurcate and anastomose more or less irregularly.

The anterior border furrow may bear a row of small pits (*Kainella*, *Angelina*). The anterior cephalic border may be flat and depressed or raised and wirelike. It may be either wider or narrower than the preglabellar field. In some trilobites it is produced into a median process, which may bifurcate or trifurcate, or may be developed as a mesial spine that is actually a projection of both the border and ventral doublure. Also, the border may bear a row of small spines.

FIXIGENAE

In trilobites devoid of facial sutures (agnostids, olenellids) side portions of the cephalon, comprising areas between the glabella and the lateral and posterior cephalic margins, are called *genal regions*. If facial sutures are present, the genal regions are subdivided into *fixigenae* and *librigenae*. The *fixigenae* ("fixed cheeks") are the lateral parts of the cranium lying between the glabella, facial sutures, and posterior cephalic margin. Their anterior boundaries in some forms are rather ill defined.

Three areas may be distinguished in each *fixigena*: (1) anterior, in front of the palpebral lobe; (2) palpebral, between the abaxial edge of the palpebral lobe and the glabella; and (3) posterior, from the palpebral lobe to the posterior margin of the cranium. The posterior areas may be very small and triangular (*Kainella*), long (*tr.*) and narrow (*exsag.*) (*Hungaria*), or wide (*tr.*) and large, as in most trilobites classed as *proparian*. The posterior border of the *fixigenae* is usually differentiated by a posterior border furrow. The posterior border and ventral doublure may be produced at some point between the axial furrows and posterolateral corners of the genae into paired spines termed *metafixigenal*, or into a row of small spines. Spines developed at the posterolateral angles of the cephalon are called *genal spines*.

PALPEBRAL LOBES

The palpebral lobes are lateral extensions of the abaxial edge of the palpebral areas of the *fixigenae* that may rise obliquely or even vertically above the main *fixigenal* surface. Their abaxial margin, separated from the visual surface of the eye by the facial suture, may have semicircular, semielliptical, or crescentic outline. The palpebral lobes may be marked off distinctly from the rest of the *fixigenae* by a palpebral furrow running parallel to the outer edge of the lobe. In many trilobites this furrow is absent, the palpebral lobe grading into the palpebral areas of the *fixigenae* without marked boundary. In a few forms (*Asaphus*, *Encrinurus*) the palpebral lobe of the *fixigenae* and the area beneath the eye (eye platform) of the *librigenae* may form a more or less tubular stalk supporting the visual surface of the eye, which is located near the tip of the peduncle.

EYE RIDGES

The eye ridges are raised, generally narrow bands running across the *fixigenae* from the vicinity of the anterolateral corners of the glabella to anterior extremities of the palpebral lobes. In most trilobites the eye ridges spring from the axial furrows close to the glabella, but in some Cambrian forms (Protolenidae, Daguinaspidae) they are direct extensions of the anterolateral portions

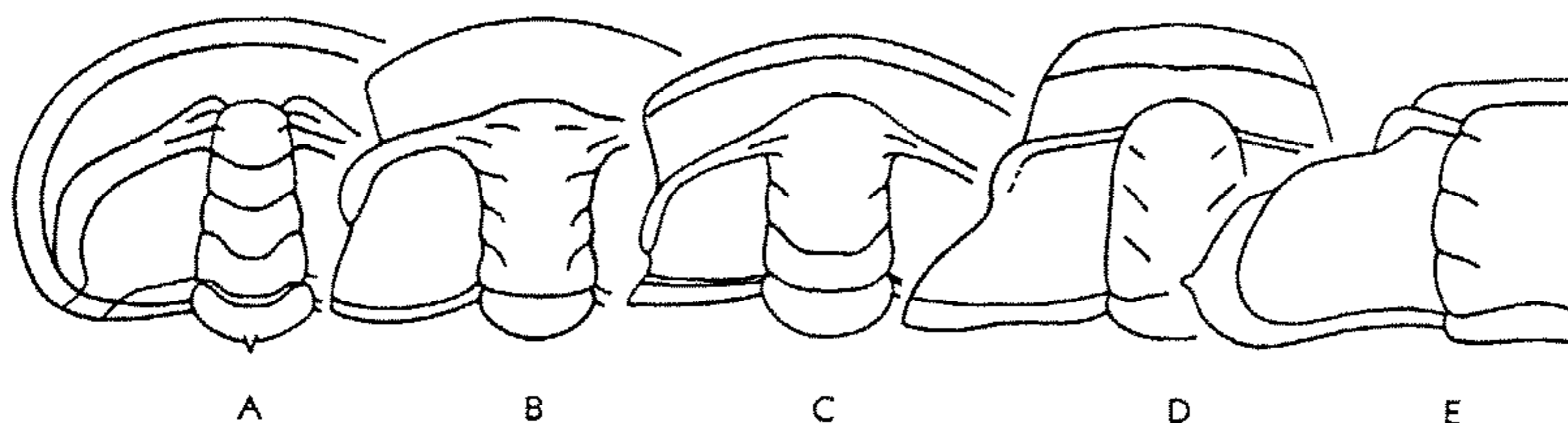

FIG. 36. Different types of eye ridges.—A,B. Trifid; A, *Choubertella spinosa* HUPÉ, L.Cam., Morocco, $\times 1.2$; B, *Kingaspis campbelli* (KING) KOBAYASHI, L.Cam., Morocco, $\times 1.8$ (both after 24).—C. Bifid; *Bigotina bivallata* COBBOLD, L.Cam., Fr.(Normandy), $\times 4$ (after 24).—D. Normal unsegmented ptychopariid type; *Elrathina fecunda* DEISS, M.Cam., USA(Montana), $\times 2.2$ (after 24).—E. Palpebro-ocular ridge; *Rossaspis superciliosa* (ROSS) HARRINGTON, L.Ord., USA(Idaho), $\times 5.3$ (after 49).

of the glabella. In these trilobites, the adaxial extremity of the eye ridges may be divided into two (*Bigotina*, Fig. 36C) or three (*Kingaspis*, *Choubertella*, Fig. 36A,B) segments, which are direct lateral extensions of the frontal glabellar and anterior lateral glabellar lobes. The eye ridges may end at the anterior extremity of the palpebral lobes or continue backward-outward so as to form the whole palpebral lobe or only its raised outer rim. The length and direction of the eye ridges is variable according to size and location of the palpebral lobes and width of the palpebral area of the fixigenae. In some Pliomeridae (*Rossaspis*, Fig. 36E) with anterior eyes and narrow (*tr.*) palpebral areas of the fixigenae, the eye ridges and the palpebral lobes form units termed palpebro-ocular ridges.

LIBRIGENAE

The librigenae ("free cheeks") are paired cephalic areas extending between the facial sutures and lateral margins. They are usually crescentic, but variation in their shape depends mostly on the course of the facial sutures. In some opisthoparian trilobites (*Basiliella*) they are very large, whereas in most proparian genera they are moderately to very small (*Pagetia*). In such genera as *Entomaspis*, *Pteroparia*, and *Loganopeltis*, as well as in the Trinucleidae, the librigenae are almost wholly ventral in position, practically coinciding with the cephalic doublure.

The librigenae carry the visual surface of the eyes, which are usually semielliptical, crescentic, or reniform areas circling the

outer edge of the palpebral lobes. In many trilobites the surface of the librigenae rises more or less abruptly close to these areas, forming a sharp-curved tract or sort of socle (eye platform) at the base of the visual surface of the eye.

CEPHALIC SPINES

Numerous species of trilobites are characterized by cephalic spines. These may spring from the glabella, occipital ring, or genae as projections of the dorsal integument, or from the cephalic margins, as projections of both the dorsal integument and doublure. In many odontopleurids (*Miraspis*, *Ceratocephala*, *Acidaspis*, *Odontopleura*, *Radiaspis*), as well as in some telephinids (*Glaphurus*), there are numerous pairs of marginal cephalic spines produced from the lateral and anterior margins, whereas in some lichids (*Terataspis*) similar spines are found also along the posterior cephalic margin. These spines, which probably had a defensive purpose that was effective during enrollment, are secondary outgrowths having no relation to the primitive cephalic segmentation. Therefore, they have little taxonomic value. Of considerable importance, on the other hand, are the so-called genal spines that characterize many trilobites. These are projections of the border and doublure of the posterolateral extremities of the cephalon, the genal angles, which may be either carried by the librigenae (opisthoparian condition) or carried by the fixigenae (proparian condition). These spines, usually hollow and circular or subtriangular in section, may diverge

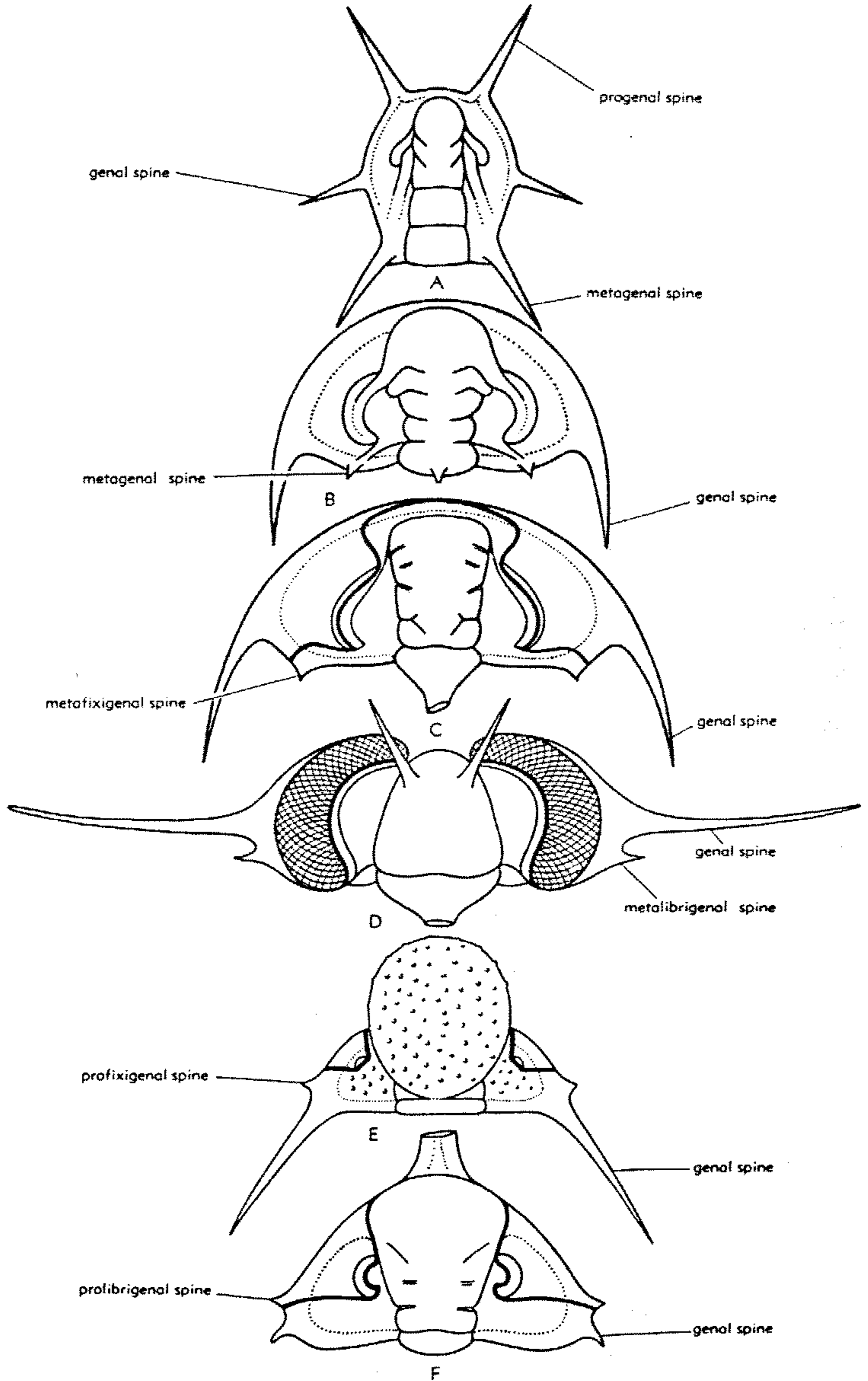

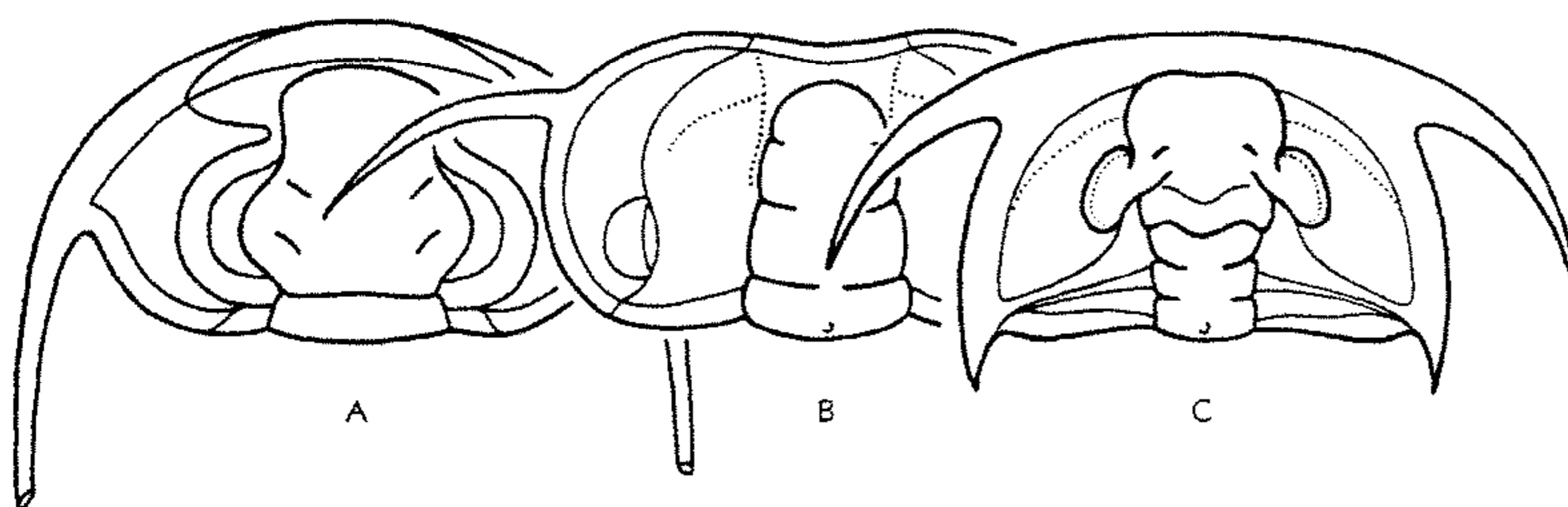

FIG. 38. Advanced cephalic spines.—A. *Menoparia genalunata* ROSS (Remopleurididae), L.Ord., USA (Utah), $\times 7.2$ (after 88, 1952).—B. *Sphaerophthalmus alatus* (BOECK) ANGELIN (Olenidae), U.Cam., Swed., $\times 10$ (after 97, 1923).—C. *Laudonia bispinata* HARRINGTON (Olenellidae), L.Cam., Can.(B.C.), $\times 2.5$ (new).

abruptly sideward from the genal angles or they may extend backward as continuations of the curved cephalic margins.

In addition to the genal spines, some trilobites bear 1 or 2 more pairs of marginal spines springing from the lateral and posterior margins. These spines, which are of considerable importance for taxonomic purposes, may be classified on the basis of their placement with reference to the genal angle and posterior sections of the facial sutures (Fig. 37). Proposed classification of these marginal spines of the cephalon is given in the following table.

Classification of Paired Marginal Spines of Trilobite Cephalata

| | |
|-----------------------------------|----------------|
| Located at genal angles | Genal |
| Located in front of genal angles. | |
| Carried by genal region | |
| (no facial sutures) | Progenal |
| Carried by fixigenae | Profixigenal |
| Carried by librigenae | Prolibrigenal |
| Located behind genal angles. | |
| Carried by genal regions | |
| (no facial sutures) | Metagenal |
| Carried by fixigenae | Metafixigenal |
| Carried by librigenae | Metalibrigenal |

Fixigenal and librigenal spines are appropriate general terms to distinguish paired marginal spines carried by the fixigenae and

librigenae, respectively. It should be pointed out in this connection that the metagenal and metafixigenal spines often have been referred to in literature on trilobites as intergenal spines. The term "intergenal," as applied to these spines, is a confusing misnomer, because the only spines carried "between the genae" very evidently are those borne by the occipital ring or glabella.

Typically, the genal spines spring from the posterolateral angles of the cephalon, but in some trilobites these and other marginal spines show a marked tendency to occupy a forward position. This tendency is already present in the Lower Cambrian Olenellidae. In such genera as *Laudonia* (Fig. 38C) what appear to be the genal spines actually are metagenal spines that have migrated outward, the true genal spines being located far forward. This tendency appeared independently in many other families, such as the Redlichiidae, Neoredlichiidae, Saukiandidae, Paradoxididae, Zacanthoididae, Damesellidae, Olenidae, Remopleurididae, Telephinidae, Lichidae, and Harpidae (Fig. 38).

DOUBLURE

The cephalic exoskeleton is continued on to the ventral side as a reflected rim or

(See facing page)

FIG. 37. Nomenclature of paired cephalic spines.—A. *Olenelloides armatus* PEACH, L.Cam., Scotland, $\times 10$ (after 83, 1894).—B. *Holmia kjerulfi* (LINNARSSON) MARCOU, L.Cam., Swed., $\times 1.5$ (after 78, 1887).—C. *Zacanthoides romingeri* RESSER, M.Cam., Can.(B.C.), $\times 1$ (after 84, new).—D. *Telephina bicornis* (ULRICH), M.Ord., USA (Virginia), $\times 2.9$ (after 94, 1930).—E. *Sphaerocoryphe* cf. *granulatus* (ANGELIN), Ord., Estonia, $\times 3$ (after 24).—F. *Paracalmonia cuspidata* (CLARKE), L.Dev., S.Am.(Brazil), $\times 0.75$ (after 73, 1913).

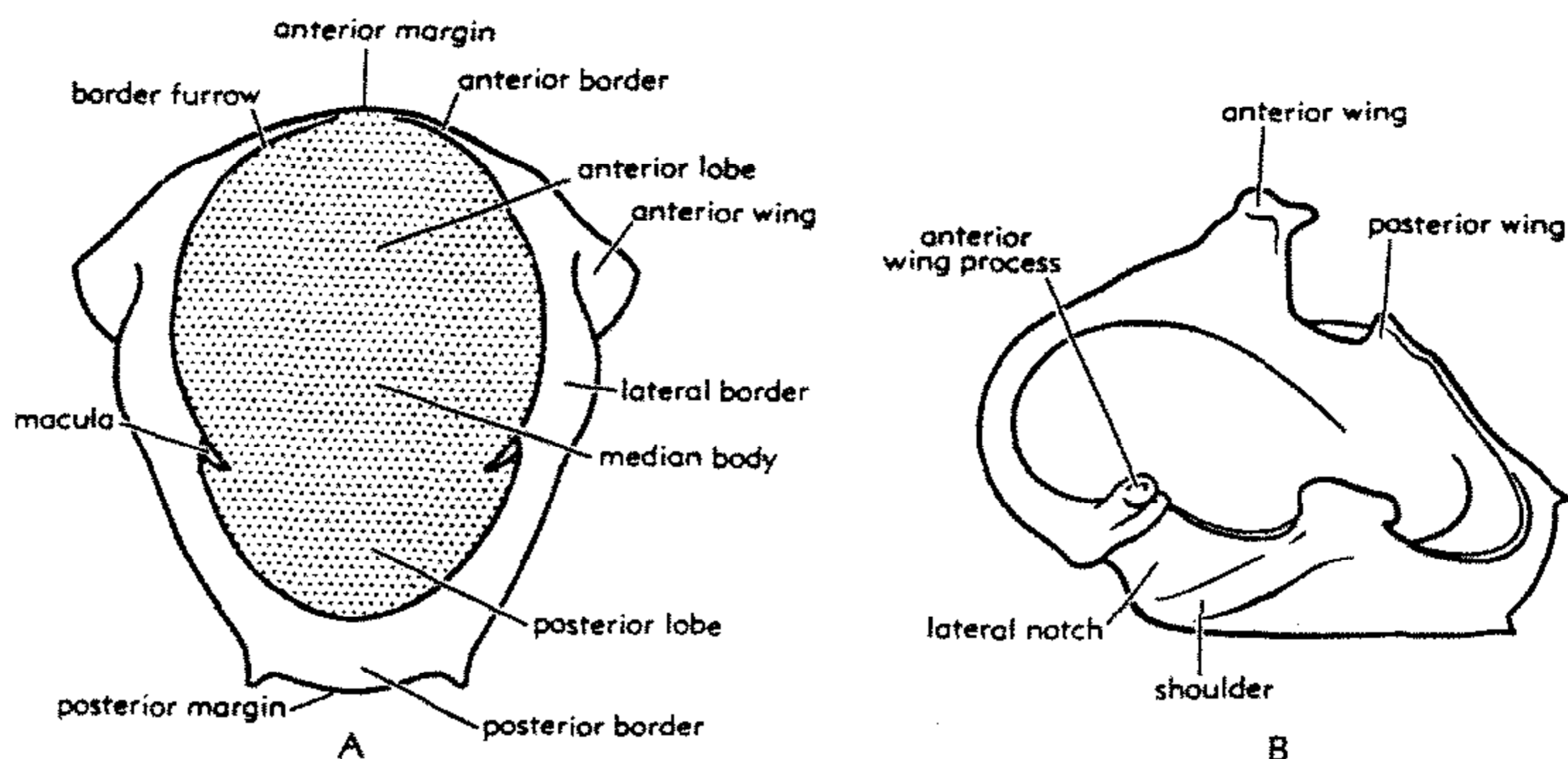

FIG. 39. Nomenclature of hypostoma, illustrated by *Ceraurina typa* B.N. COOPER, M.Ord., USA (Virginia), $\times 5$. A, Exterior view; B, oblique interior view (after 71).

doublure of variable width (Figs. 43,48). The doublure is usually marked by terrace lines, which run subparallel to the margins of the cephalon, being arranged in a Bertillon pattern. The soft ventral membrane was attached to the inner edge of the doublure.

ROSTRAL PLATE

In addition to the doublure, 3 sternites may be present on the ventral side of the cephalic region. The most anterior of these is the rostral plate, which may be separated from the doublure by a transverse rostral suture and by paired longitudinal connective sutures. The other sternites are named hypostoma and metastoma.

The rostral plate may be a large crescentic plate extending from the vicinity of one genal angle to the other, as in Olenellidae (Fig. 48B-D); a moderately wide (*tr.*) and short (*sag.*) plate, as in most ptychopariids (Fig. 48E); a small, narrow (*tr.*) band, as in many Pliomeridae; or a small subtriangular plate, as in the Homalonotidae (Fig. 48H). In the last-mentioned family, the rostral plate is partly dorsal in position. In progressive trilobites (Asaphidae, Nileidae, Phacopidae), a rostral plate is absent.

HYPOSTOMA

The 2nd sternite, called the hypostoma, covers the mouth region. Typically, it has a general ovoid outline (Figs. 39-41), consisting of a median body convex adventrally, and a surrounding flat, convex, or concave border that is bent into a dorsal doublure. The median body may be subdivided by a more or less distinct median furrow into a larger, more convex anterior lobe and a smaller, flatter posterior lobe. Also, the median body may bear a pair of varyingly elongated protuberances, termed maculae, usually located near the abaxial extremities of the median furrow.

The hypostomal border, subdivided into anterior, lateral, and posterior parts, is usually separated from the median body by a shallow border furrow. The anterior border is narrow mesially, widening laterally into a pair of anterior wings, each of which may carry a rounded boss or thornlike structure (wing process), located on the interior (dorsal) surface near their abaxial tips. A corresponding pit is located on the exterior (ventral) surface of the wings. The anterior wings are separated from the lateral borders

(See facing page)

FIG. 40. Different views of the hypostoma of *Ceraurina typa* COOPER, M.Ord., USA (Virginia) (after 71). A, B, Exterior ventral and oblique view; C-E, posterior, anterior, and lateral views; F, G, interior dorsal and oblique view; H, cranium and hypostoma mounted in approximate relative natural position, oblique ventral view (A-G, $\times 6.7$; H, $\times 5.8$).

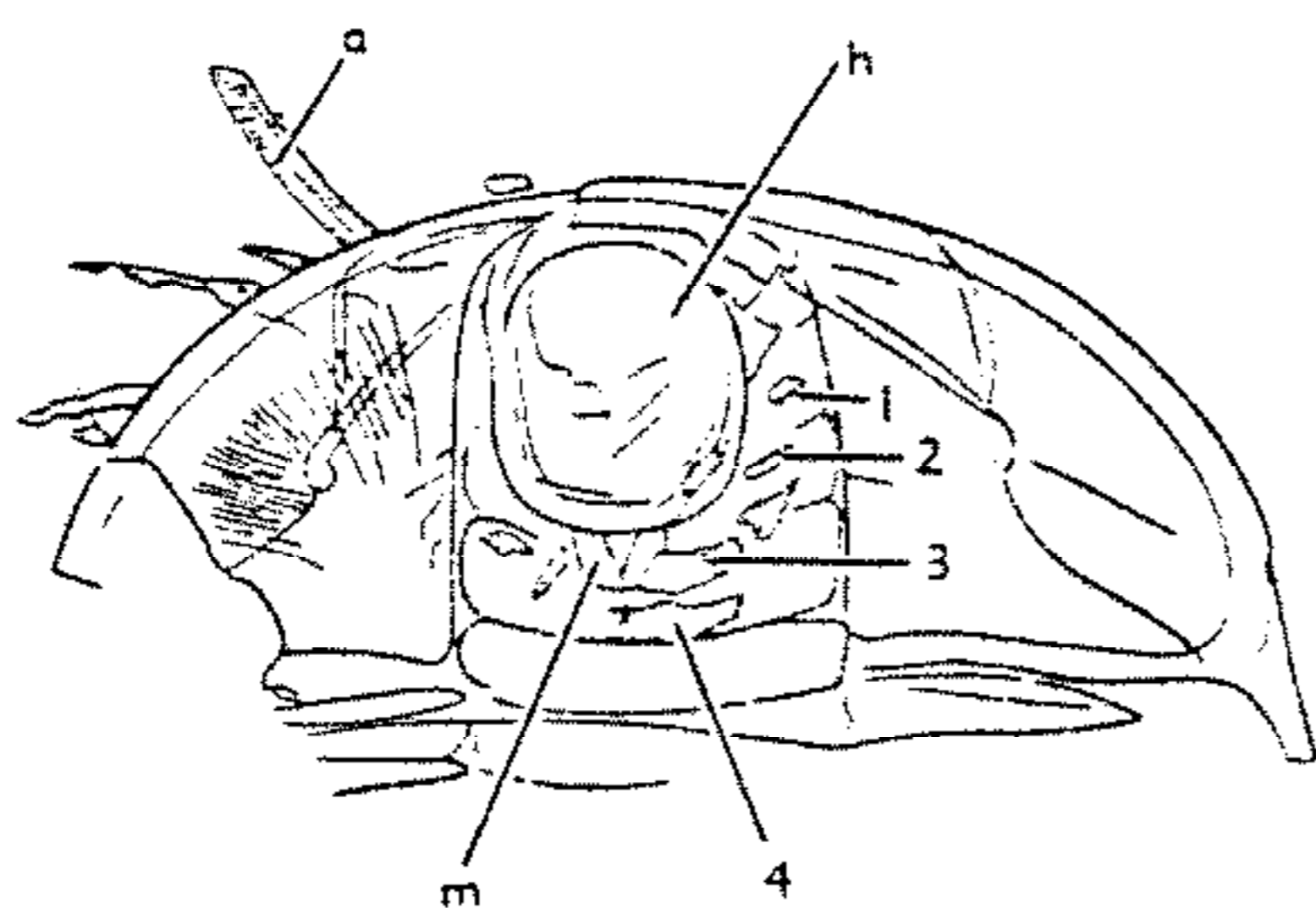

FIG. 41. Cephalic region of *Olenoides serratus* (ROMINGER) KOBAYASHI, M.Cam., Can.(B.C.), $\times 1$ (after 60) (Explanation: *h*, hypostoma; *m*, metastoma; *a*, antenna; 1-4, ?fragments of the 4 biramous cephalic appendages).

by deep lateral notches. Immediately behind the notches, the lateral border usually reaches maximum width in a somewhat inflated area (shoulder) that projects ventrally. Behind the shoulder, the doublure of the lateral border may be projected into a pair of posterior wings. These are extensions of the doublure and not parts of the border. The notches have been interpreted (WHITTINGTON & EVITT, 1953) as passageways for the forwardly directed antennae of the trilobites, and the ventral bosses on the

tips of the anterior wings are thought to be places of attachment of the antennary muscles.

The posterior border of the hypostoma may be very wide (*Kanoshia*, Fig. 42,33), or narrow (*Nileus*, Fig. 42,17), and the corresponding posterior margin may be evenly rounded (*Callavia*, *Scutellum*, Fig. 42,18), pointed (*Pseudocybele*, Fig. 42,31), or serrated (*Fremontella*, Fig. 42,4). The lateral margins may grade into the posterior margin in an uninterrupted curve (*Dalmanitina*, Fig. 42,38), or the posterolateral angles of the hypostoma may be produced into a pair of spinelike projections (*Hypodicranotus*, Fig. 43D; *Asaphus*, Fig. 42,14). In the first case the hypostoma is said to be "entire" or to have an "entire posterior margin," whereas in the second it is said to be "bifurcated" or to have a "bifurcated posterior margin."

Hypostomas have been described in less than a third of known species of trilobites. In most they are detached plates found associated with other parts of a given species. Only in comparatively few fossils has the hypostoma been found *in situ*, preserving its original relation to other cephalic parts. The study of these specimens shows that 3 different types of hypostomal attachment existed among trilobites: (1) fused with the

FIG. 42. Different shapes of hypostomata.—1. *Callavia broeggeri* (WALCOTT) MATTHEW (Olenellidae), L.Cam., Can., $\times 1$ (after 64).—2. *Olenellus thompsoni* (HALL) HALL (Olenellidae), L.Cam., USA (Tenn.), $\times 2.8$ (after 64).—3. *Wanneria walcottana* (WANNER) WALCOTT (Olenellidae), L.Cam., USA (Pa.), $\times 1$ (after 64).—4. *Fremontella halli* (WALCOTT) HARRINGTON (Olenellidae), L.Cam., USA (Ala.), $\times 12$ (after 64).—5. *Paradoxides oelandicus* ANGELIN (Paradoxididae), M.Cam., Swed., $\times 3$ (after 31).—6. *Paradoxides harlani* GREEN (Paradoxididae), M.Cam., USA (Mass.), $\times 1.2$ (after 91, 1944).—7. *Strenuaveva primaeva* (BRÖGGER) KIAER, L.Cam., Norway, $\times 10.7$ (after 28).—8. *Kootenia lakei* (COBBOLD) (Dorypygidae), M.Cam., Eng., $\times 2.5$ (after 30, 1938).—9. *Mexicaspis stenopyge* LOCHMAN (Zacanthoididae), M.Cam., Mexico, $\times 4$ (after 81, 1948).—10. *Dikelocephalus minnesotensis* OWEN (Dikelocephalidae), U.Cam., USA, $\times 1.1$ (after 95, 1930).—11. *Damesella blackwelderi* WALCOTT, (Damesellidae), M.Cam., China, $\times 1.1$ (after 96, 1913).—12. *Saukiella indenta* ULRICH & RESSER (Saukiidae), U.Cam., USA (Wis.), $\times 2.8$ (after 95, 1930).—13. *Parabolina jemilandica* WESTERGÅRD (Olenidae), U.Cam., Swed., $\times 5$ (after 97, 1922).—14. *Asaphus* (*Neosaphus*) *ludibundus* TÖRNQUIST (Asaphidae), M.Ord., Swed., $\times 1.65$ (after 79, 1953).—15. *Megistaspis* (*Megistaspis*) cf. *elongata* (SCHMIDT) JAANUSSON (Asaphidae), M.Ord., Estonia, $\times 1.9$ (after 31).—16. *Asaphellus homfrayi* (SALTER) CALLAWAY (Asaphidae), L.Ord. (Tremadoc.), Eng., $\times 1.22$ (after 30, 1942).—17. *Nileus armadillo* DALMAN (Nileidae), Ord., Swed., $\times 3$ (after 31).—18. *Scutellum polyactin* (ANGELIN) (Thysanopeltidae), U.Sil., Swed., $\times 2.8$ (after 31).—19. *Eobronteus lunatus* (BILLINGS) WILSON (Thysanopeltidae), M.Ord., Can., $\times 3$ (after 92, 1949).—20. *Platillaenus ladogensis* (HOLM) JAANUSSON (Illaenidae), L.Ord., Swed., $\times 2.3$ (after 31).—21. *Illaenus sarsi* JAANUSSON (Illaenidae), Ord., Norway, $\times 1.75$ (after 79, 1954).—22. *Stenopareia linnarssoni* (HOLM) HOLM (Illaenidae), M.Ord., Swed., $\times 2.5$ (after 79, 1954).—23. *Proetus signatus* LINDSTRÖM (Proetidae), Sib., Swed., $\times 4$ (after 31).—24. *Proetus* (*Proetus*) *concinus* (DALMAN) (Proetidae), Sib., Swed., $\times 4$ (after 87, new).—25. *Paladin* (*Paladin*) *helmiensis* WHITTINGTON (Phillipsiidae), U.Miss., USA (Tex.), $\times 5.6$ (after 99, 1954).—26. *Lioharpes venulosus* (HAWLE & CORDA) (Harpidae), L.Dev., Bohemia, $\times 1.85$ (after 99, 1950).—27. *Eoharpes primus* (BARRANDE) RAYMOND (Harpidae), L.Ord., Bohemia, $\times 3.4$ (after 99, 1950).—28. *Cryptolithus tessellatus* GREEN (Trinucleidae), M.Ord., USA (N.Y.), $\times 10.5$ (after 41).—29. *Ampyx linleyensis* WHITTARD (Raphiophoridae), L.Ord., Eng., $\times 3.35$ (after 98, 1955).—30. *Cheirurus insignis* BEYRICH (Cheiruridae),

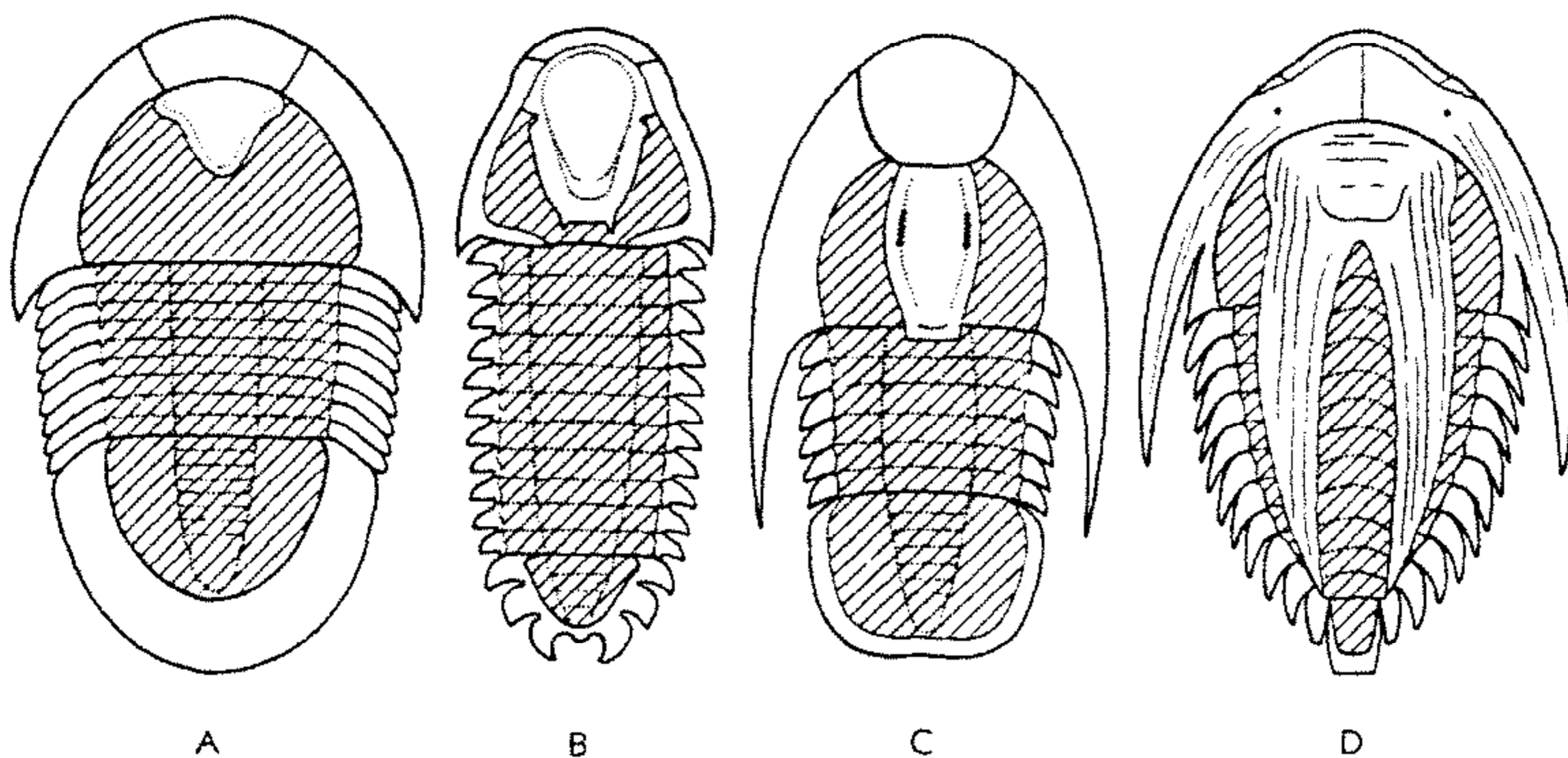

FIG. 43. Relative lengths of hypostomata in different genera, shown by carapaces and hypostomata in ventral view, with doublure, rostral plate, and hypostoma in white, and ventral (internal) surface of carapace shaded.—A. *Stygina latifrons* PORTLOCK (Styginidae), U.Ord., Ireland, $\times 1.7$ (after 99, new).—B. *Cheirurus gibbus* BARRANDE (Cheiruridae), Sil., Bohemia, $\times 0.65$ (after 2).—C. *Phillipsinella parabola* (BARRANDE) NOVÁK (Phillipsinellidae), U.Ord., Scot., $\times 4$ (after 99, 1950).—D. *Hypodicranotus striatulus* (WALCOTT) WHITTINGTON (Remopleurididae), U.Ord., USA(N.Y.), $\times 1.6$ (after 99, 1952).

rostral plate, forming a single "rostral-hypostomal plate" (Fig. 44); (2) attached to the rostral plate or anterior cephalic doublure (if rostral plate was lacking) by means of a hypostomal suture that could be either functional or in a state of complete or partial symphysis; and (3) attached to the rostral plate or anterior cephalic doublure by a stalk or peduncle. In some trilobites the hypostoma was "free," not attached by any plate to the cephalon, but supported by the soft ventral membrane.

No hypostomas have been found associated with any agnostid and only in *Pagetia* among eodiscid trilobites. RASETTI has mentioned that in enrolled silicified specimens of agnostids, no hypostoma is to be found inside the tightly closed "box" formed by the enrolled specimen. The absence of a hypostoma, however, may be due to the fact that the plate was not mineralized in the agnostids and, therefore, not preserved. In the Eodiscidae, the apparent lack of hypostomas probably is due to faulty records. Judging by the close relationship between Eodiscidae and Pagetiidae, it is only natural to suppose that the Eodiscidae possessed a small hypostoma, just as in the Pagetiidae.

METASTOMA

The 3rd sternite is postoral in position. It consists of a very small concave plate that seems to have been supported by the ventral membrane immediately behind the mouth. The metastoma is known only in a few genera, notably *Olenoides* (Fig. 41), *Triarthrus*, and *Phacops* (Fig. 57B).

SUTURES

Trilobites are typically distinguished by the presence of cephalic sutures. These are very narrow, almost lineal bands where the exoskeleton remained soft and uncalcified. They transect the mineralized integument of the cephalon and its ventral doublure. Typically, the sutures were lines of weakness along which the cephalic exoskeleton could break apart into isolated pieces at times of molting (ecdysis). Cephalic sutures are wholly lacking in some trilobites, particularly the agnostids and eodiscids, and in many others they are in such a state of partial or complete symphysis that obviously they could not have functioned in ecdysis.

FACIAL SUTURES

The name facial suture (*sutura facialis*) was introduced by DALMAN (1827) for the

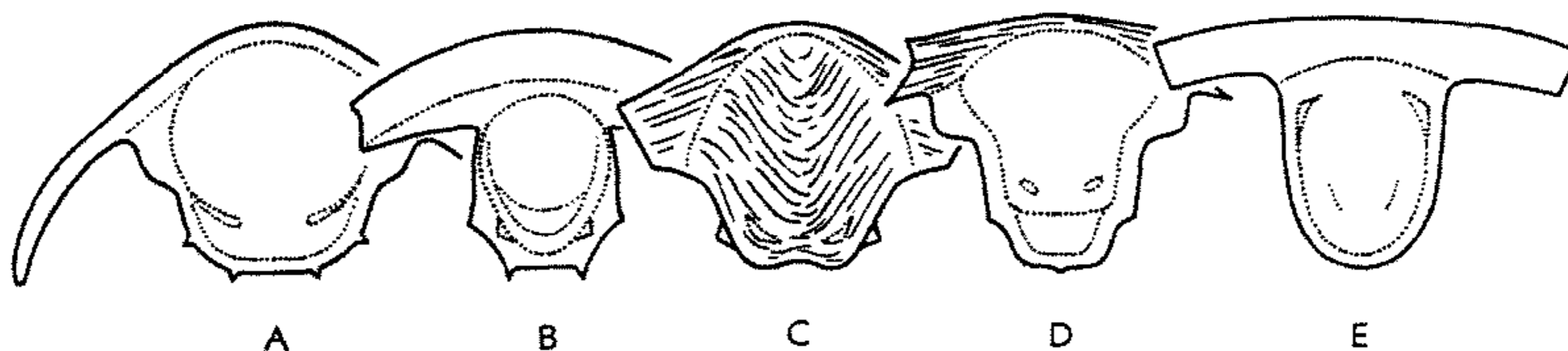

FIG. 44. Rostral-hypostomal plate resulting from ankylosis of hypostomal suture.—A. *Holmia kjerulfi* (LINNARSSON) MARCOU (Olenellidae), L.Cam., Norway, $\times 0.4$ (after 28).—B. *Redlichia noetlingi* (REDLICH) COSSMAN (Redlichiidae), L.Cam., W.Pakistan, $\times 2.7$ (after 90, 1955).—C. *Paradoxides davidis* SALTER (Paradoxididae), M.Cam., G.Brit., $\times 2.65$ (after 30, 1935).—D. *Fieldaspis furcata* RASETTI (Zacanthoididae), M.Cam., Can., $\times 3$ (after 84, new).—E. *Oryctocephalus walcotti* RESSER (Oryctocephalidae), M.Cam., USA (Idaho), $\times 6.65$ (after 39).

most conspicuous and typical of all cephalic sutures. They appear as a pair of fine impressed lines that start symmetrically on the posterior or lateral doublure, cross the cephalic border, and take symmetrical courses along the dorsal surface of the cephalon bounding the adaxial side of the visual surface of the eyes; thence they continue forward to unite anteriorly on the dorsal side, along the margin, or on the ventral side (doublure) of the cephalon. If the sutures meet anteriorly on the dorsal side, they are said to be dorsal-intramarginal anteriorly. If they meet along the margin, the sutures are described as marginal anteriorly. If they meet along the ventral side, the sutures are ventral-intramarginal anteriorly. So far as known, the pairs of facial sutures invariably meet anteriorly. RESSER's unpublished reference, mentioned by RICHTER (1933) and STUBBLEFIELD (1936), of a type of facial sutures in which individuals of the pair extend onto the anterior doublure without connection between them has not been substantiated. RASETTI (1952) pointed out that this condition may exist in the Pagetiidae, but it seems likely that even in these trilobites the anterior parts of the facial sutures were connected by a transverse marginal suture.

Each of the symmetrical pair of facial sutures is subdivided for descriptive purposes into an anterior section (incorrectly called "anterior branch"), extending from the anterior margin to the eye, and a posterior section ("posterior branch"), extending from the eye to the posterior or lateral margins. Facial sutures are classed as opisthoparian, proparian, and gonatoparian, ac-

ording to whether the posterior sections intersect the posterior margin, lateral margin, or genal angle of the cephalon. In opisthoparian sutures the posterior sections cut the posterior cephalic margins in a manner that makes the genal angles or spines carried by the librigenae. In proparian sutures, the posterior sections cut the lateral cephalic margins in front of the genal angles, which, therefore, are carried by the fixigenae. In gonatoparian sutures, the posterior sections of the facial sutures bisect the genal angles.

The course of both the anterior and posterior sections of the facial sutures shows considerable variation in different genera of trilobites. The anterior sections may diverge in forward direction (*Ptychoparia*, Fig. 45E), run subparallel (*Odontochile*, Fig. 45C), converge (*Flexicalymene*, Fig. 45D), or be retrodivergent (directed outward-backward, as in *Entomaspis*, Fig. 45I). The posterior sections may vary from very short, directed outward-backward, cutting the posterior margin very close to the occipital ring (*Kainella*, Fig. 45F), to long, directed outward-forward, cutting the lateral margin well in front of the genal angles (*Burlingia*, Fig. 45B).

No attempt has been made to classify all possible variations of the facial sutures, but certain recurrent patterns found in different trilobites have received special names. Only 2 types of proparian sutures deserve such designations. (1) One of these is the burlingiiform type, in which the anterior and posterior sections of the sutures are subparallel, diverging outward-forward at an angle of about 45° to the axial line of the cephalon (*Burlingia*, Fig. 45B). (2) The

other is the dalmanitiform type, in which the anterior sections of the sutures meet on the dorsal side of the cephalon, being wholly dorsal-intramarginal (*Odontochile*, Fig. 45C).

Several types of opisthoparian sutures have received special names. (3) The term cedariiform (or pseudoproparian) is applied

to the type in which the posterior sections of the sutures swing behind the eyes so as to intersect the adaxial portions of the lateral borders and thence swing inward-backward to the posterior margin of the cephalon (*Cedaria*, Fig. 45G). When the librigenae of species possessing cedariiform sutures are not preserved, it is often difficult to dis-

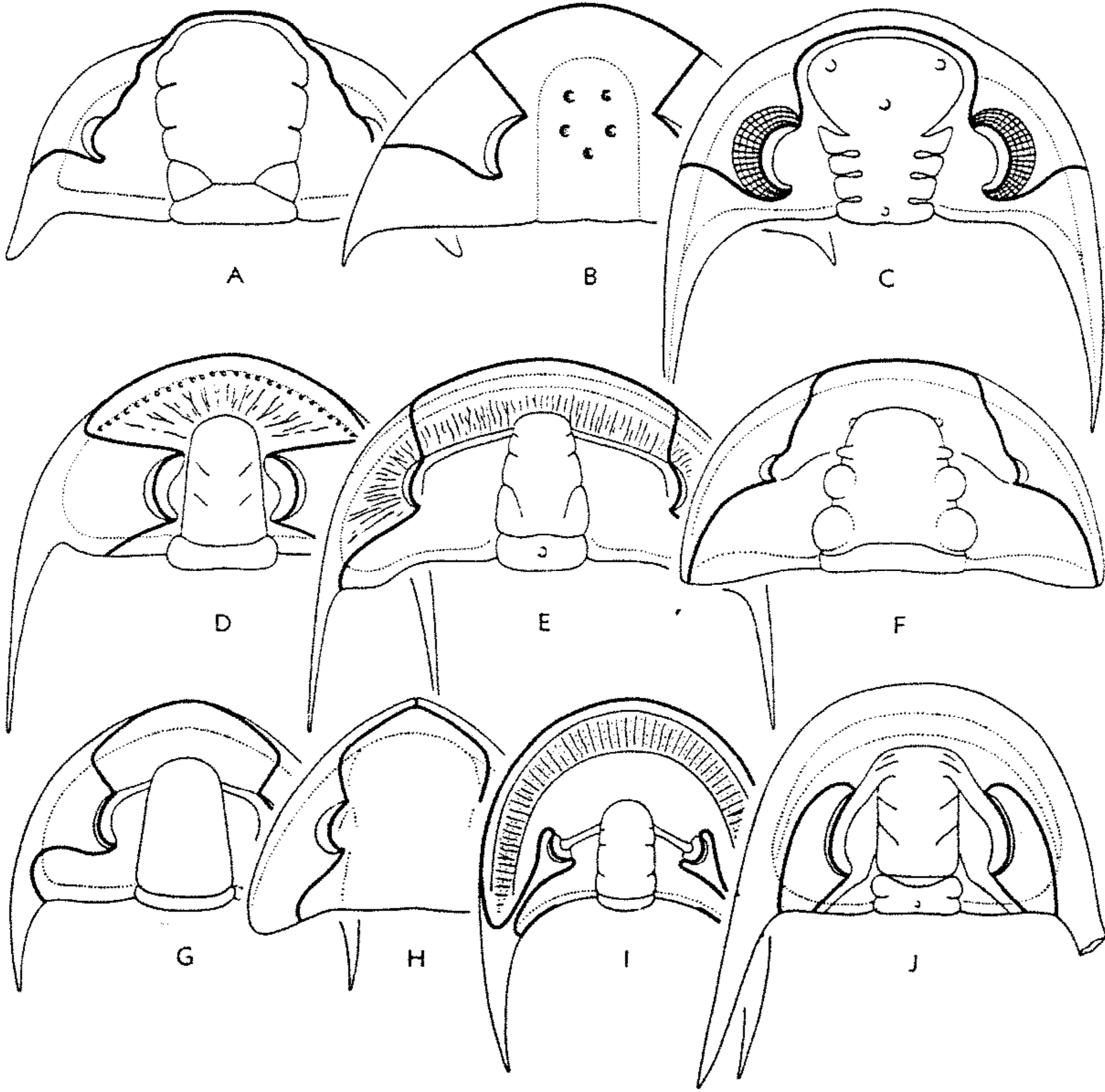

FIG. 45. Types of facial sutures.—A-C. Proparian sutures; A, cheirurid type, *Ceraurinella typa* B. N. COOPER, M.Ord., USA (Virginia), $\times 3.5$ (after 71); B, burlingiiform type, *Burlingia hectori* WALCOTT, M. Cam., Can., $\times 9.3$ (after 96, 1908); C, dalmanitiform type, *Odontochile hausmanni* (BRONGNIART) HAWLE & CORDA, Dev., Boh., $\times 1$ (after 2).—F. Gonatoparian suture; *Flexicalymene senaria* (CONRAD) WHITTINGTON, M.Ord., USA (N.Y.), $\times 3.5$ (after 70).—D, E, G-I. Opisthoparian sutures; D, kainelliform type, *Kainella meridionalis* KOBAYASHI, L.Ord., S. Am. (Arg.), $\times 0.73$ (after 19); E, ptychopariid type, *Ptychoparia striata* (EMMRICH) HAWLE & CORDA, L.Ord., Boh., $\times 1$ (after 2); G, cedariiform type, *Cedaria prolifica* WALCOTT, U. Cam., USA (Ala.), $\times 1.6$ (after 81, 1948); H, isoteliform type, *Isotelus gigas* DEKAY, M.Ord., Can., $\times 1.2$ (after 84, 1912); I, entomaspidiform type, *Entomaspis radiatus* ULRICH, U. Cam., USA (Mo.), $\times 5.6$ (after 48, 1952).—J. Metaparian sutures; *Fallotaspis taxemmourtsensis* HUPÉ, L. Cam., Afr. (Morocco), $\times 1.33$ (after 24).

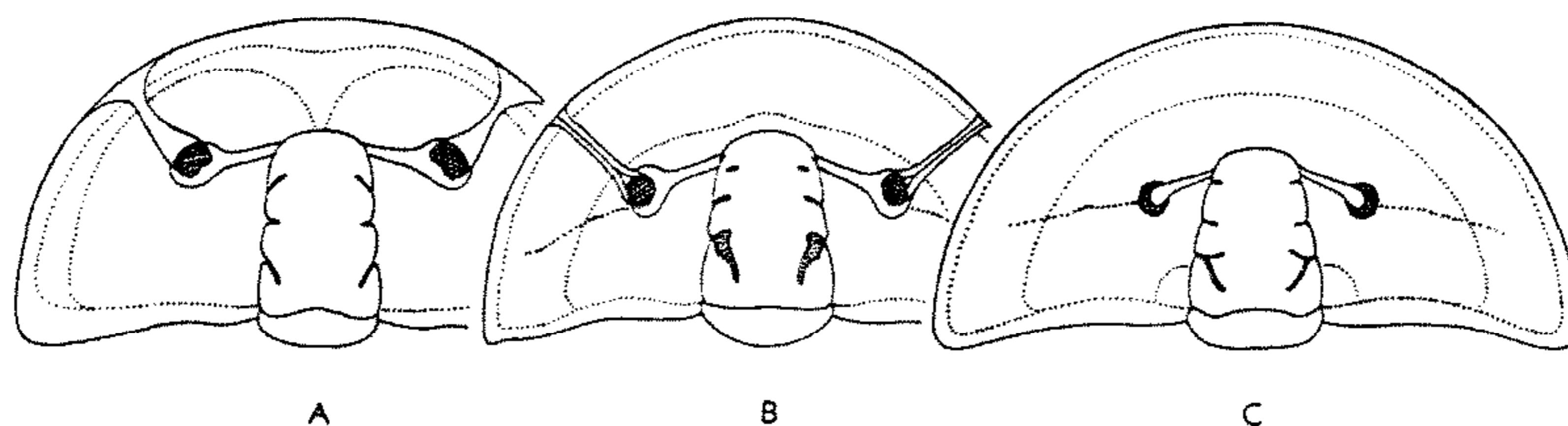

FIG. 46. Evolution of the facial sutures in the Loganopeltid stock of the Harpididae.—A. *Loganopeltoides kindlei* RASETTI, U.Cam., Can. (Newf.), $\times 5.4$.—B. *Loganopeltoides zenkeri* (BILLINGS) RASETTI, U.Cam., Can.(Que.), $\times 4.65$.—C. *Loganopeltis depressa* RASETTI, L.Ord., Can.(Que.), $\times 3.3$ (All after 38).

tinguish this kind of opisthoparian sutures from the true proparian type. (4) In the ptychopariiform type, anterior sections of the facial sutures have a more or less straight course from the eyes to the anterior margin of the cephalon, where adaxially they become marginal or ventral-intramarginal to the mid-line (*Ptychoparia*, Fig. 45E). (5) In the kainelliform type the anterior sections first diverge strongly in front of the eyes and then bend sharply inward-forward, cutting very obliquely the anterior border of the cephalon and meeting mesially either on the dorsal side or marginally (*Kainella*, Fig. 45F). (6) The terms isoteliform and niobiform formerly were used to distinguish 2 supposedly different types of opisthoparian sutures within the family Asaphidae. In isoteliform sutures the anterior sections meet in a more or less pointed ogive at the mid-point of the anterior margin of the cephalon and are, therefore, wholly dorsal-intramarginal (*Isotelus*, Fig. 45H). Niobiform sutures were regarded as being marginal anteriorly, that is, with anterior sections along the margin for a certain length. This type of sutures was believed to characterize the genus *Niobe* (hence niobiform), but LAKE (1942) was able to prove that in this genus the anterior suture sections are wholly dorsal-intramarginal even if they run very close to the cephalic margin. Clearly, then, the term niobiform is inappropriate. (7) Lastly, the name entomaspidiform may be applied to the peculiar type of opisthoparian sutures in which the anterior sections are retrodivergent, running outward-backward from the eyes to the lateral margins (*Entomaspis*, Fig. 45I). In such genera as *Entomaspis* and *Hypothetica*, the anterior sections of the

sutures reach the lateral cephalic margins just in front of the genal spines and then run marginally to the anterior mid-point of the cephalon. In these genera, the librigenae are reduced mostly to the ventral side (doublure), with a narrow dorsal extension between the eyes and the posterolateral areas of the cephalon.

In some genera of trilobites belonging to families in which the presence of well-developed facial sutures is the general rule, the sutures may become ankylosed and non-functional, and eventually traces of them may disappear entirely. This is frequently the case with blind trilobites, but many genera characterized by normal eyes also show this "regression" which, as in some Conocoryphidae and Proetidae, clearly preceded the reduction and final disappearance of the eyes.

The disappearance of facial sutures is accomplished in 2 different ways: (1) by migration of the anterior and posterior sections preceding ankylosis, and (2) by direct ankylosis without previous migration of the sections. The 1st mode is excellently illustrated in the Harpididae. RASETTI (1945, 1948) has shown that in *Loganopeltoides kindlei* (Fig. 46A) and *L. minutus*, from the Upper Cambrian of Newfoundland and Quebec, respectively, the sutures are burlingiiform, the anterior and posterior sections running outward-forward, initially approaching each other but not coming together, then diverging slightly and curving near the lateral margins to become marginal, the anterior section running forward in the mid-line and the posterior section running backward to the genal angle. Thus, the librigenae are ventral in position, corre-

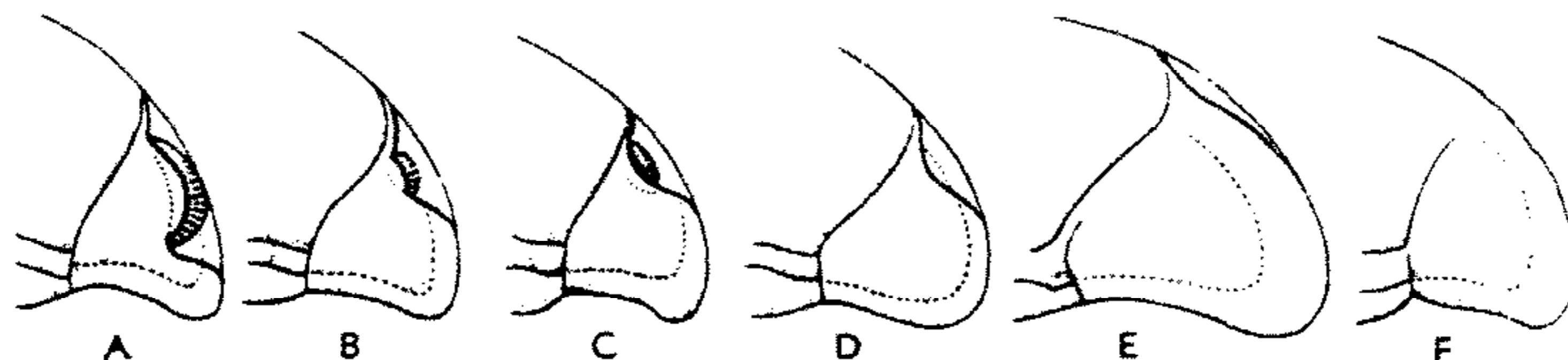

FIG. 47. Lateral migration of the facial sutures accompanying migration, reduction, and disappearance of the eyes in the Phacopidae.—A. *Phacops circumspectans* PORTLOCK, U.Dev., Ger.—B. *Phacops wedekindi* RICHTER & RICHTER, U.Dev., Ger.—C. *Cryphops? ensae* (RICHTER & RICHTER), U.Dev., Ger.—D. *Trimerocephalus mastophthalmus* (REINH. RICHTER), U.Dev., Ger.—E. *Dianops limbata* (REINH. RICHTER), U.Dev., Ger.—F. *Ductina ductifrons* (RICHTER & RICHTER), U.Dev., Ger. (All after 47.)

sponding to the cephalic doublure, with a narrow bandlike extension on to the dorsal side between the eyes and anterolateral margins of the cephalon. In *L. zenkeri*, from the Upper Cambrian of Quebec (Fig. 46B), the 2 sections have fused into a single suture running outward-forward along a narrow crest extending from the eye to the anterolateral margin of the cephalon. Lastly, in *Loganopeltis depressa*, from lowermost Ordovician rocks of Quebec (Fig. 46C), all traces of facial sutures have disappeared and, presumably, all that remains of them is an entirely marginal suture running all along the edge of the cephalon from one genal angle to the other.

In many other trilobites regression of facial sutures was accomplished "in situ," without previous migration of the sections. In many Phacopidae, for instance, where the facial sutures are apparently continuous and well developed, they were evidently non-functional in ecdysis. This seems clear from the fact that the cephalic exuviae of many species (hard cephalic exoskeleton shed during molting) consist of a single piece, the librigenae being still firmly attached to the cranidium (Fig. 83). Therefore, although the sutures are still clearly observable, they must be regarded as in a state of symphysis. Curiously enough, in certain Phacopidae the nonfunctional sutures disappeared by outward migration of the sections, accompanying outward migration, reduction, and final disappearance of the eyes. This is seen in the *Phacops circumspectans-Ductina ductifrons* series of Late Devonian age, as shown by RICHTER & RICHTER (1926) (Figs. 47, 291).

The nonfunctional character of the sutures leading to final disappearance is beau-

tifully shown by the blind proetid *Typhloproetus*, in which the facial sutures are well developed except for the rear extremities of the posterior sections that have vanished. Though it is generally true that in blind trilobites, like the Conocoryphidae and Raphiophoridae, the facial sutures tend to migrate outward and become more or less dorsal-intramarginal, this migration and disappearance are not related necessarily to migration, reduction, and final disappearance of the eyes. This is clearly shown by such blind proetids as *Drevermannia*, *Carnicia*, *Palpebralia*, and *Formonia*, which, though lacking eyes, possess well-developed facial sutures, or, reversing the conditions, by *Brachymetopus*, which possesses well-developed eyes though generally lacking facial sutures.

METAPARIAN SUTURES

The Olenellidae and related trilobites have a functional wholly ventral-intramarginal suture separating the cephalon from a large crescentic or horseshoe-shaped rostral plate. The great majority of species lack facial sutures, but a few forms are characterized by the presence of peculiar lines or fine "ocular ridges" that spring from the anterior and posterior extremities of the eye lobes, curving backward toward the posterior margin of the cephalon. Some authors (FORD, WALCOTT in early papers, BEECHER, MOBERG, KIAER, WARBURG) have been inclined to regard these lines as the last traces of fused facial sutures of opisthoparian type, whereas others (LINDSTRÖM, WALCOTT in later papers, SWINNERTON, POULSEN, STUBBLEFIELD, STØRMER) have been prone to regard them as sutures in process of development, as wrinkles orig-

inated during entombment, or as structures with no sutural significance. Until 1953 the discussion was centered on a few European and North American forms, such as *Kjerulfia lata*, *Holmia kjerulfi*, and some species of *Paedeumias* and *Wanneria*. In all these trilobites, even in better-preserved specimens, only the posterior ("postocular") ridges, springing from the posterior extremity of the eye lobes, are completely developed and reach the posterior cephalic margin. The anterior ("preocular") ridges, springing from the anterior extremity of the eye lobes and swinging backward in a gentle curve, were found to vanish before reaching the posterior border of the cephalon. This led several authors to regard the preocular ridges as impressions left on the dorsal side of the cephalon by the inner edge of the rostral plate, an hypothesis which seemed substantiated by the well-known thinness of the olenellid exoskeleton and by the fact that in some species the structures regarded as preocular ridges, instead of springing from the anterior extremity of the eye lobes, originate in the axial furrows well in front of the eyes. The fact that both the preocular and postocular ridges are raised crests was also used as an argument against their sutural significance. However, RASETTI's studies on *Loganopeltoides* have shown that facial sutures in process of disappearance may run along the crests of fine raised ridges; also, WHITTINGTON & EVITT have shown that in silicified specimens of *Dimeropyge virginensis* the facial sutures are located on narrow crests which they termed "sutural ridges." Though it is evident that in some olenellids (i.e., *Laudonia*) the anterior ridges are best regarded as impressions of the inner edge of the rostral plate, this explanation cannot be applied to fossils in which the ridges exactly join the anterior extremity of the eye lobes.

In recent years, HUPÉ's studies on the Lower Cambrian faunas of Morocco have led to discovery of several olenellid genera which seem to provide an acceptable answer to this much discussed problem. In such genera as *Fallotaspis* (Fig. 45f) and *Daguinaspis* both the preocular and postocular ridges are fully developed, the preocular ridges actually reaching the posterior cephalic margin adaxially from the genal angle. In these genera, the preocular and

postocular ridges are independent structures from the "pseudo-preocular ridges" (impression of the inner edge of the rostral plate) and the metagenal ridges, respectively, and little doubt can remain that the preocular and postocular ridges actually represent completely ankylosed facial sutures. The name *metaparian sutures* was used by RAW (1925) to distinguish this peculiar type of nonfunctional opisthoparian sutures in which both sections are directed outward-backward and cut the posterior margin of the cephalon.

ROSTRAL AND PERROSTRAL SUTURES

In typical ptychopariid trilobites having a rostral plate and facial sutures, the anterior sections of the sutures become marginal on reaching the edge of the cephalon or continue on to the anterior doublure, becoming ventral-intramarginal and meeting at a point located on the sagittal line. This transverse marginal or ventral-intramarginal suture connecting the cranidium with the rostral plate is called *rostral suture*. However, it can be regarded as being an integral part of the dorsal cephalic suture system and the name "*grande suture*" was used by BARRANDE for the ensemble of facial and rostral sutures, which he regarded as forming a single structure. This is also the view of some modern authors (RASETTI, HUPÉ), and others (KIAER, WARBURG, HENRIKSEN, RICHTER) believe that the rostral suture is a structure independent of the facial sutures.

Evidently, the rostral suture can be distinguished as such only if a rostral plate is present. If this plate is absent, as in the sauikiids, asaphids, nileids, dalmanitids, and other trilobites, the facial sutures become indistinguishable from BARRANDE's *grande suture*, for it should be clear that in these forms rostral suture cannot be used as designation of the transverse anterior section (dorsal-intramarginal, marginal, or ventral-intramarginal) connecting the anterior sections of facial sutures.

The name *perrostral suture* was applied by RICHTER to the functional ventral-intramarginal suture of olenellids. This suture extends in a semicircle or semiellipse from the vicinity of one genal angle to the other, and becomes definitely ventral in the posterolateral areas of the cephalon where it

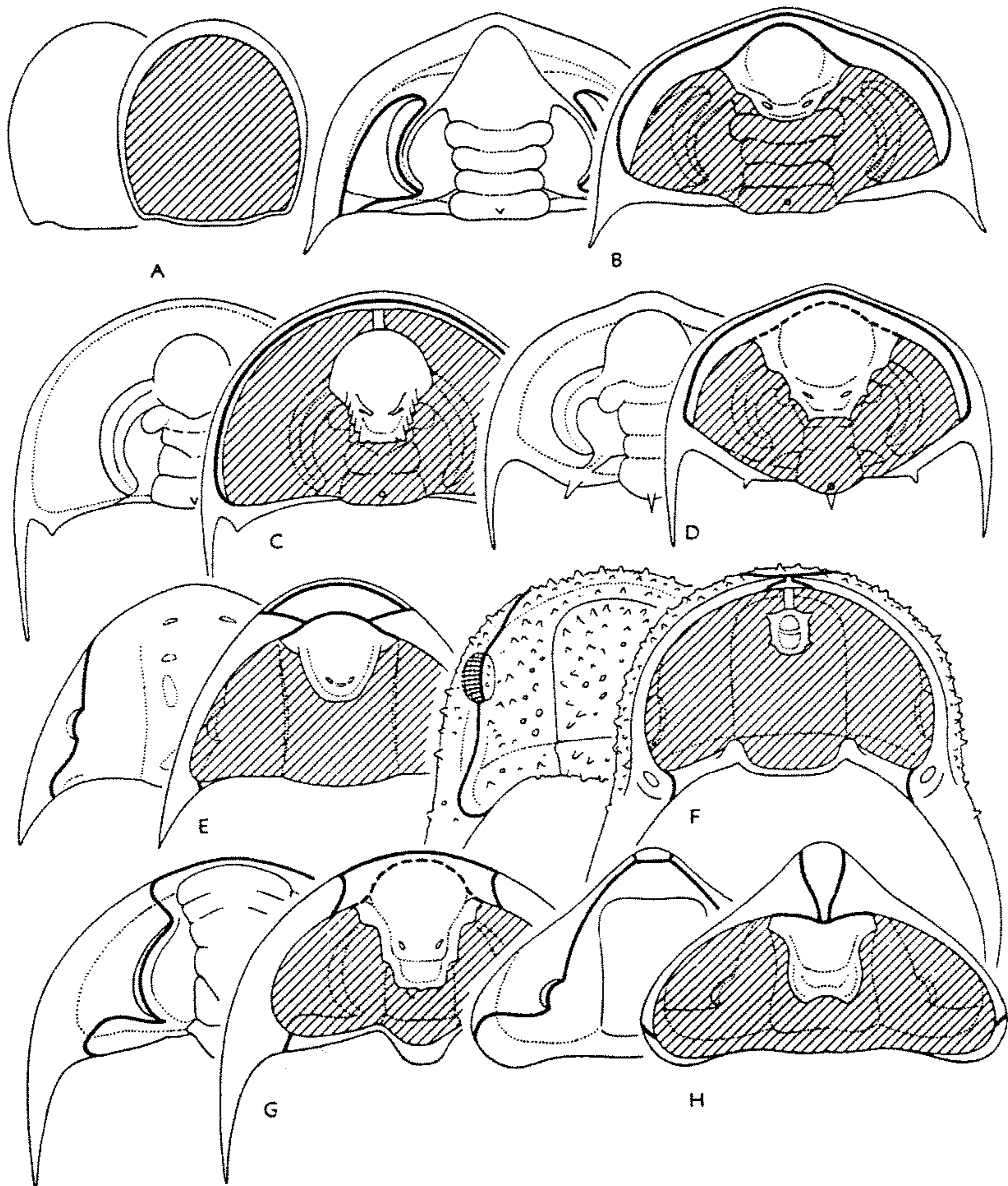

FIG. 48. Cephalic types defined by suture patterns.—A. Agnostid type, *Phalacroma glandiforme* (ANGELIN) WESTERGÅRD, M.Cam., Swed., $\times 3.3$ (after 97, 1946).—B. Olenellid type, *Kjerulfia lata* KIAER, L.Cam., Swed., $\times 0.5$ (after 28).—C. Paedeumiid type, *Paedeumias transitans* WALCOTT, L.Cam., USA (Vermont), $\times 2.5$ (after 64).—D. Holmiid type, *Holmia kjerulfi* (LINNARSSON) MARCOU, L.Cam., Swed., $\times 1.85$ (after 28).—E. Ptychopariid type, *Dysplanus centrotus* (DALMAN) BURMEISTER, L.Ord., Swed., $\times 1.2$ (after 79, 1954).—F. Dimeropygid type, *Dimeropyge virginiensis* WHITTINGTON & EVITT, M.Ord., USA (Virginia), $\times 21.7$ (after 71).—G. Corynexochid type, *Fieldaspis jurcata* RASETTI, M.Cam., Can. (B.C.), $\times 1.3$ (after 84, 1951).—H. Homalonotid type, *Dipleura dekayi* GREEN, M.Dev., USA (N.Y.), (B.C.), $\times 1.3$ (after 84, 1951).—I. Bathynotid type, *Bathynotus holopygus* (HALL) HALL, L.Cam., USA (Vermont), $\times 0.8$ (after 17).—J. Asaphid type, *Lachnostoma latucelsum* ROSS, L.Ord., USA (Utah), $\times 7.45$ (after $\times 2$ (after 81, new)).—K. Nileid type, *Nileus armadillo* DALMAN, Ord., Swed., $\times 1.5$ (after 1, 1854, and 2).—L. Phacopid type, *Odontochile hausmanni* (BRONGNIART) HAWLE & CORDA, Dev., Bohemia, $\times 1.25$ (after 2).—M. Trinucleid type, *Cryptolithus tessellatus* GREEN, M.Ord., USA (N.Y.), $\times 3$ (after 70, and 85, 1930).—N. Harpid type, *Paraharpes hornei* (REED) WHITTINGTON, U.Ord., Scot., $\times 2$ (after 99, 1950).

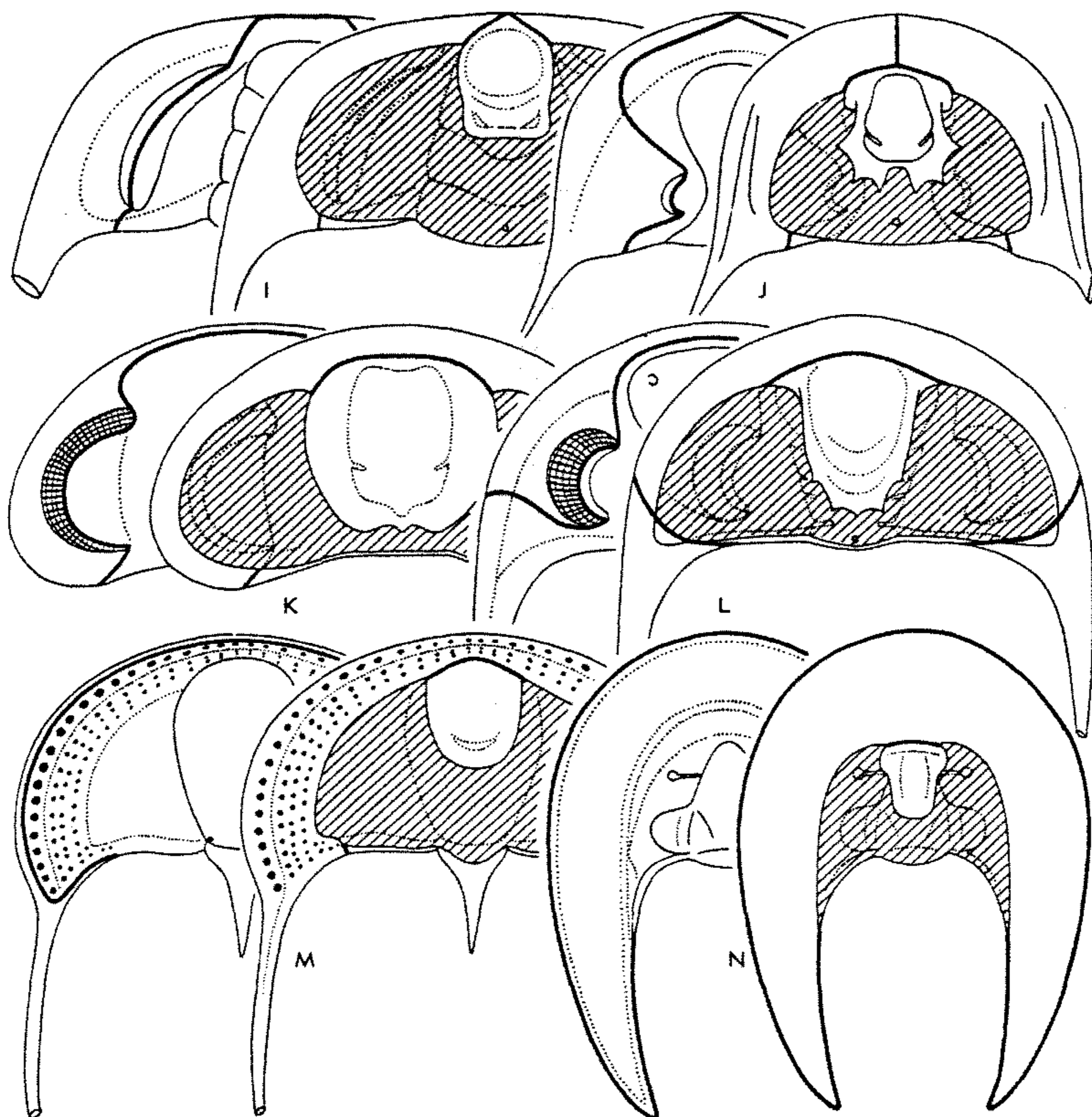

FIG. 48 (Continued from facing page)

swings inward-backward in a gentle curve across the base of the genal angle, finally ending at the inner edge of the ventral doublure (*Kjerulfia*, *Paedeumias*, *Holmia*, Fig. 48B-D). If the metaparian sutures of the olenellids is accepted as an ankylosed opisthoparian structure, the perrostral suture may be regarded as the equivalent of the rostral suture of most ptychopariid trilobites, and as the only part of the *grande suture* which has remained functional.

CONNECTIVE AND MEDIAN SUTURES

In most ptychopariids possessing a rostral plate, a pair of symmetrical sutures springs

from the abaxial extremities of the rostral suture and crosses the anterior cephalic doublure so as to reach its inner edge. These are connective sutures that bound the rostral plate abaxially, separating it from the doublure of the librigenae. The connective sutures are usually wholly ventral, but in the Homalonotidae (Fig. 48H) they are partly dorsal. They may be (1) widely separated from each other (with rostral plate wide, *tr.*, as in *Dysplanus*, Fig. 48E); (2) very close to each other (rostral plate reduced to narrow band, as in Pliomeridae and Encrinuridae); or (3) they may converge to the mid-point of the internal edge

of the doublure (rostral plate more or less triangular in outline, as in *Dipleura*, Fig. 48H).

In some trilobites, notably the Asaphidae (Fig. 48J), the connective sutures coalesce into a single median suture that runs along the sagittal line of the doublure, and the rostral plate disappears. In the Nileidae (Fig. 48K), which are closely related to the Asaphidae, the median suture disappears through ankylosis and the doublures of the librigenae are confluent along the sagittal line. The phacopid trilobites also lack a connective or median suture.

MARGINAL AND SUBMARGINAL SUTURES

Some trilobites, notably the Harpidae, which lack facial sutures, possess a marginal suture, which runs all along the outer edge of the cephalon separating the dorsal exoskeletal plate from the ventral doublure (Fig. 48N). In these trilobites, the suture is located along the mid-line of the cephalic rim, along the anterior and lateral margins, as well as adaxial margins of the prolongations. The suture is, therefore, wholly marginal.

In the Trinucleidae and Dionididae (*Cryptolithus*, Fig. 48M) the suture is marginal or dorsal-intramarginal almost all around the cephalon, but becomes dorsal near the posterolateral extremities of the shield, obliquely cutting over the base of the genal spines, which are connected directly with the ventral doublure (called "lower lamella" in the Trinucleidae). The suture, therefore, may be described as marginal to submarginal with dorsal posterior extremities. It is conceivable that the trinucleid suture may have been developed from facial sutures of cedariiform type, resembling those of *Orometopus*, suffering the following modifications: (1) backward migration of anterior sections of the sutures, passing through an entomaspidiform stage; (2) fusion of the anterior and posterior sections; and (3) ankylosis and final disappearance of the suture. This has been suggested by RASETTI (1952). The peculiar double metagenal ridges of *Dionide*, directed outward-backward toward the genal angles, suggest that they represent the ankylosed posterior and anterior sections of sutures of entomaspidiform type.

In the Raphiophoridae the suture is dorsal-intramarginal to submarginal with dorsal posterior extremities. In the Conocoryphidae it is submarginal to distinctly marginal, approaching the trinucleid condition (*Conocoryphe*, *Ctenocephalus*). This suture, however, is not homologous to the trinucleid suture, as it seems to have been derived from both the anterior and posterior sections of normal opisthoparian sutures that have migrated outward, as in the phacopid *Ductina* (Fig. 47F). The trinucleid suture, on the other hand, seems to have been developed almost exclusively from the anterior sections of opisthoparian sutures of entomaspidiform type.

HYPOSTOMAL SUTURE

The hypostoma of most trilobites was attached to the rostral plate or anterior cephalic doublure by means of a transverse hypostomal suture (Figs. 43, 48). Generally, this suture was functional in ecdysis, as indicated by the fact that hypostomas are usually found detached and isolated. Some authors, however, believe that the hypostomal suture may have had the character of a semirigid articulation, permitting slight movements of the hypostoma (such as rapid vibration) during the life of the animal. The warped curvilinear course of this suture in many trilobites, and the fact that the opposing edges of the hypostoma and doublure (or rostral plate) are cut normal to the surface of the exoskeleton, makes the possibility of any movement rather implausible.

In some trilobites belonging to different families (Olenellidae, Redlichiidae, Paradoxididae, Zacanthoididae, Oryctocephalidae), the hypostomal suture is in a state of complete symphysis, the hypostoma being fused with the rostral plate to form a single "rostral-hypostomal plate" (Fig. 44).

CEPHALIC TYPES DEFINED BY SUTURAL PATTERNS

RASETTI (1952) has attempted to systematize our knowledge concerning ventral cephalic sutures among Cambrian trilobites, distinguishing several types which he designated by the names of the characteristic genus or family portraying them. The classification of cephalic types here offered, modified from RASETTI's, with such additions as

seem needed to cover both Cambrian and later trilobites, is based on the whole sutural pattern and takes into consideration the presence or absence of marginal, facial, connective, median, rostral, and hypostomal sutures.

Descriptive List of Trilobite Cephalic Types Defined by Sutural Pattern

Agnostid type. Cephalic sutures lacking; hypostoma absent (Fig. 48A). Absence of the hypostoma may be due to chitinous natures of this plate, nonmineralized in the living animal. Agnostida.

Eodiscid type. Like agnostid type, but probably with hypostoma joined to anterior doublure by hypostomal suture. Occurrence of hypostoma known only in *Pagetia* but judging by the close relationship between the Pagetiidae and Eodiscidae, probably the latter possessed a small hypostoma. Eodiscidae.

Olenellid type. Perrostral and hypostomal sutures functional, rostral plate large, crescentic; metaparian sutures may be present (Fig. 48B). Some Olenellidae, Daguinaspidae.

Holmiid type. Like olenellid type, but with hypostoma fused to rostral plate forming a single "rostral-hypostomal plate" (Fig. 48D). Some Olenellidae.

Paedeumiid type. Like olenellid type, but without hypostomal suture, hypostoma being connected with rostral plate by a narrow (*tr.*) stalk (Fig. 48C). *Paedeumias*.

Ptychopariid type. Facial, rostral, connective, and hypostomal sutures all functional (Fig. 48E). Most Ptychopariidae, Ellipsocephalidae, some Redlichiidae, and Paradoxididae, Ogygopsidae, Catillicephalidae, Proctidae, Otarionidae, Illaenidae, Thysanopeltidae, Styginidae, Phillipsinellidae, Calymenidae, Cheiruridae, Encrinuridae, Pliomeridae. Probably also the Pagetiidae, since it is likely that *Pagetia* had an anterior marginal (rostral) suture connecting the anterior sections of the facial sutures, and a wide rostral plate to which the hypostoma was connected by a functional hypostomal suture.

Dimeropygid type. Like ptychopariid type, but without hypostomal suture, hypostoma being connected with rostral plate by a narrow (*tr.*) stalk, which seems to be a backwardly directed prolongation of the rostral plate (Fig. 48F). *Dimeropyge*.

Corynexochid type. Like ptychopariid type, but with hypostomal suture in a state of complete symphysis, hypostoma being fused with rostral plate forming a single "rostral-hypostomal plate" (Fig. 48G). Some Redlichiidae, some Paradoxididae, Gigantopygidae, Corynexochidae, Dolichometopidae, Dorypygidae, Zacanthoididae, *Hemirhodon*, *?Hysterolenus*.

Oryctocephalid type. Like corynexochid type, but with connective sutures nonfunctional in ecdysis, though usually fairly well marked. Oryctocephalidae.

Homalonotid type. Facial, rostral, connective, and hypostomal sutures all functional; rostral suture dorsal-intramarginal; connective sutures partly dorsal and partly ventral, converging backward on cephalic doublure; rostral plate subtriangular, partly dorsal in position (Fig. 48H). Homalonotidae.

Bathynotid type. Facial sutures functional, marginal anteriorly; paired ventral sutures diverge from mid-point of cephalic margin toward inner edge of doublure, separating adaxial extremities of librigenal doublures from the hypostoma; rostral plate apparently absent, but probably fused with so-called hypostoma forming a "rostral-hypostomal plate" (paired ventral sutures being then regarded as true connective sutures); rostral suture absent (Fig. 48I). *Bathynotus*.

Asaphid type. Facial, median, and hypostomal sutures functional; rostral plate and suture absent; hypostoma connected with anterior doublures of librigenae (Fig. 48J). Asaphidae, *Theodenisia lata*, *T. spinosa*, *Stenopilus*, *Leiocoryphe gemma*, *Dikelocephalus raaschi*, *Housia*, *?Proceratopyge*.

Nileid type. Facial, transverse ("rostral"), and hypostomal sutures functional; connective and median sutures absent (doublures of librigenae confluent anteriorly); rostral plate absent; hypostoma connected with anterior doublures of librigenae (Fig. 48K). Nileidae, Raphiophoridae, most Conocoryphidae, *Dikelocephalus retrorsus*, *D. subplanus*, *Levisella*, *Hungaia*, *Lauzonella*, *Loganellus*, *Leiocoryphe transversa*, *Rasettia*.

Olenid type. Like the Nileid type, but with hypostoma separated from anterior cephalic doublure, supported only by ventral membrane. Olenidae.

Phacopid type. Like the Nileid type, but with facial sutures (including transverse anterior suture, which may be dorsal-intramarginal) nonfunctional in ecdysis (Fig. 48L). Phacopidae, Dalmatidae.

Trinucleid type. Marginal to submarginal sutures functional, becoming definitely dorsal across base of genal angles; hypostomal suture functional; facial sutures absent (Fig. 48M). Trinucleidae, Dionididae, Alsataspidae, Harpididae. (Characters of the marginal flange and method of numbering pits on the flange are illustrated in Figure 84.)

Harpid type. With functional wholly marginal suture all around cephalon and prolongations; hypostomal suture functional; facial and rostral sutures absent (Fig. 48N). Harpididae. (Characters of the harpid cephalon and nomenclature applied to parts are illustrated in Figure 85.)

It is believed that the ptychopariid type should be regarded as the primitive basic

structural pattern of the whole class Trilobita. All other types can be considered as being secondarily derived from the ptychopariid by migration and regression of the dorsal and ventral sutures. For instance, it is abundantly clear that the fusion of the hypostoma with the rostral plate originated the corynexochid type independently in several Lower, Middle, and Upper Cambrian families and even in some Ordovician genera.

The asaphid type appeared independently in some genera belonging to the Cambrian families Catillicephalidae (*Theodensia*), Plethopeltidae (*Leiocoryphe*, *Stenopilus*), Dikelocephalidae (*Dikelocephalus*), and Housiidae (*Housia*), as well as in the Ordovician Asaphidae. The Nileid type characterized by functional facial and hypostomal sutures and absence of connective and median sutures, appeared independently in the

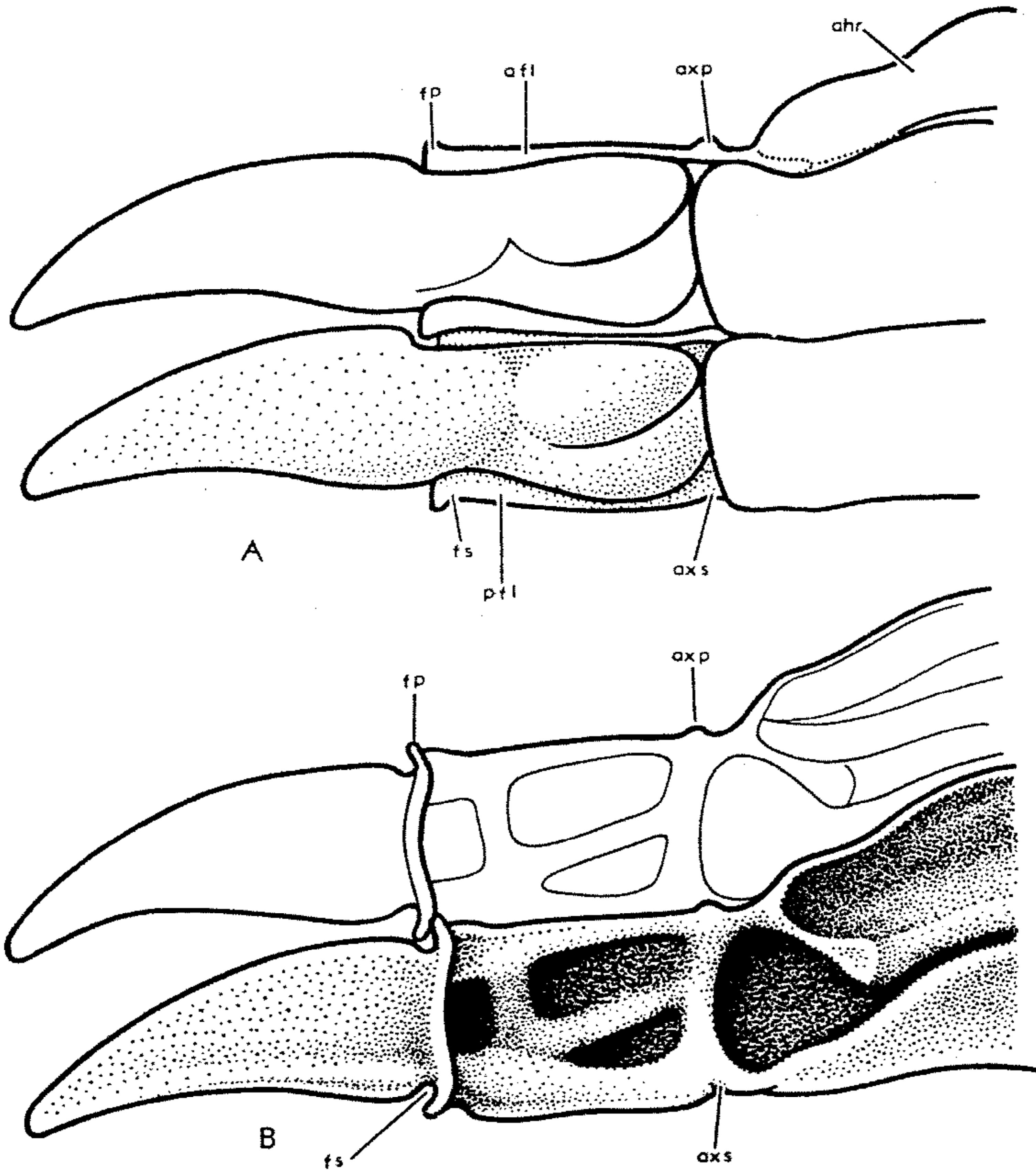

FIG. 49. Articulation of thoracic segments in *Ceraurinella typha* COOPER, M.Ord., USA (Virginia), $\times 8$ (after 71).—A. Left half of 2 articulated thoracic segments, dorsal view.—B. Same, ventral (interior) view.—C. Left half of a thoracic segment, anterior view.—D. Same, posterior view.—E. Lateral view of 2 articulated thoracic segments. (Explanation: *afl*, anterior flange; *ahr*, articulating half-ring; *ap*, apodeme; *ax*, axial furrow; *axp*, axial process; *axs*, axial socket; *fp*, fulcral process; *fs*, fulcral socket; *im*, internal margin of flange; *pfl*, posterior flange.)

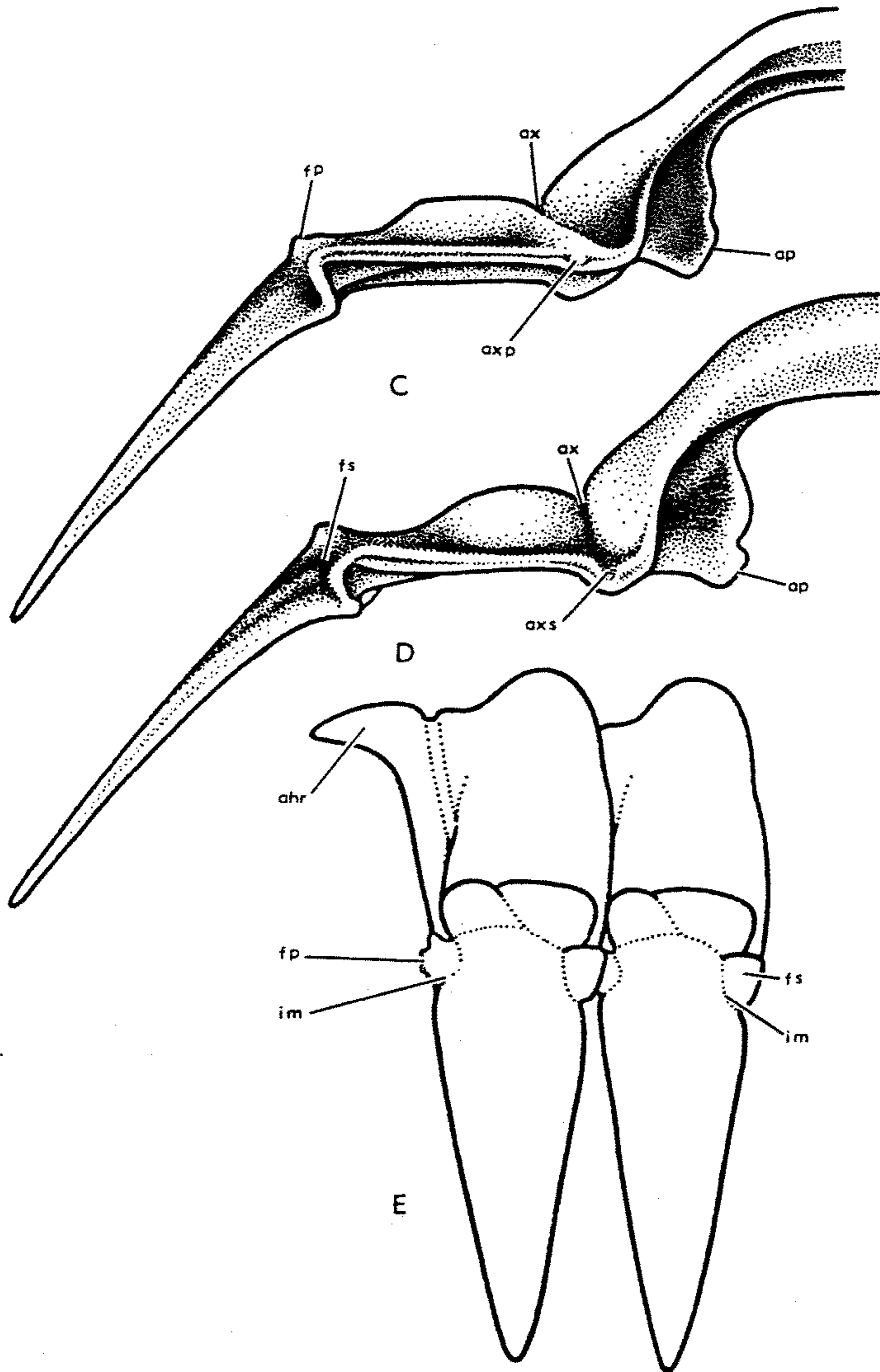

FIG. 49 (Continued from facing page)

Cambrian Hungaiidae (*Hungaiia*), Lecanopygidae (*Rasettia*), and Loganellidae (*Lauzonella*, *Loganellus*), and in the Ordovician Nileidae. The outward migration of the facial sutures, *pari passu* with the outward migration, reduction, and final disappearance of the eyes, gave origin to the dorsal-intramarginal and submarginal sutures of many Conocoryphidae during Middle Cambrian time. The same pattern appeared independently in the Raphiophoridae during the Ordovician and even in such Upper Devonian genera as the phacopid *Ductina*. In this genus, however, the marginal suture was nonfunctional in ecdysis, betraying its derivation from the phacopid type.

THORACIC REGION

As in the case of the cephalon, distinction should be made between the thoracic region and the thorax. The thoracic region is here defined as comprising the ensemble of metameric somites interposed between the cephalon and the pygidium. Naturally, in practically every fossil trilobite, all that remains of the thoracic region is its dorsal exoskeletal covering or thorax proper, which in the living animal was formed of successive tergites articulating and movable upon each other.

The thorax is usually parallel-sided, slightly tapering backward, or somewhat spindle-shaped in dorsal outline. The number of thoracic segments ranges from 2 (Agnostida) to more than 40 (Olenellidae, Menomoniidae). Some families, and even taxa of suprafamilial rank, are characterized by a fixed number of thoracic segments. All the members of the suborder Agnostina have 2 segments, those of the family Eodiscidae have 3, and those of the family Asaphidae have 8. Generally, however, the number of thoracic segments is variable within a family and even within a single genus.

The thoracic tergites are formed of a median part, the axial ring, and paired lateral extensions, or pleurae. All successive axial rings together form the axial region or axis of the thorax, and all of the lateral pleurae taken together form the paired pleural regions, separated from the axis by longitudinal axial furrows. In a large majority of trilobites, the thoracic segments are fundamentally alike, differing only in a

gradual decrease in size from the anterior to posterior segments (Fig. 28B,C). In most Olenellidae, however, 2 sharply different thoracic sections can be distinguished: an anterior part, or prothorax, comparable to the whole thorax of other trilobites, and a posterior part, or opisthothorax, characterized by very small and short (*tr.*) pleurae (Fig. 28A).

AXIAL RINGS

The axial portion of each thoracic somite has a mineralized dorsal covering (mesotergite) and a corresponding noncalcified softer sternite, which, by its very nature, is seldom if ever preserved.

The mesotergite consists of 2 parts of dissimilar size, the axial ring proper and the articulating half-ring. The name "ring" is an obvious misnomer, as the tergites are clearly not annular, but nothing would be gained by trying to uproot this well-entrenched term. The axial ring proper, forming the bulk of the mesotergite, is a comparatively narrow (*sag.*) and wide (*tr.*) band that is more or less convex transversely. It is always visible, whether the specimen has been preserved in an outstretched or enrolled attitude. The articulating half-ring is a crescentic extension of the anterior part of the mesotergite, separated from the axial ring proper by a transverse furrow. In outstretched specimens it is covered by the posterior part of the preceding ring, but it is plainly visible in enrolled individuals. The posterior border of each ring has a narrow ventral doublure which was connected to the anterior border of the succeeding articulating half-ring by a soft articulating membrane (Fig. 49). The transverse furrow separating the ring from its articulating half-ring may show paired invaginations of the dorsal integument projecting downward (ventrally). These are the apodemes, regarded as places of attachment of ventral appendage muscles (Fig. 49C,D).

The axial rings of different genera and species may show considerable differences as regard presence or absence of granules, mesial tubercles, or spines. In some genera, one or more of the axial rings may bear a macrospine which may project farther back than the posterior margin of the pygidium (Fig. 28A). In some species, paired tubercles are developed close to the axial furrows.

PLEURAE

The pleurae are comparatively narrow (*exsag.*) and long (*tr.*) lateral extensions of the thoracic tergites. They may be more or less flat, stretching horizontally outward (*Dionide*), uniformly arched outward-downward (*Nileus*), or strongly bent downward at their distal extremities (*Placoparia*, *Calymene*). The distal extremity of the pleurae is reflected ventrally into a doublure, which may be narrow (*Calymene*) or wide (*Placoparia*). In some specimens (*Ceratocephala*) it is projected downward in a secondary narrow fold. A thin membrane, attached to the adaxial margin of the doublure, covered the ventral side of the pleurae, leaving a thin body cavity between the cal-

cified dorsal exoskeleton and the soft ventral integument.

In most trilobites the pleurae had a more or less marked geniculation or fulcrum located somewhere between their adaxial and abaxial ends. The adaxial (proximal) part, extending between the axial furrow and the fulcrum, articulated with the contiguous pleurae, whereas the abaxial (distal) part was free. Different articulating mechanisms between contiguous pleurae were developed in different trilobite stocks. In the most primitive Lower and Middle Cambrian forms, such as the Olenellidae, Redlichiidae, and Paradoxididae, no special devices were present, articulation being achieved by simple overlap of a narrow posterior strip of

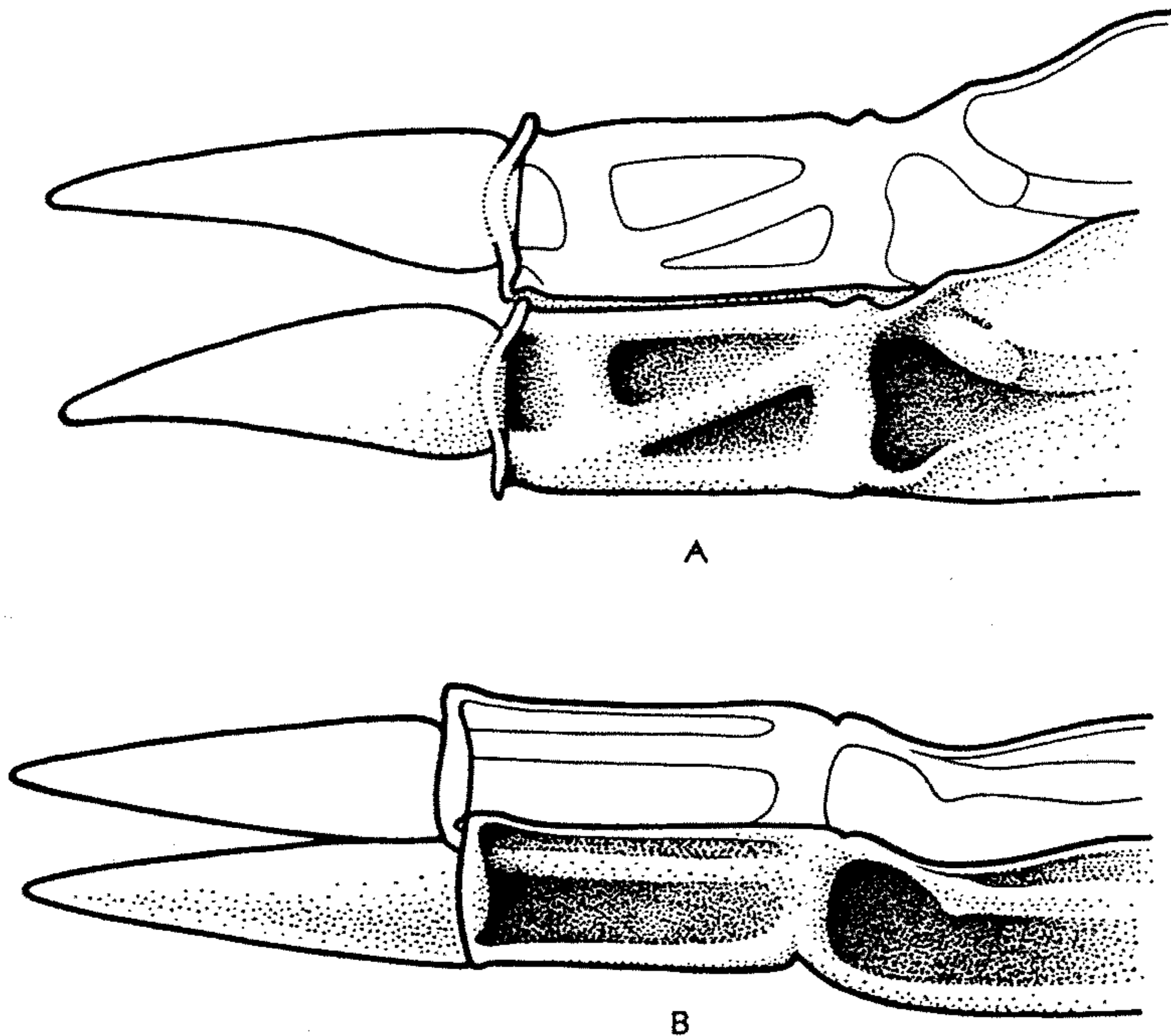

FIG. 50. Articulation of thoracic segments. Interior (ventral) view of left half of 2 articulated segments. —A. *Cerairus aculeatus* EICHWALD, M.Ord., Estonia, $\times 3.3$ (after 34). —B. *Rossaspis superciliosa* (ROSS) HARRINGTON, L.Ord., USA(Utah), $\times 18.3$ (after 88, 1952).

one pleura over the anterior border of its neighbor immediately behind. Different articulating devices appeared in Late Cambrian and Ordovician trilobites, reaching a high degree of efficiency in the Cheiruridae and Pliomeridae. In some genera belonging to these families articulation was accomplished by a narrow raised band separated from the main body of the pleura by a fine submarginal furrow, the posterior edge of a pleura fitting into the submarginal furrow of the one immediately behind (Figs. 49, 50). The mechanism was complemented with bosses and corresponding sockets located along the margins of the contiguous pleurae. In certain trilobites, particularly the Asaphidae and Illaenidae, the doublure of the pleurae bears elongated crests or rounded bosses which represent special devices to prevent overgliding of the free extremities of the overlapping pleurae during enrollment (see panderian protuberances, p. 0105).

Typically, each pleura is obliquely crossed by a pleural furrow, starting at the axial furrow opposite the anterior extremity of an axial ring and running outward-backward toward the distal extremity of the pleura. The pleural furrow marks off an anterior and a posterior pleural band. This type of furrowed pleura ("plèvre à sillon" in BARRANDE'S terminology) characterizes almost all Cambrian trilobites and many later families, such as the Asaphidae, Proetidae, and Phacopidae. In many Ordovician and later trilobites, however, this primitive type suffered different important modifications. In some forms (Illaenidae, Homalonotidae, some Nileidae) the pleurae became smooth by the disappearance of the pleural furrows. In others, the 2 principal pleural bands fused into a single band by disappearance of the pleural furrow, while auxiliary bands were developed along the anterior and posterior edges of the pleurae. This type of banded pleura ("pleura à bourrelet" of BARRANDE) characterizes many Cheiruridae and Pliomeridae (Fig. 51).

The distal extremities of the pleurae may be rounded, truncate, or prolonged into spines of varying length. In some Odontopleuridae each of the pleural bands ends in a free spine and, in some species, auxiliary spines may be developed also. In many trilobites belonging to very different fam-

ilies, such as *Paedeumias* and *Olenellus* (Olenellidae), *Bathynotus* (Bathynotidae), *Albertella* (Zacanthoididae), *Anoria* (Dolichometopidae), *Shumardia* (Shumardiidae), *Promegalaspides* (Asaphidae), and *Hypodicanotus* (Remopleurididae), one pair of pleurae is considerably more developed than the rest, and the corresponding spines are far larger than the others. These macro-

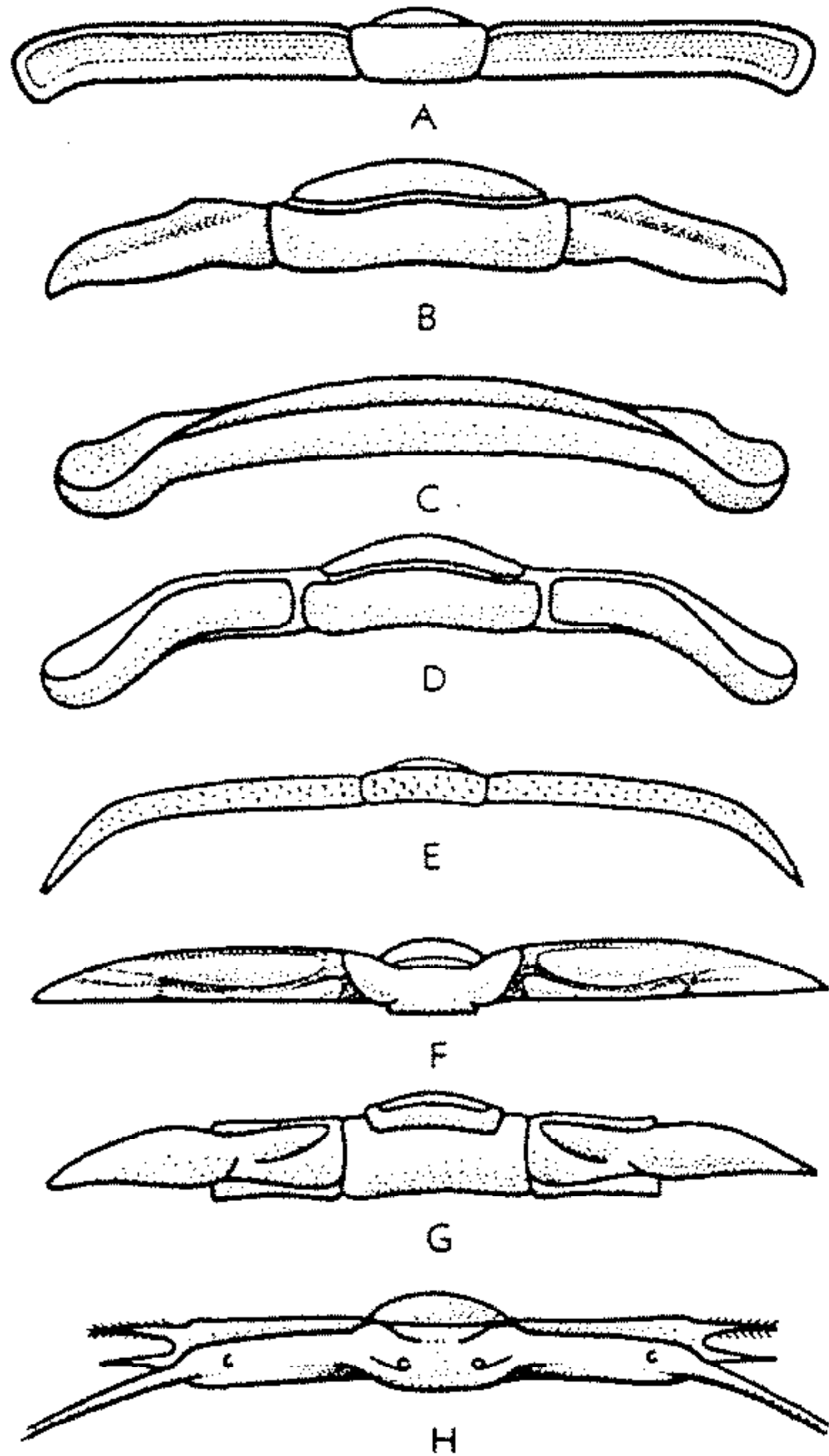

FIG. 51. Different types of thoracic segments.—A. *Hapalopleura clavata* HARRINGTON & LEANZA, L. Ord., S.Am.(Arg.), $\times 10.6$ (after 19).—B. *Peltura scarabaeoides* (WAHLENBERG) MILNE EDWARDS, U.Cam., Swed., $\times 2.33$ (after 97, 1923).—C. *Trimerus delphinocephalus* GREEN, M.Sil., USA(N.Y.), $\times 0.8$ (after 17).—D. *Pliomera fischeri* (EICHWALD) ANGELIN, M.Ord., Estonia, $\times 2.8$ (after 34).—E. *Nieszkowskia capitalis* ÖPIK, Ord., Estonia, $\times 0.3$ (after 34).—F. *Dichelepyge pascuali* HARRINGTON & LEANZA, L.Ord., E.Am.(Arg.), $\times 8.3$ (after 19).—G. *Ceraurus aculeatus* EICHWALD, Ord. Estonia, $\times 2.4$ (after 34).—H. *Miraspis miru* (BARRANDE) RICHTER & RICHTER, M.Sil., Bohemia, $\times 3.75$ (after 99, 1956).

pleurae were probably related to internal sexual organs.

In most trilobites having well-marked pleural fulcra, as the Asaphidae, Nileidae, Proetidae, and Phacopidae, the anterolateral extremity of the pleurae bears a subtriangular articulating facet, consisting of a smooth flat surface slanting forward-downward. This facet, also developed on the anterolateral angles of the pygidium, facilitated the gliding of the free extremities of the pleurae over one another. Articulating facets are absent in spiny or very long pleurae, as well as in those having auxiliary bands.

PYGIDIAL REGION

As for the cephalon and thorax, distinction should be made between pygidial region and pygidium proper. The pygidial region consists of several fused posterior somites, whereas the pygidium proper is formed of their exoskeletal coverings (tergites) fused dorsally into a single rigid plate. Exceptionally, as in some Olenellidae, the pygidium is formed of a single tergite. In all other trilobites it is formed of a variable number of segments, up to more than 30 in some Dionididae. Actually, however, the single-segmented pygidium of *Olenellus* and allied forms is not homologous to the pygidia of other trilobites. The typical olenellid pygidium is a true telson or caudal piece, the pygidia of other trilobites being the equivalent of the ensemble of opisthothorax plus "pygidium" of the Olenellidae. The reduction and "caudalization" of the opisthothorax was already achieved by some Olenellidae, as is plainly shown in the subfamily Holmiinae.

The relative size of the pygidium compared with the cephalon has taxonomic importance. A trilobite is said to be *micro-pygous*, *macropygous*, or *isopygous* according to whether the pygidium is smaller, larger, or subequal in size as compared to the cephalon.

Typically, the pygidium of trilobites is semielliptical in outline, but important departures from this basic shape are numerous and sharply marked (Fig. 52). Its convexity, both transverse and longitudinal, is also variable in different genera, for pygidia range from almost flat in some Dionididae

to highly inflated and globose in such genera as *Pemphigaspis* and *Leiagnostus*.

The pygidium of most trilobites, being formed by the fusion of several tergites fundamentally like those of the thorax, also show an axial and paired pleural region (Fig. 53).

AXIS

The axial region or axis of the pygidium is formed of a succession of axial rings separated by transverse ring furrows. The segmentation varies from well marked to obsolete, the latter giving a smooth appearance to the axis. In many pygidia, particularly large ones, segmentation is well marked on the anterior part of the axis but progressively obsolete toward the rear, so that often it is impossible to determine the true number of fused segments. The axis may end with an unsegmented terminal piece that is more or less sharply marked off from the well-segmented part. A postaxial ridge may extend from the rear end of the axis toward the posterior margin of the pygidium (Fig. 53).

PLEURAL REGIONS

The axis is separated from the pleural regions on either side by axial furrows. The pleural regions, extending from these furrows to the margins of the pygidium, are usually more or less convex. In many pygidia they display well-marked segmentation, resulting from the fusion of several pleurae similar to those of the thorax. Typically, the pleural regions are crossed obliquely by 2 different sets of furrows. The most conspicuous and well defined are usually true pleural furrows, corresponding to the furrows of the thoracic pleurae. The 2nd set consists of interpleural furrows, typically finer and less impressed, representing the line of fusion of 2 successive pleurae. Both sets of furrows usually curve outward-backward across the pleural regions, but the pleural furrows, starting at the axial furrows opposite the anterolateral extremities of the axial rings, have an oblique direction with respect to that of the interpleural furrows (Fig. 53). In some trilobites there are as many pleural segments as axial rings, but in many genera, especially those characterized by large pygidia, the correspondence

between axial rings and pleural segments is lost from front to back, the number of axial rings being greater than that of pleural segments.

In many trilobites, the fusion of the pygidial pleurae is complete and interpleural furrows disappear. Then, only the pleural furrows remain, marking off smooth ribs

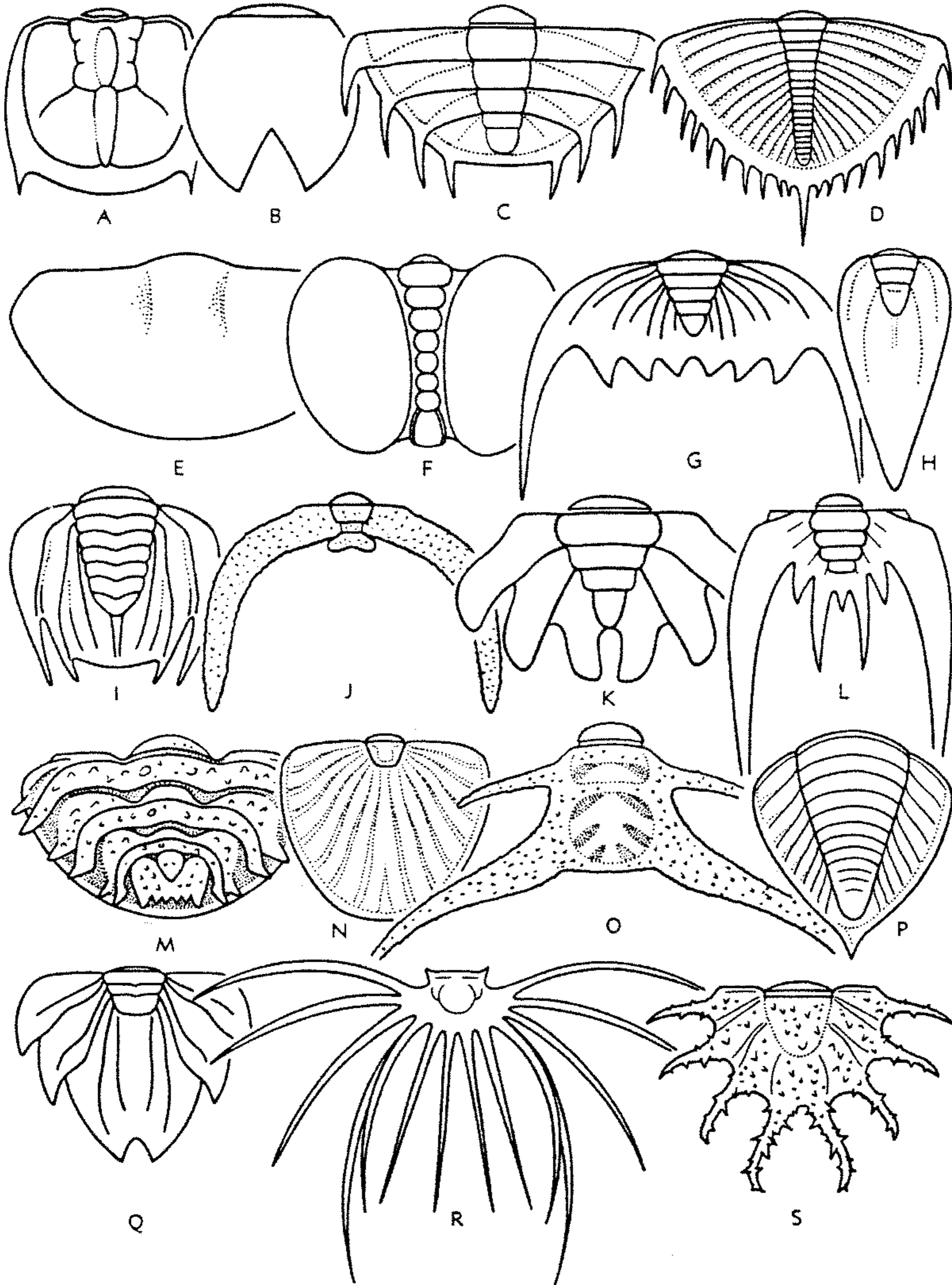

that result from complete fusion of the posterior band of a pleura with the anterior band of one immediately behind it (Fig. 53). In some species, however, the reverse is true, the pleural furrows becoming obsolete and only the interpleural furrows remaining, marking off true pleurae. Lastly, in the so-called "smooth trilobites," both the pleural and interpleural furrows disappear, the pleural regions losing all or nearly all vestiges of their segmentation. In extremely modified pygidia even the axial furrows disappear, giving rise to a uniformly convex, smooth plate (Fig. 27).

The pleural and interpleural furrows may reach the margin of the pygidium or end at some distance from it. In many trilobites, a smooth convex or concave border, more or less well defined by a border furrow, is present around the lateral and posterior margins. The term pleural field is then applied to that part of the pleural regions extending between the axis and the border (Fig. 53).

The pygidium is reflected ventrally into a doublure. Though no absolute correspondence exists, it seems that, generally speaking, the doublure is wide if the pygidial axis is narrow. No ventral sternites are known in the pygidium. It is probable that the so-called "anal plate" described by BEECHER and RAYMOND from a few specimens of *Triarthrus eatoni* with ventral appendages preserved, is nothing more than the tips of the last, tiny pairs of biramous appendages protruding from beneath the posterior pygidial margin.

Many pygidia bear marginal spines, which

are actually projections of the dorsal integument and doublure. These may be paired lateral spines, or mesial spines projecting from the posterior margin. In most fossils, the lateral spines are direct continuations of the pygidial pleurae. Whereas in some genera (*Ctenopyge*, *Coronura*, *Pliomera*, *Cromus*) each pleura ends in a free spine, in others (*Hartshillina*, *Vanuxemella*, *Housia*, *Marjumi*, some Olenidae) only a fraction of the pleurae are spinose, part of the pygidial margin being entire. In a few trilobites, such as *Ceratopyge*, the lateral spines spring from the posterior band of one pleura fused with the whole pleura next behind it, whereas in many others belonging to the families Yinitidae, Crepicephalidae, Dikelocephalidae, Dikelocephalinidae, Taihungshaniidae as well as in some Zacanthoididae, the spines spring from 2 or more fused pleurae, correspondence between the spines and pleural segmentation being usually very obscure or lost entirely. In a few genera (e.g., *Thysanopyge*) the correspondence between spines and pleural segments, plainly seen in young holaspid specimens, is lost after successive molts, the large individuals having irregularly distributed spines that commonly do not coincide in number from one margin to the other.

The mesial spine carried by many trilobites may be either a true posterior spine, springing from the border and doublure and disconnected from the axis (*Thysanopyge*, *Kayseraspis*, *Anchiopsis*, *Eocyphinium*), or a terminal axial spine that forms a posterior projection of the pygidial axis (*Symphysurina*, *Xenostegium*).

(See facing page)

FIG. 52. Different shapes and segmentation of pygidia.—A. *Machairagnostus tmetus* HARRINGTON & LEANZA, L.Ord., S.Am.(Arg.), $\times 12.3$ (after 19).—B. *Wanneria walcottana* (WANNER) WALCOTT, L. Cam., USA(Pa.), $\times 5.3$ (after 64).—C. *Parabolina heres* BRÖGGER, U.Cam., Swed., $\times 8$ (after 97, 1923).—D. *Thysanopyge argentina* KAYSER, L.Ord., S.Am.(Arg.), $\times 0.45$ (after 19).—E. *Iliaenus crassicauda* (WAHLENBERG) DALMAN, Ord., Swed., $\times 2.6$ (after 79, 1954).—F. *Pemphigaspis bullata* HALL, U.Cam., USA(Minnesota), $\times 6$ (after 82, 1951).—G. *Pseudokainella keideli* HARRINGTON, L.Ord., S.Am.(Arg.), $\times 14$ (after 19).—H. *Macropyge chermi* STUBBLEFIELD, L.Ord., Eng., $\times 4.3$ (after 93, 1927).—I. *Kainella billingsi* (WALCOTT) WALCOTT, U.Cam., Can.(B.C.), $\times 0.85$ (after 96, 1925).—J. *Holia secreti* WHITTINGTON & EVITT, M.Ord., USA(Virginia), $\times 12.2$ (after 71).—K. *Sphaerexochus pulcher* WHITTINGTON & EVITT, M.Ord., USA(Virginia), $\times 7$ (after 71).—L. *Ceraurus aculeatus* EICHWALD, M. Ord., Estonia, $\times 2$ (after 34).—M. *Dimeropyge virginensis* WHITTINGTON & EVITT, M.Ord., USA(Virginia), $\times 27$ (after 71).—N. *Scutellum brevisfrons* (BARRANDE), U.Sil., Bohemia, $\times 0.65$ (after 2).—O. *Deiphon forbesi* BARRANDE, L.Sil., Bohemia, $\times 11.3$ (after 2).—P. *Trimerus delphinocephalus* GREEN, U.Sil., Eng., $\times 0.65$ (after 89, 1865).—Q. *Dicranopeltis scabra* (BEYRICH), Ord. Bohemia, $\times 0.81$ (after 2).—R. *Ancyropyge romingeri* (HALL & CLARKE) CLARKE, M.Dev., USA(Michigan), $\times 1.33$ (after 17).—S. *Terataspis grandis* HALL, M.Dev., USA(N.Y.), $\times 0.15$ (after 91, 1944).

VENTRAL APPENDAGES

Ventral appendages of trilobites are very rarely preserved. Although EICHWALD, as far back as 1825, and later BILLINGS in 1870, had correctly described and interpreted fragmentary appendages, they failed to convince the majority of specialists as to trustworthiness of their studies. It was not until 1876, when WALCOTT first published his observations on trilobite biramous appendages, that these structures came to be recognized as such.

Ventral appendages of some 19 species of trilobites have been described up to the present, but only in 5 species are all the appendages known. The following list tabulates all such species, with citation of age, locality, mode of preservation, papers dealing with the description of the appendages, and kind of appendages known.

Trilobite Species and Ventral Appendages Studied

Olenellidae

Olenellus getzi DUNBAR, *L.Cam.* (Kinzers Formation), Rohrerstown, Pa., USA. Single specimen preserved in shale. DUNBAR, 1925.

Antennae

Dorypygidae

Olenoides serratus (ROMINGER) KOBAYASHI [= ?*Nathorstia transitans* WALCOTT], *M.Cam.* (Burgess Shale, Stephen Formation), Burgess Pass, B.C., Canada. Several complete specimens preserved in shale. RAYMOND regarded type specimen of *N. transitans* as a "recently molted *O. serratus*, still in the 'soft-shelled' condition." WALCOTT, 1912, 1918, 1921; RAYMOND, 1920; STØRMER, 1939, 1951

All appendages

Kootenia dawsoni (WALCOTT) WALCOTT, *M.Cam.* (Burgess Shale, Stephen Formation), Burgess Pass, B.C., Canada. Single specimen preserved in shale. WALCOTT, 1918.Limbs

Alokistocaridae

Elrathina cordillerae (ROMINGER) RESSER, *M.Cam.* (Burgess Shale, Stephen Formation). Burgess Pass, B.C., Canada. Single incomplete specimen preserved in shale. WALCOTT, 1918.

Fragmentary limbs

Ehmaniella burgessensis RASETTI [= *Ptychoparia permulta* WALCOTT (*partim*)]. *M.Cam.* (Burgess Shale, Stephen Formation), Burgess Pass, B.C., Canada. Single specimen preserved in shale. WALCOTT, 1918.Antennae

Olenidae

Westergaardia lata (MATTHEW) HENNINGSMOEN, *U.Cam.* (Acerocare Zone), Sandby, Skåne,

Sweden. Single cephalon preserved in black limestone. WESTERGÅRD, 1909, 1922.

Antennae

Triarthrus eatoni (HALL) RUEDEMANN [= *T. becki* AUCTION. (*non* GREEN), *M.Ord.* (Utica Shale), Holland Patent, Rome, N.Y., USA. Several complete pyritized specimens in black shale. BEECHER, 1895; WALCOTT, 1918, 1921; RAYMOND, 1920; STØRMER, 1939.

All appendages

Asaphidae

Isotelus arenicola RAYMOND, *L.Ord.* (Aylmer Formation), Britannia, Ont., Canada. Single ventral impression in sandstone. RAYMOND, 1910, 1930.Fragmentary limbs

Isotelus gigas DEKAY, *M.Ord.* (Trenton Limestone), Trenton Falls, N.Y., USA. Single specimen preserved in limestone. WALCOTT, 1881; RAYMOND, 1920.Fragmentary limbs

Isotelus maximus LOCKE, *M.Ord.* (Richmond Group), Oxford, Ohio, USA. Single fragmentary specimen preserved in limestone. MICKLEBOROUGH, 1883; WALCOTT, 1918; RAYMOND, 1920.Fragmentary limbs

Isotelus latus RAYMOND, *M.Ord.* (Trenton Limestone), Ottawa, Ont., Canada. Single fragmentary specimen preserved in limestone. BILLINGS, 1870; RAYMOND, 1920.

Fragmentary limbs

Asaphus cornutus PANDER, *M.Ord.* Baltic region of Russia. Single specimen preserved in limestone. HUPÉ, 1949.?Limb

Trinucleidae

Cryptolithus tessellatus GREEN, *M.Ord.* (Utica Shale), Holland Patent, Rome, N.Y., USA. Thirteen pyritized specimens preserved in black shale. BEECHER, 1895; RAYMOND, 1920; WALCOTT, 1921; STØRMER, 1939.All appendages

Cheiruridae

Ceraurus pleurexanthemus GREEN, *M.Ord.* (Trenton Limestone), Trenton Falls, N.Y., USA. Several complete specimens preserved in limestone. WALCOTT, 1881, 1918, 1921; RAYMOND, 1920; STØRMER, 1939, 1951.Limbs

Calymenidae

Flexicalymene senaria (CONRAD) SHIRLEY, *M.Ord.* (Trenton Limestone), Trenton Falls, N.Y., USA. Several complete specimens preserved in limestone. WALCOTT, 1918, 1921; RAYMOND, 1920; STØRMER, 1939.Limbs

Odontopleuridae

"*Acidaspis trentonensis* HALL" (identification of specimen somewhat doubtful), *M.Ord.* (Utica Shale), Holland Patent, Rome, N.Y., USA. Single specimen preserved in black shale. RAYMOND, 1920.Fragmentary limbs

Phacopidae

Phacops sp., *L.Dev.* (Hunsrück Shale), Bundenbach, Germany. Four complete specimens,

partly pyritized and partly silicified, preserved in black shale. BROILI, 1929, 1930; STØRMER, 1939.All appendages

Dalmanitidae

Asteropyge sp., L.Dev. (Hunsrück Shale), Bundenbach, Germany. Single complete specimen, partly pyritized and partly silicified, preserved in black shale. BROILI, 1930.All appendages

Incertae Sedis

Gen. et sp. indet., L.Dev. (Shumardia Limestone, Levis Formation), Levis, Quebec, Canada. Single detached appendage. CLARK, 1922 ..?Limb

Ventral appendages have been preserved under exceptional circumstances. In some fossils, such as specimens from the famous Middle Cambrian Burgess Shale of British Columbia obtained by WALCOTT, they appear as extremely fine impressions coated with a very thin silvery film. In others, as in specimens from the Middle Ordovician Utica Shale of New York and Lower Devonian Hunsrück Shale of Germany, the appendages are partly pyritized; these sediments are very fine-grained mudstones. Excellent specimens are also found in limestones, such as Middle Ordovician remains collected in the Trenton Limestone of New York and eastern Canada; the exceptional preservation of soft parts is due to entombment of enrolled or partially enrolled individuals in an extremely fine mud.

Generally, elaborate and time-consuming techniques are necessary to uncover the appendages and to prepare them for study. Enrolled or partially enrolled trilobites preserved in limestone can best be investigated by means of serial sections. Interpretation of the true structure of appendages is, at best, a difficult matter, subject to considerable divergence of opinion among specialists. The fundamental papers on the subject are by WALCOTT (1918, 1921), RAYMOND (1920), and STØRMER (1939, 1951). STØRMER's interpretations, which show considerable departure from the views of previous authors, will be followed here in the main.

Though a sweeping generalization based on the evidence furnished by only 19 species belonging to 15 genera is somewhat risky, we can accept with a certain degree of confidence the conclusion that trilobites possessed a pair of multijointed uniramous antennae succeeded by a variable number of nondifferentiated biramous appendages, 4 pairs of which were cephalic. Antenniform cerci have been discovered in a single species.

ANTENNAE

These appendages are known in 8 species of trilobites, ranging in age from Early

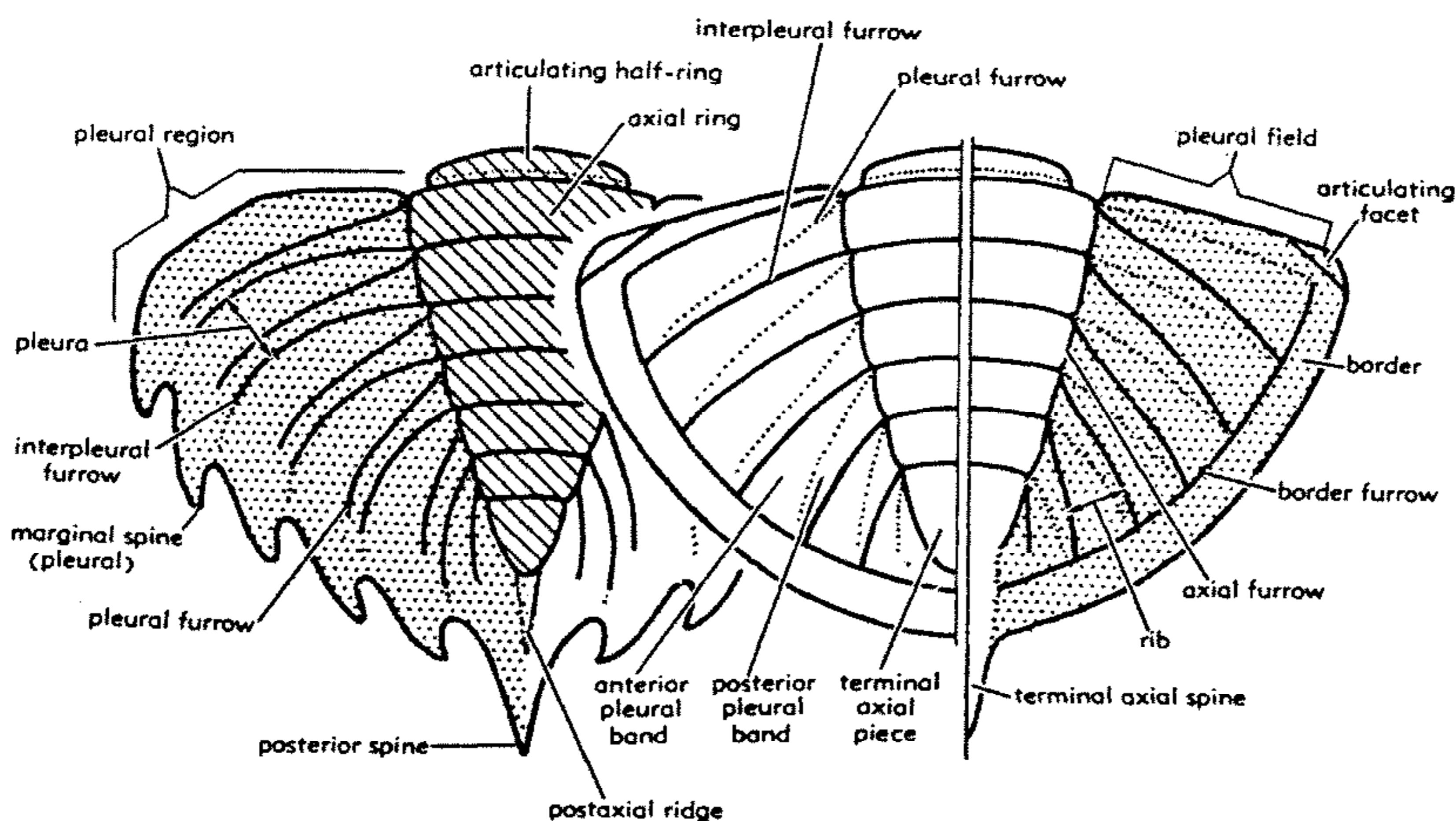

FIG. 53. Pygidial nomenclature.

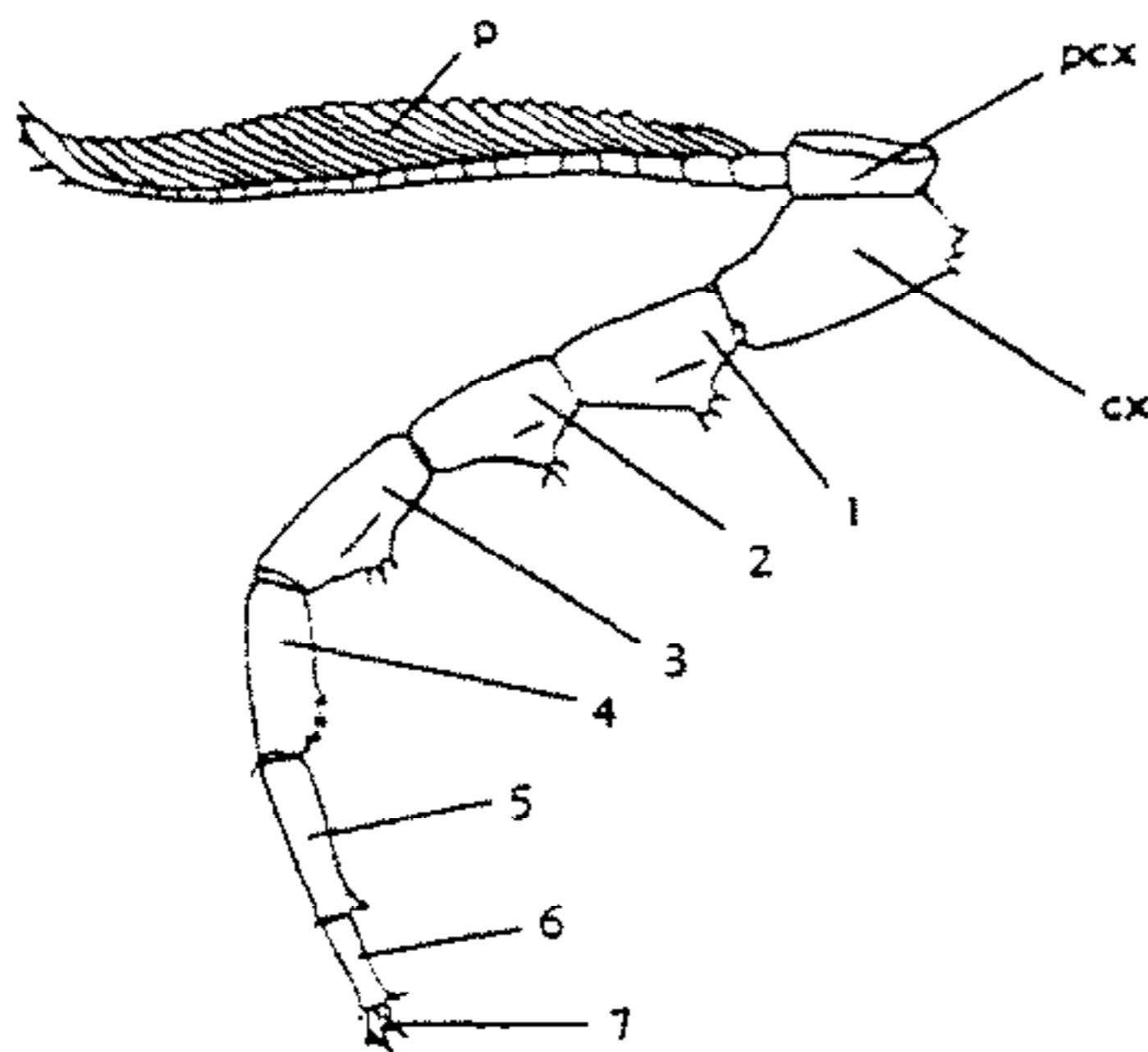

FIG. 54. General plan and terminology of the trilobite biramous appendage (after 56). (Explanation: *cx*, coxa; *p*, pre-epipodite; *pcx*, pre-coxa; 1, trochanter; 2, prefemur; 3, femur; 4, patella; 5, tibia; 6, tarsus; 7, pretarsus; 1-7, telopodite.)

Cambrian to Early Devonian. The antennae are, in all observed examples, multijointed and uniramous. They were attached to the ventral membrane close to the lateral margins of the hypostoma and, in some genera (*Cryptolithus*), directly below the dorsal fossulae or "anterior pits."

The 1st (basal) joint of the antennae is usually somewhat larger than the remainder. It is succeeded by a variable number of shorter segments, which become smaller toward the distal tip of the appendage. In *Cryptolithus*, where the joints are elongated in shape, only 15 or 20 are counted. In other trilobites, where the joints are shorter than their width or about as long as wide, their number is considerably greater: 30 in *Phacops*, 35 to 40 in *Asteropyge*, 40 in *Ceraurus*, and between 40 and 50 in *Triarthrus* and *Olenoides*. In the last-named genus, the joints carry short bristles.

The length of the antennae varies from genus to genus. In *Westergaardia* they are slightly shorter than the cephalon, in *Phacops* as long as the cephalon, and slightly longer in *Olenellus*. In *Ehmaniella* they are about 1.5 times the length of the cephalon, and in *Triarthrus* about twice this length. In *Olenoides* their length approximately equals that of the cephalon plus thorax, and in *Asteropyge* it is about equal to $\frac{2}{3}$ of the total length of the dorsal exoskeleton.

In *Olenellus*, *Westergaardia*, and *Ehmaniella*, the antennae seem to have been rather

stiff and nearly straight, directed forward and slightly outward, diverging at different angles. In *Olenoides*, *Triarthrus*, *Ceraurus*, *Phacops*, and *Asteropyge*, they were evidently very flexible. In *Olenoides*, *Triarthrus*, and *Ceraurus*, they were directed forward and S-shaped. In *Phacops* and *Asteropyge*, they seem to have been gently curved and directed outward and slightly backward. In *Cryptolithus*, they were also slightly curved but directed almost straight backward, passing below the adaxial parts of the biramous appendages and stretching as far back as the level of the anterior border of the pygidium.

BIRAMOUS APPENDAGES

The paired biramous appendages of trilobites, which apparently served the triple purpose of ambulatory, natatory, and respiratory organs, were nondifferentiated among themselves other than by location and size. The evidence available shows that, in any given genus, all the appendages were very similar in structure and shape, the only differences noted between successive pairs being a general increase in size from the 1st to the 3rd cephalic pair, and then a general decrease to the last pygidial pair.

Most authorities are agreed that 4 pairs of appendages were cephalic and postoral in position, the remainder being thoracic and pygidial, a pair of biramous appendages being attached to each postcephalic somite (with the exception of the last pygidial segment, which seems to have been apodous or in some genera to have carried caudal rami). The appendages were attached to the thickened ventral integument along the anterior half of each sternite at a place located about midway between the sagittal line and the axial furrow, directly below the ventral tips of the apodemes (when present).

The biramous appendages of all species in which they have been preserved, show that invariably they were built on the same general plan (Fig. 54). The appendages consist of 2 branches: (a) a principal "walking leg" or telopodite, and (b) a secondary "gill-bearing branch" or pre-epipodite. The appendage was attached to the ventral integument by means of a basal segment, the pre-coxa, succeeded by a considerably larger podite called the coxa (or

coxopodite). The ensemble of pre-coxa and coxa is usually termed protopodite. Contrary to previous assertions, STØRMER has shown that the inner outgrowth (endite) of the coxa (basiendite), is feebly developed and cannot be regarded as a gnathobase.

The principal branch of the appendage, the telopodite, springs from the coxa. It is formed of 7 successive articulating podites called trochanter, prefemur, femur, patella, tibia, tarsus, and pretarsus. All joints, except the distal pretarsus, are similar in structure, being subcylindrical in shape with somewhat flattened sides. The ventral side of the trochanter, prefemur, and femur (*Triarthrus*, Fig. 55A,B), and in some genera (*Cryptolithus*, Fig. 55C,D) also of the patella, was produced into subtriangular endites bearing spines or bristles. In some species, spines or bristles are found also on the flattened sides and on the distal margins of the segments. The tibia and tarsus are usually more tubular in shape and more slender than other limb segments, the tarsus being considerably smaller than the tibia. The distal joint, or pretarsus, consists of a small basal plate (equivalent to the pseudonychium of some Recent Arachnida) bearing a tripartite claw formed of 3 diverging spines, the mesial spines being longer than the others (Fig. 57C,D). The telopodite had no well-marked knee, the articulations between successive podites being of subequal importance.

The pre-epipodite, or gill branch, sprang from the pre-coxa and, in the living animal, it occupied a dorsal position with respect to the telopodite. It was usually shorter than the telopodite and, except in *Triarthrus*, it did not extend beyond the pleural extremities. The pre-epipodite, especially characteristic of the trilobite limb, was essentially formed of an elongated shaft bearing a fringe of bladelike filaments. Certain differences are evident when the pre-epipodites of different genera are compared, even if they can all be reduced to a common basic type. In *Cryptolithus*, *Triarthrus*, *Phacops*, and *Asteropyge*, the shaft is narrow, rod-like, and divided into numerous (15 to 20) subsegments. The bladelike filaments are directly attached to the shaft, but the distal spoon-shaped portion of the shaft bears no filaments, being provided, instead, with thin bristles or setae. In *Olenioides* and *Kootenia*

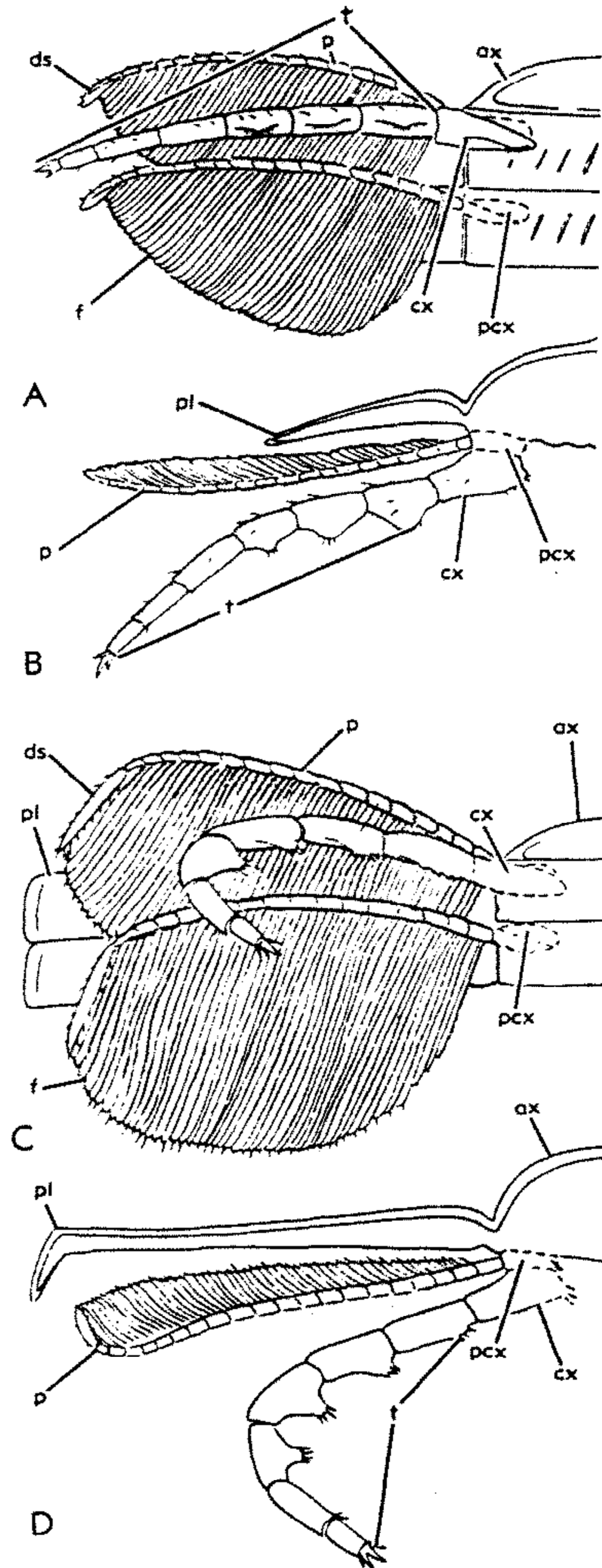

FIG. 55. Diramous appendages of trilobites; reconstructions of the appendages of 2 thoracic segments (after 56).—A,B. *Triarthrus eatoni* (HALL) RUEDEMANN, M.Ord., USA(N.Y.); A, ventral view; B, anterior view, $\times 5$.—C,D. *Cryptolithus tessellatus* GREEN, M.Ord., USA(N.Y.); C, ventral view; D, anterior view, $\times 14$. (Explanation: ax, axis; cx, coxa; ds, distal segment of pre-epipodite; f, filaments; p, pre-epipodite; pex, pre-coxa; pl, pleura; t, telopodite.)

(Fig. 56B-D), the rodlike shaft forms the anterior ridge of a rather broad paddle-shaped or spatulate lobe bearing faint traces of transverse segmentation, the filaments

being attached to the posterior border of the lobe. A distal, subtriangular segment is clearly defined from the main part of the spatulate lobe, but contrary to what hap-

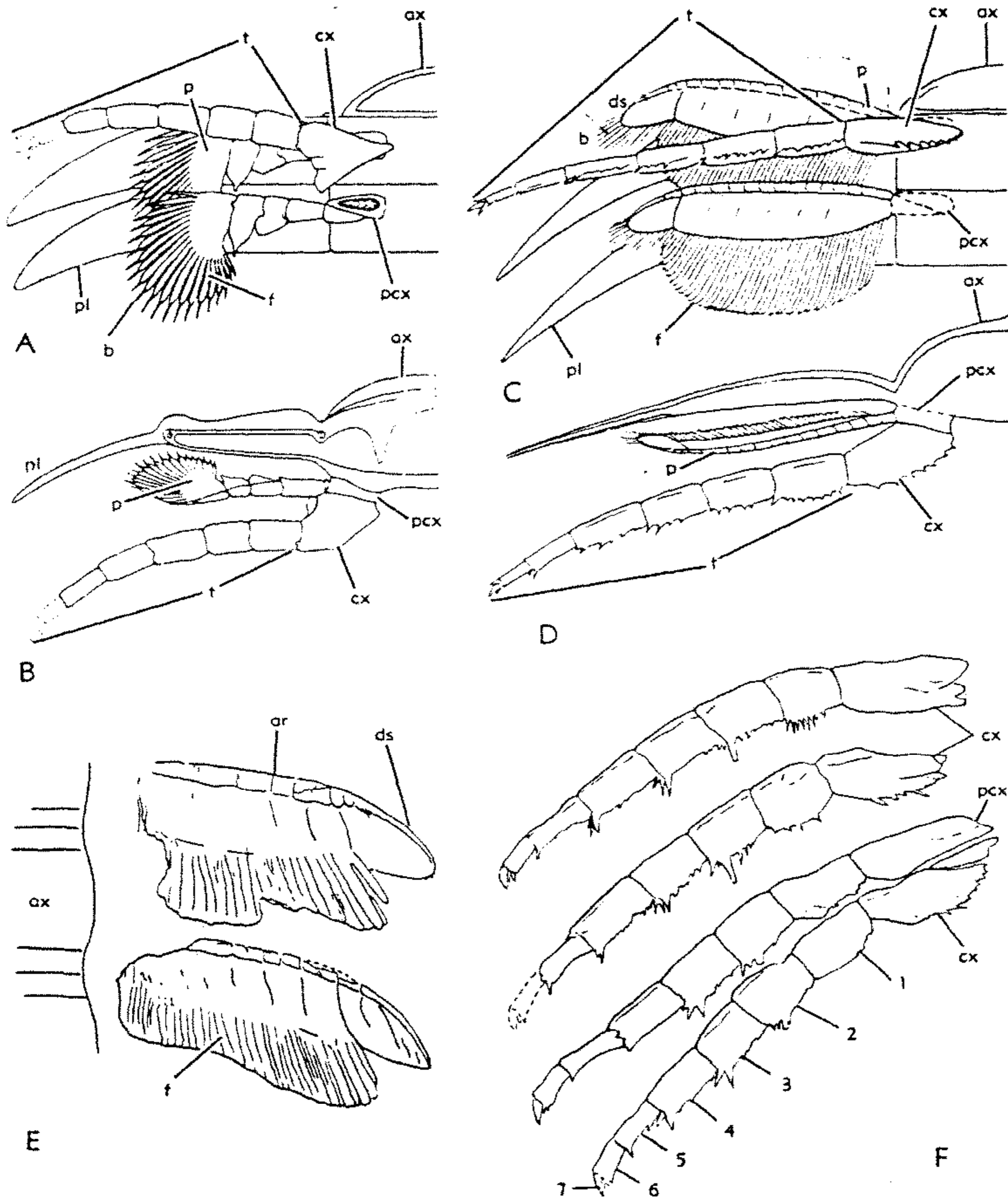

FIG. 56. Biramous appendages of trilobites.—A-D. Reconstructions of the appendages of 2 thoracic segments; A,B, *Ceraurus pleurexanthemus* GREEN, M.Ord., USA (N.Y.) (after 24, from 56); A, ventral view; B, anterior view, X6.35; C,D, *Olenoides serratus* (ROMINGER) KOBAYASHI, M.Cam., Can. (B.C.) (after 56); C, ventral view; D, anterior view, X2.—E. Pre-epipodites of *Kootenia dawsoni* (WALCOTT) WALCOTT, M.Cam., Can. (B.C.), X5 (after 56).—F. Telopodites of *Olenoides serratus* (ROMINGER) KOBAYASHI, M.Cam., Can. (B.C.), X3.3 (after 56). (Explanation: ar, anterior ridge of pre-epipodite; ax, axis; b, bristles; cx, coxa; ds, distal segment of pre-epipodite; f, filaments; p, pre-epipodite; pcx, precoxa; pl, pleura; t, telopodite; 1-7, segments of telopodite.)

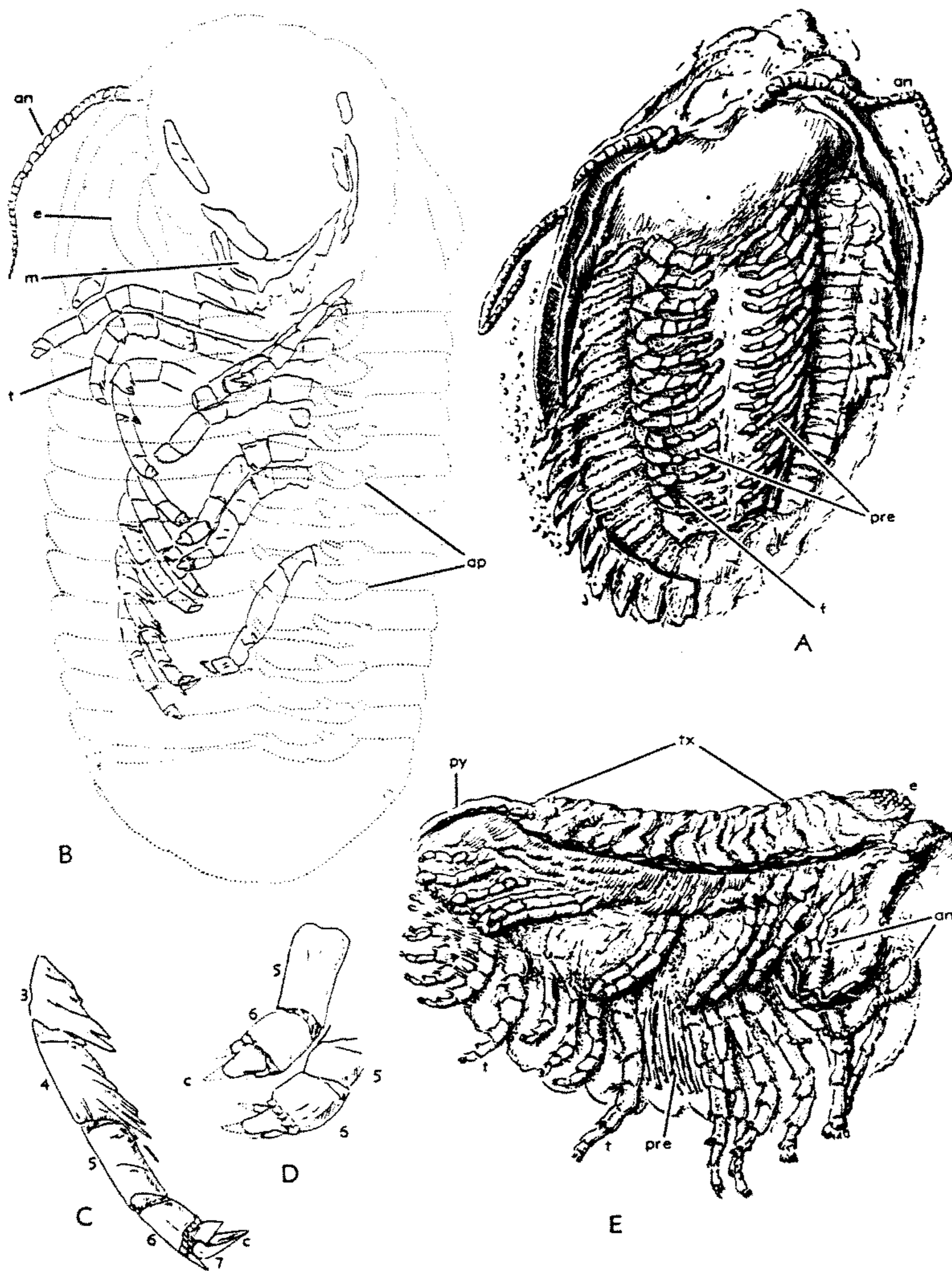

FIG. 57. Ventral appendages of trilobites.—*A.* *Asteropyge* sp., L.Dev., Ger., X2; ventral view of specimen lacking cephalic biramous appendages (after 72).—*B-E.* *Phacops* sp., L.Dev., Ger.; *B*, ventral view of specimen retaining several telopodites, right antenna, and metastoma, X1.33; *C-E*, enlargement of fragmentary telopodites, showing distal claw, X3.7 (after 55); *F*, lateral view of specimen showing biramous appendages and antennae, X0.75 (after 72). (Explanation: *an*, antenna; *ap*, apodeme; *c*, claw; *e*, eye; *f*, filaments; *m*, metastoma; *p*, pre-epipodite; *py*, pygidium; *t*, telopodite; *tx*, thorax; 3-7, segments of telopodite.)

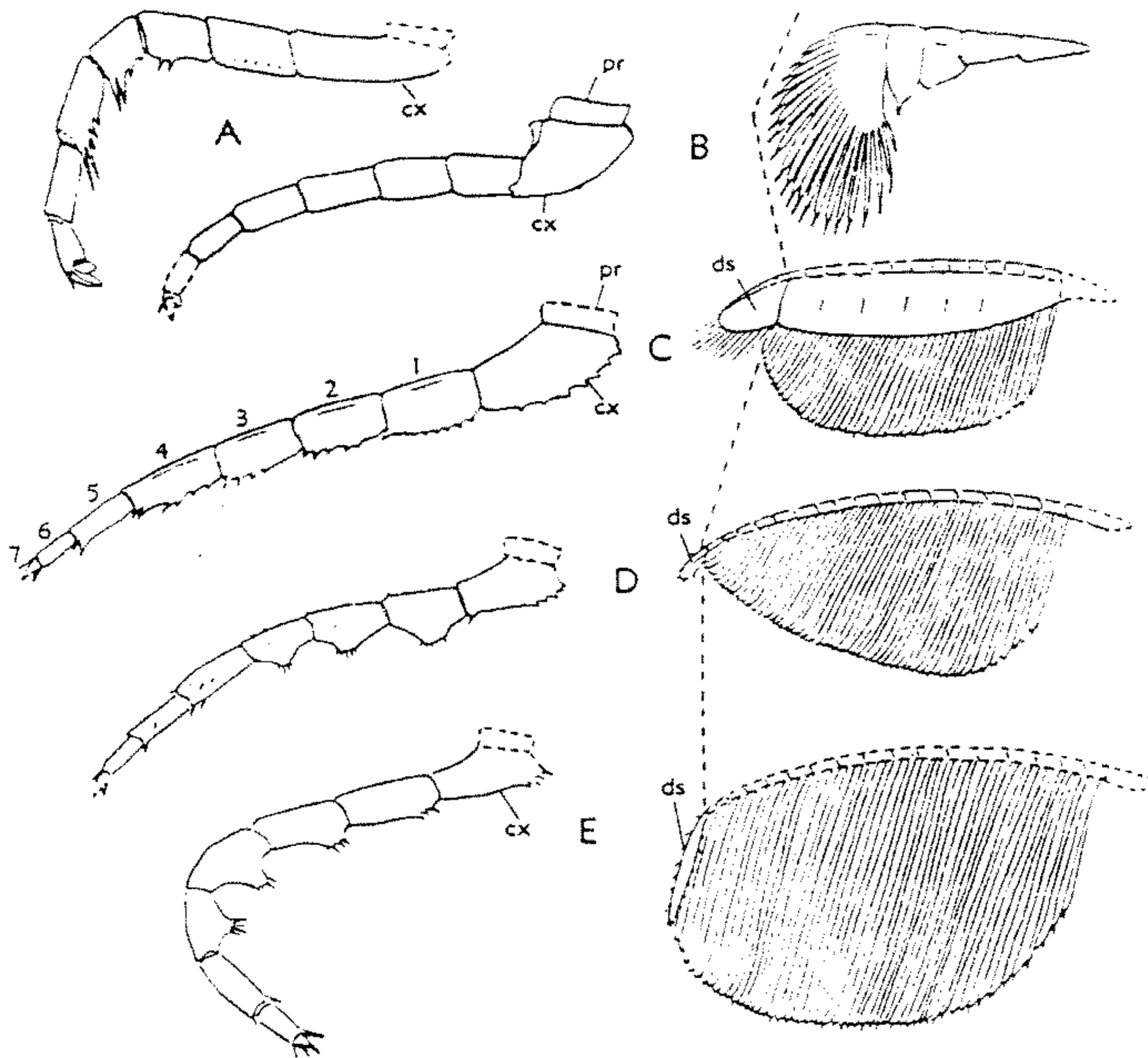

FIG. 58. Structural uniformity of trilobite biramous appendages; left side, telopodites; right side, pre-epipodites (after 56).—A. *Phacops* (Devonian).—B. *Ceraurus* (Ordovician).—C. *Olenoides* (Cambrian).—D. *Triarthrus* (Ordovician).—E. *Cryptolithus* (Ordovician). (Explanation: *cx*, coxa; *ds*, distal segment of pre-epipodite; *pcx*, precoxa; 1-7, segments of telopodite.)

pens in *Cryptolithus* and *Triarthrus*, this distal part also bears filaments, albeit much shorter than those carried by the main part of the lobe. Lastly, the pre-epipodite of *Ceraurus* (Fig. 56A,B) consists of 5 joints increasing in size abaxially, the distal joint bearing filaments attached to its outer and posterior margins. The joints may be homologized with the broad faintly jointed lobe of *Olenoides* and *Kootenia*. The rodlike shaft is apparently reduced to a faint anterior ridge, barely marked in the the 3 distal segments of *Ceraurus*. In this genus there is no structure equivalent to the distal spoon-shaped or subtriangular joints of *Triarthrus* and *Olenoides* (Fig. 58).

The bladelike filaments, regarded as breathing organs or external gills, are very similar in all genera (Fig. 59). They are thin ribbon-like structures bearing a short

cylindrical bristle at their blunt distal extremity. They were attached to the shaft or lobe so as to resemble the teeth of a comb, with their broad sides facing each other. The fringe of gill blades was usually directed backward, the anterior edge of one pre-epipodite overlapping the posterior edge of its neighbor immediately in front. In *Ceraurus* and *Cryptolithus*, however, it seems that the fringe could have been turned forward.

FUNCTION OF LIMBS

Fundamentally, the telopodites clearly are walking limbs, by means of which trilobites were capable of crawling over the sea bottom and along sea weeds or floating objects. The abundance of *Cruziana* markings in lower Paleozoic rocks and their almost total absence in post-Permian sedimentites suggests, as already pointed out by WALCOTT

and RICHTER, that they mainly represent trails left by trilobites. The structure of the strong distal claw of *Phacops* indicates that, at least in some genera, the telopodites may also have been used for digging in the soft bottom. Isolated *Cruziana* trails commonly end in a subcircular depression, suggesting that the animal responsible for the marking dug down into the soft sediment.

Several authors have suggested that the telopodites were both walking and swimming organs, the endites of the successive podites acting as paddles. This is extremely unlikely, however, since it is difficult to admit that such primitive Arthropoda could have been capable of co-ordinating the movements of the same organs for such different purposes as walking and swimming. In walking, the arthropod legs move one after the other in such a way that when one of the rear legs is being moved backward for "pushing" the body forward, one of the anterior legs is being moved forward without touching the substrate. In swimming, all legs move backward or forward synchronously, the back stroke being a sudden flip that propels the body forward. It is unbelievable that primitive Arthropoda could have had the highly developed nervous system necessary to co-ordinate at will the movements of the same appendages in these 2 very different manners. If the telopodites were used in swimming, which is very unlikely, they must have moved just as in walking, the result being a very inefficient "walking in water."

The pre-epipodites, unlike the telopodites, were probably swimming and breathing organs. Their swimming function has been suggested by several authors, although opposed by others, but it must be owned that their shape strongly indicates a swimming adaptation. The flat expanse of the spatulate lobe of *Olenoides* and *Kootenia*, and the paddle-shaped pre-epipodite of *Ceraurus*, suggest an oarlike function. These peculiar shapes indicate that, admitting a respiratory function of the fringe of bladelike filaments, the pre-epipodites must have had some other use than serving simply as supporters for the gills. Actually, the "gill blades" themselves may have aided effectively in swimming, since, during the "back stroke," they could have overlapped each other like the

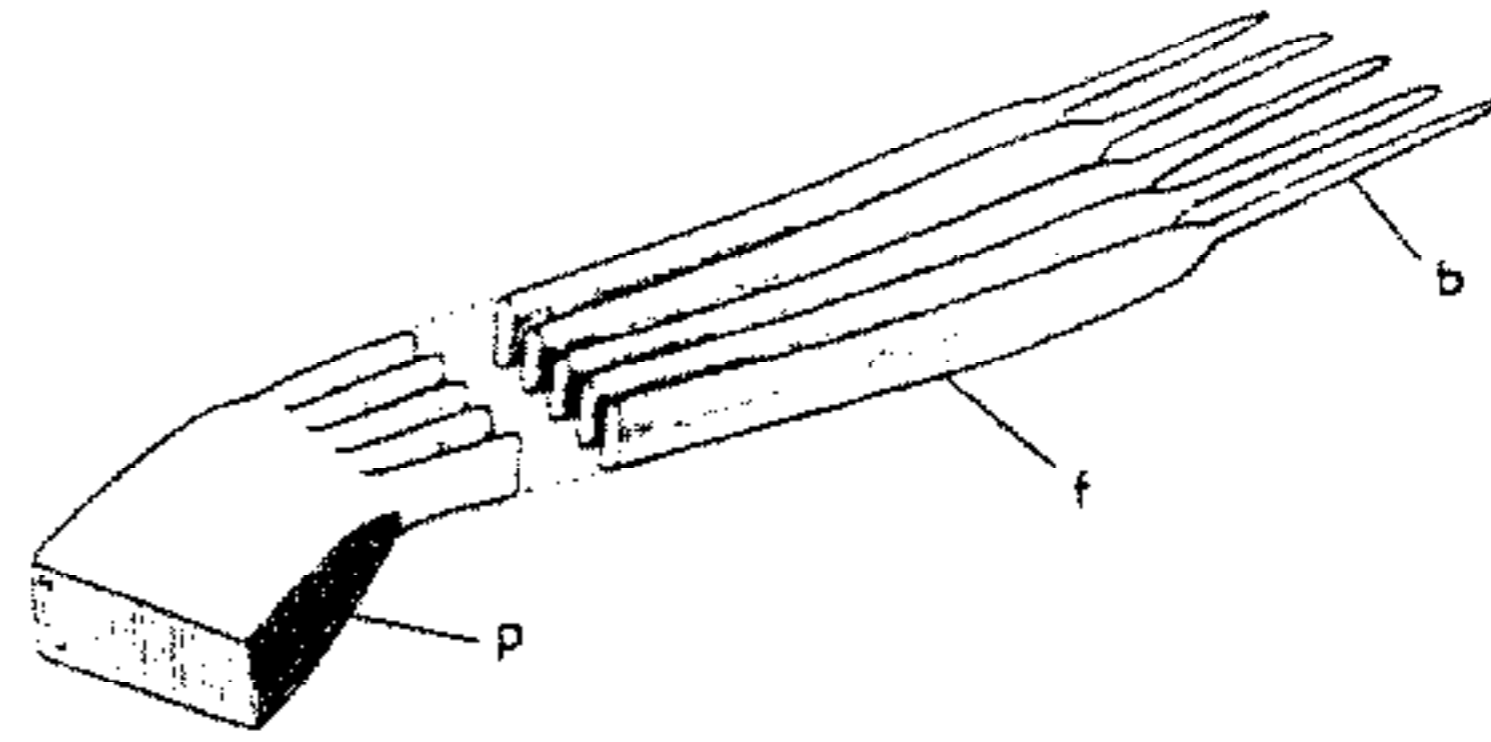

FIG. 59. Diagrammatic reconstruction of the filaments (gill blades) of *Ceraurus pleurexanthemus* GREEN, M.Ord., USA(N.Y.), greatly enlarged (after 56). (Explanation: *b*, bristle; *f*, filaments; *p*, 5th segment of pre-epipodite.)

shutters of a closed Venetian blind, thus greatly increasing the "useful swimming surface" of the pre-epipodite. During forward movement of the limb, the blades may have rotated 90° or thereabout, presenting the appearance of an open Venetian blind, which would offer minimum resistance to the water passing between the blades. The distal spoon-shaped or subtriangular segment of *Triarthrus* and *Olenoides* may have served the purpose of a flipper or horizontal rudder to control oblique upward or downward swimming. In short, it is believed that the pre-epipodites could have acted as effective swimming organs with synchronized backward and forward movements. If this was so, the telopodites were probably not used at all in swimming. They may have been bent inward and backward and left idle in that position, leaving ample room for free movement of the pre-epipodites.

The breathing function of the bladelike filaments has been accepted by most authors and, in truth, their structure and disposition strongly suggest that they acted as external branchia. ERIKSON (1934) and STØRMER (1939) have suggested that a "sucking chamber" could have been formed between the pleurae and the overlapping pre-epipodites, water being forced into the chamber by a downward movement of the pre-epipodites and expelled through the gill blades by an upward movement. The distal segments of the pre-epipodites could have acted as valves or opercula, rhythmically opening and closing the lateral borders of the chamber and alternately permitting the influx and preventing outflow of water. This suggestion, though ingenious, seems rather far-fetched and evidently it cannot be applied

to *Ceraurus*. The same results—maintaining circulation of aerated water around the gill blades—could have been achieved in a far simpler way by a gentle “fanning” of the pre-epipodites. If the pre-epipodites were used for swimming in the manner suggested, their movement would have bathed the gills with a continuous supply of aerated water.

ANTENNIFORM CERCI

In *Olenoides serratus*, the terminal (18th) pair of ventral appendages consists of multi-jointed uniramous cerci, very similar to the cephalic antennae (Fig. 60). Excellently preserved specimens show that the antenniform cerci are somewhat shorter than the antennae and evidently they were considerably stiffer. They were attached by

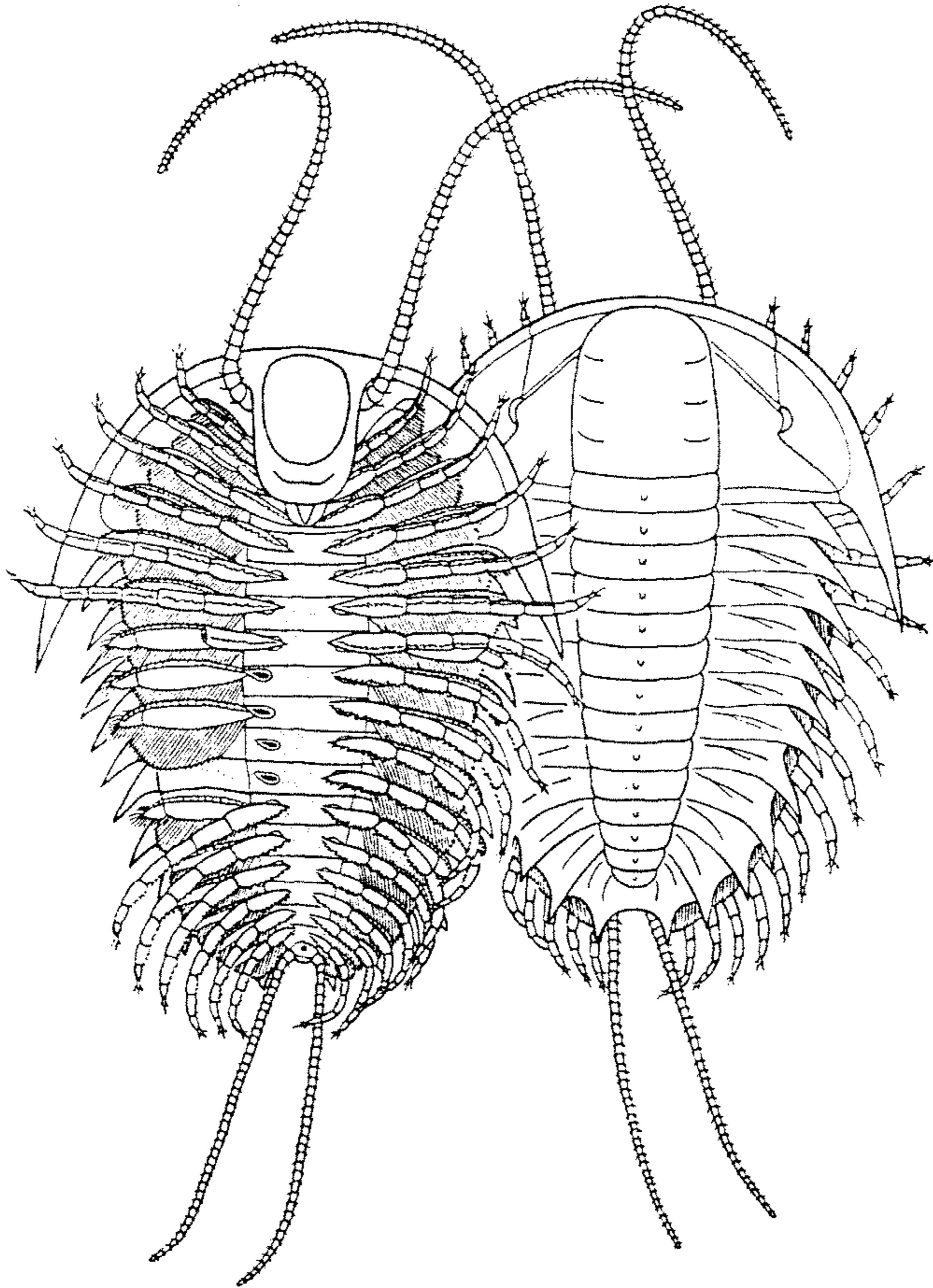

FIG. 60. Reconstruction of *Olenoides serratus* (ROMINGER) KOBAYASHI, M. Cam., Can. (B.C.), X1 (after 60).

joints to the ventral integument of the last pygidial segment. No trace of antenniform cerci has been found in other trilobites, and it is likely that they were absent in *Triarthrus*, *Ceraurus* (Fig. 61), *Phacops*, and other genera in which the ventral appendages are known.

MICROSTRUCTURE OF EXOSKELETON

The exoskeleton of trilobites consists of a thin integument that is directly comparable to the chitinous cuticle of other Arthropoda. Parts of the integument, notably that forming the dorsal covering of the body but

also certain areas of the ventral side, were mineralized and hard. In these parts, the inner layers of the cuticle were impregnated by calcareous salts (carbonate, phosphate) as in many living Crustacea. According to SCHULZE (1937), P_2O_5 may form as much as 30 per cent of the exoskeletal substance. This mineralization gave a high rigidity to the test, rendering it easily fossilizable.

Thickness of the mineralized exoskeleton is variable and not directly related to size of the trilobites. In specimens of *Tretaspis* averaging 17 to 18 mm. in length, thickness of the cephalic exoskeleton is about 0.2 mm. (STØRMER, 1930). Pygidia of *Scutellum flabelliferum* 10 to 20 mm. in length are

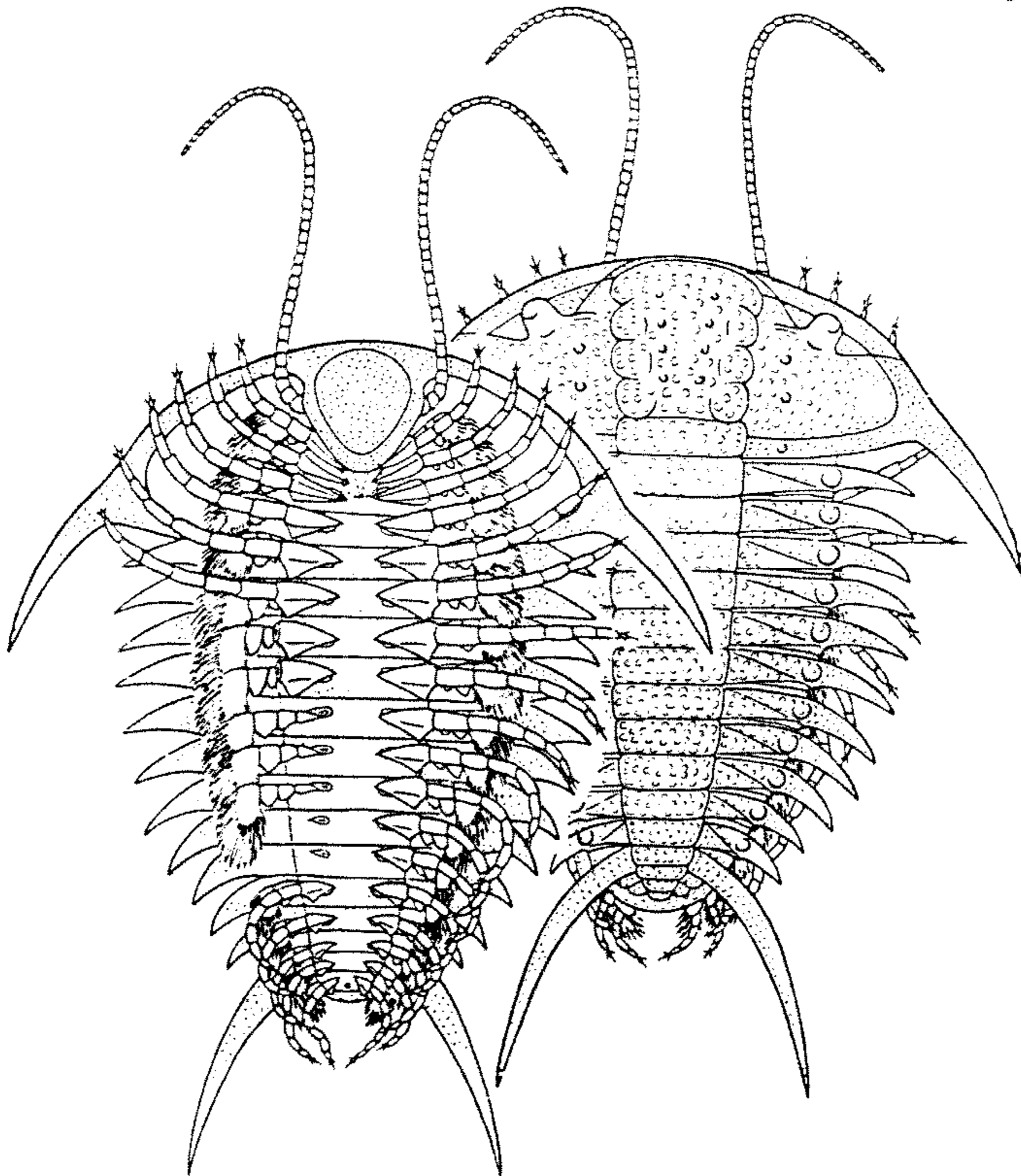

FIG. 61. Reconstruction of *Ceraurus pleurexanthemus* GREEN, M.Ord., USA(N.Y.), $\times 2.15$ (after 60).

about 0.07 mm. thick, where cephalons of *Phacops sobolevi* about 15 mm. long are approximately 0.33 mm. thick (KIELAN, 1954). Most Olenellidae have a very thin exoskeleton but specimens of *Agraulos* only 4 mm. long may have exoskeletons as much as 0.5 mm. thick¹ (HUPÉ, 1953). It seems probable that in some olenellids the dorsal integument of the opisthothoracic segments was mineralized only weakly or not at all, and accordingly, the opisthothorax of such forms is never preserved. Lack of mineralization also could explain apparent absence of the hypostoma among Agnostida.

¹ Some authors (such as RAW, 1937) have claimed that some trilobite exoskeletons have been thickened secondarily during fossilization.—C.J.S.

The microscopic constitution of the mineralized integument has been described in only a few species, notably *Trinucleus bronni*, *T. bucculentus*, *Tretaspis kjaeri*, *T. seticornis*, *Scutellum (Scutellum) flabelliferum*, and *Phacops (Phacops) sobolevi* (STØRMER, 1930; KIELAN, 1954). Sections of well-preserved specimens (Fig. 62) show that the integument is formed of 3 layers: (1) a thin apparently pigmented outer layer, (2) a median principal layer, and (3) a thin nonpigmented inner layer. In addition, some thin sections of *T. seticornis* show what seems to be a very thin outermost layer that is indicated in sections by a dark line (Fig. 67C). The principal layer makes up about 0.7 to slightly more than 0.8 of the whole

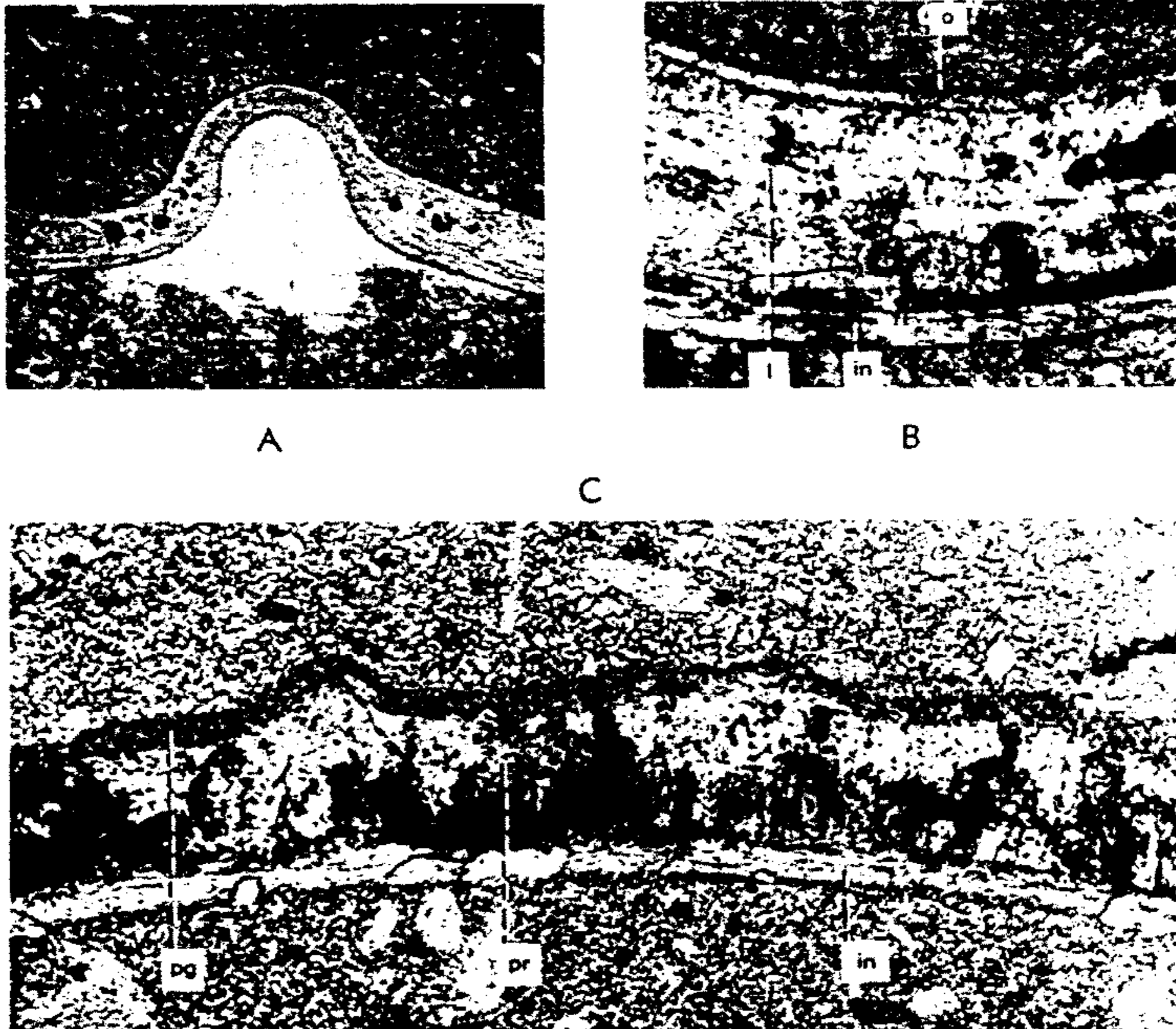

FIG. 62. Microstructure of the dorsal exoskeleton indicated by thin sections of parts of the cephalon of *Tretaspis seticornis* (HISINGER) STØRMER, Ord., Norway (after 55).—A, Transverse section across lateral eye tubercle, $\times 38$.—B, Cross-section of glabellar region, $\times 150$.—C, Transverse section across axial furrow, $\times 100$. (Explanation: *o*, possible traces of outermost layer; *pg*, pigmented layer; *pr*, principal layer; *in*, inner layer; *l*, laminations of the integument.)

thickness. In *Trinucleus* and *Tretaspis* the inner layer, in many specimens not sharply defined from the principal layer, is slightly thicker than the outer layer, whereas in *Scutellum* the reverse is true. The layers show distinct lamination, which, however, is most conspicuous in the median or principal layer. In addition, all layers are traversed by very fine straight canaliculi directed normally to the lamination, the canaliculi being most abundant and closely crowded together in the principal layer. This microscopic constitution is closely comparable to that of the dorsal integument of living Arthropoda. Taken together, the 3 main layers seem to correspond to the modern arthropod endocuticle; the pigmented (outer) and principal (median) layers of trilobite exoskeletons respectively represent the outer and inner zones of the pre-exuvial layers of living Arthropoda, and the inner layer (trilobites) corresponds to the deep postexuvial zone of the dorsal integument (modern arthropods). The doubtful outermost layer seen in *Tretaspis seticornis* may represent the thin epicuticle of other Arthropoda. It is worth while to mention that sections of the granulose pygidial integument of *Scutellum flabelliferum* show that the exoskeleton becomes very thin at the granules, where it is formed exclusively of the outer pigmented layer (Fig. 63).

SENSORY ORGANS

With the exception of the antennae and antenniform cerci, the only well-known sensory organs of trilobites are the paired dorsal eyes. Less understood are the hypostomal maculae, the median glabellar tubercle, and the possible integumentary organs connected with perforations of the exoskeleton in certain species. The antennae and antenniform cerci have already been described in dealing with the ventral appendages (p. 076).

EYES

Normally, the dorsal side of the cephalon of trilobites bears a pair of laterally placed eyes, the visual surfaces of which are carried by the librigenae if facial sutures are present. The eyes vary in size from very small, as in some Harpidae, to extremely large, as in most Cyclopygidae. Excepting a very few genera, such as *Cyclopyge*, *Ellipso-*

taphrus, and *Symphysops* (Fig. 64,2), in which the visual surfaces are confluent anteriorly, all trilobites have separate eyes.

The visual surface of the eye is usually crescentic or reniform in dorsal outline, whereas in transverse section it is convex outward-upward. In many trilobites a narrow raised area of the librigena, called eye platform, forms a sort of socle at the base of the visual surface. Adaxially, the visual surface is separated from the palpebral lobe of the fixigena by the facial suture. In a few

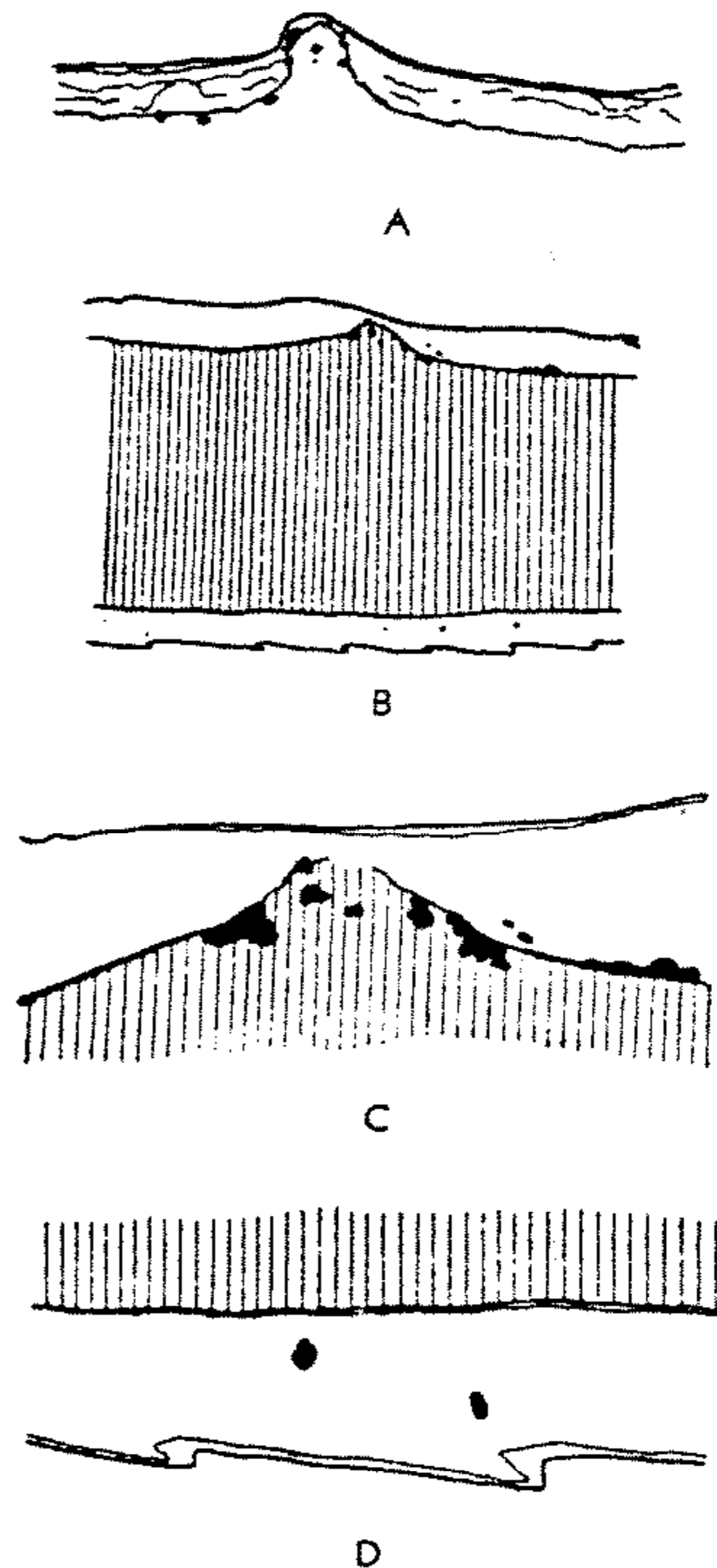

FIG. 63. Microstructure of the dorsal exoskeleton indicated by thin sections of parts of the pygidium of *Scutellum (Scutellum) flabelliferum* (GOLDFUSS) RICHTER & RICHTER, M.Dev., Poland (after 29). —A, Section across axis, cutting a tubercle, $\times 35$. —B, Longitudinal section along rib, cutting doublure (ruled area corresponds to matrix), $\times 35$. —C, Part of the upper (dorsal) integument of B, $\times 140$. —D, Part of the lower integument (doublure) of B, $\times 140$.

trilobites, the eye platform and the palpebral lobe rise almost vertically from the genal surface, forming a sort of stalk or peduncle that carries the visual surface on the abaxial side of its extremity (Fig. 400).

Several authors have described in detail the eyes of different trilobites. The most important contributions are those of CLARKE (1889), LINDSTRÖM (1901), RICHTER & RICHTER (1926), BRINK (1951), and BECKMANN (1951).

Since CLARKE'S (1889) early studies and LINDSTRÖM'S (1901) classical investigations, it has been generally accepted that 2 types of eyes are present among trilobites. These

are holochroal (compound) and schizochroal (aggregate) eyes.

HOLOCHROAL EYES

The holochroal (CLARKE) or compound (LINDSTRÖM) eyes are characterized by the presence of many small lenses packed closely together in direct contact with one another. The ensemble of all the lenses is covered by a very thin pellucid cornea, which grades laterally into the mineralized integument of the cephalon. The cornea, therefore, is a single continuous membrane that covers the whole eye. The so-called "eye facets" are nothing more than the outline of the in-

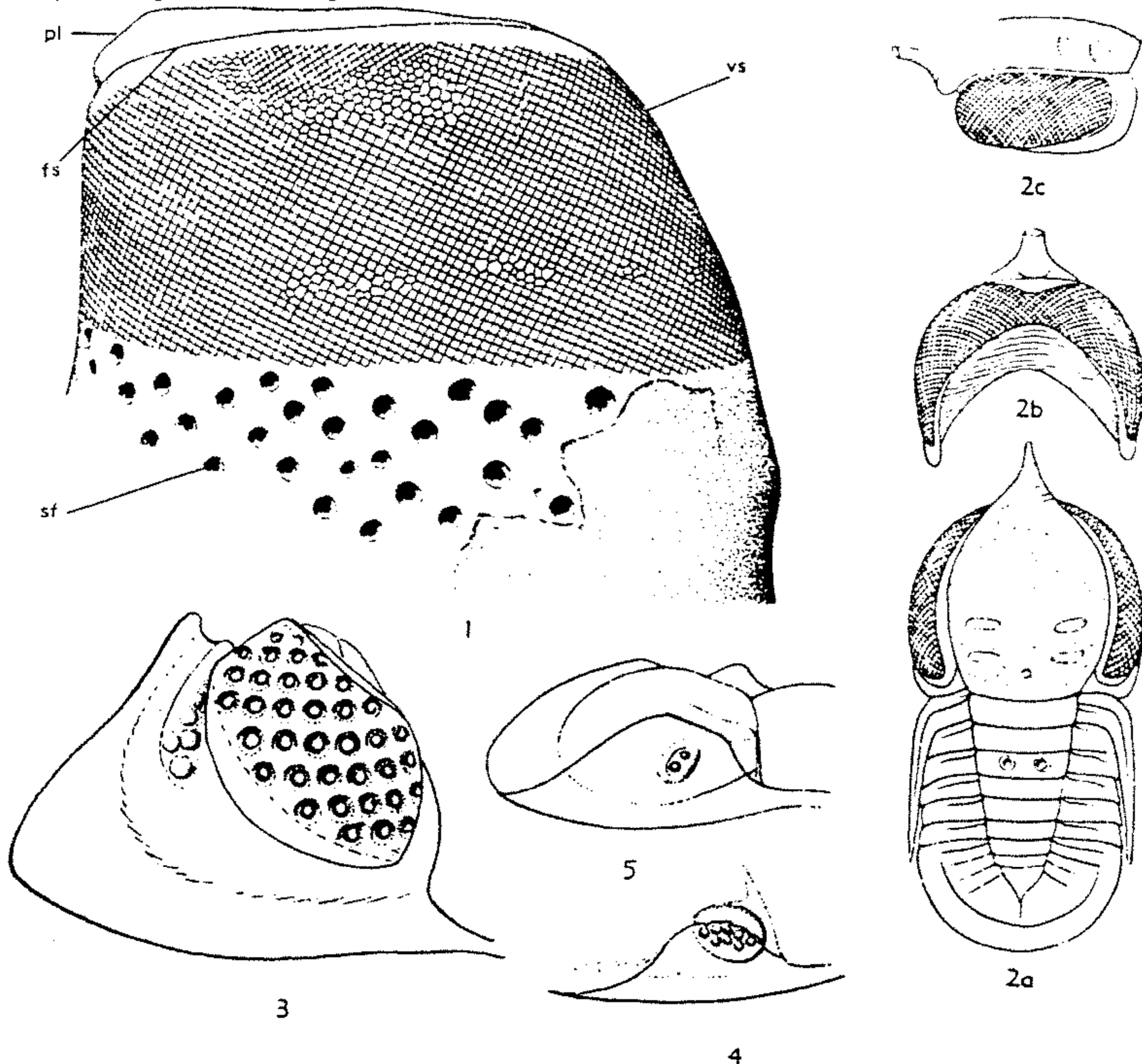

FIG. 64. Eyes of trilobites.—1. Holochroal eye of *Asaphus cornutus* PANDER, Ord., Russia, X25 (after 24). (Explanation: *fs*, facial suture; *sf*, sensorial fossette; *pl*, palpebral lobe; *vs*, visual surface.)—2. Confluent eyes of *Symphysops subarmatus* (REED) RAYMOND, U.Ord., G.Brit., X1.2; 2a, dorsal view of carapace; 2b, ventral view of cephalon; 2c, lateral view of cephalon (after 26).—3. Right eye of *Phacops latifrons* (BRONN), M.Dev., Ger., X2.5 (after 45).—4. Right eye of *Cryphops cryptophthalmus* (EMMIRICH), U. Dev., Ger., X7 (after 45).—5. Left eye of *Nephranops incisus incisus* (ROEMER), U.Dev., Ger., X2 (after 45).

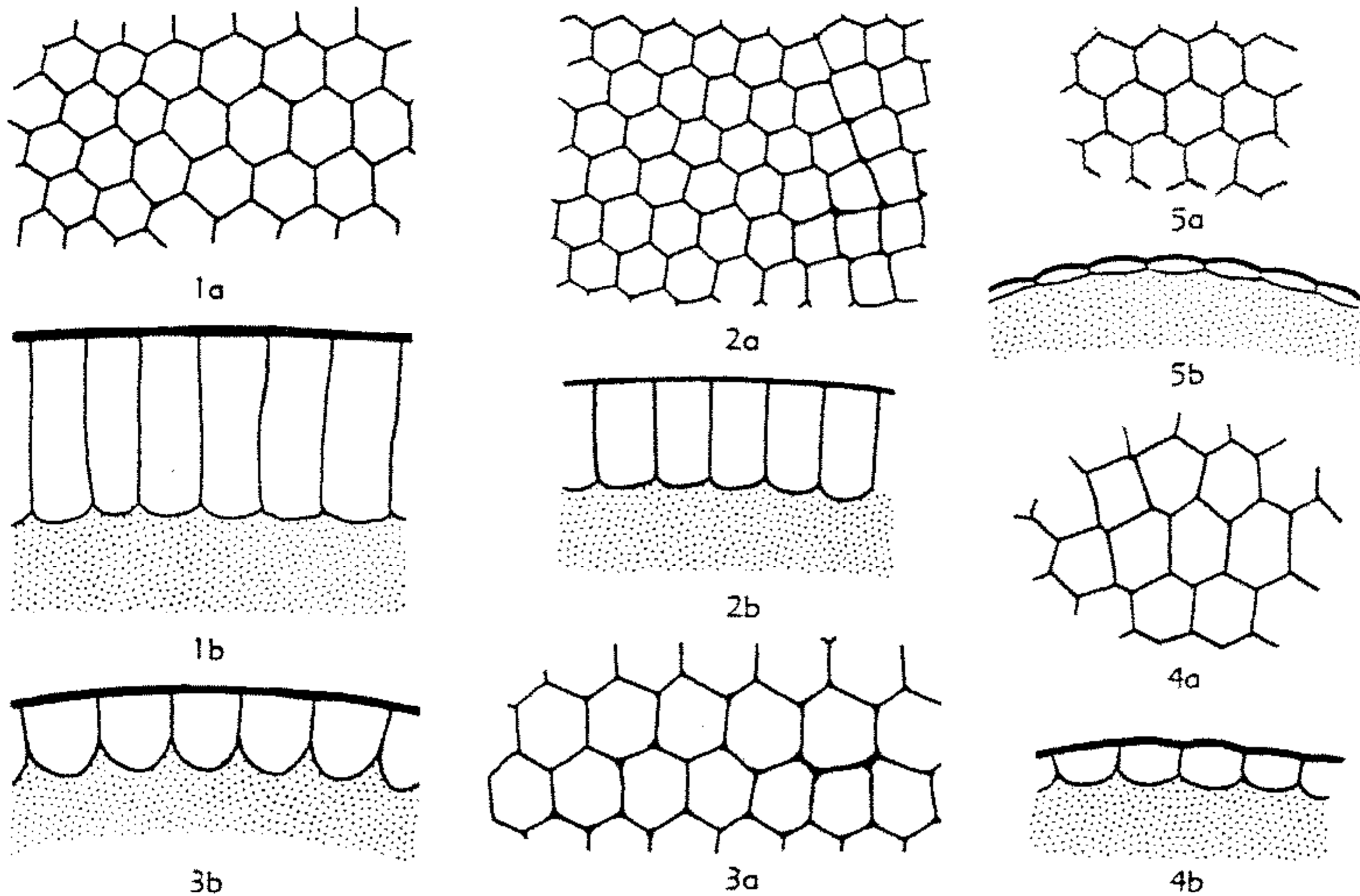

FIG. 65. Holochroal trilobite eyes (after 31).—1. *Iliaenus chiron* HOLM, Ord., Swed.; 1a,b, transv. and long secs. of several eye lenses, $\times 60$.—2. *Dysplanus centrotus* (DALMAN), Ord., Swed.; 2a,b, transv. and long. secs., $\times 60$.—3. *Cyrtometopus clavifrons* (DALMAN), Ord., Swed.; 3a,b, transv. and long. secs., $\times 60$.—4. *Sphaerophthalmus alatus* (BOECK) ANGELIN, U.Cam., Swed.; 4a,b, transv. and long. secs., $\times 100$.

dividual lenses beneath the transparent cornea. The number of lenses in a single eye ranges from a hundred in some species of *Peltura*, and more than 15,000 in some *Remopleurides*. The lenses are usually hexagonal in outline and arranged with great economy of space, but rhomboidal and even quadrate outlines are by no means rare. Lenses with quadrate outline seem to be the rule in eyes with a very large visual surface (Fig. 64,1,2), but they may occur side by side with hexagonal lenses in eyes of moderate or small size.

LINDSTRÖM recognized 2 subtypes of holochroal eyes: (1) with prismatic planoconvex lenses, and (2) with thin biconvex lenses. The eyes of *Asaphus fallax* and of *Iliaenus chiron* (Fig. 65,1) illustrate the 1st subtype. Here the lenses are hexagonal prisms that, as seen in sections normal to the visual surface of the eye, are between 2 and 3 times as long as wide. In LINDSTRÖM's words, the lenses "are columnar prisms, like the pillars of basalt," having a plane outer surface and a convex inner extremity. In *Dysplanus centrotus* (Fig. 65,2) the prisms are consid-

erably shorter than in *Asaphus fallax*, whereas in some species of *Acidaspis* they are just a little longer than their width.

The 2nd subtype is illustrated by *Cyrtometopus clavifrons* and *Sphaerophthalmus alatus* (Fig. 65,3,4). Here the lenses are truly "lenticular" in cross section, being thin and biconvex. Probably this is the most primitive subtype of holochroal eye, and it seems that transitions exist between this and all other types. The eyes of *Peltura scarabaeoides* appear to be intermediate between the "biconvex" and the "planoconvex" subtypes, and those of some Cheiruridae seem to provide a link between the holochroal and the schizochroal types.

SCHIZOCHROAL EYES

The schizochroal (CLARKE) or aggregate (LINDSTRÖM) eyes are especially characteristic of the phacopid trilobites, but as WHITTINGTON & EVITT (1953) have shown, they also occur in some Cheiruridae, notably in the genera *Holia*, *Acanthoparypha*, and *Sphaerexochus*. The eye consists of biconvex lenses, larger and less numerous than those

of the holochroal type, each lens having its own corneal covering. The individual lenses, which are circular in outline in the pha-

copids but hexagonal in the cheirurids, are separated from each other by thick sclerotic walls that project into the interior of the

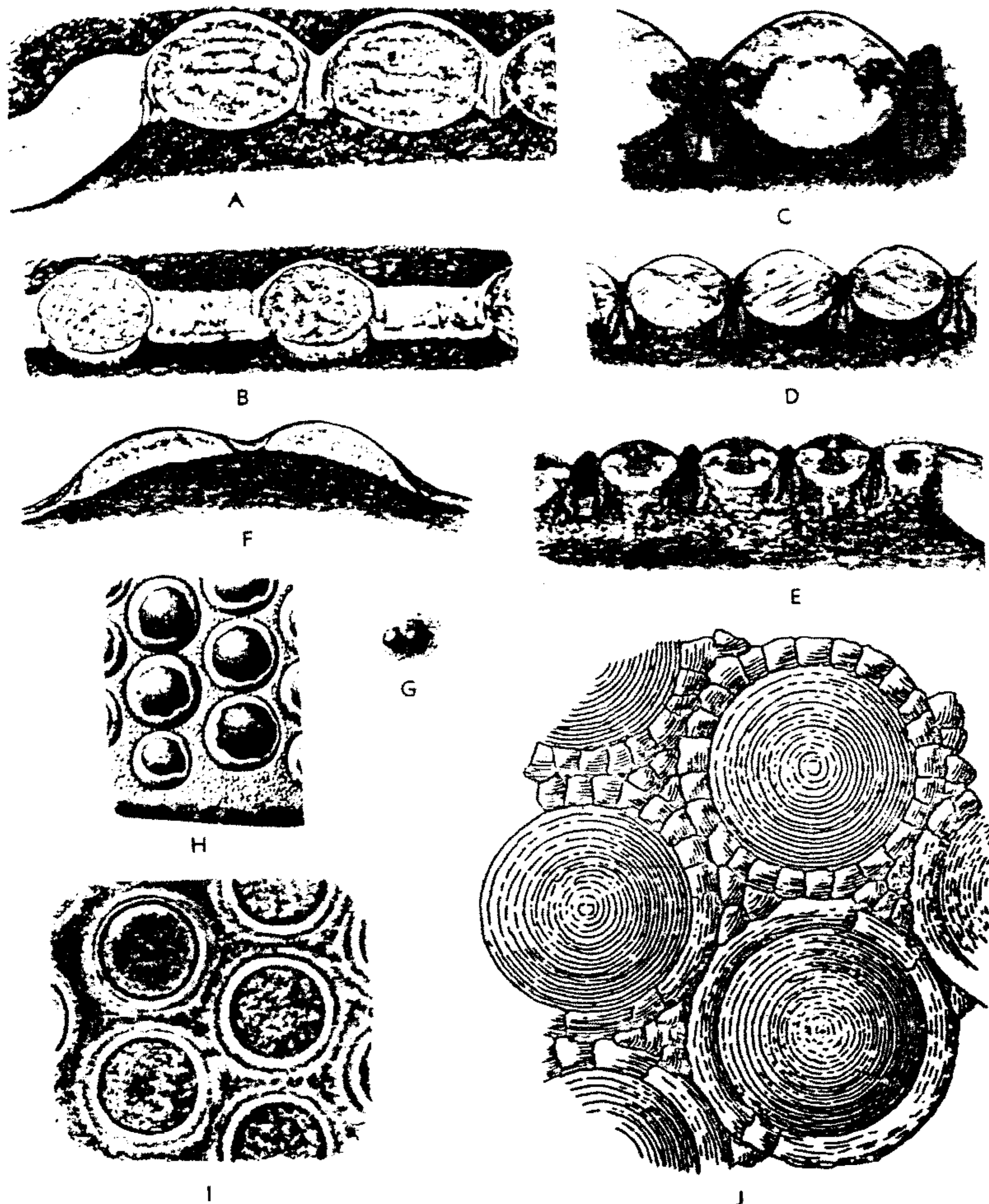

FIG. 66. Schizochroal eyes.—A, H. *Dalmanites imbricatus* (ANGELIN), Sil., Swed.; A, long. sec. of part of eye, X53; H, part of visual surface, X18.5.—B. *Dalmanites obtusus* LINDSTRÖM, Sil., Swed.; long. sec. of part of eye, showing widely separated lenses, X53.—C-E. *Phacops macrophthalmus* BURMEISTER, Dev., Ger.; C, D, E, long. secs. showing lenses separated by sclerotic walls, X53, X27.5, X27.5; I, transv. sec., X27.5.—F, G. "*Harpes*" *vitatus* BARRANDE, U.Sil., Bohemia; F, long. sec. showing the 2 lenses, X53; G, right eye, X7.—J, "*Phacops*"? sp., Dev., S.Afr.; part of visual surface, X25 (J, after 10, all others after 31).

aggregate eye. The cornea itself is a very thin pellucid membrane of uniform thickness, convex outward like a tiny watch glass. Around each of the individual lenses the cornea grades down into the sclera forming the walls. The actual lenses, lodged in the pits between the sclerotic walls and the corneal covering, were evidently structures separate from the cornea. In beautiful silicified specimens of *Holia*, *Acanthoparypha*, and *Sphaerexochus* from Ordovician rocks of Virginia (WHITTINGTON & EVITT, 1953) the lenses are never preserved, all that remains of the eyes being the convex corneas and the sclerotic walls delimiting the pits where the lenses were located. In some trilobites, the individual lenses are set considerably apart and the intervening integument is directly comparable to that forming the bulk of the cephalon. The surface of the areas between the individual lenses may bear a reticulate sculpture (Fig. 66).

The number of lenses forming the aggregate eye ranges in different genera from 2 to 300 or 400. Wide variation in the number of lenses may occur even within a single species, different specimens of *Ormathops atava* bearing any number of lenses from 15 to 300, inclusive. The reduction of the eyes in some stocks of phacopid trilobites may lead to a marked decrease in the number of lenses and even, in extremely modified forms as *Ductina ductifrons*, to their complete disappearance. A most unusual condition characterizes one observed individual of the progressive phacopid *Nephranops incisus*. In this specimen the visual surface, separated from the nonfunctional facial suture, carries 2 lenses. However, this is true only for the right side of the cephalon; the left side is blind. Other specimens have no eyes.

The lateral eyes of the Harpidae are clearly also of schizochroal type (Fig. 66F,G), but in members of this family the lenses of each eye invariably have been reduced to only 2. Probably also the lateral eyes of some Trinucleidae (*Tretaspis*), consisting of a single biconvex lens, are best interpreted as extremely simplified schizochroal eyes.

BLINDNESS

We have no means of knowing whether some trilobites provided with eyes were blind, a condition that could have been

caused by simple sclerosis of the cornea, but we know positively that many lacked eyes and were, therefore, blind. For the purposes of paleontology, "blindness" is used in the sense of being eyeless.

Though LINDSTRÖM (1901) believed blindness to have been a primitive condition of trilobites and the appearance of eyes a secondary character acquired in Late Cambrian time, it is now generally accepted (RAYMOND, 1917; RICHTER, 1921; RAW, 1925; HUPÉ, 1953) that the reverse is true, blindness being of secondary origin.

This is clearly indicated by the fact that sporadic blindness appeared at different times in the midst of families characterized by normal eyes and, conversely, by the fact that in many eyeless families, some genera retained ocular protuberances, palpebral lobes, and other such features suggestive of a derivation from eye-bearing ancestors. The first case is illustrated by *Porterfieldia* (Olenidae); *Placoparia* (Pliomeridae); *Areia* (Cheiruridae); *Dindymene* (Encrinuridae); *Typhloproetus*, *Drevermannia*, *Pteroparia* (Proetidae); and *Dianops*, *Trimeroccephalus*, *Ductina* (Phacopidae). Examples of the 2nd are *Aulacodiscus* (Eodiscidae), *Couloumania* (Conocoryphidae), and *Shumardops* (Shumardiidae). *Reedolithus* and *Tretaspis* are the only genera among blind Trinucleidae possessing lateral eyes, these eyes being characterized by a single small biconvex lens.

The overwhelming majority of Lower Cambrian trilobites, such as the olenellids, redlichiids, and ellipsocephalids, had well-developed eyes, the early conocoryphids *Atops* and *Pseudatops* being counted among the few exceptions. However, all of the small eodiscid and agnostid trilobites were blind. During Middle Cambrian time eyeless trilobites became more abundant. In addition to the Agnostida and Eodiscidae, all the Conocoryphidae were blind, as well as most Corynexochidae. Most authorities (other than POULSEN) agree that the blind Conocoryphidae are derived from an early ptychopariid stock possessing normal eyes.

Blindness was rather exceptional among Late Cambrian trilobites, the plethopeltid *Leiocoryphe* being one of the few examples, but in Ordovician time it was fairly widespread. Whole Ordovician families are characterized by lack of eyes, as for example the

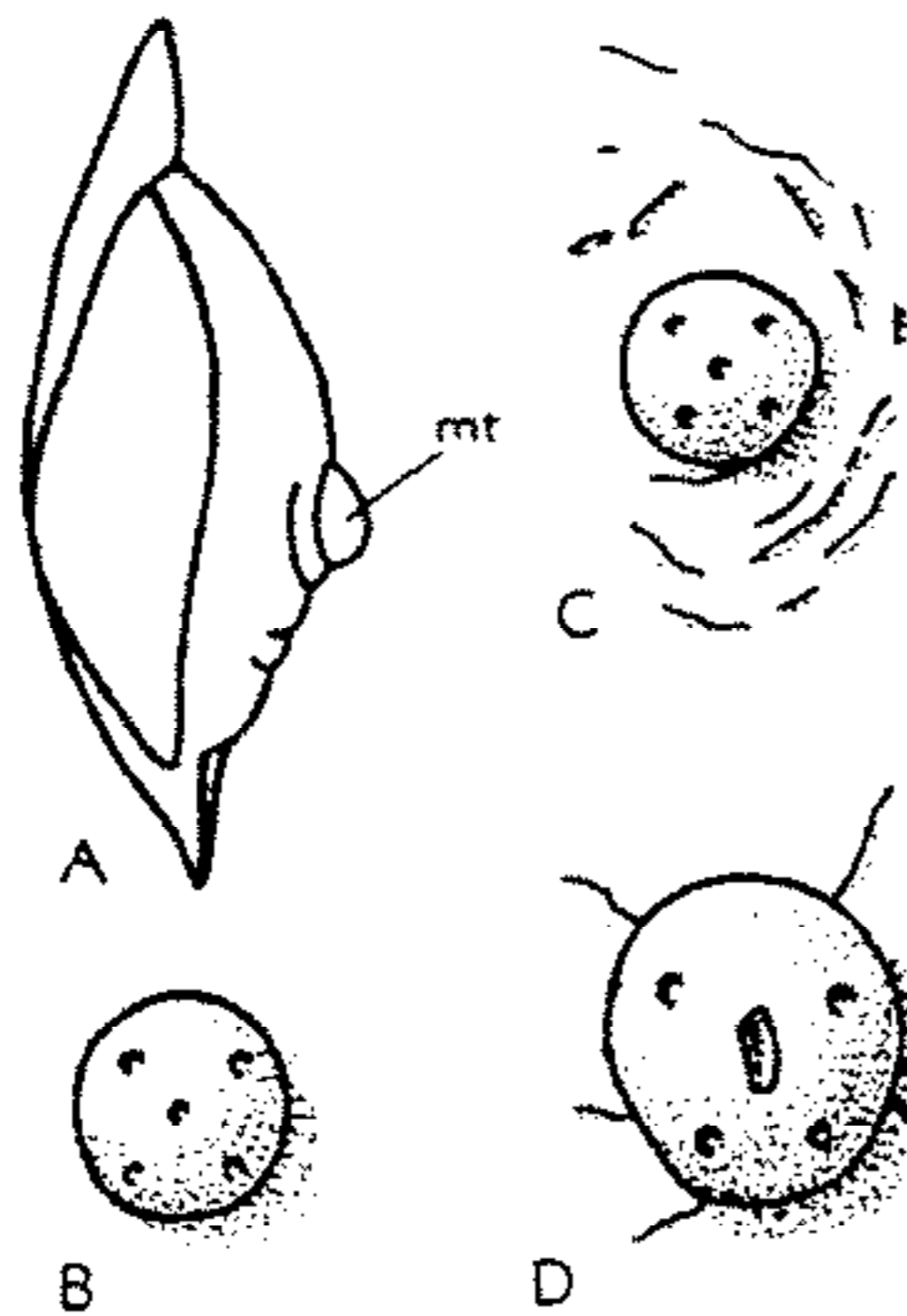

FIG. 67. Median glabellar tubercle of *Tretaspis seticornis* (HISINGER) STØRMER, Ord., Norway (after 55). A, Lateral view of meraspid cephalon (stage II) showing median tubercle (*mt*), $\times 36$; B, dorsal view of median tubercle of same cephalon, $\times 80$; C, D, dorsal views of median tubercle of 2 holaspid cephalata, $\times 50$.

Raphiophoridae, Dionididae, Alsataspididae, and Shumardiidae, while sporadic blindness appeared in some genera belonging to eye-bearing families, such as the Olenidae, Pliomeridae, Cheiruridae, and Encrinuridae.

In Silurian times blindness was again the exception (disregarding, of course, the Raphiophoridae which continued the Ordovician tradition), but in Devonian time eyeless genera appeared sporadically in the midst of families with normal eyes, such as the Proetidae and Phacopidae. The last Late Paleozoic trilobites had normal holochroal eyes.

The tendency towards development of blind forms seems to have been a persistent trend among trilobites since the very beginning of the class. Why this tendency materialized in certain stocks and not in others is yet unknown. In all probability the appearance of blind forms had no connection with environmental conditions. Some of the blind Devonian phacopids like *Ductina* and *Trimeroccephalus* were, in all likelihood, vagrant benthic forms, while the blind Ordovician olenid *Porterfieldia* was probably a pelagic epiplanktonic animal.

MEDIAN SENSORY ORGAN

A median tubercle or pustule is present on the glabella of many trilobites. Its location

is rather variable from species to species. In some it is found close to the occipital furrow, whereas in others it is located at the level of the median lateral glabellar furrows or farther forward. In many trilobites the tubercle is absent.

The median tubercle has been variously interpreted as representing the beginning of the alimentary canal (BEYRICH, 1846), as a "dorsal organ" similar to that of the living *Apus* (BERNARD, 1894), as a median eye or ocellus (M'COY, 1865; OEHLERT, 1895; BEECHER, 1895; RUEDEMANN, 1916; STØRMER, 1930), or as a "sensorial complex" similar to that existing among living syncarid crustaceans (HANSTRØM, 1926; STØRMER, 1949; HUPÉ, 1953). As RAYMOND (1920) remarked, however, it seems likely that the mesial glabellar tubercle is not homologous in all trilobites.

At least in the Trinucleidae the median tubercle seems to have been some sort of sensory organ. STØRMER'S (1930) investigations on the tubercle of *Tretaspis seticornis* have shown that it consists of an almost semispherical pustule bearing 5 tiny pits on its outer surface (Fig. 67). One pit, usually a little larger than the others, occupies a central position, the remaining 4 being evenly disposed around it. According to STØRMER, the median tubercle is highly developed in the larval stages of *T. seticornis*, being larger than the lateral eyes. In holaspid specimens the lateral eyes are larger than the median tubercle. In 1930 STØRMER concluded that "the median tubercle must be regarded as a true median eye," but in 1949 he was inclined to accept HANSTRØM'S (1934) view that it represents a "sensorial complex" comparable to that of Recent syncarids. Similar tubercles are known also in the trinucleid genera *Reedolithus*, *Trinucleus*, and *Cryptolithus*.

MACULAE

Maculae are absent in the hypostomata of many trilobites, whereas in others they consist of a pair of smooth rounded or elongate protuberances visible on the lateral or posterolateral areas of the median body (Fig. 68). In a few species the outer surface of the maculae is reticulate or bears closely set, regularly arranged tubercles resembling the lenses of the dorsal eyes.

Usually only a small portion of the macular surface is reticulate or faceted, the remainder being smooth.

The significance of the maculae and of their reticulate or faceted surface, is still a matter of subjective interpretation. LINDSTRÖM (1901), HANSTRÖM (1926), and HUPÉ (1953) regard the maculae as true ventral eyes, whereas other paleontologists such as RAYMOND (1920), STØRMER (1949), and WHITTINGTON & EVITT (1953) prefer to regard them as places of muscle attachment.

The probability that the maculae represent places of muscle attachment seems rather small. This is indicated by several features: (1) the mineralized integument of the maculae is much thinner than that of the remainder of the hypostoma, as pointed out by LINDSTRÖM and amply verified by WHITTINGTON & EVITT (1953) on silicified

material: (2) the places of muscle attachment in the cephalia of trilobites lacking apodemes invariably have a smooth surface, differing markedly in this respect from maculae with a reticulate or faceted surface; and (3) in some species of trilobites having the hypostoma firmly welded to the rostral plate (as *Holmia kjerulfi*, *Redlichia noetlingi*, *Paradoxides davidis*, *Fieldaspis furcata*) smooth maculae are well developed. In the last-named trilobites it is evident that, if the maculae represent places of muscle attachment, the muscles would function as for movements of the hypostoma alone. They may have been expensor muscles of the stomach, attached to the ventral wall of the sublabellar proventriculum, but it seems strange that such powerful muscles (judging by the size of the maculae) should have been needed to produce slight expansion of the soft-tissued stomach.

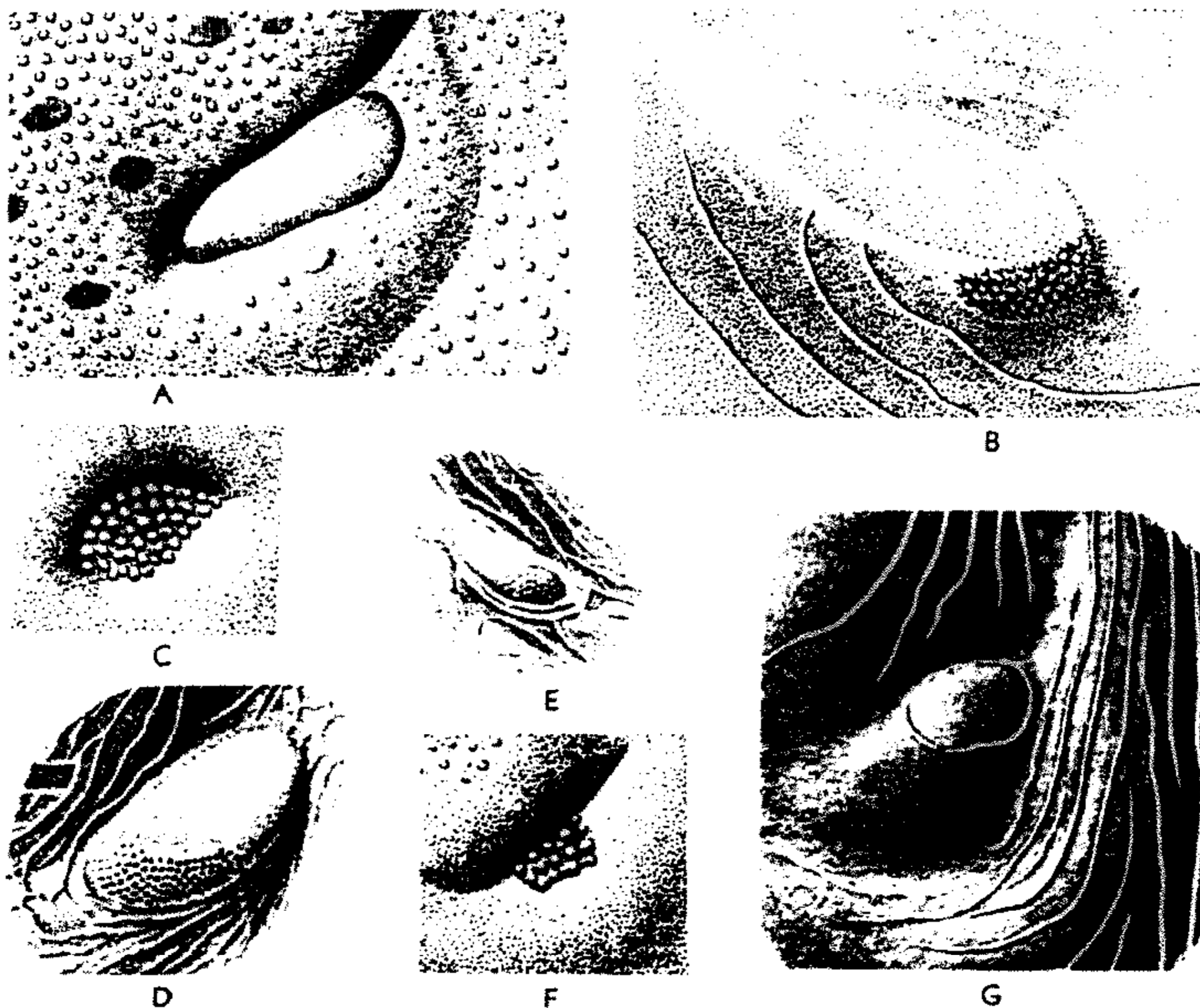

FIG. 68. Hypostomal maculae.—A, *Cheirurus* sp., Ord., Swed.; left macula, $\times 10.5$.—B, *Scutellum platyactin* (ANGELIN), Sil., Swed.; right macula, $\times 10.5$.—C, F, *Lichas* sp., ?Ord., Swed.; C, wax impression of internal side of right macula, $\times 10.5$; F, internal side of another right macula, $\times 10.5$.—D, *Scutellum* sp., Sil., Swed.; right macula, $\times 10.5$.—E, *Scutellum polyactin* (ANGELIN), Sil., Swed.; right macula, $\times 17.5$.—G, *Asuphus raniceps* DALMAN, Ord., Swed.; left macula, $\times 10.5$ (all after 31).

The available evidence seems to favor the view that the maculae had a visual function. This is especially true for the reticulate and faceted maculae present in such genera as *Scutellum*, *Lichas*, and *Iliaenus*. The smooth maculae seem best regarded as "degenerate" ventral eyes that have lost their lenses. Sections normal to the surface of the maculae show that in those of "reticulate" type the macula consists of numerous prismatic bodies very similar to the prismatic lenses of the dorsal holochroal eyes. According to LINDSTRÖM this is true of the maculae observed in several asaphids and in some species of *Iliaenus*. The "faceted" maculae show an aggregate of "globular" lenses resembling biconvex lenses of the dorsal eyes. These are especially well developed in some species of *Scutellum* and *Lichas* (Fig. 68B-F).

The presence of ventral eyes in some trilobites would certainly not constitute a unique feature among the Arthropoda, as similar organs are known among the Chelicerata and Myriapoda (HANSTRÖM, 1926).

INTEGUMENTARY SENSORY ORGANS

Trilobites possessed a variety of integumentary sensory organs which, in the main, seem to have had a tactile function. Three principal categories may be distinguished: (1) stiff setae or bristles carried by the ventral appendages and possibly also by the ventral membrane; (2) tiny funnel-shaped fossettes carried by some trilobites

on the eye platform; and (3) perforated tubercles of the exoskeleton.

In all species in which the ventral appendages are known, bristles are carried by the telopodites, pre-epipodites, and antennae. In the telopodites, the bristles are usually located on the ventral face of the endites. In the pre-epipodites, they are carried both by the distal segment and by the bladelike filaments, the free extremity of which ends in a single stiff bristle. In the antennae, they seem to spring from the base of each segment. It seems likely that bristles were also carried by the ventral membrane (HUPÉ, 1949).

Sensorial fossettes, excavated on the surface of the eye platform, are known in some trilobites. According to HUPÉ (1953), the fossettes of *Asaphus cornutus* are irregularly distributed, funnel-shaped pits connected with the interior of the cephalic region by very fine tubelike canaliculi.

Perforated tubercles have been observed in some Calymenidae, Odontopleuridae, Dimeropygidae, and Cheiruridae (SHIRLEY, 1936; WHITTINGTON, 1941; WHITTINGTON & EVITT, 1953). They are plainly visible in silicified specimens, and it is evident that they are an original feature and not due to a particular state of preservation. The perforations are located either at the tip of the tubercle or slightly behind it. Seemingly, they represent passageways for tactile setae. However, we cannot altogether discard the possibility that some of these perforations represent the external opening of cutaneous or subcutaneous glands.

INTERNAL ANATOMY

MUSCULAR SYSTEM

No actual remains of muscles have been found in trilobites but judging from the structure and location of certain areas of the exoskeleton regarded as places of muscle attachment, it is possible to draw some tentative conclusions as to distribution and function of the more important muscles. This is facilitated by a comparison with conditions in living Arthropoda, especially Arachnida and Crustacea.

Areas regarded as places of muscle attachment belong mainly in 2 categories: (1) apodemes and (2) so-called "dark markings." The apodemes are invaginations of

the dorsal exoskeleton extending inward as more or less conspicuous processes. A corresponding pit or depression is usually developed on the dorsal surface of the carapace. The dark markings are areas of darker tone which may be slightly pyritized, observed on the internal (ventral) surface of the carapace. They are usually plainly visible only when the specimens are immersed in alcohol.

CEPHALIC MUSCLES

Judging by what is known in recent Arthropoda, it is evident that the basal joint of the biramous appendages of trilo-

bites must have been connected with the ventral surface of the carapace by means of more or less powerful muscles that controlled movements of the appendage. The

assumption that all trilobites had 4 pairs of cephalic biramous appendages and a pair of antennae, leads to the inevitable conclusion that 4 pairs of muscle scars or areas of

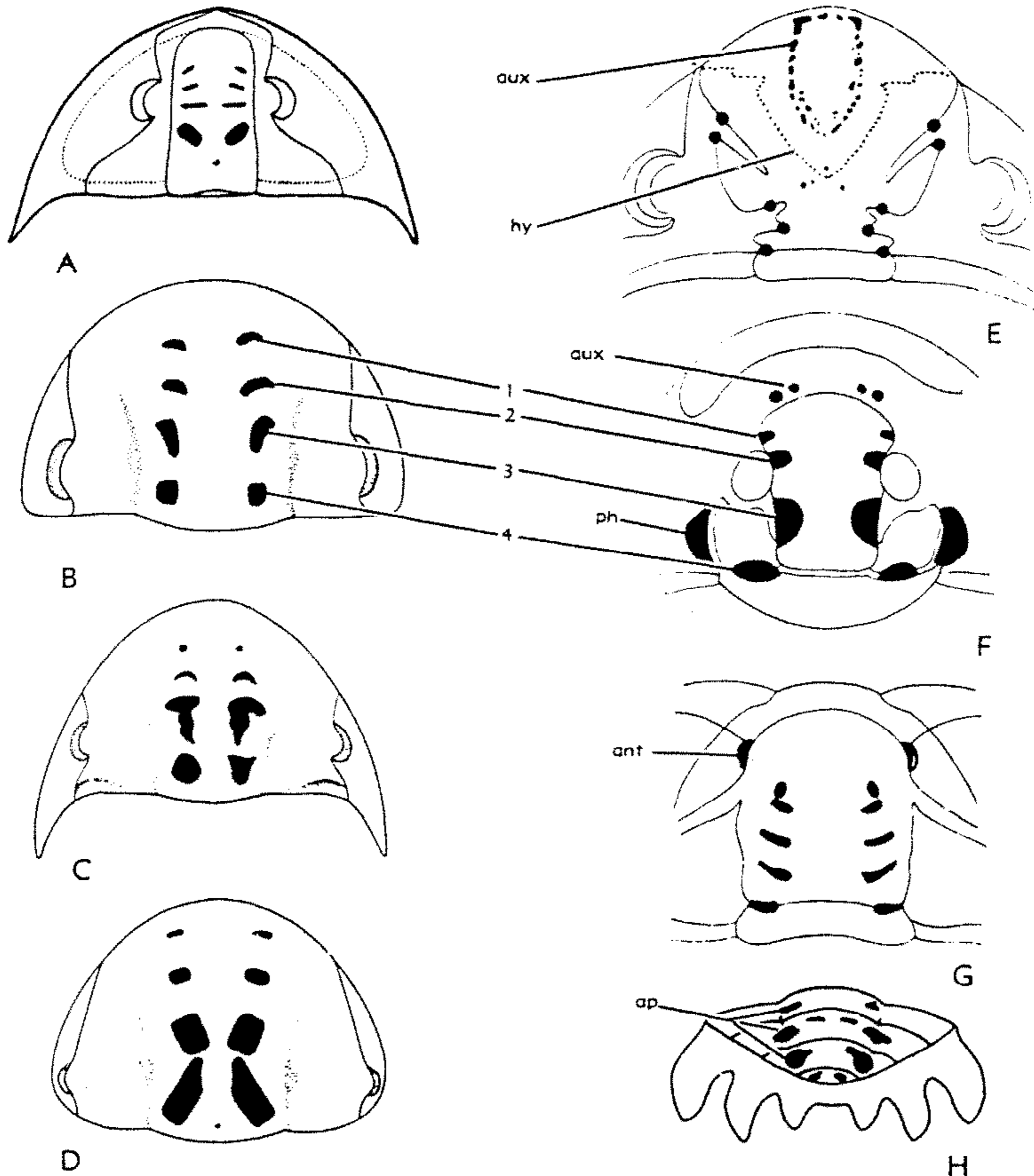

FIG. 69. Areas of muscle attachment.—*A*, Cephalon of *Notopeltis orthometopus* (HARRINGTON) HARRINGTON & LEANZA, L.Ord., Arg., $\times 2.5$ (after 19).—*B*, Cephalon of *Ilaenus dalmani* VOLBORTH, Ord., Russia, $\times 1.2$ (after 79, 1954).—*C*, Cephalon of *Dysplanus centrotus* (DALMAN) BURMEISTER, L.Ord., Swed., $\times 1.2$ (after 79, 1954).—*D*, Cephalon of *Stenopareia oviformis* (WARBURG) JAANUSSON, M.Ord., Swed., $\times 1.8$ (after 79, 1954).—*E*, Cephalic axial region of *Chasmops odini* (EICHWALD), M.Ord., Estonia, $\times 2$ (after 9).—*F*, Cephalic axial region of *Pharostoma nieszowski* SCHMIDT, Ord., Estonia, $\times 5.75$ (after 24).—*G*, Cephalic axial region of *Cybele grewingkii* SCHMIDT, Ord., Estonia, $\times 1.25$ (after 24).—*H*, Ventral view of pygidium of *Reraspis plautini* (SCHMIDT) ÖPIK, M.Ord., Estonia, $\times 3.95$ (after 34). (Explanation: *ant*, antennary muscle scar; *app*, appendage muscle scars; *aux*, auxiliary impressions; *hy*, outline of the hypostoma; *ph*, pharostomial scar; 1-4, principal muscle scars of cephalic axis, regarded as places of attachment of ventral appendage muscles.)

muscle attachment must exist on the ventral surface of the cephalon in connection with the 4 pairs of biramous appendages, and that an additional pair of scars must also be present, corresponding to the places of attachment of the antennary muscles.

In many trilobites, and especially in those possessing well-marked lateral glabellar furrows, the appendage muscles were almost certainly attached to apodemes projecting obliquely downward from infoldings of the integument represented by the glabellar furrows. These apodemes were usually located about midway between the sagittal line and the axial furrows or somewhat nearer to the axial furrows than to the mid-cephalic line. They are especially conspicuous in many Cheiruridae, and can be plainly seen in silicified specimens of *Ceraurinella*. In all probability, 2 bundles of antagonistic muscles (adductor-abductor) were attached to each apodeme.

In many other trilobites, particularly in those having a more or less smooth glabella, such as many Illaenidae, Raphiophoridae, Asaphidae, and Nileidae, no apodemes were developed, the appendage muscles being attached directly to certain areas of the ventral surface of the cephalon. These areas, which are also known in some Olenidae, Encrinuridae, Calymenidae, and Dalmanitidae, appear as paired "dark markings." They have been described and figured by many authors, including BARRANDE (1852), VOLBORTH (1863), HOLM (1886), MÖBERG (1902), RAYMOND & NARRAWAY (1908), NOVÁK (1918), BORN (1919), RICHTER & RICHTER (1926), ÖPIK (1929, 1937), REED (1935), LAMONT (1939), WHITTARD (1939), SINCLAIR (1947), STØRMER (1949), WHITTINGTON (1950), HUPÉ (1953), JAANUSSON (1957), and HENNINGSMOEN (1957).

The dark markings are best known in the Illaenidae, where they are usually represented by 4 pairs on the internal surface of the axial region (Fig. 69B). HUPÉ (1953) has interpreted the anterior pair as the places of attachment of the antennary muscles, and the 3rd (2p) pair as representing the "fused" places of attachment of the muscles of the 2nd and 3rd pairs of biramous appendages. This interpretation may be correct, especially in such forms as *Stenopareia oviformis* (Fig. 69D), which has the anterior pair of markings located far for-

ward on the cephalon. Also, the 3rd pair of markings is usually considerably larger than the others. However, it seems likely that at least in some Illaenidae (*Platillaenus*) the places of attachment of the antennary muscles were the small apodemes found immediately below the fossulae or "anterior pits."

The significance of the fossulae, and of the corresponding "fossular apodemes," is still doubtful. WHITTINGTON (1941) discussed these structures at some length, reaching the sound conclusion that they are not homologous in all trilobites and that they probably served different functions in different genera. In some cases, as *Ceraurus*, *Ceraurinella*, and *Flexicalymene*, the "fossular apodemes" seem to have acted as places of attachment of the antennary muscles and likewise as supports for anterior wings of the hypostoma. In these genera, the "fossular apodemes" bear a tiny pit on the anterior face near their ventral extremity, which has been interpreted by WHITTINGTON as a socket for the articulation of the anterior wing process of the hypostoma (Fig. 40). However, it seems very likely that the posterior face of the apodemes was the place of attachment of the antennary muscles, because in these genera the basal section of the antennae runs forward along the lateral notches of the hypostoma between the anterior wings and the lateral shoulders. In other genera, such as *Platillaenus* and *Cryptolithus*, it seems hardly possible that the fossular apodemes had any relation with the hypostoma.

In addition to the apodemes and axial-region dark markings, other paired impressions have been observed in the cephalon of a few species. The auxiliary impressions of BARRANDE are small, usually rounded dark spots, distributed in a few pairs on the preglabellar field (*Pharostoma*), along the axial furrows (*Chasmops*), or along the anterior and posterior areas of the glabella (*Dalmanites*, *Proetus*) (Fig. 69E,F). These markings were regarded by BORN (1919) and RAYMOND (1920) as the places of attachment of hypostomal muscles, but as RICHTER (1933) and SCHULZE (1937) have pointed out, it seems more likely that they represent points of attachment of expensor (dilator) muscles of the esophagus and stomach. The pharostomian scars of ÖPIK, consisting of a pair of large impressions found in *Pharo-*

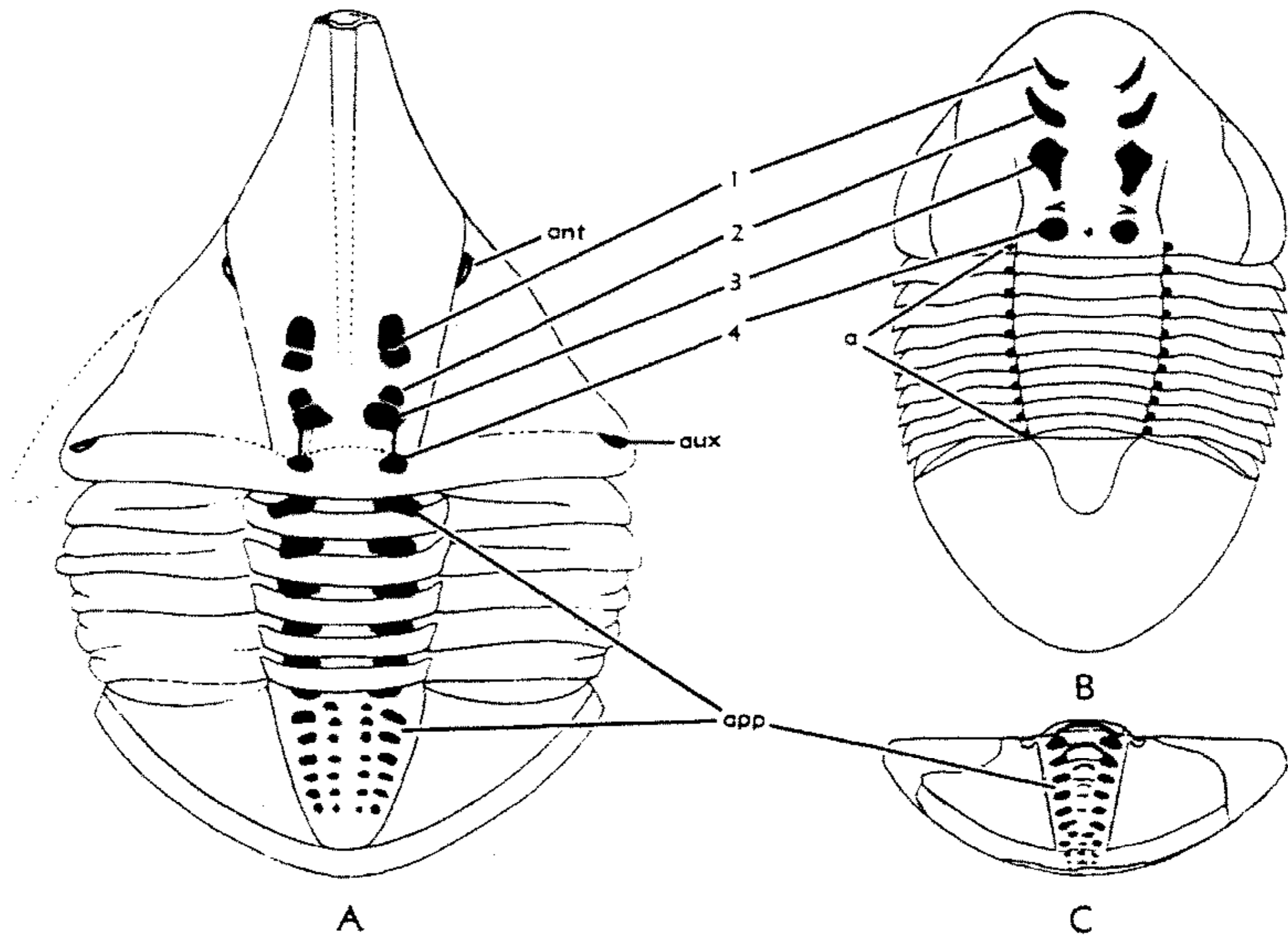

FIG. 70. Areas of muscle attachment.—A. Exoskeleton of *Lonchodomas rostratus* (SARS), L.Ord., Norway, $\times 5$ (after 24).—B. Exoskeleton of *Ectillaenus katzeri* (BARRANDE) JAANUSSON, M.Ord., Bohemia, $\times 0.8$ (after 24).—C. Pygidium of *Tretaspis kjaeri* STÖRMER, U.Ord., Norway, $\times 1.5$ (after 55). (Explanation; a, axial furrow apodemes, ?places of attachment of dorsoventral muscles; ant, antennary muscle scars; app, places of attachment of the thoracic and pygidial appendage muscles; aux, auxiliary impressions, ?places of attachment of dorsoventral muscles; 1-4, principal cephalic axis muscle scars, regarded as places of attachment of the cephalic appendage muscles.)

stoma (Fig. 69F) along the axial furrows at the level of the preoccipital glabellar lobes, are probably related to dorsoventral muscles. This seems to apply also to the small pits found in *Lonchodomas* and *Ampyx* near the distal extremities of the posterior border furrows (Fig. 70A).

THORACIC AND PYGIDIAL MUSCLES

In both the thorax and pygidium the most conspicuous places of muscle attachment correspond to the insertions of the appendage muscles. The respective apodemes, if present, are downward projections of the infolded integument forming the ring furrows that separate the axial rings proper from the articulating half-rings. They are located along the anterolateral portions of each individual ring, nearer to the axial furrows than the sagittal line of the body.

Axial ring apodemes are conspicuous in *Ceraurus*, *Ceraurinella*, and *Cryptolithus*, but are feebly developed in *Flexicalymene* and absent in many Asaphidae, Illaenidae, Raphiophoridae, and other trilobites. In their place, dark markings are found along the anterolateral portions of each ring (Fig. 70). In the pygidium there seem to be as many pairs of markings as original segments and appendages, but the markings are usually split into double pairs, probably representing the separate insertions of 2 bundles of antagonistic muscles (Fig. 70A, C).

In some Asaphidae (*Kayseraspis*, *Hoekaspis*, *Megalaspidella*) and Illaenidae (*Ectillaenus*) (Fig. 70B) a distinct pit is found on the axial furrow close to the posterior border of each thoracic pleura, and a similar pit is found close to the posterior margin of the cephalon. These probably correspond to smaller apodemes, which are best regarded

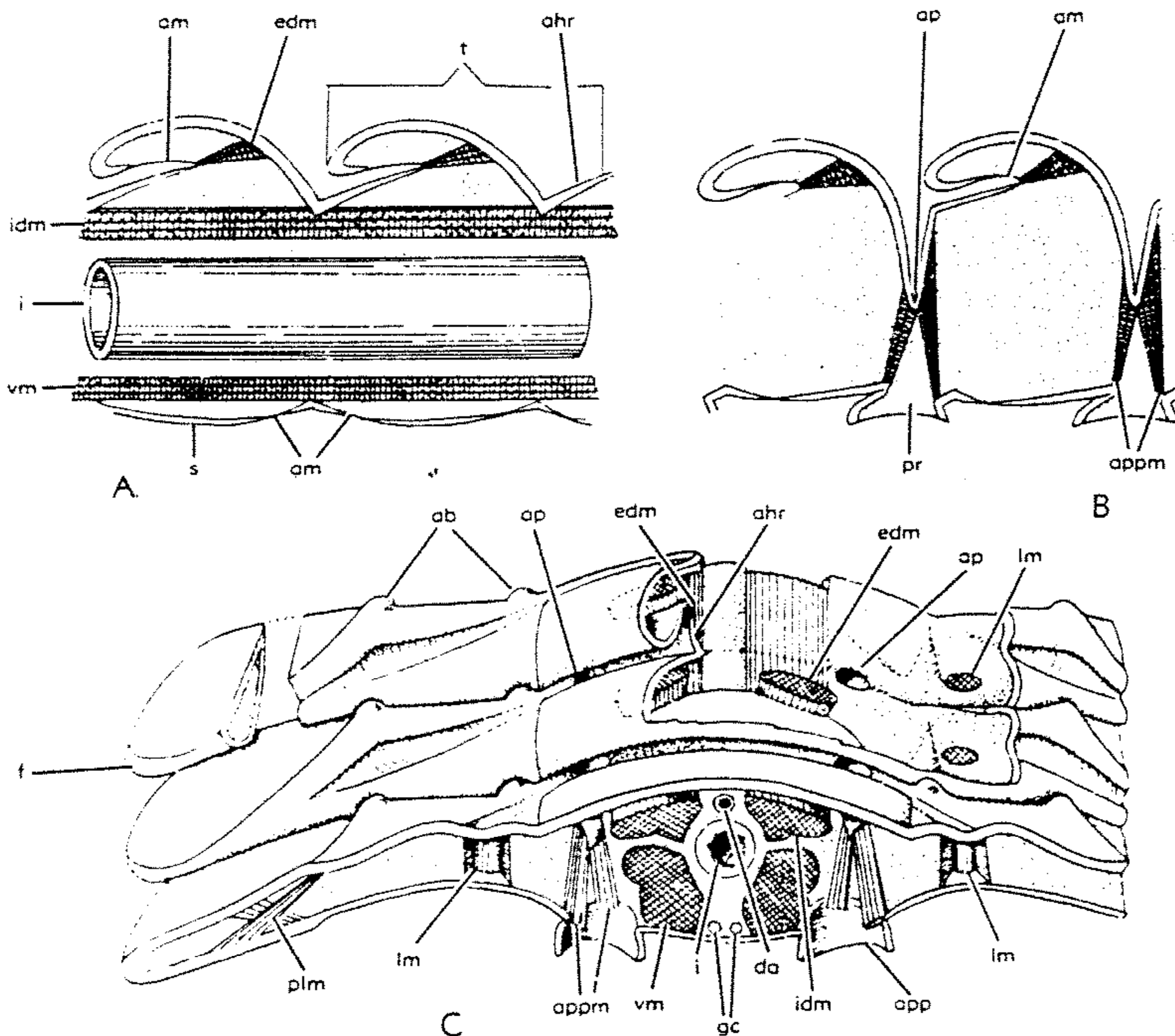

FIG. 71. Internal anatomy of the thoracic region of trilobites, according to HUPÉ (1953).—A, Sagittal section of the thorax, showing 2 segments.—B, Exsagittal section of the thorax, passing through the apodemes and the underlying basal segments of the ventral appendages.—C, Schematic reconstruction of the internal anatomy of 3 thoracic segments; one segment shown in transverse section and dorsal integument of the right side of 2 segments supposed to have been removed. (Explanation: *ab*, articulating boss on pleura; *ahr*, articulating half-ring; *am*, articulating membrane; *ap*, apodeme; *app*, appendage muscle; *da*, dorsal vessel of circulatory system; *edm*, external dorsal muscle; *f*, pleural facet; *gc*, ganglion chain of nervous system; *i*, intestine; *idm*, internal dorsal muscle; *lm*, lateral muscles; *plm*, pleural muscles, hypothetical; *pr*, precoxa; *s*, sternite; *t*, tergite; *vm*, ventral muscles.)

as places of attachment of dorsoventral muscles (compressors of the body).

Extensor muscles, in all likelihood, were well developed in most trilobites, particularly in those capable of enrollment. The principal extensors (internal dorsal muscles) were probably attached to the ventral side of the ring furrows on both sides of the sagittal line, whereas the auxiliary extensors (external dorsal muscles) probably extended from the anterior margin of one articulating half-ring to the anterior part of the axial ring immediately in front (Figs. 50, 71). Clearly, the trilobites must have had

ventral muscles, particularly flexors of the body (internal ventral muscles) attached to the intersegmental folds of the ventral membrane, but, of course, nothing remains of such muscles or of their places of attachment (Fig. 71A,C).

DIGESTIVE SYSTEM

Very little is known about the digestive system of trilobites and even the position of the mouth is not known with certainty. It is generally assumed that the oral opening was located immediately behind the hypostoma and in front of the metastoma,

somewhere in the posterior part of the ventral side of the cephalic region. In truth, this is very likely, but in no specimen have actual traces of the mouth opening been detected. In all probability this is due to the fact that the mouth was bounded by soft tissue that decayed rapidly after the death of the animal.

The accepted location of the mouth near the rear part of the ventral cephalic region suggests one of 2 possibilities: (1) the digestive tract extended directly backward from the mouth, with practically no cephalic section; and (2) the tract began with a short esophagus directed forward-upward, leading to a stomach or proventriculum lodged beneath the glabella and continued backward in a long and narrow intestine, ending near the posterior extremity of the pygidial region. The second possibility seems the more likely and it has been generally accepted by most paleontologists who have studied this problem.

Structures regarded as representing traces of the actual digestive tract have been described in a few specimens, but in most of them these structures are of more than doubtful significance. VOLBORTH (1863) described and figured an enrolled specimen of "*Iliaenus*" sp. from the Ordovician of Russia showing a narrow, multisegmented raised band running sinuously along the sagittal line of the thorax. The structure was interpreted as a camerate heart by both VOLBORTH (1863) and RAYMOND (1920), but as a metamerized intestine by HUPÉ (1953). In all likelihood, however, the structure is alien to the trilobite and it may represent a crinoid arm accidentally preserved in an unusual manner. From VOLBORTH's figure it is evident that the number of segments in the so-called "heart" or "intestine" is considerably greater than the number of somites in the trilobite. Moreover, just before it disappears on reaching the cephalic region, the "heart" or "intestine" clearly bifurcates in a manner suggesting the bifurcation of a crinoid arm.

The "alimentary canals" seen by WALCOTT (1881, 1921) and RAYMOND (1920) in some sections of enrolled specimens of *Ceraurus* and *Flexicalymene*, have been reinterpreted by STØRMER (1939) as appearances due to the differential mud-filling of the body

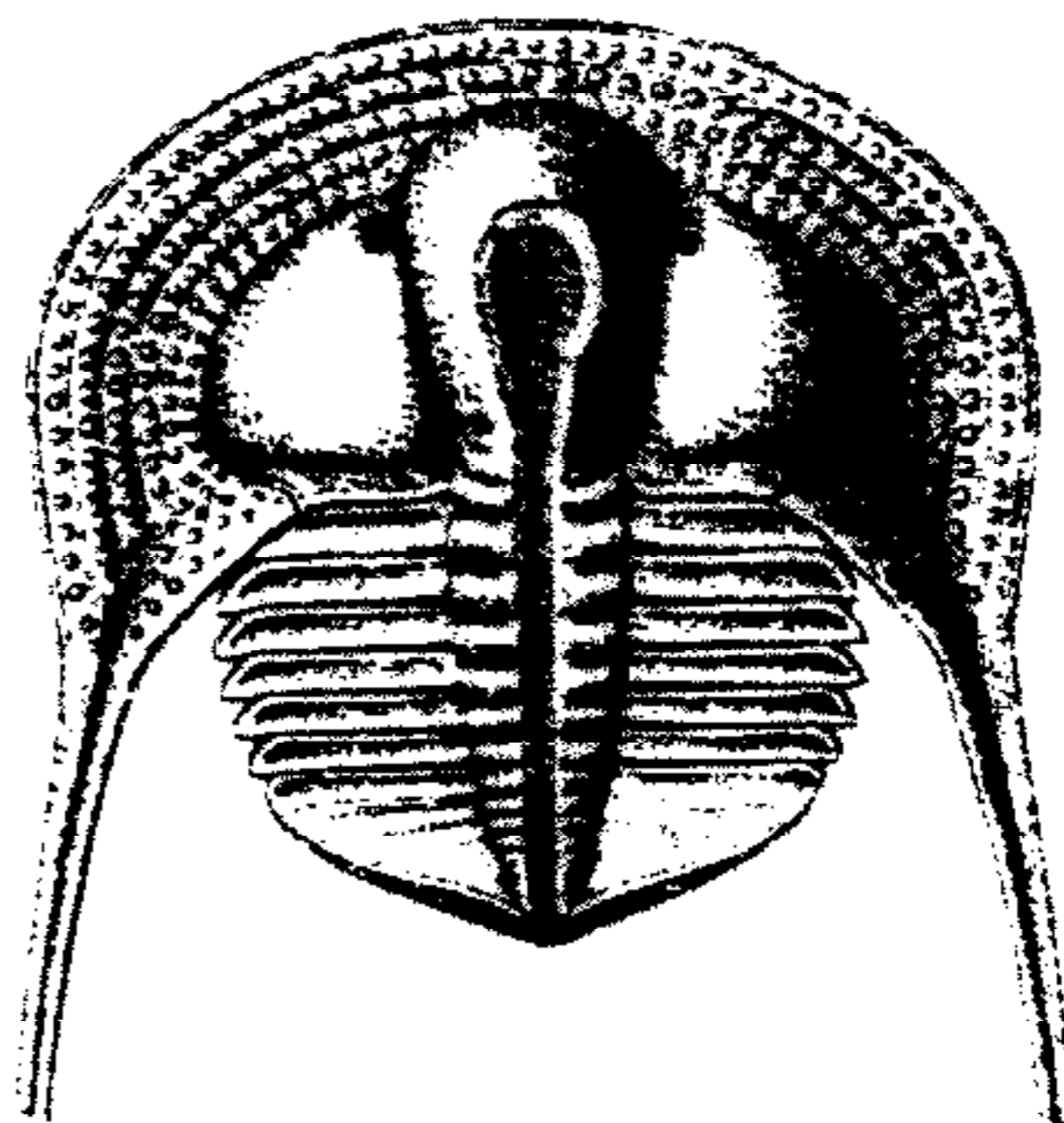

FIG. 72. Digestive system of trilobites. *Onnia ornata* (STERNBERG) WHITTINGTON, U.Ord., Bohemia, $\times 2$ (after 2, illustrated as *Trinucleus goldfussi* BARRANDE); specimen showing hollow axial tube regarded as representing the digestive tract.

cavity of the trilobites shortly after entombment of the enrolled individuals.

Skania fragilis, from the Middle Cambrian Burgess Shale of British Columbia, shows unquestionable traces of a long digestive tube, but this species, regarded by HUPÉ (1953) as "probably a larval form," is evidently not a trilobite. The type specimen, illustrated by WALCOTT (1931), is 2 cm. long and does not resemble any known trilobite meraspis.

The only described structure that may be regarded as representing true remains of a digestive tract is that figured by BARRANDE (1852) in 2 specimens of *Onnia ornata* (STERNBERG) WHITTINGTON from the Ordovician of Bohemia (originally described by BARRANDE as *Trinucleus goldfussi* BARRANDE) (Fig. 72). In both specimens, the structure consists of a pyriform excavation in the glabellar region followed by a narrow sagittal canal ending at the posterior extremity of the pygidial axis. The anterior pyriform expansion has been regarded as representing the stomach or proventriculum, located below the glabella, whereas the sagittal canal has been interpreted as representing a hollow intestinal tube. Judging by BARRANDE's figures this interpretation seems plausible enough, and it agrees with the usual assumption that the stomach pouch of trilobites was located below the glabella.

Contrary to RAYMOND's (1920) opinion, however, it seems that no close corre-

spondence could exist between size of glabella and size of stomach. In most, if not all, trilobites, the stomach probably occupied only a fraction of the space below the glabella, and it seems certain that in all species it was much narrower than the glabella. This is pointed out by the location of the "dark markings" and apodemes regarded as places of attachment of the cephalic appendage muscles. It must be evident that in most Illaenidae (Fig. 70B) very little space was left for the stomach (or any other organs, for that matter) between the appendage muscles. The same is true for

many Cheiruridae with well-developed apodemes.

GENAL CAECA

Many trilobites belonging to diverse families, such as Olenidae, Ptychopariidae, Conocoryphidae, Olenellidae, Remopleurididae, Loganopeltidae, Harpidae, Harpididae, Trinucleidae, and Dionididae, show radiating cephalic "nervures" (usually bifurcating and in cases anastomosing) that RAYMOND (1920) proposed to call "genal caeca." The "nervures" are raised lines that usually radiate outward toward the periphery of the

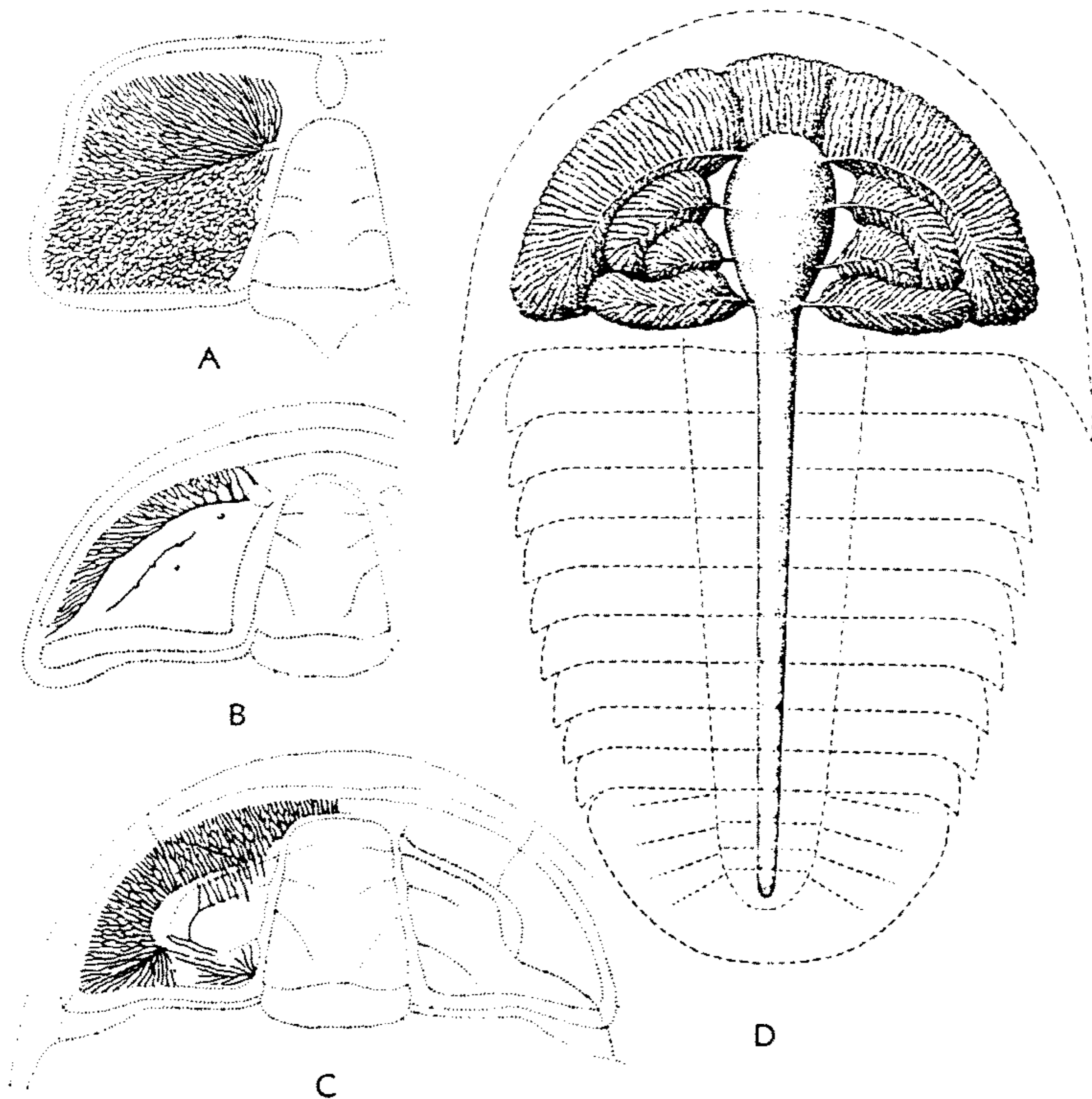

FIG. 73. Genal caeca of trilobites and schematic reconstruction of the digestive system.—A-C, Camera lucida drawing of genal caeca; A, *Elyx laticeps* (ANGELIN), M.Cam., Swed.; B, *Conocoryphe sulzeri* (SCHLOTHEIM), M.Cam., Bohemia; C, *Ptychoparia striata* (EMMRICH), M.Cam., Bohemia.—D, Schematic reconstruction of the digestive system of trilobite, showing stomach and genal diverticules in the cephalic region, and intestine in the thoracic and pygidial regions (all after 24).

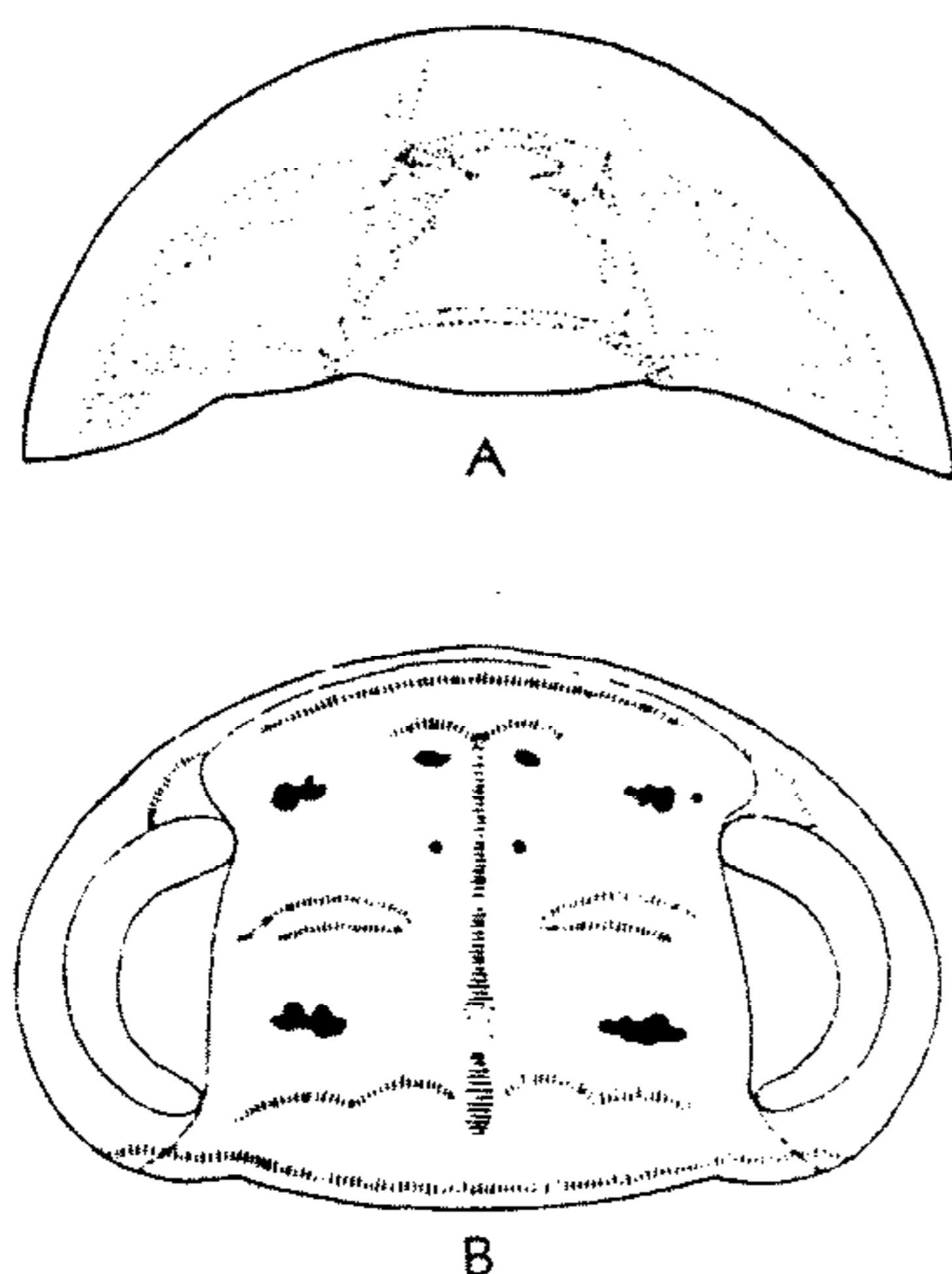

FIG. 74. Cephalic impressions.—A. Cephalic impressions of a specimen of *Asaphus cornutus* PANDER, Ord., $\times 1$, regarded by HUPÉ as possible impressions left by blood vessels.—B. Cephalic impressions of a specimen of *Nileus armadillo* DALMAN, Ord., Swed., $\times 2$, showing sagittal marking regarded as impression of the ligament suspensor of the heart, and paired muscle scars (after 24).

cephalon, transecting the librigenae, preglabellar area, or fixigenae. They never occur in the glabella or occipital ring (Fig. 73). Usually they are far better impressed on the internal (ventral) face of the cephalon. They probably represent impressions left in the integument by glandular diverticles of the digestive tube. Such organs, obviously in close correlation with the proventriculum or stomach, are beautifully preserved in several Trilobitomorpha found in the Middle Cambrian Burgess Shale of British Columbia, suggesting that they also occurred in trilobites. Fig. 73D is a theoretical reconstruction (according to HUPÉ, 1953) of a generalized trilobite showing the probable position of the digestive tract and cephalic glandular diverticles.

CIRCULATORY, NERVOUS, AND RESPIRATORY SYSTEMS

Nothing is known with certainty about the circulatory and nervous systems of trilobites. HUPÉ (1949) described what he re-

garded as doubtful traces of a circulatory system in a single cephalon of *Asaphus cornutus* from the Ordovician of Rusisa (Fig. 74). Two sets of "communicating canals filled by calcite," one set infraglabellar in position and the other infragenal, were tentatively regarded as representing traces of collateral and hepatic arteries respectively. The structures, however, seem of very doubtful significance. Equally doubtful is the meaning of a median cephalic impression seen in a specimen of *Nileus armadillo* described by MOBERG (1902) and in some cranidia as *Bellefontia chamberlaini* illustrated by ROSS (1951). These impressions have been regarded (HUPÉ, 1953) as the place of attachment of a ligament suspensory of the heart or some other large cephalic vessel.

The respiratory system of trilobites was essentially external, represented by the bladelike filaments borne by the pre-epipodites, which functioned as external branchia (p. 079). RICHTER's suggestion that the ventral membrane may have aided in respiration, probably by osmotic exchange, is beyond the possibility of factual confirmation.

REPRODUCTIVE AND EXCRETORY SYSTEMS

Again, nothing is known about the reproductive and excretory systems of trilobites. BARRANDE, in 1872, described and illustrated a specimen of *Barrandia crassa* from the Middle Ordovician of Bohemia bearing a mass of tiny ovoid bodies located below the integument of the frontal glabella lobe.¹ The bodies were regarded as eggs still in place in ovaries below the cephalic exoskeleton. If it could be proved that the tiny corpuscles are, in fact, ova, this would mean that the ovaries in *Barrandia* (and possibly in other trilobites) were unusually located very far forward in the cephalic region. However, the nature of the ovoid bodies is, to say the least, still a matter for speculation. For all we know, they could be alien to the single specimen in which

¹C. J. STUBBLEFIELD notes that in 1852 BARRANDE described as trilobite eggs various spheroidal bodies found associated with trilobite exoskeletons in Silurian and Devonian deposits of Bohemia. These bodies were red or black pellicles classifiable in 3 size groups: (1) 4 to 5 mm. diameter, (2) 2 mm. diameter, and (3) less than 0.7 mm. diameter.—R.C.M.

they have been noticed.² Equally uncertain is the possibility, suggested by HUPÉ (1953), that the macropleurae of some trilobites may have a secondary sexual meaning, representing the genital segments bearing the gonopores.

It is worthy of mention that RESSER & ENDO (1937) described 2 specimens of *Fengtienia peculiaris* from the Middle Cambrian of Manchukuo, lying side by side and apparently joined by the tips of the pygidia,

² According to C. J. STUBBLEFIELD, similar ovoid objects from Tremadocian strata of England have been referred (GROOM, 1902) to the genus *Tomaculum*, suggested to represent either excreta or eggs. RUD. RICHTER (1940) has favored the view that *Tomaculum* (identified by him and others from Ordovician strata of Germany and France) represents the excrement of organisms not confined to that of trilobites.—R.C.M.

have been tentatively regarded as 2 individuals that died *in copulo*. Probably, however, this so-called "copulating attitude" is due to accidental association.

As regards excretory organs it seems likely that trilobites, being primitive Arthropoda, possessed nephridia. In the great majority of species the external openings of these metameric organs probably were located on the ventral membrane of the genal areas and thoracic pleurae, but, as already suggested by SIEGFRIED (1936), it seems likely that in some progressive forms the openings were located on the cephalic and thoracic pleural doublures, where they are represented by the "Pander openings" (p. 0106).

ENROLLMENT

Most trilobites were capable of enrollment, being comparable in this respect to the living Isopoda and to certain insects (some blattids) and myriapods (glomerids). However, it is practically certain that the Olenellidae and other primitive Lower Cambrian micropygous forms lacked ability to enroll the carapace. This suggests that the olenellids were essentially benthic forms and that their vulnerable ventral side was protected by close apposition to the substratum.

MECHANISM OF ENROLLMENT

In the normal outstretched attitude of the trilobite, the thoracic mesotergites overlapped each other in such a way that the articulating half-ring of one segment was concealed under the posterior part of the axial ring immediately in front. In this attitude the distal parts of the pleurae overlapped each other slightly, their extremities being more or less separated and free.

During enrollment, maximum longitudinal displacement occurred both along the sagittal line of the body and along imaginary lines passing through the pleural extremities, whereas displacement was very slight along the proximal parts of the pleurae and practically none along the axial furrows. The abaxial extremities of the rings acted as pivots for the movement and, as a result, the articulating half-rings were uncovered, in contrast to the distal parts of the

pleurae, which became strongly imbricated, overlapping each other.

Several modes of enrollment may be distinguished among trilobites and, as far back as 1852, BARRANDE recognized 3 types which he called spheroidal, double, and discoidal.

SPHEROIDAL ENROLLMENT

This is the commonest type, characterizing such families as the Bathyruridae, Asaphidae, Illaenidae, Proetidae, Calymenidae, Cheiruridae, and Phacopidae, and in general most isopygous or macropygous trilobites. In the spheroidal mode, all the thoracic segments have an equal share in enrollment. As the gliding of the thoracic segments began, the articulating half-rings were progressively uncovered and the thoracic axis became increasingly convex longitudinally. At the same time the downward curvature of the distal parts of the pleurae increased and their extremities became more and more imbricated, overlapping each other. Also, the transverse curvature of the cephalon increased slightly by downward bending of the genal regions. When enrollment was complete, the pygidium touched the cephalon and the whole animal attained a subspheroidal shape, the overlapping distal parts of the thoracic pleurae forming a sort of continuous lateral closure. The vulnerable ventral part with its comparatively soft appendages was thus protected by the firmly

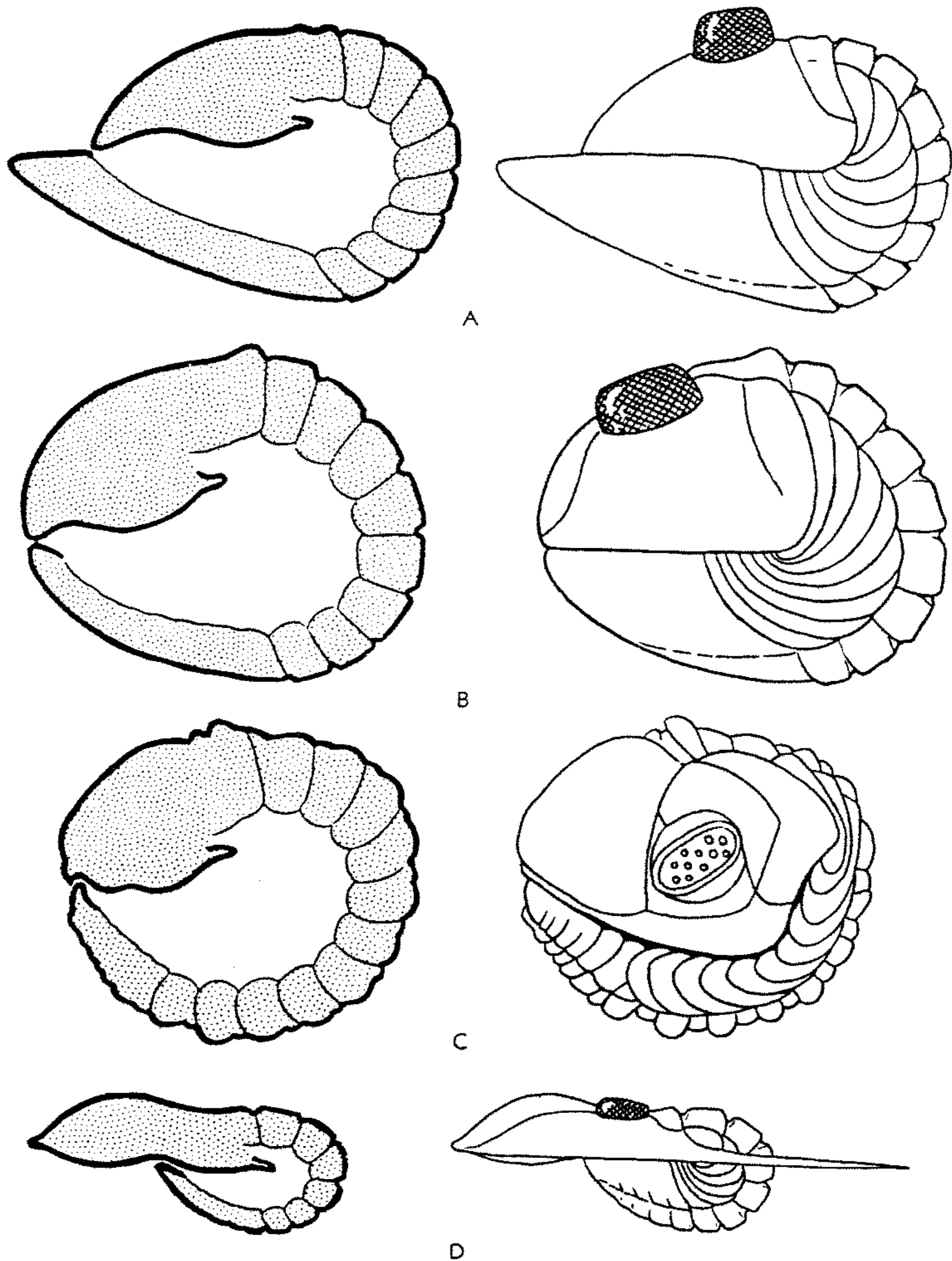

FIG. 75. Types of spheroidal enrollment; right side, lateral view of enrolled specimens; left side, sagittal section of enrolled specimens.—A. Pseudomegalaspis type, *Pseudomegalaspis formosa* (TÖRNQUIST) JAANUSSON, Ord., Swed., $\times 0.95$ (right, after 79, 1953).—B. Asaphid type, *Asaphus* (*Neosaphus*) *uplandicus* WIMAN, Ord., Swed., $\times 3.3$ (right, after 79, 1953).—C. Phacopid type *Eocryphops kayseri* (HERMANN), M.Dev., Ger., $\times 5.5$ (right, after 87, 1931).—D. Phillipsinellid type, *Phillipsinella parabola* (BARRANDE) NOVÁK, U.Ord., Scot., $\times 2$ (right, from WHITTINGTON'S 1950 data).

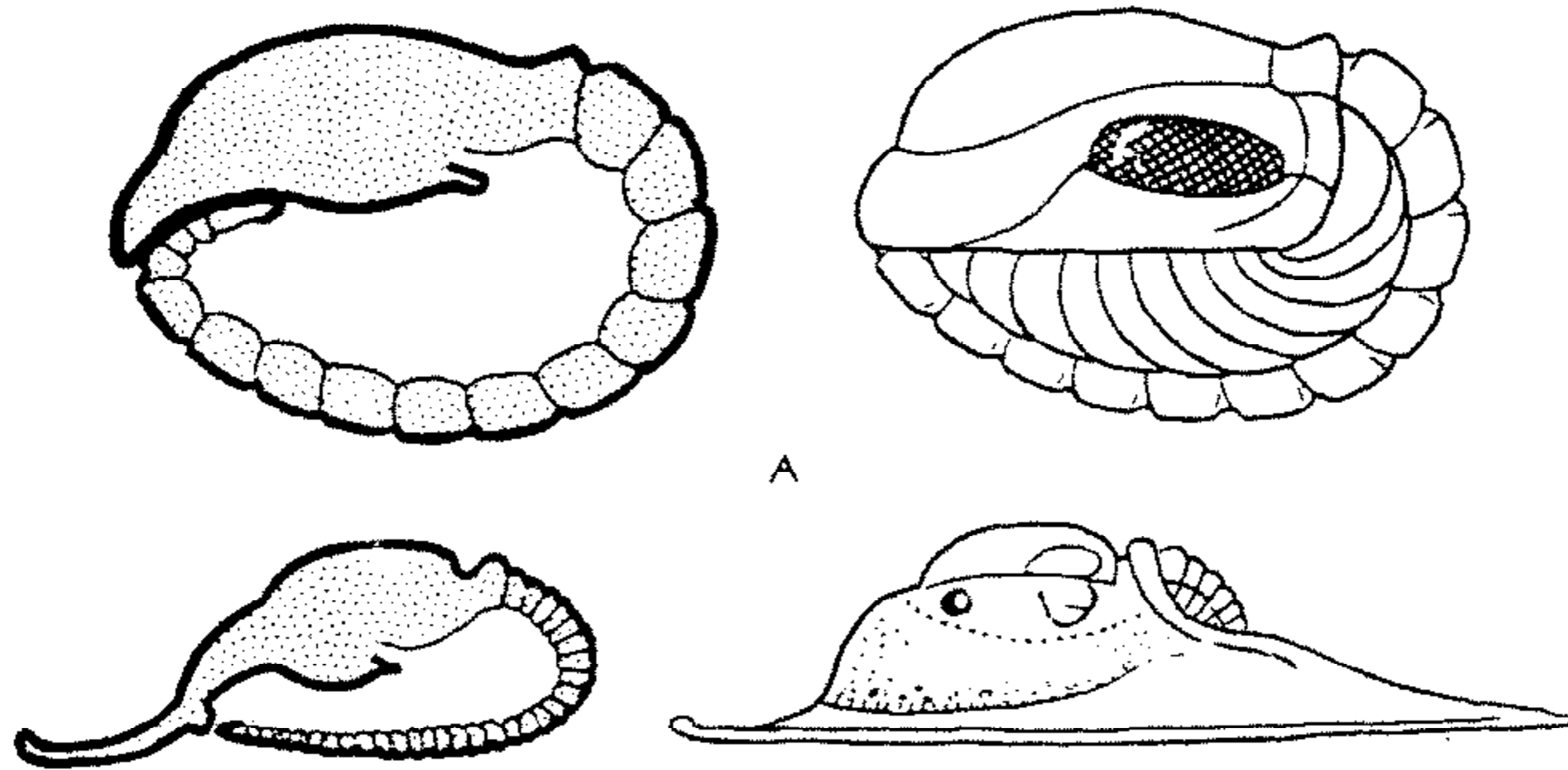

FIG. 76. Double and discoidal enrollment; right side, lateral view of enrolled specimens; left side, sagittal section of enrolled specimens.—Double enrollment (above), *Ellipsocephalus polytomus* LINNARSSON, M. Cam., Swed., $\times 8.25$ (data from 68).—Discoidal enrollment (below), *Harpes macrocephalus* GOLDFUSS, M.Dev., Ger., $\times 1.25$ (right side, after 86, 1921).

closed "box" formed by the enrolled carapace.

Depending, however, on the manner in which the pygidium comes in contact with the cephalon, 4 types of spheroidal enrollment can be distinguished. (1) In the pseudomegalaspid type (Fig. 75A), the anterior margin of the cephalon fits against the inner edge of the pygidial doublure, while the lateral margins of the cephalon come in contact with the pygidial doublure close to the lateral margins of the pygidium. The pygidium, therefore, protrudes beyond the cephalon for a distance equal to the width of its doublure. (2) In the asaphid type (Fig. 75B), the anterior margin of the cephalon comes in contact with the posterior margin of the pygidium, the cephalic and pygidial doublures facing each other. (3) In the phacopid type (Fig. 75C), the posterior margin of the pygidium fits into a furrow on the cephalic doublure, which runs parallel and close to the cephalic margin. (4) Lastly, in the phillipsinellid type (Fig. 75D), the posterior margin of the pygidium comes in contact with the hypostomal suture, in such a manner that the rostral plate is not covered by the pygidium. The cephalon, therefore, protrudes well beyond the posterior border of the pygidium.

DOUBLE ENROLLMENT

In this mode, characteristic of some primitive micropygous Cambrian trilobites such as *Ellipsocephalus* and *Bailiella*, the pos-

terior thoracic segments bend together with the small pygidium under the thorax, and then the main part of the thorax rolls up according to the spheroidal mode. As a result the dorsal side of the pygidium and last few thoracic segments come in contact with the cephalic doublure, the anterior cephalic margin touching one of the rear thoracic rings (Fig. 76A).

DISCOIDAL ENROLLMENT

In this mode, characteristic of certain progressive micropygous and isopygous forms (Harpidae, Trinucleidae, Hapalopleuridae), the thorax folds together in halves like a closing book. The flexion of the thorax is differential, being maximum in a comparatively short anterior stretch that acts as a sort of hinge, whereas it is very slight or none at all along the posterior segments. In this mode of enrollment, the posterior margin of the pygidium may come in contact (1) with the anterior margin of the cephalon (hapalopleurid type), (2) with the girder (harpid type, Fig. 76B), or (3) with the inner edge of the lower lamella (cryptolithid type). Apparently in no trilobite was the hypostoma uncovered during complete enrollment.

ANATOMIC FEATURES RELATED TO ENROLLMENT

Progressive trilobites developed special structures connected with enrollment. In the main these are devices for providing a

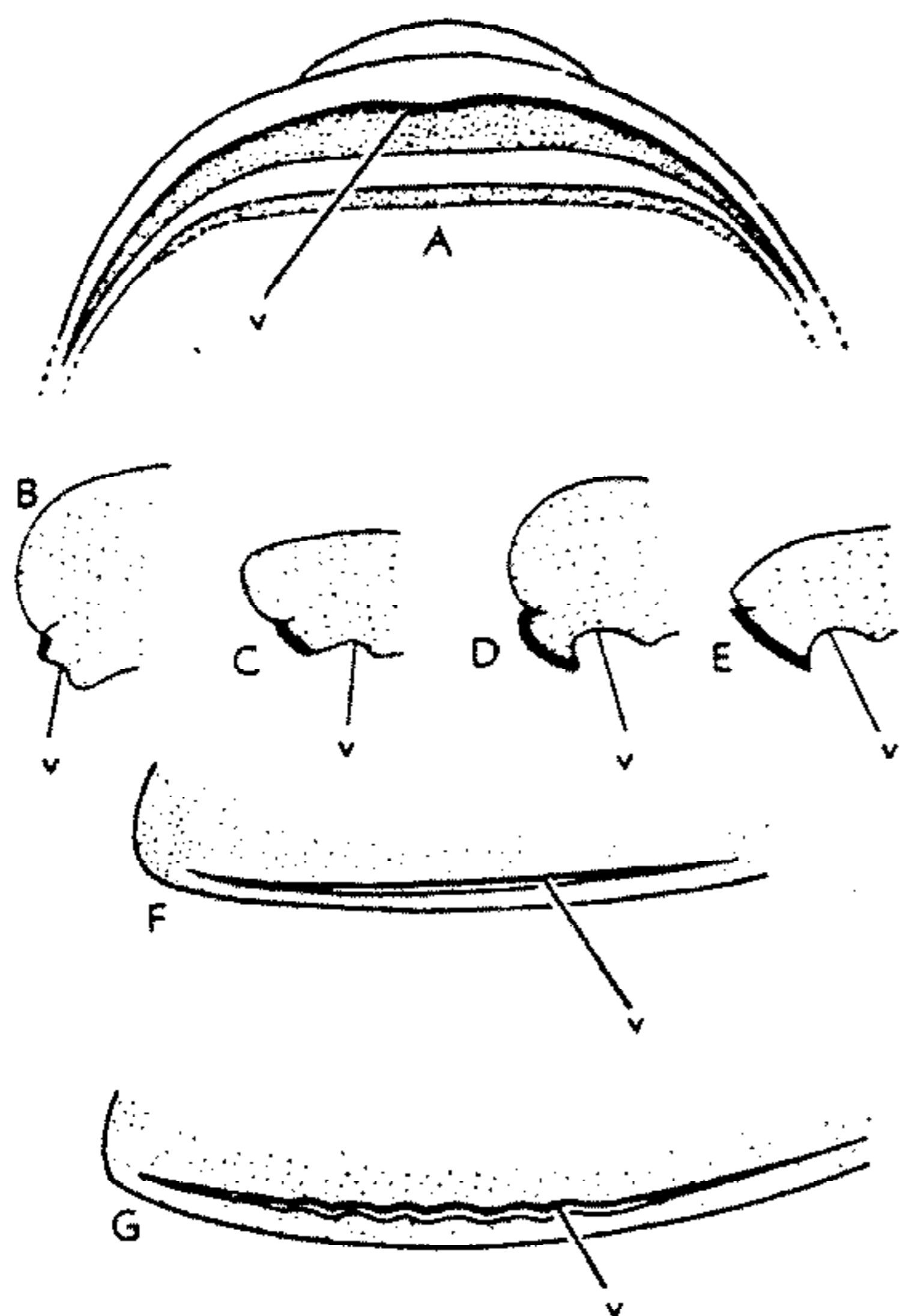

FIG. 77. Vincular furrows.—A. Anterior cephalic doublure of *Nephranops miserrimus* (DREVERMANN), U.Dev., Ger., $\times 4$, showing wide vincular furrow (after 47). B-E. Sagittal sections along anterior part of cephalon showing vincular furrow (*v*); B, *Phacops*; C, *Trimerocephalus*; D, *Nephranops*; E, *Dianops* (after 47).—F, G. Lateral vincular furrows; F, lateral cephalic doublure of *Phacopidella glockeri* (BARRANDE), Sil., Bohemia, $\times 5$ (after HUPÉ, 1953); G, lateral cephalic doublure of *Denckmannites micromma* (ROEMER), Dev., N.Afr. (Morocco), $\times 2.5$ (after 87, 1943).

firm fastening of the tightly closed "box" formed by the enrolled individual, and devices tending to prevent overgliding of the thoracic pleurae at the completion of enrollment.

VINCULAR FURROWS AND NOTCHES

The name "vincular furrow" (from Latin *vinculum*, lock or fastening) is here used as equivalent for RICHTER & RICHTER's (1926) "*Verschlussfurche*" and HUPÉ's (1953) "*sillon de fermeture*." The term "subcranial furrow" used by DELO (1935) to designate these structures is unfortunate because it is both inaccurate and inappropriate; therefore, it is rejected.

The vincular furrow, particularly well developed in the Phacopidae, consists of a

more or less deep groove incised on the cephalic doublure, running parallel and close to the cephalic margin. The furrow may be mainly anterior in position, in which case, at the completion of enrollment, the posterior edge of the pygidium fits into the groove as in a tongue-and-groove coupling, providing a very efficient fastening. Anterior vincular furrows are especially well developed in such phacopid genera as *Nephranops* and *Dianops* (Fig. 77A,D,E). In some other genera, notably *Phacopidella* and *Denckmannites* (Fig. 77F,G), the vincular furrows are found along the lateral cephalic doublures. In this case they acted as grooves for the reception of the thoracic pleural extremities. In *Denckmannites* the furrow is sinuous, providing a close fit for the overlapping pleural extremities.

In some Asaphidae, notably *Asaphus expansus* from the Ordovician of Estonia (Fig. 78), a vincular notch is developed along each posterolateral angle of the cephalon. At completion of enrollment, this notch received not only the distal extremities of the pleurae but also a hooklike process carried by the anterolateral angles of the pygidium. This process engaged against the slight anterior concavity of the notch providing a firm fastening.

A very efficient fastening device was developed in the pliomerid genus *Pliomera*. It consists of a row of denticles along the anterior cephalic border and doublure which, upon completion of enrollment, interlocked with the short free extremities of the pygidial pleurae.

PANDERIAN ORGANS

Panderian organs, originally discovered by PANDER (1857) in *Asaphus expansus*, are now known to be present in many Asaphidae, Nileidae, Illaenidae, Proetidae, Bathyruridae, Dimeropygidae, and Phacopidae (Fig. 79).

Actually, the name "panderian organs" is applied to 2 different exoskeletal structures which, though apparently related anatomically, may have had, and probably did have, quite dissimilar functions. One of these structures, which (HUPÉ, 1954) should be called "panderian protuberances," consists of rounded elliptical or elongated ridgelike protuberances found in the fixigonal and thoracic pleural doublures.

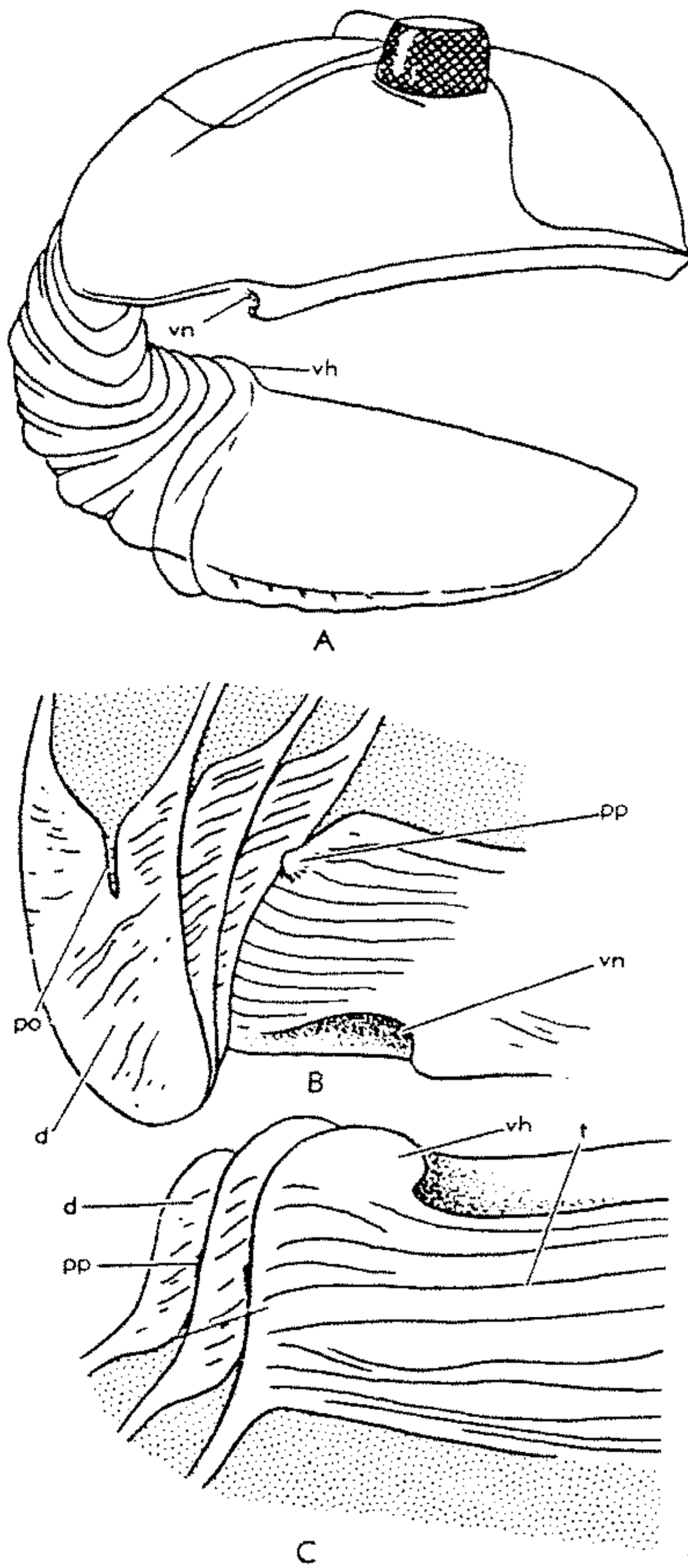

FIG. 78. Vincular notch and hook in *Asaphus expansus* DALMAN, Ord., Estonia (slightly schematic drawing after 52.)—A. Specimen not completely enrolled, $\times 2$; the thoracic pleural extremities and the anterolateral angle of the pygidium will fit, at completion of enrollment, into cephalic vincular notch.—B. Internal (ventral) view of the posterolateral angle of the cephalon and the anterior 3 overlapping thoracic pleurae, $\times 4$.—C. Internal (ventral) view of the anterolateral angle of the pygidium and of the posterior 3 overlapping pleurae, $\times 4$. (Explanation: *d*, doublure; *po*, panderian opening; *pp*, panderian protuberance; *t*, terrace lines; *vn*, vincular notch; *vh*, vincular hook.)

The other structures, which properly should be called "panderian openings," are small rounded or elliptical holes in the exoskeleton, located immediately behind the panderian protuberances. In some trilobites, they appear as notches along the adaxial margin of the pleural doublures, immediately behind the panderian crests.

All authors who have described panderian protuberances agree that they represent "stopping devices" to prevent the overgliding of the overlapping pleurae during enrollment, the anterior border of one pleura abutting against the protuberance of the pleura immediately in front of it when maximum permissible enrollment was reached by the animal.

No agreement exists, however, about the meaning of the panderian openings. Some authors, notably HUPÉ (1945, 1954), actually believe that no such openings existed in the living animal. However, since these openings actually occur in fossil specimens, notably in silicified material of *Isotelus* described by WHITTINGTON (1941), HUPÉ advanced the hypothesis that in this and other trilobites the integument near the panderian protuberances was extremely thin and that it covered a special sensory organ, which he called "*avertisseur panderien*," which "advertised" the passage of the anterior border of one pleura just before it touched the panderian protuberance of the one immediately in front. He further argued that the integument may have been so thin that, in some individuals, it may have broken away during life of the animal, the traumatism leading to death of the individual. Such an hypothesis seems far-fetched and fails to explain why all the pleurae have openings. If the tiny holes originated accidentally and caused death, it is logical to suppose that only one or at most a few of the pleurae would have been thus perforated, instead of all of them. Moreover, what is known about cicatrization of wounds and regeneration of parts in trilobites suggests that such small wounds, if made, would have healed very rapidly.

All in all, the available evidence seems to be in favor of SIEGFRIED'S (1936) suggestion that the panderian openings represent pores leading to some metameric internal organs, such as nephridia. Probably in the great majority of trilobites the pores opened

on the ventral membrane of the pleurae and fixigenae, whereas in a few (*Dimeropyge spinifera*, *Iliaenus sarsi*) the pores were located on the ventral membrane directly along the adaxial edge of the doublure

("panderian notches"). In a few species the pores seem to have opened in the doublure itself behind the panderian protuberances, which may have served as protecting bosses or ridges.

OTHER CHARACTERS

COLOR PATTERNS

It is hardly conceivable that living trilobites were colorless, as this would mean that their carapace was translucent. In all probability their exoskeleton was pigmented, but whether it was uniformly or irregularly colored is difficult to judge. Possibly both types of patterns occurred. To the writer's knowledge only 4 instances of color markings on trilobites have been described. These include (1) a pygidium of *Anomocare vittata* from the Middle Cambrian of Alabama (Fig. 80B), described by RAYMOND (1922), with color markings that consist of somewhat irregular fan-shaped bands traversing the pleural regions and continuing across the axis in narrower belts; (2) a pygidium of *Phillipsia? tenuituberculata* from the Mississippian of Missouri (Fig. 80A), described by WILLIAMS (1930), showing paired rows of rounded pigmented spots on the abaxial part of the rings; (3) a few specimens of *Isotelus maximus* from the Upper Ordovician of Ohio, described by WELLS (1940), showing dark areas along the thoracic axial furrows; and (4) a pygidium of *Ditomopyge meridionalis* from the Permian of Western Australia, described by TEICHERT (1944), showing numerous small rounded spots scattered over the surface of both the pleural regions and the axis.

CICATRIZATION, REGENERATION, PATHOLOGY, AND TERATOLOGY

Trilobites possessed the ability to heal their wounds and to regenerate broken parts. This is clearly shown by different specimens displaying unmistakable evidence of cicatrization of injuries and secondary growth of parts. A notable individual of *Paedeumias robsonensis*, from the Lower Cambrian of British Columbia, illustrated by BURLING (1917), has the 4th, 5th, and 6th right prothoracic pleurae damaged, the injuries having healed during the life of the animal

(Fig. 81). A pygidium of *Tricrepicephalus paraconus* from the Upper Cambrian of Missouri, described by LOCHMAN (1941), has the left spine broken at the base and a callus, obviously formed during the life of the animal, covering the wound. A pygidium of *T. texanus*, also from the Upper Cambrian of Missouri (LOCHMAN, 1936), has the tip of one of the spines bent abruptly from its normal position. A cephalon of *Iliaenus wahlenbergi* from the Middle Ordovician of Estonia, described by HOLM (1885), shows an extra facial suture on one side and a duplication of the posterior border. As suggested by RAYMOND (1916) this seems to have been due to partial retention of the old integument after molting.

Several cases of regeneration of parts also are known. A cephalon of *Ceraurus matranseris*, from the Upper Ordovician of Quebec, described by SINCLAIR (1947), shows a regenerated spine. The right genal spine was broken near the middle part and the secondary outgrowth differs from the original spine in having a sculpture of concentric striae instead of tubercles. Eye surfaces, being salient unprotected areas, were also easily damaged. Several instances of regeneration of eye lenses are known. In a specimen of *Asaphus cornutus* from the Ordovician of the Baltic region of Russia, described by HUPÉ (1953), the regenerated parts can be recognized easily. The newly formed facets are either smaller than the original, or polygonal in outline. A similarly damaged eye of *Telephina mobergi*, from the Lower Ordovician of Sweden, was figured by HÄRDING (1913) and described by ISBERG (1917). It is probable that these eye injuries occurred during molting.

Pathological specimens of trilobites are also known. A classical example is a cephalon of *Megistaspis acuticauda* from the Ordovician of the Baltic region illustrated by SCHMIDT (1906) (Fig. 82A) that shows a large tumor on the left side and a corresponding deformation of the anterior sec-

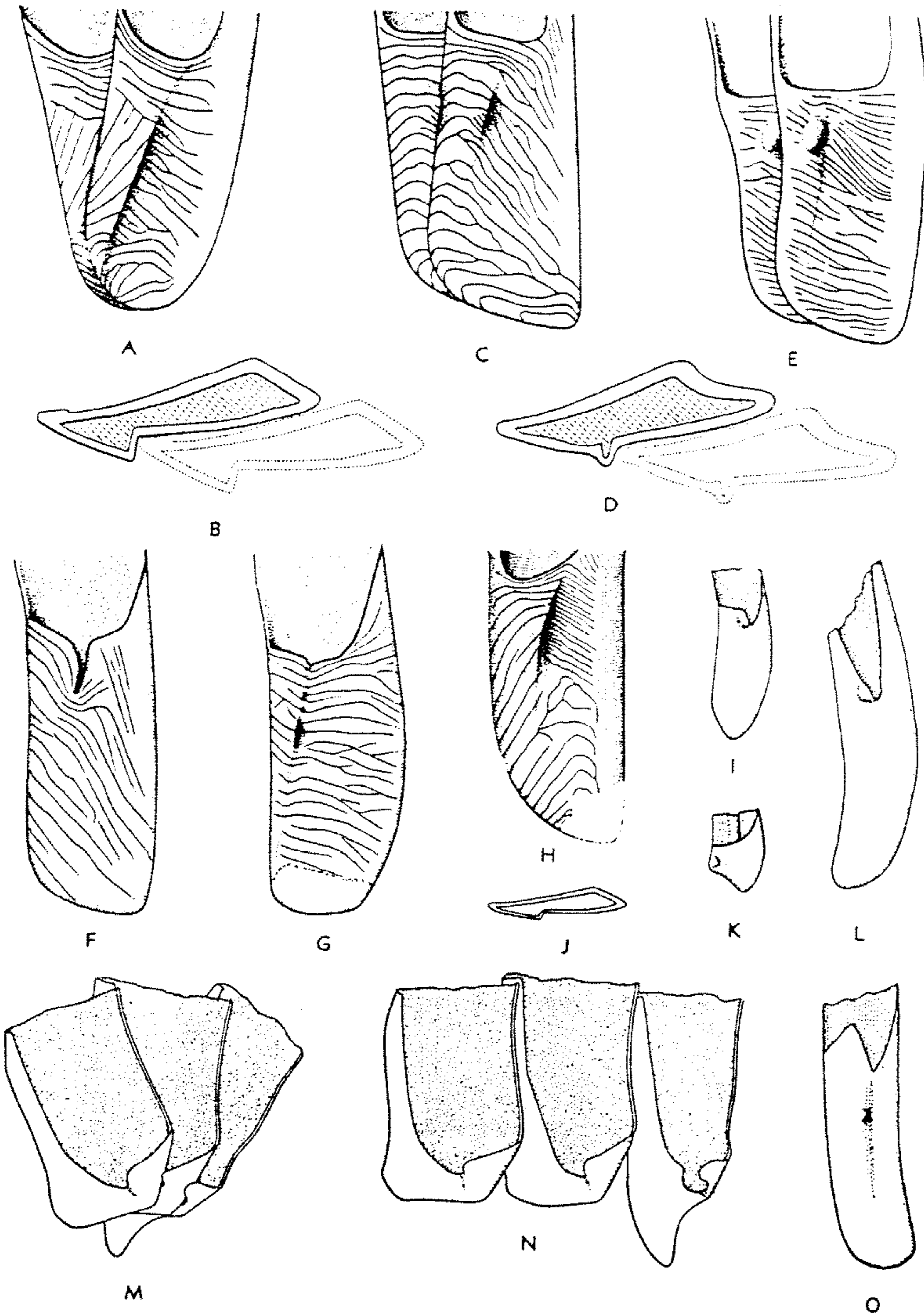

FIG. 79. Panderian protuberances and openings.—A,B. *Symphysurus palpebrosus* (DALMAN), Ord., Swed., A, ventral view of 2 thoracic pleurae in enrolled position, $\times 10$; B, cross section of same passing through panderian protuberance, $\times 18$ (after 25).—C,D. *Asaphus* (*Neosaphus*) *cornutus* (PANDER), Ord., Russia: C, ventral view of 2 thoracic pleurae in enrolled position, $\times 10$; D, cross section of same, passing through

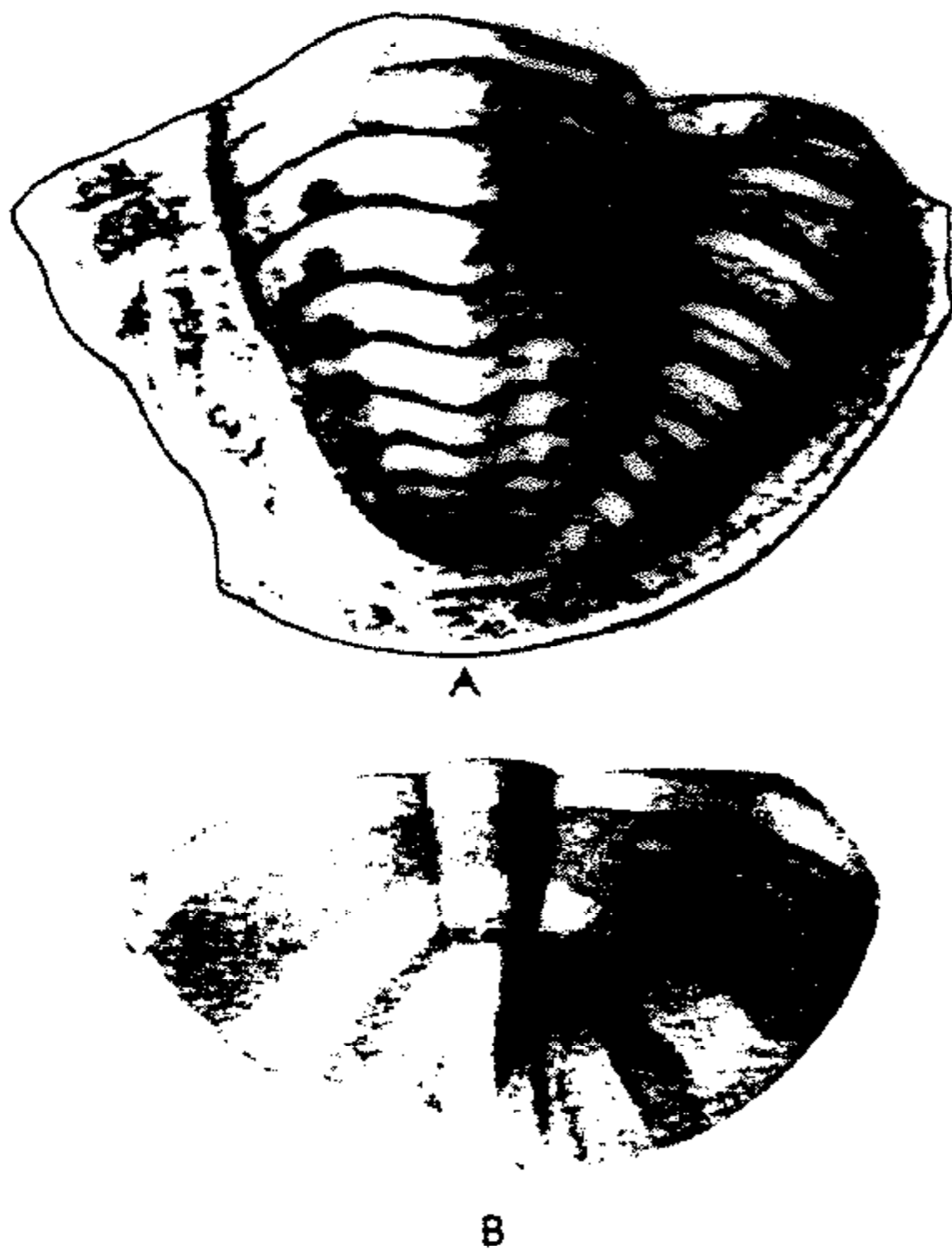

FIG. 80. Color patterns.—A. Pygidium of *Phillipsia? tenuituberculata* (J.S. WILLIAMS) HARRINGTON, Miss., USA (Missouri), $\times 4$, showing paired spots on axial rings (after 100, 1930).—B. Pygidium of *Anomocare vittata* RAYMOND, M. Cam., USA (Alabama), $\times 2$, showing fan-shaped light and dark bands (after 42).

tion of the facial suture.¹ A pygidium of *Nieszkowska capitalis* from the Ordovician of Estonia, illustrated by ÖPIK (1937), shows strong deformity of the right side affecting both the axis and the pleural region. A pygidium of *Coronura aspectans*

¹ Another example from Tremadocian strata of England (STUBBLEFIELD, 1926) is a specimen of *Shumardia pusilla* with normal 4th macropleural spine on the left side but showing on the right side an abnormal 3rd macropleural spine succeeded by the 4th and 5th pleurae fused at about mid-length to form a stout nonmacropleural lateral termination; this is inferred to denote an injury to the right macropleural thoracic spine in a preceding molt.—C.J.S.

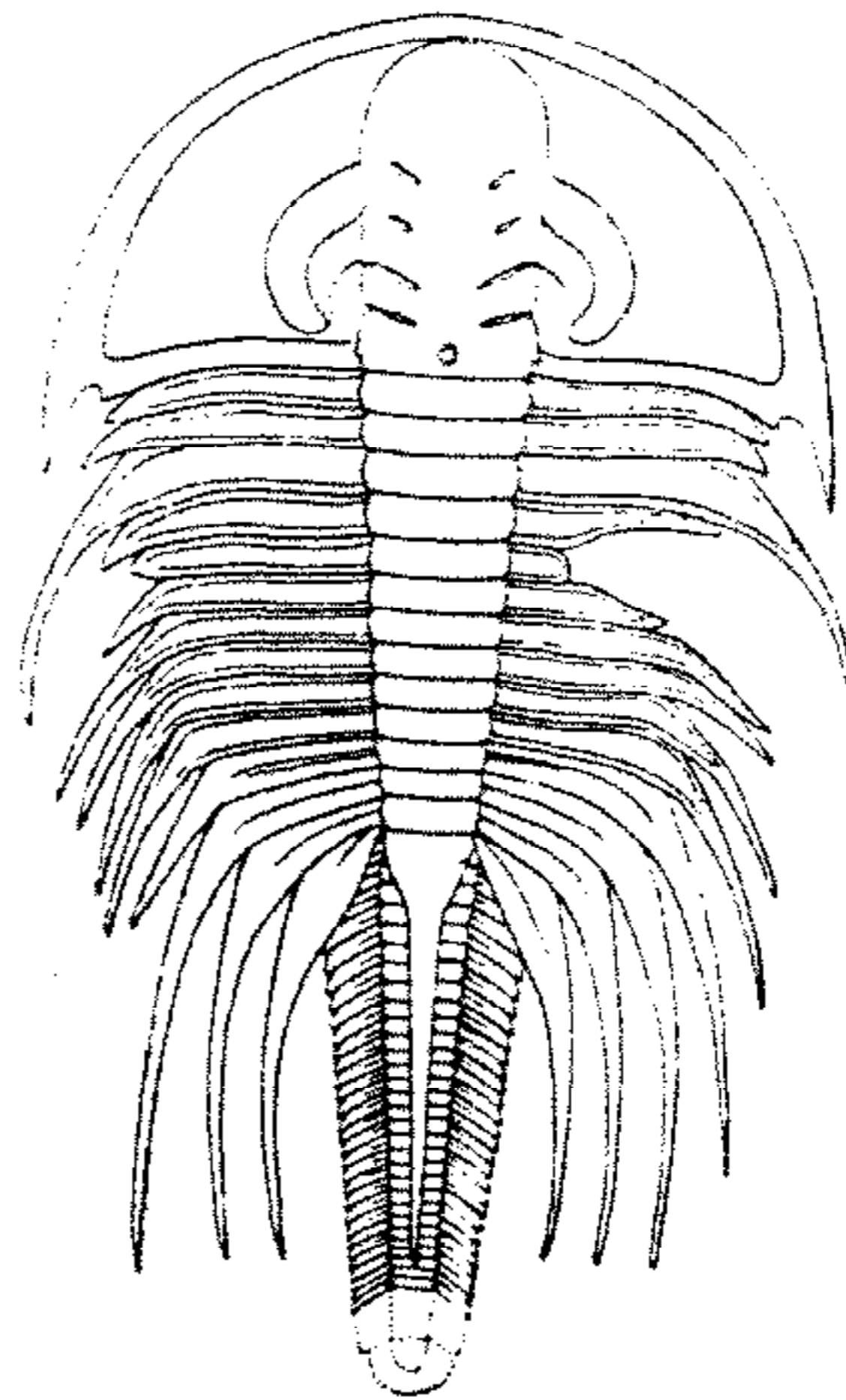

FIG. 81. *Paedeumias robsonensis* BURLING, L. Cam., Can., $\times 1$, specimen showing healed injuries on right side of prothorax (2+, after BURLING).

from the Devonian of Ohio, illustrated by HALL & CLARKE (1888) (Fig. 82D), shows marked deformities in the right pleural region. Notable is the case of the deformities observed in pygidia of *Scutellum flabelliferum* and allied forms, from the Middle Devonian of Germany, described by RICHTER & RICHTER (1934). Here several pathological pygidia were found, suggesting either deformations of parasitic origin or cicatrization of injuries inflicted during molting (Fig. 82B). As long ago as 1843 PORTLOCK described and illustrated a deformed pygidium of *Phillipsia ornata* from Lower Carboniferous rocks of Ireland.

Teratological cases are also known among trilobites. In most specimens the malforma-

(Continued from facing page)

panderian protuberances, $\times 20$ (after 25). E. *Pseudomegalaspis formosa* (TÖRNQUIST) JAANUSSON, Ord., Swed.; ventral view of 2 thoracic pleurae in enrolled position, $\times 4.7$ (after 79, 1953).—F. *Asaphus lepidurus* NIESZKOWSKI, Ord., Baltic region; ventral view of thoracic pleura, $\times 6$ (after 25).—G. *Niobe frontalis* (DALMAN), Ord., Swed.; ventral view of thoracic pleura, $\times 9$ (after 25).—H. *Nileus armadillo* DALMAN, Ord., Swed.; H, ventral view of thoracic pleura, $\times 10$; I, cross section of same, passing through panderian protuberance, $\times 10$ (after 25).—J. *Illaenus chudleighensis* HOLM, Ord., Baltic region; ventral view of thoracic pleura, $\times 3$ (after 25).—K. *Acaste downingiae* (MURCHISON), Sil., G. Brit.; ventral view of thoracic pleura, $\times 9$ (after 25).—L. *Illaenus sarsi* JAANUSSON, Ord., Swed.; ventral view of thoracic pleura, $\times 4$ (after 25).—M, N. *Dimeropyge spinifera* WHITTINGTON & EVITT, M. Ord., USA (Virginia); M, ventral view of 3 thoracic pleurae in enrolled position, $\times 30$; N, same in outstretched position, $\times 30$ (after 71).—O. *Ptychopyge* sp., Ord., ?Swed.; ventral view of thoracic pleura, $\times 2$ (after 25). (Explanation: in Figs. M, N, anterior margins of pleurae face to the right but in all others they face to the left.)

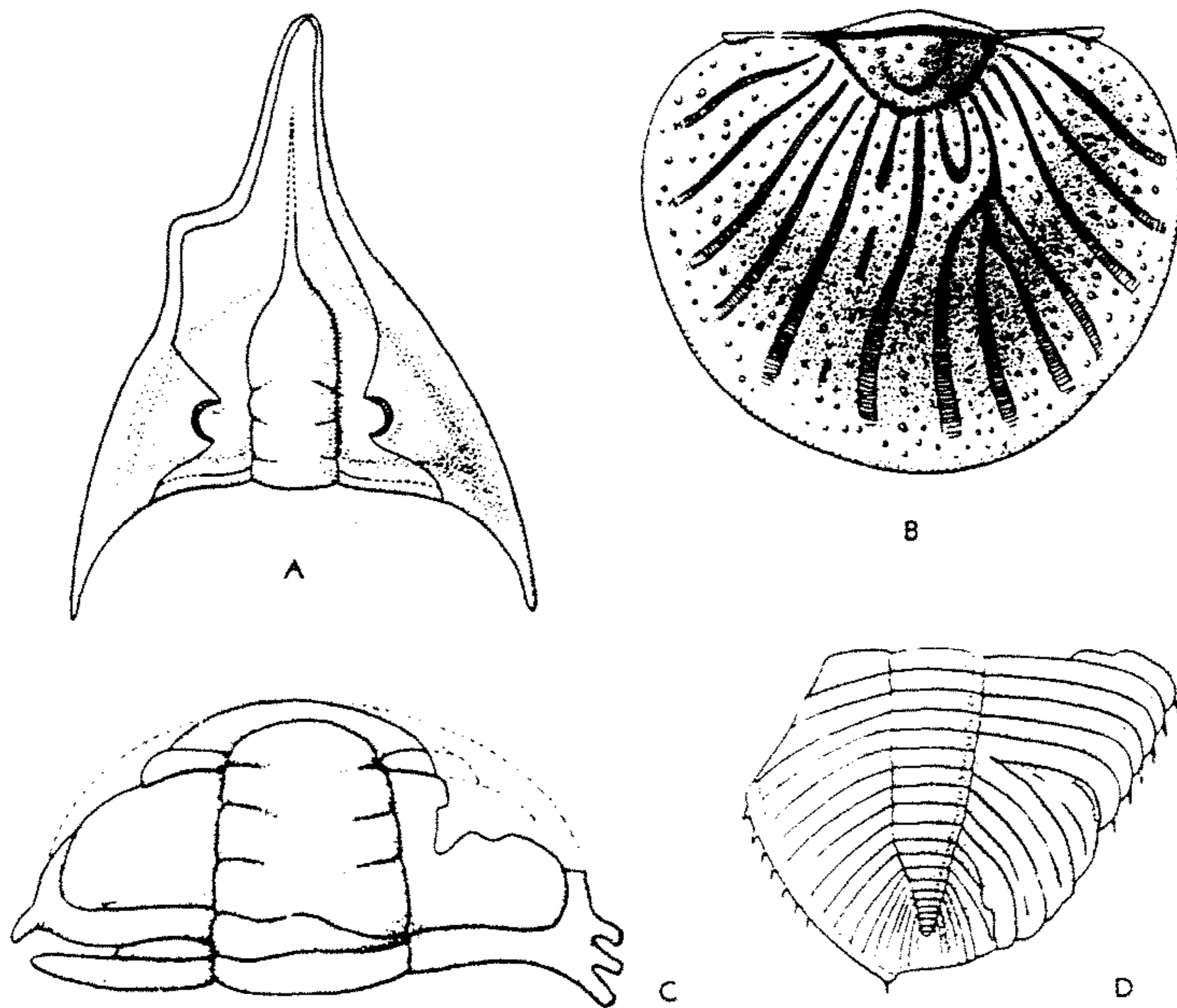

FIG. 82. Pathological and teratological individuals.—A. Pathological cephalon of *Megistaspis acuticauda* (ANGELIN) JAANUSSON, Ord., Baltic region, $\times 0.6$, showing tumor on left side and deformation of anterior section of facial suture (after 24).—B. Pathological pygidium of *Scutellum (Scutellum) flabelliferum* (GOLDFUSS), M.Dev., Ger., $\times 3$ (after 24, from 48).—C. Teratological specimen of *Rossaspis superciliosa* (ROSS) HARRINGTON, L.Ord., USA(Utah), $\times 1$; the 2 anterior thoracic segments of the right side are fused with the cephalon, whereas on the left side the 1st thoracic pleura is abortive (after 24, from 49).—D. Pathological pygidium of *Coronura aspectans* (CONRAD) HALL & CLARK, L.Dev., USA(Ohio), $\times 1.33$ (after 17).

tions consist of abnormal fusion of segments. In an individual of *Paradoxides* from the Middle Cambrian of Sweden described by WESTERGÅRD (1936) the last thoracic segment is fused with the pygidium, whereas in a specimen of *Bathyriscus brighamensis* from the Upper Cambrian of Utah figured by RESSER (1939), the 1st thoracic segment is fused with the cephalon. An exceptional fossil described by ROSS (1951) is a specimen of *Rossaspis superciliosa* from the Lower Ordovician of Utah (Fig. 82C). Here the 1st and 2nd right pleurae are fused with the cephalon, whereas they are developed on the left side. However, the 1st left pleura is deformed and abortive.

A special case is that of "*Trinucleus*" *pongerardi* from the Ordovician of France, described by ROUAULT (1846) and OEHLERT

(1895). OEHLERT's studies have shown that, in a collection of 2,000 specimens, about 40 per cent are characterized by bifurcated genal spines. The bifurcation may affect only one (right or left) or both spines, and it may occur at the base, the middle, or close to the extremity of the spine. The abundance of teratological individuals may even suggest hybridism and hereditary transmission of malformations.

MOLTING

Trilobites, having a hard unyielding exoskeleton, could grow only by molting or, more precisely, only during the brief periods immediately after they had shed their exoskeletons.

Probably the great majority of trilobite remains known as fossils are exuviae shed

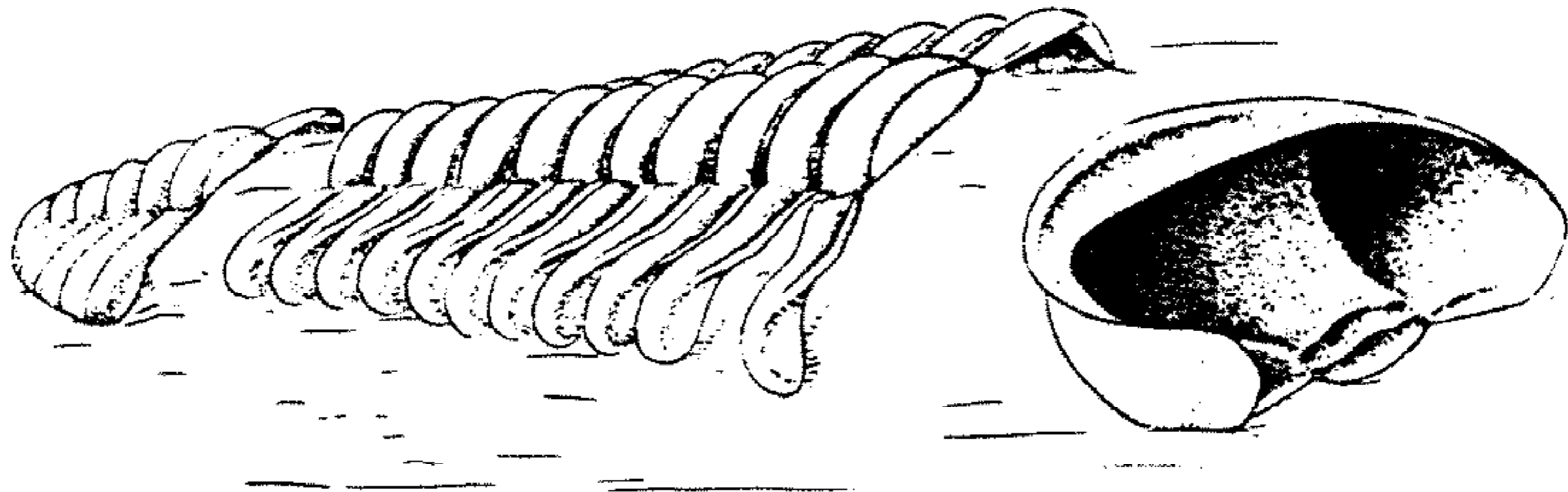

FIG. 83. Phacopid mode of ecdysis. Exuviae of *Nephranops* sp., U.Dev., Ger., showing thoracic and pygidial parts in normal position (ventral face downward), whereas the cephalon has rotated backward about 180° and lies upside down; as the facial sutures are nonfunctional, the librigenae remain attached to the cranidium (after 46).

during molting, either found "*in situ*" or transported and accumulated by waves and sea currents. This is suggested by 2 facts: (1) remains of dead individuals must have been destroyed rapidly by bottom scavengers, whereas the empty exuviae devoid of soft tissues were left undisturbed; and (2) a single individual, attaining the normal life expectancy of the species, probably molted many times. RAW (1927) estimated that not less than 29 molts took place in *Leptoplastoides salteri* from early protaspid to late holaspid stages, and it seems likely that in large trilobites the number of molts was considerably greater. This means that, even if one accepts the postulate that a trilobite carcass had the same chance of preservation as the exuviae, probably not more than 10 per cent of the fossil remains would correspond to those of dead animals.

It is generally accepted that the cephalic sutures played an important role during ecdysis, acting as lines of weakness along which different cephalic exoskeletal pieces cleaved apart, providing spaces through which the animal could crawl out of the old integument. It seems certain, however, that the junction line between cephalon and thorax also played an important part in molting, particularly in those trilobites that, like most phacopids, had nonfunctional facial sutures. The different sutural patterns must have controlled the mechanics of molting in different trilobites, but our knowledge of the modes in which ecdysis was accomplished is unsatisfactory and confined to the data furnished by comparatively scarce specimens interpreted as representing undisturbed exuviae. The best understood

are, at present, the phacopid and the olenid modes of molting.

The phacopid mode, illustrated by SALTER (1864), was analyzed in detail by RICHTER (1937), who styled it "*Salter'sche Einbettung*" (Salterian molting).¹ The term "phacopid mode" seems more appropriate. According to RICHTER, it characterizes several Devonian phacopids, including several species of *Phacops*, *Nephranops*, *Trimerocephalus*, *Dianops*, *Cryphops*, *Phacopidella*, and *Asteropyge*, in which the facial sutures are nonfunctional. The exuviae consist of thorax and pygidium in normal position and of a complete cephalon (librigenae firmly attached to the cranidium) lying somewhat in front of the thorax in upside-down position (Fig. 83). The main line of ecdysis seems to have been the junction between cephalon and thorax. As these 2 pieces cleaved apart, the animal crawled backward and buckled upward, forcing its head through the opening while shedding the old cephalon, which was tilted forward, rotating on its anterior margin. Once the cephalic region was free, the animal crawled forward, leaving behind the old thoracic and pygidial integuments and causing the old cephalon to overturn completely, so as to rest on its dorsal surface with its anterior margin facing the thorax.

A somewhat similar mode of molting seems to have characterized some telephinid trilobites. A specimen of *Telephina spinifera* from the Upper Ordovician of Virginia, illustrated by FISCHER (1946) and re-

¹ This was first illustrated by J. DE C. SOWERBY in 1840 and later by PHILLIPS (1841) and SANDBERGER & SANDBERGER (1850).—C.J.S.

garded by GLAESSNER (1948) as representing undisturbed exuviae, shows the thorax and cranidium in a position similar to that of the phacopid postecdysial attitude, but in this case the librigenae (still united anteriorly by the narrow cephalic doublure) lie in normal upside-up position between the thorax and the cranidium. In this species, therefore, the facial sutures were functional, and the librigenae, with their very large

visual surfaces, were shed independently by wiggling the head, probably before the animal crawled out of its old thoracic integument.

The olenid mode of molting has been recently analyzed by HENNINGSMOEN (1957) on the evidence furnished by numerous individuals of *Acerocare ecorne* from the Upper Cambrian of Norway, regarded as undisturbed exuviae. This mode seems to have

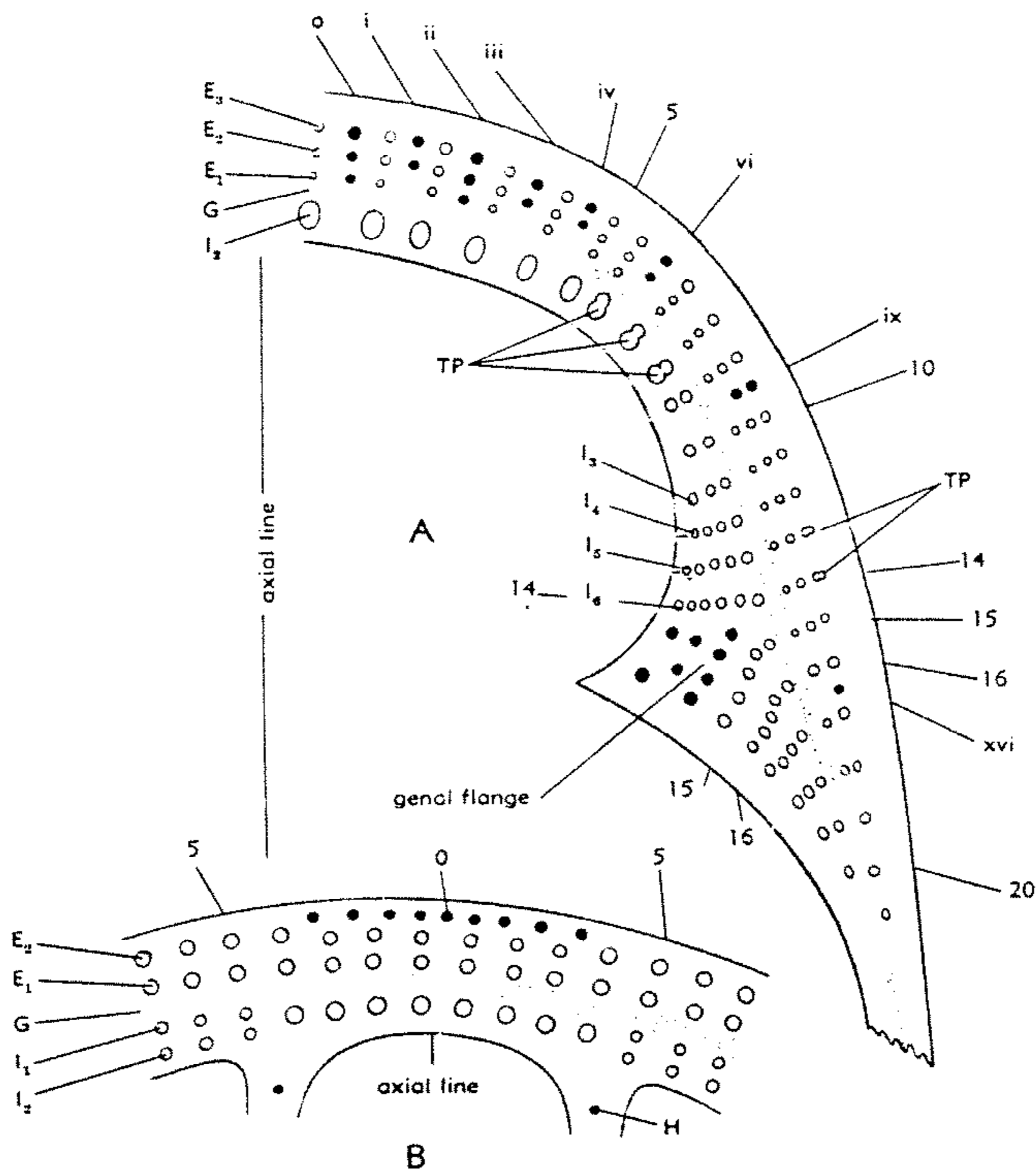

FIG. 84. Notation used for numbering of pits in the Trinucleidae (after 98, 1955).—A. Diagram of the lower lamella of a hypothetical trinucleid.—B. Diagram of the median part of the upper lamella of a hypothetical trinucleid. [Explanation: adventitious pits (9) marked in black; radii (R) indicated by arabic, and interradii (IR) by roman numerals; 1st to 3rd concentric rows of primary pits external to girder designated E₁, E₂, E₃; 1st to 6th rows of pits internal to girder (G) indicated I₁, I₂, I₃, I₄, I₅, I₆; twin pits (TP), indicated by square brackets in notation given below, are frequently dumbbell-shaped and incompletely divided; pits (marked in black) indicate (i) an interradiial position; (ii) a region on the genal flange where the notation cannot be used; in the figure, 8 pits are irregularly arranged on the genal flange between R14-15. The fringe-formula, which applies to half the complete fringe as illustrated, is E₁1—21, E₂1—18, E₃1—15, (E₄13-14): e_{10,ii,e20}—iv,vi,ix,xvi,e30—iv,vi,ix; I₁1—20, (I₂6—8), I₂9—10, I₃11—18, I₄12—17, I₅13—16, I₆14.]

characterized many other trilobites belonging to this family. Among the Lower Ordovician olenids from Argentina described by HARRINGTON & LEANZA (1957), specimens belonging to not less than 7 species consist of undisturbed exuviae closely similar to the Norwegian material. These include species of *Parabolina*, *Saltaspis*, *Angelina*, *Parabolinella*, *Plicatolina*, and *Triarthrus*. The undisturbed exuviae consist of a cranial-thoracic-pygidial unit and of a librigenal unit which lies below the cranidium and is somewhat displaced backward. As interpreted by HENNINGSMOEN, fission occurred along the facial sutures, which were connected anteriorly by a transverse marginal stretch. By slight wiggling of the head the molting trilobite was able to enlarge the opening so as to free itself from the old librigenal integument, which then came to

rest beneath the cephalic region. As no median or connective sutures were present in the Olenidae, the 2 librigenae formed a single piece connected anteriorly by the narrow cephalic doublure. Once the librigenae were shed, the trilobite crawled forward, leaving the old thoracic and pygidial integument behind and in so doing, pushing the librigenal exuviae slightly backward (the librigenae being still connected by the ventral membrane that supported the free hypostoma). As a result, the exuviae consist of a cranial-thoracic-pygidial complex and a backward displaced librigenal unit that underlies the cranidium and anterior part of the thorax. In some specimens of *Acerocare ecorne* the cranidium is missing, and this led HENNINGSMOEN to suggest that, in molting of some specimens, ecdysis may have been laborious, the freed trilobite carrying

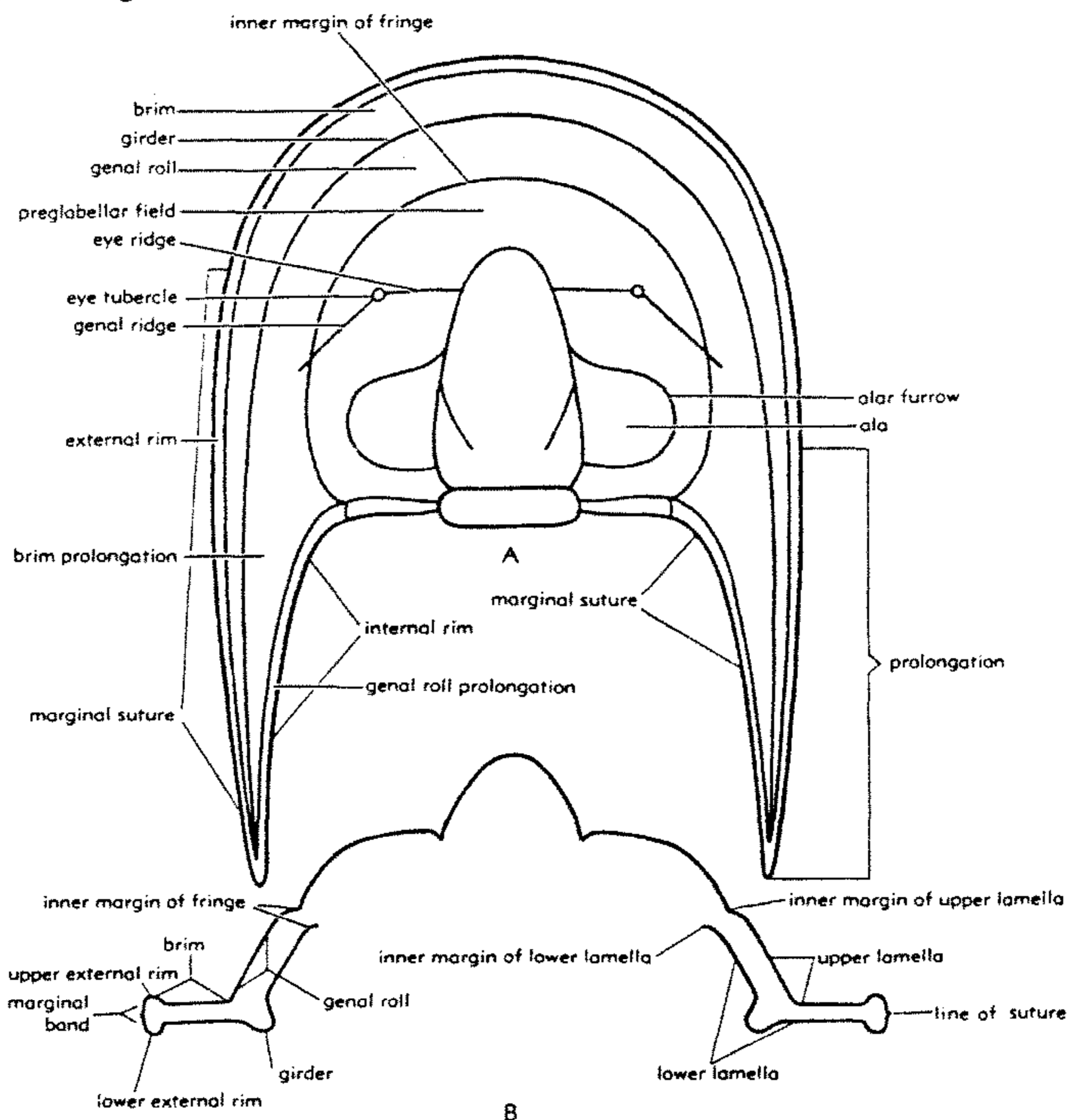

FIG. 85. Cephalic nomenclature of Harpidae; A, B, dorsal view and transverse section of cephalon.

away the almost loose cranial integument that finally was shed at some distance from the remainder of the exuviae. Similar examples are known in Argentine specimens of *Parabolina argentina*, *Saltaspis steinmanni*, and *Triarthrus parchaensis*.

A mode of molting somewhat similar to that of the Olenidae seems to have characterized some Richardsonellidae, particularly *Pseudokainella* and *Apatokēphalus*, as can be inferred from specimens illustrated by HARRINGTON & LEANZA (1957) from the Lower Ordovician rocks of Argentina. In these genera, however, the librigenae are always separated, indicating the presence of functional median (?or connective) sutures.

A small (1.5 cm.) cephalon of *Paedeumias transitans* from the Lower Cambrian of Pennsylvania, illustrated by WALCOTT (1910) and RESSER (1937), has been interpreted by SWINNERTON (1919) and HUPÉ (1953) as probably representing undisturbed exuviae. The cephalon has the rostral plate (bearing the stalked hypostoma) still attached to its rear part, but the plate lies directly behind the cephalon and on the same surface, having rotated 180° on its posterior extremities and so as to rest upside

down on its dorsal (internal) face. HUPÉ interpreted the remains as cephalic exuviae shed in a manner similar to that of the phacopid mode of molting, but this can hardly be the case. The remains suggest that the perrostral suture was the main line of ecdysis, and not the junction between cephalon and thorax, as in the phacopid trilobites. The wide gap left by the fission along the perrostral suture must have provided a very easy means of escape for the molting trilobite, which had simply to crawl forward to free itself from the old integument. It is difficult to imagine how, in so doing, the trilobite could have caused the rostral plate (and ventral cephalic membrane) to rotate downward and backward by about 180°. It is conceivable that such a rotation may have occurred accidentally in small specimens, but it seems completely out of the question for large individuals.

FEATURES OF TRINUCLEIDS AND HARPIDS

Morphological characters of trinucleid and harpid trilobites, omitted in earlier discussion, are illustrated in Figures 84 and 85, with indication of nomenclature of parts.

REFERENCES

Angelin, N. P.

- (1) 1851-78, *Palaeontologica Scandinavica: Academiae Regiae Scientiarum Suecanae (Holmiae); Pars I. Crustacea formationis transitionis*, p. 1-24, pl. 1-24 [1851]; *Pars II.* [no separate title], p. i-ix, 21-92, pl. 25-41 [1854]; republished in combined and revised form (ed., G. LINDSTRÖM), x+96 p., 42 pl., [1878].

Barrande, Joachim

- (2) 1852, *Système Silurien du Centre de la Bohême: 1^{re} Partie, Crustacés, Trilobites*: v. I, 935 p., 51 pl. (Prague & Paris).
 (3) 1872, *Système Silurien du Centre de la Bohême: 1^{re} Partie, Supplement au Vol. I. Trilobites, Crustacés divers et Poissons*: 647 p., 37 pl. (Prague & Paris).

Beckmann, Heinz

- (4) 1951, *Zur Ontogenie der Sehfläche gross-äugiger Phacopiden* (mit tafel 10): *Paläont. Zeitschr.*, Band 24, Heft 3/4, p. 126-141, pl. 10, 16 fig.

Beecher, C. E.

- (5) 1894, *On the mode of occurrence and the structure and development of Triarthrus becki*: *Am. Geol.*, v. 13, p. 38-43.

- (6) 1895, *Structure and appendages of Trinucleus*: *Am. Jour. Sci.*, ser. 3, v. 49, p. 307-311.

- (7) 1897, *Outline of a natural classification of the trilobites*: Same, ser. 4, v. 3, p. 89-106, 181-207, pl. 3.

Billings, Elkanah

- (8) 1870, *Notes on some specimens of lower Silurian trilobites*: *Quart. Jour. Geol. Soc.* (London), v. 26, p. 479-486, pl. 31-32.

Born, A.

- (9) 1919, *Zur Organisation der Trilobiten. 1. Das Kopfschild von Chasmops odini Eichwald*: *Senckenbergiana*, Band 1, p. 159-171, 6 fig.

Brink, A. S.

- (10) 1951, *On the compound eye of an unusually large trilobite from the Bokkeveld beds south of Steytlerville, Cape Province*: *S. Afr. Jour. Sci.*, v. 46, p. 162-164, 2 fig.

Burling, L. D.

- (11) 1917, *Was the lower Cambrian trilobite supreme?*: *Ottawa Naturalist*, v. 31, p. 77-79, 1 fig.

- Burmeister, H.**
 (12) 1843, *Die Organisation der Trilobiten, aus ihren lebenden Verwandten entwickelt; etc.*: 147 p., 6 pl. (Berlin).
- Clarke, J. M.**
 (13) 1889, *The structure and development of the visual area in the trilobite Phacops rana Green*: Jour. Morphology, v. 2, p. 253-270, pl. 21.
- Delo, D. M.**
 (14) 1935, *Locomotive habits in some trilobites*: Am. Midland Naturalist, v. 16, p. 406-409.
- Endo, Riuji, & Resser, C. E.**
 (15) 1937, *The Sinian and Cambrian formations and fossils of southern Manchoukuo*: Manch. Sci. Mus., Bull. 1, 474 p., 73 pl. (Mukden).
- Goldfuss, A.**
 (16) 1843, *Systematische Übersicht der Trilobiten und Beschreibung einiger neuen Arten derselben*: Neues Jahrb. f. Mineral Geognosie Geol. u. Petrefakten-Kunde, p. 537-567, pl. 4-6.
- Hall, James, & Clarke, J. M.**
 (17) 1888, *Palaeontology: Trilobites and other Crustacea*: Geol. Survey State of N.Y., v. 7, 236 p., 36 pl.
- Hanström, B.**
 (18) 1926, *Eine genetische Studie über die Augen und Sehzentren von Turbellarien, Anneliden, und Arthropoden (Trilobiten, Xiphosuren, Eurypteriden, Arachnoiden, Myriapoden, Crustaceen und Insekten)*: Kongliga Svenska Vetenskapsakademiens Handl., ser. 3, v. 4, no. 1, 766 p.
- Harrington, H. J., & Leanza, A. F.**
 (19) 1957, *Ordovician Trilobites of Argentina*: Dept. Geol., Univ. Kansas, Spec. Pub. 1, 276 p., 140 fig.
- Hawle, Ignaz, & Corda, A. J. C.**
 (20) 1847, *Prodrom einer Monographie der Bömischen Trilobiten*: Abhandl. k. Böhm. Gesell. Wiss., Band 5, 176 p., 7 pl. (Prague).
- Henningsmoen, Gunnar**
 (21) 1957, *The trilobite family Olenidae*: Skr. Norske Vidensk.-Akad. Oslo, I. Mat.-Naturv. Kl., no. 1, 303 p., 31 pl., 19 fig.
- Holm, Gerhard**
 (22) 1866, III. *Iliaeniden*, in SCHMIDT, FR., *Revision der Ostbaltischen Silurischen Trilobiten*: Mém. Acad. Imp. Sci. St. Pétersbourg, v. 7, no. 33, 173 p., 12 pl.
- Howell, B. F., et al.**
 (23) 1947, *Terminology for describing Cambrian trilobites*: Jour. Paleont., v. 21, p. 72-76, fig. 1.
- Hupé, Pierre**
 (24) 1953, *Classification des Trilobites*: Ann. Paléont., v. 39, p. 61-168 [1-110], fig. 1-92.
- (25) 1954, *A propos des organes de pander des trilobites*: Soc. Géol. France, Bull., ser. 6, tome 4, p. 701-711, fig. 1-8.
- (26) 1955, *Classification des Trilobites*: Ann. Paléont., v. 41, p. 91-325 [111-345], fig. 93-247.
- Jaanusson, Valdar**
 (27) 1957, *Unterordovizische Iliaeniden aus Skandinavien*: Pub. Palaeont. Inst. Univ. Uppsala, no. 15, p. 79-165, pl. 1-10, fig. 1-27 [Geol. Inst. Univ. Uppsala, Bull., v. 37].
- Kiaer, Johan**
 (28) 1917, *The lower Cambrian Holmia fauna at Tømten in Norway*: Skr. Vidensk.-Selsk. i Kristiana, I. Mat.-Naturv. Kl., Bind 2, p. 1-140, pl. 1-14, fig. 1-15.
- Kielan, Zofia**
 (29) 1954, *Les trilobites Mésodévonien des Montes de Sainte-Croix*: Palaeont. Polonica, no. 6, p. 1-50, pl. 1-7, fig. 1-35.
- Lake, Philip**
 (30) 1906-1946, *A monograph of the British Cambrian trilobites*: Palaeontogr. Soc. (London), p. 1-350, pl. 1-47 [p. 1-28, pl. 1-2, 1906; p. 29-48, pl. 3-4, 1907; p. 49-64, pl. 5-6, 1908; p. 65-88, pl. 7-10, 1913; p. 89-120, pl. 11-14, 1919; p. 121-148, pl. 15-18, 1931; p. 149-172, pl. 19-22, 1932; p. 173-196, pl. 23-25, 1934; p. 197-224, pl. 26-31, 1935; p. 225-248, pl. 32-35, 1937; p. 249-272, pl. 36-39, 1938; p. 273-306, pl. 40-43, 1940; p. 307-332, pl. 44-46, 1942, p. 333-350, pl. 47, addenda, errata, 1946].
- Lindström, G.**
 (31) 1901, *Researches on the visual organs of the trilobites*: Kongliga Svenska Vetenskapsakademiens Handl., v. 34, no. 8, p. 1-89, pl. 1-6.
- Lochman, Christina**
 (32) 1936, *New trilobite genera from the Bonnetterre dolomite (Upper Cambrian) of Missouri*: Jour. Paleont., v. 10, p. 35-43, pl. 9.
 (33) 1941, *A pathologic pygidium from the Upper Cambrian of Missouri*: Jour. Paleont., v. 15, p. 324-325, fig. 1-3.
- Öpik, A.**
 (34) 1937, *Trilobiten aus Estland*: Acta et Commentationes Univ. Tartuensis, A. Math.-Phys.-Med., v. 32, p. 1-163, pl. 1-26, fig. 1-42.
- Palmer, A. R.**
 (35) 1957, *Ontogenetic development of two olenellid trilobites*: Jour. Paleont., v. 31, p. 105-128, pl. 19, 9 fig.
- Poulsen, Christian**
 (36) 1927, *The Cambrian, Ozarkian and Canadian faunas of Northwest Greenland*: Meddel. om Grønland, v. 70, no. 2, p. 233-343, pl. 14-21.

Rasetti, Franco

- (37) 1945, *Evolution of the facial sutures in the trilobites Loganopectoides and Loganopeltis*: Am. Jour. Sci., v. 243, p. 44-50, pl. 1.
- (38) 1948, *Cephalic sutures in Loganopeltoides and the origin of "Hypoparian" trilobites*: Jour. Paleont., v. 22, p. 25-29, pl. 7.
- (39) 1952, *Cephalic sutures in the upper Cambrian trilobite Entomaspis*: Same, v. 26, p. 797-802, pl. 117, fig. 1-5.
- (40) 1952, *Ventral cephalic sutures in Cambrian trilobites*: Am. Jour. Sci., v. 250, p. 885-898, pl. 1.

Raymond, P. E.

- (41) 1920, *The appendages, anatomy, and relationships of trilobites*: Mem. Conn. Acad. Arts & Sci., v. 7, p. 1-169, pl. 1-11, fig. 1-46.
- (42) 1922, *A trilobite retaining color markings*: Am. Jour. Sci., ser. 5, v. 4, p. 461-464, fig. 1.

Raw, Frank

- (43) 1927, *The ontogenetics of trilobites, and their significance*: Am. Jour. Sci., ser. 5, v. 14, p. 7-35, p. 131-149, p. 240, 27 fig.

Reed, F. R. C.

- (44) 1935, *The lower Paleozoic trilobites of Girvan [Scotland]*, supplement no. 3: Palaeontogr. Soc. (London), v. 88, p. 1-64, 4 pl.

Richter, Rudolf

- (45) 1933, *Crustacea (Paläontologie)*: Handwörterbuch der Naturwissenschaften (2nd ed.), v. 2, p. 840-864, fig. A, 1-65.
- (46) 1937, *Vom Bau und Leben der Trilobiten. 8. Die Salter'sche Einbettung als Folge und Kennzeichen des Häutungs-Vergangs*: Senckenbergiana, v. 19, p. 413-431, 3 fig.

———, & Richter, Emma

- (47) 1926, *Die trilobites des Oberdevons. Beiträge zur Kenntniss devonischer Trilobiten, IV: Abhandl. Preuss. Geol. Landesanst., Neue Folge, Heft 99, 314 p., 12 pl., 18 fig., tables A-C.*
- (48) 1934, *Missbildungen bei Scutellidae und Konstruktive Konvergenzen*: Senckenbergiana, Band 16, p. 155-160, 11 fig.

Ross, R. J., Jr.

- (49) 1951, *Stratigraphy of the Garden City Formation in northeastern Utah, and its trilobite faunas*: Peabody Mus. Nat. Hist., Bull. 6, 161 p., 36 pl. (New Haven).

Schmidt, Friedrich

- (50) 1881-1907, *Revision der Ostbaltischen Silurischen Trilobiten, nebst geognostischen Übersicht, etc*: Mém. Acad. Imp. Sci. St. Pétersbourg.

Schulze, P.

- (51) 1937, *Trilobita, Xiphosura, Acarina. Eine morphologische Untersuchung über Plan- gleichheit zwischen Trilobiten und Spinnin-*

tieren: Zeitschr. f. Morphologie und Ökologie der Tiere, v. 32, p. 81-223, 39 figs.

Siegfried, P.

- (52) 1936, *Über das Pandersche Organ bei den Asaphiden des Ostbaltischen Ordoviciums*: Pub. Geol. Inst., Univ. Tartu, no. 49, p. 1-42, pl. 1-10, fig. 1-12.

Sinclair, G. W.

- (53) 1947, *Two examples of injury in Ordovician trilobites*: Am. Jour. Sci., v. 245, p. 250-257, pl. 1.

Snodgrass, R. E.

- (54) 1952, *A textbook of arthropod anatomy*: Comstock Publishing Associates (Ithaca), viii+363 p., 88 fig.

Størmer, Leif

- (55) 1930, *Scandinavian Trinucleidae, with special reference to Norwegian species and varieties*: Norske Vidensk.-Akad. Oslo, I. Mat.-Naturv. Kl., no. 4, p. 1-111, pl. 1-14, fig. 1-47.
- (56) 1939, *Studies on trilobite morphology, Part I. The thoracic appendages and their phylogenetic significance*: Norsk geol. tidsskr., v. 19, p. 143-273, pl. 1-12, fig. 1-35.
- (57) 1942, *Studies on trilobite morphology, Part II. The larval development, the segmentation and the sutures, and their bearing on trilobite classification*: Same, v. 21, p. 49-164, pl. 1-2, fig. 1-19.
- (58) 1944, *On the relationships and phylogeny of fossil and recent Arachnomorpha. A comparative study on Arachnida, Xiphosura, Eurypterida, Trilobita, and other fossil Arthropoda*: Skr. Vidensk.-Akad. Oslo, I. Mat.-Naturv. Kl., no. 5, 158 p., 30 figs.
- (59) 1949, *Classe Trilobita*, in GRASSE, P. P., *Traité de Zoologie*: Masson et Cie (Paris), v. 6, p. 159-197, 24 fig.
- (60) 1951, *Studies on trilobite morphology, Part III. The ventral cephalic structures with remarks on the zoological position of the trilobites*: Norsk geol. tidsskr., v. 29, p. 108-158, pl. 1-4, 14 fig.

Stubblefield, C. J.

- (61) 1936, *Cephalic sutures and their bearing on current classification of trilobites*: Biol. Rev. (Cambridge Philos. Soc.), v. 11, p. 407-440, fig. 1-9.

Swinnerton, H. H.

- (62) 1915, *Suggestions for a revised classification of trilobites*: Geol. Mag., new ser., v. 2, p. 407-496, p. 538-545.

Volborth, A.

- (63) 1863, *Über die mit glatten Rumpfgliedern versehenen russischen Trilobiten*: Mém. Imp. Acad. Sci. St. Pétersbourg, ser. 7, tome 6, p. 1-47, pl. 1-4, fig. 1-2.

Walcott, C. D.

- (64) 1910, *Olenellus and other genera of the Mesonacidae*: Smithsonian Misc. Coll., v. 53, no. 6, p. 231-422+unpaged index, pl. 23-44.
 (65) 1918, *Appendages of trilobites*: Same, v. 67, no. 4, p. 115-216, pl. 14-42, fig. 1-3.
 (66) 1921, *Notes on the structure of Neolenus*: Same, v. 67, no. 7, p. 365-456, 15 pl., 23 fig.

Warburg, Elsa

- (67) 1925, *The trilobites of the Leptaena limestone in Dalarne*: Geol. Inst. Univ. Uppsala, Bull., v. 17, 446 p., 11 pl., 23 fig.

Westergård, A. H.

- (68) 1936, *Paradoxides oelandicus beds of Oland*:

Sver. Geol. Undersök., ser. C, no. 394 (Årsbok 30, no. 1), p. 1-66, pl. 1-12.

Whittard, W. F.

- (69) 1939, *The Silurian illaenids of the Oslo region*: Norsk geol. tidsskr., v. 19, hafte 2-3, p. 275-295, 4 pl.

Whittington, H. B.

- (70) 1941, *The Trinucleidae, with special reference to North American genera and species*: Jour. Paleont., v. 15, p. 21-41, pl. 1-6, fig. 1.

———, & Evitt, W. R.

- (71) 1953, *Silicified Middle Ordovician trilobites*: Geol. Soc. America Mem. 59, 137 p., 33 pl., 27 fig.

SOURCES OF ILLUSTRATIONS

- | | | |
|--------------------------------------|---------------------------|----------------------------------|
| (72) Broili, F. | (81) Lochman, Christina | (91) Shimer, H.W. & Shrock, R.R. |
| (73) Clarke, J.M. | (82) Palmer, A.R. | (92) Sinclair, G.W. |
| (74) Cooper, B.N. | (83) Peach, B.N. | (93) Stubblefield, C.J. |
| (75) Evitt, W.R. & Whittington, H.B. | (84) Rasetti, Franco | (94) Ulrich, E.O. |
| (76) Harrington, H.J. | (85) Raymond, P.E. | (95) ———, & Resser, C.E. |
| (77) Hintze, L.F. | (86) Richter, Rudolf | (96) Walcott, C.D. |
| (78) Holm, Gerhard | (87) ———, & Richter, Emma | (97) Westergård, A.H. |
| (79) Jaanusson, Valdar | (88) Ross, R. J. | (98) Whittard, W.F. |
| (80) Lake, Philip | (89) Salter, J.W. | (99) Whittington, H.B. |
| | (90) Schindewolf, O.H. | (100) Williams, J.S. |

MORPHOLOGICAL TERMS APPLIED TO TRILOBITA

By H. J. HARRINGTON, R. C. MOORE, and C. J. STUBBLEFIELD

The somatic terminology of trilobites in the English language has undergone considerable changes since the early descriptions by GREEN, MILNE EDWARDS, and M'COY. Several attempts have been made during the last 25 years to stabilize nomenclature, and important papers on the subject have been published by WARBURG, HOWELL, *et al.*, WHITTINGTON, RASETTI, JAANUSSON, ROSS, WHITTARD, and HENNINGS-MOEN; but to this day no comprehensive glossary of terms has been published. The following attempt to list morphological terms used by different authors has as one of its purposes the stabilizing of nomenclature by redefinition of terms and introduction of new names where thought to be necessary.

Most important terms are printed in boldface capital letters (as **ANTERIOR BORDER**), useful but less important terms in boldface small letters (as **abaxial**), and

least important (in part obsolete) terms in italic letters (as *antennary pit*).

GLOSSARY OF TRILOBITE MORPHOLOGICAL TERMS

abaxial. Away from axial line.

adaxial. Toward axial line.

aggregate eye. See *schizochroal eye*.

ala (pl. *alae*). Smooth semicircular area adjoining posterior portion of glabella, outlined distally by furrow and commonly depressed below adjacent part of gena, as in Harpidae. See *paraglabellar area*.

alar furrow. Curved furrow bounding ala peripherally as in Harpidae.

anaprotaspis (pl., *anaprotaspides*). Smallest protaspides in a size series, in which protopygidium is extremely small and ill defined.

antenna (pl. *antennae*). Multijointed sensory appendage attached to front part of cephalon on ventral side.

antennary pit. See *fossula*.

antenniform cercus (pl., *cerci*). Uniramous appendage on ventral side of last pygidial segment,

- known only in *Olenoides serratus* (syn., caudal ramus, cercus, uropod).
- antennular pit.* See fossula.
- anterior area (of fixed cheek).* See anterior area (of fixigena).
- anterior area (of fixigena).* Portion of fixigena in front of eye ridge. If eye ridges are absent, posterior boundary of the area is marked off by imaginary line connecting anterior extremity of palpebral lobe with anterolateral border of glabella (syn., anterior area of fixed cheeks, anterior region of fixed cheek or of fixigena).
- ANTERIOR BORDER.** Portion of cephalic border between anterior sections of facial sutures (if present); otherwise ill defined.
- ANTERIOR BORDER FURROW (OF CEPHALON).** Portion of border furrow bounding anterior border (syn., front furrow, frontal furrow).
- anterior branch (of facial suture).* See anterior section (of facial suture).
- anterior flange.* Narrow border extending along anterior edge of adaxial portion of a pleura, as in *Ceraurinella*.
- ANTERIOR LATERAL GLABELLAR FURROW.** First lateral glabellar furrow when numbering from front to back (see lateral glabellar furrow).
- ANTERIOR LATERAL GLABELLAR LOBE.** Lateral portion of glabellar region between anterior lateral and median glabellar furrow, or between anterior lateral and preoccipital glabellar furrows.
- anterior limb.* See frontal area.
- anterior lobe (of glabella).* See frontal lobe.
- anterior lobe (of hypostoma).* Portion of middle body of hypostoma in front of middle furrow.
- anterior median process.* See frontal process.
- anterior pit.* See fossula.
- anterior pleural band.* Strip of thoracic or pygidial pleura bounded posteriorly by pleural furrow.
- anterior pleural spine.* Extension of distal end of an anterior pleural band.
- anterior region (of fixigena or fixed cheek).* See anterior area (of fixigena).
- ANTERIOR SECTION (OF FACIAL SUTURE).** Portion of facial suture lying in front of eye [syn., anterior branch (of facial suture), preocular branch (of facial suture)].
- anterior wing (of hypostoma).* Extension of anterolateral borders of hypostoma.
- apodemal pit.* Excavation in external surface of a tergite corresponding to apodeme on internal surface, as in *Ceraurinella* (syn., appendiferal pit).
- apodeme.* Process for attachment of muscles or ligaments, formed by inbending or thickening of dorsal exoskeleton on internal side of a tergite (syn., appendifer).
- appendifer.* See apodeme.
- appendiferal pit.* See apodemal pit.
- area.** Portion of region or lobe.
- articulating boss (and socket).** Corresponding structures on the margins of thoracic segments, in some cases situated in the axial furrows, as in Remopleurididae.
- ARTICULATING FURROW.** Transverse groove between main portions of articulating half ring.
- ARTICULATING HALF RING.** Anterior extension of axial ring which bends downward to pass under posterior edge of ring just in front of it (syn., half ring).
- associated.* See attributed.
- attributed.* Term used for isolated parts of exoskeleton found near together and considered to belong to the same species.
- AXIAL FURROW.** Groove outlining axial regions of cephalon, thorax and pygidium (syn., dorsal furrow).
- axial glabellar furrow.* Furrow in axial line of cranidium extending onto frontal lobe of glabella from preglabellar furrow, as in Encrinuridae and Cheiruridae.
- axial line.* See sagittal line.
- axial lobe.* See axis.
- AXIAL NODE.** Medial (or paired) tubercle on external surface of axial ring.
- axial region.* See axis.
- AXIAL RING.** Central portion of thoracic or pygidial tergite bounded laterally by axial furrow (syn., ring).
- AXIAL SPINE.** Medial (or paired) pointed structure projecting from external surface of axial ring.
- AXIS (pl., AXES).** Medial region of dorsal exoskeleton, outlined by axial furrows (syn., axial lobe, axial region, rachis, rhachis).
- axis (of pygidium).* Medial region of pygidium, outlined by axial furrows (syn., pygothorax).
- axis (of thorax).* Medial region of thorax, outlined by axial furrows (syn., axothorax).
- axothorax.* See axis (of thorax).
- basal furrow.* See preoccipital glabellar furrow.
- basal lobe (of glabella).* Lateral lobe adjacent to posterolateral extremity of glabella, as in Agnostida and *Schizoproetus*. See lateral preoccipital lobe.
- basipodite.* See trochanter.
- Bertillon pattern.** Pattern of subconcentrically arranged, raised, terrace lines on external surface, simulating a fingerprint.
- bicomposite glabellar lobe.** Lateral glabellar lobe representing fused anterior and median lateral glabellar lobes, separated from frontomedian lobe of glabella by anterior lateral glabellar furrow, as in Lichidae.
- biramous appendage.** Ventral appendage consisting of outer branch (pre-epipodite) and inner branch (telopodite).

BORDER. Outer, dorsal flange of cephalon and pygidium usually bounded by border furrow (syn., marginal limb, marginal rim).

BORDER FURROW. Furrow bounding border of cephalon and pygidium (syn., marginal furrow).

border pit. One of a row of pits along anterior border furrow of cephalon, as in *Angelina*; may occur also in lateral border furrow, as in *Euloma* (syn., marginal pit).

brim. Peripheral portion of fringe, bounded on inward side by girder or corresponding inflection of upper lamella, as in Harpidae, Harpididae, and Trinucleidae (formerly used also in the sense of "frontal area" or "preglabellar field").

brim prolongation. Peripheral portion of fringe prolongation, bounded by girder; represents an extension of brim, as in Harpidae and Harpididae.

burlingiiform sutures. Proparian sutures in which the anterior and posterior sections are subparallel, diverging outward-forward at an angle of about 45° to axial line of cephalon (as in *Burlingia*).

butress (of fixed cheek). See butress of fixigena.

butress (of fixigena). Projection of fixigena into axial furrow, meeting a papillate glabellar lobe and bridging over axial furrow, as in Calymeniidae (syn., butress of fixed cheeks).

Carapace. See dorsal exoskeleton.

caudal ramus (pl., rami). See antenniform cercus.

caudal shield. See pygidium.

caudal spine. See posterior spine.

cedariiform suture. Opisthoparian suture in which posterior sections run outward across the lateral border furrow before curving backward and inward to posterior margin, as in *Cedaria* (syn., pseudoproparian suture).

CENTRAL AREA (OF GLABELLA). Middle portion of glabella between frontal lobe and occipital furrow, bounded laterally by adaxial ends of lateral glabellar furrows (syn., median lobe of glabella, central region of glabella, median cervical lobe).

central body (of hypostoma). See middle body (of hypostoma).

central region (of glabella). See central area (of glabella).

cephalic region. Area of trilobite body formed by fusion of several anterior somites.

cephalic spine. Spine carried by cephalon.

CEPHALON (pl., CEPHALA). Anterior area of dorsal exoskeleton separated from thorax by an articulation (syn., head, head shield).

cercus (pl., cerci). See antenniform cercus.

cervical lobe. See preoccipital glabellar lobe.

cheek. See genal region.

cheek area. See genal region.

cheek lobe. See gena.

cheek region. See genal region.

cheek roll. See genal roll.

cheek roll prolongation. See genal roll prolongation.

composite internal mold. Mold showing the internal surface of dorsal exoskeleton and impression of internal surface of doublure.

compound eye. See holochroal eye.

CONNECTIVE SUTURE. Longitudinal suture transecting doublure in front of hypostoma (paired).

corner furrow. Groove extending obliquely outward from axial furrow at anterolateral borders of glabella, as in *Strenuella*.

coxa. Proximal joint of biramous appendage (syn., coxite, coxopodite).

coxite. See coxa.

coxopodite. See coxa.

CRANIDIUM (pl., CRANIDIA). Central dorsal portion of cephalon bounded laterally by facial sutures.

crenulation. Rounded scallop in a series cutting a margin.

dalmanitiform suture. Proparian suture in which anterior sections meet on dorsal side of cephalon near anterior margin, as in *Dalmanites*.

DEGREE OF MERASPID PERIOD. Successive stages in development characterized by number of thoracic segments, from 0 to holaspid number minus one.

denticle. Small tooth or projection.

distal. End of a part or organ away from the point of origin of medial line of the body.

DORSAL EXOSKELETON. Resistant, mineralized dorsal integument extended onto ventral side in a reflexed border or doublure (syn., carapace, dorsal shield, test).

dorsal furrow. See axial furrow.

dorsal shield. See dorsal exoskeleton.

DOUBLURE. Reflexed continuation of dorsal exoskeleton onto ventral side as a rim or shelf.

ecdysis. Act of molting or shedding outer cuticular layer.

endite. Median or inner lobe of segment (podite) of biramous appendage.

endopodite. See telopodite.

entomaspidiform suture. Opisthoparian suture in which the anterior sections are retrodivergent, running outward-backward from the eyes to the lateral margins (as in *Entomaspis*).

epebic stage. Mature or adult growth stage, loosely applied to part of the holaspid period.

epimera. See pleura.

epistoma. See rostral plate.

epistomal plate. See rostral plate.

epistome. See rostral plate.

exite. Lateral or outer lobe of joint (podite) of biramous appendage.

exopodite. See pre-epipodite.

EXOSKELETON. Resistant external integument covering part of body and appendages (see dorsal exoskeleton).

exsagittal. Term used to describe a measurement

- parallel to, but outside of the medial line (abbrev., *exsag.*).
- external mold.** Mold of outer surface of dorsal exoskeleton.
- external rim.** Outer smooth border of fringe along anterior and lateral edges extending back to posterior tip of the prolongation, as in Harpididae, Harpididae, and Trinucleidae.
- exuviae.** Any parts of trilobite exoskeleton that are shed or cast off.
- EYE.** Visual organ on external side of cephalon, bearing eye lenses or facets.
- eye lappet.* See visual surface of eye.
- eye list.* See eye ridge.
- eye lobe.** Ensemble of palpebral lobe and eye.
- eye platform.** Librigenal area adjacent to visual surface of eye.
- EYE RIDGE.** Raised band extending from anterior end of eye to or just back of anterolateral angles of glabella, usually simple but may be bifid, as in *Pruvostina*, or trifid, as in *Daguinaspis* (syn., eye list, ocular band, ocular ridge, paired eye ridges).
- eye tubercle.** Raised knob bearing simple eyes, as in Trinucleidae.
- FACET.** Small triangular area located at anterolateral corners of pygidium and lying at a depressed angle to surface of last thoracic segment, also developed on anterolateral portion of thoracic pleurae, as in *Phucops* and *Bumastus*.
- FACIAL SUTURE.** One of 2 lateral sutures starting symmetrically on posterior or lateral doublure, crossing the border and taking a symmetrical course to bound adaxial side of visual surface of eye, continuing forward either to unite anteriorly on dorsal surface or marginally; a facial suture may exist where compound eye is absent, its course being then similar to that in nearest eye-bearing relative. Separates cranium from librigena.
- false eye ridge.* See sutural ridge.
- femur.** Third joint of telopodite.
- fixed cheek.* See fixigena.
- FIXIGENA** (pl., **FIXIGENAE**). Portion of cranium between glabella and facial suture (syn., fixed cheek).
- fixigenal boss.** Fixigenal protuberance at level of last lateral glabellar lobe, as in *Neoredlichia*.
- FIXIGENAL SPINE.** Any spine borne by fixigena.
- flange.* See fringe.
- fossula** (pl., **fossulae**). Small circular or oval depression which may occur in axial furrow at or near anterolateral edges of glabella (syn., anterior pit, antennary pit, antennular pit, pseudantennary pit, pore).
- fossular apodeme.** Process formed by inbending of dorsal integument corresponding to fossulae on external side.
- free cheek.* See librigena.
- fringe.** External, pitted portion of cephalon in Harpididae, Harpididae, and Trinucleidae (syn., flange).
- front furrow.* See anterior border furrow.
- FRONTAL AREA.** Portion of cranium between anterior margin, facial sutures, front of glabella and eye ridges; if eye ridges are absent, the posterolateral boundaries of this area are marked off by imaginary lines connecting anterior extremities of palpebral lobes with anterolateral borders of glabella (syn., preglabellar area, anterior limb, limb); distinct from preglabellar field.
- frontal glabellar spine.** Median structure projecting forward from frontal part of glabella, as in *Lonchodomas*.
- frontal furrow.* See anterior border furrow.
- FRONTAL LOBE (OF GLABELLA).** Lobe of glabella between preglabellar furrow and most anterior lateral glabellar furrows (syn., anterior lobe of glabella).
- frontal process.** Projection of anterior border and doublure of cephalon into a stout prolongation in cases bi- or trifurcate anteriorly, as in *Neoproboium* (syn., anterior median process).
- frontal spine.** Projection of anterior border and doublure of cephalon ending anteriorly in a point, as in *Seleneceme*.
- fronto-median lobe.** Frontal lobe and central area of glabella, as in Lichidae and Odontopleuridae.
- fulcral process.** Projection on anterior edge at fulcrum (and inner edge of doublure), as in *Ceraurinella*.
- fulcral socket.** Excavation on posterior edge at fulcrum, as in *Ceraurinella*.
- FULCRUM** (pl., **FULCRA**). Genuation of individual pleurae separating a proximal from distal portion.
- GENA** (pl., **GENAE**). Area enclosed within cephalic border furrows and axial furrows (used if suture is marginal or absent, as in Olenellidae, Agnostida) (syn., cheek lobe).
- GENAL ANGLE.** Posterolateral corner of cephalon.
- genal caeca.** Radiating and more or less anastomosing fine ridges on periglabbellar portion of cephalon.
- genal field.** Portion of librigena between facial suture and border furrow.
- genal lobe.* See genal region.
- GENAL REGION.** Area enclosed within cephalic margin and axial furrows (syn., cheek, cheek area, cheek region, genal lobe).
- genal ridge.** Raised narrow band running outward and backward from outer side of eye or eye tubercle toward genal angle, as in Harpididae.
- genal roll.** Inner portion of fringe bounded on the outer side by girder or corresponding inflection of upper lamella and on inner side by genal regions, as in Harpididae, Harpididae, and Trinucleidae (syn., cheek roll).

- genal roll prolongation.** Inner portion of fringe prolongation, bounded outward by girder; represents an extension of genal roll, as in Harpidae and Harpididae (syn., cheek roll prolongation).
- GENAL SPINE.** Posterior extension of border and doublure at genal angle forming a pointed projection.
- geniculate.** Bent abruptly or at an angle.
- gerontic stage.** Senile or old growth stages, to be applied when general evidence of senility is available.
- girder.** Thickening or ridge of lower lamella parallel to cephalic margin, found at some distance from external rim at angulation of lamella, as in Harpidae, Harpididae, and Trinucleidae.
- GLABELLA** (pl., **GLABELLAE**). Raised axial portion of cephalon, bounded by axial furrows and by occipital furrow (syn., hologlabella). In some trilobites (Illaenidae, Asaphidae, Odontopleuridae) this term is used to include the occipital ring.
- glabellar furrow.* See lateral glabellar furrow.
- glabellar lobe.* See lateral glabellar lobe.
- GLABELLAR NODE.** Median (or paired) tubercles developed in some part of fronto-median lobe of glabella (syn., glabellar tubercle).
- glabellar tongue.** Subparallel-sided axial part of cranidium anterior to eye lobes, bounded by confluent sections of facial sutures, and continuous with remainder of glabella, which latter occupies axial region between eye lobes (as in Remopleuridae).
- glabellar tubercle.* See glabellar node.
- GONATOPARIAN SUTURE.** Facial suture with posterior sections reaching cephalic margin at genal angles.
- granule.** Minute protuberance from exoskeleton, smaller than tubercle or node.
- half ring.* See articulating half ring.
- head.* See cephalon.
- head shield.* See cephalon.
- HOLASPIS** (pl., **HOLASPIDES**). Exoskeleton at any particular stage of development during holaspid period.
- HOLASPID PERIOD.** Period of growth after specific number of thoracic segments has been attained.
- holochroal eye.** Compound eye consisting of numerous adjoining planoconvex or biconvex lenses, covered by a continuous cornea (syn., compound eye).
- hologlabella.* See glabella.
- horn.* See prolongation.
- hyperglabella.** Glabella with 7 segments, seen in immature forms of certain genera such as *Daguinaspis*.
- HYPOSTOMA** (pl., **HYPOSTOMATA**). Small plate anterior to or covering mouth opening on ventral surface of cephalon (syn., labrum, hypostome, epistoma of some early authors).
- HYPOSTOMAL SUTURE.** Line of junction between posterior margin of frontal doublure or rostral plate and anterior margin of hypostoma.
- hypostome.* See hypostoma.
- inner margin (of fringe).** Line separating genal regions and preglabellar field (if present) from pitted area and running into posterior border, as in Harpidae (syn., lateral line of fringe).
- inner margin (of lower lamella).** Free inner edge of lower lamella, as in Harpidae and Trinucleidae.
- inner margin (of upper lamella).** Boundary between genal region and fringe on dorsal side of cephalon; coincides with inner margin of fringe, as in Harpidae and Trinucleidae.
- integument.** Enveloping layer of body (syn., tegument).
- intercalary lobe.* See median preoccipital lobe.
- intercheek suture.* See median suture.
- intergenal spine.* See metafixigenal spine (also used as metagenal spine).
- internal mold.** Mold of interior surface of dorsal exoskeleton or of surface of doublure, hypostoma, metastoma or large spine.
- internal rim.** Smooth inner border of fringe, adjacent to thorax, and extending from posterior margin of genal regions to posterior tips of prolongations, as in Harpidae.
- interocular spine.* See metafixigenal spine.
- INTERPLEURAL FURROW.** Transverse groove extending from axial furrow across pleural region of pygidium, indicating boundary of fused pleurae (syn., interpleural groove, rib furrow).
- interpleural groove.* See interpleural furrow.
- INTRAMARGINAL SUTURE.** Suture running along border of cephalon, close to margin.
- ISOPYGOUS.** Exoskeleton with pygidium similar in size to that of cephalon.
- isoteliform suture.** Opisthoparian suture of certain Asaphidae where anterior sections meet in an ogive on exterior surface of dorsal exoskeleton, as in *Isotelus*.
- kainelliform suture.** Opisthoparian suture in which anterior sections first strongly diverge outward and then bend sharply inward and frontward, meeting anterior cephalic margin at its median point, as in *Kainella*.
- labium.* See metastoma.
- labrum.* See hypostoma.
- larva.** Early form of invertebrate that, while immature, is unlike its parents and must pass through more or less of a metamorphosis before assuming adult characteristics (syn., larval stage).
- larval stage.* See larva.
- lateral articulating furrow (of pleura).** Transverse groove parallel to and a little behind anterior margin of proximal half of a thoracic pleura, as in *Rossaspis*.

- LATERAL BORDER (OF CEPHALON).** Portion of cephalic border between anterior section of facial suture and genal angle.
- LATERAL BORDER FURROW (OF CEPHALON).** Portion of border furrow bounding lateral border.
- LATERAL GLABELLAR FURROW.** Narrow groove extending inward on each side of glabella from axial furrow part way across glabella; occurs in bilaterally symmetrical pairs (syn., median lateral glabellar furrows, glabellar furrow). Usually these are referred to by numbering from front to back (or by the adjectives anterior, median and preoccipital when 3 pairs are present), but some writers prefer to number preoccipital lobe as first and continue forward; this last convention is used here as 1p, 2p, etc.
- LATERAL GLABELLAR LOBE.** Portion of glabella outlined and more or less separated by successive pairs of lateral glabellar furrows (syn., glabellar lobe).
- lateral line (of fringe).* See inner margin of fringe.
- lateral lobe (of pygidium).* See pleural field (of pygidium).
- lateral notch (of hypostoma).** Incision between shoulder and anterior wing of hypostoma.
- lateral occipital lobe.** Lateral or anterolateral portion of occipital ring, if differentiated (syn., occipital lobe).
- LATERAL PREOCCIPITAL LOBE.** Lateral portion of glabellar region directly in front of occipital ring where differentiated, as in *Otarion*, *Ditomopyge*. See basal lobe (of glabella).
- lateral tongue furrow.** Portion of axial furrow bounding sides of glabellar tongue, as in *Remopleurides*.
- LIBRIGENA (pl., LIBRIGENAE).** Lateral portion of cephalon outside facial suture (syn., free cheek, movable cheek, paria).
- LIBRIGENAL SPINE.** Spine borne by librigena (syn., parial spine).
- limb.* See frontal area.
- longitudinal glabellar furrow.** Posteriorly directed extension of anterior glabellar furrow, as in Lichidae and Odontopleuridae.
- longitudinal preglabellar furrow.** Median furrow along sagittal line in front of glabella, as in Agnostida and Dimeropygidae.
- lower (external or internal) rim.** Smooth, raised or thickened portions of lower lamella of fringe, as in Harpidae, Harpididae, and Trinucleidae.
- lower lamella.** Inferior plate of fringe, as in Harpidae, Harpididae, and Trinucleidae.
- macropleura (pl., macropleurae).** Pleura, much larger than average (syn., macropleural segment).
- macropleural segment.* See macropleura.
- macropleural spine.** Pleural spine, much larger than average.
- MACROPYGOUS.** Having a large pygidium.
- macrospine.** Axial spine, much larger than average.
- macula (pl., maculae).** Small, usually smooth area lying laterally in front of middle furrow of hypostoma; it may be sunk, flat, or elevated.
- MARGIN.** Edge of cephalon, pygidium, thoracic pleurae or sternite.
- marginal band.** Narrow vertical band uniting upper and lower edges of rim, as in Harpidae.
- marginal furrow.* See border furrow.
- marginal limb.* See border.
- marginal pit.* See border pit.
- marginal rim.* See border.
- marginal spine (of cephalon).** Spine in a series projecting from cephalic border and doublure, as in *Odontopleura*.
- marginal spine (of pygidium).** Spine in a series projecting from lateral border and doublure of pygidium.
- MARGINAL SUTURE.** Suture running along edge of cephalon, as in Harpidae.
- median border spine.* See posterior spine.
- median cervical lobe.* See central area (of glabella).
- MEDIAN LATERAL GLABELLAR FURROW.** Second lateral glabellar furrow when numbering from front to back, in case 3 pairs of such furrows are present (see lateral glabellar furrow).
- MEDIAN LATERAL GLABELLAR LOBE.** Lateral portion of glabellar region between median lateral glabellar furrow and preoccipital glabellar furrow.
- median lobe (of glabella).* See central area (of glabella).
- median preoccipital lobe.** Median portion of glabellar region between lateral preoccipital lobes, as in *Ditomopyge* [syn., intercalary lobe, preoccipital lobe (*partim*)].
- MEDIAN SUTURE.** Median longitudinal suture transecting doublure in front of hypostoma (syn., intercheek suture).
- MERASPID PERIOD.** Period of development from appearance of first transverse joint in exoskeleton until specific number of thoracic segments less one has been attained.
- MERASPIS (pl., MERASPIDES).** Exoskeleton at any particular degree of development during meraspid period.
- mesotergite.** Axial portion of a tergite.
- metacranial spine.* See metafixigenal spine (also used as metagenal spine).
- METAFIXIGENAL SPINE.** Spine projecting from border and doublure of fixigena inside genal angle [syn., intergenal spine (*partim*), interocular spine, metacranial spine (*partim*)].
- METAGENAL SPINE.** Spine projecting from border and doublure inside genal angle in trilobites with no facial suture, as in Olenellidae [syn.,

- intergenal spine (*partim*), metacranial spine (*partim*).
- metamere*. See segment.
- metaparian suture**. Nonfunctional opisthoparian suture in state of complete symphysis in which trace of fused anterior section on dorsal surface of cephalon curves outward and backward from eye, cutting posterior margin inside genal angle, as in some Olenellidae.
- METAPROTASPIS** (pl., **METAPROTASPIDES**). Large protaspides, or the larger protaspides in a size-series, in which the protopygidium is relatively large and well defined.
- metastoma** (pl., **metastomata**). Small plate lying posterior to mouth opening on ventral side of body (syn., labium, metastome, postoral plate).
- metastome*. See metastoma.
- MICROPYGOUS**. Having a small pygidium.
- middle body** (of hypostoma). Swollen middle portion of hypostoma (syn., central body of hypostoma).
- middle furrow**. Transverse furrow dividing middle body of hypostoma into anterior and posterior lobes.
- movable cheek*. See librigena.
- muscle scar**. Smooth, or slightly depressed paired areas, in cases darker in color than surrounding regions, in external surface of axial region of exoskeleton, interpreted as areas of muscle attachment.
- neanic stage*. Immature or adolescent growth stage, loosely applied to part of the holaspis period.
- neck furrow*. See occipital furrow.
- neck node*. See occipital node.
- neck ring*. See occipital ring.
- neck spine*. See occipital spine.
- nepionic stage**. Infantile or young growth stage, applied to the meraspis period as here defined.
- node**. Swelling on any part of exoskeleton resembling a knot or knob (syn., tubercle).
- nuchal furrow*. See occipital furrow.
- nuchal node*. See occipital node.
- nuchal ring*. See occipital ring.
- nuchal spine*. See occipital spine.
- OCCIPITAL FURROW**. Transverse groove running from axial furrow to axial furrow forming posterior boundary of glabella (syn., neck furrow, nuchal furrow).
- occipital lobe*. See lateral occipital lobe.
- OCCIPITAL NODE**. Median (or paired) tubercle developed on exterior of occipital ring (syn., neck node, nuchal node).
- OCCIPITAL RING**. Axial region of most posterior segment of cephalon, bounded at sides by axial furrows, at front by occipital furrow and at back by posterior margin (syn., neck ring, nuchal ring).
- OCCIPITAL SPINE**. Median (or paired) pointed structure projecting from exterior of occipital ring (syn., neck spine, nuchal spine).
- ocular band*. See eye ridge.
- ocular platform**. Area of librigena adjacent to visual surface of eye.
- ocular ridge*. See eye ridge.
- OPISTHOPARIAN SUTURE**. Facial suture with posterior sections cutting posterior margin of cephalon inside genal angle, which is carried by librigena.
- opisthothorax**. Posterior portion of thorax with reduced pleurae, observed in certain Olenellidae.
- paired eye ridges*. See eye ridge.
- palpebral area* (of fixed cheek). See palpebral area (of fixigena).
- palpebral area** (of fixigena). Portion of fixigena lying between eye ridge and imaginary transverse line connecting posterior corner of palpebral lobe with axial furrow (syn., palpebral area or region of fixed cheek).
- PALPEBRAL FURROW**. Usually curved groove separating palpebral lobe from palpebral area of fixigena.
- PALPEBRAL LOBE**. Protruding flange of fixigena bounded distally by facial suture and included within arc of proximal edge of visual surface of eye.
- palpebral region* (of fixed cheek). See palpebral area of fixigena.
- palpebral region* (of fixigena). See palpebral area of fixigena.
- palpebral rim**. Raised or thickened portion of palpebral lobe bordering facial suture.
- palpebro-ocular ridge**. Raised strip connecting proximal side of eye with axial furrow, as in *Protopliomerops*; the ridge contracts near glabella and expands adjacent to eye, appearing as a combination of palpebral lobe and eye ridge.
- pander organ*. See panderian opening and panderian protuberance.
- panderian opening**. Small rounded or elliptical hole in posterior fixigenal and thoracic pleural doublure close to panderian protuberance; in some cases developed as a notch on inner margin of doublure [syn., panderian organ (*partim*)].
- panderian organ*. See panderian opening and panderian protuberance.
- panderian protuberance**. Small rounded, elliptical, or elongate protuberance in posterior fixigenal and thoracic pleural doublure; in some cases developed as raised anterior edge of a notch on inner margin of doublure [syn., panderian organ (*partim*)].
- parafrontal band**. Narrow raised band encircling anterior border of frontal lobe of glabella forming continuation of eye ridges, as in *Termierella*.
- paraglabellar area**. Arcuate tract on fixigena adjoining base of glabella on either side, commonly defined by independent convexity and faint bounding furrows, as in Homalonotidae. See ala.

paraprotaspis (pl., *paraprotaspides*). Late protaspid stage, not precisely defined.

paria. See *librigena*.

parial spine. See *librigenal spine*.

patella. Fourth joint of a telopodite.

perfixigenal spine. Spine carried by *fixigena* in front of *librigena* (syn., *procranial spine*, *pergenal spine* in *Olenellidae*).

pergenal spine. See *perfixigenal spine*.

periglabella area. Ill-defined portion of cephalon encircling *glabella*.

PERROSTRAL SUTURE. Ventral-intramarginal cephalic suture crossing *genal angle* below *spine*, as in *Olenellidae* (syn., *ventromarginal suture*).

pit. Depression, hollow, or excavation developed on any part of exoskeleton.

plate. Skeletal part of cephalon separated by sutures from other plates.

PLEURA (pl., **PLEURAE**). Lateral portion of thoracic segment or pygidium (syn., *epimera*, *pleuron*).

pleural band. Anterior and posterior strips resulting from transverse division of a thoracic or pygidial *pleura* by *pleural furrow*.

PLEURAL FIELD (OF PYGIDIUM). Lateral portion of pygidium bounded *adaxially* by *axial furrow* and *abaxially* by *border furrow* (syn., *pleural platform*, *pygopleura*, *lateral lobe* of pygidium).

PLEURAL FURROW. Groove along surface of thoracic or pygidial *pleura*.

pleural lobe. See *pleural region*.

pleural platform. See *pleural field*.

PLEURAL PYGIDIAL SPINE. Projection of lateral border and doublure of pygidium corresponding to outward extension of a *pleura*.

PLEURAL REGION (OF THORAX). Longitudinal lateral portion of thorax (syn., *pleural lobe*, *side lobe*, *pleurothorax*).

pleural rib. See *rib*.

PLEURAL SPINE. Pointed extension of distal end of a *pleura*.

pleuron (pl., *pleura*). See *pleura*.

pleurothorax. See *pleural region* (of thorax).

podite. Each joint of a biramous appendage.

porc. See *fossula*.

postaxial field. Area on pygidium between posterior end of *axis* and *posterior margin*.

postaxial furrow. Longitudinal groove bounding *postaxial ridge* of pygidium.

postaxial keel. See *postaxial ridge*.

postaxial ridge. Raised median portion of pygidium behind *axis* (syn., *postaxial keel*).

posterior area (of fixed cheek). See *posterior area* (of *fixigena*).

POSTERIOR AREA (OF FIXIGENA). Postocular portion of *fixigena* (syn., *posterolateral limb*, *posterior limb*, *postocular area* or *region* of fixed

cheek, posterior region of *fixigena*, posterior region of fixed *cheek*, posterior area of fixed *cheek*).

posterior band of occipital ring. Narrow (*sag.* and *exsag.*) band, widest in mid-line, situated below and behind main part of *occipital ring*.

POSTERIOR BORDER (OF CEPHALON). Portion of cephalic border between *genal angle* and *occipital ring*.

POSTERIOR BORDER FURROW (OF CEPHALON). Portion of border furrow bounding posterior border.

posterior branch (of facial suture). See *posterior section* (of *facial suture*).

posterior flange. Narrow border extending along posterior edge of *adaxial part* of a *pleura*, as in *Ceraurinella*.

posterior genal ridge. See *postocular ridge*.

posterior limb. See *posterior area* (of *fixigena*).

posterior lobe (of glabella). Main *glabella* lobe of *Agnostida*.

posterior lobe (of hypostoma). Portion of middle body of *hypostoma* behind *middle furrow*.

POSTERIOR MARGIN (OF CEPHALON). Edge of cephalon between *genal angles*.

posterior pleural band. Strip of thoracic or pygidial *pleura* bounded anteriorly by *pleural furrow*.

posterior pleural spine. Pointed extension of distal end of a *posterior pleural band*.

posterior region (of fixed cheek). See *posterior area* (of *fixigena*).

posterior region (of fixigena). See *posterior area* (of *fixigena*).

POSTERIOR SECTION (OF FACIAL SUTURE). Portion of *facial suture* lying behind *eye* [syn., *posterior branch* (of *facial suture*), *postocular branch* (of *facial suture*)].

POSTERIOR SPINE. Posterior extension of border and doublure of pygidium (syn., *median border spine*, *caudal spine*).

posterior wing (of hypostoma). Extension of posterolateral doublure of *hypostoma*.

posterolateral limb. See *posterior area* (of *fixigena*).

posterolateral spine (of pygidium). Spine (paired) at posterolateral border of pygidium, as in *Agnostida* and *Dikelocephalidae*.

post-eyeline. See *postocular ridge*.

postocular area (of fixed cheek). See *posterior area* (of *fixigena*).

postocular branch (of facial suture). See *posterior section* (of *facial suture*).

postocular region (of fixed cheek). See *posterior area* (of *fixigena*).

postocular ridge. Raised line running obliquely outward and backward from back end of *eye* toward but not necessarily touching *posterior margin* of cephalon, as in *Olenellidae* (syn., *post-eyeline*).

postoral plate. See *metastoma*.

precoxa. Extra basal joint inserted between coxa of a biramous appendage and body wall (syn., subcoxa, sympodite, protopodite).

pre-epipodite. Outer and upper branch of a paired biramous appendage, attached to posterior face of precoxa (syn., exopodite).

prefemur. Second segment of a telopodite.

preglabellar area. See frontal area.

PREGLABELLAR FIELD. Portion of cranidium lying between front of glabella and anterior border furrow; distinct from frontal area.

PREGLABELLAR FURROW. Portion of axial furrow outlining front of glabella. See longitudinal preglabellar furrow.

preglabellar keel. See preglabellar ridge.

preglabellar pit. Pit in longitudinal furrow in preglabellar field, as in Dimeropygidae.

preglabellar ridge. Longitudinal median ridge crossing preglabellar field (syn., preglabellar keel).

PREOCCIPITAL GLABELLAR FURROW. Furrow separating preoccipital glabellar lobe from main part of glabella (syn., basal furrow).

PREOCCIPITAL GLABELLAR LOBE. Lateral portion of glabellar region directly in front of occipital ring when differentiated (syn., basal lobe of glabella, cervical lobe). See median preoccipital lobe.

preoccipital glabellar spine. Pointed projection from preoccipital part of glabella, as in *Orometopus*.

preocular branch (of facial suture). See anterior section (of facial suture).

preocular ridge. Raised line curving outward and backward from anterior end of eye running toward but not necessarily touching posterior margin of cephalon, as in *Fallotaspis*.

pretarsus. Terminal joint of a telopodite.

procranidial spine. See perfixigenal spine.

PROFIXIGENAL SPINE. Spine projecting from border and doublure of fixigena in front of genal angle, as in *Sphaerocoryphe granulatus*.

PROLIBRIGENAL SPINE. Spine projecting from border and doublure of librigena in front of genal angle, as in *Paracalmonia pessula*.

prolongation. Extension of fringe beyond posterior margin of genal regions, as in Harpididae and Harpididae (syn., horn).

PROPARIAN SUTURE. Facial suture with posterior sections cutting lateral margin of cephalon in front of genal angles which are carried by fixigenae.

PROTASPID PERIOD. Period of development during which there is no transverse joint in the exoskeleton.

PROTASPIS (pl., **PROTASPIDES**). Smallest known exoskeletons, subhemispherical to spherical in form; may exhibit a size-series, but lacking a transverse joint.

prothorax. Anterior portion of thorax with normal pleurae, observed in certain Olenellidae.

protopodite. See precoxa.

PROTOPYGIDIUM. Postcephalic portion of a protaspis.

proximal. End of a part or organ which is nearest to point of origin or mesial line of body.

pseudantennary pit. See fossula.

pseudopalpebral furrow. Furrow running obliquely across eye ridge, as in some *Resserops*.

pseudoproparian suture. See cedariiform suture.

ptychopariiform suture. Opisthoparian suture in which anterior section is directed outward and frontward to margin and then marginally (or along doublure) to center, as in *Ptychoparia*.

pustule. Small pimple-like elevation or spot resembling a blister developed on any part of exoskeleton.

pygaxis. See axis (of pygidium).

pygidial region. Area of trilobite body formed by fusion of several posterior somites.

PYGIDIUM (pl., **PYGIDIA**). Posterior part of dorsal exoskeleton separated from thorax by an articulation (syn., tail, tail shield, caudal shield).

pygopleura. See pleural field (of pygidium).

rachis (pl., **rachises**). See axis.

REGION. Each portion of dorsal exoskeleton resulting from its longitudinal trilobation.

rhachis (pl., **rhachises**). See axis.

RIB. Portion of pygidial pleural region bounded by 2 successive pleural furrows (syn., pleural rib).

rib furrow. See interpleural furrow.

ring. See axial ring.

RING FURROW. Groove bounding successive axial rings of pygidium.

ring process. Projection extending inward from posterolateral corner of axial ring, fitting into socket in next posterior ring, as in *Ceraurinella*.

ring socket. Hollow formed by extremities of articulating furrow and articulating half-ring for reception of ring process of next anterior ring, as in *Ceraurinella*.

rostral flange. Hindmost part of rostral plate when it is strongly curved in anterior or dorsal direction so as to form a fold, as in *Iliaenus*.

ROSTRAL PLATE. Median cephalic ventral plate of variable size and relations, may be bounded anteriorly and laterally by the perrostral suture (Olenellidae) or bounded anteriorly by the rostral suture and laterally by the paired connective sutures, and in the Homalonotidae it is partly dorsal (syn., epistoma, epistomal plate, epistome, rostrum).

ROSTRAL SUTURE. Anterior portion of facial suture forming line of junction between anterior margin of rostral plate and cranidium.

rostrum. See rostral plate.

- sagittal.** Term used to describe a measurement in median line (abbrev., *sag.*).
- sagittal line.** Medial line of body (syn., axial line).
- schizochroal eye.** Eye with visual surface consisting of a number of biconvex lenses, rounded or polygonal in outline, each lens covered by individual cornea and separated from others by sclerotic walls (syn., aggregate eye).
- sclerite.** Hard part of exoskeleton belonging to each body segment.
- scrobiculate.** Having numerous small, shallow depressions or hollows; pitted.
- SEGMENT.** Each of the metameric transverse elements forming body; also used as a general term for successive units of an appendage (syn., metamere, somite).
- shield.** See carapace.
- shoulder.** Anterolateral part of lateral border of hypostoma, generally the widest and most inflated part, projecting ventrally.
- side lobe.** See pleural region.
- somite.** See segment.
- spatulate.** Any part shaped like a spatula; spoon-shaped.
- SPINE.** Pointed projection from exoskeleton.
- sternite.** Hard ventral covering of body segment.
- subcephalic furrow.** See vincular furrow.
- subcoxa.** See precoxa.
- subcranial furrow.** See vincular furrow.
- subocular area.** Small smooth area of librigena adjoining posterior portion of eye, as in *Phillipsia hildae*.
- subocular groove.** Smooth bandlike depression of librigena surrounding visual surface of eye, as in *Griffithides indicus*.
- sutural ridge.** Narrow ridge upon (or beside) which either section of facial suture may run on exterior surface of dorsal exoskeleton (syn., false eye ridge).
- SUTURE.** Line of union, or seam, in immovable articulation, consisting of very narrow uncalcified band perceivable on external side of cephalon or between cephalic sternites.
- sympodite.** See precoxa.
- tail.** See pygidium.
- tail shield.** See pygidium.
- tarsus.** Sixth joint of a telopodite.
- tegument.** See integument.
- telopodite.** Free postcoxal inner branch (walking leg) of a biramous appendage, attached to ventrolateral portion of precoxa (syn., endopodite).
- telson.** Terminal or anal segment (sometimes incorrectly used for first opisthothoracic macrospine of Olenellidae).
- tergite.** Hard dorsal covering of each body segment.
- TERMINAL AXIAL PIECE (OR RING).** Last segment of axis of pygidium.
- terminal axial segment.** See terminal axial piece.
- TERMINAL AXIAL SPINE.** Projection of median dorsal surface of terminal portion of axis of pygidium.
- terrace lines.** Fine raised lines on doublure (and in some trilobites also on border) running subparallel to margins or arranged in Bertillon pattern.
- test.** See dorsal exoskeleton.
- thoracic region.** Area of trilobite body formed by the ensemble of metameric somites interposed between cephalic and pygidial regions.
- THORACIC SEGMENT.** Transverse division of thorax consisting of 2 pleurae and axial ring.
- tibia.** Fifth joint of a telopodite.
- transglabellar furrow.** Continuous furrow across glabella resulting from meeting of adaxial ends of a pair of lateral glabellar furrows.
- TRANSITORY PYGIDIUM.** Fused segments of the posterior region during the meraspid period.
- transverse.** Term used to describe a measurement at right angles to median line (abbrev., *tr.*).
- traversing pad.** Distinctly thickened posterior pleural band, as in Asteropyginae.
- tricomposite glabellar lobe.** Lateral glabellar lobe representing fused anterior, median and posterior lateral glabellar lobes, separated from fronto-medial lobe of glabella by the longitudinal furrow, as in some Lichidae.
- trochanter.** Basal joint of a telopodite (syn., basipodite).
- tropidia.** Crest on fixigena or librigena or both, running parallel to cephalic margin, as in some Proetidae.
- tubercle.** Small knoblike prominence on any part of exoskeleton (syn., node).
- upper lamella.** Upper or dorsal plate of fringe, as in Harpidae, Harpididae, and Trinucleidae.
- upper rim (external or internal).** Smooth, raised portion of upper lamella of fringe, as in Harpidae, Harpididae, and Trinucleidae.
- uropod.** See antenniform cercus.
- ventromarginal suture.** See perrostral suture.
- vincular furrow.** Ventral groove along anterior (as in Phacopinae) or posterolateral (as in Phacopidellinae) cephalic doublure for reception of posterior margin of pygidium or thoracic pleurae extremity at enrollment (syn., subcephalic furrow, subcranial furrow).
- visual surface of eye.** External surface of eye showing outline of lenses (syn., eye lappet).
- wing process (of hypostoma).** Rounded boss or thornlike structure which may be developed on inner surface of anterior wing of hypostoma.

ONTOGENY OF TRILOBITA

By H. B. WHITTINGTON

CONTENTS

| | PAGE |
|---|------|
| INTRODUCTION | 0127 |
| PROTASPID PERIOD | 0127 |
| General characters | 0127 |
| Types of protaspides | 0129 |
| MERASPID PERIOD | 0135 |
| Manner and amount of growth | 0135 |
| Transitory pygidium | 0135 |
| Cephalon | 0138 |
| Eye lobes and facial sutures | 0139 |
| Hypostoma | 0140 |
| Genal and other lateral cephalic spines | 0140 |
| Occipital spines | 0140 |
| External surface | 0141 |
| Agnostid trilobites | 0141 |
| HOLASPID PERIOD | 0141 |
| REFERENCES | 0143 |
| SOURCES OF ILLUSTRATIONS | 0145 |

INTRODUCTION

For more than 100 years trilobite exoskeletons have been known, preserved as molds in shales, siltstones, and fine sandstones, and exhibiting a gradational size series. In these fine-grained sediments some of the exoskeletons, though flattened, are partly, or not at all, disarticulated. The smallest members of series that have been found are about 1 mm. in length or less, subcircular in outline, convex, and without articulation. The name *protaspis* (pl., *protaspides*) was coined for these minute shields by BEECHER (3).

Somewhat larger exoskeletons exhibit an articulation between the part that is to become the cephalon, and that which is to become thorax and pygidium. In successively larger exoskeletons thoracic segments appear until the total number (characteristic of the particular species) is reached. RAW (16) proposed the terms *meraspis* period for the series beginning with subdivision of the *protaspis*, and *holaspis* period for the development that takes place after completion of the thorax. He also suggested a division of the *meraspis* period into "degrees" char-

acterized and distinguished by the number of thoracic segments present. These terms are adopted here, and discussed below in the appropriate sections. The *holaspis* period may be attained at a length (*sag.*) of less than 1 cm. and this is followed by great increase in size during the period.

Growth stages of trilobites have also been found in calcareous rocks (15), particularly calcilutites, and in some of these rocks the exoskeletons are not flattened or distorted, though commonly they are disarticulated. Extraction of silicified specimens from such rocks, first by BEECHER (2), has given much new information in recent years (19, 20, 21, 33, 37).

PROTASPID PERIOD

GENERAL CHARACTERS

The trilobite *protaspis* represents the earliest stage at which, presumably, the exoskeleton is mineralized and therefore may be preserved. A range in length (*sag.*) from about 0.25 to 1 mm. is known, rarely larger. Outline in dorsal aspect is usually subcircular, convexity moderate to strong, and a subspherical form may be attained. The axis

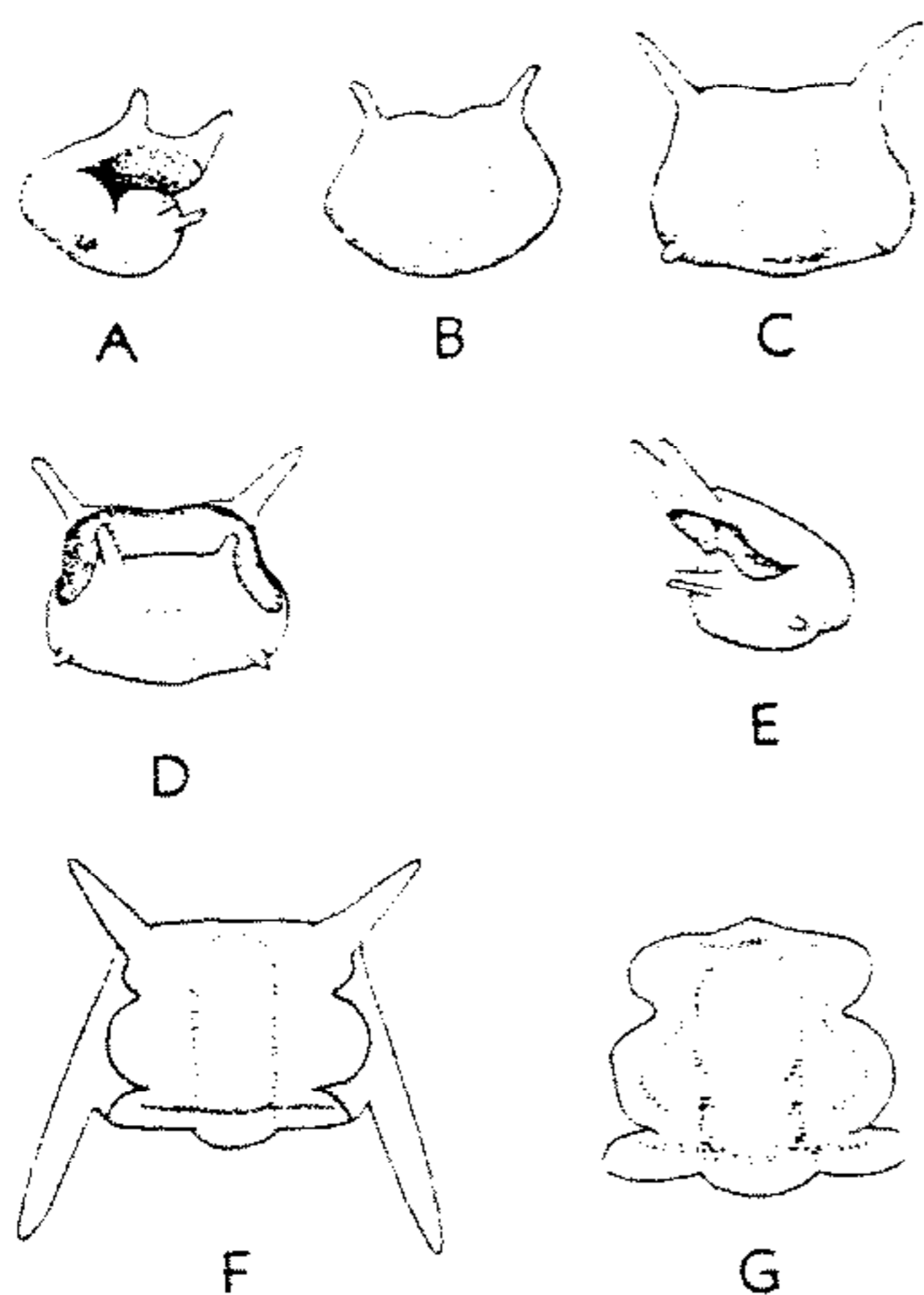

FIG. 86. Ontogenetic stages of *Menoparia genalunata* Ross, L. Ord., Utah; A, B, small protaspis, antero-ventral and dorsal views; C-E, larger protaspis, dorsal, ventral, and lateral views; F, meraspisid cephalon; G, late meraspisid cranium; all $\times 20$ (19).

is at least partially defined in the smallest protaspides (Fig. 86B) and may be completely outlined by furrows. From a length of 0.4 mm. upwards it is in most specimens divided into rings, the anterior being longer (*sag.*) than those following it. The 5th (+th in *Shumardia*, Fig. 87A) ring is the occipital, and behind this is the short axial portion of the protopygidium (e.g., *Sao*, Fig. 88A). The pleural regions of the smallest known protaspides (Figs. 87A, 89A; Ross, 20, Pl. 32, figs. 2, 3) are either incompletely divided or not at all. At a length of 0.5 to 0.6 mm. the transverse ridge (posterior border of cephalon) and furrow have either appeared or been completed, thus dividing the protaspis into larger cephalic portion and smaller protopygidium (Figs. 88B, 89B, 90A, 91A). An exception is *Menoparia* (Fig. 86C-E), but the position of the occipital ring and presence of the doublure define the protopygidium.

BEECHER (3) suggested that the protaspisid period might be divided into successive stages called anaprotaspisid, metaprotaspisid, and paraprotaspisid but did not characterize

these stages. STÖRMER (24) defined the anaprotaspisid stage as that in which the axis includes only 5 segments, and the metaprotaspisid as including "secondary somites" forming the protopygidium. This interpretive definition is not satisfactory, and in practice STÖRMER (24) and ROSS (19) have recognized the metaprotaspisid stage as beginning when the pleural region becomes divided by the posterior cephalic border and the protopygidium consequently is distinctly defined. This practice cannot be followed exactly in *Menoparia* (Fig. 86), for example. Accordingly, while early and late protaspides can be distinguished, no one morphological character can be used in all trilobites to subdivide the period (25, p. 350). BEECHER'S term paraprotaspisid stage has not been generally adopted. Substages of the metaprotaspisid stage based on number of axial segments in the protopygidium (19, p. 584) have been proposed.

In the smallest protaspides of trilobites having compound eye lobes in the holaspisid period, the eye lobe is recognizable by the relatively small, raised, palpebral lobe, connected by an eye ridge to the frontal axial lobe (Fig. 88A-E, 90). In protaspides like those of *Welleraspis* (Fig. 90) or *Sao* (Fig. 88A-E) the frontal axial lobe widens forward and is extended along the anterolateral margin of the shield by a sutural ridge. In protaspides such as belong to *Pseudocybele* (Fig. 89), *Acanthoparypha* (Figs. 91A), or *Flexicalymene* (Fig. 92) the palpebral lobe is connected to the anterior cephalic border by a sutural ridge, and in *Pseudocybele* the eye ridge appears later in ontogeny. In protaspides of *Paradoxides* (Fig. 93A, B) the eye lobe is exceptionally long and in those of *Menoparia* (Figs. 86A, B) the palpebral lobe is not raised. Probably in all protaspides there is a narrow doublure and a relatively large hypostoma (Fig. 88E, 92B). Wherever preservation is good enough (usually in late protaspisid stages), it has been shown that facial sutures are present, as well as rostral, hypostomal, and probably connective sutures (Figs. 86C-E, 92, 94B, C, 95). Characteristically spines arise from the borders of protaspides: fixigenal, librigenal, and additional spines from the lateral and anterolateral cephalic borders; hypostomal from posterolateral borders of

the hypostoma, and pygidial from the proto-pygidial borders. The external surface may be pitted, tuberculate, granulate, or spinose.

TYPES OF PROTASPIDES

Generalities just stated seem to apply to

at least the later protaspid stages of all trilobites except agnostids and olenellids. The smallest known specimens of the latter group are about 1 mm. in length (STÖRMER, 24, figs. 4, 5a-e), and silicified material described by PALMER (12) includes speci-

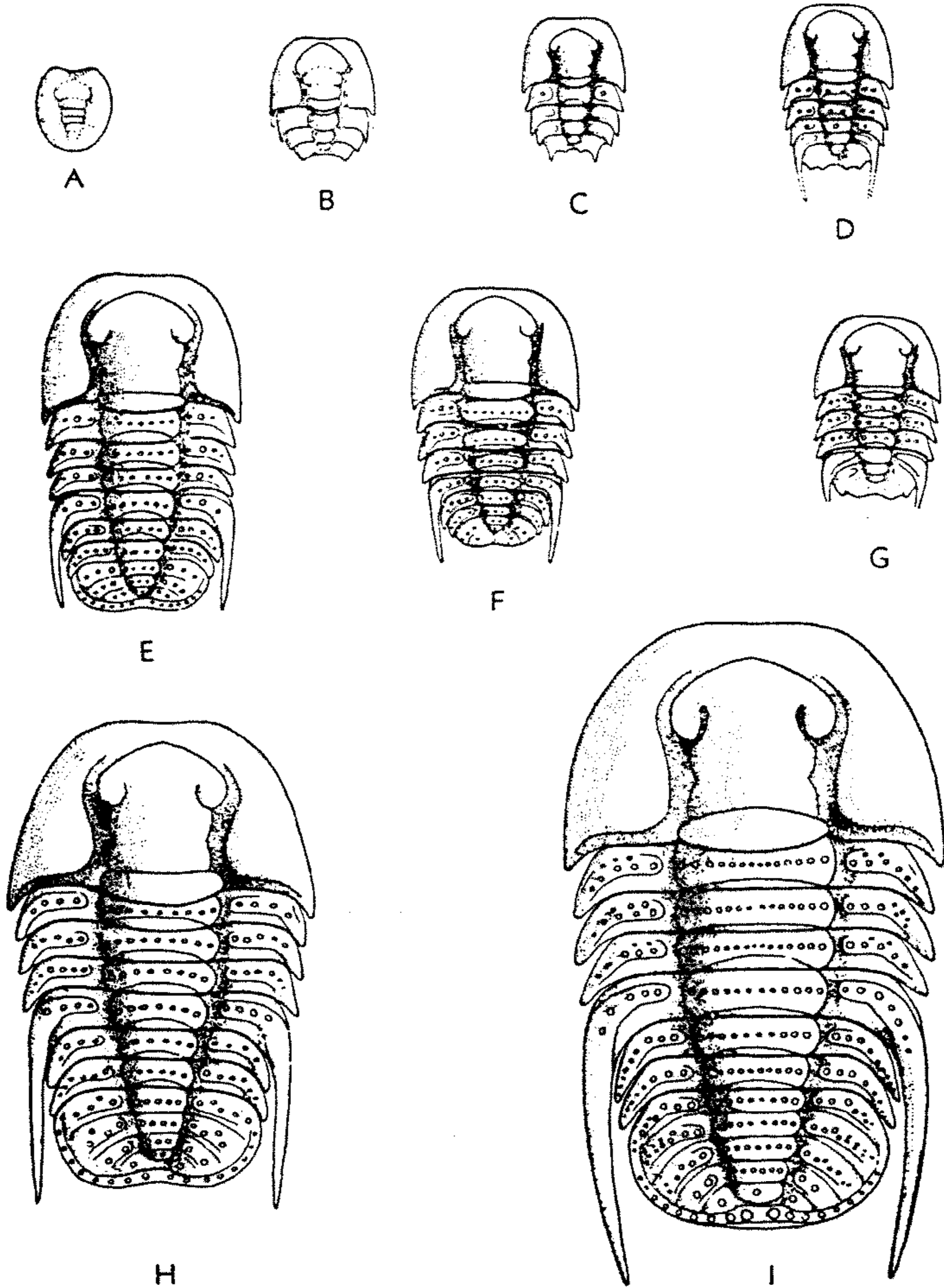

FIG. 87. Ontogenetic stages of *Shumardia pusilla* (SARS), L.Ord.(Tremadoc.), Eng.; A, protaspis, X40; B, meraspis, "degree" 0, X40; C-G, meraspis, "degrees" 1-5, X30; H, holaspis, X30; I, larger holaspis with additional segment in pygidium, X20 (25*).

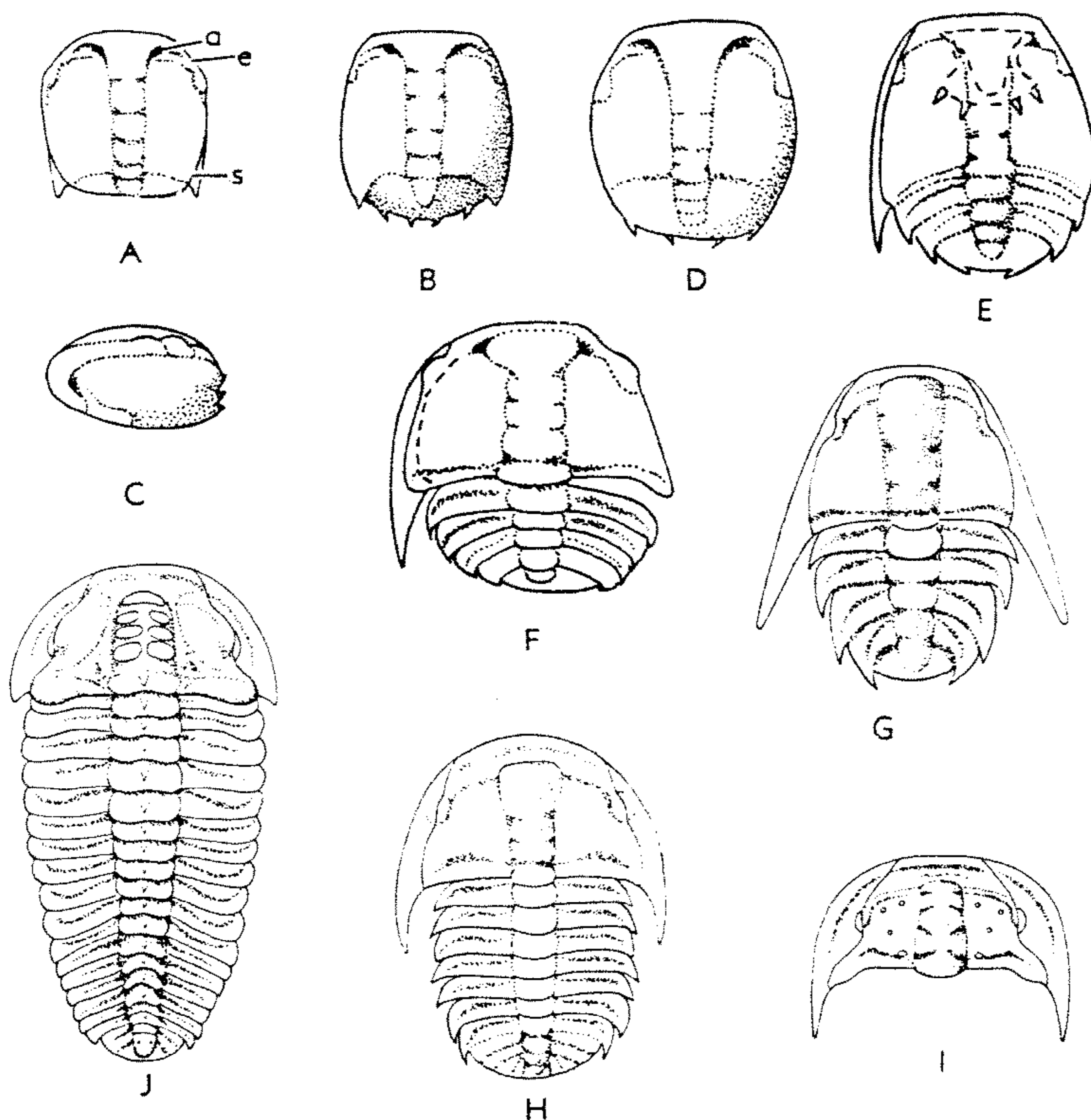

FIG. 88. Ontogenetic stages of *Szö hirsuta* BARRANDE, M. Cam., Bohemia; A, protaspis with librigena (*a*, anterior pit; *e*, eye ridge; *s*, suture), $\times 30$; B, C, protaspis lacking librigenae, dorsal and anterolateral views, $\times 30$; D, protaspis, $\times 30$; E, protaspis with left librigena and hypostoma shown by dashed outline, $\times 30$; F, "degree" 0 with left librigena, dashed line showing inner edge of doublure, $\times 30$; G, "degree" 1, $\times 30$; H, "degree" 6, $\times 15$; I, "degree" 12 cephalon, $\times 7$; J, holaspisid exoskeleton, $\times 2$ (4In).

mens (cephala of early meraspisid "degrees") of this size and considerably smaller. STÖRMER (24, p. 61) considered that the original of his figures 4 and 5e was probably an early meraspisid cephalon. My reinvestigation of FORD's (6) original material of *Elliptocephala asaphoides* shows no trace of the "rudimentary thorax and pygidium" (6, p. 268, Pl. 4, fig. 2; cf. 46, fig. 3), the smallest specimens being meraspisid cephalon. This evidence combines to cast grave doubts on the view that any of the early olenellid stages so far described include the protopygidium

within the unjointed shield, allowing them to be regarded as protaspides.

It seems possible that the exoskeleton of the protaspis is either so tiny that it has not yet been found, or was not mineralized and hence not preserved. Figure 96, emended from WALCOTT's drawings (28), shows present knowledge of early "degrees" in the ontogeny of *Paedeumias yorkense*. In the smallest specimen (Fig. 96A) tiny spines are present on the anterolateral cephalic border; long metagenal ("intergenal") spines, and 5 axial rings are preserved in the thorax.

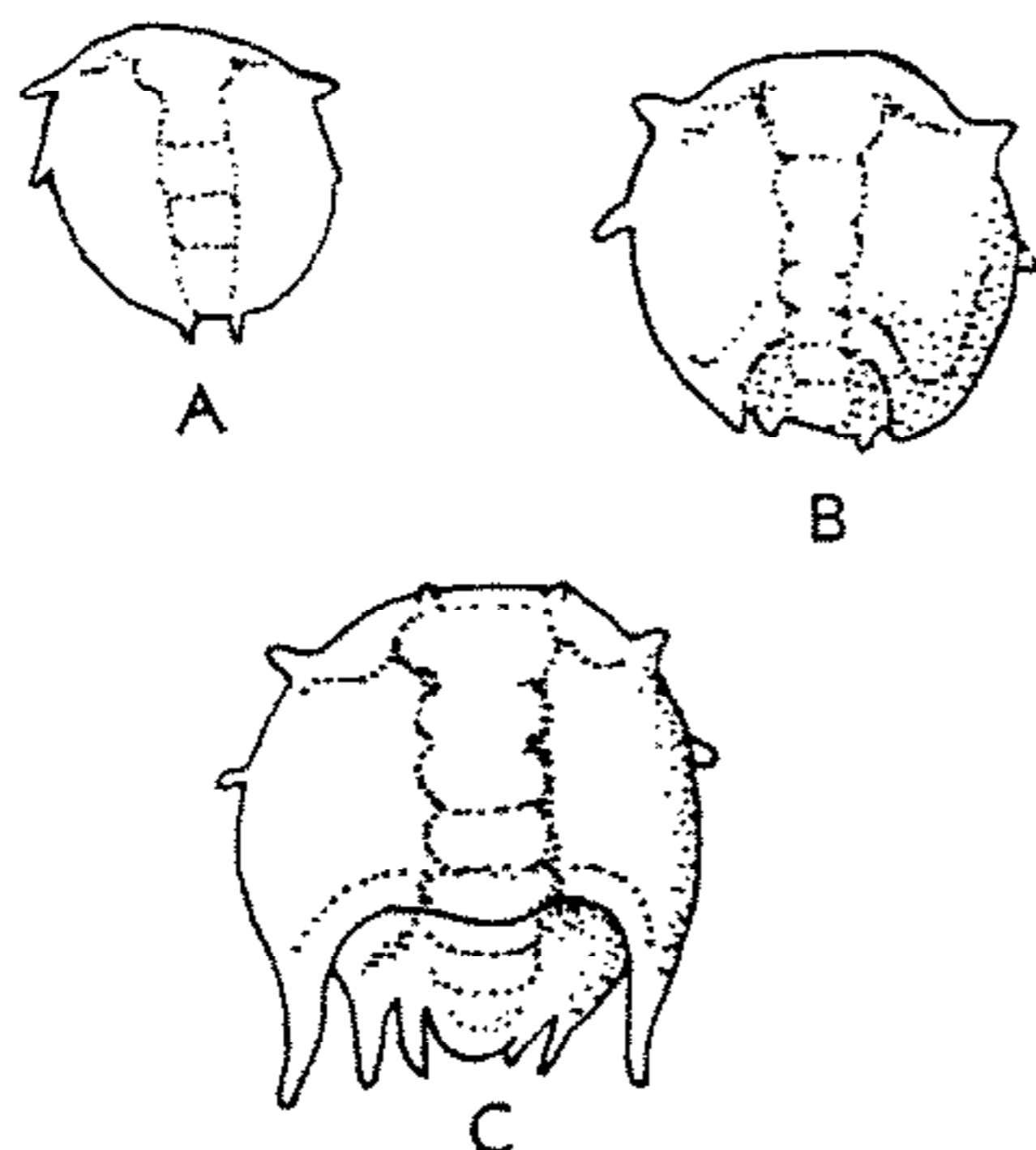

FIG. 89. Protaspides of *Pseudocybele nasuta* Ross, L.Ord.(U.Canad.), W.USA(Utah); A-C, growth series, $\times 30$ (19).

The original of Figure 96B has short genal spines present outside the metagenal, and one can see 9 thoracic segments, including the 3rd with its long pleural spine. In the largest specimen (Fig. 96C) the anterior cephalic spines are lost, and while 12 thoracic segments can be counted, the pygidium is not preserved. The earliest known developmental "degrees" of this and possibly other olenellids, then, seem to be meraspides, and their peculiar features include the long eye lobes, lack of facial sutures (but rostral plate, relatively large hypostoma, and rostral suture present in stages corresponding to those shown in Figure 96), broad (*tr.*) genal region outside of the eye lobes, and long frontal area. The short genal and long metagenal spines have been observed frequently, but PALMER's investigations are the first to reveal the stage (Fig. 96B) in which anterior border spines also are present.

In meraspides of *Paedeumias yorkense* there is seemingly no trace of preocular ridges, and the postocular ridges (connecting the posterior end of the eye lobes to the base of the metagenal spine) are only faintly developed. In *Elliptocephala asaphoides* the postocular ridge is prominently displayed in the smallest stages known, and retained in the holaspis. It has been claimed by HUPÉ (8) and earlier authors that the postocular ridges follow the course of the fused, posterior section of the facial sutures. Recently HUPÉ (8) has also claimed that the pre-

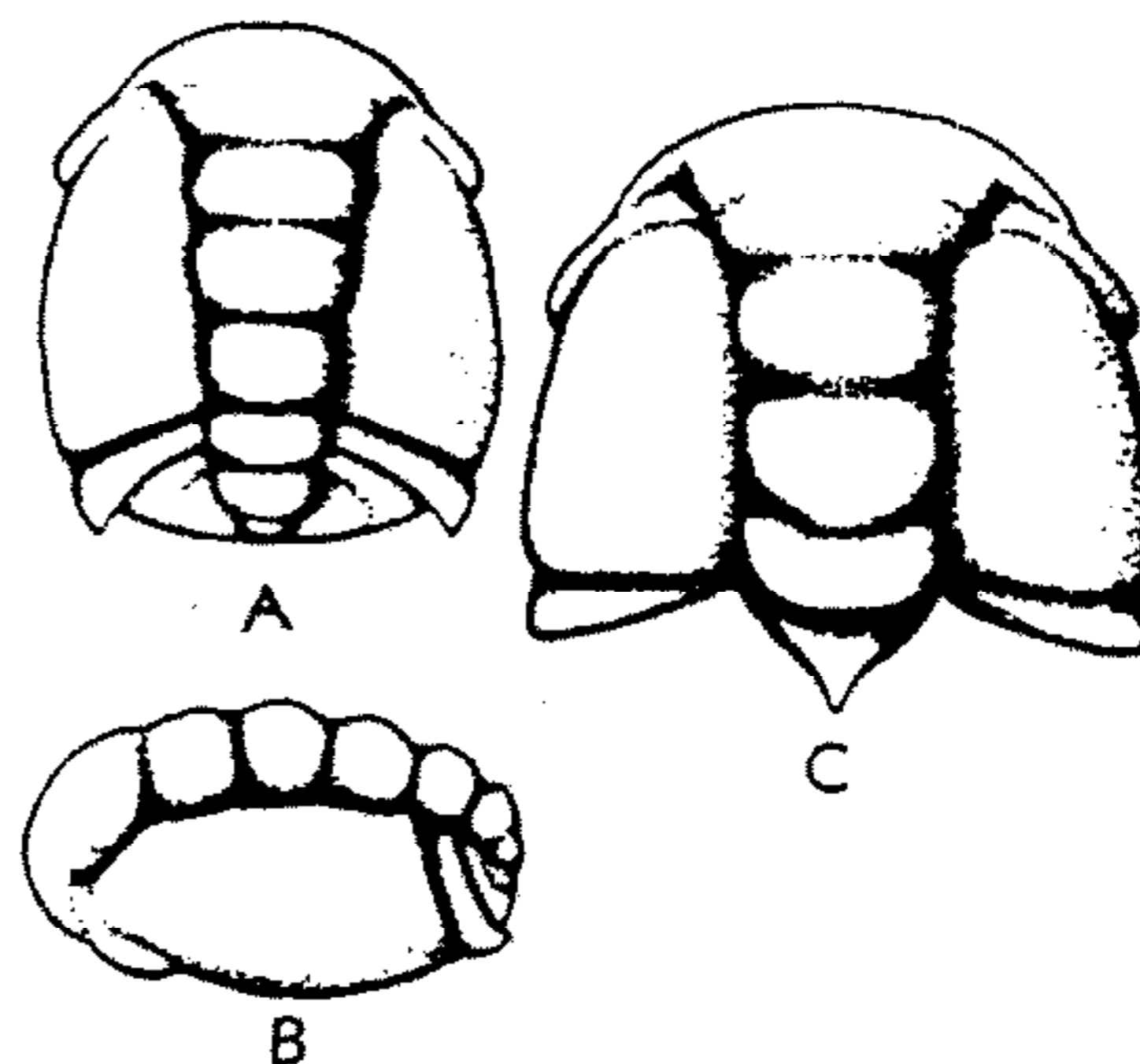

FIG. 90. Ontogenetic stages of *Welleraspis swartzii* (TASCH), U.Cam.(Dresbach.), E.USA(Pennsylvania); A,B, protaspis lacking librigenae, dorsal, lateral, $\times 60$; C, meraspis cranidium, $\times 60$ (39*).

ocular ridges, which in some genera run to points on the posterior border just inside the base of the genal spines, follow the course of the fused anterior section. Known olenellid ontogenies offer no support for these views, nor for the suggestion of STØRMER (24, p. 138) that the postocular ridges follow intersegmental boundaries. STUBBLEFIELD (26, p. 421) considered that the postocular ridges may be vestiges of a larval structure, and such they seem to be in *E. asaphoides*, but their significance is not known.

Knowledge of the ontogeny of *Paradoxides pinus*? begins with late protaspis stages (Fig. 93A,B). Smaller specimens have been described (30, p. 46, Pl. 4, figs. 1, 2; 24, p. 73, text-fig. 7a), but I think it likely that the lateral and posterior portions of these strongly convex shields are concealed in matrix and that there are spine-bearing librigenae, fixigenal spines, and perhaps pleural spines on margins of a tiny protopygidium. In other words, I consider that they are essentially like Figure 93A,B, but smaller and with fewer segments in the protopygidium, and not "anaprotaspides" as STØRMER claimed. Early meraspis "degrees" of paradoxidids show considerable similarity to corresponding olenellid "degrees," particularly in the length of the eye lobes and presence of fixigenal and metagenal spines, respectively. Especially distinctive of paradoxidids are the dorsal facial sutures.

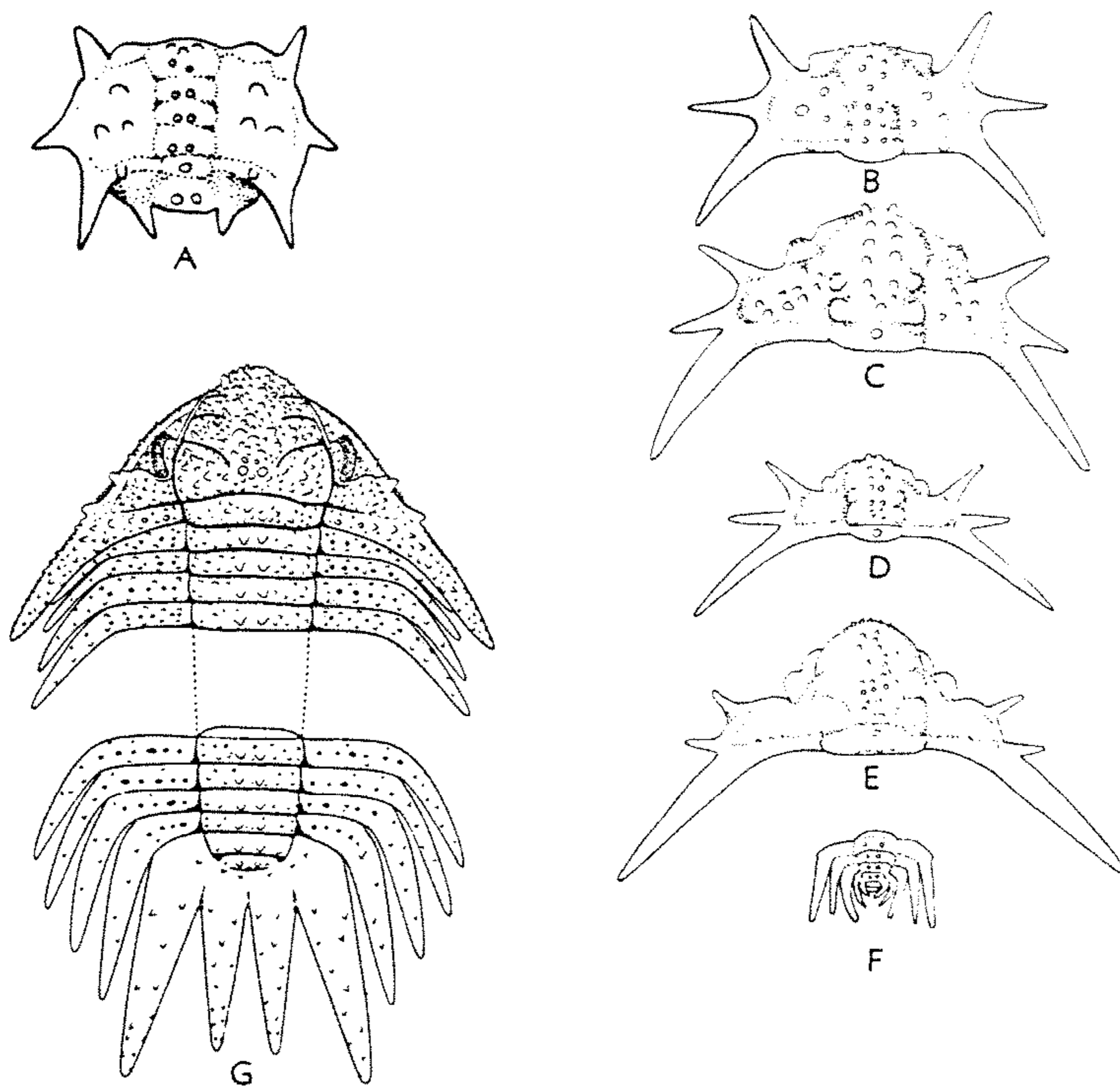

FIG. 91. Ontogenetic stages of *Acanthoparypha perforata* WHITTINGTON & EVITT, M.Ord., E.USA (Virginia): A, protaspis, $\times 30$; B-E, series of cranidia showing development, $\times 20$, $\times 20$, $\times 10$, $\times 12$; F, transitory pygidium, $\times 10$; G, incomplete exoskeleton, $\times 5$ (A-F, 41n; G, 37*).

Figure 88 shows ontogeny of *Sao*, based on previous work (1, 22) and my own studies (36). The earliest stage (Fig. 88A) shows a length (*sag.*) of 0.6 mm., with the cephalic axis divided into 5 rings decreasing in length posteriorly, and the protopygidial axis short and low. Pleural regions are faintly divided at the posterior margin of the cephalon. Eye lobes are close to the margin of cephalon, eye ridges curve in to the axial furrow just behind anterior pits, and a sutural ridge is adjacent to the extremity of the frontal glabellar lobe. Librigenae are narrow, posteriorly extended into short librigenal spines and defined by sutures running a short distance inside anterior and lateral cephalic margins. The dorsal part of the

librigenae is steeply inclined, so that in Figure 88A only the posterolateral portion is visible. The protaspis increases to a length (*sag.*) of about 1 mm. (Figs. 88B-E) and is strongly convex. The posterior cephalic border becomes distinct, the number of axial rings in the protopygidium increases to 4, and faint interpleural grooves appear. The relatively large, spinose hypostoma is known in specimens having a length (*sag.*) of 0.85 to 1 mm. At a length (*sag.*) of 1 mm., and slightly larger (Fig. 88F) the transverse joint between the cephalon and transitory pygidium becomes clear.

Protaspides of *Olenus* (24; 36, p. 467-468) range in size from a length of (*sag.*) 0.33 to 0.52 mm. They are like those of *Sao* ex-

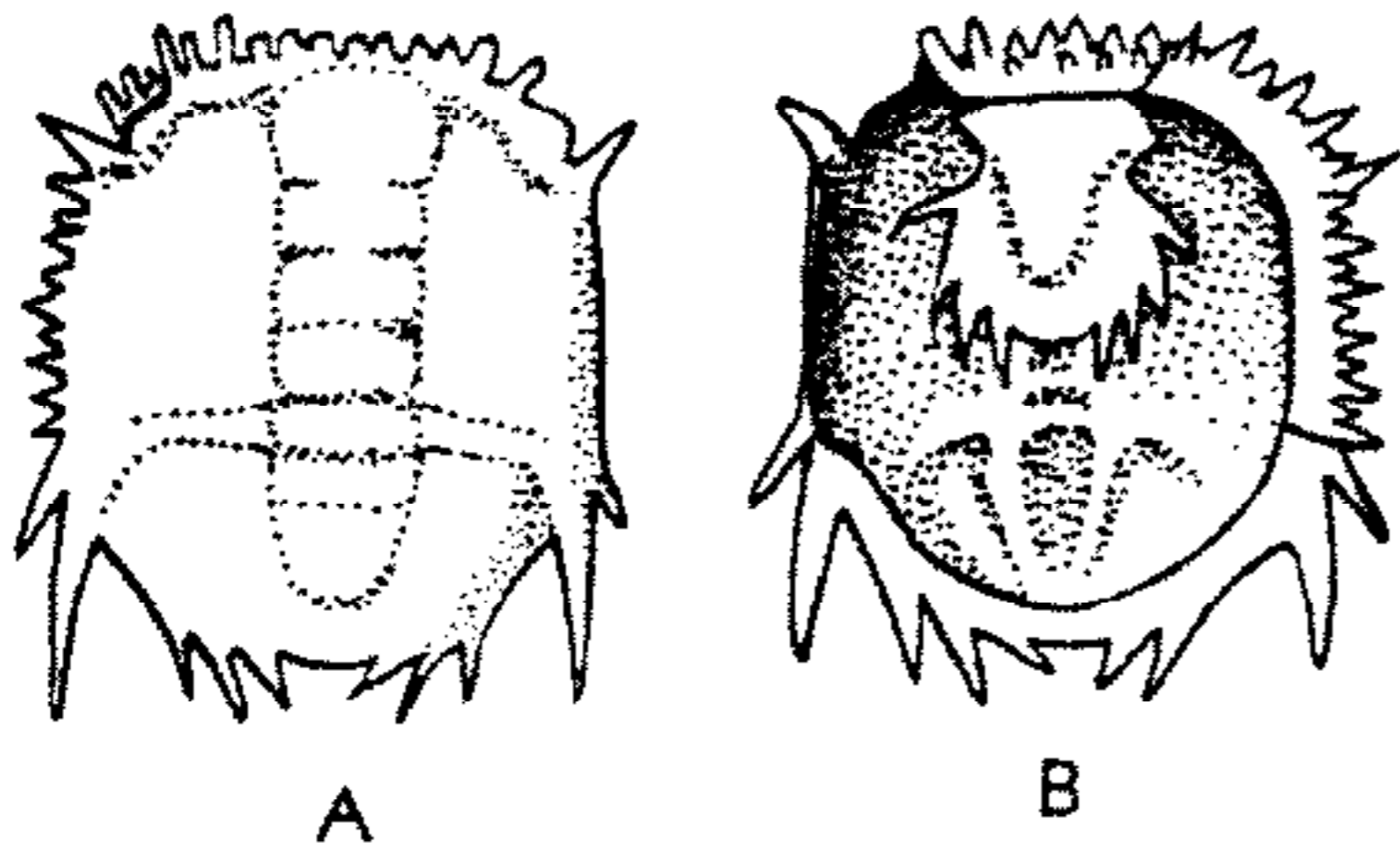

FIG. 92. Protaspis of *Flexicalymene senaria* (CONRAD), M.Ord., E.U.S.A. (Virginia); A, B, dorsal and ventral views, left librigena, rostral plate, and hypostoma present, $\times 30$ (41n).

cept that fixigenal spines occur. These fixigenal spines are reduced and lost in early meraspid "degrees," as they are in *Leptoplastoides* (Fig. 97).

The protaspis of *Welleraspis* (Fig. 90), 0.40 mm. in length (*sag.*), is of a similar type, subhemispherical in form, and lacking librigenae. The latter must be narrow (*tr.*), the dorsal portion lying in the vertical plane. How readily they would be concealed in such specimens when flattened in shale is evident.

Protaspides of post-Cambrian trilobites exhibit a variety of types. That of *Menoparia* (Fig. 86A-E, lacking librigenae and hypostoma) is unusual in its subspherical form. In the smaller figured example only the anterior portion of the axis is outlined by furrows, but the suture is present, as well as anterolateral, mediolateral, and posterior pairs of spines. The larger specimen has the axis completely outlined, and the occipital

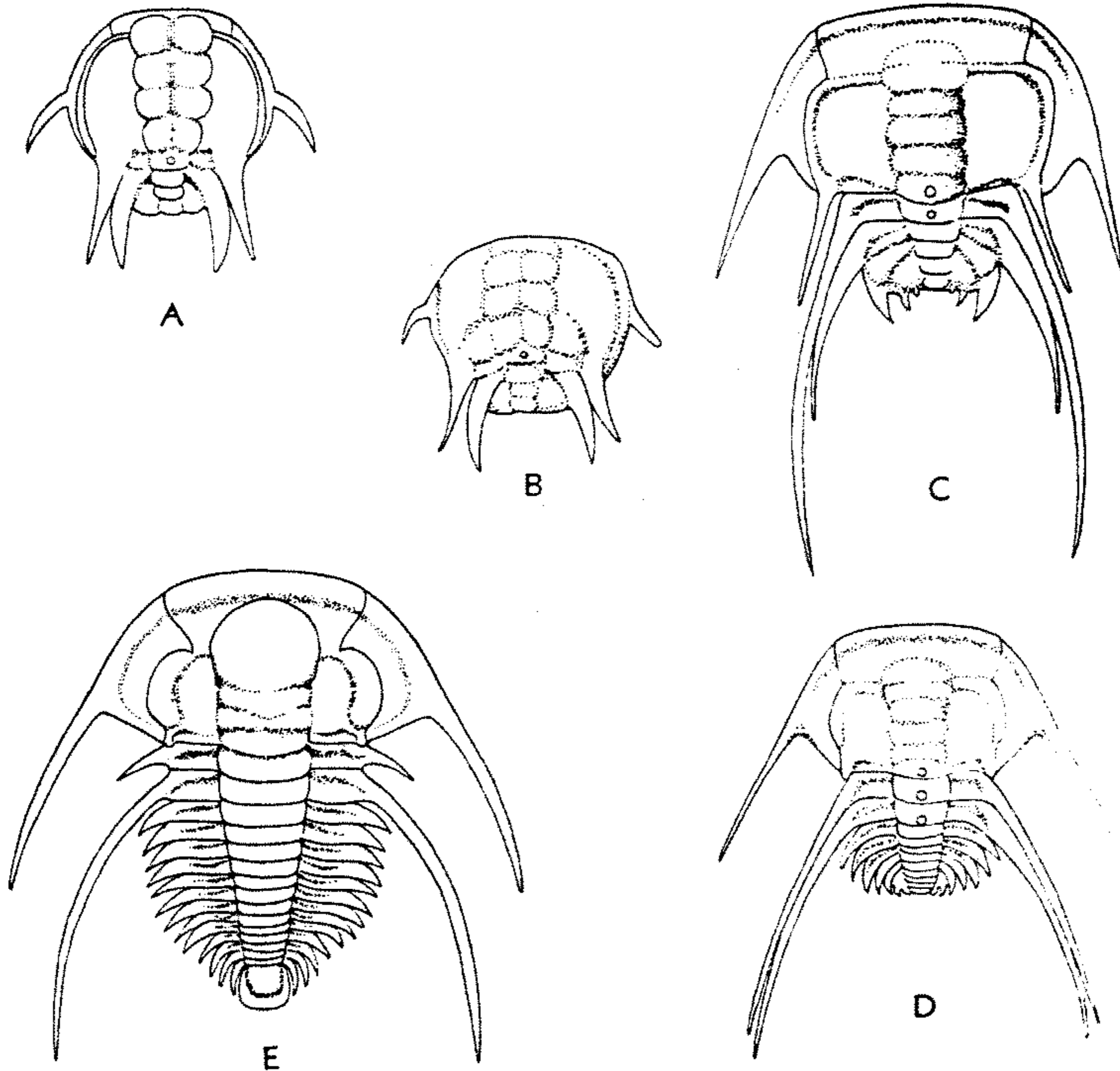

FIG. 93. Ontogenetic stages of *Paradoxides pinus* HOLM, M.Cam., Swed.; A, B, protaspides (A, reconstr.), $\times 20$; C-E, meraspid "degree" 1, $\times 20$; "degree" 4, $\times 10$, "degree" 15, $\times 5.4$ (30).

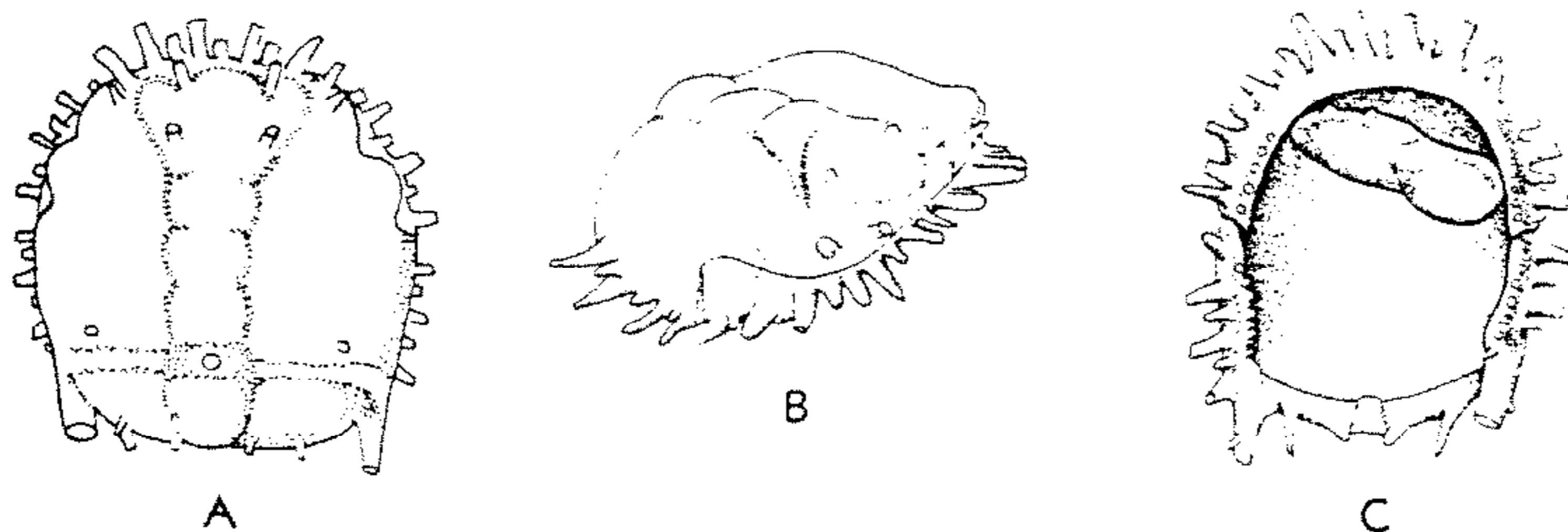

FIG. 94. Phacopid protaspis, L.Dev., E.U.S.A.(N.Y.); A-C, dorsal, anterolateral, ventral views (C with immature ostracode carapace adhering to specimen), $\times 30$ (+1n; 3+*).

ring and 2 protopygidial rings are defined (Fig. 86D). The posterior pair of spines is on the posterior border of the protopygidium. Librigenae, bearing a librigenal spine, are known in early meraspid cephalata (Fig. 86F).

The protaspis of the bathyurid *Licnocephala* (Fig. 98), recently described by Ross (21), is approximately 0.8 mm. in length (*sag.*), and lacks librigenae. The axial region is divided into occipital ring, glabella with 3 rings of similar length and a longer anterior ring that narrows forward. There is a broad (*sag.*) preglabellar area, showing a striking difference from such Cambrian protaspides as those of *Sao* (Fig. 88A-E) and *Welleraspis* (Fig. 90).

The only known lichid protaspis (35; Fig. 95, length, *sag.*, 0.94 mm.) represents a late stage in the protaspid period. The 4 paired spines and median occipital spine suggest the typical 5 rings of the well-defined, parallel-sided glabella and occipital ring. The prominent eye lobes are well inside the borders of the genal regions, and facial sutures are present. There is a prominent librigenal spine and 4 pairs of spines on the protopygidium.

The protaspis of *Shumardia* (Fig. 87A) is extremely small (length, *sag.*, 0.24 mm.; length at "degree" 0, 0.31 mm.), strongly convex, and unusual in that the glabella is divided into only 4 segments.

Protaspides of post-Cambrian proparian trilobites show considerable resemblance to each other (Figs. 89, 91A, 92, 94, 99A). Their length (*sag.*) ranges from about 0.25 to 0.95 mm., only those of *Rossaspis* (20) and *Pseudocybele* (Figs. 89A) including ex-

amples less than 0.5 mm. long. These latter tiny shields are subcircular in outline, strongly convex, with the axis in larger specimens divided into 5 rings (of which the anterior is longest). The eye lobes are close to the anterolateral margins, dorsal sutures are present, and their form and the presence of shallow anterior pits suggests that librigenae, rostral plate, and hypostoma may have been present. There are 3 pairs of border spines, the posterior pair being fixigenals. The tiny region between these latter, which includes the tip of the axis, is the protopygidium, which may bear a pair of border spines (*Rossaspis*).

The larger protaspides of these and other genera have the pleural regions subdivided so that cephalon and protopygidium are distinct. The well-defined glabella and occipital ring comprise 5 segments, the anterior markedly longer and wider, the occipital shorter (*sag.*) and, in some genera, narrower (*tr.*), than the remainder. The posterior cephalic border runs out into the base of the fixigenal spine, and there may be spines of similar size on the lateral and anterolateral borders (Fig. 91A).

The protaspides of *Flexicalymene* (Fig. 92) and phacopids (Figs. 94, 99A) have a row of small spines around the anterior and lateral cephalic margins. The eye lobes are situated on the anterolateral part of the genal regions, close to the border, and the sutures are fully developed. A few tiny facets are probably present on the visual surface of the eyes. If present, the eye ridges run into the most anterior part of the glabella. The hypostoma in *Flexicalymene* (Fig. 92B) is relatively large and spinose. The

small, down-bent protopygidium has a clearly defined axis and border bearing pairs of spines. Doublures of the cephalon and protopygidium are narrow and curled under posteriorly. Paired spines on the axis and symmetrically arranged spines on the genal regions commonly occur, and there may also be granulation or pitting of the external surface.

MERASPID PERIOD

This period of trilobite larval development begins at "degree" 0 with appearance of the first transverse joint in the exoskeleton, separating the cephalon from what is now termed the transitory pygidium. As thoracic segments become fully formed in the anterior part of the transitory pygidium new joints appear between them. Successive "degrees" of the meraspid period are numbered to correspond with the number of segments released to form the thorax. For each species there is a constant number of these segments, and after this is reached no more are freed from the pygidium. The final "degree" of the meraspid period is here considered to be that in which there is one less than the complete number of freely articulating thoracic segments.

For the study of the meraspid period a series of complete specimens is necessary, such material being found in some shales, siltstones and fine-grained sandstones (1, 16, 25, 30). These fossils are disadvantageous for study in being compressed and some of them otherwise distorted, but they may show a progressively increased number of segments up to the holaspid number. The much-better-preserved silicified exoskeletons obtained by etching some limestones with acid almost invariably consist of dissociated parts, and consequently "degrees" of the meraspid period for all parts of the exoskeleton cannot be ascertained.

MANNER AND AMOUNT OF GROWTH

During the meraspid period the length (*sag.*) of the trilobite is augmented to some 6 to 12 times that of the largest protaspis. This increase is achieved by a series of larval molts (instars), but how many is a matter of debate. In *Leptoplastoides* (Fig. 97; 16, Table I; 31) and *Onnia* (Fig. 100; 32, Table I) the average size increases at

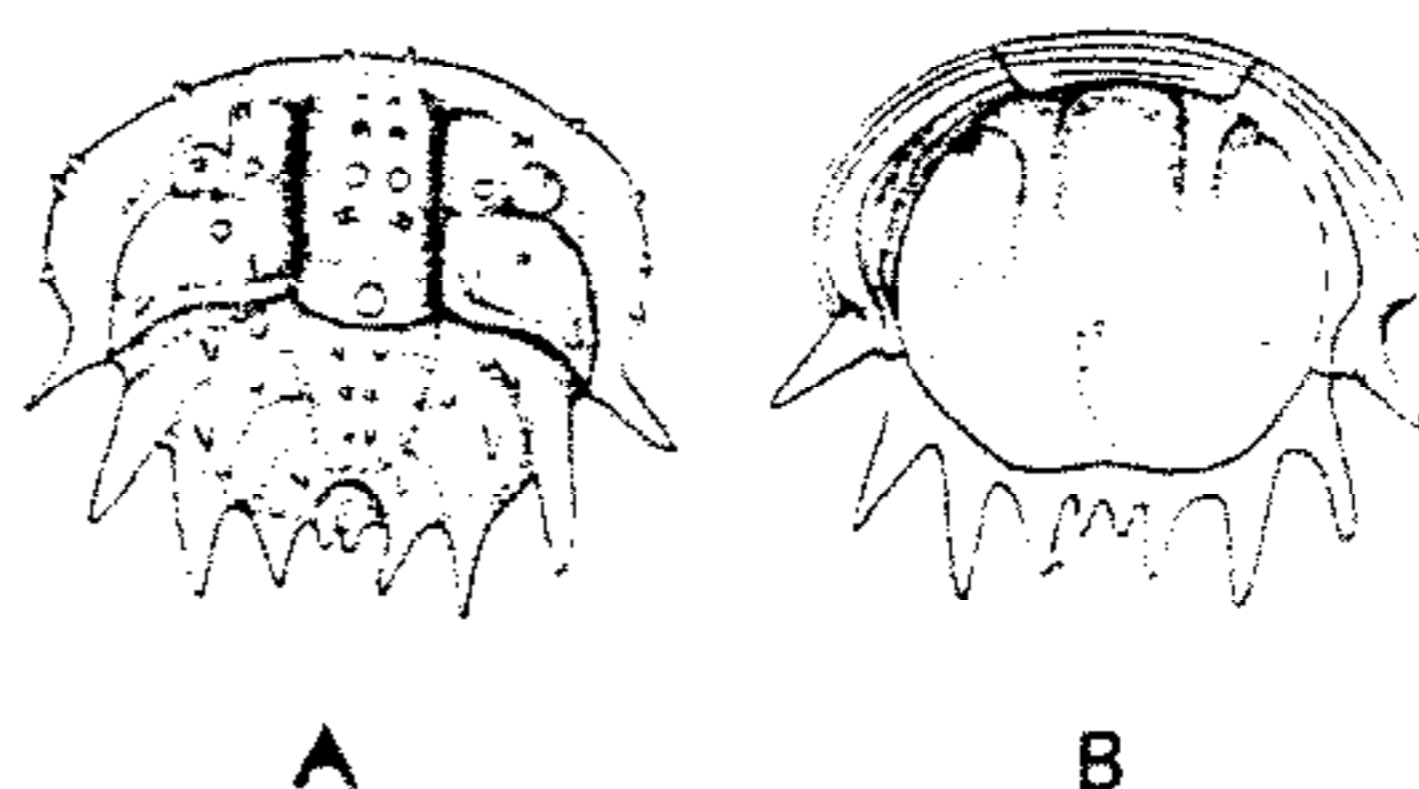

FIG. 95. Lichid protaspis, L.Dev., E.USA (N.Y.); A,B, dorsal, ventral, $\times 20$ (35*).

each "degree," and more rapidly in *Onnia* than in *Leptoplastoides*. Size of individuals belonging in any one "degree" varies, suggesting that more than a single molt may occur within each "degree." In *Leptoplastoides* no example of "degree" 8 has been found, and "degrees" 7 and 9 are almost the same in length. This similarity in length of successive "degrees" may signify that more than one segment was added to the thorax during certain molts. In this connection, the "degree" 0 exoskeleton of *Ceraurinella typa* (Fig. 101) is instructive, for the transitory pygidium is found to have its maximum length (*ca.* 2 mm.) and to contain in a single unit the 11 segments destined to form the thorax, these lying in front of the part that is to become the true pygidium. The other transitory pygidia observed (37) have only 4, 3, and 1 segments, respectively, in front of the true pygidium and are 1.05 to 0.77 mm. in length. It seems possible that in this species perhaps 7 segments were released simultaneously into the thorax. These observations indicate that the count of free thoracic segments may not necessarily correspond with growth as measured by increase of length.

TRANSITORY PYGIDIUM

As pointed out by various authors, the transitory pygidium comprises a relatively longer part of the early meraspid exoskeleton than the pygidium in the holaspid exoskeleton. Examples of these proportions, contrasting early meraspides with late holaspides, are: *Leptoplastoides*, 33 per cent to 7 per cent (16); *Shumardia*, 44 per cent to 23 per cent (25, p. 268); *Onnia*, 48 per cent to 23 per cent (32); *Ceraurinella*, 63 per cent to 14 per cent (37). In *Dalmanitina* (1, Pl. 26) there is scarcely any change, the pro-

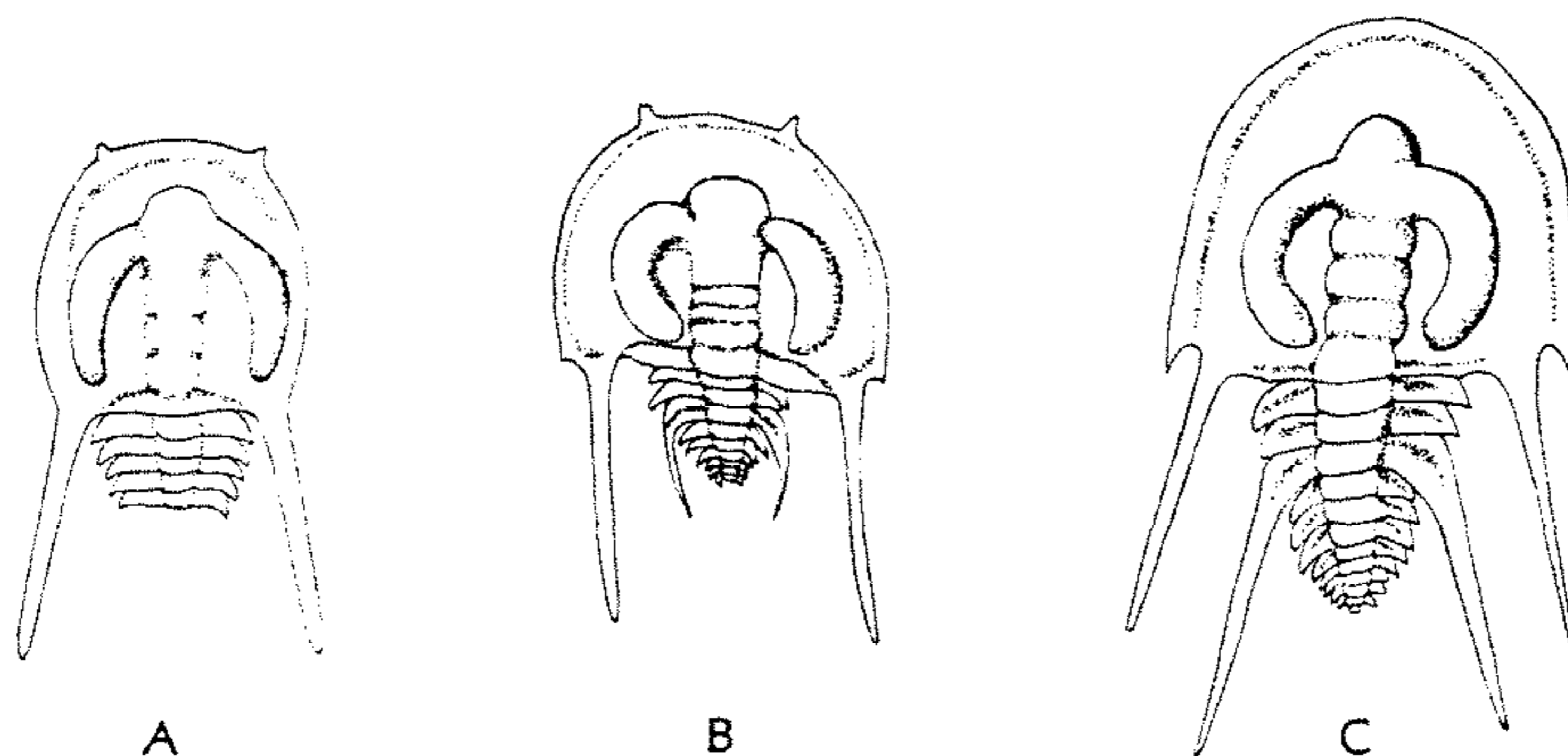

FIG. 96. Meraspid "degrees" of *Paedeumias yorkense* RESSER & HOWELL, L. Cam., E. USA (Pennsylvania); *A*, specimen with incomplete thorax showing 5 segments, $\times 20$; *B*, specimen with 9 thoracic segments; pygidium not preserved, $\times 10$; *C*, specimen with 12 thoracic segments, pygidium lacking, $\times 6.6$ (WALCOTT, ref. 28, pl. 32, fig. 2, 5, 6, emended in accordance with advice of A. R. PALMER).

portion being about 22 per cent at "degree" 0 and in a large holaspis. As might be anticipated, the length (*sag.*) of the transitory pygidium usually increases in successive "degrees" (e.g., in *Leptoplastoides*, 16, and *Ceraurus*, 5). An exception is the transitory pygidium of *Ceraurinella*, which decreases in size (37).

Evidence of segmentation in the transitory pygidium may be found in the form of axial rings, median or paired spines on the axis, pleural furrows, pleural bands and spines on these bands, pleural spines at the margins, or interpleural grooves. Indications of new segments may appear first in the axial region or in the pleural region, or simultaneously in both regions (5, p. 44). The work of BARRANDE on *Sao* (1) and STUBBLEFIELD on *Shumardia* (25) shows that segments may be added to the transitory pygidium during individual "degrees." These observations may be taken as indicating growth, and the occurrence of more than one molt within each "degree." The anterior segments of the transitory pygidium are the most fully formed, that is, are most like the thoracic segments. This is true of both dorsal and ventral surfaces of the exoskeleton. The ventral surface of *Ceraurus*

(Fig. 102), for example, shows the articulating half-ring, and doublure of the axial ring in front of it, growing as a single fold, and both this fold and the apodemes are progressively more complete anteriorly. The suture that develops to release new segments into the thorax divides the fold into its component parts and distally follows the interpleural grooves.

In the transitory pygidium axial and pleural spines show an increase in size from the most posterior to the anterior segments, and this size gradation is continued in the thorax. Exceptionally long median axial or pleural spines appear abruptly in a posterior position and after moving forward are released into the thorax (Fig. 87; also *Dimeropyge* and *Mesotaphraspis*, 37; *Menoparia*, 21). The change in position of these spines during growth, as well as the development of articulating structures, pleural subdivisions, and spines, are all consistent with the view that new somites are added by growth to the anterior border of the hindmost somite (25), and do not suggest that post-cephalic segments were formed at the anterior margin of the "pygidium" and propagated anteriorly and posteriorly, as some have believed. In most species the large

(See facing page)

FIG. 97. Ontogenetic stages of *Leptoplastoides salteri* (CALLAWAY), L. Ord. (Tremadoc.), Eng.; *A-D*, meraspid "degrees" 1, 5, 7, 10, $\times 20$; *E, F*, holaspis cephalon, last thoracic segment, and pygidium, $\times 1.3$ (40*).

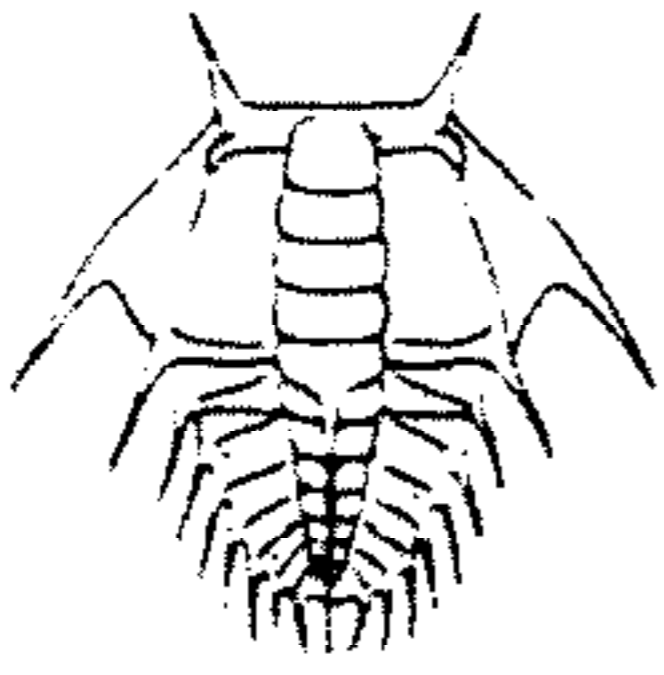

A

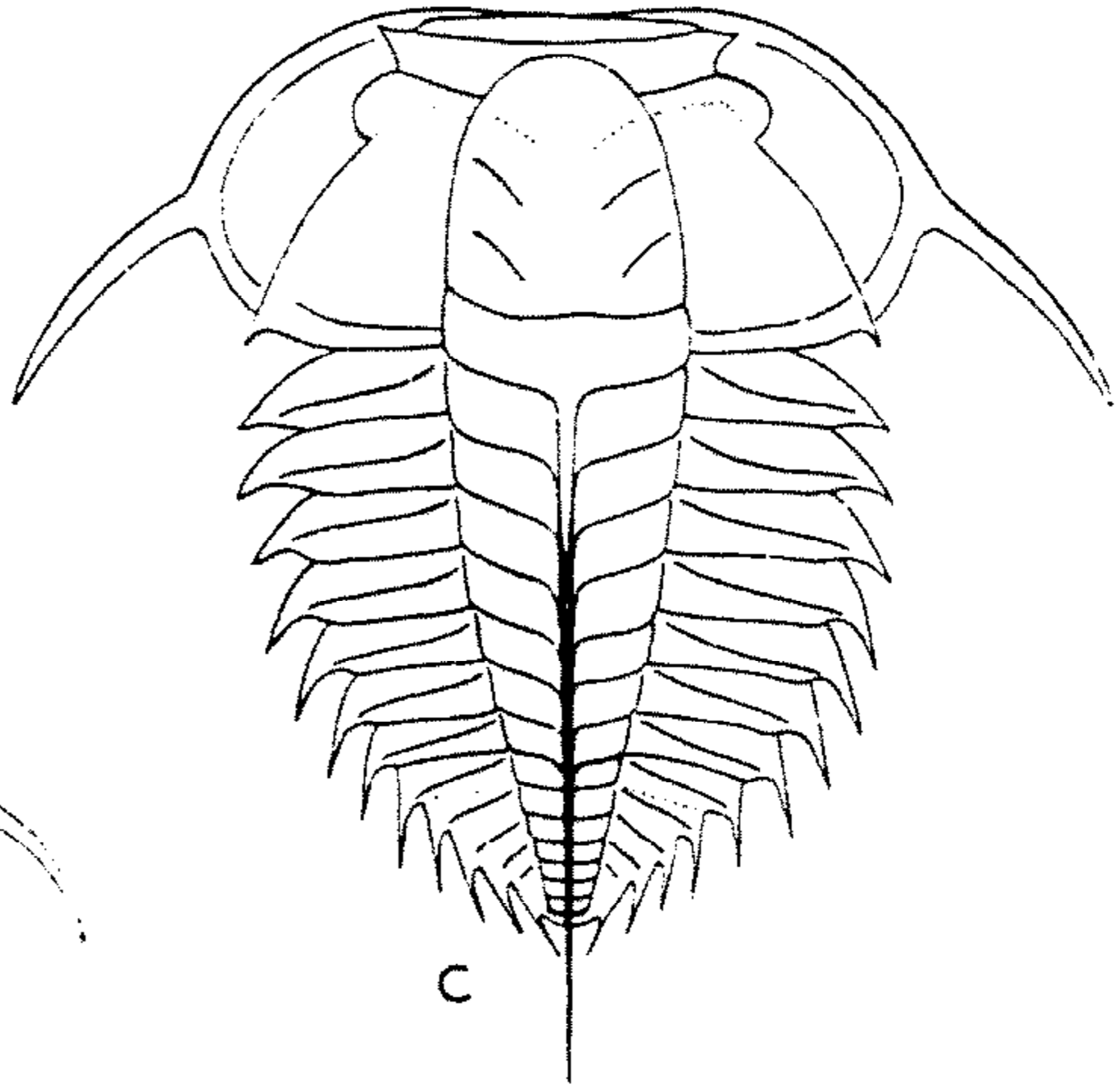

C

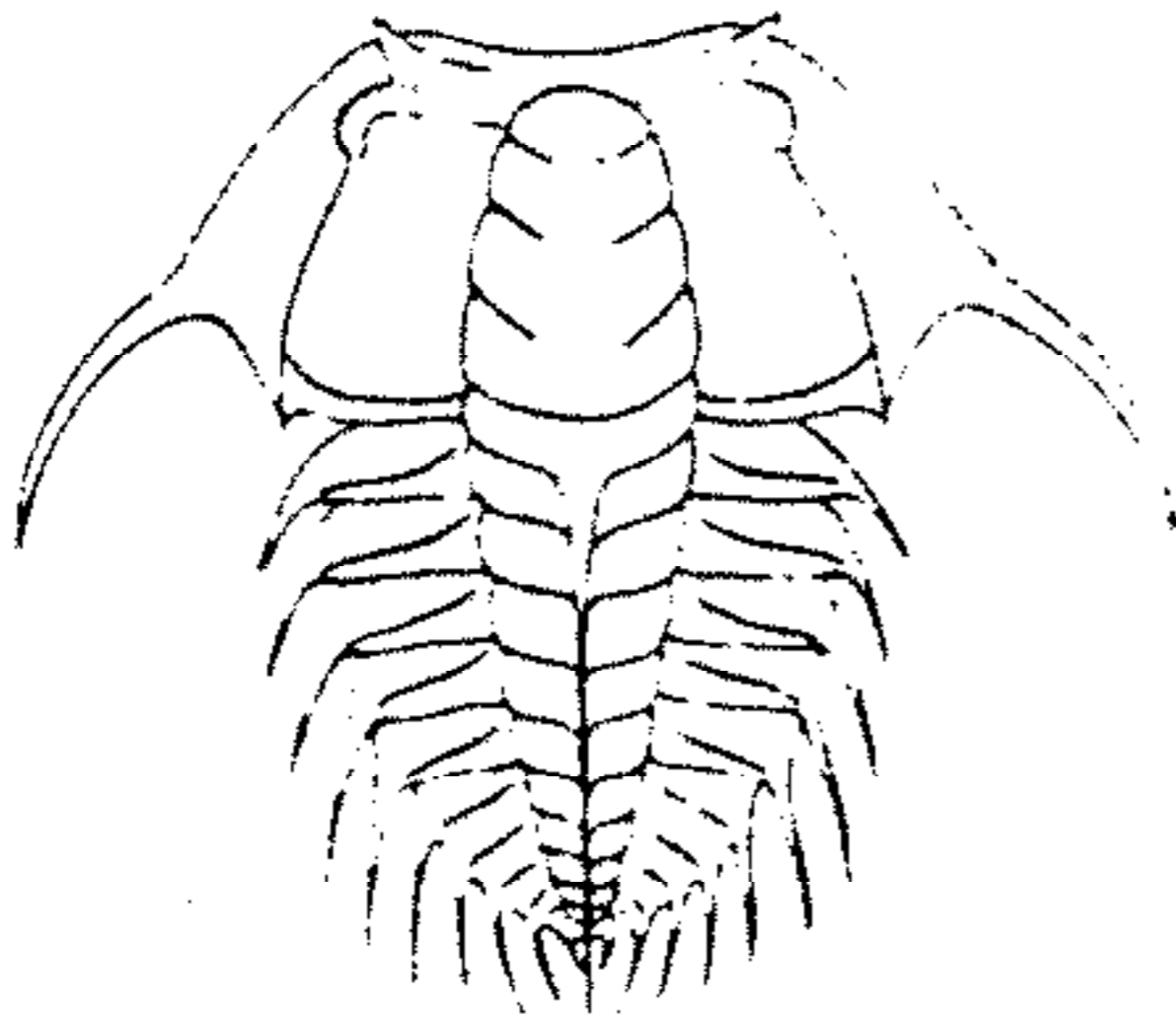

B

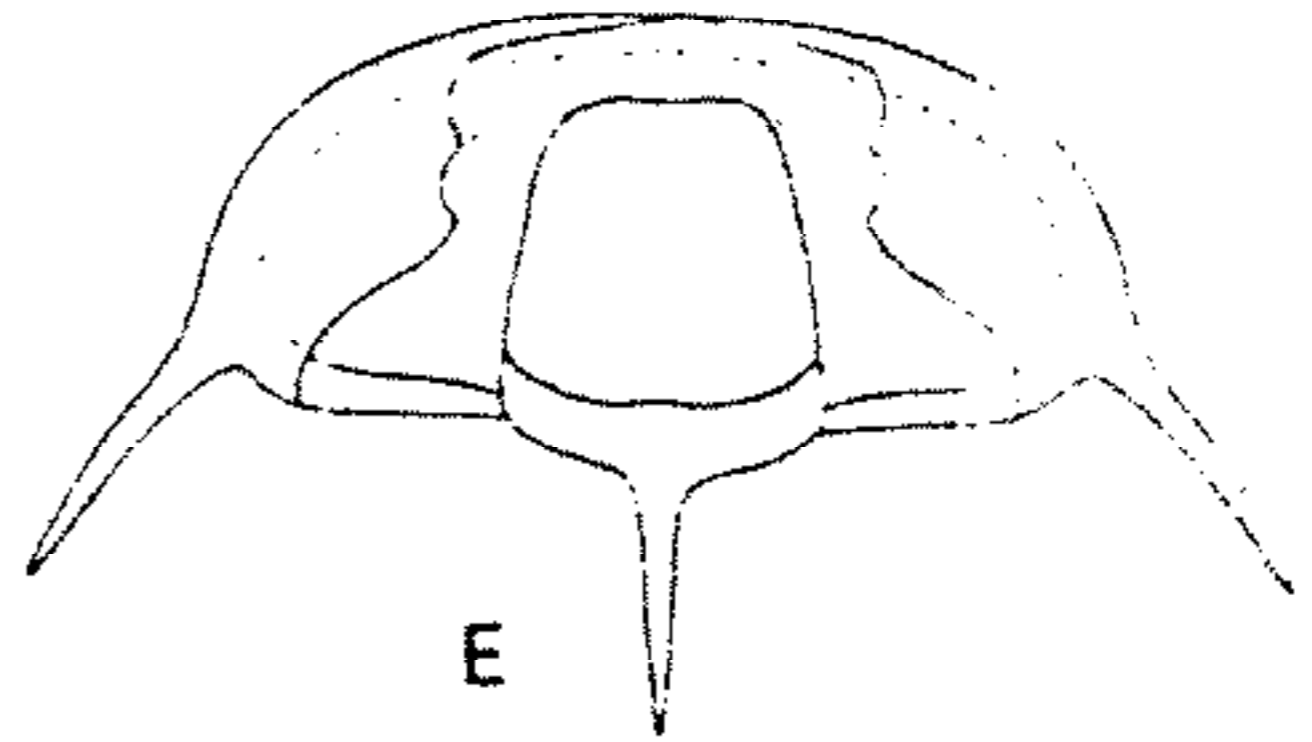

E

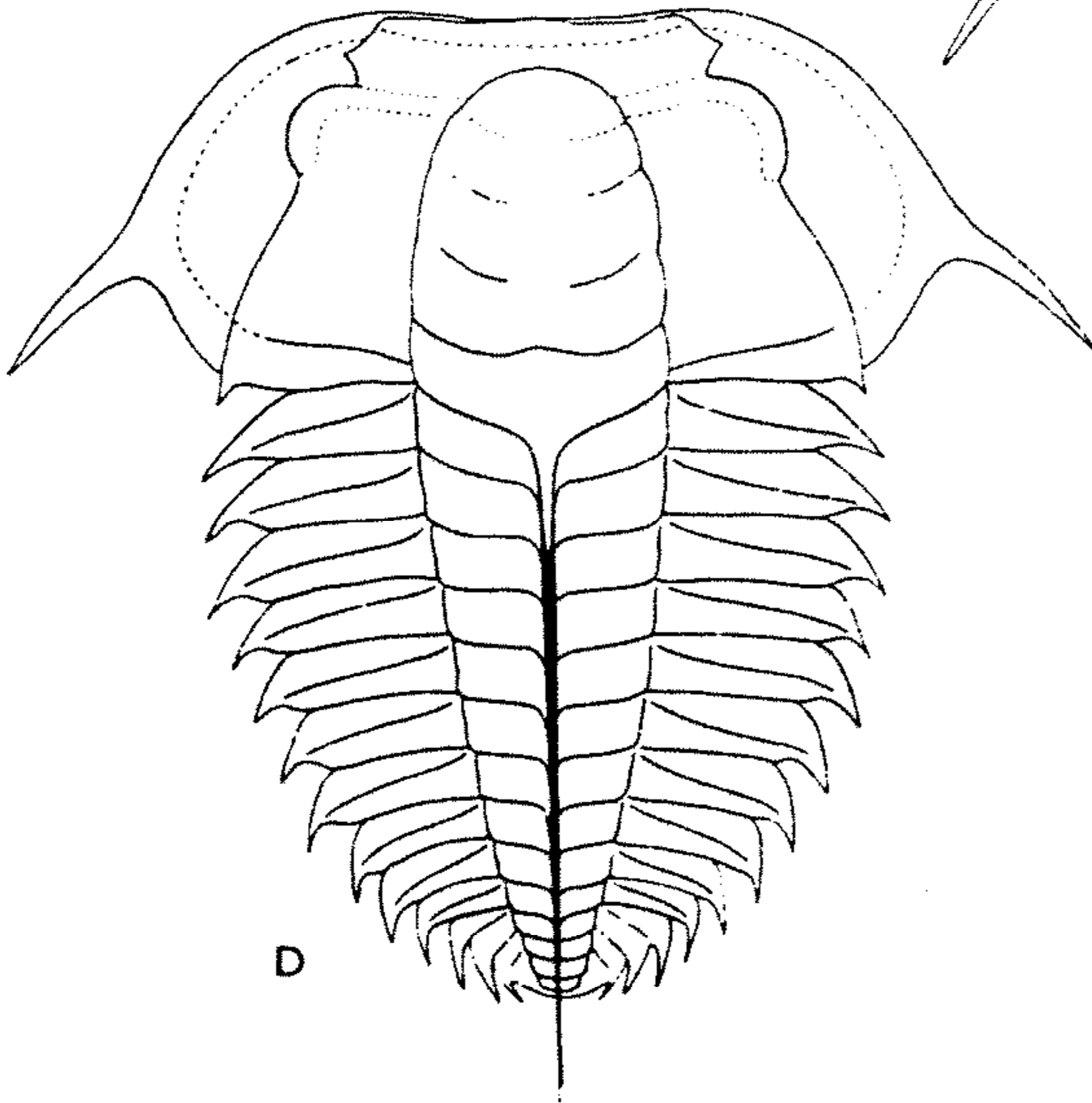

D



F

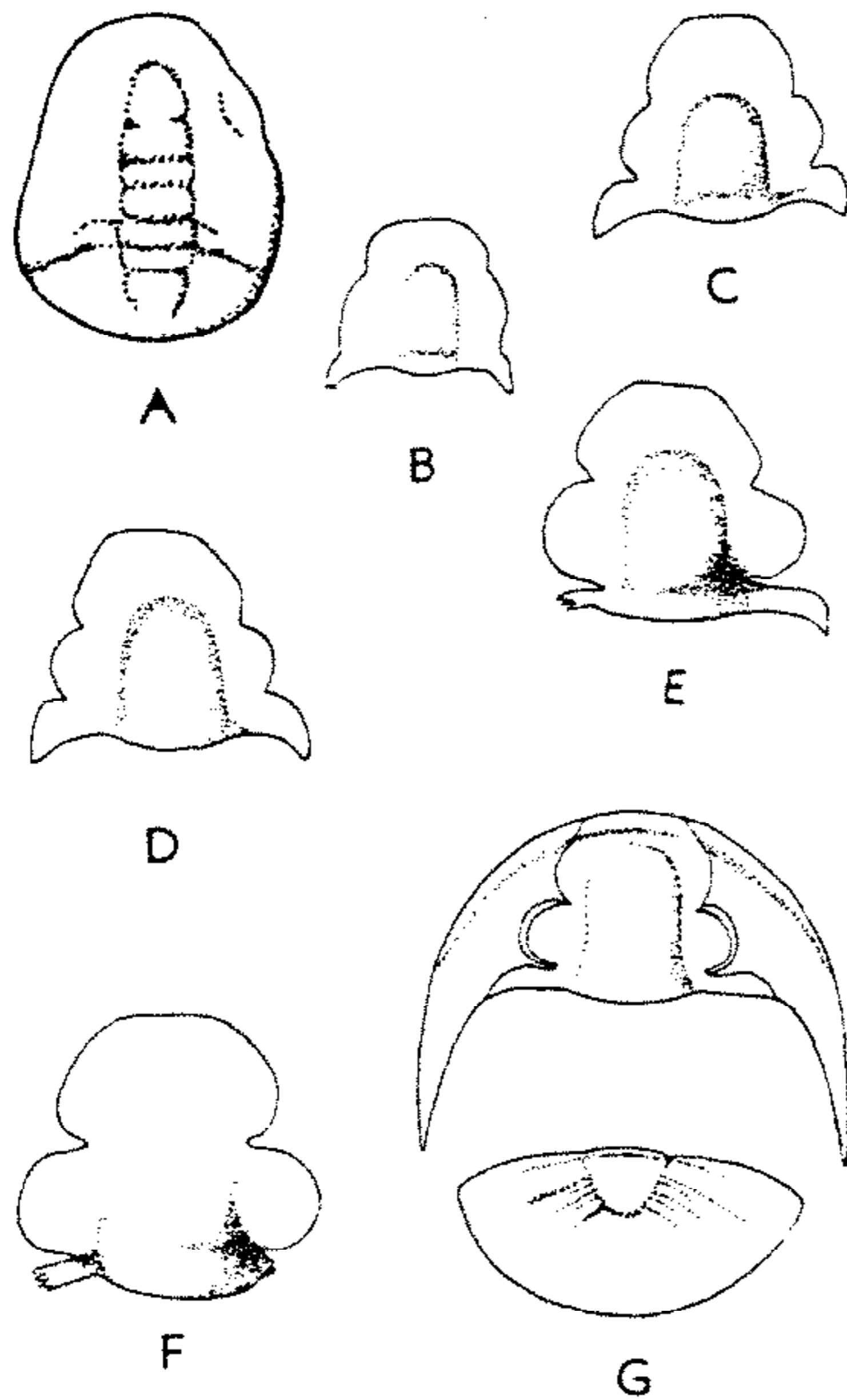

FIG. 98. Ontogenetic stages of *Licnocephala cavigladius* (HINTZE), L.Ord., W.USA (Utah); A, protaspis lacking librigenae, $\times 30$ (21); B-F, series of cranidia, $\times 20$, $\times 14$, $\times 14$, $\times 7$, $\times 7$ (21); G, holaspis cephalon and pygidium, $\times 2$ (38).

pleural spines that appear during the meraspis period are retained in the holaspis, but in *Paradoxides pinus*? (Fig. 93C-E) that on the 1st thoracic segment is reduced early in the meraspis period and that on the 2nd is also reduced by the end of this period (30, Pl. 5, fig. 10).

CEPHALON

During the meraspis period changes take place in the cephalon, both in the form and relative proportions of individual parts. The changes may be summarized as follows.

The glabella in many genera is widest and most convex anteriorly at "degree" 0. In *Onnia* (Fig. 100), *Dalmanitina* (Fig. 99), and, to a less extent, *Paradoxides* (Fig. 93), the initial anterior expansion is progressively augmented; TEMPLE (27) has shown that the frontal lobe in *Dalmanitina* grows at a

rate 4 times that of any of the lobes behind it. On the other hand, in late meraspis "degrees" of such genera as *Sao* (Fig. 88), *Leptoplastoides* (Fig. 97), *Welleraspis* (15), *Acanthoparypha* (Fig. 91), and *Flexicalymene* (33), the widest and most convex part of the glabella has become the posterior part.

Licnocephala (Fig. 98) illustrates the development of a different type of glabella which is not expanded anteriorly at any time, and remains low and poorly defined (21).

Along with changes in outline and convexity of the glabella, the glabellar furrows change. In most protaspides the glabella is divided into 5 rings (4 in *Shumardia*, Fig. 87A, none in *Menoparia*, Fig. 86A,B) and there is a median longitudinal furrow in *Paradoxides* (Fig. 93A,B). This median furrow, and the median part of the anterior 3 (i.e., not the occipital) ring furrows, usually disappear in the early meraspis "degrees," while the lateral parts of the ring furrows deepen. This deepening may be accompanied by the development of lateral glabellar lobes. Development of these lobes is shown by *Sao* (Fig. 88) and is striking, for example, in odontopleurids (Fig. 103). In remopleuridids lateral glabellar furrows are not developed until the meraspis "degrees," whereas in *Isotelus* (33) and *Licnocephala* (Fig. 98) lateral furrows present in early meraspis "degrees" and ring furrows of the metaprotaspis, respectively, are later lost. Of the 4 ring furrows of the protaspis

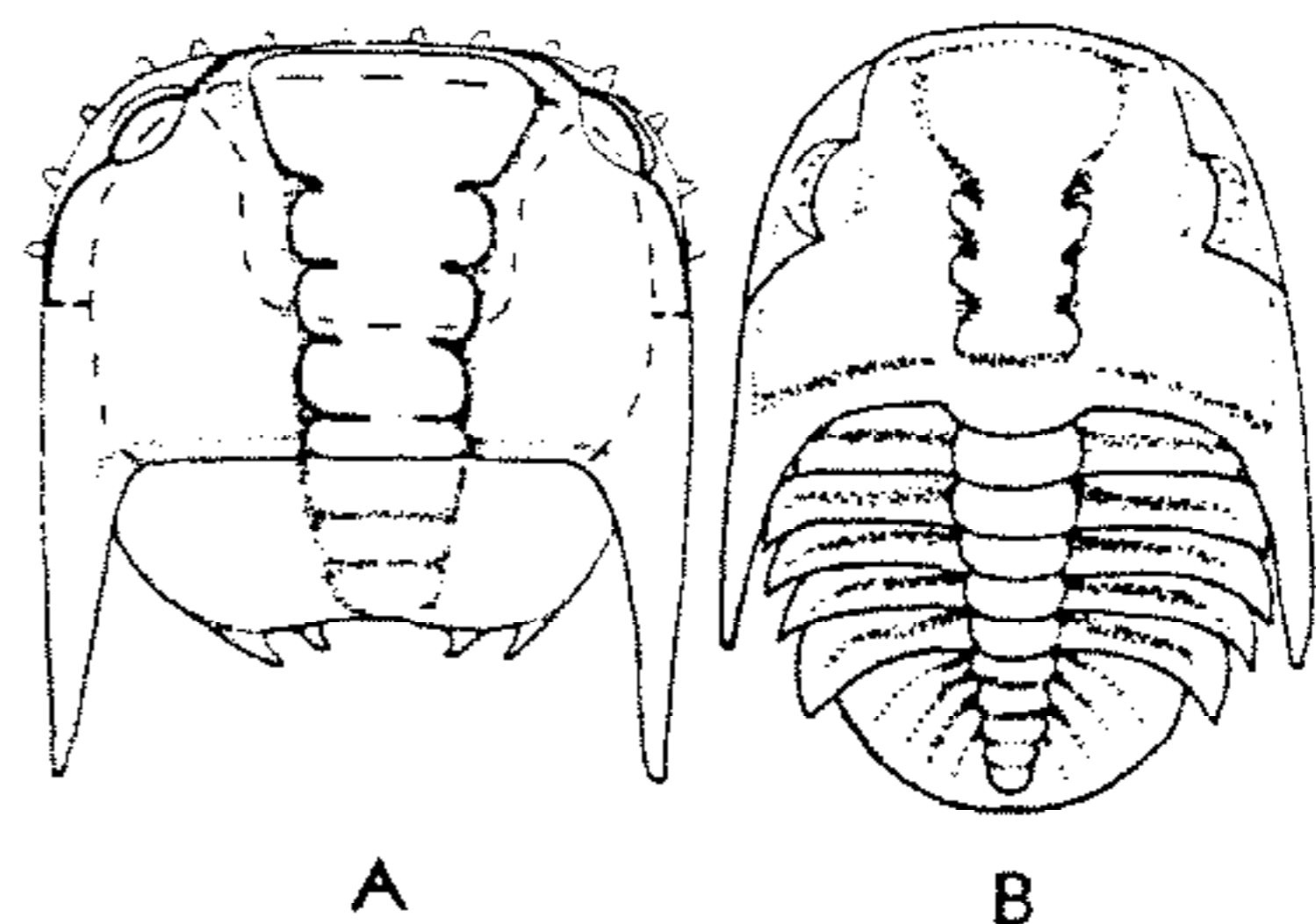

FIG. 99. Ontogenetic stages of *Dalmanitina socialis* (BARRANDE), M.Ord.-U.Ord., Bohemia; A, protaspis with librigenae (reconstr.), dashed lines showing inner margin of doublure, outline of hypostoma, and posterior sections of sutures crossing doublure, $\times 30$ (34*); B, meraspis "degree" 5, $\times 15$ (41n).

glabella, the posterior (occipital) is most persistent (though even the occipital furrow is lost in *Licnocephala*), and those adjacent to it develop into the deepest lateral furrows. *Paradoxides* (Fig. 93) is exceptional in retaining 2 complete ring furrows in front of the occipital in the holaspis. The deep lateral parts of these occipital and lateral glabellar furrows form ventral projections, the apodemes, to which it is believed the appendages are linked by muscles. In trilobites in which lateral glabellar furrows are lost, paired muscle scars, seemingly in the position of these furrows, are developed, e.g., in asaphids.

Genal regions and the frontal area also show some increase in convexity during the meraspid period, associated with an increase in convexity of the cephalon as a whole. The genal region, and particularly the inner, posterior portion, may show particularly marked inflation (Fig. 103). The frontal area, at first short (*sag. exsag.*) and steeply sloping, may become relatively longer, the glabella becoming relatively shorter, and the anterior border defined. This change is well shown by *Sao* (Fig. 88), *Leptoplastoides* (Fig. 97), *Paradoxides* (Fig. 93), and *Welleraspis* (15). In other trilobites the frontal area shows little change in relative size, for example, *Shumardia* (Fig. 87), *Acanthoparypha* (Fig. 91), *Dalmanitina* (Fig. 99; 34). In trinucleids (Fig. 100) rapid increase in width of the fringe occurs in early meraspid "degrees."

EYE LOBES AND FACIAL SUTURES

In trilobites with compound eyes in the holaspid period the eye lobes are present on the dorsal surface of the protaspis near the anterolateral margin. During the meraspid period the lobes move inward and backward, number of facets on the eye surfaces increases, and the palpebral furrows and rims develop. The eye ridges, which run from eye lobe to axial furrow opposite the anterior glabellar lobe, pivot with movement of the eye lobes and may be reduced in prominence or lost.

During the meraspid period changes that take place in the course of the dorsal sections of the facial sutures are associated in part with change in position of the eye lobes. In *Leptoplastoides* (Fig. 97), *Sao* (Fig. 88), and *Welleraspis* (Fig. 90; 15), these changes

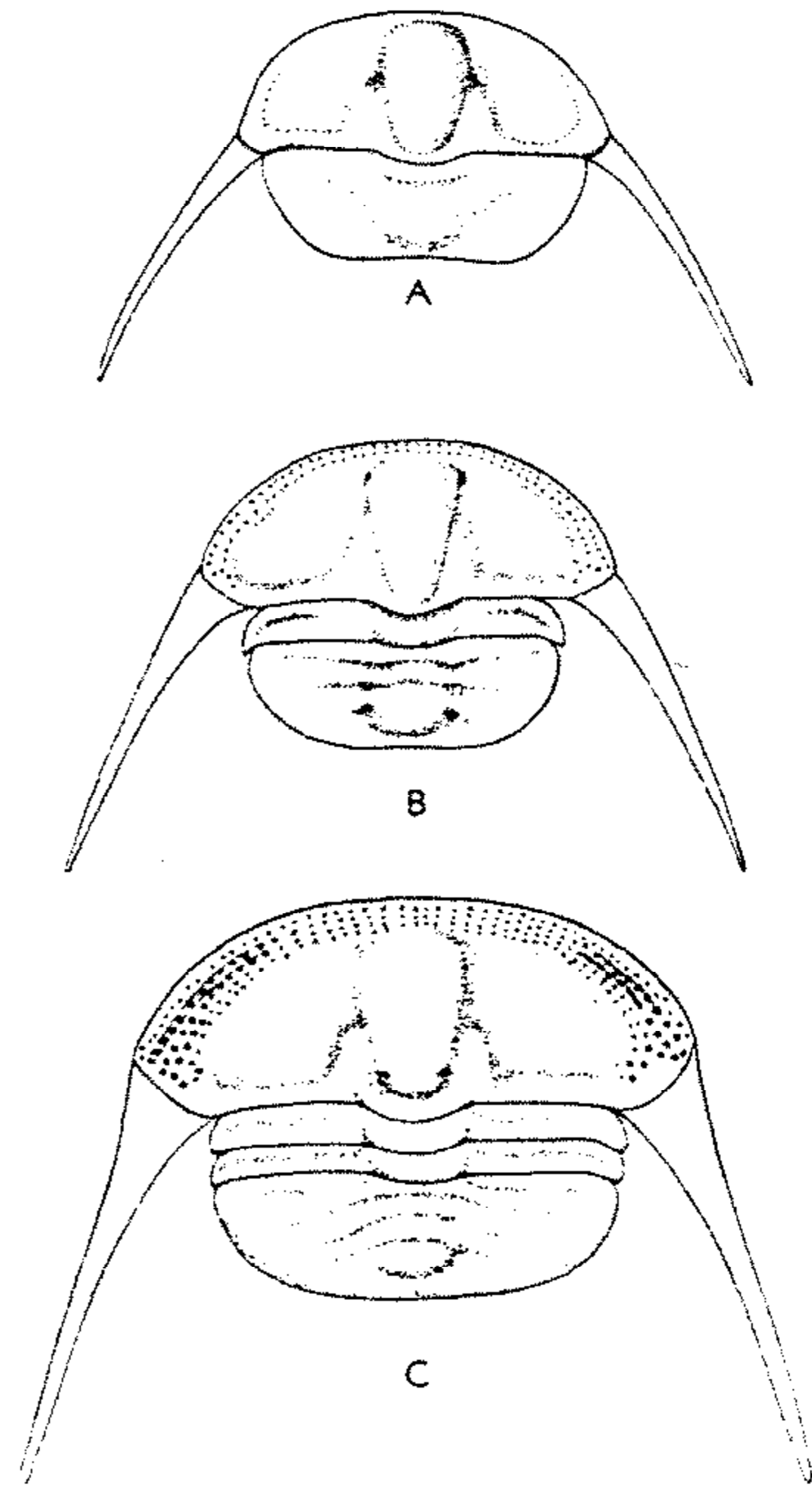

FIG. 100. Meraspid "degrees" of *Onnia ornata* (STERNBERG), M.Ord.-U.Ord., Bohemia; A-C, "degrees" 0 ($\times 22$), 1 ($\times 10$), 2 ($\times 12.5$) (41n).

do not affect the points where posterior sections of the sutures cross the cephalic margin and doublure. In *Acanthoparypha* (Fig. 91), *Sphaerexochus* (37), and *Rossaspis* (20), these points migrate backward considerably. Claim has been made that during the meraspid period of *Peltura scarabaeoides* (14) and other olenids (24, p. 88) the posterior sections of the dorsal sutures at first cut the lateral cephalic margins and later the posterior margins, so that the trilobite changes from proparian to opisthoparian during ontogeny. STØRMER (24, p. 88) has pointed out, however, that the development of facial sutures in the olenids he studied was not clear. In *Sao* and *Welleraspis*, the protaspides and meraspides are opisthoparian, the posterior segments of the sutures in the protaspis running back close

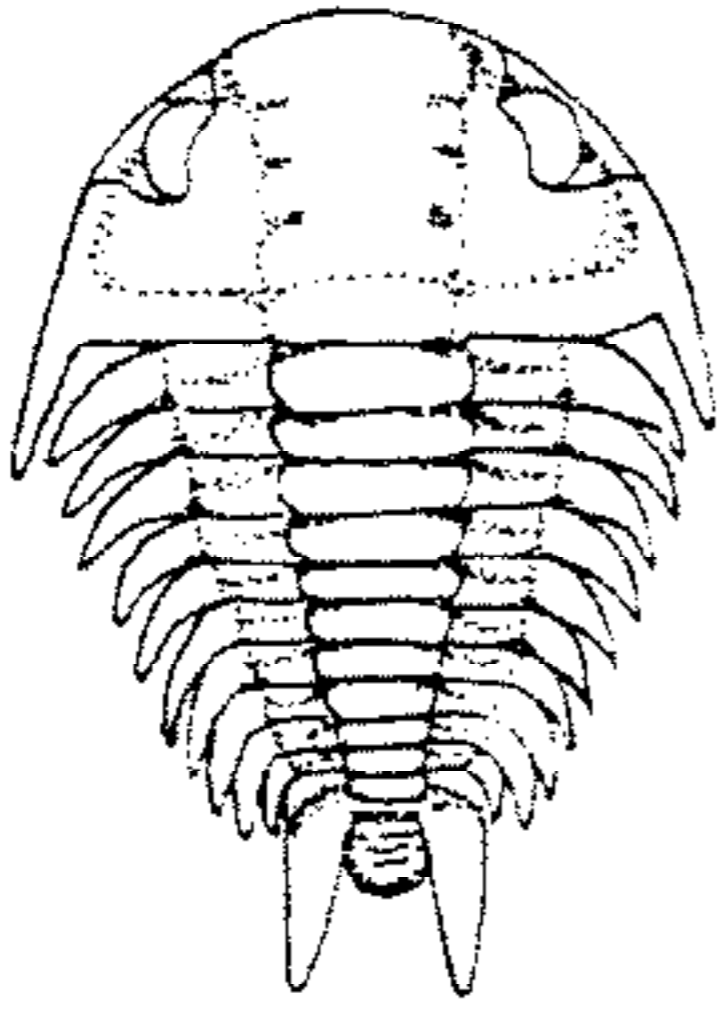

FIG. 101. Meraspid stage of *Ceraurinella typha* B.N. COOPER, M.Ord., E.U.S.A. (Virginia); "degree" 0, $\times 20$ (37).

to the lateral margins before curving inward across the base of the librigenal spines. In this position, on the almost vertically sloping flank of the genae, the sutures readily may be concealed. Possibly they have the same course in late protaspides and early meraspides of olenids, but only a reinvestigation will confirm or deny this suggestion. In view of the theoretical importance that has been attributed to the supposed change from a proparian to opisthoparian condition in olenids (8, 26), such an investigation would be of great interest.

HYPOSTOMA

The development of the hypostoma is not known in relation to "degrees" of the meraspid period (37). Small cheirurid hypostomata have a prominent, crescentic, posterior lobe of the middle body. As growth proceeds, the posterior lobe decreases in size at expense of the anterior. Also, the shoulder becomes more prominent and relatively more anterior in position. To judge by known examples of the protaspid hypostoma (Figs. 88E, 92B) a reduction in relative size may be inferred to occur during the meraspid period.

GENAL AND OTHER LATERAL CEPHALIC SPINES

Characteristic of known protaspides are the stout spines at or near the genal angle, and spines of almost the same size may be present on the lateral and anterolateral cephalic borders. In *Flexicalymene* (Fig. 92) and phacopid protaspides (Fig. 94), many additional smaller spines are observed on the cephalic border. During the meraspid

period the spine at or near the genal angles (genal spines) is retained and may be enlarged. It may be librigenal (*Sao*, Fig. 88; *Leptoplastoides*, Fig. 97; lichid, Fig. 95) or fixigenal (*Acanthoparypha*, Figs. 91, 106; *Dalmanitina*, Fig. 99). In genera such as *Flexicalymene* (33) and *Sphaerexochus* (37), the stout fixigenal spines are reduced during the meraspid period. The same is true of *Leptoplastoides* (Fig. 97) and *Paradoxides* (Fig. 93), in which reduction is rapid. In *Paradoxides*, as in some other genera, the librigenal spines are retained, increasing in size. In early meraspid "degrees" of olenellids (Fig. 96), a pair of stout metagenal ("intergenal") spines occurs and in some genera small spines are seen also on the anterior cephalic borders. At slightly larger size, before the anterior spines are lost, small spines (genal) begin to grow at the genal angles, just outside the metagenal spines. In considerably later "degrees" the metagenals are rapidly reduced, while the genals increase in size to become the main cephalic spines. This increase of genal spines and diminution of metagenal spines are not unlike the increase of librigenals and reduction of fixigenals in *Paradoxides*, *Leptoplastoides*, and other genera. Because of lack of facial sutures in olenellids, however, it cannot be shown that these differently designated spines are homologous.

OCCIPITAL SPINES

A median occipital tubercle is commonly present in protaspides and this is retained

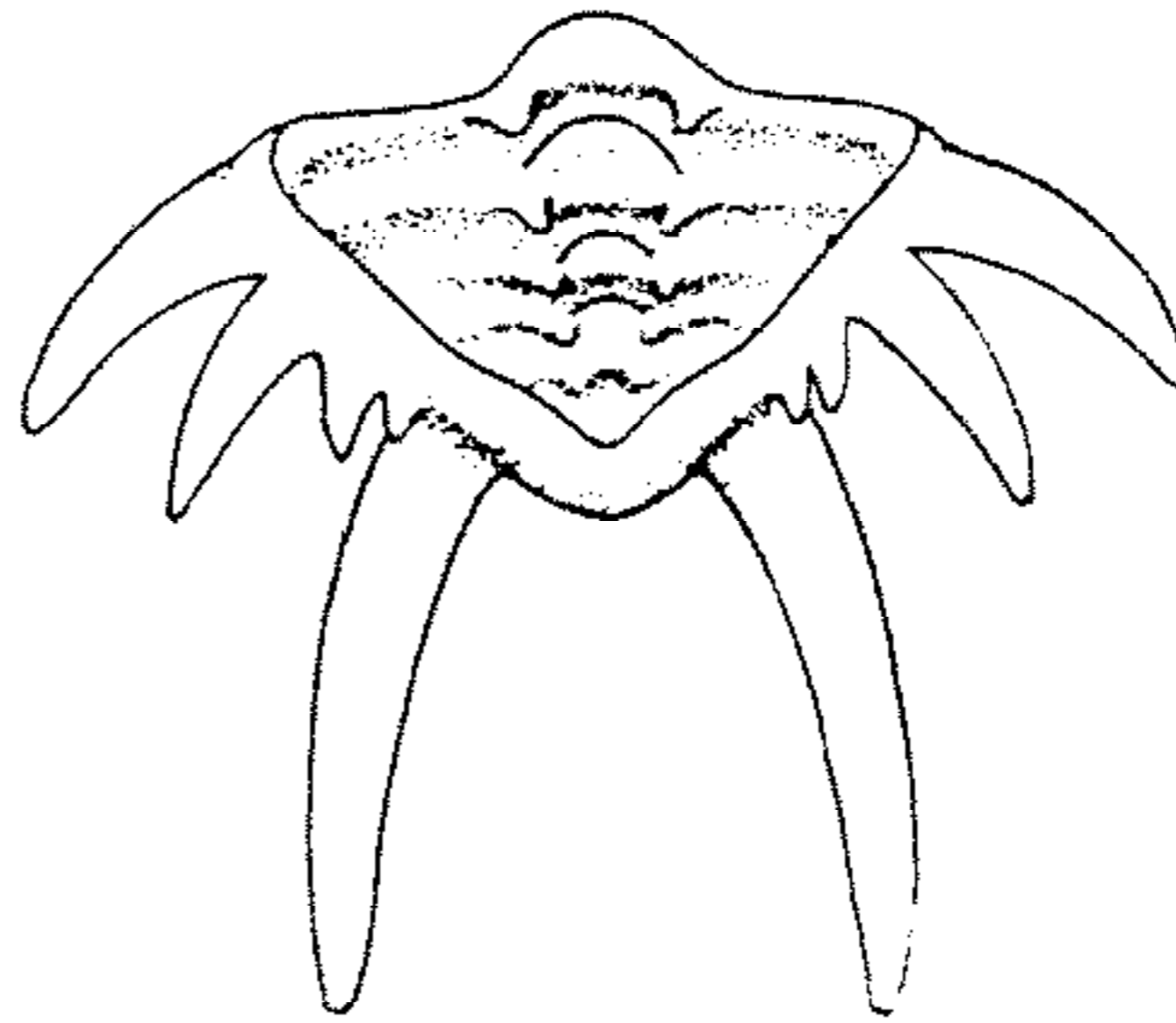

FIG. 102. Transitory pygidium of *Ceraurus whitingtoni* EVITT, M.Ord., E.U.S.A. (Virginia); ventral view, showing apodemes and fold that (when divided) forms articulating half-ring and doublure of axial ring. $\times 30$ (41n).

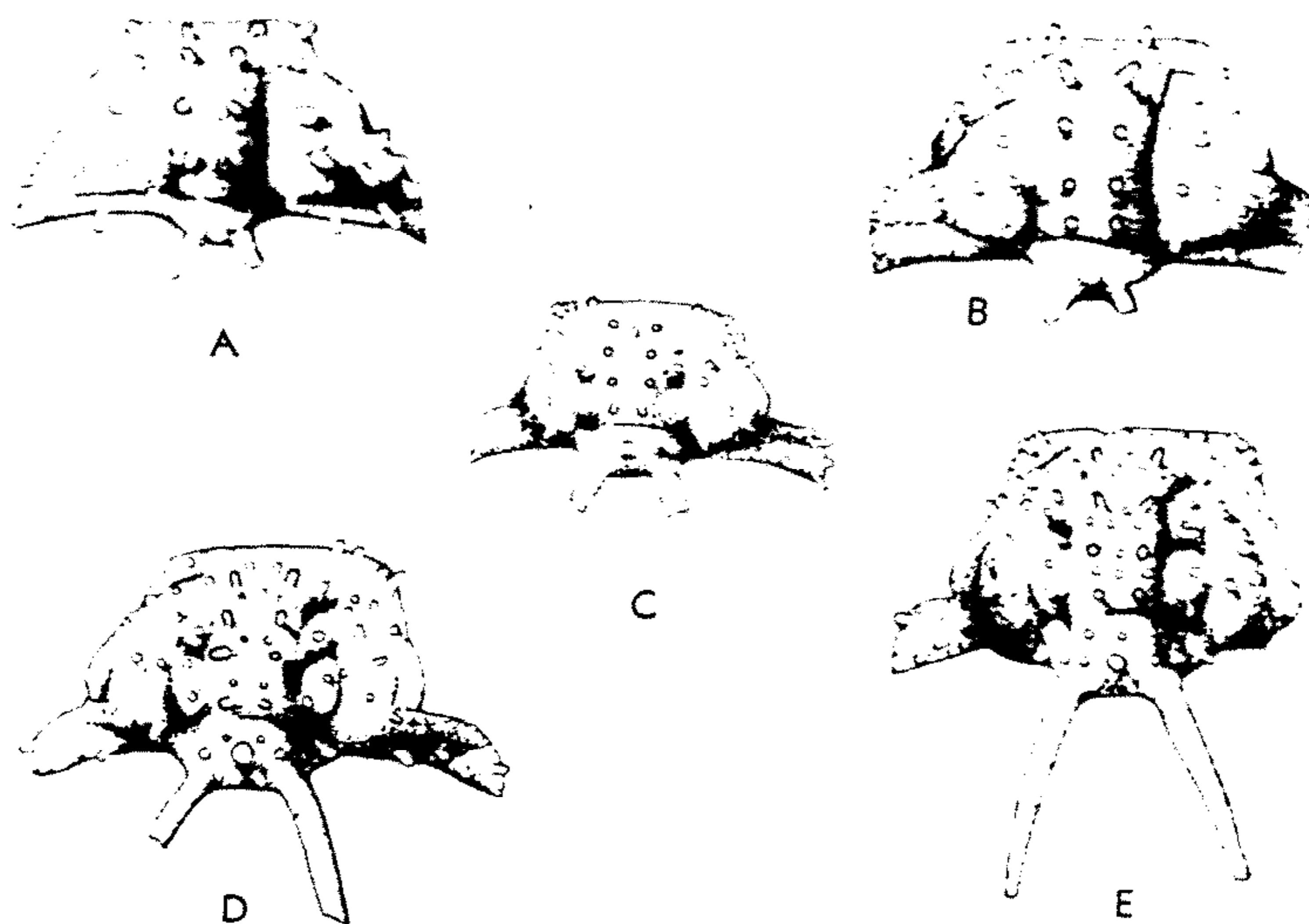

FIG. 103. Cranidia of *Diacanthaspis cooperi* WHITTINGTON, M.Ord., E.U.S.A. (Virginia); A-E, series showing growth stages, A, B, $\times 50$, C-E, $\times 25$ (33*).

through the meraspid period and into the holaspid. The tubercle may be relatively reduced in size or lengthen rapidly into a median occipital spine, e.g., in *Welleraspis* (15) and *Holia* (37). Similarly, paired occipital tubercles or short spines may increase in size and length into the holaspid period, e.g., in *Diacanthaspis* (Fig. 103).

EXTERNAL SURFACE

Short spines, tubercles, granules, and pits occur on the external surface of protaspides, including the hypostomal borders. A paired arrangement is common, especially on the axis. The spines and tubercles generally are reduced in relative size as the meraspid period progresses, and may disappear altogether. Among holaspides provided with spines, tubercles, or granules on the outer surface, growth during the meraspid period is characterized by an increase in number of these elements and loss or masking of their paired arrangement.

AGNOSTID TRILOBITES

The ontogeny of agnostid trilobites commonly is neglected in discussions of trilobite

larval development, and this is true despite early observations by BARRANDE (1; Figs. 104, 105). The smallest known agnostid specimens seem to be meraspides representing "degree" 0; their length (*sag.*) ranges from 1 mm. to a little more than 2 mm. Ring furrows and interpleural grooves appear in the transitory pygidium, and 2 segments are released successively into the thorax. The tendency seems to be for furrows on the cephalon and glabella to deepen as size increases. STUBBLEFIELD (25, p. 366) refers to a similar suite of specimens of Early Ordovician (Tremadocian) age, and points out that "unless the process for the development of new segments in the Agnostidae is entirely different from that of all other Arthropoda," orientation of the agnostid pygidium must be as depicted by BARRANDE and others, and not as advocated by WAHLENBERG, DALMAN, and RAYMOND.

HOLASPID PERIOD

The view of RAW (16, p. 226) that cessation in the addition of segments to the thorax forms a convenient break in the de-

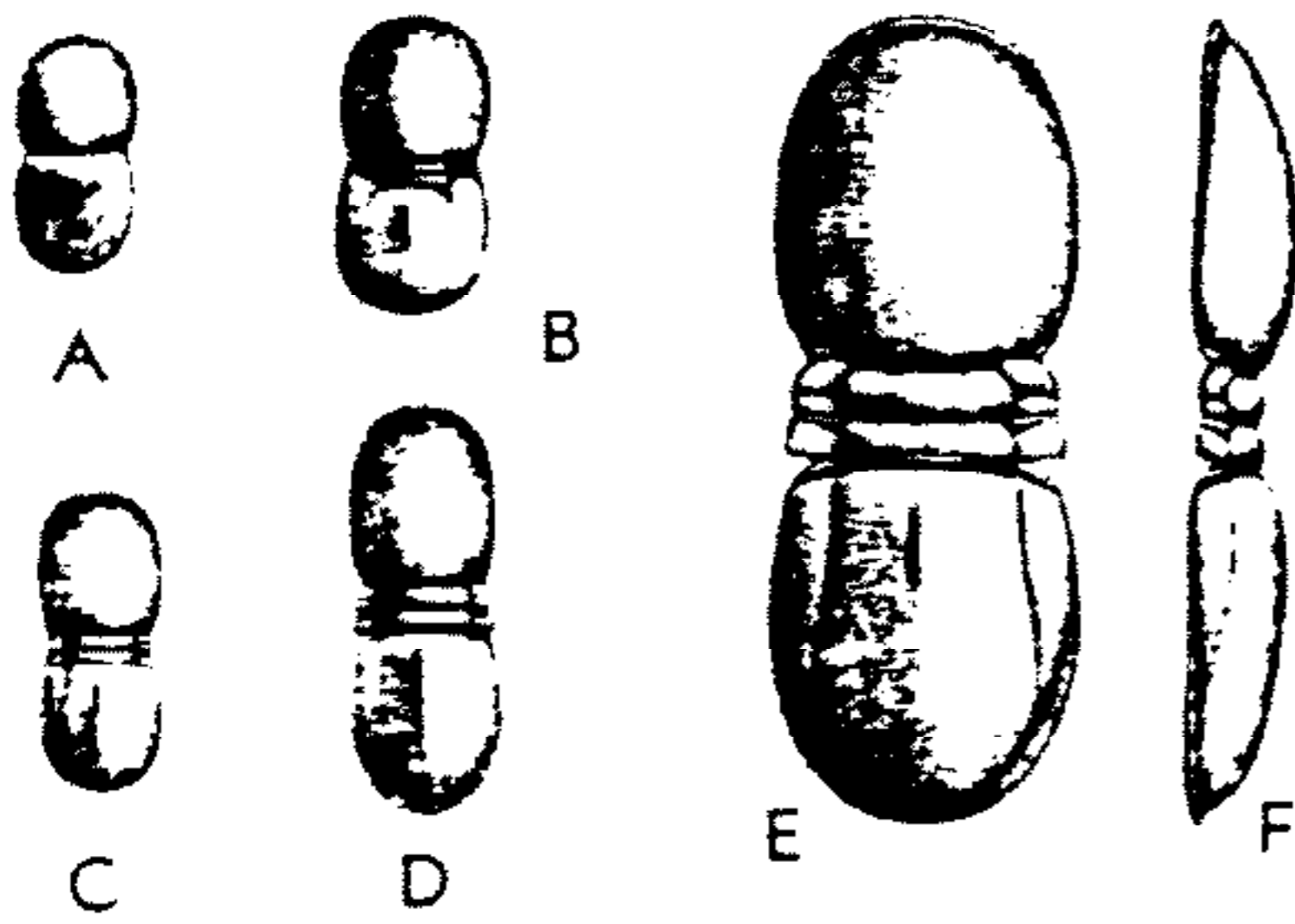

FIG. 104. Ontogenetic stages of *Phalacroma bibullatum* (BARRANDE), Cam., Bohemia; A-C, meraspid "degrees" 0 (X4), 0 (X3), 1 (X4); D, holaspis, X3; E, F, holaspis, dorsal, lateral, X6 (all 1*).

velopment of trilobites is accepted here, and, accordingly, the holaspis period is regarded as beginning when the last-formed segment (making a full complement for the species) is added to the thorax. When this period begins, the term "pygidium" is applied to the posterior shield of fused segments. The holaspis period extends to death of the individual.

No evidence is found to support RAW's suggestion (16, p. 226) that segments are added to the thorax of some trilobites throughout life; on the contrary, each species has its characteristic complement of thoracic segments. Most holaspides have fewer than 20 thoracic segments, but some have 25, the Devonian *Harpes* has 29, and one Upper Cambrian species of *Menomonina* is reported to have 42.

STUBBLEFIELD (25) has suggested that in view of the literal meaning of "holaspis" (complete shield), this term should be applied only to trilobite individuals in which complete postcephalic segmentation has been attained. Since in *Shumardia* (Fig. 87H, I) a 5th segment is added to the pygidium after the complete number of thoracic segments has been developed, STUBBLEFIELD called only the original of Figure 87I an holaspis, and not that of Figure 87H. Similar addition of segments to the pygidium has long been known to take place in *Dalmanitina* (1, Pl. 26). Probably it occurs also in other genera having many segments in the pygidium or with a larger number of axial rings than indicated segments in the

pleural regions; examples are *Dionide*, which has 20 or more segments in the pygidium, Carboniferous proetids (29), and encrinurids. That such additions do not always take place, however, is demonstrated by *Ceraurinella* (Fig. 101) and *Ceraurus* (5). In species of both of these genera the complement of segments of the holaspis pygidium is present in the transitory pygidium and no later additions occur.

Addition of segments to the pygidium must be the result of continued activity of the zone of growth after the thorax is complete. Evidently one could select either completion of the thorax or cessation of budding of new segments as important points in development. Seemingly, in *Ceraurus* and *Ceraurinella* new segments cease to appear before the thorax is complete, whereas in many other trilobites the reverse is true. Future studies may call for recognition of ontogenetic stages that subdivide development at both points, but here prevailing practice is followed in making a subdivision only at completion of the thorax.

Records of minimum length (*sag.*) of holaspides include those of *Shumardia pusilla*, 1.8 mm. (25); *Leptoplastoides salteri*, 5.73 mm. (16); *Sao hirsuta*, 7.0 mm. (1); and *Paradoxides*, 13.5 mm. (30). Commonly, holaspides attain a length of several cm. but records (18) of much greater length are found, for example, holaspides of *Isotelus*

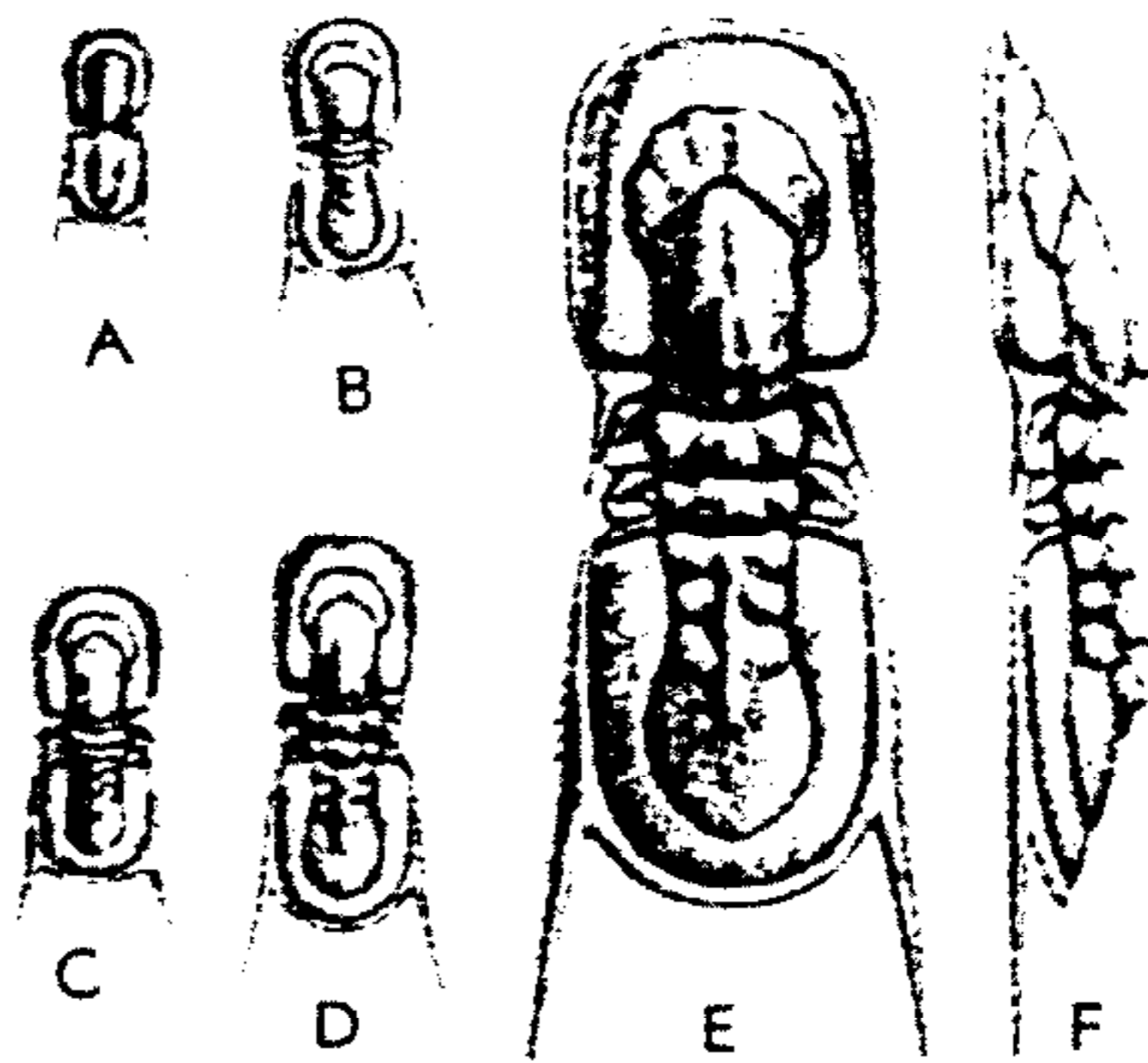

FIG. 105. Ontogenetic stages of *Pleuroctenium granulatum* (BARRANDE), Cam., Bohemia; A-C, meraspid "degrees" 0 (X6), 0 (X5), 1 (X4); D, holaspis, X4; E, F, holaspis, dorsal, lateral, X6 (all 1*).

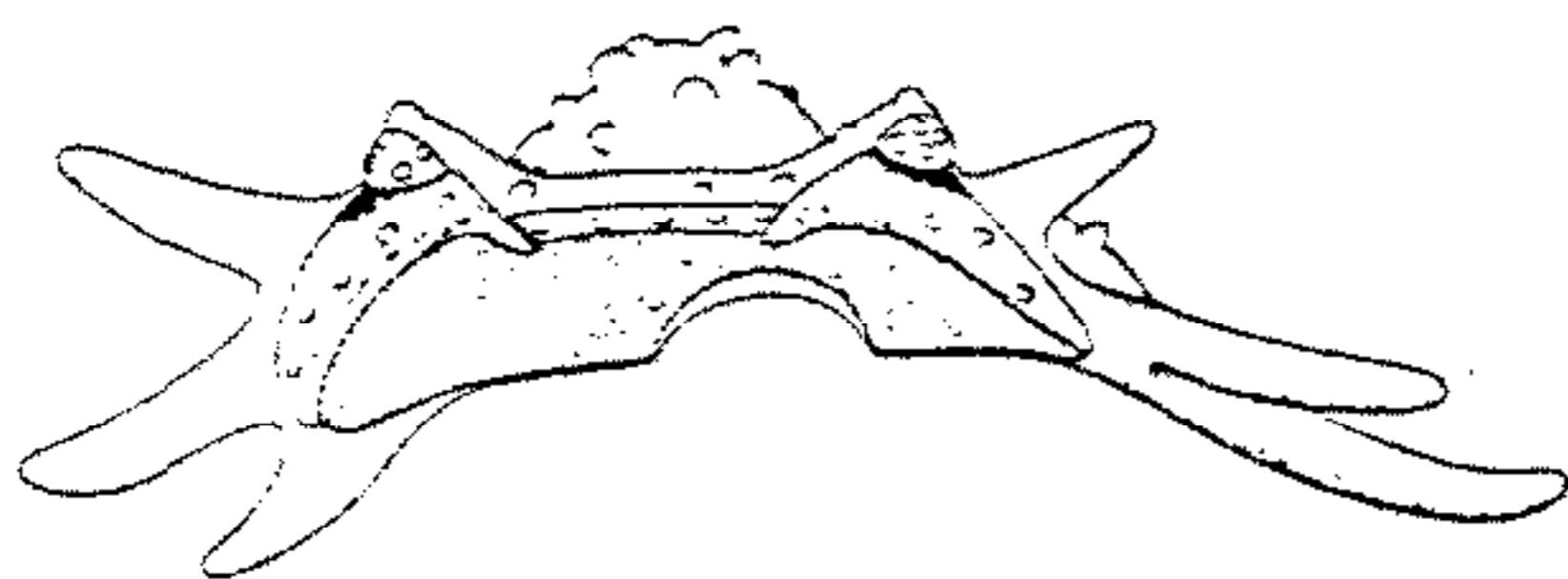

FIG. 106. Cranidium of *Acanthoparypha chiropyga* WHITTINGTON & EVITT, M.Ord., E.USA (Virginia); specimen showing librigenae and rostral plate, $\times 65$ (37*).

gigas showing a range from 8 to 440 mm., and holaspides of species of *Paradoxides* attaining a length (*sag.*) of 300 to 400 mm. While at least a 5-fold increase in length may occur during this period, increase may be 30- or 40-fold. Augmentation of length during complete ontogeny of a trilobite is of the order of at least 50-fold (e.g., *Sao*, 0.6 mm. to about 30 mm.) and it may reach 400-fold (e.g., *Isotelus*, *Paradoxides*). *Uralichas ribeiroi*, from Lower Ordovician rocks of Portugal, is stated (18) to be the largest known trilobite, 70 cm. in length; no complete specimen is known, about a fifth of the reported length being that of the posterior pygidial spine.

Comparison of holaspides of different length (*sag.*) shows that changes occur during this period of growth. These include outline, relative proportions, convexity of parts of the exoskeleton, depth of furrows, and the nature of various other features. Adequate suites of complete exoskeletons are not many, so that it is rarely possible to go beyond generalities. One example is RAYMOND'S (17) study of *Isotelus gigas*. The smallest known holaspis is 9.4 mm. in length (36). As size increases, both cephalon and

pygidium becoming longer than the cephalon, the axial lobe widens, librigenal spines, after being reduced, disappear, and the genal angles become rounded. In what is probably the late meraspid period of *Isotelus* the glabella is convex, with lateral furrows and lobes and a median tubercle, and the transitory pygidium has a well-defined axis showing many axial rings, pleural furrows, and interpleural grooves (33, Pl. 75, figs. 27-29, 34-36). In small holaspides these convexities and furrows are smoothed out.

In the Devonian *Dipleura* COOPER (4) has described how holaspides ranging in length from 8 to 40 mm. undergo a series of changes that include loss of 3 pairs of lateral glabellar furrows (at 11 to 14 mm. length), gradual loss of ring and pleural furrows, smoothing of the pygidial axis, and widening of the thoracic axis. Some of these changes are like those observed in the ontogeny of *Isotelus*, a genus belonging to a very different family, although the changes occur at different stages in development.

In *Acanthoparypha* (Figs. 91, 106), *Holia* (37), and *Flexicalymene* (33), deep lateral glabellar furrows, occipital furrows, and axial ring furrows are retained in the holaspid period. Convexity of the axial regions may increase with size, and genal or occipital spines become longer and stouter. If the external surface is spinose or tuberculate, the symmetrical paired arrangement of larger spines or tubercles seen in the meraspid period is less conspicuous. While these changes in convexity, outline, and size of particular parts do occur, measurements made on Cambrian trilobites (7, 11, 23) suggest a general rectilinear relationship between dimensions at different sizes.

REFERENCES

Barrande, Joachim

- (1) 1852, *Système Silurien du Centre de la Bohême: 1ere Partie, Crustacés, Trilobites: v. I, texte*, 935 p., planches, 51 pl. (Prague & Paris).

Beecher, C. E.

- (2) 1893, *Larval forms of trilobites from the Lower Helderberg Group: Am. Jour. Sci., ser. 3, v. 46*, p. 142-147, pl. 2.
 (3) 1895, *The larval stages of trilobites: Am. Geol., v. 16*, p. 166-197, pl. 8-10.

Cooper, G. A.

- (4) 1935, *Young stages of the Devonian trilo-*

bite Dipleura dekayi Green: Jour. Paleont., v. 9, no. 1, p. 3-5, pl. 1.

Evitt, W. R.

- (5) 1953, *Observations on the trilobite Ceraurus: Jour. Paleont., v. 27, no. 1*, p. 33-48, pl. 5-8, fig. 1.

Ford, S. W.

- (6) 1877, *On some embryonic forms of trilobites from the Primordial Rocks at Troy, N.Y.: Amer. Jour. Sci., ser. 3, v. 13*, p. 265-273, pl. 4.

Gaines, R. B., Jr.

- (7) 1951, *Statistical study of Irvingella, Upper*

Cambrian trilobite: Texas Jour. Sci., no. 4, p. 606-616, 5 fig., 1 pl.

Hupé, Pierre

- (8) 1953, *Classification des trilobites*: Ann. Paléont., v. 39, p. 61-168 [1-110], fig. 1-92.
 (9) 1955, *Classification des trilobites*: Ann. Paléont., v. 41, p. 91-325 [111-345], fig. 93-247.

Lalicker, C. G.

- (10) 1935, *Larval stages of trilobites from the Middle Cambrian of Alabama*: Jour. Paleont., v. 9, no. 5, p. 394-399, pl. 47.

Palmer, A. R.

- (11) 1954, *The faunas of the Riley formation in central Texas*: Jour. Paleont., v. 28, no. 6, p. 709-786, pl. 76-92, 6 fig.
 (12) 1957, *Ontogenetic development of two olenellid trilobites*: Same, v. 31, no. 1, p. 105-128, pl. 19, 9 fig.
 (13) 1958, *Morphology and ontogeny of a Lower Cambrian ptychoparioid trilobite from Nevada*: Same, v. 32, no. 1, p. 154-170, pl. 25-26.

Poulsen, Christian

- (14) 1923, *Bornholms Olenuslag og deres Fauna*: Danm. Geol. Undersøg., ser. 2, no. 40, p. 1-83, pl. 1-3.

Rasetti, Franco

- (15) 1953, *Phylogeny of the Cambrian trilobite family Catillicephalidae and the ontogeny of Welleraspis*: Jour. Paleont., v. 28, p. 599-612, pl. 62, 4 fig.

Raw, Frank

- (16) 1925, *The development of Leptoplastus salteri and other trilobites*: Quart. Jour. Geol. Soc. (London), v. 81, p. 223-324, pl. 15-18, 1 fig.

Raymond, P. E.

- (17) 1914, *Notes on the ontogeny of Isotelus gigas DeKay*: Harvard Univ., Mus. Comp. Zool., Bull., v. 58, p. 247-263, pl. 1-3.
 (18) 1931, *Notes on invertebrate fossils, with descriptions of new species*: Same, v. 55, no. 6, p. 165-213, pl. 1-5.

Ross, R. J.

- (19) 1951, *Ontogenies of three Garden City (early Ordovician) trilobites*: Jour. Paleont., v. 25, p. 578-586, pl. 81-84.
 (20) 1951, *Stratigraphy of the Garden City Formation in northeastern Utah, and its trilobite faunas*: Peabody Mus. Nat. Hist., Bull. 6, 161 p., 36 pl. (New Haven).
 (21) 1953, *Additional Garden City (early Ordovician) trilobites*: Jour. Paleont., v. 27, p. 633-646, pl. 62-64.

Růžička, R.

- (22) 1943, *Příspěvek k ontogenii českých Paradoxidu a rodu Sao* (with German summary): Věstník Král. České Spol. Nauk, tř. Mat.-Přir., p. 1-42, pl. 1-5.

Shaw, A. B.

- (23) 1952, *Paleontology of northwestern Vermont. II. Fauna of the Upper Cambrian Rockledge conglomerate near St. Albans*: Jour. Paleont., v. 26, no. 3, p. 458-483, fig. 1-5, pl. 57.

Størmer, Leif

- (24) 1942, *Studies on trilobite morphology, Part II. The larval development, the segmentation and the sutures, and their bearing on trilobite classification*: Norsk geol. tidsskr., v. 21, p. 49-164, pl. 1-2, fig. 1-19.

Stubblefield, C. J.

- (25) 1926, *Notes on the development of a trilobite, Shumardia pusilla (Sars)*: Jour. Linn. Soc., Zool. (London), v. 36, p. 345-372, pl. 14-16.
 (26) 1936, *Cephalic sutures and their bearing on current classifications of trilobites*: Biol. Rev. (Cambridge Philos. Soc.), v. 11, p. 407-440, fig. 1-9.

Temple, J. T.

- (27) 1952, *The ontogeny of the trilobite Dalmanitina olini*: Geol. Mag., v. 89, no. 4, p. 251-262, pl. 9-10.

Walcott, C. D.

- (28) 1910, *Cambrian geology and paleontology. No. 6, Olenellus and other genera of the Mesonacidae*: Smithsonian Misc. Coll., v. 53, no. 6, p. 231-422+unpaged index, pl. 23-44.

Weller, J. M.

- (29) 1937, *Evolutionary tendencies in American Carboniferous trilobites*: Jour. Paleont., v. 2, no. 4, p. 337-346, fig. 1-4.

Westergård, A. H.

- (30) 1936, *Paradoxides oelandicus beds of Öland*: Sver. Geol. Undersök., ser. C., no. 394 (Årsbok 30, no. 1), p. 1-66, pl. 1-12.

Westoll, T. S.

- (31) 1950, *Some aspects of growth studies in fossils*: Proc. Roy. Soc., London, ser. B, v. 137, no. 889, p. 490-509, figs.

Whittington, H. B.

- (32) 1940, *On some Trinucleidae described by Joachim Barrande*: Am. Jour. Sci., v. 238, p. 241-259, pl. 1-4.
 (33) 1941, *Silicified Trenton trilobites*: Jour. Paleont., v. 15, p. 492-522, pl. 72-75, 13 fig.
 (34) 1956, *Beecher's supposed odontopleurid protaspis is a phacopid*: Same, v. 30, p. 104-109, pl. 24, fig. 1-2.
 (35) 1956, *Beecher's lichid protaspis and Acanthopyge consanguinea (Trilobita)*: Same, v. 30, p. 1200-1204, pl. 131.
 (36) 1957, *The ontogeny of trilobites*: Biol. Rev. (Cambridge Philos. Soc.), v. 32, p. 421-469, fig. 1-29.

———, & Evitt, W. R.

- (37) 1953, *Silicified Middle Ordovician trilobites*: Geol. Soc. America Mem. 59, 137 p., 33 pl., 27 fig.

SOURCES OF ILLUSTRATIONS

The following index numbers refer to sources other than those given in the preceding list of references.

- (38) Hintze, L. F.
 (39) Rasetti, Franco
 (40) Raw, Frank
 (41) Whittington, H. B.

CLASSIFICATION

By H. J. HARRINGTON

CONTENTS

| | PAGE |
|---|------|
| DEVELOPMENT OF CLASSIFICATION | O146 |
| Early work | O146 |
| Beecher's classification | O146 |
| Gürich's classification | O148 |
| Swinnerton's classification | O149 |
| Poulsen's classification | O149 |
| Rudolf Richter's classification | O150 |
| Størmer's classification | O150 |
| Classifications by Henningsmoen and Hupé | O151 |
| SUTURES AS CRITERIA FOR DEFINITION OF MAJOR TRILOBITE DIVISIONS | O152 |
| Origin of sutures | O153 |
| Primary suture patterns | O153 |
| Opisthoparian and proparian sutures | O154 |
| Marginal sutures | O156 |
| Secondarily derived suture patterns | O158 |
| Trilobite types defined by suture patterns | O158 |
| AGNOSTID TRILOBITES | O159 |
| TRILOBITE CLASSIFICATION ADOPTED IN <i>Treatise</i> | O160 |
| REFERENCES | O167 |

A wholly satisfactory, natural classification of trilobites is beyond possibility at the present moment. The truth of this assertion becomes immediately apparent by simply calling attention to the fact that among genera recognized in this volume 121 are regarded as "*incertae sedis*," without familial allocation. It is true that some of these genera are imperfectly known, but many are as well known as most trilobites that can be readily classified into families. The fault is not with the fossils but with our understanding of the truly relevant and diagnostic characters to be used for establishment of familial and suprafamilial taxa.

Difficulties in the way of a natural

classification are (1) entire lack of information concerning the internal anatomy of trilobites, particularly that referring to the nervous system, (2) inadequate knowledge of larval development, complete ontogenies being known only for a few species, (3) insufficiency of data on the nature of ventral appendages, (4) unsatisfactory knowledge of the ventral cephalic sutures in many genera, (5) inadequate understanding of the original cephalic segmentation, (6) homeomorphy of some trilobites, especially the so-called "smooth" forms, and (7) likely possibility that some trilobite lineages may have developed a mineralized carapace late in their phylogenetic evolution.

DEVELOPMENT OF CLASSIFICATION

EARLY WORK

As the number of described genera of trilobites steadily increased during the course of the last century, several paleontologists attempted at various times to classify them into families and taxa of supra-familial rank. Most of these classifications laid undue stress on morphological characters that now are regarded as having less than secondary value. Some, however, contained the germs of ideas that when fully developed by different paleontologists during the present century led to proposal of more satisfactory groupings.

The first classification of trilobites, by BRONGNIART (1822), amounted only to division into 5 genera of species that previously had been referred to *Entomolithus paradoxus*. In 1827, DALMAN arranged the trilobites in 2 groups, according to whether they possessed eyes or lacked them. QUENSTEDT (1837) based his classification on structure of the eyes and number of thoracic segments. EMMRICH (1839) made use of ocular characters for his first classification, taking account also of shape of the pleurae. MILNE EDWARDS (1840) regarded the enrollment ability of trilobites as of primary importance. GOLDFUSS (1843), entertaining ideas similar to those of DALMAN, divided the trilobites into 3 groups based on the presence or absence of eyes, and on their structure. BURMEISTER (1843) accepted MILNE EDWARDS' ideas and stressed the importance of size of the pygidium and characters of the pleurae. EMMRICH's second classification (1845) took into account thoracic features, structure of the eyes and facial sutures. HAWLE & CORDA (1847) divided trilobites into 2 groups, one characterized by an entire pygidium and the other by a lobate or serrated pygidium. M'COY (1849) regarded the presence or absence of articulating facets on the pleurae as a character of prime importance. BARRANDE (1852) based his classification on the structure of the pleurae.

SALTER (1864) used a combination of different features, particularly number of the thoracic segments, size of the pygidium, presence and course of the facial sutures, and ocular characters. On these features, he

divided the trilobites into 4 groups termed Agnostini, Ampycini, Asaphini, and Phacopini. The first 2 groups included genera with reduced number of thoracic segments and pygidium proportionally enlarged. The Agnostini lacked eyes and facial sutures, whereas the Ampycini had "eyes often absent" and "facial suture obscure, or submarginal, or none." The last 2 groups included genera with a "considerable number" of thoracic segments and reduced pygidium. The Asaphini had smooth eyes usually moderately developed and facial sutures "ending on the posterior margin," whereas the Phacopini had well-developed eyes (usually faceted) and facial sutures "ending on the external (=lateral) margin." SALTER's scheme was a great improvement over all previous attempts to classify the trilobites and, in truth, it contains the germs of both BEECHER's and GÜRICH's later classifications. CHAPMAN's (1889) and HAECKEL's (1896) groupings were certainly very inferior to SALTER's and are now forgotten. CHAPMAN recognized 4 primary groups of trilobites based on quite arbitrary morphological features, whereas HAECKEL proposed 2 orders (Protrilobita or Archiaspides, and Eutrilo-bita or Pygidata) based on the absence or presence of "true pygidium" and on characters of the thoracic segments.

BEECHER'S CLASSIFICATION

Near the close of the last century, C. E. BEECHER (1897) attempted to establish a "natural" classification of trilobites based on biological considerations. As his ideas have deeply influenced the thoughts of later paleontologists, it seems desirable to give a summary of his classification and of the underlying principles. BEECHER's conception, in its turn deeply influenced by HAECKEL's famous "law of morphogenesis" or "recapitulation theory," which asserts that the ontogenetic development of the individual recapitulates the phylogenetic development of the species, was based on the assumption that the trilobite protaspis was a phylembryo in JACKSON's (1890) sense. The protaspides, therefore, shared certain features regarded as characterizing the whole class. Using the recapitulation theory as a guiding principle, BEECHER analyzed the ontogenetic development of trilobites out of

the so-called phylembryonic stage, and believed that he could unravel the natural sequence of evolutionary events. He regarded the eye-bearing librigenae as the most significant feature of trilobites and assumed that in the earliest larval stages of all but the highest trilobites they were ventral in position. During ontogeny the librigenae migrated from the ventral to the dorsal side of the cephalon together with the marginal suture, which thus gave origin to the facial sutures. This was accompanied by migration of the eyes from the ventral side, "first forward to the margin and then backward over the cephalon to their adult position." He concluded, therefore, that eyeless adult trilobites with ventral librigenae were primitive, whereas those possessing eyes and facial sutures were progressive, higher forms. To circumvent the difficulty raised by the presence of dorsal eyes in *Trinucleus* and *Harpes*, BEECHER assumed that these structures were "fixigenal ocelli," not homologous with the "librigenal eyes" of other trilobites.

These considerations led BEECHER to classify trilobites in 3 orders, which he named Hypoparia (Gr., *hypo*, below; *paria*, cheek piece), Opisthoparia (*opisthe*, behind), and Proparia (*pro*, in front of). The Hypoparia were characterized as having ventral librigenae, and ventral, marginal, or submarginal sutures, and lacking compound eyes. The Opisthoparia were defined to include trilobites with librigenae extending on to the dorsal side, bounded by facial sutures that cut the posterior margins of the cephalon so as to leave the genal angles with the librigenae. Librigenal holochroal eyes are well developed in all but the most primitive genera. Lastly, the Proparia were interpreted to comprise trilobites with librigenae extending on to the dorsal side but bounded by facial sutures that cut the lateral margins of the cephalon, so as to leave the genal angles with the fixigenae. Librigenal eyes are scarcely developed or absent in the most primitive genera, but well developed and schizochroal in progressive genera.

At the time when Beecher's paper was published, only 14 trilobite families were recognized; they were distributed among the 3 orders of his classification as follows.

*Summary of Trilobite Classification by
Beecher (1897)*

Order HYPOPARIA—Agnostidae, Harpedidae [=Harpidae]. Trinucleidae

Order OPISTHOPARIA—Conocoryphidae, Olenidae (Paradoxinae, Oryctocephalinae, Oleninae, Dikelocephalinae), Asaphidae [incl. Illaenidae (*sic*)], Proetidae, Bronteidae [=Thysanopeltidae], Lichadidae [=Lichidae], Acidaspidae [=Odontopleuridae]

Order PROPARIA—Encrinuridae, Calymenidae, Cheiruridae, Phacopidae

BEECHER'S classification, adopted readily and unqualifiedly by his former student, P. E. RAYMOND, gained widespread recognition through the latter's contribution (1913) to the ZITTEL-EASTMAN *Textbook of Palaeontology*. By the time of this publication, the number of recognized families had increased to 28, but RAYMOND'S distribution of them among the Hypoparia, Opisthoparia, and Proparia was essentially the same as BEECHER'S, particularly as regards the strange and unnatural grouping of agnostids, harpids, and trinucleids in the same order. Such grouping from the outset called forth objections to BEECHER'S classification, opposing particularly his order Hypoparia.

The first to voice disagreement was POMPECKJ (1898). Subsequently, BEECHER'S classification has been severely criticized by GÜRICH (1907), LAKE (1907, in LAKE, 1906-46), JAEKEL (1909), WOODS (1909), POMPECKJ (1912), SWINNERTON (1915, 1919), POULSEN (1927, 1934), RICHTER (1933), STUBBLEFIELD (1936), STØRNER (1942, 1944), HENNINGSMOEN (1951), and HUPÉ (1953). So many arguments have been accumulated against the classification that it is now completely untenable, even under the modified forms proposed by SWINNERTON (1915), RICHTER (1933), and STØRNER (1942). Most of the objections are based on discoveries made subsequent to the date of BEECHER'S publication. Some of these may be summarized as follows. (1) It is now known that the agnostids have no cephalic sutures and therefore no reason exists for interpretation of the cephalic doublure as "ventral librigenae." (2) No trilobites are known, either in adult or larval stages, bearing ventral eyes on the librigenae. (3) The eodiscid genera *Pagetia* and *Opsidiscus* suggest that the agnostids are derived from eye-

bearing ancestors; *Pagetia*, described by WALCOTT in 1916, has well-developed eyes and proparian sutures; *Opsidiscus*, described by WESTERGÅRD in 1950 (= *Aulacodiscus* WESTERGÅRD, 1936), has ocular tubercles and eye ridges but no facial sutures. (4) The lateral eyes of the harpids now are regarded, following RICHTER's investigations, as simplified or "degenerate" eyes derived from normal schizochroal eyes formed by numerous lenses; far from being "fixigenal ocelli," they are homologous with the "librigenal eyes" of other trilobites. (5) Proparian genera are now known in the midst of otherwise opisthoparian families, and conversely, opisthoparian genera are known in proparian families; these include the proparian *Saltaspis* and *Nericiaspis*, among the opisthoparian Olenidae, and the opisthoparian *Placoparia* and *Bouleia*, among the proparian Pliomeridae and Phacopidae, respectively.

BEECHER's classification, for all its defects, had the virtue of simplicity. Actually, it was a modification of SALTER's (1864) scheme, and the terms Opisthoparia and Proparia paid homage to SALTER's perspicacity in distinguishing the 2 types of facial sutures characterizing his Asaphini and Phacopini.

Though BEECHER's order Hypoparia has been rejected by most paleontologists, his orders Opisthoparia and Proparia have been accepted in many subsequent classifications, though more or less modified in content. This is readily understandable, because distinctions based on characters of the facial sutures provided a very objective and easy means of dividing trilobites into at least 2 main groups. Even at present, when the orders Opisthoparia and Proparia are discarded, the words are widely used (in adjectival form) to denote different conditions of the facial sutures.

GÜRICH'S CLASSIFICATION

BEECHER's classification was never well received by European paleontologists, particularly those of the German school. In 1907, GÜRICH proposed a very different arrangement of trilobites, which, though accepting some of BEECHER's ideas in a modified form, was based mainly on the number of thoracic segments and relative size of the pygidium. GÜRICH's classification, therefore, combined the ideas of QUENSTEDT, EMMRICH, BUR-

MEISTER, SALTER, and BEECHER. His subdivisions were as follows.

Summary of Trilobite Classification by Gürich (1907)

Order OLIGOMERIA (Trilobites with few thoracic segments)

Suborder ISOPYGIA (Pygidium about equal in size to cephalon) — Agnostidae, Microdiscidae [= Eodiscidae]

Suborder HETEROPYGIA (Pygidium distinctly smaller than cephalon) — Trinucleidae [= Trinucleinae], Ampycinae [= Raphiophoridae], Dionideae [= Dionidinae], Aeglininae [= Cyclopyginae]

Order PLIOMERIA (Trilobites with many thoracic segments)

Suborder MICROPYGIA (Pygidium minute, thoracic segments numerous) — Olenellidae, Remopleuridae [= Remopleuridinae], Ellipsocephalidae, (Triarthrae [= Triarthrinae]), Paradoxididae (Paradoxidae [= Paradoxidinae]), Harpedidae [= Harpididae], Olenidae, Cyphaspidae [= Otarionidae], Arethusinidae [= Aulacopleuridae]

Suborder MACROPYGIA (Pygidium longer than half of cephalic length, thoracic segments fewer than half number of pygidial axial rings)

Group OPISTHOPARIA (Facial sutures crossing posterior edge of cephalon) — Proetidae, Dicelloccephalidae [= Dikelocephalidae], Lichidae, Acidaspidae [= Odontopleuridae], Bronteidae [= Thysanopeltidae], Asaphidae (Asaphinae, Nileinae, Illaeninae)

Group GONATOPARIA (Facial sutures intersecting genal angles) — Homalonotidae, Calymenidae

Group PROPARIA (Facial sutures intersecting edges of cephalon in front of genal angles) — Phacopidae, Cheiruridae, Encrinuridae

As pointed out by SWINNERTON (1915), the main weakness of GÜRICH's system lies in its ignoring of the fact that progressive caudalization of thoracic segments is a tendency found in different, quite independent trilobite lineages, the micropygous, isopygous, and macropygous conditions being "evolutionary stages" in various trilobite stocks. Less open to criticism is GÜRICH's subdivision based on number of thoracic segments, but as JAEKEL (1909) remarked, the natural dividing line lies between trilobites having 2 or 3 segments and those having more than 5. JAEKEL (1909) proposed the order Miomera for the first group (including agnostids and eodiscids) and the order Polymera for the second (including all other trilobites). JAEKEL's divisions have

been adopted by such modern authors as WHITEHOUSE (1936) and HUPÉ (1953).

SWINNERTON'S CLASSIFICATION

SWINNERTON (1915), like most paleontologists who have dealt with classification of the trilobites, disagreed with BEECHER mainly on the order Hypoparia. He regarded the agnostid trilobites as "secondarily sutureless," agreeing with JAEKEL (1909) that they "are forms in which the eyes have degenerated and the free cheeks have fused with the fixed cheeks." Accordingly, he placed the agnostids in the order Proparia. On the other hand, he regarded the Olenellidae as being "primarily sutureless," and as exhibiting "the trilobite organization just when these [suture] lines are coming into being." The Olenellidae, however, he placed in the order Opisthoparia. For the genera *Marrella* and *Nathorstia*, he proposed the order Protoparia designed for "the reception of Trilobites and Trilobite-like organisms in which the absence of facial sutures is primary." *Marrella*, however, is not a trilobite, whereas *Nathorstia* is now regarded as a "butter-crab" of *Olenoides serratus*. Accordingly these 2 genera should be removed from Protoparia, which thus fails as an ordinal unit.

SWINNERTON's classification had the merit of not only doing away with the Hypoparia (as GÜRICH had done) but of attempting for the first time to subdivide the Opisthoparia. The guiding principles were: (1) appearance of the facial sutures out of the protoparian stock at various times; (2) progressive caudalization of thoracic segments according to GÜRICH's ideas, but recognizing that this tendency appeared in different trilobite stocks; and (3) increasing importance of the pleurae. His classification is as follows.

Summary of Trilobite Classification by Swinnerton (1915)

- Order PROTOPARIA—*Marrellidae* [=non-Trilobita], *Nathorstia* [=Olenoides]
 Order OPISTHOPARIA
 Suborder MESONACIDA—*Mesonacidae* [=Olenellidae], *Remopleuridae* [=Remopleurididae], *Paradoxidae* [=Paradoxididae], *Zacanthoidae* [=Zacanthoididae]
 Suborder CONOCORYPHIDA
 Section OLENINA—*Olenidae*, *Proetidae*, *Oryctocephalidae*
 Section CONOCORYPHINA—*Conocoryphidae*

Section PTYCHOPARINA—*Ptychoparidae* [=Ptychopariidae], *Solenopleuridae*, *Dicelicephalidae* [=Dikelocephalidae], *Bathyruridae*, *Asaphidae*, *Iliaenidae*

Section CALYMENINA—*Calymenidae*, *Homalontidae*

Suborder TRINUCLEIDA—*Trinucleidae*, *Harpedidae* [=Harpidae], *Raphiophoridae*, *Aeglinidae* [=Cyclopygidae], ?*Ellipsocephalidae*, ?*Shumardiidae*

Suborder ODONTOPLEURIDA—*Odontopleuridae*, *Lichadidae* [=Lichidae], *Bronteidae* [=Thysanopeltidae]

Order PROPARIA—*Encrinuridae*, *Cheiruridae*, *Phacopidae*, *Burlingidae* [=Burlingiidae], ?*Agnostidae*

POULSEN'S CLASSIFICATION

Based on facial sutures, C. POULSEN's (1927) classification was somewhat different from those of BEECHER and SWINNERTON. He regarded the Olenellidae as having functional marginal (perrostral) and facial sutures "*in statu nascendi*." He also regarded the marginal suture of BEECHER's Hypoparia (trinucleids, harpids) as homologous with the perrostral suture of the Olenellidae and believed that the Conocoryphidae also have similar marginal sutures. He concluded that "all trilobites with real facial sutures are descendants from the Olenellidae."

POULSEN's conception was based on (1) objection to BEECHER's classification "because in several cases he has used sutures which are not homologous with the facial suture"; (2) belief that the Olenellidae "undoubtedly represent the most primitive type," since they have a marginal (perrostral) suture and incipient facial sutures with well-developed posterior sections but "not yet developed" anterior sections; (3) belief that the marginal suture of BEECHER's Hypoparia, as well as the marginal suture of the Conocoryphidae, is homologous with the perrostral suture of the Olenellidae; (4) belief that the hypoparian type of trilobite was "probably formed before the frontal branches (anterior sections) of the facial sutures came into being in the Opisthoparia"; and (5) belief that all trilobites with "real facial sutures" have descended from the Olenellidae.

POULSEN, therefore, raised SWINNERTON's suborder Mesonacida to the rank of order, and proposed 2 new orders for the remainder of the trilobites: *Integricephalida*, for those without facial sutures, and *Suturi-*

cephalida, for those with facial sutures. The Integricephalida (equivalent to BEECHER's Hypoparia with addition of the Conocoryphidae), were divided into the suborders Opisthoparia and Proparia. In 1932, POULSEN replaced the etymologically hybrid term Suturicephalida with Epiparia, and, in 1934, he revived the name Hypoparia for Integricephalida. POULSEN's classification was as follows.

*Summary of Trilobite Classification by
Poulsen (1927-1934)*

Order HYPOPARIA (=Integricephalida, 1927)—
Conocoryphidae, Eodiscidae, Agnostidae, Trinucleidae, Harpidae, ?Shumardidae [=Shumardiidae]

Order MESONACIDA—Olenellidae

Order EPIPARIA (=Suturicephalida, 1927)

Suborder OPISTHOPARIA—Redlichidae [=Redlichidae], Zacanthoidae [=Zacanthoididae], Ptychopariidae [=Ptychopariidae], Paradoxidae [=Paradoxidae], Corynexochidae, Oryctocephalidae, Illaenidae, Bronteidae [=Thysanopeltidae], Symphysuridae [=Nileidae], Dikelocephalidae, Asaphidae, Bathyuridae, Proctidae, Remopleuridae [=Remopleuridae], Raphiophoridae, Aeglinidae [=Cyclopygidae], Ellipsocephalidae, Anomocaridae, Solenopleuridae, Olenidae, Cyphaspidae [=Otarionidae], Calymenidae, Homalonotidae, Odontopleuridae, Lichidae [=Lichidae]

Suborder PROPARIA—Burlingidae [=Burlingiidae], Norwoodiidae, Cheiruridae, Encrinuridae, Phacopidae, ?Menomoniidae

**RUDOLF RICHTER'S
CLASSIFICATION**

RUDOLF RICHTER (1933) accepted BEECHER's orders Opisthoparia and Proparia but, like most authors, rejected the Hypoparia. He considered that the marginal sutures of the Harpidae are not facial sutures but a "new development" consequent on the loss of facial sutures and development of the cephalic fringe. The orders Opisthoparia and Proparia were divided into suborders and superfamilies that generally follow the arrangement of SWINNERTON. In essentials, therefore, RICHTER's classification amounts to a grouping of families in superfamilies according to their presumed affinities and assignment of these superfamilies to suborders. His classification is as follows.

*Summary of Trilobite Classification by
Rudolf Richter (1933)*

Order OPISTHOPARIA

Suborder REDLICHINA

Superfamily REDLICHIDEA—Paradoxidae, Mesonacidae [=Olenellidae], Redlichidae

Superfamily ZACANTHOIDEA—Lichidae, Odontopleuridae, Remopleuridae, Zacanthoididae, Ceratopygidae, Oryctocephalidae

Superfamily BATHYURISCIDEA — Corynexochidae, Bathyuriscidae, Scutellidae [=Thysanopeltidae], Illaenidae

Superfamily DIKELOCEPHALIDEA—Dikelocephalidae, Asaphidae, Symphysuridae [=Nileidae], Cyclopygidae

Suborder PTYCHOPARIINA

Superfamily ELLIPSOCEPHALIDEA—Olenidae, Otariionidae, Proetidae, Ellipsocephalidae

Superfamily CRYPTOLITHIDEA — Raphiophoridae, Cryptolithidae [=Trinucleidae], Shumardiidae

Superfamily PTYCHOPARIIDEA — Conocoryphidae, Harpidae, Ptychopariidae, Solenopleuridae

Superfamily CALYMENIDEA—Menomoniidae, Calymenidae, Homalonotidae

Order PROPARIA

Superfamily EODISCIDEA—Agnostidae, Eodiscidae

Superfamily NORWOODIDEA—Norwoodiidae

Superfamily BURLINGIDEA—Burlingiidae

Superfamily PHACOPIDEA—Phacopidae, Cheiruridae, Encrinuridae

STØRMER'S CLASSIFICATION

LEIF STØRMER's (1942) classification, "based chiefly on the ontogenetic development" of trilobites, is actually a modification of BEECHER's scheme with addition of some of SWINNERTON's ideas. STØRMER is the only modern paleontologist who recognizes BEECHER's order Hypoparia. He places the Olenellidae, however, in what he considers to be SWINNERTON's Protoparia but he uses this term invalidly since SWINNERTON's original definition of the group did not include the Olenellidae. His classification is as follows.

*Summary of Trilobite Classification by
Størmer (1942)*

Order PROTOPARIA (Primitive trilobites with ventromarginal or marginal cephalic suture; lateral eyes well developed; preantennal segment well developed on dorsal side of protaspis; intergenal [metagenal] spines present in anaprotaspis, meta-protaspis, meraspis, and partly in holaspis periods)—Olenellidae

Order HYPOPARIA (Trilobites with marginal, supra-marginal or ?ventromarginal sutures; lateral eyes absent or little developed; protaspis broad with preantennal segment probably well developed on dorsal side; metagenal spines absent in meraspid and later periods)—Cryptolithidae [=Trinucleidae], Harpidae, ?Raphiophoridae, ?Agnostidae, ?Shumardidae [=Shumardiidae]

Order OPISTHOPARIA (Trilobites with facial sutures crossing margin behind genal angles, at corners, of which genal spines may occur; protaspis with preantennal segment slightly or not at all developed on dorsal side; metagenal spines present in the metaprotaspid and meraspid periods)—All remaining trilobite families exclusive of Proparia.

Order PROPARIA (Trilobites with facial sutures crossing margin in front of genal angles, at corner of which intergenal [metagenal] spines may occur; protaspis with preantennal segment not developed on dorsal side; metagenal spines present in metaprotaspid and later periods)—Eodiscidae, Norwoodidae [=Norwoodiidae], Burlingiidae, Phacopidae

CLASSIFICATIONS OF HENNINGSMOEN AND HUPÉ

The most modern classifications, by GUNNAR HENNINGSMOEN (1951) and PIERRE HUPÉ (1953, 1953-55), are alike in doing away finally with all traces of BEECHER's scheme. Both agree with KOBAYASHI (1935), STUBBLEFIELD (1936), and RASETTI (1948) that no classification of trilobites can be based on a single feature and both pay special attention to STUBBLEFIELD's prediction that "it will probably be found that the safest criteria of affinity are collective characters developed in the axial region of the shield" and especially of the cephalon. HENNINGSMOEN in particular has stressed the importance of development of the glabella and its furrows, especially the "form, direction, and relative position of the glabellar furrows," accepting STØRMER's (1942) views that the glabellar furrows appear to be boundaries between primary cephalic somites.

HENNINGSMOEN's classification is actually an attempt to group trilobite families into superfamilies without further grouping into orders or suborders. HUPÉ's classification, on the other hand, recognizes JAEKEL's orders Miomera and Polymera, these being subdivided into various superfamilies. With this exception, and with some differences of opinion as to grouping of families into

superfamilies, the 2 classifications are basically similar.

Summary of Trilobite Classification by Hupé (1953-1955)

Order MIOMERA (Diminutive trilobites with subequal cephalon and pygidium and with 2 or 3 thoracic segments)

Superfamily EODISCOIDAE — Hebediscidae, Weymouthiidae, Pagetiidae, Eodiscidae (Eodiscinae, Calodiscinae, Spinodiscinae, Brevidiscinae), Dawsoniidae, Aulacodiscidae

Superfamily AGNOSTOIDAE—Platagnostidae, Lejopygidae, Phalacromidae, Leiagnostidae, Sphaeragnostidae, Condylopygidae, Diplagnostidae, Agnostidae, Hastagnostidae, Micragnostidae, Spinagnostidae, Clavagnostidae, Geragnostidae, Cyclagnostidae, Trinodidae

Order POLYMERA (Trilobites having more than 3 thoracic segments, minimum 5)

Superfamily OLENELLOIDAE—Olenellidae (Fallotaspidae, Nevadiinae, Olenellinae, Elliptocephalinae, Wanneriinae, Neltneriinae, Holmiinae, Olenelloidinae), Daguinaspidae [=Daguinaspididae], Lancastriidae

Superfamily REDLICHIOIDAE [=Paradoxididae] Redlichiidae (Redlichiinae, Pararedlichiinae), Neoredlichiidae, ?Yinitidae, Latiredlichiidae, Saukiandidae, Dolerolenidae, Abadiellidae, Bathynotidae, Metadoxididae, Protolenidae (Protoleninae, Termierellinae, Bigotinae, Myopsoleninae, Strenuellinae), Antatlasidae, Ellipsocephalidae (Ellipsocephalinae, Aldoniinae), Palaeolenidae (Palaeoleninae, Kingaspidinae, Hartshilliinae), Paradoxididae (Paradoxidinae, Centroleurinae, Xystridurinae), Hicksiidae

Superfamily CORYNEXOCHOIDAE — ?Proerbiidae, ?Edelsteinaspidae [=Edelsteinaspididae], Dinesidae, Zacanthoididae, Albertellidae, Dolichometopidae (Bathyriscinae [=Dolichometopinae], Mexicaspinae [=Mexicaspinae], Orriinae, Glossopleurinae, Hanburiinae, Vanuxemellinae), Corynexochidae (Corynexochinae, Acontheinae), Ogygopsidae, Protypidae, Dorypygidae (Dorypyginae, Holteriinae), Oryctocephalidae (Oryctocephalinae, Oryctocarinae, Tonkinellidae [=Tonkinellinae])

Superfamily AGRAULOIDAE—Agraulidae, Micragraulidae, Pelthopeltidae

Superfamily PARASOLENOPLEUROIDAE [=Yokusenioidae] — Yokuseniidae, Yunnanocephalidae, Parasolenopleuridae, Anomocarellidae

Superfamily PTYCHOPARIOIDAE [=Conocoryphoidae]—Alokistocaridae (Alokistocarinae, Amececephalinae), Nepeidae, ?Antagmididae, Elrathinidae (Elrathininae, Plagiurinae, Solenopleurellinae), Ptychopariidae (Ptychopariinae, Howellaspidinae [=Howellaspidinae], Elrathiellinae,

- Clappaspinae [=Clappaspidinae], Iraniinae), Saoidae, Conocoryphidae (Conocoryphinae, Bailiellinae, Ctenocephalinae, Holocephalinae, Meneviellinae), Atopsidae
- Superfamily SOLENOPLEUROIDAE — Solenopariidae, Solenopleuridae (Solenopleurinae, Menocephalinae, Heterocaryoninae), Acrocephalitidae, Lonchocephalidae, Talbotinidae, Burnetiidae [=Dokimocephalidae], Glyptometopidae, Hystricuriidae, Toernquistiidae, Dimeropygidae, Bathyriidae (Bathyurinae, Bathyurellinae), Otariionidae (Otariioninae, Cyphaspididinae), Punctulariidae, Raymondinidae, Isocolidae
- Superfamily UTIOIDAE [=Shumardioidae] — ?Emmrichellidae, Utiidae [=Utiidae], Liostracinidae, Paracedariidae, Cedariidae, Norwoodiidae (Norwoodiinae, Levisaspidae [=Levisaspidinae]), Shumardiidae, Myindidae, Toxotididae
- Superfamily ASAPHISCOIDAE [=Ceratopygoidae] — Asaphiscidae (Asaphiscinae, Lecanopleurinae), Blountiidae, Crepicephalidae (Crepicephalinae, Kopturinae), Tsinaniidae, Marjumiidae, Housiidae, Ceratopygidae (Ceratopyginae, Mansuyellinae, Hysteroleninae)
- Superfamily OLENOIDAE — Damesellidae (Damesellinae, Dorypygellinae, Drepanurinae), Missisquoiidae, Elviniidae (Elviniinae, Maladiinae [=Maladaiinae]), Richardsonellidae, Sarkiidae [=Sarkiidae], Olenidae (Oleninae, Papyriaspinae [=Papyriaspidinae], Leptoplastinae, Triarthrinae, Jujuyaspinae [=Jujuyaspidinae], Aulacopleurinae), Lloydidae, Eurekiidae, Illaenuriidae, Leiostegiidae (Leiostegiinae, Mansuyinae [=Mansuyiinae], Eochuanginae [=Eochuangiinae]) Genevievellidae, Menomoniidae, Remopleurididae
- Superfamily DIKELOCEPHALOIDAE — Anomocaridae, Changshaniidae, Dike'locephalidae (Dikelocephalinae, Osceolinae), Hungaidae [=Hungaiidae] (Hungainae [=Hungaiinae], Dikelocephalinae, Tingocephalinae)
- Superfamily PTYCHASPIDOIDAE [=Conokephalinoiidae] — Conokephalinidae, Saukiidae (Saukiinae, Prosaukiinae), ?Shirakiellidae, Euptychaspidae [=Euptychaspididae], Ptychaspidae [=Ptychaspididae]
- Superfamily BURLINGIOLIDAE — Burlingiidae
- Superfamily PROETOIDAE — Holotrachelidae, Proetidae, (Proetinae, Proetidellinae, Prionopeltinae, ?Permoproetinae), Tropidocoryphidae (Tropidocoryphinae, Astycoryphinae, Denmarkiinae), Cyrtosymbolidae (Cyrtosymbolinae, Eodrevermanniinae, Pteropariinae), Dechenellidae, Phillipsiidae (Phillipsiinae, Griffithidinae, Ditomopyginae, Anisopyginae), Brachymetopidae
- Superfamily ASAPHOIDAE — Nileidae (Nileinae, Parabarrandiinae), Asaphidae (Asaphinae, Taihungshaninae [=Taihungshaniinae], Ogygiocarinae [=Ogygiocaridinae], Macropyginae), Cyclopygidae
- Superfamily SCUTELLOIDAE [=Illaenoidae] — Styginidae, Theamataspidae [=Theamataspididae], Phillipsinellidae, Scutellidae [=Thysanopeltidae], Illaenidae (Illaeninae, Bumastinae)
- Superfamily LICHADOIDAE — Lichadidae [=Lichidae] (Lichadinae [=Lichinae] Homolichadinae, Tetralichadinae, Echinolichadinae), Trochuridae (Trochurinae, Dicranopeltinae, Platyllichadinae, Euarginae)
- Superfamily ODONTOPLEUROIDAE — Odontopleuridae (Odontopleurinae, Acantholominae [=Leonaspidinae]), Selenopeltidae, Ceratocephalidae (Ceratocephalinae, Dicranurinae, Miraspinae [=Miraspidinae])
- Superfamily TELEPHOIDAE — Komaspidae [=Komaspidae], Ellipsocephaloidae [=Ellipsocephaloididae] Telephidae [=Telephinidae], Glaphuridae
- Superfamily CALYMENOIDAE — Pharostomidae [=Pharostomatidae], Calymenidae (Calymeninae, Colpocoryphinae, Reedocalymeninae), Homalonotidae (Homalonotinae, Eohomalonotinae, Trimerinae)
- Superfamily PHACOPIDAE — Dalmanitidae (Dalmanitinae, Zeliszskellinae, Pterygommetopinae, Astero-pyginae, Neosynphoriinae), Phacopidae (Phacopinae, Bouleinae [=Bouleiinae], Phacopidellinae, Acastinae, Calmoniinae)
- Superfamily CHEIROIDAE — Pliomeridae (Pliomerinae, Protopliomeropsinae, Placopariinae, Pliomerillinae), Cheiruridae (Cheirurinae, Cyrtometopinae, ?Crotalurinae, Sphaerexochinae, Deiphoninae, Areiinae, Staurocephalinae, Helio-merinae), Encrinuridae (Encrinurinae, Cybellinae)
- Superfamily HARPOIDAE — ?Hypotheticidae, Loganopeltidae, Harpididae, Harpidae, Entomaspidae [=Entomaspidae]
- Superfamily TRINUCLEOIDAE — Ithyophoridae, Trigryposidae [=Trigrypidae], Orometopidae, Raphiophoridae (Raphiophorinae, Ampyxini-nae), Selenecemidae, Endymioniidae, Dionididae, Trinucleidae (Trinucleinae, Tretaspinae [=Tretaspidinae], Cryptolithinae, Novaspinae [=Novaspidinae])

SUTURES AS CRITERIA FOR DEFINITION OF MAJOR TRILOBITE DIVISIONS

Since the early times of EMMRICH and SALTER, cephalic sutures have been granted a very prominent position in trilobite classification, and since publication of BEECHER'S (1897) classical paper, it has been almost mandatory to take them into serious consideration. It seems, therefore, worth while to discuss at some length the significance of cephalic sutures as bearing on taxonomic problems.

ORIGIN OF SUTURES

Most modern authors agree that cephalic sutures first developed in trilobites as an answer to the need of facilitating ecdysis. This applies particularly to the facial sutures, which played an important role during molting of the delicate ocular integument. But authors do not agree regarding the relationship of the sutures to the original cephalic segmentation. Do the purely exoskeletal sutures coincide with lines of fusion between cephalic somites, or do they cut across the original cephalic segmentation? Much depends on the answer to these questions. If sutures are purely mechanical devices of secondary origin, cutting across the original cephalic segmentation, as RAW (1953) believes, their taxonomic value is greatly impaired. If, on the other hand, they follow lines of fusion between somites, being, so to speak, a surface expression of deep-seated original segmentation, their taxonomic value is less open to challenge.

Theoretically, at least, it seems logical to accept the premise that lines of weakness represented by the exoskeletal sutures had better chances to develop along lines of fusion between somites than across them. If we but knew the number, position, and boundaries of the fused cephalic segments, it would be easy to settle the issue one way or another. As it is, the problem cannot be solved objectively. The fused cephalic segments have undergone such radical changes that it is impossible to ascertain, beyond dispute, their true number, distribution, and boundaries. This uncertainty is clearly reflected in the 10 different opinions on the subject expressed by 12 different paleontologists: M'COY (1849), BEECHER (1897), JAEKEL (1901, 1909), RAYMOND (1920), HOLMGREN (1916), WALCOTT (1918), WARBURG (1925), HENRIKSEN (1926), RICHTER (1933), STØRMER (1942), RAW (1953), and HUPÉ (1953). The crucial, most difficult, and most debatable point is the interpretation of anterior parts of the cephalon and the preoral ventral plates (hypostoma, rostral plate) in terms of original cephalic segmentation. Of all hypotheses proffered, I favor that of HUPÉ (1953). According to him, the rostral plate, hypostoma, and librigenae are different parts of a single cephalic (ocular) segment. The rostral plate pre-

sumably represents the mesotergite, the hypostoma (or at least its median body) the mesosternite, and the librigenae (probably together with the hypostomal borders and wings) pleural extensions of the segment. If this hypothesis is accepted, the hypostomal and connective sutures are intrasegmental, but corresponding to tergosternal (hypostomal suture) and tergopleural (connective sutures) boundaries. The rostral suture, on the other hand, is part of BARRANDE'S "grande suture," and together with the facial sutures it bounds the ocular segment adaxially. The *grande suture* (rostral plus facial sutures) is thus truly intersegmentary, separating the ocular segment from the mesotergites and pleural extension of the fused postocular somites.

PRIMARY SUTURE PATTERN

With this hypothesis in mind we may now take up the problem of the primary sutural pattern of trilobites. Again, opinions differ greatly in this regard. Published discussions have centered mainly on the origin and interrelations of marginal, opisthoparian, and proparian sutures. BEECHER (1897), for instance, regarded the marginal suture of harpids and trinucleids as primary. SWINERTON (1915) believed that the perrostral ("marginal") suture of the olenellids, as well as the opisthoparian and proparian sutures, arose independently at different times from sutureless ancestors. POULSEN (1927), and apparently also KIAER (1917) and WARBURG (1925), believed the perrostral suture of olenellids to be primary. RAW (1925) and RICHTER (1933), on the other hand, were inclined to regard the proparian sutures as the most primitive but STUBBLEFIELD (1936) and HUPÉ (1953), on the contrary, regard all proparian trilobites as "permanently neotenous opisthoparians."

If we adhere to the hypothesis mentioned above regarding relationship of sutures to original cephalic segmentation, it seems inevitable to conclude that the primary sutural pattern of trilobites was of ptychopariid type, characterized by functional facial, rostral, connective, and hypostomal sutures. Moreover, this is the only type of suture pattern that persisted uninterruptedly throughout the entire life span of the class, from earliest Cambrian times (redlichiids)

to the late Permian (phillipsiids). All other sutural patterns were of transient appearance, and I believe that all of them were derived, at various times and in different ways, from the primary ptychopariid type.

OPISTHOPARIAN AND PROPARIAN SUTURES

Since BEECHER's time, facial sutures have been classed as opisthoparian and proparian, without reference to whether they belong to a ptychopariid type of sutural pattern or some other. The distinction between these 2 types of facial sutures is based on relative position of the rear extremity of the posterior section of the sutures with regard to the genal angle of the cephalon. If the posterior section cuts the posterior cephalic margin "behind" (actually adaxially from) the genal angle, the suture is classed as opisthoparian. If it cuts the lateral margin "in front" of the genal angle, the suture is termed proparian. It should be evident that this purely morphological distinction is based on the conscious or unwitting assumption that the genal angle is a sort of "topographic fixed point" which can be recognized easily in all trilobites. By definition, the genal angle is the posterolateral extremity or "corner" of the cephalon, which is usually marked off by a more or less clear angulation of the margin. Genal angles, however, are far from being "topographic fixed points." In the first place, no genal angles can be recognized objectively in many species belonging to such genera as *Telephina*, *Holotrachelus*, *Acerocare*, *Boeckaspis*, *Peltocare*, and *Peltura*—to mention a few. In these forms, the genal "angles" are perfectly rounded, and there is no way to ascertain the location of the "fixed points" along the cephalic margin. We assume that in these species the genal angles must lie somewhere in front of the rear extremities of the facial sutures, simply because we assume that the facial sutures are opisthoparian. This, however, involves a "*petitio principii*," because we are now defining the genal angle in terms of the facial sutures.

In the second place, it is evident that in many trilobite families the genal angles show a marked tendency to "migrate" forward. This is manifest in such families as the Olenellidae, Zacanthoididae, Remopleurididae, and Olenidae, to mention a few. If

the genal angles are produced into spines, and if within a family intermediate forms exist between those with "normal" and "advanced" genal angles, we can recognize that the advanced spines (which may spring from the anterolateral corners of the cephalon) are homologous with those borne by the "normal" genal angles of other species. This is the case in *Bristolia bristolensis* and *Laudonia bispinata* among the Olenellidae, and in several species of *Ctenopyge* among the Olenidae. It is evident that in these forms, the "genal angles" have shifted forward until they come to occupy an anterolateral position. However, in many of these forms, the posterolateral "corners" of the cephalon are sharply marked off by angulations of the margin. In *L. bispinata* the posterolateral angle even bears a stout spine. What has happened to our "fixed point"? Where now is the "true" genal angle? Our "fixed point" has changed position; whereas by definition the "true" genal angle is the posterolateral corner of the cephalon, by homology it is the anterolateral corner.

Consider now the case of such species as *Ctenopyge flagellifera* and *C. spectabilis*. If these forms lacked anterolateral ("advanced genal") spines, nobody would hesitate to classify the posterolateral angles as "true" genal spines. Moreover, since in both these species the rear extremities of the posterior sections of the facial sutures cut the lateral margins immediately *in front* of these angles, both species would be properly regarded as proparian. Indeed, these species, described respectively by ANGELIN in 1854 and BRØGGER in 1882, as well as several others belonging to the genus *Ctenopyge*, are actually proparian. If they have rarely been recognized as such, it has been due simply to the mesmeric effect of the "advanced genal spines." If these species were to be regarded as opisthoparian on the grounds that the posterolateral corners of the cephalon are not homologous with the "true" (advanced) genal angles, then *Saltaspis* and *Nericiaspis* should also be regarded as opisthoparian, and, for that matter, all classical proparian phacopid and cheirurid genera as well. Probably nobody will deny that the genal angles of *Phacops* and *Cheirurus* are not homologous with the "true" (advanced) genal angles of *Ctenopyge spectabilis*.

What, then, is the distinction between opisthoparian and proparian sutures? Accepting the conclusion that posterior sections of the sutures invariably bound the rear (adaxial) part of the ocular segment, the suture is opisthoparian if the posterolateral corners of the cephalon belong to this segment. On the other hand, if the posterolateral angles belong to one of the rear post-ocular segments, the suture is proparian. The olenellid trilobites differ from others in that the posterolateral angles of the cephalon belong to one of the anterior post-ocular segments ("frontal region" of HUPÉ), both sections of the facial sutures cutting the posterior cephalic margin. This suture is metaparian. It should be apparent that, in all 3 types, the relation between the posterior sections of the facial sutures and the ocular segment is the same, and that in all 3 the posterior sections of the sutures are homologous, even though they have different "topographic" positions. On the other hand, the relation between posterolateral cephalic angles and cephalic segmentation is different in the 3 cases, the "angles" being heterologous even if they have the same topographic position. Obviously, then, the distinction between opisthoparian and proparian sutures is one of degree, and accordingly it is not apparent why we grant it fundamental importance and stand in its awe. Whether the rear extremities of the sutures will cut the posterior or the lateral cephalic margins is an incidental feature depending on the differential growth of the fused cephalic segments during ontogeny. It is seemingly clear that reduction of the ocular segment leading to a proparian condition is a persistent feature characterizing whole trilobite lineages, but it is also evident that such a tendency appeared independently in many trilobite stocks characterized by opisthoparian sutures. Several olenids are now known to be proparian. These include not only the genera *Saltaspis* and *Nericiaspis*, but also several species of *Ctenopyge*, and possibly also of *Peltura*. *Illaenurus quadratus*, among the Illaenuridae, is another example of a proparian form in the midst of an otherwise opisthoparian family. Conversely, opisthoparian genera are known in the midst of otherwise proparian families. These include *Bouleia* among the Phacopiidae, and *Placoparia* among the Pliomeridae.

The genus *Pliomera* itself is not proparian, but gonatoparian.

In my opinion, the proparian condition is a progressive "evolutionary novelty" which appeared independently in several unrelated trilobite lineages after early Cambrian times. POULSEN's (1923) observations on the ontogeny of *Peltura scarabaeoides*, however, often have been quoted as proof to the contrary. *P. scarabaeoides*, a reputedly opisthoparian olenid, would pass, according to POULSEN, through a meraspid stage showing proparian conditions. If we take POULSEN's observations at their face value, this probably means that *P. scarabaeoides* (in the holaspid stage) is simply another proparian olenid. It should be recalled that this is one of the olenid species having smoothly rounded genal "angles"—so much so, in fact, that the genal angles simply cannot be recognized as such. The opisthoparian condition of *P. scarabaeoides* results from comparisons with closely related species, such as *P. paradoxa*, which bear small librigenal spines close to and in front of the posterior extremities of the facial sutures. From what is known about "migration" of genal angles, this is certainly not a sure way to locate the critical "fixed point" when no spine or angulation of the margin is present. The fact that at least 2 pelturid genera (*Saltaspis*, *Nericiaspis*) are decidedly proparian would make a similar condition in the adult *P. scarabaeoides* not at all strange. It should be recalled, moreover, that the alleged proparian condition in the ontogeny of *P. scarabaeoides* is of comparatively late (meraspid) appearance, a fact that seems accordant with the view that the proparian condition is derived from a primary opisthoparian suture. The early larval (protaspid) sutural condition of *P. scarabaeoides* is unknown, but POULSEN (1927) tried to show that it was also proparian by making comparison with conditions in the protaspides of *Sao hirsuta*, originally regarded as opisthoparian by BARRANDE (1852) but reinterpreted as proparian by POULSEN.

STRAND's (1927) description and illustrations of 2 protaspides of *Olenus gibbosus*, showing what he regarded as proparian sutures, seemed to lend support to POULSEN's contention. In 1942, STØRMER redescribed and illustrated STRAND's specimens, together with 3 other protaspides of *O. gibbosus*, and

(though stating that "the development of the facial suture is not clear") he was prone to believe in a probable proparian condition. The force of these arguments in favor of an early protaspid proparian suture has been recently weakened by WHITTINGTON's re-examination of the ontogeny of *Sao hirsuta*, in which he has claimed the presence of opisthoparian sutures from early larval stages, and discrediting the proparian-sutured small forms figured by RŮŽIČKA.

In other Upper Cambrian trilobites, such as *Welleraspis*, both the protaspides and meraspides also have opisthoparian sutures. This renders likely a similar condition for the protaspides of *Olenus gibbosus*. Actually, no facial sutures can be observed in the protaspides illustrated by STÖRMER, and it is conceivable that the sutures are concealed by the nearly vertical margins of the minute cephalia. It seems, therefore, that no grounds exist for thinking that the early larval (protaspid) stage of *Peltura scarabaeoides* was characterized by a proparian suture. If we should accept the conclusion that in this species both the protaspid and the holaspid stages show opisthoparian sutures, we would be forced to admit that during ontogeny of this trilobite an early (protaspid) opisthoparian condition was succeeded by a proparian (meraspid) stage, lastly to be substituted by a permanent (holaspid) opisthoparian suture. The likelihood of such an ontogeny is more than doubtful. On the other hand, if an early opisthoparian condition were to be succeeded by a proparian condition during the meraspid stage, we would have discovered the first actual proof of the evolutionary origin of the proparian type of suture out of the opisthoparian. However, no matter how tempting this line of thought may be, the problem is plagued with so many uncertainties that it seems best to end this discussion with a "*non sequitur*." It may well be that *P. scarabaeoides* is an opisthoparian species after all, and that the proparian condition of the meraspid stage is nothing more than an appearance due to chances of preservation of the tiny specimens.

MARGINAL SUTURES

The name "marginal sutures" has been used to designate the sutures running directly along the margin, or close to the

margin on either the dorsal or ventral sides of the cephalon of a number of trilobites. In the minds of many paleontologists, these sutures are structures independent of the dorsal facial sutures, and some authors believe that they were the first to appear in trilobites. Sutures classed as marginal, however, include such different structures as the perrostral sutures of olenellids, rostral sutures of some ptychopariids, dorsal intramarginal sutures of raphiophorids, dorsal submarginal sutures of some phacopids (*Ductina*), dorsal submarginal sutures of conocoryphids, submarginal sutures of trinucleids and dionidids, and wholly marginal sutures of harpids. It should be immediately apparent that the only thing held in common by most of these sutures is the name. Their origin is as different as that of the different trilobite groups just mentioned. None of these "marginal" sutures is primary. Their secondary derivation from primary facial sutures is evident in some forms and very plausible in others.

The so-called "marginal" sutures of the raphiophorids actually are dorsal opisthoparian sutures, which in some genera tend to be intramarginal in position. In all, the posterior extremities of the sutures are decidedly dorsal, cutting across the base of the genal spine, which is borne by the librigenae. It is evident that the dorsal intramarginal sutures of these blind trilobites are derived from normal opisthoparian sutures that have migrated outward (abaxially), probably accompanying migration, reduction, and final disappearance of the eyes. The same type of dorsal intramarginal sutures characterizes the blind Alsataspidae. In these we can be practically certain that the sutures were derived from normal opisthoparian structures. This is more than suggested by the close affinities between the eye-bearing Haplopleuridae with normal opisthoparian sutures and the eyeless, sutureless Alsataspidae. Even more evident is the origin of the dorsal intramarginal proparian sutures of *Ductina*. RICHTER's detailed studies of Upper Devonian phacopids of central Europe have shown conclusively that the submarginal sutures of the eyeless *D. ductifrons* are "end products" in an evolutionary suite characterized by progressive outward migration, reduction, and final disappearance of the eyes. Here, however, the sutures are pro-

parian, and as in most phacopids, they are ankylosed and nonfunctional.

The marginal sutures of blind conocoryphids also clearly are derived from normal opisthoparian facial sutures. The close similarities between such genera as *Ptychoparia* and *Conocoryphe* seem to dispel all possible doubts in this regard, making it evident that the conocoryphids are derived from the main ptychopariid stock characterized by well-developed eyes and normal opisthoparian sutures. Two types of "marginal" sutures, however, seem to be present among the Conocoryphidae. In such genera as *Conocoryphe*, *Bailiaspis*, and *Bailiella*, characterized by lack of eyes, ocular protuberances, or eye ridges, the sutures are marginal anteriorly, submarginal laterally, and dorsal intramarginally across the base of the genal spines, which are borne by the librigenae. In such genera as *Couloumania*, *Dasometopus*, and *Elyx*, which retain either ocular protuberances or eye ridges, the sutures seem to be wholly marginal. The "marginal" sutures of the first group seem to have originated by outward migration of normal opisthoparian sutures, accompanying outward migration, reduction, and disappearance of the eyes, much as in the Raphiophoridae and Alsataspididae. The wholly marginal sutures of the second group, however, seem to have originated in a manner similar to that of the marginal sutures of harpidids. This seems strongly suggested not only by the vestigial eyes of *Couloumania*, but especially by the notable homeomorphy between such genera as *Dasometopus* and *Loganopeltis*. If this is actually true, the Conocoryphidae are to be regarded as a polyphyletic family, the members of which were derived along different lines from the main ptychopariid stock.

The marginal sutures of harpidids, though truly marginal almost all around the cephalon, become dorsal across the base of the genal spines (when present). These are borne by the librigenae, which are almost exclusively ventral and coincide with the cephalic doublure. RASETTI'S studies on *Loganopeltoides* and *Loganopeltis* have proved beyond dispute that the marginal sutures originated, in this case, by forward migration of the posterior sections of normal facial sutures and backward migration on the anterior sections, until the 2 sections

met, became fused, ankylosed, and finally were obliterated. The anterior parts of the marginal sutures therefore, are derived from the anterior sections of the ancestral facial sutures, while the posterior parts arose from the posterior sections. It should be noted, incidentally, that such forms as *Loganopeltoides zenkeri* are apparently opisthoparians, since the genal angles belong to the ocular segment. In these forms, the posterior sections of the facial sutures have migrated forward, their adaxial extremities pivoting on the eyes, but the genal angles seem to have remained in their original location at the posterolateral corners of the cephalon.

The submarginal sutures of trinucleids and dionidids and the wholly marginal sutures of harpidids seem to have developed in a somewhat different way. The sutures of trinucleids and dionidids are actually dorsal-submarginal in position, though they run very close to the cephalic margin. Their rear extremities, however, are decidedly dorsal, cutting across the genal spines borne by the ventral librigenae or "lower lamellae." The sutures of harpidids, on the other hand, are exactly marginal, running all along the margins of the cephalon, including its prolongations. Consider first *Entomaspis* and its relation with the harpidids. In this genus the 2 sections of the facial sutures run outward-backward from the eyes to the vicinity of the genal angles. The posterior sections cut the posterior margin just a little adaxially from the base of the genal spines, whereas the anterior sections swing outward-forward and reach the lateral margins just in front of the genal spines. The entire marginal suture is, therefore, formed by the anterior section of the facial sutures. This condition resembles that of the metaparian sutures of olenellids, but in *Entomaspis* the posterolateral (genal) spines belong to the ocular segments, the condition being, therefore, opisthoparian. If the 2 sections of the facial sutures were to fuse, become ankylosed, and finally disappear (as in the *Loganopeltoides-Loganopeltis* suite), the harpid condition would be achieved. It seems, therefore, that in harpidids, the marginal suture running along the cephalic rim and the outer rim of the prolongations is derived from the anterior sections of opisthoparian sutures of entomaspidiform type, while the marginal suture running along the inner rim of the

prolongations is derived from the posterior sections of such sutures.

Attention next may be directed to the eye-bearing, suture-bearing *Orometopus* in relation to the trinucleids and dionidids. As LAKE suggested in 1909, the similarities between *Orometopus* and some Trinucleidae are so close that little doubt can remain that the latter were derived from the former. The relationship is strictly comparable to that between the Hapalopleuridae and the Alsataspidae. *Orometopus* has opisthoparian sutures of almost cedariiform type. Backward migration of the anterior sections by pivoting their adaxial extremities on the eyes, would bring a condition quite similar to that of *Entomaspis*. Fusion, ankylosis, and disappearance of the sutures will conduce to the trinucleid condition. Here, however, the submarginal suture becomes decidedly dorsal across the base of the genal spines, which are borne by the librigenae (lower lamellae). The double metagenal ridges observed in some species of *Dionide* (as *D. formosa*), springing from the axial furrows and running outward-backward toward the genal angles, actually suggest ankylosed facial sutures of entomaspidiiform type. If this is truly so, the submarginal suture of trinucleids and dionidids is derived from the anterior sections of entomaspidiiform sutures.

From what has been said, it should be clear that "marginal" sutures are heterologous and secondarily derived from metaparian, opisthoparian, or proparian sutures.

SECONDARILY DERIVED SUTURAL PATTERNS

From the above discussion it seems evident that if proparian, metaparian, and "marginal" sutures are secondary in origin, the opisthoparian sutures must be primary. "When you have discarded the impossible, whatever remains, no matter how improbable, must be the truth." As already mentioned, I believe that the primary sutural pattern of trilobites was of ptychopariid type with opisthoparian conditions, meaning that this was the first type to appear in adult trilobites. Clearly, however, trilobites descend from some sutureless, wormlike, metameric ancestor, and if the "law of morphogenesis" has any significance, we may accept the view that this ancestor had eyes located

in anterolateral position. This ancestor, however, was not a trilobite. As the eyes began to migrate "backward-inward" on the dorsal side, and as facial sutures appeared, the earliest true trilobites came into being. They were probably late Precambrian creatures provided with a soft, nonmineralized, chitinous dorsal exoskeleton. The integument of the cephalic region must have been transected by a set of sutures of ptychopariid type, though it seems logical to admit that, in these primitive forms, the facial sutures ran on the dorsal side close to the lateral margins.

Trilobites characterized by an opisthoparian ptychopariid sutural pattern are plentiful among the earliest known Cambrian forms. These are the redlichiids, which seem to be the nearest known approach to the theoretical primitive Precambrian trilobites and descendants of the primitive stock along the main evolutionary line of the class. Since early Cambrian to late Permian times, trilobites characterized by a ptychopariid sutural pattern were always in existence and from this main stock, numerous lateral branches sprang at various times.

TRILOBITE TYPES DEFINED BY SUTURE PATTERNS

Evolution of the ptychopariid type was along different lines. Some of the evolutionary trends reappeared independently in several offshoots at different times, the end products showing a considerable degree of homeomorphy due to convergent or parallel evolution. The main progressive changes distinguished in ptychopariid trilobites include types indicated as follows.

Corynexochid type, characterized by ankylosis of the hypostomal suture leading to its final disappearance, represented by some Redlichiidae, some Paradoxidae, Gigantopygidae, Corynexochidae, Dolichometopidae, Dorypygidae, Zacanthoididae, and seemingly also by *Hemirhodon* (Dolichometopidae) and *Hysterolenus* (Ceratopygidae).

Oryctocephalid type, characterized by ankylosis of the hypostomal and connective sutures, represented by the Oryctocephalidae.

Asaphid type, characterized by reduction of the rostral plate until the connective sutures fused into a single median suture, re-

presented by the Asaphidae, some species of *Theodenisia* (Catillicephalidae), *Stenopilus* (Plethopeltidae), some species of *Leiocoryphe* (Plethopeltidae), *Dikelocephalus* (Dikelocephalidae), *Housia* (Housiidae) and possibly also *Proceratopyge* (Ceratopygidae).

Nileid type, characterized by complete disappearance of connective or median sutures, represented by the Nileidae, Raphiophoridae, most Conocoryphidae, some species of *Dikelocephalus* (Dikelocephalidae), *Levisella* (Loganellidae), *Hungaia* (Hungaiidae), *Lauzonella* (Loganellidae), *Loganellus* (Loganellidae), some species of *Deiocoryphe* (Plethopeltidae), and *Rasettia* (Le-canopygidae).

Olenid type, characterized by complete disappearance of connective and hypostomal sutures, the hypostoma being separated from the anterior cephalic doublure and supported by the ventral membrane, represented by the Olenidae.

Dimeropygid type, characterized by disappearance of the hypostomal suture, the hypostoma becoming "free" and supported by the ventral membrane, with other features as in the primitive ptychopariid type, represented by the Dimeropygidae and apparently also by some Ptychopariidae, including various species of the genus *Ptychoparia* itself.

Bathynotid type, characterized by complete fusion of the hypostomal suture and reduction of the rostral suture to a point from which the connective sutures diverge backward, represented by the Bathynotidae.

Calymenid type, characterized by appearance of a gonatoparian and lastly of a proparian condition, owing to reduction of the posterior part of the ocular segment, represented by the Calymenidae, Pagetiidae, Cheiruridae, most Pliomeridae and Encrinuridae, and probably also Menomoniidae, Burlingiidae, and Norwoodiidae.

Homalonotid type, characterized by the forementioned evolutionary trends combined with others consisting of backward migration of the rostral suture to a dorsal position and backward convergence of the connective sutures, represented by the Homalonotidae.

Phacopid type, characterized by fusion and disappearance of the connective sutures, backward migration of the rostral suture to

a dorsal intramarginal position, and ankylosis of the facial sutures, represented by the Dalmanitidae and most Phacopidae.

Proparian olenid type, characterized by development of proparian sutures in olenid stocks, represented by *Saltaspis*, *Nericiaspis*, some species of *Ctenopyge*, and probably also species of *Peltura* and ?*Peltocare*.

Raphiophorid type, characterized by appearance of submarginal sutures by outward migration of the facial sutures in a nileid or phacopid type, represented by some Conocoryphidae, Raphiophoridae, and some Phacopidae like *Ductina*.

Trinucleid type, characterized by development of submarginal sutures by ankylosis and fusion of entomaspidiform sutures, represented by the Trinucleidae.

Harpid type, characterized by appearance of marginal sutures in the same manner as that just specified, represented by the Harpididae.

Harpidid type, characterized by appearance of submarginal sutures by forward migration of posterior sections of normal opisthoparian sutures and fusion with anterior sections, represented by Harpididae such as *Loganopeltoides* and *Loganopeltis*.

AGNOSTID TRILOBITES

No mention has been made, so far, of the agnostids. These sutureless, eyeless trilobites, regarded as primitive by BEECHER (1887) and his school, are considered by STUBBLEFIELD (1936) and HUPÉ (1953) as probably "partly neotenic" forms. This partial neoteny could apply to the thoracic features, but certainly not to the cephalic characters. We now know that blindness is a secondary character developed in various trilobites, an "evolutionary novelty" that can hardly be accepted as a neotenic feature. Moreover, *Pagetia* and *Opsidiscus* indicate that in all likelihood the agnostids are descendants from eye-bearing trilobites. *Pagetia* shows that the sutureless agnostids probably descended from trilobites characterized by a ptychopariid sutural pattern with proparian conditions.

The total loss of eyes and sutures in the agnostids, far from indicating partial neoteny, seems to indicate that they are a progressive, specialized offshoot from stock characterized by a ptychopariid sutural pattern. *Pagetia bootes* has a well-developed

hypostoma which, according to ÖPIK (1952), probably was attached to a wide rostral plate. Though RASETTI (1952) suggested that *Pagetia* has no rostral suture, there is nothing to substantiate this opinion. If *Pagetia* lacked this suture, it would be the only trilobite in which the 2 symmetrical facial sutures do not unite anteriorly but continue directly (and separately) to the inner margin of the doublure. Probably *Pagetia* has rostral and connective sutures, the sutural pattern being, therefore, of ptychopariid type (with proparian condition). The reduction of the ocular segment in a *Pagetia*-like trilobite would lead to gradual approach of the 2 sections of the facial sutures toward each other, then to their fusion, and finally to their disappearance in a manner illustrated by evolution of the sutures in the *Loganopeltoides-Loganopeltis* stock of the Harpididae. *P. bootes* is similar in this respect to *Loganopeltoides zenkeri*, while *Opsidiscus* practically duplicates the sutural conditions of *Loganopeltis*. This, of course, does not mean that *P. bootes* and *Opsidiscus* belong to the same evolutionary suite. They simply symbolize stages in the possible evolution of the agnostids. The marginal suture developed from the anterior and posterior sections of the facial sutures would finally disappear by ankylosis "in situ."

The foregoing discussion indicates that cephalic sutures cannot be used by themselves as criteria for major subdivisions in trilobite classification. They are useful in tracing lineages and establishing familial relationships, but their "evolutionary plasticity" and the obvious polygenetic origin of some recognized types, render them useless above superfamilial rank, or even above the familial category.

TRILOBITE CLASSIFICATION ADOPTED IN TREATISE

It is now abundantly clear that no single feature can be used to classify trilobites. Agreement is expressed with both STUBBLEFIELD and HENNINGSMOEN that in the present state of our knowledge the sum of the cephalic axial characters is the best guide for the establishment of major divisions. However, trilobites were "plastic" and "dynamic" in an evolutionary sense, and the end products of any given lineage may show marked deviations from the primitive or

fundamental cephalic axial characters of the stock. This makes it exceedingly difficult to define taxa of more than superfamilial rank without giving extremely detailed descriptions. Moreover, exoskeletal homeomorphy resulting from parallel or convergent evolution is common among trilobites.

The classification adopted in this volume is based mainly on (1) cephalic axial characters, (2) pattern of sutures, and (3) caudalization of postcephalic segments. It may be stated that a majority of the contributors to this volume are in more or less close agreement with the arrangement but some hold very different opinions. Like all other trilobite classifications, it is provisional, for we must admit frankly that 60 years after BEECHER's announcement of what he believed to be a "natural" classification, we are still far from the goal.

In the tabular outline of classification that follows, the numbers of recognized genera and subgenera in each family-group and higher-rank taxa are recorded; where only a single number is given, this refers to genera, but if 2 numbers are given, the first indicates genera and the second, subgenera (for example, "4; 6" signifies 4 genera and 6 subgenera). The outline affords a useful means of explicit statement of the authorship of systematic descriptions in following pages of this volume; the authors are indicated by code letters as here listed.

Authorship of Systematic Descriptions

| | |
|-------------------------------------|----|
| HARRINGTON, H. J. | HA |
| HENNINGSMOEN, GUNNAR | HE |
| HOWELL, B. F. | HO |
| JAANUSSON, VALDAR | JA |
| LOCHMAN-BALK, CHRISTINA | LB |
| MOORE, R. C. | MO |
| POULSEN, CHRISTIAN | PO |
| RASETTI, FRANCO | RA |
| RICHTER, RUDOLF, & RICHTER, EMMA .. | RR |
| SCHMIDT, HERTA | SC |
| SDZUY, KLAUS | SD |
| STRUVE, WOLFGANG | ST |
| TRIPP, RONALD | TR |
| WELLER, J. M. | WE |
| WHITTINGTON, H. B. | WH |

OUTLINE OF CLASSIFICATION

| |
|--|
| Trilobita (<i>class</i>) (1,401; 128). <i>L.Cam.-M.Ferm.</i> (MO) |
| Agnostida (<i>order</i>) (79). <i>L.Cam.-U.Ord.</i> (MO) |
| Agnostina (<i>suborder</i>) (66). <i>L.Cam.-U.Ord.</i> (MO) |

- Agnostidae (6). *M.Cam.-L.Ord.* (HO)
 Clavagnostidae (1). *M.Cam.-U.Cam.* (HO)
 Condylopygidae (3). *L.Cam.-M.Cam.* (HO)
 Cyclopagnostidae (1). *M.Cam.* (HO)
 Diplagnostidae (4). *M.Cam.* (HO)
 Geragnostidae (6). *L.Ord.-U.Ord.* (HO)
 Hastagnostidae (10). *M.Cam.-U.Cam.* (HO)
 Micragnostidae (5). *U.Cam.-L.Ord.* (HO)
 Phalacromidae (8). *M.Cam.-L.Ord.* (HO)
 Pseudagnostidae (4). *U.Cam.-L.Ord.* (HO)
 Sphaeragnostidae (1). *Ord.* (HO)
 Spinagnostidae (17). *L.Cam.-U.Cam.* (HO)
 Eodiscina (*suborder*) (13). *L.Cam.-M.Cam.*
 (MO)
 Eodiscidae (6). *L.Cam.-M.Cam.* (HO)
 Pagetiidae (7). *L.Cam.-M.Cam.* (HO)
 Redlichiida (*order*) (107; 22). *L.Cam.-M.Cam.*
 (MO)
 Olenellina (*suborder*) (22; 3). *L.Cam.* (MO)
 Olenellidae (20). *L.Cam.* (PO)
 Olenellinae (7). *L.Cam.* (PO)
 Callaviinae (3). *L.Cam.* (PO)
 Elliptocephalinae (1). *L.Cam.* (PO)
 Fallotaspidinae (1). *L.Cam.* (PO)
 Holmiinae (3). *L.Cam.* (PO)
 Neltneriinae (1). *L.Cam.* (PO)
 Nevadiinae (2). *L.Cam.* (PO)
 Olenelloidinae (1). *L.Cam.* (PO)
 Wanneriinae (1). *L.Cam.* (PO)
 Daguinaspididae (2; 3). *L.Cam.* (PO)
 Redlichiina (*suborder*) (83; 19). *L.Cam.-M.Cam.*
 (MO)
 Redlichiacea (*superfamily*) (25; 2). *L.Cam.-M.*
Cam. (MO)
 Redlichiidae (10). *L.Cam.* (PO)
 Redlichiinae (5). *L.Cam.* (PO)
 Pararedlichiinae (5). *L.Cam.* (PO)
 Neoredlichiidae (4; 2). *L.Cam.* (HA)
 Saukiandidae (2). *L.Cam.* (HA)
 Gigantopygidae (1). *L.Cam.* (HA)
 Despujolsiidae (1). *L.Cam.* (HA)
 Yinitidae (1). *M.Cam.* (HA)
 Abadiellidae (3). *L.Cam.-M.Cam.* (HA)
 Dolerolenidae (1). *Up.L.Cam.* (HA)
 Family Uncertain (2). *L.Cam.* (HA)
 Ellipsocephalacea (*superfamily*) (42; 17). *L.*
Cam.-M.Cam. (HE)
 Ellipsocephalidae (18; 9). *L.Cam.-M.Cam.*
 (HE)
 Ellipsocephalinae (8). *L.Cam.-M.Cam.* (HE)
 Strenuellini (4; 7). *L.Cam.-M.Cam.* (HE)
 Kingaspidinae (2; 2). *L.Cam.* (HE)
 Palaeoleninae (3). *L.Cam.* (HE)
 Antatlasinae (1). *L.Cam.* (HE)
 Protolenidae (21; 8). *L.Cam.* (HE)
 Termierellini (6; 3). *L.Cam.* (HE)
 Myopsoleninae (3). *L.Cam.* (HE)
 Protoleninae (8; 5). *L.Cam.* (HE)
 Bigotiniinae (1). *L.Cam.* (HE)
 ?Aldonaiinae (1). *L.Cam.* (HE)
 Subfamily Uncertain (2). *L.Cam.* (HE)
 ?Yunnanocephalidae (1). *L.Cam.* (HE)
 Family Uncertain (2). *L.Cam.* (HE)
 Paradoxidacea (*superfamily*) (16). *Up.L.Cam.-*
M.Cam. (MO)
 Paradoxididae (15). *Up.L.Cam.-M.Cam.* (PO)
 Paradoxidinae (5). *M.Cam.* (PO)
 Centropleurinae (3). *M.Cam.* (PO)
 Metadoxidinae (3). *Up.L.Cam.* (PO)
 Xystridurinae (2). *Up.L.Cam.-M.Cam.* (PO)
 Subfamily Uncertain (2). *M.Cam.* (MO)
 Hicksiidae (1). *L.Cam.* (HA)
 Bathynotina (*suborder*) (2). *Up.L.Cam.-Low.M.*
Cam. (LB)
 Bathynotidae (2). *Up.L.Cam.-Low.M.Cam.*
 (LB)
 Corynexochida (*order*) (73; 4). *L.Cam.-U.Cam.*
 (MO)
 Dorypygidae (20). *L.Cam.-U.Cam.* (PO)
 Ogygopsidae (1). *M.Cam.* (RA)
 Oryctocephalidae (7). *L.Cam.-M.Cam.* (RA)
 Dolichometopidae (29; 4). *L.Cam.-U.Cam.*
 (PO)
 Corynexochidae (4). *M.Cam.* (PO)
 Corynexochinae (3). *M.Cam.* (PO)
 Acontheinae (1). *M.Cam.* (PO)
 Zacanthoididae (8). *L.Cam.-M.Cam.* (RA)
 Dinesidae (4). *Up.L.Cam.-Low.M.Cam.* (LB)
 Ptychopariida (*order*) (798; 61). *L.Cam.-M.Perm.*
 (HE)
 Ptychopariina (*suborder*) (474; 11). *L.Cam.-U.*
Ord. (HE)
 Ptychopariacea (*superfamily*) (63). *L.Cam.-L.*
Ord. (MO)
 Ptychopariidae (32). *L.Cam.-L.Ord.* (MO)
 Ptychopariinae (10). *M.Cam.-U.Cam.* (HO)
 Periommelinae (1). *L.Cam.* (RA)
 Eulominae (2). *L.Ord.* (RA)
 Nassoviinae (4). *M.Cam.* (HO)
 Antagminae (13). *L.Cam.-Low.M.Cam.* (RA)
 Conocephalininae (3). *M.Cam.-U.Cam.* (LB)
 Alokistocaridae (30). *L.Cam.-U.Cam.* (HO)
 Conocoryphacea (*superfamily*) (23). *L.Cam.-U.*
Ord. (MO)
 Conocoryphidae (16). *L.Cam.-L.Ord.* (PO)
 ?Shumardiidae (7). ?*M.Cam., U.Cam.-U.Ord.*
 (PO)
 Emmrichellacea (*superfamily*) (15). *M.Cam.-L.*
Ord. (MO)
 Emmrichellidae (13). *M.Cam.-L.Ord.* (MO)
 Emmrichellinae (9). *M.Cam.-L.Ord.* (HO,
 MO)
 Changshaniinae (4). *M.Cam.* (HO-MO)
 Liostracinidae (2). *M.Cam.-U.Cam.* (HO)
 Crepicephalacea (*superfamily*) (7). *M.Cam.-U.*
Cam. (LB)
 Crepicephalidae (5). *M.Cam.-U.Cam.* (LB)
 Tricrepicephalidae (2). *U.Cam.* (LB)
 Nepeacea (*superfamily*) (1). *M.Cam.* (LB)
 Nepeidae (1). *M.Cam.* (LB)
 Dikelocephalacea (*superfamily*) (34). *L.Cam.-*
U.Cam. (LB)

- Idahoiidae (7). *U.Cam.* (LB)
 Dikelocephalidae (5). *U.Cam.* (LB)
 Pterocephalidae (16). *U.Cam.* (LB)
 Housiidae (1). *U.Cam.* (LB)
 Andrarinidae (5). *L.Cam.-M.Cam.* (HO)
 Olenacea (*superfamily*) (45; 5). *M.Cam.-U.Ord.* (HE)
 Olenidae (37; 5). *U.Cam.-U.Ord.* (PO)
 Oleninae (6). *U.Cam.-L.Ord.* (PO)
 Leptoplasinae (6; 3). *U.Cam.-L.Ord.* (PO)
 Pelturinae (16). *U.Cam.-L.Ord.* (PO)
 Triarthrinae (9; 2). *U.Cam.-U.Ord.* (PO)
 Papyriaspidae (6). *M.Cam.-U.Cam.* (PO)
 Hypermecaspididae (2). *L.Ord.-M.Ord.* (HA)
 Illaenuracea (*superfamily*) (13). *U.Cam.* (LB)
 Illaenuridae (2). *U.Cam.* (LB)
 Shirakiellidae (1). *U.Cam.* (LB)
 Parabolinoiidae (10). *U.Cam.* (LB)
 Solenopleuracea (*superfamily*) (73). *M.Cam.-L.Ord.* (HE)
 Solenopleuridae (33). *M.Cam.-L.Ord.* (PO)
 Solenopleurinae (13). *M.Cam.-U.Cam.* (PO)
 Acrocephalittinae (7). *M.Cam.-U.Cam.* (PO)
 Saoinae (4). *M.Cam.* (PO)
 Hystriurinae (9). *U.Cam.-L.Ord.* (PO)
 Agraulidae (2). *M.Cam.* (HE)
 Lonchocephalidae (11). *U.Cam.* (RA)
 Dokimocephalidae (10). *U.Cam.* (LB)
 Avoninidae (3). *Up.M.Cam.-U.Cam.* (LB)
 Catillicephalidae (8). *U.Cam.* (RA)
 Kingstoniidae (6). *M.Cam.-U.Cam.* (LB)
 Anomocaracea (*superfamily*) (26; 2). *M.Cam.-U.Cam.* (HO)
 Anomocaridae (26; 2). *M.Cam.-U.Cam.* (HO)
 Asaphiscacea (*superfamily*) (19; 2). *M.Cam.-U.Cam.* (HO)
 Asaphiscidae (19; 2). *M.Cam.-U.Cam.* (HO)
 Asaphiscinae (16). *M.Cam.-U.Cam.* (HO)
 Blountinae (3; 2). *U.Cam.* (HO)
 Burlingiacea (*superfamily*) (2). *M.Cam.-U.Cam.* (PO)
 Burlingiidae (2). *M.Cam.-U.Cam.* (PO)
 Komaspidae (*superfamily*) (16). *M.Cam.-U.Ord.* (LB)
 Komaspidae (8). *Up.M.Cam.-L.Ord.* (LB)
 Elviniidae (5). *U.Cam.* (LB)
 Telephinae (1). *M.Ord.-U.Ord.* (WH)
 Glaphuridae (2). *M.Ord.* (WH)
 Raymondinacea (*superfamily*) (11). *U.Cam.* (LB)
 Raymondinidae (11). *U.Cam.* (LB)
 Raymondininae (5). *U.Cam.* (LB)
 Cedariinae (2). *U.Cam.* (LB)
 Llanoaspidinae (4). *U.Cam.* (LB)
 Norwoodiacea (*superfamily*) (15). *M.Cam.-L.Ord.* (LB)
 Norwoodiidae (5). *U.Cam.-L.Ord.* (LB)
 Menomoniidae (6). *M.Cam.-U.Cam.* (LB)
 Bolaspidae (4). *M.Cam.* (HO)
 Marjumiacea (*superfamily*) (35). *M.Cam.-L.Ord.* (LB)
 Marjumiidae (20). *M.Cam.-U.Cam.* (LB)
 Coosellidae (4). *U.Cam.* (LB)
 Pagodiidae (10). *M.Cam.-L.Ord.* (LB)
 Cheilocephalidae (1). *U.Cam.* (LB)
 Leiostegiacea (*superfamily*) (16; 2). *M.Cam.-L.Ord.* (LB)
 Leiostegiidae (16; 2). *M.Cam.-L.Ord.* (LB)
 Leiostegiinae (12; 2). *U.Cam.-L.Ord.* (LB)
 Eochuangiinae (2). *M.Cam.-U.Cam.* (LB)
 Iranaspidinae (2). *U.Cam.-L.Ord.* (LB)
 Damesellacea (*superfamily*) (10). *M.Cam.-U.Cam.* (LB)
 Damesellidae (6). *M.Cam. U.Cam.* (LB)
 Damesellinae (4). *M.Cam.* (LB)
 Drepanurinae (2). *M.Cam.-U.Cam.* (LB)
 Kaolishaniidae (4). *U.Cam.* (LB)
 Ptychaspidae (*superfamily*) (24). *U.Cam.* (LB)
 Ptychaspidae (13). *U.Cam.* (LB)
 Saukiidae (6). *U.Cam.* (LB)
 Eurekiidae (5). *Up.U.Cam.* (LB)
 Remopleuridacea (*superfamily*) (25). *U.Cam.-U.Ord.* (WH)
 Remopleurididae (21). *U.Cam.-U.Ord.* (WH)
 Remopleuridinae (6). *L.Ord.-U.Ord.* (WH)
 Richardsonellinae (12). *U.Cam. - M.Ord.* (WH)
 Subfamily Uncertain (3). *U.Cam.* (WH)
 Loganellidae (3). *U.Cam.* (RA)
 Hungaiidae (1). *U.Cam.* (LB)
 Superfamily Uncertain (1). *U.Cam.* (HE)
 Diceratocephalidae (1). *U.Cam.* (HE)
 Asaphina (*suborder*) (112; 20). *Up.M.Cam.-U.Ord.* (JA)
 Asaphacea (*superfamily*) (94; 20). *U.Cam.-U.Ord.* (JA)
 Asaphidae (68; 16). *U.Cam.-U.Ord.* (JA)
 Asaphinae (11; 7). *L.Ord.-U.Ord.* (JA)
 Isotelinae (27; 7). *L.Ord.-U.Ord.* (JA)
 Niobinae (7). *U.Cam.-L.Ord.* (JA)
 Ogygiocaridinae (5). *L.Ord.-M.Ord.* (JA)
 Promegalaspidae (2). *U.Cam.-L.Ord.* (JA)
 Symphysurinae (5; 2). *L.Ord.* (JA)
 Thysanopyginae (3). *L.Ord.* (JA)
 Subfamily Uncertain (3). *U.Cam.-M.Ord.* (JA)
 Unrecognizable asaphid genera (5). *Ord.* (JA)
 Taihungshaniidae (4). *L.Ord.* (JA)
 Tsinaniidae (2). *U.Cam.* (LB)
 Nileidae (11; 4). *L.Ord.-U.Ord.* (PO)
 Dikelocephalinidae (9). *L.Ord.* (LB)
 Cyclopygacea (*superfamily*) (7). *Ord.* (RR)
 Cyclopygidae (7). *Ord.* (RR)
 Ceratopygacea (*superfamily*) (11). *M.Cam.-L.Ord.* (PO)
 Ceratopygidae (11). *M.Cam.-L.Ord.* (PO)
 Illaenina (*suborder*) (144; 33). *Ord.-M.Perm.* (JA)
 Illaenacea (*superfamily*) (25; 10). *Ord.-Sil.*

- (JA)
 Styginidae (4). *L.Ord.-U.Ord.* (WH)
 Thysanopeltidae (4; 6). *M.Ord.-Low.U.Dev.* (RR)
 Illaenidae (17; 14). *L.Ord.-Sil.* (JA)
 Illaeninae (7). *L.Ord.-Sil.* (JA)
 Bumastinae (5; 4). *M.Ord.-Sil.* (JA)
 Ectillaeninae (3). *L.Ord.-U.Ord.* (JA)
 ?Theamataspidinae (1). *M.Ord.-U.Ord.* (JA)
 Subfamily Uncertain (1). *Ord.* (JA)
 Bathyracea (*superfamily*) (22). *U.Cam.-M.Ord.* (WH)
 Bathyridae (17). *L.Ord.-M.Ord.* (WH)
 Lecanopygidae (5). *U.Cam.-L.Ord.* (LB)
 Holotrachelacea (*superfamily*) (1). *U.Ord.* (JA)
 Holotrachelidae (1). *U.Ord.* (JA)
 Proetacea (*superfamily*) (96; 23). *L.Ord.-M. Perm.* (RR-ST)
 Proetidae (41; 19). *M.Ord. - L.Carb.(Miss.)* (RR-ST)
 Proetinae (4; 2). *M.Ord.-M.Dev.* (RR-ST)
 Cornuproetinae (6; 3). *Ord.-U.Dev.* (RR-ST)
 Dechenellinae (3; 4). *Up.L.Dev.-U.Dev.* (RR-ST)
 Cyrtosymbolinae (13, 10). *L.Dev.-L.Carb.* (RR-ST)
 Proetidellinae (9). *M.Ord.-M.Dev.* (RR-ST)
 Tropicocoryphinae (6). *Sil.-Low.U.Dev.* (RR-ST)
 Phillipsiidae (24). *L.Carb.(Miss.) - M.Perm.* (WE)
 Otarionidae (4). *M.Ord.-U.Carb.* (RR-SC)
 Otarioninae (3). *M.Ord.-U.Carb.* (RR-SC)
 Cyphaspidinae (1). *L.Dev.-M.Dev.* (RR-SC)
 Aulacopleuridae (2; 2). *M.Ord.-M.Dev.* (RR-SC)
 Brachymetopidae (5; 2). *L.Dev.-U.Carb.* (SC)
 Phillipsinellidae (1). *U.Ord.* (WH)
 Celmidae (1). *L.Ord.* (JA)
 Plethopeltidae (7). *U.Cam.-L.Ord.* (LB)
 Dimeropygidae (5). *L.Ord.-U.Ord.* (WH)
 Family Uncertain (6). *Sil.-Miss.* (RR-ST-WE)
 Harpina (*suborder*) (18). *U.Cam.-U.Dev.* (WH)
 Harpidae (12). *L.Ord.-U.Dev.* (WH)
 Harpididae (4). *U.Cam.-L.Ord.* (WH)
 Entomaspididae (2). *U.Cam.-L.Ord.* (RA)
 Trinucleina (*suborder*) (50). *L.Ord.-M.Sil.* (WH)
 Trinucleidae (27). *L.Ord.-U.Ord.* (WH)
 Trinucleinae (2). *L.Ord.-M.Ord.* (WH)
 Tretaspidinae (3). *M.Ord.-U.Ord.* (WH)
 Cryptolithinae (21). *L.Ord.-U.Ord.* (WH)
 Novaspidinae (1). *U.Ord.* (WH)
 Orometopidae (1). *L.Ord.* (WH)
 Dionididae (4). *M.Ord.-U.Ord.* (WH)
 Raphiophoridae (9). *L.Ord.-M.Sil.* (WH)
 Endymioniidae (2). *L.Ord.-M.Ord.* (WH)
 Alsataspidae (2). *L.Ord.* (WH)
 Hapalopleuridae (4). *L.Ord.* (HA)
 Ityophoridae (1). *U.Ord.* (WH)
 Phacopida (*order*) (173; 37). *L.Ord.-U.Dev.* (HE)
- Cheirurina (*suborder*) (73; 9). *L.Ord.-M.Dev.* (HE)
 Cheiruridae (32; 7). *L.Ord.(Tremadoc.)-M.Dev.* (HE)
 Cheirurinae (11; 2). *L.Ord.-M.Dev.* (HE)
 Cyrtometopinae (7; 5). *L.Ord.-Sil.* (HE)
 Acanthoparyphinae (4). *L.Ord.-U.Ord.* (HE)
 Sphaerexochinae (2). *M.Ord.-Sil., ?Dev.* (HE)
 Deiphoninae (4). *M.Ord.-Sil.* (HE)
 Areiinae (1). *M.Ord.-U.Ord.* (HE)
 ?Heliomerinae (2). *M.Ord.-U.Ord.* (HE)
 Subfamily Uncertain (1). *Sil.-L.Dev.* (HE)
 Pliomeridae (25). *L.Ord.-U.Ord.* (HA)
 Pliomerinae (5). *L.Ord.-U.Ord.* (HA)
 Pilekiinae (8). *L.Ord.* (HA)
 Protopliomeropinae (9). *L.Ord.* (HA)
 Pliomerellinae (1). *M.Ord.-U.Ord.* (HA)
 Placopariinae (1). *M.Ord.* (HA)
 Diaphanometopinae (1). *L.Ord.* (JA)
 Encrinuridae (14; 2). *L.Ord.-Sil.* (HE)
 Encrinurinae (4; 2). *M.Ord.-Sil.* (HE)
 Cybelinae (5). *L.Ord.-U.Ord.* (HE)
 Dindymeninae (3). *M.Ord.-U.Ord.* (HE)
 Staurocephalinae (2). *M.Ord.-Sil.* (HE)
 Family Uncertain (2). *L.Ord.-M.Ord.* (HE)
 Calymenina (*suborder*) (27; 8). *LowL.Ord.-M.Dev.* (SD)
 Calymenidae (15; 2). *L.Ord.(Arenig.)-M.Dev.* (WH)
 Calymeninae (14; 2). *L.Ord.-M.Dev.* (WH)
 Pharostomatinae (1). *M.Ord.-U.Ord.* (WH)
 Homalonotidae (12; 6). *L.Ord.-M.Dev.* (SD)
 Bavarillinae (1). *L.Ord.* (SD)
 Eohomalonotinae (2; 2). *L.Ord.-U.Ord.* (SD)
 Colpocoryphinae (3). *L.Ord.-M.Ord.(Llan-deil.)* (SD)
 Homalonotinae (5; 4). *M.Sil.-M.Dev.* (SD)
 Phacopina (*suborder*) (73; 20). *L.Ord.-Up.U.Dev.* (RR-ST)
 Phacopacea (*superfamily*) (18). *Sil.-U.Dev.* (RR-ST)
 Phacopidae (18). *Sil.-U.Dev.* (RR-ST)
 Phacopinae (10). *Sil.-U.Dev.* (RR-ST)
 Bouleinae (1). *Dev.* (ST)
 Phacopidellinae (6). *Sil.-U.Dev.* (ST)
 Subfamily Uncertain (1). *Sil.* (ST)
 Dalmanitacea (*superfamily*) (55; 20). *L.Ord.-U.Dev.* (RR-ST)
 Dalmanitidae (31; 9). *Low.M.Ord. - U.Dev.* (RR-ST)
 Dalmanitinae (13). *Sil.-M.Dev.* (RR-ST)
 Zeliszkeinae (4; 4). *Low.M.Ord. - U.Ord., ?M.Sil.* (ST)
 Acastavinae (3). *U.Sil.-L.Dev.* (ST)
 Acastopyginae (11; 5). *L.Dev.-U.Dev.* (ST)
 Calmoniidae (15; 2). *Ord.-M.Dev.* (ST)
 Calmoniinae (11). *Ord.-M.Dev.* (ST)
 Acastinae (4; 2). *Ord.-L.Dev.* (ST)
 Pterygometopidae (5; 6). *M.Ord.-U.Ord.* (ST)

(Continued on page O167)

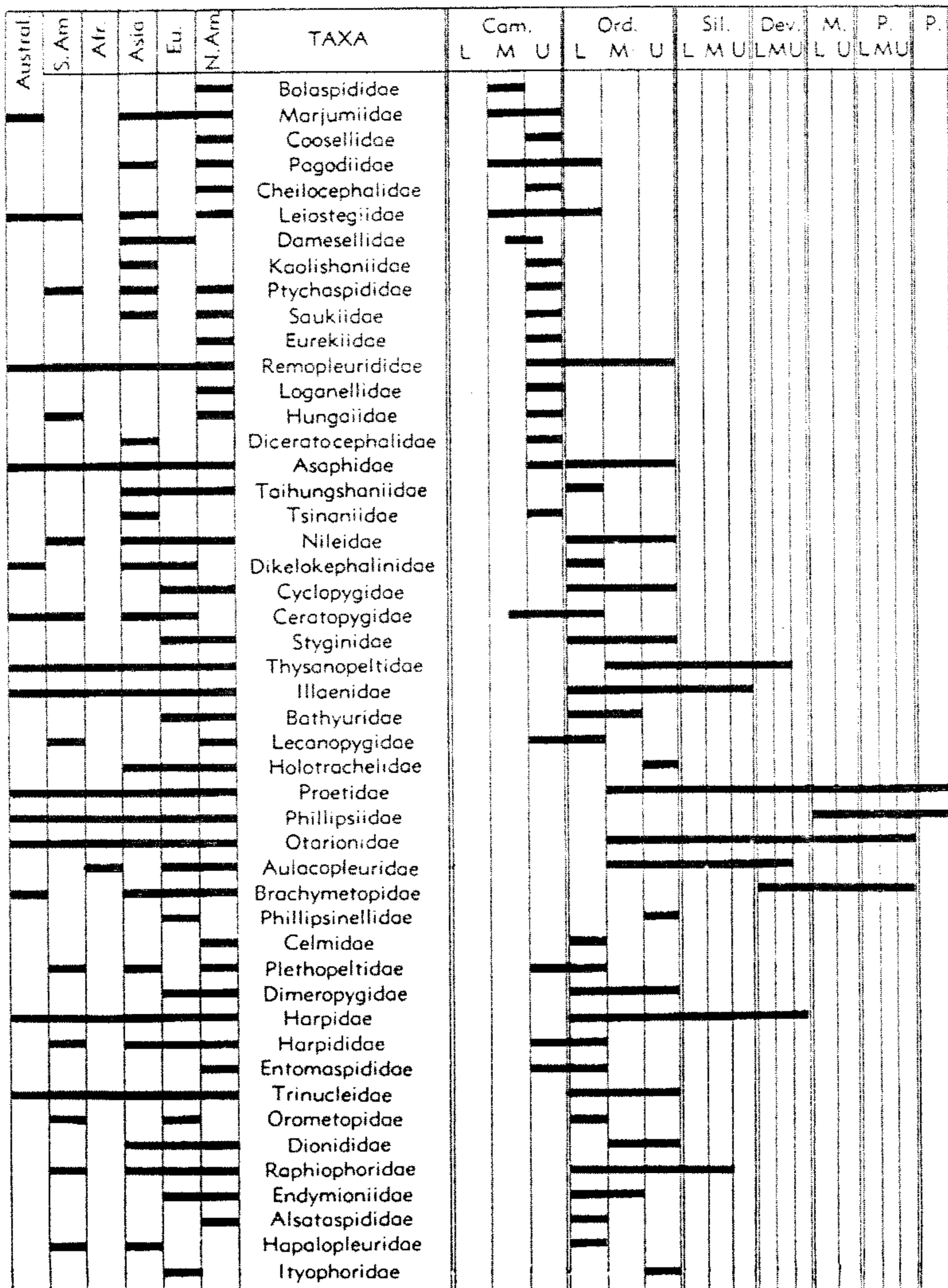

FIG. 107c. Stratigraphic and geographic distribution of trilobite orders, suborders, and families—Part 3 (MOORE, n).

| Austral | S.Am. | Afr. | Asia | Eu. | N.Am. | TAXA | Cam. | | | Ord. | | | Sil. | | | Dev. | | M. | | P. | | P. |
|---------|-------|------|------|-----|-------|------------------|------|---|---|------|---|---|------|---|---|------|---|----|-----|----|---|----|
| | | | | | | | L | M | U | L | M | U | L | M | U | LMU | L | U | LMU | L | U | |
| | | | | | | Cheiruridae | | | | | | | | | | | | | | | | |
| | | | | | | Pliomeridae | | | | | | | | | | | | | | | | |
| | | | | | | Encrinuridae | | | | | | | | | | | | | | | | |
| | | | | | | Calymenidae | | | | | | | | | | | | | | | | |
| | | | | | | Homalonotidae | | | | | | | | | | | | | | | | |
| | | | | | | Phacopidae | | | | | | | | | | | | | | | | |
| | | | | | | Pterygometopidae | | | | | | | | | | | | | | | | |
| | | | | | | Monorakidae | | | | | | | | | | | | | | | | |
| | | | | | | Dalmanitidae | | | | | | | | | | | | | | | | |
| | | | | | | Calmoniidae | | | | | | | | | | | | | | | | |
| | | | | | | Lichidae | | | | | | | | | | | | | | | | |
| | | | | | | Lichakephalidae | | | | | | | | | | | | | | | | |
| | | | | | | Odontopleuridae | | | | | | | | | | | | | | | | |
| | | | | | | Eoacidaspididae | | | | | | | | | | | | | | | | |
| | | | | | | Missisquoiidae | | | | | | | | | | | | | | | | |
| | | | | | | Isocolidae | | | | | | | | | | | | | | | | |
| | | | | | | Myindidae | | | | | | | | | | | | | | | | |
| | | | | | | Granulariidae | | | | | | | | | | | | | | | | |
| | | | | | | Sarkiidae | | | | | | | | | | | | | | | | |

FIG. 107d. Stratigraphic and geographic distribution of trilobite orders, suborders, and families—Part 4 (MOORE, n). [Range of Phacopidae and Dalmanitidae revised; see p. 0163.]

(Continued from page 0163)

- | | |
|---|---|
| Pterygometopinae (4; 6). <i>M.Ord.-U.Ord.</i> (ST) | Subfamily Uncertain (3). <i>L.Sil.-M.Dev.</i> (WH) |
| Chasmopinae (1). <i>Ord.</i> (ST) | Eoacidaspididae (3). <i>Up.M.Cam.-U.Cam.</i> (JA) |
| Monorakidae (4; 3). <i>M.Ord.-U.Ord.</i> (ST) | Order Uncertain (8) |
| Lichida (order) (25). <i>L.Ord.-U.Dev.</i> (MO) | Missisquoiidae (1). <i>L.Ord.</i> (LB) |
| Lichidae (24). <i>L.Ord.-U.Dev.</i> (TR) | Isocolidae (4). ? <i>L.Ord., M.Ord.-U.Ord.</i> (WH) |
| Lichinae (10). <i>L.Ord.-M.Dev.</i> (TR) | Myindidae (1). <i>L.Ord.</i> (WH) |
| Homolichinae (3). <i>L.Ord.-M.Sil.</i> (TR) | Granulariidae (1). <i>Up.L.Cam.</i> (HE) |
| Tetralichinae (2). <i>M.Ord.-U.Ord.</i> (TR) | Sarkiidae (1). <i>M.Ord.</i> (HE) |
| Ceratarginae (9). <i>M.Ord.-U.Dev.</i> (TR) | Order and Family Uncertain (121) |
| Lichakephalidae (1). <i>L.Ord.</i> (TR) | Lower Cambrian genera (14). <i>L.Cam.</i> |
| Odontopleurida (order) (25; 4). <i>Up.M.Cam.U.Dev.</i> (WH) | Middle Cambrian genera (26). <i>M.Cam.</i> |
| Odontopleuridae (22; 4). <i>L.Ord.-U.Dev.</i> (WH) | Upper Cambrian genera (41). <i>U.Cam.</i> |
| Odontopleurinae (7; 2). <i>M.Ord.-U.Dev.</i> (WH) | Ordovician genera (38). <i>Ord.-U.Ord.</i> |
| Miraspidae (9; 2). <i>M.Ord.-M.Dev.</i> (WH) | Devonian genera (2). <i>Dev.</i> |
| Selenopeltinae (1). <i>M.Ord.-U.Ord.</i> (WH) | Unrecognizable genera (60) |
| Apianurinae (2). <i>M.Ord.-U.Ord.</i> (WH) | Nomina nuda (3) |
| | Supposed Trilobita here rejected from class (2) |

REFERENCES

Barrande, Joachim

(1) 1850, *Versuch einer Classification der Trilobiten*: Neues Jahrb. f. Mineral., p. 769-787.

Beecher, C. E.

(2) 1897, *Outline of a natural classification of the trilobites*: Am. Jour. Sci., ser. 4, v. 3, no. 13, p. 89-106, p. 181-207, pl. 3.

Gürich, G.

(3) 1907, *Versuch einer Neueinteilung Trilobiten*: Centralbl. f. Mineral., p. 129-133.

Henningsmoen, Gunnar

(4) 1951, *Remarks on the classification of Trilobites*: Norsk geol. tidsskr., v. 29, p. 174-217.

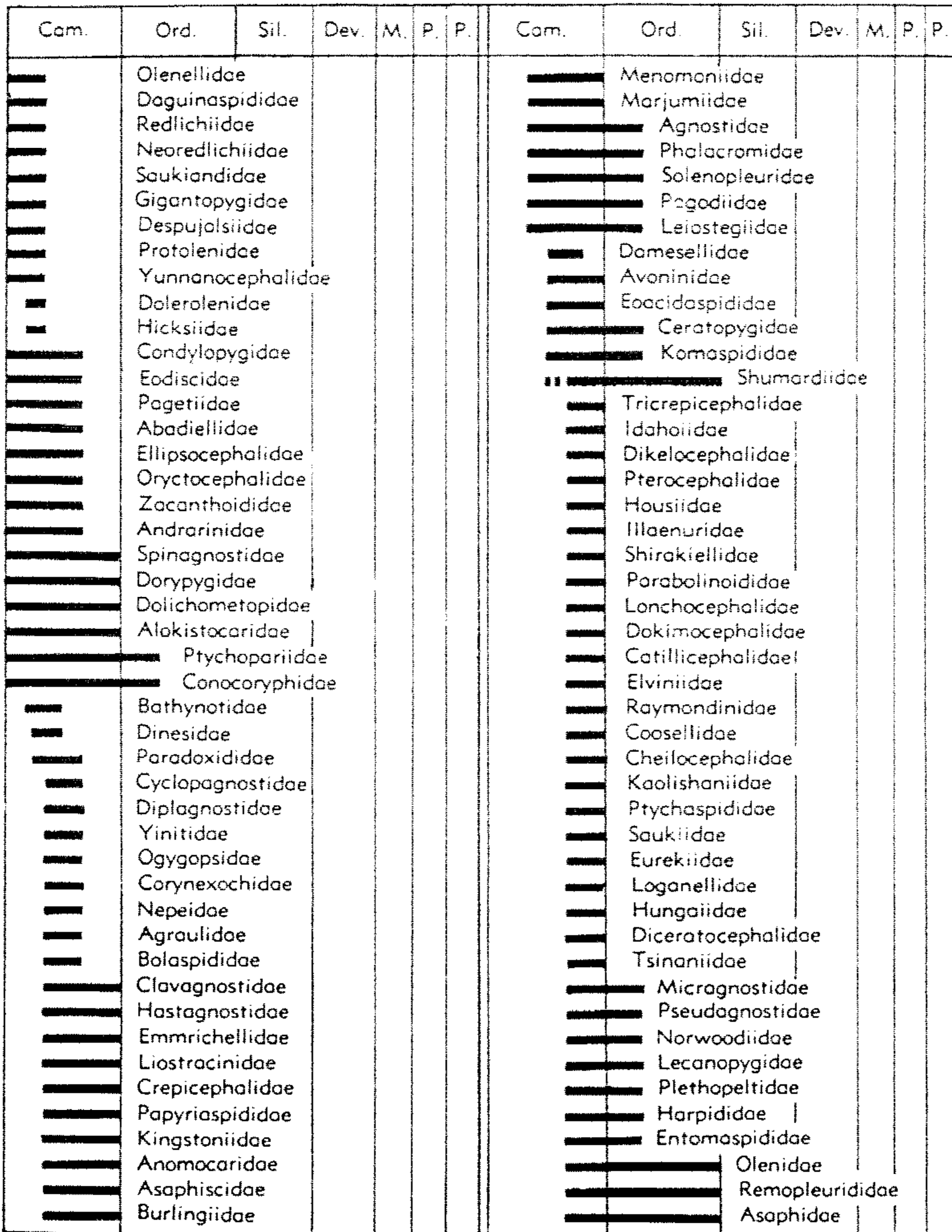

FIG. 107e. Stratigraphic and geographic distribution of trilobite orders, suborders, and families—Part 5. In this diagram only families present in Cambrian rocks are shown, stratigraphically arranged; of the group, which comprises two thirds of all currently recognized trilobite families, only 4 families persist through the Ordovician and none are post-Ordovician (MOORE, n). [Range of Emmrichellidae revised; see p. 0161.]

| Cam. | Ord. | Sil. | Dev. | M. | P. | P. | Cam. | Ord. | Sil. | Dev. | M. | P. | P. |
|------|------|--------------------|------|----|----|----|-------------------|------|------|------|----|----|----|
| | | Lichakephalidae | | | | | Homalonotidae | | | | | | |
| | | Taihungshaniidae | | | | | Cheiruridae | | | | | | |
| | | Dikelokephalinidae | | | | | Calymenidae | | | | | | |
| | | Celmidae | | | | | Harpidae | | | | | | |
| | | Orometopidae | | | | | Phacopidae | | | | | | |
| | | Alsataspididae | | | | | Lichidae | | | | | | |
| | | Hopalopleuridae | | | | | Odontopleuridae | | | | | | |
| | | Missisquoiidae | | | | | Glaphuridae | | | | | | |
| | | Myindidae | | | | | Sarkiidae | | | | | | |
| | | Geragnostidae | | | | | Telephinidae | | | | | | |
| | | Hypermecaspididae | | | | | Dionididae | | | | | | |
| | | Bathyruridae | | | | | Pterygomelopidae | | | | | | |
| | | Endymioniidae | | | | | Monorakidae | | | | | | |
| | | Sphaeragnostidae | | | | | Thysanopeltidae | | | | | | |
| | | Nileidae | | | | | Calmoniidae | | | | | | |
| | | Cyclopygidae | | | | | Aulacopleuridae | | | | | | |
| | | Styginidae | | | | | Otarionidae | | | | | | |
| | | Dimeropygidae | | | | | Proetidae | | | | | | |
| | | Trinucleidae | | | | | Holotrachelidae | | | | | | |
| | | Pliomeridae | | | | | Phillipsinellidae | | | | | | |
| | | Isocolidae | | | | | Ityophoridae | | | | | | |
| | | Raphiophoridae | | | | | Dalmanitidae | | | | | | |
| | | Iliaenidae | | | | | Brachymetopidae | | | | | | |
| | | Encrinuridae | | | | | Phillipsiidae | | | | | | |

FIG. 107f. Stratigraphic and geographic distribution of trilobite orders, suborders, and families—Part 6. This diagram shows post-Cambrian families stratigraphically arranged, all except 3 families occurring in Ordovician rocks and two thirds of these being confined to the Ordovician (MOORE, n). [Ranges of Geragnostidae, Phacopidae, and Dalmanitidae revised; see p. O161, O163.]

Hupé, Pierre

- (5) 1953, *Classe des Trilobites*: in PIVETEAU, JEAN, *Traité de Paléontologie*, Masson (Paris), tome 3, p. 44-246, fig. 1-140.
- (6) 1953, *Classification des trilobites*: Ann. de Paléont., v. 39, p. 62-168 [1-110], fig. 1-92.
- (7) 1955, *Classification des Trilobites*: Ann. de Paléont., v. 41, p. 91-325, [111-345], fig. 93-247.

Jaekel, O.

- (8) 1909, *Über die Agnostiden*: Zeitschr. deutsch. Geol. Gesell., v. 61, p. 380-401.

Kobayashi, Teiichi

- (9) 1935, *The Cambro-Ordovician formations and faunas of South Chosen. III. Cambrian fauna of South Chosen.*: Jour. Fac. Sci. Imp. Univ. Tokyo, sec. 2, v. 4, pt. 2, p. 49-344, pl. 1-24.

Lake, Philip

- (10) 1906-1946, *A monograph of the British Cambrian trilobites*: Palaeontogr. Soc. (London), p. 1-350, pl. 1-47 [p. 1-28, pl. 1-2, 1906; p. 29-48, pl. 3-4, 1907; p. 49-64, pl. 5-6, 1908; p. 65-88, pl. 7-10, 1913; p. 89-120, pl. 11-14, 1919; p. 121-148, pl. 15-18, 1931; p. 149-172, pl. 19-22, 1932; p. 173-196, pl. 23-25, 1934; p. 197-224, pl. 26-31, 1935;

p. 225-248, pl. 32-35, 1937; p. 249-272, pl. 36-39, 1938; p. 273-306, pl. 40-43, 1940; p. 307-332, pl. 44-46, 1942, p. 333-350, pl. 47, addenda, errata, 1946].

Poulsen, Christian

- (11) 1923, *Bornholms Olenuslag og deres Fauna*: Danm. Geol. Undersøg., ser. 2, no. 40, p. 1-83, pl. 1-3.
- (12) 1927, *The Cambrian, Ozarkian and Canadian faunas of Northwest Greenland*: Meddel. om Grønland, v. 70, no. 2, p. 233-343, pl. 14-21.
- (13) 1932, *The Lower Cambrian Faunas of East Greenland*: Meddel. om Grønland, v. 87, no. 6, p. 1-66, pl. 1-14.
- (14) 1934, *The Silurian faunas of Northern Queensland. 1. The Fauna of the Cape Schuchurt formation*: Meddel. om Grønland, v. 72, no. 1, p. 1-46, 3 pl.

Rasetti, Franco

- (15) 1948, *Lower Cambrian trilobites from the conglomerates of Québec*: Jour. Paleont., v. 22, p. 1-24, pl. 1-6.

Raw, Frank

- (16) 1953, *The external morphology of the trilobite and its significance*: Jour. Paleont., v. 27, p. 82-129, fig. 1-7.

Raymond, P. E.

- (17) 1920, *The appendages, anatomy, and relationships of trilobites*: Mem. Conn. Acad. Arts & Sci., v. 7, p. 1-169, pl. 1-11, fig. 1-46.

Richter, Rudolf

- (18) 1933, *Crustacea (Paläontologie)*: in Handwörterbuch der Naturwissenschaften (2nd ed.), v. 2, p. 840-864, fig. A, 1-65.

Salter, J. W.

- (19) 1864-83, *A monograph of the British trilobites*: Palaeontogr. Soc. (London), p. 1-244, pl. 1-30 [p. 1-80, pl. 1-6, 1864; p. 81-128, pl. 7-14, 1865; p. 129-176, pl. 15-25, 1866; p. 177-214, pl. 26-30, 1867; p. 215-224, 1883: compenda, 1864; errata, 1865: addenda et compenda, 1866].

Stormer, Leif

- (20) 1942, *Studies in trilobite morphology, II. The larval development, the segmentation and the sutures, and their bearing on trilobite classification*: Norsk. geol. tidsskr., v. 21, p. 49-164, pl. 1-2, fig. 1-19.

- (21) 1944, *On the relationships and phylogeny of fossil and recent Arachnomorpha. A comparative study on Arachnida, Xiphosura, Eurypterida, Trilobita, and other fossil Arthropoda*: Skr. Vidensk.-Akad. Oslo, I. Mat.-Naturv. Kl., no. 5, 158 p., 30 fig.

Stubblefield, C. J.

- (22) 1936, *Cephalic sutures and their bearing on current classification of trilobites*: Biol. Rev. (Cambridge Philos. Soc.), v. 11, p. 407-440, fig. 1-9.

Swinnerton, H. H.

- (23) 1915, *Suggestions for a revised classification of trilobites*: Geol. Mag., new ser., v. 2, p. 407-496, p. 538-545.
 (24) 1919, *The facial sutures of trilobites*: Same, v. 6, p. 103-110.

Warburg, Elsa

- (25) 1925, *The trilobites of the Leptaena limestone in Dalarna*: Geol. Inst. Univ. Uppsala, Bull. v. 17, 446 p., 11 pl., 23 fig.

SYSTEMATIC DESCRIPTIONS

By H. J. HARRINGTON, GUNNAR HENNINGSMOEN, B. F. HOWELL, VALDAR JAANUS-SON, CHRISTINA LOCHMAN-BALK, R. C. MOORE, CHRISTIAN POULSEN, FRANCO RASETTI, EMMA RICHTER,¹ RUDOLF RICHTER,² HERTA SCHMIDT, KLAUS SDZUY, WOLFGANG STRUVE, RONALD TRIPP, J. M. WELLER, and H. B. WHITTINGTON

CONTENTS

| | |
|---|------|
| CLASS TRILOBITA Walch, 1771 | 0172 |
| ORDER AGNOSTIDA Kobayashi, 1935 | 0172 |
| Suborder Agnostina Salter, 1864 | 0172 |
| Suborder Eodiscina Kobayashi, 1939 | 0187 |
| ORDER REDLICHIDA Richter, 1933 | 0190 |
| Suborder Olenellina Resser, 1938 | 0191 |
| Suborder Redlichiina Harrington, nov. | 0198 |
| Superfamily Redlichiacea Poulsen, 1927 | 0198 |
| Superfamily Ellipsocephalacea Matthew, 1887 | 0207 |
| Superfamily Paradoxidacea Hawle & Corda, 1847 | 0212 |
| Suborder Bathynotina Lochman-Balk, nov. | 0216 |
| ORDER CORYNEXOCHIDA Kobayashi, 1935 | 0217 |
| ORDER PTYCHOPARIIDA Swinnerton, 1915 | 0231 |
| Suborder Ptychopariina Richter, 1933 | 0231 |

¹ Deceased 15 November 1956.

² Deceased 5 January 1957.

Systematic Descriptions

0171

| | |
|---|------|
| Superfamily Ptychopariacea Matthew, 1887 | 0233 |
| Superfamily Conocoryphacea Angelin, 1854 | 0242 |
| Superfamily Emmrichellacea Kobayashi, 1935 | 0246 |
| Superfamily Crepicephalacea Kobayashi, 1935 | 0248 |
| Superfamily Nepeacea Whitehouse, 1939 | 0250 |
| Superfamily Dikelocephalacea Miller, 1889 | 0251 |
| Superfamily Illaenuracea Vogdes, 1890 | 0270 |
| Superfamily Solenopleuracea Angelin, 1854 | 0274 |
| Superfamily Anomocaracea Poulsen, 1927 | 0286 |
| Superfamily Asaphiscacea Raymond, 1924 | 0290 |
| Superfamily Burlingiacea Walcott, 1908 | 0293 |
| Superfamily Komaspidae Kobayashi, 1935 | 0294 |
| Superfamily Raymondinacea Clark, 1924 | 0298 |
| Superfamily Norwoodiacea Walcott, 1916 | 0301 |
| Superfamily Marjumiacea Kobayashi, 1935 | 0305 |
| Superfamily Leiostegiacea Bradley, 1925 | 0313 |
| Superfamily Damesellacea Kobayashi, 1935 | 0316 |
| Superfamily Ptychaspidae Raymond, 1924 | 0320 |
| Superfamily Remopleuridacea Hawle & Corda, 1847 | 0326 |
| Superfamily Uncertain | 0334 |
| Suborder Asaphina Salter, 1864 | 0334 |
| Superfamily Asaphacea Burmeister, 1843 | 0334 |
| Superfamily Cyclopygacea Raymond, 1925 | 0361 |
| Superfamily Ceratopygacea Linnarsson, 1869 | 0362 |
| Suborder Illaenina Jaanusson, nov. | 0365 |
| Superfamily Illaenacea Hawle & Corda, 1847 | 0365 |
| Superfamily Holotrachelacea Warburg, 1925 | 0381 |
| Superfamily Proetacea Salter, 1864 | 0382 |
| Suborder Harpina Whittington, nov. | 0415 |
| Suborder Trinucleina Swinnerton, 1915 | 0419 |
| ORDER PHACOPIDA Salter, 1864 | 0430 |
| Suborder Cheirurina Harrington & Leanza, 1957 | 0430 |
| Suborder Calymenina Swinnerton, 1915 | 0450 |
| Suborder Phacopina Struve, nov. | 0461 |
| Superfamily Phacopacea Hawle & Corda, 1847 | 0462 |
| Superfamily Dalmanitacea Vogdes, 1890 | 0468 |
| ORDER LICHIDA Moore, nov. | 0495 |
| ORDER ODONTOPLEURIDA Whittington, nov. | 0504 |
| ORDER UNCERTAIN | 0510 |
| ORDER AND FAMILY UNCERTAIN | 0512 |
| SUPPOSED TRILOBITA REJECTED FROM CLASS | 0525 |
| REFERENCES | 0526 |
| SOURCES OF ILLUSTRATIONS | 0539 |

As explained in the introduction to this volume, the authorship of sections concerned with the Trilobita is divided in a manner that makes explicit indication of parts contributed by different individuals difficult. This pertains especially to the systematic descriptions. By use of index letters associated with the names of taxa given in the tabular outline of divisions of the Trilobita (p. O160), the authors of diagnoses and discussions relating to each taxon are specified. It is needed to add the statement that just before submittal of the assembled typescript to the press, the Editor has inserted approximately 75 genera introduced in recent Russian publications on Trilobita, distributing these among families according to judgment of the respective Russian authors; the *Treatise* authors concerned with these families could not be asked to study the new genera unless a prospective considerable delay in publication was thought to be warranted. Such delay is considered undesirable, and therefore, the inclusion of various nominal genera in different families is by action of MOORE or HENNINGSMOEN (indicated by Mo or HE).

Class TRILOBITA Walch, 1771

[as Trilobitae Walch, 1771] [Type—*Dalmanites* BARRANDE, 1852, designated by HARRINGTON, HENNINGSMOEN, and MOORE, herein]

Marine arthropods characterized by a generally subelliptical, arched or flat dorsal exoskeleton of mineralized chitinous composition, divided longitudinally into 3 distinct parts (lobes) and with a distinct, relatively large head shield (cephalon), which articulates axially with the thorax composed of articulated transverse segments, the hindmost almost invariably articulating with a tail shield (pygidium) formed by fusion of segments like those of the thorax. Margins of exoskeleton may bend inward ventrally to form a doublure. Length of average adults commonly 2 to 10 cm. but extreme range extending from approximately 2 mm. to a known maximum of 70 cm. Cephalon typically marked by a somewhat raised axial portion (glabella) that is bounded by a narrow furrow and superficially indented by transverse depressions (glabellar furrows); compound eyes present in most forms, located along lines (facial sutures) of ecdysial cleavage that divide the cephalon into a

central portion (cranidium, comprising glabella and fixigenae) and lateral portions (librigenae), which tend to become dissociated. Cephalic doublure may include separate median plates such as hypostoma and also a rostral plate that exceptionally may encroach upon dorsal side. Thoracic segments 2 to 40 or more, each commonly with strongly defined axial portion and somewhat flattened and grooved lateral portions (pleurae). Pygidium highly variable in shape and size. Lateral and dorsal hollow spines may be present on cephalon, thorax, or pygidium. Ventral appendages (rarely preserved) include an anterior pair of uniramous antennae followed by a series of pairs of similarly constructed biramous limbs decreasing in size toward posterior end and distributed with one pair to each segment; in one genus (*Olenoides*) the posterior segment possesses a pair of antenniform cerci. Trilobite remains usually are found dissociated into their component skeletal elements. *L.Cam.-M.Perm.*

Order AGNOSTIDA Kobayashi, 1935

[=suborder Isopygia GÜERICH, 1907; order Miomera JAEGER, 1909] [Type—*Agnostus* BRONGNIART, 1822]

Diminutive trilobites with subequal cephalon and pygidium and possessing only 2 or 3 thoracic segments. *L.Cam.-U.Ord.*

Suborder AGNOSTINA Salter, 1864

[*nom. correct.* HARRINGTON & LEANZA, 1957 (*pro* Agnostini SALTER, 1864)] [=superfamily Eodiscidea RICHTER, 1933 (*partim*); suborder Agnostida WHITEHOUSE, 1939; superfamily Agnostidea WESTERGÅRD, 1946; order Agnostida RASETTI, 1948; superfamily Agnostacea HENNINGSMOEN, 1951 (*partim*); superfamily Agnostoidae HUPÉ, 1953] [Type—*Agnostus* BRONGNIART, 1822]

Cephalon without eyes or facial sutures; hypostoma unknown. Thorax with 2 segments. Pygidium with 3 or fewer rings on axis, border evenly rounded or bearing a pair of spines. *L.Cam.-U.Ord.*

Family AGNOSTIDAE M'Coy, 1849

[=Bactoides HAWLE & CORDA, 1847]

Longitudinal furrow in front of glabella, which has 2 main lobes; axis of pygidium with 2 main lobes rounded at rear end. *M. Cam.-L.Ord.*

Agnostus BRONGNIART, 1822 [**Entomostracites, pisiiformis* WAHLENBERG, 1821] [=*Battus* DALMAN, 1827]. Axis of pygidium with 3 lobes, posterior one only a little expanded at rear and not approaching border of shield; surface of genae

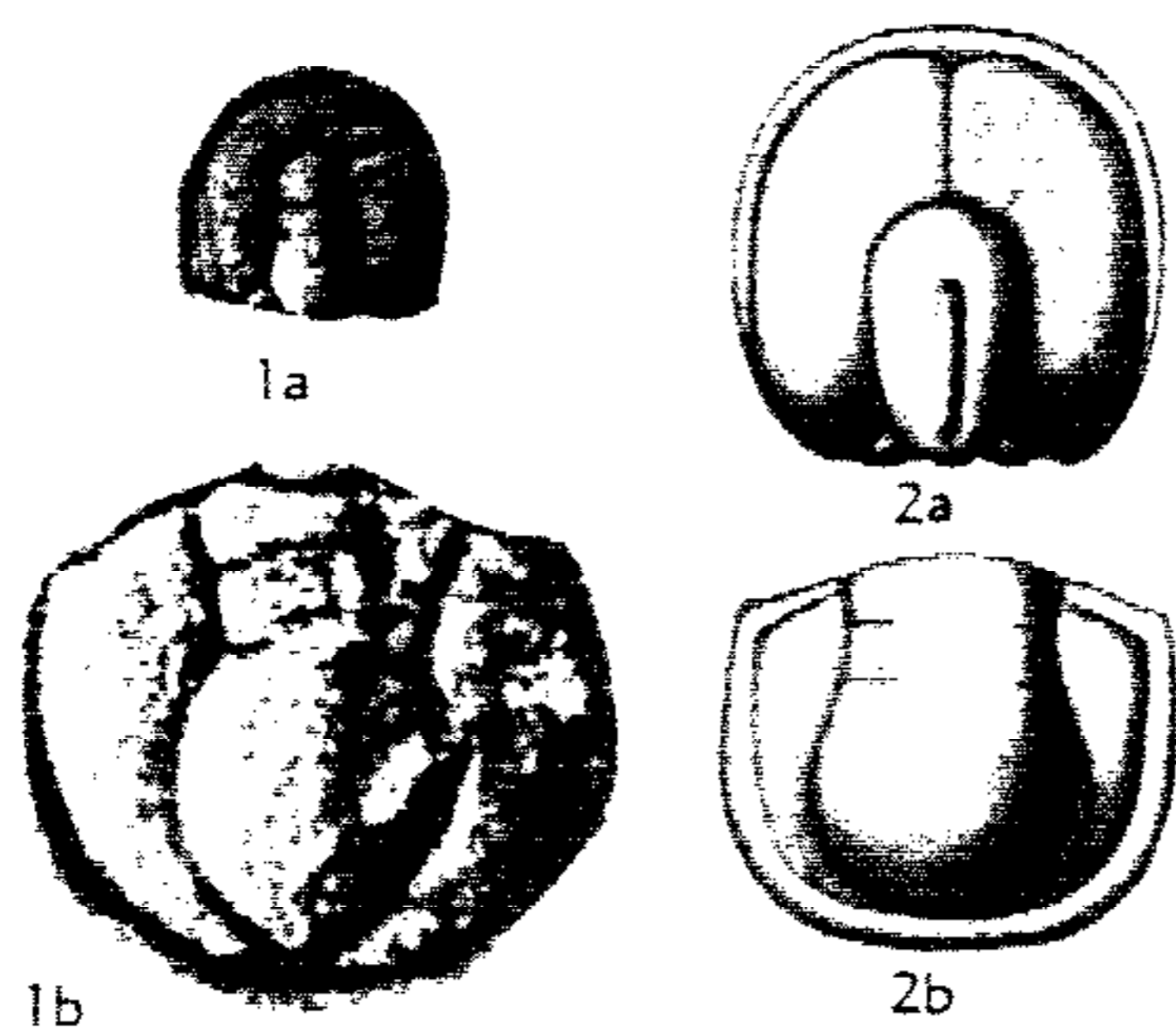

FIG. 108. Agnostidae (p. 0173).

smooth or corrugated. *U.Cam.*, Eu.-China.—FIG. 109,1. **A. pisiformis* (WAHL.), *Agnostus pisiformis* Z., Swed.; 1a,b, ceph., pyg., $\times 4.7$ (331*).

Acmarhachis RESSER, 1938 [**A. typicalis*]. Longitudinal furrow in front of glabella poorly developed; rear lobe of pygidial axis expanded but bluntly pointed at posterior extremity, which reaches the border. *U.Cam.*—FIG. 108,1. **A. typicalis*, Nolicucky F., Ala.; 1a, ceph., $\times 8.5$; 1b, pyg., $\times 14.5$ (457*).

Aspidagnostus WHITEHOUSE, 1936 [**A. parvatus*]. Glabella with longitudinal furrow in front of single lobe that is half as long as cephalon; axis of pygidium expanded at rear, reaching back to border, and bearing 2 faint transverse furrows.

U.Cam., Queensl.—FIG. 108,2. **A. parvatus*, Elrathieella Z.; 2a,b, ceph., pyg., $\times 6$ (339*).

Fallagnostus HOWELL, 1935 [**F. blayaci*]. Cephalon like that of *Agnostus*; axis of pygidium distinctly lobed, with parallel sides, not reaching rear border. *M.Cam.*, Fr.—FIG. 109,2. **F. blayaci*, Paradoxides beds; 2a, ceph., $\times 8$; 2b, pyg., $\times 8.85$ (410*).

Homagnostus HOWELL, 1935 [**Agnostus pisiformis obesus* BELT, 1867] [= *Proagnostus* BUTTS, 1926; *Oncagnostus* WHITEHOUSE, 1936]. Longitudinal furrow in front of glabella poorly developed; axis of pygidium expanded and evenly rounded at rear, reaching almost to posterior end of shield; surface of shields smooth or corrugated. *U.Cam.*, Eu.-Newf.-Que.-Vt.-Tex.-B.C.-Sib.-China-Queensl.—FIG. 109,3. **H. obesus* (BELT), Olenus Z., Kiu-lung F., Rhodonaspid Stage, Queensl.; $\times 10.3$ (331*).

Neoagnostus KOBAYASHI, 1955 [**N. aspidoides*]. Glabella narrow, with longitudinal furrow in front of anterior main lobe, which is divided into 3 subglobular parts of equal size; axis of pygidium rather small, trilobed, not reaching backward to border. *L.Ord.*, B.C.-Arg.—FIG. 110,1. **N. aspidoides*, McKay F., B.C.; 1a,b, ceph., $\times 11$; pyg., $\times 10.5$ (108*).

Family CLAVAGNOSTIDAE Howell, 1937

Glabella with single main lobe, longitudinal furrow in front of it present or absent; axis of pygidium long and narrow, with pointed rear end dividing shield into 2 side lobes; dorsal exoskeleton smooth.

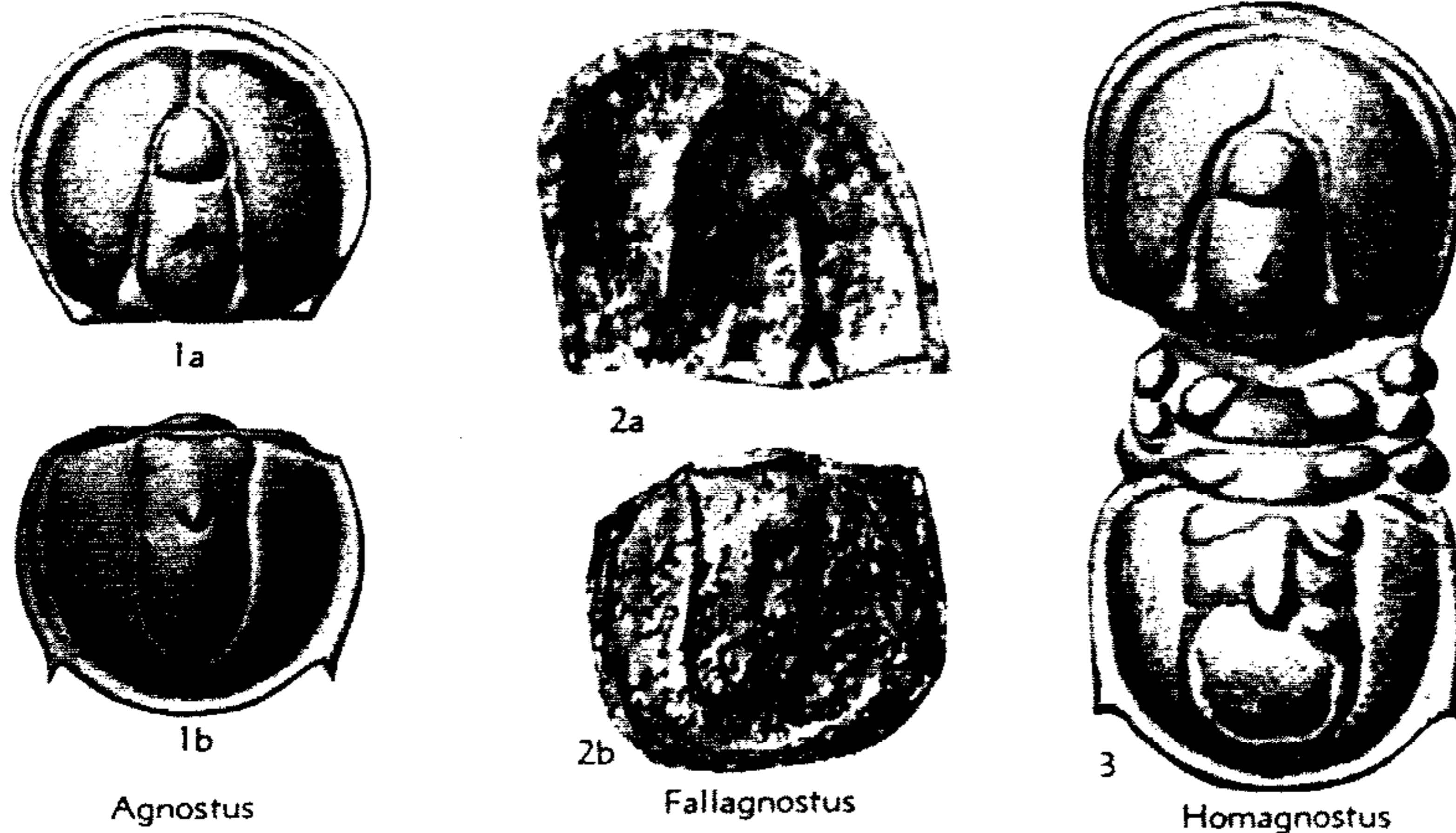

FIG. 109. Agnostidae (p. 0172-0173).

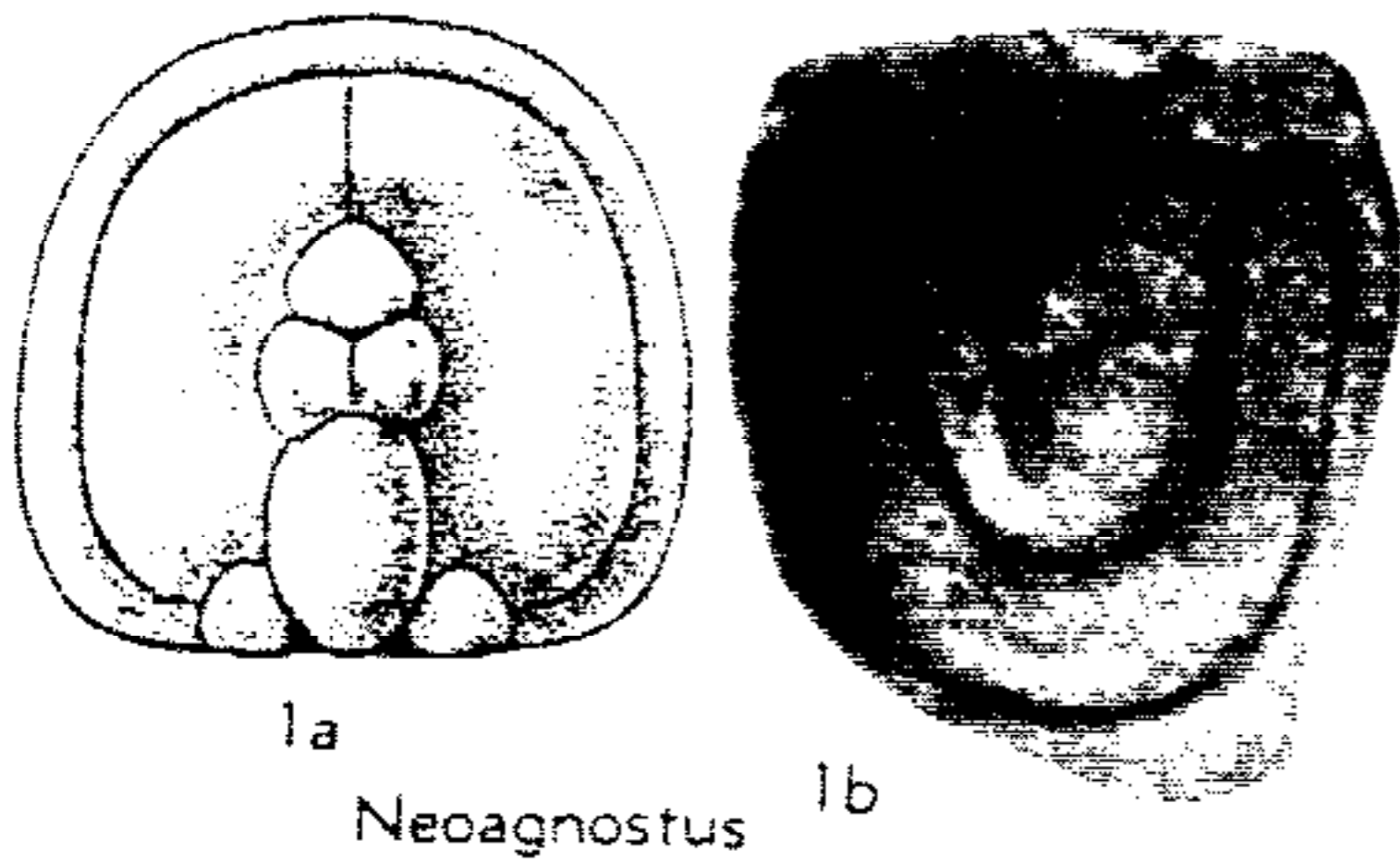

FIG. 110. Agnostidae (p. 0173).

M. Cam.-U. Cam.

Clavagnostus HOWELL, 1937 [*Aagnostus repandus* WESTERGÅRD, 1930] [= *Tomorhachis* RESSER, 1938]. *M. Cam.-U. Cam.*, Swed.-Sib.-Vt.-Ala.—FIG. 111, 1. **C. repandus* (WESTERGÅRD), *Paradoxides forchhammeri* Z., Swed.; 1a, b, ceph., $\times 12$; 1c, d, pyg., $\times 12$ (334*).

Family CONDYLOPYGIDAE Raymond, 1913

[*nom. transl.* HOWELL, 1935 (= *Condylopygenae* RAYMOND, 1913)] [= *Mallagnostidae* HOWELL, 1935]

Anterior lobe of glabella wider than main lobe; rear part of pygidial axis usually somewhat expanded and evenly rounded at posterior extremity. *L. Cam.-M. Cam.*

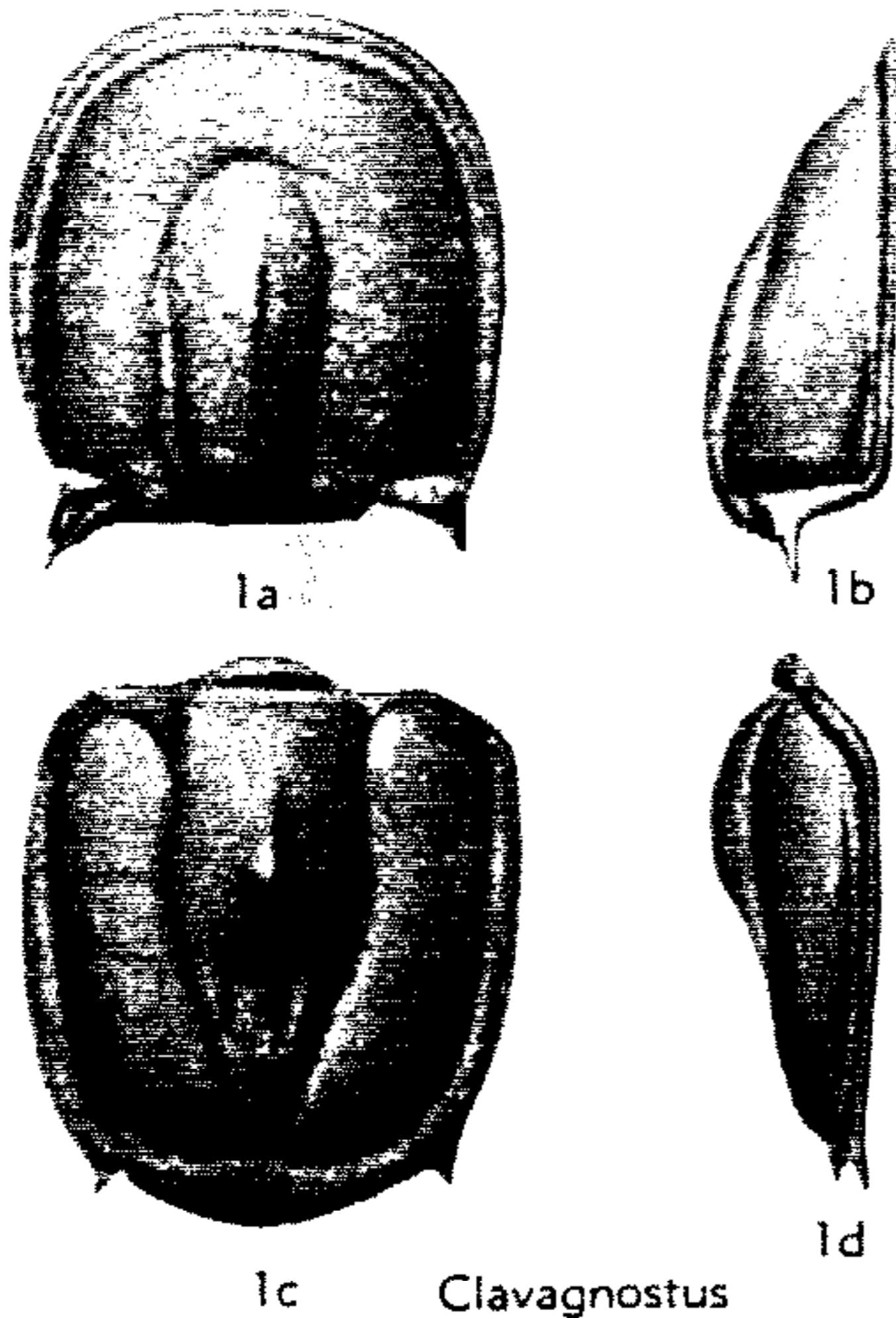

FIG. 111. Clavagnostidae (p. 0174).

Condylopyge HAWLE & CORDA, 1847 [**Battus rex* BARRANDE, 1846] [= *Paragnostus* JAEKEL, 1909]. Front lobe of glabella semicircular in outline; surface smooth. *M. Cam.*, Boh.-Swed.-Wales-Eng.-Newf.—FIG. 112, 1. **C. rex* (BARRANDE), Jince F., Boh.; $\times 4.8$ (3*).

Mallagnostus HOWELL, 1935 [*Aagnostus desideratus* WALCOTT, 1890]. Axis of pygidium rather short, not expanded at rear; surface smooth. *L. Cam.*, N.Y.—FIG. 112, 2. **M. desideratus* (WALCOTT), Schodack F., N.Y.; pyg., $\times 6.7$ (309*).

Pleuroctenium HAWLE & CORDA, 1847 [**Battus granulatus* BARRANDE, 1846; SD VOGDES, 1925] [= *Dichagnostus* JAEKEL, 1909 (obj.)]. Front lobe of glabella curved ovoid; surface granulate. *M. Cam.*, Boh.-Fr.-Scand.-Eng.-Wales-Newf.—FIG. 112, 3. **P. granulatum* (BARRANDE), Jince F., Boh.; $\times 4.5$ (3*).

Family CYCLOPAGNOSTIDAE Howell, 1937

No frontal lobe on glabella, remaining lobe being evenly rounded in front; axis of pygidium short and ovoidly rounded at rear, with its transverse furrows faint or obsolete;

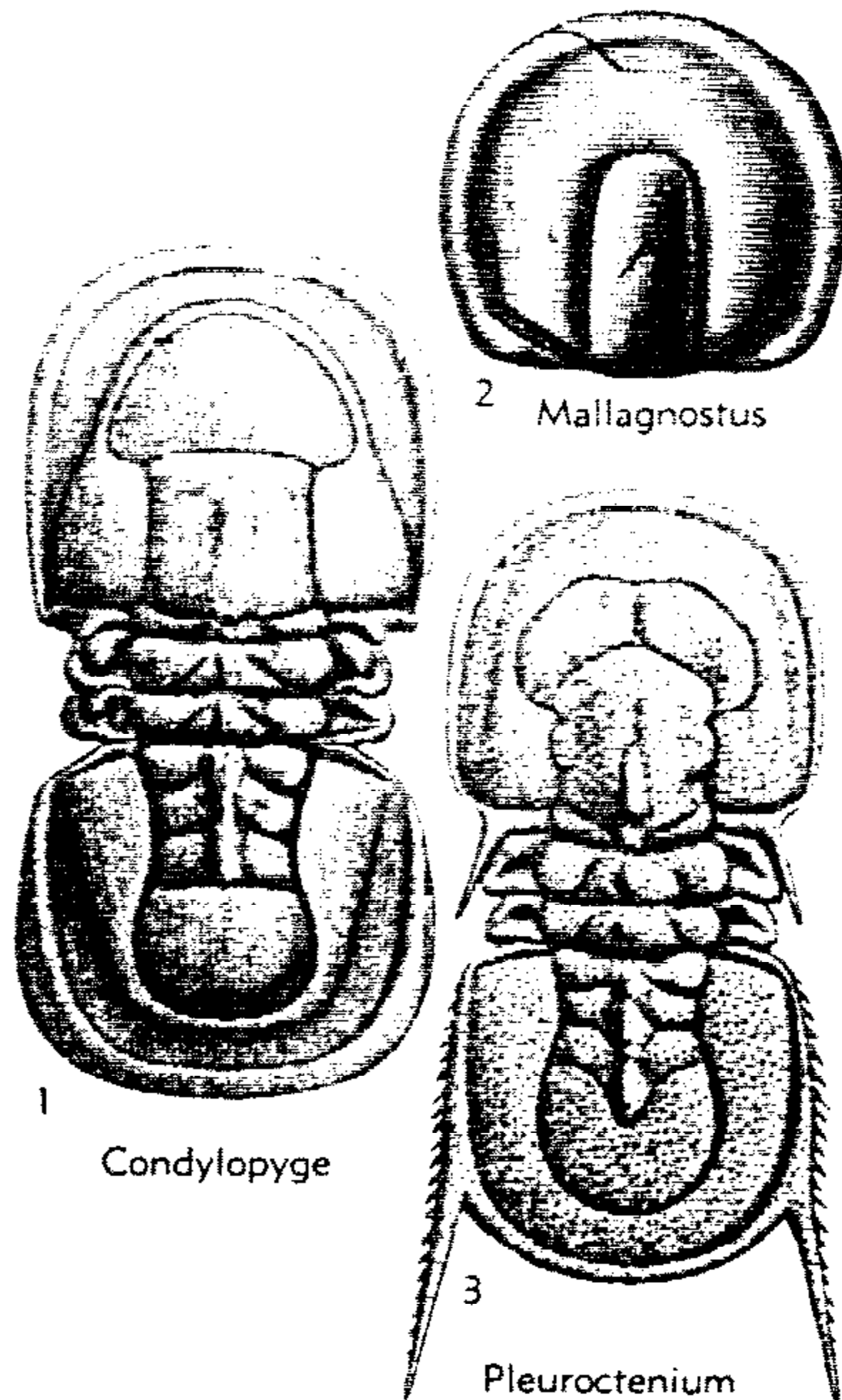

FIG. 112. Condylopygidae (p. 0174).

Family DIPLAGNOSTIDAE
Whitehouse, 1936

Glabella with 2 main lobes, anterior ones medially indented by longitudinal furrow; pygidial axis with 3 lobes and an elongate tubercle on its anterior portion; surface of cephalon smooth or corrugated, that of pygidium smooth. *M. Cam.*

Diplagnostus JAEKEL, 1909 [**Agnostus planicauda* TULLBERG, 1880 (non ANGELIN, 1851)] [= *Enetagnostus* WHITEHOUSE, 1936]. Axis of pygidium subtriangular in outline, reaching almost to border; genae smooth or rugose. *M. Cam.*, Eu.-Newf.-Arg.-Sib.-Queensl.—FIG. 114,1. **D. planicauda* (TULLBERG), Andrarum F., Swed.; 1a, ceph., $\times 9.25$; 1b, pyg., $\times 8.85$ (334*).

Linguagnostus KOBAYASHI, 1939 [**Agnostus kjerulfi* BRØGGER, 1878]. Axis of pygidium short and bluntly pointed at rear. *M. Cam.*, Eu.-Sib.-Newf.-Arg.—FIG. 114,2. **L. kjerulfi* (BRØGGER), Andrarum F., Swed.; 2a,b, ceph., pyg., $\times 4.5$ (334*).

Oidalagnostus WESTERGÅRD, 1946 [**O. trispinifer*]. Rear half of pygidial axis swollen and reaching back to border, which bears 3 spines. *M. Cam.*, Swed.—FIG. 114,3. **O. trispinifer*, *Lejopyge laevigata* Z., Swed.; 3a, ceph., $\times 4.4$; 3b, pyg., $\times 6.85$ (334*).

Tomagnostus HOWELL, 1935 [**Agnostus fissus* LUNDGREN in LINNARSSON, 1879]. Rear half of pygidial axis narrower and shorter than in *Diplagnostus* and not reaching so near to border; genae of cephalon rugose. *M. Cam.*, Eu.-Newf.-N.B.—FIG. 114,4. **T. fissus* (LUNDGREN), *Ctenocephalus exsulans* Z.—*Tomagnostus fissus* Z., Swed.; $\times 7.7$ (334*).



1a

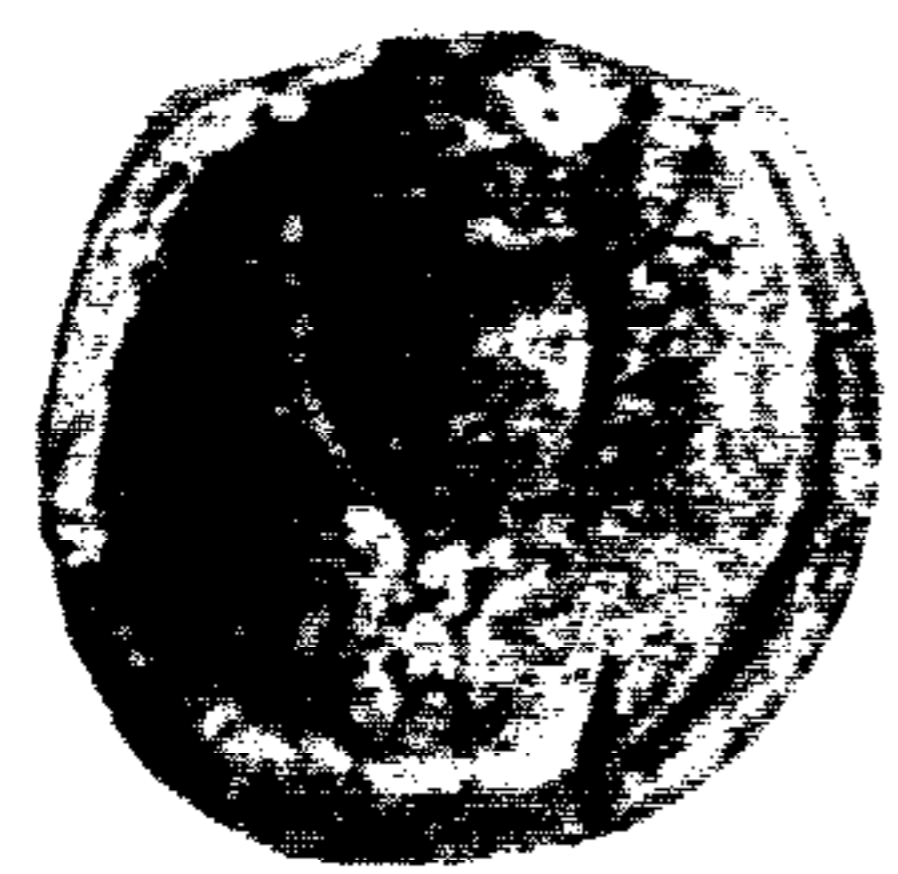

1b
Cyclopagnostus

FIG. 113. Cyclopagnostidae (p. 0175).

border moderate in width on both shields; dorsal exoskeleton smooth. *M. Cam.*

Cyclopagnostus HOWELL, 1937 [**C. hesperius*]. *M. Cam.*, Vt.—FIG. 113,1. **C. hesperius*, St. Albans F., Vt.; 1a, ceph., $\times 13.5$; 1b, pyg., $\times 9.6$ (72*).



1a



2a



3a

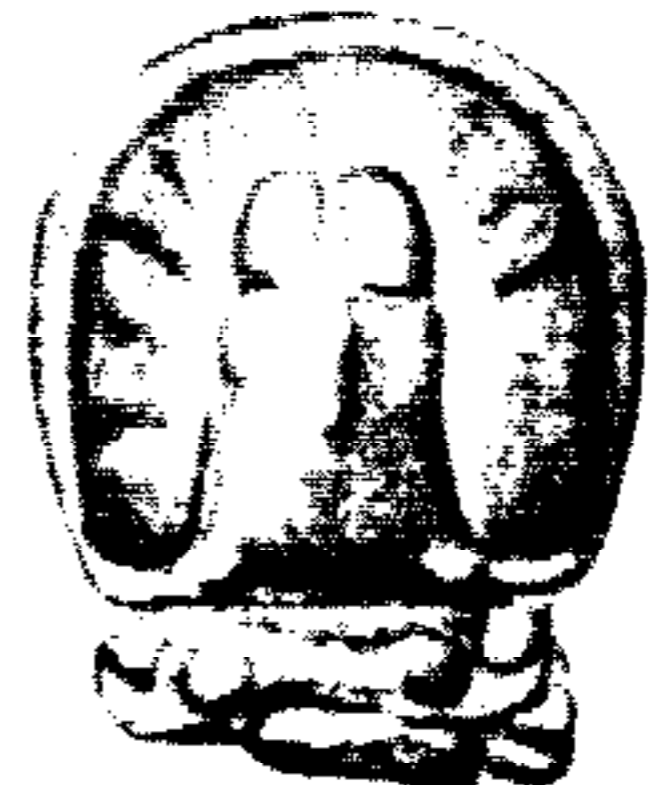

4

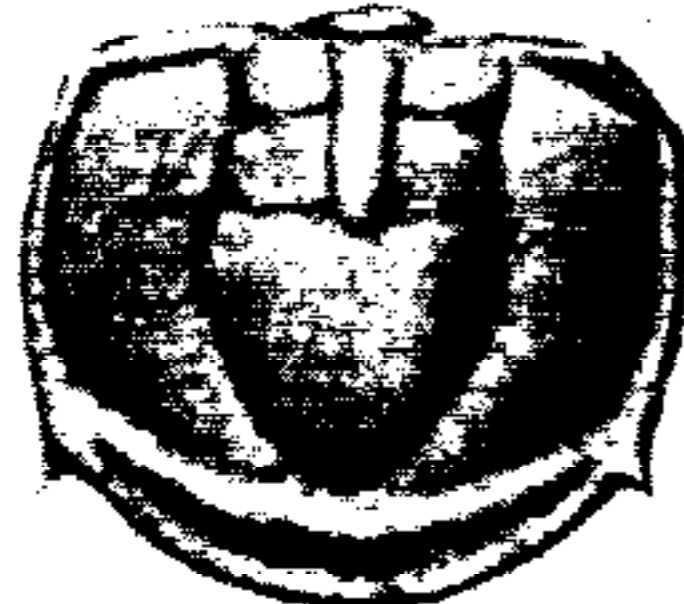

1b
Diplagnostus



2b
Linguagnostus

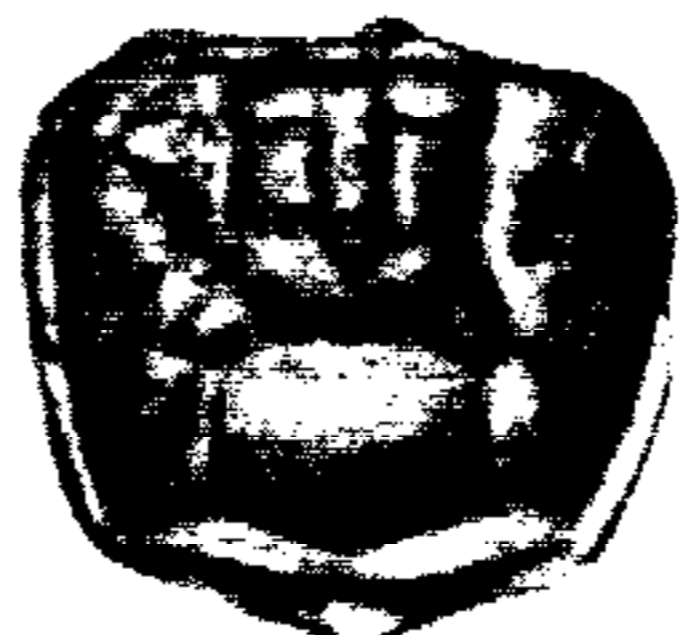

3b
Oidalagnostus



Tomagnostus

FIG. 114. Diplagnostidae (p. 0175).

Family GERAGNOSTIDAE Howell,
1935

[=Arthrorhachinae RAYMOND, 1913; Trinodidae HOWELL,
1935]

Glabella having essentially only a single long main lobe that is evenly rounded in front, well-developed transverse furrow lacking; pygidial axis short in most genera but divided into 3 lobes. *L.Ord.*-*U.Ord.*

Geragnostus HOWELL, 1935 [*Agnostus sidenbladhi* LINNARSSON, 1869]. Glabella showing only faint trace of transverse furrow; pygidial axis parallel-sided, slightly more than half as long as whole shield; surface of both shields smooth. *L.Ord.*, Eu.-USA (Tex.)-Can. (B.C.)-Arg.-Colom.-China. —FIG. 115,3. **G. sidenbladhi* (LINNARSSON), Tremadoc., Wales; $\times 11.5$ (11+).
Corrugatagnostus KOBAYASHI, 1939 [*Agnostus per-rugatus* BARRANDE, 1872]. Glabella wide at rear;

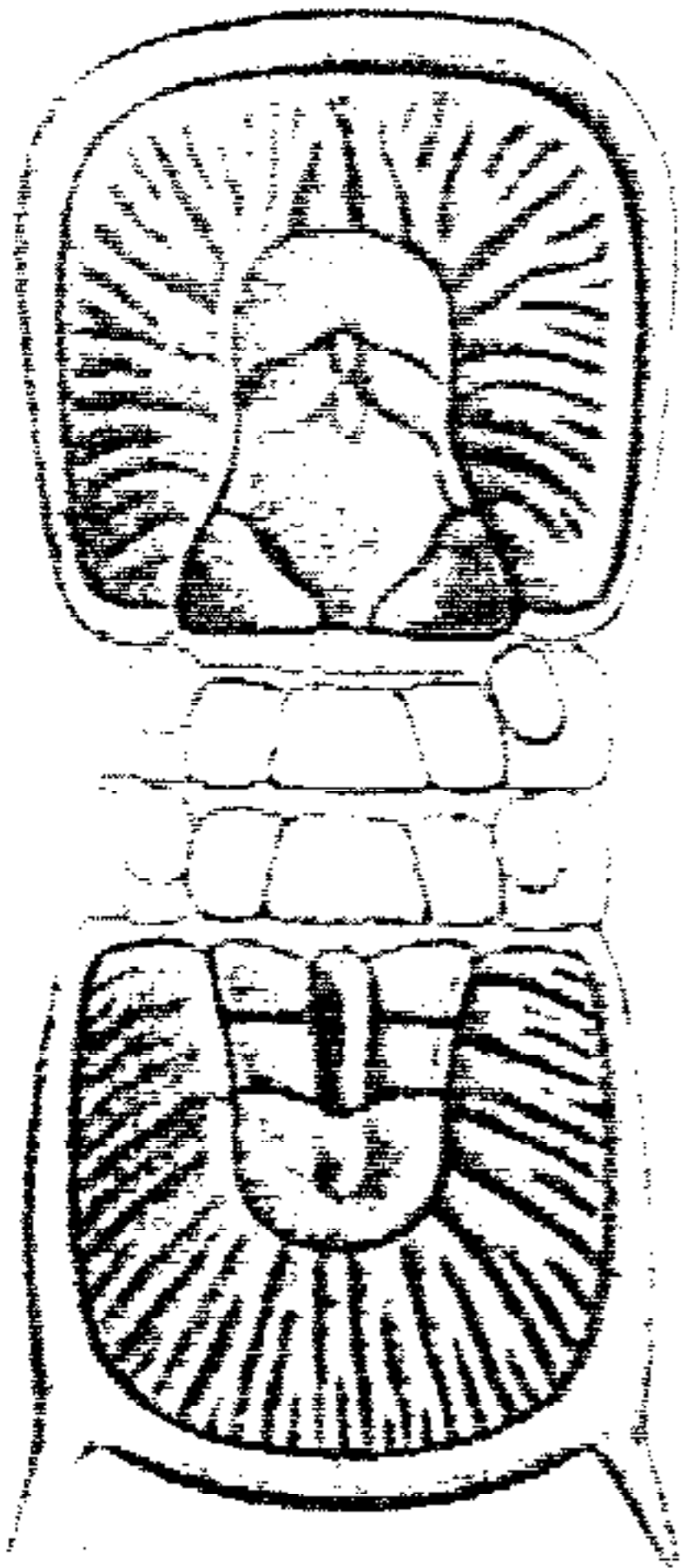

1
Corrugatagnostus

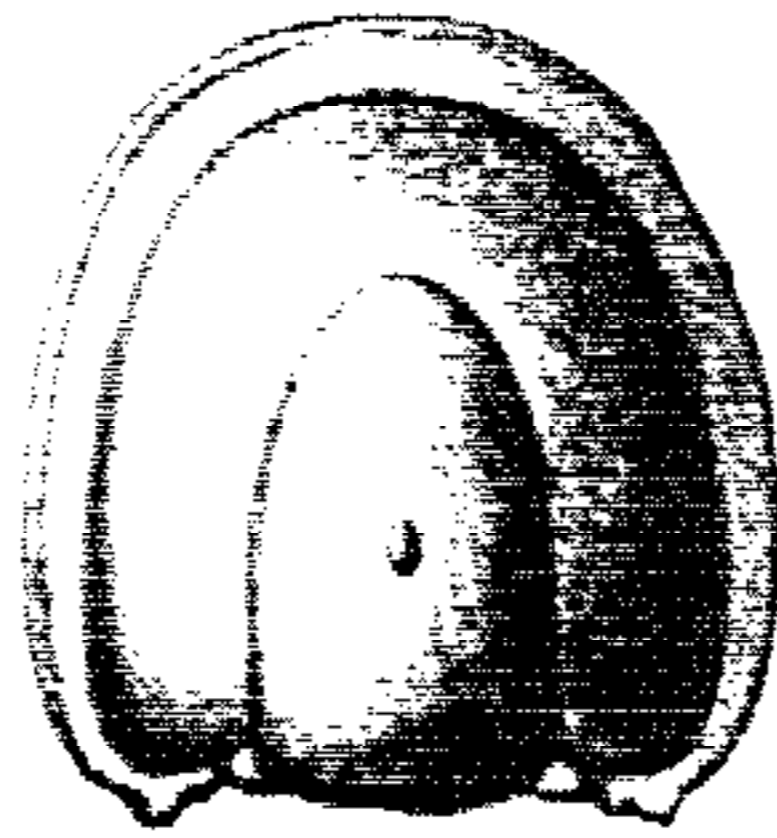

2a

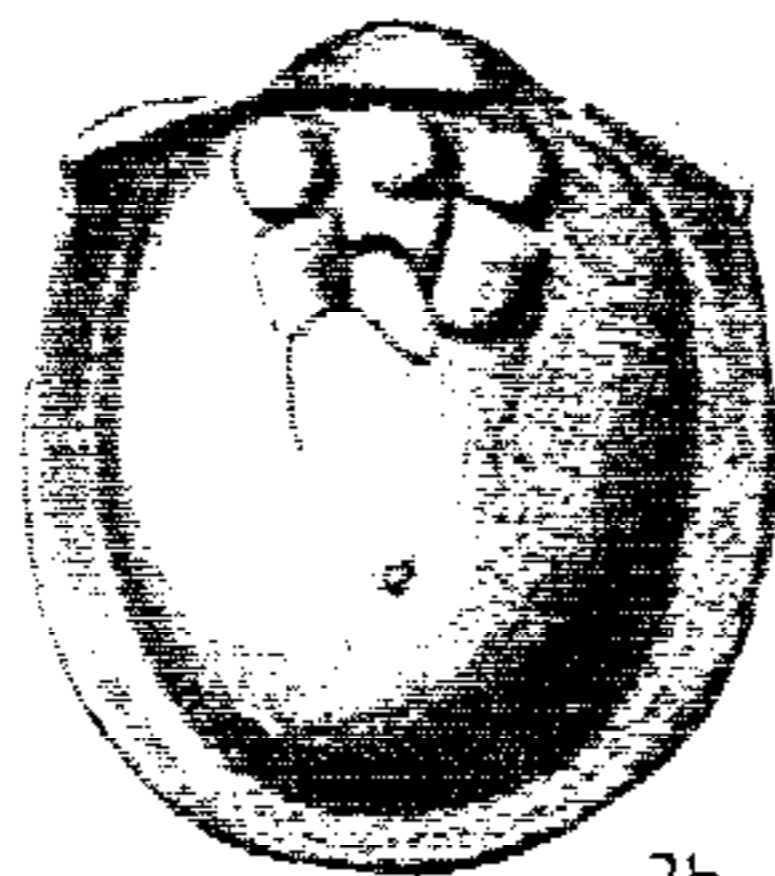

2b

Geragnostella

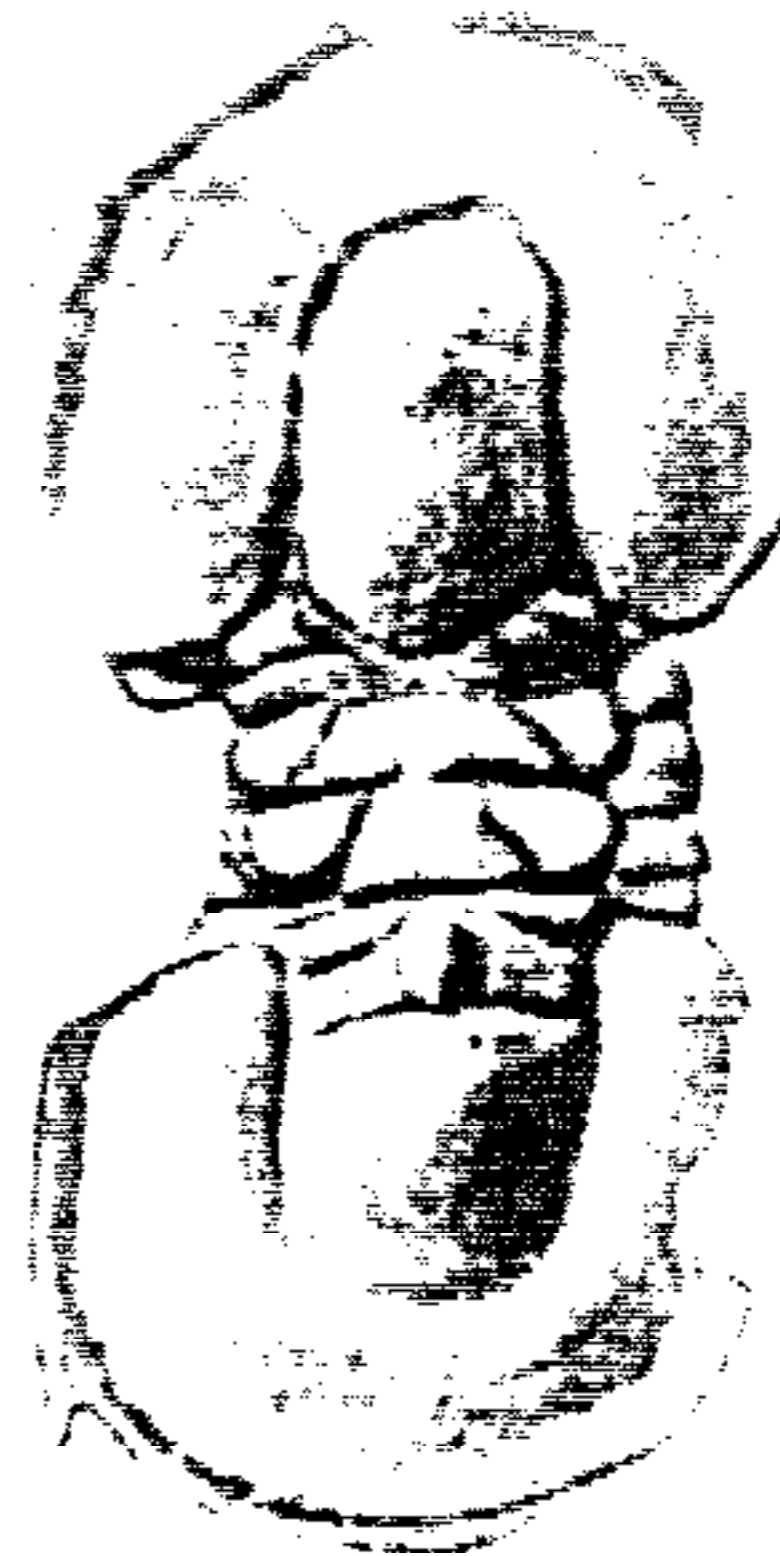

3

Geragnostus

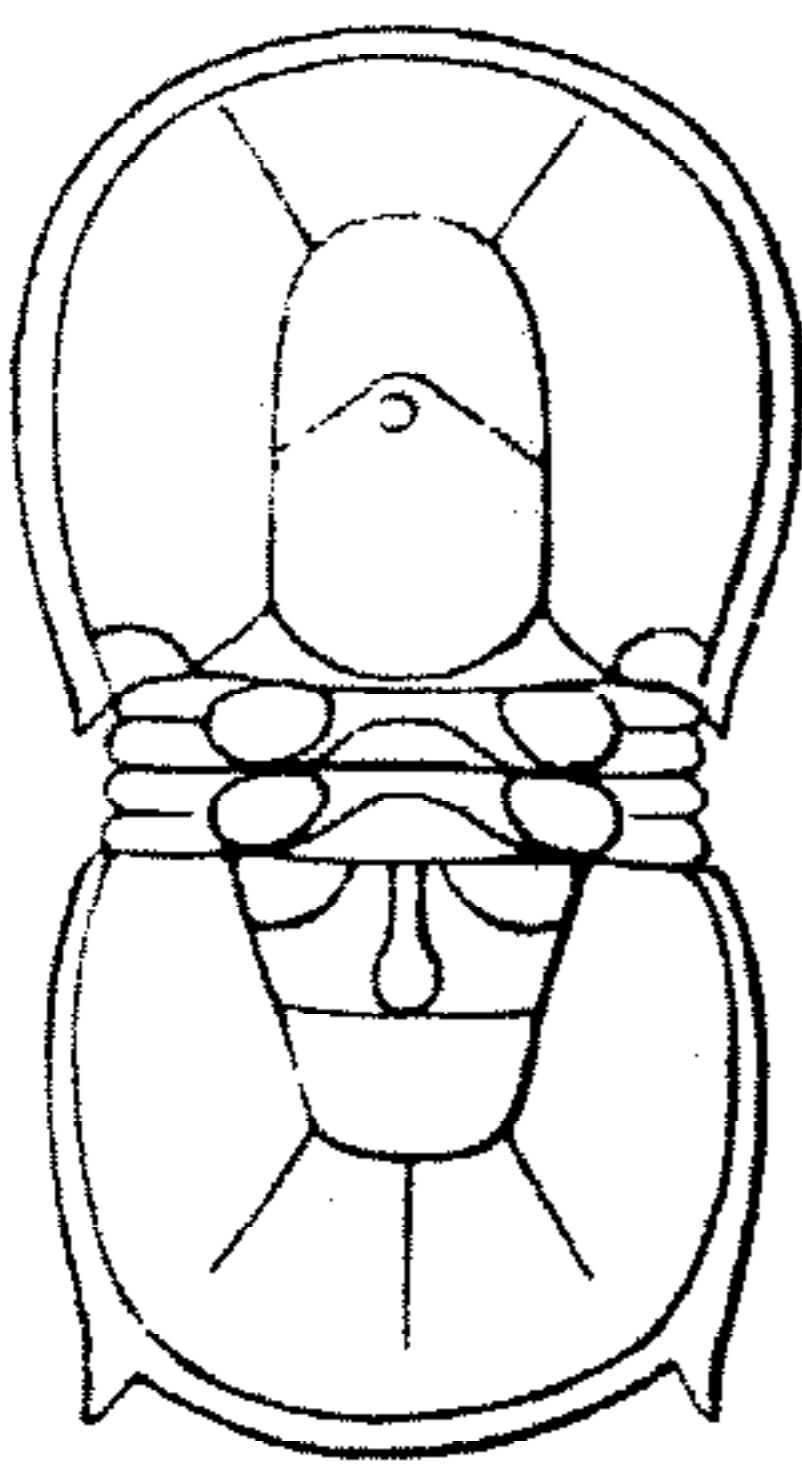

4

Girvanagnostus



5a

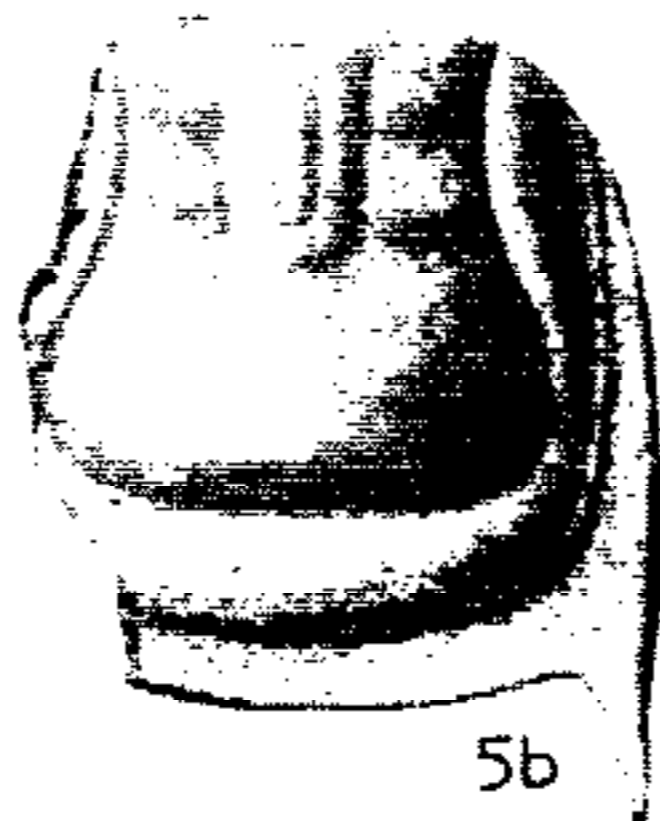

5b

Homagnostoides

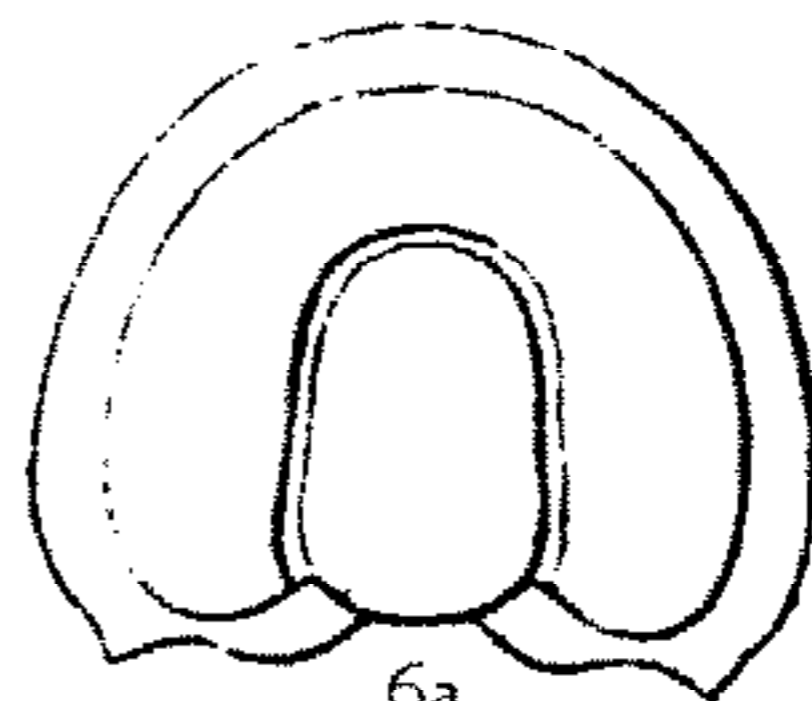

6a

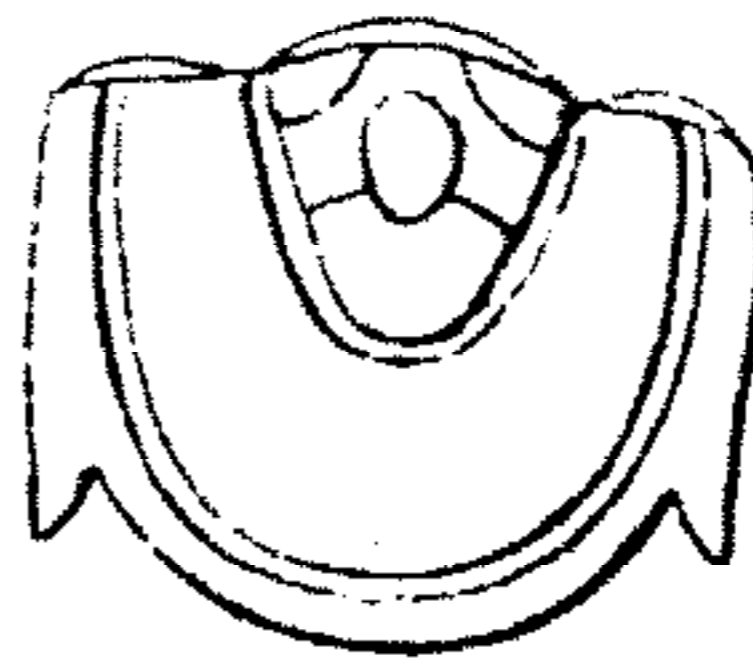

6b

Trinodus

FIG. 115. Geragnostidae (p. 0176-0178).

pygidial axis only half as long as pygidium; genal regions and pygidial pleural regions corrugated. *L.Ord.-M.Ord.*, Eu.-?Korea.—FIG. 115.1. **C. perrugatus* (BARRANDE), *L.Ord.*, Boh.; $\times 4.6$ (4*).
Geragnostella KOBAYASHI, 1939 [**Agnostus tullbergi* Novák, 1883]. Glabella ovate in outline, with no trace of transverse furrow; pygidial axis trilobed but rear end not defined by axial furrow; surface smooth. *L.Ord.*, Boh.-Swed.—FIG. 115.2. **G. tullbergi* (Novák), Boh.; 2*a,b*, ceph., pyg., $\times 5.4$ (159*).
Girvanagnostus KOBAYASHI, 1939 [**Agnostus girvanensis* REED, 1903]. Glabella 0.7 of length of

cephalon, with faint curved transverse furrow; pygidial axis half as long as pygidium, subtriangular, roundly truncated at rear, trilobed; dorsal exoskeleton smooth. *M.Ord.*, Scot.—FIG. 115.4. **G. girvanensis* (REED), Balclatchie F.; $\times 4.8$ (217*).
Homagnostoides KOBAYASHI, 1939 [**Agnostus ferralsensis* MUNIER-CHALMAS & BERGERON, 1889]. Glabella very large, subquadrate, lacking transverse furrows; pygidial axis very large, much expanded at rear but not reaching posterior border; surface smooth. *L.Ord.*, Fr.—FIG. 115.5. **H. ferralsensis* (MUNIER-CHALMAS & BERGERON), *L. Tremadoc.*; 5*a,b*, ceph., pyg., $\times 7.2$ (377*).

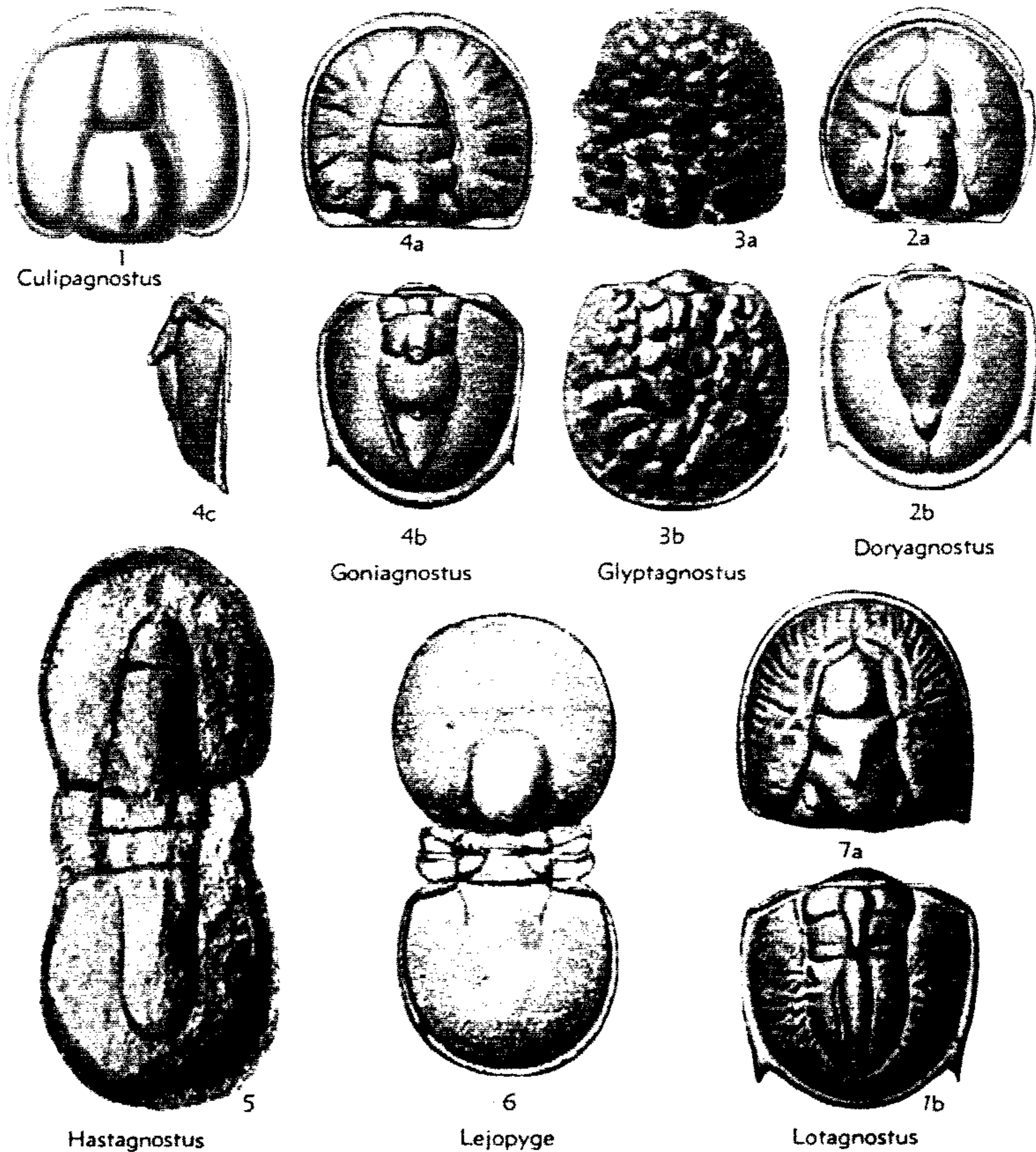

FIG. 116. Hastagnostidae (p. 0178-0179).

Trinodus McCoy, 1846 [**T. agnostiformis*] [= *Archrorhachis* Hawle & Corda, 1847; *Metagnostus* Jaekel, 1909]. Glabella 0.5 to 0.7 of length of cephalon, without transverse furrow; pygidial axis ovoid, trilobed, only half as long as pygidium; dorsal exoskeleton smooth. *Ord.*, Eu.-Newf.-Que.-Va.-Tenn.-B.C.-Arg.-China-Burma.—FIG. 115,6. **T. agnostiformis*, Drummuick Group, Scot.; 6a,b, ceph., pyg., $\times 4.9$ (217*).

Family HASTAGNOSTIDAE Howell, 1937

Longitudinal furrow in front of glabella, which has 2 main lobes, front one triangular or subtriangular in outline; pygidial axis with 3 lobes, rear one reaching or not reaching to border, which is of moderate width or narrow; axial furrows mostly obsolete in *Lejopyge*. *M.Cam.-U.Cam.*

Hastagnostus Howell, 1937 [**H. angustus*]. Front of anterior glabellar lobe rounded; pygidial axis narrow, bluntly rounded at rear, not reaching backward to border, with longitudinal furrow behind axis of pygidium dividing pleural fields at rear; surface of both shields smooth. *M.Cam.*, USA.—FIG. 116,5. **H. angustus*, St. Albans F., Vt.; $\times 6$ (72*).

Culipagnostus Rusconi, 1952 [**C. chipiquensis*]. Front lobe of glabella very long, reaching border of shield; pygidium as in *Hastagnostus* but longer, reaching border; surface of both shields smooth. *M.Cam.*, Arg.—FIG. 116,1. **C. chipiquensis*, Villavicencio F., Arg.; ceph., $\times 16.5$ (259*).

Doryagnostus Kobayashi, 1939 [**Aagnostus incertus* Brogger, 1878] [= *Ceratagnostus* Whitehouse, 1939]. Front lobe of glabella bluntly subtriangular; pygidial axis sharply pointed at rear, bearing small tubercle on its middle lobe, not reaching border; pleural fields divided at rear by longitudinal furrow; surface of both shields smooth. *M.Cam.*, Eu.-Newf.-Queensl.—FIG. 116,2. **D. incertus* (Brogger), *Ptychagnostus punctuosus* Z., Swed.; 2a, ceph., $\times 4.75$; 2b, pyg., $\times 5.3$ (334*).

Glyptagnostus Whitehouse, 1936 [**G. toreuma*]. Genae and pleural fields covered with reticulate pattern of furrows. *U.Cam.*, Eu.-Ala.-Queensl.—FIG. 116,3. **G. toreuma*, *Glyptagnostus* Stage, Queensl.; 3a, ceph., $\times 4$; 3b, pyg., $\times 4.8$ (339*).

Goniagnostus Howell, 1935 [**Aagnostus nathorsti* Brogger, 1878] [= *Harpagnostus* Rusconi, 1950]. Front lobe of glabella triangular, genae crossed by radiating furrows; pygidial axis tapering to rounded rear end, not reaching border; surface of pleural fields granular. *M.Cam.*, Eu.-N.B.-Queensl.—FIG. 116,4. **G. nathorsti* (Brogger), *Goniagnostus nathorsti* Z., Swed.; 4a, ceph., $\times 6.5$; 4b,c, pyg., $\times 6.5$ (334*).

Lejopyge Hawle & Corda, 1847 [**Battus laevigatus* Dalman, 1828] [= *Miagnostus* Jaekel, 1909 (obj.)]. Axial furrows of both shields obsolete except near base of glabella and at upper end of pygidial axis; genae smooth or rugose; surface of pygidium smooth. *M.Cam.-U.Cam.*—Swed.-Norway.—FIG. 116,6. **Lejopyge laevigata* (Dalman), *Lejopyge laevigata* Z., Swed.; $\times 7.7$ (334*).

Lotagnostus Whitehouse, 1936 [**Aagnostus trisectus* Salter, 1864]. Genae and pleural fields of

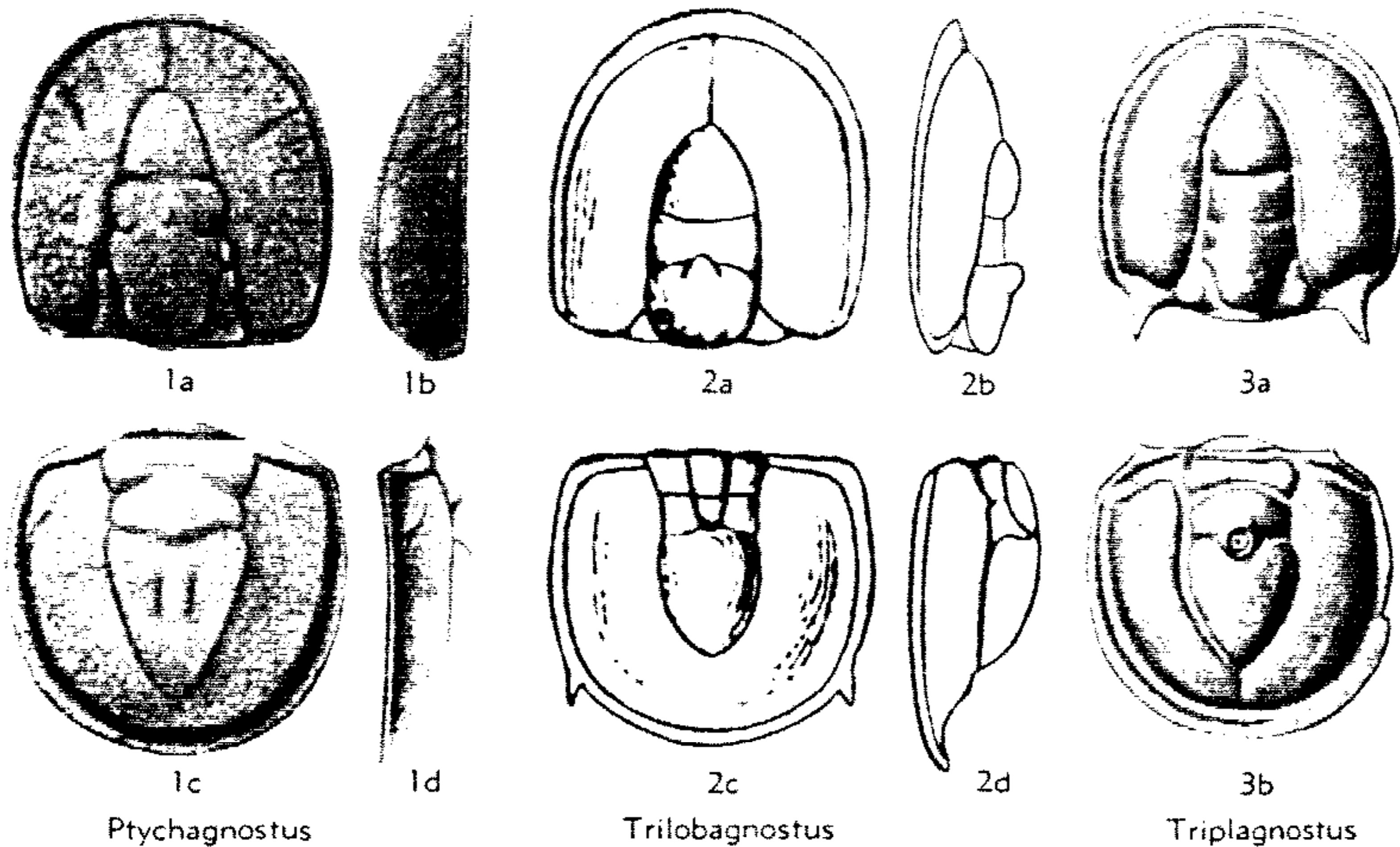

FIG. 117. Hastagnostidae (p. 0179).

pygidium with radiating furrows, rear lobe of pygidial axis divided longitudinally into 3 lobes. *U. Cam.*, Eu.-N. Scot.-Que.-Vt.-Arg.-China. — FIG. 116.7. **L. trisectus* (SALTER), *Peltura minor* Z., Swed.; 7a,b, ceph., pyg., $\times 6$ (331*).

Ptychagnostus JAEKEL, 1909 [**Agnostus punctuosus* ANGELIN, 1851; SD VOGDES, 1925] [= *Canoagnostus* RUSCONI, 1951]. Front lobe of glabella subtriangular; pygidial axis subtriangular, not reaching posterior border, middle lobe of axis bearing a large tubercle that may extend backward over front part of rear lobe; surface of genae and pleural fields granular, genae crossed by radiating furrows. *M. Cam.*, Eu.-Newf.-N.B.-Arg. — FIG. 117.1. **P. punctuosus* (ANGELIN) *Ptychagnostus punctuosus* Z., Swed.; 1a,b, ceph., $\times 5.4$; 1c,d, pyg., $\times 5.4$ (334*).

Trilobagnostus HARRINGTON, 1938 [**Agnostus innocens* CLARK, 1924]. Main lobe of glabella with transverse furrow across middle; pygidial axis short, with elongate tubercle that extends across first 2 lobes; surface of both shields smooth. *U. Cam.*, Que. — FIG. 117.2. *T. innocens* (CLARK); 2a,b, ceph., $\times 7.1$; 2c,d, pyg., $\times 8$ (385*).

Triplagnostus HOWELL, 1935 [**Agnostus gibbus* LINNARSSON, 1869] [= *Solenagnostus* WHITEHOUSE, 1936]. Front lobe of glabella subtriangular; pygidial axis wide, with bluntly triangular rear lobe not reaching backward to border but with longitudinal furrow behind it that does extend to border; dorsal exoskeleton smooth. *M. Cam.*, Eu.-Newf.-N.B.-Sib.-Queensl. — FIG. 117.3. **T. gibbus* (LINNARSSON), *Triplagnostus gibbus* Z., Swed.; 3a, ceph., $\times 5.1$; 3b, pyg., $\times 4.75$ (334*).

Family MICRAGNOSTIDAE Howell, 1935

Glabella with 2 main lobes, anterior one evenly rounded at front; pygidial axis short, more or less segmented; surface of both shields smooth. *U. Cam.-L. Ord.*

Micragnostus HOWELL, 1935 [**Agnostus calvus* LAKE, 1906]. Glabella with 2 well-defined main lobes, pygidial axis distinctly trilobed but rather short and not expanded toward rear, not reaching border. *U. Cam.-L. Ord.*, Eu.-Can.-Vt. — FIG. 118.3. **M. calvus* (LAKE), Tremadoc., Wales; $\times 10$ (114*).

Anglagnostus HOWELL, 1935 [**Agnostus dux* CALLAWAY, 1877]. Glabella rather short; pygidial axis very short, with only 2 segments. *U. Cam.-L. Ord.*, Eng.-Fr.-Vt.-Arg. — FIG. 118.1. **A. dux* (CALLAWAY), Tremadoc., Eng.; $\times 8$ (114*).

Hyperagnostus KOBAYASHI, 1955 [**H. binodosus*]. Glabella with double triangular lobe between 2 main lobes; pygidial axis trilobed, bluntly rounded at rear, not reaching backward to border. *L. Ord.*, B.C. — FIG. 118.2. **H. binodosus*, McKay F.; 2a, ceph., $\times 7$; 2b, pyg., $\times 7$ (108*).

?**Rudagnostus** LERMONTOVA, 1951 [**Agnostus princeps* var. *rudis* SALTER, 1864 (= *Agnostus rudis* SALTER, 1864, LAKE, 1907)]. *U. Cam.*, Kazakstan, Eu.

?**Eurudagnostus** LERMONTOVA, 1951 [**E. grandis*]. Cephalon with prominent rim and well-developed posterolateral short spines, glabella with fairly distinct rounded lobe in front; pygidium with

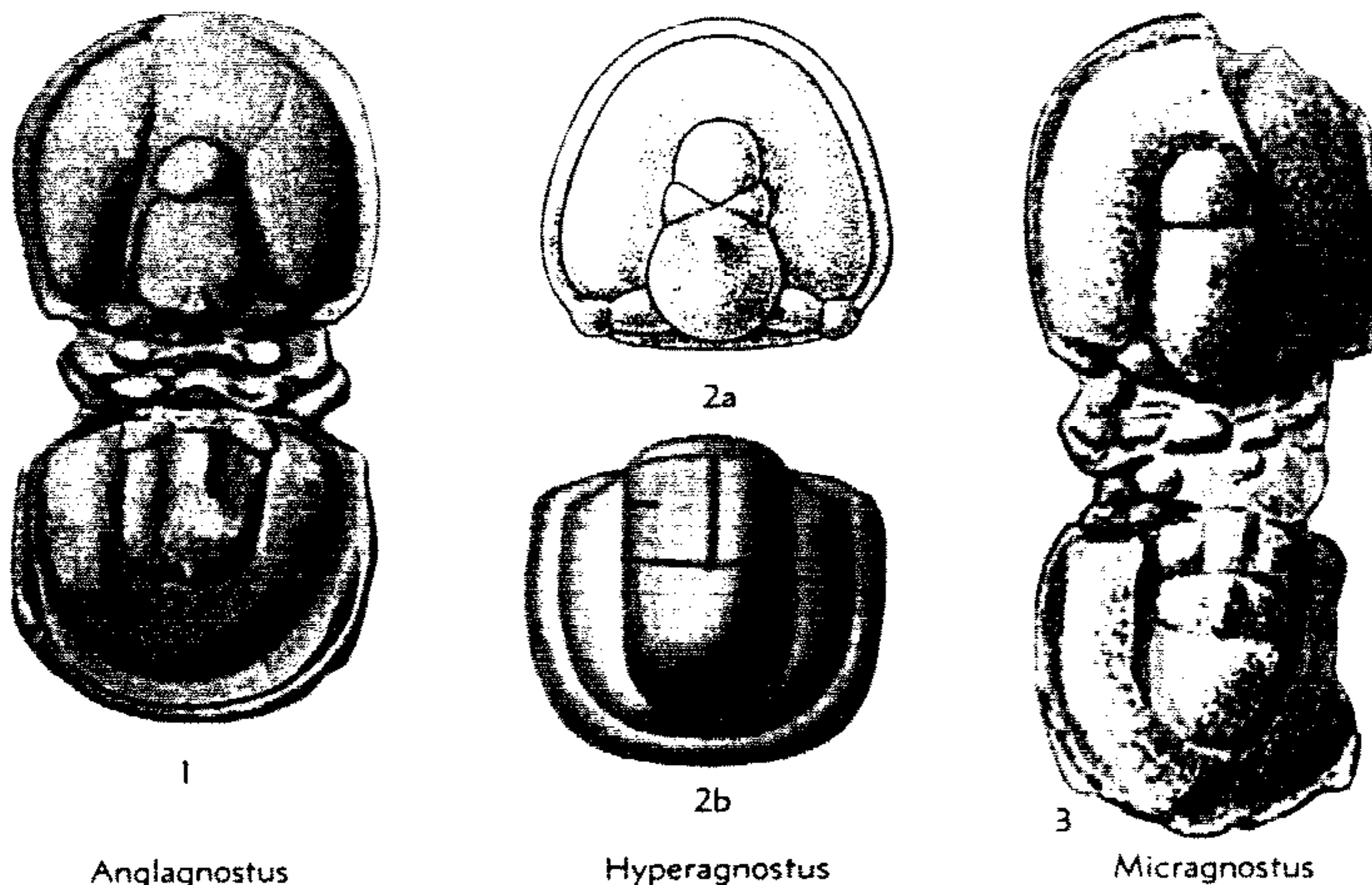
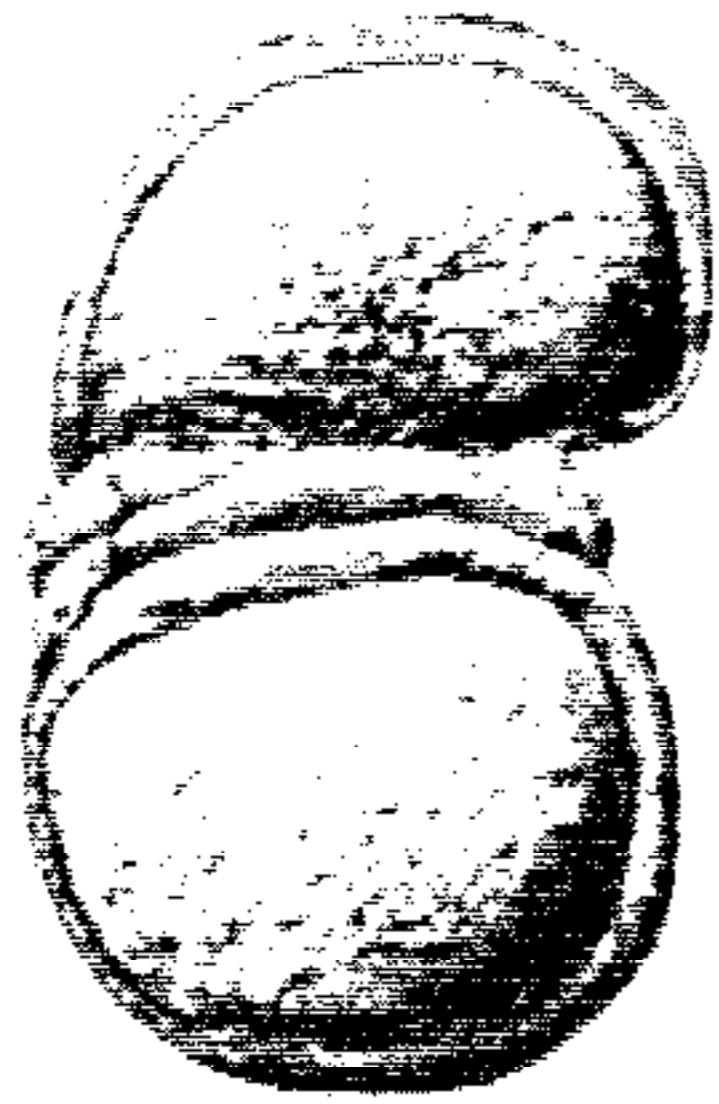
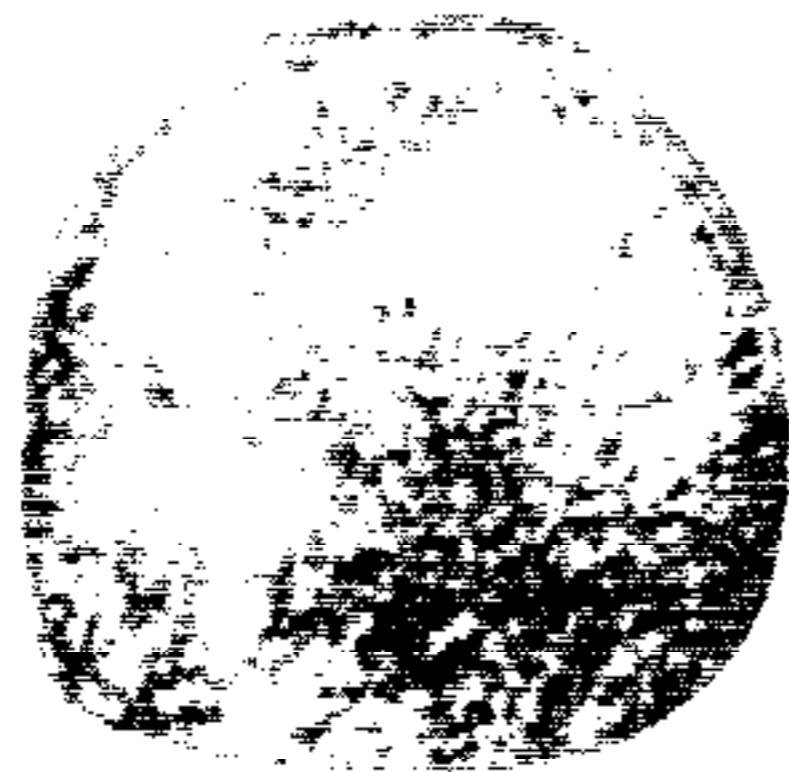

FIG. 118. Micragnostidae (p. 0179).



1
Gallagnostus



2a
Grandagnostus

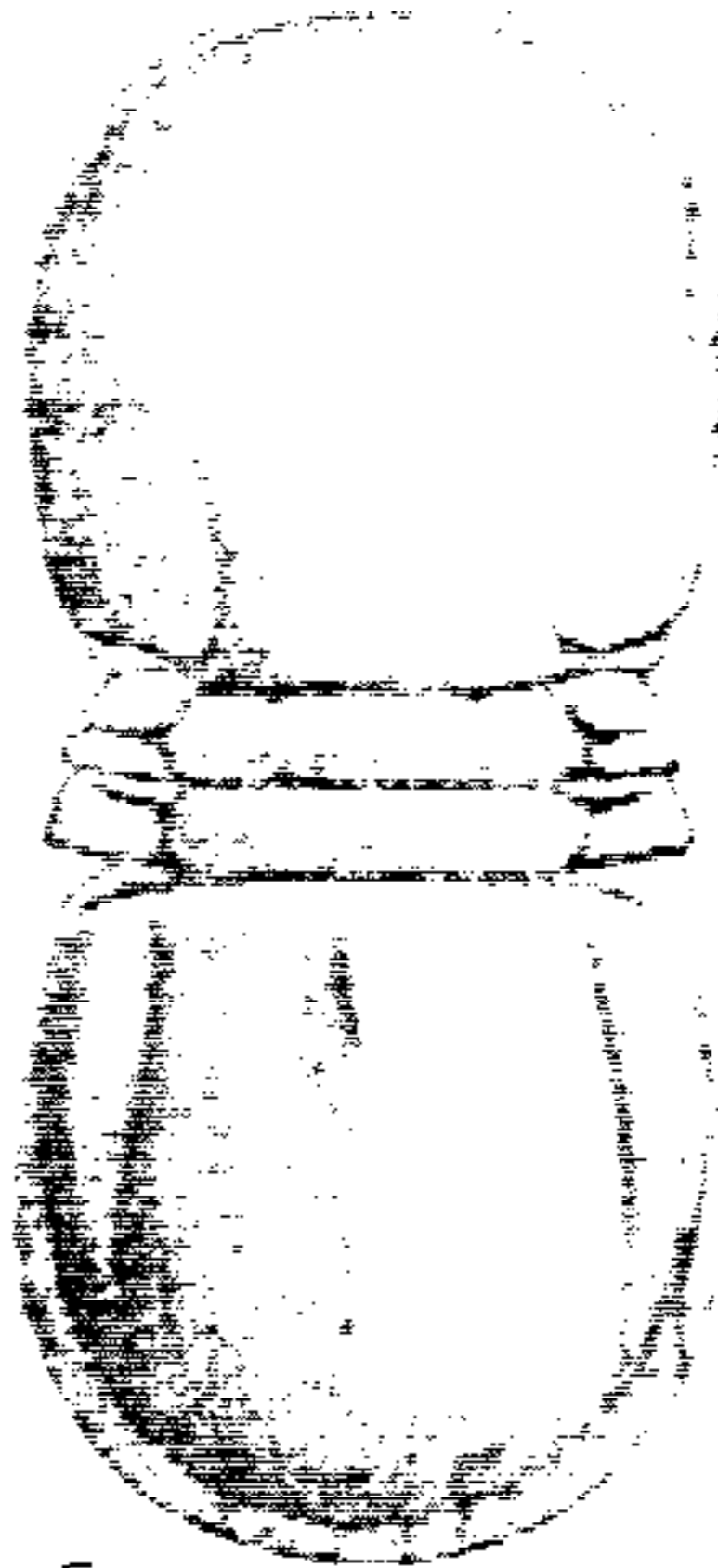

5
Phalacroma

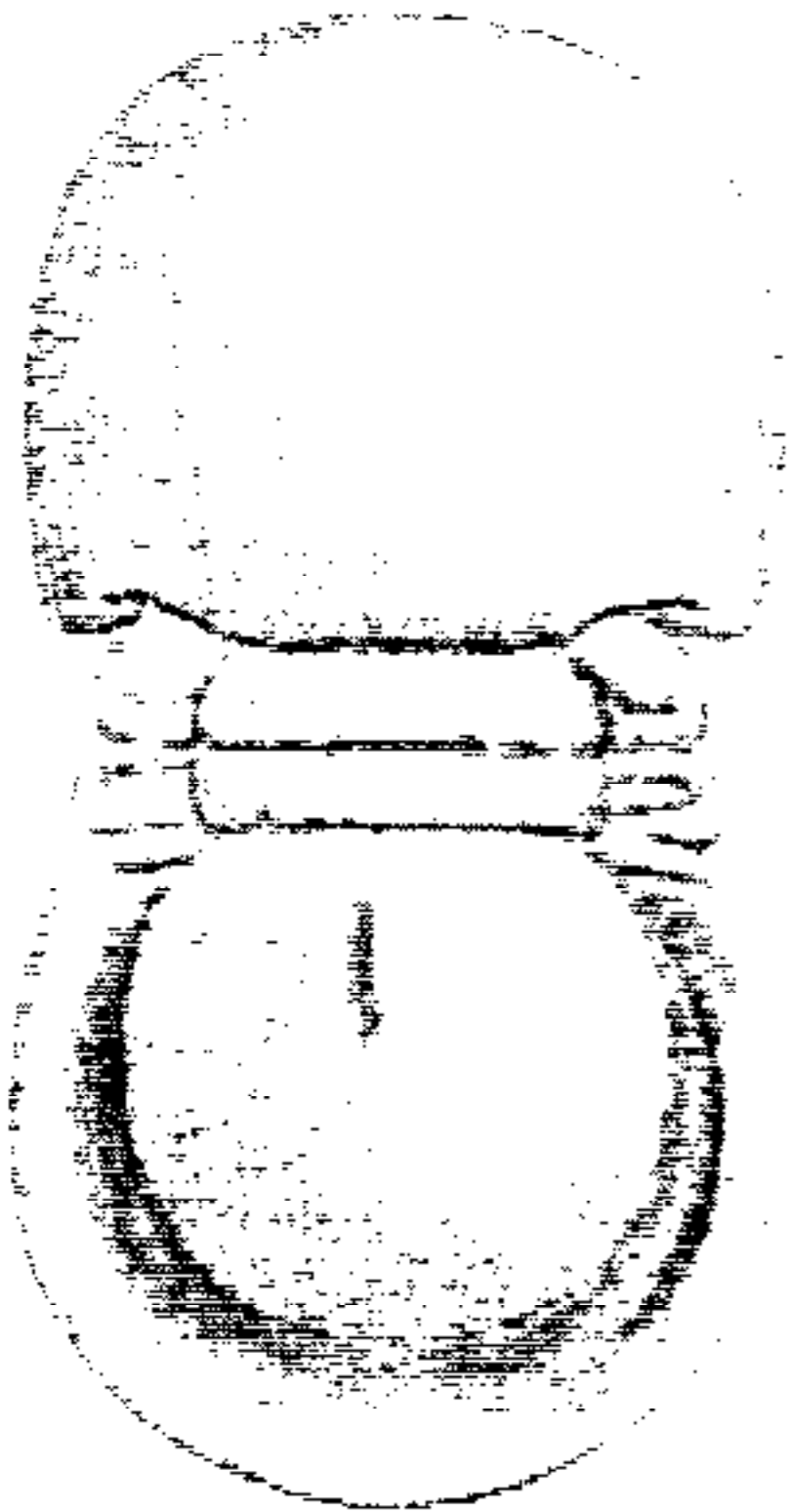

6
Phalagnostus



4a

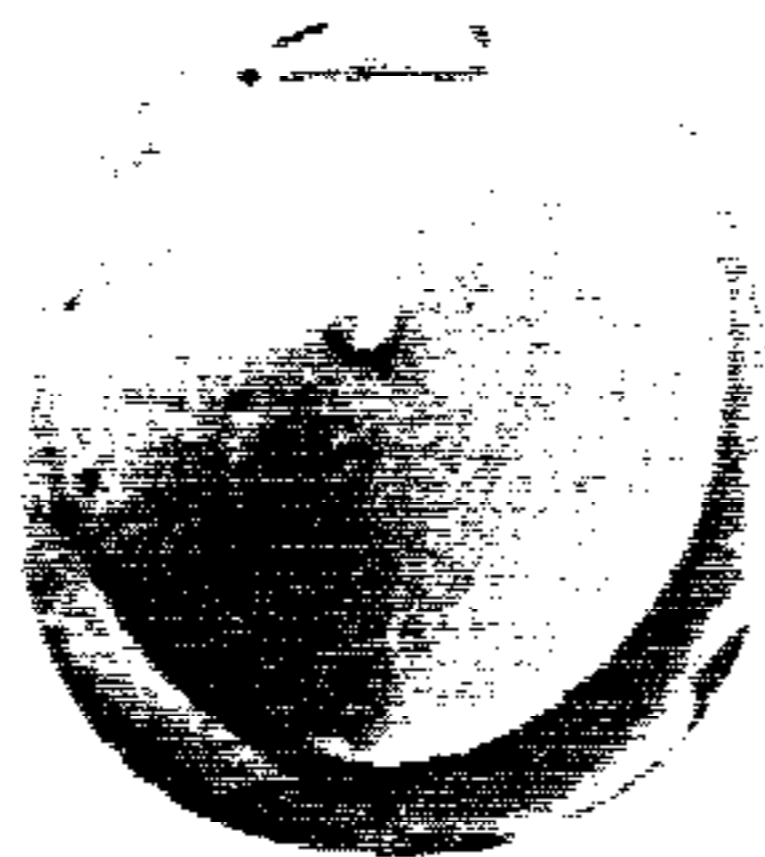

4b
Litagnostus



2b
Grandagnostus

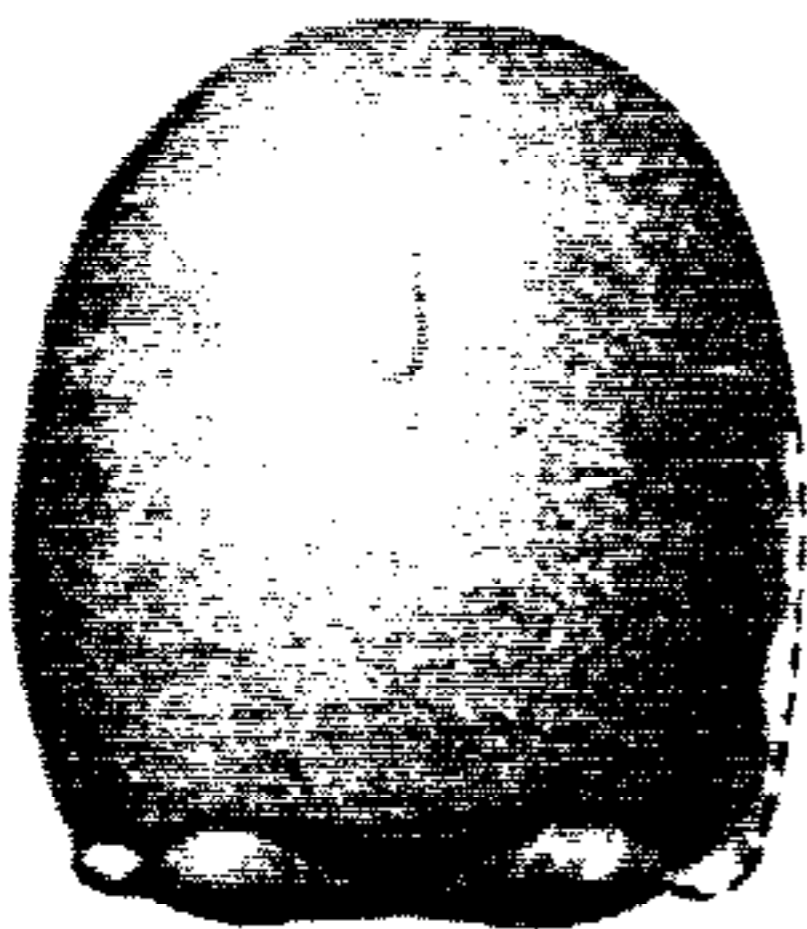

7a



7c

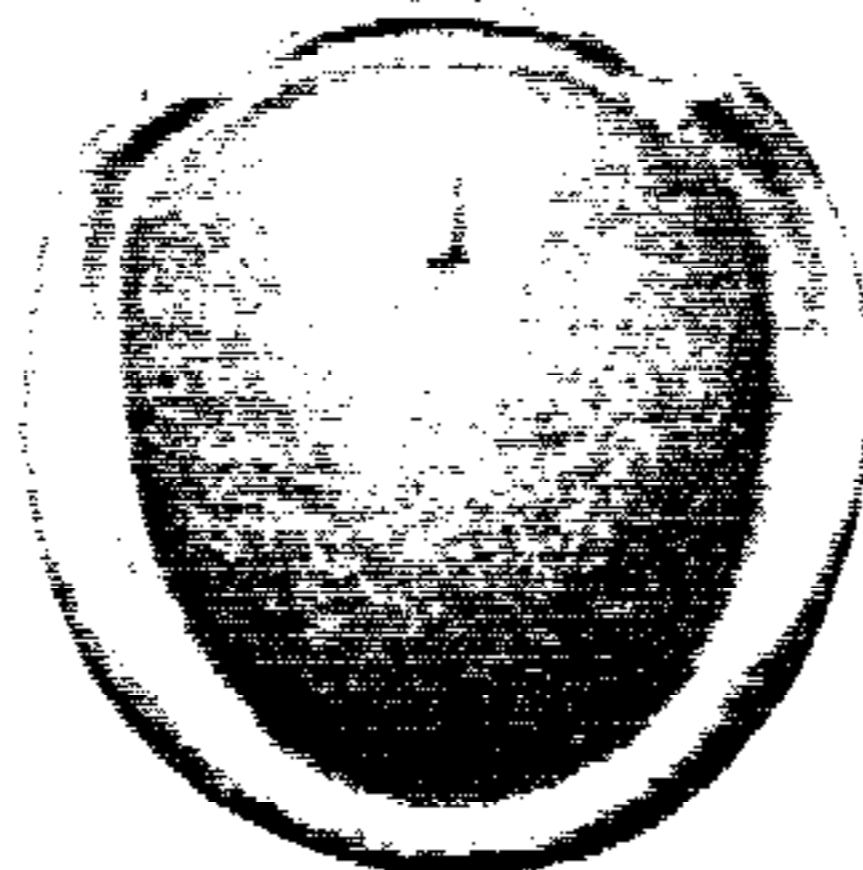

7b

Phoidagnostus

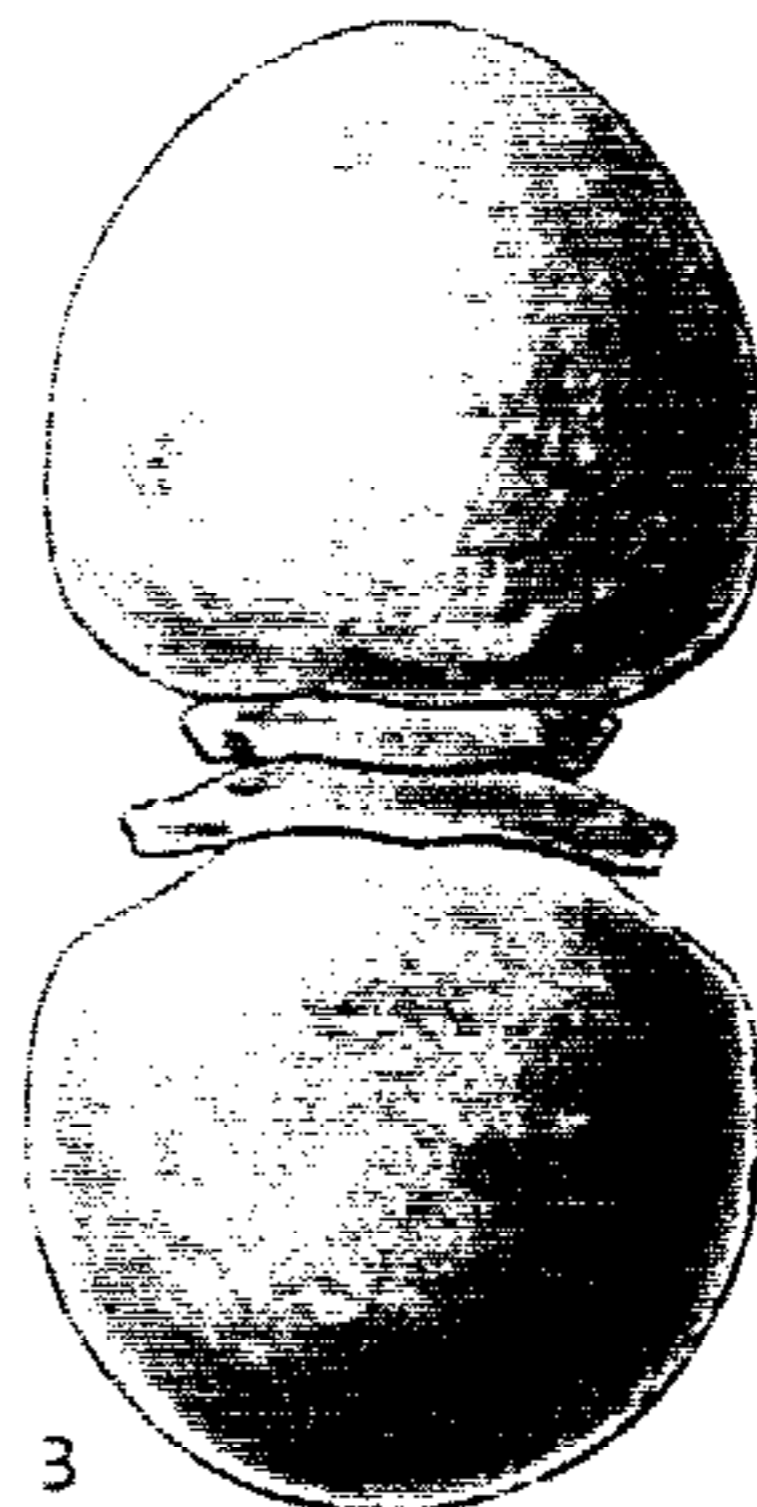

3
Leiagnostus

FIG. 119. Phalacromidae (p. O181).

broad, well-defined axis that bears strong tubercle, margin with pair of slender, long, slightly incurved spines. *U.Cam.*, Kazakstan.—FIG. 128,1. **E. grandis*; 1a,b, ceph., pyg., $\times 6$ (423) (M).

Family PHALACROMIDAE Hawle & Corda, 1847

[*nom. correct.* HOWELL, 1935 (*pro* Phalacromides Hawle & Corda, 1847)] [=Leignostidae JAEKEL, 1909; Platagnostidae HOWELL, 1935]

Cephalon smooth, with little or no trace of axial furrow; pygidium smooth, dorsal furrow lacking or barely visible; surface smooth. *M.Cam.-L.Ord.*

Phalacroma HAWLE & CORDA, 1847 [**Battus bibullatus* BARRANDE, 1846; SD RAYMOND, 1913] [=Platagnostus HOWELL, 1935 (*obj.*)]. Cephalon smooth, with only faint traces of rear ends of dorsal furrow, border narrow; pygidium smooth, with faintly impressed axial furrow, axis only slightly expanded at rear, reaching backward to narrow border. *M.Cam.*, Boh.-Eng.-Newf.—FIG. 119,5. **P. bibullatum* (BARRANDE), Paradoxides beds, Boh.; $\times 11.5$ (3*).

Gallagnostus HOWELL, 1935 [**G. geminus*]. Cephalon smooth, without trace of axial furrow but with border of moderate width; pygidium lacking axial furrow but with border of moderate width. *M.Cam.-L.Ord.*, Fr.-Arg.—FIG. 119,1. **G. geminus*, Paradoxides beds, Fr.; $\times 7.7$ (71*).

Gallagnostoides KOBAYASHI, 1939 [**Aeglina boia* HICKS, 1875]. Like *Gallagnostus*, but with a narrower thoracic axis. *L.Ord.*, Wales.

Grandagnostus HOWELL, 1935 [**G. vermontensis*]. Cephalon smooth, with only faint trace of rear ends of axial furrow, and little or no indication of border; pygidium smooth, lacking axial furrow but with wide border; doublure present on both shields. *M.Cam.*, Vt.-Eur.-Sib.—FIG. 119,2. **G. vermontensis*, Centropleura vermontensis Z., Vt.; 2a, ceph., $\times 4.5$; 2b, pyg., $\times 3.4$ (71*).

Leignostus JAEKEL, 1909 [**L. erraticus*]. Cephalon smooth, lacking axial furrow but with moderately wide border. *L.Ord.*, Eu.—FIG. 119,3. **L. erraticus*, Echinospaerites Z. (glacial erratic), N. Ger.; $\times 4.8$ (83*).

Litagnostus RASETTI, 1944 [**L. levisensis*]. Cephalon smooth, lacking axial furrow but with narrow border; pygidium smooth, without trace of axial furrow, border moderately wide. *U.Cam.*, Que.-Vt.-Wis.—FIG. 119,4. **L. levisensis*, Que.; 4a,b, ceph., pyg., $\times 10$ (188*).

Phalagnostus HOWELL, 1955 [**Battus nudus* BEYRICH, 1845]. Cephalon smooth, lacking axial furrow and border or with very narrow border and no basal lobes; pygidium smooth, without axial furrow but with side border. *M.Cam.*, Eu.-Newf.-Queensl.—FIG. 119,6. **P. nudus* (BEYRICH), Paradoxides beds, Boh.; $\times 7.6$ (3*).

Phoidagnostus WHITTHOUSE, 1936 [**P. limbatus*]. Cephalon smooth, lacking axial furrow but with narrow border and basal lobes; pygidium smooth, without axial furrow but with wide border. *M.Cam.*, Eu.-Sib.-Queensl.—FIG. 119,7. *P. bituberculatus* (ANGELIN), Solenopleura brachymetopa Z., Swed.; 7a, ceph., $\times 8$; 7b,c, pyg., $\times 8.3$ (334*).

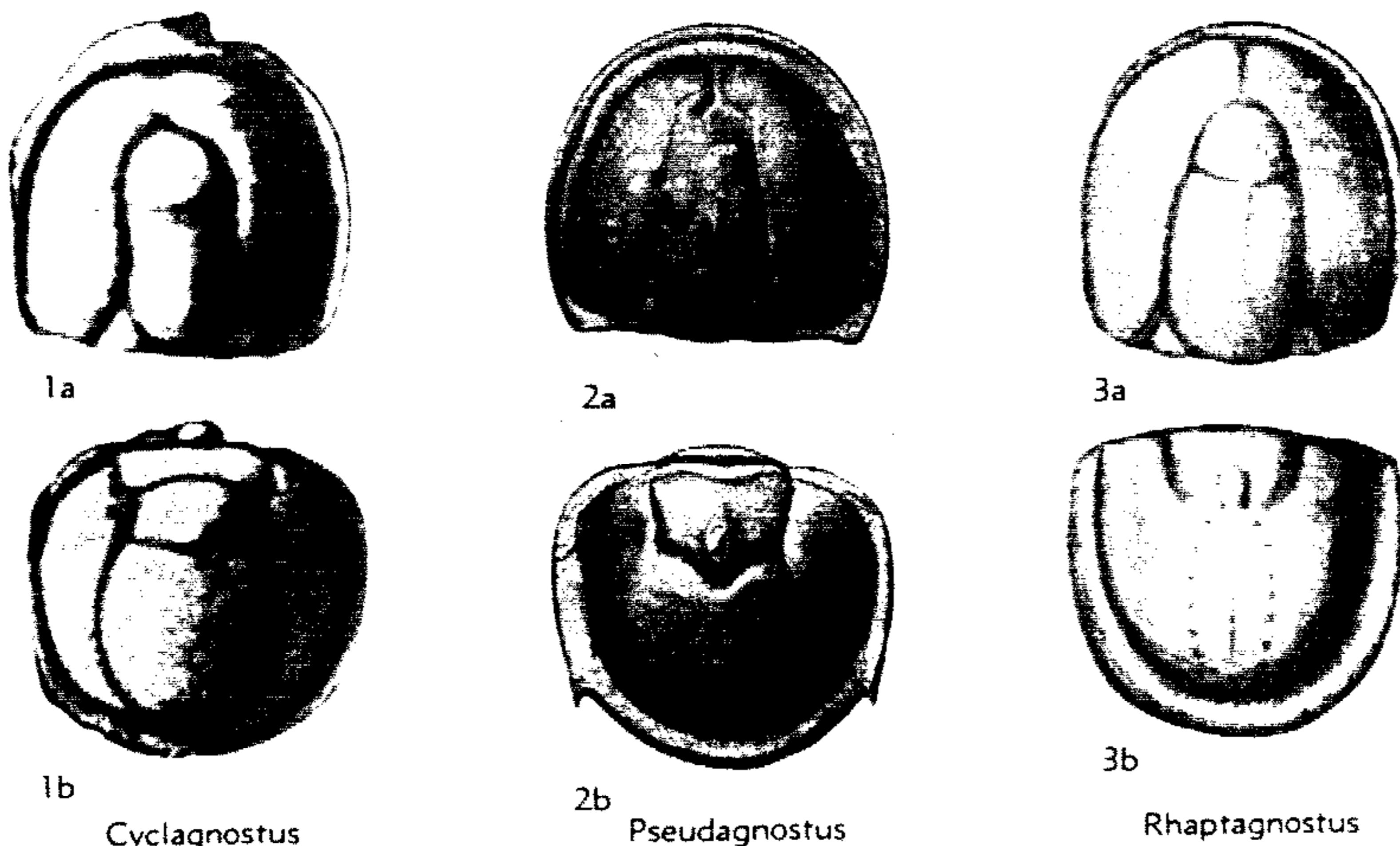

FIG. 120. Pseudagnostidae (p. 0182-0183).

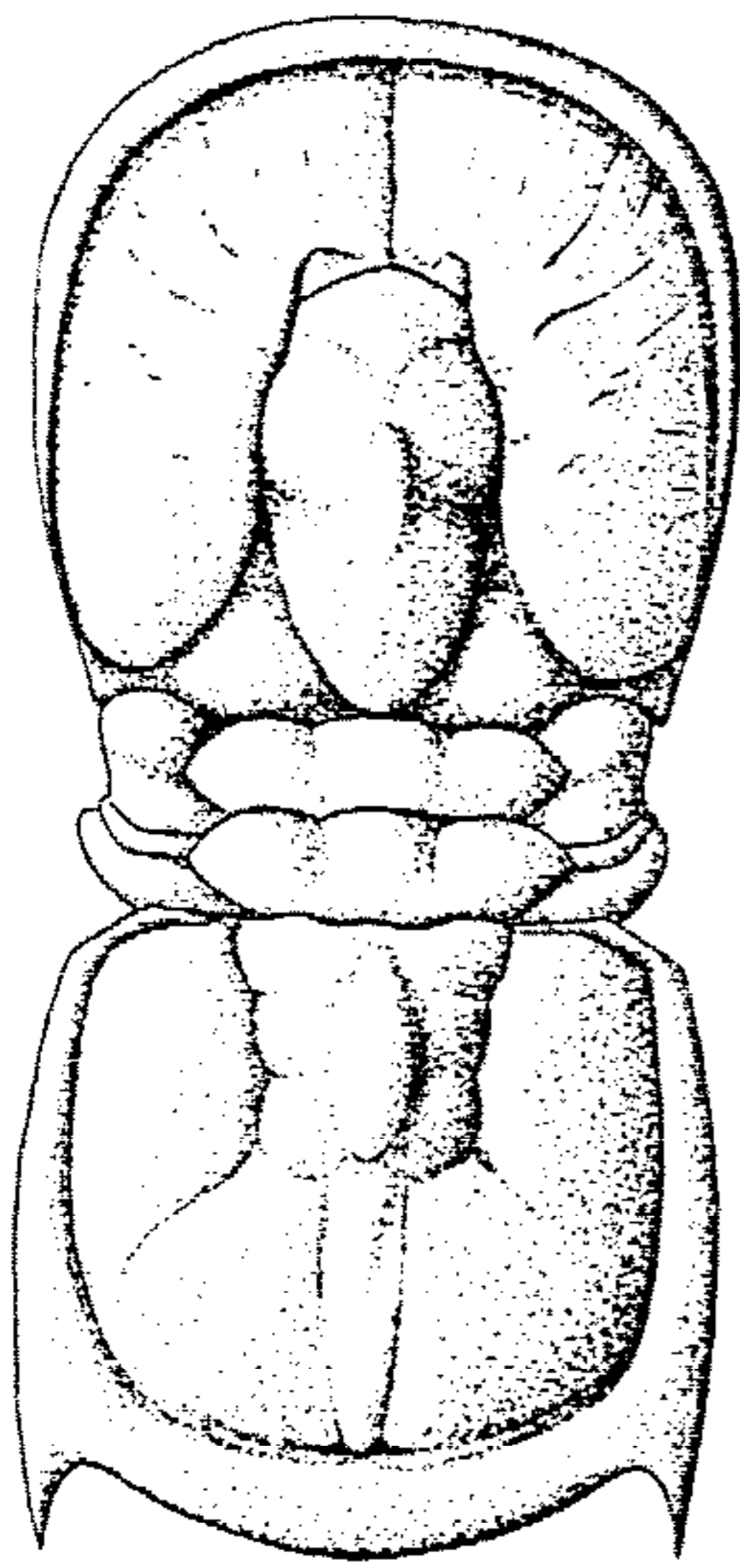

FIG. 121. **Machairagnostus tmectus* HARRINGTON & LEANZA (Pseudagnostidae), L.Ord., Arg., $\times 18.5$ (59*, 1957).

Family PSEUDAGNOSTIDAE
Whitehouse, 1936

Longitudinal furrow in front of subtriangular anterior lobe of glabella, which is separated from rear main lobe by poorly developed transverse furrow; pygidial axis trilobed, with rear lobe greatly expanded, reaching border and reducing size of pleural fields; surface of cephalon smooth or rugose, that of pygidium smooth. *U.Cam.-L.Ord.*

Pseudagnostus JAEKEL, 1909 [**Aagnostus cyclopyge* TULLBERG, 1880] [= *Plethagnostus* CLARK, 1924; *Euplethagnostus* LERMONTOVA, 1940]. Front lobe of glabella subtriangular in outline; surface of cephalon smooth or rugose; pygidial axis with front portion well defined by axial furrow but with greatly expanded rear lobe more or less indistinctly outlined; surface of pygidium smooth. *U.Cam.*, Swed.-Wales-Sib.-China-Korea-Queensl.-Que.-Vt.-Wis.-Nev.-Tex.-Alaska-Arg.—FIG. 120, 2. **P. cyclopyge* (TULLBERG), Francon., Swed.; 2a, b, ceph., pyg., $\times 6.4$ (334*).

Cyclagnostus LERMONTOVA, 1940 [**C. elegans*]. Glabella with 2 main lobes, anterior one evenly rounded at front; pygidial axis distinctly trilobed and clearly defined throughout by axial furrow. *U.Cam.*, Sib.-Que.-Vt.—FIG. 120, 1. **C. elegans*, Sib.; 1a, ceph., $\times 11$; 1b, pyg., $\times 11.7$ (117*).

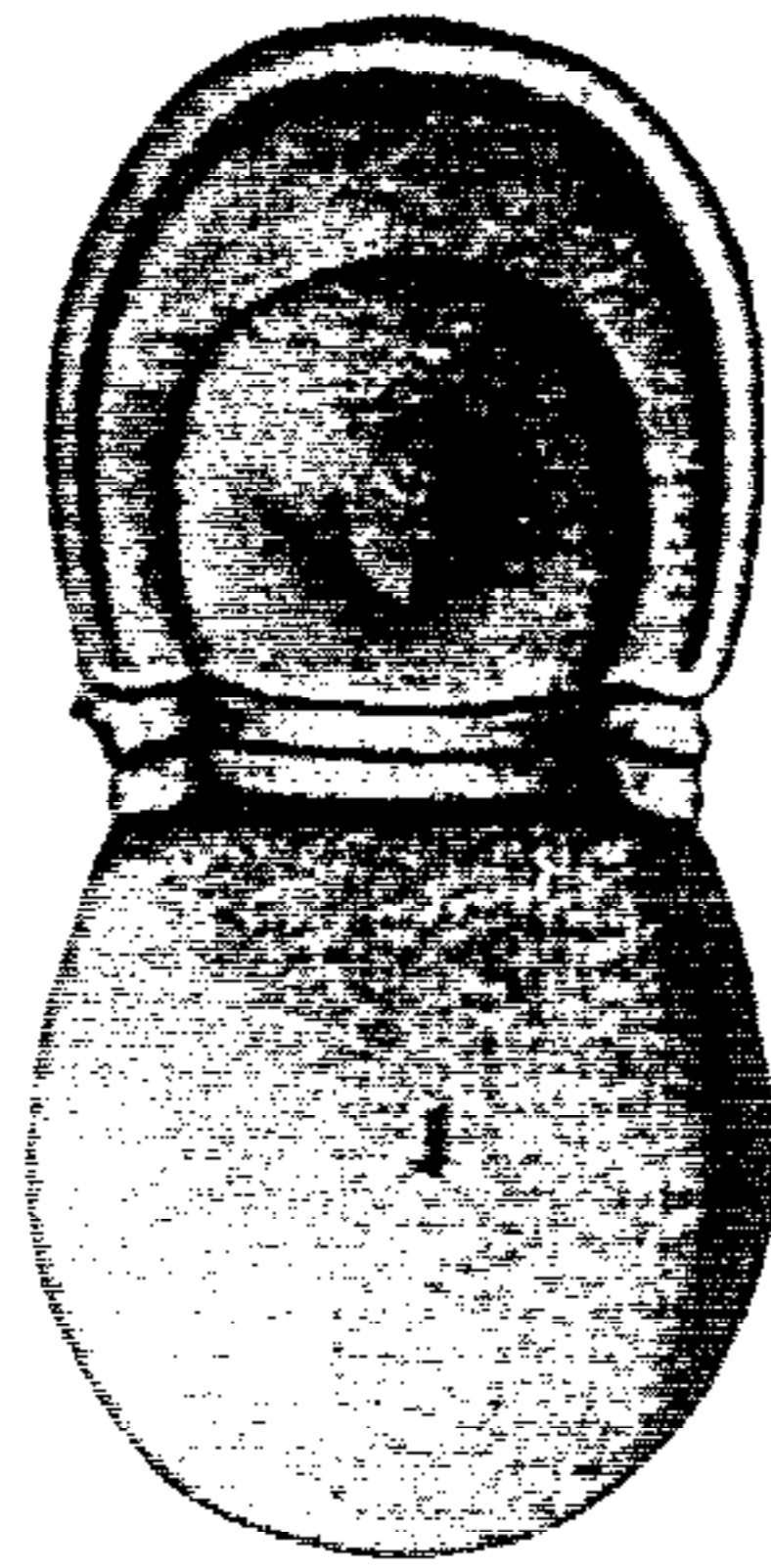
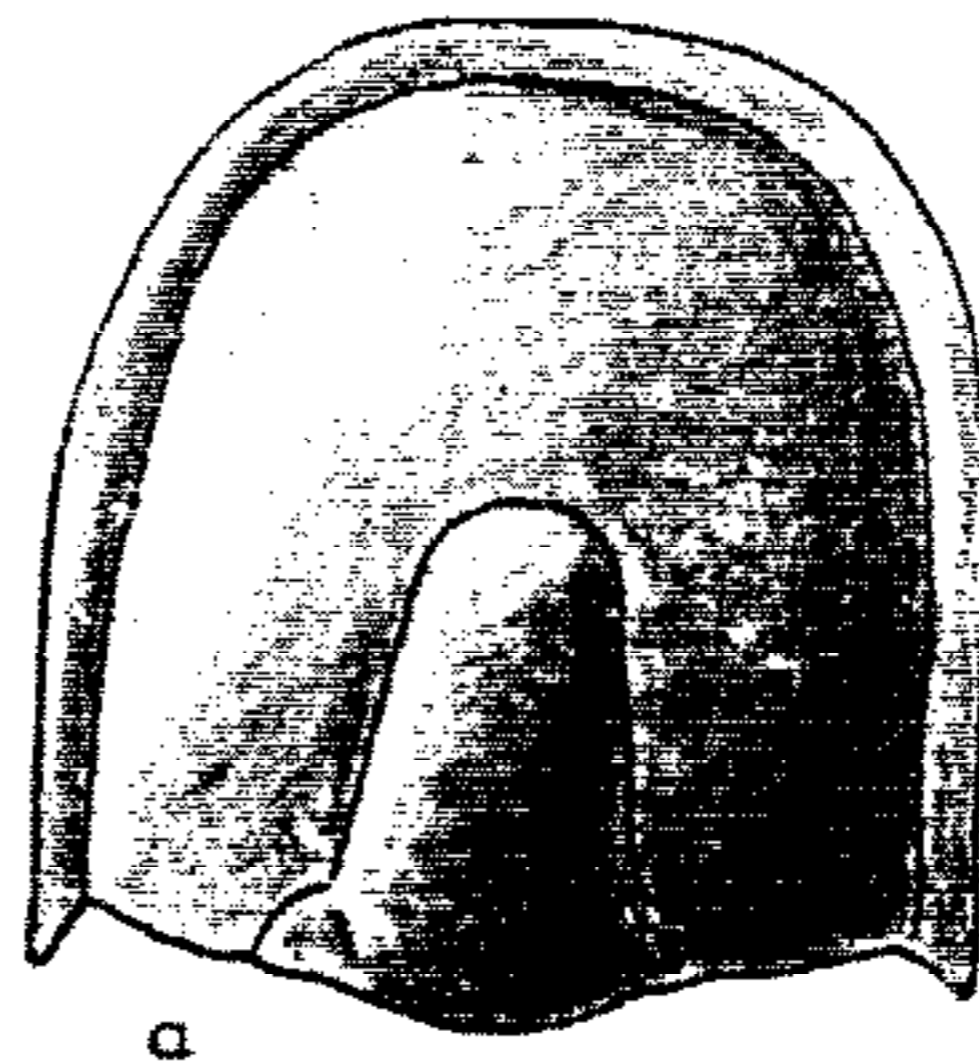
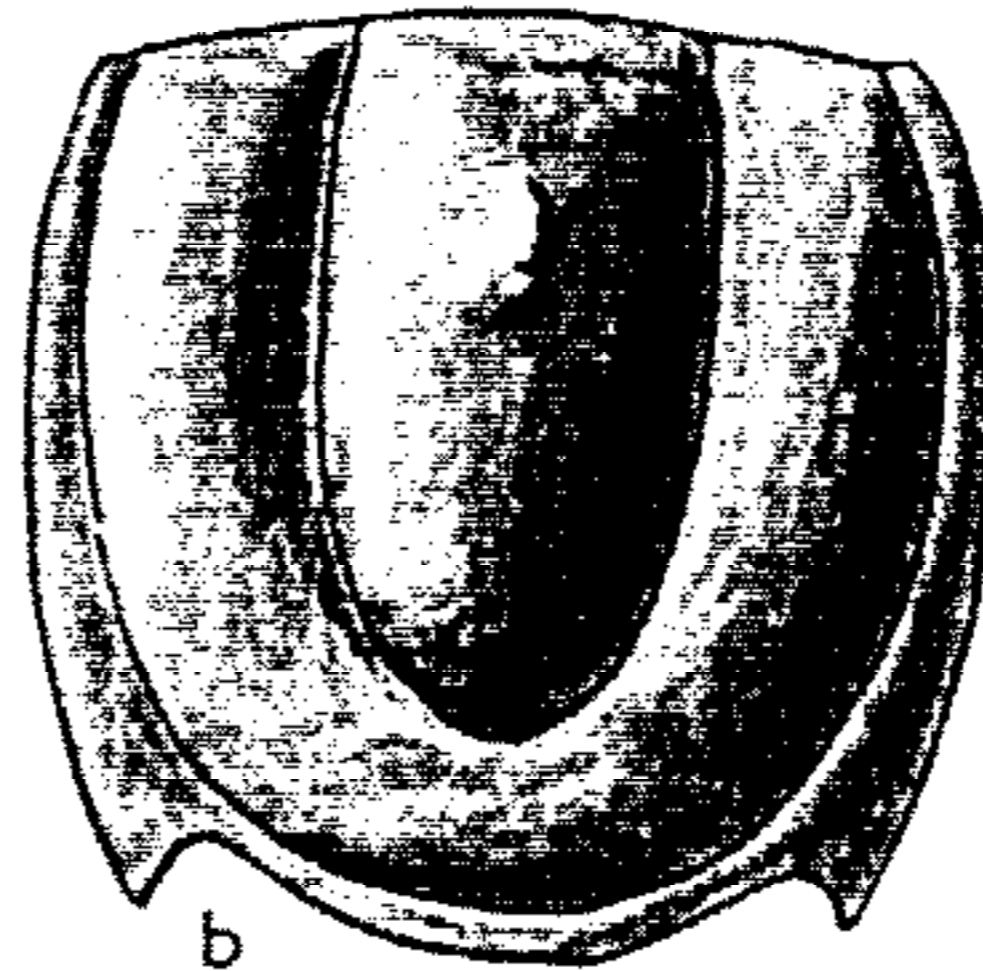

FIG. 122. **Sphaeragnostus similis* (BARRANDE) (Sphaeragnostidae), Ord., Eu., $\times 15.5$ (4*, 1872).

Machairagnostus HARRINGTON & LEANZA, 1957 [**M. tmectus*]. Glabella faintly trisegmented, blunt at front end; genae rugose; anterior half of pygidial axis trisegmented, rear half very much expanded, with narrow central elevated portion set off by 2 parallel-sided longitudinal furrows that reach backward to border; surface smooth. *L.Ord.*, Arg.



a



b

FIG. 123. **Spinagnostus franklinensis* HOWELL (Spinagnostidae), M.Cam., Vt., $\times 13$ (71, 1935).

—FIG. 121. **M. imetus*, Tremadoc., Arg., $\times 18.5$ (59*).

Rhaptagnostus WHITEHOUSE, 1936 [**Agnostus cyclopygeformis* SUN, 1924] [= *Pseudorhaptagnostus* LERMONTOVA, 1940]. Glabella faintly trisegmented, anterior main lobe rounded at front; pygidial axis trisegmented, with first 2 segments very short, 3rd greatly expanded, faintly outlined by axial furrow and marked along its medial axis by elongate elliptical ring of pits; surface smooth. *U.Cam.-L.Ord.*, China-Sib.-Arg.—FIG. 120,3. **R. cyclopygeformis* (SUN), China; 3a, ceph., $\times 5.5$; 3b, pyg., $\times 6.3$ (478*).

Family SPHAERAGNOSTIDAE
Kobayashi, 1939

Cephalon smooth, without trace of axial furrow or border; pygidium smooth, with subcircular axis that is only a little more than half of shield length, border narrow. *Ord.*

Sphaeragnostus HOWELL & RESSER in COOPER & KINDLE, 1936 [**Agnostus similis* BARRANDE, 1872]. Characters of family. *Ord.*, Eu.-Que.—FIG. 122. **S. similis* (BARRANDE), Boh.; $\times 15.5$ (4*).

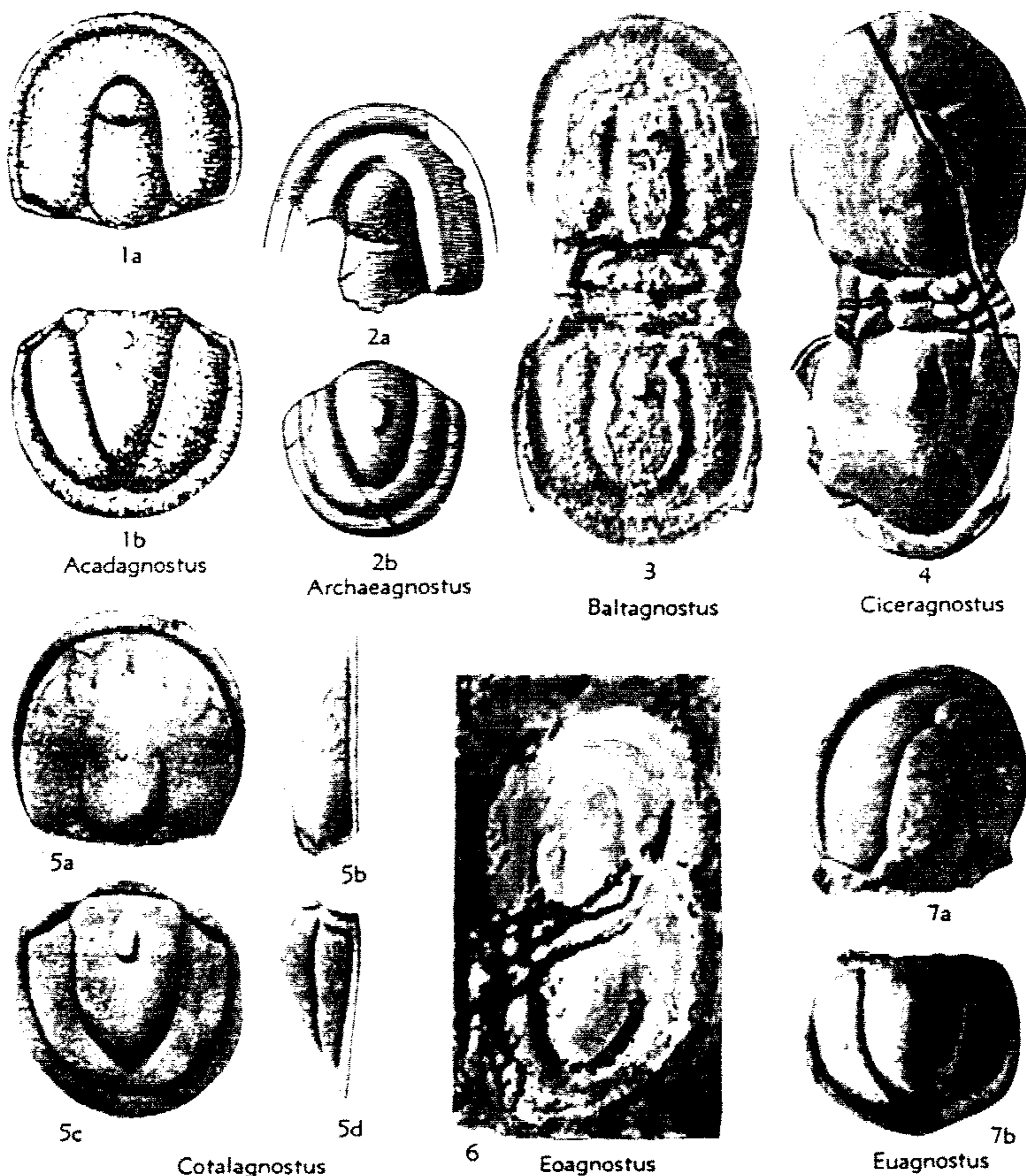

FIG. 124. Spinagnostidae (p. O184).

Family SPINAGNOSTIDAE Howell, 1935

[incl. Quadragnostinae HOWELL, 1935; Hypagnostinae IVSHIN, 1953] [=Peronopsidae WESTERLUND, 1946; Rudagnostidae LERMONTOVA, 1951]

Glabella with 2 main lobes, anterior one rounded in front or with this lobe partly or entirely obsolete, longitudinal furrow in front of glabella lacking or barely visible; pygidial axis varying from long narrow and pointed at rear (where it may or may not reach border) to long wide and more or less bluntly pointed (in some expanded and rounded at rear where it may reach border) or rather short and evenly rounded at rear, not approaching border. *L.Cam.-U.Cam.*

Spinagnostus HOWELL, 1935 [**S. franklinensis*]. Glabella lacking frontal lobe, small spines at posterolateral corners of cephalon; pygidium with wide flange bearing moderately large, backward-directed spines, axis bluntly rounded at rear, with submedian, inconspicuous tubercle; surface smooth. *M.Cam.*, NE.USA.—FIG. 123,1. **S. franklinensis*, Up.M.Cam., Centroleura vermontensis Z. St. Albans Sh., NW.Vt.; 1a,b, ceph., pyg., $\times 13$ (71).

Acadagnostus KOBAYASHI, 1939 [**Agnostus acadicus* DAWSON, 1868]. Front lobe of glabella small but present; pygidial axis long, not segmented, subtriangular in outline, separating pleural fields at rear; surface smooth. *M.Cam.*, Eu.-Newf.-N.B.-Mont.—FIG. 124,1. **A. acadicus* (DAWSON), Fossil Brook F., N.B.; 1a,b, ceph., pyg., $\times 7$ (429*).

Archagnostus KOBAYASHI, 1939 [**A. primigenus*]. Glabella with 2 main lobes; pygidial axis subtriangular in outline, not segmented, not reaching border; surface smooth. *L.Cam.*, N.Y.—FIG. 124,2. **A. primigenus*, Schodack F.; 2a,b, ceph., pyg., $\times 10$ (309*).

Armagnostus HOWELL, 1937 [**A. megalaxis*]. Glabella with 2 main lobes; pygidial axis wide, somewhat expanded toward rear, with very poorly developed transverse furrows, posterior end evenly rounded, touching border; surface smooth. *M.Cam.*, Vt.—FIG. 125,1. **A. megalaxis*, St. Albans F.; 1a, ceph., $\times 11.5$; 1b, pyg., $\times 12.3$ (72*).

Baltagnostus LOCHMAN in LOCHMAN & DUNCAN, 1944 [**Proagnostus? centerensis* RESSER, 1938]. Glabella with 2 main lobes; pygidial axis with slightly expanded rear lobe, bearing little or no trace of transverse furrows, reaching border; surface smooth. *M.Cam.-U.Cam.*, Ala.-Tenn.-Tex.-Mont.—FIG. 124,3. **B. centerensis* (RESSER), Conasauga F., Ala.; $\times 14.25$ (235*).

Ciccragnostus KOBAYASHI, 1937 [**Agnostus barlowi* BELT, 1868]. Glabella obsolete except for rear end; pygidial axis faint except at anterior end; shields thus like those of *Cotalagnostus* except for loss of most of axial furrow. *M.Cam.*, Eu.-Sib.—FIG.



1a



1b

Armagnostus

FIG. 125. **Armagnostus megalaxis* HOWELL (Spinagnostidae), *M.Cam.*, Vt.; ceph., $\times 11.5$; pyg., $\times 12.3$ (72*, 1937).

124,4. **C. barlowi* (BELT), Menevian, Wales; $\times 8$ (114*).

Cotalagnostus WHITEHOUSE, 1936 [**Agnostus lens* GRÖNWALL, 1902]. Glabella with only rear main lobe present and that only partly outlined; pygidial axis subtriangular in outline, with transverse furrows nearly or quite obsolete, not reaching border at rear; surface smooth. *M.Cam.*, Eu.-Newf.-Sib.-China-Queensl.—FIG. 124,5. **C. lens* (GRÖNWALL), *Ptychagnostus punctuosus* Z., Swed.; 5a,b, ceph., $\times 8.3$; 5c,d, pyg., $\times 8.85$ (334*).

Eoagnostus RESSER & HOWELL, 1938 [**E. rodnyi*]. Only rear main lobe of glabella outlined but that one defined by axial furrow and straight transverse furrow; pygidial axis rounded triangular in outline, evenly rounded at rear, not reaching backward to border; surface smooth. *L.Cam.*, Pa.—FIG. 124,6. **E. rodnyi*, Kinzers F.; $\times 17$ (241*).

Euagnostus WHITEHOUSE, 1936 [**E. opimus*]. Anterior lobe of glabella subtriangular in outline, with faint longitudinal furrow in front of it; pygidial axis large, subtriangular in outline, extending almost, but not quite, back to border, with little or no trace of transverse furrows; surface smooth. *M.Cam.*, Queensl.—FIG. 124,7. **E. opimus*, Anomocare Stage, Queensl.; 7a,b, ceph., pyg., $\times 4.6$ (339*).

Hypagnostus JAEKEL, 1909 [**Agnostus parvifrons* LINNARSSON, 1869]. Single main lobe in glabella bluntly rounded in front; pygidial axis long, subtriangular, transverse furrows faint or absent, axis reaching border and separating pleural fields at the rear; surface smooth. *M.Cam.*, Eu.-Newf.-N.B.-Sib.-Arg.-China-Queensl.—FIG. 126,1. **H. parvifrons* (LINNARSSON), *Hypagnostus parvifrons* Z.,

Swed.; 1a,b, ceph., with thoracic segments, pyg., $\times 8.2$ (334*).

Kormagnostus RESSER, 1938 [**K. simplex*]. No front lobe on glabella, rear main lobe truncated anteriorly by straight transverse furrow; pygidial axis large, slightly expanded backward, dividing narrow pleural fields widely at rear; surface smooth. *U.Cam.*, Tenn.-Que.-Mont.—FIG. 126.2. **K. simplex*, Nolichucky F., Tenn.; 2a,b, ceph., pyg., $\times 7.6$ (235*).

Oedorhachis RESSER, 1938 [**O. typicalis*]. Front main lobe of glabella subquadrate in outline; rear lobe of pygidial axis subcircular in outline, much wider than anterior part of axis; surface smooth. *U.Cam.*, Ala.—FIG. 126.4. **O. typicalis*, Nolichucky F.; $\times 8.5$ (235*).

Pentagnostus LERMONTOVA, 1940 [**P. anabarensis*]. Anterior lobe of glabella evenly rounded in front, with slight trace of longitudinal furrow in front of it; pygidial axis trilobed, with rear lobe sub-

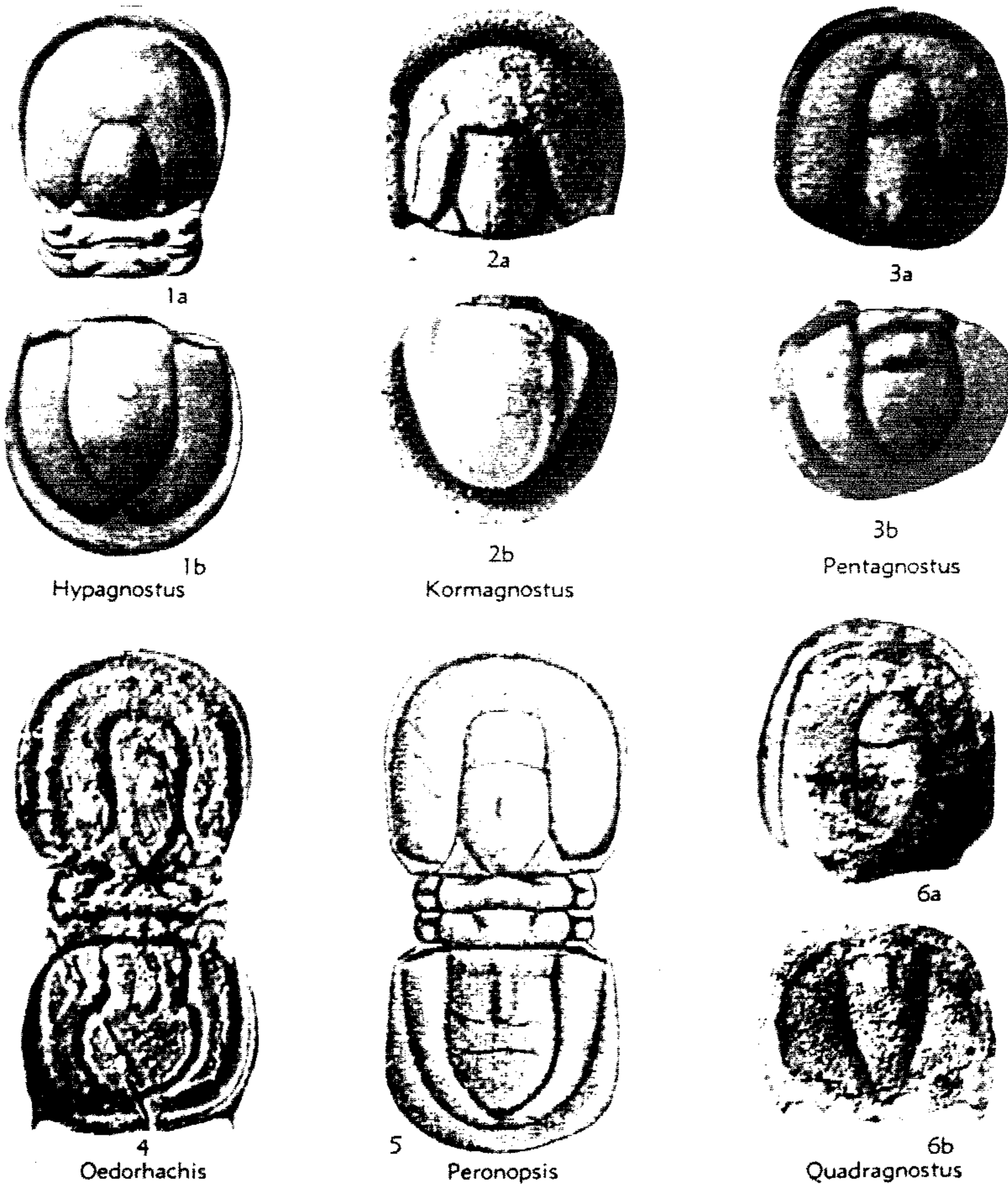
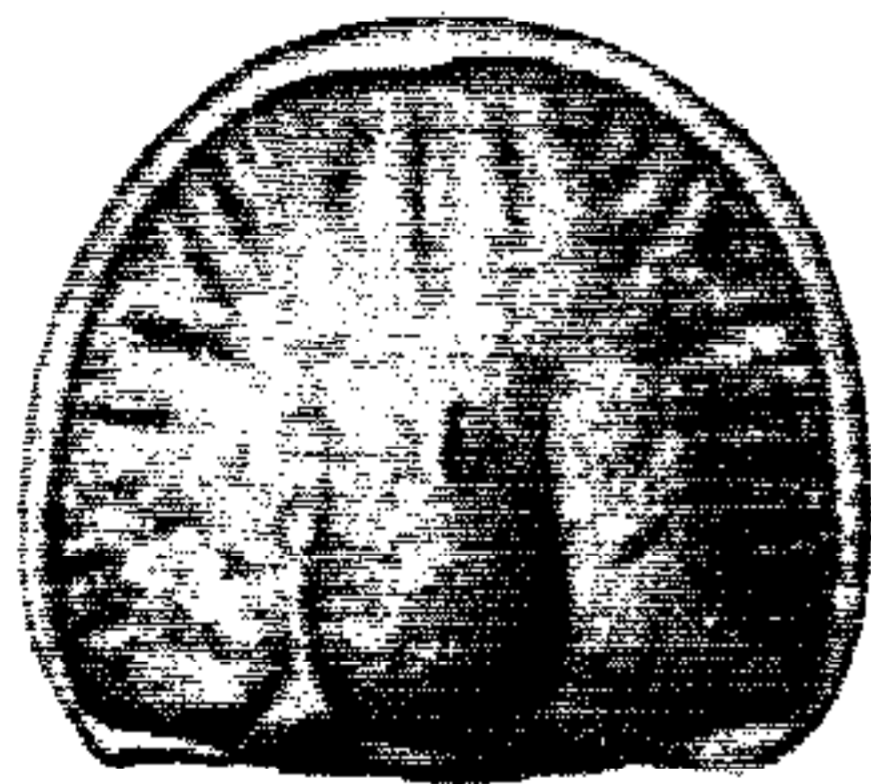

FIG. 126. Spinagnostidae (p. 0184-0186).

triangular in outline and not reaching backward to border; surface smooth. *M.Cam.*, Sib.—FIG. 126.3. **P. anaburensis*; 3a, ceph., $\times 8.2$; 3b, pyg., $\times 7.6$ (117*).



1
Sulcatagnostus



2a



2b

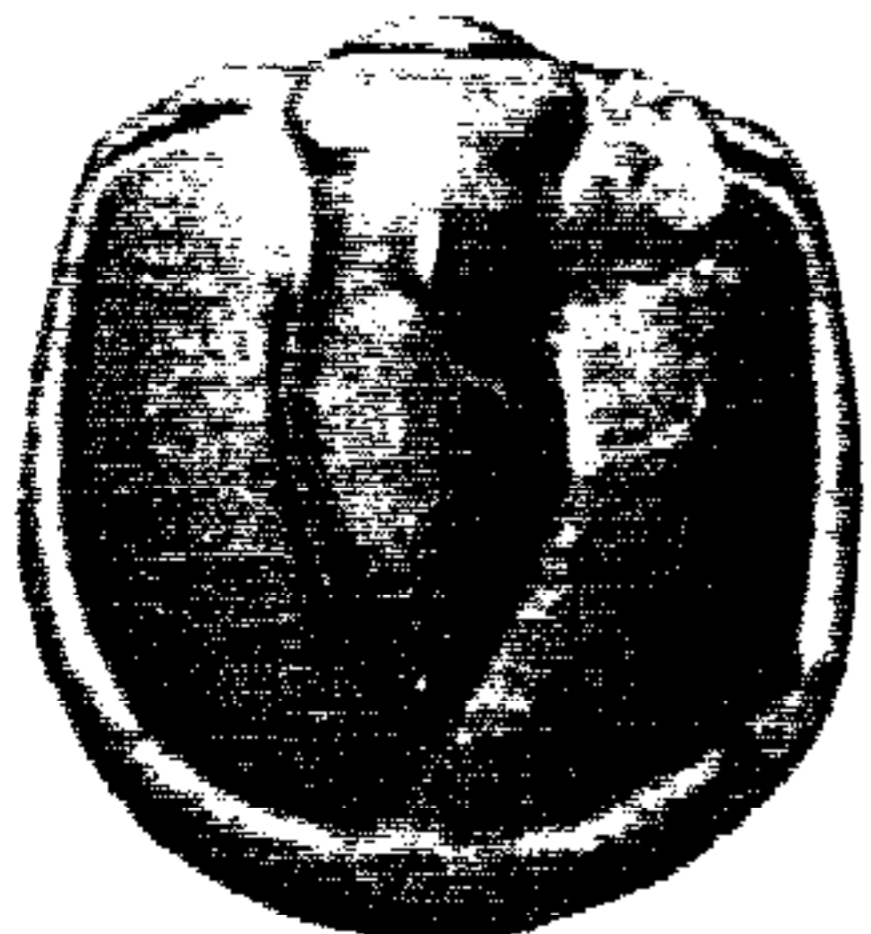

2c



2d

Tomagnostella

FIG. 127. Spinagnostidae (p. O186).

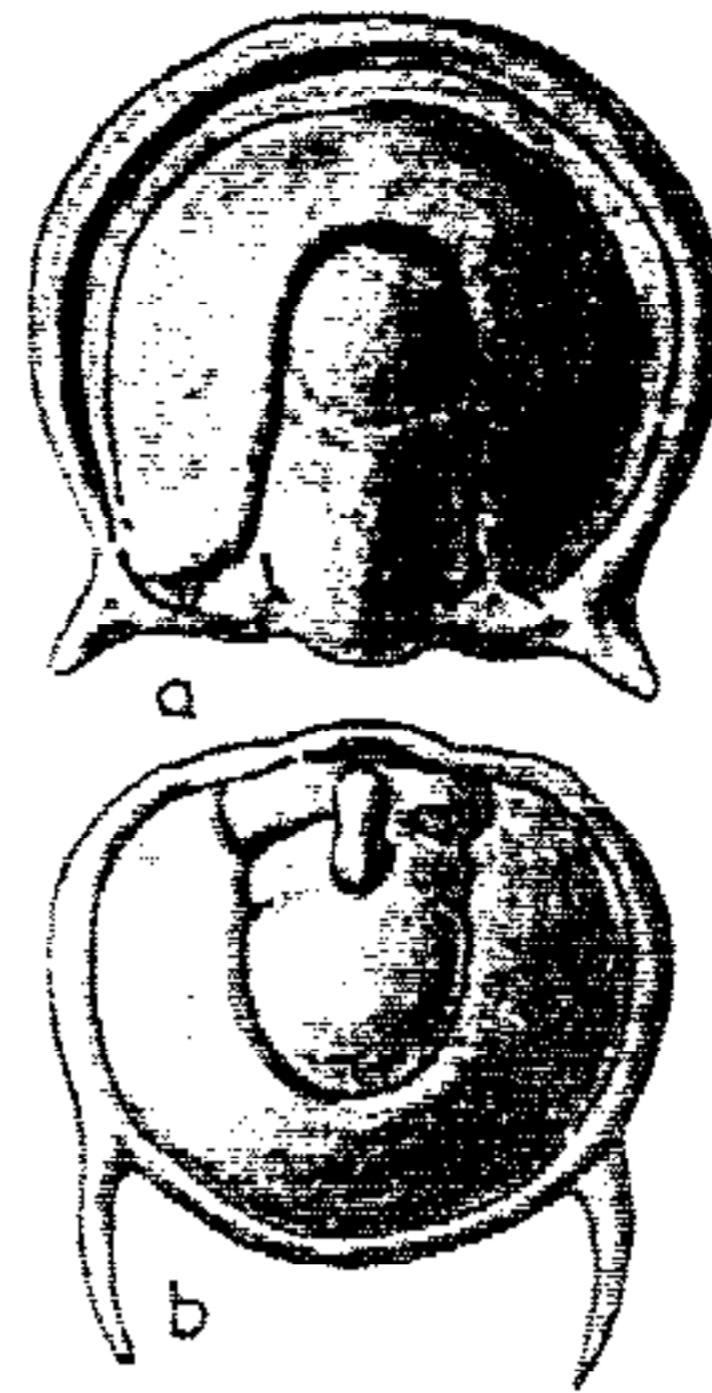

FIG. 128. **Eurudagnostus grandis* LERMONTOVA (?*Micragnostidae*), *U.Cam.*, Kazakhstan; ceph., pyg., $\times 6$ (423, 1951) (p. O179).

Peronopsis HAWLE & CORDA, 1847 [**Battus integer* BEYRICH, 1845] [= *Diplorrhina* HAWLE & CORDA, 1847; *Mesospheniscus* HAWLE & CORDA, 1847; *Mesagnostus* JAEKEL, 1909 (obj.); *Pseudoperonopsis* HARRINGTON, 1938]. Front lobe of glabella subquadrate; pygidial axis widely subtriangular in outline, with little or no trace of transverse furrows, reaching backward to border or not; surface smooth. *M.Cam.*, Eu.-Sib.-Manch.-N.B.-Mont.—FIG. 126.5. **P. integra* (BEYRICH), Paradoxides beds, Boh., $\times 12$ (3*).

Quadragnostus HOWELL, 1935 [**Q. solus*]. Cephalon like that of *Peronopsis*; pygidial axis narrowly triangular in outline, reaching back almost or quite to border; surface smooth. *M.Cam.*, Vt.-Swed.-Denm.—FIG. 126.6. **Q. solus*, St. Albans F., Vt.; 6a, ceph., $\times 6.4$; 6b, pyg., $\times 5.3$ (71*).

Sulcatagnostus KOBAYASHI, 1937 [**Aagnostus securiger* LAKE, 1906]. Cephalon like that of *Peronopsis* but with furrows radiating across genae; rear lobe of pygidial axis broadaxe-shaped, greatly expanded at rear, where it reaches border, pleural fields narrow and widely separated by axis. *U.Cam.*, Eng.—FIG. 127.1. **S. securiger* (LAKE); $\times 6$ (114*).

Tomagnostella KOBAYASHI, 1939 [**Aagnostus exsculptus* ANGELIN, 1851]. Front main lobe of glabella obsolete, rear main lobe truncated in front; genae crossed by radiating furrows; pygidium not definitely known. *M.Cam.*, Swed.-Denm.—FIG. 127.2. **T. exsculpta* (ANGELIN), Andrarum F., Swed.; 2a,b, ceph., $\times 5.5$; 2c,d, pyg., $\times 7.5$ (334*).

Suborder EODISCINA Kobayashi, 1939

[*nom. correct.* MOORE, herein (*pro* Eodiscini KOBAYASHI, 1939)] [=superfamily Eodiscidea RICHTER, 1932 (*partim*); Dawsoniidea KOBAYASHI, 1943; order Dawsonida LERMONTOVA, 1951; superfamily Agnostacea HENNINGSMOEN, 1951 (*partim*); superfamily Eodiscoidae HUPÉ, 1953] [Type—*Eodiscus* HARTT in WALCOTT, 1884]

Small isopygous trilobites with 2 or 3 thoracic segments. Glabella usually well defined, subcylindrical or tapered; occipital ring rounded or spinose. Genae elevated laterally, depressed in front of glabella. Cephalic border may have tubercles or radial markings. Facial sutures either of proparian type, with small, lateral librigenae (Pagetidae) or entirely lacking (Eodiscidae); eyes usually absent in latter case. Hypostoma present (*Pagetia*). Pygidial axis with nor-

mal segmentation, of 4 to 12 rings, usually long and prominent; pleural regions furrowed or not, with distinct, narrow border; margin smooth, rarely denticulate. Axial or terminal spine present in some genera. Cephalic and pygidial doublures invariably narrow. Animal possessing faculty of enrollment. *L. Cam.-M. Cam.* (46, 117, 339).

Family EODISCIDAE Raymond, 1913

[Incl. Calodiscinae, Spinodiscinae, Brevidiscinae KOBAYASHI, 1943] [=Dawsoniidae RESSER, 1937; Weymouthiidae KOBAYASHI, 1943]

Both eyes and facial sutures usually lacking; exceptionally (*Opsidiscus*) vestigial eyes may be retained but sutures are fused. Thorax with 2 or 3 segments. *L. Cam.-M. Cam.* (46, 117).

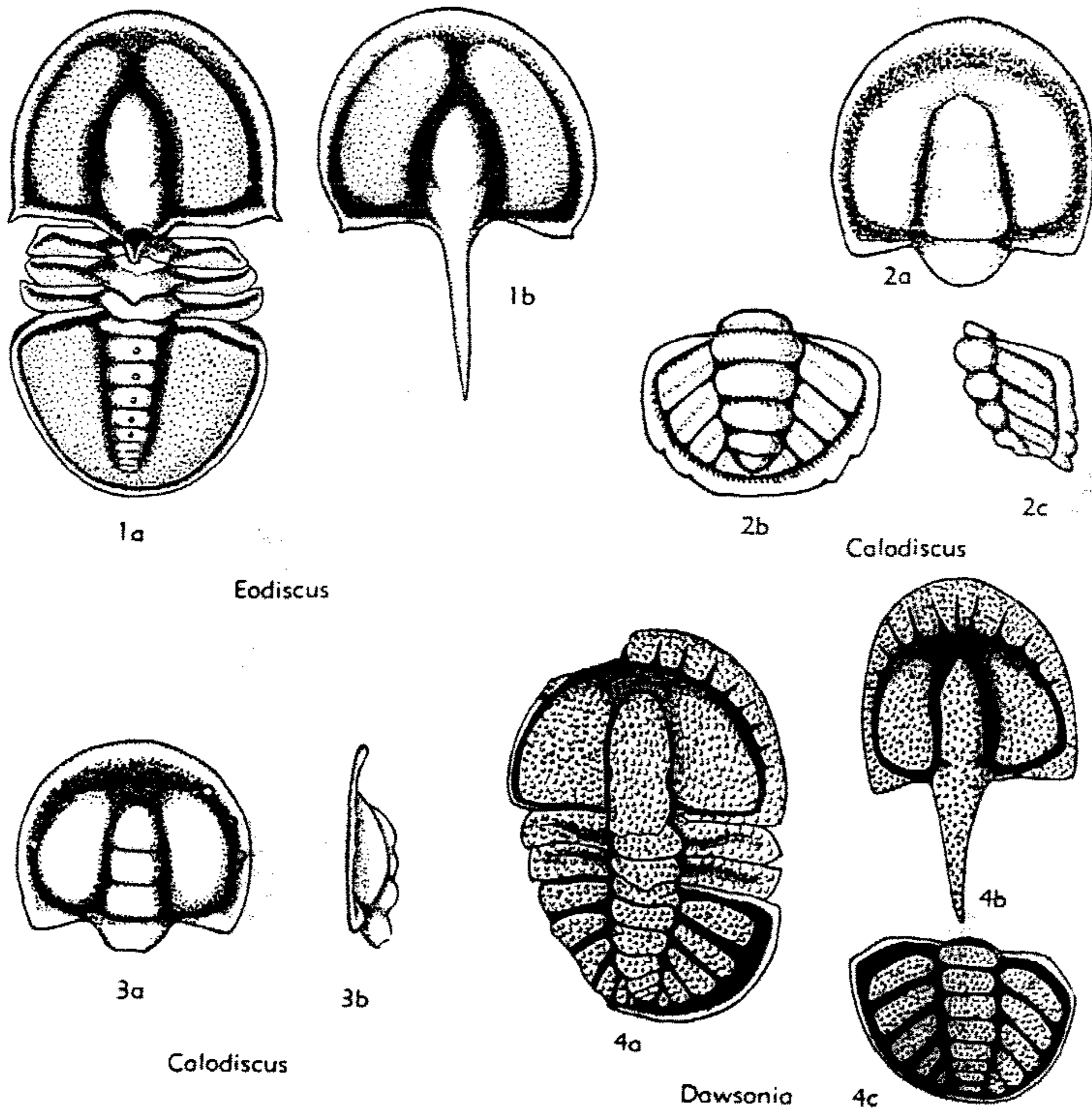
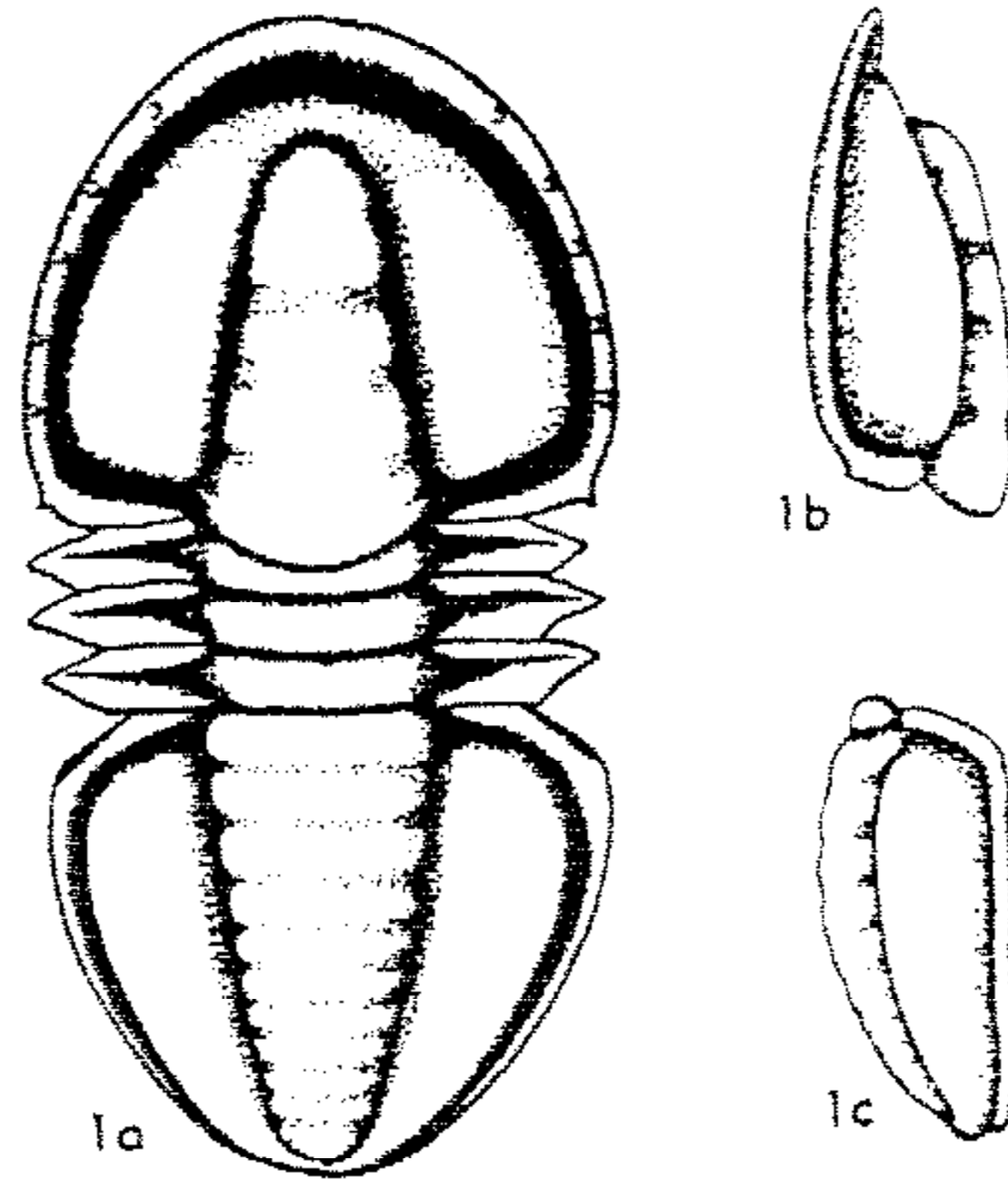

FIG. 129. Eodiscidae (p. O188).



Eodiscus HARTT in WALCOTT, 1884 [**E. pulchellus* (= *Microdiscus scanicus* LINNARSSON, 1883)] [= *Microdiscus* SALTER, 1864 (non EMMONS, 1855); *Spinodiscus*, *Deltadiscus* KOBAYASHI, 1943]. Glabella short, extended into strong spine; preglabellar depression in shape of longitudinal furrow; cephalic border narrow, finely crenulated or smooth. Thorax with 3 segments. Pygidium with long axis divided into numerous rings; pleural fields usually unfurrowed. Surface punctate or tuberculate. *M. Cam.*, E.N.Am.-NW.Eu. (Acad.-Balt. prov.)—FIG. 129, 1. *E. punctatus* (SALTER), Newf.; 1a, b, whole exoskel., ceph., $\times 7.5$ (448n).



Calodiscus HOWELL, 1935 [pro *Goniodiscus* RAYMOND, 1913 (non MÜLLER & TROSCHEL, 1842)] [**Agnostus lobatus* HALL, 1847] [= *Brevidiscus* KOBAYASHI, 1943]. Cephalon semicircular; glabella parallel-sided to tapering, in some species with shallow transglabellar furrows; occipital furrow impressed, occipital ring rounded or with short spine; border of medium width, smooth or tuberculate. Pygidial axis prominent, segments few; pleural fields furrowed or smooth; margin entire or faintly serrate. Size small. *L. Cam.*, Eu.-N.Am.—FIG. 129, 2. **C. lobatus* (HALL), N.Y.; 2a, ceph., $\times 12$; 2b, c, pyg., $\times 12$ (448n).—FIG. 129, 3. *C. meeki* (FORD), N.Y.; 3a, b, ceph., $\times 7.5$ (448n).

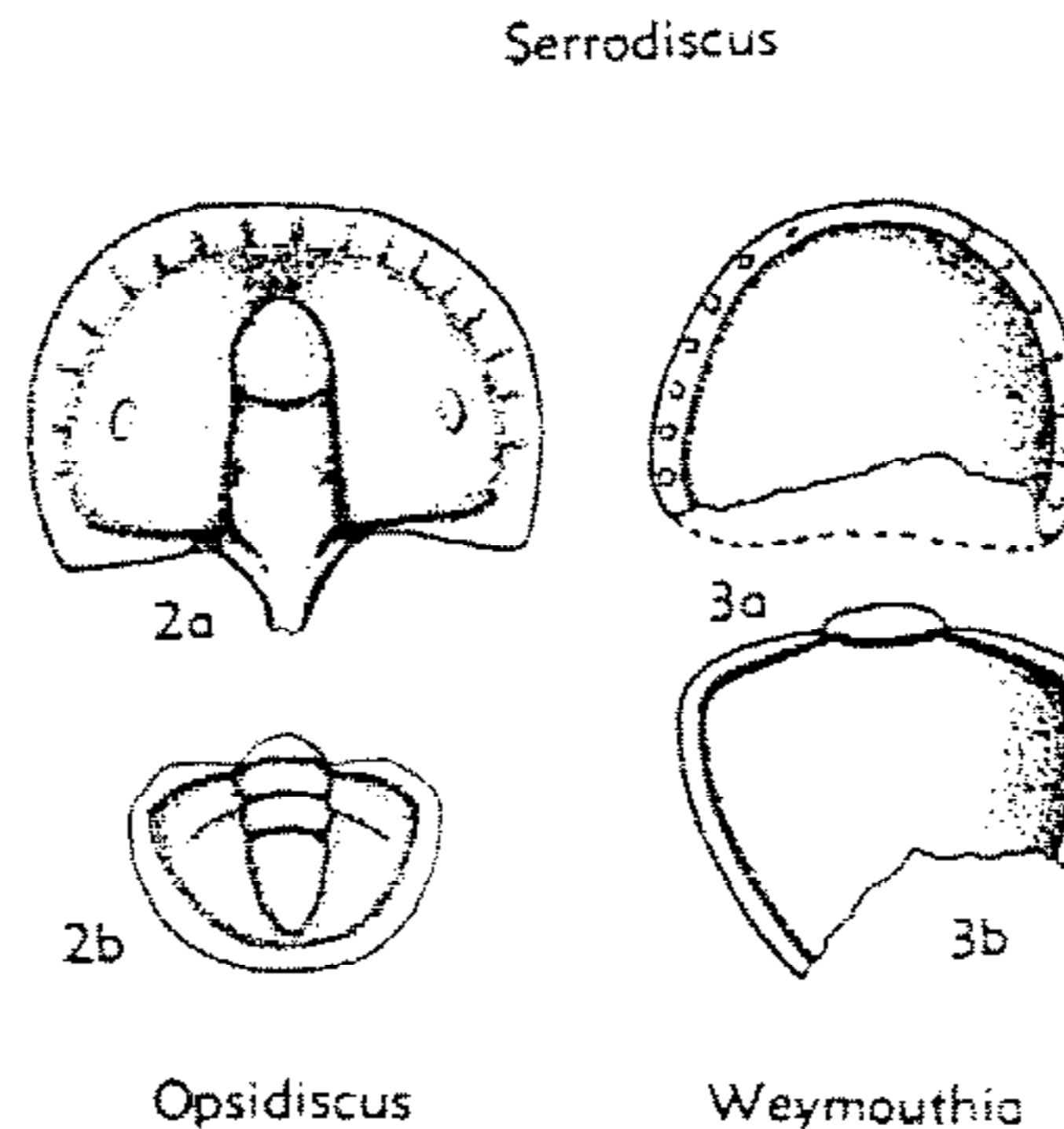

Dawsonia HARTT in DAWSON, 1868 [**Microdiscus dawsoni* HARTT in DAWSON, 1868] [= *Aculeodiscus* SNAJDR, 1951; ?*Metadiscus* KOBAYASHI, 1943]. Glabella tapered; occipital ring extended into long spine; genae elevated, preglabellar depression deep; border wide, elevated, with coarse crenulations. Thorax with 2 segments. Pygidium with long, furrowed axis; pleural fields furrowed. Surface granulate. Size small. *M. Cam.*, E.N.Am.-NW.Eu. (Acad.-Balt. prov.)—FIG. 129, 4. **D. dawsoni* (HARTT), N.B.; 4a-c, whole exoskel., ceph., pyg., $\times 7.5$ (448n).

Opsidiscus WESTERGÅRD, 1950 [pro *Aulacodiscus* WESTERGÅRD, 1946 (non DOUVILLÉ, 1921)] [**Aulacodiscus bilobatus* WESTERGÅRD, 1946]. Glabella divided by anterior transglabellar furrow; occipital furrow and spine developed; eyes marked as tubercles, but facial sutures fused. Pygidium with furrowed axis, smooth pleural fields. Size small. *M. Cam.*, Eu.—FIG. 130, 2. **O. bilobatus* (WESTERGÅRD), Swed.; 5a, b, ceph., pyg., $\times 12$ (334).

Serrodiscus RICHTER & RICHTER, 1941 [**S. serratus*] [= *Paradiscus* KOBAYASHI, 1943]. Cephalon semi-elliptical; glabella tapered; occipital ring simple; border narrow, tuberculate; preglabellar depression shallow. Thorax with 3 segments. Pygidial axis long, with numerous rings; pleural fields unfurrowed; border narrow, with small marginal spines. Size large (15 to 40 mm.) for eodiscids.

FIG. 130. Eodiscidae (p. 0188).

L. Cam., Eu.-N.Am.—FIG. 130, 1. *S. speciosus* (FORD), N.Y.; 1a-c, exoskel., ceph., pyg., $\times 4.5$ (448n).

Weymouthia RAYMOND, 1913 [**Agnostus? nobilis* FORD, 1872]. Cephalon and pygidium subequal, with all furrows except border one obsolete, at least on outer surface. Thorax with 3 segments. Size small. *L. Cam.*, Eu.-N.Am.—FIG. 130, 3. **W. nobilis* (FORD), N.Y.; 3a, b, holotype, thorax lacking, $\times 9$ (46).

Family PAGETIIDAE Kobayashi, 1935

[*nom. correct.* WESTERGÅRD, 1946 (pro *Pagetidae* KOBAYASHI, 1935)] [incl. *Delgadoiinae* KOBAYASHI, 1943]

Eyes and facial sutures well developed; course of sutures proparian, librigenae small.

Thorax with 2 or 3 segments. *L. Cam.-M. Cam.* (46, 117, 339).

Pagetia WALCOTT, 1916 [**P. bootes*] [= *Eopagetia*, *Mesopagetia* KOBAYASHI, 1943; ?*Pagetina* LERMONTOVA, 1940 (*non* BARNARD, 1931)]. Glabella well defined, tapered; occipital ring extended into long

spine; fixigenae elevated posteriorly, preglabellar depression well marked; border rather narrow, with radial markings; palpebral lobes short and narrow, eye ridges distinct in some species; librigenae lateral, small; facial sutures directed transversely to margin both in front and behind eyes. Thorax with 2 segments. Pygidium with long, well-seg-

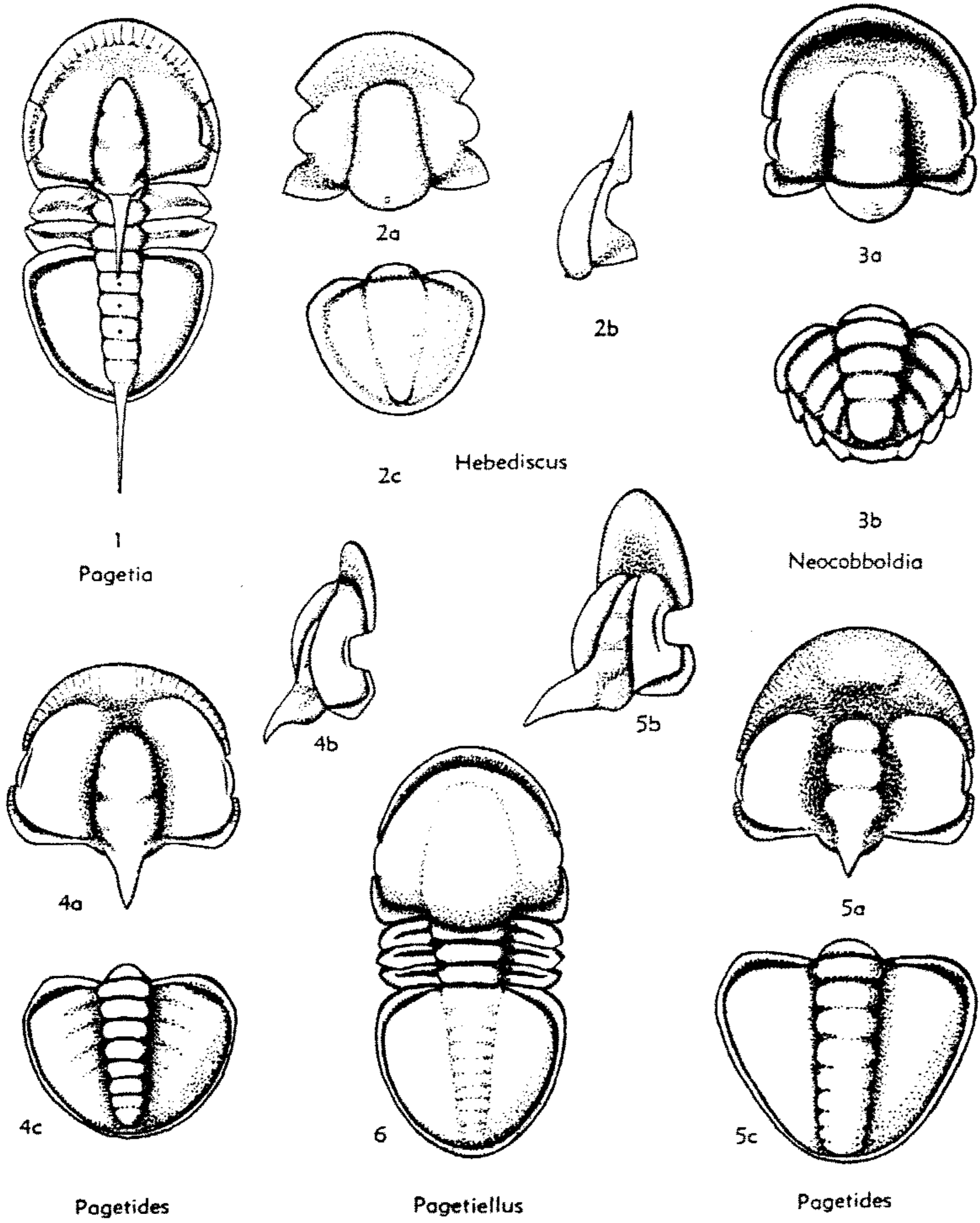

FIG. 131. Pagetiidae (p. 0189-0190).

mented axis extended into spine; pleural regions furrowed or not, with narrow border; margin smooth. *L.Cam.-M.Cam., N.Am.-Asia-Austral.*—FIG. 131.1. **P. bootes*, M.Cam., B.C.; whole exoskel., $\times 7.5$ (448n).

Delgadella WALCOTT, 1912 [**Lingulepis lusitanica* DELGADO, 1904 (= *Microdiscus souzai*, M. woodwardi DELGADO, 1904)] [= *Delgadoia* VOODES, 1917; *Delgadodiscus* KOBAYASHI, 1935; *Alemtejoia* KOBAYASHI, 1943]. Cephalon with undefined glabella, distinct border furrow, and narrow, smooth border; librigenae as in *Pagetia*. Thorax with 3 segments. Pygidium subtriangular, trilobed; border distinct, in some species extended into terminal spine (292). *L.Cam., Eu.(Port.)*.

Hebediscus WHITEHOUSE, 1936 [**Ptychoparia? atleborensis* SHALER & FOERSTE, 1888]. Glabella straight-sided, tapered, unfurrowed; occipital ring simple; border furrow shallow, border flat; palpebral lobes relatively long, palpebral furrows indistinct; librigenae larger than in other genera of family, sutures doubtfully proparian. Thorax with 3 segments. Pygidium of typical eodiscid shape; axial furrows shallow; pleural fields smooth; margin rounded. *L.Cam., Eu.-N.Am.(Acad.-Balt. prov.)*.—FIG. 131.2. **H. atleborensis* (SHALER & FOERSTE), Newf.; 2a,b, cran., $\times 6$; 2c, pyg., $\times 6$ (448n).

Neocobboldia RASETTI, 1952 [*pro Cobboldia* LERMONTOVA, 1940 (non BRAUER, 1887; nec LEIPER, 1910)] [**Cobboldia dentata* LERMONTOVA, 1940]. Glabella prominent, sides subparallel; occipital ring rounded; cephalic border rather narrow; palpebral lobes and furrows well developed. Thorax with 3 segments. Pygidial axis elevated, with few rings; pleural fields furrowed; margin denticulate. *L.Cam., Sib.*—FIG. 131.3. **N. dentata* (LERMONTOVA), Lena Valley; 3a,b, cran., pyg., $\times 12$ (117).

Pagetides RASETTI, 1945 [**P. elegans*]. Similar to *Pagetia* but palpebral lobes and furrows more distinct; cephalic border expanded mesially, border and axial furrows meeting in preglabellar depression. Thorax with 3 segments. Pygidium with long, multisegmented axis lacking terminal spine; pleural fields usually smooth. *L.Cam., N.Am. (Appal.)*—FIG. 131.4. **P. elegans*, Que.; 4a,b, cran., $\times 7.5$; 4c, pyg., $\times 7.5$ (448n).—FIG. 131.5. *P. rupestris* RASETTI, Que.; 5a,b, cran., $\times 7.5$; 5c, pyg., $\times 7.5$ (448n).

Pagetiellus LERMONTOVA, 1940 [**Microdiscus lenaicus* TOLL, 1899]. Cephalon highly convex; axial furrows almost obsolete, glabellar and occipital furrows lacking; border furrow and narrow border distinct; palpebral lobes poorly defined. Thorax with 3 segments, markedly trilobed. Pygidium strongly convex, with long, poorly defined axis; border furrow and narrow border present. *L.Cam., Sib.*—FIG. 131.6. **P. lenaicus* (TOLL), Lena Valley; specimen lacking only librigenae, $\times 7.5$ (117).

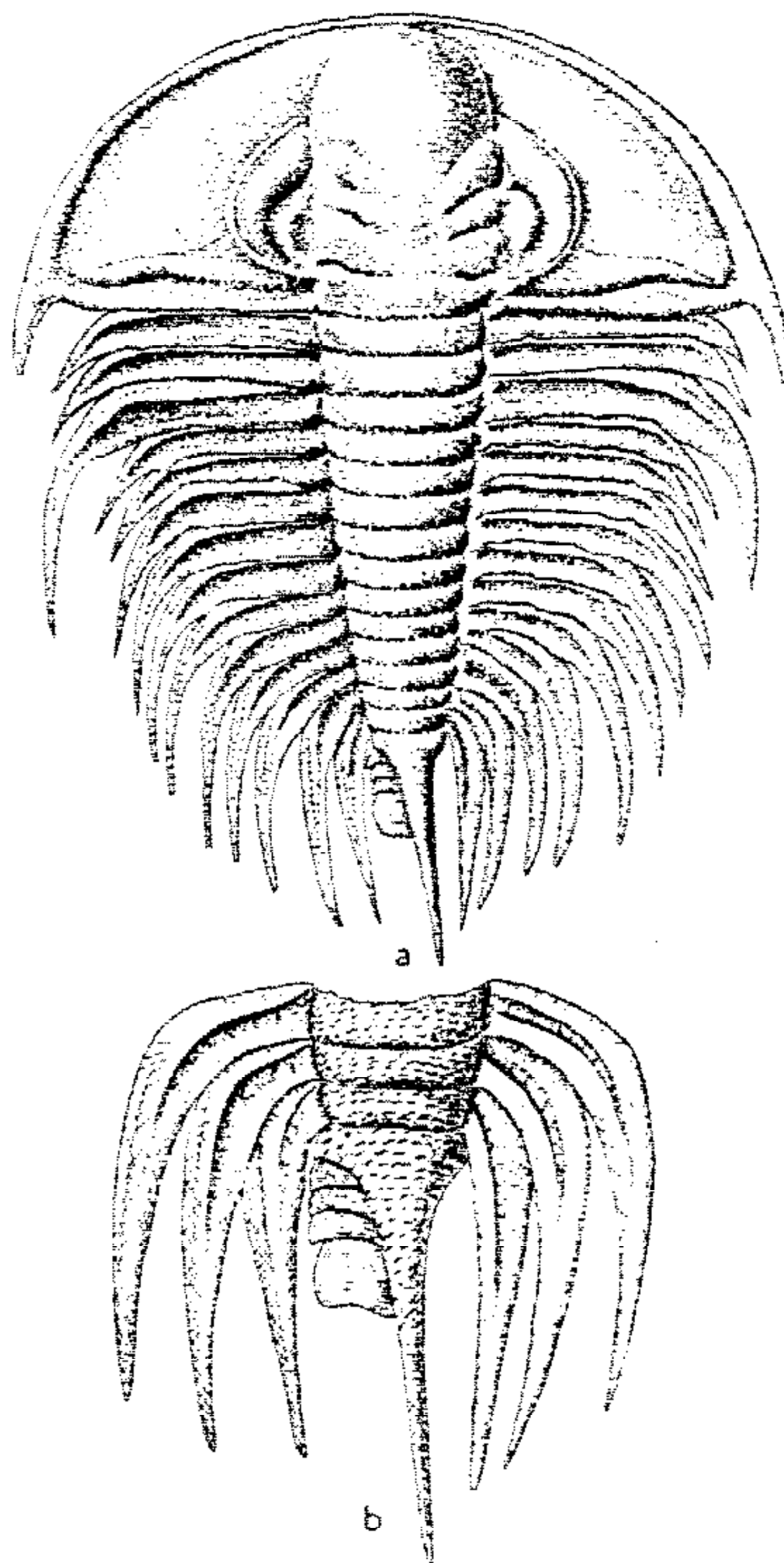

FIG. 132. **Olenellus thompsoni* (HALL), *L.Cam., Vt.*; a, dorsal exoskel., $\times 0.6$; b, posterior extremity, $\times 1.7$ (312).

?*Triangulaspis* LERMONTOVA, 1940 [**Ptychoparia meglitzkii* TOLL, 1899]. Glabella prominent, tapering, extended posteriorly into large spine; fixigenae wide, rising toward eyes; anterior border furrow straight, transverse, merging with axial furrows on mid-line; border wide (*sag.*), swollen, subtriangular. [May be an eodiscid or multisegmented trilobite related to *Sirenuacva*.] *L.Cam., Sib.*

Order REDLICHIIA Richter, 1933

[*nom. correct.* MOORE, herein (*pro Redlichia* RICHTER, 1933)] [= suborder *Micropygia* GÜNTHER, 1907 (*partim*); suborder *Mesonacida* SWINNERTON, 1915 (*partim*); order *Mesonacida* POUlsen, 1927; suborder *Redlichia* RICHTER, 1933 (*partim*)] [Type—*Redlichia* COSSMANN, 1902]

Trilobites with relatively large semicircular cephalon, commonly with well-developed genal spines, numerous thoracic segments, and diminutive or rudimentary pygidium;

facial sutures of opisthoparian type or ankylosed, glabella typically well segmented, eyes tending to be elongate crescentic. *L. Cam.-M. Cam.*

composed of numerous segments that bear strong furrows and commonly terminate in spines. Pygidium diminutive to rudimentary. *L. Cam.*

Suborder OLENELLINA Resser, 1938

Family OLENELLIDAE Vogdes, 1893

[*nom. correct.* MOORE, herein (*pro* order Olenellida RESSER, 1938)] [=suborder Mesonacida SWINNERTON, 1915; order Mesonacida POULSEN, 1927; superfamily Olenellidea RICHTER, 1941; order Protoparia STÖRMER, 1942 (*non* SWINNERTON, 1915); superfamily Olenellacea HENNINGSMOEN, 1951; superfamily Olenelloidea HUPÉ, 1953] [Type—*Olenellus* HALL, 1881]

[=emend. Mesonacidae WALCOTT, 1891] [Mesonacidae WALCOTT, 1910] [*nom. conserv.* proposed MOORE, 1958, ICZN pend.]

Exoskeleton elongate, nearly flat or with low convexity. Cephalon relatively large, subsemicircular, commonly with well-marked border and prominent genal spines; glabella elongate, generally with distinct furrows; eyes typically large, crescentic; facial sutures ankylosed. Rostral plate sickle-shaped, reaching to genal angles. Thorax

Exoskeleton subovate to elongate, almost flat to moderately convex, micropygous. Cephalon subsemicircular to semielliptical, devoid of dorsal sutures, with well-defined border, 3 to 5 pairs of lateral glabellar furrows, eyes mostly large, genal spines usually present. Thorax generally composed of numerous segments with well-defined pleural furrows and well-developed pleural spines or acutely terminating, falcate distal portions. Pygidium of a single segment or with a couple of segments indicated. Outer

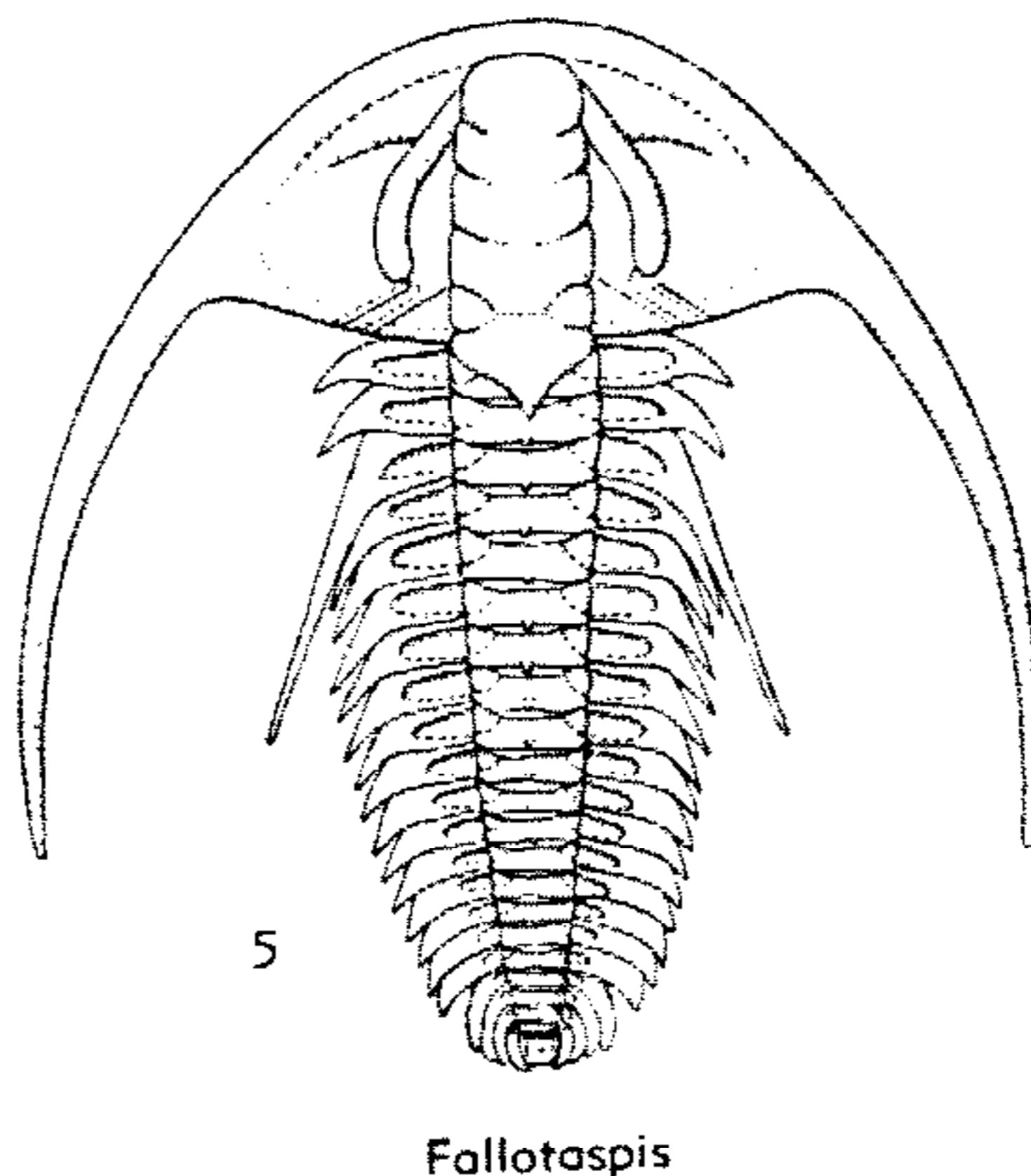
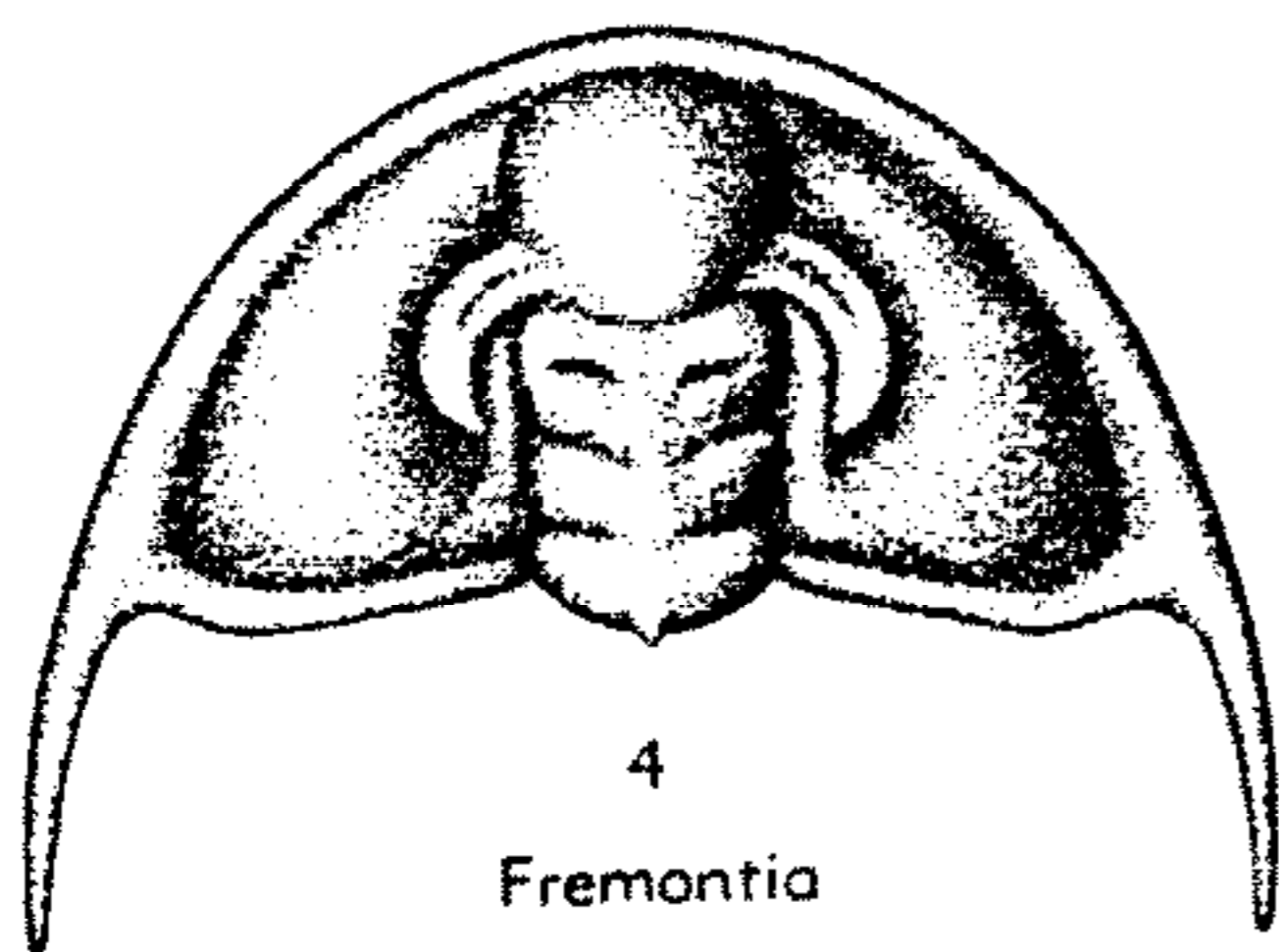
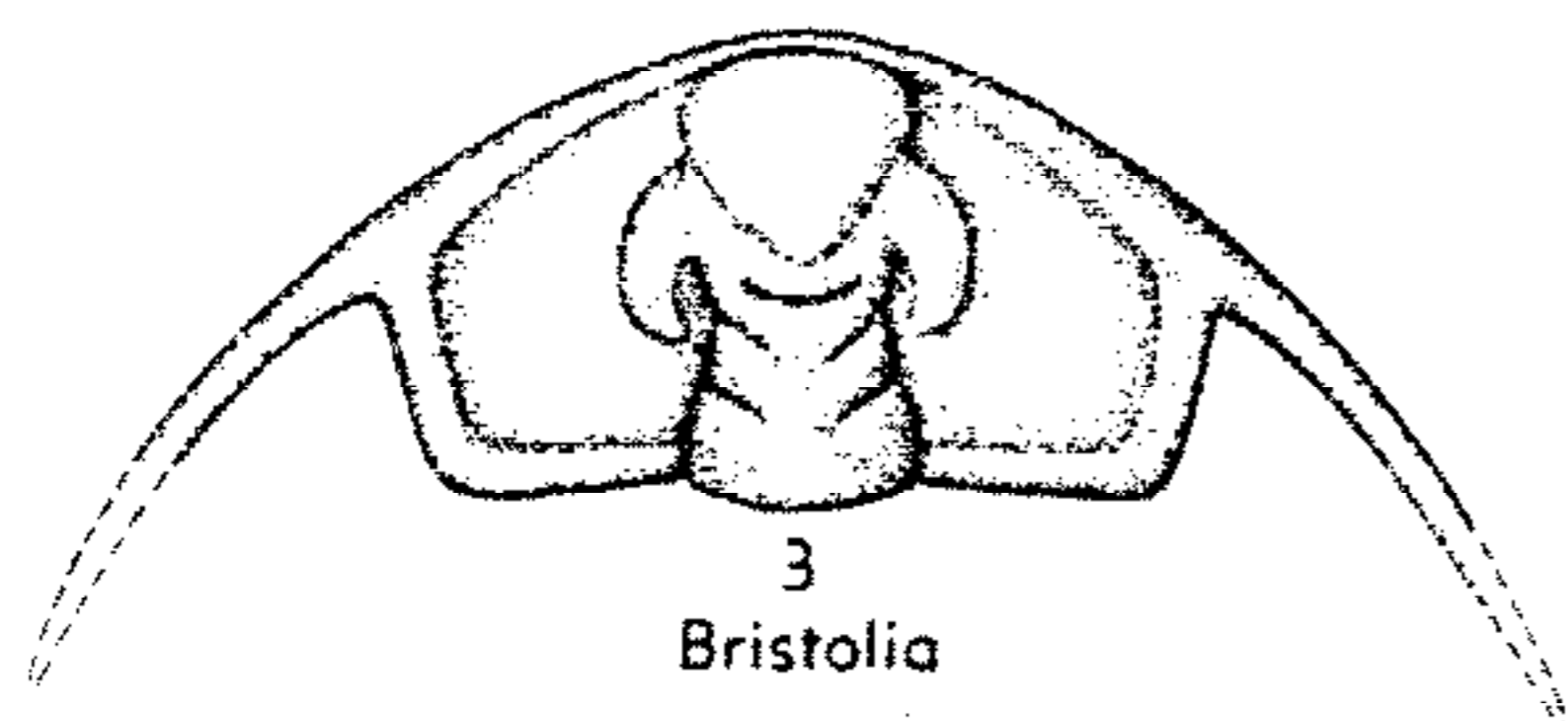
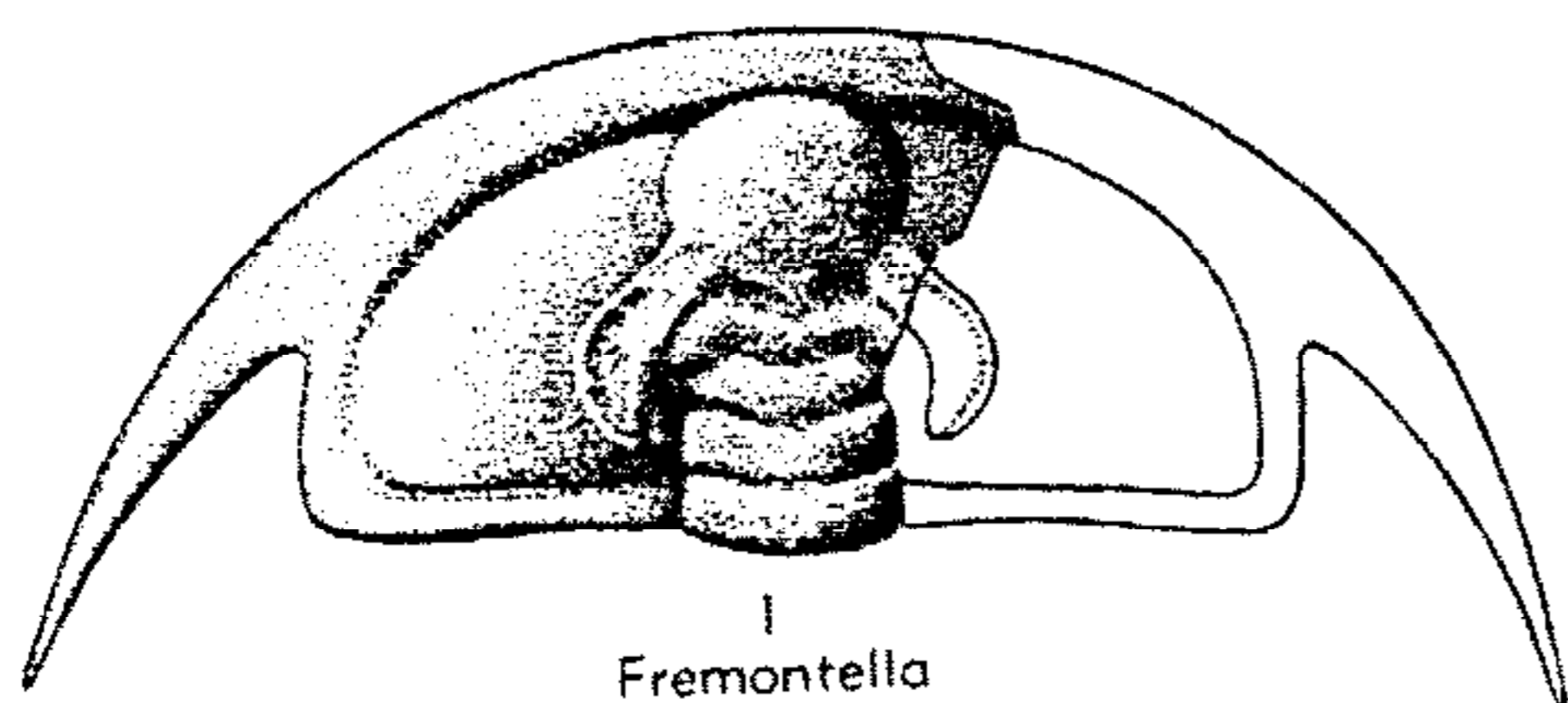

FIG. 133. Olenellidae (Olenellinae, Callaviinae, Fallotaspidinae) (p. 0192-0194).

surface usually covered with granules or delicate network of raised lines or both. *L.Cam.*

Subfamily OLENELLINAE Vogdes, 1893

[*nom. transl.* HUPÉ, 1953 (ex Olenellidae VOGDES, 1893)]

Exoskeleton subovate or (rarely) elongate. Glabella usually subcylindrical, with 3 pairs of lateral furrows, 2nd pair separated from axial furrows by confluent lateral glabellar lobes (in mature specimens); metagenal spines may be present in adult specimens. Hypostoma with multidentate or (rarely) entire posterior margin. Thorax of 14 prothoracic segments with well-developed pleurae terminating in long, obliquely backward- to strictly backward-directed pleural spines, followed by a variable number (to 30 or more) of poorly developed opisthothoracic segments with more or less rudimentary pleura; 3rd prothoracic segment strongly macropleural; 1st opisthothoracic segment with long axial spine. Pygidium a minute, undivided plate. Outer surface irregularly line or finely reticulate or smooth. *L.Cam.*

Olenellus BILLINGS, 1861 [*pro Barrandia* HALL, 1860 (non M'COY, 1849)] [**Olenus thompsoni* HALL, 1859; SD WALCOTT, 1896] [= *Mesonacis* WALCOTT, 1885]. Glabella long, with rounded frontal lobe, usually reaching anterior border furrow; palpebral lobes mostly long, terminating, opposite occipital furrow or farther back. Hypostoma without stalk (241, 282, 312). *L.Cam.*, N. Am.-Greenl.-Scot.—FIG. 132. **O. thompsoni* (HALL), Vt.; *a*, dorsal exoskel., $\times 0.7$; *b*, posterior part of same, $\times 1.7$ (312).

Bristolia HARRINGTON, 1956 [**Mesonacis bristolensis* RESSER, 1928]. Differs from *Olenellus* in having hourglass-shaped glabella with pyriform frontal lobe, much shorter, slightly anterior palpebral lobes, narrowly obtuse to acute metagenal angles, well-advanced genal spines, and anteriorly narrowing cephalic border (56). *L.Cam.*, N. Am.—FIG. 133,3. **B. bristolensis* (RESSER), Calif.; cephalon, $\times 1$ (231).

Fremontella HARRINGTON, 1956 [**Wanneria halli* WALCOTT, 1910]. Differs from *Bristolia* in having parallel-sided glabella with evenly rounded frontal lobe slightly encroaching on anterior border, slightly posterior palpebral lobes, and almost flat, much wider anterior border (56). *L.Cam.*, N. Am.—FIG. 133,1. **F. halli* (WALCOTT), Ala.; cephalon, $\times 1$ (56).

Fremontia RAW, 1939 [**Olenellus fremonti* WALCOTT, 1910]. Differs from *Olenellus* in having much shorter palpebral lobes, broadly obtuse metagenal angles, and somewhat advanced genal spines

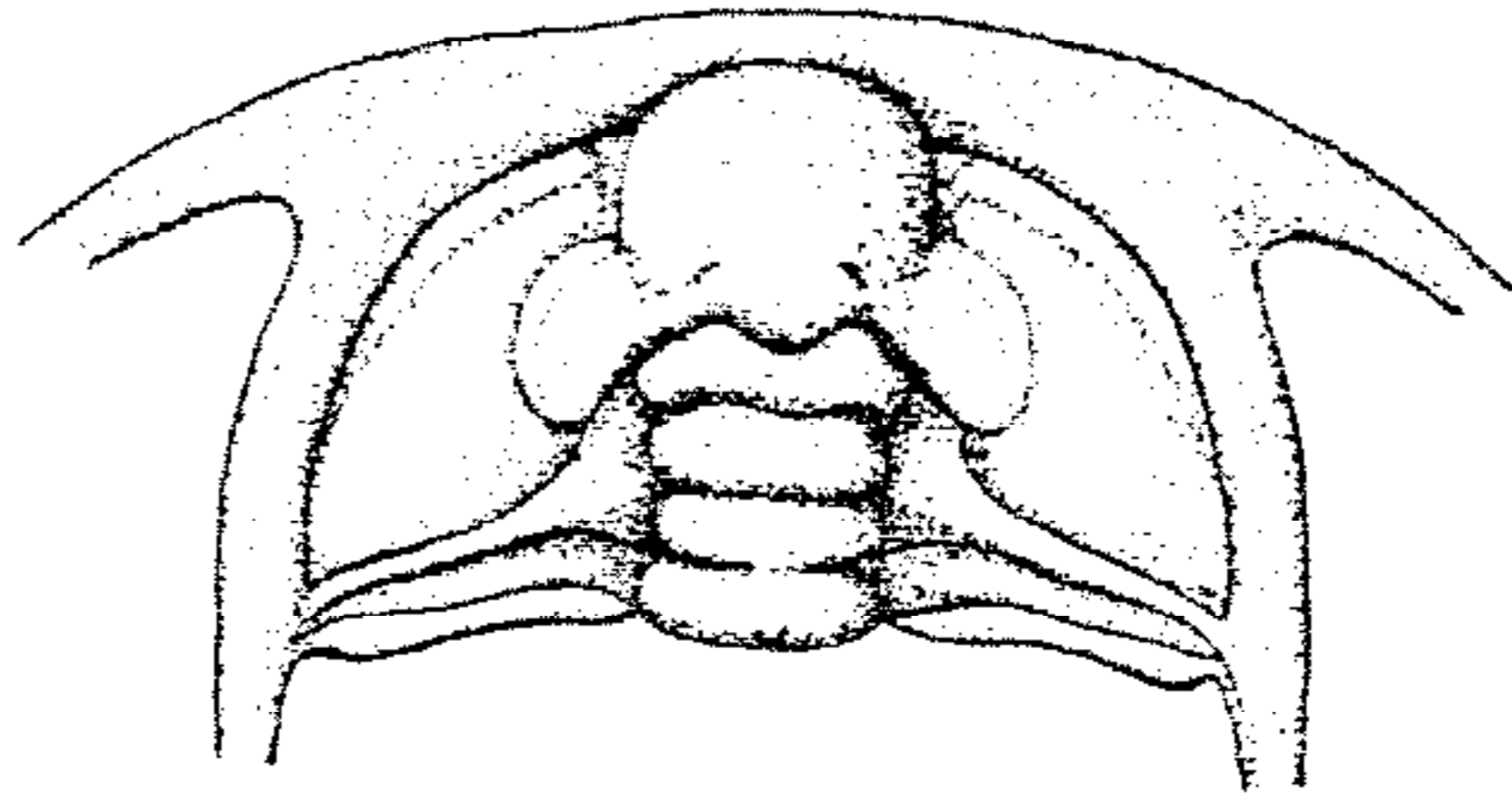

FIG. 134. **Laudonia bispinata* HARRINGTON (Olenellinae), *L.Cam.*, W. Can. (B.C.); cephalon, $\times 3$ (56).

(56). *L.Cam.*, N. Am.—FIG. 133,4. **F. fremonti* (WALCOTT), Calif.; cephalon, $\times 1.5$ (231).

Laudonia HARRINGTON, 1956 [**L. bispinata*]. Differs from *Fremontella* in having conspicuous metagenal spines in direct continuation of lateral border, simulating true genal spines (56). *L.Cam.*, N. Am.—FIG. 134. **L. bispinata*, B.C.; cephalon, $\times 4.5$ (56).

Paedeumias WALCOTT, 1910 [**P. transitans*]. Differs from *Olenellus* in having median ridge extending from frontal glabellar lobe to anterior border, and stalk connecting hypostoma with rostral plate (312, 241). *L.Cam.*, N. Am.-Greenl.-Scot.-Sib.—FIG. 135,5. **P. transitans*, Vt.; dorsal exoskel., $\times 1.8$.—FIG. 138,2. *P. yorkense* RESSER & HOWELL, Pa.; median part of rostral plate with hypostoma, $\times 2$ (312).

Peachella WALCOTT, 1910 [**Olenellus iddingsi* WALCOTT, 1884]. Differs from *Olenellus* in having tumid, bluntly terminating genal spines (312). *L.Cam.*, N. Am.—FIG. 135,6. **P. iddingsi* (WALCOTT), Nev.; *6a*, cephalon, $\times 2$; *6b*, genal angle and genal spine, $\times 3$ (312).

Subfamily CALLAVIINAE Poulsen, nov.

Exoskeleton subovate. Glabella subcylindrical to slightly clavate, with 3 to 5 pairs of glabellar furrows; occipital spine usually present; anterior and lateral cephalic border wide, slightly convex; palpebral lobes long, evenly curved. Posterior margin of hypostoma entire. Thorax (as far as known) consisting of 16 or 17 prothoracic and 1 or 2 slightly reduced opisthothoracic segments; a median axial spine usually present on each axial ring; pleurae straight to gently curved, sword-shaped, passing gradually into strong, falcate extremities; 3rd thoracic segment normal; articulation apparatus consisting of a row of articular cones and sockets in axial furrows. Pygidium a minute, apparently undivided plate. Outer surface finely reticulate. *L.Cam.*

Callavia MATTHEW, 1897 [**Olenellus (Mesonacis) bröggeri* WALCOTT, 1890; SD WALCOTT, 1910] [= *Cobboldus* RAW, 1936]. Glabella usually sub-cylindrical, fairly narrow, with 4 or 5 pairs of lateral furrows and frontal lobe tapering to a more or less narrowly rounded front; strong occipital spine usually present; posterior cephalic border generally with well-developed metagenal spines situated very close to genal angles. Hypostoma connected with rostral plate by median part of its anterior margin (204, 312). *L. Cam., E. N. Am.-Eng.-?Sp.-N. Afr.*—FIG. 136. **C. bröggeri* (WALCOTT), Newf.; *a*, restored dorsal exoskel.,

×0.5; *b*, median part of rostral plate with hypostoma, ×1.3 (312).

Judomia LERMONTOVA, 1951 [**J. dzevanovskii*]. Differs from *Callavia* and *Kjerulfia* in having palpebral genal region occupied by obliquely backward-directed extensions of anterior and next following lateral glabellar lobe (118). *L. Cam., Sib.*—FIG. 133.2. **J. dzevanovskii*; fragmentary ceph., ×1 (118*).

Kjerulfia KIAR, 1917 [**K. lata*]. Differs from *Callavia* in having frontal glabellar lobe expanded laterally beyond lateral glabellar lobes, 3 pairs of lateral glabellar furrows only, minute occipital

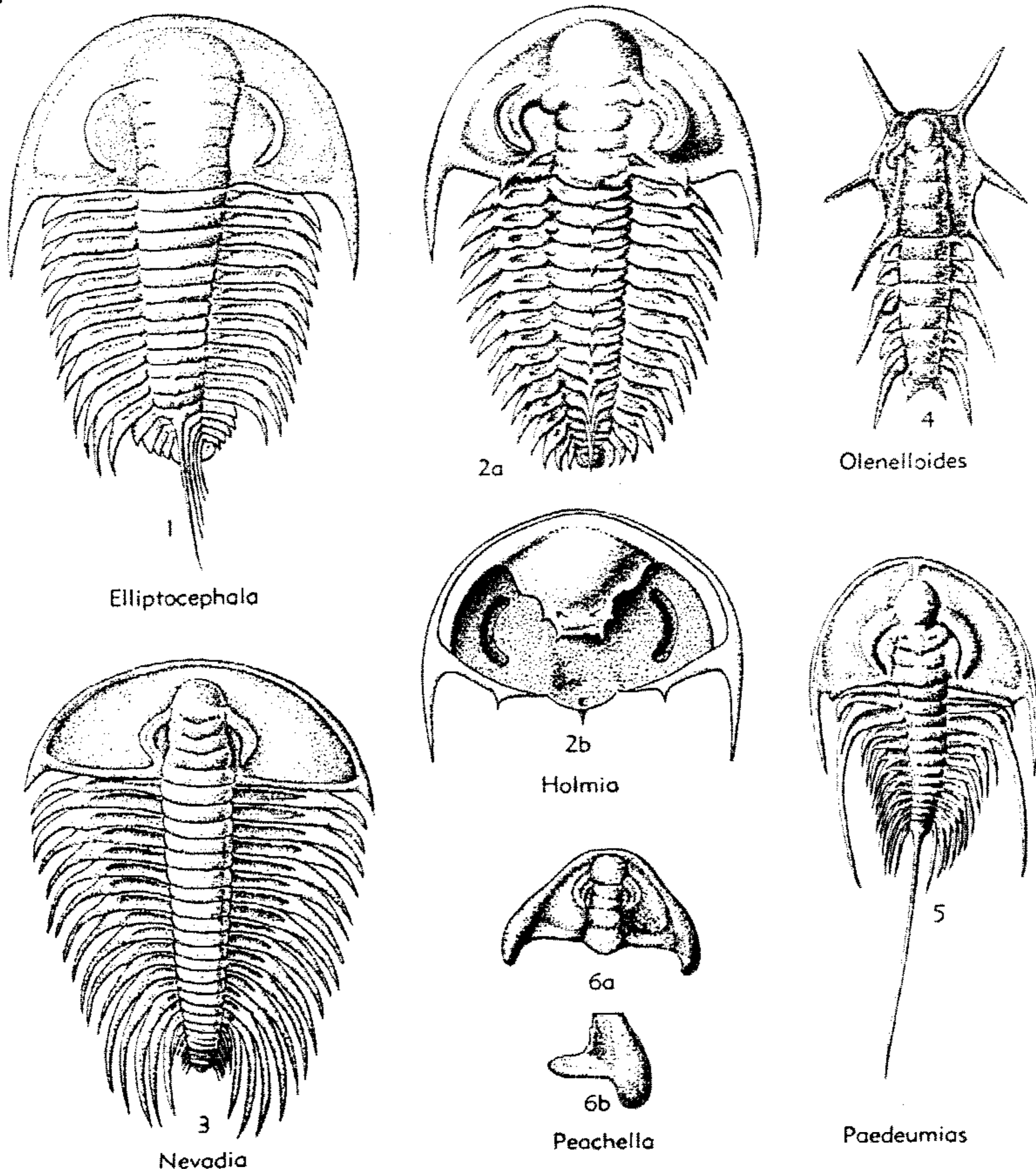

FIG. 135. Olenellidae (Olenellinae, Elliptocephalinae, Holmiinae, Nevadiinae, Olenelloidinae) (p. 0192-0195).

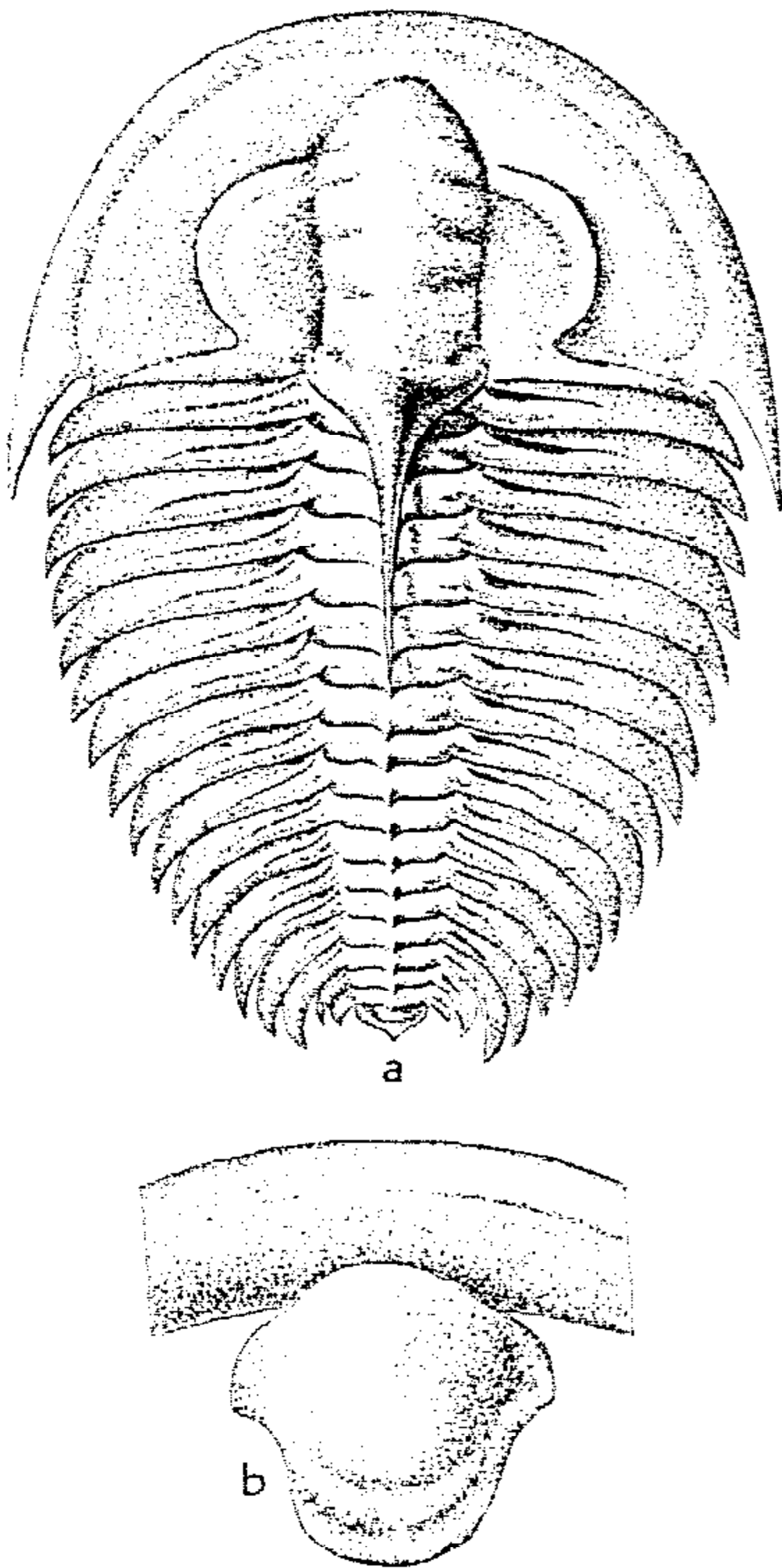

FIG. 136. **Callavia broeggeri* (WALCOTT) (Olenellidae, Callaviinae). *L.Cam.*, Newf.; *a*, dorsal exoskel., $\times 0.4$; *b*, hypostoma and part of rostral plate, $\times 1.8$ (312).

spine, posterior cephalic border without metagenal spines, metagenal angles situated remote from genal angles and total anterior margin of much wider hypostoma connected with rostral plate (90). *L.Cam.*, Norway-?Swed.-?Eng.—FIG. 137, 1. **K. lata*, Norway; *1a*, restored dorsal exoskel., $\times 0.57$; *1b*, ventral side of ceph., showing rostral plate and hypostoma, $\times 0.57$ (90).

Subfamily ELLIPTOCEPHALINAE Hupé, 1953

Exoskeleton subovate. Glabella very wide, somewhat clavate, with broadly rounded front and 4 pairs of lateral furrows; preglabellar field short in mature specimens; palpebral lobes long, semicircular, surrounding relatively large intra-ocular genal regions; cephalic border fairly narrow, mod-

erately convex. Hypostoma not known with certainty. Thorax of 13 prothoracic segments with fairly wide axis, median axial nodes, and straight to gently curved pleurae passing gradually into strong, falcate extremities, and 5 considerably reduced opisththoracic segments, typically with long, backward-directed axial spines. Pygidium minute, transverse, with only a trace of an anterior segment. Outer surface finely granulate and reticulate. Character of ventral parts unknown. *L.Cam.*

Elliptocephala EMMONS, 1884 [**E. asaphoides*] [=*Ebenezeria* MARCOU, 1888 (obj.); *Georgiellus* MOBERG, 1899 (obj.)] (303). *L.Cam.*, E.N.Am.—FIG. 135, 1. **E. asaphoides*, N.Y.; dorsal exoskel., $\times 0.45$ (312).

Subfamily FALLOTASPIDINAE Hupé, 1953

Exoskeleton elongate. Cephalon much wider than thorax, with subconical glabella commonly separated from anterior border by short preglabellar field, 5 pairs of lateral furrows (anterior 2 pairs indistinctly defined in some), trilobate occipital ring, wide anterior and lateral border furrow, moderately wide, slightly convex anterior and lateral border, long, prominent, slightly curved palpebral lobes terminating opposite to occipital furrow or farther back, and very long genal spines. Hypostoma unknown. Thorax of 17 prothoracic and some opisththoracic segments, with trilobate axial rings and broad, very short pleural furrows; prothoracic pleurae straight to slightly curved, with spined to obliquely truncated, pointed extremities; 3rd segment strongly macropleural; opisththoracic pleurae strongly curved. Pygidium minute, of 1 or ?2 segments with very narrow pleural fields. Outer surface (as far as known) granulate. *L.Cam.*

Fallotaspidis HUPÉ, 1953 [*pro Fallotia* HUPÉ, 1953 (non DOUVILLÉ, 1902)] [**F. typica*] (77). *L.Cam.*, N.Afr.-?Eng.—FIG. 133, 5. **F. typica*, Morocco; restored dorsal exoskel., $\times 1$ (77).

Subfamily HOLMIINAE Hupé, 1953

Exoskeleton subovate to elongate. Cephalon considerably wider than anterior part of thorax. Glabella subcylindrical to more or less clavate, with 3 pairs of lateral furrows. Metagenal angles situated fairly close to occipital ring. Thorax (as far as known) of 16 to 17 normally developed segments with wide axis and relatively narrow pleu-

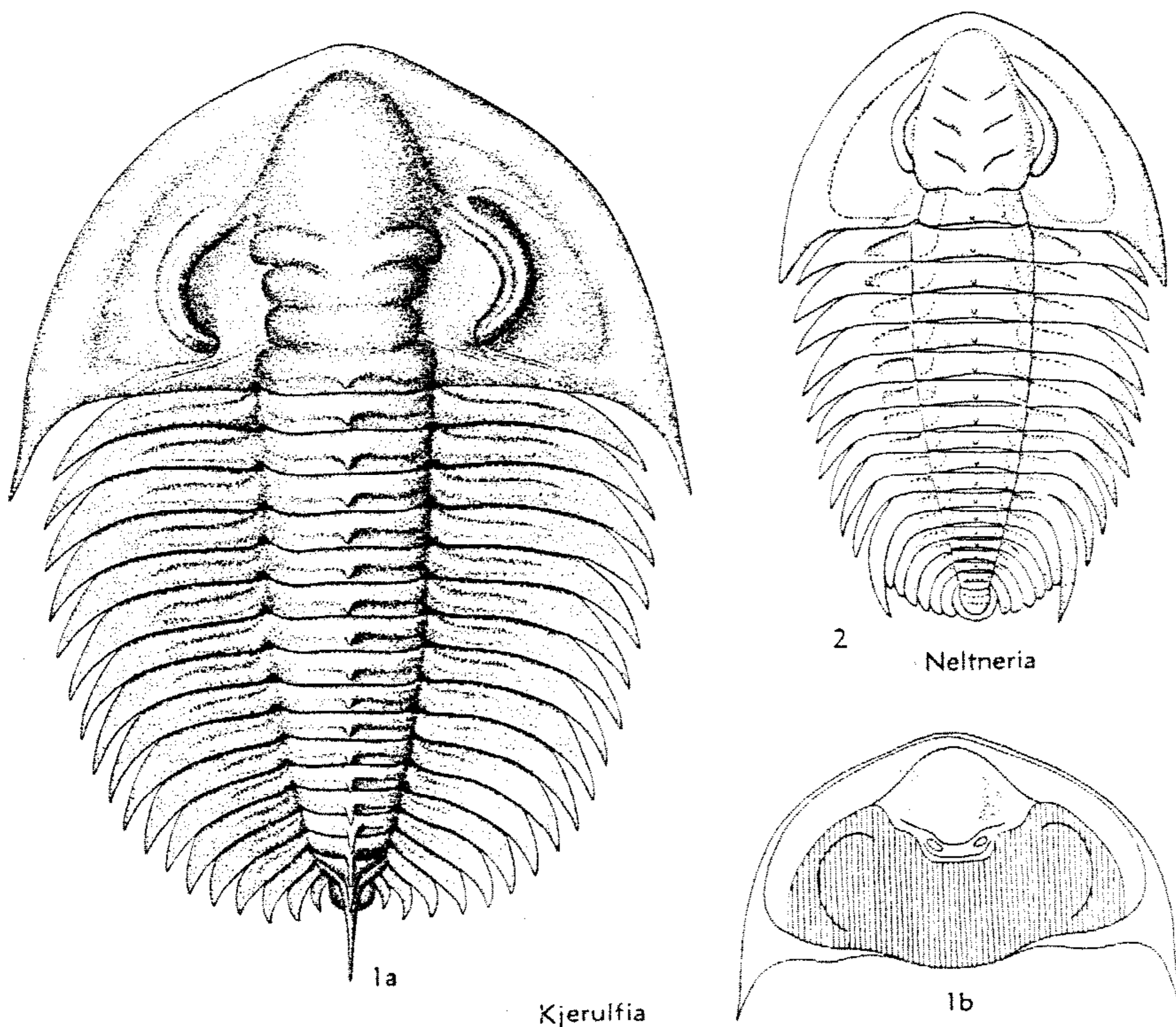

FIG. 137. Olenellidae (Callaviinae, Neltneriinae) (p. 0193-0196).

ral regions. Pygidium minute, with 1 to ?3 segments. *L.Cam.*

Holmia MATTHEW, 1890 [**Paradoxides kjerulfi* LINNARSSON, 1871] [= *Esmeraldina* RESSER & HOWELL, 1938]. Cephalon considerably wider than thorax; glabella clavate, broadly rounded in front, with laterally expanded frontal lobe; small occipital spine present; palpebral lobes strongly and evenly curved; posterior cephalic border with well-developed metagenal spines in type species. Thorax of 16 segments with axial spines especially well developed near pygidium, and pleurae terminating in obliquely backward-directed spines, posterior ones being approximately falcate and almost enveloping pygidium. Pygidium with 2 axial rings in addition to rounded terminal portion, extremely narrow pleural fields gently curved lateral margins, and almost rectilinear posterior margin. Outer surface finely reticulate (90). *L.Cam.*,

Eu.-N.Am.—FIG. 135.2. **H. kjerulfi* (LINNARSSON), Norway; 2a, restored dorsal exoskel., $\times 0.7$; 2b, ventral view of ceph., showing rostral plate and hypostoma, $\times 0.7$ (90).

Bondonella HUPÉ, 1953 [**B. typica*]. Differs from *Holmia* in having cephalon of about same width as middle portion of thorax, subcylindrical glabella, longer, moderately curved palpebral lobes, anteriorly contracted thorax of 17 segments without axial spines, and pygidium with 1 or 2 axial segments and probably dentate posterior margin. Surface markings unknown (77). *L.Cam.*, N.Afr.—FIG. 138.3. **B. typica*, Morocco; restored dorsal exoskel., $\times 1$ (77).

?*Schmidtellus* MOBERG in MOBERG & SEGERBERG, 1906 [*pro Schmidtia* MARCOU, 1890 (*non* VOLBORTH, 1869)] [**Olenellus mickwitzii* SCHMIDT, 1888]. Differs from *Holmia* in much-reduced frontal glabellar lobe, unevenly curved palpebral lobes with long, almost straight proximal

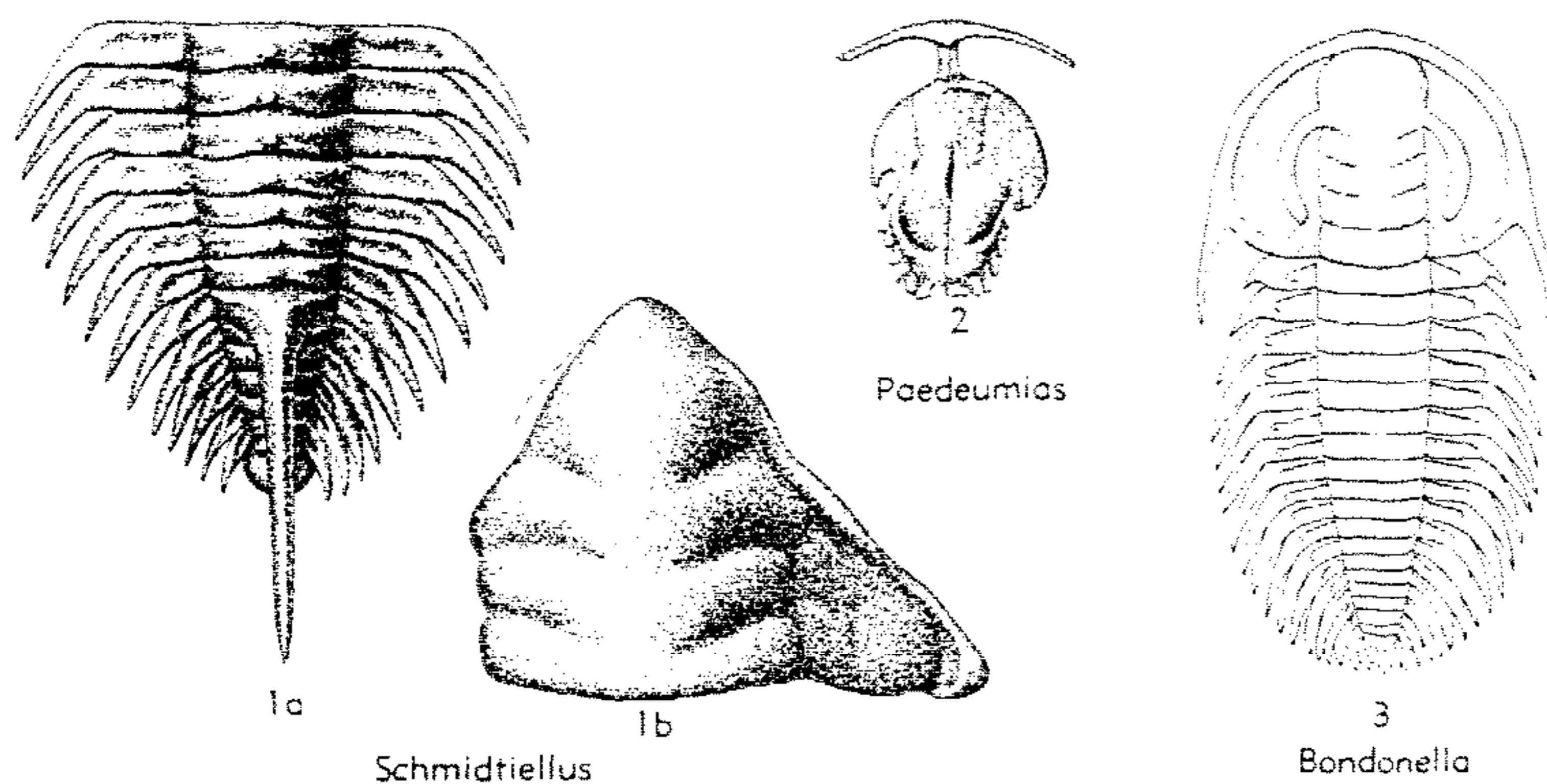

FIG. 138. Olenellidae (Olenellinae, Holmiinae) (p. 0192-0195).

portion and short, more or less abruptly curved distal portion, thorax (number of segments unknown) with long axial spine on 6th segment from pygidium, which has narrower axis and wider pleural fields, and outer exoskeletal surface with finely granulate areas in addition to fine reticulation (270). *L. Cam.*, Balt.-Swed.—FIG. 138.1. **S. mickwitzii* (SCHMIDT), Est.; 1a, fragmentary glabella with palpebral lobe, $\times 2$; 1b, posterior part of dorsal exoskel., $\times 1$ (270).

Subfamily NELTNERIINAE Hupé, 1953

Exoskeleton ovate. Glabella inverted ovate, encroaching on anterior cephalic border, with 3 pairs of oblique lateral furrows separated from axial furrows by confluent lateral glabellar lobes; occipital ring trilobate, narrower than glabella and 1st thoracic axial ring; anterior and lateral cephalic border very wide, slightly convex; palpebral lobes long, slightly curved, delimiting extremely narrow intra-ocular genal portion, their distal ends touching posterior lateral glabellar lobe; genal spines short, stout, rapidly tapering. Hypostoma unknown. Thorax of 11 prothoracic segments with trilobate axial rings, very short pleural furrows, and strong falcate extremities; 11th segment macropleural, followed by 5 or 6 opisthothoracic segments with more strongly curved, bluntly terminating pleurae. Pygidium minute, number of segments unknown, with evenly curved posterolateral margin. Surface markings unknown. *L. Cam.*

Neltneria HUPÉ, 1953 [**Wanneria jaqueti* NELTNER & POCTEY, 1950] (77). *L. Cam.*, N.Afr.—FIG. 137.2. **N. jaqueti* (NELTNER & POCTEY), Morocco; restored dorsal exoskel., $\times 0.7$ (77).

Subfamily NEVADIINAE Hupé, 1953

Exoskeleton subovate. Cephalon very wide, with narrow, conical glabella, 3 transglabellar furrows, short to long, moderately to strongly curved palpebral lobes, very wide extra-ocular genal regions, and short, rapidly tapering genal spines. Hypostoma unknown. Thorax (as far as known) of 17 to 28 segments with gradually tapering axis, prothoracic ones having short-furrowed pleurae with long, acutely terminating, falcate distal portion; 3rd segment normal. Pygidium a minute, undivided plate. Outer surface minutely granulate and irregularly reticulate. *L. Cam.*

Nevadia WALCOTT, 1910 [**N. weeksi*]. Cephalon about 3 times as wide as long, with well-developed preglabellar field and narrow border. Thorax (as far as known) of 17 prothoracic segments, followed by 11 post-thoracic ones with rudimentary spinelike pleurae (312, 204). *L. Cam.*, W.N.Am.-Eng.—FIG. 135.3. **N. weeksi*, Nev.; dorsal exoskel. without pygidium and posterior part of opisthothorax, $\times 0.45$ (312).

Nevadella RAW, 1936 [**Callavia eucharis* WALCOTT, 1913; SD WHITEHOUSE, 1939]. Differs from *Nevadia* in having longer cephalon with longer glabella, short preglabellar field or lacking it, border wide. Thorax of 17 to 23 segments; char-

acter of posterior part of thorax incompletely known (20+). *L. Cam.*, N. Am.

Subfamily OLENELLOIDINAE Hupé, 1953

Minute (?neotenic) forms. Exoskeleton narrow, elongate. Cephalon more or less distinctly hexagonal, with well-developed pergenal, genal, and metagenal spines, sub-tapering glabella extended to narrow anterior border, 3 pairs of lateral furrows (generally transglabellar), genae narrower than glabella, palpebral lobes very short. Hypostoma unknown. Thorax of 8 segments with axis about twice as wide as pleural regions, and macropleural development of 3rd and 6th segments. Pygidium unknown. Outer surface finely reticulate. *L. Cam.*

Olenelloides PEACH, 1894 [**O. armatus*] (114, 312, 164). *L. Cam.*, Scot.—FIG. 135, 4. **O. armatus*: ceph. and thorax, $\times 3$ (164).

Subfamily WANNERIINAE Hupé, 1953

Exoskeleton subovate. Cephalon inconsiderably wider than anterior part of thorax, with fairly wide anterior and lateral border. Glabella clavate, with strongly expanded frontal lobe and 3 pairs of lateral glabellar furrows. Metagenal angles remote from occipital ring. Thorax (as far as known) of 15 prothoracic and a few opisththoracic segments; 3rd thoracic segment normal, and 15th furnished with long, very strong axial spine; pleural regions fairly wide. Outer surface finely granulate and more or less coarsely reticulate. *L. Cam.*

Wanneria WALCOTT, 1910 [**Olenellus (Holmia) walcottanus* WANNER, 1901]. Cephalon of adult specimens without metagenal spines. Prothoracic segments with axial nodes or spines, broad pleural furrows, and long, acutely terminating, falcate extremities; 16th and 17th (opisththoracic) segments without axial spines and with somewhat reduced pleurae. Pygidium bilobate, apparently consisting of an axial ring and a pair of backwardly directed, incompletely fused pleurae (173, 241, 312). *L. Cam.*, N. Am.-Greenl.-?Eng.-Silesia.—FIG. 139. **W. walcottana* (WANNER), Pa.; *a*, dorsal exoskel., $\times 0.7$; *b*, pygidium and posterior part of thorax, showing base of strong axial spine on 15th segment, $\times 2$; *c*, posterolateral portion of hypostoma, showing reticulate surface and marginal spines, $\times 6$ (312).

Family DAGUINASPIDIDAE Hupé, 1953

[*nom. correct.* POULSEN, herein (*ex Daguinaspidae* HUPÉ, 1953)]

Exoskeleton elongate, moderately convex, micropygous. Cephalon heart-shaped to subelliptical, devoid of dorsal sutures; taper-

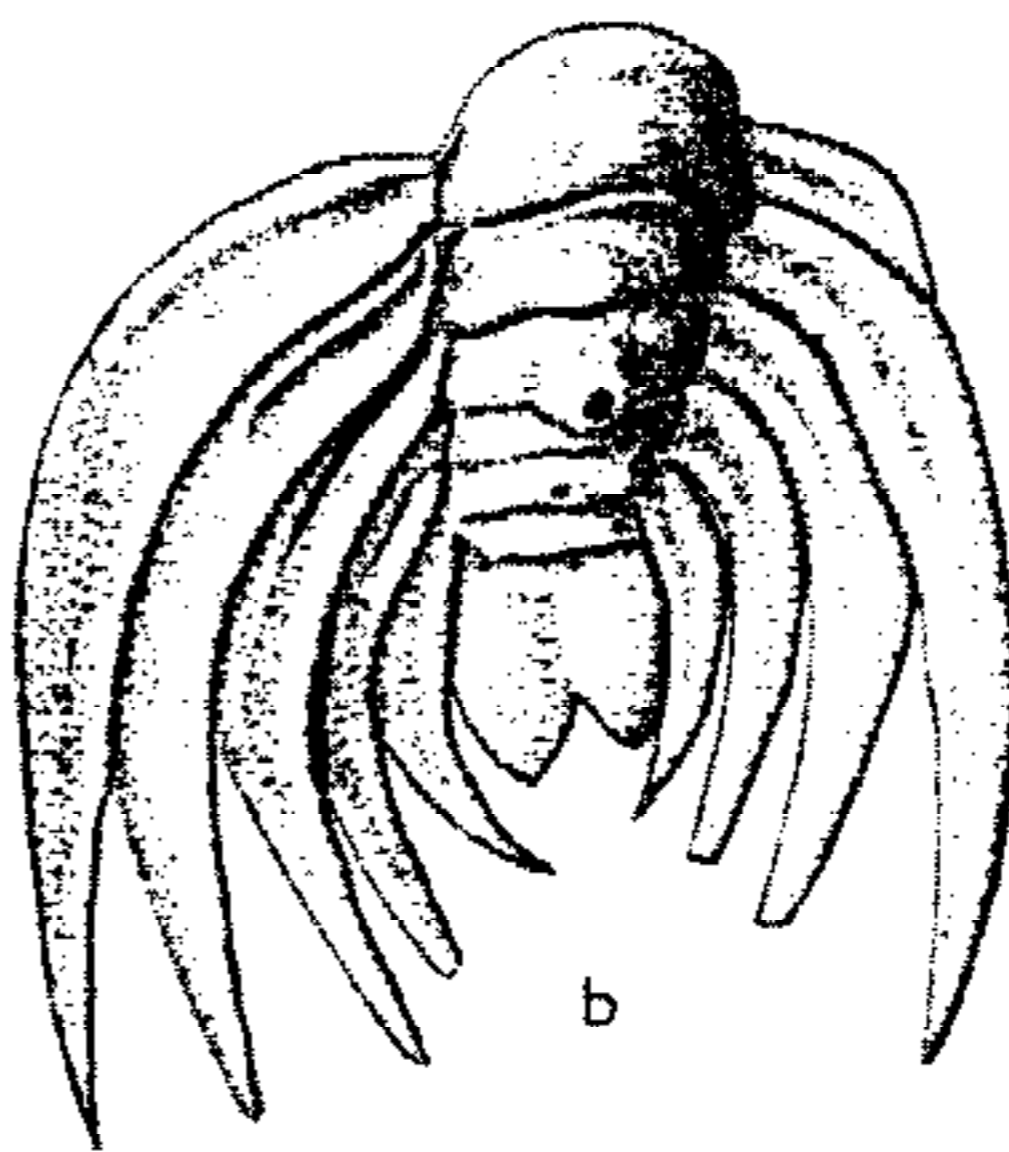
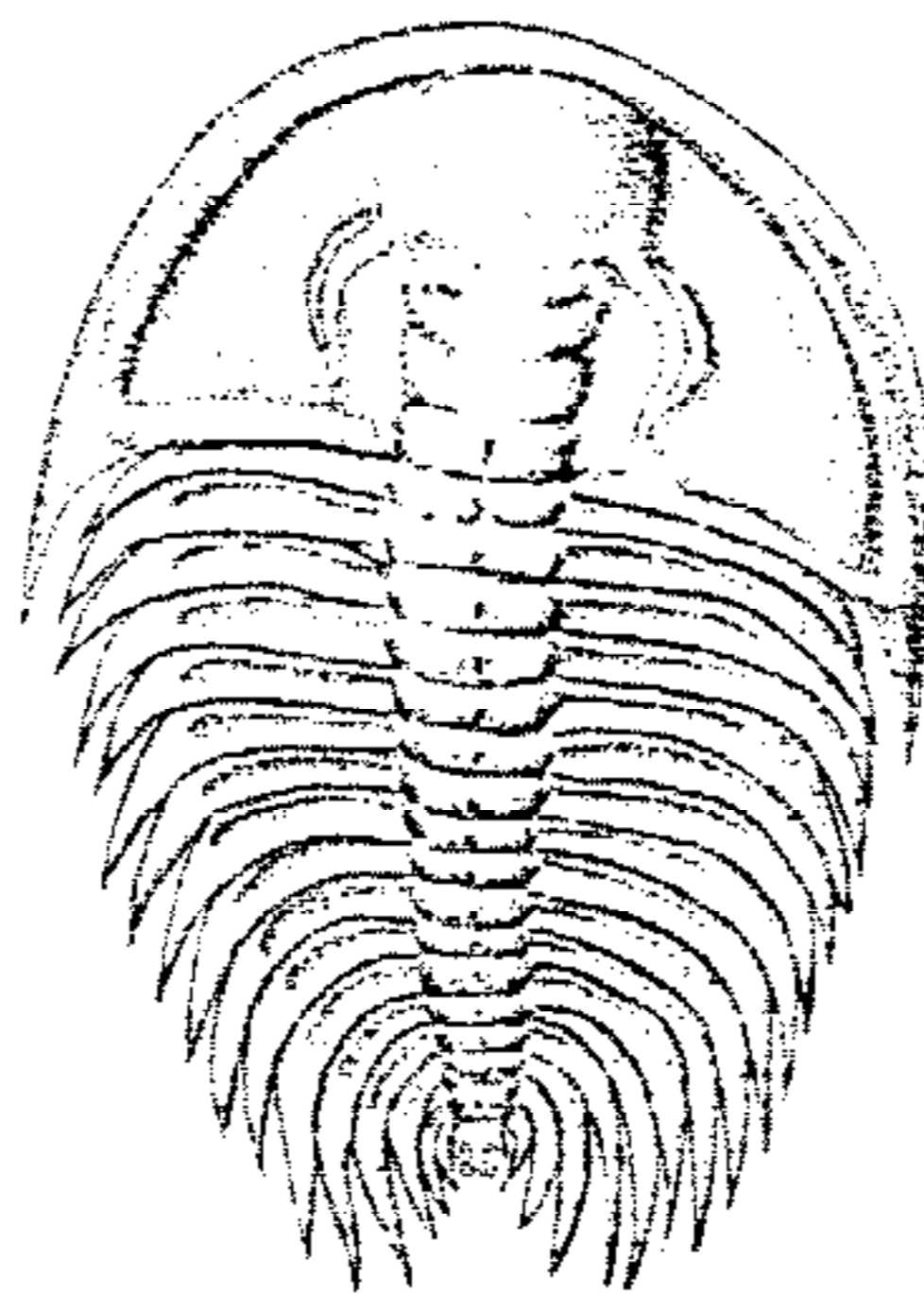
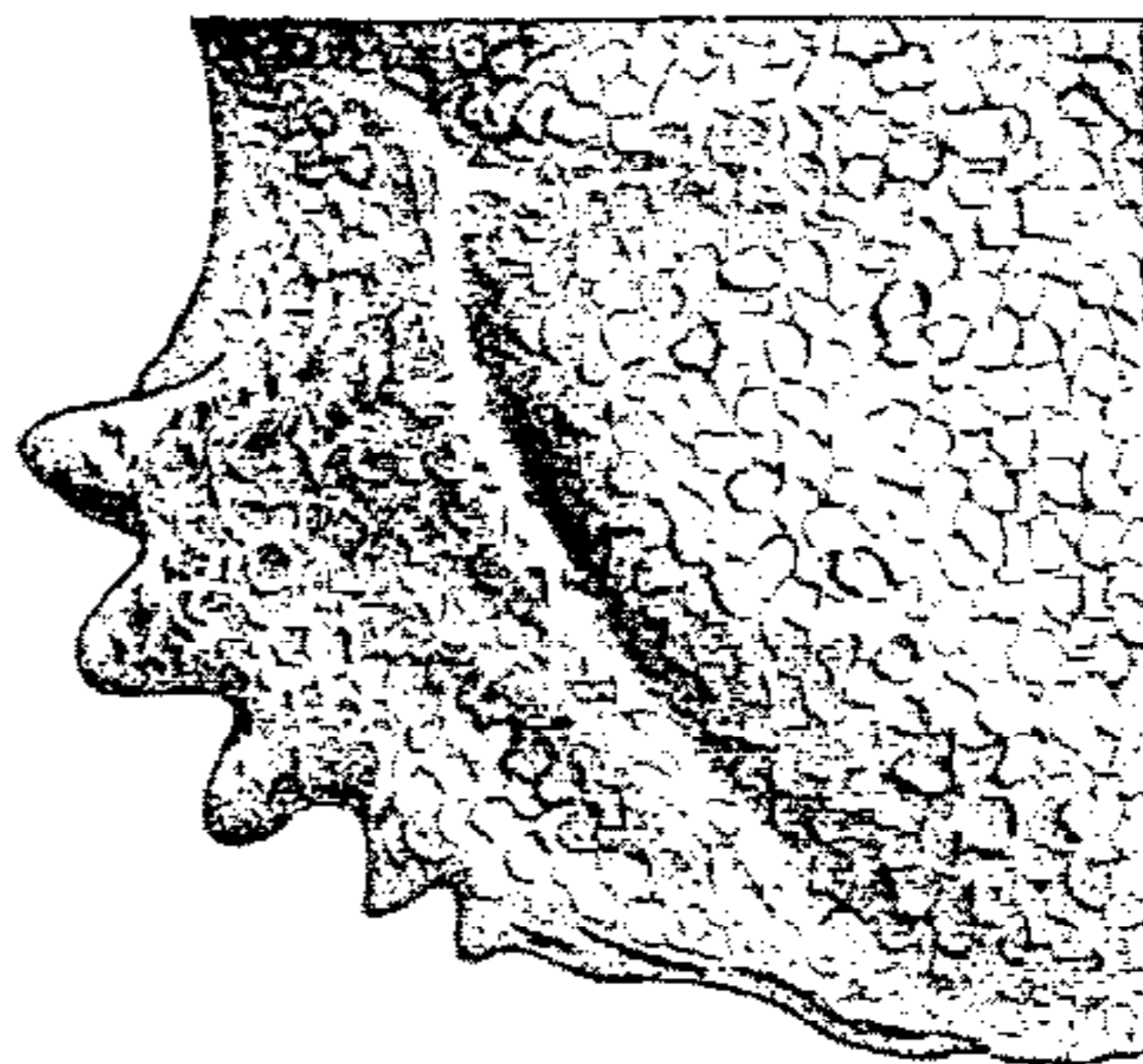
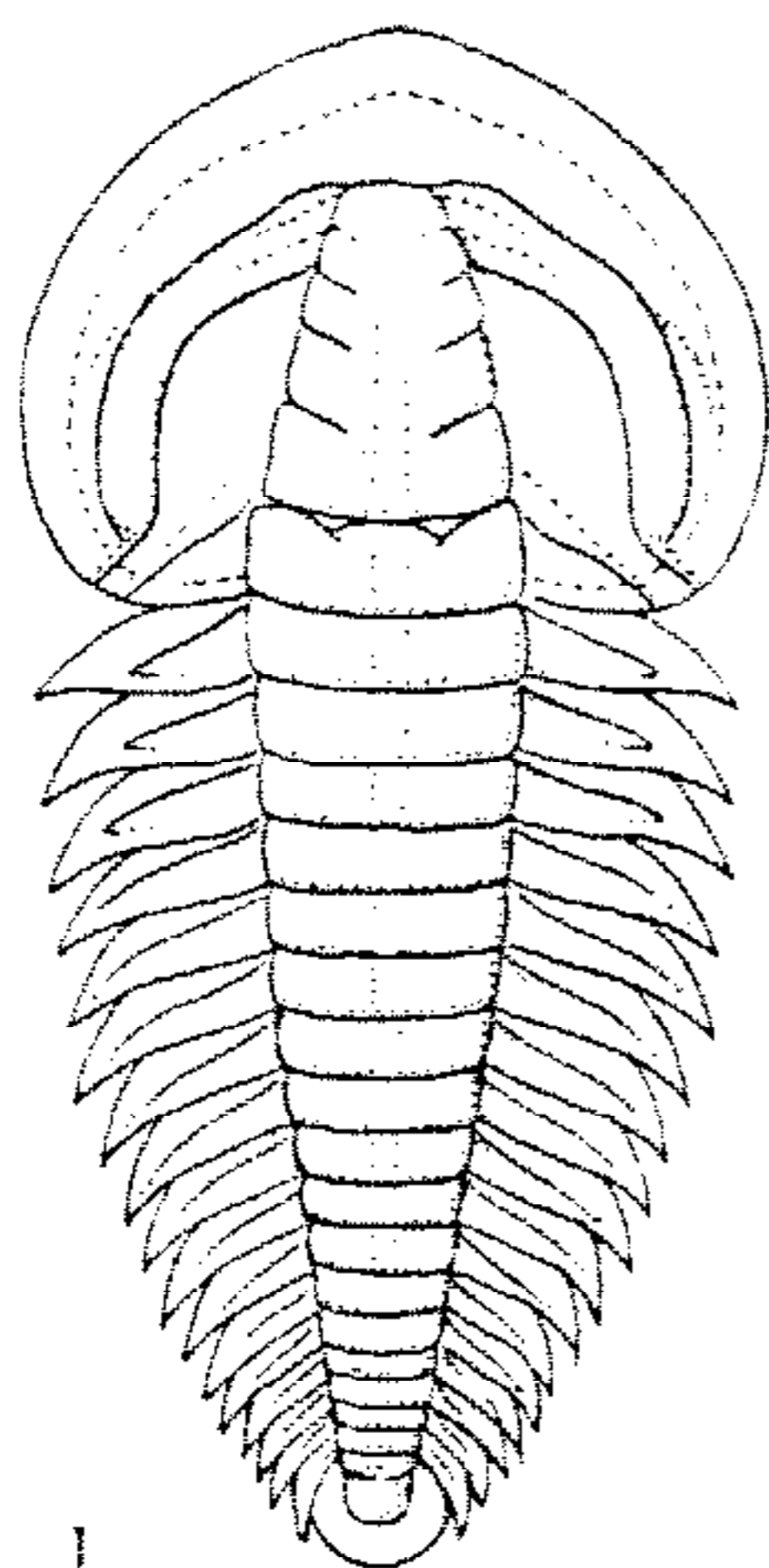
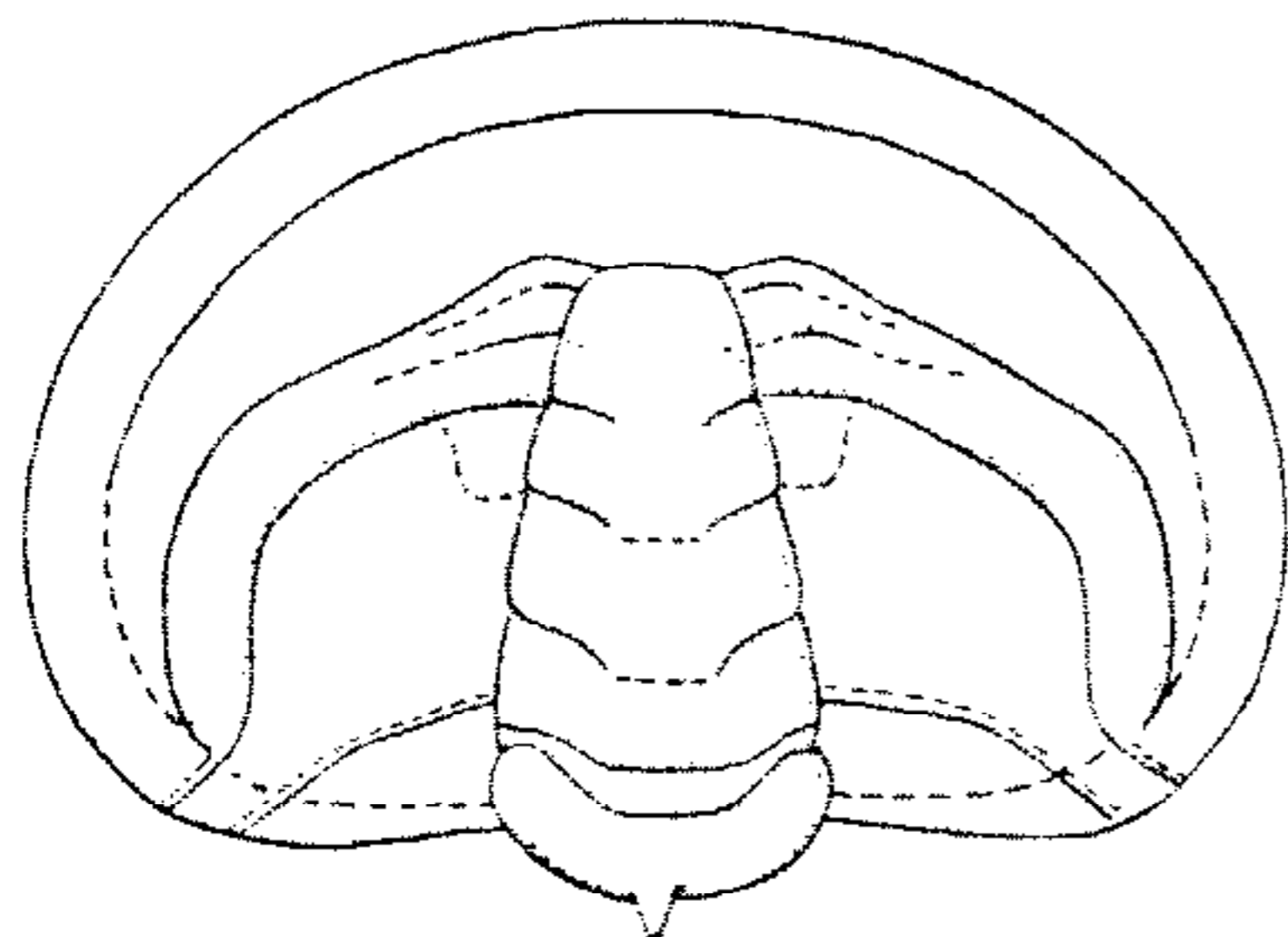

FIG. 139. **Wanneria walcottana* (WANNER) (Olenellidae, Wanneriinae), *L. Cam.*, E. USA (Pa.); *a*, dorsal exoskel., $\times 0.7$; *b*, pyg. and part of thorax, $\times 2$; *c*, posterolateral part of hypostoma, $\times 6$ (312).



Daguinaspis



Choubertella

FIG. 140. Daguinaspidae (p. O198).

ing anteriorly truncated glabella with 3 to 5 pairs of lateral furrows; preglabellar field well developed; with very long, more or less distinctly trifid palpebral lobes; genal angles rounded, spineless; lateral portion of extra-ocular gena narrow, with broad border furrow and narrow border; hypostoma unknown. Thorax of 17 (?16) segments in the type genus, with gradually tapering axis and short, furrowed, acutely terminating pleurae. Pygidium very small. *L.Cam.*

Daguinaspis HUPÉ & ABADIE, 1950 [**D. ambroggii*]. Cephalon heart-shaped, more or less acuminate in front, almost as long as wide (in most subgenera), with intrapalpebral portion of genae considerably narrower than occipital ring. Pygidium subcircular, with single axial ring and rounded axial termination (77). *L.Cam.*, N.Afr.

D. (*Daguinaspis*). Length of cephalon generally exceeding 0.75 of width. Intrapalpebral genal region wider than posterior extra-ocular part of cephalon (77). *L.Cam.*, Morocco.—FIG. 140,1. **D. (D.) ambroggii*; restored dorsal exoskeleton, $\times 1.5$ (445).

D. (*Eodaguinaspis*) HUPÉ, 1953 [**D. (E.) abadie*]. Length of cephalon about 0.75 of width. Intrapalpebral genal region practically equal in width to posterior extra-ocular part of cephalon (77). *L.Cam.*, Morocco.

D. (*Epidaguinaspis*) HUPÉ, 1953 [**D. (E.) angusta*]. Cephalon almost as long as wide. Width of intrapalpebral genal region practically equal to that of posterior extra-ocular part of cephalon (77). *L.Cam.*, Morocco.

Choubertella HUPÉ, 1953 [**C. spinosa*]. Differs from *Daguinaspis* in having much wider, transversely subelliptical cephalon with broadly rounded anterior margin and wider intrapalpebral genal region (77). *L.Cam.*, N.Afr.—FIG. 140,2. **C. spinosa*, Morocco; restored ceph., $\times 3$ (77).

Suborder REDLICHIANA

Harrington, nov.

[=superfamily Redlichidea RICHTER, 1933; Redlichacea (HENNINGSMOEN, 1951: Redlichioidea HUPÉ, 1953) [Type—*Redlichia* COSSMANN, 1902]]

Dorsal exoskeleton elongate, subelliptical in outline. Cephalon semicircular to semi-elliptical, mostly with prominent genal spines; glabella with subparallel sides, narrowing forward, or expanding forward, generally well segmented; facial sutures opisthoparian; eyes mostly large, tending to be crescentic. Thorax with numerous segments. Pygidium small. *L.Cam.-M.Cam.*

Superfamily REDLICHIACEA

Poulsen, 1927

[*nom. correct.* HENNINGSMOEN, 1951 (*pro* superfamily Redlichidea RICHTER, 1933. *nom. transl.*, ex Redlichidae POULSEN, 1927)]

Characters of the suborder, but distinguished by lack of expanded anterior part of glabella and very elongate, crescentiform nature of eyes; preglabellar field very narrow or lacking. *L.Cam.-M.Cam.*

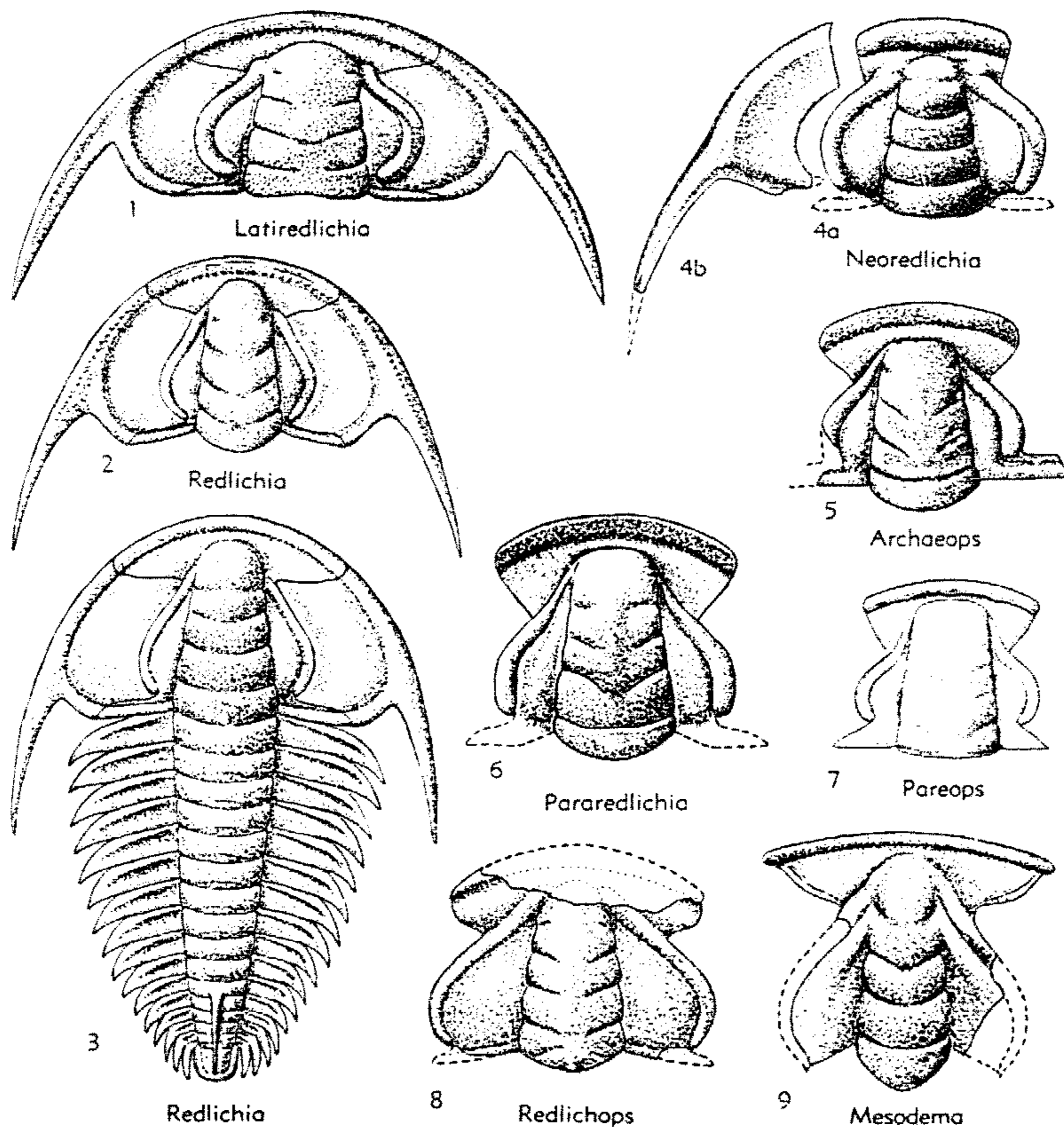

FIG. 141. Redlichiidae (Redlichiinae, Pararedlichiinae), Neoredlichiidae (p. 0200, 0201).

Family REDLICHIIDAE Poulsen, 1927

[*nom. correct.* RICHTER, 1933 (*pro* Redlichiidae POULSEN, 1927)] [=Latiredlichiidae HURÉ, 1953 (*partim*)]

Dorsal exoskeleton opisthoparian, ovate, very gently convex, micropygous. Cephalon semielliptical; glabella long, tapering forward, rounded in front, with 3 pairs of evenly spaced lateral glabellar furrows, anterior pair (*3p*) faint, short, slightly oblique forward-backward, remainder oblique backward-inward, subparallel to occipital furrow; preglabellar field narrow; anterior border wider, raised; eye lobes arcuate, long, arising from frontal glabellar lobe, extend-

ing to level of occipital furrow or farther back; facial sutures kainelliform, anterior sections very divergent (90° to 45°); posterior area of fixigenae narrow (*exsag.*), librigenae wide, with advanced genal spines. Thorax of 11 to 17 segments; pleurae ending in spines, fulcrum distal. Pygidium small, 1 or 2 segments. Surface of exoskeleton smooth or very finely granulose. *L. Cam.*

Subfamily REDLICHIIINAE Poulsen, 1927

[*nom. transl.* HARRINGTON, herein (*ex* Redlichiidae POULSEN, 1927)]

Proximal extremities of anterior sections of facial sutures close to axial furrow, meet-

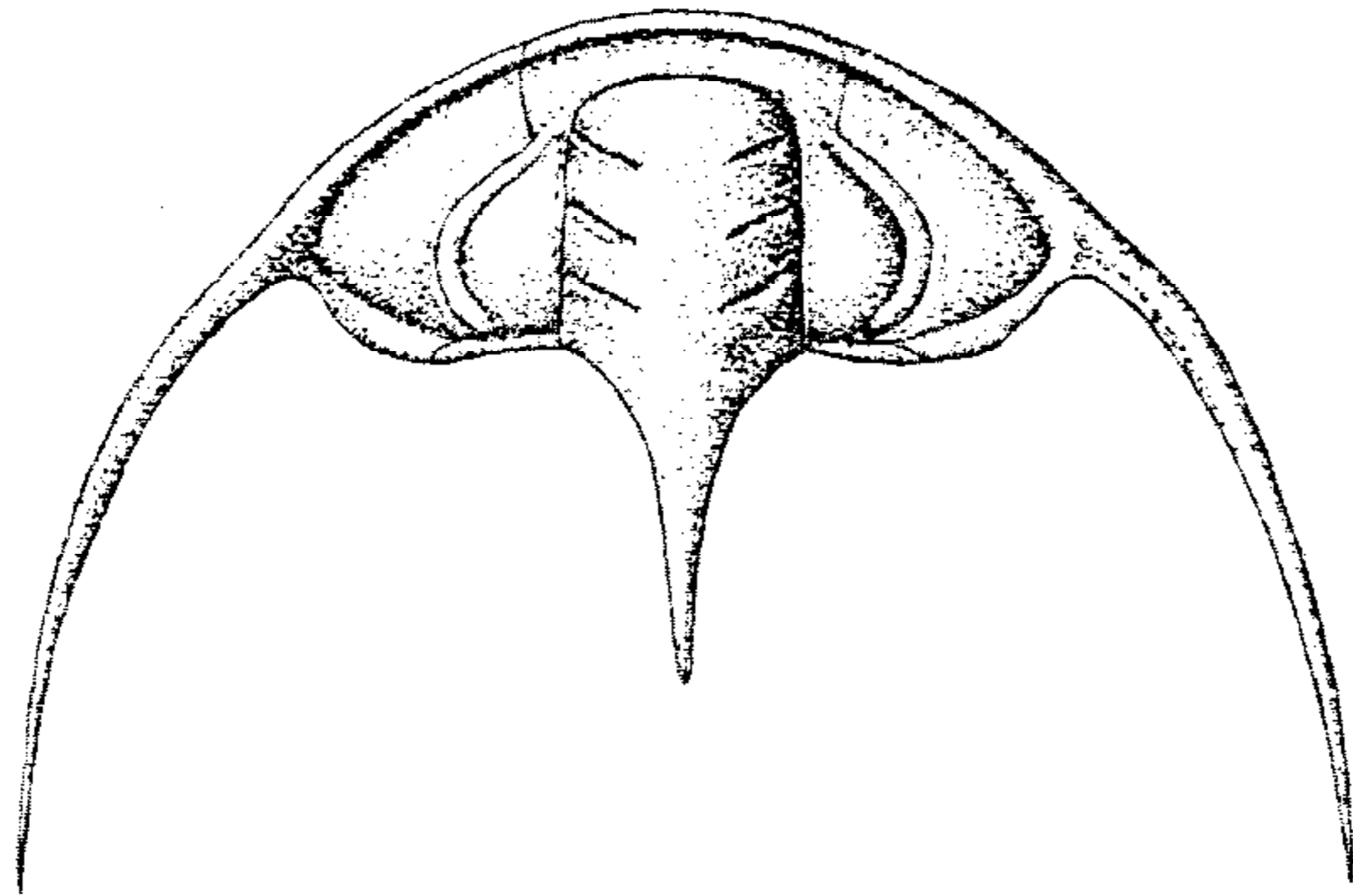

FIG. 142. **Redlichaspis finalis* (WALCOTT) KOBAYASHI (Redlichiidae, Redlichiinae), *L. Cam.*, China, $\times 2$ (405).

ing eye lobe at level of mid-length of frontal glabellar lobe; posterior extremity of eye lobe close to axial furrow. *L. Cam.*

Redlichia COSSMANN, 1902 [*pro Hoeferia* REDLICH, 1899 (non BITTNER, 1895)] [**Hoeferia noeltingi* REDLICH, 1899]. Anterior lateral glabellar furrows almost normal to axis, remainder oblique, pre-occipital and occipital furrows transglabellar in internal molds; anterior border furrow pits may be present in large individuals, anterior border striated; eye lobes reaching level of occipital ring. Thorax with 11 to 17 segments, 11th bearing long axial spine; mesial spine also may be developed on 4th or 5th ring. Pygidium small, 1 or 2 segments. Rostral plate long; hypostoma fused to rostral plate, with globose anterior body and 2 pairs of short posterolateral spines. *L. Cam.*, Korea-China-W. Pak.-Iran-Austral.-?Sib. — FIG. 141,2. **R. noeltingi* (REDLICH) COSSMANN, W. Pak.; ceph., restored (paratype librigenae attached to holotype cran.); $\times 1.35$ (418). — FIG. 141,3. *R. chinensis* WALCOTT, China; restored, $\times 1.8$ (488).

Latiredlichia HUPÉ, 1953 [**L. saitoi* (= *Redlichia* cf. *walcotti* SAITO, 1934; non MANSUY, 1912)]. Differs from *Redlichia* in having shorter, wider, and finely granulose glabella. Thorax and pygidium unknown. *L. Cam.*, China. — FIG. 141,1. **L. saitoi*; ceph., restored (paratype librigenae attached to holotype cran.); $\times 1$ (465).

Redlichaspis KOBAYASHI, 1955 [**Redlichia?* *finalis* WALCOTT, 1913]. Like *Redlichia* but differs in nature of glabellar furrows, course of facial suture, and prominent occipital spine. *L. Cam.*, China. — FIG. 142. **R. finalis* (WALCOTT); ceph., $\times 2$ (405).

?**Bulaiaspis** REPINA, 1956 [**B. vologdini*]. *L. Cam.*, E. Sib. [Published as attributed to LERMONTOVA "in

coll." but L. N. REPINA indicated as actual author; referred by author to Redlichiidae (RCM).]

Saukiandiops HUPÉ, 1953 [**Redlichia walcotti* MANSUY, 1912]. Differs from *Pseudosaukianda* in having chevron-shaped preoccipital furrow, straight occipital furrow, occipital ring wider at middle, no occipital node, transversely elongated anterior pits, anterior branches of facial suture diverging at 45° and longer eye lobes reaching level of occipital furrow. Thorax and pygidium unknown. *L. Cam.*, China. — FIG. 145,3. **S. walcotti* (MANSUY), cran., $\times 2.5$ (411).

Subfamily PARAREDLICHIINAE Hupé, 1953

Proximal ends of anterior sections of facial sutures distant from axial furrows, meeting eye lobes at level of 1st lateral glabellar lobes (3p); posterior extremities of eye lobes distant from axial furrows. *L. Cam.*

Pararedlichia HUPÉ, 1953 [**P. pulchella*]. Glabella rounded-subtruncate in front, occipital furrow transglabellar; eye lobes widening posteriorly, reaching level of occipital furrow. Thorax and pygidium unknown. *L. Cam.*, China-Morocco. — FIG. 141,6. **P. pulchella*, Morocco; cran. (holotype), $\times 3$ (411).

Archaeops HUPÉ, 1953 [**A. lui* (= *Redlichia walcotti* LU, 1941; non MANSUY, 1912)]. Differs from *Pararedlichia* in having shorter frontal glabellar lobe. *L. Cam.*, China. — FIG. 141,5. **A. lui*; cran. (holotype), $\times 2$ (426).

Mesodema WHITEHOUSE, 1939 [**M. venulosa*]. Differs from *Pararedlichia* in having narrower glabella, ill-defined axial furrow at level of 1st (3p) and preoccipital glabellar lobes, narrower anterior border, mesially subpointed occipital ring, more divergent anterior sections of facial suture,

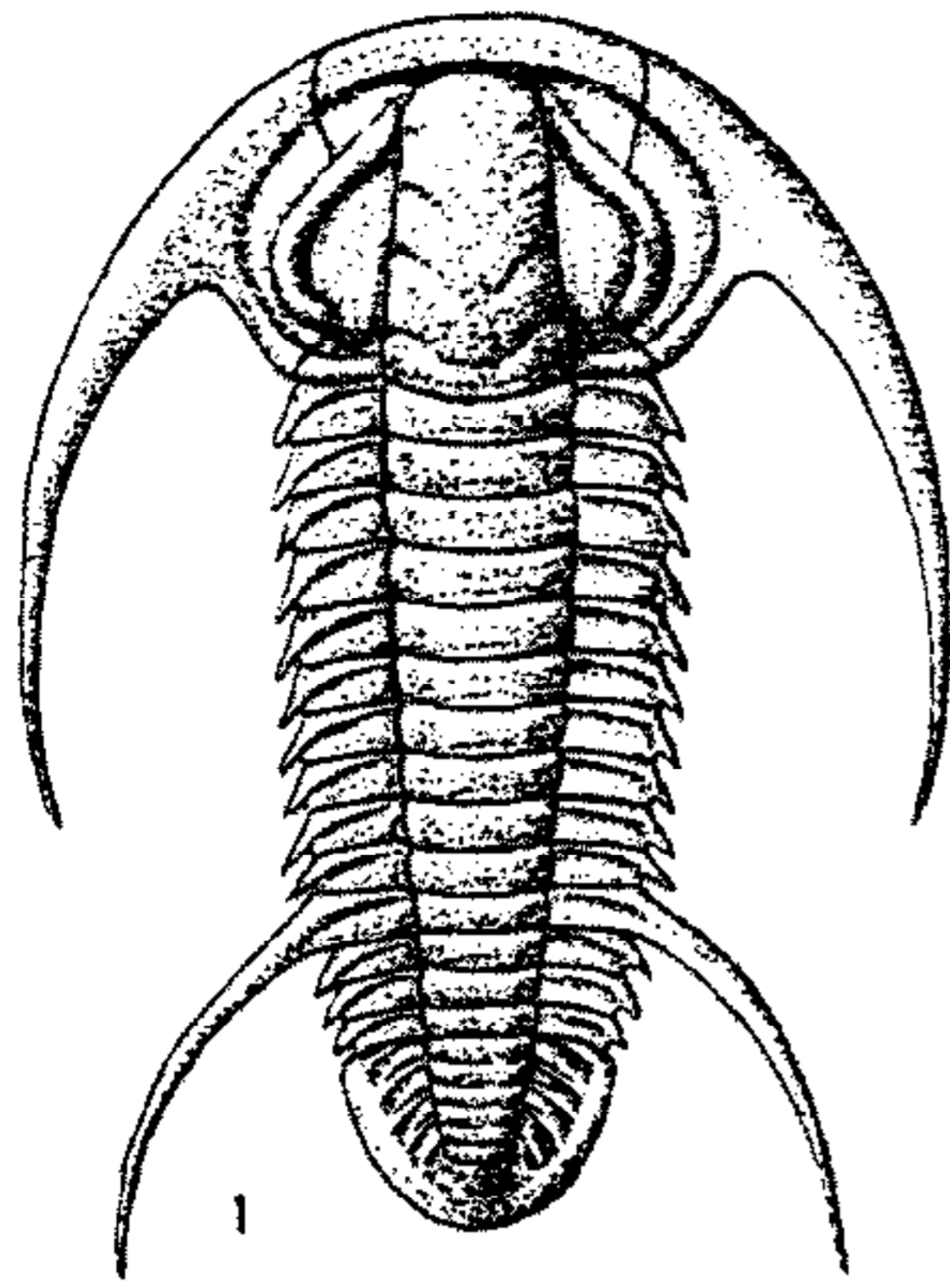

Richterops

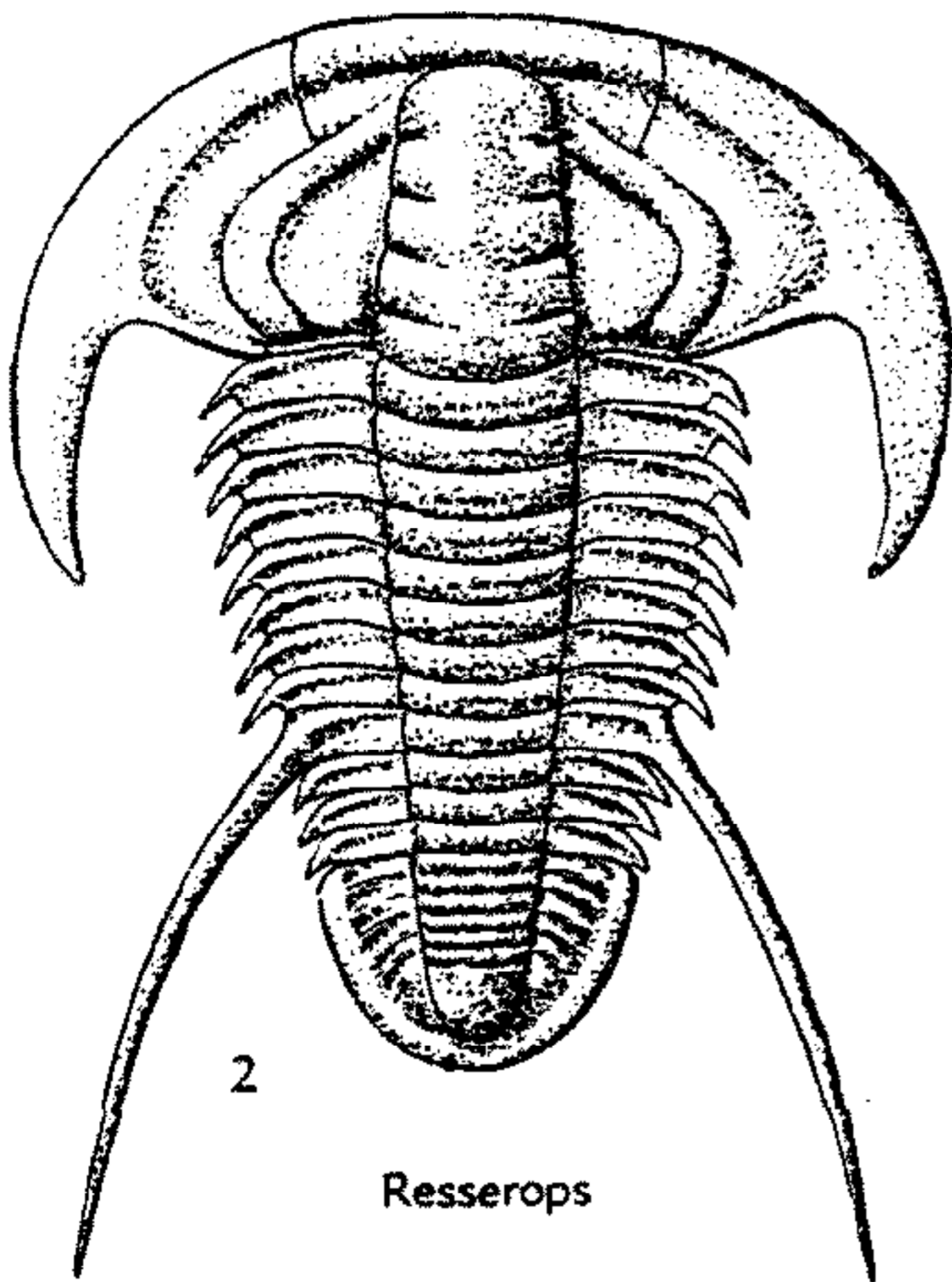

Resserops

FIG. 143. Neoredlichiidae (p. O202).

more arcuate and longer eye lobes extending almost to level of posterior edge of occipital ring, and swollen areas of fixigenae directly behind eye lobes. *L.Cam.*, NE.Austral.—FIG. 141,9. **M. venulosa*; cran. (holotype), $\times 1.35$ (493).

Pareops HUPÉ, 1953 [**P. transitans*]. Differs from *Pararedlichia* in having more arcuate eye lobes, disconnected occipital furrow and straight occipital ring. *L.Cam.*, Morocco.—FIG. 141,7. **P. transitans*; cran. (holotype), $\times 1$ (411).

Redlichops RICHTER & RICHTER, 1941 [**Redlichia*

(*Redlichops*) *blanckenhorni*]. Differs from *Pararedlichia* in having anterior lateral glabellar furrows (*3p*) directed obliquely forward, disconnected occipital furrow, small occipital node, shorter anterior sections of facial suture, longer and more arcuate eye lobes, widening anteriorly and extending back to level of mid-length of occipital ring, much wider fixigenae, and finely granulose surface. *L.Cam.*, Jordan.—FIG. 141,8. **R. blanckenhorni*; cran. (holotype), $\times 2.35$ (461).

Family NEOREDLICHIIDAE HUPÉ, 1953

Dorsal exoskeleton opisthoparian, ovate, slightly convex, isopygous. Cephalon semi-elliptical; glabella conical, with 3 pairs of evenly spaced lateral glabellar furrows, anterior pair (*3p*) slightly oblique forward or backward, remainder oblique backward; preglabellar field narrow or absent; anterior border wide, flat; anterior pits generally present, transversely elongated; anterior sections of facial suture moderately divergent (less than 45°) to border furrow, slightly curved outward across border; eye lobes long, decurrent along frontal glabellar lobe, strongly arcuate posteriorly, reaching level of occipital furrow or farther back, posterior extremities distant from axial furrows, pseudopalpebral furrows usually present; proximal portion of posterior area of fixigenae swollen in front of posterior border furrow; librigenae wide, with advanced genal spine. Thorax of 12 to 14 segments; pleural regions narrower than axis; pleurae ending in spines, 9th or 11th macrospinose, fulcrum proximal. Pygidium parabolic; axis large, conical, with 5 to 10 rings; pleural regions with 5 to 8 pleurae; border smooth, not delimited by border furrow. *L.Cam.*

Neoredlichia SAITO, 1936 [**Redlichia nakamurai* SAITO, 1934]. Frontal glabellar lobe short, anterior lateral glabellar furrows (*3p*) normal to axis, remainder well marked, transglabellar, slightly bent backward; occipital furrow subparallel to preoccipital; occipital ring of uniform width; preglabellar field absent; pseudopalpebral furrow present; eye lobes reaching level of mid-length of occipital ring; genal spine stout, slightly advanced. Thorax and pygidium unknown. *L.Cam.*, China-Morocco.—FIG. 141,4. **N. nakamurai* (SAITO), China; 4a, cran. (holotype), $\times 6$; 4b, librigena (paratype), $\times 2.65$ (465).

Clariondia HUPÉ, 1953 [**C. chazani*]. Differs from *Neoredlichia* in having longer and narrower glabella, lateral glabellar and occipital furrows

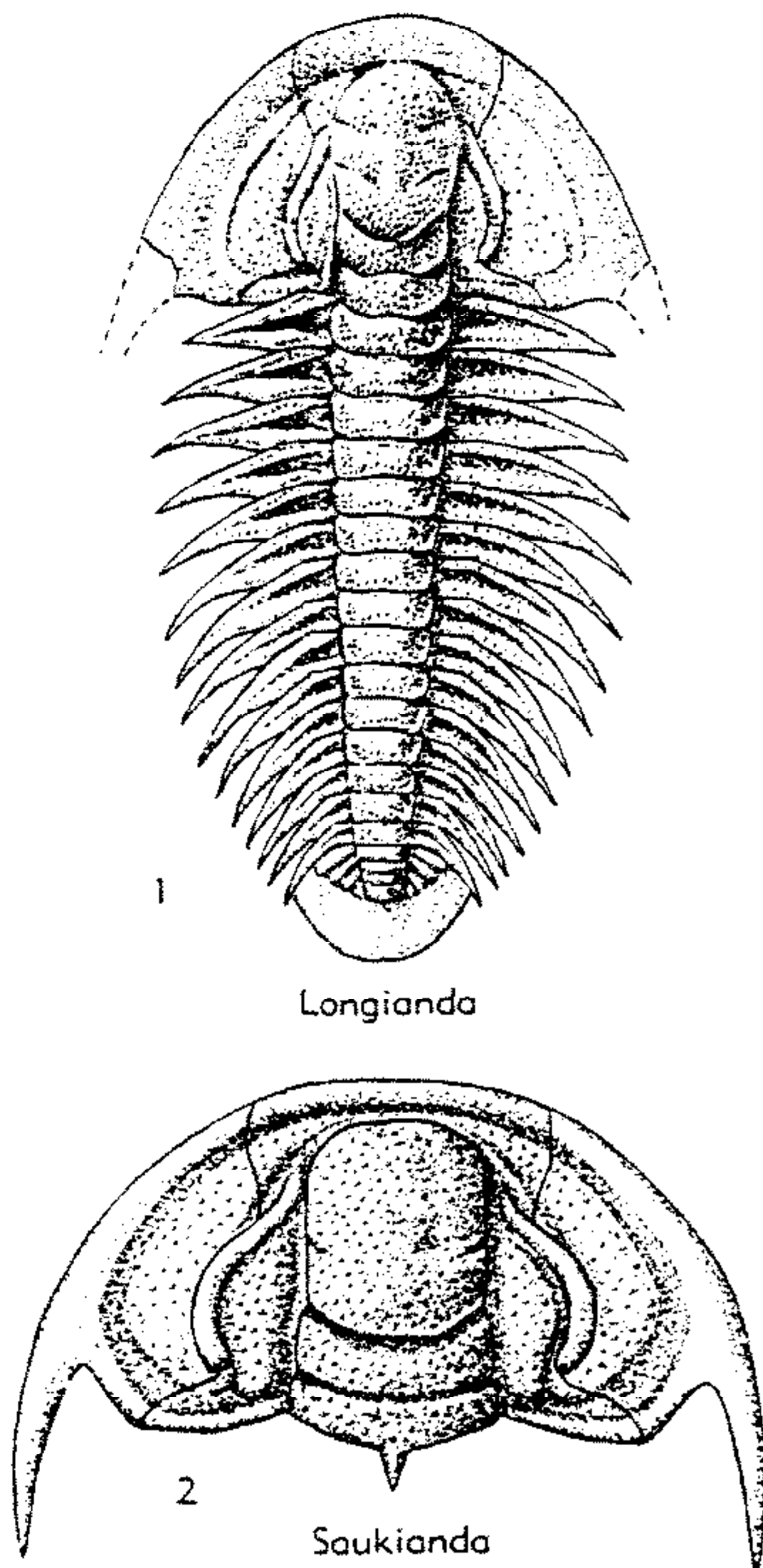

FIG. 144. Saukiandidae (p. O202. O203).

very oblique backward, discontinuous at middle, posterior edge of occipital ring semicircular, moderately wide preglabellar field and shorter eye lobes reaching level of occipital furrow. Thorax unknown. Assigned pygidium with 5 axial rings, short terminal axial piece and 5 pleurae. *L.Cam.*, Morocco.—FIG. 146, 1. **C. chazani*; 1a, cran. (holotype), $\times 2$; 1b, assigned pyg.; $\times 3$ (411).

Resserops RICHTER & RICHTER, 1940 [**R. resserianus*] [(=*Perrector* RICHTER & RICHTER, 1940) (= *R. (Rawops)* HUPÉ, 1953)]. Differs from *Neoredlichia* in having discontinuous lateral glabellar and occipital furrows and well-advanced genal spines. *L.Cam.*, Sp.-Morocco.

R. (Resserops). Lateral glabellar and occipital furrows slightly oblique backward, eye lobe reaching level of mid-length of occipital ring. Thorax of ?12 segments, ?9th macrospinose, pleurae slightly narrower than axis. Pygidium with 6

or 7 rings, large terminal axial piece and 6 to 8 pleurae. *L.Cam.*, Sp.-Morocco.—FIG. 143, 2. **R. (R.) resserianus*, Sp.; exoskel. (reconstr.), $\times 3$ (461).

R. (Richterops) HUPÉ, 1953 [**R. (R.) falloti*] [(=*Marsaisia* HUPÉ, 1953)]. Glabella narrower, frontal glabellar lobe longer, lateral glabellar and occipital furrows very oblique backward, eye lobe shorter, reaching level of occipital furrow; thorax of 14 segments, 11th macrospinose, pleurae much narrower than axis; pygidium with 7 axial rings, short terminal axial piece and 4 pleurae. *L.Cam.*, Morocco.—FIG. 143, 1. **R. (R.) falloti*; holotype exoskel. (reconstr.), $\times 1$ (411).

?**Eops** RICHTER & RICHTER, 1940 [**E. eo*]. Differs from *Saukianda* in having shorter glabella, longer frontal glabellar lobe, chevron-shaped pre-occipital furrow, straight occipital furrow and ring, no occipital node, wider preglabellar field, anterior sections of facial suture diverging at 45° , longer eye lobes reaching level of mid-length of occipital ring. *L.Cam.*, Sp.—FIG. 145, 4. **E. eo*; cran. (holotype), $\times 2$ (461).

Family SAUKIANDIDAE Hupé, 1953

Dorsal exoskeleton opisthoparian, ovate, gently convex, micropygous. Cephalon semi-elliptical; glabella long, cylindrical or constricted posteriorly, with 3 pairs of lateral glabellar furrows, 1st (*3p*) commonly obsolete, when present short, oblique backward, 2nd (*2p*) similar to 1st, preoccipital furrow transglabellar, deep, oblique backward abaxially and normal to axis at middle; occipital furrow deep; preglabellar field very narrow or absent; anterior border wide; facial sutures kainelliform, anterior sections moderately divergent to border furrow, gently curved outward across border; eye lobes arcuate, long, reaching level of occipital furrow; fixigenae swollen posteriorly; librigenae wide, genal spines present. Thorax of 15 segments; axis narrower than pleural regions; pleurae ending in spines, fulcrum proximal. Pygidium small, semi-elliptical, paucisegmented; axis short, tapering backward; pleural regions subtriangular, small; border very wide, flat. Surface of dorsal exoskeleton finely granulose. *L.Cam.*

Saukianda RICHTER & RICHTER, 1940 [**S. andalusiae*] [(=*Pseudosaukianda* HUPÉ, 1953)]. Glabella dikelocephaliform, cylindrical, subtruncate in front, anterior lateral glabellar furrows (*3p*) obsolete, middle furrows (*2p*) very short, occipital furrow slightly curved backwards; occipital ring of uniform width with short mesial spine; preglabellar field very narrow; genal spines advanced. Thoracic

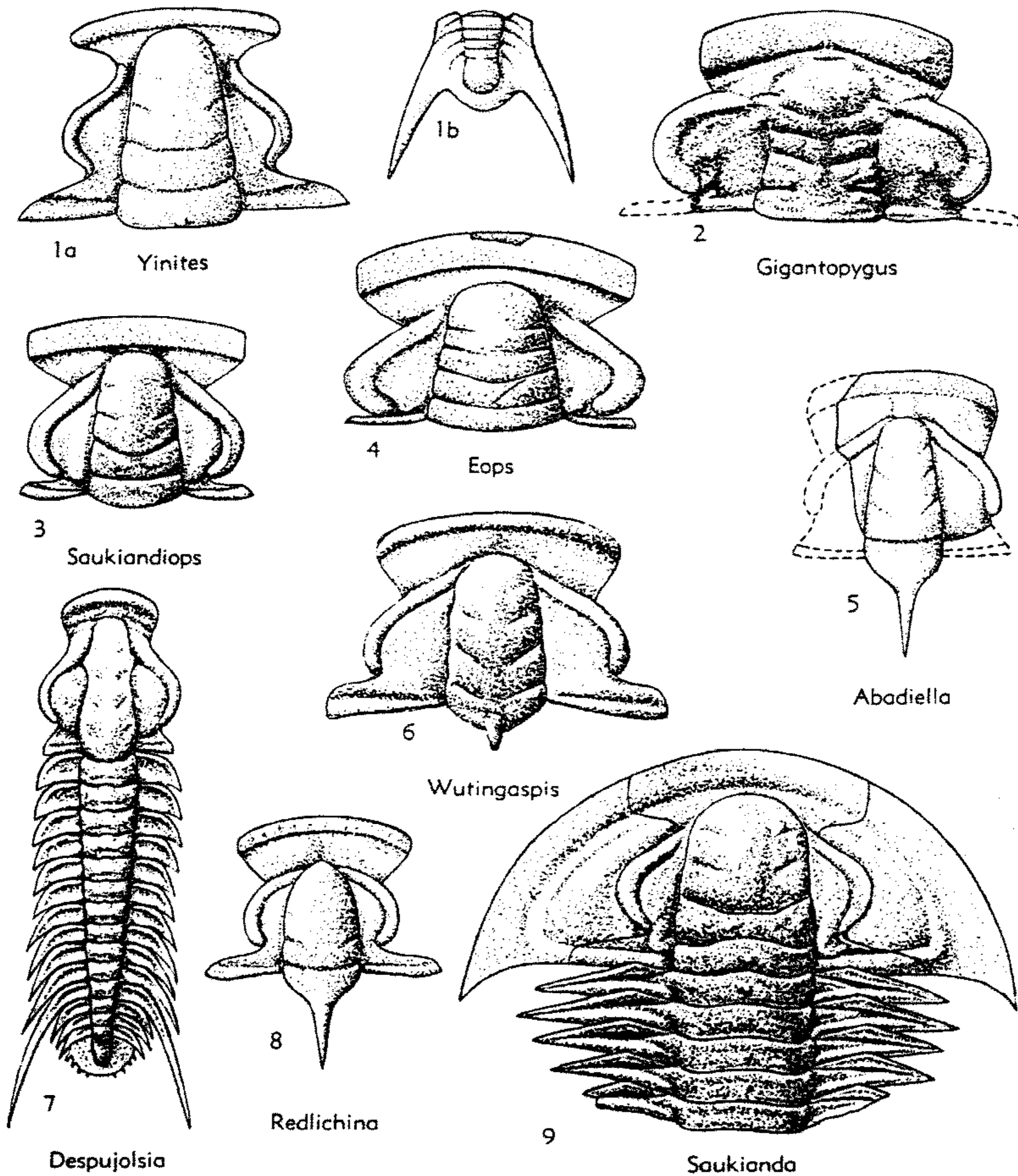

FIG. 145. Redlichiidae, Neoredlichiidae, Saukiandidae, Gigantopygidae, Despujolsiidae, Yinitidae, Abadiellidae (p. O200-O205).

segments 15. Pygidium unknown. *L.Cam.*, Sp.—
FIG. 144,2. **S. andalusiae*; ceph., restored (based
on holotype cran. and paratype librigenae), $\times 1$
(461).—FIG. 145,9. *S. lata* (HUPÉ) (type species
of *Pseudosaukianda*), Morocco; holotype, $\times 1.65$
(411).

Longianda HUPÉ, 1953 [**L. termieri*]. Differs from
Saukianda in having longer and narrower glabella
constricted at level of preoccipital furrows, rounded

in front, 3 pairs of lateral glabellar furrows,
occipital furrow bent forward at middle, no
occipital spine, no preglabellar field, anterior pits
and normal genal spines. Thorax of 15 segments;
backward curvature of pleural spines progressively
increasing posteriorly. Pygidium with 3 axial rings,
short terminal axial piece and 4 ?ribs. *L.Cam.*,
Morocco.—FIG. 144,1. **L. termieri*; restored
dorsal exoskel. (based on holotype and paratype
specimens), $\times 1.2$ (411).

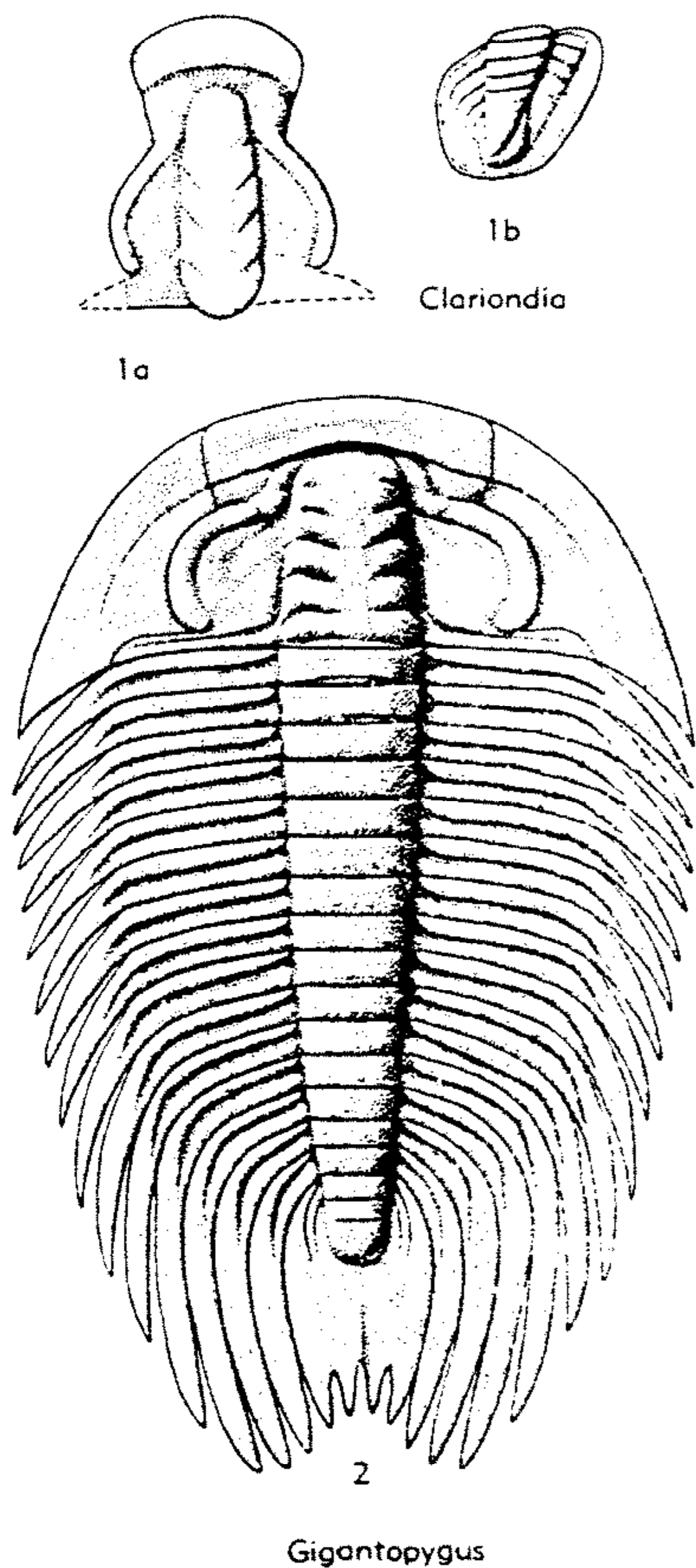

FIG. 146. Neoredlichiidae, Gigantopygidae
(p. 0201, 0204).

**Family GIGANTOPYGIDAE Harrington,
nov.**

Dorsal exoskeleton opisthoparian, ovate, gently convex, isopygous. Cephalon semi-elliptical; glabella conical, subtruncated in front, with 4 pairs of lateral glabellar furrows; occipital ring straight; preglabellar field absent; anterior border wide, flat; anterior pits present, transversely elongated; eye lobes long, decurrent along frontal and

anterior glabellar lobes, strongly arcuate posteriorly, extending to level of occipital furrow; pseudopalpebral furrow present; anterior sections of facial sutures moderately divergent to border furrow, subparallel across border; librigenae wide, genal angle produced into broad spine. Thorax of 14 (or ?15) segments, wide; pleural region twice as wide as axis; pleurae ending in spines, fulcrum distal. Pygidium long, narrow; axis short with 3 rings; border very wide, flat, produced into 2 pairs of marginal spines directed backward. *L. Cam.*

Gigantopygus HUPÉ, 1953 [**G. papillatus*]. Anterior (4*p*) lateral glabellar furrows faint; posterior (2*p*) and preoccipital almost transglabellar; occipital furrow disconnected at the middle; eye lobes decurrent along frontal and anterior glabellar lobes, then semicircular to level of occipital furrow; fixigenae wide, posterior area narrow (*exsag.*) and long (*tr.*). *L. Cam.*, Morocco.—FIG. 145,2. **G. papillatus*; cran. (holotype), $\times 1.1$ (411).—FIG. 146,2. *G. bondoni* HUPÉ; exoskel. (reconstr.), $\times 0.7$ (411).

**Family DESPUJOLSIIDAE Harrington,
nov.**

Dorsal exoskeleton opisthoparian, ovate, very gently convex, micropygous. Cranidium long; glabella long, constricted at middle, with 3 pairs of faint, short, lateral glabellar furrows separated from axial furrows; occipital furrow faint, short; occipital ring wide (*sag.*); preglabellar field as wide as anterior border; eye lobes arcuate, expanded in front, tapering backward, extending from anterolateral corners of glabella to level of occipital furrow; anterior sections of facial sutures moderately divergent. Thorax narrow, long, with 14 segments; pleurae narrower than axis, spinose, 11th segment macrospinose, fulcrum distal. Pygidium small; axis narrow, unsegmented; pleural regions smooth, wide; 4 pairs of tiny marginal spines. *L. Cam.*

Despujolsia NELTNER & POCTEV, 1949 [**D. rochi*]. Glabella contracted at level of 2nd (2*p*) lateral lobe; pseudopalpebral furrow present; posterior area of fixigenae triangular; first 6 pleurae ending in short subequal spines, spines increasing rapidly in size between 7th and 11th pleurae, last 3 pleurae with short spines. *L. Cam.*, Morocco.—FIG. 145,7. **D. rochi*; incompl. exoskel. (holotype), $\times 1.75$ (411).

Family YINITIDAE Hupé, 1953

Opisthoparian. Glabella long, conical, with 3 pairs of evenly spaced lateral glabellar furrows, anterior ($3p$) almost obsolete, middle ($2p$) furrows short, faint, oblique backward, preoccipital furrow transglabellar; occipital ring of uniform width; preglabellar field absent; anterior border narrow, raised; facial sutures kainelliform, anterior sections divergent (45°), palpebral lobe arcuate, long, touching axial furrows at level of anterior lateral glabellar lobe and extending back to level of mid-length of preoccipital lobe. Thorax unknown. Pygidium paucisegmented, axis tapering backward, pleural regions narrow, one pair of long lateral spines. *M.Cam.*

Yinites LU, 1946 [**Y. typicalis*]. Glabella rounded in front, preoccipital and occipital furrows gently curved backward; small mesial occipital node; proximal end of anterior sections of facial suture near axial furrows; posterior area of fixigenae triangular. Pygidium with 4 axial rings, large terminal axial piece, 4 pleurae and pair of long backwardly directed lateral spines. *M.Cam.*, China.—FIG. 145, 1. **Y. typicalis*; 1a, cran. (holotype), $\times 2.7$; 1b, pyg. (paratype), $\times 2.5$ (426).

Family ABADIPELLIDAE Hupé, 1953

Opisthoparian. Glabella conical to subovate, with 3 pairs of evenly spaced, faint lateral glabellar furrows oblique backward, anterior ($3p$) and middle ($2p$) furrows may be obsolete; occipital furrow slightly curved backward; occipital ring produced into stout mesial spine; preglabellar field wide; anterior border raised; anterior sections of facial sutures moderately divergent (less than 45°), proximal extremities distant from axial furrows; eye lobes arcuate, extending from anterolateral corners of glabella to level of anterior 3rd of preoccipital lobe. Thorax and pygidium unknown. *L.Cam.*—*M.Cam.*

Abadiella HUPÉ, 1953 [**A. bourgini*]. Glabella conical, rounded in front, with 3 pairs of lateral furrows; preglabellar field with low mesial ridge, anterior border as wide as preglabellar field, anterior sections of facial suture moderately divergent, posterior extremity of eye lobes distant from axial furrows. *L.Cam.*, Morocco.—FIG. 145, 5. **A. bourgini*; cran. (holotype), $\times 1.75$ (411).

Redlichina LERMONTOVA, 1940 [**R. vologdini*]. Differs from *Abadiella* in having subovate glabella, rounded-subpointed in front, obsolete anterior

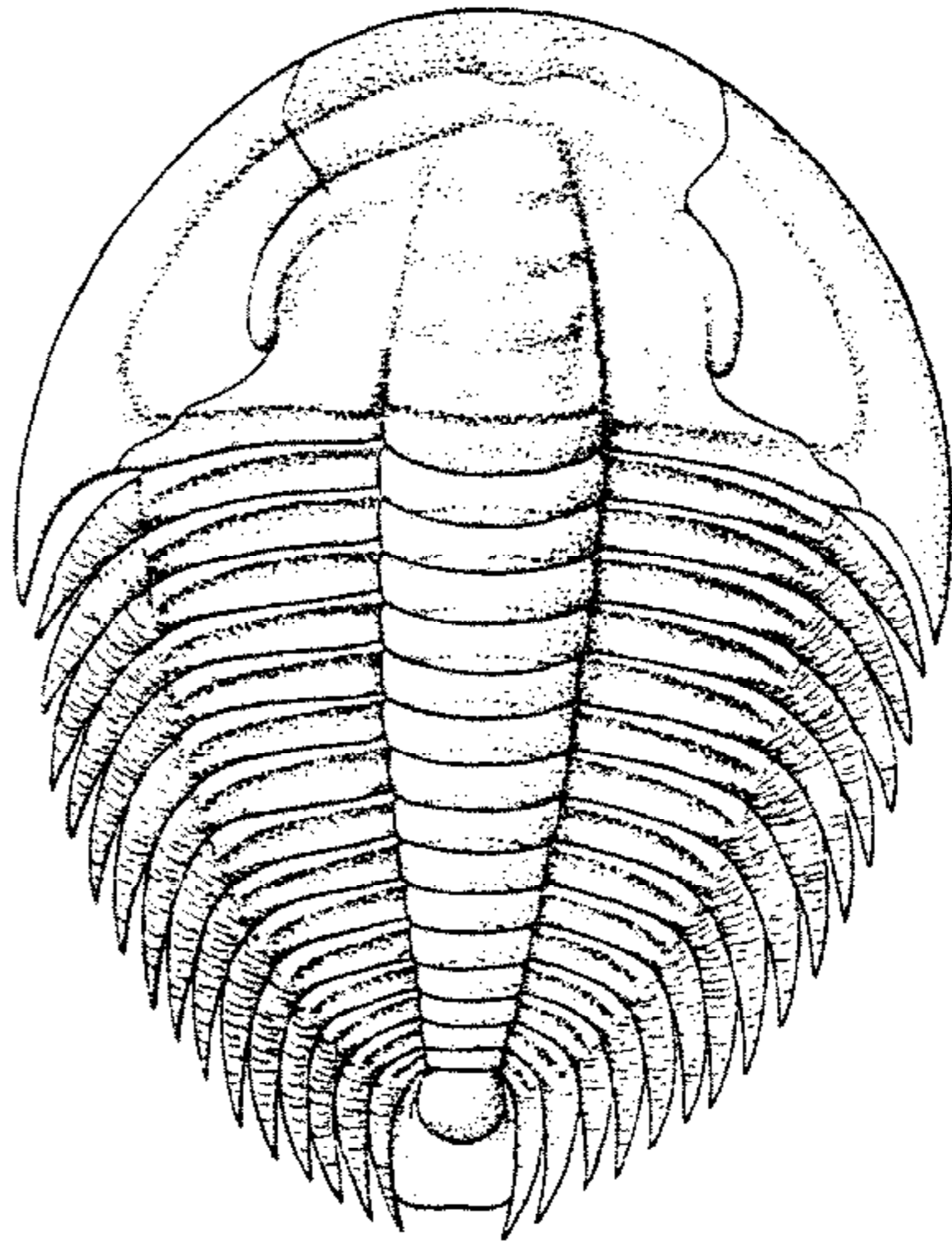

FIG. 147. *Dolerolenus zoppii* (MENECHINI) LEANZA (*Dolerolenidae*), *M.Cam.*, Sardinia, $\times 3$ (380, 488).

($3p$) and middle ($2p$) lateral glabellar furrows, wider preglabellar field with mesial depression, narrower anterior border with faint knobs, more divergent anterior sections of facial suture and posterior extremity of eye lobes nearer to axial furrows. *M.Cam.*, Sib.—FIG. 145, 3. **R. vologdini*; cran., restored (holotype), $\times 1$ (423).

Wutingaspis KOBAYASHI, 1944 [**W. tingi*]. Differs from *Abadiella* in having wider preglabellar field with shallow mesial depression, anterior sections of facial sutures slightly more diverging forward, occipital furrow disconnected at middle, and short mesial occipital spine. *L.Cam.*, China.—FIG. 145, 6. **W. tingi*; cranium (holotype), $\times 2.45$ (419).

Family DOLEROLENIDAE Kobayashi, 1951

[*nom. subst.* KOBAYASHI, 1951 (*pro* Olenopsidae KOBAYASHI, 1935, invalid name based on junior homonym)]

Dorsal exoskeleton opisthoparian, ovate, gently convex, micropygous. Cephalon semielliptical to semicircular. Glabella long, tapering forward, with 3 pairs of very faint, evenly spaced, lateral glabellar furrows normal to axis; occipital furrow straight; preglabellar field wide; anterior border wide, flat; facial sutures ptychopariiform, anterior sections moderately divergent (less than 45°) to border furrow, curved outwards

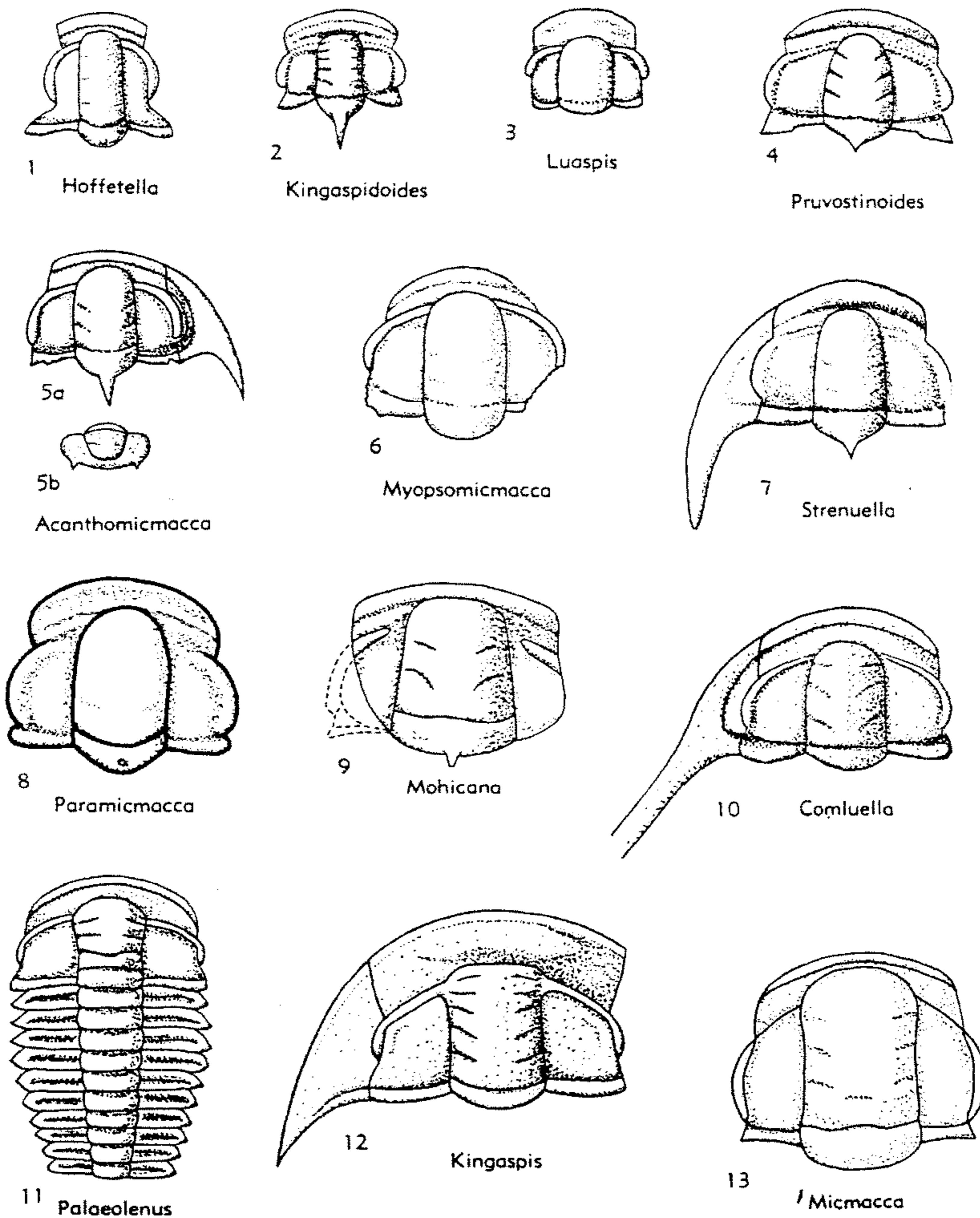

FIG. 148. Ellipsocephalidae (Strenuellinae, Kingaspidinae, Palaeoleninae) (p. 0207-0209).

across border; palpebral lobe arcuate, long, subposterior; eye ridge wide, faint; fixigenae wide, posterior areas large, triangular; libri-genae wide, genal angles produced into stout spines. Thorax with 14 to 15 segments; axis

narrower than pleural regions; pleurae ending in spines progressively curved backward, fulcrum proximal. Pygidium small, axis short with 1 or 2 rings, posterior border wide, flat. *Up.L.Cam.*

Dolerolenus LEANZA, 1949 [pro *Olenopsis* BORNE-MANN, 1891 (non AMEGHINO, 1889)] [**Olenus zoppii* MENECHINI, 1882; SD WALCOTT, 1912]. Glabella rounded in front, posterior extremities of anterior sections of facial suture distant from axial furrows, palpebral lobe extending between level of mid-length of anterior (3p) lateral glabellar lobe and mid-length of preoccipital lobe. *Up.L.Cam.*, Italy (Sardinia).—FIG. 147. **D. zoppii* (MENECHINI) LEANZA; restored dorsal exoskel., $\times 3$ (488, pygidium from 380).

Family UNCERTAIN

Bathyriscellus LERMONTOVA, 1951 [**B. robustus*]. *Up.L.Cam.*, E.Siberia.

Micmaccopsis LERMONTOVA, 1940 [**M. redlichoides*]. *L.Cam.*, Sib.

Superfamily ELLIPSOCEPHALACEA Matthew, 1887

[*nom. transl.* HENNINGSMOEN, herein (ex Ellipsocephalidae MATTHEW, 1887) [=Ellipsocephalidea RICHTER, 1933 (*partim*); Ellipsocephaloidae HUPÉ, 1953; order Protolenida LERMONTOVA, 1951]

Like Redlichiacea, from which this superfamily probably developed, but generally with longer eye ridges, and with greater variety of forms. Many features used in distinguishing genera are easily affected by deformations subsequent to entombment (88). *L.Cam.-M.Cam.*

Family ELLIPSOCEPHALIDAE Matthew, 1887

Cephalic axis tapering forward or with subparallel or slightly concave sides; glabella with as many as 5 pairs of lateral furrows; preglabellar field present or not; thin eye ridges present except in very smooth forms, palpebral lobes not distinctly separated from eye ridges; librigenae with or without genal spine. Thoracic segments generally 12 to 14. Pygidium small. *L.Cam.-M.Cam.*

Subfamily ELLIPSOCEPHALINAE Matthew, 1887
[*nom. transl.* KOBAYASHI, 1935 (ex Ellipsocephalidae MATTHEW, 1887)]

With distinct preglabellar field or with more or less inflated frontal area; glabella with as many as 3 pairs of lateral furrows. *L.Cam.-M.Cam.*

Ellipsocephalus ZENKER, 1833 [**E. ambiguus* (= *Trilobites hoffi* SCHLOTHEIM, 1823) [= *Ellipsocephalus* ZENKER, 1833 (emend. to *Ellipsocephalus*, ICZN pend.)]. Cephalic axis widening slightly at anterior corners; librigenae with long rudimentary genal spine or none. Thoracic segments 12. Pygidium small but relatively wide. *L.Cam.-M.Cam.*, Eu.-Morocco-N.B.-?Austral.—FIG. 150,

3. **E. hoffi* (SCHLOTHEIM), Eu.; exoskel. $\times 2$ (406n).

Alanisia HUPÉ, 1953 [**Camaraspis guillermoi* RICHTER & RICHTER, 1940]. With well-developed preglabellar field, occipital spine, and long palpebral lobes reaching posterior border furrow. *L.Cam.*, Sp.—FIG. 149,2. **A. guillermoi* (RICHTER & RICHTER); cran., $\times 3.3$ (461).

?*Angusteva* HUPÉ, 1953 [**Ptychoparia? annio* COBBOLD, 1910]. Like *Strenuaeva* but with shorter palpebral lobes. *L.Cam.*, Eng.-Sp.-Morocco.—FIG. 149,1. **A. annio* (COBBOLD), Eng.; cran., $\times 6.8$ (387).

Ellipsostrenua KAUTSKY, 1945 [**Strenuella (Ellipso-strenua) gripi*]. Like *Ellipsocephalus* but cephalic axis not expanded at anterior corners. *L.Cam.*, Eu.—FIG. 150,7. **E. gripi*; exoskel., $\times 2$ (88).

Hindermeyeria HUPÉ, 1953 [**Strenuella (Strenuaeva) insecta* RICHTER & RICHTER, 1940]. Like *Alanisia* but preglabellar field inflated. *L.Cam.*, Sp.—FIG. 149,8. **H. insecta*; exoskel., $\times 5$ (461).

Inoyellaspis IVSHIN, 1953 [**I. expectans*]. Resembles *Strenuaeva*. *M.Cam.*, Kazakstan.

Strenuaeva RICHTER & RICHTER, 1940 [**Arionellus primaeva* BRÖGGER, 1879]. Like *Strenuella* but with inflated frontal area. *L.Cam.*, Eu.—FIG. 149,3. **S. primaeva* (BRÖGGER); cran., $\times 2.2$ (417).

?*Protagraulos* MATTHEW, 1895 [**P. priscus*]. Like *Strenuaeva* but with narrower (*tr.*) frontal area and facial sutures slightly converging in front of eyes; palpebral lobes long and thin. *L.Cam.*, N.B.—FIG. 149,7. **P. priscus*; cran., $\times 2.5$ (429).

Subfamily STRENUELLINAE Hupé, 1953

With short (*sag.*) preglabellar field or none, glabella with as many as 3 pairs of lateral furrows. *L.Cam.-M.Cam.*

Strenuella MATTHEW, 1887 [**Agraulos strenuus* BILLINGS, 1874; SD KIAER, 1916]. Cephalic axis tapering slightly forward or almost parallel-sided; palpebral lobes long, reaching posterior border; genal spines present. *L.Cam.*, NE.N.Am.-Eu.-Morocco.

S. (Strenuella). With occipital spine. *L.Cam.*, NE.N.Am.-Eu.-Morocco.—FIG. 148,7. **S. (S.) strenua* (BILLINGS), N.Am.; incompl. ceph., $\times 2$ (77, 471).

S. (Comluella) HUPÉ, 1953 [**Anomocare platycephalum* COBBOLD, 1910]. Without occipital spine. *L.Cam.*, NE.N.Am.-Eu.-Morocco.—FIG. 148,10. **S. (C.) platycephala* (COBBOLD), Eu.; incompl. ceph., $\times 3$ (387).

?*Luaspis* HUPÉ, 1953 [**Pseudoptychoparia reedi* LU, 1941]. Like *Micmacca (Myopsomicmacca)* but apparently with even shorter palpebral lobes. *L.Cam.*, Yunnan.—FIG. 148,3. **L. reedi* (LU); cran., $\times 2$ (426).

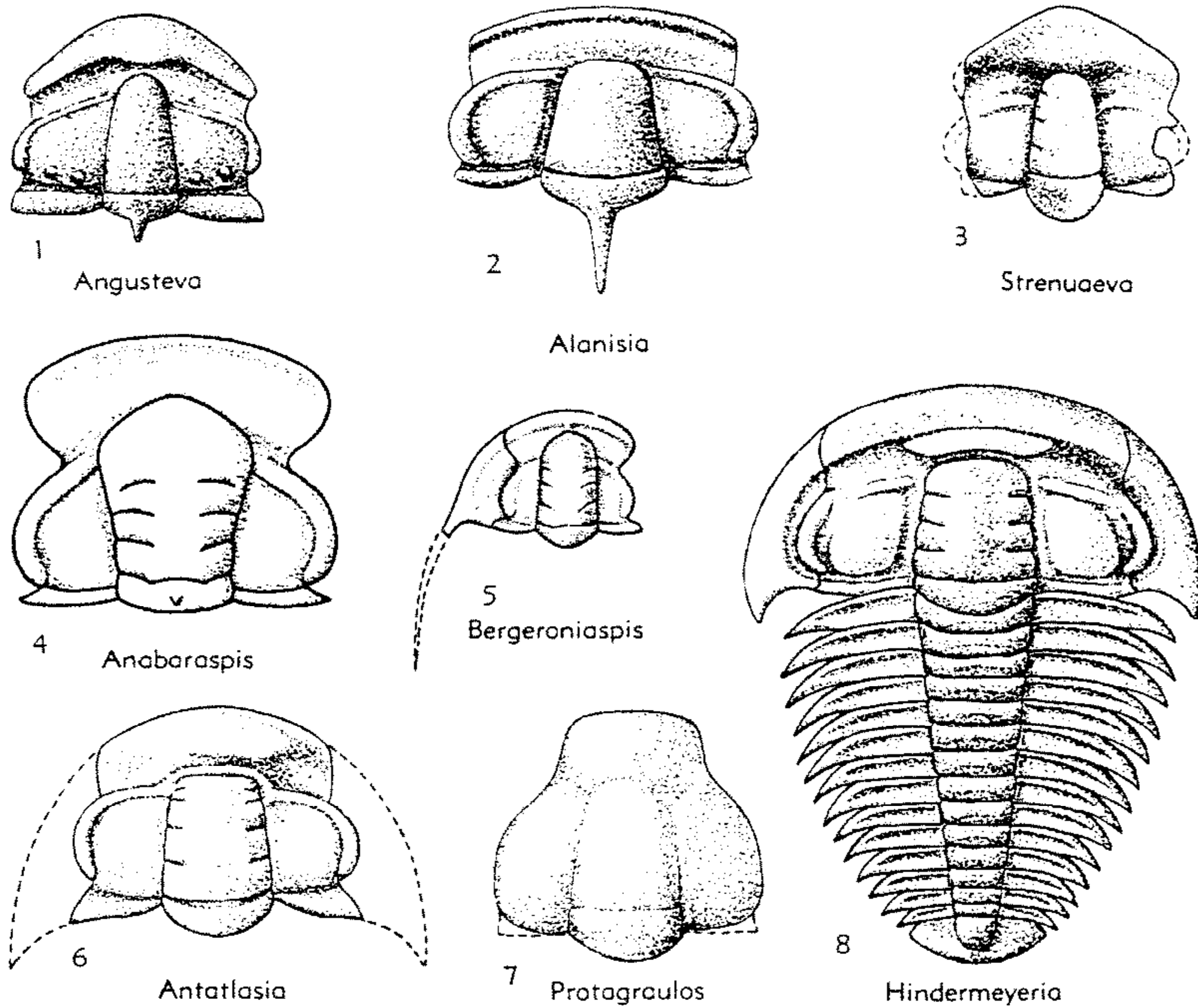

FIG. 149. Ellipsocephalidae (Antatlasinae, Ellipsocephalinae), Protolenidae (Protoleninae) (p. O207-O212).

Micmacca MATTHEW, 1895 [**M. matthewi*, SD MILLER, 1897]. Cephalic axis generally wider than in *Strenuella*. *L.Cam.*, N.B.-Eu.-Morocco-Asia.
M. (Micmacca). Cephalic axis with slightly concave or subparallel sides; librigenae without genal spine. *L.Cam.*, N.B.-Eu.-Morocco-Asia.—FIG. 148,13. **M. (M.) matthewi*, N.B.; cran., $\times 1.5$ (77, 429).
M. (Acanthomicmacca) HUPÉ, 1953 [**M. walcotti* MATTHEW, 1899]. Cephalic axis relatively slender, sides subparallel, with occipital and genal spines. *L.Cam.*, N.B.-?Morocco.—FIG. 148,5. **M. (A.) walcotti*; 5a,b, ceph., pyg., $\times 1$ (77, 429).
M. (Myopsomicmacca) HUPÉ, 1953 [**M. protolenoides* COBBOLD, 1910]. With short palpebral lobes. *L.Cam.*, Eng.-N.B.-Asia.—FIG. 148,6. **M. (M.) protolenoides*, Eng.; cran., $\times 2.7$ (77).
M. (Mohicana) COBBOLD, 1910 [**Micmacca? plana* MATTHEW, 1895; SD VOGDES, 1925] [= *Conomicmacca* HUPÉ, 1953 (obj.)]. Cephalic axis tapering forward or with subparallel sides. *L.Cam.*, N.B.-Eu.—FIG. 148,9. **M. (M.) plana* (MATTHEW), N.B.; cran., $\times 1.4$ (77).

M. (Paramicmacca) LERMONTOVA, 1951 [**P. siberica*]. Cephalic axis with subparallel sides, large frontal area; close to *Strenuella*. *L.Cam.*, Sib.—FIG. 148,8. **M. (P.) siberica* (LERMONTOVA); cran., $\times 1.5$ (423).
?Pruvostinoides HUPÉ, 1953 [**P. angustilineatus*]. Like *Strenuella* but with shorter and more strongly tapering cephalic axis. *L.Cam.-M.Cam.*, Morocco.—FIG. 148,4. **P. angustilineatus*; cran., $\times 1.5$ (77).

Subfamily KINGASPIDINAE Hupé, 1953

Like *Strenuellinae* but cephalic axis with slightly concave sides and as many as 5 pairs of lateral glabellar furrows. *L.Cam.*

Kingaspis KOBAYASHI, 1935 [**Anomocare campbelli* KING, 1923]. Characters of subfamily. *L.Cam.*, Morocco-M.East.

K. (Kingaspis). Without occipital spine. *L.Cam.*, Morocco-M.East.—FIG. 148,12. **K. (K.) campbelli* (KING); incompl. ceph., $\times 2.2$ (77, 461).

K. (Kingaspidoides) HUPÉ, 1953 [**K. (K.) armatus*]. With occipital spine. *L.Cam.*, Morocco.—

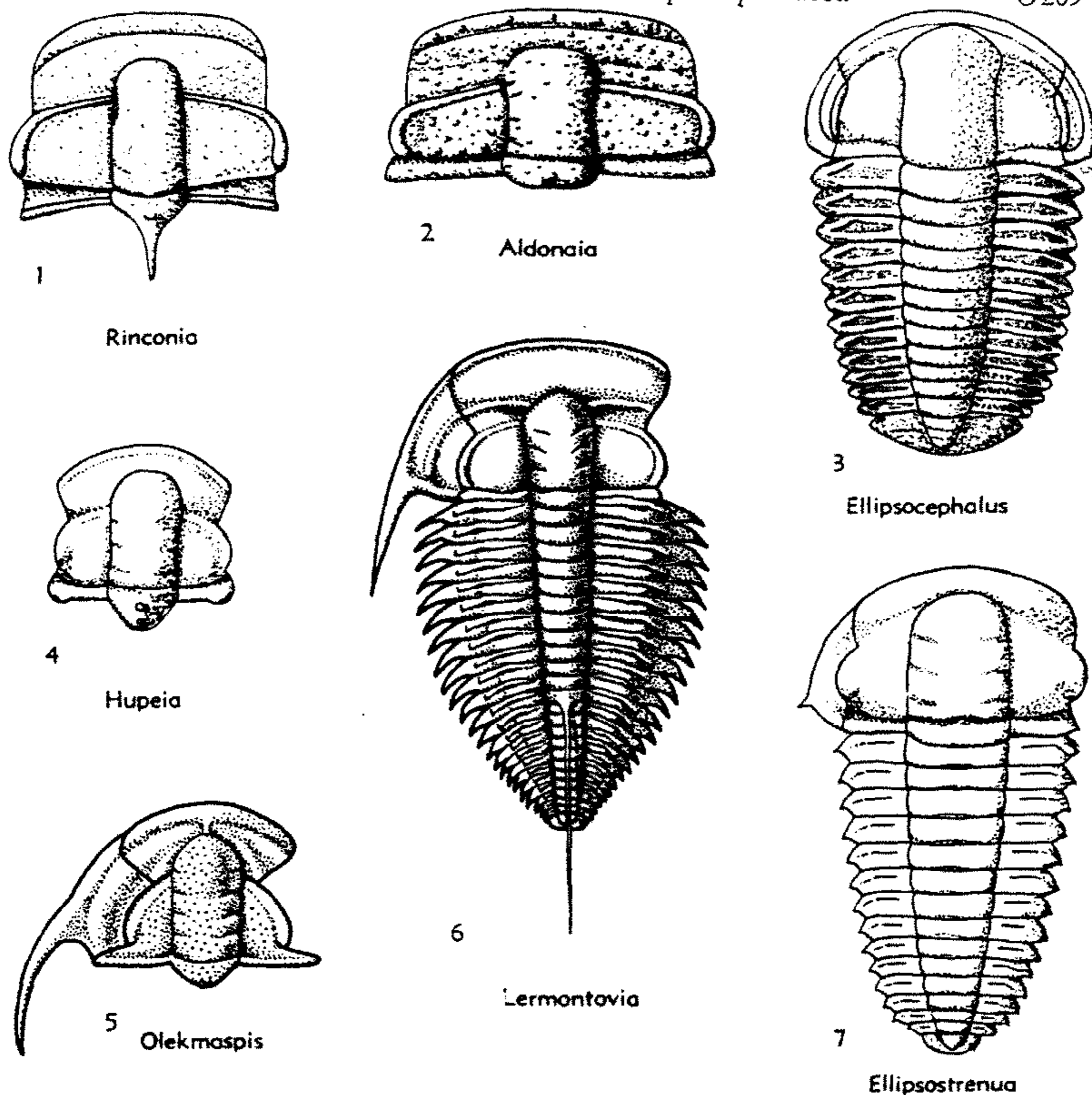

FIG. 150. Ellipsocephalidae (Ellipsocephalinae), Protolenidae (Protoleninae, Aldonaiinae), Family uncertain (p. O207-O212).

FIG. 148.2. **K. (K.) armatus*; cran., $\times 1.4$ (77). *Mesetaia* HUPÉ, 1953 [**Hartshillia marocana* GIGOUR, 1951]. Like *Kingaspis* but cephalic axial furrow effaced. *L. Cam.*, Morocco.

Subfamily PALAEOLENINAE Hupé, 1953

Cephalic axis expanding forward or with subparallel sides, glabella bearing 3-4 pairs of lateral lobes, posterior pair being connected across glabella in some genera; palpebral lobes small. *L. Cam.*

Palaeolenus MANSUY, 1912 [**P. douvillei*; SD VOGDES, 1925]. Characters of subfamily. *L. Cam.*, China.—FIG. 148, 11. **P. douvillei*; incompl. exoskel., $\times 4$ (428).

?*Hoffetella* HUPÉ, 1953 [**Micmacca elongata* LU, 1941]. Like *Palaeolenus* but without preglabellar

field and with palpebral lobes closer to glabella. *L. Cam.*, China.—FIG. 148, 1. **H. elongata* (LU), cran., $\times 2$ (426).

?*Manchurocephalus* ENDO, 1944 [**Palaeolenus deprati* MANSUY, 1912]. *Low. U. Cam.*, S. Manch.

Subfamily ANTATLASIINAE Hupé, 1953

[*nom. transl.* HENNINGSMOEN, herein (ex *Antatlasidae* HUPÉ, 1953)]

Cephalic axis slightly tapering forward, with + pairs of lateral glabellar furrows; parafrenal band present; palpebral lobes long, reaching posterior border furrow. *L. Cam.*

Antatlasia HUPÉ, 1953 [**A. hollardi*]. Characters of subfamily. *L. Cam.*, Morocco.—FIG. 149, 6. **A. hollardi*; cran., $\times 2.75$ (77).

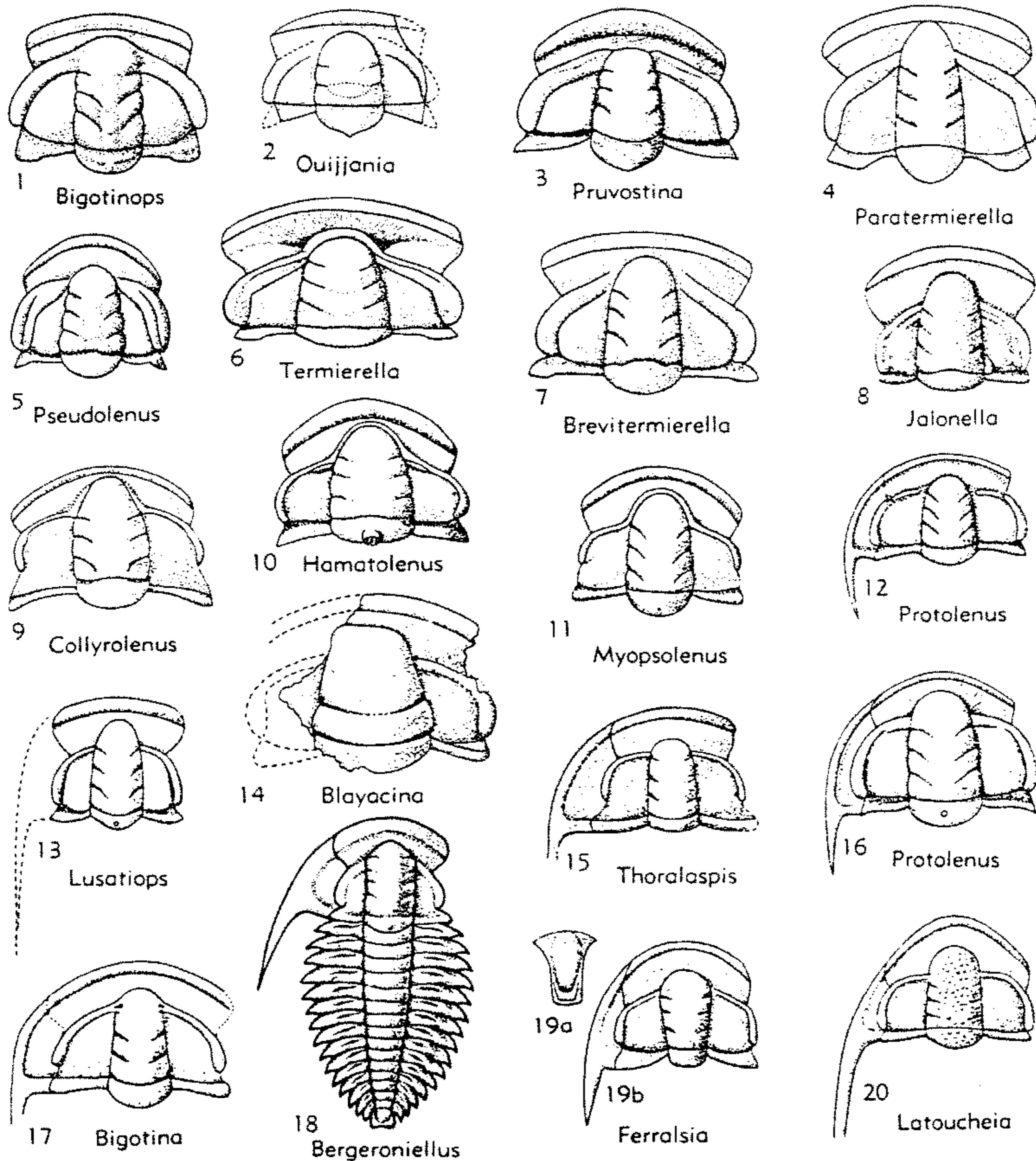

FIG. 151. Protolenidae (Termierellinae, Myopsoleninae, Protoleninae, Bigotininae) (p. 0211, 0212).

Family PROTOLENIDAE Richter & Richter, 1948

Cephalic axis tapering forward, or with subparallel sides, or widening slightly forward, rather narrow and with up to 4 pairs of lateral glabellar furrows. Preglabellar field present or not. Palpebral lobes more or less confluent with eye ridges. Librigenae with genal spine. Up to 25 thoracic segments. Pygidium very small. *L.Cam.*

Subfamily TERMIERELLINAE Hupé, 1953

With thick palpebro-ocular ridges, in part commonly bisegmented longitudinally. *L. Cam.*

Termierella HUPÉ, 1953 [**T. latifrons*]. Facial sutures diverging markedly in front of eyes; preglabellar field present; with 3 pairs of lateral glabellar furrows. *L.Cam.*, Morocco-Sp.

T. (*Termierella*). Palpebral lobes markedly broader than eye ridges, which are longitudinally biseg-

mented; with parafrontal band. *L.Cam.*, Morocco.—FIG. 151,6. **T. (T.) latifrons*; cran., $\times 1$ (77).

T. (Brevitermierella) HUPÉ, 1953 [**T. (B.) brevifrons*]. Like *T. (Termierella)* but palpebro-ocular ridges increasing evenly in width distally. *L.Cam.*, Morocco.—FIG. 151,7. **T. (B.) brevifrons*; cran., $\times 1$ (77).

T. (Jalonella) HUPÉ, 1953 [**T. (J.) celiberica* HUPÉ, 1953 (= **Lusatiops ribotanus* RICHTER & RICHTER, 1948)]. Like *T. (Brevitermierella)* but with narrower (*tr.*) fixigenae. *L.Cam.*, Sp.—FIG. 151,8. **T. (J.) ribotana* (RICHTER & RICHTER); cran., $\times 1$ (252).

Bigotinops HUPÉ, 1953 [**B. dangeardi*]. Like *Termierella* but anterior sections of facial sutures less divergent and lateral glabellar furrows faintly connected across glabella. *L.Cam.*, Morocco.—FIG. 151,1. **B. dangeardi*; cran., $\times 3.35$ (77).

Ouijjanina HUPÉ, 1953 [**O. meridionalis*]. Like *Termierella* but anterior sections of facial sutures less divergent and only 2 pairs of lateral glabellar furrows, preoccipital pair bifurcating, both branches faintly connected across glabella. *L.Cam.*, Morocco.—FIG. 151,2. **O. meridionalis*; cran., $\times 1.5$ (77).

Paratermierella HUPÉ, 1953 [**P. elegans*]. Like *Termierella* but without preglabellar field. *L.Cam.*, Morocco.—FIG. 151,4. **P. elegans*; cran., $\times 1.5$ (77).

Pruvostina HUPÉ, 1953 [**P. nicklesi*]. Like *Termierella* but anterior sections of facial sutures less divergent; proximal part of palpebro-ocular ridge longitudinally bisegmented. *L.Cam.*, Morocco.—FIG. 151,3. **P. nicklesi*; cran., $\times 1.3$ (77).

Pseudolenus HUPÉ, 1953 [**P. ourikaensis*]. Like *Termierella* but anterior sections of facial sutures less divergent, and palpebro-ocular ridge longitudinally bisegmented even in distal end. *L.Cam.*, Morocco.—FIG. 151,5. **P. ourikaensis*; cran., $\times 2$ (77).

Subfamily MYOPSOLENINAE HUPÉ, 1953

[Emend. HENNINGSMOEN, herein]

With more or less distinct parafrontal band. *L.Cam.*

Myopsolenus HUPÉ, 1953 [**M. magnus*]. Long palpebral lobes reaching posterior border furrow, parafrontal band distinct; with short auxiliary eye ridge close to each eye ridge and close to glabella. *L.Cam.*, Morocco.—FIG. 151,11. **M. magnus*; cran., $\times 0.6$ (77).

Collyrolenus HUPÉ, 1953 [**C. staminops*]. Frontal lobe long and tapering markedly forward, rest of cephalic axis with slightly convex sides; palpebral lobes short, not reaching posterior border furrow; parafrontal band indistinct and disconnected. *L.Cam.*, Morocco.—FIG. 151,9. **C. staminops*; cran., $\times 0.6$ (77).

Hamatolenus HUPÉ, 1953 [**H. continuus*]. Short palpebral lobes not reaching posterior border furrow; parafrontal band well developed. *L.Cam.*, Morocco.—FIG. 151,10. **H. continuus*; cran., $\times 0.9$ (77).

Subfamily PROTOLENINAE Richter & Richter, 1948

[*nom. transl.* HUPÉ, 1953 (ex *Protolenidae* RICHTER & RICHTER, 1948) [incl. *Lermontoviinae* SUVOROVA, 1956]]

With thin palpebro-ocular ridges and no parafrontal band. *L.Cam.*

Protolenus MATTHEW, 1892 [**P. elegans*; SD VOGDES, 1893] [= *Bergeronia* MATTHEW, 1895 (obj.); *Matthewlenus* HUPÉ, 1953 (**Protolenus articephalus* MATTHEW, 1895)]. Cephalic axis tapering slightly forward, with 3 pairs of lateral glabellar furrows; palpebral lobes long, reaching posterior border furrow; anterior border narrow; librigenae with stout genal spine. Thorax with many segments and bearing pleural spines. Pygidium very small. *L.Cam.*, N.B.-Eu.-Morocco.

P. (Protolenus). Test smooth. *L.Cam.*, N.B.-Eu.-Morocco.—FIG. 151,12. **P. (P.) elegans*, N.B.; incompl. ceph., $\times 1$ (77).—FIG. 151,16. *P. paradoxoides* (MATTHEW), Eu.; incompl. ceph., $\times 0.8$ (77, 387).

P. (Latoucheia) HUPÉ, 1953 [**P. latouchei* COBBOLD, 1910]. Surface tuberculate. *L.Cam.*, Eu.-Morocco.—FIG. 151,20. **P. (L.) latouchei* (COBBOLD), Morocco; incompl. ceph., $\times 0.9$ (77, 387).

Anabaraspis LERMONTOVA, 1951 [**A. splendens*]. Palpebro-ocular ridges rather thick. Expanded frontal area. Cephalic axis expanding forward, widest at anterior corners. *L.Cam.*, Sib.—FIG. 149,4. **A. splendens*; cran., $\times 1.25$ (423).

Bergeroniellus LERMONTOVA, 1940 [**B. asiaticus*]. Like *Protolenus*, but generally with more diverging facial sutures and wider anterior border; thoracic segments 15 to 17. Close to *Lusatiops*. *L.Cam.*, Sib.

B. (Bergeroniellus). Broad-based genal spine. *L.Cam.*, Sib.—FIG. 151,18. **B. asiaticus*; incompl. exoskel., $\times 1.5$ (290).

B. (Bergeroniaspis) LERMONTOVA, 1951 [**B. kutorginorum*]. Genal spine with narrow base. *L.Cam.*, Sib.—FIG. 149,5. **B. kutorginorum*; incompl. ceph., $\times 1.3$ (290).

B. (Olekmaspis) SUVOROVA, 1956 [**O. bobrovi*]. Like *B. (Bergeroniaspis)*, but with more diverging facial sutures. *L.Cam.*, Sib.—FIG. 150,5. **O. bobrovi*; incompl. ceph., $\times 1.5$ (290).

Blayacina COBBOLD, 1931 [**B. miqueli*]. Glabella wide, tapering markedly forward, with transglabellar preoccipital furrow. *L.Cam.*, Fr.—FIG. 151,14. **B. miqueli*; cran., $\times 1$ (387).

?*Ferralsia* COBBOLD, 1935 [**F. blayaci*]. Like *Protolenus* but with cephalic axis widening forward.

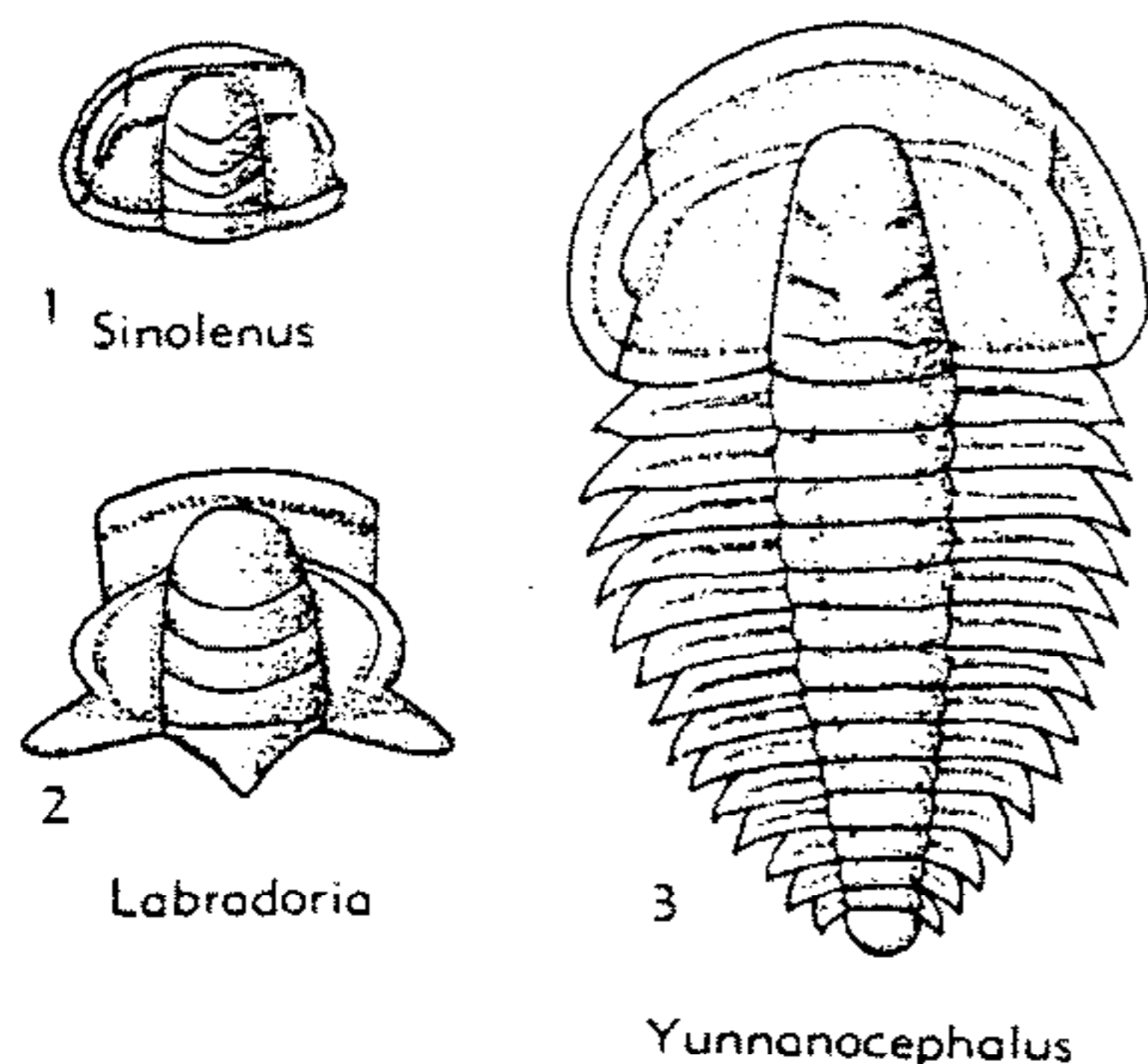

FIG. 152. Yunnanocephalidae, Ellipsocephalacea (Family uncertain) (p. 0212).

L.Cam., Fr.—FIG. 151,19. **F. blayaci*; 19a,b, hypostoma, incompl. ceph., $\times 1$ (387).

Lermontovia SUVOROVA, 1956 [**L. dzevanowskii*]. Like *Anabaraspis*, but with thin palpebro-ocular ridges. 20-25 thoracic segments. *L.Cam.*, Sib.—FIG. 150,6. **L. dzevanowskii*; incompl. exoskel., $\times 1$ (290).

Lusatiops RICHTER & RICHTER, 1941 [**Protolenus lusaticus* SCHWARZBACH, 1934] [= *Coreolenus* HUPÉ, 1953 (**Protolenus coreanicus* SAITO, 1933)]. Like *Protolenus* but anterior sections of facial sutures more divergent. *L.Cam.*, Eu.-Korea.—FIG. 151,13. **L. lusaticus* (SCHWARZBACH), Eu.; cran., outline of librigena, $\times 0.7$ (461).

Thoralaspis HUPÉ, 1953 [**Olenopsis thorali* COBBOLD, 1935]. Like *Protolenus*, but apparently with shorter palpebral lobes not reaching posterior border furrow. *L.Cam.*, Fr.—FIG. 151,15. **T. thorali*; incompl. ceph., $\times 1$ (387).

Subfamily BIGOTININAE Hupé, 1953

Proximal end of thin eye ridges longitudinally bisegmented. *L.Cam.*

Bigotina COBBOLD, 1935 [**B. bivallata*]. Characters of subfamily. *L.Cam.*, Fr.—FIG. 151,17. **B. bivallata*; incompl. ceph., $\times 2$ (387).

?Subfamily ALDONAIINAE Hupé, 1953

Cephalic axis with slightly concave sides; preglabellar field present, fixigenae markedly wider than cephalic axis. Surface tuberculate. *L.Cam.*

Aldonaia LERMONTOVA, 1940 [**A. ornata*]. Characters of subfamily. *L.Cam.*, Sib.—FIG. 150,2. **A. ornata*; cran., $\times 3.5$ (423).

Subfamily UNCERTAIN

Hupeia KOBAYASHI, 1944 [**H. pulchra*]. Cephalic axis with slightly concave sides; fixigenae about as wide as cephalic axis, preglabellar field present, palpebral lobes reaching posterior border furrow. Surface smooth. *L.Cam.*, China.—FIG. 150,4. **H. pulchra*; cran., $\times 2.5$ (419).

Rinconia HUPÉ, 1953 [**Protolenus schneideri* RICHTER & RICHTER, 1941]. Cephalic axis narrow, with subparallel sides and bearing occipital spine, facial sutures subparallel in front of eyes. *L.Cam.*, Sp.—FIG. 150,1. **R. schneideri*; cran., $\times 1.5$ (461).

?Family YUNNANOCEPHALIDAE Hupé, 1953

Cephalic axis tapering markedly forward, with 2 pairs of lateral glabellar furrows; preglabellar field distinct; palpebral lobes small, not reaching posterior border furrow, confluent with eye ridges; librigenae without genal spine. Thoracic segments 14. Pygidium minute. *L.Cam.*

Yunnanocephalus KOBAYASHI, 1936 [**Psychoparia yunnanensis* MANSUY, 1912] [= *Pseudopsychoparia* TING, 1940 (obj.)]. Characters of family. *L.Cam.*, China.—FIG. 152,3. **Y. yunnanensis*; exoskel., $\times 1.65$ (411, 428).

Family UNCERTAIN

Labradoria RESSER, 1936 [**Conocephalites miser* BILLINGS, 1861]. Preglabellar field lacking; with 3 pairs of transglabellar furrows; palpebral lobes reaching posterior border furrow. *L.Cam.*, Labrador.—FIG. 152,2. **L. miser*; cran., $\times 2.25$ (488).

Sinolenus KOBAYASHI, 1944 [**S. trapezoidalis*]. Like *Labradoria* but palpebral lobes short. *L.Cam.*, China.—FIG. 152,1. **S. trapezoidalis*; incompl. ceph., $\times 2.7$ (419).

Superfamily PARADOXIDACEA Hawle & Corda, 1847

[*nom. transl.* POULSEN, herein (ex Paradoxides HAWLE & CORDA, 1847)] [=order Paradoxida Lermontova, 1951 (*partim*)]

Dorsal exoskeleton elongate, elliptical to pyriform in outline, medium to large in size. Cephalon semicircular, with rather prominent glabella that expands forward and generally reaches anterior border; facial sutures opisthoparian; eyes medium to large; librigenae with genal spines. Thorax with numerous segments (13 to 22); axis prominent, tapering backward; pleurae nearly flat, with well-defined furrows, terminating in spines. Pygidium usually small. *Up.L.Cam.-M.Cam.*

Family PARADOXIDIDAE Hawle &
Corda, 1847

[*nom. correct.* RICHTER, 1932 (*pro* Paradoxides HAWLE & CORDA, 1847, ICZN opinion 496)]

Dorsal exoskeleton opisthoparian, ovate to elongate, usually large, micropygous to heteropygous, almost flat. Cephalon semi-circular; glabella broadly clavate, with 2 to 4 pairs of lateral glabellar furrows; cephalic border well developed; palpebral lobes generally prominent, anterior sections of facial suture commonly diverging from eyes to front margin; eyes usually large to medium in size; librigenae medium in width, with genal spines. Thorax (as far as known) with 13 to 22 segments, axis evenly tapering, moderately convex, pleurae deeply furrowed, bearing spines. Pygidium with few segments. Hypostoma relatively large, subquadrate, with anterior corners somewhat extended at each side and in some fused with rostral plate. *Up.L.Cam.-M.Cam.*

Subfamily PARADOXIDINAE Hawle & Corda,
1847

[*nom. transl.* HOWELL, 1933, as Paradoxinae (*ex* Paradoxides HAWLE & CORDA, 1847), *nom correct.* POULSEN, herein]

Micropygous. Glabella extended to anterior border furrow; front end of palpebral lobes placed opposite or behind widest portion of glabella and separated from it, fixigenae narrow. Thorax with 16 to 21 segments. Pygidium usually elongate, with very narrow pleural fields and entire margin or with 1 to 3 pairs of small spines on posterior margin. Hypostoma with a small spine at posterior corners, and in some fused with reduced rostral plate. *M.Cam.*

Paradoxides BRONGNIART, 1822 [*Entomostracites paradoxissimus WAHLENBERG, 1821; SD BARRANDE, 1852] [=Hydrocephalus BARRANDE, 1846; Phanoptes, Phylsucium HAWLE & CORDA, 1847; Plutonia HICKS, 1869; Plutonides HICKS, 1895] (3, 144, 114, 1, 143, 146, 322, 71). *M.Cam.*, Eu.-E.N.Am. (Atl.prov.)-N.Afr.-N.Zem.-?NE.Austral. — FIG. 153,2. *P. paradoxissimus (WAHLENBERG), Swed.; exoskel., $\times 0.75$ (1). — FIG. 153,1. P. minor (BOECK), Boh.; rostral plate with hypostoma, $\times 3$ (3).

Eccaparadoxides SNAJDR, 1957 [*Paradoxides pusillus BARRANDE, 1846] (260). *M.Cam.*, Bohemia.

Acadoparadoxides SNAJDR, 1957 [*Paradoxides sacheri BARRANDE, 1852] (260). *M.Cam.*, Bohemia.

Luhops SNAJDR, 1957 [*Paradoxides expectans BARRANDE, 1852] (260). *M.Cam.*, Bohemia.

?Vinicella SNAJDR, 1957 [*Paradoxides desideratus BARRANDE, 1846] (260). *M.Cam.*, Bohemia.

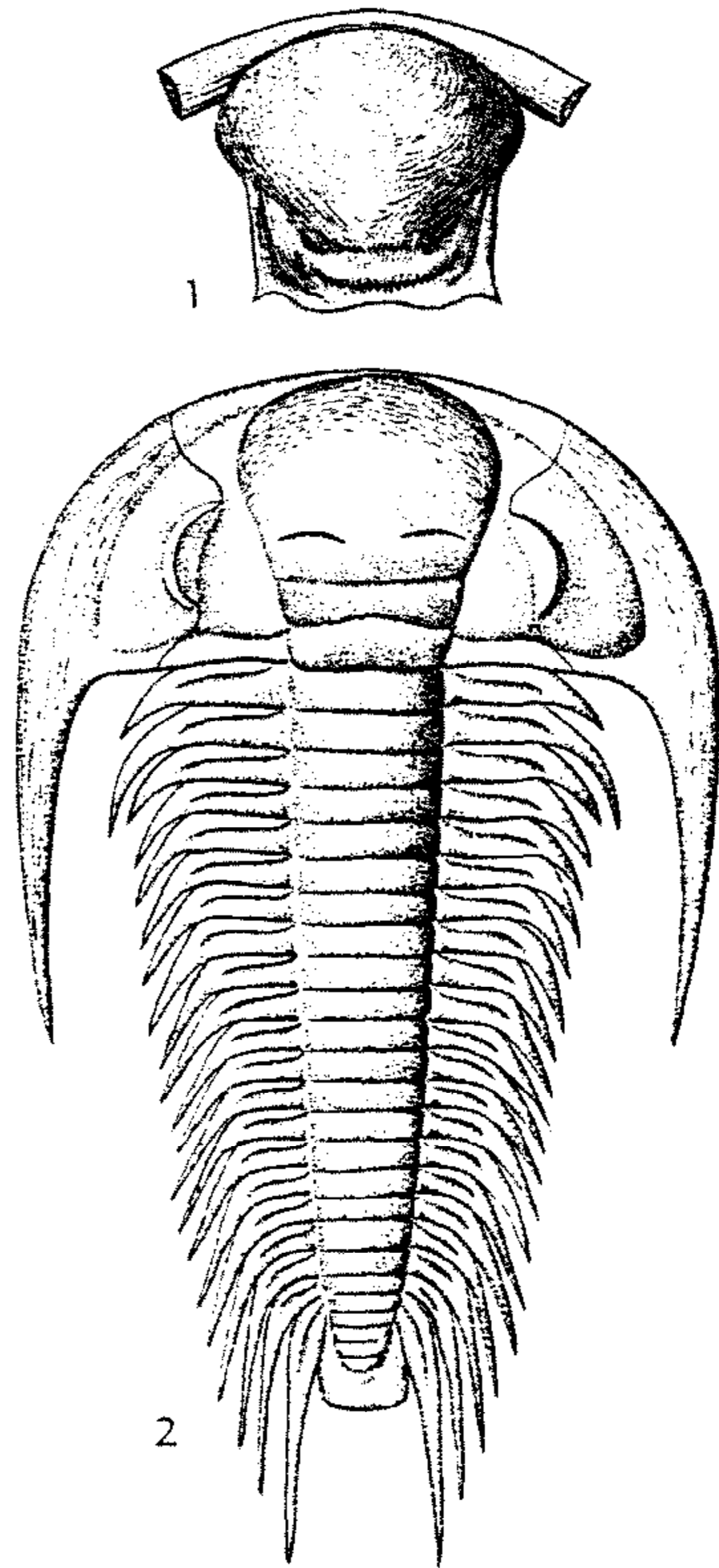
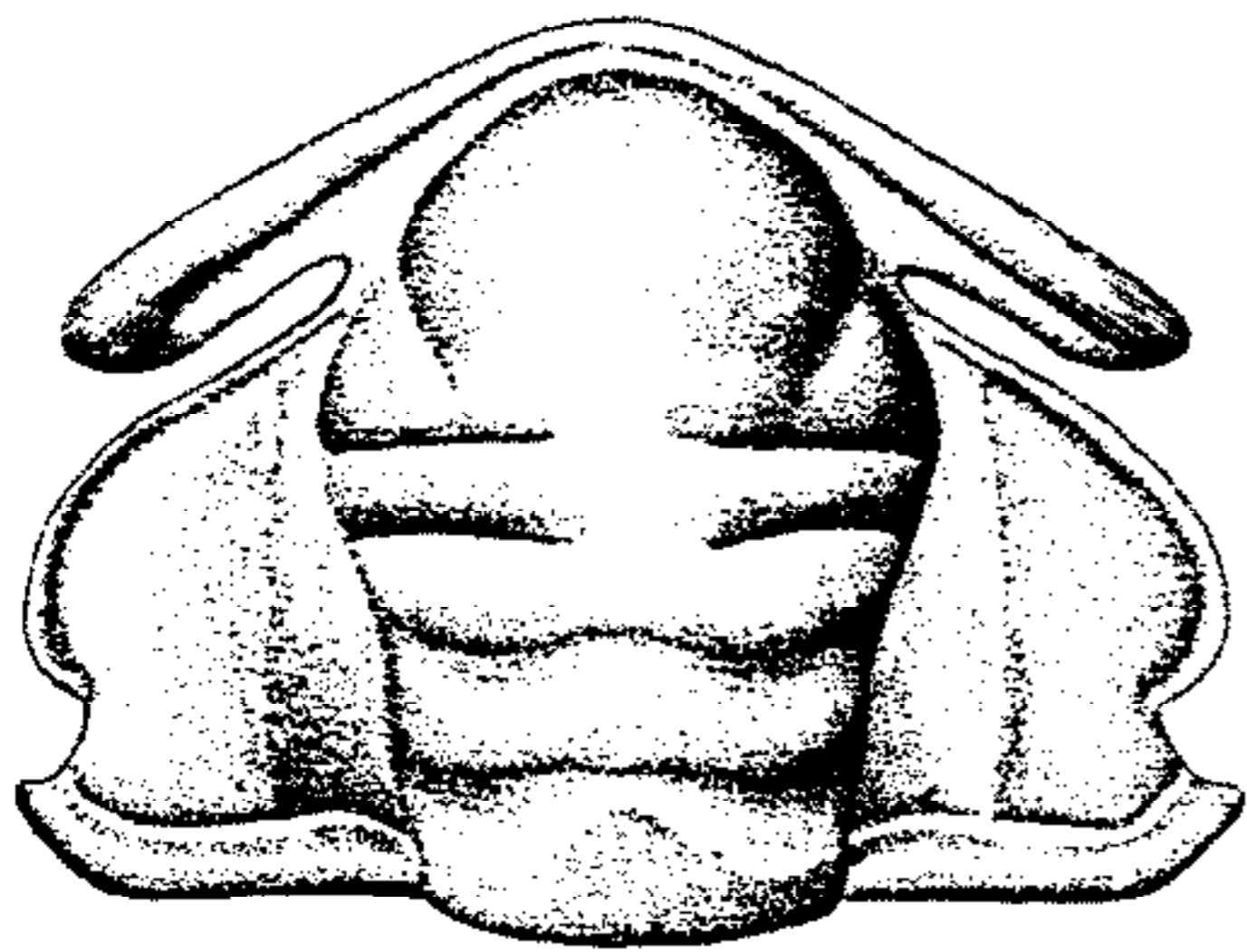

FIG. 153. *Paradoxides* (Paradoxididae, Paradoxidinae), *M.Cam.*—1. *P. minor* (BOECK), Bohemia; rostral plate with hypostoma, $\times 3$ (3).—2. **P. paradoxissimus* (WAHLENBERG), Swed.; exoskel., $\times 0.5$ (1).

Subfamily CENTROPLEURINAE Angelin, 1854

[*nom. transl.* HOWELL, 1933 (*ex* Centropleuridae ANGELIN, 1854)]

Heteropygous. Anterior pair of lateral glabellar furrows directed diagonally backward; anterior end of palpebral lobes in front of widest part of glabella; anterior sections of facial sutures at right angles to glabella or running obliquely backward paralleling anterior part of palpebral lobes and lateral portions of anterior border. Thorax with 14 or more segments. Pygidium wide, with well-developed pleural fields



a

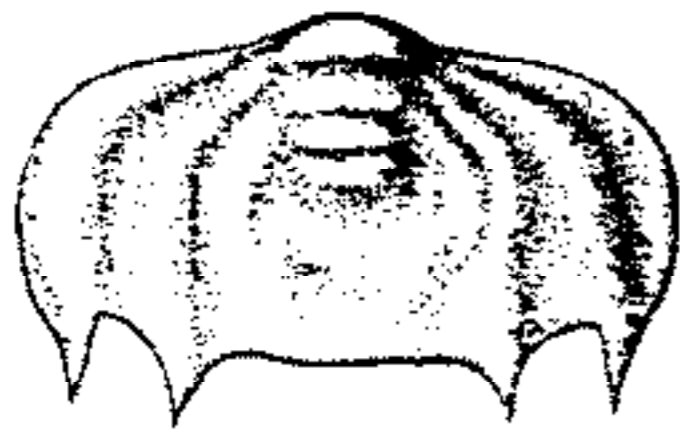

b

FIG. 154. *Centropleura loveni* (ANGELIN) (Paradoxidae, Centropleurinae), M.Cam., Swed.; *a, b*, cran., associated pyg., $\times 1$ (337).

and small spines on posterior margin. *M. Cam.*

Centropleura ANGELIN, 1854 [**Paradoxides loveni* ANGELIN, 1851]. Palpebral lobes curving in an uneven arc; anterior sections of facial suture paralleling anterior border and anterior part of palpebral lobes for a considerable length; metafixigal spines present in some. Pygidium without border. Hypostoma without spines (337, 70). *M.Cam.*, Eu.-E. N. Am.-Sib.-SE.Austral. — FIG. 154. **C. loveni* (ANGELIN), Swed.; *a, b*, cran., associated pyg., $\times 1$, $\times 0.75$ (337).

Anopolenus SALTER, 1864 [**A. henrici*]. Differs from *Centropleura* in having evenly curved palpebral lobes and distinctly defined pygidial border (337, 70). *M.Cam.*, Eu.-E.N.Am.(Atl.prov.)-E.Sib.

Clarella HOWELL, 1933 [**Anopolenus venustus* BILLINGS, 1874]. Differs from *Centropleura* and *Anopolenus* in having almost straight to slightly sigmoidal palpebral lobes (70, 337). *M.Cam.*, Eu.-Newf.

Subfamily METADOXIDINAE Whitehouse, 1939

Micropygous. Glabella strongly tapering forward; anterior and palpebral areas of fixigenae wide, with well-defined eye ridges and relatively small palpebral lobes. Thoracic segments up to 22, with broadly furrowed, more or less pointed pleura. *Up.L. Cam.*

Metadoxides BORNEMANN, 1891 [**Paradoxides torosus* MENECHINI, 1881; SD VOGDES, 1925]. Cephalic border narrow, anterior sections of facial suture

subparallel or slightly converging from eyes to anterior border, posterior sections long, directed obliquely backward. Pygidium elongated ovate, apparently unsegmented (14). *Up.L.Cam.*, Sard. — FIG. 155. **M. torosus* (MENECHINI); *a, b*, cran., fragment of thorax with pyg., $\times 0.7$ (14).

Anadoxides MATTHEW, 1899 [**Paradoxides armatus* MENECHINI, 1881; SD VOGDES, 1925]. Differs from *Metadoxides* in having wider, triangular pygidium with distinctly segmented axis and pleural fields (14). *Up.L.Cam.*, Sard.

Catadoxides MATTHEW, 1899 [**Metadoxides magnificus* MATTHEW, 1899]. Differs from *Metadoxides* and *Anadoxides* in having wide cephalic border, anteriorly expanded cranidium, short, backward-directed posterior sections of facial suture; and fairly wide, subreniform pygidium with indistinctly segmented axis and unfurrowed pleural fields. *Up.L.Cam.*, Newf. — FIG. 156.2. **C. magnificus* (MATTHEW); ceph., $\times 0.3$ (429).

Subfamily XYSTRIDURINAE Whitehouse, 1939

Heteropygous, with dorsal side of cephalon similar to that of Paradoxidinae but without transglabellar furrows; rostral plate unreduced, crescentic, reaching to genal angles. Thorax with 13 segments and pygidium quadrispinose, of the same type as that of Centropleurinae. *Up.L.Cam.-M.Cam.*

Xystridura WHITEHOUSE, 1936 [**Olenellus browni* ETHERIDGE, 1897] [= *Milesia* CHAPMAN, 1929 (non LATREILLE, 1804)] (340). *M.Cam.* Austral.

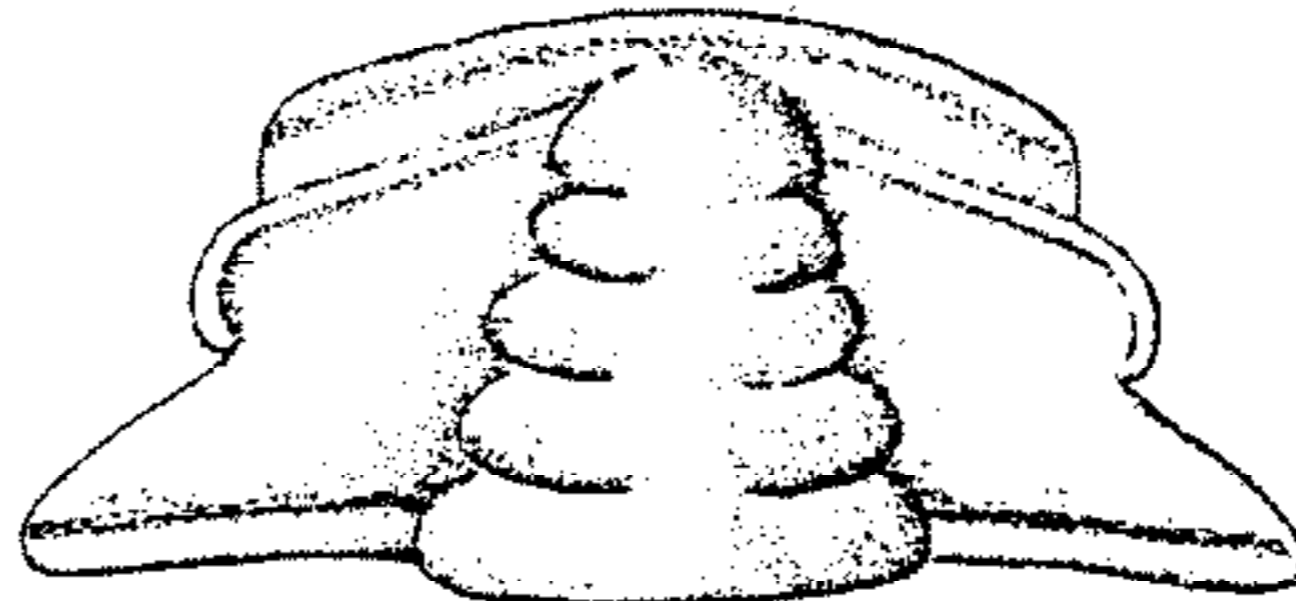

a

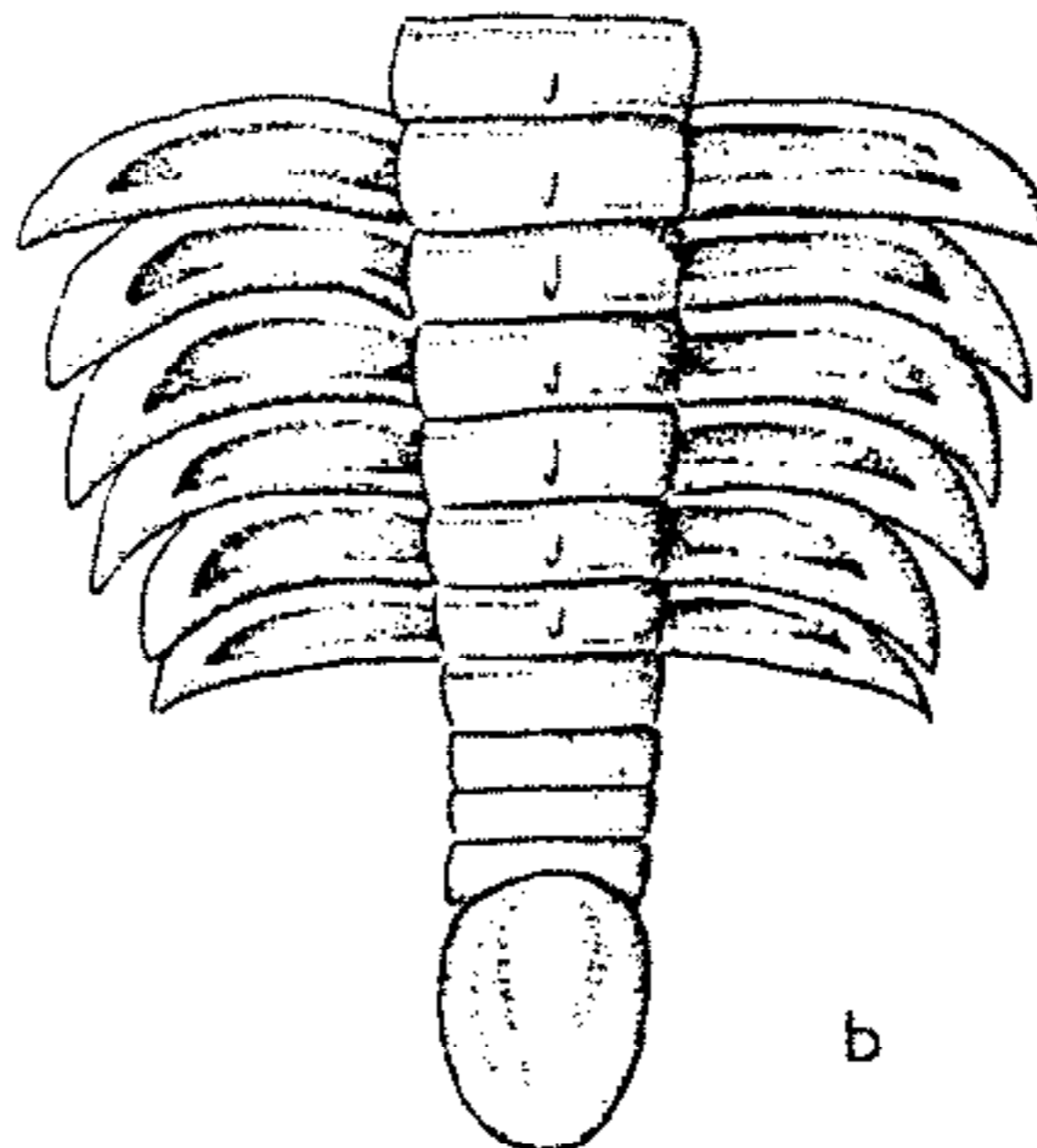

b

FIG. 155. **Metadoxides torosus* (MENECHINI), M. Cam., Sardinia; *a, b*, cran., part of thorax with pyg., $\times 0.5$ (14).

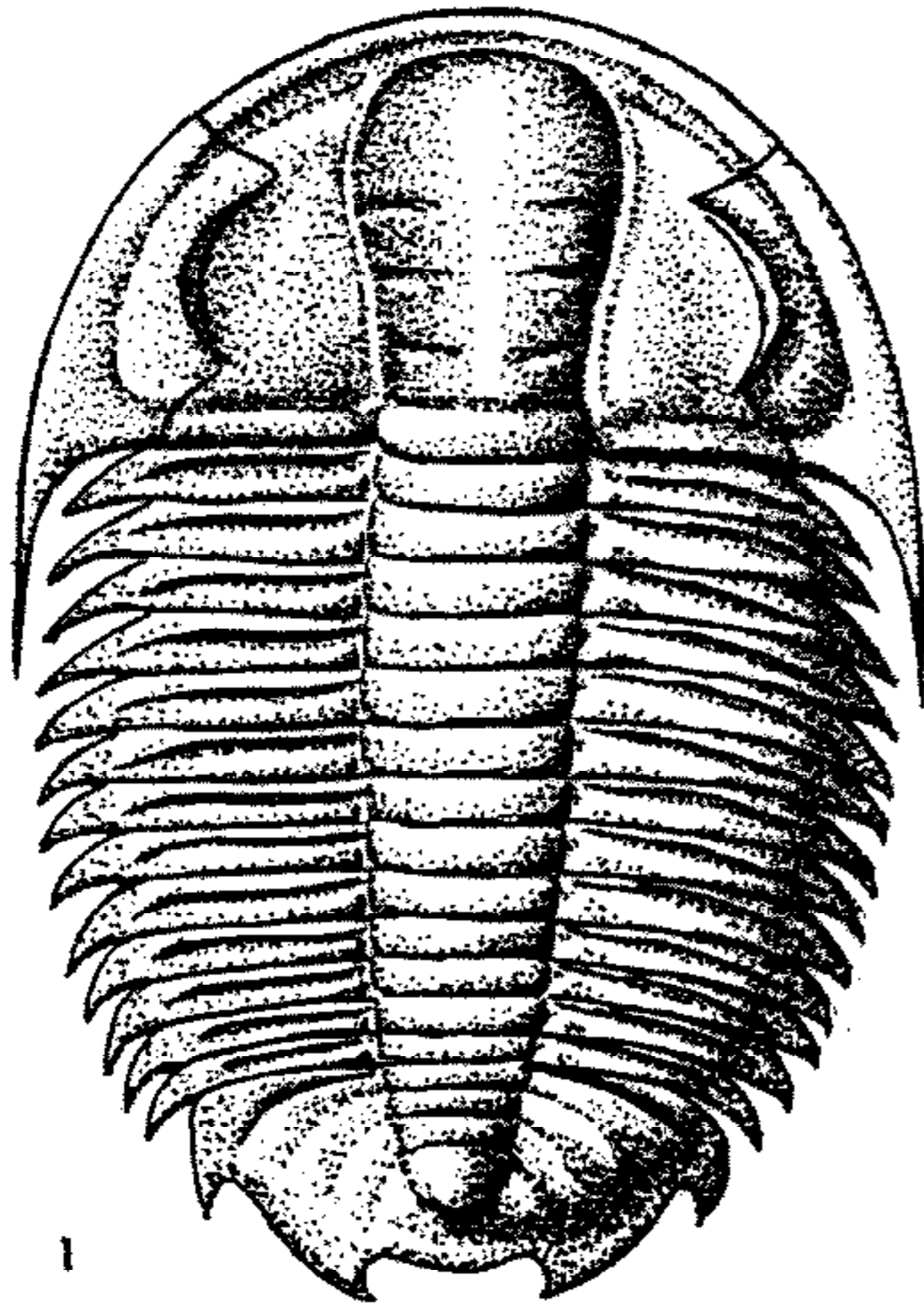

Xystridura

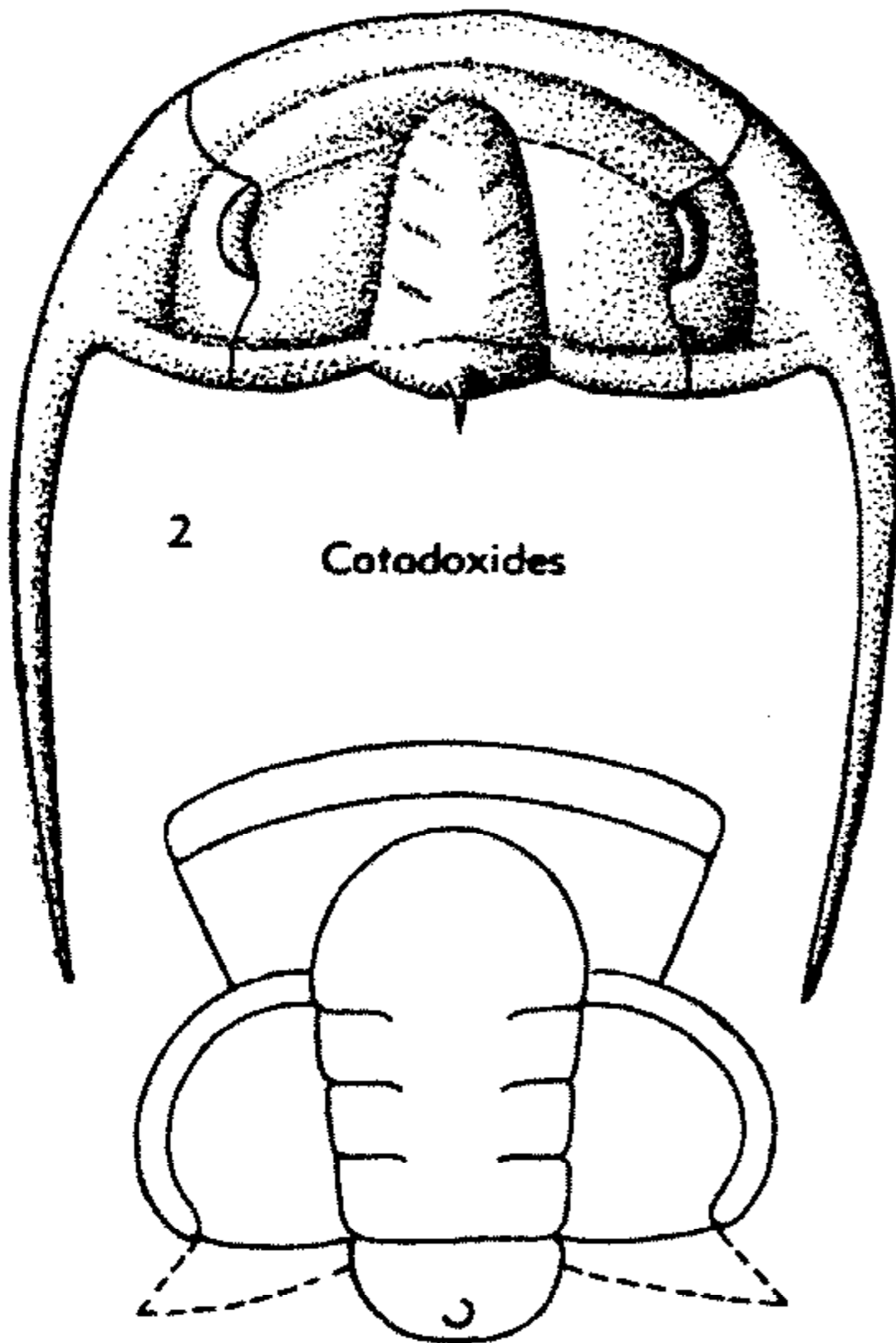

Cotadoxides

Gigoutella

FIG. 156. Paradoxididae (Metadoxidinae, Xystri-
durinae) (p. 0214, 0215).

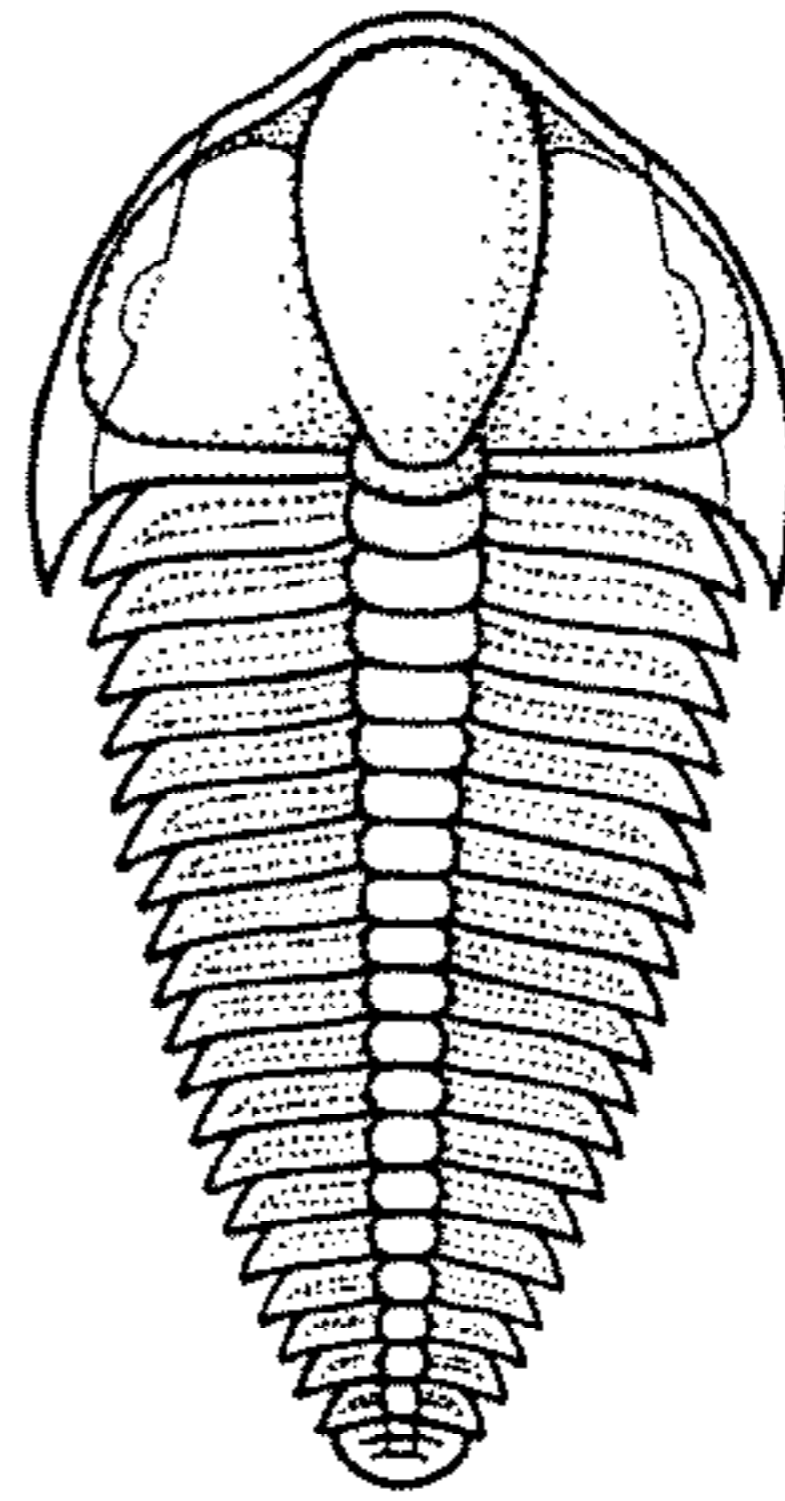

FIG. 157. **Hicksia elvensis* DELGADO (Hicksiidae),
L. Cam., Portugal; exoskel. (reconstr.), $\times 2$ (31,
405).

—FIG. 156.1. *X. saintsmithi* (CHAPMAN); $\times 1.5$
(340).

?*Gigoutella* HUPÉ, 1953 [**G. atlasensis*]. Differs
from *Xystridura* in having preglabellar field and
less diverging anterior sections of facial suture
(77). *Up. L. Cam.*, Morocco.—FIG. 156.3. **G.*
atlasensis; cran., $\times 2.25$ (77).

Subfamily UNCERTAIN

Schagonaria POLETAEVA, 1956 [**S. tannuola*]. *M.*
Cam. W. Sib. (RM).

Schistocephalus CHERNYSHEVA, 1956 [**S. enig-*
maticus]. *M. Cam.*, C. Sib. [Although attributed
to LERMONTOVA "in coll.," the description of the
new genus and its type species is recorded as pre-
pared by N. E. CHERNYSHEVA.] (RM).

Family HICKSIIDAE Hupé, 1953

Opisthoparian, micropygous, with ovoid
outline. Cephalon semielliptical, strongly
convex; glabella pyriform, strongly convex,
smooth, reaching anterior border; fixigenae
convex, wide, subtriangular in outline, pal-
pebral lobes small, submedian, located far
from glabella, without eye ridges; facial
sutures slightly convergent forward from
eyes and divergent backward, cutting pos-
terior margin close to genal angles; libri-
genae small, narrow, with short genal spines.
Thorax with 19 segments; axis much nar-
rower than pleural regions, tapering back-
ward; pleurae with wide oblique furrow,
distal fulcrum and spinose extremities.
Pygidium very small, semielliptical in out-
line, with 2 or ?3 axial rings and faint indi-

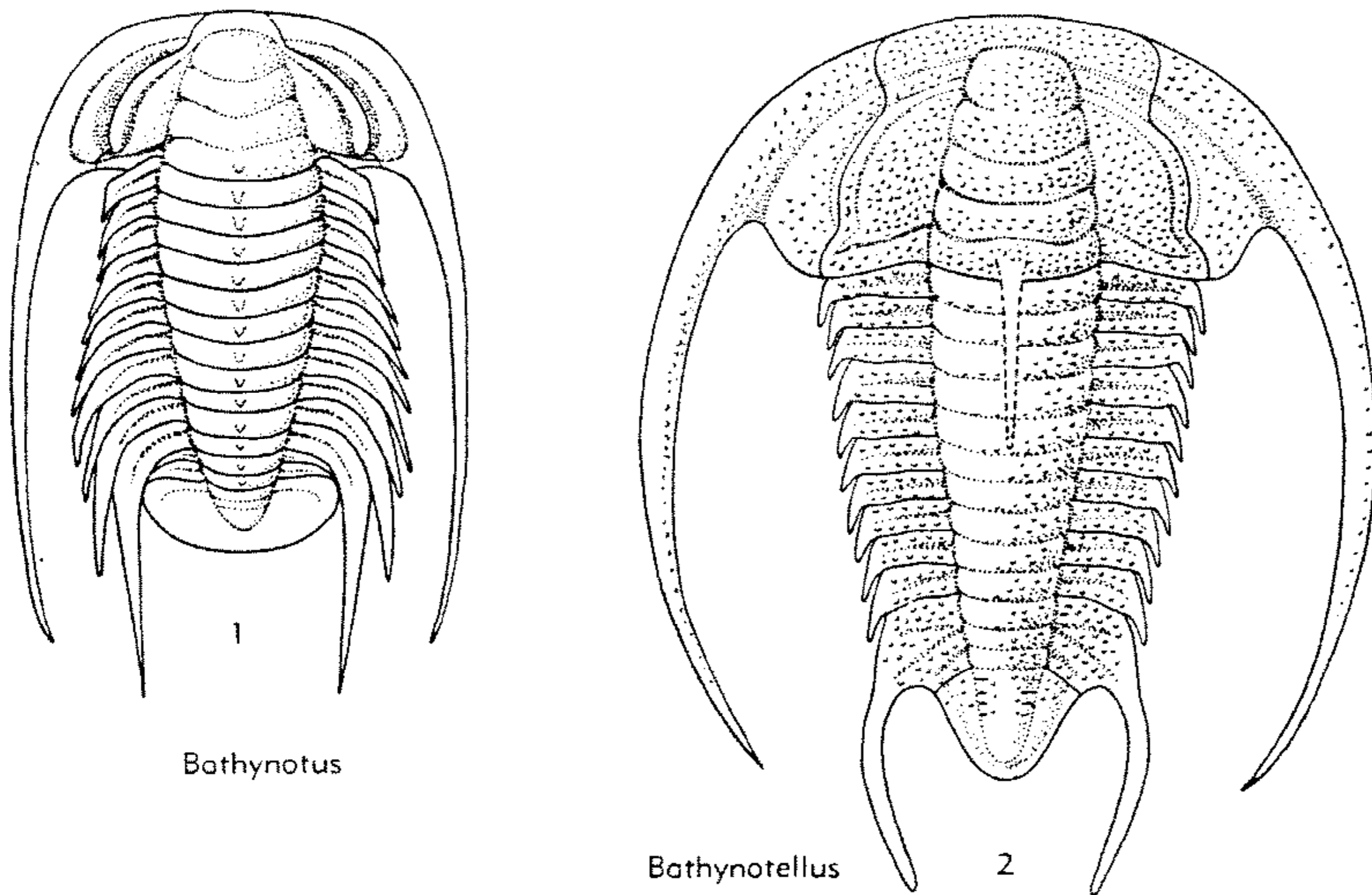

FIG. 158. Bathynotidae (p. 0216, 0217).

cations of ?2 pleural furrows; border absent; margin entire. *L.Cam.*

Hicksia DELGADO, 1904 [**H. elvensis*; SD VOGDES, 1925 (= *H. sphaerica*, *H. transtaganensis*, *H. walcotti*, *H. castroi*, *H. hughesi*, *H. barroisi*, *H. dewalquei*, *H. minuta*, all DELGADO, 1904]. Characters of family. [The 9 "species" described by DELGADO from a single locality in Monte de Valbom, Alto Aleintejo, Portugal, are based on differently distorted specimens belonging to a single species.] *L.Cam.*, Portugal.—FIG. 157. **H. elvensis*, exoskel. (reconstr.), $\times 2$, (405, based on 31).

Suborder BATHYNOTINA

Lochman-Balk, nov.

[Type—*Bathynotus* HALL, 1860]

Exoskeleton opisthoparian, elliptical, micropygous. Glabella large, strongly convex, tapering to rounded front, with 2 to 3 pairs of glabellar furrows, posterior pairs complete; facial suture marginal anteriorly, on ventral side diverging from mid-point along sides of hypostoma; preglabellar area very small or lacking, all furrows well defined; eyes large, 0.75 of length of glabella, eye ridges wide; occipital spine or node present; fixigenae downsloping, palpebral area a little less than glabellar width, posterior area only

slightly wider; librigenae with very narrow eye platform and long stout recurved genal spine. Thorax of 13 segments; axis wide, convex, may have axial spine or node; pleurae narrow, furrowed, ending in rigid spines, 11th segment macropleural, 12th and 13th reduced. Pygidium semicircular or subtriangular; axis wide, nearly full length, up to 5 faint axial rings; pleural regions very narrow, up to 4 faint pleurae, all furrows faint to obsolete. Outer surface granulate. *Up.L.Cam.-Low.M.Cam.*

Family BATHYNOTIDAE Hupé, 1953

Characters of the suborder. *Up.L.Cam.-Low.M.Cam.*

Bathynotus HALL, 1860 [**Peltura (Olenus) holopyga* HALL, 1859] [= *Pagura* EMMONS, 1860; *Bathynotus* BIGSBY, 1868]. Glabella broad, front nearly straight. Thoracic axis with median node, size of pleural spines increasing regularly from 4th to 11th segment. Pygidium semicircular; axial furrow shallow but complete, axial rings 1 or 2; pleural furrows obsolete (307). *Up.L.Cam.-Low.M.Cam.*, E.N.Am.-Arct.Eurasia.—FIG. 158, 1. **B. holopyga* (HALL), *Up.L.Cam.*, Vt.; exoskel., $\times 1$ (307).

Bathynotellus LERMONTOVA, 1940 [**B. yermolaevi*]. Glabella convex, with occipital spine. Thorax with

pleural spines on 1st to 10th segments, all of medium size, only 11th segment macropleurale. Pygidium triangular, with 5 faint axial rings (including terminal) and 3 to 4 faint pleurae; border furrow faint, narrow, border narrow (117). *Low.M.Cam.*, Arct. Eurasia.—FIG. 158,2. **B. yermolaevi*, N.Zem.; exoskel., $\times 0.75$ (117).

Order CORYNEXOCHIDA Kobayashi, 1935

[*nom. transl.* MOORE, herein (ex Suborder Corynexochida KOBAYASHI, 1935)] [=Superfamilies Bathyriscidea RICHTER, 1933 (*partim*) + Zacantheididea RICHTER, 1933 (*partim*); Corynexochidea RICHTER & RICHTER, 1941; Bathyriscidea RASETTI, 1948 (attributed to RICHTER, 1933); Zacantheidacea HENNINGSMOEN, 1951 (attributed to RICHTER, 1932); Corynexochidae HUPÉ, 1953 (attributed to RICHTER & RICHTER, 1941)] [Type—*Corynexochus* ANGELIN, 1854]

Exoskeleton elongate subelliptical, mostly macropygous. Cephalon semicircular, mostly with well-developed genal spines; glabella long, with subparallel sides but in some genera expanding anteriorly, reaching anterior border, lateral furrows generally distinct; eyes elongate and narrow, commonly associated with eye ridges; facial sutures opisthoparian, with sections in front of eyes generally subparallel. Rostral plate fused with hypostoma or rudimentary. Thorax composed of 5 to 11 segments, pleurae with well-marked furrows, terminations spinose. Pygidium medium in size to large, commonly with marginal spines, but some genera with smooth border. *L.Cam.-U.Cam.*

Family DORYPYGIDAE Kobayashi, 1935

[*nom. transl.* RASETTI, 1948 (ex Dorypyginae KOBAYASHI, 1935)] [=Kooteniidae RESSER, 1939 (*nom. correct.* RASETTI, 1948, *pro* Kooteniidae RESSER, 1939); Holteriinae HUPÉ, 1953]

Dorsal exoskeleton opisthoparian, ovate, almost isopygous to macropygous. Glabella strongly convex, reaching anterior border or (rarely) anterior margin, axial furrows deepening into a pair of pits near anterior corners of glabella; fixigenae of moderate width, palpebral lobes small to medium in size. Thorax (as far as known) commonly of 7 or 8 segments. Pygidium usually with border, 3 to 12 axial rings, and marginal spines. Hypostoma fused with rostral plate, the latter forming strong "anterior wings" and separating doublures of librigenae. *L.Cam.-U.Cam.*

Dorypyge DAMES, 1883 [**D. richthofeni*]. Glabella wide, more or less contracted at both ends; cephalic border moderately convex, genal spines of moderate length. Pygidium with 3 to 7 axial rings, strongly impressed pleural furrows, and 6 (rarely

5) pairs of well-developed marginal spines, 1 or 2 posterior pairs differing in size from the others; outer surface generally coarsely granulate (238). *M.Cam.* E.N.Am.-Br.I.-Denm.-Swed.-Arg.-Asia-N. E.Austral.—FIG. 159,1. *D. aenigma* (LINNARSSON), Swed.; *1a,b*, cran., dors. and lat. views, $\times 3$; *1c*, librigena, $\times 3$; *1d*, associated hypostoma, $\times 4$; *1e*, incomplete thoracic seg., $\times 2$ (336).—FIG. 159,2. *D. chihliensis* RESSER, China; pyg., $\times 3$ (478).

Basocephalus IVSHIN, 1953 [**B. nominalis*]. *M.Cam.*, W.Sib.

Bonnaria LOCHMAN, 1956 [**Bonnaria salemensis* RESSER, 1936]. Differs from *Bonnaria* and *Bonniella* in shape of glabella, posterior half being narrow, with nearly parallel sides, anterior half markedly swollen, with strongly diverging sides (131). *L.Cam.*, N.Am.

Bonnaria WALCOTT, 1916 [**Bathyrurus parvulus* BILLINGS, 1861]. Small, strongly arched, with subcylindrical or clavate to ovate glabella, deeply impressed anterior border furrow, prominent anterior border. Thoracic segments 8. Pygidium almost semicircular, with 4 or 5 axial rings; narrow, well-impressed border furrow, narrow border, and 1 to 3 pairs of minute lateral marginal spines. Surface smooth or granulate, with granules commonly arranged in irregular concentric lines on glabella (194, 317). *L.Cam.*, N.Am.-Greenl.-E. Asia.—FIG. 159,3. *B. brennus* (WALCOTT), Que.; *3a,b*, cran., dors. and lat. views, $\times 4$; *3c*, pyg., $\times 3$ (194).

Bonniella RESSER, 1937 [**Olenoides (Dorypyge) desiderata* WALCOTT, 1890]. Differs from *Bonnaria* in having pygidium with flattened marginal extension on each side behind 2nd segment, making a median marginal indentation (234). *L.Cam.*, E.N.Am.-?Sp.

Bonniopsis POULSEN, 1946 [**B. nasuta*]. Differs from *Bonnaria* in having anteriorly tapering, bluntly acuminate glabella and pygidium without border (175). *L.Cam.*, Ellesm.

Dorypygina LERMONTOVA, 1940 [**D. delicatula*]. Differs from *Dorypyge* in having pygidium with strongly impressed interpleural grooves and no definite pygidial border (117). *M.Cam.*, USSR.

?*Erbiopsis* LERMONTOVA, 1940 [**E. grandis*]. Differs from *Dorypyge* in having strongly clavate glabella extending to anterior margin, 2 pairs of strongly impressed lateral furrows; thorax of 11 or more segments with narrower axis and wider pleural regions; and subtriangular, considerably convex pygidium of about 10 segments apparently without border and marginal spines (117). *M.Cam.*, Sib.—FIG. 160,2. **E. grandis*; incompl. exoskel., $\times 3$ (423).

Fordaspis LOCHMAN, 1956 [**Solenopleura nana* FORD, 1878]. Differs from *Bonnaria* in having glabella perfectly rounded at both ends, more for-

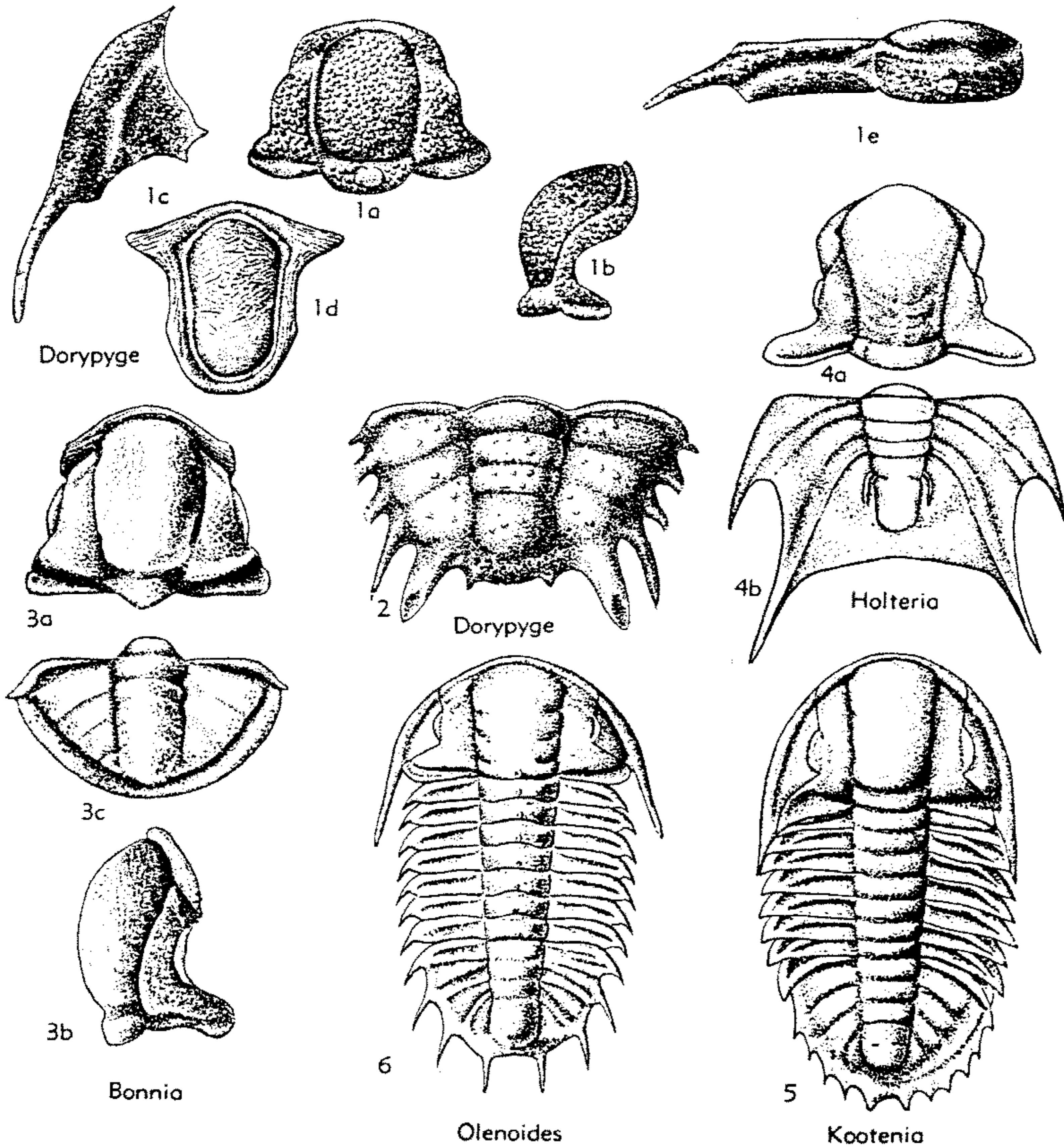

FIG. 159. Dorypygidae (p. O217-O219).

ward position of eyes, and greater number of pygidial segments (131). *L.Cam.*, N.Am.
Holteria WALCOTT, 1924 [**Ogygia? problematica* WALCOTT, 1884]. Differs from other Dorypygidae in lack of anterior border and in having subtrapezoidal pygidium with wider border and 2 pairs of well-developed pleural spines (321, 316). *U.Cam.*, N.Am.—FIG. 159,4. **H. problematica* (WALCOTT), Nev.; 4a,b, cran., pyg., $\times 1$ (488).
Kootenia WALCOTT, 1888 [**Bathyuriscus (Kootenia) dawsoni*] [*?=Kooteniella* LERMONTOVA, 1940]. Differs from *Dorypyge* in having narrower glabella, deeply impressed anterior border furrow and prominent anterior border; pygidium with better defined border, 4 to 7 (generally 6) pairs of marginal spines varying from mere scallops to long

heavy spines of subequal size in the same species; and smooth or finely granulate surface of exoskeleton (196). *L.Cam.-U.Cam.*, N.Am.-S.Am.-Greenl.-N.Eu.-Asia-NE.Austral. — FIG. 159,5. *K. burgessensis* RESSER, M.Cam., B.C.; exoskel., $\times 0.7$ (488).
Notasaphus GREGORY, 1903 [**N. fergusoni*]. *M. Cam.*, E.Austral.
?Paraolenoides IVSHIN, 1953 [**P. medoevi*]. *M. Cam.*, W.Sib.
Olenoides MEEK, 1877 [**Paradoxides? nevadensis* MEEK, 1877] [*=Neolenus* MATTHEW, 1899]. Differs from *Dorypyge* in having parallel-sided to slightly clavate glabella; pygidium with 5 to 11 axial rings, distinctly marked interpleural grooves in addition to pleural furrows, and 4 to 8 pairs

of marginal spines, generally of equal length; and surface covered with smaller granules (196, 311). *M.Cam.*, ?*U.Cam.*, N.Am.-S.Am.(Arg.)-Asia.—

FIG. 159,6. *O. curticei* WALCOTT, *M.Cam.*, Ala.; exoskel. (reconstr.), $\times 0.7$ (488).

?*Strettonia* COBBOLD, 1931 [**S. comleyensis*]. *L.Cam.*, Eng.

?*Tolanaspis* IVSHIN, 1953 [**T. almaematrix*]. *M.Cam.*, W.Sib.

Prokootenia LERMONTOVA, 1940 [**P. rara*]. Differs from *Kootenia* in having much wider palpebral area of fixigenae, longer palpebral lobes, and pygidium with more strongly impressed pleural furrows and indistinctly defined border (117). *L.Cam.*, USSR.

?*Tabatopygellina* Sivov, 1955 [**T. babakoviensis*]. *Up.L.Cam.*, Sib. (MO)

?*Kooteniellina* Sivov, 1955 [**K. tubaenia*]. *Low.M.Cam.*, Sib. (MO)

?*Babakovia* Sivov, 1955 [**B. dorypygaeiformis*]. *Up.L.Cam.-Low.M.Cam.*, Sib. (MO)

Family OGYGOPSIDAE Rasetti, 1951

[Generic names ending in *-opsis* have the stem ending in *-ops* (neo-Latin genitive, *-opsis*), according to Prof. GREENSTED, ICZN Classical Adviser.—Ed.]

Dorsal exoskeleton large, isopygous. Glabella approximately parallel-sided, reaching anterior border; eyes of medium size, at level of glabellar mid-point; anterior facial sutures moderately divergent; rostral plate present, not fused with hypostoma. Thorax with 8 segments. Pygidium rounded, with many axial and pleural segments (197). *M.Cam.*

Ogygopsis WALCOTT, 1889 [**Ogygia klotzi* ROMINGER, 1887] [= *Taxioura* RESSER, 1939]. Glabella prominent, reaching anterior border, unfurrowed; occipital ring simple; palpebral areas about 0.3 of glabellar width; eye ridges present; palpebral lobes 0.25 of glabellar length; anterior border furrow merging with axial furrows; border present; anterior section of facial sutures directed slightly outward, curving inward across border, posterior section defining subtriangular posterior area; librigenae with moderately long genal spines. Hypostoma subrectangular, commonly attached to rostrum, suggesting incipient fusion; indistinct maculae present. Thorax with 8 segments; pleural furrows parallel to edges of pleurae, pleurae not extended into long spines. Pygidium with long, multisegmented axis almost reaching posterior border; pleural fields convex, with numerous pairs of furrows and shallow or indistinct interpleural grooves; border furrow and border poorly defined; margin usually entire. *M.Cam.*, N.Am.—FIG. 160,1. **O. klotzi* (ROMINGER), B.C.; 1a, exoskel., $\times 0.7$; 1b, rostral plate and hypostoma, $\times 3$ (448n).

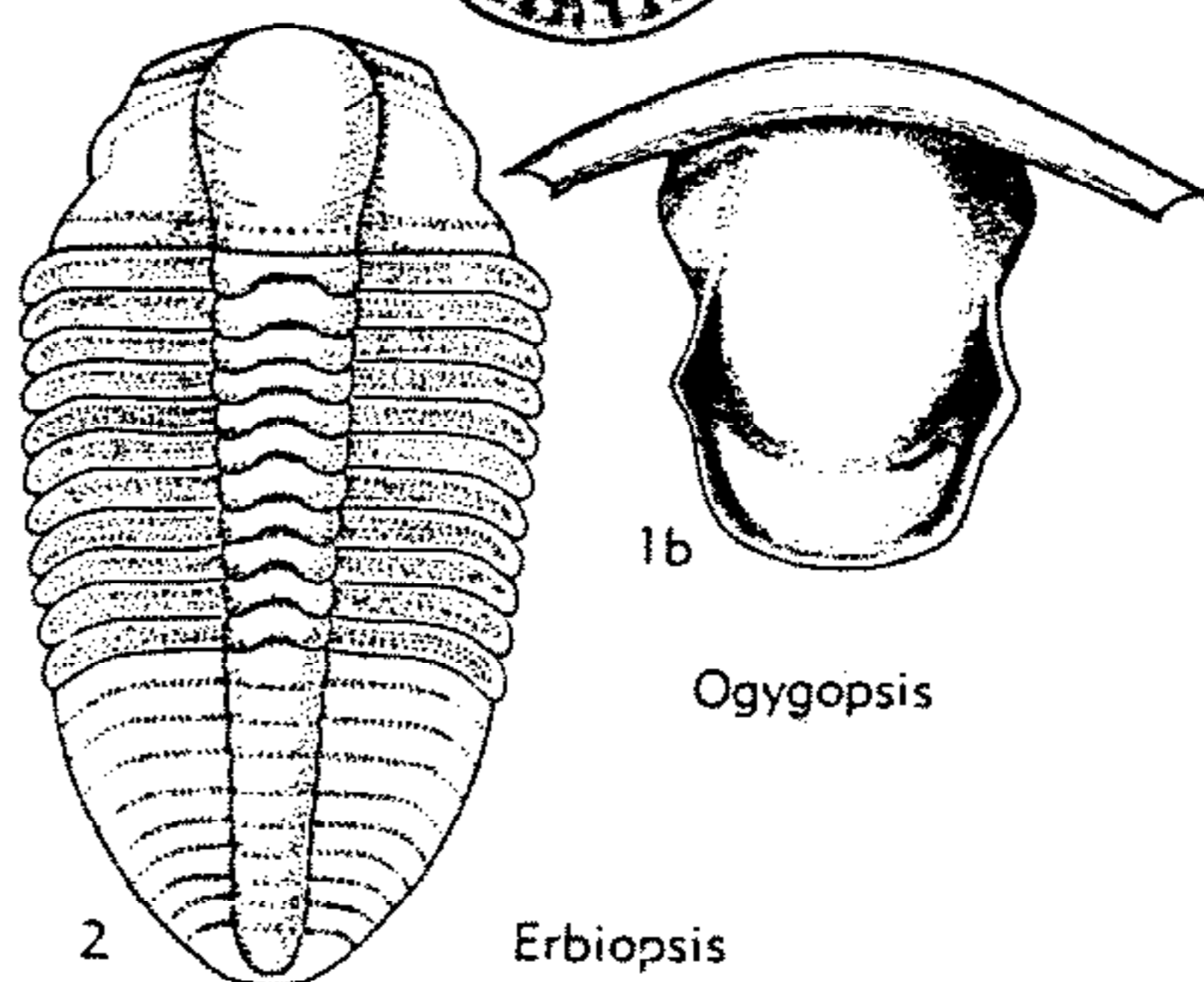
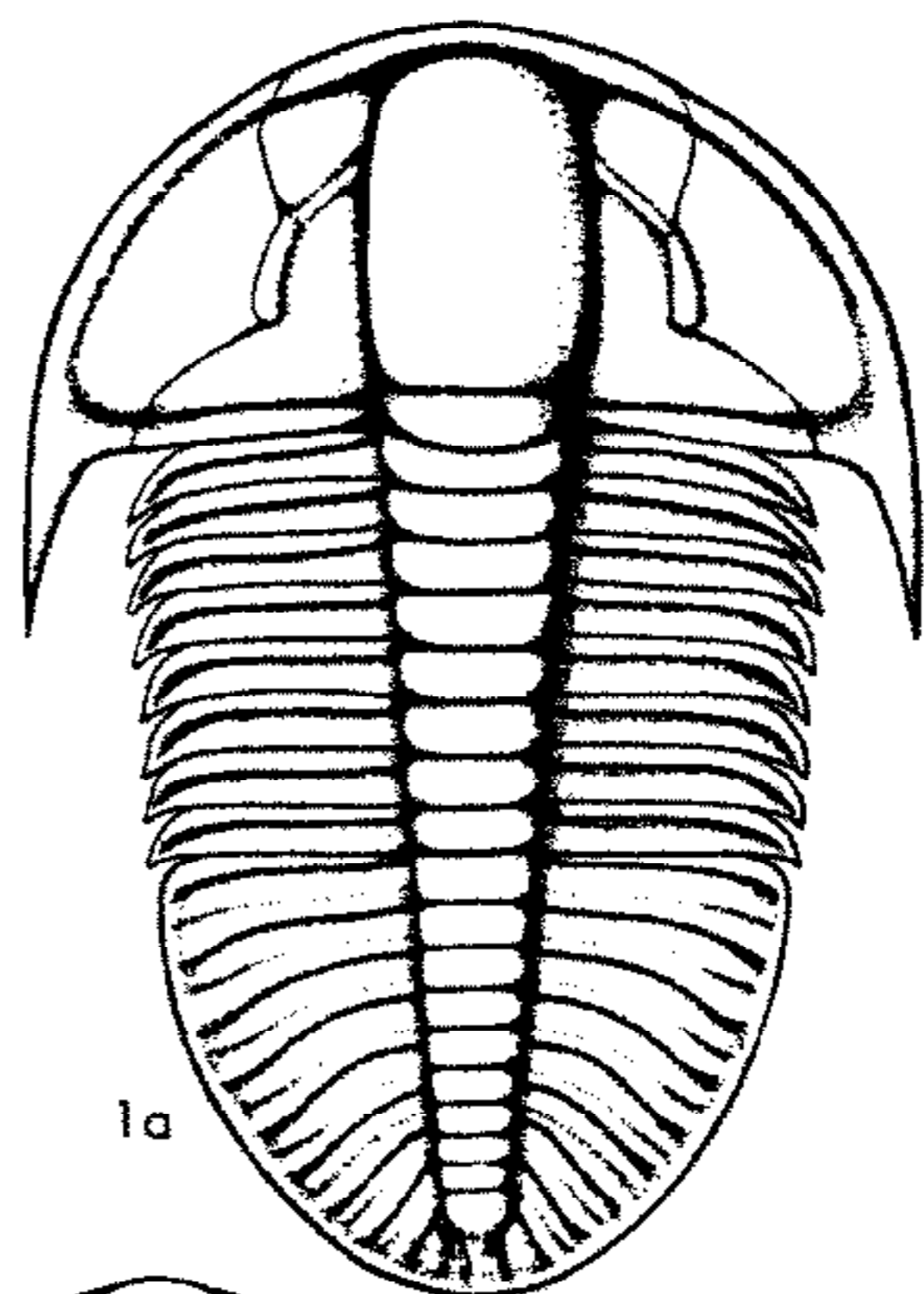

FIG. 160. Dorypygidae, Ogygopsidae (p. 0217-0219).

Family ORYCTOCEPHALIDAE Beecher, 1897

[*nom. transl.* RASETTI, herein (ex *Oryctocephalinae* BEECHER, 1897)] [= *Tonkinellidae* REED, 1934; *Lancastriidae* KOBAYASHI, 1935 (*nom. correct.* HENNINGSMOEN, 1951, *pro* *Lancastriidae* KOBAYASHI, 1935); *Oryctocephalinae* HUPÉ, 1953]

Dorsal exoskeleton with low convexity, small or at most medium-sized. Glabella parallel-sided or expanded forward, reaching frontal border; glabellar and occipital furrows typically composed of pairs of pits not reaching axial furrow but commonly connected across glabella; occipital ring short, simple; fixigenae usually wide; palpebral lobes usually of medium length and distant from glabella; eye ridges developed; librigenae generally narrow, bearing long genal spines; hypostoma fused with rostrum

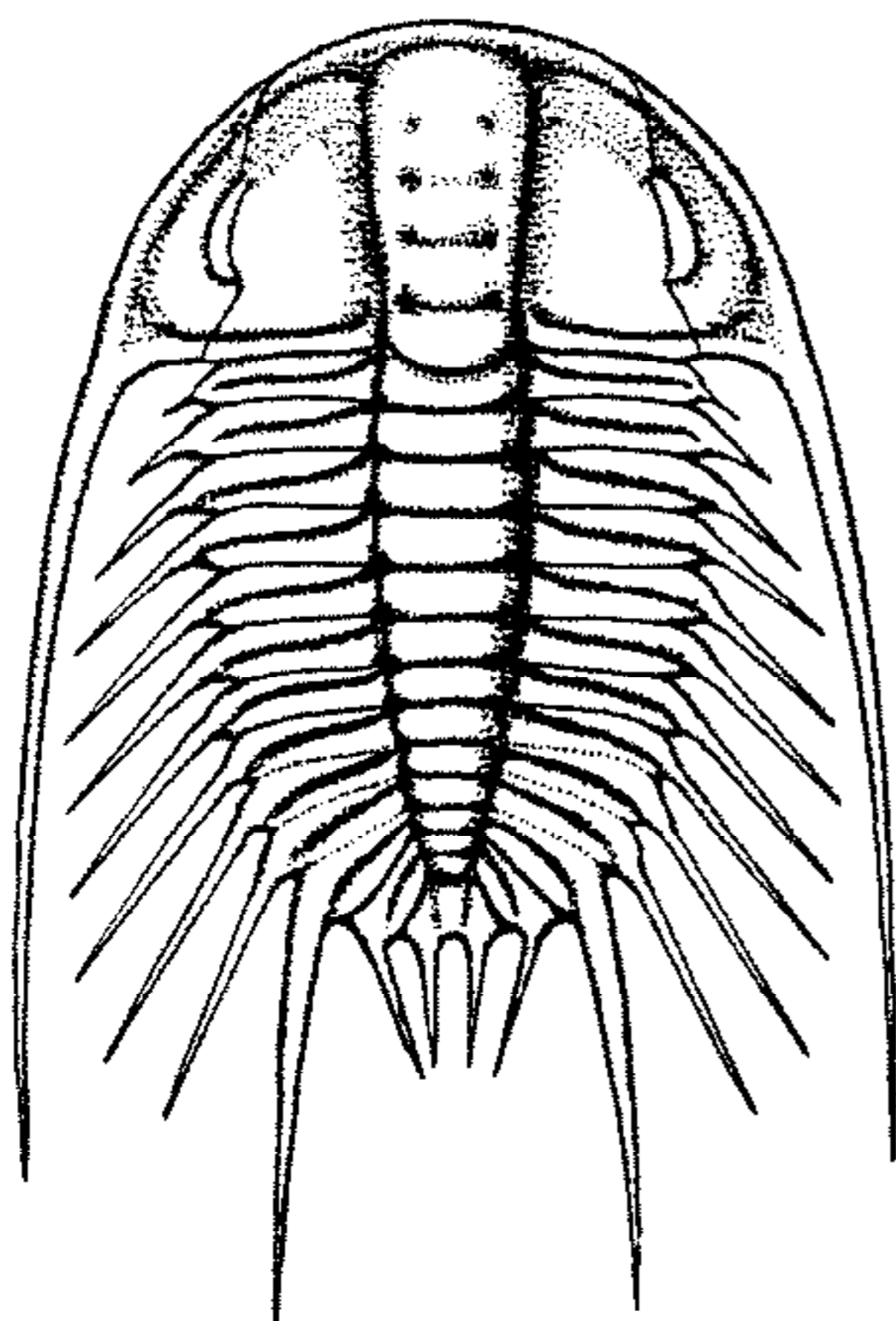

FIG. 161. *Oryctocephalus burgessensis* RESSER, M. Cam., W.Can.(B.C.); exoskel., $\times 2$ (448n).

(*Oryctocephalus*). Thorax with 5 to 18 segments; pleurae typically extended into long spines, more rarely truncated. Pygidium small, and simple in earliest forms (*Lancastria*), increasing in size at expense of thorax up to later, isopygous genera where pygidium comprises 6 to 7 segments; axis usually short; pleural regions generally with distinct, radially arranged pleural furrows and grooves; border undefined, margin generally extended into several pairs of spines, in a few genera rounded (97, 109, 117, 197, 198, 236, 237, 259, 265, 340). *L.Cam.-M. Cam.*

Oryctocephalus WALCOTT, 1886 [**O. primus*]. Glabella parallel-sided or slightly expanded forward; glabellar furrows well impressed as pits; palpebral lobes 0.3 of glabellar length, distant from glabella, posterior to glabellar mid-point; posterior areas of fixigenae not extending much beyond palpebral lobes, genal spines long. Thorax with 7 segments; pleurae extended into spines. Pygidium almost as large as cephalon; axis tapered, with 5 to 7 segments; pleural furrows and grooves impressed, not parallel to each other; 5 or 6 pairs of marginal spines, 4th pair strongest in most species. *M.Cam., Eu.-Asia-N.Am.-S.Am.*—FIG. 162,1. **O. primus*, Nev.; *lab*, cran., pyg., $\times 2$ (448n).—FIG. 161. *O. burgessensis* RESSER, W. Can.(B.C.); exoskel., $\times 2$ (448n).—FIG. 162,2.

O. walcotti RESSER, W.USA(Idaho); hypostoma and doublure of librigenae, $\times 2$ (448n). [Genera considered synonymous with *Oryctocephalus* include *Oryctocephalina* LERMONTOVA, 1940, and *Viñakainella* RUSCONI, 1952.]

?*Cheiruroides* KOBAYASHI, 1935 [**Atops orientalis* RESSER & ENDO in KOBAYASHI, 1935 (= *Arthricocephalus? primigenius* SAITO, 1934)]. Glabella broad, parallel-sided with 3 pairs of lateral furrows, of which 2 connect across glabella; occipital ring short; fixigenae triangular; palpebral lobes small, at level of glabellar mid-point. Thorax of ?14 segments; pleurae rounded. Pygidium small, transverse, with rounded margin. *L.Cam., Manch.-Korea* (97).

Lancastria KOBAYASHI, 1935 [**Olenopsis roddyi* WALCOTT, 1912]. Cephalon as in *Oryctocephalus*. Thorax long, with 18 segments; pleurae extended into spines. Pygidium small, elongated, with 2 segments. *L.Cam., N.Am.*—FIG. 162,4. **L. roddyi* (WALCOTT), Pa.; complete, somewhat distorted holotype, $\times 2$ (448n).

Oryctocara WALCOTT, 1908 [**O. geikiei*]. Very small. Cranidium differs from *Oryctocephalus* in narrower fixigenae, longer palpebral lobes, and much wider (*tr.*) posterior areas of fixigenae. Thorax with 11 segments; pleurae bluntly terminated. Pygidium rounded, with short, segmented axis and numerous pairs of pleural furrows and grooves, no marginal furrow or border. *M.Cam., N.Am.*—FIG. 162,5. **O. geikiei*, Idaho; specimen lacking librigenae, $\times 5$ (448n).

Oryctocephalites RESSER, 1939 [**O. typicalis*]. Similar to *Oryctocephalus* but anterior outline of cranidium less straight and glabella more definitely expanded forward. Pygidium with obsolete interpleural grooves and 5 pairs of marginal spines. *M.Cam., N.Am.*—FIG. 162,3. **O. typicalis*, Idaho; *3a,b*, cran., pyg., $\times 2$ (448n).

Oryctocephalops LERMONTOVA, 1940 [**O. frischfeldi*]. Cephalon as in *Oryctocephalus*. Thorax with 12 segments. Pygidium small; pleurae with 2 pairs of spines. *M.Cam., Sib.* (117).

Tonkinella MANSUY, 1916 [**T. flabelliformis*]. Cephalic proportions as in *Oryctocephalus* but glabellar furrows less distinctly pit-shaped. Thorax with 5 segments (*T. stephensis*); pleurae bluntly terminated. Pygidium semicircular, as large as cephalon; margin rounded; axis tapered, segmented; pleural regions convex, with equally spaced, radially arranged furrows, lacking interpleural grooves; no marginal furrow or border. *M.Cam., E.Asia-N.Am.*—FIG. 162,6. *T. stephensis* KOBAYASHI, B.C.; exoskel., $\times 1.5$ (448n).

Family DOLICHOMETOPIDAE

Walcott, 1916

[*nom. transl.* HUPÉ, 1953 (ex *Dolichometopinac* WALCOTT, 1916)] [= *Bathyriscidae* RICHTER, 1933; *Parmiganiidae* RESSER, 1935 (*nom. correct.* RASETTI, 1948, pro *Parmiganiidae* RESSER, 1935); *Orriniac*, *Glossopleurinae* HUPÉ, 1953]

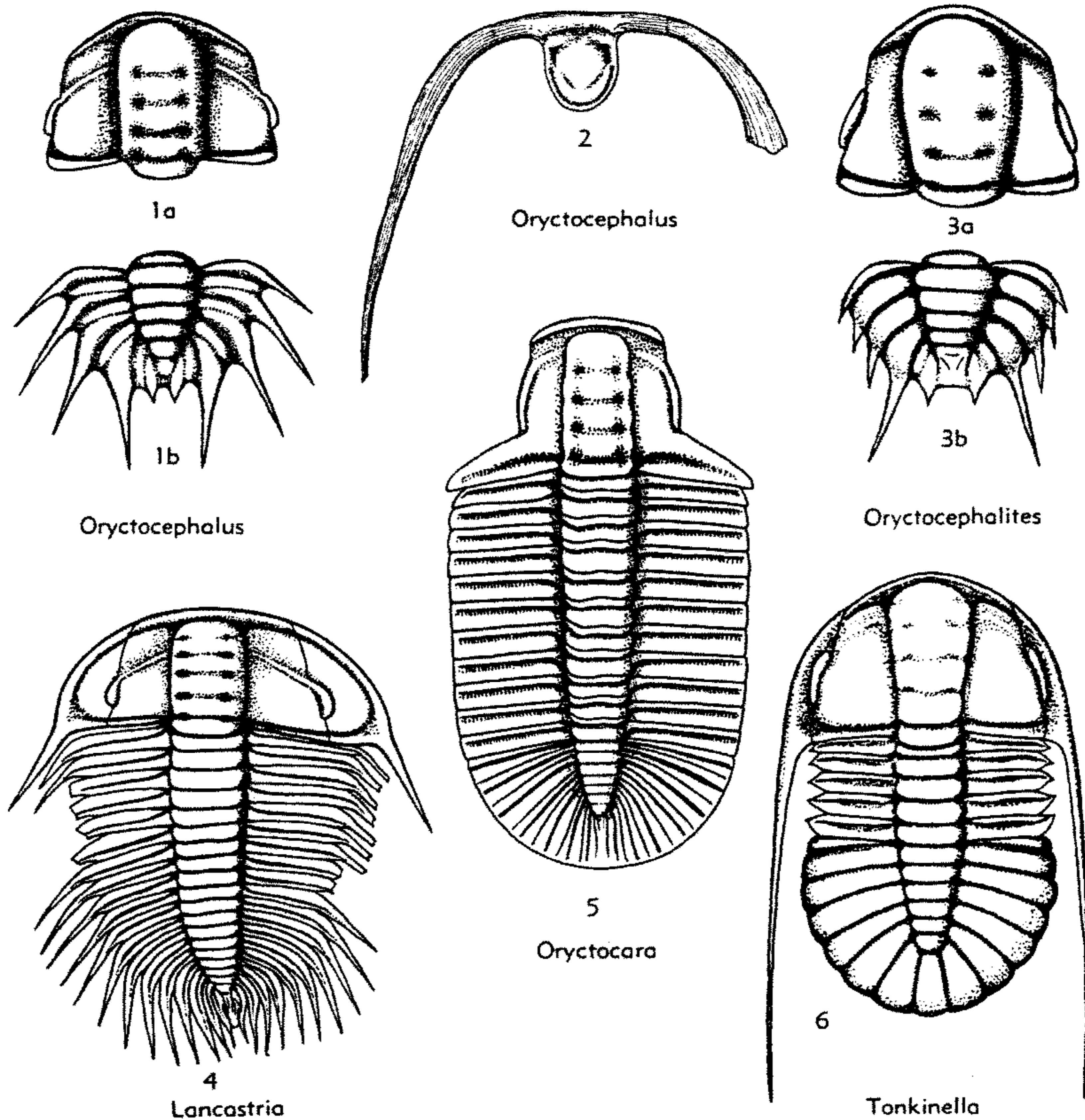

FIG. 162. Oryctocephalidae (p. O220).

Dorsal exoskeleton opisthoparian, ovate to elongate, heteropygous to macropygous. Cephalon semicircular, with parallel-sided to clavate glabella reaching anterior border or margin; anterior areas narrow; palpebral areas of fixigenae narrow to moderately wide; palpebral lobes usually very long, close to glabella, their front ends generally almost touching it; genal angles very commonly produced into spines. Thorax (as far as known) with 6 to 12 segments. Pygidium greatly varying in size, shape, and number of segments. Hypostoma fused with rostral plate, the latter forming strong "anterior wings." *L.Cam.-U.Cam.*

Dolichometopus ANGELIN, 1854 [**D. svecicus*]. Cephalon strongly arched transversely and longitudinally; glabella moderately convex, subcylindrical to slightly clavate, devoid of glabellar furrows in full-grown specimens, defined by shallow axial furrow, encroaching upon moderately wide, flat, or slightly convex anterior border; occipital ring widened medially, lenticular in outline; fixigenae posteriorly of about same width as glabella; eye ridges oblique; posterior areas of fixigenae with rounded, strongly sloping extremities terminating at genal angles; palpebral lobes half as long as glabella; genal angles bluntly pointed or with short, strong genal spines. Pygidium large, approximately semicircular, moderately convex, indistinctly segmented, with narrow, poorly defined

axis extended into wide border; surface minutely punctate or granulate (101, 317, 336). *M.Cam.*, Eu.-E.N.Am. (Atl. prov.)-?Asia.—FIG. 163,1. **D. suecicus*, Swed.; 1a, cran., $\times 2$ (101); 1b, pyg., $\times 1$ (336).

Amphoton LORENZ, 1906 [**Dolichometopus deois* WALCOTT, 1905; SD KOBAYASHI, 1935]. Heteropygous. Glabella subcylindrical, extended to anterior border, occipital ring well defined; palpebral areas of fixigenae narrow, palpebral lobes slightly curved, upturned cephalic border narrow. Thorax with 7 segments bearing pointed pleurae. Pygidium with well-defined border and smooth outer surface (101). *M.Cam.*, E.Asia-E.Austral.

A. (Amphoton). Glabella with slightly concave sides, lacking lateral furrows; occipital ring very short, without median spine; palpebral lobes fairly long, situated opposite central portion of glabella; genal angles rounded, without genal spine. Pygidium almost semicircular, with 3 or 4 axial rings; pleural fields distinctly segmented, border wide, depressed; with shallow indentation behind moderately tapering axis (101). *M.Cam.*, E.Asia.—FIG. 163,5. **A. (A.) deois* (WALCOTT), ?Shantung; exoskel., $\times 2$ (101).

A. (Amphotonella) KOBAYASHI, 1942 [**Dolichometopus alceste* WALCOTT, 1905]. Differs from *A. (Amphoton)* in having tapered glabella with straight sides and 4 pairs of deeply impressed lateral furrows, longer occipital ring, genal angles with short, rapidly tapering genal spine, narrower pygidium with narrow border, rapidly tapering axis, median axial nodes, and posterior margin without indentation (101). *M.Cam.*, E.Asia-SE. Austral.—FIG. 163,2. **A. (A.) alceste* (WALCOTT), Shantung; 2a,b, ceph., pyg., $\times 1$ (101).

A. (Fuchouia) RESSER & ENDO in KOBAYASHI, 1935 [**Bathyriscus manchuriensis* WALCOTT, 1911]. Differs from *A. (Amphoton)* in having parallel-sided glabella with 3 pairs of lateral furrows, occipital node or short spine, palpebral lobes of medium length, long straight, slender genal spines, and pygidium with rapidly tapering axis of 5 or 6 rings, extremely narrow border, and posterior margin without indentation (101). *M.Cam.*, E.Asia.—FIG. 163,10. **A. (F.) manchuriensis* (WALCOTT), Manch.; 10a,b, ceph., pyg., $\times 2$ (101).

A. (Sunia) KOBAYASHI, 1942 [**A. (S.) typica*]. Differs from *A. (Amphoton)* in having long, stout occipital spine; long, stout, curved genal spines; and narrower pygidium, with narrow border and posterior margin without indentation (101). *M.Cam.*, E.Asia-NE.Austral.—FIG. 163,4. **A. (S.) typica*, Shantung; 4a-c, ceph., thoracic seg., pyg., $\times 1$ (101).

Anoria WALCOTT, 1924 [**Dolichometopus tontoensis* WALCOTT, 1916]. Cranidium without anterior border; glabella more or less clavate, smooth or indistinctly furrowed; axial furrow effaced be-

tween anterior corners of glabella; posterior areas of fixigenae rapidly tapering; palpebral lobes relatively short, slightly curved, situated opposite glabellar center; anterior sections of facial suture strongly converging toward frontal margin; librigenae with wide lateral border; genal angles produced into fairly strong, backward-directed genal spines. Thorax with 7 segments, wide axis, and pointed extremities, 5th segment commonly having long, backward-directed pleural spines. Pygidium slightly smaller than cephalon, relatively long, with evenly curved posterolateral margin, moderately tapering axis of 4 or 5 or more rings, indistinctly segmented pleural fields, and well-defined, wide, concave border (101, 316, 321). *M.Cam.*, N.Am.—FIG. 163,7. **A. tontoensis* (WALCOTT), Ariz.; exoskel. (reconstr.), $\times 0.5$ (488).

Asperocare V. POULSEN, 1958 [**A. argentinum*]. *M.Cam.*, S.Am. (Arg.).

Athabaskia RAYMOND, 1928 [**A. ostheimeri*]. Glabella extending to frontal margin, its anterior half strongly expanding, with 3 or 4 pairs of lateral furrows; palpebral lobes of medium size, close to posterior part of glabella; posterior areas of fixigenae slightly tapering, divided into subequal parts by deep posterior border furrow; librigenae with moderately convex border and stout, flat, rapidly tapering, backward-directed genal spines. Thorax with 7 or 8 segments bearing pointed extremities. Pygidium with fairly short, moderately tapering axis of 6 or 7 axial rings, distinctly marked pleural furrows becoming increasingly deep and wide on wide, concave, indistinctly defined border, and in some faintly marked interpleural grooves. ?*L.Cam.*, *M.Cam.*, N.Am.—FIG. 163,8. **A. ostheimeri*, Alba.; exoskel., $\times 0.5$ (101).

Athabaskiella KOBAYASHI, 1942 [**Bathyriscus (Poliella) probus* WALCOTT, 1916]. Differs from *Bathyriscidella* in having narrow anterior border in front of glabella (101, 317). *M.Cam.*, N.Am.—FIG. 163,9. **A. proba* (WALCOTT), Utah; 9a, cran., $\times 4$; 9b, pyg., $\times 5$ (317).

Bathyriscidella RASETTI, 1948 [**B. socialis*]. Exoskeleton tapering from large cephalon to small pygidium. Glabella narrow, somewhat expanded anteriorly, reaching front margin, with 1 to 3 pairs of shallow anterior lateral furrows and a well-impressed oblique posterior pair; occipital ring very long; anterolateral border fairly narrow, upturned; eye ridges present; palpebral lobes relatively short, situated opposite or anterior to glabellar center; anterior sections of facial sutures straight between eyes and anterior border, parallel to axial furrows; posterior sections defining wide, triangular posterior areas of fixigenae; librigenae wide, with short, stout, somewhat outward-directed genal spine. Thorax with 9 segments, having narrow convex axis and flat, broadly furrowed

pleurae that terminate in sharp, obliquely backward-directed spines, those of 5th and 8th segments longer than others (in type species). Pygidium with few segments, approximately semi-circular, with very prominent axis, postaxial ridge,

flat pleural regions, shallow pleural furrows and interpleural grooves, and poorly defined border, which may bear marginal spines (196). *M. Cam.*, E.N.Am.—FIG. 163,6. **B. socialis*, Que.; 6a,b, cran., librigena, X3; 6c, hypostoma, X4; 6d, 2nd-

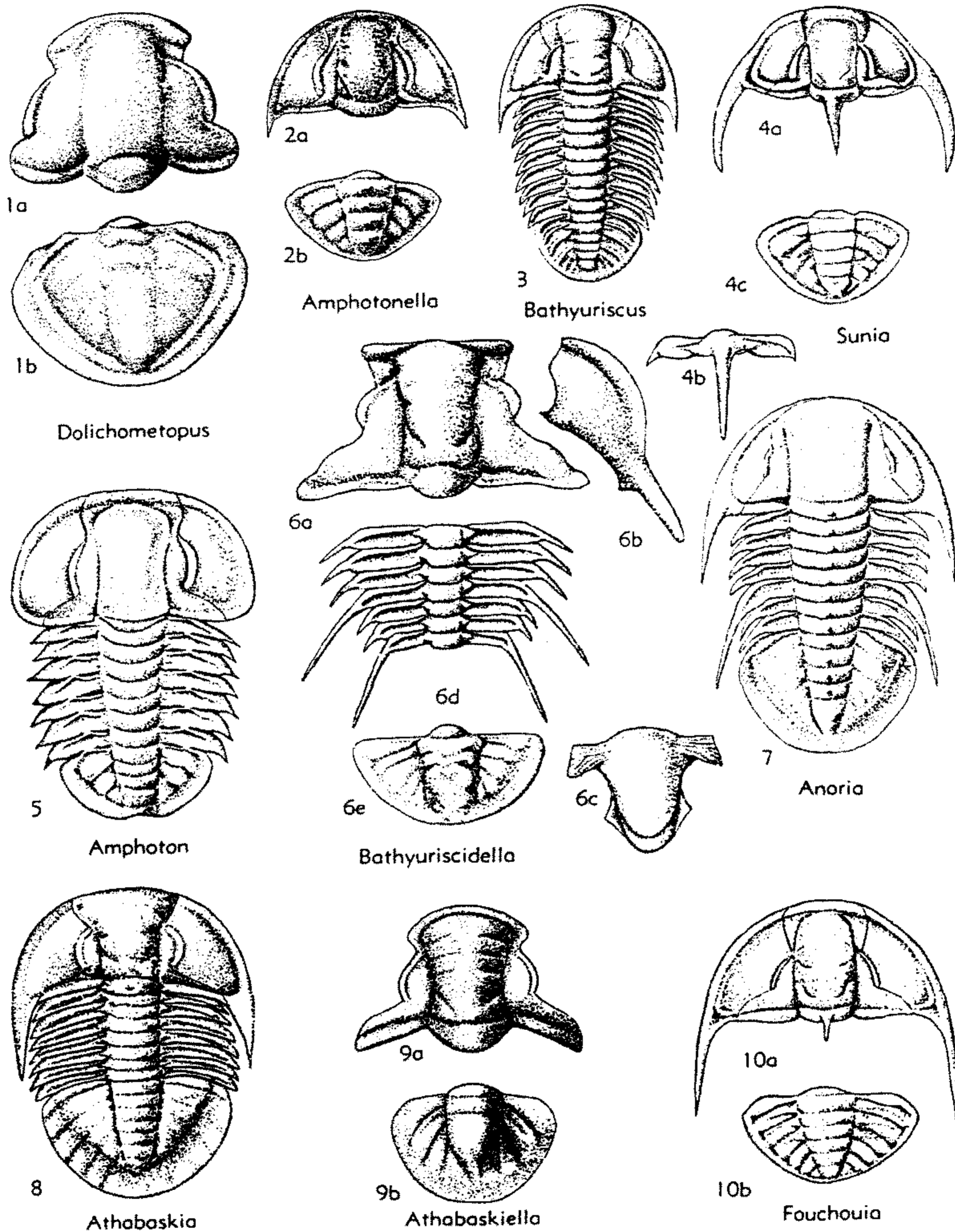

FIG. 163. Dolichometopidae (p. 0222-0224).

- 8th thoracic segments, $\times 6$; 6e, pyg., $\times 3$ (196).
Bathyriscus MEEK, 1873 [**Bathyriscus? haydeni*]. Differs from *Bathyriscidella* in having narrow anterior border in front of glabella; short occipital ring; narrower fixigenae with more slowly tapering posterior areas; longer, more posteriorly placed palpebral lobes; pointed pleurae or very short pleural spines; and larger pygidium with about 7 axial rings, deeper pleural furrows and interpleural grooves, narrower, well-defined border, and in some a pair of lateral spines (101, 197, 317). *M.Cam.*, N.Am.-?Eng.—FIG. 163,3. *B. rotundatus* (ROMINGER), W.Can.(B.C.); exoskel., $\times 1$ (317).
- Chilometopus** RUSCONI, 1952 [**C. asperoensis*]. Differs from *Bathyriscus* in having narrower anterior area of fixigenae, longer, more prominent palpebral lobes, and smaller, very short (associated) pygidium of few segments with much more prominent, indistinctly segmented axis (259). *M.Cam.*, Arg.
- Chilonorria** RUSCONI, 1952 [**C. perlotii*]. Differs from *Orria* in having semicircular pygidium with longer axis. Cephalon and thorax unknown (259). *M.Cam.-U.Cam.*, Arg.
- Clavaspidella** POULSEN, 1927 [**C. sinupyga*]. Differs from *Athabaskia* in having much wider palpebral and narrower posterior areas of fixigenae; relatively long, well-defined eye ridges; and pygidium with narrower axis, distinct border furrow, and broad, shallow marginal indentation behind axis (101, 172). *M.Cam.*, NW.Greenl.-?Arg.—FIG. 164,1. **C. sinupyga*; 1a,b, ceph., pyg., $\times 1$ (101).
- Corynexochides** RASETTI, 1948 [**C. gregarius*]. Differs from *Bathyriscidella* in having longer palpebral lobes, narrower posterior area of fixigenae, thorax of ?7 segments with bluntly terminating pleurae, and only 1st pygidial segment well differentiated (196). *M.Cam.*, E.N.Am.
- Dolichometopsis** POULSEN, 1927 [**D. resseri*]. Glabella parallel-sided to slightly clavate, reaching narrow, slightly convex anterior border, with 3 or 4 pairs of lateral furrows; occipital furrow deeply impressed; palpebral lobes moderately curved, about half as long as glabella, terminating opposite occipital furrow and anteriorly almost touching axial furrows, fixigenae here being almost completely reduced; posterior areas of fixigenae slightly wider than glabella; anterior sections of facial sutures diverging between eyes and anterior border; librigenae with almost flat lateral border, well-marked border furrow, and long flat slightly curved genal spine projecting from more or less rounded genal angle. Associated pygidium small, transverse, with short axis, 4 or 5 axial rings; wide, shallow pleural furrows, interpleural grooves between raised pleural edges; poorly defined border; and entire margin with shallow indentation behind axis (101, 172). *Up. L.Cam.*, NW.Greenl.-?N.Am.—FIG. 164,3. **D. resseri*, NW.Greenl.; 3a,b, ceph., pyg., $\times 2$ (101, slightly modified).
- Glossopleura** POULSEN, 1927 [**Dolichometopus boccar* WALCOTT, 1916] [*?=Sonoraspis* STOYANOW, 1952]. Differs from *Anoria* in its much longer palpebral lobes and wider, slightly tapering posterior areas of fixigenae (101, 172, 317). *M.Cam.*, N.Am.-NW.Greenl.-S.Am.(Arg.). —FIG. 164,2. **G. boccar* (WALCOTT), Mont.; exoskel. (reconstr.), $\times 1$ (317).
- Hemirhodon** RAYMOND, 1937 [**H. schucherti*]. Glabella moderately convex, expanding from poorly defined occipital ring, reaching anterior margin; lateral furrows indistinct or effaced; anterior and palpebral areas of fixigenae very narrow, and posterior areas moderately wide, with rapidly tapering lateral extremities; palpebral lobes extremely short, moderately curved. Thoracic axis less than 0.3 of width of thorax; pleurae flat, with shallow furrows, terminating in falcate points. Pygidium about same in size as cephalon, almost flat, with little relief, nearly semicircular, with narrow, rapidly tapering axis of about 6 rings extending to wide, slightly concave border which may have a median marginal notch (101, 193, 213). *U.M.Cam.-U.Cam.*, N.Am.—FIG. 164,9a. **H. schucherti*, U.Cam., Vt.; cran. and thoracic segs., $\times 2$ (213). —FIG. 164,9b, *H. simplex* RASETTI, U.Cam., Que.; pyg., $\times 3$ (193).
- Klotziella** RAYMOND, 1928 [**Bathyriscus ornatus* WALCOTT, 1908]. Differs from *Bathyriscidella* in having narrow anterior border in front of glabella, more rapidly tapering posterior areas of fixigenae, extremely short palpebral lobes, narrower librigenae without genal spine; thoracic segments (except 1st) with rounded extremities; and larger pygidium with very narrow border (101, 197, 317). *M.Cam.*, N.Am.
- Mendospidella** RUSCONI, 1952 [**M. asperoensis*]. Differs from *Athabaskia* in having shorter pygidium with more tapering axis and strongly marked interpleural grooves (259). *M.Cam.*, Arg.
- Neochilonorria** RUSCONI, 1953 [**N. coronillensis*]. Differs from *Chilonorria* in having pygidial pleural furrows and interpleural grooves defined by very sharp ridges. Cephalon and thorax unknown (260). *U.Cam.*, Arg.
- Orria** WALCOTT, 1916 [**O. elegans*]. Glabella narrow, parallel-sided, reaching narrow anterior border, with 4 pairs of indistinctly defined lateral furrows; anterior and palpebral areas of fixigenae very narrow, and posterior areas very wide, extending obliquely backward to genal angles, divided into subequal parts by wide and deep posterior border furrow; palpebral lobes of medium size, slightly behind glabellar center; anterior sections of facial suture parallel between eyes and anterior border; librigenae wide, with irregular network of raised lines, and short back-

ward-directed genal spine. Thorax with 9 segments, axis narrow, pleurae horizontal, broadly furrowed, and obliquely truncated. Pygidium semielliptical, longer than cephalon, with short axis of 8 or 9 rings, strongly marked pleural furrows and inter-

pleural grooves, and very narrow, raised border (101, 317). *M. Cam.*, N. Am.—FIG. 164, 4. **O. elegans*, Utah; exoskel., X0.5 (317). Orriella RASETTI, 1948 [**O. gaspensis*]. Intermediate between *Bathyriscus* and *Orria*, differing from

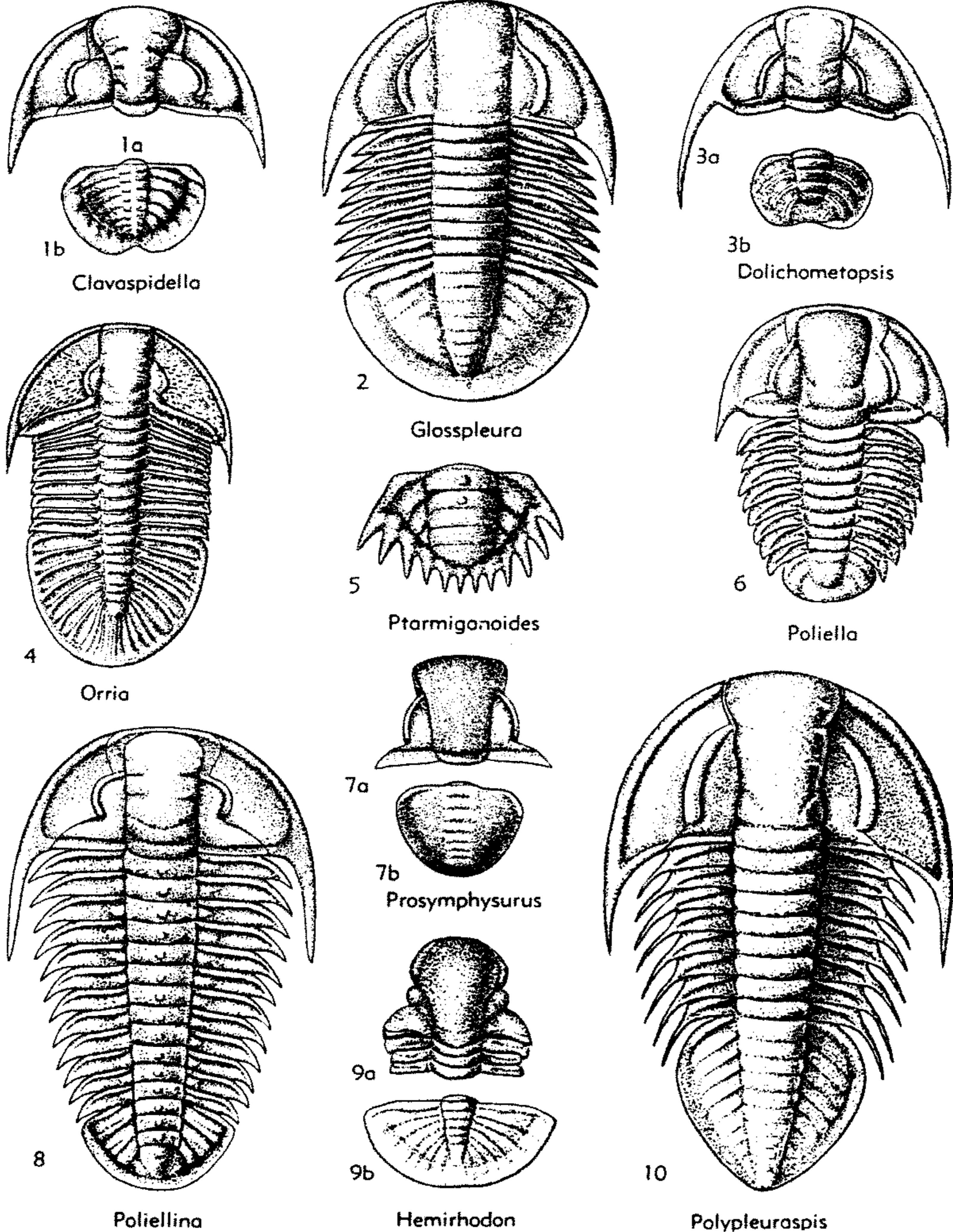

FIG. 164. Dolichometopidae (p. 0224-0226).

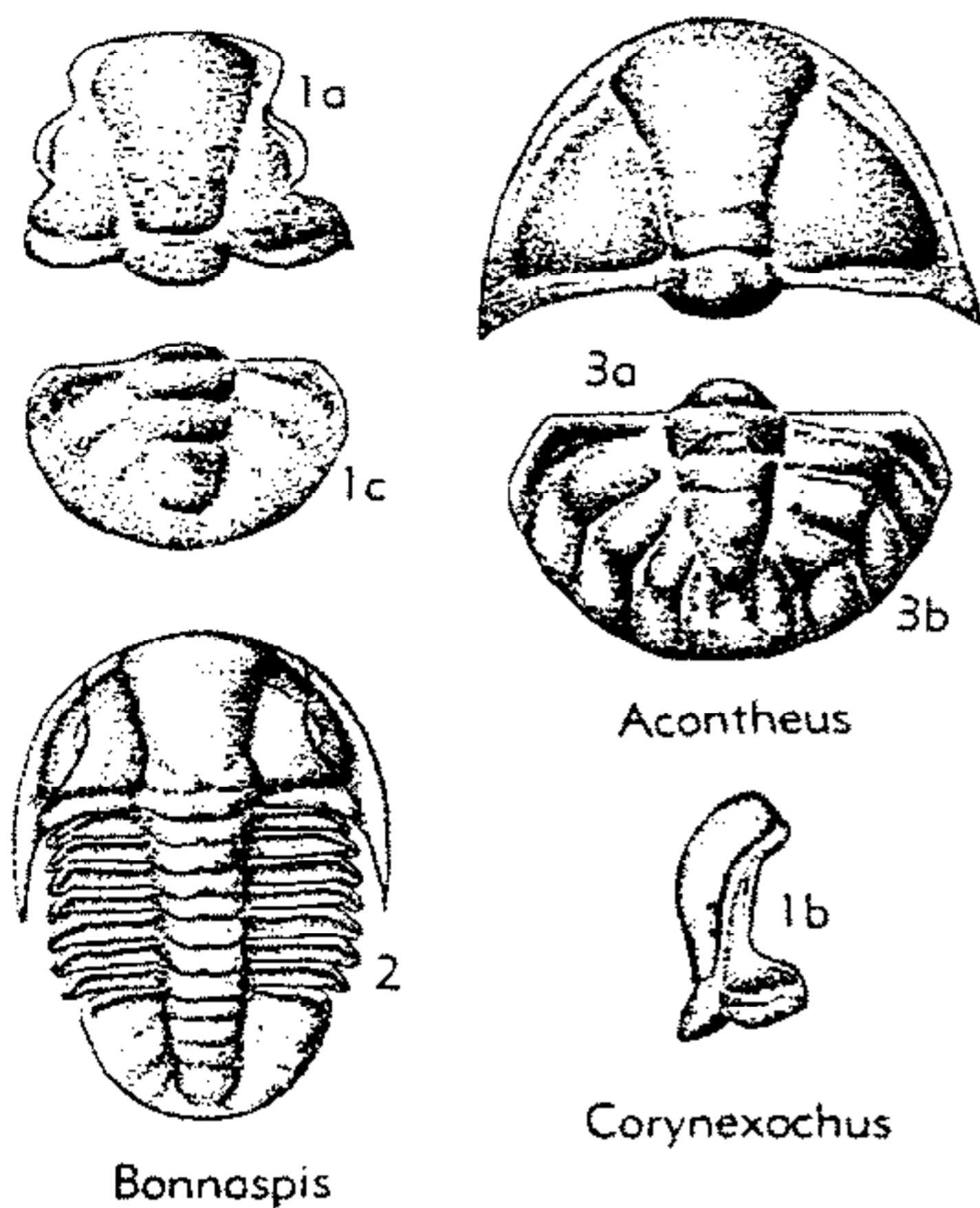

FIG. 165. Corynexochidae (p. 0227).

the former in having much longer palpebral lobes, no anterior border in front of glabella, presence of occipital spine, and short pygidial axis; differing from the latter in having deeper axial furrow, more prominent glabella, wider anterior and narrower posterior areas of fixigenae, and fewer pygidial segments (196). *M.Cam.*, E.N.Am.

Parapoliella CHERNYSHEVA, 1956 [**Olenoides obrutchevi* LERMONTOVA, 1925]. *Up.L.Cam.*, USSR.

Parkaspis RASETTI, 1951 [**P. endecamera*]. Differs from *Bathyriscus* in having 10 or 11 thoracic segments (*B.* has 9), smaller pygidium without border and with fewer segments, indistinctly marked interpleural grooves, and denticulated margin (197). *M.Cam.*, N.Am.

Poliella WALCOTT, 1916 [**Bathyriscus (P.) anteros*] [= *Bornemannia* VOGDES, 1925]. Differs from *Bathyriscus* in having only one pair of distinctly marked glabellar furrows, 7 to 11 thoracic segments, shorter pygidium with 2 or 3 axial rings, faintly marked or effaced interpleural grooves, indistinct border, with denticulate margin or median marginal notch in some (101, 317). *L.Cam.-M.Cam.*, N.Am.—FIG. 164,6. **P. anteros*, *M.Cam.*, Idaho; exoskel., $\times 2$ (317).

Poliellaspis LERMONTOVA, 1940 [**Poliellina sayanica* POLETAYEVA, 1936]. *M.Cam.*, Asia.

Poliellina POLETAYEVA, 1936 [**P. lermontovae*]. Differs from *Poliella* in having up to 4 pairs of distinct lateral glabellar furrows, relatively short, strongly curved palpebral lobes, thorax of 10 to 12 segments with axial nodes and better-developed pleural spines, and pygidium with axial nodes and distinctly defined border (101, 117). *M.*

Cam., Asia-N.Am.—FIG. 164,8. **P. lermontovae*, Sib.; exoskel. (reconstr.), $\times 2$ (101).

Polypleuraspis POULSEN, 1927 [**P. solitaria*]. Differs from *Glossopleura* in having more prominent axis; narrower thorax with long, obliquely backward-directed pleural spines; and much longer, more convex pygidium with about 10 fairly well-marked segments and narrower border (197). *M.Cam.*, NW.Greenl.-N.Am.—FIG. 164,10. *P. insignis* RASETTI, W.N.Am.; exoskel., $\times 2.5$ (197).

Prosymphysurus POULSEN, 1927 [**P. kochi*]. Differs from *Glossopleura* in having evenly arched cranium and almost evenly arched pygidium with flat, indistinctly defined axis, unfurrowed pleural field, and narrower, slightly convex border (101, 172). *M.Cam.*, NW.Greenl.—FIG. 164,7. **P. kochi*; 7a, cran., $\times 2$; 7b, pyg., $\times 1$ (172).

Ptarmigania RAYMOND, 1928 [**Bathyriscus rossensis* WALCOTT, 1917]. Differs from *Dolichometopsis* in having appreciably wide fixigenae at anterior end of palpebral lobes, well-defined eye ridges, and pygidium with flat marginal spines or scallops and pleural furrows extending across wide border almost to margin (101, 197). *M.Cam.*, N. Am.

Ptarmiganoides RASETTI, 1951 [**P. bowensis*]. Differs from *Dolichometopsis* in having longer pygidial axis and margin of pygidium extended into at least 4 pairs of strong, cylindrical spines (197). *M.Cam.*, N.Am.—FIG. 164,5. **P. bowensis*, W.Can.; pyg., $\times 3$ (197).

Wenkchemnia RASETTI, 1951 [**W. walcotti*]. Differs from *Poliella* in having shorter palpebral lobes, rapidly tapering posterior areas of fixigenae, and last thoracic segment less curved, not enveloping pygidium (197). *M.Cam.*, N.Am.

Family CORYNEXOCHIDAE Angelin, 1854

Dorsal exoskeleton small, opisthoparian, subovate to subelliptical, moderately convex, heteropygous to almost isopygous. Glabella clavate, extended to anterior margin, lateral furrows more or less effaced; fixigenae moderately wide, librigenae narrow; palpebral lobes of small to medium size, placed opposite or a little posterior to glabellar center. Thorax (as far as known) with 7 segments. Pygidium, semicircular with 2 to 5 indistinctly defined axial rings, border slightly convex and margin entire. Hypostoma fused with rostral plate, the latter forming strong "anterior wings." *M.Cam.*

Subfamily CORYNEXOCHINAE Angelin, 1854

[*nom. transl.* RAYMOND, 1928 (ex Corynexochidae ANGELIN, 1854)]

Corynexochidae with eyes and facial sutures. *M.Cam.*

Corynexochus ANGELIN, 1854 [**C. spinulosus*] [= *Karlia* WALCOTT, 1889]. Exoskeleton elongate oval. Glabella strongly expanding from base to front; occipital ring long; anterior area of fixigenae extremely narrow; eyes of medium size. Thoracic pleurae deeply furrowed, pointed (233, 336). *M. Cam.*, Eu.-E.N.Am. (Atl. prov.)-N.E. Austral.-Asia.—FIG. 165,1. **C. spinulosus*, Swed.; 1a,b, cran., dorsal, lateral, $\times 4$; 1c, pyg., $\times 4$ (336).

Bonnaspis RESSER, 1936 [**Karlia stephenensis* WALCOTT, 1889]. Differs from *Corynexochus* in its nearly even elliptical outline, short occipital ring, wider anterior area of fixigenae, small eyes, bluntly terminating thoracic pleurae, and larger pygidium (233). *M. Cam.*, N.Am.—FIG. 165,2. **B. stephenensis* (WALCOTT), B.C.; exoskel. (reconstr.), $\times 2$ (317).

Corynexochina LERMONTOVA, 1940 [**C. weberi*]. *M. Cam.*, USSR.

Subfamily ACONTHEINAE Westergård, 1950

Small forms lacking eyes and facial sutures; otherwise resembling *Corynexochinae* but somewhat doubtfully classed in the same family. *M. Cam.*

Acontheus ANGELIN, 1851 [**A. acutangulus*] [= *Aneucanthus* ANGELIN, 1854 (obj.); *Aneucanthus* BARRANDE, 1856 (obj.)] (337). *M. Cam.*, Swed.-Br.I.—FIG. 165,3. **A. acutangulus*, Swed.; 3a,b, ceph., pyg., $\times 4$ (337).

Family ZACANTHOIDIDAE Swinnerton, 1915

[*nom. correct.* RICHTER, 1933 (pro *Zacanthoidae* SWINNERTON, 1915)] [= *Albertellidae*, *Mexicaspinae*, *Vanuxemellinae* HUPÉ, 1953]

Exoskeleton slender, of low convexity. Glabella long, parallel-sided or expanded forward, generally with 4 pairs of lateral furrows. Palpebral lobes long, semicircular, close to glabella; frontal area usually reduced to anterior border, rarely obsolete; posterior areas slender, in some genera bearing metafixigenal spines; genal spines present. Hypostoma fused with rostral plate. Thorax of 4 to 9 segments; axial rings usually spinose; pleurae generally bearing elongate, triangular ridges at proximal end, extended into long spines; macropleural segments may be present. Pygidium smaller than cephalon; axis of 4 to 8 segments; pleural fields with marginal spines. Closely allied to and not sharply separated from *Corynexochidae*. *L. Cam.-M. Cam.* (236, 197, 130).

Zacanthoides WALCOTT, 1888 [pro *Embolimus* ROMINGER, 1887 (non AGASSIZ, 1846; nec MARSHALL, 1868; nec WEISE, 1902)] [**Z. romingeri* RESSER, 1942 (pro *Embolimus spinosa* ROMINGER,

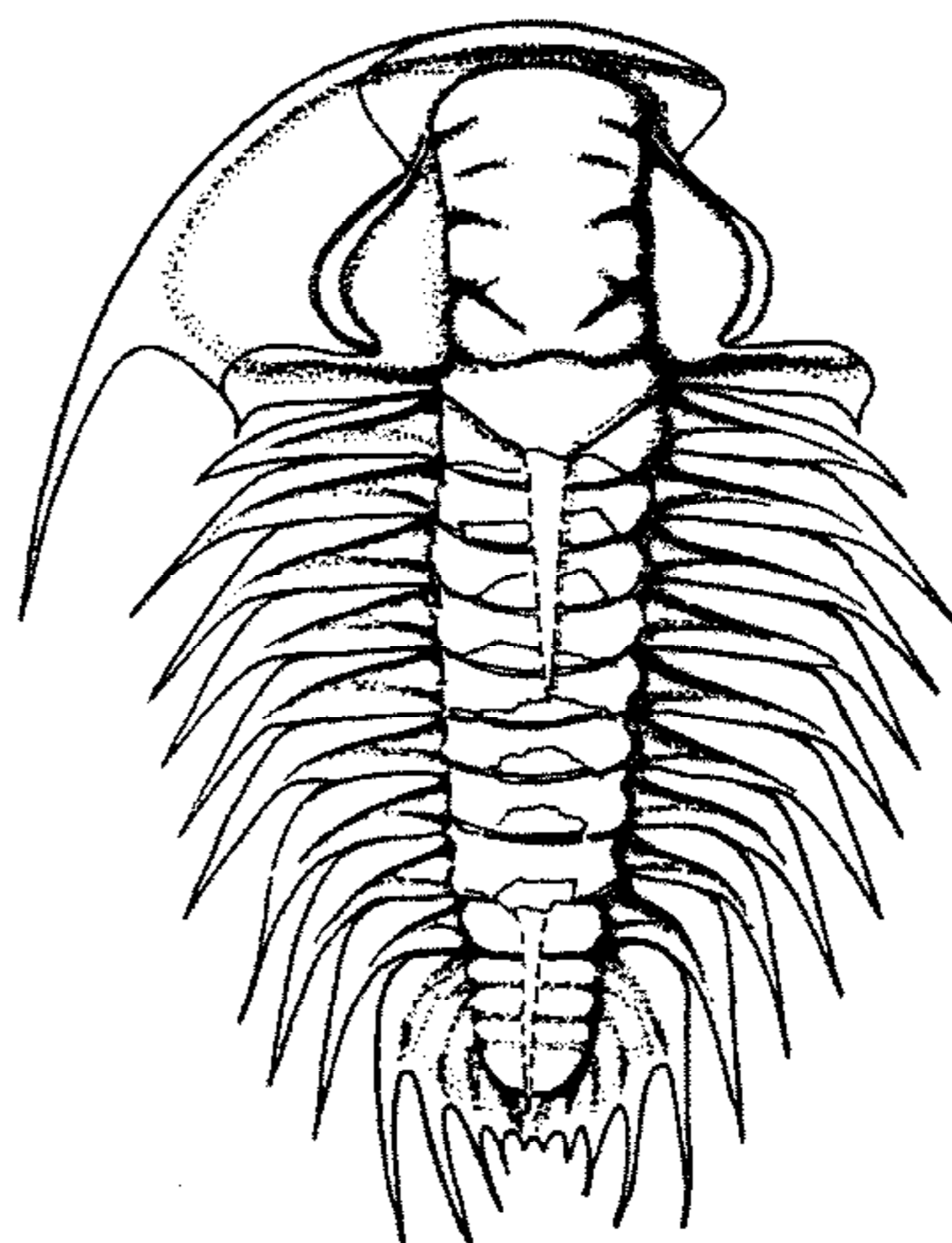

FIG. 166. **Zacanthoides romingeri* WALCOTT (*Zacanthoididae*), *M. Cam.*, W.Can. (B.C.); exoskel., $\times 0.6$ (448n).

1887, non *Ogygia? spinosa* WALCOTT, 1884); SD RESSER, 1942]. Glabella parallel-sided; metafixigenal spines present. Thorax of 9 segments; pleurae obliquely furrowed; no macropleural segments. Pygidium with elevated, abruptly terminated axis; general outline subtriangular; pleural fields flat; marginal furrow and border indistinct; pleurae directed backward, extended into several pairs of marginal spines. *M. Cam.*, N.Am.—FIG. 166. **Z. romingeri*, W.Can. (B.C.); exoskel., $\times 0.6$ (448n). *Albertella* WALCOTT, 1908 [**A. helena*]. Glabella parallel-sided; eyes of variable length; no metafixigenal spines. Thorax of 7 segments; third or fourth segment macropleural. Pygidium with one pair of marginal spines. *M. Cam.*, N.Am.—FIG. 167,3a,b. *A. limbata* RASETTI, W.Can. (B.C.); 3a,b, cran., pyg., $\times 3$ (448n).—FIG. 167,3c. *A. bosworthi* WALCOTT, W.Can. (B.C.); exoskel., $\times 1$ (448n).—FIG. 167,3d. **A. helena*, Mont.; exoskel., $\times 1$ (448n).

Fieldaspis RASETTI, 1951 [**F. furcata*]. Glabella expanded forward; eyes long; palpebral lobes close to axial furrow at both ends; no metafixigenal spines. Thorax of 9 segments, none macropleural; pygidial margin extended into pair of spines or rounded lobes. *M. Cam.*, N.Am.—FIG. 168,1a-e. **F. furcata*, W.Can. (B.C.); 1a, cran., $\times 1.5$; 1b, librigena, $\times 1.5$; 1c,d, hypostoma, ventral, lateral, $\times 4$; 1e, pyg., $\times 1.5$ (448n).—FIG. 168,1f,g. *F. superba* RASETTI, W.Can. (B.C.); 1f,g, cran., pyg., $\times 1$ (448n).

Mexicaspis LOCHMAN, 1948 [**M. stenopyge*]. Glabella expanded forward; axial furrow shallow; eyes

short; no metafixigenal spines. Pygidium elongated, with 2 pairs of large, backward-directed spines. *M. Cam.*, N.Am.—FIG. 168.4. **M. stenopyge*, Mex.(Sonora); 4a, cran., X1.4; 4b, pyg., X2 (130).

Prozacanthoides RESSER, 1937 [**Olenoides stissingensis* DWIGHT, 1889]. Cephalon as in *Zacanthoides*. Pygidial pleurae not directed sharply backward. *L. Cam.*, N.Am.—FIG. 168.2. *P. virginicus* RESSER, Va.; 2a,b, cran., pyg., X2 (448n).

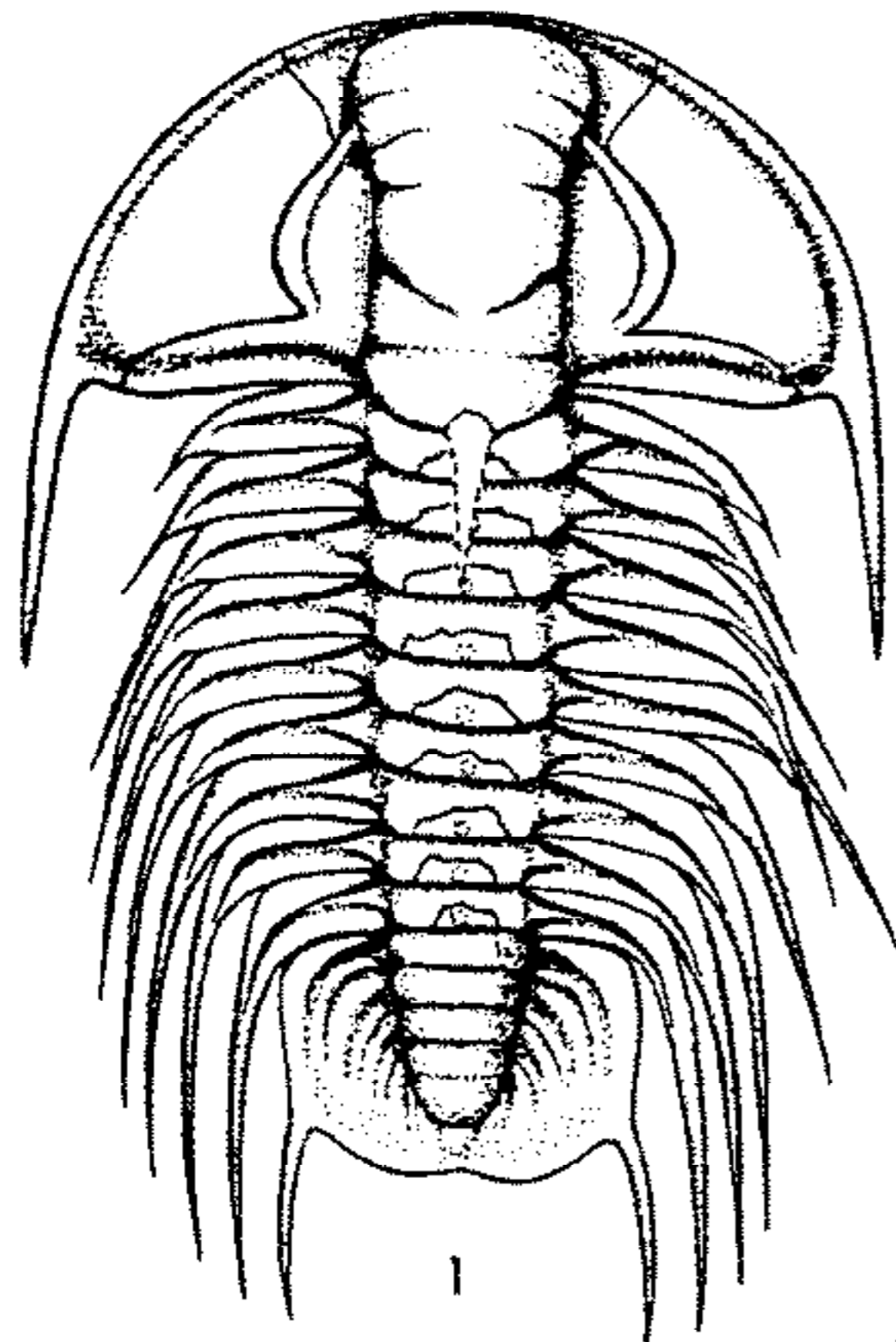

Stephenaspis

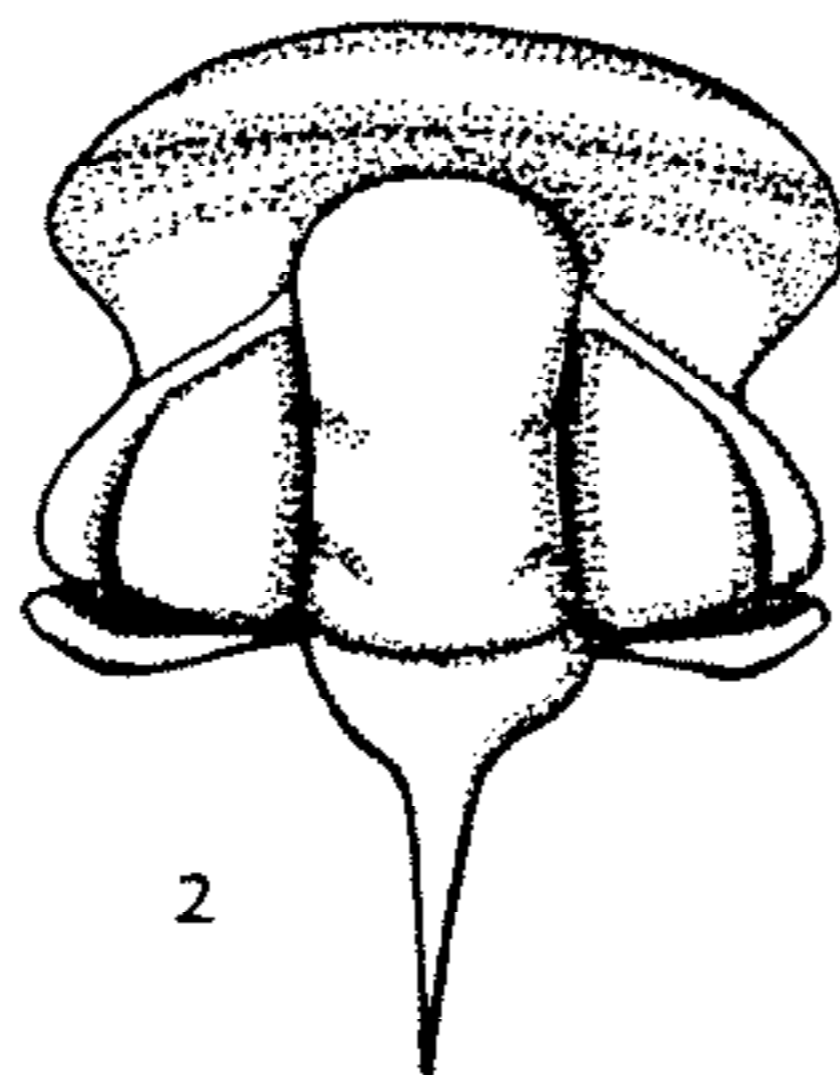

Zacanthopsis

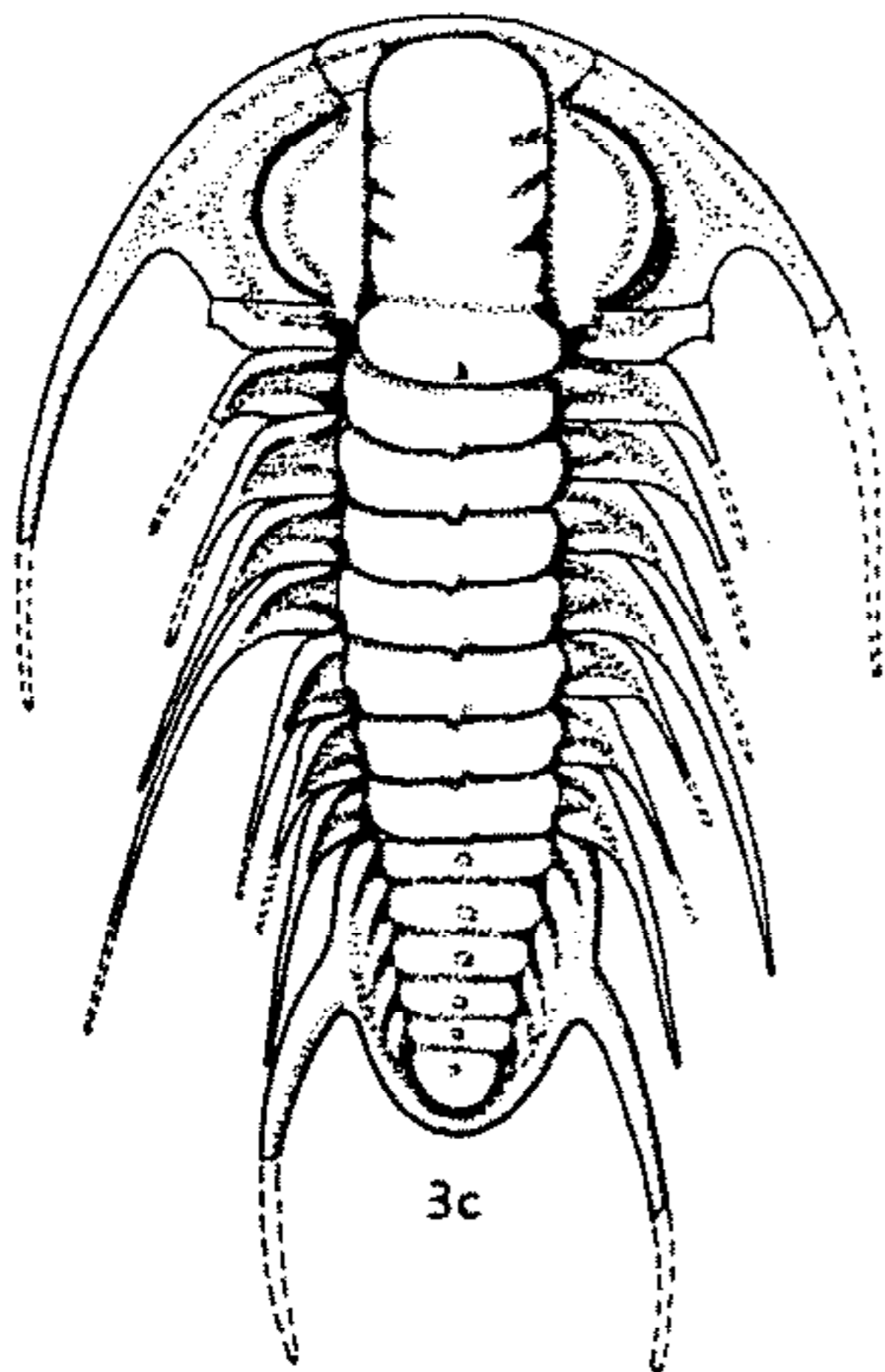
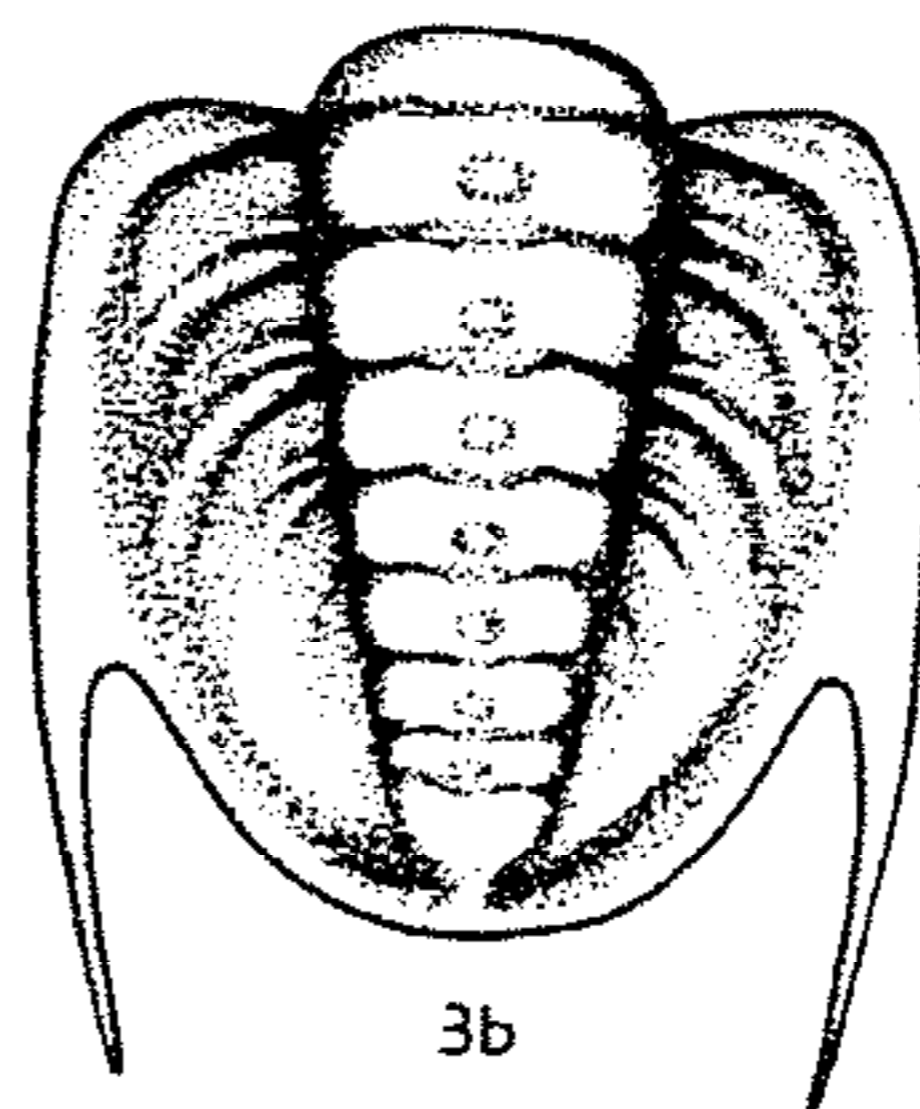
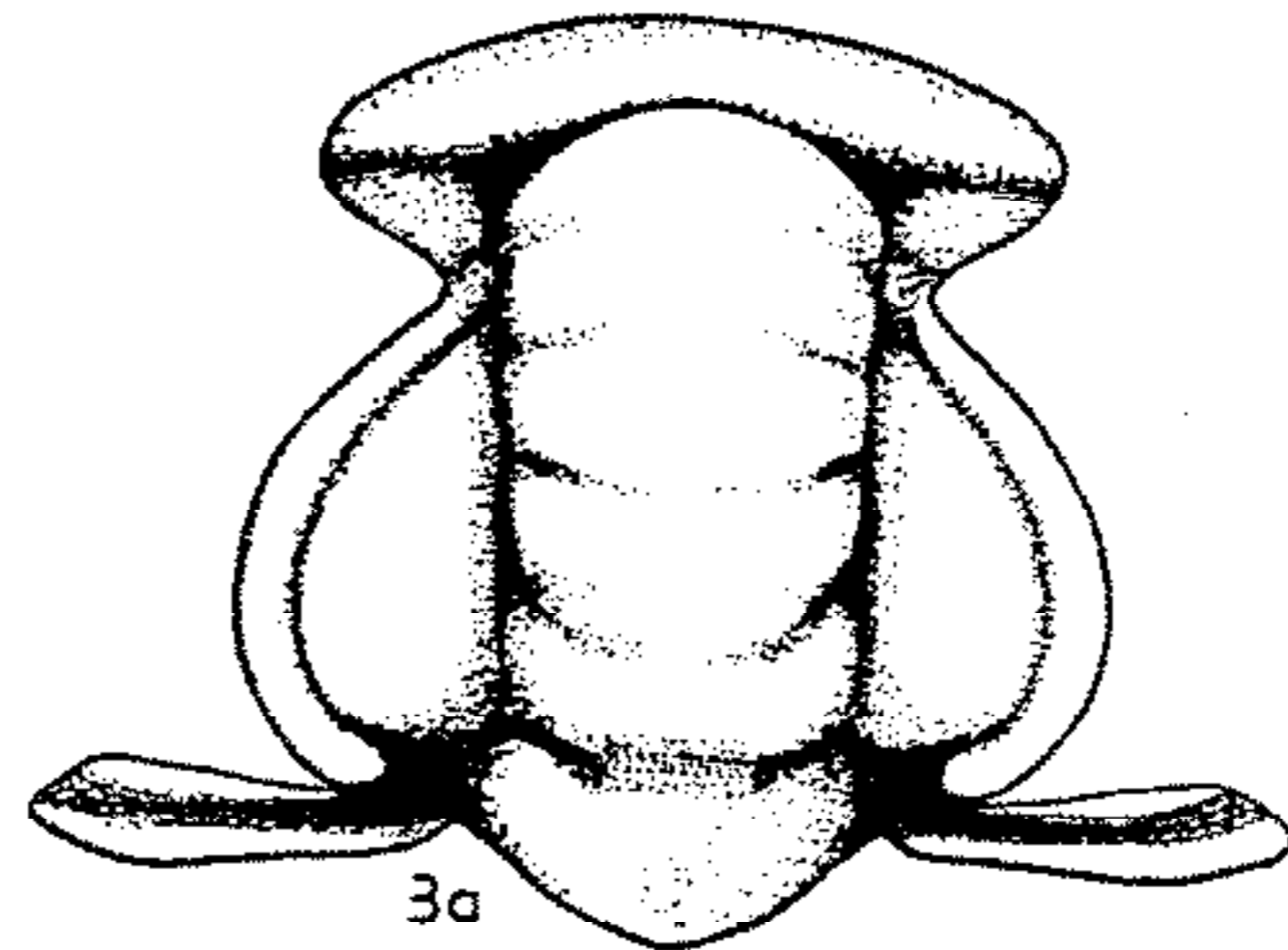

Albertella

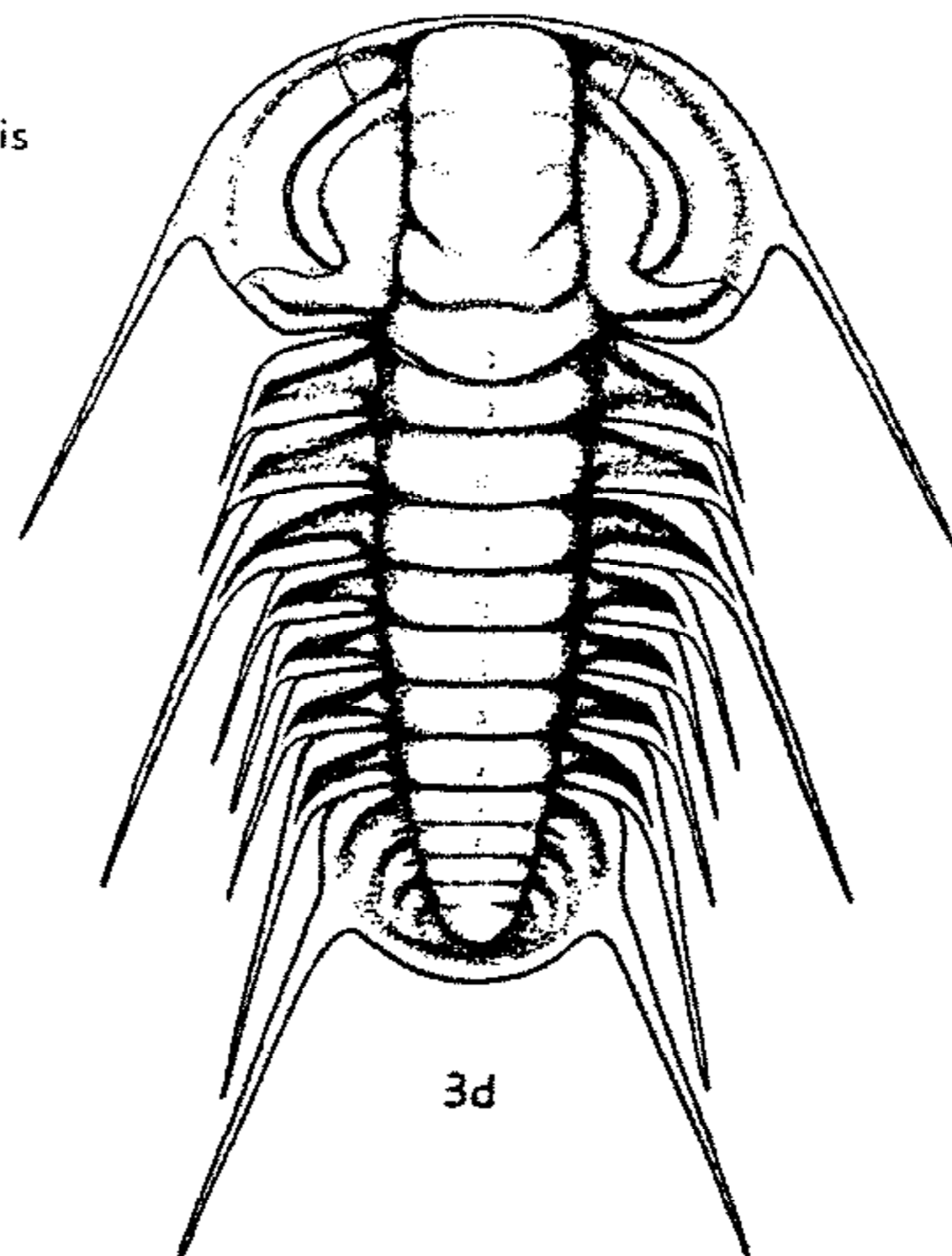

FIG. 167. Zacanthoididae (p. 0227-0230).

Stephenaspis RASSETTI, 1951 [**S. bispinosa*]. Cephalon as in *Fieldaspis*. Thorax of 9 segments, with axial spines. Pygidium subrectangular, with median

notch and pair of marginal spines. *M. Cam.*, N. Am. —FIG. 167, 1. **S. bispinosa*, W. Can. (B.C.); exoskel., $\times 1$ (448n).

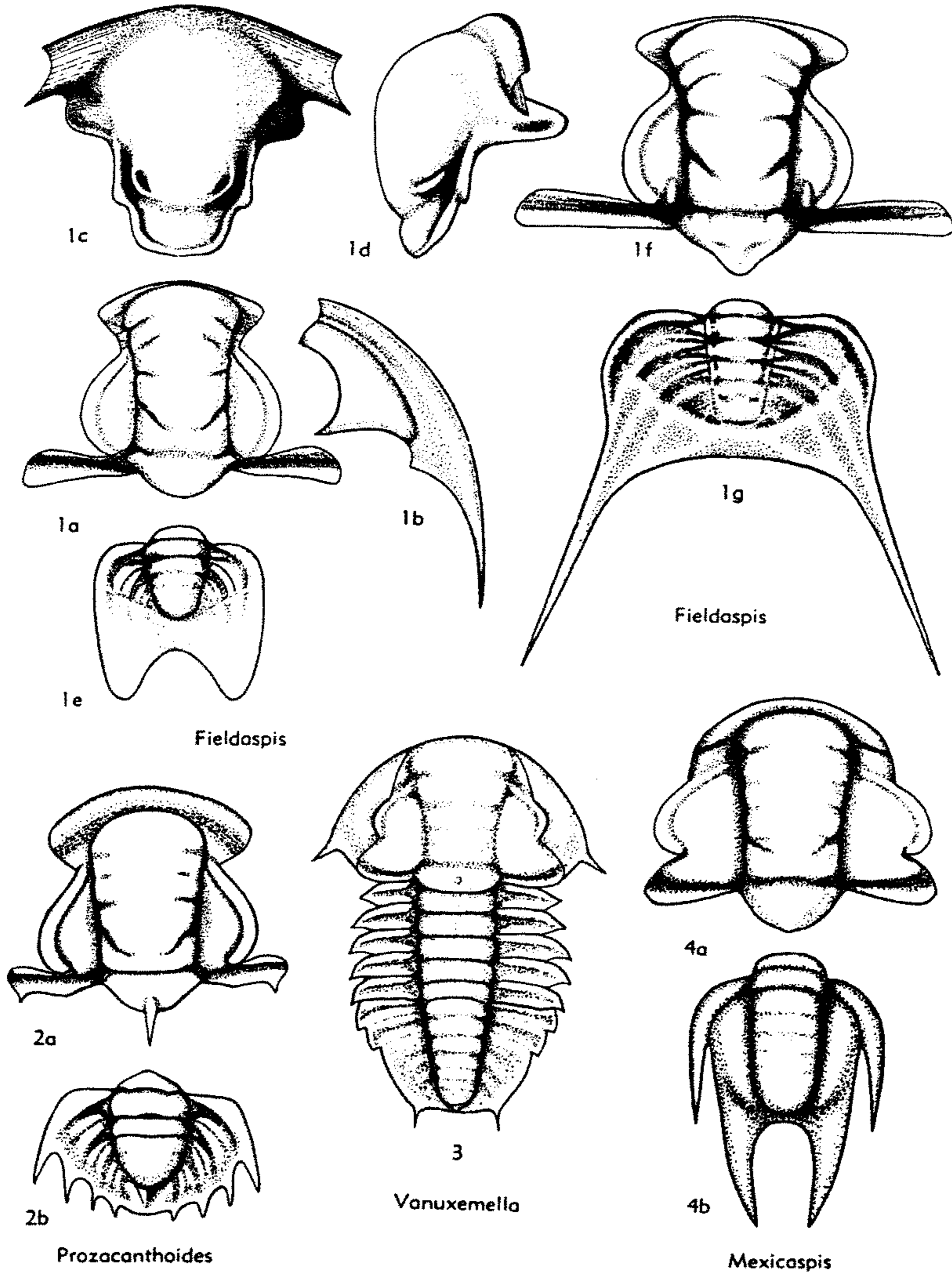

FIG. 168. Zecanthoididae (p. 0227-0230).

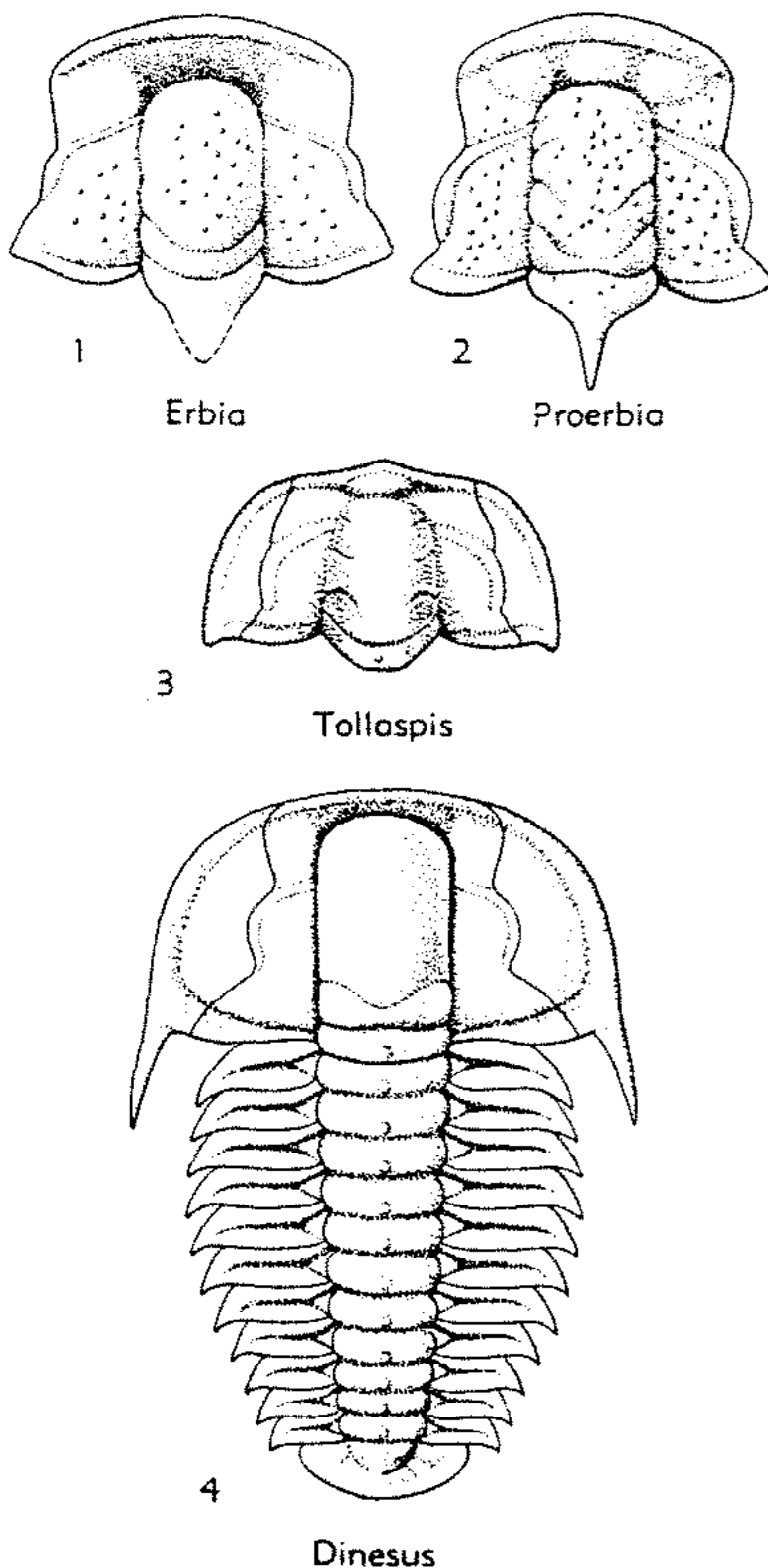

FIG. 169. Dinesidae (p. O230-O231).

Vanuxemella WALCOTT, 1916 [**V. contracta*] [= *Vistoia* WALCOTT, 1925]. Glabella expanded forward; axial and glabellar furrows shallow; palpebral lobes short; genal spines small; anterior border obsolete; librigenae narrow. Thorax of 4 or 5 segments; pleurae bluntly terminated. Pygidium trapezoidal; axis long, prominent; first 2 or 3 pleural segments less fused and extended into lateral spines; a pair of posterior marginal spines; size small. *M.Cam.*, N.Am.—FIG. 168,3. *V. nortia* WALCOTT, W.Can.(B.C.); exoskel., $\times 2$ (448n).

Zacanthopsis RESSER, 1938 [**Olenoides levis* WALCOTT, 1886]. Differs from *Prozacanthoides* in shorter palpebral lobes, greater development of fixigenae in front of eyes, and posterior areas not extending much beyond palpebral lobes; frontal

area concave. *L.Cam.*, N.Am.—FIG. 167,2. *Z. virginica* RESSER, Va.; cran., $\times 2$ (448n).

Family DINESIDAE Lermontova, 1940

[= *Tollaspidae* KOBAYASHI, 1943; *Proerbiidae* HUPÉ, 1953; also *Dinesidae* HUPÉ, 1953, introduced as new family, evidently without knowledge of LERMONTOVA's prior publication]

Exoskeleton opisthoparian, elliptical, micro-pygous. Glabella hemicylindrical, front rounded, with 4 or fewer pairs of lateral furrows; eye ridges narrow but distinct, palpebral rim and furrow present, occipital spine present or absent; preglabellar field crossed by pair of furrows running diagonally outward from anterior corners of glabella, anterior border furrow narrow and curved, anterior border narrow; eyes of medium size, position variable; fixigenae very convex, horizontal, palpebral areas, about 0.75 of glabellar width, posterior area triangular, as long (*tr.*) or longer than occipital ring; librigenae quadrangular, with rounded genal angle or rather short genal spine. Thorax with 11 to 13 segments; axis wide, convex, with lateral nodes; pleurae about same in width (*tr.*), flat, with short curved spine at end and broad deep pleural furrow. Pygidium very small, transverse; axis wide, convex broadly rounded, 0.5 of length, may have 1 axial ring and terminal; pleural fields low, narrower, 1 or 2 pleurae may show faintly, without border furrow, border ill defined, narrow. Outer surface granular. *Up.L.Cam.-Low.M.Cam.*

Dinesus ETHERIDGE, JR., 1896 [**D. ida*]. Glabella with single pair of posterior lateral furrows curved back to occipital furrow to produce basal lobes, with occipital node or small spine; preglabellar field very narrow; eyes of medium size, opposite center of glabella; fixigenae with palpebral areas more than 0.5 of glabellar width, posterior areas same length (*tr.*) as occipital ring. Thorax of 11 segments with short median axial spines or nodes. Pygidium narrowly transverse; axis semicircular, with poorly defined axial furrow; all pleural furrows obsolete (97, 340). *Low.M.Cam.*, Austral.—FIG. 169,4. **D. ida*, NW. Queensl.; exoskel., $\times 1$ (411).

Erbia LERMONTOVA, 1940 [**Cyphaspsis sibirica* SCHMIDT, 1886] [= *Paratollaspis* KOBAYASHI, 1943 (obj.)]. Glabella convex to globose, with single pair of deep posterior lateral furrows curved posteriorly, may touch occipital furrow to form basal lobes, with stout broad-based occipital spine; preglabellar field of variable width, depressed; eyes below medium size, near center of glabella; fixigenae with palpebral areas 0.75 of glabellar width,

posterior areas longer (*tr.*) than occipital ring; librigenae with short genal spine. Thorax with 11 to 13 segments. Pygidium narrow-transverse; axis short and wide, with 1 or 2 poorly defined axial rings; pleurae 1 or 2, poorly defined (117). *Low. M. Cam., Sib.*—FIG. 169,1. **E. sibirica* (SCHMIDT), near Krasnoyarsk; cran., $\times 2$ (411).

Proerbia LERMONTOVA, 1940 [**P. prisca*]. Glabella strongly convex, with 4 pairs of lateral furrows, anterior 2 pairs short, faint, diagonal forward, posterior 2 pairs strong, curved backward, last pair may touch occipital furrow, with occipital spine; preglabellar field of medium width, divided longitudinally by 2 additional furrows into 3 oval convex areas; eyes slightly above medium size, located a little behind center of glabella; fixigenae with palpebral areas slightly less than glabellar width, posterior areas same length (*tr.*) as occipital ring. Librigenae, thorax, and pygidium unknown. Surface coarsely granular (117). *Up. L. Cam., Sib.*—FIG. 169,2. **P. prisca*, Lower course of River Lena; cran., $\times 3$ (411).

Tollaspis KOBAYASHI, 1943 [**Anomocare pawlowskii* SCHMIDT, 1886]. Glabella strongly convex, subparallel-sided, with 3 pairs of lateral furrows, anterior 2 pairs very faint and short, posterior pair deeper, curved back to occipital furrow, occipital node present; preglabellar field of medium width, anterior margin broadly pointed; eyes of medium size, posterior to center of glabella; fixigenae with palpebral areas about 0.7 of glabellar width, posterior areas 0.7 of length (*tr.*) of occipital ring; librigenae with rounded genal angle. Thorax and pygidium unknown (102). *Low. M. Cam., Sib.*—FIG. 169,3. **T. pawlowskii* (SCHMIDT), mouth of Little Batobiji on Wiliu River; ceph., ? $\times 1$ (419).

Order PTYCHOPARIIDA Swinnerton, 1915

[*nom. correct.* HENNINGSMOEN, herein (ex *Ptychopariina* SWINNERTON, 1915) [= *Opisthoparia* BEECHER, 1897 (*partim*) + *Hypoparia* BEECHER, 1897 (*partim*); *Conocoryphida* SWINNERTON, 1915 + *Trinucleida* SWINNERTON, 1915] [Type—*Ptychoparia* HAWLE & CORDA, 1847]

A large order of trilobites having more than 3 thoracic segments. A few are proparian (some *Ptychopariina*) and some modified forms have marginal or submarginal sutures (some *Ptychopariina*, most *Harpina* and *Trinucleina*), but a large majority are opisthoparian. The glabella is primarily of simple, generalized type, tapering forward, and glabellar furrows, if present (many *Ptychopariina*) are commonly simple, subparallel linear depressions. In some modified forms, the glabella deviates in shape (*Illaenina*, *Harpina*, *Trinucleina*, most *Asaphina*, some *Ptychopariina*), and

the different pairs of lateral glabellar furrows, if present, are more or less dissimilar. A preglabellar field commonly is present but may be secondarily reduced. A rostral plate and connective sutures are present or absent; if a rostral plate is lacking (modified forms), the librigenae are either separated by a median suture or fused together (*Asaphina*, *Harpina*, *Trinucleina*, some *Ptychopariina*). The hypostoma is separated from the cephalon by a hypostomal suture or uncalcified membrane. Most early forms have a relatively large thorax and small pygidium (e.g., *Alokistocare*), whereas later forms especially have fewer thoracic segments and a large pygidium (e.g., *Asaphus*).

Early representatives of the *Ptychopariida* resemble *Redlichiina*, but many of these latter have eye lobes that are longer or less separated from the eye ridges, or they are characterized by a glabella that expands forward. The *Corynexochida* differ from the *Ptychopariida* in having the hypostoma fused with the rostral plate; also, many of the *Corynexochida* differ from contemporaneous Cambrian *Ptychopariida* in having more divergent lateral glabellar furrows, and in having a glabella that expands forward. The *Lichida* and *Odontopleurida* differ from the *Ptychopariida*, among various features, in their peculiar types of glabella and glabellar furrows. Among the *Phacopida*, early forms, especially of *Calymenina*, resemble the *Ptychopariida*, but most differ in the pattern of the glabellar furrows and are predominantly proparian or gonatoparian.

The *Ptychopariida* seem to be closely related to the *Redlichiina*, and probably gave rise to most or all post-Cambrian trilobite groups (except, of course, post-Cambrian agnostids). *L. Cam.-M. Perm.*

Suborder PTYCHOPARIINA Richter, 1933

[Includes *Olenina* SWINNERTON, 1915 (*partim*); *Conocoryphina* SWINNERTON, 1915; *Ptychopariina* SWINNERTON, 1915 (*partim*)] [Type—*Ptychoparia* HAWLE & CORDA, 1847]

Exoskeleton typically with the following combination of characters; (1) simple, generalized glabella tapering forward; (2) simple, commonly subparallel lateral glabellar furrows (if present); (3) opisthoparian facial sutures; (4) preglabellar field; (5) relatively large thorax; and (6) small pygidium.

In some more or less specialized, derived, or advanced forms, one or more of these characters may differ from the norm. For example, shape of glabella is subrectangular in some Saukiidae; one or more lateral glabellar furrows are sigmoidal or bifurcate in *Hypermecaspididae* and some *Olenidae*; only longitudinal glabellar furrows are present in the *Telephinidae*; some *Ptychopariina* have proparian sutures (*Norwoodiidae*, *Burlingiidae*, some olenids and others), and some blind forms have marginal facial su-

tures or none at all (some *Conocoryphidae*); the preglabellar field is missing within various groups; and several genera included in the suborder have a relatively short thorax and large pygidium (e.g., *Dikelocephalidae*, *Anomocaridae*, *Asaphiscidae*).

No members of the *Ptychopariina* are known to have; (1) a glabella with concave sides, narrowest toward the rear; (2) a mesial glabellar node well in front of occipital furrow; or (3) a cephalic fringe (as in harpids and trinucleids). *L.Cam.-U.Ord.*

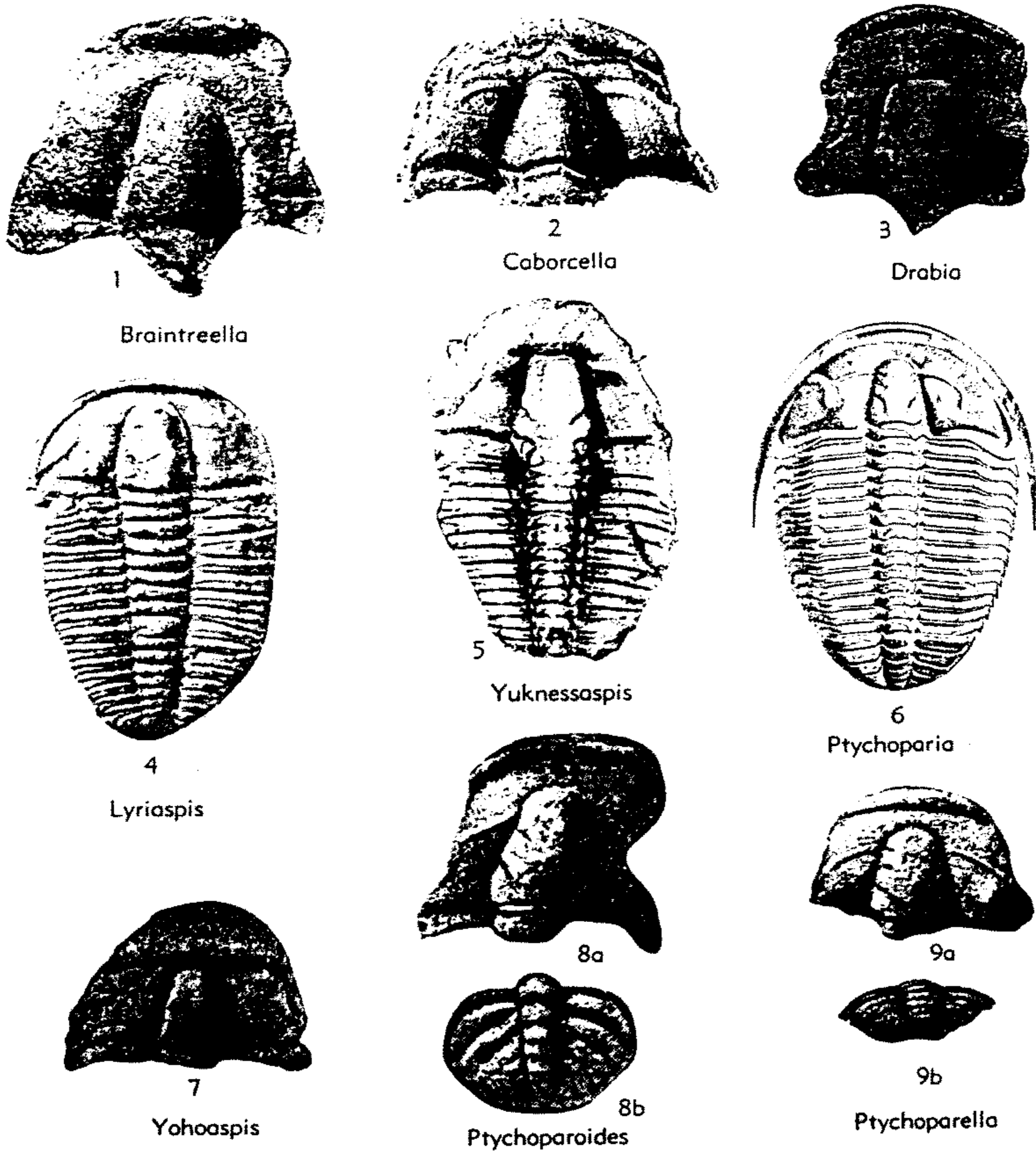

FIG. 170. *Ptychopariidae* (*Ptychopariinae*) (p. 0233, 0234).

Superfamily PTYCHOPARIACEA Matthew, 1887

[*nom. transl. et correct.* RASETTI, 1954 (ex Ptychopariidae MATTHEW, 1887)] [=Ptychopariidea RICHTER, 1933 (*partim*); Ptychoparioidae RASETTI, 1951 (*partim*); Ptychoparioidae HUPÉ, 1953 (attributed to RICHTER, 1933)]

Exoskeleton elongate oval, opisthoparian, with relatively large thorax and small pygidium. Cephalon semicircular, with well-defined border, glabella tapering forward, generally with 3 or 4 pairs of more or less distinct lateral glabellar furrows, with rounded or truncate front separated from border by a short to relatively long (*sag.*), moderately convex to flat (or rarely concave) preglabellar field; facial sutures converging or diverging in front of eyes, eye ridges commonly present; librigenae commonly with genal spines of short to medium length. Thorax composed of 12 to 17 segments; axis moderately convex, sharply defined; pleurae nearly flat, with distinct grooves. Pygidium with few segments, lacking border. Surface generally smooth. *L.Cam.-L.Ord.*

Family PTYCHOPARIIDAE Matthew, 1887

[*nom. correct.* RICHTER, 1933 (*pro* Ptychopariidae MATTHEW, 1887)]

Dorsal exoskeleton elongate oval, opisthoparian, with relatively large thorax and small pygidium. Cephalon semicircular, with well-defined convex border; glabella tapering forward, generally with 3 or 4 pairs of distinct lateral furrows, with rounded or truncate front separated from border by a short, moderately convex to flat (or rarely concave) preglabellar field; facial sutures diverging in front of eyes; eye ridges commonly present; librigenae commonly with genal spines of short to medium length. Thorax composed of 12 to 17 segments; axis moderately convex, sharply defined; pleurae nearly flat, with distinct grooves. Pygidium with few segments, lacking border. Surface generally smooth. *L.Cam.-L.Ord.*

Subfamily PTYCHOPARIINAE Matthew, 1887

[*nom. correct.* WESTERGÅRD, 1950 (ex Ptychopariinae MATTHEW, 1887)]

Preglabellar area rather flat or somewhat concave, medium in length and width; glabella usually somewhat tapering, with or without glabellar furrows. Pygidium small. *M.Cam.-U.Cam.*

Ptychoparia HAWLE & CORDA, 1847 [**Conocephalus striatus* EMMRICH, 1839; SD WALCOTT, 1884]. Preglabellar area with radiating striae; 4 glabellar furrows. Pygidium half as long and half as wide as cranidium, with 5 segments. *M.Cam.*, Boh.—FIG. 170,6. **P. striata* (EMMRICH), Jince F.; exoskel., $\times 0.6$ (3*).

Braintreella WHEELER, 1942 [**Ptychoparia rogersi* WALCOTT, 1884]. Cranidium subquadrate, with straight front margin and well-developed anterior border; glabellar furrows faint; short occipital spine. *M.Cam.*, Mass.—FIG. 170,1. **B. rogersi* (WALCOTT), Braintree F.; cran., $\times 2.7$ (492*).

Caborcella LOCHMAN, 1948 [**C. arrojensis*]. Cranidium short, wider than long; glabella broadly tapering, with rounded front and 3 pairs of furrows; anterior border furrow broad, with a low median rise; border upturned; curved eye ridges prominent; palpebral lobes small. *M.Cam.*, Sonora.—FIG. 170,2. **C. arrojensis*, Los Arrojos F.; cran., $\times 3$ (128*).

Drabia WILSON, 1951 [**D. acroccipita*]. Cranidium small; fixigenae wide; border narrow. *U.Cam.*, Pa.—FIG. 170,3. **D. acroccipita*, Ore Hill F.; cran., $\times 6.5$ (363*).

Lyriaspis WHITEHOUSE, 1939 [**L. sigillum*]. Glabella bearing 2 pairs of short furrows; fixigenae wide; palpebral lobes small; eye ridges narrow; preglabellar area convex; anterior border narrow and convex. Thorax with 13 or 14 segments. Pygidium small, with prominent axis, 3 pleural furrows, border narrow or lacking. *M.Cam.*, Queensl.—FIG. 170,4. **L. sigillum*, Dinesus Stage; exoskel., $\times 2.5$ (340*).

Ptychoparella POULSEN, 1927 [**P. brevicauda*]. Cranidium like that of *Ptychoparia* but pygidium very short, with well-developed border and very short axis containing only 4 segments. *M.Cam.*, Greenl.—FIG. 170,9. **P. brevicauda*, Cape Frederick VII F.; 9a, cran., $\times 2$; 9b, pyg., $\times 3.5$ (172*).

Ptychoparioides RŮŽIČKA, 1939 [**P. nobilis*]. Cranidium like that of *Ptychoparia* but more elongate and lacking striae on preglabellar area. *M.Cam.*, Boh.—FIG. 170,8. **P. nobilis*, Orthis Ss.; 8a,b, cran., pyg., $\times 1.5$ (264*).

Yohoaspis RASETTI, 1951 [**Y. pachycephala*]. Glabella strongly convex, with indistinct furrows; frontal area consisting of border only, border furrow running into axial furrows in front of glabella; palpebral lobes narrow, moderately long, set off by palpebral furrows; eye ridges poorly developed; fixigenae very convex. *M.Cam.*, B.C.—FIG. 170,7. **Y. pachycephala*, Cathedral F.; cran., $\times 1$ (197*).

Yuknessaspis RASETTI, 1951 [**Y. paradoxa*]. Glabella moderately convex, sharply truncate in front; axial furrows very deep at sides; preglabellar area as wide (*sag.*) as glabella, with narrow anterior border and covered with longitudinal striae; palpe-

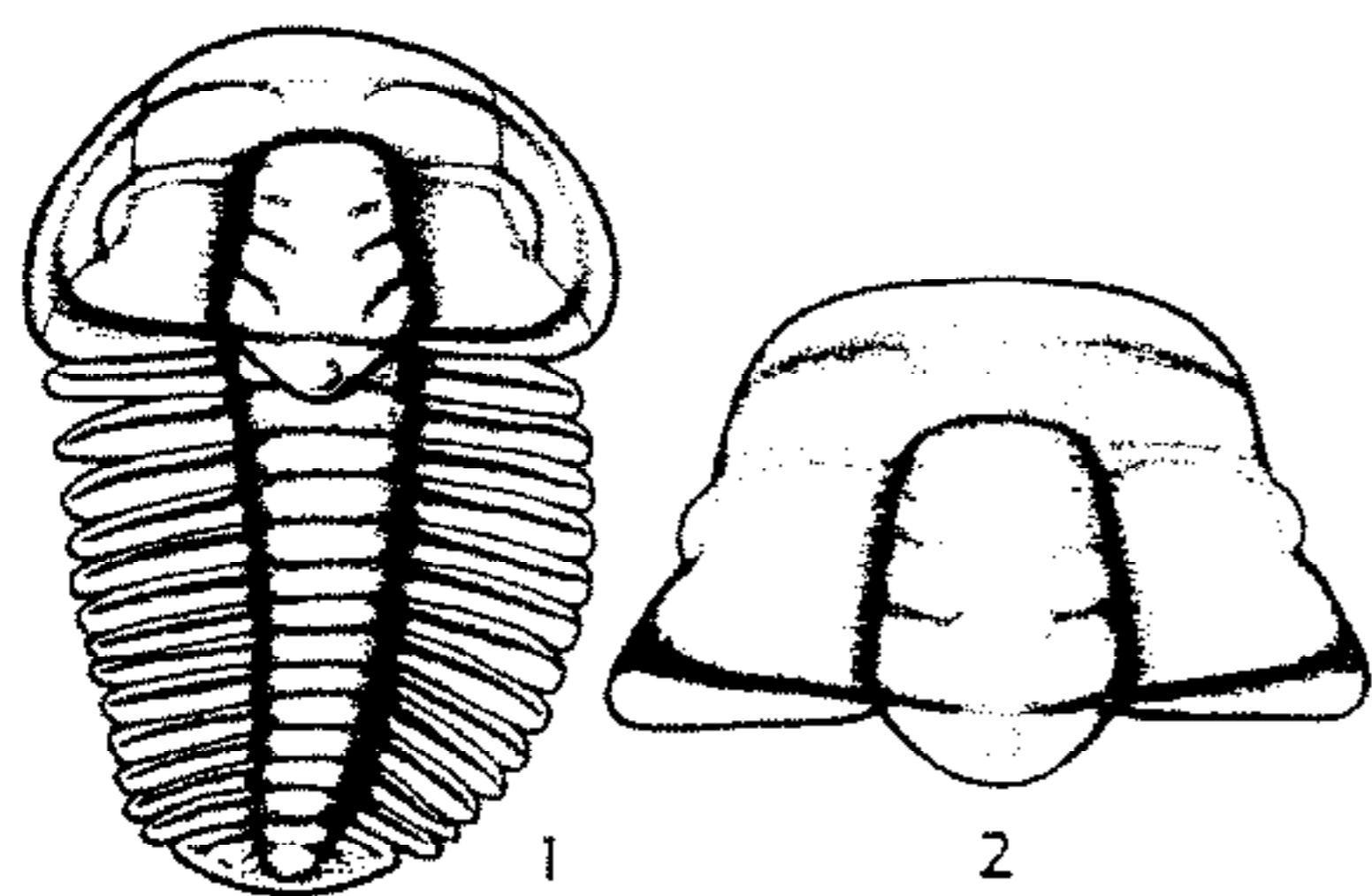

FIG. 171. Ptychopariidae (Antagminae). 1, *Syspancephalus gregarius* RASETTI, M.Cam., W.Can.(B.C.); exoskel., $\times 5$ (448n). 2, *S. charops* (WALCOTT), L.Cam., W.Can.(B.C.); cran., $\times 6$ (448n).

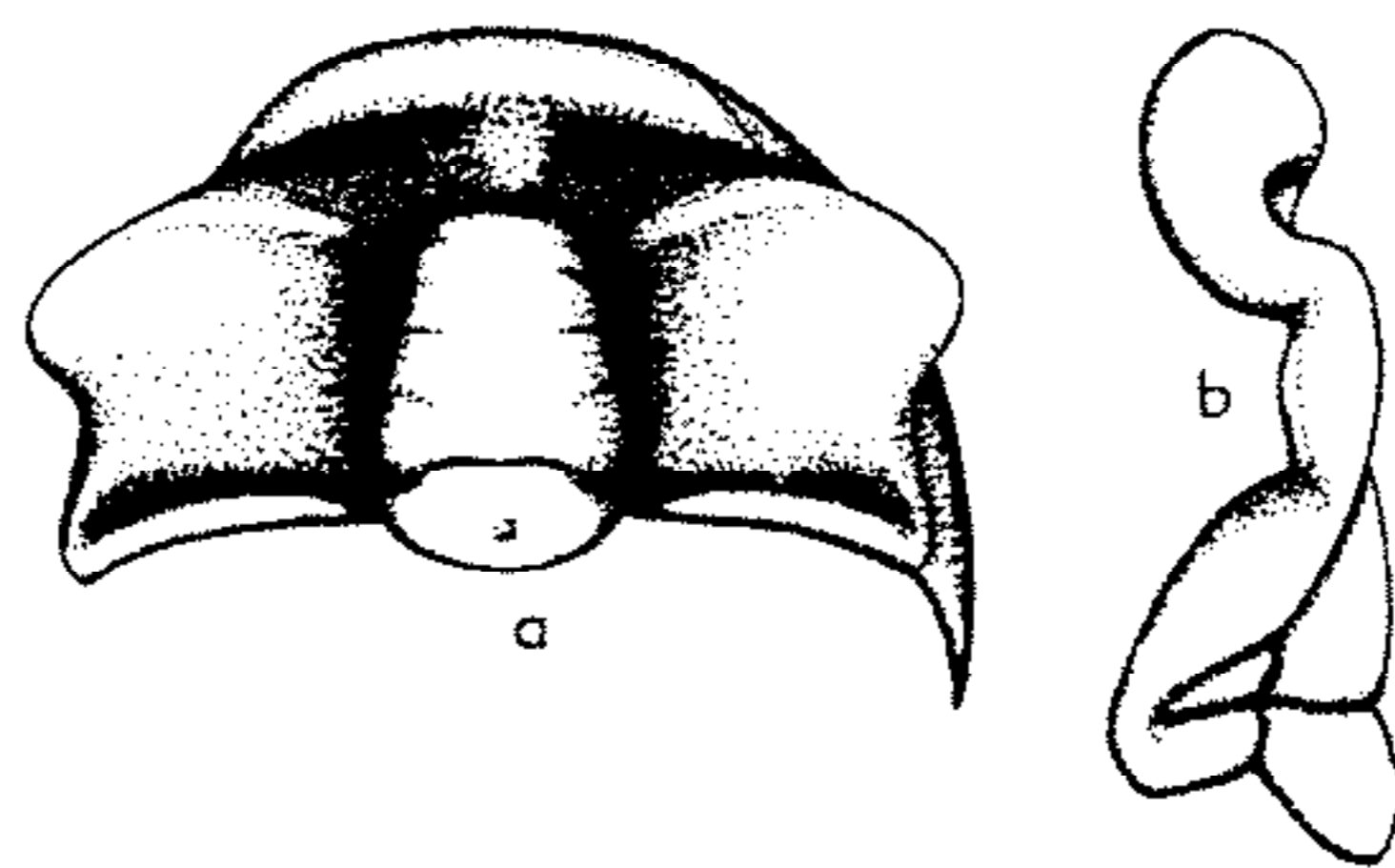

FIG. 172. *Periomella yorkensis* RESSER (Ptychopariidae, Periomellinae), L.Cam., Que.; a, b, ceph., $\times 6$ (448n).

bral lobes short and narrow; eye ridges prominent. Thorax with at least 14 segments. *M.Cam.*, B.C.—FIG. 170, 5. **Y. paradoxa*, Stephen F.; exoskel., $\times 1.5$ (197*).

?*Agraulopsis* RŮŽIČKA, 1940 [**A. resseri*]. Cephalon moderately convex with weak anterior border furrow; glabella elongate, tapering, truncate at front; eyes small, submedian; anterior and posterior sections of facial sutures divergent. *M.Cam.*, Boh.—FIG. 406, 5. **A. resseri*; cran., $\times 2$ (293) (HE).

Subfamily PERIOMMELLINAE Rasetti, 1955

Ptychopariidae with very wide palpebral area; margin of fixigenae downturned, placing small palpebral lobes in subventral position; posterior area of fixigenae deeply furrowed, not extending laterally beyond palpebral lobes. *L.Cam.*

Periomella RESSER, 1938 [**P. yorkensis*]. Glabella tapered, truncate in front, faintly furrowed; preglabellar field may have median boss; border convex; eye ridges directed forward from glabella; palpebral area twice as wide as glabella; border furrow on posterior areas not reaching cranial margin; librigenae narrow, with genal spines. *L.Cam.*, N.Am.—FIG. 172. **P. yorkensis*, Que.; a, b, ceph., $\times 6$, $\times 9$ (448n).

Subfamily EULOMINAE Kobayashi, 1955

Late Ptychopariidae mainly characterized by deep glabellar furrows merging with the axial furrows, curving backward, posterior pair almost isolating basal lobes; eyes large to small; anterior border present; border furrow in most species with series of pits. Thorax of 13 segments, where known. Pygidium small, transverse, of generalized ptychopariid type. *L.Ord.*

Euloma ANGELIN, 1854 [**E. laeve* ANGELIN; SD VOGDES, 1925] [= *Calymenopsis* BERGERON, 1895].

Glabella about 0.7 of cranial length, defined by deep axial furrows, with at least 2 pairs of deep lateral glabellar furrows; occipital furrow deep, occipital ring simple; eye ridges broad, poorly defined; palpebral lobes large (in type species) to medium (*E. monile*), semicircular; palpebral furrows deep; anterior sections of facial sutures slightly divergent; anterior border furrow with row of pits; posterior area slender, extending laterally well beyond palpebral lobes. Thorax of 13 segments (*E. monile*). *L.Ord.*, Eu.—FIG. 173, 1. **E. laeve*, Swed.; 1a, cran., $\times 2.5$; 1b, pyg., $\times 2.5$ (299).

Pareuloma RASETTI, 1954 [**P. brachymetopa*]. Glabella narrow, almost parallel-sided, only half of cranial length; axial furrows very deep laterally, shallow anteriorly; preglabellar field with median boss; eyes small, opposite anterior end of glabella; posterior areas of fixigenae large, broadly triangular, deeply furrowed. *L.Ord.*, N.Am.—FIG. 173, 2. **P. brachymetopa*, Que.; cran., $\times 5$ (448n).

Subfamily NASSOVIINAE Howell, 1937

[*nom. correct.* HOWELL, herein (ex Nassovinae HOWELL, 1937)]

Glabella with faint furrows or none at all, palpebral lobes small, frontal area rather narrow, more or less convex, fixigenae narrow or moderate in width. *M.Cam.*

Nassovia HOWELL, 1937 [**Liostracus globiceps* GRÖNWALL, 1902]. Preglabellar area rather large, border almost flat; eye ridges strongly developed. *M.Cam.*, Denm.—FIG. 174, 3. **N. globiceps* (GRÖNWALL), *Paradoxides davidis* Z.; cran., $\times 2$ (402*).

Brunswickia HOWELL, 1937 [**Conocephalites robbi* HARTT in DAWSON, 1868]. Preglabellar area of moderate size, border of cranium low; fixigenae of moderate width; eye ridges not strongly developed; glabella subquadrate. *M.Cam.*, E.Can.(N.B.).—FIG. 174, 1. **B. robbi* (HARTT), Fossil Brook F.; exoskel., $\times 1.8$ (429*).

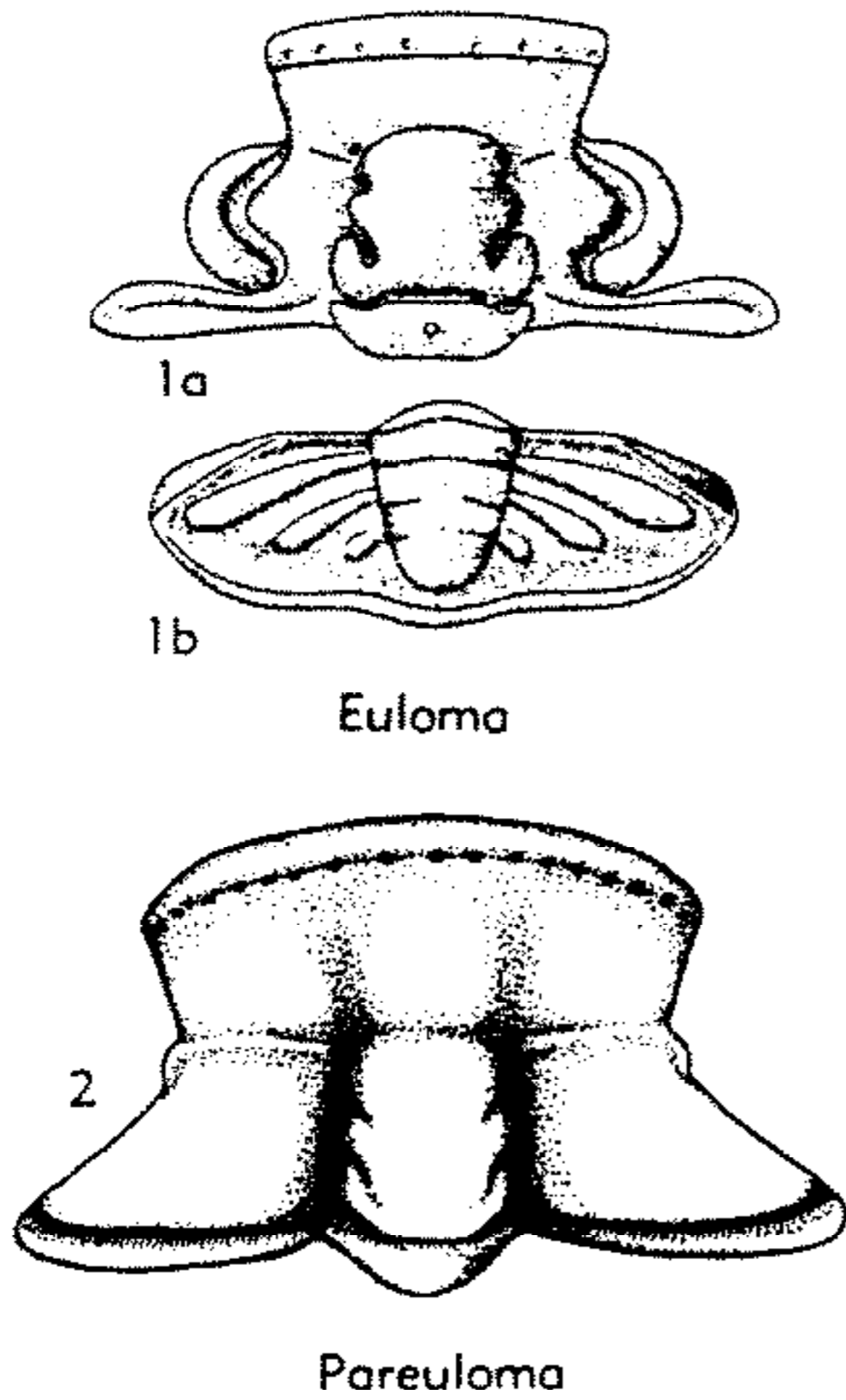

FIG. 173. Ptychopariidae (Eulominae) (p. 0234).

Champlainia HOWELL, 1937 [**C. rectimargo*]. Glabella extending almost to convex border, front of which is straight, eye ridges poorly developed. *M.Cam.*, Vt.—FIG. 174,4. **C. rectimargo*, St. Albans F.; cran., $\times 6.7$ (410*).

Vermontella HOWELL, 1937 [**V. clarae*]. Cranidium and glabella tapering forward; eye ridges poorly developed, border slightly convex and tilted upward. *M.Cam.*, Vt.—FIG. 174,2. **V. clarae*, St. Albans F.; 2a,b, cran., librigena, $\times 3.8$ (410*).

Subfamily ANTAGMINAE Hupé, 1953

[*nom. transl.* RASETTI, 1955 (*ex* Antagmidae HUPÉ, 1953)]

Generalized ptychopariids, usually of small size. Cephalon with all parts clearly defined; glabella tapering forward, rounded or truncate in front, with up to 4 pairs of furrows; occipital ring usually with node, never extended into spine; fixigenae from half to fully as wide as glabella, eye ridges distinct, palpebral lobes small or medium-sized, nearly opposite glabellar midpoint; frontal area usually divided into preglabellar field and border; border furrow with tendency to develop a median inbend; posterior border furrow invariably deep. Thorax of about 15 segments; pleurae rounded distally. Pygidium small, transverse. Surface generally granulated. [Includes earliest members of the superfamily. The genera intergrade and are difficult to characterize.] *L.Cam.-Low.M.Cam.*

Antagmus RESSER, 1936 [**A. typicalis* (*=Ptychoparia teucer* WALCOTT, 1887, *non* BILLINGS, 1861)]. Glabella convex; palpebral areas convex, on average horizontal, 0.5 to 0.7 times as wide as glabella at mid-length; palpebral lobes 0.25 to 0.3 as long as glabella, slightly behind glabellar mid-length; anterior border furrow with median inbend; anterior sections of facial sutures slightly divergent; posterior areas of fixigenae relatively slender, as wide (*tr.*) as occipital ring. *L.Cam.*, N. Am.—FIG. 175,1. *A. gigas* RASETTI, Que.; cran., $\times 1.5$ (448n).

Austinvillea RESSER, 1938 [**A. virginica*]. Differs from *Antagmus* in shallower glabellar and axial furrows and almost obsolete, regularly curved border furrow delimiting long (*sag.*), flat border from short (*sag.*) preglabellar field. *L.Cam.*, N. Am.—FIG. 175,2. **A. virginica*, Que.; cran., $\times 2$ (448n).

Bicella RASETTI, 1955 [**Austinvillea bicensis* RESSER, 1938]. Glabella truncate in front; axial furrows deep; eye ridges wide; palpebral lobes convex, prominent; palpebral areas less than half as wide as glabella; anterior areas of fixigenae convex, divided by border furrow; border long (*sag.*); anterior sections of facial sutures slightly convergent; posterior areas of fixigenae with deep

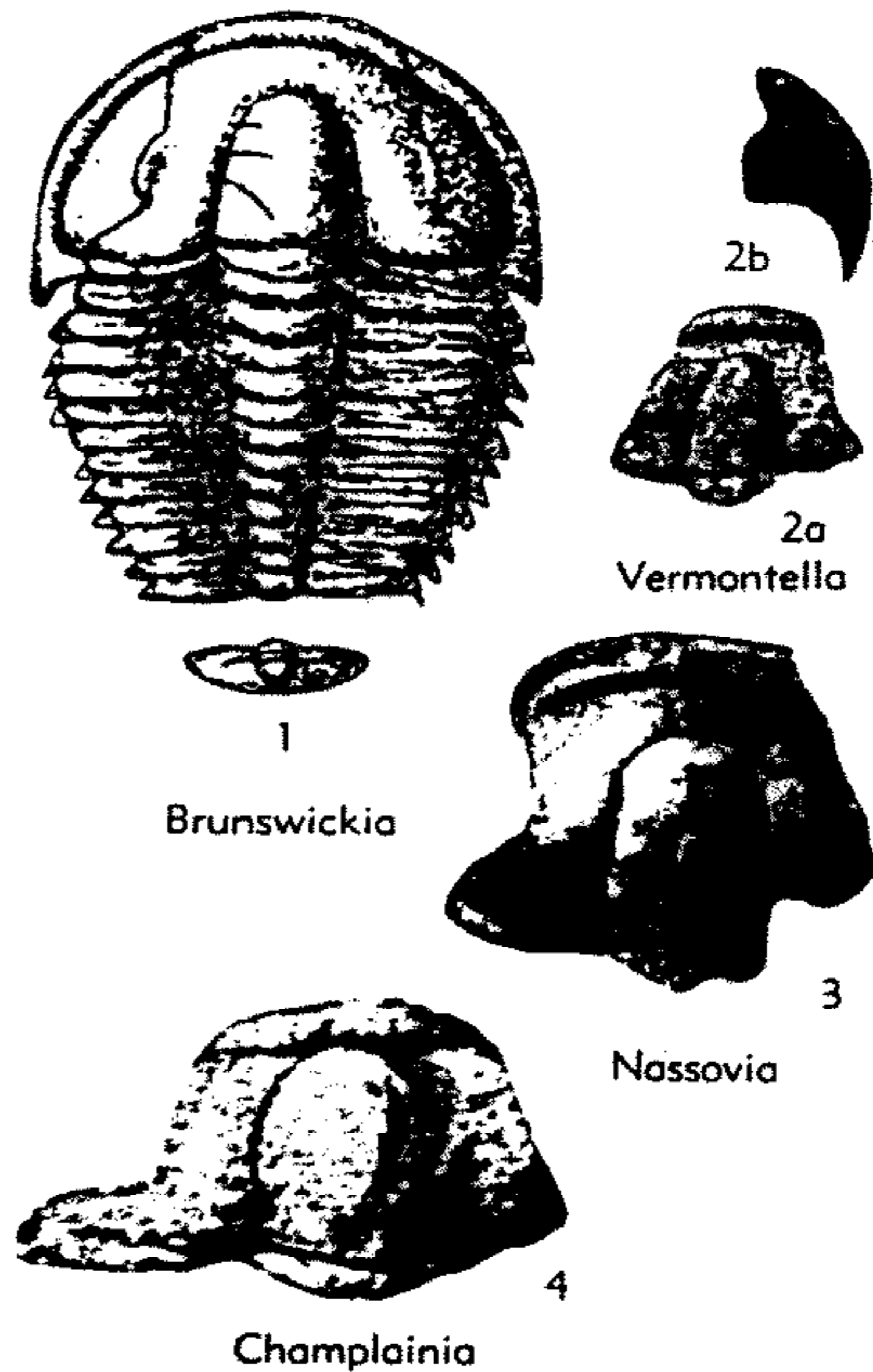

FIG. 174. Ptychopariidae (Nassoviinae) (p. 0234, 0235).

border furrows not reaching cranial margin. *L.Cam.*, N.Am.—FIG. 175,3. **B. bicensis* (RESSER), Que.; cran., $\times 2.5$ (448n).

Crassifimbria LOCHMAN, 1947 [**Onchocephalus walcotti* RESSER, 1937]. Glabella low, delimited by shallow axial furrows; palpebral areas narrow; eyes opposite glabellar mid-length; border furrow with median inbend; posterior areas of fixigenae narrower (*tr.*) than occipital ring. *L.Cam.*, N.Am.

—FIG. 175,4. **C. walcotti* (RESSER), Nev.; cran., $\times 8$ (448n).

Eoptychoparia RASETTI, 1955 [**E. normalis*]. Similar to *Antagmus*, with anterior border furrow regularly curved. *L.Cam.*, N.Am.—FIG. 175,5. **E. normalis*, Que.; cran., $\times 3$ (448n).

Luxella RASETTI, 1955 [**Ptychoparia lux* WALCOTT, 1917]. Glabella low, almost merging with preglabellar field, occupying about half of cran-

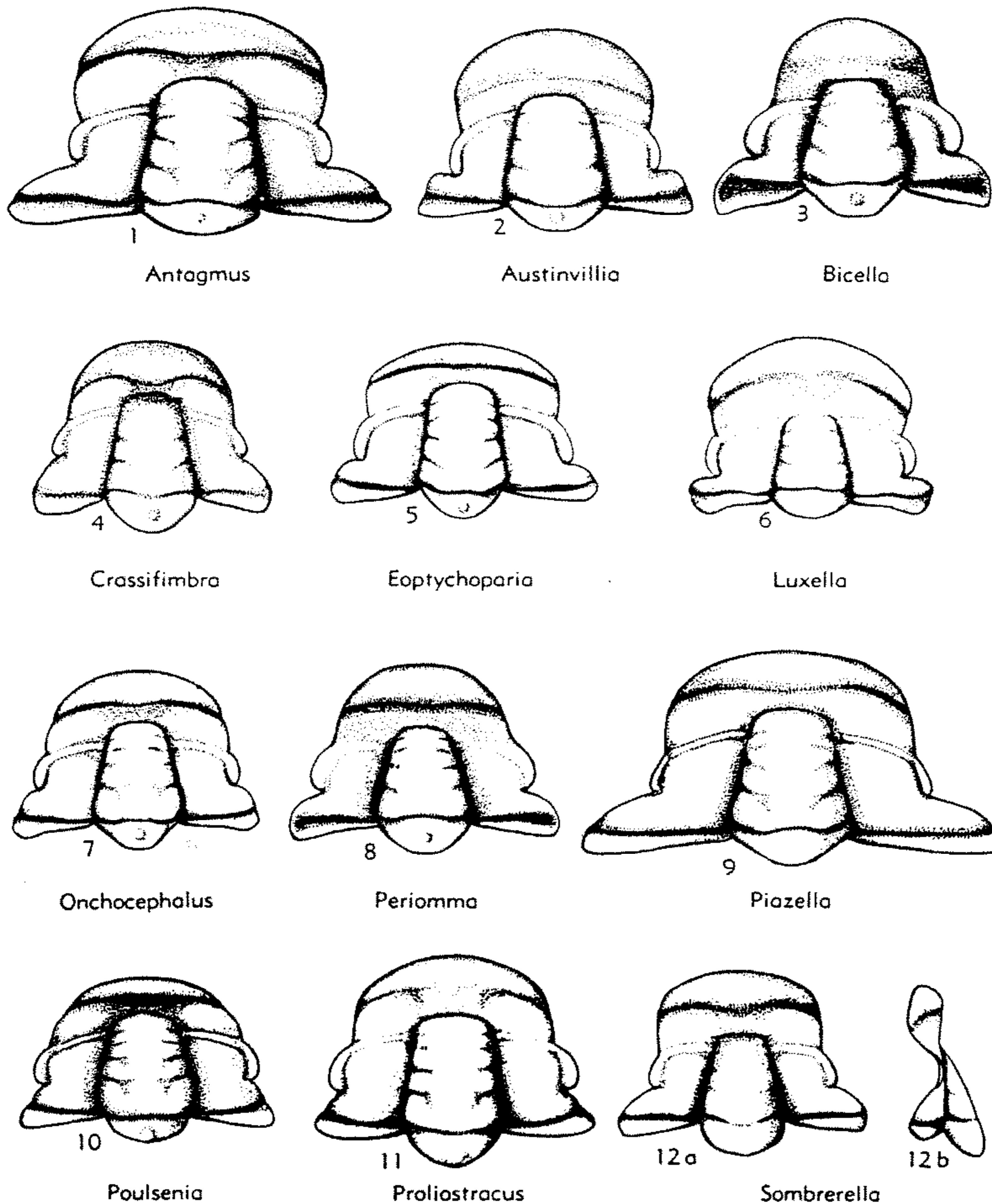

FIG. 175. Ptychopariidae (Antagminae) (p. 0235-0237).

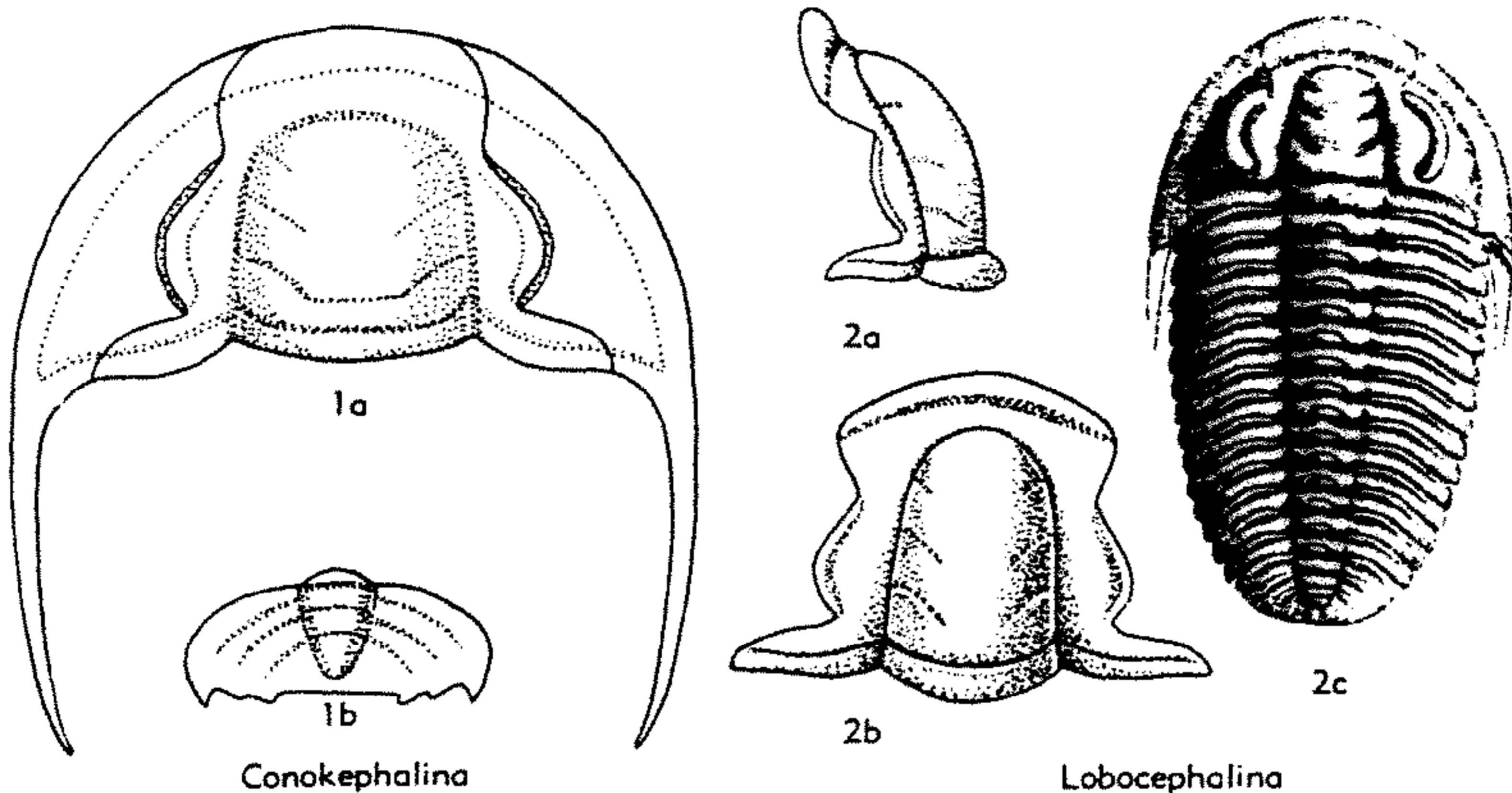

FIG. 176. Ptychopariidae (Conoquephalininae) (p. 0238).

dial length; palpebral areas wide; palpebral lobes relatively long; posterior areas of fixigenae short (*exsag.*); anterior sections of facial sutures divergent. *L. Cam.*, N. Am.—FIG. 175, 6. **L. lux* (WALCOTT), W. Can. (B. C.); cran., $\times 4$ (448n).

Onchocephalus RESSER, 1937 [**Ptychoparia thia* WALCOTT, 1917]. Glabella low; eyes opposite glabellar mid-length, anterior sections of facial sutures parallel or slightly convergent; posterior areas of fixigenae as wide (*tr.*) as occipital ring. Intergrades with *Antagmus*, *Crassifimbria*, *Eoptychoparia* and *Proliostracus*. *L. Cam.-Low. M. Cam.*, N. Am.—FIG. 175, 7. *O. sulcatus* RASETTI, *L. Cam.*, Que.; cran., $\times 4$ (448n).

Periomma RESSER, 1937 [**P. typicalis*]. Glabella strongly tapered; axial furrows deep; anterior border thick; preglabellar field commonly with median boss; palpebral areas wide, upsloping; palpebral lobes prominent; border furrow not reaching end of posterior areas of fixigenae. *L. Cam.*, N. Am.—FIG. 175, 8. *P. walcotti* RESSER, Que.; cran., $\times 6$ (448n).

Piaziella LOCHMAN, 1947 [**Ptychoparia pia* WALCOTT, 1917] Like *Antagmus*, with which it intergrades; glabella proportionately small, fixigenae wider. *L. Cam.*, N. Am.—FIG. 175, 9. **P. pia* (WALCOTT), W. Can. (B. C.); cran., $\times 2$ (448n).

Poulsenia RESSER, 1936 [**Solenopleura grönwalli* POULSEN, 1927]. Glabella convex; axial furrows deep; front border arched transversely; anterior sections of facial sutures slightly convergent. *L. Cam.*, Greenl.—FIG. 175, 10. **P. grönwalli* (POULSEN), NW. Greenl.; cran., $\times 2.5$ (172).

Proliostracus POULSEN, 1932 [**P. strenuelliiformis*]. Glabella truncate in front; preglabellar field with faint median boss; palpebral lobes relatively long,

opposite glabellar mid-length; anterior sections of facial sutures slightly convergent. *L. Cam.*, Greenl.—FIG. 175, 11. **P. strenuelliiformis*, E. Greenl.; cran., $\times 6$ (173).

Sombrerella LOCHMAN, 1948 [**S. mexicana*]. Glabella elevated posteriorly, low anteriorly, truncate in front; anterior border furrow with median inbend; palpebral lobes slightly in front of glabellar mid-length. *L. Cam.*, N. Am.—FIG. 175, 12. **S. mexicana*, Sonora; 12a, b, cran., $\times 5$ (128).

Syspacephalus RESSER, 1936 [**Agraulos charops* WALCOTT, 1917]. Glabella low, sloping down anteriorly; anterior border furrow more or less obsolete medially; palpebral lobes anterior to glabellar mid-point; anterior facial sutures convergent; genal angle rounded. Thorax of 13 to 15 segments. *L. Cam.-Low. M. Cam.*, N. Am.—FIG. 171, 1. *S. gregarius* RASETTI, M. Cam. (Mt. Whyte F.), W. Can. (B. C.); exoskeleton slightly flattened, $\times 5$ (448n).—FIG. 171, 2. **S. charops* (WALCOTT), *L. Cam.*, W. Can. (B. C.); cran., $\times 6$ (448n).

Subfamily CONOKEPHALININAE Hupé, 1953

[*nom. transl.* LOCHMAN-BALK herein (ex Conoquephalinidae HUPÉ, 1953) (not attributable to WALCOTT, 1913, on basis of "Conoquephalinae," as published by him as a group designation without diagnosis or any indication of intent to introduce a family-group name)]

Exoskeleton opisthoparian, micropygous. Glabella tapering forward, truncate-rounded in front, with 2 or 3 pairs of well-defined, arcuate lateral furrows; faint eye ridges may be present; palpebral rims prominent, palpebral furrows deep, arcuate; preglabellar field of variable width, anterior border furrow well defined; eyes large, behind level

of center of glabella, fixigenae horizontal, with arcuate palpebral areas, about 0.5 of glabellar width, posterior areas narrow (*exsag.*); librigenae rectangular, with genal spine of medium length. Thorax of 14 segments; axis convex, about 0.5 of width (*tr.*) of pleurae; pleural furrows distinct, on front part of segments, ends rounded. Pygidium transverse; axis convex, tapering nearly full length, with 2 or 3 axial rings; 3 pleurae, interpleural grooves and border furrow very faint or obsolete, border narrow. Surface granulate. *M.Cam.-U.Cam.*

Conocephalina BRÖGGER, 1886 [**Conocephalites ornatus* BRÖGGER, 1878; SD BASSLER, 1915]. Glabella low, front rounded or straight, with 3 pairs of lateral furrows; eyes behind glabellar midlength; fixigenae narrow anteriorly, posterior area narrow (*exsag.*), 0.7 of length (*tr.*) of occipital ring. Pygidium narrow transverse; axis convex, equal to pleural field in width; interpleural grooves faint or obsolete, border furrow faint, posterior margin nearly straight; some bearing up to 3 pairs of very small spines. *M.Cam.-U.Cam.*, W.Eu.—FIG. 176.1. **C. ornatus* (BRÖGGER), *M.Cam.*, Norway; 1a,b, ceph., pyg., $\times 1.3$ (382).

Lobocephalina RŮŽIČKA, 1940 [**Lobocephalus carinatus* RŮŽIČKA, 1939] [= *Ružičkaia* PŘIBYL, 1950 (*pro Lobocephalus* RŮŽIČKA, 1940, *non* DIESING, 1838, *nec* KRAMER, 1898)]. Glabella moderately convex, tapering forward, front rounded, with 2 or 3 pairs of lateral furrows; eyes almost opposite posterior 0.3 of glabella; fixigenae of medium width anteriorly, posterior area narrow (*exsag.*), equal in length (*tr.*) to occipital ring. Pygidium transverse; axis convex, as wide as pleural field; interpleural grooves obsolete, border furrow very faint or obsolete, posterior margin curved, without spines. *M.Cam.*, W.Eu.—FIG. 176.2a,b. **L. carinata* (RŮŽIČKA), Czech.; cran., $\times 1.3$ (464). —FIG. 176.2c. *L. emmrichi* (BARRANDE), Czech.; exoskel., $\times 1.3$ (370*).

Schoriella STROV, 1955 [**S. schorica*]. *U.Cam.*, W. Sib. (276).

Family ALOKISTOCARIDAE Resser, 1939

Preglabellar area wide, glabella somewhat tapering, facial sutures rather deeply concave opposite glabella, eye ridges well developed, palpebral lobes small, genal spines of moderate length. Pygidium small. *L.Cam.-U.Cam.*

Alokistocare LORENZ, 1906 [**Ptychoparia subcoronatus* HALL & WHITFIELD, 1877] [= *Amecephalus* WALCOTT, 1924; *Strotocephalus* RESSER, 1935].

Border of cranium wide and flat except for low boss in front of glabella and shallow border furrow; glabella defined by strong axial furrows, with 2 or 3 pairs of short lateral furrows; palpebral lobes of moderate size, eye ridges crossing fixigenae; occipital ring bearing small node; librigenae spined. Thorax with 17 to 19 segments; axis narrow; pleurae broad, with well-defined furrows. Pygidium small; axis prominent, with 3 rings; pleural regions bearing 1 to 3 furrows. *M.Cam.*, W.USA.—FIG. 177.1. **A. subcoronatum* (HALL & WHITFIELD), Ute F., Utah; cran., $\times 5$ (488*).

Alokistocarella RESSER, 1938 [**A. typicalis*]. Like *Alokistocare* but with border concave and narrower. *M.Cam.*, USA.—FIG. 178.1. *A. brighamensis* RESSER, Utah; $\times 1.5$ (457*).

Amecephalina POULSEN, 1927 [**A. mirabilis*]. Like *Alokistocare* but border concave, wider, and more bowed forward, fixigenae narrower, and pygidium larger. *M.Cam.*, Greenl.—FIG. 177.2. **A. mirabilis*, Cape Wood F., NW.Greenl.; 2a,b, cran., pyg., $\times 3$ (172*).

Annamitia MANSUY, 1916 [**Ptychoparia (Annamitia) spinifera*]. Like *Alokistocare*, but with narrower border, larger palpebral lobes, and occipital spine. *M.Cam.*, SE.Asia.—FIG. 177.3. **A. spinifera* (MANSUY), Indochina; exoskel., $\times 1.75$ (142*).

Arellanella LOCHMAN, 1948 [**A. caborcana*]. Three pairs of glabellar furrows, palpebral lobes small, axis of pygidium wide. *M.Cam.*, NW.Mex.—FIG. 177.5. **A. caborcana*, Los Arroyos F., Sonora; cran., $\times 2.6$ (128*).

Bythicheilus RESSER, 1939 [**B. typicum*]. Preglabellar area short, with medial depression; 14 thoracic segments; pygidium small. *M.Cam.*, NW.USA.—FIG. 177.4. **B. typicum*, Spence Sh., Idaho; exoskel., $\times 2.6$ (457*).

Chancia WALCOTT, 1924 [**C. ebdome*]. Frontal area shorter and less bowed forward than in *Alokistocare*, palpebral lobes smaller; frontal area and pygidium wider than in *Alokistocare*. *M.Cam.*, NW.USA.—FIG. 179.4. **C. ebdome*, Spence Sh., Idaho; $\times 1$ (320).

Chelidonocephalus KING, 1937 [**C. alifrons*]. Anterior border of cephalon convex, glabella truncate, with very faint furrows, palpebral lobes large. *M.Cam.*, or *U.Cam.*, SW.Asia.—FIG. 179.3. **C. alifrons*, Iran; cran., $\times 3$ (418).

Dunderbergia WALCOTT, 1924 [**Crepicephalus (Loganellus) nitidus* HALL & WHITFIELD, 1877]. Resembles *Alokistocare* but frontal area and glabella wider, fixigenae narrower; pygidium longer and rounder than in *Chancia*. *U.Cam.*, W.USA.-E.Sib.—FIG. 179.2. **D. nitidu* (HALL & WHITFIELD), Secret Canyon F., Nev.; 2a,b, $\times 1$ (320).

Ehmania RESSER, 1935 [**E. weedi*]. Like *Ehmaniella* but with glabellar furrows shallower and surface smooth. *M.Cam.*, NW.USA.—FIG. 177.6.

**E. weedi*, Meagher Ls., Wyo.; exoskel., $\times 2.2$ (488*).
Ehmaniella RESSER, 1937 [**Crepicephalus?* (*Loganella*) *quadrans* HALL & WHITFIELD, 1877] [= *Anomaloccephalus*, *Clappaspis* DEISS, 1939]. Like

Ehmania but with wider cranidium, heavier eye ridges, longitudinal striae on wider preglabellar area, commonly with tubercles on cranidium, and fewer segments in pygidium. M. Cam., W. USA. —FIG. 177,7. **E. quadrans* (HALL & WHIT-

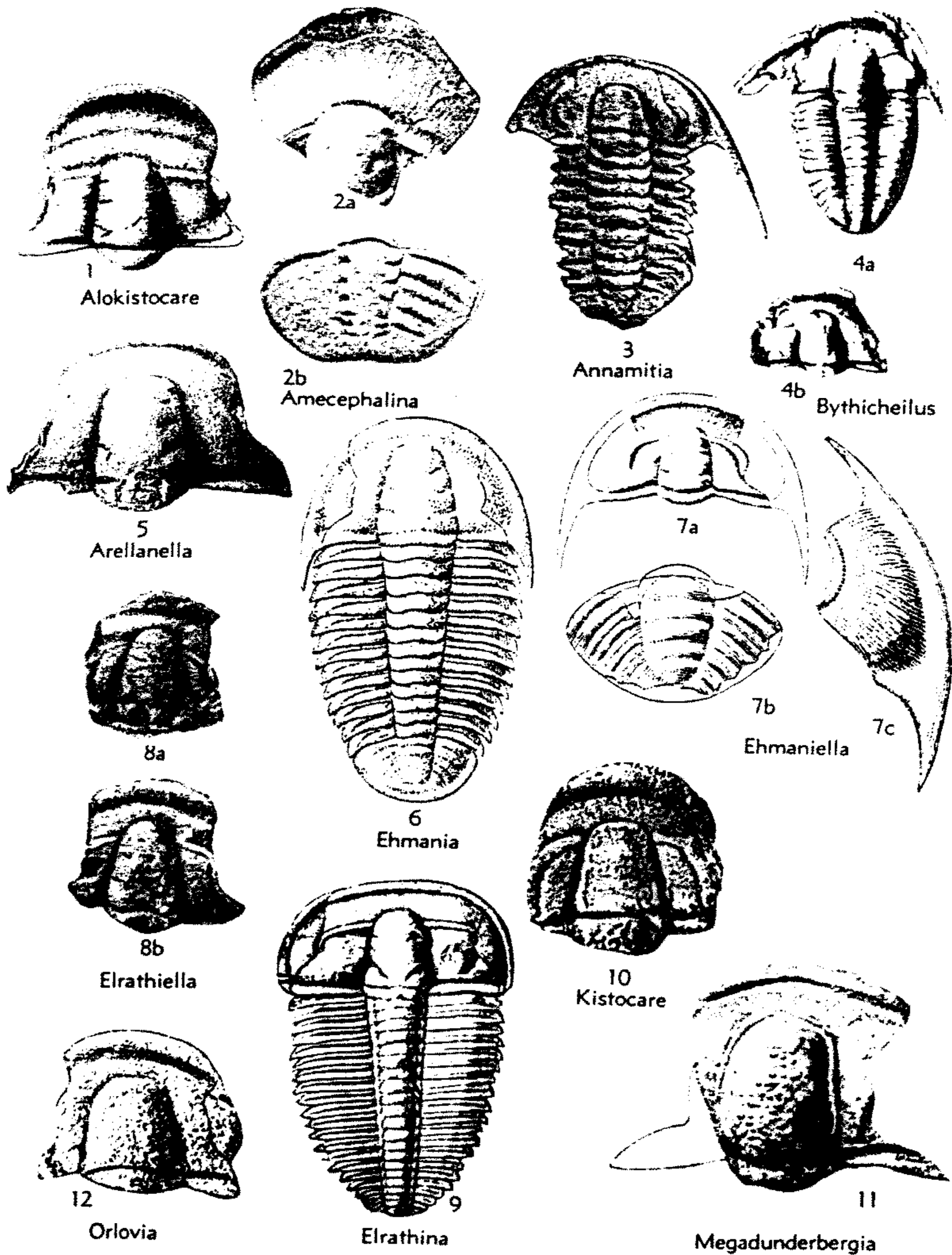

FIG. 177. Alokistocaridae (p. O238-O241).

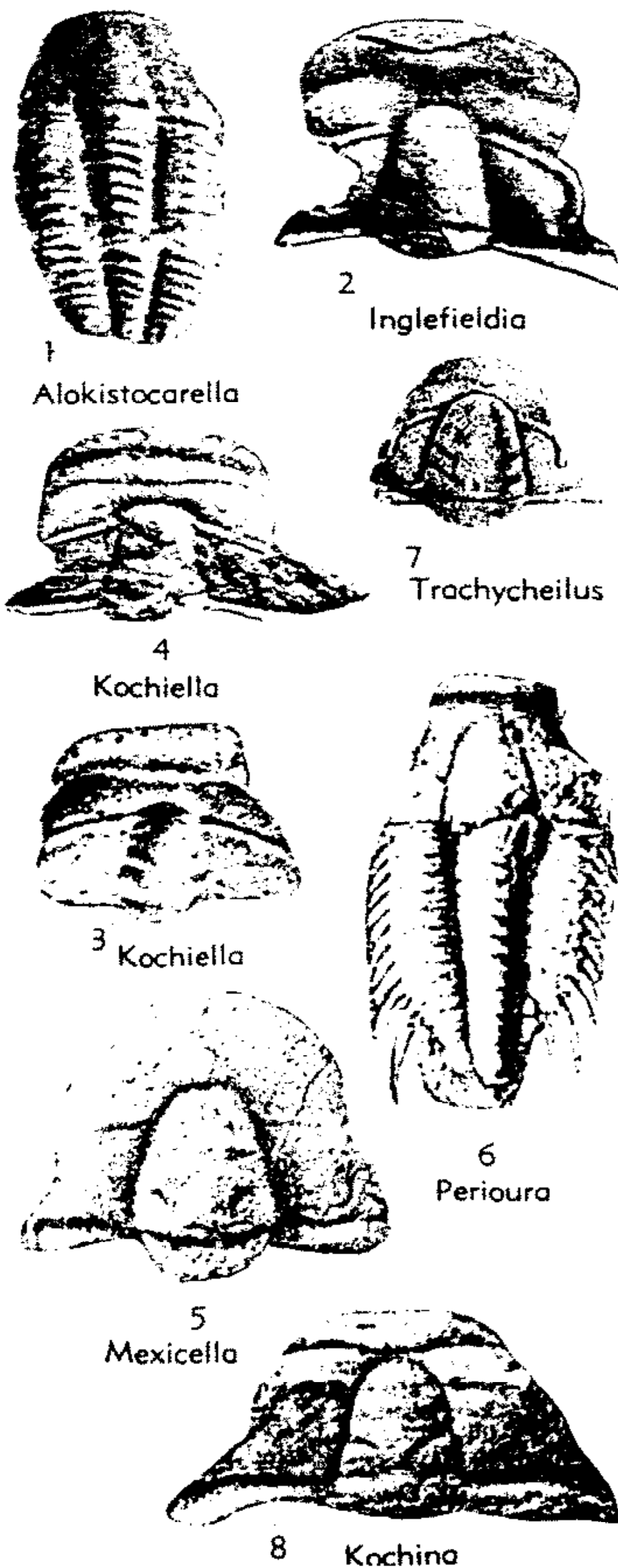

FIG. 178. Alokistocaridae (p. O238-O241).

FIELD), Ophir F., Utah; 7a-c, ceph., librigena, pyg., enlarged (488*).

Elrathia WALCOTT, 1924 [*Conocoryphe* (*Conocephalites*) *kingii* MEEK, 1870]. Like *Ehmaniella*, but pygidium larger, with segmentation less well developed. *M.Cam.*, W.USA.—FIG. 179,1. **E. kingii* (MEEK), Wheeler F., Utah; $\times 1$ (320).

Elrathiella POULSEN, 1927 [*E. obscura*] [= *Coelaspis*, *Glassocoryphus* DEISS, 1939]. Like *Elrathia* but with narrower cranidium, wider anterior border, longer and narrower glabella, and longer

palpebral lobes. *M.Cam.*, Greenl.—FIG. 177,8. **E. obscura*, Pemmican River F.; 8a,b, cranidia, $\times 2$ (172*).

Elrathina RESSER, 1937 [*Conocephalites cordillerae* ROMINGER, 1887]. Like *Elrathia*, but with narrower border, more numerous thoracic segments, and smaller pygidium. *M.Cam.*, W.Can.—FIG. 177,9. **E. cordillerae* (ROMINGER), Stephen F., B.C.; exoskel., $\times 2.2$ (319*).

Inglefieldia POULSEN, 1927 [*I. porosa*]. Like *Amecephalus* but with preglabellar area consisting of flat tract in front of glabella and with anterior border convex. *L.Cam.*, Greenl.—FIG. 178,2. **I. porosa*, Cape Kent F.; $\times 1.8$ (172*).

Ithyektyphus SHAW, 1956 [*Marjumiya? tetonensis* MILLER, 1936]. *Up.M.Cam.*, Wyo.

Kistocare LOCHMAN, 1948 [*K. corbini*]. Palpebral lobes beside posterior third of glabella, fixigenae nearly 0.7 of width of glabella, no trace of bulge or anterior border furrow on border. *M.Cam.*, NW. Mex.—FIG. 177,10. **K. corbini*, Los Arroyos F., Sonora; cran., $\times 7.2$ (128*).

Kochiella POULSEN, 1927 [*K. tuberculata*]. Like *Chancia*, but with border concave and less flaring; scattered tubercles on cranidium. *L.Cam.-M.Cam.*, Greenl.—FIG. 178,3. **K. tuberculata*, Cape Kent F.; $\times 1.2$ (172*).—FIG. 178,4. *K. propinqua* POULSEN, Cape Kent F.; $\times 1.2$ (172*).

Kochina RESSER, 1935 [*Olenopsis americanus* WALCOTT, 1912]. Border narrower and palpebral lobes more anterior than in *Kochiella*. *M.Cam.*, NW. USA.—FIG. 178,8. **K. americana* (WALCOTT), Gordon F., Mont.; $\times 1$ (488*).

?*Kounamkites* POLETAEVA & CHERNYSHEVA, 1956 [*K. virgatus* CHERNYSHEVA, 1956]. *Low.M.Cam.*, USSR. (MO).

Kujandaspis IVSHIN, 1956 [*K. kujandensis*]. Glabella short, tapered, truncate, 3 pairs of faint lateral furrows, anterior border and preglabellar field separated by a broad, deep, curved anterior border furrow, elliptical boss filling all of preglabellar field in front of glabella; eye ridges present, eyes of medium size, opposite center of glabella; fixigenae upsloping; palpebral area 0.5 of glabellar width, posterior area narrow, straplike. Fixigenae and pygidium unknown. Outer surface granulate. *U.Cam.*, SW.Sib.

Megadunderbergia KOBAYASHI, 1938 [*Ptychaspis pustulosa* HALL & WHITFIELD, 1877]. Like *Dunderbergia* but with cranidium more convex, palpebral lobes longer, and surface pustulose. *U.Cam.*, W.Can.—FIG. 177,11. *M. convexa* (KOBAYASHI), B.C.; cran., $\times 0.65$ (419*).

Mexicella LOCHMAN, 1948 [*M. mexicana*]. Like *Alokistocare* but with smaller palpebral lobes, in front of mid-line of glabella, and with wider fixigenae. *M.Cam.*, NW.Mex.—FIG. 178,5. **M. mexicana*, Los Arroyos F., Sonora; cran., $\times 5$ (128*).

Orlovia WALCOTT & RESSER, 1925 [*O. arctica*]. Without glabellar furrows, anterior border wide

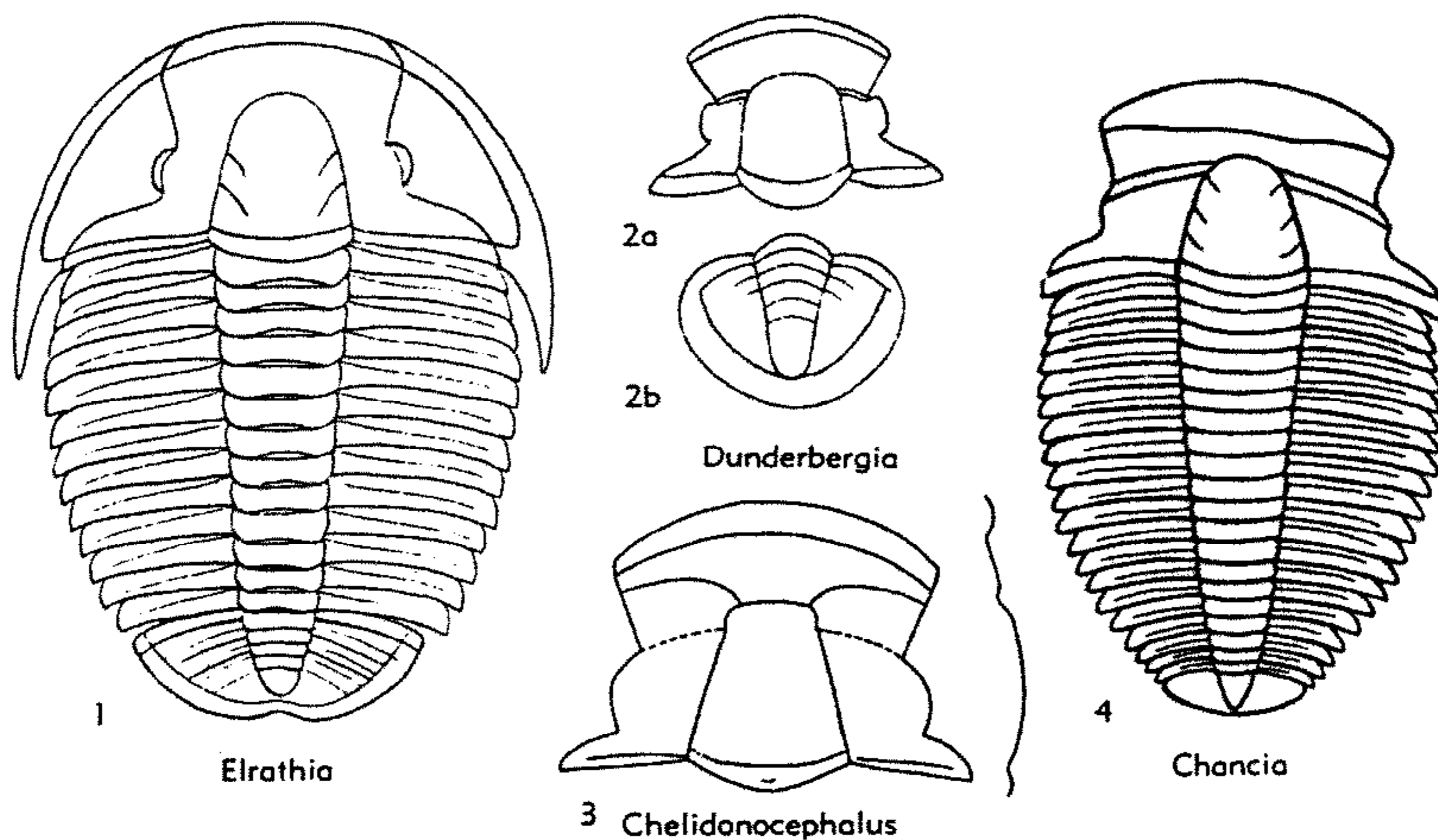

FIG. 179. Alokistocaridae (p. 0238-0240).

and thickened, pygidium with a narrow, flattened border. *U.Cam.*, N.Russia.—FIG. 177,12. **O. arctica*, N.Zem.; cran., $\times 2.75$ (322*).

Pachyaspis RESSER, 1939 [**P. typicalis*]. With 4 faint glabellar furrows, palpebral lobes small. *M.Cam.*, NW.USA.—FIG. 180,2. **P. typicalis*, Langston F., Idaho; cran., $\times 5$ (457*).

Parehmania DEISS, 1939 [**P. princeps*] [=Mc-nairia, Rowia, Thompsonaspis DEISS, 1939]. Like *Ehmania*, but with concave and wider border, up-turned frontal area, more convex fixigenae, and stronger eye ridges, directed more nearly perpendicular to the axial furrow. *M.Cam.*, NW. USA.—FIG. 180,1. **P. princeps*, Pentagon F., Mont.; exoskel., $\times 3.8$ (30*).

Perioura RESSER, 1938 [**P. typicalis*]. Differs from *Ehmania* in having ends of its 14 thoracic segments produced into spines and in having a longer and wider axis in pygidium. *M.Cam.*, SE.USA.—FIG. 178,6. **P. typicalis*, Conasauga Sh., Ala.; exoskel., $\times 2.6$ (457*).

Prevedoria LOCHMAN, 1948 [**P. starquistae*]. Like *Kochiella* but eyes relatively larger and glabella less broadly tapering. *M.Cam.*, NW.Mex.—FIG. 180,4. **P. starquistae*, Los Arroyos F., Sonora; cran., $\times 6.3$ (128*).

Ptychoparopsis HUPÉ, 1953 [**P. issafenensis*]. Like *Alokistocare* but with front of cranium more quadrate. *L.Cam.*, N.Afr.—FIG. 180,3. **P. issafenensis*, Morocco; $\times 1$ (411*).

Trachycheilus RESSER, 1945 [**T. typicale*]. Like *Kochina* but with a much narrower preglabellar

field. *M.Cam.*, SW.USA.—FIG. 178,7. **T. typicale*, Bright Angel or Muav beds, Ariz.; $\times 1$ (457*).

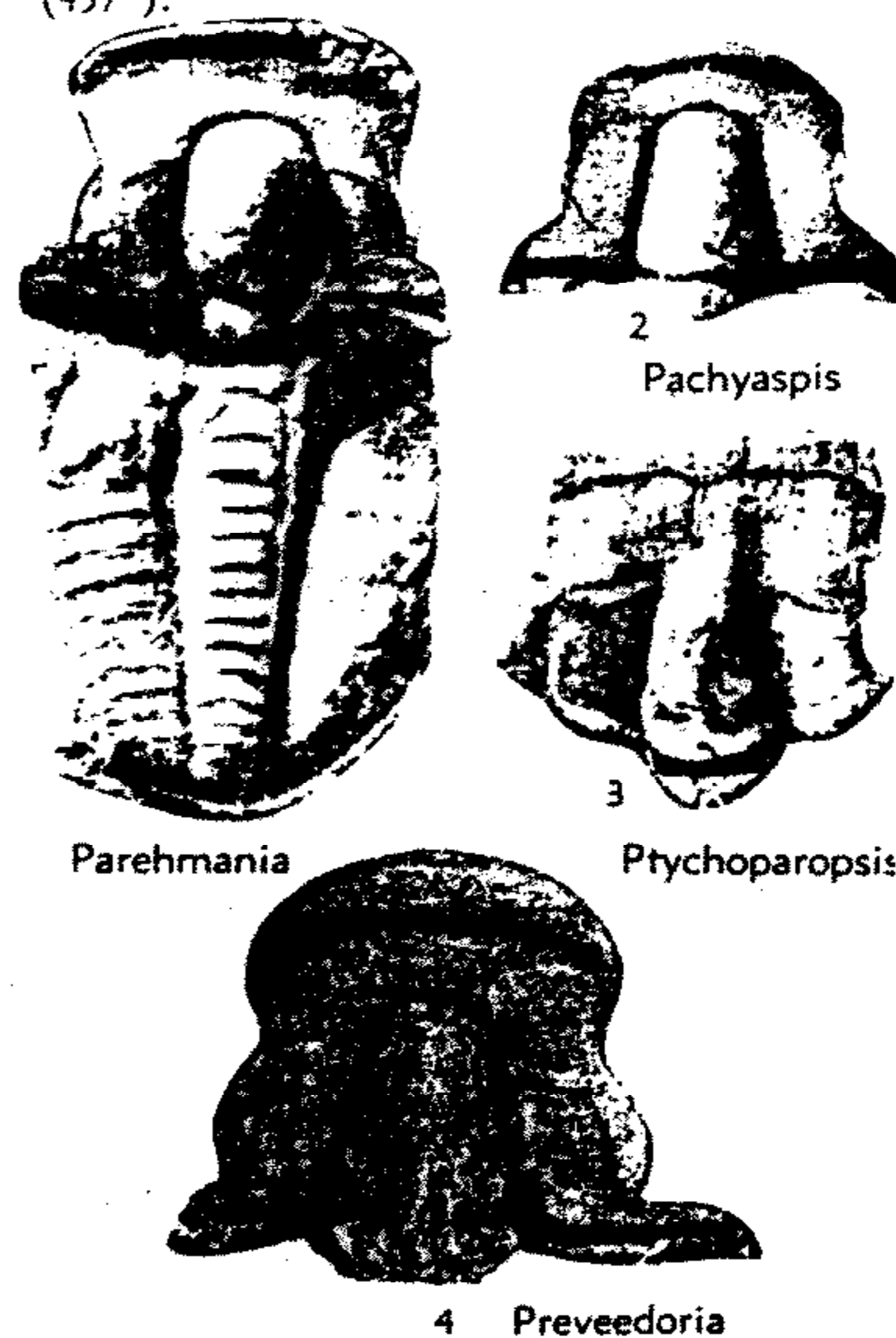

FIG. 180. Alokistocaridae (p. 0241).

Superfamily CONOCORYPHACEA Angelin, 1854

[*nom. transl.* HENNINGSMOEN, 1951 (ex Conocoryphidae ANGELIN, 1854)] [HENNINGSMOEN'S attribution of this superfamily name to SWINNERTON, 1915, is erroneous, inasmuch as neither SWINNERTON'S "Suborder Conocoryphida" nor his "Section Conocoryphina" are definable as family-group taxa; rather, they are classifiable as belonging to the class/order category of taxa, which is entirely distinct nomenclaturally from the family-group (Copenhagen Decisions on Zoological Nomenclature, London, 1953). RCM.]

Dorsal exoskeleton very diminutive to medium in size, elongate oval in outline, mostly micropygous. Cephalon semicircular, to subtrapezoidal, with prominent glabella (except *Hartshillia*) defined by deep axial furrows, separated from anterior margin by narrow to wide preglabellar field, occipital ring generally distinct; eyes lacking; cephalic sutures at or near margins or lacking. Thorax with 6 to 25 or more segments. Pygidium with 1 to 8 axial rings. Postcephalic characters rather widely variable in different genera. *L.Cam.-U.Ord.*

Family CONOCORYPHIDAE Angelin, 1854

[=Campylopleuri BURMEISTER, 1843; Conocephalidae SALTER, 1864; Ptychopariidae MATTHEW, 1887 (*partim*)]

Ovate to elongate exoskeleton, micropygous to heteropygous. Cephalon, semicircular to trapezoidal, without eyes; glabella typically tapering forward, well defined; preglabellar field usually well developed, cephalic border narrow or lacking; ?facial sutures marginal or dividing lateral cephalic border longitudinally or trespassing on lateral border furrow. Thorax of 7 to 25 or more segments. Pygidium with 1 to 8 axial rings, posterolateral margin evenly curved, outer surface granulated, lined, or both. Hypostoma free in type genus and probably so in others of family; cephalic doublure and ventral sutures imperfectly known. *L.Cam.-L.Ord.* (*Tremadoc.*)

Conocoryphe HAWLE & CORDA, 1847 [**Trilobites sulzeri* SCHLOTHEIM, 1823; SD MILLER, 1889] [= *Conocephalus* ZENKER, 1833 (*non* THUNBERG, 1833); *Conocephalites* BARRANDE, 1852 (*obj.*)]. Exoskeleton ovate. Cephalon semicircular; glabella with 3 pairs of strongly oblique lateral furrows; axial furrows continued divergently forward defining low preglabellar lobate tract; eye ridges (when present) threadlike, evenly curved, extending from anterior corners of glabella to genal angles; lateral cephalic border divided longitudinally by suture and continued into slender, backward-directed genal spines. Thorax of 14

segments, with deeply furrowed pleurae and truncate extremities. Pygidium of about 6 to 8 segments, semicircular, with narrow, well-defined border (3, 233). *M.Cam.*, N.Am. (Atl. prov.), Eu.-Asia.—FIG. 181, 1. **C. sulzeri* (SCHLOTHEIM), Czech.; *1a, b*, exoskel., hypostoma, $\times 1$ (3).

Atops EMMONS, 1844 [**A. trilineatus*]. Differs from *Conocoryphe* in having glabella extended to anterior border furrow, less oblique lateral furrows, shorter, less oblique eye ridges, suture trespassing on lateral border furrow. Thorax with 17 segments. Pygidium indistinctly segmented, with wide, rapidly tapering axis (75). *L.Cam.*, E.N.Am.—?Sp.—FIG. 181, 2. **A. trilineatus*, N.Y.; exoskel., $\times 1$ (488).

Bailiaspis RESSER, 1936 [**Conocephalites elegans* HARTT in DAWSON, 1868]. Differs from *Conocoryphe* in thickened anterior border in front of glabella, depressed preglabellar field without lobate tract; sutures cutting across lateral border at least to border furrow. Pygidium without border and with only 2 or 3 defined segments (337). *M.Cam.*, N.Am. (Atl. prov.)-Eu.—FIG. 181, 6. *B. dalmani* (ANGELIN), Swed.; cran., $\times 1.5$ (337).

Bailiella MATTHEW, 1885 [**Conocephalites baileyi* HARTT, 1868; SD RESSER, 1936] [= *Liocephalus* GRÖNWALL, 1902; ?*Tangshiella* HUPÉ, 1953]. Differs from *Bailiaspis* in having anterior border without median backward projection and pygidium with well-defined border (337). *M.Cam.*, N.Am. (Atl. prov.)-Eu.-N.Afr.-Asia.—FIG. 182. *B. emarginata* (LINNARSSON), Swed.; exoskel., partly restored, $\times 2$ (337).

Cainatops MATTHEW, 1899 [**Conocoryphe pustulosa* MATTHEW, 1897]. Small forms with large glabella and wide cephalic border with median, forward-projecting spine (147). *M.Cam.*, N.Am. (Atl. prov.).

Couloumania THORAL, 1946 [**Conocoryphe heberti* MUNIER-CHALMAS & BERGERON, 1889]. Differs from *Bailiella* in having suture on lateral cephalic border like that of *Conocoryphe* (295). *M.Cam.*, Eu.-N. Afr.

Ctenocephalus HAWLE & CORDA, 1847 [**C. barrandei* (= *Conocephalus coronatus* BARRANDE, 1846)] [= *Harttella* MATTHEW, 1884]. Differs from *Conocoryphe* in semiglobular shape of preglabellar lobate tract reaching level of genae. Thorax of 15 segments. Pygidium very small, with extremely wide pleural fields, axis consisting of 1 or 2 rings and short terminal portion (3, 233, 337). *M.Cam.*, Eu.-N.Am. (Atl. prov.)-N.Afr.-E.Sib.—FIG. 181, 3. **C. coronatus* (BARRANDE), Czech., exoskel., $\times 1$ (3).

Dasometopus RESSER, 1936 [**Harpides breviceps* ANGELIN, 1854]. Cephalon approximately semicircular; glabella about half length of cephalon, with 2 or 3 pairs of lateral furrows, posterior pair recurved; genae moderately convex, separated from each other by considerable preglabellar de-

pression; border and border furrow lacking, cephalic margin merely being upturned, forming wide, concave marginal zone; sutures apparently marginal or nearly so (233, 337). *M. Cam.*, Denm.-Swed.-E. Sib.—FIG. 181, 4. **D. breviceps* (ANGELIN), Swed.; ceph. (?cran.), X4 (337).

Elyx ANGELIN, 1854 [*pro Eryx* ANGELIN, 1851 (*non* DAUDIN, 1803; *nec* STEPHENS, 1832; *nec* SWAINSON, 1840)] [**Eryx laticeps* ANGELIN, 1851]. Differs from *Ctenocephalus* in trapezoidal cephalic outline, preglabellar lobate tract joining anterior border, and thoracic segments terminating

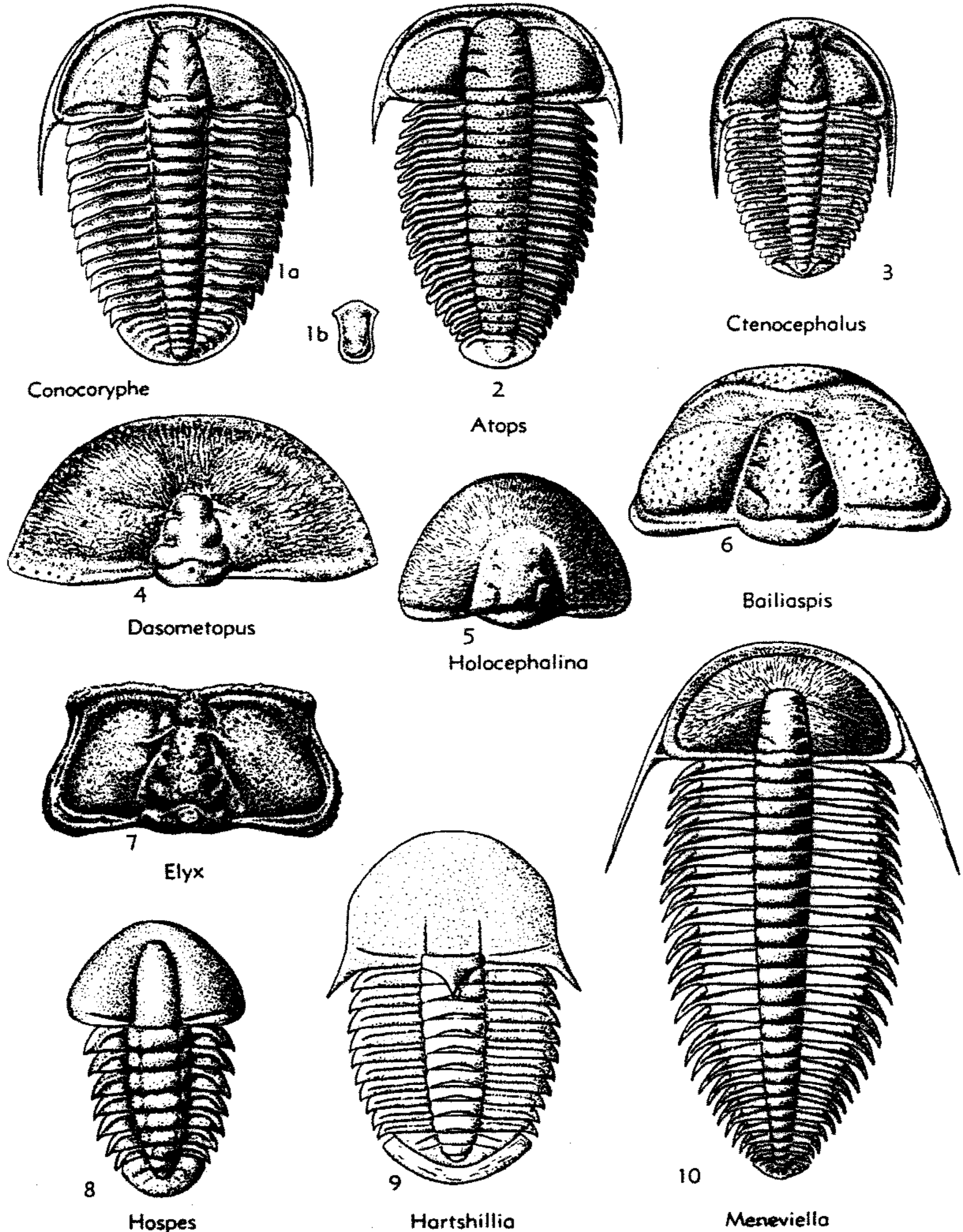

FIG. 181. Conocoryphidae (p. 0242-0244).

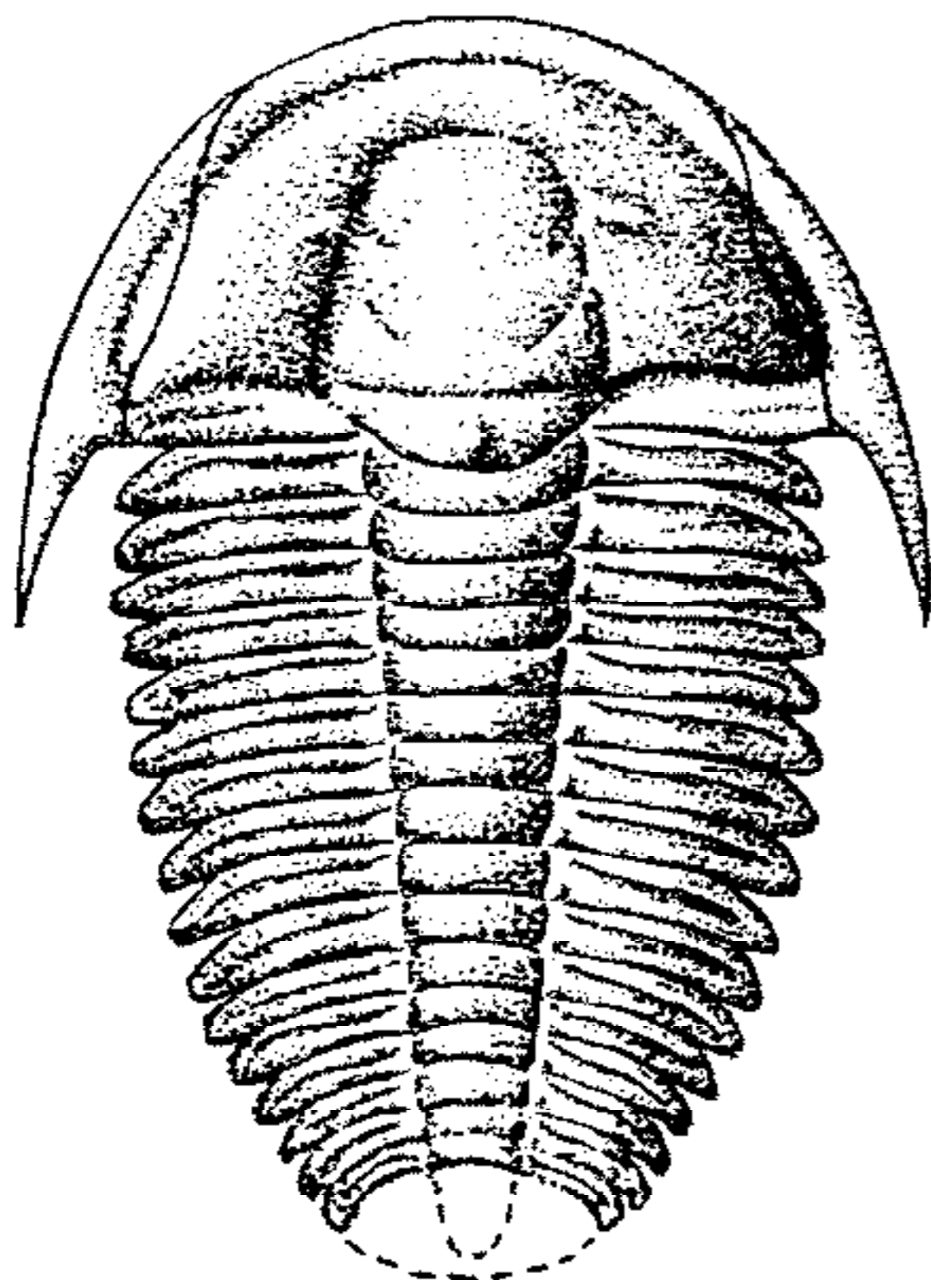

FIG. 182. *Bailiella emarginata* (LINNARSSON) (Conocoryphidae), M.Cam., Swed.; exoskel., $\times 2$ (337).

in recurved pleural spines (337). *M.Cam.*, Scand.-E.N.Am. — FIG. 181,7. **E. laticeps* (ANGELIN), Swed.; ceph. (?cran.), $\times 2$ (337).

Hartshillia ILLING, 1916 [**Holocephalina inflata* HICKS, 1872; SD VOGDES, 1925]. Broadly ovate, cephalon and thorax subequal in length, pygidium short. Cephalon evenly convex, almost semicircular, without border; glabella very little raised above genae, indistinctly defined in front, lateral furrows effaced and occipital ring with short, strong spine; preglabellar furrow and anterior portion of axial furrows obliterated; sutures apparently marginal; genal spines short, strong, somewhat outwardly directed. Thorax of 8 or more segments; axis a little narrower than pleural regions, fairly prominent; pleurae horizontal nearly to extremities, terminating in short backward-directed points. Pygidium very wide, with strongly tapering axis of 2 to 5 rings, and well-defined, wide, strongly sloping border (114). *M.Cam.*, Br.I.-E.N.Am.(Atl. prov.)-?N.Afr. — FIG. 181,9. **H. inflata* (HICKS), Br.I.; exoskel. (reconstr.), $\times 3$ (446).

?**Hartshillina** LAKE, 1940 [**Hartshillia spinata* ILLING, 1916]. Differs from *Hartshillia* in lack of occipital and genal spines, and in having wider thoracic axis with median spines on axial rings, pleural regions of thorax and pygidium much narrower than axis, and pygidial segments probably terminating in spines (114). *M.Cam.*, Eng.

Holocephalina SALTER, 1864 [**H. primordialis*] [= *Carausia* HICKS, 1872]. General form ovate, thorax longer than cephalon, narrowing posteriorly to very small pygidium. Cephalon semielliptical, length exceeding half total width, evenly convex, with almost imperceptible anterior and lateral border furrows; glabella very little raised above genae,

about half as long as cephalon and one-third as wide, rounded in front, with 3 pairs of usually obscure lateral furrows; preglabellar furrow and anterior part of axial furrows shallow; occipital furrow wide, well impressed; sutures practically marginal; genal spines strong, straight, extending backward to about 5th thoracic segment. Thorax of about 15 to 17 segments with prominent axis and obliquely truncated pleurae (114). *M.Cam.*, Br.I.-Denm.-E.N.Am.(Atl. prov.). — FIG. 181,5. *H. teres* (GRÖNWALL), Denm.; ceph. (?cran.), $\times 4$ (51).

?**Hospes** STUBBLEFIELD, in STUBBLEFIELD & BULMAN, 1927 [**H. clonograpti*]. Ovate, very small. Cephalon relatively large, rounded triangular, without anterior and lateral borders; glabella convex, slender, narrowing anteriorly to a blunt termination, without lateral furrows, separated from anterior margin by short preglabellar field. Thorax of 7 segments with wide, convex axis, very narrow pleural regions, and strongly ridged pleurae terminating in backward-directed, falcate points. Pygidium small, convex, semielliptical, segments few (287). *L.Ord.(Tremadoc.)*, Eng.-Ger. — FIG. 181,8. **H. clonograpti*, Eng.; exoskel., $\times 15$ (287).

Meneviella STUBBLEFIELD, 1951 [*pro Erinnyis* SALTER, 1865 (non AGASSIZ, 1846); *Salteria* WALCOTT, 1884 (non W. THOMSON, 1864); *Menevia* LAKE, 1938 (non SCHAUS, 1928)] [**Erinnyis venulosa* SALTER, 1872]. General form elongate, tapering from wide cephalon to very small pygidium. Cephalon occupying less than 0.25 of total length, differing from that of *Bailiella* in having sutures on lateral borders; genal spines slender, extending obliquely backward to about 6th thoracic segment. Thorax of 25 or more segments with narrow axis and wide pleural regions; pleurae terminating in strong, backward-curving spines. Pygidium small, with flat border, narrow, rapidly tapering axis of about 3 rings and terminal portion, and distinctly segmented pleural fields (51, 114). *M.Cam.*, Br.I.-Denm.-E.N.Am.(Atl. prov.)-Asia. — FIG. 181,10. **M. venulosa* (SALTER), Br.I.; exoskel., $\times 2$ (114, somewhat modified).

Parabailiella THORAL, 1946 [**P. languedocensis*]. Differs from *Conocoryphe* in having sutures cutting across lateral borders at least to border furrows (295). *M.Cam.*, S.Fr.

Pseudatops LAKE, 1940 [**Conocoryphe reticulata* WALCOTT, 1890]. Differs from *Atops* in having glabella encroaching on anterior border, no indication of sutures on dorsal side of cephalon; surface covered with network of raised lines (75, 114). *L.Cam.*, E.N.Am.-Br.I.

?Family SHUMARDIIDAE Lake, 1907¹

¹ Assignment of this family to superfamily Conocoryphacea is doubtful; alternatively it should be classified in Families Incertae Sedis.—Ed.

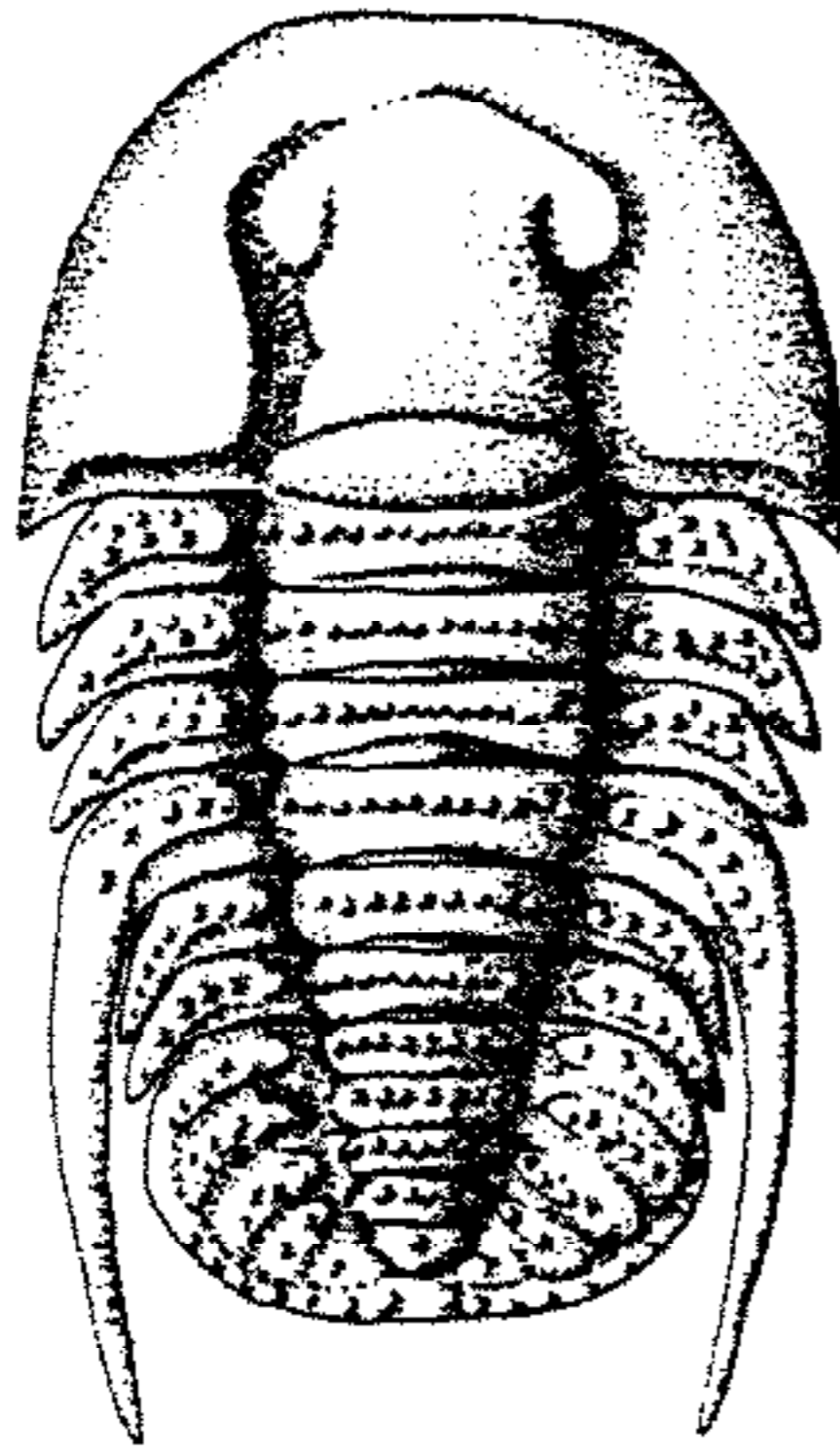

FIG. 183. *Shumardia pusilla* (SARS) (Shumardiidae), ?L.Ord.(Tremadoc.), Eng.; exoskel (reconstr.), $\times 22.5$ (475).

Minute, ovate, convex, heteropygous. Cephalon semicircular, without eyes, and apparently without facial sutures; glabella delimited at sides by unusually deep and wide axial furrows and in front by their narrower and shallower, (in some) almost effaced continuation; occipital ring well defined; convex preglabellar field usually well developed; almost evenly convex genae with acute genal angles or with genal spines; posterior border furrows strongly impressed, posterior border narrow. Thorax (as far as known) with 6 or 7 segments. Pygidium greatly varying in shape, with 4 to 7 axial rings. Cephalic doublure, ventral sutures, and hypostoma unknown. ?M.Cam., U. Cam.-U.Ord.

Shumardia BILLINGS, 1862 [**S. granulosa*] [= *Conophrys* CALLAWAY, 1877]. Glabella wide, slightly clavate, strongly inflated, with pair of eyelike lobes at anterior corners delimited by forward-curved anterior pair of lateral furrows, a pair of notches in glabellar margin representing a posterior pair of glabellar furrows; genal angles pointed. Thorax slightly narrower than cephalon; axis wide, strongly tapering, with wide, deeply impressed axial furrows; narrow pleural regions with obliquely backward-curved, pointed pleural extremities, and macropleural 4th thoracic segment terminating in long, backward-directed spines. Pygidium subquadrate to semicircular or (rarely) subtriangular in outline, with strongly tapering axis. Surface of thorax and pygidium bearing transverse rows of tubercles, a row on each

axial ring and 1 or 2 rows on each pleura; pygidium with tuberculated border in some species (114, 153). ?M.Cam., U.Cam.-U.Ord., Eu.-N.Am.-S. Am.-Asia.—FIG. 183. *S. pusilla* (Sars), L.Ord. (Tremadoc.), Eng.; exoskel. (reconstr.), $\times 22.5$ (475).

Acanthopleurella GROOM, 1902 [**A. grindrodi*]. Differs from *Shumardia* in having strongly impressed preglabellar furrow and long, slender, backward-directed genal spines; 4 pairs of long pleural spines (114). L.Ord.(Tremadoc.), Eng.

Eoshumardia HUPÉ, 1953 [**Shumardia orientalis* MANSUY, 1916]. Differs from *Shumardia* in having rounded genal angles and tapering, very wide glabella with broadly rounded front (78). U.Cam., E.Asia.

Idiomesus RAYMOND, 1924 [**I. tantillus*] [= *Stigmametopus* RASETTI, 1944]. Differs from *Shumardia* in having narrower glabella that tapers forward-backward, front indistinctly delimited, eyelike lobes at anterior corners lacking, posterior pair of lateral furrows deeply impressed across glabella, and occipital furrow wider and deeper (192). U.Cam., N.Am.—FIG. 184,2. **I. tantillus*, Vt.; ceph., $\times 9$ (192).

?*Lunacrania* KOBAYASHI, 1955 [**L. trisecta*]. Differs from *Idiomesus* in having well-defined anterior and lateral cephalic borders, wide occipital ring, and

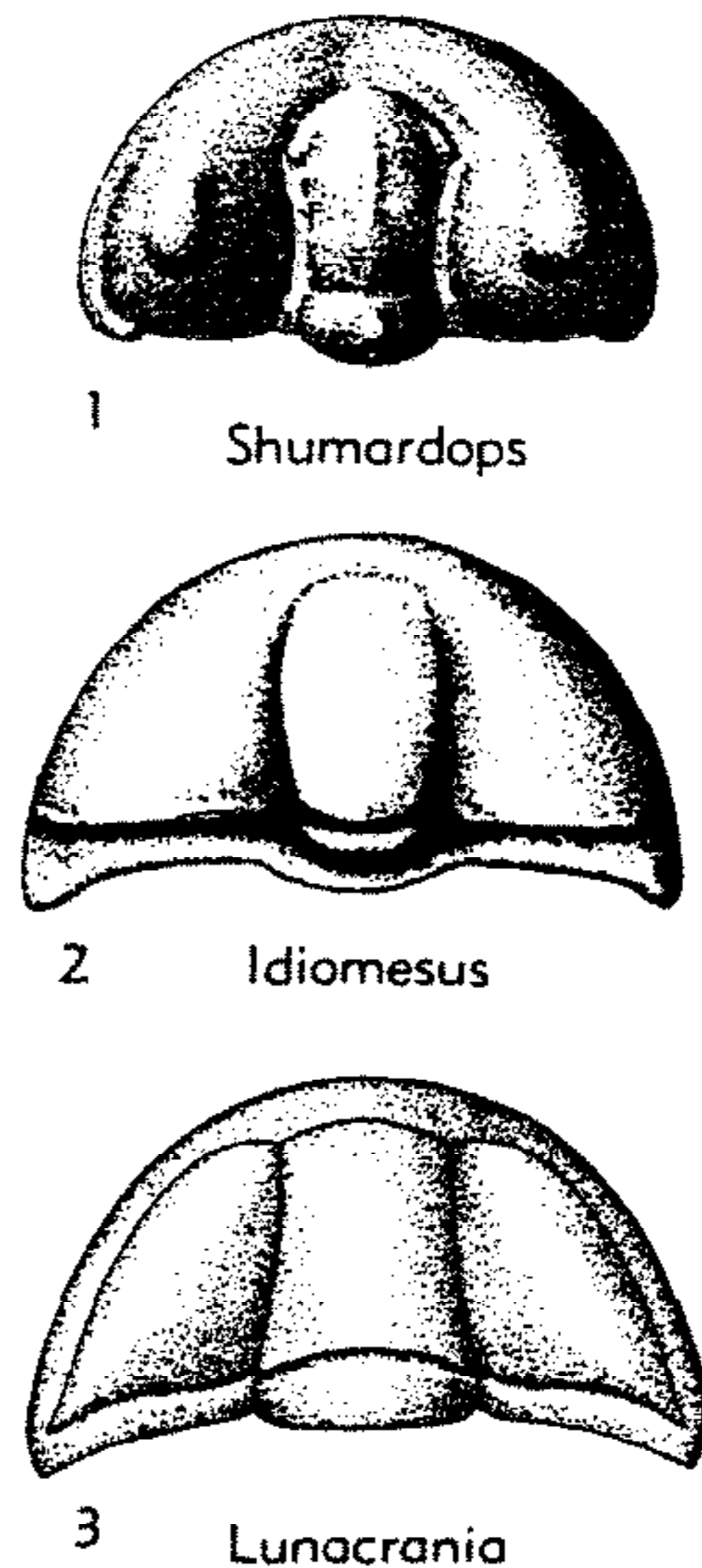

FIG. 184. Shumardiidae (p. 0245, 0246).

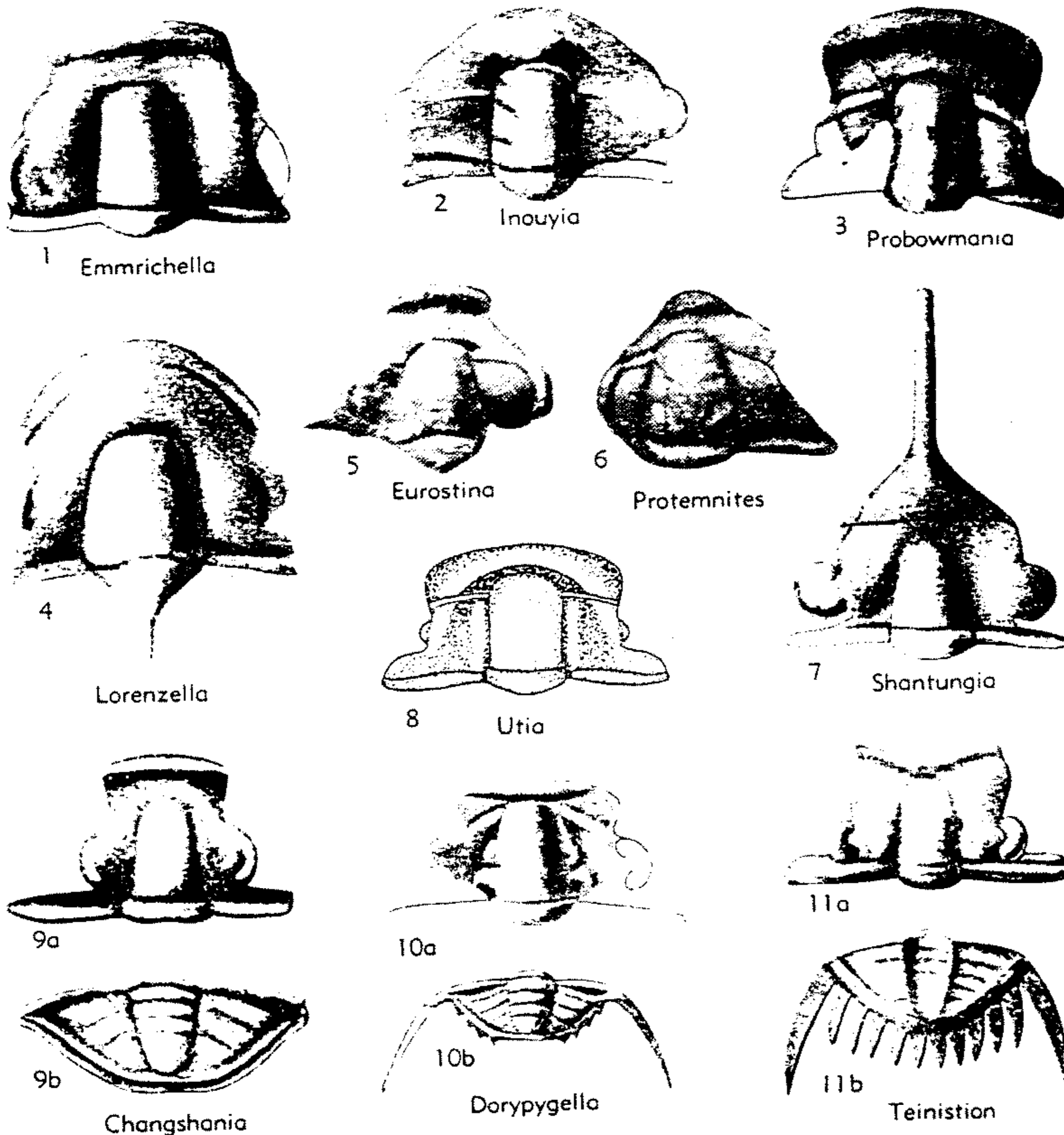

FIG. 185. Emmrichellidae (p. O247, O248).

tapering glabella devoid of transglabellar furrow and defined in front by anterior border furrow (108). *L.Ord.*, N.Am.—FIG. 184,3. **L. trisecta*, W.Can.(B.C.); ceph., $\times 20$ (108).

Koldinioidia KOBAYASHI, 1930 [**K. typicalis*]. Differs from *Idiomesus* in having parallel-sided to tapering glabella, narrower and shallower occipital and posterior border furrows, and in lacking transglabellar extension of posterior pair of lateral furrows (37, 95). *U.Cam.-L.Ord.*, E.Asia.

Shumardops HUPÉ, 1953 [**Shumardia longifrons* TROEDSSON, 1937]. Differs from *Shumardia* in having wider cephalon, longer occipital ring, narrower glabella with median ridge, wider genae with rounded genal angles, a pair of eyelike swellings, and distinct lateral cephalic border (78). *L.Ord.*

(*Tremadoc.*), C.Asia.—FIG. 184,1. **S. longifrons* (TROEDSSON), Tien-shan; ceph., $\times 11$ (301).

Superfamily EMMRICHELLACEA Kobayashi, 1935

[*nom. transl.* HOWELL, herein (ex Emmrichellidae KOBAYASHI, 1935)] [=Utioidae HUPÉ, 1953]

Cephalon relatively wide, semielliptical, cranidium quadrate to subtrapezoidal; glabella mostly with subparallel sides well impressed by axial furrows; fixigenae variable in width, gently to rather strongly convex; eyes generally small and palpebral lobes narrow. Pygidium small, transverse, with border. *M.Cam.-L.Ord.*

Family EMMRICHELLIDAE Kobayashi, 1935

[=Utiidae KOBAYASHI, 1935 (*nom. correct.* MOORE, herein, *pro* Utiidae KOBAYASHI, 1935, *nom. transl.* HUPÉ, 1953, *ex* Utiidae KOBAYASHI, 1935)]

Cranidium subtrapezoidal to subtriangular (*Shangtungia*), with parallel-sided or forward-tapering glabella that is mostly separated from anterior border by distinct preglabellar area; fixigenae variable in width, bearing prominent posterior border. Pygidium much wider than long (*sag.*), with distinct axis tapering backward, border entire, smooth or with marginal spines. *M. Cam.-L. Ord.*

Subfamily EMMRICHELLINAE Kobayashi, 1935

[=Utiidae KOBAYASHI, 1935, *nom. correct.* RUD. RICHTER, 1943 (*pro* Utiidae KOBAYASHI, 1935)]

Cranidium subtrapezoidal to semielliptical, with anterior margin nearly straight or strongly curved forward; glabella parallel-sided or tapering forward, with or without distinct lateral furrows; preglabellar field narrow to wide (*sag.*), convex; eyes mostly small, posterior to mid-length of cranidium, eye ridges present or absent. Pygidium with raised border, margin smooth. *M. Cam.-L. Ord.*

Emmrichella WALCOTT, 1911 [**Ptychoparia theano* WALCOTT, 1905]. Cranidium narrow (*tr.*), glabella narrow and lacking furrows. *M. Cam.*, E. Asia. —FIG. 185, 1. **E. theano* (WALCOTT), Ch'anghia F., China; cran., $\times 6.6$ (488*).

Eurostina WHITEHOUSE, 1939 [**E. trigona*]. Cranidium subtrigonal to subquadrate, anterior border prominent; glabella tapering forward, with 3 pairs of discontinuous furrows; librigenae and preglabellar field inflated, with pair of faint anterolateral depressions; palpebral lobes small but prominent. *M. Cam.*, Austral. —FIG. 185, 5. **E. trigona*, Eurostina Stage, Queensl.; cran., $\times 3.9$ (493*).

Inouyia WALCOTT, 1911 [**Agraulos? capax* WALCOTT, 1906]. Glabella subquadrate, with 3 pairs of discontinuous furrows; preglabellar area with boss in front of glabella; palpebral lobes small, not prominent. *M. Cam.*, E. Asia. —FIG. 185, 2. **I. capax* (WALCOTT), Ki-chou F., China; cran., $\times 4$ (488*).

Lorenzella KOBAYASHI, 1935 [**Agraulos abaris* WALCOTT, 1905]. Like *Inouyia* but without boss on convex preglabellar area, and with occipital spine. *M. Cam.*, E. Asia. —FIG. 185, 4. **L. abaris* (WALCOTT), Kiu-lung F., China; cran., $\times 5$ (488*).

Metabowmania KOBAYASHI, 1955 [**M. latilimba*]. *L. Ord.*, W. Can. (B. C.) [Author's assignment.]

Probowmania KOBAYASHI, 1935 [**Ptychoparia ligea* WALCOTT, 1905]. Cranidium and glabella medium

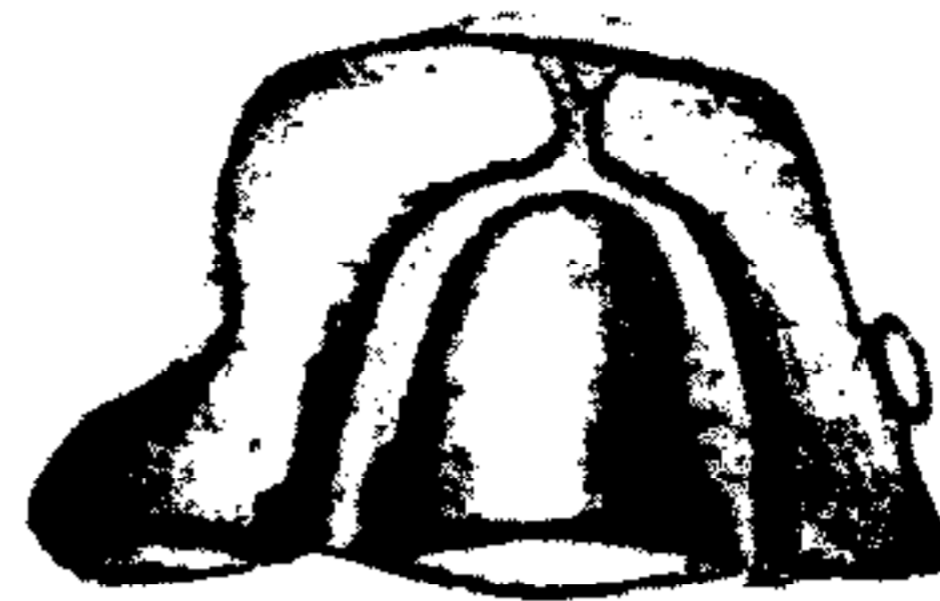

1 Liostracinoides

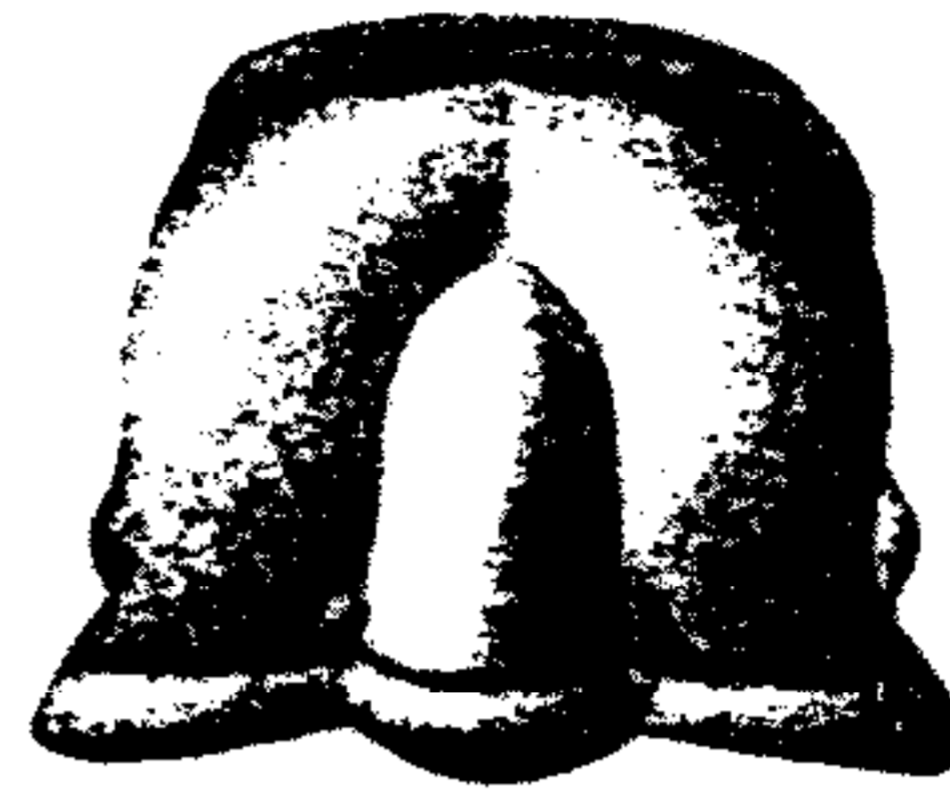

2a



2b

Liostracina

FIG. 186. Liostracinidae (p. 0248).

in width, glabella bearing short furrows. *M. Cam.*, E. Asia. —FIG. 185, 3. **P. ligea* (WALCOTT), Ch'anghia F., China; cran., $\times 4$ (419*).

Protemnites WHITEHOUSE, 1939 [**P. elegans*]. Cranidium like that of *Eurostina* but glabella with only 2 pairs of furrows, narrower fixigenae, and less prominent palpebral lobes and anterior border. *U. Cam.*, Austral. —FIG. 185, 6. **P. elegans*, El-rathiella Stage, Queensl.; cran., $\times 3.3$ (493*).

Utia WALCOTT, 1924 [**U. curio*]. Cranidium and glabella broad, glabella without furrows. *M. Cam.*, W. USA. —FIG. 185, 8. **U. curio*, Spence Sh., Idaho; cran., $\times 1.8$ (488*).

?*Inouyops* RESSER, 1942 [**Ptychoparia titiana* WALCOTT, 1905]. *M. Cam.*, China.

Subfamily CHANGSHANIINAE Kobayashi, 1935

[*nom. correct.* MOORE, herein (*pro* Changshaninae KOBAYASHI, 1935)] [=Changshaniidae HUPÉ, 1953]

Cranidium with parallel-sided to tapering truncate glabella that lacks furrows; palpebral lobes large, behind mid-length of cranidium; fixigenae narrow, with broad transverse posterior areas and raised borders. Pygidium short, wide. *M. Cam.*

Changshania SUN, 1923 [**C. conica*; SD SUN, 1924]. Preglabellar area subquadrate. Pygidium

subtriangular, without spines. *M.Cam.*, E.Asia.—FIG. 185,9. **C. conica*, Kushan F., China; 9a,b, cran., pyg., $\times 3$ (478*).

Dorypygella WALCOTT, 1905 [**D. typicalis*]. Glabella tapering, truncate in front, with 2 pairs of faint lateral furrows; eye ridges strong; anterior border narrow; palpebral lobes rather large; librigenae elongate rectangular, with short genal spines. Pygidium with axis of 4 segments and pair of long recurved spines at anterolateral extremities, border with 4 pairs of short spines. *M.Cam.*, E.Asia.—FIG. 185,10. **D. typicalis*, Kushan F., China; 10a, cran., $\times 5$; 10b, pyg., $\times 6.5$ (488*).

Shangtungia WALCOTT, 1905 [**S. spinifera*] [= *Shantungia* WALCOTT, 1913]. Cranidium like that of *Changshania* but middle of preglabellar area extended forward as spine. *M.Cam.*, E.Asia.—FIG. 185,7. **S. spinifera*, Kushan F., China; cran., $\times 2.9$ (488*).

Teinistion MONKE, 1903 [**T. lansi*; SD VOGDES, 1925]. Cranidium short, wide and subquadrate; palpebral lobes small. Pygidium with numerous spines. *M.Cam.*, E.Asia.—FIG. 185,11. **T. lansi*, China; 11a, cran., $\times 6.7$; 11b, pyg., $\times 6.3$ (433*).

Family LIOSTRACINIDAE Raymond, 1937

Glabella ovate, palpebral lobes very small, fixigenae strongly convex, preglabellar area bearing median longitudinal furrow. *M.Cam.-U.Cam.*

Liostracina MONKE, 1903 [**L. krausei*]. Glabella narrow, preglabellar area longer and fixigenae wider than in *Liostracinoidea*. Pygidium short, wide. *M.Cam.*, E.Asia.—FIG. 186,2. **L. krausei*, China; 2a, cran., $\times 5.5$; 2b, pyg., $\times 7$ (433*).

Liostracinoidea RAYMOND, 1937 [**L. vermontanus*]. Glabella wider and more tapering than that of *Liostracina*, and preglabellar area shorter, fixigenae narrower, and palpebral lobes not so far back. *U.Cam.*, E.USA.—FIG. 186,1. **L. vermontanus*, Gorge F., Vt.; cran., $\times 10$ (449*).

Superfamily CREPICEPHALACEA Kobayashi, 1935

[*nom. transl.* LOCHMAN-BALK, herein (ex *Crepicephalidae* KOBAYASHI, 1935)]

Exoskeleton opisthoparian, elliptical, isopygous or heteropygous. Glabella convex, tapering, front rounded or straight, with 2 or 3 pairs of short diagonal lateral furrows (may be faint or obsolete); eye ridges present or absent, occipital spine or node common; eyes medium-sized, opposite or posterior to center of glabella; fixigenae variable in width and slope; librigenae with medium or long genal spine. Thorax of 13 or fewer segments; axis convex, less than 0.5 of width

(*tr.*) of pleurae; pleural furrows well defined, pleural ends falcate. Pygidium compact, subquadrate to subpentagonal, axis and pleural regions about same in width, with 3 to 6 axial rings and pleurae, border narrow, bearing a pair of posterolateral spines derived from pleurae or border, variable in length and divergence. Surface finely to coarsely granulose, rarely smooth. Polyphyletic derivation. *M.Cam.-U.Cam.*

Family CREPICEPHALIDAE Kobayashi, 1935

[= *Crepicephalidae* LOCHMAN, 1936]

Exoskeleton isopygous. Glabella convex, tapering, front rounded or straight, with 2 or 3 pairs of short diagonal lateral furrows; internal venation on preglabellar field and eye platforms usually prominent, eye ridges present or absent, occipital spine may be present; eyes of medium size, position variable; fixigenae horizontal; librigenae with medium to long, flat genal spine. Thorax of 12 segments, axis convex, less than 0.5 of width (*tr.*) of pleurae, pleural furrows distinct, pleural ends falcate. Pygidium subrectangular to subpentagonal, axis convex, tapered, about same width as triangular pleural platforms, with 3 to 6 axial rings and pleurae, border narrow anteriorly, and at posterior median line, expanding into broad bases of a pair of very short to medium-length flat spines at posterolateral corners. Outer surface smooth or very finely granulose. Derived from a ptychopariid stock. *M.Cam.-U.Cam.*

Crepicephalus OWEN, 1852 [**Dikelocephalus? iowensis* OWEN, 1852; SD WALCOTT, 1886] [= *Crepicocephalus* BIGSBY, 1868; *Crepicephalus* VOGDES, 1890; *Sneedvillia* RESSER, 1938; *Crepicephalus* KOBAYASHI, 1944]. Eyes opposite center of glabella; eye ridges and palpebral furrows prominent; fixigenae horizontal, with palpebral area about 0.3 of glabellar width, posterior area long (*tr.*). Thorax of 12 segments. Pygidium subrectangular, axis 0.7 to 0.75 of its length, with 4 or 5 axial rings and pleurae, interpleural grooves ending at border, without border furrow, border flat or slightly concave, widest at base of spines, length and divergence highly variable (316). *Low. U.Cam.* (*Dresbach.*), N.Am.-Sib.—FIG. 187,3. **C. iowensis* (OWEN), Wis.; 3a,b, cran., $\times 1$; 3c, librigena, $\times 1$; 3d, pyg., $\times 1$ (316).

Bonneterrina LOCHMAN, 1936 [**B. prima*] [= *Holstonia*, *Piedmontia* RESSER, 1938]. Glabella broadly rounded in front, with 2 pairs of faint glabellar

furrows; eyes opposite posterior 0.3 of glabella; eye ridges and palpebral furrows prominent; occipital furrow shallow, occipital spine prominent; fixigenae horizontal, with palpebral areas less than 0.5 of glabellar width, posterior area short (*tr.*);

librigenae with strong genal spine. Pygidium unknown (123). *Low.U.Cam.(Dresbach.)*, N.Am. —FIG. 187.6. **B. prima*; cran. and librigena, $\times 1$ (123, 126).

Crepicephalina RESSER & ENDO, in KOBAYASHI, 1935

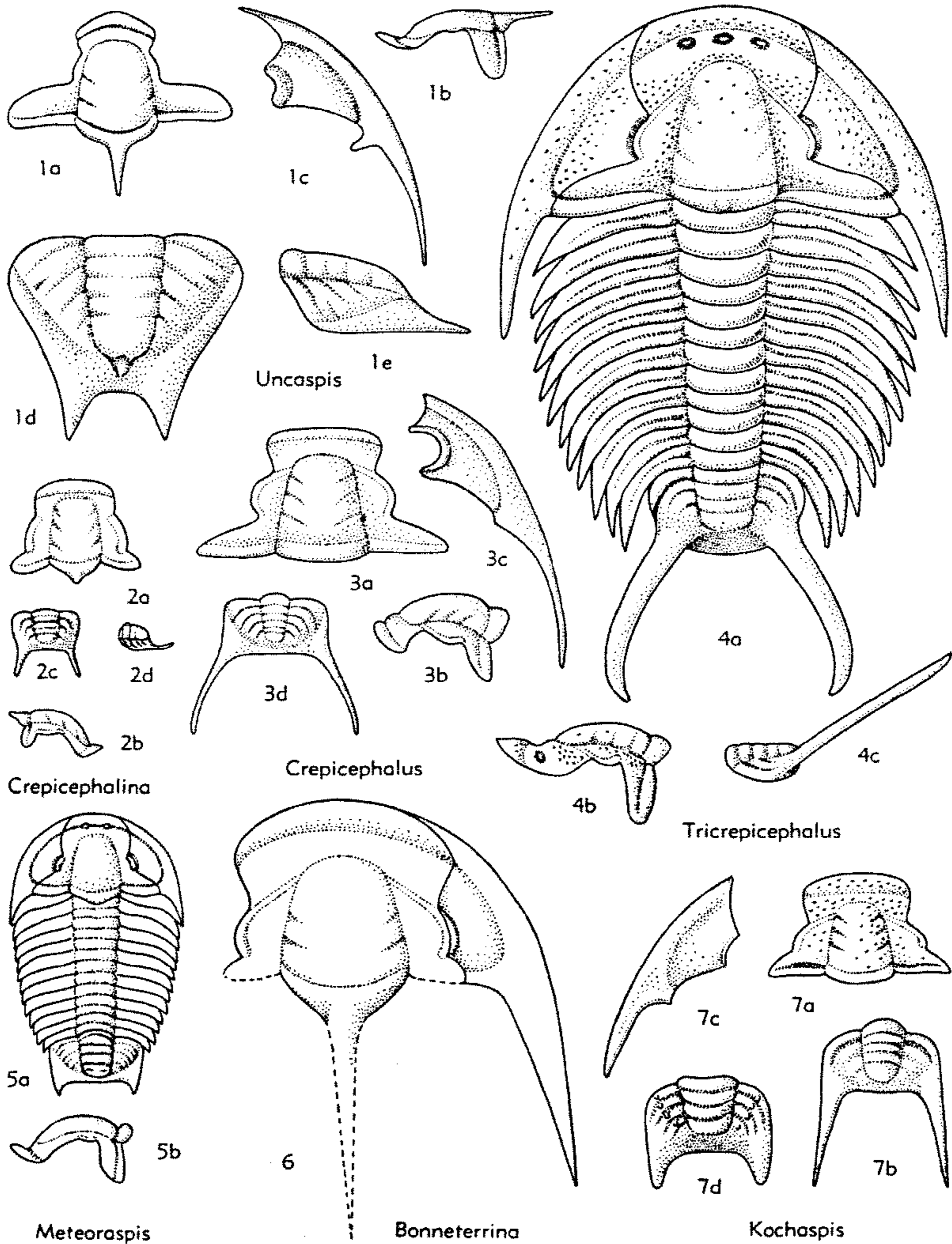

FIG. 187. Crepicephalidae (p. O248-O250).

KOBAYASHI (non RESSER & ENDO), 1935 [**Crepicephalus convexus* WALCOTT, 1913] [= *Mesocrepicephalus* KOBAYASHI, 1935]. Eyes slightly behind center of glabella; palpebral furrows deep but eye ridges faint; preglabellar area narrow to absent; with occipital node or short spine; fixigenae horizontal, with palpebral area less than 0.5 of glabellar width, posterior area of medium length (*tr.*). Pygidium subquadrate; axis convex, wider than pleural regions, 0.8 of pygidial length, with 2 to 4 axial rings; 3 low, broad pleurae curve sharply back into base of spines, border along posterior only (37). *M. Cam.*, E. Asia.- Austral.—FIG. 187,2. **C. convexa* (WALCOTT), Liau-tung, Manch.; 2*a,b*, cran.; 2*c,d*, pyg., both $\times 2$ (37).

Kochaspis RESSER, 1935 [**Crepicephalus liliana* WALCOTT, 1886] [= *Palaeocrepicephalus* KOBAYASHI, 1935 (obj.)]. Eyes opposite center of glabella, palpebral furrows and eye ridges present; fixigenae horizontal or upsloping, with palpebral areas almost 0.7 of glabellar width, posterior area long (*tr.*). Pygidium subquadrate, axis wide, convex, 0.75 of length, with 3 or 4 axial rings; 3 or 4 low, broad pleurae curve abruptly back near margin into base of spines which are variable in length and divergence, border along posterior only (197, 307). *M. Cam.*, N. Am.—FIG. 187,7*a-c*. **K. liliana* (WALCOTT), Low. M. Cam., Nev.; 7*a-c*, cran, pyg., librigena, $\times 1$.—FIG. 187,7*d*. *K. cecinna* (WALCOTT), Low. M. Cam., Alba.; pyg., $\times 2$ (307).

Uncaspis KOBAYASHI, 1935 (emend. RAASCH & LOCHMAN, 1943) [**Crepicephalus unca* WALCOTT, 1916]. Eyes slightly in front of center of glabella, glabellar furrows faint; palpebral furrows and eye ridges lacking; occipital spine may be present; fixigenae with palpebral areas consisting only of palpebral lobes, posterior area rectangular, wide (*sag.*) and long (*tr.*). Thoracic segment may have axial spine. Pygidium subpentagonal; axis tapered through 0.75 of length, with a short postaxial ridge, with 4 or 5 axial rings; pleural regions narrow, triangular, 3 broad pleurae; border furrow faint, border narrow anteriorly, widening posteriorly with a median inward bend or short spine on each side (186). *Low. U. Cam. (Dresbach.)*, N. Am.—FIG. 187,1. **U. unca* (WALCOTT), Wis.; 1*a,b*, cran.; 1*c*, librigena; 1*d,e*, pyg.; all $\times 2$ (186).

Family TRICREPICEPHALIDAE Palmer, 1954

Exoskeleton heteropygous. Glabella convex, elongate tapering, front rounded, glabellar furrows faint or obsolete, 2 or 3 pits on anterior border furrow; eye ridges present or absent; occipital spine or node common; eyes of medium size, opposite or posterior to center of glabella; fixigenae variable in width and slope; librigenae with medium

or long genal spines. Thorax with 13 or fewer segments; axis convex, less than 0.5 of width (*tr.*) of pleurae, pleural furrows well defined, pleural ends falcate. Pygidium compact, subquadrate; axis wide, subparallel-sided, extending nearly full length, 3 or 4 axial rings; pleural regions narrow, with 3 or 4 pleurae; no border furrow, narrow border, pair of round, medium to long spines at posterolateral corners. Surface granulose. Derivation—ptychopariid stock. *U. Cam. (Dresbach.)*.

Tricrepicephalus KOBAYASHI, 1935 [**Arionellus (Bathyurus) texanus* SHUMARD, 1861] [= *Paracrepicephalus* LOCHMAN, 1936]. Eyes behind mid-level of glabella, lateral furrows shallow, with 3 evenly spaced, round or elliptical pits in anterior border furrow; palpebral furrows shallow, eye ridges narrow, with occipital spine or node; fixigenae horizontal, with palpebral area more than 0.5 of glabellar width, posterior area long (*tr.*). Thorax of 12 segments. Pygidium quadrate; axis convex, wider than pleural regions, more than 0.7 of length, with 3 axial rings; 3 broad, low pleurae forming into a long hollow, rounded spine at posterolateral corners, narrow border along posterior continues under spines along sides (235, 316). *Low. U. Cam. (Dresbach.)*, N. Am.-S. Am.—FIG. 187,4. **T. texanus* (SHUMARD), Tex.; 4*a*, exoskel., $\times 0.9$; 4*b*, cran. profile, $\times 1$; 4*c*, pyg. profile, $\times 1$ (123, 316).

Meteoraspis RESSER, 1935 [**Ptychoparia? metra* WALCOTT, 1890] [= *Meteraspis* KOBAYASHI, 1936; *Greylockia*, *Coleopachys* RAYMOND, 1937]. Eyes slightly behind mid-glabellar level, without glabellar furrows; 2 pits in anterior border furrow with rarely a faint 3rd median pit; palpebral furrows deep, without eye ridges; occipital node may be present; fixigenae upsloping, with palpebral area 0.2 to 0.3 or less of glabellar width, posterior area of medium length (*tr.*). Thorax of 13 segments. Pygidium subquadrate; axis wide, 0.8 to 0.83 of length, with 3 or 4 axial rings; pleurae 3, broad, convex, interpleural grooves and pleural furrows ending at border which widens into base of posterior spines, border furrow lacking (125, 132). *Low. U. Cam. (Dresbach.)*, N. Am. (E. Can.-Mont.-Tex.)-S. Am.—FIG. 187,5. *M. borealis* LOCHMAN, Mont.-Tex.; 5*a*, exoskel.; 5*b*, cran. profile; both $\times 3$ (125).

Superfamily NEPEACEA Whitehouse, 1939

[*nom. transl.* LOCHMAN-BALK, herein (ex Nepeidae WHITEHOUSE, 1939)]

Exoskeleton apparently proparian, micro-pygous. Glabella short, tapering to subquadrate, with straight front, glabellar fur-

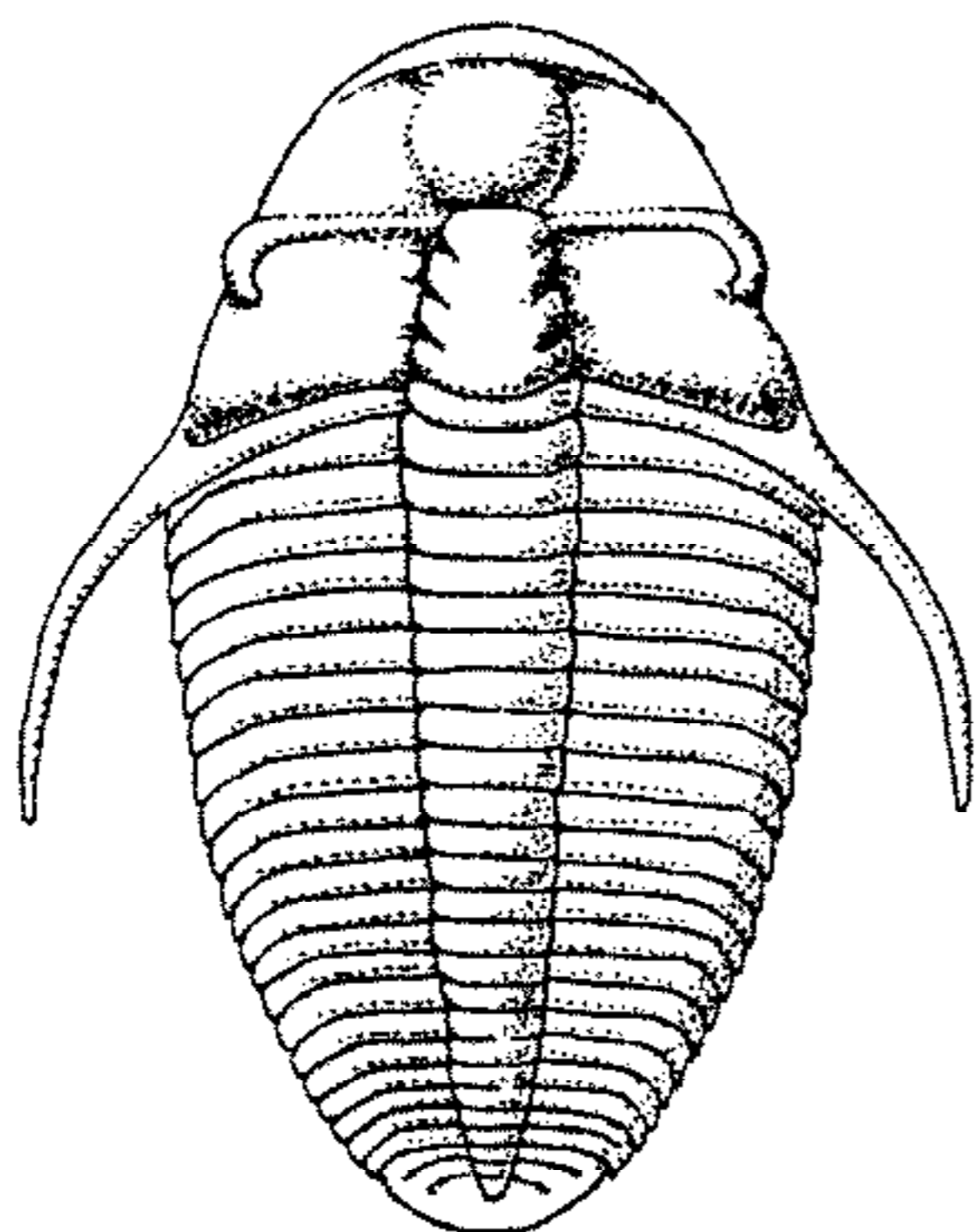

FIG. 188. **Nepea narinosa* WHITEHOUSE (Nepeidae), M. Cam., Queensl.; exoskel. lacking librigenae (reconstr.), $\times 2$ (493).

rows present, with prominent median boss on preglabellar field; with anterior border and marginal furrow; occipital spine may be present; eye ridges present, may be double, eyes small, opposite anterior third of glabella; fixigenae upsloping, with palpebral areas as wide or wider than glabella, posterior area narrow, much wider (*tr.*) than occipital ring, posterior marginal furrow curving forward, genal spines present; librigenae forming small convex triangles. Thorax of 22 or fewer narrow segments, axis much narrower than pleurae, pleural furrows narrow, distinct, on anterior third of pleurae. Pygidium transverse; axis broad, tapered to rounded end, about same in width as pleural regions, border narrow. Surface unknown. *M. Cam.*

Family NEPEIDAE Whitehouse, 1939

Characters of superfamily. *M. Cam.*

Nepea WHITEHOUSE, 1939 [**N. narinosa*]. Glabella tapering forward, truncate at front, with 3 pairs of lateral furrows; swollen median boss occurs on preglabellar field, bounded laterally by furrows continuous from axial furrows, boss may impinge forward onto marginal furrow; anterior border very narrow; occipital spine present; fixigenae steeply upsloping, with palpebral areas 1.5 times width of glabella, posterior area elongate, about 3 times width (*tr.*) of occipital ring, with long or short slender genal spines. Thorax of no fewer than 22 segments. Pygidium very small, axis convex, with 2 or 3 axial rings; pleural regions low, with 2 or 3 pleurae (340). *Up. M. Cam.*

(Amphoton Stage), NW. Queensl.—FIG. 188. **N. narinosa*; exoskel. lacking librigenae (reconstr.), $\times 2$ (493, modified).

Superfamily DIKELOCEPHALACEA Miller, 1889

[*nom. transl.* HENNINGSMOEN, 1951, but attributed by him to RICHTER, 1933 (*ex* Dikelocephalidae MILLER, 1889)] [=Dikelocephalidea RICHTER, 1933 (*partim*); Dikelocephaloidae HUPÉ, 1953 (attributed to RICHTER, 1933)]

Exoskeleton opisthoparian, medium-sized to large, ellipsoidal in outline, heteropygous to subsipygous. Cephalon mostly semi-circular, with more or less broadly tapering glabella that bears 2 or 3 pairs of lateral glabellar furrows, posterior pairs commonly complete; frontal area broad (*sag.* and *tr.*), anterior border furrow shallow to obsolete; palpebral lobes prominent, eyes usually medium-sized; librigenae bearing medium to long genal spine. Thorax with 13 or fewer segments. Pygidium broadly ovate to transverse, with interpleural and pleural furrows tending to curve conspicuously backward across broad border, some forms with pair of short posterolateral spines. Surface smooth to finely granulose. *L. Cam.-U. Cam.*

Family IDAHOIIDAE Lochman, 1956

Exoskeleton opisthoparian, heteropygous. Glabella tapering, truncate-tapering or subrectangular, with 3 pairs of arcuate lateral furrows distinct to very faint; eye ridges narrow; with broad palpebral furrows and wide palpebral rims; eyes medium-size to large, opposite or somewhat behind mid-length of glabella; ratio of preglabellar field to anterior border highly variable; anterior border furrow narrow; fixigenae variable in position and width, with palpebral area arcuate, 0.3 to 0.5 of glabellar width, posterior area narrow (*exsag.*), straplike, of medium length (*tr.*); librigenae quadrate, with obsolete marginal furrows at genal angles, genal spines rounded. Pygidium with convex axis, tapered to broadly rounded end with usual median indentation and short postaxial ridge, with 3 or 4 axial rings and terminal ring; pleural field low, pleurae 3, with broad shallow furrows and narrower interpleural grooves that are distinct to very faint, without border furrow; border of variable width. Surface granulose. Derived from Ptychopariidae. *U. Cam.*

Idahoia WALCOTT, 1924 [**I. serapio*]. Glabella truncate-tapering, with lateral furrows faint to obsolete, occipital spine commonly present; eyes somewhat behind mid-length of glabella; frontal area between 0.3 and 0.5 of length of cranium, bearing row of small granules along anterior border furrow; fixigenae horizontal to slightly upsloping, with palpebral areas about 0.3 of glabellar width; librigenae with long anteriorly or posteriorly recurved genal spine. Pygidium semicircular; axis about equal in width to pleural field, somewhat more than 0.5 of length of pygidium, pleural furrows distinct, interpleural grooves faint; border wide, flat to concave. Surface smooth or very finely granulose (8, 321). *U.Cam.(Francon.)*, N. Am.—FIG. 189,2. **I. serapio*, Idaho; 2a, ceph.; 2b, hypostoma; 2c, pyg., all $\times 1$ (321).

Bellaspidella RASETTI, 1945 [**B. resseri*]. Glabella convex, subrectangular, with 2 pairs of lateral deep furrows; eyes of medium size, slightly behind center of glabella; frontal area 0.12 of length of cranium; fixigenae horizontal to slightly upsloping, narrow, with palpebral areas about 0.3 of glabellar width, posterior area very narrow (*exsag.*). Surface finely granulose (189). *U.Cam.(Trempeal.)*, E.N.Am.

Comanchia FREDERICKSON, 1950 [**Ptychopleurites amplooculata* FREDERICKSON, 1948]. Glabella subrectangular, with distinct lateral furrows; eyes relatively large, slightly behind mid-length of glabella, frontal area between 0.2 and 0.25 of length of cranium; preglabellar field narrow, fixigenae slightly upsloping, very narrow, with palpebral area 0.3 of glabellar width. Surface finely granulose. *U.Cam.(Francon.)*, C.N.Am.—FIG. 189,1. **C. amplooculata* (FREDERICKSON), Okla.; 1a,b, cran., dorsal, side, $\times 10$ (47).

Pseudosaratogia WILSON, 1951 [**P. magna*]. Glabella elongate-tapering to truncate-tapering, with distinct lateral furrows, posterior pair in some complete; eyes relatively large, opposite mid-length of glabella; frontal area a little more than 0.25 of length of cranium; anterior border narrow; fixigenae horizontal to upsloping, with palpebral areas slightly less than 0.5 of glabellar width, posterior area very narrow (*exsag.*); librigenae with short genal spine. Pygidium narrow-transverse; axis equal in width to pleural field, 0.7 of length of pygidium; pleural furrows and interpleural grooves distinct, running nearly to margin, with narrow flat to concave border (363). *U.Cam.(Francon.)*, C.N.Am.-E.N.Am.—FIG. 189,4. **P. magna*, Pa.; 4a, ceph., $\times 10$; 4b, profile of cran., $\times 4.5$; 4c, pyg., $\times 6$ (363).

Saratogia WALCOTT, 1916 [**Conocephalites calciferous* WALCOTT, 1879 (*sic*)]. Glabella truncate-tapering, with faint lateral furrows; eyes of medium size, near center of glabella; occipital spine present, frontal area about 0.3 of length of cranium, very narrow (*tr.*); anterior border furrow shallow, border narrow; fixigenae upsloping, very

narrow, with palpebral area 0.3 of glabellar width, posterior area very narrow (*exsag.*). Pygidium narrow-transverse; axis somewhat wider than pleural field, 0.75 of length of pygidium; pleural furrows and parallel interpleural grooves both distinct, border very narrow, poorly defined. Surface finely granulose. *U.Cam.(Trempeal.)*, E.N.Am.—FIG. 189,3. **S. calcifera* (WALCOTT), N.Y.; 3a, cran., $\times 1.5$; 3b, pyg., $\times 3$ (316).

Wilbernia WALCOTT, 1924 [**Ptychoparia pero* WALCOTT, 1890]. Glabella elongate, tapering to subrectangular, lateral furrows faint to obsolete; eyes of medium size, somewhat behind center of glabella; frontal area broad (*tr.*), about 0.25 of length of cranium; ratio of preglabellar field to border variable, anterior border furrow narrow, straight or curved; fixigenae slightly upsloping, with palpebral areas somewhat more than 0.3 of glabellar width, posterior area very narrow (*exsag.*); librigenae with long slender genal spine. Pygidium transverse; axis narrower than pleural field, 0.83 of length of pygidium; pleural furrows and interpleural grooves distinct, slightly curved, abutting against a narrow ridge in position of border furrow, border narrow, flat. Surface may be smooth (8). *U.Cam.(Francon.)*, N. Am.—FIG. 189,5a,b. *W. explanata* (WHITFIELD), Wis.; 5a, ceph.; 5b, pyg., both $\times 1.5$ (8). —FIG. 189,5c,d. **W. pero* (WALCOTT), Tex.; cran., $\times 1.5$ (321).

Meeria FREDERICKSON, 1949 [**M. lirae*]. Glabella moderately convex, elongate truncate-tapering, with 3 pairs of faint lateral furrows, posterior pair arcuate, usually complete, shallow axial furrows may have a pair of anterior pits; frontal area 0.25 to 0.3 of length of cranium, shallow curved anterior border furrow; eyes below medium size, slightly anterior to center of glabella; fixigenae upsloping, with arcuate palpebral areas about 0.25 of glabellar width, posterior areas straplike, about 0.7 length (*tr.*) of occipital ring, posterior sections of facial sutures sigmoidally curved. *U.Cam.(Francon.)*, C.USA.—FIG. 202,2. **M. lirae*, Okla.; ceph., $\times 1.7$ (399). [Transferred to Idahoiidae at request of LOCHMAN-BALK after earlier assignment of genus by her to Parabolinoiidae.]

Family DIKELOCEPHALIDAE Miller, 1889

Exoskeleton opisthoparian, isopygous. Glabella rectangular to broad quadrate, with 2 or 3 pairs of lateral furrows, posterior pair usually complete, arcuate; frontal area with anterior border furrow usually faint to obsolete; eyes above medium size, opposite posterior 0.3 of glabella; palpebral rims prominent, palpebral furrows deep, arcuate, about 0.3 of glabellar width, posterior area narrow (*exsag.*), straplike; librigenae rec-

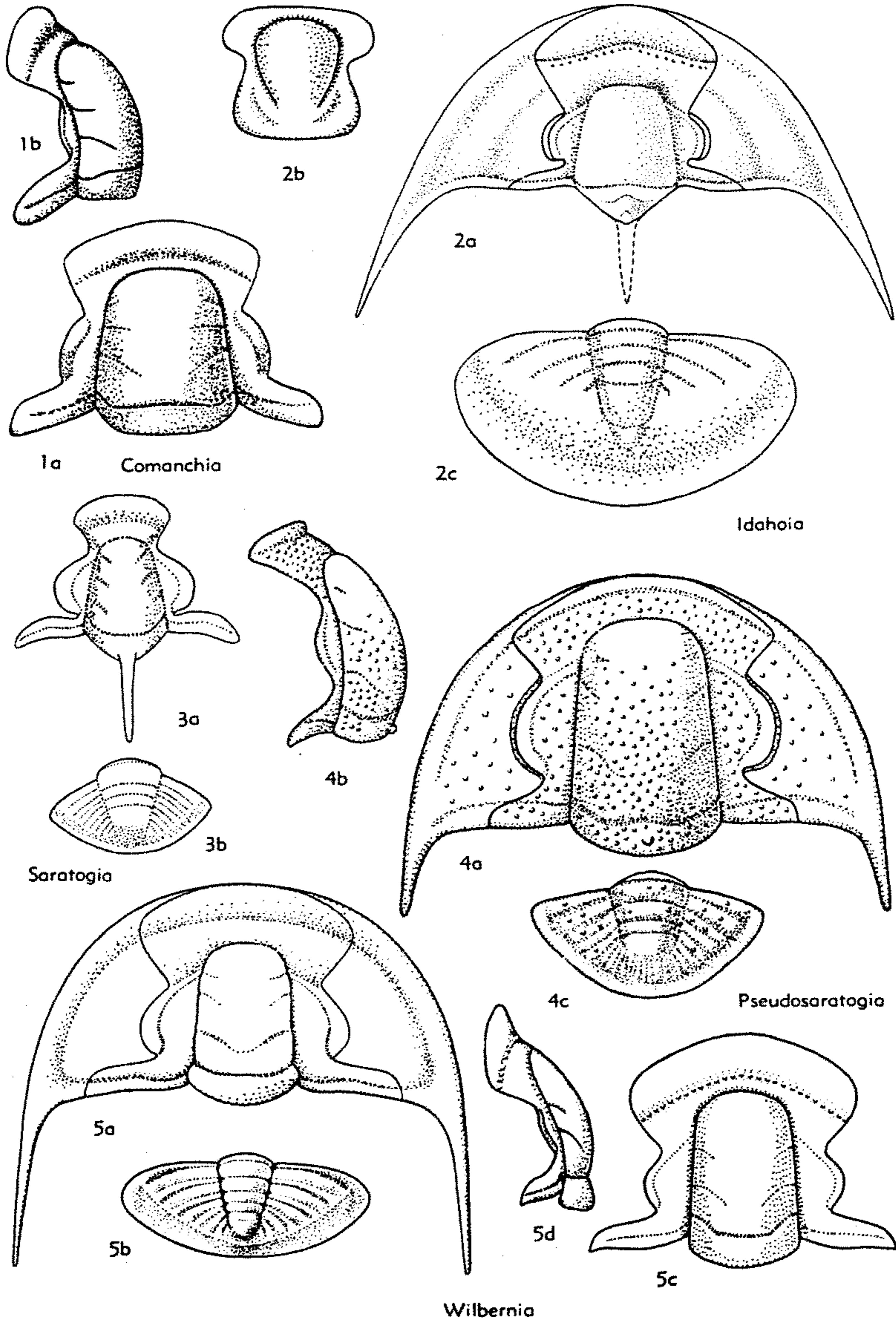

FIG. 189. Idahoiidae (p. 0252).

tangular, with genal spine; hypostoma subquadrate to rectangular, with small anterior wings, globose central lobe, convex curved posterior lobe, and pair of deep oval maculae at posterior corners of central lobe. Thoracic segments with wide low axis, length of pleurae (*tr.*) twice axial width, slightly curved, ends bluntly pointed, pleural furrow diagonal. Pygidium elliptical; axis tapered to narrow rounded end, posterior axial furrow obsolete, postaxial ridge extending onto border; interpleural grooves and pleural furrows curving back onto inner edge of border, last pair running nearly straight back, without border furrow, border of variable width. Surface smooth or granular, with Bertillon pattern on borders and doublure. Derived from *Wilbernia*. *U.Cam.*

Dikelocephalus OWEN, 1852 [**D. minnesotensis*]. Glabella low, broadly quadrate, front nearly straight, with 2 pairs of lateral furrows; eye ridges faint; frontal area about 0.3 of length (*sag.*) of cranidium, anterior and lateral border furrow obsolete, posterior border furrow distinct to base of genal spine; fixigenae with palpebral areas about 0.3 of glabellar width, posterior area nearly as long (*tr.*) as occipital ring; librigenae with slender genal spine of medium length. Pygidium broadly elliptical; axis and pleural field of same width, axis tapering through 0.6 of its length, with 4 distinct axial rings and long terminal with 1 or 2 faint additional rings; pleural field low, merging into broad flat semicircular border, 4 pairs of interpleural grooves, each segment may be crossed by a nearly parallel pleural furrow, a pair of short flat spines at posterolateral corners of margin. *U.Cam.(U.Francon.-Trempeal.)*, N.Am.—FIG. 191,3. **D. minnesotensis*, Trempeal., Wis.; pyg., $\times 0.4$ (461, 487).—FIG. 190,1. *D. regalis* ULRICH & RESSER, Trempeal., Wis.; 1a, ceph.; 1b, thoracic segment, both $\times 0.3$; 1c, hypostoma, $\times 0.4$ (461, 487).

Briscoia WALCOTT, 1924 [**B. sinclairensis*]. Glabella convex, rectangular, with sides converging slightly to rounded front, 3 pairs of lateral furrows, anterior pair very faint; low eye ridges; frontal area about 0.25 of length of cranidium, divided by broad shallow anterior furrow into preglabellar field and narrow convex anterior border; fixigenae with palpebral areas about 0.3 of glabellar width, posterior areas 0.75 of length of occipital ring; librigenae with heavy medium-length spine. Pygidium broadly elliptical; axis and pleural field of same width, axis tapering 0.5 to more than 0.7 of its length, with 4 distinct axial rings and terminal showing one faint ring; pleural field low, merging into flat or concave border of variable width, with 5 pairs of interpleural grooves,

pleural furrows parallel, on anterior part of segment, posterior border smooth, with slight median inward bend. Surface granulose (321). *U.Cam.(Francon.-Trempeal.)*, NE. Asia-N. Am.-NW. Eu.—FIG. 190,2. **B. sinclairensis*, Francon., W.Can. (B.C.); 2a, ceph.; 2b, thoracic segment; 2c, pyg.; all $\times 0.67$ (461, 487).

Elkia WALCOTT, 1924 [**Dicellosephalus nasutus* WALCOTT, 1884] [= *Parabriscoia* KOBAYASHI, 1935]. Glabella moderately convex, rectangular, with sides converging slightly to rounded front, posterior glabellar furrow very shallow across center, frontal area 0.3 of length of cranidium, divided by straight shallow anterior border furrow into narrow preglabellar field and wide, convex, triangular anterior border; fixigenae very narrow anteriorly, with palpebral area about 0.3 of glabellar width, posterior area about 0.7 of length (*tr.*) of occipital ring; librigenae with long slender genal spine. Pygidium broadly elliptical; axis and pleural fields of same width, convex, axis tapering 0.5 to 0.75 of pygidial length, with 4 axial rings and terminal with one faint additional ring; 4 interpleural grooves between 5 pleural segments, narrow pleural furrows placed anteriorly on segments, becoming shallower posteriorly; border narrow, flat, with 4 or 5 pairs of short flat marginal spines, posterior margin inwardly bent. Surface smooth, with Bertillon pattern on borders, doublures, and posterior part of glabella (321). *U.Cam.(U.Francon.-Trempeal.)*, W.N.Am.—FIG. 191, 4a,b. **E. nasuta*, Trempeal., Nev.; 4a,b, ceph., pyg., $\times 1$ (321).—FIG. 191,4c. *E. elegans* (KOBAYASHI) (type species of *Parabriscoia*), U. Francon., W.Can.(B.C.), pyg., $\times 1.5$ (419).

Osceolia WALCOTT, 1914 [**Dikelocephalus osceola* HALL, 1863]. Glabella moderately convex, rectangular, sides converging slightly to rounded front, with 2 pairs of lateral furrows; frontal area slightly more than 0.25 of length (*sag.*) of cranidium, usually divided by narrow anterior border furrow into a medium-width preglabellar field and narrow convex anterior border; fixigenae extremely narrow anteriorly, with palpebral area a little more than 0.3 of glabellar width, posterior area very narrow (*exsag.*), about 0.7 of length of occipital ring; librigenae with slender, medium-length genal spines. Pygidium narrow elliptical; axis convex, narrower than pleural fields, tapering through 0.7 of its length, postaxial ridge running onto border, with 3 or 4 axial rings and terminal with one faint ring; with 3 to 5 pairs of distinct interpleural grooves, pleural furrows obsolete, a pair of stout medium-length lateral spines, arising from 1st and 2nd segments, narrow flat border, posterior margin curved. Surface may be smooth. *U.Cam.(Trempeal.)*, W. N.Am.-C.N.Am.—FIG. 191,2. **O. osceola* (HALL), Wis.; 2a,b, ceph., pyg., $\times 2$ (461, 487). *Walcottaspis* ULRICH & RESSER, 1930 [**Dikelocephalus vanhornei* WALCOTT, 1914]. Glabella low,

broadly quadrate, front slightly rounded, with 1 or 2 pairs of very shallow lateral furrows; eye ridges very faint; frontal area slightly more than 0.3 of length (*sag.*) of cranidium, anterior border furrow obsolete; fixigenae with posterior area about 0.75 of length (*tr.*) of occipital ring. Pygidium

narrow elliptical; axis and pleural fields of same width, axis tapering through 0.75 of its length, with 4 axial rings and long terminal with 3 faint rings, pleural fields with 4 interpleural grooves and 3 pleural furrows, border flat, medium in width, posterior margin smoothly curved. Outer

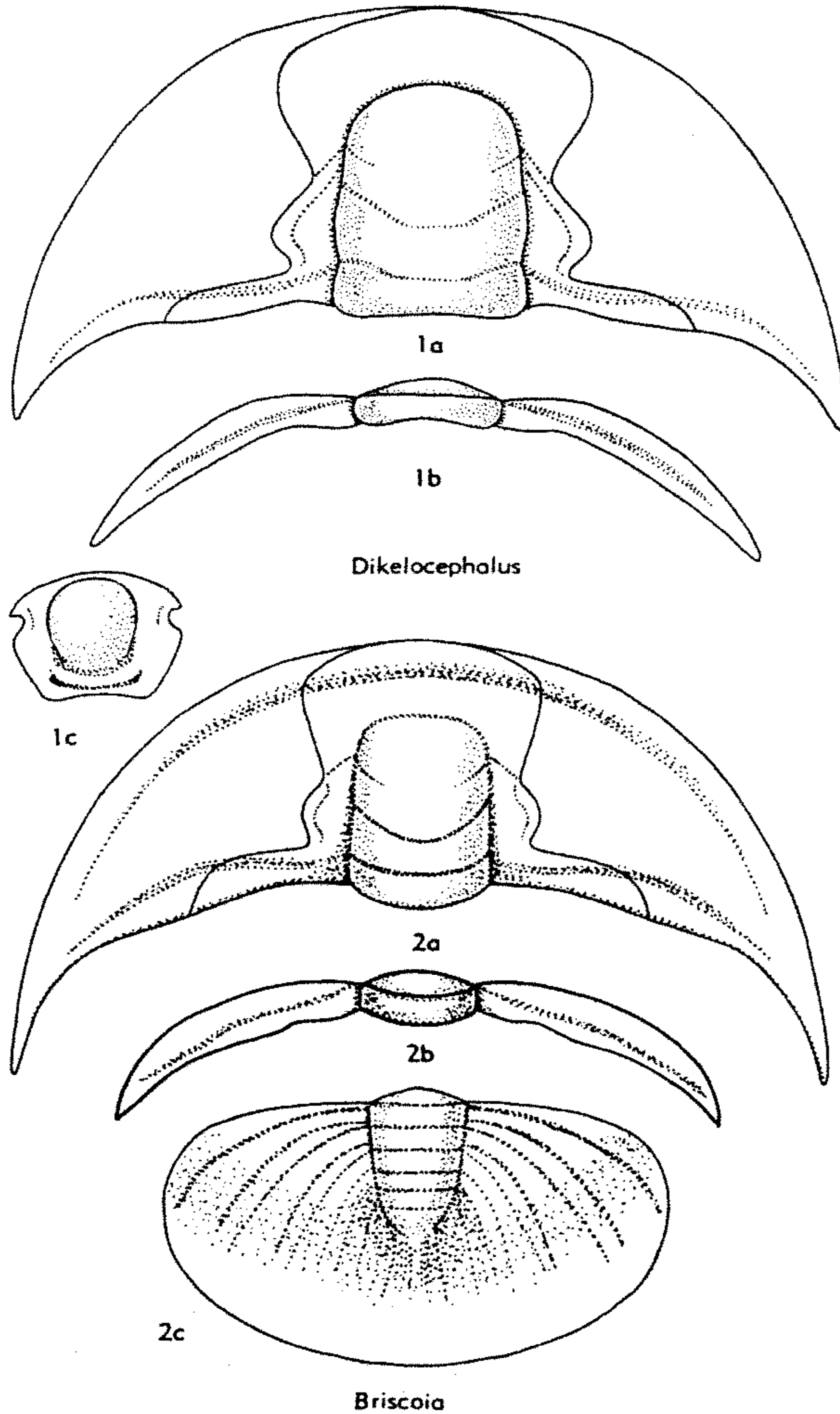

FIG. 190. Dikelocephalidae (p. 0254).

surface granulose (321). *U.Cam.(Trempeal.)*, C. N.Am.—FIG. 191,1. **W. vanhornei* (WALCOTT), Minn.; 1a,b, cran., pyg., $\times 0.5$ (321).

Family PTEROCEPHALIIDAE
Kobayashi, 1935

[*nom. transl. et correct.* LOCHMAN, 1956 (ex Pterocephalinae KOBAYASHI, 1935)] [=Camaraspidae LOCHMAN, 1953]

Opisthoparian, heteropygous. Glabella low to moderately convex, tapering to truncate-tapering, with 3 pairs of lateral glabellar furrows; eye ridges, palpebral lobes and palpebral furrows present, of variable strength; occipital spine may occur; frontal area 0.25 to more than 0.5 length (*sag.*) of cranidium; anterior border furrow shallow to obsolete; eyes of medium size or smaller, position variable; fixigenae variable in position, with palpebral area width and posterior area shape variable; librigenae elongate rectangular, with broad-based flat genal spine. Thorax with at least 13 segments; axis convex; pleurae wider (*tr.*) than axis, with broad shallow central pleural furrow extending to sharply pointed tips. Pygidium ovate to transverse; axis convex, tapered to rounded end, with short postaxial ridge, 2 to 10 axial rings and terminal; pleural field variable in width, interpleural grooves obsolete or faint, pleural furrows broad and shallow, border furrow obsolete, border of variable width. Surface smooth, finely punctate or granulose. Derived from Ptychopariidae. *U.Cam.*

Pterocephalia F. ROEMER, 1852 [**P. sanctisabae*] [=Pterocephalus HALL & WHITFIELD, 1877]. Glabella tapering to truncate-tapering; eye ridges distinct; frontal area 0.5 or more of length (*sag.*) of cranidium, with concave preglabellar field and border, anterior border furrow obsolete; eyes of medium size, somewhat posterior to center of glabella; fixigenae upsloping, with palpebral areas about 0.5 of glabellar width, posterior areas narrow, straplike, long (*tr.*); librigenae with very broad concave border but no marginal furrow, bearing broad-based medium-length genal spine. Pygidium broadly semicircular; axis narrower than pleural fields, tapered 0.5 to 0.7 of its length, with 7 to 10 axial rings and terminal; pleurae 4 to 7, pleural furrows broad, shallow, curving backward onto broad concave border; short narrow interpleural groove may appear just behind the posterior edge of several pleurae. Surface finely granulose (15, 162). *U.Cam.(Francon.)*, N.Am. — FIG. 192,1. **P. sanctisabae*, Tex.; 1a,b, ceph., pyg., $\times 1.3$ (15).

Aphelaspis RESSER, 1935 [**A. walcotti* RESSER, 1938, ICZN pend.] [=Clevelandella RESSER, 1938]. Glabella tapering to truncate-tapering; eye ridges and glabellar furrows faint; occipital spine may be present; frontal area about 0.3 of length (*sag.*) of cranidium; anterior border furrow very shallow to obsolete; eyes of medium size, opposite center of glabella; fixigenae horizontal, with palpebral areas 0.5 of glabellar width, posterior areas straplike, long (*tr.*); librigenae with very shallow to obsolete marginal furrow and flat slender genal spine; hypostoma elongate ovoid, with very small alae, large tumid anterior lobe, and narrow semicircular posterior lobe separated by shallow curved furrow, shallow semicircular marginal furrow, and marginal rim. Thorax of 13 segments. Pygidium transverse; axis tapered nearly full length, slightly wider than pleural field, with 2 or 3 axial rings and terminal; pleurae 2 or 3, interpleural grooves and pleural furrows faint to obsolete, border of medium width. Surface smooth or finely punctate (162). *U.Cam.(U.Dresbach.)*, N.Am.-SW.Sib.—FIG. 193,5. **A. walcotti*, Tex.; 5a,b, ceph., pyg., $\times 2$ (162).

Blandicephalus PALMER, 1954 [**B. texanus*]. Glabella low, truncate-tapering, with all furrows nearly obsolete on exterior, faint on interior; eye ridges faint; frontal area nearly 0.5 of length (*tr.*) of cranidium, anterior border furrow obsolete; eyes of medium size, opposite center of glabella; fixigenae slightly downsloping, with palpebral areas more than 0.5 of glabellar width, posterior areas 0.7 of length (*tr.*) of occipital ring; librigenae with obsolete marginal furrows and short flat genal spine. Pygidium broad-transverse; axis tapering nearly full length, slightly wider than pleural field; all furrows obsolete except shallow axial furrow, border of medium width. Surface smooth (162). *U.Cam.(U.Dresbach.)*, C.USA.—FIG. 193,8. **B. texanus*, Tex.; 8a,b, ceph., pyg., $\times 2$ (162).

Camaraspis ULRICH & RESSER, 1924 [**Arionellus (Agraulos) convexus* WHITFIELD, 1878] [=Berkeia RESSER, 1937 (obj.)]. Glabella low, tapering to truncate-tapering, with 2 pairs of shallow lateral furrows on interior only; faint eye ridges may be present; frontal area 0.25 of length (*sag.*) of cranidium; all furrows faint to obsolete on exterior, faint on interior; eyes slightly below medium size, behind mid-length of glabella; fixigenae downsloping, with palpebral areas 0.3 to 0.5 of glabellar width, posterior areas short, triangular; librigenae with shallow lateral border furrow and short slender genal spine. Pygidium transverse; axis wider than pleural field, extending nearly full length, with 2 or 3 axial rings and terminal; with 2 or 3 broad pleurae, all furrows obsolete on exterior, faint on interior, border narrow. Surface smooth (8, 47). *U.Cam.(Francon.)*, N.Am.—

FIG. 193,7. **C. convexa* (WHITFIELD), Wis.; 7a,b, ceph.; 7c, pyg., all $\times 1$ (8, 47).

Camaraspoides FREDERICKSON, 1949 [*Modocia berkeyi* RESSER, 1935]. Glabella moderately convex, tapering to truncate-tapering, with lateral furrows on interior; eye ridges and all other fur-

rows distinct on exterior; frontal area between 0.3 and 0.25 of length (*sag.*) of cranidium; eyes about medium in size, somewhat posterior to center of glabella; fixigenae downsloping, with palpebral areas about 0.5 of glabellar width, posterior area straplike, of medium length (*tr.*). Pygidium trans-

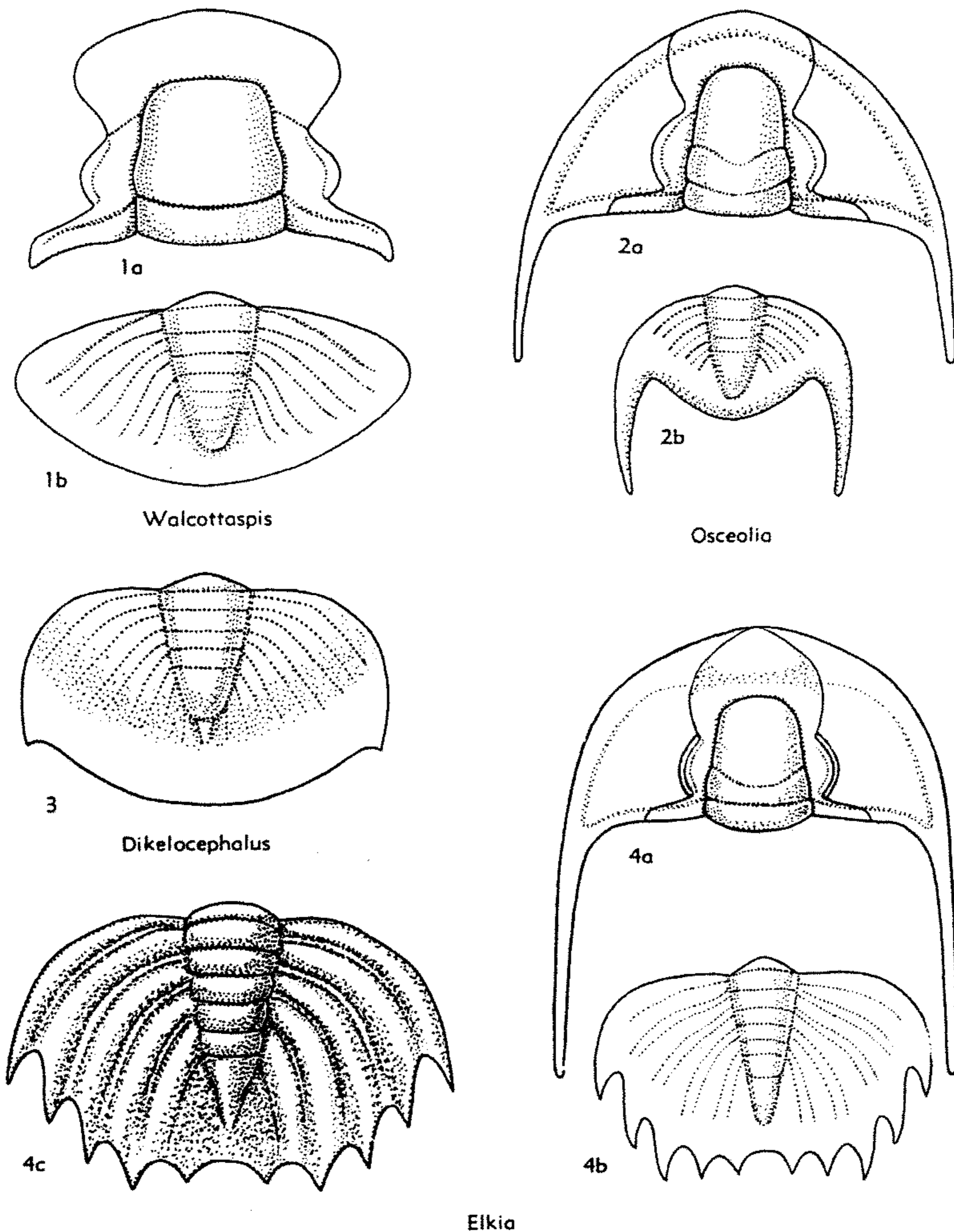

FIG. 191. Dikelocephalidae (p. 0254-0256).

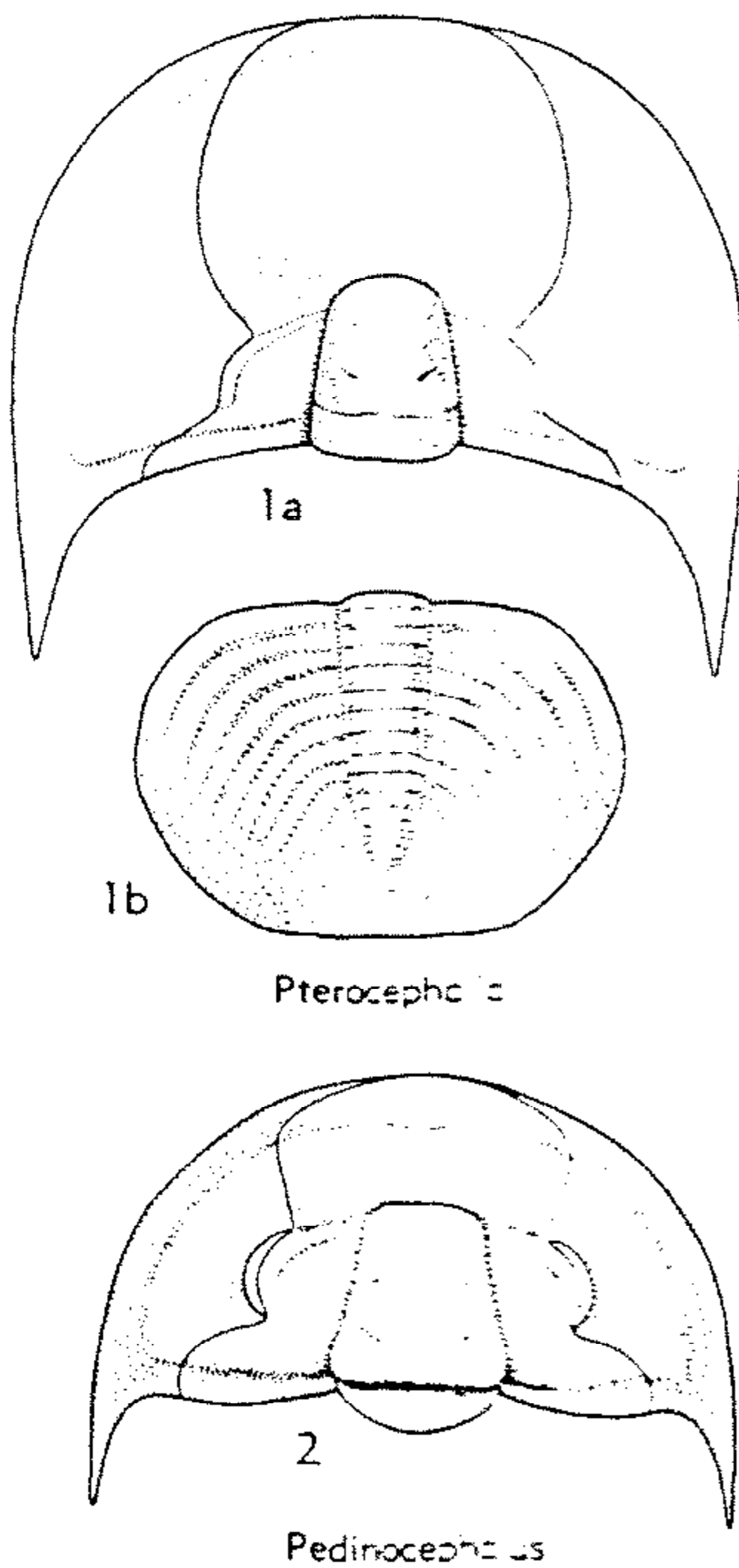

FIG. 192. Pterocephalidae (p. 0256, 0260).

verse; axis wider than pleural field, moderately long, with 3 axial rings and terminal; with 3 broad pleurae, interpleural grooves and pleural furrows distinct on exterior, border narrow (48). *U.Cam. (Francon.)*, N.Am.—FIG. 193,9. **C. berkeyi* (RESSER), Wis.; 9a,b, cran., $\times 1.5$, $\times 5$; 9c,d, pyg., $\times 4$ (48).

Dikelocephalites SUN, 1935 [**D. flabelliformis*]. Glabella tapering, frontal area 1.5 of length (*sag.*) of cranidium, flat to slightly convex; anterior border furrow obsolete; eye ridges faint; eyes of medium size, opposite center of glabella; fixigenae horizontal, narrow, with palpebral areas little over 0.3 of glabellar width, posterior areas straplike, long (*tr.*); librigenae broadly triangular, with short genal spine. Pygidium circular; axis convex, narrower than pleural fields, tapered about 0.5 of its length, with 3 or 4 axial rings and terminal; pleurae 3 or 4, interpleural grooves faint to obsolete, with short, faint pleural furrows and broad flat border. Surface granulate (289). *U. Cam. (Daizanian)*, NE Asia.—FIG. 193,1. **D.*

flabelliformis, China; 1a,b, ceph., pyg., $\times 0.7$ (289).

Dytremacephalus PALMER, 1954 [**D. granulatus*]. Glabella moderately convex, truncate-tapering, with pair of anterior pits; eye ridges narrow; frontal area about 0.3 of length (*sag.*) of cranidium; anterior border furrow shallow to obsolete, border narrow; eyes of medium size, somewhat anterior to center of glabella; fixigenae horizontal or slightly upsloping, with palpebral areas between 0.25 and 0.3 of glabellar width, posterior areas narrowly triangular, long (*tr.*); librigenae, thorax and pygidium unknown. Surface smooth or finely granulate (162). *U. Cam. (U. Dresbach.)*, C. USA.—FIG. 193,6. **D. granulatus*, Tex.; cran., $\times 4$ (162).

Eugonocare WHITEHOUSE, 1939 [**E. tessellatum*]. Glabella truncate-tapering; eye ridges distinct; frontal area 0.3 of length (*sag.*) of cranidium with distinct anterior border furrow and narrow convex border; eyes of medium size, opposite center of glabella; fixigenae upsloping, with palpebral areas somewhat more than 0.5 of glabellar width, posterior areas unknown. Pygidium broad-transverse; axis narrower than pleural field, tapered nearly full length, with 5 axial rings and terminal; pleurae 5 or 6, interpleural grooves and pleural furrows shallow, border of medium width with slight posterior median inward bend. Surface finely granulate. *U. Cam.*, Austral.

Iranella HUPÉ, 1953 [**Sarutogia latifrons* KING, 1937]. *U. Cam.*, Iran.

Kazelia WALCOTT & RESSER, 1924 [**K. speciosa*]. Glabella low, truncate-tapering, with 2 pairs of shallow lateral furrows on interior; eye ridges obsolete, all other furrows faint to obsolete on exterior, faint on interior; frontal area 0.25 of length of cranidium, eyes about medium in size, posterior to center of glabella; fixigenae downsloping, with palpebral areas about 0.3 of glabellar width, posterior areas short, triangular; librigenae with rounded genal angle. Pygidium unknown (322). *U. Cam. (Francon.)*, N.Am.-N.Zem.—FIG. 193,2. **K. speciosa*, N.Zem.; 2a,b, cran.; 2c, librigena, all $\times 2$ (322).

Labiostria PALMER, 1954 [**L. conveximarginata*]. Glabella moderately convex, tapering to truncate-tapering; eye ridges faint; occipital spine may be present; frontal area 0.3 of length (*tr.*) of cranidium, with narrow anterior border furrow; eyes of medium size, opposite center of glabella; fixigenae horizontal, with palpebral areas somewhat more than 0.5 of glabellar width, posterior areas straplike, long (*tr.*); librigenae with distinct marginal furrows and flat slender genal spine. Pygidium broad-transverse; axis tapered nearly full length, slightly wider than pleural field, with 4 or 5 axial rings and terminal; pleurae 4, pleural furrows broad, shallow, curving posteriorly, interpleural grooves obsolete, border of medium width

with slight posterior median inward bend. Surface smooth or punctate (162). *U.Cam.* (*U.Dresbach.*), N.Am.—FIG. 193.3. **L. conveximarginata*, Tex.; 3a,b, ceph., pyg., ×2 (162).

Litocephalus RESSER, 1937 [**Dicellocephalus richmondensis* WALCOTT, 1884, based on cranium

(= *Dikellocephalus* (*Pterocephalus*) *bilobatus* HALL & WHITFIELD, 1877, based on pygidium)] [= *Pterocephalina* RESSER, 1938]. Glabella moderately convex, tapering; eye ridges faint; frontal area between 0.25 and 0.3 in length (*sag.*) of cranium, with distinct anterior border furrow;

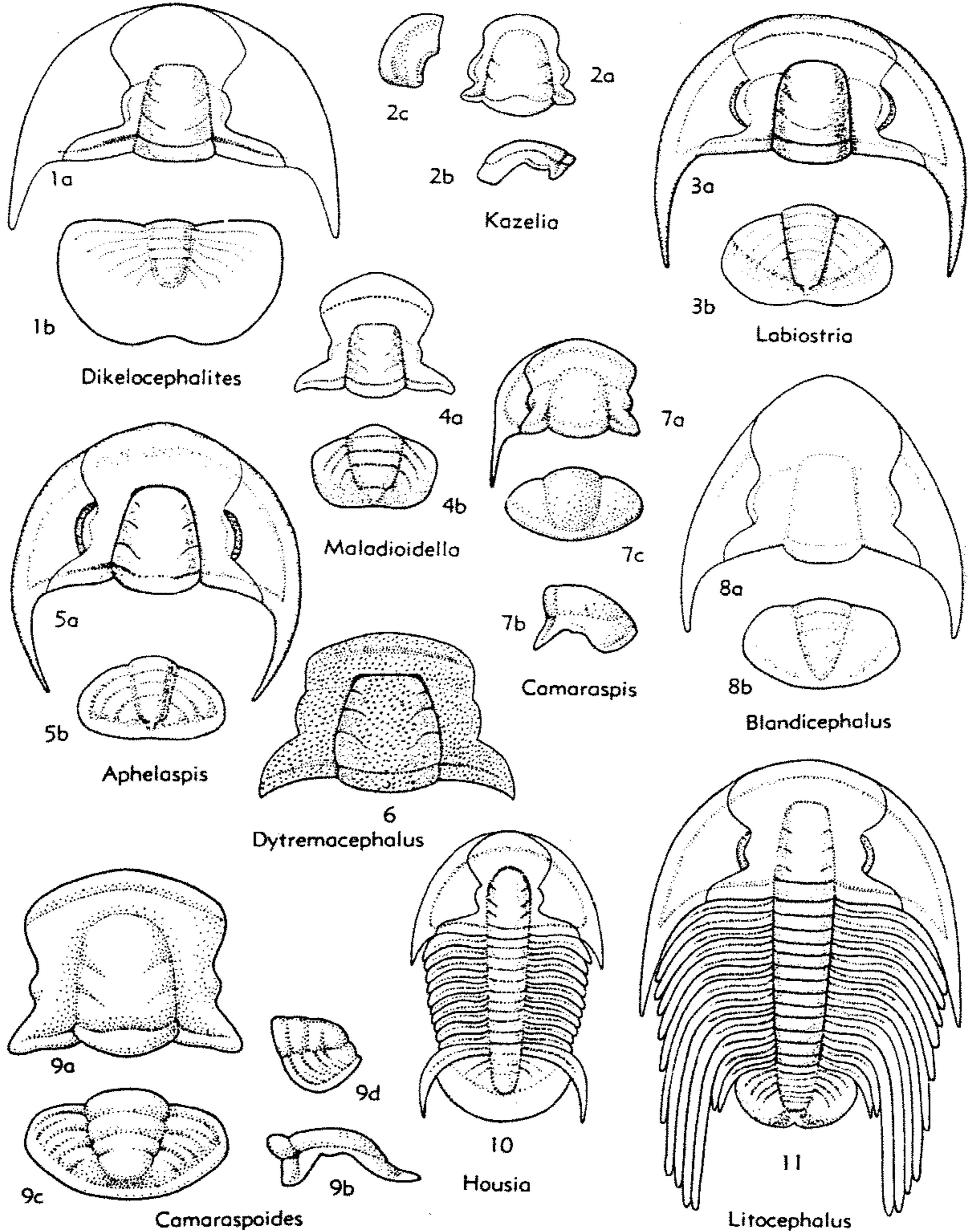

FIG. 193. Pterocephaliidae, Housiidae (p. 0256-0260).

eyes of medium size, opposite center of glabella; fixigenae upsloping, with palpebral areas about 0.7 of glabellar width, posterior area straplike, long (*tr.*); librigenae rectangular, with well-defined lateral border furrow, convex border, and medium-length genal spine. Thorax of 13 segments; axis convex, one-half width (*tr.*) of pleurae; pleurae geniculate, faintly furrowed, ending in very long, posteriorly-drooping spines. Pygidium ovate: axis tapered nearly full length, as wide as pleural fields; with 4 or 5 axial rings and terminal; pleurae 4 or 5, interpleural grooves obsolete, pleural furrows broad and shallow, curving back across medium-width concave border almost to margin with prominent posterior medium inward bend. Surface finely granulose. *U.Cam. (Francon.)*, N.Am.—FIG. 193,11. **L. bilobatus* (HALL & WHITFIELD), Nev.; exoskel., $\times 2.7$ (162).

Maladioidella ENDO, 1937 [**M. splendens*]. Glabella moderately convex, tapering; eye ridges distinct; frontal area almost 0.3 of length of cranidium, with distinct anterior border furrow; eyes less than medium size, opposite center of glabella; fixigenae horizontal, with palpebral area 0.3 of glabellar width, posterior area narrow triangular, long (*tr.*). Pygidium ovate: axis tapered 0.75 of its length, wider than pleural field, with 2 or 3 axial rings and terminal; pleurae 3, pleural furrows and interpleural grooves faintly impressed, border poorly defined. Surface finely punctate (37). *U.Cam. (Daizanian)*, NE.Asia.—FIG. 193,4. **M. splendens*, Manch.; 4a, cran., $\times 0.7$; 4b, pyg., $\times 1$ (37). [Authorship of genus should be cited as ENDO, in ENDO & RESSER, 1937.—Ed.]

Olentella IVSHIN, 1956 [**O. olentensis*]. Glabella low, elongate-tapering, lateral furrows obsolete; eye ridges faint, frontal area 0.3 of glabellar length (*sag.*), anterior border furrow narrow, distinct; eyes medium in size, nearly opposite center of glabella; fixigenae horizontal, with palpebral areas 0.5 of glabellar width, posterior areas triangular, medium in width (*exsag.*). Pygidium broad, transverse, with convex axis and pleural fields subequal in width; 3 axial rings and long terminal; 3 or 4 pleurae, pleural furrows broad, border medium width. Surface unknown. *U.Cam.*, SW.Sib.

Pedinocephalus IVSHIN, 1956 [**P. bublichenkoi*]. Glabella truncate-tapering with median keel, lateral furrows weak; eye ridges distinct, frontal area slightly more than 0.3 of length (*sag.*) of cranidium, anterior border furrow curved, very shallow; eyes medium in size, opposite center of glabella; fixigenae slightly upsloping, with palpebral areas 0.7 of width of glabella, posterior areas triangular, medium in width (*exsag.*); librigenae with broad, shallow marginal furrow, flat short genal spines. *U.Cam.*, E.Sib.—FIG. 192,2. **P. bublichenkoi*, Kazakhstan; ceph., $\times 2$ (413).

Pterocephalops RASETTI, 1944 [**P. acrophthalma*].

Glabella moderately convex, subrectangular, lateral furrows nearly obsolete; eye ridges faint; frontal area not quite 0.3 of length (*sag.*) of cranidium; preglabellar field steeply downsloping, with anterior border furrow very shallow to obsolete and horizontal border narrow; eyes below medium size, somewhat behind center of glabella; fixigenae upsloping, with palpebral areas about 0.7 of glabellar width, posterior areas straplike, narrow, long (*tr.*). Librigenae, thorax, and pygidium unknown. Surface smooth (188). *U.Cam. (?Francon.)*, Que.

Family HOUSIIDAE Hupé, 1953

Exoskeleton opisthoparian, subisopygous. Cranidium narrow, elongate; glabella low, tapering, all furrows very shallow to obsolete, with 3 pairs of lateral furrows on interior; frontal area about 0.3 of length of cranidium, crossed by change in slope or very shallow anterior border furrow; no eye ridges, eyes below medium size, in front of center of glabella; fixigenae very narrow, upsloping, with arcuate palpebral areas less than 0.25 of glabellar width, posterior areas straplike, long (*tr.*); librigenae quadrate, with short genal spines or rounded genal angles. Thorax with 10 segments; axis convex; pleurae low, somewhat wider than axis (*tr.*), with deep pleural furrows extending about 0.7 of length and bluntly pointed ends. Pygidium narrowly transverse; anterior segment with or without long spines, poorly ankylosed; axis convex, tapered 0.7 of length to narrow end, with 3 or 4 axial rings and terminal; pleural regions about same in width as axis, interpleural grooves obsolete, 3 or 4 pleurae with shallow pleural furrows; broad shallow marginal furrow, flat border. Outer surface smooth. *U.Cam.* [The family Housiidae is placed close to the family Pterocephaliidae, from which it may have developed, according to information given by A. R. PALMER.]

Housia WALCOTT, 1916 [**Dolichometopus (Housia) varro* WALCOTT, 1916] [= *Housiella* KOBAYASHI, 1955]. *U.Cam. (Francon.)*, N.Am. (321).—FIG. 193,10. *H. canadensis* (WALCOTT), Can.(B.C.); exoskel., $\times 1$ (488, modified).

Family ANDRARINIDAE Raymond, 1937

[= *Liostracidae* ANGELIN, 1854 (invalid because based on junior homonym)]

Preglabellar area of medium width, nearly straight at front; facial sutures slightly concave in front and behind palpebral lobes,

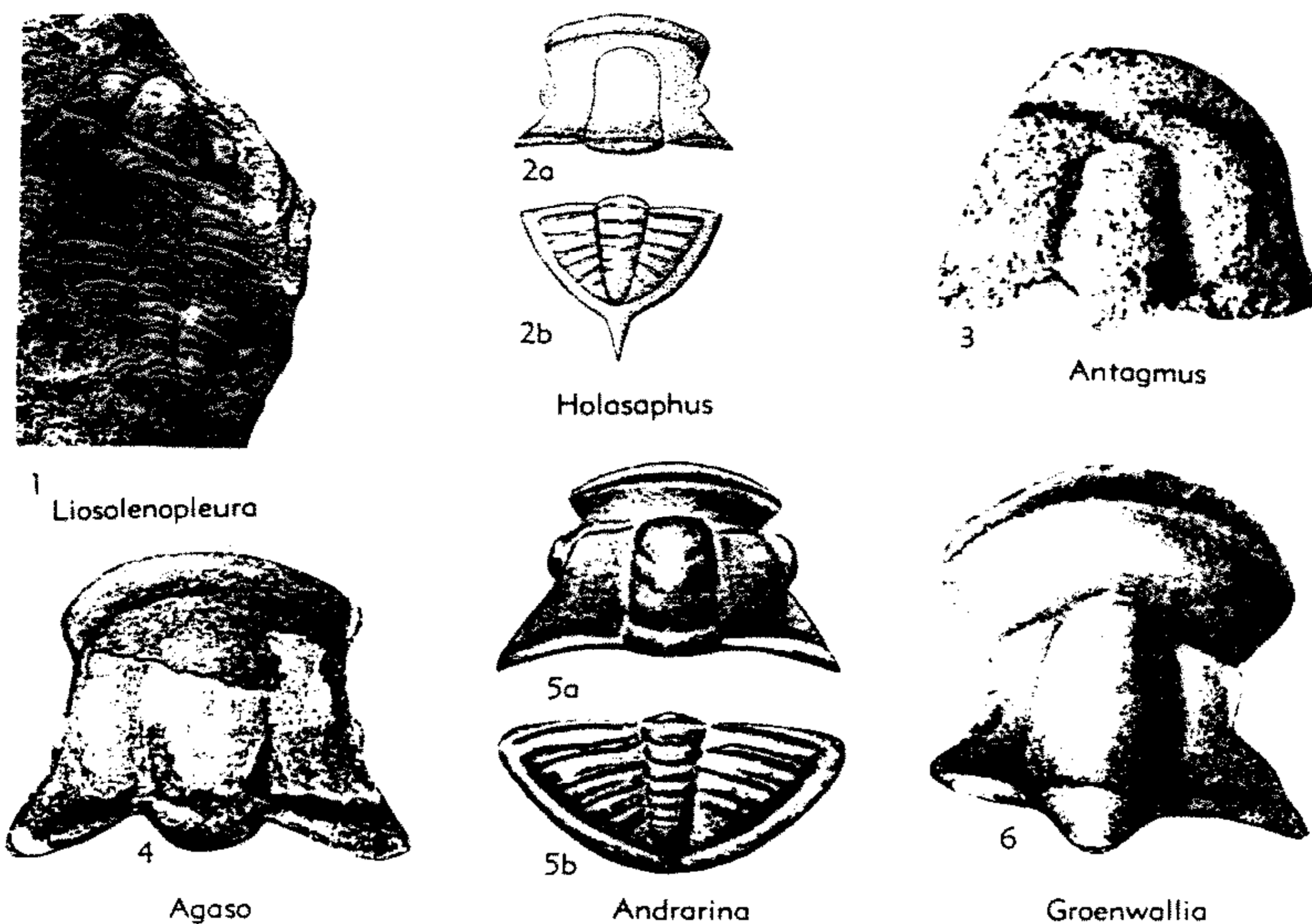

FIG. 194. Andrarinidae (p. O261).

which are short but prominent; glabella parallel-sided, its front end bluntly rounded. Pygidium short, wide, and well segmented. *L.Cam.-M.Cam.*

Agaso COBBOLD & POCKOCK, 1934 [**Liostracus (Agaso) rushtonensis*]. Cranidium trapezoidal, with rounded front and flat anterior border, from which convex surface rises abruptly and curves evenly back to weak occipital furrow. Surface pitted. *M.Cam.*, NW.Eu.—FIG. 194,4. **A. rushtonensis* (COBBOLD & POCKOCK), *Paradoxides forchhammeri* Grit, Eng.; cran., $\times 3.5$ (388*).

Andrarina RAYMOND, 1937 [*pro Liostracus* ANGELIN, 1854 (*non* MÖRCH, 1852)] [**Liostracus costatus* ANGELIN, 1854; SD LINNARSSON, 1873]. Glabella with 3 pairs of furrows, sides of glabella and facial sutures nearly parallel with axial line; genae convex, bent downward. Surface more minutely pitted than in *Agaso*. *M.Cam.*, Eu.(Swed.-Norway).—FIG. 194,5. **A. costata* (ANGELIN), *Lejopyge laevigata* Z., Swed.; 5a, cran., $\times 3.7$; 5b, pyg., $\times 3$ (491a*).

Groenwallia KOBAYASHI, 1935 [**Liostracus platyrhinus* GRÖNWALL, 1902]. Preglabellar area large, facial sutures flaring anteriorly; no lateral glabellar furrows; large occipital spine. *M.Cam.*, NW.Eu.—FIG. 194,3. **G. platyrhinus* (GRÖNWALL),

Paradoxides forchhammeri Z., Denm.; cran., $\times 5.25$ (402*).

Holasaphus MATTHEW, 1895 [**H. centropyge*]. Preglabellar area short; glabella like that of *Andrarina* but lacking furrows; facial sutures only slightly curved. Pygidium with spine at rear. *M.Cam.*, NE.Can.—FIG. 194,2. **H. centropyge*, MacMullin F., N.Scot.; 2a,b, cran., pyg., $\times 1.3$ (429).

Liosolenopleura THORAL, 1948 [**L. serventi*]. Small; surface smooth. Pygidium smaller than in *Solenopleura*. *M.Cam.*, W.Eu.—FIG. 194,1. **L. serventi* Bailiella levyi Z., Fr.; exoskel., $\times 2$ (483*).

Superfamily OLENACEA Burmeister, 1843

[*nom. transl.* HENNINGSMOEN, 1957 (*ex Olenidae* BURMEISTER, 1843)] [=Olenidea RICHTER & RICHTER, 1941 (*partim*); Olenoidea HUPÉ, 1953 (*partim*)]

Exoskeleton subovate to elongate, opisthoparian (exceptionally proparian), micropygous to subisopygous (rare), and with rounded or spinose genal angles. Cephalon with narrow border, small to medium-sized eyes and in most forms distinct eye ridges; glabella tapering forward, with simple, sigmoidal, or bifurcate lateral furrows (if pres-

ent); preglabellar field present or absent; librigenae separated by median suture or fused together. Hypostoma probably free. Thorax with 9 to 24 segments. Pygidium with or without marginal spines. *M.Cam.* (some Papyriaspidae)-*U.Ord.*

Family OLENIDAE Burmeister, 1843

[=Leptoplastidae ANGELIN, 1854]

Exoskeleton opisthoparian, subovate to elongate, usually small, micropygous to heteropygous. Cephalon usually with narrow threadlike, prominent border, usually distinctly defined eye ridges, and eyes of small to medium size. Thoracic segments 9 to 19, with furrowed pleurae. Pygidium with 3 to 7 axial rings, pleural fields distinctly segmented. Hypostoma probably free. Other characters greatly varying even in same subfamily; cephalic doublure and ventral sutures imperfectly known. *U.Cam.-U.Ord.*

Subfamily OLENINAE Burmeister, 1843

[*nom. transl.* KOBAYASHI, 1935 (ex Olenidae BURMEISTER, 1843)] [=CONTINUE PERSSON, 1904]

Heteropygous olenids with almost flat exoskeleton, narrow to moderately wide glabella, more or less well-developed preglabellar field, palpebral lobes opposite or anterior to cranial center, genal spines in direct continuation of lateral margin of librigenae; more or less oblique pleural furrows, fairly well-developed pleural spines. Hypostoma subovate, with large strongly convex ovate anterior lobe, small depressed crescentic posterior lobe, small acute anterior wings, and narrow raised posterolateral border. *U.Cam.-L.Ord.(Tremadoc.)*.

Olenus DALMAN, 1827 [(illegally proposed by 1822, but now long recognized as applicable to a DALMAN, 1827, *pro Paradoxides* BRONGNIART, distinct group of species, ICZN Opinion 496)] [**Entomostracites gibbosus* WAHLENBERG, 1821; SD ICZN Op. 496]. Exoskeleton more or less elongated ovate. Cephalon 0.25 to 0.4 of total length; cranidium subtrapezoidal; glabella subcylindrical or slightly tapering, somewhat truncate in front, with 2 or 3 pairs of oblique lateral furrows; preglabellar field long; fixigenae fairly wide, with acute posterior extremities; eye ridges at right angles to axis or running obliquely forward from anterior corners of glabella; anterior sections of facial sutures slightly convergent between eyes and anterior border. Thorax of 13 to 15 segments. Pygidium small, triangular to semicircular, with narrow raised border, and commonly with a few

minute marginal spines (114, 331). *U.Cam.*, N. Eu.-N.Am.-Asia.—FIG. 195,1a. **O. gibbosus* (WAHLENBERG), Swed.; pyg., $\times 3$ (331).—FIG. 195,1b,c. *O. truncatus* (BRÜNNICH), Swed.; 1b,c, exoskel., hypostoma, $\times 4$ (331).

?*Highgatella* SHAW, 1955 [**Terranovella gelasinata* SHAW, 1951]. Convex tapering glabella with rounded front, 3 pairs of lateral furrows, anterior pair faint, posterior pairs deep, arcuate; small occipital node; preglabellar field 0.3 of cranial length; anterior border furrow narrow; eyes small, anterior to center of glabella, eye ridges distinct, straight; fixigenae horizontal, with palpebral areas more than 0.3 of glabellar width, posterior areas long (*tr.*), triangular; librigenae with long slender genal spines. Pygidium unknown. Surface finely granulose. *L.Ord.(Tremadoc.)*, NE.N.Am.-W.N.Am.—FIG. 195,6. **H. gelasinata* (SHAW), Vt.; ceph., $\times 6$ (245).

Parabolina SALTER, 1849 [**Entomostracites spinulosus* WAHLENBERG, 1821] [=*Odontopyge* HAWLE & CORDA, 1847 (*non* BRANDT, 1841)]. Differs from *Olenus* in having larger glabella, shorter preglabellar field, palpebral lobes placed nearer to anterior border; larger, usually semicircular pygidium with 2 to 6 fairly well-developed, more or less converging pleural spines; and hypostoma with almost completely reduced anterior wings (331). *U. Cam. - L. Ord. (Tremadoc.)*, Eu. - E. Can. (Atl. prov.)-Arg. — FIG. 195,3. **P. spinulosa* (WAHLENBERG), Swed.; exoskel., $\times 3$ (331).

Parabolinites HENNINGSMOEN, 1957 [**Parabolinitella laticauda* WESTERGÅRD, 1922]. Cranidium as in *Parabolina* but with larger preglabellar field; facial sutures subparallel or diverging in front of palpebral lobes; glabella tapered forward, rounded in front; librigenae with spines (where known). Pygidium entire (61). *U.Cam.*, Swed.-?Wales.—FIG. 195,4. **P. laticaudus* (WESTERGÅRD), Swed.; 4a, cran. and librigena, $\times 1.2$; 4b, pyg., $\times 1.2$ (61).

?*Paraolenus* LERMONTOVA, 1951 [**P. papilionaceus*]. *U.Cam.*, Kazakhstan.

?*Plesioparabolina* HARRINGTON & LEANZA, 1942 [**P. proparia*]. *L.Ord.(Tremadoc.)*, Arg.

Subfamily LEPTOPLASTINAE Angelin, 1854

[*nom. transl.* KOBAYASHI, 1935 (ex Leptoplastidae ANGELIN, 1854)] [=ABRUPTAE PERSSON, 1904]

Micropygous to nearly isopygous olenids with almost flat to strongly convex dorsal exoskeleton. Cephalon with narrow to moderately wide glabella, short or completely reduced preglabellar field, genal spines abruptly projecting from lateral portion of cephalic margin well in front of posterior margin. Thorax with moderately oblique pleural furrows. Hypostoma usually subrectangular but may have very small anterior wings. *U.Cam.-L.Ord.(Tremadoc.)*.

Leptoplastus ANGELIN, 1854 [**L. stenozus*; SD VOGDES, 1890]. Exoskeleton ovate, depressed. Glabella wide, parallel-sided to slightly tapering, rounded in front, with 2 or 3 pairs of oblique

lateral furrows; preglabellar field very short or lacking; anterior and palpebral areas of fixigenae relatively narrow, and posterior areas moderately wide, with acute extremities; eye ridges more or

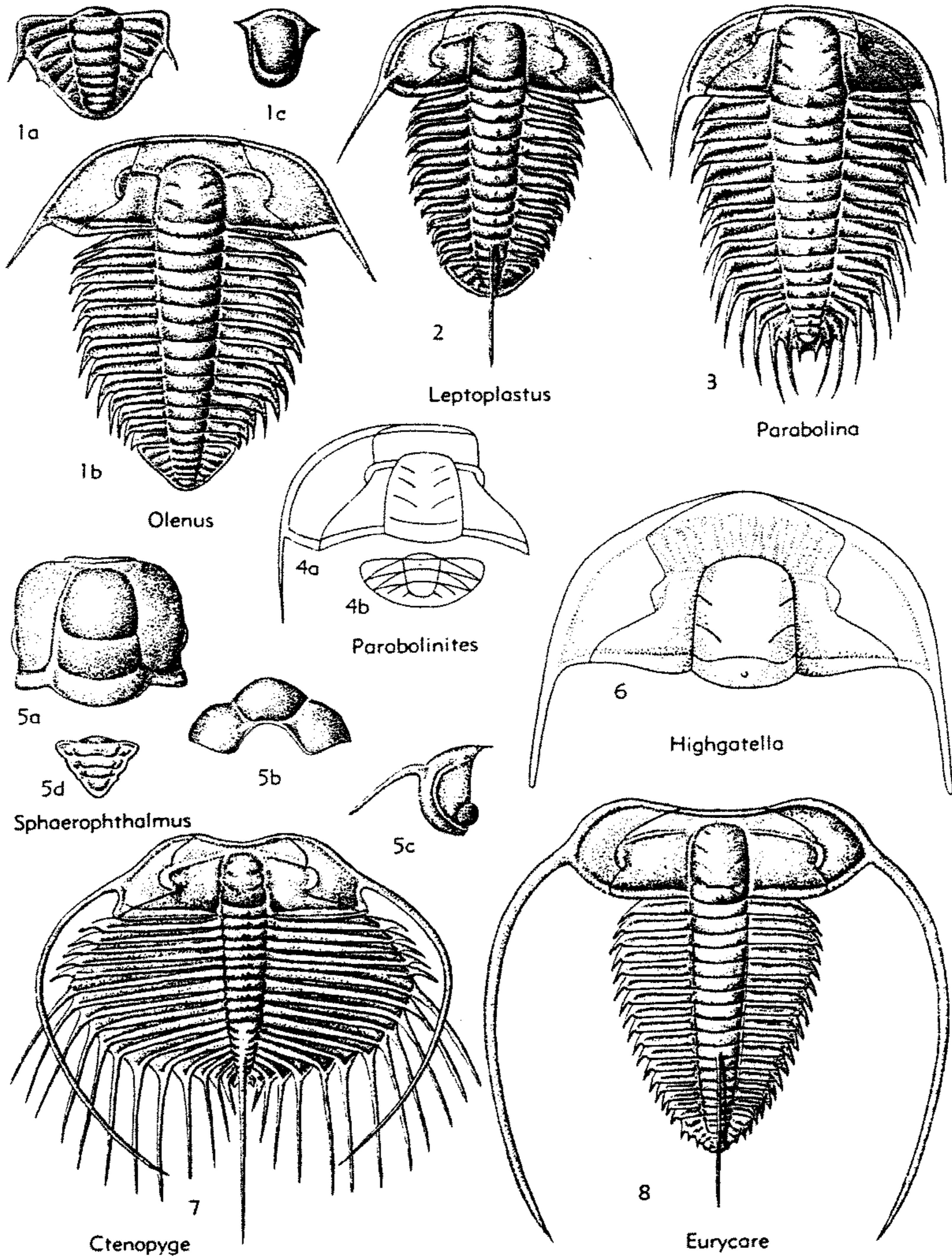

FIG. 195. Olenidae (Oleninae, Leptoplastinae) (p. 0262-0264).

less oblique; palpebral lobes usually opposite or a little in front of glabellar center; librigenae with almost evenly curved outer margin and slender, almost straight genal spines. Thorax of 9 to 12 segments, with short (to long) pleural spines and axial nodes or spines, 11th segment of some forms with very long, backward-directed axial spine. Pygidium small, rounded triangular to semi-circular, with rapidly tapering axis, 3 or 4 axial rings and generally 2 or 3 pairs of minute pleural spines (114, 331, 333). *U.Cam.-L.Ord.(Tremadoc.)*, Eu.-E.Can.(Atl.prov.).—FIG. 195,2. **L. stenotus*, U.Cam., Swed.; exoskel., $\times 3$ (331).

Ctenopyge LINNARSSON, 1880 [**Olenus (Sphaerophthalmus) pecten* SALTER, 1864; SD VOGDES, 1890]. Exoskeleton depressed, ovate to subcircular. Cephalon wide, with straight or emarginate front, long, narrow, slightly tapering glabella more or less truncate in front, 1 to 3 pairs of lateral furrows, posterior pair represented in some by a transglabellar furrow; preglabellar field short or lacking; fixigenae moderately to very wide, with posterior areas of greatly varying length and width, and with acute or rounded extremities; palpebral lobes usually opposite or a little anterior to glabellar center; librigenae moderately wide, with long, curved genal spines springing from anterior or middle part of lateral margins. Thorax of 8 to 10 segments with long pleural spines, especially in posterior part. Pygidium (of type species) very large, consisting of several fused axial rings, small terminal plate, free pleurae similar to those of thorax, and axial ridge continued backward as long, straight spine (114, 331, 335). *U.Cam.*

C. (Ctenopyge). Hypostoma without expanded posterior brim; pleural spines flattened (61). *U.Cam.*, Eu.-E.Can.(Atl.prov.).—FIG. 195,7. **C. (C.) pecten* (SALTER); exoskel. (reconstr. from figures by LAKE and WESTERGÅRD), $\times 3$ (445n).

C. (Eoctenopyge) HENNINGSMOEN, 1957 [**Sphaerophthalmus flagellifer* ANGELIN, 1854]. Differs from *C. (Ctenopyge)* in having rounded pleural spines (61). *U.Cam.*, Eu.

C. (Mesoctenopyge) HENNINGSMOEN, 1957 [**Ctenopyge spectabilis* BRÖGGER, 1882]. Differs from *C. (Ctenopyge)* in having hypostoma with expanded posterior brim, and rounded pleural spines (61). *U.Cam.*, Eu.

Eurycare ANGELIN, 1854 [**E. brevicauda*; SD VOGDES, 1925]. Differs from *Leptoplastus* in having wider fixigenae, much longer, more curved genal spines, and 12 to 17 thoracic segments; and from *Ctenopyge* in number of thoracic segments with short pleural spines throughout and small pygidium with fused pleurae terminating in minute spines (114, 331, 333). *U.Cam.*, Denm.-Norway-Swed.-?Wales.—FIG. 195,8. *E. latum* (BOECK), Swed.; exoskel. (reconstr.), $\times 2$ (445n).

?**Leptoplastides** RAW, 1907 [**Conocoryphe salteri* CALLAWAY, 1877]. *L.Ord.(Tremadoc.)*, Eng.

?**Mekynophrys** HARRINGTON, 1938 [**M. nanna*]. *L.Ord.(Tremadoc.)*, Arg.

Sphaerophthalmus ANGELIN, 1854 [**Trilobites alatus* BOECK, 1838; SD LINNARSSON, 1880]. Differs from *Ctenopyge* in having narrower, strongly convex cephalon, much narrower posterior areas of fixigenae, spherical eyes usually placed far back, and very small, almost perfectly triangular pygidium with very narrow, threadlike, raised border and entire or slightly undulating margin (114, 331). *U.Cam.*, Eu.-E.Can.(Atl.prov.).—FIG. 195,5. *S. humilis* (PHILLIPS), Swed.; 5a,b, cran., dorsal, anterior, $\times 6$; 5c, librigena, $\times 6$; 5d, pyg., $\times 8$ (331).

Subfamily PELTURINAE Hawle & Corda, 1847

[*nom. transl. et correct.* HENNINGSMOEN, 1957 (ex *Pelturides* HAWLE & CORDA, 1847)] [=Juiuyaspidinae HUPÉ, 1953; Pelturinae HARRINGTON & LEANZA, 1952]

Micropygous to heteropygous olenids having subovate to elongate, moderately to considerably convex exoskeleton. Cephalon semicircular, transversely elliptical or subreniform, with moderately to very wide, anteriorly more or less rounded glabella; very short or completely reduced preglabellar field; palpebral lobes usually close to anterior border; librigenae with rounded (rarely angular) genal angles without spines or (rarely) with short genal spines. Thoracic segments usually with strongly oblique pleural furrows. Pygidium greatly varying in shape and number of segments. Hypostoma wide, subrectangular to octagonal or subovate, with fairly small, strongly convex middle body and very wide, flat lateral and posterior border, and raised margin. *U.Cam.-L.Ord.(Tremadoc.)*.

Peltura MILNE EDWARDS, 1840 [BURMEISTER, 1843 (pro *Peltoura* MILNE EDWARDS, 1840); emendation to *Peltura* of *Peltoura* MILNE EDWARDS validated by ICZN, 1958, Opinion 499] [**Entomostrocites scarabaeoides* WAHLENBERG, 1821; SD HAWLE & CORDA, 1847] [=Anthes GOLDFUSS, 1843 (obj.); *Anopocare* ANGELIN, 1854]. Exoskeleton elongated subovate, strongly convex. Cephalon subreniform, with rounded genal angles lacking genal spines or (rarely) with poorly developed spines; cranidium subtrapezoidal to semicircular; glabella much wider than posterior areas of fixigenae, reaching wholly or nearly to anterior border, with 2 or 3 pairs of shallow, oblique lateral furrows; fixigenae very narrow; eye ridges usually obscure; palpebral lobes very small, close to glabella and anterior border. Thorax of about 12 segments, slightly contracted in front; axis rapidly tapering, usually wider than pleural regions; pleurae obliquely truncated, with short, obliquely backward-directed pleural spines. Pygidium small, wide,

with 2 axial rings, short terminal axial portion, 2 or 3 pairs of pleurae, and narrow border with pleural spines or entire margin (331). *U.Cam.*, Eu.-E.Can.(Atl.prov.).—FIG. 196,3. **P. scarabaeoides* (WAHLENBERG), *U.Cam.*, Swed.; exoskel., X1 (331).

Acerocare ANGELIN, 1854 [**A. ecorne*]. Differs from *Peltura* in having moderately convex exoskeleton. Cephalon transversely elliptical; glabella equal in width to posterior areas of fixigenae or narrower; small palpebral lobes prominent, not close to anterior border yet well in front of

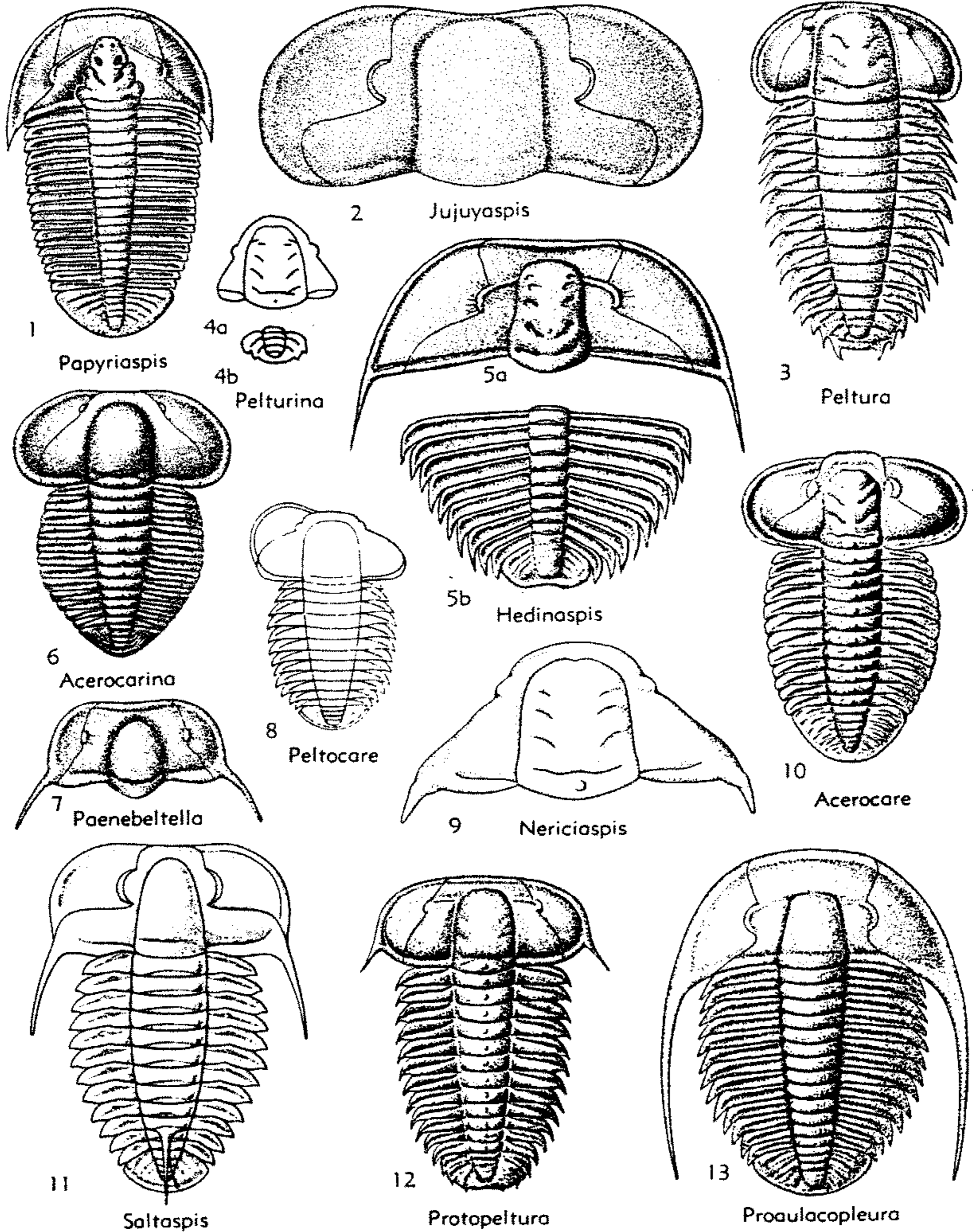

FIG. 196. Olenidae (Pelturinae), Papyriaspididae (p. 0265, 0266, 0269).

glabellar center; posterior areas of fixigenae broadly rounded. Thoracic axis moderately tapering, equal in width to pleural regions or narrower; truncate pleurae spineless, or with rudimentary pleural spines. Pygidium large, approximately semicircular, multisegmentate (152, 331). *U.Cam.*, Norway-Swed.—FIG. 196,10. **A. ecorne*, *U.Cam.*, Swed.; exoskel. (reconstr.), $\times 2$ (152).

Acerocarina POULSEN, 1951 [*pro Cyclognathus* LINNARSSON, 1875 (non ST. HILLAIRE, 1833)] [**Cyclognathus micropygus* LINNARSSON, 1875]. Differs from *Acerocare* in having glabella wider than posterior areas of fixigenae, effaced lateral furrows, extremely small palpebral lobes opposite front of glabella; shorter, anteriorly strongly contracted thorax with rapidly tapering axis; and much smaller, paucisegmented pygidium without border (152, 331). *U.Cam.-L.Ord.(Tremadoc.)*, Norway-Swed.-E.Can.(Atl.prov.)-?Arg. — FIG. 196,6. **A. micropyga* (LINNARSSON), *U.Cam.*, Swed.; exoskel., $\times 4$ (331).

Beltella LAKE, 1919 [**Ellipsocephalus depressus* SALTER, 1859; SD VOGDES, 1925]. Differs from *Peltura* in having semicircular cephalon, anterior sections of facial sutures diverging from eyes to anterior border and then converging so as to meet at axial line; more prominent, distinctly defined eye ridges, angular genal angles, and well-developed genal spines; thoracic segments with truncate extremities (55, 114, 331). *U.Cam.-L.Ord.(Tremadoc.)*, Eu.-S.Am.-N.Am.

Boeckaspis HENNINGSMOEN, 1955 [*pro Boeckia* BRØGGER, 1882 (non MALM, 1870; nec BRADY, 1871; nec THOMSON, 1883; nec GRIMM in SARS, 1894)] [**Boeckia hirsuta* BRØGGER, 1882]. Differs from *Acerocare* in having very wide anterior and palpebral areas of fixigenae, distinctly marked eye ridges, palpebral lobes placed opposite to glabellar center or farther back; thoracic segments terminating in long pleural spines, and almost perfectly trapezoidal pygidium with pair of short spines projecting from posterior part of border (18, 330). *L.Ord.(Tremadoc.)*, Norway-Swed.

Cyclognathina LERMONTOVA, 1951 [**C. microps*]. *U.Cam.*, Kazakhstan (HE).

Jujuyaspis KOBAYASHI, 1936 [**J. keideli*]. Differs from *Acerocare* in having effaced glabellar furrows, palpebral lobes situated opposite to glabellar center; wider, rapidly tapering thoracic axis, thoracic segments terminating in long pleural spines (55, 58, 98). *L.Ord.(Tremadoc.)*, Arg.-Norway-N.Am.—FIG. 196,2. **J. keideli*, Arg. (Jujuy); ceph. (restored), $\times 3$ (58).

Nericiaspis TJERNVIK, 1955 [**Jujuyaspis? robusta* TJERNVIK, 1953]. Differs from *Saltaspis* in having 3 pairs of strong lateral glabellar furrows, smaller, more anteriorly situated eyes, and obliquely backward-directed, almost straight course of

posterior sections of facial sutures (298). *U.Cam.*, Swed.—FIG. 196,9. **N. robusta* (TJERNVIK), cran., $\times 4.5$ (298).

?**Paenebeltella** ROSS, 1951 [**P. vultulata*]. Differs from *Beltella* in having ovate glabella, wider palpebral area of fixigenae and converging course of anterior sections of facial sutures from eyes to anterior border (258). *L.Ord.*, W.N.Am.—FIG. 196,7. **P. vultulata*, Utah; ceph. (reconstr.), $\times 4$ (258).

Parabolinopsis HOEK, 1912 [**P. mariana*] [= *Andesaspis* KOBAYASHI, 1935 (obj.)]. Like *Paenebeltella* but having much narrower fixigenae and genal angles remote from facial sutures (279). *L.Ord.(Tremadoc.)*, S.Am.

Peltocare HENNINGSMOEN, 1957 [**Acerocare norvegicum* MOBERG & MÖLLER, 1898]. Like *Acerocarina* but having wider fixigenae and posterior sections of facial sutures cutting lateral cephalic borders (61). *L.Ord.(Tremadoc.)*, Eu.-E.Can.(Atl.prov.)-Arg.—FIG. 196,8. **P. norvegicum* (MOBERG & MÖLLER); exoskel. (reconstr.), $\times 1.5$ (61).

Pelturina HENNINGSMOEN, 1957 [**P. punctifera*]. Differs from *Peltura* in having palpebral lobes farther back (opposite 2nd lateral furrows) (61). *U.Cam.*, Norway-Swed.—FIG. 196,4. **P. punctifera*, Norway; 4a,b, cran., pyg., $\times 3$ (61).

Protopeltura BRØGGER, 1882 [**Peltura praecursor* WESTERGÅRD, 1909; SD by ICZN, 1958, Opinion 499]. Differs from *Peltura* in having transversely elliptical cephalon, narrower glabella, wider fixigenae, distinctly marked eye ridges, genal spines almost in continuation of lateral cephalic border, narrower thoracic axis, and wider pleural regions (18, 331). *U.Cam.-L.Ord.(Tremadoc.)*, Norway-Swed.-USSR-?Arg.—FIG. 196,12. **P. praecursor* (WESTERGÅRD), *U.Cam.*, Swed.; exoskel., $\times 4$ (331).

Saltaspis HARRINGTON & LEANZA, 1952 [**Jujuyaspis steinmanni* KOBAYASHI, 1936]. Differs from *Jujuyaspis* in having posterior areas of fixigenae produced into a pair of well-developed intergenal spines and in having facial sutures of proparian type (58). *L.Ord.(Tremadoc.)*, S.Am.-Swed.-Norway.—FIG. 196,11. **S. steinmanni* (KOBAYASHI), Arg.(Salta); exoskel. (reconstr.), $\times 3.3$ (445n).

?**Sphaerophthalmella** KOBAYASHI, 1955 [**S. inexpectans*]. *L.Ord.*, W.Can.

Westergardia RAYMOND, 1924 [**Boeckia scanica* WESTERGÅRD, 1909] [= *Sphaerophthalmoides* HUTCHINSON, 1952 (subj.)]. Differs from *Acerocare* in having wider, more tapering glabella extended to anterior border and somewhat depressed between fixigenae, much wider anterior and palpebral areas of fixigenae, palpebral lobes situated farther back and remote from glabella; shorter

thorax with rapidly tapering axis much wider than pleural regions; and much smaller, paucisegmented pygidium (333). *U.Cam.*, Norway-Swed.-E.Can.(Atl.prov.).

Subfamily TRIARTHRIINAE Ulrich, 1930

[*nom. transl.* KOBAYASHI, 1935 (ex Triarthridae ULRICH in BRIDGE, 1930)]

Micropygous to heteropygous, with subovate to elongate, moderately convex exoskeleton. Cephalon semicircular to semielliptical; glabella wide, usually quadrate, with strongly impressed occipital and lateral furrows, usually a preglabellar field, narrow to moderately wide fixigenae, small palpebral lobes anterior to glabellar center, and librigenae generally with genal spines continuing lateral cephalic borders or (rarely) without genal spines. Cephalic doublure and ventral sutures imperfectly known. *U.Cam.-U.Ord.*

Triarthrus GREEN, 1832 [**T. beckii*]. Exoskeleton elongate. Cephalon semicircular; glabella considerably wider than posterior areas of fixigenae, separated from front border by anterior border furrow or by short preglabellar field, with 2 to 4 pairs of lateral furrows, usually 1 or 2 anterior pairs separated from axial furrows; fixigenae very narrow, especially anterior and palpebral areas; anterior sections of facial sutures converging from eyes to front border; librigenae extremely narrow, spineless or (rarely) with slender, curved genal spines. Thorax of 13 to 16 segments, with axis wider than pleural regions, obliquely truncated or rounded pleural extremities, and fulcrum placed very close to axis. Pygidium small, with 3 to 5 axial rings and entire, evenly rounded posterolateral margin. *Ord.*, N.Am.-S.Am.-Eu.—FIG. 197, 8. *T. eatoni* (HALL), *U.Ord.*, N.Y.; exoskel. and distal ends of ventral appendages (reconstr.), $\times 1.3$ (374).

?*Angelina* SALTER, 1859 [**A. sedgwickii*; SD VOGDES, 1890] [= *Keidelaspis* HARRINGTON, 1937]. Differs from typical Triarthrinae in having much larger exoskeleton, narrower glabella, shallow occipital furrow, effaced or obscure lateral furrows, more posteriorly located palpebral lobes, anterior sections of facial sutures convergent on front border so as to meet at median line, and with very long, broad genal spines (114). *L.Ord.* (*Tremadoc.*), Wales-?Swed.-S.Am.-?Can.—FIG. 197, 5. **A. sedgwickii*, Wales; ceph., $\times 1$ (114).

Bienvillia CLARK, 1924 [**Dikelocephalus? corax* BILLINGS, 1865] [= *Diatemnus* RAYMOND, 1937]. Cranium uniformly convex; glabella broadly conical to subquadrate, about 0.8 of length of cranium, lateral furrows distinct to obsolete; small occipital node; convex preglabellar field; eye ridges faint, small eyes opposite anterior 0.3

of glabella; fixigenae downsloping, with palpebral areas not more than 0.25 of glabellar width, posterior areas triangular, broad, short (*tr.*); librigenae elongate triangular with bluntly pointed genal angles. Pygidium unknown. Surface smooth. *U.Cam.-L.Ord.*, N.Am.

B. (*Bienvillia*). Axial, occipital, and posterior lateral furrows deeply impressed; 3 pairs of lateral furrows, posterior 2 pairs deep, arcuate, complete, anterior pair shallower, incomplete; frontal area differentiated by narrow border furrow into very narrow anterior border and wider convex preglabellar field; librigenae with narrow lateral border furrows. *U.Cam.*, NE.N.Am.—FIG. 197, 1. **B. corax* (BILLINGS), Que.; ceph., $\times 5$ (445n).

B. (*Desmetia*) WALCOTT, 1925 [**D. annectans*]. Axial, occipital, and posterior lateral furrows moderately impressed; 2 pairs of shallow, arcuate incomplete glabellar furrows; frontal area undifferentiated, anterior border furrows obsolete; lateral border furrows obsolete on librigenae. *L.Ord.* (*Tremadoc.*), NE.N.Am.-W.N.Am.—FIG. 197, 3. B. (*Desmetia*) *terranovica* RASETTI, Newf.; 3a,b, ceph., dorsal, lateral, $\times 5$ (445n).

Leiobienvillia RASETTI, 1954 [**L. laevigata*]. Cranium uniformly convex, all furrows obsolete abaxially but adaxially with very shallow axial, occipital, and posterior border furrows; glabella low, broad, subquadrate, length about 0.8 of cranium, with 3 pairs of shallow arcuate lateral furrows; short, convex undifferentiated frontal area, eyes small, opposite anterior third of glabella; fixigenae downsloping, with palpebral areas about 0.5 of glabellar width, posterior areas triangular, broad, medium in length (*tr.*); librigenae and pygidium unknown. Surface smooth. *L.Ord.* (*Tremadoc.*), NE.N.Am.—FIG. 197, 7. **L. laevigata*, Newf.; cran., $\times 6$ (445n).

Moxomia WALCOTT, 1924 [**M. hecuba*]. Differs from *Parabolinella* in having subrectangular cranium with corner furrows and very narrow posterior areas of fixigenae (320). *L.Ord.* (*Tremadoc.*), W.Can.(B.C.)—FIG. 197, 2. **M. hecuba*, Mt. Robson; cran., $\times 3$ (320).

Parabolinella BRØGGER, 1882 [**P. limitis*; SD BASSLER, 1915]. Differs from *Triarthrus* in having regularly ovate exoskeleton, much wider, semielliptical cephalon, longer preglabellar field, wider fixigenae, prominent eye ridges, diverging course of anterior sections of facial sutures from eyes to front border, wide librigenae with straight genal spines. Thorax of 16 to 21 segments with axis narrower than pleural regions and short pleural spines. Pygidium smaller, with 1 to 3 axial rings (18, 55, 114). *U.Cam.?*, *L.Ord.* (*Tremadoc.*), Eu.-N.Am.-S.Am.—FIG. 197, 9. **P. limitis*, *L.Ord.* (*Tremadoc.*), Norway; ceph., $\times 1$ (18)—FIG. 197, 6. *P. triarthra* (CALLAWAY), *L.Ord.* (*Tremadoc.*), Eng.; nearly whole dorsal exoskeleton, lacking librigenae, $\times 1.7$ (114).

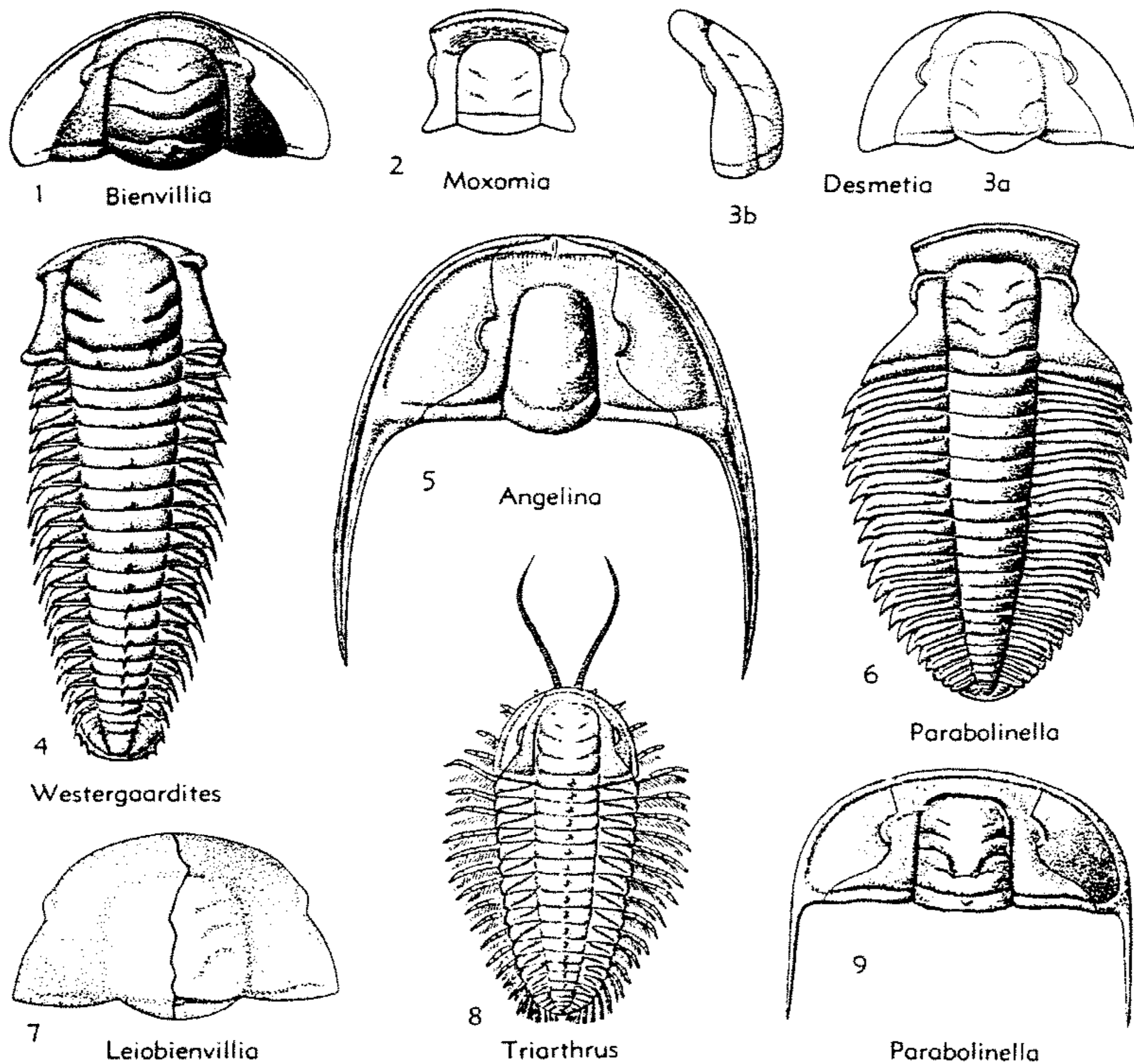

FIG. 197. Olenidae (Triarthrinae) (p. O267, O268).

Plicatolina SHAW, 1951 [**P. kindlei*]. Differs from *Triarthrus* in having median notch in front margin of glabella, 1 or 2 transglabellar furrows formed by posterior lateral furrows, prominent eye ridges, diverging course of anterior sections of facial sutures from eyes to front border, and thorax of more than 16 segments with pleural spines (273). *L.Ord. (Tremadoc.)*, N.Am.-S.Am.

Porterfieldia B. N. COOPER, 1953 [**Triarthrus caecigenus* RAYMOND, 1920]. Differs mainly from *Triarthrus* in lacking eyes and facial sutures, and in having genae crossed by furrows extending obliquely backward from axial furrows at anterior corners of glabella and merging with lateral border furrows, evenly rounded genal angles. Thorax of 11 segments. Pygidium larger than in *Triarthrus*, with 7 axial rings (26). *M.Ord.*, E.N.Am.-Arg.

Westergaardites TROEDSSON, 1937 [**W. pelturaeformis*]. Differs from *Triarthrus* in having extremely long exoskeleton, wider anterior areas of fixi-

genae, smaller, more anteriorly placed eyes, thorax of 19 segments with extremely wide axis, extremely narrow pleural regions, pleural spines, and pygidium with marginal spines (301). *U.Cam., C.Asia.*—FIG. 197,4. **W. pelturaeformis*, E.T'ien-shan; exoskel. without librigenae, $\times 1.3$ (301).

Family PAPYRIASPIDIDAE
Whitehouse, 1939

[*nom. transl. et correct.* POULSEN, herein (*ex Papyriaspididae* WHITEHOUSE, 1939)]

Micropygous to heteropygous olenaceans with ovate, remarkably flat and thin dorsal exoskeleton. Cephalon with well-developed preglabellar field, genal spines in direct continuation of lateral cephalic border. Thoracic axis very narrow, pleural furrows parallel or subparallel to edges of segments. Hypo-

stoma, cephalic doublure, and ventral sutures unknown. *M.Cam.-U.Cam.*

Papyriaspis WHITEHOUSE, 1939 [**P. lanceola*]. Cephalon approximately semicircular, 0.3 of total length; cranidium subtrapezoidal; glabella short, strongly tapering; occipital ring markedly wider than 1st thoracic axial ring; occipital furrow continuous; 4 pairs of lateral furrows (2 pit-shaped anterior pairs separated from axial furrows, 2 posterior pairs of furrows extending obliquely backward from axial furrows); preglabellar field very long; fixigenae wide, with acute posterior areas; eye ridges almost rectilinear, oblique; palpebral lobes fairly small; situated a little behind glabellar center; anterior sections of facial sutures converging between eyes and anterior border. Thorax of 18 segments, with gradually tapering axis and bluntly terminating pleurae. Pygidium about 0.125 of total length, almost semicircular, with 4 axial rings in addition to terminal axial portion, and with entire margin (340). *M.Cam.*, NE.Austral. —FIG. 196,1. **P. lanceola*, Queensl.; exoskel. (reconstr.), $\times 1$ (340).

Hedinaspis TROEDSSON, 1952 [*pro Hedinia* TROEDSSON, 1937 (*non* NAVÁS, 1936)] [**Hedinia regalis* TROEDSSON, 1937]. Differs from *Papyriaspis* in having wider cephalon, less tapering glabella, occipital and all glabellar furrows separated from axial furrows, shorter preglabellar field, wider posterior areas of fixigenae, palpebral lobes situated slightly anterior to glabellar center. Thorax of about 24 segments, with narrower, less tapering axis and short, backward-directed pleural spines. Pygidium very small, with faintly indicated axial rings, wide, shallow indentation behind axis, and subreniform outline (301). *U.Cam.*, Asia. —FIG. 196,5. **H. regalis* (TROEDSSON), E. T'ien-shan; 5a, ceph., $\times 1.4$; 5b, pyg. and part of thorax, $\times 2$ (301).

Pianaspis SAITO & SAKAKURA, 1936 [**P. kodairai*]. Differs from *Papyriaspis* in having wider thoracic axis and more deeply furrowed thoracic pleurae with short pleural spines. *M.Cam.*, E.Asia.

?**Proaulacopleura** KOBAYASHI, 1936 [**P. buttsi*]. Differs from *Hedinaspis* in having shorter, wider glabella, longer preglabellar field, longer palpebral lobes; thorax of 13 segments, wider thoracic axis, 1st thoracic axial ring almost as wide as occipital ring, narrowly furrowed thoracic pleurae with obliquely backward-directed pleural spines; and larger, rounded triangular pygidium without posterior marginal indentation (98). *U.Cam.*, E.N. Am. —FIG. 196,13. **P. buttsi*, Ala.; exoskel., $\times 1.5$ (419).

?**Prohedinia** LERMONTOVA, 1955(?) [**P. attenuata*]. *M.Cam.*, Sib. (HE).

?**Rhodonaspis** WHITEHOUSE, 1939 [**R. longula*]. Differs from *Papyriaspis* in having parallel-sided glabella, 3 pairs of lateral furrows, rapidly tapering posterior areas of fixigenae, eye ridges at right angles to axis, longer palpebral lobes, 1st thoracic

axial ring as wide as occipital ring; thoracic segments terminating in fairly long, slender, obliquely backward-directed pleural spines; and pygidium with 3 pairs of pleural spines (340). *U.Cam.*, NE. Austral.

Family HYPERMECASPIDIDAE
Harrington & Leanza, 1957

Subisopygous to micropygous, with elliptical dorsal exoskeleton. Cephalon semi-elliptical in outline, transversely elongate, with rounded or spinose genal angles and opisthoparian sutures; glabella wide, tapering forward, truncate anteriorly, with 5 pairs of lateral furrows, 3p furrows sigmoidal, 2p, sigmoidal and bifurcated distally; occipital ring strongly trisegmented longitudinally; preglabellar field narrow; anterior border narrow, depressed, not differentiated by border furrow; eyes large, submedian, close to glabella; anterior sections of facial sutures convergent forward.

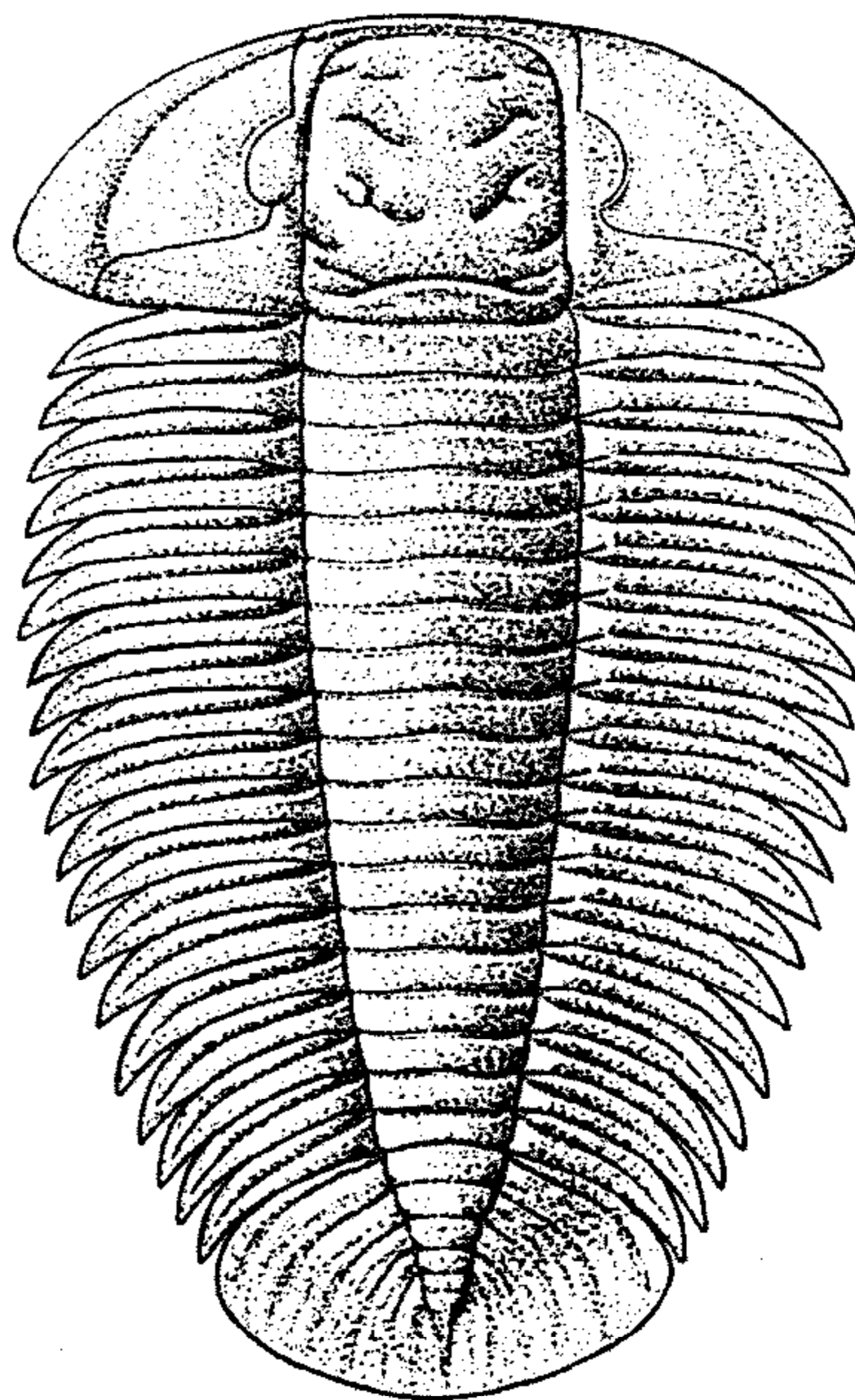

FIG. 198. **Hypermecaspis inermis* HARRINGTON & LEANZA (Hypermecaspidae), L.Ord.(Arenig.), NW.Arg.; exoskel. (holotype), restored, $\times 1.6$ (59*).

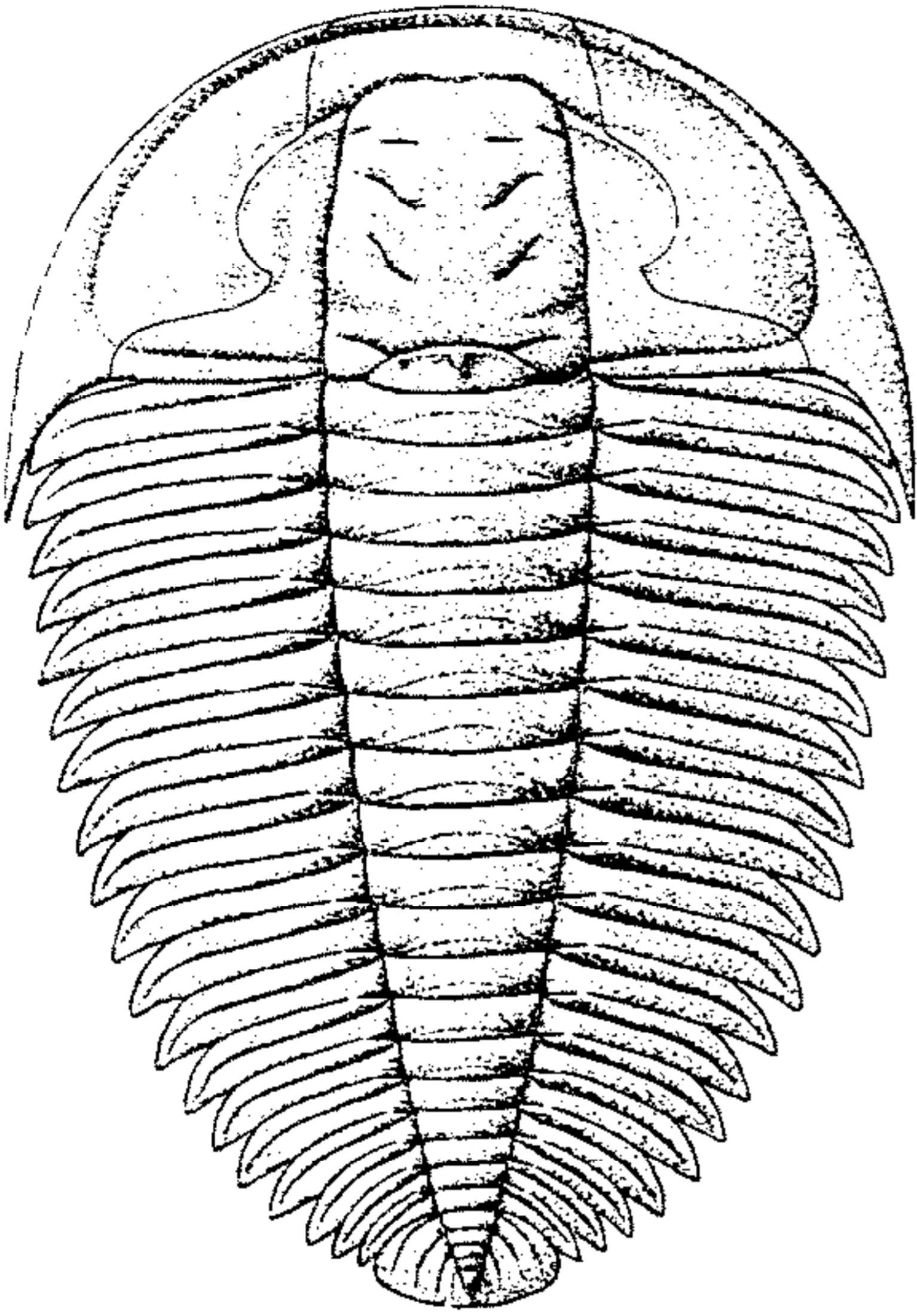

FIG. 199. *Hypermecaspis armata* HARRINGTON & LEANZA (Hypermecaspididae), L.Ord.(Arenig.), NW.Arg.; exoskel. (holotype), $\times 5.2$ (59*).

Thorax with 19 segments; pleurae spinose, with proximal fulcra and oblique furrows. Pygidium large to moderately small, elliptical in outline, with tapering axis prolonged in postaxial ridge; segmentation strong to obsolete; axis with 5 to 8 rings or nearly smooth; pleural furrows curved; border ill- or nondifferentiated; margin entire. *L.Ord.-M.Ord.*

Hypermecaspis HARRINGTON & LEANZA, 1957 [**H. inermis*]. Exoskeleton large. Cephalic border flat, wide near genal angles, progressively narrowing anteriorly; genal angles rounded or produced into spines; anterior sections of facial sutures short, convergent in front of eyes, marginal to mid-line. Pygidium elliptical in outline, transversely elongate, with 5 to 7 rings; pleural fields with 5 to 7 well-marked, curved pleural furrows and much fainter interpleural grooves; border wide, depressed, not differentiated from pleural fields; margin evenly rounded. *L.Ord.-M.Ord.*, Arg.-Bol. —FIG. 198. **H. inermis*, L.Ord.(Arenig.), NW. Arg.; exoskel. (holotype), restored, $\times 1.6$ (59*). —FIG. 199. *H. armata* HARRINGTON & LEANZA, L.Ord.(Arenig.), NW.Arg.; exoskel. (holotype), $\times 5.2$ (59*).

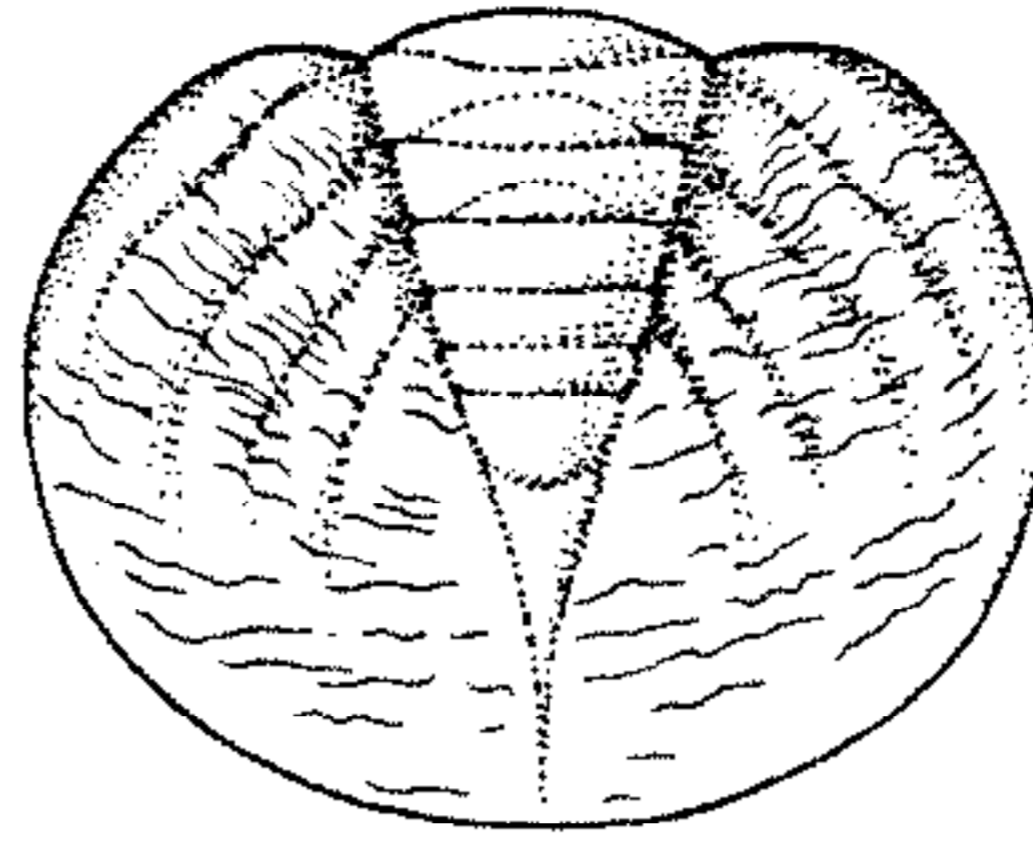

FIG. 200. **Tropidopyge broeggeri* (MOBERG & SEGERBERG) (Hypermecaspididae), L.Ord., Swed.; pyg. (holotype), $\times 2$ (432,* 1906).

Tropidopyge HARRINGTON & KAY, 1951 [**Dikelocephalus broeggeri* MOBERG & SEGERBERG, 1906]. Differs from *Hypermecaspis* in having pygidium gently convex, subelliptical in outline, slightly wider than long, with postaxial ridge reaching posterior margin, pleural fields with few short pleurae without pleural furrows and ill-defined wide depressed border. Cephalon and thorax unknown. [*Parabolinella rugosa* BRÖGGER, 1882, known only from cranidia from Norway and Great Britain, may correspond to this genus.] *L.Ord.*, Swed.-S.Am.(Colom.). —FIG. 200. **T. broeggeri* (MOBERG & SEGERBERG), Swed.; pyg. (holotype), $\times 2$ (153).

Superfamily ILLAENURACEA Vogdes, 1890

[*nom. transl.* LOCHMAN-BALK, herein (ex Illaenuridae VOGDES, 1890)]

[Families grouped in this assemblage are so placed by MOORE on recommendations of HARRINGTON and HENNINGSMOEN primarily. LOCHMAN-BALK considers the Parabolinoididae and Shirakiellidae as most closely related to the Olenidae, signifying their assignment to the Olenacea]

Exoskeleton opisthoparian, micropygous to subisopygous. Glabella quadrate or tapering forward, lateral glabellar furrows generally obsolete but with 3 distinct pairs in some Parabolinoididae; anterior border furrow distinct to absent; eyes medium in size or small; fixigenae typically horizontal or upsloping, with rather narrow palpebral areas; librigenae generally bearing short to moderately long, slender genal spines but with rounded genal angles in some genera. Thorax mostly unknown, that of *Illaeenus* with 11 segments showing broad, low axis and faintly furrowed, blunt-ending pleurae. Pygidium transverse to subtriangular, with axis reaching almost to posterior extremity, axial furrows shallow or obsolete; pleural fields with distinct to obsolete pleural furrows and interpleural grooves; border fur-

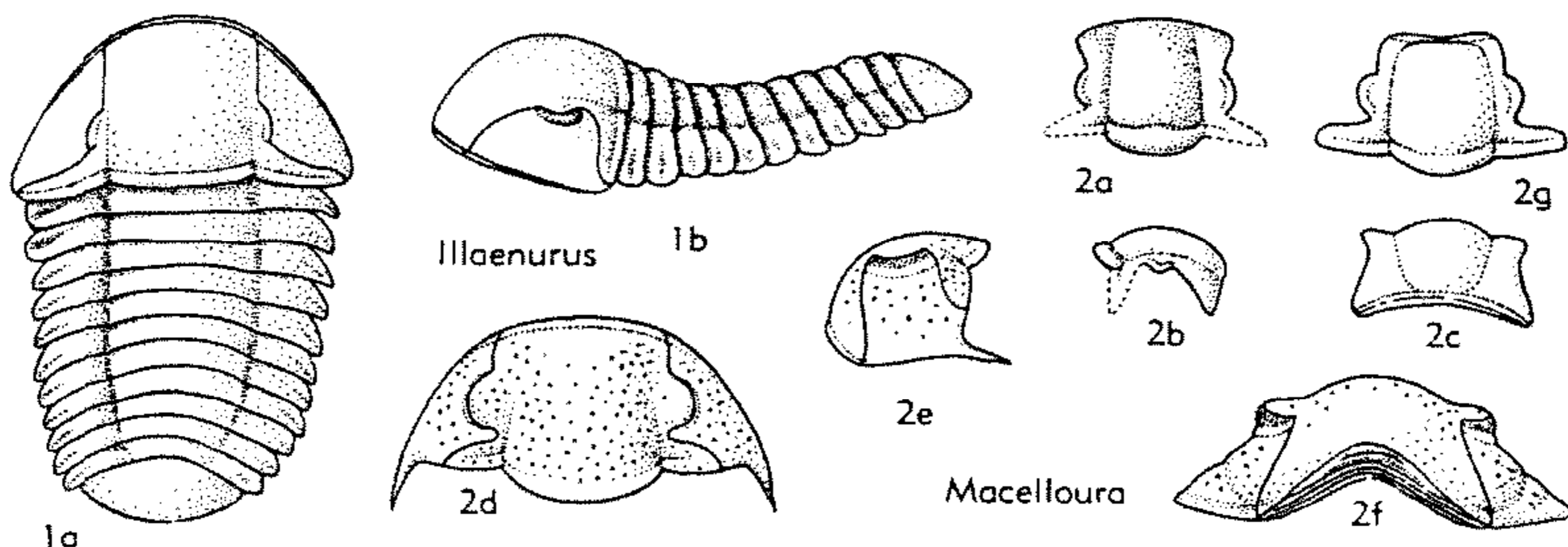

FIG. 201. Illaenuridae (p. 0271).

row usually absent; 1 to 4 pairs of marginal spines may be present. *U. Cam.*

Family ILLAENURIDAE Vogdes, 1890

Exoskeleton opisthoparian, ovate, micro-pygous. Glabella low, quadrate to rectangular, without lateral furrows, other furrows faint or obsolete on exterior and faint on interior; preglabellar field narrow or absent, border rimlike; eyes of medium size, slightly behind mid-level of glabella; fixigenae horizontal, with very narrow palpebral areas, posterior areas short, straplike, length (*tr.*) variable; librigenae unfurrowed, with short genal spines or rounded genal angles. Thorax with 11 segments; axis low, broad; pleurae narrower than axis, faintly furrowed. Pygidium narrowly transverse; axis low, wider than pleural fields, with smooth or punctate, transverse ridges on anterior border. Polyphyletic derivation. *U. Cam.*

Illaenurus HALL, 1863 [**I. quadratus*] [= *Illaenurus* KOBAYASHI, 1943]. Cranidium rectangular, with low apparently quadrate glabella; anterior border furrow obsolete; anterior border narrow, rimlike; faint axial furrows only developed posteriorly; occipital and posterior border furrows shallow; fixigenae with posterior areas 0.7 of length (*tr.*) of occipital ring; librigenae with rounded genal angles. Pygidium unfurrowed (317). *U. Cam. (Trempeal.)*, N.Am.—FIG. 201, 1. **I. quadratus*, Wis.; 1a, b, exoskel., $\times 1.5$ (317).

Macelloura RESSER, 1935 [**Illaenurus? dia* WALCOTT, 1890] [= *Tatonaspis* KOBAYASHI, 1935; *Yukonaspis* KOBAYASHI, 1936]. Cranidium quadrate, with low subrectangular glabella; no preglabellar field or anterior border furrow; anterior border vertical, with median upward bend; axial

furrows only visible posteriorly on exterior but complete though shallow on interior; occipital and posterior border furrows faint or obsolete on exterior, shallow on interior; small occipital node may be present; fixigenae with posterior areas about 0.3 of length (*tr.*) of occipital ring; librigenae with short slender genal spines. Pygidium unknown. Surface may be punctate (172, 189). *U. Cam. (Trempeal.)*, N.Am.—FIG. 201, 2a-c. **M. dia* (WALCOTT), Tex.; 2a-c, cran. (interior), $\times 1.5$ (488, modified).—FIG. 201, 2d-g. *M. levisensis* (RASETTI), Que.; 2d-f, ceph. (exterior), $\times 3$; 2g, cran. (interior), $\times 2$ (189).

Family SHIRAKIELLIDAE Hupé, 1953

Exoskeleton opisthoparian. Glabella tapering or truncate-tapering, lateral furrows obsolete; no eye ridges, shallow palpebral furrows; frontal area convex, about 0.25 of length of cranidium; anterior border furrow obsolete or very faint; eyes below medium size, opposite anterior 0.3 of glabella; fixigenae horizontal or upsloping, with arcuate palpebral areas, 0.3 of glabellar width, posterior areas triangular, of medium width (*exsag.*), same in length as occipital ring; librigenae elongate, rectangular, marginal furrows nearly obsolete, with short genal spines. Thorax and pygidium unknown. *U. Cam.*

Shirakiella KOBAYASHI, 1935 [**S. elongata*]. Characters of family (97). *U. Cam. (Kaolishanian)*, N.E. Asia (Korea).—FIG. 202, 9. **S. elongata*; ceph., $\times 2$ (419).

Family PARABOLINOIDIDAE Lochman, 1956

Exoskeleton opisthoparian, subisopygous. Glabella tapering to truncate-tapering, with 3 pairs of distinct to obsolete lateral fur-

rows; frontal area 0.25 to 0.3 of length of cranium, with distinct to obsolete anterior border furrow; eye ridges distinct or faint, eyes small to medium in size; fixigenae variable in width and position, with posterior areas triangular to straplike; librigenae rectangular, with genal spines or rounded angles. Pygidium transverse to subtriangular, with convex axis tapered nearly full length to broadly rounded end; border furrow usually obsolete; border narrow, poorly defined; pleurae may end in 1 to 4 pairs of marginal spines or margin smooth. Surface finely granulose or smooth. *U.Cam.*

Parabolinoidea FREDERICKSON, 1949 [**P. contractus*]. Glabella moderately convex, tapering, with 2 anterior pairs of lateral furrows short, diagonal, arcuate posterior pair may be complete; frontal area 0.25 to 0.3 of length of cranium, crossed by distinct curved anterior border furrow; eyes small, opposite anterior 0.3 of glabella; fixigenae nearly horizontal, with arcuate palpebral areas equalling about 0.3 of glabellar width, posterior areas broadly (*exsag.*) triangular, not quite same length (*tr.*) as occipital ring; librigenae with long genal spines. Pygidium narrowly transverse; axis wider than pleural fields, with 3 or 4 axial rings and terminal; 4 pleurae with distinct interpleural grooves and faint to obsolete pleural furrows; border furrow faint or obsolete; 1 to 4 pairs of marginal spines. *U.Cam.(Francon.)*, N.Am.—FIG. 202.6. **P. contractus*, Okla.; *6a,b*, ceph., pyg., $\times 2$ (399).

Bernia FREDERICKSON, 1949 [**B. obtusa*]. Glabella moderately convex, broadly truncate-tapering, with 2 pairs of complete arcuate lateral furrows; frontal area 0.25 to 0.3 of length of cranium, with straight anterior border furrow; eyes small, opposite anterior 0.3 of glabella; fixigenae slightly downsloping, with palpebral areas almost 0.3 of glabellar width, posterior areas broad (*exsag.*), triangular, almost same in length (*tr.*) as occipital ring. *U.Cam.(Francon.)*, C.U.S.A.—FIG. 202.8. **B. obtusa*, Okla.; cran., $\times 3$ (399).

Croixana NELSON, 1951 [**Arionellus bipunctatus* SHUMARD, 1862]. Glabella moderately convex, truncate-tapering, lateral furrows obsolete, axial furrows shallow, with pair of anterior pits; frontal area 0.25 of length of cranium, anterior border furrow obsolete, anterior margin may be pointed; eyes small, opposite anterior 0.3 of glabella; fixigenae slightly upsloping, with palpebral areas 0.3 to 0.5 of glabellar width, posterior areas medium in width (*exsag.*), almost same in length (*tr.*) as occipital ring; librigenae with medium-length genal spines (316). *U.Cam.(Francon.)*, C.U.S.A.—FIG. 202.3. **C. bipunctata* (SHUMARD), Wis.; ceph., $\times 3$ (435).

Kendallina BERG, *nom. subst.* herein [*pro Kendallia* BERG, 1953 (*non* EVERMANN & SHAW, 1927)] [**Conocephalites eryon* HALL, 1863]. Glabella moderately convex, truncate-tapering, axial furrows shallow, may have pair of anterior pits, 1 or 2 pairs of very faint lateral furrows; frontal area 0.25 of length of cranium, narrow (*tr.*), anterior border furrow straight, very faint, anterior border narrow (*sag.*), anterior margin bluntly pointed; eyes small, opposite anterior third of glabella; fixigenae horizontal or slightly upsloping, with palpebral areas 0.25 of glabellar width, posterior areas triangular, of medium width (*exsag.*), almost same in length (*tr.*) as occipital ring; librigenae with medium-length genal spines. Pygidium narrowly transverse; axis same in width as pleural fields, with 3 axial rings and terminal; 4 pleurae with obsolete interpleural grooves and shallow pleural furrows; posterior margin smooth. *U.Cam.(Francon.)*, C.U.S.A.—FIG. 202.1. **K. eryon* (HALL), Wis.; *1a,b*, ceph., pyg., $\times 3$ (376).

Maustonia RAASCH in LOCHMAN, 1950 [**Conocephalites nasutus* HALL, 1863]. Glabella convex, truncate-tapering, with 3 pairs of short, faint to obsolete lateral furrows; frontal area 0.25 of glabellar length or slightly less, anterior border furrow straight or concave, anterior border short (*tr.*), triangular, anterior margin pointed; eyes small, opposite anterior third of glabella; fixigenae slightly upsloping with palpebral areas about 0.3 of glabellar width, posterior areas straplike, almost same in length (*tr.*) as occipital ring, posterior sections of facial sutures sigmoidally curved; librigenae with medium-length genal spines. Pygidium narrowly transverse; axis same in width as pleural fields, with 3 axial rings and terminal; probably 4 pleurae, with obsolete interpleural grooves and very faint pleural furrows; posterior margin smooth or with single pair very small marginal spines. *U.Cam.(Francon.)*, C.U.S.A.—FIG. 202.4. **M. nasuta* (HALL), Wis.; ceph., $\times 2$ (376).

Orygmaspis RESSER, 1936 [**Ptychoparia llanoensis* WALCOTT, 1890]. Glabella moderately convex, elongate tapering, faintly keeled, with 3 pairs of faint lateral furrows; frontal area 0.25 to 0.3 of length of cranium, anterior border furrow shallow, straight, may have row of granules; eyes slightly below medium size, barely anterior to center of glabella; fixigenae horizontal, with palpebral areas 0.3 of glabellar width, posterior areas straplike, almost same in length (*tr.*) as occipital ring, posterior sections of facial sutures sigmoidally curved. Pygidium subtrigonal; axis wider than pleural fields, with 4 axial rings and terminal; 4 pleurae, with obsolete interpleural grooves and 3 broad shallow pleural furrows, anterior 3 pleurae ending in medium-length posteriorly directed marginal spines, 4th pleura in a very small spine. *U.Cam.(Francon.)*, C.U.S.A.—FIG. 202.12. **O.*

llanoensis (WALCOTT), Tex.; 12a,b, cran., pyg.,
 ×1.3 (457).

Psalaspis RESSER, 1937 [*Conocephalites patersoni*
 HALL, 1863]. Glabella low, truncate-tapering with
 2 pairs of faint, arcuate lateral furrows, axial
 and occipital furrows faint; frontal area 0.3 of
 length of cranium, anterior border furrow very
 faint to obsolete, anterior border short (*tr.*), tri-
 angular, anterior margin pointed or curved; slender
 occipital spine may be present; eyes small,

slightly anterior to center of glabella; fixigenae
 horizontal to slightly downsloping, with palpebral
 areas a little less than 0.3 of glabellar width, pos-
 terior areas straplike, almost same in length (*tr.*)
 as occipital ring, posterior sections of facial su-
 tures sigmoidally curved; librigenae broad, bearing
 prominent inwardly curved genal spines. Pygidium
 narrowly transverse, diamond-shaped; axis
 wider than low pleural fields, with 2 or 3
 axial rings and terminal; 3 pleurae with distinct

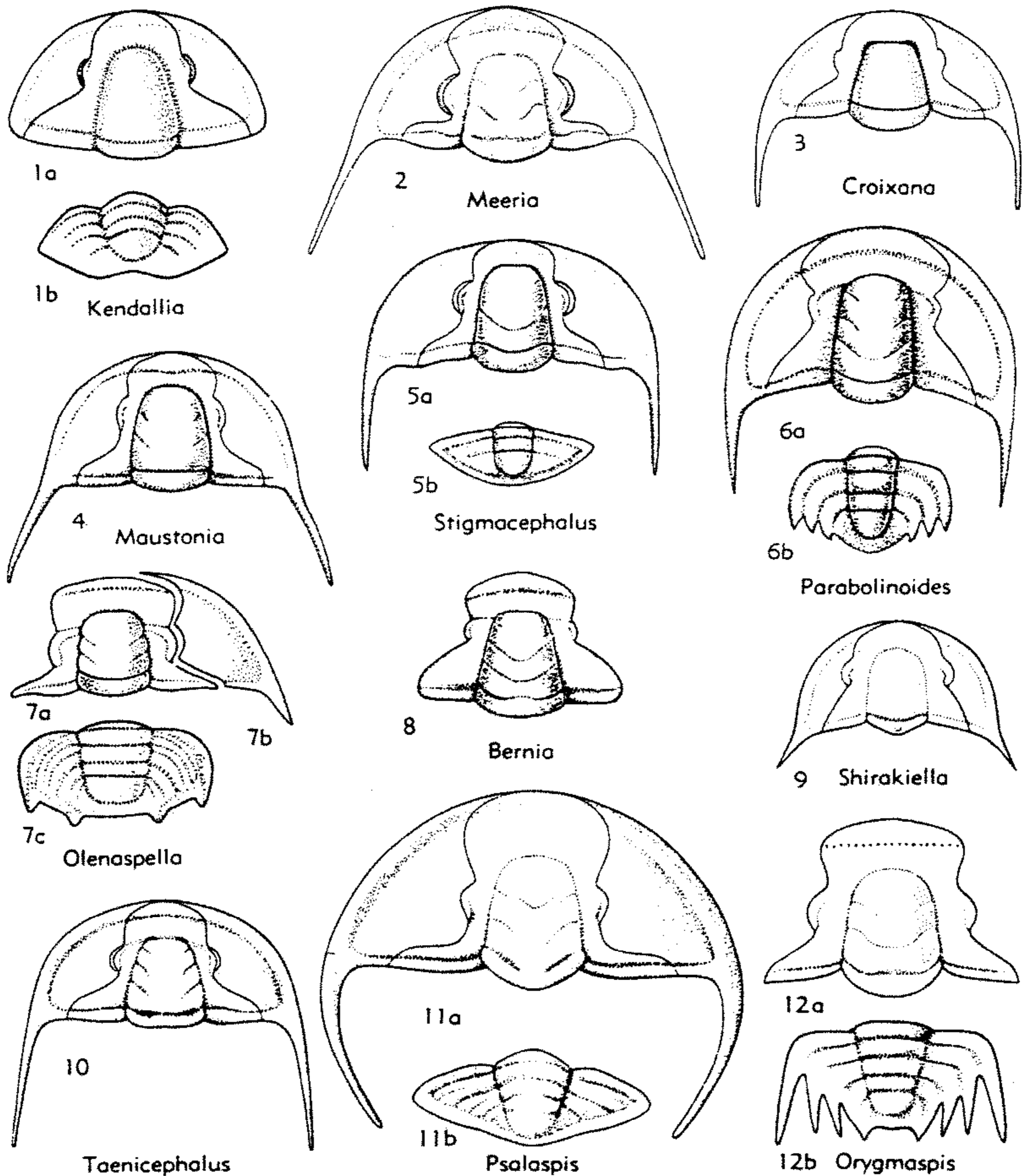

FIG. 202. Idahoiidae, Shirakiellidae, Parabolinoiidae (p. 0252, 0271-0274).

pleural furrows, and faint to obsolete interpleural grooves; border furrow narrow, posterior margin smooth (8). *U.Cam.(Francon.)*, C.U.S.A.—FIG. 202,11. **P. patersoni* (HALL), Wis.; 11a,b, ceph., pyg., ×1 (457).

Stigmacephalus RESSER, 1936 [**Conocephalites oweni* HALL, 1863]. Glabella low, elongate tapering with 2 pairs of faint lateral furrows, axial and occipital furrows shallow; convex frontal area about 0.25 of length of cranidium, anterior border furrow faint to obsolete; eyes slightly below medium size, nearly opposite center of glabella; fixigenae horizontal or slightly upsloping, with palpebral areas slightly less than 0.25 of glabellar width, posterior areas straplike, about 0.7 of length (*tr.*) of occipital ring, posterior sections of facial sutures sigmoidally curved; librigenae with short genal spines. Pygidium narrowly transverse; axis wider than pleural fields, with 3 axial rings and terminal; 3 pleurae with obsolete interpleural grooves, and broad shallow pleural furrows; border furrow shallow, border narrow (156). *U.Cam.(Francon.)*, C.U.S.A.—FIG. 202,5. **S. oweni* (HALL), Wis.; 5a,b, ceph., pyg., ×1 (435).

Taenicephalus ULRICH & RESSER in WALCOTT, 1924 [**Conocephalites shumardi* HALL, 1863]. Glabella low, truncate-tapering, axial furrows deep, in some with pair of anterior pits, 3 pairs of short diagonal lateral furrows; frontal area 0.25 to 0.3 of length of cranidium, anterior border furrow straight or slightly curved, anterior border pointed or curved; eyes small, opposite anterior third of glabella; fixigenae upsloping, with arcuate palpebral areas, about 0.3 of glabellar width, posterior areas subtriangular, about same in length (*tr.*) as occipital ring, posterior sections of facial sutures slightly curved inward; librigenae with medium-length genal spines. Pygidium narrowly transverse axis about same in width as pleural fields, with 3 or 4 axial rings and small terminal; 4 pleurae with faint interpleural grooves and distinct pleural furrows; posterior margin smooth. *U.Cam.(Francon.)*, N.Am.—FIG. 202,10. **T. shumardi* (HALL), Wis.; ceph., ×2 (487).

Olenaspella WILSON, 1956 [**Parabolinella? evansi* KOBAYASHI, 1936]. Glabella slightly convex, subrectangular, front rounded, posterior 2 pairs of lateral furrows distinct; wide (*tr.*) frontal area 0.25 to 0.3 of length of cranidium, crossed by slightly curved anterior border furrow; eye ridges distinct, eyes of medium size, opposite center of glabella; fixigenae nearly horizontal, with palpebral areas about 0.5 of glabellar width, posterior areas narrowly (*exsag.*) triangular, posterior sections of facial sutures sigmoidally curved; librigenae with tapered genal spines. Pygidium transverse; axis same in width as pleural fields, with 4 axial rings and terminal; 4 pleurae with distinct interpleural grooves and faint pleural furrows; border furrow faint; 2 pairs of short, widely spaced marginal

spines. *U.Cam.(U.Dresbach-Francon.)*, N.Am.—FIG. 202,7. **O. evansi* (KOBAYASHI), W.Can.(B.C.); 7a-c, cran., librigena, pyg., ×2 (497).

Superfamily SOLENOPLEURACEA Angelin, 1854

[*nom. transl.* HENNINGSMOEN, herein (ex Solenopleuridae ANGELIN, 1854)] [=Solenopleuroidea HUPÉ, 1953 + Parasolenopleuroidea HUPÉ, 1953 + Agrauloidea HUPÉ, 1953]

Exoskeleton mostly of rather generalized ptychopariid appearance, with small to medium-sized pygidium (Solenopleuridae, Agraulidae, Lonchocephalidae, Dokimocephalidae). Characteristically, the glabella is ovate, but in many forms it tapers forward or is parallel-sided; also the rather prominent glabella may be pyriform (e.g., Catilliocephalidae, which apparently developed from the Lonchocephalidae). Axial and occipital furrows characteristically deep and wide, but may be less distinct or obsolete (Agraulidae, Kingstoniidae). The preoccipital lateral glabellar furrows commonly curve inward-backward, in some forms almost isolating the basal (preoccipital) lobes. Dorsal surface generally granulose or tuberculate, but may be smooth. *M.Cam.-L. Ord.*

Family SOLENOPLEURIDAE Angelin, 1854

Opisthoparian, ovate to elongate fairly convex exoskeleton, micropygous to heteropygous. Cephalon generally semicircular, with tapering to ovate glabella defined by very wide and deep axial and occipital furrows, generally deep border furrow, and prominent, commonly narrow border. Thorax (as far as known) of 11 to 17 segments with prominent axis and deeply furrowed pleurae. Pygidium with 1 to 9 axial rings, more or less distinctly segmented pleural fields, entire margin, and usually well-defined narrow border. Surface granulose or tuberculate. Character of cephalic doublure, ventral sutures, and hypostoma imperfectly known. *M.Cam.-L.Ord.*

Subfamily SOLENOPLEURINAE Angelin, 1854

[*nom. transl.* POULSEN, 1954 (ex Solenopleuridae KOBAYASHI, 1935)]

Strongly convex, anteriorly rounded glabella with 2 or 3 pairs of oblique lateral furrows; eye ridges usually distinct; palpebral lobes short, librigenae spineless or with poorly developed genal spines. Thorax (as

far as known) of 13 to 17 segments with rounded extremities or (rarely) short pleural spines. Pygidium with 2 to 9 axial rings. Surface granulate or finely tuberculate. *M. Cam.-U. Cam.*

Solenopleura ANGELIN, 1854 [**Aulacopleura (Calymene) canaliculata* ANGELIN, 1851; SD MILLER, 1889]. Cephalon with approximately trapezoidal cranidium and evenly curved anterior margin; glabella tapering to subovate; preglabellar field usually short (*sag.*); fixigenae with considerably elevated palpebral areas and posterior areas extending almost to genal angles, short palpebral lobes situated opposite or slightly in front of glabellar center, more or less converging course of anterior sections of facial sutures from eyes to anterior border, and usually more or less rudimentary acute genal spines. Thorax of about 14 segments with rounded extremities and pleural furrows almost parallel to edges of segments. Pygidium fairly wide, with 7 or 8 axial rings and strongly marked segmentation of pleural fields (51, 114, 338). *M. Cam., Eu.-Asia-E.N. Am. (Atl. prov.)-N. Zem.* — FIG. 203. **S. canaliculata* (ANGELIN). Swed.; exoskel. (reconstr.), $\times 0.5$ (1, somewhat modified).

?*Albansia* HOWELL, 1937 [**A. pusilla*]. Very small, differing from *Solenopleura* in having ovate glabella, more oblique posterior pair of lateral furrows, and effaced or very indistinctly defined eye ridges (74). *Up. M. Cam., E.N. Am.*

Asthenopsis WHITEHOUSE, 1939 [**A. levior*]. Differs from *Solenopleura* in having palpebral lobes situated close to posterior border furrow, and thoracic segments terminating in obtuse pleural spines (340). *M. Cam., NE. Austral.* — FIG. 204, 2. **A. levior*; exoskel. (reconstr.), $\times 1$ (340).

?*Crusoia* WALCOTT, 1924 [**C. cebes*]. Differs from *Solenopleura* in having upturned cephalic front with broad indentation of anterior margin between anterior sections of facial sutures, smaller palpebral lobes situated very far forward, obliquely truncated pleurae, and minute pygidium (321). *M. Cam., N. Am.* — FIG. 204, 3. **C. cebes*, Mont.; exoskel., $\times 3$ (321).

Jincella ŠNAJDR, 1957 [**Solenopleura prantli* RŮŽIČKA, 1935]. *M. Cam., Eu. (USSR).*

Maiaspis CHERNYSHEVA, 1956 [**M. mirabilis*]. *Up. M. Cam., USSR.*

?*Menocephalites* KOBAYASHI, 1935 [**Solenopleura acantha* WALCOTT, 1905]. *M. Cam., E. Asia.*

Parasolenopleura WESTERGÅRD, 1953 [**Calymene aculeata* ANGELIN, 1851] [*non* POLETAEVA, 1955 (**P. subconsocialis*)]. Differs from *Solenopleura* in having less convex dorsal exoskeleton; less sloping anterior portion of cephalon; shallower axial and border furrows; less inflated genae, less convex anterior border, nearly flat lateral border; pygidium with more pronounced interpleural

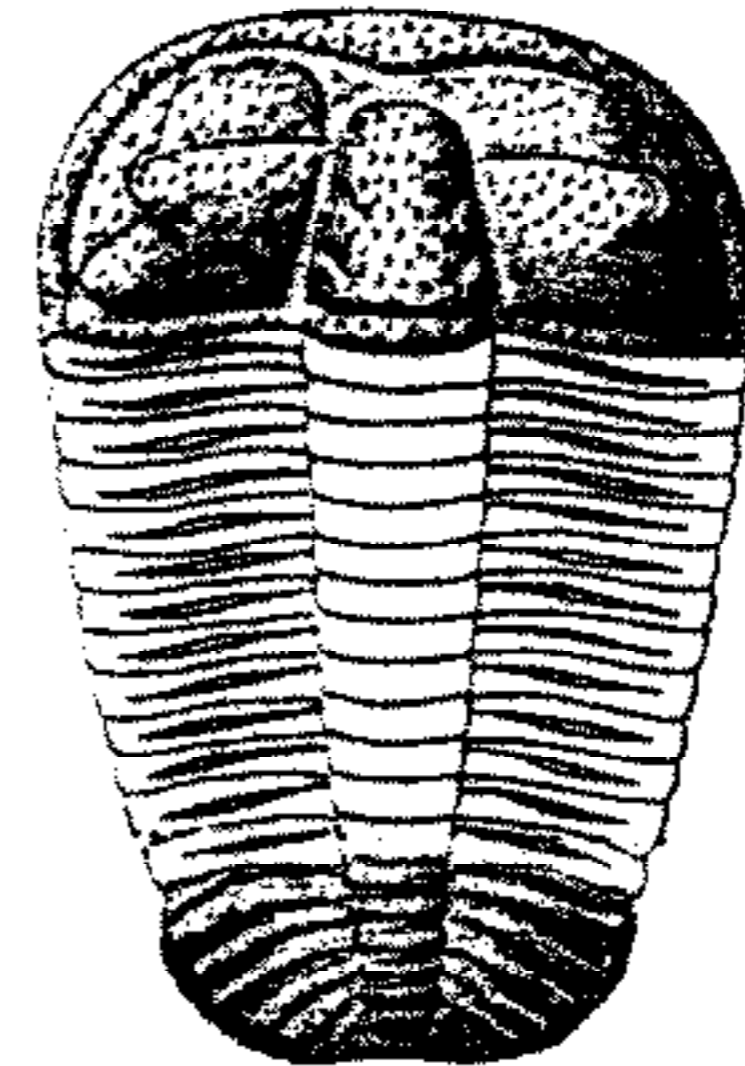

FIG. 203. **Solenopleura canaliculata* (ANGELIN) (Solenopleuridae), *M. Cam., Swed.*; exoskel. (reconstr.), $\times 0.5$ (1, mod.).

grooves; and outer surface of exoskeleton smooth to the naked eye (338). *M. Cam., Eu.-E.N. Am. (Atl. prov.)-Asia.* — FIG. 204, 12. **P. aculeata* (ANGELIN). Swed.; exoskel. (reconstr.), $\times 2$ (based on WESTERGÅRD).

Perneraspis PRANTL, 1947 [*pro Perneria* RŮŽIČKA, 1940 (*non* FRITSCH, 1904)] [**Perneria lata* RŮŽIČKA, 1940]. Differs from *Solenopleura* in having wider, more rapidly tapering glabella; narrower fixigenae; same width of anterior border for greater part of its extension between facial sutures, diverging course of anterior sections of facial sutures from eyes to anterior border; and pygidium with 3 or 4 axial rings and faintly marked segmentation of pleural fields (264). *M. Cam., Czech.* — FIG. 204, 5. **P. lata* (RŮŽIČKA); cran., $\times 2$ (264).

Pseudosolenopleura SUN, 1935 [**Solenopleura kotoi* KOBAYASHI, 1933]. *U. Cam., E. Asia.*

Solenopleurella POULSEN, 1927 [**S. ulrichi*]. Differs from *Solenopleura* in having smaller, much narrower exoskeleton, almost quadrate glabella extended to anterior border furrow, and less oblique lateral furrows (172, 197). *M. Cam., Greenl.-N. Am.* — FIG. 204, 6. **S. ulrichi*, Greenl.; cran., $\times 8$ (172).

Solenopleurina RŮŽIČKA, 1938 [**S. týřovicensis*]. Differs from *Solenopleura* in having considerable distance between genal angle and posterior end of facial sutures (263). *M. Cam., Czech.*

Spencia RESSER, 1939 [**S. typicalis*] [= *Staurholcus* RESSER, 1939]. *M. Cam., N. Am.*

Subfamily ACROCEPHALITINAE HUPÉ, 1953

[*nom. transl.* POULSEN, 1954 (*ex* Acrocephalitidae HUPÉ, 1953)]

Strongly convex, anteriorly truncate glabella, usually with 3 pairs of oblique lateral furrows; swelling or boss occupying more or less well-developed preglabellar field; eye

ridges faintly marked; genal spines fairly well developed. Pygidium with 1 to 8 axial rings. Surface granulate to finely tuberculate. *M.Cam.-U.Cam.*

Acrocephalites WALLERIUS, 1895 [**Calymene stenometopa* ANGELIN, 1851]. Cranidium approximately pentagonal, with tapering glabella, more or less angular anterior margin that usually bears a forward-directed median cusp or spine; converging course of anterior sections of facial sutures from eyes to anterior border. Thoracic segments with short pleural spines. Pygidium very short, wide, with few segments (331, 336). *M.Cam.-U.Cam.*, Eu.-Asia-?N.Zem.—FIG. 204,11. **A. stenometopus* (ANGELIN), *M.Cam.*, Swed.; cran., $\times 4$ (331).

Acrocephalaspis IVSHIN, 1956 [**A. fidus*]. Glabella short, truncate-tapering with 2 pairs of faint curved lateral furrows; wide (*sag.*) preglabellar field with globose boss filling all area in front of glabella and impinging on preglabellar and anterior border furrows; anterior border narrow, anterior border furrow distinct, narrow, curving forward on sagittal line; eyes of medium size opposite center of glabella, palpebral lobes crescentiform, eye ridges present; fixigenae upsloping, with palpebral areas slightly more than 0.5 of glabellar width, posterior areas narrow (*exsag.*), triangular. Surface finely granulate. *U.Cam.*, SW.Sib.

?**Acrocephalina** TROEDSSON, 1937 [**A. armata*]. Resembles *Acrocephalites*, but with longer anterior spine and with distinct eye ridges. *U.Cam.*, eastern T'ien-shan, Sinkiang, C.Asia (HE).

Aldanaspis LERMONTOVA, 1940 [**A. punctata*]. Differs from *Acrocephalites* in having subrectangular glabella; longer, much stronger median spine on anterior border; and diverging course of anterior sections of facial sutures from eyes to anterior border (117). *M.Cam.*, USSR.

Cliffia J. L. WILSON, 1951 [**Acrocephalites lataegenae* J. L. WILSON, 1949]. Differs from *Acrocephalites* in having evenly curved anterior cephalic margin without median cusp or spine; moderately converging, almost subparallel course of anterior sections of facial sutures from eyes to anterior border; wider posterior area of fixigenae; wider librigenae; and long, fairly large, rounded triangular, borderless (associated) pygidium with about 8 axial rings and strongly marked segmentation of pleural fields (363). *U.Cam.*, N. Am.—FIG. 204,10. **C. lataegenae* (J. L. WILSON), Tex.; ceph., $\times 4$ (363).

?**Paracrocephalites** POULSEN, 1954 [*pro Arctaspis* LERMONTOVA, 1940 (*non* HEINTZ, 1929)] [**Arctaspis robusta* LERMONTOVA, 1940]. Differs from *Acrocephalites* in having less angular cephalic front without median cusp or spine; effaced glabellar furrows; shorter preglabellar field without appreciable swelling; and almost rectilinear an-

terior border furrow (117). *U.Cam.*, Asia.—FIG. 204,15. **P. robustus* (LERMONTOVA), Sib.; cran., $\times 1.5$ (117).

Pesaia WALCOTT & RESSER, 1924 [**P. exsculpta*]. Differs from *Cliffia* in having shorter preglabellar field; anterior border furrow almost effaced along preglabellar swelling; effaced glabellar furrows; narrower (*sag.*) occipital ring; short wide pygidium with few indistinctly defined segments and well-defined border (322). *U.Cam.*, N. Zem.—FIG. 204,7. **P. exsculpta*; cran., $\times 2$ (322).

Subfamily SAOINAE Hupé, 1953

[*nom. transl.* POULSEN, 1954 (*ex* Saoidae Hupé, 1953)]

Moderately convex glabella with 2 or 3 pairs of transverse or (rarely) oblique lateral furrows; eye ridges usually well defined; palpebral lobes of medium size; genal spines short, poorly developed. Thorax of 16 or 17 segments with rounded or truncated extremities. Pygidium small, with up to 4 axial rings. Surface covered with spine-like tubercles or spines or both. *M.Cam.*

Sao BARRANDE, 1846 [*non* BILLBERG, 1820, ICZN Opinion 512] [**S. hirsuta*] [= *Monadina* BARRANDE, 1846; *Acanthocnemis*, ?*Acanthogramma*, *Crithias*, *Endogramma*, *Enneacnemis*, *Goniacanthus*, ?*Micropyge*, *Selenosema*, *Staurogmus*, *Tetracnemis* HAWLE & CORDA, 1847]. Lateral glabellar furrows wide, impressed, transverse, united with longitudinal furrow on crest of glabella; cephalic border moderately wide, strongly convex; axial and anterior border furrows confluent so as to form considerable concave space without surface markings between glabella and anterior border. Thorax of 17 segments with truncated extremities. Pygidium very short, wide, with 2 segments. All convex parts of outer surface covered with small tubercles forming regular transverse rows on glabella, thorax, and pygidium, also a median spine and smaller lateral spines on occipital and thoracic axial rings (3). *M.Cam.*, Eu.—FIG. 204,13. **S. hirsuta*, Czech.; 13a, exoskel. (reconstr.), $\times 2$; 13b, thoracic segment, $\times 4$ (3).

Pardailhania THORAL, 1947 [**Solenopleura?* *hispida* THORAL, 1935]. Differs from *Sao* in having glabella without median longitudinal furrow; moderately long, slightly convex preglabellar field with surface markings; fairly flat or slightly concave anterior cephalic border with upturned anterior margin, and coarser surface markings consisting of spines or (rarely) crests (296). *M.Cam.*, S.Eu.-?N.Afr.

Rimouskia RESSER, 1938 [**R. typica*]. Differs from *Sao* in the less tapered, longer glabella, lack of definite longitudinal glabellar furrow; straight posterior sections of facial sutures; and stronger, more distally located geniculation of posterior cephalic

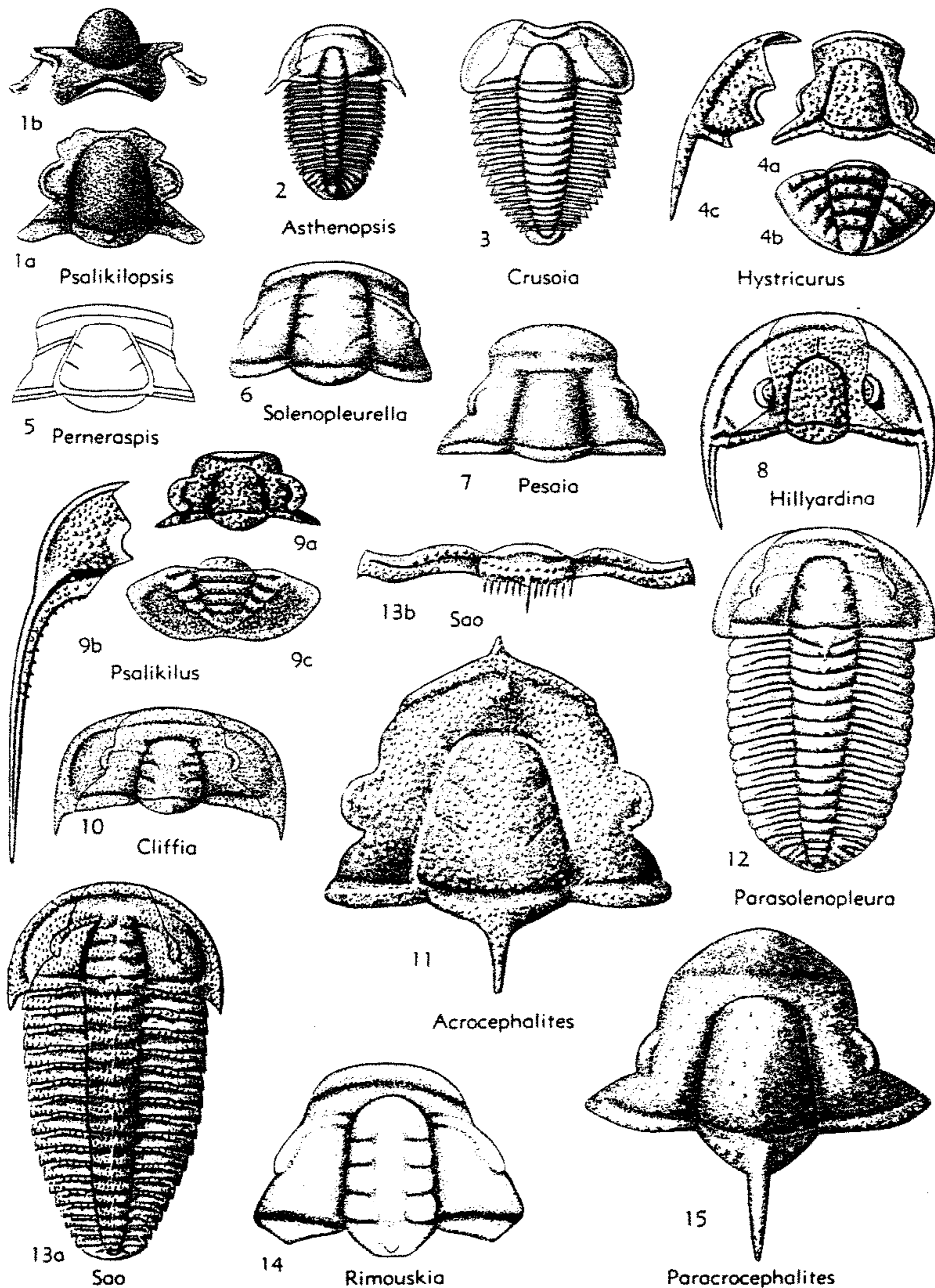

FIG. 204. Solenopleuridae (p. 0275-0278).

border (203). *L.Cam.*, E.N.Am.—FIG. 204,14.
**R. typica*, Que.; cran., $\times 4$ (203).

Solenopleuropsis THORAL, 1947 [**Conocoryphe rouayrouxi* MUNIER-CHALMAS & BERGERON, 1889]. Differs from *Sao* in having glabella without median longitudinal furrow, oblique lateral furrows; very long slightly convex tuberculate preglabellar field; very narrow cephalic border; rounded extremities of thoracic segments; and coarser tuberculation forming regular transverse rows on occipital and postoccipital parts only (296). *M.Cam.*, Eu.

Subfamily HYSTRICURINAE Hupé, 1953

[*nom. transl.* POULSEN, 1954 (ex Hystricuridae HUPÉ, 1953)]

Glabella moderately to strongly convex, rounded anteriorly, with effaced lateral furrows or these represented by nonpustulose patches; eye ridges usually effaced; palpebral lobes short to long; genal spines generally well developed. Thorax of about 11 segments (in type genus) with blunt or spined extremities. Pygidium with about 3 to 6 axial rings. Surface usually coarsely tuberculate. *U.Cam.-L.Ord.*

Hystricurus RAYMOND, 1913 [**Bathyrurus conicus* BILLINGS, 1859]. Cephalon with tapering to subovate glabella; preglabellar field varying in length; fixigenae with narrow to moderately wide anterior and palpebral areas, slender lateral extremities of posterior areas divided into subequal portions by deeply impressed posterior border furrows, medium to long palpebral lobes behind or (rarely) opposite glabellar center and terminating fairly close to posterior border furrows; strongly diverging course of posterior sections of facial sutures from eyes to posterior border furrow; moderately wide librigenae. Thoracic segments with spined or bluntly rounded pleural tips. Pygidium with long axis, narrow border, and evenly curved posterolateral margin. Ventral sutures delimit a small trapezoidal rostral plate (63, 258). *L.Ord.*, N.Am.-Greenl.-E.Asia. — FIG. 204,4a,b. **H. conicus* (BILLINGS), N.Y.; 4a, cran., $\times 2$; 4b, pyg., $\times 2$ (494). — FIG. 204,4c. *H. genalatus* Ross, Utah; librigena, $\times 4$ (258).

Amblycranium Ross, 1951 [**A. variable*]. Differs from *Hystricurus* in having much wider posterior areas of fixigenae, and palpebral lobes situated anterior to glabellar center (258). *L.Ord.*, N.Am.

?**Apachia** FREDERICKSON, 1949 [**A. trigonis*]. *U.Cam.*, N.Am.

Hillyardina Ross, 1951 [**H. semicylindrica*]. Differs from *Hystricurus* in having flat-topped, acutely edged anterior and lateral cephalic border; preglabellar field divided by median furrow; very acute lateral extremities of posterior areas of fixigenae, short palpebral lobes situated opposite to glabellar center; boss in posterolateral corners of librigenae, and genal spines divided longitudi-

nally by continuation of lateral border furrows (258). *L.Ord.*, N.Am.—FIG. 204,8. **H. semicylindrica*, Utah; ceph., $\times 4$ (258).

Pachycranium Ross, 1951 [**P. faciclunis*]. Differs from *Hillyardina* in having convex, narrower cephalic border; more strongly impressed preglabellar median furrow; palpebral lobes situated anterior to glabellar center; librigenae with unfurrowed genal spines and without boss in posterolateral corners, and smooth surface (258). *L.Ord.*, N.Am.

Parahystricurus Ross, 1951 [**P. fraudator*]. Differs from *Hystricurus* in having more strongly curved palpebral lobes; more acute extremities of posterior areas of fixigenae; moderately diverging course of posterior sections of facial sutures from eyes to posterior borders (258). *L.Ord.*, N.Am.

Psalikilopsis Ross, 1953 [**P. cuspidicauda*]. Differs from *Psalikilus* in having more ovate glabella without lateral furrows; extremely slender palpebral lobes situated opposite to glabellar center; and much shorter occipital ring. *L.Ord.*, N.Am.—FIG. 204,1. **P. cuspidicauda*, Utah; 1a,b, cran., dorsal, anterior, $\times 3$ (463).

Psalikilus Ross, 1951 [**P. typicum*]. Differs from *Hystricurus* in having 2 pairs of distinct, very short nonpustulose depressions on steep sides of glabella adjacent to axial furrows; sharply deflected anterior areas of fixigenae; librigenae with ridge extending obliquely backward to genal angles so as to prevent confluence of lateral and posterior border furrows; very long genal spines furrowed to tip by backward extension of posterior border furrow; subtriangular pygidium with shorter axis and wide fairly flat, more or less downward-directed border (63, 258). *L.Ord.*, N.Am.—FIG. 204,9. **P. typicum*, Utah; 9a, cran., $\times 4$; 9b, librigena, $\times 4$; 9c, pyg., $\times 8$ (258).

Rollia CULLISON, 1944 [**R. goodwini*]. Differs from *Hystricurus* in having relatively shorter, less prominent, furrow-bearing glabella, wider and flatter frontal area, and larger pustulose palpebral lobes (392). *L.Ord.*, N.Am.

Family AGRAULIDAE Raymond, 1913

Cephalic axis tapering forward; preglabellar field present; palpebral lobes small, opposite anterior half of glabella, librigenae with genal spine. Thorax with as many as 16 segments, proximal ends of pleurae bent upward toward axial rings. Pygidium small. *M.Cam.*

Agraulos HAWLE & CORDA, 1847 [**Arion ceticephalus* BARRANDE, 1846; SD MILLER, 1889] [*pro Arion* BARRANDE, 1846] [= *Arionides* BARRANDE, 1847 (*pro Arion* BARRANDE, 1846); *Arionellus* BARRANDE, 1850 (*pro Arionides* BARRANDE, 1847); *Proampyx* FRECH, 1897 (subj.); *Agrauloides* HOWELL, 1937 (subj.)]. Relatively long (*tr.*) frontal

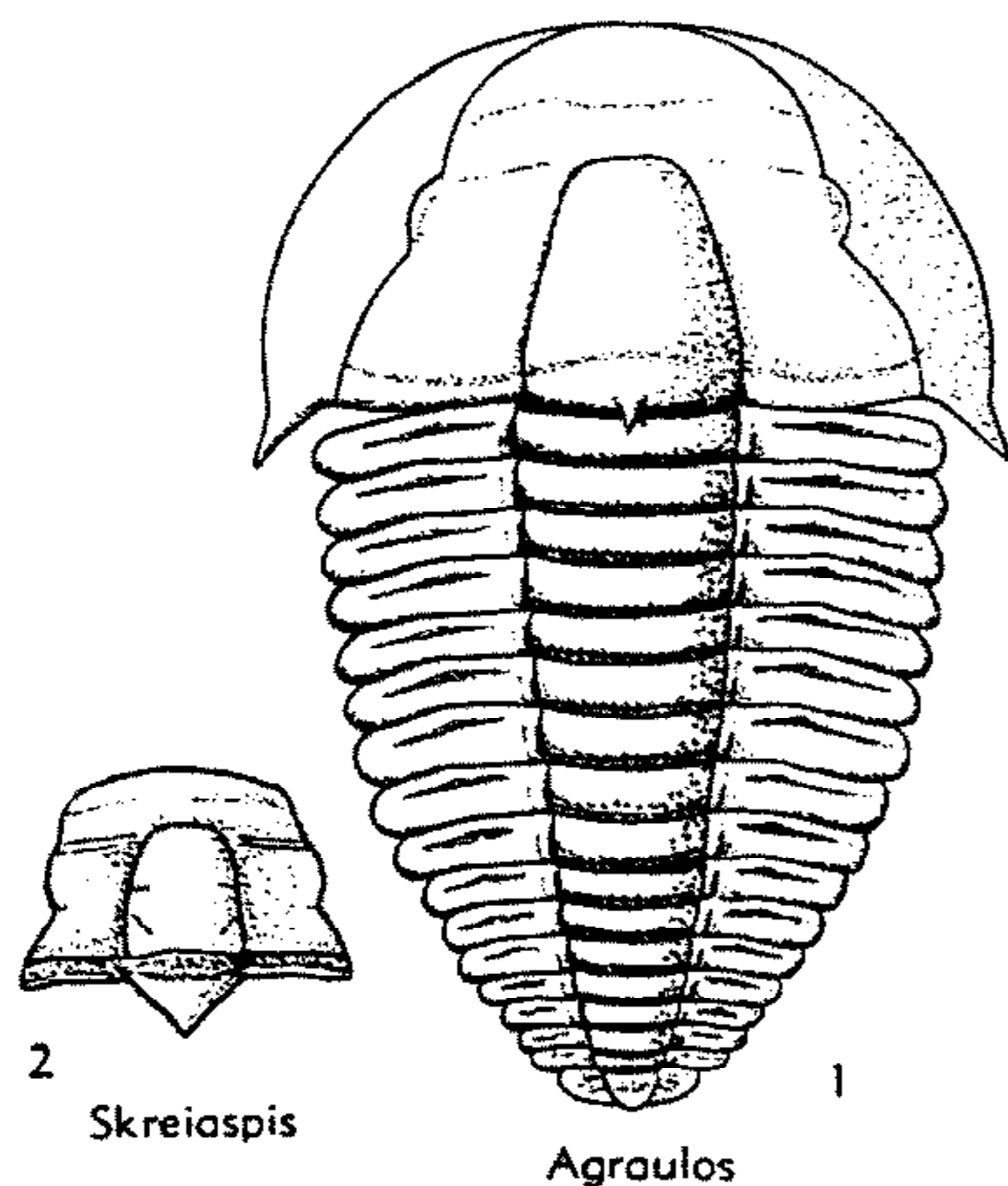

FIG. 205. Agraulidae (p. O278-O279).

area; eye ridges, lateral glabellar furrows, and border furrows practically effaced. *M.Cam.*, Eu., N.Am.—FIG. 205,1. **A. ceticephalus*, Czech.; restored exoskel., $\times 2$ (406n).

Skreiaspis RŮŽIČKA, 1944 [**Agraulos spinosus* JAHN, 1895] [=*Herse* HAWLE & CORDA, 1847, *partim* (non OKEN, 1815; nec LESSON, 1837; nec GISTL, 1848)]. Like *Agraulos* but with shorter frontal area and distinct axial furrow. *M.Cam.*, Czech.—FIG. 205,2. **S. spinosus* (JAHN); cran., $\times 4$ (464).

Family LONCHOCEPHALIDAE Hupé, 1953

Small, compact trilobites with presumably 7 to 10 thoracic segments and pygidium of medium size. Glabella well defined, rather large, tapering, rounded or truncate in front, commonly deeply furrowed; furrows of posterior pair invariably curving inward and backward, in many forms almost isolating basal lobes; fixigenae usually convex, with palpebral areas of moderate width, eye ridges generally present, palpebral lobes narrow, short or of medium length, usually near level of glabellar mid-point, border furrow usually not confluent with axial furrows, border elevated; librigenae usually carrying genal spines. Rostral plate presumably present in all genera. Thoracic pleurae rounded distally. Pygidium wide and short,

subtriangular, with several segments; axis long, border commonly turned down vertically. *U.Cam.* (201).

Lonchocephalus OWEN, 1852 [**L. chippewaensis*; SD MILLER, 1889]. Glabella tapering, rounded; palpebral area convex, less than half as wide as glabella; eye ridges prominent; occipital ring with spine; librigenae with genal spines. Thorax of 7 segments (*L. chippewaensis*). Pygidium subtriangular, with flat, furrowed pleural fields and downturned border. *U.Cam.*(Dresbach.), N.Am.—FIG. 206,1. **L. chippewaensis*, Wis.; 1a,b, cran., pyg., $\times 4$ (448n).

Amiaspis LOCHMAN, in LOCHMAN & DUNCAN, 1944 [**A. erratica*]. Cephalon strongly convex; glabella ovate, rising above fixigenae; long occipital spine; anterior area downsloping; border indistinct; palpebral lobes small, anterior in position. *U.Cam.* (Dresbach.), N.Am.—FIG. 206,4. **A. erratica*, Mont.; 4a,b, cran., dorsal and lateral, $\times 15$ (132).

Calymenidius RASETTI, 1944 [**C. tuberculatus*]. Cranidium proportionately wide and short; glabella truncate; axial and glabellar furrows exceptionally deep; preglabellar field short (*sag.*), border elevated, arched transversely; posterior area very wide (*tr.*). *U.Cam.*(Trempeal.), N.Am.—FIG. 206,2. **C. tuberculatus*, Que.; cran., $\times 5$ (448n).

Glyptometopus RASETTI, 1944 [**Solenopleura laflammei* CLARK, 1924]. Glabella as in *Calymenidius*; no occipital spine; border not greatly elevated; posterior area much narrower (*tr.*). *U.Cam.* (Trempeal.), N.Am.—FIG. 206,5. **G. laflammei* (CLARK), Que.; cran., $\times 5$ (448n).

Quebecaspis RASETTI, 1944 [**Q. breviceps*]. Glabella subtrapezoidal, of moderate convexity; occipital spine present; border and axial furrows almost confluent in front of glabella; eye ridges faint; palpebral lobes relatively long; posterior area short (*exsag.*). *U.Cam.*(?Francon.), N.Am.—FIG. 206,9. **Q. breviceps*, Que.; cran., $\times 4$ (448n).

Glaphyraspis RESSER, 1937 [**Liostracus parvus* WALCOTT, 1899] [=*Raaschella* LOCHMAN, 1938]. Glabella truncate; fixigenae downsloping; palpebral lobes anterior to glabellar mid-point; posterior areas of fixigenae long (*exsag.*); no occipital or genal spines. Pygidium with sharply downturned border. Size very small. *U.Cam.*(Dresbach.), N.Am.—FIG. 206,6. *G. ornata* (LOCHMAN), Tex.; 6a,b, cran., pyg.; 6c, librigena, $\times 10$ (162).

Talbotina LOCHMAN, 1938 [**T. degreasensis*]. Glabella rounded in front; fixigenae downsloping, palpebral lobes at level of glabellar mid-point. May be synonymous with *Weeksina*. *U.Cam.*(Dresbach.), N.Am.—FIG. 206,7. **T. degreasensis*, Newf.; 7a, cran., $\times 6$; 7b, pyg., $\times 8$ (125).—FIG. 228,4. *T. jewelli* LOCHMAN, in LOCHMAN & DUNCAN, Pilgrim F., Mont.; 4a,b, cran.; $\times 2$; 4c, librigena, $\times 4$, 4d,e, pyg., $\times 3$ (425).

Terranovella LOCHMAN, 1938 [**T. obscura*]. Glabella tapered, subtruncate in front; occipital spine present; axial furrows deep; anterior areas of fixigenae convex, lacking border, palpebral lobes small, near level of glabellar mid-point. Pygidium subtriangular; axis long, prominent; pleural fields furrowed; border downturned. *U. Cam. (Dresbach.)*, N. Am.—FIG. 206.8a. **T. obscura*, Newf.; cran.,

×8 (448n).—FIG. 206.8b. *T. dorsalis* (HALL), Va.; pyg., ×10 (448n).

Weeksina RESSER, 1935 [**Asaphiscus? unispinus* WALCOTT, 1916]. Anterior angles of cranidium rounded; anterior sections of facial sutures reaching margin only near mid-line; fixigenae with relatively long palpebral lobes, posterior areas short (*exsag.*), genal spines present. Thorax of 10

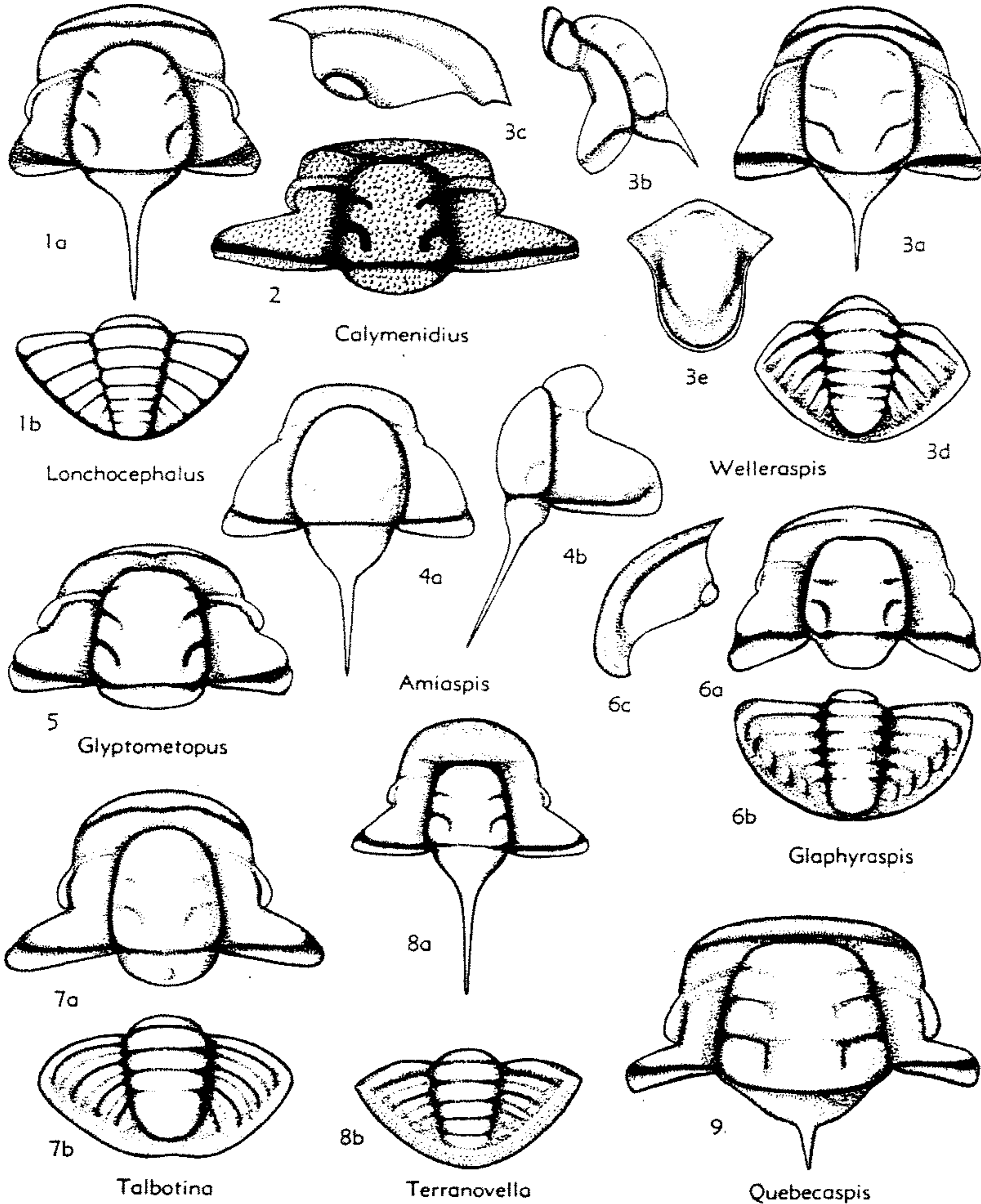

FIG. 206. Lonchocephalidae (p. 0279-0281).

segments. 8th with axial spine. *U.Cam.(Dresbach.)*, N.Am.—FIG. 207. **W. unispina* (WALCOTT), Utah; exoskel. flattened in shale, $\times 4.5$ (448n).

Welleraspis KOBAYASHI, 1935 [**Solenopleura jerseyensis* WELLER, 1900] [= *Avonaspis* LOCHMAN, 1940]. Like *Lonchocephalus*, with which it intergrades; glabella subrectangular, proportionately larger; preglabellar field shorter (*sag.*); pleural fields of pygidium downsloping. *U.Cam.(Dresbach.)*, N.Am.—FIG. 206.3. **W. jerseyensis* (WELLER), Pa.; 3a,b, cran., dorsal and lateral. $\times 5$; 3c,d, librigena, pyg., $\times 5$; 3e, hypostoma, $\times 8$ (448n).

Bucksella HOWELL, 1957 [**B. brevis*]. Similar to *Welleraspis*, but differs in having the glabella in the more typical species less quadrate in outline and more evenly curved in front, in not having the front of the glabella as close to the border, and in having the fixigenae more widely confluent in front of the glabella and the border more definitely turned up, so that it rises above the confluent portion of the fixigenae. *U.Cam.*, N.Am. (Pa.) (HE).

Family DOKIMOCEPHALIDAE
Kobayashi, 1935

[= *Burnetiidae* RESSER, 1942; *Heterocaryoninae* HUPÉ, 1953]

Exoskeleton opisthoparian, subisopygous. Glabella broadly tapering, convex to tumid, front rounded, with 2 or 3 pairs of usually deep lateral furrows; preglabellar field wide to very narrow (*sag.*) or absent, all furrows well defined, anterior border commonly modified in shape; eye ridges and occipital node or spine common, eyes medium in size, behind center of glabella; fixigenae horizontal to elevated; librigenae large, with medium to long genal spines, commonly directed laterally. Thorax unknown. Pygidium transverse to ovate; axis and pleural regions variable in width, pleural furrows and interpleural grooves may cross flat or concave border, border furrow faint or obsolete. Surface granulose, coarse pustules common. Derived from *Ptychopariidae*. *U.Cam.*

Dokimocephalus WALCOTT, 1924 [**Ptychoparia? pernasutus* WALCOTT, 1884]. Preglabellar field variable in width (*sag.*), anterior border commonly extended into concave tongue, spine, or spatulate process; occipital spine may be present; eyes opposite posterior third of glabella; fixigenae upsloping, with palpebral areas about 0.5 of glabellar width; librigenae with short laterally directed genal spines. Pygidium with wide axis extending 0.6 of length to broad end, 3 axial rings; 3 pleurae curving back on to concave border, no

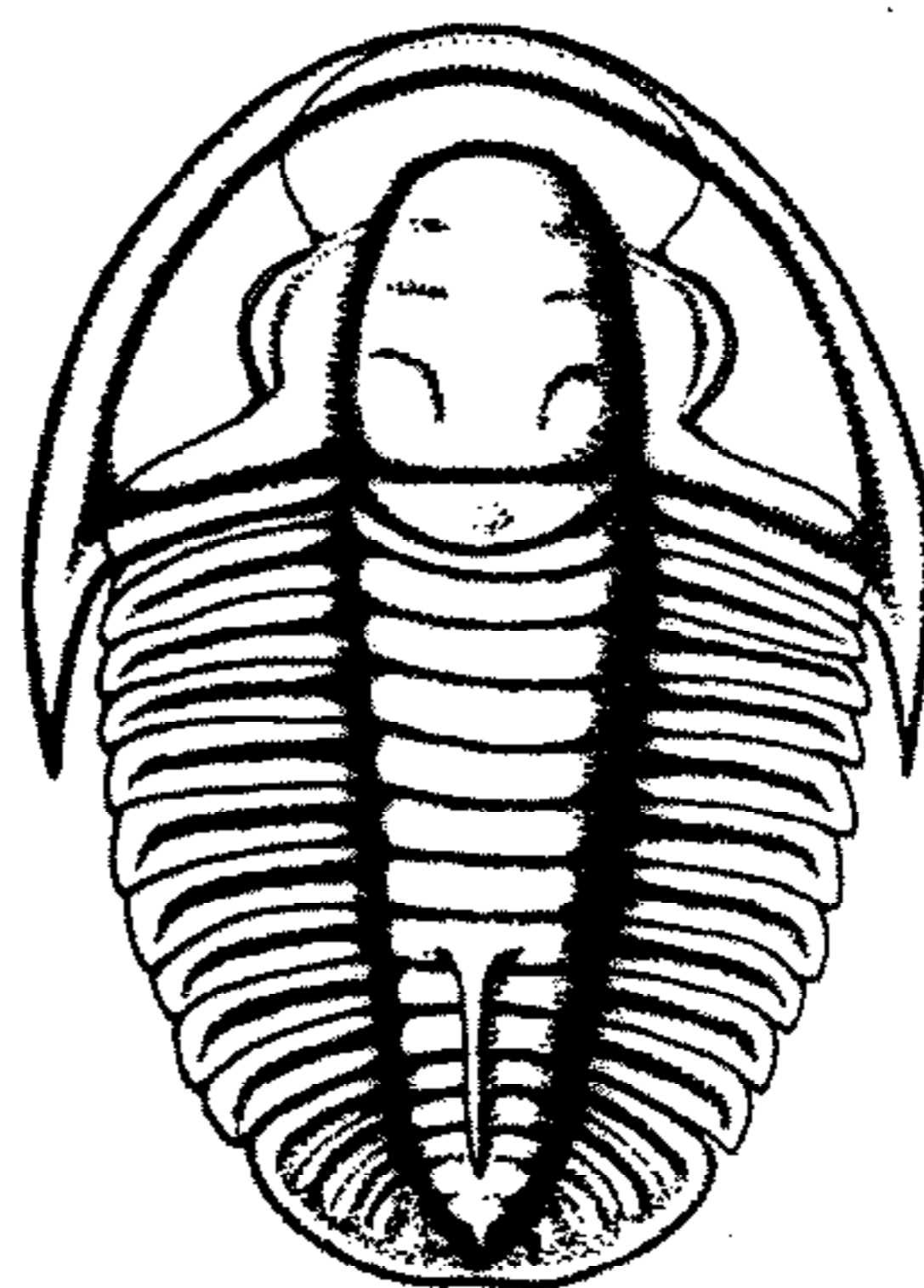

FIG. 207. **Weeksina unispina* (WALCOTT) (*Lonchocephalidae*), *U.Cam.(Dresbach.)*, Utah; exoskel., $\times 4.5$ (448n).

border furrow (47, 362). *U.Cam.(Francon.)*, N. Am.—?N.E.Asia.—FIG. 208.1. **D. pernasutus* (WALCOTT), Nev.; 1a,b, cran., $\times 0.75$; 1c, librigena, $\times 0.75$; 1d, pyg., $\times 1.5$ (47, 362).

Sulcocephalus J. L. WILSON, 1948 [**Talbotina candida* RESSER, 1942]. Glabella short, broadly tapering, posterior 2 pairs of lateral furrows deep, diagonal; preglabellar field of medium width to narrow, anterior border furrow well defined, may bend posteriorly at mid-length (*sag.*); eyes slightly behind mid-length of glabella; fixigenae horizontal, with palpebral areas slightly less to slightly more than 0.5 of glabellar width. Librigenae, thorax, and pygidium unknown (363). *U.Cam.(Francon.)*, N.Am.—FIG. 208.8a,b. **S. candidus* (RESSER), Tex.; 8a,b, cran., $\times 2$ (363).—FIG. 208.8c,d. *S. typicus* (RESSER), Wis.; 8c,d, cran., $\times 2$ (239).

Burnetiella LOCHMAN, 1958 [*nom. subst. pro Burnetia* WALCOTT, 1924 (*non* BROOM, 1923)] [**Ptychoparia? urania* WALCOTT, 1890]. Two pairs of glabellar furrows; preglabellar field narrow or absent, anterior border wide; eyes opposite posterior third of glabella; fixigenae slightly upsloping, with palpebral areas about 0.5 of glabellar width; librigenae quadrate, with slender genal spines. Pygidium narrowly transverse; axis 0.7 of length, with rounded end and postaxial ridge extending to margin, 4 axial rings; pleural fields wider than axis, 4 broad pleurae curving sharply backward on to flat border (48, 363). *U.Cam.(Francon.)*, N.Am.—FIG. 208.2. **B. urania* (WALCOTT), Tex.; 2a,b, cran., $\times 1$; 2c, librigena, $\times 1$; 2d, pyg., $\times 2$ (363).

Deckera FREDERICKSON, 1949 [**D. aldenensis*]. Glabella short broad, with 2 pairs of lateral fur-

rows; eyes below medium size, opposite posterior third of glabella; fixigenae upsloping, with palpebral areas almost equal in width to glabella; librigenae quadrate, with medium-length genal spines. Pygidium narrowly transverse; axis parallel-sided, extending full length of pygidium, with 6 axial rings; pleural fields wider than axis, with 4 broad pleurae bearing furrows that curve backward on to border; border widest at sides, very narrow on mid-length (*sag.*), posterior margin sinuous (363). *U.Cam.(Francon.)*, N.Am.-N.Zem.—FIG. 208,4.

D. completa WILSON, Pa.; 4*a,b*, cran., X2, X1.5; 4*c*, librigena, X2; 4*d,e*, pyg., X4 (363).

Heterocaryon RAYMOND, 1937 [**H. platystigma*]. (213). *U.Cam.(Trempeal.)*, E.N.Am.

Iddingsia WALCOTT, 1924 [**Ptychoparia? similis* WALCOTT, 1884] [= *Plataspella* WILSON, 1949]. Glabella with 2 or 3 pairs of strong lateral furrows, posterior pair complete or faint; anterior border furrow deep to broad and shallow; occipital node or spine may be present; eye ridges diagonal, eyes opposite posterior third of glabella;

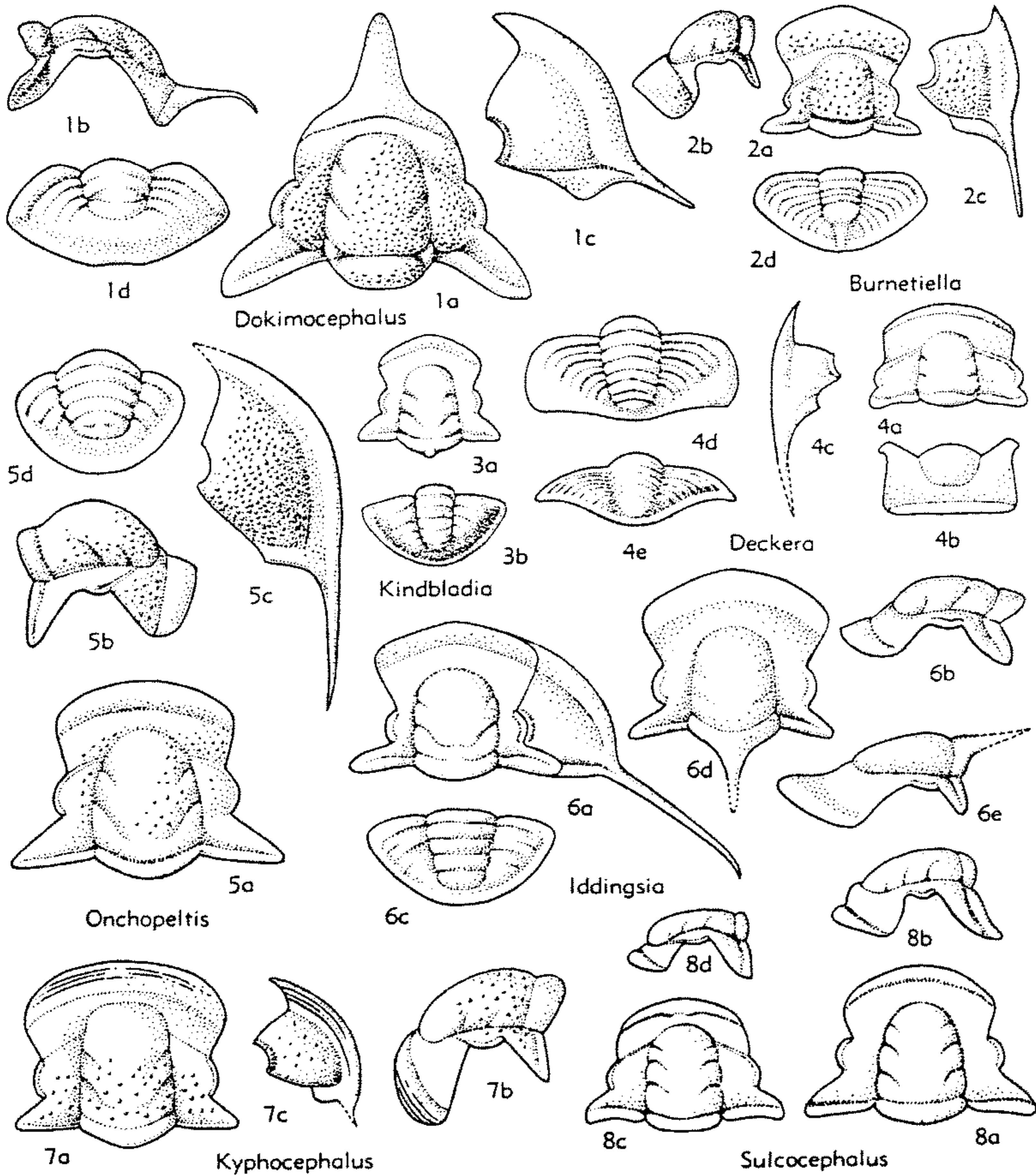

FIG. 208. Dokimocephalidae (p. O281-O283).

fixigenae horizontal, with palpebral areas 0.3 to 0.5 of glabellar width, posterior areas narrow (*sag.*), straplike; librigenae quadrate, with long laterally directed genal spines. Pygidium subovate; axis slightly tapered to rounded end, extending nearly full length of pygidium, 3 axial rings; pleural fields wider than axis, 2 broad pleurae; border slightly concave (362). *U.Cam.(Francon.)*, N.Am.—FIG. 208,6a-c. **I. similis* (WALCOTT), Nev.; 6a,b, cran. (with librigena), 6c, pyg., $\times 1$ (8, 362).—FIG. 208,6d,e. *I. anatina* (RESSER), Okla.; 6d,e, cran., $\times 2$, $\times 1$ (362).

Kindbladia FREDERICKSON, 1948 [**Berkeia wichitaensis* RESSER, 1942]. Glabella tapered, with 3 pairs of lateral furrows, posterior 2 pairs deep; axial and anterior border furrows deep; occipital spine or node present; eyes slightly behind mid-length of glabella; fixigenae upsloping, with palpebral areas about 0.3 of glabellar width; librigenae unknown. Pygidium subovate; axis tapered nearly full length, with 5 or 6 axial rings; pleural fields wider than axis, 5 broad pleurae with faint furrows continuing on to concave border (47, 363). *U.Cam.(Francon.)*, N.Am.—FIG. 208,3. **K. wichitaensis* (RESSER), Okla.; 3a,b, cran., pyg., $\times 2$ (363).

Kyphocephalus B. M. MILLER, 1936 [**K. bridgerensis*]. Glabella elongate, broadly tapering; anterior border heavy; eye ridges present, eyes near posterior third of glabella; fixigenae horizontal, with palpebral areas more than 0.5 of glabellar width; librigenae quadrate, with very short genal spines. Pygidium unknown (363). *U.Cam.(Francon.)*, N. Am.—FIG. 208,7. *K. ponderosus* WILSON, Pa.; 7a,b, cran., $\times 3$; 7c, librigena, $\times 1.3$ (363).

Onchopeltis RASETTI, 1944 [**O. spectabilis*]. Glabella with 2 pairs of lateral furrows, posterior pair deep and arcuate; eye ridges faint, eyes only slightly behind mid-length of glabella; fixigenae horizontal, with palpebral areas about 0.3 of glabellar width; librigenae with medium-length genal spines. Pygidium ovate; axis wide, slightly tapered to rounded end, with 3 axial rings; pleural fields narrower than axis, 2 broad pleurae with furrows sloping backward onto concave border (188). *U.Cam.(Francon.)*, E.N.Am.—FIG. 208,5. **O. spectabilis*, Que.; 5a,b, cran., $\times 1.5$; 5c, librigena, $\times 1$; 5d, pyg., $\times 1.5$ (188).

Tatulaspis IVSHIN, 1956 [**T. princeps*]. Convex, broadly tapering glabella, 2 pairs of arcuate lateral furrows; preglabellar field narrow; faint diagonal eye ridges, eyes posterior to center of glabella; fixigenae slightly upsloping with palpebral areas almost 0.7 of width of glabella, posterior areas long (*tr.*), narrow (*exsag.*). Librigenae and pygidium unknown. Outer surface granulose (82). *U.Cam.*, SW.Sib.

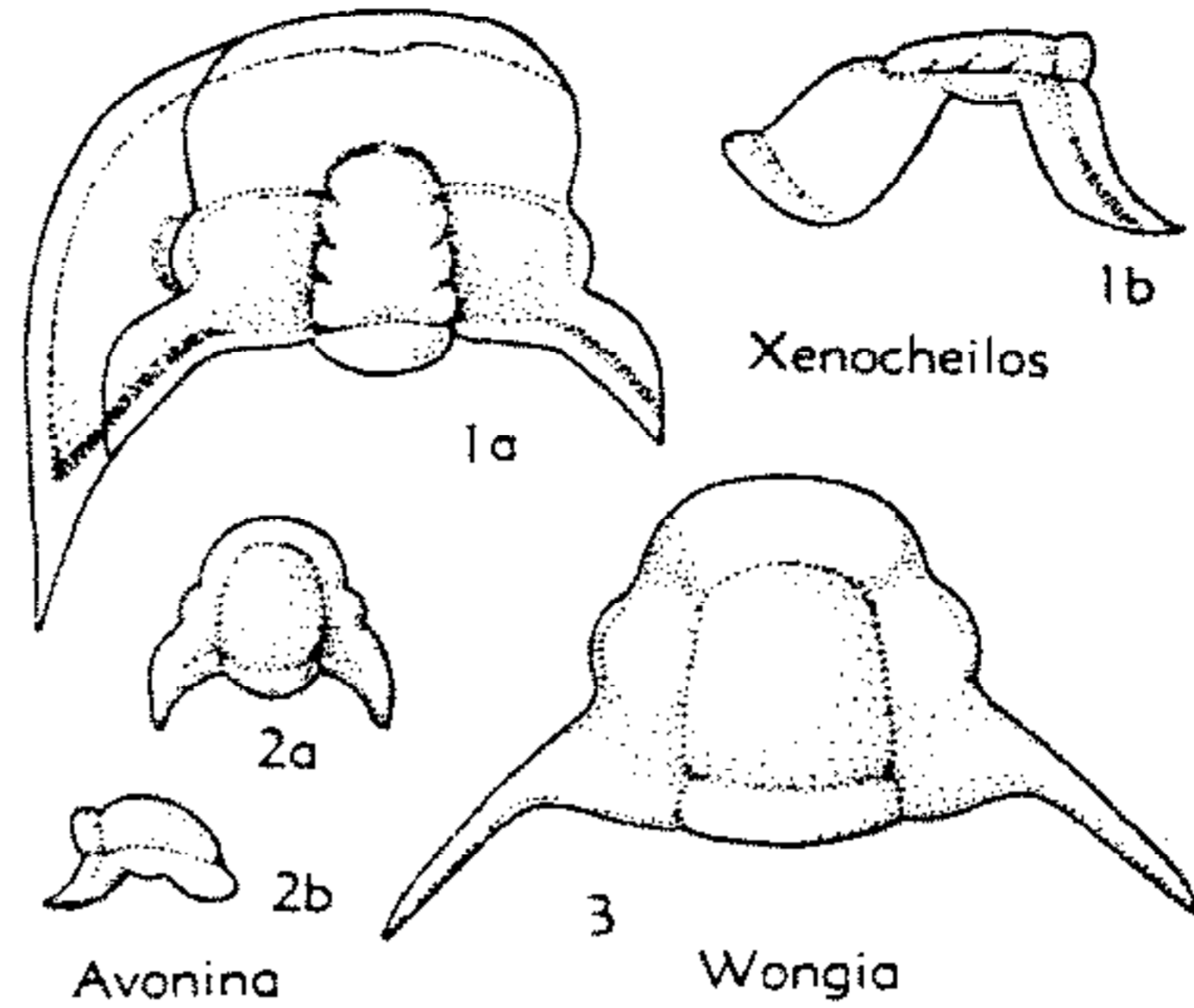

FIG. 209. Avoninidae (p. 0283).

Family AVONINIDAE Lochman, 1936

Exoskeleton opisthoparian. Glabella tapering to parallel-sided, lateral furrows present; preglabellar field and anterior border furrow present or absent; eyes just below medium size, opposite or slightly in front of center of glabella, eye ridges present or absent; fixigenae of variable width, with posterior areas showing variable development of metafixigenal spines, librigenae narrow, elongate, with short genal spines. Thorax and pygidium unknown. Surface finely granulose or smooth. Polyphyletic derivation. *Up.M.Cam.-U.Cam.*

Avonina LOCHMAN, 1936 [**A. bizarria*]. Glabella, strongly convex, gently tapering, front rounded, without lateral furrows, preglabellar field, or anterior border furrow; with narrow convex anterior border; eyes opposite center of glabella, fixigenae downsloping, with palpebral areas 0.3 of glabellar width, posterior areas long (*tr.*), ending in short flat metafixigenal spines; librigenae and pygidium unknown (123). *U.Cam.(Dresbach.)*, Mo.—FIG. 209,2. **A. bizarria*, Mo.; 2a,b, cran., $\times 6$ (123).

Wongia SUN, 1924 [**W. triangulata*]. Glabella convex, truncate-tapering, without lateral furrows or preglabellar field, faint anterior border furrow running diagonally in to front corners of glabella, medium wide anterior border; eyes in front of glabella mid-length; fixigenae slightly upsloping, with palpebral areas more than 0.5 of glabellar width, posterior areas short (*tr.*), with stout diverging metafixigenal spines; librigenae and pygidium unknown (288). *Up.M.Cam.*, E. Asia.—FIG. 209,3. **W. triangulata*, China (Lincheng); cran., $\times 7$ (288).

Xenocheilos J. L. WILSON, 1949 [**X. minutum*]. Glabella low, tapering, with 3 pairs of short

lateral furrows; preglabellar field, anterior border furrow, and eye ridges present, anterior border narrow, eyes opposite center of glabella; fixigenae horizontal to upsloping, with palpebral areas wider than glabella, posterior areas long (*tr.*), ending in flat metafixigenal spines of variable length and prominence; librigenae elongate, with short genal spines. Pygidium unknown (235, 363). *U.Cam.(Francon.)*, N.Am.—FIG. 209.1. *X. spineum* WILSON, Pa.; 1a,b, cran. (with librigenae). X6 (363).

Family CATILLICEPHALIDAE
Raymond, 1938

[=Cephalocoelidae RAYMOND, 1937; invalid as based on junior homonym]

Small ptychopariids with convex, compact exoskeleton and few thoracic segments. Glabella large, prominent, ovate, subrectangular, or pyriform, reaching anterior margin of cephalon or at least anterior border; posterior lateral furrows invariably curving inward and backward; fixigenae relatively narrow, with palpebral lobes small to medium-sized, usually at level of glabellar mid-point, in some genera located more anteriorly. Doublures of librigenae either separated by a rostral plate (*Catillicephala*) or

joined along a median suture (*Theodenisia*). Genal spines present or absent; in latter case, posterior sections of facial sutures may reach margins at genal angles (*Catillicephala*, *Madarocephalus*). Thorax with prominent axis; pleurae with distinct geniculation, bluntly terminated. Pygidium variable in shape, small to medium-sized, usually with few segments and large axis, exceptionally with bulbous development of pleural regions (*Pemphigaspis*). *U.Cam.* (161, 188, 193, 201, 274, 363).

Catillicephala RAYMOND, 1938 [*pro Cephalocoelia* RAYMOND, 1937 (*non* ÉTALLON, 1859)] [**Cephalocoelia ovoides* RAYMOND, 1937]. Cephalon highly convex; glabella pyriform or shortly ovate, overhanging anterior cephalic margin; glabellar furrows usually obsolete, occipital furrow deep, occipital ring rounded; fixigenae downsloping, eyes small, prominent, at level of glabellar mid-point, posterior sections of facial sutures reaching margins at genal angles, no genal spines. Rostral plate present, hourglass-shaped. Pygidium triangular, with prominent axis, down-rolled margin. *U.Cam.*, (*Dresbach.*), N.Am.—FIG. 210.7. *C. impressa* RASSETTI, Que.: 7a-c, ceph., dorsal, lateral, anterior. X4; 7d,e, pyg., dorsal, lateral. X4 (448n).

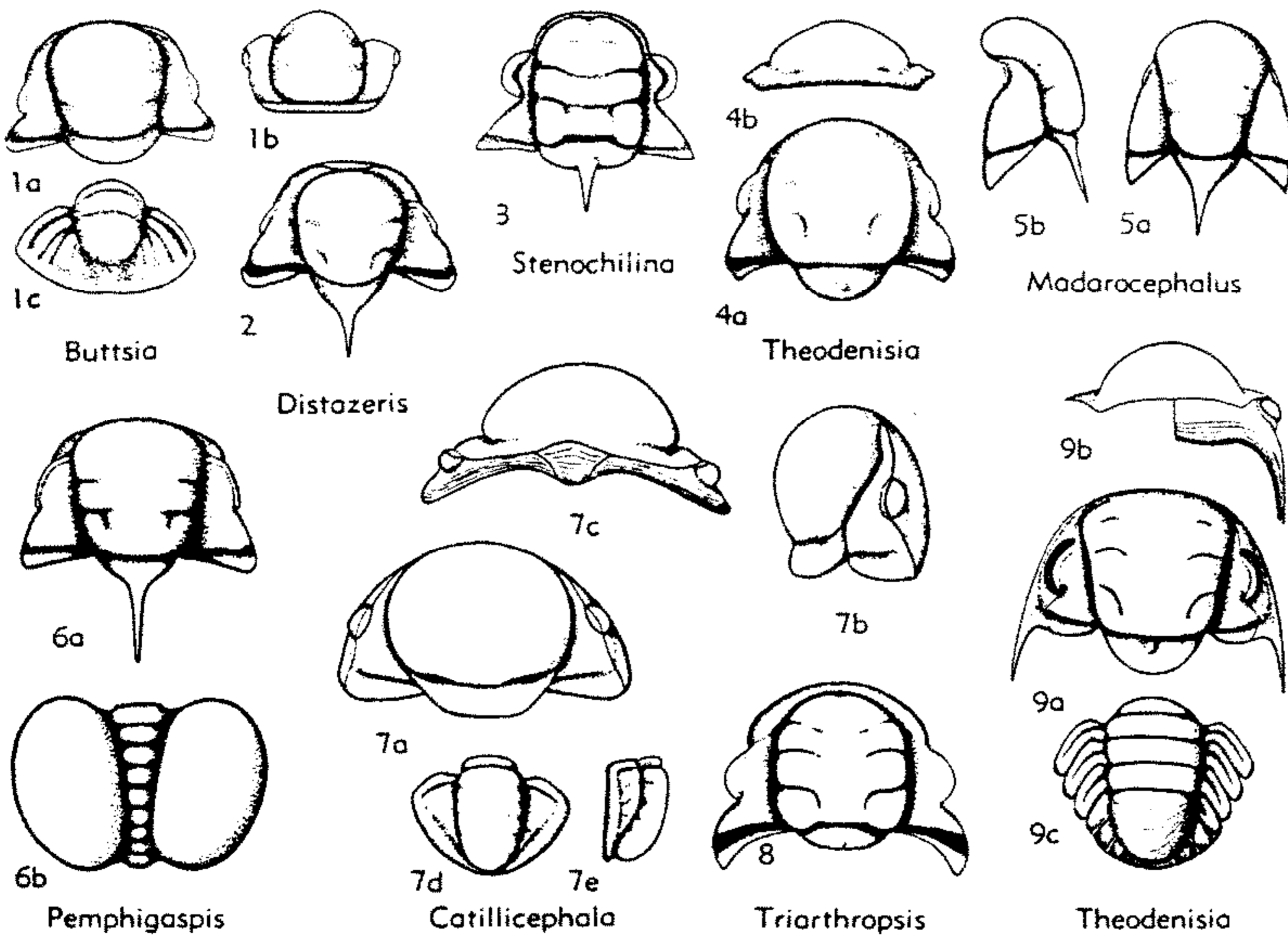

FIG. 210. Catillicephalidae (p. O284-O285).

Buttsia J. L. WILSON, 1951 [**B. drabensis*]. Differs from *Catillicephala* in having bandlike border in front of glabella, opisthoparian sutures; pygidium with shorter axis, downsloping pleural lobes, no down-rolled margin. *U.Cam.(Francon.)*, N.Am. —FIG. 210,1. **B. drabensis*, Pa.; *1a,b*, cran., dorsal, lateral, $\times 2$; *1c*, pyg., $\times 3$ (363).

Distazeris RAYMOND, 1937 [**D. acuta*]. Glabella pyriform, occipital ring spinose; narrow frontal area poorly differentiated into preglabellar field and border or not divided. Closely related to *Welleraspis*, indicating ptychoparian origin of family. *U.Cam.(Dresbach.)*, N.Am. —FIG. 210,2. **D. acuta*, Vt.; cran., $\times 6$ (448n).

Madarocephalus RESSER, 1938 [**M. laetus*]. Glabella straight-sided, expanded forward, overhanging front margin; occipital ring spinose; position of eyes anterior, close to axial furrows; posterior sections of facial sutures reaching margins at genal angles; no genal spines. *U.Cam.(Dresbach.)*, N.Am. —FIG. 210,5. *M. minor* RASSETTI, Que.; *5a,b*, cran., dorsal, lateral, $\times 8$ (448n).

Pemphigaspis HALL, 1863 [**P. bullata* (= *Amphion?* *matutina* HALL, 1863)] [= *Hallaspis* RAASCH & LOCHMAN, 1943]. Glabella expanded forward, occipital ring spinose; frontal area almost or totally obsolete. Pygidium with narrow, multi-segmented axis reaching posterior margin, and swollen, ovate, unfurrowed pleural fields extended into doublure with almost uniform convexity. *U.Cam.(Dresbach.)*, N.Am. —FIG. 210,6. **P. bullata*, Minn.; *6a,b*, cran., pyg., $\times 4$ (161).

Stenochilina ULRICH in BRIDGE, 1930 [**S. spinifera*]. Glabella parallel-sided, rounded in front; occipital ring spinose; frontal area reduced to narrow band; fixigenae with relatively large palpebral lobes well defined by palpebral furrows, close to glabella, anterior to glabellar mid-point. posterior sections of facial sutures straight. *U.Cam.(Trempeal.)*, N.Am. —FIG. 210,3. **S. spinifera*, Mo.; cran., $\times 3$ (448n).

Theodenisia CLARK, 1948 [*pro Denisia* CLARK, 1924 (non HÜBNER, 1825)] [**Denisia eminens* CLARK, 1924] [= *Acheilus* RAYMOND, July 1924 (non CLARK, June 1924)]. Glabella pyriform or parallel-sided, reaching anterior cephalic margin; eyes small to medium-sized, rather close to glabella; anterior sections of facial sutures close to axial furrows; posterior areas downsloping, rounded distally; librigenae with genal spines; doublures joining along median suture. Thorax with prominent axis; pleurae strongly geniculated, bluntly terminated. Pygidium small, steeply inclined; axis large, with few segments; pleural fields downsloping. Surface granulate. Size very small. *U.Cam.(Trempeal.)*, N.Am. —FIG. 210,4. **T. eminens*, Que.; *4a,b*, cran., dorsal, anterior, $\times 6$ (448n). —FIG. 210,9. *T. lata* (RASSETTI), Que. *9a*,

ceph.; *9b*, cran. and left librigena, anterior view; *9c*, pyg. and last 3 thoracic segments; all $\times 6$ (448n).

Triarthropsis ULRICH in BRIDGE, 1930 [**T. nitida*]. Differs from *Theodenisia* in presence of narrow, bandlike frontal area. *U.Cam.(Trempeal.)*, N.Am. —FIG. 210,8. **T. nitida*; cran., $\times 3$ (448n).

Family KINGSTONIIDAE Kobayashi, 1933

[*nom. transl. et correct.* LOCHMAN-BALK, herein (ex KINGSTONIIDAE KOBAYASHI, 1933)]

Exoskeleton opisthoparian, subisopygous. Glabella broadly tapering to subquadrate, front rounded, anterior border usually ill defined, all furrows faint or obsolete on exterior, faint on interior, axial, occipital and posterior border furrows most persistent; occipital spine and eye ridges may be present, eyes small, near anterior third of glabella; fixigenae downsloping, with palpebral areas variable, posterior areas triangular; librigenae unfurrowed, with bluntly pointed or rounded genal angles. Thorax unknown. Pygidium subtriangular; axis 0.3 or less of width of pygidium, length variable, exterior furrows obsolete, faint on interior. Surface smooth, with transverse ridges on border. Polyphyletic derivation. *Up.M.Cam.-U.Cam.*

Kingstonia WALCOTT, 1924 [**K. apion*] [= *Ucebia* WALCOTT, 1925]. Glabella low, broadly subquadrate, without lateral furrows, axial furrows obsolete or at posterior only on exterior; occipital and posterior border furrows obsolete on exterior, all present on interior; preglabellar field narrow, continuing slope of glabella, anterior border furrow narrow, anterior border vertical, rim-like; fixigenae with palpebral areas about 0.3 of glabellar width. Pygidium with low axis tapered nearly full length, may continue in spine, axial furrows at sides only, border downcurved to vertical, exterior unfurrowed but interior may show 5 to 7 axial rings; 3 or 4 pleurae; no border furrow (126). *U.Cam.(Dresbach.)*, N.Am.-NE.Asia. —FIG. 211,1. **K. apion*, Tenn.; *1a,b*, cran. with librigena, $\times 4$; *1c,d*, pyg., $\times 3$, $\times 4$ (126, 321).

Ankoura RESSER, 1938 [**A. triangularis*]. Glabella low, broad, tapering or quadrate, without lateral furrows; narrow preglabellar field downsloping, anterior border furrow obsolete, anterior border downsloping or horizontal, all other furrows obsolete on exterior but present on interior; fixigenae with palpebral areas about 0.5 of glabellar width. Pygidium with low axis tapered nearly full length, end commonly upturned, axial furrows at sides only, 6 or 7 axial rings on interior; pleural fields flat, without furrows on exterior; border vertical

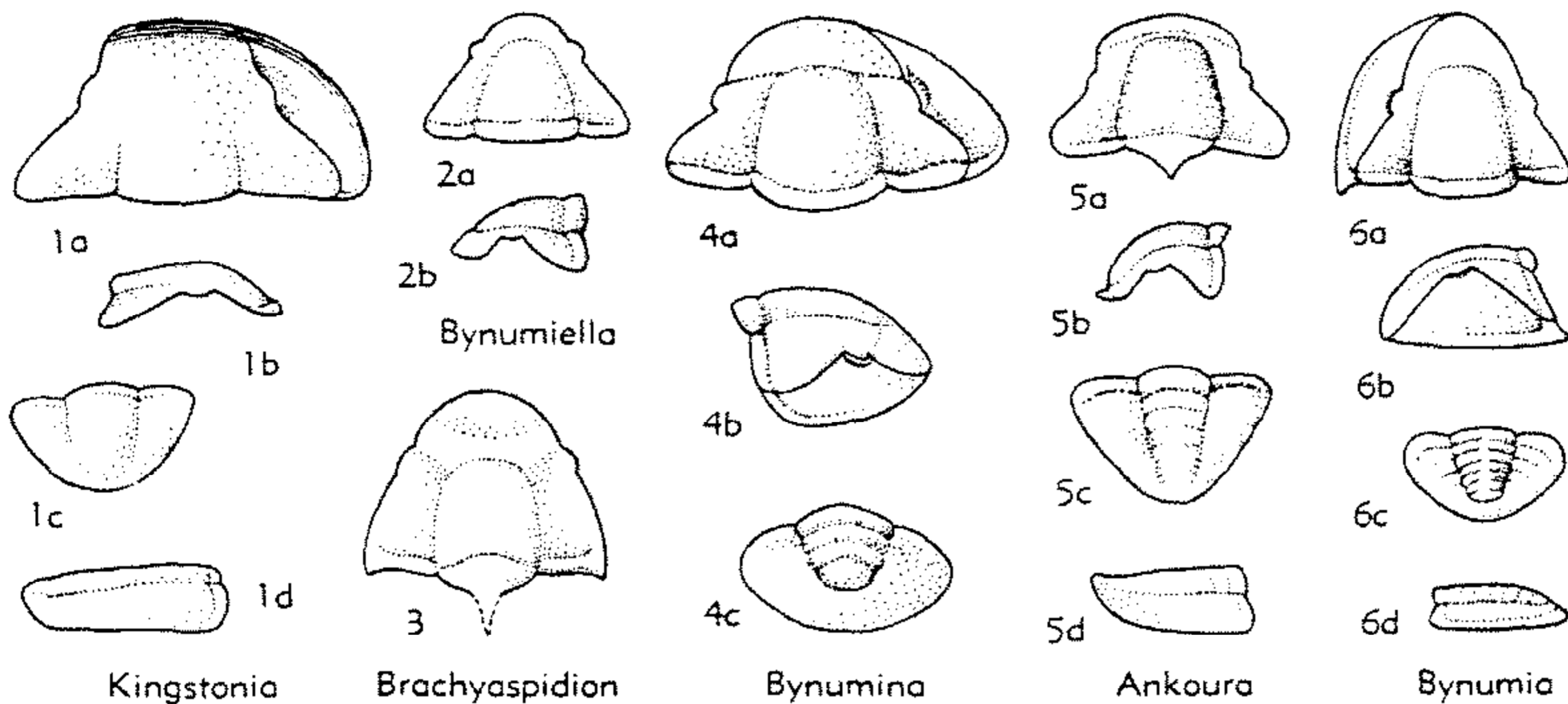

FIG. 211. Kingstoniidae (p. 0285-0286).

(126, 132). *U.Cam.* (Dresbach.), N.Am.—FIG. 211,5. **A. triangularis*, Tenn.; 5a,b, cran., $\times 4$; 5c,d, pyg., $\times 4$ (126).

Brachyaspidion B. M. MILLER, 1936 [pro *Brachyaspis* B. M. MILLER, 1936 (non SALTER, 1866; nec BOULENGER, 1896)] [**Brachyaspis rhynchina* B. M. MILLER, 1936]. Glabella low, short, tapering, front rounded, without lateral furrows; preglabellar field depressed, no anterior border furrow, anterior border broadly convex, axial furrows shallow; occipital spine and narrow arcuate eye ridges present; eyes opposite front of glabella; fixigenae with palpebral areas about 0.5 of glabellar width; librigenae and pygidium unknown (150). *Up.M.Cam.*, N.Am.—FIG. 211,3. **B. rhynchina* (MILLER), Wyo.; cran., $\times 3$ (150).

Bynumia WALCOTT, 1924 [**B. eumus*]. Cranidium subtriangular, with low subquadrate glabella, front rounded, lacking lateral furrows; triangular preglabellar field continuing slope of glabella, all furrows obsolete on exterior; axial furrows, occipital furrow, deep posterior border furrows, and very faint anterior border furrow visible on interior; fixigenae with palpebral areas 0.25 of glabellar width. Pygidium flat; axis low, tapered nearly full length, exterior unfurrowed, with 6 to 8 axial rings; 4 to 6 pleurae on interior; no border furrow (132, 239). *U.Cam.* (Dresbach.), N.Am.—FIG. 211,6. **B. eumus*, Alba.; 6a,b, cran. with librigena, $\times 2$; 6c,d, pyg., $\times 2$ (132, 239).

Bynumiella RESSER, 1942 [**B. typicalis*]. Cranidium subtriangular; glabella tapered to narrow rounded front, no lateral furrows; rounded or pointed preglabellar field, no anterior border furrow, other furrows visible on exterior; eyes near front of glabella; fixigenae with palpebral areas about 0.25 of glabellar width; librigenae and

pygidium unknown (239). *U.Cam.* (Francon.), W.N.Am.—FIG. 211,2. **B. typicalis*, Alba.; 2a,b, cran., $\times 4$ (239).

Bynumina RESSER, 1942 [**B. caelata*]. Glabella low, broadly tapering, front nearly straight with 2 pairs of short arcuate lateral furrows on interior; downsloping preglabellar field crossed by faint anterior border furrow on interior, all other furrows visible on exterior; eye ridges narrow; fixigenae with palpebral areas less than 0.5 of glabellar width. Pygidium with convex axis tapered 0.7 of length, axial furrows shallow, with 3 or 4 axial rings on interior; no border furrow (239). *U.Cam.* (Francon.), N.Am.—FIG. 211,4. **B. caelata*, Mo.; 4a,b, cran., $\times 4$; 4c, pyg., $\times 6$ (239).

Superfamily ANOMOCARACEA Poulsen, 1927

[*nom. transl.* POULSEN, herein (ex Anomocaridae POULSEN, 1927)]

Preglabellar field wide and concave, flat or gently convex; palpebral lobes long and sickle-shaped. Pygidium large, with broad, usually concave border. *M.Cam.-U.Cam.*

Family ANOMOCARIDAE Poulsen, 1927

Characters of superfamily. *M.Cam.-U.Cam.*

Anomocare ANGELIN, 1852 [**A. laeve*]. Preglabellar field concave; fixigenae narrower than in *Anomocaroides* and *Anomocarina*. Pygidium narrower than in *Anomocarina*. *M.Cam.*, NW.Eu.—FIG. 212,1. **A. laeve* ANGELIN, *Paradoxides forchhammeri* Z., Swed.-Denm.; 1a, cran., $\times 1.2$; 1b, pyg., $\times 2.4$ (51).

[NOTE.—Information furnished by C. J. STUBBLEFIELD indicates that the type species of *Anomocare*, not fixed by ANGELIN (1854), was subsequently designated by VOCDER (1890) as *A. aculeatum* (ANGELIN) (*recte Proetus difformis aculeatus* ANGELIN, 1851), which is a species subjectively assigned to *Agraulos* by BRØGGER, GRÖNWALL, WESTERGÅRD, and other authors. POOLSEN (1927), KOBAYASHI (1935), and WESTERGÅRD (1950) have incorrectly construed *A. laeve* as the type species of *Anomocare*, and the genus, chosen as type of the family Anomocaridae, has been interpreted on this basis. Application is being made to ICZN for fixation of *A. laeve* as type species of *Anomocare*.—Ed.]

Anomocarina LERMONTOVA, 1940 [**Proetus excavatus* ANGELIN, 1851]. Preglabellar field concave; palpebral lobes extending almost to glabella at front. Pygidium wider than in *Anomocare*. *M. Cam., NW.Eu.-Sib.*—FIG. 212,4. **A. excavata* (ANGELIN), *Paradoxides forchhammeri* Z., *Swed.-Denm.; cran., ×1.5* (51).

Anomocarioides LERMONTOVA, 1940 [**Proetus limbatus* ANGELIN, 1851]. Preglabellar field flat

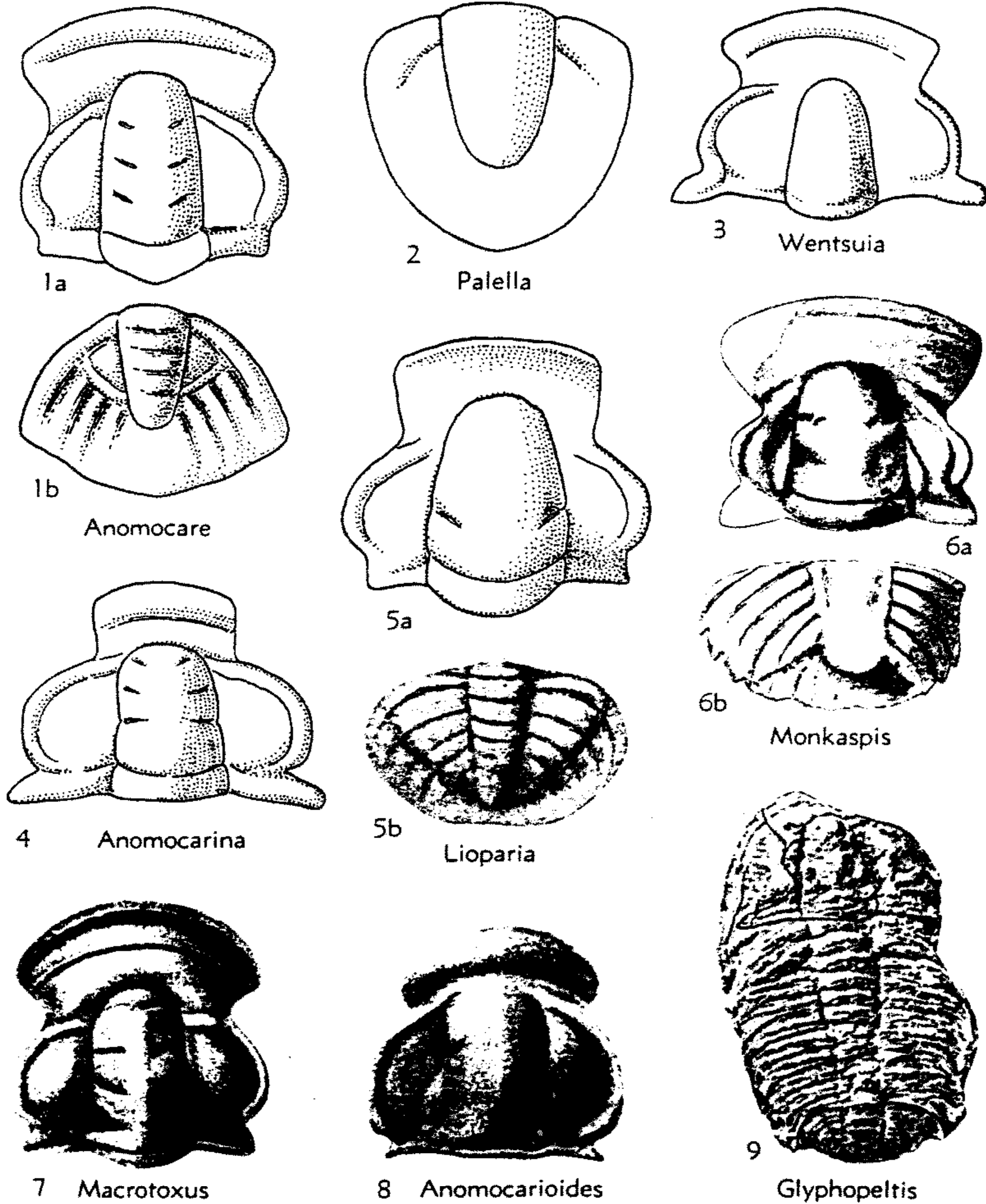

FIG. 212. Anomocaridae (p. O286-O288).

- or weakly convex; fixigenae bearing small kidney-shaped knobs near glabella. Pygidium semicircular. *M.Cam.*, NW.Eu.—FIG. 212,8. **A. limbatus* (ANGELIN), *Paradoxides forchhammeri* Z., Swed.-Denm.; cran., $\times 1.5$ (51*).
- Eymekops* KOBAYASHI (non RESSER & ENDO), 1935 [**Anomocarella hermius* WALCOTT, 1911]. Preglabellar field relatively short; anterior border strongly developed, convex; glabella quadrate. *M.Cam.*, NE.Asia.—FIG. 213,2. **E. hermius* (WALCOTT), Fu-chóu Ser., Manch.; cran., $\times 5.4$ (313).
- Glyphaspis* POULSEN, 1927 [**Asaphiscus? capella* WALCOTT, 1916]. Preglabellar field concave; palpebral lobes shorter than in *Anomocare*; pleural furrows extending almost to rear edge of broad pygidium. *M.Cam.*, W.N.Am.—FIG. 213,6. **G. capella* (WALCOTT), Wolsey F., Mont.; exoskel., $\times 0.9$ (488*).
- Glyphopeltis* DEISS, 1939 [**G. primus*]. Cranidium narrow, with narrow glabella and fixigenae; palpebral lobes shorter than in *Anomocare*. Pygidium smaller than in *Glyphaspis* and bearing spines. *M.Cam.*, W.N.Am.—FIG. 212,9. **G. prima*, Mont.; exoskel., $\times 1.6$ (30*).
- Haniwa* KOBAYASHI, 1933 [**H. sasanensis*]. Like *Eymekops* but with more quadrate preglabellar field. *U.Cam.*, E.Asia.—FIG. 213,10. **H. sasanensis*, Tsinania Z., Korea; 10a, cran., $\times 4.5$; 10b, pyg., $\times 5.5$ (419).
- Haniwoides* KOBAYASHI, 1935 [**H. longus*]. Cranidium narrow; palpebral lobes relatively short and close to glabella. *M.Cam.*, E.Asia.—FIG. 213,8. **H. longus*, Olenoides Z., Korea; cran., $\times 4.2$ (97).
- Inouyella* RESSER & ENDO in ENDO & RESSER, 1937 [**I. peiensis*]. Preglabellar field subtriangular; palpebral lobes rather small. *M.Cam.*, E.Asia.—FIG. 213,4. **I. peiensis*, Taitzu beds, Manch.; 4a,b, cran., pyg., $\times 1.65$ (240). [*Inouyella* KOBAYASHI, 1935, attributed to RESSER & ENDO is *nom nud.*—Ed.]
- Kokuria* KOBAYASHI, 1935 [**K. typha*]. Preglabellar field rather narrow, and small. *U.Cam.*, E.Asia.—FIG. 213,3. **K. typha*, Kaolishania Z., Korea; cran., $\times 4.3$ (97).
- Koptura* KOBAYASHI (non RESSER & ENDO), 1935 [**Anomocare lisani* WALCOTT, 1911]. Like *Anomocarioides* but with longer (*sag.*) preglabellar field and narrow bifid pygidium. *M.Cam.*, E.Asia.—FIG. 213,5. **K. lisani* (WALCOTT), Fu-chóu Ser., Manch.; 5a, cran., $\times 1.5$; 5b, pyg., $\times 3.3$ (313).
- Lioparia* LORENZ, 1906 [**Anomocare latelimbatum* DAMES, 1883; SD KOBAYASHI, 1935 [= *Lorentzia* COSSMANN, 1908; *Yokusenina* KOBAYASHI, 1935]. Like *Anomocare* but with longer preglabellar field (*sag.*) and shorter palpebral lobes. *M.Cam.*, E.Asia.—FIG. 212,5. **L. latelimbata* (DAMES), Fu-chóu Ser., Manch.; 5a, cran., $\times 1.9$; 5b, pyg., $\times 1.6$ (315).
- Macrotoxus* LORENZ, 1906 [**Anomocare angelini* GRÖNWALL, 1902; SD WESTERGÅRD, 1950]. Like *Anomocare* but with wider preglabellar field and fixigenae, deeper dorsal furrow on cranidium, and shagreened surface. *M.Cam.*, NW.Eu.—FIG. 212,7. **M. angelini* (GRÖNWALL), *Paradoxides davidis* Z., Denm.; cran., $\times 3$ (51*).
- Mapania* KOBAYASHI (non RESSER & ENDO), 1935 [**M. striata*]. Like *Eymekops* but preglabellar field narrower (*sag.*), glabella tapering instead of quadrate, and palpebral lobes not so large. *M.Cam.*, E.Asia.—FIG. 213,1. **M. striata*, Mapan beds, Manch.; cran., $\times 1.5$ (240).
- Metanomocare* LERMONTOVA, 1940 [**Metanomocare petaloides*]. Like *Macrotoxus* but with longer preglabellar area, more tapering glabella, and narrower fixigenae; pygidium large and wide, like that of *Anomocarioides*. *M.Cam.*, N.Asia.—FIG. 213,12. **M. petaloides*, *Paradoxides forchhammeri* Z., Sib.; 12a,b, cran., pyg., $\times 1$ (423).
- Monkaspis* KOBAYASHI, 1935 [**Anomocare daulis* WALCOTT, 1913]. Cranidium like that of *Macrotoxus* but with shorter palpebral lobes; pygidium with interpleural furrows almost reaching edge and with marginal spines. *M.Cam.*, E.Asia.—FIG. 212,6. **M. daulis* (WALCOTT), Ch'ang-hia F., China; 6a,b, cran., pyg., $\times 2.5$ (315*).
- Monocheilus* RESSER, 1927 [**Conocephalites anatinus* HALL, 1863]. Preglabellar field rather short, narrow; palpebral lobes short; librigenae bearing long curved spine. *U.Cam.*, N.Am.—FIG. 213,7. **M. anatinus* (HALL), Franconia F., Wis.; 7a, cran., $\times 1.4$; 7b, librigena, $\times 1.6$ (403).
- Pallela* HOWELL, 1937 [**P. paradoxa*]. Pygidium very narrow, subtriangular; cranidium unknown. *M.Cam.*, USA (Vt.-Utah).—FIG. 212,2. **P. paradoxa*, *Centroleura vermontensis* Z., Vt.; pyg., $\times 7$ (72).
- Paracoosia* KOBAYASHI, 1936 [**P. mansuyi* KOBAYASHI, 1936 (*pro asiatica* MANSUY, 1916, preoccupied)]. Preglabellar field long and wide, palpebral lobes relatively short, interpleural furrows short. *M.Cam.*, SE.Asia.—FIG. 213,9. **P. mansuyi* KOBAYASHI, Annamitia Z., Indochina; exoskel., $\times 1.3$ (142*).
- Saimachia* KOBAYASHI, 1937 [**S. damesi*]. Cranidium small, with convex border and bluntly truncated glabella. *M.Cam.*, E.Asia.—FIG. 213,11. **S. damesi*, Kiu-lung Group, China; cran., $\times 8.3$ (419).
- Wentsuia* SUN, 1935 [**W. granulosa*]. Like *Anomocare* but with shorter glabella, no glabellar furrows, and thicker palpebral lobes. *U.Cam.*, E.Asia.—FIG. 212,3. **W. granulosa*, Tawenkou beds, China; cran., $\times 3.6$ (289).
- Anomocariopsis* STIVOV, 1955 [**A. salairensis*]. *Low. U.Cam.*, Salair, USSR. [Author's assignment.]

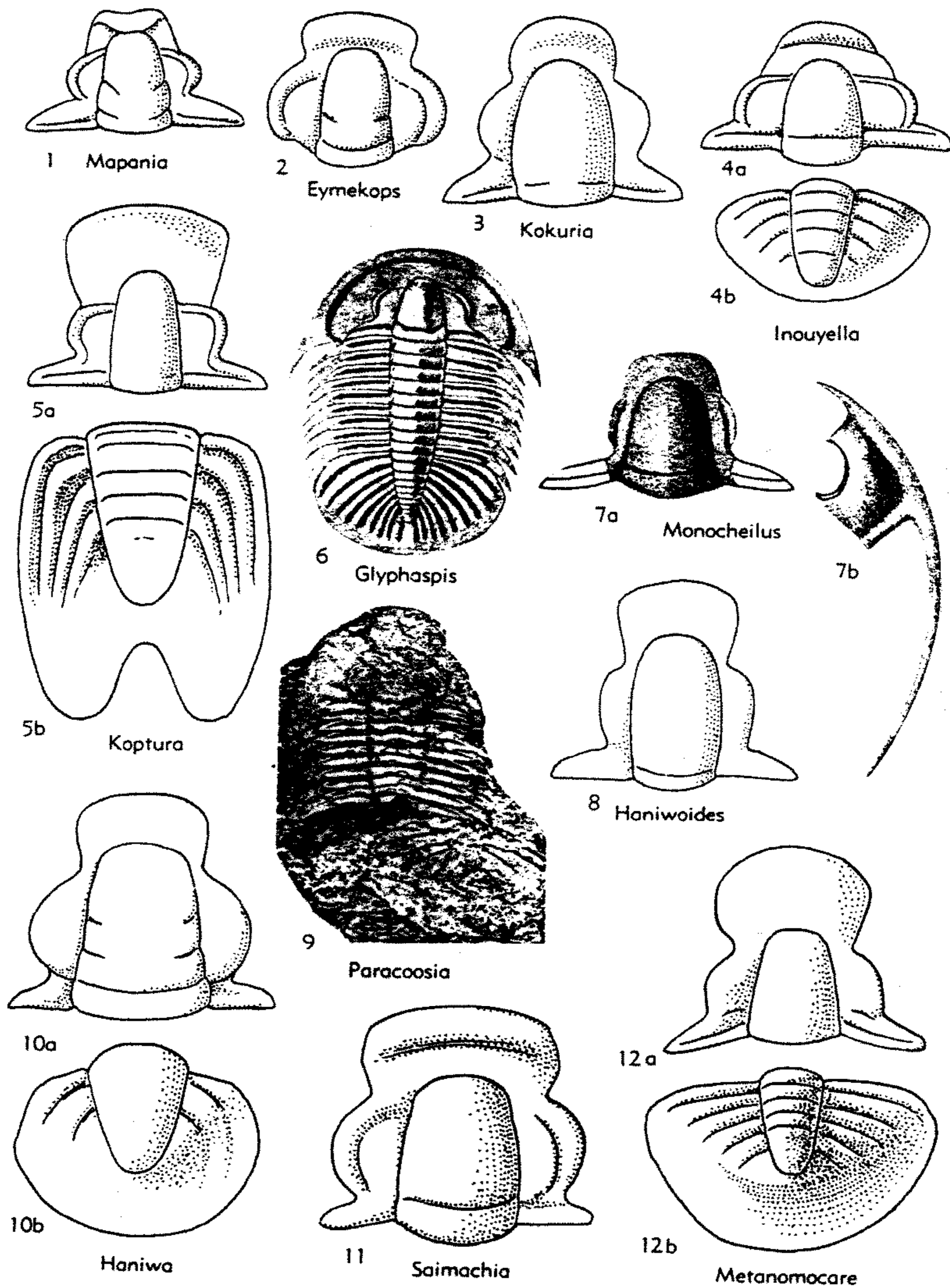

FIG. 213. Anomocaridae (p. 0288).

- Catuniella JEGOROVA, 1956 [**C. digna*]. *Up.M.Cam.*, USSR. [Author's assignment.]
- Chondranomocare POLETAeva, 1956 [**C. bidjensis*]. *Low.M.Cam.*, USSR. [Author's assignment.]
- Glyphaspellus IVSHIN, 1953 [**G. primus*]. *M.Cam.*, Kazakhstan. [Author's assignment.]
- G. (Glyphaspellus).
- G. (Glyphanellus) IVSHIN, 1953 [**G. (G.) margaritus*].
- Pseudanomocarina CHERNYSHEVA, 1956 [**P. plana*]. *M.Cam.*, USSR. [Author's assignment.]

Superfamily ASAPHISCACEA Raymond, 1924

[*nom. transl.* HOWELL, herein (*ex* Asaphiscidae RAYMOND, 1924) [=Asaphiscoidae HUPÉ, 1953]]

Exoskeleton opisthoparian, elliptical to ovate in outline, isopygous. Cephalon with genal angles rounded or produced into spines; glabella tapering forward, with front rounded; preglabellar field and anterior border present. Thorax with 7 to 11 segments. Pygidium semicircular to subtriangular, with tapered axis; pleural fields equal in width to axis or slightly wider; border variable in width. Surface smooth. *M.Cam.-U.Cam.*

Family ASAPHISCIDAE Raymond, 1924

Characters of superfamily. *M.Cam.-U.Cam.*

Subfamily ASAPHISCINAE Raymond, 1924

[*nom. transl.* HOWELL, herein (*ex* Asaphiscidae RAYMOND, 1924)]

Cephalon with lateral and axial furrows distinct; glabella with 3 pairs of furrows well defined to obsolete; preglabellar field wide to quite narrow (*sag.*); fixigenae bearing narrow but distinct eye ridges, eyes median in size or larger, located opposite or slightly behind center of glabella, palpebral areas 0.3 to 0.5 of glabellar width, posterior areas triangular; librigenae medium in width (*tr.*), with medium-length genal spines or rounded genal angles. Thorax of 7 to 11 segments. Pygidium semicircular, with 5 to 8 segments; border of medium width or narrow. *M.Cam.-U.Cam.*

Asaphiscus MEEK, 1873 [**A. wheeleri*] [=Eteraspis RESSER, 1935]. Preglabellar field wide (*sag.*), palpebral lobes small. Thorax with 7 to 11 segments. Pygidium large, with wide flat border. *M.Cam.*, W.USA.—FIG. 214,1. **A. wheeleri*, Wheeler F., Utah; exoskel., $\times 0.6$ (488*).

Anomocarella WALCOTT, 1905 [**A. chinensis*] [=Psilaspis RESSER & ENDO in KOBAYASHI, 1935]. Glabellar furrows lacking, border flat and narrow.

M.Cam., E.Asia.—FIG. 215,1. **A. chinensis*, Chang Hsia F., China; *1a,b*, cran., pyg., $\times 2.6$ (488*).

Blainia WALCOTT, 1916 [**Asaphiscus (Blainia) gregarius*]. Like *Asaphiscus* but glabella less tapering; thoracic segments 9; pygidium with interpleural furrows extending to margin. *M.Cam.*, SE. USA.—FIG. 214,2. **B. gregaria* (WALCOTT), Conasauga F., Ala.; exoskel., $\times 1.2$ (488*).

Blainiopsis POULSEN, 1947 [**B. holtedahli*]. Like *Blainia* but with shorter preglabellar field (*sag.*) and flat border. *M.Cam.*, Arct.—FIG. 214,3. **B. holtedahli*, Cape Wood F., Ellesmere I.; *3a*, cran., $\times 4.3$; *3b*, pyg., $\times 3.3$ (445*).

Dolgaia WALCOTT & RESSER, 1925 [**D. megalops*]. Like *Blainia* but preglabellar field smaller, glabella larger, and palpebral lobes longer. *U.Cam.*, NE. Eu.—FIG. 215,2. **D. megalops*, N.Zem.; cran., $\times 2.7$ (322*).

Dunderbergella HOWELL, 1945 [**D. typicalis*]. Preglabellar field large, anterior border narrow; glabella short, without furrows. *U.Cam.*, E.USA.—FIG. 214,4. **D. typicalis*, Up.Kittatinny F., N.J.; $\times 3$ (410*).

Grandiocus COSSMAN, 1908 [*pro Megalophthalmus* LORENZ, 1906 (*non* LEACH, 1830; *nec* GRAY, 1832)] [**Liostracus megalurus* DAMES, 1883; SD KOBAYASHI, 1935]. Preglabellar field large; glabella nearly parallel-sided, with 3 pairs of furrows; palpebral lobes long. Pygidium with long tapering narrow axis. *M.Cam.*, E.Asia.—FIG. 214,5. **G. megalurus* (DAMES), China; *5a*, cran., $\times 2.7$; *5b*, pyg., $\times 2.25$ (393*).

Hundwarella REED, 1934 [**H. personata*]. Preglabellar field wide (*sag.*); anterior border strongly developed; palpebral lobes wide and long; glabella with 3 pairs of furrows, outer ends of rear pair directed anteriorly. *M.Cam.*, E.Asia.—FIG. 214,6. **H. personata*, Slate Ser., Kashmir; cran., $\times 3.8$ (452*).

Iranoleesia KING, 1955 [*pro Irania* KING, 1937 (*non* DE FILIPPI, 1863)] [**Irania pisiiformis* KING, 1937]. Cranidium like that of *Hundwarella* but palpebral lobes narrower and with inner ends of halves of interrupted rear pair of glabellar furrows bifurcate, lower branch being directed posteriorly. Pygidium with wide flat border. *U.Cam.*, S.Asia.—FIG. 214,7. **I. pisiiformis* (KING), India; cran., $\times 4$ (418*).

Kaninia WALCOTT & RESSER, 1925 [**K. lata*]. Like *Anomocarella* but with shorter preglabellar field (*sag.*), flatter anterior border, wider fixigenae, and shallower interpleural furrows and more definite flattened border on pygidium. *U.Cam.*, N. Zem.—FIG. 215,3. **K. lata*; *3a,b*, cran., pyg., $\times 1.4$ (488*).

Kaniniella KOBAYASHI, 1938 [**K. concinna*]. Cranidium as in *Kaninia* but with very narrow fixigenae and shorter palpebral lobes. *U.Cam.*, W.Can. (B.C.).—FIG. 215,4. **K. concinna*, Plethopeltis Z.; cran., $\times 4.3$ (419*).

Lioparella KOBAYASHI, 1937 [**L. walcotti*]. Preglabellar field long and wide; eye ridges strongly developed. *M.Cam.*, E.Asia.—FIG. 215,5. **L. walcotti* KOBAYASHI, Kiu-lung F., China (Shantung); cran., $\times 1.3$ (488*).

Manchuriella KOBAYASHI (*non* RESSER & ENDO in Koba.) 1935 [**M. typa*]. Preglabellar field small, axial and glabellar furrows shallow; palpebral lobes short. Pygidium with narrow border. *M.Cam.*, E.Asia.—FIG. 214,8. **M. typa*, Mapan F.,

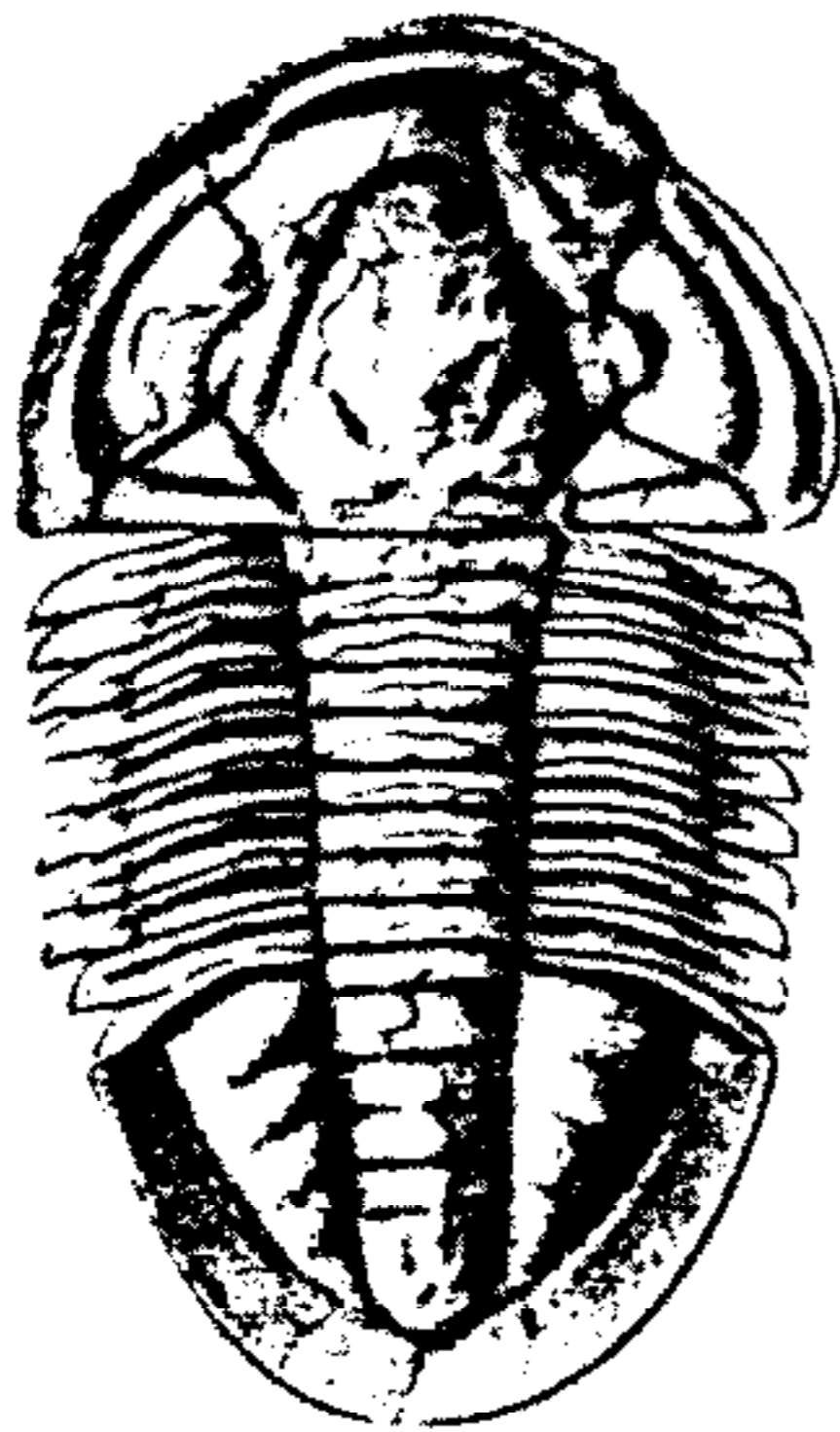

1
Asaphiscus

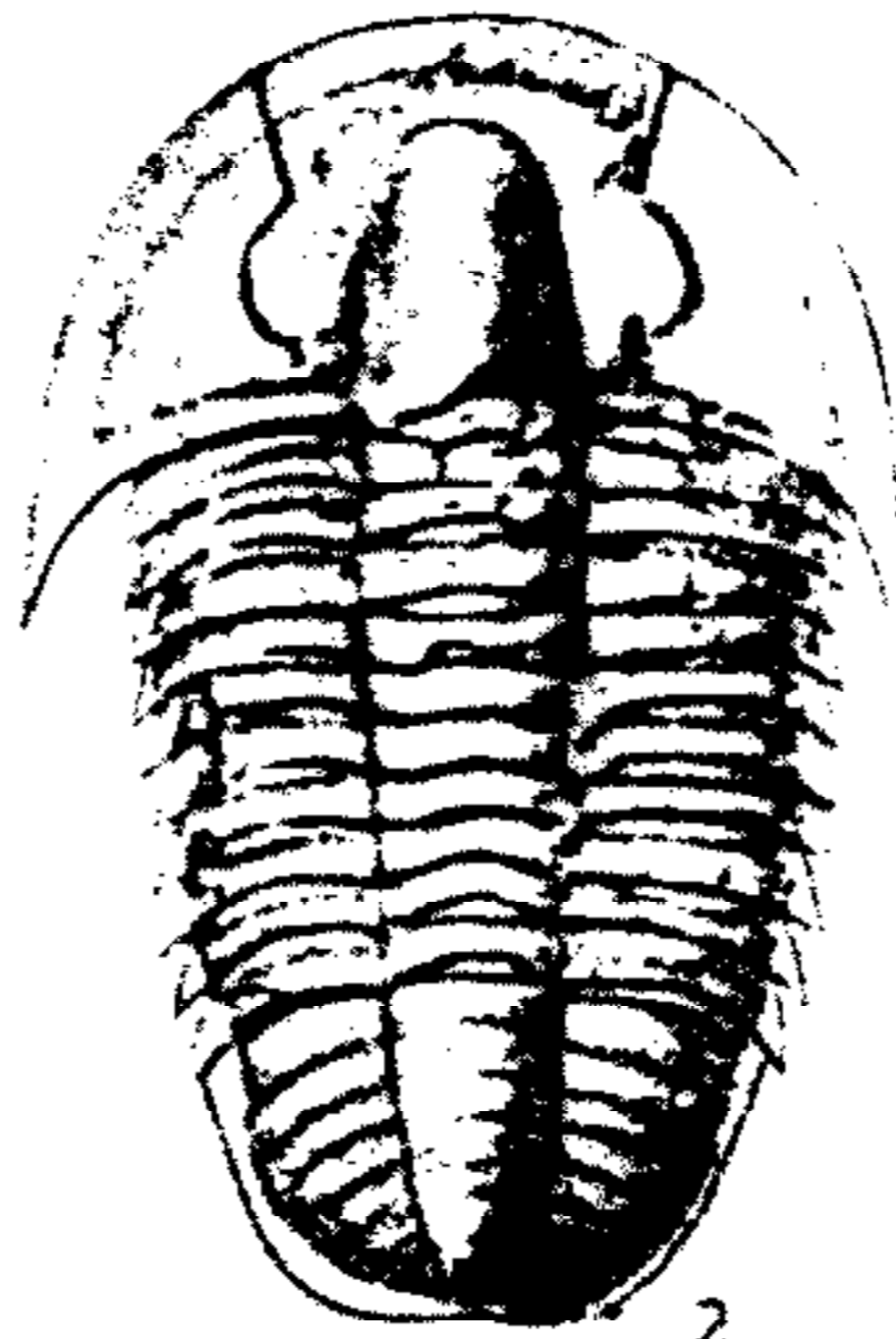

2
Blainia



3a

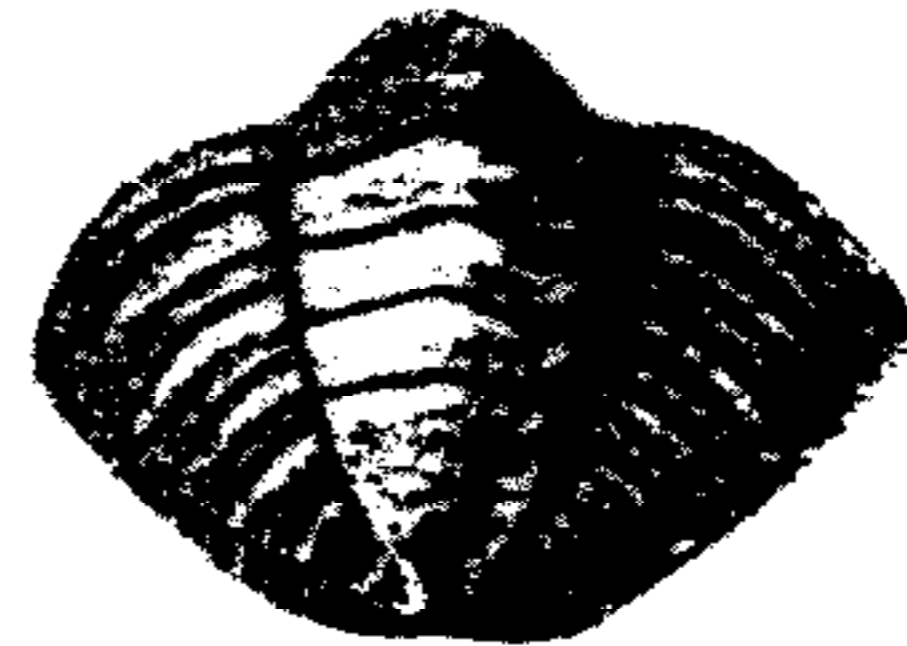

3b

Blainiopsis

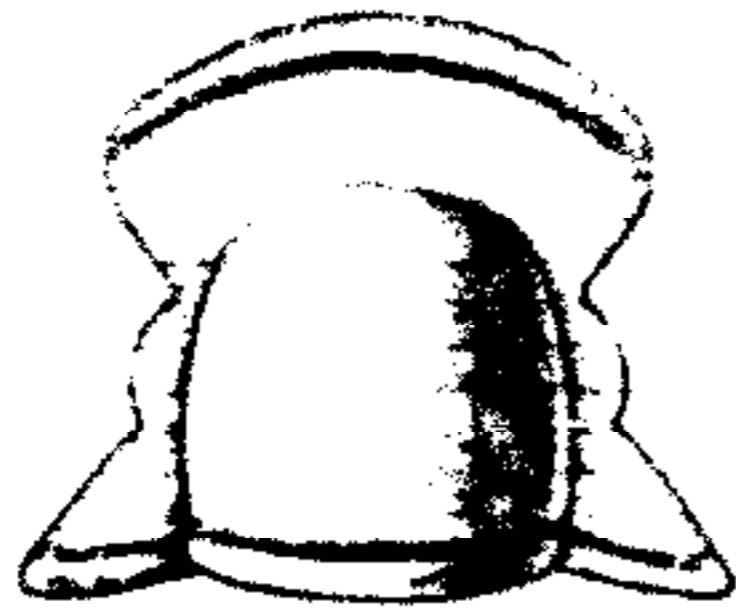

4
Dunderbergella



5a



5b

Grandiocus

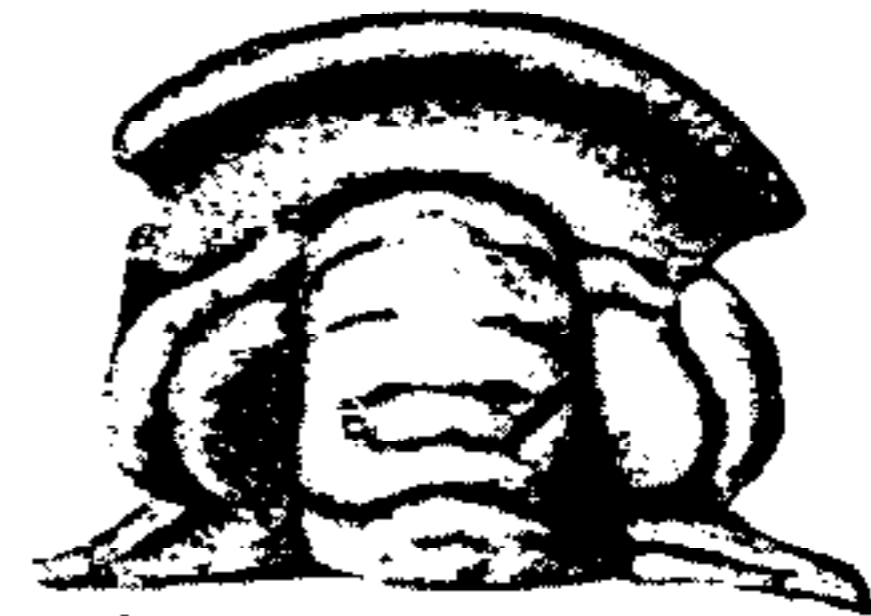

6

Hundwarella

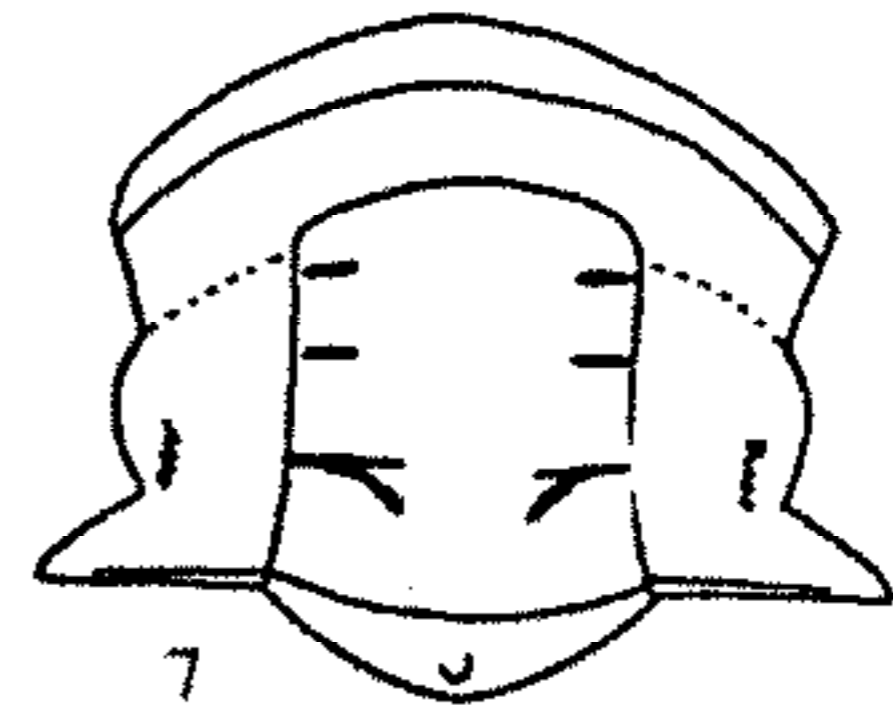

7

Iranoleesia



8a



8b

Manchuriella



9a



9b
Peishania



10

Proasaphiscus

FIG. 214. Asaphiscidae (Asaphiscinae) (p. 0290-0292).

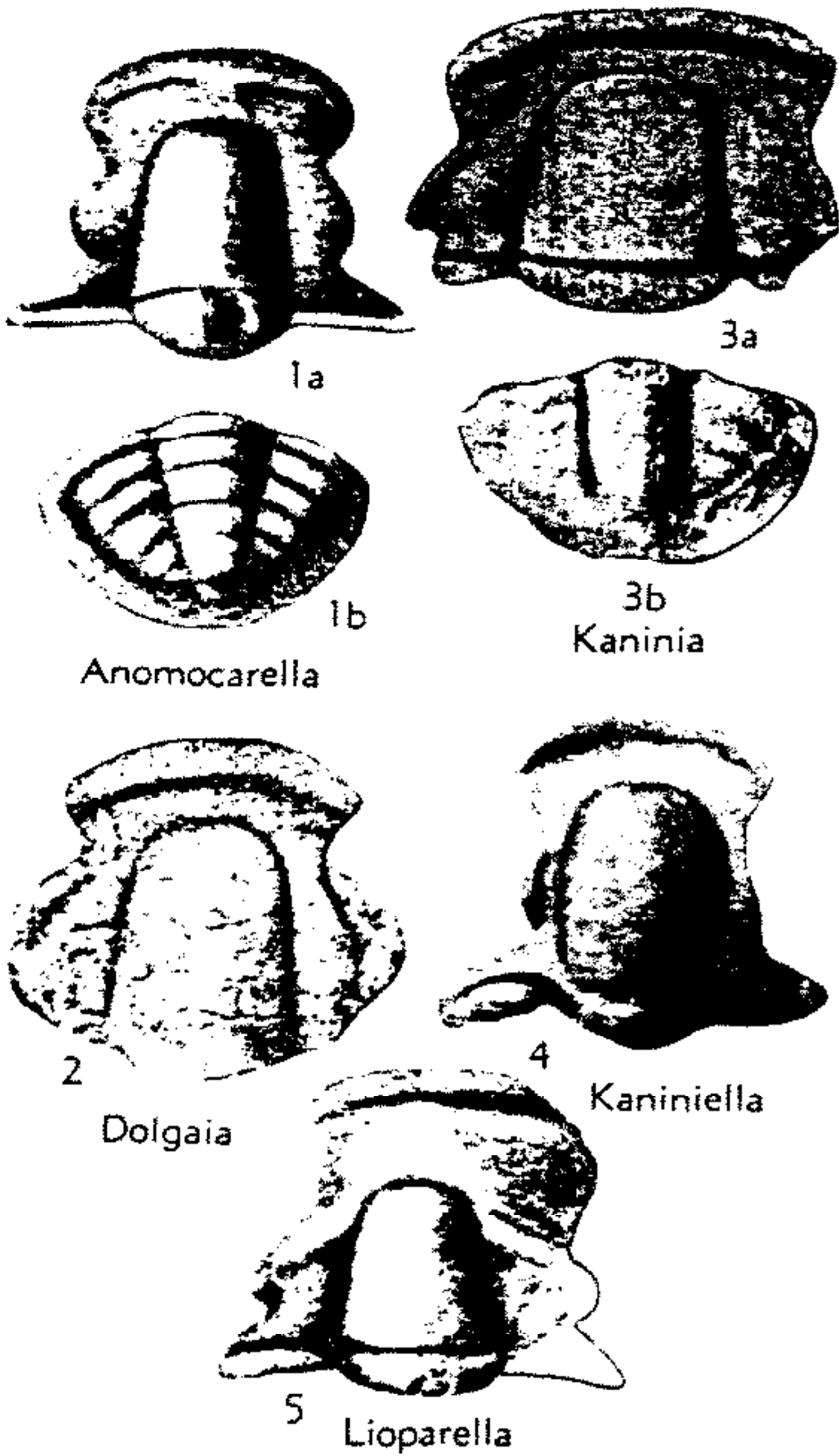

FIG. 215. Asaphiscidae (Asaphiscinae) (p. 0290-0291).

Manch.; 8a, cran., $\times 2.3$; 8b, pyg., $\times 1.5$ (37*).

Paraorlovia TCHERNYSHEVA, 1956 [**P. sequens*].
Up.M.Cam., USSR. [Author's assignment.]

Peishania RESSER & ENDO, in ENDO & RESSER, 1937 [**P. convexa*]. Cranidium minutely punctate, convex; preglabellar field short (*sag.*); anterior border slightly convex, anterior border furrow shallow; without distinct glabellar furrows. Thorax with shallow interpleural furrows on segments. *M.Cam.*, E.Asia.—FIG. 214,9. **P. convexa*, Taitzu F., Manch.; cran., pyg., $\times 4.5$ (37*). [*Peishania* KOBAYASHI, 1935, attributed to RESSER & ENDO, is *nom. nud.*—ED.]

roasaphiscus KOBAYASHI (*non* RESSER & ENDO in Koba.) 1935 [**P. yabei*]. Cranidium as in *Asaphiscus* but pygidium smaller and with almost no border, interpleural furrows curving more toward rear. *M.Cam.*, E.Asia.—FIG. 214,10. **P. yabei*, Tangshih F., Manch., exoskel., $\times 1.5$ (37*).

Subfamily BLOUNTIINAE Lochman, 1944

[*nom. correct. & transl.* HOWELL, herein (*ex* Blountidae LOCHMAN, 1944)]

Cephalon with exterior furrows well defined to shallow or obsolete, interior furrows

all better marked; eyes small, anterior to center of glabella; fixigenae downsloping, with palpebral areas about 0.3 of glabellar width, posterior areas broadly triangular; librigenae narrow, with short genal spines or rounded angles. Thorax with 7 to 9 segments, pleural furrows narrow, extending nearly to bluntly pointed ends. Pygidium subtriangular, with 5 to 10 segments, border relatively narrow. *U.Cam.*

Blountia WALCOTT, 1916 [**B. mimula*] [= *Stenocombus* RAYMOND, 1937]. Glabella tapering, front rounded, axial and border furrows present. Pygidium moderately convex, axis tapered, furrows faint to obsolete, border distinct, narrow. *U.Cam.* (*Dresbach.*), N.Am.

B. (Blountia). Glabella broad or with subparallel sides, front widely rounded, lateral furrows very faint, axial and border furrows well defined; librigenae with short genal spines. Pygidium with axis sharply tapered to narrow end, 0.75 to 0.83 length of pygidium, with 8 to 11 axial rings, all furrows present but faint on exterior, clear on interior.—FIG. 216,3a,b. **B. (B.) mimula*, Tenn.; exoskeleton, dorsal and profile views of holotype (immature specimen), $\times 8$ (317).—FIG. 216,3c. *B. sp.*, Tenn.; specimen clearly showing 9 thoracic segments, $\times 8.5$ (425).

B. (Homodictya) RAYMOND, 1937 [**H. imitatrix*]. Glabella with sides converging to narrow, rounded front, without lateral furrows, axial and occipital furrows narrow, but distinct, anterior border furrow obsolete on exterior, faint on interior. Pygidium with axis extending 0.7 of length, all except axial furrow obsolete on exterior, faint on interior, border widest at rear. *M.Cam.* (*Dresbach.*), N.Am.—FIG. 216,2. **B. (H.) imitatrix* (RAYMOND), Vt.; 2a,b, cran., dorsal and profile; 2c, pyg.; all $\times 3$ (193).

Blountiella RESSER, 1938 [**Blountia? alemon* WALCOTT, 1916]. Glabella broadly tapering, convex, sides only slightly tapered to rounded front, axial furrow distinct, lateral furrows faint, occipital and border furrows narrow and faint or obsolete on exterior; anterior border vertical, smooth or striate; librigenae with rounded genal angle. Pygidium short and wide, profile low, with vertical border, axis tapered, with 6 or 7 axial rings; pleurae 5 or 6, only axial furrow on exterior, other furrows faint on interior but border furrow obsolete (132). *U.Cam.* (*Dresbach.*), N.Am.—FIG. 216,4. *B. cordillera* DUNCAN, Mont.; 4a,b, cran., dorsal, profile; 4c, librigenae; 4d,e, pyg., dorsal, profile; all $\times 4.5$ (132).

Maryvillia WALCOTT, 1916 [**M. arion*] [= *Protillaenus* RAYMOND, 1937; *Blountina* LOCHMAN, 1944; *Blountiana* SHAW, 1952]. Glabella broad, low, sides nearly parallel, front broadly rounded, all furrows except occipital and posterior border obsolete on

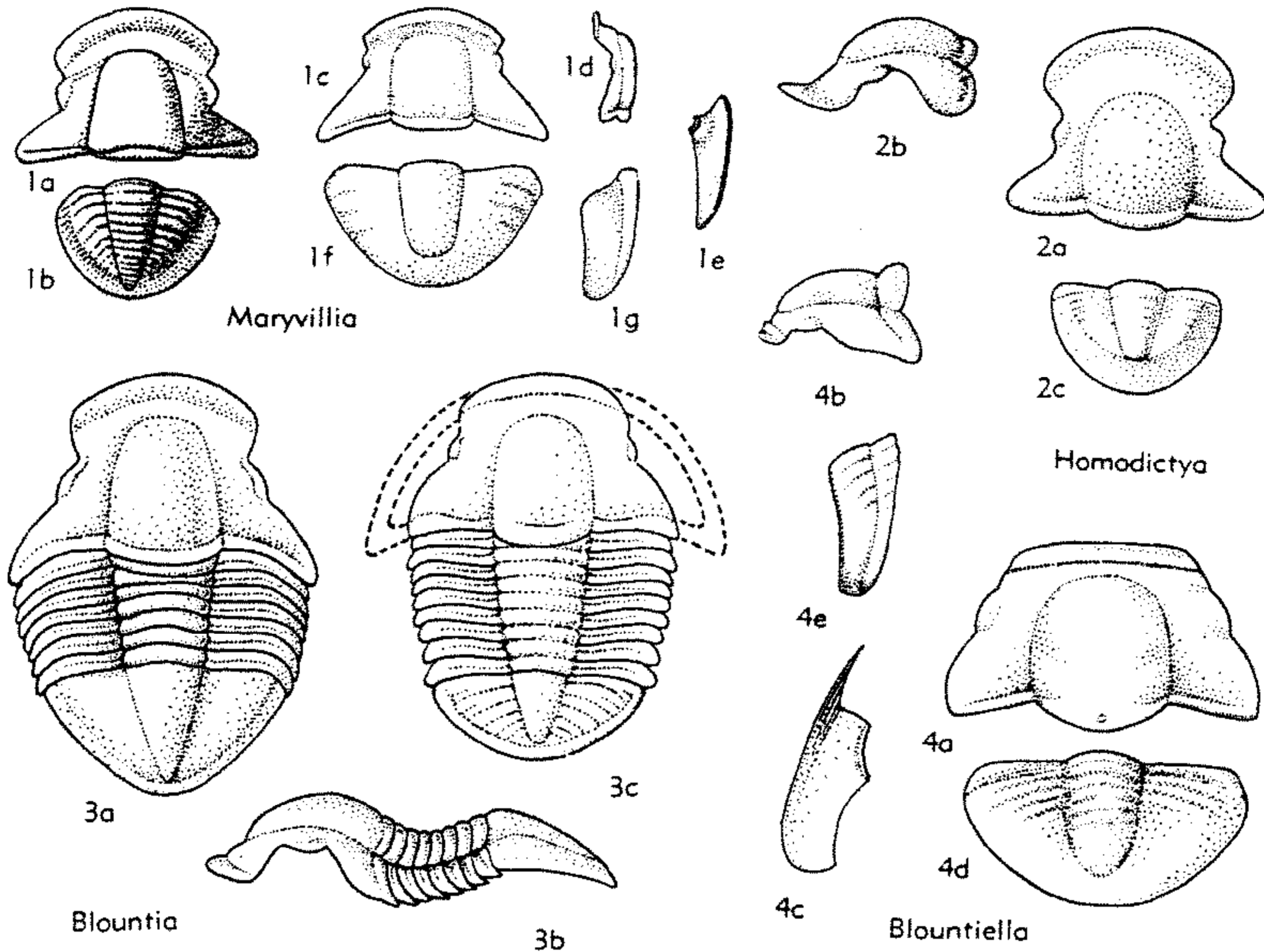

FIG. 216. Asaphiscidae (Blountiinae) (p. 0292).

exterior, anterior border furrow also obsolete on interior, others faint; librigenae with short blunt genal spine. Pygidium convex, with nearly vertical border; long tapered axis may extend beyond border furrow, with 7 to 12 axial rings, only faint axial furrow on exterior, all furrows present on interior. (448). *U.Cam. (Dresbach.)*, N.Am.—FIG. 216, 1a, b. **M. arion*, Tenn.; 1a, b, cran., pyg., $\times 4$ (488).—FIG. 216, 1c-g. *M. eleanora* (LOCHMAN), Mont.; 1c, d, cran., dorsal, profile; 1e, librigena; 1f, g, pyg., dorsal, profile; all $\times 4$ (425).

Superfamily BURLINGIACEA
Walcott, 1908

[*nom. transl.* POULSEN, herein (*ex* Burlingidae WALCOTT, 1908)] [=Burlingiidea RICHTER, 1933; Burlingioidae RASETTI, 1951; Burlingioidae HUPÉ, 1953]

Exoskeleton proparian, ovate, very gently convex, heteropygous. Cephalon semicircular in outline, without border; glabella subcylindrical, anteriorly rounded; preglabellar field long, posterior areas of fixigenae wide, laterally expanding; slightly curved palpebral lobes situated very close to glabella, fairly short; anterior and posterior sections of facial sutures almost rectilinear, both extending obliquely backward from cephalic

margins to eyes; librigenae subtrapezoidal. Thorax of 7 to 15 segments; pleural regions wide; flat, truncate pleurae with acute posterior terminations and direct, very wide and shallow pleural furrows. Pygidium greatly varying in size and structure. Character of cephalic doublure, ventral sutures, and hypostoma unknown. *M.Cam.-U.Cam.*

Family BURLINGIIDAE Walcott, 1908

[*nom. correct.* RICHTER, 1933 (*pro* Burlingidae WALCOTT, 1908)]

Characters of superfamily. *M.Cam.-U.Cam.*

Burlingia WALCOTT, 1908 [**B. hectori*]. Cephalon about 0.3 total length of exoskeleton; occipital furrow and ring indiscernible; glabellar furrows lacking or represented by 2 pairs of pits on anterior half of glabella. Thorax of 14 or 15 segments; posterior half of axis tapering; pleurae strongly curved. Pygidium small, elongate, without defined segments (311, 336). *M.Cam.*, N.Am.-Eu.—FIG. 217, I. **B. hectori*, W.Can.(B.C.); exoskel., $\times 7.5$ (311).

Schmalensecia MOBERG, 1903 [**S. amphionura*]. Differs from *Burlingia* in its longer cephalon, well-defined occipital furrow and ring, 3 pairs of

strongly impressed lateral furrows, thorax of 7 or 8 segments, almost rectilinear pleurae, evenly tapering axis, and fairly large, wide pygidium of about 7 segments, segmentation being similar to that of thorax (331, 336). *M. Cam.-U. Cam.*, Swed. —FIG. 217.2. **S. amphionura*, U. Cam., Swed.; exoskel. without librigenae, X24 (331).

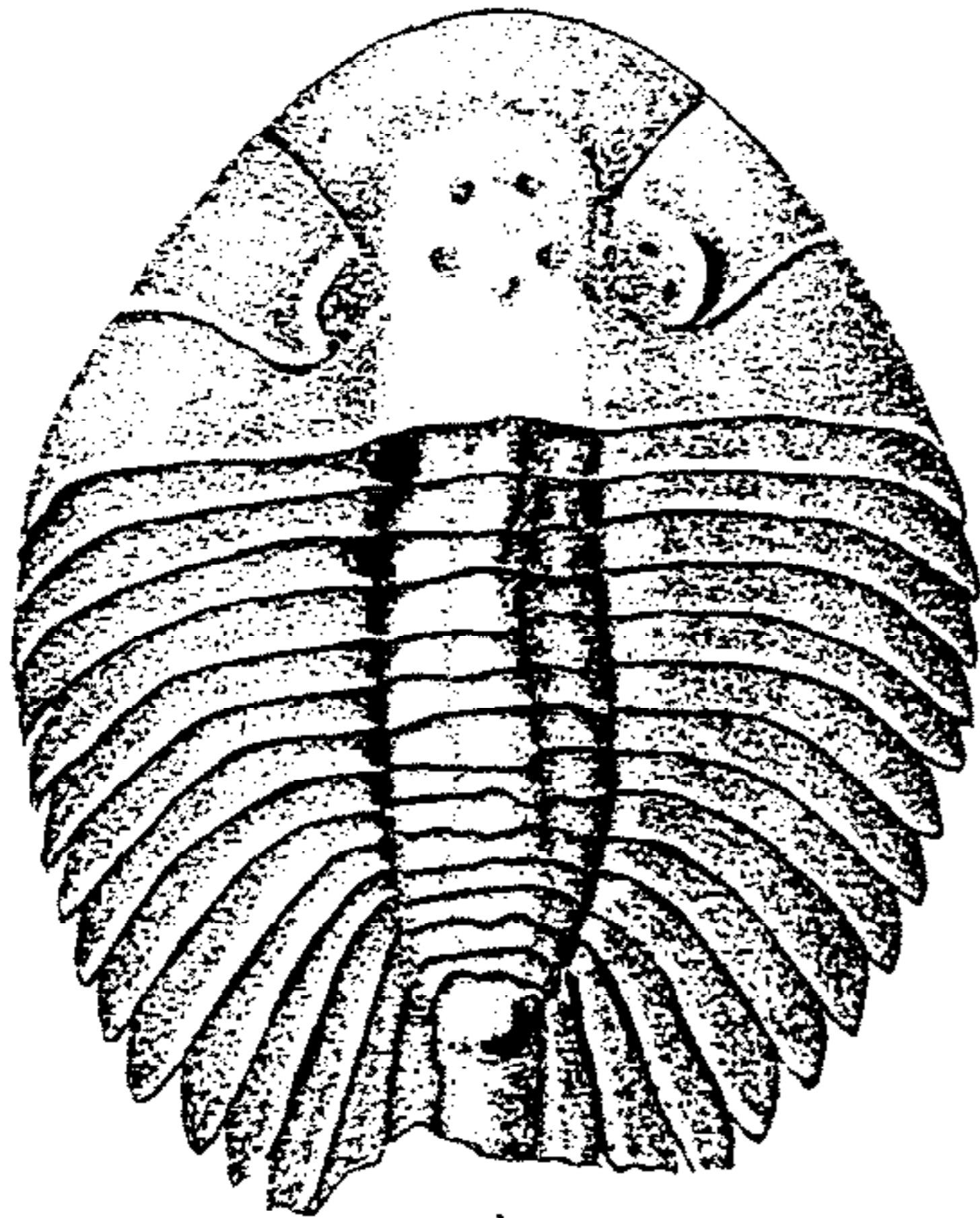

1
Burlingia

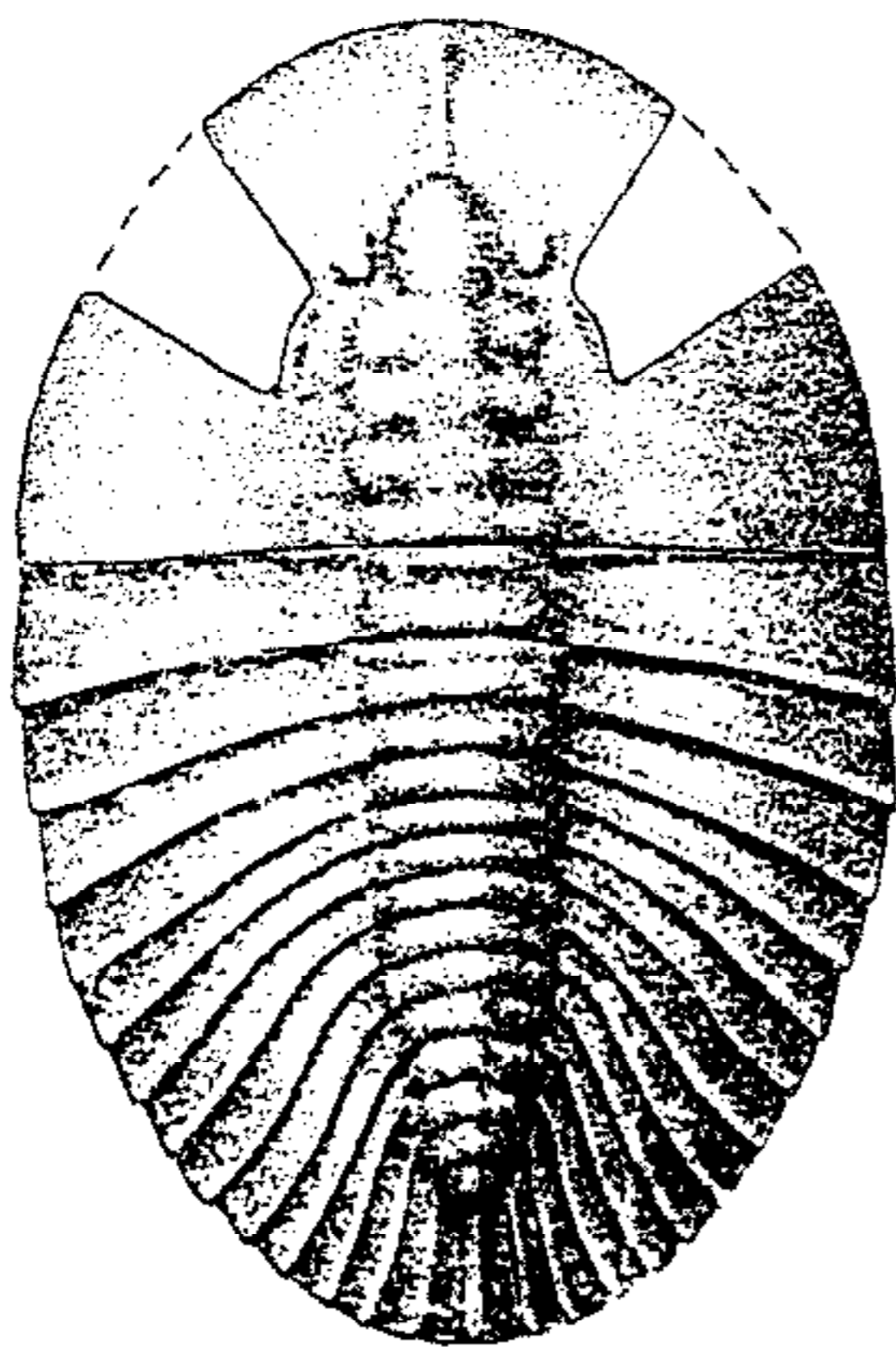

2
Schmalenseeia

FIG. 217. Burlingiidae (p. 0293).

Superfamily KOMASPIDACEA Kobayashi, 1935

[*nom. transl.* HENNINGSMOEN, herein (ex Komaspidae KOBAYASHI, 1935) [=Telephidaceae STUBBLEFIELD, 1950; Telephoidae HUPÉ, 1953] [Superfamily name based on *Telephus* BARRANDE, 1852 (non GISTEL, 1848) is not permissible.]

Exoskeleton opisthoparian, small, ellipsoidal. Glabella short, tapering to broadly quadrate, anterior lobe expanding slightly in some, with 3 pairs of lateral furrows, posterior pair commonly transglabellar, all 3 pairs becoming obsolete in late genera; preglabellar field narrow or absent, anterior border furrow tending to become obsolete; palpebral lobes prominent, arcuate, eyes medium-sized in early genera, becoming very large in later genera; librigenae bearing short to medium-sized stout genal spines. Thorax with 9 or fewer segments. Pygidium micropygous, narrowly transverse to triangular, with prominent convex axis extending nearly full length, border narrow, border furrow narrow. Surface finely to coarsely granulate. *M. Cam.-U. Ord.*

Early members are rather generalized ptychopariid in appearance, but showing trends towards the characteristic telephinid appearance, with very large eyes, diminutive posterior parts of fixigenae, and lack of both preglabellar field and anterior border furrow; eyes may be small (Glaphuridae) but forms so distinguished agree with some telephinids in having longitudinal lateral glabellar furrows.

Family KOMASPIDIDAE Kobayashi, 1935

[*nom. correct.* HENNINGSMOEN, 1951 (*pro* Komaspidae KOBAYASHI, 1935)]

Exoskeleton opisthoparian, isopygous. Glabella broadly tapering to quadrate, with sides slightly converging forward, parallel, or (in late genera) diverging forward to rounded front, with 2 or 3 pairs of lateral furrows that become obsolete in late genera; preglabellar field narrow or absent; palpebral lobes and eyes large, extending more than half of full length of glabella, arcuate or broad, palpebral furrows deep; fixigenae horizontal or downsloping, posterior areas short (*tr.*); librigenae with eye platforms narrow or absent, genal spines short or long and recurved. Thorax with wide convex axis, number of segments unknown; pleurae narrower than axis, blunt-ended, with small spines. Pygidium

short, transverse, with convex axis wider than pleural fields, extending nearly full length of pygidium, tapering moderately to rounded end; median spine and nodes may be present; furrows well defined, border narrow. Surface smooth or granulose. Derived from Ptychopariidae. *Up.M.Cam.-L. Ord.*

Komaspis KOBAYASHI, 1935 [**K. typa*]. Glabella convex, tapering, with 3 pairs of well-defined lateral furrows, posterior pair complete; preglabellar field narrow, anterior border furrow faint, anterior border narrow, rimlike; eyes about 0.6 of glabellar length, slightly in front of center of glabella; fixigenae downsloping, with palpebral areas slightly less than 0.5 of glabellar width (97). *M.Cam.(Taitzuan)*, NE.Asia.—FIG. 218,1. **K. typa*, S.Korea; *1a,b*, cran., dorsal, profile, $\times 2$ (97).

Benthampis POULSEN, 1947 [**B. problematica*]. Glabella convex, broadly subquadrate, with sides parallel nearly to front and then diverging slightly, without lateral furrows; anterior border furrow faint or obsolete, no preglabellar field, anterior border rimlike; occipital furrow probably obsolete; eyes more than 0.5 of glabellar length, slightly behind center of glabella; fixigenae downsloping, with palpebral areas about 0.5 of glabellar width. Pygidium with low broad axis, tapering rapidly to narrow end, 0.7 of length of pygidium; axial furrows very shallow, all other furrows obsolete; 3 or 4 axial rings and interpleural grooves on inner surface. Outer surface unknown (175). *Up.L.Ord.*, W.Arct.N.Am.—FIG. 218,6. **B. problematica*, Ellesmere I.; *6a-c*, cran., dorsal, front, profile, $\times 3$ (175).

Carolinites KOBAYASHI, 1940 [**C. bulbosa*] [= *Dimastocephalus* STUBBLEFIELD, 1950; *Keidelia* HARRINGTON & LEANZA, 1957]. Glabella convex, subquadrate, expanding to slightly bulbous front, without lateral furrows; axial furrows deep, with posterior sinuous inbend; no preglabellar field, anterior border furrow merging with preglabellar furrow; eyes extending nearly full length of glabella; fixigenae horizontal or downsloping, with node at each inner posterior corner; palpebral areas about 0.6 of glabellar width; librigenae without eye platforms, border furrow narrow, librigenal spines long, recurved. Pygidium with wide axis, slightly tapered to broad end, axial segments 3 or 4, terminal merging into steep posterior slope, each ring with low axial node or spine, terminal axial spine may be present; pleurae 3 or 4, broad, faintly defined, with node or short spine where curvature steepens, border furrow shallow, border rimlike (258). *Up.L.Ord.*, N.Am.-Arg.-Ire.-Austral.-Tasm.—FIG. 218,7. *C. gena-*

cinaca Ross, Utah; *7a-c*, cran., dorsal, front, profile, $\times 10$; *7d*, librigena, $\times 6$; *7e-g*, pyg., dorsal, back, profile, $\times 10$ (258).

Dartonaspis B. M. MILLER, 1936 [**D. knighti*] [= *Schmidtaspis* KOBAYASHI, 1944]. Glabella broadly quadrate, sides parallel to rounded front or diverging slightly to expanded front, with 2 or 3 pairs of lateral furrows, faint exteriorly, posterior pair strong interiorly, may meet at mid-length; no preglabellar field, anterior border furrow faint or obsolete, anterior border a narrow rectangle in front of glabella; eyes extending nearly full length of glabella; fixigenae downsloping, with palpebral areas about 0.3 of glabellar width; librigenae with narrow eye platforms and short to medium diverging genal spines. Pygidium with wide axis, tapered throughout to broad end, with 3 or 4 axial rings; 3 broad pleurae; narrow border furrow and border (150, 239). *U.Cam.(Francon.)*, N.Am.-Arct.Asia.—FIG. 218,4. **D. knighti*, Wyo.; *4a-c*, cran. (with librigena), dorsal, profile, front, $\times 2$; *4d-f*, pyg., dorsal, profile, back, $\times 2$ (150, 239).

Goniophrys Ross, 1951 [**G. prima*]. Glabella convex, tapering, no lateral furrows; preglabellar field narrow or absent, anterior border furrow distinct; eyes large, strongly bowed, with point of flexure anterior to center of glabella; fixigenae downsloping, with palpebral areas 0.7 of glabellar width; librigenae with very narrow eye platforms and long curved genal spines. Thorax with wide convex axis; pleurae low, 0.5 of width of axis. Pygidium with wide axis, tapered nearly full length to narrow end, 3 axial rings; 3 broad faint pleurae, faint border furrow, rimlike border (258). *L.Ord.*, W.N.Am.—FIG. 218,5. **G. prima*, Utah; *5a-c*, cran. (with librigena), dorsal, front, profile, $\times 6$; *5d-f*, pyg., dorsal, back, profile, $\times 6$ (258).

Irvingella ULRICH & RESSER in WALCOTT, 1924 [**I. major*] [= *Irvingellina*, *Parairvingella* KOBAYASHI, 1938]. Glabella convex, subquadrate, tapering, with 2 or 3 pairs of lateral furrows, posterior pair complete; preglabellar field narrow or absent, anterior border furrow faint or obsolete; eyes large, bowed, with point of flexure near center of glabella; fixigenae downsloping, with palpebral areas 0.5 or more of glabellar width; librigenae with eye platforms narrow anteriorly, wider posteriorly, genal spines of medium size. Pygidium subrectangular, with axis tapered nearly full length to rounded end, 2 axial rings and terminal; no pleurae, faint border furrow, rimlike border, commonly sinuous (48, 239, 335). *U.Cam.(Francon.)*, N.Am.-S.Am.-W.Eu.-Arct.Asia-E.Asia-C.Asia.—FIG. 218,2. **I. major*, Wis.; *2a,b*, cran. (with librigena), dorsal, profile, $\times 1$; *2c,d*, pyg., dorsal, profile, $\times 3$ (48, 363).

Irvingelloides KOBAYASHI, 1935 [**Irvingella?* *orientalis* KOBAYASHI, 1934]. *L.Ord.*, Korea.

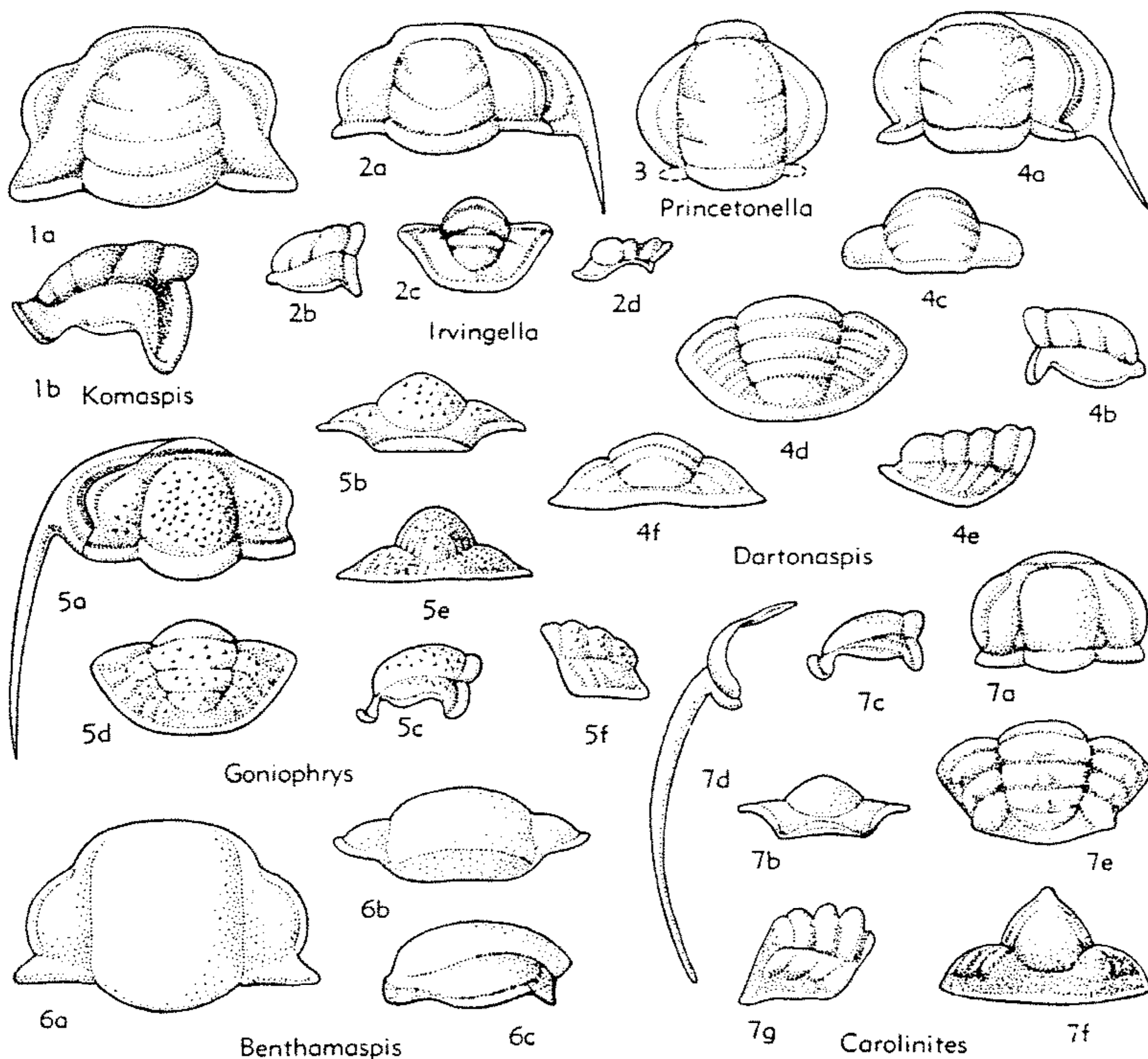

FIG. 218. Komaspididae (p. 0295-0296).

Princetonella LOCHMAN, 1953 [*pro Calyptomma* RESSER, 1942 (*non* TATTERSALL, 1909)] [**Calyptomma typicale* RESSER, 1942]. Glabella convex, subquadrate, sides parallel to rounded corners, with 2 pairs of faint lateral furrows; no preglabellar field, anterior border furrow running into preglabellar furrow, anterior border a rectangle shorter (*tr.*) than width of glabella; eyes same length as glabella; fixigenae horizontal, with palpebral areas 0.3 or less of glabellar width (239). *U.Cam.* (*Francon.*), W.N.Am.—FIG. 218,3. **P. typicalis* (RESSER), Mont.; cran., $\times 4$ (239).

Family ELVINIIDAE Kobayashi, 1935

[*nom. transl. & correct.* HENNINGSMOEN, 1951 (*ex Elvininae* KOBAYASHI, 1935)]

Exoskeleton opisthoparian, subisopygous. Glabella broad subquadrate to quadrate, with 3 pairs of strong to faint lateral furrows; preglabellar field and anterior border

furrow present or absent; palpebral lobes wide, palpebral furrows and eye ridges usually prominent; eyes above medium size, 0.5 to 0.7 of length of glabella; fixigenae horizontal or downsloping; librigenae with wide eye platforms and short genal spines. Thorax unknown. Pygidium subtriangular to transverse, axis and pleural fields about same in width, axis tapered slightly to broadly rounded end, length variable; border furrow distinct, border narrow, commonly rimlike. Surface smooth or granulate. Derived from Ptychopariidae (same ancestor as for Komaspididae). *U.Cam.*

Elvinia WALCOTT, 1924 [**Dikelocephalus roemeri* SHUMARD, 1861] [= *Moosia* WALCOTT, 1925]. Glabella broad subquadrate, sides tapered to semi-straight front, posterior pair of lateral furrows

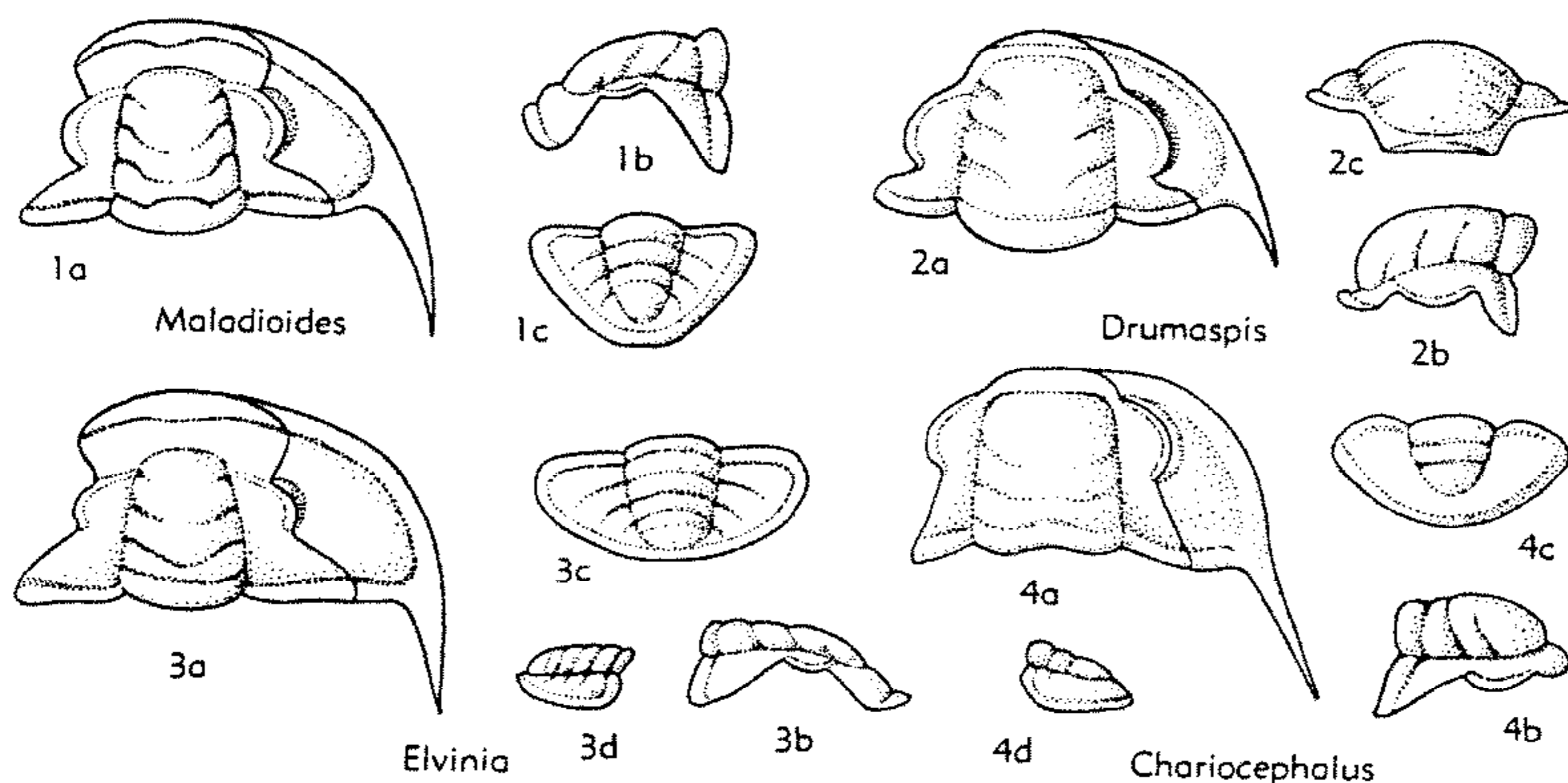

FIG. 219. Elviniidae (0296-0297).

complete; eyes anterior to center of glabella; fixigenae slightly downsloping, with palpebral areas 0.5 of glabellar width, posterior area straplike, long (*tr.*). Pygidium transverse, with axis slightly tapered to broadly rounded end, nearly full length, 3 or 4 axial rings; 3 low broad pleurae, narrow rimlike border (15). *U.Cam.(Francon.)*, N.Am.-S.Am.—FIG. 219.3. **E. roemeri* (SHUMARD), Tex.; 3*a,b*, cran., dorsal (with librigena), profile, $\times 0.7$; 3*c,d*, pyg., dorsal, profile, $\times 0.7$ (15).

Chariocephalus HALL, 1863 [**C. whitfieldi*]. Glabella large, quadrate, anterior corners rounded, front straight, lateral furrows faint; preglabellar field absent, anterior border furrow obsolete; eye ridges faint to obsolete, eyes opposite anterior 0.3 of glabella with anterior ends even with front of glabella; fixigenae slightly downsloping, with palpebral areas 0.3 of glabellar width, posterior area a steep convex, short (*tr.*) triangle; librigenae with eye platforms tapered to zero anteriorly. Pygidium transverse, axis with rounded end, 0.7 length of pygidium, with 2 axial rings; furrows obsolete on pleural fields, border furrow obsolete, narrow border steep to vertical (8, 53). *U.Cam.(Francon.)*, Wis.—FIG. 219.4. **C. whitfieldi*; 4*a,b*, cran., dorsal (with librigena), profile, $\times 4$; 4*c,d*, pyg., dorsal, profile, $\times 4$ (8).

Drumaspis RESSER, 1942 [**D. walcotti*]. Glabella subquadrate, sides tapered slightly, front straight, posterior pair of lateral furrows may be complete; narrow preglabellar field may be present; eyes opposite or slightly anterior to center of glabella; fixigenae downsloping, with palpebral areas about 0.3 of glabellar width, posterior area straplike, short (*tr.*); librigenae with eye platforms narrow anteriorly. Pygidium unknown

(239). *U.Cam.(Francon.)*, W.USA-C.USA.—FIG. 219.2. **D. walcotti*, Idaho; 2*a-c*, cran., dorsal (with librigena), profile, front, $\times 4$ (239).

Maladioides KOBAYASHI, 1933 [**M. asiaticus*]. Glabella broad, subquadrate, sides tapered to rounded front, posterior pair of lateral furrows long, arcuate; eyes opposite or slightly anterior to center of glabella; fixigenae horizontal, with palpebral areas less than 0.5 of glabellar width, posterior area straplike, medium in length (*tr.*). Pygidium subtriangular, with axis tapered nearly full length, 3 axial rings; 3 broad, poorly defined pleurae; border furrow and border narrow (95). *Low.U.Cam.(Changshan.)*, E.Asia.—FIG. 219.1. **M. asiaticus*, S.Manch.(Liaotung Pen.); 1*a,b*, cran., dorsal (with librigena), profile, $\times 2$; 1*c*, pyg., $\times 2$ (95).

Taishania SUN, 1935 [**T. taianensis*]. *Low.U.Cam.(Changshan.)*, China (Shantung).

Family TELEPHINIDAE Marek, 1952

[=Telephidae ANGELIN, 1854] [Family name based on *Telephus* BARRANDE, 1852 (non GISTEL, 1848) is not permissible.]

Exoskeleton elongate elliptical in outline except for projecting genal spines, micro-pygous. Cephalon convex, wider than long; convex glabella narrowing forward; posterior glabellar furrows may be represented by short longitudinal depressions and anterior pair of furrows by smooth area; pair of spines may occur on frontal lobe; occipital ring convex, commonly with backwardly directed median spine; convex eye surfaces forming large part of librigenae, long and curved, with many tiny facets, en-

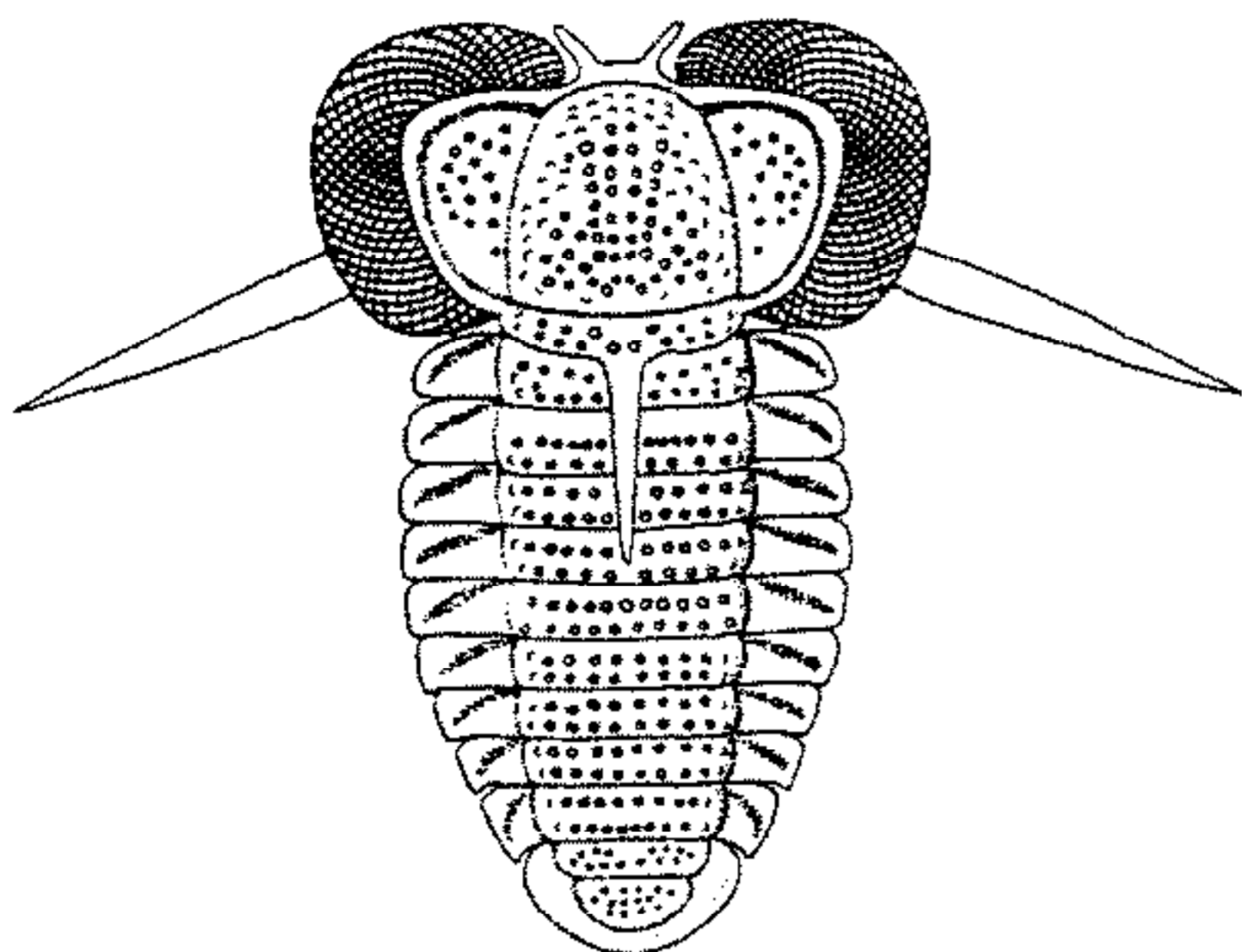

FIG. 220. *Telephina spinifera* WHITTINGTON (Telephinidae), M.Ord., Va.-Tenn.; exoskel. (reconstr.), $\times 2.5$ (496n).

closing crescentic palpebral lobe with prominent ring; narrow cephalic border outside eye lobes and extended anteriorly; short, forward and slightly downwardly directed pair of spines on anterior border; long slim genal spines, with or without a short spine behind the genals; narrow (*exsag.*) posterior border, cut by outward and backwardly directed posterior sections of facial sutures. Thorax (known in one species only) of 9 segments, with wide axis, narrow (*tr.*) pleurae, and broad diagonal pleural furrows. Pygidium small, semicircular in outline; convex, axis with 2 or 3 rings that may bear paired spines; pleural fields narrow, unfurrowed; terminal axial spine may be present. Surface tuberculate, with pattern of anastomosing raised lines (302). *M.Ord.-U.Ord.*

Telephina MAREK, 1952 [*pro Telephus* BARRANDE, 1852 (*non Telephus* GISTEL, 1848)] [**Telephus fractus* BARRANDE, 1852]. Characters of family. *M.Ord.-U.Ord.*, E.N.Am.-W.Eu.-Austral. — FIG. 220. *T. spinifera* (ULRICH), M.Ord., Va.-Tenn.; exoskel. (reconstr.), $\times 2.5$ (496n).

Family GLAPHURIDAE Hupé, 1953

Exoskeleton subelliptical in outline, opisthoparian, micropygous. Cephalon rather strongly convex, wider than long (*sag.*); glabella semielliptical to nearly semicircular in outline, posterior part bearing pair of short, rather deeply indented longitudinal glabellar furrows; preglabellar field present or absent; librigenae may bear slender, out-

wardly directed genal spines; occipital ring distinct. Thorax with 10 segments (*Glaphurus*). Pygidium small, with distinct but short, tapering axis. Surface tuberculate. *M.Ord.*

Glaphurus RAYMOND, 1905 [**Arionellus pustulatus* WALCOTT, 1877]. Glabella evenly rounded in front, separated from anterior margin by wide (*sag.*) preglabellar field, anterior border furrow, and convex border, with 2 pairs of glabellar furrows, anterior pair short and obliquely transverse, posterior pair gently arcuate and longitudinal; fixigenae wide (*tr.*), convex, sloping downward, palpebral lobes small but prominent, anterior sections of facial sutures converging slightly forward, posterior sections strongly diverging to margins just behind genal spines; librigenae subtriangular in shape, downsloping, with outwardly directed slender genal spines at posterior extremities; cephalic border convex, margin spinose. Hypostoma shield-shaped, with convex lateral and posterior borders, convex middle body, and crescentic posterior lobe. Thorax with 10 segments; pleurae relatively wide (*tr.*), anterior ones with spinose terminations. Pygidium small; axis convex, with 2 rings and terminal; pleural fields with single pair of anterolateral pleural furrows. Surface tuberculate and bearing short spines, glabella with prominent but low paired spines (79, 302). *M.Ord.*, E.USA (Vt.-Va.-Ala.). — FIG. 221, 1. **G. pustulatus* (WALCOTT), Chazy, Vt.; 1a, exoskel. (reconstr.), $\times 6$; 1b, ceph., profile, $\times 6$ (496n).

Glaphurina ULRICH, 1930 [**G. lamottensis*]. Only cranidium known, like *Glaphurus*, but lacking deep anterior glabellar furrows and preglabellar field, anterior cephalic border not spinose, external surface with smaller, low tubercles (302). *M.Ord.*, E.USA (Vt.-Va.-Tenn.)-E.Can. (Mingan I.). — FIG. 221, 2. **G. lamottensis*, Chazy, Vt.; cran., $\times 3$ (302*).

Superfamily RAYMONDINACEA Clark, 1924

[*nom. transl.* LOCHMAN-BALK, herein (*ex Raymondinacae* CLARK, 1924)]

Exoskeleton typically opisthoparian, elliptical, heteropygous. Facial sutures with posterior sections running beyond lateral border furrow before turning backward to cut posterior margins, extending straight outward or curving forward, with tendency to approach anterior sections with which fusion may occur; anterior sections converging, straight, or diverging widely forward; glabella tapering to quadrate, front rounded or straight, lateral furrows present or absent, preglabellar field present or absent; eye ridges and occipital spine may be pres-

ent, eyes medium in size to small, position variable; fixigenae with palpebral areas variable in width, posterior areas long (*tr.*), commonly subrectangular to quadrate in shape; librigenae with medium to short genal spines or blunt genal angles. Thorax with 7 or fewer segments; axis narrower than blunt-ended pleurae. Pygidium transverse, ovate or semicircular, axis tapering nearly full length, narrower than pleural fields, with all furrows commonly well defined. Surface smooth or granulose. Polyphyletic derivation. *U.Cam.*

Family RAYMONDINIDAE Clark, 1924

[*nom. transl.* LOCHMAN-BALK, herein (*ex Raymondininae* CLARK, 1924)]

Characters of superfamily. *U.Cam.*

Subfamily RAYMONDININAE Clark, 1924

[=Pilgrimiidae HUPÉ, 1953]

Glabella narrowly tapering to subquadrate, with 2 or 3 pairs of short lateral furrows; preglabellar field present or absent; eyes below medium size to small, anterior to center of glabella; fixigenae horizontal, with palpebral areas 0.3 to 0.75 of

glabellar width, posterior areas widening or narrowing (*sag.*) outward; librigenae with genal spines or blunt genal angles. Thorax unknown. *U.Cam.*

Raymondina T. H. CLARK, 1924 [**R. respecta*] [=Raymondia KOBAYASHI, 1935]. Strongly convex, subquadrate glabella with broadly rounded front, 2 pairs of faint lateral furrows, posterior pair appearing in some as 2 connected pits; anterior border furrow may be very faint; eyes below medium size; fixigenae with palpebral areas 0.2 of glabellar width; librigenae narrow, genal angles narrow. Thorax and pygidium unknown (188, 192). *U.Cam.* (*Trempeal.*), E.Can.—FIG. 222.5. **R. respecta*, Que.; 5a,b, cran., dorsal (with librigena), profile, X4 (188, 192).

Amquia RASETTI, 1946 [**A. truncata*]. Narrowly tapering glabella without lateral furrows; anterior border furrow deep, anterior border modified; eye ridges distinct; fixigenae with palpebral areas more than 0.7 of glabellar width; librigenae narrow elongate, with bluntly pointed genal angles. Thorax and pygidium unknown (193). *U.Cam.* (*Dresbach.*), E.Can.—FIG. 222.9. **A. truncata*, Que.; 9a,b, cran., dorsal (with librigena), profile, X8 (193).

Brassicicephalus LOCHMAN, 1940 [**B. pulchellus*]. Subquadrate glabella with rounded front; pre-

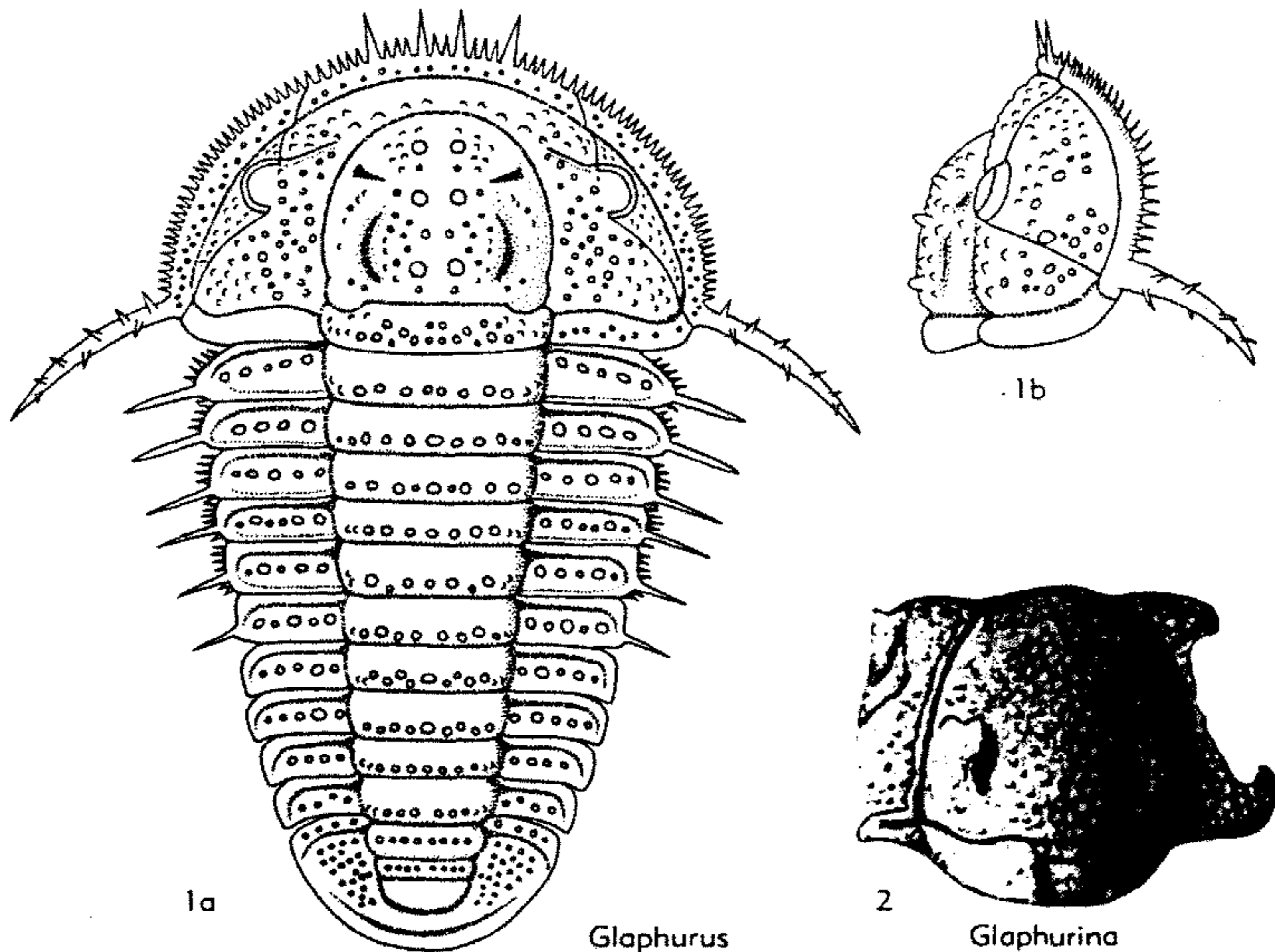

FIG. 221. Glaphuridae (p. 0298).

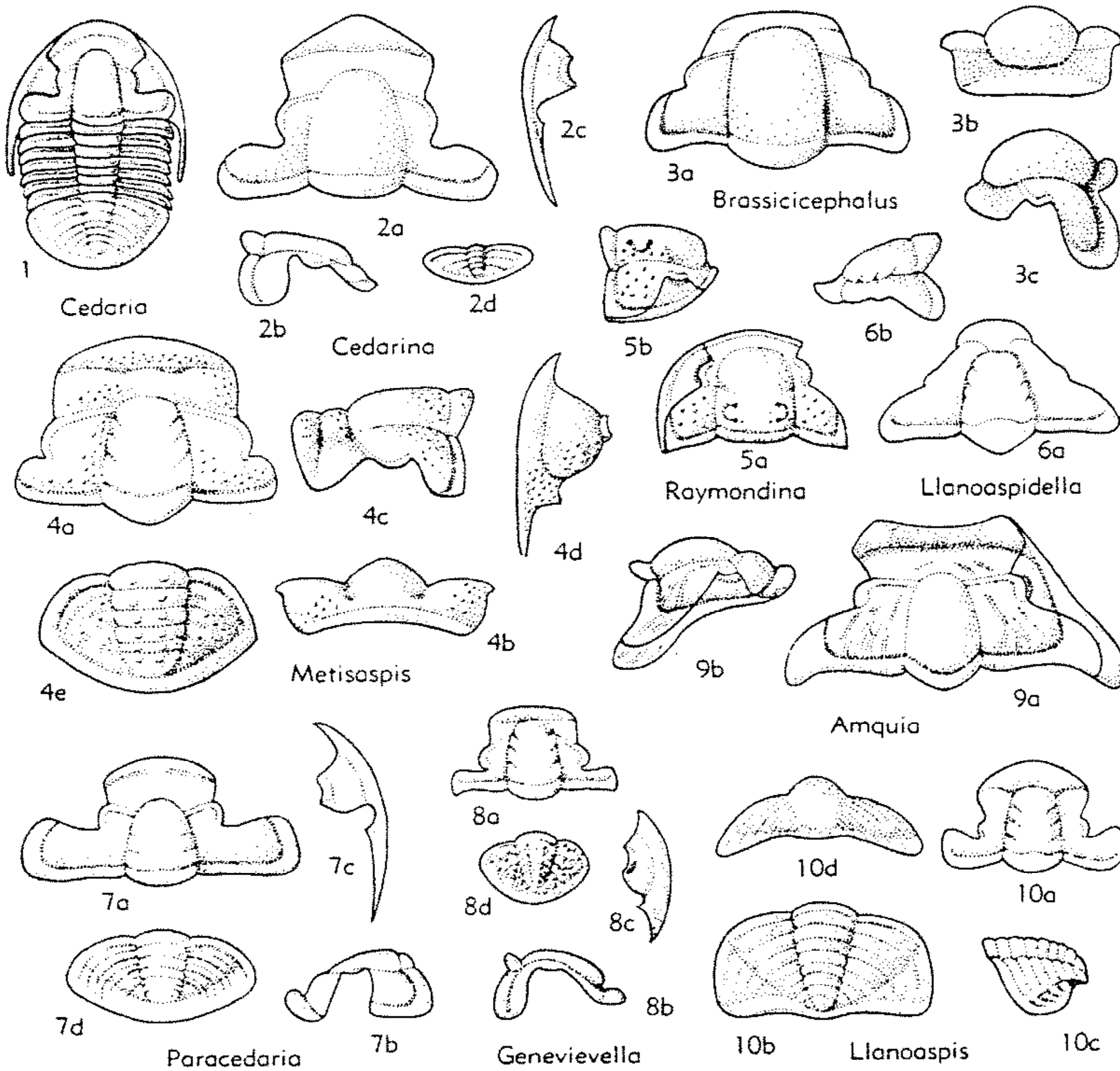

FIG. 222. Raymondinidae (p. O299-O301).

glabellar field very narrow or absent, anterior border furrow faint or obsolete; eye ridges narrow; fixigenae with palpebral areas 0.5 to 0.75 of glabellar width; librigenae, thorax and pygidium unknown (132). *U.Cam.(Dresbach.)*, N. Am.—FIG. 222,3. **B. pulchellus*, Mo.; 3a-c, cran., dorsal, front, profile, X6 (132).

Llanoaspidella TASCH, 1951 [**L. warriorsmarkensis*]. Tapering glabella, front nearly straight, with 3 pairs of short lateral furrows; preglabellar field interrupted at mid-length (*sag.*) by extension of anterior border, anterior border furrow broken and curved back to preglabellar furrow; eyes small; fixigenae with palpebral areas more than 0.5 of glabellar width, posterior areas subtriangular. Librigenae, thorax, and pygidium unknown (291). *U.Cam.(Dresbach.)*, E.U.S.A.—

FIG. 222,6. **L. warriorsmarkensis*, Pa.; 6a,b, cran., dorsal, profile, X2.75 (291).

Paracedaria DUNCAN in LOCHMAN & DUNCAN [*pro Pilgrimia* DUNCAN, 1944 (*non* OSBORN, 1925)] [**Pilgrimia montanensis* DUNCAN in LOCHMAN & DUNCAN, 1944]. Tapering glabella, front narrowly rounded, with 2 pairs of faint lateral furrows; eye ridges distinct; fixigenae with palpebral areas 0.5 of glabellar width; librigenae narrow, with long genal spines. Pygidium broadly transverse, axis tapered to rounded end, 5 or 6 axial rings, 4 pleurae, pleural furrows and interpleural grooves turning sharply back at faint border furrow and continuing onto border (132). *U.Cam.(Dresbach.)*, W.U.S.A.—FIG. 222,7. **P. montanensis* (DUNCAN), Mont.; 7a,b, cran., dorsal, profile, X2; 7c, librigena, 7d, pyg., X3 (132).

Subfamily CEDARIINAE Raymond, 1937

[*nom. transl.* LOCHMAN-BALK, 1953 (*ex* Cedariidae RAYMOND, 1937)]

Tapering glabella with 3 pairs of faint or obsolete lateral furrows; preglabellar field present; eyes of medium size, opposite or very slightly anterior to center of glabella; fixigenae horizontal, with palpebral areas about 0.3 of glabellar width, posterior areas widening (*sag.*) outward; librigenae with medium-length genal spines. Thorax of 7 segments. *U.Cam.*

Cedaria WALCOTT, 1924 [**C. prolifica*]. Facial sutures with anterior and posterior sections tending to approach each other so as to meet and fuse below eyes; no glabellar furrows. Pygidium semicircular, with long, low, tapered axis, 5 or 6 axial rings, 4 or 5 pleurae, and shallow border furrow (321). *U.Cam.*(*Dresbach.*), N.Am.—FIG. 222.1. **C. prolifica*, Ala.; exoskel., $\times 1$ (321).

Cedarina LOCHMAN, 1940 [**C. vale*]. Facial sutures with anterior sections diverging only slightly; glabella smooth or with 3 pairs of very faint lateral furrows. Pygidium narrowly transverse; axis tapered, with 2 to 5 axial rings; 3 pleurae; narrow border furrow, border may have pair of small anterior marginal spines (132). *U.Cam.*(*Dresbach.*), N.Am.—FIG. 222.2. **C. vale*, Mo.; 2*a,b*, cran., dorsal, profile; 2*c*, librigena; 2*d*, pyg.; all $\times 3$ (132).

Subfamily LLANOASPIDINAE Lochman, 1944

[*nom. correct.* LOCHMAN-BALK, herein (*ex* Llanoaspidinae LOCHMAN, 1944)] [=Genevievellidae HUPÉ, 1953]

Glabella tapering to subquadrate, with 3 pairs of short lateral furrows; preglabellar field present or absent; eyes below medium size, posterior to center of glabella; fixigenae upsloping, with palpebral areas 0.5 of glabellar width to equal, posterior areas may widen (*sag.*) outward; librigenae with short genal spines. Thorax unknown. *U.Cam.*

Llanoaspis LOCHMAN, 1938 [**L. modesta*]. [=Rogersvillia HUPÉ, 1955]. Tapering to subquadrate glabella, front flatly rounded; no preglabellar field, anterior border furrow running straight into or curving back to axial furrows, anterior border may undulate; eye ridges faint; fixigenae with palpebral areas 0.5 to 0.7 of glabellar width. Pygidium broadly transverse, with 6 to 8 axial rings and 6 pleurae, interpleural grooves curving back across faint border furrow on to border, posterior margin sinuous (132). *U.Cam.*(*Dresbach.*), N.Am.—FIG. 222.10. **L. modesta*, Tex.; 10*a*, cran.; 10*b-d*, pyg., dorsal, profile, back; all $\times 3$ (132).

Arcuolimbus PALMER, 1954 [**A. convexus*]. Tapering glabella with front broadly rounded; preglabellar

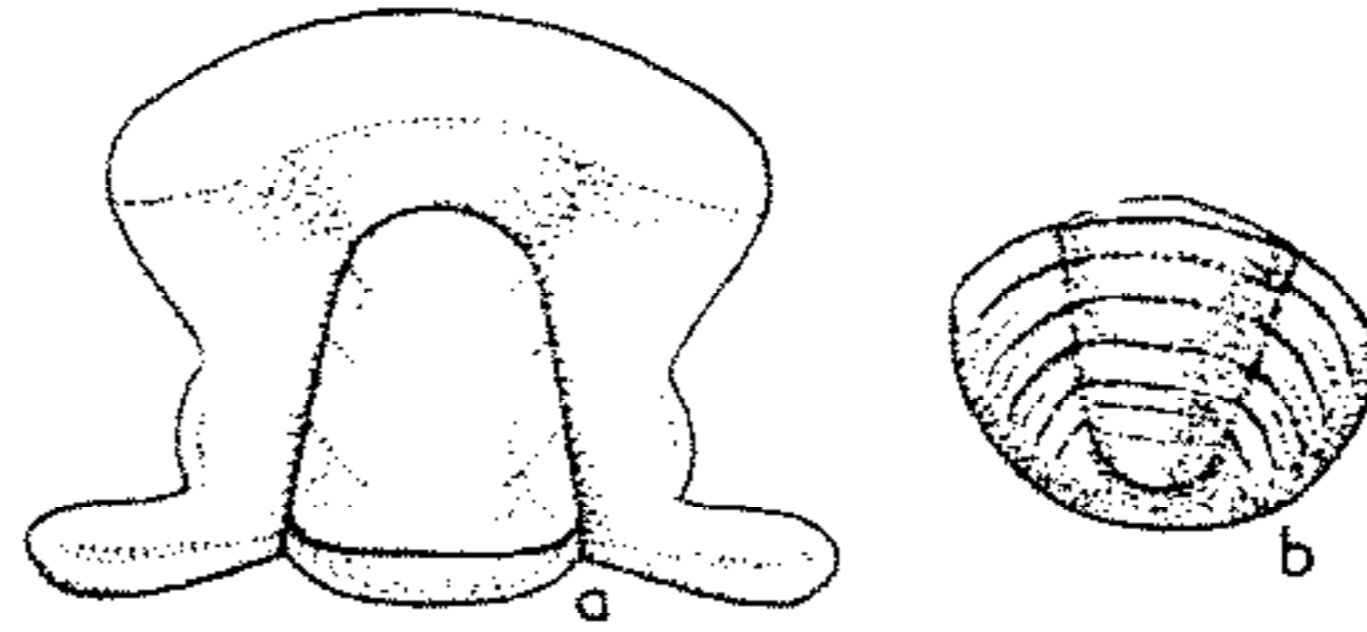

FIG. 223 **Arcuolimbus convexus* PALMER (Cedariidae), *U.Cam.*(*Dresbach.*), Tex.; *a,b*, cran., pyg., $\times 4$ (440).

lar field present, anterior border furrow narrow and sinuous; eye ridges faint; fixigenae with palpebral areas more than 0.3 of glabellar width, posterior areas narrow (*exsag.*), medium in length (*tr.*). Pygidium nearly circular, strongly convex; with 6 axial rings and terminal; pleural fields steeply sloping, with 5 pleurae, shallow pleural furrows; no border furrow, posterior margin curving upward to median line. Surface smooth. *U.Cam.*(*Dresbach.*), C.USA.—FIG. 223. **A. convexus*, Tex.; *a,b*, cran., pyg., $\times 4$ (440).

Genevievella LOCHMAN, 1936 [**G. neunia*] [=Stenelymus RAYMOND, 1937]. Tapering glabella with broadly rounded front; preglabellar field narrow or absent, anterior border furrow broad; eye ridges distinct; fixigenae with palpebral areas about 0.5 of glabellar width. Pygidium semicircular; axis tapered to narrow end, with 4 to 6 axial rings; 4 or 5 pleurae, interpleural grooves curving back and fading out on border; no border furrow (123, 132). *U.Cam.*(*Dresbach.*), N.Am.—FIG. 222.8. **G. neunia*, Mo.; 8*a,b*, cran., dorsal, profile; 8*c*, librigena; 8*d*, pyg.; all $\times 3$ (123).

Metisaspis RASETTI, 1946 [**M. hispida*]. Low tapering glabella with truncate front; preglabellar field present; eye ridges distinct; fixigenae with palpebral areas same in width as glabella. Pygidium ovate; axis tapered slightly to rounded end, with 6 axial rings; 4 pleurae, interpleural grooves curving back to shallow border furrow; border narrow (193). *U.Cam.*(*Dresbach.*), E. Can.—FIG. 222.4. **M. hispida*, Que.; 4*a-c*, cran., dorsal, front, profile; 4*d*, librigena, 4*e*, pyg.; all $\times 2$ (193).

Superfamily NORWOODIACEA
Walcott, 1916

[*nom. transl.* LOCHMAN-BALK, herein (*ex* Norwoodidae WALCOTT, 1916)] [=Norwoodiidea RICHTER, 1933]

Exoskeleton proparian or gonatoparian, micropygous or heteropygous. Glabella mostly tapering forward, with or without lateral furrows; preglabellar field present, with or without boss in front of glabella; cephalic border distinct. Thorax varying

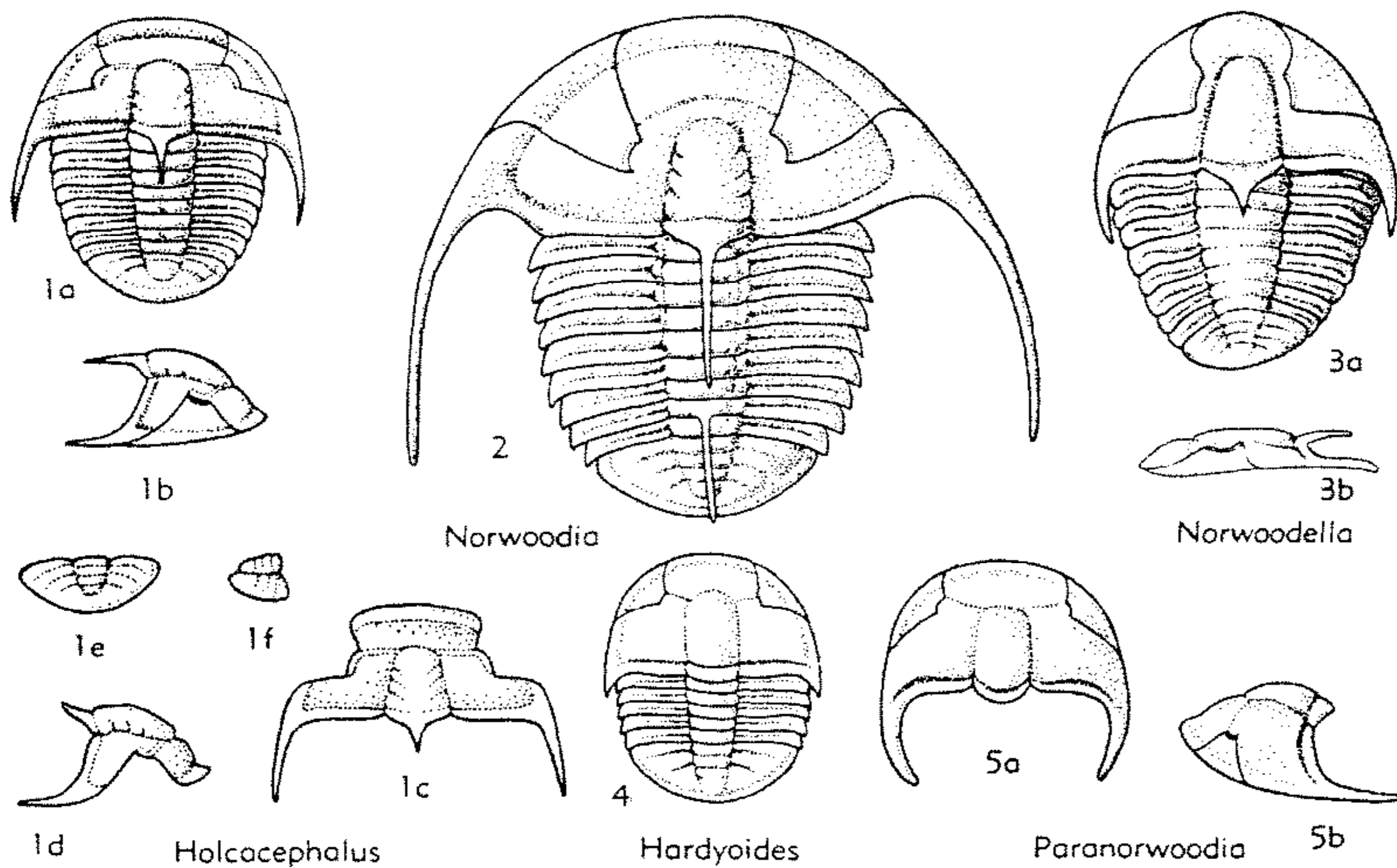

FIG. 224. Norwoodiidae (p. O302-O303).

widely in number of segments (5 to 42), axis subequal in width to pleurae or narrower. Pygidium transverse to subcircular, generally small. *M. Cam.-L. Ord.*

Family NORWOODIIDAE Walcott, 1916

[*nom. correct.* RICHTER, 1933 (*ex* Norwoodidae WALCOTT, 1916)]

Exoskeleton proparian, ovate, heteropygous. Glabella tapering to parallel-sided, lateral furrows present or absent; eye ridges and occipital spine may be present; eyes below medium size to small, opposite anterior part of glabella; fixigenae horizontal or slightly downsloping; librigenae triangular. Thorax with 5 to 9 segments, axis narrower than pleurae, pleural furrows distinct, axial nodes or spines commonly present. Pygidium transverse, with axis tapered nearly full length to rounded end, narrower than pleural fields, border narrow. Outer surface granulate or smooth. Polyphyletic derivation. *U. Cam.-L. Ord.*

Norwoodia WALCOTT, 1916 [**N. gracilis*] [= *Whitfieldina* RESSER, 1937]. Glabella with 3 pairs of short, faint lateral furrows, axial and occipital furrows distinct; preglabellar field long (*sag.*), anterior border furrow commonly broad, fixigenae with palpebral areas 0.5 of glabellar width, posterior areas very large, with long slender genal

spines. Thorax with 9 segments, some with axial spine. Pygidium small, with 3 axial rings and 3 pleurae, narrow border furrow and border (316). *U. Cam. (Dresbach.)*, N. Am.—FIG. 224, 2. **N. gracilis*, Ala.; exoskel., $\times 4$ (316).

Hardyoides KOBAYASHI, 1938 [**H. minor*] [= *Levisaspis* RASETTI, 1943]. Glabella parallel-sided or with sides diverging slightly to rounded front, lateral furrows short and faint, visible only on interior; anterior and lateral border furrows broad, very shallow; eye ridges faint, narrow; occipital node may be present; eyes very small, opposite front of glabella; fixigenae with palpebral areas 0.5 of glabellar width, posterior areas large, quadrate, with short, flat genal spines. Thorax with 5 segments. Pygidium narrow-transverse, 3 or 4 axial rings and pleurae, all furrows tending to obsolescence, border narrow (187). *L. Ord. (Tremadoc.)*, N. Am.—FIG. 224, 4. **H. typicalis* (RASETTI), Que.; exoskel., $\times 5$ (187).

Holcacephalus RESSER, 1938 [**H. granulatus*] [= *Norwoodina* LOCHMAN, 1940]. Glabella tapering, with 3 pairs of short deep lateral furrows, short occipital spine; eye ridges distinct, nearly straight, eyes opposite anterior 0.3 of glabella; fixigenae with palpebral areas as wide as glabella or wider, posterior areas rectangular, with genal spines of medium size. Thorax with 8 segments, bearing axial spines on 3, 5, and 7. Pygidium small, with 3 axial rings and 3 pleurae, border furrow faint, border narrow (126, 127). *U. Cam. (Dresbach.)*, N. Am.—FIG. 224, 1c-f. **H. granu-*

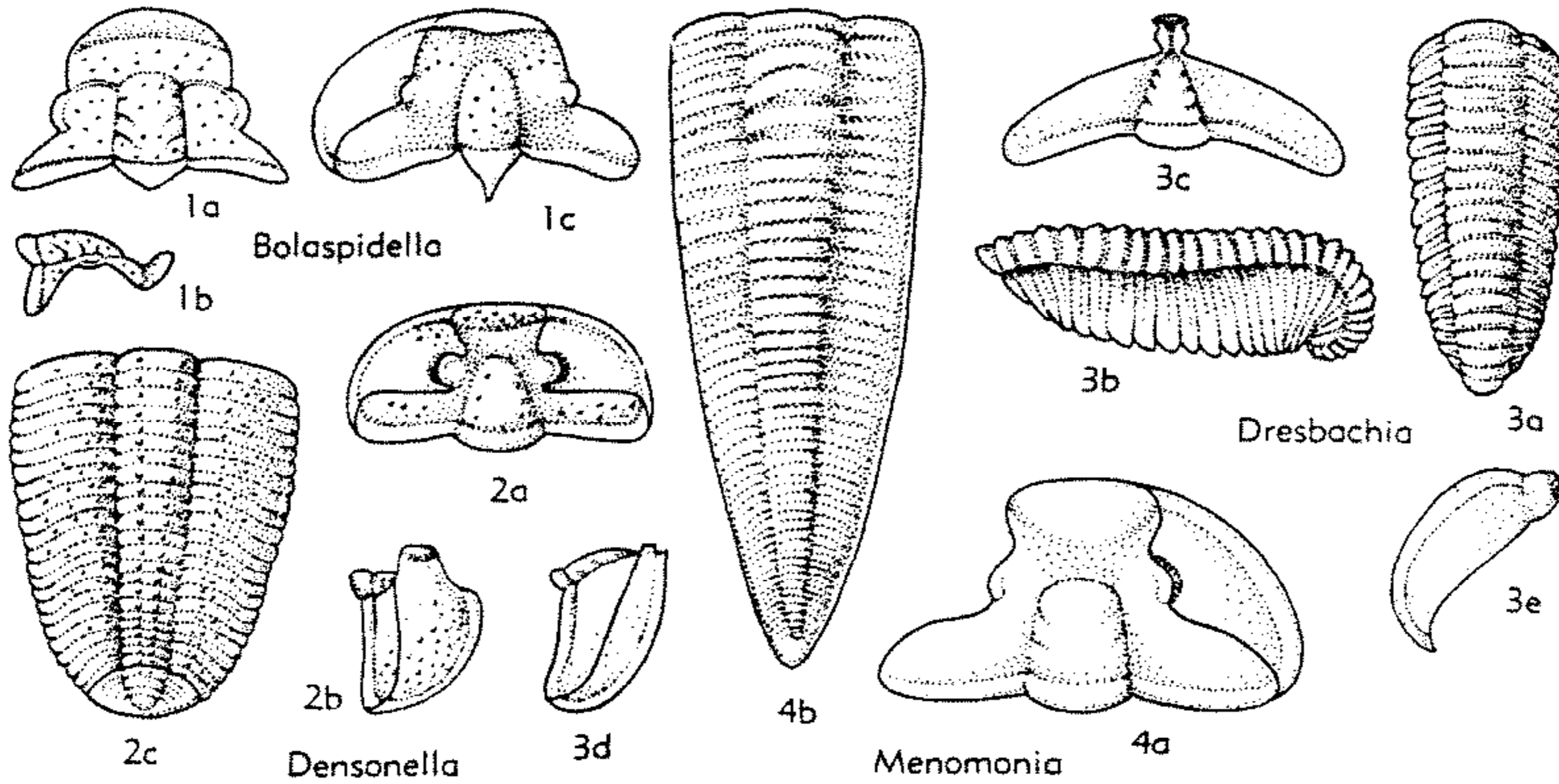

FIG. 225. Menomoniidae (p. 0303-0304).

latus, Tenn.; 1c,d, cran., dorsal, profile, $\times 6$; 1e,f, pyg., dorsal, profile, $\times 6$.—FIG. 224, 1a,b, *H. tenerus* (WALCOTT), Utah; 1a, exoskel., $\times 6$; 1b, ceph., profile, $\times 6$ (316).

Norwoodella RESSER, 1938 [**Norwoodia saffordi* WALCOTT, 1916]. Glabellar furrows, anterior and lateral border furrows obsolete on exterior, faint or obsolete on interior, all other furrows faint on exterior; frontal area about 0.3 of length of glabella; fixigenae with extremely narrow palpebral areas, posterior areas long (*tr.*) with stout medium-sized genal spines. Thorax with 8 segments. Pygidium very small, with 3 axial rings and 3 pleurae, border furrow obsolete, border very narrow (126). *U.Cam.*(*Dresbach.*), N.Am.—FIG. 224,3. **N. saffordi* (WALCOTT), Tenn.; 3a, exoskel., $\times 4$; 3b, cran., profile, $\times 4$ (235, 316).

Paranorwoodia RASETTI, 1945 [**P. venusta*]. Glabella parallel-sided to rounded front, without lateral furrows; axial, anterior and lateral border furrows shallow; no occipital spine; eye ridges faint, eyes very small, opposite front of glabella; fixigenae with palpebral areas wider than glabella, posterior areas large, subquadrate, with short, thick, curved genal spines. Pygidium unknown (189). *U.Cam.*(*Trempeal.*), E.Can.—FIG. 224,5. **P. venusta*, Que., 5a,b, ceph., dorsal, profile, $\times 6$ (189).

Family MENOMONIIDAE Walcott, 1916

[*nom. correct.* RICHTER, 1933 (*ex Menomonidae* WALCOTT, 1916)]

Exoskeleton micropygous, gonatoparian, elongate-elliptical. Facial sutures with anterior sections running straight forward or

diverging slightly, posterior sections cutting exactly through center of genal angles; glabella truncate-tapering to subtriangular, with 2 or 3 pairs of short lateral furrows; preglabellar field depressed, anterior border commonly upturned or rimlike, occipital spine may be present; eyes small, anterior to center of glabella, may be stalked; fixigenae upsloping to elevated, with palpebral areas of variable width, posterior areas of medium to great length (*tr.*); librigenae triangular to rectangular. Thorax with 42 or fewer segments, axis and pleurae subequal in width, pleurae blunt-ended. Pygidium subcircular, axis extending nearly full length with 1 to 3 axial rings; pleural regions slightly narrower, furrows faint. Surface granulate. Derived from Ptychopariidae. *M.Cam.-U.Cam.*

Menomononia WALCOTT, 1916 [**Conocephalites calymenoides* WHITFIELD, 1878]. Glabella truncate-tapering, with 2 pairs of lateral furrows; preglabellar field concave, anterior border wide, convex; eyes small, opposite front of glabella; fixigenae steeply upsloping, with palpebral areas 0.7 of glabellar width, posterior areas long (*tr.*); librigenae large, triangular. Thorax with 42 segments. Pygidium minute; axis convex, with 2 or 3 axial rings; pleural regions low, narrow (316). *U.Cam.*(*Dresbach.*), N.Am.—FIG. 225,4. **M. calymenoides* (WHITFIELD), Wis.; 4a, cran., dorsal (with librigena), $\times 2$; 4b, thorax and pyg.; $\times 2$ (316).

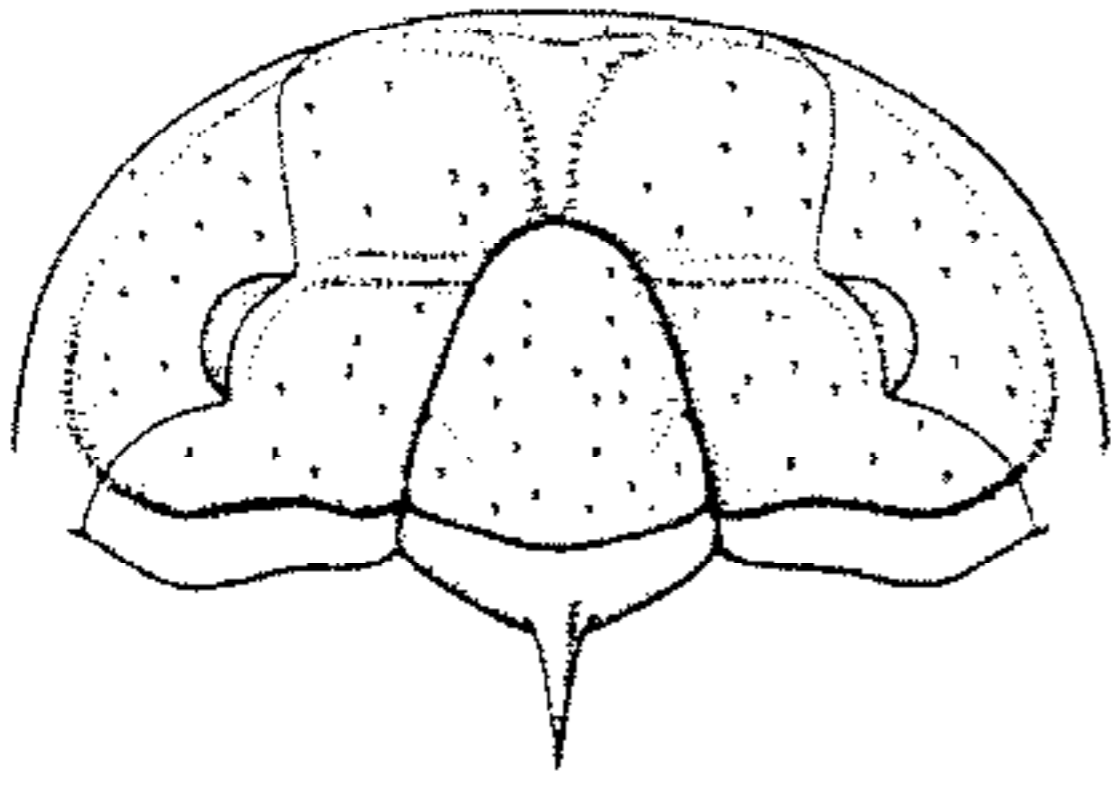

FIG. 226. **Deiracephalus aster* (WALCOTT) (Menomoniidae), *U.Cam.*(*Dresbach.*), Tenn.; ceph., $\times 4$ (488).

Bolaspidella RESSER, 1937 [**Ptychoparia housensis* WALCOTT, 1886] [= *Hysteropleura*, *Apedopyanus* RAYMOND, 1937; *Deltophthalmus* RESSER, 1938; *Deissella* HOWELL & DUNCAN, 1939; *Howellaspis* LOCHMAN & DENSON, 1944]. Glabella truncate tapering, lateral furrows strong to faint; preglabellar field horizontal, flat or slightly convex, anterior border strongly convex; eye ridges distinct to faint; occipital spine may be present; fixigenae steeply upsloping to elevated, so that eyes may appear stalked, with palpebral areas about same in width as glabella, posterior areas long; librigenae elongate triangular. Thorax with at least 15 segments. Pygidium very small, with 3 axial rings, 3 pleurae (132, 213). *Up.M.Cam.-Low.U.Cam.*(*Dresbach.*), N.Am.—FIG. 225,1a,b. *B. wellsvillensis* (LOCHMAN & DENSON), *Up.M.Cam.*, Utah; 1a,b, cran., dorsal, profile, $\times 4$ (132).—FIG. 225,1c. *B. macgerriglei* (RAYMOND), Vt.; cran. (with librigena), $\times 4$ (213).

Coenaspis RESSER, 1938 [**C. spectabilis*]. Glabella short, tapering, with 2 pairs of lateral furrows; preglabellar field depressed, anterior border furrow narrow, border narrow, rimlike; eyes small, anterior to center of glabella; occipital spine may be present; fixigenae steeply upsloping, eyes appearing stalked, with palpebral areas same in width as glabella, posterior areas wide, triangular, long (*tr.*); librigenae, thorax, and pygidium unknown. Surface with granules of 2 sizes (235). *U.Cam.*(*Dresbach.*), E.N.Am.

Deiracephalus RESSER, Feb. 1935 [**Acrocephalites? aster* WALCOTT, 1916] [= *Asteraspis* KOBAYASHI, Nov. 1935 (obj.)]. Glabella subtriangular, with 3 pairs of short lateral furrows; preglabellar field downsloping, with median ridge that interrupts anterior border furrow, anterior border rimlike; occipital spine present; eye ridges straight, eyes small, nearly opposite center of glabella; fixigenae upsloping, with palpebral areas 0.7 of glabellar width, posterior areas wide, triangular, long (*tr.*); librigenae triangular, lateral border furrow narrow, genal angles rounded. Thorax and pygidium unknown. Surface granulose (235). *U.Cam.*(*Dres-*

bach.), S.U.S.A.—FIG. 226. **D. aster* (WALCOTT), Tenn.; ceph., $\times 4$ (488).

Densonella SHAW, 1952 [*pro Millardia* WALCOTT, 1916 (*non* THOMAS, 1911)] [**Millardia semele* WALCOTT, 1916]. Glabella subtriangular, with 3 pairs of short lateral furrows; preglabellar field concave, anterior border upturned; eyes opposite front of glabella, fixigenae strongly elevated, so that eyes appear stalked, with palpebral areas about equal in width to glabella, posterior areas very long (*tr.*); librigenae rectangular. Thorax with 23 segments, pleurae slightly wider than axis. Pygidium small, with axis and pleural fields same in width, 2 or 3 axial rings (316). Surface granulose with longitudinal rows of granules on glabella and thoracic axis. *U.Cam.*(*Dresbach.*), N.Am.—FIG. 225,2. **D. semele* (WALCOTT), Utah; 2a,b, ceph., dorsal, profile, $\times 4$; 2c, thorax and pyg., $\times 4$ (316).

Dresbachia WALCOTT, 1916 [**D. amata*]. Glabella triangular, with 3 pairs of short diagonal lateral furrows; preglabellar field a very narrow (*tr.*) flat strip, anterior border a small rim; eyes in front of glabella opposite preglabellar field; fixigenae modified, with palpebral areas developed as vertical strips on each side of preglabellar field bearing horizontal palpebral lobes at top, posterior areas wide (*sag.*), very long (*tr.*), subrectangular; librigenae rectangular, with elevated eyes at inner angle. Thorax with about 32 segments, pleural furrows short. Pygidium minute (316). *U.Cam.*(*Dresbach.*), N.Am.—FIG. 225,3. **D. amata*, Wis.; 3a,b, thorax and pyg., dorsal, profile; 3c, cran.; 3d, ceph., profile; 3e, librigena; all $\times 3.5$ (316, 447).

Family BOLASPIDIDAE Howell, nov.

Preglabellar field wide (*sag.*), bearing a boss in front of glabella; glabella subtriangular or gently tapering, lateral furrows shallow or absent; border well developed, more or less thickened; palpebral lobes small; axial and occipital furrows distinct; occipital ring with or without a spine. *M.Cam.*

Bolaspis RESSER, 1935 [**Alokistocare? labrosum* WALCOTT, 1916]. Glabella subtriangular, bearing one or more pairs of lateral furrows; cranium bluntly subtriangular in outline, somewhat resembling *Acrocephalops* but anterior portion narrower; each fixigena wider than glabella; border thickened and prominent; occipital ring heavy, in some forms bearing a spine. Surface punctate or granulose. *M.Cam.*, NW.U.S.A.—FIG. 227,4. **B. labrosa* (WALCOTT), Meagher F., Mont.; cran., $\times 1.3$ (488).

Acrocephalops POULSEN, 1927 [**A. gibber*]. Glabella rather narrow, gently tapering; lateral

furrows present; each fixigena about as wide as glabella; cranidium bluntly subtriangular in form, anterior portion narrower than in the other genera of family except *Bolaspis*; border thickened, but not so much as in *Eldoradia*; no occipital spine. Surface granulose or lined. *M. Cam. Arct. N. Am.*—FIG. 227, 1. **A. gibber* POULSEN, Cape Wood F., N.W. Greenl.; cran., $\times 8$ (445).

Eldoradia RESSER, 1935 [**Ptychoparia? linnarssoni* WALCOTT, 1884]. Front half of cranidium more quadrate than in *Acrocephalops* and *Bolaspis*; each fixigena wider than glabella, which tapers gently and bears faint lateral furrows or none; border ill defined, anterior furrow faint; small palpebral lobes located about in line with front of glabella; no spine on occipital ring. Surface punctate. *M. Cam., W. USA.*—FIG. 227, 3. **E. linnarssoni* (WALCOTT), Eldorado F., Nev.; cran., $\times 3$ (457).

Rawlinsella SHAW, 1956 [**Acrocephalites? glomeratus* WALCOTT, 1916]. Glabella tapering slightly, bluntly rounded in front; axial furrows deep, with pits at anterolateral angles of glabella; each fixigena as wide as glabella; border widest in middle, tapering laterally. *M. Cam., W. USA.*—FIG. 227, 2. **R. glomerata* (WALCOTT), Buck Spring R., Wyo.; cran., $\times 2$ (488).

Superfamily MARJUMIACEA
Kobayashi, 1935

[*nom. transl.* LOCHMAN-BALK, herein (*ex Marjumidae* KOBAYASHI, 1935)]

Exoskeleton opisthoparian, medium-sized, ellipsoidal, mostly heteropygous (isopygous in *Coosellidae*). Glabella tapering forward or quadrate, with 2 or 3 pairs of lateral glabellar furrows; preglabellar field may be absent, anterior border furrow distinct, but variable in width and depth; librigenae generally bearing short to medium-length genal spines. Thorax containing up to 14 pleurae with blunt or somewhat falcate extremities, distinctly furrowed. Pygidium transverse, with axis extending nearly full length, border narrow or absent, border furrow narrow or obsolete. Surface smooth or finely granulose. *M. Cam.-L. Ord.*

Family MARJUMIIDAE Kobayashi, 1935

[*nom. correct.* HENNINGSMOEN, 1951 (*pro Marjumidae* KOBAYASHI, 1935)] [= *Punctulariidae* RAYMOND, 1937; *Talbotinidae*, HUPÉ, 1953]

Exoskeleton opisthoparian, elliptical, heteropygous. Glabella narrowly to broadly tapering forward, front rounded, lateral furrows present or absent, other furrows well defined; occipital spine may be pres-

ent; eye ridges commonly present, eyes medium in size, about opposite center of glabella; fixigenae horizontal, sloping slight-

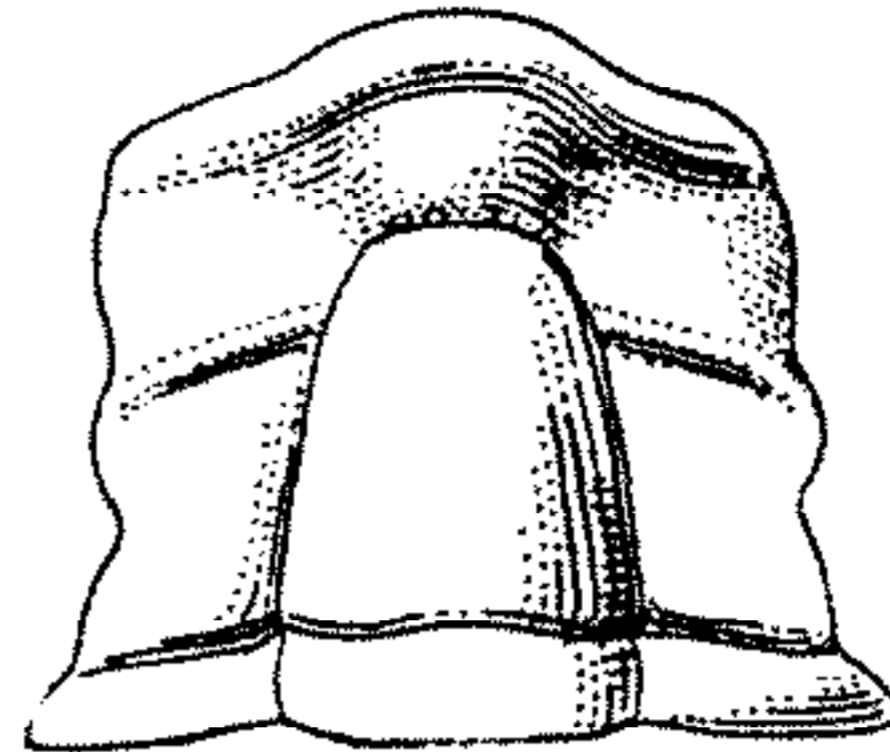

1 *Acrocephalops*

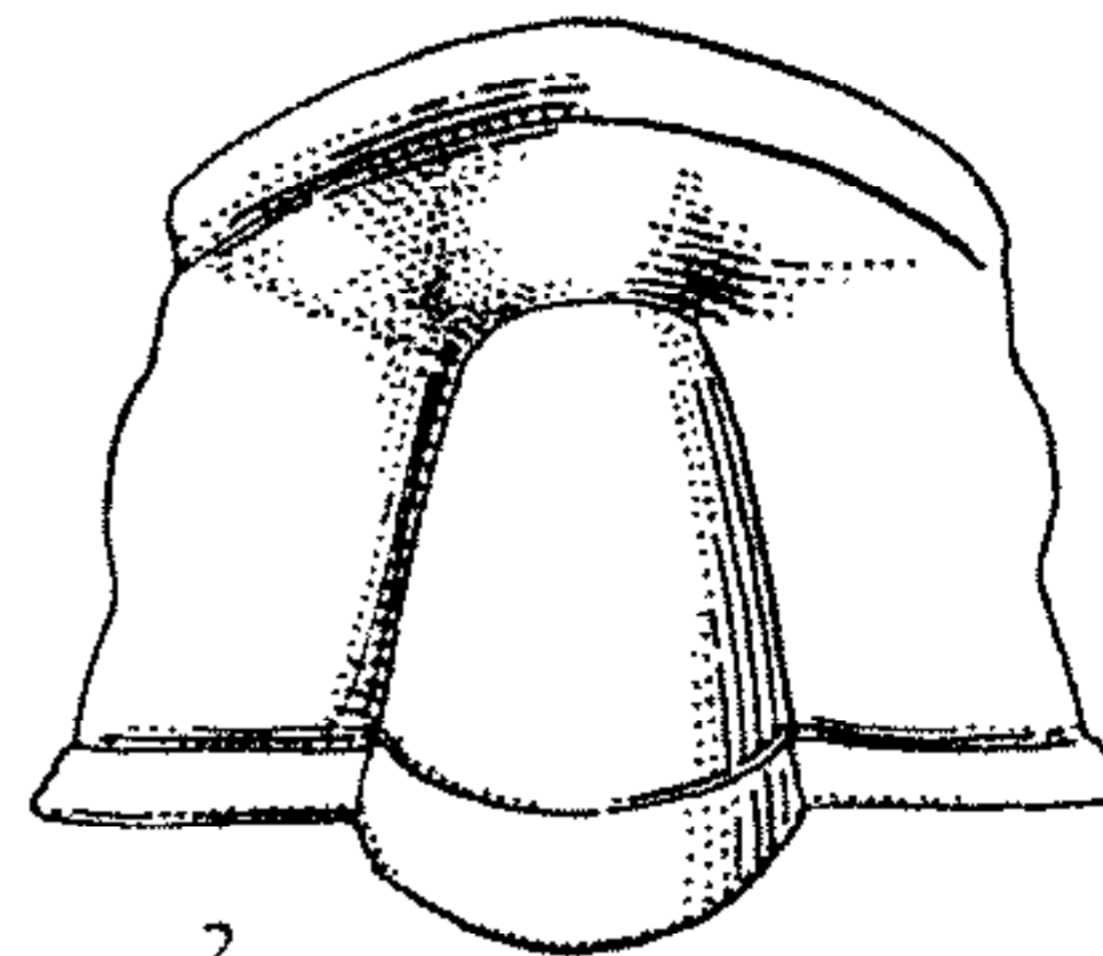

2 *Rawlinsella*

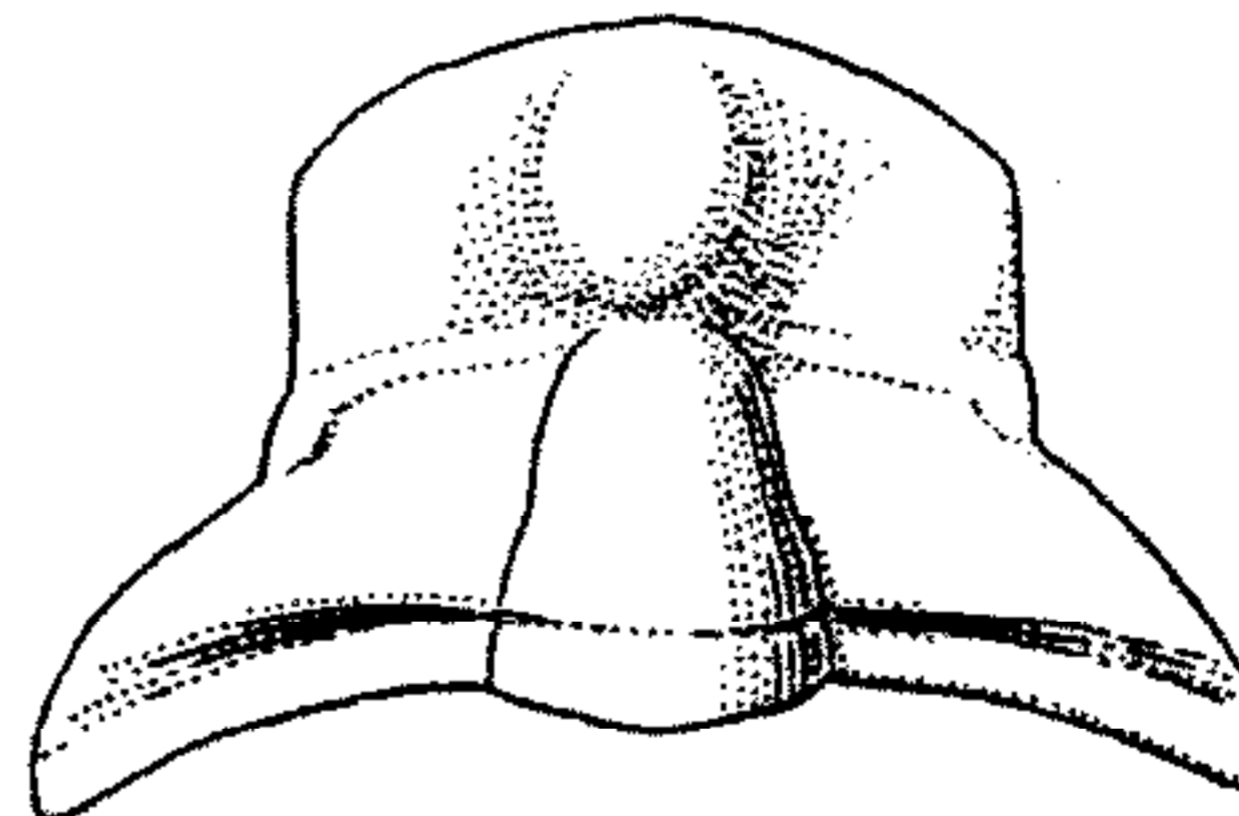

3 *Eldoradia*

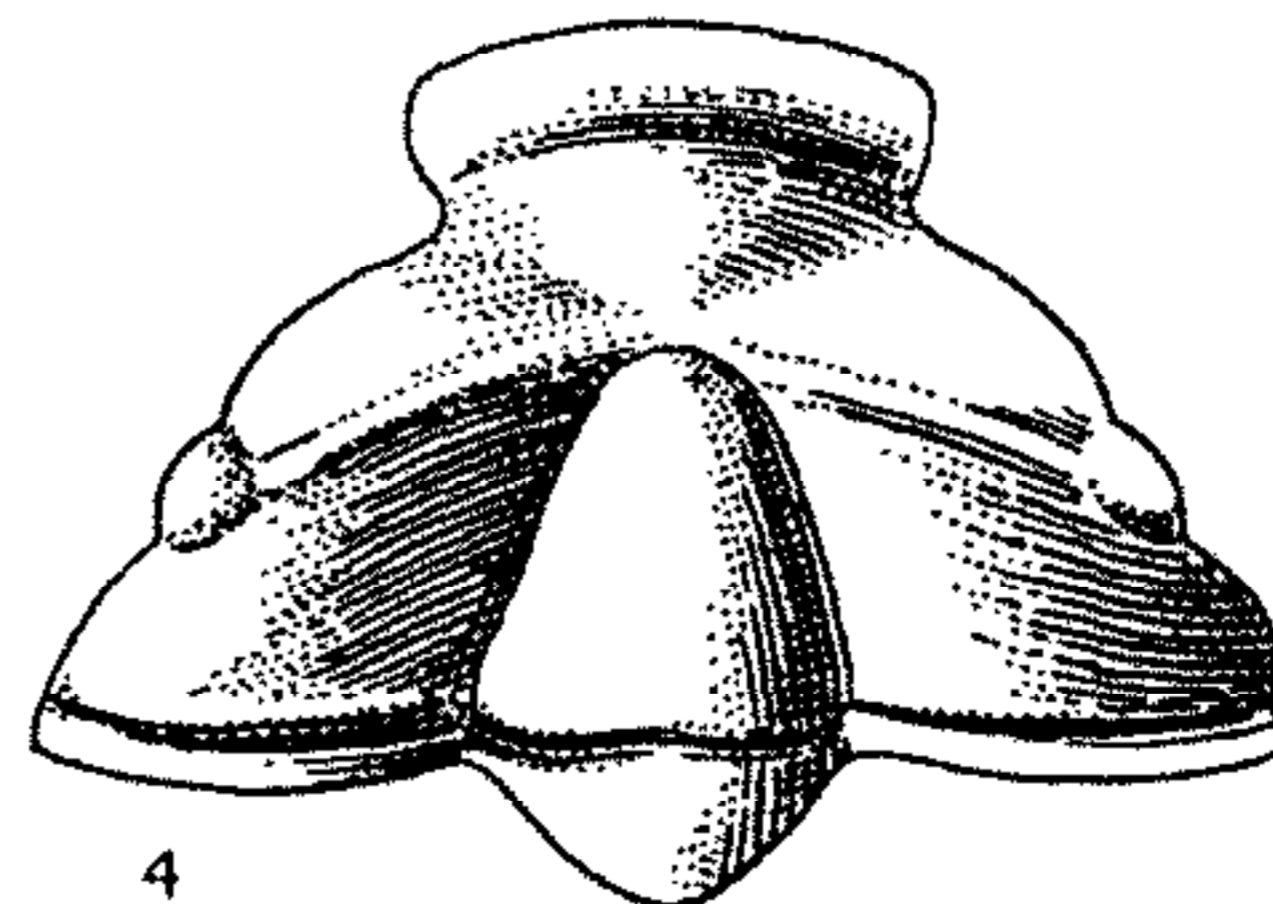

4 *Bolaspis*

FIG. 227. Bolaspididae (p. 0304-0305).

ly upward or downward, with palpebral areas 0.25 to 0.5 of glabellar width, posterior areas straplike; librigenae with medium to short genal spines. Thorax with 14 or fewer segments; axis convex, with one or more axial spines; pleurae wider and lower than axis, ends blunt or falcate. Pygidium transverse; axis convex, tapered nearly full length to broadly rounded end, may be wider or narrower than pleural fields, all furrows distinct except faint or obsolete border furrow; axial rings and pleurae 3 or 4; as many as 5 pairs of short marginal spines. Surface finely granulose, rarely punctate, inner surface commonly punctate, with or without prominent anastomosing venations on cephalon. Polyphyletic derivation from various genera of Ptychopariidae. *M.Cam.-U.Cam.*

Marjuria WALCOTT, 1916 [**M. typa*]. Glabella narrowly tapering, with 3 pairs of lateral furrows; eye ridges distinct; fixigenae with palpebral areas less than 0.5 of glabellar width, posterior areas long (*tr.*); librigenae with broad eye platforms and short, flat genal spines. Thorax with 14 segments, pleurae falcate. Pygidium with axis and pleural fields of same width, border very narrow, 1 to 4 pairs of marginal spines (317). *Up.M.Cam.*, N.Am.—FIG. 228,1. **M. typa*, Utah; exoskel. $\times 1$ (317).

Aposolenopleura RAYMOND, 1937 [**A. dunbari*] [= *Punctularia* RAYMOND, 1937]. Glabella convex tapering, with 2 or 3 pairs of short faint lateral furrows; preglabellar field may be very narrow; eye ridges faint; fixigenae with palpebral areas about 0.5 of glabellar width, posterior areas medium in length (*tr.*). Librigenae, thorax, and pygidium unknown (188, 189). *U.Cam.(Trempeal.)*, E.USA.—FIG. 228,10a,b. **A. dunbari*, Vt.; 10a,b, cran., dorsal, profile, $\times 3$ (188).—FIG. 228,10c,d. **A. quebecensis* (RASETTI), Que.; 10c,d, cran., dorsal, profile, $\times 8$ (189).

Bellaspis RASETTI, 1945 [**B. billingsi*]. Glabella broadly tapering, with 2 pairs of faint lateral furrows; palpebral furrows well defined, eye ridges faint or absent; fixigenae with palpebral areas about 0.25 of glabellar width, posterior areas medium in length (*tr.*). Librigenae, thorax, and pygidium unknown (189). *U.Cam.(Trempeal.)*, E.N.Am.—FIG. 228,6. **B. billingsi*, Que.; 6a,b, cran., dorsal, profile, $\times 5$ (189).

Bemaspis FREDERICKSON, 1949 [**B. gouldi*]. Glabella convex, keeled, truncate-tapering, with 2 pairs of short diagonal lateral furrows; with preglabellar field and distinct anterior border furrow, anterior border narrow; eye ridges faint, palpebral furrows shallow, palpebral rims present, eyes below medium size, opposite center of

glabella; fixigenae horizontal, with palpebral areas almost 0.5 of glabellar width, posterior areas triangular, medium in width (*exsag.*), 0.75 of length (*tr.*) of occipital ring. Librigenae, thorax, and pygidium unknown. Surface finely granulose. *U.Cam.(Francon.)*, C.USA(Okla.).

Crepichilella WILSON, 1951 [**C. antietaensis*]. Glabella narrowly tapering, with 3 pairs of lateral furrows, anterior border furrow may have median inward bend; eyes slightly posterior to center of glabella; fixigenae with palpebral areas a little less than 0.3 of glabellar width, posterior areas long (*tr.*). Librigenae, thorax, and pygidium unknown (363). *U.Cam.(Francon.)*, E.N.Am.

Deadwoodia RESSER, 1938 [**Ptychoparia (Liostracus) panope* WALCOTT, 1890]. Glabella broadly tapering, with 2 pairs of very faint lateral furrows; eye ridges narrow; fixigenae with palpebral areas 0.5 of glabellar width, posterior areas of medium length (*tr.*); librigenae with slender genal spines. Pygidium unknown (363). *U.Cam.(Francon.)*, N.Am.—FIG. 228,9. *D. duris* (WALCOTT), Pa.; 9a-c, cran., dorsal, profile, front, $\times 2$; 9d, librigena, $\times 2$ (497).

Dellea WILSON, 1949 [**D. wilbernsensis* (= **Ptychoparia suada* WALCOTT, 1890)]. Glabella tapering, with 2 or 3 pairs of faint lateral furrows; eye ridges narrow; fixigenae with palpebral areas about 0.3 of glabellar width, posterior areas medium in length (*tr.*); librigenae with slender genal spines. Thorax unknown. Pygidium with axis and pleural fields of same width, axis 0.75 of length of pygidium, border narrow (363). *U.Cam.(Francon.)*, N.Am.—FIG. 228,8. **D. suada* (WALCOTT), Tex.; 8a,b, cran., dorsal, profile; 8c, librigena; 8d, pyg.; all $\times 2$ (363).

Eshelmania WILSON, 1951 [**E. snoburgensis*]. Glabella elongate, tapering, with 3 pairs of lateral furrows; eye ridges narrow; fixigenae with palpebral areas about 0.3 of glabellar width, posterior areas long (*tr.*). Librigenae, thorax, and pygidium unknown (363). *U.Cam.(Francon.)*, E.N.Am.

Lecanopleura RAYMOND, 1937 [**L. interrupta*]. Glabella narrowly tapering, no lateral furrows or eye ridges, eyes slightly anterior to center of glabella; fixigenae with palpebral areas about 0.25 of glabellar width, posterior areas medium in length (*tr.*). Librigenae, thorax, and pygidium unknown (213). *Up.M.Cam.-U.Cam.*, E.N.Am.

Modocia WALCOTT, 1924 [**Arionellus (Crepicephalus) oweni* MEEK & HAYDEN, 1861] [= *Armonia* WALCOTT, 1924; *Metisia* RESSER, 1937; *Semnocephalus* RESSER, 1942]. Glabella tapering, narrowly rounded in front, with 3 pairs of faint to obsolete, short lateral furrows; anterior border furrow straight or with median inward bend; eye ridges faint or absent, eyes below medium size; fixigenae downsloping, with palpebral areas about 0.5 of glabellar width, posterior areas subtriangular, long (*tr.*); librigenae rectangular, with

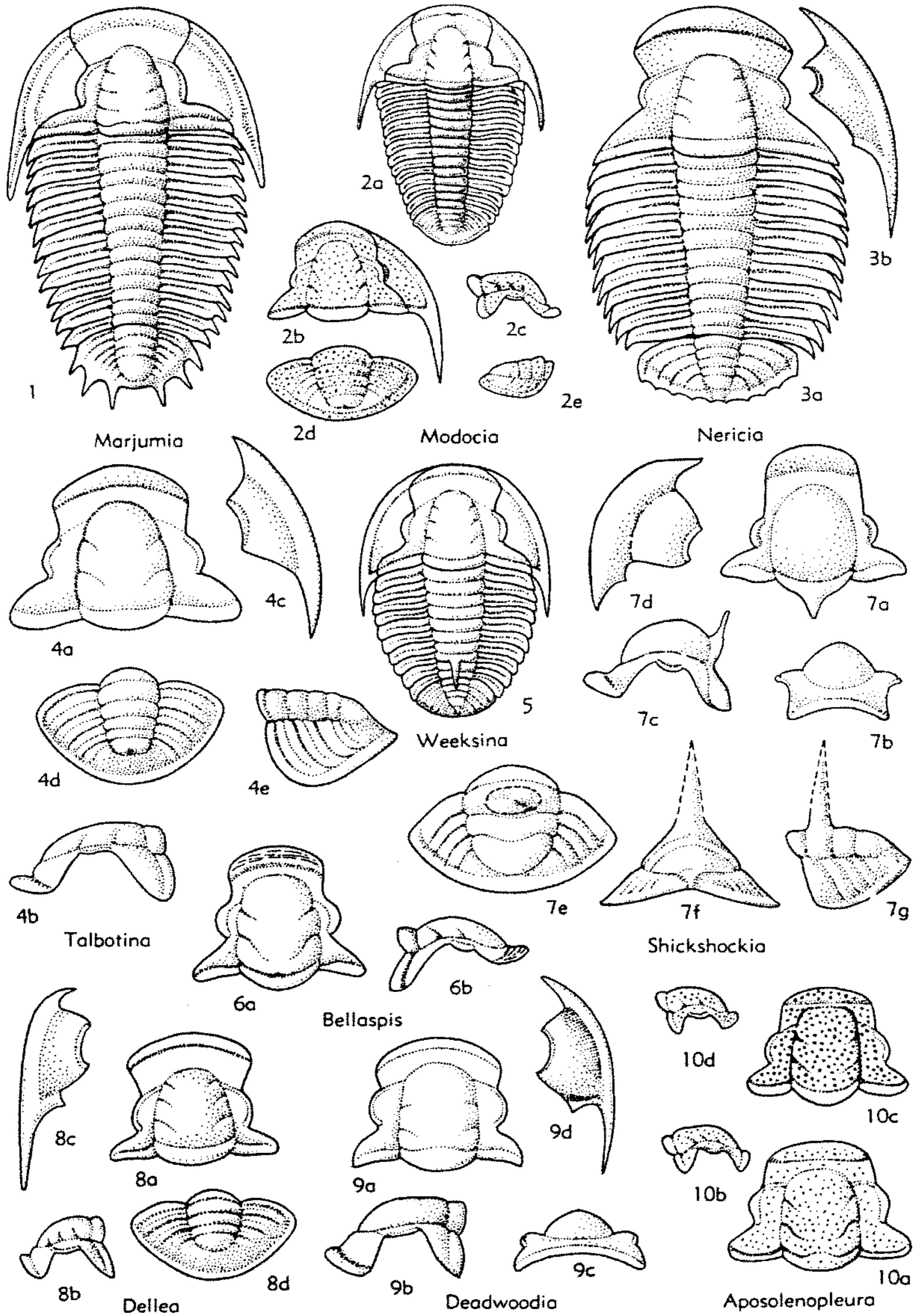

FIG. 228. Lonchocephalidae, Marjumiidae (p. 0279-0280, 0306-0309).

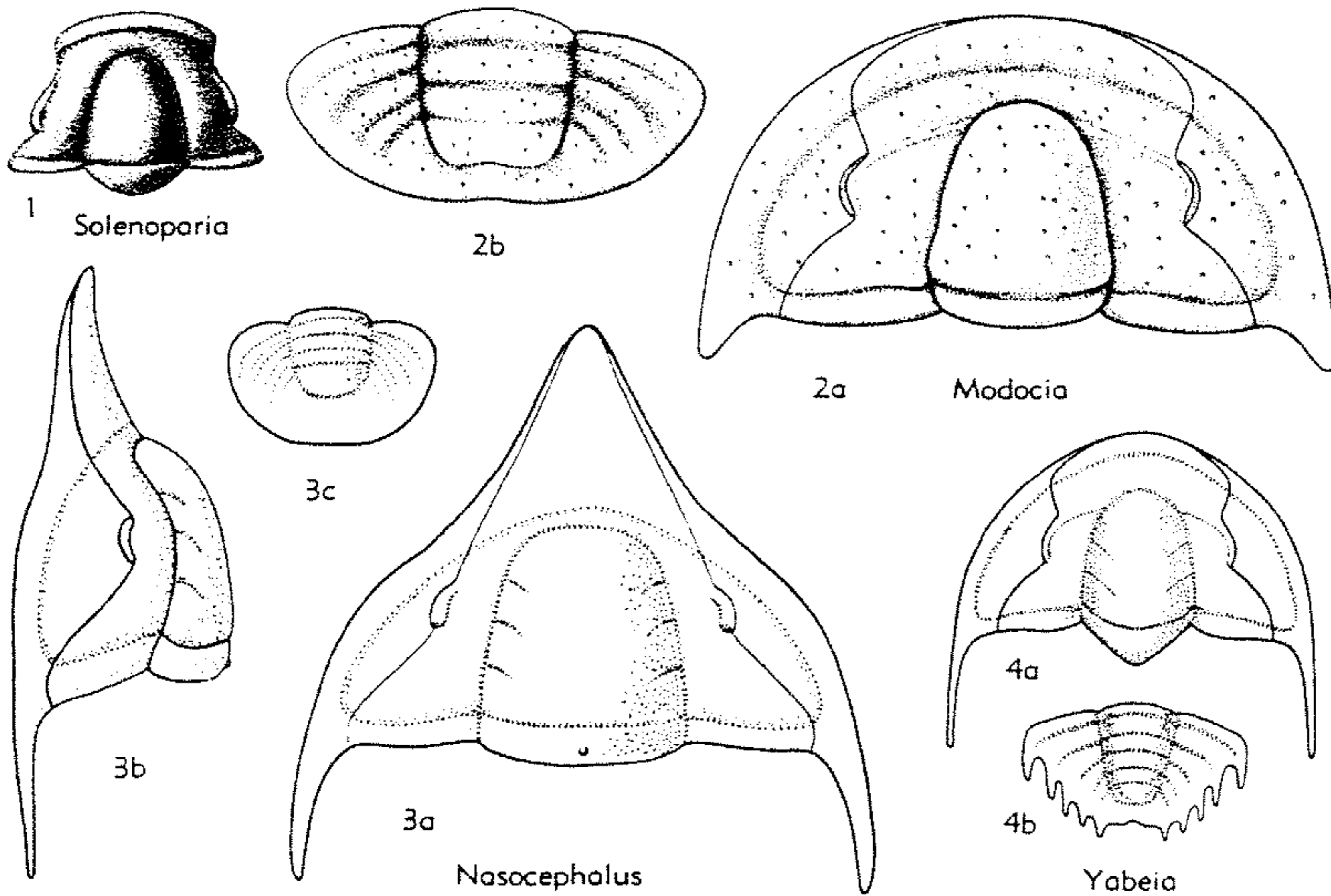

FIG. 229. Marjumiidae (p. 0308-0309).

genal spines variable in length. Thorax with 14 segments, pleurae blunt. Pygidium narrowly transverse, with convex axis about same in width as pleural fields, with 3 axial rings and terminal, may have median indentation; 3 pleurae with deep pleural furrows, interpleural grooves faint to distinct, border furrow obsolete, narrow poorly defined border, may have pairs of very small anterior marginal spines (132, 162, 321). *Up.M. Cam.-U. Cam.*, N. Am.—FIG. 228, 2a. *M. elongata* (WALCOTT), Dresbach., Ala.; exoskel., $\times 1$ (317).—FIG. 228, 2b-e. *M. metisensis* (WALCOTT), *Up.M. Cam.*, Que.; 2b,c, cran., dorsal (with librigena), profile, $\times 2$; 2d,e, pyg., dorsal, profile, $\times 2$ (308).—FIG. 229, 2. **M. oweni* (MEEK & HAYDEN), *Up.M. Cam.-Low.U. Cam.* (Dresbach.), Wyo.; 2a,b, ceph., pyg., $\times 4$ (162, 321).

Nasocephalus WILSON, 1954 [**N. nasutus*]. Glabella low, broadly tapering, front moderately rounded or nearly straight, with 3 pairs of short lateral furrows; occipital spine or small node present; preglabellar field narrow or absent, anterior border wide, may be markedly prolonged; eye ridges narrow, faint, eyes slightly below medium size, opposite center of glabella; fixigenae horizontal or slightly upsloping, with palpebral areas about 0.3 of glabellar width, posterior areas narrow, short (*tr.*); librigenae narrow, elongate, with short flat genal spines. Pygidium small, transverse,

convex; axis and pleural fields of same width, with 3 axial rings and terminal, 2 or 3 interpleural grooves, pleural furrows very faint or obsolete, no marginal furrow. Surface smooth. *Low.U. Cam.* (Dresbach.), SE. N. Am.-NW. Eu.—FIG. 229, 3. **N. nasutus*, Tex.; a,b, ceph., dorsal, profile, $\times 4$; 2c, pyg., $\times 4$ (364).

Neotaenicephalus KOBAYASHI, 1955 [**N. obsoletus*]. Glabella tapering, with straight front, no lateral furrows; eye ridges very faint, with pair of anterior pits in axial furrows; fixigenae upsloping, with palpebral areas 0.5 of glabellar width, posterior areas narrow (*exsag.*), triangular. *L. Ord.* (Tremadoc.), W. Can. (B.C.).

Nericia WESTERGÅRD, 1948 [**N. quinquedentata*]. Glabella narrowly tapering, with 3 pairs of faint lateral furrows; eye ridges narrow, eyes slightly anterior to center of glabella; fixigenae with palpebral areas 0.5 of glabellar width, posterior areas subtriangular, long (*tr.*); librigenae with medium-length, slender genal spines. Thorax with 12 segments, pleurae with short spines. Pygidium with axis narrower than pleural fields, border furrows faint, interpleural grooves running on to border, 5 pairs small marginal spines (336). *Up.M. Cam.*, W. Eu.—FIG. 228, 3. **N. quinquedentata*, Swed. (Ullavi); 3a, incompl. exoskel., $\times 2$; 3b, librigena, $\times 2$ (336).

Obrucheviaspis IVSHIN, 1953 [**O. inornata*]. Similar to *Dellea*, *U.Cam.*, SW.Sib.

Shickshockia RASETTI, 1946 [**S. cristata*]. Glabella broadly tapering, narrowly rounded in front, lacking lateral furrows; no eye ridges, occipital spine present; fixigenae with palpebral areas 0.25 of glabellar width, posterior areas of medium length (*tr.*); librigenae with very short genal spines. Strong axial spine on one or more thoracic segments. Pygidium with convex axis, wider than pleural regions, large axial spine on 1st ring, border narrow (193). *U.Cam.(Dresbach.)*, E.N. Am.—FIG. 228,7. *S. cristata*, Que.(Gaspé); 7a-c, cran., dorsal, front, profile; 7d, librigena; 7e-g, pyg., dorsal, back, profile; all $\times 2.5$ (193).

Solenoparia KOBAYASHI, 1935 [**Ptychoparia (Liostracus) toxeus* WALCOTT, 1905]. Glabella convex, tapering to narrowly rounded front, without lateral furrows; frontal area wide (*tr.*); fixigenae convex, downsloping, eye ridges faint, eyes slightly in front of glabellar mid-length, palpebral areas about 0.5 of glabellar width, posterior areas triangular. Pygidium subtriangular, with axis and pleural fields about equally wide, 5 to 7 axial rings and pleurae, interpleural grooves distinct, pleural furrows faint to obsolete; border very narrow, border furrow faint. Surface granulose. *M. Cam.*, Asia-W.Austral.—FIG. 229,1. **S. toxea* (WALCOTT), China(Shantung); cran., $\times 3$ (488).

Taenicephalina RASETTI, 1945 [**T. lechevalieri*]. Glabella short, tapering, with 3 pairs of faint short lateral furrows, deep axial furrows; eye ridges faint, eyes below medium size; fixigenae downsloping, with palpebral areas about 0.3 of glabellar width, posterior areas triangular, 0.7 of length (*tr.*) of occipital ring. Librigenae, thorax and pygidium unknown. Surface smooth (189). *U.Cam.(Trempeal.)*, E.Can.(Que.).

Urbanaspis IVSHIN, 1956 [**U. notabilis*]. Similar to *Deadwoodia*, *U.Cam.*, SW.Sib.

Vermilionites KOBAYASHI, 1955 [**V. bisulcatus*]. Glabella narrow, tapering, no lateral furrows; eye ridges present, eyes above medium size; fixigenae with palpebral areas about 0.3 of glabellar width, posterior areas straplike. Surface sparsely granulose. *L.Ord.(Tremadoc.)*, W.Can.(B.C.).

Yabeia RESSER & ENDO, in ENDO & RESSER, 1937 [**Y. laevigata*]. Glabella narrow, tapering, lateral furrows faint or absent; anterior border furrow obsolete; eye ridges faint or absent, eyes below medium size; fixigenae with palpebral areas 0.5 of glabellar width, posterior areas medium in length (*tr.*). Pygidium subtriangular, axis convex, wider than low flat pleural regions, interpleural grooves and border furrow obsolete, narrow pleural furrows run to base of short marginal spines (5 pairs) (37). *M.Cam.*, NE.Asia.—FIG. 229,4. **Y. laevigata*, Manch.; 4a,b, cran., pyg., $\times 4$ (37). [*Yabeia* KOBAYASHI, 1935, attributed to RESSER & ENDO, is *nom. nud.*—ED.]

Family COSELLIDAE Palmer, 1954

[*emend.* LOCHMAN, 1956]

Exoskeleton opisthoparian, isopygous. Glabella short to elongate tapering, with rounded front, 3 pairs of faint to obsolete lateral furrows; anterior border furrow variable in width and depth; palpebral lobes and shallow palpebral furrows present, eye ridges faint to obsolete, eyes of medium size, opposite center of glabella; fixigenae variable in position, with palpebral areas 0.3 to 0.5 of glabellar width, posterior areas straplike, narrow (*exsag.*), 0.5 to 0.7 length (*tr.*) of occipital ring; librigenae narrowly rectangular, with genal spines or rounded genal angles. Thorax with 11 to 13 segments, axis and pleurae about same in width (*tr.*), ends of pleurae bluntly or sharply pointed. Pygidium semicircular, with convex axis tapered to a broadly rounded end, commonly with median indentation, short postaxial ridge present; 3 or 4 axial rings and terminal, 3 or 4 pleurae; pleural furrows broad, distinct; interpleural grooves obsolete or narrow, shallow; border furrow obsolete; border of medium width to wide. Outer surface finely granulose to smooth. Derived from Ptychopariidae. *U.Cam.(Dresbach.)*.

Coosella LOCHMAN, 1936 [**C. prolifica*]. Glabella of medium length, tapering to narrow rounded front, lateral furrows faint; frontal area 0.25 length of cranium, anterior border furrow broad and shallow; eye ridges faint; fixigenae horizontal, with palpebral areas 0.3 to 0.5 of glabellar width, posterior areas 0.7 of length (*tr.*) of occipital ring; librigenae with short genal spines or rounded angles. Thorax with 11 or 12 segments, deep furrow in center of pleurae. Pygidium with axis 0.6 to 0.7 of length; pleural fields slightly narrower than axis, 4 pleurae with wide pleural furrows and obsolete or narrow interpleural grooves located near next posterior pleural furrow; border of medium width with posterior median inbend. Surface finely granulose (123, 162). *U.Cam.(Dresbach.)*, N.Am.—FIG. 230,3. **C. prolifica*, Mo.; 3a,b, ceph., pyg., $\times 2.7$ (123).

Coosia WALCOTT, 1911 [**C. superba*]. Glabella low, elongate, tapering to rounded front, lateral furrows obsolete on exterior, all other furrows faint; frontal area about 0.3 length of cranium, border wider than preglabellar field, broad shallow anterior border furrow; eye ridges obsolete; fixigenae horizontal or slightly upsloping, with palpebral areas 0.3 of glabellar width, posterior areas 0.5 length (*tr.*) of occipital ring; librigenae

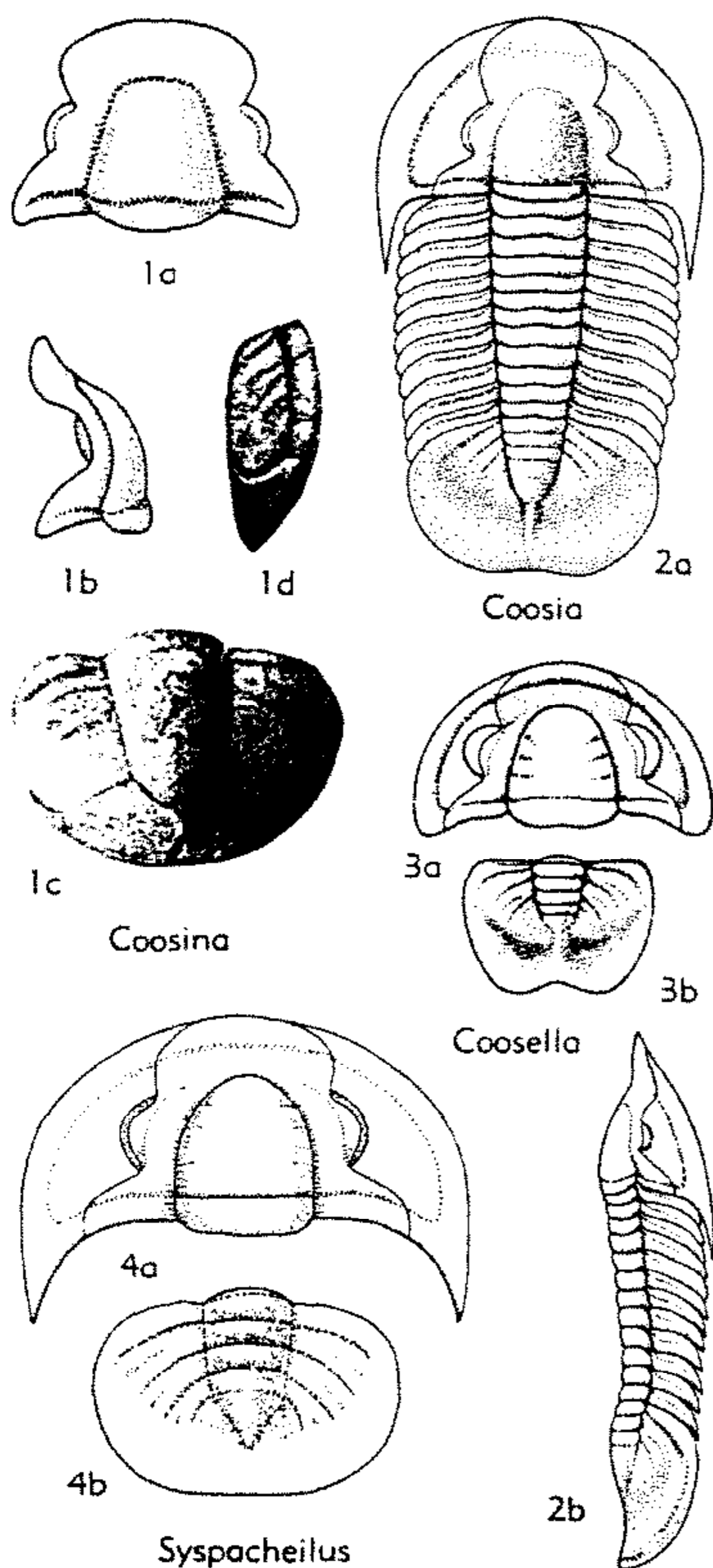

FIG. 230. Coosellidae (p. 0309-0310).

with wide marginal furrow, wide border and broad-based flat genal spines. Thorax with 12 segments, pleurae with pointed ends, pleural furrow on anterior portion of pleurae. Pygidium with axis 0.5 to 0.7 of length, pleural fields slightly wider than axis, 3 or 4 pleurae; all furrows faint to obsolete on exterior but on interior are broad pleural furrows and 2 short shallow interpleural grooves located near next posterior pleural furrow; border medium to wide, flat to concave, with slight posterior median inward bend. Surface smooth (129, 162). *U. Cam. (Dresbach.)*, N. Am.—FIG. 230, 2. **C. superba*, Ala.; 2a, b, exoskel., dorsal, profile, $\times 0.7$ (488).

Coosina RASETTI, 1956 [**Maryvillia ariston* WALCOTT, 1916 (*partim*)]. Cranidium low, with

tapering glabella, no lateral furrows; frontal area with ill-defined broad shallow anterior border furrow, other furrows shallow; eye ridges very faint, eyes of medium size, slightly anterior to center of glabella; fixigenae downsloping, with posterior areas short, broadly triangular. Pygidium semi-circular, with wide stout axis, extending 0.75 of its length, 4 or 5 axial rings, postaxial ridge present; pleural fields regularly convex, with 3 or 4 broad pleurae, furrows faint to obsolete on exterior and faint on interior; border medium in width, downsloping, border furrow obsolete. Surface smooth. *U. Cam. (Dresbach.)*, N. Am.—FIG. 230, 1. **C. ariston* (WALCOTT), Tenn.; 1a, b, cran., dorsal, profile; 1c, d, pyg., dorsal, profile, all $\times 1.5$ (488).

Sypacheilus RESSER, 1938 [**S. typicalis*]. Glabella short, broad-based, tapering to narrow rounded front, lateral furrows faint to obsolete; frontal area about 0.2 length of cranidium, narrow distinct anterior border furrow; eye ridges faint; fixigenae horizontal or downsloping, with palpebral areas 0.3 to 0.5 of glabellar width, posterior areas 0.7 length (*tr.*) of occipital ring. Thorax with 13 segments, pleural furrows deep, running to ends of bluntly rounded tips. Pygidium with axis 0.7 of its length; pleural fields slightly narrower than axis, with 4 pleurae, pleural furrows broad, distinct, 2 or 3 narrow shallow interpleural grooves; border medium in width, flat or slightly concave. Surface finely granulate (162). *U. Cam. (Dresbach.)*, N. Am.—FIG. 230, 4. *S. camurus* LOCHMAN, Mo.-Tex.; 4a, b, cran., pyg., $\times 2$ (440).

Family PAGODIIDAE Kobayashi, 1935

[*num. correct.* HENNINGSMOEN, 1951 (*pro* Pagodidae KOBAYASHI, 1935)]

Exoskeleton opisthoparian, heteropygous. Glabella convex, subcylindrical to quadrate, lateral furrows, palpebral furrows and eye ridges may be present; preglabellar field usually absent; occipital spine may be present; eyes above medium size to small, opposite or anterior to center of glabella; fixigenae variable in shape and slope; librigenae with genal spine. Thorax unknown. Pygidium transverse; axis tapered nearly full length; 2 to 6 axial rings and pleurae; border furrow and border narrow. Surface smooth or granulate. Derived from Ptychopariidae. *M. Cam.-L. Ord.*

Pagodia WALCOTT, 1905 [**P. lotos*]. Glabella subquadrate, sides nearly parallel to broad straight front, with 2 pairs of short shallow lateral furrows; eye ridges faint, eyes about medium in size; fixigenae downsloping, with palpebral areas slightly more than 0.3 of glabellar width, posterior areas stout, long (*tr.*). Pygidium transverse; axis narrower than pleural regions, with 4 axial

rings; 3 broad curved pleurae with faint pleural furrows; border narrow (315). *U.Cam.* (*Fengshanian*), E.Asia.—FIG. 231,8. **P. lotos*, China (Shantung); 8a,b, cran.; 8c, librigena; 8d,e, pyg.; all ×4 (315).

Aojia RESSER & ENDO, in ENDO & RESSER, 1937 [**A. spinosa*]. Glabella parallel-sided, front broadly rounded, with 2 pairs of short faint lateral furrows; occipital spine, palpebral furrows, and faint eye ridges present; eyes above medium size; fixigenae horizontal, with palpebral areas about 0.3 of

glabellar width, posterior areas small, triangular. Pygidium transverse, with axis twice width of pleural fields; 3 or 4 axial rings and pleurae; border furrow very faint, narrow border may have anterior pair of small spines (37). *M.Cam.* (*Taitzuian*), NE.Asia.—FIG. 231,3. **A. spinosa*, Manch.; 3a, cran., ×6; 3b,c, pyg., ×6 (37). [*Aojia* KOBAYASHI, 1935, attributed to RESSER & ENDO, is *nom. nud.*—ED.]

Bienella LOCHMAN, 1944 [**B. problematica*]. Glabella subrectangular, front flatly rounded, with-

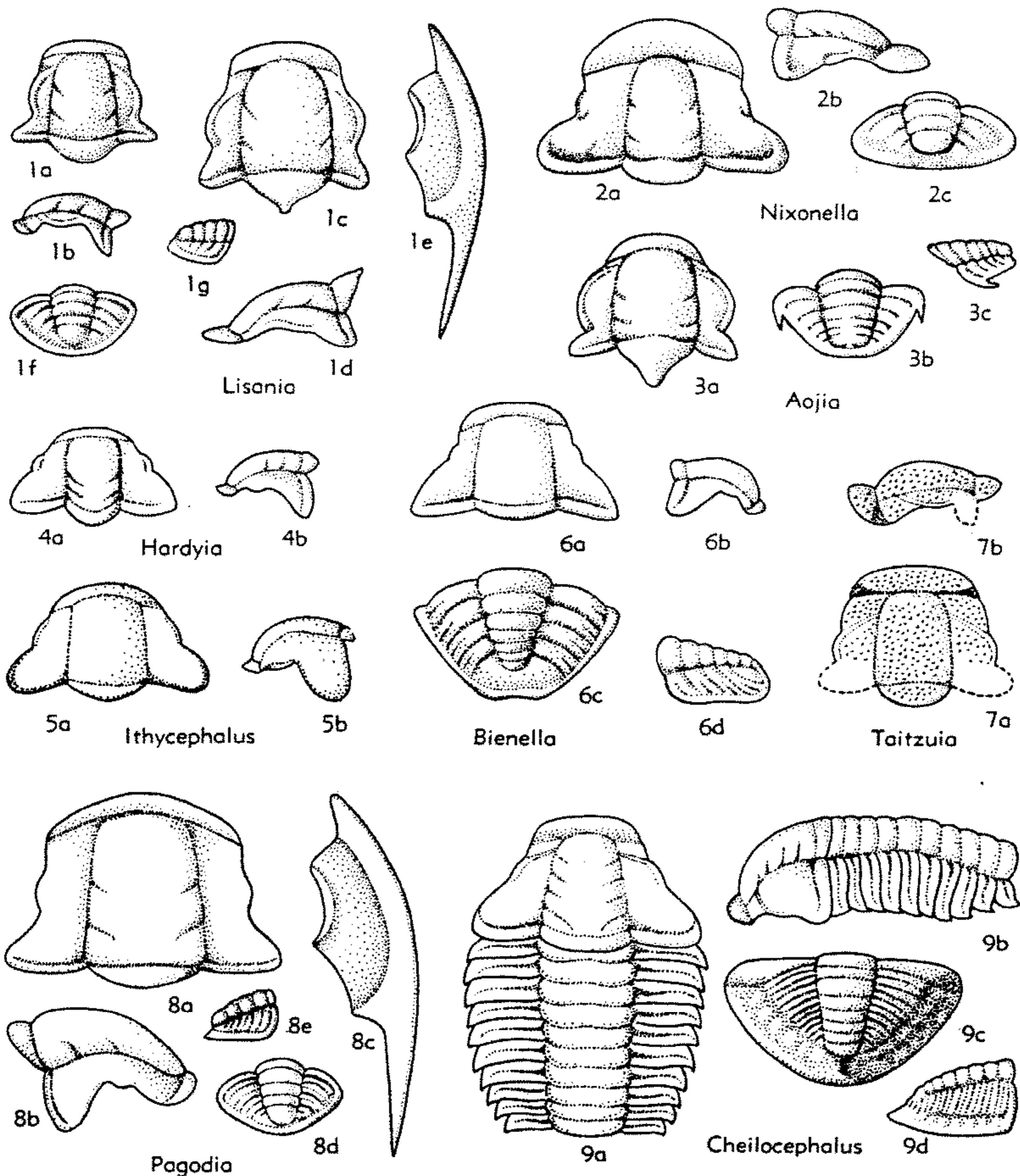

FIG. 231. Pagodiidae, Cheilocephalidae (p. 0310-0312).

- out lateral furrows, no palpebral furrows or eye ridges, eyes small; fixigenae downsloping, with palpebral areas 0.3 of glabellar width, posterior areas large, long (*tr.*) triangular. Pygidium subtriangular, with axis somewhat narrower than pleural regions, 6 axial rings; 3 or 4 wide pleurae; border narrow, with sinuous median inward bend (132). *U.Cam.(Dresbach.)*, N.Am.—FIG. 231, 6. **B. problematica*, Mont.; 6*a,b*, cran., $\times 9$, $\times 8$; 6*c,d*, pyg., $\times 9$, $\times 8$ (132).
- Girandia** KOBAYASHI, 1944 [**G. typa*] [= *Giradia* KOBAYASHI, 1944]. *Up.M.Cam.*, Sib.
- Hardyia** WALCOTT, 1924 [**H. metion*]. Glabella rectangular, sides parallel to nearly straight front, with 2 pairs of short lateral furrows; fixigenae horizontal, with palpebral areas 0.5 of glabellar width, posterior areas long (*tr.*); triangular. Librigenae, thorax, and pygidium unknown (321). *L.Ord.*, W.N.Am.—FIG. 231,4. **H. metion*, Alba.; 4*a,b*, cran., $\times 6$ (321).
- Ithycephalus** RESSER, 1938 [**I. typicalis*]. Glabella low, rectangular, sides parallel to slightly rounded front, without lateral furrows; anterior border furrow running into preglabellar furrow; eyes medium in size, anterior to center of glabella; fixigenae downsloping, with palpebral areas about 0.5 of glabellar width, posterior areas bluntly rounded, triangular, longer (*tr.*) than occipital ring; posterior border furrow obsolete. Librigenae thorax and pygidium unknown (235). *U.Cam.(Dresbach.)*, E.N.Am.—FIG. 231,5. **I. typicalis*, Tenn.; 5*a,b*, cran., $\times 7$ (425).
- Kiowaia** FREDERICKSON, 1949 [**K. timberensis*]. Glabella parallel-sided, tumid, with 2 pairs of shallow arcuate lateral furrows; no preglabellar field, shallow anterior border furrow tangent to preglabellar furrow, eye ridges faint, eyes below medium size, posterior to center of glabella; fixigenae downsloping, with palpebral areas 0.25 of glabellar width, posterior areas narrow (*exsag.*), straplike, short (*tr.*). Librigenae, thorax and pygidium unknown. Outer surface smooth (48). *U.Cam.(Francon.)*, C.USA.
- Lisania** WALCOTT, 1911 [**Anomocarella? bura* WALCOTT, 1905]. Glabella parallel-sided, front slightly rounded with 2 pairs of faint lateral furrows; palpebral furrows and eye ridges present, occipital spine may be present; eyes slightly above medium size; fixigenae downsloping, with palpebral areas about 0.3 of glabellar width, posterior areas small and short (*tr.*). Pygidium transverse, with axis and pleural fields of same width; 3 axial rings; 3 pleurae; border furrow shallow, border narrow (315). *M.Cam.*, E.Asia.—FIG. 231,1*a,b*. **L. bura* (WALCOTT), China(Shantung); 1*a,b*, cran., $\times 5$ (488).—FIG. 231,1*c-g*. *L. alala* (WALCOTT), China(Shantung); 1*c,d*, cran.; 1*e*, librigena; 1*f,g*, pyg.; all $\times 4$ (315).
- Nixonella** LOCHMAN, 1944 [**N. montanensis*]. Glabella parallel-sided, front broadly rounded, with 2 pairs of faint lateral furrows; palpebral furrows and eye ridges faint, eyes of medium size; fixigenae horizontal, with palpebral areas 0.5 to 0.7 of glabellar width, posterior areas long (*tr.*), stout, triangular. Pygidium transverse, with axis same as pleural fields in width, 2 axial rings; 2 pleurae; border narrow (132). *U.Cam.(Dresbach.)*, N.Am.—FIG. 231,2. **N. montanensis*, Mont.; 2*a,b*, cran., $\times 10$; 2*c*, pyg., $\times 10$ (132).
- Taitzuia** RESSER & ENDO, 1937 [**T. insueta*]. Glabella parallel-sided, front nearly straight, without lateral furrows; palpebral furrows and eye ridges present, eyes of medium size; fixigenae horizontal, with palpebral areas less than 0.5 of glabellar width, posterior areas unknown. Librigenae and pygidium unknown (37). *M.Cam.(Taitzuian)*, NE.Asia.—FIG. 231,7. **T. insueta*, Manch.; 7*a,b*, cran., $\times 3$ (37). [Authorship of genus should be cited as RESSER & ENDO. in ENDO & RESSER, 1937.]

Family CHEILOCEPHALIDAE Shaw, 1956

Exoskeleton opisthoparian, elliptical, macropygous. Facial sutures cedariiiform; glabella elongate, lateral furrows and eye ridges present; preglabellar field absent; eyes below medium size; fixigenae downsloping; librigenae unknown. Thorax with more than 9 segments, axis and pleurae of same width (*tr.*). Pygidium broadly semicircular, axis tapered nearly full length, with 5 to 7 axial rings; border furrow distinct, border medium in width. Surface smooth. Derived from Ptychopariidae. *U.Cam.*

Cheilocephalus BERKEY, 1898 [**C. saint croixensis*] [= *Pseudolisania* KOBAYASHI, 1935; *Bernicella* FREDERICKSON, 1949]. Glabella subrectangular, front nearly straight, up to 4 pairs of faint lateral furrows; eye ridges narrow, eyes small, opposite anterior 0.3 of glabella; fixigenae with palpebral areas 0.3 to 0.25 of glabellar width, posterior areas broadly triangular. Thorax with more than 9 segments. Pygidium semicircular; with axis wider than pleural fields, 5 to 7 axial rings and pleurae, interpleural grooves distinct, pleural furrows somewhat weaker, both in some species crossing shallow border furrow onto medium wide border (124, 317). *U.Cam.(U.Dresbach.-Francon.)*, N.Am.—FIG. 231,9. *C. brevilobus* (WALCOTT), Dresbach., Tenn.; 9*a,b*, cran. and thorax, $\times 3$; 9*c,d*, pyg., $\times 3$ (317).

Superfamily LEIOSTEGIACEA

Bradley, 1925

[*nom. transl.* LOCHMAN-BALK, herein (*ex* Leiostrigiidae BRADLEY, 1925)]

Exoskeleton opisthoparian, heteropygous. Glabella subrectangular to quadrate, rarely broad-based tapering, lateral furrows faint to obsolete; preglabellar field very narrow or usually absent; palpebral furrows and eye ridges commonly present, eyes above or below medium size, position variable; fixigenae horizontal; librigenae may bear genal spines. Thorax with 9 or fewer segments. Pygidium broadly transverse to subtriangular; axis tapered nearly full length, may continue in terminal spine; furrows commonly faint or obsolete; border furrow and border present or absent. Surface smooth or finely granulose. Derived from Ptychopariidae. *M.Cam.-L.Ord.*

Family LEIOSTEGIIDAE Bradley, 1925

Characters of superfamily. *M.Cam.-L.Ord.*

Subfamily LEIOSTEGIINAE Bradley, 1925

[*nom. correct.* LOCHMAN-BALK, herein (*pro* Leiostrigiinae KOBAYASHI, 1935); *nom. transl.* KOBAYASHI, 1935 (*ex* Leiostrigiidae BRADLEY, 1925)] [=Lloydidae KOBAYASHI, 1935 (*as* Lloydidae); Ordosiinae LU, 1954]

Glabella tapering to rectangular; pygidium broadly transverse or semicircular, with pair of marginal spines or lacking spines. *U.Cam.-L.Ord.*

Lloydia VOGDES, 1890 [**Bathyurus bituberculatus* BILLINGS, 1860]. Glabella subquadrate to tapering, front rounded, with 2 pairs of anterior pits, one pair at corners of glabella and another pair slightly farther back in axial furrow; no preglabellar field; eyes below medium size, posterior to center of glabella; librigenae with rounded genal angles or short genal spines. Thorax with 9 segments. Pygidium broadly transverse to semicircular (11, 207). *L.Ord.*, N.Am.-S.Am.

L. (Lloydia). Glabella, moderately convex, broad-based tapering, with posterior pair of arcuate lateral furrows; eyes slightly behind center of glabella; fixigenae with palpebral areas very narrow, posterior areas short (*tr.*). Pygidium with axis and pleural fields of equal width, 5 to 7 axial rings, border furrow well defined (11, 207). *L.Ord.*, E.N.Am.—FIG. 232,1. **L. (L.) bituberculata* (BILLINGS), Beekmantown., Que.; 1a,b, cran., ×1; 1c,d, pyg., ×1 (425).

L. (Leiostrigium) RAYMOND, 1913 [**Bathyurus quadratus* BILLINGS, 1860]. Glabella low subrectangular, lacking lateral furrows; palpebral furrows shallow; eye ridges narrow, eyes

opposite posterior 0.3 of glabella; fixigenae with palpebral areas about 0.5 of glabellar width, posterior areas short (*tr.*). Pygidium with axis narrower than pleural fields, 4 to 6 axial rings, all furrows tending to be obsolete, border furrow on interior only, rarely a pair of posterior border spines (207). *L.Ord.*, N.Am.-S.Am.—FIG. 232,2. **L. (L.) quadratum* (BILLINGS), Beekmantown., Que.; 2a,b, cran., ×1; 2c,d, pyg., ×1 (425).

Ambonolium RAYMOND, 1924 [**A. lioderma*] [=Ambonolium KOBAYASHI, 1941]. Glabella low, broadly tapering, with posterior pair of very faint lateral furrows; no preglabellar field; eyes slightly anterior to center of glabella; fixigenae with palpebral areas very narrow, posterior areas medium in length (*tr.*). Pygidium broadly transverse; axis narrower than pleural fields, 12 faint axial rings; pleural furrows and interpleural grooves obsolete; very faint border furrow and narrow border (210). *U.Cam.(Trempeal.)*, E.N.Am.—FIG. 232,6. **A. lioderma*, Vt.; 6a,b, cran., ×2; 6c,d, pyg., ×2 (210).

Cholopilus RAYMOND, 1924 [**C. vermontanus*]. Glabella low, broad subquadrate, front straight, without lateral furrows; no preglabellar field; palpebral furrows distinct, eyes above medium size, posterior to center of glabella; fixigenae with narrow palpebral areas, posterior areas small. Pygidium transverse, axial furrows very faint posteriorly, axis same in width as pleural fields, axial rings and pleurae 2 or 3, very faint, no border furrow (210). *L.Ord.*, E.N.Am.—FIG. 232,5. **C. vermontanus*, Beekmantown., Vt.; 5a,b, cran. (with librigena), ×4; 5c, pyg., ×2.3 (210).

Chuangia WALCOTT, 1911 [**Ptychoparia? batia* WALCOTT, 1905] [=Shantungia LORENZ, 1906 (*non* Shantungia and Shantungia WALCOTT, 1905, ICZN pend.); Shantungia WALCOTT, 1913; Chuangia KOBAYASHI, 1936]. Glabella moderately convex, truncate-tapering, with 2 or 3 pairs of faint lateral furrows; preglabellar field very narrow; palpebral furrows and eye ridges narrow; eyes of medium size, posterior to center of glabella; fixigenae with palpebral areas 0.6 of glabellar width, posterior areas narrow, long (*tr.*). Pygidium broadly transverse, axis narrower than pleural fields; low short postaxial ridge present; only axial furrows visible on exterior but 3 axial rings and long terminal seen on interior; 3 broad faint pleurae, no border furrow (315). *Low.U.Cam.(Changshanian)*, NE.Asia.—FIG. 232,4. **C. batia* (WALCOTT), China(Shantung); 4a,b, cran., ×1; 4c,d, pyg., ×1 (315).

Chuangiella KOBAYASHI, 1935 [**C. elongata*]. *U.Cam.(Fengshanian)*, Korea.

Chuangiopsis SIVOV, 1955 [**C. sibirica*]. *U.Cam.*, Siberia. [Author's assignment.]

Evansaspis KOBAYASHI, 1955 [**Leiostrigium (Evansaspis) glabrum*]. Glabella rectangular, anterior

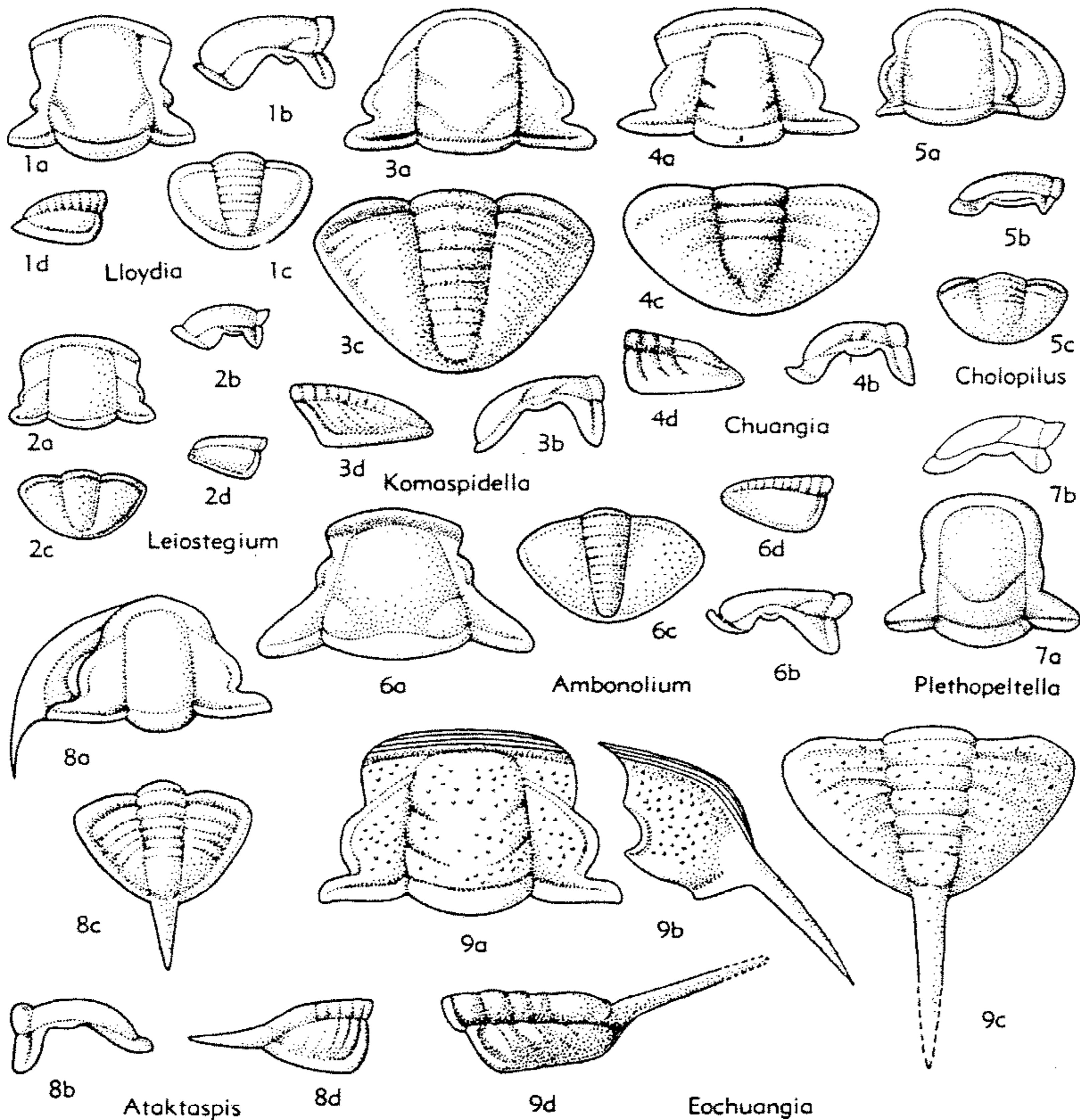

FIG. 232. Leiosteigiidae (p. 0313-0315).

lobe slightly expanded, no lateral furrows; no preglabellar field; eye ridges absent, eyes just above medium size, posterior to center of glabella; fixigenae with palpebral areas about 0.5 width of glabellar area, posterior areas short (*tr.*). Pygidium broadly transverse; axis narrower than pleural fields, with 6 axial rings (posterior 2 faint) and terminal; pleural fields convex, smooth; narrow border furrow; border medium in width, convex; posterior margin curved, with pair of round, straight, medium-length spines at posterolateral corners. *L.Ord.*, W.N.Am.

Idamea WHITEHOUSE, 1939 [*I. venusta*]. Glabella convex, subrectangular, front rounded, without lateral furrows; no preglabellar field; eyes of medium size, posterior to center of glabella; fixi-

genae with palpebral areas about 0.5 of glabellar width. Pygidium broadly transverse, axis narrower than pleural fields; 5 or 6 axial rings, 3 or 4 pleurae; border furrow shallow, border medium (340). *U.Cam.*, Austral.

Kassinius IVSHIN, 1953 [*K. kassini*]. Glabella moderately convex, truncate-tapering, with 3 pairs of diagonal lateral furrows; preglabellar field narrow, anterior border furrow distinct, anterior border medium in width, convex; palpebral furrows and eye ridges present, eyes medium in size, posterior to center of glabella; fixigenae with palpebral areas 0.5 of glabella width, posterior areas triangular; librigenae and pygidium unknown. *M. Cam.*, SW.Sib.

Komaspidella KOBAYASHI, 1938 [*Agraulos? thea*

WALCOTT, 1890]. Glabella low quadrate, front rounded, with 2 or 3 pairs of shallow lateral furrows; no preglabellar field; palpebral furrows and eye ridges faint, eyes of medium size, posterior to center of glabella; fixigenae with palpebral areas less than 0.5 of glabellar width, posterior areas narrow long (*tr.*). Pygidium triangular; axis long, narrower than pleural fields; 5 to 7 faint axial rings and pleurae, very faint pleural furrows and interpleural grooves; no border furrow, very narrow border (186). *U.Cam.* (*Dresbach.*), N.Am.—FIG. 232,3. **K. thea* (WALCOTT), Wis.; 3*a,b*, cran., $\times 3$; 3*c,d*, pyg., $\times 3$ (186).

Ordosia LU, 1954 [**O. fimbriicauda*]. Glabella moderately convex, truncate-tapering, with 2 or 3 pairs of short lateral furrows; narrow, restricted, concave preglabellar field; short occipital spine; faint eye ridges, eyes of medium size, opposite center of glabella; fixigenae with palpebral areas 0.75 of glabellar width, posterior areas narrow, long (*tr.*). Pygidium broadly semielliptical; axis about same in width as pleural fields, axis convex, tapered nearly full length, 7 or 8 axial rings, may have minute median axial nodes; 6 or 7 pleurae with distinct interpleural grooves and faint pleural furrows; border furrow narrow, distinct; border medium in width, concave. Surface smooth. *Up.M.Cam.* (*Kushanian*), NE.Asia. FIG. 233,1. **O. fimbriicauda*, Inner Mongolia (Tsingshuiho dist.); *a,b*, cran., pyg., $\times 5$ (426).

Perischodory (*sic*) RAYMOND, 1937 [**P. grandgei*]. Cephalon unknown. Pygidium broadly transverse, axis narrower than pleural fields, 6 axial rings and long terminal, pleural fields smooth, narrow border furrow, narrow convex border, a pair of rounded, medium-size, curved spines at anterolateral corners. Surface smooth. *L.Ord.*, Vt.

Subfamily Eochuangiinae Kobayashi, 1935

[*nom. correct.* LOCHMAN-BALK, herein (*pro Eochuanginae* KOBAYASHI, 1935)]

Glabella subrectangular to quadrate. Pygidium subtriangular with terminal axial spine. *M.Cam.-U.Cam.*

Eochuangia KOBAYASHI, 1935 [**E. hana*]. Glabella low truncate-tapering, front nearly straight, with 2 pairs of faint lateral furrows; no preglabellar field; narrow palpebral furrows, diagonal eye ridges, eyes above medium size, slightly posterior to center of glabella; fixigenae with palpebral areas 0.5 of glabellar width, posterior areas very narrow, medium in length (*tr.*). Pygidium subtriangular, axis narrower than pleural fields, with 5 axial rings; 3 broad pleurae crossed by 1 or 2 narrow ridges and broad interpleural grooves (97). *M.Cam.* (*Taitzuian*), NE.Asia.—FIG. 232, 9. **E. hana*, China; 9*a*, cran.; 9*b*, librigena; 9*c,d*, pyg.; all $\times 1.5$ (97).

Ataktaspis LOCHMAN & DUNCAN, 1944 [**A. modesta*]. Glabella low subrectangular, front rounded,

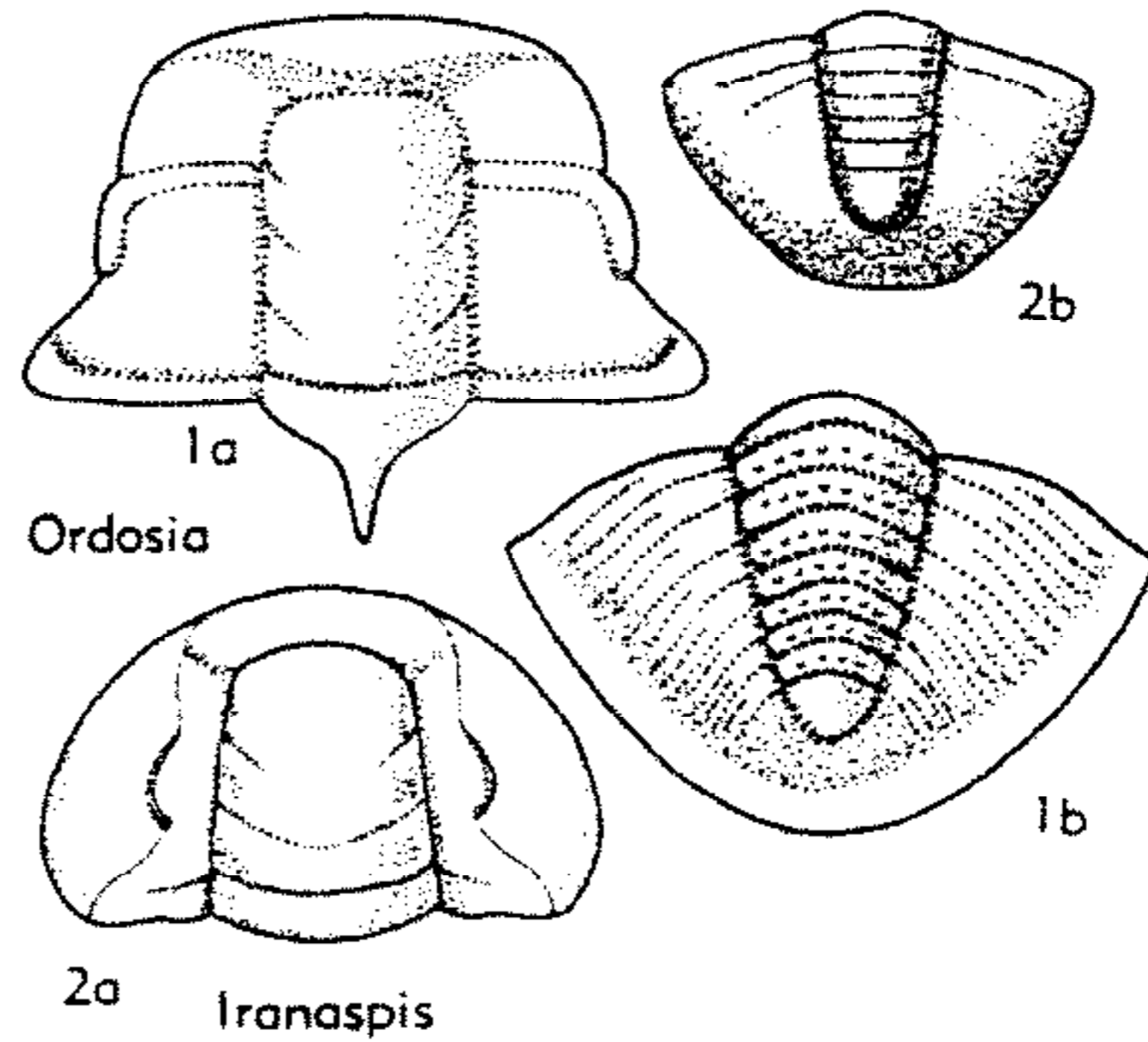

FIG. 233. Leiostegiidae (p. 0315).

without lateral furrows; no preglabellar field; palpebral furrows shallow, eye ridges narrow, eyes of medium size, posterior to center of glabella; fixigenae with palpebral areas 0.5 of glabellar width, posterior areas narrow, quite long (*tr.*). Pygidium triangular; axis narrower than pleural fields, with 3 to 5 axial rings and long terminal, with faint furrows; 1 to 4 broad faint pleurae; border furrow faint, border narrow (132). *U.Cam.* (*Dresbach.*), N.Am.—FIG. 232,8. **A. modesta*, Mont.; 8*a,b*, cran. (with librigena), $\times 5$; 8*c,d*, pyg.; $\times 5$ (132).

Subfamily IRANASPIDINAE Lochman, nov.

Glabella broadly rectangular. Pygidium semicircular, without spines. *U.Cam.-L.Ord.*

Iranaspis KING, 1937 [**I. harrisoni*]. Glabella low, rectangular, front slightly rounded, posterior lateral furrows faint, complete, 2nd pair very faint and short; no preglabellar field, diagonal anterior border furrow in front of fixigenae only; eyes of medium size, slightly posterior to center of glabella; fixigenae with palpebral areas 0.3 of glabellar width, posterior areas medium in length (*tr.*); librigenae elongate, with rounded genal angles. Pygidium low, smooth on outer surface, faint furrows on inner surface; axis of medium width, tapering nearly full length, 6 axial rings and terminal, pleural fields wider than axis, bearing 3 faint interpleural grooves; border furrow, narrow and shallow, border narrow, flat to down-sloping. *Up.U.Cam.*, Iran.—FIG. 233,2. **I. harrisoni*, PaVashtah; 2*a,b*, ceph., pyg., $\times 2$ (418).

Plethopeltella KOBAYASHI, 1943 [**Plethopeltis resseri* KOBAYASHI, 1933]. Glabella low, rectangular, front corners rounded, posterior lateral furrows complete, very faint; no preglabellar field or anterior border furrow; eyes of medium size, slightly

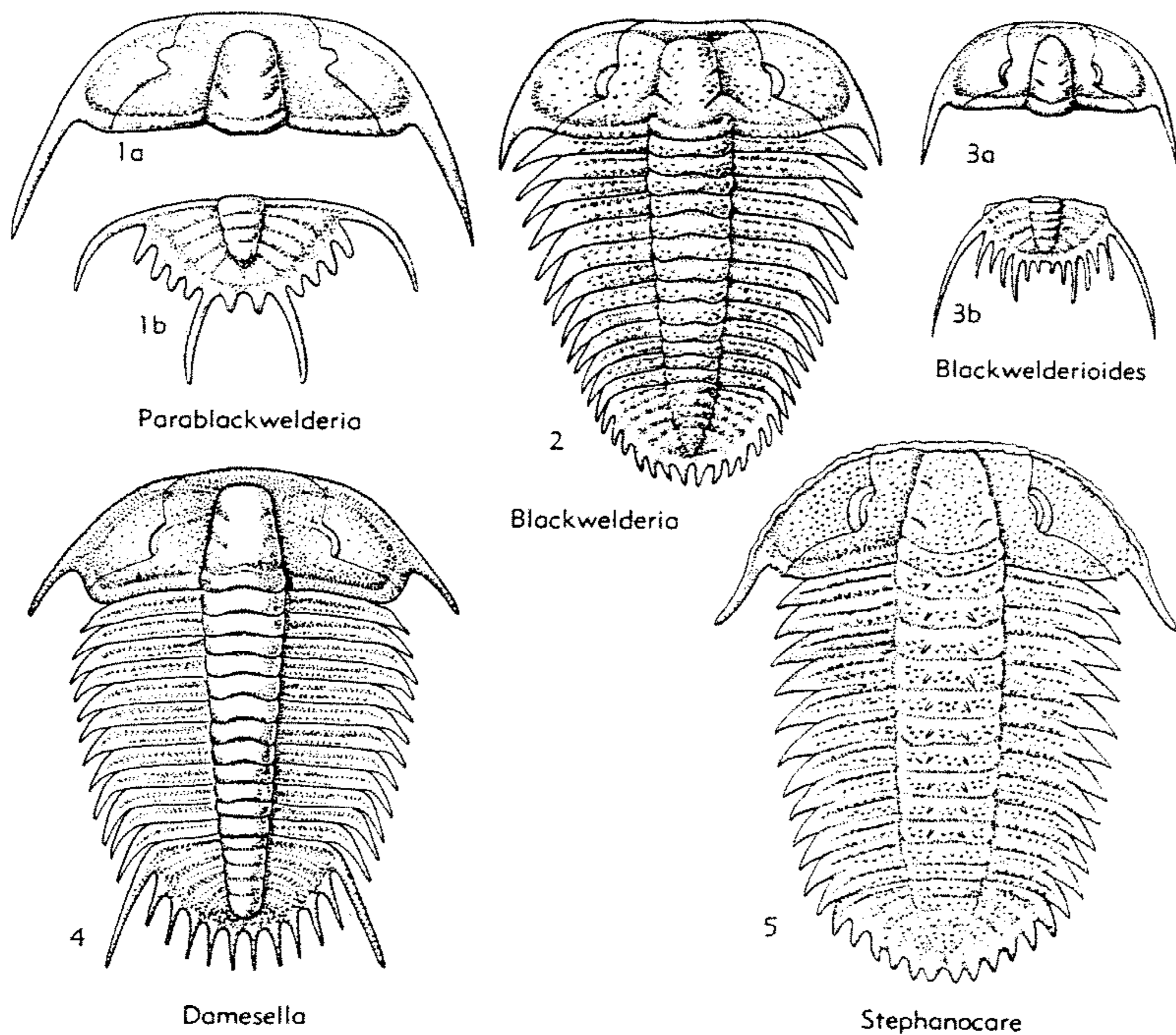

FIG. 234. Damesellidae (p. 0317-0318).

behind center of glabella; fixigenae with palpebral areas about 0.2 of glabellar width, posterior areas medium in length (*tr.*); librigenae, thorax, and pygidium unknown (102). *L.Ord.*, NE.Asia. —FIG. 232,7. **P. resseri* (Kobayashi), Wan-wanian, S.Manch.; 7a,b, cran., $\times 1.5$ (102).

**Superfamily DAMESELLACEA
Kobayashi, 1935**

[*nom. transl.* LOCHMAN-BALK, *hercin* (ex Damesellidae KOBAYASHI, 1935)]

Exoskeleton opisthoparian, medium-sized, ellipsoidal, subisopygous. Glabella narrow to broad-based, tapering forward, with rounded or truncate anterior extremity, bearing deep to faint lateral furrows; preglabellar field usually narrow or absent, anterior border furrow distinct; librigenae bearing short to medium-length genal spines. Thorax with 13 or fewer segments.

Pygidium transverse, with rapidly tapered axis, extending nearly full length; border narrow; border furrow obsolete or extending only along posterior margin; 1 to 7 pairs of pleural pygidial spines of variable lengths. Surface finely to coarsely granu-lose; short marginal spines may be present on cephalon. *Up.M.Cam.-U.Cam.*

**Family DAMESELLIDAE Kobayashi,
1935**

Exoskeleton opisthoparian, subisopygous. Glabella tapering, with 2 or 3 pairs of lateral furrows; palpebral rim and furrow present, eye ridges present or absent, eyes variable in size and position; preglabellar field present or absent; fixigenae upslop- ing, with wide palpebral areas, posterior areas triangular, of variable length; libri- genae subrectangular, with stout genal

spines, may be lateral in position. Thorax with 10 to 13 segments; axis convex; pleurae flat, ending in spines, 1.5 to 2 times width (*tr.*) of axis, with broad pleural furrow in center. Pygidium semicircular to transverse; axis convex, extending nearly full length to rounded end, with 3 or 4 axial rings and terminal; 5 or 6 pleurae ending in spines of variable length along margin, interpleural grooves obsolete except for faint anterior pair or line of granules, pleural furrows broad; border furrow shallow or obsolete, border narrow or absent. Surface with granules and small spines. *Up.M.Cam.-Low.U.Cam.*

Subfamily DAMESELLINAE Kobayashi, 1935

Glabella moderately convex, narrow tapering, front slightly rounded to nearly straight; eyes of medium size, opposite or behind center of glabella; fixigenae slightly upsloping; librigenae wide, subquadrate. *Up.M.Cam.*

Damesella WALCOTT, 1905 [**Cheirurus paronai* AIRAGHI, 1902 (= *Damesella blackwelderi* WALCOTT, 1905)]. Glabella with 3 pairs of short diagonal lateral furrows; no preglabellar field, anterior border furrow running into preglabellar furrow, narrow convex border; eye ridges long, diagonal, eyes behind mid-length of glabella; fixigenae with palpebral areas 0.7 to equal width of glabella, posterior areas of medium width (*exsag.*), long, with deep posterior border furrow; librigenae with genal spines in lateral or longitudinal position. Thorax with 12 segments. Pygidium semicircular; 4 axial rings and terminal; pleural fields slightly convex, equal to axis in width, with 5 to 7 pleurae, 6 to 8 marginal spines of variable length, of which anterior pair may be longest. Surface with granules of several sizes. *Up.M.Cam., E.Asia.*—FIG. 234,4. **D. paronai* (AIRAGHI), Wentsui Sh., China (Shantung); exoskel., $\times 0.7$ (419).

Blackwelderia WALCOTT, 1906 [**Calymene sinensis* BERGERON, 1899]. Glabella with 2 or 3 pairs of lateral furrows; preglabellar field present, anterior border furrow concave, anterior border rimlike; eye ridges very faint or obsolete, eyes opposite center of glabella; fixigenae with palpebral areas about equal to glabella in width, posterior areas of medium width (*exsag.*), as long or longer than occipital ring; librigenae with short to medium-length genal spines. Thorax with 13 segments. Pygidium semicircular; 4 axial rings and terminal; pleural fields moderately convex, same as axis in width, 5 pleurae with faint anterior interpleural grooves; border furrow shallow,

border narrow, with 7 pairs of subequal to variably long marginal spines. Surface with coarse granules, a fringe of small nodes on posterior margin of librigenae. *Up.M.Cam., E.Asia.*—FIG. 234,2. **B. sinensis* (BERGERON), Kushanian, China (Shantung); exoskel., $\times 1.3$ (419).

Blackwelderioides HUPÉ, 1955 [**Stephanocare? monkei* WALCOTT, 1911]. Glabella with narrow, rounded front, 2 pairs of short lateral furrows; preglabellar field straight, narrow; eye ridges obsolete, eyes opposite center of glabella; fixigenae with palpebral areas 0.7 of glabellar width, posterior areas of medium width (*exsag.*), as long or longer than occipital ring; librigenae with short genal spines. Thorax unknown. Pygidium transverse; 4 axial rings and terminal; pleural fields wider than axis, low, with 5 pleurae that bear broad deep pleural furrows running into base of spines; border furrow obsolete, border narrow, poorly defined, with 7 or 8 pairs of marginal spines, anterior pair much longer than others. Surface very finely granulose or smooth. *Up.M.Cam., E.Asia.*—FIG. 234,3. **B. monkei* (WALCOTT), Kushanian, China (Shantung); *3a,b*, ceph., pyg., $\times 1.3$ (419).

Stephanocare MONKE, 1903 [**S. richthofeni*; SD WALCOTT, 1913]. Glabella nearly straight in front, with 2 pairs of lateral furrows; no preglabellar field, anterior border furrow running into preglabellar furrow, border rimlike; eye ridges obsolete, eyes posterior to center of glabella, fixigenae with palpebral areas 0.5 of glabellar width, posterior areas of medium width (*exsag.*), same in length (*tr.*) as occipital ring; librigenae with short, laterally directed genal spines. Thorax with 12 segments. Pygidium narrow semicircular; 3 axial rings and terminal; pleural fields low, narrower than axis, with 6 pleurae ending in marginal spines, 4 shallow pleural furrows; no border furrow or border. Outer surface densely granulose, pair of short median spines on axis of thoracic segments, posterior margin and anterior and lateral borders of cephalon fringed with short spines and nodes (65). *Up.M.Cam., E.Asia.*—FIG. 234,5. **S. richthofeni*, Kushanian, China (Shantung); exoskel., $\times 2$ (419).

Subfamily DREPANURINAE Hupé, 1953

Glabella convex, tapering to broad-based truncate-tapering; eyes small, opposite or in front of mid-length of glabella; fixigenae steeply upsloping to elevated; librigenae elongate, rectangular. *Up.M.Cam.-Low.U.Cam.*

Drepanura BERGERON, 1899 [**D. premesnili*]. Glabella broad-based tapering, front nearly straight, with 2 pairs of short deep lateral furrows; no preglabellar field, shallow border furrow running into preglabellar furrow, anterior border rimlike;

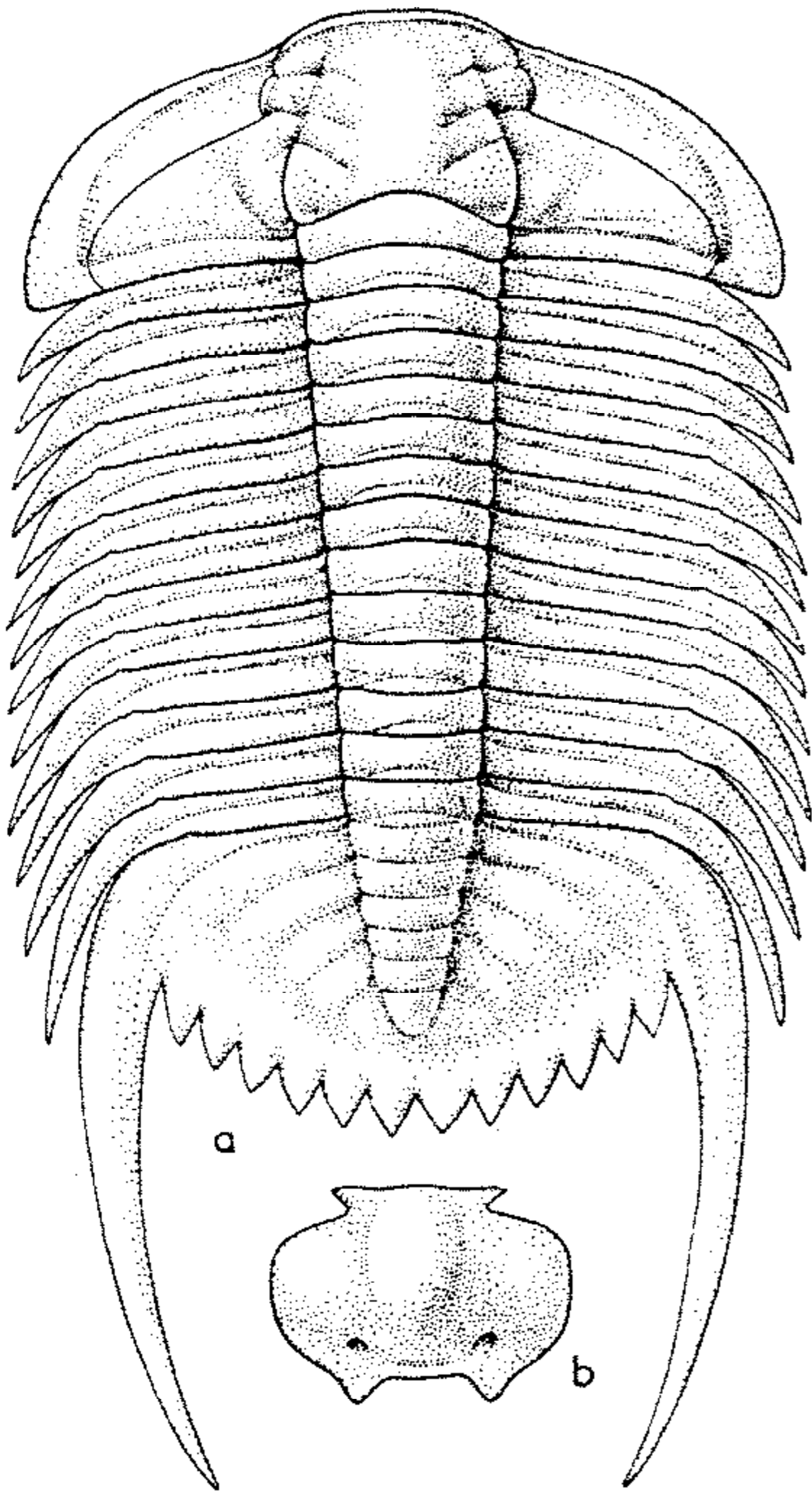

FIG. 235. **Drepanura premesnili* BERGERON (Damesellidae), *Low.U.Cam.*, China; *a, b*, exoskel., hypostoma, $\times 1.5$ (377).

eyes slightly anterior to center of glabella, faint diagonal eye ridges; fixigenae with palpebral areas 0.3 of glabellar width or slightly less, posterior areas of variable width (*exsag.*), length (*tr.*) equal to occipital ring; librigenae with medium-length genal spines or blunt genal angles. Hypostoma subquadrate, with small anterior wings, oval central lobe, semicircular posterior lobe wide at sides with pair of posterior projections, bearing 2 deep pits joined by furrow. Thorax with 13 segments. Pygidium semicircular; 3 to 5 axial rings and terminal; pleural fields moderately convex, about equal to axis in width, with 5 pleurae, anterior pair enlarged, 5 pleural furrows, anterior pair continuing into spines; no border furrow, border very narrow, with 7 to 9 marginal spines, anterior pair enlarged. Surface granulose (65). *Up.M.Cam.-Low.U.Cam.*, E.Asia.-W.Eu.—FIG. 235. **D. premesnili*, Kushanian, China (Shantung); *a*, exoskel., $\times 1.5$; *b*, hypostoma, $\times 1.5$ (419).

Parablackwelderia KOBAYASHI, 1942 [**Blackwelderia spectabilis* RESSER & ENDO, 1937]. Glabella tapering, with 2 pairs of short faint diagonal lateral furrows; preglabellar field and anterior border furrow present, anterior border rimlike; eye ridges faint, eyes opposite anterior 0.25 of glabella; fixigenae with palpebral areas 0.7 of glabellar width, posterior areas wide (*exsag.*), longer (*tr.*) than occipital ring; librigenae with medium-length genal spines. Pygidium semicircular; 3 axial rings and terminal; pleural fields moderately convex, equal to axis in width, with 5 pleurae, 5 pairs of pleural furrows; no border furrow, narrow flat border with 7 pairs of marginal spines of variable length. Surface unknown. *Up.M.Cam.*, E.Asia.—FIG. 234, I. **P. spectabilis* (RESSER & ENDO), Kushanian, Manch.; *a, b*, ceph., pyg., $\times 7$ (419). [Authorship of type species should be cited as RESSER & ENDO, in ENDO & RESSER.—Ed.]

Family KAOLISHANIIDAE Kobayashi, 1935

[*nom. transl. et correct.* LOCHMAN-BALK, herein (ex Kaolishaniinae KOBAYASHI, 1935)] [=Mansuyinae HUPÉ, 1955]

Exoskeleton opisthoparian, subisopygous. Glabella truncate-tapering to quadrate, with lateral furrows; preglabellar field present or absent, anterior border convex, narrow; eye ridges present or absent, narrow palpebral rims and palpebral furrows present, eyes of medium size, variable in position; fixigenae very slightly upsloping, with palpebral areas 0.3 to 0.5 of glabellar width, posterior areas triangular, about equal to occipital ring in length (*tr.*); librigenae rectangular, genal spines short to medium length. Thorax unknown. Pygidium semicircular to subrectangular; axis convex, tapering slightly to rounded end; 4 to 7 axial rings and terminal; pair of large straight or curved spines originating from pleural fields incorporate posterior 0.5 of 1st segment and anterior 0.5 or all of the 2nd segment, interpleural grooves and pleural furrows present or obsolete; border furrow obsolete, border only along posterior. Surface coarsely or finely granulose. *U.Cam.*

Kaolishania SUN, 1924 [**K. pustulosa*]. Glabella moderately convex, broad, with nearly straight front, posterior lateral furrows deep and arcuate; no preglabellar field, anterior border furrow running into preglabellar furrow; eye ridges distinct, eyes opposite center of glabella; fixigenae with palpebral areas about 0.3 of glabellar width, posterior areas medium in width (*exsag.*); librigenae elongate rectangular, with long genal

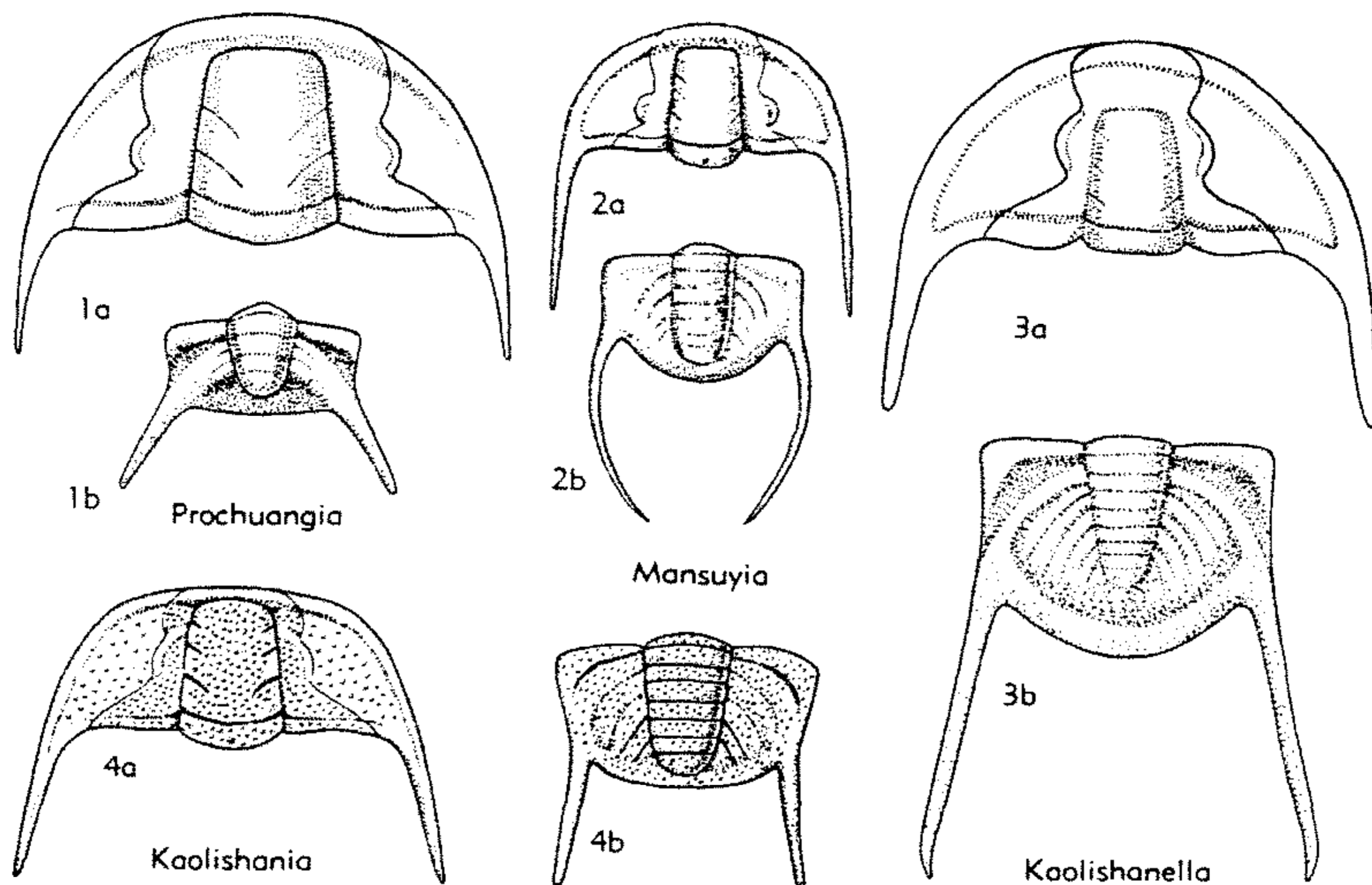

FIG. 236. Kaolishaniidae (p. 0318-0319).

spines, posterior and lateral border furrows fading into base of spines. Pygidium subrectangular; axis tapered nearly full length, with 6 axial rings and terminal; moderately convex, pleural fields same in width as axis, interpleural grooves obsolete, with 5 pairs of distinct curved pleural furrows, spines extended from posterior 0.5 of 1st pleurae and anterior 0.5 of 2nd pleurae; narrow flat border (288). *U. Cam. (Kaolishan.)*, E. Asia.—FIG. 236, 4. **K. pustulosa*, China (Shantung); 4a, b, ceph., pyg., $\times 4$ (478).

Kaolishaniella SUN, 1935 [**K. transita*]. Glabella low, with rounded front, lateral furrows faint; preglabellar field present; no eye ridges, eyes opposite anterior 0.3 of glabella; fixigenae with arcuate palpebral areas, 0.3 of glabellar width, posterior areas of medium width (*exsag.*); librigenae narrow, rectangular, with short genal spines. Pygidium semicircular; axis tapered, 0.7 of length of pygidium, with 7 axial rings and terminal; pleural fields low, wider than axis, with 7 pleurae separated by curved interpleural grooves, anterior 2 segments crossed by pleural furrows, spines developed from 2nd segment; border flat (289). *U. Cam. (Kaolishan.)*, E. Asia.—FIG. 236, 3. **K. transita*, China (Hopei); 3a, b, ceph., pyg., $\times 2$, (478).

Mansuyia SUN, 1924 [*emend.* SUN, 1935] [**M. orientalis*] [= *Paramansuyella* ENDO in ENDO & RESSER, 1937]. Glabella convex, narrow, with rounded front, lateral furrows faint; no pre-

glabellar field, broad shallow anterior border furrow, narrow upturned anterior border; eye ridges faint, eyes opposite posterior 0.3 of glabella; fixigenae with palpebral areas 0.5 of glabellar width, posterior areas narrow (*exsag.*); librigenae narrow, rectangular, with long slender genal spines. Pygidium semicircular; axis tapered nearly full length, with 4 axial rings and terminal, may have 2 faint additional rings; pleural fields low, same in width as axis, with 4 pleurae and 4 or 5 pleural furrows, interpleural grooves obsolete, spines developed from posterior 0.5 of 1st pleurae and anterior 0.5 of 2nd pleurae; border undeveloped (288, 289). *U. Cam. (Kaolishan.)*, E. Asia.—FIG. 236, 2. **M. orientalis*, China (Shantung); 2a, b, ceph., pyg., $\times 1.3$, $\times 2$ (a, 478; b, 419).

Prochuangia KOBAYASHI, 1935 [**P. mansuyi*]. Glabella low, front nearly straight, lateral furrows very faint; no preglabellar field, broad shallow anterior border furrow, narrow anterior border; no eye ridges, eyes almost opposite posterior 0.3 of glabella; fixigenae with palpebral areas 0.5 of glabellar width, posterior areas below medium width (*exsag.*); librigenae with short genal spines. Pygidium subrectangular, axis tapered nearly full length, with 4 axial rings and terminal; pleural fields low, about same in width as axis, anterior pair of pleural furrows distinct, all others and interpleural grooves obsolete, spines developed from posterior 0.5 of 1st pleurae and entire 2nd pleurae; border undeveloped (97).

U. Cam. (Changshan.), E. Asia.-S. Asia.—FIG. 236, 1. **P. mansuyi*, S. Korea; *1a, b*, ceph., pyg., $\times 1.5$ (419).

Superfamily PTYCHASPIDACEA Raymond, 1924

[*nom. correct.* LOCHMAN-BALK, 1956 (*pro* Ptychaspidae RAYMOND, 1924)] [=Ptychaspidoidea HUPÉ, 1953]

Exoskeleton opisthoparian, medium-sized, ellipsoidal, subisopygous. Glabella broad-based, rectangular to tapering forward, in some with expanded anterior lobe, with 2 or 3 pairs of lateral glabellar furrows, posterior pairs commonly transglabellar; preglabellar field narrow or absent, anterior border furrow tending to be obsolete; librigenae with medium-length to long genal spines. Thorax with 12 or fewer segments. Pygidium ovoid to narrow transverse; with border furrow shallow to obsolete, margin bearing 1 to 5 pairs of pleural spines in some genera. Surface finely or coarsely granulate, marked by imbricating ridges. *U. Cam.*

Family PTYCHASPIDIDAE Raymond, 1924

[*nom. correct.* LOCHMAN-BALK, 1956 (*pro* Ptychaspidae RAYMOND, 1924)] [=Euptychaspidae HUPÉ, 1953]

Exoskeleton opisthoparian, isopygous. Glabella tapering, subquadrate or subrectangular, anterior lobe swollen in late genera, with 3 or 4 pairs of lateral furrows, posterior pair commonly deep and complete, middle pair may be likewise; preglabellar field and anterior border furrow may be lost; palpebral furrows and eye ridges usually distinct, eyes of medium size or below, position variable; fixigenae horizontal or upsloping; librigenae with wide eye platforms and stout genal spines. Thorax unknown. Pygidium broadly transverse to semicircular; axis tapered nearly full length, may have postaxial ridge; pleural fields wider than axis; border furrow shallow or obsolete. Surface granulate, ridged or punctate. Derived from Ptychopariidae. *U. Cam.*

Ptychaspis HALL, 1863 [**Dikelocephalus miniscaensis* OWEN, 1852; SD MILLER, 1889] [=*Asioptychaspis* KOBAYASHI, 1933; *Fengshania* SUN, 1935]. Glabella subrectangular to subquadrate, front rounded, anterior lobe commonly swollen; anterior border furrow obsolete; eyes opposite or in front of mid-length of glabella; fixigenae upslop-

ing, with palpebral areas slightly more than 0.3 of glabellar width, posterior areas stout, of medium length (*tr.*). Pygidium with all furrows distinct, 4 or 5 axial rings, 4 or 5 pleurae, border flat. Surface granulate, irregular ridges invariably on border of cephalon and in some also on genae and glabella (8, 156). *U. Cam. (Francon.)*, N. Am.-E. Asia.—FIG. 237, *5a-e*. **P. miniscaensis* (OWEN), Wis.; *5a, b*, cran.; *5c*, librigena; *5d, e*, pyg.; all $\times 0.7$ (53).—FIG. 237, *5f-j*. *P. granulosa* (OWEN), Wis.; *5f, g*, cran., $\times 1.2$, $\times 1$; *5h*, librigena, $\times 1$; *5i, j*, pyg., $\times 1$ (8, 53).

Anderssonella KOBAYASHI, 1936 [*pro Anderssonia* SUN, 1924 (*non* STREBEL, 1908; *nec* KLUGE, 1914)] [**Ptychaspis (Anderssonia) fengtienensis* SUN, 1924] [=*Andersonia* KOBAYASHI, 1930; *Sunina* STRAND, 1943 (*obj.*)]. Glabella subrectangular or tapering forward, front rounded; anterior border furrow well defined; eye ridges faint, eyes opposite or slightly behind mid-length of glabella; fixigenae upsloping, with palpebral areas less than 0.5 of glabellar width, posterior areas unknown. Pygidium semicircular, all furrows distinct, with 5 axial rings and 5 broad pleurae separated by interpleural ridges rather than grooves that curve across flat border to margin (288). *U. Cam.*, E. Asia.—FIG. 237, 7. **A. fengtienensis* (SUN), China (Fengtien); *7a, b*, cran., pyg., $\times 4$ (288).

Changia SUN, 1924 [**C. chinensis*]. Glabella rectangular, front straight, posterior part low, anterior lobe swollen, with 3 pairs of lateral furrows; frontal area 0.25 of length (*sag.*) of cranium, anterior border furrow obsolete; eyes of medium size, opposite center of glabella; fixigenae upsloping, with palpebral areas 0.5 of glabellar width, posterior areas 0.75 of length (*tr.*) of occipital ring; librigenae with obsolete lateral border furrows and medium-length slender genal spines. Pygidium semicircular, with short postaxial ridge extending to margin, 4 axial rings and terminal with 1 or 2 faint axial rings; 4 or 5 pleurae, with shallow pleural furrows; border furrow obsolete. Surface smooth (288). *U. Cam. (Fengshan.)*, E. Asia.—FIG. 238, 1. **C. chinensis*, China (Shantung); *1a, b*, ceph., pyg., $\times 1$ (478).

Conaspis HALL, 1863 [**Conocephalites perseus* HALL, 1863; SD WALCOTT, 1914]. Glabella parallel-sided or tapering, front rounded; anterior border furrow distinct, palpebral furrows present, eye ridges very weak, eyes opposite center of glabella; fixigenae horizontal, with palpebral areas 0.3 of glabellar width, posterior areas narrow, of medium length (*tr.*). Pygidium narrowly semicircular, furrows shallow, especially border furrow; 3 axial rings, 3 broad pleurae; border narrow (156). *U. Cam. (Francon.)*, C. USA.—FIG. 237, 1. **C. perseus* (HALL), Wis.; *1a, b*, cran.; *1c*, librigena; *1d*, pyg.; all $\times 1.5$ (53, 156).

Coreanocephalus KOBAYASHI, 1935 [**C. kogonensis*]. Glabella low, truncate-tapering, front nearly

straight with 2 pairs of shallow complete arcuate lateral furrows; frontal area about 0.25 of length (*sag.*) of cranidium, anterior border furrow obsolete; eyes of medium size, opposite center of glabella; fixigenae upsloping, with arcuate palpebral areas about 0.5 of glabellar width, posterior areas

of medium width (*exsag.*), 0.75 of length (*tr.*) of occipital ring; librigenae with medium-length genal spines, lateral border furrows obsolete. Pygidium unknown. Surface smooth (97). *U.Cam.* (*Fengshan.*), E.Asia.—FIG. 238.2. **C. kogensis*, S.Korea; ceph., $\times 1.5$ (419).

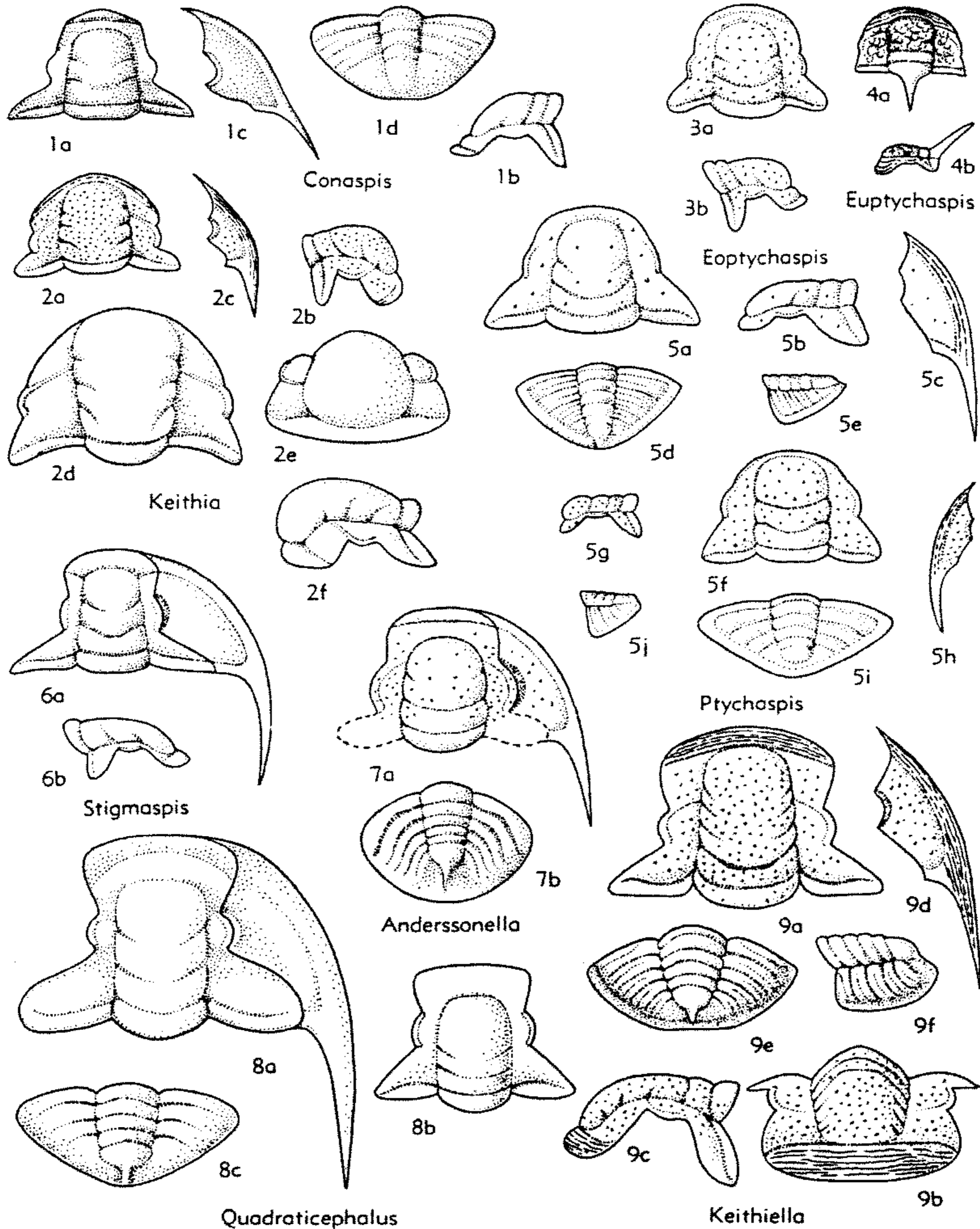

FIG. 237. Ptychaspidae (p. 0320-0322).

Eoptychaspis NELSON, 1951 [**E. cylindrica*]. Glabella parallel-sided, subquadrate, front rounded; anterior border furrow very faint; eyes opposite center of glabella; fixigenae horizontal, with palpebral areas more than 0.3 of glabellar width, posterior areas of medium width and length (*tr.*). Librigenae and pygidium unknown (156). *U.Cam. (Francon.)*, C.USA.—FIG. 237,3. **E. cylindrica*, Wis.; 3a,b, cran., $\times 1.3$, $\times 1$ (156, 425).

Euptychaspis ULRICH in BRIDGE, 1930 [**E. typicalis*]. Glabella parallel-sided, subquadrate, sides parallel to swollen anterior lobe; anterior border furrow obsolete; frontal area convex, ridged; short stout occipital spine; eye ridges faint, eyes below medium size, slightly behind mid-length of glabella; fixigenae slightly upsloping, with palpebral areas more than 0.5 of glabellar width and posterior areas about same in width (*tr.*). Librigenae and pygidium unknown. Surface reticulate (303). *U.Cam. (Trempeal.)*, W.USA-C.USA.—FIG. 237,4. **E. typicalis*, Mo.; 4a,b, cran., $\times 4$ (303).

Keithia RAYMOND, 1924 [**K. schucherti*]. Glabella parallel-sided, subquadrate, sides tapered to rounded front or diverging to swollen anterior lobe; no preglabellar field, anterior border furrow running into axial furrows; eye ridges faint, eyes below medium size, behind mid-length of glabella; fixigenae upsloping, with palpebral areas almost 0.5 of glabellar width, posterior areas triangular, long (*tr.*). Pygidium unknown (188, 189). *U.Cam. (Trempeal.)*, E.N.Am.—FIG. 237,2a-c. *K. connexa* RASETTI, Que.; 2a,b, cran., $\times 2$; 2c, librigena, $\times 2$ (188).—FIG. 237,2d-f. *K. similis* RASETTI, Que.; 2d-f, cran., dorsal, front, profile, $\times 3$ (188).

Keithiella RASETTI, 1944 [**Arionellus cylindricus* BILLINGS, 1860]. Glabella parallel-sided, subquadrate, front rounded; no preglabellar field, anterior border furrow running into axial furrows; eye ridges faint, eyes slightly behind mid-length of glabella; fixigenae upsloping, with palpebral areas almost 0.5 of glabellar width, posterior areas subtriangular, long (*tr.*). Pygidium narrowly semicircular, all furrows distinct except shallow border furrow; 4 or 5 axial rings, 5 broad pleurae separated by interpleural ridges crossing flat border to margin (188, 192). *U.Cam. (Trempeal.)*, E.N.Am.-S.Am.—FIG. 237,9. **K. cylindrica* (BILLINGS), Que.; 9a-c, cran., dorsal, front, profile; 9d, librigena; 9e,f, pyg.; all $\times 3.5$ (188, 192).

Quadraticephalus SUN, 1924 [**Q. walcotti*]. Glabella parallel-sided, subrectangular, front nearly straight; anterior border furrow shallow or obsolete, preglabellar field downsloping; eyes of medium size, slightly in front of mid-length of glabella; fixigenae upsloping, with palpebral areas more than 0.3 of glabellar width, posterior areas large, subtriangular, long (*tr.*). Pygidium broadly transverse, furrows shallow, no border furrow; 4

axial rings, 3 broad pleurae, interpleural grooves extending to margin. Surface ridged or punctate (37, 288). *U.Cam. (Fengshanian)*, E.Asia.—FIG. 237,8a. **Q. walcotti*, China (Shantung); cran. (with librigena) $\times 1$ (288).—FIG. 237,8b,c. *Q. teres* RESSER & ENDO, in ENDO & RESSER (1937), Manch.; 8b,c, cran., pyg., $\times 4$ (37).

Saukioides KOBAYASHI, 1952 [*pro Pseudosaukia* KOBAYASHI, 1951 (non RASETTI, 1944)] [**Pseudosaukia suni* KOBAYASHI, 1951] [= *Jeholaspis* KOBAYASHI, 1953 (obj.)]. Glabella parallel-sided subrectangular, sides converging to rounded front, with 2 pairs of lateral furrows; no preglabellar field, anterior border furrow obsolete, anterior border of medium width, convex; eyes medium in size, opposite center of glabella; fixigenae upsloping, with palpebral areas about 0.5 of glabellar width, posterior areas same in length (*tr.*) as occipital ring. Pygidium broadly transverse; 3 axial rings and terminal; 4 broad pleurae, with obsolete pleural ridges, and 4 pairs of pleural furrows, shallow distally; border furrow very shallow, border narrow downsloping. Surface smooth. *U.Cam. (Fengshan.)*, E.Asia.—FIG. 238,4. **S. suni* (KOBAYASHI), Manch.; 4a,b, ceph., pyg., $\times 2$ (419).

Stigmataspis NELSON, 1951 [**S. hudsonensis*]. Glabella parallel-sided, subrectangular, front straight; no preglabellar field, faint anterior border furrow running into axial furrows; eyes of medium size, opposite center of glabella; fixigenae upsloping, with palpebral areas less than 0.3 of glabellar width, posterior areas subtriangular, long (*tr.*). Pygidium unknown (156). *U.Cam. (Francon.)*, C.USA.—FIG. 237,6. **S. hudsonensis*, Wis.; 6a,b, cran., (with librigena), $\times 1$ (156).

Wuhuia KOBAYASHI, 1933 [**Solenopleura belus* WALCOTT, 1905]. Glabella parallel-sided, tapering, front broadly rounded, with 2 pairs of short, distinct, arcuate lateral furrows; anterior border furrow narrow, curved; eye ridges obsolete, eyes of medium size, opposite center of glabella; fixigenae horizontal, with palpebral areas 0.3 of glabellar width, posterior areas straplike, medium in width (*tr.*). Pygidium semicircular; 4 axial rings and terminal; 5 pleurae with pleural furrows; border furrow obsolete, border narrow, ill-defined. Surface granulate (315). *U.Cam. (Fengshan.)*, E.Asia.—FIG. 238,3. **W. belus* (WALCOTT), China (Shantung); 3a,b, cran., $\times 3$; 3c,d, pyg., $\times 3$ (419).

Family SAUKIIDAE Ulrich & Resser, 1930

[*nom. transl.* LOCHMAN-BALK, 1956 (ex Saukiinae ULRICH & RESSER, 1930)]

Exoskeleton opisthoparian, subisopygous. Glabella quadrate to rectangular, with 2 or 3 pairs of lateral furrows, posterior pair usually complete, 2nd pair likewise in some;

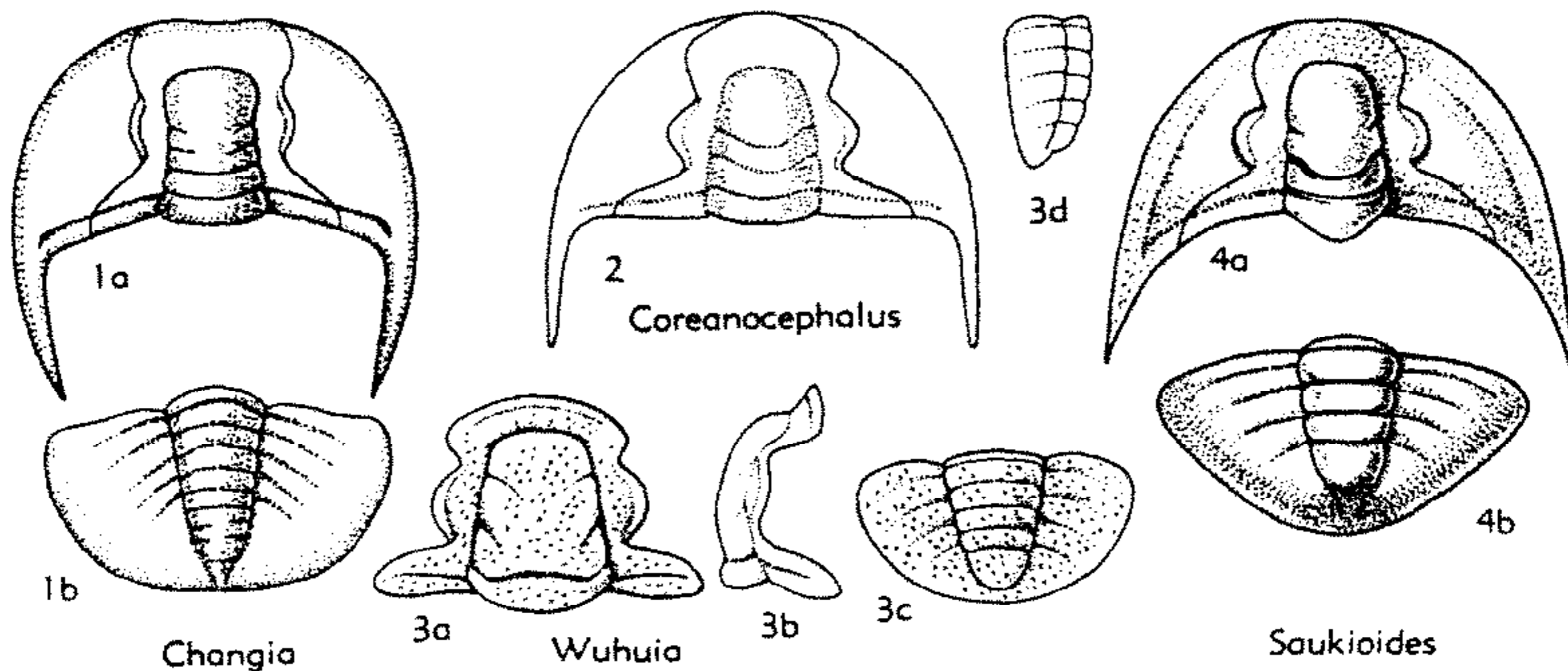

FIG. 238. Ptychaspidae (p. 0320-0322).

preglabellar field present or absent, anterior border furrow may be obsolete; eyes above medium size, posterior to center of glabella, eye ridges usually obsolete, arcuate palpebral furrows deep, palpebral rims prominent; occipital spine may be present; fixigenae with arcuate palpebral areas, 0.3 to 0.5 of glabellar width, posterior areas very narrow (*exsag.*), straplike; librigenae wide, quadrate, with genal spines; hypostoma elongate rectangular, with short anterior wings, convex ovoid central lobe, narrow semicircular posterior lobe, narrow lateral and posterior rim, and pair of elongate pits at outer corners of posterior lobe. Thorax with 12 segments; axis strongly convex; pleurae slightly longer than axis, with ends bluntly pointed, deep pleural furrow running diagonally from anterior to center of segments. Pygidium elliptical to circular; axis tapered to rounded end, posterior axial furrow obsolete, with postaxial ridge; interpleural grooves and pleural furrows curving abruptly backward on to border; no border furrow, border of variable width. Surface smooth or granulose. Derived from *Conaspis*. *U.Cam.*

Saukia WALCOTT, 1914 [*Dikellocephalus lodensis* WHITFIELD, 1880, based on librigena (= *Saukia ornata* ULRICH & RESSER, 1933, based on cranium, *vide* LOCHMAN, 1956)] [= *Sinosaukia* SUN, 1935]. Glabella rectangular, sides diverging slightly forward, front nearly straight, posterior part low, anterior lobe convex, with 2 pairs of lateral furrows, posterior pair complete; no preglabellar field, anterior border furrow narrow, straight and paralleling preglabellar furrow or running into it

at corners of glabella, anterior border narrow; fixigenae narrow, with posterior areas about 0.5 of length (*tr.*) of occipital ring; librigenae with narrow posterior and lateral border furrows meeting, long slender genal spines. Pygidium ovoid; axis wider than pleural regions, convex, tapering 0.75 of length, with postaxial ridge reaching margin, 4 axial rings and terminal; pleural fields low, merging into narrow sloping border, with 4 pairs of interpleural grooves and 5 pairs of parallel pleural furrows lying anteriorly on each segment. Surface coarsely granulose. *U.Cam.* (*Trempeal.*), N. Am.-NE. Asia.—FIG. 239, 1. *S. acuta* ULRICH & RESSER, Wis.; exoskel., $\times 1.3$ (461, 487).

Calvinella WALCOTT, 1914 [*Dikellocephalus spiniger* HALL, 1863]. Glabella low, rectangular, sides converging slightly to straight squared front, posterior glabellar furrows usually complete, 2nd pair short, faint; slender occipital spine; preglabellar field absent, anterior border furrow diagonal at sides to corners of glabella, convex anterior border narrow; fixigenae narrow, with posterior areas 0.75 of length (*tr.*) of occipital ring; librigenae with posterior and lateral border furrows fading into base of medium-length genal spines. Pygidium nearly circular; axis narrow, same in width as pleural fields, convex, tapered rapidly 0.5 of length, with narrow postaxial ridge fading on to border, 3 axial rings and terminal with one faint ring, pleural fields low, merging into medium to broad concave border, 4 pairs of interpleural grooves, 5 pairs of pleural furrows close to anterior edge of each segment, may touch interpleural grooves on edge of border; posterior margin may bend inward on median line. Surface granulose. *U.Cam.* (*Francon.-Trempeal.*), N. Am.-NE. Asia.—FIG. 239, 2. **C. spiniger* (HALL), Trempeal.; Wis.; 2a, ceph., $\times 1$; 2b, pyg., $\times 1$ (461 mod.; 487 mod.).

Lichengia KOBAYASHI, 1942 [**L. onigawara*]. Gla-

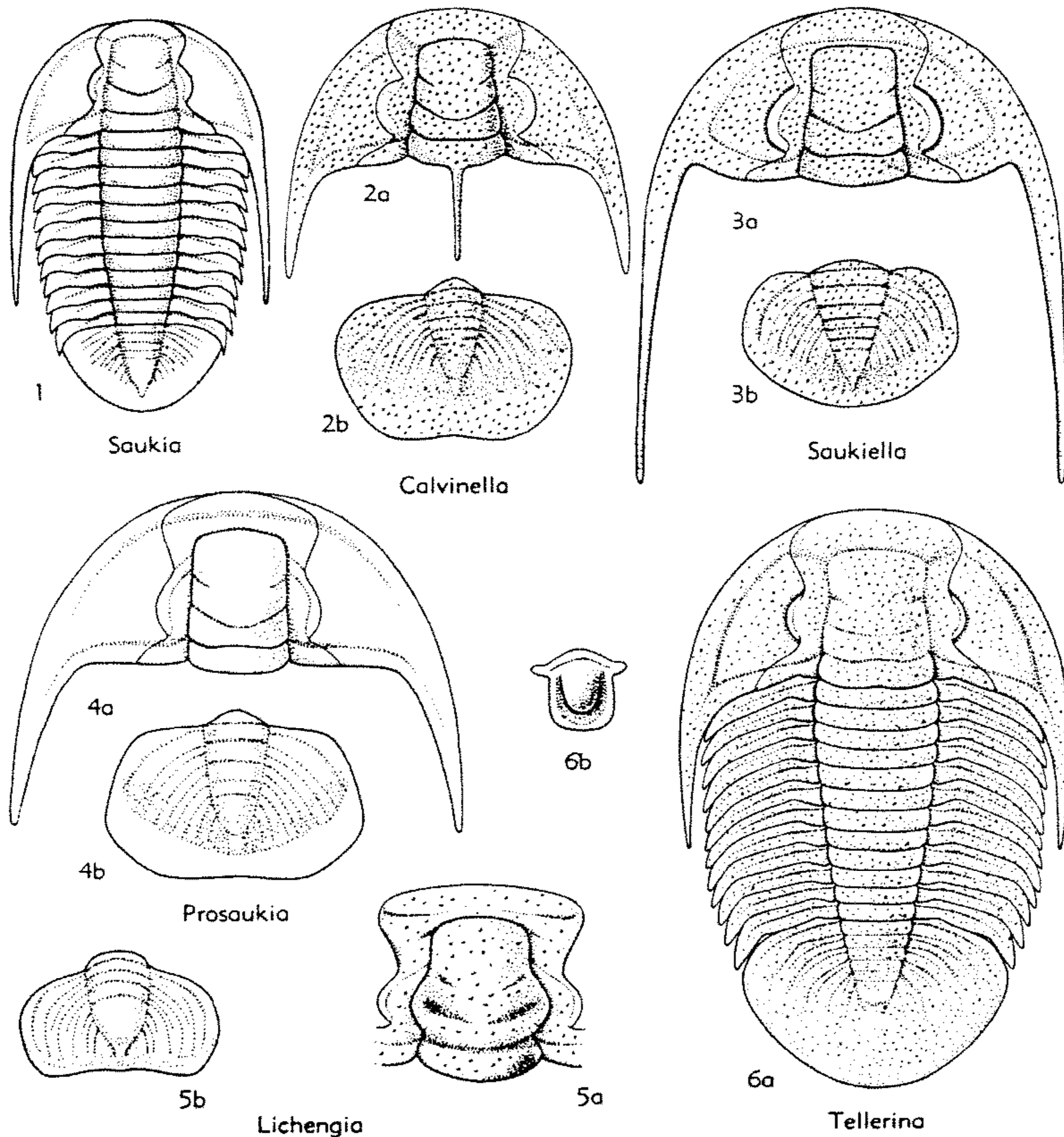

FIG. 239. Saukiidae (p. 0323-0325).

bella moderately convex, quadrate, base broadly expanded and front slightly rounded, with 3 pairs of lateral furrows, posterior pair deep, complete, 2nd short, diagonal, anterior pair very faint; eye ridges faint, preglabellar field very narrow, anterior border furrow deep at sides, obsolete at center, anterior border of medium width, down-sloping; fixigenae with posterior areas unknown. Pygidium transverse elliptical, sides curving abruptly backward, posterior margin nearly straight with slight median inward bend; axis convex, wider than pleural fields, tapering 0.6 of its length, with narrow post-axial ridge extending nearly to margin, 3 axial rings and terminal with 1 or 2 faint rings; pleural fields low, merging

into medium-width concave border, 3 pairs of interpleural grooves and parallel shallow pleural furrows. Surface granulate. *U. Cam. (Fengshan.)*, NE. Asia.—FIG. 239, 5. **L. onigawara*, China (Shansi); *5a, b*, cran., pyg., $\times 1.5$ (*a*, 419; *b*, 478). *Prosaukia* ULRICH & RESSER, 1933 [**Dikelocephalus misa* HALL, 1863] [= *Stenosaukia* RAYMOND, 1938]. Glabella low, quadrate to rectangular, sides converging slightly, front nearly straight, with 2 pairs of distinct lateral furrows, posterior pair complete; occipital spine may be present; eye ridges faint, preglabellar field present, narrow anterior border furrow distinct, anterior border narrow, fixigenae with posterior areas almost 0.5 of length of occipital ring; librigenae with me-

dium-length genal spines, posterior border furrows running into spine bases, not meeting lateral furrows. Pygidium transverse elliptical, lateral margins curving abruptly backward, posterior margin slightly curved with median flattening; axis convex, slightly wider than pleural fields, tapering 0.75 of length, with narrow postaxial ridge extending to margin, 3 or 4 axial rings and terminal with one faint ring; pleural fields low, merging into concave border of variable width, 4 (rarely 5) pairs of interpleural grooves and 5 parallel, evenly spaced pleural furrows crossing border nearly to margin. Surface smooth or granulose. *U.Cam.* (Francon-Trempeal.), N.Am.-NE. Asia.—FIG. 239,4. **P. misa* (HALL), Francon., Wis.; 4a,b, ceph., pyg., $\times 1.3$ (461 mod.; 487 mod.)

Saukiella ULRICH & RESSER, 1933 [**Dikellocephalus pepinensis* OWEN, 1852 (= *Saukiella typicalis* ULRICH & RESSER, 1933)]. Glabella low, rectangular, sides diverging slightly forward, front straight, posterior pair of lateral furrows complete, 2nd pair strong and complete to obsolete; preglabellar field extremely narrow, anterior border furrow distinct, anterior border medium in width; fixigenae with posterior areas about 0.5 of length of occipital ring; librigenae with continuous lateral and posterior border furrows and long slender genal spines. Pygidium ovoid to circular; axis convex, wider than pleural fields, tapering 0.7 of length, with short postaxial ridge, 4 axial rings and terminal with one faint axial ring; pleural fields low, curving down to narrow flat border, 4 pairs of narrow shallow interpleural grooves and 5 pairs of deep parallel pleural furrows. Surface finely granulose. *U.Cam.* (Francon-Trempeal.), N. Am.-NE. Asia.—FIG. 239,3. **S. pepinensis* (OWEN), Trempeal., Wis.; 3a,b, ceph., pyg., $\times 1$ (461 mod.; 487 mod.).

Tellerina ULRICH & RESSER, 1933 [**Dikellocephalus crassimarginatus* WHITFIELD, 1882]. Glabella low, rectangular, front nearly straight, posterior glabellar furrow complete, 2nd pair short, faint; no preglabellar field, anterior border furrow shallow, occurring only at sides and slanting backward to corners of glabella, anterior border medium in width; fixigenae with posterior areas 0.7 of length (*tr.*) of occipital ring; librigenae with united lateral and posterior border furrows running into bases of short broad genal spines. Pygidium subcircular; axis convex, wider than pleural fields, tapering 0.7 of length, with short, broad postaxial ridge, 4 to 5 axial rings and terminal with 1 faint ring; pleural fields low, merging into broad flat border, 4 pairs of interpleural grooves curving on to border, 5 pairs of pleural furrows, anterior on segments, fading out on edge of border. Surface finely granulose. *U.Cam.* (Trempeal.), N.Am.-NE. Asia.—FIG. 239,6. **T. crassimarginatus* (WHITFIELD), Wis.; 6a, exoskel., $\times 0.7$; 6b, hypostoma, $\times 1$ (487, 488).

Family EUREKIIDAE Hupé, 1953

[=Maladiinae HUPÉ, 1953]

Exoskeleton opisthoparian, heteropygous. Glabella truncate-tapering to quadrate, with 2 pairs of lateral furrows; eye ridges present or obsolete, palpebral rims and palpebral furrows usually well developed, eyes about medium in size, position variable, preglabellar field may be very narrow or restricted; fixigenae horizontal, with palpebral areas of variable width, posterior areas triangular to straplike; librigenae quadrangular, with short blunt genal spines. Pygidium transverse to semicircular; axis convex, tapered nearly full length, 1 to 5 axial rings and terminal; 3 or 4 pleurae, interpleural grooves or pleural furrows or both may be present; border furrow obsolete, border ill-defined, narrow, with 4 or 5 pairs of short marginal spines. Surface granulose or smooth. Derived from *Conaspis-Wuhuia* stock. *U.Cam.*

Eurekia WALCOTT, 1924 [**E. granulosa*]. Glabella moderately convex, subquadrate, anterior corners rounded, with deep arcuate lateral furrows; eye ridges obsolete, eyes of medium size, opposite posterior 0.3 of glabella; preglabellar field very narrow or at sides only, anterior border furrow curved, anterior border rimlike; fixigenae very narrow, with arcuate palpebral areas 0.2 of glabellar width, posterior areas very narrow (*exsag.*), of medium length (*tr.*). Pygidium transverse; axis and pleural fields about same in width, with 3 wide axial rings and terminal; 4 pleurae separated by faint interpleural grooves and crossed by broad pleural furrows, 5 pairs of stout marginal spines. Outer surface coarsely granular (321). *U.Cam.* (Trempeal.), C.USA-W.USA.—FIG. 240,3. **E. granulosa*, Nev.; ceph., $\times 1.5$ (411).

Bayfieldia T. H. CLARK, 1924 [**B. tumifrons*]. Glabella moderately convex, truncate-tapering, lateral furrows very faint, arcuate; preglabellar field narrow to absent, anterior border furrow narrow, anterior border rimlike; eye ridges obsolete, eyes just below medium size, slightly behind mid-length of glabella; fixigenae very narrow, with arcuate palpebral areas 0.12 of glabellar width, posterior areas very narrow (*exsag.*), of medium length (*tr.*). Pygidium narrowly transverse; axis wider than pleural fields, with 2 wide axial rings and terminal; 3 pleurae separated by faint interpleural grooves and crossed by broad pleural furrows, 4 pairs of small marginal spines. Surface densely granulose (188, 189). *U.Cam.* (Trempeal.), E.Can.—FIG. 240,5. **B. tumifrons*, Que.; 5a, cran., $\times 2$; 5b, pyg., $\times 2.7$ (188). *Corbinia* WALCOTT, 1924 [**C. horatio*]. Glabella low, narrow, truncate tapering, lateral furrows

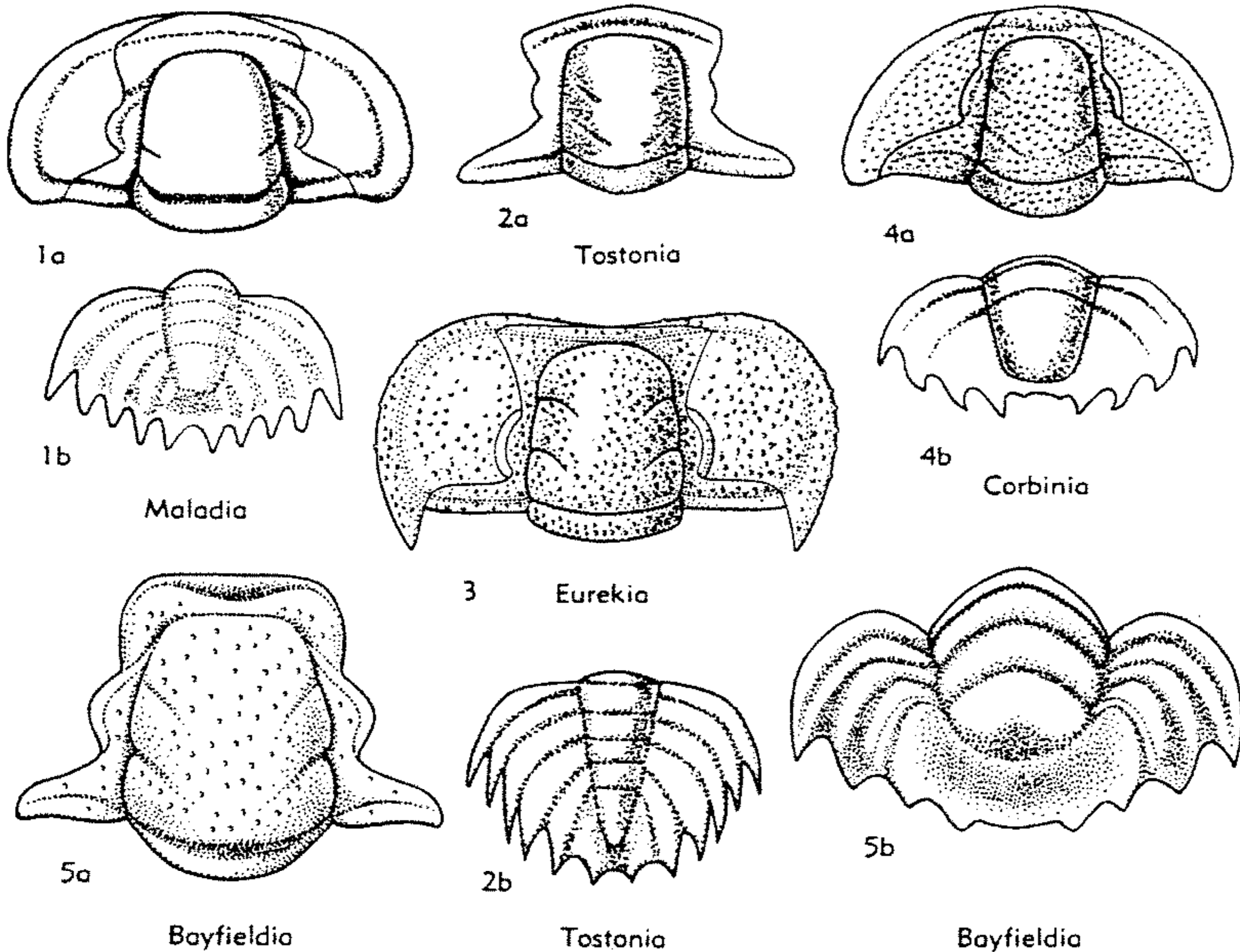

FIG. 240. Eurekaidae (p. 0325-0326).

very shallow; preglabellar field narrow (*sag.*), anterior border furrow curved, anterior border narrow, flattened; eye ridges obsolete, eyes below medium size, opposite center of glabella; fixigenae very narrow, with palpebral areas 0.12 of glabellar width, posterior areas wide (*exsag.*), triangular, of medium length (*tr.*). Pygidium narrowly transverse; axis and pleural fields of same width, 1 anterior axial ring and terminal with several very faint rings; 4 pleurae, interpleural grooves obsolete, 4 pleural furrows, posterior pairs very faint, 4 or 5 pairs of small marginal spines. Surface finely granulose (321). *U.Cam.(Trempeal.)*, C.N.Am.-W.N.Am.—FIG. 240,4. **C. horatio*, Alba.; 4a,b, ceph., pyg., $\times 2$ (488).

Maladia WALCOTT, 1924 [**M. americana*]. Glabella moderately convex, truncate-tapering, anterior corners rounded, lateral furrows shallow, arcuate; eyes about medium in size, slightly in front of mid-length of glabella; preglabellar field present; narrow eye ridges distinct; fixigenae with arcuate palpebral areas about 0.3 of glabellar width, posterior areas wide (*exsag.*), triangular, of medium length (*tr.*). Pygidium transverse; axis narrower than pleural fields, with 3 axial rings and long terminal; 5 pleurae, interpleural grooves very broad, deep, may have coalesced

pleural furrows, 5 pairs of stout marginal spines. Outer surface very finely granulose (321). *U.Cam.(Francon.-Trempeal.)*, W.N.Am.—FIG. 240,1. **M. americana*, Idaho; 1a,b, ceph., pyg., $\times 1$ (488).

Tostonia WALCOTT, 1924 [**Dicellosephalus iole* WALCOTT, 1884]. Glabella moderately convex, broad, subquadrate, with long deep diagonal lateral furrows; eyes below medium size, slightly behind mid-length of glabella, preglabellar field narrow; eye ridges faint; fixigenae with palpebral areas about 0.3 of glabellar width, posterior areas straplike, of medium length (*tr.*). Pygidium semicircular; axis narrower than pleural fields, with 5 axial rings and pointed terminal; 5 pleurae separated by narrow interpleural grooves, pleural furrows obsolete, 5 pairs of small marginal spines. Surface may be smooth (321). *U.Cam.*, W.N.Am.—FIG. 240,2. **T. iole* (WALCOTT), Nev.; 2a,b, cran., pyg., $\times 4$ (488).

Superfamily REMOPLEURIDACEA Hawle & Corda, 1847

[*nom. transl.* RICHTER, 1933, herein (*ex Remopleurides* HAWLE & CORDA, 1847)]

Exoskeleton opisthoparian, medium-sized.

Characters displayed by many genera include tapering glabella with 3 or fewer pairs of lateral furrows not reaching axial furrows; short to long (*sag.*) frontal area crossed by radiating ridges; occipital ring distinct; eye lobes close to glabella; facial sutures opisthoparian, with widely divergent anterior sections. Thorax of 9 to 12 segments, pleurae with diagonal furrows. Pygidium with short axis, pleural fields furrowed, margins spinose. In some genera (Remopleuridinae) glabella occupies entire area between eye lobes and extends forward as tongue, frontal area being short or absent; median suture crossing anterior doublure; in Loganellidae this median suture is lacking and margins of the pygidium are smooth. *U.Cam.-U.Ord.*

Family REMOPLEURIDIDAE Hawle & Corda, 1847

[*nom. correct.* RICHTER, 1933 (*ex* Remopleurides HAWLE & CORDA, 1847) (*emend.* HUPÉ, 1955; WHITTINGTON, *herein*)]

Eye lobes long, curved, with extremities adjacent to axial furrows and posterior margins at or near posterior border furrows; facial sutures opisthoparian, median suture across anterior doublure; eye lobes may inclose narrow (*tr.*) palpebral lobes, or glabella may occupy entire space between eye lobes, in front of which glabella narrow; up to 3 pairs of lateral glabellar furrows; frontal area present or absent; librigenae commonly narrow (*tr.*), genal spines originating at variable points on lateral margins. Thorax of 9 to 12 segments; axis convex, pleural furrows diagonal, pleural tips pointed and directed backward. Pygidium with axis not extending full length; pleural fields flattened, furrowed; margin commonly spinose. Doublure of thorax and pygidium extends inward almost to axial furrow; doublure of cephalon may be narrow or extended to full width of librigenae. Outer surface of exoskeleton (including doublure) with raised anastomosing lines or rarely tubercles. *U.Cam.-U.Ord.*

Subfamily REMOPLEURIDINAE Hawle & Corda, 1847

[*nom. transl. et correct.* WHITTINGTON, *herein* (*ex* Remopleurides HAWLE & CORDA, 1847)]

Median part of glabella occupying entire area between eye lobes, glabellar tongue varying in length (*sag.*) and convexity; frontal area short (*sag.*) or absent (26, 258, 350, 351). *L.Ord.-U.Ord.*

Remopleurides PORTLOCK, 1843 [**R. colbii*; SD S. A. MILLER, 1889]. Glabellar tongue short (*sag.*), narrow (*tr.*), bent vertically down; 2 faint pairs of lateral furrows present; librigenae triangular in outline, with bases of long genal spines opposite broad (*tr.*), occipital ring. Doublure broad anteriorly, narrower laterally. Hypostoma transversely rectangular, borders convex, with diagonally directed paired oval areas on middle body. Thorax with 11 segments, axis wide (*tr.*), pleurae narrow (*tr.*), with prominent articulating boss and socket immediately outside axial furrows; longer pleural spines on 7th segment and backwardly directed axial spine on 8th segment may be present. Pygidium small, triangular, margin of pleural fields with 2 pairs of spines. *M.Ord.*, Norway-Swed.-Ire.-Scot.-Va.-Asia. — FIG. 241.1. **R. colbii*, Ire.; *1a*, exoskel. (reconstr.), $\times 2$; *1b*, hypostoma (exterior), $\times 3$ (496).

Amphytrion HAWLE & CORDA, 1847 [*pro* Caphyra BARRANDE, 1846 (*non* Caphyra GUÉRIN, 1832)] [**Caphyra radians* BARRANDE, 1846 (= *A. murchisonii* HAWLE & CORDA, 1847)] [= *Brachypleura* ANGELIN, 1854]. Like *Remopleurides* but cephalon with broad, flat border in front of eyes and glabellar tongue, border continuous laterally with broad genal spines; glabella with 3 pairs of lateral furrows, tongue extremely narrow (*tr.*) and short (*sag.*); anterior sections of facial sutures uniting just before reaching anterior margin of border. Hypostoma subsquare in outline, with oval areas on posterolateral parts of middle body. Thorax with relatively wide (*tr.*) pleurae drawn out into long spines; median axial spine on 8th segment. Pygidium with short axis and long (*sag.*, *exsag.*) pleural fields, 2 pairs of spines on posterior margin. *U.Ord.*, Boh.-Swed. — FIG. 242.1. **A. radians* (BARRANDE), Boh.; exoskel. (reconstr.), $\times 0.8$ (79).

Hypodicranotus WHITTINGTON, 1952 (**Remopleurides striatulus* WALCOTT, 1875). Like *Remopleurides* but glabellar tongue projects farther in front of eye lobes, 3 pairs of lateral glabellar furrows present; with broad lateral cephalic spines in addition to short genal spines. Hypostoma very long, deeply forked, without borders. *M.Ord.*, N. Am. — FIG. 241.2. **H. striatulus* (WALCOTT); N.Y.-Ont.; *2a,b*, lateral and ventral view of exoskel. (outline of pygidium restored), $\times 3$ (351*).

Remopleuridiella ROSS, 1951 [**R. caudilimbata*]. Like *Remopleurides* but posterior sections of facial sutures more divergent; narrow, convex cephalic border extending around glabellar tongue; genal spines arising far forward. Pygidium with 4 or 5 pairs of spinose pleurae. *L.Ord.*, Utah. — FIG. 242.2. **R. caudilimbata*; *2a-c*, cran. (profile), librigena, pyg., $\times 4$ (463*).

Robergia WIMAN, 1905 [**Remopleurides microphthalmus* LINNARSSON, 1875]. Length of eye lobes (*exsag.*) less than 0.5 of cephalon (*sag.*); gla-

bella narrow posteriorly, expanding between eye lobes, glabellar tongue long (*sag.*) and broad (*transv.*); 3 pairs of deep lateral furrows pres-

ent; with narrow cephalic border and doublure anteriorly and laterally; genal spines originating opposite mid-point of eye lobes; posterior sections

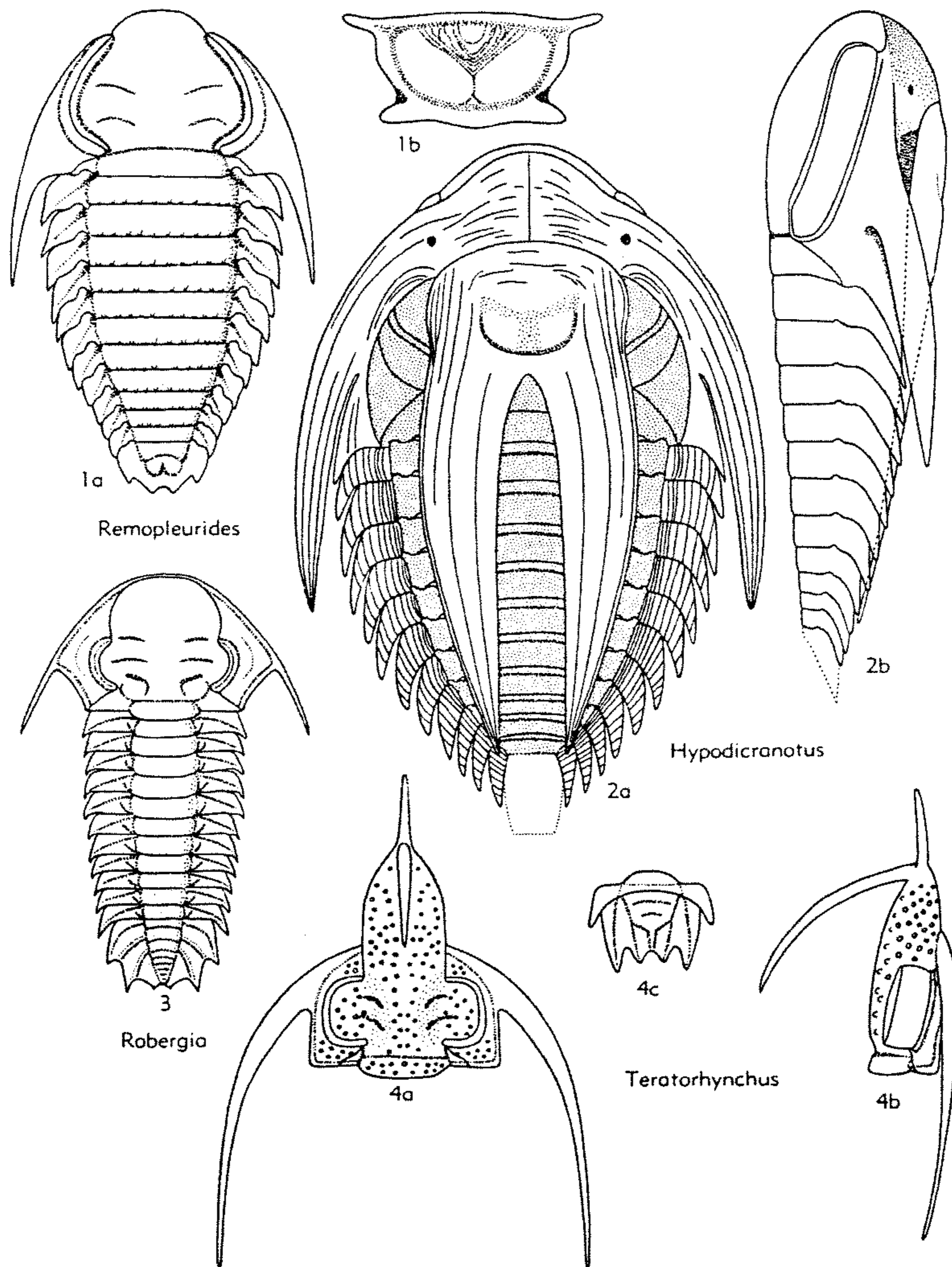

FIG. 241. Remopleurididae (p. 0327-0329).

of facial sutures running out to posterolateral corners of fixigenae. Thorax of 11 segments; pleurae transversely directed, terminating in small posteriorly directed spines, with deep diagonal pleural furrows. Pygidium with length about equal to width; axis extending close to posterior margin; pleural fields flat, with 3 pairs of pleural furrows and posterior spines. *M.Ord.*, Norway-Swed.-Scot.-Va.-Ala.-Okla.-Manch.—FIG. 241,3. *R. deckeri* B. N. COOPER, Okla.; exoskel (reconstr.), $\times 4$ (496n).

Teratorhynchus REED, 1903 [**Remopleurides* (T.) *bicornis*]. Maximum width of glabella almost twice length; glabellar tongue subcylindrical, tapering and rounded anteriorly, length 1.5 to 3 times posterior part of glabella so that it projects in front of rest of cephalon; glabellar tongue with 2 anterior median spines, one directed forward, the other curving upward and backward; with shallow longitudinal depressions bending across glabella between extremities of eye lobes, and within these depressions 2 pairs of lateral glabellar furrows, posterior the longer; librigenae narrow (*tr.*), genal spines originating opposite anterior ends of eye lobes. Width of each thoracic pleura about equal to width of axis. Pygidium with 2 pairs of spines on posterior margin. Surface tuberculate. *M.Ord.*, Scot.—FIG. 241,4. **T. bicornis*; 4a,b, ceph., dorsal and right lateral; 4c, pyg.; all $\times 2$ (496).

Subfamily RICHARDSONELLINAE Raymond, 1924

[*emend.* WHITTINGTON, herein] [=Kainellidae ULRICH & RESSER, 1930; Macropygidae KOBAYASHI, 1937]

Anterior sections of facial sutures widely divergent; frontal area long (*sag.*), may include preglabellar field, which may bear radiating ridges, pits in anterior border furrow. *U.Cam.-M.Ord.*

Richardsonella RAYMOND, 1924 [**Dikelocephalus megalops* BILLINGS, 1860] [= *Protapatokephalus* RAYMOND, 1937]. Like *Kainella* but glabella tapering slightly forward, reaching only slightly in front of eye lobes, which are longer (*exsag.*), equalling 0.5 or more of length of cephalon (*sag.*); with 2 pairs of lateral furrows or none; anterior sections of facial sutures less strongly divergent, posterior sections extending far out, parallel to and just in front of posterior border furrows. Pygidium relatively shorter, pleurae less strongly curved and pleural furrows shallow (188). *U.Cam.*, Que.-Vt.—FIG. 242,3. **R. megalops* (BILLINGS), Que.; 3a,b, cran. (librigena partially reconstr.), pyg., $\times 2.5$ (79).

Apatokephalus BRÖGGER, 1896 [**Trilobites serratus* BOECK, 1838; SD BASSLER, 1915] [= *Diplapatokephalus* RAYMOND, 1937]. Glabella convex, broad where it occupies entire space between palpebral furrows, narrower and rounded where it projects

a short distance in front of eye lobes, with 3 pairs of lateral furrows; short preglabellar area (*sag.*); anterior border convex; large, deep pits in anterior border furrow; librigena narrow (*tr.*), with long, slender genal spines originating at posterolateral corners. Thorax of 12 segments; long median axial spine on 8th segment; deep diagonal pleural furrows, pleural tips long, pointed. Pygidium with convex axis; pleural fields with 5 pairs of spinose pleurae, curving outward-backward. Surface of glabella and pygidial axis tuberculate (281). *L.Ord.*, S.Am.-N.Am.-Eng.-Norway-Swed.-Ger.—FIG. 243,2. **A. serratus* (BOECK), Swed.; 2a,b, ceph., pyg., $\times 2$ (496n).

Eobergia COOPER, 1953 [**Robergia marginalis* RAYMOND, 1925]. Cranidium like *Robergia* except that anterior sections of facial sutures apparently diverge and palpebral rims are longer, broader, and sharply curved posteriorly; anterior border broad (*sag.*), convex, deep border furrow with pits. Pygidium like *Apatokephalus*, with 4 long, paired spines on margins. Surface with fine ridges in Bertillon pattern and small tubercles (26). *M.Ord.*, Tenn.—FIG. 242,5. **E. marginalis* (RAYMOND); 5a, cran., $\times 2.7$; 5b, pyg., $\times 2$ (26*).

Kainella WALCOTT, 1925 [**Hungaia billingsi* WALCOTT, 1924]. Glabella subparallel-sided or tapering slightly forward, with 2 or 3 pairs of diagonally directed lateral furrows; long (*sag.*) frontal area; genal regions broad (*tr.*); cephalon with wide convex border and long genal spines arising at posterolateral corners; eye lobes (*exsag.*) about 0.3 of length of cephalon, with broad palpebral rim; posterior sections of facial sutures running outward-backward to reach posterior margins at about 0.5 of width of posterior borders; anterior border furrow with close-spaced pits; radiating, anastomosing ridges crossing preglabellar field and reaching furrow between these pits. Pygidium with length about equal to width; axis with about 6 rings; 3 pleural furrows in pleural fields directed backward and slightly inward; 3 pairs of spines on posterior margin (321). *L.Ord.*, N.Am.-S.Am.—FIG. 243,3. *K. meridionalis* KOBAYASHI, Arg.; 3a,b, ceph., pyg., $\times 1$ (496, n).

Macropyge STUBBLEFIELD in STUBBLEFIELD & BULMAN, 1927 [**M. chermi*] [= *Gladiatoria* HUPÉ, 1955]. Glabella narrowing forward, deep basal lateral furrows isolating triangular basal lobe, 2 further faintly defined lateral glabellar furrows; frontal area including only narrow (*sag.*) anterior border; genal spines arising at posterolateral corners of wide (*tr.*) genae; long eye lobes; anterior sections of facial sutures only moderately divergent. Thorax of 9 segments. Pygidium with relatively short axis; pleural fields prolonged back to form long, broad terminal spine; 1st 2 pleural furrows present (114). *L.Ord.*, Br.I.-Utah.—FIG. 243,1. **M. chermi*, Tremadoc., Br.I.; exoskel., $\times 1$ (496, n).

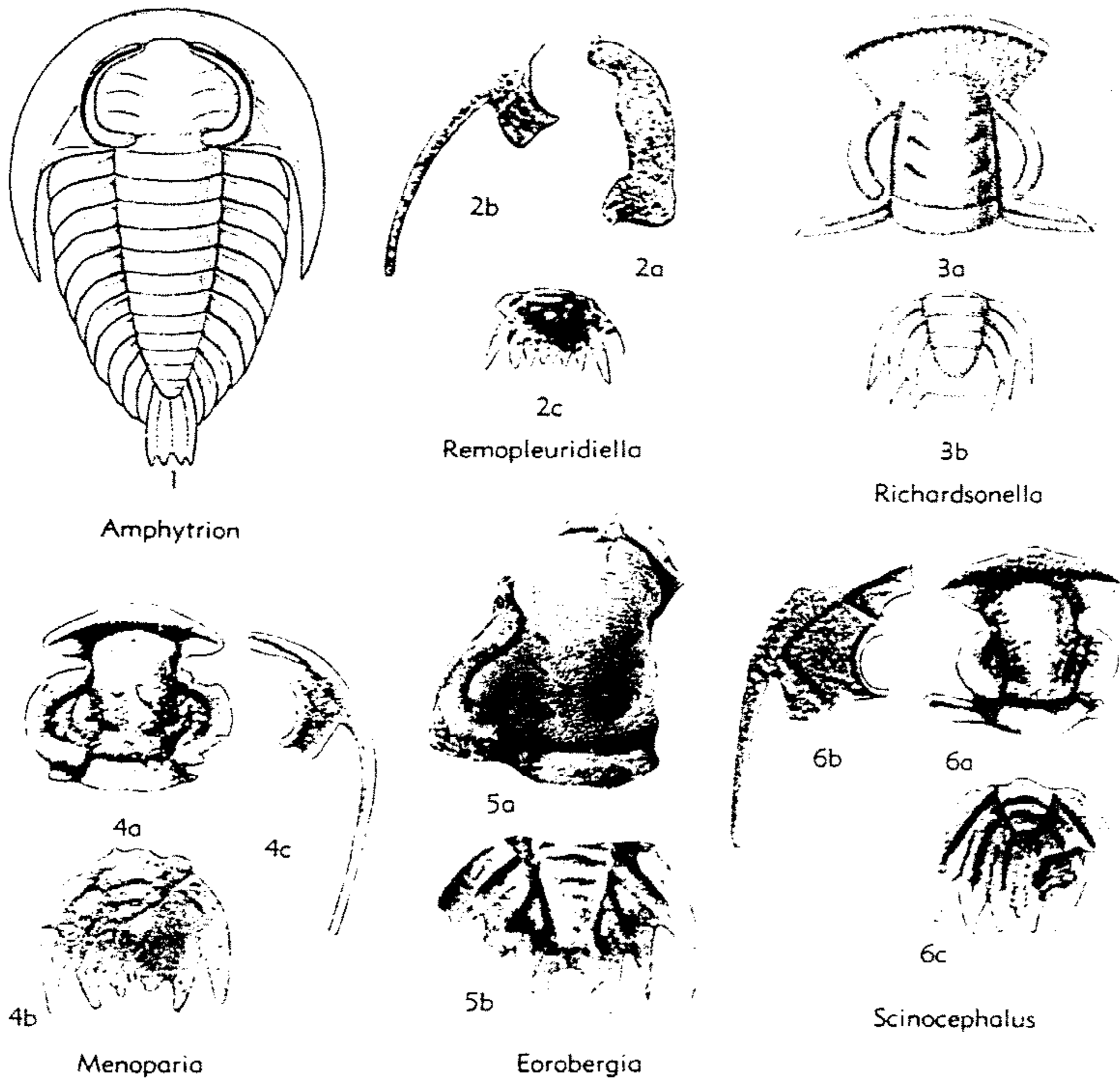

FIG. 242. Remopleurididae (p. 0327-0330).

Menoparia Ross, 1951 [**M. genalunata*]. Like *Apatokephalus* but small crescentic area between lateral margins of glabella and palpebral furrows; 2 pairs of lateral furrows; no preglabellar field in mid-line, short (*exsag.*) laterally; genal spines originating on lateral margins opposite mid-point of eye lobes. Axis of pygidium with fewer rings; pleural fields with 4 pairs of marginal spines, inner pair minute (258). *L.Ord.*, Utah.—FIG. 242,4. **M. genalunata*; 4a, cran., $\times 8$; 4b, pyg., $\times 6$; 4c, librigena, $\times 8$ (258*).

Pseudokainella HARRINGTON, 1938 [**P. keideli*] [= *Parakainella* KOBAYASHI, 1953]. Like *Kainella* but glabella tapering markedly forward; anterior sections of facial sutures less divergent; preglabellar field shorter (*sag.*). Thorax of 12 segments, long median axial spine on 8th segment; deep diagonal pleural furrows. Pygidium like that of *Apatokephalus*, wider than long, 4 pairs of spinose pleurae, directed diagonally outward and back-

ward (55). *L.Ord.*, Arg.-Korea.—FIG. 244. **P. keideli*, Tremadoc., S.Am.; exoskel., $\times 13.5$ (59*).

Scinocephalus Ross, 1951 [**S. solitecti*]. Like *Apatokephalus* but anteromedian part of glabella strongly inflated, posterolateral part outside posterior lateral furrows depressed, extending out to palpebral furrows, median and anterior glabellar furrows short, shallow; librigenae broad, genal spines originating opposite anterior end of eye lobes, doublure extending in to margin of eye lobes. Pygidium with short, convex axis, long pleural fields with 3 pairs of backwardly curving spinose pleurae, minute median marginal spine (258). *L.Ord.*, Utah.—FIG. 242,6. **S. solitecti*; 6a, cran., $\times 8$; 6b, librigena, $\times 4$; 6c, pyg., $\times 4$ (258*).

Tramoria REED, 1899 [**T. punctata*]. Only cranium known, apparently like *Apatokephalus* but glabella with posterior pair of furrows only and part in front of eye lobes shorter; anterior sections of facial sutures less divergent. ?*L.Ord.*, Ire.

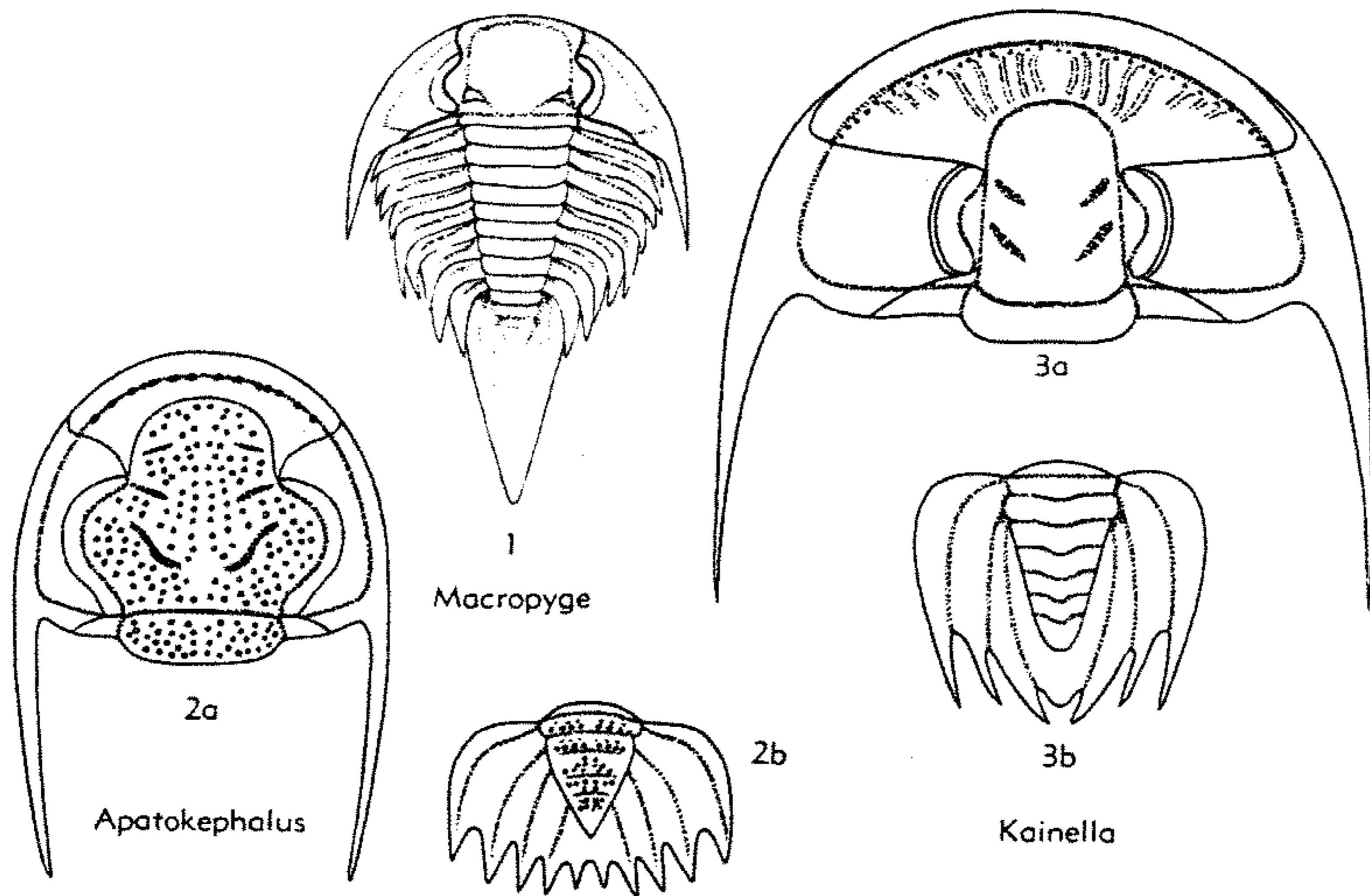

FIG. 243. Remopleurididae (p. 0329).

Lingukainella KOBAYASHI, 1953 [**L. robusta*]. Doubtful value, based on single pygidium of *Kainella* type bearing 2 pairs of pleural spines and median posterior spine. ?*L.Ord.*, B.C.

Hukasawaia KOBAYASHI, 1953 [**Richardsonella* (*H.*) *cylindrica*]. Based on cranidium said to be like *Richardsonella* but lacking preglabellar field; cranidium resembles that of *Menoparia*. *L.Ord.*, Korea.

?*Lichapyge* CALLAWAY, 1877 [**L. cuspidata*]. Only pygidium known, in type species $\frac{1}{8}$ inch long; outline subtriangular, length of axis about 0.5 of total pygidial length, continued to margin by postaxial ridge; 1st 2 pleural furrows and interpleural grooves subparallel, curving to point backward, tips of 1st 2 pleurae pointed; other furrows on remainder of pleural regions. *L.Ord.*(*Tremadoc.*), Eng.-Ger.

Subfamily UNCERTAIN

Apatokephalina SIVOV, 1955 [**A. bruta*]. *U.Cam.*, W.Sib. [Author's assignment to family.]

Artokephalus SIVOV & JEGOROVA, 1955 [**A. minimus* SIVOV, 1955]. *U.Cam.*, W.Sib. [Author's assignment to family.]

Portentosus JEGOROVA, 1955 [**P. brevis*]. *U.Cam.*, W.Sib. [Author's assignment to family.]

Family LOGANELLIDAE Rasetti, nov.

Exoskeleton opisthoparian subisopygous to micropygous. Glabella subrectangular,

occipital ring simple; glabellar furrows unconnected with axial furrows; frontal area short to long (*sag.*); border furrow present or obsolete; eyes small to medium-sized, close to glabella, median or posterior in position; anterior facial sutures strongly divergent, frontal portion dorsal-intramarginal; librigenae wide, fused together through doublure. Thorax of 11 or 12 segments; macropleural segments may be present. Pygidium wide and short; margin entire; axis elevated, of 5 to 7 rings; pleural fields furrowed; border flat or concave. Probably derived from ptychopariids through *Wilbernia* or similar forms; also closely related to early Remopleurididae (*Richardsonella*) (188, 189). *U.Cam.*

Loganellus DEVINE, 1863 [**L. quebecensis* (= *Olenus? logani* DEVINE, 1863)] [= *Highgatea* RAYMOND, 1937]. Glabella convex, tapered; preglabellar field short (*sag.*) or absent; border elevated; eyes small, at level of glabellar mid-point; eye ridges distinct. Thorax of 11 or 12 segments, one of which macropleural; pleurae extended into spines. Pygidium subtriangular, with narrow border. *U.Cam.*(*Trempeal.*), N.Am.—FIG. 245.1. **L. logani* (DEVINE), Que.; exoskel., $\times 2$ (448n).

Lauzonella RASETTI, 1944 [**Dikelocephalus planifrons* BILLINGS, 1860]. Glabella flat, subrectangu-

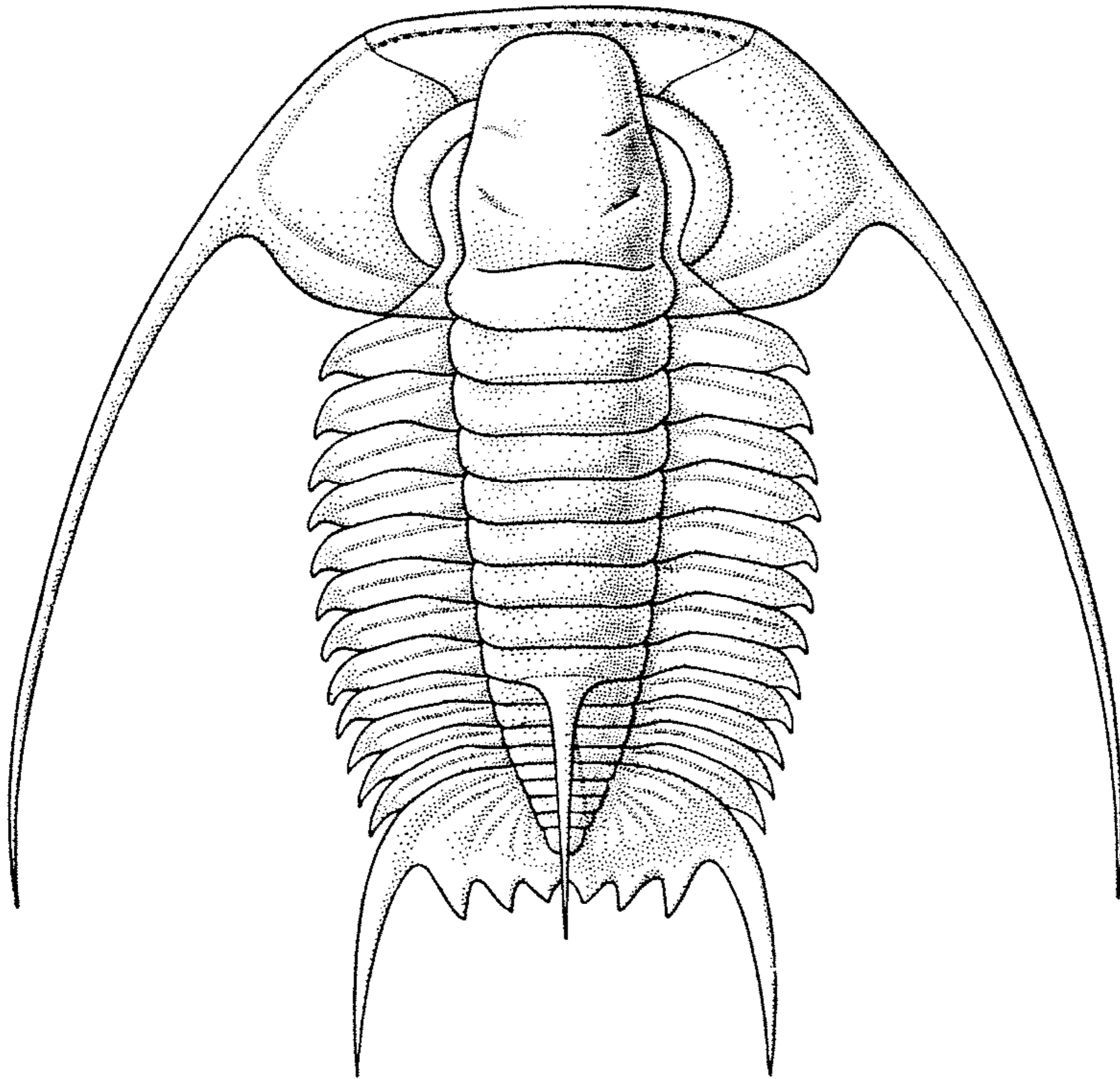

FIG. 244. **Pseudokainella keideli* HARRINGTON (Remopleurididae), L.Ord., Arg.; exoskel., $\times 13.5$ (59*).

lar, frontal area long (*sag.*) and wide, lacking border; eyes medium-sized, close to dorsal furrow, posterior in position. *U.Cam. (Trempeal.)*, N.Am. —FIG. 245.2. **L. planifrons* (BILLINGS), Que.; 2*a,b*, cran., pyg., $\times 1.5$ (448n).

Levisella ULRICH in RASETTI, 1944 [**Dikelocephalus oweni* BILLINGS, 1860]. Glabella subrectangular, of low convexity; preglabellar field of medium length (*sag.*), border convex, wider mesially; eyes as in *Lausonella*. Thorax of 11 segments; 5th macropleural (*L. brevifrons* RASETTI). *U.Cam. (Trempeal.)*, N.Am. —FIG. 246, **L. oweni* (BILLINGS), Que.; *a-c*, cran., pyg., united librigenae, $\times 2$ (448n).

Family HUNGAIIDAE Raymond, 1924

[*nom. transl.* KOBAYASHI, 1935 (ex Hungiinae RAYMOND, 1924)]

Exoskeleton opisthoparian, subisopygous.

Glabella tapering with rounded front; eye ridges may be present; palpebral rims and palpebral furrows narrow; eyes about medium in size, behind center of glabella; frontal area of variable width, consisting of wide flat or concave anterior border furrow and narrow anterior border; fixigenae upsloping, narrow, with palpebral areas arcuate and posterior areas narrow (*exsag.*), long, with a pair of faint posterior alae present in some; librigenae wide, flat or concave, with narrow convex border and short genal spine. Hypostoma rounded, with short anterior wings, globose central lobe, and pair of deep pits in posterior marginal furrow. Pygidium subquadrate; axis narrow, convex, short, with postaxial ridge,

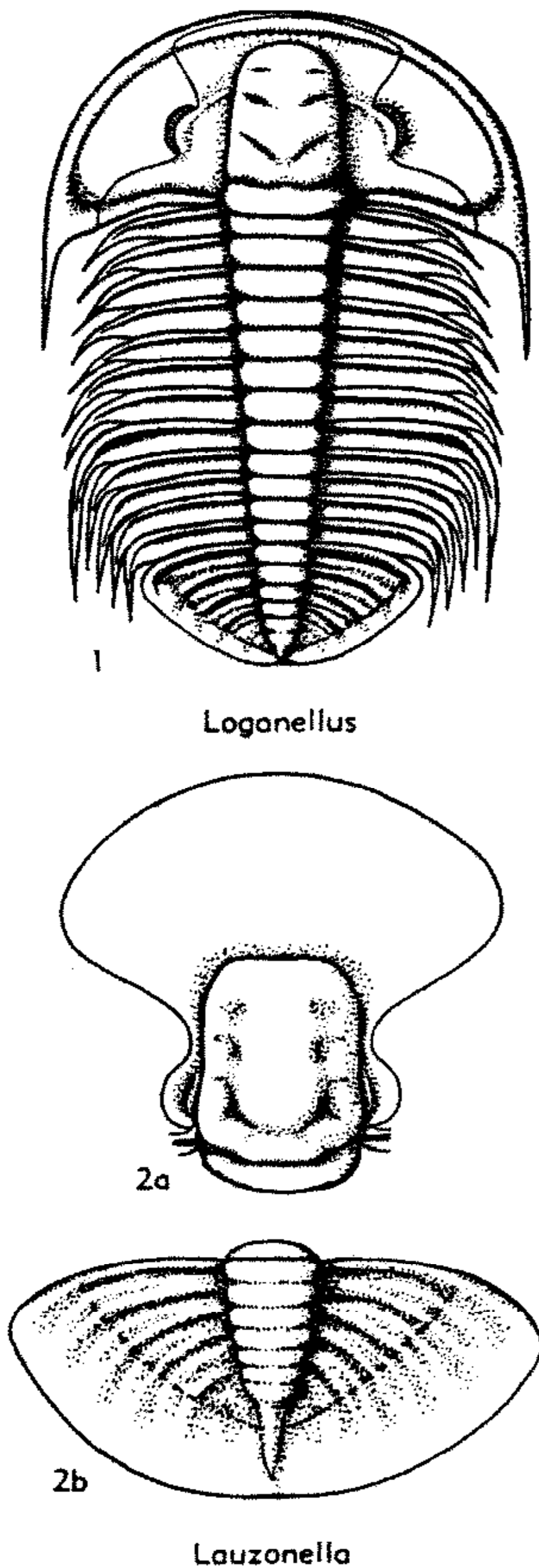

FIG. 245. Logonellidae (p. 0331).

axial rings 3 or 4; pleural fields wider than axis, pleurae and pleural furrows curved abruptly backward, ending in prominent spines on posterior margin, lacking border furrow and border. Surface finely granu-lose; a few genal caeca prominent on cephalon. *U.Cam.*

Hungaria WALCOTT, 1914 [**Dikeloccephalus magni-ficus* BILLINGS, 1865]. Glabella convex, broad-based tapering, with 3 pairs of faint lateral

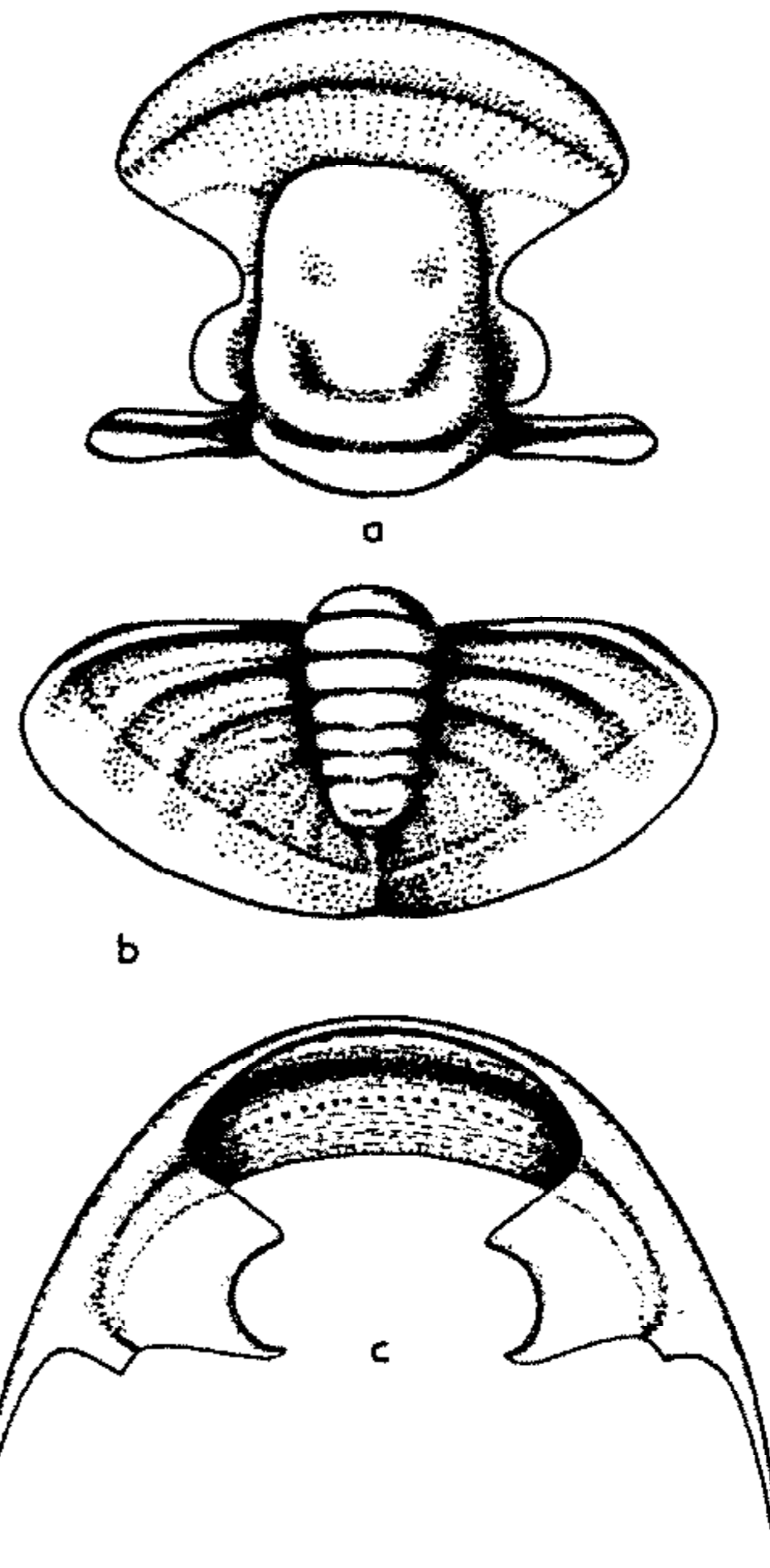

FIG. 246. **Levisella oweni* (BILLINGS) (Logonelli-dae), *U.Cam.*(Trempeal.), Que.; a-c, cran., united librigenae, pyg., $\times 1.5$ (448n).

furrows, posterior pair complete, shallow axial furrows obsolete posteriorly; eye ridges faint, eyes below medium size, opposite posterior 0.3 of glabella; frontal area concave, 0.40 of length (*sag.*) of cranidium; fixigenae with palpebral areas less than 0.3 of glabellar width, posterior areas very narrow (*exsag.*), 0.7 of length (*tr.*) of occipital ring, posterior alae weak or absent; libri-genae wide, concave, lateral marginal furrow obso-lete, with short blunt genal spines. Thoracic seg-ments geniculate, with broad deep pleural fur-rows running to flat-spaced ends. Pygidium with convex axis, tapered 0.40 of its length to rounded end, with postaxial ridge extending 0.40 or more of length, with 3 axial rings and terminal; pleurae 4, with broad shallow pleural furrows extending into base of posterior spines, 3 or all 4 of pleurae in some forms ending in flat-pointed spines along posterior margin (188). *U.Cam.*(Trempeal.), W. N.Am.-E.N.Am.-S.Am.—FIG. 247. **H. mag-nifica* (BILLINGS), Que.; a,b, ceph., pyg., $\times 0.6$ (79, 288).

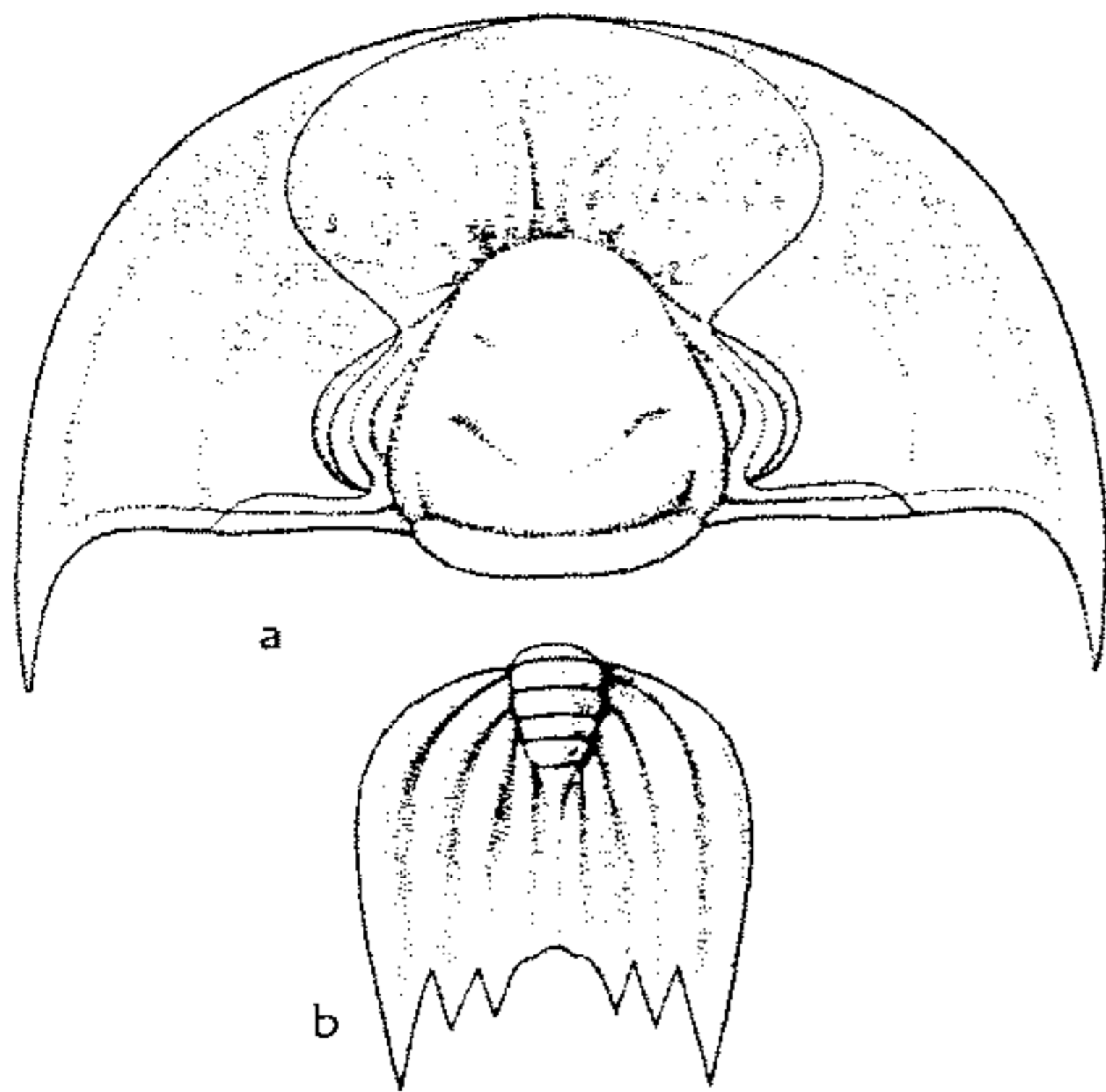

FIG. 247. **Hungaia magnifica* (BILLINGS) (Hungaiidae), U.Cam.(Trempeal.), Que.; a,b, ceph., pyg., $\times 0.7$ (79).

Superfamily UNCERTAIN

Family DICERATOCEPHALIDAE Lu, 1954

Anterior corners of cranidium with prominent spines, as long as main part of cranidium, and curving almost to meet in front; glabella tapering forward; occipital ring with long, mesial spine; fixigenae about as wide as glabella; eyes small, opposite posterior half of glabella; librigenae narrow, with long genal spines. Pygidium wider than long, with poorly defined axial furrows, and with ridge parallel to posterior margin, separating wide border with terrace lines from remainder of pygidium. *U. Cam.*

Diceratocephalus LU, 1954 [**D. armatus*]. Characters of family. *U. Cam.*, S.Manch.—FIG. 405, 2. **D. armatus*; cran., $\times 2$ (406n).

Suborder ASAPHINA Salter, 1864

[*nom. transl.* HARRINGTON & LEANZA, 1957 (*ex* Asaphini SALTER, 1864)] [Type—*Asaphus* BRONGNIART, 1822]

Exoskeleton opisthoparian, subisopygous. Librigenae separated anteriorly by median suture or fused; doublure broad; glabella with faint lateral glabellar furrows or smooth, commonly with glabellar tubercle; eye ridges rarely present, faint. Thorax with 6 to 9 segments. Pygidium more or less equal to cephalon in size. Tuberculate ornamentation rare. *Up.M. Cam.-U.Ord.*

Superfamily ASAPHACEA

Burmeister, 1843

[*nom. transl.* HENNINGSMOEN, 1951 (*ex* Asaphidae BURMEISTER, 1843)].

Thoracic segments generally 8 (in a few genera 7). Eyes commonly more or less conical, short or moderate in length; eye ridges present in a few genera, faint or scarcely discernible. Pygidium rounded or with terminal spine (in Taihungshaniidae with pair of spines). *U. Cam.-U.Ord.*

Family ASAPHIDAE Burmeister, 1843

Librigenae separated anteriorly by a median suture; glabella well defined to obsolete, considerably longer than frontal area; lateral glabellar furrows mostly weak or absent; most genera with distinct glabellar tubercle; eyes generally somewhat distant from axial furrows; faint, almost obsolete eye ridges known only in 2 genera. Doublure commonly broad; posterior margin of hypostoma varying from pointed to deeply notched. Thorax of 8 segments; pleural furrows generally diagonal, if present. Panderian organs developed as notches or separate openings, but absent in some (Ogygiocaridinae, Symphysurininae). External margin of pygidium varying from rounded to pointed, in some genera with terminal spine; paired pygidial spines present only in single genus of uncertain affinities. Dorsal surface of carapace with small pits, terrace lines, or both; no tuberculate or granulose ornamentation. Family tends toward loss of apparent segmentation of cephalon and pygidium, obsolescence of axial furrows, and deep notching of posterior margin of hypostoma. *U. Cam.-U.Ord.*

Subfamily ASAPHINAE Burmeister, 1843

[*nom. transl.* M'COV, 1850 (*ex* Asaphidae BURMEISTER, 1843)]

Glabella commonly expanded in front of eyes; posterior lateral glabellar furrows commonly strong, obliquely directed, mostly deeper than part of axial furrows laterally delimiting posterior lateral glabellar lobe; glabellar tubercle situated immediately in front of occipital furrow or of area corresponding to this furrow; posterior border furrow generally distinct. Panderian organs developed as notches or separate openings. Anterior wings of hypostoma broad (*tr.*), more or less quadrangular in outline; posterior margin of hypostoma with deep

notch (except *Aulacoparia*). Pygidium with ribs of pleural fields unfurrowed, if present, or rarely with faint furrows; posterior margin rounded, without spine. *L.Ord.*(*U. Tremadoc.*)-*U.Ord.*

Asaphus BRONGNIART in BRONGNIART & DESMAREST, 1822 [*non Asaphus* BRONGNIART in DESMAREST, 1817 (suppressed, ICZN Opinion 510)] [**Entomotrachites expansus* WAHLENBERG, 1821 (= *Entomolithus paradoxus a expansus* LINNÉ, 1768, suppressed, ICZN opinion 296)]. Cephalon and

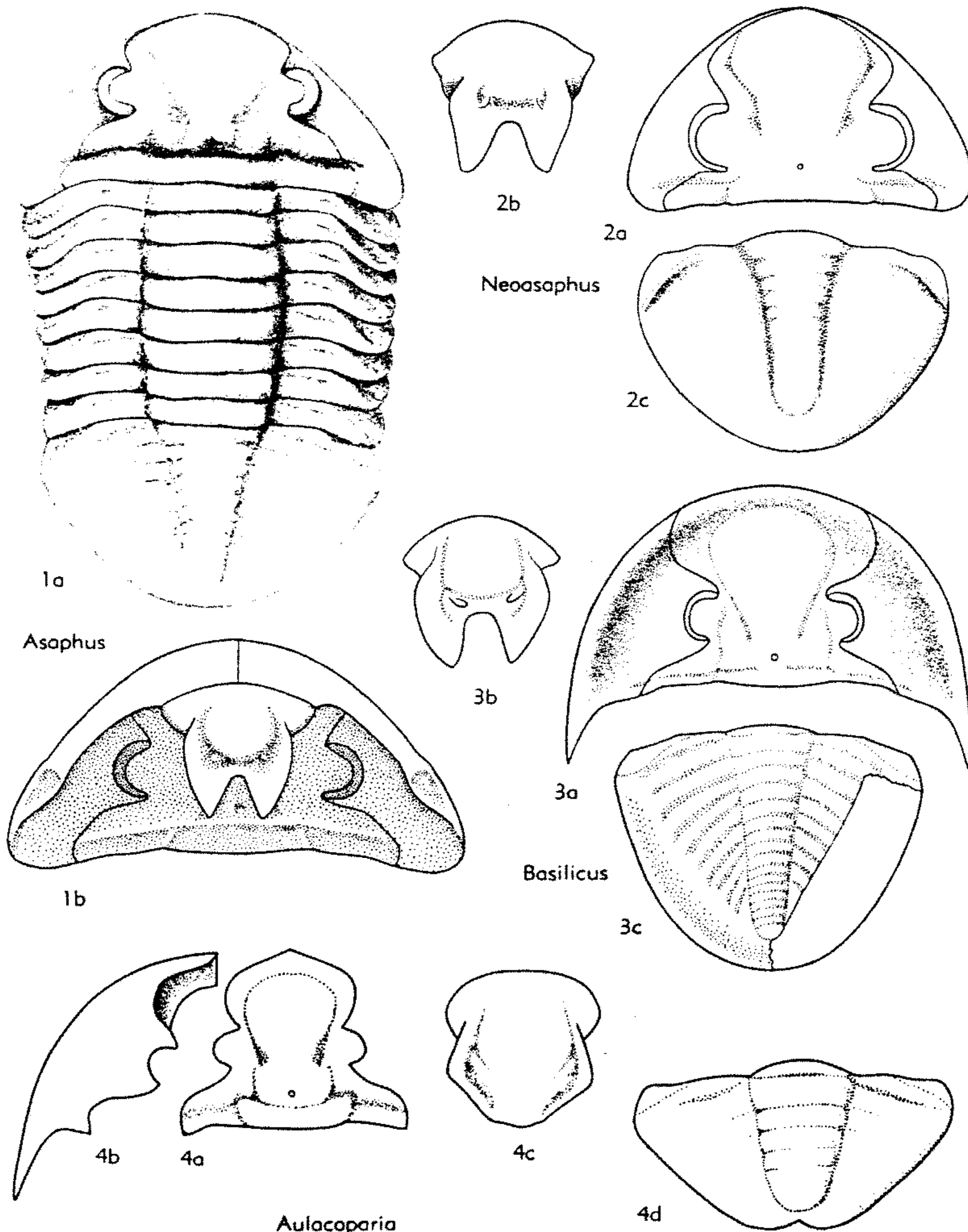

FIG. 248. Asaphidae (Asaphinae) (p. 0336).

pygidium without any trace of border. Glabella long, reaching external cephalic margin, frontal area absent or very narrow; posterior margin of librigenae typically convex, genal angles rounded or (rarely) pointed (adult specimens only in 1 or 2 species with genal spines). Lateral corners of hypostoma more or less protruding. Librigenal panderian organs developed as notches. Pygidial axis long, prominent; pleural fields smooth or very faintly ribbed; pygidial doublure moderately broad. *L.Ord.*(*U.Arenig.*)-*M.Ord.*, NW.Eu.

A. (*Asaphus*) [= *Schizophorus* BALASCHOVA, 1953]. Panderian organs on thoracic pleurae developed as notches. Eyes relatively small, length approximately equal to distance between eyes and posterior margin of cephalon. Cephalic doublure without median hook and vincular furrow. *L.Ord.*(*U.Arenig.*-*L.Llanvirn.*), Balt.—FIG. 248,1a. **A. (A.) expansus* (WAHLENBERG), Swed.; exoskel., $\times 1.5$ (414n).—FIG. 248,1b. *A. (A.) fallax* ANGELIN; ceph., ventral, showing doublure and hypostoma, $\times 1.5$ (414n).

A. (*Onchometopus*) FR. SCHMIDT, 1898 [**A. (O.) volborthi*]. Like *A. (Asaphus)* but with median hook on cephalic doublure and vincular furrow along whole extension of cephalic doublure. *L.Ord.*(*U.Arenig.*), Ingermanland(USSR).

A. (*Neoasaphus*) JAANUSSON, 1953 (Aug.) [= *Trematophorus* BALASCHOVA, 1953 (Dec.)]. [**Asaphus ludibundus* TÖRNQUIST, 1884]. Panderian organ on thoracic pleurae developed as separate opening. Inner margin of thoracic pleural doublure concave. Eyes relatively large, their length considerably exceeding distance between eyes and posterior margin of cephalon. *L.Ord.*(*Llanvirn.*)-*M.Ord.*, Balt.—FIG. 248,2. **A. (N.) ludibundus* (TÖRNQUIST), 2a-c, ceph., hypostoma, pyg., $\times 1$ (414).

Aulacoparia HINTZE & JAANUSSON, 1956 [**Asaphellus? venta* HINTZE, 1953]. Frontal area moderately long; cephalic axis well defined, with occipital furrow in all known species; eyes medium in size, situated at about transverse mid-line of cephalon or slightly behind it; genal angles produced into spines. Panderian organs developed as broad notches on librigenae (only known genus of Asaphinae with rounded posterior margin of hypostoma). Thorax unknown. Pygidial axis long, prominent; pleural fields smooth, with mere traces of ribs. *L.Ord.*(*M.Canad.*), N.Am.(Utah).

A. (*Aulacoparia*). Cephalon and pygidium without concave border. Pygidium with short postaxial field, doublure narrow, its inner margin concave on both sides of axis.—FIG. 248,4. **A. (A.) venta* (HINTZE); 4a,b, cran., librigena, $\times 4$; 4c, hypostoma, $\times 5$; 4d, pyg., $\times 1.5$ (407).

A. (*Aulacoparina*) HINTZE & JAANUSSON, 1956 [**Asaphellus? quadrata* HINTZE, 1953]. Cephalon and pygidium with more or less distinct concave border; postaxial field of pygidium mod-

erately long; pygidial doublure fairly broad, with inner margin on both sides of axis straight or feebly convex.

Basilicus SALTER, 1849 [**Asaphus tyrannus* MURCHISON, 1839]. Only known genus of Asaphinae with marginal position of facial suture in front of glabella. Cephalon surrounded by convex rim; glabella long; preglabellar field narrow; eyes rather large, situated slightly behind transverse mid-line of cranium; genal angles with spines. Lateral margin of the hypostoma broadly rounded, posterior margin deeply notched. Pygidium with well-defined concave border; inner part of the pygidial pleural fields with strong, rounded ribs; pygidial doublure moderately broad, as in *Asaphus*. *L.Ord.*-*M.Ord.*, N.Am.-Eu.

B. (*Basilicus*). Pygidium long, with subparabolic outline; postaxial field short. Cephalic border rounded. *M.Ord.*(*Llandeil.*), Wales.—FIG. 248,3. **B. (B.) tyrannus* (MURCHISON); 3a, ceph., $\times 0.7$; 3b, hypostoma, $\times 1$; 3c, pyg., showing at right shape of inner margin of doublure, $\times 0.7$ (466).

B. (*Basiliella*) KOBAYASHI, 1934 [**Asaphus barrandei* HALL, 1851]. Pygidium with more or less subcircular outline; postaxial field moderately long. Cephalic border angular. *M.Ord.*(*Blackriver*). E.C.U.S.A., *L.Ord.*(*U.Tremadoc.*), ?Arg.—FIG. 249,3. **B. (B.) barrandei* (HALL); 3a-d, cran., librigena, hypostoma, pyg., $\times 1$ (414n).

Eoisotelus WANG, 1938 [**E. orientalis*]. Glabella long, almost reaching margin of cephalon; genal angles produced into spines in the type species; librigenae more or less evenly convex; eyes relatively small. Pygidium with pleural fields smooth or very faintly ribbed, and broad, deeply concave border. *L.Ord.*, China.

Ogmasaphus JAANUSSON, 1953 [**Asaphus praetextus* TÖRNQUIST, 1884]. Like *Pseudoasaphus* but cephalon with considerably narrower frontal area and pygidium with distinct flattened border and moderately strong ribs on inner part of pleural fields. Panderian organs of type species notchlike on librigenae and developed as separate openings on thoracic pleurae; inner margin of the thoracic pleural doublure straight. Pygidial doublure moderately broad (broader than in *Asaphus*, narrower than in *Pseudoasaphus*). *M.Ord.* Scand.—FIG. 249,2. **O. praetextus* (TÖRNQUIST); 2a, ceph., $\times 2$; 2b, pyg. showing at left shape of inner margin of doublure, $\times 1.5$ (414n).

Plectasaphus JAANUSSON, 1953 [**Asaphus plicicostis* TÖRNQUIST, 1884]. Glabella and frontal area much as in *Ogmasaphus*; cephalon and pygidium without border; librigenae with straight to faintly concave posterior margin, genal angles pointed. Panderian organs on thoracic pleurae and inner margin of thoracic doublure as in *Asaphus* (*Neoasaphus*). Hypostoma as in *Asaphus*. Pygidial pleu-

ral regions evenly convex, their inner part with 3 or 4 conspicuous short (*tr.*) rounded ribs; pygidial doublure broad. *M.Ord.*(*Llandeil.*), Swed.—FIG. 249,1. **P. plicicostis* (TÖRNQVIST); carapace, X2 (414n).

Pseudoasaphus FR. SCHMIDT, 1904 [**Ptychopyge*

globifrons EICHWALD, 1857; SD REED, 1930] [= *Pseudoasaphus* FR. SCHMIDT, 1904, *nom. null.*]. Cephalon and pygidium with more or less distinct (in some species poorly defined), concave border. Frontal area moderately long; eyes large, as in *Asaphus* (*Neosaphus*); genal angles pointed

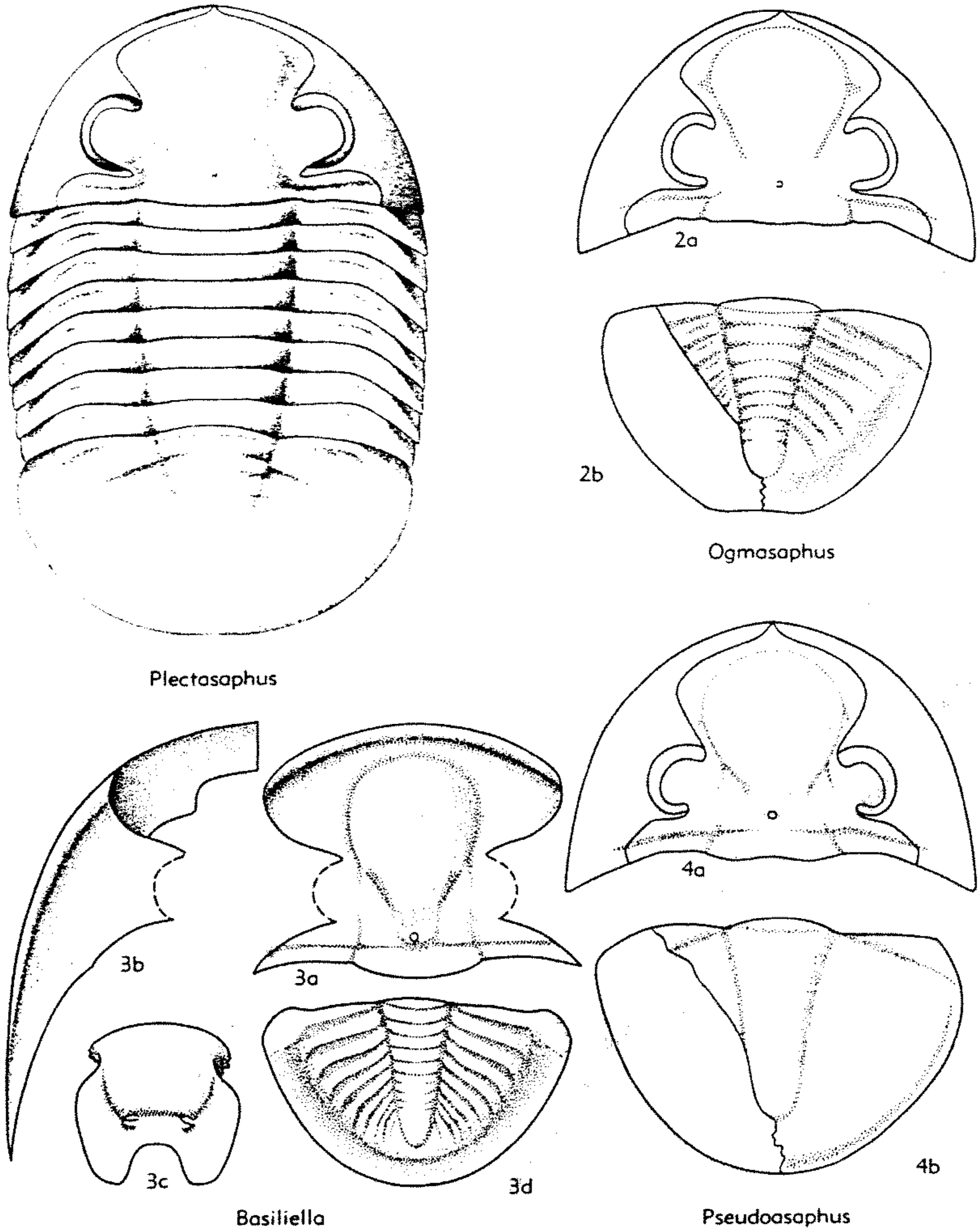

FIG. 249. Asaphidae (Asaphinae) (p. 0336-0337).

or with genal spines. Hypostoma as in *Asaphus*. Panderian organs developed as notches or separate openings on librigenae and as separate openings on thoracic pleurae. Inner margin of the thoracic pleural doublure slightly to moderately convex. Pygidium with pleural fields smooth or bearing faint ribs on inner parts, doublure broad, and outer surface generally with strong ornamentation of terrace lines. *L.Ord.* (Llanvirn.)-*M.Ord.*, Baltoscandia.—*FIG.* 249,4. **P. globifrons* (EICHWALD); 4a, ceph., $\times 1.5$; 4b, pyg., showing at left

shape of inner margin of doublure, $\times 1.5$ (468). **Pseudobasilicus** REED, 1931 [**Ptychopyge lawrowi* FR. SCHMIDT, 1898]. Exoskeleton rather flattened. cephalon and pygidium with a broad flattened border. Frontal area moderately long; eyes large, as in *Asaphus* (*Neoasaphus*); librigenae broad, with genal spines. Lateral terminations of thoracic pleurae, unlike all other Asaphinae, pointed and curved backward, resembling short spines. Panderian organs and inner margin of thoracic pleural doublure as in *Ptychopyge*. Inner part of pygidial

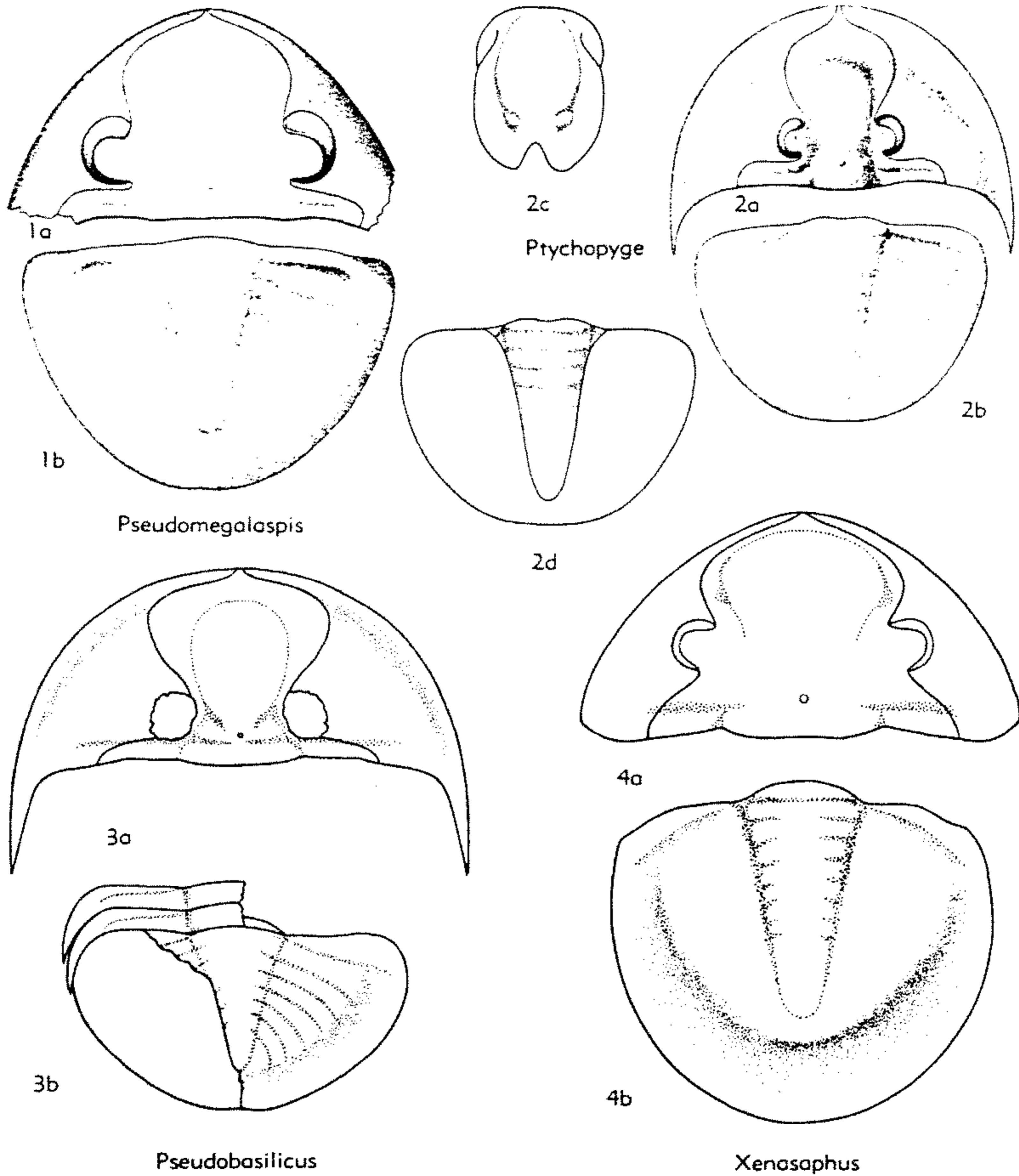

FIG. 250. Asaphidae (Asaphinae) (p. O338-O339).

pleural fields with conspicuous rounded ribs that reach border (one species without ribs); pygidial doublure very broad, as in *Ptychopyge*. *M.Ord.*, Baltoscandia.—FIG. 250,3. **P. lawrowi* (FR. SCHMIDT); 3a, ceph.; 3b, parts of 2 hindmost thoracic segments and pygidium showing at left shape of pygidial doublure, $\times 1$ (468). [*Pseudobasilicus* REED, 1930 (*nom. nud.*), did not include *Ptychopyge lawrowi* as species assigned to genus.—C.J.S.]

Pseudomegalaspis JAANUSSON, 1953 [**Megalaspis formosa* TÖRNQUIST, 1884]. Cephalon and pygidium without trace of concave border. Genal angles produced into spines. Hypostoma as a whole as in *Asaphus*. Posterior lateral glabellar furrows poorly developed; eyes large, as in *Asaphus* (*Neoasaphus*). Thoracic axis narrow, its width considerably less than 0.3 of total width of thorax. Panderian organs on thoracic pleurae and inner margins of thoracic pleural doublure, as in *A.* (*Neoasaphus*), their development on librigenae unknown. Pygidium with axis rather flattened; inner part of pleural fields with faint, slightly furrowed ribs; doublure narrow, its inner margin more or less parallel to outer margin of pygidium. *M.Ord.* (*Llandeil.*), Scand.—FIG. 250, 1. **P. formosa* (TÖRNQUIST); a, b, ceph., pyg., $\times 1$ (414).

Ptychopyge ANGELIN, 1854 [**Asaphus angustifrons* DALMAN, 1827; SD proposed JAANUSSON, 1956 (ICZN pend.)]. Cephalon and pygidium with flattened border. Glabella comparatively narrow; frontal area long to moderately long; eyes relatively small, generally as in *Asaphus* (*Asaphus*); characteristic nodes typically developed behind eyes (may be present also in *Pseudoasaphus*); posterior margins of librigenae concave, genal angles produced into spines. Hypostoma with comparatively short (*tr.*) notch in posterior margin, lateral margin more or less evenly rounded, without a distinct protruding corner. Thoracic axis narrow, its width considerably less than 0.3 of total width of thorax; lateral terminations of thoracic pleurae straight. Panderian organs developed as separate openings on librigenae and thoracic segments. Inner margin of thoracic pleural doublure strongly convex. Inner part of the pygidial pleural fields with faint, rounded, unfurrowed ribs; pygidial doublure very broad. *L.Ord.* (*Arenig.-L. Llanvirn.*). Baltoscandia.—FIG. 250,2. **P. angustifrons* (DALMAN); 2a, ceph., $\times 1$; 2b, pyg., $\times 1$ (414n); 2c, hypostoma, $\times 1.5$ (424); 2d, pyg., ventral view showing shape of doublure (414n).

Xenasaphus JAANUSSON, 1953 [**Asaphus devexus* EICHWALD, 1840]. Cephalon without trace of border; frontal area very short; eyes relatively small, as in *Asaphus* (*Asaphus*); posterior margin of librigenae convex, genal angles rounded or faintly pointed. Hypostoma essentially as in

Asaphus. Thorax with long and deep articulating furrows. Panderian organs developed as broad notches on librigenae and as separate openings on thoracic pleurae. Pygidium with broad, deeply concave border; postaxial field moderately long; inner part of pygidial pleural fields smooth or with very faint traces of unfurrowed ribs; doublure moderately broad, as in *Asaphus*. *M.Ord.* (*Llandeil.*), Est., Ingermanland (Leningrad district).—FIG. 250,4. **X. devexus* (EICHWALD); 4a, ceph. (reconstr.), $\times 1$ (414); 4b, pyg., $\times 1$ (468).

Subfamily ISOTELINAE Angelin, 1854

[*nom. transl.* JAANUSSON, herein (*ex* Isotelidae ANGELIN, 1854)]

Glabella, if defined, slightly tapering forward, parallel-sided, or somewhat expanding in front of eyes; glabellar tubercle immediately in front of or at some distance from occipital furrow or of area corresponding to it, distance between this tubercle and occipital furrow (with some exceptions) smaller than length (*sag.*) of occipital ring. Anterior wings of hypostoma more or less triangular. Panderian organs generally developed as separate openings. Ornamentation of terrace lines mostly poorly developed or absent. [The tendency toward obsolescence of axial furrows is more common in this subfamily than in others. The tribes here distinguished may not represent natural units.] *L.Ord.* (*Arenig.*)-*Up.U.Ord.*

Group A

Posterior margin of hypostoma strongly concave to deeply notched (including genera in which hypostoma is still unknown, but which probably have similar shape of hypostomal posterior margin). *L.Ord.* (*Arenig.*)-*Up.U.Ord.*

Isotelus DEKAY, 1824 [**I. gigas*]. Cephalon and pygidium mostly with poorly defined flattened border. Frontal area moderately long, cephalic axis ill defined, almost obsolete in several species, slightly expanding in front of medium-size eyes situated somewhat behind transverse mid-line of cranidium; no posterior border furrow; genal angles rounded, pointed, or with short genal spines. Hypostoma almost parallel-sided, posterior margin with broad (*tr.*), deep notch; anterior lobe short. Thoracic axis considerably broader than pleurae. Pygidial axis broad, poorly defined, almost obsolete in several species; pleural fields smooth or very faintly ribbed. *M.Ord.-U.Ord.* N. Am.-Sib.-N.Eu.-Greenl.—FIG. 251,2. **I. gigas*; 2a, carapace, $\times 1$ (496); 2b, hypostoma, $\times 0.7$ (414n).

Anataphrus WHITTINGTON, 1954 [**A. borraeus*]. No border on cephalon or pygidium, axial furrows obsolete; foremost portions of facial sutures very close to external cephalic margins; eyes large, their mid-point slightly behind the transverse mid-line of cephalon; no posterior border furrow;

genal angles rounded. Thoracic axis considerably broader than pleural regions; pleural furrows absent. Pygidium smooth, axis completely obsolete. *U.Ord.*, N.Am.-Greenl.-Baffin I.—FIG. 251,4. **A. borraeus*: 4a,b, ceph., 8th thoracic segment and pyg., X3 (496).

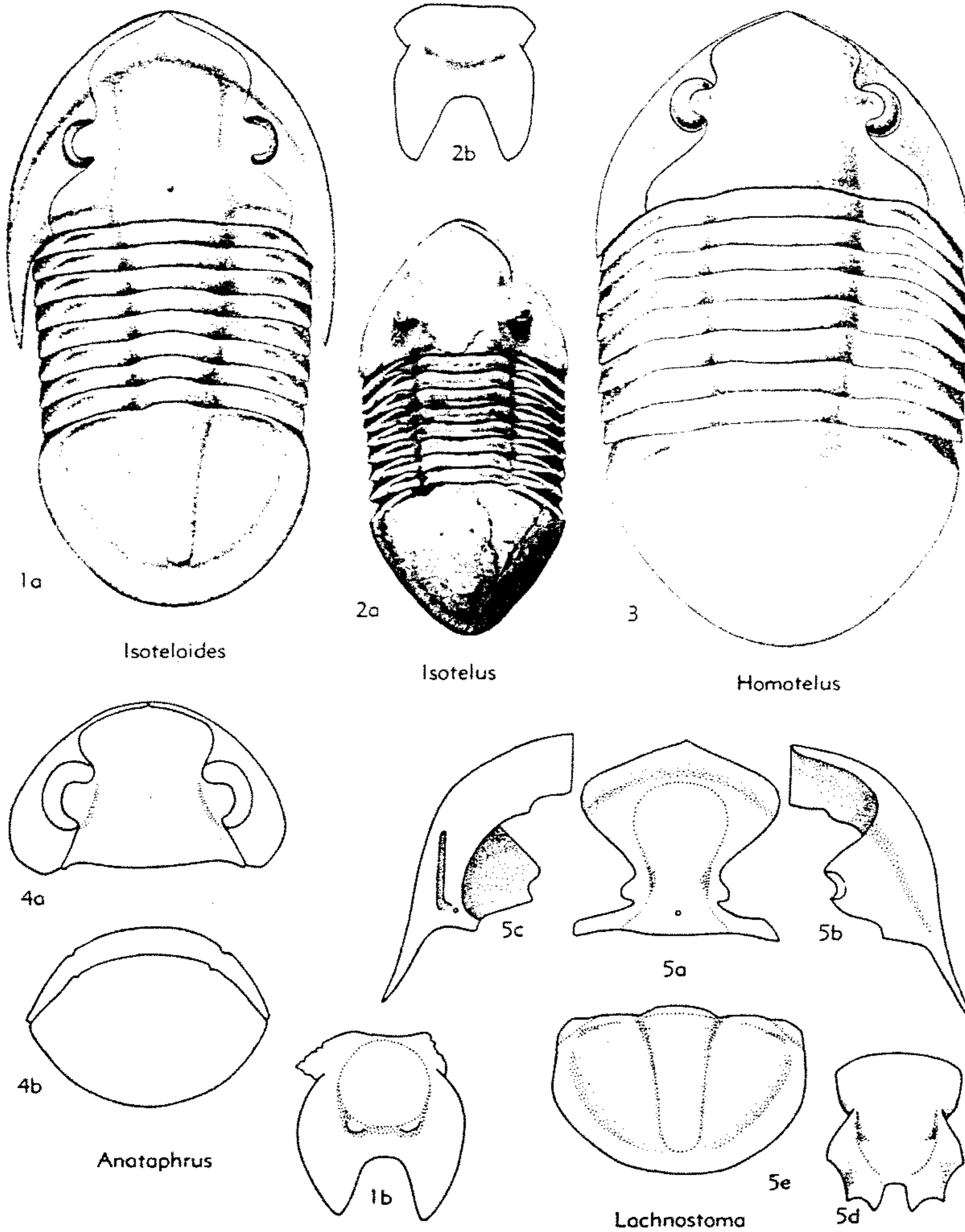

FIG. 251. Asaphidae (Isotelinae) (p. 0339-0340).

- Ectenaspis* RAYMOND, 1920 [**Megalaspis beckeri* SLOCUM, 1913]. Anterior part of cephalon produced into long, tonguelike process; cephalic axis not distinguished; no distinct cephalic border or posterior border furrow; eyes on long stalks; genal corners rounded. Hypostoma unknown. Thoracic axis well defined, considerably broader than pleurae. Pygidium triangular, with faint narrow flattened border posteriorly; axis well defined, triangular. *U.Ord.(Maquoketa)*. USA(Iowa).—FIG. 252,4. **E. beckeri* (SLOCUM); carapace, $\times 1$ (496n).
- Homalopyge* JAANUSSON, 1956 [**Asaphus stacyi* FR. SCHMIDT, 1898]. Cephalon and pygidium without trace of border and axial furrows on dorsal surface of carapace; eyes small, considerably behind transverse mid-line of cranidium; no posterior border furrow; librigenae relatively narrow, genal angles rounded; foremost portions of facial sutures at some distance from external cephalic margins. Thorax and hypostoma unknown. Pygidial doublure moderately broad. *L.Ord.(Llanvirn.)*. Baltoscandia.—FIG. 252,3. **H. stacyi* (FR. SCHMIDT); 3a, ceph., $\times 0.7$; 3b, pyg., showing at left shape of inner margin of doublure, $\times 0.7$ (414).
- Homotelus* RAYMOND, 1925 [**H. ulrichi*] [= *Homotelus* RAYMOND, 1920, *nom. nud.* (no fig. of type species)]. Cephalon without trace of border; cephalic axis poorly defined, expanding in front of eyes; no frontal area, glabella reaching cephalic margin; eyes of moderate size, slightly in front of transverse mid-line of cranidium; no posterior border furrow; genal angles pointed in type species. Hypostoma as in *Isotelus*. Thoracic axis about twice width of pleurae in dorsal view. Pygidium with narrow, poorly defined, flattened border; axis wide (*tr.*) anteriorly, comparatively well defined, pleural fields smooth. *U.Ord.(Eden.)*. N.Am.(Ohio).—FIG. 251,3. **H. ulrichi*; carapace, $\times 1.5$ (496).
- Isoteloides* RAYMOND, 1910 [**I. whitfieldi*]. Cephalon and pygidium with well-defined, flattened border; frontal area moderately long, in type species slightly shorter than 0.25 of total length of cephalon; glabella rather well defined, slightly expanding in front of moderately large eyes situated at about transverse mid-line of cephalon; faint posterior border furrow may be present; genal angles produced into spines. Hypostoma in type species with broadly rounded lateral margin and broad (*tr.*) notch in posterior margin. Thoracic axis about as broad as pleurae. Pygidial axis rather well defined, moderately broad; pleural fields in type species with faint ribs. *L.Ord.(U. Canad.)*, N.Am.-Greenl.—FIG. 251,1. **I. whitfieldi*; 1a, carapace (reconstr.), $\times 2$ (414n); 1b, hypostoma, $\times 2$ (414n).
- Lachnostoma* ROSS, 1951 [**L. latucelsum*]. Frontal area moderately long, cephalic axis rather poorly defined, slightly expanding in front of eyes, which are small, situated well behind transverse mid-line of cephalon; no posterior border furrow; librigenae broad, with poorly defined flattened border and relatively long genal spines; librigenal doublure with conspicuous furrow. Hypostoma with rather broad lateral border, pointed lateral corner, short and narrow (*tr.*) notch in posterior margin, and short pointed process between notch and lateral corner. Thoracic axis distinctly narrower than corresponding pleurae; pleural furrows absent. Pygidium with well-defined flattened border and equally well-defined relatively narrow axis; pleural fields very faintly ribbed to smooth; doublure narrow, with inner margin on both sides of axis parallel to external margin of pygidium. *L.Ord.(U. Canad.)*. USA(Utah).—FIG. 251,5. **L. latucelsum*; 5a, cran., $\times 2$; 5b,c, librigena, dorsal, ventral, $\times 1.5$; 5d, hypostoma, $\times 2$; 5e, pyg., $\times 1.5$ (407).
- Lannacus* TJERNVIK, 1956 [**Megalaspides nericiensis* WIMAN, 1905]. Like *Megalaspides* but with broad flattened pygidial border. *L.Ord.(Arenig.)*, Swed.—FIG. 252,2. **L. nericiensis* (WIMAN); carapace (reconstr.), $\times 1$ (414n).
- Megalaspides* BRØGGER, 1886 [**Megalaspis dalecarlicus* HOLM, 1882]. Cephalon with distinct flattened border; frontal area moderately long (in type species 0.16 of total length of cephalon); glabella fairly distinct, more or less parallel-sided; eyes moderately large, at or slightly behind mid-line of cranidium; posterior border furrow absent or faint; genal angles produced into spines. Lateral margin of hypostoma evenly rounded, posterior margin with broad (*tr.*) short notch. Thoracic axis considerably narrower than pleurae. Pygidium with axis commonly flattened and rather poorly defined; without border; pleural fields smooth; doublure narrow, with inner margin on both sides of axis more or less parallel to external margin. *L.Ord.(Arenig.)*, Baltoscandia.—FIG. 252,1. **M. dalecarlicus* (HOLM); 1a, carapace (reconstr.), $\times 1$ (414n); 1b, hypostoma, $\times 2$ (484a).
- Nileoides* RAYMOND, 1920 [**Nileus perkinsi* RAYMOND, 1910]. Cephalon without trace of border; cephalic and pygidial axial furrows completely obsolete, those of thorax very faint; eyes large, close to posterior cephalic margin; foremost portions of facial sutures very close to external cephalic margins and nearly parallel to them; no posterior border furrow. Thoracic axis much broader (*tr.*) than pleurae; pleural furrows absent; shape of genal angles and hypostoma unknown. Pygidium incompletely known. *M.Ord.(Chazy.)*. USA.(Vt.-N.Y.).—FIG. 253,3. **N. perkinsi* (RAYMOND), ceph., $\times 1$ (414n).
- Ogygitoides* KOBAYASHI, 1934 [**O. raymondi*]. Cephalon and pygidium with poorly defined concave border; preglabellar field fairly long, 0.20 to 0.25 of total length of cranidium; cephalic axis

comparatively narrow, fairly well-defined, parallel-sided or slightly tapering forward; eyes moderately large, at about transverse mid-line of cranidium; no posterior border furrow; genal spines long and anteriorly rather broad. Hypostoma unknown. Thoracic axis considerably narrower than pleurae.

Pygidial axis well-defined, narrow, pygidial pleural fields smooth. *M.Ord.*, S.Korea.—FIG. 253, 1. **O. raymondi*; 1a,b, ceph., 2 hindmost thoracic segments and pyg., $\times 1$ (41+n). *Parabasilius* KOBAYASHI, 1934 [**P. typicalis*]. Type species poorly known. *M.Ord.*, S.Korea.

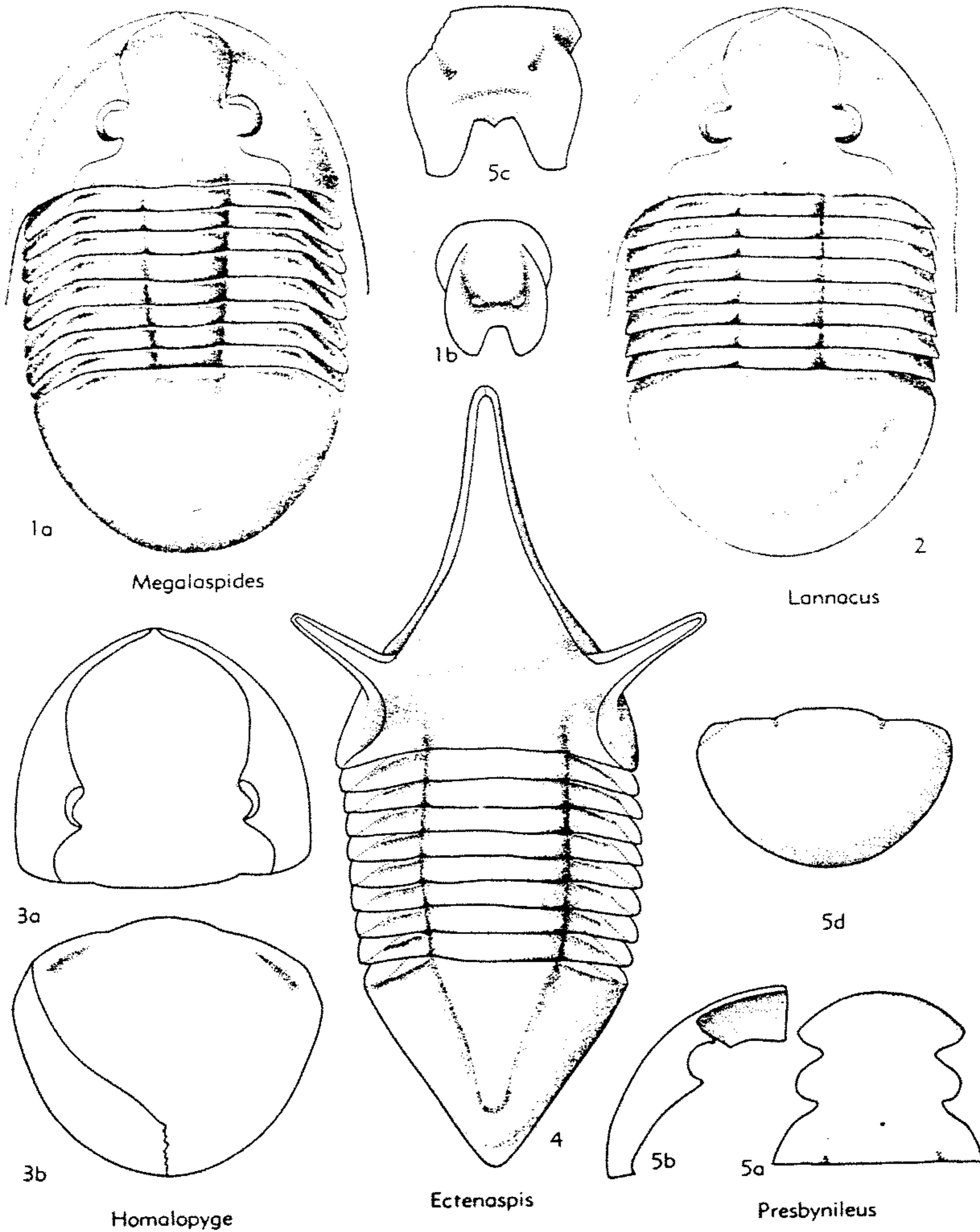

FIG. 252. Asaphidae (Isotelinae) (p. 0341-0343).

Presbynileus HINTZE, 1954 [*pro Paranileus* HINTZE, 1953 (*non* KOBAYASHI, 1951)] [**Paranileus ibexensis* HINTZE, 1953]. Cephalon and pygidium without trace of border and with almost completely obsolete axial furrows; foremost portions of facial sutures close to external cephalic margins and nearly parallel to them; eyes of moderate size, at transverse mid-line of cranidium; no posterior border furrow; genal angles rounded. Thorax unknown. Pygidial pleural regions smooth, doublure moderately broad. *L.Ord.(M.Canad.-U.Canad.)*, N.Am.

P. (Presbynileus). Carapace rather strongly convex. Hypostoma with deeply notched posterior margin and short, pointed median spine; lateral corners slightly protruding, broadly rounded. *L.Ord.(M.Canad.-U.Canad.)*, N.Am. (Utah). — FIG. 252,5. **P. (P.) ibexensis* (HINTZE); 5a, cran., $\times 3.5$; 5b,c, librigena, hypostoma, $\times 4$; 5d, pyg., $\times 2$ (407).

P. (Protopresbynileus) HINTZE, 1954 [*pro Pseudonileus* HINTZE, 1953 (*non* KOBAYASHI, 1951)] [**Pseudonileus willdeni* HINTZE, 1953]. Exoskeleton moderately convex. Posterior margin of hypostoma slightly notched, posterior and lateral furrows well developed, middle furrow absent. *L.Ord.(M.Canad.)*, N.Am. (Utah). — FIG. 254,1. **P. (P.) willdeni* (HINTZE); 1a, cran., $\times 1.5$; 1b,c, librigena, hypostoma, $\times 3$; 1d, pyg. showing at right shape of inner margin of doublure, $\times 6$ (407).

Pseudogygites KOBAYASHI, 1934 [**Asaphus canadensis* CHAPMAN, 1856]. Cephalon and pygidium with well-defined flattened border; prelabellar field long, slightly less than 0.25 of total length of cephalon; cephalic axis distinctly defined, expanding in front of eyes, which are comparatively small, situated well behind transverse mid-line of cranidium, their length about equal to distance between eyes and posterior cephalic margin; posterior border furrows rather distinct; genal angles produced into spines. Thoracic axis moderately broad, about same in width as pleurae. Pygidium with prominent axis, pleural fields with numerous strong unfurrowed ribs that almost reach external margin; doublure apparently narrow. [May not belong to this subfamily.] *M.Ord.* or *U.Ord. (Utica)*, Can. — FIG. 253,5. **P. canadensis* (CHAPMAN); 5a, ceph., $\times 1$; 5b, pyg., $\times 0.7$ (449).

Ptyocephalus WHITTINGTON, 1948 [**P. vigilans*] [= *Kirkella* KOBAYASHI, 1942 (*non* GUNNELL, 1933)]. Cephalic outline more or less pentagonal; prelabellar field moderately long, 0.15 to 0.2 of total length of cephalon; cephalic axis rather poorly defined, nearly parallel-sided; eyes of moderate size, slightly behind transverse mid-line of cranidium; no posterior border furrow; librigenae narrow, genal angles rounded; all species with conspicuous furrow on librigenal doublure. Hypostoma of peculiar shape, widest (*tr.*) near anterior

end of comparatively very broad lateral border, notch in posterior margin relatively narrow (*tr.*) and short; no middle furrow. Pygidium more or less pentagonal in outline, with wide, flattened border which is broadest (*tr.*) anteriorly and decreases in width posteromedially; axis poorly defined, wide (*tr.*), facets narrow (*tr.*) and long; doublure broad. [May not belong to this subfamily.] *L.Ord.(U.Canad.)*, N.Am. — FIG. 253,4. *P. yersini* (HINTZE), Utah; 4a, cran., $\times 4$; 4b,c, librigena, hypostoma, $\times 3$; 4d,e, pyg., dorsal, ventral, $\times 2$ (407).

Stenorhachis HINTZE & JAANUSSON, 1956 [**Isoteloides? genalticurvatus* HINTZE, 1953]. Preglabellar field long, slightly more than 0.5 of length of cephalic axis, which is narrow, flattened, almost parallel-sided or slightly tapering forward; eyes small, far from axial furrows and well behind transverse mid-line of cephalon; faint posterior border furrow present; librigenae broad, with shallow, poorly defined concave border and long genal spines. Hypostoma and thorax unknown. Pygidium comparatively broad, with distinct concave border; axis narrow, fairly prominent; pleural fields with mere traces of ribs; doublure moderately broad. *L.Ord.(U.Canad.)*, USA. (Utah). — FIG. 253,2. **S. genalticurvata* (HINTZE); 2a, cran., $\times 2$; 2b,c, librigena; pyg., showing at right shape of inner margin of doublure, $\times 4$ (407).

Trigonocerca Ross, 1951 [**T. typica*]. Preglabellar field narrow, cephalic axis poorly defined, slightly expanding in front of eyes, which are moderately large, situated slightly behind transverse mid-line of cranidium; no posterior border furrow; librigenae with poorly defined flattened border and genal spines. Hypostoma with concave posterior margin and short pointed median spine; lateral corners pointed, protruding; posterior furrow distinct, no middle furrow. Thorax unknown. Pygidium triangular, with short terminal spine and narrow border; axis rather poorly defined; pleural fields smooth or very faintly ribbed; doublure narrow, with inner margin parallel to external margin. *L.Ord.(U.Canad.)*, N.Am. — FIG. 254,3. *T. piochensis* (HINTZE), Utah; 3a, cran., $\times 4$; 3b,c, librigena, hypostoma, $\times 2$; 3d,e, pyg., dorsal, ventral, $\times 2.5$ (407).

Trigonocercella HINTZE, 1953 [**T. acuta*]. Cephalon strongly elongated, cephalic axis poorly defined; eyes comparatively small, slightly behind transverse mid-line of cranidium; foremost part of facial sutures close to external cephalic margins and almost parallel to them; librigenae without trace of border and with genal spines. No posterior border furrow. Hypostoma with deeply notched posterior margin and strongly protruding lateral corners; no posterior furrow, middle furrow partly obsolete. Thorax unknown. Pygidium without border, with poorly defined axis and compara-

tively long terminal spine; pleural fields smooth. *L.Ord.(U.Canad.), N.Am.(Utah).*—FIG. 254,2. **T. acuta*; 2a, cran., X3; 2b,c, librigena, hypostoma, X4; 2d, pyg., X3 (407). *Vogdesia* RAYMOND, 1910 [**Isotelus? bearsi* RAYMOND, 1905]. Cephalic axis long, almost reaching

anterior margin, cephalic axial furrows poorly defined; eyes rather large, situated at about transverse mid-line of cranidium, stalked on type species; no posterior border furrow; librigena with poorly defined, slightly concave border and rounded genal corners. Hypostoma and thorax un-

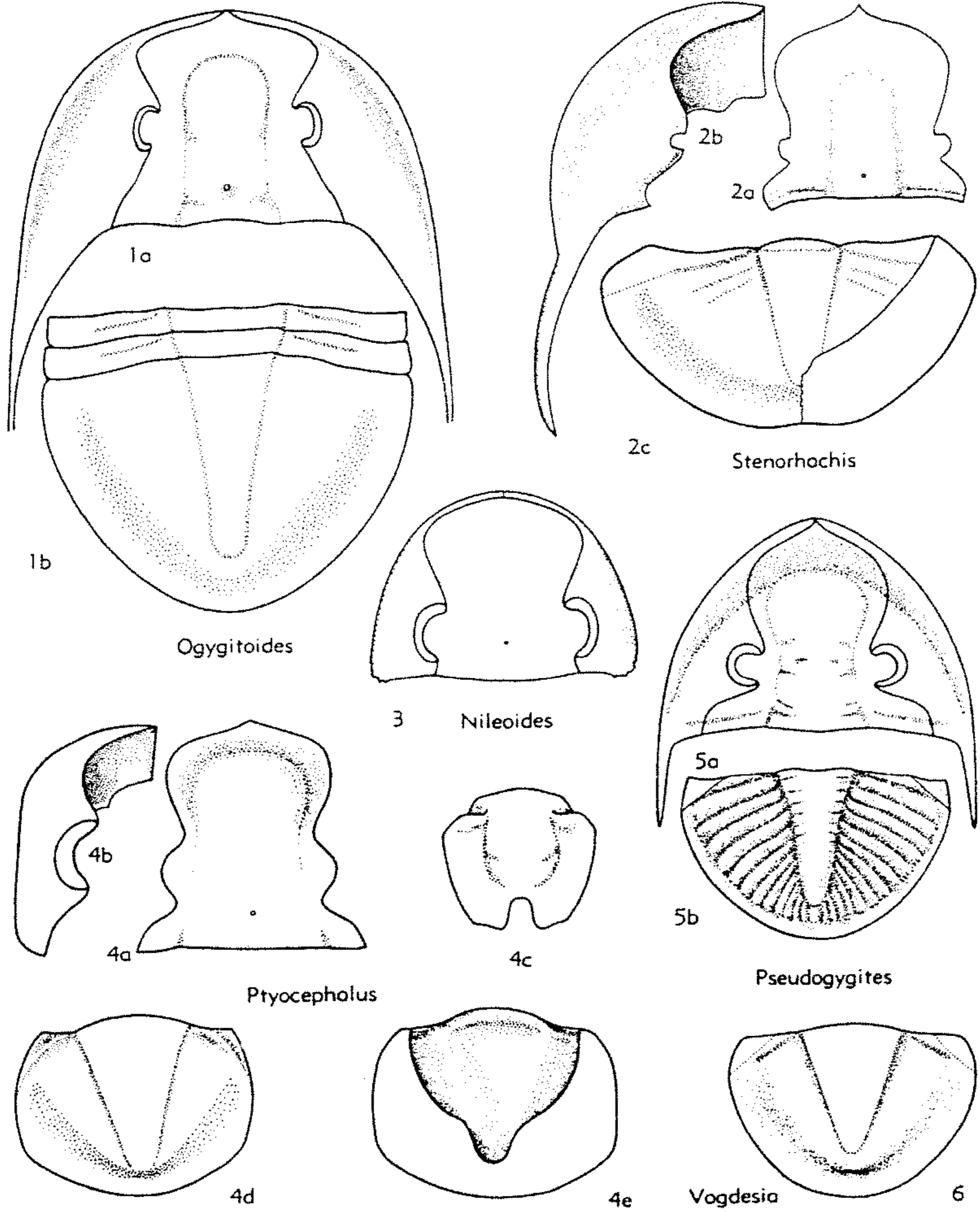

FIG. 253. Asaphidae (Isotelinae) (p. 0341-0344).

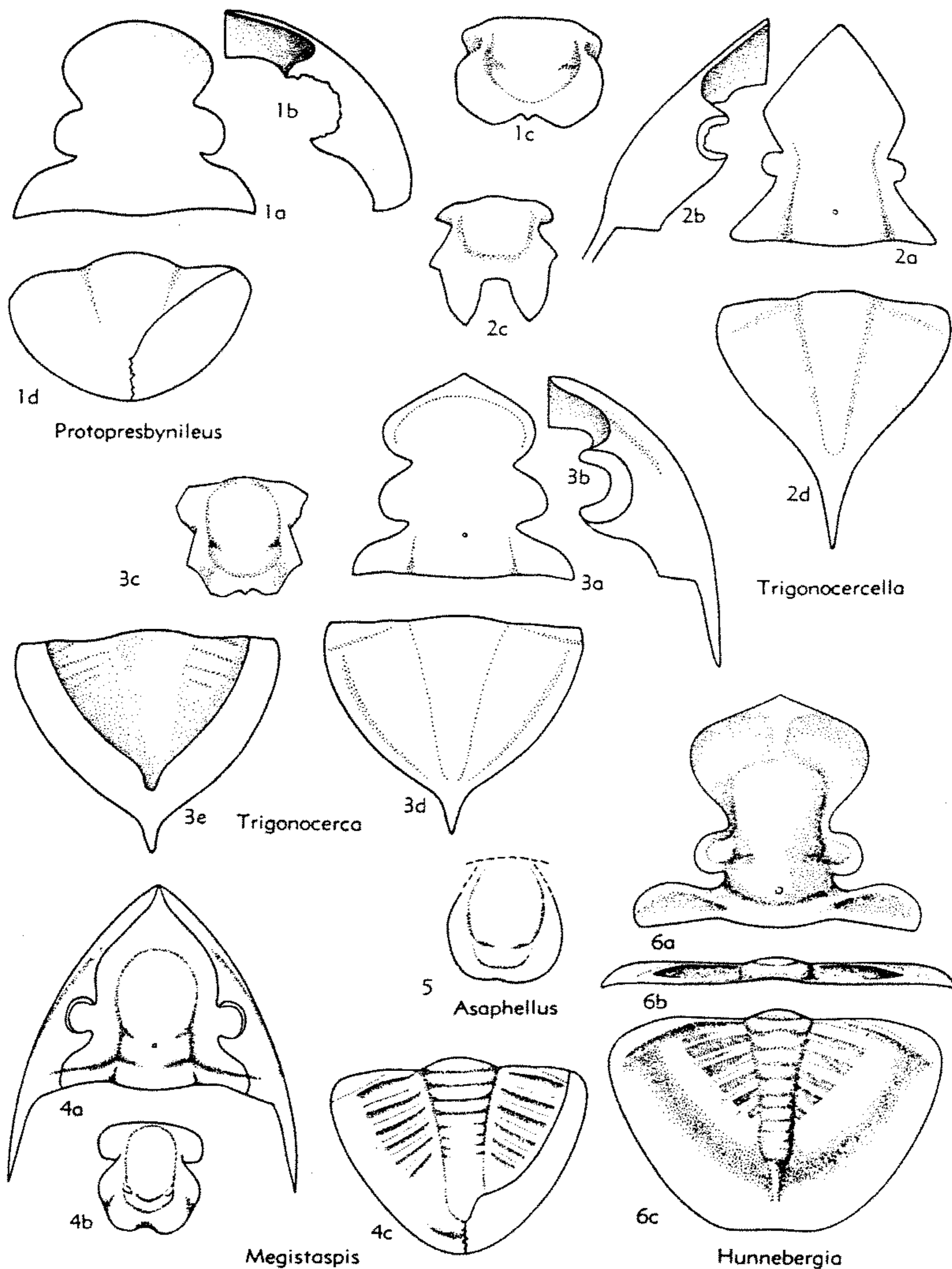

FIG. 254. Asaphidae (Isotelinae) (p. 0343-0347).

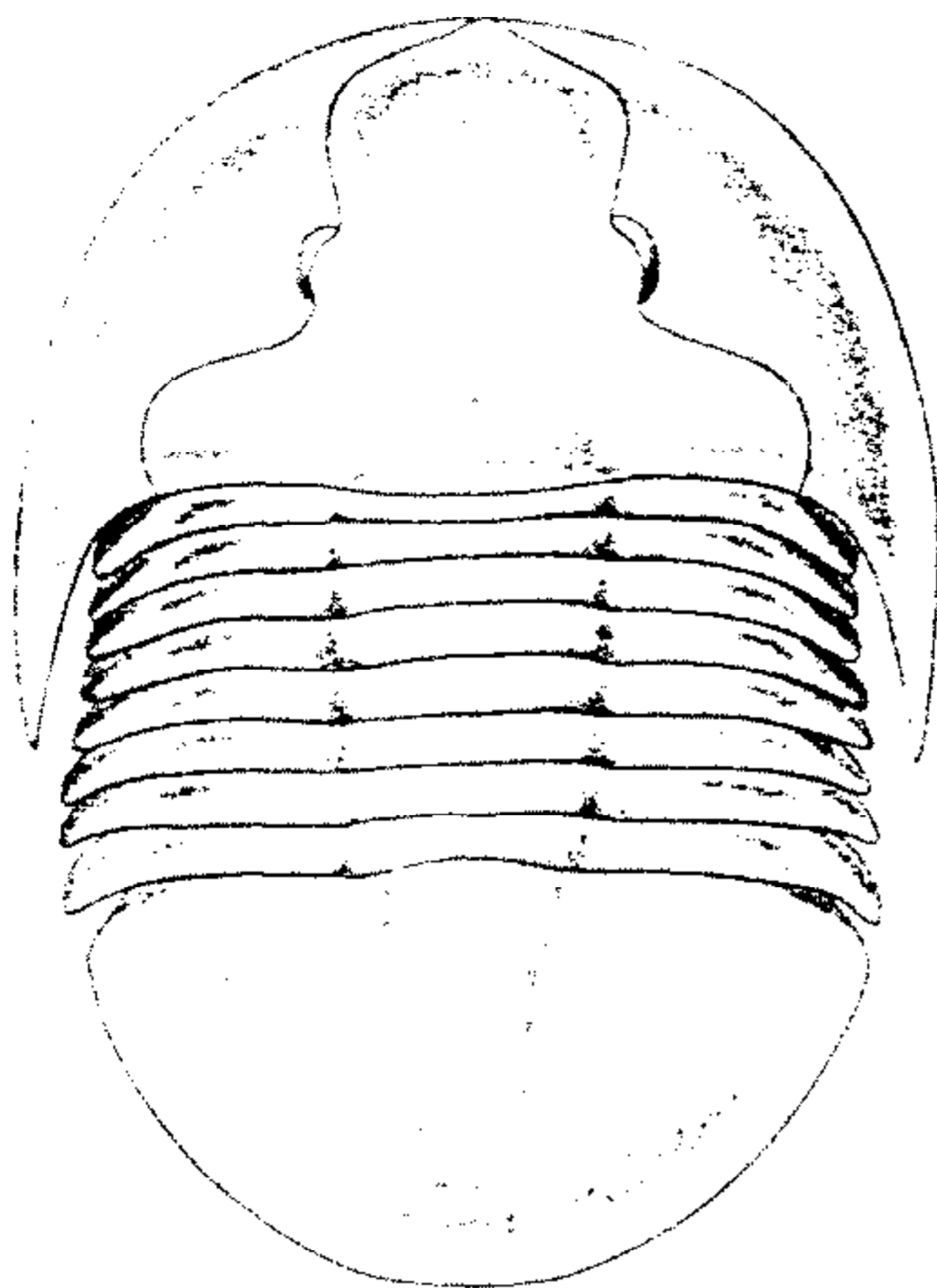

FIG. 255. **Asaphellus homfrayi* (SALTER) (Asaphidae), L.Ord.(Tremadoc.), Eng.; carapace (reconstr.), $\times 1.5$ (414).

known. Pygidium with faintly concave border; axis flattened, broad, triangular; pleural fields smooth. M.Ord.(Chazy.), N.Am.—FIG. 253,6. **V. bearsi* (RAYMOND); pyg., $\times 1.5$ (414n).

Group B

Posterior margin of hypostoma pointed, rounded, straight, or only faintly concave. L.Ord.(Tremadoc.-Llanvirn.).

Asaphellus CALLAWAY, 1877 [**Asaphus homfrayi* SALTER, 1866] [= *Hemigyraspis* RAYMOND, 1910]. Cephalon and pygidium with concave border; frontal area moderately broad (in type species about 0.13 of total length of cranium); cephalic axis flattened, mostly poorly defined; eyes small, slightly in front of transverse mid-line of cranium; posterior border furrow distinct; genal angles produced into spines. Hypostoma with slightly concave to rounded posterior margin. Thoracic axis considerably narrower than pleurae. Pygidium fairly broad, flattened, with narrow well-defined axis, pleural fields with very faint to obsolete ribs; doublure narrow, as in *Megistaspis*. L.Ord.(Tremadoc.), Eng.-Wales-E.N.Am.-?N.Arg.—FIGS. 254,5; 255. **A. homfrayi* (SALTER), Eng.; 254,5, hypostoma, $\times 1.5$ (421); 255, carapace (reconstr.), $\times 1.5$ (414n).

Hoekaspis KOBAYASHI, 1937 [**Megalaspis metacensis* HOEK, 1912]. Cephalon and pygidium with flattened border; frontal area narrow; glabella

slightly expanding in front of eyes; facial sutures intramarginal in front of glabella; glabellar tubercle situated immediately in front of area corresponding to occipital furrow; eyes moderately large, slightly in front of transverse mid-line of cranium; genal spines long. Hypostoma with slightly acuminate posterior margin. Thorax with axis somewhat narrower than pleurae. Pygidium with prominent axis; pleural fields with faint ribs, border well distinguished; doublure narrow, as in *Megistaspis*. Development of panderian organs unknown. [May not belong to this subfamily.] L.Ord.(Llanvirn.), N.Arg.-Bol.—FIG. 256. *H. megacantha* (LEANZA); carapace (reconstr.), $\times 1.4$ (59*).

Hunnebergia TJERNVIK, 1956 [**H. retusa*]. Cephalon and pygidium with wide, flattened border; frontal area broad, 0.25 to 0.3 of total length of cranium; glabella slightly tapering forward; eyes moderately large, somewhat behind transverse mid-line of cranium; posterior border furrow distinct; genal angles produced into spines. Hypostoma poorly known, apparently with rounded posterior margin. Thoracic axis comparatively very narrow, pleural terminations pointed. Pygidium flattened, axis narrow, inner part of pleural fields with faint ribs, postaxial field moderately

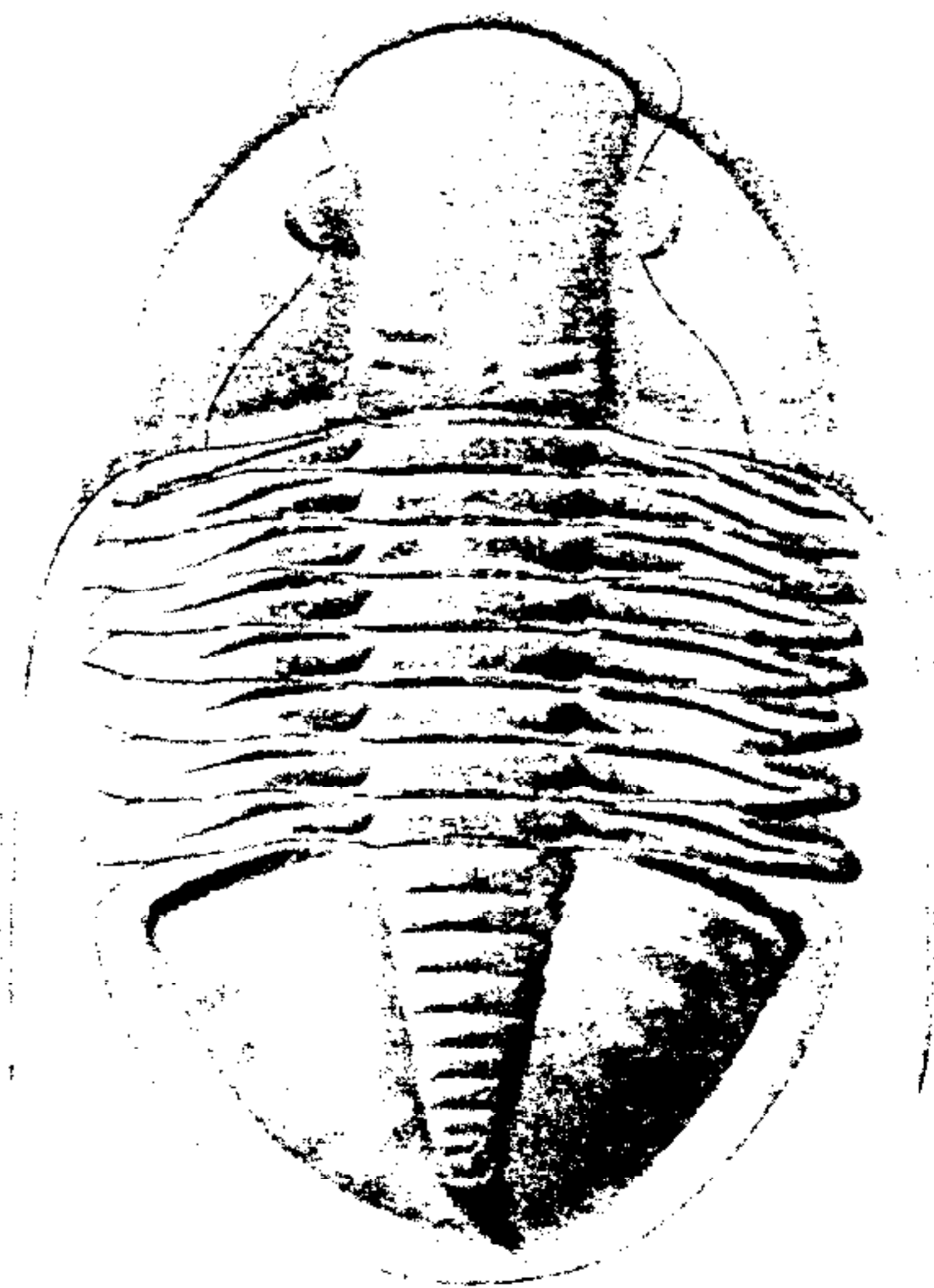

FIG. 256. **Hoekaspis megacantha* (LEANZA) (Asaphidae), L.Ord.(Llanvirn.), Arg.; carapace (reconstr.), $\times 1.4$ (59*).

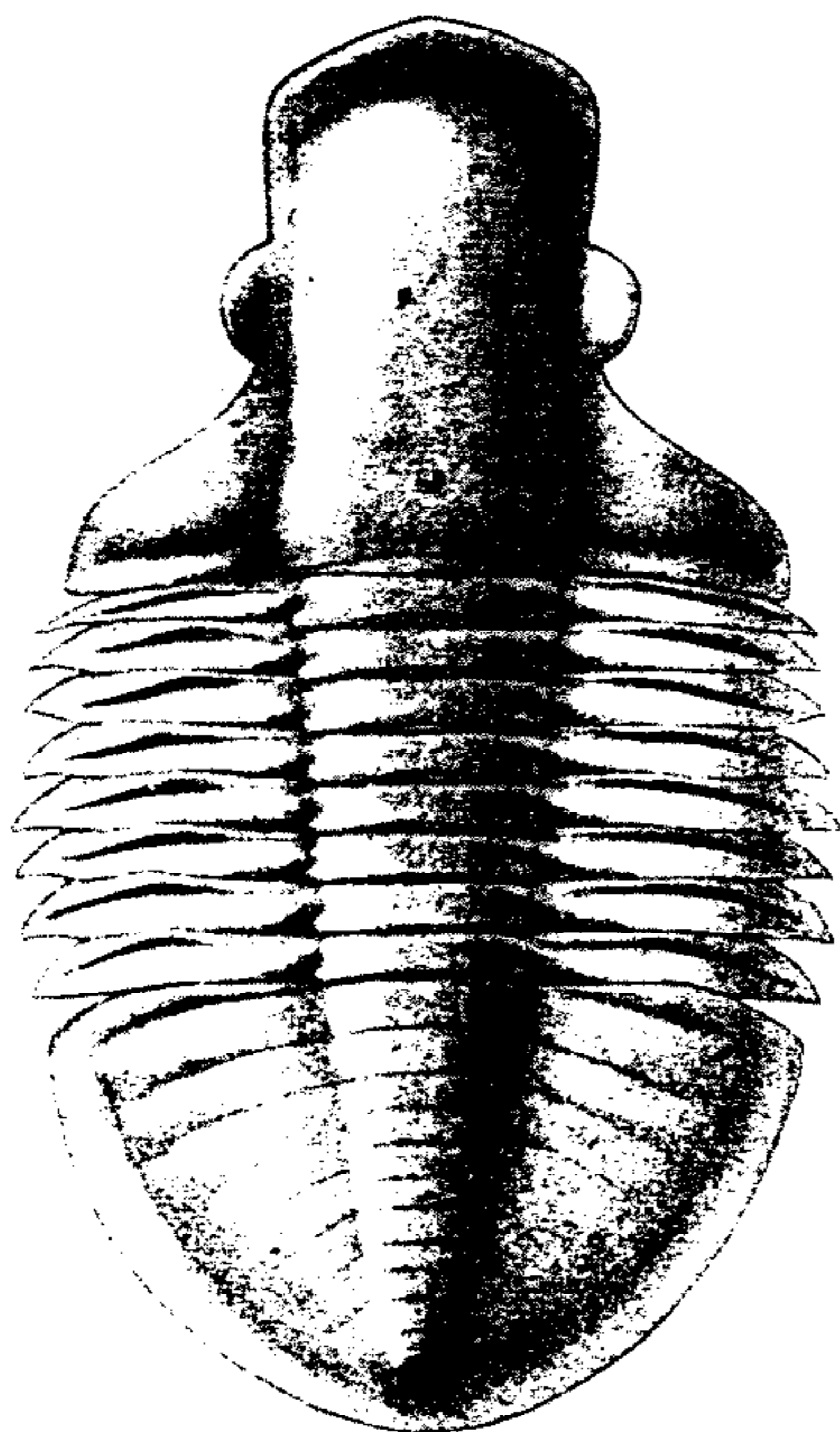

FIG. 257. **Megalaspidella (Megalaspidella) kayseri* KOBAYASHI (Asaphidae), L.Ord.(Arenig.), Arg.; carapace lacking librigenae (reconstr.), $\times 1.7$ (59*).

long; doublure wide. Development of panderian organs unknown. [May not belong to this subfamily; represents an early member of Asaphinae.] L.Ord.(L.Arenig.), Swed.—FIG. 254,6. **H. retusa*; 6a-c, cran., thoracic segment, pyg., $\times 1$ (484a).

Megalaspidella KOBAYASHI, 1937 [**M. kayseri*]. Like *Megistaspis*, but with considerably shorter frontal area, occupying 0.12 to 0.16 of total length of cranidium; posterior border furrow generally well defined. Lateral margin of hypostoma evenly rounded, posterior margin rounded or faintly pointed. [Subgeneric classification somewhat uncertain at present.]

M. (Megalaspidella) [= ?*Plesiomegalaspis* THORAL, 1946; ?*Ogygitella* HARRINGTON & LEANZA, 1957]. Glabella parallel-sided or faintly tapering forward; posterior margin of pygidium rounded. L.Ord. (Arenig.), N. Arg.-?Fr.-?N.Afr.—FIG. 257. **M. (M.) kayseri*, Arg.; carapace lacking librigenae (reconstr.), $\times 1.7$ (59*).

M. (Kayseraspis) HARRINGTON, 1938 [**K. asaphelloides*]. Glabella strongly tapering forward, pygidium with terminal spine. L.Ord.(Arenig.),

N.Arg.—FIG. 258. **M. (K.) asaphelloides* (HARRINGTON), carapace (reconstr.), $\times 1.8$ (59*).

Megistaspis JAANUSSON, 1956 [pro *Megalaspis* ANGELIN, June 1851 (non BLEEKER, May 1851)] [**Trilobites limbatus* BOECK, 1838] [= *Rhinaspis* REMELÉ, 1885, nom. nud. (non PERTY, 1830)]. Cephalon and pygidium with concave border, distinct in most species, weak to obsolete in some large species; frontal area 0.25 or more of total length of cranidium; eyes mostly small; occipital furrow and posterior border furrow distinct in some species, obsolete in others; cephalic axis well defined, slightly tapering forward or parallel-sided; genal angles produced into spines. Hypostoma with strongly convex anterior body and broad lateral margin that protrudes slightly laterally, posterior body triangular or trapezoidal, posterior margin concave, rounded, or with a short terminal spine. Thoracic axis narrow. Ribs on pygidial pleural fields, if developed, with distinct longitudinal furrow; pygidial doublure narrow. L.Ord.(Arenig.-Llanvirn.), Baltoscandia.

M. (Megistaspis). Cephalic outline more or less triangular. Posterior margin of hypostoma faintly concave. Thoracic axial rings strongly convex, articulating furrow deep. All known species lack-

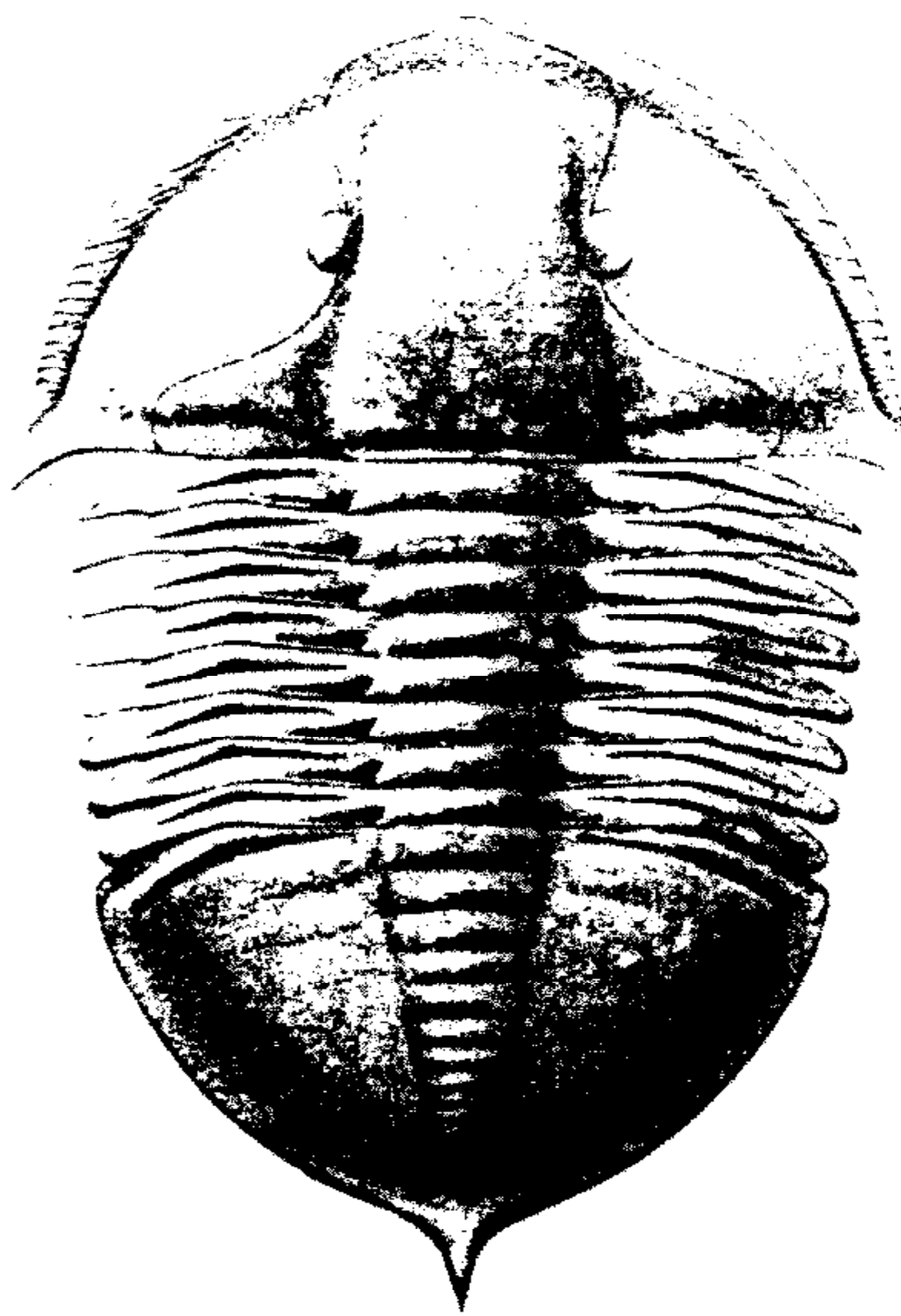

FIG. 258. **Megalaspidella (Kayseraspis) asaphelloides* (HARRINGTON) (Asaphidae), L.Ord.(Arenig.), Arg.; carapace (reconstr.), $\times 1.8$ (59*).

ing terminal pygidial spine. *L.Ord.(U.Arenig.)*.
 —FIG. 254,4a,b. *M. (M.)* sp. cf. *M. (M.)*
elongata (FR. SCHMIDT); 4a, ceph., $\times 1$; 4b,
 hypostoma, $\times 1.5$ (± 14).—FIG. 254,4c. **M.*
(M.) limbata (BOECK); pyg. showing at right

shape of inner margin of doublure. $\times 0.7$ (414).
M. (Megistaspidella) JAANUSSON, 1956 [**Entomos-*
tracites extenuatus WAHLENBERG, 1821]. Anterior
 part of cephalon produced into an elongate,
 tonguelike process. Posterior body of hypostoma

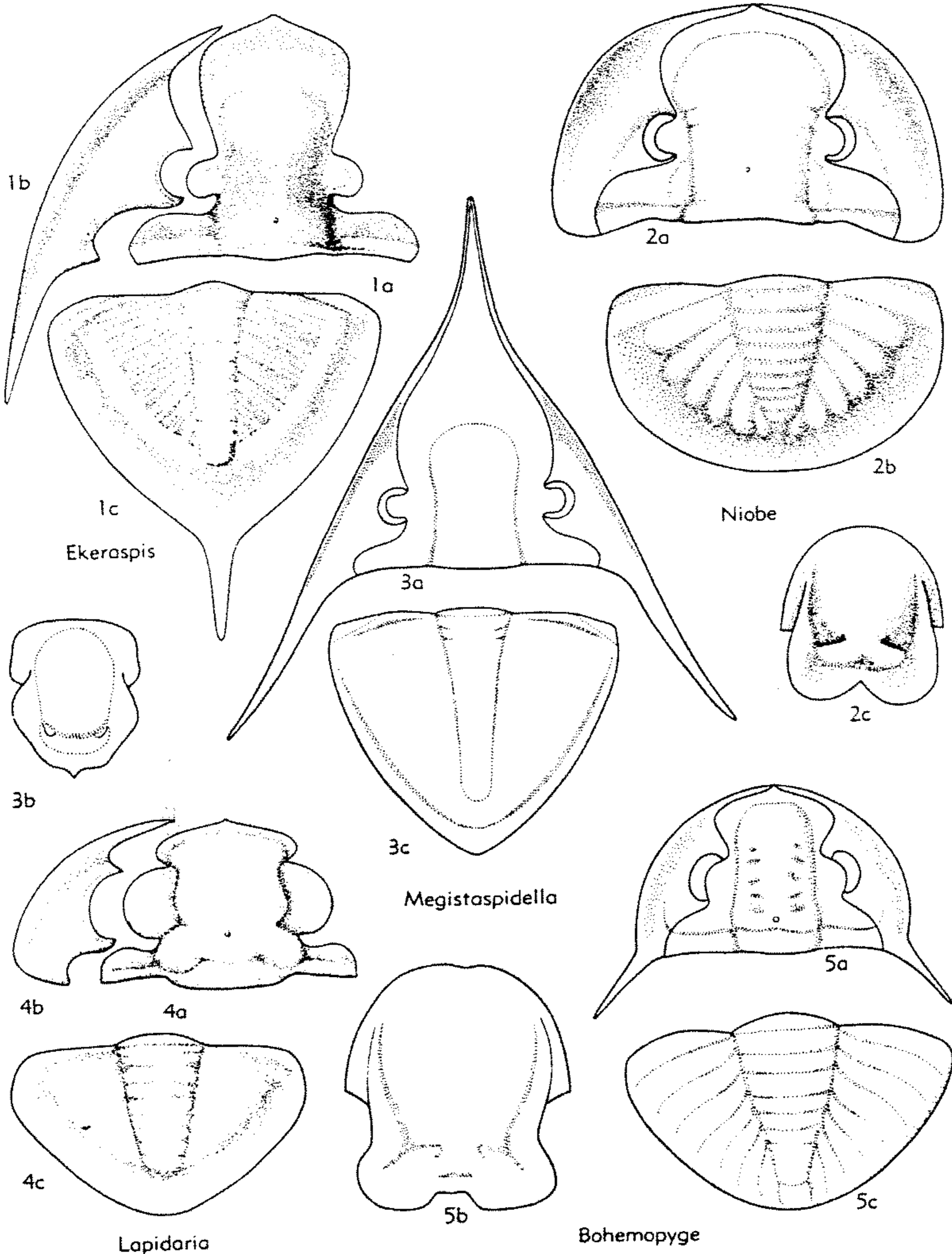

FIG. 259. Asaphidae (Isotelinae, Niobinae) (p. 0349-0350).

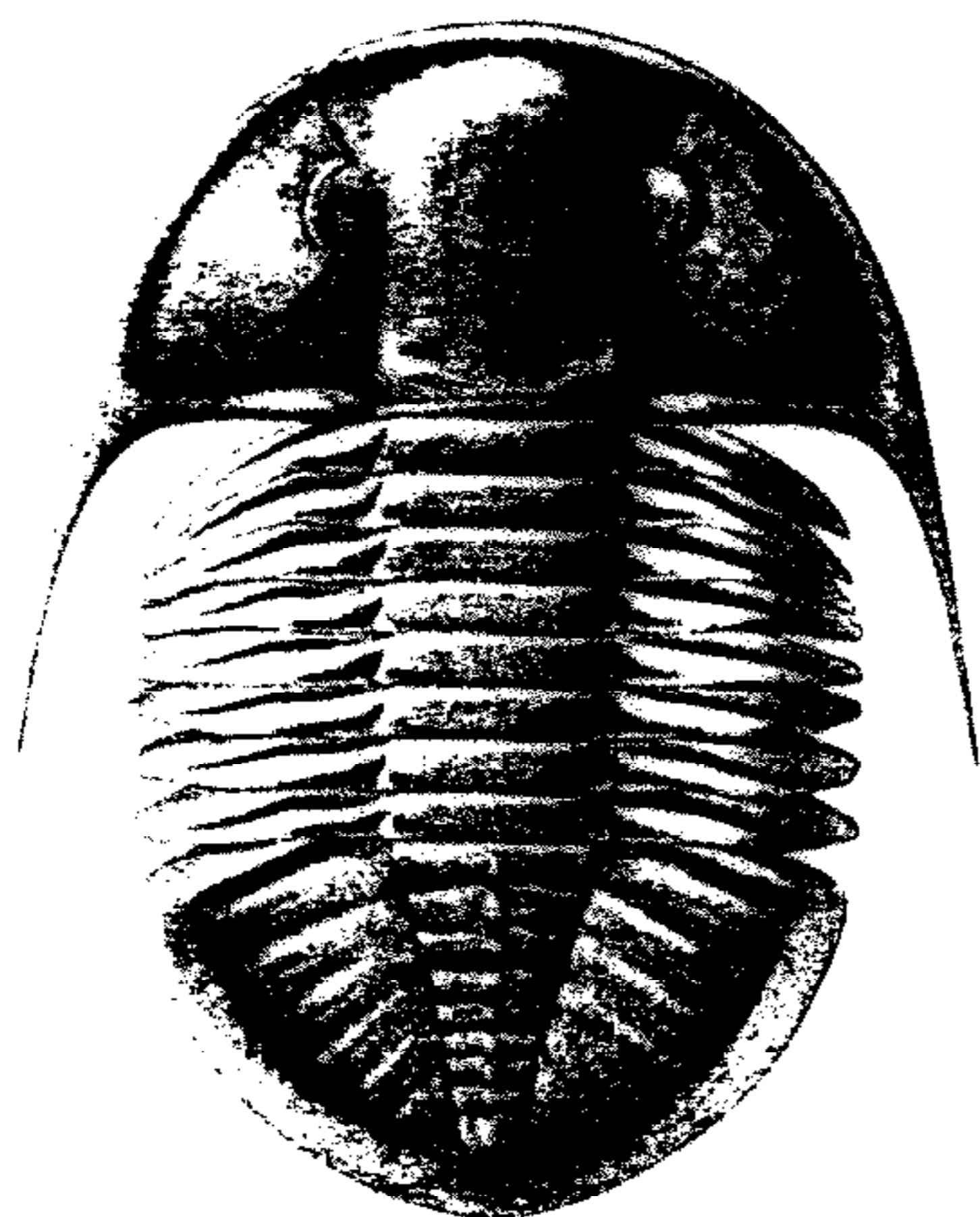

FIG. 260. **Niobides armatus* HARRINGTON & LEANZA (Asaphidae), L.Ord.(Arenig.), Arg.; carapace (reconstr.), $\times 1.2$ (59*).

triangular, mostly with short terminal spine. Thoracic axial rings moderately convex, articulating furrow moderately deep or shallow. Pygidial outline triangular to parabolic, in some species with terminal spine. L.Ord.(U.Arenig.-Llanvirn.).—FIG. 259,3. **M. (M.) extenuata* (WAHLENBERG); 3a, ceph., $\times 1$; 3b, hypostoma, $\times 2$; 3c, pyg., $\times 1$ (414).

M. (Ekeraspis) TJERNVIK, 1956 [**Plesiomegalaspis (Ekeraspis) armata*]. Cephalic outline more or less semicircular; eyes moderately large. Pygidium with terminal spine. Posterior margin of hypostoma straight to faintly convex. [Subgeneric classification of species resembling *M. (E.) armata* but lacking the terminal pygidial spine is still uncertain.] L.Ord.(L.Arenig.)—FIG. 259,1. **M. (E.) armata* (TJERNVIK); cran., librigena, pyg., $\times 1$ (484a).

Niobides HARRINGTON & LEANZA, 1957 [**N. armatus*]. Cephalon and pygidium with flattened border, narrow on cephalon, moderately wide and well defined on pygidium; facial sutures marginal in front of glabella; cephalic axis more or less parallel-sided, frontal area narrow; eyes of moderate size, somewhat in front of transverse mid-line of cranium; glabellar tubercle not recognizable, its location unknown; posterior border furrow distinct; genal angles produced into spines. Hypostoma with entire posterior margin. Thoracic axis moderately broad. Pygidium with long strongly tapering axis; pleural fields with faint ribs. Development of the panderian organs unknown.

[May not belong to this subfamily.] L.Ord. (Arenig.), N.Arg.—FIG. 260. **N. armatus*; carapace (reconstr.), $\times 1.2$ (59*).

Notopeltis HARRINGTON & LEANZA, 1957 [**Megalaspidella orthometopa* HARRINGTON, 1938]. Anterior part of cephalon with distinct border; frontal area narrow; facial sutures intramarginal in front of glabella, which is long, almost parallel-sided or slightly tapering forward; eyes of moderate size, in front of transverse mid-line of cranium; posterior border furrow distinct; genal angles produced into spines. Posterior margin of hypostoma entire, acuminate. Pygidium without flattened border, axis long, prominent, postaxial field narrow; pleural fields with weak to almost obsolete furrowed ribs. L.Ord.(U.Tremadoc.), N.Arg.—FIG. 261. **N. orthometopa* (HARRINGTON); carapace (reconstr.), $\times 2.8$ (59*).

Paramegalaspis THORAL in JAANUSSON, 1956 [**Megalaspis (Paramegalaspis) immarginata* THORAL, 1935] [= *Megalaspis (Paramegalaspis)* THORAL, 1935 (nom. nud.; no type species); *Dolerasaphus* HARRINGTON & LEANZA, 1957]. Cephalon and pygidium without border; frontal area moderately long, 0.20 to 0.25 of total length of cephalon; eyes of moderate size, situated at about transverse mid-line of the cranium; cephalic axis more or less parallel-sided; posterior border furrow fairly distinct; genal angles produced into spines. Posterior margin of hypostoma rounded. Pygidium

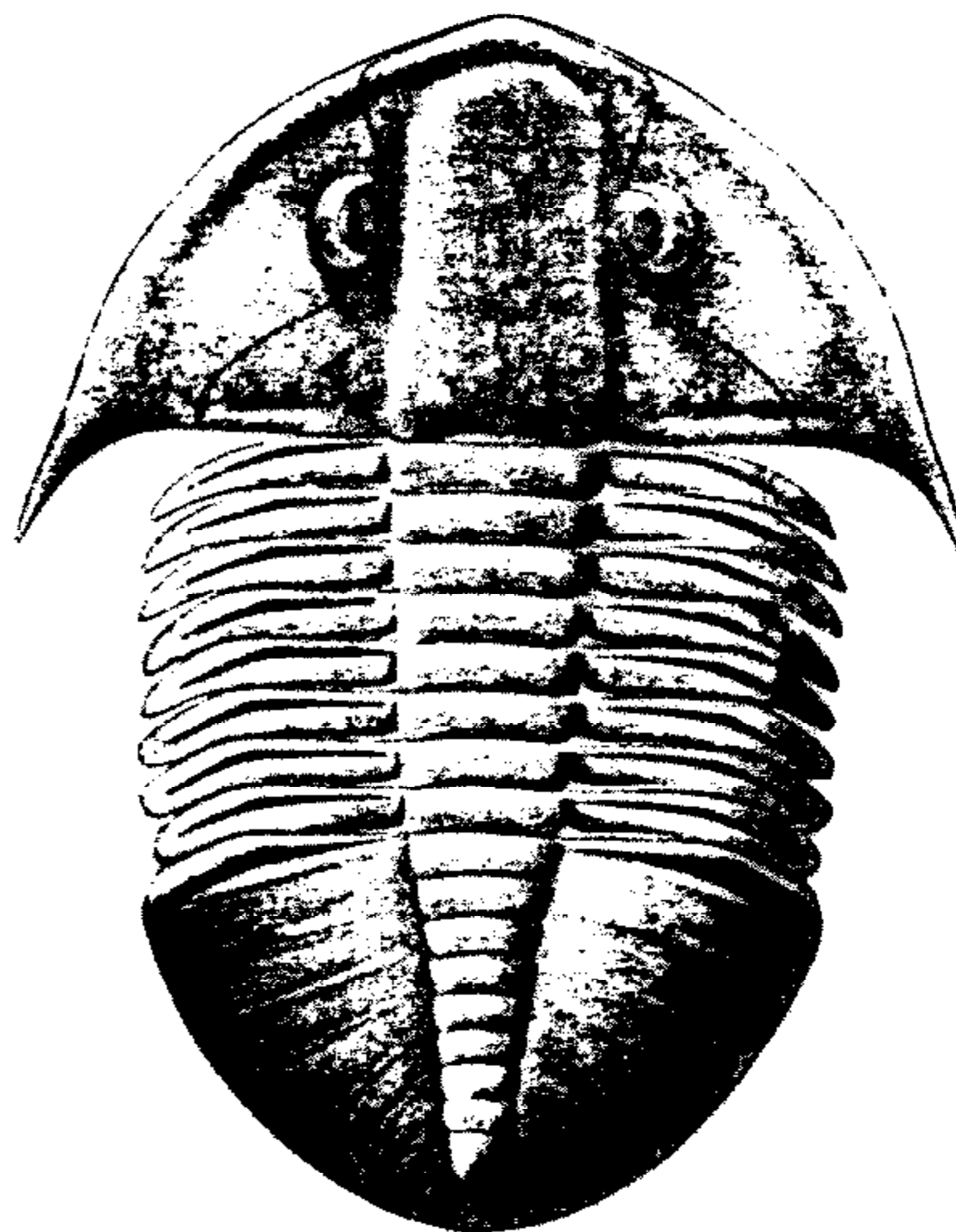

FIG. 261. **Notopeltis orthometopa* (HARRINGTON) (Asaphidae), L.Ord.(U.Tremadoc.), Arg.; carapace (reconstr.), $\times 2.8$ (59*).

with flattened axis, pleural fields with weak to obsolete furrowed ribs, doublure narrow, as in *Megistaspis*. *L.Ord.*(*Tremadoc.*), Fr.-N.Arg.

Subfamily NIOBINAE Jaanusson, nov.

Cephalic axis prominent, tapering forward in early species, parallel-sided or expanded in front of eyes in late species; distance between glabellar tubercle and occipital furrow on area corresponding to it mostly equal to or longer than length of the occipital ring; librigenae mostly very broad (*tr.*), larger than in any other asaphid group; posterior border furrow generally distinct. Posterior margin of hypostoma rounded, straight, or with short narrow (*tr.*) notch; in late representatives hypostomal outline is characteristically somewhat trapezoidal, being widest (*tr.*) close to its posterior margin; anterior wings fairly broad (*tr.*), triangular. Panderian organs developed as separate openings, except for some Upper Cambrian species, which have a narrow doublure and apparently no panderian organs. Thorax without macropleurae. External pygidial margin rounded. *U. Cam.-L.Ord.*

Niobe ANGELIN, 1851 [**Asaphus frontalis* DALMAN, 1827; SD VOGDES, 1890]. Cephalic outline commonly somewhat trapezoidal; axis long, frontal area short; eyes of moderate size, situated at transverse mid-line of cranidium close to glabella; genal angles rounded. Pygidial doublure generally rather wide, pleural ribs extending beyond inner margin of doublure, their well-defined terminations bulging outward; pygidial border distinct, flattened or concave. Early members with slightly tapering to parallel-sided glabella and rounded to more or less straight posterior margin of hypostoma; evolution tends toward widening of glabella in front of eyes and formation of triangular notch in posterior margin of hypostoma. *L.Ord.* (*Tremadoc.-Llanvirn.*), Eu.—FIG. 259,2. **N. frontalis* (DALMAN); 2a, ceph. (reconstr.), $\times 1.5$; 2b, hypostoma, $\times 1$; 2c, pyg., $\times 1.5$ (414n).

Bohemopyge PŘIBYL, 1950 [**Ogygia discreta* BARRANDE, 1872] [= *Ptychocheilus* NOVÁK, 1883 (*non* AGASSIZ, 1855; *nec* BOETTGER, 1880)]. Cephalon with faint concave border; glabella slightly tapering forward, frontal area short; glabellar tubercle fairly close to occipital furrow; eyes fairly large, at about transverse mid-line of cranidium moderately distant from axial furrows; genal angles produced into spines. Hypostoma broadest posteriorly, with short trapezoidal notch. Pygidium without border; axis prominent, long; pleural fields with flattened ribs, separated by distinct

furrows that almost reach external margin. [May not belong to this subfamily.] *L.Ord.*, Boh.—FIG. 259,5. **B. discreta* (BARRANDE); 5a, ceph., $\times 2$; 5b,c, hypostoma, pyg., $\times 0.7$ (437).

Lapidaria TJERNVIK, 1956 [**L. tenella*]. Eyes large; glabella expanded in front of eyes, frontal area short; librigenae with broad, convex posterior areas (alae) and flattened borders; genal angles rounded. Hypostoma and thorax unknown. Pygidium with distinct, wide, concave border; long, prominent axis; almost smooth pleural fields. *L.Ord.* (*Arenig.*), Swed.—FIG. 259,4. **L. tenella*; 4a-c, cran., librigena, pyg., $\times 3$ (484a).

Niobella REED, 1931 [**Niobe homfrayi* SALTER, 1866]. Like *Niobe* but pygidial doublure narrow in early species and moderately wide in latest species; pygidial pleural ribs (if developed) flattened, merging smoothly into outer part of pygidial surface or at slightly outside line corresponding to inner margin of doublure; ribs mostly with shallow pleural furrow. Evolutionary trend as in *Niobe*. *U. Cam.-L.Ord.*, Eu.-?N.Am.(Newf.).—FIG. 262,7. *N. homfrayi smithi* STUBBLEFIELD; 7a,b, ceph., pyg., $\times 1.3$ (421).

Niobina LAKE, 1946 [**N. davidis*]. Resembling *Niobe* but pygidial pleural fields with pleural and interpleural furrows about equal in distinctness; occipital ring, occipital furrow, and posterior border furrow narrow, distinct; position of glabellar tubercle and development of panderian organs unknown. Hypostoma with pointed terminal end. *L.Ord.*(*U. Tremadoc.*), Eng.-Swed.-N.Arg.

Norinia TROEDSSON, 1937 [**N. convexa*]. Only cranidia known with certainty. Like *Niobe* or *Niobella* but with more lateral position of eyes. *L.Ord.*, Asia(E.T'ienShan).—FIG. 262,2. **N. convexa*; cran., $\times 2$ (486a).

Yuepingia LU, 1956 [**Y. niobiformis*]. Like *Niobella* but with larger eyes and with genal spines. Only cranidia, librigenae, and pygidia known. *U. Cam.*, SW.China. [Published as *Yüpengia*.]

Subfamily OGYGIOCARIDINAE Raymond, 1937

[*nom. correct.* JAANUSSON, herein (*ex* Ogygiocarinae RAYMOND, 1937) [= Ogygiinae RAYMOND, 1913; invalid as based on junior homonym.]

Glabella prominent, slightly tapering forward, parallel-sided, or expanded in front of eyes; occipital ring or area corresponding to it considerably constricted in middle; glabellar tubercle immediately in front of occipital ring; posterior border furrow generally distinct. Hypostoma with rounded or pointed posterior margin and narrow (*tr.*) triangular anterior wings. Type genus apparently without panderian organs, in other genera presence or absence of these organs unknown. Posterior margin of pygidium rounded. *L.Ord.*(*Llanvirn.*)-*M.Ord.* (*Llandeil.*).

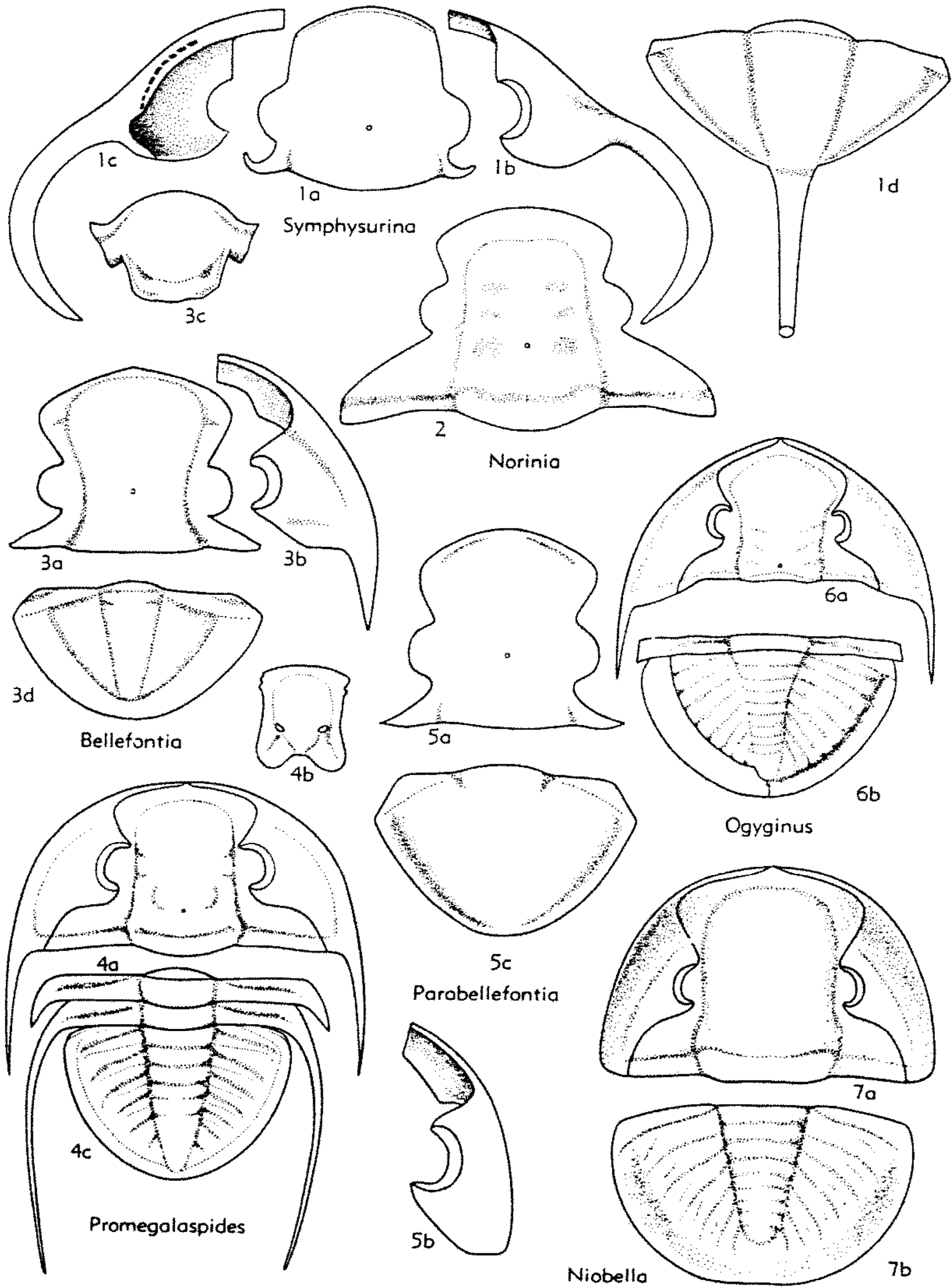

FIG. 262. Asaphidae (Niobinae, Ogygiocaridinae, Promegalaspidinae, Symphysurininae) (p. 0350-0353).

Ogygiocaris ANGELIN, 1854 [*nom. conserv.*, proposed HENNINGSMOEN, JAANUSSON, RILEY & STUBBLEFIELD, 1956 (ICZN pend.)] [**Trilobus dilatatus* BRÜNNICH, 1789]. Facial sutures intramarginal

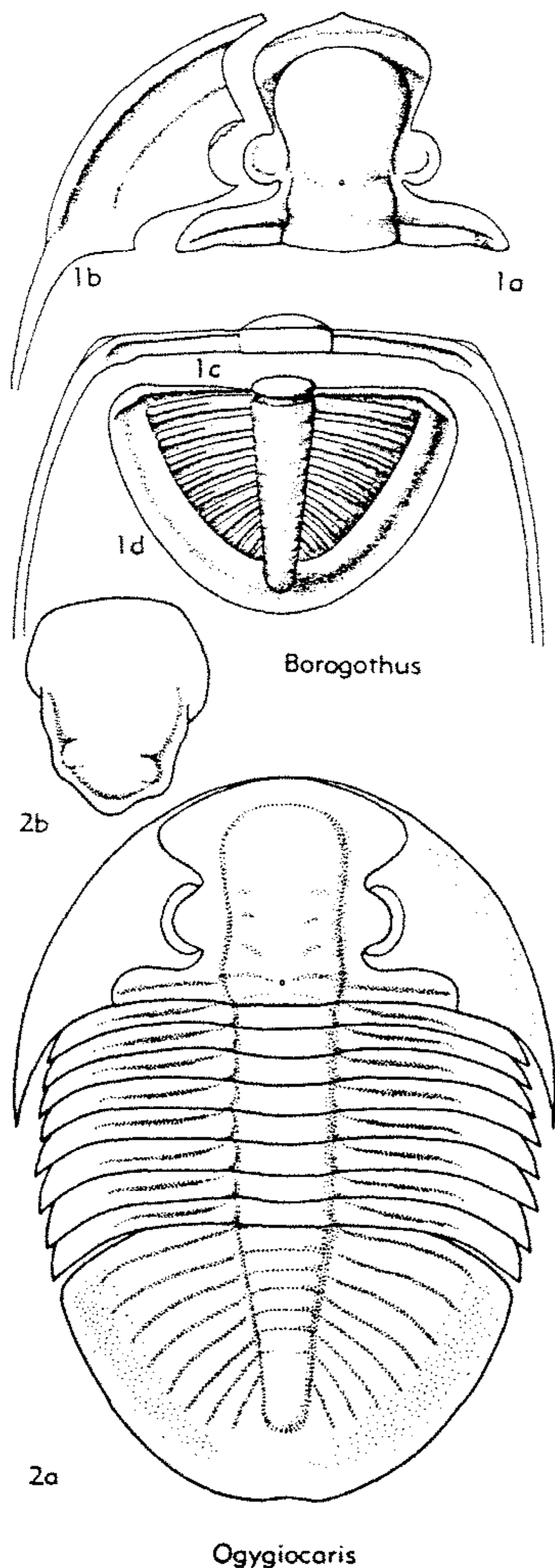

FIG. 263. Asaphidae (Ogygiocaridinae, Promegalaspidinae (p. 0352-0353)).

in front of glabella; frontal area narrow; glabella slightly expanding in front of eyes. Posterior margin of hypostoma pointed. Pygidial pleural fields with flattened, unfurrowed ribs that continue on inner part of faint, flattened border. *L.Ord.* (*Llanvirn.*)-*M.Ord.* (*Llandeil.*), N.Eu., N.Arg.—FIG. 263.2. *O. sarsi* ANGELIN; 2a, carapace, $\times 0.7$ (473); 2b, hypostoma, $\times 1.5$ (414n).

Homalopteon SALTER, 1866 [**Oxygia portlocki* SALTER, 1849; SD VOCDES, 1925]. Frontal area very short; glabella strongly expanded in front of eyes; facial sutures ?marginal in front of glabella; eyes somewhat in front of transverse mid-line of cranidium. Inner part of pygidial pleural fields with distinct pleural and interpleural furrows. [May not belong to this subfamily.] *M.Ord.* (*Llandeil.*), Ire.

Ogyginus RAYMOND, 1912 [**Asaphus corndensis* MURCHISON, 1839]. Frontal area short; glabella moderately expanding in front of eyes; facial sutures intramarginal in front of glabella. Pygidium with distinct, narrow, concave border; pleural fields with 7 to 9 strong, rounded, unfurrowed ribs that reach border. *L.Ord.* (*Llanvirn.*), Eng.—FIG. 262.6. **O. corndensis* (MURCHISON); 6a,b, ceph. (reconstr.), thoracic segment and pyg. showing at left shape of doublure, $\times 0.7$ (414n).

Ogygiocarella HARRINGTON & LEANZA, 1957 [**Asaphus debuchii* BRONGNIART in BRONGNIART & DESMAREST, 1822 (*non Asaphus debuchianus* BRONGNIART in DESMAREST, 1817; suppression proposed HENNINGSMOEN, JAANUSSON, RILEY & STUBBLEFIELD, 1956, ICZN pend.)]. Like *Ogygiocaris* but facial sutures marginal in front of glabella; pleural ribs of pygidium with distinct pleural furrows. *M.Ord.* (*Llandeil.*), Eng.

Ogygites TROMELIN & LEBESCONTE, 1876 [**Ogygia desmaresti* BRONGNIART in BRONGNIART & DESMAREST, 1822] [*pro Ogygia* BRONGNIART in BRONGNIART & DESMAREST, 1822 (*non Ogygia* BRONGNIART in DESMAREST, 1817, suppression proposed HENNINGSMOEN, JAANUSSON, RILEY & STUBBLEFIELD, 1956, ICZN pend.; *non Ogygia* HÜBNER, 1821)]. Type species poorly known. Differs from other Ogygiocaridinae in having only 4 or 5 rounded, unfurrowed ribs on pygidial pleural fields. [May not belong to this subfamily.] *M.Ord.* (*Llandeil.*), Fr.

Subfamily PROMEGALASPIDINAE Jaanusson,
nov.

Cephalic axis more or less parallel-sided or expanding in front of eyes; position of glabellar tubercle as in Niobinae; fixigenae with alae narrow to obsolete; posterior border furrow distinct. Posterior margin of hypostoma generally with broad notch, which is short in early species and long in late species. Panderian organs developed as short (*tr.*) notches in early species and as separate openings in late species. Outer part

of pleurae of 8th thoracic segment produced into long, backward-directed spines, forming macropleurae. External pygidial margin rounded. *U.Cam.-L.Ord.(Arenig.)*.

Promegalaspides WESTERGÅRD, 1939 [**P. kinnekullensis*]. Glabella parallel-sided or slightly tapering forward. Notch in posterior margin of hypostoma short. Thoracic and pygidial axis moderately broad. *U.Cam., Swed.*—FIG. 262,4. **P. kinnekullensis*; 4a-c, ceph., hypostoma, pyg. with 2 last thoracic segments, $\times 1.5$ (414n, 491a).

Borogothus TJERNVIK, 1956 [**Megalaspis stenorhachis* ANGELIN, 1851]. Glabella expanded in front of eyes. Notch in the posterior margin of hypostoma long. Thoracic and pygidial axis narrow. *L.Ord.(Arenig.)*, Scandinavia-Fr.—FIG. 263,1. **B. stenorhachis* (ANGELIN); 1a-d, cran., librigena, 8th thoracic segment, pyg., $\times 1.5$ (484a).

Subfamily SYMPHYSURININAE Kobayashi, 1955

Cephalic axis, if defined, parallel-sided or expanding in front of eyes; generally with glabellar tubercle between eyes. No notches or openings of panderian organs known. Anterior wings of hypostoma quadrangular in genera where known. *L.Ord.*

Symphysurina ULRICH in WALCOTT, 1924 [**S. woosteri*] [= *Symphysurina* WALCOTT, 1923, *nom. nud.*; *Symphysurinella* RAYMOND, 1937; ?*Symphysuroides* RAYMOND, 1937]. Facial sutures marginal in front of glabella, running in front of narrow rim that forms anterior margin of cranium; cephalic axis long, flattened, mostly nearly obsolete; palpebral lobes large, at transverse midline of cranium or somewhat behind it; no posterior border furrow; librigenae with or without depressed border; genal angles rounded, acuminate, or produced into spines. Librigenal doublures with 5 to 9 characteristic pits. Posterior end of pygidium rounded, acuminate, or with terminal spine; pygidial axis long; pleural regions smooth or with some faint ribs anteriorly, and with or without a flattened border; pygidial doublure fairly broad. *L.Ord.(L.Canad.)*, N.Am.-Greenl.-?Swed.—FIG. 262,1. *S. uncaespicata* HINTZE, Utah; 1a-d, cran., librigena, dorsal and ventral, pyg., $\times 3$ (407).

Bellefontia ULRICH in WALCOTT, 1924 [**Hemigyrispis collicana* RAYMOND, 1910]. Cephalic axis flattened, more or less parallel-sided or expanding in front of eyes; facial sutures intramarginal; palpebral lobes large, almost at transverse midline of cranium or slightly behind it, their length generally exceeding distance between posterior end of lobes and the posterior border furrows; genal angles produced into spines. Pygidium with well distinguished, fairly broad flattened border; pleural fields smooth or with faint ribs. *L.Ord.(L.Canad.)*, N.Am.

B. (Bellefontia). Frontal area narrow; posterior end of the pygidium rounded. *L.Ord.(L.Canad.)*, N.Am.—FIG. 262,3. **B. (B.) chamberlaini** CLARK; 3a, cran., $\times 1.5$; 3b-d, librigena, hypostoma, pyg., $\times 2$ (407).

B. (Xenostegium) WALCOTT, 1924 [**Megalaspis belemnurus* WHITE, 1874; SD by suspension of Rules, proposed, Ross, 1956 (ICZN pend.)]. Like *B. (Bellefontia)* but with a longer frontal area, and terminal spine on pygidium. *L.Ord.(L.Canad.)*, N.Am.

Kobayashia HARRINGTON, 1938 [**Xenostegium taurus* WALCOTT; 1924]. Only cranidia and pygidia known. Differs from *Bellefontia* in longer frontal area, narrower glabella in front of eyes, stronger lateral glabellar furrows, and presence of few comparatively strong ribs on inner part of pygidial pleural fields. Size of the palpebral lobes unknown, glabellar tubercle as in other Symphysurinae. *L.Ord.(L.Canad.)*, W.Can.(B.C.).

Parabellefontia HINTZE, 1953 [**P. concinna*]. Differs from *Bellefontia* in almost complete obsolescence of cephalic and pygidial axis, absence of posterior border furrows, and narrower pygidial border; genal angles rounded in adult specimens of type species; anterior border furrow poorly defined to obsolete. Hypostoma and thorax un-

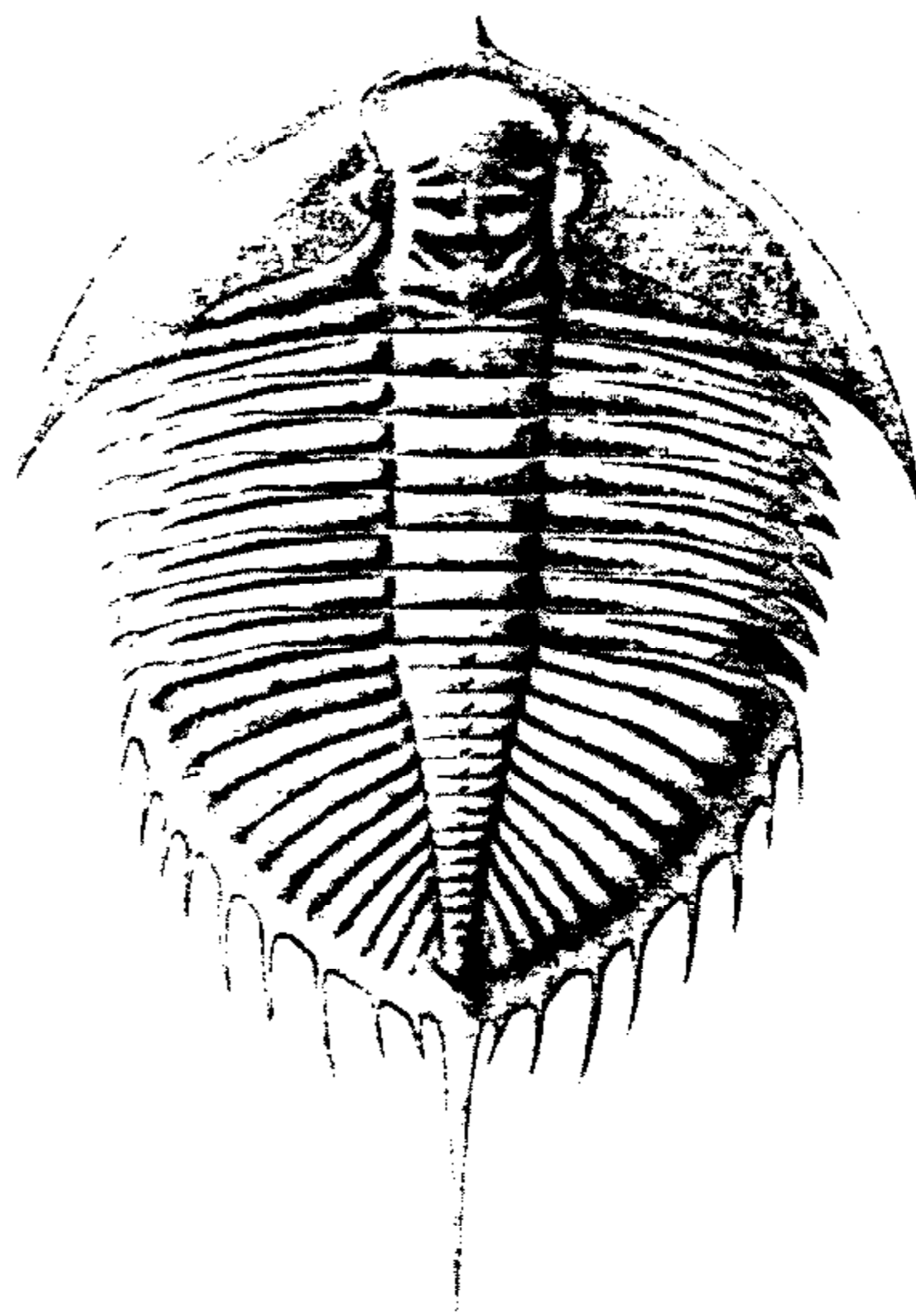

FIG. 264. **Thysanopyge argentina* KAYSER (Asaphidae), *L.Ord.(Arenig.)*, Arg.; carapace (reconstr.), $\times 0.6$ (59*).

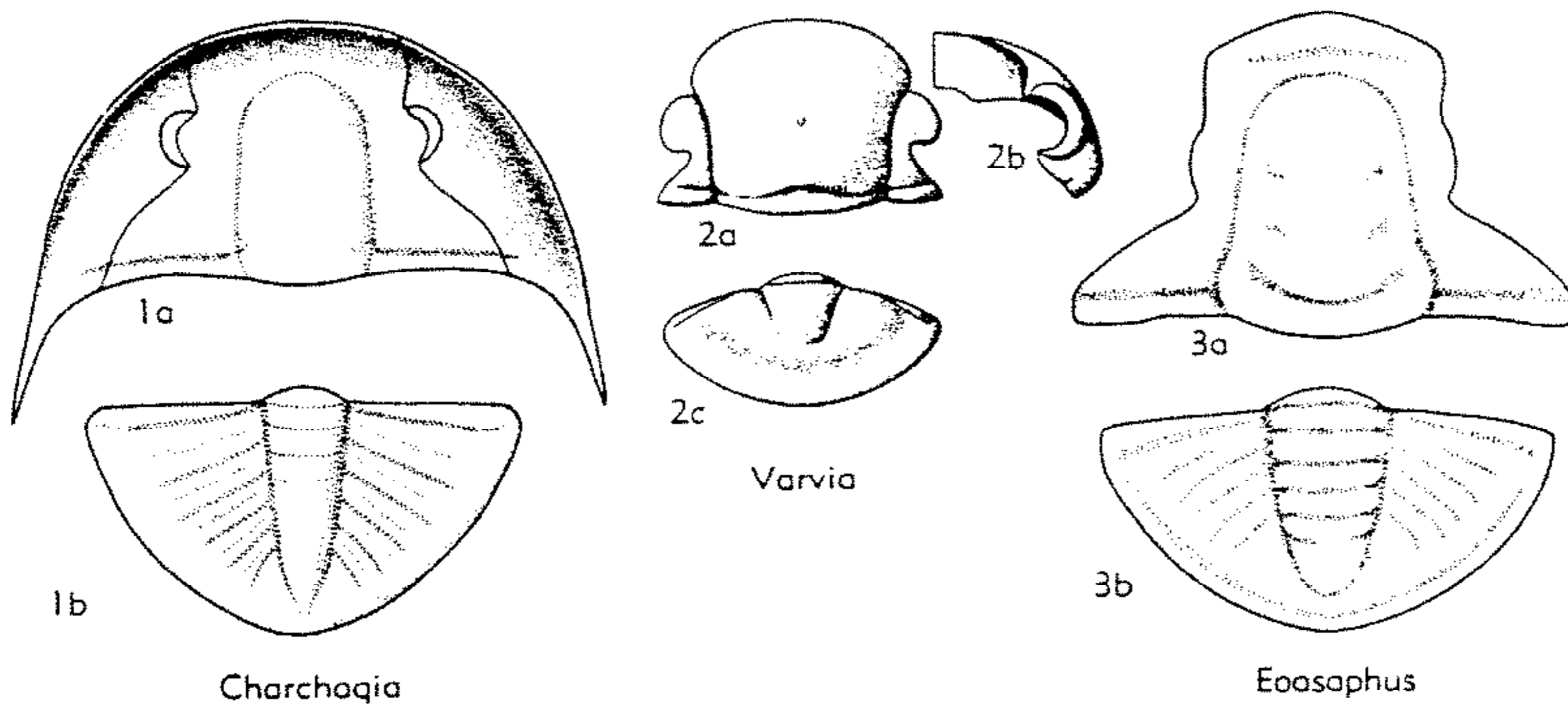

FIG. 265. Asaphidae (Symphysurinae, Subfamily Uncertain) (p. 0354-0355).

known. *L.Ord.*(*L.Canad.*), USA(Utah).—FIG. 262,5. **P. concinna*; 5a-c, cran., librigena, pyg., $\times 3$ (407).

Varvia TJERNVIK, 1956 [**Symphysurus breviceps* ANGELIN, 1854]. Facial sutures marginal in front of glabella; eyes fairly large, about at transverse mid-line of cranidium; cephalic axis long, parallel-sided to somewhat expanding in front of eyes; no frontal area; anterior margin of the cranidium without distinct border; posterior border furrow distinct; librigenae narrow, without border; genal angles rounded. Hypostoma resembling that of *Symphysurus*, with broad lateral border and faintly concave posterior margin. Pygidium broad, with short axis and faint, depressed border. *L.Ord.*(*U.Tremadoc.-L.Arenig.*), Scand.—FIG. 265, 2. *V. breviceps* (ANGELIN); 2a-c, cran., librigena, pyg., $\times 2.5$ (484a).

Subfamily THYSANOPYGINAE Jaanusson, nov.

Similar to early Isotelinae but pygidium with numerous marginal spines; glabella slightly tapering forward to parallel-sided; glabellar tubercle immediately in front of occipital furrow. Development of panderian organs unknown. Posterior margin of hypostoma entire. Ribs on pygidial pleural regions without furrows. *L.Ord.*(*Arenig.*).

Thysanopyge KAYSER, 1898 [**T. argentina*] [= *Basilicoides* HARRINGTON, 1937 (*non* MA, 1938)]. Eyes small, somewhat in front of transverse mid-line of cranidium. Pygidium with about 8 pairs of lateral spines and long terminal spine. *L.Ord.*(*Arenig.*), N.Arg.-Bol.—FIG. 264. **T. argentina*; carapace (reconstr.), $\times 0.6$ (59*).

Australopyge HARRINGTON & LEANZA, 1957 [**A. acanthanura*]. Only hindmost thoracic segments

and pygidium known. Pygidium differs from that of *Thysanopyge* mainly in absence of terminal spine. *L.Ord.*(*Arenig.*), N.Arg.

Zuninaspis HARRINGTON & LEANZA, 1957 [**Z. acuminata*]. Only cranidia known. Differs from *Thysanopyge* mainly in presence of faint preglabellar ridge and more posteriorly situated eyes. *L.Ord.*(*Arenig.*), N.Arg.

Subfamily UNCERTAIN

Charchoqia TROEDSSON, 1937 [**C. norini*] [= *Charchoqia* KOBAYASHI, 1944, *nom. null.*]. Anterior sections of facial sutures running more or less in exsagittal direction to external cephalic margin, their continuation along which or on doublure being unknown (?marginal); cephalon with narrow, deeply concave border; cephalic axis more or less parallel-sided, smooth, prominent, without glabellar tubercle; frontal area moderately broad; eyes small, well in front of transverse mid-line of cranidium, posterior border furrow distinct; genal angles produced into spines. Hypostoma unknown. Thoracic axis narrow, prominent. Pygidium without border, with narrow, prominent, long axis; pleural fields with distinct interpleural and faint pleural furrows. [May be an early member of Isotelinae.] *U.Cam.*, C.Asia(E.T'ienShan)-?China.—FIG. 265,1. **C. norini*; 1a,b, ceph., pyg., $\times 3$ (414n).

Dolerobasilicus HARRINGTON & LEANZA, 1942 [*pro Basilicoides* MA, 1938 (*non* HARRINGTON, 1937)] [**Basilicus yokusensis* KOBAYASHI, 1937]. Type species poorly known. Posterior margin of hypostoma with notch. Pygidium elongate; axis narrow, prominent; pleural fields with numerous distinct unfurrowed ribs that reach narrow, well-defined, concave border; postaxial field short. *M.Ord.*, Korea.

Eoasaphus KOBAYASHI, 1936 (March) [**Liostracus? superstes* LINNARSSON, 1875] [= *Anorina* WHITEHOUSE, April, 1936 (obj.)]. Only one specimen (exoskeleton without librigenae) known. Facial sutures probably intramarginal in front of glabella; cephalic axis tapering forward, prominent, without glabellar tubercle; frontal area moderately broad; palpebral lobes narrow, at about transverse mid-line of cranium; posterior border furrow distinct. Thoracic axis narrow. Pygidium with narrow, flattened border; axis moderately long, prominent; pleural fields with faint flattened ribs. *U.Cam.*, Swed.—FIG. 265,3. **E. superstes* (LINNARSSON); 3a,b, cran., pyg., ×3 (414n).

UNRECOGNIZABLE ASAPHID GENERA

Asaphelloides KOBAYASHI, 1937 [**Megalaspis? americana* HOEK, 1912]. Type species, *nom. dubium*. *L.Ord.*, Bol.

Brachyaspis SALTER, 1866 [**Isotelus rectifrons* PORTLOCK, 1843; SD BASSLER, 1915]. May not be an asaphid since presence of median suture is questionable. *Ord.*, Ire.-?Swed.

Columbicephalus KOBAYASHI, 1955 [**C. macrops*]. Only cranidia known. *Ord.*, W.Can.(B.C.).

Gerasaphes CLARKE, 1897 [**G. ulrichana*] [= *Gerasaphus* VOGDES, 1925, *nom. null.*]. Erected on small, immature specimens; genus cannot be defined at present. *Ord.*, USA.

Metoptogyrus RAYMOND, 1937 [**M. grandgei*]. Type species very poorly known. *L.Ord.*, E.USA. (Vt.).

Family TAIHUNGSHANIIDAE Sun, 1931

[*nom. correct.* HENNINGSMOEN, 1951 (ex Taihungshanidae SUN, 1931)]

Carapace as in Asaphidae but with pair of broad, prominent pygidial spines. Librigenae separated anteriorly by median suture; glabellar tubercle in at least one genus (*Asaphellina*); no eye ridges; known genera with short frontal area. Posterior margin of hypostoma entire. Thorax with 8 segments. Panderian organs not known but in

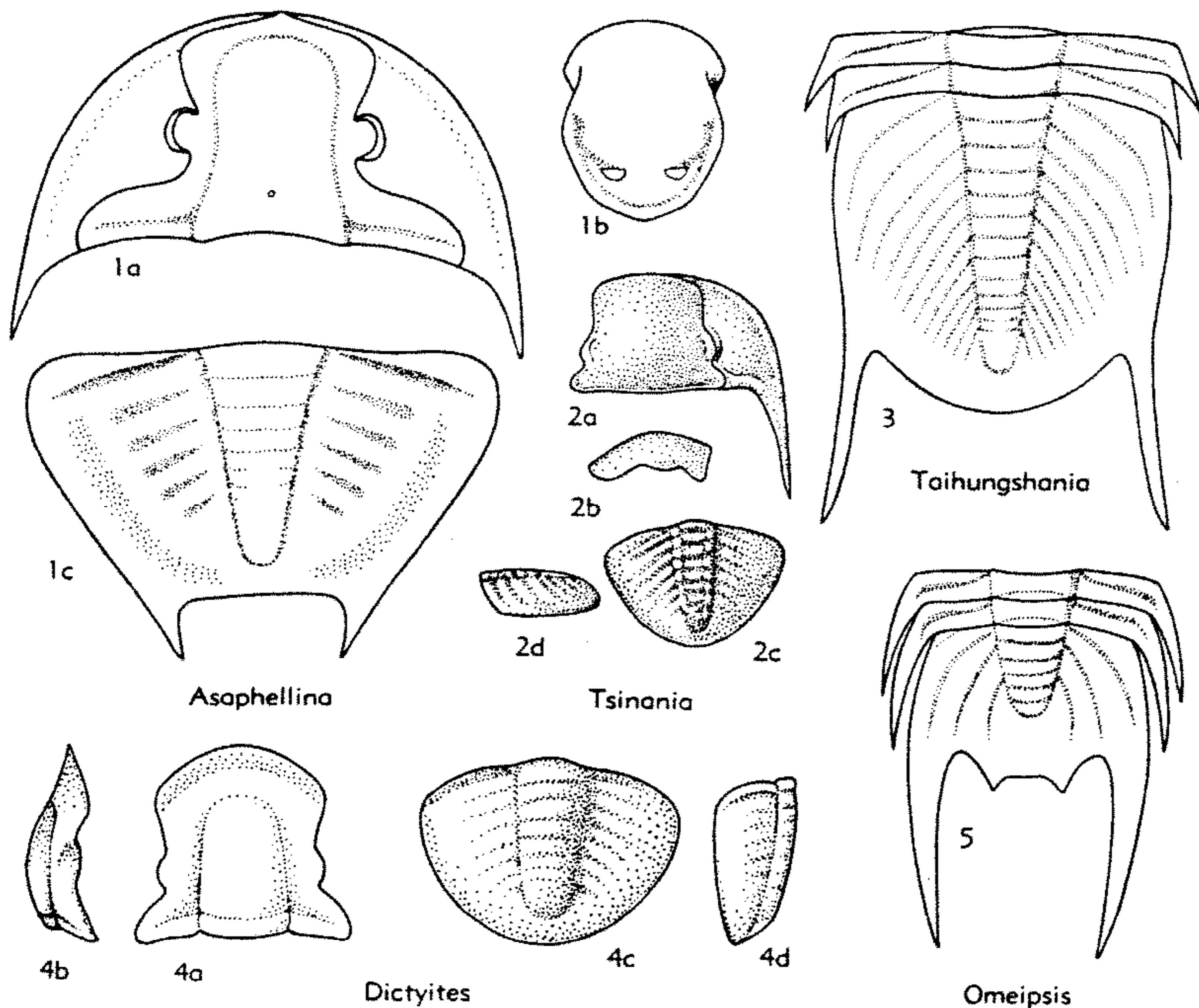

FIG. 266. Taihungshaniidae, Tsinaniidae (p. 0356).

some genera they seem to be absent, judging from published figures. [May belong as subfamily of Asaphidae.] *L.Ord.* (*Tremadoc.-Llanvirn.*).

Taihungshania SUN, 1931 [**T. shui*] [= *Miquelina* THORAL, 1935]. Facial sutures marginal in front of glabella; eyes comparatively small, in front of transverse mid-line of cranidium; glabella more or less trapezoidal in outline, expanding in front of eyes. Lateral terminations of thoracic pleurae pointed and curved posterolaterally. Inner portion of pygidial pleurae with numerous strong ribs; pygidium without border, posterior margin strongly convex between pair of long spines; *L.Ord.* (*Tremadoc.-Llanvirn.*), Fr.-China. — FIG. 266,3. **T. shui*, China; 2 hindmost thoracic segments and pyg., $\times 1.5$ (478).

Asaphellina MUNIER-CHALMAS & BERGERON in BERGERON, 1889 [**A. barroisi*]. Facial sutures intramarginal; eyes moderately large, at about transverse mid-line of cranidium; glabella more or less parallel-sided, with small tubercle in posterior part. Lateral terminations of thoracic pleurae straight. Pygidium with poorly defined flattened border and generally straight posterior margin between pygidial spines, which are short to moderately long and posteromedially directed; inner part of pygidial pleurae with faint to moderately strong, unfurrowed ribs. *L.Ord.* (*Tremadoc.*), Fr.-USA. (Utah). — FIG. 266,1. **A. barroisi*; 1a,b, ceph., hypostoma, $\times 1$; 1c, pyg., $\times 0.7$ (483).

Omeipsis KOBAYASHI, 1951 [**Acidaspis huangi* SUN, 1931]. Facial sutures apparently marginal; eyes small, in front of transverse mid-line of cranidium; glabella parallel-sided or slightly tapering forward. Lateral ends of the thoracic pleurae produced into posteriorly directed, broad spines. Pygidium without border; inner part of pleural fields with few distinct ribs; postaxial field rather long; posterior margin between main pygidial spines produced into 2 short additional pointed spines. *L.Ord.* (*Llanvirn.*), China. — FIG. 266,5. **O. huangi* (SUN); 2 hindmost thoracic segments and pyg. (reconstr.), $\times ?$ (419).

Tungtzuella SHENG in LU, 1957 [**T. kueichowensis*]. Poorly known. *L.Ord.*, C. and SW. China.

Family TSINANIIDAE Kobayashi, 1933

[*nom. correct.* HENNINGSMOEN, 1951 (ex Tsinanidae KOBAYASHI, 1933)]

Exoskeleton opisthoparian, isopygous. Glabella low, sides subparallel or tapering, front rounded; frontal area present, all furrows faint or obsolete; eyes of medium size slightly behind center of cranidium; fixigenae downsloping, with palpebral areas slightly more than 0.5 of glabellar width, posterior areas short; librigenae with wide doublure and long genal spines. Thoracic

segments with deep narrow furrow and broadly falcate ends, small paired anterior projection, number unknown. Pygidium subtriangular, axis low, long, and narrow, with 7 to 9 axial rings; pleural fields wider than axis, with 7 to 9 pleurae; border narrow. Surface smooth. Derived from Asaphiscidae. *U.Cam.*

Tsinania WALCOTT, 1914 [**Illaenurus canens* WALCOTT, 1905] [= *Tsinain* SUN, 1935; *Tsinavia* KOBAYASHI, 1935; *Tsiania* KOBAYASHI, 1942]. Cranidium subquadrate, all furrows obsolete. Pygidium rarely with pair of minute anterolateral spines; only axial furrows visible externally but 9 faint furrows on axis and pleural regions seen on interior (107). *U.Cam.* (*Fengshan.*), NE. Asia. — FIG. 266,2. **T. canens* (WALCOTT), China (Shantung); 2a, cran. and librigena, dorsal (exterior); 2b, cran., profile; 2c,d, pyg., ventral (interior), profile; all $\times 1$ (107, 315).

Dictyites KOBAYASHI, 1936 [*pro Dictya* KOBAYASHI, 1933 (*non* MEIGEN, 1803; *nec* AGASSIZ, 1846; *nec* DE CHAUDOIR, 1871)] [**Illaenurus dictys* WALCOTT, 1905]. Cranidium subquadrate, preglabellar field and anterior border separated by shallow anterior border furrow on exterior, axial furrows present on exterior. Pygidium with axial and border furrows exteriorly, up to 9 furrows on axis and pleural fields interiorly (95, 107). *U.Cam.* (*Fengshanian*), NE. Asia. — FIG. 266,4. **D. dictys* (WALCOTT), China (Shantung); 4a,b, cran., dorsal, profile (exterior); 4c, pyg., ventral (interior); 4d, pyg., profile; all $\times 1.5$ (95).

Family NILEIDAE Angelin, 1854

[= *Symphysuridae* POULSEN, 1927]

Exoskeleton opisthoparian, almost isopygous. Glabella very wide, usually unfurrowed, with eyes closely adjoining; librigenae united into a single piece; cephalic doublure continuous. Thorax of 7 or 8 segments. Pygidium smooth or indistinctly segmented, with indistinct border of medium width. Hypostoma wide, with broadly ovate middle body and very wide, flat lateral border. *L.Ord.* (*Tremadoc.*)-*U.Ord.*

Nileus DALMAN, 1827 [**Asaphus (Nileus) armadillo*]. Dorsal exoskeleton strictly parallel-sided, evenly rounded at both ends, strongly and almost evenly convex transversely. Cephalon subreniform, evenly convex, with indistinctly defined, narrow, threadlike border, occipital furrow effaced; glabella slightly convex, almost parallel-sided, indistinctly defined anteriorly; anterior and posterior areas of fixigenae extremely narrow; eyes large, semicircular; librigenae narrow, with rounded, spineless genal angles. Thorax of 8 segments,

with wide, parallel-sided, slightly convex axis and rounded pleural extremities. Pygidium approximately semicircular, with effaced or indistinct axis and unfurrowed pleural fields. Surface apparently smooth but under a strong lens appears

minutely pitted (1, 18, 62, 151). *L.Ord.*(*Tremadoc.*)-*U.Ord.*, Eu.-E.N.Am.-E.Asia.—FIG. 267,1.
**N. armadillo*, Swed.; 1a, ceph., ventral showing hypostoma, $\times 1$ (62); 1b, exoskel., $\times 1$ (1).
Barrandia M'COY, 1849 [non HALL, 1860] [*B.

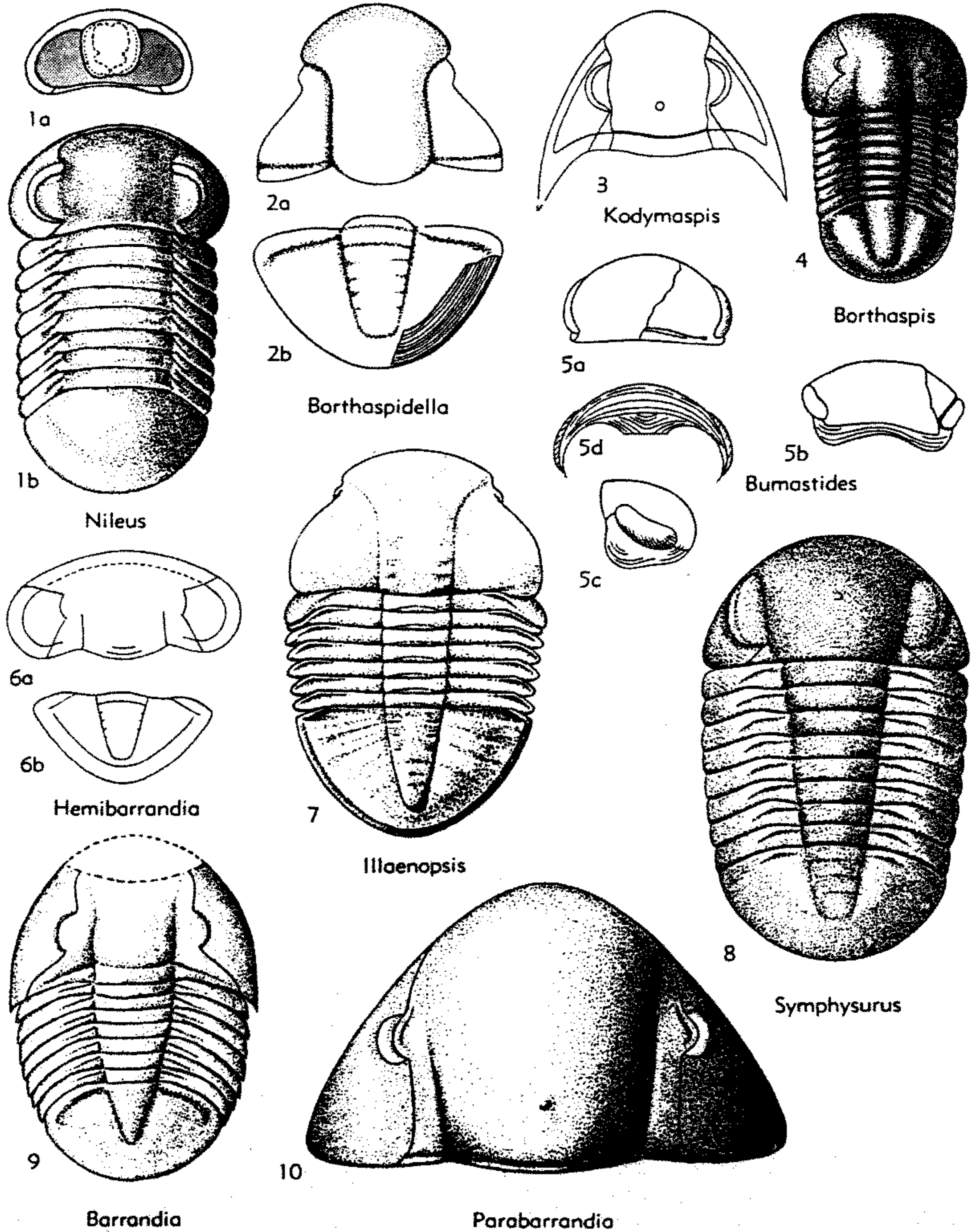

FIG. 267. Nileidae (p. 0356-0358).

- cordai*]. Differs from *Nileus* in having semi-oval or parabolic cephalon, clavate glabella, smaller eyes, thorax with tapering axis and obliquely truncated pleural extremities, and pygidium with well-defined axis (180). *L.Ord.(Tremadoc.)-M.Ord., Eu.*
- B. (*Barrandia*). Cephalon semioval, gently convex; glabella moderately convex; occipital furrow shallow; posterior area of fixigenae wide; eyes fairly large, moderately curved; librigenae with pointed genal angle; axis slightly less than 0.3 of total thoracic width. Pygidium with indistinct concave border zone (180). *M.Ord., Br.I.*—FIG. 267,9. *B. (*B.*) *cordai*, Wales; exoskel., $\times 2$ (180).
- B. (*Parabarrandia*) PRANTL & PŘIBYL, 1948 [**B. bohémica* NOVÁK, 1884]. Differs from *B. (Barrandia)* in its parabolic convex cephalon; prominent glabella; narrow posterior areas of fixigenae; rounded, spineless genal angles or librigenae gradually produced into broad genal spines; small eyes; wider thoracic axis; and pygidium with wide, flat, well-defined border (180). *L.Ord.(Tremadoc.)-M.Ord., Czech.*—FIG. 267,10. *B. (*P.*) *bohémica* (NOVÁK), *M.Ord., Czech.*; ceph., $\times 1$ (180).
- ?*Borthaspidella* RASETTI, 1954 [**B. gaspensis*]. Differs from *Borthaspis* in having well-impressed axial furrows delimiting a better-defined glabella with strongly expanded anterior third (202). *L.Ord.(Tremadoc.)*, E.N.Am., ?C.Asia.—FIG. 267,2. **B. gaspensis*, Can.; 2a,b, cran., pyg. (reconstr.), $\times 3$ (202).
- ?*Borthaspis* STUBBLEFIELD, 1951 [*pro Psilocephalus* SALTER, 1866 (*non* SWAINSON, 1839)] [**Psilocephalus innotatus* SALTER, 1866] [= *Psilocephalina* STUBBLEFIELD, 1951 (*non* Hsü, 1948)]. Differs from *Platypeltoides* in having very small eyes placed far forward and 8 thoracic segments; cephalic doublure and hypostoma unknown (114). *L.Ord.(Tremadoc.)*, Wales.—FIG. 267,4. **B. innotata* (SALTER), Wales; exoskel., $\times 1$ (466).
- Bumastides* WEBER, 1948 [**B. bedpakensis*]. Differs from *Nileus* in having wider cephalon without discernible glabella; less curved eyes; vertically standing librigenae; and strongly projecting median posterior extension of doublure (259). *Ord., USSR.*—FIG. 267,5. **B. bedpakensis*; 5a-c, ceph., dorsal, frontal, lateral, $\times 2$; 5d, cephalic doublure, $\times 2$ (259).
- ?*Hemibarrandia* PRANTL & PŘIBYL, 1950 [**Nileus holoubkovensis* RŮŽIČKA, 1926]. Differs from typical Nileidae in having extremely wide cephalon with wide, raised lateral border becoming indistinct in front of glabella; anterior sections of facial sutures running outward from eyes to meet lateral margins nearly opposite anterior end of palpebral lobes. Surface coarsely granulose. Cephalic doublure and hypostoma unknown (182). *L.Ord.(Tremadoc.)*, Czech.—FIG. 267,6.
- **H. holoubkovensis* (RŮŽIČKA); 6a, ceph., $\times 0.5$; 6b, pyg., $\times 0.5$ (182). [= *Pseudonileus* KOBAYASHI, 1951 (obj.).]
- ?*Illaeopsis* SALTER, 1866 [**Illaeus (Illaeopsis) thomsoni*]. Differs from *Borthaspis* in having glabella well defined throughout by distinct axial furrows, anterior portion of glabella strongly expanded; much wider posterior areas of fixigenae; minute eyes very close to anterior cephalic margin; extremely narrow librigenae; thorax of 7 segments; pygidium with narrow well-defined border (268). *L.Ord., Br.I.-Arg.*—FIG. 267,7. *I. stenorrhachis* (HARRINGTON), *L.Ord.(Tremadoc.)*, Arg.; exoskel., $\times 3.5$ (59*).
- ?*Lakaspis* KOBAYASHI, 1937 [**Symphysurus apollonista* LAKE, 1906]. Differs from *Symphysurus (Symphysurus)* in having deeply impressed occipital furrow, anterior half of glabella somewhat constricted, wider posterior area of fixigenae, and much smaller eyes (113). *Ord., Bol.*
- ?*Platypeltoides* PŘIBYL, 1949 [*pro Platypeltis* CALLAWAY, 1877 (*non* FITZINGER, 1835)] [**Platypeltis croftii* CALLAWAY, 1877]. Differs from *Symphysurus (Symphysurus)* in having eyes of medium size, posterior sections of facial sutures running outward and backward in sigmoid curve delimiting relatively wide posterior areas of fixigenae and meeting posterior margins almost at right angles; thorax of 7 segments; cephalic doublure and hypostoma unknown (114). *L.Ord.(Tremadoc.)-M.Ord., Br.I.-Czech.*
- ?*Psilocephalina* Hsü, 1948 [**P. lubrica*]. Differs from *Borthaspis* in having genal spines and wider axis of pygidium (76). *L.Ord.(Tremadoc.)*, C. China.
- Symphysurus* GOLDFUSS, 1843 [**Asaphus palpebrosus* DALMAN, 1827; SD BARRANDE, 1852]. Differs from *Nileus* in having semicircular to parabolic cephalon; strongly convex glabella, defined by well-impressed axial furrows; narrower, more convex, tapering thoracic axis; and more evenly convex pygidium, without border and with distinct axis. It differs from *Barrandia* in its narrower exoskeleton, and pygidium shorter than thorax; surface usually covered with fine, raised, inosculating lines (18, 114, 153, 182, 294). *L.Ord.(Tremadoc.)-M.Ord., Eu.-N.Am.-S.Am.*
- S. (*Symphysurus*) [= *Paranileus* KOBAYASHI, 1951 (*non* HINTZE, 1953)]. Cephalon short, semicircular, transversely convex, with broadly quadrangular glabella delimited by straight axial furrows, effaced occipital furrow, small librigenae with rounded, spineless genal angle, and furrowed thoracic pleurae with rounded extremities (182). *L.Ord.(Tremadoc.)-M.Ord., Eu.-N.Am.-S.Am.*—FIG. 267,8. *S. (*S.*) *palpebrosus* (DALMAN), *M.Ord., Swed.*; exoskel., $\times 1$ (modified from 1).
- S. (*Kodymaspis*) PRANTL & PŘIBYL, 1950 [**Illaeus puer* BARRANDE, 1872]. Differs from S. (*Symphysurus*) in having parabolic cephalon,

glabella delimited by undulating axial furrows, well-marked occipital furrow, fairly large librigenae gradually passing into broad, rapidly tapering genal spines, and unfurrowed thoracic pleurae with obliquely backward-curved, pointed extremities (182). *L.Ord.* (*Tremadoc.*)-*M.Ord.*, Eu.—*FIG. 267,3. *S. (K.) puer* (BARRANDE), *M.Ord.*, Czech.; ceph., $\times 1$ (182).

Family DIKELOKEPHALINIDAE Kobayashi, 1936

Exoskeleton opisthoparian, isopygous. Glabella tapering with 1 to 4 pairs of usually deep slitlike lateral furrows, not reaching axial furrows, eye ridges strong, palpebral rims prominent and palpebral furrows well defined, frontal area of variable length (*sag.*), anterior furrow obsolete or very shallow; eyes of medium size to large, behind center of glabella; fixigenae upsloping, of medium width, with arcuate palpebral areas and pair of alae usually present opposite rear part of glabella; librigenae quadrate, with genal spines of variable length. Thorax with at least 8 segments; axis convex; pleurae twice length (*tr.*) of axis, with short pointed ends. Pygidium subcircular to subquadrate; axis extending 0.75 or more of length, with 6 to 8 axial rings; pleural fields usually wider than axis, with 6 to 8 pleurae merging into narrow border, pleural furrows and border furrow obsolete; posterior margin smoothly curved or with 1 or 2 pairs of prominent flat spines. Surface smooth or finely granulose. Bertillon pattern strong on doublures. *L.Ord.*

Dikelokephalina BRÖGGER, 1896 [**Centropleura? dicraeura* ANGELIN, 1854; SD VOGDES, 1925]. Glabella convex, tapering, with 3 pairs of deep, slitlike lateral furrows; frontal area 0.3 to 0.5 length of cranidium; eyes of medium size to large, behind center of glabella; fixigenae with palpebral areas slightly more than 0.5 of glabellar width, posterior areas very long (*tr.*). Pygidium subquadrate; axis convex, narrow, tapered 0.75 or more of length to narrow pointed end, with 7 or 8 axial rings and long terminal; pleural fields twice width of axis, with 7 pleurae separated by backward-curved interpleural grooves; medium-width border, posterior margin with short, backward-directed spine on each side of median line (96). *L.Ord.*, W.Eu.-E.Asia.—*FIG. 268,3c,d. *D. dicraeura* (ANGELIN), Scandinavia; *3c,d.* cran., pyg., $\times 1$.—*FIG. 268,3a,b. D. asiatica* KOBAYASHI, Korea; *3a,b.* cran., pyg., $\times 1$ (419).

Asaphopsis MANSUY, 1920 [**A. jacobi*]. Glabella moderately convex, broadly tapering, front rounded, with 3 pairs of short, pitlike lateral

furrows; eyes of medium size, slightly behind center of glabella; frontal area slightly more than 0.3 of length (*sag.*) of cranidium; fixigenae with palpebral areas slightly less than 0.5 of glabellar width, posterior areas of medium width (*exsag.*), 0.75 of length (*tr.*) of occipital ring. Pygidium subquadrate; axis convex, narrow, tapering 0.83 of length to narrow pointed end, with 7 or 8 axial rings and terminal; pleural fields twice width of axis, with 6 or 7 pleurae separated by backward-curved interpleural grooves running nearly to margin; border narrow, flat or concave, with pair of medium-length spines at posterolateral corners, posterior margin straight. *L.Ord.*, E.Asia-Tasm.—*FIG. 268,2. A. nakamurai* KOBAYASHI, Korea; *2a,b.* cran., pyg., $\times 1$ (419).

Asaphopsoides HUPÉ, 1955 [**Dicellosephalus? villebruni* BERGERON, 1895]. Glabella broadly tapering, front somewhat pointed, with 3 pairs of short slitlike lateral furrows; frontal area 0.3 of length (*sag.*) of cranidium; eyes large, opposite posterior 0.3 of glabella; fixigenae with palpebral areas 0.5 of glabellar width, length of posterior areas unknown. Pygidium subcircular; axis convex, narrow, tapered 0.75 of length to narrow pointed end, with 7 or 8 axial rings and long terminal; pleural fields twice width of axis, with 7 or 8 pleurae separated by well-defined curved interpleural grooves; medium-width border, posterior margin broadly curved with short spine at each posterolateral corner. *L.Ord.* W.Eu.—*FIG. 268,6. *A. villebruni* (BERGERON), Fr.; *6a,b.* cran., pyg., $\times 1$ (377).

Birmanites SHENG, 1934 [**Ogygites birmanicus* REED, 1915]. Glabella convex, urceolate tapering, with anterior pair of short oblique lateral furrows and 2 slitlike posterior pairs (latter pairs not shown in figure); frontal area almost 0.5 of length (*sag.*) of cranidium; eyes large, slightly posterior to center of glabella; fixigenae with palpebral areas 0.7 of glabellar width, posterior areas narrow (*exsag.*), same in length (*tr.*) as occipital ring, no alae observed; librigenae with short flat genal spines. Thorax with 8 segments. Pygidium subcircular; axis convex, narrow, tapered 0.83 of length to narrow pointed end, with 7 or 8 axial rings and terminal with 1 faint ring; pleural fields twice width of axis, merging into narrow border, with 7 or 8 pleurae separated by broad shallow interpleural grooves running to edge of border; posterior margin smoothly curved. Caecal folds prominent on cephalon. *L.Ord.*, E.Asia.—*FIG. 268,7. *B. birmanicus* (REED), Tremadoc., Burma; exoskel. (reconstr.), $\times 1$ (419).

Dactylocephalus Hsü, 1948 [**D. dactyloides*]. Glabella moderately convex, tapering, front narrow rounded, with 2 pairs of arcuate lateral furrows; eyes large, opposite posterior 0.3 of glabella; frontal area about 0.25 of length (*sag.*) of cranidium, with very shallow anterior furrow near front; fixigenae with palpebral areas about

0.7 of glabellar width, posterior areas narrow (*exsag.*), same in length (*tr.*) as occipital ring, posterior border furrow nearly obsolete; librigenae with shallow lateral border furrow anteriorly and long slender genal spines. Pygidium subquadrate; axis convex, medium-width, tapered

0.8 of length to narrow rounded end, with 6 axial rings and terminal; pleural fields about same in width as axis, sloping into very narrow border, with 6 pleurae separated by backward-curved interpleural grooves running nearly to margin, short backward-directed spine on each side of

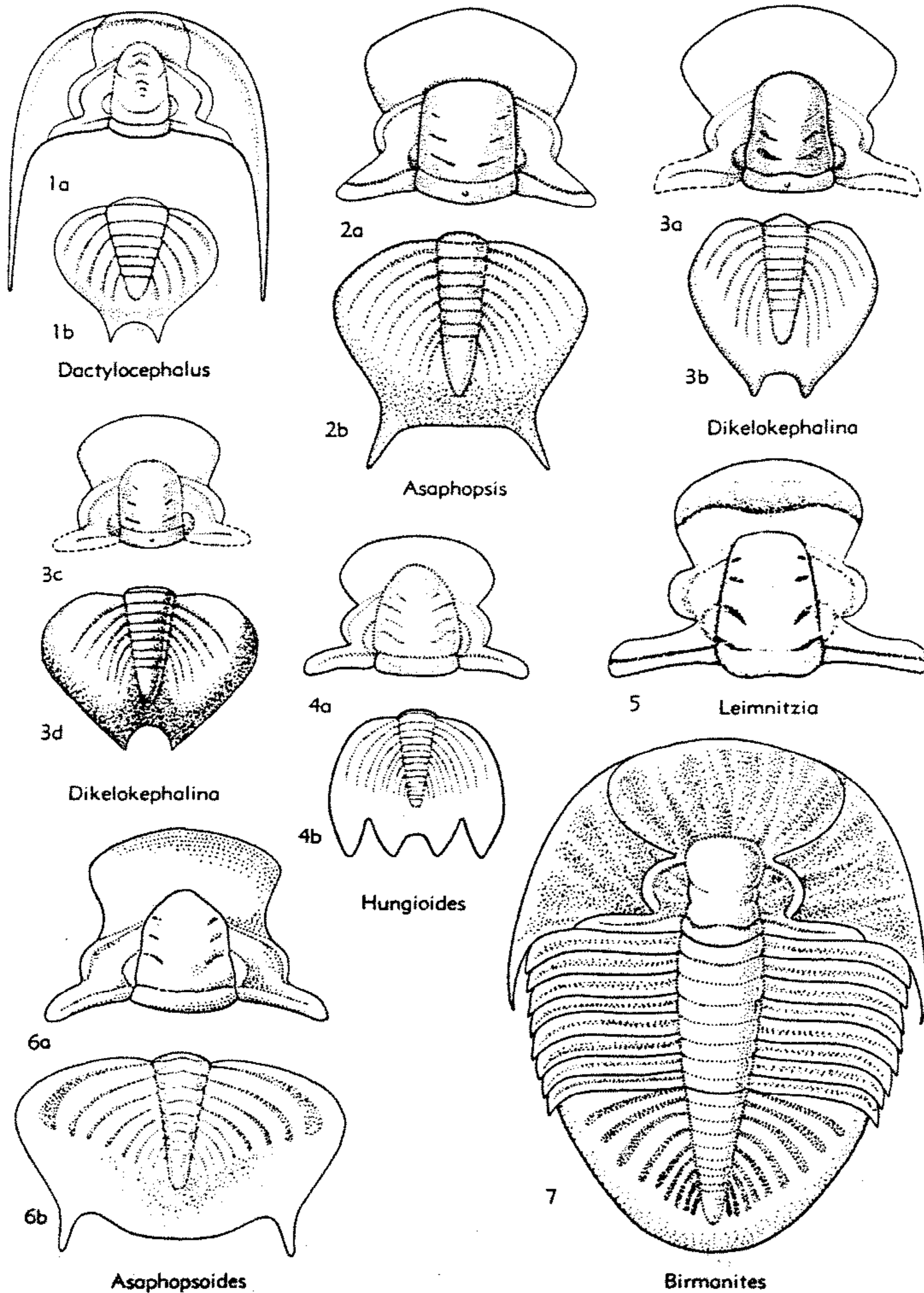

FIG. 268. Dikelocephalinidae (p. 0359-0361).

median line. Concentric wrinkles on cephalon. *L.Ord.*, E.Asia.—FIG. 268,1. **D. dactyloides*, Tremadoc., China (W.Hupeh); *la,b*, ceph., pyg., $\times 1$ (419).

Dikelocephalopsis POLETAEVA, 1955 [**D. amzassen-sis*]. Resembles *Leimitzia*. *L.Ord.* (*U.Tremadoc.*), USSR (HE).

Hungioides KOBAYASHI, 1936 [**Dicellocephalina bohémica* J. PERNER, 1918]. Glabella moderately convex, tapering with narrow rounded front and 4 pairs of slitlike glabellar furrows; eye ridges narrow, eyes of medium size, opposite posterior 0.3 of glabella; frontal area about 0.25 length (*sag.*) of cranidium; fixigenae with palpebral areas almost 0.5 of glabellar width, posterior areas not quite equal in length (*tr.*) to occipital ring. Pygidium subcircular; axis convex, narrow, tapered 0.8 of length to narrow rounded end, with 11 axial rings and terminal with 1 or 2 faint rings; pleural fields twice width of axis, with 10 pleurae separated by backward-curved interpleural grooves; medium-width border extended into 2 pairs of very broad, flat, posterior marginal spines (64). *L.Ord.*, C.Eu.—FIG. 268,4. **H. bohémica* (PERNER), Czech.; *4a,b*, cran., pyg., $\times 1$ (442). [Authorship of type species should be cited as J. PERNER in NOVÁK & PERNER, 1918.]

Leimitzia SZUY, 1955 [**Conocephalites bavaricus* BARRANDE, 1868]. Glabella low, tapering, with 3 pairs of deep, slitlike lateral furrows; frontal area 0.3 of length of cranidium, anterior border furrow distinct, with prominent median posterior curve; eyes large, about opposite center of glabella; fixigenae with palpebral areas slightly more than 0.5 of glabellar width, posterior areas of medium width, about same in length (*tr.*) as occipital ring. Pygidium subcircular; axis convex, narrow, tapered 0.75 of length to narrow rounded end, with 5 or 6 axial rings and long terminal; pleural fields slightly wider than axis, with 6 pleurae separated by backward-curved interpleural grooves running on to moderately wide, flat border; posterior margin with median inward bend. Outer surface very finely granulose (272). *L.Ord.* (*Tremadoc.*), Eu.—FIG. 268,5. **L. bavarica* (BARRANDE), Tremadoc., Ger.; cran., $\times 1$ (272).

Temnoura RESSER & ENDO, in ENDO & RESSER, 1937 [**T. granosa*] [= *Temnura*, *Temnurus* KOBAYASHI, 1935]. Single pygidium in drift block. *L.Ord.*, Manch.

Superfamily CYCLOPYGACEA Raymond, 1925

[*nom. transl.* RICHTER & RICHTER, herein (*ex Cyclopygidae* RAYMOND, 1925)]

Exoskeleton gibbous. Cephalon large, without marginal border; glabella large, fused with occipital ring (?except *Ellip-*

sotaphrus); fixigenae reduced to minute band, palpebral lobes not defined; facial sutures cutting posterior margin close to axial furrows, not withdrawing from them along whole contour of glabella; librigenae in most genera reduced, angles rounded, united ventrally by doublure; eyes hypertrophied, visual areas very convex, occupying nearly whole librigenae, continuing to ventral side where they may remain separated or unite (in some species this trend being advanced to different degrees within same genus), with 750 to 3,500 biconvex lenses in each eye. Hypostoma incompletely known; no connective sutures or rostral plate. Thorax with 5 or 6 segments; sides parallel or diverging backward; axis broad, at least anteriorly; pleurae grooved, increasing backward in width (*tr.*). Pygidium of moderate size to large; axis with few rings (up to 5); pleural fields with few ribs, generally no more than 1 or 2 distinct. Surface smooth or with fine striae, few species granulose. Most species small, a few up to 14 cm. in length (3, 4, 211, 218, 255, 343). *Ord.* (*U.Tremadoc.-Ashgill.*).

Family CYCLOPYGIDAE Raymond, 1925

[*nom. conserv.* RICHTER & RICHTER proposed 1955 *pro* Aeglinidae PICTET, 1854 (ICZN pend.)]

Characters of superfamily. *Ord.* (*U.Tremadoc.-Ashgill.*).

Cyclopyge HAWLE & CORDA, 1847 [*nom. subst. pro* *Egle* BARRANDE, 1846 (*non* DESVOIDY, 1830)] [**Egle rediviva* BARRANDE, 1846] [= *Selenoptychus* HAWLE & CORDA, 1847; *Aeglina* BARRANDE, 1852 (*obj.*); *Phylacops* COOPER & KINDLE, 1936]. Glabella broad, sides straight, converging forward; with single pair of lateral furrows, directed backward; eyes covering much of ventral surface, separated by 0.3 or less of cephalon width or meeting. Thorax with 6 segments; sides diverging and axis strongly tapering backward. Pygidium large, semicircular; axis narrow, short; pleural regions large; marginal border absent or faint. *Ord.*, Eu.-E.N.Am.—FIG. 269,2. **C. rediviva* (BARRANDE), "d epsilon" Zone, Czech.; exoskel., $\times 1.5$ (3, 4).

Aspidaeglina HOLUB, 1911 [**A. miranda*]. Cephalon imperfectly known, with pair of pits in posterior region of glabella. Thorax as in *Cyclopyge* but axis moderately tapering backward. Pygidium with short triangular axis; scarcely segmented; border depressed, with median border spine. *L.Ord.*, Eu.—FIG. 270,2. **A. miranda*, "d beta" Zone, Czech.; thorax and pyg., $\times 1.5$ (67).

Ellipsotaphrus WHITTARD, 1952 [**Aeglina monophthalma* KLOUČEK, 1917]. Glabella short, narrow-

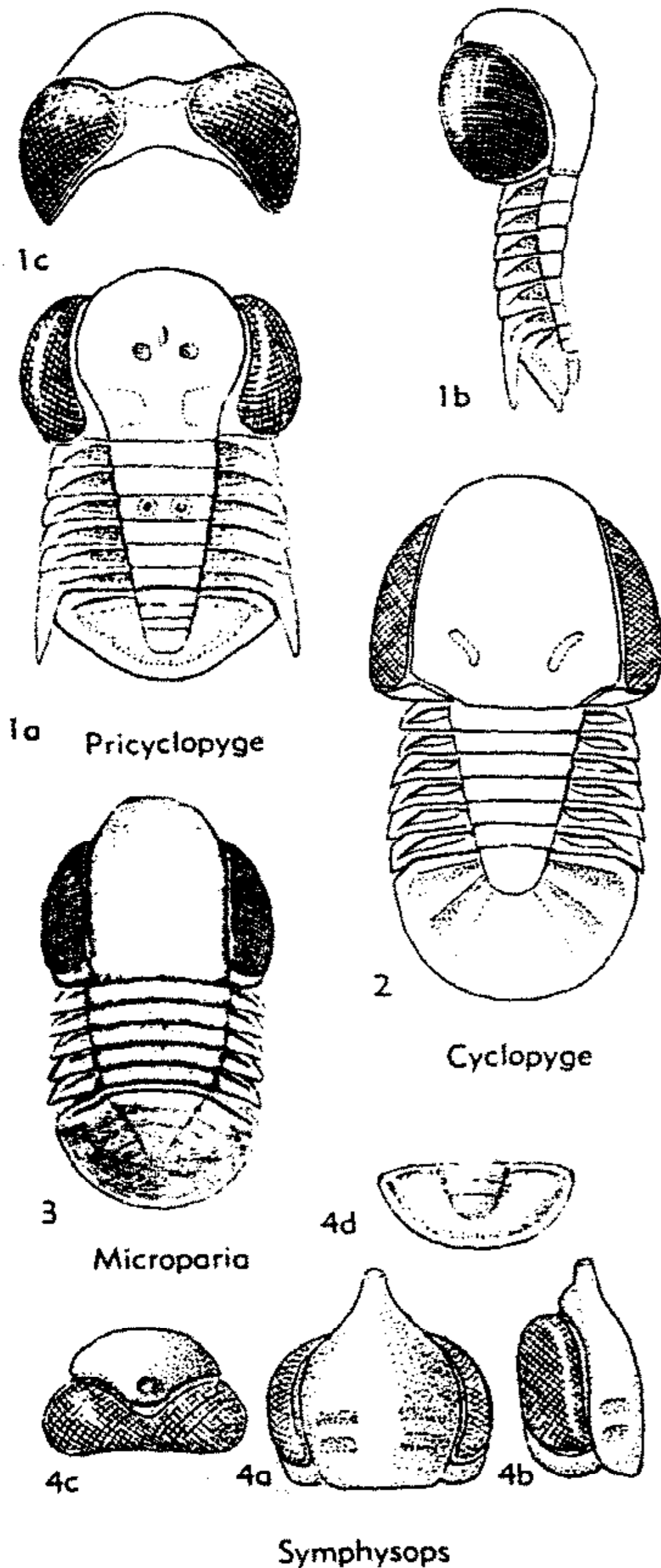

FIG. 269. Cyclopygidae (p. 0361-0362).

ing backward, front broadly rounded, with 2 entire furrows (posterior regarded as occipital furrow) and anterior pair of discontinuous furrows; posterior region of genae considerably elongated; facial sutures uniting dorsally; eyes separating glabella from anterior border, coalesced. Thorax and pygidium imperfectly known. *L.Ord.*, Czech.-Eng.-Wales.—FIG. 270,1. **E. monophthalmus* (KLOUČEK), "d gamma 2" Zone, Czech.; 6a,b, ceph., dorsal, lateral, $\times 4$ (94).

Microparia HAWLE & CORDA, 1847 [**M. speciosa*].

Glabella with straight sides or somewhat convergent forward, without furrows; eyes barely continuing to ventral side or not at all. Thorax with 5 or 6 segments; axis very broad, scarcely tapering backward. Pygidium semicircular; segmentation faint; axis triangular, anteriorly very broad; border faint or absent. *Ord.*, C.Eu.-W.Eu.-E.N.Am.—FIG. 269,3. **M. speciosa*, "d epsilon" Zone, Czech.; exoskel., $\times 1$ (3, 4).

Pricyclopyge RICHTER & RICHTER, 1954 [**Aeglina prisca* BARRANDE, 1872]. Glabella pear-shaped, with 2 centrally located pits; eyes covering much of ventral surface, separated by approximately 0.25 width of cephalon. Thorax with 6 segments; axis strongly tapering backward; 6th segment with pleural spines. Pygidium triangular; axis narrow, 0.7 of length of pygidium, few rings; ribs faint; with marginal border. *Ord.*, C.Eu.-W.Eu.—FIG. 269,1. **P. prisca* (BARRANDE), "d gamma 1" Zone, Czech.; 1a,b, exoskel., dorsal, profile; 1c, ceph., ventral; all $\times 1$ (4).

Psilacella WHITTARD, 1952 [**P. trirugata*]. Imperfectly known. Glabella nearly parallel-sided, front broadly rounded, with 3 pairs of pronounced furrows; eyes presumed to coalesce. Pygidium semicircular; axis triangular, 0.5 of pygidial length, with few rings and ribs. *Ord.*, Scot.-Czech.—FIG. 270, 3. **P. trirugata* WHITTARD, Ashgillian, Scot.; glabella, $\times 3$ (343).

Symphysops RAYMOND, 1925 [**Aeglina armata* BARRANDE, 1872]. Glabella with greatest width at mid-length, produced into frontal spine, with 2 pairs of transverse furrows; eyes coalescent ventrally; posterior region of free cheeks developed as a rather broad band. Pygidium rather small, semicircular; axis of moderate length; few rings and ribs; marginal border narrow. *M.Ord.-U.Ord.*, Eu.-E.N.Am.—FIG. 269,4. **S. armatus* (BARRANDE), "d zeta 1" Zone, Czech.; 4a-c, ceph., dorsal, side, anterior; 4d, pyg., all $\times 1$ (4).

Superfamily CERATOPYGACEA Linnarsson, 1869

[*nom. transl.* POULSEN, herein (ex *Ceratopygidae* LINNARSSON, 1869)]

Opisthoparian, ovate, slightly convex exoskeleton, heteropygous to almost isopygous. Cephalon approximately semicircular; glabella clavate to tapering forward, with median tubercle on posterior part; preglabellar field well developed, cephalic border furrow strongly impressed, adjoining narrow, convex border; librigenae fairly wide, with slender genal spines in direct continuation of lateral border or nearly so. Thorax of 6 to 9 segments (as far as known). Pygidium semicircular to subtriangular, with 1 or 2 pairs of lateral spines originating from an-

terior segments. Cephalic doublure, ventral sutures, and hypostoma imperfectly known; doublures of librigenae apparently separated by median suture in *Proceratopyge*, and hypostoma probably fused with rostral plate in *Hysterolenus*. *Up.M.Cam.-L.Ord.*

Family CERATOPYGIDAE Linnarsson, 1869

Characters of superfamily. *Up.M.Cam.-L.Ord.*

Ceratopyge HAWLE & CORDA, 1847 [*Olenus forficula* SARS, 1835]. Cephalon slightly less than 0.5 of total length; cranidium narrow; glabella slender, slightly expanding forward, truncate in front; occipital furrow strongly impressed; preoccipital lateral glabellar furrows pit-shaped, strongly impressed, other glabellar furrows shallow, almost effaced; palpebral region of fixigenae narrow; palpebral lobes short, strongly curved, situated a little posterior to glabellar center; anterior sections of facial sutures strongly diverging between eyes and anterior border, forming angles of about 90° with posterior sections. Thorax of 6 segments with narrow axis; straight, deeply furrowed pleurae with pointed, outward-directed ends. Pygidium semicircular, somewhat smaller than cephalon, with very narrow, slightly convex border, 5 or 6 axial rings, 2 anterior segments perceptible in pleural fields, and a pair of backward-directed, gently curved spines formed by coalescence of distal parts of 1st and 2nd segment (153). *L.Ord.* (*Tremadoc.*), Norway-Swed.-Arg.—FIG. 271,1. **C. forficula* (SARS), Swed.; 1a,b, ceph., pyg., ×2.8 (153).

Boschchekulia LERMONTOVA, 1951 [*B. lata*]. *U. Cam.*, NE.Kazakhstan.

Diceratopyge TROEDSSON, 1937 [*D. mobergi*]. Differs from *Ceratopyge* in having parallel-sided glabella without glabellar furrows and with rounded front, and more slender pygidial spines originating from posterior pleural band of 2nd segment (301). *U.Cam.*, C.Asia.—FIG. 272,2. **D. mobergi*, *U. Cam.*, China(T'ien-Shan); pyg., ×3 (301).

?*Dichelepyge* HARRINGTON & LEANZA, 1952 [*D. pasquali*]. Differs from *Ceratopyge* in having wider cranidium, tapering glabella with 3 pairs of well-defined lateral furrows, anterior region of fixigenae crossed by corner furrow in continuation of preglabellar furrow, wider posterior region of fixigenae, palpebral lobes slightly in front of glabellar center, less diverging anterior sections of facial sutures; thoracic segments with extremely oblique proximal part of pleural furrows and long pleural spines; pygidium with concave border, strongly marked segmentation throughout, and 1st and 2nd segment terminating in obliquely backward-directed pleural spines (58). *L.Ord.*

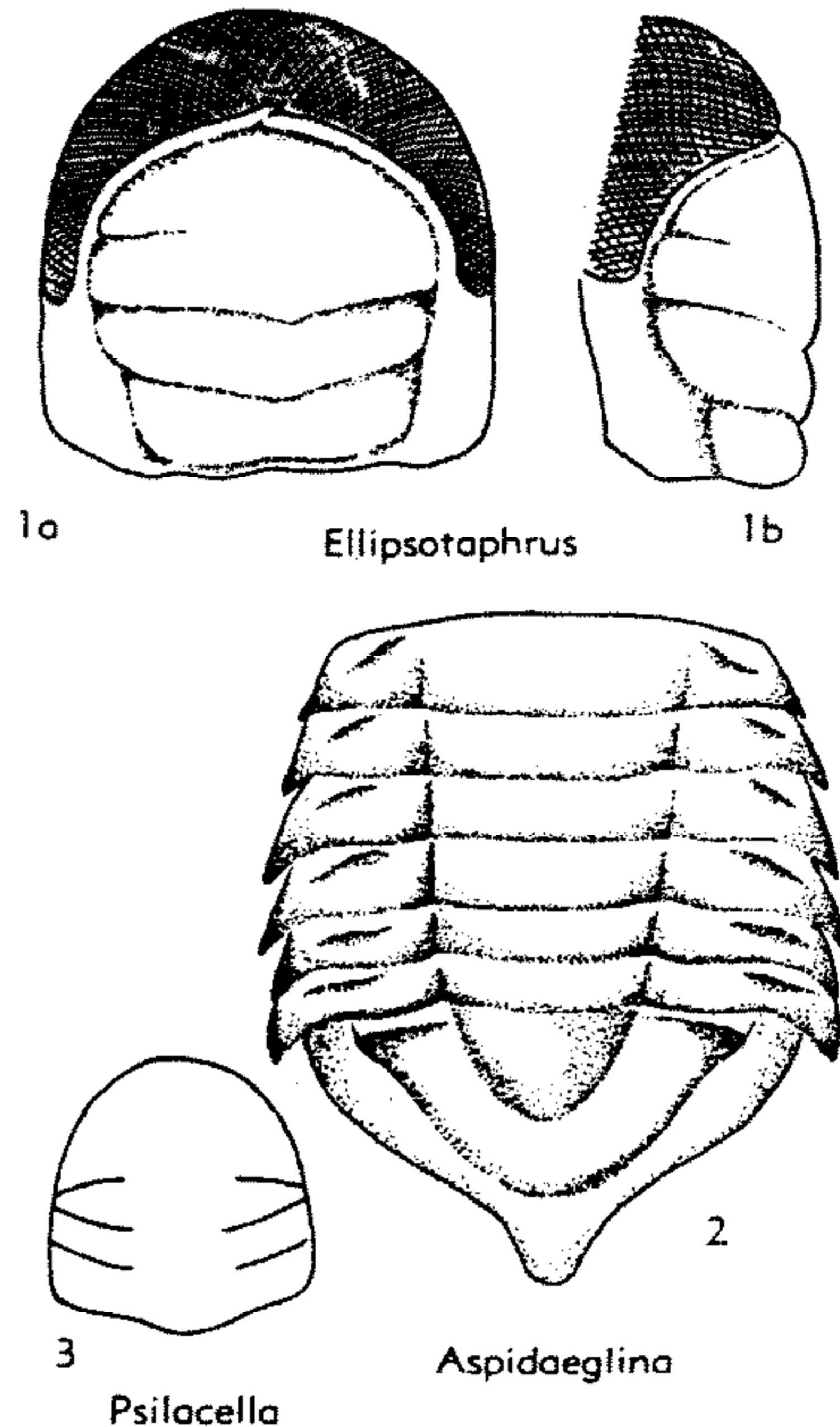

FIG. 270. Cyclopygidae (p. 0361-0362).

(*Tremadoc.*), Arg.—FIG. 272,1. **D. pasquali*, Salta; cran. and 3 thoracic segments; ×6.5 (58).

Dipleuropyge LERMONTOVA, 1951 [*D. striata*]. Pygidium rather similar to that of *Onychopyge*. *U.Cam.*, Kazakhstan (HE).

Hysterolenus MOBERG, 1898 [*H. törnquisti*]. Differs from *Ceratopyge* in having parallel-sided glabella with rounded front, 4 pairs of distinctly marked lateral glabellar furrows, and larger, subtriangular pygidium with about 10 axial rings, at least 6 defined segments in pleural fields, concave border, and 2nd segment produced into pleural spines (153). *L.Ord.*(*Tremadoc.*), Eu.-?C.Asia.—FIG. 271,4. **H. toernquisti*, Swed.; 4a,b, ceph., pyg., ×1.5; 4c, hypostoma, ×1.3 (153).

Kogenium KOBAYASHI, 1935 [*K. rotundum*]. Pygidium like that of *Proceratopyge*; associated cranidium differing from those of typical Ceratomygidae in being strongly convex and having wider palpebral regions of fixigenae and more rapidly tapering, considerably sloping lateral extremities of posterior areas (97). *M.Cam.*, E.Asia.

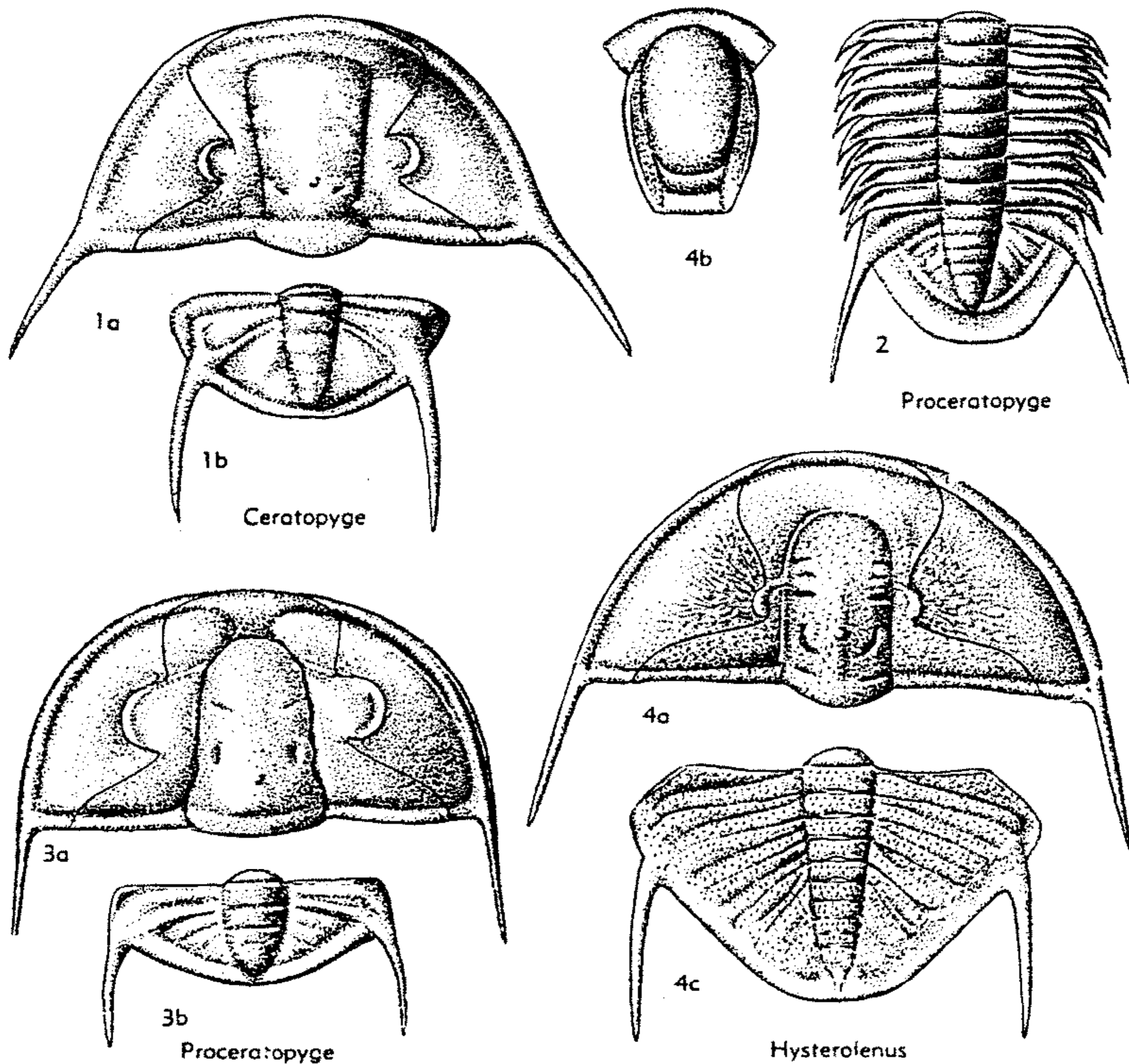

FIG. 271. Ceratopygidae (p. 0363-0364).

Mansuyella ENDO, in ENDO & RESSER, 1937 [**Coosia tokunagai* KOBAYASHI, 1931]. Differs from *Proceratopyge* in wider, more rapidly tapering, more or less truncated glabella and longer preglabellar field (37). *U.Cam.*, E.Asia.

Onychopyge HARRINGTON, 1938 [**O. riojana*] [= *Prionopyge* HARRINGTON & LEANZA, 1942 (obj.)]. Cephalon differing from that of *Ceratopyge* in having larger eyes, less diverging anterior sections of facial sutures, and glabella indistinctly defined anteriorly. Pygidium differing from that of *Proceratopyge* in having indistinct segmentation of pleural fields behind 1st pleura, and much wider border (59). *L.Ord. (Tremadoc.)*, Arg.—FIG. 273. **O. riojana*; a, cran. and librigena, $\times 2$; b, pyg. (holotype) (reconstr.), $\times 1.8$ (59*).

Proceratopyge WALLERIUS, 1895 [**P. conifrons*] [= *Lopnorites* TROEDSSON, 1937]. Differs from *Ceratopyge* in having cephalon about 0.3 of total

length of exoskeleton, wider, tapering to almost parallel-sided glabella, palpebral lobes situated opposite glabellar center, slightly diverging or almost parallel courses of anterior sections of facial sutures between eyes and anterior border; thorax of 9 segments with obliquely backward-directed pleural spines; and larger pygidium with 3 to 11 axial rings, well-segmented pleural fields, concave border, and 1st segment terminating in pleural spines (335, 336). *Up.M.Cam.*, Swed.-Asia-Austral. ?*L.Ord. (Tremadoc.)*, Arg.—FIG. 271.3. **P. conifrons*, *M.Cam.*, Swed.; 3a,b, ceph., pyg., $\times 3$ (336).—FIG. 271.2. *P. magnicauda* WESTERGÅRD, *M.Cam.*, Swed.; incomplete thorax with pyg., $\times 3$ (336).

Pseudohysterolenus HARRINGTON & LEANZA, 1957 [**P. infidus*]. Differs from *Hysterolenus* in having wider, anteriorly subtruncate glabella, very small posterior areas of fixigenae, and short, semi-elliptical pygidium with much wider, strongly

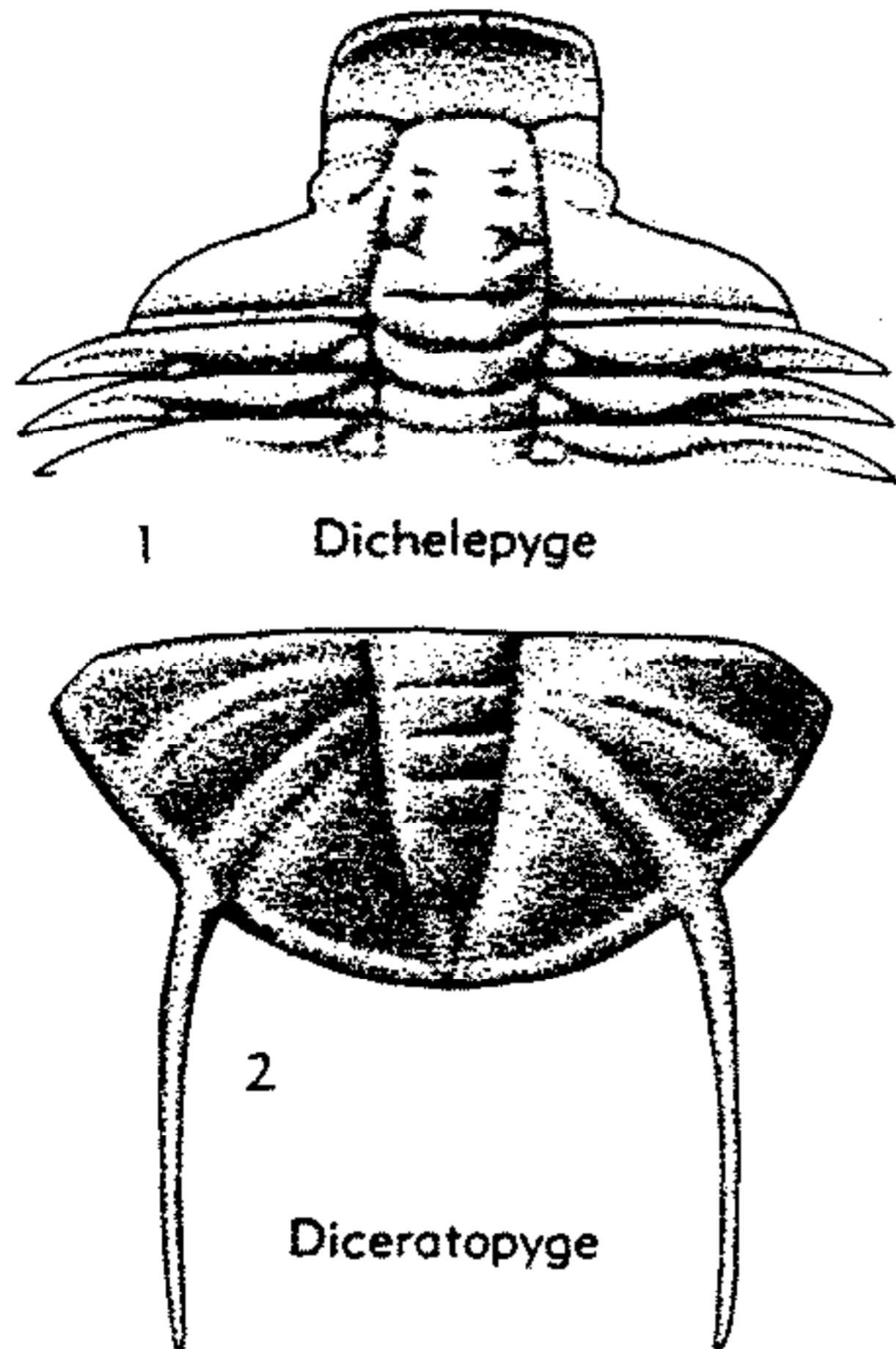

FIG. 272. Ceratopygidae (p. 0363).

tapering axis of 5 rings and short terminal portion, and pleural fields divided into 3 indistinctly defined pleurae, apparently without spines (59). L.Ord.(Tremadoc.), Arg.—FIG. 274. **P. infidus*; a, cran. (holotype) (reconstr.), $\times 6.6$; b, pyg. (exfoliated), $\times 9.2$ (59*).

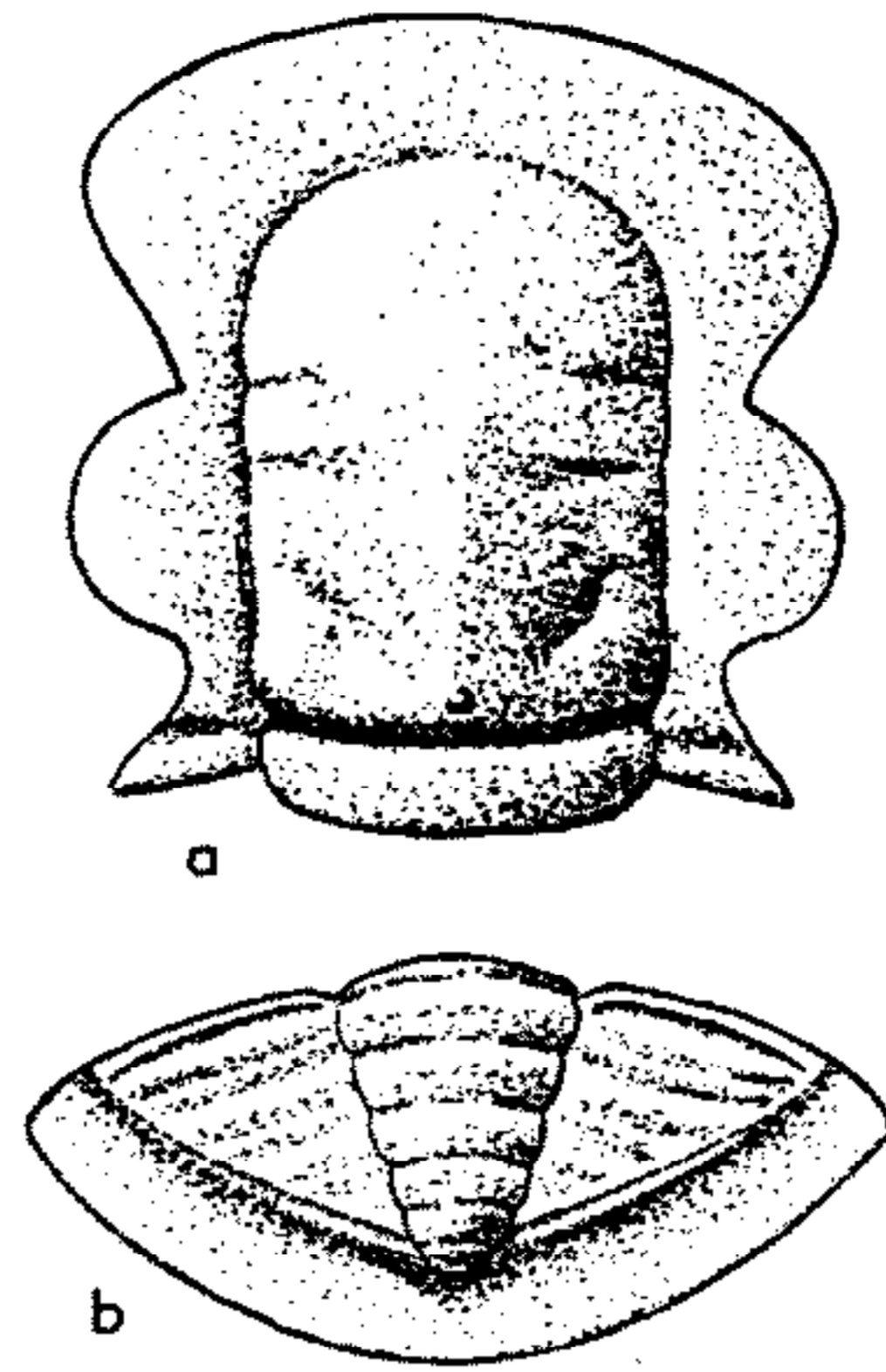

FIG. 274. **Pseudohysterolenus infidus* HARRINGTON & LEANZA (Ceratopygidae), L.Ord.(Tremadoc.), Arg.; a, cran. (reconstr.), $\times 6.6$; b, pyg. (exfoliated), $\times 9.2$ (59*).

Suborder ILLAENINA Jaanusson, nov.

[Type—Illaenus DALMAN, 1827]

Opisthoparian trilobites with large or moderately large rostral shield separated by sutures; one family includes, in current delimitation, some genera with anteriorly fused librigenae. Lateral glabellar furrows commonly faint or absent. Doublure broad. Thoracic segments 6 to 10. Pygidium about equal in size to cephalon or somewhat smaller. Tuberculae ornamentation rare. All typical forms lack eye ridges. Ord.-M.Perm.

Superfamily ILLAENACEA Hawle & Corda, 1847

[nom. correct. HARRINGTON & LEANZA, 1957 (pro Illaenidae WHITTINGTON, 1953, nom. transl. ex Illaenides HAWLE & CORDA, 1847)] [=Scutelloidae HUPÉ, 1953]

Exoskeleton of moderate size. Glabella expanding anteriorly, alae commonly well defined, at least on ventral face of cephalon. Thoracic segments 8 to 10; pleural furrows, if present, approximately parallel to margins of segments. Ord.-Sil.

Family STYGINIDAE Vogdes, 1890

Cephalon and pygidium moderately convex, subequal in size, outline semicircular, genal regions prolonged behind rest of cephalon as broad-based spines. Glabella

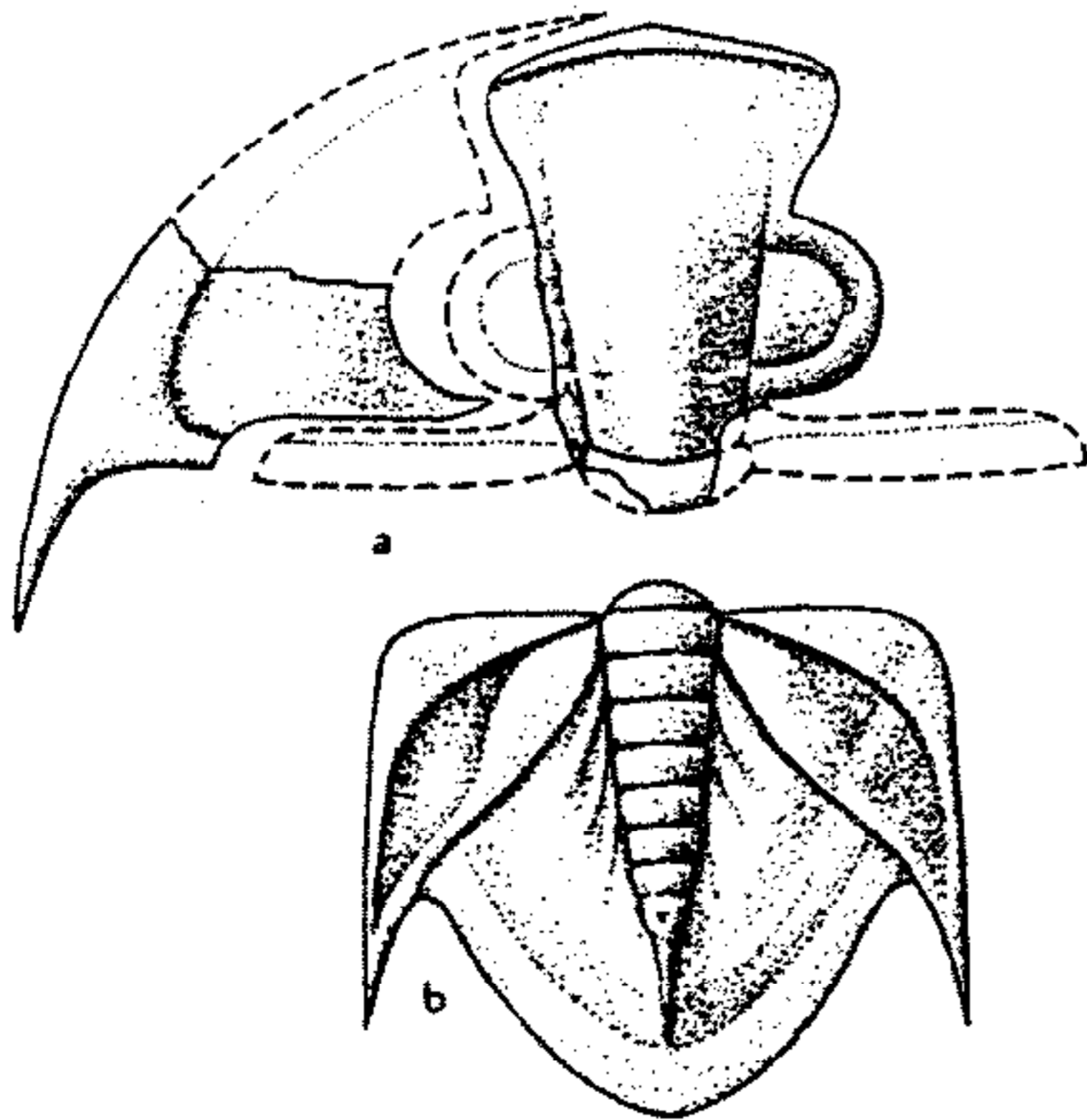

FIG. 273. **Onychopyge riojana* HARRINGTON (Ceratopygidae), L.Ord.(Tremadoc.), Arg.; a, cran., $\times 10$; b, librigena, $\times 2$; c, pyg. (reconstr.), $\times 1.8$ (59*).

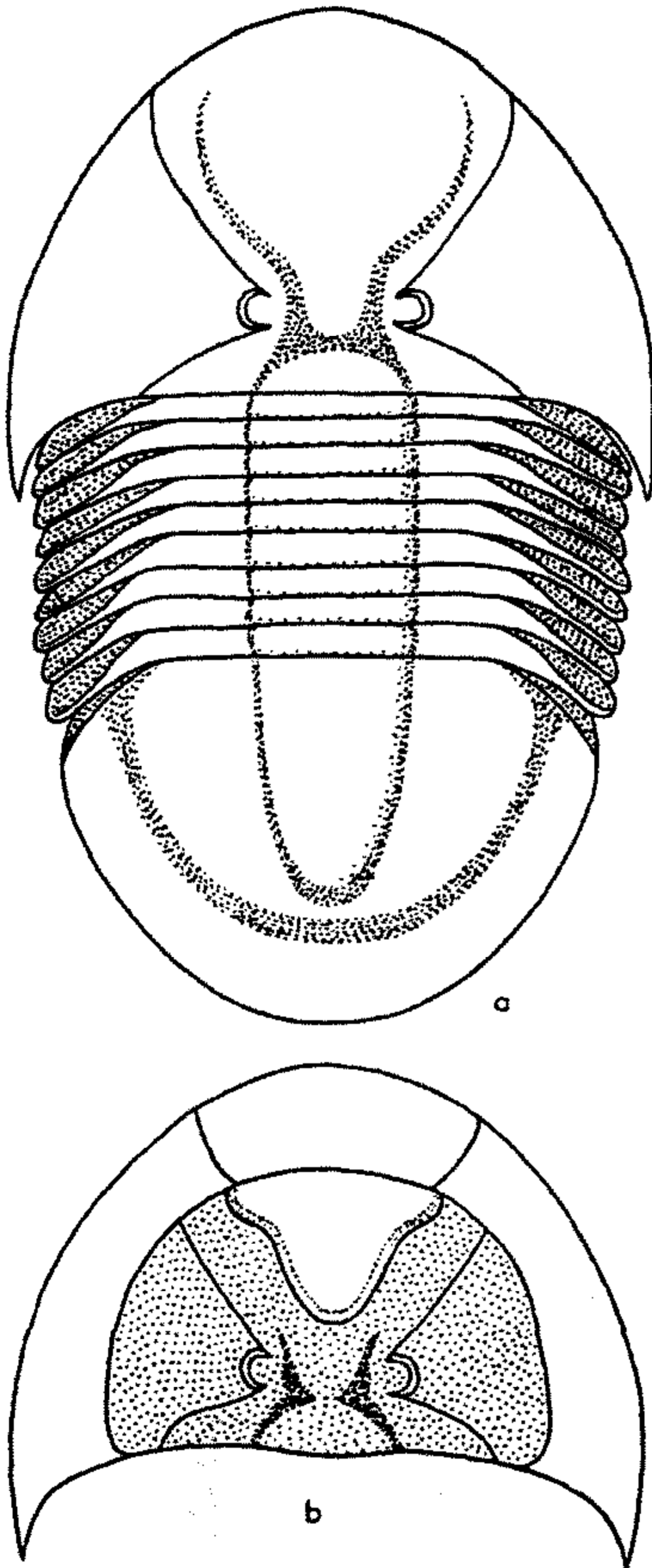

FIG. 275. **Stygina latifrons* (PORTLOCK) (Stygini-
dae), M.Ord.-U.Ord., NW.Eu.; *a, b*, exoskel., dorsal
(reconstr.), and ceph., ventral (reconstr.), $\times 2$
(496n).

narrowest just in front of occipital ring, expanding forward, defined by faint to well-marked axial and preglabellar furrows; occipital furrow moderately deep; 4 lateral glabellar furrows may be present, posterior 2 converging to meet just inside axial furrows, anterior 2 short, ovate; preglabellar field short (*sag.*) or absent; genal regions divided into inner convex portion and outer

flattened region, with distinct change of slope or faint furrow between them; narrow posterior border may be developed; eye lobes situated close to posterior margins of inner part of genal regions, at varying distance from axial furrows; faint eye ridges may run inward-forward. Sutures opistho-parian, anterior sections divergent, joined along anterior margin by rostral suture. Doublure broad, rostral plate isolated by backwardly convergent connective sutures. Hypostoma shield-shaped, with undivided convex middle body, lateral and posterior borders flattened. Thorax of 7 to 9 segments; fulcrum of pleurae at 0.5 to 0.7 of width from axial furrows, outer parts bent down and faceted. Pygidium with well-defined axis, continued rearward by more or less well-defined postaxial ridge; pleural fields with well-marked facet and shallow furrow behind it. Broad doublure reaching in to tip of axis, border not defined by furrow, but may be gently concave. Surface smooth or with terrace lines, latter characteristic of doublure (278, 350). *L.Ord.-U.Ord.*

Stygina SALTER, 1853 [**Asaphus latifrons* PORTLOCK, 1843; SD VOGDES, 1890]. Four glabellar furrows in some species; no preglabellar furrow; anterior pit situated in axial furrows at distance from anterior margin slightly greater than width of doublure; eye lobes small, elevated, close to rear part of glabella; posterior border faint or absent, genal spines short. Rostral plate subtrapezoidal; hypostoma nearly triangular in outline. Thorax with 9 segments; no pleural furrows. Pygidium with axial ring faint or absent, no pleural furrows, broad concave border. *M.Ord.-U.Ord.*, Ire.-Scot.-Wales-Swed.-Norway-Est.—FIG. 275. **S. latifrons* (PORTLOCK); *a, b*, exoskel., dorsal (reconstr.), ceph., ventral (reconstr.), $\times 2$ (496n).

Bronteopsis NICHOLSON & ETHERIDGE, 1879 [**Ogygia? concentrica* LINNARSSON, 1853 (= *H. scotica* NICHOLSON & ETHERIDGE, 1879); *Homoglossa* RAYMOND, 1912]. Four pairs glabellar furrows visible; preglabellar field absent; genal spines broader (*tr.*) at base and longer than those of *Stygina*. Thorax with 8 segments; pleurae with shallow pleural furrows extending beyond fulcrum, low ridge immediately posterior to furrow, narrow anterior and posterior bands. Pygidium with 7 or 8 axial rings, tip of axis unfurrowed; pleural fields with broad, gently concave border. 7 pairs of shallow pleural furrows separated by low broad ridges, directed progressively more strongly backward. Dorsal external surface with terrace lines. *M.Ord.*, Scot.-Norway-Swed.-Est.

—FIG. 276. **B. concentrica* (LINNARSSON), Swed.; *a, b*, ceph., dorsal, ventral; *c*, pyg.; all $\times 1.5$ (360*, 496n).

Protostygina PRANTL & PŘIBYL, 1948 [*Illaenus bohemicus* BARRANDE, 1872]. Like *Stygina* but posterior part of glabella parallel-sided, anterior part only slightly expanded; eye lobes farther out; genal spines broad (*tr.*) and long. Pygidium shorter (*sag.*). *M.Ord.*, Boh.

Raymondaspis PŘIBYL, 1948 [*pro Holometopus* ANGELIN, 1854 (*non* MILNE EDWARDS, 1853)] [*Holometopus limbatus* ANGELIN, 1854; SD MILLER, 1889] [= *Warburgella* RAYMOND, 1937 (*non* REED, 1931)]. Like *Stygina* but posterior part of glabella subparallel-sided and anterior lobe more convex and separated by sharp change in slope from narrow (*sag.*, *exsag.*) preglabellar field; eye lobes larger; genal spines broader (*tr.*) at base, short. Thorax with 7 segments (*R. tennesseensis*).

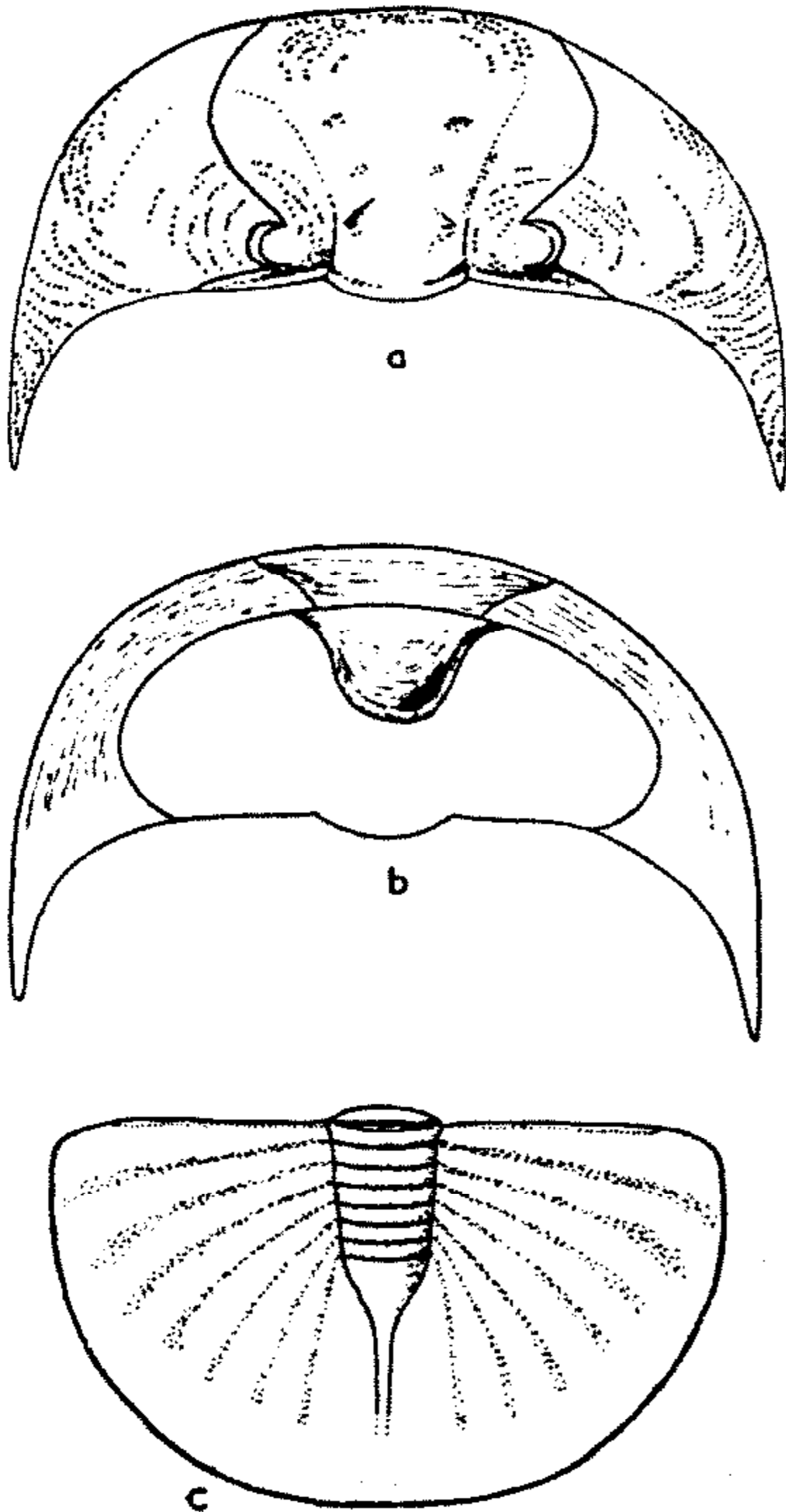

FIG. 276. **Bronteopsis concentrica* (LINNARSSON) (Styginiidae), *M.Ord.*, NW.Eu.; *a, b*, ceph., dorsal, ventral, $\times 1.5$ (350, * 496n).

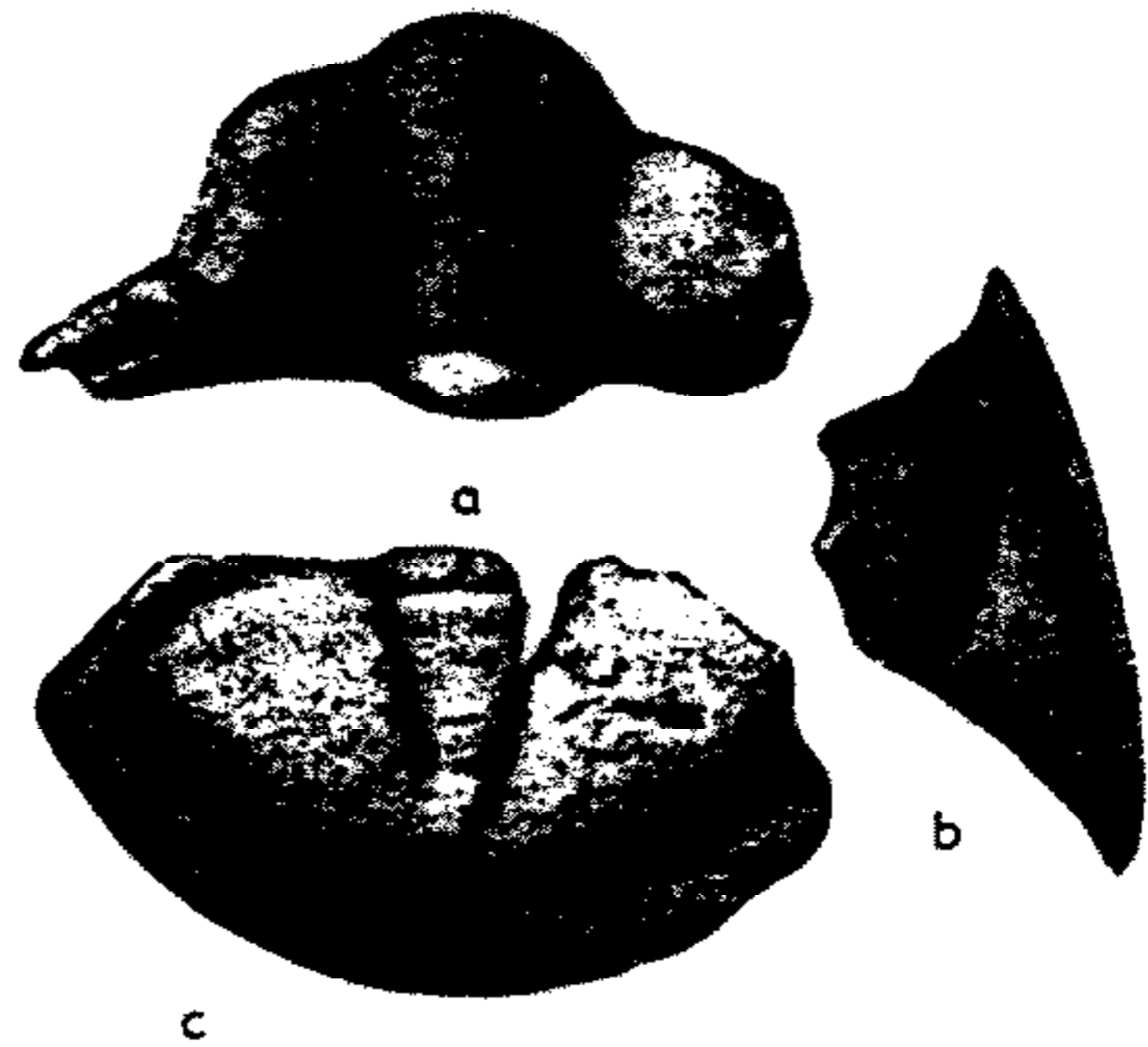

FIG. 277. **Raymondaspis limbata* (ANGELIN) (Styginiidae), *M.Ord.*, Norway; *a, c*, cran., pyg., $\times 3$; *b*, librigena, $\times 4$ (278).

Pygidium with axis narrower posteriorly, well-marked postaxial ridge, no border or narrow, faintly concave border. Dorsal external surface with terrace lines (26). *L.Ord.-M.Ord.*, Norway-Swed.-Scot.-E.N.Am.—FIG. 277. **R. limbatus* (ANGELIN), *L.Ord.*, Norway; *a, c*, cran., pyg., $\times 4$; *b*, librigena, $\times 5$ (278*).

Family THYSANOPELTIDAE Hawle & Corda, 1847

[*nom. correct.* MOORE, herein (*pro* Thysanopeltides HAWLE & CORDA, 1847)] [= Bronteidae HAWLE & CORDA, 1847 (*nom. correct.* ANGELIN, 1854, *pro* Bronteides HAWLE & CORDA, 1847); Goldiidae RAYMOND, 1913; Scutellidae RICHTER & RICHTER, 1925 (*non* GRAY, 1825); Eobronteidae SINCLAIR, 1949; Scutellidae RICHTER & RICHTER, 1955] [Acceptable designation of this family assemblage offers vexatious problems that arise mainly from homonymy and synonymy of names applied to one of the genera elected as type of the family, as well as homonymy and synonymy of published family-group names themselves. HAWLE & CORDA first used Bronteides and Thysanopeltides as family-group names based on genera now recognized as belonging together in this family assemblage. Bronteides was based on *Bronteus* GOLDFUSS, 1843 (= *Brontes* GOLDFUSS, 1839, *non* FABRICIUS, 1801) (= *Scutellum* PUSCH, 1833; *Goldius* DEKONINCK, 1841); Thysanopeltides was based on *Thysanopeltis* HAWLE & CORDA, 1847. ANGELIN's Bronteidae (1854), whether construed merely as a correction in form of HAWLE & CORDA's Bronteides, or as a new family-group name introduced by ANGELIN, has priority over other names based on the same genus (Goldiidae, Scutellidae, Scutellidae) and according to the Copenhagen Decisions, 1953, par. 54(1) (a) is valid even though almost universally discarded in palaeontological literature during many decades. Surely it is very undesirable to revive Bronteidae, especially in view of widespread opposition to the Copenhagen Decision providing for retention of family-group names based on junior synonyms; appeal is made for rescission of this rule at the 1958 Zoological Congress in London. Such rescission would make Scutellidae RICHTER & RICHTER, 1925, eligible for acceptance, if this name were not itself a homonym of Scutellidae GRAY, 1825 (based on *Scutella* LAMARCK, 1816, an echinoid). The proposal of RICHTER & RICHTER (1955) to substitute the arbitrarily modified spelling of Scutellidae, under proposed appeal to ICZN for exercise of Plenary Powers, is far less acceptable as a solution than recognition of Thysanopeltidae HAWLE & CORDA, 1847, which is entirely eligible, and, moreover, is an unclouded family-group name having priority equal to that of Bronteidae HAWLE & CORDA, 1847. Records published in the *Bulletin of Zoological Nomenclature* do not reveal that the RICHTERS' intended application has been filed, and in any case, approval of it is opposed.—Ed.]

Exoskeleton broadly oval in outline, with length ranging from 1.5 to 25 cm. Cephalon large; glabella very large, widening forward, with 3 pairs of lateral furrows that generally are dissimilar (*lp* furrows transverse or curved forward so that *lp* lobes coalesce with posterior part of glabella), axial furrows moderately well impressed, diverging forward and backward from base of glabella; occipital furrow generally broad (*sag.*), occipital ring prominent, rather broad; fixigenae commonly with circumscribed small areas adjoining axial furrows opposite position of eyes, palpebral lobes semicircular, small; posterior border furrows short, not continuing onto librigenae; posterior borders very narrow; facial sutures curving strongly around eye lobes, with anterior sections crossing front margin so as to run closely parallel to it on underside to point of junction with rostral suture; librigenae very large, triangular, bearing sharp genal angles or spines; eyes small, near posterior margin of cephalon, with ring-shaped holochroal visual areas containing 1,000 to 4,000 lenses. Connective sutures long, converging backward; rostral plate conspicuous, crescentic; hypostoma subrectangular, with well-developed wings, convex central body and crescentic posterior body that bears pronounced maculae, posterior margin rounded or pointed. Thorax with 10 segments of approximately uniform width; pleurae ridged, without furrows (rarely with furrows very indistinctly marked), with narrow anterior and posterior flanges (Fig. 278, 3a-c) but no facets, ends of pleurae pointed. Pygidium very large, longer than cephalon and commonly equal to 0.5 of length of body, semicircular to semielliptical in outline (except *Koliha-peltis*); axis very short (*sag.*), subtriangular, with no axial rings (or at most only faint indication of segments), commonly trilobate owing to presence of 2 longitudinal furrows; articulating half-rings and furrows pronounced, but no articulating half-ribs or facets; pleural fields with 6, 7, or 8 radiating lateral ribs that represent simple pleurae (Fig. 278, 2) and long, simple or bifurcate median rib; pygidial doublure expanded. Surface with irregular terrace lines, punctate or tuberculate. [Extreme width of doublure, extending 0.7 of length of pygidium,

generally is associated with thin-shelled flat pygidia bearing strong ribs (*paliferum* type, Fig. 279, 1d,e), whereas moderate width of doublure (0.3 to 0.5 of length of pygidium) commonly occurs in thick-shelled highly vaulted pygidia with faint ribs (*campani-*

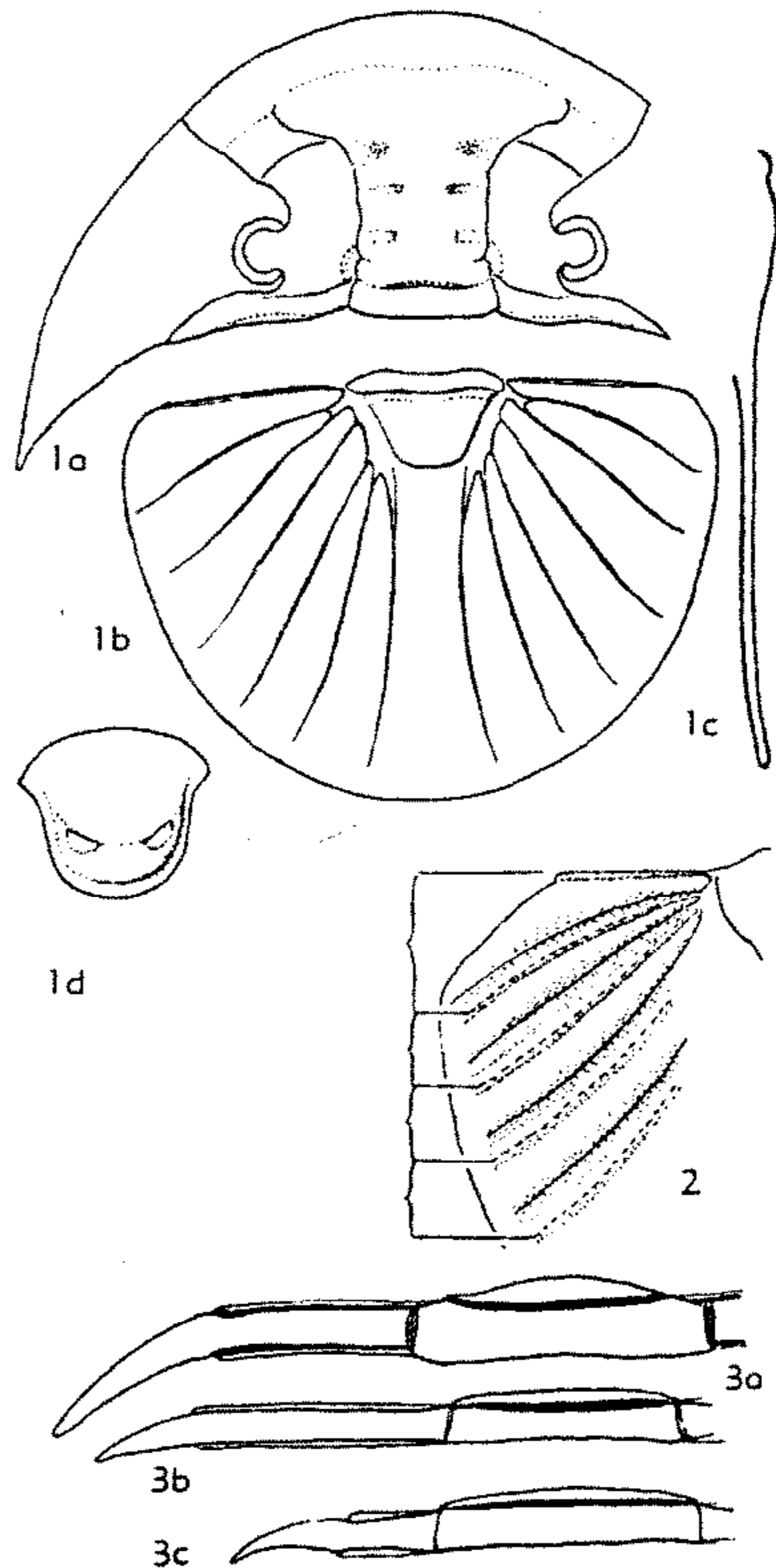

FIG. 278. Thysanopeltidae.—1a-d, **Eobronteus laticauda* (WAHLENBERG), U.Ord., Swed.—2, Left anterior part of thysanopeltid pygidium with anterior flange, instead of articulating half-rib and facet (1-4, outermost 4 pleurae, interpleural sutures presumed to lie along narrow furrow between posterior side of main ribs and adjacent small intercostal ribs), diagrammatic (461n).—3a-c, Ridged thoracic pleurae bearing anterior and posterior flanges; 3a, *Scutellum flabelliferum* (GOLDFUSS), M.Dev., Ger.; 3b, **E. laticauda*; 3c, **S. (Planiscutellum) planum* (HAWLE & CORDA), Sil., Czech.; all $\times 10$ (461n).

ferum type, Fig. 279,3, 280,3c,d); statistically determined combinations of characters have taxonomic significance.] *M.Ord.-Low. U.Dev.*

Scutellum PUSCH, 1833 [**S. costatum*] [= *Brontes* GOLDFUSS, 1839; *Goldius* DEKONINCK, 1841; *Brontes* GOLDFUSS, 1843]. Glabella gradually expanding forward; occipital furrow commonly with tumor-like swelling at each end; anterior areas of fixigenae narrowing forward; posterior sections of facial sutures parallel and close to posterior margin, reaching it by abrupt inward bending (except *Planiscutellum*), anterior sections of sutures approaching axial furrows forward; oblique eye ridges commonly present. Thoracic axis narrower than pleurae (except *Paralejurus*). Pygidium with 7 lateral ribs, median rib simple or bifurcate. Surface may bear tubercles on glabella, occipital ring, palpebral lobes, and axis of thorax and pygidium. *Sil.-U.Dev.*, cosmop.

S. (*Scutellum*) [= *Dicranactis* HAWLE & CORDA, 1847]. Cephalon flat or only moderately convex; frontal area narrow or absent; lateral furrows differentiated (*1p* curving forward to join *2p* furrows in manner reducing *2p* lobes to small tubercles, *3p* furrows not distinctly limited adaxially, supplementary groove between *2p* and *3p* furrows commonly present). Pygidium rather flat, commonly with central elevated platform surrounded by flat or concave zone; ribs well developed; doublure extremely broad. Shell thin. *Sil.-U.Dev.* (*Adorfian-I*), cosmop.—FIG. 279, 1a,b. **S.* (*S.*) *costatum*, *M.Dev.* (Givet.), Ger. (Iserlohn); 1a,b, exoskel. (reconstr.), rostral plate, $\times 1$ (257).—FIG. 279, 1c-f. *S.* (*S.*) *palliferum* (BEYRICH), *L.Dev.* (Koněprusy Ls.), Czech.; 1c, ceph.; 1d,e, pyg., dorsal, profile; 1f, hypostoma; all $\times 1$ (3, 257).—FIGS. 278, 3a; 279, 1g. *S.* (*S.*) *flabelliferum* (GOLDFUSS), *M.Dev.* (Couvin.), Ger. (Eifel); 278, 3a, ridged thoracic pleura with anterior and posterior flanges, $\times 1.5$; 279, 1g, exoskel. (reconstr.), profile, $\times 1$ (243, 257).

S. (*Kolihapeltis*) PRANTL & PŘIBYL, 1947 [**Brontes parabolinus* BARRANDE, 1882]. Pygidium narrow, tongue-shaped or lanceolate, maximum width about 0.5 of length, rather flat; anterior margin short (*tr.*), mostly occupied by broad axis, with angular anterolateral wings; lateral ribs diverging very slightly, nearly parallel to median rib, outermost ribs angulated, following anterior margin and coalescing with axis so as to cut off ribs 2 and 3 (counting inward). Cephalon and thorax poorly known. *L.Dev.-M.Dev.*, C.Eu.—FIG. 280, 4. *S.* (*K.*) *parolinum* (BARRANDE), *M.Dev.* (g alpha), Czech. (Malá Chuchle); pyg., $\times 1.5$ (159, 177, 257).

S. (*Paralejurus*) HAWLE & CORDA, 1847 [**Brontes campanifer* BEYRICH, 1845; SD RUD. RICHTER,

1923] [= *Holomeris* HAWLE & CORDA, 1847; *Paralejurus* PRANTL & PŘIBYL, 1947]. Exoskeleton vaulted. Lateral glabellar furrows and lobes absent or faint; librigenae smaller than in *S.* (*Scutellum*), with sharp but not pointed genal angles; occipital furrow and ring very broad (*tr.*). Rostral plate large, very convex. Thoracic axis much broader than pleurae. Pygidium bell-shaped; axis mostly indistinct, without trilobation or observable segmentation; ribs broad, flat, only outermost pair strikingly convex and separated by broad furrow, other intercostal furrows merely thin lines that are proximally indistinct. Doublure moderately broad. Shell thick. *L.Dev.-M.Dev.*, Eu.-N.Afr.—FIG. 280, 3. **S.* (*P.*) *campaniferum* (BEYRICH), *L.Dev.* (Koněprusy Ls.), Czech.; 3a,b, ceph., dorsal, profile; 3c,d, pyg., dorsal, long. sec.; 3e, rostral plate (RS, rostral suture; CS, connective suture) all $\times 0.7$ (3, 257).—FIGS. 278, 3c, 279, 3. *S.* (*P.*) *brongniarti* (BARRANDE), *M.Dev.*, Czech.; 278, 3c, ridged thoracic pleurae with anterior and posterior flanges, $\times 2.5$; 279, 3, exoskel. (reconstr.), profile, $\times 1$ (243, 257).

S. (*Planiscutellum*) RICHTER & RICHTER, 1956 [**Brontes planus* HAWLE & CORDA, 1847]. Cephalon very flat; frontal area broad; lateral furrows primitive (*1p* directed slightly forward, *2p* and *3p* transverse, all isolated), glabellar lobes not limited adaxially, no supplementary grooves; eyes not so far backward as in other subgenera; posterior sections of facial sutures oblique. Pygidium very flat; median rib simple, broadening strongly backward; lateral ribs broad, flat, intercostal furrows narrow. Doublure broad. Shell thin. *Sil.*, Eu.-N.Am.—FIG. 279, 2. **S.* (*P.*) *planum* (HAWLE & CORDA), Czech. (Sedlec); 2a-c, ceph., pyg., hypostoma, $\times 1.5$ (3, 257).

S. (*Scabriscutellum*) RICHTER & RICHTER, 1956 [**Brontes scaber* GOLDFUSS, 1843]. Exoskeleton resembling that of *S.* (*Thysanopeltis*) but pygidium without marginal spines. *L.Dev.-M.Dev.*, N.Hemis.—FIG. 280, 2. **S.* (*S.*) *scabrum* (GOLDFUSS), *M.Dev.* (Couvin.), Ger. (Eifel); 2a,b, ceph., pyg., $\times 2$ (257).

S. (*Thysanopeltis*) HAWLE & CORDA, 1847 [**Thysanopeltis speciosa*]. Glabella small at base, with lateral furrows *1p-3p* connected by longitudinal furrow, lateral *3p* lobe being distinctly circumscribed and extended exsagittally, *2p* lobe a minute tubercle, no supplementary grooves. Thoracic axis very much narrower than pleurae. Axis of pygidium trilobate; lateral ribs appear as narrow prominent ridges, median rib scarcely broader than others, mostly bifurcate distally; intercostal furrows broad, with flat or evenly convex bottom (so-called intercostal ribs); margin with spines. *L.Dev.-M.Dev.*, N.Hemis.—FIG. 280, 1. **S.* (*T.*) *speciosum* (HAWLE &

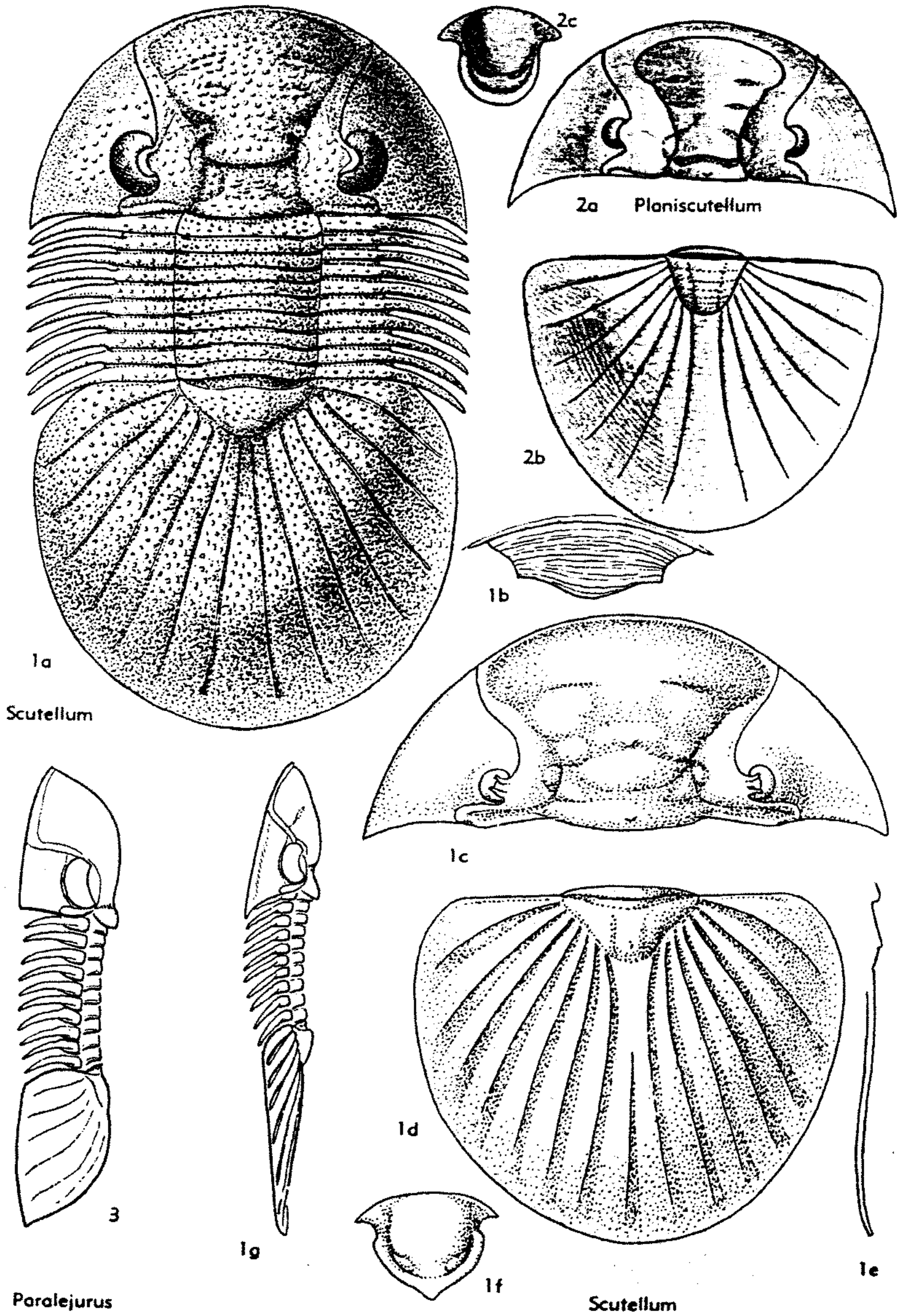

FIG. 279. Thysanopeltidae (p. 0369).

CORDA), M.Dev.(Couvin.), Ger.(Wildungen);
 exoskel. (reconstr.), $\times 1$ (257).
 Eobronteus REED, 1928 [*Entomostracites laticauda*
 WAHLENBERG, 1821]. Glabella mushroom-like,
 anterior portion (consisting only of frontal lobe)

short, abruptly expanded, posterior portion very
 long, parallel-sided, with 3 pairs of little-differ-
 entiated lateral furrows, directed transversely,
 isolated from one another and deepening inward,
 3p furrow at base of anterior expansion of glabella;

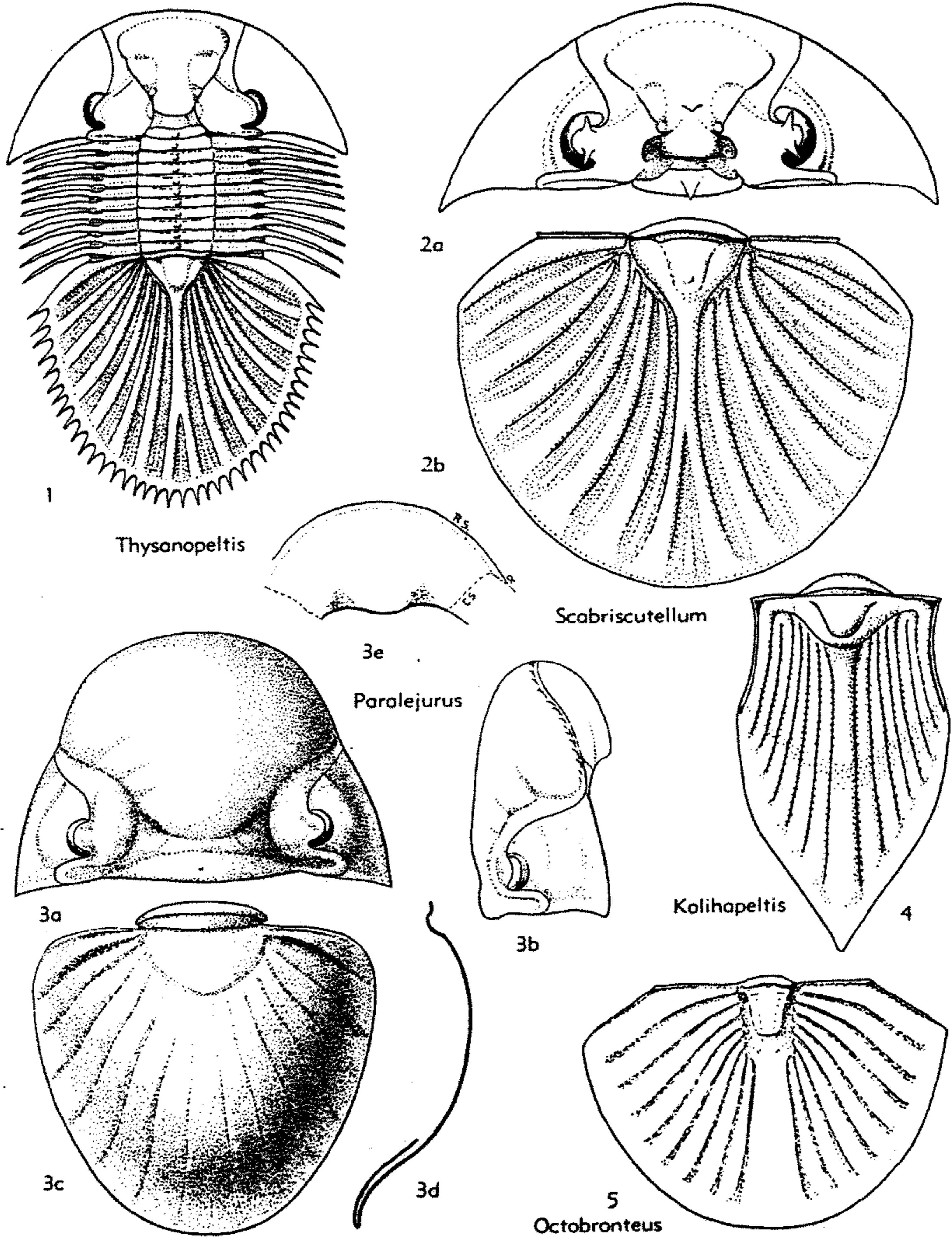

FIG. 280. Thysanopeltidae (p. 0369, 0372).

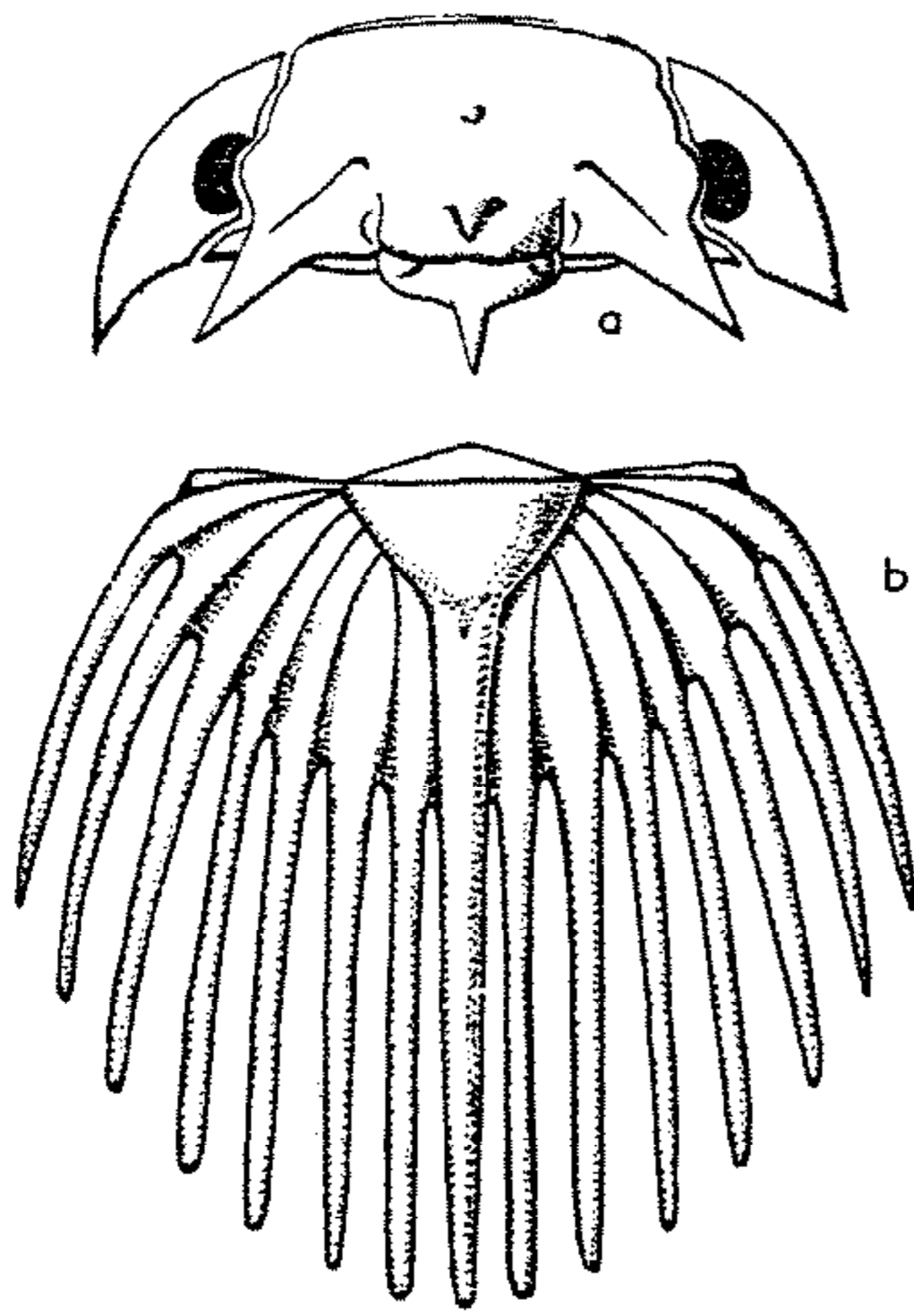

FIG. 281. **Weberopeltis aculeata* (WEBER) (Thysanopeltidae), U.Sil., USSR; *a, b*, ceph., pyg., $\times 0.7$, $\times 1.3$ (490, 1945).

fixigenae of considerable and equal breadth, divided by furrows that start from lateral $3p$ furrows curving backward; anterior sections of facial sutures parallel to axial furrows, therefore diverging strongly forward. Pygidium slightly elongate semicircular; with 6 broad flattened lateral ribs, median rib much broader than others, only faintly bifurcated or not at all; intercostal furrows linear (350). *U.Sil.-M.Ord.*, Eu.-N.Am. FIG. 278, 1, 3b. **E. laticauda* (WAHLENBERG), *U.Ord.* (Leptaena Ls.), Swed.; *1a*, cran. with librigena, $\times 1$; *1b*, pyg., $\times 1.4$; *1c*, section of tall pygidium, $\times 0.75$; *1d*, hypostoma, $\times 0.75$; *3b*, ridged thoracic pleurae with anterior and posterior flanges, $\times 1.3$ (257).

Weberopeltis MAKSIMOVA, 1957 [**Bronteus aculeatus* WEBER, 1945]. Cephalon short and wide, glabella narrow, posteriorly rectangular; fixigenae broad, produced backward into stout spines. Pygidium with broad ribs between narrow furrows; marginal spines strongly developed as prolongations of ribs; middle rib divided distally in some. *Sil.-M.Dev.*, Eu.—FIG. 281. **W. aculeata* (WEBER), U.Sil., USSR (N.Urals); *a*, ceph., $\times 1$; *b*, pyg., $\times 1.7$ (490).

Octobronteus WEBER, 1945 [**O. rhodalevitchi*] [= *Stoermeria* PRANTL & PŘIBYL, 1946; *Stoermeraspis* PRANTL & PŘIBYL, 1947]. Supposed cephalon rather similar to that of *Eobronteus*. Thorax unknown. Pygidium semicircular, with broad concave limb; 8 slightly raised lateral ribs;

median rib much broader than laterals, not bifurcate; intercostal furrows scarcely 0.5 of width of ribs. *Ord.-Sil.*, C.Eu.-USSR (Urals)-N.Am.—FIG. 280, 5. *O. franconicus* (GÜMBEL), *Sil.*, Ger.; pyg., $\times 3$ (257).

Family ILLAENIDAE Hawle & Corda, 1847

[*nom. correct.* ANGELIN, 1854 (ex *Illacnides* HAWLE & CORDA, 1847)]

Axial region of cephalon smooth, merging forward into frontal area without boundary; instead of glabellar and occipital furrows, 4 pairs of muscle scars can be observed in well-preserved specimens; facial sutures opisthoparian. Rostral shield broad (*tr.*); posterior margin of hypostoma rounded. Thorax with 8 to 10 segments; pleurae without pleural furrows or exceptionally with faint transverse furrows. Axis and pleural fields of pygidium smooth or with very faint traces of unfurrowed ribs. Surface ornamented with terrace lines or small pits, or both, no tuberculate or granulate ornamentation. *L.Ord.* (*Arenig.*)-*Sil.* (*Ludlov.*).

Subfamily ILLAENINAE Hawle & Corda, 1847

[*nom. transl.* GÜRICH, 1908 (ex *Illacnides* HAWLE & CORDA, 1847)]

Eyes well developed; glabella club-shaped or ovoid where indicated, commonly expanding in front of eyes and narrowing close to anterior cephalic margin. Rostral shield with more or less convex posterior margin in ventral view and rostral flange. Thorax with 8 to 10 segments, axial furrows generally well defined. *L.Ord.* (*Arenig.*)-*Sil.* (*Wenlock.*).

Illacnides DALMAN, 1827 [**Entomostracites crassicauda* WAHLENBERG, "1818" (=1821); SD MILLER, 1889] [*non Cryptonymus* EICHWALD, 1825 (suppressed, ICZN opinion 508)] [= *Deucalion* STSCHEGLOFF, 1827; *Actinobolus*, *Actinobolus* EICHWALD, 1860 (*non* MÖRCH, 1853); ?*Svobodapeltis* SNAJDR, 1957]. Thorax with 10 segments. Eyes of moderate size. Rostral flange long, hour-glass-shaped. Anterior wings of hypostoma broad (*tr.*), quadrangular. Pygidium about as large as cephalon or slightly smaller; axis short, narrowing toward rear. *Ord.* (*Arenig.-Llanvirn.-Ashgill.*), cosmop.—FIG. 282, 1a-c. **I. crassicauda* (WAHLENBERG); *1a, b*, ceph., dorsal, ventral, $\times 1.5$; *1c*, pyg., $\times 1.5$ (414).—FIG. 282, 1d. *I. sarsi* JAANUSSON; hypostoma, $\times 2$ (414).

Cekovia SNAJDR, 1956 [**Illacnides transfuga* BARRANDE, 1852]. Like *Illacnides* but with smaller eyes. Poorly known; rostral shield and hypostoma unknown. *M.Ord.-U.Ord.* Boh.-Eng.

Nanillaenus JAANUSSON, 1954 [*Illaenus conradi* BILLINGS, 1859]. Thorax with 8 segments. Pygidium considerably smaller than cephalon, axis well defined, longer than postaxial field. Eyes of moderate size; posterior parts of cephalic axial furrows converging forward. Rostral shield and

hypostoma unknown. M.Ord., N.Am.-?S.Am.-Scot.—FIG. 282,3. **N. conradi* (BILLINGS); *a,b*, ceph., thorax and pyg., ×2 (414). *Octillaenus* SALTER, 1867 [*Illaenus hisingeri* BAR-
RANDE, 1846] [=? *Alceste* HAWLE & CORDA, 1847 (based on larval specimen)]; *Octoillaenus* BIGSBY,

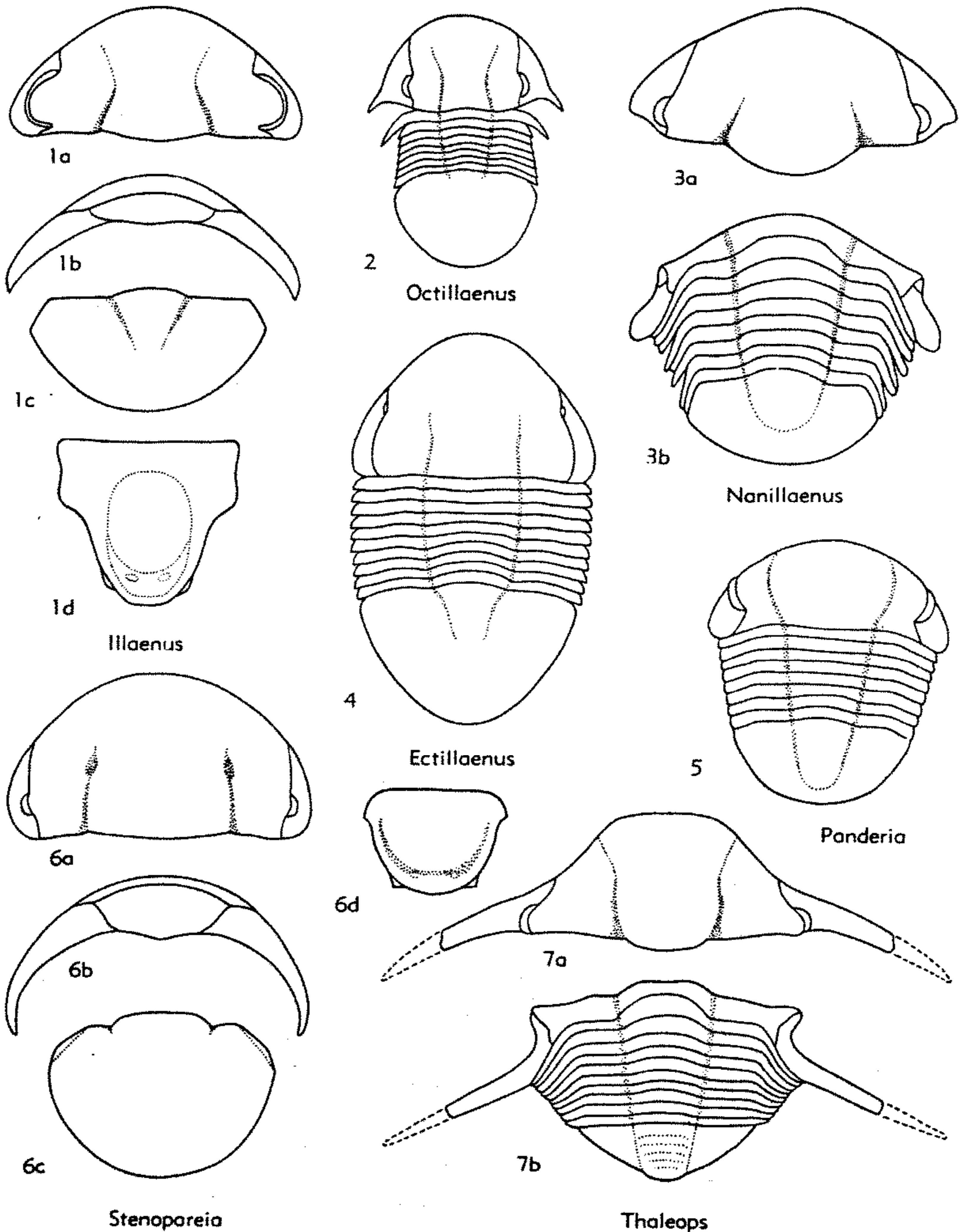

FIG. 282. Illaenidae (Illaeninae) (p. 0372-0374).

1868 (*nom. null.*). Thorax with 8 segments; 1st extended into spinelike process (macropleura). Eyes moderately large. Pygidial axis short, poorly defined. Rostral shield and hypostoma unknown. *U.Ord.*, Czech.-S.Swed.—FIG. 282,2. **O. hisingeri* (BARRANDE); exoskel., $\times 1$ (414).

Panderia VOLBORTH, 1863 [**P. triquetra*; SD VOGDES, 1890] [= *Rhodope* ANGELIN, 1854 (*non* KÖLLIKER, 1847)]. Thorax with 8 segments. Posterior parts of cephalic axial furrows diverging forward; eyes long, narrow. Pygidium considerably smaller than cephalon; axis well defined, considerably longer than postaxial field. Hypostoma unknown. *L.Ord.* (*Llanvirn.*)-*U.Ord.*, Eu.—FIG. 282,5. **P. triquetra*; exoskel. (reconstr.) (414).

Stenoparcia HOLM, 1886 [**Iliaenus linnarssonii* HOLM, 1882]. Thorax with 9 segments. Eyes small, visual surface strongly convex. Rostral flange short, connecting sutures converging until they reach inner margin of cephalic doublure. Hypostoma short, subquadrate, anterior wings narrow (*tr.*), triangular. Pygidium slightly smaller than cephalon; axis short, poorly defined. *M.Ord.-Sil.* (*Wenlock.*), Eu.-Asia-N.Am. (Que.).—FIG. 282,6. **S. linnarssonii* (HOLM); 6a,b, ceph. dorsal, ventral, $\times 1$; 6c, hypostoma, $\times 1$; 6d, pyg., $\times 1$ (414n).

Thaleops CONRAD, 1843 [**T. ovata*] [= *Hydro-laenus* SALTER, 1867]. Thorax with 10 segments. Eyes of moderate size, comparatively high. Pygidium much smaller than cephalon, with axis well defined, much longer than postaxial field. Rostral shield and hypostoma unknown. *M.Ord.*, N.Am.-Greenl.—FIG. 282,7. **T. ovata*; 7a,b, ceph., enrolled exoskel., $\times 2$ (414).

Subfamily BUMASTINAE Raymond, 1916

Foremost portions of cephalic axial furrows in front of eyes, when present, diverging forward. No rostral flange. *M.Ord.-Sil.*

Bumastus MURCHISON, 1839 [**B. barriensis*]. Thorax with 8 to 10 segments; axis very broad, axial furrows poorly defined. Pygidial axial furrows generally not developed. *M.Ord.-Sil.*, cosmop.
B. (*Bumastus*). Thorax with 10 segments. Eyes large; at least posterior part of cephalic axial furrows distinct. Rostral plate convex, strongly narrowing (*tr.*) toward inner margin of cephalic doublure; anterior wings of hypostoma triangular. *U.Ord.-Sil.* (*Ludlov.*), cosmop.—FIG. 283,3a. **B. (B.) barriensis*; exoskel., $\times 0.5$ (466).—FIG. 283,3b. *B. (B.) cf. sp.*, *B. (B.) barriensis*; hypostoma, $\times 4$ (424).

B. (*Bumastoides*) WHITTINGTON, 1954 [**Iliaenus milleri* BILLINGS, 1859]. Thorax with 8 to 10 segments. Cephalic axial furrows very faint, in most species developed as pair of oblong impressions; eyes of moderate size. Rostral shield and hypostoma unknown. *M.Ord.-U.Ord.*, N. Eu.-N.Am.-Greenl.—FIG. 283,6. *B. (B.) belle-*

villensis RAYMOND & NARRAWAY; ceph., $\times 2$ (451).

Dysplanus BURMEISTER, 1843 [**Asaphus (Iliaenus) centrotus* DALMAN, 1827] [= *Zetillaenus* SNAJDR, 1957]. Thorax with 9 segments. Eyes small; posterolateral corners of librigenae pointed or with genal spines. Rostral shield faintly convex, wide at posterior margin; anterior wings of hypostoma broad (*tr.*), lateral part elongated into hollow tube at least in early species. Thoracic axial furrows well defined, axis moderately broad (*tr.*). Pygidium about equal in size to cephalon, with short axis. *L.Ord.* (*Arenig.*)-*U.Ord.*; Baltoscandia-Boh.-Kazakh.—FIG. 283,7. **D. centrotus* (DALMAN); 7a-b, ceph., dorsal, ventral; 7c, hypostoma, $\times 1$; 7d, pyg., $\times 1.5$ (414).

Iliaenoides WELLER, 1907 [**I. triloba*]. Cephalic axial furrows long, well defined; distinct posterior border furrow present. Rostral shield, hypostoma, and thorax unknown. Pygidium without trace of axis; with well-developed concave border.

I. (*Iliaenoides*). Palpebral lobes narrow, short, at about transverse mid-line of cranidium or slightly in front of it. ?*U.Ord.*, *L.Sil.*, N.Am.—FIG. 283,2. I. (*I.*) *triloba*; 2a,b, cran., pyg., $\times 1$ (491).

I. (*Goldillaenus*) SCHINDEWOLF, 1924 [**Trinucleus? nilsoni* MÜNSTER, 1840]. Palpebral lobes moderately long, behind transverse mid-line of cranidium. *Sil.*, Eu.-N.Am.—FIG. 283,4. *I. (*G.*) *nilsoni* (MÜNSTER); 4a,b, cran., pyg., $\times 3$, $\times 2$ (414n).

Platillaenus JAANUSSON, 1954 [**Iliaenus ladogensis* HOLM, 1886]. Thorax with 10 segments. Eyes of moderate size; cephalic axial furrows long, continuing laterally in shallow but distinct anterior border furrow; genal corners rounded. Rostral shield, hypostoma, thoracic axis, and pygidium generally as in *Dysplanus*. *L.Ord.* (*Llanvirn.*), Baltoscandia.—FIG. 283,1. **P. ladogensis* (HOLM); 1a,b, ceph., dorsal, ventral; 1c, hypostoma (414); 1d, pyg. (409); all $\times 1.5$.

Thomastus ÖPIK, 1953 [**T. thomastus*]. Similar to *Bumastus* (*Bumastus*) but without eyes. *L.Sil.*, Austral.

Subfamily ECTILLAENINAE Jaanusson, nov.

Eyes very small or absent; outline of glabella club-shaped, as in *Iliaenus*, rostral shield trapezoidal, with straight or slightly concave posterior margin and without rostral flange. Thorax with 9 or 10 segments; axis moderately broad to narrow, well defined. *L.Ord.* (*Llanvirn.*)-*U.Ord.*

Ectillaenus SALTER, 1867 [**Iliaenus perovalis* MURCHISON, 1839] [= *Wossekia* RAYMOND, 1916]. Thoracic segments 10. Eyes very small, commonly at about transverse mid-line of cephalon, or absent; genal corners rounded. Anterior wings of

the hypostoma broad (*tr.*), quadrangular. Pygidium about equal in size to cephalon; semi-circular to subtriangular outline, as in *Illaenus*. *Ord.* (Llanvirn.-Ashgill.), Boh.-Pol.-Bornholm-S. Swed.-Eng.—FIG. 282,4. *E. katzeri* (BARRANDE), $\times 0.7$ (414).

than the cephalon, pentangular in outline, with narrow (*tr.*) long facets. Eyes lacking; facial sutures crossing cephalon almost in straight line; genal corners rounded. Hypostoma unknown. *M. Ord.* (Llandeil.-L. Caradoc.). Boh.

Zbivoia SNAJDR, 1956 [*Illaenus aratus* BARRANDE, 1872]. Thoracic segments 10. Pygidium smaller

Zdicella SNAJDR, 1957 [*Illaenus zeidleri* BARRANDE, 1872]. Thoracic segments 10. Pygidium somewhat smaller than the cephalon. Cephalic

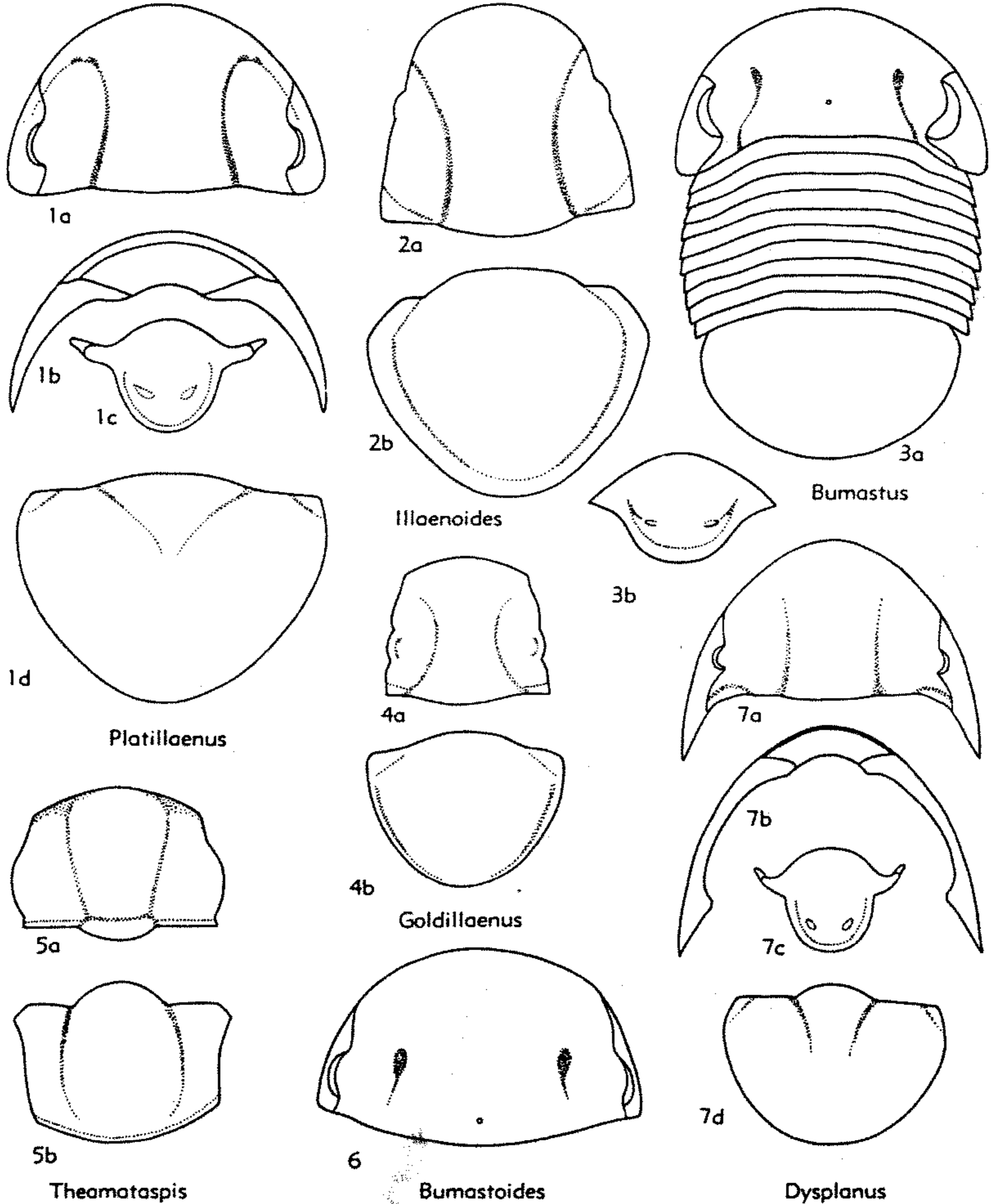

FIG. 283. Illaenidae (Bumastinae, Theamataspidinae) (p. 0374-0376).

axis narrow, almost parallel-sided; eyes lacking, anterior portion of librigenae small, posterior portion elongated into long and fairly broad genal spines which reach pygidium. Hypostoma generally as in *Ectillaenus*. Thoracic axis narrow. *U. Ord.* (Ashgill.), Boh.

?Subfamily THEAMATASPIDINAE Hupé, 1953

[*nom. transl.* JAANUSSON, herein (*ex* Theamataspidae, *nom. correct.* JAANUSSON, herein *ex* Theamataspidae Hupé, 1953)]

Characters of *Theamataspis*. *M.Ord.-U. Ord.*

Theamataspis ÖPIK, 1937 [**T. illaenoides*]. Only cranidia known with certainty; palpebral lobes long; cephalic axial furrows long, their rear portions diverging backward and front portions converging forward; strong occipital furrow present. [Cranidium similar to *Panderia* except for strongly developed occipital furrow, unknown in illaenids proper. Taxonomic position of genus not determinable without knowledge of other parts of exoskeleton.]. *M.Ord.-U.Ord.*, Baltoscandia.—FIG. 283,5. **T. illaenoides*; 5a,b, cran., dorsal (×12), anterior (×10) (439).

Subfamily UNCERTAIN

Hyboaspis RAYMOND, 1925 [**H. shuleri*] [= *Hyboaspis* RAYMOND, 1920 (*nom. nud.*, no figs.)]. Only pygidia known. Axis short, well defined; postaxial field very long. [May be synonym of *Illaeus* or *Platillaenus*, both of which include species with similar pygidium.] *Ord.* (Chazy.), N. Am. (Va.-N.Y.).

Superfamily BATHYURACEA
Walcott, 1886

[*nom. transl.* WHITTINGTON, herein (*ex* Bathyuridae WALCOTT, 1886)]

Exoskeleton opisthoparian, heteropygous to subisopygous. Cephalon large, convex, with distinct border that may be broad and concave (Bathyuridae) or narrow (Lecanopygidae); glabella well defined, parallel-sided or with anterior part widened or narrowed, lateral glabellar furrows 3 or fewer, mostly faint. Occipital ring well defined; eye lobes close to glabella, opposite or behind its mid-length; librigenal spines short (Lecanopygidae) to long (Bathyuridae). Thorax (where known) with 9 or 10 segments, pleurae with distinct furrows. Pygidium gently convex, with short or long axis that may be prolonged into axial spine; pleural fields not delimited by border furrow. *U. Cam.-M.Ord.*

Family BATHYURIDAE Walcott, 1886

[*emend.* WHITTINGTON, 1953]

Cephalon subsemicircular or nasute in outline, moderately to strongly convex, with long, broad genal spines in some; well-marked occipital furrow; glabella expanding forward or subparallel-sided, 3 or fewer faint lateral furrows; eye lobes large, situated far back and generally close to glabella, eyes with many minute facets; opisthoparian facial sutures, anterior sections widely or slightly divergent; rostral suture marginal and rostral plate with lateral margins convexly incurved. Hypostoma (where known) with short middle furrow and crescentic convex posterior lobe of middle body. Thorax of 9 or 10 segments, commonly deep pleural furrows but no long pleural spines. Pygidium of 5 or 6 segments; backward-directed axial or terminal-axial spine may be present (354). *L.Ord.-M.Ord.*

Bathyurus BILLINGS, 1859 [**Asaphus? extans* HALL, 1847]. Glabella with expanded frontal lobe and 2 pairs of lateral furrows; genal spines curved, long. Hypostoma with short deep furrows in middle body opposite inflated lateral borders. Thorax with 9 segments. Pygidium triangular, axis with prominent termination. *M.Ord.*, N. Am.—FIG. 284,1. **B. extans* (HALL), Blackriv., N.Y.-Ont.; exoskel., ×1.5 (496n).

?*Agerina* TJERNVIK, 1956 [**A. erratica*]. Subrectangular glabella with 3 pairs of lateral furrows; rostral plate triangular; genal spines short. Thorax of 8 segments (species from USSR). Pygidium short, with 3 or 4 axial rings. *L.Ord.*, Eu. (Swed.-USSR).

Bathyurellus BILLINGS, 1865 [**B. abruptus*; SD RAYMOND, 1905]. Like *Uromystrum* but cephalon lower; glabella shorter and parallel-sided; anterior sections of sutures less divergent; with broad concave cephalic border. Outer parts of thoracic pleurae bent downward. Pygidium with pleural regions sloping gently outward. *L.Ord.-Low.M.Ord.*, N. Am.-Greenl.-Ire.—FIG. 284,4. *B. nitidus* (BILLINGS), *Low.M.Ord.*, Newf.; 4a,b, exoskel., dorsal, lateral, ×4 (354*).

Bathyurina POULSEN, 1937 [**B. megalops*]. Cranium with convex glabella expanding slightly forward, with 3 or ?4 pairs of faint lateral furrows; short (*sag.*) steep preglabellar field; large strongly curved eye lobes. Other parts of exoskeleton not certainly known. *L.Ord.* (U. Canad.), Greenl., ?N. Am.

Bolbocephalus WHITFIELD, 1890 [**Bathyurus seelyi* WHITFIELD, 1886]. Cephalon convex; glabella narrowing in front of occipital ring, then expand-

ing forward and projecting beyond anterior border, without lateral furrows; eye lobes small, situated at cephalic mid-length; genal spines short. Thorax unknown. Associated pygidium semicircular, with 4 axial rings and terminal; pleurae with

oblique furrows. Surface with raised lines. *L.Ord.* (*M.-U.Canad.*), N.Am.-Greenl.—FIG. 285, 1. **B. seelyi* (WHITFIELD), U.Canad., Vt.; 1a, b, ceph., lateral, dorsal, $\times 1$; 1c, associated pyg., $\times 1$ (354*).

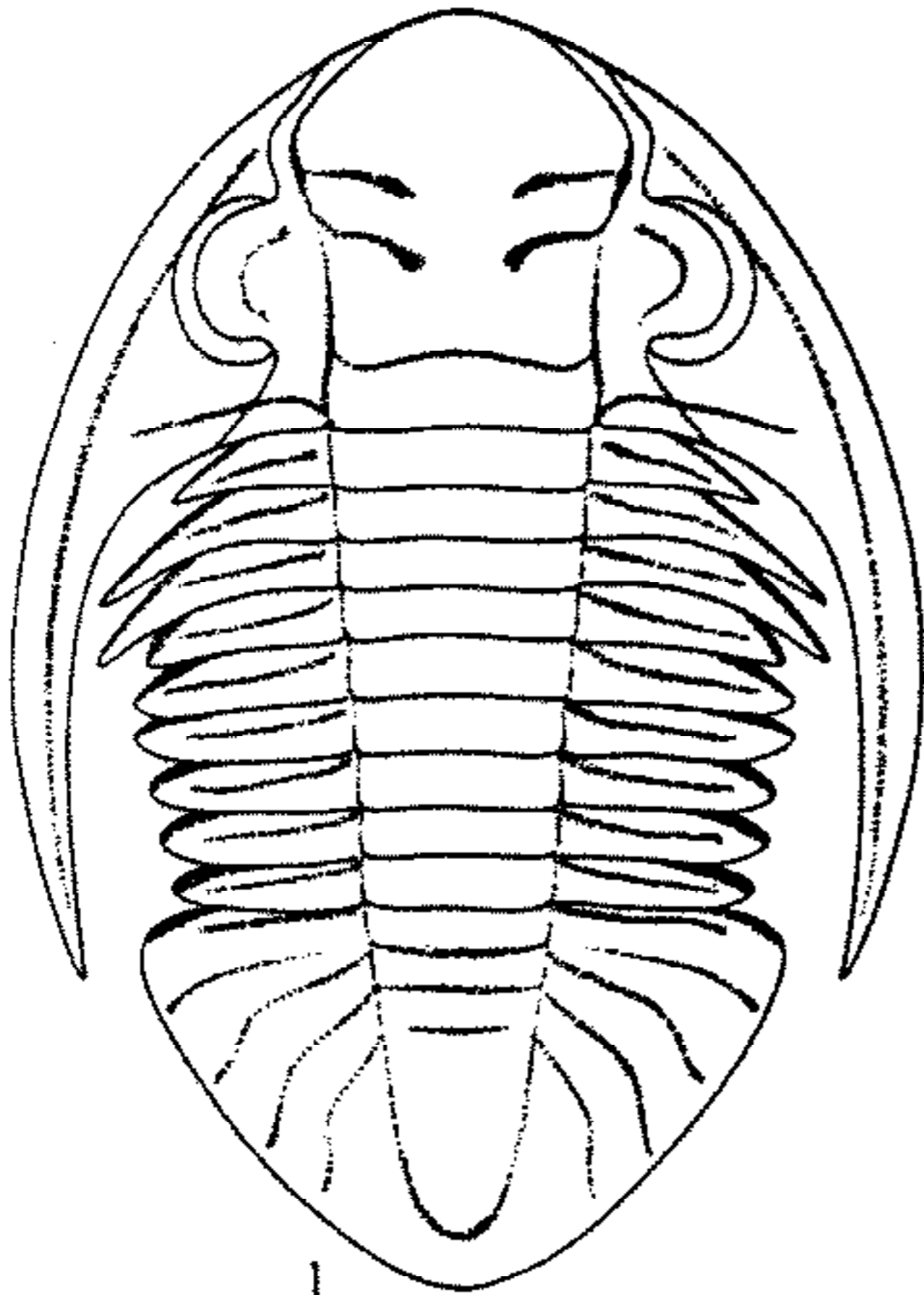

1
Bathyrurus

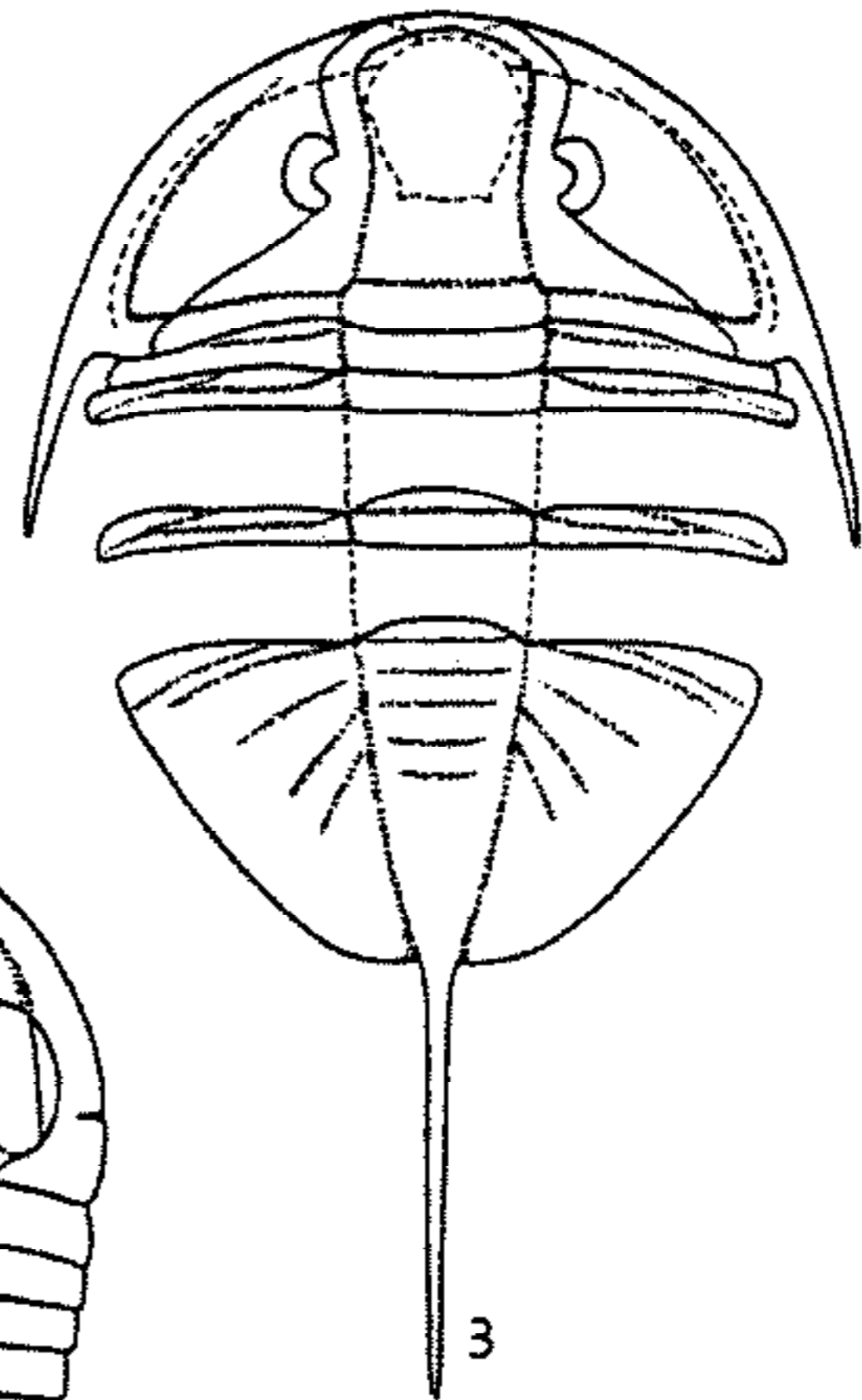

3
Eleutherocentrus

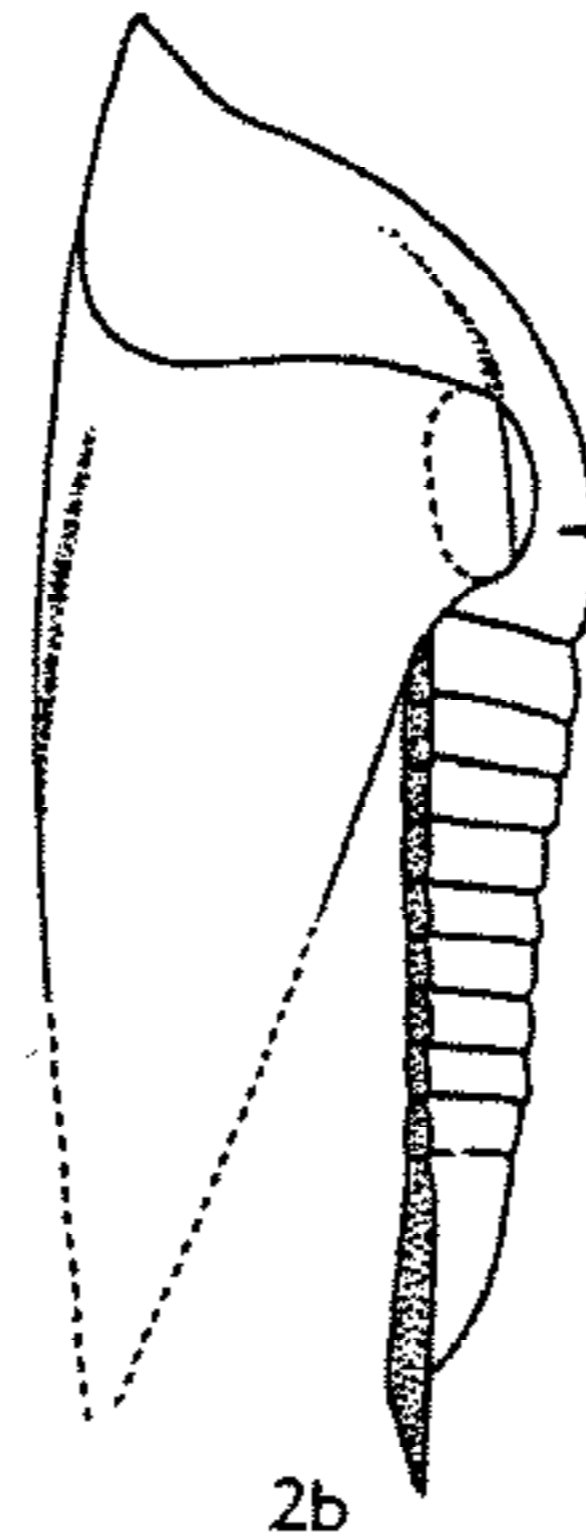

2b

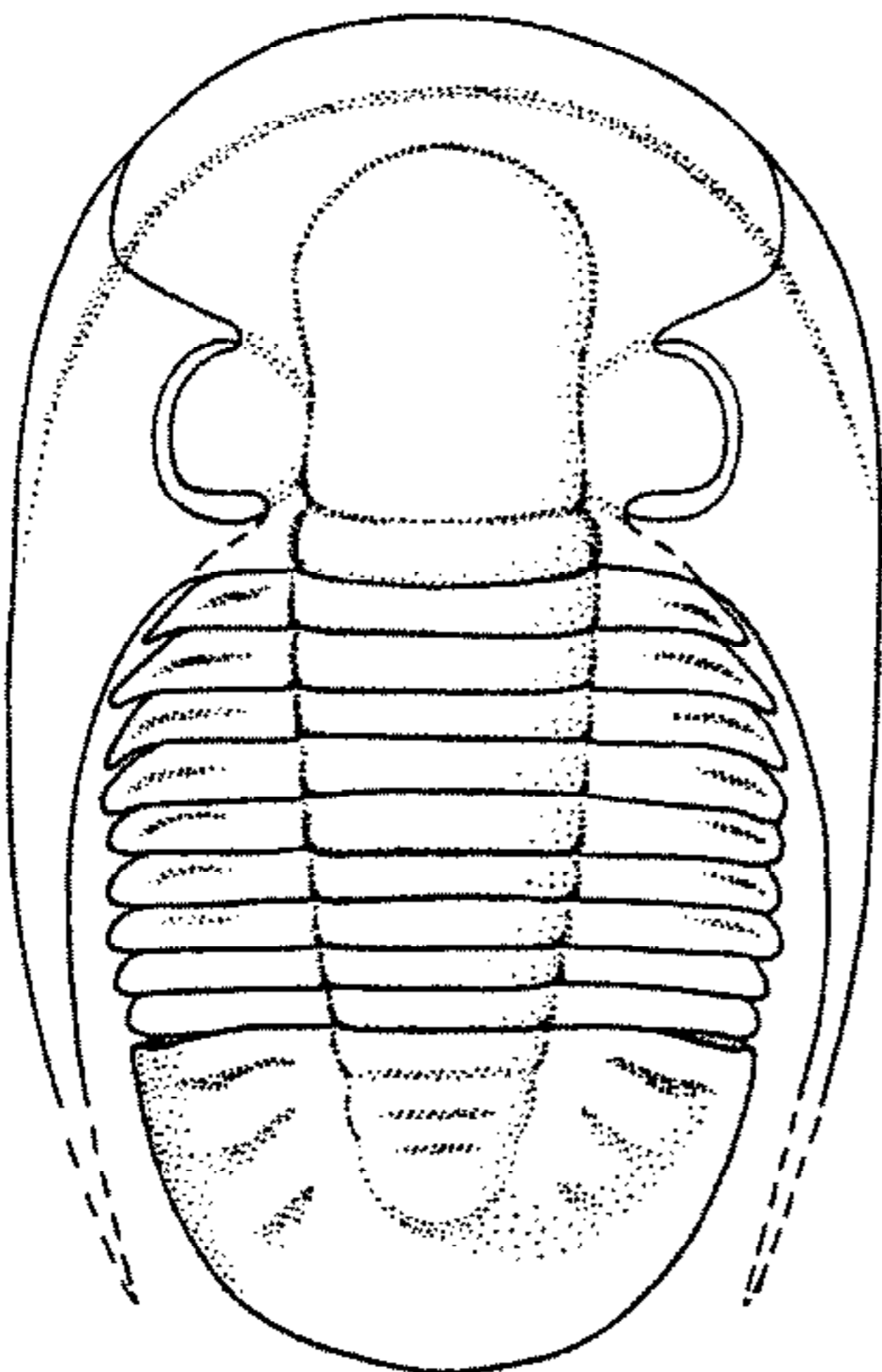

2a
Uromystrum

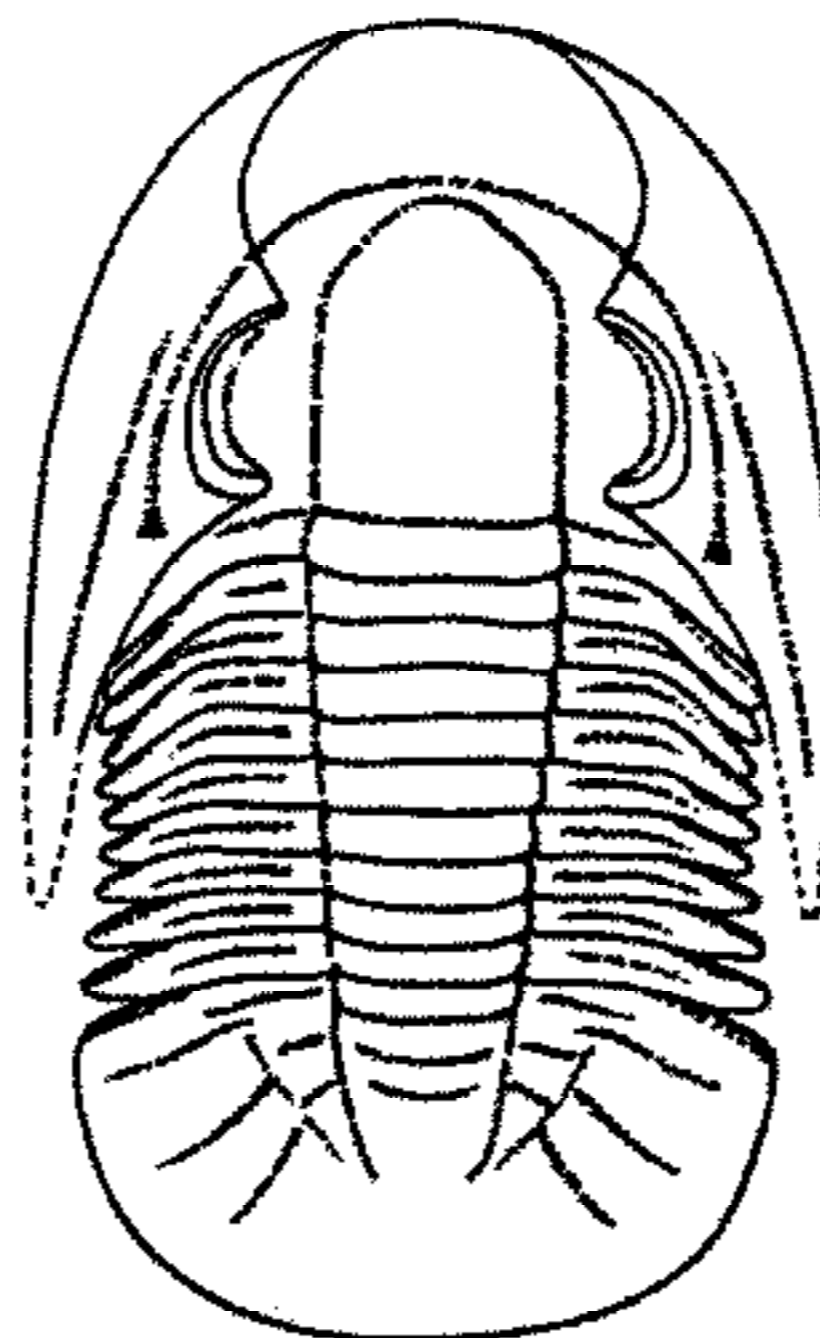

4a

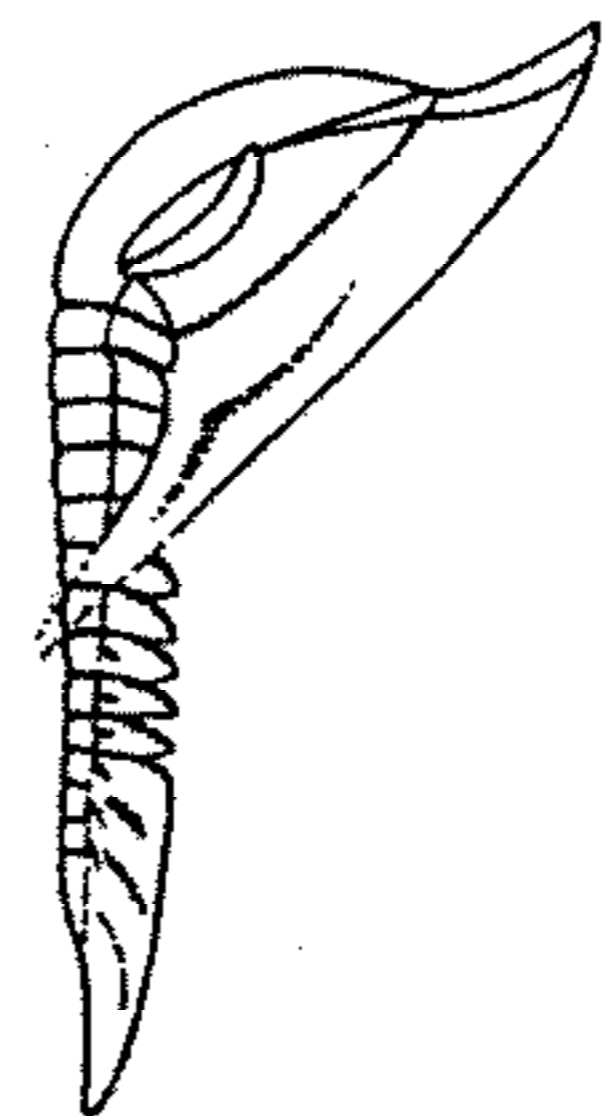

4b

Bathyrellus

FIG. 284. Bathyridae (p. 0376-0380).

Eleutherocentrus CLARK, 1935 [**E. petersoni*].
 Axis relatively narrow; glabella narrowest at half
 cephalic length between small eye lobes. Hypo-
 stoma as in *Goniotelina* but with broader anterior

wings and short posterolateral spines. Number of
 thoracic segments unknown. Pygidium large, sub-
 triangular, with long, slim terminal axial spine.
Low.M.Ord., Utah.—FIG. 284,3. **E. petersoni*;

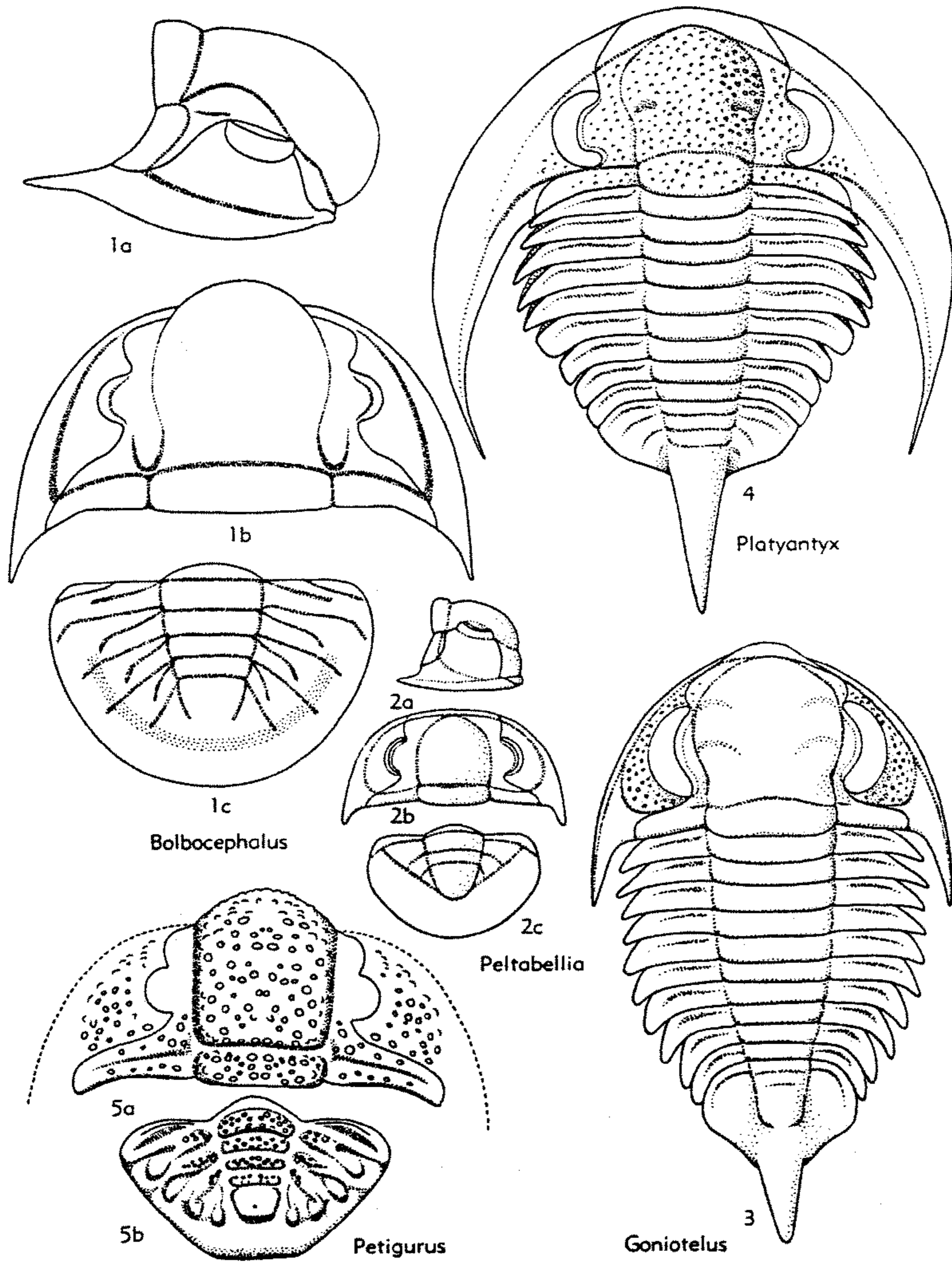

FIG. 285. Bathyruridae (p. 0376, 0379).

incompl. exoskel. (reconstr.), connective sutures, hypostoma, inner edge of doublure, part of thoracic axis shown by broken lines, $\times 0.7$ (354*).

Goniotelina WHITTINGTON & ROSS in WHITTINGTON, 1953 [**Eleutherocentrus williamsi* Ross, 1951] [?= *Acidiphorus* RAYMOND, 1925]. Like *Goniotelus* but glabella parallel-sided, not overhanging anterior border, without lateral furrows; short (*sag.*) preglabellar field; eye lobes far back and more strongly curved; genal spines variable. Hypostoma oval, with short diagonal furrow on middle body and long straplike anterior wing. Number of thoracic segments unknown. Pygidium with deep axial and 4 pleural furrows, variable terminal-axial spine. Surface tuberculate. *L.Ord.*(*U. Canad.*), N.Am.-Greenl.—FIG. 286,1. **G. williamsi* (Ross), Utah; 1a, cran., $\times 6$; 1b, pyg., $\times 5$ (258*).

Goniotelus ULRICH, 1927 [**Bathyrurus perspicator* BILLINGS, 1865] [*pro Goniturus* RAYMOND, 1913 non HÜBNER, 1819] [= *Gonotelus* STRAND, 1932; ?*Acidiphorus* RAYMOND, 1925]. Glabella large, subrectangular, overhanging preglabellar furrow, widest in front of mid-point, with 2 pairs of lateral furrows faint on external surface; genal regions small; eye lobes large, curved, long; anterior sections of facial sutures curving inward to narrow (*tr.*) convex rostral plate; genal spines short. Thorax of 10 segments; pleural furrows deep; outer parts of pleurae falcate. Pygidium small, triangular, with thick terminal-axial spine. Surface with raised anastomosing lines, genae tuberculate. *Low.M.Ord.*, Que.-Newf. — FIG. 285,3. **G. perspicator* (BILLINGS), Que.; exoskel. (reconstr.), $\times 4.7$ (496n).

Jeffersonia POULSEN, 1927 [**J. exterminata*]. Only pygidium known. *L.Ord.*(*U. Canad.*), Greenl.

Licnocephala ROSS, 1951 [**L. bicornuta*]. Like *Bathyrellus*, but convexity of cephalon low and cephalic border narrow; glabella varying in length and convexity, narrowing slightly forward, weakly or clearly outlined by furrows. Hypostoma subcircular in outline, anterior part of middle body prolonged in vertical direction, with short middle furrow; lateral border broad, posterior narrower; long, slender anterior wing directed upward, short posterior wing. Pygidium with well-marked axis and ring furrows, short pleural furrows and longer interpleural grooves on inner part of pleural region, broad outer part flattened and smooth; broad doublure. *L.Ord.*(*U. Canad.*), USA(Utah-Nev.). — FIG. 286,2. **L. bicornuta*, Utah; 2a,b, cran., librigena, $\times 5$; 2c, pyg. (tentatively assigned to species), $\times 6$ (258*).

Lutesvillia CULLISON, 1944 [**L. bispinosa*]. Like *Peltabellia* but cephalon gently convex. Pygidium with pair of backward-directed spines on border. External surface ?smooth. *L.Ord.*(*M. Canad.*), Mo.

Peltabellia WHITTINGTON, 1953 [**Jeffersonia peltabellia* Ross, 1951]. Cephalon strongly convex; glabella parallel-sided, without lateral furrows; long

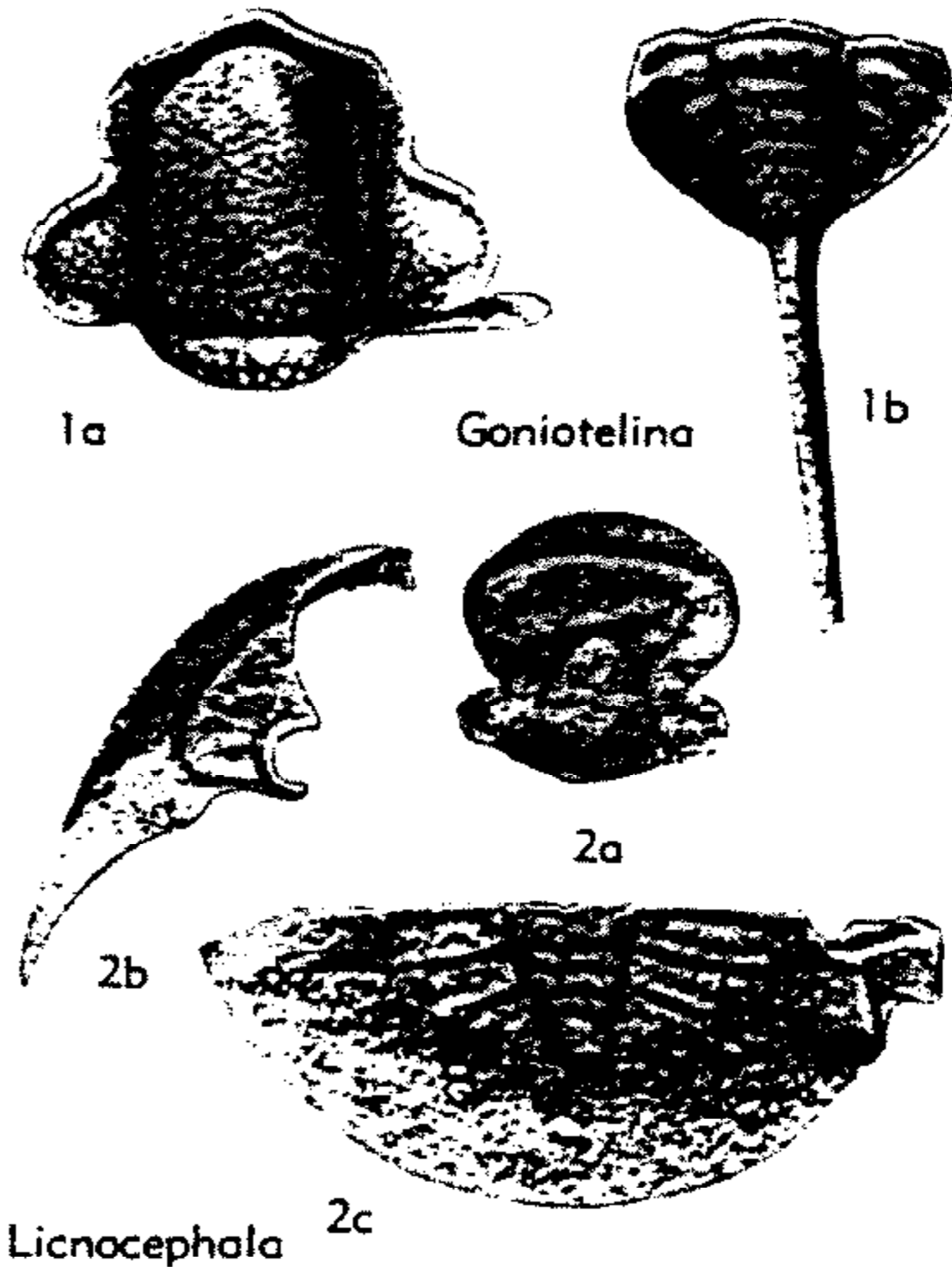

FIG. 286. Bathyruridae (p. 0379).

(*sag.*) preglabellar field; anterior sections of facial sutures slightly divergent; genal spines short. Thorax unknown. Pygidium with broad smooth border. Surface tuberculate. *L.Ord.*(*M. Canad.-U. Canad.*), N.Am.—FIG. 285,2. **P. peltabellia* (Ross), U.Canad., Utah; 2a,b, ceph., lateral, dorsal, $\times 2$; 2c, pyg., $\times 2$ (496n).

Petigurus RAYMOND, 1913 [**Bathyrurus nero* BILLINGS, 1865]. Like *Bolbocephalus* but glabella parallel-sided. Associated pygidium with 4 broad deep pleural furrows. Surface tuberculate. *L.Ord.*(*U. Can.*), N.Am.-Greenl.-Scot.—FIG. 285,5. **P. nero* (BILLINGS), Newf.; 5a, ceph., $\times 1.5$; 5b, pyg., $\times 1.25$ (354*).

Platyantyx WHITTINGTON, 1953 [**Bathyrurus arcuatus* BILLINGS, 1865]. Glabella expanding forward, anterior lobe bluntly pointed and overhanging anterior border, single pair of faint lateral furrows; eye lobes large, curved, well out from glabella; anterior sections of facial sutures curving inward; flat cephalic border continuous with broad falcate genal spine. Thorax with 9 segments, pleurae furrowed. Pygidium small, triangular, with long thick terminal-axial spine. Surface of glabella and genae tuberculate, remainder smooth. *Low.M.Ord.*, Que.—FIG. 285,4. **P. arcuatus* (BILLINGS); exoskel. (reconstr.), $\times 2.3$ (496n).

Rananasus CULLISON, 1944 [**R. conicus*]. Like *Bolbocephalus* but glabella relatively larger and projecting farther beyond anterior border. Associated pygidium with few faint pleural furrows. *L.Ord.*(*M. Canad.*), Mo.-Tex.

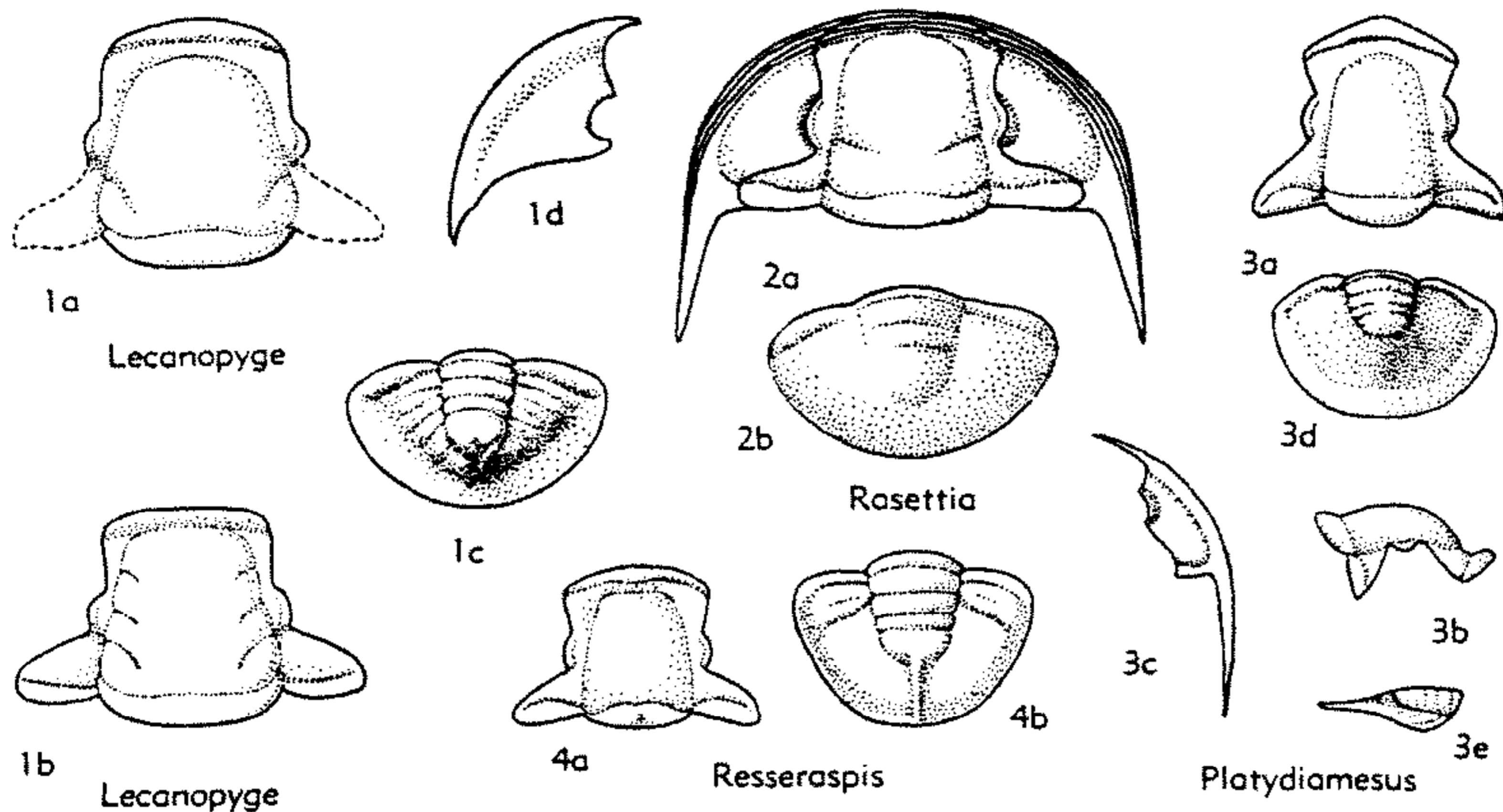

FIG. 287. Lecanopygidae (p. O380-O381).

Raymondites SINCLAIR, 1944 [**Bathyurus ingalli* RAYMOND, 1913]. Like *Bathyurus* but with frontal glabellar lobe less inflated and with single pair of lateral glabellar furrows; eye lobes farther back; anterior sections of facial sutures diverging forward; border of cephalon and pygidium broad. Surface with tubercles; axial spines may occur on occipital ring and pygidium. *M.Ord.* (*Blackriv.-Trenton.*), N.Am.

Uromystrum WHITTINGTON, 1953 [**Bathyurellus validus* BILLINGS, 1865]. Cephalon high; genal spines broad, long; glabella long (*sag.*), expanding slightly forward, without furrows; anterior sections of facial sutures widely divergent. Thorax with 9 segments, tips of pleurae upturned. Pygidium with pleural regions concave faintly furrowed. Surface with raised lines. *Low.M.Ord.*, N. Am.-Greenl.—FIG. 284,2. **U. validum* (BILLINGS), Newf.; 2a,b, exoskel. (reconstr.), dorsal, lateral, $\times 1.7$, $\times 1.5$ (354°, 496n).

Gonioteloides KOBAYASHI, 1955 [**G. monoceros*]. *L.Ord.*, W.Can.(B.C.).

Family LECANOPYGIDAE Lochman, 1953

Exoskeleton opisthoparian, subisopygous. Glabella broadly tapering to subquadrate, all furrows narrow and shallow; occipital node may be present; preglabellar field present or absent; eyes of medium size, usually opposite center of glabella; fixigenae with very narrow palpebral areas, posterior areas straplike; librigenae with short slender genal spines. Thorax unknown. Pygidium

semicircular; axis wider or narrower than pleural fields, length variable, commonly with low postaxial ridge, usually 3 axial rings; no border furrow, other furrows may be present, border medium in width. Surface smooth. Derived from Asaphiscidae. *U.Cam.-L.Ord.*

Lecanopyge RAYMOND, 1937 [**L. expansa*]. Glabella low, broadly tapering, front broadly curved, with 3 pairs of short faint lateral furrows; short (*sag.*) preglabellar field may be present, axial and anterior border furrows faint and shallow; fixigenae horizontal. Pygidium with axis wider than pleural fields, extending more than 0.5 of pygidial length, with 3 axial rings and terminal with low short postaxial ridge; 3 broad pleurae, pleural furrows shallow or obsolete (188). *U.Cam.* (*Trempeal.*), E.U.S.A.—FIG. 287,1a. **L. expansa*, Vt.; 1a, cran., $\times 0.75$ (188).—FIG. 287,1b-d. *L. prolifica* RASETTI, Que.; 1b,c, cran., pyg., $\times 0.75$; 1d, librigena, $\times 1$ (188).

Platydiamesus RAYMOND, 1937 [**P. depressus*]. Glabella convex, tapering without lateral furrows; preglabellar field present; occipital furrow faint or obsolete, other furrows shallow; eyes slightly in front of center of glabella; fixigenae upsloping. Pygidium with axis narrower than pleural fields, 0.5 or less of pygidial length, with 2 or 3 faint axial rings and terminal with low short postaxial ridge; pleural fields with furrows and grooves faint or obsolete border concave (189). *U.Cam.* (*Trempeal.*), E.U.S.A.—FIG. 287,3. **P. depressus*, Vt.; 3a,b, cran., $\times 3$, $\times 2$; 3c, librigena, $\times 3$; 3d,e, pyg., $\times 3$, $\times 2$ (189).

Rasettia LOCHMAN, 1953 [*pro Platycolpus* RAY-

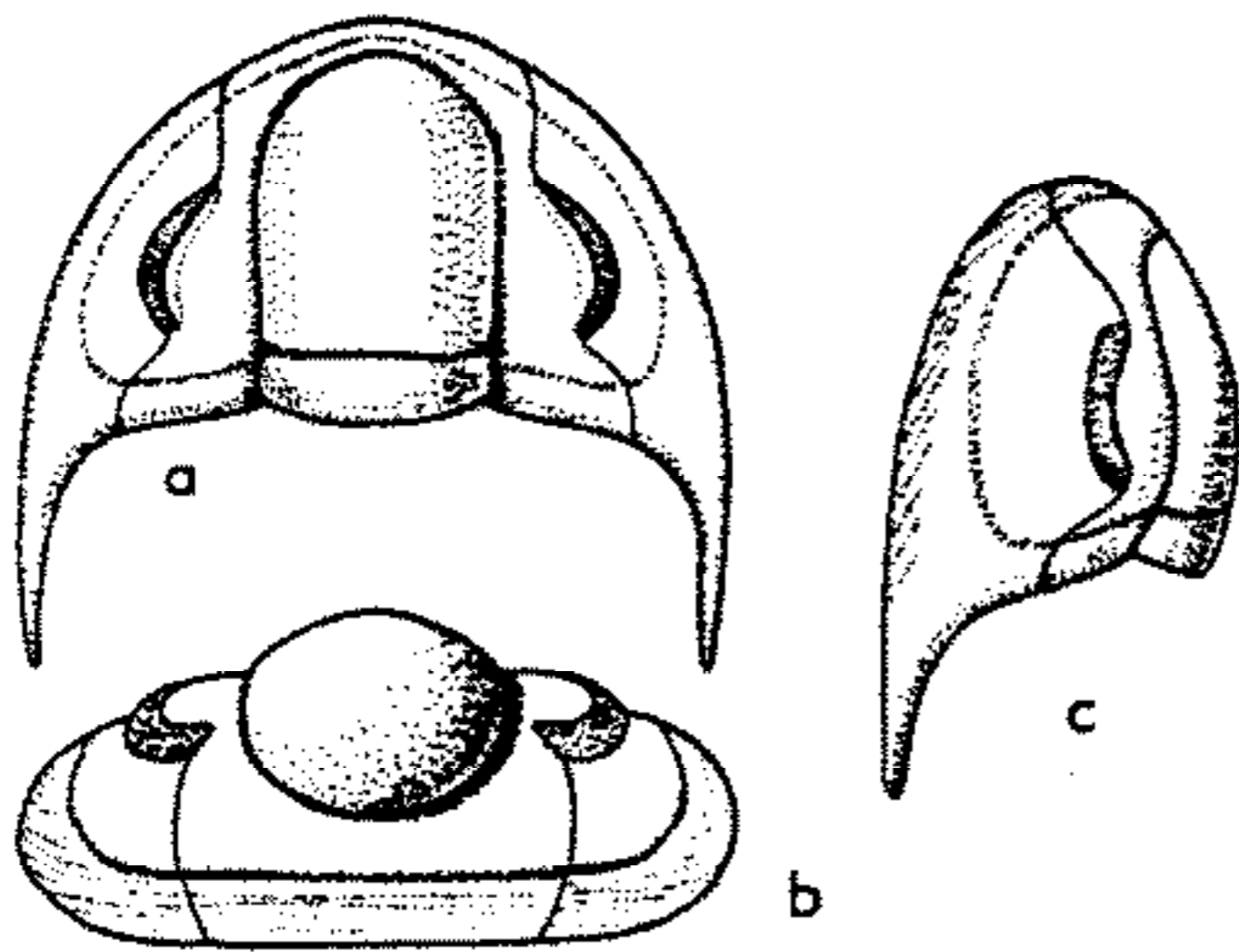

FIG. 288. **Strigigenalis cassinensis* WHITTINGTON (Lecanopygidae), L.Ord.(Canad.), Vt.; a-c, ceph., dorsal, anterior, side, $\times 2$ (496).

MOND, 1913 (non DONALD, 1901)] [*Bathyrurus capax* BILLINGS, 1860]. Glabella low, subquadrate, front rounded or nearly straight, without glabellar furrows; preglabellar field may be present, border downsloping, crossed by ridges, furrows shallow; eyes slightly behind center of glabella; fixigenae upsloping; librigenae with short genal spines and ridged border; median facial sutures on doublure fused. Pygidium with axis narrower than pleural fields, slightly more than 0.5 of pygidial length, with 2 or 3 faint axial rings and terminal; pleural fields with single anterior interpleural groove; no border furrow (188). *U.Cam.(Trempeal.)*, N.Am.-S.Am.—FIG. 287,2. **R. capax* (BILLINGS), Que.; 2a, ceph., $\times 1$; 2b, pyg., $\times 0.5$ (188).

Resseraspis RASETTI, 1945 [*R. carinata*]. Glabella low, tapering, front nearly straight, without lateral furrows; preglabellar field present, all furrows shallow, small occipital node present; fixigenae upsloping. Pygidium with axis wider than pleural fields, extending more than 0.5 of pygidial length, with 3 axial rings and terminal with prominent postaxial ridge extending to margin; 2 or 3 broad pleurae; no border furrow, border concave (189). *U.Cam.(Trempeal.)*, E.Can.—FIG. 287,4. **R. carinata*, Que.; 4a,b, cran., pyg., $\times 1$ (189).

Strigigenalis WHITTINGTON & ROSS, 1953 [*S. cassinensis* WHITTINGTON in WHITTINGTON & ROSS, 1953]. Glabella low, subquadrate, front rounded, no lateral furrows; preglabellar field of medium width (*sag.*), anterior border narrow, dying out laterally; eyes slightly above medium size, a little behind center of glabella; fixigenae horizontal, with arcuate, palpebral areas almost 0.5 of width of glabella, posterior areas narrow (*exsag.*), of medium length (*tr.*); rostrum broadly triangular, undercurved; librigenae elongate, with short genal spines or rounded genal angles. Thoracic pleurae with broad furrows, tips pointed, with wide doublure. Pygidium with axis narrower than pleural fields, tapered 0.5 of length, with 5 faint to obsolete axial rings; pleural fields with several

interpleural grooves anteriorly; no border furrow. Outer surface smooth, with narrow ridges on border and doublure (354). *L.Ord.(Canad.)*, N.Am.—FIG. 288. **S. cassinensis*, Vt.; a-c, ceph., dorsal, anterior, side, $\times 2$ (354).

Superfamily HOLOTRACHELACEA Warburg, 1925

[*nom. transl.* JAANUSSON, herein (*ex Holotrachelidae* WARBURG, 1925)]

Cephalon large, surrounded by distinct border; cephalic axis long, rather strongly convex, narrowing forward, smooth, with-

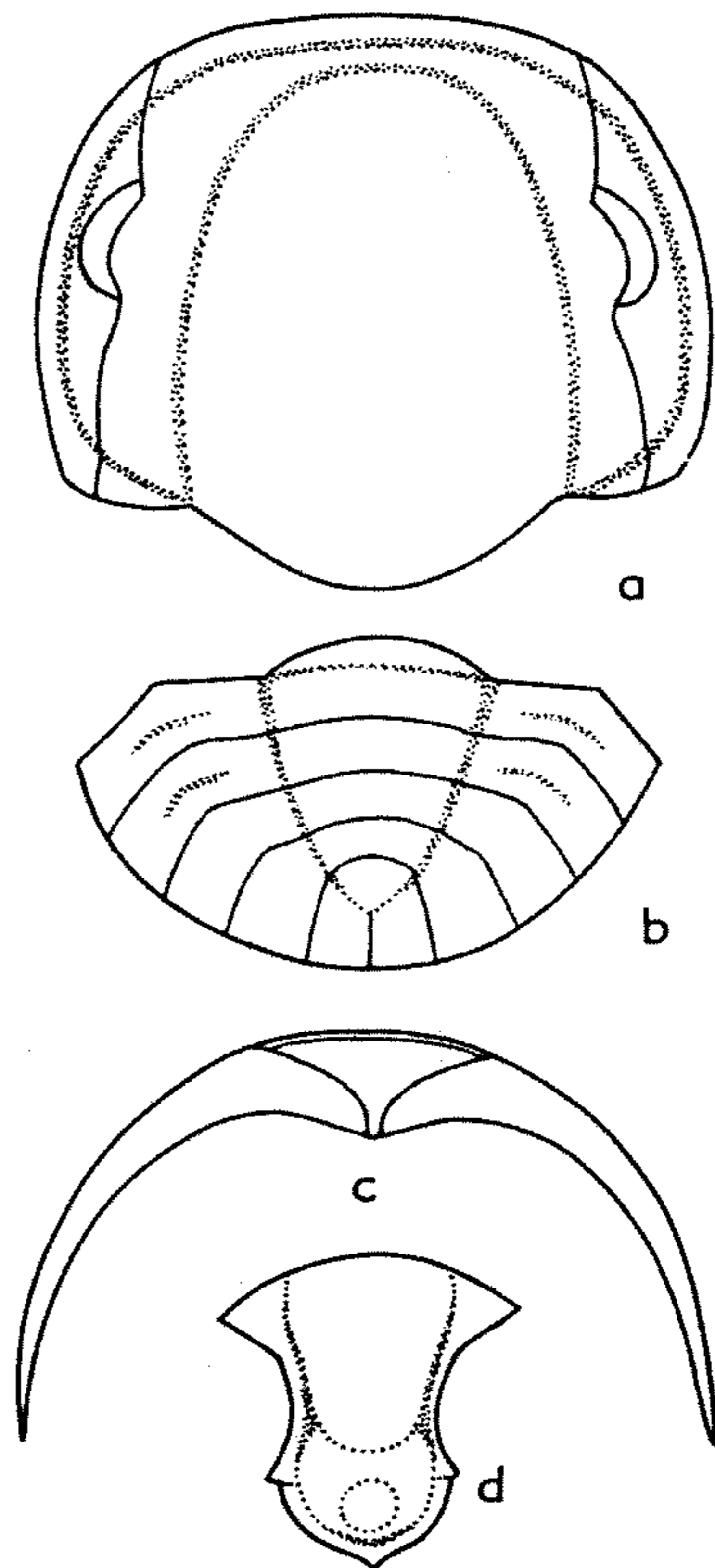

FIG. 289. **Holotrachelus punctillosus* (TÖRNQUIST) (Holotrachelidae), U.Ord., Swed.; a,c, ceph., dorsal, ventral, $\times 1.5$; b, pyg., $\times 4.5$; d, hypostoma, $\times 1.5$ (489).

out glabellar or occipital furrows; facial sutures opisthoparian. Rostral shield wide (*tr.*) anteriorly, strongly narrowing backward, hindmost part forming a very short rostral doublure; hypostoma with strong lateral and middle furrows, posterior lobe with prominent rounded boss, anterior wings triangular. Thorax with 8 segments (in type genus); pleurae with distinct diagonal pleural furrows and well-developed facets. Pygidium (in type genus) with gently convex axis, composed of 3 rings and terminal; pleural fields without border, bearing 4 pairs of flattened tergites, anterior pairs carrying pleural furrows, boundaries between pygidial tergites sharp and suture-like. Surface ornamented by terrace lines and small pits. [Assignment to Illaenina is very uncertain.] *U.Ord.*

Family HOLOTRACHELIDAE Warburg, 1925

Characters of superfamily. *U.Ord.*

Holotrachelus LINNARSSON in TÖRNQUIST, 1919 [**Homalonotus punctiliosus* TÖRNQUIST, 1884]. *U.Ord.*, N. Eu. (Ire.-Eng.-Swed.)-Sib. (Kuznetsk-Kirghiz)-N. Am. (Que.).—FIG. 289. **H. punctiliosus* (TÖRNQUIST); *a, c*, ceph., dorsal, ventral, $\times 1.5$; *b*, 8th thoracic seg. and pyg., $\times 4.5$; *d*, hypostoma, $\times 1.5$ (489).

Superfamily PROETACEA Salter, 1864

[*nom. transl.* KOBAYASHI, 1935 (ex Proetidae SALTER, 1864)] [*=Proctoidae* HURÉ, 1953] [*Authorship*.—Diagnosis of superfamily by RICHTER & RICHTER with additions by W. STRUVE]

Exoskeleton opisthoparian, small to moderately large (average length 1 to 4 cm., exceptional maximum about 12 cm.). Cephalon semicircular, semielliptical, parabolic, or ogival in outline, but not rectangular or trapezoidal; cephalic border well developed in most genera (in plan view somewhat overlapped by glabella in some Otarionidae, *Celmus*, some Proetinae, suppressed by frontal lobe in several Phillipsiidae); preglabellar field narrow to very large (*sag.*); glabella semielliptical, conical, ogival, pear-, egg-, club-, or fiddle-shaped, with more or less enlarged frontal lobe (*Phillipsinella*, Phillipsiidae), front generally rounded, exceptionally truncated (*Plethopeltis*, *Celmus*, few Proetidae), with 1 to 4 pairs of lateral glabellar furrows that are parallel, or in many genera, increasingly

oblique in posteromesial direction from *4p* to *1p*, *4p* furrows present only exceptionally, *3p* and *2p* tending to disappear and *1p* to fuse with occipital furrow so that *1p* lateral lobes are detached; all furrows obsolete in Plethopeltidae, most Dimeropygidae, *Phillipsinella*, few Proetidae; holochroal eyes of considerable size in most genera (0.3 to more than 0.5 of glabellar length), close to glabella and behind mid-length of cephalon (except for Plethopeltidae, *Celmus*, Otarionidae with small eyes and reduced-eyed or blind Proetidae, e.g., *Drevermannia*, *Typhloproetus*, *Pteroparia*), no eye ridges (except in *Cyphaspidetes* and a few Proetidae); posterior sections of facial sutures generally shorter than anterior sections and diverging more obliquely than anterior sections, which are notably distant from each other at anterior margin, as especially in *Pteroparia* (sutures ankylosed in Brachymetopidae and few Proetidae); librigenae generally larger than fixigenae; genal spines mostly well developed. Thorax with 6 to 17 segments (average about 10); pleurae furrowed. Pygidium transversely to longitudinally semielliptical in outline, length 0.3 to slightly more than equal that of cephalon; segmentation typically well developed with about 4 to 10 pairs of ribs (many more in some Phillipsiidae). *U. Cam.-M. Perm.*

The Cambrian family Plethopeltidae and the Ordovician families Celmidae and Phillipsinellidae differ so much from other Proetacea that they should be regarded only as an annex to this superfamily. Very closely allied are the Proetidae and Phillipsiidae, next to them the Brachymetopidae; somewhat more distant are the Dimeropygidae and Otarionidae.

Family PROETIDAE Salter, 1864

[*=Prionurides* HAWLE & CORDA, 1847 (invalid name; based on junior homonym); Proetiden HAWLE & CORDA, 1847 (invalid vernacular name)] [*Authorship*.—Generic diagnoses by RICHTER & RICHTER with additions by W. STRUVE; assignments of genera to subfamilies mainly by STRUVE]

Exoskeleton elongate elliptical (1 to 12 cm. in length). Cephalon semicircular to parabolic; glabella tapering to inverse pyriform, mostly suboval, with 3 or 4 pairs of lateral furrows, indistinct in some, *1p* furrows tending to develop an adaxial branch that causes basal deterioration ("basisolution") of glabella in some late genera, increased width of furrows in basal

part of glabella leading ultimately to their coalescence, with development of small remnant separated lobes (Fig. 290, E, E', F, F'); occipital ring defined, commonly with lobes; facial sutures opisthoparian; eyes close to glabella, opposite or behind its mid-length; fixigenae narrow, in some genera of Cyrtosymbolinae with disappearance of sutures over eyes (allowing them to migrate outward, Fig. 291); visual areas ring-shaped, holochroal, with prismatic lenses, proxi-

mally convex; librigenae broad (except narrow in eyeless Cyrtosymbolinae), genal angles mostly with spine, seldom rounded. Rostral plate narrow, transversely extended, rostral suture long, parallel to frontal margin, connective sutures short, slightly converging (Fig. 292A); hypostoma subrectangular, elongate, with conspicuous wings, posterior margin mostly with paired teeth, central body vaulted. Thorax with 8 to 10 segments (typically 10), pleurae with

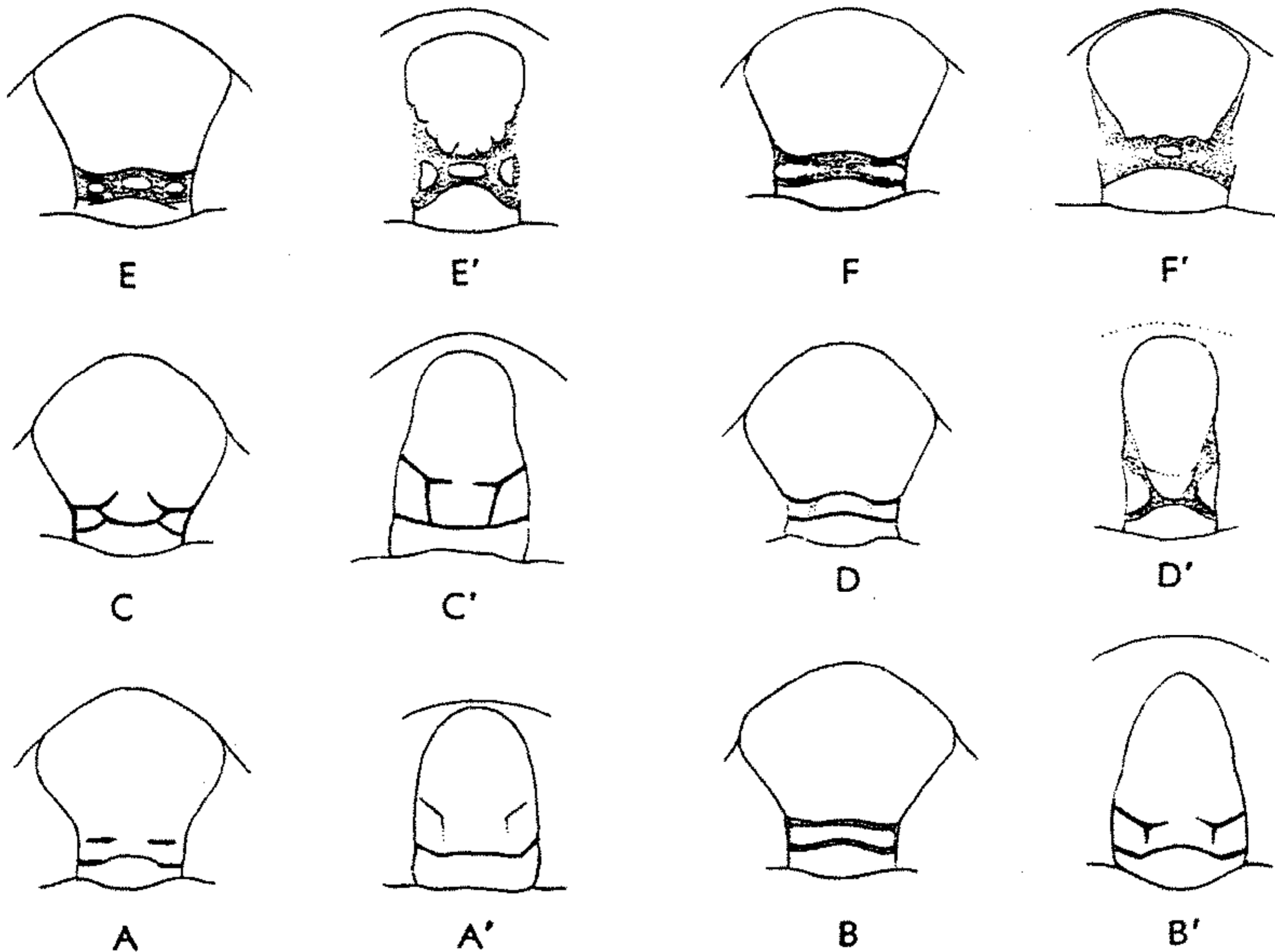

FIG. 290. Deterioration ("basisolution") of basal part of glabella in Proetidae and Phacopidae. The diagrams show homologous evolutionary changes but arrangement of the illustrated forms indicating neither chronologic nor phylogenetic sequences; furrows in front part of glabella omitted (461n).

A-F, PHACOPIDAE.—A, U.Dev., furrows (*pl*) in front of occipital furrow short slits ending blind.—B, *Phacops confluens*, Up.L.Dev., transglabellar furrow in front of occipital furrow.—C, *Trimeroccephalus caecus*, U.Dev., linkage of furrows at and near base of glabella with development of small lobes circumscribed by furrows.—D, *Phacops granulatus*, U.Dev., pattern of furrows related to both B and C.—E, *P. papulatus*, M.Dev., like D but with widened furrows isolating 3 small lobes.—F, *P. accipitrinus*, U.Dev., like E but showing coalescence of furrows through disappearance of median small lobe.
A'-F', PROETIDAE.—A' *Proetus (Proetus) cuvieri*, M.Dev., with short oblique furrows in front of occipital furrow.—B', *Cyrtosymbola gotica*, U.Dev., short glabellar furrows inwardly forked but separate.—C', *Schizoproetus celechovicensis*, M.Dev., posterior branch of glabellar furrows extended to occipital furrow.—D', *Phillipsia* sp., Low.U.Carb.(Namur.), like C' but with furrows widened and extended.—E', *Pseudophillipsia sumatrensis*, Carb., like D' but with marked enlargement of furrows leaving 3 small lobes as isolated remnants of basal glabellar ring.—F', *Ditomopyge artinskiensis*, M.Perm.(Artinsk.), like E' but with only median small lobe remaining in broad coalesced groove area.

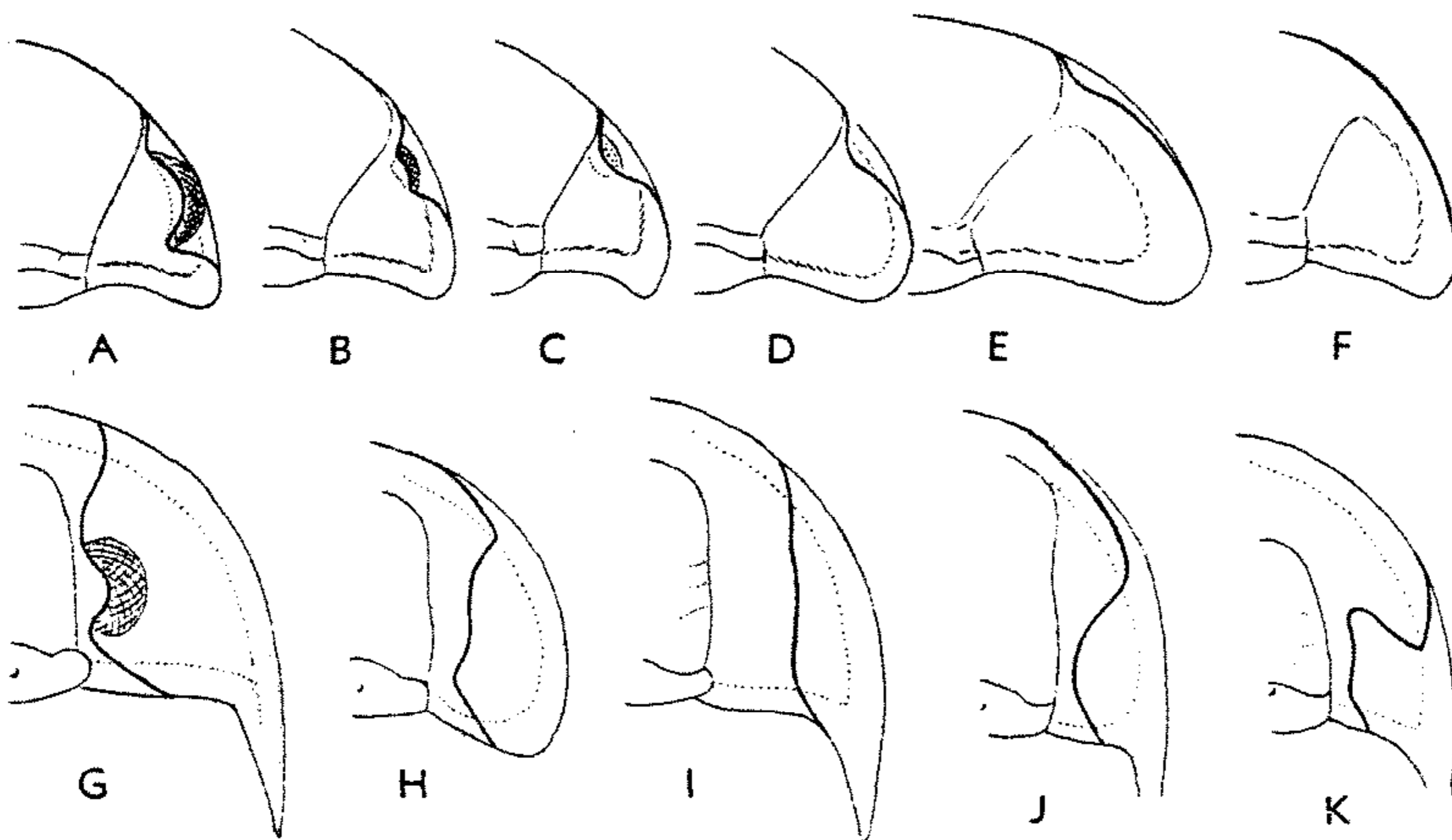

FIG. 291. Migration of facial sutures in relation to degeneration of eyes in Proetidae and Phacopidae, illustrated by Upper Devonian species (461n).

A-F, PHACOPIIDAE (*Ductina* series), showing progressive straightening of facial sutures.—A, *Phacops circumspectans*, eyes and palpebral lobes large.—B, *P. wedekindi*, eyes reduced in size, palpebral lobes flattened.—C, *Cryphops? ensae*, small eyes with elliptical visual area, palpebral lobes vanished (*cryptophthalmus* pattern).—D, *Trimerocephalus mastophthalmus*, eyes lacking, course of facial sutures close to border.—E, *Dianops limbatus*, like D but sutures nearly marginal throughout.—F, *Ductina ductifrons*, like E but sutures entirely marginal.

G-I, PROETIDAE (*Drevermannia* series), showing tendency toward straightened facial sutures.—G, *Cyrtosymbole (Waribole) warsteinensis*, eyes large, palpebral lobes prominent, facial sutures strongly sinuous.—H, *Drevermannia (Palpebralia) palpebralis*, eyes lost, palpebral lobes much reduced, facial sutures somewhat straight.—I, *D. (Drevermannia) schmidti*, like H but palpebral lobes disappeared and sutures very straight.

G, J, K, PROETIDAE (*Pteroparia* series), showing accentuation in curvature of facial sutures.—G, as in *Drevermannia* series.—J, *Typhloproetus subcarintiacus*, lacking palpebral lobes and eyes, anterior segments of facial sutures deflected so as to approach border closely.—K, *Pteroparia columbella*, like J except for marked change in course of facial sutures, with anterior segments intersecting cephalic margin far back of frontal extremity.

pleural furrows; mesotergite in many genera bipartite, with praeannulus and postannulus (Fig. 292B). Pygidium mostly semicircular, with few segments, but in some late genera long, parabolic, with up to 28 segments. *M.Ord.-L.Carb.(Miss.)*

Subfamily PROETINAE Salter, 1864

[*nom. transl.* PHIBYL, 1947 (*ex* Proetidae SALTER, 1864)]

Cephalon vaulted; exterior border convex, border furrow sharp; no preglabellar field; glabella large, suboval to rectangular, glabellar region in front of 3*p* furrows short, similar to length of 1*p* glabellar lobes; anterior sections of facial sutures slightly diverging; librigenae with genal angles rounded or with short spines. Thorax with

10 segments, ends truncate, axis as wide or wider than pleurae. Pygidium vaulted, semicircular, entire; axis broad, with 6 to 9 rings; 5 to 7 ribs, nearly parallel, slightly curved backward, segmental bands little different in size, pleural and interpleural furrows merely incised lines. *M.Ord.-M.Dev.*

Proetus STEININGER, 1831 [**Calymene concinna* DALMAN, 1827] [= *Aeonia* BURMEISTER, 1843 (*obj.*); *Gerastos* GOLDFUSS, 1843; *Forbesia* M'COY, 1846; *Trigonaspis* SANDBERGER & SANDBERGER, 1850]. Glabella touching border furrow, glabellar furrows 1*p* more or less distinct; occipital ring not narrowed laterally but may have lobes laterally. *Ord.-M.Dev.*, cosmop.

P. (Proetus) [= *P. (Euproetus)* RUD. RICHTER, 1913]. Cephalon strongly vaulted; glabellar fur-

rows faint or missing; occipital ring with or without lobes; genal angles rounded or with short spine. Hypostoma with median spine on central body (FIG. 293,1h). *Ord.M.Dev.*, cosmop.—

FIG. 293,1a-e. **P. (P.) concinnus* (DALMAN), Sil., Gotl.; 1a-c, ceph.; 1d, pyg; 1e, hypostoma; all $\times 3.5$ (461).—FIG. 293,1f,g. *P. (P.) bohemicus* HAWLE & CORDA, L.Dev., Czech.(Koněprusy Ls.); 1f,g, ceph., pyg., $\times 4$ (3).—FIG. 293,1h. *P. (P.) cuvieri* STEININGER, M.Dev., Ger.; hypostoma from side, $\times 4$ (460).

P. (Cyphoproetus) KEGEL, 1927 [**Cyphaspis depressa* BARRANDE, 1846; SD PŘIBYL, 1946]. Cephalon vaulted; border furrow broadened in front of glabella; lateral furrows *lp* pronounced, separating lateral lobes *lp*; with occipital lobes; librigenae with genal spines. Pygidium moderately vaulted; axis with 6 to 8 rings; pleural fields with 3 to 6 ribs. *Sil.*, Eu.—FIG. 293,3. **P. (C.) depressus* (BARRANDE), Czech.; exoskel., $\times 2$ (3).

?*Crassiproetus* STUMM, 1953 [**Proetus (Crassiproetus) traversensis* STUMM, 1953]. Highly vaulted cephalon typical of Proetinae combined with pygidium of type characteristic of Dechenellinae; glabella quadrate, lateral furrows obsolete; occipital lobes developed; anterior sections of facial sutures scarcely diverging, short; genal angles rounded. Pygidium as long as wide, highly convex; axis broad and long; segmentation weakly defined, with 14 to 16 rings; pleural fields with 9 to 12 ribs. *M.Dev.*, N.Am.—FIG. 293,5. *C. traversensis* (STUMM), Mich.; 5a,b, small ceph., large pyg., $\times 2$, $\times 1$ (476).

?*Isbergia* WARBURG, 1925 [**I. planifrons*]. Cephalon (length 1.5 to 3 mm.) like that of *Proetus* but with long preglabellar field bent vertically downward and genae steeply inclined; occipital ring narrowed laterally; posterior sections of facial sutures directed sharply outward as straight line from eyes to points on posterior margins just inside genal angles; no genal spines. Thorax and pygidium unknown. *Ord.(Ashgill.)*, Swed.-Ire.—FIG. 293,2. **I. planifrons*, Swed.(Dalarne); 2a,b, ceph., $\times 6$ (323).

?*Unguliproetus* ERBEN, 1951 [**Proetus unguoides* BARRANDE, 1846]. Cephalon with somewhat ogival outline; border wide, convex, preglabellar field of same width (*sag.*); glabella slender, tapering to narrow front; anterior sections of facial sutures moderately long, diverging, posterior sections short; librigenae narrow, with long genal spines. Thorax with 10 segments rounded at ends. Pygidium 0.5 as long as broad, truncated, depressed; axis narrow, without axial ridge, rings 7 or more; pleural fields with faint ribs, segmental bands equally developed; pleural and interpleural furrows very narrow, faint. *L.Dev.-M.Dev.*, Eu.—FIG. 293,4. **U. unguoides* (BARRANDE), L.Dev., Czech.; 4a,b, ceph., thorax and pyg., $\times 3$, $\times 4.5$ (3).

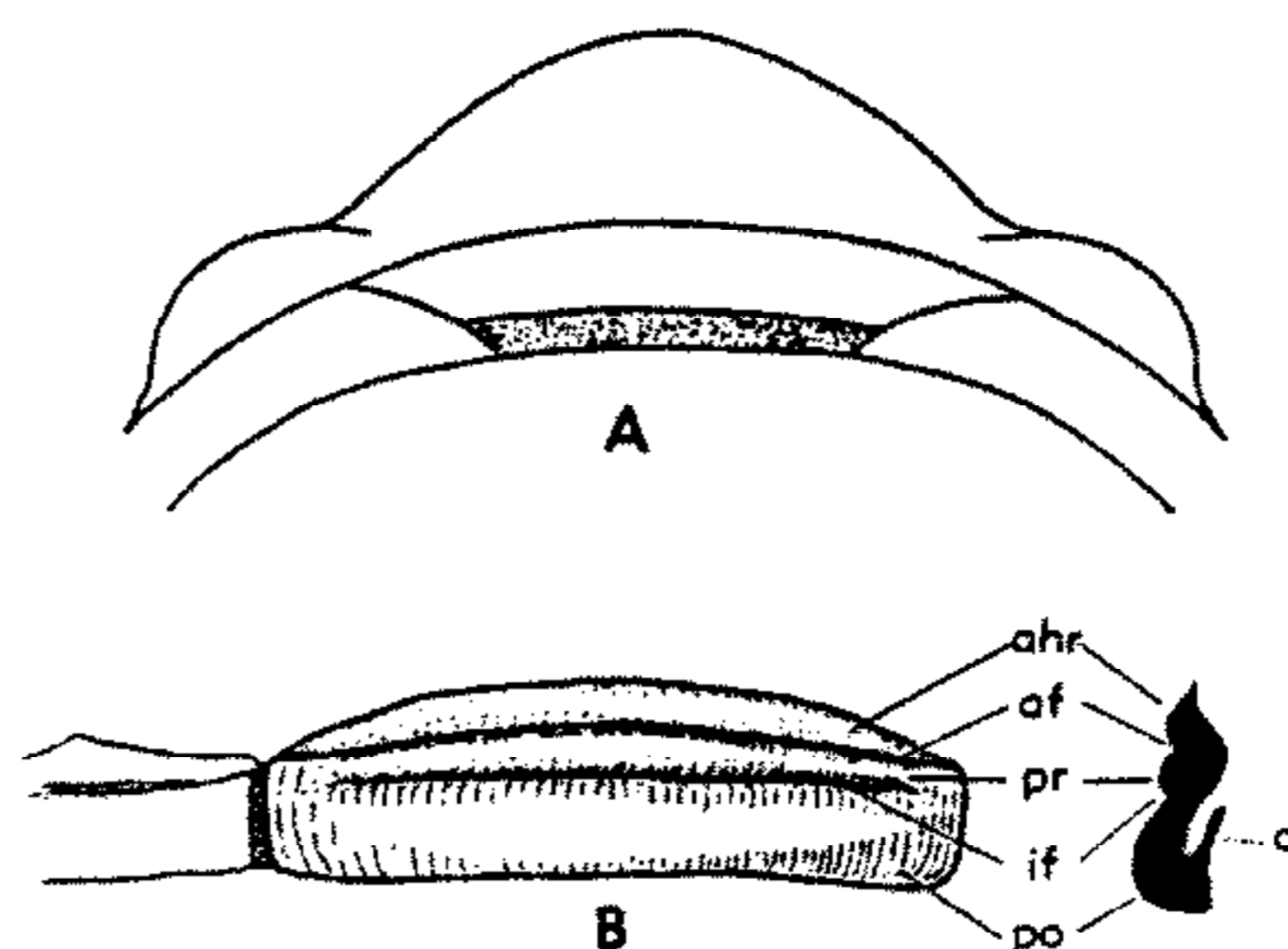

FIG. 292. *Proetus (Proetus) cuvieri*, M.Dev., showing (A) rostral plate (stippled) *in situ*, $\times 6$, and (B) mesotergite with bipartite axial ring or annulus, $\times 10$ (ahr, articulating half-ring; af, articulating furrow; if, intra-annular furrow; po, postannulus; pr, pre-annulus; d, doubleure) (461n).

Subfamily CORNUPROETINAE Richter & Richter, 1956

Exoskeleton depressed. Cephalon with moderate-sized preglabellar field or none; glabella scarcely tapering, with broad front and restricted sides, 3 faint lateral furrows or obsolete; occipital ring remarkable in width (*tr.*), not narrowed (*sag.*) laterally; anterior sections of facial sutures slightly diverging; librigenae broad, extended into long, furrowed genal spines. Hypostoma without spine on central body. Thorax with 10 (seldom 9) segments, ending in obtuse or sharp points; axis as wide or wider than pleurae, which are flat. Pygidium wide (*tr.*), short, entire, without distinct border or border furrow; axis short, wide, with blunt end, remarkably elevated above flat pleural fields, showing 4 to 6 rings; pleural fields with 4 to 6 nearly parallel straight ribs, curved backward only near ends. *Ord.-U.Dev.*

Cornuproetus RICHTER & RICHTER, 1919 [**Proetus cornutus* GOLDFUSS, 1843]. Cephalon with exterior border demarcated by sharp border furrow; preglabellar field minute or lacking; occipital ring without lobes. Hypostoma without spine on central body. Thorax with 9 or 10 segments; axis scarcely narrowing backward. Pygidium shorter than semicircle; axis nearly reaching posterior margin, no axial ridge. *Sil.-U.Dev.*, Eu.-N.Afr.-N. Am.

C. (Cornuproetus) [= *P. (Sculptoproetus)* ERBEN, 1951]. Glabella nearly rectangular, somewhat

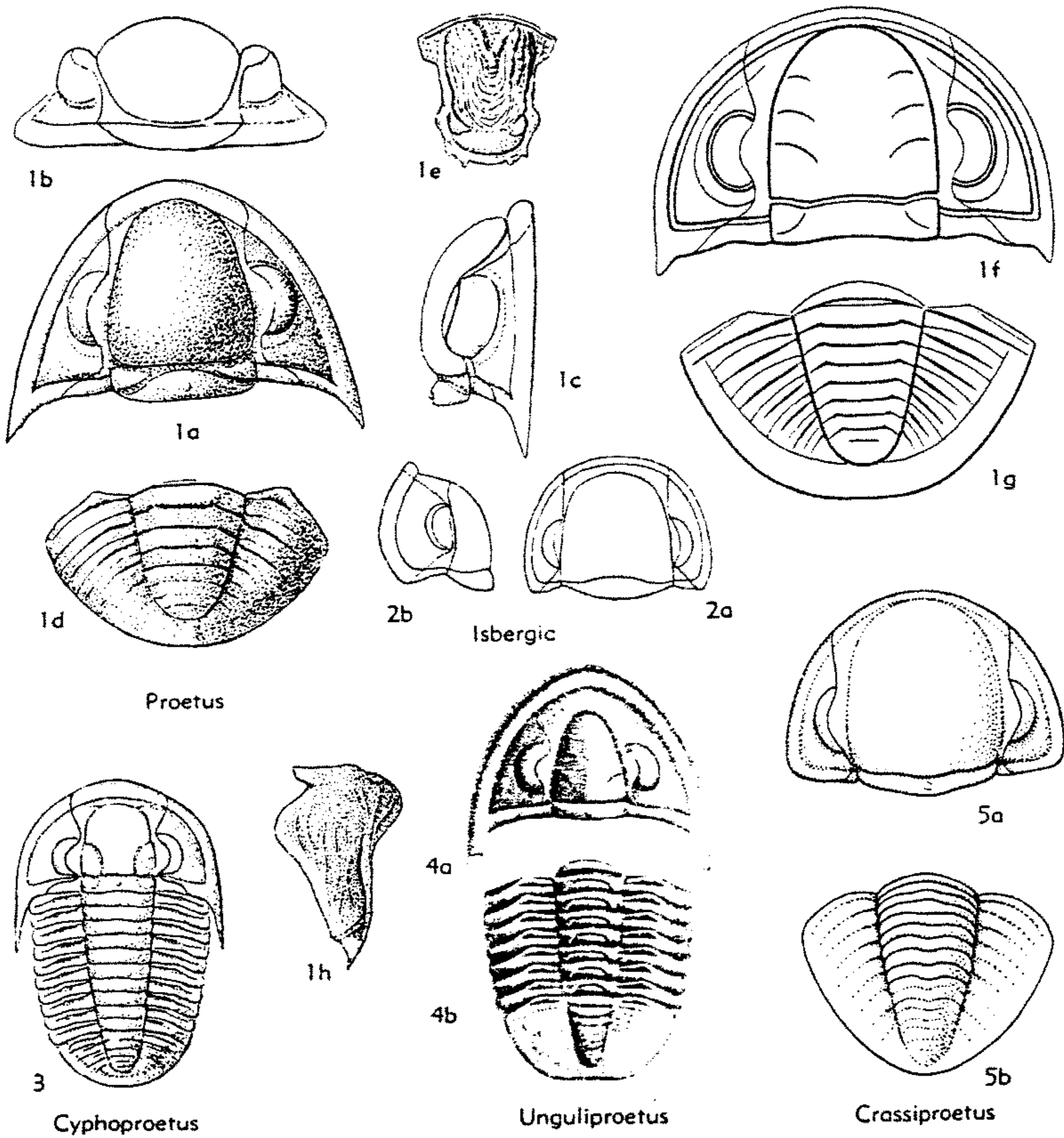

FIG. 293. Proetidae (Proetinae) (p. 0384-0385).

fiddle-shaped; palpebral lobes nearly reaching posterior border furrow; librigenae uniformly and moderately vaulted. *Sil.-U.Dev., Eu.-N.Afr.-N. Am.*—FIG. 294,1. **C. (C.) cornutus* (GOLDFUSS), *M.Dev., Ger.(Gerolstein)*; 1a,b, exoskel., hypostoma, $\times 1.5$ (461).

C. (Piriproetus) ERBEN, 1952 [**Proetus (Piriproetus) pirus*]. Glabella tapering slightly, though with broad front, palpebral lobes distant from posterior border furrow. Thorax and pygidium unknown. *Up.L.Dev.-Low.M.Dev., C.Eu.*—FIG. 294,2. **C. (P.) pirus* (ERBEN), *L.Dev., Ger. (Harz)*; cran., $\times 16$ (397, mod.).

C. (Lepidoproetus) ERBEN, 1951 [**Proetus lepidus* BARRANDE, 1846]. Like *C. (Cornuproetus)* but

with concave preglabellar field; no demarcated border or sharp border furrow in front; librigenae steeply sloping to flat border. *Sil.-M.Dev., C.Eu.*—FIG. 295,4. **C. (L.) lepidus* (BARRANDE), *Sil. (e gamma Zone), Czech.*; exoskel., $\times 3$ (3).

Phactonellus NOVÁK, 1890 [**Phacton planicauda* BARRANDE, 1846; SD VOGDES, 1925]. Cephalon with narrow exterior border and incised border furrow, preglabellar field short; glabella rectangular, sides well marked. Thorax with 10 distally pointed segments, posterior ones with spined ends. Pygidium semicircular; axis with 5 rings; pleural fields with 2 to 4 pleurae that continue into spines. *Ord.-M.Dev., Eu.*—FIG. 295,2. *P. rhenanus*

Novák, M.Dev., Ger.(Bicken); 2a,b, exoskel., X2.8, with detail of sculpture, enlarged (437).

Xiphogonium HAWLE & CORDA, 1847 [**Proetus loveni* BARRANDE, 1846; SD VOGDES, 1893]. Cephalon with broad flat anterior border and very broad anterior border furrow, preglabellar field moderate in size; glabella rectangular. Thorax with 10 segments; axis anteriorly broad, narrowing backward; pleurae flat, heteromeric, nos. 1 to 6 pointed, 7 to 10 with spines. Pygidium shorter than semicircle, no border. M.Dev., C.Eu. —FIG. 295,3. **X. loveni* (BARRANDE), g alpha Z., Czech.(Hostin); exoskel., X2 (3).

?*Eremiproetus* RICHTER & RICHTER, 1919 [**Proetus eremita* BARRANDE, 1852]. Glabella approximately rectangular, nearly reaching convex frontal border; occipital ring directed laterally forward, presence of lobes indicated. Thorax with 10 segments like those of *Cornuproetus*. Pygidium depressed, semi-circular in outline or shorter, anterior margin straight, outer edge sharp, entire; axis short, prominent, with 4 to 6 rings that bear recurved median tubercles, succeeded by long axial ridge; pleural fields slightly concave near margin; with 3 or 4 distant ribs consisting only of anterior straight segmental bands, that bend abruptly backward distally. [This genus combines cephalic and thoracic features of *Cornuproetinae* with pygidial characters of *Tropidocoryphinae* and thus presumably is the root of these subfamilies.] Sil.-M.Dev., Eu.—FIG. 295,5. **E. eremita* (BARRANDE), L.Dev.-M.Dev. near boundary; 5a, ceph., Ger.(Greifenstein), X1 (437); 5b, pyg., Czech.(Koněprusy Ls.), X2 (3).

?*Pribylia* ERBEN, 1951 [*pro Pribylia*] [**Proetus inaequicostatus* BARRANDE, 1846]. Pygidium lenticular, anterior and posterior margins curved similarly, uniting in sharp angular corners, without distinct border; axis somewhat wider than pleural fields, with 7 rings followed by stout short axial ridge; pleural fields with anterior and posterior segmental bands developed as 4 or 5 strong semi-pleural ribs of nearly equal size, pleural and interpleural furrows equally distinct. L.Dev., C.Eu.—FIG. 295,1. **P. inaequicostata* (BARRANDE), Czech.(Koněprusy Ls.); pyg., X3 (3).

?*Perliproetus* RICHTER & RICHTER, 1926 [**Calymene marginata* MÜNSTER, 1842]. Late genus with some features of *Phillipsiinae*. Cephalon with concave outer border; glabella long, scarcely tapering, region in front of 3p lateral furrows long, 1p-3p glabellar furrows sharp, 1p with separate adaxial branch, 1p glabellar lobes separated; occipital ring narrowing laterally; palpebral lobes far removed from posterior border furrow; anterior sections of facial sutures scarcely diverging; genal spines stout, short. Hypostoma like that of *Cornuproetus*. Pygidium with 6 to 9 rings and 6 or 7 strong ribs with posterior segmental bands longer and higher than anterior, border very narrow. U.Dev., C.Eu.

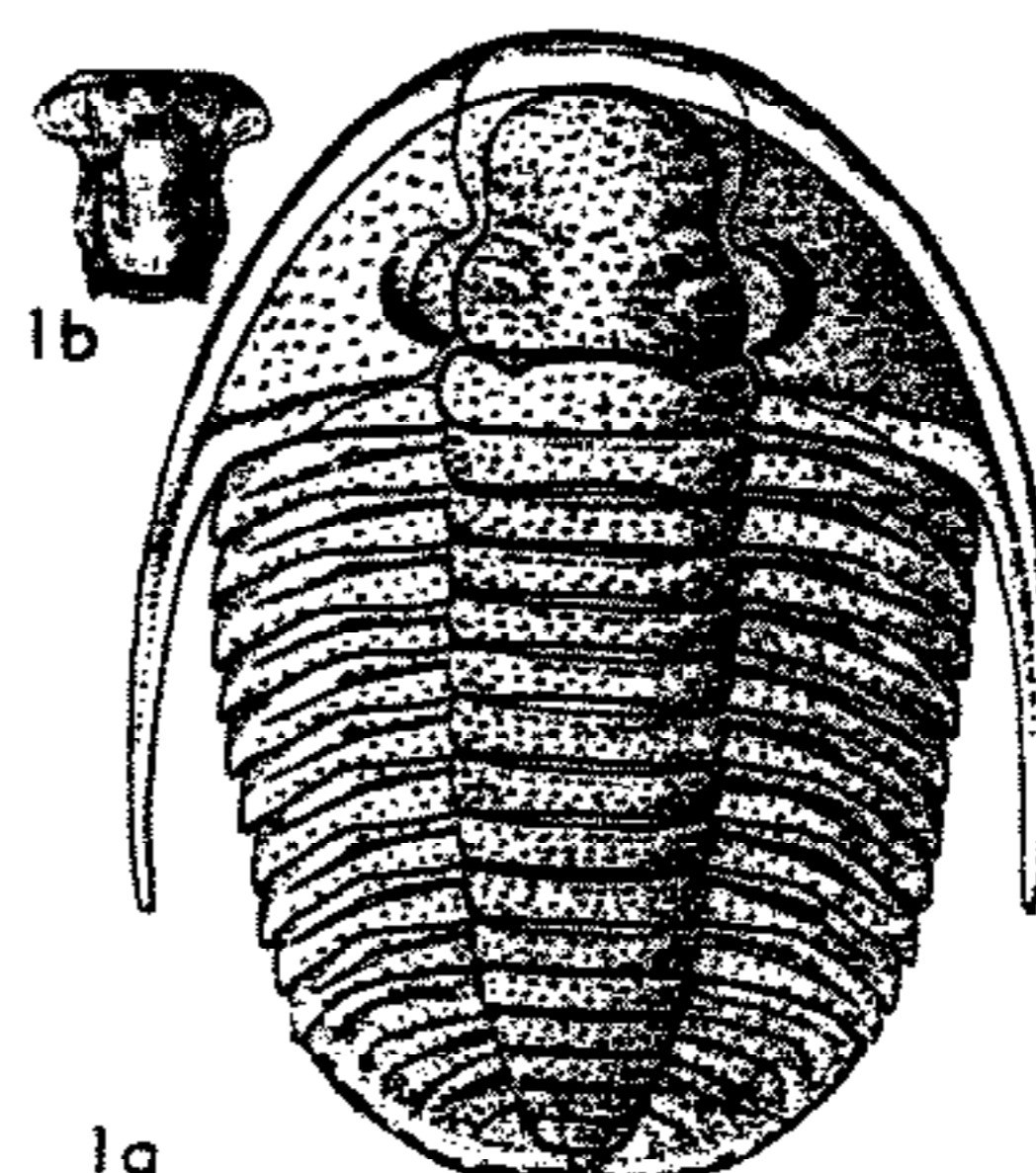

Cornuproetus

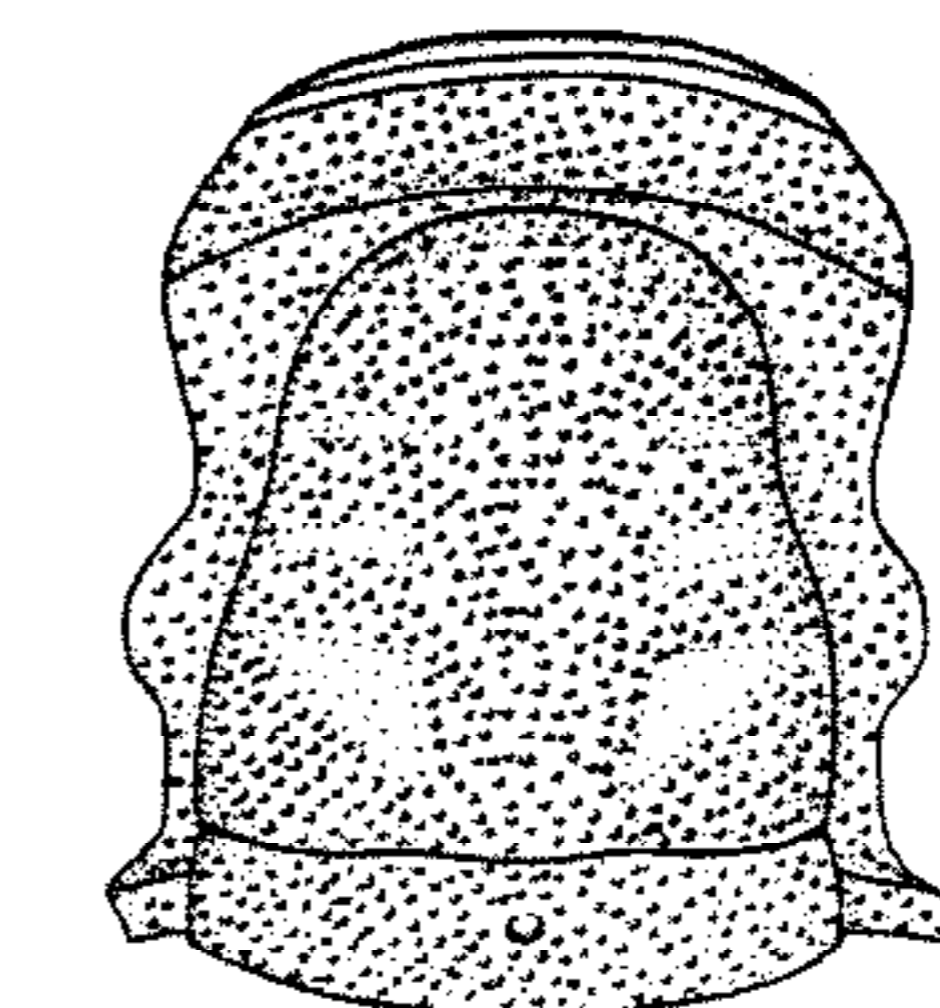

Piriproetus

FIG. 294. Proetidae (Cornuproetinae) (p. 0385-0386).

—FIG. 296,1. **P. marginatus* (MÜNSTER), Up. U.Dev., Ger.(Warstein); 1a-d, cran., librigena, pyg., hypostoma, all X3 (461, mod.).

Subfamily DECHENELLINAE Pribyl, 1946

Glabella tapering, pear-shaped or subtrapezoidal, with 3 or 4 pairs of mostly deep lateral furrows, 1p with adaxial branch; occipital lobes developed; anterior sections of facial sutures long, markedly diverging; eyes large, crescentic close to axial furrows, palpebral lobes large; librigenae with strong genal spines. Thorax with 10 segments. Pygidium large, elongate; border distinct, at least marked by abrupt disappearance of segmentation of pleural fields; axis long, narrow, with 12 to 19 rings, no axial ridge; pleural fields with 7 to 14 ribs. Up.L.Dev.-U.Dev.

Dechenella KAYSER, 1880 [**Phillipsia verneuili* BARRANDE, 1852; SD VOGDES, 1890]. Glabella with 3 or 4 distinct, mostly deep lateral fur-

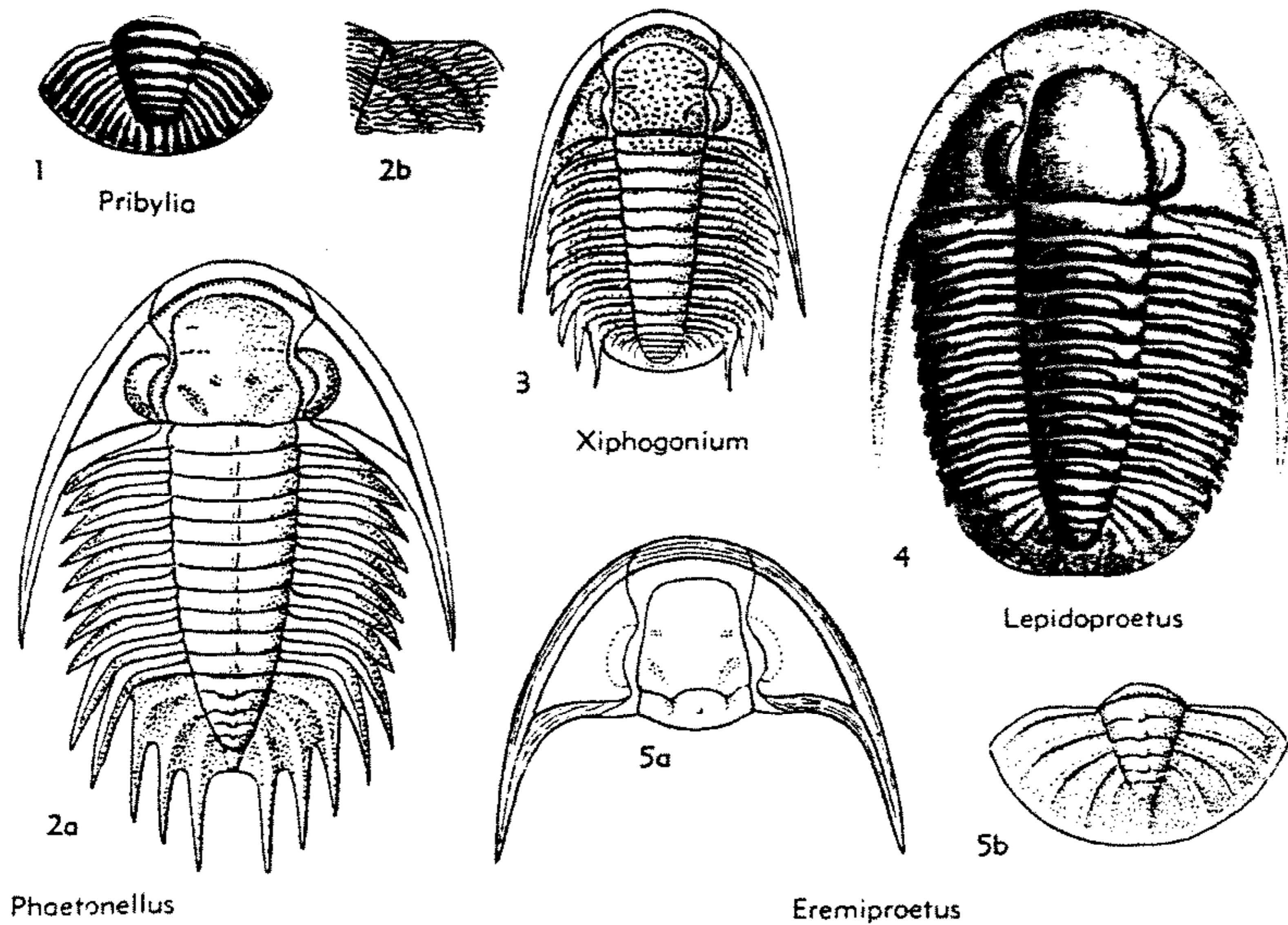

FIG. 295. Proetidae (Cornuproetinae) (p. 0386-0387).

rows; anterior sections of facial sutures angulated at border furrow; librigenae with flat, convex, or keeled platforms. Hypostoma elongate, with long, oval anterior lobe that is sharply defined anteriorly, equally convex and without spine, with middle furrow, posterior margin bearing pair of points. Pygidium very elongate; anterior part of axis more tapering than posterior. *Up.L.Dev.-M.Dev., N.Hemis.*

D. (Dechenella) [=D. (*Eudechenella*) RUD. RICHTER, 1912 (obj.)]. Cephalon with convex exterior border and distinct border furrow, lacking preglabellar field; glabella pear-shaped, with *1p* lobes projecting, frontal region narrower, lateral furrows very deeply incised; occipital lobes separated; genal platforms convex or keeled. Pygidium long, strongly segmented; axis with 14 to 19 rings; pleural fields with 10 to 14 sigmoidal ribs. *M.Dev., N.Hemis.*—FIG. 297,1. *D. (*D.*) *verneuili* (BARRANDE), Ger.(Gerolstein); exoskel., $\times 2$ (460n).—FIG. 297,6. *D. (D.) burmeisteri* (RUD. RICHTER), Ger.(Hagen); 6a,b, ceph., pyg., $\times 2$ (460).

D. (Basidechenella) RUD. RICHTER, 1912 [*D. (*Basidechenella*) *kayseri*; SD VOGDES, 1925]. Glabella tapering rather gradually, lateral furrows faint; occipital lobes not separated; genal

platforms plane. Pygidium moderately elongate; axis with 12 or 13 rings; pleural fields with about 8 ribs. *Up.L.Dev., ?M.Dev., Eu.-N.Am.*—FIG. 297,3. *D. (*B.*) *kayseri*, L.Dev., Ger.(Eifel); 3a-d, cran., librigena, pyg., internal mold of pygidial axis, $\times 4$ (460n).

D. (Monodechenella) STUMM, 1953 [**Proetus macrocephalus* HALL, 1861]. Glabella semioval, barely tapering, moderately to highly convex, *1p* lateral furrows deeply incised, *2p* and *3p* faint or obsolete, *1p* lateral lobes separated; occipital lobes isolated. Pygidium similar to that of *D. (Dechenella)*, large, vaulted. *M.Dev., N.Am.*—FIG. 297,2. *D. (*M.*) *macrocephala* (HALL), Mich.; exoskel. lacking librigenae, $\times 1$ (476).

D. (Praedechenella) MAKSIMOVA, 1952 [*———]. *M.Dev., Sib.(Altai).*

Paradechenella RUD. RICHTER, 1912 [**Dechenella ischernyschewi* RUD. RICHTER, 1909]. Preglabellar field minute; glabella long, sides nearly straight, with 3 lateral furrows similar to those of *D. (Dechenella)*, occipital lobes present; anterior sections of facial sutures sigmoidal; fixigenae very convex and librigenae equally globose. Pygidium as in *D. (Dechenella)* but with stout terminal spine projecting from distinct, convex border; axis with 13 to 17 rings; pleural fields with 7 to

11 ribs. *M.Dev.*(*Givet.*), USSR(Urals).—FIG. 297,5. **P. tschernyschewi* (RUD. RICHTER); 5a-c, cran., librigena, pyg., $\times 3.3$ (141, 460 mod.).

Schizoproetus RUD. RICHTER, 1912 (**Proetus celechovicensis* SMYČKA, 1895]. Glabella parallel-sided to tapering, anterior end broadly rounded, with 4 pairs of sharp lateral furrows, 1p lobes separated; occipital ring broad, narrowing laterally, with very distinct lobes; posterior sections of facial sutures long, located near glabella; librigenae broad, with angulated keel and small genal spines. Pygidium very convex; axis strongly raised, reaching border, with 13 or 14 rings; pleural fields with 7 to 9 prominent ribs separated by sharp pleural furrows. *M.Dev.*, Eu.—FIG. 297,4. **S. celechovicensis* (SMYČKA), Czech.; 4a,b, ceph., pyg., $\times 2.7$ (460n).

Subfamily CYRTOSYMBOLINAE Hupé, 1953

[*nom. transl.* RICHTER & RICHTER, herein (*ex* *Cyrtosymbolidae* HUPÉ, 1953)]

Exoskeleton mostly minute; glabella long, tapering, in some late genera becoming nearly rectangular, with 3 or 4 pairs of distinct to fading lateral furrows, without basal deterioration ("basisolution"); occipital ring typically narrowing laterally, without lobes; eyes degenerating in some groups, giving way to straightening of facial sutures so as to migrate outward or coalesce. Thorax with 8 or 9 segments. Pygidium generally not longer than semicircle; with few segments, axis having at most 6 to 11 rings and pleural fields 4 to 10 (or ?11) ribs. [The *Cyrtosymbolinae* contain homeomorphic genera of perhaps different origin and others with trend toward *Tropidocoryphinae* and *Phillipsiinae*, from which they are distinguished mainly by features of the pygidium.] *L.Dev.-L.Carb.*

Cyrtosymbole RUD. RICHTER, 1913 [**Dechenella escoti* KOENEN, 1886]. Exoskeleton of moderate size, some species minute. Cephalon without distinct frontal border, preglabellar field more or less developed, concave; glabella tapering, with 3 pairs of generally pronounced lateral furrows; occipital ring narrowing laterally, occipital lobes not present; anterior sections of facial sutures long, diverging; eyes not far from axial furrows, palpebral lobes distinctly curved; librigenae broad, with genal spines. Thorax with 8 to 10 segments. Pygidium semicircular to slightly elongate, with few segments; pleural fields with 5 (seldom 9) transversely directed ribs, segmental bands not very different in width (*exsag.*) and height, pleural and interpleural furrows distinct; doublure convex upwards. *M.Dev.-L.Carb.*, Eu.

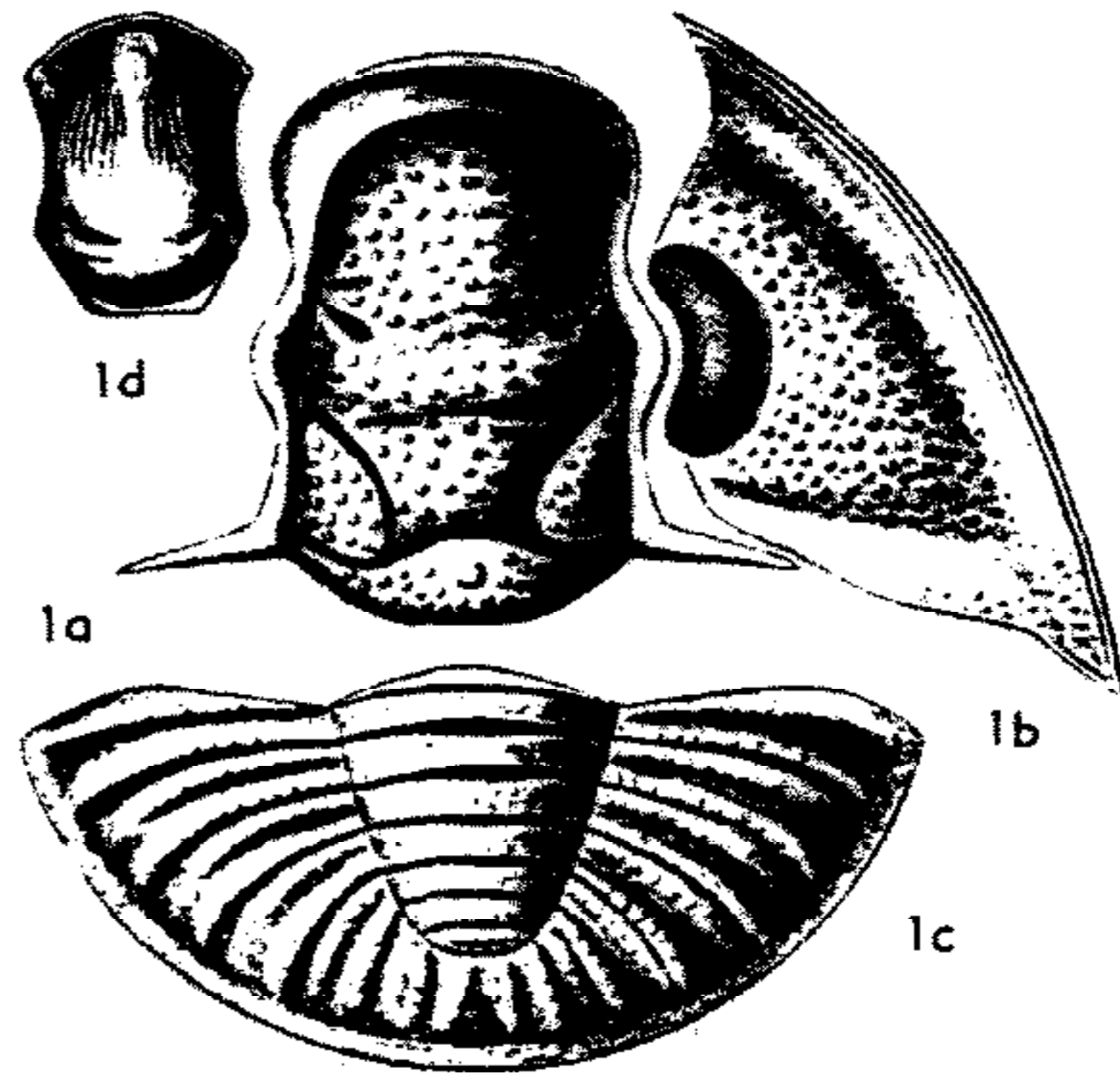

Perliproetus

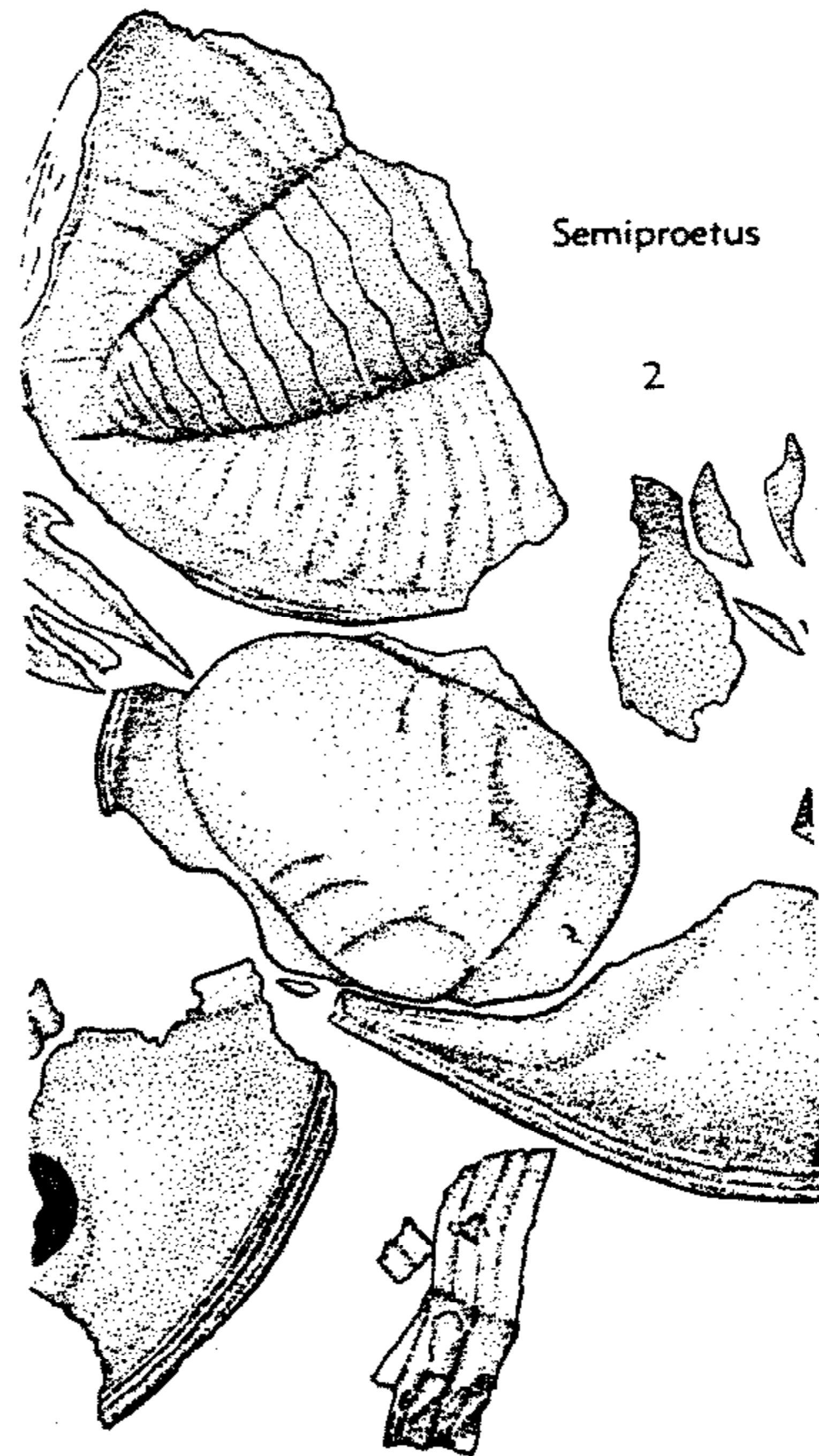

Semiproetus

FIG. 296. Proetidae (*Cornuproetinae*, *Cyrtosymbolinae*) (p. 0387, 0392).

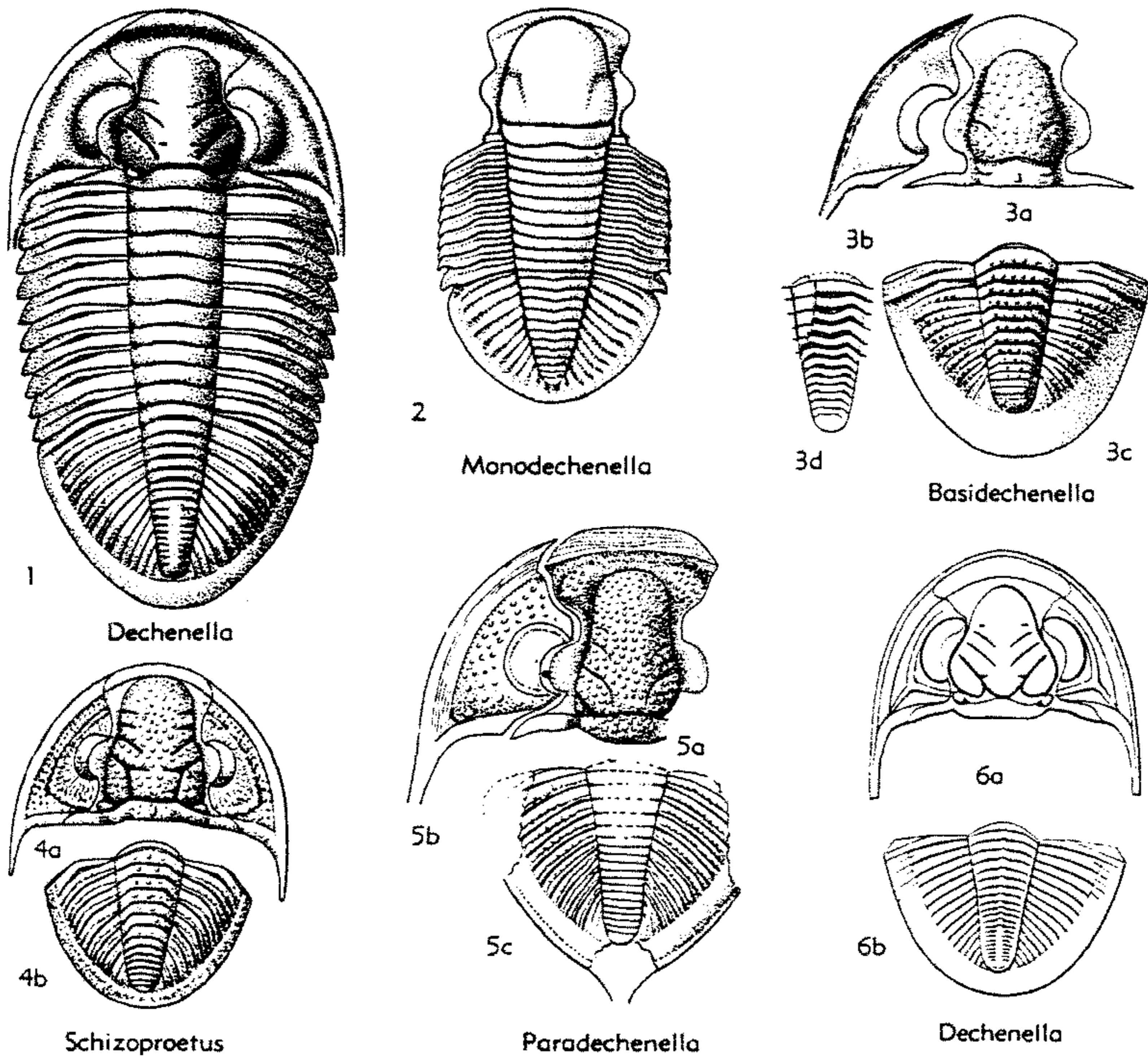

FIG. 297. Proctidae (Dechenellinae) (p. 0388-0389).

C. (Cyrtsymbole). Glabella moderately slender; occipital ring narrowing strongly toward sides; palpebral lobes somewhat distant from posterior border furrow; facial sutures mainly near axial furrows but anterior sections strongly diverging forward, posterior sections diverging only slightly for short distance behind eyes but then turning abruptly outward in border furrow. Pygidium semicircular, border and doublure rather narrow. *U.Dev.*, Eu.—FIG. 298,1. *C. (C.) *escoti* (KOENEN), Fr.(Cabrières); 1a, cran., $\times 8$; 1b, pyg., $\times 4$ (460, mod.).

C. (Calybole) RICHTER & RICHTER, 1926 [**Cyrtsymbole calymmene* RUD. RICHTER, 1913]. Glabella slender, with deep lateral furrows; palpebral lobes in type species elevated above apparently coalesced genae. Pygidium with very pronounced ribs; border not differentiated from pleural fields; doublure narrow. *U.Dev.*, Eu.—FIG. 298,2. *C. (C.) *calymmene* (RUD. RICHTER),

Ger.(Oberscheld); 2a,b, incompl. ceph., pyg., $\times 8$ (460, mod.).

C. (Cyrto-dechenella) RICHTER & RICHTER, 1950 [*C. (Cyrto-dechenella) *cyrto*]. Cephalon with broad (*sag.*) preglabellar field, frontal border missing or very narrow rim present; 2*p* and 3*p* lateral furrows indistinct; occipital ring abruptly narrowing toward sides and then expanding near ends; palpebral lobes extending far backward with anterior ends rather distant from glabella; posterior sections of facial sutures close to glabella and then turning outward nearly at right angles; librigenae slightly vaulted. Pygidium relatively long, with broad steeply sloping border that is not delimited from pleural fields by furrow; axis with 10 or 11 rings; pleural fields with 7 distinct ribs. *M.Dev.* *Low.U.Dev.*, Eu.—FIG. 298,10. *C. (C.) *cyrto*, *M.Dev.*(Givet.), Ger.(Eifel); 10a-c, cran., librigena, pyg., $\times 6$ (474n).

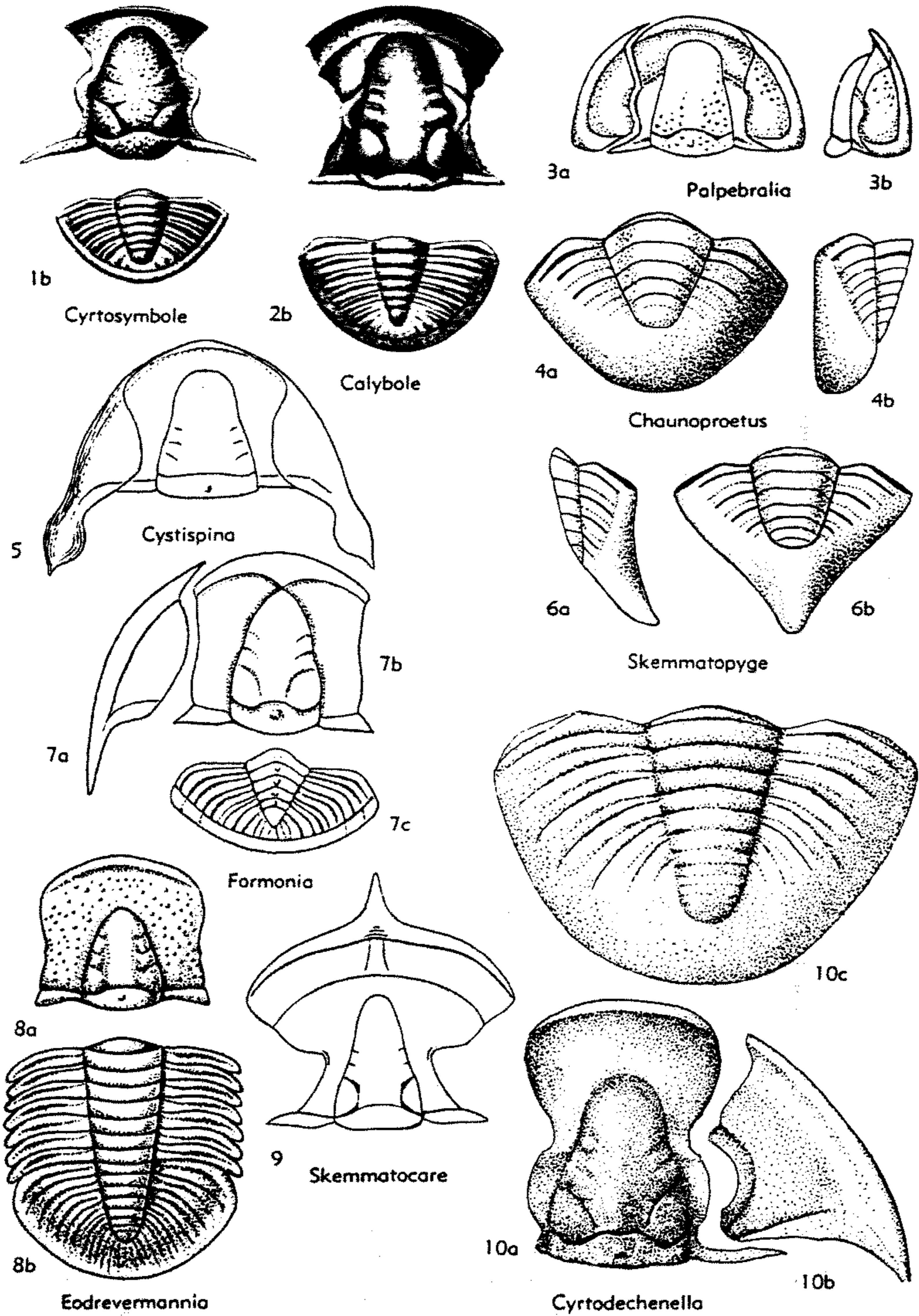

FIG. 298. Proetidae (Cyrtosymbolinae) (p. 0390-0394).

C. (Macrobole) RICHTER & RICHTER, 1951 [**Cyrto-symbole (Macrobole) drewerensis*]. Glabella moderately tapering, with obtuse front; palpebral lobes at mid-length of cephalon, narrow, moderately curved; anterior sections of facial sutures moderately divergent, posterior sections long, parallel to axial furrows behind eyes, turned abruptly outward in border furrow. Pygidium somewhat broader than long, with indistinct border and long axis that bears 9 rings; pleural fields with 10 ribs, posterior segmental bands predominating. *Low.L.Carb., Ger.*—FIG. 299,1. **C. (M.) drewerensis*, Ger.(Sauerland); cran., $\times 3.3$ (461, mod.).

C. (Semiproetus) REED, 1943 [**Proetus (Semiproetus) twistonensis*]. Cephalon with distinct border, preglabellar field moderately broad (*sag.*), concave; glabella well defined, slightly pear-shaped, lateral furrows *3p* and *1p* moderately distinct, lateral lobes *1p* slightly detached from central area; occipital ring broad (*sag.*), with lateral parts indistinctly detached from middle part and somewhat broader (*sag.*), median occipital node present; palpebral lobes well developed, opposite lateral lobes *3p* and *2p*; anterior sections of facial sutures moderately diverging; eyes well developed on swelling of librigenae; border furrows broadly concave; long genal spines. Pygidium semielliptical, broader than long; axis prominent, broad, tapering backward; with about 13 flat rings, posterior margins of which curve backward mesially; with post-axial ridge; pleural lobes gently vaulted; 7 to 9 pairs of broad (*sag.*), flat ribs that show slight swelling where they begin to slope down to border; interpleural furrows faint; border flatly padded; no border furrow. *L.Carb., Eng.-?Ger.*—FIG. 296,2. **C. (S.) twistonensis* (REED), Lancs.; fragments, $\times 4$ (drawn by W. STRUVE from cast of type material, courtesy of A. G. BRIGHTON).

C. (Waribole) RICHTER & RICHTER, 1926 [**Cyrto-symbole (Waribole) warsteinensis*]. Glabella moderately tapering, with obtuse front; occipital ring narrowing laterally from middle but with broad ends, wider (*tr.*) than glabella; palpebral lobes reaching far backward; facial sutures close to axial furrows just in front and behind eyes, thence rather strongly diverging sideward. Pygidium with broad indistinct border; doublure broad, very convex upward. *U.Dev.-L.Carb., Eu.*—FIG. 299,5. **C. (W.) warsteinensis*, L.Carb., Ger.(Warstein); *5a*, cran. and librigenae, $\times 4$; *5b*, pyg., $\times 4.5$ (461, mod.).

Archegonus BURMEISTER, 1843 [**Calymene? aequalis* MEYER, 1831; SD HAWLE & CORDA, 1847] [= *Cylindraspis* SANDBERGER, 1850 (*non* FITZINGER, 1836)]. Cephalon moderately vaulted; frontal border a narrow rim; glabella slender, tapering, not rounded anteriorly or reaching the distinct but rather narrow anterior border fur-

row; occipital ring maintaining width (*sag.*) laterally or slightly broadening; palpebral lobes distinct, slightly behind mid-length of glabella; anterior sections of facial sutures moderately divergent, posterior sections directed posterolaterally; librigenae with short, sharply pointed genal spines. Pygidium rather flat, slightly longer than semicircle; axis slender, well above pleural fields, with 8 or 9 distinct rings; abaxial part of pleural fields gently sloping, with 5 to 9 flat ribs consisting of nearly balanced anterior and posterior segmental bands, pleural furrows narrow, distinct, passing onto indistinct border, interpleural furrows visible only in anterolateral part of pleural fields; no border furrow. *L.Carb., Ger.*—FIG. 299,9. **A. aequalis* (MEYER), Culm (III), Herborn; *9a,b*, cran., librigena, $\times 4$ (461, mod.).

Phillibole RICHTER & RICHTER, 1937 [**P. aprathensis*]. Glabella slightly pear-shaped to tapering; occipital ring with broad ends, lacking lobes; palpebral lobes opposite mid-length of glabella with anterior ends nearest to glabella; anterior sections of facial sutures moderately long and divergent, posterior sections long, close and subparallel to axial furrows; posterior part of fixigenae narrow; librigenae with genal spines present or absent. Thorax with 9 segments. Pygidium semicircular or slightly elongate, without border; pleural fields with 11 or more segments. [Like *Liobole*, related to Phillipsiinae.] *L.Carb., Eu.*—FIG. 299,4. **P. aprathensis*, Ger.(Aprath); cran., $\times 2$ (461, mod.).

Liobole RICHTER & RICHTER, 1949 [**Phillipsia glabra* HOLZAPFEL, 1889]. Glabella with subparallel sides; ends of occipital ring very wide, occipital lobes present but not separated; palpebral lobes in front of mid-length of cranium, very short and narrow, with margins only slightly curved and anterior ends nearest to glabella; anterior sections of facial sutures short, little divergent, posterior sections very long, strongly divergent; posterior part of fixigenae long, broadening uniformly to posterior margin. [*Liobole* combines pygidial features of the *Cyrto-symbole* with cephalic characters of the Phillipsiinae.] *L.Carb., Eu.*—FIG. 299,2. **L. glabra* (HOLZAPFEL), Ger.; cran., $\times 2$ (461, mod.).

Liobolina RICHTER & RICHTER, 1951 [**L. nebulosa*]. Glabella subparallel-sided; ends of occipital ring slightly narrowed, not vaulted, without lobes; palpebral lobes very indistinct, nearly at mid-length of cranium, with anterior ends nearest to glabella; anterior sections of facial sutures nearly parallel, posterior sections long, subparallel near palpebral lobes, then strongly divergent toward posterior margin; posterior part of fixigenae narrow, with long prolongation on posterior border. [Relations to Phillipsiinae like *Liobole*.] *L.Carb., Eu.*—FIG. 299,3. **L. nebulosa*, Ger.(Sauerland); cran., $\times 2.7$ (461, mod.).

Drevermannia RUD. RICHTER, 1909 [*Drevermannia schmidti* RUD. RICHTER, 1913]. Glabella tapering, anterior part in some species finger-shaped; occipital ring narrowing laterally, without lobes;

facial sutures distant from glabella, nearly straight; without palpebral lobes (except indicated in some *Palpebralia*), no visual area; librigenae moderately vaulted, pointed or spine-bearing. Thorax (as far

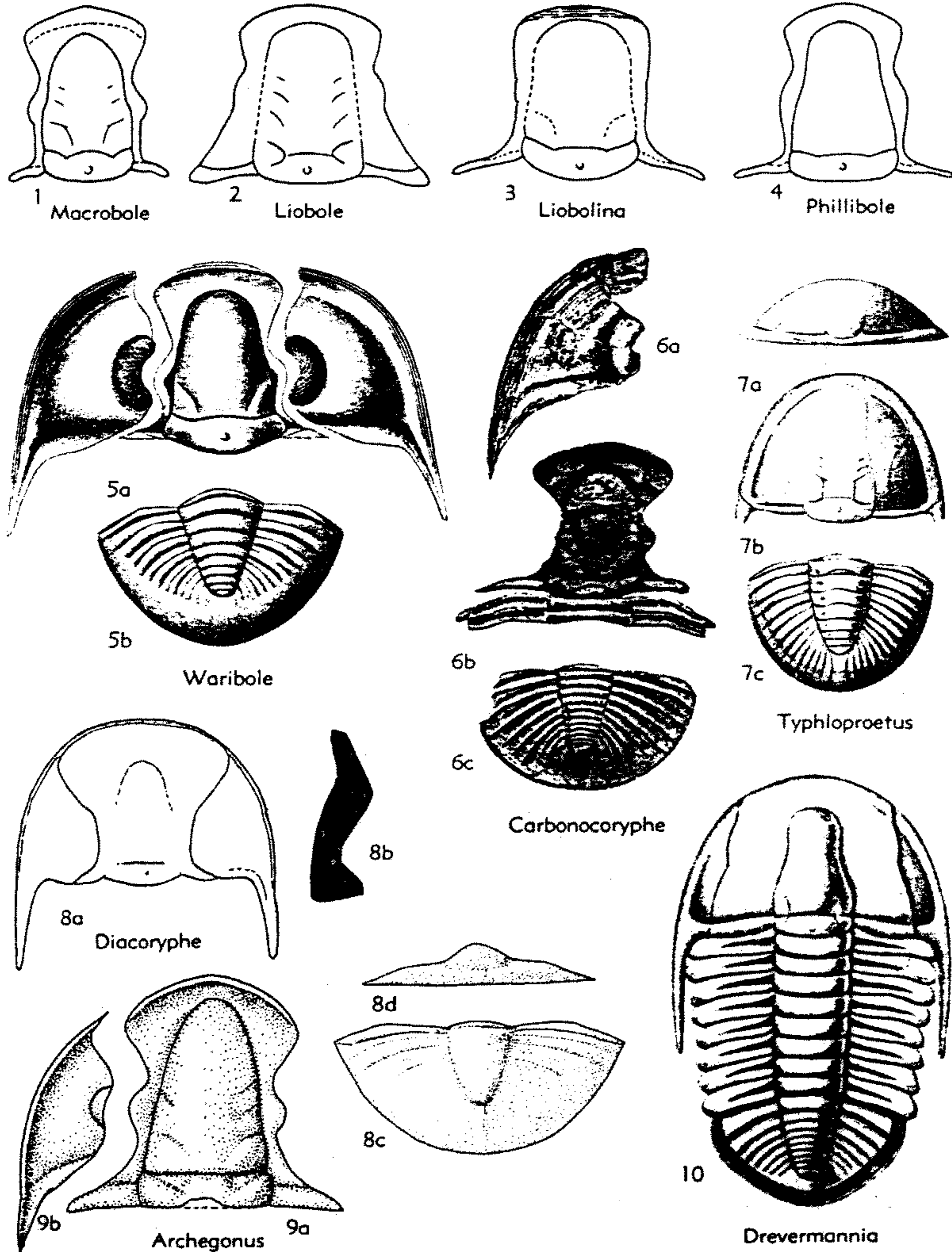

FIG. 299. Proetidae (Cyrtosymbolinae) (p. 0392-0395).

as known) with 8 segments, ends pointed. Pygidium semicircular; axis with 5 to 11 rings; pleural fields with 6 to 10 ribs, pleural and interpleural furrows distinct. *Up.L.Dev.-L.Carb.*, Eu.

D. (*Drevermannia*). Preglabellar field minute. Pygidium with narrow convex border. *Up.U.Dev.-L.Carb.*, Eu.—FIG. 299,10. *D.* (*D.*) *pruvosti* RICHTER & RICHTER, *L.Carb.*, Menorca; exoskel., $\times 4$ (461).

D. (*Eodrevermannia*) PŘIBYL, 1946 [**D.* (*Eodrevermannia*) *bouškai*]. Cephalon with distinct narrow anterior border; preglabellar field broad, moderately convex; fixigenae very broad; genal angles pointed. Pygidium with slightly concave margin; axis short, with 6 to 11 rings; pleural fields wide, with 6 to 10 distinct ribs. *Up.L.Dev.-Low.M.Dev.*, Czech.—FIG. 298,8. **D.* (*E.*) *bouškai*; *8a,b*, cran., thorax and pyg., $\times 7$ (445a, mod.).

D. (*Formonia*) RICHTER & RICHTER, 1927 [**D.* *formosa* RUD. RICHTER, 1913]. Cephalon with distinct convex border; glabella narrow, appearing plunged into strongly vaulted fixigenae. Pygidium with narrow convex border; axis with 5 or 6 rings; pleural fields with 4 to 6 ribs. *U.Dev.*, Eu.—FIG. 298,7. **D.* (*F.*) *formosa*, (RUD. RICHTER), Ger.(Oberscheld); *7a-c*, librigena, cran., pyg., $\times 8$ (461n).

D. (*Palpebralia*) RICHTER & RICHTER, 1927 [**D.* *palpebralis* RICHTER & RICHTER, 1926]. Cephalon without distinct border; glabella rather stout; mostly with vestiges of eye ridges, some also showing indications of palpebral lobes. Pygidium with convex border, segmentation indistinct. *M.Dev.-U.Dev.*, Eu.-Afr.—FIG. 298,3. **D.* (*P.*) *palpebralis* RICHTER & RICHTER, *Low.U.Dev.*, Ger.(Langenaubach); *3a,b*, cran. with librigenae, dorsal, side, $\times 5$ (461).

Chaunoproctus RICHTER & RICHTER, 1919 [**Proctus palensis* RUD. RICHTER, 1913]. [= *Drevermannia* (*Carnicia*) RICHTER & RICHTER, 1927]. Cephalon highly vaulted, with anterior border concave, erect; no preglabellar field; glabella stout, anterior end broadly rounded, with 4 pairs of lateral furrows; occipital ring broad, narrowing laterally, no lobes; facial sutures nearly straight, coalesced, crossing posterior border furrow on ridge; no palpebral lobes or eyes; genal angles rounded. Pygidium vaulted, laterally and posteriorly down curved steeply to margin, without border or border furrow; axis short, no axial ridge; segmentation fading on posterior region; doublure parallel to very convex upper test. *U.Dev.*, Eu.—FIG. 298,4. **C.* *palensis* (RUD. RICHTER), Ger.(Ebersdorf); *4a,b*, pyg., $\times 6$ (461).—FIG. 300,2. *C.* *carnicus* (RUD. RICHTER), Austr. (Carnic Alps); *2a,b*, ceph., $\times 4$ (460).

Skemmatopyge RICHTER & RICHTER, 1919 [**S.* *tietzei*]. Pygidium triangular, prolonged backward into point, very convex, without border or border furrow; axis short; with few rings; pleural fields

with few broad low ribs. *U.Dev.*, C.Eu.—FIG. 298,6. **S.* *tietzei*, Ger.(Ebersdorf); *6a,b*, pyg., $\times 6$ (461).

Skemmatocare RICHTER & RICHTER, 1927 [**Otarion elegans* MÜNSTER, 1842]. Cephalon (possibly belonging to pygidium named *Skemmatopyge*) narrow, with flat border bearing frontal spine; preglabellar field broad (*sag.*), anterior part concave, sharply defined from convex posterior part; glabella slender triangular, with pair of ovoid separated *1p* lateral lobes; occipital ring with narrowed ends, without lobes; posterior sections of facial sutures long, directed outward, forming sharp angle with anterior sections. *U.Dev.*, C.Eu.—FIG. 298,9. **S.* *elegans* (MÜNSTER), Ger. (Wildungen); cran., $\times 6.5$ (461n).

Cystispina RICHTER & RICHTER, 1939 [**Phillibole?* (*Cystispina*) *cystispina* RICHTER & RICHTER, 1939]. Cephalon with narrow preglabellar field; glabella tapering with broad front; no occipital lobes; palpebral lobes slightly curved or absent; facial sutures curved, anterior sections divergent; eyes very narrow or visual area missing; fixigenae with broad posterior areas; inflated genal spines. Pygidium with narrow, slightly tapering axis, distant from posterior margin; border not separated. *L.Carb.*, Eu.—FIG. 298,5. **C.* *cystispina* (RICHTER & RICHTER), Ger.(Frankenau); ceph., $\times 5$ (461).

?*Carbonocoryphe* RICHTER & RICHTER, 1950 [**Carbonocoryphe bindemanni*]. Cephalon with broad preglabellar field, concave, without border, margin sharp; glabella tapering gently, with rather long glabellar region in front of *3p* furrows; occipital ring not narrowed laterally, no lobes; palpebral lobes distant from posterior border furrow; anterior sections of facial sutures strongly divergent, posterior sections long, increasingly divergent; librigenae broad, flat, continuing gradually into broad, sickle-shaped genal spines. Thoracic segments (number unknown) with sickle-shaped ends. Pygidium large, without border or border furrow; axis rather long, narrow, with 12 rings and axial ridge; pleural fields with 9 or 10 ribs that (unlike *Tropidocoryphinae*) consist predominantly of posterior segmental bands, higher than anterior; interpleural furrows distinct. Doublure extremely broad. [*Carbonocoryphe* possesses some characters of genera assigned to *Tropidocoryphinae* and *Phillipsiinae*.] *L.Carb.*, Ger.—FIG. 299,6. **C.* *bindemanni*, Herborn; *6a-c*, librigena, cran., pyg., $\times 2$ (461).

?*Diacoryphe* RICHTER & RICHTER, 1951 [**Diacoryphe pfeifferi*]. Cephalon with very broad slightly concave preglabellar field, no border; glabella tapering, glabellar region in front of (only indicated) pair of *3p* furrows long; axial furrows obsolete; occipital ring narrowed laterally, confluent with glabella and fixigenae; anterior sections of facial sutures strongly divergent, palpebral lobes and eyes minute or lacking; genal

spines long. Pygidium shorter than semicircle; axis narrow, short, with 8 barely discernible rings, axial ridge present; pleural fields with 3 faint ribs (in space for 7), broadening outward, anterior segmental bands somewhat broader than posterior. [Some features correspond to *Pteroparia*.] *Low.L. Carb., Ger.*—FIG. 299,8. **D. pfeifferi*, Saalfeld; 8a, ceph.; 8b, cran., side; 8c,d, pyg., dorsal, post.; all $\times 4$ (461n).

?*Typhloproetus* RUD. RICHTER, 1913 [**T. microdiscus*] [= *Helioproetus* RICHTER & RICHTER, 1918]. Cephalon forming high uniform vault that includes glabella and genae; border furrow incised; glabella reaching border, long, slender; glabellar region in front of *3p* furrows long; axial furrows generally obsolete; occipital ring narrowed laterally, no lobes; facial sutures coalesced, anterior sections divergent, supramarginal nearly throughout; palpebral lobes and eyes vestigial or entirely vanished; with genal spines. Pygidium elongate semicircular, vaulted, without distinct border; axis short, slender, with about 8 rings, axial ridge present; pleural fields with 6 to 10 radiating ribs, anterior segmental bands broader than posterior, pleural and interpleural furrows equally distinct. *Up.U.Dev.-L.Carb., Eu.*—FIG. 300,1. **T. microdiscus*, U.Dev., Austr.(Carn.Alps); 1a-c, ceph., $\times 4$ (460).—FIG. 299,7. *T. subcarinthiacus* (RUD. RICHTER), U.Dev., Ger.(Sauerland); 7a-c, ceph., pyg., $\times 4$ (461).

Subfamily PROETIDELLINAE Hupé, 1953

Exoskeleton depressed, 8 to 20 mm. in length. Cephalon with broad (*sag.*) preglabellar field; glabella tapering forward, suboval or trapezoidal, *1p* lateral furrows distinct; anterior sections of facial sutures long, strongly divergent; eyes large, restricted to posterior half-length of cephalon, tending to be strongly crescentic; librigenae broad, slightly vaulted uniformly, extended into broad genal spines. Thorax with 9 or 10 segments. Pygidium rather long, nearly semicircular, entire; axis narrow, long, with 6 to 11 rings; pleural fields with 4 to 7 ribs, radiating, broadening outward, segmental bands and furrows diverging. *M.Ord.-M. Dev.*

Proetidella BANCROFT, 1949 [**Proetidella fearnsidesi*]. Cephalon with moderately broad preglabellar field, anterior part ascending; glabella short, with subangular front; occipital ring broad, lobes indicated. Thorax with 10 segments (20 mm. long.), ends sharply pointed. Pygidium with axis having 10 rings; pleural fields with about 6 ribs curved backward. *M.Ord.(Caradoc.), Eng.*—FIG. 301,1. *P. fearnsidesi*, Shrops.; exoskel., $\times 2$ (2).

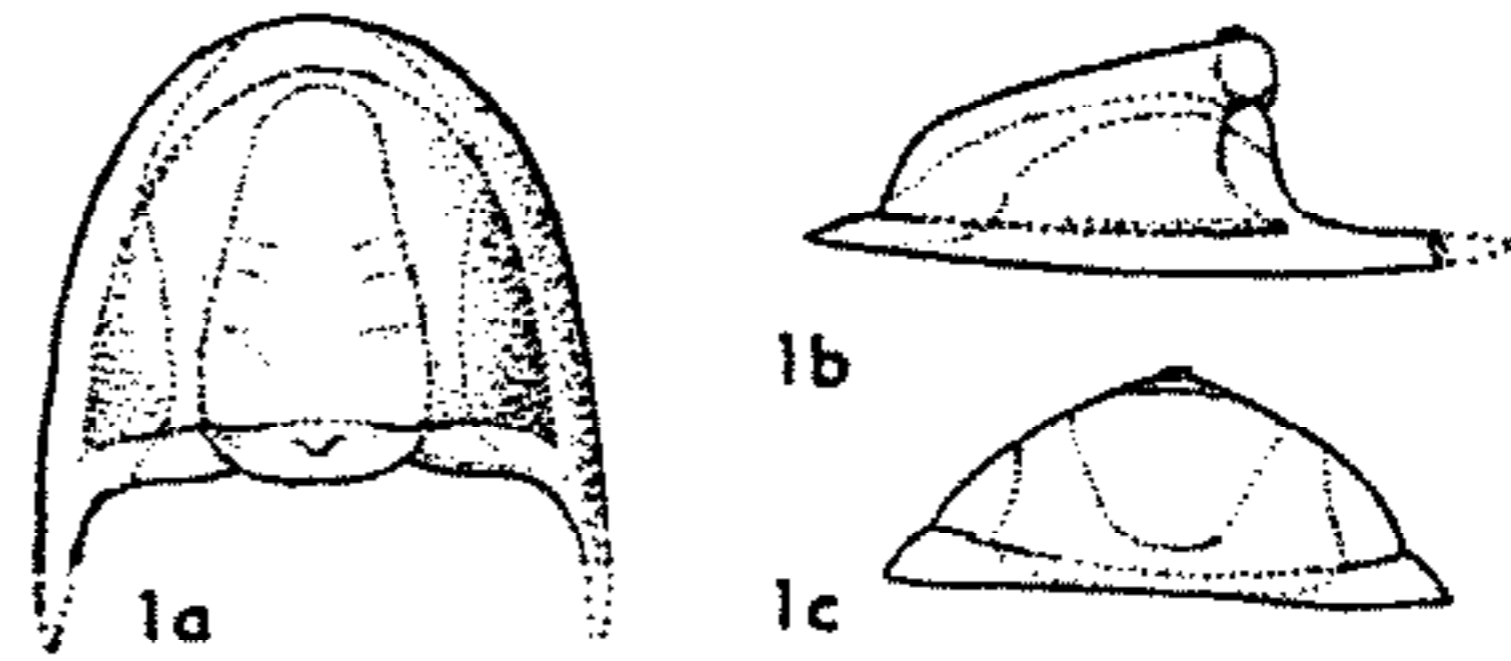

Typhloproetus

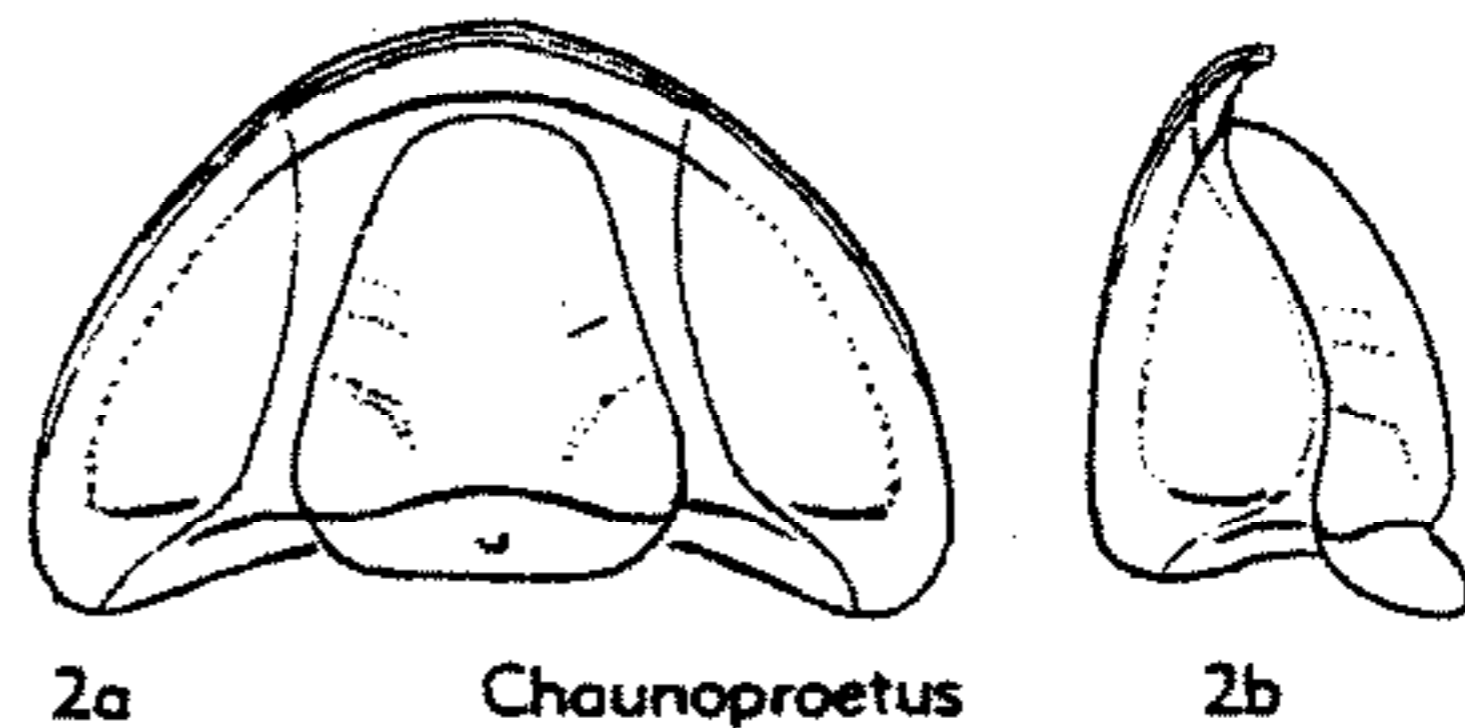

Chaunoproetus

FIG. 300. Proetidae (Cyrtosymbolinae) (p. 0394-0395).

Astroproetus BEGG, 1939 [**Astroproetus reedi*]. Cephalon with preglabellar field scarcely 0.7 of length of glabella; glabella trapezoidal, gently tapering; eyes long, strongly arcuate. Thorax with 10 segments (length 16 mm.). *U.Ord.(Ashgill.), G.Brit.*—FIG. 301,4. **A. reedi*, Scot.(Girvan); exoskel., $\times 1.5$ (375).

Clypoproetus BEGG, 1939 [**Clypoproetus asteroides*]. Cephalon with preglabellar field nearly 0.7 of length of broadly subtriangular glabella, which has *1p* lobes separated. Thorax with 9 segments (length 8 mm.). Pygidium with axis containing 6 rings; pleural fields with 6 ribs. *U.Ord.(Ashgill.), G.Brit.*—FIG. 301,5. **C. asteroides*, Scot.(Girvan); exoskel., $\times 2.2$ (375).

Paryfenus HADDING, 1913 [*pro Colymbus* HADDING, 1913 (non LINNÉ, 1758, nec PAETEL, 1875)] [**Colymbus louisae* HADDING, 1913]. Glabella finger-shaped, reaching close to broad anterior border; *1p* lateral glabellar lobes egg-shaped, detached, about 0.125 of glabellar length (*exsag.*); palpebral lobes semicircular, 0.2 of glabellar length, close to glabella and posterior border furrow; anterior sections of facial sutures strongly divergent. *Low.M.Ord., Swed.*

Prantlia PŘIBYL, 1946 [**Proetus longulus* HAWLE & CORDA, 1847]. Cephalon and thorax like those of *Clypoproetus*; lobes of occipital ring distinct, long (*tr.*). Pygidium very large, considerably longer than semicircle; tapered axis long and narrow, with 11 distinct rings, axial ridge short; pleural fields with 6 or 7 ribs with narrow low anterior segmental bands and high posterior ones, broadening outward. *U.Sil., Eu.*—FIG. 301,6.

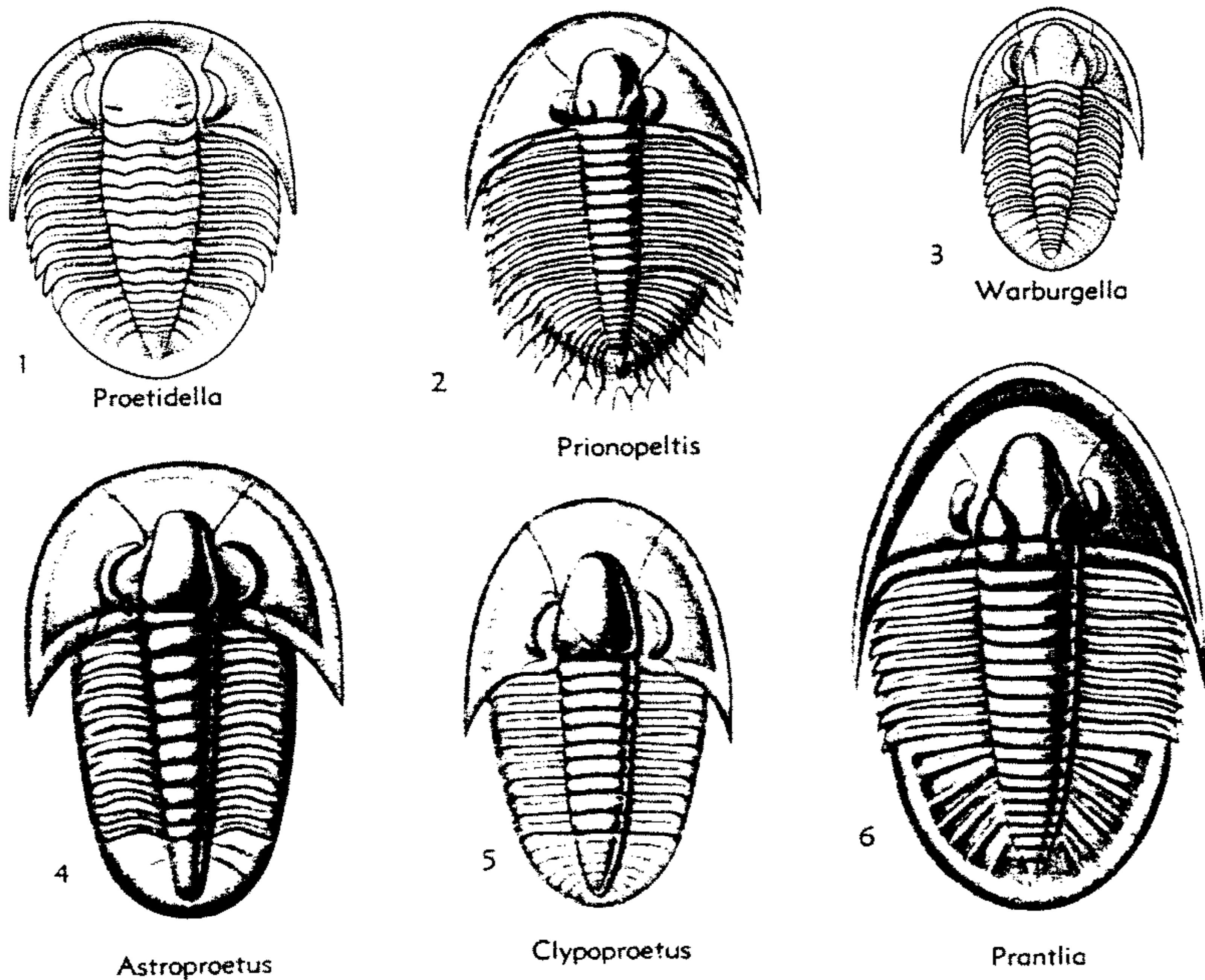

FIG. 301. Proetidae (Proetidellinae) (p. 0395-0396).

**P. longula* (HAWLE & CORDA), Czech.; exoskel., $\times 2.7$ (445a).

?*Prionopeltis* HAWLE & CORDA, 1847 [*pro Phaeton* BARRANDE, 1846 (*non* LINNÉ, 1758)] [**Phaeton archiaci* BARRANDE, 1846; SD VOGDES, 1925] [= *Prionurus* HAWLE & CORDA, 1847, p. 288 (*non* LACÉPÈDE, 1804; *non* RAFINESQUE, 1815; *non* HEMPRICH & EHRENBURG, 1829); *Phaetonides* ANGELIN, 1854]. Cephalon with outer border rather narrow, border furrow distinct and preglabellar field conspicuous; glabella short, scarcely tapering, with broad rounded front, *1p* lateral lobes separated; anterior sections of facial sutures long, strongly divergent; librigenae broad, continuing into long furrowed genal spines; visual surface of eyes large but short. Thorax with 10 segments, pleurae with pointed ends. Pygidium large; axis long and narrow, with 9 or 10 rings; pleural fields with 4 to 7 pleurae that continue into marginal spines; no border or border furrow. *Sil.-M.Dev.*, Eu.—FIG. 301,2. **P. archiaci* (BARRANDE), *Sil.* (c beta Zone), Czech.; exoskel., $\times 1.5$ (3).

?*Pseudoproetus* POULSEN, 1934 [**Proetus (Pseudoproetus) regalis*]. Cephalon with narrow border and distinct border furrow, preglabellar field long (*sag.*); glabella short, semioval, glabellar region in front of *2p* furrows short; occipital ring not narrowed laterally, lobes distinct; palpebral lobes short, eye ridges distinct; anterior sections of facial sutures almost straight and subparallel; librigenae moderately convex, genal spines furrowed. Pygidium longer than semicircle; axis narrow, touching narrow convex border, with 12 or 13 rings; pleural fields with 10 faint furrowed ribs. *Sil.(Llandov.)*, Greenl.—FIG. 302,2. **P. regalis* (POULSEN); 2a-c, cran., librigena, pyg., $\times 2$ (445).

?*Warburgaspis* PŘIBYL, 1946 [**Proetus modestus* TÖRNQUIST, 1884]. Cephalon as in *Proetus (Proetus)*, but librigenae and pygidium as in *Proetidella*. Thorax with 10 segments (total length 14 mm.). *Ord.(Ashgill.)*, Swed.

?*Warburgella* REED, 1931 [**Asaphus stokesii* MURCHISON, 1839]. Cephalon as in *Proetus (Cyphoproetus)* but with narrow convex preglabellar

field. Thorax with 10 segments (length 13 mm.). Pygidium like that of *Proetidella*. *Sil.*(Wenlock.), Eng.—FIG. 301,3. **W. stokesii* (MURCHISON), Dudley; exoskel., ×2 (495).

Subfamily TROPIDOCORYPHINAE Přibyl, 1946

Cephalon with large preglabellar field marked by narrow ridge (tropidia) concentric to border; glabella short (0.5 to 0.7 length of cephalon), narrow, tapering, front rounded to truncate; glabellar region in front of *3p* furrows very short, *1p* lateral lobes not separated; occipital ring not narrowed laterally, without lobes; genal spines

furrowed. Thorax with 9 or 10 segments, ends sickle-shaped. Pygidium entire; slender tapering axis with 6 to 9 rings, axial ridge present; pleural fields with 5 to 7 ribs developed as sharp, wide-spaced ridges consisting only of anterior segmental bands, pleural furrows broad, interpleural furrows faint. Shell thin, doublure broad. *Sil.-Low. U.Dev.*

Tropidocoryphe Novák, 1890 [**T. flicostata*; SD VOGDES, 1925]. Cephalon depressed, margin sharp, without border or rim; glabella about 0.5 of length of cephalon; anterior sections of facial su-

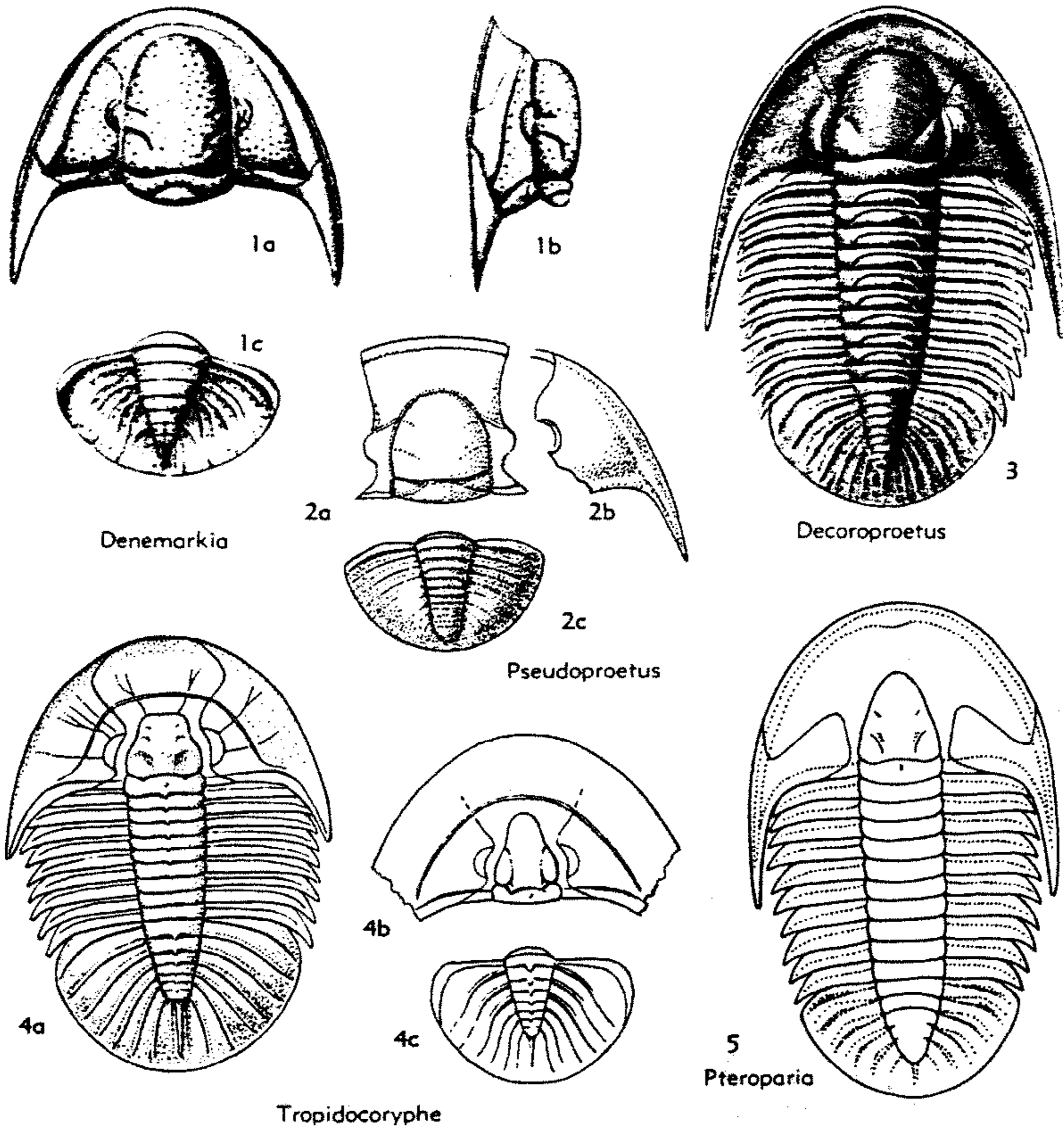

FIG. 302. Proetidae (Proetidellinae, Tropidocoryphinae) (p. 0396-0398).

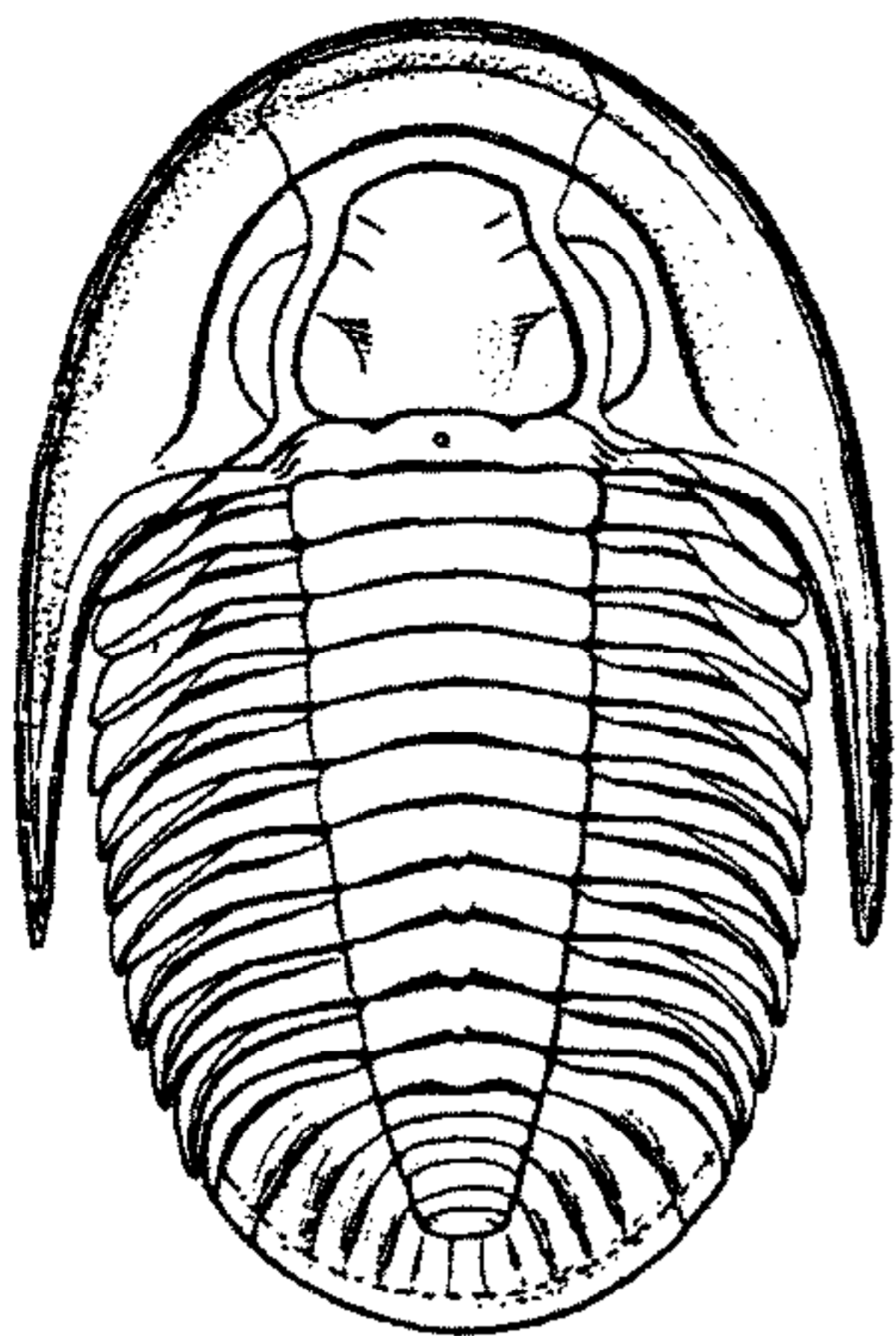

FIG. 303. *Astycoryphe senckenbergiana* RICHTER & RICHTER (Proetidae), M.Dev., Ger.; exoskel., $\times 4$ (461, 1919).

tures strongly divergent, marginal in front; genae commonly with radiating "vascular" ridges, genal spines prominent, stout. Thorax with 9 segments. Pygidium large, length equaling thorax, margin sharp without border; axis short; pleural region large, flat. M.Dev., Ger.—FIG. 302,4b,c. **T. filicostata*, Bicken; 4b,c, ceph., pyg., $\times 2$ 461, mod.).—FIG. 302,4a. *T. barroisi* (MAILLIEUX), Gerolstein; exoskel., $\times 2.7$ (474n).

Astycoryphe RICHTER & RICHTER, 1919 [**Astycoryphe senckenbergiana*]. Cephalon moderately vaulted with convex border and distinct border furrow; glabella about 0.7 of length of cephalon; anterior sections of facial sutures moderately divergent. Thorax with 10 segments. Pygidium vaulted, 0.5 of length of thorax; axis moderately long. M.Dev., Ger.—FIG. 303. **A. senckenbergiana*, Gerolstein; exoskel., $\times 6$ (461).

?*Decoroproetus* PŘIBYL, 1946 [**Proetus decorus* BARRANDE, 1846]. Cephalon depressed, with narrow rim; preglabellar field broad (sag.), distally concave, proximally convex; glabella nearly rectangular; occipital ring, genae and genal spines resembling those of *Astycoryphe*. Thorax with 10 segments, ends pointed. Pygidium like that of *Tropidocoryphe*. Sil.-M.Dev., Eu.—FIG. 302,3. **D. decorus* (BARRANDE), Sil., Czech.; $\times 2.4$ (3).

Denemarkia PŘIBYL, 1946 [**Proetus frontalis* HAWLE & CORDA, 1847]. Cephalon vaulted, with narrow anterior rim, tropidia present; glabella long, scarcely tapering; 1p and 2p lateral furrows distinct; occipital ring narrowing laterally, no lobes; anterior sections of facial sutures strongly

divergent, posterior sections long, parallel to axial furrows; eyes small; librigenae continuing gradually into broad genal horns. Thorax with 10 segments, ends pointed. Pygidium similar to that of *Tropidocoryphe* but with broader and longer axis bearing 7 rings; pleural fields with 5 ribs. L.Dev., Czech.—FIG. 302,1. **D. frontalis* (HAWLE & CORDA) Koněprusy Ls., 1a,b, ceph., $\times 7$; 1c, pyg., $\times 10$ (445a).

?*Phyllaspis* REINH. RICHTER, 1863 [**P. raniceps*]. Cephalon ogival, flat; genal regions and preglabellar field very large; marginal part of cephalic border bent slightly upward, accompanied inward by 2 faint, flat, parallel swellings; glabella small, slender, flat, axial furrows distinct; lateral furrows faint, directed obliquely backward. [Poorly known genus established on a single, fragmentary cranidium that shows similarities to *Pteroparia* and *Astycoryphe*. Whether outline of posterolateral margin of figured fragment represents a facial suture or merely a fracture is uncertain.] M.Dev., Ger.—FIG. 304. **P. raniceps*, Tentaculiten-Schiefer, Thuringia; cephalon(incompl.), $\times 2$ (459).

Pteroparia RUD. RICHTER, 1913 [**P. columbella*]. Cephalon moderately vaulted; outer border convex, border furrow incised, without tropidia, preglabellar field broad; glabella tapering; occipital ring not narrowed laterally, no lobes; anterior section of facial sutures curved backward; palpebral lobes and eyes minute or missing; genal spines long. Pygidium resembling that of *Astycoryphe*. Low.U.Dev., Eu.-Austral.—FIG. 302,5. **P. columbella*, Ger.(Oberscheld); exoskel., $\times 6$ (460n).

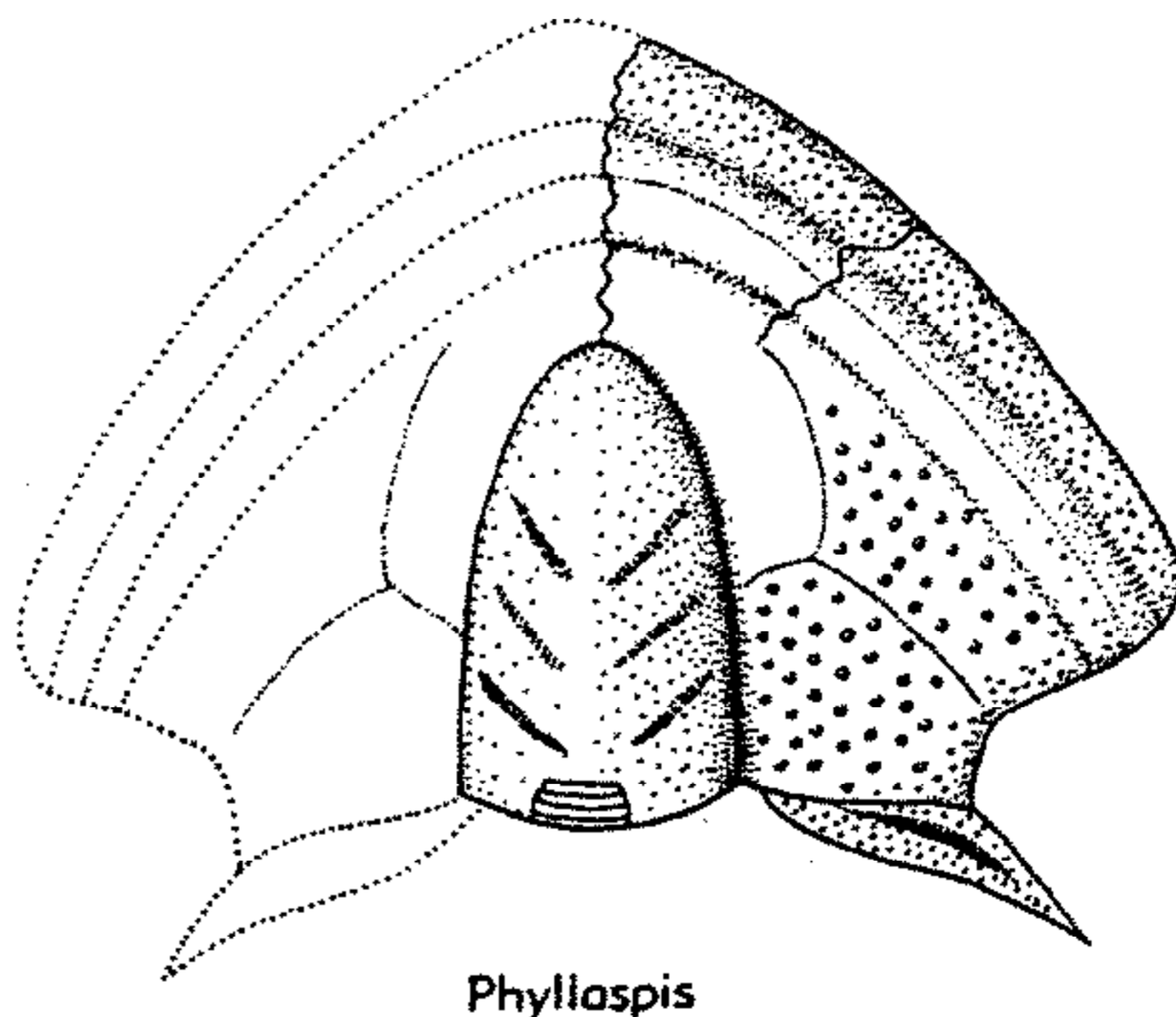

Phyllaspis

FIG. 304. **Phyllaspis raniceps* REINH. RICHTER (Proetidae), M.Dev., Ger.; incompl. cran., $\times 2$ (461, 1919).

Family PHILLIPSIIDAE Oehlert, 1886

[emend. HUPÉ, 1953]

Small (2 cm. maximum width); isopygous. Glabella long, generally expanded in front, generally reaching to or beyond anterior border furrow; lateral preoccipital lobes invariably present, lateral glabellar furrows 3 or 4, *Ip* distinct, others commonly indistinct; occipital ring normally without lobes. Thorax with 9 segments. Pygidium generally long, multisegmented (7 to 33 axial rings, 6 to 14 pleural ribs). Surface generally bearing granules, tubercles, or very short spines. *L. Carb. (Miss.)-M. Perm.*

Most phillipsiids are small trilobites (width 15 mm. or less). A few from Lower Mississippian strata have 10 thoracic segments, but all others, so far as known, have 9. All are distinguished by a comparatively large glabella that reaches to the anterior border furrow or even overhangs the frontal margin; none has a preglabellar field. Strength of the glabellar furrows varies greatly and their number seems not to be a character of generic significance. Likewise, the presence or length of genal spines is not a generic character. Segmentation of the pygidium varies between wide limits. In several phyletic lines segmentation increases in stratigraphically younger forms. Axial segments usually are more numerous than pleural segments and numerical discrepancy increases upward stratigraphically. Intra-pleural furrows generally are distinguishable at least on anterior segments but commonly they have not been described and they are not visible in most published figures. The pygidial axis of most Lower Carboniferous (Mississippian) forms is rather uniformly arched transversely, in later ones sides of the axis tend to become flattened and more and more steeply inclined posteriorly. The pygidial border is not well defined in some Lower Mississippian forms, but in later ones it is generally demarcated clearly and tends to be flattened, particularly anteriorly. In some Permian genera it becomes steeper behind and may be overturned behind the axis. Most forms have a prominent tubercle at the center of the occipital ring and most are ornamented with granules that are coarsest on the central and posterior parts of the glabella and

occipital ring. Segments of the thorax and pygidium commonly bear a row of granules along the posterior borders. A few Lower Mississippian forms have granules accentuated as short spines.

Phillipsia PORTLOCK, 1843 [emend. J. M. WELLER, 1936] [**P. kellii* (?= **Asaphus gemmuliferus* PHILLIPS, 1836); SD VOODES, 1890]. Glabella parallel-sided or slightly tapering forward, ending at anterior border furrow. Pygidium slightly wider than long, with axis uniformly arched transversely without sharply demarcated border. *L. Miss.-M. Miss., N. Am.; L. Carb., Eu.*—FIG. 305, 3. *P. gemmulifera* (PHILLIPS), *L. Carb., Eng.*; exoskel. (reconstr.), $\times 3.5$ (498).

Griffithides PORTLOCK, 1843 [emend. WELLER, 1936] [**G. longiceps*; SD VOODES, 1890] [= *Metaphillipsia* REED, 1943]. Cephalon semi-oval, eyes small, central or slightly posterior; like *Phillipsia* but glabella expanding forward, reaching or nearly reaching anterior margin, basal lobes of glabella long. Pygidium as in *Phillipsia* but with fewer segments. *L. Miss.-M. Miss., N. Am.; L. Carb., Eu.*—FIG. 306, 1. **G. longiceps*, *L. Carb., Eng.*; *a, b*, ceph., pyg., $\times 3.5$ (498).—FIG. 306, 4. *G. seminiferus* (PHILLIPS), type species of *Metaphillipsia*, *L. Carb., Eng.*; exoskel. (reconstr.), $\times 1.7$ (498).

Eocyphinium REED, 1942 [**E. clitheroense*]. Cephalon subtriangular in outline, rounded in front, glabella nearly reaching anterior margin, contracted at mid-length, with indistinct median preoccipital lobe between lateral preoccipital lobes; occipital ring narrowed laterally; eyes posterior. Pygidium unknown. Surface coarsely pustulose. *L. Carb.; G. Brit.*—FIG. 305, 7. **E. clitheroense*, *Eng.*; ceph., $\times 2.7$ (452).

Bollandia REED, 1943 [**Asaphus globiceps* PHILLIPS, 1836]. Resembles *Griffithides* but cephalon distinctly subtriangular; glabella parallel-sided, overhanging front margin, with very large lateral preoccipital lobes; palpebral lobes extending well above eyes. Pygidium with broad axis; no well-defined border. *L. Carb., G. Brit.*—FIG. 305, 4. **B. globiceps* (PHILLIPS), *Eng.*; exoskel. (reconstr.), $\times 2$ (498).

Exochops WELLER, 1936 [**Phillipsia (Griffithides) portlocki* MEEK & WORTHEN, 1873]. Resembles *Bollandia* but relatively small eyes not covered by palpebral lobes. Pygidium with high, strongly tapering axis; without distinct border. *Low. M. Miss., C. USA.*—FIG. 306, 5. **E. portlocki* (MEEK & WORTHEN), *Ill.*; *5a, b*, ceph., pyg., $\times 2$ (491).

Kaskia WELLER, 1936 [**K. chesterensis* WELLER & WELLER in J. M. WELLER, 1936]. Glabella nearly parallel-sided, with large lateral preoccipital lobes; eyes medium-sized, central. Resembles *Griffithides* but pygidium has well-defined border and more

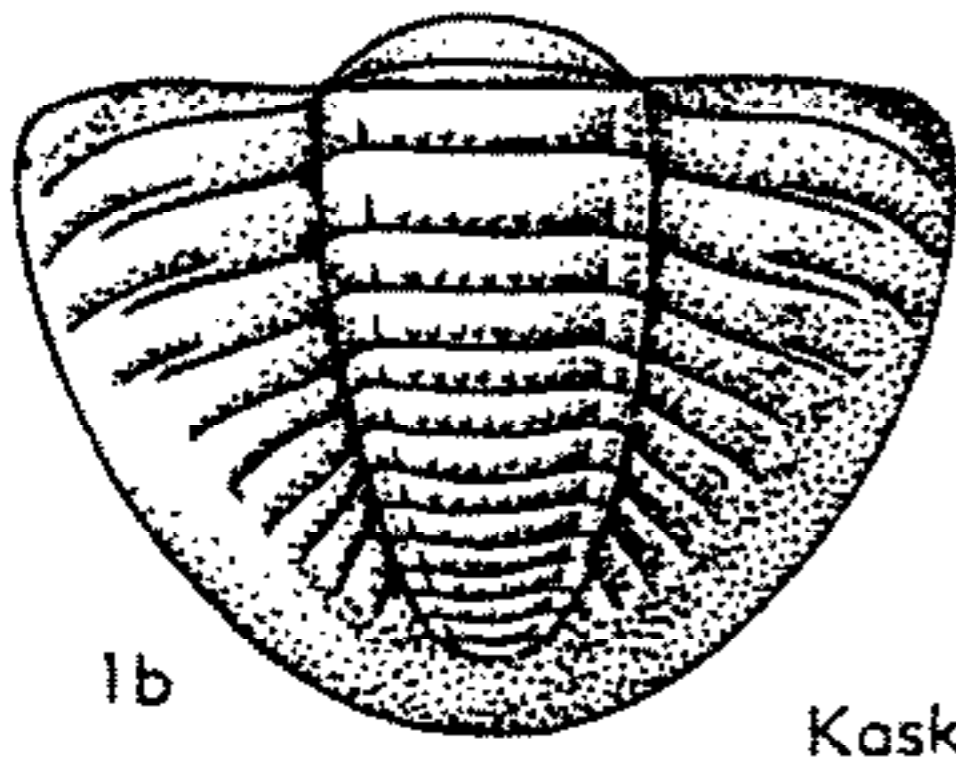

Kaskia

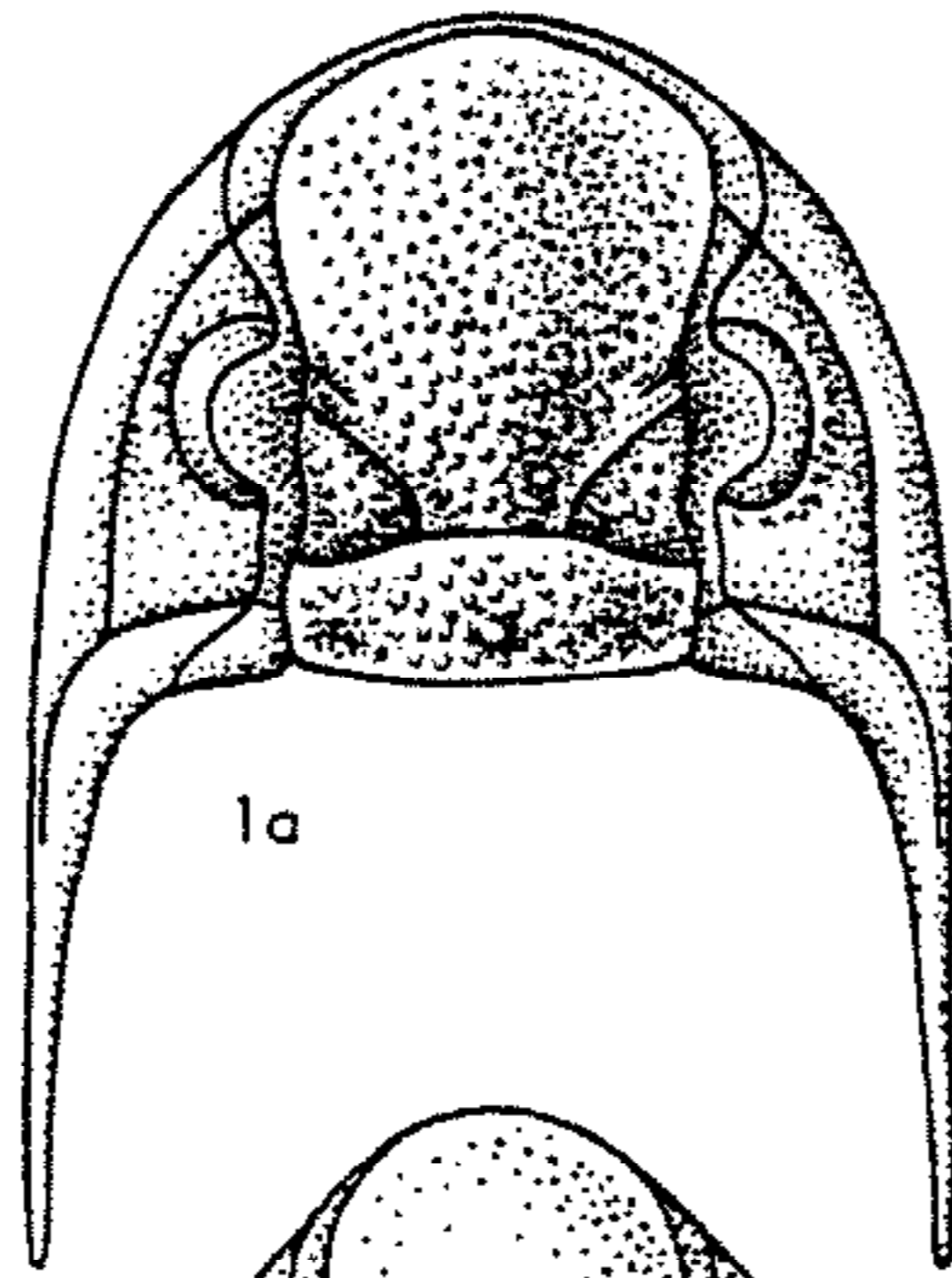

Bollandia

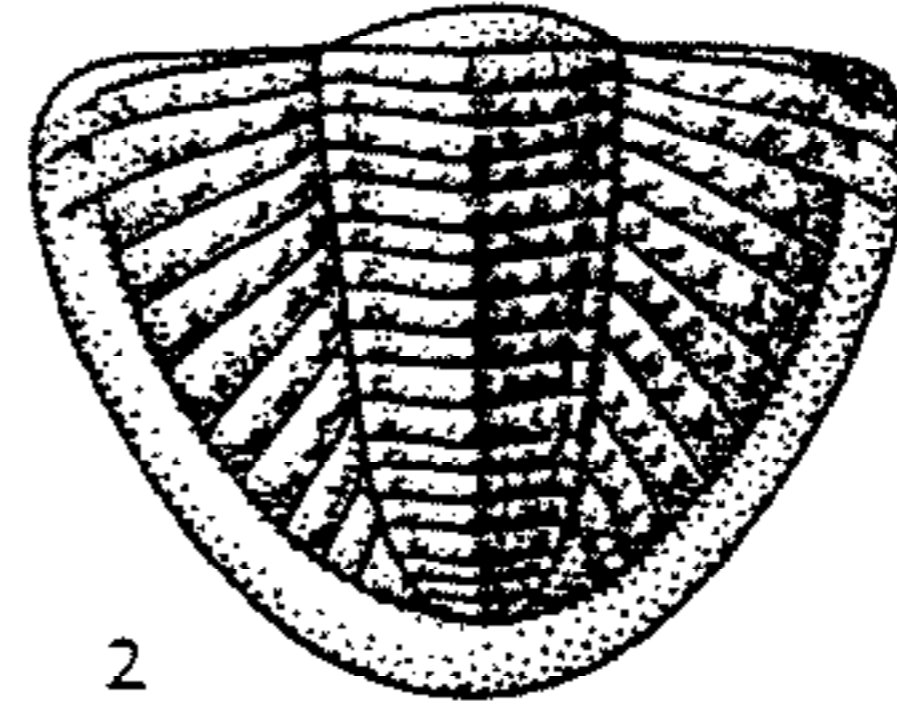

Paragriffithides

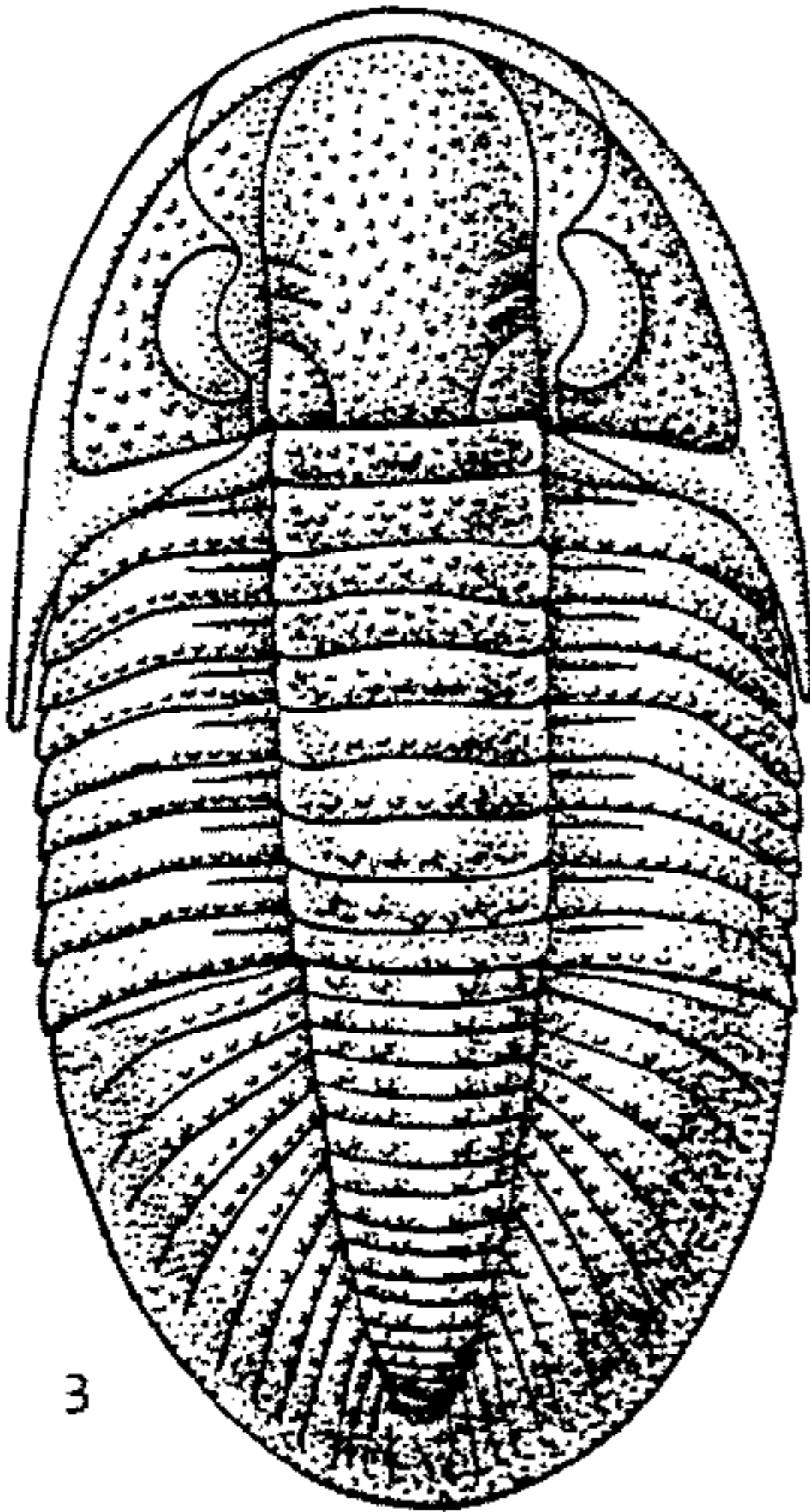

Phillipsia

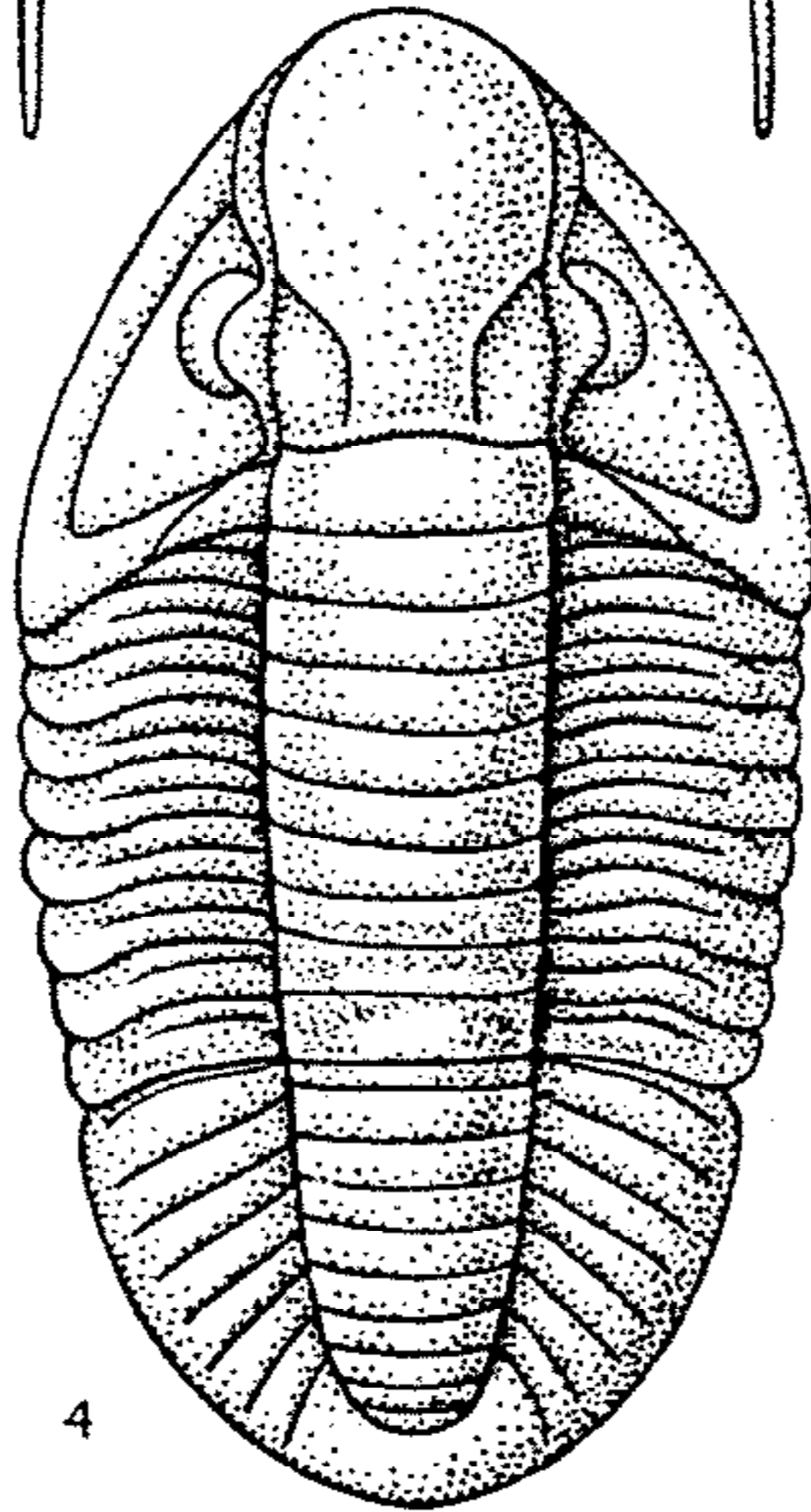

Bollandia

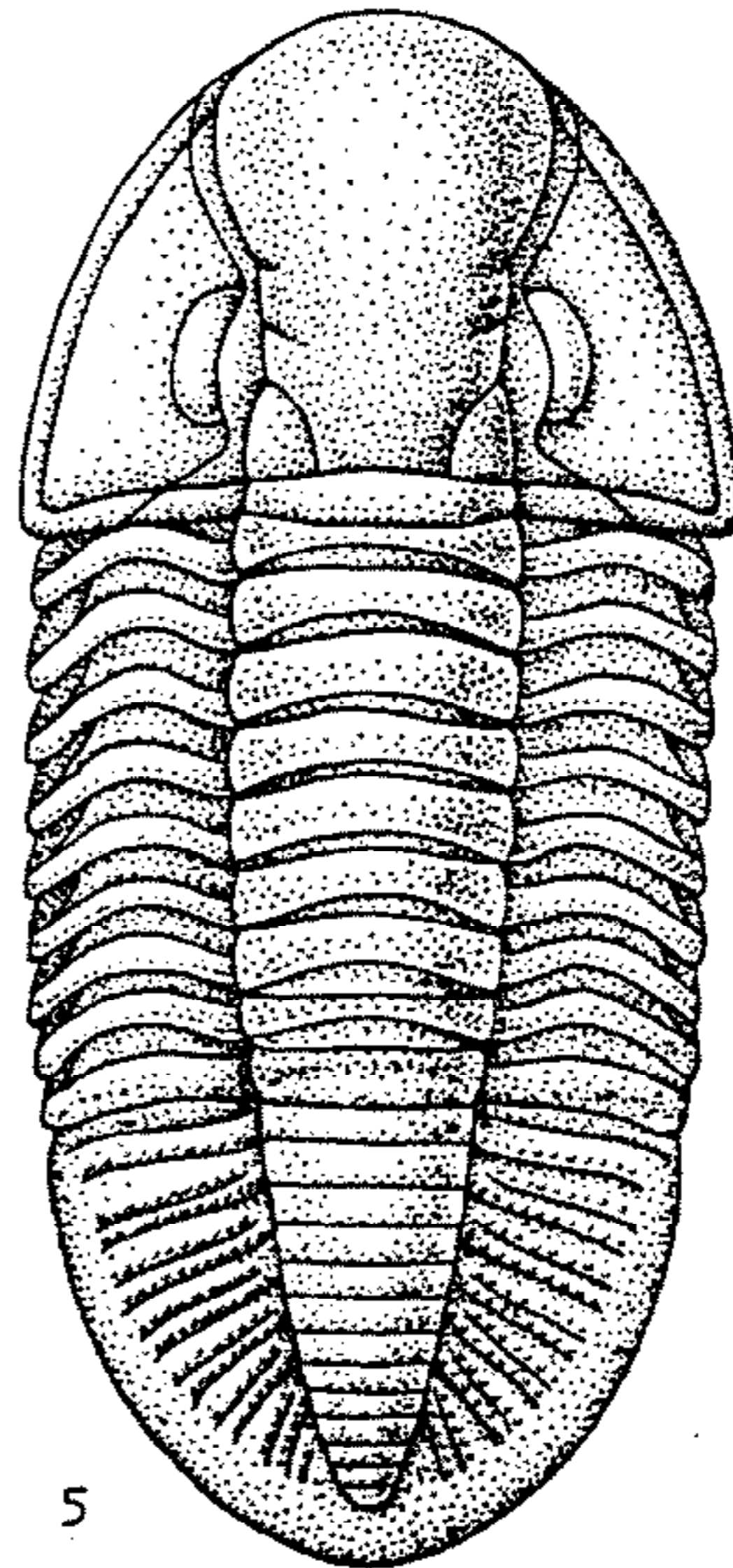

Humilogriffithides

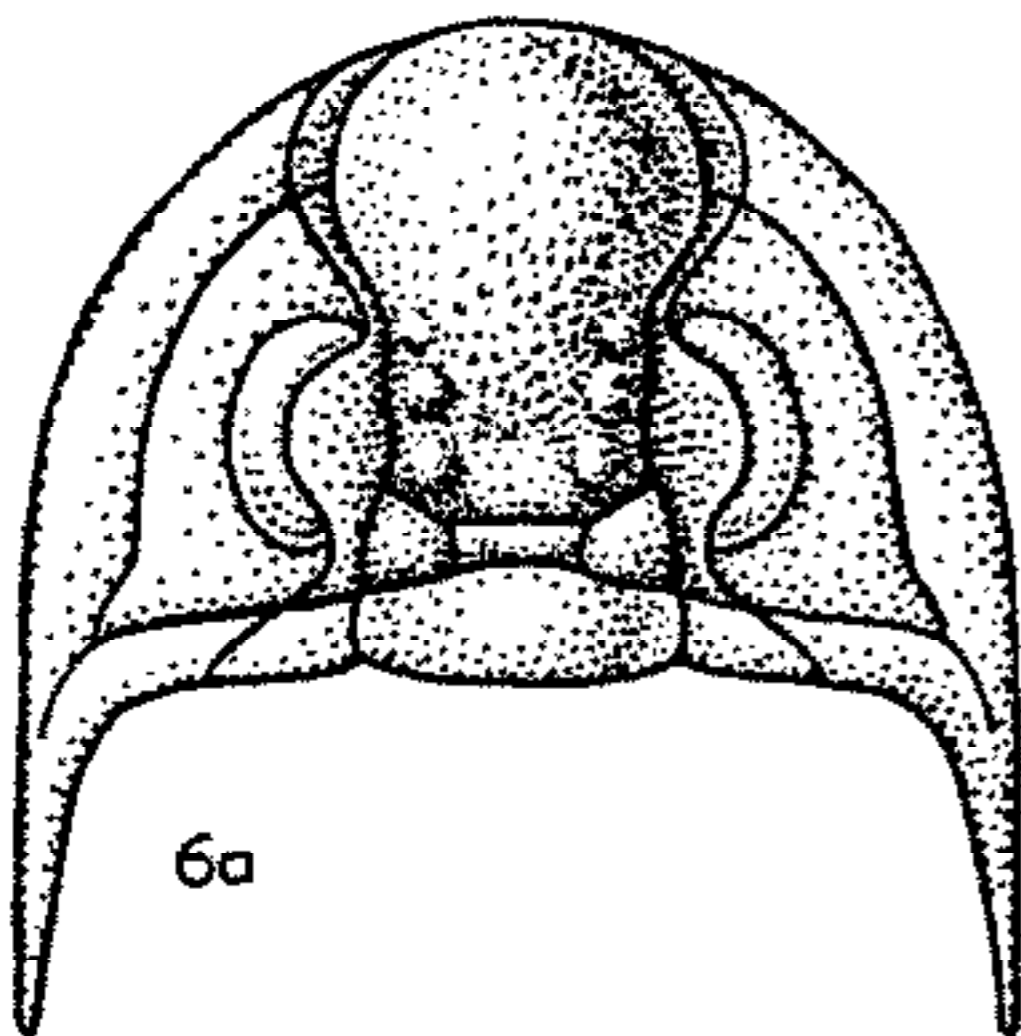

Delaria

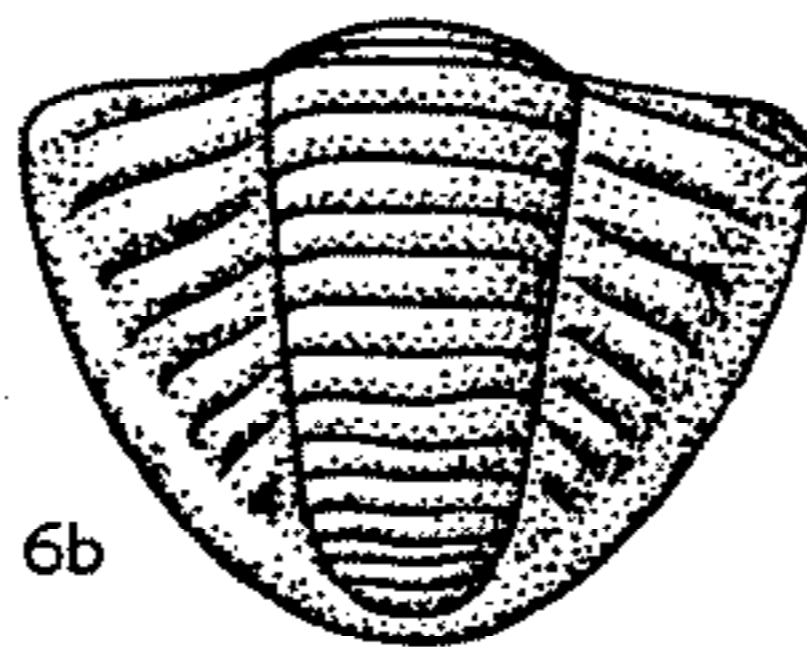

Kaskia

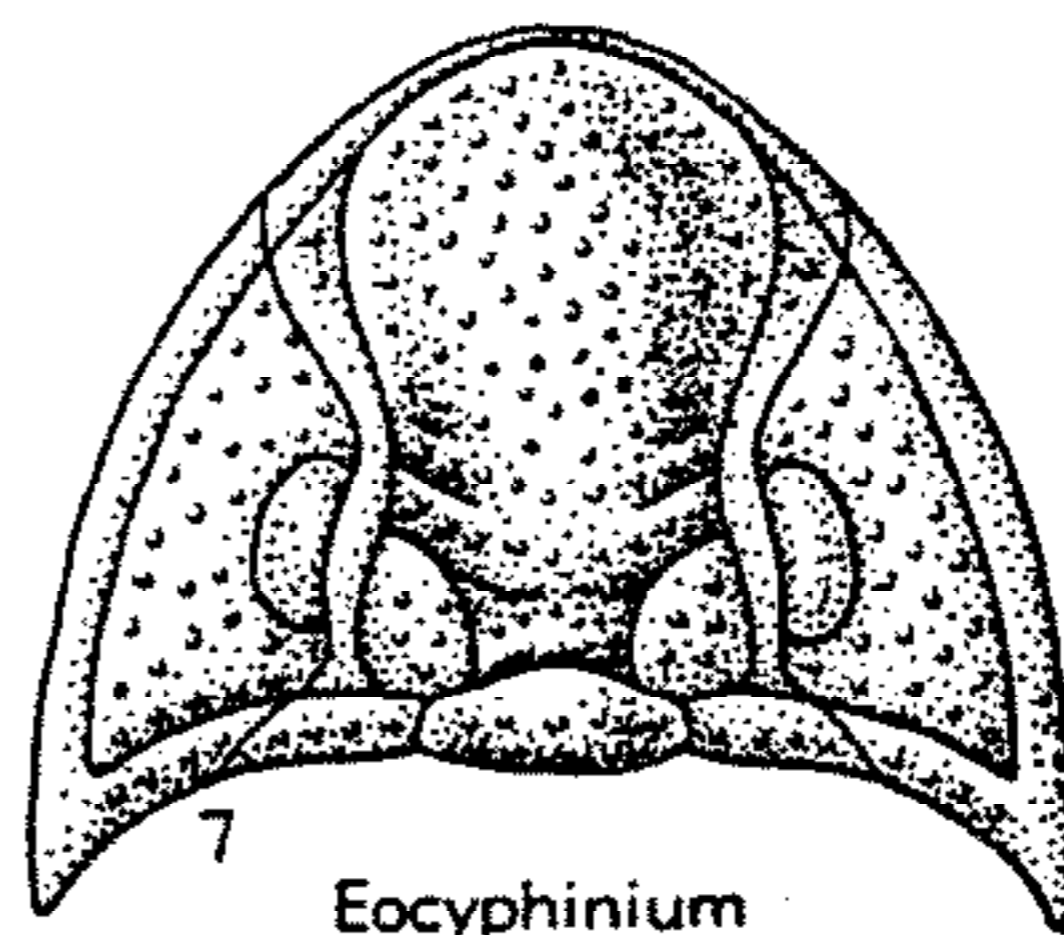

Eocyphinium

FIG. 305. Phillipsiidae (p. 0399-0401).

- prominent axis that tapers less strongly. *M. Miss.-L. Penn.*, USA.; *Low. U. Carb.*, Eu.—FIG. 305,1. **K. chesterensis*; U. Miss. (Chester.), Ill.-Ky.; 1a,b, ceph., pyg., $\times 3.3$ (491).
- Humilogriffithides** INAI, 1936 [**H. divinopleurus*]. Like *Kaskia* but glabella more expanded in front, eyes farther back, and occipital ring much narrower (*sag.*). Pygidium with more regularly tapered axis. *U. Carb.*, S. Manch.—FIG. 305,5. **H. divinopleurus*; exoskel. (reconstr.), $\times 3$ (412).
- Neogriffithides** TOUMANSKY, 1935 [**N. gemmellaroi*]. Like *Kaskia* but eyes smaller, farther forward, entirely in front of lateral preoccipital lobes of glabella. Pygidium with longer, more regularly tapered axis, and more numerous axial rings. *M. Perm.*, Crimea-Sicily.—FIG. 305,6. **N. gemmellaroi*, Crimea; exoskel. (reconstr.), $\times 2.6$ (485).
- Paragriffithides** REED, 1943 [**Phillipsia carinata* SALTER in WOODWARD, 1884]. Cephalon unknown. Pygidium like that of *Kaskia* but axis triangular in cross section. *L. Carb.*, G. Brit.—FIG. 305,2. **P. carinatus* (SALTER); pyg., $\times 3$ (498).
- Paladin** WELLER, 1936 [**Griffithides morrowensis* MATHER, 1915]. Like *Kaskia* but glabella only slightly expanded in front, encroaching on anterior border but not reaching anterior margin, slightly contracted opposite eyes, which are large and posterior in location. Pygidium with well-defined border. *M. Miss.-L. Perm.*, USA.; *Low. L. Carb.* Eu.—FIG. 306,3. **P. morrowensis* (MATHER), L. Penn., Ark.; 3a,b, ceph., pyg., $\times 3.8$ (491).
- Weberides** REED, 1942 [**Phillipsia mucronata* M'COY, 1844]. Like *Paladin* but glabella strongly expanded in front; eyes large, posterior. Pygidium with distinct border and commonly bearing terminal spine. Surface smooth except for rows of tubercles on occipital ring and axial rings of thorax and pygidium. *L. Carb.-Low. U. Carb.*, Eu.-E. N. Am.—FIG. 306,2. **W. mucronatus* (M'COY), Eng.; exoskel. (reconstr.), $\times 2.8$ (498).
- Ditomopyge** NEWELL, 1931 [**D. lansingensis*] [= *Cyphinium* WEBER, 1933, **Phillipsia (Griffithides) scitula* MEEK & WORTHEN, 1865; *Neophillipsia* GHEYSELINCK, 1937, **Phillipsia (N.) decurtata* GHEYSELINCK]. Like *Kaskia* but glabella broad, with median and lateral preoccipital lobes. Pygidium with broad axis flattened on top and strongly geniculate pleural fields; young stages with posterior pair of spines. *Penn.-L. Perm.*, cosmop.—FIG. 307,5a,b. *D. scitula* (MEEK & WORTHEN), Penn., Ill.; 5a,b, ceph., pyg., $\times 4$ (491).—FIG. 307,5c. **D. lansingensis*, U. Penn., Kans.; juvenile pyg., $\times 22$ (436).
- Delaria** WELLER, 1944 [**Anisopyge? antiqua* GIRTY, 1908]. Like *Ditomopyge* but glabella narrower, expanded in front, reaching anterior margin, distinctly contracted opposite eyes with smaller median and lateral preoccipital lobes and with lateral glabellar lobes appearing as small rounded protuberances. Pygidial axis narrowly arched to subtriangular in cross section. *L. Perm.-M. Perm.*, SW. USA.—FIG. 305,6. **D. antiqua* (GIRTY), Tex.; 6a,b, ceph., pyg., $\times 3.5$ (491).
- Cyphinioides** REED, 1942 [**C. ashfellenensis*]. Like *Ditomopyge* but glabella greatly expanded in front, reaching anterior margin; occipital ring wide (*sag.*) but much less than 0.3 of cephalic width; eyes posterior. Pygidial axis narrow, tapering; border distinct. *L. Carb.*, Eng.—FIG. 308,1. **C. ashfellenensis*; 1a,b, ceph., pyg., $\times 3$ (452).
- Permoproetus** TOUMANSKY, 1935 [**P. teschi*; SD J. M. WELLER, 1944]. Cephalon poorly known, probably similar to *Ditomopyge* but eyes smaller, more posterior; preoccipital glabellar lobes well defined. Pygidium very broad. *M. Perm.*, Crimea.—FIG. 308,6. **P. teschi*; exoskel. (reconstr.), $\times 3$ (485).
- Ameura** WELLER, 1936 [**Phillipsia (Griffithides) sangamonensis* MEEK & WORTHEN, 1865]. Glabella not reaching anterior margin, widest between the large strongly crescentic eyes; lateral preoccipital lobes large but no median lobe. Pygidium elongate subtriangular; axis with flattened sides and gently arched crest; border progressively wider and flatter toward rear. Surface smooth. *Penn.-L. Perm.*, USA.—FIG. 308,3. **A. sangamonensis* (MEEK & WORTHEN), Penn., Ill.; 3a,b, ceph., pyg., $\times 2$ (404).
- Sevillia** WELLER, 1936 [**S. sevillensis*]. Like *Ameura* but glabella narrower, with median preoccipital lobe; eyes large, semicircular. Pygidium with prominent axis characterized by flat sides and gently arched crest; border distinct. Surface finely granulose. *L. Penn.*, USA.—FIG. 308,5. **S. sevillensis*, Ill.; 5a,b, ceph., pyg., $\times 2.5$ (491).
- Cummingella** REED, 1942 [**Phillipsia jonesii* PORTLOCK, 1843; ICZN Opinion 352]. Glabella broad, reaching anterior margin, narrowest between front ends of large, reniform eyes; fixigenae extremely narrow (*tr.*). Pygidium with intrapleural furrows that cross onto border anteriorly. Surface smooth or with small pits. *L. Carb.*, Eu.—FIG. 308,4. **C. jonesii* (PORTLOCK), Eng.; exoskel. (reconstr.), $\times 3.5$ (498).
- Linguaphillipsia** STUBBLEFIELD, 1948 [**L. terapaiensis*]. Like *Cummingella* but glabella narrower anteriorly, not reaching front border; eyes long, relatively narrow (*tr.*). Pygidium with border. *L. Carb.*, Malaya.—FIG. 307,1. **L. terapaiensis*; 1a,b, ceph., pyg., $\times 3.2$ (475).
- Paraphillipsia** TOUMANSKY, 1935 [**P. karpinskyi*]. Like *Kaskia* but glabella very wide, eyes central. Pygidium short, wide. *M. Perm.*, Crimea-C. Himalaya.—FIG. 308,2. **P. karpinskyi*, Crimea; exoskel. (reconstr.), $\times 6$ (485).
- Neoproetus** TESCH, 1923 [**N. indicus*]. Cephalon subtriangular, anterior part of glabella swollen;

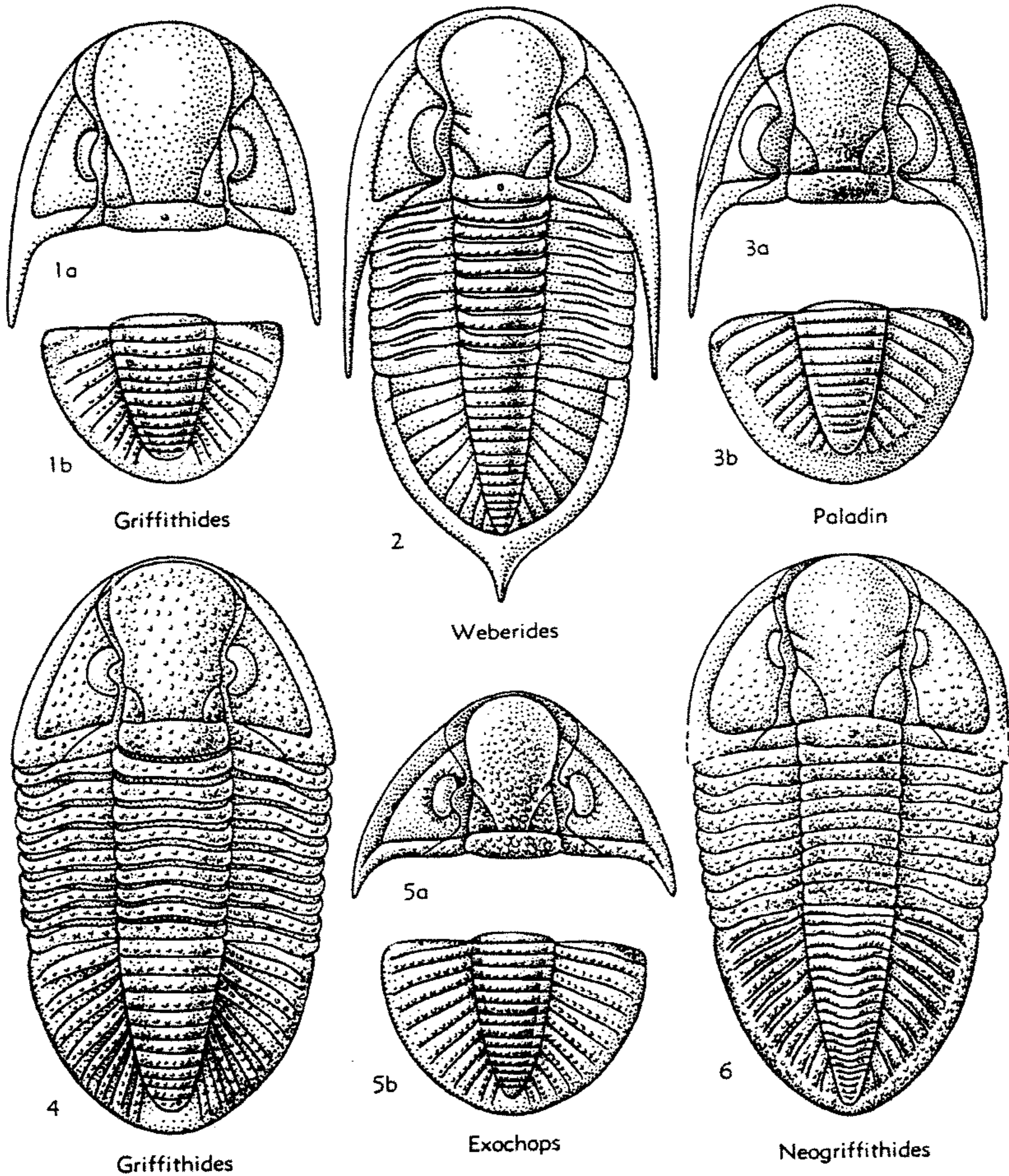

FIG. 306. Phillipsiidae (p. O399-O401).

tending to overhand anterior margin. Pygidium short, with few segments. *M.Perm.*, E.Indies-SE. Asia-Crimea-Sicily.—FIG. 307,3. **N. indicus*, Timor; 3a,b, ceph., pyg., X2.5 (480).

Anisopyge GIRTY, 1908 [**Phillipsia perannulata* SHUMARD, 1858]. Resembles *Ditomopyge* but pygidium subtriangular, with strongly elevated axis extending to rear margin, axial rings very numerous; posterior border vertical or overturned, pleural segments equal in width. Eyes long; me-

dian preoccipital lobe of glabella large, lateral preoccipital lobes very small. *M.Perm.*, SW.USA.—FIG. 307,6. **A. perannulata* (SHUMARD), Tex.; 6a,b, ceph., pyg., X3.5 (491).

Vidria WELLER, 1944 [**V. vespa*]. Pygidium semi-oval, with terminal spine in young stages. Cephalon unknown. *M.Perm.*, SW.USA.—FIG. 307,2. **V. vespa*, Tex.; pyg., X2 (491).

Pseudophillipsia GEMMELLARO, 1892 [**Phillipsia sumatrensis* ROEMER, 1880]. Like *Paladin* but

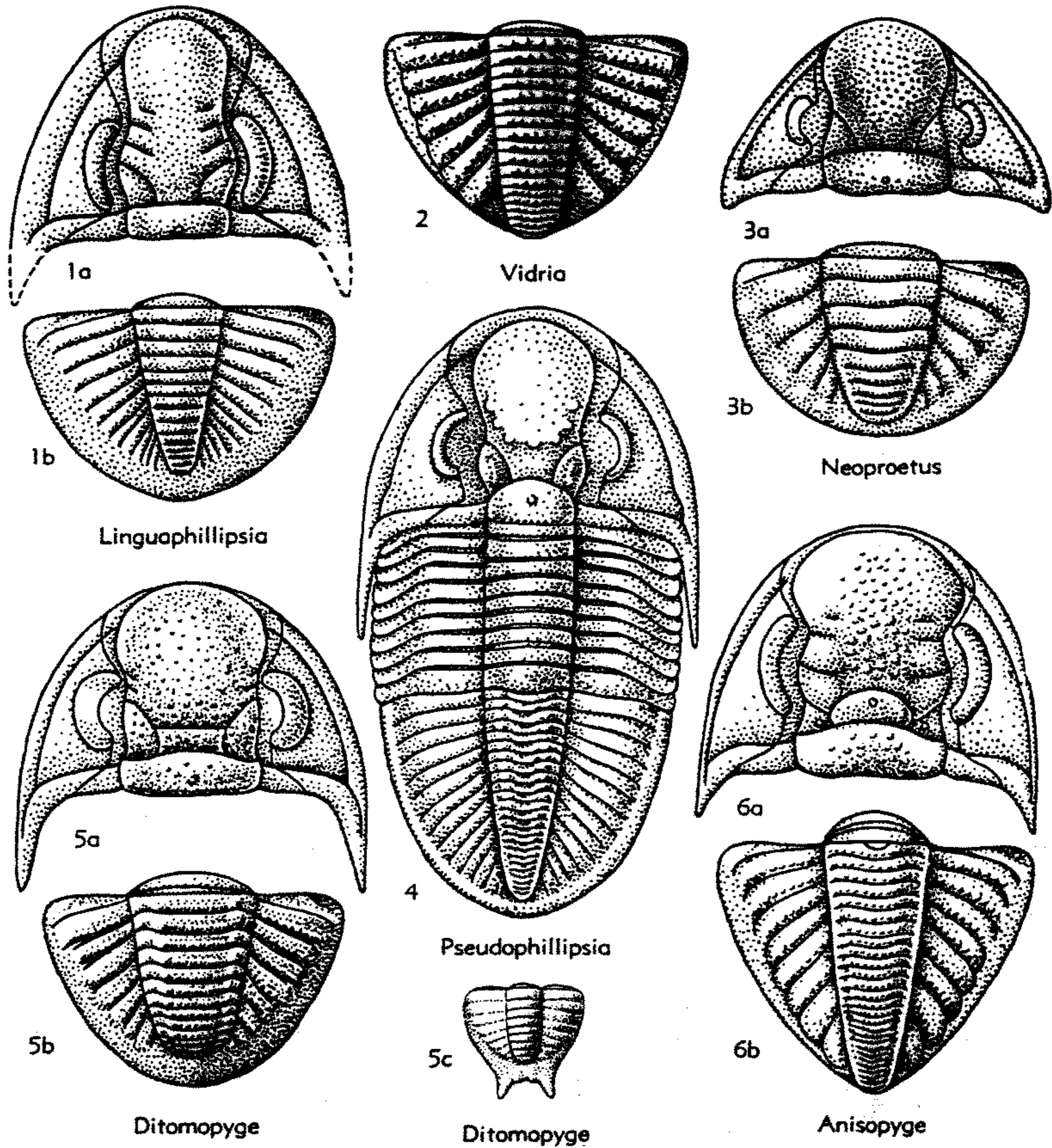

FIG. 307. Phillipsiidae (p. 0401-0402).

with depressed area between lateral preoccipital glabellar lobes, glabella expanded in front, not reaching anterior margin. Pygidium longer and more segmented; border distinct. *M. Perm.*, Sicily-Crimea-SE. Asia-E. Indies-Calif.—FIG. 307, 4. **P. sumatrensis* (ROEMER), Sumatra; exoskel. (reconstr.), $\times 2$ (462).

Family OTARIONIDAE Richter & Richter, 1926

[=Cyphaspidae SALTER, 1864]

Exoskeleton opisthoparian, of small to medium in size. Cephalon conspicuously

vaulted, with genal spines; preglabellar field narrow to moderately broad or absent, convex; glabella more or less inflated, with single pair of distinct glabellar furrows (*1p*) reaching occipital furrow and separating a pair of basal lobes; 1 or 2 other pairs of glabellar furrows may be present; glabella surrounded by deep axial and preglabellar furrows; genae convex to inflated or even conical; eyes small to medium in size, sub-circular in outline; anterior sections of facial sutures divergent forward, subparallel,

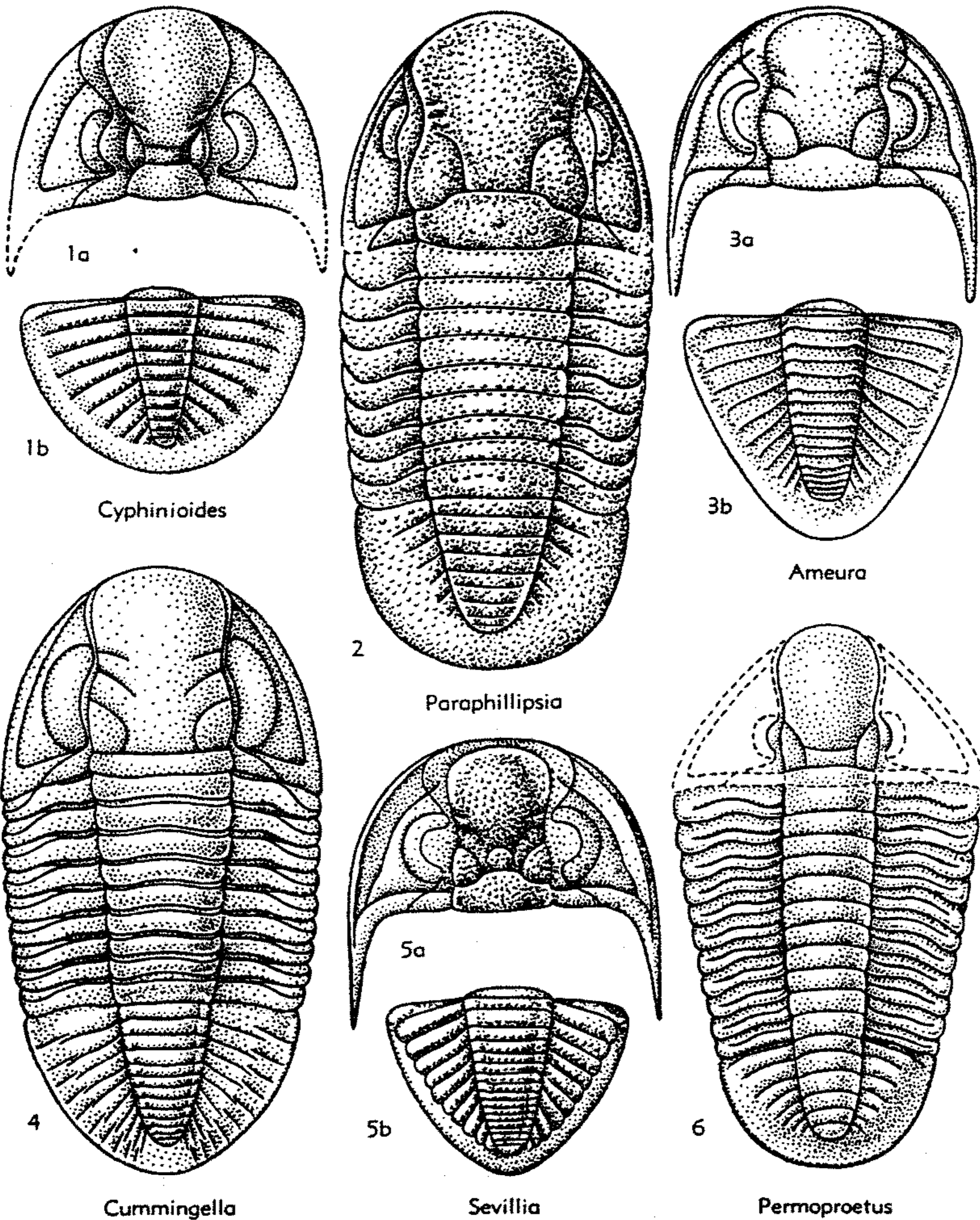

FIG. 308. Phillipsiidae (p. O401).

or somewhat convergent; posterior sections strongly divergent, reaching posterior margin near genal angles. Thorax with 11 to 17 segments. Pygidium small, with few segments (247). *M.Ord.-U.Carb.*

Subfamily OTARIONINAE Richter & Richter, 1926

[*nom. transl.* PŘIBYL, 1947 (ex Otariionidae RICHTER & RICHTER, 1926)]

Cephalon semicircular, with narrow to moderately broad preglabellar field; gla-

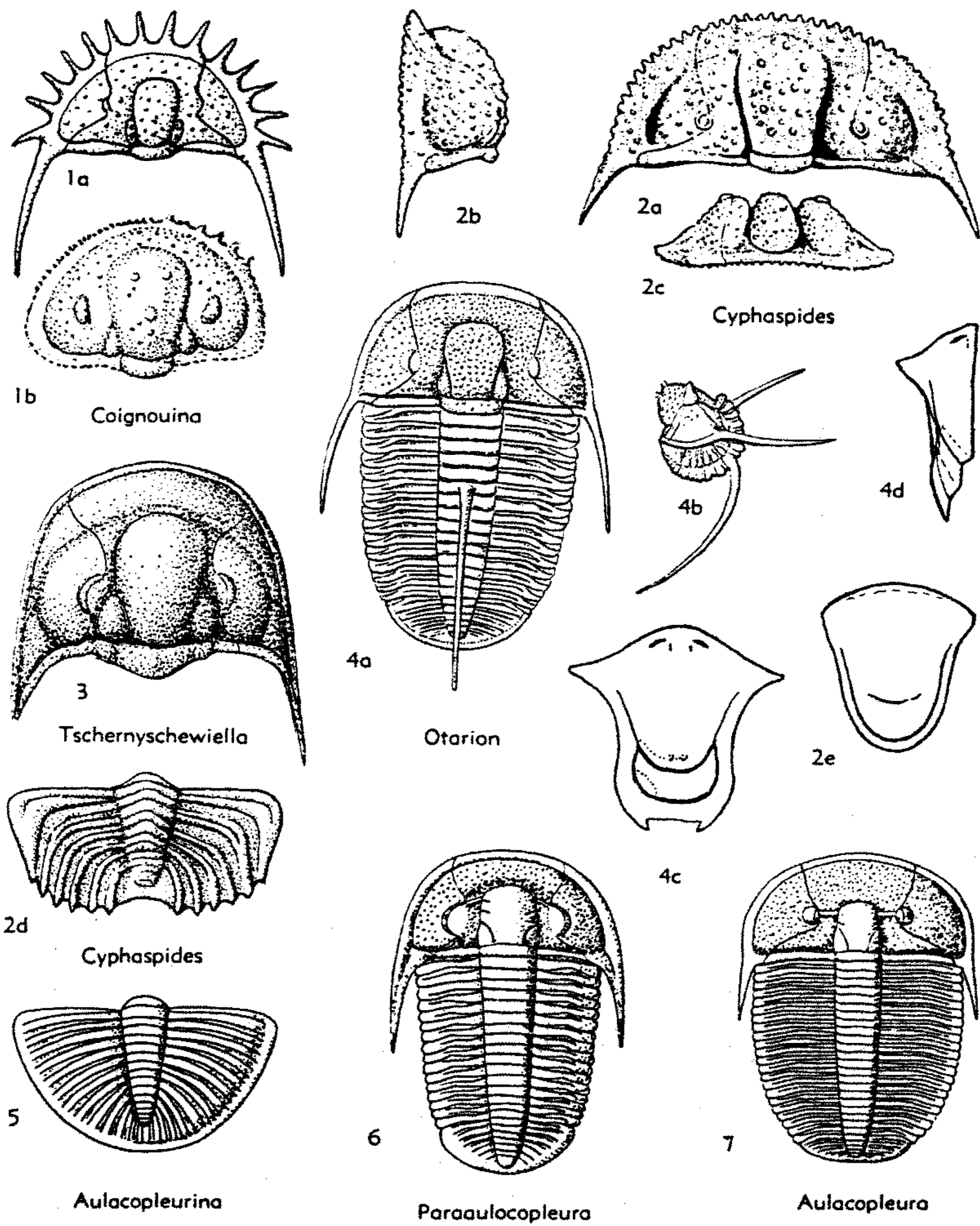

FIG. 309. Otarionidae, Aulacopleuridae (p. O405-O406).

bella with pair of broad, deep lateral furrows (*lp*) completely separating strongly developed basal lobes; no eye ridges. Thorax with 11 to 17 segments, outer ends rounded. Pygidium small, short, with even margin. *M.Ord.-U.Carb.*

Otarion ZENKER, 1833 [**O. diffractum*] [= *Cyphaspis* BURMEISTER, 1846 (non BURMEISTER, 1843); *Conoparia* HAWLE & CORDA, 1847; ?*Goniopleura* HAWLE & CORDA, 1847 (non WESTWOOD, 1832); ?*Harpidella* M'COY, 1849; *Novukaspis* PŘIBYL, 1946]. Cephalon with narrow border and distinct border furrow; genal spines long; anterior and

lateral margins even. Sixth ring of thoracic axis in almost all species stronger than others bearing long backward-curved spine. Pygidial axis with 5 to 7 rings. Hypostoma resembling that of Proctidae but with complete median furrow separating anterior and posterior lobes; anterior border furrow reduced. Surface granulose. *M.Ord.-U.Dev.*, cosmop.—FIG. 309,4a. **O. diffractum*, Sil. (c Zone), Czech.; exoskel., $\times 2$ (3).—FIG. 309, 4b-d. *O. ceratophthalmus* (GOLDFUSS), M.Dev., Ger.(Eifel); 4b, exoskel. (reconstr.), $\times 1.7$; 4c,d, hypostoma, ventral, lateral, $\times 8$ (460*).

Coignouina REED, 1943 [**Cyphaspid acanthina* COIGNOU, 1890]. Cephalon as in *Otarion*; anterior and lateral margins with row of radiating spines; 2nd pair of glabellar furrows weakly developed (type species); anterior and lateral borders flat, without distinct border furrow. *L.Dev.-M.Dev.* (Czech.-Ger.) - *U.Dev.*(N.Am.) - *U.Carb.*(Eng.).—FIG. 309,1b. **C. acanthina* (COIGNOU), Eng. (Yorks.); ceph., $\times 6$ (389).—FIG. 309,1a. *C. coronata* (BARRANDE), M.Dev., Czech.; ceph., $\times 3$ (445a*).

Tschernyschewiella TOLL, 1899 [*nom. subst. pro Schmidtella* CHERNYSHEV, 1893 (non ULRICH, 1892)] [**Schmidtella uralica* CHERNYSHEV, 1893]. Cephalon resembling *Otarion*, strongly convex transversely; genae divided into 3 parts by furrows originating at axial furrows near anterior part of glabella, curving backward and running nearly parallel to lateral border, then bifurcating, with branches running to posterior and lateral borders. *L.Dev.*, USSR(Urals).—FIG. 309,3. **T. uralica* (CHERNYSHEV), cephalon, $\times 3$ (383).

Subfamily CYPHASPIDINAE Přibyl, 1947

[=Cyphaspidinae PRANTL & PŘIBYL, 1950 (invalid *nom. correct. pro* Cyphaspidinae PŘIBYL, 1947)]

Cephalon low-arched, with 1 to 3 rows of short spines on anterior and lateral margins; preglabellar field narrow or absent; glabella with small basal lobes; eye ridges present. Thorax with 11 or 12 segments; pleurae bent downward in knee shape, prolonged into spines. Pygidium nearly trapezoidal; axis roof-shaped, with rings strongly curved forward; pleural fields with ribs bent backward-downward in knee shape, and produced marginally into short spines, outer (1st) pair of ribs forming acute angles, others obtuse angles. Hypostoma rounded-triangular; with anterior border furrow faint or absent, posterior and especially lateral border furrows deep, posterior lobe lower than anterior, with pair of maculae, separated from anterior lobe by shallow furrow. *L.Dev.-M.Dev.*

Cyphaspides Novák, 1890 [**C. scuticauda*; SD VOGDES, 1925]. Characters of subfamily, *L.Dev.-*

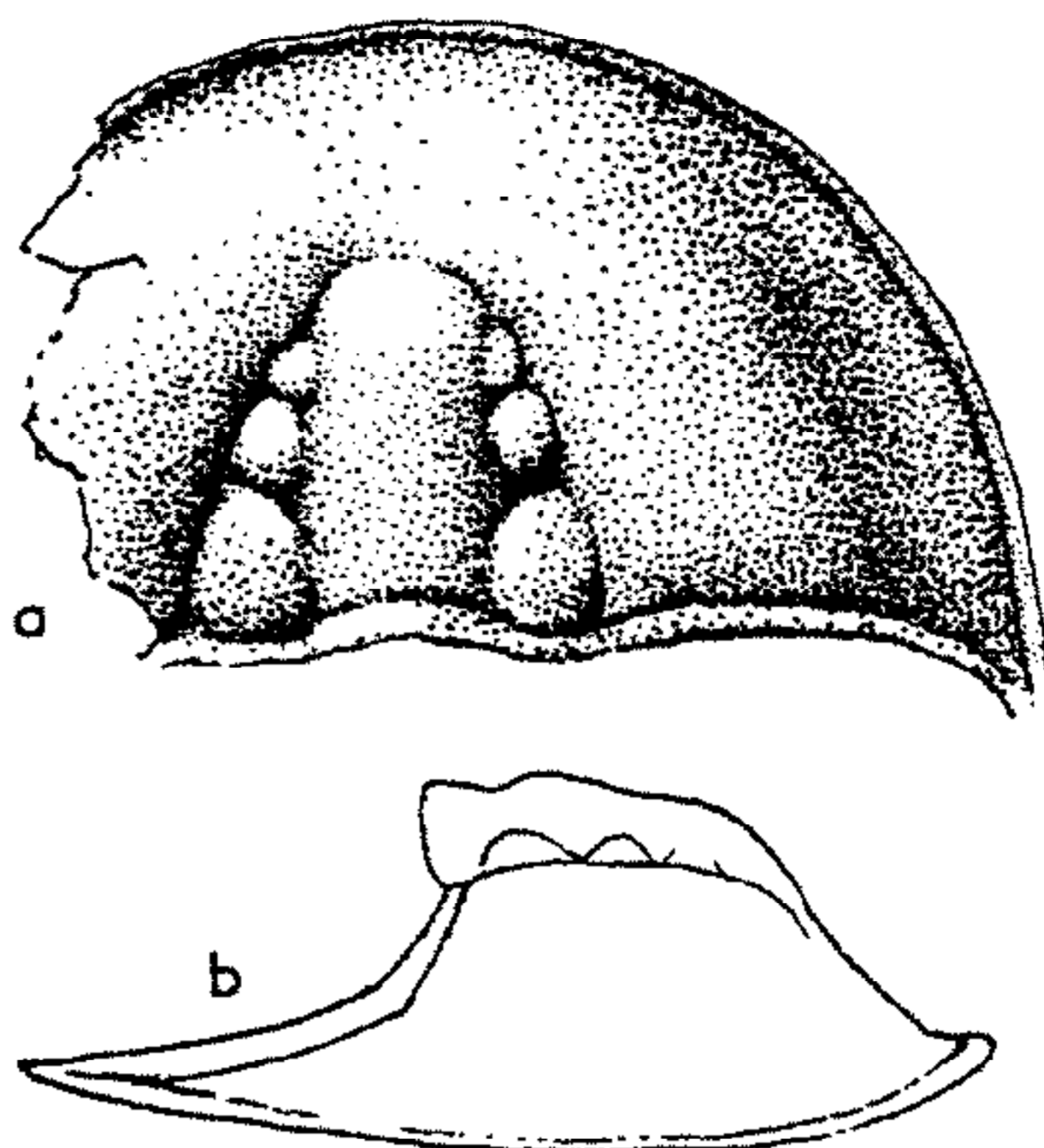

FIG. 309A. **Aulacopleurina peltata* (NOVÁK), M.Dev., Ger.; a,b, ceph., dorsal, profile, $\times 9$ (SCHMIDT, n).

M.Dev.—FIG. 309,2d. **C. scuticauda*, M.Dev., Ger.(Greifenstein); pyg., $\times 4$ (437).—FIG. 309, 2a-c. *C. cerberus* (BARRANDE), L.Dev., Vlnafice (Czech.); ceph., dorsal, lateral, frontal, $\times ?$ (*3).—FIG. 309,2e. *C. holinensis* RŮŽIČKA, M.Dev., Czech.; hypostoma, $\times 5$ (445a).

Family AULACOPLEURIDAE Angelin, 1854

Cephalon slightly to moderately convex and with relatively long (*sag.*) preglabellar field; glabella with 2 or 3 pairs of lateral furrows, posterior pair curved to reach occipital furrow; axial furrows with or without pits; eyes sessile; distinct eye ridges present. Thorax with 12 to 22 segments, pleural ends rounded. Pygidium small, without spines. Surface of genae and preglabellar field pitted. *M.Ord.-M.Dev.*

Aulacopleura HAWLE & CORDA, 1847 [**Arethusa koninckii* BARRANDE, 1846] [*pro Arethusa* BARRANDE, 1846 (non DE MONTFORT, 1808; nec OKEN, 1815; nec BONAPARTE, 1838; nec DUMERIL & BIBRON, 1841)] [= *Arethusina* BARRANDE, 1852, obj. (*pro Arethusa* BARRANDE, 1846)]. Pygidium with 6 or 7 axial rings. *M.Ord.-M.Dev.*, Eu.-Morocco-Greentl.

A. (*Aulacopleura*). Eyes opposite anterior part of glabella. *Sil.-M.Dev.*, Eu.-Moroc.-Greenl.—FIG. 309,7. **A. koninckii koninckii* (BARRANDE), *Sil.*, Czech.; exoskel., $\times 2$ (370).

A. (*Paraaulacopleura*) CHAUBET, 1937 [**A. (P.) roquemauillerensis*]. Like *A. (Aulacopleura)* but with eyes opposite middle part of glabella, shorter preglabellar field, and relatively fewer thoracic

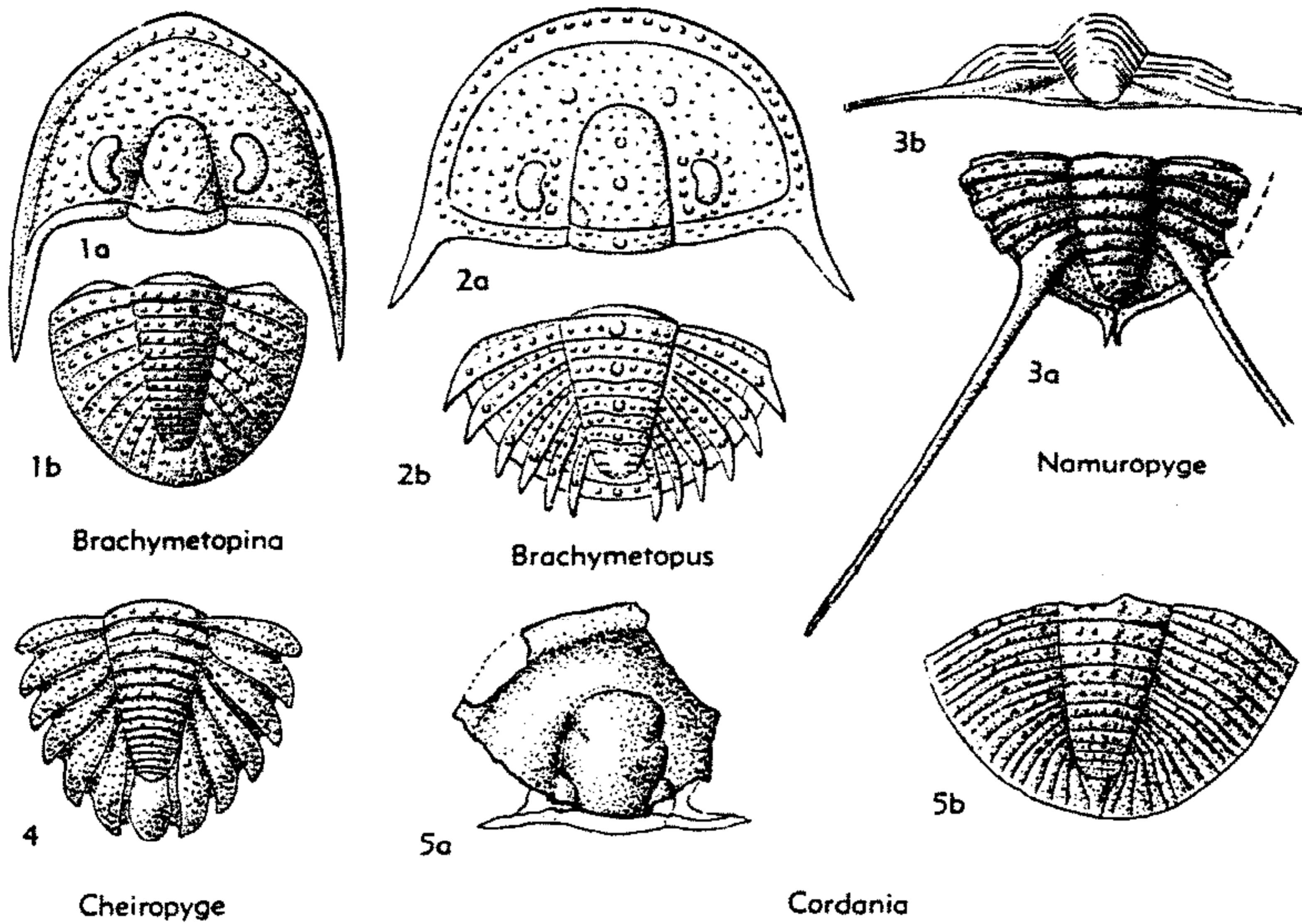

FIG. 310. Brachymetopidae (p. O407-O408).

and more pygidial segments. *M.Ord.-M.Dev.*, Eu.
—FIG. 309,6. *A. (P.) beyrichi* Novák, *M.Dev.*,
Ger.; exoskel., $\times 2$ (184).

?*Aulacopleurina* PŘIBYL, 1949 [**Arethusina peltata*
Novák, 1890]. Cephalon semicircular, high; pre-
glabellar field long (*sag.*); inner parts of genae
vaulted, outer parts sloping steeply, flattened near
border; glabella rounded-triangular, bounded by
deep axial furrows without pits, preglabellar fur-
row nearly obsolete, 3 pairs of lateral glabellar fur-
rows and lobes present, all lobes moderately well
separated from central area of glabella; eyes, eye
ridges, and facial sutures lacking. Thorax with 8
segments. Pygidium with 14 to 16 axial rings.
M.Dev., Eu.—FIGS. 309,5, 309A. **A. peltata*
(Novák); 309,5, *pyg.*, Czech., $\times 4$ (181); 309A,
ceph., dorsal and profile views, Ger. (Ballersbach),
 $\times 9$ (SCHMIDT, n).

**Family BRACHYMETOPIDAE Prantl &
Příbyl, 1950**

[*nom. transl.* HUPÉ, 1955 (*ex Brachymetopinae* PRANTL &
PŘIBYL, 1950)]

Exoskeleton opisthoparian. Cephalon semi-
circular or semielliptical, convex border dis-
tinct, posterolaterally produced into genal
spines; glabella short, moderately convex,
tapering forward, with 1 or 2 pairs of
lateral furrows, basal glabellar lobes al-

most completely isolated by glabellar fur-
row *1p*; eyes medium-sized; facial sutures
not discernible; preglabellar field broad.
Thorax with ?10 segments. Pygidium para-
bolic to semicircular, abundantly segmented
(up to 17 axial rings); margin even or
spined. Surface with tubercles of various
size. *L.Dev.-U.Carb.*

Brachymetopus M'COY, 1847 [**B. strzeleckii*; SD
REED, 1903]. Cephalon with raised border and
distinct border furrow; genal spines not longer
than 0.5 of length of cephalon; glabella paral-
lel-sided or subtriangular, with single pair of lateral
furrows; eyes reniform, situated far backward.
Pygidium half-circle or longer; axis about 0.3 of
width of pygidium, with 9 to 17 rings; pleurae
gently curved backward, divided by longitudinal
furrows into a narrow anterior strip and a raised,
broader posterior ridge. *U.Dev.*(Eu.)-*L.Carb.*(N.
Am.-Asia-Austral.).

[According to GOLDRING & STUBBLEFIELD (*Geol. Mag.*, v. 94,
p. 421-424, 1957) no type species was indicated for
Brachymetopus by M'COY and this became established when
VOGDES (1890) validly named *Phillipsia maccoyi* PORTLOCK
(1843) as type species of this genus. It would then follow
that *Brachymetopina* REED is an objective junior synonym
of *Brachymetopus*, because RICHTER & RICHTER in 1926
designated *Phillipsia maccoyi* as type species of *Brachymeto-*
pina. In the opinion of SCHMIDT (*Senckenbergiana*, v. 39,
p. 153-156, 1958) M'COY did adequately indicate *Brachy-*
metopus strzeleckii M'COY, 1847, as type species and pro-
poses application to ICZN for decision.—HERTA SCHMIDT.]

B. (*Brachymetopus*). Axis of pygidium with 9 to 10 segments; posterior ridges of pygidial pleurae prolonged beyond thickened border into spines curved backward and bearing large tubercle where they cross border. *U.Dev.*(Eu.)-*L.Carb.*(N. Am.- Austral.-Eu.-Kazakhstan).—FIG. 310,2. **B. (B.) strzeleckii*, Carb., (Dunvegan) N.S. W.; 2a,b, ceph., pyg., $\times 8$ (452).

B. (*Brachymetopina*) REED, 1903 [**Phillipsia maccoyi* PORTLOCK, 1843; SD RICHTER & RICHTER, 1926]. Pygidium with larger number (up to 17) of segments than in *B. (Brachymetopus)*; margin even, no distinct border nor spines. *L. Carb.*, N.Am.-Asia-Eu.—FIG. 310,1. **B. (B.) maccoyi* (PORTLOCK), Ire. (Limerick); 1a,b, ceph., pyg., $\times 3$ (498).

Cordania CLARKE, 1892 [**Phaetonides cyclurus* HALL, 1888]. Cephalon with elevated margin and short genal spines; preglabellar field and sides of cephalon concave; glabella short, ovoid, with 2 pairs of lateral furrows and lobes, basal lobes conspicuous and completely separated from glabella. Thorax with not more than 10 segments. Pygidium relatively large; axis with 6 to 12 rings; 6 to 8 pleural fields with ribs divided into subequal bands. Surface with tubercles irregularly scattered on cephalon, in regular rows on pygidium; in some species tubercles prolonged into spines extending beyond margin of pygidium. *L.Dev.-M.Dev.*, N.Am.—FIG. 310,5. **C. cyclurus* (HALL), L.Helderberg, N.Y. (Clarksville); 5a,b, ceph., pyg., $\times 3$ (404).

?*Cheiropyge* DIENER, 1897 [**C. himalayensis*]. Pygidium nearly as long as broad, moderately vaulted; axis with 15 segments; lateral lobes abruptly bent down toward margin; 6 pleurae, defined by deep depressions; originate as sharp ridges and broaden towards margin, tapered ends extending beyond margin; posterior pleurae broader than anterior ones, not distinctly carinate; posterior termination of axis surrounded by axial lappet exceeding pleurae in width. Surface granulate. *Permocarboiferous*, Himalaya.—FIG. 310,4. **C. himalayensis*, Chitichun; pyg., $\times 1$ (316).

?*Namuropyge* RICHTER & RICHTER, 1939 [**N. demaneti*]. Pygidium short, semicircular; border narrow, convex; axis reaching nearly to border, with 9 rings (6 distinct, 3 faint); pleural fields with 4 (4.5) segments, anterior band of segments low, posterior much higher; posterior band of 4th segment by far largest and highest, prolonged beyond border into long spine; 2 small spines at posterior end of pygidium. Surface with granules distributed in longitudinal and transverse rows. *U.Carb.*, Belg.—FIG. 310,3. **N. demaneti*, Belg.(Bioul); 3a,b, pyg., dorsal, posterior, $\times 8$ (461).

?*Panarchaeogonus* ÖPIK, 1937 [**P. parvus*]. Cephalon subsemicircular; glabella acute-ovoid, with 3 pairs of lateral furrows, *1p* very shallow, reaching to occipital furrow, separating pair of tri-

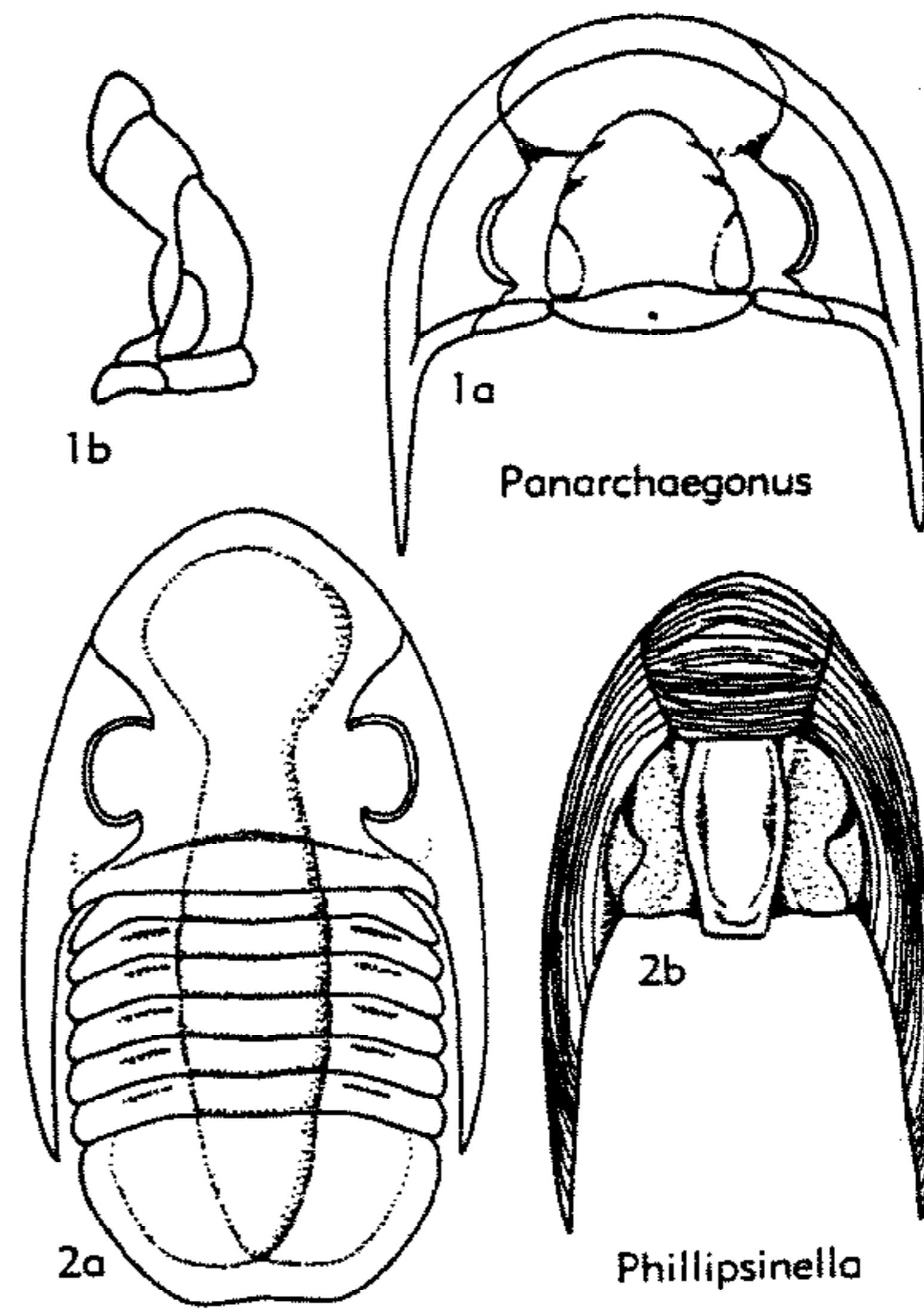

FIG. 311. Brachymetopidae, Phillipsinellidae (p. 0408-0409).

angular basal furrows, anterior 2 pairs only slightly indicated; axial furrows shallow; palpebral lobes long, crescentic, eye ridges may be present; anterior sections of facial sutures sigmoid, posterior sections strongly divergent, crossing middle of posterior border; preglabellar field gently sloping; occipital ring widest at mid-line. *M.Ord.*, ?*L.Sil.*, Eu.(Est.-?Swed.).—FIG. 311,1. **P. parvus*, Kukruse (Kuckers) Shale (C2), Est.; 1a, ceph., 1b, cran., lateral; $\times ?$ (439).

[NOTE.—According to present view of HERTA SCHMIDT, *Panarchaeogonus* should be classed as *incertae sedis*, rather than included doubtfully in the Brachymetopidae—Ed.]

Family PHILLIPSINELLIDAE Whittington, 1950

Cephalon as long (*sag.*) as wide, moderately convex; glabella defined by broad, shallow furrows, narrowest between eye lobes, widest across frontal lobe, no glabellar furrows; eye lobes large; facial sutures opisthoparian, anterior sections diverging forward, curving to meet along anterior margin; genal spines long; rostral plate and hypostoma elongate (*sag.*). Thorax of 6 segments, pleural furrows shallow. Pygidium with axial and pleural furrows faint or absent. Surface of dorsal exoskeleton smooth, doublure with anastomosing raised lines (350). *U.Ord.*

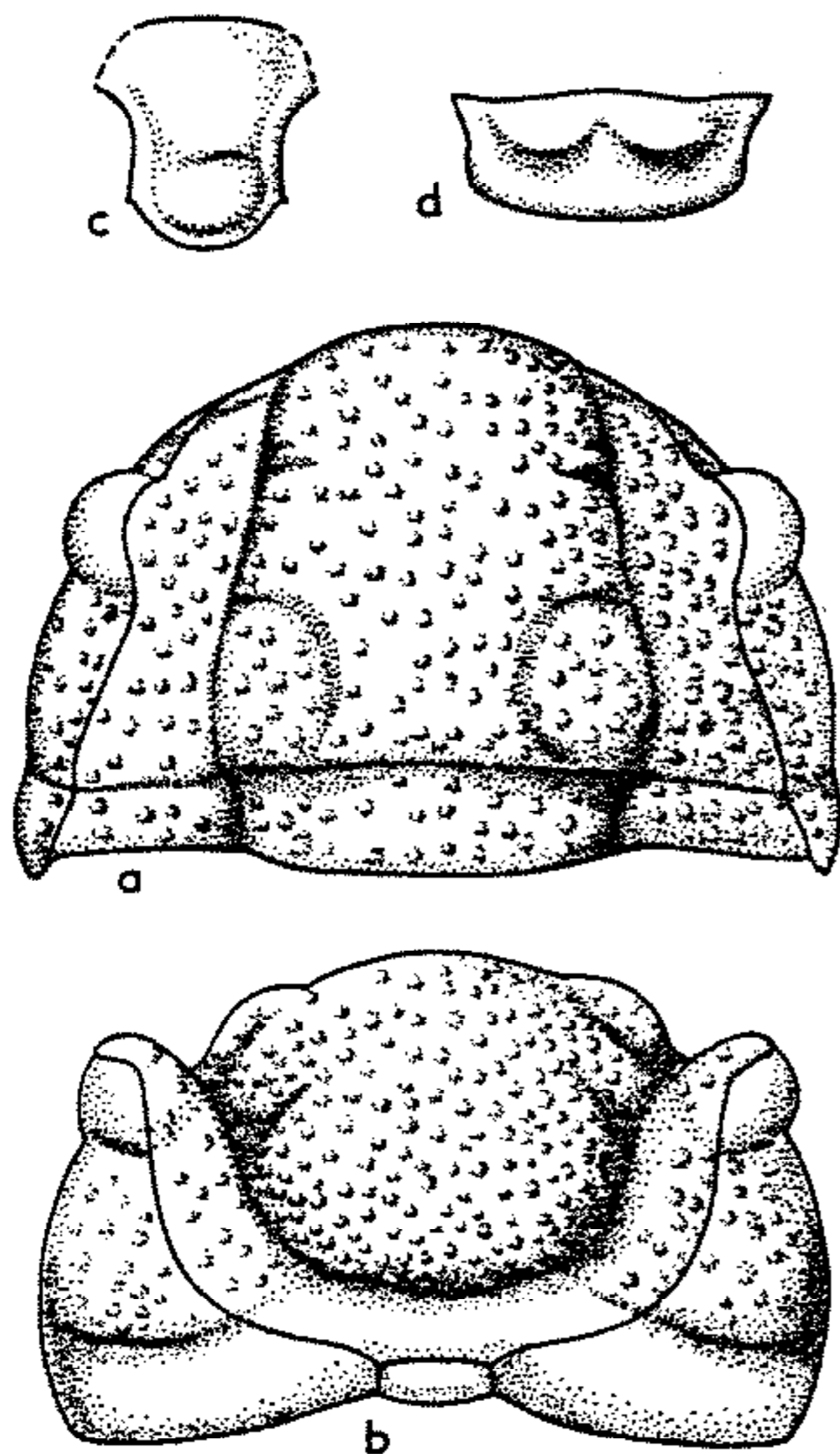

FIG. 312. **Celmus granulatus* ANGELIN (Celmidae), L.Ord.(Llanvirn.), Baltoscandia; *a,b*, hypostoma, pyg., $\times 5.3$; *c,d*, ceph., dorsal, front, $\times 4$ (414n).

Phillipsinella NOVÁK, 1886 [**Phacops parabola* BARRANDE, 1846] [= *Phillipsella* OEHLERT, 1886, suppressed, ICZN opinion 476]. Characters of family. *U.Ord.*, Br.I.-Swed.-Czech.—FIG. 311,2. **P. parabola* (BARRANDE); *2a,b*, exoskel., ceph. (ventral, showing rostral plate, hypostoma, and cephalic doublure), both reconstr., $\times 3.3$ (496n).

Family CELMIDAE Jaanusson, 1956

Exoskeleton small, opisthoparian. Cephalon surrounded by distinct border; glabella slightly narrowing forward, with 2 or 3 pairs of lateral glabellar furrows, lateral pre-occipital glabellar lobe comparatively long; occipital furrow present. Rostral plate narrow (*tr.*), short, trapezoidal; hypostoma with comparatively strong lateral furrows, posterior lobe rather convex, anterior wings apparently narrow (*tr.*), triangular. Thorax with 12 segments (type genus); pleurae of ridged type, without pleural furrows or facets. Pygidium very small, trapezoidal, apparently consisting of single tergite only; no axis, 2 crescent-shaped elevations near the anterior margin. *L.Ord.*

Celmus ANGELIN, 1854 [**C. granulatus*] [= *Crotalurus* VOLBORTH, 1858]. *L.Ord.*(Llanvirn.), Bal-

toscandia.—FIG. 312. **C. granulatus*; *a,b*, ceph., dorsal, anterior, $\times 4$; *c,d*, hypostoma, pyg., $\times 5.3$ (414n).

Family PLETHOPELTIDAE Raymond, 1925

Exoskeleton opisthoparian, micropygous. Glabella tapering to rectangular, with convex frontal area, all furrows faint or obsolete on exterior and interior, occipital and posterior border furrows most persistent, occipital spine or node may occur; eyes of medium size or absent, placed near anterior 3rd of glabella; fixigenae with narrow palpebral areas, posterior areas triangular; librigenae unfurrowed, with genal spines or rounded genal angles. Thorax with up to 10 segments; axis tending to be wider than pleurae; pleural furrows faint to obsolete, pleural ends blunt. Pygidium narrow-transverse; axis long, bluntly rounded, about same in width as pleural regions, with up to 6 axial rings, furrows variable in strength. Surface smooth, with transverse ridges on borders, rarely pitted. Derived from Ptychopariidae. *U.Cam.-L.Ord.*

Plethopeltis RAYMOND, 1913 [**Agraulos saratogensis* WALCOTT, 1890]. Cranidium elongate, with convex glabella having subparallel sides, and rounded front, lateral furrows faint to obsolete on exterior, faint on interior; frontal area 0.25 to 0.3 of glabellar length, axial furrows on exterior, with occipital spine or node; fixigenae upsloping slightly; librigenae broad, with short genal spines. Thorax unknown. Pygidium with convex axis and 3 axial rings; pleural regions narrower, 3 pleurae with short pleural furrows, no border furrow (303). *U.Cam.*(*Trempeal.*); Sib.-N.Am.-?S.Am.—FIG. 313,1. **P. saratogensis* (WALCOTT), N.Y.; *1a-c*, cran., dorsal, side, front, $\times 2$; *1d,e*, pyg., dorsal, rear; $\times 2$ (16).

Arapahoia B. M. MILLER, 1936 [**A. typa*] [= *Hesperaspis* STOYANOW, 1936]. Cranidium narrow-elongate; glabella low, tapering, front rounded, all furrows except posterior border furrow very faint or obsolete on exterior, faint on interior, occipital spine usually present; fixigenae horizontal or upsloping; librigenae elongate, with short genal spine. Thorax unknown. Pygidium with convex axis and 2 to 4 poorly defined axial rings; pleural regions about equal to axis in width, with 2 to 4 broad pleurae; faint border furrow, narrow border (132). *U.Cam.*(*Dresbach.*), N.Am.—FIG. 313,2. **A. typa*, Wyo.; *2a-c*, cran., pyg., librigena, $\times 1$, $\times 2$, $\times 1$ (472).

Leiocoryphe T. H. CLARK, 1924 [**L. gemma*]. Cephalon hemispherical, glabella seemingly broad

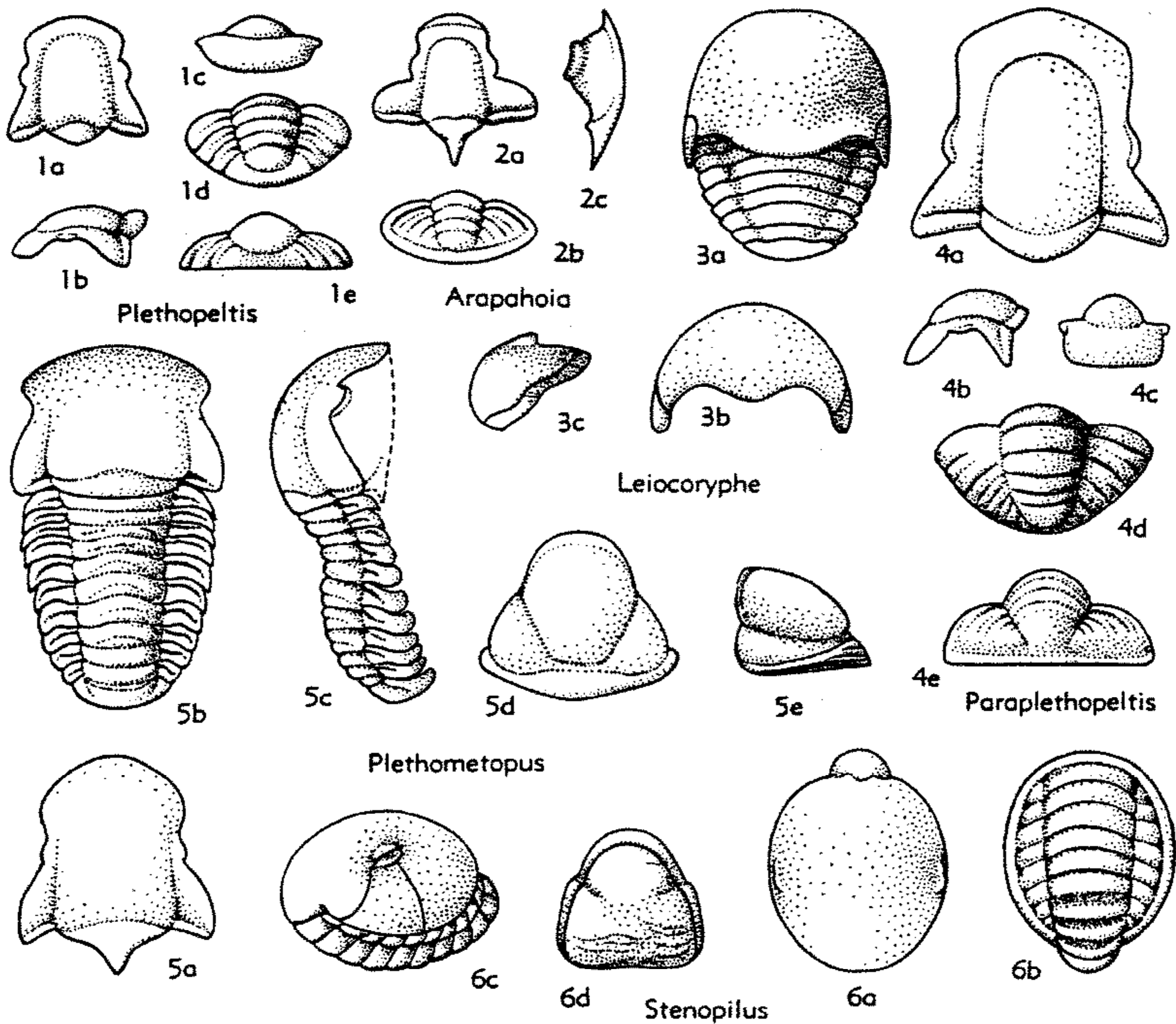

FIG. 313. Plethopeltidae (p. 0409-0412).

but shape unknown, without lateral, axial, or border furrows, faint occipital furrow may occur; frontal area continuous with glabella; eyes absent; facial sutures faint; fixigenae downsloping; librigenae with blunt genal spines. Thorax with 8 segments; axis very wide, low; axial furrows shallow; pleurae much narrower than axis, unfurrowed. Pygidium very narrow, unfurrowed, or with very faint axial furrows. Outer surface may be pitted (190). *U.Cam.(Trempeal.)*, N.Am.—FIG. 313,3a. **L. gemma*, Que.; exoskel., X4 (385).—FIG. 313,3b,c. *L. transversa* RASETTI, Que.; 3b,c, ceph., X3 (190).

Paraplethopeltis BRIDGE & CLOUD, 1947 [**P. obesa*]. Cranidium elongate, with convex, tapering glabella, no lateral furrows; frontal area 0.5 of glabellar length, axial furrows distinct, occipital and posterior border furrows faint on exterior, anterior border furrow visible on interior only; fixigenae downsloping, with posterior areas shorter than usual; librigenae unknown. Thorax unknown. Pygidium with wide convex axis with end merging into posterior margin, with 5 axial

rings; pleural regions convex, with 3 or 4 broad pleurae; faint border furrow, very narrow border (16). *L.Ord. (Gasconad.)*, N.Am.—FIG. 313,4. **P. obesa*, Tex.; 4a-c, cran., dorsal, side, front, X2, X1, X1; 4d,e, pyg., dorsal, rear, X2 (16). **Plethometopus** ULRICH in BRIDGE, 1930 [**Bathyrurus armatus* BILLINGS, 1860] [= *Enontoura* RESSER, 1942]. Cranidium with low subrectangular glabella, no lateral furrows; frontal area continuous with glabella, axial and anterior border furrows obsolete on exterior, very faint on interior; with short occipital spine or node; eyes below medium size; fixigenae horizontal; librigenae unfurrowed, with rounded genal angles or short genal spines. Thorax with 10 segments; axis convex, twice width of pleurae, which bear distinct pleural furrows. Pygidium with strongly convex axis, up to 3 axial rings, axial furrows faint, all other furrows faint to obsolete; narrow rimlike border (239, 303). *U.Cam.(Francon.-Trempeal.)*, N.Am.-S.Am.—FIG. 313,5a. **P. armatus* (BILLINGS), Que.; cran., X1 (207).—FIG. 313,5b,c. *P. sp.*, Mo.; 5b,c, exoskel., X3

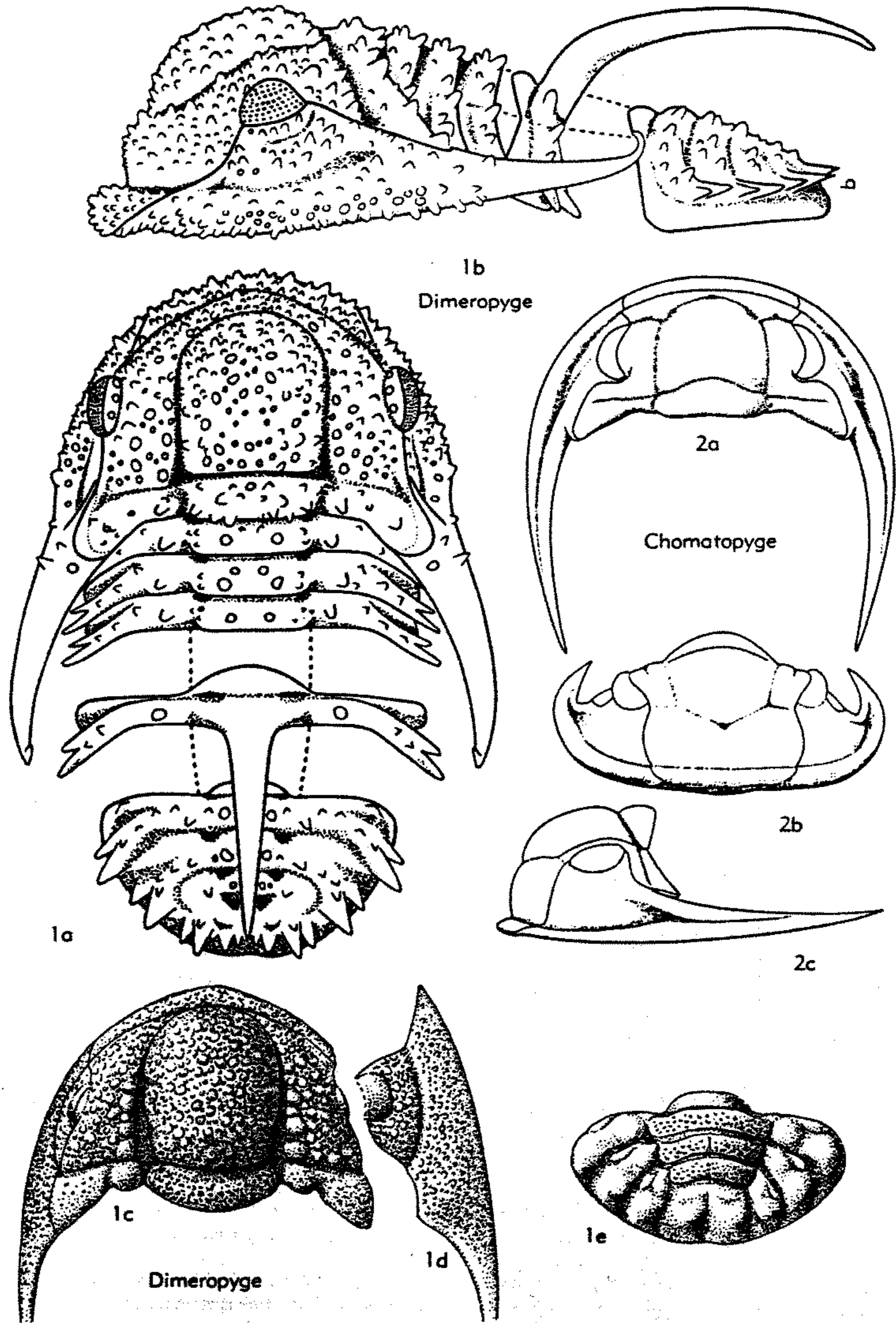

FIG. 314. Dimeropygidae (p. 0412).

(425).—FIG. 313,5*d,e*. *P. dubius* (RASETTI), Que.; 5*d,e*, pyg., $\times 5$ (189).

Stenopilus RAYMOND, 1924 [**S. pronus*]. Cephalon ovate, strongly convex with low, apparently subquadrate glabella; frontal area continuous with glabella, all furrows obsolete on exterior, faint posterior half of axial furrow visible on interior; eyes small; fixigenae downsloping; librigenae with blunt genal angles. Thorax with 10 segments; axis convex, twice width of unfurrowed pleurae. Pygidium spade-shaped, inclined at 90° to thorax, axial furrows appearing only as pair of short depressions at anterior margin, no other furrows. Surface covered with irregular narrow ridges (190). *U.Cam.(Trempeal.)*, N.Am.-NE. Asia.—FIG. 313,6. *S. elongatus* RASETTI, Que.; 6*a-c*, exoskel., dorsal, thorax, side, 6*d*, pyg., and last thoracic segment; all $\times 6$ (190).

Strotocephala RAYMOND, 1937 [**S. howelli*]. *U.Cam.(Trempeal.)*, Vt.

Family DIMEROPYGIDAE Hupé, 1953

[*emend.* WHITTINGTON & EVITT, 1954]

Exoskeleton about 1 cm. or less in length. Cephalon gently to strongly convex, cephalic border convex; glabella ovate convex, subparallel-sided or narrowing forward, with 3 or fewer pairs of lateral glabellar furrows, never deeply impressed; preglabellar field short to long (*sag.*), steeply sloping; median pit may occur in preglabellar furrow; facial sutures opisthoparian, with anterior sections running directly forward to anterior border, then inward along edge of border; connective sutures may isolate narrow rostral plate or be absent. Thorax of few segments (8 in *Dimeropyge*); V-shaped panderian openings in pleural doublure. Pygidium moderately convex, 3 to 6 segments, axis characteristically with median longitudinal depression (360). *L.Ord.-U.Ord.*

Dimeropyge ÖPIK, 1937 [**Sphaerexochus minutus* NIESZKOWSKI, 1857] [= *Haploconus* RAYMOND, 1913 (*non* COPE, 1882)]. Cephalon subsemicircular, with long genal spines hooked slightly at tips; with narrow, steeply sloping preglabellar field and broad convex border; glabella parallel-sided, rounded anteriorly, with 2 or 3 pairs of lateral glabellar furrows represented by ovate smooth areas adjacent to axial furrows; eye lobes small, far out on genae. Rostral plate T-shaped, hypostoma subquadrate in outline, with gently convex middle body. Thorax with shallow axial furrows; one segment (probably 5th) bears stout backwardly directed median spine; outer parts of pleurae bent strongly downward. Pygidium with 3 or 4 segments, longitudinal depression in posterior part of axis, steeply sloping border beneath pleural spines. External surface of exoskeleton

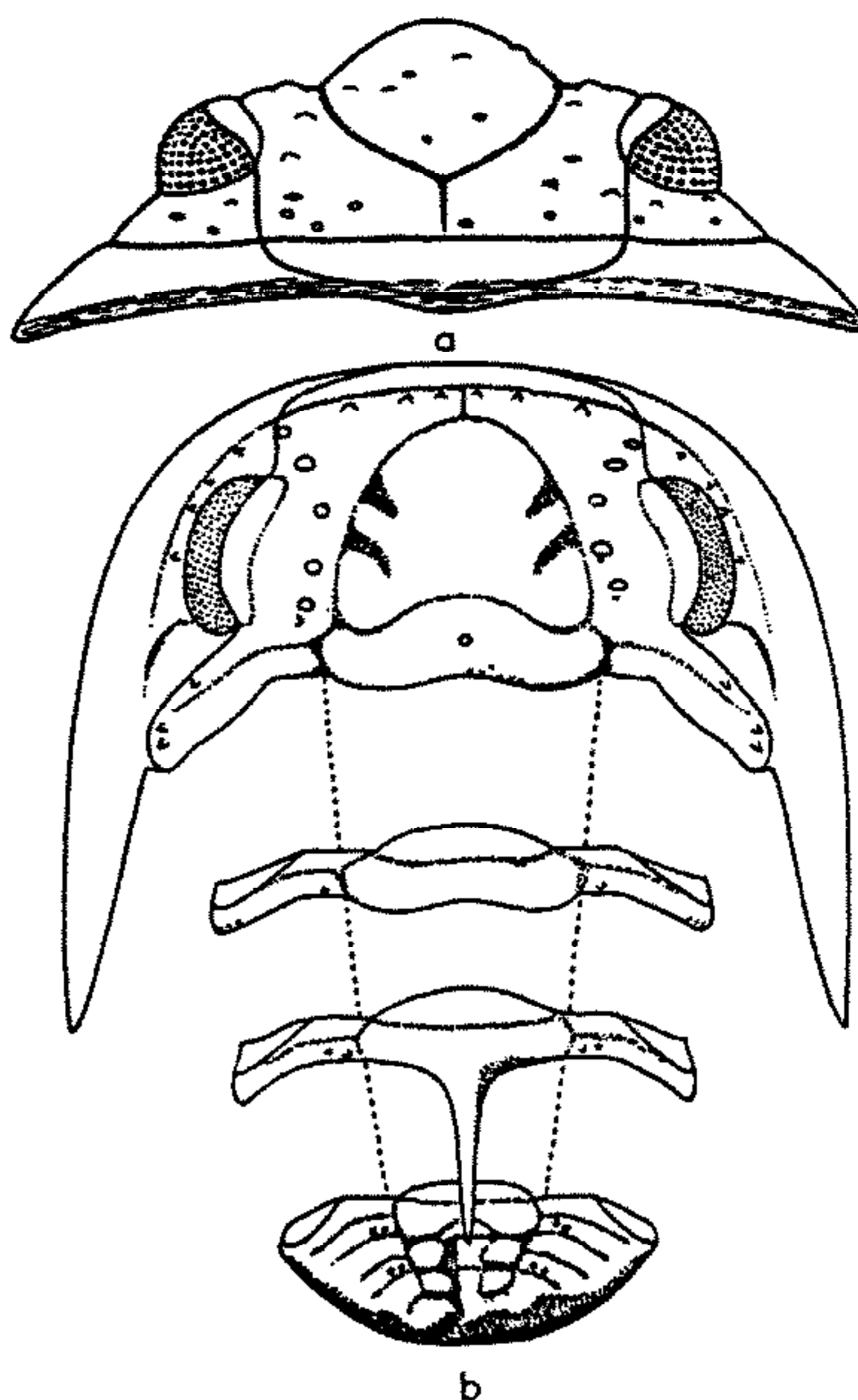
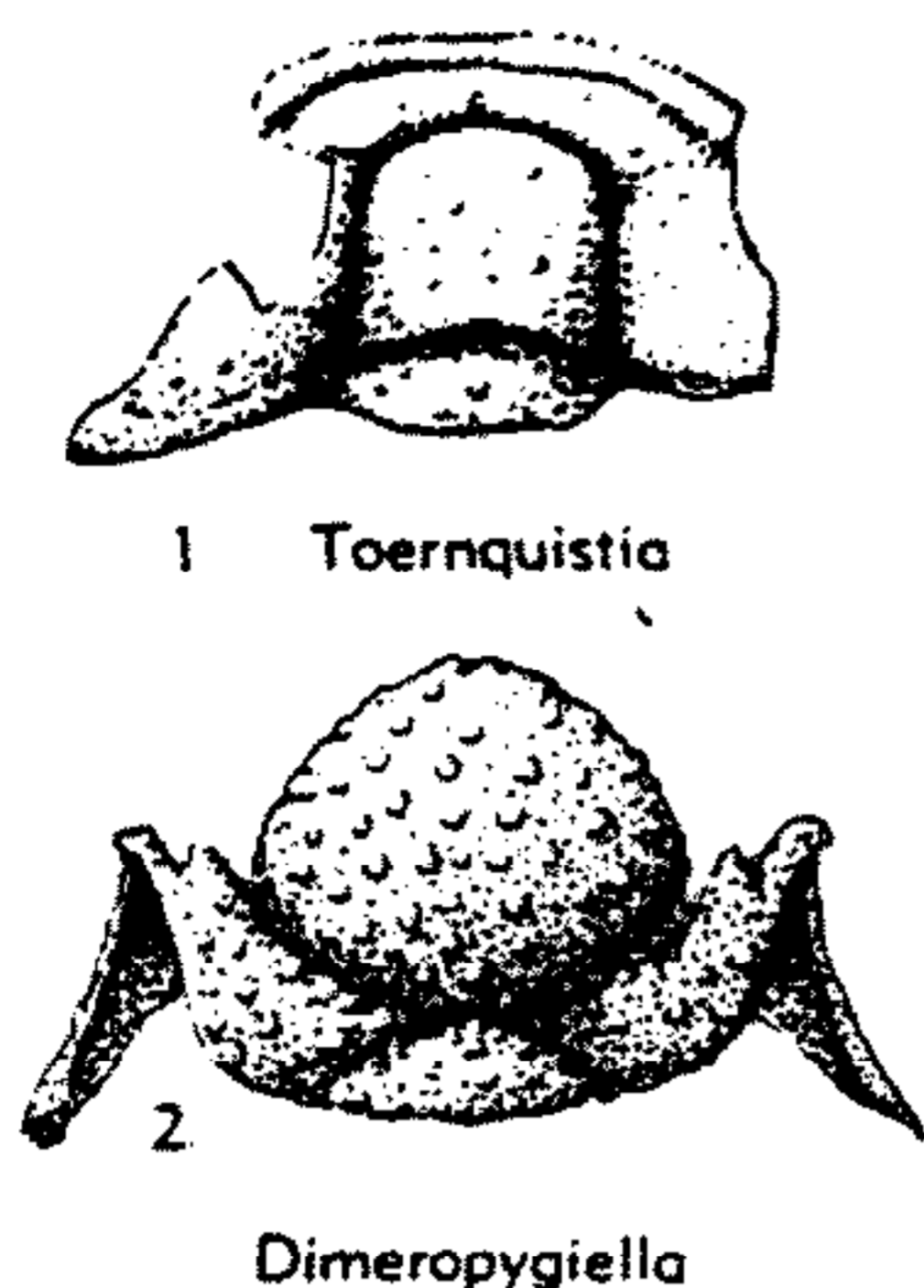

FIG. 315. **Mesotaphraspis parva* WHITTINGTON & EVITT (Dimeropygidae, M.Ord., Va.; *a,b*, incompl. exoskel. (reconstr.), ceph., front, $\times 10$ (360).

with numerous short spines, groups on pleural terminations characteristically arranged. *M.Ord.-U.Ord.*, N.Am.-Swed.-Est.—FIG. 314,1*a,b*. *D. virginiensis* WHITTINGTON & EVITT, M.Ord., Va.; 1*a,b*, incompl. exoskel. (reconstr.), dorsal, side, $\times 20$ (360*).—FIG. 314,1*c-e*. **D. minuta* (NIESZKOWSKI), M.Ord. (Kuckers Sh.), Est.; 1*c*, ceph. (incompl.), $\times 11$; 1*d*, librigena, $\times 11$; 1*e*, pyg., $\times 13$ (*c,d*, 439; *e*, 461n).

Chomatopyge WHITTINGTON & EVITT, 1953 [**C. falcata*]. Like *Mesotaphraspis* but without lateral glabellar furrows, with longer, steeper preglabellar field lacking sagittal furrow, deep median pit in preglabellar furrow. Pygidium with short axis, indistinct axial rings, less prominent sagittal depression, and pleural fields with outer parts steeply sloping. *M.Ord.*, Va.—FIG. 314,2. **C. falcata*; 2*a-c*, ceph., dorsal, front, side (reconstr.), $\times 8$ (360*).

Dimeropygiella Ross, 1951 [**D. caudanodosa*]. Like *Dimeropyge* but cephalon nasute; glabella suboval, preglabellar field short or absent at mid-line; genal spines represented by tubercle or absent. Pygidium with 3 to 5 axial rings, pair of pustules behind axis; pleural fields strongly ribbed. Sur-



1 Toernquistia

Dimeropygiella

FIG. 316. Dimeropygiidae (p. 0412-0413).

face coarsely to finely tuberculate or smooth, no groups of spines on pleural terminations (258). *L. Ord.*, Utah-Nev.—FIG. 316,2. **D. caudanodosa*; ceph., front, $\times 14$ (258).

Mesotaphraspis WHITTINGTON & EVITT, 1953 [**M. parva*]. Glabella narrowing forward, with 1 or 2 pairs of shallow, lateral glabellar furrows; preglabellar field with sagittal furrow; eye lobes long, curved; anterior sections of facial sutures united along anterior margin, no median or connective sutures; genal spines long. One thoracic segment with median spine. Pygidium with sagittal depression in axis, pleural regions furrowed. Surface smooth or finely granulate, lines of paired tubercles on cephalon. *M. Ord.*, Va.—FIG. 315. **M. parva*; a, incompl. exoskel. (reconstr.); b, ceph., front; both $\times 10$ (360*).

Toernquistia REED, 1896 [pro *Törnquistia* (ICZN Op. 367)] [**Cyphaspis* (*Törnquistia*) *nicholsoni*] Like *Dimeropyge* but less completely known, with glabella narrowing forward, deep median pit in preglabellar furrow, pair of faint furrows running from anterolateral margins of glabella outward and forward to anterior corners of large eye lobes; rostral plate may be wider (*tr.*). *M. Ord.-L.Sil.*, Eng.-Scot.-Swed.—FIG. 361,1. **T. nicholsoni* (REED), Keisley Ls., Eng.; cran., $\times 9$ (360*).

Family UNCERTAIN

[Authorship.—Diagnoses by RICHTER & RICHTER with additions by W. STRUVE, except *Cyrtoproetus* and *Palaeophillipsia* by J. M. WELLER]

Cyrtoproetus REED, 1943 [**Phillipsia cracoensis* REED, 1899]. Glabella tapering slightly forward; lateral occipital lobes present behind basal lobes; eyes long, median; pygidium with poorly defined border. *L. Carb.*, G.Brit.—FIG. 318,1. **C. cracoensis* (REED); 1a,b, ceph., pyg., $\times 3.3$ (452).

Palaeophillipsia SUGIYAMA & OKANO, 1944 [**P. japonica*]. Cephalon subtriangular; glabella narrower than genae, widest at basal lobes; preglabellar field present; eyes long, posterior; pygidium of uncertain character. *Up.U.Dev.*, Japan.—FIG. 318,3. **P. japonica*; 3a,b, ceph., pyg., $\times 2.8$ (477).
Perunaspis PŘIBYL, 1949 [**Perunaspis longispinus*]. Cephalon and thorax unknown. Pygidium small, moderately convex; axis strongly tapering, with

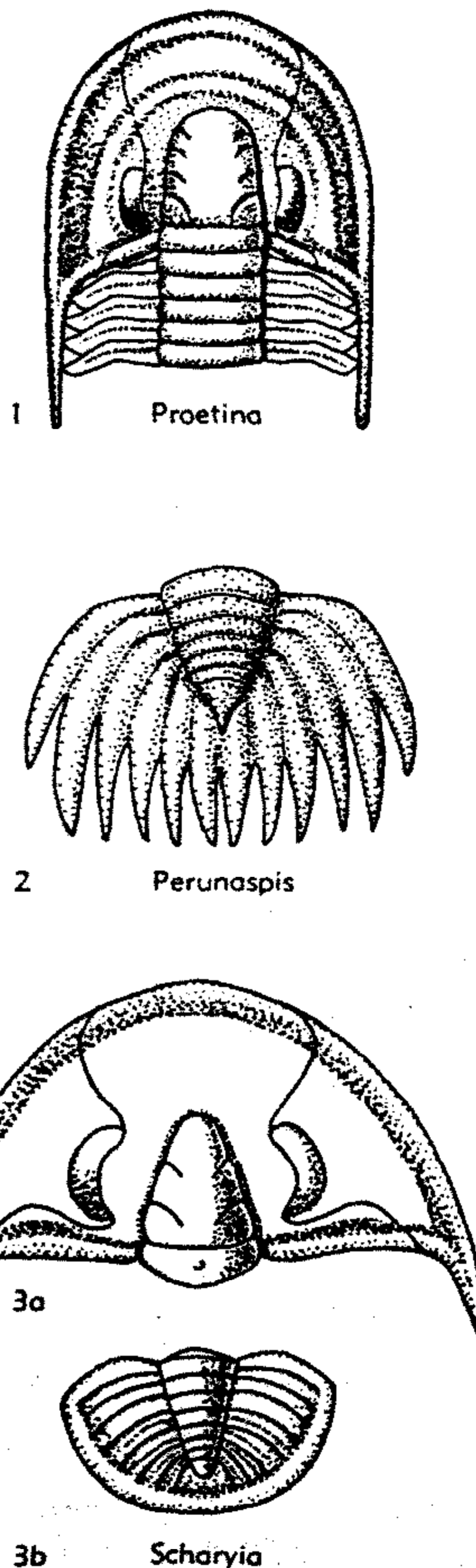

1 Proetina

2 Perunaspis

3a

3b Scharyia

FIG. 317. Proetacea (Family Uncertain) (p. 0413, 0415).

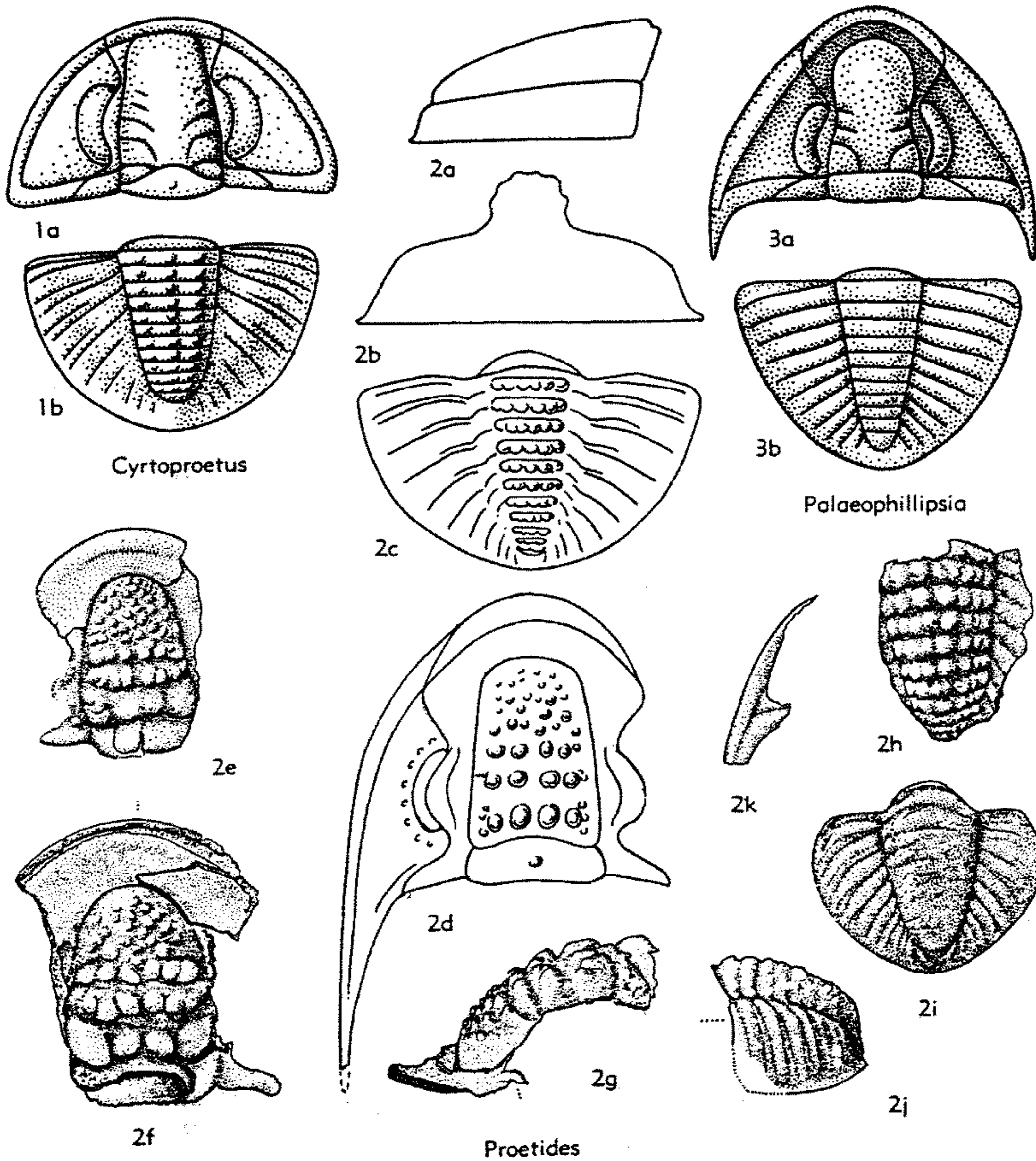

FIG. 318. Proetacea (Family Uncertain) (p. 0413-0414).

6 or 7 rings, postaxial ridge present; pleural fields with 6 pairs of long, ensiform ribs that become free spines in their distal halves, posterior 4 or 5 pairs ending in nearly straight transverse line. *M. Dev.*, Czech.—FIG. 317,2. **P. longispinus*; pyg., X12 (445a).

Proetides O. T. WALTER, 1924 [**Phillipsia insignis* WINCHELL, 1863]. Cephalon elongate (*sag.*) semi-elliptical; cephalic border distinct; preglabellar field large, deeply concave; glabella tapering, lateral furrows fairly distinct, connected by transglabellar depressions that divide posterior part of

glabella in 3 transverse stripes, each with row of very coarse nodes; anterior part of glabella coarsely granulose; *lp* lobes ("basal lobes") detached; eyes close to glabella and posterior border furrows; anterior sections of facial sutures distinctly divergent; long genal spines. Pygidium short, strongly vaulted; axis broad, elevated, not reaching posterior border; about 11 rings, each with single row of tubercles; 10 pairs of broad ribs, last pair converging behind axis; anterior pleural bands progressively reduced adaxially, none in posterior ribs; border narrow, indistinctly de-

tached. *L.Miss.*, USA.—FIG. 318,2. **P. insignis* (WINCHELL), U.Kinderhookian, Iowa; 2a-d, specimens "better-preserved than types," drawn by J. M. WELLER, $\times 2.7$ (2a,b, long. and transv. profiles, pyg.; 2c, dorsal, pyg.; 2d, dorsal, ceph.); 2e-k, syntype specimens, courtesy of G. M. EHLERS, drawn by W. STRUVE (2e, cran., $\times 2.7$; 2f,g, lectotype cran., $\times 2.7$ —here designated by STRUVE; 2h, pyg., axis $\times 2.7$; 2i,j, pyg., $\times 2.7$; 2k, librigena, $\times 1.4$).

Proetina PŘIBYL, 1946 [**Proetina latimargo*]. Cephalon an elongate paraboloid; preglabellar field broad (*sag.*), with anterior concavity; slightly convex rounded ridge parallel to cephalic border surrounding glabella and eyes; glabella narrow, gently tapering, with broad rounded front, glabellar region in front of 3*p* furrows short, 1*p* with separate adaxial branch, 1*p* lateral lobes not separated; occipital ring broad, not narrowed laterally, without lobes; anterior sections of facial sutures long, gently curved sigmoidally; eyes large; genal spines long. Thorax with unknown number of segments, ends rounded. Pygidium unknown. [Cephalon combines features of several proetid subfamilies.] *L.Dev.*, Czech.—FIG. 317,1. **P. latimargo*, Koněprusy Ls.; $\times 3$ (445a).

Scharyia PŘIBYL, 1946 [**Proetus micropygus* HAWLE & CORDA, 1847]. Small (5 mm. long). Cephalon semicircular, with slightly convex border, preglabellar field rather broad (*sag.*); glabella tapering; no occipital lobes; palpebral lobe strongly curved, moderately distant from axial furrows; anterior sections of facial sutures divergent, posterior sections running laterally considerably in front of posterior border furrow, describing arc that ends close to genal spines. Thorax with 6 segments having pointed ends. Pygidium semicircular, relatively large, slightly convex, with distinctly separated broad border; axis rapidly tapering, not reaching border, with 6 to 9 rings; pleural fields with 5 ribs. [Shape of posterior section of facial sutures and small number of thoracic segments are unique in Proetacea. *Scharyia* may represent larval stages of one or more other proetid genera.] *Sil.-M.Dev.*, Czech.-Pol.—FIG. 317,3. **S. micropyga* (HAWLE & CORDA), Sil., Loděnice; 3a, ceph., $\times 12$; 3b, pyg., $\times 10$ (445a).

Suborder HARPINA Whittington,

NOV.

[=Superfamily Harpedacea KOBAYASHI, 1935; Harpoidae HUPÉ, 1953 (*nom. transl.*, ex Harpedacea KOBAYASHI, 1935)]
[Type—*Harpes* GOLDFUSS, 1839]

Cephalon subsemicircular to ovate in outline, with long genal prolongations or spines. Glabella convex, narrowing forward, with 1 to 3 pairs of lateral glabellar furrows, preoccipital pair isolating triangular lateral lobes; occipital ring convex; genae

convex; preglabellar field sloping outward and downward to flat or upwardly concave fringe or bilaminar border; alae may be present; prominent eye lobes or tubercles centrally located on genae, with strong eye ridges and in some forms with genal ridges also; sutures marginal except on dorsal side at genal angles, and (in genera with eye lobes) where sections of sutures run inward close together. Thorax with 12 or more segments; axis convex; pleurae flat, with broad pleural furrows. Pygidium short, subtriangular or elongate, with convex axis. Radiating, anastomosing genal caecae commonly present on genae and preglabellar field, and extending onto fringe; external surface of cephalon may be tuberculate or granulose (78, 79, 355). *U.Cam.-U.Dev.*

Family HARPIDAE Hawle & Corda, 1847

[*nom. correct.* MILLER, 1889 (ex Harpides HAWLE & CORDA, 1847)] [emend. WHITTINGTON, 1950] [=Arraphidae ANGELIN, 1854; Harpedidae (HAWLE & CORDA, 1847) RAYMOND, 1913]

Eye tubercles each with 2 lenses; semi-circular alae adjacent to posterior glabellar lobes; bilaminar fringe with opposed pits in outer surfaces, genal rolls steeply sloping, brim gently sloping, with stout girder on lower lamella separating these 2 parts, prolongations of fringe varying in length; cephalic suture traverses marginal band of fringe. Hypostoma pear-shaped in outline, with ovate middle body, large anterior, small posterior, and wings. Thorax with 12 to 29 segments, pleurae bent down at tips. Pygidium small, short (*sag.*), triangular, with few segments. External surface of glabella and genae with raised ridges in reticulate pattern, tuberculate, or smooth; minute tubercles on fringe between pits and marginal band, on internal rim, and elsewhere (183, 348). *L.Ord.-U.Dev.*

Harpes GOLDFUSS, 1839 [**H. macrocephalus*].

Cephalic outline inverted U-shape, length of prolongations equaling length of cephalon along mid-line; height of cephalon about 0.5 of median length; glabella with ovate anterior lateral lobes larger than posterior; alae extending across genae, each subdivided into 2 crescentic portions; genal roll broad, with inner margin lying against anterior margin of glabella and eye tubercles; girder meeting internal rim; rows of large pits in front of glabella, on each side of girder, on genal roll prolongations, and adjacent to margin of fringe, with quincunxially arranged small pits between these rows. Thorax with 29 segments. External surface of glabella and genae tuberculate (242).

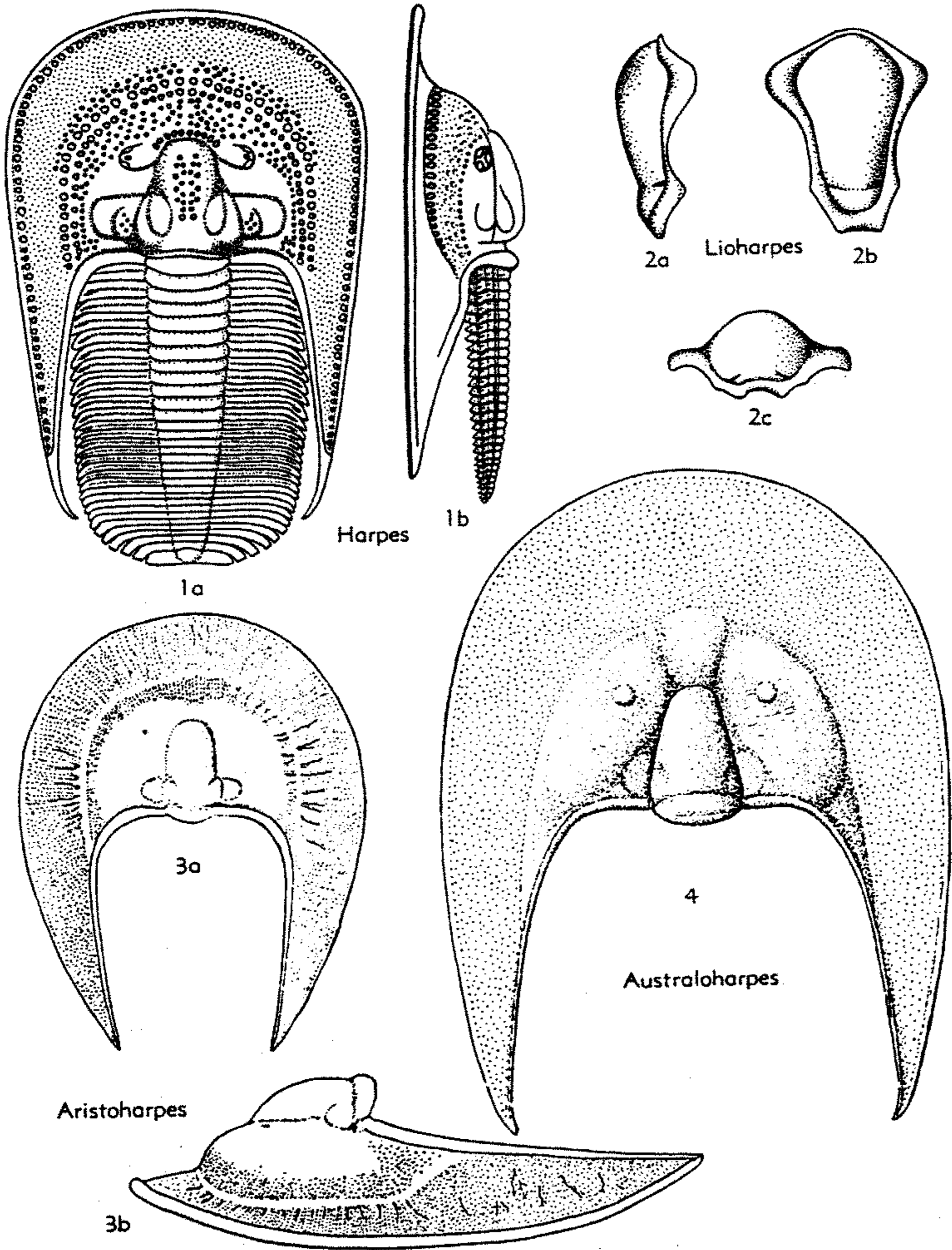

FIG. 319. Harpidae (p. 0415-0418).

M.Dev., Eu.-N.Afr.-?Asia-?Austral.—FIG. 319,1.
 **H. macrocephalus*, Ger.; 1a, exoskel. (reconstr.),
 X1.1 (496n); 1b, same, lateral, X1 (242°).

Aristoharpes WHITTINGTON, 1950 [**A. willsi*]
 [?=Scotoharpes LAMONT, 1948]. Like *Seleno-*
harpes but cephalon oval in outline; alae small;
 fringe with external surfaces of upper and lower

lamellae traversed by narrow, ramifying, raised
 ridges, small pits between the ridges. Thorax with
 at least 16 segments. Pygidium with strongly
 curved rib furrows. *L.Sil.*, Eng.—FIG. 319,3.
 **A. willsi*; 3a,b, ceph., dorsal, lateral, X2 (348°).
Arraphus ANGELIN, 1854 [**A. corniculatus*]. Na-
 ture and affinities uncertain. Brim unknown. *U.*
Ord., Swed. (HE).

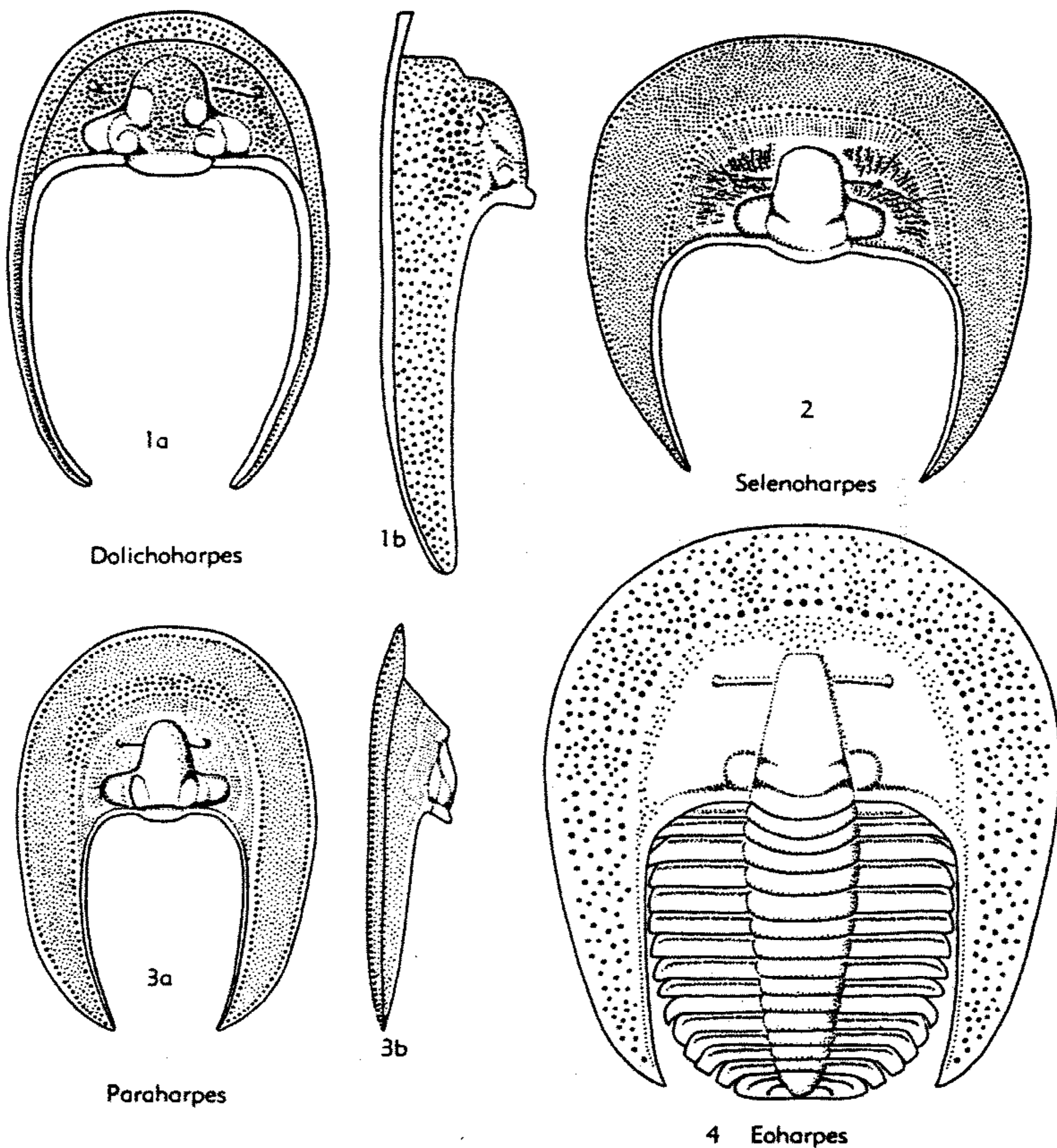

FIG. 320. Harpidae (p. 0417-0418).

Australoharpes HARRINGTON & LEANZA, 1957 [**A. depressus*] Cephalon oval in outline, of low convexity. Small posterior lateral glabellar lobes. Alae faint, eye tubercles opposite preglabellar furrow, preglabellar field elevated, laterally outlined by furrows which diverge forward. Fringe with girder extending to tips of prolongations, genal roll narrow, brim broad, flattened; pits small, closely and irregularly distributed. *L.Ord.(Tremadoc.)*, S. Am.—FIG. 319,4. **A. depressus*, Arg.; ceph., $\times 3.5$ (59*).

Dolichoharpes WHITTINGTON, 1949 [**Eoharpes uniserialis* RAYMOND, 1925]. Cephalon ovate in outline, strongly convex; glabella strongly convex, with short median and anterior lateral glabellar

furrows; alae depressed below rest of genae; fringe with deep girder extending to tips of prolongations, genal roll and prolongation broad and vertical, brim narrow, with flat lower and concave upper lamellae; pits large, irregularly and closely spaced, with tendency to radial arrangement in brim; coarse reticulate ornament on external surface of glabella and genae (except posterior lobes and alae), merging into fringe; curved ridge on posterior glabellar lobes, smooth paired oval area between posterior and median lateral glabella furrows. Hypostoma as in *Lioharpes* but with deeper and more oblique middle furrow and more pointed posterior ring. Pygidium short, wide (*tr.*), with 3 or 4 distinct segments (42). *M.Ord.*,

- N.Am.-Ire.—FIG. 320,1. **D. uniserialis* (RAYMOND), Mo.; 1a,b, ceph., dorsal, lateral, $\times 2$ (348*).
- Dubhglasina LAMONT, 1948 [**D. aldonensis*]. Nature and affinities uncertain. *M.Ord.*, Scot.
- Eoharpes RAYMOND, 1905 [pro *Harpina* NOVÁK, 1885 (non *Harpina* BOECK, 1871; nec DEJEAN in BURMEISTER, 1844) [**Harpes primus* BARRANDE, 1872; SD BASSLER, 1915]. Cephalon subcircular in outline, convex; anterior part of glabella depressed below genae, posterior lateral glabellar lobes small; alae small, faint, depressed; genal roll prolongation broad (*tr.*), with bluntly rounded tip, girder extending to tips of prolongations, brim flat with low anterior fold, pits of medium size, irregularly spaced. Thorax with 12 to 15 segments. External surface of glabella and genae apparently smooth but inner surface of genae impressed with pattern of radiating, anastomosing ridges and lines of pits between them. *M.Ord.*, Boh.—FIG. 320,4. *E. benignensis* (BARRANDE); exoskel. (reconstr.), $\times 2.7$ (496n).
- Hibbertia JONES & WOODWARD, 1898 [**Harpes stanagani* PORTLOCK, 1843 (= *Hibbertia orbicularis* JONES & WOODWARD, 1898)] [= *Platyharpes* WHITTINGTON, 1950 (obj.)]. Like *Paraharpes* but outline of cephalon subcircular, fringe with narrower genal roll and broader brim, pits smaller, thorax with few more than 10 segments. *M.Ord.*, Scot.-Ire.
- Lioharpes WHITTINGTON, 1950 [**Harpes venulosus* HAWLE & CORDA, 1847]. Like *Harpes* but alae narrower (*tr.*), no conspicuous rows of large pits flanking girder or at external margin; radiating ridges prominent on inner part of brim, faint on genal roll. *M.Dev.*, Boh.-?Fr.-?Sp.—FIG. 319,2. **L. venulosus* (HAWLE & CORDA), Boh.; 2a-c, hypostoma, left side, ventral (exterior), posterior, $\times 2.5$ (348*).
- Metaharpes LAMONT, 1948 [**M. amibouei*]. Only brim known. *L.Sil.*, Scot.
- Paraharpes WHITTINGTON, 1950 [**Harpes (Eoharpes) hornei* REED, 1914]. Outline of cephalon oval; glabella convex, carinate; alae large, not depressed; fringe with girder extending to tips of prolongations, brim flat, large pits in rows flanking the girder, along external margin, and on prolongations. Thorax with 23 to 25 segments. External surface of genae (not alae) with raised, radiating, reticulate pattern of ridges. *M.Ord.-U.Ord.*, Eng.-Scot.-?Ala.—FIG. 320,3. **P. hornei* (REED), U.Ord., Scot.; 3a,b, ceph., dorsal, side, $\times 1.5$ (348*).
- Selenoharpes WHITTINGTON, 1950 [**Harpes (Eoharpes) youngi* REED, 1914]. Cephalon subcircular in outline; genal ridges faint, alae large, depressed below level of genae; fringe with girder curving in behind genal angles to meet internal rim, broad genal roll and brim, latter with outward-sloping prolongation, pits tiny and close-spaced, larger ones flanking girder and at external margin. External surface of genae with radiating ridges that continue inward to genal roll only. Hypostoma, thorax, and pygidium unknown. *L.Ord.-M.Ord.*, Eu.—FIG. 320,2. **S. youngi* (REED), *M.Ord.*, Scot.; ceph., $\times 9$ (348*).

Family HARPIDIDAE Whittington, 1950

[= *Loganopeltidae* Huré, 1955]

Cephalic border not sharply set off from convex genae and preglabellar field; alae small, semicircular; facial sutures marginal, or with parallel anterior and posterior sections running close to each other and directed anterolaterally from eye tubercles to margin; genal caeca radiating over cheek lobes and in some extending onto cephalic border. Hypostoma subrectangular (*Harpides*), length (*sag.*) equal to that of glabella. Thorax with 20 or more segments; axis narrow; long (*tr.*) pleurae curving back at outer part may be extended into spines, with deep pleural furrows and convex posterior bands. *U.Cam.-L.Ord.*, Vt.-Que.-Newf.-S. Am.-Eu.-C. Asia (105, 117, 194, 249, 348, 349).

Harpides BEYRICH, 1846 [**H. hospes*] [= ?*Dictyocephalites* BERGERON, 1895]. Glabella 0.3 of length (*sag.*) of cephalon, with prominent posterior lateral lobes; eye tubercles opposite anterior margin of glabella, eye ridges directed slightly backward; alae depressed below level of genae; genal caeca strong, anastomosing, extending to narrow, convex, marginal rim, irregularly spaced tiny pits between caeca on concave cephalic border. Probably cephalic doublure of same width as border (without opposing pits?), with genal spines borne by such doublure. Pygidium unknown (348). *L.Ord.*, Vt.-Que.-Eu.-Arg.-C. Asia.—FIG. 321,3a. *H. rugosus* (SARS & BOECK), Norway-Swed.; cran., $\times 1$ (444).—FIG. 321,3b. *H. grimmi* (BARRANDE), Czech.; incomplete cran. and thorax, $\times 0.7$ (370*).

Fissocephalus LERMONTOVA, 1951 [**F. expansus*]. Resembles *Loganopeltoides*. *U.Cam.*, NE. Kazakhstan (HE).

Loganopeltis RASETTI, 1943 [**L. depressa*]. Glabella short, subconical, elevated above fixed cheeks, not sunk in depression; eyes disconnected from facial sutures, which are marginal. Thorax of 20 or more segments. Pygidium elongate, with short axis, pleurae converging backward and terminating in pair of flat spines. *L.Ord.*, N.Am.—FIG. 321,2. **L. depressa*, Que.; 2a, incompl. exoskel. (holotype), $\times 3$; 2b, cran., oblique lateral, $\times 3$; 2c, pyg., $\times 4$ (448n).

Loganopeltoides RASETTI, 1945 [**Conocephalites zenkeri* BILLINGS, 1860]. Like *Loganopeltis* but both sections of facial sutures running outward and forward from eyes close together but sep-

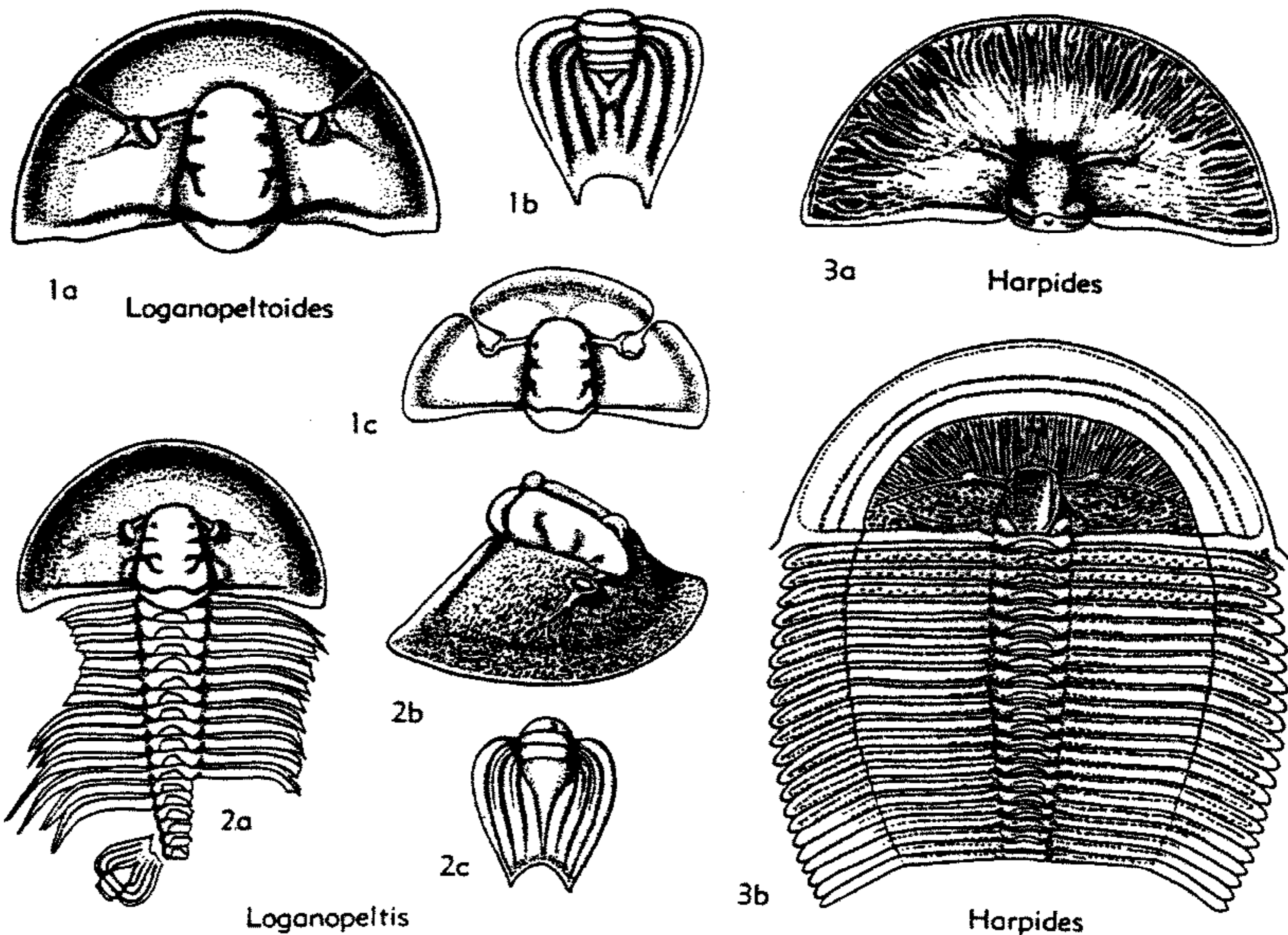

FIG. 321. Harpididae (p. 0418).

arately (*L. kindlei*) or merged into one (*L. zenkeri*). *U.Cam.(Trempeal.)*, N.Am.—FIG. 321,1a,b. **L. zenkeri* (BILLINGS), Que.; 1a, cran., $\times 1.5$; 1b, pyg., $\times 3$ (448n).—FIG. 321,1c. *L. kindlei* RASETTI, Newf.; cran., $\times 4$ (448n).

Family ENTOMASPIDIDAE Ulrich in Bridge, 1930

[*nom. correct.* HENNINGSMOEN, 1951 (*pro* Entomaspidae ULRICH in BRIDGE, 1930)]

Exoskeleton small. Cephalon semicircular, characterized by anterior and posterior sections of facial sutures close to each other, both directed outward-backward; librigenae fused together through doublure, dorsally consisting of narrow strips connecting eyes to margin and genal spines. *U.Cam.-L.Ord.*

Entomaspidis ULRICH in BRIDGE, 1930 [**E. radiatus*]. Glabella tapering, truncate, less than 0.5 of length of cephalon; fixigenae convex; border wide, radially striated; eyes small, at level of glabellar midpoint; eye ridges strong, oblique; posterior areas slender, curving backward. Pygidium widely triangular; axis prominent, with several segments; pleural fields flat, with downturned margin. *U.Cam.(Trempeal.)*, N.Am.—FIG. 322,2. **E. radiatus*, Mo.; 2a-c, cran., pyg., librigenae, $\times 7.5$ (448n).

Hypothetica Ross, 1951 [**H. rawi*]. Cranidium weakly convex; glabella short, subovate; eye ridges thick, directed transversely. *L.Ord.*, N.Am.—FIG. 322,1. **H. rawi*, Utah; cran., $\times 15$ (258).

Suborder TRINUCLEINA Swinnerton, 1915

[*nom. correct.* WHITTINGTON herein (*pro* Trinucleida SWINNERTON, 1915)] [=Ampycini SALTER, 1864; superfamily *Cryptolithidea* RICHTER, 1933; Trinucleacea KOBAYASHI, 1935, Raphiophoracea HENNINGSMOEN, 1951; Trinucleoidae HUPÉ, 1953] [Type—*Trinucleus* MURCHISON, 1839]

Cephalon subsemicircular to triangular in outline; glabella convex, subquadrate to clavate, with 3 or fewer pairs of lateral furrows and oval lateral lobes in some, median tubercle or glabellar spine in some genera; occipital ring short, narrow; alae characteristic of young stages, retained in some adults; genae convex, eye lobes absent or represented by tubercles, genal ridges present in some genera; cephalic border narrow, rolled, or comprising broad, bilaminar fringe with opposed pits; long genal spines; facial sutures opisthoparian, submarginal or marginal anteriorly and anterolaterally, becoming dorsal posterolaterally near or at genal angles. Thorax generally with

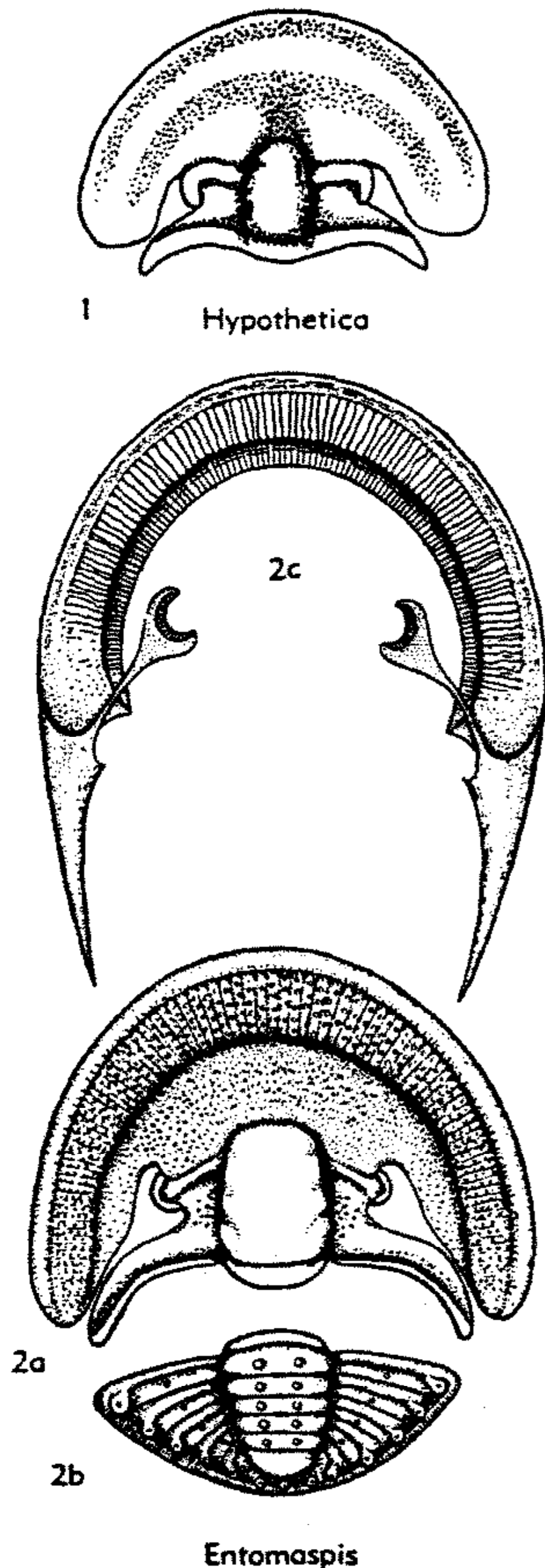

FIG. 322. Entomaspidae (p. 0419).

5 to 7 segments (but as many as 30 in *Seleneceme*); axis narrow; pleurae broad (*tr.*), flat, with deep pleural furrows. Pygidium subsemicircular or subtriangular in outline; narrow axis reaching posterior margin; commonly with many rings and furrows or double rows of muscle scars; pleural fields flat, margin broad. Surface smooth or with raised ridges generally in reticulate pattern

but tending to anastomosed radial arrangement on genae. *L.Ord.-M.Sil.*

Family TRINUCLEIDAE Hawle & Corda, 1847

[*nom. correct.* (ex *Trinucleides* HAWLE & CORDA, 1847; ICZN Opinion 505)] [= *Trinucleen* EMMERICH, 1844 (invalid vernacular name)]

Cephalic fringe broad, sloping outward, bilaminar, with numerous opposed pits on external surfaces, extending posterolaterally somewhat behind rest of cephalon; convex occipital ring commonly with backward-directed spine, occipital furrow with deep apodemal pit; glabella expanding forward, reaching to inner margin of fringe, deep anterior pits at extremities of axial furrows; genae subtriangular in outline, with or without eye tubercles and faint eye ridges; lower lamellae of fringe bearing genal spines. Thorax with 6 segments; convex axial rings, with deep apodemal pits in articulating furrows; pleurae with broad diagonal pleural furrows, pleural tips bent down. Pygidium triangular, length (*sag.*) 0.25 to 0.5 of width (*tr.*); axis with many rings; pleural fields with shallow pleural furrows. Surface of glabella and genae may bear reticulate pattern of raised ridges, margin of fringe and pygidial border with terraced lines (2, 78, 79, 344, 346). *L.Ord.-U.Ord.*

Subfamily TRINUCLEINAE Hawle & Corda, 1847

[*nom. transl. & correct.* WHITTINGTON, 1941 (ex *Trinucleides* HAWLE & CORDA, 1847)]

Glabella with convex frontal lobe, 3 pairs of short, deep, lateral glabellar furrows; pits in upper lamella of fringe deeply sunk in radial sulci anteriorly and laterally. *L.Ord.-M.Ord.*

Trinucleus MURCHISON, 1839 [*non* LINK, 1807 (ICZN Op. 505)] [**T. fimbriatus*; SD VOGDES, 1890] [= *Edgellia* SHAW, 1950 (obj.); *Botrioides* STETSON, 1927]. Median and posterior glabellar furrows deepest and longest. Pygidium strongly transverse, with breadth 3 or 4 times length (*sag.*). *L.Ord.-M.Ord.*, Br.I.-Norway-Swed.—FIG. 323.5. **T. fimbriatus*, *M.Ord.*, Wales; exoskel., $\times 2.7$ (496n).

Paratrinucleus WHITTINGTON, 1941 [**Trinucleus acervulosus* RAYMOND, 1920]. Like *Trinucleus* but median and posterior glabellar furrows isolating pair of triangular lateral lobes. Pygidium with width about twice length (*sag.*), many segments. *M.Ord.*, Va.

Subfamily TRETASPIDINAE Whittington, 1941

[*nom. correct.* WHITTINGTON, herein (*pro* Tretaspinae WHITTINGTON, 1941)]

Glabella with prominent frontal lobe, 3 pairs of lateral glabellar furrows; fringe

divided into convex genal roll and concave brim, former commonly with concentric ridges between pits, latter with pits in deep radial sulci anteriorly. *M.Ord.-U.Ord.*

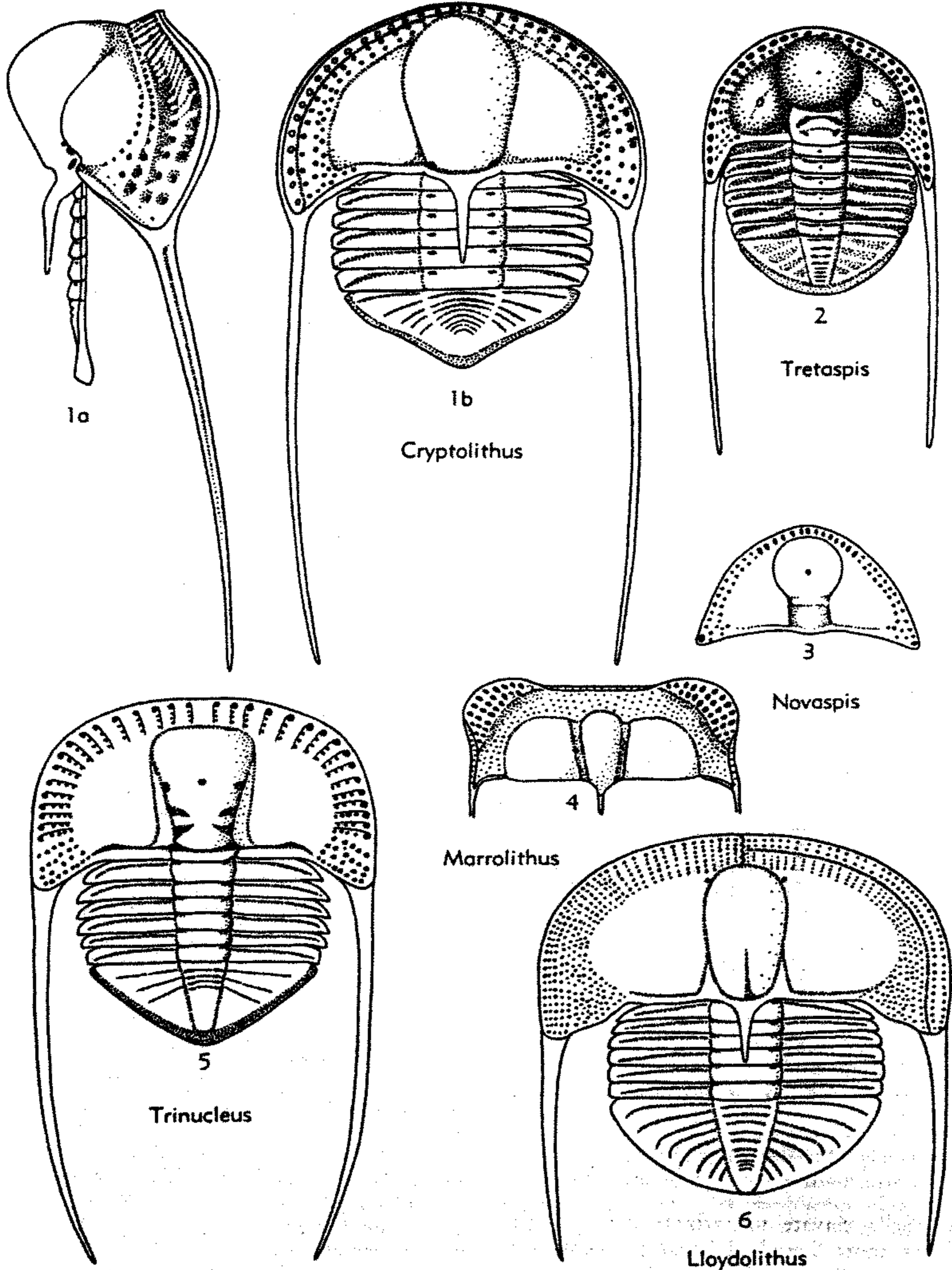

FIG. 323. Trinucleidae (Trinucleinae, Cryptolithinae, Novaspidinae) (p. O420-O424).

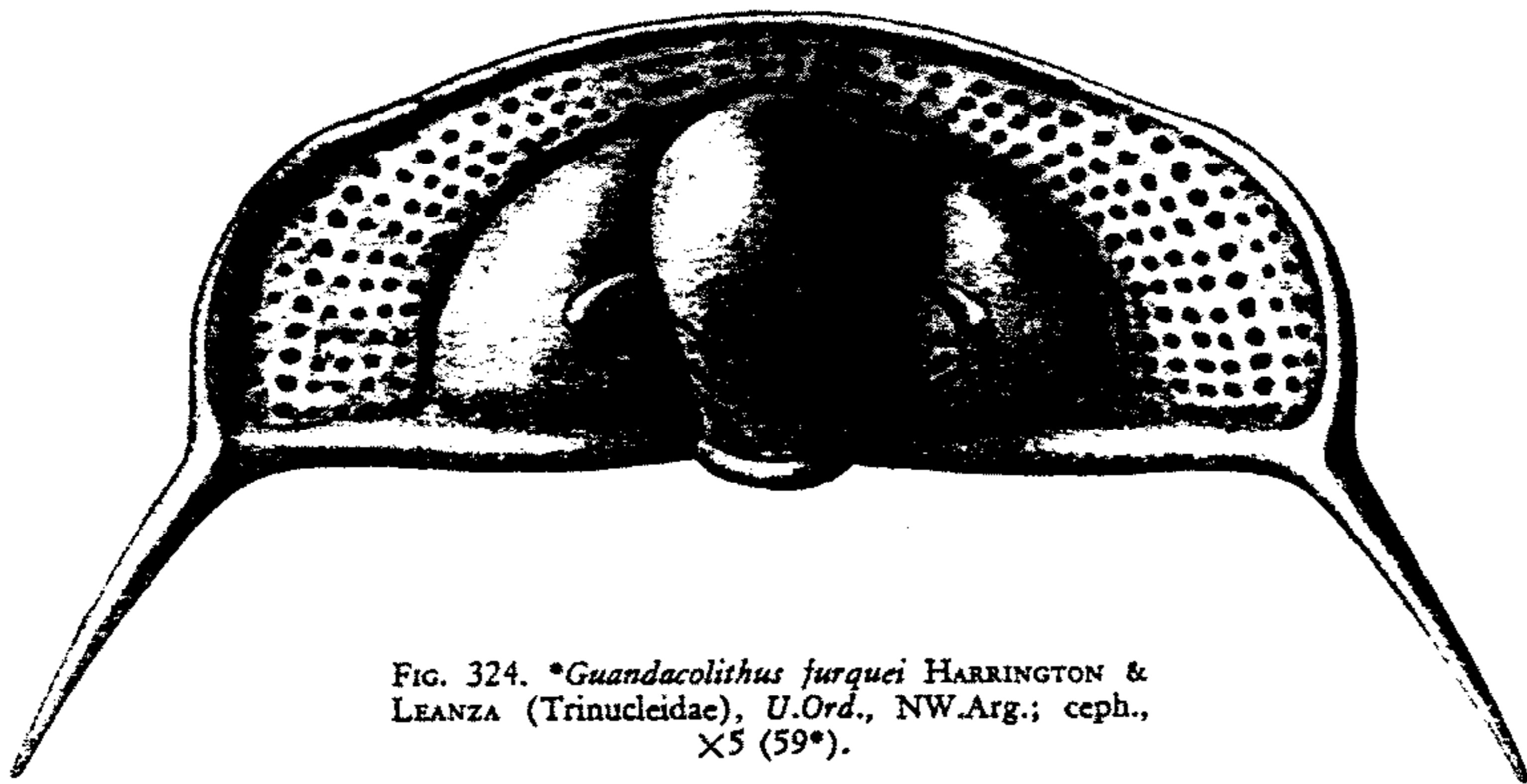

FIG. 324. **Guandacolithus furquei* HARRINGTON & LEANZA (Trinucleidae), U.Ord., NW.Arg.; ceph., $\times 5$ (59*).

Tretaspis M'COY, 1849 [non *Tretaspis* MURCHISON, 1839 (ICZN Op. 505)] [**Asaphus seticornis* HISINGER, 1840; SD BASSLER, 1915]. Frontal glabellar lobe subcircular in outline, posterior part of glabella with median posterior glabellar furrows converging inward; 2 rows of pits external to girder, in some species fusing anteriorly into single row; no median occipital spine. M.Ord.-U.Ord., E. N. Am.-Br. I.-Norway-Swed.-Boh.—FIG. 323,2. **T. seticornis* (HISINGER), Up.M.Ord.-U.Ord., Br.I.-N.Eu.; exoskel., $\times 2$ (473*).

Reedolithus BANCROFT, 1929 [**Trinucleus subradiatus* REED, 1903]. Glabella carinate, lateral glabellar furrows short; with median occipital spine; eye tubercles and eye ridges present; fringe with single row of large external pits, 5 or more rows of smaller pits internally, arranged concentrically and radially. M.Ord., Scot.-Norway-Swed.-Que.

?*Guandacolithus* HARRINGTON & LEANZA, 1957 [**G. furquei*]. Glabella pyriform, with 3 pairs of lateral glabellar furrows; eye tubercles and eye ridges present; fringe broad laterally, narrow anteriorly, position of girder unknown; 4 complete rows of pits, outermost of which are large, with 21 or 22 pits on each side in concentric and curved-radial arrangement, also inside innermost complete row, 2 additional rows bordering genae and laterally 3 incomplete rows outside outermost complete row of large pits, incomplete rows being arranged concentrically and radially with respect to complete rows. M.Ord. (Caradoc.), S. Am.—FIG. 324. **G. furquei*, NW.Arg.; ceph., $\times 10$ (59*).

Subfamily CRYPTOLITHINAE Angelin, 1854

[nom. transl. BANCROFT, 1933 (ex Cryptolithidae ANGELIN, 1854)]

Glabella clavate to carinate, with single pair of short lateral glabellar furrows; eye tubercles and eye ridges usually absent. L.Ord.-U.Ord.

Cryptolithus GREEN, 1832 [**C. tessellatus*]. Fringe with concentric rows of pits that show radial arrangement also anteriorly, characteristically with raised radial ridges between outer row or rows and concentric ridges between inner rows, one row of pits external to girder. L.Ord.-U.Ord., N. Am.-Br.I.—FIG. 323,1. **C. tessellatus*, M.Ord., E.N.Am.; 1a, exoskel., dorsal, with left half of upper lamella of fringe removed; 1b, same, lateral; both $\times 2.7$ (496n).

Onnia BANCROFT, 1933 [non *Tetrapsellium* HAWLE & CORDA, 1847, ICZN pend.] [**Cryptolithus superbus* BANCROFT, 1929]. Upper lamella of fringe convex, with 2 complete rows external to girder and 2 internal in concentric arrangement, rows on each side of girder larger, outermost row of many small pits; bordering genae additional rows, depressed or with marked radial arrangement. M.Ord.-U.Ord., Eng.-Boh.-Fr.-Port.-N.Afr.-Venez.—FIG. 325,1. **O. superba* (BANCROFT), U.Ord., Eng.; ceph., $\times 2$ (422*).

Broeggerolithus BANCROFT in LAMONT, 1935 [pro *Broeggeria* BANCROFT, 1933, non *Broeggeria* WALCOTT, 1903] [**Cryptolithus broeggeri* BANCROFT, 1929] [?= *Ulricholithus* BANCROFT, 1949]. Fringe with 4 rows of pits in concentric and radial arrangement, 2 external; additional pits posterolaterally, 1 or 2 pits intercalated in external row in front of glabella. M.Ord., Eng.-Wales.

Cryptolithoides WHITTINGTON, 1941 [**C. ulrichi*]. Anterolateral cephalic margin angulate; fringe with numerous small pits, single regular external row, 1st internal row in radial concentric arrangement with it, inside this row pits irregularly arranged. M.Ord., Okla.-Tex.—FIG. 325,2. **C. ulrichi*, Okla.; exoskel. (paratype), $\times 2.5$ (496*).

Reuscholithus BANCROFT, 1929 [**R. reuschi*]. Fringe with 4 continuous rows of pits, 2 of which form narrow zone external to girder, 4 additional rows laterally; pits irregular in size and distribution. M.Ord., Eng.

Salterolithus BANCROFT, 1929 [**Trinucleus caractaci* MURCHISON, 1839]. Fringe with 3 or 4 rows of pits outside girder, 2 complete rows inside, additional rows laterally; arrangement in concentric rows adjacent to girder. *M.Ord.*, Eng.

Marrolithus BANCROFT, 1929 [**Trinucleus ornatus* var. *javus* SALTER, 1848]. Fringe with angulate margin anterolaterally, pits in radial and concentric arrangement, variable area of upper lamella inflated anterolaterally. *M.Ord.*, Wales-Eng.-Fr.-Port.-N.Afr.—FIG. 323,4. **M. javus* (SALTER), *M.Ord.*, Wales; ceph., $\times 1.5$ (361*).

Marrolithoides A. WILLIAMS, 1948 [**M. simplex*]. Pits in simple radial arrangement, anterolateral inflation of upper lamella rare or absent. *M.Ord.*, Eng.

Talaeomarrolithus A. WILLIAMS, 1948 [**Trinucleus radiatus* MURCHISON, 1839]. Glabella with poorly developed frontal lobe, fringe with pits in radiating sulci that bifurcate anterolaterally. *M.Ord.*, Eng.-Wales.

Lloydolithus BANCROFT, 1933 [**Trinucleus lloydi* MURCHISON, 1839]. Pygidium with posterolateral margins in smooth arc; outer parts of pleural furrows curving sharply back; small convex alae at base of glabella; fringe with pits in concentric rows, strong radial arrangement anteriorly, irregular posterolaterally, 2 rows external to girder. *M.Ord.*, Eng.-Wales.—FIG. 323,6. **L. lloydi* (MURCHISON); exoskel. (reconstr.), with right half of upper lamella of fringe removed, $\times 2.7$ (496n).

Protolloydolithus A. WILLIAMS, 1948 [**Trinucleus ramsayi* HICKS, 1875]. Glabella with 2 pairs of glabellar furrows; fringe with single row of pits external to girder, inside girder numerous small pits, radial arrangement anteriorly, elsewhere irregular; otherwise like *Lloydolithus* (352, 361). *M.Ord.* (Llanvirn.), Eng.-Wales.

Eirelithus LAMONT, 1941 [**Trinucleus thersites* SALTER, 1853]. Triangular depressed regions bordering posterior part of glabella; fringe narrow, with 2 rows of pits external to girder, some additional pits anterolaterally, 1st internal row complete, few additional pits anterolaterally; eye tubercles and eye ridges present (115). *M.Ord.*, Ire.

Famatinolithus HARRINGTON & LEANZA, 1957 [**F. noticus*]. Fringe narrow, outer surface of upper lamella deeply concave, broad rim and deep girder forming rolled outer edge of fringe; 2 rows of pits, outer large, inner incomplete only in front of glabella, additional pits anterolaterally between these 2 rows. *M.Ord.* (Llanvirn.), S.Am.—FIG. 326. **F. noticus*, NW.Arg.; exoskel. (reconstr.), $\times 4.5$ (59*).

Myttonia WHITTARD, 1955 [**M. confusa*]. *L.Ord.* (Arenig.), Eng.

Bergamia WHITTARD, 1955 [**B. rhodesi*]. *L.Ord.* *M.Ord.*, Eng.

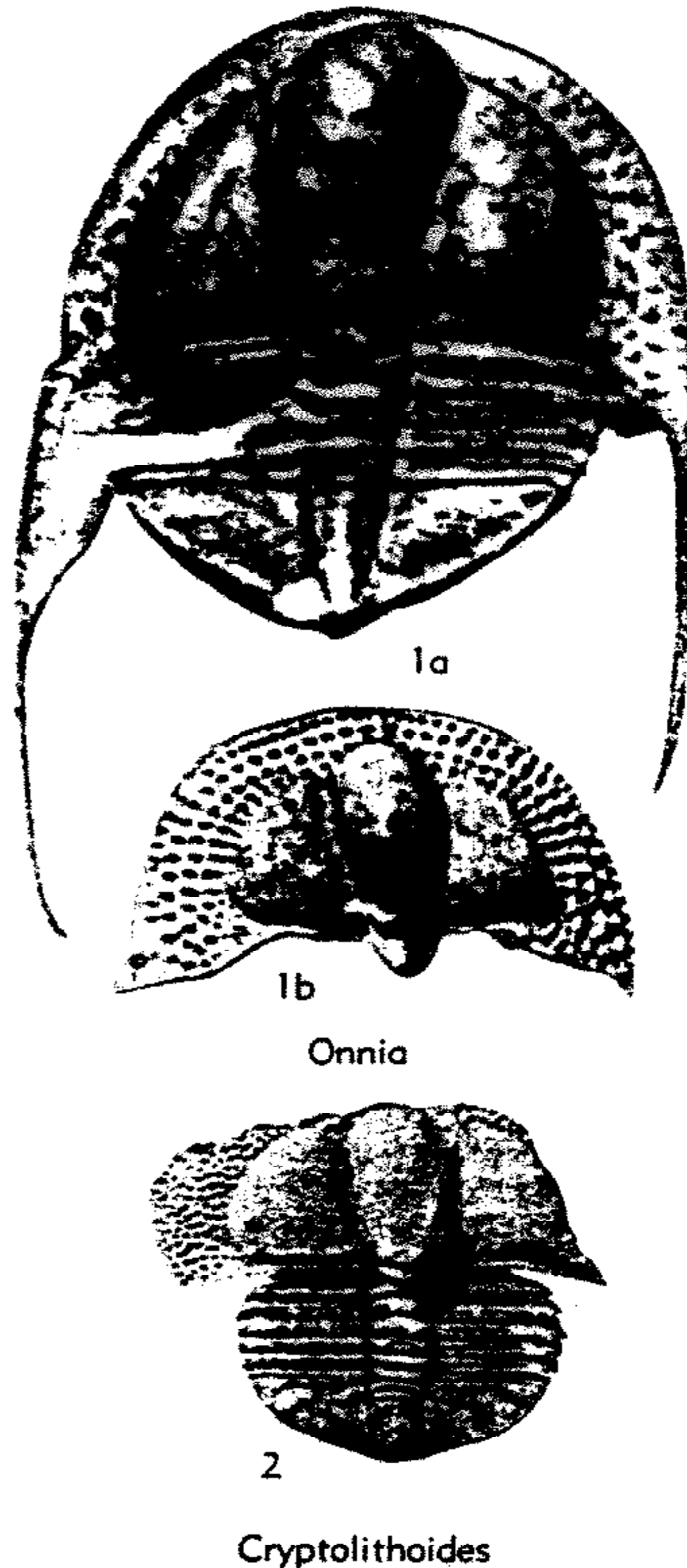

FIG. 325. Trinucleidae (Cryptolithinae) (p. 0422).

Incaia WHITTARD, 1955 [**Trinucleus nordenskioldi* BULMAN, 1931]. *M.Ord.* (Llanvirn.), Peru.

Stapeleyella WHITTARD, 1955 [**S. inconstans*]. *M.Ord.* (Llanvirn.), Eng.

Bettonia WHITTARD, 1956 [**B. frontalis*]. *M.Ord.*, Eng.

Hangchungolithus LU, 1956 [**Cryptolithus multi-seriatus* ENDO, 1932]. Like *Myttonia*. *L.Ord.*, W. Tapashan, China.

Ningkianolithus LU, 1956 [**Cryptolithus welleri* ENDO, 1932]. Like *Protolloydolithus*. *L.Ord.*, W. Tapashan, China.

Nankinolithus LU, 1957 [**N. nankinensis*]. Fringe like *Broeggerolithus*, external pits in deep radial sulci, all pits in such sulci anteriorly; laterally internal pits irregularly arranged. *U.Ord.*, Tangshan, China.

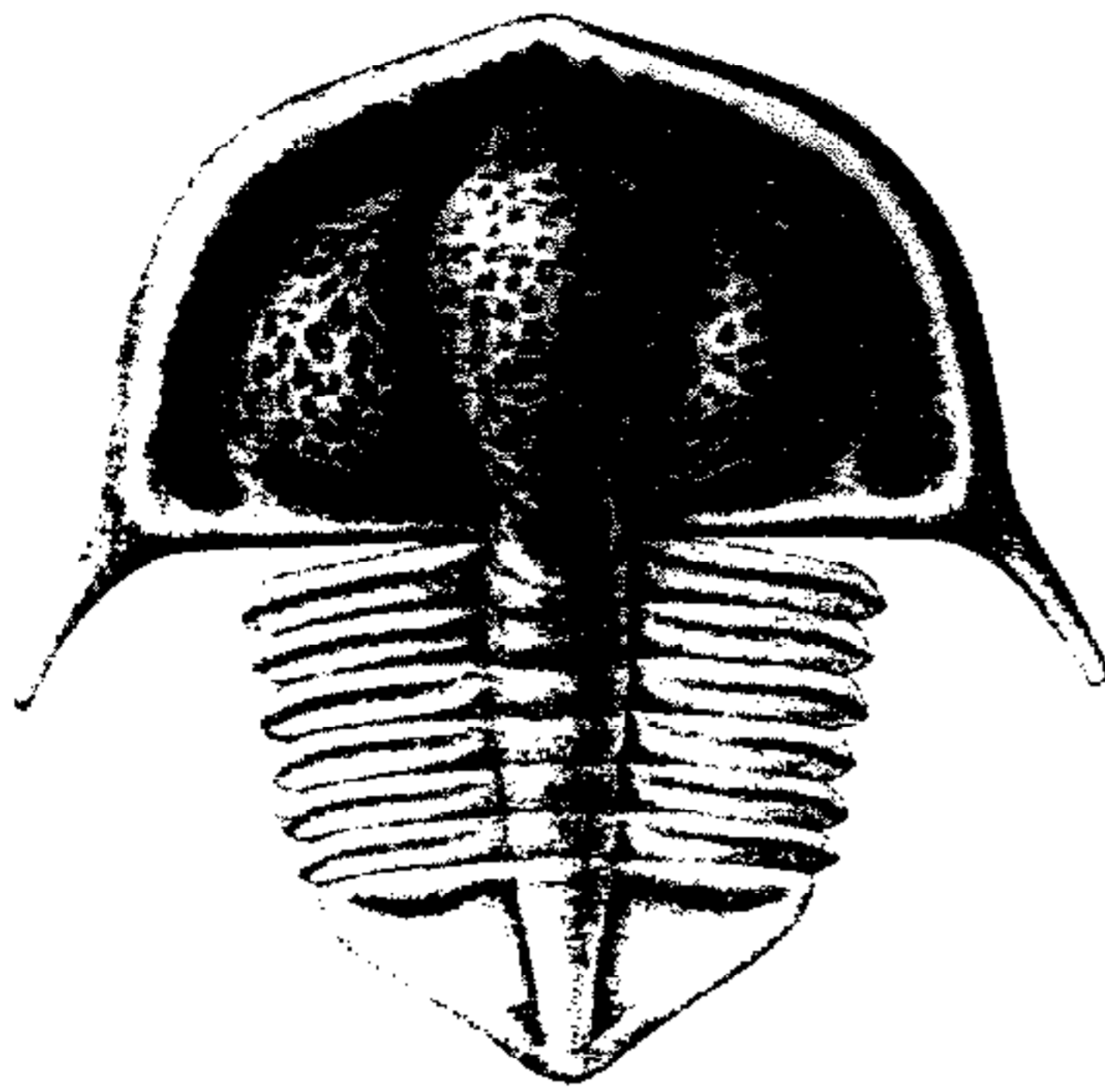

FIG. 326. **Famatinolithus noticus* HARRINGTON & LEANZA (Trinucleidae), M.Ord., NW.Arg.; exoskel. (reconstr.), $\times 4.5$ (59*).

Subfamily NOVASPIDINAE Whittington, 1941

[*nom. correct.* WHITTINGTON, herein (*pro* Novaspidinae WHITTINGTON, 1941)]

Glabella with subspherical frontal lobe, posterior portion low, 2 pairs of short lateral glabellar furrows; no eye tubercles; narrow, flat fringe, with 2 rows of pits in radial sulci anteriorly. *U.Ord.*

Novaspis WHITTINGTON, 1941 [**Tretaspis elevata* COOPER & KINDLE, 1936]. Characters of subfamily. *U.Ord.* Que.-?Scot.—FIG. 323,3. **N. elevata* (COOPER & KINDLE); ceph., $\times 1.5$ (346*).

Family OROMETOPIDAE Hupé, 1955

Glabella subparallel-sided or expanding forward, convex, basal lateral furrow (if present) short and close to occipital furrow, preoccipital part of glabella extended backward as a spine; occipital ring short (*sag.*), convex; axial and preglabellar furrows shallow, with anterior pit in some forms; broad (*sag.*, *exsag.*) preglabellar field, narrow anterior and lateral cephalic border; convex triangular genae, with posterior border widening (*exsag.*) laterally, border furrow terminating distally in deep pit; large eye lobes centrally situated on genae, palpebral rims continuous with eye ridges; gently convex alae triangular in outline, not separated from occipital ring by axial furrows; genal spines extended back far beyond pygidium. Doublure narrow, rolled, hypostoma not known in place (associated hypostomas with transversely rectangular outline), with shal-

low depression at posterolateral corners. Thorax with 7 or 8 segments; axial rings may bear median spine on 3rd and 4th segments; pleurae horizontal; shallow, straight pleural furrow. Pygidium with 6 or fewer axial ring furrows; pleural fields with 1st pleural furrow. External surface of cephalon with raised reticulate pattern, terraced lines on doublure and hypostoma (287). *L.Ord.* (*Tremadoc.*).

Orometopus BRØGGER, 1896 [**Holometopus? elatifrons* ANGELIN, 1854]. Characters of family. *L.Ord.* (*Tremadoc.*), Eu.-S.Am.—FIG. 327,3. **O. elatifrons* (ANGELIN), Swed.; exoskel. (reconstr.), $\times 7$ (496n).

Family DIONIDIDAE Gürich, 1908

[*nom. correct.* RAYMOND, 1920 (*pro* Dionideae GÜRICH, 1908)]

Cephalon, thorax, and pygidium subequal in length (*sag.*); glabella with anterior part strongly convex, suboval posterolateral lobes, median tubercle, or short glabellar spine; eyes absent; with 2 genal ridges; facial sutures curving across genal angles on dorsal side; cephalic fringe bilaminar with lamellae close together and opposing pits, largest externally, irregularly arranged; girder external. Hypostoma with ovate middle body and broad (*tr.*) lateral areas. Thorax with 6 segments, 1st longest (*sag.*, *exsag.*), pleural furrows curving forward, concave toward front. Pygidium with narrow axis having about 20 or fewer rings and pleural furrows (352). *M.Ord.*-*U.Ord.*

Dionide BARRANDE, 1847 [ICZN Opinion 350] [**Dione formosa* BARRANDE, 1846] [= *Polytomurus* HAWLE & CORDA, 1847 (*obj.*); *Trigrypos* KOBAYASHI, 1940]. Glabella subquadrate, with median tubercle; preglabellar field short (*sag.*) or absent; fringe broad. Axial rings of thorax and pygidium with anterolateral corner isolated by diagonal furrows; sigmoidal course of posterior edge of rings characteristic. Inner part of anterior band of 1st thoracic pleurae inflated. Surface of genae and pleurae pitted, ridges between pits forming reticulate pattern. *M.Ord.*-*U.Ord.*, Eu.-Va.-Yunnan.—FIG. 327,2. **D. formosa* (BARRANDE), *M.Ord.*, Boh.; exoskel. (reconstr.), $\times 1.25$ (496n).

Digrypos KOBAYASHI, 1940 [**Dionide hybrida* REED, 1915]. Cephalon only known, like *Dionide*, fringe narrowing posterolaterally and pits not extending to genal angle. *M.Ord.*, Burma.

Dionidella PRANTL & PŘIBYL, 1948 [**D. incisa*]. Like *Dionide* but relatively longer thorax and shorter pygidium, latter with terminal axial spine. *M.Ord.*, Boh.

Trinucleoides RAYMOND, 1917 [**Trinucleus reussi* BARRANDE, 1856]. Glabella clavate in outline, with upwardly directed glabellar spine and prominent posterolateral lobes; girder stout, pitted portion

of fringe narrow. Pygidium short (*sag.*), triangular, with 8 to 10 axial rings. *M.Ord.*, Boh. —FIG. 327, 1. **T. reussi* (BARRANDE); 1a, exoskel.; 1b, hypostoma, ventral; both $\times 1.7$ (496n).

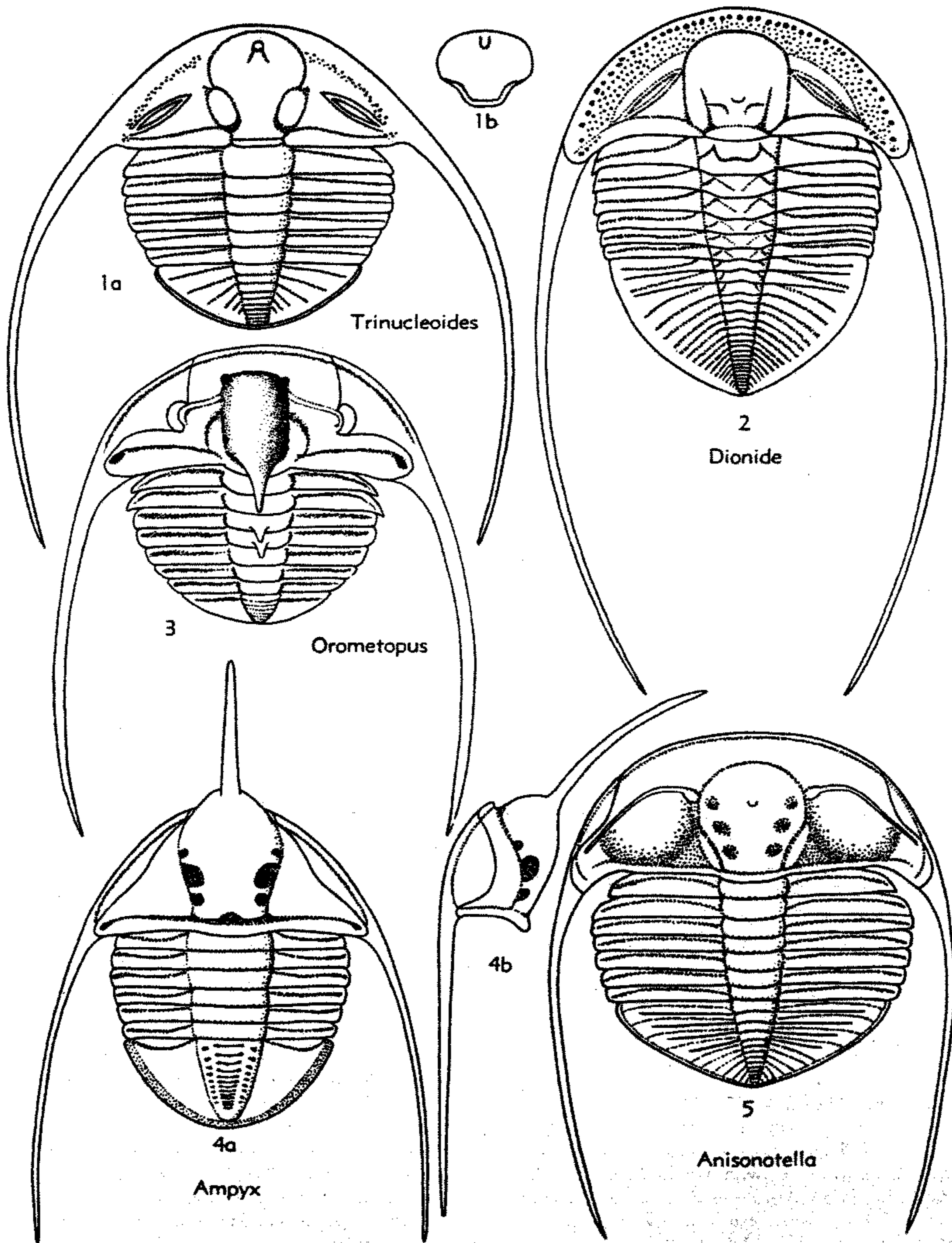

FIG. 327. Orometopidae, Dionididae, Raphiophoridae (p. 0424-0426).

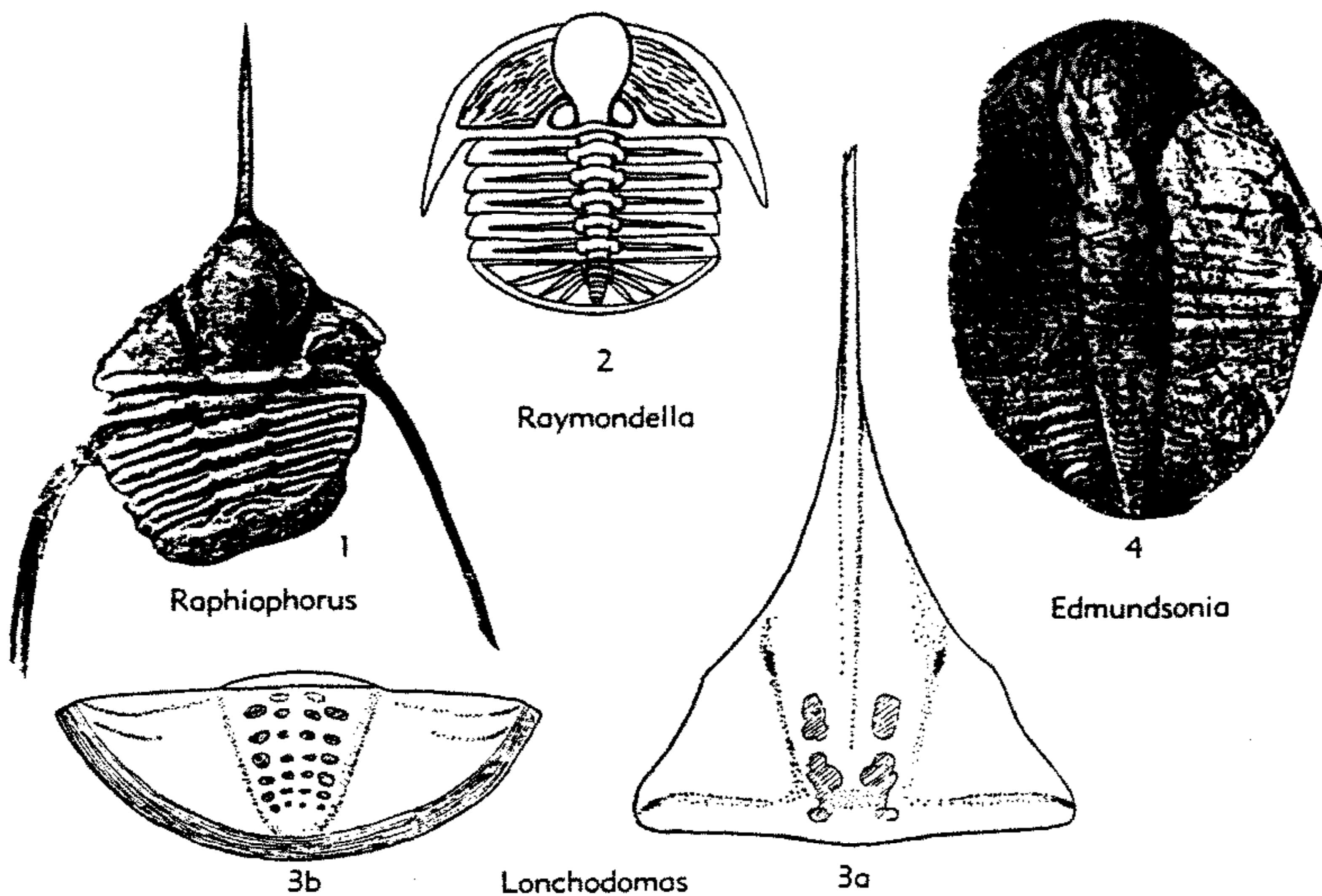

FIG. 328. Rhiphiophoridae (p. 0426-0427).

Family RAPHIOPHORIDAE Angelin, 1854

[=Ampycidae CHAPMAN, 1890]

Cephalon and pygidium subtriangular in outline. Glabella expanding forward, with median glabellar spine directed upward-forward in some genera; occipital ring convex; elongate (*exsag.*) convex alae united with occipital ring present in some adults; eyes absent; facial sutures in curved path along outer part of genae, uniting along anterior margin of cephalon; cephalic border and doublure narrow, latter not crossed by sutures. Hypostoma unknown. Thorax with 5 to 7 segments, 1st commonly longer (*exsag.*) than others. Pygidium with many ring furrows, pleural regions with one or many pleural furrows (350, 352). *L.Ord.-M.Sil.*

Raphiophorus ANGELIN, 1854 [**R. setirostris*; SD RAYMOND, 1925]. Glabellar spine long; alae small. Thorax with 5 segments, 1st longer (*exsag.*) than others. Pygidium short, with broad border. *M.Ord., ?M.Sil., Eu.-?USA (Ark.)*.—FIG. 328, 1: **R. setirostris*, *M.Ord.*, Swed.; exoskel., $\times 5$ (496*).

Ampyx DALMAN, 1827 [**A. nasutus*] [= *Brachyampyx* FORBES, 1849 (obj.)]. Glabellar spine long, upwardly curved, circular in cross section; with 3

pairs of ovate muscle scars on glabella, 4th pair at extremities of occipital furrow; alae absent; genal spines circular in cross section. Thorax with 6 segments; pleural furrows deepening outward, last 3 pairs curving forward, concave toward front. Pygidium with 2 paired rows of muscle scars on axis; pleural fields with single pair pleural furrows. External surface with fine pits, terraced lines on vertical borders and doublure. *L.Ord.-M.Ord., N.Am.-Eu.*—FIG. 327, 4. **A. nasutus*, *L.Ord.*, Swed.-Norway-USSR.; 4a, exoskel., $\times 1.5$; 4b, ceph., left lateral, $\times 1.5$ (496n).

Ampyxina ULRICH, 1922 [**A. bassleri* (= **Endymionia bellatula* SAVAGE, 1917)]. No glabellar spine; alae large; rolled cephalic border narrow. Thorax with 5 segments, 1st longer (*sag., exsag.*) than others; pleural furrows curving forward, convex toward front. Pygidium with 6 pairs of pleural furrows curving outward-backward. *M.Ord.-U.Ord., Va.-Ala.-Tenn.-Ill.-Mo.*—FIG. 329, 1. **A. bellatula* (SAVAGE), *U.Ord.*, Ill.; exoskel. (reconstr.), $\times 4.7$ (496n).

Anisonotella WHITTINGTON, 1952 [*pro Anisonotus* RAYMOND, 1920 (non WHITE, 1847, *nom. nud.*; nec MILNE EDWARDS, 1879)] [**Shumardia glacialis* BILLINGS, 1865]. Glabella clavate, with 3 pairs of lateral furrows as subcircular pits, small median tubercle; narrow (*tr.*) alae extending forward outside axial furrows to opposite median glabellar furrows; genal ridges commencing in axial fur-

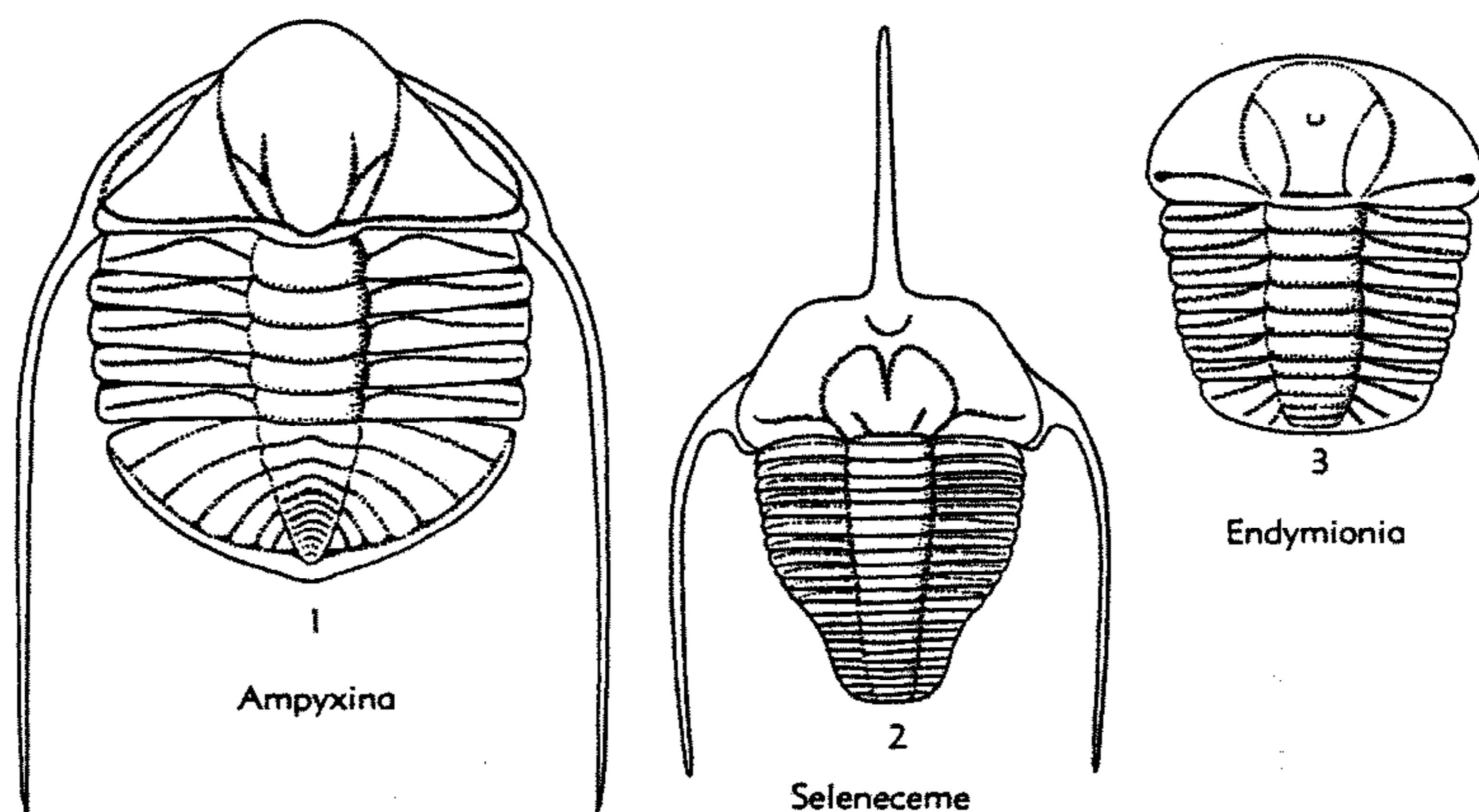

FIG. 329. Raphiophoridae, Endymionidae, Alsataspididae (p. 0426-0428).

rows opposite anterior glabellar furrows and curving outward-backward to genal angles; genae behind genal ridges inflated; posterior borders wide (*exsag.*) at genal angles. Thorax with pleural furrows of 1st 3 to 5 segments curving convex forward. Pygidium with 13 axial rings; 7 or 8 pairs of pleural furrows, 4 interpleural grooves. External surface of cephalon inside border with fine raised lines in Bertillon pattern, faint radial ridges peripherally on genae and preglabellar field. *M.Ord.*, Newf.-?Scot.-?Swed.—FIG. 327,5. **A. glacialis* (BILLINGS), Newf.; exoskel. (reconstr.), $\times 4$ (496n).

Cnemidopyge WHITTARD, 1955 [**Trinucleus nudus* MURCHISON, 1839]. Like *Ampyx* but distinguished by many axial rings and pleural furrows of pygidium. *M.Ord.*, Eng., Wales.

Edmundsonia B. N. COOPER, 1953 [**E. typha*]. Like *Anisonotella* but glabella with 2 pairs of shallow lateral furrows and ovate lateral lobes; preglabellar field short; genal ridges trifold. Thorax with 6 segments (26). *M.Ord.*, Va.-?Scot.—FIG. 328,4. **E. typha*; exoskel., $\times 1.3$ (26*).

Lonchodomas ANGELIN, 1854 [**Ampyx rostratus* SARS, 1835; SD BASSLER, 1915]. Like *Ampyx* but glabella diamond-shaped in outline, carinate, with long median glabellar spine subquadrate in section directed horizontally; glabella with 2 pairs of muscle scars; genal spines subquadrate in section. Thorax with 5 segments. Pleural regions of pygidium with 2 pairs of narrow pleural furrows. *L.Ord.-U.Ord.*, N.Am.-S.Am.-Eu.-Asia.—FIG. 328,3. **L. rostratum* (SARS), Up.L.Ord., Norway; 3a, cran., dorsal, $\times 2.7$; 3b, pyg., $\times 4$ (496).

Mendolaspis RUSCONI, 1951 [**M. salagastensis*]. Based on pygidium like that of *Ampyx* but with

axis tapering more rapidly and lacking muscle scars; glabella of attributed cranidium (?*Asaphus salagastensis* RUSCONI, 1951) does not project over anterior border, lacks glabellar spine, and has short basal lateral glabellar furrows. *M.Ord.* (Llanvirn.), S.Am.—FIG. 330. **M. salagastensis*, NW.Arg.; a,b, ceph., pyg., $\times 2.4$ (59*).

Raymondella REED, 1935 [non BANCROFT, 1933 (*nom. nud.*); nec WHITTINGTON, 1938] [**Ampyx? macconochiei* NICHOLSON & ETHERIDGE, 1879]. Like *Ampyxina* but glabella flask-shaped, with hemispherical anterior part; alae subcircular in outline. Thorax with broad, shallow pleural furrows. External surface with small, closely spaced tubercles; genae with raised anastomosing ridges subparallel to anterolateral margins, crest of each ridge with single line of tubercles. *M.Ord.*, Scot.—FIG. 328,2. **R. macconochiei* (NICHOLSON & ETHERIDGE); exoskel. (reconstr.), $\times 4$ (452).

Family ENDYMIONIIDAE Raymond, 1920

[*nom. correct.* WHITTINGTON, herein (*pro* Endymionidae RAYMOND, 1920)]

Glabella subcircular in outline, with 3 or fewer pairs of furrows; convex genae continuous with convex preglabellar field; eyes absent; facial sutures marginal anterolaterally, probably curving across posterolateral areas of genae to isolate narrow (*tr.*) librigenae. Thorax with 7 segments; pleural furrows curving concavely forward. Pygidium triangular. *L.Ord.-M.Ord.*

Endymionia BILLINGS, 1865 [*pro* *Endymion* BILLINGS, 1862 (non SWAINSON, 1832)] [**Endymion*

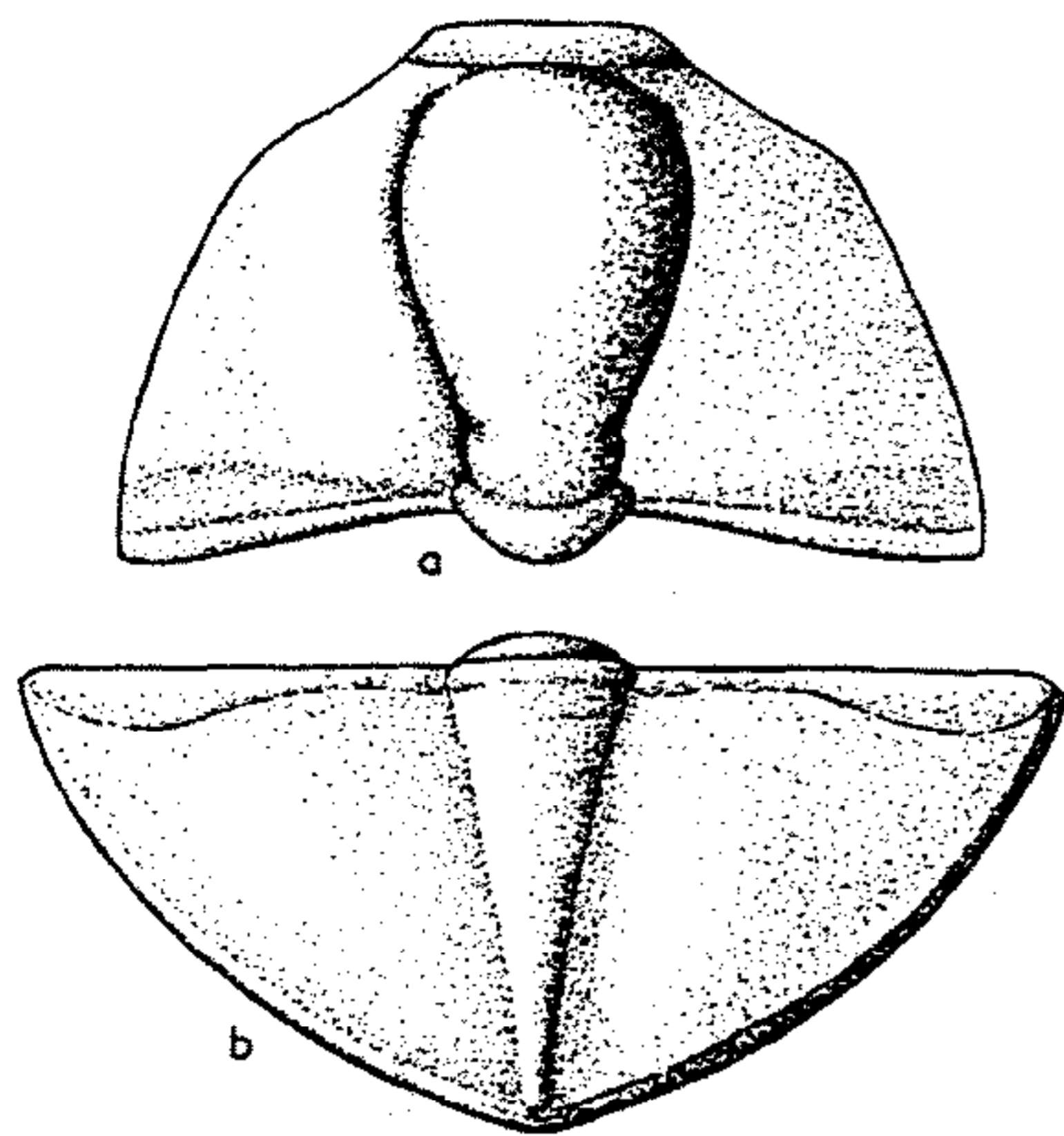

FIG. 330. **Mendolaspis salagastensis* RUSCONI (Raphiophoridae), M.Ord. (Llanvirn.), NW. Arg.; a, b, ceph., pyg., $\times 2.4$ (59*).

meekei BILLINGS, 1862]. Frontomedian glabellar lobe convex, with median tubercle, lateral glabellar lobes long, undivided; preglabellar field steeply bent down; posterior border furrows arcuate forward, ending distally in shallow pits; nature of cephalic border, course of sutures, librigenae, and genal spines unknown. Pygidium short, with 4 or 5 axial rings, 3 pairs of pleural furrows, and steep border. External surface of preglabellar field with concentric raised lines. M.Ord., Que.-Newf.—

FIG. 329, 3. **E. meekei* (BILLINGS), Que.; exoskel. (reconstr.), $\times 4$ (496n).

Salteria W. THOMSON, 1864 [non WALCOTT, 1884] [**S. primaeva*]. Glabella subcircular with 3 pairs of pits representing lateral furrows, posterior pair connected by shallow longitudinal grooves to occipital furrow, median tubercle between these grooves; preglabellar field short. Pygidium with 10 to 12 axial rings, 6 or 7 pairs of pleural furrows. External surface with radial ridges on preglabellar field; fine anastomosing raised lines running transversely on posterior cephalic border and thoracic pleurae. M.Ord., Scot.-Va.

Family ALSATASPIDIDAE Turner, 1940

[*nom. correct.* WHITTINGTON, herein (*pro* Alsataspidae TURNER, 1940)]

Cephalon with long frontal axial spine distally upcurved, genal spines curving back and reaching beyond pygidium. Glabella subcircular in outline, occipital ring narrow (*tr.*), short (*sag.*), anterior median longitudinal glabellar furrow deep, paired lateral longitudinal furrows shallow, extending forward short distance from occipital furrow;

long (*sag.*) frontal area with low convexity; genal regions gently convex, without eye lobes, facial sutures curving across genal angles, presumably marginal anterolaterally and anteriorly. Thorax with 30 or fewer segments, widest at about 4th segment; axis narrow, pleurae bent down at extremities, with deep slightly diagonal pleural furrows. Pygidium narrow, with 10 or fewer segments (352). L.Ord.

Seleneceme T. H. CLARK, 1924 [**S. propinqua*] [= *Alsataspis* TURNER, 1940]. Characters of family. L.Ord., Newf.-Que.-Tex.—FIG. 329, 2. *S. evansi* (KINDLE), Newf.; exoskel. (reconstr.), $\times 2.2$ (496n).

Falanaspis TJERNVIK, 1956 [**F. aliena*]. Like *Seleneceme*, but glabella lacks anterior median longitudinal glabellar furrow, and has short, shallow paired lateral longitudinal furrows and a median tubercle. Facial suture marginal and frontal axial spine borne by doublure. L.Ord. (L. Arenig.), Swed.

Family HAPALOPLEURIDAE

Harrington & Leanza, 1957

Exoskeleton small, isopygous, opisthoparian. Cephalon semielliptical in outline, transversely elongate; glabella convex, expanded forward, with 3 pairs of short lateral furrows which may be almost obsolete;

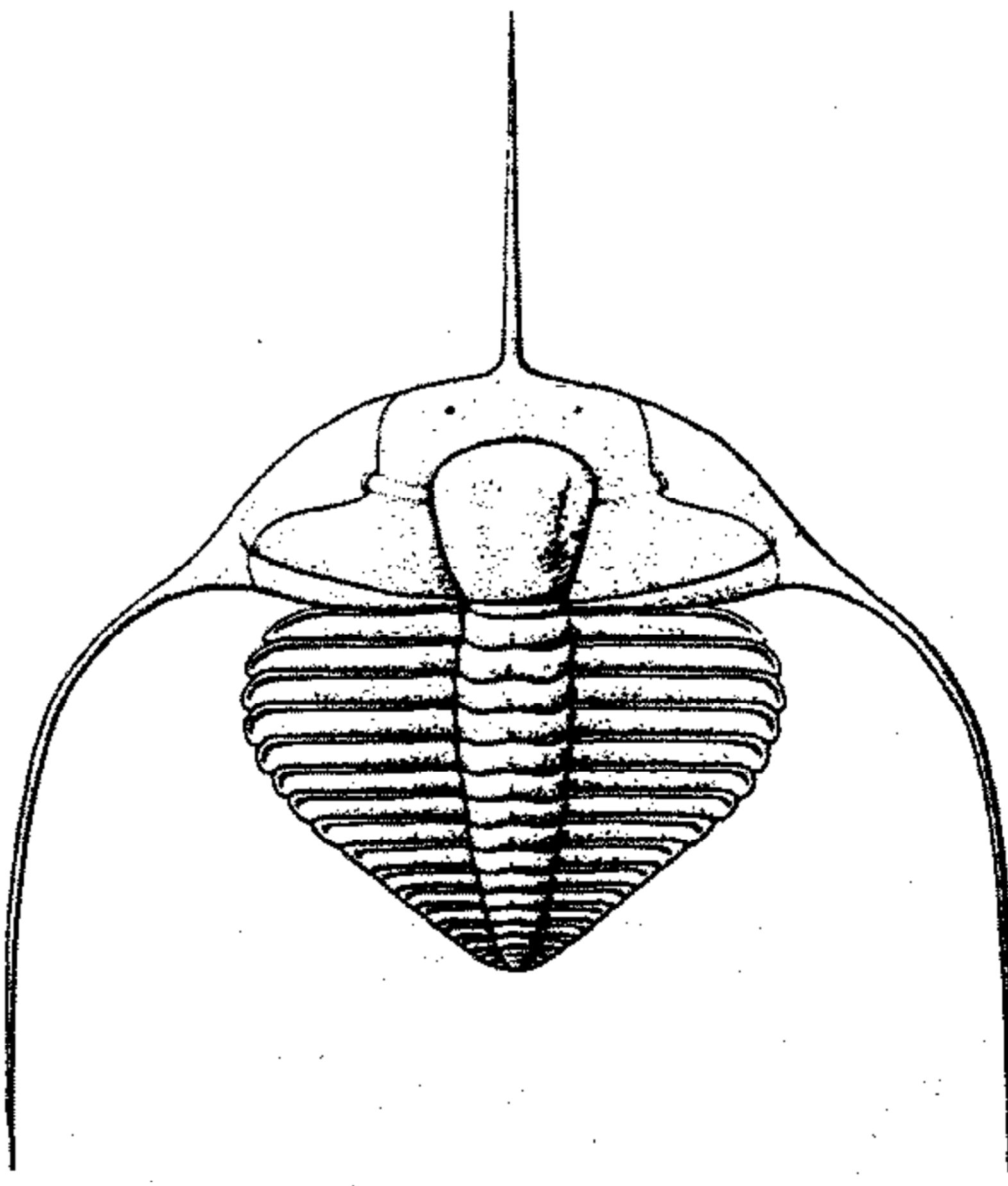

FIG. 331. *Hapalopleura longicornis* HARRINGTON & LEANZA (Hapalopleuridae), L.Ord., Arg.; exoskel. (reconstr.), $\times 5.5$ (59*).

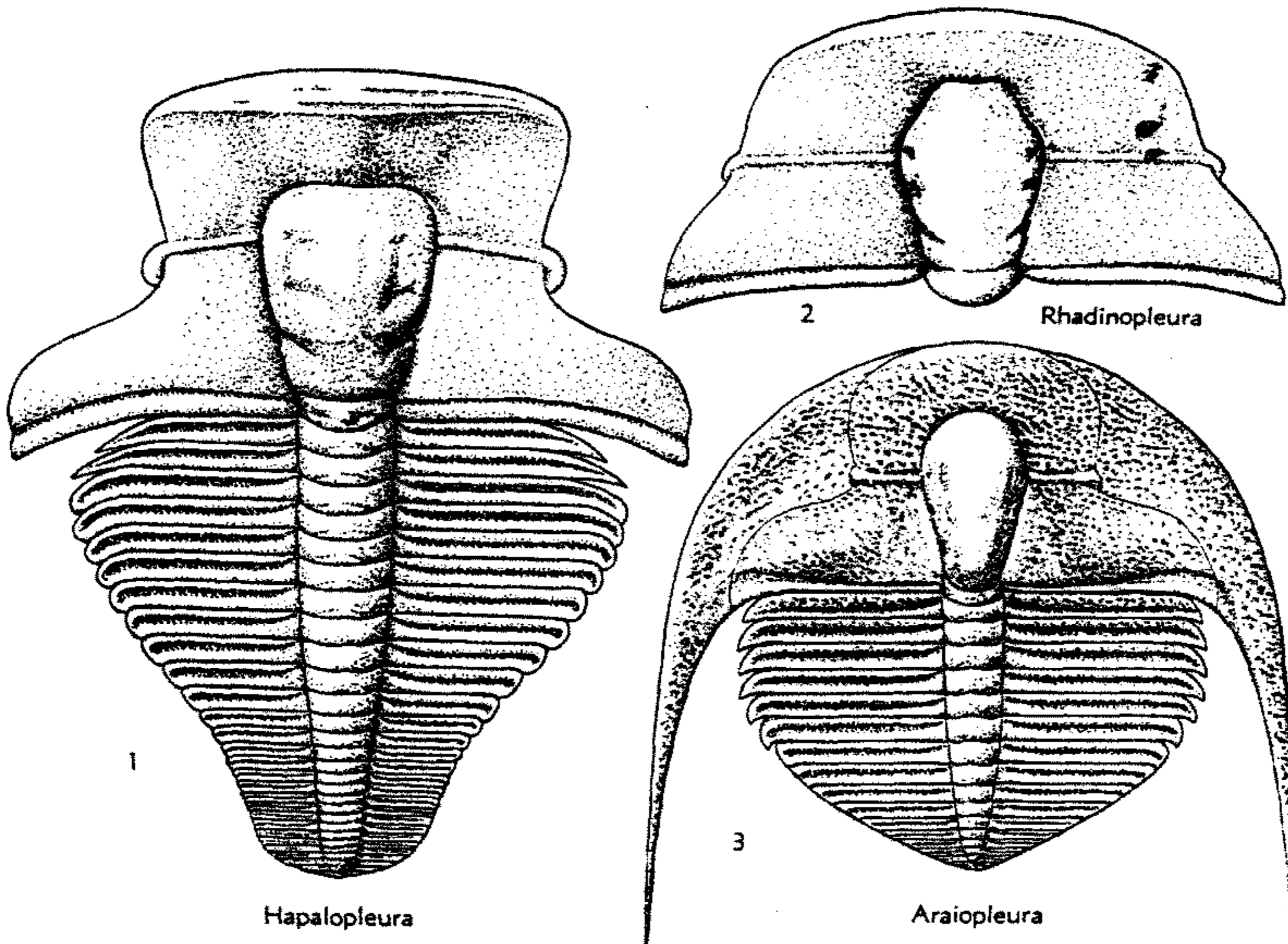

FIG. 332. Hapalopleuridae (p. 0429).

preglabellar field wide; anterior border wide, sloping steeply downward, eyes small, submedian, located far from glabella; eye ridges narrow, long, raised, librigenae narrow, with very long curved genal spines. Thorax with 6 segments, not clearly differentiated from pygidium; axis narrow; pleurae narrow (*exsag.*), ribbon-like, straight, normal to axis, with very distal fulcrum, deep submedian furrow and extremities rounded or ending in short spines. Pygidium very similar to thorax, with 10 to 22 segments, spatulate to rounded-subtriangular in outline; segmentation of pleural regions reaching margin; border absent. *L.Ord.*

Hapalopleura HARRINGTON & LEANZA, 1957 [**H. clavata*]. Exoskeleton ovoid in outline. Cranium subtrapezoidal; glabella convex, raised above level of fixigenae, clavate, expanded forward, with 3 pairs of lateral furrows that normally are faint; preglabellar field wide, raised forward; anterior border not differentiated by border furrow, steeply sloping downward; posterior areas of fixigenae subtrapezoidal; eyes small, submedian, located

far from glabella; eye ridges narrow, long, raised, straight, normal to axis or oblique forward-outward; librigenae subtriangular, narrow, with long curved genal spines. Thorax with 6 segments; axis narrow; pleurae with rounded extremities. Pygidium spatuliform to triangular-subspatulate in outline, with 11 to 22 segments identical to thoracic. *L.Ord.*, Arg.—FIG. 332,1. **H. clavata*; incompl. exoskel. (reconstr.), $\times 9$ (59*).—FIG. 331. *H. longicornis* HARRINGTON & LEANZA; exoskel. (reconstr.), $\times 5.5$ (59*).

Araiopleura HARRINGTON & LEANZA, 1957 [**A. reticulata*]. Differs from *Hapalopleura* in having glabella long, narrow, pyriform, expanded forward, with 3 pairs of very faint small lateral depressions; frontal area depressed; posterior areas of fixigenae very wide, subrhomboidal in outline, slightly inflated, with vaguely differentiated triangular areas near glabella; eyes located very far from glabella, eye ridges normal to axis; anterior sections of facial sutures subparallel in front of eyes; surface of cephalon (excluding glabella, eye ridges, and anterior border) with irregularly distributed pits separated by network of raised lines. Thoracic pleurae with extremities ending in very short spines, surface of anterior 4 pleurae bearing sculpture similar to that of cephalon. Pygidium subtriangular in outline, with not less than 10

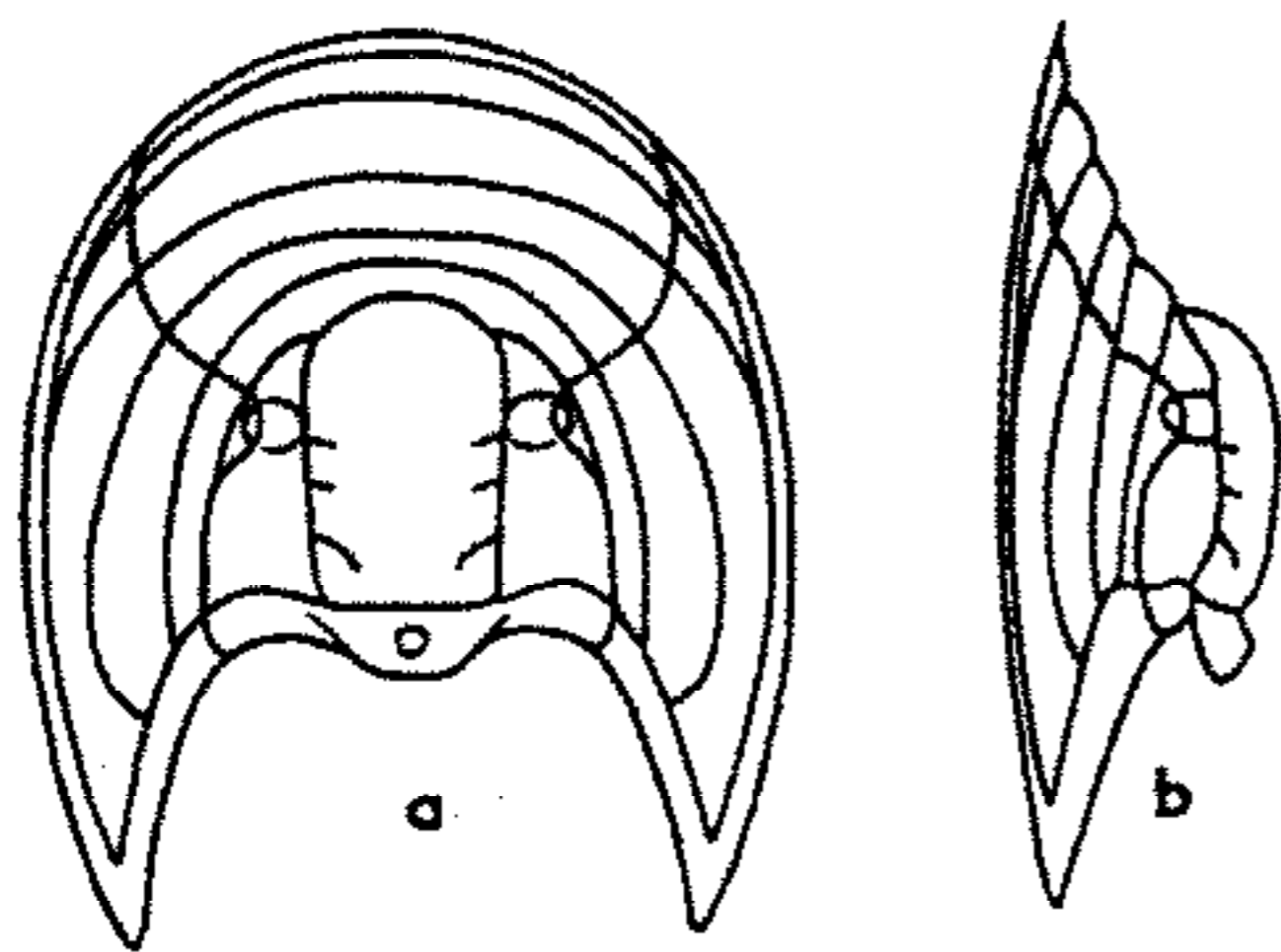

FIG. 333. **Ityophorus undulatus* WARBURG (Ityophoridae), U.Ord., Swed.; *a, b*, ceph., dorsal, lateral, $\times 9$ (489).

segments identical to those of thorax. *L.Ord.*, Arg.—FIG. 332,3. **A. reticulata*; exoskel (reconstr.), $\times 14.6$ (59*).

Clavatellus POLETAEVA, 1955 [**C. globosus*]. Resembles *Hapalopleura*. *L.Ord.* (*U. Tremadoc.*), USSR (HE).

Rhadinopleura HARRINGTON & LEANZA, 1957 [**R. eurycephala*]. Differs from *Hapalopleura* in having cranidium semielliptical-subtrapezoidal in outline, glabella pyriform-subhexagonal, with 3 pairs of short deep lateral furrows; frontal area slightly convex; fixigenae very wide; eyes located far from glabella, eye ridges normal to axis, anterior sections of facial sutures convergent in front of eyes. Thoracic pleurae slightly sinuous. Pygidium unknown. *L.Ord.*, Arg.—FIG. 332,2. **R. eurycephala*; cran. (holotype), $\times 10$ (59*).

Family ITYOPHORIDAE Warburg, 1925

[In the opinion of H. B. WHITTINGTON, this family is so doubtfully classifiable as belonging in the Trinucleina that it should be segregated under the designation "affinities uncertain."—Ed.]

Cephalon of harpid form; convex glabella reaching to inner margin of bilaminar fringe, expanding slightly forward, with 3 short lateral glabellar furrows; occipital ring prolonged backward, with low median tubercle; genae narrower than glabella, convex, sloping steeply outward, with narrow (*exsag.*) posterior border; eye lobes close to anterolateral margins of genae, broad (*exsag.*) eye ridges extending directly inward to axial furrows; anterior sections of facial sutures running outward-forward in curve to margins, posterior sections curving outward along edge of genae to posterior margins; fringe concave upward, genal roll steeply sloping to gently inclined brim, with prolongations about 0.5 of length (*sag.*) of cephalon; narrow convex external and internal rims; lamellae of fringe bent into 4

folds that are separated by narrow furrows subconcentric to rim so that 3 inner folds extend back along prolongation, outer fold being placed just outside anterior sections of facial sutures. Thorax with 6 segments; axis convex; pleurae straight, inner part horizontal, outer portion beyond fulcrum bent down and faceted, with deep pleural furrows. Pygidium wider than long, convex axis divided into 5 or 6 rings, narrow post-axial ridge; inner part of pleural fields horizontal, outer part sloping gently to narrow border, 5 pairs pleural furrows extending to border, interpleural grooves shallower. Doublure narrow. External surface smooth (323). *U.Ord.*

Ityophorus WARBURG, 1925 [**I. undulatus*]. Characters of family. *U.Ord.*, Swed.—FIG. 333. **I. undulatus*; *a, b*, ceph., dorsal, lateral, $\times 9$ (323).

Order PHACOPIDA Salter, 1864

[*nom. transl.* HARRINGTON & LEANZA, 1957, ex Phacopini SALTER, 1864] [=order Proparia BEECHER, 1897; order Phacopida HARRINGTON & LEANZA, 1957 (erroneously attributed by them to RICHTER, 1932)] [Type—*Phacops* EMMRICH, 1839]

An order of post-Cambrian trilobites, probably derived from the Ptychopariida. Cephalon with facial sutures typically proparian (most Phacopina and Cheirurina) or gonatoparian (most Calymenina, some Cheirurina), but may be opisthoparian (some Calymenina and Cheirurina) or even lacking (some Cheirurina); glabella variously shaped, commonly expanding forward (Phacopina, most Cheirurina) or tapering forward (Calymenina, some Cheirurina), lateral glabellar furrows (if present) variously developed; preglabellar field short (*sag.*) or lacking; rostral plate present (Calymenina, most Cheirurina) or lacking (Phacopina, some Cheirurina). Thorax with 8 to 19 segments. Pygidium mostly medium to large, but small in some exceptional early representatives. Known protaspides of similar type (496). *L.Ord.-U.Dev.*

Suborder CHEIRURINA

Harrington & Leanza, 1957

[Erroneously ascribed to ÖPİK, 1937, by HARRINGTON & LEANZA, 1957] [Superfamily Cheiruracea ÖPİK, 1937; Cheiruroidea HURK, 1953 (attributed to ÖPİK, 1937)] [Type—*Cheirurus* BEVAICH, 1845]

Exoskeleton proparian, rarely gonatoparian or exceptionally opisthoparian; cephalon with axis expanding forward or tapering, or oval in outline, with whole or

part more or less strongly inflated; glabella with as many as 4 pairs of lateral or transglabellar furrows; preglabellar field very short (*sag.*) or lacking; fixigenae with or without genal spines; eyes small or absent, and facial sutures may be lacking. Rostral plate present; hypostoma free. Thorax with 8 to 19 segments, with smooth, ridged, or furrowed pleurae. Pygidium with 2 to 16 pairs of ribs. Appendages only of *Ceraurus* described. *L.Ord.-M.Dev.*

Family CHEIRURIDAE Salter, 1864

[=*Chirurides* HAWLE & CORDA, 1847; *Chiruridae* ANGELIN, 1854, suppression of both pend. ICZN; =*Cerauridae* MILLER, 1889]

Pleurae with pointed or bluntly rounded spines and oblique or transverse pleural furrows, in some genera represented by row of pits, or effaced. Pygidium with 2 to 4 pairs of pleural ribs and spines; axial rings few. Surface commonly tuberculate, pitted, or both. Appendages only of *Ceraurus* described; antennae uniramous, other appendages biramous, with gill branches bearing filaments only on distal segments (178, 359). *L.Ord.(Tremadoc.)-M.Dev.*

The ancestral stock from which various representatives of this suborder assigned to the Pliomeridae, Cheiruridae, and Encrinuridae are interpreted to have been derived is contained in the subfamily Pilekiinae of the Pliomeridae. Direct descendants of the Pilekiinae presumably are genera of the Cheirurinae and Cyrtometopinae (subfamilies of Cheiruridae), whereas other cheirurids (*Acanthoparyphinae*, *Sphaerexochinae*, *Deiphoninae*, *Arciinae*), except the *Heliomerinae*, of uncertain relationships, are derivatives of the *Cyrtometopinae*.

Subfamily CHEIRURINAE Salter, 1864

[*nom. transl.* RAYMOND, 1913 (*ex* *Cheiruridae* SALTER, 1864)]

Glabella expanding forward or with subparallel sides; preoccipital lateral glabellar furrow generally curved backward, commonly joining occipital furrow. Hypostoma with elongate middle body. Thorax generally of 11 segments; proximal part of pleurae with distinct oblique pleural furrows. Pygidium with 3 pairs of pleural spines, 2 posterior pairs more or less reduced in some. *L.Ord.-M.Dev.*

Cheirus BEYRICH, 1845 [**C. insignis*; SD BARTON, 1913 (*non C. exsul*, SD REED, 1896, because this species was not originally assigned to *Cheirus*)]

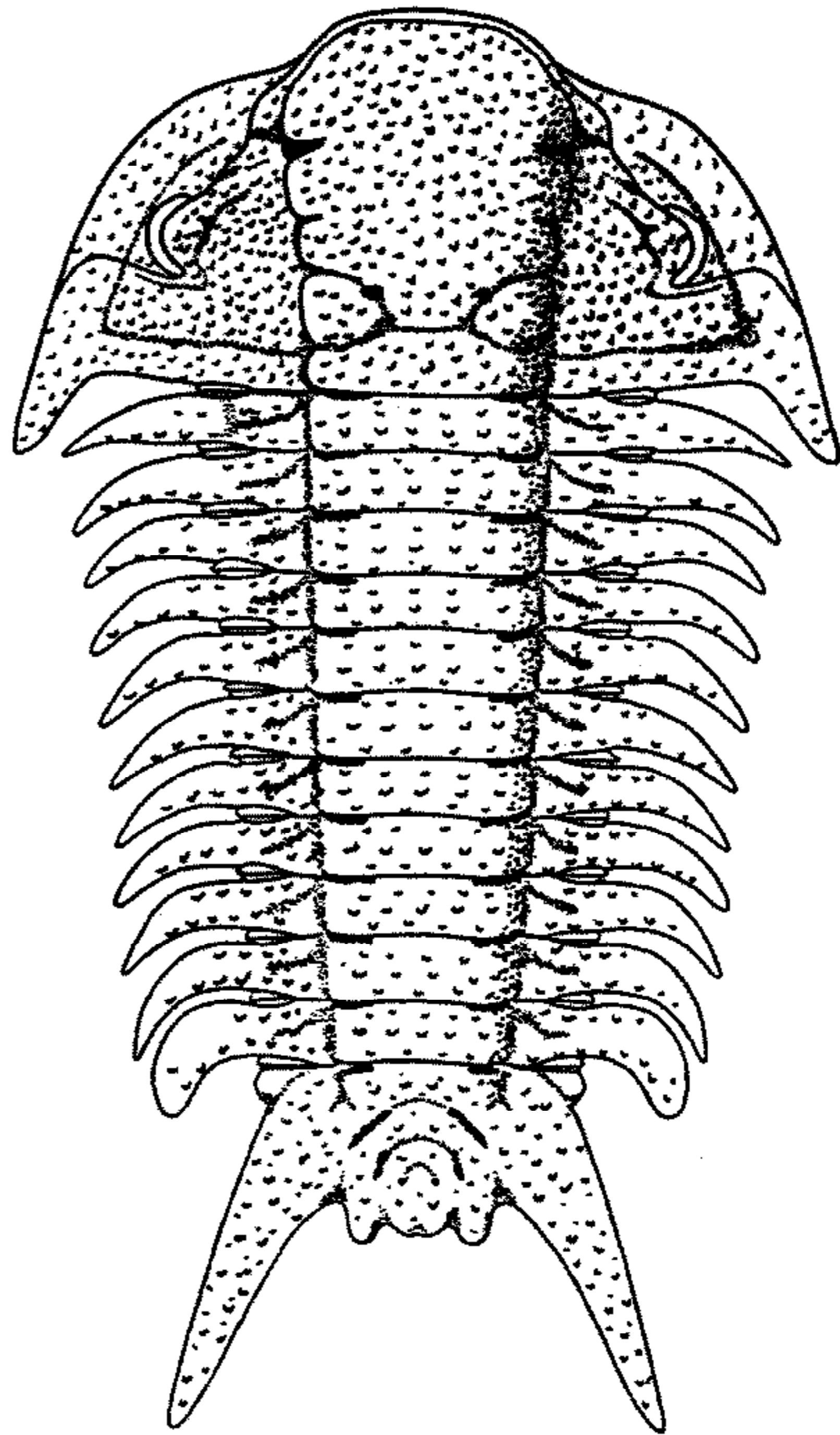

FIG. 334. **Ceraurinella typa* COOPER (Cheiruridae), *M.Ord.*, Va.; exoskel. (reconstr.), $\times 4.5$ (359).

[=*Chirus* BURMEISTER, 1846 (obj.)]. Glabella expanding forward, overhanging anterior border, occipital and preoccipital furrows joined at middle. Thorax with 11 segments. Pygidium with 3 pairs of subequal pleural spines and a terminal spine. *U.Ord.-M.Dev.*, cosmop.

C. (*Cheirus*). Eyes moderately close to glabella, fixigenae wider (*tr.*) than occipital ring, glabella with 2 pairs of lateral furrows in front of preoccipital furrow. Pygidium with slender pleural spines. *U.Ord.-Sil.*, cosmop.—FIG. 335.9. **C. (C.) insignis*, *Sil.* (Motel beds), Boh.; 9a, exoskel.; 9b, hypostoma; both $\times 1$ (370).

C. (*Crotalocephalus*) SALTER, 1853 [**Calymene articulata* MÜNSTER, 1840]. Eyes close to glabella; fixigenae narrower (*tr.*) than occipital ring; 2 pairs of transglabellar furrows in front of preoccipital furrow. Pygidium with broad hooklike pleural spines. *L.Dev.-M.Dev.*, Eu.-AsiaM.—FIG. 335.6. *C. (C.) gibbus* (BEYRICH) Bránik beds, Boh.; 6a, ceph.; 6b, thoracic segment; 6c, pyg.; all $\times 1$ (370).

Ceraurinella COOPER, 1953 [**C. typa*]. Like *Ceraurus*, but with eyes farther back (opposite 2*p*) and nearer glabella; with short genal spines. *M.Ord.*, N.Am.—FIG. 334. **C. typa*, Va.; exoskel. (reconstr.), X4.5 (359).
Ceraurinus BARTON, 1913 [**C. marginatus*]. Like *Ceraurus* but with longer lateral glabellar furrows

and finer surface ornamentation. *M.Ord.-U.Ord.*, N.Am.-Eu.-Asia.—FIG. 335.2. **C. marginatus* Richmond, Manitou I., Lake Huron; incompl. ceph., X1 (372).

Cerauroides PRANTL & PŘIBYL, 1947 [**Cheirurus hawlei* BARRANDE, 1852]. Eyes opposite base of anterior lobe; short genal spines. Pygidium with

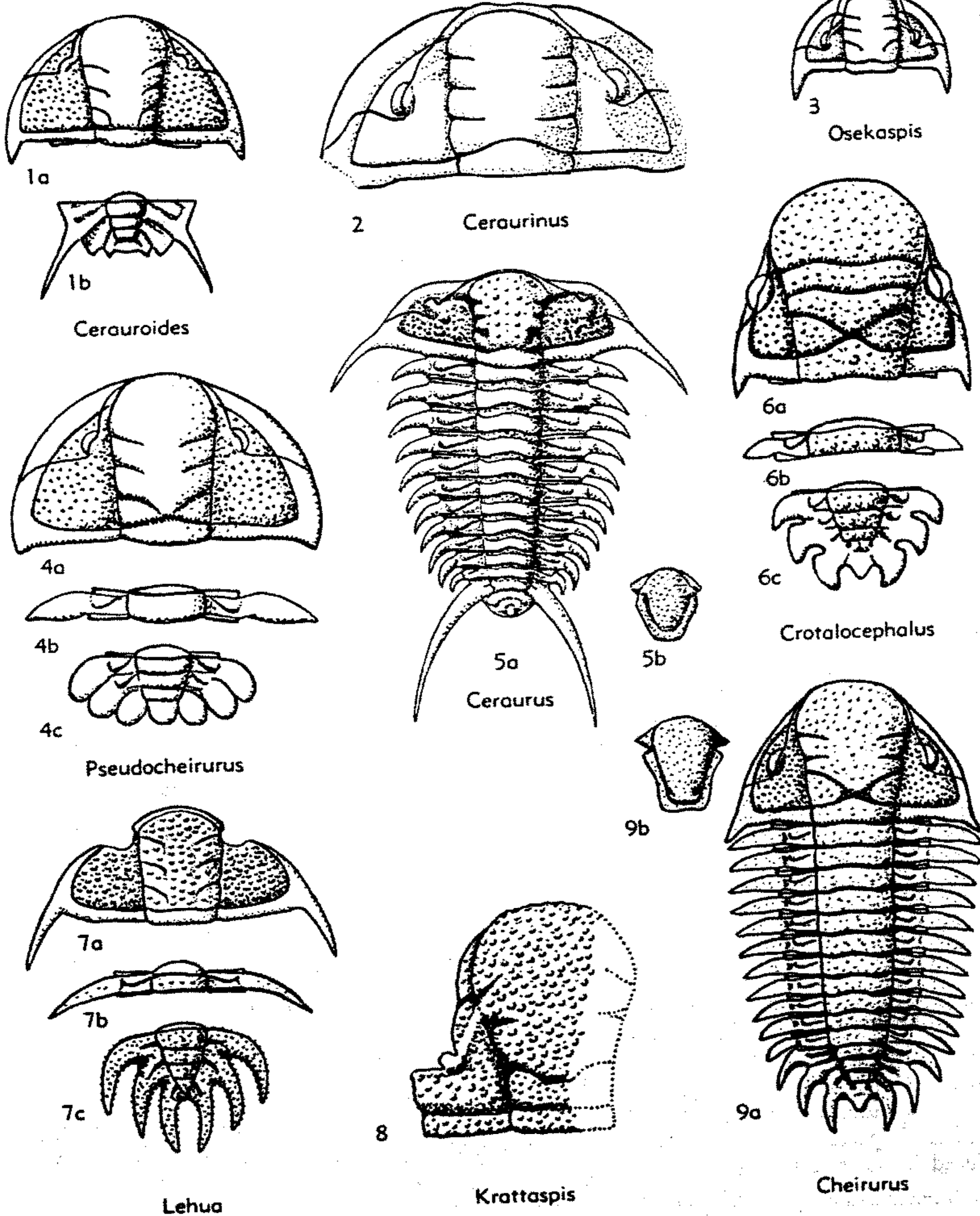

FIG. 335. Cheiruridae (Cheirurinae) (p. 0431-0433).

long anterior pair of pleural spines and 2 rudimentary posterior pairs. *U.Sil.*, Eu.—FIG. 335,1. **C. hawlei* (BARRANDE), *U.Sil.* (Budňany beds), Boh.; 1a,b, ceph., pyg., both $\times 0.5$ (178, 370).

Ceraurus GREEN, 1832 [**C. pleurexanthemus*]. Glabella expanding forward, with 3 pairs of short lateral furrows; eyes set well away from glabella, opposite 3*p*; fixigenae with long genal spines. Thoracic segments generally 11. Pygidium with long pair of axially recurved pleural spines from anterior segment. Surface tuberculation coarse. *M.Ord.-U.Ord.*, Eu.-Greenl.-N.Am. Himalaya.—FIG. 335,5. **C. pleurexanthemus*, *M.Ord.*, E.USA; 5a, exoskel. (reconstr.); 5b, hypostoma; both $\times 1.5$ (43, 450).

Hapsiceraurus WHITTINGTON, 1954 [**H. hispidus*]. Like *Ceraurus* but glabella parallel-sided, outer parts of genae bent down steeply, lateral and anterolateral borders broad, and with large paired tubercles on occipital and axial rings. Rostral plate short, narrow. *U.Ord.*, Arct.N.Am.-Greenl.—FIG. 336,1. **H. hispidus*, *U.Ord.*, Baffin I.; 1a-c, incompl. cran., hypostoma, thoracic segment, $\times 2.5$ (496).

?*Krattaspis* ÖPIK, 1937 [**K. viridatus*]. Glabella expanding markedly forward, with transglabellar preoccipital furrow and 2 pairs of short lateral furrows; eyes rather close to glabella, opposite 2*p* lobes and with distinct eye ridges joined to 3*p* lobes; only incomplete cranidium and hypostoma known. *L.Ord.*, Est.—FIG. 335,8. **K. viridatus*; *L.Ord.*(Mäeküla), Est.; incompl. cran., $\times 3$ (160).

Lehua BARTON, 1915 [**Cheirurus vinculum* BARRANDE, 1872] [= *Krejčia* NOVÁK, in PRANTL & PŘIBYL, 1947 (obj.)]. Glabella with 3 pairs of subequal lateral furrows, eyes opposite anterior pair. Thorax with 11 segments. Pygidium with 3 pairs of slender axially recurved spines. *L.Ord.-M.Ord.*, Eu.-S.Afr.-?India.—FIG. 335,7. **L. vinculum* (BARRANDE), *M.Ord.*(Sv. Dobrotiva beds), Boh.; 7a-c, cran., thoracic segment, pyg., $\times 1$ (370).

Osekaspis PRANTL & PŘIBYL, 1947 [**Cheirurus comes* BARRANDE, 1872]. Glabella subrectangular, with 3 pairs of lateral furrows, preoccipital pair not reaching occipital furrow; eyes rather close to glabella opposite 2*p* lobes. Surface partly pitted minutely. Thorax and pygidium unknown. *M.Ord.*, Czech.—FIG. 335,3. **O. comes* (BARRANDE), *M.Ord.*(Sv. Dobrotiva beds), Boh.; 7a-c, cran., thoracic segment, pyg., $\times 1$ (370).

Pseudocheirurus PRANTL & PŘIBYL, 1947 [**Cheirurus beyrichi* BARRANDE, 1846]. Glabella with 3 pairs of lateral furrows, preoccipital pair reaching occipital furrow; fixigenae about as wide (tr.) as occipital ring. Pygidium with 3 pairs of broad, bluntly rounded pleural spines. *U.Sil.*, Czech.—FIG. 335,4. **P. beyrichi* (BARRANDE), 4a-c, ceph., thoracic segment, pyg., all $\times 2$ (370).

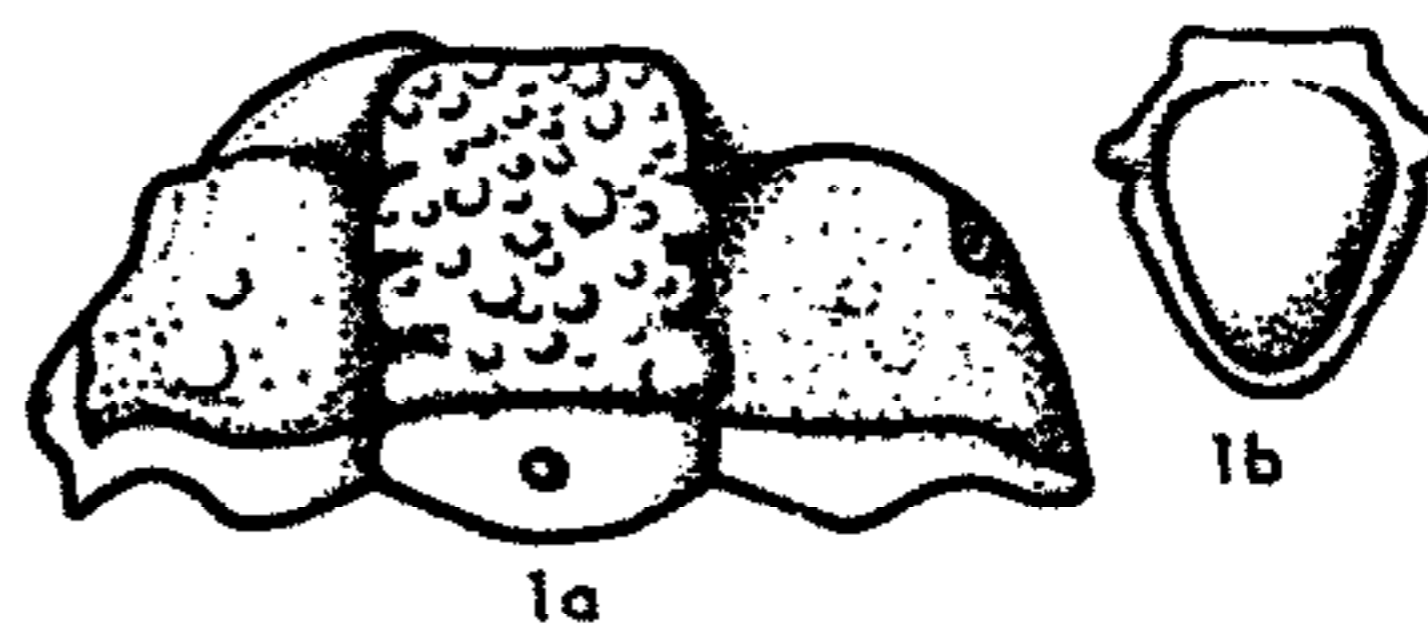

Hapsiceraurus

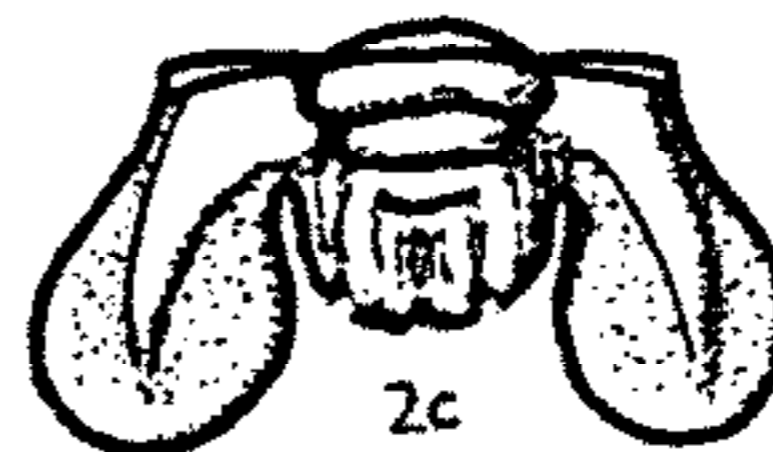
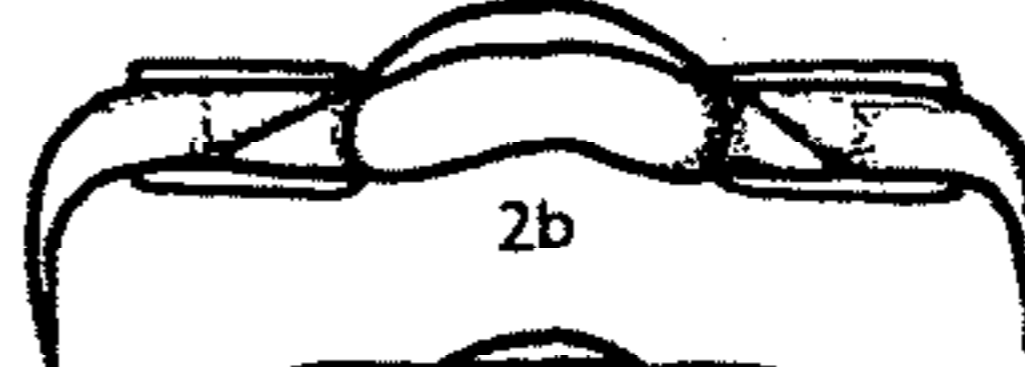
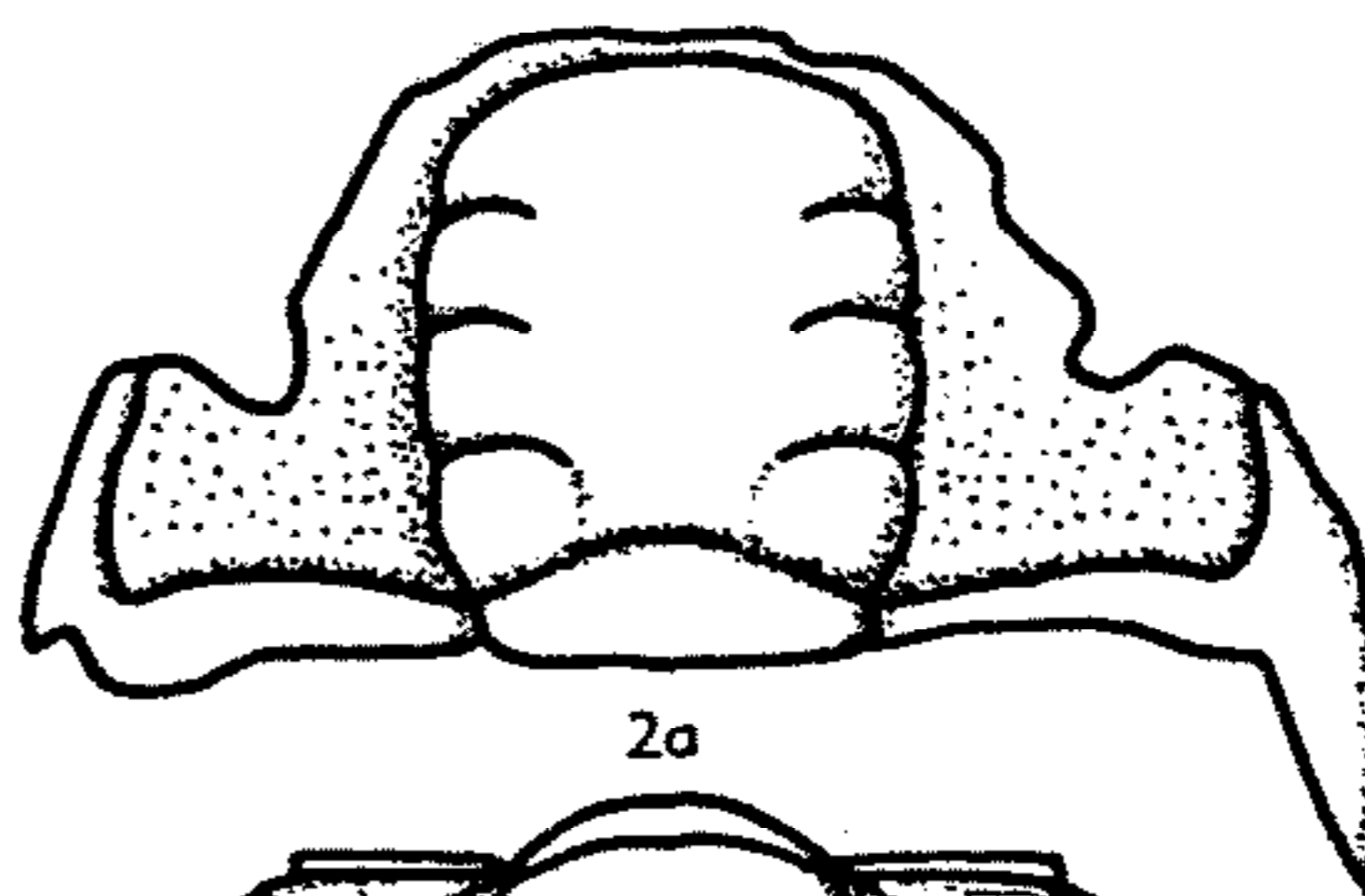

Remipyga

FIG. 336. Cheiruridae (Cheirurinae) (p. 0433).

Remipyga WHITTINGTON, 1954 [**R. glabra*]. Like *Ceraurina* but glabella subrectangular in outline, with 3 gently curved lateral furrows directed backward-inward. Pygidium with paddle-shaped 1st pleural spine expanding distally and bearing strong median carina. *U.Ord.*, Arct.N.Am.—FIG. 336,2. **R. glabra*, *U.Ord.*, Baffin I.; 2a-c, incompl. cran., thoracic segment, pyg., $\times 3.75$ (496).

Subfamily CYRTOMETOPINAE Öpik, 1937

Glabella tapering or widening forward, or oval in outline, with 3 pairs of more or less differentiated lateral furrows, preoccipital pair usually curved backward, commonly meeting occipital furrow; sutural ridges present or not, eye ridges lacking. Middle body of hypostoma usually about as wide as long. Thorax with 10 to 12 seg-

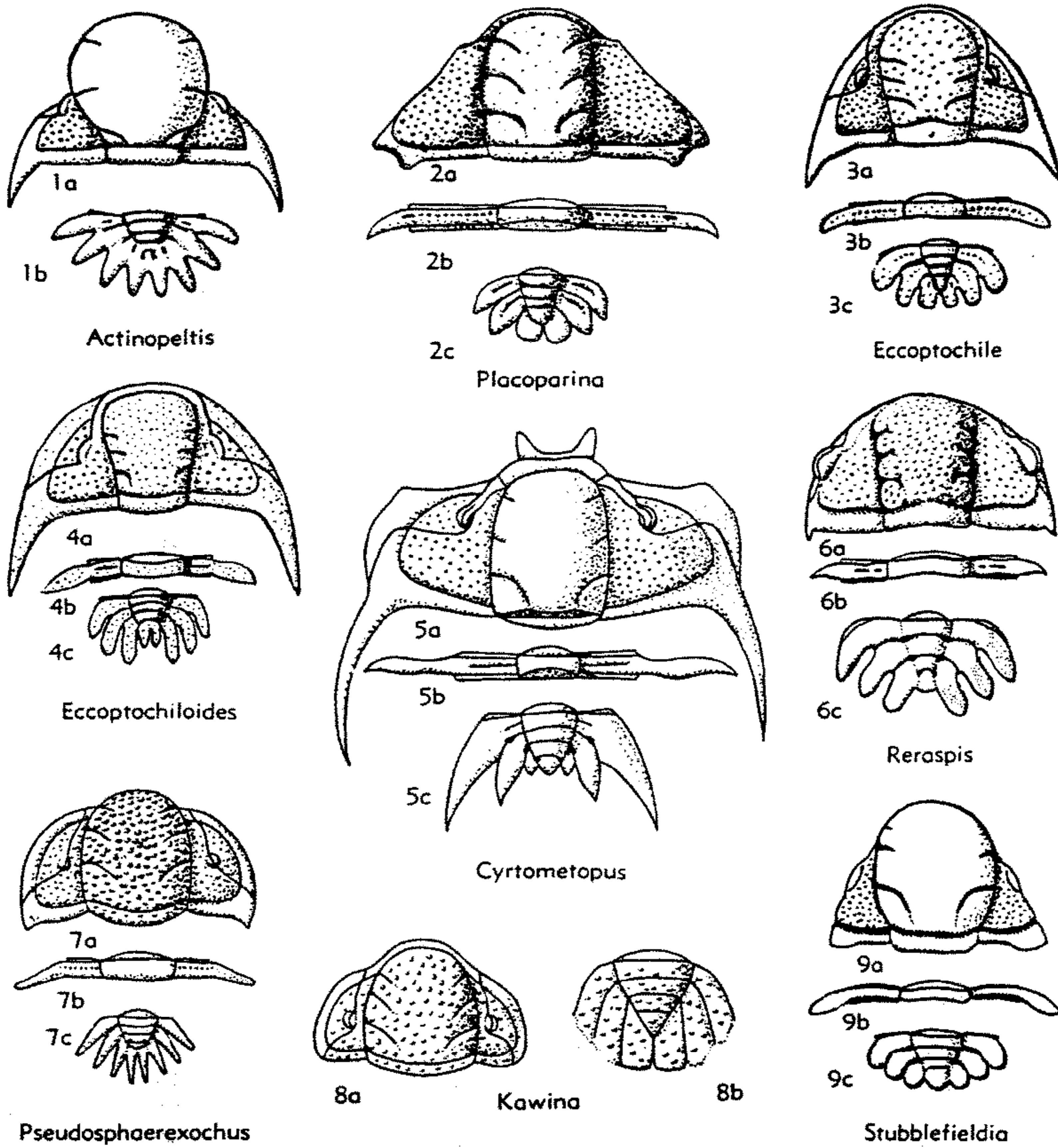

FIG. 337. Cheiruridae (Cyrtometopinae) (p. 0434-0435).

ments, with spinose or bluntly rounded pleurae bearing transverse furrows that may be represented by a row of pits, or effaced. Pygidium with 3 or 4 pairs of pleural spines. *L.Ord.-Sil.*

Cyrtometopus ANGELIN, 1854 [**Calymene clavifrons* DALMAN, 1827]. Glabella with convex sides, preoccipital lateral furrows curved to meet occipital furrow; posterior sections of facial sutures sigmoidal, for some distance transverse; eyes opposite *2p* lobes, sutural ridges in front of eyes; genal spines strong. Thoracic pleurae with short furrows. Pygidium with 3 pairs of pleural spines, progressively smaller backward. *L.Ord., Eu.-?Asia.*

—FIG. 337,5. **C. clavifrons* (DALMAN), *L.Ord., N.Eu.*; 5a-c, ceph., thoracic segment, pyg., all $\times 1$ (382, 468).

Actinopeltis HAWLE & CORDA, 1847 [**A. carolial-exandri* (= **Cheirurus globosus* BARRANDE, 1846)] [non *Actinopeltis* POULSEN, 1946 (= *Grinnellaspis* POULSEN, 1948)]. Bulbous glabella protruding over anterior margin, with preoccipital lateral furrows curved to meet occipital furrow; eyes opposite *2p* lobes; posterior sections of facial sutures almost transverse. Thorax with 11 segments, pointed pleurae with transverse row of minute pits. Pygidium with 4 pairs of pleural spines. *U.Ord., Boh.*—FIG. 337,1. **A. globosus* (BAR-

- RANDE), U.Ord. (Králuv Drur beds), Boh.; *1a,b*, ceph., pyg., both $\times 1.5$ (370).
- Eccoptochile* HAWLE & CORDA, 1847 [**Cheirurus claviger* BEYRICH, 1845; SD BARTON, 1920]. Glabella with 3 pairs of subequal lateral furrows, pre-occipital pair not reaching occipital furrow. Pygidium with 3 or 4 pairs of broad, bluntly rounded spines. *M.Ord.-U.Ord.*, Eu.
- E.* (*Eccoptochile*). Thorax with 12 segments, pleurae with transverse row of pits. Pygidium with 3 pairs of pleural spines. *M.Ord.*, Eu.—FIG. 337,3. **E. (E.) clavigera* (BEYRICH), *M.Ord.*, Boh.; *3a-c*, ceph., thoracic segment, pyg., all $\times 0.5$ (370).
- E.* (*Eccoptochiloides*) PRANTL & PŘIBYL, 1947 [**Cheirurus tumescens* BARRANDE, 1852]. Thorax with 10 segments bearing short pleural furrows. Pygidium with 4 pairs of pleural spines. *M.Ord.-U.Ord.*, Eu.—FIG. 337,4. **E. (E.) tumescens* (BARRANDE), U.Ord. (Lodenice beds), Boh.; *4a-c*, ceph., thoracic segment, pyg., all $\times 1.5$ (370).
- E.* (*Placoparina*) WHITTARD, 1940 [**Cryphaeus sedgwicki* M'COY, 1849]. Like *E. (Eccoptochile)* but with pedunculated eyes close to anterior border. *M.Ord.*, Eng.—FIG. 337,2. **E. (P.) sedgwicki* (M'COY); *2a-c*, cran., thoracic segment, pyg., all $\times 1$ (495).
- Kawina* BARTON, 1915 [**Cheirurus vulcanus* BILLINGS, 1865]. Glabella tapering slightly forward. Pygidium with 3 pairs of ribs. Poorly known. *L.Ord.*, N.Am.—FIG. 337,8. **K. vulcanus* (BILLINGS), *L.Ord.*, E. Can.; *8a,b*, ceph., incompl. pyg., both $\times 1$ (379).
- Pseudosphaerexochus* SCHMIDT, 1881 [**Sphaerexochus hemicranium* KUTORGA, 1854; SD REED, 1896] [*?=Zethus* PANDER, 1830 (*non* FABRICIUS, 1805), **Z. uniplicatus*; SD EICHWALD, 1855 (*?=*P. hemicranium*)]. Glabella oval in outline; posterior sections of facial sutures running obliquely backward. Thoracic pleurae with transverse row of pits. Pygidium with 3 or 4 pairs of pointed pleural spines. *L.Ord.-Sil.*, Eu.-?N.Am.
- P.* (*Pseudosphaerexochus*). Pygidium with 4 pairs of pleural spines. *M.Ord.-Sil.*, Eu.-?N.Am.—FIG. 337,7. **P. hemicranium* (KUTORGA); *7a-c*, ceph., thoracic segment, pyg., all $\times 2$ (370).
- P.* (*Pateraspis*) PRANTL & PŘIBYL, 1947 [**Cheirurus pater* BARRANDE, 1872]. Pygidium with 3 pairs of pleural spines. Thorax with 12 segments. *L.Ord.-M.Ord.*, Boh.—FIG. 338. **P. pater* (BARRANDE), *M.Ord.* (Sárka beds), Boh.; *a-d*, ceph., thoracic segment, pyg., hypostoma, all $\times 1$ (370).
- Reraspis* ÖPIK, 1937 [**Cyrtometopus plautini* SCHMIDT, 1881]. Glabella expanding slightly forward, with deep lateral furrows; posterior sections of facial sutures oblique; sutural ridges present; eyes close to lateral margins. Thorax with 10 segments, pleurae with interrupted pleural furrows. Pygidium with 3 pairs of flattened pleural spines.

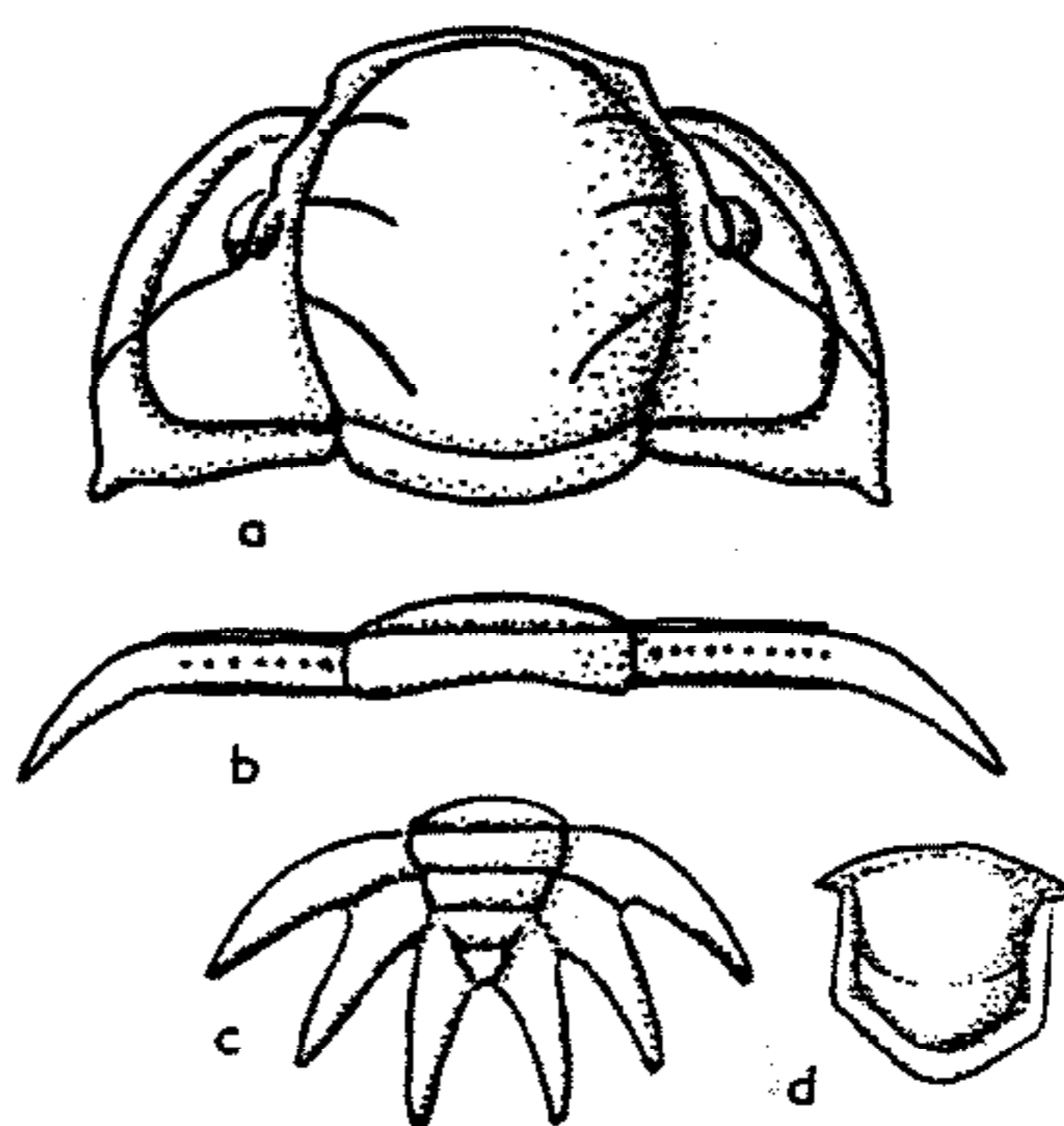

FIG. 338. **Pseudosphaerexochus (Pateraspis) pater* (BARRANDE) (*Cheiruridae*), *M.Ord.*, Czech.; *a-d*, ceph., thoracic segment, pyg., hypostoma, all $\times 1$ (370).

- M.Ord.-U.Ord.*, Est.—FIG. 337,6. **R. plautini* (SCHMIDT), *M.Ord.* (Kukruse), Est.; *6a-c*, ceph., thoracic segment, pyg., all $\times 2.2$ (160).
- Stubblefieldia* PRANTL & PŘIBYL, 1947 [**Cheirurus neglectus* BARRANDE, 1872]. Glabella bulbous. Thoracic segments 11, pleurae without furrows ending in bluntly pointed spines. Pygidium with 3 pairs of short, bluntly rounded spines and a similar terminal spine. *U.Ord.*, Boh.—FIG. 337,9. **S. neglecta* (BARRANDE); *9a-c*, cran., thoracic segment, pyg., all $\times 1$ (370).

Subfamily ACANTHOPARYPHINAE

Whittington & Evitt, 1953

Glabella tapering toward anterior margin, more or less inclined forward; eyes opposite *1p* or *2p* lobes. Hypostoma with prominent lateral shoulders and relatively wide lateral notch. Thoracic pleurae with transverse row of pits. Pygidium with 2 pairs of pleural spines, anterior pairs commonly more strongly developed than others. *L.Ord.-U.Ord.*

- Acanthoparypha* WHITTINGTON & EVITT, 1953 [**A. perforata*]. Glabella without spine and not divided in 3 longitudinally; without occipital spine. *M.Ord.*, N.Am.-Eu.—FIG. 339. **A. perforata*, Va.; restored incompl. exoskel., $\times 5.7$ (359*).
- ?*Hadrohybus* RAYMOND, 1925 [**H. dunbari*]. Glabella without lateral furrows but with spinelike inflation, smooth. Only cranidium known. *M.Ord.*, Newf.—FIG. 341,5. **H. dunbari*; incompl. cran., $\times 1$ (449).
- Holia* BRADLEY, 1930 [**H. magnaspina*]. Glabella faintly divided in 3 longitudinally, without large

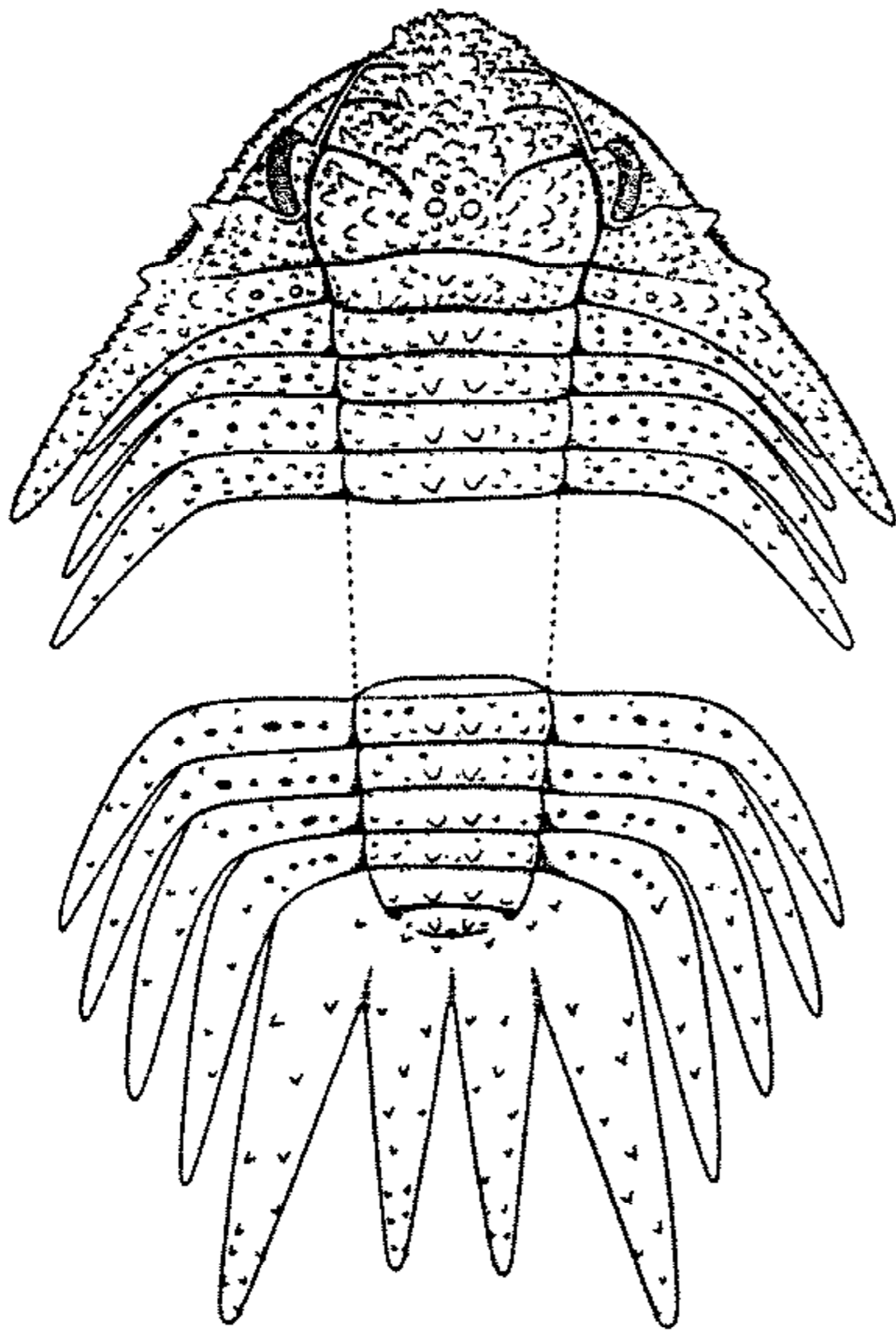

FIG. 339. **Acanthoparypha perforata* WHITTINGTON & EVITT (Cheiruridae), M.Ord., Va.; incompl. exoskel. (reconstr.), $\times 5.7$ (359).

glabellar spine; occipital spine present. M.Ord., N.Am.—FIG. 340. *H. secreti* WHITTINGTON & EVITT, Va.; restored incompl. exoskel., $\times 8.5$ (359*).

Nieszkowskia SCHMIDT, 1881 [**Sphaerexochus cephaloceros* NIESZKOWSKI, 1857; SD REED, 1896]. Glabella with spine and not divided in 3 longitudinally; without occipital spine. ?L.Ord., M.Ord.-U.Ord., Eu.-N.Am.—FIG. 341,4. **N. cephaloceros* (NIESZKOWSKI), M.Ord., Est.; 4a, restored ceph., 4b, side view of ceph., 4c, pyg., all $\times 1$ (468n).

Subfamily SPHAEREXOCHINAE Öpik, 1937

Glabella dominating, almost circular in outline, strongly inflated, overhanging anterior margin and front parts of fixigenae, which are markedly narrower (*tr.*) than glabella; genal spines rudimentary or absent. Hypostoma cyrtometopinoid. M.Ord.-Sil., ?Dev.

Sphaerexochus BEYRICH, 1845 [**S. mirus*]. Pre-occipital pair of lateral glabellar furrows distinct, curved, usually reaching occipital furrow, with 2 additional pairs of short lateral glabellar furrows in some species. Thorax with 10 segments, pleurae

with poorly defined flanges, bluntly rounded spines, and lacking pleural furrows. Pygidium with 3 pairs of short and broad, bluntly rounded spines. Surface smooth. M.Ord.-Sil., Eu.-N.Am.-India-Austral.—FIG. 341,2. **S. mirus*, L.Sil., Boh.; 2a,b, cran.; 2c,d, thoracic segment, pyg., all $\times 1$ (370).

Pompeckia WARBURG, 1925 [**Sphaerexochus wegelini* ANGELIN, 1854]. Preoccipital lateral glabellar furrows not recurved to meet occipital furrow. Pleurae with short furrows running obliquely forward. Pygidium with 3 pairs of pleural spines and terminal spine. Surface smooth. U.Ord., N. Eu.—FIG. 341,1. **P. wegelini* (ANGELIN), U. Ord., Swed.; 1a,b, cran., 1c-e, thoracic segment, pyg., hypostoma, all $\times 1$ (323).

Subfamily DEIPHONINAE Raymond, 1913

Glabella in front of preoccipital furrow greatly inflated and wider than rest of glabella. Thorax with ?8 or 9 segments. M.Ord.-Sil.

Deiphon BARRANDE, 1850 [**D. forbesi*]. Librigenae very small, fixigenae reduced to a long genal spine. Thorax with 9 segments, pleurae not in contact with each other. Pygidium with 2 pairs of pleural spines, posterior pair largest. Sil., Eu.-N. Am.—FIG. 342. **D. forbesi*, Wenlock, Eng.; exoskel. (reconstr.), $\times 1.75$ (341, 466*).

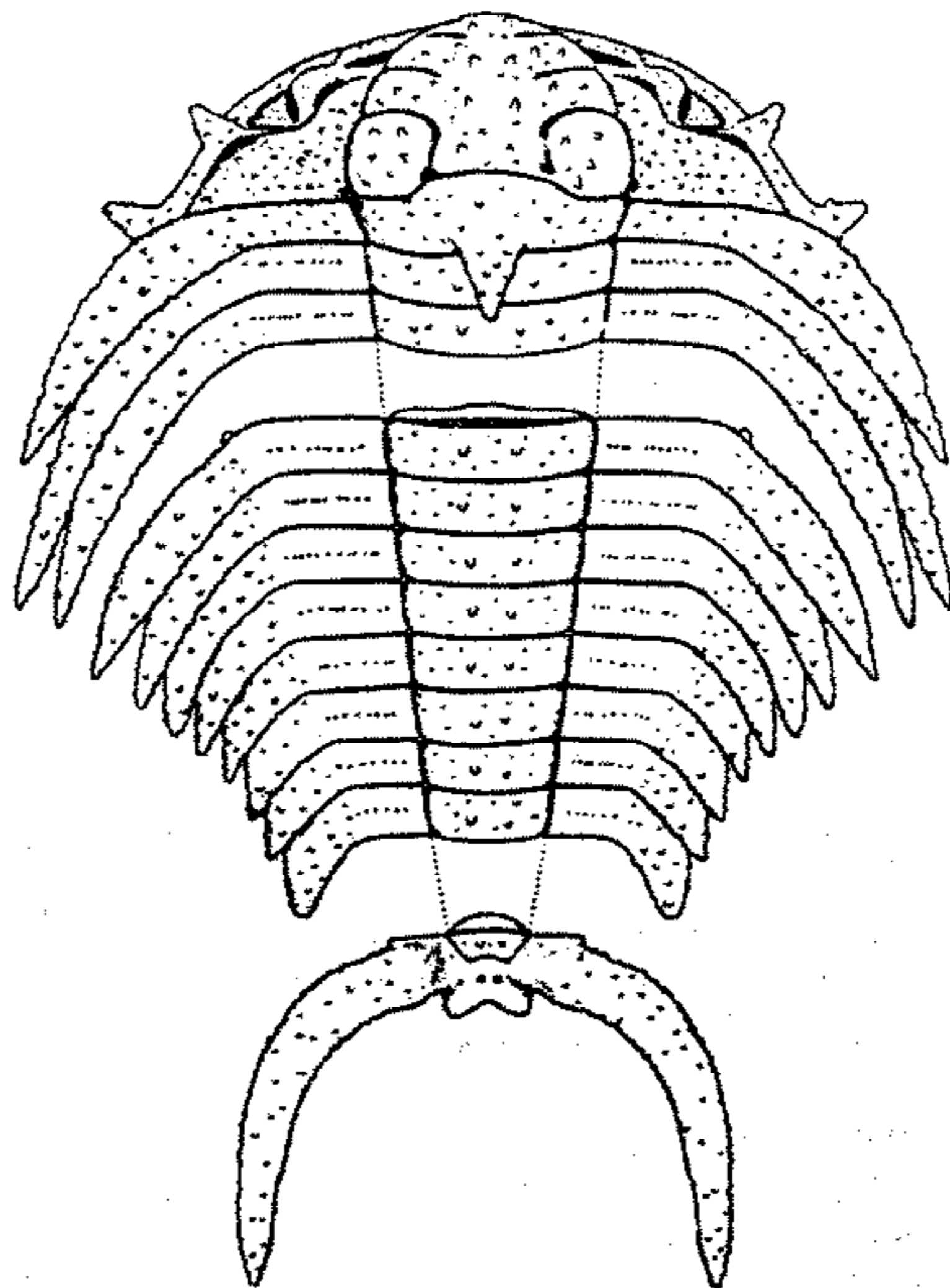

FIG. 340. **Holia secreti* WHITTINGTON & EVITT (Cheiruridae), M.Ord., Va.; incompl. exoskel. (reconstr.), $\times 8.5$ (359).

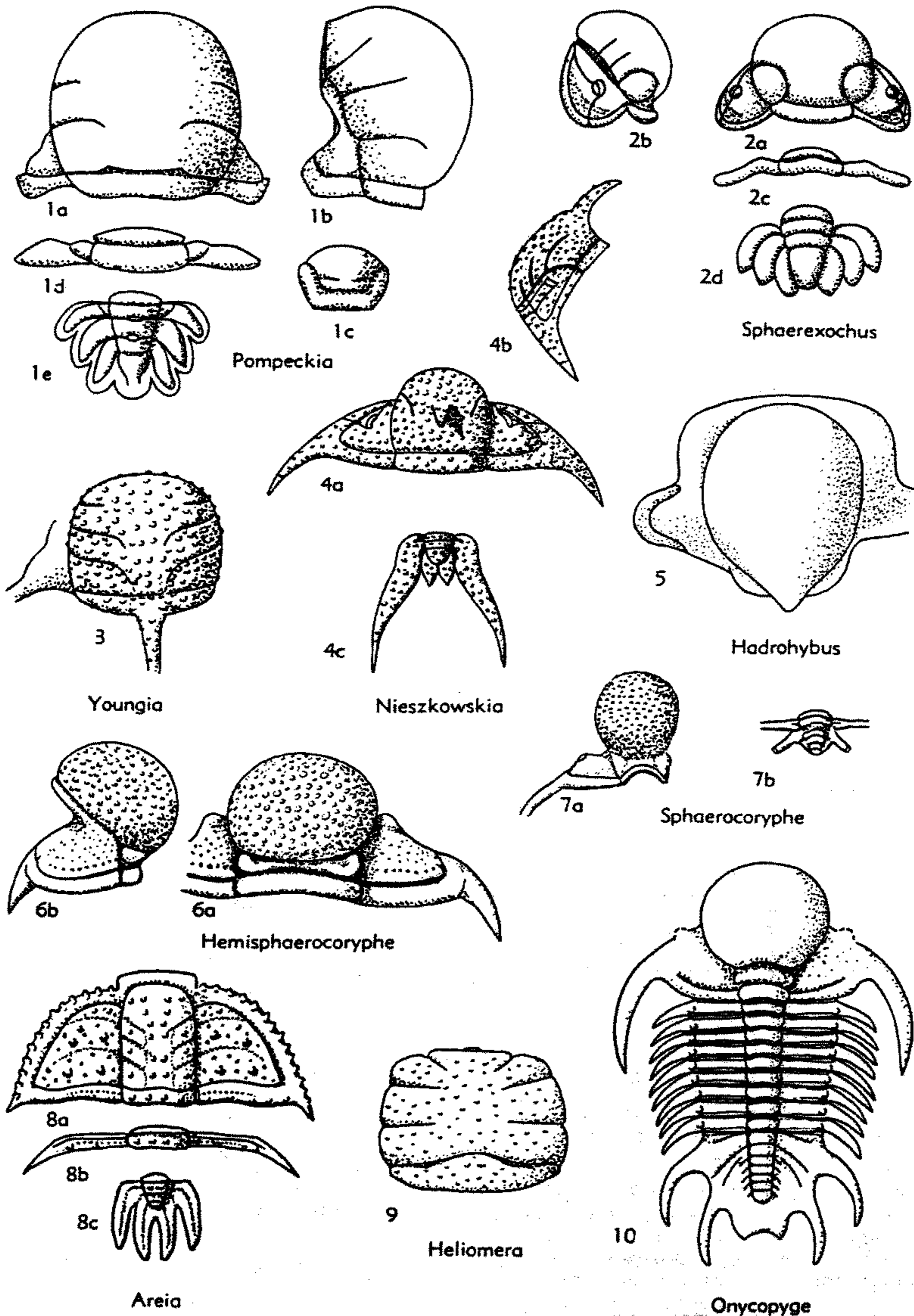

FIG. 341. Cheirurida (Acanthoparyphinae, Sphaerexochinae, Deiphoninae, Areiinae, Heliomerinae, Subfamily Uncertain) (p. 0435-0439).

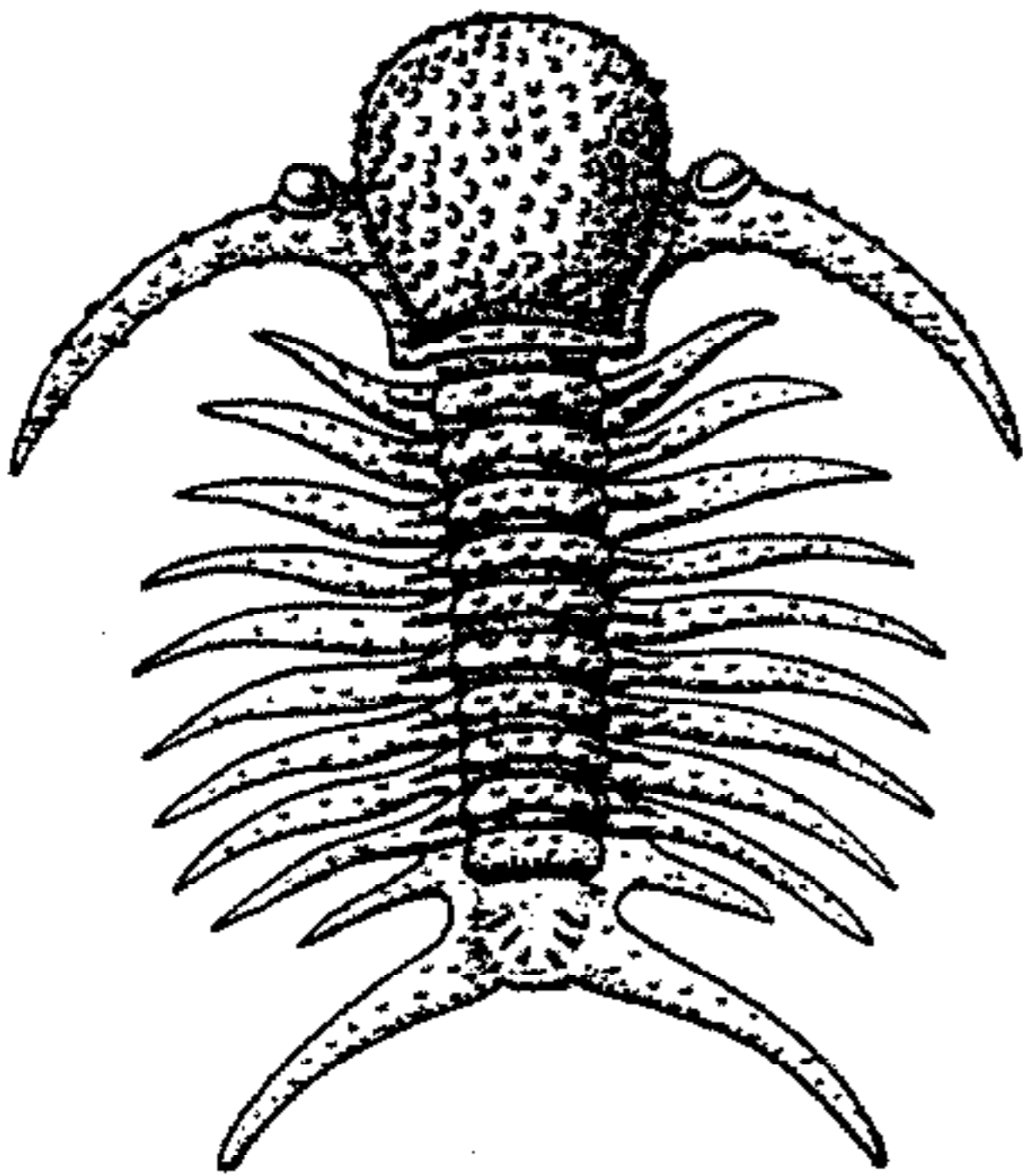

FIG. 342. **Deiphon forbesi* BARRANDE (Cheiruridae), M.Sil., Eng.; exoskel. (reconstr.), $\times 1.75$ (466).

Hemisphaerocoryphe REED, 1896 [**Sphaerexochus pseudohemicranium* NIESZKOWSKI, 1859; SD BARRON, 1920]. Well-developed fixigenae with genal spine; bulbous part of glabella only slightly wider than remainder. *M.Ord.-U.Ord.*, N.Eu.—FIG. 341.6. **H. pseudohemicranium* (NIESZKOWSKI), M.Ord. (Jöhvi), Est.; 6a,b, cran., both $\times 1.5$ (160).

Onycopyge WOODWARD, 1880 [**O. liversidgei*]. Resembles *Deiphon* but with less reduced fixigenae and with pleurae in contact with each other. Thorax with ?8 or 9 segments. Pygidium with 3 pairs of pleural spines, posterior pair broad-based. *Sil.*, Austral.(N.S.W.)—FIG. 341.10. **O. liversidgei*, restored exoskel., $\times 1.5$ (341).

Sphaerocoryphe ANGELIN, 1854 [**S. dentata* (ICZN pend.)] [= *Sphaerometopus* ANGELIN, 1854 (suppression pend. ICZN)]. Like *Hemisphaerocoryphe* but bulbous part of glabella more dominating. *M.Ord.-U.Ord.*, Eu.-N.Am.—FIG. 341.7. *S. punctata* ANGELIN, 1854, U.Ord., Swed.; 7a,b, incompl. ceph. and pyg., both $\times 2$ (323).

Subfamily AREIINAE Prantl & Přibyl, 1947

Glabella with subparallel sides; no facial sutures or eyes. Thorax with 9 or 10 segments, pleurae with transverse rows of pits. Pygidium with 2 pairs of long pleural spines. *M.Ord.-U.Ord.*

Arcia BARRANDE, 1872 [**A. bohemia* BARRANDE, 1872; SD VOGDES, 1890]. Characters of subfamily. *M.Ord.-U.Ord.*, Boh.—FIG. 341.8. **A. bohemia*, U.Ord., Boh.; 8a-c, ceph., thoracic segment, pyg., all $\times 2$ (370).

?Subfamily HELIOMERINAE Evitt, 1951

Glabella dominating, wider than long and not strongly convex, with 3 pairs of lat-

eral furrows in more or less radial orientation; fixigenae and librigenae very narrow. Hypostoma rectangular, cyrtometopinoid. Thoracic axis very wide, tapering backward, proximal parts of pleurae very narrow (*tr.*), distal parts comprising hollow projections. Pygidial segments few and poorly differentiated from the thoracic ones. *M.Ord.-U.Ord.*

Heliomera RAYMOND, 1905 [**Cheirurus sol* BILLINGS, 1865]. Inner ends of lateral glabellar furrows not joined by longitudinal furrows. *M.Ord.*, Newf.—FIG. 341.9. **H. sol* (BILLINGS); cephalic axis, $\times 5$ (42).

Heliomeroides EVITT, 1951 [**H. teres*]. Median glabellar lobe set off by distinct longitudinal furrows joining inner ends of lateral glabellar furrows. *L.Ord.-M.Ord.*, N.Am.—FIG. 343. **H. teres*, M.Ord., Va.; incompl., restored exoskel., $\times 4.25$ (42*).

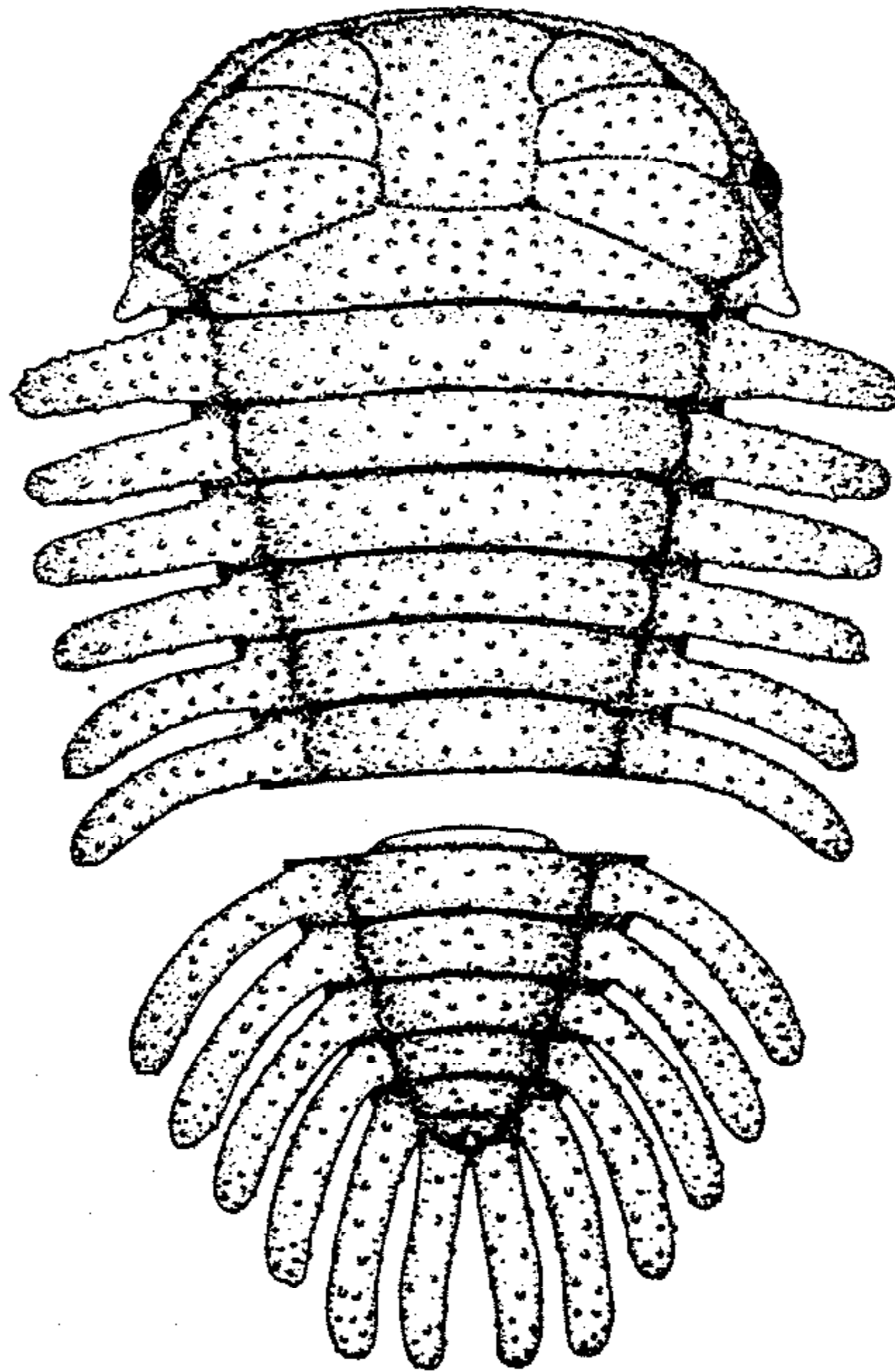

FIG. 343. **Heliomeroides teres* EVITT (Cheiruridae), M.Ord., Va.; incompl. exoskel. (reconstr.), $\times 4.25$ (42).

Subfamily UNCERTAIN

Youngia LINDSTRÖM, 1885 [**Cheirurus trispinosus* YOUNG, 1868; SD VOGDES, 1917, p. 8] [non *Youngia* JONES & KIRKBY, 1886]. Glabella about as long as wide, with 3 pairs of lateral furrows; stout occipital spine; fixigenae narrow (*tr.*), with long genal spine. *Sil.-L.Dev.*, Scot.-Ural.—FIG. 341,3. **Y. trispinosa* (YOUNG); incompl. cran., $\times 1$ (452).

Family PLIOMERIDAE Raymond, 1913

[*nom. transl.* ÖPIK, 1937 (ex *Pliomerinae* RAYMOND, 1913)]
[=*Amphionidae* PICTET, 1854]

Cephalon semicircular to semielliptical in outline; facial sutures proparian, exceptionally gonatoparian or opisthoparian; glabella moderately convex, with 2 or 3 pairs of lateral glabellar furrows; preglabellar field absent; eyes small to medium size, exceptionally absent. Thorax with 11 to 19 segments; pleurae smooth, ridged or furrowed. Pygidium with 2 to 6 axial rings and terminal piece; pleural regions with as many pleurae as there are axial rings; pleurae ending in free spines or blunt edges. *L.Ord.-U.Ord.*

Subfamily PLIOMERINAE Raymond, 1913

Cephalon with proparian or gonatoparian sutures; glabella about as wide as long, evenly expanding forward, with 3 pairs of lateral glabellar furrows, of which anterior (*3p*) pair is usually located in front of anterolateral angles of glabella; genal angles rounded; eyes submedian to posterior. Pygidium with 4 or 5 axial rings and terminal piece. *L.Ord.-U.Ord.*

Pliomera ANGELIN, 1852 [**Asaphus fischeri* EICHWALD, 1825; SD VODGES, 1925 (= *Calymene polytoma* DALMAN, 1827 (subj.); *Calymene frontiloba* STSCHEGLOFF, 1827 (sub.)) [= *Amphion* PANDER, 1830 (non HÜBNER, 1816)]. Facial sutures gonatoparian; anterior (*3p*) lateral glabellar furrows located in front of anterolateral angles of glabella, reaching anterior border furrow; frontal glabellar lobe with mesial indentation; anterior cephalic border bearing 7 to 9 denticulations; fixigenae L-shaped, pitted; eyes small, posterior; palpebral lobes raised; eye ridges absent. Thorax with 12 to 18 segments. Pygidium with 4 or 5 axial rings and minute terminal piece; pleurae ending in very short spines or blunt points, last pair completely embracing terminal axial segment. *M.Ord.*, Norway-Swed.-Est.-Arg. — FIG. 344, 345,5. **P. fischeri* (EICHWALD), Est.; 344, exoskel. (reconstr.), $\times 2.7$; 345,5, hypostoma, $\times 2$ (405n, based on 439, 468).

Cybelopsis POULSEN, 1927 [**C. speciosa*]. Differs from *Pliomera* in lacking mesial indentation on

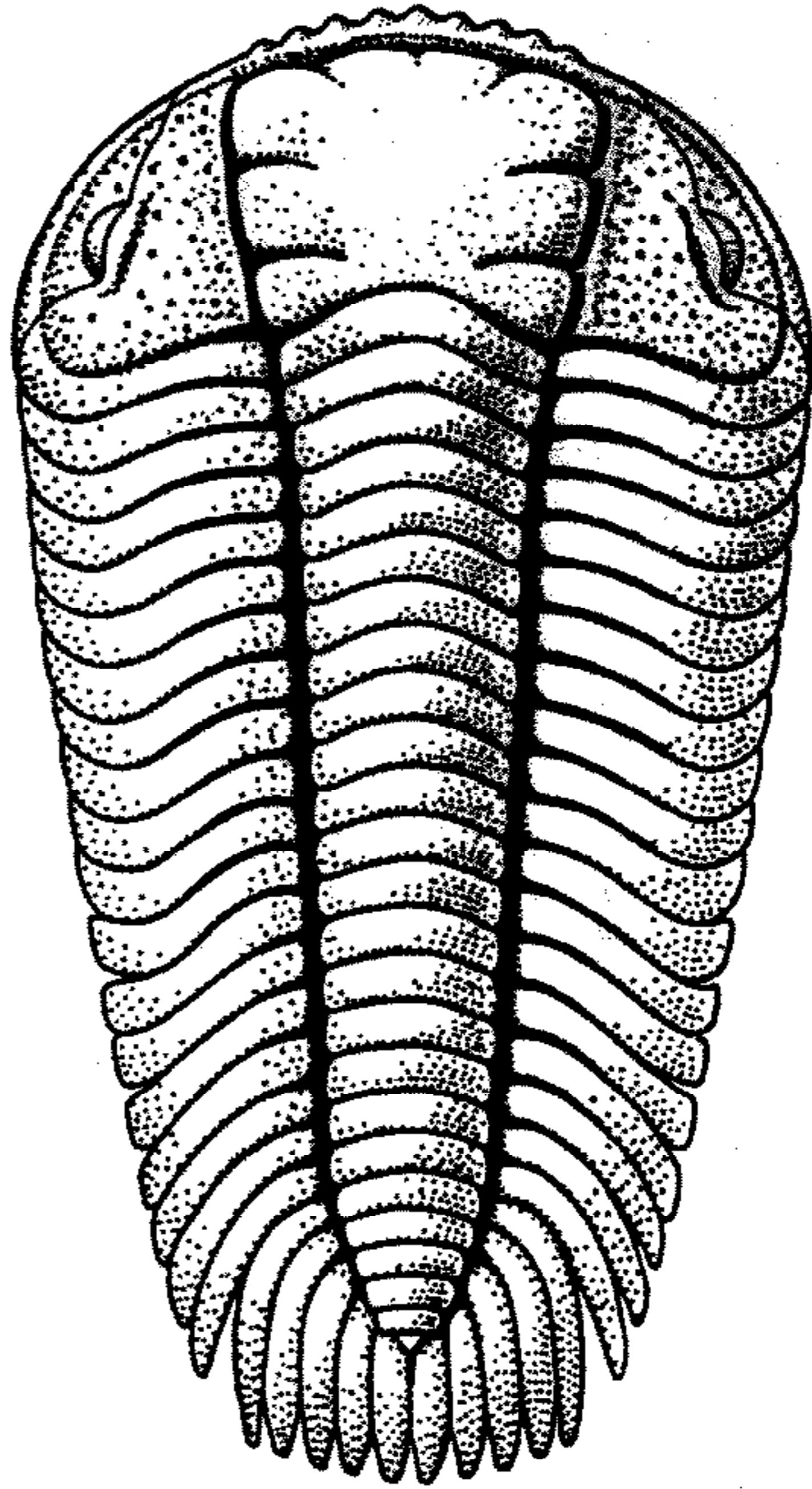

FIG. 344. **Pliomera fischeri* (EICHWALD) (Pliomeridae), *M.Ord.*, Est.; exoskel. (reconstr.), $\times 2.7$ (405n).

frontal glabellar lobe and denticulations on anterior cephalic border, and in having proparian sutures; eyes moderately long, submedian, located at level of median (*2p*) lateral glabellar lobes; palpebral lobes elongated. Thorax with 13 segments. Pygidium cybeliform, with 5 axial rings, long triangular terminal axial piece bearing 2 longitudinal rows of small pits on each side of axial line; 5 pairs of reclined pleurae ending in blunt points. *L.Ord.*, Greenl.-USA (Utah). — FIG. 345,4. **C. speciosa*; 4a, cran. (Utah), $\times 1.7$; 4b, pyg. (Greenl.), $\times 1.7$; 4c, hypostoma (Utah), $\times 2$; (4a,c, 407*; 4b, 445*).

Pliomerina CHOUGAEVA, 1956 [**Pliomera martelli* REED, 1917] [= *Pliomeraspis* HARRINGTON, 1957 (obj.)]. Differs from *Pliomera* in lacking mesial indentation on frontal glabellar lobe and denticulations on anterior cephalic border, and in having anterior (*3p*) lateral glabellar furrows springing from anterolateral corners of glabella, much larger frontal glabellar lobe with pair of oviform longitudinal depressions separated by low sagittal crest, and much smaller preoccipital lateral glabellar lobes. *M.Ord.*, China (Yunnan).

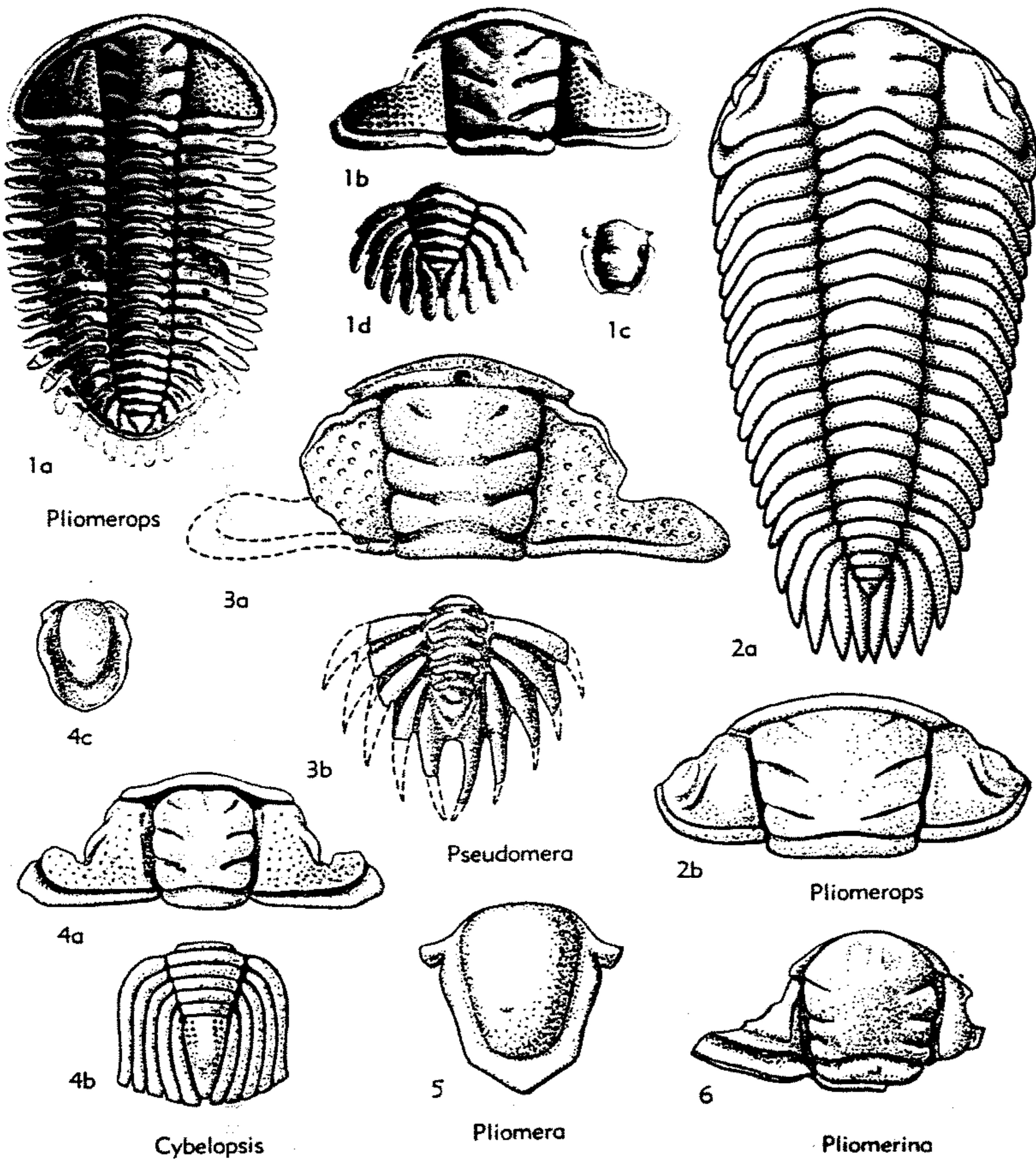

FIG. 345. Pliomeridae (Pliomerinae) (p. O439-O440).

—FIG. 345,6. **P. martelli* (REED); cran. (holotype), $\times 6.7$ (452*).

Pliomerops RAYMOND, 1905 [**Amphion canadensis* BILLINGS, 1859]. Differs from *Pliomera* in lacking indentation on frontal glabellar lobe and denticulations on anterior cephalic border, in having proparian facial sutures, and small submedian eyes. Thorax with 14 to 19 segments. Pygidium with 5 axial rings and long terminal axial piece. *M.Ord.-U.Ord.*, Can.(Que.-Newf.)-USA(Vt.-N.Y.-Va.-Tenn.-Okla.)-Eu.-(Eng.-Swed. - Czech.). — FIG. 345,2. **P. canadensis* (BILLINGS), *M.Ord.* (Tenn.); 2b, cran., $\times 1$ (390*). — FIG. 345,1. *P.*

senilis (BARRANDE), *M.Ord.*, Czech.; 1a, exoskel. (lectotype), $\times 0.7$; 1b-d, cran., pyg., hypostoma, $\times 0.7$ (370).

Pseudomera HOLLIDAY, 1942 [**Amphion barrandei* BILLINGS, 1865]. Differs from *Pliomera* in lacking denticulations on anterior cephalic border and in having proparian sutures; anterior (3p) lateral glabellar furrows not reaching anterior border furrow; fixigenae without anterior areas, anterior border furrow with deep mesial pit; eyes moderately large, submedian; long palpebro-ocular ridges. Pygidium with 5 axial rings, long terminal axial piece with lunate furrow, and pleurae ending

in long free spines. *L.Ord.*, Can.(Newf.), Greenl.
—FIG. 345,3. **P. barrandei* (BILLINGS), Newf.;
3a, cran. (holotype), $\times 2$; 3b, pyg. (paratype),
 $\times 1.35$ (408*).

Subfamily PILEKIINAE Sdzuy, 1955

[*nom. transl.* HARRINGTON, herein (*ex* Pilekiidae Sdzuy,
1955)]

Cephalon with proparian sutures; glabella oval in outline, parallel-sided or tapering forward, with 3 pairs of lateral glabellar furrows; genal angles produced into spines or exceptionally ?rounded; eyes anterior; eye ridges or palpebro-ocular ridges present or absent. Thorax with ?11 or ?12 segments; pleurae furrowed. Pygidium with 2 to 4 axial rings and terminal piece; 2 to 4 pairs of furrowed pleurae ending in long free spines. *L.Ord.*

Pilekia BARTON, 1915 [**Cheirurus apollo* BILLINGS, 1864]. Glabella prominent, wider than long, strongly tapering forward, strawberry-shaped; lateral glabellar furrows directed inward and slightly backward; length (*exsag.*) of successive lateral glabellar lobes increasing from front to back; frontal glabellar lobe short and small; surface of glabella granulose; fixigenae narrow (*tr.*) without anterior areas, pitted; eyes small, well forward, close to glabella; palpebro-ocular ridges short; posterior sections of facial sutures cutting lateral margins immediately in front of genal angles which are ?rounded or produced into spines. Thorax of ?12 segments; pleurae with oblique furrows, pleural extremities produced into long curved spines. Pygidium with 4 axial rings and triangular terminal axial piece reaching posterior margin; pleural regions with 4 pairs of furrowed pleurae ending in long free spines arranged in groups of 2. *L.Ord.*, Can.(Que.), USA(Vt.-Utah-Ohio).—FIG. 346,1b,c. **P. apollo* (BILLINGS), Vt.; 1b, cran., $\times 2.7$; 1c, pyg., $\times 0.7$ (449).—FIG. 346,1a. *P. trio* HINTZE, Utah; cran. (holotype) $\times 3$ (407).

Anacheirurus REED, 1896 [**Cheirurus (Eccoptychile) frederici* SALTER, 1864]. Differs from *Pilekia* in having glabella slightly longer, gently tapering forward, with evenly spaced lateral glabellar furrows; eyes rather far from glabella without eye ridges or palpebro-ocular lobes; posterior sections of facial sutures cutting lateral margins well in front of spinose genal angles. Thorax with ?11 segments. Pygidium apparently similar to that of *Parapilekia*. *L.Ord.*(*Tremadoc.*), Wales.—FIG. 346,4. **A. frederici* (SALTER); distorted specimen (lectotype), $\times 1$.—FIG. 346,3. *A. frederici?* (SALTER); 3a, cran., $\times 0.7$; 3b, pyg., $\times 0.7$ (406n).

Metapilekia HARRINGTON, 1938 [**M. bilirata*]. Differs from *Pilekia* in having glabella as long as wide, gently tapering forward, longer (*sag.*) and larger frontal glabellar lobe; yoke-shaped anterior

cephalic border; very wide fixigenae with well-developed anterior areas; eyes located far from glabella, eye ridges long, arcuate fixigenal ridges extending from level of mesial (2*p*) lateral glabellar furrows to genal angles; posterior sections of facial sutures cutting lateral margins well in front of spinose genal angles. Pygidium with 3 axial rings, small triangular terminal axial piece and 3 pairs of pleurae ending in long free spines directed backward. *L.Ord.*, Arg.—FIG. 346,6. **M. bilirata*; 6a, cran. (holotype), $\times 1.2$; 6b, pyg., $\times 4.65$ (405).

Metapliomerops KOBAYASHI, 1934 [**Pilekia extenuata* RAYMOND, 1924]. Differs from *Pilekia* in lacking palpebro-ocular ridges and in having glabella longer than wide, evenly tapering forward, with regularly spaced lateral glabellar furrows. Pygidium with 5 axial rings and terminal piece, 4 pairs of furrowed pleurae ending in long free spines, and traces of 2 more pairs of pleurae behind posterior pair, each produced into incipient spines. *L.Ord.*, USA(Vt.).—FIG. 346,2. **M. extenuatus* (RAYMOND); 2a, cran. (holotype), $\times 4.3$; 2b, pyg. (paratype), $\times 2.7$ (449).

Parapilekia KOBAYASHI, 1934 [**Calymene? speciosa* DALMAN, 1827; SD HOLLIDAY, 1942]. Differs from *Pilekia* in having glabella longer than wide, oval in outline, with lateral glabellar lobes of subequal length (*exsag.*); longer frontal glabellar lobe; wider fixigenae; posterior sections of facial sutures cutting lateral margins well in front of spinose genal angles. Pygidium with 4 axial rings and terminal axial piece, which does not reach posterior margin; 4 pairs of pleurae ending in evenly distributed long free spines. *L.Ord.*, Swed.-Czech.—FIG. 346,8. **P. speciosa* (DALMAN), Swed.; 8a,b, cran., pyg., $\times 0.7$ (432).

?*Emsurina* SIVOV, 1955 [**E. sibirica*]. Cranidium imperfectly known, resembles *Pilekia*. Other parts of exoskeleton unknown. Horizon given as *Up.U. Cam.*, but may be *L.Ord.*(*Tremadoc.*), Sib. (HA).

?*Scisonia* KOBAYASHI, 1934 [**S. sphericauda*]. Cranidium imperfectly known, similar to that of *Parapilekia*. Pygidium with 2 axial rings and short, posteriorly rounded terminal axial piece, which does not reach posterior margin, and 2 pairs of broad furrowed pleurae ending in long free spatulate spines. *L.Ord.*, S.Korea.—FIG. 346,7. **S. sphericauda*; 7a, cran. (paratype), $\times 2.5$; 7b, pyg. (holotype), $\times 1$ (419).

?*Tesselacauda* ROSS, 1951 [**T. depressa*]. Differs from *Pilekia* in having glabella longer than wide, subrectangular in outline, evenly spaced lateral glabellar furrows; very wide posterior areas of fixigenae; genal angles bluntly pointed; incomplete palpebro-ocular ridges, ill defined from anterior cephalic border. Pygidium with 4 axial rings and terminal piece; 4 pairs of paddle-shaped pleurae with square ends, anterior 2 pairs bearing oblique pleural furrows. *L.Ord.*, USA(Idaho-Utah).—FIG. 346,5. **T. depressa*, Utah; 5a, cran.

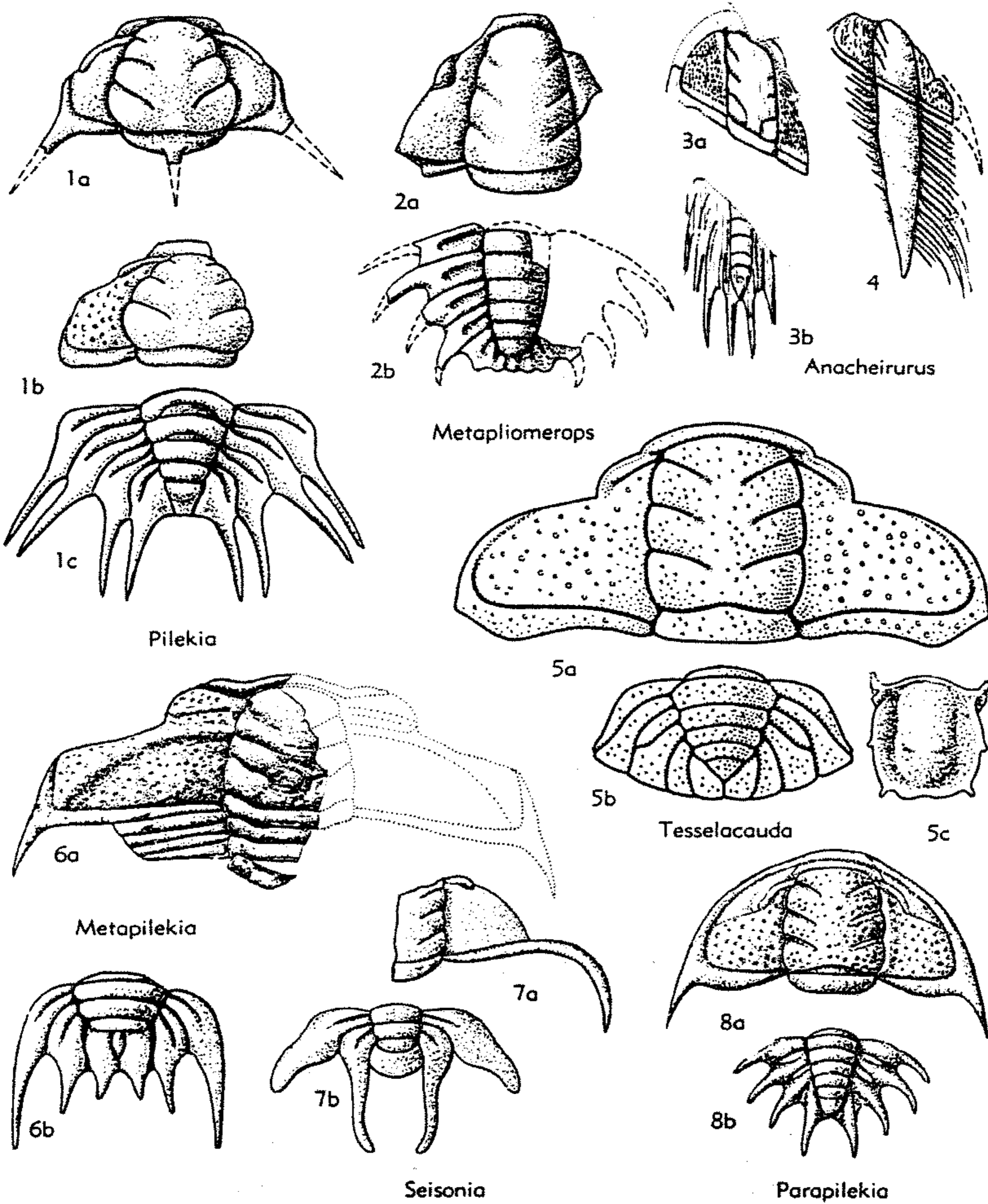

FIG. 346. Pliomeridae (Pilekiinae) (p. 0441).

(holotype), $\times 2$; 5b, pyg. (paratype), $\times 2$; 5c, hypostoma (paratype) $\times 5.3$ (463).

Subfamily PROTOPLIOMEROPINAE Hupé, 1953
 [nom. correct. HARRINGTON, herein (pro Protopliomeropsinae Hupé, 1953)]

Cephalon with proparian sutures; glabella longer than wide, with 3 pairs of evenly spaced lateral glabellar furrows, of

which anterior (3p) pair is usually located at level of anterolateral angles of glabella or behind it; eyes anterior to submedian; genal angles rounded or produced into spines. Thoracic pleurae smooth or ridged. Pygidium with 4 to 6 axial rings and terminal piece; pleurae smooth. *L.Ord.*

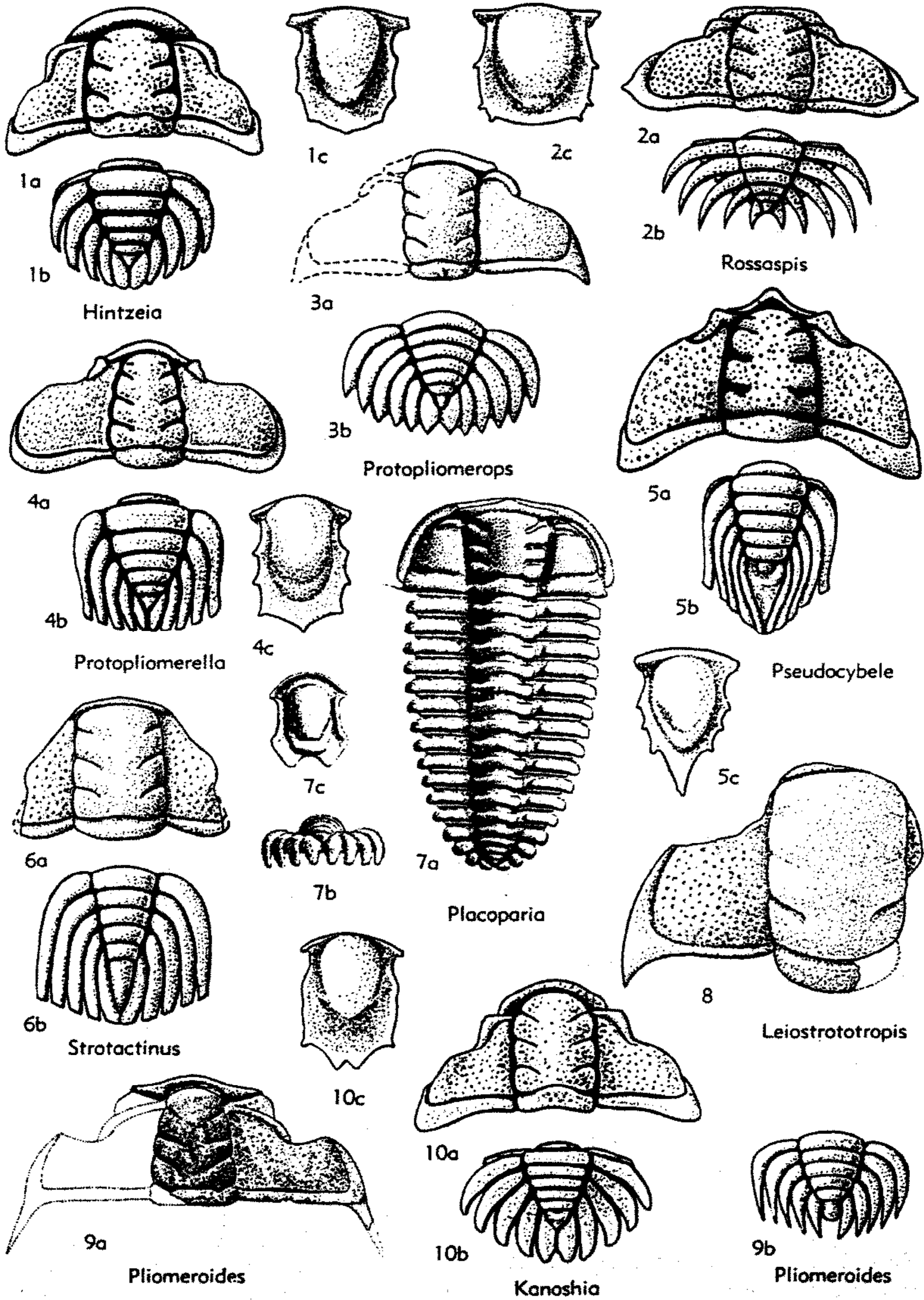

FIG. 347. Pliomeridae (Protopliomeropinae, Placopariinae) (p. 0444-0445).

Protopliomerops KOBAYASHI, 1934 [**P. seisonensis*] [= *Strototropis* RAYMOND, 1937 (subj.); examination of holotype cranium of *S. laeviuscula* RAYMOND, type species of *Strototropis*, shows that what RAYMOND regarded as anterior sections of facial sutures are anterior border furrow of cranium, behind which short palpebro-ocular ridges are developed]. Glabella parallel-sided, elongately subquadrate in outline; anterior (3*p*) pair of lateral glabellar furrows located well behind anterolateral angles of glabella; anterior areas of fixigenae absent, posterior areas wide (*tr.*), subtriangular; genal angles produced into spines; eyes anterior, located near glabella; palpebro-ocular ridges conspicuous. Number of thoracic segments unknown; pleurae slightly inflated, with spinose extremities. Pygidium with 5 or 6 axial rings and triangular terminal axial piece; pleurae ending in free spines; last pair completely embracing terminal axial segment. Dorsal surface of cranium finely granulate. *L.Ord.*, S.Korea.-Bol.-USA (Vt.-?Utah).—FIG. 347,3*a*. **P. seisonensis*; cran. (syntype) (S. Korea), $\times 10$ (419*).—FIG. 347,3*b*. *P. punctatus* KOBAYASHI; pyg. (holotype) (S.Korea), $\times 2$ (419*).

Hintzeia HARRINGTON, 1957 [**Protopliomerops aemula* HINTZE, 1952]. Differs from *Protopliomerops* in having glabella tapering forward or slightly elliptical in outline, anterior (3*p*) lateral glabellar furrows located in front of anterolateral angles of glabella; eyes anterior or submedian; genal angles rounded. Hypostoma pointed posteriorly. *L.Ord.*, USA (Utah-Nev.-Idaho)-Arg.—FIG. 347,1. **H. aemula* (HINTZE), Utah; 1*a*, cran. (paratype), $\times 4.7$; 1*b*, pyg. (paratype), $\times 4.15$; 1*c*, hypostoma (paratype), $\times 4.15$ (407*).

Kanoshia HARRINGTON, 1957 [**Pseudomera kanoshensis* HINTZE, 1952]. Differs from *Protopliomerops* in having anterior (3*p*) pair of lateral glabellar furrows located at level of anterolateral angles of glabella; eyes longer, less anteriorly located; genal angles rounded; surface of glabella granulate; fixigenae pitted. Pygidium with 5 axial rings. Hypostoma bifurcate, with very wide posterior border. *L.Ord.*, USA (Utah).—FIG. 347,10. **K. kanoshensis* (HINTZE); 10*a*, cran. (holotype), $\times 4$; 10*b*, pyg. (paratype), $\times 3$; 10*c*, hypostoma (paratype), $\times 3.35$ (407*).

Leiostrototropis RAYMOND, 1937 [**L. phlegeri*]. Differs from *Protopliomerops* in having larger, more convex glabella with very faint anterior (3*p*) lateral glabellar furrows directed inward and slightly forward, and faint median (2*p*) lateral glabellar furrows. Thorax, pygidium and hypostoma unknown. *L.Ord.*, USA (Vt.).—FIG. 347,8. **L. phlegeri*; cran. (holotype), $\times 2.7$ (405n from photograph of holotype.)

Pliomeroides HARRINGTON & LEANZA, 1957 [**Protopliomerops deferrariisi* HARRINGTON, 1938]. Differs from *Protopliomerops* in having glabella

strongly tapering forward; eyes submedian, located moderately far from glabella at level of median (2*p*) lateral glabellar lobes; eye ridges well developed, curved; anterior areas of fixigenae well developed. *L.Ord.*, Arg.-Swed.-Norway.—FIG. 347,9. **P. deferrariisi* (HARRINGTON), Arg.; 9*a*, cran. (holotype), $\times 1.2$; 9*b*, pyg., $\times 3$, Arg. (405*).

Protopliomerella HARRINGTON, 1957 [**Protopliomerops contracta* Ross, 1952]. Differs from *Protopliomerops* in having glabella strongly tapering forward, anterior (3*p*) lateral glabellar furrows located well behind anterolateral angles of glabella, supplementary (4*p*) pair of lateral glabellar depressions at about level of anterolateral angles of glabella; genal angles rounded. Pygidium with much wider axis and narrow (*tr.*) wirelike pleurae. Hypostoma with strong posterior spine. *L.Ord.*, USA (Idaho-Utah).—FIG. 347,4. **P. contracta* (Ross), Idaho; 4*a*, cran. (holotype), $\times 4$; 4*b*, pyg. (paratype), $\times 10$; 4*c*, hypostoma (paratype), $\times 7$ (463*).

Pseudocybele Ross, 1951 [**P. nasuta*]. Differs from *Protopliomerops* in having accessory (4*p*) pair of faint lateral glabellar creases; genal angles rounded; eyes small, located well forward, close to glabellar; anterior cephalic border angulate; anterior border furrow with mesial pit and smaller anterior pits. Thorax with 15 segments. Pygidium cybeliform, with 5 axial rings and long subtriangular terminal axial piece, 5 pairs of reclined pleurae ending in blunt points. *L.Ord.*, USA (Utah-Idaho-Nev.).—FIG. 347,5. **P. nasuta*, Utah; 5*a*, cran. (paratype), $\times 3.5$; 5*b*, pyg., $\times 3.25$; 5*c*, hypostoma (paratype), $\times 8.3$ (407*, 463*).

Rossaspis HARRINGTON, 1957 [**Protopliomerops superciliosa* Ross, 1951]. Differs from *Protopliomerops* in having glabella elliptical in outline, anterior (3*p*) lateral glabellar furrows located at anterolateral angles of glabella; genal angles bluntly spinose. Pygidium with narrower axis and outstretched pleurae directed outward, then gently curved backward-outward, terminal axial pieces trapezoidal in outline reaching posterior margin, separating posterior pleurae. Hypostoma rounded posteriorly. *L.Ord.*, USA (Idaho)-Arg.—FIG. 347,2. **R. superciliosa* (Ross), Idaho; 2*a*, cran. (holotype), $\times 4$; 2*b*, pyg. (paratype), $\times 4$; 2*c*, hypostoma (paratype), $\times 10.5$ (463*).

Strotactinus BRADLEY, 1925 [**Amphion salteri* BILLINGS, 1861]. Differs from *Protopliomerops* in having eyes moderately long, submedian, located at level of median (2*p*) lateral glabellar lobes; eye ridges absent; fixigenae narrow (*tr.*). Pygidium cybeliform, with 5 axial rings and long triangular terminal axial piece; 5 pairs of reclined pleurae ending in blunt points. *L.Ord.*, Can. (Que.).—FIG. 347,6. **S. salteri* (BILLINGS); 6*a,b*, cran., pyg., $\times 2.7$ (381*).

Subfamily PLIOMERELLINAE Hupé, 1953

Cephalon with proparian sutures; glabella about as wide as long, evenly expanded forward, with 2 pairs of lateral glabellar furrows converging toward center of glabella; eyes moderately large, submedian. Thorax with 19 segments. Pygidium with 5 axial rings and long terminal piece. *M.Ord.-U.Ord.*

Pliomerella REED, 1941 [**P. serotina*]. Glabella subpentagonal in outline; fixigenae narrow (*tr.*), L-shaped; posterior sections of facial sutures directed backward behind eyes. Pygidium with long subrectangular terminal axial piece reaching posterior margin. *M.Ord.-U.Ord.*, G.Brit.-USA (Va.). —FIG. 348,2a. **P. serotina*, U.Ord., Scot.; cran. (holotype), $\times 1.5$ (452). —FIG. 348,2b. *P. americana* COOPER, M.Ord., Va.; pyg. (paratype), $\times 2.3$ (390).

Subfamily PLACOPARIINAE Hupé, 1953

Cephalon with opisthoparian sutures; glabella somewhat longer than wide, evenly expanded forward, with 3 pairs of lateral glabellar furrows, of which anterior (*3p*) pair reaches axial furrows at anterolateral angles of glabella; fixigenae shaped as quarter circle, without anterior areas; genal angles pointed; eyes absent; eye ridges present; librigenae very narrow. Thorax with 12 segments; pleural extremities rounded. Pygidium small, with 4 axial rings and minute terminal axial piece; pleurae ending in free spatulate spines. *M.Ord.*

Placoparia HAWLE & CORDA, 1847 [**Trilobites zippei* BOECK, 1828]. Anterior (*3p*) lateral glabellar furrows directed inward-backward, median (*2p*) and pre-occipital (*1p*) furrows directed normally to axis; facial sutures running very close to margin of cephalon; entire surface of cranidium finely granulose. Hypostoma bifurcate. *M.Ord.*, Eng.-Wales-Fr.-Sp.-Port.-Czech.-N. Afr. — FIG. 347,7. **P. zippei* (BOECK), Czech.; 7a, complete specimen, $\times 1.3$; 7b, pyg., posterior, $\times 1.3$; 7c, hypostoma, $\times 1.3$ (370*).

Subfamily DIAPHANOMETOPINAE Jaanusson, nov.

Cephalon with proparian sutures; glabella long, flattened; lateral glabellar furrows very faintly defined or absent; cephalon surrounded; rostral plate triangular (in some species), connecting sutures meeting each other at posterior margin of doublure. Hypostoma unknown. Thorax with 11 or 12 segments; pleurae with long diagonal

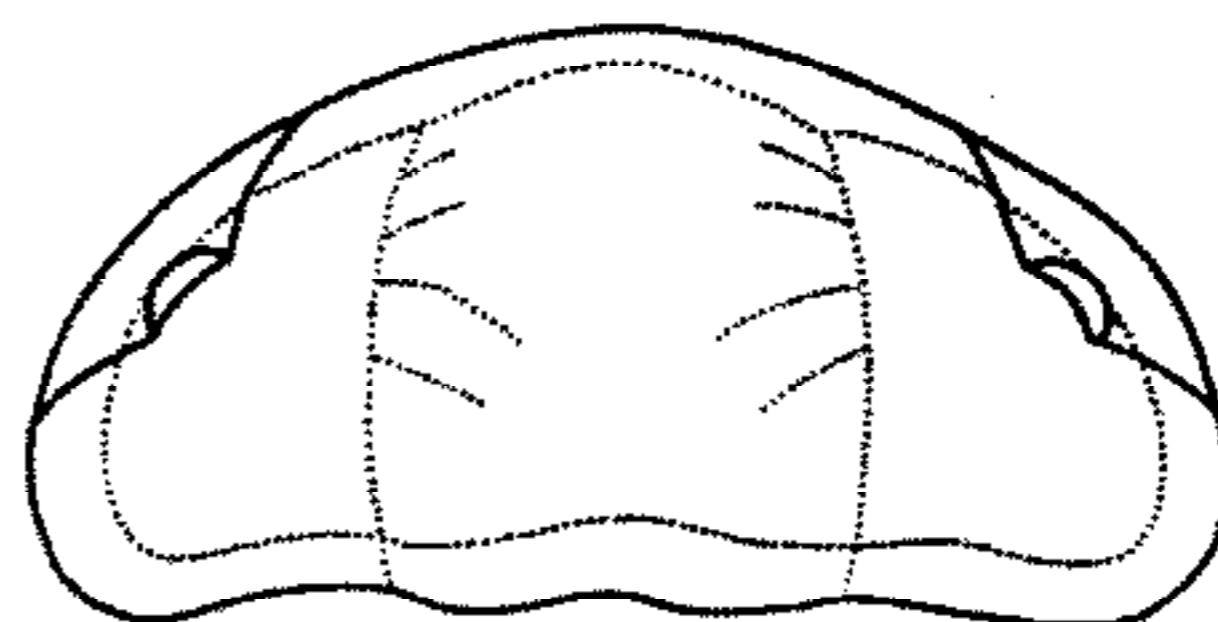

1a

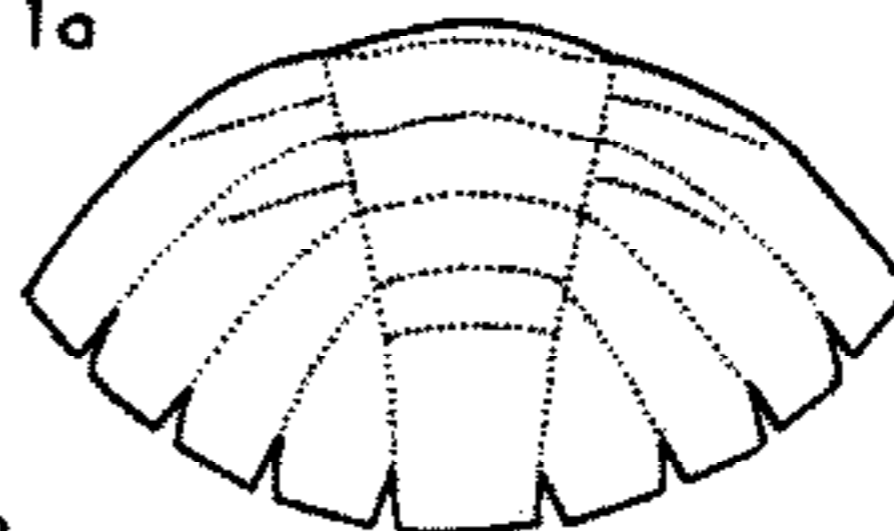

1b

Diaphanometopus



2a

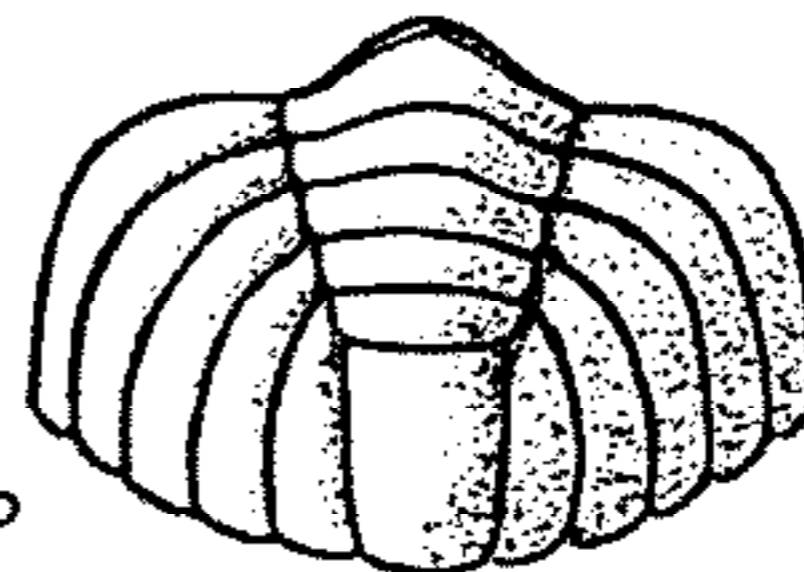

2b

Pliomerella

FIG. 348. Pliomeridae (Pliomerellinae, Diaphanometopininae) (p. 0445).

pleural furrow and well-developed facet. Pygidial pleurae consisting of 4 tergites and terminal piece; ends of all or only of anterior tergites free; foremost 2 tergites with diagonal pleural furrows. *L.Ord.*

Diaphanometopus FR. SCHMIDT, 1881 [**D. volborthi*]. Characters of subfamily. *L.Ord.* (*Arenig.-Llanvirn.*), Baltoscandia. — FIG. 348,1. **D. volborthi*; 1a, ceph., $\times 2$; 1b, pyg., $\times 2$ (414).

Family ENCRINURIDAE Angelin, 1854

Glabella with subparallel or slightly convex sides, or widening forward. Rostral plate wide to very narrow (*tr.*); hypostoma with elongate middle body. Thorax of 10 to 12 segments, pleurae with transverse pleural furrow or lacking them. Pygidium with or

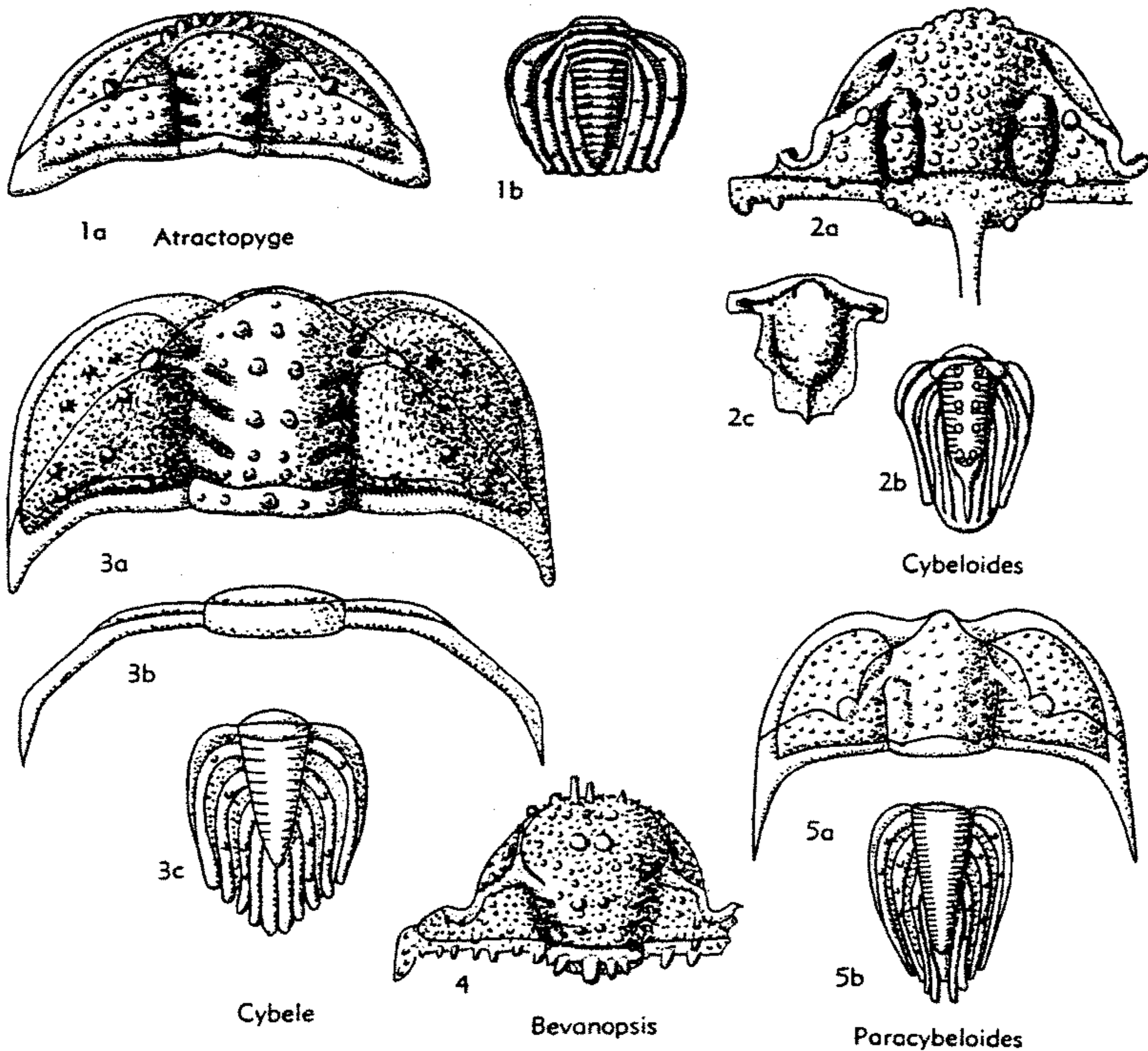

FIG. 349. Encrinuridae (Cybelinae) (p. 0448).

without pleural spines, with 2 to 16 pairs of ribs and a considerably greater number of axial rings (except in Staurocephalinae). Surface generally tuberculate or pitted or both (91, 227). *L.Ord.-Sil.*

The Cybelinae gave rise to the Encrinurinae. It is uncertain whether the Dindymeniinae developed from the Cybelinae or the Encrinurinae.

Subfamily ENCRINURINAE Angelin, 1854

[*nom. transl.* HURÉ, 1955 (*ex* Encrinuridae ANGELIN, 1854)]

Glabella expanding forward; facial sutures generally crossing. No eye ridges. Thorax of cephalic axis. Thorax with 11 or 12 segments, pleurae without pleural furrows. Pygidium with 5 to 16 pairs of ribs. *M.Ord.-Sil.*

Encrinurus EMMRICH, 1844 [**Entomostracites punctatus* WAHLENBERG, 1821 (1819), by suppression of *Trilobus punctatus* BRÜNNICH, 1781 (proposed by R. P. TRIPP, 1956, ICZN pend.)] [=*Cryptonymus* EICHWALD, 1840 (obj.), *non Cryptonymus* EICHWALD, 1825]. Glabella widening markedly forward, with 3 pairs of lateral or transglabellar furrows; eyes more or less stalked. Thorax with 11 or 12 segments. Pygidium subtriangular, longer than broad, with 5 to 10 pairs of ribs. *M.Ord.-Sil.*, cosmop.

E. (Encrinurus). Glabella with 3 pairs of short lateral furrows, more or less obscured by coarse tuberculation. *M.Ord.-Sil.* cosmop.—FIG. 350, 4.

E. sp. cf. *E. punctatus* (WAHLENBERG), 4a, ceph., front; 4b, hypostoma; 4c, exoskel.; all $\times 2.2$ (406n, reconstr. based on material from Llandov. Sh., Oslo, Norway).

E. (*Coronocephalus*) GRABAU, 1924 [**Encrinurus* (*Coronocephalus*) *rex*]. Three pairs of trans-

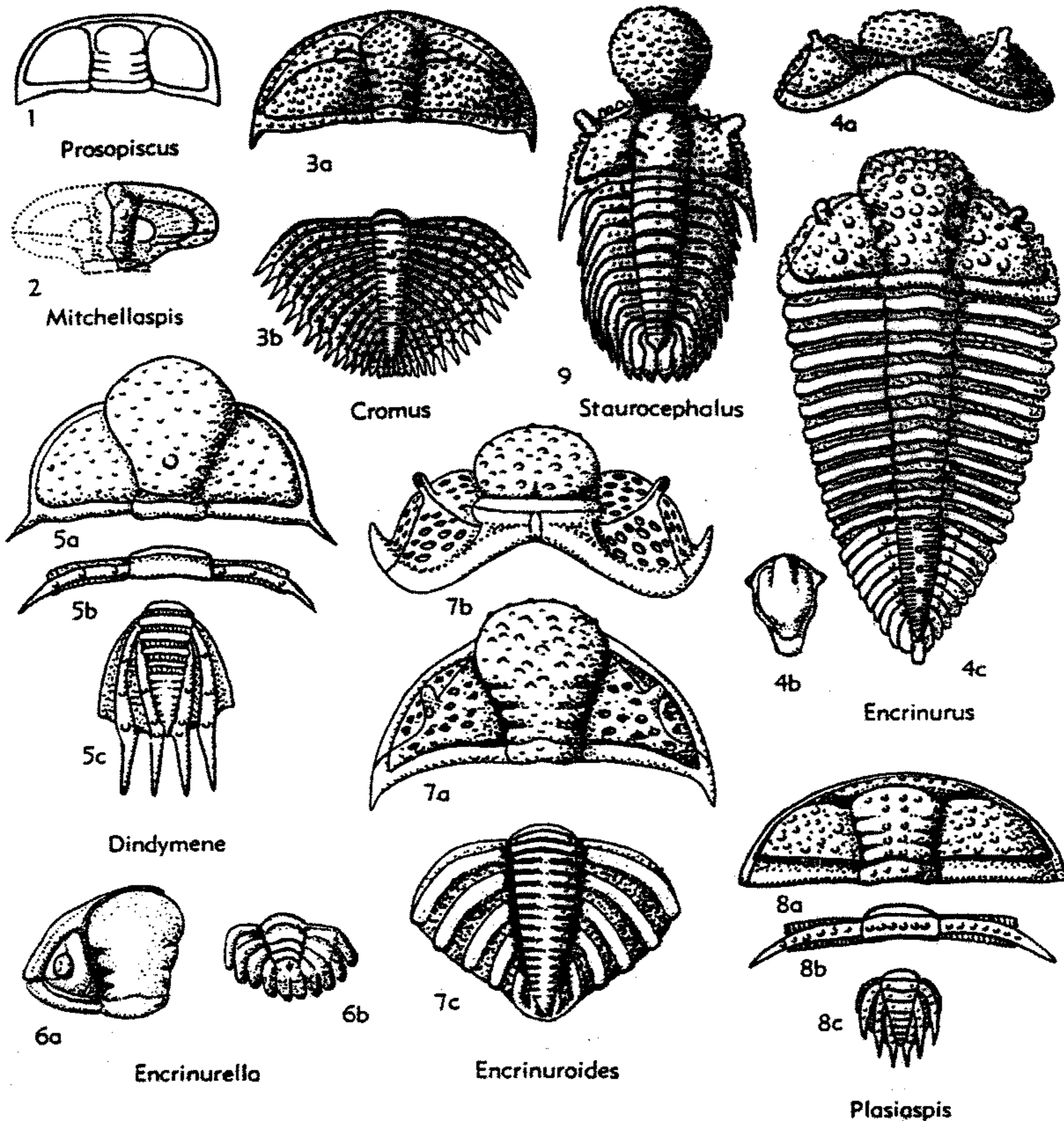

FIG. 350. Encrinuridae (Encrinurinae, Dindymeninae, Staurocephalinae) (p. 0446-0449).

glabellar furrows accentuated by intervening rows of tubercles. *L.Sil.*, China.

Cromus BARRANDE, 1852 [**C. intercostatus*; SD VOGDES, 1890]. Glabella widening slightly forward, with 4 pairs of lateral furrows; eyes moderately close or very close to glabella, opposite its anterior half. Thorax with 10 segments. Pygidium with 10 to 16 pairs of ribs. *Sil.*, Eu.—FIG. 350, 3. **C. intercostatus*, *Sil.*, Boh., 3a, ceph.; 3b, pyg., both $\times 1$ (370).

Encrinuroides REED, 1931 [**Cybele sexcostatus* SALTER, 1848]. Like *Encrinurus* but glabella with more distinct lateral furrows and anterior medial furrow. Thorax with 11 segments. Pygidium

broader than long, with 5 or 6 pairs of ribs. *M. Ord.-U.Ord.*, Eu.-N.Am.—FIG. 350.7. **E. sexcostatus* (SALTER), Rhiwlas Ls., Bala, Wales; 7a,b, ceph. (reconstr.), dorsal, front; 7c, pyg., $\times 1.5$ (350).

?**Mitchellaspis** HENNINGSMOEN, *nom. subst.* herein [*pro Mitchellia* VOGDES, 1917 (305, p. 17) (non DE KONINCK, 1877)] [**Encrinurus? duntroonensis* ETHERIDGE & MITCHELL, 1916]. Resembles *Cromus*, with eyes close to glabella but far back, and with transverse posterior sections of facial sutures. *U.Sil.*, Austral.(N.S.W.).—FIG. 350.2. **M. duntroonensis* (ETHERIDGE & MITCHELL); incompl. ceph., $\times 1$ (398).

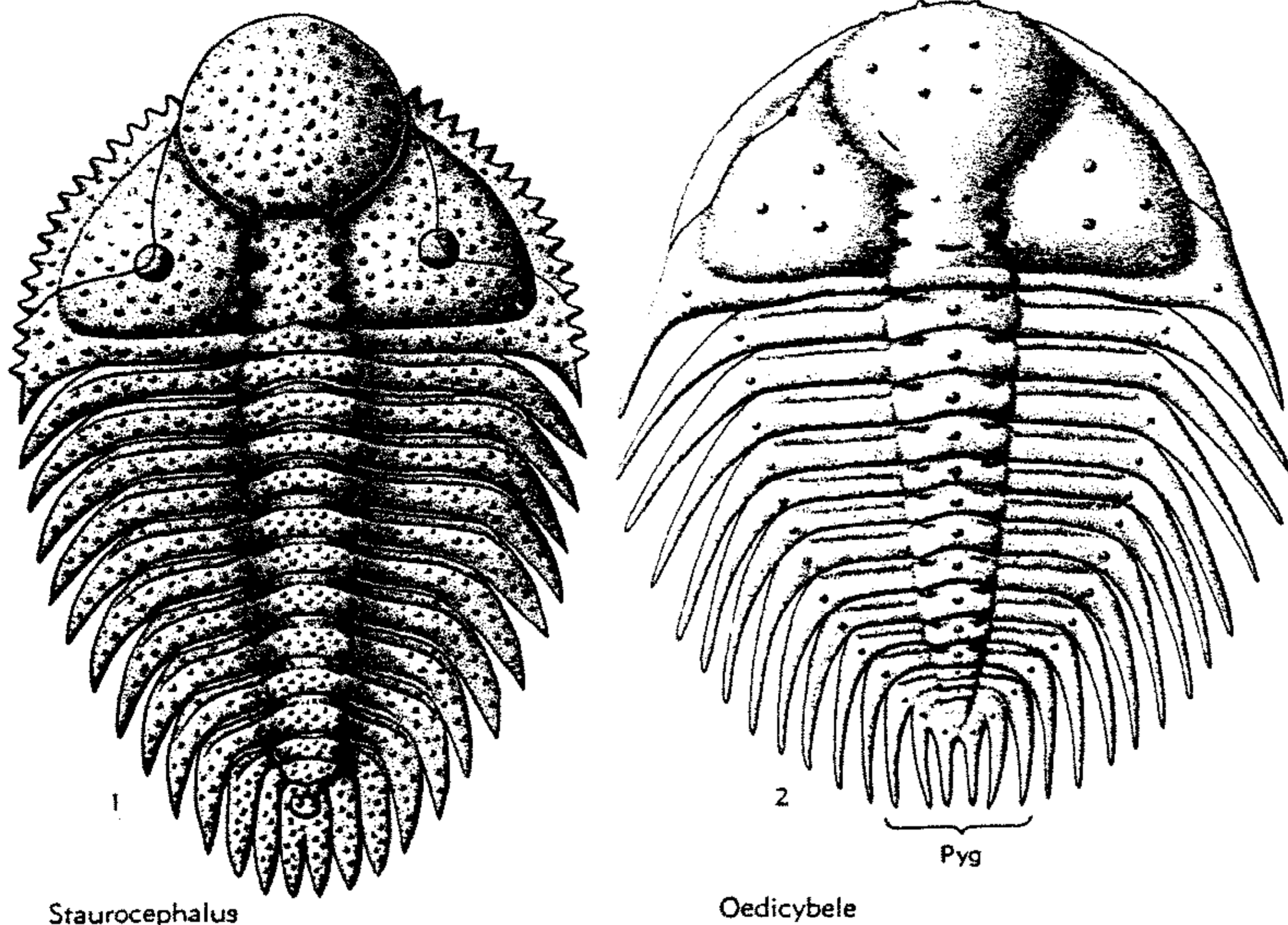

FIG. 351. Encrinuridae (Staurocephalinae) (p. 0449).

Subfamily CYBELINAE Holliday, 1942

[*nom. transl.* HUPÉ, 1955 (by error as "sous-famille de Cybelidae") (ex Cybelidae HOLLIDAY, 1942)] [*emend.* HUPÉ, 1955]

Eye ridges more or less distinct. Thorax with 11 or 12 segments. Pygidium with 4 or 5 pairs of ribs. *L.Ord.-U.Ord.*

Cybele LOVÉN, 1846 [**Calymene? bellatula* DALMAN, 1827; SD VOGDES, 1890] [= *Cybelina* REED, 1928]. Glabella with subparallel or slightly convex sides, with 3 pairs of subequal lateral furrows; eyes pedunculate, opposite anterior half of glabella. Thorax with 12 segments, pleurae bearing transverse furrows. Pygidium with 5 pairs of ribs. *L.Ord.*, Eu.-N.Am.—FIG. 349,3. **C. bellatula* (DALMAN), Expansus Sh., Oslo, Norway; 3a-c, ceph., thoracic segment, pyg., X3 (406n).

Atractopyge HAWLE & CORDA, 1847 [**Calymene verrucosa* DALMAN, 1827] [= *Cybellula* REED, 1928 (**Zethus rex* NIESZKOWSKI, 1857); *Cybellula* WEBER & LERMONTOVA in RJABININ, 1934 (*nom. van.*)]. Glabella with subparallel sides or widening somewhat forward, with 3 pairs of lateral furrows; row of tubercles or spines in front of glabella; eyes stalked or sessile. Pygidium with 4 pairs of ribs. *M.Ord.-U.Ord.*, Eu.-N.Am.—FIG. 349,1. **A. verrucosa* (DALMAN), Red Tretaspis Sh., Billingen, Västergötland, Swed.; type material, 1a,b, ceph., pyg., X0.6 (406n).

Bevanopsis COOPER, 1953 [**B. ulrichi*]. Glabella widening forward, with 3 pairs of lateral furrows; eyes far back, eye ridges distinct. Thorax and pygidium unknown. *M.Ord.*, E.N.Am.—FIG. 349,4. **B. ulrichi*, Va.; cran., X6 (26).

Cybeloides SLOCOM, 1913 [**C. iowensis*]. Three lateral glabellar lobes more or less distinctly separated from remainder of the glabella by longitudinal furrows, eyes far back, eye ridges distinct. Pygidium with 4 pairs of ribs. *M.Ord.*, N. Am.-Eu.—FIG. 349,2. *C. virginensis* COOPER, Va.; 2a-c, ceph., pyg., hypostoma, X3 (26).

Paracybeloides HUPÉ, 1955 [**Cybele loueni girvanensis* REED, 1906]. Like *Cybeloides* but with lateral glabellar furrows represented by pits, not united into longitudinal furrows. Thorax with 11 segments. *M.Ord.*, Eu.-N.Am.—FIG. 349,5. **P. girvanensis* (REED), Scot.; 5a, restored ceph.; 5b, pyg., both X1.5 (411, 452).

Subfamily DINDYMENINAE Henningsmoen, nov.

Eyes lacking. Thorax with 11 or 12 segments, without pleural furrows. Pygidium with 2 or 3 pairs of ribs. *M.Ord.-U.Ord.*

Dindymene HAWLE & CORDA, 1847 [**D. fredericiangusti*; SD BARRANDE, 1852]. Glabella widening forward and projecting over anterior border; facial sutures present or not. Thorax with 10

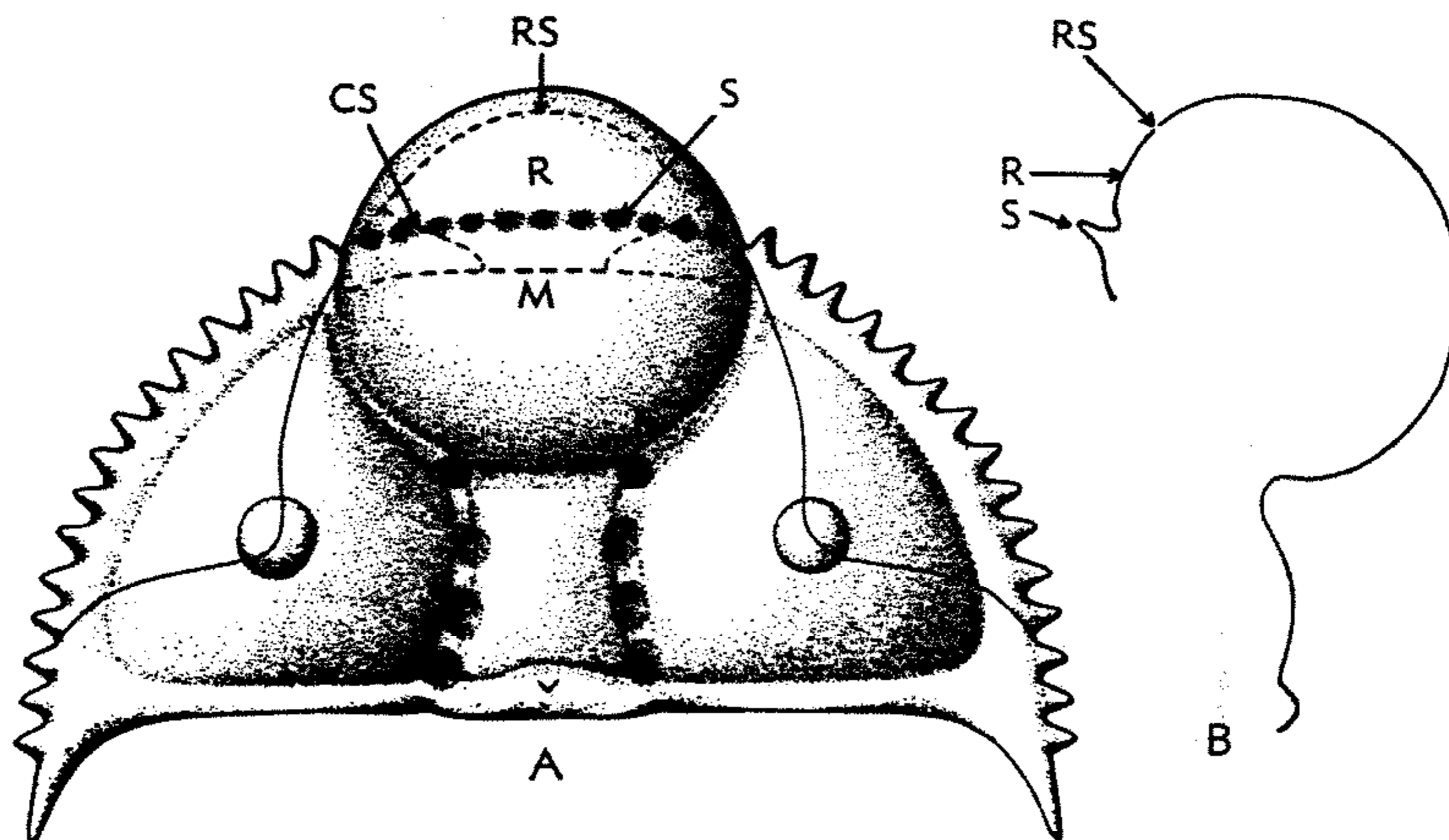

FIG. 352. *Staurocephalus clavifrons* ANGELIN (Encrinuridae), U.Ord., Baltic region (Swed.-Pol.), $\times 8.5$ (reconstr.). A, Dorsal view of cephalon, with representation of features on the underside in the anterior region. B, Sagittal profile of cephalon. (Explanation—CS, connective suture; M, margin of cephalon; R, rostral suture; S, spine.) (91).

segments. Pygidium with 2 pairs of ribs. *M.Ord.*-*U.Ord.*, Eu.—FIG. 350,5. **D. fredericiaugusti* (BARRANDE), Boh.; 5a-c, ceph., thoracic segment, pyg., all $\times 2$ (370).

Plasiaspis PRANTL & PŘIBYL, 1949 [**Dindymene bohemia* BARRANDE, 1872]. Glabella widening slightly forward, not projecting over anterior border; facial sutures close to margin. Thorax with 12 segments. Pygidium with 3 pairs of ribs. *M.Ord.*, Boh.—FIG. 350,8. **P. bohemia* (BARRANDE), 8a, ceph.; 8b, thoracic segment; 8c, pyg.; all $\times 1.5$ (370).

?*Prosopiscus* SALTER, in SALTER & BLANFORD, 1865 [**P. mimus*]. Resembles *Plasiaspis* but glabella tapers slightly forward. *M.Ord.* Himalaya.—FIG. 350,1. **P. mimus*; ceph. (reconstr.), $\times 1$ (6).

Subfamily STAUROCEPHALINAE Prantl & Přibyl, 1947

Glabella with inflated anterior lobe, overhanging in front, and narrow, parallel-sided posterior portion with 3 pairs of lateral glabellar furrows; fixigenae with genal spines. Thorax with 10 or 11 segments, pleurae with long spines. Pygidium with 3 or 4 axial rings and 3 pairs of pleural spines, pointing backward. *M.Ord.*-*Sil.*

Staurocephalus BARRANDE, 1846 [**S. murchisoni*]. Glabella with anterior lobe extremely inflated, separated from posterior part by transglabellar furrows. Ventral sutures of euptychopariid type;

rostral plate large and long (*sag.*), divided into anterior part, forming direct continuation of inflated lobe of glabella, and posterior subtrapezoidal part. Hypostoma with flattish margin bearing wings and raised central portion with 2 knobs. Thorax with 10 segments. *M.Ord.*-*Sil.*, Eu.-N.Am.-Austral.(N.S.W.)-C.Asia.—FIG. 350,9. **S. murchisoni*, *Sil.*(Wenlock), Eng.; exoskel., $\times 2.5$ (267).—FIG. 351,1, 352. *S. clavifrons* ANGELIN, U.Ord., Pol.-Swed.; 351,1, exoskel. (reconstr.), $\times 5.2$ (91*); 352A,B, ceph. (reconstr.), dorsal view showing features of under side, profile, $\times 8$ (91).

Oedicybele WHITTINGTON, 1938 [**O. kingi*] [= *lemtella* THORSLUND, 1940 (obj.)]. Anterior lobe of glabella inflated and separated from posterior part by short lateral glabellar furrows. Ventral sutures and hypostoma unknown. Thorax with 11 segments. *U.Ord.*, Eu.—FIG. 351,2. **O. kingi*, U.Ord., Pol.-Swed.; exoskel. (reconstr.), $\times 5.2$ (91*).

Family UNCERTAIN

Ectenonotus RAYMOND, 1920 [**Amphion westoni* BILLINGS, 1865]. Glabella with subparallel sides and 3 pairs of lateral furrows, anterior pair in front of anterior corners. Pygidium with 8 to 10 pairs of ribs and a greater number of axial rings. *L.Ord.*, N.Am.-Ire.—FIG. 353,4. **E. westoni* (BILLINGS), N.Am.; 4a,b, incompl. cran., pyg., pyg., both $\times 4$ (452).

Encrinurella REED, 1915 [**Pliomera ingsangensis*

REED, 1906]. Glabella widening forward, with 3 pairs of lateral furrows; genal spines absent. Pygidium pliomerid-like, with 5 pairs of pleural spines. *M.Ord.*, E.Asia(N.Shan).—FIG. 350,6. **E. ingsangensis* (REED); 6a, incomplete ceph.; 6b, pyg., both $\times 4$ (452).

Suborder CALYMENINA Swinnerton, 1915

[=Superfamily Calymenidea RUB. RICHTER, 1933; superfamily Calymenacea KOBAYASHI, 1935; superfamily Calymenoidae HUPÉ, 1953 (attributed to SWINNERTON, 1915)] [Type—*Calymene* BRONGNIART, 1822]

Exoskeleton medium to large in size. Cephalon semicircular to subtriangular, with or without border. Glabella narrowing forward, bell-shaped to trapezoidal in outline, with 4 or fewer pairs of lateral furrows of varying depth (in a few forms no furrows); posterior adaxial parts of fixigenae commonly differentiated as distinct quarter-circle-shaped tracts (paraglabellar areas); genal spines mostly lacking (present only in a few Ordovician genera); posterior sections of facial sutures cutting margins of cephalon mostly at or in front of genal angles. Hypostoma subrectangular, small anterior wings with indented posterior margin (except in a few early forms with rounded margin). Thorax narrowing moderately backward; almost uniformly composed of 13 segments but rarely with fewer; axis occupying 0.3 or more of thoracic width; pleural ends rounded. Pygidium transversely elliptical to elongate triangular, mostly medium to large (small in early genera only), with number of segments ranging from few in early genera to many in later genera; pleural portions downward-backward from axis. *L.Ord.-M.Dev.*

Opinions differ as to whether trilobites assigned to the Calymenina are opisthopteran. In this connection, it is pertinent to note that (1) affinities of the Calymenina (especially early forms) to ptychopariid trilobites are far greater than with any other trilobite group, and (2) some Calymenina (e.g. *Pharostoma*, *Pharostomina*, *Bavarilla*) possess genuine librigenal spines, whereas no genus of the assemblage incontestably bears fixigenal spines in the adult.

Two fairly homogeneous evolutionary lines can be recognized in the Calymenina, which respectively are grouped in the families Calymenidae and Homalonotidae. They must have split apart early in Ordovician

time or before. The Homalonotidae may have been derived from the early Tremadocian genus *Bavarilla* or a similar form. The Calymenidae may be descendants of the early Tremadocian *Pharostomina*, or alternatively, may have branched off from the homalonotid stem somewhat later in Ordovician time through *Synhomalonotus*. The first possibility seems to be more probable.

Family CALYMENIDAE Burmeister, 1843

[=Calymmenidae ANGELIN, 1854]

Cephalon semicircular, convex, glabella bell-shaped or parabolic, widest across occipital ring or preoccipital lateral may or may not project in front of genae, with 2 to 4 pairs of lateral furrows; lateral lobes of glabella diminishing in size forward, tending to be isolated by shallow furrows from median lobe and independently convex, 2nd (2p) and 3rd (3p) lateral lobes (counting forward) may be papillate (that is, with distal edge in contact with projection from gena on opposite side of axial furrow); axial furrows bordering lateral glabellar lobes deep, anterior pit deep; genae highest adjacent to axial furrows, sloping steeply downward anterolaterally; relatively small eye lobes situated on highest part of genae opposite 2p or 3p glabellar lobes; low eye ridges may be present; convex anterior, lateral, and posterior cephalic borders clearly defined by broad furrows, which become shallow or die out close to facial sutures; doublure rolled under borders and not extending inside them; frontal area variable in length (*sag.*), in some forms extending into frontal spine; preglabellar furrow and anterior border variable in form; anterior sections of facial sutures running directly forward from eyes and then curving inward to cross border outside projected line of axial furrows. Rostral suture transverse on doublure in some genera, connective sutures converging backward; rostral plate widest at anterior margin and sharply flexed upward under border; posterior sections of sutures running backward-outward in anterolaterally convex curve to cross border at rounded genal angles which may bear short spine or tubercle on posterior edge inside of suture lines. In *Pharostoma* (and ?*Bashycheilus*) sutures cut posterior mar-

gins just inside relatively long genal spines. Hypostoma longer than wide, subovate middle body divided by short, shallow, diagonal middle furrows so that posterior lobe is crescentic; macula faint, smooth; anterior lobe may have raised central portion; exoskeleton at anterior border flexed so that edge faces ventrally, hypostoma with large anterior wing bearing prominent wing process, posterior wing small; wide lateral notch, behind which lateral and posterior borders are wide, with deep median notch adjoining parts of border drawn out into blunt points. Thorax with ?11, 12, or 13 segments; axis convex; pleurae bent downward at fulcrum and almost vertical distally; axial rings undivided, but distal portion swollen; deep articulating furrows and apodemal pits, inner part of pleurae horizontal, with deep slightly diagonal pleural furrow, outer part with wide facet partly indented by pleural furrow; articulating processes and sockets in axial furrows and at fulcra; narrow doublure around outer part of pleurae, projecting inward at anterior edges. Pygidium with axis extending almost to posterior margin, sloping steeply backward and sideward; anterior edge of pleural fields curving back, maximum width between anterolateral corners; axis divided by 5 to 8 ring furrows that are deepest abaxially, posterior tip of axis unfurrowed; pleural fields unfurrowed or with deep pleural furrows and shallow interpleural grooves; mostly without border; pygidial doublure narrow and rolled tightly under margins. External surface commonly granulose, tuberculate, or both, with deeper parts of furrows smooth. Fine canals penetrating exoskeleton scattered over surface, largest on anterior border of cephalon and posterior part of pygidium, smaller in tubercles along axis (44, 275). *L. Ord. (Arenig.)-M.Dev.*

Subfamily CALYMENINAE Burmeister, 1843

[*nom. transl.* Huré, 1955 (*ex* Calymenidae BURMEISTER, 1843)]

Glabella with 2 to 4 pairs of lateral furrows, without differentiated oval areas at adaxial ends of *lp* furrows; axial furrows moderately narrow and deep, with or without anterior pits; facial sutures gonatoparian (except *Bathycheilus*); genal angles typically not produced in spines. *L. Ord.-M.Dev.*

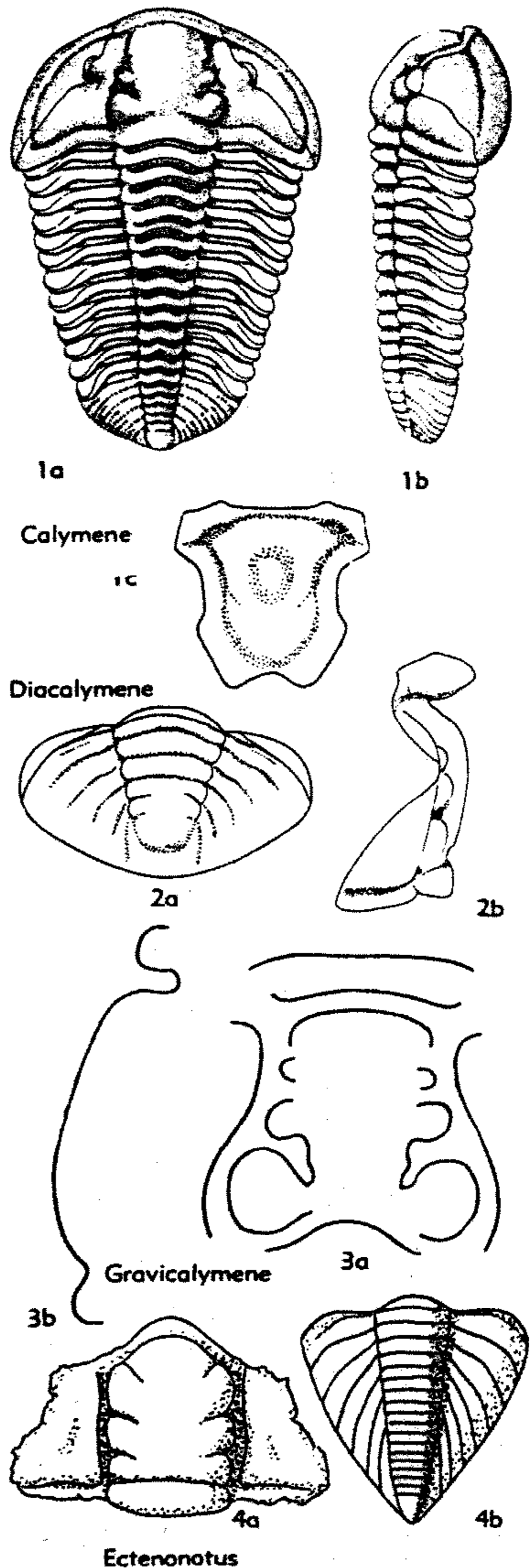

FIG. 353. Calymenidae (Calymeninae); Encrinuridae (4a,b) (p. 0449-0452).

Calymene BRONGNIART, 1822 (ICZN pend.) [**C. blumenbachii*] [= *Calymena* DESMAREST, 1817]; *Calymmene* KOENIG, 1825 (obj.); *Calymaena* BERTHOLD, 1827 (obj.); *Calymmene* AGASSIZ, 1846]. Glabella convex, standing high above genae and projecting well in front of them, anterior lobe sloping steeply forward; with 3 pairs of lateral lobes, *1p* and *2p* isolated by shallow longitudinal furrows, all independently convex, *2p* lobes papillate; eye lobes opposite *2p* glabellar lobes; preglabellar furrow narrow, deep; anterior border evenly convex. Hypostoma with subrectangular raised area, highest anteriorly, in center of anterior lobe of middle body. Thorax with 13 (rarely 12) segments. Pygidium with 6 complete axial rings and 6 deep pleural furrows, which extend to margin of borderless pleural regions, interpleural grooves shallow, best-marked distally. *L.Sil.-M. Dev.*, Eu.-N.Am.-S.Am.-Austral.—FIG. 353,1. **C. blumenbachii*, *M.Sil.*, Eng.; *1a,b*, exoskel. (reconstr.), dorsal, lateral, $\times 0.7$; *1c*, hypostoma, $\times 1.3$ (496n).

Calymenesun KOBAYASHI, 1951 [**Calymmene tingi* SUN, 1931]. Glabella with 3 pairs of lateral furrows, anterior pair (*3p*) faint; with long (*sag.*) frontal area extended into long frontal spine (106). *M.Ord.*, SW.China.—FIG. 354,5. **C. tingi* (SUN); cran., $\times 1.5$ (478).

Diacalymene KEGEL, 1927 [**Calymene diademata* BARRANDE, 1846]. Like *Calymene*, with glabella extending forward as far as most anterior part of genae or slightly beyond; preglabellar furrow broad and deep, anterior side of this furrow sloping at first steeply, then gently to horizontal, before reaching sharp flexure at outer edge of anterior border; border descends steeply outward, vertically, or slightly inward to rostral suture; also, anterior border between sutures may be strongly arched transversely. Hypostoma with subcircular raised area or narrow longitudinal ridge in center of anterior lobe of middle body. Thorax with 13 segments; outer parts of pleurae bent downward less steeply than in *Calymene*. Pygidium relatively wide, pleural furrows dying out about half way across pleural regions, no interpleural grooves; ribs between last 2 pairs of pleural furrows form prominent ridges adjoining tip of axis. *U.Ord.-U.Sil.*, Eu.-N.Am.—FIG. 353,2. **D. diademata* (BARRANDE), *M.Sil.-U.Sil.*, Boh.; *2a,b*, *pyg.*, cran., $\times 1$ (496n).

Flexicalymene SHIRLEY, 1936 [**Calymene caractaci* SALTER, 1865] [= *Orimops* RAFINESQUE, 1832, ICZN pend.]. Glabella with 3 pairs of lateral lobes; axial furrows contracted slightly opposite *1p* and *2p* lateral furrows; preglabellar furrow broad (*sag.*, *exsag.*); eye lobes opposite, ahead, or behind *2p* glabellar lobes. Hypostoma without raised area in center of anterior lobe of middle body. Thorax with 12 or 13 segments. Pygidium with deep pleural furrows and shallow interpleural

grooves extending close to margins of pleural regions. *M.Ord.-U.Ord.*, ?*Sil.*

F. (Flexicalymene). Anterior side of preglabellar furrow inclined upward with no break in slope to sharp narrow crest of anterior border; anterior slope of border descending vertically to rostral suture (44, 347, 356). *M.Ord.-U.Ord.*, ?*Sil.*, Eu.-N.Am.—FIG. 354,1. *F. senaria* (CONRAD), *M.Ord.*, N.Am.; *1a-c*, ceph., dorsal, lateral, anterior; *1d,e*, hypostoma, exterior, lateral; all $\times 2$ (496n).

F. (Reacalymene) SHIRLEY, 1936 [**Reacalymene limba* SHIRLEY, 1936]. Distinguished by abrupt change in slope between steep anterior edge of preglabellar furrow and surface of frontal area, which slopes gently up to outer edge of anterior border. *M.Ord.-U.Ord.*, Eu.-(Eng.), ?N.Am.

Gravicalymene SHIRLEY, 1936 [**G. convolva*]. Glabella with 3 pairs of lobes, none papillate; deep preglabellar furrow with anterior edge merging into thick (*sag.*) rolled anterior border. *U.Ord.-L. Dev.*, Wales-SE.Asia-Austral.-N.Z.—FIG. 353,3. **G. convolva*, *U.Ord.*, Wales; *3a,b*, ceph., outline of middle portion, sagittal profile, $\times 1$, $\times 1.75$ (275*).

Liocalymene RAYMOND, 1916 [**Hemicrypturus clintonii* VANUXEM, 1842]. Glabella with 3 pairs of lateral lobes, apparently nonpapillate. Pygidium with smooth pleural regions. *L.Sil.-M.Sil.*, E.N.Am.

Metacalymene KEGEL, 1927 [**Calymene baylei* BARRANDE, 1846]. Exoskeleton less convex than typical in family, with outer parts of pleural regions curved downward less sharply. Glabella with 4 pairs of lateral furrows, *3p* furrows short and shallow, *3p* lobes faintly convex; small eye lobes opposite *3p* glabellar lobes; eye ridges well defined; frontal area continuing slope of frontal glabellar lobe, then flattening out and faintly ridged by low anterior border; lateral cephalic border low. Hypostoma with circular raised area in anterior part of anterior lobe of middle body. *U.Sil.*, Boh.—FIG. 354,2. **M. baylei* (BARRANDE); *2a,b*, ceph., dorsal, right lateral; *2c*, *pyg.*; all $\times 1.25$ (496n).

Platycalymene SHIRLEY, 1936 [**Asaphus duplicatus* MURCHISON, 1839]. Like *Metacalymene* but only 3 pairs of lateral glabellar furrows and lobes and frontal area consisting of deep preglabellar furrow and convex rolled anterior border. *M.Ord.*, Br.I.-Swed.

Papillicalymene SHIRLEY, 1936 [**Calymmene papillata* LINDSTRÖM, 1885]. Glabella with *2p* and *3p* lateral lobes and anterolateral corner of frontal lobe papillate. *Sil.*, Swed.

Ptychometopus SCHMIDT, 1894 [**Calymene (P.) volborthi*]. Glabella with 3 pairs of lateral furrows; eye lobes opposite *2p* furrows; low ridges rising in front of extremity of preglabellar furrow run sideward across fixigenae near anterior border. Thorax with 11 segments. Pygidium with 4 axial rings and 3 pleural furrows. *L.Ord.*, USSR

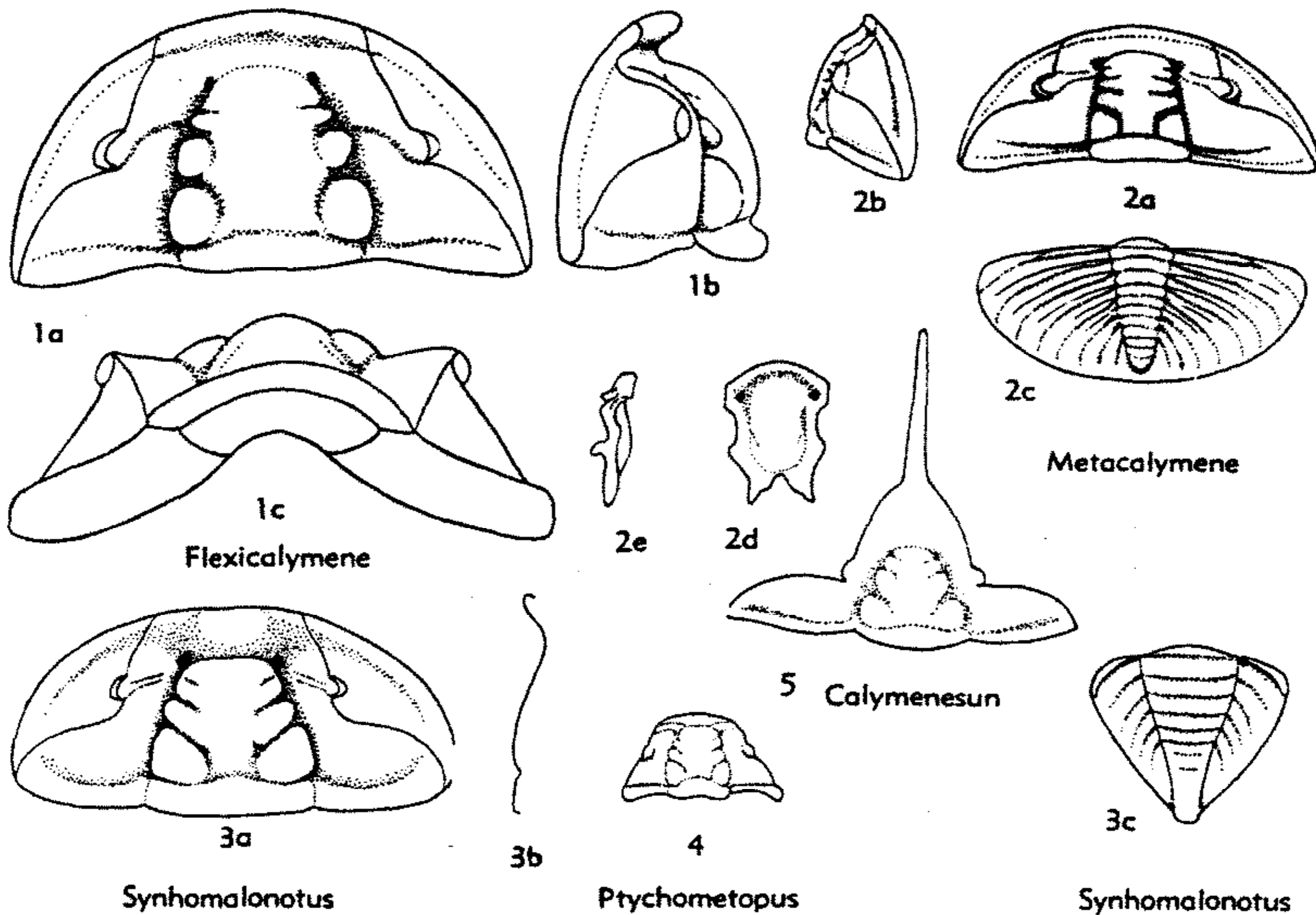

FIG. 354. Calymenidae (Calymeninae) (p. 0452-0453).

(Balt.).—FIG. 354,4. **P. volborthi* (SCHMIDT); cran., $\times 1.5$ (468).

Reedocalymene KOBAYASHI, 1951 [**Calymene unicornis* REED, 1917]. Like *Calymenesun* but frontal area comprising spatulate projection 1.5 times length (*sag.*) of glabella, with median part in front of glabella inflated and tapering anterior part with sagittal ridge (106). *Low.M.Ord.*, SW. China.

Synhomalonotus POMPECKJ, 1898 [**Calymene tristani* BRONGNIART, 1822]. Glabella subparabolic in outline, anterior margin straight medially, with 3 pairs of lateral glabellar furrows, *1p* furrows long and with slight forward turn at inner end, *3p* furrows short and faint; frontal area relatively long (*sag.*), bent upward along sagittal line, with curvature strongest at anterior margin and diminishing toward preglabellar furrow; small eye lobes opposite *2p* or *3p* glabellar lobes. Pygidium almost as long as wide, tip projecting beyond pleural regions, with 6 or 7 axial rings and deep pleural furrows. [This genus is regarded by K. SZUY as belonging to the Homalonotidae (Eohomalonotinae).] *L.Ord.-Low.M.Ord.*, Eng.-Wales, Fr.-Port.-S.Am.-N.Afr.-W.China. — FIG. 354,3. **S. tristani* (BRONGNIART), *Low.M.Ord.*, Fr.-Port.-N.Afr.; 3a,b, ceph., dorsal, sagittal profile; 3c, pyg.; all $\times 0.75$ (496n).

Bathycheilus HOLUB, 1908 [**Dalmanites perplexus* BARRANDE, 1872]. Like *Pharostoma* (Pharostomatinae) but glabella with 2 lateral furrows and lobes, without convex oval areas at inner ends of *1p* (preoccipital) furrows, and much narrower across *2p* lobes than *1p* (preoccipital) lateral lobes; occipital furrow absent medially; axial furrows widen opposite preoccipital lobes into semicircular ala-like depressions; eye lobes exceptionally large for family, opposite *1p* glabellar lobes; eye ridges absent; course of facial sutures apparently as in *Pharostoma*. Cephalon surrounded by wide border described as channel (may be external mold of doublure) and continued by genal spines reaching back to pygidium. Hypostoma unknown. Thorax with more than 11 segments. Length of pygidium 0.75 of width. *Low.M.Ord.* (Llanvirn.), Boh. — FIG. 355. **B. perplexus* (BARRANDE); exoskel., $\times 2$ (66*).

Pharostomina SZUY, 1955 [**P. öpiki*] [= *Colpocoryphoides* HARRINGTON & LEANZA, 1957]. Differs from *Pharostoma* (Pharostomatinae) in that oval areas at inner ends of preoccipital lateral glabellar furrows are lacking; genae not markedly convex in front of eye lobes; genal spines short; no row of spines on under side of cephalic border. Hypostoma without median notch in posterior border. Pygidium with short posterior part of axis

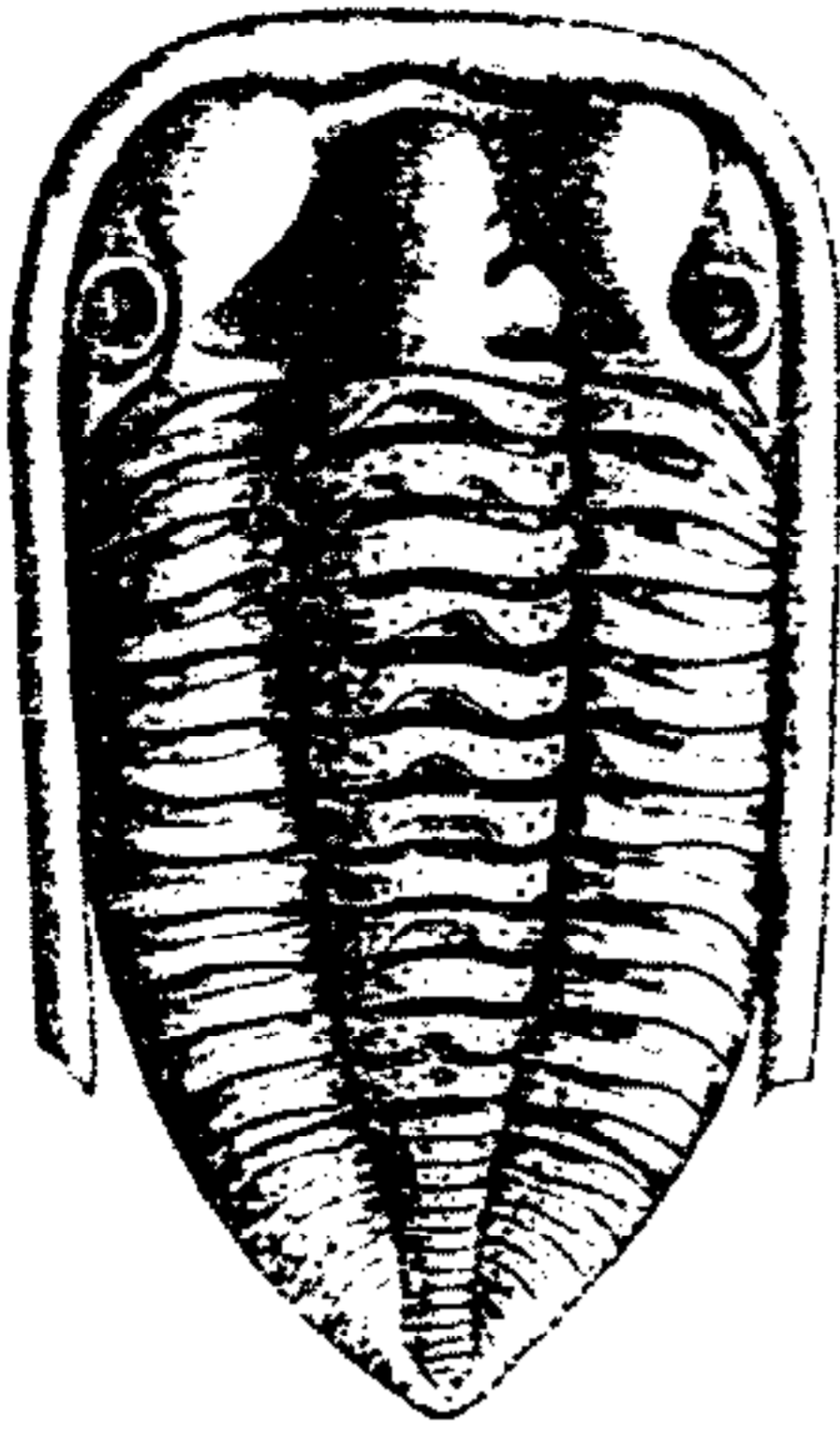

FIG. 355. **Bathyscheilus perplexus* (BARRANDE) (Calymenidae), M.Ord. (Llanvirn.), Boh.; exoskel., $\times 2$ (66).

and narrow pleural border. L.Ord., Ger.-S.Am. —FIG. 356. **P. oepiki*, Leimitz Sh., Tremadoc.; *a*, cran., $\times 4$; *b*, fragmentary exoskel., $\times 5$ (272).

Subfamily PHAROSTOMATINAE Hupé, 1953

[*nom. transl. et correct.* WHITTINGTON, herein (ex Pharostomidae HUPÉ, 1953)]

Glabella with 3 pairs of lateral furrows and lobes, with faintly convex oval areas outlined by narrow smooth zone at inner ends of *1p* (preoccipital) furrows; axial furrows widening opposite *1p* and *2p* lobes, most conspicuously opposite *1p* lobes; with deep anterior pit; small eye lobes opposite *2p* glabellar lobes; eye ridges distinct; genae most strongly convex in front of eye lobes; cephalic border broadest (*sag.*) anteriorly, prolonged laterally into genal spines, with row of close-set small spines on under side of border; posterior sections of facial sutures crossing lateral border furrows opposite preoccipital glabellar lobes and extending over borders to inner edge at genal angles. Hypostoma of typical calymenid form. Thorax with 13 segments, with broad (*tr.*), horizontal inner parts, outer parts bent down vertically; pleural furrows deep. Pygidial axis with 6 rings and long, convex posterior part; pleural regions with deep pleural furrows. Surface tuberculate. M.Ord.-U.Ord.

Pharostoma HAWLE & CORDA, 1847 [**Calymene pulchra* BARRANDE, 1846] [= *Prionocheilus* ROUAULT, 1847]. Characters of subfamily. M.Ord.-U.Ord., Eu.-Que.-Asia. —FIG. 357. **P. pulchrum*

(BARRANDE), M.Ord., Boh.; *a*, exoskel., $\times 1.25$; *b*, ceph., lateral, $\times 1.25$; *c*, hypostoma, $\times 1.25$ (496n).

Family HOMALONOTIDAE

E. J. Chapman, 1890

Cephalon with or without faintly defined broad border; glabella subtrapezoidal, with 4 or fewer pairs of glabellar furrows, usually shallow or may be entirely lacking, *1p* (preoccipital) furrows commonly bent sigmoidal; arcuate tracts (preglabellar areas) adjoining base of glabella on fixigenae commonly well defined by their independent convexity, absence of pitting, or faint bounding furrows; librigenal spines present only in oldest genus known; posterior sections of facial sutures in all later genera cutting margins of cephalon at genal angles or in front of them. Rostral suture commonly transverse, in primitive genera on lower side or at anterior margin of cephalon, in

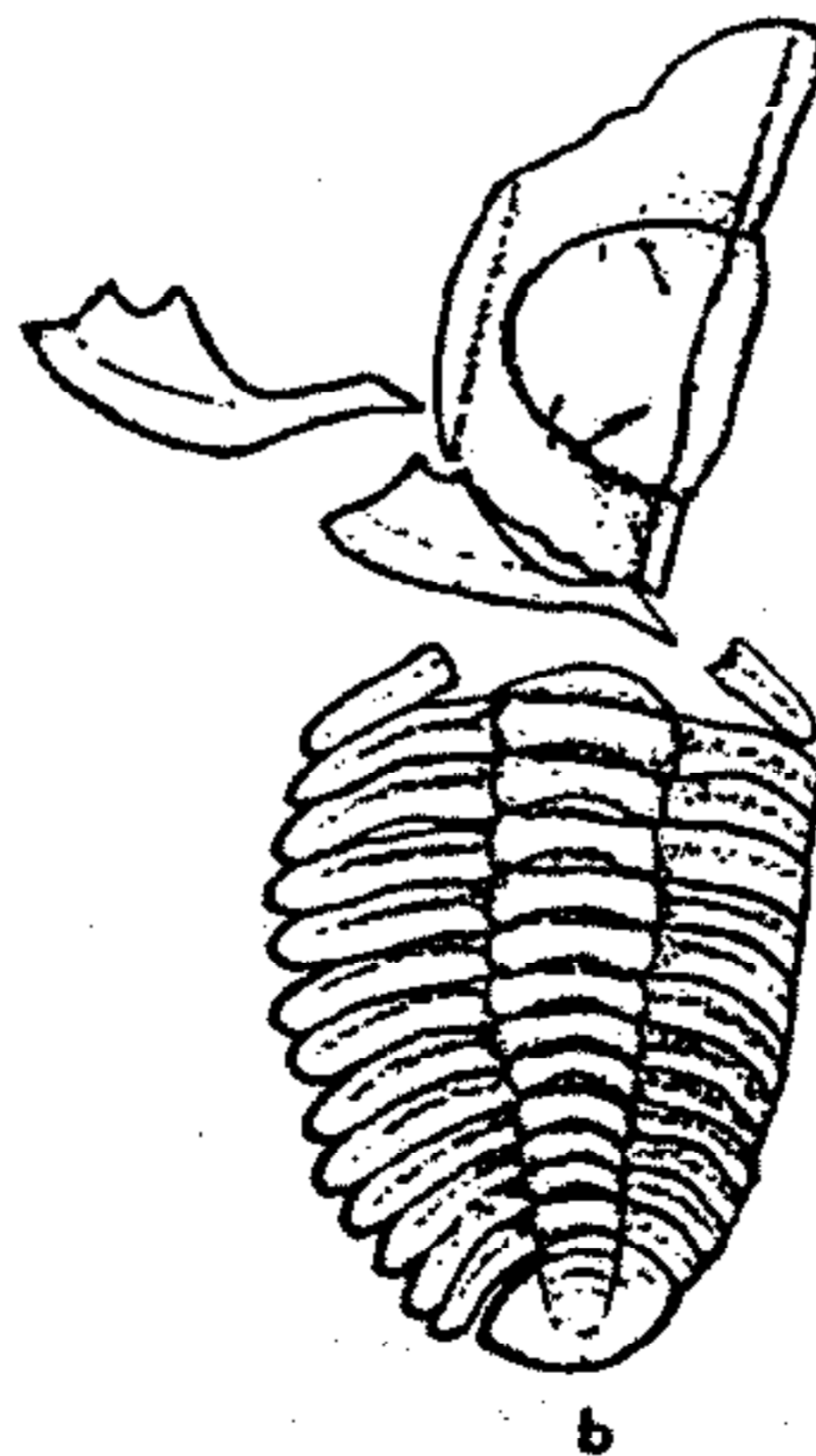
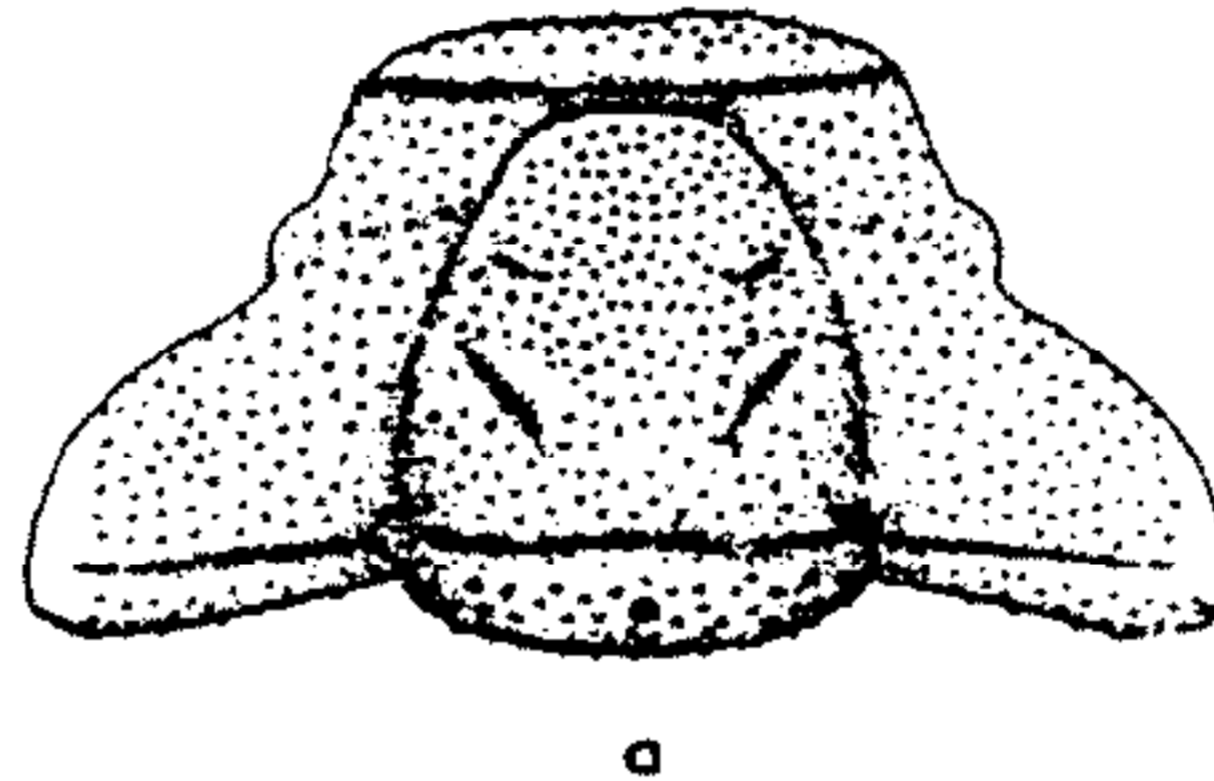

FIG. 356. **Pharostomina oepiki* Sdzuy (Calymenidae), L.Ord., Ger.; *a*, cran., $\times 4$; *b*, fragmentary exoskel., $\times 2.5$ (272).

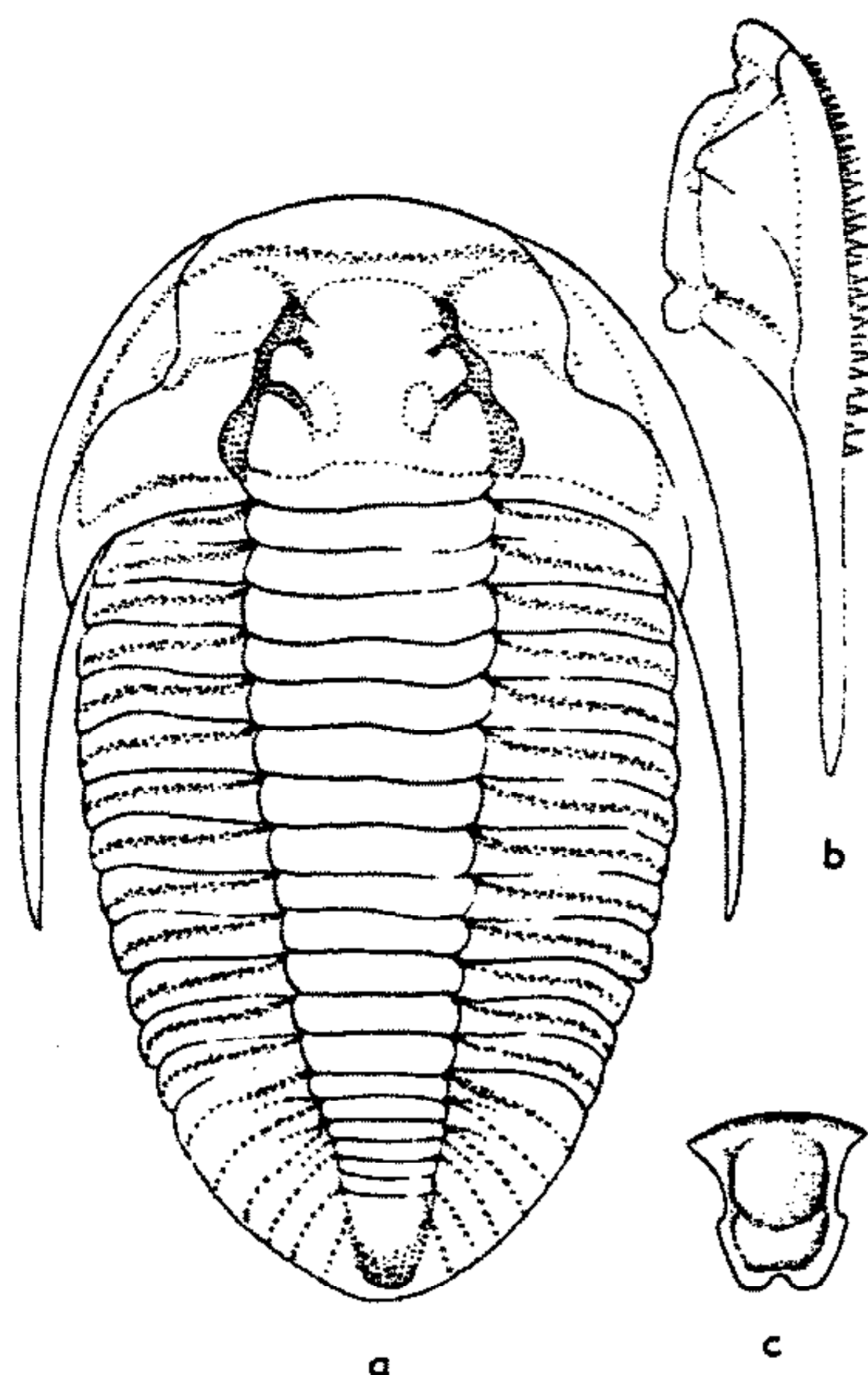

FIG. 357. **Phacostoma pulchrum* (BARRANDE) (Calymenidae), M.Ord., Boh.; *a*, exoskel., $\times 1$; *b*, cephal., lateral, $\times 1$; *c*, hypostoma, $\times 1.5$ (496n).

advanced genera on upper side; rostral plate subtriangular, pointed behind. Hypostoma subquadrate to trapezoidal, with small anterior wings; posterior margin rounded in very primitive forms, indented in advanced. Thorax with 13 segments; axis well defined, moderately wide in early genera, indistinct and very broad in later ones; pleural extremities rounded or angular, never pointed. Pygidium transversely elliptical to elongate triangular in outline, strongly convex, with pleural regions bent downward somewhat strongly at sides; with few (primitive genera) to many segments (advanced genera). *L.Ord.-M.Dev.*

Subfamily BAVARILLINAE Sdzuy, 1957

Cephalon with ill-defined anteriorly widened border; anterior margin with short pointed or blunt projection; glabella trapezoidal, well defined, but axial furrows shallow, with 3 pairs of lateral glabellar furrows, *1p* (preoccipital) furrows sigmoidal and in some specimens bifurcated; eyes

large, eye ridges transverse; posterior sections of facial sutures intersecting posterior margins of cephalon; librigenae provided with short spines. Rostral suture on lower side of cephalon. Hypostoma rounded behind. Thoracic axis well defined, only about 0.3 as wide as thorax. Pygidium much wider than long, composed of 2 or 3 segments. *L.Ord.*

Bavarilla BARRANDE, 1868 [**Conocephalites* (*Bavarilla*) *hofensis*]. Characters of subfamily. [This oldest known homalonotid is the only one uncontestedly having opisthoparian facial sutures and possessing the smallest pygidium. It may be ancestral to later Homalonotidae.] *L.Ord.*, Czech.-Ger. —FIG. 358.7. **B. hofensis* (BARRANDE), *L.Ord.*, Ger.; *7a*, exoskel. (reconstr.), $\times 1.5$; *7b,c*, hypostoma, $\times 1.5$ (470).

Subfamily EOHOMALONOTINAE Hupé, 1953

Cephalon usually with ill-defined anteriorly widened border; glabella subtrapezoidal, more or less rounded in front; usually with 2 to 4 pairs of lateral glabellar furrows, *1p* furrows sigmoidal; paraglabellar areas commonly outlined; eyes somewhat larger than in Homalonotinae; eye ridges usually present; posterior sections of facial sutures cutting genal angles; rostral suture on lower side of cephalon, at anterior margin, or on upper side close to it. Hypostoma rounded or indented behind. Thoracic axis usually well defined, width medium to large. Pygidium mostly triangular with strongly bent anterior margin, rarely parabolic in outline and longer than wide; trilobation and segmentation distinct, with 6 to 12 segments; ribs usually reaching margin of pygidium. *L.Ord.-U.Ord.*

Calymenella BERGERON, 1890 [**C. boisseli*]. Cephalon with ill-defined border; glabella defined by shallow but distinct axial furrows, with 2 or 3 pairs of weak lateral glabellar furrows, *1p* (preoccipital) sigmoidal; paraglabellar areas defined; eye ridges present, oblique; posterior sections of facial sutures intersecting margins of cephalon near genal angles. Rostral suture a wide even curve. Hypostoma with rounded or indented posterior margin. Thorax with distinctly set off axis of moderate width (appearing to be very broad because pleural regions are bent strongly downward). Pygidium wider than long, broadly triangular, with semicircular anterior margin; trilobation and segmentation distinct, with 6 to 8 segments; axis rapidly narrowing backward, not reaching posterior margin (179). *M.Ord.* (*Llandeil.*)-*U.Ord.*, Eng.-Fr.-Ger.-Czech.-Medit.-N.Afr.

C. (Calymenella). Anterior margin of cephalon drawn out into blunt or pointed projection; front of glabella moderately rounded. Rostral suture on lower side or along anterior margin of cephalon. Pygidium with distinct interpleural grooves. [The projecting anterior cephalic margin is reminiscent of *Bavarilla*, whereas the rostral suture and segmentation of the pygidium correspond to characters of *Synhomalonotus*.] *M.Ord.*(*Llandeil.*)-*U.Ord.*(*Caradoc.*), Fr.-Ger.-Czech.-N.Afr.—FIG. 358,8. **C. (C.) boisseli*, *M.Ord.*, Fr.; 8*a,b*, cran. (reconstr.), pyg., $\times 1$ (377).—FIG. 358,9. *C. (C.) media* (BARRANDE), *U.Ord.*, Czech.; exoskel. (reconstr.), $\times 0.9$ (411*).

C. (Eohomalonotus) REED, 1918 [**Asaphus brongniarti* DESLONGCHAMPS, 1822]. Anterior margin of cephalon not projecting; front of glabella weakly rounded. Rostral suture on anterior margin of cephalon or close to it on upper side. Pygidium without distinct interpleural grooves. *M.Ord.*(*Llandeil.*)-*U.Ord.*, Eng.-Fr.-Czech.-Medit.—FIG. 358,3*a,b*. **C. (E.) brongniarti* (DESLONGCHAMPS), *M.Ord.*, Fr.; 3*a*, cran. (reconstr.), $\times 1.1$ (348, 470n); 3*b*, pyg., $\times 1.1$ (461n).—FIG. 358,3*c*. *C. (E.) bohemicus* (BARRANDE), *M.Ord.*, Czech.; hypostoma, $\times 1.1$ (370).

Synhomalonotus POMPECKJ, 1898 [**Calymene tristani* BRONGNIART, 1822]. Described (p. 453) as genus of Calymenidae but believed by SZUY to belong in this subfamily of the Homalonotidae, as indicated by shape of glabella, nature of cephalic border, presence of distinct paraglabellar areas, and general cuneiform shape of exoskeleton. The exceptional relief of the cephalon is not viewed as a significant taxonomic character indicating calymenid affinities. Illustrations of the type species given here differ slightly from those in Fig. 354,3, for example, in showing paraglabellar areas of the cephalon; sources of the compared figures are not exactly the same.—FIG. 359,2. **S. tristani* (BRONGNIART), *M.Ord.*, Medit.; 2*a,b*, cran., pyg., $\times 1$ (470n).

Brongniartella REED, 1918 [*pro Brongniartia* SALTER, 1865 (*non* LEACH, 1824; *nec* EATON, 1832)] [**Homalonotus bisulcatus* SALTER, 1851]. Cephalon semicircular to semielliptical, without border; glabella well defined, urceolate to tapering forward, generally unfurrowed; axial furrows strongly converging forward at sides of occipital ring; paraglabellar areas outlined in some specimens; frontal area rather wide; posterior sections of facial sutures intersecting margins of cephalon near genal angles. Rostral suture a wide curve on upper side of cephalon near or on anterior margin. Thorax with wide, indistinctly marked axis. Pygidium rounded, parabolic, longer than wide, with rather indistinct border; axis well defined, ending considerably in front of posterior margin, with 9 to 12 segments and a postaxial ridge in some forms; ribs not extended to lateral margins of pygidium. [*Brongniartella* differs from other Eohomalonotinae

in lack of a cephalic border; usually unlobed glabella; shape of occipital ring; indistinct, broad thoracic axis, and shape, length, and border of the pygidium. In these features the genus approaches the Homalonotinae.]. *U.Ord.*, Eu.-N.Afr.-N.Am.—FIG. 358,1. **B. bisulcata* (SALTER), Eng.; 1*a,b*, ceph., pyg., $\times 0.5$ (466).

Subfamily COLPOCORYPHINAE Hupé, 1955

Cephalon semicircular or semielliptical, much wider than long; border defined in front only, very narrow, touching front of glabella, in anterior view strongly bent down at sides; glabella narrowing forward considerably, with smoothly convex sides, anterior end truncate, circumglabellar furrows sharp and rather deep, with 2 to 4 pairs of lateral glabellar furrows, 1*p* bent backward in simple curve; paraglabellar areas present or absent; eyes usually far forward, eye lobes strikingly small, not elevated above genae, hardly interrupting general course of facial sutures; weak eye ridges may be present; fixigenae very wide (*tr.*); posterior sections of facial sutures forming evenly convex curves that cut margins of cephalon near genal angles. Rostral suture apparently on anterior margin. Thorax with well-marked moderately wide axis. Pygidium transversely elliptical or subtriangular, wider than long; trilobation distinct; axis nearly reaching posterior margin; segmentation reduced. [*Colpocoryphe* and *Plaesiacomia*, previously assigned to different families, agree well in essential characters. They are interpreted to represent a separate line of homalonotid specialization in which *Plaesiacomia* seems to be more advanced than *Colpocoryphe*.] *L.Ord.*-*M.Ord.*(*Llandeil.*).

Colpocoryphe NOVÁK in PERNER, 1918 [**Calymene arago* ROUAULT, 1849] [=“Gruppe der *Calymene arago*” POMPECKJ, 1898]. Cephalon convex, much wider than long; glabella occupying less than 0.3 of cephalic width (in dorsal view seemingly more than 0.3 because of convexity of cephalon); with 3 or 4 pairs of distinct lateral glabellar furrows, 1*p* and 2*p* furrows deep; eye ridges rather weak. Thorax with moderately wide axis. Pygidium triangular, with strongly curved anterior margin; axis with 8 or fewer rings, extended nearly to posterior margin, connected to it by short postaxial ridge; pleural fields behind articulating half rib nearly smooth, with 2 or 3 very indistinct ribs; wide border distinctly set off by marked change in convexity. *L.Ord.*-*M.Ord.*(*Llandeil.*), Fr.-Czech.-Medit.-N.Afr.-N.Am.(Fla.)-China.—FIGS. 358,5, 359,1. **C. arago* (Rou-

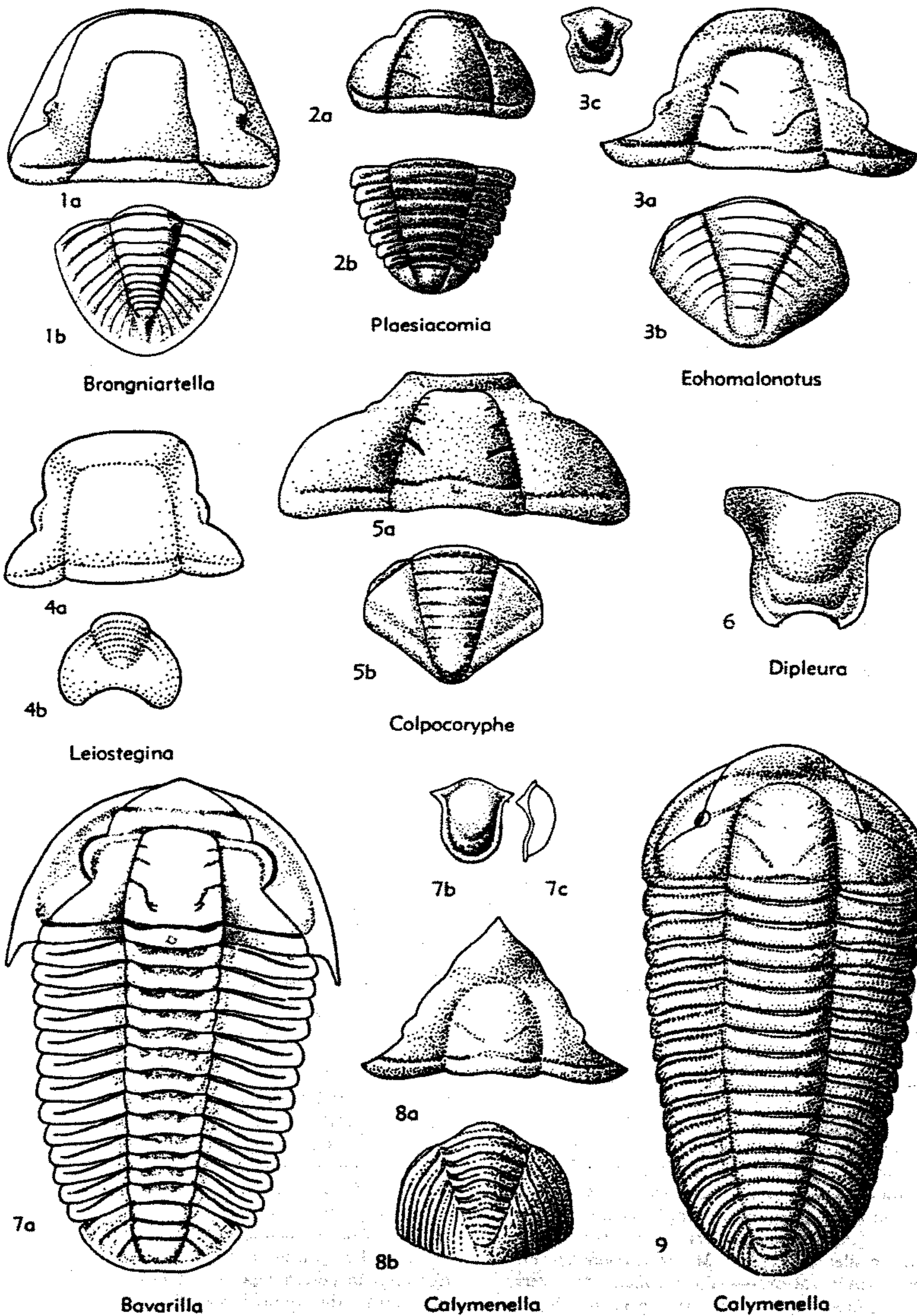
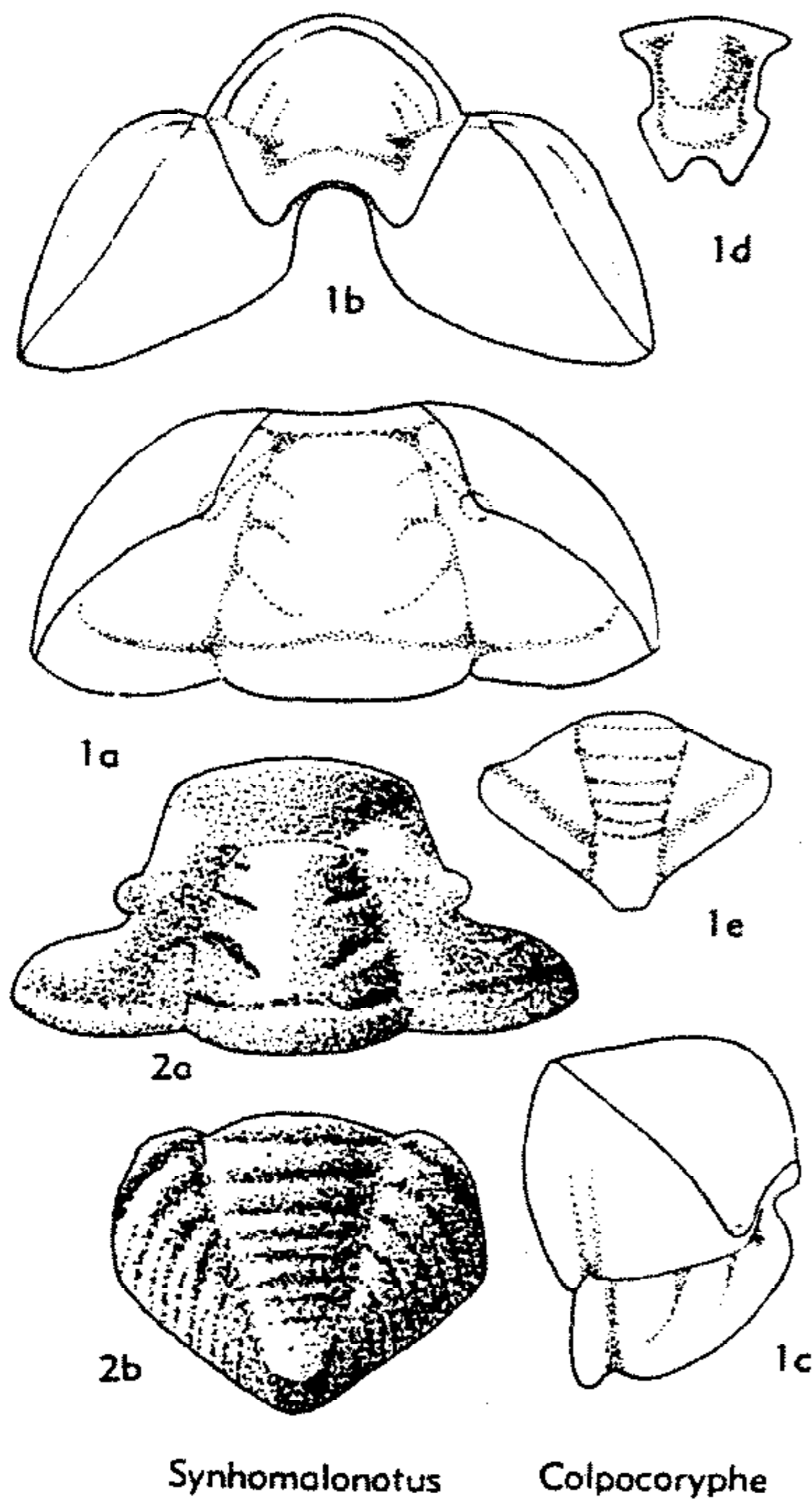

FIG. 358. Homalonotidae (Bavarillinae, Eohomalonotinae, Colpocoryphinae, Homalonotinae) (p. 0455-0460).



cranidium; fixigenae narrow (*tr.*); facial sutures parallel in front of eyes and diagonal behind them. Pygidium convex, relatively small, with posterior margin bent up at middle; axis tapering, with 8 rings; marginal brim narrow, ill defined. *U.Ord.*(*Caradoc.*), *Bol.*—FIG. 358,4. **L. inexpectans*; cran., pyg., $\times 1$ (425).

Subfamily HOMALONOTINAE

E. J. Chapman, 1890

[*nom. transl.* HUPÉ, 1953 (ex Homalonotidae E. J. CHAPMAN, 1890) [=Trimerinae HUPÉ, 1953]

Cephalon tending to be subtriangular in outline, moderately convex; border almost invariably lacking; glabella urceolate to trapezoidal, lateral glabellar furrows indistinct or absent; axial furrows shallow, generally not defined at sides of occipital ring; paraglabellar areas commonly distinct; eyes small, rising high on convex genae; posterior sections of facial sutures cutting margin of cephalon at or in front of genal angles. Rostral suture uniformly on upper side of cephalon. Hypostoma subquadrate, with small to medium-sized anterior wings and deeply indented posterior margin. Thorax with very wide axis, trilobation tending to be very indistinct. Pygidium longer than wide, triangular, rarely semi-circular to parabolic; composed of many segments; axis in most genera triangular in outline, very broad anteriorly, trilobation commonly indistinct but segmentation mostly well defined. *M.Sil.-M.Dev.*

Homalonotus KÖNIG, 1825 [**H. knighti*] [= *Koenigia* SALTER, 1865 (obj.)]. Cephalon much wider than long, seemingly with sharply defined border, touching glabella along the front, deep indentations at sides of rostral plate making anterior margin tricuspid, margin appearing strongly folded in anterior view; dorsal surface of cephalon convex upward, middle part with rostral plate being convex downward; glabella trapezoidal, slightly narrowing forward, sharply cut off in front by border, glabellar lobation indistinct; paraglabellar areas fairly well marked; posterior sections of facial sutures cutting margins near genal angles. Rostral suture not far from front of glabella, transverse, with small median point; rostral plate without spine. Thorax and pygidium with trilobation very indistinct. Pygidium triangular, pointed behind, segmentation distinct except in posterior portion. [As remarked by REED (1918), this genus is specialized and hardly typical of the family. Interpretation of structure of anterior portion of cephalon is difficult; the border seems not to have been described previously even though shown clearly in published figures.] *U.Sil.*,

FIG. 359. Homalonotidae (Eohomalonotinae, Colpocoryphinae) (p. 0456).

AULT), *M.Ord.*, Czech.; 358,5a,b, cran., pyg., $\times 1.5$ (470n); 359,1a-c, ceph., dorsal, front, side, $\times 1.5$; 359,1d,e, hypostoma, pyg., $\times 1.5$ (496).

Plaesiacomia HAWLE & CORDA, 1847 [**P. rara*]. Cephalon convex, semicircular; glabella broader than genae, with 2 or 3 pairs of weakly impressed lateral glabellar furrows; paraglabellar areas present, eye ridges lacking. Thoracic axis wide. Pygidium small, much wider than long, transversely elliptical; axis triangular, narrowing backward rapidly, nearly reaching posterior margin; only a single axial ring; pleural regions smooth. [*Plaesiacomia* differs from *Colpocoryphe* in its smaller pygidium.] *M.Ord.*(*Llandeil.*), Fr.-Czech.-N.Afr.-Medit.—FIG. 358,2. **P. rara*, Czech.; 2a,b, ceph., pyg., and part of thorax, $\times 3.5$ (370).

?**Leiostegina** KOBAYASHI, 1937 [**L. inexpectans*]. Cranidium subtrapezoidal; glabella long, truncate tapering, smooth; eyes small, at mid-length of

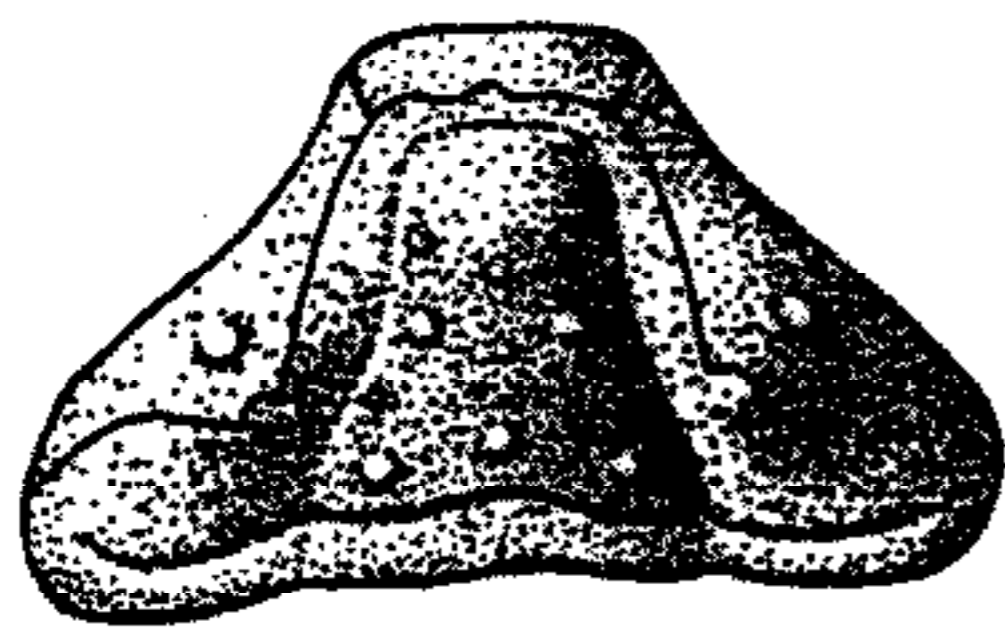

1a

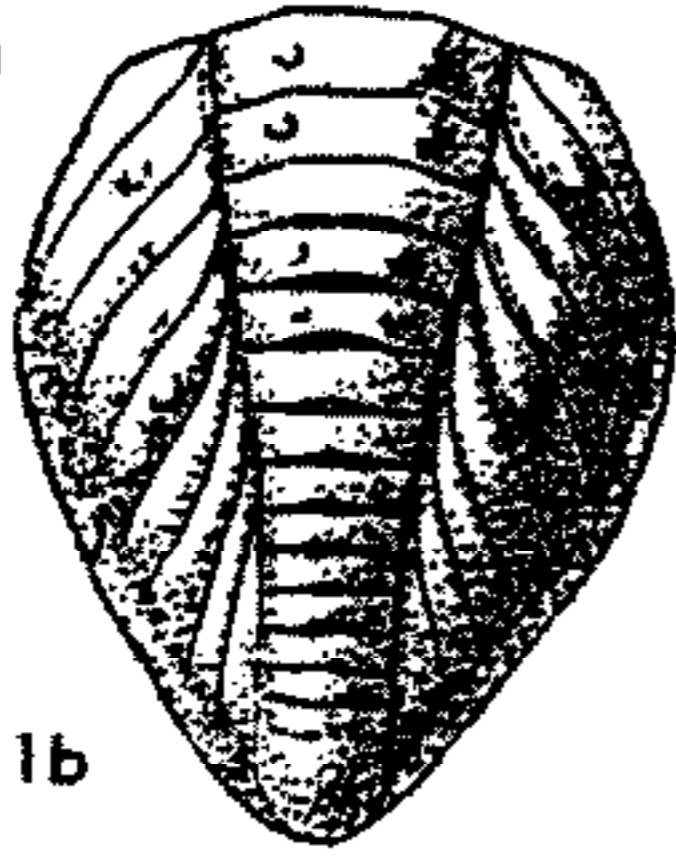

1b

Burmeisterella



Homalonotus

3c



3b

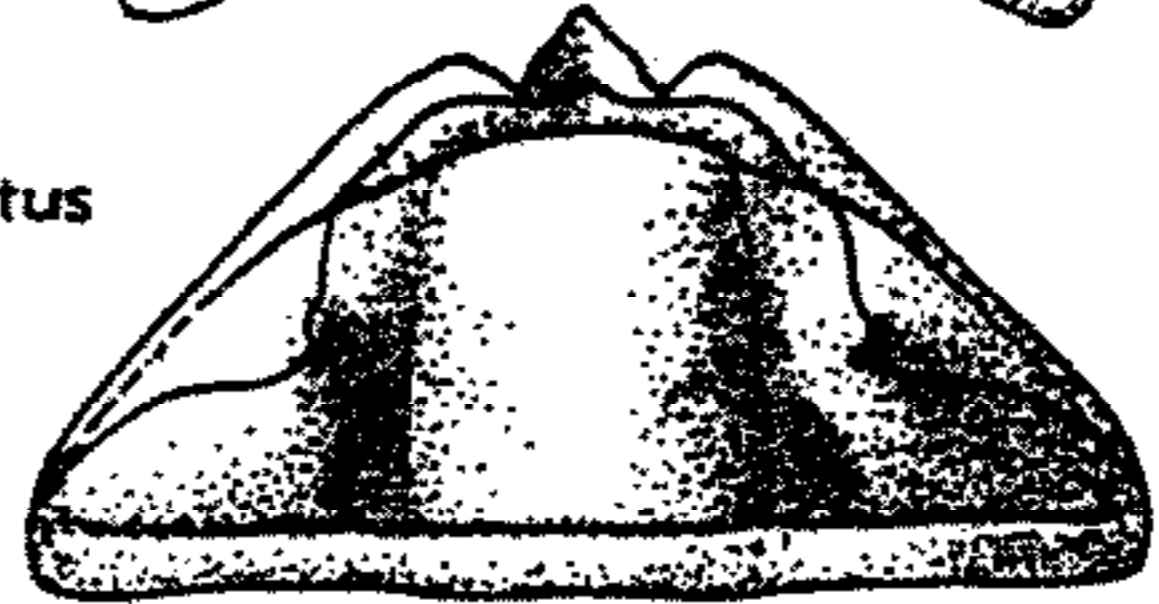

3a

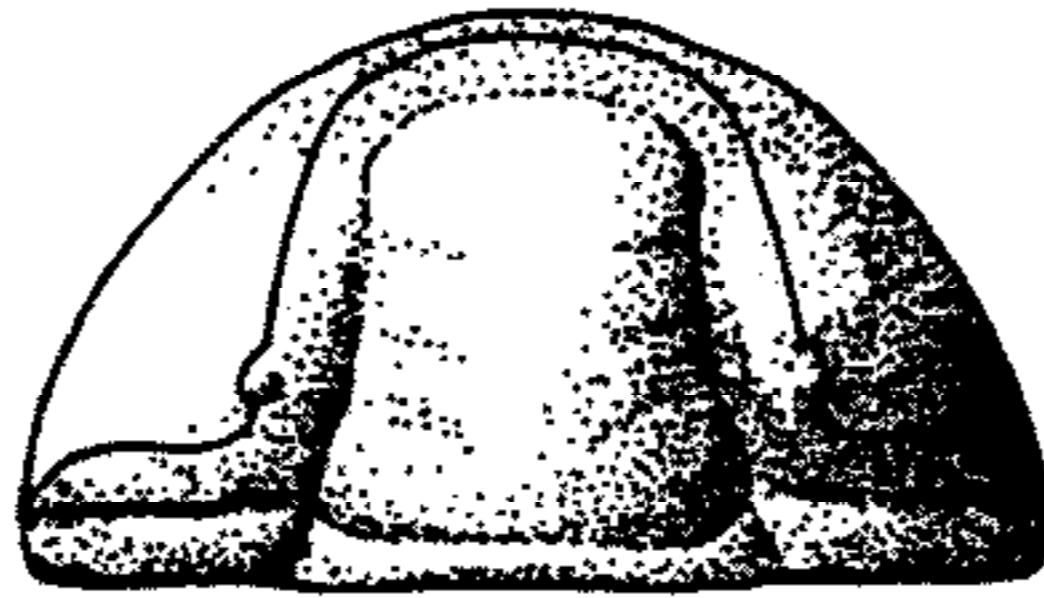

2a

Parahomalonotus

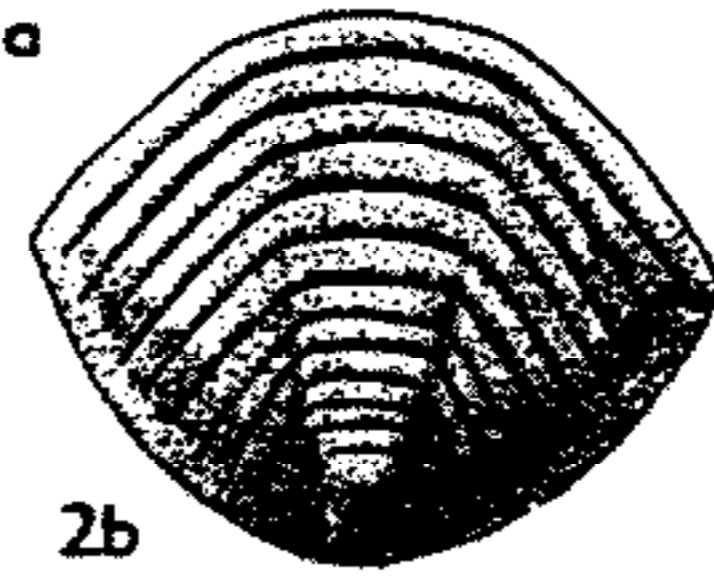

2b

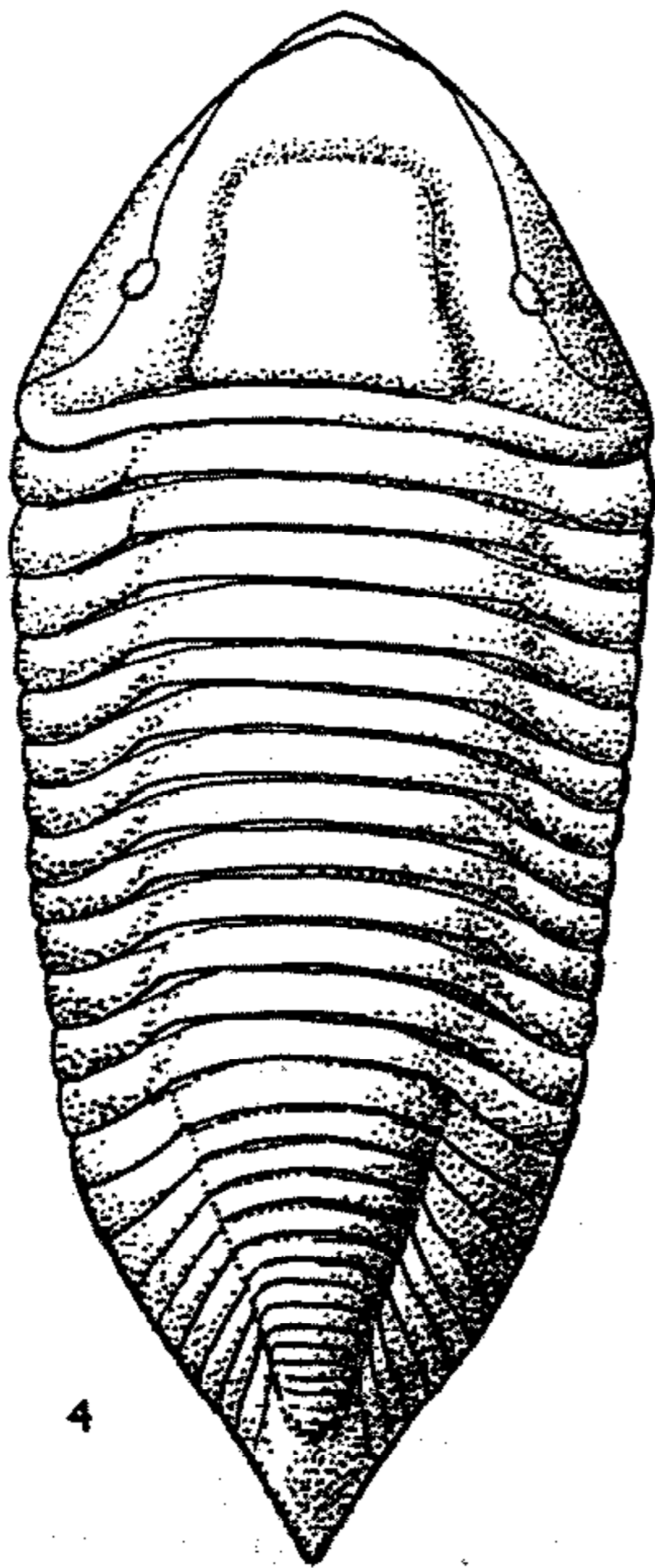

4

Trimerus

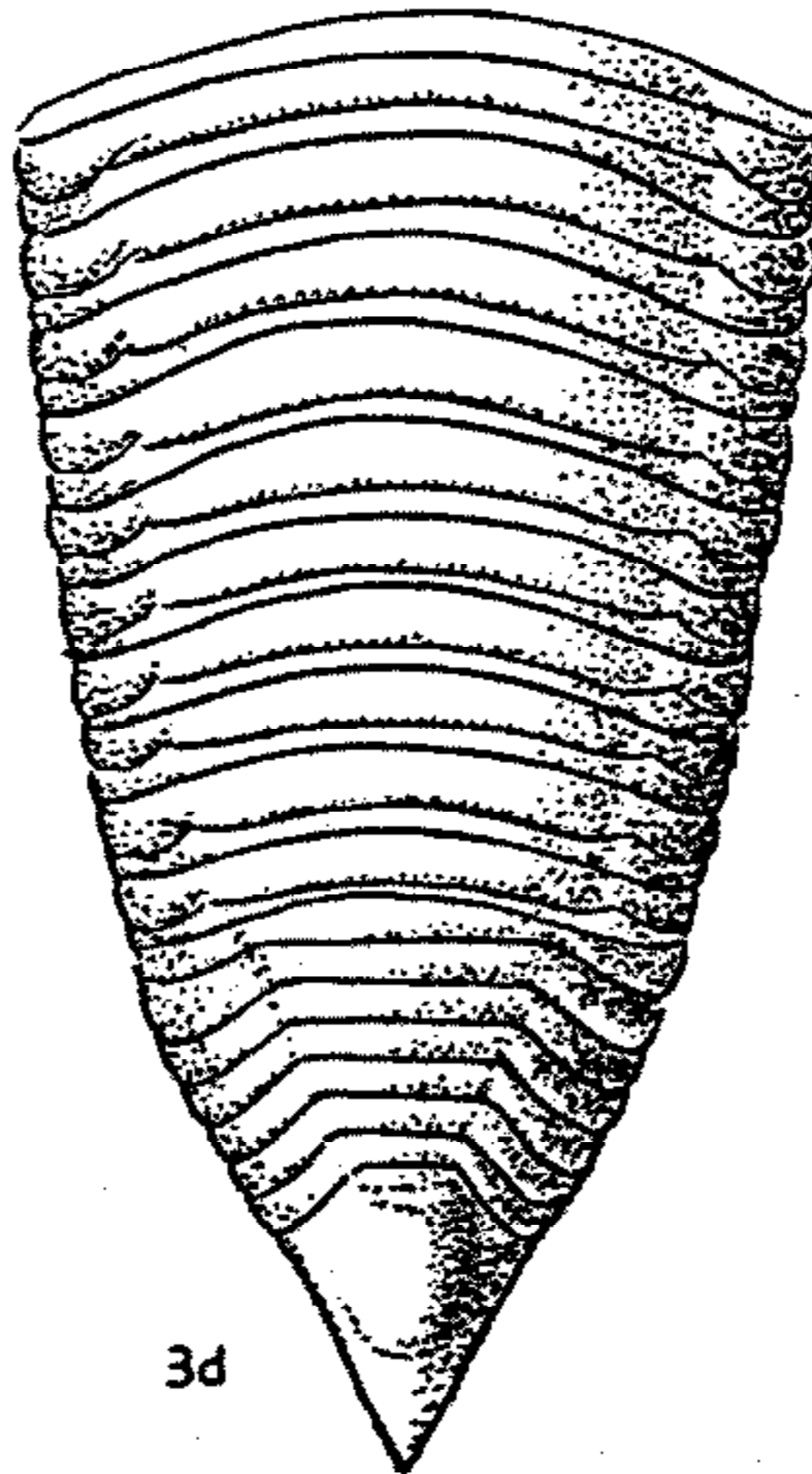

3d

Homalonotus

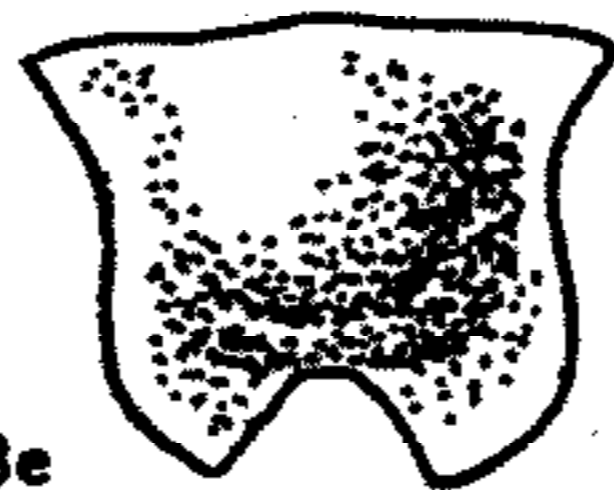

3e

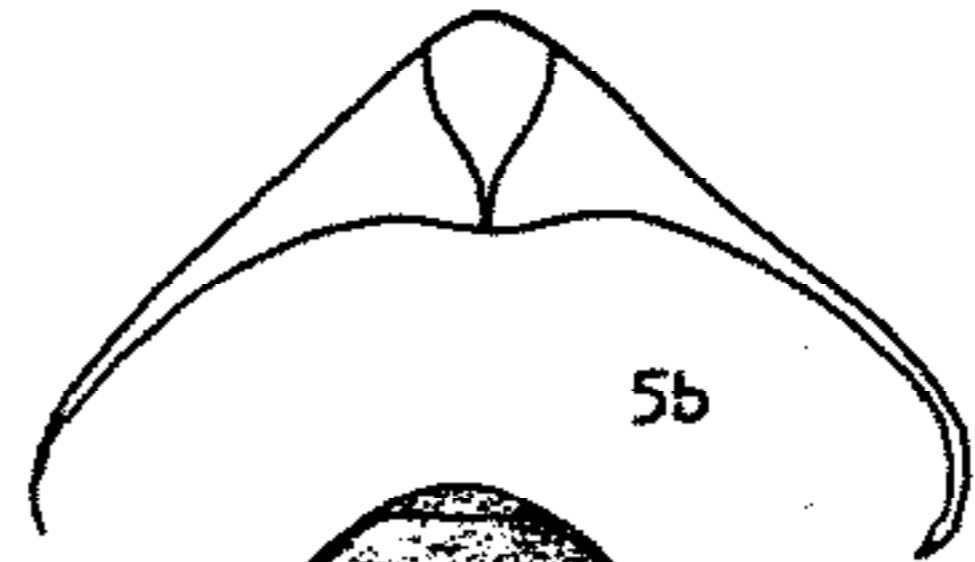

5b

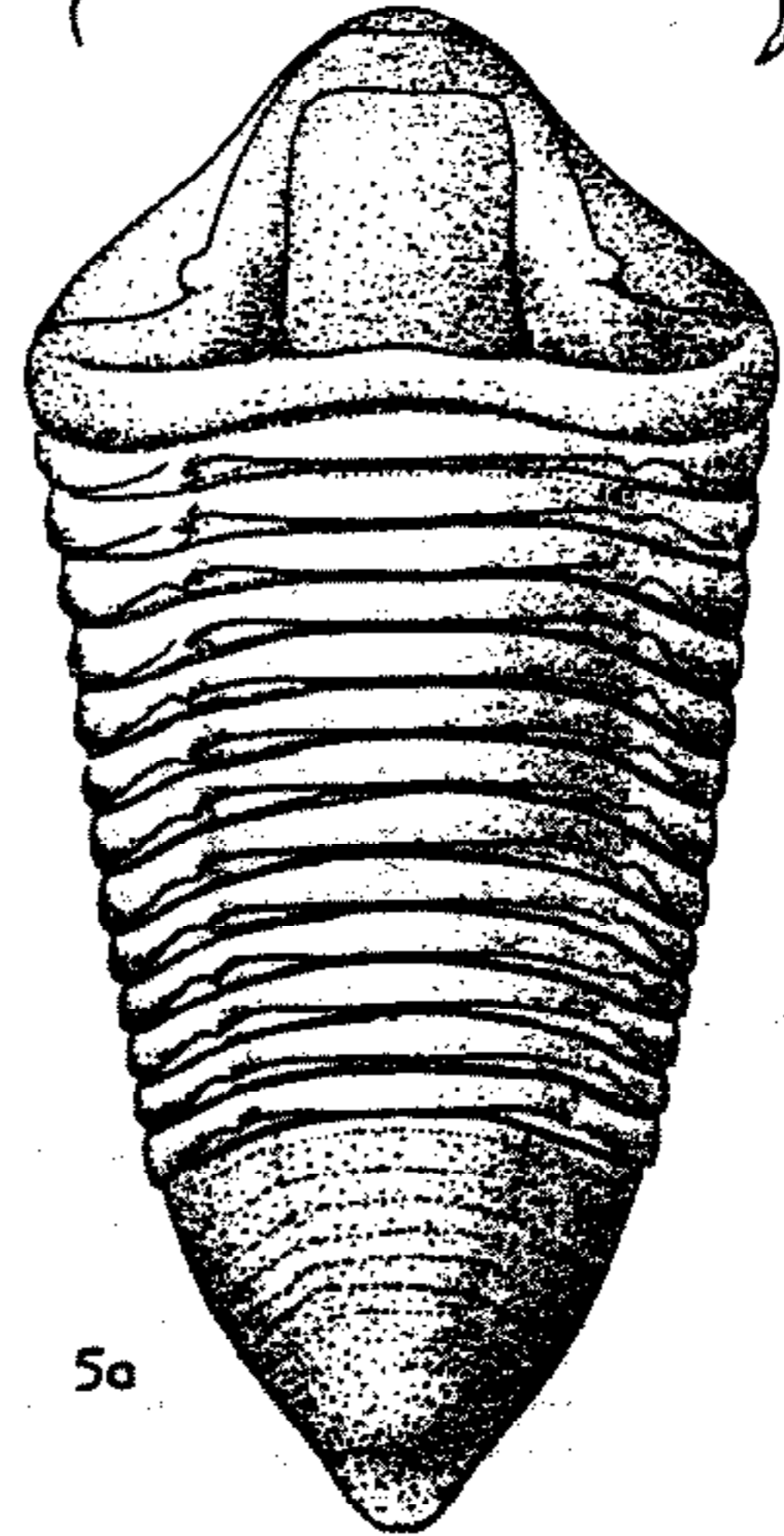

5a

Dipleura

FIG. 360. Homalonotidae (Homalonotinae) (p. 0458-0461).

Eng.-Swed.-Nova Scotia.—FIG. 360,3a-c. *H. rhinotropis* ANGELIN, Swed.; 3a,b, ceph. (reconstr.), dorsal, anterior, $\times 0.5$ (431); 3c, ceph., lateral, $\times 0.5$ (368).—FIG. 360,3d,e. **H.*

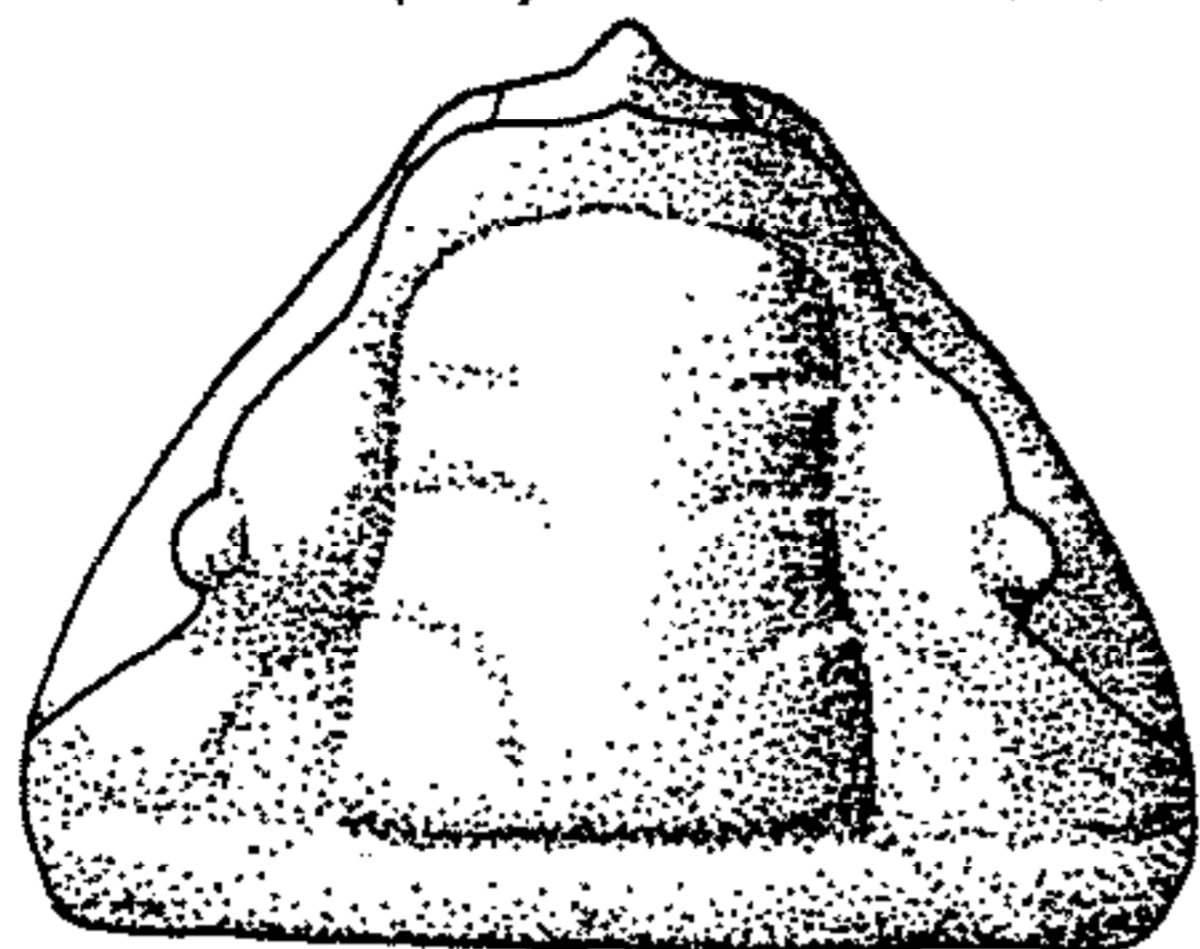

1a

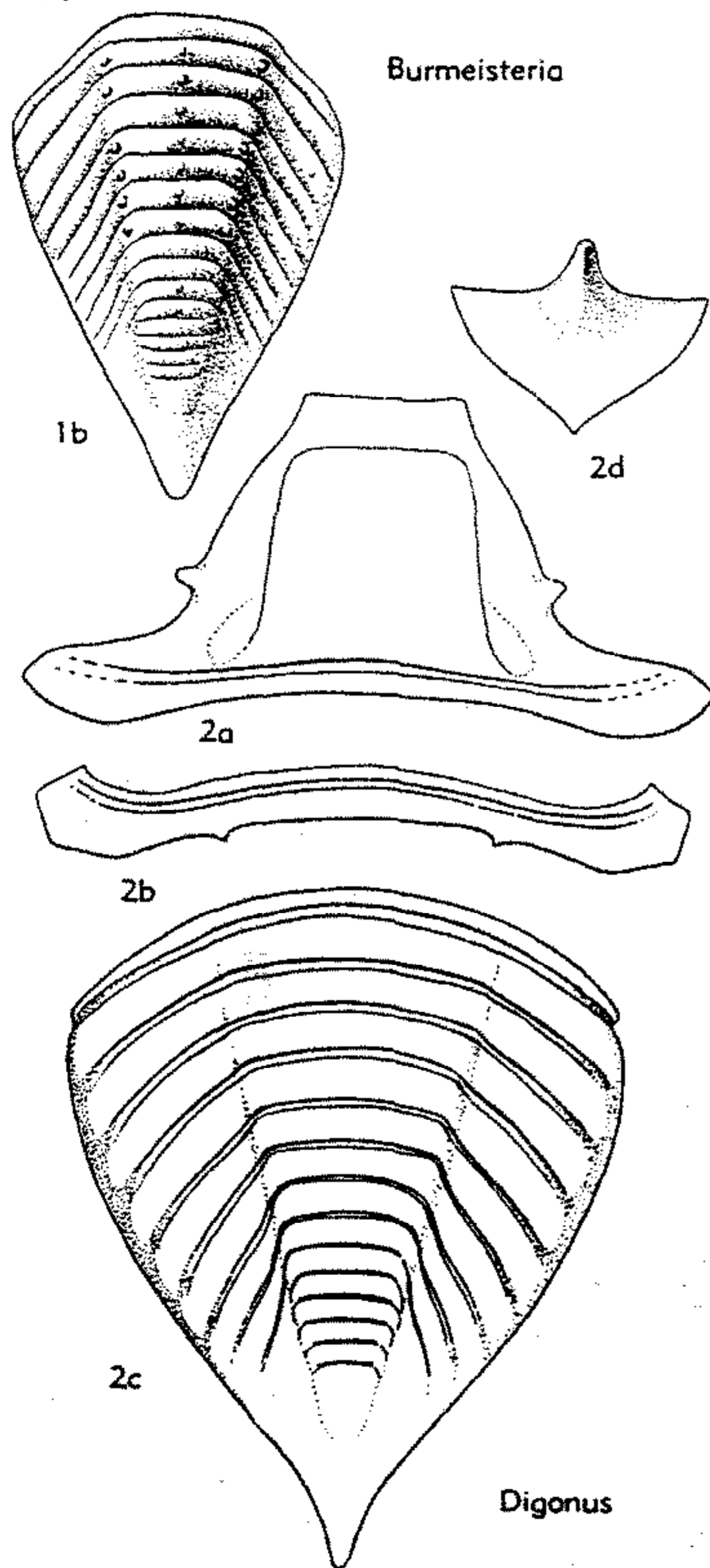

Burmeisteria

1b

2d

2a

2b

2c

Digonus

FIG. 361. Homalotidae (Homalotinae) (p. 0460-0461).

knighti, Eng.; 3d,e, thorax with pygidium, hypostoma, $\times 0.6$, $\times 1$ (466).

Trimerus GREEN, 1832 [**T. delphinocephalus*]. Cephalon subtriangular, without border; glabella subtrapezoidal, with indistinct lobation, postsutural portion of frontal area large. Rostral plate smooth. Thoracic axis very poorly defined. Pygidium triangular; axis not extended to posterior margin. [Closely related to *Burmeisteria*.] *M.Sil.-M.Dev.*, N.Eu.-N.Am.-S.Am.-N.Afr.-?Austral.-Mongol.

T. (*Trimerus*). Cephalon more than a half as long as wide, glabella slightly narrowing forward, some species with indistinct lobation; paraglabellar areas defined. Rostral suture forming somewhat pointed arch close to anterior margin. Pygidium acuminate behind, with faint trilobation but distinct segmentation. *M.Sil.* N.Eu.-N.Am.-?Austral.-Mongolia.—FIG. 360,4. **T.* (*T.*) *delphinocephalus*, N.Y.; exoskel. (reconstr.), $\times 0.6$ (403).

T. (*Dipleura*) GREEN, 1832 [**D. dekeyi*]. Cephalon less than half as long as wide; glabella almost imperceptibly narrowing forward, lobation recognizable only in young stages; paraglabellar areas not distinct. Rostral suture tending to become straight transverse. Pygidium obtusely pointed behind, with very indistinct trilobation and segmentation. [REED (1918) has emphasized the straight rostral suture as characteristic of *Dipleura* but many published figures of the type species indicate great variation.] *L.Dev.-M.Dev.*, N.Am.-S.Am.-Ger.-N.Afr.—FIGS. 358,6; 360,5. **T.* (*D.*) *dekeyi*, *M.Dev.*, N.Y.; 358,6, hypostoma, $\times 1$ (404); 360,5a,b, exoskel. (reconstr.), cephalic doublure with rostral plate, $\times 0.5$ (404).

Burmeisteria SALTER, 1865 [**Homalotus herschelii* MURCHISON, 1839]. Cephalon subtriangular, without border; glabella urceolate to trapezoidal; paraglabellar areas distinct; postsutural portion of frontal area of moderate size. Rostral suture transverse, more or less straight; rostral plate with short blunt median spine. Thorax with very broad axis and indistinct trilobation. Pygidium triangular, pointed behind; axis not reaching posterior margin; trilobation and segmentation fairly distinct. [On basis of type species only, *Burmeisteria* and *Digonus* might be accepted as independent genera, but South African species indicate that assignment of subgeneric rank is appropriate.] ?*U.Sil.*, *L.Dev.*, Eu.-Afr.-S.Am.-N.Z.

B. (*Burmeisteria*). Glabella urceolate, slightly tapering forward, distinctly lobate; rostral suture composed of 2 slightly sigmoidal halves meeting in weak median point or straight across. Whole exoskeleton may be ornamented by scattered spines. *L.Dev.*, S.Afr.-Sahara-Malvin I.-N.Z.—FIG. 361,1. **B.* (*B.*) *herschelii* (MURCHISON), Afr.; 1a, ceph., $\times 0.8$ (470n); 1b, pyg., $\times 0.8$ (466).

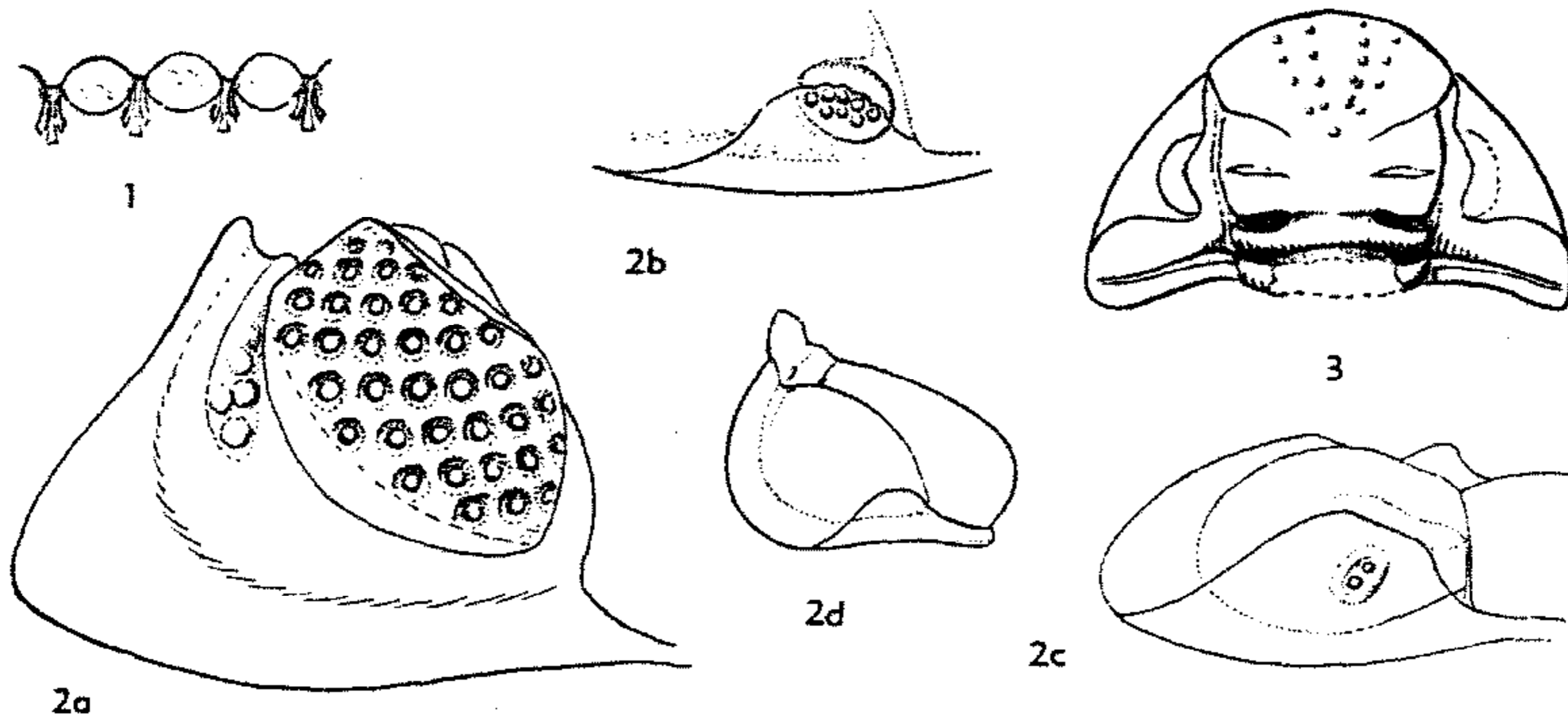

FIG. 362. Morphological features of Phacopina.—1, Section through schizochroal lenses of eye of *Phacops schlotheimi*, M.Dev., Ger.; $\times 15$ (424, 1901).—2a-d, Degeneration of schizochroal eyes of Phacopinae, showing diminished number of lenses accompanied by reduction and ultimate disappearance of palpebral lobes and by alteration in course of facial sutures as evolution progresses; 2a, *Phacops latifrons*, M.Dev., Ger., with normal eyes, $\times 2.5$; 2b, *Cryphops cryptophthalmus*, U.Dev., Ger., with reduced eyes (*cryptophthalmus* pattern), $\times 7$; 2c, *Nephranops incisus incisus*, U.Dev., Ger., with vestigial lenses, $\times 2$; 2d, *N. incisus dillanus*, U.Dev., Ger., showing absence of eyes and palpebral lobes and change in facial sutures, $\times 2$ (all 460, 1933).—3, *Acastoides henni*, L.Dev., Ger., showing radially arranged nodes on frontal lobe of glabella (internal mold), possibly representing scars of muscle attachment, $\times 2$ (244).

B. (Digonus) GÜRICH, 1909 [**Homalonotus gigas* F. A. ROEMER, 1843]. Glabella trapezoidal, broad, without lobation; anterior sections of facial sutures bending abruptly into straight or slightly concave rostral suture. Pleural ends of thoracic segments angular (type species). ?*U.Sil.*, *L.Dev.*, Belg.-Ger.-?Eng.-Medit.-N.Afr.-S.Afr.-Bol.-Brazil-?Arg.-N.Z.—FIG. 361,2. **B. (D.) gigas* (F. A. ROEMER), *L.Dev.*, Ger.; 2a-d, cran., thoracic segment, pyg., rostral plate, $\times 1.5$ (461n).

Burmeisterella REED, 1918 [**Homalonotus (Burmeisterella) elongatus* SALTER, 1865]. Cephalon (unknown in type species) subtriangular, without border; glabella subtrapezoidal; paraglabellar areas more or less distinct; postsutural portion of frontal area very narrow. Rostral suture transverse, straight or gently curved, in some with small median point; rostral plate with stout median prominence. Thoracic axis faintly marked. Pygidium parabolic in outline, rounded or pointed behind, surrounded by smooth narrow border; axis rather narrow, distinct, reaching to or nearly to posterior margin, may bear 1 or 2 terminal spines. Surface ornamented by regularly spaced spines. *L.Dev.*, Eng.-Belg.-Ger.—FIG. 360,1a, *B. bifurcata* REED, Eng.; ceph. (reconstr.), $\times 0.5$ (452).—FIG. 360,1b. **B. elongata* (SALTER), Eng.; PYG., $\times 0.5$ (466).

Parahomalonotus REED, 1918 [**Homalonotus gervillei* DE VERNEUIL, 1850]. Cephalon semicircular, without border; glabella slightly urceolate, with gently rounded front, some species with indistinct lobation; paraglabellar areas not known. Rostral

suture regularly arched close to anterior margin; rostral plate apparently smooth. Thorax with obsolete trilobation. Pygidium semicircular or semioval, little longer than wide, with strongly curved anterior margin; narrow ill-defined border not crossed by ribs; axis of moderate width, anterior part poorly defined, not quite reaching posterior margin but connected to it by postaxial ridge; segmentation generally distinct. *L.Dev.*, Fr.-Ger.-N.Afr.—FIG. 360,2. **P. gervillei* (VERNEUIL), Fr.; 2a,b, ceph., pyg. (reconstr.), $\times 0.5$ (373, 470n).

Suborder PHACOPINA Struve, nov.

[=Superfamily Phacopidae RUD. RICHTER, 1933; Phacopidacea DELO, 1935; Phacopacea HENNINGSMOEN, 1951; Phacopoidae HUPÉ, 1953] [The first author to define main features of this assemblage seems to have been QUENSTEDT (1837, Wiegmann's Arch. Naturgesch., Berlin, Jahrg. 3, Band 1, p. 343), although he cannot be recognized as its nomenclatural author.—W. STRUVE.] [Type—*Phacops* EMMERICH, 1839] [Authorship. The following diagnosis and discussion of Phacopina was contributed by RUD. RICHTER.]

Cephalon with schizochroal eyes, proparian facial sutures, supramarginal or marginal in front without rostral plate. Thorax with 11 segments, pleurae furrowed, articulating facets distinct. *L.Ord.-Up.U.Dev.*

The schizochroal eyes (Fig. 362) of Phacopina are generally well developed and in many genera quite large. However, several genera (especially belonging to the Phacopinae and Phacopidellinae) display a gradual degeneration of eyes (Fig. 362,2a-d), during

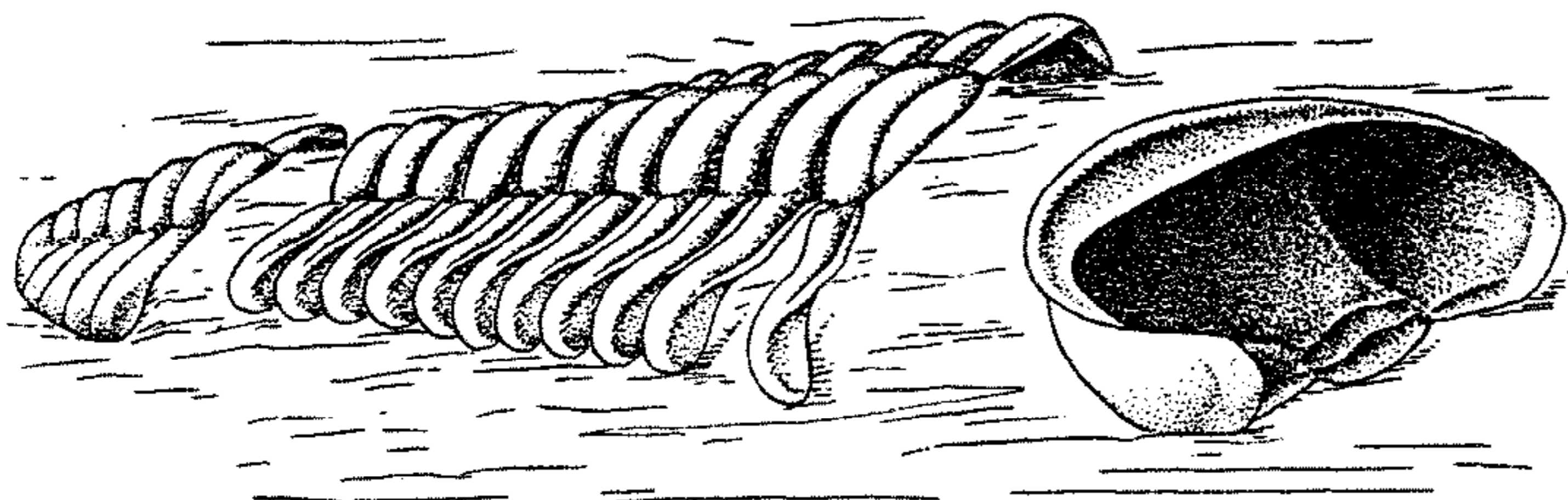

FIG. 363. Displaced parts of exoskeleton of *Trimerocephalus* as left behind after the "Salterian mode of molting," hypostoma not shown (reconstr.), $\times 2.7$ (460, 1942).

which the facial sutures tend to straighten and migrate outward (Fig. 291A-F). The vestigial eyes move toward anterior corners of the genae, remaining reniform (*Nephranops*) or more commonly becoming elliptical in outline (*cryptophthalmus* pattern); the facial sutures may shift close to the cephalic margin and eventually become entirely marginal (*Ductina*). On the frontal lobe, pits (or nodes by reversion of relief) may appear, perhaps representing scars of stomach muscles (Fig. 362,3); they are arranged in a radiating pattern.

Even in forms with normal eyes, the facial sutures are ankylosed in some genera (Phacopinae, especially *Phacops*, and Phacopidellinae) so that in ecdysis and death, librigenae remain connected with the cranium. In several genera with ankylosed sutures and degenerated eyes (e.g., *Trimerocephalus*, *Nephranops*, *Cryphops*, *Dianops*, *Denckmannites*), the molting animal evidently emerged from the exoskeleton between cephalon and thorax, the cephalon being turned upside down with the back forward and entirely separated from the thorax; this is the "Salterian mode of molting" (RUD. RICHTER, 1937; Fig. 363). When in eyeless genera the sutures migrate into a marginal position, they become functional again, allowing parts of the animal inside the carapace to be extruded forward between the cephalon and doublure (as typically in *Harpes*, *Limulus*, *Triops*), with thorax and cephalon remaining connected; this is the "*Ductina* mode of molting" (RICHTER & RICHTER, 1926). In *Trimerocephalus*, as MAKSIMOVA (1955) has pointed out, the type of molting undergoes change

during ontogeny from the *Ductina* mode to the Salterian mode.

Superfamily PHACOPACEA Hawle & Corda, 1847

[*nom. transl.* RUD. RICHTER, 1933; *nom. correct.* HENNINGS-MOEN, 1951 (*pro* Phacopidea RUD. RICHTER, 1933)]
[=*Phacopidae*: HUPÉ, 1953]

Micropygous. Cephalon with strongly divergent axial furrows; glabella with frontal lobe generally obliterating frontal area and fusing with *3p* and *2p* lateral glabellar lobes to form a single tricomposite lobe that in most genera is distinctly separated from an "intercalating ring" (connected *1p* lobes); *3p* lateral furrows definitely bipartite but *2p* furrows single and faint to obsolete in most genera; eyes in anterior position; genal angles generally well rounded and lacking genal spines; vincular furrow generally present. *Sil.-U.Dev.*

Family PHACOPIDAE Hawle & Corda, 1847

[*nom. correct.* SALTER, 1864 (*pro* family Phacopides HAWLE & CORDA, 1847)] [*Authorship.* The selection of genera assigned to this family and their arrangement in subfamilies is by RUD. RICHTER, who also furnished data on all genera, except *Plagiolaria*, prepared by W. STRAUVE.]

Glabella broadening markedly forward, with *2p* and *3p* lateral glabellar furrows obsolescent, *3p* furrows (?composite) consisting of an anterior branch subparallel to axial furrows and a posterior branch directed transversely (except *Bouleia*), *1p* furrows transglabellar (with some exceptions) so that *1p* glabellar lobes thus form a more or less distinct "intercalating ring"; genal angles rounded, lobiform, or angular, no genal spines. Thoracic pleurae with rounded ends. Pygidium well rounded, semicircular or shorter, margin entire, without lateral and posterior projections. *Sil.-U.Dev.*

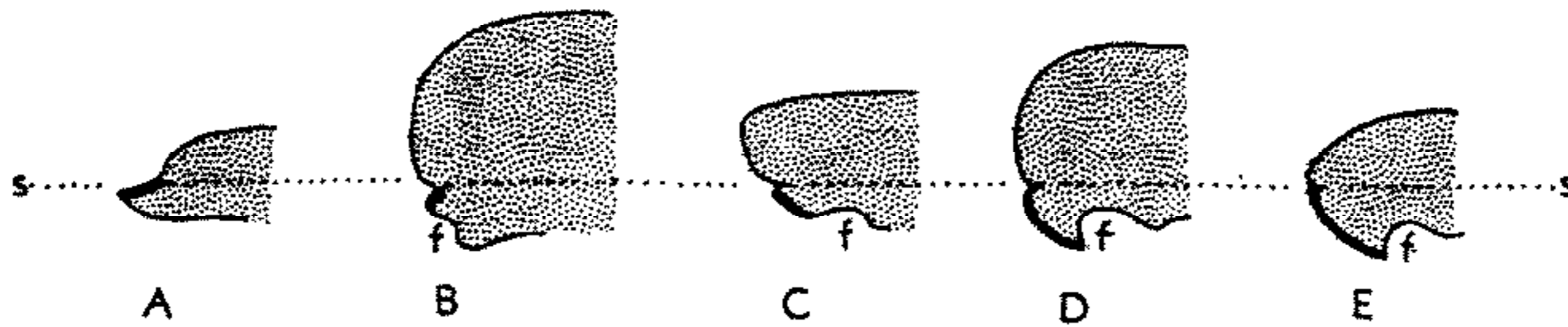

FIG. 364. Sagittal sections through anterior part of phacopid cephala aligned on intersections of facial sutures (s—s), beneath which thick lines denote cephalic border and "f" the vincular furrow (A, dalmanitid genera; B, *Phacops*; C, *Trimerocephalus*; D, *Nephranops*; E, *Dianops*; B-E belong to Phacopinae) (247).

Subfamily PHACOPINAE Hawle & Corda, 1847
[*nom. transl.* REED, 1905 (ex Phacopidae HAWLE & CORDA, 1847)]

Exoskeleton compact. Glabella inflated, anterior slope steep or overhanging, "intercalating ring" separated from anterior part of glabella at least by shallow depression (except *Eocryphops*, *Dianops*), that commonly is very distinct, with tendency to decay in isolated nodes; subcephalic furrow (Fig. 364) on doublure continuous along whole cephalon (but in *Eophacops* and *Reedops* reduced mesially). [The edge of the pygidium and ends of the pleurae fit into the subcephalic (vincular) furrow, when the body is enrolled; initially simple, the furrow may be modified to fit better into a series of pits (Fig. 365,6b).] Hypostoma triangular to trapezoidal, wings inclined vertically, posterior margin denticulated in some genera (Fig. 365,7d,e). Pygidium short. *Sil.-U.Dev.*

Phacops EMMRICH, 1839 [**Calymmene latifrons* BRONN, 1825; SD BARRANDE, 1852] [= ?*Somatrikelon* McMURTRIE, 1819; *Portlockia* M'COY, 1846; ?*Somatrikopon* VOGDES, 1925]. Vincular furrow continuous, rear edge sharp, higher than anterior; marginal ridge narrow, doublure concave. Hypostoma elongate, posterior margin with 3 denticles. *Sil.-Dev.*, cosmop.—FIG. 365,7a,b. **P. latifrons* (BRONN), M.Dev., Ger. (Gerolstein); 7a,b, ceph., dorsal, side, $\times 1.2$ (461n).—FIGS. 365,7c; 366,2. *P. schlotheimi* (BRONN), M.Dev., Ger. (Gees, Gerolstein); 365,7c, enrolled specimen showing pygidium and doublure of cephalon with vincular furrow, $\times 2$; 366,2, enrolled specimen (librigena shaded), $\times 4$ (461).—FIG. 365,7d,e. *P. secundus* BARRANDE, L.Dev., Czech.; 7d,e, hypostoma, exterior and side, $\times 1$ (3). [Other species illustrated in Figs. 290, 291, showing comparisons with Proetidae.]

Cryphops RICHTER & RICHTER, 1926 [*nom. conserv.* proposed STRUVE, 1958 (ICZN pend.)] [**Phacops cryptophthalmus* EMMRICH, 1844] [= *Microphthalmus* GORTANI, 1907 (non MECHNIKOV, 1865)

(obj.); *Gortania* COSSMANN, 1909 (obj.)]. Eyes very small, with *cryptophthalmus* pattern; border broad, vincular furrow wide, deep; doublure short, concave. Pygidium very short and broad (*tr.*). *U.Dev.*, Eu.—FIG. 365,1. **C. cryptophthalmus* (EMMRICH), Ger. (Oberscheld); 1a,b, ceph., dorsal, side; 1c, ceph., anterior edge from below showing vincular furrow; all $\times 4$ (461).

Dereimsia KOZŁOWSKI, 1923 [**Phacops (Dereimsia) sphaericeps*]. Glabella hemispherical, without traces of 2p and 3p lateral glabellar furrows, 1p furrow and occipital furrow, both indicated by lateral pits that unite to form groove; 1p glabellar lobes replaced by a depression (as in *Phacops accipitrinus* PHILLIPS, Fig. 209F); occipital ring elevated. *Dev.*, Bol.—FIG. 365,5. **D. sphaericeps* (KOZŁOWSKI); cephalon, dorsal view, $\times 1$ (111).

Dianops RICHTER & RICHTER, 1923 [**Phacops limbatus* REINH. RICHTER, 1848]. Glabella inflated, with truncated lateral corners, axial furrows curved inward, lateral glabellar furrows faint (especially 2p), 3p fading mesially so that here "intercalating ring" coalesces anteriorly; eyes absent; facial sutures restricted to border, marginal in front, not transecting border furrow; genae strongly vaulted; border very broad at genal angles where border furrow diminishes; vincular furrow deep, broad, with anterior edge higher than posterior; doublure long, even. Pygidium rather long, length 0.5 of width, transversely vaulted; posterior border slightly curved, anterior angulated; axial furrows and segmentation indistinct. *U.Dev.*, Eu.—FIG. 365,2a,b. **D. limbatus* (REINH. RICHTER), Ger. (Saalfeld), 2a,b, ceph., dorsal, side, $\times 3$ (461).—FIG. 365,2c. *D. anophthalmus* (FRECH), Ger. (Ebersdorf); ceph. from below, showing vincular furrow, $\times 3$ (461).

Eocryphops RICHTER & RICHTER, 1931 [**Phacops kayseri* HERRMANN, 1909]. Eyes small with few lenses (*cryptophthalmus* pattern); genal angles with curved indentation, against which anterior pleurae fit; 1p lateral glabellar furrows faint mesially. Pygidium not shorter than in *Phacops*. *Low.M.Dev.*, Eu.-N.Afr.—FIGS. 366,1; 367,1. **E. kayseri* (HERRMANN), Ger. (Marburg); 366,1, enrolled specimen (librigena shaded), $\times 6.7$ (461); 367,1a,b, ceph., dorsal, anterior, $\times 1.5$ (251).

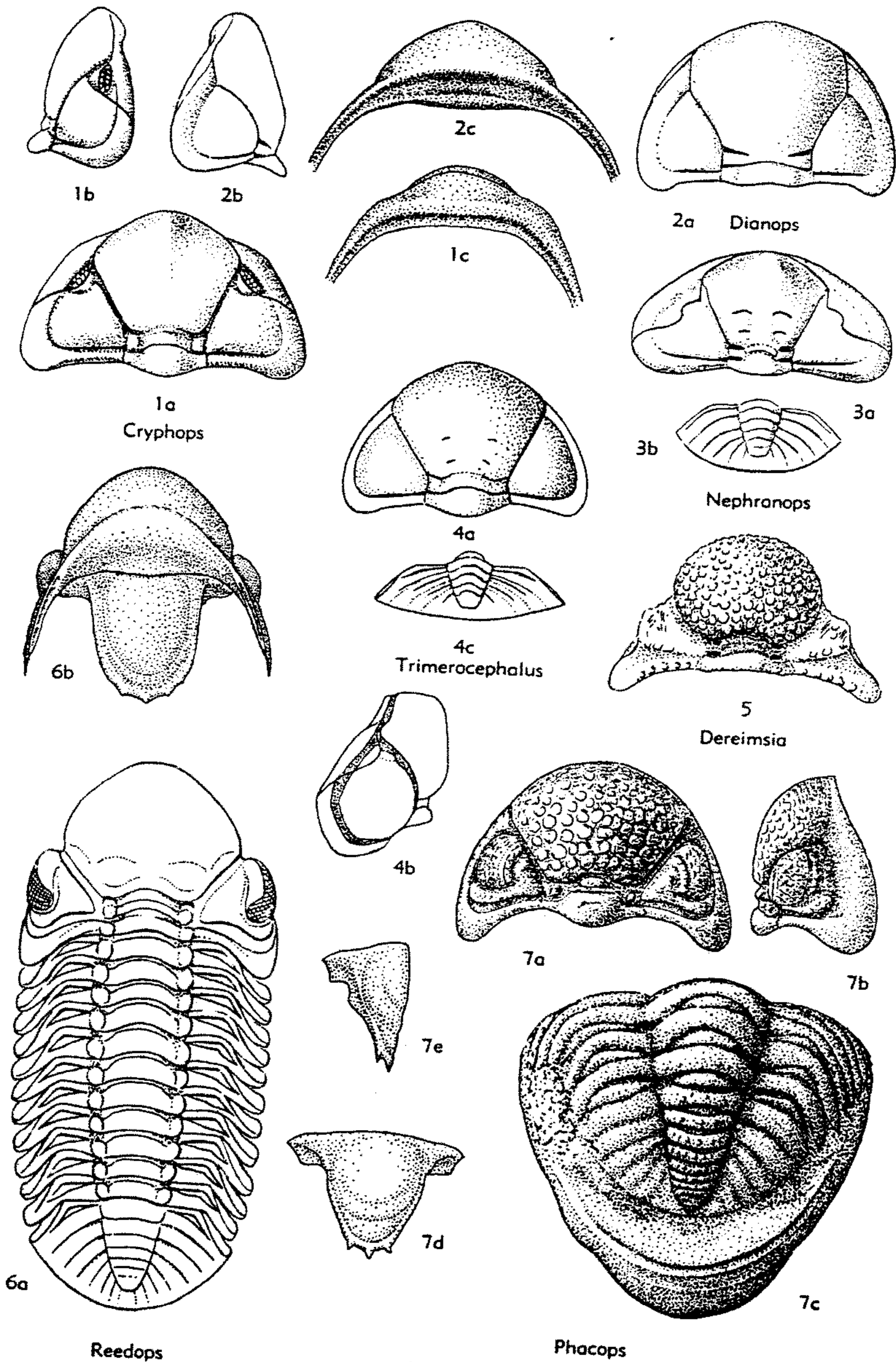

FIG. 365. Phacopidae (Phacopinac, Subfamily Uncertain) (p. 0463-0466).

Eophacops DELO, 1935 [**Phacops handwerki* WELLER, 1907]. Small, cephalon with vincular furrow present laterally; doublure concave; glabella curving gently downward to anterior margin, not overhanging; axial furrows not diverging laterally. *M.Sil.*, N.Am.-NW.Eu.—FIG. 368. **E. handwerki* (WELLER), Ill. (Chicago); *a,b*, exoskel., ceph., $\times 2$ (491).

Nephranops RICHTER & RICHTER, 1926 [**Phacops (Trimeroccephalus) incisus* F. A. ROEMER, 1866]. Eyes degenerating but visual area or homologous field retains kidney-shaped outline of eyes in

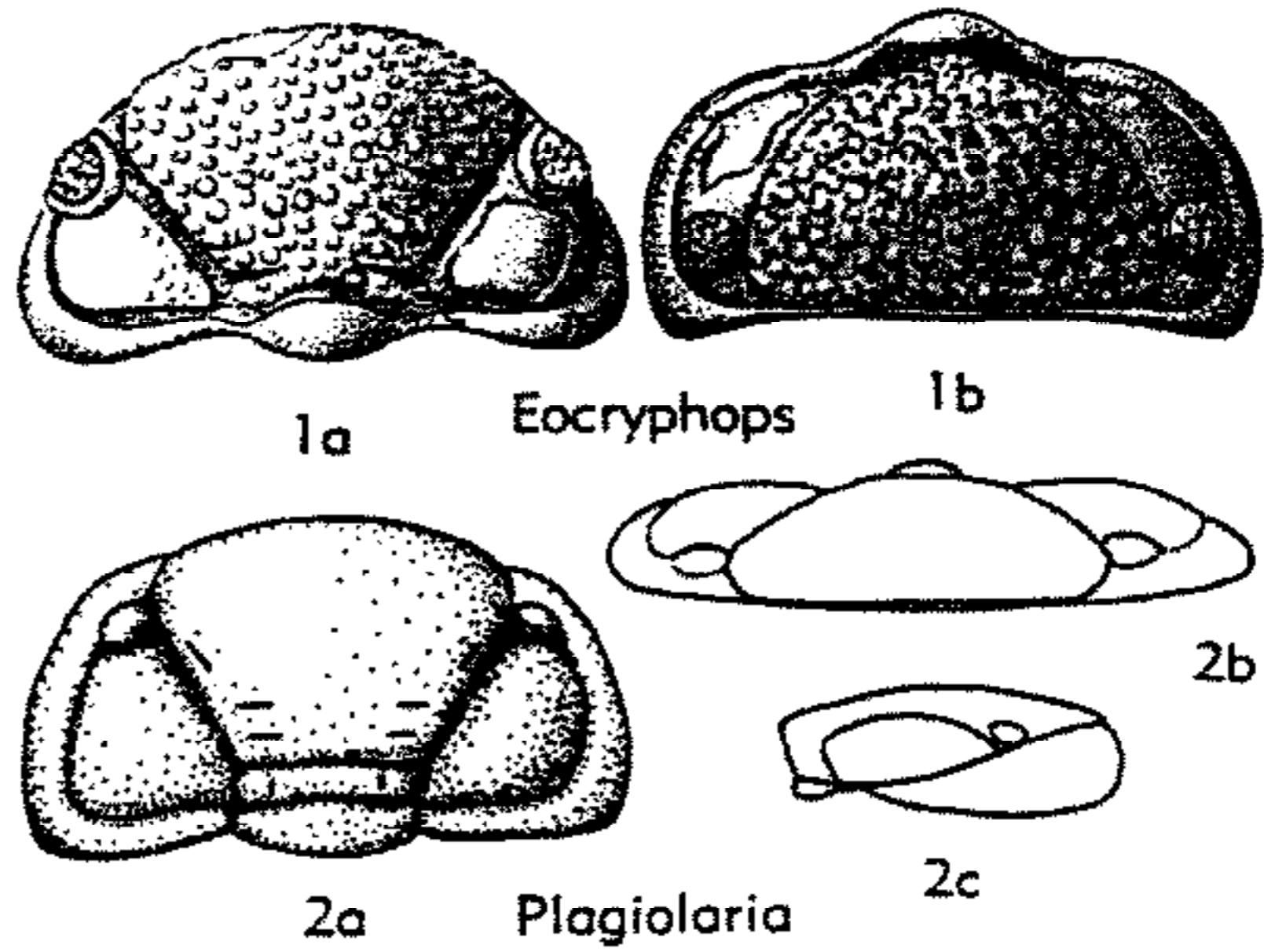
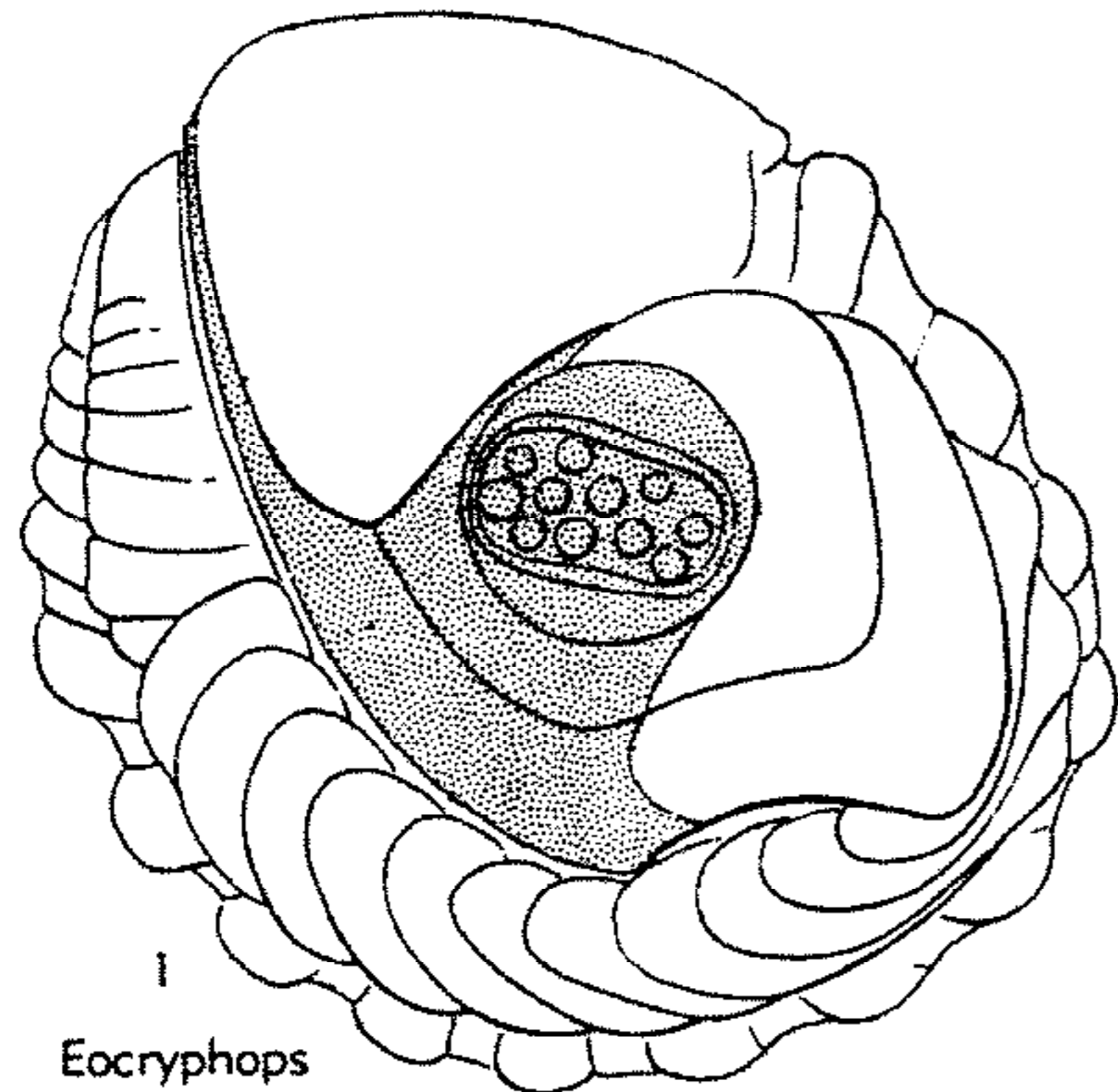

FIG. 367. Phacopidae (Phacopinae) (p. 0463-0465).

Phacops, eyes of some species provided with about 40 lenses, a few with 2 lenses, and others with none; palpebral lobes invariably present, elevated; vincular furrow broad, with overhanging anterior edge, marginal ridge broad; doublure very short. Pygidium rather large, segmentation not pronounced. *U.Dev.*, Eu.—FIG. 365,3. **N. incisus incisus* (F. A. ROEMER), Ger. (Obersheld); *3a,b*, ceph., pyg., $\times 1.5$ (461).

Plagiolaria KEGEL, 1952 [*pro Plagiops* KEGEL, 1932 (non AMYOT, 1846; nec TOWNSEND, 1912; nec CRESSON, 1918) [**Phacops plagiophthalmus* REINH. RICHTER, 1865]. Similar to *Cryphops*, with generally broad cephalic border but very narrow below frontal lobe of glabella; border furrow in front of eyes faint to obsolete; glabella subtrapezoidal in outline, with anterior margin a gently curved line, "intercalating ring" flat, *1p* lobes slightly detached, transglabellar furrow connecting *1p* furrows nearly straight, clearly visible; occipital ring about as broad as "intercalating ring"; eyes of *cryptophthalmus* pattern on somewhat rounded



1
Eocryphops

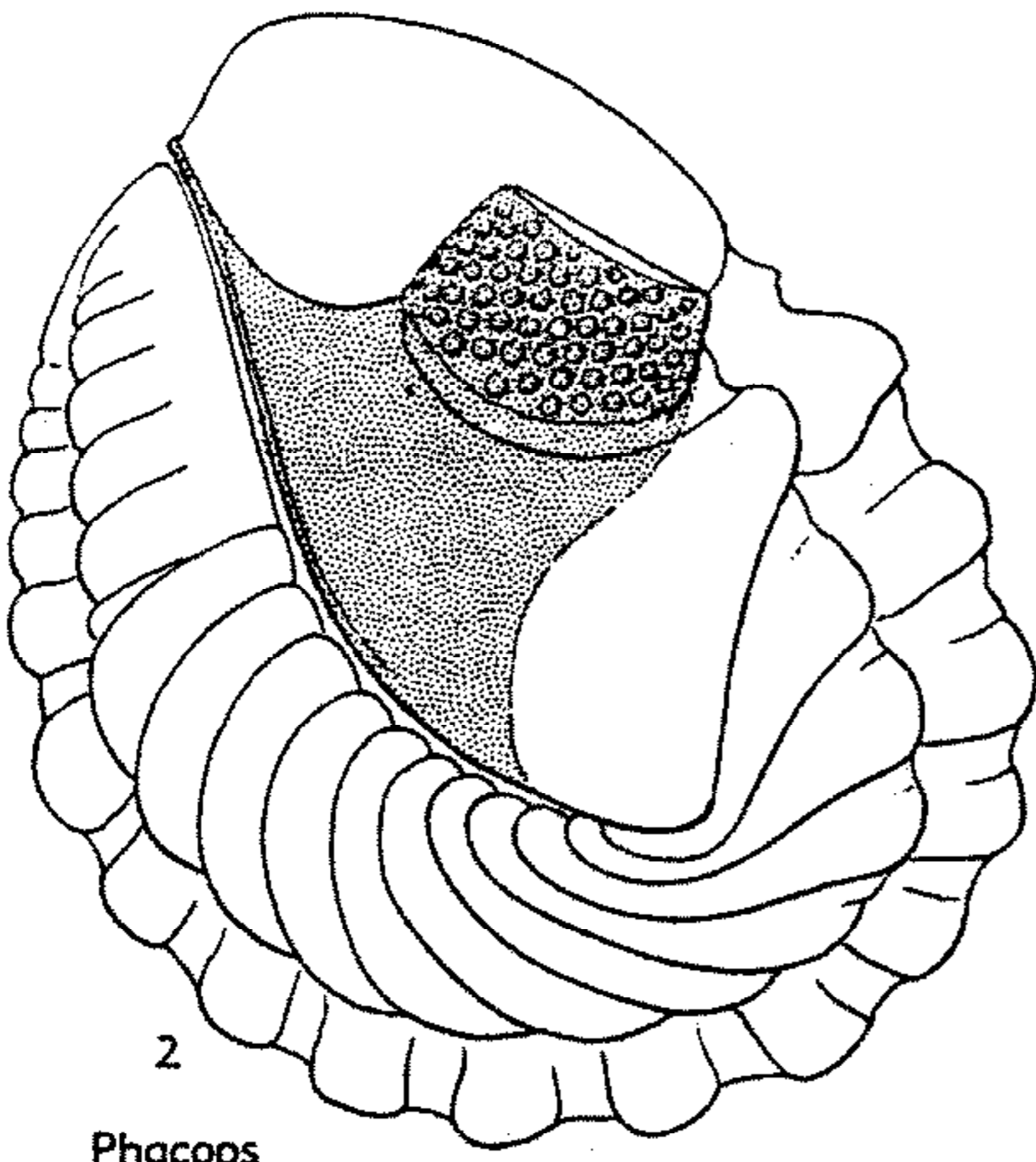

2
Phacops

FIG. 366. Phacopidae (Phacopinae); enrolled specimens, *M.Dev.*, Ger. (1, *Eocryphops kayseri*; 2, *Phacops schlotheimi*).

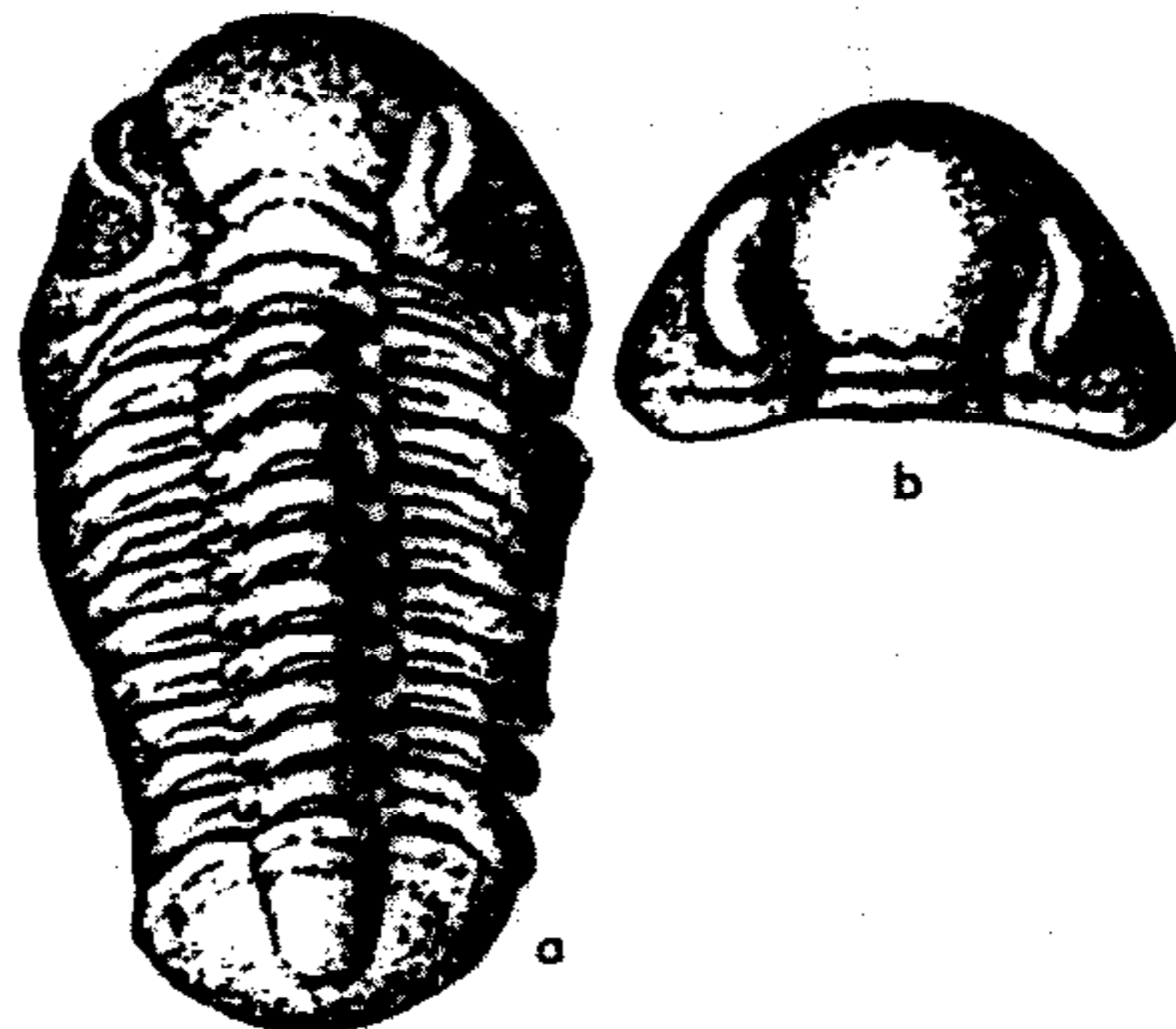

FIG. 368. **Eophacops handwerki* (WELLER), *M.Sil.*, Ill.; *a,b*, exoskel., ceph., $\times 2$ (491).

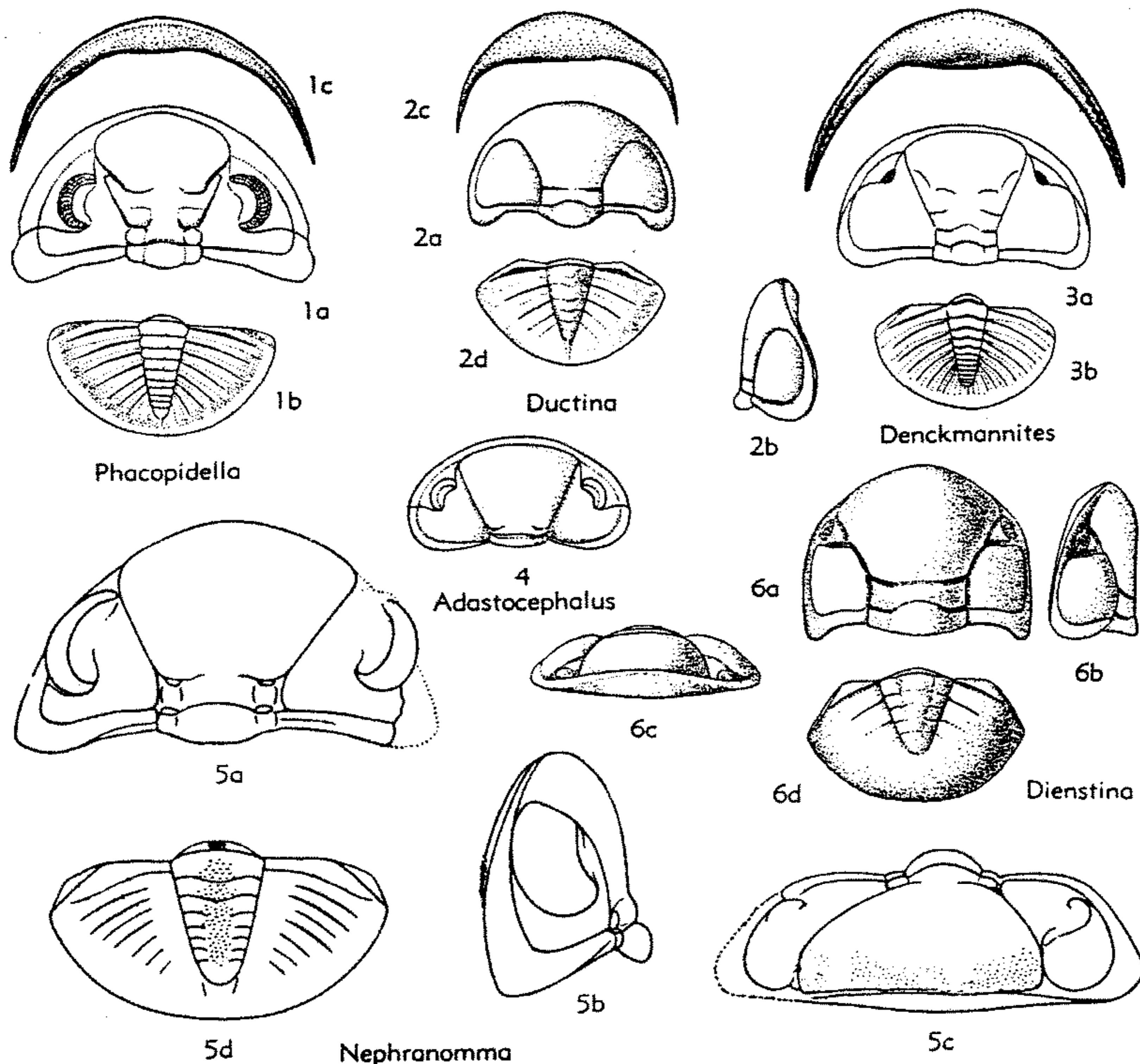

FIG. 369. Phacopidae (Phacopidellinae) (0467-0468).

knob that is separated posteriorly by broad deep furrow extending from axial furrows to lateral border furrows; vincular furrow continuous along whole subcephalic edge. Pygidium transversely elongate; with 6 distinct axial rings; pleural fields with 5 pairs of ribs that indicate border by fading away distally. *M.Dev.*, Ger.—FIG. 367,2. **P. plagiophthalmus* (REINH. RICHTER), Tentaculiten-Schiefer, Thuringia; 2a-c, ceph., dorsal, anterior, side, X4 (415).

Reedops RICHTER & RICHTER, 1925 [*pro Reedia* WEDEKIND, 1911 (*non* ASHMEAD, 1904)] [**Phacops bronni* BARRANDE, 1846]. Like *Phacops* but vincular furrow absent in front of cephalon; glabella extremely inflated, in some species protruding forward. *Sil.-U.Dev.*, Eu.-N.Am.—FIG. 365, 6. *R. cephalotes* (HAWLE & CORDA), *M.Dev.*, Czech.; 6a, exoskel., X1; 6b, ceph. from below with hypostoma in place, vincular furrow appear-

ing only below genae and modified into series of pits, X1 (3).

Trimeroccephalus M'COY, 1849 [**Phacops mastophthalmus* REINH. RICHTER, 1856] [= *Eutrimerocephalus* GORTANI, 1907]. Eyes absent; marginal ridge wide, convex; vincular furrow wide, deep; doublure short, flat. Pygidium as in *Cryphops*. *U.Dev.*, Eu.-Anatolia.—FIG. 365,4. **T. mastophthalmus* (REINH. RICHTER), Ger.; 4a,b, ceph., dorsal, side, X3; 4c, pyg., X3 (461).

Subfamily BOULEIINAE Hupé, 1955

Exoskeleton very compact. Glabella highly inflated, 1p to 3p lateral glabellar furrows distinct, 3p glabellar lobes very large, distinct, 2p small, crescentic, 1p united to form an "intercalating ring"; genal angle sharp. Thoracic pleurae with rounded ends. Pygidium rounded, entire. *Dev.*

Bouleia KOZŁOWSKI, 1923 [**Phacops dagincourti* ULRICH, 1892]. Glabella spheroidal, with deep axial furrows, 1*p* to 3*p* lateral glabellar furrows communicating with axial furrows, 3*p* long, straight and simple, 2*p* transverse, short, 1*p* concave forward, 1*p* and 2*p* forming mesially a single large groove; exterior margin with row of pointed teeth directed downward, largest in front. Posterior ends of facial sutures near genal angles. [The opisthoparian appearance of *Bouleia*, in contrast to all other Phacopacea, presumably is caused by secondary addition of a denticulated border to the librigenae. Thus, the posterior sections of the facial sutures are visible from above to their ends, whereas regularly they reach the genal angles only along the margin, being visible only in side view of the cephalon. The posterior ends of the sutures seem actually to have the same position at the true genal angles as in other Phacopina.] *Dev., Bol.*—FIG. 370. **B. dagincourti* (ULRICH); *a*, exoskel., $\times 0.7$; *b,c*, ceph., $\times 0.7$ (474n).

Subfamily PHACOPIDELLINAE Delo, 1935

Exoskeleton depressed, as in Dalmanitidae, in the late genus *Dienstina* somewhat compact. Glabella not inflated, anterior slope gentle; 1*p* lateral glabellar furrows united by shallow depression or separated; "intercalating ring," if developed, not sharply defined from anteromesial part of glabella; doublure flat or gently vaulted, no vincular furrow (except in *Phacopidella* and *Denckmannites*, where it is restricted to posterolateral part, Fig. 369,1*c*,3*c*). Pygidium large. *Sil.-U.Dev.*

Phacopidella REED, 1905 [**Phacops glockeri* BARRANDE, 1846] [= *Glockeria* (*Glockeria*) WEDEKIND, 1911]. Margin of cephalon sharp, upper and lower surfaces meeting at acute angle; 3*p* and 2*p* lateral glabellar lobes coalesced and detached from frontal lobe (as in Phacopinae), 3*p* glabellar furrow being deeper than 2*p* and uniting with dorsal furrow (as in *Dalmanites*); "intercalating ring" tripartite; eyes reniform, relatively large; posterior sections of facial sutures convexly curved on genae; genal angles truncated. Pygidium large, rounded. *Sil., Eu.*—FIG. 369,1. **P. glockeri* (BARRANDE), *e alpha Z.*, Czech.; 1*a,b*, ceph., pyg., $\times 0.9$; 1*c*, subcephalic margin, showing vincular furrows only at lateral extremities, $\times 0.9$ (474n).

Denckmannites WEDEKIND, 1914 [*pro Glockeria* (*Denckmannia*) WEDEKIND, 1911 (*non* BUCKMAN, 1898; *nec* HOLZAPFEL, 1908)] [**Phacops volborthi* BARRANDE, 1852; SD VOGDES, 1925] [= *Volborthia* WEDEKIND, 1911]. Margin of cephalon as in *Phacopidella*; glabellar surface uniform; frontal lobe, 3*p* and 2*p* lateral glabellar lobes coalesced (as in *Phacops*), 3*p* glabellar furrows being not deeper than 2*p* and separated from axial furrows; inter-

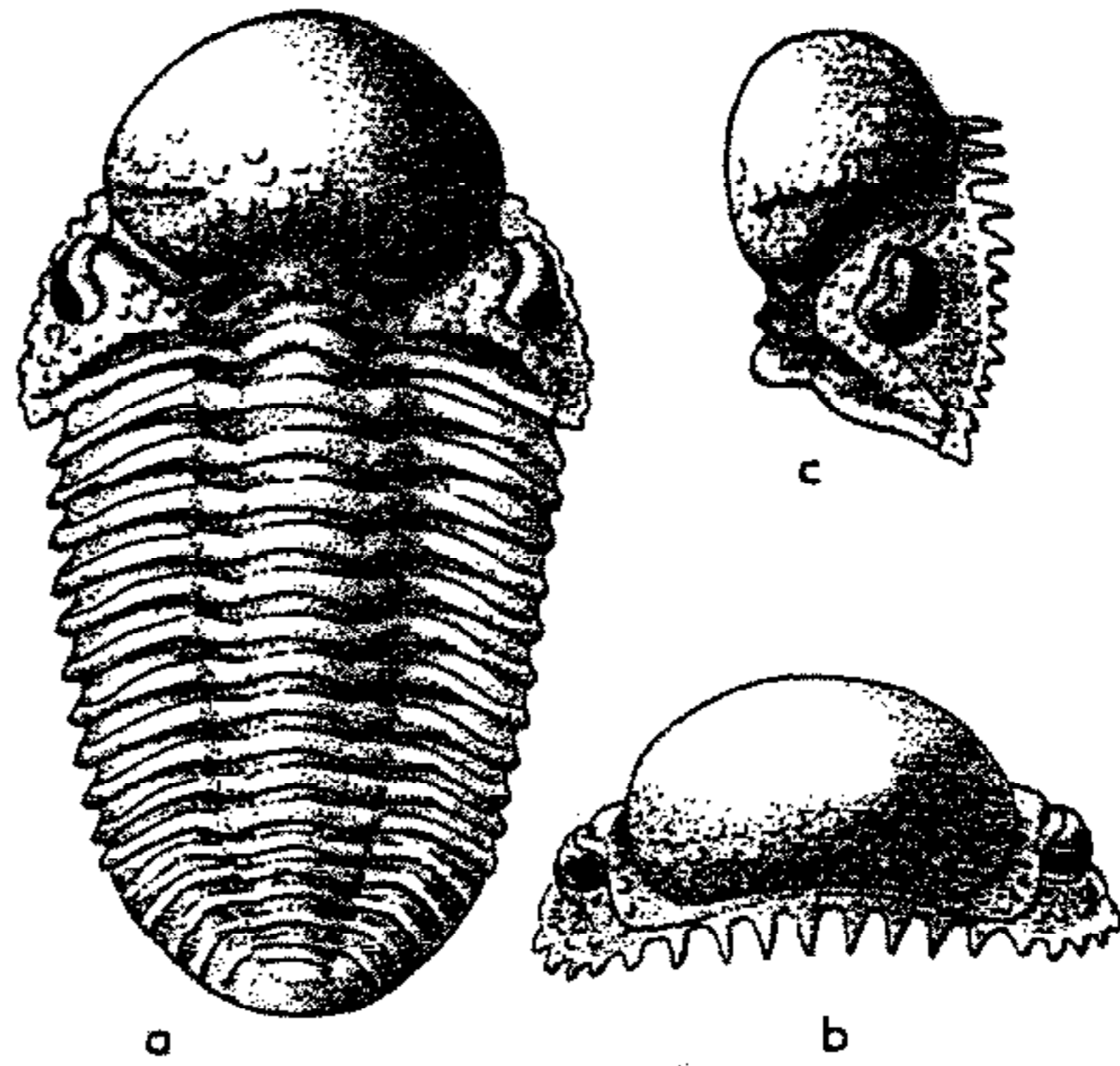

FIG. 370. *Bouleia dagincourti* (ULRICH), *Dev., S. Am.(Bol.)*; *a*, exoskel., $\times 0.7$; *b,c*, ceph., $\times 0.7$ (474n).

calating furrow tripartite; eyes small, with *cryptophthalmus* pattern, few lenses; posterior sections of facial sutures concavely curved on genae; genal angles truncate. Pygidium like that of *Phacopidella*. *Sil.-L.Dev., Eu.-N.Afr.*—FIG. 369,3*a,b*. **D. volborthi* (BARRANDE), *Sil., Czech.*; 3*a,b*, ceph., pyg., $\times 0.7$ (3).—FIG. 369,3*c*. *D. micromma* (A. ROEMER), *M.Dev., Moroc.*; ceph., from below showing vincular furrow developed only laterally, undulated, $\times 0.9$ (474n).

Dienstina RICHTER & RICHTER, 1931 [**Phacopidella diensti* RICHTER & RICHTER, 1923]. Cephalon pentagonal; 2*p* and 3*p* lateral glabellar furrows lacking on surface, 1*p* shallow in median part; "intercalating ring" undivided; eyes reduced to *cryptophthalmus* pattern, palpebral lobes becoming triangular; posterior sections of facial sutures on genae very short, rectilinear; genal angle rounded, not truncate. Pygidium large, vaulted; axis short. *U.Dev., Eu.*—FIG. 369,6. **D. diensti* (RICHTER & RICHTER), *Ger. (Obersheld)*; 6*a-c*, ceph., dorsal, side, front, $\times 2$; 6*d*, pyg., $\times 2$ (461).

Ductina RICHTER & RICHTER, 1931 [**Phacopidella ductifrons* RICHTER & RICHTER, 1923]. Cephalon semicircular, margin evenly rounded; glabella with anterolateral recurved wings, confluent with marginal border, 2*p* and 3*p* lateral glabellar furrows absent on surface, 1*p* disappearing in median part, "intercalating ring" undivided; eyes and palpebral lobes absent; facial sutures restricted entirely to margin (alone among Phacopidae); genal angles rounded, not truncated. Pygidium large, axis narrow, long; axial ridge present. *U.Dev., Eu.*—FIG. 369,2. **D. ductifrons* (RICHTER & RICHTER), *Ger. (Dill Basin)*; 2*a,b*, ceph., dorsal, side; 2*c*, ceph. margin from below, showing

absence of vincular furrow; 2*d*, pyg., all $\times 2.7$ (2*a,b,d*, 461; 2*c*, 474n).

Nephranomma ERBEN, 1952 [*Phacopidella* (*Nephranomma*) *drepanomma*]. Cephalon like that of *Phacopidella*, with large reniform eyes; lateral glabellar furrows indistinct; posterior sections of facial sutures on genae short, concave forward; genal angles not truncated, rounded. *L.Dev.-U.Dev.*, Eu.—FIG. 369,5. **N. drepanomma* (ERBEN), *L.Dev.*, Ger. (Harz); 5*a-c*, ceph., dorsal, side, front, $\times 2.3$; 5*d*, pyg., $\times 4$ (39).

?*Adastocephalum* MITCHELL, 1919 [**A. teleotypicum*]. Cephalon short, broad; axial furrows rectilinear, 2*p* and 3*p* lateral glabellar furrows not discernible; eyes reniform; genal angles rounded. Pygidium unknown. [Cephalic characters doubtful owing to poor preservation.] ?*L.Dev.*, N.S. Wales.—FIG. 369,4. **A. teleotypicum*; ceph., $\times 1.3$ (430).

Subfamily UNCERTAIN

Pterygometopidella WEDEKIND, 1912 [**Phacops quadrilineatus* ANGELIN, 1851]. According to ANGELIN's original description, the type species has bipartite 3*p* lateral glabellar furrows. Therefore the genus seems to be a phacopid. Determination of generic distinctness and family assignment are expected from study of the type species. *Sil.*, Swed. Gotl.).

Superfamily DALMANITACEA Vogdes, 1890

[*nom. transl.* STRUVE, herein (ex Dalmanitidae VOGDES, 1890)]
[=*Phacopidea* RUD. RICHTER, 1933 (*partim*); *Phacopacea* HENNINGSMOEN, 1951 (*partim*); *Phacopoidae* HUPÉ, 1953 (*partim*)]

Generally isopygous. Cephalon commonly with well-developed preglabellar area and distinct glabellar lobation; 3*p* lateral glabellar furrows well developed (except in some Calmoniidae), continuous, subbipartite exceptionally (with both parts of each furrow connected); eyes in mesial or posterior position (except in some Zeliskellinae and Calmoniinae); genal spines generally present; true vincular furrows lacking. *L.Ord.-U.Dev.*

Family DALMANITIDAE Vogdes, 1890

[Because VOGDES (1890, p. 83) included *Phacops* in his Dalmanitidae (together with *Dalmanites*, *Coronura*, *Cryphacops*, and *Charmops*), the family name, when published, was a junior synonym of Phacopidae HAWLE & CORDA, 1847. Exclusion of *Phacops* by REED (1905) places Dalmanitidae in good standing.] [*Authorship.* Except for materials furnished by RUD. RICHTER on the genera *Dalmanites*, *Dalmanina*, *Dalmanitoides*, *Hausmannia*, *Helioccephalus*, *Malladaia*, *Malvernina*, *Odontochile*, *Eudolatites*, *Ormathops*, *Zeliskella*, *Acastava*, *Acastella*, and *Acastellina*, all of the organization and content of information on this family is contributed by W. STRUVE.]

Exoskeleton flat to moderately vaulted. Segmentation of glabella scarcely modified

as far as proportions of lobes are concerned, no hypertrophy of anterior glabellar lobes (frontal, 3*p*, 2*p*), 1*p* lobes tending to be narrow but invariably present; 3*p* lateral glabellar furrows very distinct in almost all genera, 2*p* reduced abaxially in some, 1*p* furrows deepest; eyes generally large, posterior in position; genae most commonly produced into genal spines with outer edge forming straight continuation of lateral cephalic margins but may have shape of lappets; posterior sections of facial sutures form genal sulcus in many genera; no vincular furrow. *Low.M.Ord.-U.Dev.*

Subfamily DALMANITINAE Vogdes, 1890

[Includes Coronurinae PILLET, 1954; Synphoriinae DELO, 1935 (*nom. correct.* DELO, 1940, *pro* Synphoriinae DELO, 1935, =Neosynphoriinae HUPÉ, 1955, *nom. subst. pro* Synphoriinae DELO, 1935)]

Cephalon gently to moderately vaulted, border visible from above in front of glabella, distinct also anterolaterally in most genera, tending to develop processes; frontal lobe of glabella may be gently inflated, slightly above level of central area and with varying distinctness detached from it; longitudinal glabellar furrows generally present, 3*p* lateral furrows well developed but 2*p* (and exceptionally 1*p*) may retreat from axial furrows; eyes moderately to very large, located near glabella and posterior border furrows in most genera; subocular grooves present; posterior sections of facial sutures in shallow to very deep genal sulci; genal angles produced as lappets or forming short to very long spines. Hypostoma elongate, narrowing backward, each lateral margin with 1 to 3 denticles, 1 posterior denticle. Pygidium generally large, with 8 to 22 rings and 7 to 15 pairs of ribs (exceptionally 6 or as many as 20); posterior and anterior pleural bands of pleural fields subequal, tending to fuse (especially adaxially), pleural furrows deep; posterior processes present in several genera. *Sil.-M.Dev.*

Dalmanites BARRANDE, 1852 [**Trilobus caudatus* BRÜNNICU, 1781; SD BARRANDE, 1852] [*pro Dalmanina* EMMRICH, 1844 (*non* ROBINEAU-DESVOIDY, 1830); *Dalmania* BARRANDE, 1852 (*nom. van.*); *Hausmannia* HALL & CLARKE, 1888]. Cephalon with broad flat frontal margin visible from above. Hypostoma long, with long central body, lateral margins converging, each with denticle, posteriorly a broad border without denticles but prolonged into flat tongue. Pygidium long; with slender axis showing 11 to 16 rings; pleural fields with 6 or 7

pairs of ribs; doublure narrow. *Sil.-L.Dev.*, Eu.-N.Am.-S.Am.-?Austral.—FIG. 371,1a. **D. caudatus* (BRÜNNICH), Eng.; exoskel., $\times 0.7$ (267, 434).—FIG. 371,1b. *D. vulgaris* SALTER, Eng.; hypostoma, $\times 1$ (267).

Anchiopella REED¹, 1907 [*Calymene anchiops*

¹ REED (1907, p. 169) referred several South African species (including *crisagalli*) "to a special subgroup of *D. anchiops*." RICHTER & RICHTER (1942, p. 174) interpreted this as an original designation of the type species of *Anchiopella*. RENNIE (1930, p. 332-334) tended to the same opinion but was less sure. REED (1925, p. 75) definitely named for the "subgenus *Anchiopella*. . . the type species *Dalmanites anchiops*," which can be interpreted as mere confirmation of an original designation. In contradiction, REED (1927, p. 310) stated that the "type which was chosen

for this special group and exemplified by *Dalmanites anchiops* GREEN was *Ph. crisagalli* (WOODW.)." This subsequent change of the type species is inadmissible under the Rules. KOZŁOWSKI (1923, p. 32) named "*An. tumiloba* CLARKE" as "representative species" of *Anchiopella*, but this cannot be interpreted as a valid subsequent designation of the type species, since *A. tumiloba* was not included in the original description of the genus by REED.

In publishing the name *Anchiopsis* (based on *Calymene anchiops* GREEN as type species), DELO (1935) was misled by REED's (1927) incorrect designation of the type species of *Anchiopella*, as *Phacops crisagalli* WOODWARD. A genus founded on WOODWARD's species is *Bainella* RENNIE, 1930. It is noteworthy that DELO (1935, p. 409) does not record *Anchiopella* (*sensu* DELO, = *Bainella*) from North America (where *A. anchiops* is found) but from South Africa and South America and he ascribes to this genus mesial axial spines on the thorax, which are lacking in true *Anchiopella*. Thus DELO actually was dealing with 2 genera belonging to different families.

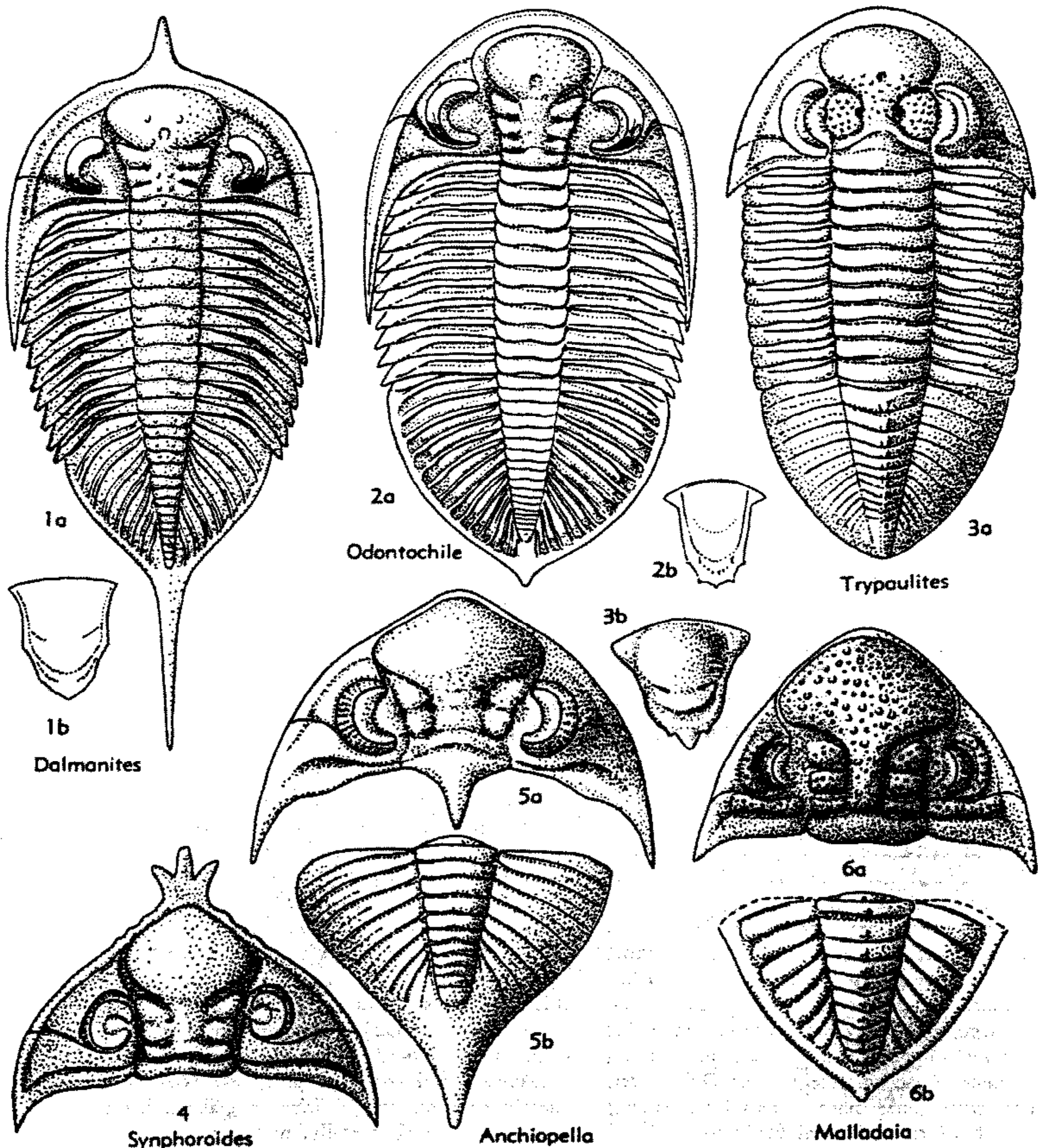

FIG. 371. Dalmanitidae (Dalmanitinae) (p. 0468-0472).

GREEN, 1832] [= *Anchiopsis* DELO, 1935 (obj.)]. Cephalon wide; axial furrows moderately deep; frontal lobe of glabella may reach anterior margin, slightly detached posteriorly; 2*p* and 3*p* lateral glabellar lobes fused more or less completely; 3*p* lateral glabellar furrows moderately deep, 2*p* and 1*p* with adaxial pits, shallow, but tending to be connected by transglabellar furrows, longitudinal glabellar furrows distinct; median occipital spine present; eyes small to rather large, close to posterior border furrows; genal spines present. Pygidium triangular, with long posterior process; axis short, ending bluntly, with less than 15 rings (typically 8); pleural fields with 7 to 10 pairs of ribs, interpleural furrows visible only distally; long posterior process. *L.Dev.-M.Dev.*, N.Am.—FIG. 371,5. **A. anchiops* (GREEN), *L.Dev.* (Schoharie F.), N.Y.; 5*a,b*, ceph., pyg., $\times 1$ (404).

CORONATA HALL & CLARKE, 1888 [**Asaphus aspectans* CONRAD, 1841; SD VOGDES, 1893]. Exoskeleton large. Cephalon (incompletely known) wide, with granulose surface, border entire, broad; axial furrows deep; frontal lobe of glabella large, subpentangular, broadly rounded anteriorly, not detached posteriorly, 2*p* and 3*p* lateral glabellar lobes detached from central area by moderately distinct longitudinal furrows, 3*p* lateral glabellar furrows distinct, moderately oblique, 2*p* furrows shallow, with deep adaxial pits; eyes very high; posterior sections of facial sutures in deep genal sulci; genal spines present. Pygidium large, with long slender axis bearing 15 to 20 rings; pleural fields with 15 to 20 pairs of ribs; border with numerous (?anterior) pleural spines, of which the last pair is pronounced, bifid or trifid, and generally separated from each other by a broad straight margin behind pygidial axis. Surface of thorax and pygidium with scattered tubercles. *Up. L.Dev.*, N.Am.-S.Am.?(Colom.)-N.Afr.—FIG. 372,1. **C. aspectans* (CONRAD), Columbus Ls., Ohio; 1*a*, ceph., $\times 0.7$ (476); 1*b*, pyg., $\times 0.7$ (404).

CORYCEPHALUS HALL & CLARKE, 1888 [**Dalmanites regalis* HALL, 1876; SD VOGDES, 1925]. Cephalon strongly vaulted, with border bearing pointed or spatulate denticles, axial furrows curving outward at somewhat hypertrophic 3*p* lateral glabellar lobes; frontal glabellar lobe steeply sloping or vertical anteriorly and anterolaterally, slightly detached from central area; other glabellar lobes separated from central area by moderately distinct longitudinal furrows; 1*p* to 3*p* lateral glabellar furrows more or less distinct, with deep adaxial pits; eyes large, highly elevated; posterior sections of facial sutures in deep genal sulci; long genal spines present. Pygidium like that of *Dalmanites*, triangular, with entire margin; axis long, ending bluntly, with 14 rings; pleural fields with 8 or 9 pairs of ribs; long posterior process. Surface of exoskeleton with scattered tubercles. *L.Dev.*, N. Am.—FIG. 372,3*a,b*. **C. regalis* (HALL), *Up.L.*

Dev., N.Y.; ceph., $\times 0.7$ (404).—FIG. 372,3*c*. *C. dentatus* (BARRETT), *L.Dev.*, N.Y.; pyg., $\times 1.3$ (404).

DALMANITOIDES DELO, 1935 [**Dalmanites drevermanni* IVOR THOMAS, 1906]. Cephalon with 5 very short frontal processes; frontal lobe of glabella slightly detached from central area, 1*p* to 3*p* lateral glabellar furrows well marked, short, connected by indistinct transglabellar furrows, longitudinal glabellar furrows well developed; genal spines present. Pygidium elongate, subtriangular, with slender axis reaching posterior end, bearing 18 rings; pleural fields with 14 pairs of ribs. Surface of thorax and pygidium with scattered tubercles. *L.Dev.-M.Dev.*, S.Am.(Arg.).—FIG. 372,4. **D. drevermanni* (I. THOMAS); 4*a,b*, ceph., pyg., $\times 0.7$ (482, 1906).

HELIOCEPHALUS DELO, 1936 [*pro Malvernina* DELO, 1935 (non JACOBY, 1889)] [**Phacops* (*Dalmania*) *coronatus* H. H. THOMAS, 1900 (non *Dalmania coronata* HALL, 1861, = *Odontocephalus*)]. Exoskeleton small. Cephalon with border bearing series of short wide-spaced sharp spines; glabellar lobes detached from central area by longitudinal furrows; long genal spines present. Pygidium relatively narrow and short, but with about 12 rings and 12 pairs of ribs; border broad; posterior process present. [According to Rules, type species of this genus does not call for renaming because it is not considered homonymous with HALL's species.] *M.Sil.*, Eu.—FIG. 373,2. **H. coronatus* (H. H. THOMAS) Wenlock., Eng.; exoskel., $\times 4$ (481).

MALLADAIA OEHLERT, 1896 [**Cryphaeus* (*Malladaia*) *luciae*]. Cephalon subtriangular, with narrow anterior border; axial furrows straight and barely diverging opposite 1*p* to 3*p* lateral glabellar lobes but strongly curved outward around laterally protruding frontal lobe of glabella, which is fused with central area, latter being sharply separated from 1*p* to 3*p* lateral glabellar lobes by deep longitudinal furrows; lateral glabellar furrows deep, not in center of genal areas; posterior sections of facial sutures in deep sulci; genal spines short. Pygidium triangular, with short terminal spine; axis rather broad, ending bluntly, with 11 rings; pleural fields with 6 or 7 pairs of nearly unfurrowed ribs that end abruptly along flat border; lateral margins with faint pleural undulations showing tendency to develop denticles. *L.Dev.*, Sp.—FIG. 371,6. **M. luciae* (OEHLERT); 6*a,b*, ceph., pyg., $\times 1.5$ (438).

ODONTOCEPHALUS CONRAD, 1840 [**Asaphus selenourus* EATON, 1832]. Cephalon ogival in outline, with anterior border bearing a series of distally broadened and coalesced processes; axial furrows nearly straight; frontal lobe of glabella inappreciably protruding laterally, more or less coalesced with central area, 2*p* and 3*p* lateral glabellar lobes detached from central area by generally distinct longitudinal furrows that may reach occipital

furrow; 2*p* lateral glabellar furrows may be reduced distally, adaxial pits in 1*p* and 2*p* furrows; genal spines or lappets present. Pygidium ogival in form, generally small as compared with *Coronura*, with entire margin except for pair of pointed or blunt spines at posterior end; axis moderately broad, with about 7 to 10 rings; pleural

fields with 7 to 10 pairs of distinct ribs (but 18 rings and 13 ribs in *O. magnus* STUMM). *Up.L. Dev.*, N.Am. — FIG. 374. **O. selenourus* (EATON), Onondaga Ls., N.Y.; *a, b*, ceph., pyg., ×1 (404).

Odontochile HAWLE & CORDA, 1847 [**Asaphus hausmanni* BRONGNIART, 1822; SD TRIPP & WHIT-

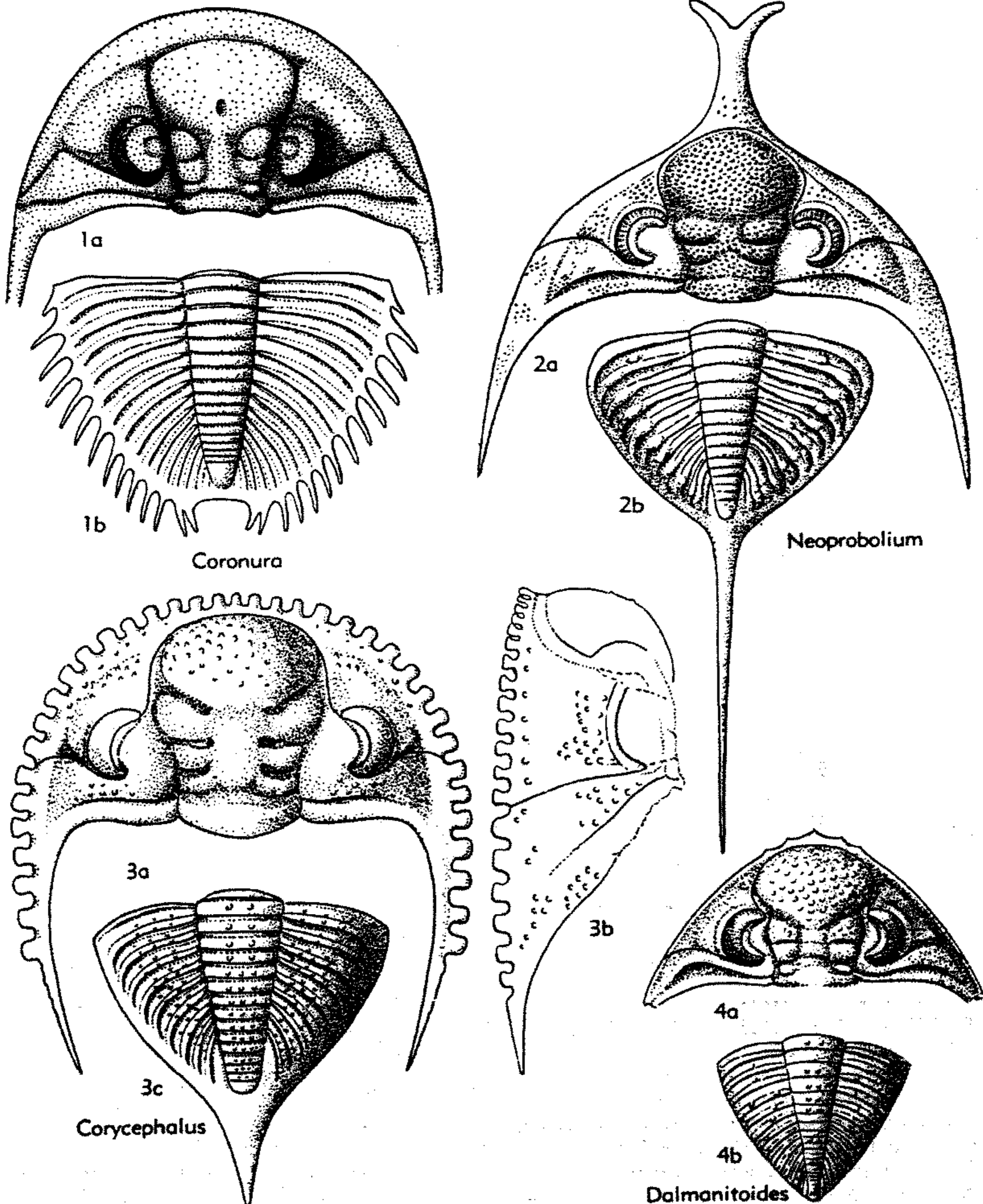

FIG. 372. Dalmanitidae (Dalmanitinae) (p. 0470-0472).

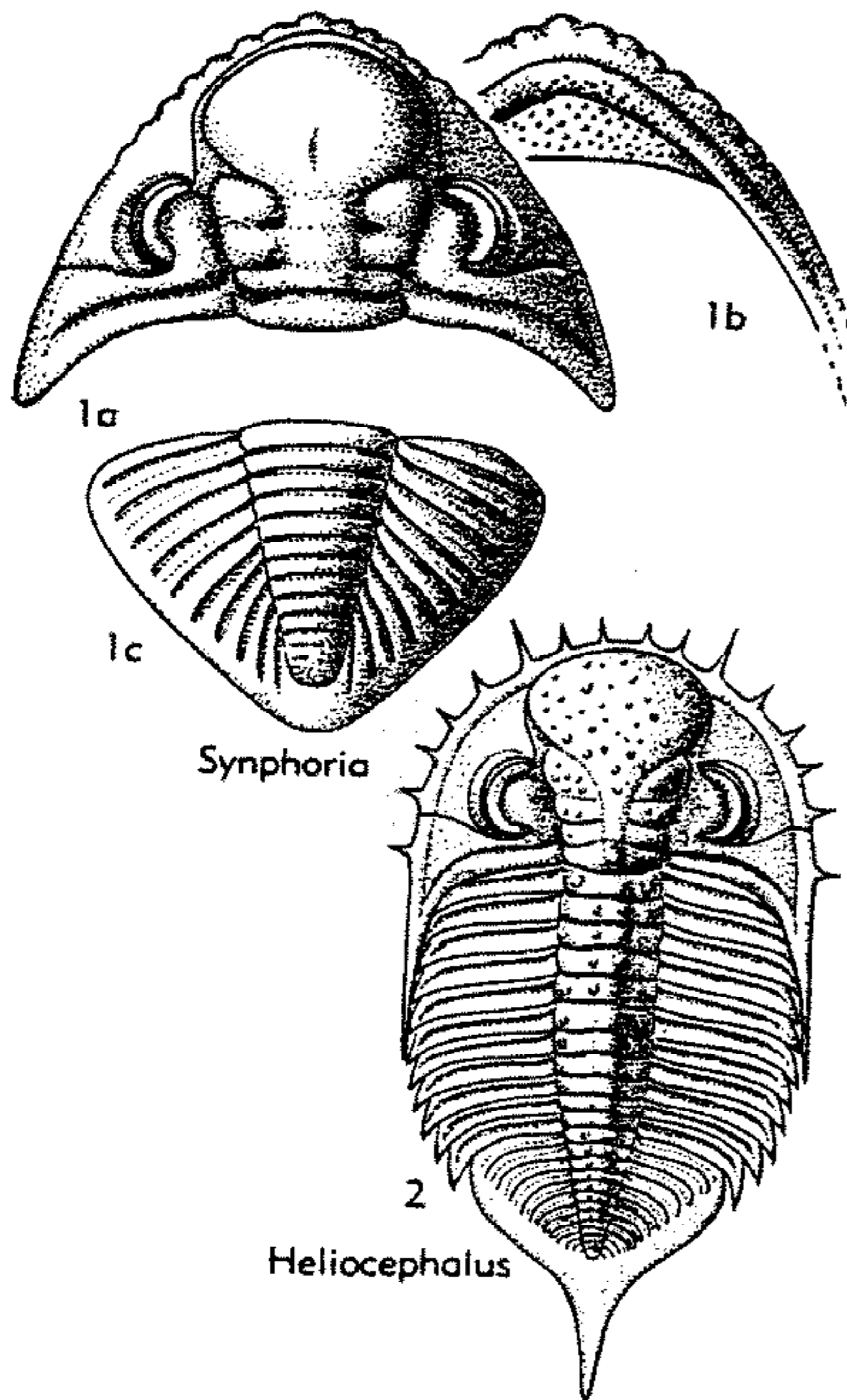

FIG. 373. Dalmanitidae (Dalmanitinae) (p. 0470-0472).

TARD, 1956 (ICZN pend.)). Cephalon resembling that of *Dalmanites*, but anterior sections of facial sutures distant from glabellar frontal lobe. Hypostoma with 5 to 7 denticles along posterior edge. Pygidium very long, with 16 to 22 rings and 12 to 15 pairs of ribs; doublure broad. *L.Dev.-M.Dev.*, Eu.-N.Am.-S.Am.-Austral. — FIG. 371,2. **O. hausmanni* (BRONGNIART), *M.Dev.*, Czech.; 2a,b, exoskel., hypostoma, $\times 1$ (3).

Neoprobolium STRUVE, 1958 [*pro Probolium* OEH-LERT, 1889 (non COSTA, 1853)] [**Asaphus nasutus* CONRAD, 1841]. Cephalon like that of *Synphoroides*, glabellar lobe may be detached posteriorly; *1p* to *3p* lateral glabellar furrows distinct, *1p* furrows being connected in some species by transglabellar furrows, longitudinal furrows more or less developed; long genal spines present. Pygidium with slender axis bearing 10 to 14 rings; pleural fields with 7 to 11 pairs of ribs; long posterior spine present. *L.Dev.*, N.Am.-Fr. — FIG. 372,2. **N. nasutum* (CONRAD), L. Helderberg. (New Scotland Ls.), N.Y.; 2a,b, ceph., pyg., $\times 0.7$ (403).

Synphoria CLARKE¹, 1900 [**Dalmanites* (*Synphoria*) *stemmatum* CLARKE, 1900; SD VOGDES, 1925] [= *Eocorycephalus* REED, 1925 (obj.); *Neosynphoria* PILLET, 1954 (obj.)]. Cephalon resembling that of *Dalmanitoides*; anterior and anterolateral margins entire or crenulate; frontal glabellar lobe and *1p* to *3p* lateral lobes detached from central area by shallow furrows, *2p* and *3p* lobes fused abaxially; *1p* and *3p* lateral glabellar furrows distinct, *2p* reduced abaxially, *1p* and *2p* being faintly transglabellar in some and bearing deep adaxial pits; genal lappets or short spines present. Pygidium subtriangular with rather broad axis bearing 10 to 15 rings; pleural fields with about 9 pairs of ribs; posterior spine may be present. *L.Dev.*, N.Am.-S.Am. — FIG. 373,1. **S. stemmata* (CLARKE), Bercraft Ls., N.Y.; 1a,b, ceph., dorsal and ventral; 1c, pyg.; all $\times 0.7$ (23).

Synphoroides DELO, 1940 [**Dalmanites* (*Probolium*) *biardi* CLARKE, 1907]. Cephalon closely resembling that of *Synphoria* and *Neoprobolium*; crenulated anterior margin produced in a short (bifid or trifid) frontal process; frontal glabellar lobe more or less detached from central area; *1p* and *2p* furrows with adaxial pits connected in some species by transglabellar furrows, longitudinal furrows fairly distinct; short to long genal spines present. Pygidium subtriangular; with rather slender axis that may reach posterior margin, with 12 to 18 rings; pleural fields with 9 to 16 pairs of ribs; pointed posterior lappet may be present. *L.Dev.*, N.Am. — FIG. 371,4. **S. biardi* (CLARKE), Can.(E.Que.); ceph., $\times 0.7$ (386).

Trypaulites DELO, 1935 [**Dalmania calypso* HALL, 1861]. Cephalon semicircular, with rather broad, entire border; frontal glabellar lobe tending to be detached from central area, elliptical to sub-circular bicomposite lobes (*2p*+*3p*) high abaxially,

¹ *Synphoria* was introduced by CLARKE (1897, p. 733) as name for a group of subgenera classed as belonging to *Dalmanites*. Because employed for an unrecognized taxonomic category intermediate between genus and subgenus, the term had no nomenclatorial status at the time of original publication but remained available for use by any author who recognized *Synphoria* in a generic or subgeneric sense. In the opinion of DELO (1940, p. 65) this author was CLARKE (1900, p. 19) when he wrote "it is very probable that the term *Synphoria*. . . may prove of subgeneric importance." Later, CLARKE (1913, p. 148) used *Synphoria* as a "synthetic term," without thereby affecting nomenclature, because a valid name does not become invalid when it is not used for taxonomic reasons. *Synphoria* was published again and again as a generic or subgeneric name, and VOGDES (1925, p. 113) subsequently designated *S. stemmatum* as "genotype" of *Dalmanites* (*Synphoria*). REED (1927, p. 352) named *Synphoria* in a list of subgenera of *Dalmanites* but DELO (1935, p. 412; 1940, p. 6, 64) treated it as a genus, assigning authorship to CLARKE, 1900. Contrary to the opinion of RICHTER & RICHTER (1942, p. 175), the name *Synphoria* evidently is valid in nomenclature. The only question concerns authorship and year of original publication. Application of the Rules indicates CLARKE, 1900.

Eocorycephalus REED, 1925, is a junior objective synonym by reason of the subsequent designation (RENNIE, 1930, p. 334) of *S. stemmatum* as type species. The substitute name *Neosynphoria* PILLET, 1954, introduced because of reasoning advanced by RICHTER & RICHTER (1942) is also a junior objective synonym of *Synphoria*.

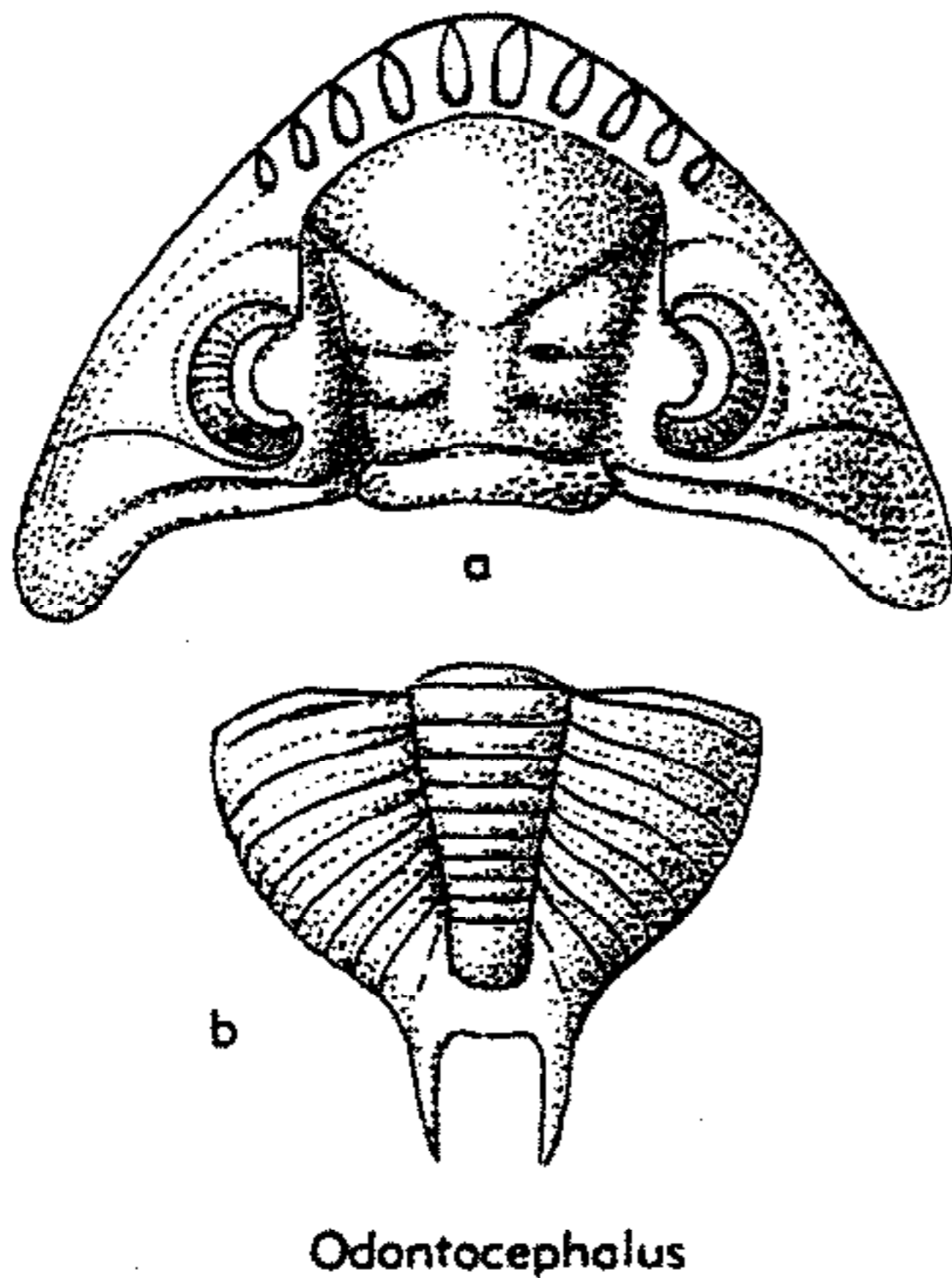

Odontocephalus

FIG. 374. **Odontocephalus selenourus* (EATON), (Dalmanitidae), L.Dev. (Onondaga Ls.), N.Y.; a, b, cephal., pyg., $\times 1$ (404).

1p lobes very narrow, obsolescent; longitudinal glabellar furrows continuous with *1p* and *3p* furrows but *2p* reduced to deep adaxial pits, *1p* also with adaxial pits in some forms; eyes large to very large, high, close to glabella; short genal spines present. Thorax with very broad axis and subangular ends of pleurae. Pygidium with rather broad axis reaching posterior margin, 12 to 15 distinct rings; pleural fields with about 12 pairs of flat, broad ribs; no posterior spine. [Resemblance of *Trypaulites* to genera of the Monorakidae seems due to convergence.] *Up.L.Dev.*, N.Am.—FIG. 371,3. **T. calypso* (HALL), Onondaga Ls., Ohio; 3a, b, exöskel., hypostoma, $\times 1$ (404).

Subfamily ZELISZKELLINAE Delo, 1935

Cephalon with margin entire; axial furrows in most genera more or less parallel adjacent to *1p* and *2p* lateral glabellar lobes, rather divergent bordering *3p* glabellar lobes and frontal lobe, glabella thus club-shaped; segmentation of glabella scarcely modified, lateral glabellar furrows more or less curved, *1p* and *2p* furrows converging outward, *1p* furrows adaxially bifurcated more or less; eyes generally small, distant or far distant from posterior border furrows. Hypostoma rather short, with narrow border, and commonly without marginal denticles. *Low.M.Ord.-U.Ord.*, ?*M.Sil.*

In the new arrangement of dalmanitid genera the Zeliszkellinae include rather dif-

ferent forms, which, however, are allied especially by peculiar segmentation of the glabella and simple shape of the hypostoma. The subfamily may be divided into 2 groups that may themselves represent taxa of subfamily rank, but here they are not given more than informal status as assemblages.

ZELISZKELLA Group

Exoskeleton small. Cephalon with entire margin; border more or less distinct laterally and visible from above in front of glabella; eyes reaching close to anterolateral border furrows; no genal sulci on posterior sections of facial sutures; genal angles rounded, lacking spines. Pygidium distinctly smaller than cephalon, rather vaulted, subtriangular, consisting of few segments; no posterior spines. *M.Ord.*

The *Zeliszkella* probably is a somewhat specialized offshoot of the early dalmanitids that became extinct soon after its appearance.

Zeliszkella DELO, 1935 [**Phacops deshayesi* BARRANDE, 1846]. Cephalon with rather narrow frontal area, anterior sections of facial sutures close to frontal lobe anteriorly; eyes large, reaching far backward. Posterior thoracic pleurae curving progressively backward, their pointed ends longer than those of anterior pleurae. Pygidium elongate subtriangular with about 10 rings; pleural fields with 3 or 4 ribs. *M.Ord.*, Czech.

Z. (*Zeliszkella*). Cephalon with relatively wide axial furrows; *3p* lateral glabellar lobes notably below level of vaulted to somewhat inflated frontal glabellar lobe; occipital lobe prominent; palpebral lobes and furrows well developed, summit of palpebral lobes in or above level of palpebral region of fixigenae. *M.Ord.*, Czech.—FIG. 375,1. *Z. (*Z.*) *deshayesi* (BARRANDE); exöskel., $\times 1$ (3).

Z. (*Mytocephala*) STRUVE, 1958 [**Dalmanites oriens mytoensis* KLOUČEK, 1916]. Cephalon with distinct but very narrow axial and lateral glabellar furrows; anterior slope of glabella formed by entire scarcely vaulted frontal lobe, as well as by essential to prevailing parts of *3p* lateral glabellar lobes; central part of cephalon flattened or level; occipital lobe scarcely elevated; palpebral lobe missing or almost inappreciable, upper margins of visual areas distinctly below level of palpebral region of fixigenae. *M.Ord.*, Czech.

Ormathops DELO, 1935 [**Dalmanites atavus* BARRANDE, 1872]. Cephalon with broad frontal border, facial sutures in front distant from glabella; laterally with shallow vincular furrow; eyes small, in anterolateral corner of genae. Lateral margins of hypostoma re-entering at half length. Pygid-

ium subtriangular, with about 10 rings and 5 pairs of ribs. *M.Ord.*, Eu.—FIG. 375,5. **O. atavus* (BARRANDE), Czech.; 5a,b, exoskel., hypostoma, X1 (4).

sulci visible or missing; short to moderately long genal spines. Pygidium subcircular to ogival in outline, generally with more numerous segments than in *Zeliszella* group. *M.Ord.-L.Sil.*, ?*M.Sil.*

DALMANITINA Group

Cephalon with distinct border and border furrows, but narrow or missing in front of glabella, which mostly is club-shaped; genal

The *Dalmanitina* group shows distinct resemblance to the Dalmanitinae in outline and increasing number of segments of the

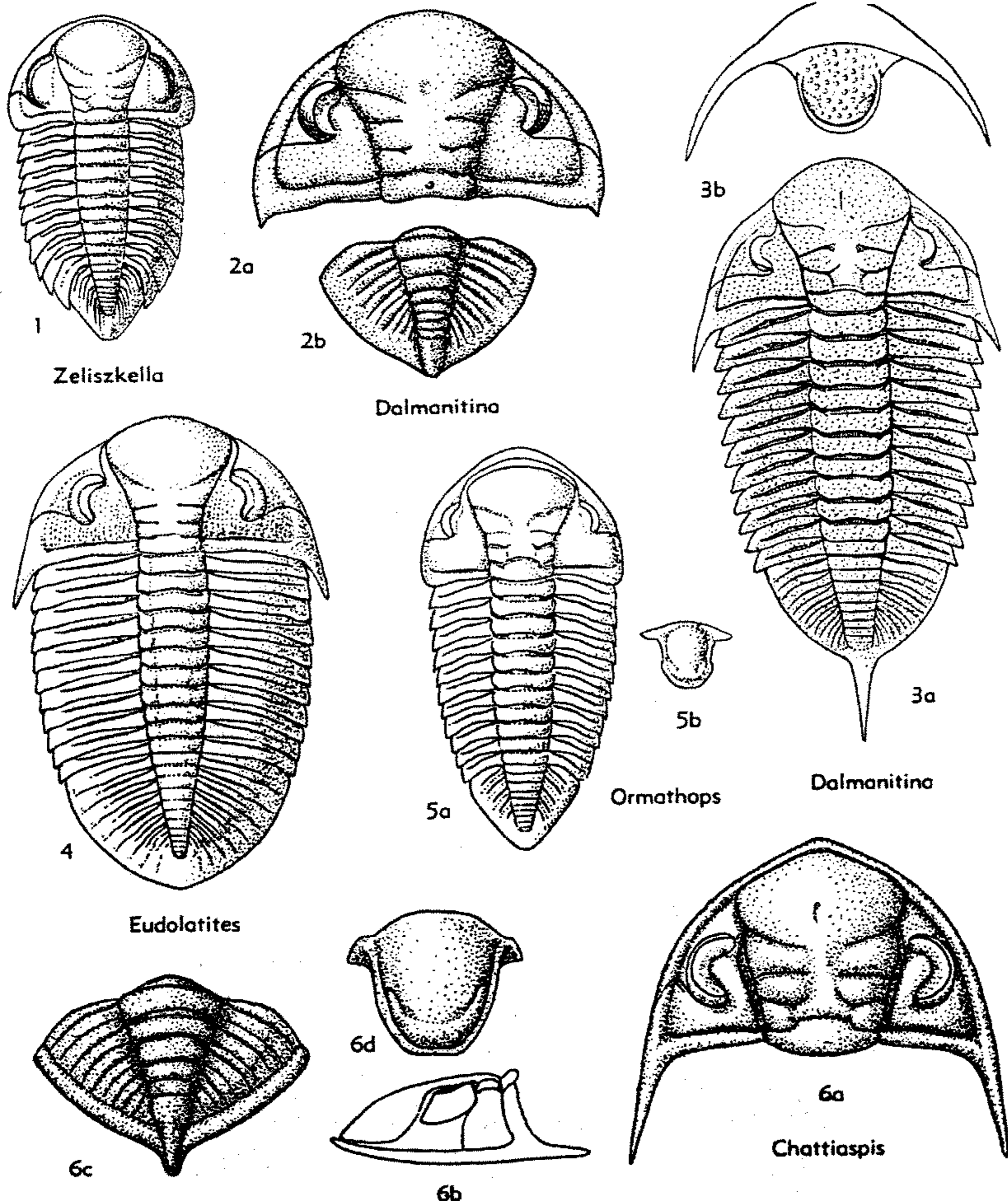

FIG. 375. Dalmanitidae (Zeliszellinae) (p. 0473-0475).

pygidium but is distinguished by segmentation of the glabella and shape of the hypostoma. Additional differences seen in typical representatives of the *Dalmanitina* group are the suppressed frontal border, club-shaped glabella, faint or missing genal sulcus, and size and position of the eyes. With little doubt, the Dalmanitinae are descendants of the *Dalmanitina* group of the Zelisz-kellinae.

Dalmanitina REED, 1905 [**Phacops socialis* BARRANDE, 1846]. Cephalon with 3*p* lateral glabellar furrows slightly to moderately oblique, 1*p* and 2*p* furrows distinctly converging outward, adaxial bifurcation of 1*p* furrows generally distinct; genal spines very short to about 0.5 of glabellar length. Pygidium ogival, in some attaining considerable length; axis rather broad, with postaxial ridge, posterior spine generally present. *M.Ord.-U.Ord.*, ?*M.Sil.*, Eu.-N.Afr.-N.Am.-E.Asia.

D. (*Dalmanitina*). Exoskeleton tending to considerable elongation. Cephalon with anterior border more or less completely suppressed; glabella club-shaped; eyes small, far removed from posterior border furrows. Hypostoma with lateral margins slightly convergent backward, posterior margin broadly rounded. Pygidium with 8 to 14 rings and 7 or 8 (exceptionally 5) pairs of ribs. *M.Ord.-U.Ord.*, ?*M.Sil.*, Eu.-?N.Am.-?E.Asia. —FIG. 375,3. **D. (D.) socialis* (BARRANDE), Czech.; 3*a,b*, exoskel., ceph. and hypostoma from below, $\times 1$ (3). —FIG. 375,2. *D. (D.) morrisiana* (BARRANDE), Czech.; 2*a*, ceph., $\times 2$; 2*b*, pyg., $\times 1.3$ (3).

D. (*Chattiaspis*) STRUVE, 1958 [**Dalmanitina kegeli* RICHTER & RICHTER, 1927]. Outline of cephalon subpentangular, with anterior border well developed; axial furrows nearly straight, moderately divergent, somewhat re-entrant at 3*p* lateral glabellar furrows; glabella expanding forward but not distinctly swollen in front, 2*p* furrows almost transverse, curving slightly backward abaxially, 2*p* lobes narrowing sideward, shallow longitudinal furrows present; eyes somewhat less than 0.5 of glabellar length (*exsag.*), closer to posterior border furrows than in *D. (Dalmanitina)*; long genal spines in straight continuation of lateral cephalic margins. Hypostoma with sides distinctly converging. Pygidium transversely elongate ogival; with 8 or 9 rings and 4 or 5 pairs of ribs; border distinct; posterior spine present. *Ord.*, Ger. —FIG. 375,6. **D. (C.) kegeli* RICHTER & RICHTER, Kleinlinden; 6*a-d*, ceph., pyg., hypostoma, $\times 3$ (461 mod.).

Eudolatites DELO, 1935 [**Dalmanites angelini* BARRANDE, 1852]. Glabella with frontal lobe scarcely detached from central area; all glabellar furrows distinct, 3*p* lateral furrows somewhat widened (*exsag.*), abaxially, 1*p* and 2*p*, furrows slightly

converging or transverse; genal spines present. Pygidium nearly as large as cephalon; slender axis with 11 to 15 rings and 8 to 13 pairs of ribs, without posterior spine. [Pygidial features of this genus are closer to Dalmanitinae than those of *Dalmanitina*, which it resembles closely in cephalic features. Nature of the hypostoma, now unknown, may have considerable taxonomic importance.] *M.Ord.-U.Ord.*, ?*M.Sil.*, Eu.-?E.Asia. —FIG. 375,4. **E. angelini* (BARRANDE), *Ord.*, Czech.; exoskel., $\times 2.5$ (3).

Subfamily ACASTAVINAE Struve, 1958

Cephalon similar to that of Asteropyginae (*Dalmanitidae*), outline typically ogival to pentangular; axial furrows moderately diverging; lateral glabellar furrows distinct in most species, 2*p* and 3*p* obsolescent exceptionally, 2*p* straight, transverse or slightly oblique in posterolateral direction, exceptionally a little oblique in anterolateral direction, and more or less reduced abaxially; longitudinal furrows may be developed; eyes attaining considerable size, rather close to posterior border furrows and glabella; genal angles produced into angular lappets or short spines that lie in straight continuation of lateral margins. Pygidium composed of few segments (5 or fewer pairs of ribs); axis broad; with tendency to develop protrusions of soft body inside of doublure (indicated only on internal mold) as pleural marginal indentations or minute lappets; small posterior spine may be present. *U.Sil.-L.Dev.*

The Acastavinae include such genera of the "Acastinae" (in the hitherto usual arrangement as Phacopidae) that show a distinct Asteropyginae trend. Several cephalic features may come close to those of Acastinae (restricted) but on the whole display more similarity to Dalmanitinae and Asteropyginae, especially in having genal spines of the same shape as in these subfamilies and generally quite different from those in the Calmoniidae. Of genera included in the Acastavinae, *Acastellina* is most similar to Acastinae.

Acastava RICHTER & RICHTER, 1954 [**Cryphaeus atavus* W. E. SCHMIDT, 1907]. Cephalon similar to that of *Asteropyge*, frontal border having a sharp margin; 2*p* lateral glabellar lobes narrow (*sag.*), 3*p* broader; "intercalating ring" narrow; genal spines present. Pygidium with entire margin on exterior surface but on internal molds showing tendency to develop 5 lateral denticles,

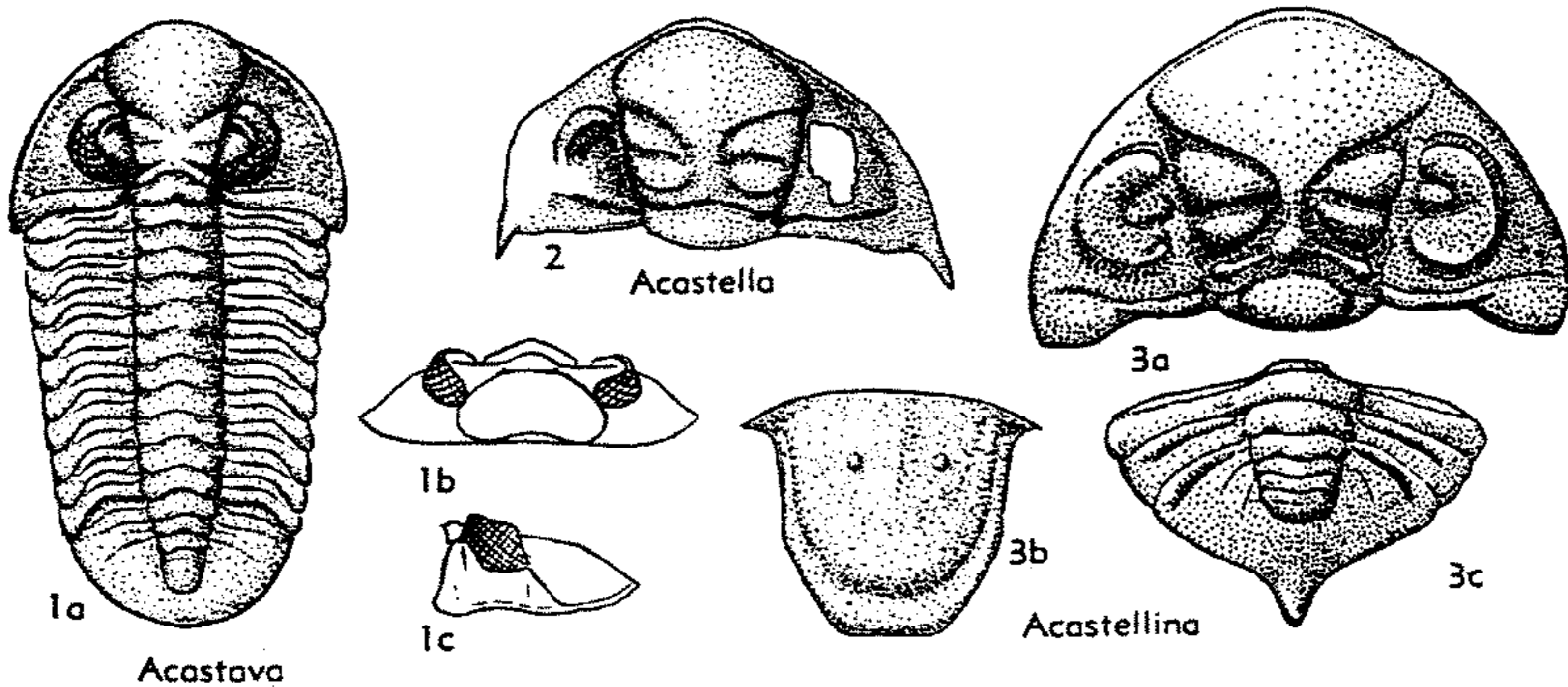

FIG. 376. Dalmanitidae (Acastavinae) (p. 0475-0476).

2 posterior not always distinct, margin between 5th denticles broad, entire. *L.Dev.*, Eu.—FIG. 377,1. **A. atavus* (W. E. SCHMIDT), Siegenian, Ger.; 1a, ceph., $\times 4$ (469, 1907); 1b, pyg., $\times 2.8$ (255).—FIG. 376,1. *A. schmidti* (RUD RICHTER), Emsian, Ger.; 1a, exoskel., $\times 2$; 1b,c, ceph., $\times 2$ (460, 1916).

Acastella REED, 1925 [**Acaste downingiae spinosa* SALTER, 1864]. Cephalic frontal margin visible from above, pointed; axial furrows only slightly diverging; 3p lateral glabellar furrows directed backward, 1p and 2p deep, transverse, 1p not continuous, curved backward, with inner ends bending forward; eyes large; genal angles with spines. Hypostoma with maculae near margin. Pygidium broadly triangular, with terminal spine, about 7 axial rings and 4 ribs; margin tending to develop interior denticles. *U.Sil.-L.Dev.*, Eu.—FIG. 376,2. **A. spinosa* (SALTER), *Sil.(U. Ludlow)*, Eng.; ceph., $\times 2$ (255).—FIG. 377,2. *A. tiro* RICHTER & RICHTER, *L.Dev.*, Ger.(Ebbe); 2a,b, ceph., pyg., internal molds showing inner denticulations on pygidium, $\times 4.3$ (255).

Acastellina RICHTER & RICHTER, 1954 [**Acaste (Acastella) nolens* RICHTER & RICHTER, 1952]. Exoskeleton minute. Cephalon with axial furrows divergent (about 35°); lateral glabellar lobes swollen, 3p much broader and higher than 2p, "intercalating ring" inflated in median part as node; all glabellar furrows uniting near sagittal line; eyes very long; palpebral regions of fixigenae nodelike, visual areas low; genal angles acute but without spines. Hypostoma broad, with small maculae near sagittal line. Pygidium pointed, tending to develop a terminal spine; axis relatively short, posteriorly truncated, with 5 rings (1 to 3 distinct); pleural fields with 3 or 4 ribs. *L.Dev.*, Eu.—FIG. 376,3. **A. nolens* (RICHTER & RICHTER), *Up.L.Dev.*, Ger.(Eifel); 3a, ceph.,

$\times 8$; 3b, hypostoma (probably belonging to this species), $\times 9$; 3c, pyg., $\times 6$ (254).

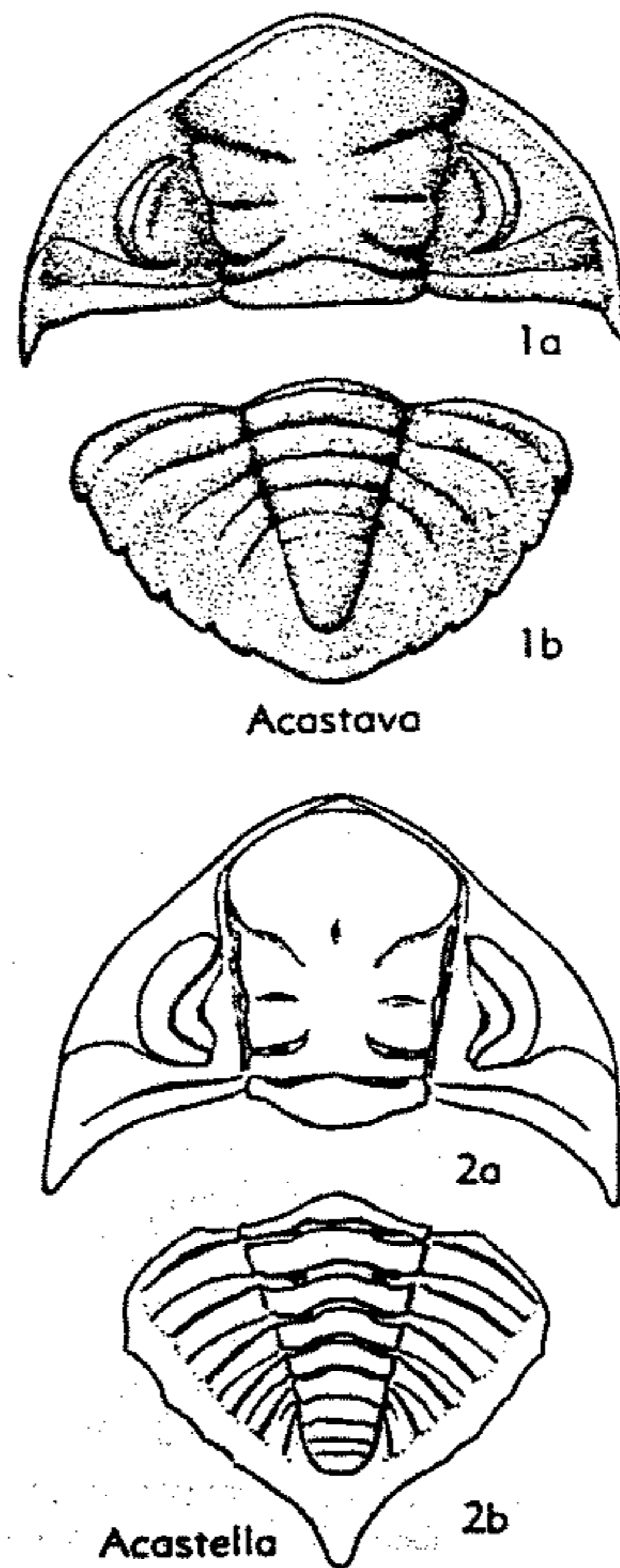

FIG. 377. Dalmanitidae (Acastavinae) (p. 0475-0476).

Subfamily ASTEROPYGINAE Delo, 1935

Cephalon rather closely similar to those of Dalmanitinae; 3*p* lateral glabellar furrows distinct, straight, rather oblique, 2*p* transverse, tending to retreat from axial furrows, 1*p* deep, gently curving in anteromesial direction; eyes generally large about 0.5 of glabellar length (*exsag.*), palpebral lobes close to glabella in front and to posterior border furrows at rear; genal sulcus may be present, genal angles acutely pointed or bearing medium-length to very long genal spines in straight continuation of lateral margins. Hypostoma short, similar to that in Zeliszcellinae and Acastinae. Thorax with rather long pleural spines or spinelike lappets. Pygidium with 7 to 15 or more axial rings (av. 10 to 12) and 5 pairs of distinct ribs (in some genera with 1 or 2 additional pairs of reduced ribs); lateral border generally with 5 pairs of lappets or spines (*Gourdonia*, 6 pairs; *Cryphina*, 7 pairs) and in most genera an unpaired posterior lappet or spine. [*Philonyx*, *Cryphina*, and *Gourdonia* are included in this subfamily with reservation.] *L.Dev.-U.Dev.*

In generic diagnoses 4 patterns of pleural fields (2 conservative and 2 progressive) are usefully distinguished by names derived from species that show them typically. These severally need to be described.

CONSERVATIVE TYPES. Pleural bands equal or subequal; border with lappet-shaped processes correlated with pleurae or posterior pleural bands. (1) *Prorotundifrons pattern* (named from *Treveropyge prorotundifrons*), with anterior and posterior than posterior, interpleural furrows broadening distally to give ribs a bifurcate appearance, pleural furrows rather broad and deep, border obliterated by traversing pads (thickened tracts between ribs and processes); pleural border lappets tending to be posterior on internal molds. (2) *Boothi pattern* (from *Greenops boothi*), with anterior and posterior pleural bands subequal or anterior somewhat narrower, anterior lower than posterior bands, disappearing at border furrow or extending faintly to anteroproximal part of posteriorly adjacent border lappet, posterior pleural bands gently expanded distally, passing into traversing pads that attain size of border lappets; interpleural furrows narrow and distinct; pleural furrows

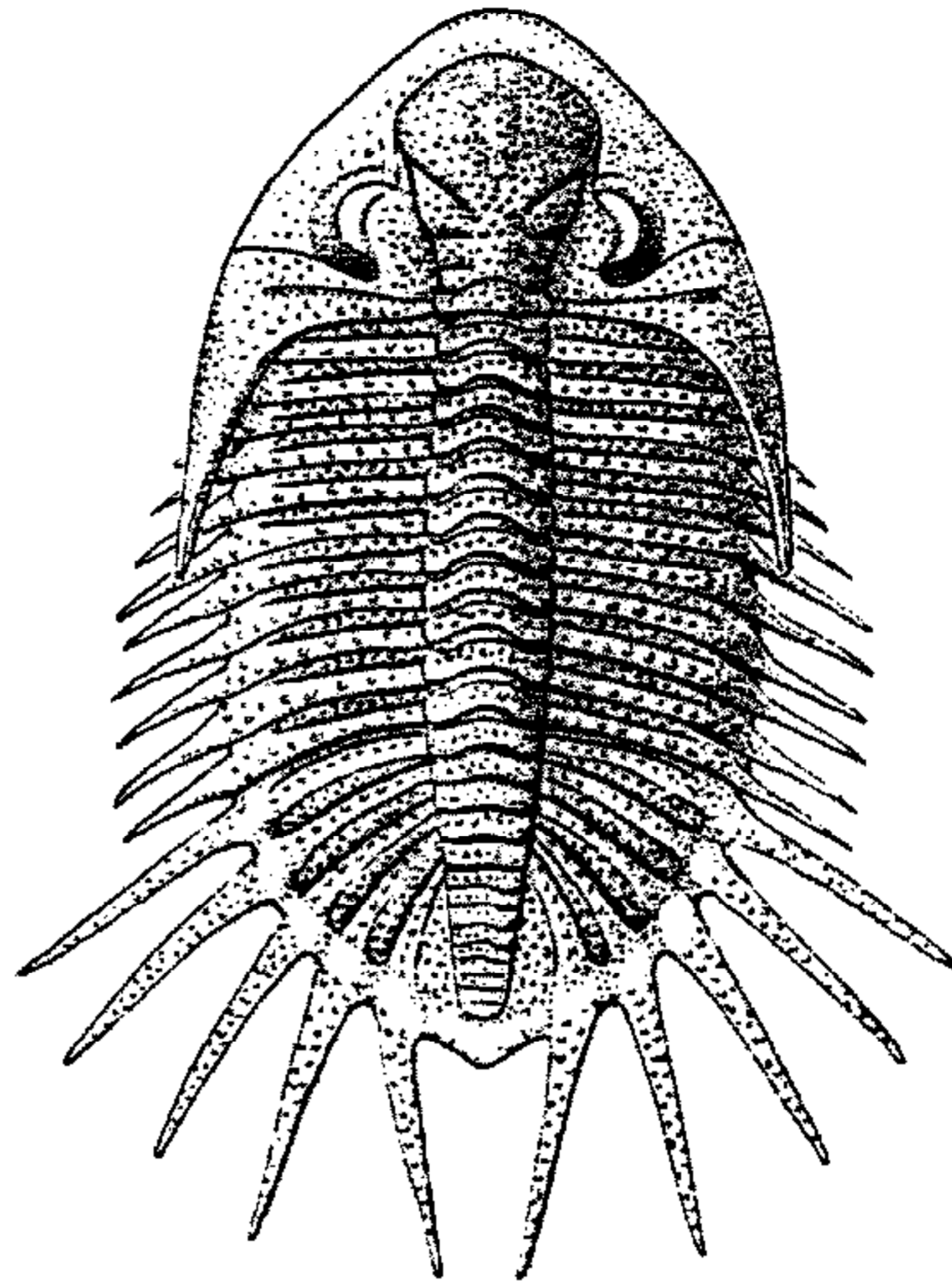

FIG. 378. **Asteropyge punctata* (STEININGER) (Dalmanitidae), M.Dev., Ger.(Eifel); exoskel. (reconstr.), $\times 1.5$ (458n).

moderately wide and deep; posterior border lappets tending to be pleural on exoskeleton.

PROGRESSIVE TYPES. Distinct to complete lowering and reduction of anterior pleural bands; traversing pads and spinelike processes distinctly correlated with posterior pleural bands. (3) *Supradevonica pattern* (from *Asteropyge supradevonica*) with anterior pleural bands moderately to much reduced in width and depressed below posterior pleural bands, both sets of bands well separated in steplike arrangement, interpleural furrows distinct, pleural furrows deep and rather wide; furrows finally bicomposite owing to disappearance of anterior bands. (4) *Cometa pattern* (from *Comura cometa*), with anterior pleural bands increasingly narrowed and depressed well below level of posterior bands to which they appear welded without sharp boundaries, also tending to retreat from border furrow; interpleural furrows narrow to faint; pleural furrows broad and deep.

Asteropyge HAWLE & CORDA, 1847 [*pro Pleuracanthus* MILNE EDWARDS, 1840 (*non* GRAY, 1832; *nec*

AGASSIZ, 1837)] [*Calymene arachnoides* GOLD-FUSS in HOENINGHAUS, 1835 (= *Olenus punctatus* STEININGER, 1831)]. Cephalon gently to moderately vaulted, border distinct; no median frontal process; glabellar frontal lobe sloping, fused with

slightly elevated, transversely arched central area, 2*p* and 3*p* lateral glabellar lobes detached abaxially by longitudinal furrows, 1*p* lobes considerably below level of 2*p* lobes, 3*p* lateral glabellar furrows only moderately oblique; occipital ring very prom-

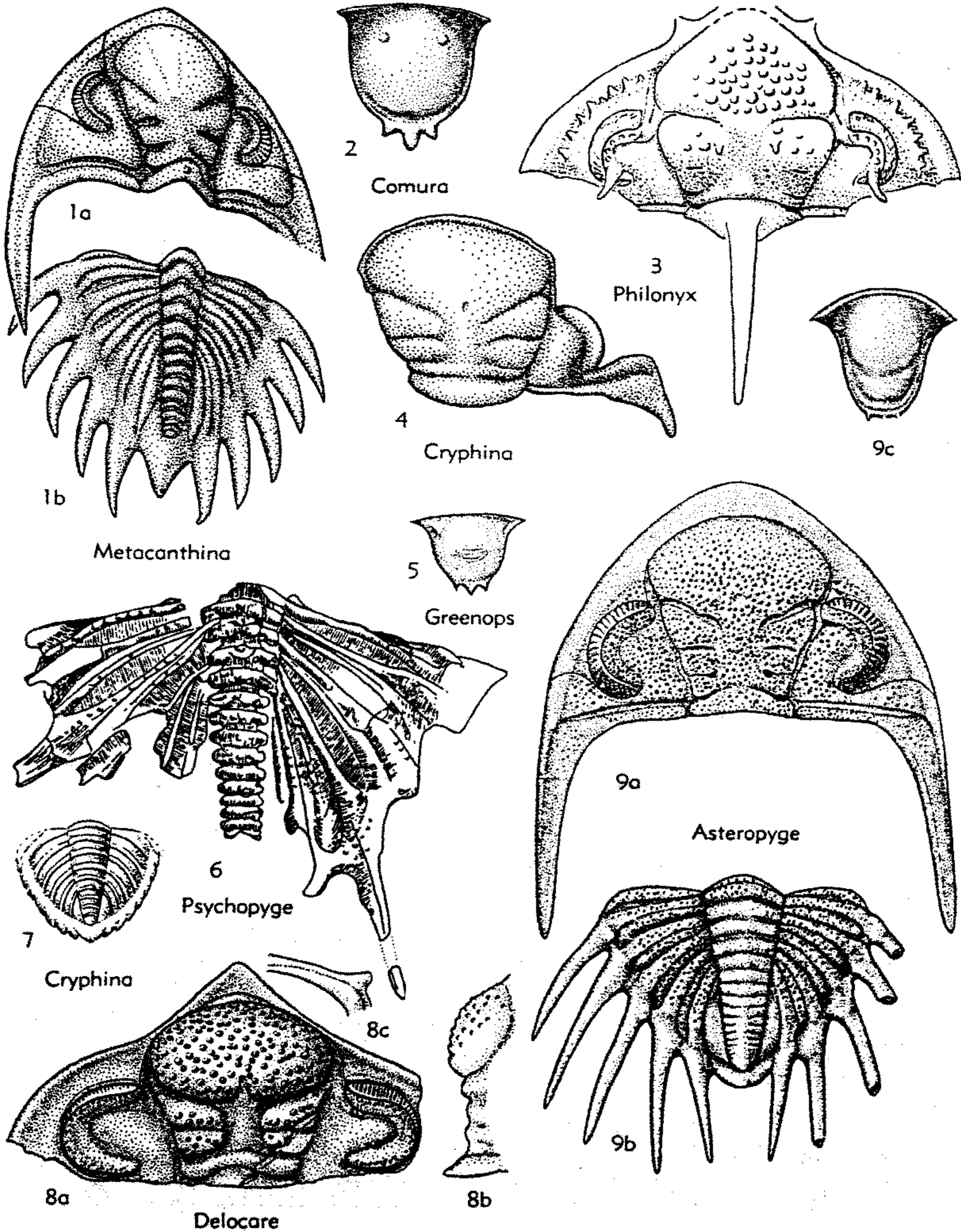

FIG. 379. Dalmanitidae (Asteropyginae) (p. 0477-0483).

inent; palpebral lobes well above glabella; genal areas bordering eyes steeply sloping or even vertical, subocular ridges generally distinct; genal spines moderately to very long. Thorax with long pleural spines (type species). Pygidium with slender axis showing 10 to 15 rings, those near front bent slightly forward and near rear not bent; pleural fields with segmentation of *supradevonica* pattern showing 5 pairs of ribs (5th about as long as 1st) that are separated from axis by space for an unribbed field or 1 or 2 pairs of short ribs; border furrow, border, and traversing pads distinct in most species; 5 pairs of long, gently curved posterior pleural spines (5th distinctly shorter than 4th); posterior border produced in minute lappet or short spine. *M.Dev.-Low.U.Dev.*, Eu.—FIGS. 378; 379,9a,b. **A. punctata* (STEININGER), *M.Dev.*, Ger. (Eifel); 378, exoskel. (reconstr.), $\times 1.5$ (458n); 379,9a,b, ceph., pyg., $\times 2.7$, $\times 1.7$ (474n).—FIG. 379,9c. *A. supradevonica* (FRECH), *Low.U.Dev.*, Ger. (Eifel); hypostoma, $\times 2.7$ (474n).

Comura RICHTER & RICHTER, 1926 [**Cryphaeus cometa* RUD. RICHTER, 1909]. Cephalon transversely elongate; glabella with frontal lobe sloping peripherally on all sides, detached from central area which is depressed between 2*p* and 3*p* lateral glabellar lobes, lobes distinctly decreasing in size and elevation from 3*p* to 1*p*; 3*p* lateral glabellar furrows moderately oblique and 2*p* tending to be reduced laterally; genal angles unknown. Pygidium with 7 to 10 axial rings bent forward near front and distinctly backward near rear, each with medial node; pleural fields with segmentation of *cometa* pattern, showing 5 pairs of ribs (5th subequal in length to 1st) and 5 pairs of long, posterior pleural spines; posterior spine or lappet present. [Under International Rules, *Comura* dates from 1926 despite the contrary opinion of RICHTER & RICHTER (1952, p. 81).] *Up.L.Dev.*, ?*Low.M.Dev.*, Eu.

C. (*Comura*). Frontal glabellar lobe somewhat inflated but with broad flat top; all lobes distinctly detached from central area, 3*p* lobes at about level of frontal lobe, 2*p* lobes considerably smaller than 3*p*, 1*p* lobes deep below level of glabella, very small, forming narrow "intercalating ring." Pygidium with 7 to 10 rings, near rear bent strongly backward; anterior pleural bands of pleural fields very narrow; border indistinct; traversing pads bearing short, vertical node or spine; posterior pleural spines very long, circular in cross section; posterior spine of same shape but shorter. *Up.L.Dev.*, Ger.-Sp.—FIG. 380,3. **C. (C.) cometa* (RUD. RICHTER), Ger. (Eifel); 3a, cran., $\times 2.5$ (474n); 3b, pyg. (holotype), $\times 2.6$ (251, 458, 474 mod.).—FIG. 379,2. *G. (C.) cometa?*, Ger. (Eifel); hypostoma, $\times 5.3$ (254, 474 mod.).

C. (*Delocare*) STRUVE, 1958 (**Cryphaeus boopis* RUD. RICHTER, 1909). Cephalon with moderately

broad convex border and broadly triangular median frontal process, border furrow wide, shallow; posterior part of glabella considerably below level of highly inflated frontal lobe, lateral glabellar lobes detached from central area, becoming low toward axial furrows; librigenae rather flat. Pygidium with 10 axial rings, bent moderately backward near rear; pleural fields with anterior pleural bands moderately reduced, posterior pleural bands bearing erect spine on geniculate bend of distal part; border furrow distinct, border moderately wide; posterior pleural spines long, vertically elongate subrectangular in cross section, 5th pair of spines longest; slightly upturned posterior lappet broadly triangular and pointed. *Up.L.Dev.*, Ger.—FIG. 379,8a-c; 380,2. **C. (D.) boopis* (RUD. RICHTER), Eifel; 379,8a, ceph. (lectotype); 379,8b, ceph. (another specimen), profile; 379,8c, part of 1st pygidial rib, posterior view; 380,2, pyg.; all $\times 1.65$ (251, 474 mod.).

C.? (*Philonyx*) RICHTER & RICHTER, 1952 [**Asteropyge?* (*Philonyx*) *philonyx*]. Cephalic border distinctly convex, with conspicuous broadly subtriangular median frontal process and close to it on either side another short pointed process, border furrow distinct; glabella with frontal lobe somewhat inflated at sides, lateral glabellar lobes steeply descending in level from 3*p* to 1*p*, becoming low toward axial furrows; 3*p* lobes fused laterally with much smaller 2*p* lobes and raised considerably above frontal lobe; occipital ring with very long median spine; eyes somewhat distant from posterior border furrows and glabella, eye ridges(?) extending from posterolateral corners of frontal lobe to anterior end of palpebral lobes which bear long, erect spine on posterior end. Thorax and pygidium unknown. Surface of frontal lobe, 3*p* lobes, palpebral lobes, and subocular ridges coarsely granulose. [Genus combines features of *Comura* and *Cryphaeoides*; relationships uncertain in view of lack of knowledge of pygidium.] *Up.L.Dev.-Low.M.Dev.*, Ger.—FIG. 379,3. **C.?* (*P.*) *philonyx* (RICHTER & RICHTER), *Low.M.Dev.*, Harz; ceph. (holotype), $\times 1.3$ (254).

Cryphina OEHLERT, 1889 [**C. andegavensis*]. Cephalon rather flat, with broadly rounded front margin and narrow well-marked anterior border; frontal lobe of glabella sloping gradually forward; 2*p* lateral glabellar lobes slightly smaller than 3*p*; "intercalating ring" narrow; occipital ring broad; eyes well behind 3*p* furrows, slightly shorter than 0.5 of glabellar length (*extag.*); genal spines short, blunt. Pygidium with prominent axis, bearing 8 to 10 distinct rings; lateral part of pleural fields sloping steeply, with subequal anterior and posterior pleural bands, interpleural furrows faint, pleural furrows rather broad, deep, 6 or 7 pairs of prominent ribs (last pair distinctly shorter than 1st); no border furrow, border distinct, with 7

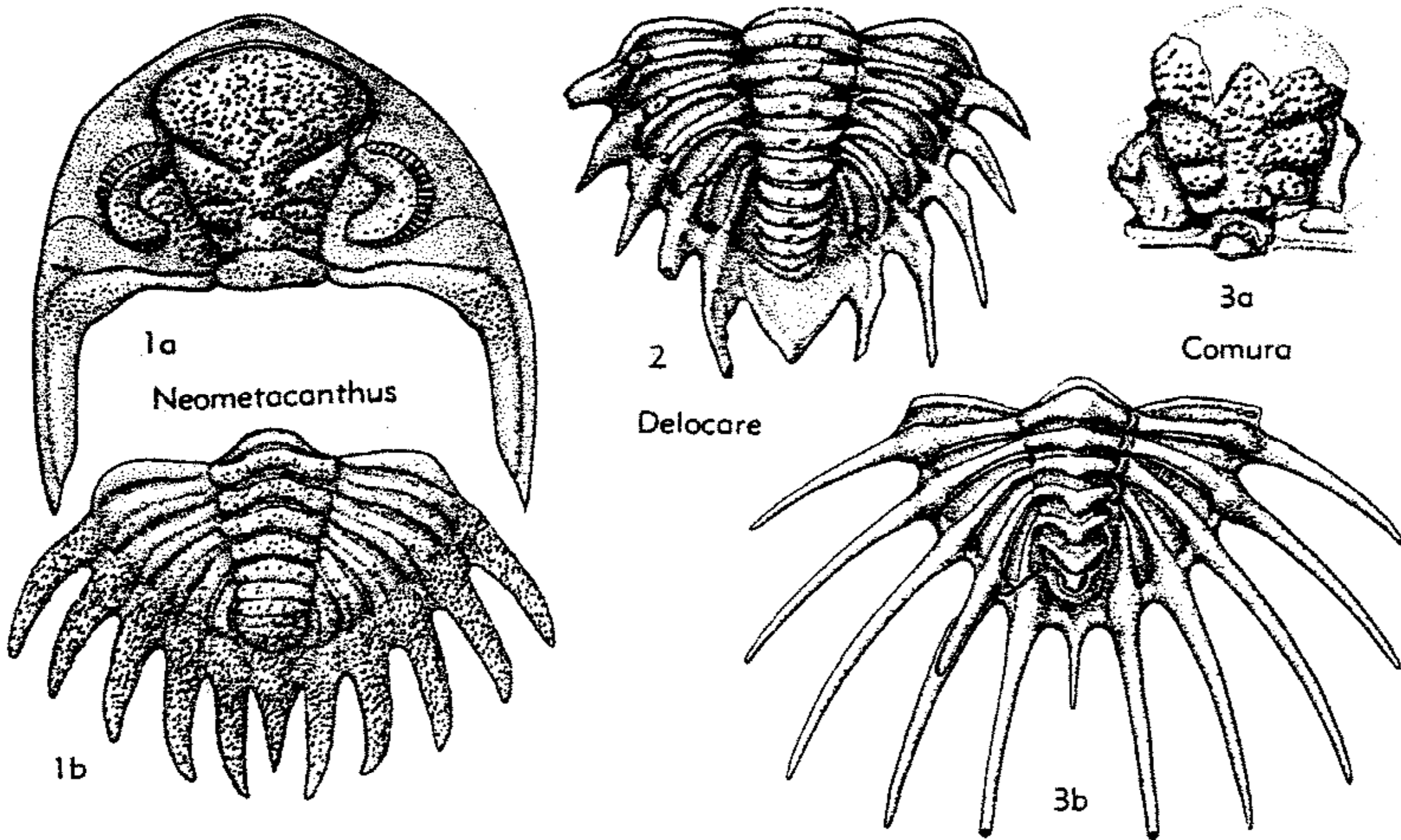

FIG. 380. Dalmanitidae (Asteropyginae) (p. 0479-0480).

pairs of pleural processes and terminal process. *L. Dev.*, Gr.-Belg.-Ger.—FIG. 379,7. **C. andegavensis*, Fr.(St. Malo); pyg., $\times 0.7$ (438, 458). —FIG. 379,4. *C.?* *gdoumontensis* (ASSELBERGHS), Belg. (Weismes); cran., $\times 2.5$ (461, 474).

Gourdonia PILLET, 1954 [*Dalmanites gourdoni* BARROIS, 1884]. Cephalon with fairly distinct border and very short angular median frontal process; frontal lobe of glabella not isolated from central area, decrease of size of lateral glabellar lobes well graded; eyes relatively small, considerably less than 0.5 of glabellar length, centrally on genae; genal spines long. Thorax with short pointed pleural lappets. Pygidium with long, slender axis containing about 12 rings (anterior 6 distinct); pleural fields with anterior pleural bands somewhat narrower than posterior bands; interpleural furrows faint proximally, broadening distally; pleural furrows broad proximally, narrowing distally; 6 pairs of ribs (6th subequal in length to 1st, close to axis), 6 pairs of short, slightly curved, pleural lappets; posterior lappet triangular, broad, long. *Dev.*, Fr.—FIG. 381,4. **G. gourdoni* (BARROIS), Haute Garonne; 4a, ceph. (reconstr.), $\times 2.25$; 4b, pyg., $\times 1.5$ (474).

Greenops DELO, 1935 [*pro Cryphaeus* GREEN, 1837 (non KLUG, 1833)] [**Cryphaeus boothi* GREEN, 1837]. Cephalon moderately convex; with border and border furrow scarcely visible, with preglabellar area but no median frontal process; frontal lobe of glabella sloping, not detached posteriorly from transversely arched forward sloping central area, 2*p* lateral glabellar lobes distinctly smaller

than 3*p* and fused with them distally, 1*p* lobes smaller than 2*p*, not much depressed; lateral glabellar furrows deepening adaxially, 2*p* furrows reduced abaxially to elongate pits, 1*p* furrows abaxially above level of axial furrows; palpebral region of fixigenae sloping steeply toward glabella; genal spines broad, blunt, long. Pygidium with broad low axis containing 7 to 10 rings bent forward near front; pleural fields with segmentation of *boothi* pattern, with 5 pairs of ribs (5th distinctly shorter than 1st, close to axis) and 5 pairs of long, gently curved, posterior pleural lappets ranging from blunt to slender terminal lappet of similar shape, length, and breadth. [Taxonomic distinctness of subgenera doubtful.] *M.Dev.*, ?*Low.U.Dev.*, N.Am.-Eu.

G. (*Greenops*). Thoracic pleural processes comprising short, blunt lappets. Pygidial ribs flat, anterior and posterior pleural bands subequal, traversing pads very broad, obliterating border; processes of lateral and posterior border developed as broad, flat lappets. *M.Dev.*, ?*Low.U.Dev.*, N.Am.—FIG. 381,1. **G. (G.) boothi* (GREEN), *M.Dev.*(Hamilton); 1a, ceph. (Ont.), $\times 3$ (474, 476); 1b, pyg. (Naples, N.Y.), $\times 3.75$ (474). —FIG. 379,5. *G. (G.?) collitelus* (GREEN), *M.Dev.*(Hamilton), Ont.; hypostoma, $\times 1.3$ (54).

G. (*Neometacanthus*) RICHTER & RICHTER, 1948 [*pro Metacanthus* HAWLE & CORDA, 1847 (non COSTA, 1838)] [**Phacops stellifer* BURMEISTER, 1843]. Cephalon with palpebral lobes high above posterior part of glabella, adjacent region of fixigenae sloping steeply toward axial furrows. Thoracic pleural processes long, spinelike. Pygid-

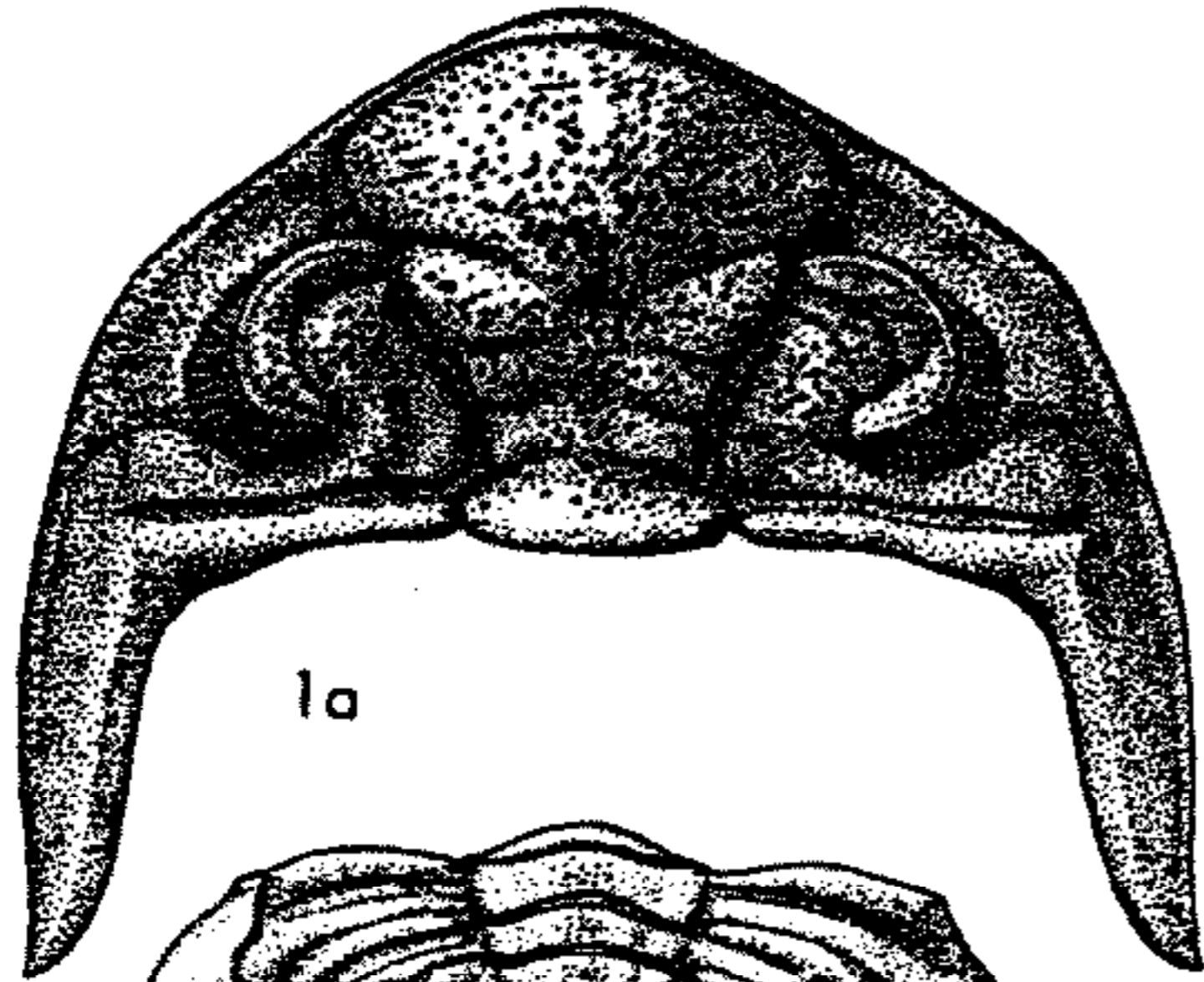

1a

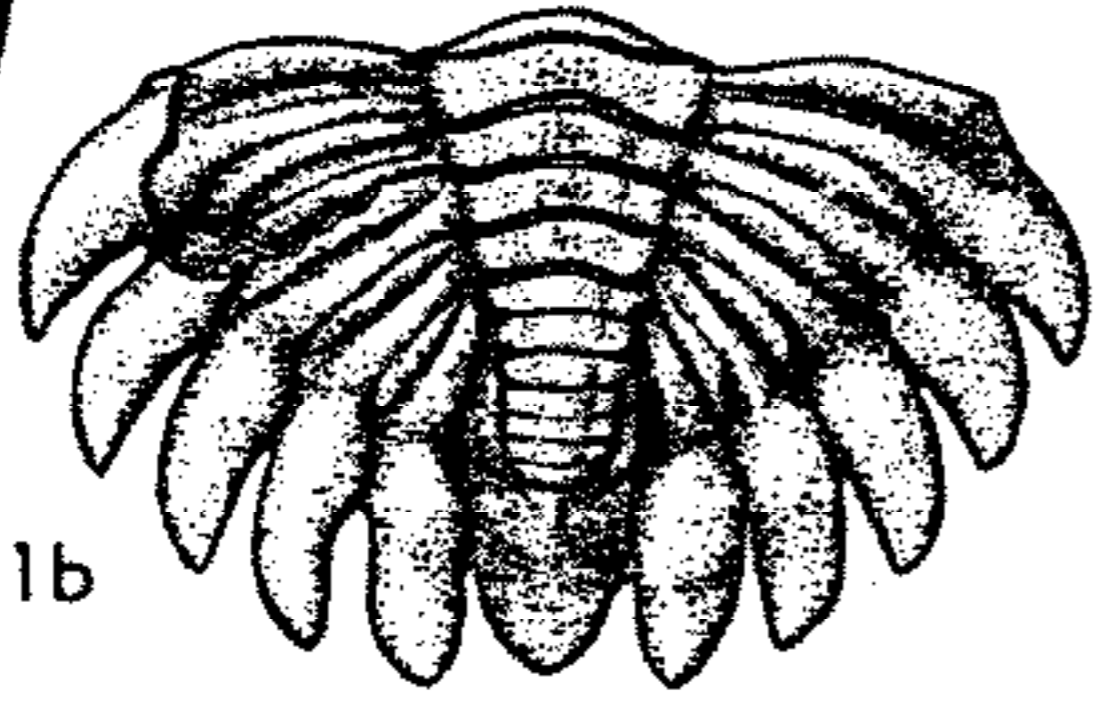

1b

Greenops

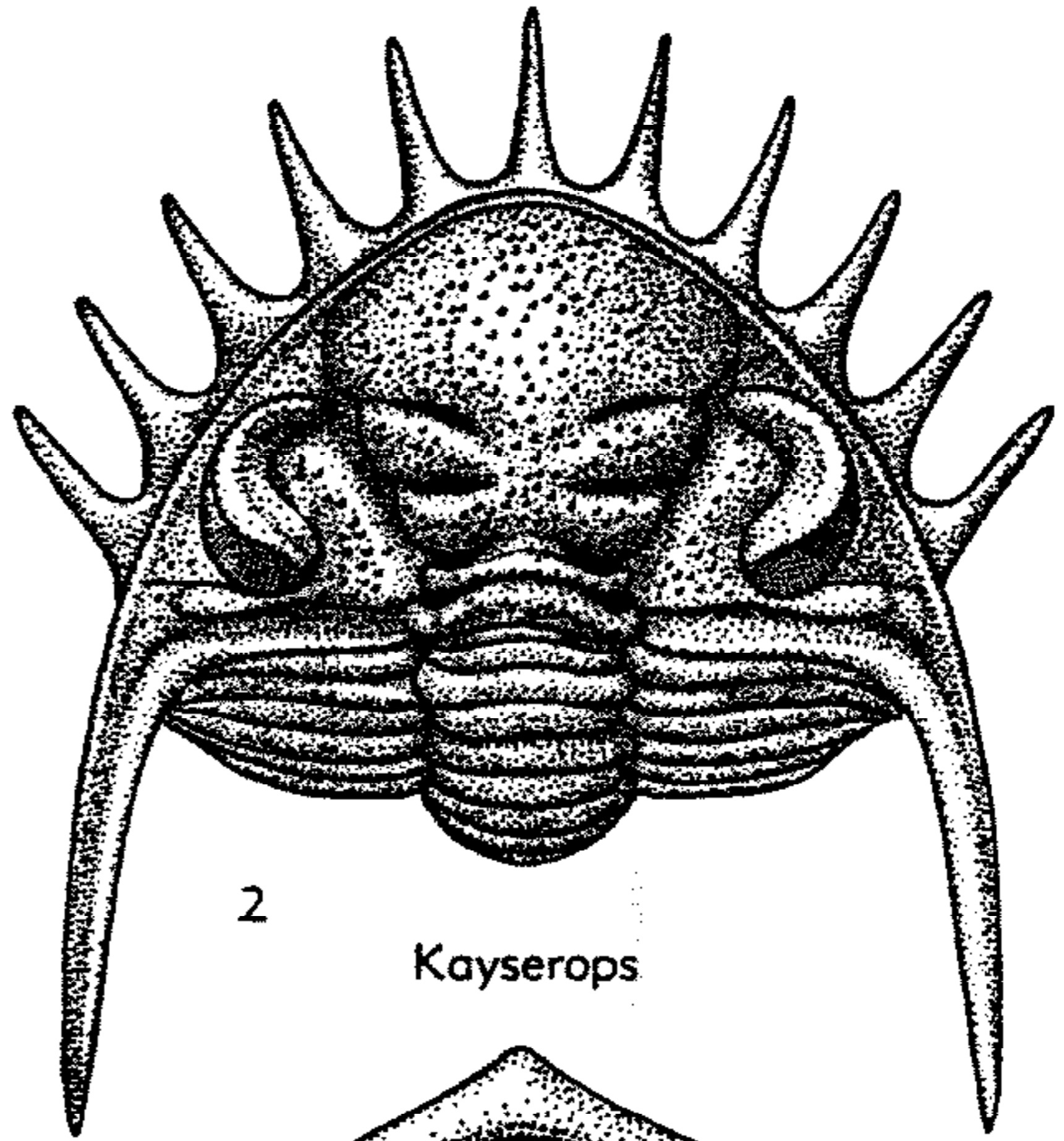

2

Kayserops

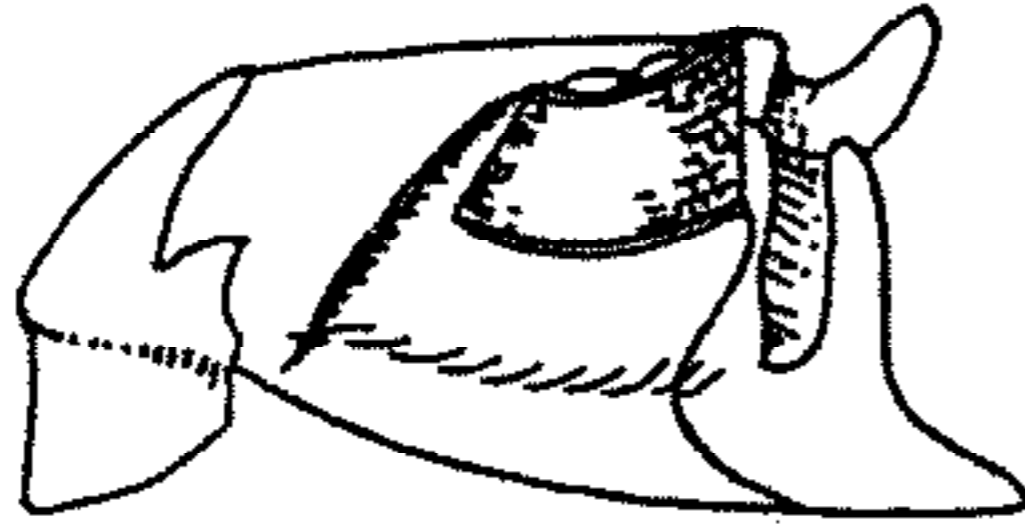

3c

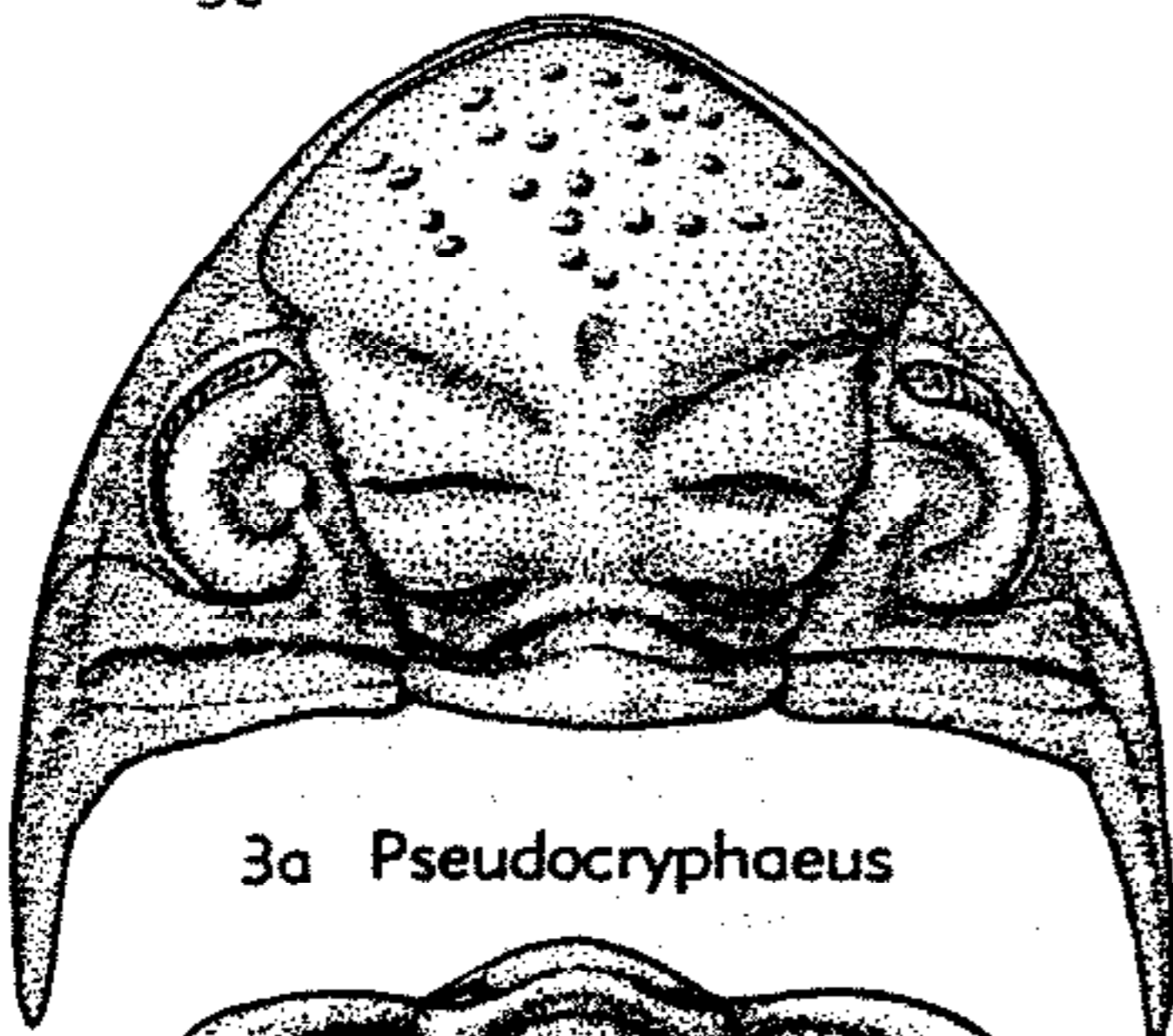

3a Pseudocryphaeus

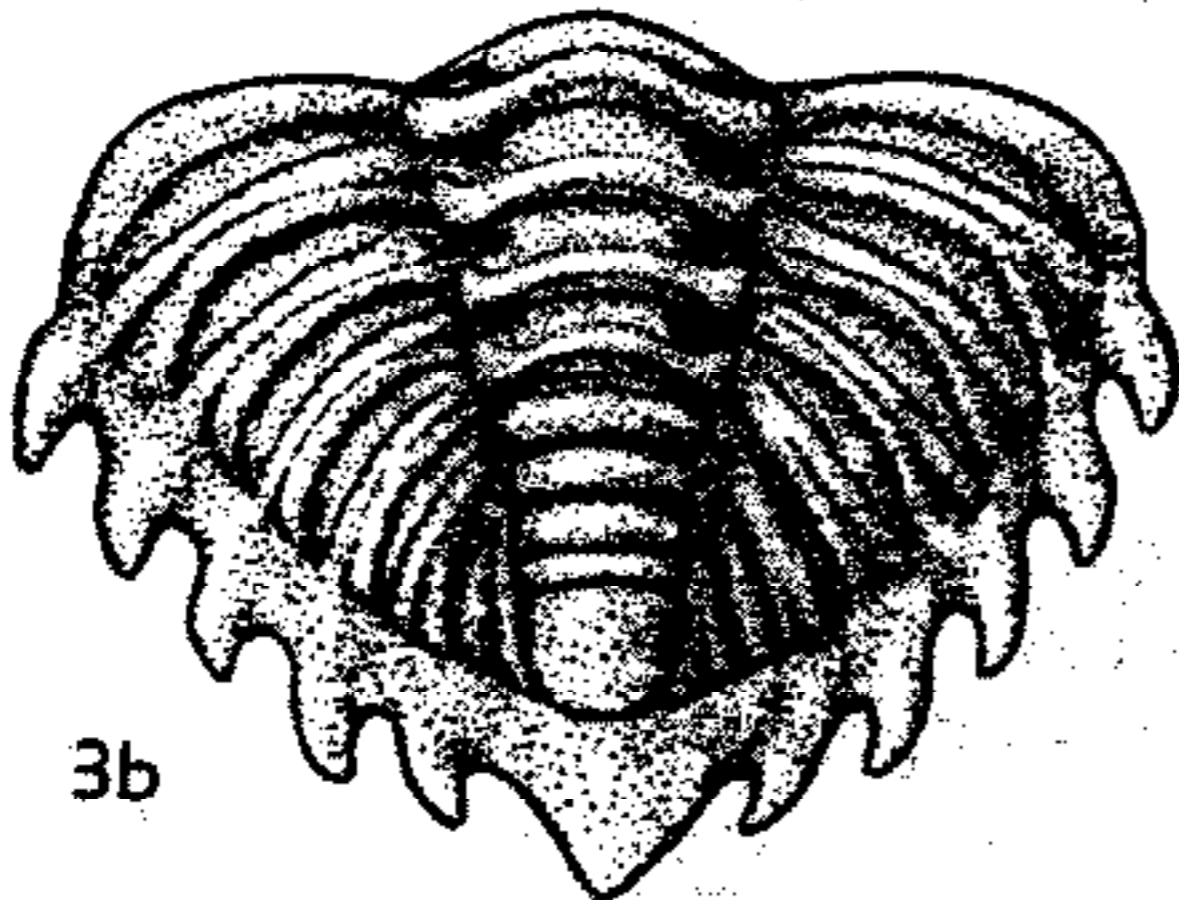

3b

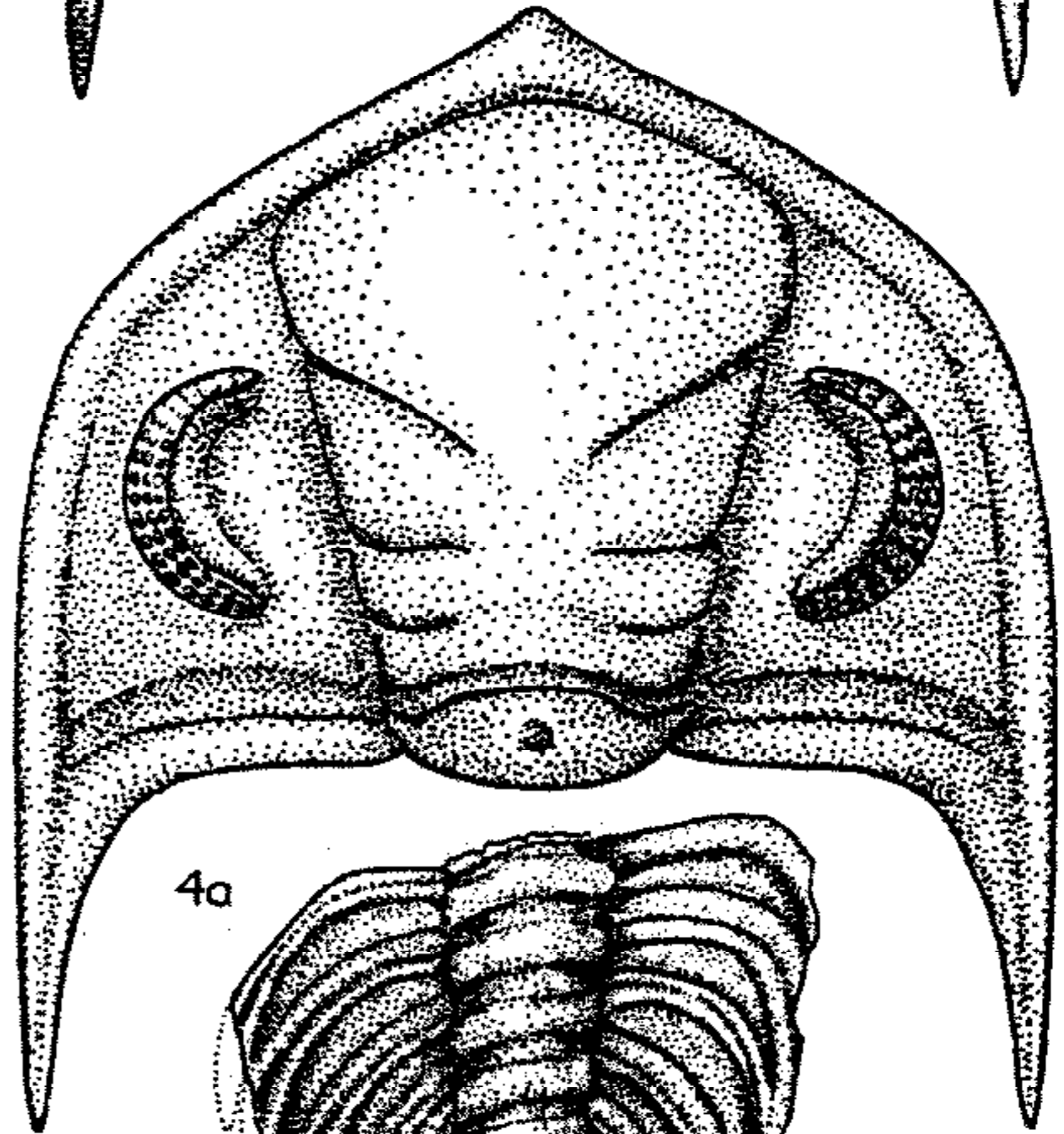

4a

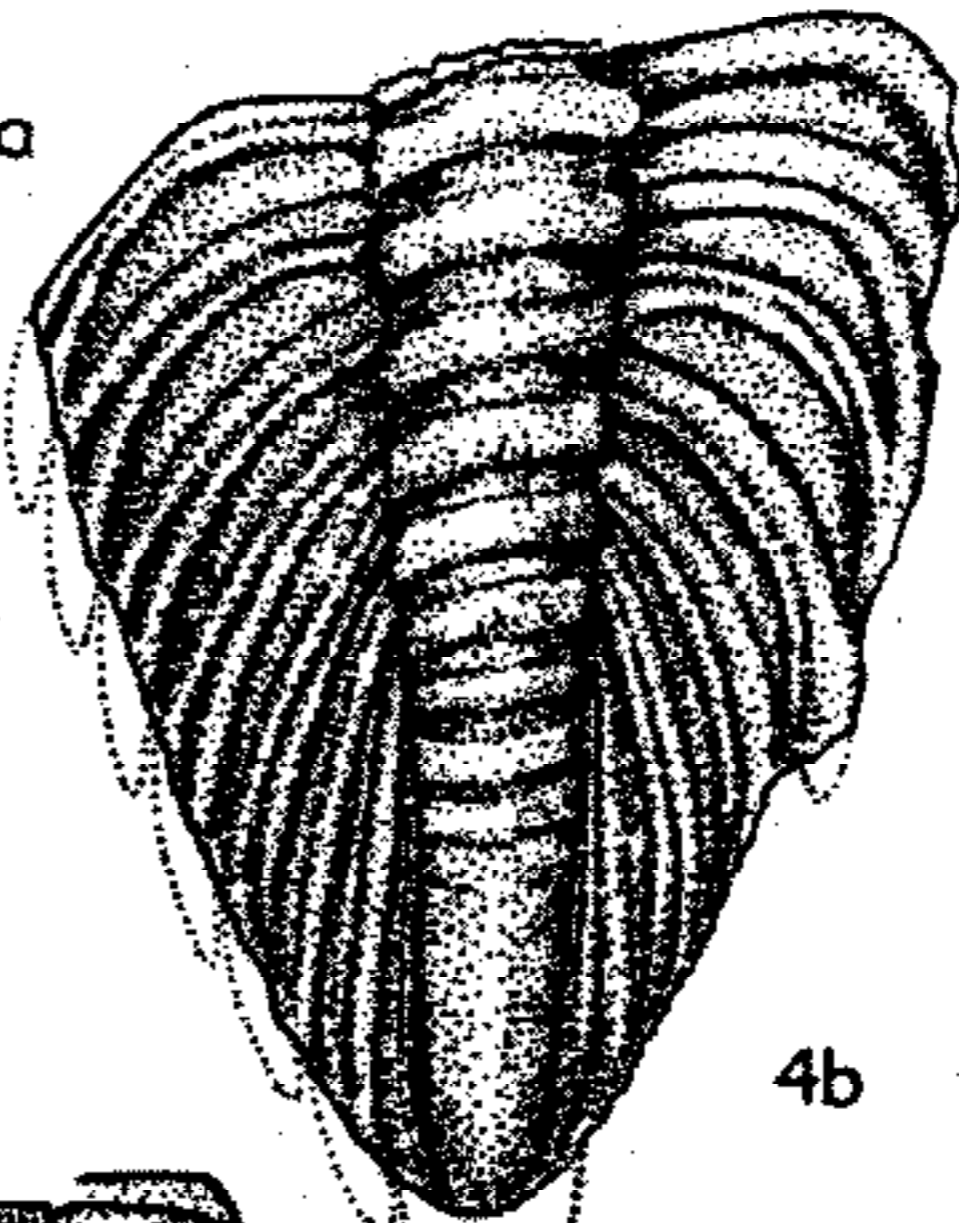

4b

Gourdonia

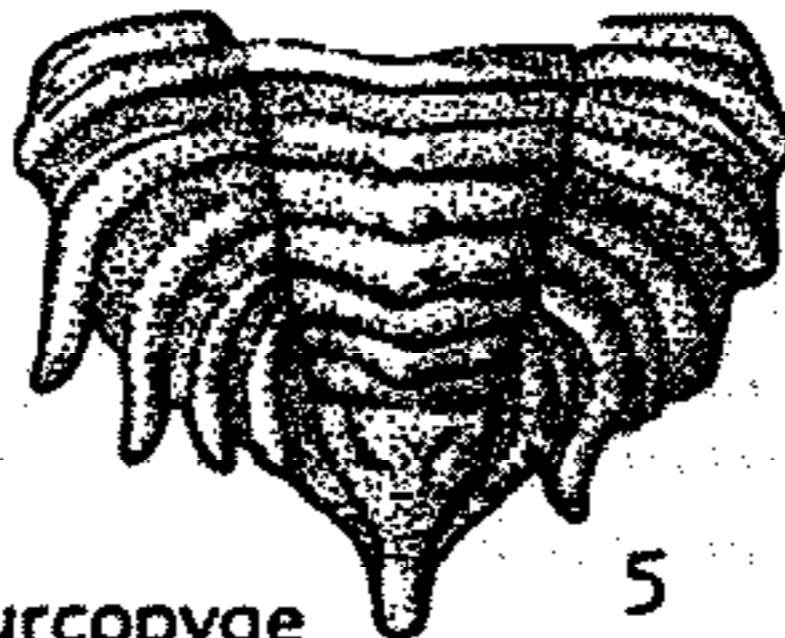

5

Turcopyge

FIG. 381. Dalmanitidae (Asteropyginae) (p. 0480-0482); Suborder Uncertain (*Turcopyge*, p. 0495).

ium with fairly distinct border furrow and slightly inflated border that is visible between traversing pads; lateral and posterior processes of border slender. *Low.M.Dev.*, Ger.-Pol.—FIG. 380,1. **G. (N.) stellifer* (BURMEISTER), Eifel; 1a,b, ceph., pyg., $\times 4.5$ (474).

Kaysers DELO, 1935 [**Cryphaeus kochi* KAYSER, 1883]. Cephalon high, without distinct border and median frontal process; preglabellar area very narrow; frontal lobe of glabella steeply sloping, faintly detached from central area, median and posterior parts of glabella subequal in elevation with palpebral lobes, so that central part of cephalon has a flattened appearance; 2*p* and 3*p* lateral glabellar lobes inflated, 1*p*, depressed, decreasing in size from 3*p* to 1*p*; genae steeply sloping, with long genal spines. Thorax with moderately long straight pleural spines. Pygidium with rather prominent axis containing 10 to 12 rings bent gently forward near front and backward near rear; each with median node; pleural fields with segmentation of *cometa* pattern showing 5 pairs of distinct, equally long ribs; border and border furrow distinct; traversing pads well marked; 5 pairs of long, straight, posterior pleural spines; posterior spine of same shape and about equal length. *L.Dev.(Emsian)*, Ger.—FIG. 381,2. **K. kochi* (KAYSER); exoskel., enrolled, $\times 3$ (251, 474).

Metacanthina PILLET, 1954 [**Cryphaeus barrandei* OEHLERT, 1889]. Border and border furrow of cephalon rather distinct, preglabellar area well developed; frontal lobe of glabella scarcely widened, backward decrease in size of glabellar lobes well graded, 1*p* lateral glabellar lobes slightly narrower than occipital ring; eyes somewhat less than 0.5 of glabellar length (*exsag.*), distant from lateral border furrow and distant from posterior border furrow; librigenae rather flat; long, broad genal spines. Thoracic pleural processes spinelike, straight, moderately long. Pygidium with moderately or very slender axis, 12 to 15 rings; pleural fields with segmentation of *boothi* to *prorotundifrons* pattern, 5 pairs of ribs (5th as long as 1st), 5 pairs of long, curved, pointed, pleural lappets; posterior lappet triangular, subequal to others in length but broader proximally. *L.Dev.-M.Dev.*, Fr.—FIG. 379,1. **M. barrandei* (OEHLERT), Pt. Maillet; 1a,b, ceph., pyg. (distorted holotype), $\times 1.3$ (371 mod., 441 mod., 474).

Pseudocryphaeus PILLET, 1954 [**Phacops michelini* ROUAULT, 1851]. Cephalon considerably vaulted, with front margin narrowly rounded to subangular, cephalic border moderately distinct, narrow in front of glabella; frontal lobe rather steeply sloping forward and sideward, 2*p* and 3*p* lateral glabellar lobes about same in elevation and more or less fused laterally, 2*p* not much smaller than 3*p*, 1*p* lobes depressed deeply below general level of glabella, "intercalating ring" very narrow; 2*p* lateral glabellar furrows reduced distally, lacking

adaxial pits, but 1*p* deep, with elongate pits; genal spines broad and short. Pygidium with moderately broad high axis containing 10 rings bent somewhat forward near front; pleural fields with segmentation of *boothi* pattern showing 5 pairs of ribs (5th distinctly shorter than 1st; a 6th pair of incomplete ribs may occur); 5 pairs of short, slightly curved, posterior pleural lappets; posterior lappet of about same length, but broader proximally. *L.Dev.*, Fr.—FIG. 381,3. **P. michelini* (ROUAULT); 3a, ceph., $\times 2.2$ (474); 3b, pyg., $\times 3.75$ (474); 3c, ceph., showing plowshare-

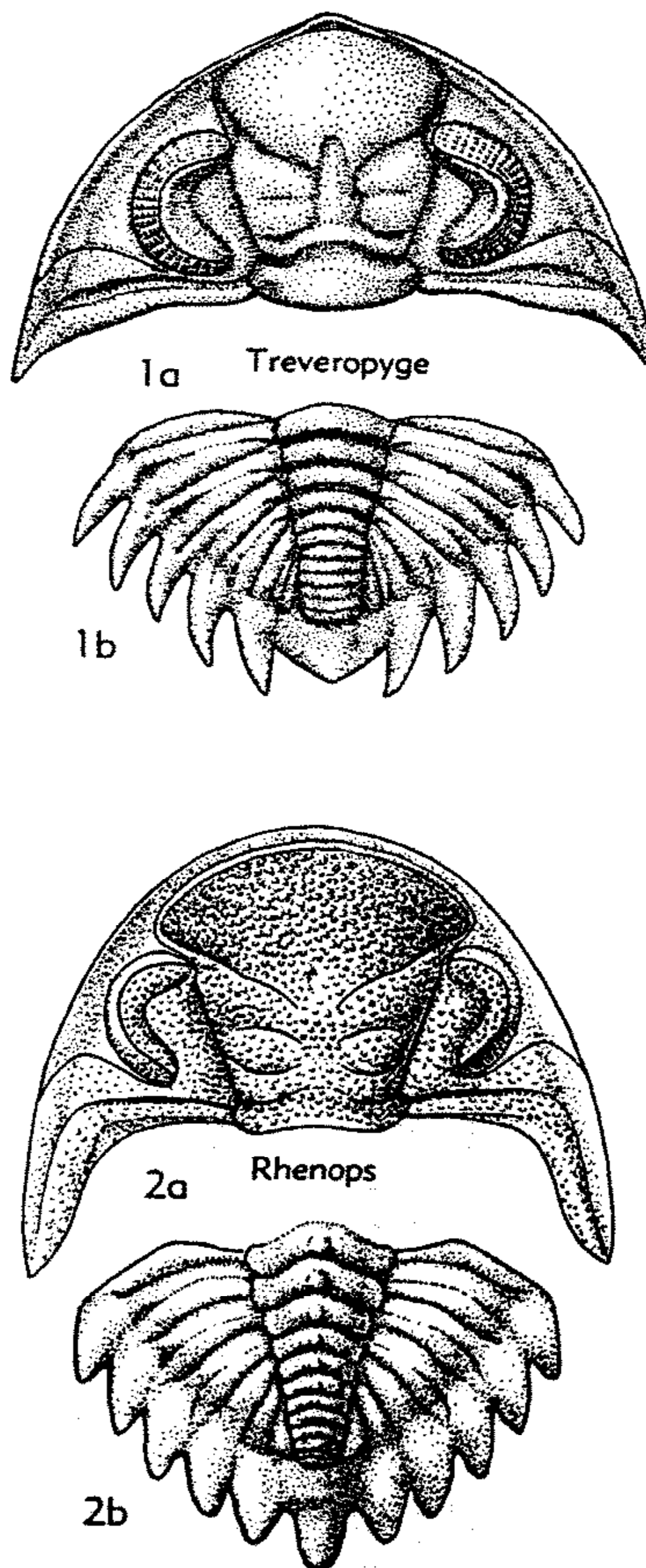

FIG. 382. Dalmanitidae (Asteropyginae (p. 0483)).

like process of frontal part of doublure, $\times 3$ (460).

Psychopyge TERMIER & TERMIER, 1950 [**Psychopyge elegans*]. Cephalon and thorax unknown. Pygidium with very slender axis containing many rings (14 preserved with space for some more), posterior rings probably transverse; pleural fields with 5 pairs of distinctly biramous ribs (5th as long as 1st), broad distal endings of ribs fused with border; posterior segmental bands narrow but anterior bands still narrower; interpleural furrows narrow, deep; pleural furrows broad, deep; 25 pairs of long, posterior pleural spines; posterior part of pygidium unknown. *L.Dev.*, Morocco.—FIG. 379,6. **P. elegans*; pyg. (holotype), $\times 1.3$ (479).

Rhenops RICHTER & RICHTER, 1943 [**Cryphaeus anserinus* RICHTER & RICHTER in RUD. RICHTER, 1916]. Cephalon gently to moderately vaulted, with rounded front margin, border well developed both laterally and anteriorly, border furrow shallow, but distinct; axial furrows distinctly divergent forward; decrease in size of glabellar lobes well graded, 2*p* and 3*p* lateral glabellar lobes fused distally, about same in elevation as central area, middle part of "intercalating ring," and palpebral area; 3*p* lateral glabellar furrows only moderately oblique; eyes large (about 0.7 of glabellar length), extending to lateral border furrow; broad, blunt, moderately long genal spines. Thoracic pleurae with long sickle-shaped processes. Pygidium with moderately broad, not very prominent axis containing up to 10 rings; pleural fields with segmentation of modified *boothi* pattern showing subequal posterior and anterior pleural bands that tend to fuse by reduction of interpleural furrows; pleural furrows narrow; 5 pairs of flat ribs (5th distinctly shorter than 1st, close to axis); border distinct; no border furrow; 5 pairs of rather short, curved, pleural to posterior pleural lappets; posterior lappet of same shape and breadth, of same length or longer. *L.Dev.*, Ger.-AsiaM.—FIG. 382,2. **R. anserinus* (RICHTER & RICHTER), Ger.(Eifel); 2*a*, ceph., $\times 1.7$ (251, 458); 2*b*, pyg., $\times 3.4$ (251, 474 mod.).

Treveropyge STRUVE, 1958 [**Astero-pyge (Astero-pyge) prorotundifrons* RICHTER & RICHTER, 1943]. Cephalon gently vaulted, much widened, with distinct subhorizontal border that is narrow anteriorly; short median frontal process; axial furrows diverging slightly forward with re-entrants at 3*p* lateral glabellar furrows, frontal lobe somewhat inflated, usually above level of transversely arched, wedge-shaped central area; 2*p* and 3*p* lateral glabellar lobes gently sloping sideward, fused distally, more or less detached adaxially, 1*p* lobes somewhat depressed, tending to fuse with 2*p* lobes distally; genae sloping gently to moderately sideward, with very short genal spines pointing obliquely outward. Thorax with long,

spinelike pleural lappets. Pygidium with broad, moderately high axis containing 10 to 12 rings bent gently forward near front; pleural fields with segmentation of *prorotundifrons* pattern showing 5 pairs of flat ribs (5th pair considerably shorter than 1st, distant from axis, with 6th pair of rudimentary ribs present in some) that bifurcate distinctly by distal broadening of interpleural furrows; traversing pads broad; 5 pairs of gently curved, short to moderately long, pleural lappets; posterior lappet broad, short, slightly tipped and upturned. *L.Dev.-M.Dev.*, Eu.-?N.Afr.—FIG. 382, 1. **T. prorotundifrons* (RICHTER & RICHTER), *L.Dev.*, Ger.(Eifel); 1*a*, ceph., $\times 2.6$; 1*b*, pyg. (holotype), $\times 2.6$ (251, 474 mod.).

Family CALMONIIDAE Delo, 1935

[*nom. transl.* STRUVE, 1958 (ex Calmoniinae, *nom. correct.* DELO, 1940, *pro* Calmoninae DELO, 1935)] [*Authorship.* Except for contributions by RUD. RICHTER relating to *Calmonia*, *Paracalmonia*, *Pennaia*, *Probolops*, *Schizostylus*, *Acaste*, *Acastoides*, and *Kloucekia*, all parts of the section here published on Calmoniidae are by W. STRUVE.]

Exoskeleton typically compact, in many genera with *Phacops*-like bluntness. Cephalic border (frontal processes excluded) narrow in front of glabella or not visible from above; axial furrows slightly to moderately divergent; 3*p* lateral glabellar furrows simple, in none bipartite, tending to become faint and (exceptionally) obsolete, 2*p* furrows moderately deep or shallow (exceptionally obsolete), in most genera not reaching axial furrows, 1*p* deepest of glabellar furrows; 2*p* and 3*p* lateral glabellar lobes fused marginally; eyes small to moderately large (especially in Acastinae), in most genera distinctly to far distant from posterior border furrows; genal sulcus shallow if present; no vincular furrows (?except *Typhloniscus*). Hypostoma short, with maculae close to lateral borders. Pygidium short, semicircular, with moderately to very broad axis; pleural fields with 3 to 5 pairs of ribs or a few more. *Ord.-M.Dev.*

Subfamily CALMONIINAE Delo, 1935

[*nom. correct.* DELO, 1940 (*pro* Calmoninae DELO, 1935)]

Exoskeleton small to moderately large. Cephalon rounded subtriangular, with median frontal processes a common feature; 2*p* and 3*p* lateral glabellar furrows present in all genera but faint in many, 2*p* slightly oblique in posteromesial direction, 1*p* deep, exceptionally not reaching axial furrows; 1*p* to 3*p* lateral glabellar lobes subequal in length (*exsag.*) in most genera; eyes small, at mid-length of genae (*exsag.*), more or less distant from glabella; anterior sections of

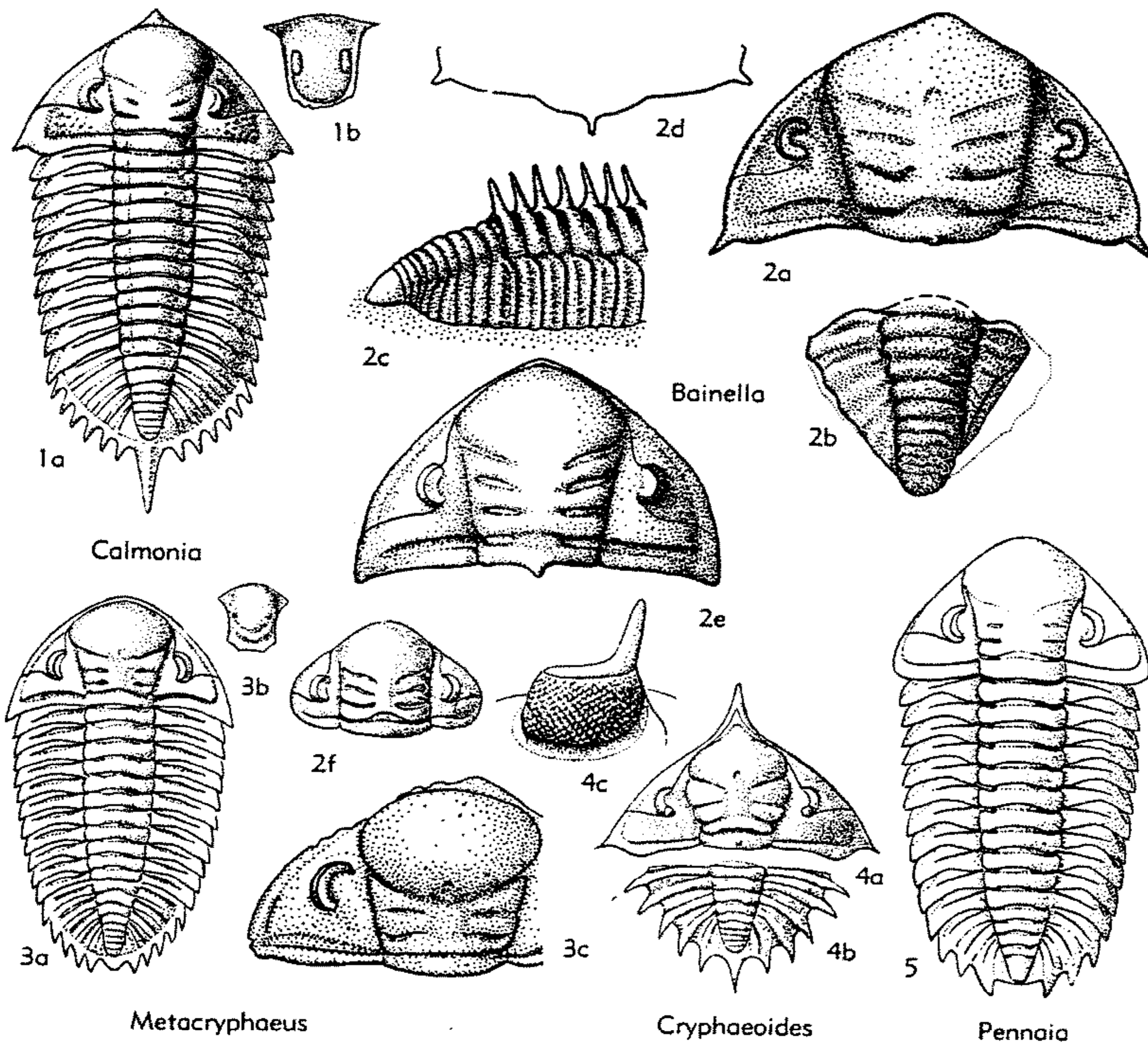

FIG. 383. Calmoniidae (Calmoniinae) (p. 0484-0486).

facial sutures may cut off lateral corners of glabella; genal angles rounded or (exceptionally) angular, without true genal spines in straight continuation of lateral cephalic margins but spiniform processes (in diagnoses simply termed "spines") that originate on rounded genal angles. Thoracic pleural endings rounded, pointed angular, or bearing short spines (in several species resembling shape of genal spines). Pygidium showing tendency to develop pleural border spines or lappets; posterior lappet or spine in many genera. *Ord.-M.Dev.*

Calmonia CLARKE, 1913 [**C. signifer*; SD VOGDES, 1917]. Cephalon with short median frontal process; glabella depressed, resembling that of *Acaste*; axial furrows slightly divergent; *3p* lateral glabel-

lar furrows shallow and *2p* reduced to elongate, shallow adaxial grooves; eyes rather small, distant from posterior border; in type species facial sutures cut lateral corners of glabella; with short genal spines. Pygidium as in *Asteropyginae* but with 5 pairs of ribs and 6 pairs of long pleural spines; type species with long posterior spine. *L.Dev.*, S.Hemis.—FIG. 383,1a. **C. signifer*, Braz.(Paraná); $\times 0.7$ (24).—FIG. 383,1b. *C. subseciva* CLARKE, Braz.(Paraná); hypostoma, $\times 2.7$ (24).

Bainella RENNIE, 1930 [**B. bokkeveldensis*] [= *Paradalmanites* PILLET, 1954]. Cephalon stout, with wide subtriangular, subpentagonal, or semi-elliptical outline; frontal border visible from above or not, without median frontal process; glabella rather uniformly vaulted, compact, subpentagonal to pear-shaped, frontal lobe of 0.5 glabellar size or considerably less, not detached from central area; all glabellar furrows more or less distinctly

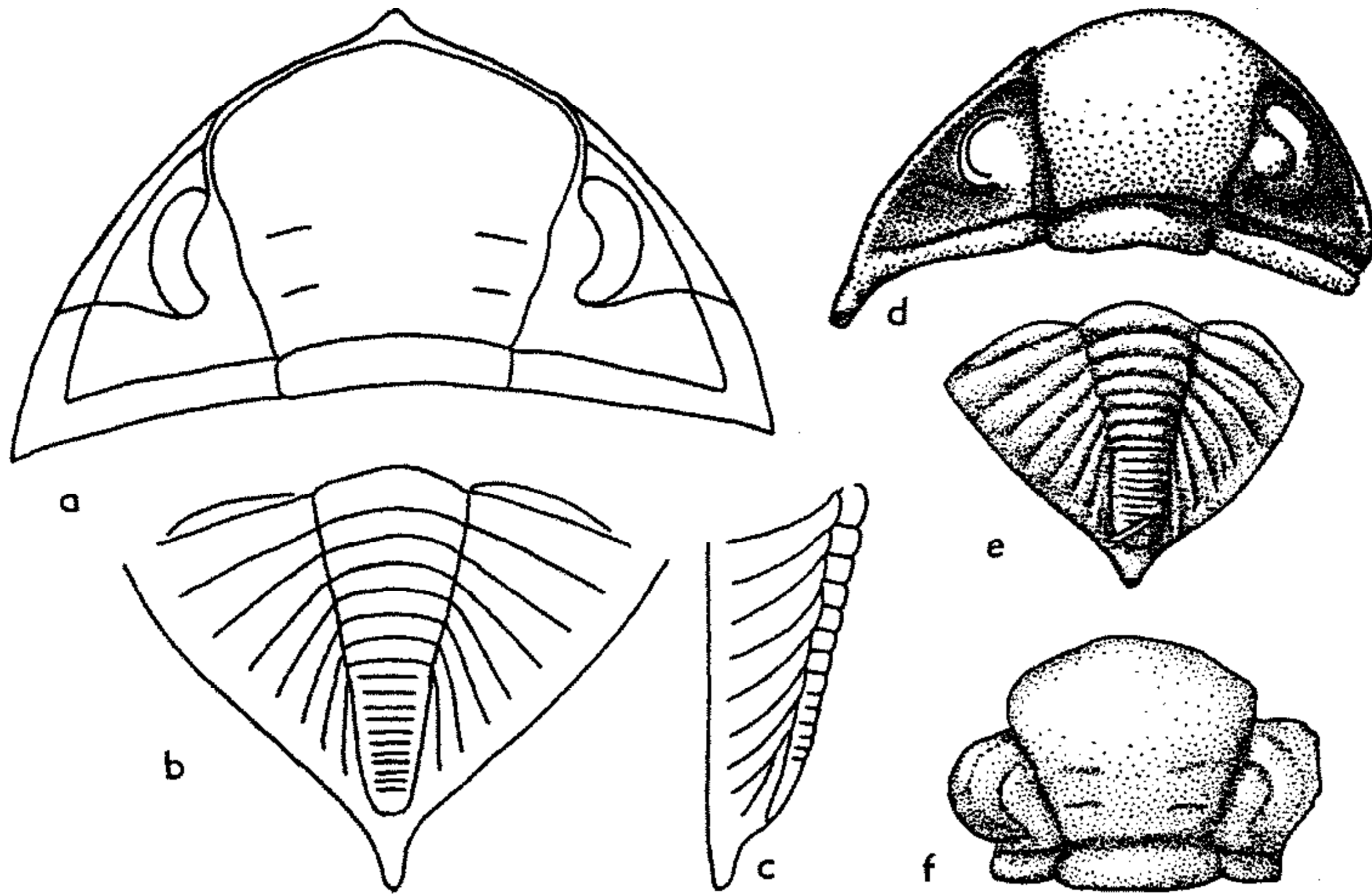
FIG. 384. *Dalmaniturus* (Calmoniidae) (p. O485).

oblique in posteromesial direction (with few exceptions) and distant from axial furrows; $3p$ lateral glabellar furrows shallow, $2p$ generally a little deeper, and $1p$ very deep, especially adaxially; median occipital spine present; eyes small, about in center of genae; genal angles rounded, short genal spines may be present. Thoracic axis broad, with mesial spines. Pygidium highly vaulted, subtriangular, with broad, prominent axis containing 8 to 10 rings; pleural fields with 5 to 8 pairs of distinct ribs showing anterior pleural bands reduced or obsolete; posterior margin bluntly pointed or with spine. *L.Dev.*; *S.Afr.*-?*Malvin.*-?*Braz.*—

FIG. 383,2a-c. **B. bokkeveldensis*, Bokkeveld beds, *S.Afr.*; 2a, ceph. (reconstr. from 2 specimens) (474); 2b, pyg. (partly reconstr. from external mold; 2a and 2b preserved in same nodule), $\times 1.3$ (474); 2c, part of thorax and pyg., $\times 0.7$ (456).

—FIG. 383,2d. *B. acacia* (SCHWARZ), Bokkeveld beds, *S.Afr.*; posterior region of cephalon of holotype (reconstr.), $\times 0.7$ (456). [This is the type species of *Paradalmanites*, holotype very poorly preserved (456, p. 348) but showing many features of *B. bokkeveldensis* and perhaps junior synonym. The form called *B. acacia* by CLARKE (1913) presumably does not belong to this species.]—FIG. 383,2e. *B.?* sp., *L.Dev.*, Malvin I.; ceph., $\times 1$ [= *B. acacia* (*sensu* CLARKE)].

FIG. 383,2f. *B.?* ocellus (LAKE), Bokkeveld beds, *S.Afr.*; ceph., $\times 0.7$ (421).

Cryphaeoides DELO, 1935 [**Cryphaeus rostratus* KOZŁOWSKI, 1923]. Cephalon with median frontal

spine; glabella subpentagonal; frontal lobe less protruding laterally than $3p$ lateral lobes, $1p$ to $3p$ completely separated by distinct lateral furrows, central area between $2p$ and $3p$ lobes slightly detached anteriorly, laterally, and posteriorly, gently arched (*tr.*); eyes with about 0.3 of glabellar length, in center of genae; long erect spines on posterior ends of palpebral lobes; anterior sections of facial sutures meet at half length (*sag.*) of dorsal surface of frontal spine; short genal spines present. Pygidium with 10 distinct rings and 5 pairs of ribs, anterior pleural bands subequal in width to posterior bands and below their level; no distinct border; 5 pairs of long posterior pleural spines and long posterior spine present. *M.Dev.*, Bol.—FIG. 383,4. **C. rostratus* (KOZŁOWSKI), Sicacica; 4a,b, ceph., pyg., $\times 0.7$; 4c, side view of eye, $\times 2$ (111).

[Contrary to previous usage *Cryphaeoides* here is included in the Calmoniinae because the genal spines and small eyes are in a typical position for the subfamily. The segmentation of the glabella is comparable to that of *Schizostylus*. The course of anterior sections of the facial sutures is intermediate between *Calmonia* and *Schizostylus*. The genal angles are as in *Calmonia*. The similarities with *Comura?* (*Philonyx*) probably are due to convergence (see Asteropyginae). solution of this question depending on discovery of complete specimens of *Philonyx*.]

Dalmaniturus CHERNYCHEVA, 1937 [**D. weberi*].

Cephalon rather flat; with small median frontal process; axial furrows narrow; glabella subpentagonal in outline; $1p$ and $2p$ lateral glabellar furrows faintly visible but not reaching axial furrows; eyes distant from posterior border furrows, very prominent, embraced by a shallow depres-

sion; anterior sections of facial sutures in marginal position anteriorly; genal angles pointed. Pygidium triangular, with slender axis, 16 to 20 rings; pleural regions with 7 or 8 pairs of ribs separated by narrow furrows, 8th pair of ribs parallel and close to axis; without distinct border; posterior spine present. [This genus displays mingled calmonioid (cephalon) and dalmanitid (pygidium) features, being related seemingly to *Phacopidina*.] *Sil.*, C.Asia.—FIG. 384, a-e. **D. weberi*, W.Mongol.; a, ceph., $\times 4$; b-c, pyg., $\times 4.8$; d, ceph. (holotype); e, pyg., $\times 3.2$ (all 384).—FIG. 384, f. *D.* sp. cf. *D. weberi*, Tuva; cran., $\times 3.2$ (384).

Metacryphaeus REED, 1907 [**Phacops* (*Cryphaeus*) *caffer* SALTER, 1856; SD RENNIE, 1930 (non *Phacops ocellus* LAKE, 1904; SD RICHTER & RICHTER, 1942)] [= *Hadorachus* DELO, 1935; *Hadorakos* DELO, 1940. (nom. van.)]. Cephalon moderately vaulted in most species, lateral cephalic border and border furrows faintly distinct, anterior margin rounded or produced in short median frontal process; axial furrows straight, moderately divergent; frontal lobe of glabella gently to considerably inflated and distinctly detached from lower posterior part of glabella, central area tending to be gently arched (*tr.*); *3p* lateral glabellar furrows well defined, *2p* reduced distally, somewhat transverse, *1p* deepest furrows, reaching axial furrows or not, more or less transverse; *2p* and *3p* (even *1p*) lateral glabellar lobes fused; eyes about 0.3 of glabellar length (*exsag.*), near center of genae; genal angles subangular or bluntly pointed. Thoracic axis broad; anterior pleurae with subangular to pointed ends, approaching shape of pygidial pleural lappets in posterior pleurae. Pygidium with 9 to 11 rings and 5 pairs of ribs (6th incomplete); pleural furrows deep, interpleural furrows narrow, faint; 5 pairs of moderately long, slightly curved, pointed (exceptionally rounded) pleural lappets; posterior lappet short, rather broad. *L.Dev.*, Braz.-Bol.-Falkland I.-S.Afr.—FIG. 383, 3c. **M. caffer* (SALTER), Bokkeveld beds, S.Afr.; ceph., part, $\times 1$ (452).—FIG. 383, 3a, b. *M. australis* (CLARKE) [type species of *Hadorachus* DELO, 1935], *L.Dev.*, Braz.(Paraná); 3a, b, exoskel., hypostoma, $\times 0.7$ (24).

[This genus usually is included in the Asteropyginae (Dalmanitidae) because of its pygidial features. The eyes, however, are very small for this subfamily and in a typical Calmoniinae position. Special weight on shape of the genal spines (not clearly shown by available figures) is warranted and comparison of these structures belonging to *M. australis* and *Asteropyge*, for example, shows significant differences.]

Paracalmonia STRUVE, 1958 [pro *Proboloides* CLARKE, 1913 (non VALLE, 1893; nec MORLEY, 1903)] [**Proboloides cuspidatus* CLARKE, 1913; SD VOGDES, 1917]. Cephalon with long median frontal spine, separated from glabella by facial sutures surrounding frontal lobe closely; *2p* glabellar furrows short, not reaching axial furrows;

fixigenal and prolibrigenal spines short. Pygidium presumably with long terminal spine. [Very similar to *Calmonia* in segmentation of glabella, course of anterior sections of facial suture, eyes, and genal spines.] *L.Dev.*, Braz.—FIG. 385, 2. **P. cuspidata* (CLARKE); ceph., $\times 1$ (24).

Pennaia CLARKE, 1913 [**P. pauliana*]. Cephalon similar to that of *Calmonia*, without median frontal process or genal spines. Thoracic axis very broad. Pygidium short, as in Asteropyginae, with moderately long pleural lappets (but only 3 pairs) and 3 pairs of ribs; posterior margin between lappets broadly rounded. *L.Dev.*, S.Hemis.—FIG. 383, 5. **P. pauliana*, Braz.(Paraná); exoskel., $\times 1.3$ (24).

Phacopidina BANCROFT, 1949 [**Phacopidina harnagensis*]. Cephalon subpentangular, resembling that of *Kloucekia*, with narrow angular anterior border; axial furrows straight, moderately divergent; lateral glabellar furrows increasingly deep from *3p* to *1p*, all gently oblique in posteromesial direction, separating subequal glabellar lobes, *1p* furrows bifurcated adaxially; eyes moderately large, considerably distant from posterior border furrows; short genal spines. Pygidium subtriangular; with about 6 rings and 5 pairs of ribs; postaxial ridge continued into an upturned posterior spine. *Ord.*, Br.I.—FIG. 385, 4a, b. **P. harnagensis*, Harnage Sh., Eng.(Shrops.); 4a, b, ceph., pyg., $\times 2.7$ (369).—FIG. 385, 4c, d. *P.?* *solitaria* (BARRANDE), Czech.; 4c, d, ceph., $\times 1.3$ (3).

[*Phacopidina* resembles Acastinae (*Kloucekia*) and Zeliskellinae in showing presence of all glabellar furrows, bifurcation of *1p* furrows, and eyes in anterolateral position, but seems to be closer to the Calmoniinae trend, as indicated by direction of the *2p* glabellar furrows, all glabellar lobes of about same size, and shape of genal spines (if imperfect figure of the type species by BANCROFT is interpreted correctly).]

Probolops DELO, 1935 [**Proboloides glabellirostris* KOZŁOWSKI, 1923]. Frontal lobe of glabella produced into a forward-directed spine; anterior sections of facial sutures border frontal lobe and meet beneath the spine; posterior margin of cephalon with a sharp angularity or rudimentary metafixigenal spine on either side, halfway between axial furrows and genal spines. Pygidium unknown. [Comparable with *Schizostylus* and *Paracalmonia*, and in glabellar segmentation with *Calmonia*; angularity of the posterior margins suggests *Cryphaeoides*.] *L.Dev.*, Bol.—FIG. 386, 1. **P. glabellirostris* (KOZŁOWSKI), Padilla; ceph., $\times 1$ (111).

Tibagya STRUVE, 1958 [pro *Schizopyge* CLARKE, 1913 (non HECKEL in RUSSEGER, 1847)] [**Homalonotus* (*Schizopyge*) *parana* CLARKE, 1913; SD VOGDES, 1925]. Cephalon and thorax unknown. Pygidium with broad, flat axis containing 9 rings; pleural fields with 4 pairs of broad ribs continued into 4 pairs of curved, rounded pleural pygidial lappets; posterior degenerated ribs embrace end of axis; posterior end bluntly pointed, upturned; no border. [Re-

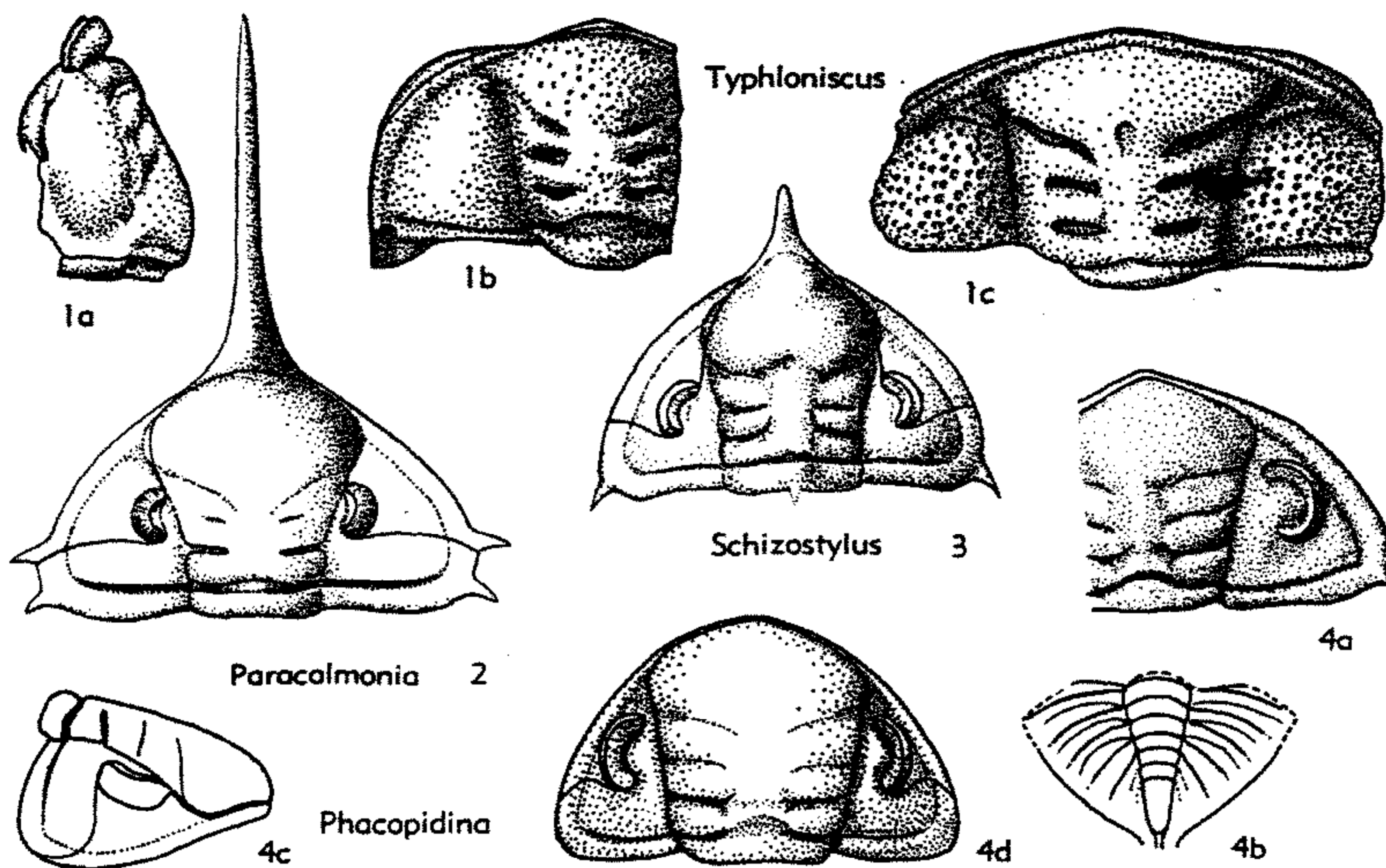

FIG. 385. Calmoniidae (Calmoniinae) (p. 0486-0487).

sembles pygidium of *Pennaia*.] *L.Dev.*, Braz.—
FIG. 386,2. **T. parana* (CLARKE), Tibagy; pyg.,
×1 (24).

Schizostylus DELO, 1935 [**Dalmanites brevicaudatus* KOZŁOWSKI, 1923]. Cephalon with strong median frontal process; facial sutures cut off lateral corners of glabellar frontal lobe, anteriorly being in marginal position, dividing process into a dorsal convex half (prolongation of cephalic border) and ventral concave half (continuation of doublure); axial furrows subparallel; *1p* to *3p* lateral glabellar furrows distinct, *2p* fading away distally, *1p* not transglabellar; eyes distant from glabella; median occipital spine ?invariably present; short genal spines. Pygidium very small, rounded; with 5 or 6 rings and 3 or 4 pairs of ribs. *M.Dev.*, Bol.—FIG. 385,3. **S. brevicaudatus* KOZŁOWSKI, Letanias; ceph., ×0.7 (111).

[The glabellar segmentation shows more resemblance to Dalmanitinae than to typical Calmoniinae, but outline of the cephalon, genal angles, median frontal process, smallness and position of eyes, and lateral corners of frontal lobe cut off by facial sutures correspond to features of *Calmonia*, *Paracolmonia*, *Pennaia*, and *Probolops*. The short pygidium would be unusual for Dalmanitinae.]

Typhloniscus SALTER, 1856 [**Typhloniscus bainii*].

Cephalon wide, roughly subpentagonal, with distinct border and broad, shallow border furrows; axial furrows also broad, shallow; frontal glabellar lobe gently vaulted, lateral ends pointed; *3p* lateral glabellar furrows shallow, *2p* and *1p* deep, rather short, somewhat distant from dorsal furrows, and slightly oblique in posteromesial direction; genae swollen, subtriangular; eyes possibly

represented by swellings at anterior ends of genae; facial sutures may be represented by groove that runs along upper side of rounded border, becoming inframarginal toward genal angles, which are slightly produced; vincular furrow ?present anteriorly and anterolaterally. Surface of cephalon covered with scattered pits which are particularly coarse on genae. Thorax strongly tapering posteriorly; with prominent, rather narrow axis and pleural ends pointed. Pygidium comparatively small, rounded, with entire margin; axis very prominent, not becoming narrower and lower backward but abruptly truncate and slightly overhanging posteriorly; 4 (+1 indistinct) rings; pleural lobes depressed; 3 (+1 reduced) pairs of very prominent ribs. [Systematic position of *Typhloniscus* is uncertain; despite peculiar features it seems most similar to *Bainella*, as in glabellar segmentation and pitted ornamentation of the genae.] *L.Dev.*, S.Afr.—FIG. 385,1. **T. bainii*, Bokkeveld beds, Gamka Poort; 1a-c, cephalo, ×1.3 (456).

Subfamily ACASTINAE Delo, 1935

Exoskeleton small. Cephalon semicircular to rounded subtriangular, without frontal processes; *3p* lateral glabellar furrows undulating in many species, *2p* typically transverse, slightly convex forward or straight; *2p* and *3p* lateral glabellar lobes generally fused distally; in some species entire glabella

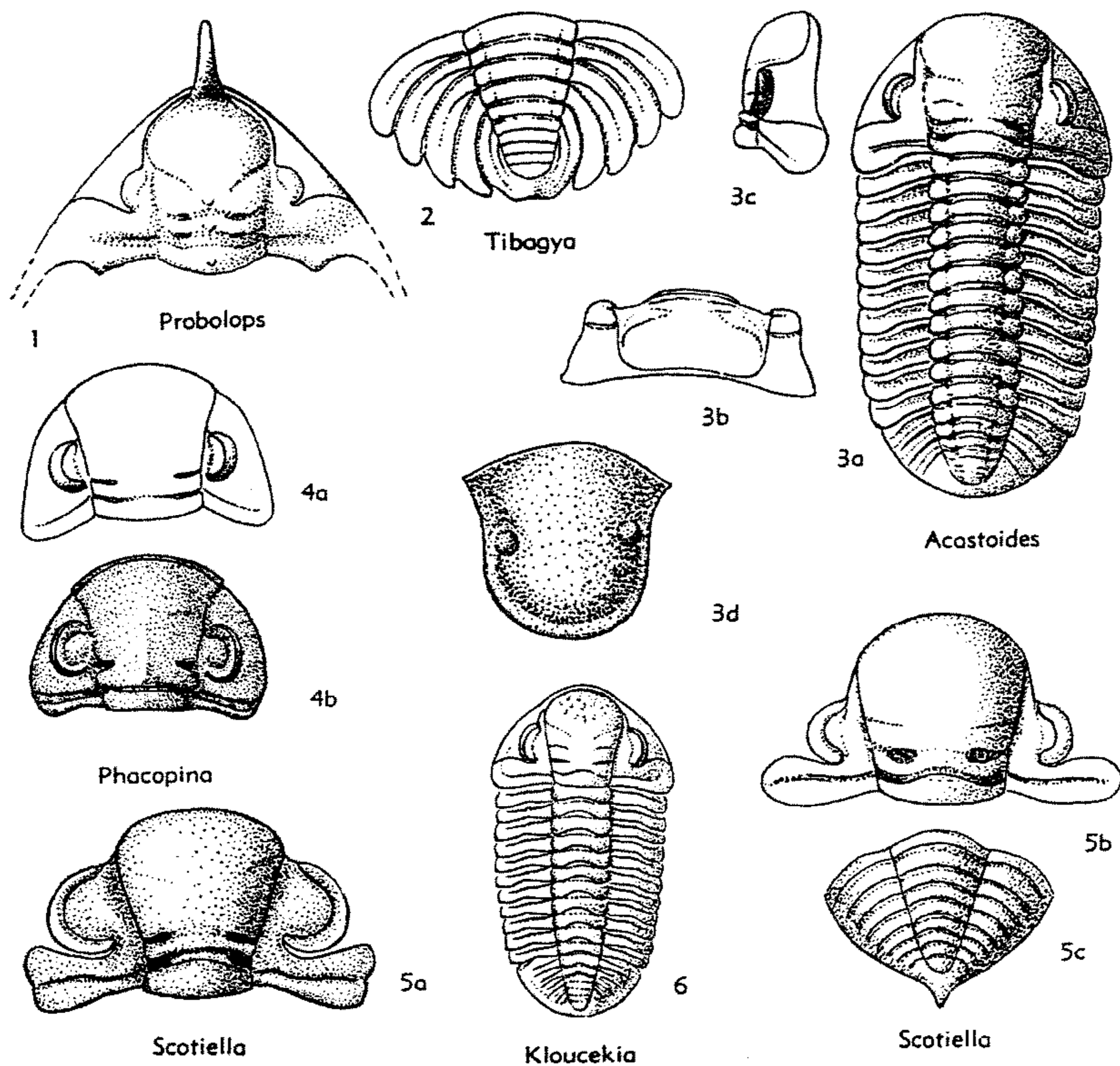

FIG. 386. Calmoniidae (Calmoniinae, Acastinae) (p. 0486-0489).

in front of *1p* furrows may form a uniform, unsegmented lobe; *2p* and *3p* lobes about equal in size exsagittally, *1p* commonly much narrower (*exsag.*); eyes of moderate or considerable size; genal angles rounded or angular, may be produced into lobes, in some species slightly pointed but without true genal spines. Thorax with pleural endings blunt, rounded, or angular. Pygidium with entire margin; short posterior spine present. *Ord.-L.Dev.*

Acaste GOLDFUSS, 1843 [**Calymene? downingiae* MURCHISON, 1839; SD BURMEISTER, 1843] [= *Acastina* REED, 1927 (*nom. van.*)]. Cephalon with convex border, in side view projecting without edge; glabella gently sloping anteriorly; glabellar lobes differing little in size; *1p* lateral gla-

bellar furrows deepest; genae gently sloping laterally; genal angles without spines, at most slightly pointed. Hypostoma with maculae near margin. Pygidium relatively long, rounded, tending to become triangular; margin without interior denticles; axis anteriorly narrow, scarcely tapering. *Sil., Eu.-N.Am.*—FIG. 387. **A. downingiae* (MURCHISON), Wenlock., Eng.(Dudley); *a*, exoskel.; *b*, cephalic doublure and hypostoma; *c,d*, cephalon, showing pointed genae; all $\times 2$ (*a,b*, 266; *c,d*, 255).

Acastoides DELO, 1935 [**Acaste henni* RUB. RICHTER, 1916]. Cephalon short, stout, frontal margin rounded, not visible from above; glabella high, abruptly sloping anteriorly; axial furrows nearly parallel; frontal glabellar lobe short, scarcely protruding sideward; genae abruptly sloping laterally, frontal view of cephalon rectangular; eyes very

small, visual areas high above genae, narrow, with 4 lenses at most in vertical rows; genal angles rounded. Hypostoma with maculae near margin. Pygidium steeply sloping laterally, with entire, rounded margin; only on doublure 6 spine-like tubercles may occur, directed downward, segmental, but different from marginal denticles of *Acastella*, *Acastellina*, *Acastava*; axis flat, in transverse section scarcely interrupting outline of pygidium, anteriorly very broad, tapering rapidly, its posterior end passing over into general surface, only 3 rings distinct, without interruption continuing across the indistinct axial furrows into the faint ribs, following rings coalesced; 3 to 5 ribs, only anterior ones distinct. *L.Dev.*, Eu.-Bol.—FIG. 386,3. **A. henni* (RUD. RICHTER), Ger.; 3a-c, exoskel., ceph. front and side, $\times 2$; 3d, hypostoma, $\times 7$ (460, 1916).

Kloucekia DELO, 1935 [**Phacops phillipsi* BARRANDE, 1846]. Frontal border a narrow rounded ridge; axial furrows straight, diverging slightly; 3*p* lateral glabellar furrows faint, 1*p* distinct, narrow, short; eyes large; surface of genae behind them almost vertical. Pygidium small, rounded; axis narrow, with 3 to 5 rings; pleural fields with 3 to 6 ribs. *Ord.*, Czech.—FIG. 386,6. **K. phillipsi* (BARRANDE); exoskel., $\times 2$ (3).

Phacopina CLARKE, 1913 [**Phacops braziliensis* CLARKE, 1890; SD VOGDES, 1925]. Cephalon with axial furrows subparallel or slightly diverging; glabella moderately convex, roughly rectangular to trapezoidal; 2*p* and 3*p* lateral glabellar furrows faint or obsolete, 1*p* and 2*p* not converging outward, 1*p* deep, faintly transglabellar or not con-

nected; distal ends of occipital furrow deep, middle part moderately deep or shallow; genal angles rounded in general (less commonly angular; short genal spines recorded exceptionally). Surface smooth. *Ord.-L.Dev.*, N.Am.-S.Am.-Eu.

P. (*Phacopina*). Exoskeleton small. Cephalon with moderately deep axial furrows, swinging slightly outward; glabella subrectangular to subtrapezoidal; frontal glabellar lobe broadly rounded anteriorly; 2*p* and 3*p* lateral glabellar furrows obsolete; occipital ring scarcely broadened medially; eyes moderately large. Pygidium blunt, convex. *L.Dev.*, N.S.Am.-E.N.Am.—FIG. 386,4a. **P.* (*P.*) *braziliensis* (CLARKE), Braz.(Pará); ceph., $\times 3$ (386).—FIG. 386,4b. *P.* (*P.*) *anceps* (CLARKE), Onondaga Ls., Ont.(Cayuga); ceph., $\times 3.5$ (386).

P. (*Scotiella*) DELO, 1935 [**Dalmania logani* HALL, 1860]. Cephalon moderately vaulted, with straight, deep axial furrows; glabella subrectangular, subtrapezoidal, or subpentangular; 2*p* and 3*p* lateral glabellar furrows indistinct or obsolete, 3*p* oblique, 2*p* transverse; occipital furrow curved gently forward mesially, so that middle part of occipital ring is somewhat broadened; eyes large. Pygidium moderately vaulted; with 3 to 8 rings and 3 to 6 pairs of furrowed or unfurrowed ribs distinct; short posterior spine may be present. *Ord.-Sil.*, N.Am.?Eu.—FIG. 386,5. *P.* (*S.*) *logani* (HALL), Sil. (Stonehouse F.), N.Scotia (Arisaig); 5a,b, cran. (5a, reconstr.), $\times 2.5$ (403, 427); 5c, pyg., $\times 2.5$ (403).

Family PTERYGOMETOPIDAE Reed, 1905

[*nom. transl.* PILLET, 1954 (ex Pterygometopinæ REED, 1905)] [*Authorship.* Selection of genera for assignment to this family, their arrangement in subfamilies, and description of genera are by W. STRUVE, except for contributions by RUD. RICHTER on *Josephulus*.]

Exoskeleton highly vaulted (with some exceptions). Glabella with frontal lobe more or less hypertrophic, especially in transverse direction, 3*p* lateral glabellar lobes slightly to strongly hypertrophic at cost of 2*p* (and even 1*p*) lobes, 1*p* lobes narrow, tending to become detached from central area; 2*p* lateral glabellar furrows slightly to very oblique in anteromesial direction; posterior sections of facial sutures may be in distinct genal sulcus; genal spines present or absent. Pygidium subequal to cephalon in size, without posterior spine. *M.Ord.-U.Ord.*

Subfamily PTERYGOMETOPINAE Reed, 1905

[Includes *Eomonoracheinae* PILLET, 1954]

Glabella with frontal lobe protruding sideward slightly more than 3*p* lateral glabellar lobes or much beyond them, lateral corners of frontal lobe tending to become

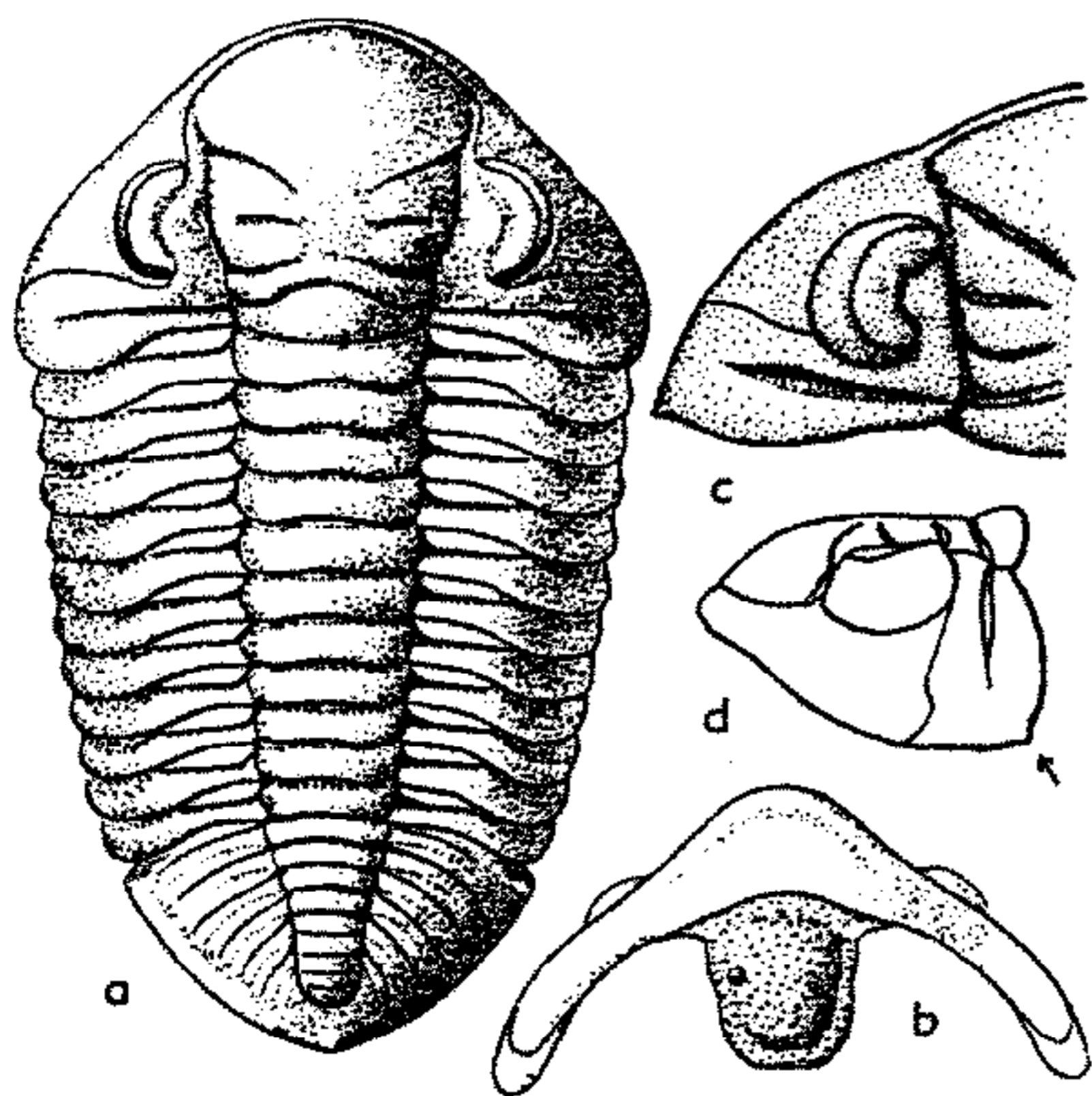

FIG. 387. **Acaste downingiae* (MURCHISON) (Calmoniidae), M.Sil., Eng.; a, exoskel.; b, cephalic doublure and hypostoma; c,d, cephalia; all $\times 3$ (a,b, 266; c,d, 255).

alate by coalescence with adjacent parts of genal region (*Pterygometopus*); slight to considerable hypertrophy of $3p$ lobes, impinging on $2p$ lobes and reducing their size, $1p$ lobes narrow, depressed, more or less de-

tached from central area so as to form small rounded bodies; generally all furrows distinct, $2p$ lateral glabellar furrows directed somewhat obliquely in anteromesial direction, in some genera reduced distally in manner causing $2p$ and $3p$ lobes to coalesce, $1p$ furrows subparallel to $2p$ furrows; longitudinal furrows may be developed; eyes (with some exceptions) moderately large to very large, close to posterior border furrows or at moderate distance from them. Pygidium triangular or semicircular. *M.Ord.-U. Ord.*

Pterygometopus FR. SCHMIDT, 1881 [*Calymene sclerops* DALMAN, 1827]. Cephalon broadly rounded or elongate ogival (*tr.* or *sag.*); border distinct, narrowed in front of glabella in several; frontal glabellar lobe may fuse with swellings of adjacent parts of genal region (*cf.* *Ductina*) so as to become alate (e.g., as compared with *Calyptaulax*) (1) by broadening, re-entering, and swelling of border at contact with lateral corners of proper frontal lobe, (2) by formation of swellings of genae that may remain detached from proper frontal lobe, or cut off coalesced parts to produce short to very long processes between cephalic border and remainder of genae, or exceptionally (3) by entire coalescence of frontal lobe with border; anterior sections of facial sutures cutting off or running around lateral corners of proper frontal lobe, or cutting off coalesced parts of genal region from proper frontal lobe; $1p$ and $2p$ lateral glabellar furrows slightly to moderately oblique in anteromesial direction (with few exceptions); eyes elevated or highly conical, generally small to large and distant from posterior border furrows. Pygidium semicircular to triangular, in many species truncate posteriorly; border narrow to moderately wide, not distinctly detached; axis long, slender to moderately broad, with 5 to 13 rings; pleural regions with 6 to 13 pairs of furrowed ribs. [Recognized subgenera are so closely related that diagnoses are applicable to only a few species in each, others being classified in the genus *sensu lato.*] *Ord.*, N.Eu.-Br.I.-NE.N. Am.

P. (*Pterygometopus*). Cephalon semicircular to transversely elongate; cephalic border broadening toward axial furrows, slightly elevated at contact with lateral corners of frontal lobe which are distinctly limited; lateral glabellar lobes slightly decreasing in size from $3p$ to $1p$; eyes relatively small, somewhat distant from posterior border furrows; genal angles rounded or subangular. *Ord.*, N.Eu.-Br.I.—FIG. 388, 2. **P.* (*P.*) *sclerops* (DALMAN), *Expansus* Ls., Swed. (Östergötland); 2a-c, ceph. (holotype), dorsal, lateral, anterolateral, $\times 2$, $\times 2$, $\times 3$ (474, 496); 2d,e,

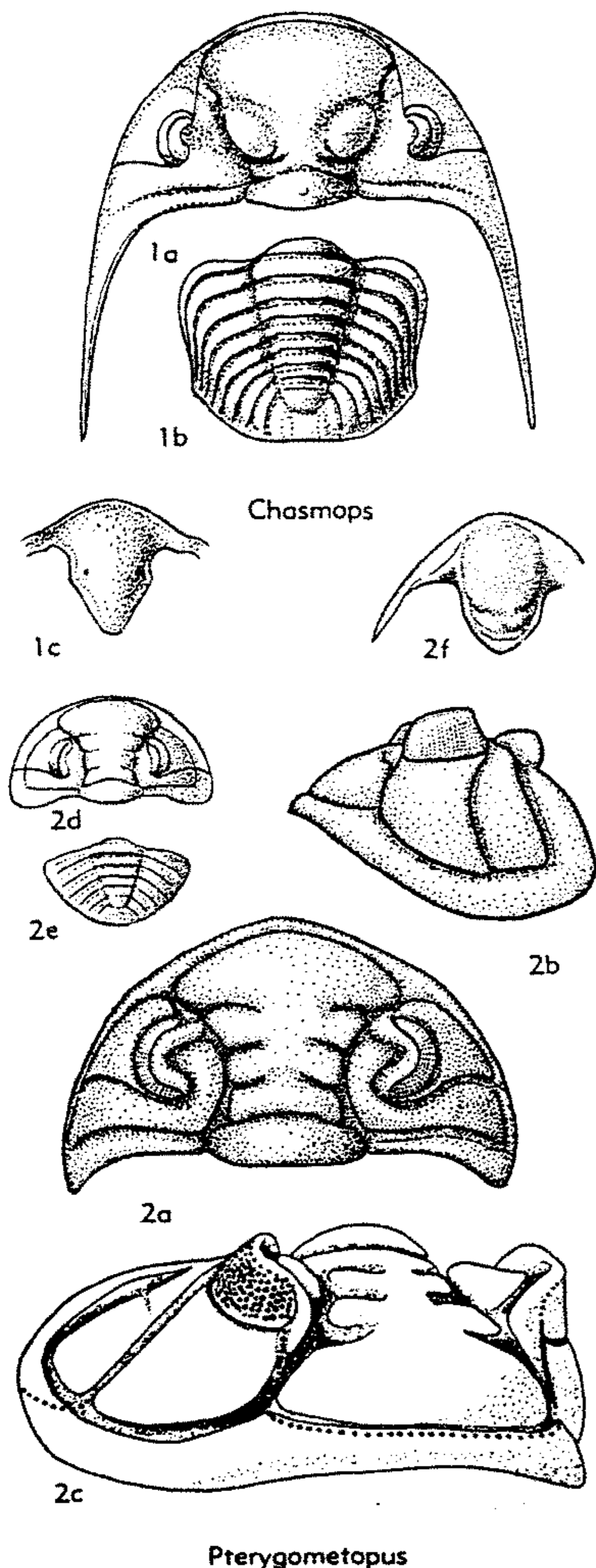

FIG. 388. Pterygometopidae (Pterygometopinae, Chasmopinae) (p. 0490-0493).

ceph., pyg., $\times 1$ (269, 458); 2f, hypostoma, $\times 2$ (474, 496).

P. (Achatella) DELO, 1935 [*Dalmanites achates* BILLINGS, 1860]. Exoskeleton rather flat. Cephalon semicircular to transversely subrectangular; axial furrows divergent; frontal lobe of glabella transversely elongate elliptical, 3p lateral glabellar lobes larger than 1p and 2p lobes, which are

subequal in size; occipital ring broad, elevated; eyes relatively small, highly elevated, near center of genae; genal spines well developed. Pygidium triangular to subtriangular; with 9 to 13 pairs of ribs distinct. *M.Ord.-U.Ord.*, N.Am.-Br.I.—FIG. 389,4. **Achatella achates* (BILLINGS), *M.Ord.* (Trenton.), N.Y.; ceph. (reconstr.), $\times 1.5$ (33).

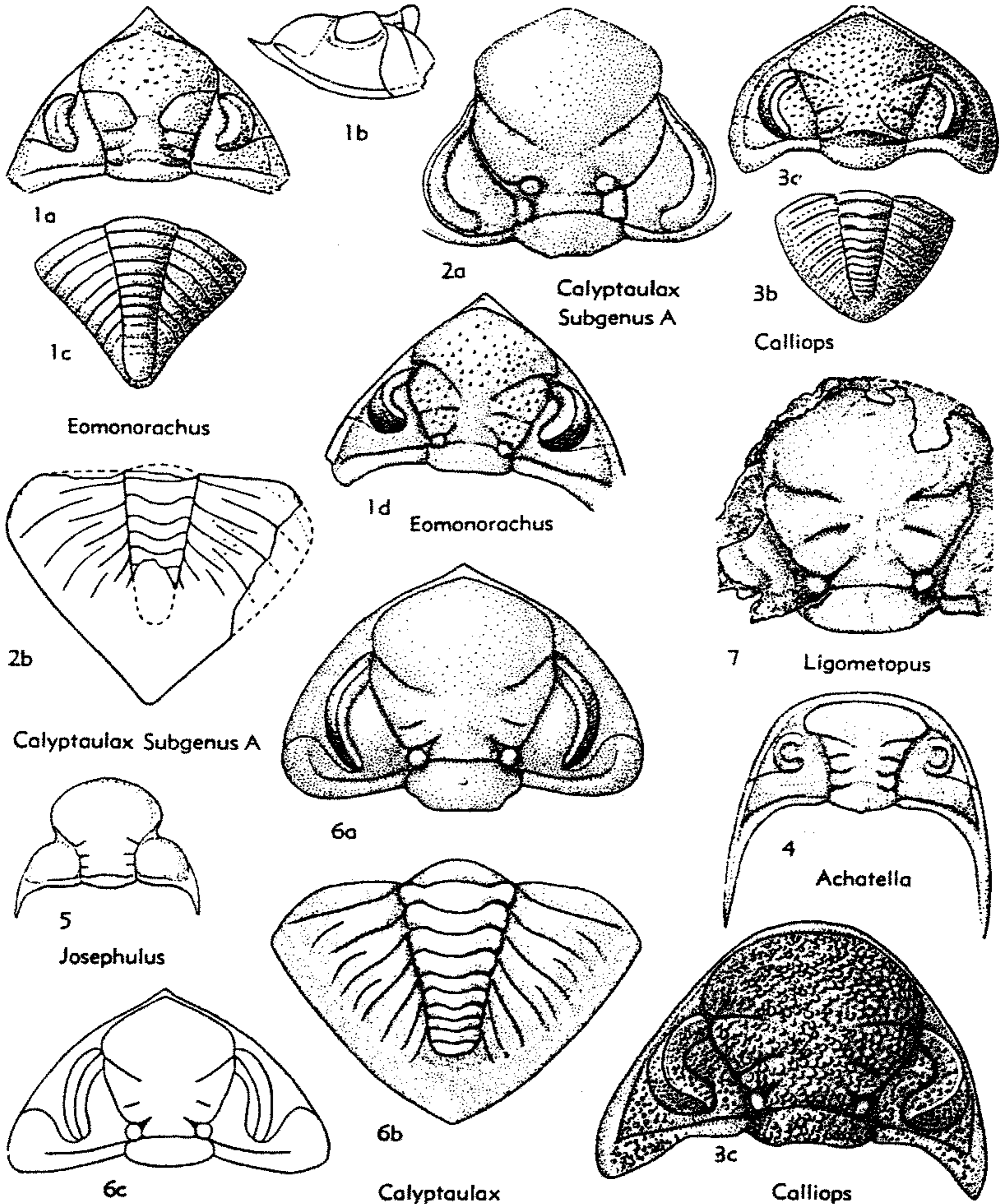

FIG. 389. Pterygometopidae (Pterygometopinac) (p. 0491-0492).

Calyptaulax G. A. COOPER, 1930 [**Calyptaulax glabella*]. Cephalon highly vaulted; frontal lobe of glabella may be prolonged sideward in sickle-shaped elevations of genae that embrace eyes anteriorly and laterally and are cut off from frontal lobe by facial sutures; 3*p* lateral glabellar lobes distinctly triangular, large, protruding sideward a little less than frontal lobe, 2*p* lobes smaller than in *Eomonarachus*; central area more or less arched, never depressed; longitudinal furrows may be present; 2*p* lateral glabellar furrows distinctly oblique in anteromesial direction, 1*p* furrows subparallel to 2*p* furrows; genal spines present or absent. Pygidium highly vaulted, generally subtriangular; posterior margins of rings undulating (narrow curve laterally, flat broad curve mesially). *M.Ord.-U.Ord.*, N.Am.-Eu. [Authorship of genus should be cited as G. A. COOPER in COOPER & SCHUCHERT, 1930.]

C. (*Calyptaulax*). Glabella with 2*p* and 3*p* lateral lobes coalesced by abaxial reduction of shallow 2*p* lateral glabellar furrows, which do not reach axial furrows; 1*p* lobes distinctly detached; eyes in most species very large, close to glabella and posterior border furrows. Pygidium with 5 to 12 rings and 3 to 12 pairs of distinct ribs, pleural furrows distinct, interpleural furrows fairly well marked distally. *M.Ord.-U.Ord.*, N.Am.-Eu. —FIG. 389.6. **C. (C.) glabella*, *U.Ord.*, Que. (Percé); 6*a,b*, ceph., pyg., ×3 (33 mod., 474); 6*c*, ceph., ×2 (391 mod., 474).

C. (*Calliops*) DELO, 1935 [**Phacops callicephalus* HALL, 1847]. Glabella with 1*p* lateral lobes detached; 2*p* lateral glabellar furrows narrower and shallower than 1*p* and 3*p* furrows but reaching axial furrows; eyes very large, close to glabella and posterior border furrows. Pygidium with 8 to 11 axial rings and 4 to 8 pairs of ribs, pleural furrows distinct, interpleural furrows distinct or obsolete. *M.Ord.-U.Ord.*, N.Am.—FIG. 389.3. **C. (C.) callicephalus* (HALL), *M.Ord.*; 3*a,b*, ceph., pyg., (Galena Dol., Minn.), ×1.5 (386, 458); 3*c*, ceph. (Trenton., N.Y.), ×3 (26 mod., 33 mod., 474).

C. (*Ligometopus*) ULRICH & DELO, in DELO, 1940 [**L. typus*]. Cephalon closely resembling that of *C. (Calliops)*, glabella with subelliptical frontal lobe, not alate; 2*p* lateral glabellar lobes smaller than 3*p*, these lobes fused laterally and separated from gently arched central area by shallow longitudinal furrows; 1*p* lobes distinctly detached; 2*p* furrows very shallow abaxially, deep elongate pits adaxially; eyes moderately large, close to glabella and posterior border furrows. Pygidium strongly vaulted, broadly rounded posteriorly; with about 10 axial rings and 7 or 8 pairs of broad, furrowed ribs. *M.Ord.*, USA.—FIG. 389.7. **C. (L.) typus* (ULRICH & DELO), Va.; ceph. (holotype), ×3 (26, 33).

C. (Subgen. A) [= *Homalops* REMELÉ, 1885 (*non*

MOTSCHULSKY, 1850)]. Cranidium flattened; frontal glabellar lobe subpentagonal, somewhat wider than long, large (more than twice length of central area, *sag.*); 3*p* lateral glabellar lobes very hypertrophic, especially in anterolateral direction; 2*p* lobes reduced to small, detached, rounded bodies; 1*p* lobes also detached; subquadrate in outline; eyes large (about 0.7 of glabellar length), extremities close to glabella and posterior border furrows. Pygidium with faint furrows on pleural lobes and very slender axis. *Ord.*, NW.Eu.—FIG. 389.2*a*. C. (subgen. A) *altumii* (REMELÉ), ?*U.Ord.* (Pleist. erratic), Ger. [type species of *Homalops*]; ceph. (holotype), ×3 (455, 474). —FIG. 389.2*b*. C. (subgenus A) cf. *altumii* (REMELÉ), *U.Ord.* (Slandron Ls.), Swed.; pyg., ×6 (414, 1953).

Eomonarachus DELO, 1935 [**Dalmanites intermedius* WALCOTT, 1877]. Cephalon vaulted; glabella with large subrhombic frontal lobe, 3*p* lateral lobes subtriangular, protruding laterally less than frontal lobe, 2*p* lobes smaller than 3*p* lobes, 1*p* lobes well detached, small, round tubercles; narrow 2*p* lateral glabellar furrows slightly oblique in anteromesial direction, shallow, deeper adaxially but complete, central area depressed; eyes moderately large, close to glabella, somewhat distant from posterior border furrows; genal spines slender, rather long. Pygidium distinctly triangular, strongly vaulted; axis slender, almost reaching posterior margin; with 8 clearly defined rings distinct and some indistinct; pleural regions with 7 or 8 pairs of broadly rounded, unfurrowed ribs. *M.Ord.*, USA.—FIG. 389.1. **E. intermedius* (WALCOTT), Minn.; 1*a,b*, ceph., dorsal, lateral (Blackriv.), ×2 (386, 458); 1*c*, pyg. (Blackriv.), ×2 (386, 458); 1*d*, ceph. (Decorah), ×2 (33 mod., 474).

Josephulus WARBURG, 1925 [**J. gracilis*]. Only cranidium known; axial furrows curved anterolaterally, well impressed; glabella strongly convex, with frontal lobe twice as broad (*tr.*) as posterior part of glabella; 1*p* to 3*p* lateral glabellar furrows short, equally developed; fixigenae swollen; eye lobes apparently small; anterior sections of facial sutures not intersecting lateral corners of frontal lobe, posterior sections reaching margin near base of genal spines. *U.Ord.*, Swed.—FIG. 389.5. **J. gracilis*, Leptaena Ls., Dalarne; ×2 (323).

Subfamily CHASMOPINAE Pillet, 1954

[*nom. correct.* STRUVE, herein (*pro* "Sous-famille des Chasmopsidae," PILLET, 1954, *laps. cal.*)]

Glabella with frontal lobe and 3*p* lateral glabellar lobes extremely hypertrophic (except in primitive forms), 2*p* lobes much reduced or obsolete, 1*p* lobes tending to be slightly detached from central area. Pygidium more or less elongate (*sag.*), with distinct segmentation, axial rings and pleurae

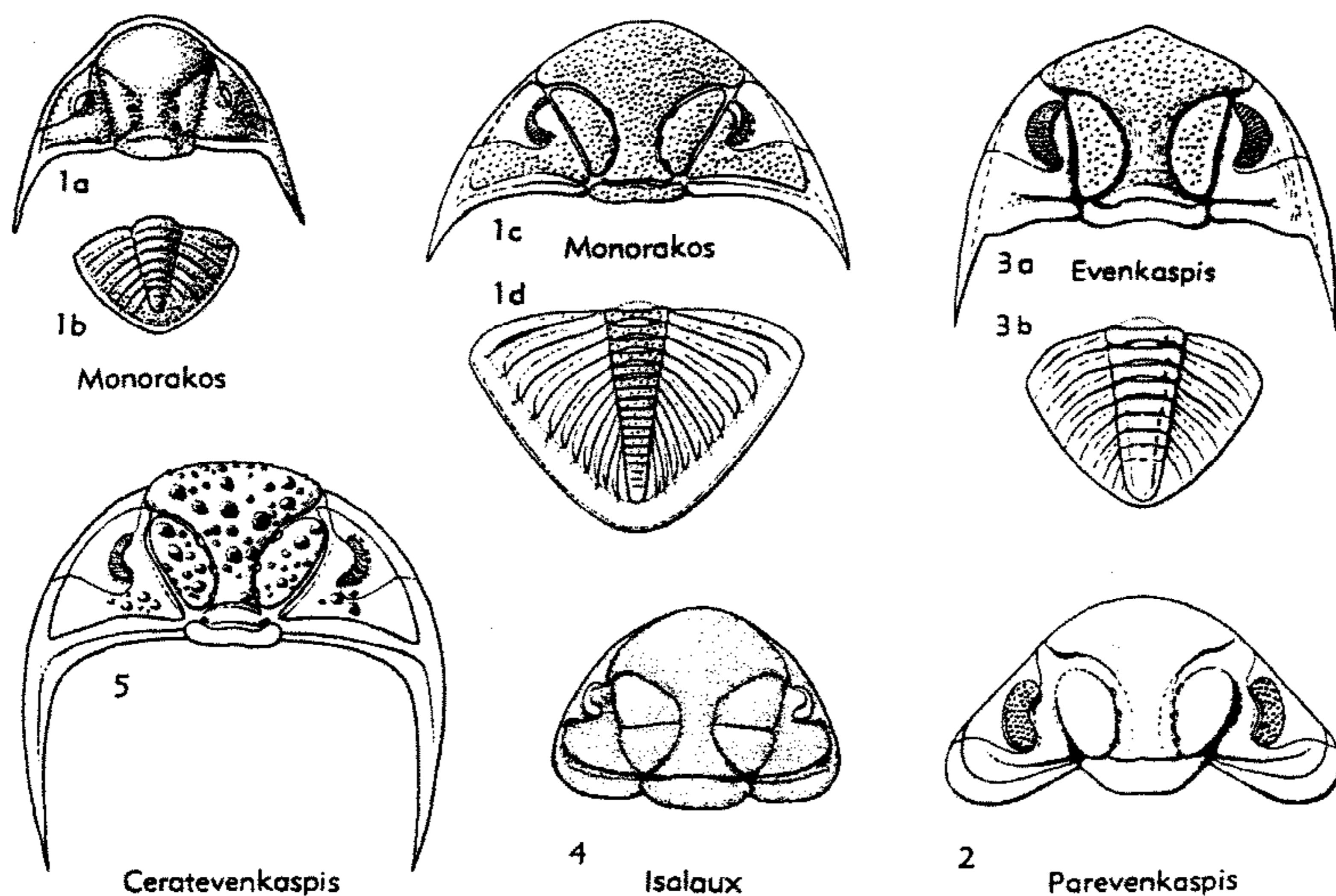

FIG. 390. Monorakidae (p. 0494-0495).

generally numerous, ribs reaching margin or terminating close to it. *Ord.*

Chasmops M'COY, 1849 [**Calymene odini* EICHWALD, 1840]. Cephalon semicircular, ogival, transversely subrectangular or subpentangular; glabella with frontal lobe inflated, not alate as in *Pterygometopus*, anterior slope steep or overhanging, posterior part fused with central area; *3p* lateral glabellar lobes triangular, less commonly rounded, detached from central area or not, anterior corners tending to indent posterior margin of frontal lobe, posterior part reaching far backward so as to compress remnants of *2p* lobes and even *1p* lobes toward sagittal line of glabella (*cf. Calyptraulax* subgen. A), *1p* lobes complete or somewhat reduced abaxially; "intercalating ring" may be distinct; eyes moderately to very high and ranging from small to large; genal spines generally present and very long. Pygidium with long axis containing 6 to 20 rings; distal parts of pleural lobes steeply sloping or vertical with 6 to 20 pairs of ribs; border indistinctly marked, may be indicated by bending backward of distal ends of ribs; posterior margin rounded, acute, or truncated, in many species arched (vert.). *Ord.*, N.Eu.-Br.I.-N.Am. — FIG. 388, I. **C. odini* (EICHWALD), Est. (Kukruse); 1a-c, ceph., pyg., hypostoma, $\times 1.5$ (458).

Family MONORAKIDAE Kramarenko, 1952

[*nom. correct.* STRUVE, herein (*pro* Monorakidae, *nom. transl.* PILLET, 1954, *ex* Monorakeinae KRAMARENKO, 1952)]
[*Authorship.* All contributions on this family here published are by W. STRUVE.]

Glabella with *2p* lateral lobes hypertrophic in backward direction, fused with *3p* lobes to form a single pair of large, bicomposite lobes, *1p* lobes very narrow or completely suppressed; *1p* and *3p* lateral glabellar furrows connected by generally deep longitudinal furrows, *2p* furrows reduced to adaxial pits (except in *Isalaux*); eyes small to large (0.2 to nearly 0.5 of glabellar length), distant from posterior border furrows; with or without genal spines. Pygidium little shorter than cephalon; with 10 to 15 rings and 7 or more pairs of ribs, no posterior spine. *M. Ord.-U.Ord.*

The tendency to form a single pair of lobes in the place normally occupied by *2p* and *3p* lateral glabellar lobes combined with reduction of *1p* lobes, is also displayed by *Chasmops* and several genera of the *Pterygometopinae*. In these latter genera, however, such trends are combined with

recession and reduction of the 2*p* lobes. The final stage of evolution leads to very similar glabellar features in both families (also *Trypaulites* in Dalmanitinae). It seems appropriate to recognize the Monorakidae as a family. *Trypaulites* and the Coronurinae (*Coronura*, *Anchiopella*, *Corycephalus*, *Malladaia*, and *Odontocephalus*), assigned by PILLET (1954, p. 835) to the Monorakidae, seem to be true Dalmanitinae.

Monorakos FR. SCHMIDT, 1886 [*Phacops* (*Monorakos*) *lopatini*; SD VOGDES, 1925] [= *Monorhachis* VOGDES, 1925 (*nom. van.*); *Monorachus* CLARKE, 1897 (*nom. van.*)]. Cephalon with straight axial furrows, anterior cephalic border more or less visible from above; glabella with frontal lobe transversely expanded, subrhombic in outline, 3*p* lateral glabellar furrows nearly straight, longitudinal furrows shallow to very deep; bicomposite lobes (3*p*+2*p*) moderately to very elongate, 1*p* lobes reduced to small, wedge-shaped lappets; genal spines present. *U.Ord.*, Sib. (Podkamennaja Tunguska).

M. (Monorakos). Cephalon wide crescent-shaped, gently convex; axial furrows considerably divergent forward in most species; frontal lobe of glabella transversely much expanded, bicomposite lateral glabellar lobes slender, slightly elevated; genal spines of moderate length. Pygidium gently convex, subtriangular, with broad border. Surface finely granulose or smooth. *U.Ord.*, Sib.—FIG. 390,1*a,b*. **M. (M.) lopatini* (FR. SCHMIDT); ceph., pyg., ×1 (468).—FIG. 390,1*c,d*. *M. (M.) magnus* KRAMARENKO; ceph., pyg., ×1.5 (112).

M. (Ceratevenkaspis) KRAMARENKO, 1952 [*Ceratevenkaspis armata*]. Cephalon horseshoe-shaped, frontal border not visible from above; axial furrows strongly divergent forward, glabella inflated, with frontal lobe subtriangular in outline, overhanging frontal margin, central area narrow (*tr.*), depressed (except posterior part); 1*p* and 3*p* glabellar furrows and longitudinal furrows deep; bicomposite lobes inflated, highly elevated; glabella (except depressed part of central area) coarsely granulated; genal spines long. Thorax and pygidium unknown. *U.Ord.*, Sib.—FIG. 390,5. **M. (C.) armatus* (KRAMARENKO); ceph., ×1.9 (112).

M. (Evenkaspis) KRAMARENKO, 1952 [*Evenkaspis marina*]. Cephalon semicircular, subangular, anteriorly; axial furrows moderately divergent; frontal lobe moderately wide, subrhombic to elliptical, more or less inflated, but not overhanging frontal margin; central area depressed (except posterior part); 1*p* and 3*p* lateral glabellar furrows and longitudinal furrows deep; bicomposite glabellar lobes strongly elevated; genal spines

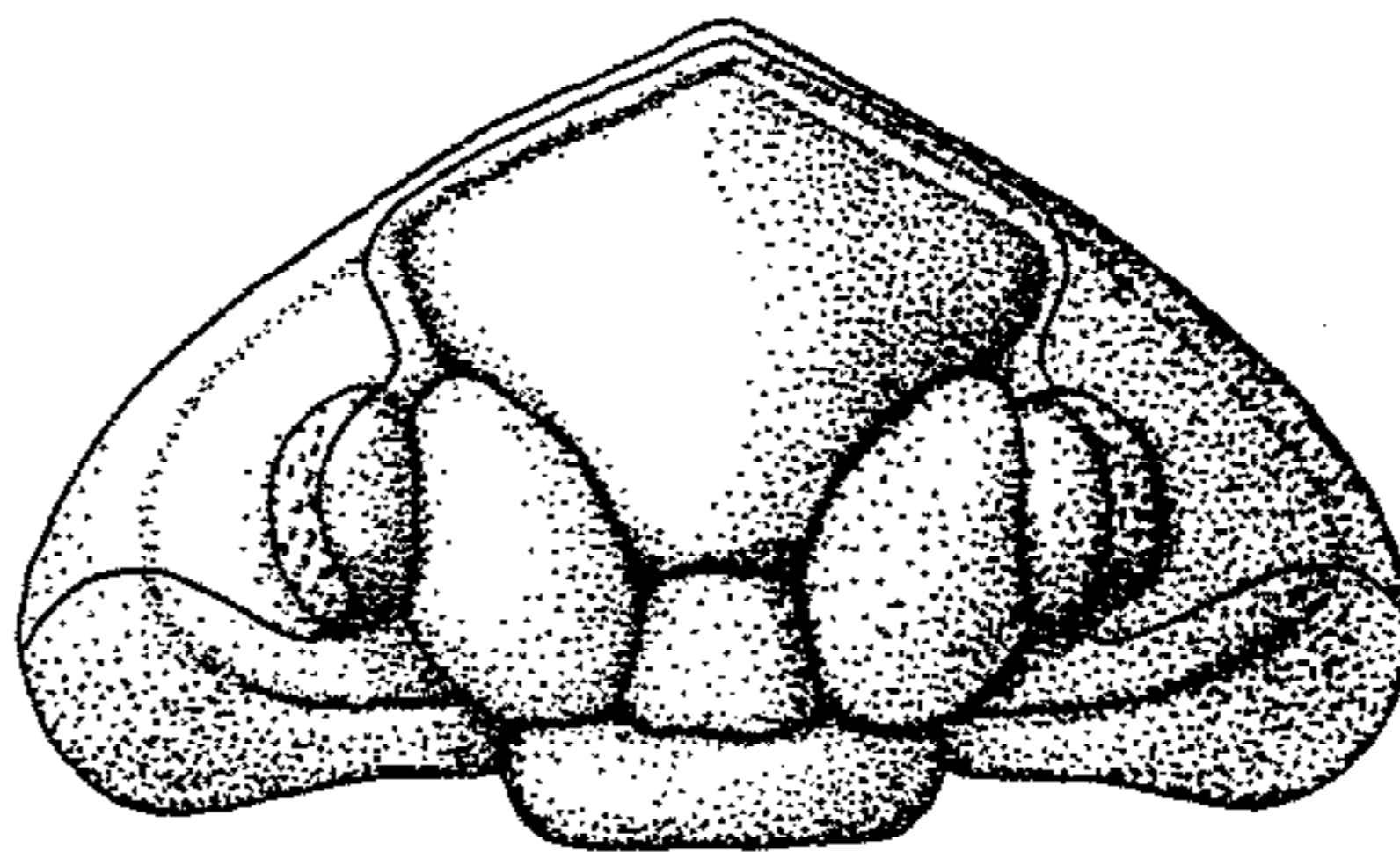

FIG. 391. **Elasmaspis speciosa* KRAMARENKO (Monorakidae), *U.Ord.*, Sib.; ceph., ×4 (112).

moderately long. Surface may be finely granulose (except in central area). Pygidium lacking border. *U.Ord.*, Sib.—FIG. 390,3. **M. (E.) marinus* (KRAMARENKO); 3*a,b*, cran., pyg., ×1.3 (112).

Elasmaspis KRAMARENKO, 1956 [*Elasmaspis speciosa*]. Cephalon wide subogival, cephalic border very broad posterolaterally, narrow anteriorly, visible from above in front of glabella; axial furrows pushed outward by bicomposite glabellar lobes, returning toward 3*p* lateral furrows; glabella slightly broadened forward; frontal lobe large, nearly rhombic in outline; bicomposite lobes large, roughly egg-shaped; 3*p* and longitudinal furrows very narrow and deep; transglabellar furrow deeply incised; 1*p* lateral glabellar lobes entirely suppressed; genal angles well rounded, lacking spines. *U.Ord.*, Sib.—FIG. 391. **E. speciosa*, Podkamennaja Tunguska; ceph., ×4 (420, 1956).

Isalaux FREDERICKSON & POLLACK, 1952 [*I. cañonensis*]. Cephalon rather vaulted, with rounded anterior margin; glabella broadening forward, frontal lobe sloping forward steeply, fused with central area to form a single mushroom-shaped lobe similar to *Parevenkaspis*; 2*p* and 3*p* lateral glabellar lobes detached from central area by longitudinal furrows, 2*p* lobes very hypertrophic at expense of 1*p* lobes, which are reduced to short wedge-shaped lappets; 1*p* to 3*p* lateral glabellar furrows distinct; eyes small with visual surface curved in semicircle; lateral parts of genae steeply sloping; genal angles subangular, without spines. Pygidium rounded triangular with axis reaching posterior margin; about 11 rings; pleural fields steeply sloping, with about 7 pairs of ribs distinct. [Except 2*p* furrows, the glabellar features of *Isalaux* are very like those of *Parevenkaspis*. Despite some similarities to *Eomonorachus* and closely related forms, *Isalaux* is more advanced in the trend toward typical Monorakidae. The name *Isalaux* presumably is a misspelling of *Isaulax* (Gr., *is*+*aulax*, equal furrow) but if so, under the Rules it is not correctable.] *M.Ord.*, C. USA.—FIG. 390,4. **I. cañonensis*, Harding F. Colo.; ceph., ×2.5 (400).

Parevenkaspis KRAMARENKO, 1952 [**Parevenkaspis egloni*]. Cephalon wide semiparaboloid; axial furrows convex outward; glabella roughly circular in outline, with segmentation like that of *Isalaux*, frontal lobe inflated, bicomposite lobes subelliptically bulbous; 2*p* lateral glabellar furrows completely reduced to adaxial pits, 3*p* and longitudinal furrows deep and wide; eyes strongly elevated, visual areas nearly horizontal; genal angles rounded, without spines. *U.Ord.*, Sib.—FIG. 390, 2. **P. egloni*, Podkamennaja Tunguska; ceph., $\times 3.4$ (112).

Suborder UNCERTAIN

Turcopyge RICHTER & RICHTER, 1939 [**T. eduardi*]. Cephalon and thorax unknown. Pygidium with very broad axis, 5 or 6 rings with medial nodes, posterior part of axis not annulated, passing over into a posterior process; pleural fields with at least 5 pairs of geniculate to curved ribs, ending in cylindrical lateral (?posterior) processes that become shorter toward posterior extremity. *L.Dev.*, Thrace-Morocco.—FIG. 381, 5. **T. eduardi*, Thrace; pyg., $\times 1.5$ (386). [Contributed by W. STRUVE.]

Order LICHIDA Moore, nov.

[=Superfamily Lichacea KOBAYASHI, 1935; Lichadacea PHLEGGER, 1936; Lichadoidae HUPÉ, 1953 (attributed to KOBAYASHI, 1935); Lichacea TRIPP, 1957] [Type—*Lichas* DALMAN, 1827].

Medium-sized to exceptionally large trilobites chiefly characterized by distinctive cephalic and pygidial features. Glabella broad, extending to anterior border, which may be ill defined; with pair of lateral glabellar furrows longitudinally elongated; lateral glabellar and occipital lobes tending to fuse with one another and with other parts of the cranidium; facial sutures opisthoparian. Pygidium large; pleural regions usually flattened, and composed of 3 pairs of pleurae that commonly exhibit leaflike or strongly spinose form. Dorsal surface almost invariably tuberculate. *L.Ord.-U.Dev.*

Family LICHIDAE Hawle & Corda, 1847

[*nom. correct.* ANGELIN, 1854 (*ex* Lichades HAWLE & CORDA, 1847, *nom. imperf.*)] [=Lichasidae PICTET, 1854; Lichadae SALTER, 1864; Lichadidae BEECHER, 1897] [According to the opinion of a British specialist in classical languages, Professor L. W. GREENSTED, who is ICZN adviser, the name *Lichas* ought to be treated as masculine in gender, with genitive *Lichae*. That makes the family name Lichidae. *Lichas* is the name of the squire of Herakles.]

Cranidium usually moderately convex, but ranging from flattened to extremely convex; glabella broad and subrectangular; median lobe expanded anteriorly, basal area tending to become depressed; foremost pair of lateral glabellar furrows extended backward to form longitudinal furrows, which

may reach occipital furrow; middle lateral furrows obsolete or represented by notches on longitudinal furrows; basal lateral furrows may be complete (bicomposite lobes then usually circumscribed), or incomplete (bicomposite lobes then partially defined), or lacking (lateral lobes then tricomposite); axial furrows tend to die out or to be diverted posteriorly; circumscribed occipital lobes present (*Lichas* and other genera) but commonly fused with posterior lateral glabellar lobes; occipital ring broad; glabellar lobes vary greatly in definition and inflation, in some genera becoming bulbous; preglabellar field absent; anterior border may be ill defined or strongly developed and projecting at an angle; fixigenae subtriangular; palpebral lobes marked off by furrows; anterior sections of facial sutures converging forward, running parallel and close to axial furrows; posterior sections curving backward-outward to cross posterior borders; eyes of moderate size, pedunculate in some species, usually situated behind mid-length of glabella and close to it; librigenae usually broadly falciform but may develop broad subgenal notch inside librigenal spine. Rostral plate usually subtrapezoidal, transversely elongate, bounded laterally by connective sutures continuous with facial sutures; flattened or convex; produced anteriorly beneath cranial projection in some species. Hypostoma subquadrate; posterior margin transverse or indented; middle body swollen, circumscribed or undefined at rear; posterior lateral lobes of middle body varying in size and definition; lateral borders moderately broad to broad, anterior wings more or less strongly developed; surface tuberculate, pitted, and with anastomosing raised lines. Thorax composed of 11 segments in species with 3 pairs of pleurae in pygidium (one species has 10 segments in thorax and 4 pairs of pleurae in pygidium); axis broad, arched transversely; articulating half-rings short; axial furrows shallow; pleurae horizontal and transverse proximally, bent downward and backward at fulcra, terminating in short free points; submedial pleural furrows usually present. Pygidium with axis extending part or whole of length, wide anteriorly, tapering or flaring posteriorly; with 1 to 5 axial rings; posterior pair of pleurae may be unfurrowed; pleurae

usually end in free points, but margin of posterior pair may be rounded or produced into a posterior spine, of great length in some species; pygidium modified in certain Devonian ceratarginids. Doublure broad, particularly on pygidium, carrying usual terrace lines, spaced far apart. Apodemes not developed. Dorsal surface characteristically marked by scattered large tubercles with smaller tubercles between them but may be smooth or punctate; some forms, especially among Devonian genera, tend to develop spines or skeletal outgrowths on parts of dorsal exoskeleton. Most species medium-sized but some are exceptionally large. *L. Ord.-U.Dev.*

Subfamily LICHINAE Hawle & Corda, 1847

[*nom. transl.* GÜRICH, 1901 (*ex Lichades* HAWLE & CORDA, 1847)]

Bicomposite, basal and occipital lobes defined except in *Arctinurus* and Devonian genera. Hypostoma with posterior margin strongly indented; middle body undefined posteriorly, except in *Uralichas* and *Metopolichas*; posterior lateral lobes of middle body large, shaped like cat's ears. Pygidium with axis flaring or tapering; posterior pair of pleurae usually furrowed; posterior margin indented, unindented, or with long posterior spine. [*"Lichas" kloučeki* RŮŽIČKA, Tremadoc., Boh., probably belongs in this subfamily.] *L.Ord.-M.Dev.*

Lichas DALMAN, 1827 [**Entomostracites laciniatus* WAHLENBERG, 1821] [= *Autolichas* REED, 1923]. Characteristically, longitudinal furrows do not extend beyond bicomposite lobes, but they may be produced to occipital furrow. Axis of pygidium widening at back; 3 pairs of furrowed pleurae, posterior margin of 3rd rounded or sublanceolate. *U.Ord.-M.Sil.*, Eu.-N.Am.—FIG. 392,3. **L. laciniatus* (WAHLENBERG), Dalmanites Sh., Swed.; 3a,b, cran., dorsal, lateral, $\times 1.25$; 3c, hypostoma probably belonging to this species, $\times 2.1$; 3d, pyg., $\times 1.25$ (324).—FIG. 393,3. Pathological pygidium possibly belonging to *L. laciniatus*, locality and horizon unknown, $\times 2$ (486n).

Metopolichas GÜRICH, 1901 [*pro Metopias* EICHWALD, 1842 (*non* GORY, 1832)] [**Metopias hübnéri* EICHWALD, 1842; SD REED, 1902] [= *Macroterolichas* PHLEGER, 1937]. Longitudinal furrows do not extend beyond bicomposite lateral lobes. Middle body of hypostoma circumscribed, with relatively small posterior lateral lobes; lateral borders broad. Axis of pygidium widening at back; 3 pairs of furrowed pleurae, posterior margin of 3rd pair rounded or indented. *L.Ord.-M.Ord.*, N.Eu.-Asia.—FIG. 392,1a,b,d. **M. hübnéri*

(EICHWALD), Tallinna Ls., Est.; 1a,b, cran., dorsal, lateral, $\times 0.85$; 1d, pyg., $\times 0.85$ (468).—FIG. 392,1c. *M. verrucosus* (EICHWALD), Vaginatium Ls., Swed.; hypostoma, $\times 0.85$ (489).—FIG. 393,1. *Metopolichas?* sp., Limbata or Planilimbata Ls., Swed.; pyg., $\times 1.8$ (453n).

Uralichas DELGADO, 1892 [**Lichas (Uralichas) ribeiroi* DELGADO, 1892] [= *Platopolichas* GÜRICH, 1901]. Longitudinal furrows not extending beyond bicomposite lateral lobes; axial furrows faint posteriorly. Middle body of hypostoma faintly defined posteriorly; lateral borders narrow. Pygidium with relatively broad axis, narrowing slightly toward back; 3 or 4 pairs of pleurae, posterior pair ending in short free points or produced into long posterior spine. Type species estimated to have attained length of 70 cm. to tip of posterior spine. *M.Ord.*, Eu.—FIG. 394,3. **U. ribeiroi* (DELGADO), M.Ord. Port.; 3a, cephal., $\times 0.25$; 3b, hypostoma, $\times 0.4$; 3c, pyg., $\times 0.25$ (394).—FIG. 393,2. *U. avus* (BARRANDE) (type species of *Platopolichas*), Sárka beds, Boh.; 2a, cran., $\times 1.3$; 2b, pyg., $\times 1.3$ (486n).

Leiolichas SCHMIDT, 1885 [**Platymetopus illaenoides* NIESZKOWSKI, 1857]. Longitudinal furrows faintly connected to occipital furrow; posterior lateral glabellar furrows lightly impressed on some internal molds; glabellar lobes with little independent convexity. Hypostoma unknown. Pygidium with lateral and posterior margin rounded; dorsal surface smooth; internal molds show tapering axis and 3 pairs of furrowed pleurae. *M.Ord.-U.Ord.*, N.Eu.—FIG. 394,1. **L. illaenoides* (NIESZKOWSKI), Keila Ls., Est.; 1a,b, cran., dorsal, lateral, $\times 0.85$; 1c, pyg. (left, external cast; right, internal mold), $\times 0.85$ (468).

Dicranopeltis HAWLE & CORDA, 1847 [**Lichas scabra* BEYRICH, 1845; SD REED, 1902] [= *Trachylichas* GÜRICH, 1901 (obj.); *Dicranopeltoides*, *Makromuktis* PHLEGER, 1936; ?*Raymondarges* PHLEGER, 1937]. Bicomposite lateral lobes usually circumscribed; longitudinal furrows may be connected to occipital furrow by depressions; occipital lobes commonly ill defined. Axis of pygidium long, narrowing toward back; 3 pairs of furrowed pleurae ending in free points. *U.Ord.-U.Sil.*, Eu.-N.Am.—FIGS. 392,5, 393,5. **D. scabra* (BEYRICH), Motol beds, Boh.; 392,5a, exoskel., $\times 0.85$; 392,5b, 393,5, hypostoma, $\times 0.9$, $\times 2.7$ (486n).

Arctinurus CASTELNAU, 1843 [*pro Platynotus* CONRAD, 1838 (*non* FABRICIUS, 1801)] [**Paradoxus (laps. cal. for Paradoxides) boltoni* BIGSBY, 1825] [= *Oncholichas* SCHMIDT, 1885 (obj.); *Pterolichas* GÜRICH, 1901 (obj.); *Pseudotupolichas*, *Arctinuroides*, *Trimerolichas* PHLEGER, 1936]. Longitudinal furrows extending more or less distinctly to occipital furrow; occipital lobes may be present; occipital ring and axis of thorax wide. Pygidium with long axis widening posteriorly; 3 pairs of furrowed pleurae ending in free points. *L.Sil.-M.Sil.*, N.Eu.-N.Am.—FIG. 392,4. **A. boltoni* (BIGSBY), Lock-

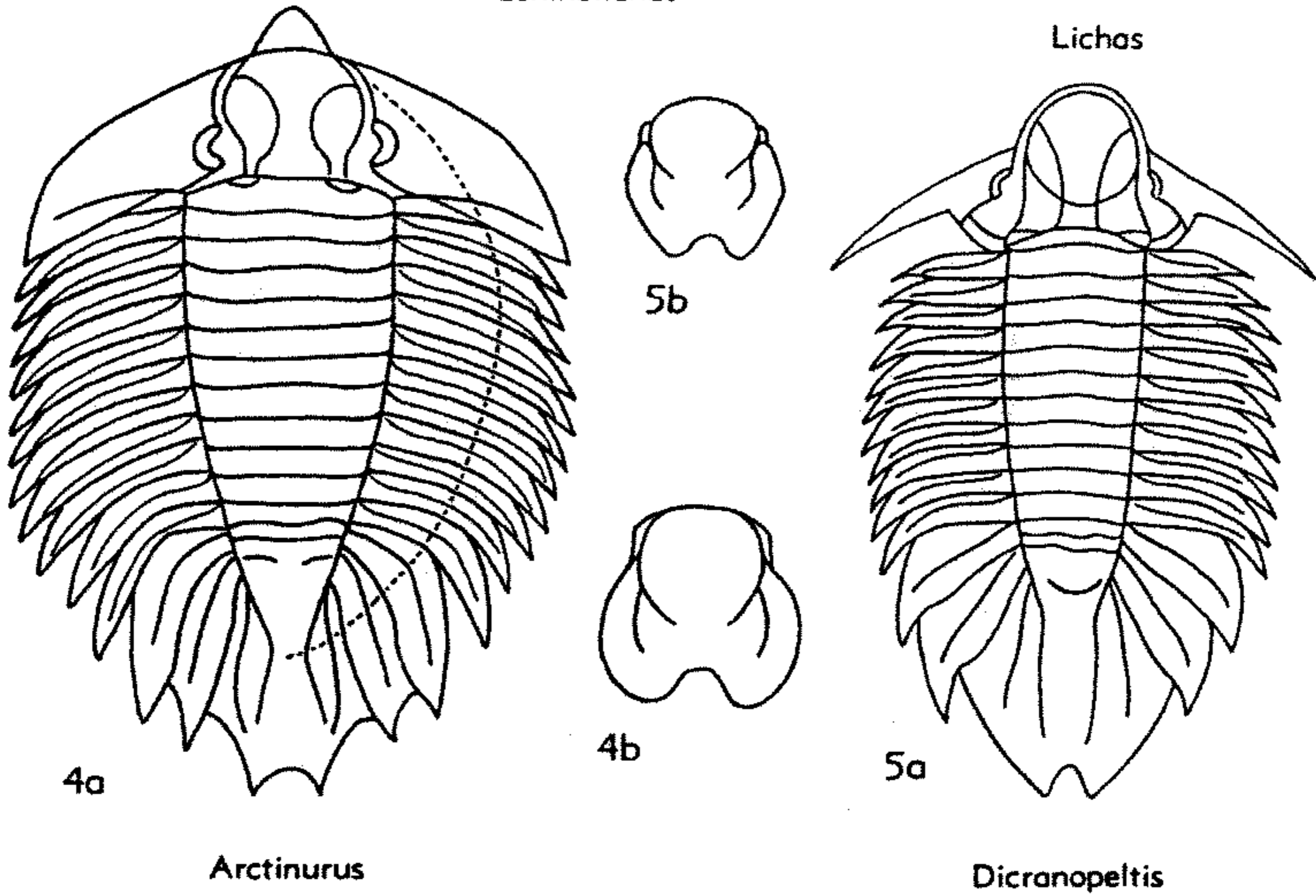
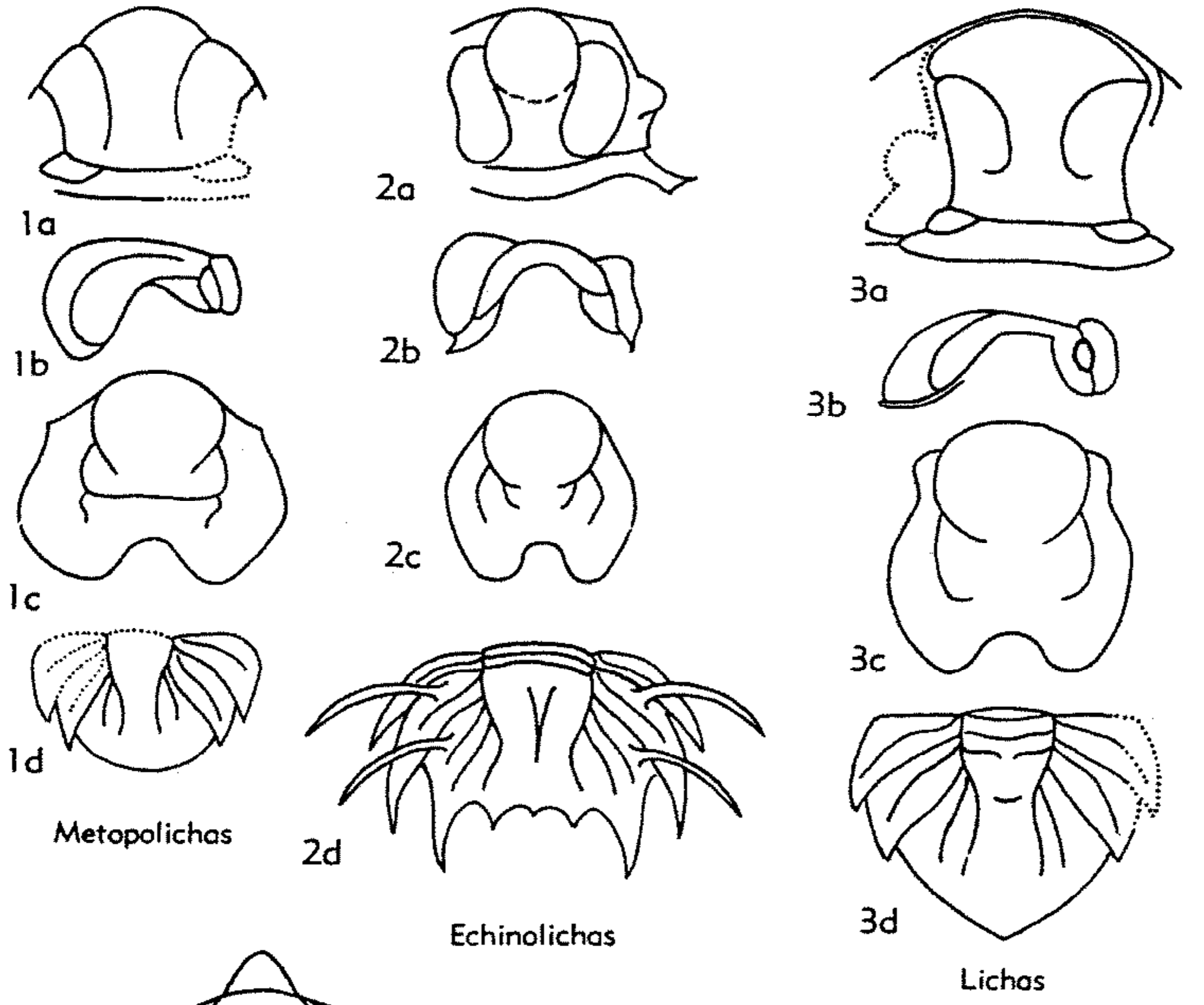

FIG. 392. Lichidae (Lichinae) (p. 0496-0498).

port Sh., N.Am.; 4a, exoskel., $\times 0.5$ (167); 4b, hypostoma, $\times 0.6$ (486n).—FIG. 393,4. *A. marginatus* (LINDSTRÖM) (type species of *Trimerolichas*), Gotlandian, Swed.; 4a,b, syntype cranidia, $\times 2.7$ (486n).

Gaspelichas CLARKE, 1907 [**Lichas (Gaspelichas) forillonis*]. Cranidium elongate and strongly spinose; cranial furrows almost obsolete. *L.Dev.*, Can.—FIG. 394,4. **G. forillonis* (CLARKE), Grande Grève Ls., Can.(E.Que.); 4a,b, cran., dorsal, lateral, $\times 0.55$ (386).

Echinolichas GÜRICH, 1901 [**Lichas eriopis* HALL, 1863; SD REED, 1902]. Longitudinal furrows extend to occipital furrow; frontal area of glabella strongly swollen; occipital lobes fused with tricomposite lateral lobes. Pygidium with 4 pairs of free points, or more. *L.Dev.-M.Dev.*, N.Am.—FIG. 392,2a,b,d. **E. eriopis* (HALL), Onondaga Ls., N.Am.(N.Y.); 2a,b, cran., dorsal, lateral, $\times 1.2$; 2d, pyg., $\times 1.2$ (404).—FIG. 392,2c. *E. bigsbyi* (HALL), New Scotland Ls., N.Am.(N.Y.); hypostoma, $\times 0.85$ (403).

Ceratolichas HALL & CLARKE, 1888 [**Lichas (Ceratolichas) gryps*; SD REED, 1902]. Differs from *Echinolichas* in possessing glabellar and occipital spines. Cranidia only known. *M.Dev.*, N.Am.—FIG. 394,5. **C. gryps* (HALL & CLARKE), Onondaga Ls., N.Am.(N.Y.); 5a,b, cran., dorsal, lateral, $\times 1.2$ (404).

Terataspis HALL, 1863 [**Lichas grandis* HALL, 1861] [= *Deuterolichas* REED, 1902]. Like *Echinolichas* but with frontal lobe of glabella bulbous and constricted round base; neck of median lobe depressed. Pygidium with 4 pairs of long barbed spines. One of the largest trilobites known, almost 70 cm. in length. *Up.L.Dev.*, N.Am.—FIG. 394,2. **T. grandis* (HALL), Onondaga Ls., N.Am.(N.Y.); 2a, exoskel. (reconstr.), $\times 0.1$ (454); 2b, hypostoma, $\times 0.3$ (494).

Subfamily HOMOLICHINAE Phleger, 1936

[*nom. correct.* TRIPP, 1957 (*pro* Homolichadinae PHLEGER, 1936)]

Lateral glabellar lobes tricomposite but modified in some species of *Platylichas*; occipital lobes well defined. Hypostoma with posterior margin strongly indented; middle body circumscribed, with small posterior lateral lobes. Pygidium with axis flaring; posterior pair of pleurae usually furrowed, with free points or short posterior spine. *L.Ord.-M.Sil.*

Conolichas DAMES, 1877 [**Lichas aequiloba* STEINHARDT, 1874; SD VOGDES, 1890] [= *Homolichas* SCHMIDT, 1885; *Cypholichas* PHLEGER, 1936]. Occipital ring simple. Pygidium with 3 pairs of furrowed pleurae; posterior margin usually indented. *L.Ord.-U.Ord.*, N.Eu.-?Asia.—FIG. 395,6a-c. **C. aequilobus* (STEINHARDT), Keila Ls., Est.; 6a,b, cran., dorsal, lateral, $\times 1$; 6c, pyg., $\times 0.8$

(468).—FIG. 395,6d. *C. triconicus*, Idavere beds, Est.; hypostoma, $\times 1$ (468).

Hoplolichas DAMES, 1877 [**Lichas tricuspadata* BEYRICH, 1846 (= **Lichas dissidens* BEYRICH, 1845); SD VOGDES, 1890] [= *Hoplolichoides*, *Cyranolichas* PHLEGER, 1936]. Occipital ring with single or bifurcated median spine. Pygidium with 3rd pair of pleurae unfurrowed or with short furrows situated far back; posterior margin with median point or 2 short projecting free points. *L.Ord.-M.Ord.*, N.Eu.—FIG. 395,5a-c. **H. dissidens* (BEYRICH), M.Ord.; 5a,b, cran., dorsal, lateral, $\times 0.8$ (Schroeteri Ls., Swed.) (12); 5c, pyg., $\times 0.6$ (Echinospaerites Ls., Est.) (22).—FIG. 395,5d. *H. furcifer* (SCHMIDT), Aseri Ls., Est.; hypostoma, $\times 1.5$ (468).

Platylichas GÜRICH, 1901 [**Lichas margaritifera* NIESZKOWSKI, 1857] [= *Metalichas* REED, 1902; *Autoloxolichas*, *Linguecephalichas* PHLEGER, 1936]. Axial furrows joining longitudinal furrows at occipital furrow in stratigraphically lower species, becoming modified and joining longitudinal furrows well in front of occipital furrow in later species, or dying out posteriorly. Pygidium with 3 pairs of furrowed pleurae ending in free points. *M.Ord.-M.Sil.*, N.Eu.-N.Am.—FIG. 396,1. **P. margaritifera* (NIESZKOWSKI), Porkuni Ls., Est.; 1a,b, cran., dorsal, lateral, $\times 1.5$; 1c, hypostoma, $\times 2.25$; 1d, pyg., $\times 1.25$ (468).—FIG. 393,7a. *P. grayi* (FLETCHER), Wenlock Ls., Eng.; ceph., $\times 1.5$ (486n).—FIG. 393,7b. *P. halli* (FOERSTE), Maysville Sh., N.Am.; hypostoma, $\times 2.4$ (486n).

Subfamily TETRALICHINAE Phleger, 1936

[*nom. correct.* TRIPP, 1957 (*pro* Tetralichadinae PHLEGER, 1936)]

Lateral glabellar lobes tricomposite and completely fused with occipital lobes. Hypostoma with posterior margin strongly indented; middle body circumscribed, with small posterior lateral lobes. *M.Ord.-U.Ord.*

Amphilichas RAYMOND, 1905 [*pro Parolichas* REED, 1902 (*non* WHITE, 1859), *pro Platymetopus* ANGELIN, 1854 (*non* DEJEAN, 1829)] [**Platymetopus lineatus* ANGELIN, 1854] [= *Acrolichas* FOERSTE, 1919; *Tetralichas*, *Kerakephalichas*, *Probolichas* PHLEGER, 1936]. Longitudinal furrows short (in type species) but mostly reaching occipital furrow. Pygidium usually with pointed axis reaching posterior margin, and unfurrowed 3rd pleurae with single free points. *M.Ord.-U.Ord.*, N.Eu.-N.Am.-Asia.—FIG. 395,1a,b. **A. lineatus* (ANGELIN), U.Ord.; 1a, cran., $\times 1.2$ (Boda Ls., Swed.) (489); 1b, hypostoma, $\times 1.6$ (Lyckholm Ls., Est.) (468).—FIG. 395,1c. *A. cucullus* (MEEK & WORTHEN) (type species of *Acrolichas*), Kimmswick Ls., N.Am.; pyg., $\times 1.5$ (45).—FIG. 393,6. *A. hibernicus* (PORTLOCK), Bardahessiagh beds(U.Ord.), N.Ire.; pyg., $\times 1.5$ (468n).

Lyrilichas WEBER, 1948 [**Lichas (Amphilichas)*



?Metopolichas

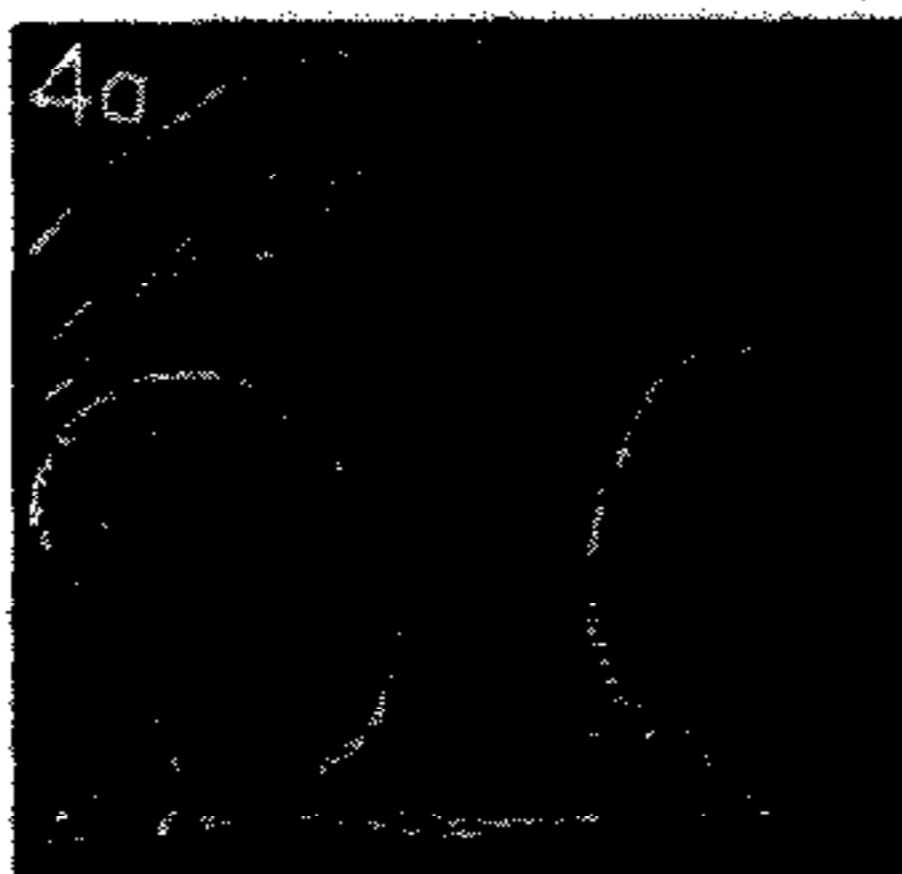

Arctinurus



Platylichas

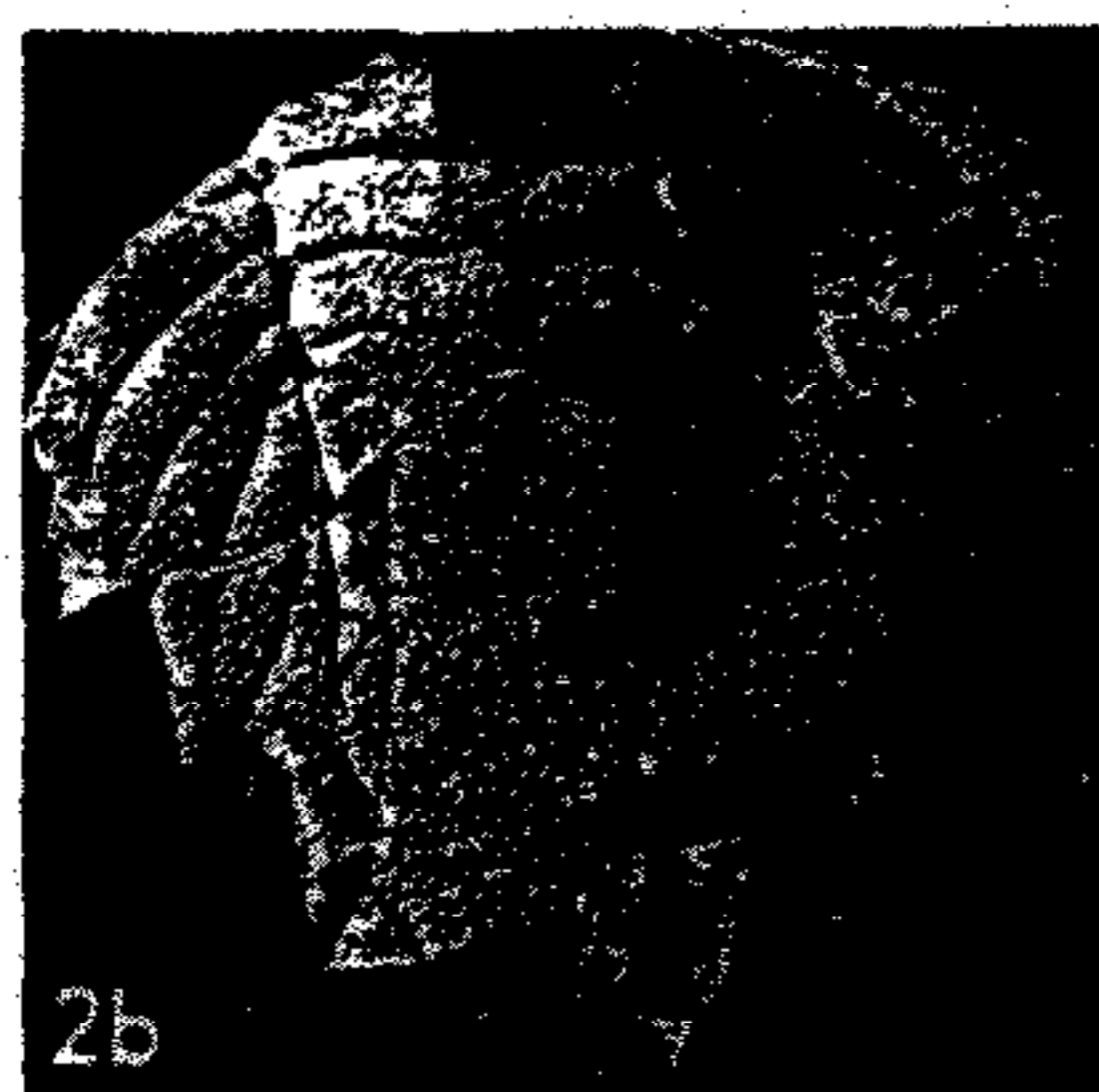
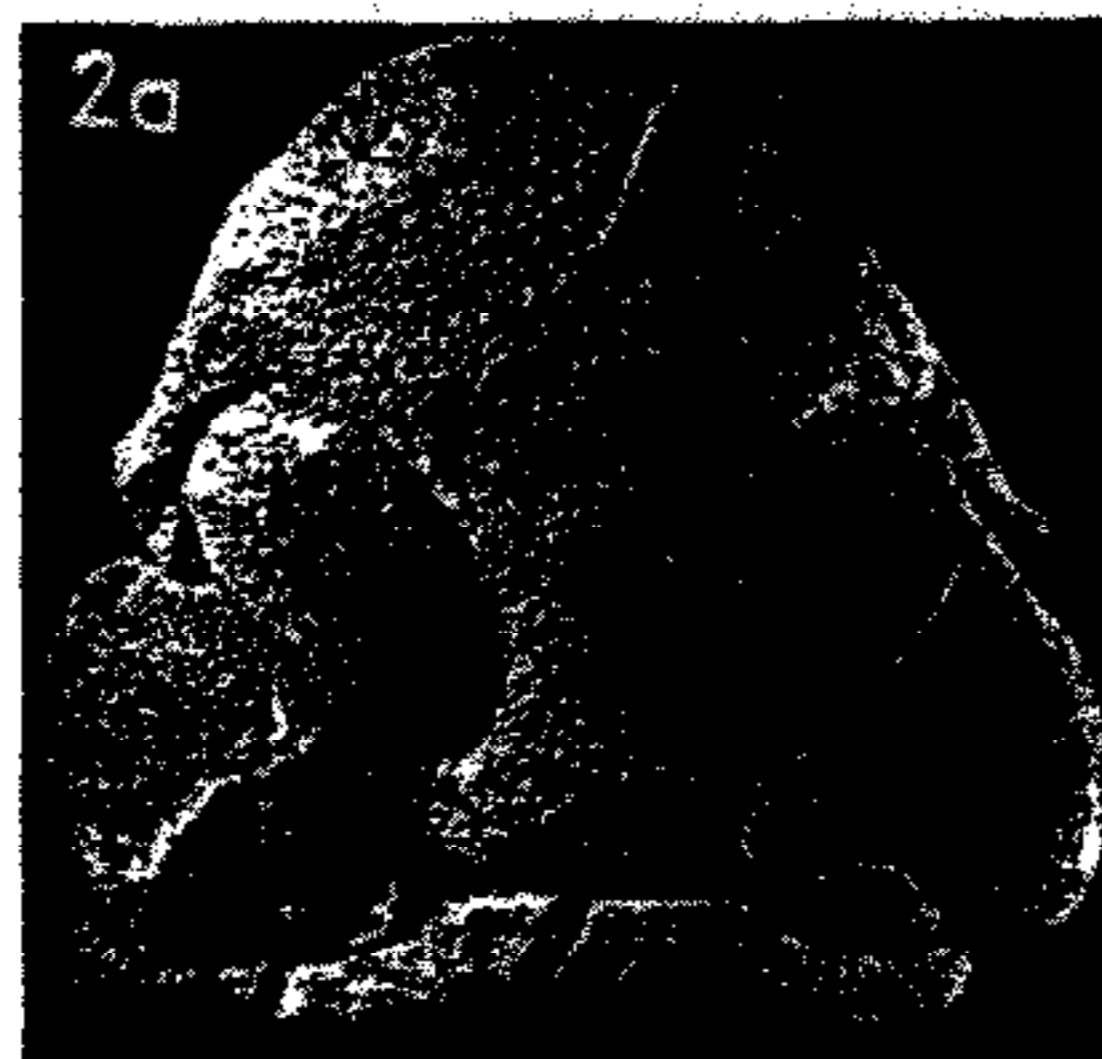

Urolichas

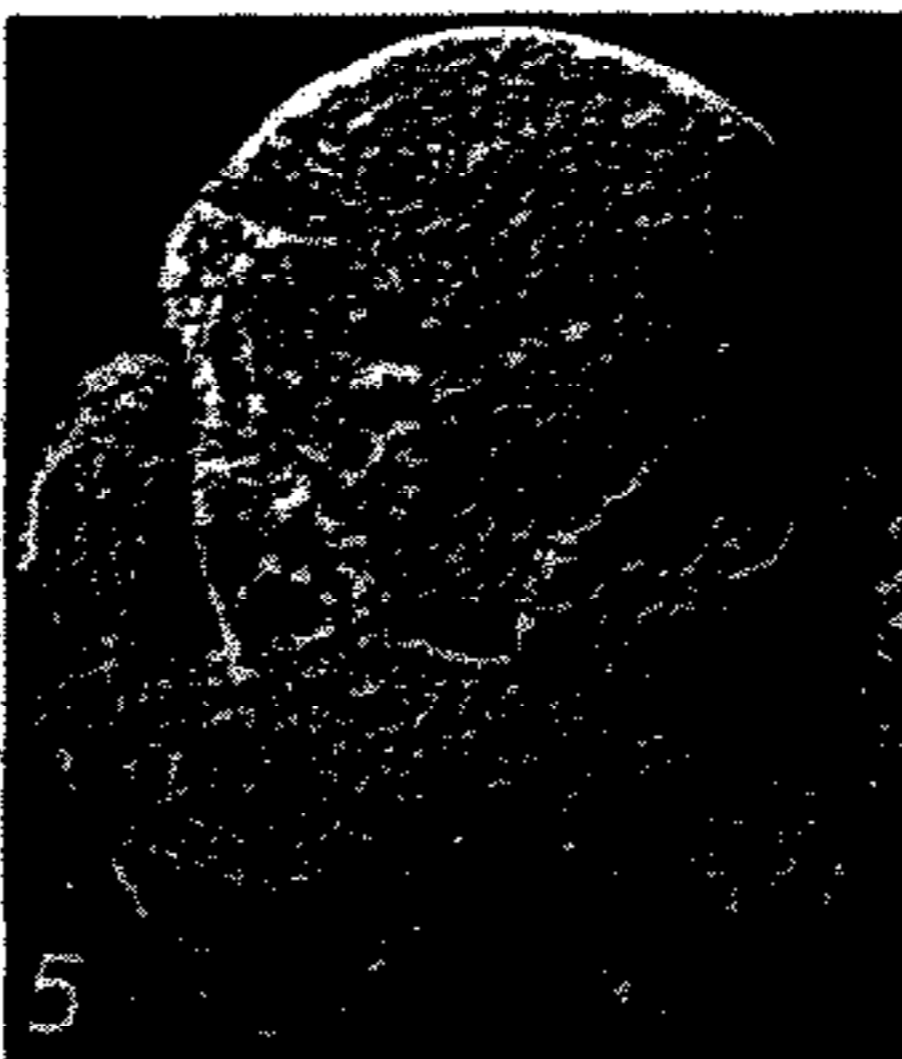

Dicranopeltis

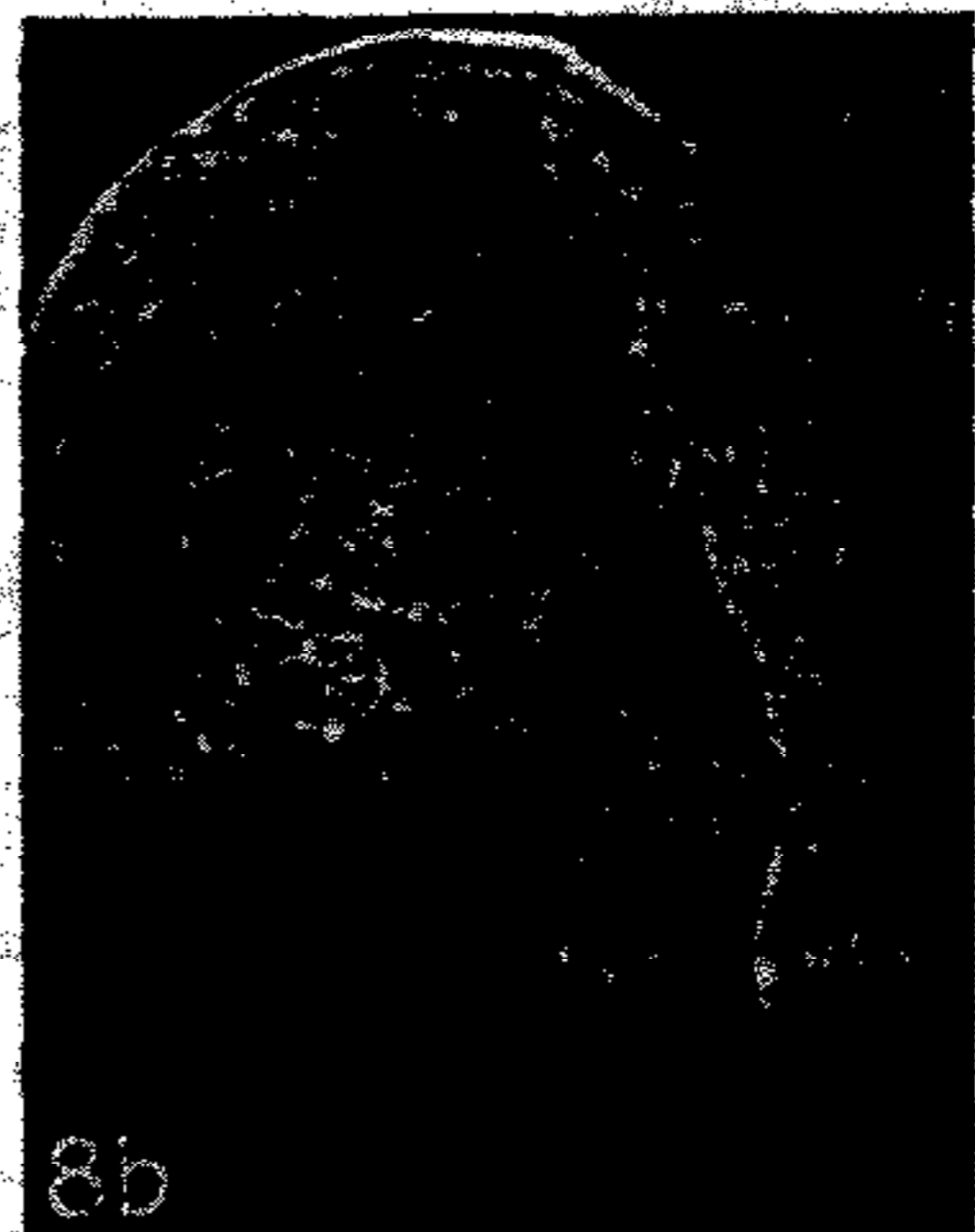
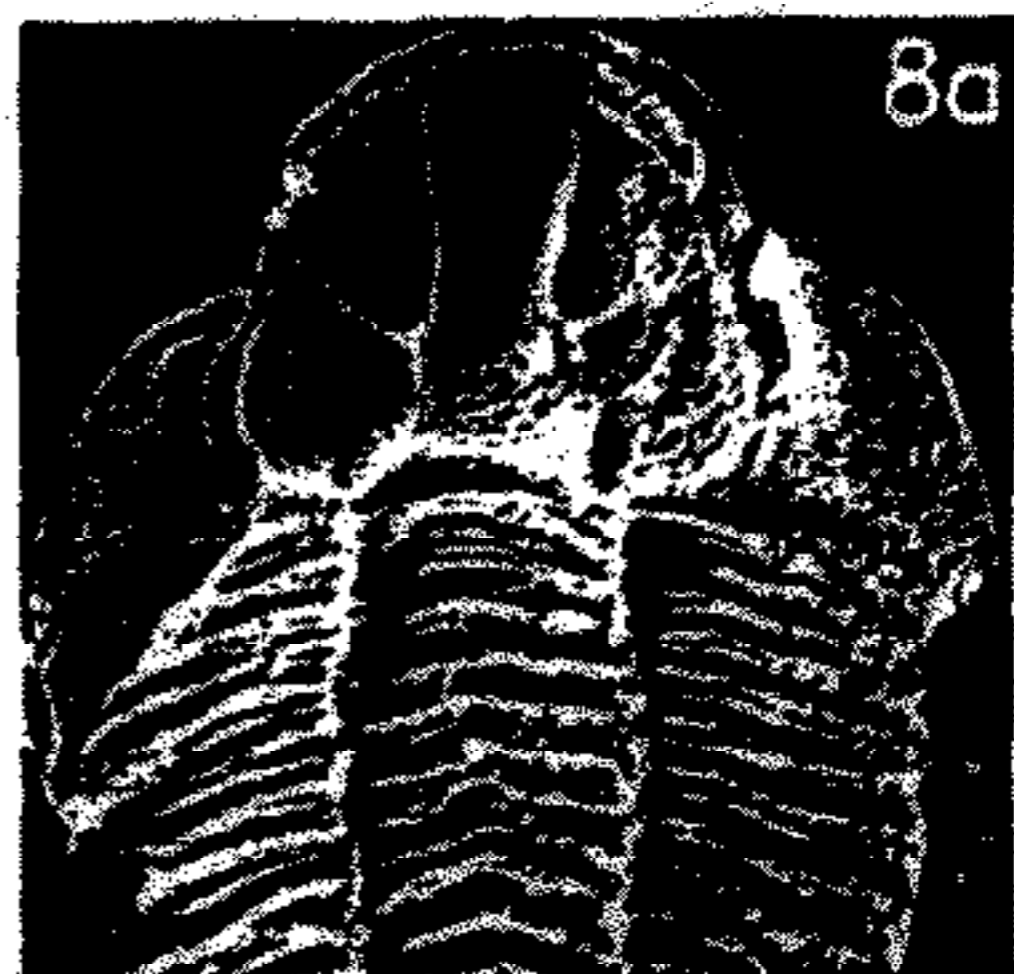

Hemiarges



Lichas



Amphilichas

FIG. 393. Lichidae (Lichinae, Homolichinae, Tetralichinae, Ceratarginae) (p. 0496-0498, 0503).

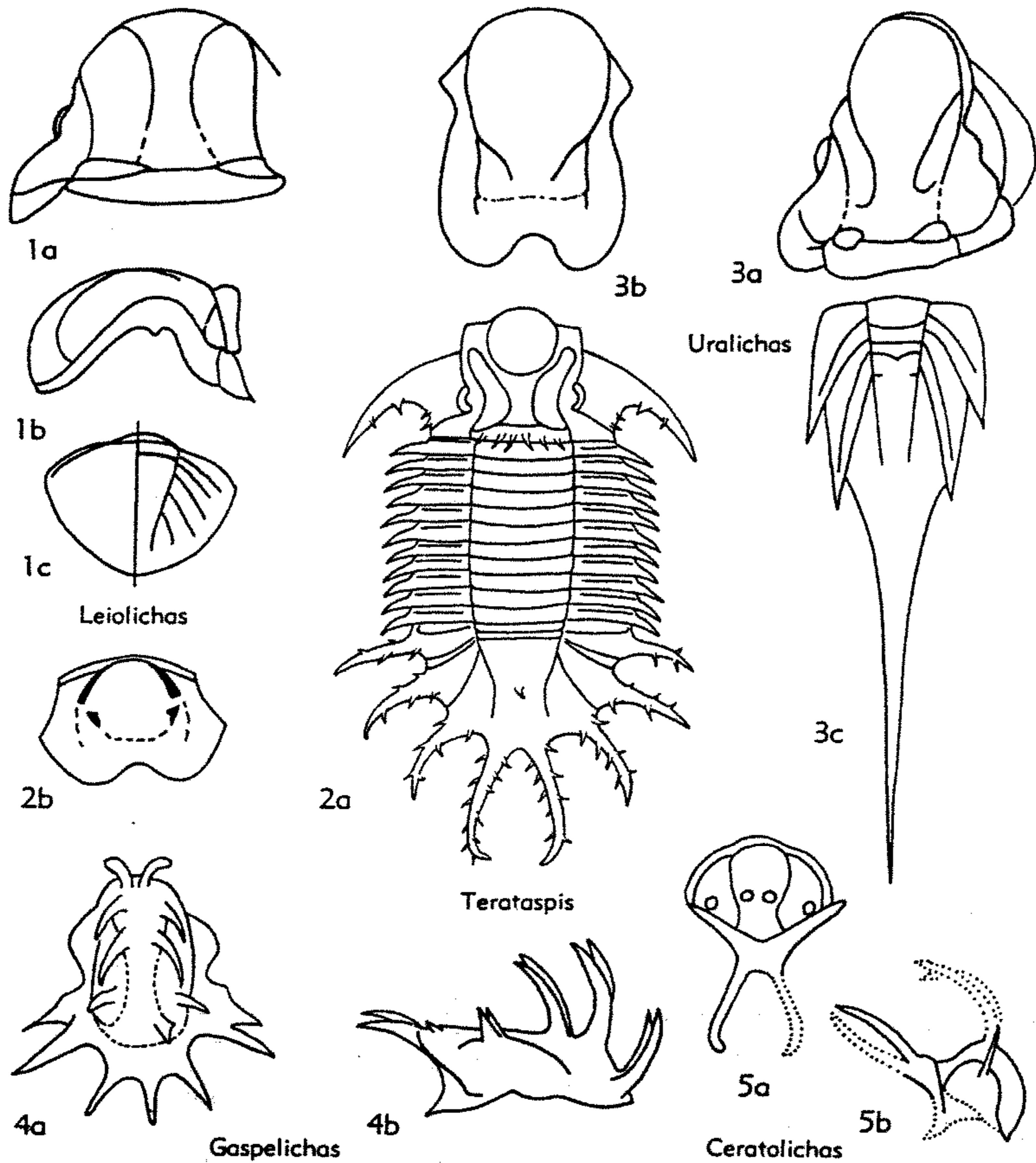

FIG. 394. Lichidae (Lichinae, Homolichinae) (p. 0496-0498).

bronnikovi WEBER, 1932]. Longitudinal furrows not reaching occipital furrow. Pygidium with short axis narrowing posteriorly; 4 pairs of furrowed pleurae ending in short free points. *M.Ord.* (= *Chazy.*), Turkestan.—FIG. 396.3. **L. bronnikovi* (WEBER); 3a,b, cran., dorsal, lateral, $\times 1.5$; 1c, hypostoma, $\times 1.8$; 1d, pyg., $\times 1.5$ (490).

Subfamily CERATARGINAE Tripp, 1957

[*pro* Argentinae GÜNTHER, 1901, *nom. neg.*]

Bicomposite lateral glabellar lobes bounded at back by posterior lateral furrows (except in some species of *Hemiarges*); axial

furrows usually obsolete behind bicomposite lobes; occipital lobes fused with basal lateral glabellar lobes (except in *Trochurus* and *Dicranogmus*). Hypostoma with posterior margin not markedly indented; middle body circumscribed, with small posterior lateral lobes. Pygidium with axis extended to posterior border or margin by narrow ridge; posterior bands of 1st and 2nd pleurae narrower and more swollen than anterior bands; posterior pair of pleurae unfur-

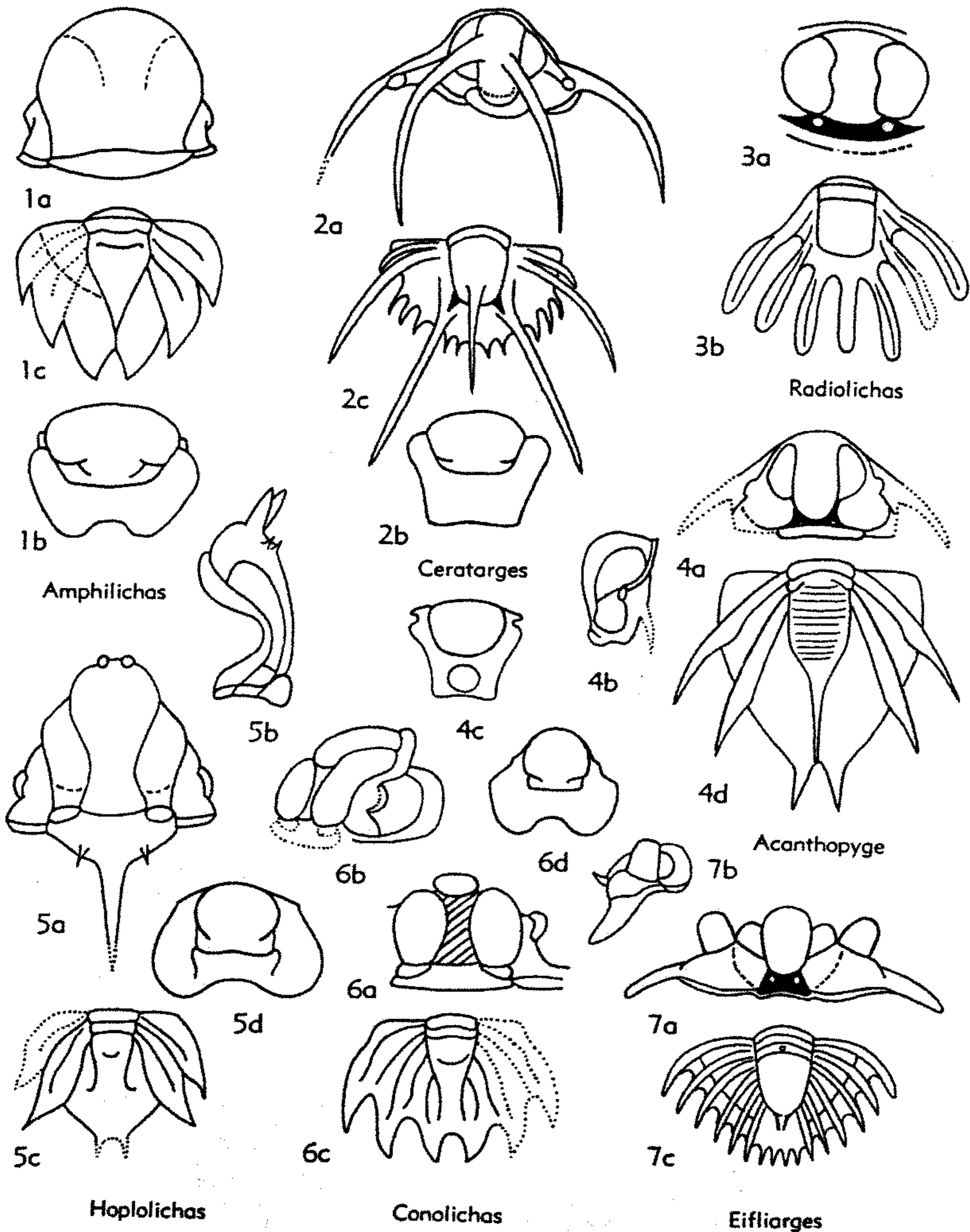

FIG. 395. Lichidae (Homolichinae, Tetralichinae, Ceratarginae) (p. 0498-0503).

rowed; pygidium modified in certain Devonian genera. *M.Ord.-U.Dev.*

Ceratarges GÜRICH, 1901 [*pro Arges* GOLDFUSS, 1839 (*non* DEHAAN, 1833)] [**Arges armatus* GOLDFUSS, 1839]. Glabellar furrows faintly im-

pressed; librigenal spines long and slender, forwardly placed. Long spines curving upward and backward on frontal lobe of glabella and pygidium; marginal spines on pygidium. *M.Dev., Eu.*
 —FIG. 395,2. **C. armatus* (GOLDFUSS), U. Cal-

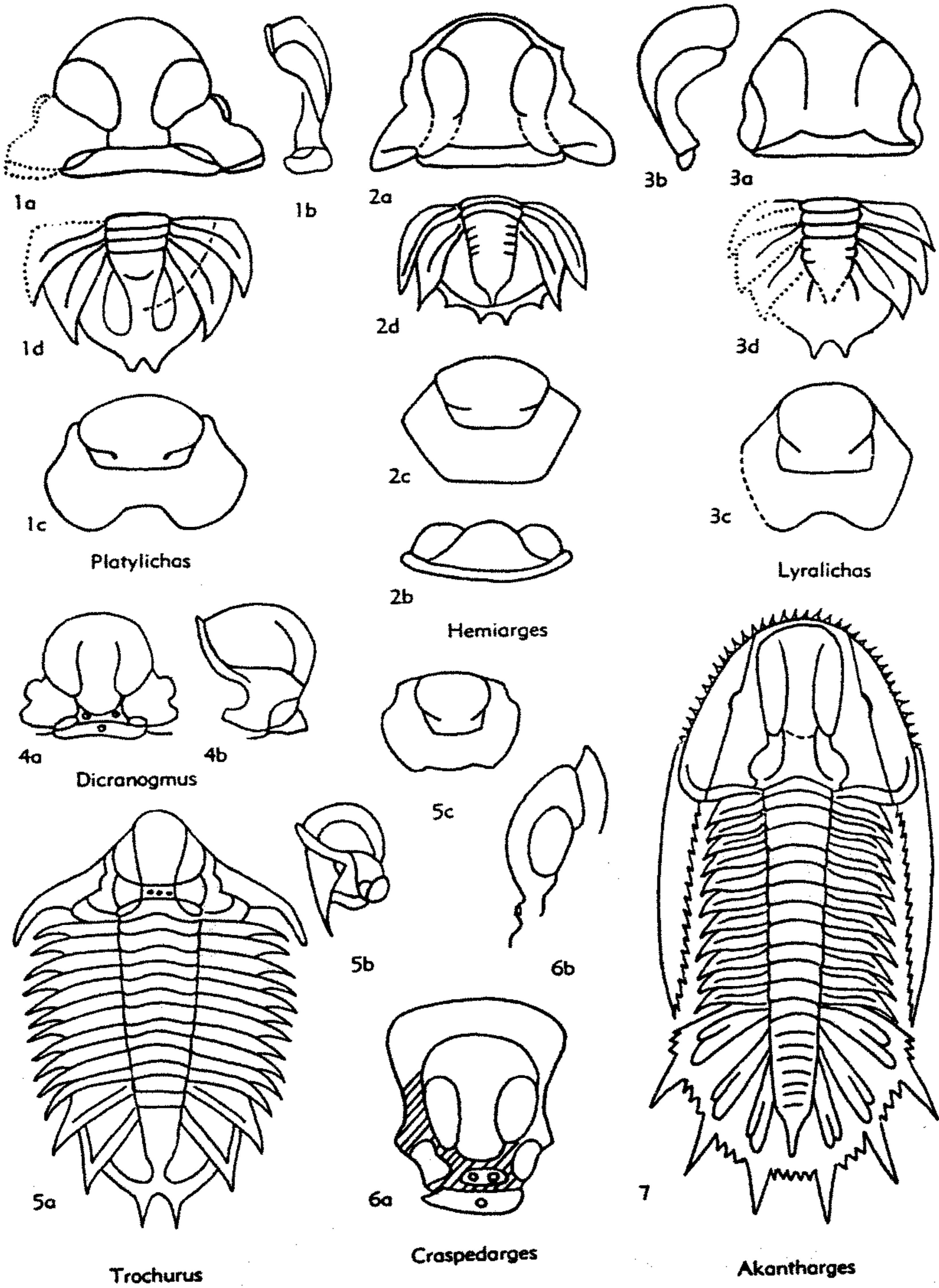

FIG. 396. Lichidae (Homolichinae, Tetralichinae, Ceratarginae) (p. 0498-0503).

ceola Ls., Ger.; 2a, ceph., $\times 0.9$ (461); 2b, hypostoma, $\times 1.2$ (401); 2c, pyg., $\times 0.9$ (461).

Hemiarges GÜRICH, 1901 [**Lichas wesenbergensis* SCHMIDT, 1885; SD REED, 1902] [= *Richterarges*, *Choneilobarges* PHLEGER, 1936]. Bicomposite and basal lateral glabellar lobes partially confluent (in typical species); genal angles produced in stout, broad-based spines. *M.Ord.-U.Sil.*, Eu.-N.Am.—FIG. 396, 2a,b,d. **H. wesenbergensis* (SCHMIDT), Rakvere Ls., Est.; 2a,b, cran., dorsal, anterior, $\times 3.75$; 2d, pyg., $\times 3.75$ (468).—FIG. 396, 2c. *H. antelucanus* TRIPP, Craighead Ls., Scot.; hypostoma, $\times 7.5$ (486).—FIG. 393, 8a. *H. maccullochi* (REED) (type species of *Choneilobarges*), Drummuck Ls., Scot.; ceph., thoracic segments, $\times 2$ (486n).—FIG. 393, 8b. *H. scutalis* (SALTER), Wenlock Ls., Eng.; ceph., ventral, showing doublures of librigenae, rostral plate and hypostoma, $\times 2.67$ (486n).

Trochurus BEYRICH, 1845 [**T. speciosus*] [= *Corydocephalus* HAWLE & CORDA, 1847; *Plusiarges* GÜRICH, 1901; *Protolichas* REED, 1902]. Glabellar lobes with strong independent convexity; area at base of median lobe depressed; axial furrows extending to occipital furrow (in type species); occipital lobes circumscribed. *U.Ord.-M.Sil.*, Eu.-N.Am.—FIG. 396, 5. **T. speciosus*, Motol beds, Boh.; 5a, exoskel. (reconstr.), $\times 1$; 5b, ceph., lateral, $\times 1$; 5c, hypostoma, $\times 1.5$ (370).

Dicranognmus HAWLE & CORDA, 1847 [**D. pustulatus* (= **Lichas simplex* BARRANDE, 1846) [= *Liparges* GÜRICH, 1901 (obj.)]. Glabellar lobes with little independent convexity; longitudinal furrows dying out or becoming shallow anteriorly; occipital lobes circumscribed. Cranidia only known. *U.Ord.-U.Sil.*, Eu.-Austral.—FIG. 396, 4. **D. simplex* (BARRANDE), Budňany Ls., Boh.; 4a,b, cran., dorsal, lateral, $\times 1$ (370).

Acanthopyge HAWLE & CORDA, 1847 [**A. leuchtenbergii* (= **Lichas haueri* BARRANDE, 1846); SD REED, 1902] [= *Euarges* GÜRICH, 1901 (obj.); *Mephiarges* RICHTER & RICHTER, 1930; *Diplolichas* PHLEGER, 1936; *Lobopyge*, *Nitidulopyge* PŘIBYL & ERBEN, 1952]. Area at base of median glabellar lobe strongly depressed. Librigenal spines slender, forwardly placed; deep subgenal notches in genae. *M.Sil.-M.Dev.*, Eu.-N.Am.-S.Am.-Asia-Austral.—FIG. 395, 4. **A. haueri* (BARRANDE), Koněprusy Ls., Boh.; 4a,b, ceph., dorsal, lateral, $\times 0.8$; 4c, hypostoma, $\times 1$; 4d, pyg., $\times 0.8$ (370).

Eisfiarges RICHTER & RICHTER, 1917 [**Lichas (Eisfiarges) caudimirus*]. Cephalon differing from *Acanthopyge* in strong convexity of glabellar lobes and short subgenal notches. Pygidium with 6 pairs of ribs ending in spines, with 4 marginal spines on the postaxial area. *M.Dev.*, Ger.—FIG. 395, 7. **E. caudimirus* (RICHTER & RICHTER), U. Calceola Ls.; 7a,b, ceph., dorsal, lateral, $\times 4$; 7c, pyg., $\times 3$ (461).

Radiolichas REED, 1923 [**Lichas aranea* HOLZAPFEL, 1895 (= **R. araneiformis* TRIPP, 1957, ICZN

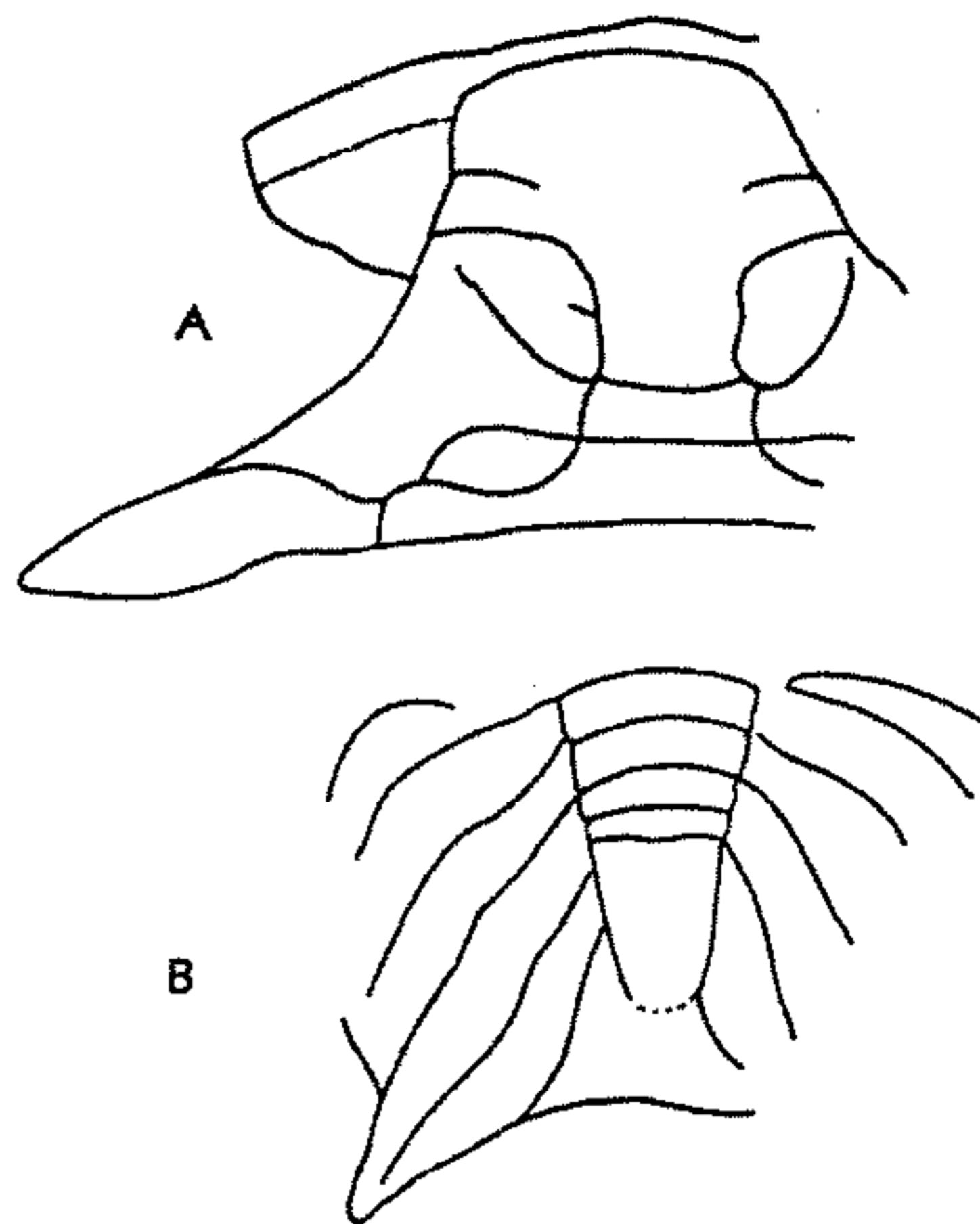

FIG. 397. **Lichakephalus erbeni* SZUY (Lichakephalidae), L.Ord. (Tremadoc.), Ger.; A, cran., $\times 4$; B, pyg., $\times 1$ (272).

pend.)). Bicomposite lateral glabellar lobes extending to occipital furrow. Emaciated pygidium with 3 pairs of pleurae modified to form long, narrow, furrowed bands, with postaxial unfurrowed band. *M.Dev.*, Ger.—FIG. 395, 3. **R. araneiformis* TRIPP; 3a, cran., $\times 1.2$; 3b, pyg., $\times 1.8$ (185).

Akantharges PHLEGER, 1936 [**Lichas gourdoni* BARROIS, 1886]. Cephalon elongate; longitudinal furrows dying out anteriorly; axial furrows reaching occipital furrow. Genal angles produced backward into long, straight spines. Margin of cephalon and pygidium spinose. *M.Dev.*, Fr.—FIG. 396, 7. **A. gourdoni* (BARROIS); exoskel. (reconstr.), $\times 1$ (371).

Craspedarges GÜRICH, 1901 [**C. wilcanniae*]. Cranidium differing from *Acanthopyge* in long (*sag.*) anterior border. Pygidium with numerous subequal marginal spines. *U.Dev.*, Austral.—FIG. 396, 6. **C. wilcanniae*; 6a,b, cran., dorsal, lateral, $\times 2.5$ (52).

Family LICHAKEPHALIDAE Tripp, 1957

Cranidium rather flat; glabella narrowing forward, with pair of short furrows anterior to elongated pair that reach occipital furrow; "middle" lateral glabellar lobes large, possibly bicomposite, bounded except at anterior lateral angles; basal lateral furrows connected across median lobe; axial furrows

obsolete posteriorly; occipital ring broad; occipital lobes large and well defined, not projecting in front of occipital ring; anterior border moderately long; anterior sections of facial sutures strongly divergent, outlining broad anterior areas of fixigenae; posterior sections divergent cutting long posterior borders at low angles. Pygidium broad; axis narrow, relatively short, tapering toward back; with 4 axial rings; apparently 3 pairs of furrowed pleurae, posterior margin exceptionally broad and gently indented. Dorsal surface finely tuberculate. *L.Ord.*(*L. Tremadoc.*).

Lichakephalus SZUY, 1955 [**L. erbeni*]. Characters of family. *L.Ord.*(*L. Tremadoc.*), Ger.—FIG. 397. **L. erbeni*; A, cran., $\times 4$; B, pyg., $\times 1$ (272).

Order ODONTOPLEURIDA Whittington, nov.

[Superfamily Odontopleuracea PRANTL & PRIBYL, 1949; Odontopleuroidea HUPÉ, 1953 (attributed to PRANTL & PRIBYL, 1949)] [*emend.* WHITTINGTON, herein] [Type—*Odontopleura* EMMRICH, 1839]

Cephalon convex, posteromedian region high above anterolateral margin; glabella with maximum width generally at occipital ring, subparallel-sided or tapering forward; occipital ring may be elongated behind adjacent part of genal regions and bear lateral lobes, with median or paired spines or tubercles characteristic; 2 or 3 pairs of lateral glabellar lobes present; genal regions convex, inner posterior corners merging with anterolateral parts of occipital ring; eye lobes prominent, situated centrally on genal regions or may be inside and behind this point, eye ridges curving forward to merge with anterolateral margins of frontal glabellar lobe; anterior sections of facial sutures running forward-inward, posterior sections outward-backward, sutural ridges characteristic; usually stout librigenal spines present, base merging into posterolateral cephalic borders; row of shorter spines arising from outer edge of borders of librigenae, progressively shorter anteriorly; notches in borders of librigenae adjacent to anterior sections of sutures. Rostral plate short (*sag.*, *exsag.*) and wide (*tr.*). Width and length of hypostoma subequal or width greater than length, posterolateral margins rounded; with convex middle body, faint middle furrows running backward and slightly inward from depression at anterolateral corners of

middle body; lateral and posterior borders moderately wide; small anterior wing, no wing process, posterior wing small or absent. Thorax with 8 to 10 segments; axis convex; pleurae horizontal, with or without pleural furrow dividing them into 2 convex bands, with short anterior pleural spine or spines, long posterior pleural spine directed horizontally outward and progressively more backward toward rear. Pygidium short, subtriangular in outline; axis with 2 or 3 rings (3rd faint); pleural regions horizontal; paired spines on border, with or without median posterior spine (one pair of border spines may be larger than others and directed horizontally or upward, or large pair of spines may arise from pleural region), large spine connected by raised ridge to 1st axial ring. External surface rarely smooth, generally with thornlike spines or tubercles, granules between them, arrangement of larger spines or tubercles may be symmetrical (39, 176). *Up.M.Cam.-U.Dev.*

Family ODONTOPLEURIDAE Burmeister, 1843

[=Mastigopleuridae ANGELIN, 1854 (invalid, not based on a generic name); Acidaspidae SALTER, 1864; Ceratocephalidae RICHTER & RICHTER, 1925]

Characters of order. *L.Ord.*(*U.Canad.*)-*U.Dev.*

Subfamily ODONTOPLEURINAE Burmeister, 1843

[*nom. transl.* WHITTINGTON, herein (ex *Odontopleuridae* BURMEISTER, 1843)]

Glabella tapering forward slightly or moderately; occipital ring usually elongate, with median or paired tubercles or spines; eye lobes far back and at variable distance outward from glabella on genal regions, external angle between anterior and posterior sections of sutures adjacent to eye lobes 90 to 120 degrees. Hypostoma wider than long, with shallow lateral notches and sharp shoulders. Thoracic pleurae with broad (*exsag.*), convex posterior band and stout posterior pleural spine, each directed outward and successively more strongly backward. Pygidium with prominent pair of border spines with 1 or 2 pairs of small spines between them. *M.Ord.-U.Dev.*

Odontopleura EMMRICH, 1839 [**O. ovata*]. Glabella with relatively large lateral lobes; median part of occipital ring elevated and produced into long pair of occipital spines, also with faint occi-

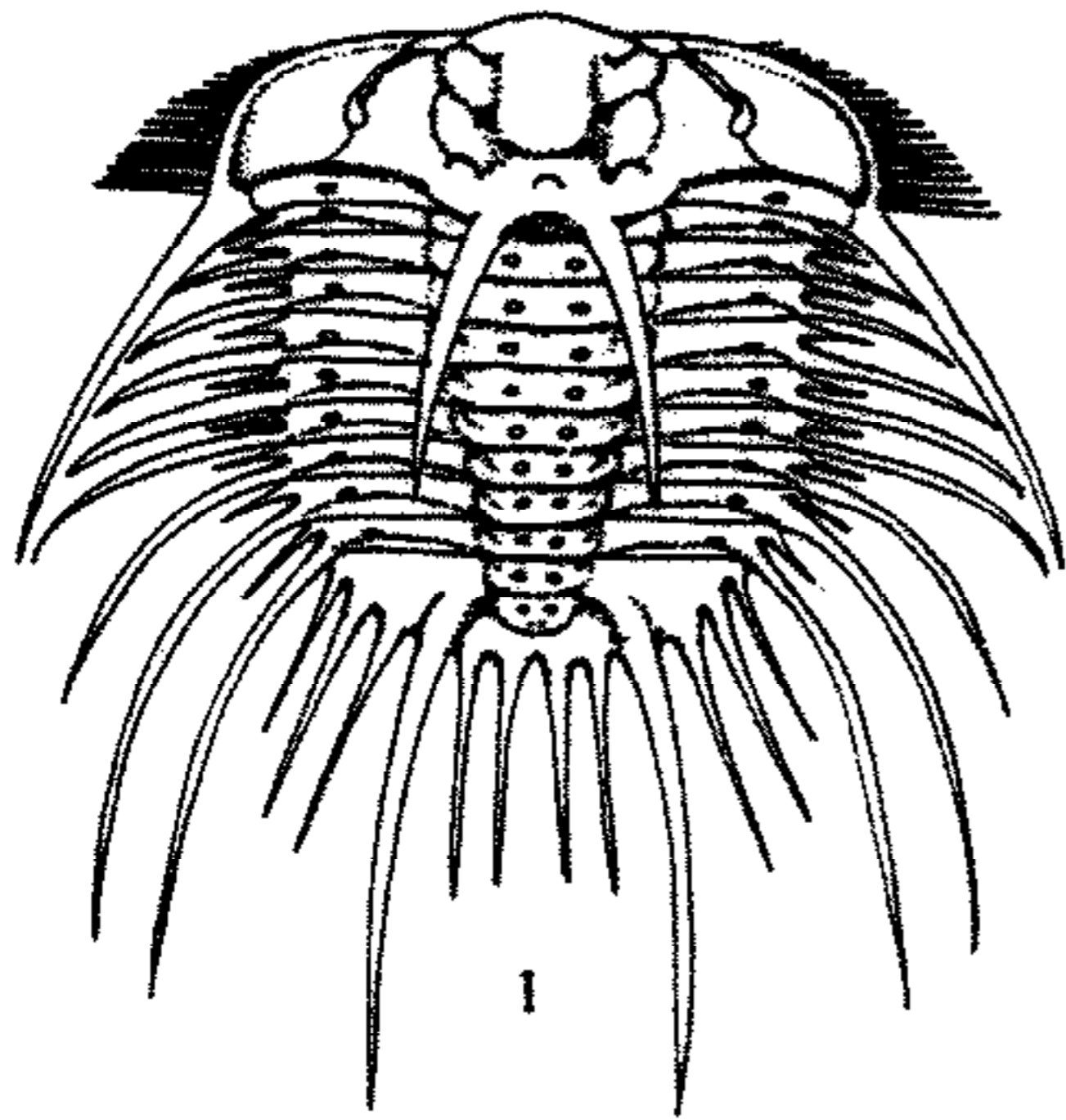

Odontopleura

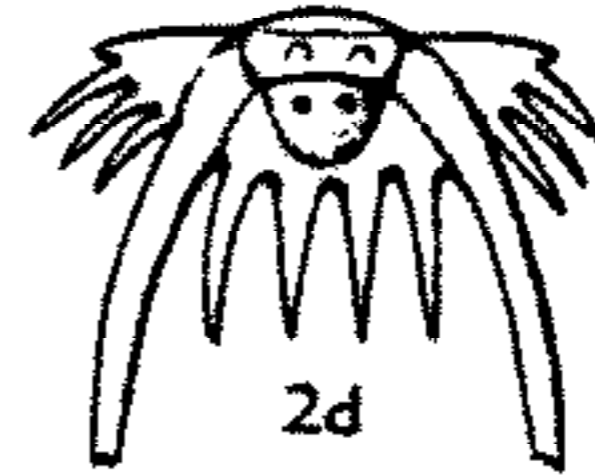
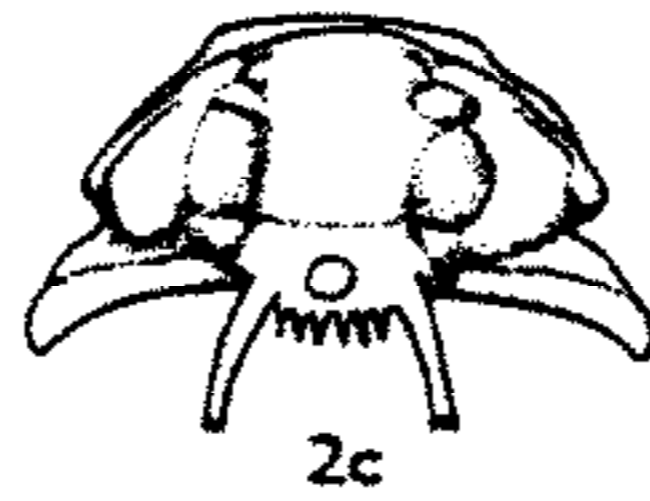
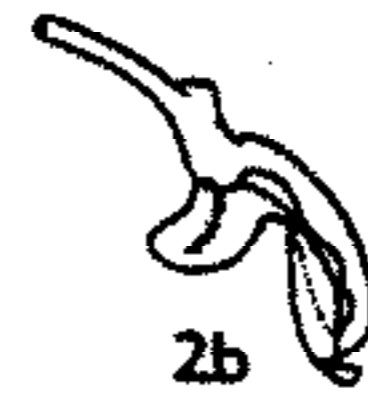
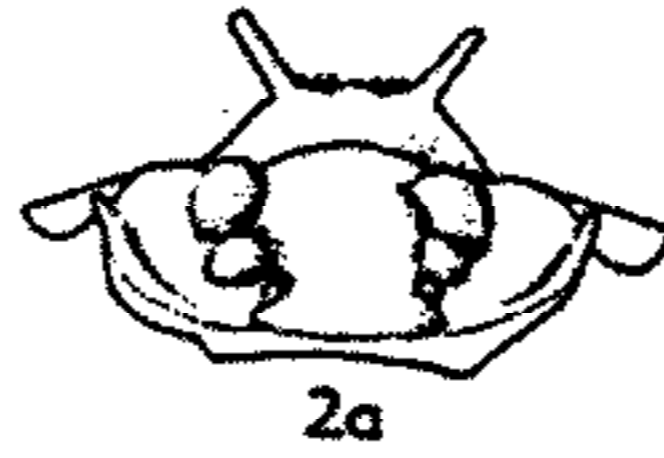

Primaspis

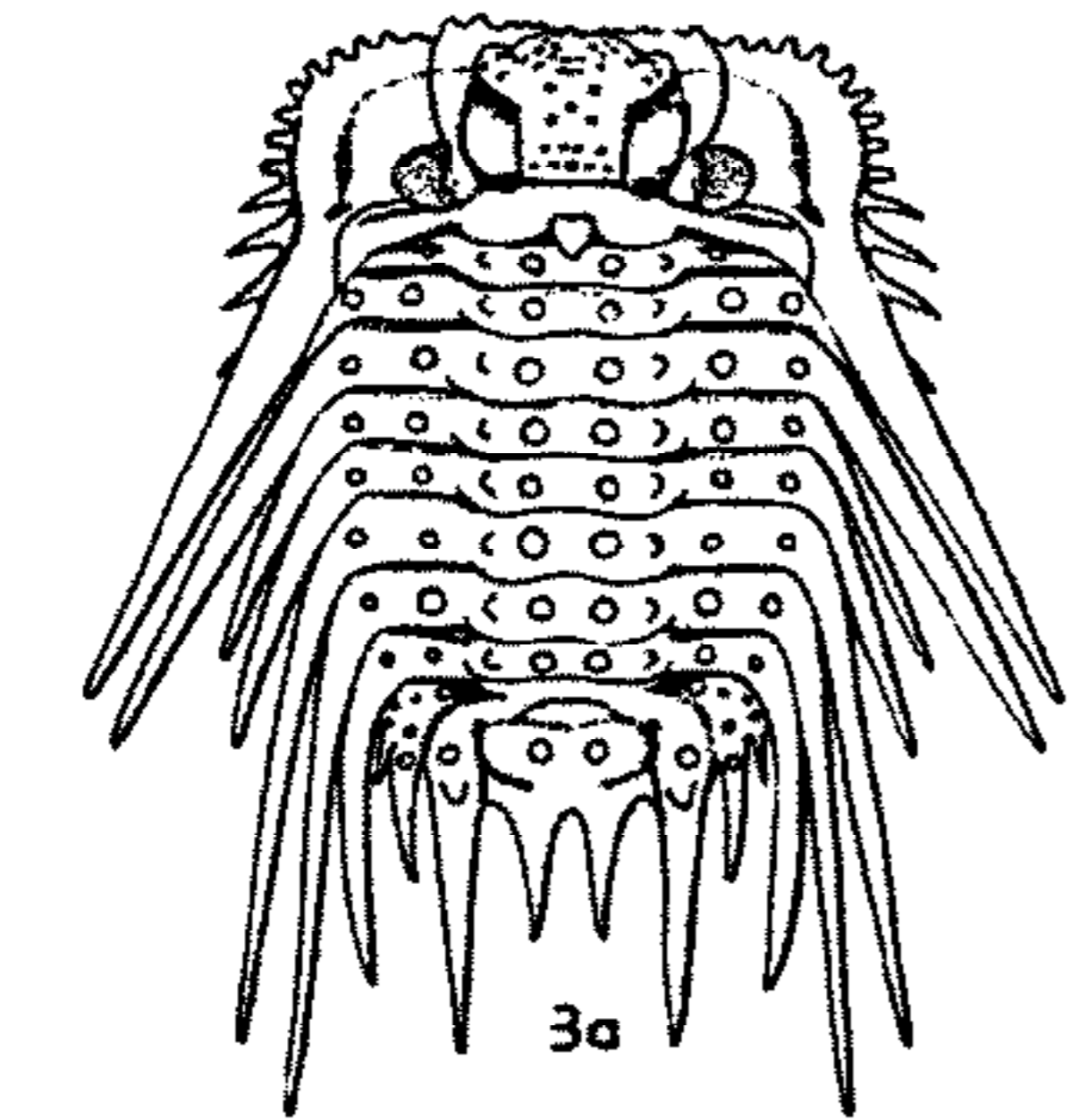

3a



3b

Leonaspis

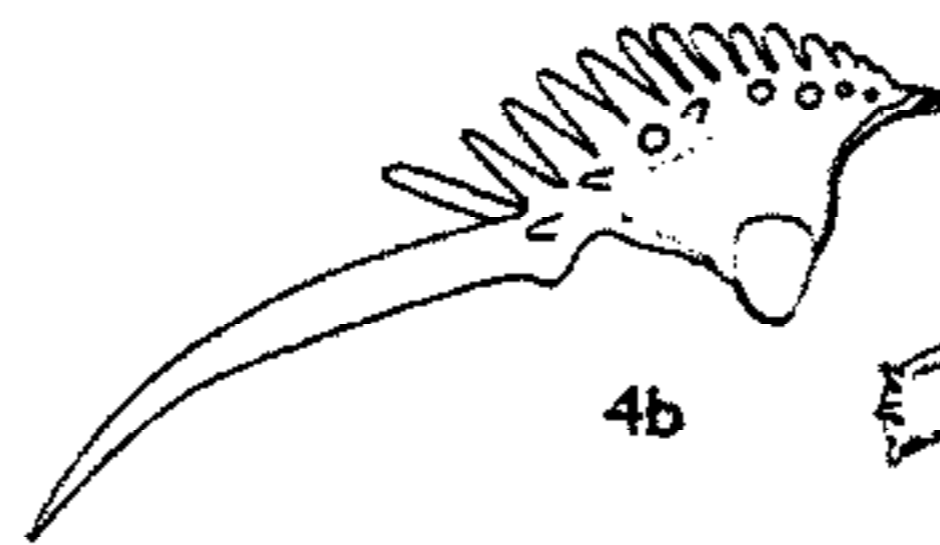

4b

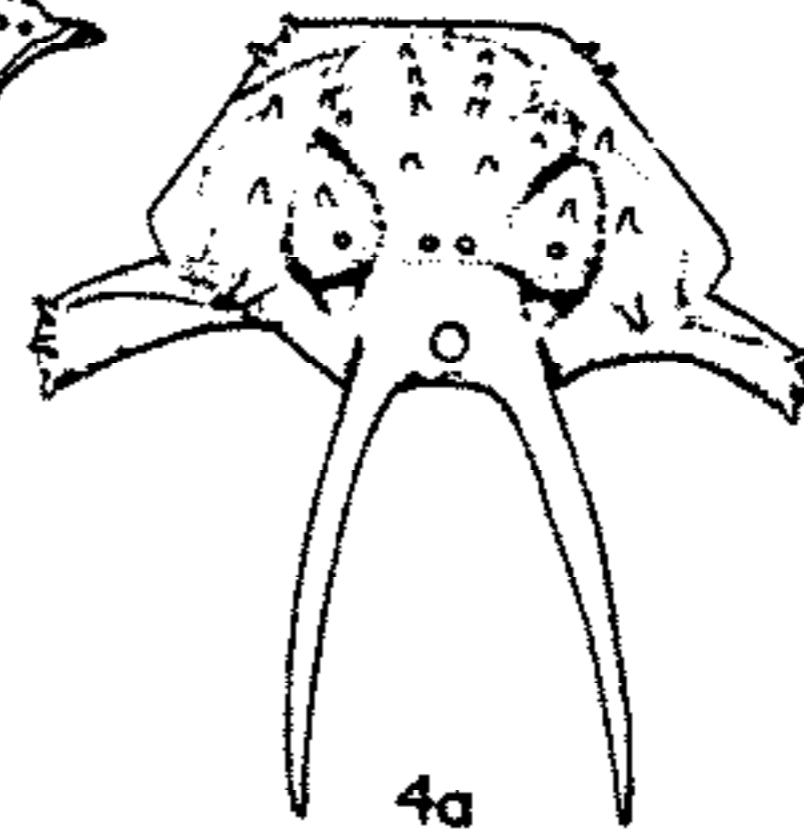

4a



4c

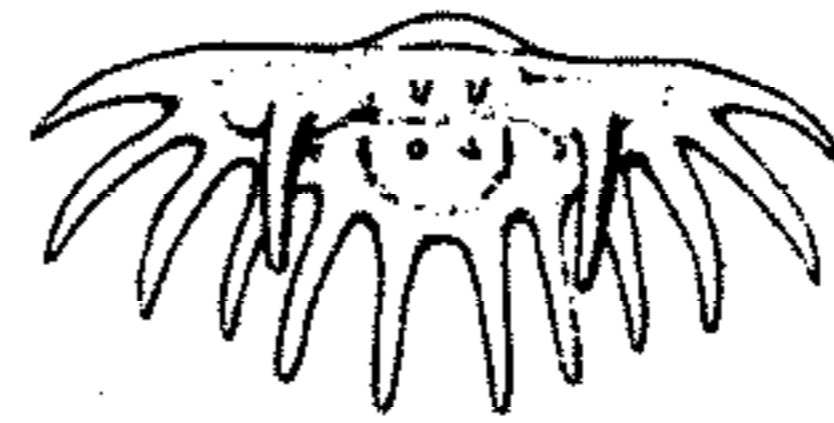

4d

Diacanthaspis



3c

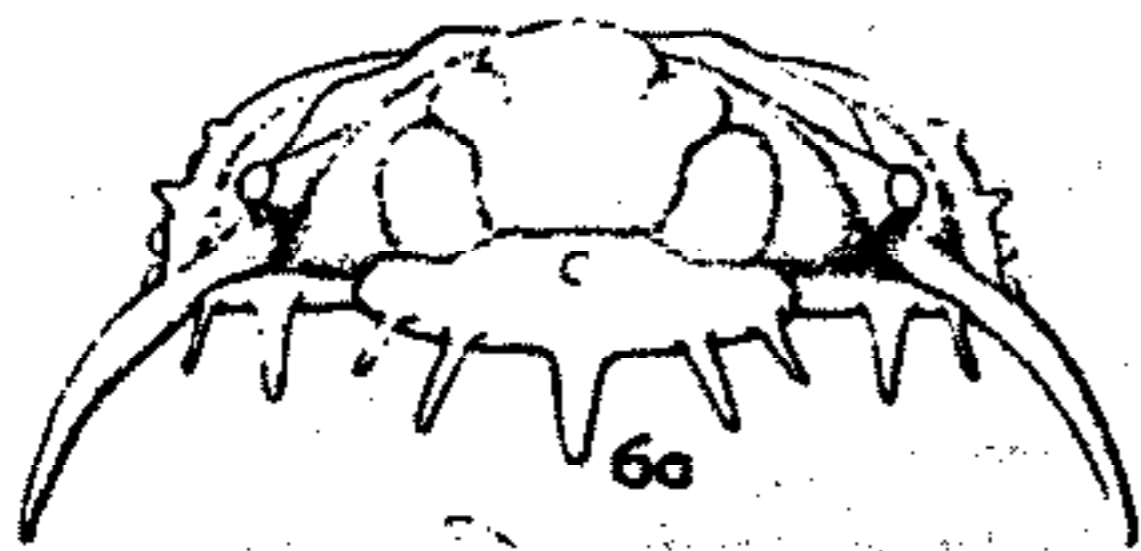

6a



6b

Dudleyaspis



5c

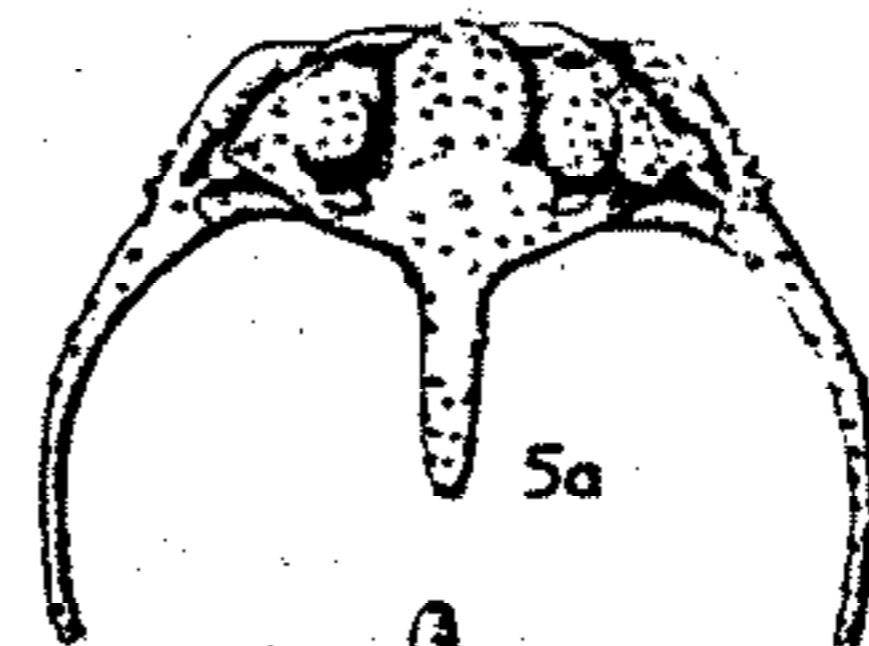

5a



5b

Acidaspis

FIG. 398. Odontopleuridae (Odontopleurinae) (p. 0504-0506).

pital lobes; small eye lobes situated opposite basal glabellar furrows, angle between anterior and posterior sections of facial sutures 120 degrees, slender librigenal and posterior pleural spines, long anterior pleural spines. Pygidium relatively wide, posterior part with long horizontal pair of major border spines. *M.Sil.*, Eu.—FIG. 398,1. **O. ovata*, Boh.; exoskel. (reconstr.), $\times 1$ (496*).

Acidaspis MURCHISON, 1839 [**A. brightii*] [= *Pseudomonaspis* RICHTER & RICHTER, 1917 (obj.)]. Glabella tapering forward from basal lateral lobes; with 3 pairs of lateral lobes; occipital ring with lateral lobes, inflated and prolonged backward into thick, long median spine; eye lobes close to posterior border and situated at about half-width of genal regions, eye lobes and sutural ridges prominent; lateral cephalic border spines directed vertically, librigenal spines thick, long. Thorax with 10 segments; posterior pleural bands strongly convex, inflated at fulcra. Pygidium with 7 pairs of border spines, 5th thicker and more elongate than others. Surface tuberculate. *M.Ord.-M.Dev.*, Eu.-N.Am.—FIG. 398,5. **A. brightii*, *M.Sil.*, Eng.; 5a-c, ceph., dorsal, anterior, right lateral, $\times 1$ (496*, 1956).

Diacanthaspis WHITTINGTON, 1941 [**D. cooperi*]. Glabella widest across occipital ring and basal lateral lobes, length (*sag.*) greater than maximum width; with 2 pairs of lateral glabellar lobes; occipital ring not greatly elongate, small lateral lobes, short median spine and commonly long paired spines; eye lobes on inner part of genal regions opposite basal glabellar lobes; librigenal spines long, slender. Number of thoracic segments unknown; posterior pleural bands not inflated at fulcra. Pygidium with 3 axial rings and 6 or 7 pairs of horizontal border spines, large spine on pleural region directed upward-backward. Surface bearing symmetrically arranged thornlike spines, with granules between them (347). *M.Ord.*, N. Am.-Scot.—FIG. 398,4. **D. cooperi*, Va.; 4a-d, cran., librigena, hypostoma, pyg., $\times 3$ (496*).

Dudleyaspis PRANTL & PŘIBYL, 1949 [**Acidaspis quinquespinosa* LAKE, 1896]. Like *Acidaspis* but occipital ring without lateral lobes, bearing median and 2 pairs of spines on posterior margin and 2 pairs of spines on posterior cephalic border, all directed backward and slightly upward; librigenal spines slender, short. *M.Sil.*, Eu.-N.Am.—FIG. 398,6. **D. quinquespinosa* (LAKE), Eng.; 6a,b, ceph., dorsal, lateral, $\times 2$ (496*, 1956).

Leonaspis RICHTER & RICHTER, 1917 [**Odontopleura leonhardi* BARRANDE, 1846] [= *Acantholoma* CONRAD, 1840 (suppressed, ICZN Opinion 498); *Acantholoma* CASTELNAU, 1843, L. (*Acanthomina*) PRANTL & PŘIBYL, 1949]. Distinguished from *Odontopleura* by smaller, lower, lateral glabellar lobes, occipital ring with median tubercle or spine and lacking occipital lobes, larger eye lobes situated in inner, posterior corners of genal regions,

stouter librigenal and posterior pleural spines, latter more backwardly directed, narrower (*tr.*) pygidium. *L.Sil.-L.Dev.*, Eu.-N.Am.-Bol.

L. (*Leonaspis*). All thoracic segments with backward-directed pleural spines. *L.Sil.-L.Dev.*, Eu.-N.Am.-Bol.—FIG. 398,3. L. (*L.*) *williamsi* WHITTINGTON, L.Dev., Okla.; 3a, exoskel. (reconstr.); 3b, ceph., anterior; 3c, hypostoma; all $\times 1.5$ (496*).

L. (*Kettneraspis*) PRANTL & PŘIBYL, 1949 [**Acidaspis pigra* BARRANDE, 1872]. First 2 thoracic segments faceted and having short posterior pleural spines. *M.Sil.-M.Dev.*, Boh.-Ger.

Primaspis RICHTER & RICHTER, 1917 [**Odontopleura primordialis* BARRANDE, 1846]. Glabella with small 3p lateral lobes; occipital ring not greatly lengthened or inflated, median tubercle or small paired occipital spines, small occipital lobes, eye lobes opposite basal glabellar lobes and about halfway across genal regions; librigenal spines broad at base, adjoining short lateral cephalic spines. Thorax with 10 segments; posterior pleural bands inflated at fulcra, stout posterior pleural spines, small anterior pleural spines. *M.Ord.-U.Dev.*, ?*Sil.*, Eu.-N.Am.—FIG. 398,2. **P. primordialis* (BARRANDE), *M.Ord.*, Boh.; 2a-c, cran., anterior, right lateral, dorsal; 2d, pyg.; all $\times 2$ (496*).

Radiaspis RICHTER & RICHTER, 1917 [*Arges radialis* GOLDFUSS, 1843]. Like *Acidaspis* but inflated median part of occipital ring prolonged into paired spines. Thorax with 9 segments. Pygidium with posterior part of axis bilobed, 8 pairs of subequal border spines. *L.Dev.-U.Dev.*, Ger.-Boh.

Subfamily MIRASPIDINAE Richter & Richter, 1917
[= *Ceratocephalidae* PRANTL & PŘIBYL, 1949]

Glabella wide; occipital ring long (*sag.*, *exsag.*), convex, with prominent paired spines; median glabellar lobe subparallel-sided; small 3rd lateral lobes usually present; genal regions subrectangular in outline, librigenal spines arising from upper surface of border and directed upward-outward; sections of sutures form obtuse angle. Hypostoma wider than long, middle furrow forming triangular depression in anterolateral corners of middle body; shallow median posterior notch. Thoracic pleurae may lack pleural furrow; anterior pleural spine blade-like, with lateral barbs; 1st 2 or 3 posterior pleural spines directed outward and slightly forward, successively more posterior pleural spines directed outward and more strongly backward. *M.Ord.-M.Dev.*

Miraspis RICHTER & RICHTER, 1917 [**Odontopleura mira* BARRANDE, 1846]. Occipital ring with posterior band; eye lobes opposite basal glabellar lobes, pedunculate; long, slender spines on lat-

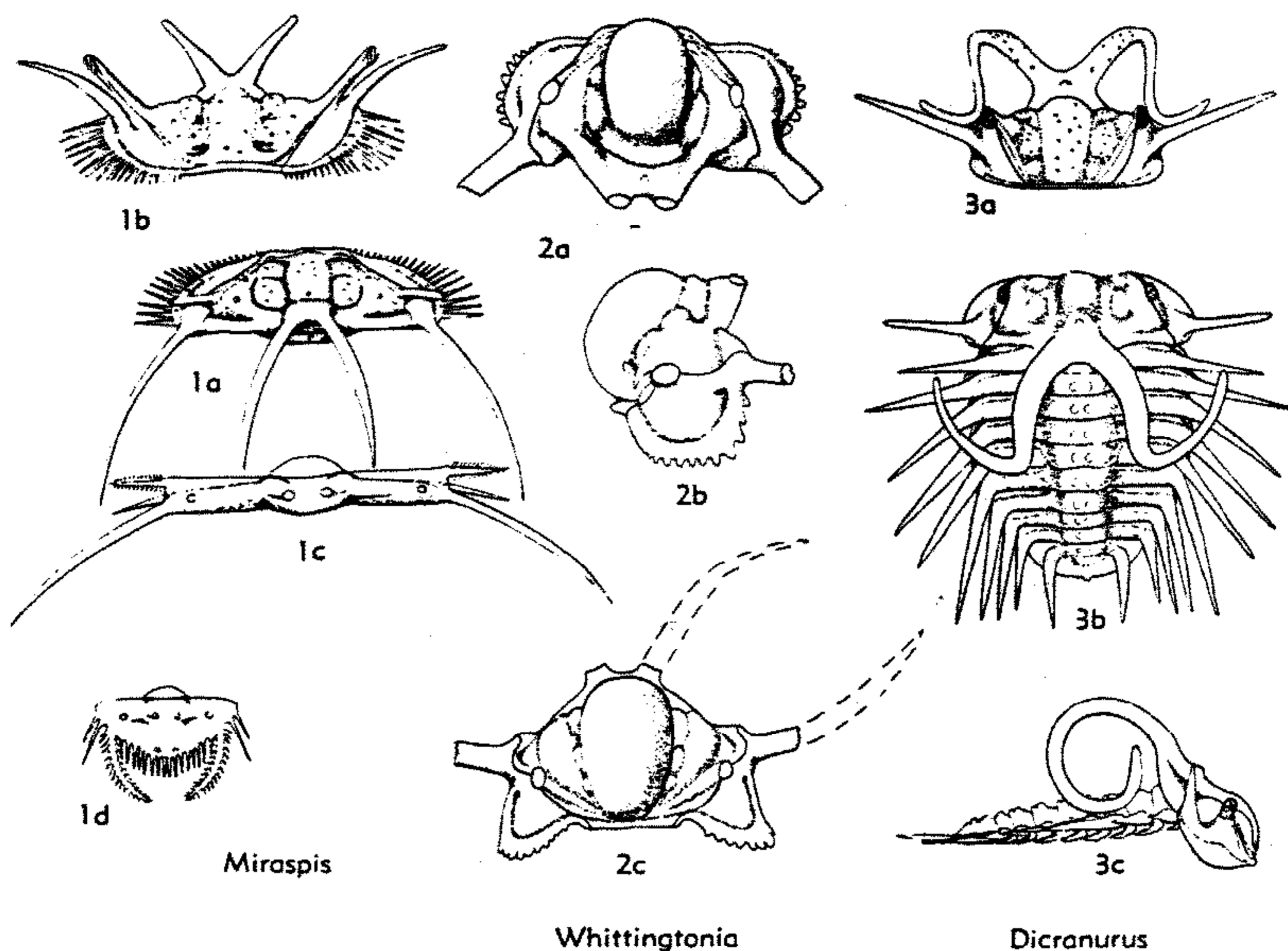

FIG. 399. Odontopleuridae (Miraspidinae) (p. 0506-0508).

eral cephalic border. Thorax with 9 segments bearing deep pleural furrows; slender pleural spines between anterior and posterior spines. Pygidium with 11 pairs of border spines, 3rd pair thick, long, others slim and short; ridge on pleural region running out transversely from 1st axial ring, then turning abruptly back to base of large 3rd border spine. *M.Sil.*, Eu.—FIG. 399,1. **M. mira* (BARRANDE); 1a,b, ceph., dorsal, anterior; 1c, thoracic segment; 1d, pyg., all $\times 1$ (496*).

Ceratocephala WARDER, 1838 [**C. goniata*] [= *Trapelocera* HAWLE & CORDA, 1847; = *Onchaspis* RAYMOND, 1925]. Occipital ring with posterior band; eye lobes opposite 1st lateral glabellar furrows and halfway across genal regions, not pedunculate; lateral cephalic spines short. Thorax with 10 segments, pleural furrows faint or absent, anterior pleural spines almost vertically directed. Pygidium short, with 1 to 3 pairs of border spines and median posterior spine, none conspicuously longer than others (360). *M.Ord.-M.Dev.*, Eurasia-Austral.-N.Am.

C. (Ceratocephala). *M.Ord.-M.Dev.*, Eurasia-Austral.-N.Am.—FIG. 400. *C. laciniata* WHITTINGTON & EVITT, *M.Ord.*, Va.; a,b, exoskel. (reconstr.), number of thoracic segments unknown, dorsal and left lateral views, $\times 3$ (360*).

C. (Ceratocephalina) WHITTINGTON, 1956 [**Ceratocephala (Ceratocephalina) tridens*]. *M.Ord.*, USA (Va.).

Ceratonurus PRANTL & PŘIBYL, 1949 [**Acidaspis krejčí* NOVÁK, 1883]. Inadequately known, cephalon as in *Ceratocephala*; 9 thoracic segments, convex posterior pleural band and long spines like those of *Dicranurus*; pygidium like that of *Miraspis* (38). *L.Dev.-M.Dev.*, Boh.-Ger.

Dicranurus CONRAD, 1840 [**Acidaspis hamata* HALL, 1859]. Massive paired occipital spines recurved over thorax, small 3rd lateral glabellar lobes; eye lobes opposite basal glabellar lobes, high on genal regions; no lateral cephalic spines. Thorax with 9 segments; convex posterior pleural band running outward in curve gently convex forward; short, curved anterior pleural spines. Pygidium with single pair of border spines. *L.Dev.-M.Dev.*, Eu.-N.Am.-Austral.—FIG. 399,3. *D. monstrosus* BARRANDE, *M.Dev.*, Boh.; 3a, ceph., anterior; 3b,c, exoskel., dorsal, right lateral; all $\times 0.75$ (496*, 1956).

Koneprusia PRANTL & PŘIBYL, 1949 [**Acidaspis fuscina* NOVÁK, 1883]. Inadequately known, seemingly like *Ceratocephala*; with 10 thoracic segments; pygidium with single long pair of border spines and median spine. *L.Dev.-M.Dev.*, Boh.

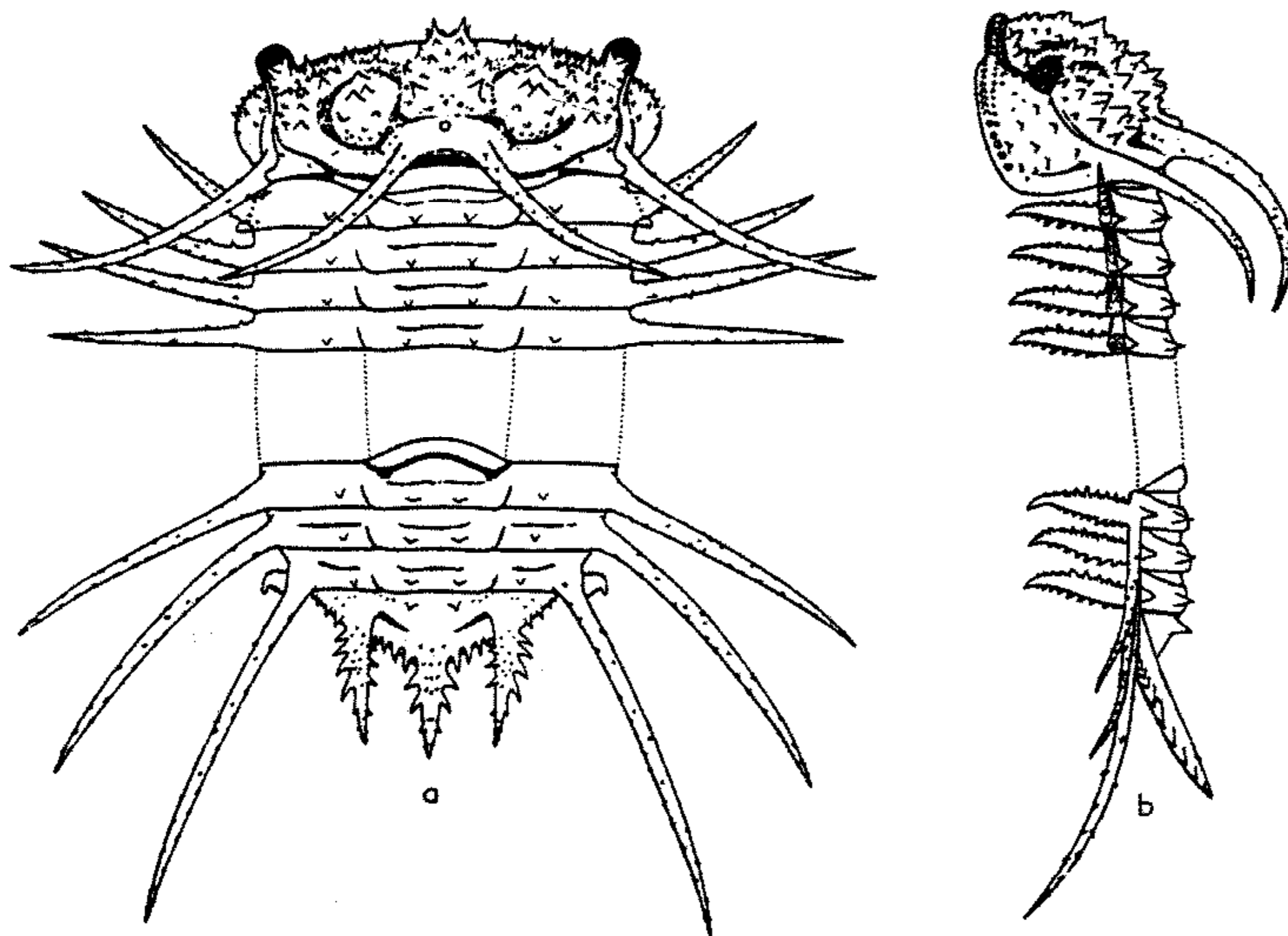

FIG. 400. **Ceratocephala laciniata* WHITTINGTON (Odontopleuridae), M.Ord., Va.; *a, b*, incomple. exoskel. (reconstr.), dorsal and lateral views, $\times 3$ (360*).

Orphanaspis PRANTL & PŘIBYL, 1949 [**Trilobites orphana* BARRANDE, 1852]. Few thoracic segments known. Pygidium with short axis, 3 axial rings, usually raised border on pleural regions, one pair of border spines (38). *M.Sil.-M.Dev.*, Boh.-Ger.

Proceratocephala PRANTL & PŘIBYL, 1949 [**Acidaspis terribilis* REED, 1914] [= *Drummuckaspis* PRANTL & PŘIBYL, 1949]. Like *Ceratocephala*; position of eye lobes uncertain; lateral lobes and long paired spines on occipital and axial rings; 9 thoracic segments, deep pleural furrows; pygidium with horizontal long pair, and short median, border spines. *U.Ord.*, Scot.

Selenopeltoides PRANTL & PŘIBYL, 1949 [**Acidaspis hawlei* BARRANDE, 1852]. Like *Ceratocephala* but eye lobes opposite and close to basal part of posterior glabellar lobes. Thorax with 9 segments, pleurae with furrow and posterior band. Axis of pygidium with 2 rings, pleural regions traversed by ridge running from 1st axial ring to base of paired border spines. *M.Sil.*, Boh.

Whittingtonia PRANTL & PŘIBYL, 1949 [**Acidaspis bispinosus* M'COY, 1846]. Only cephalon known; frontomedian glabellar lobe strongly convex, overhanging anterior border, convex band across base; with 3 pairs of narrow (*tr.*) lateral glabellar lobes; eye lobes centrally situated on genal regions; lateral cephalic spines short. *U.Ord.*, Ire.-Swed.—FIG. 399,2. **W. bispinosa* (M'COY); 2*a-c*, ceph., dorsal, left lateral, anterior, $\times 2$ (496*).

Subfamily SELENOPELTINAE Hawle & Corda, 1847

[*n. n. transl.* WHITTINGTON, herein (ex Selenopeltidae, *nom. correct.* PRANTL & PŘIBYL, 1949, *pro* Selenopeltides HAWLE & CORDA, 1847)]

Characters of *Selenopeltis*. M.Ord.-U.Ord.

Selenopeltis HAWLE & CORDA, 1847 [**Odontopleura buchii* BARRANDE, 1846] [= *Polyeres* ROUAULT, 1847]. Cephalon transversely subrectangular in outline; glabella gently convex, narrowing slightly forward; occipital ring short (*sag.*), with median tubercle; frontomedian lobe wide (*tr.*) narrow (*sag.*), gently convex band across base; apparently 3 lateral glabellar lobes, basal furrow shallow, at inner end turning back into deep furrow that becomes shallow as it meets furrow defining band at base of median lobe; basal lateral glabellar lobes divided subequally by shallow transverse furrow, posterior part divided again by shallow longitudinal furrow; 2*p* lateral furrows diagonal, deepest at inner end, 2*p* lobes gently convex, 3*p* lobes small; crescentic eye lobes situated about centrally on genal regions, sections of sutures at obtuse angle; narrow anterolateral cephalic border; librigenal spines long, arising from upper surface of border at genal angles. Hypostoma wider than long, with broad lateral and posterior borders, shallow median posterior notch; middle furrow shallow. Thorax with 9 segments; rings with convex lateral lobe; pleurae with narrow posterior

pleural ridge running outward in curve convex forward; short, curved anterior pleural spine, long backwardly directed posterior pleural spine. Pygidium with short axis, faint 3rd ring, pleural regions crossed by strong ridges continuous with base of single border spine. Surface tuberculate or granulose. *L.Ord.-U.Ord.*, Eu.-N.Afr.—FIG. 401. **S. buchii* (BARRANDE), *M.Ord.-U.Ord.*, Boh.; *a*, ceph., anterior; *b*, hypostoma; *c*, exoskel. (reconstr.); all $\times 0.5$ (496n).

Subfamily APIANURINAE Whittington, 1956

Glabella narrowing forward; median lobe well defined, parallel-sided, 2 pairs of lateral glabellar lobes fused; occipital ring long (*sag.*), convex, with long paired spines and median tubercle; eye lobes situated far back and about midway across genae, 2 sections of sutures forming straight line inclined inward-forward to sagittal line; librigenae narrow, with genal spines arising about midway along lateral border and curving back. Hypostoma shield-shaped, middle furrow arising at anterolateral corners of middle body and running inward-backward, with small, pointed shoulders and shallow lateral notch. Thorax of unknown number of segments, pleurae convex (*exsag.*), single large pleural spine. Pygidium with paired border spines and unpaired median border spine in some, also long major spine directed upward. *M.Ord.-U.Ord.*

Apianurus WHITTINGTON, 1956 [**A. barbatus*]. Occipital spines long, diverging at angle of 60 to 80 degrees; fused lateral lobes kidney-shaped; large eye lobes opposite basal glabellar lobe. Hypostoma widest anteriorly, convex middle body divided into triangular anterior and crescentic posterior lobe; small anterior, tiny posterior, wings. Pygidium with 6 or 7 pairs of border spines, flat pleural fields bearing centrally situated upright major spine. Long spines (except occipital) with thornlike lateral spines, remainder of exoskeleton tuberculate or spinose. *M.Ord.-U.Ord.*, Eu.-USA (Va.).

Calipernurus WHITTINGTON, 1956 [**C. insolitus*]. *M.Ord.*, USA (Va.).

Subfamily UNCERTAIN

Ancyropyge CLARKE, 1892 [**Acidaspis romingeri* HALL & CLARKE, 1888]. Pygidium only known; axis little longer than wide, including anterior ring and subhemispherical rear part; pleural regions comprising merely bases of 6 pairs of long spines that curve outward-backward. *M.Dev.*, Mich.

Bounyongia ETHERIDGE & MITCHELL, 1917 [**B. bowningensis*]. Based on 2 poorly preserved cephalae, inadequate for diagnosis. *Sil.*, Austral.

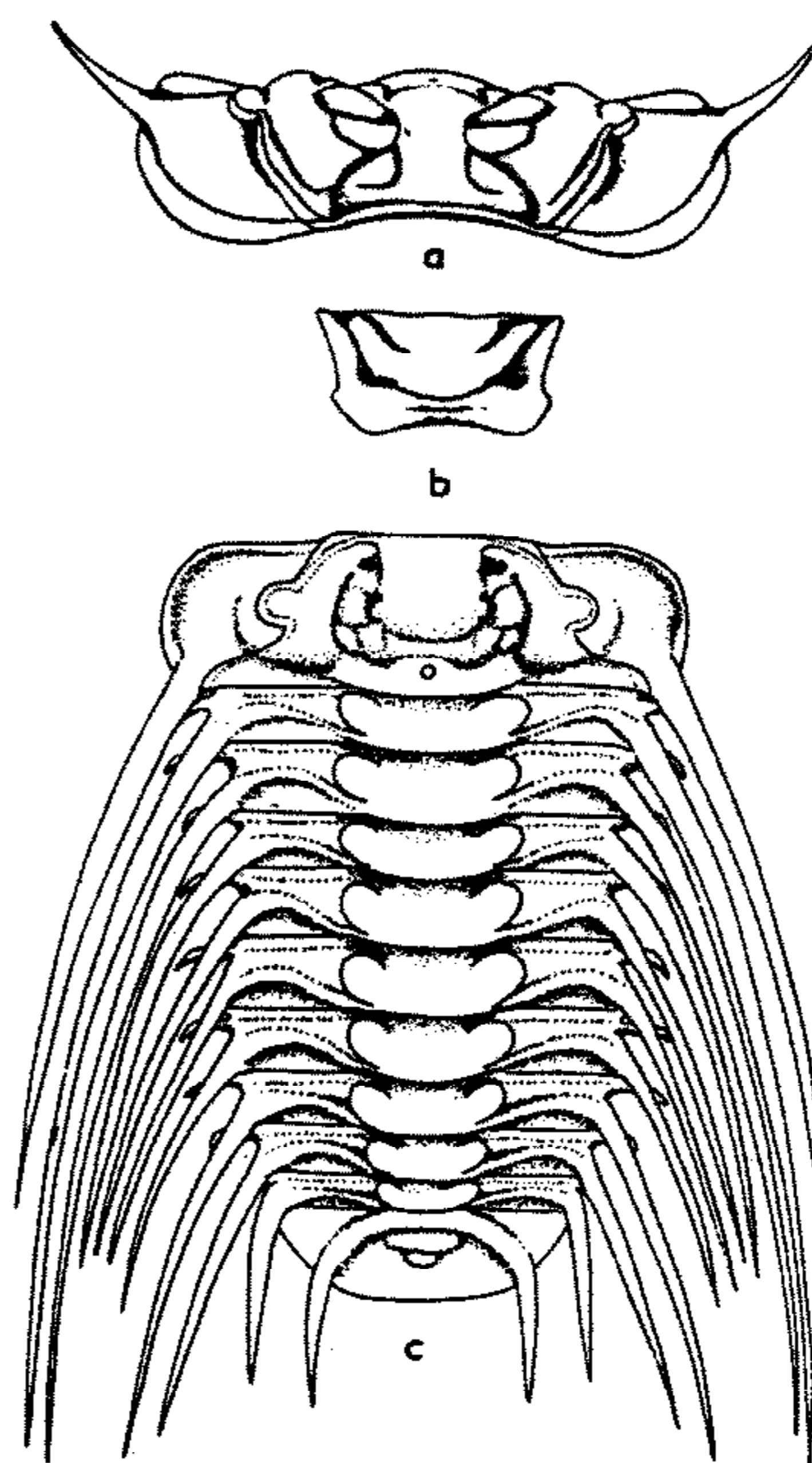

FIG. 401. **Selenopeltis buchii* (BARRANDE) (Odontopleuridae), *Ord.*, Boh.; *a*, ceph., anterior; *b*, hypostoma; *c*, exoskel. (reconstr.); all $\times 0.5$ (496).

Globulaspis REED, 1931 [**Acidaspis (Globulaspis) prominens*]. Based on internal mold of incomplete cranidium; strongly convex glabella with small basal lateral lobes, librigenae strongly convex posteriorly. *L.Sil.*, Scot.

Family EOACIDASPIDIDAE Poletaeva, 1957

[*nom. correct.* JAANUSSON, herein (ex *Eoacidaspidae* POLETAEVA, 1957)]

Apparently primitive odontopleuraceans with facial sutures conspicuously divergent in front of eyes. Cranidium with prominent anterior border separated from glabella by distinct furrow; glabella long, more or less trapezoidal, with lateral glabellar furrows well defined to almost obsolete, posterior or middle (*Eoacidaspis*) lateral glabellar lobes large; eye ridges well developed, like those of other odontopleuraceans; librigenae, rostral shield, hypostoma, and number of thoracic segments unknown, details of thoracic

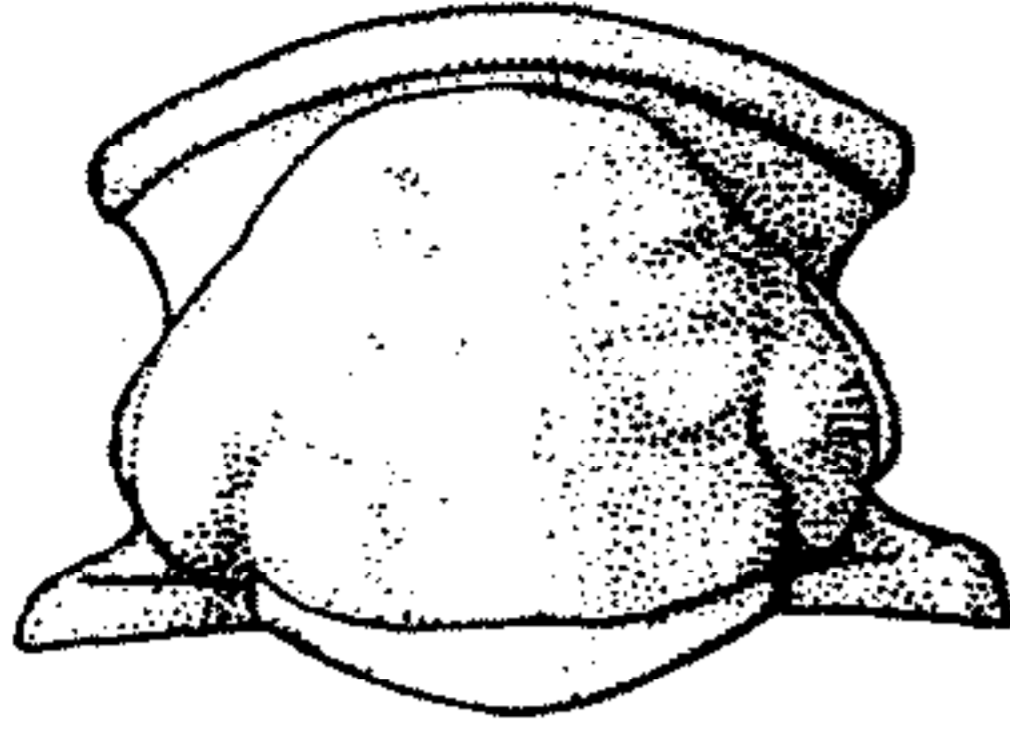

1 Belovia

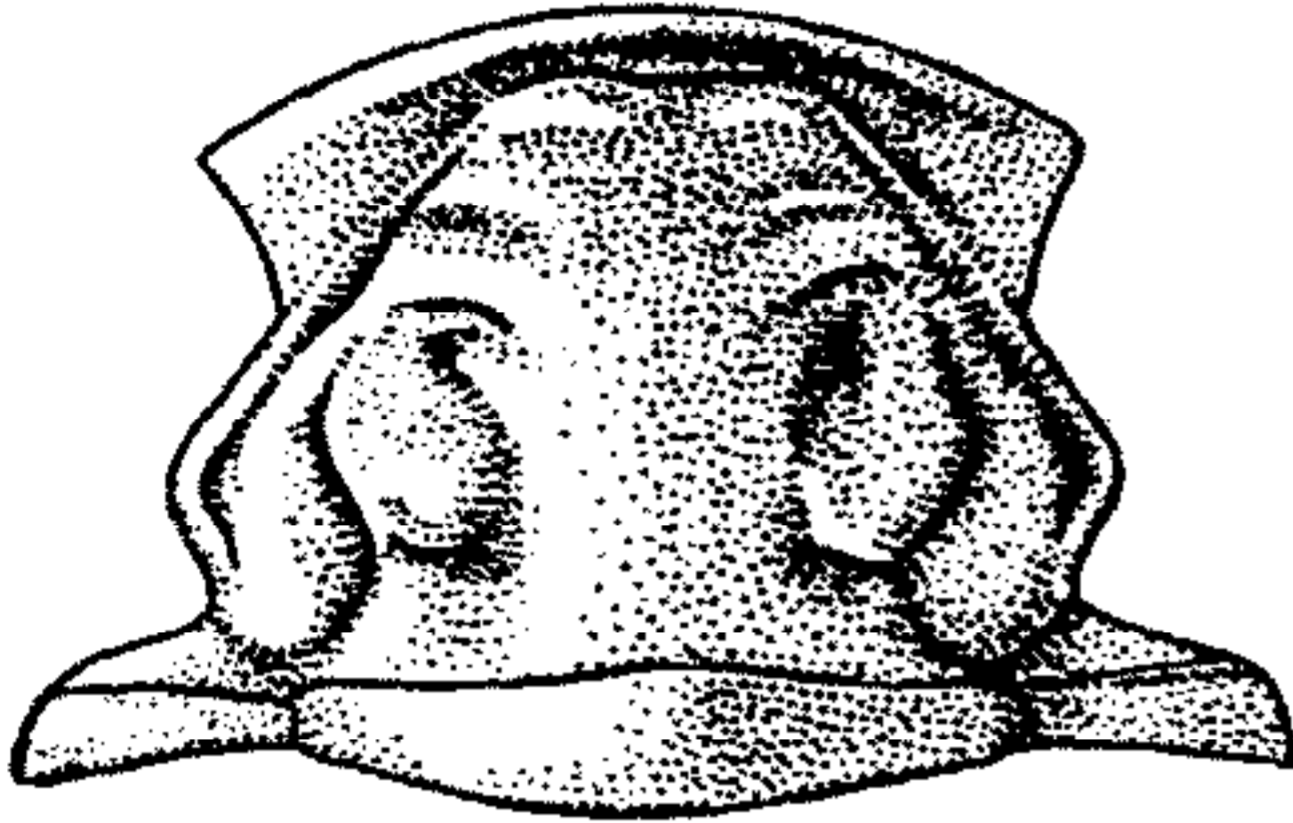

2 Eoacidaspis

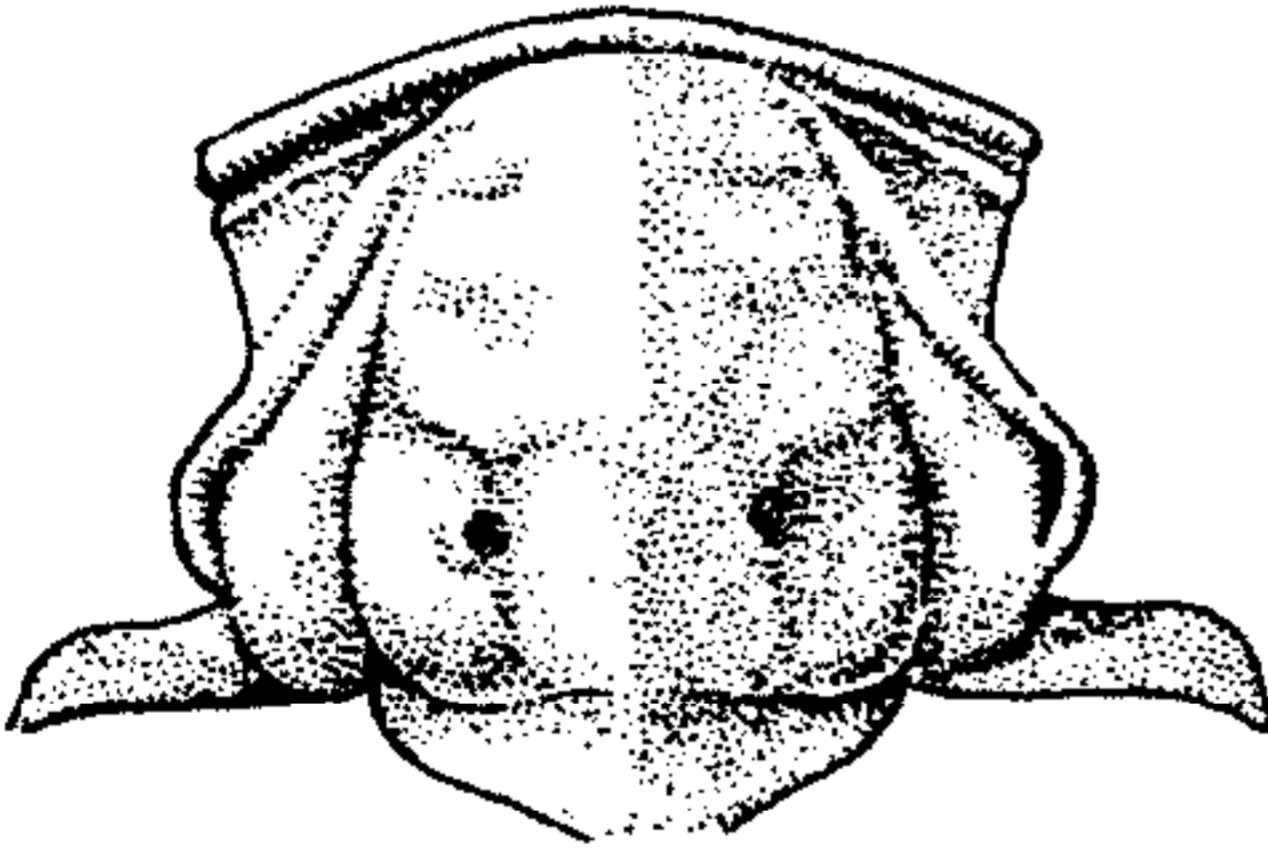

3 Acidaspides

FIG. 402. Eoacidaspididae (p. 0510).

segments poorly known. Pygidium (known only in *Acidaspides*) with 3 pairs of prominent, posteriorly directed spines of subequal length and width. *Up.M.Cam.-U.Cam.*

Eoacidaspis POLETAeva, 1956 [**E. salairica*]. Lateral glabellar furrows well defined, middle lobes (*2p*) large, separated from remainder of glabella by distinct furrows. Posterior (preoccipital) glabellar lobes (*1p*) shorter (*exsag.*) than middle lobes, poorly defined. *U.Cam., Sib.*—FIG. 402,2. **E. salairica*; cran., X? (443).

Acidaspides LERMONTOVA, 1951 [**A. precurrens*]. Posterior lateral glabellar lobes (*1p*) large, separated from remainder of glabella by distinct furrow, middle lateral glabellar lobes (*2p*) shorter

(*exsag.*) than posterior lobes, well defined. *Up.M.Cam.-U.Cam., Sib.-Kazakhstan.*—FIG. 402,3. *A. lermontovae* CHERNYSHEVA; cran., X? (443).

Belovia POLETAeva, 1956 [**B. calva* CHERNYSHEVA, 1956]. Lateral glabellar lobes and furrows generally as in *Acidaspides*, but poorly defined, lateral glabellar furrows faint to obsolete; eye ridges comparatively faint. *U.Cam., Sib.*—FIG. 402,1. **B. calva* (CHERNYSHEVA); cran., X? (443).

Order UNCERTAIN

Family MISSISQUOIDAE Hupé, 1953

Exoskeleton gonatoparian, subisopygous. Glabella parallel-sided to tapering, with 3 to 4 pairs of glabellar furrows; eye ridges faint or obsolete; palpebral furrows shallow; palpebral rims, occipital and axial furrows deep; eyes of medium size, position probably variable; preglabellar area probably absent in all; fixigenae upsloping, with straplike posterior areas and rounded genal angles; librigenae small, quadrate, steeply inclined. Thorax with 5 or more segments; axis convex, about same in width (*tr.*) as pleurae, ends of pleurae pointed. Pygidium subtriangular; axis convex, extending nearly full length; pleural fields about same in width, without border furrow or border, pleurae continuing directly to margin; marginal and terminal axial spines may be present. *L.Ord.(Tremadoc.)*.

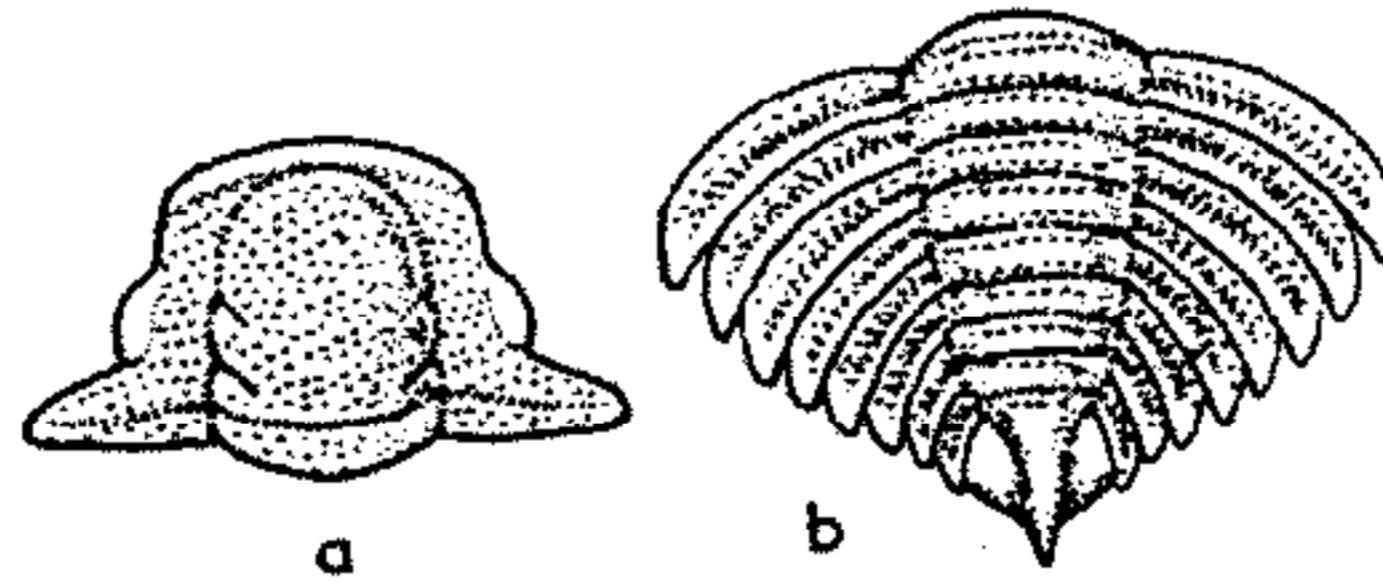

FIG. 403. **Missisquoia typicalis* SHAW (Missisquoidae), *L.Ord.(Tremadoc.)*, USA(Vt.); a, b, ceph., pyg., X6 (471).

Missisquoia SHAW, 1951 [**M. typicalis*]. Glabella parallel-sided to tapering, front broadly rounded, with median notch and 3 or 4 pairs of short deep lateral furrows at sides; eyes slightly below medium size, opposite center of glabella; no preglabellar field, curved anterior border furrow meeting preglabellar furrow, anterior border narrow; fixigenae with palpebral areas a little less than 0.5 of glabellar width, posterior areas about 0.7 of length (*tr.*) of occipital ring. Pygidium with axis showing 7 or 8 axial rings and terminal continued into median terminal spine; pleurae 6, separated by narrow shallow interpleural grooves and crossed by broad deep pleural furrows to

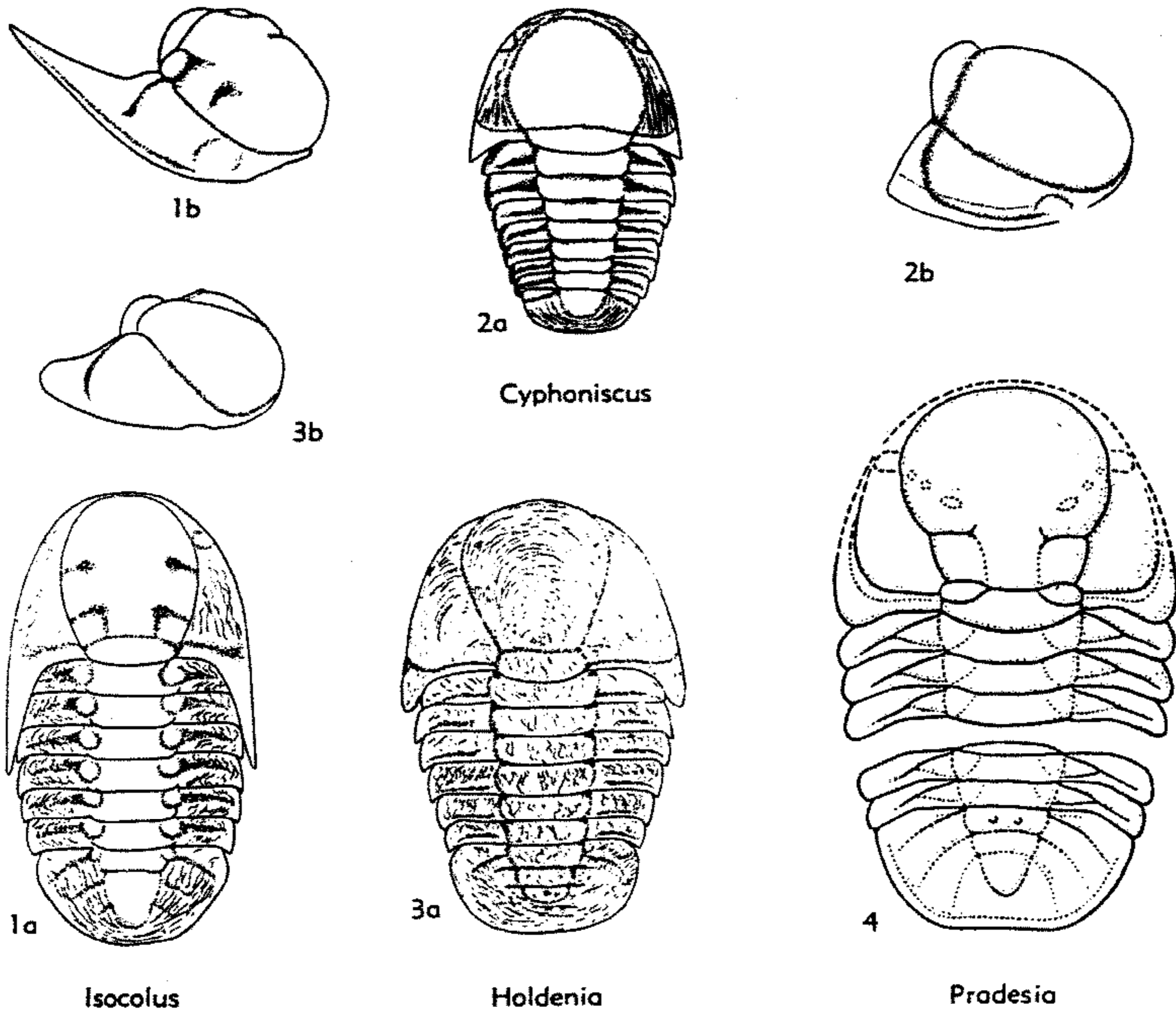

FIG. 404. Isocolidae (p. 0511-0512).

margin, terminating in short marginal spines. Outer surface finely granulose. *L.Ord.* (*Tremadoc.*), E.N.Am.—FIG. 403. **M. typicalis*, Vt.; *a,b*, ceph., pyg., $\times 6$ (471).

Family ISOCOLIDAE Angelin, 1854

Exoskeleton. 1 or 2 cm. in length. Convex cephalon, glabella ovate, outlined by deep axial and preglabellar furrows, greatest width at or in front of mid-length, deep occipital furrow, with or without 3 pairs of lateral glabellar furrows; genal regions and frontal area confluent, descending vertically distally, posterior and lateral borders gently convex, defined by furrows, long genal spines may occur; eye lobes (if present) gently convex, situated adjacent to axial furrows on anterolateral parts of genae, seemingly combined with eye ridges; eye facets absent; facial sutures opisthoparian, posterior sections curving across distal part of

posterior borders, anterior sections confluent along margin of frontal area. Anterior cephalic doublure and hypostoma unknown. Thorax with 6 or 7 segments; axis about 0.3 of width; small anterolateral lobes may be present on rings; inner part of pleurae horizontal, outer part bent steeply down, with deep pleural furrow. Pygidium with bluntly terminated axis not reaching posterior margin, 1 to 3 rings, convex pleural regions crossed by one or more pleural furrows. External surface with raised, anastomosing lines running subparallel to margins, except in furrows (78, 79, 358). ?*L.Ord.*, *M.Ord.*-*U.Ord.*

Isocolus ANGELIN, 1854 [*I. sjögreni*]. Maximum width of glabella at mid-length and less than length (*sag.*), with 2 pairs of short, deep lateral furrows directed transversely, inner end of basal furrow expanding into pit and connected by

shallow furrow to occipital furrow, thus isolating small, subcircular basal lobe; eye lobes ovate in outline, transversely directed; genal spines extending back close to thorax and reaching 3rd segment. Thorax with 6 segments with small axial rings bearing isolated anterolateral lobes, pleural furrows running in curves gently convex forward. Pygidial axis with faint 1st ring furrow, pleural regions with 3 pleural furrows, progressively shorter and fainter posteriorly (323). *U.Ord.*, Swed.-?C.Asia.—FIG. 404,1. **I. sjoegreni*, Swed.: 1a,b, exoskel., ceph. (anterolateral), $\times 12$ (358*).
Cyphoniscus SALTER, 1853 [**C. socialis*]. Glabella subcircular in outline, lateral furrows not impressed, posterior border widening (*exsag.*) distally, continuous with convex lateral border; apparently without genal spines; low eye lobes. Thorax with 7 segments; axial rings with faint anterolateral lobes; pleurae with deep diagonal pleural furrows. Pygidium without ring furrows on axis; only 1st pleural furrows present, extending to margin (266). *U.Ord.*, Eng.—FIG. 404,2. **C. socialis*, Eire; 2a,b, exoskel., ceph. (anterolateral), $\times 5$ (358*).

Holdenia COOPER, 1953 [**H. typa*]. Glabella pear-shaped, widest near front; basal and median lateral furrows represented by smooth areas, anterior laterals by small pits; librigenae unknown; emarginations in anterolateral parts of cranidium indicate position of eyes but no lobes present; posterior border furrows deep. Thorax with 6 segments; pleurae with pleural furrows close to posterior margins, deepening outward. Pygidial axis with 3 ring furrows; pleural regions with inner ends of 1st 2 interpleural grooves, 1st pleural furrows distinct, 2nd furrows faint (26). *M.Ord.*, Va.—FIG. 404,3. **H. typa*; 3a,b, exoskel., cran. (anterolateral), $\times 2.5$ (358*).

?*Pradesia* THORAL, 1935 [**P. martyi*]. Like *Holdenia*, but basal lateral glabellar furrows deep, curving back and shallowing toward occipital furrow; three further glabellar furrows indicated by shallow depressions. Convex lobe in anterolateral part of occipital ring. Eye lobe and lateral cephalic border unknown. Doublure broad (*sag.*) anteriorly, no median suture. Number of thoracic segments unknown, but not less than 6; convex anterolateral lobes on axial rings, pleural furrow diagonal. Pleural regions of pygidium with 3 shallow pleural furrows. *L.Ord.*(*Tremadoc.*), Fr.—FIG. 404,4. **P. martyi*, incomplete exoskel., $\times 5$ (79).

Family MYINDIDAE Hupé, 1955

Cephalon approximately semicircular, slightly convex, with narrow, prominent border; glabella short, convex, parallel-sided, rounded anteriorly, 3 pairs of short lateral glabellar furrows; eye ridges short, distinct; preglabellar field long, crossed by well-

marked median ridge; suture apparently marginal (287). *L.Ord.*(*Tremadoc.*).

Myinda STUBBLEFIELD in STUBBLEFIELD & BULMAN, 1927 [**M. uriconii*]. Characters of family. *L.Ord.*(*Tremadoc.*), Eng.—FIG. 405,3. **M. uriconii*; ceph., $\times 7.5$ (287).

Family GRANULARIIDAE Poletaeva, ?1936

[*nom. correct.* HENNINGSMOEN, herein (ex Granularidae POLETAEVA, ?1936)]

Cranidium proparian, with pyriform glabella and preglabellar field. Pygidium isopygous, with many segments and relatively narrow axis. Surface densely granulose. *Up.L.Cam.*

Granularia POLETAEVA, ?1936 [**G. obrutchevi*]. Characters of family. *Up.L.Cam.*, USSR.

Family SARKIIDAE Hupé, 1953

[*nom. correct.* HENNINGSMOEN, herein (pro Sarkiidae HUPÉ, 1953)]

Cephalon without facial sutures and with stout posterolateral spines; glabella with parallel sides and 3 pairs of short lateral furrows; eyes absent. Cephalic border furrows pitted. Thorax with at least 10 segments. Pygidium small, transverse, and with 3 or 4 axial rings. *M.Ord.*(*Llandeil.*).

Sarkia KLOUČEK, 1916 [**S. bohémica*]. Characters of family. *M.Ord.*(*Llandeil.*), Boh.—FIG. 405,1. **S. bohémica*; 1a,b, ceph.; 1c, hypostoma; all $\times 2.2$ (411).

Order and Family UNCERTAIN

LOWER CAMBRIAN GENERA

[Authorship of text is indicated by code letters given at the end of each section; these letters are explained on page 0160]

Aguaraya RUSCONI, 1955 [**A. acutispina*]. *Up.L.Cam.*, Arg. (Mendoza) (LB).

Avalonia WALCOTT, 1891 [**A. manuelensis*]. Cranidium trapezoidal; glabella parallel-sided, extended to anterior border; occipital ring rounded; eye ridges conspicuous; palpebral lobes small; facial sutures almost straight from anterior to posterior margin; posterior areas large, deeply furrowed. May belong to *Corynexochidae*. *L.Cam.*, N.Am. (Acad.-Balt. prov.)—FIG. 406,4. **A. manuelensis*, Newf.; cran., $\times 2.25$ (448n) (RA).

Binodaspis LERMONTOVA, 1951 [**B. spinosa*]. Resembles *Ptychopariidae*. *Up.L.Cam.*, E.Sib. (HE).

Giordanella; BORNEMANN, 1891 [**Iliaenus meneghinii* BORNEMANN, 1883; SD VOGDES, 1925]. *Up.L.Cam.*, Sard. (LB).

Jakutus LERMONTOVA, 1951 [**Dorypyge quadriceps* RYONSNITSKY]. Glabella only slightly tapering forward and with 5 pairs of lateral furrows; no preglabellar field; wide anterior border; eye lobes

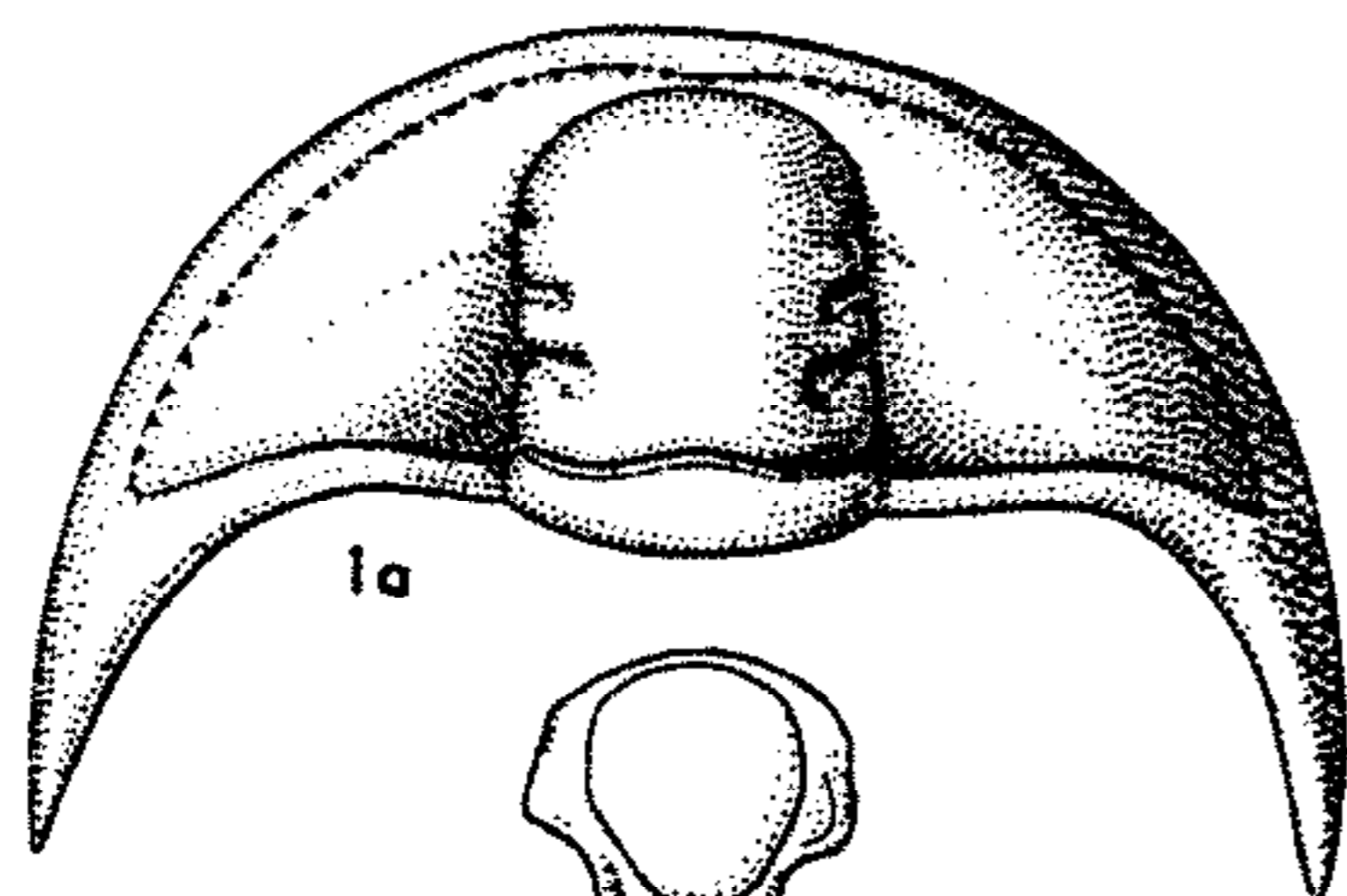

1a



1c

Sarkia

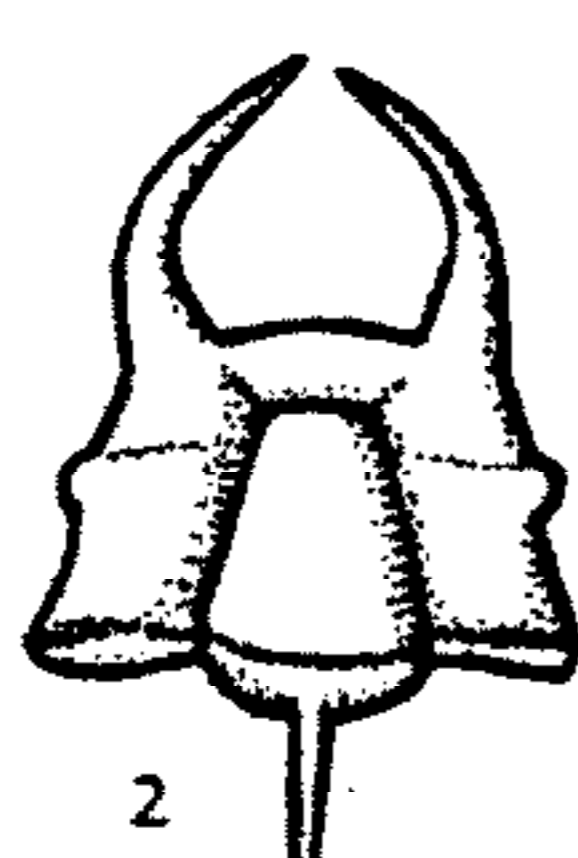

2

Diceratocephalus

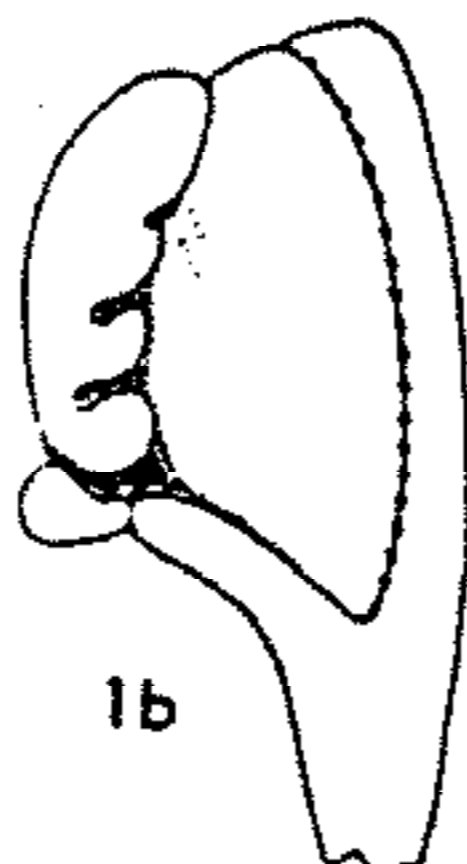

1b

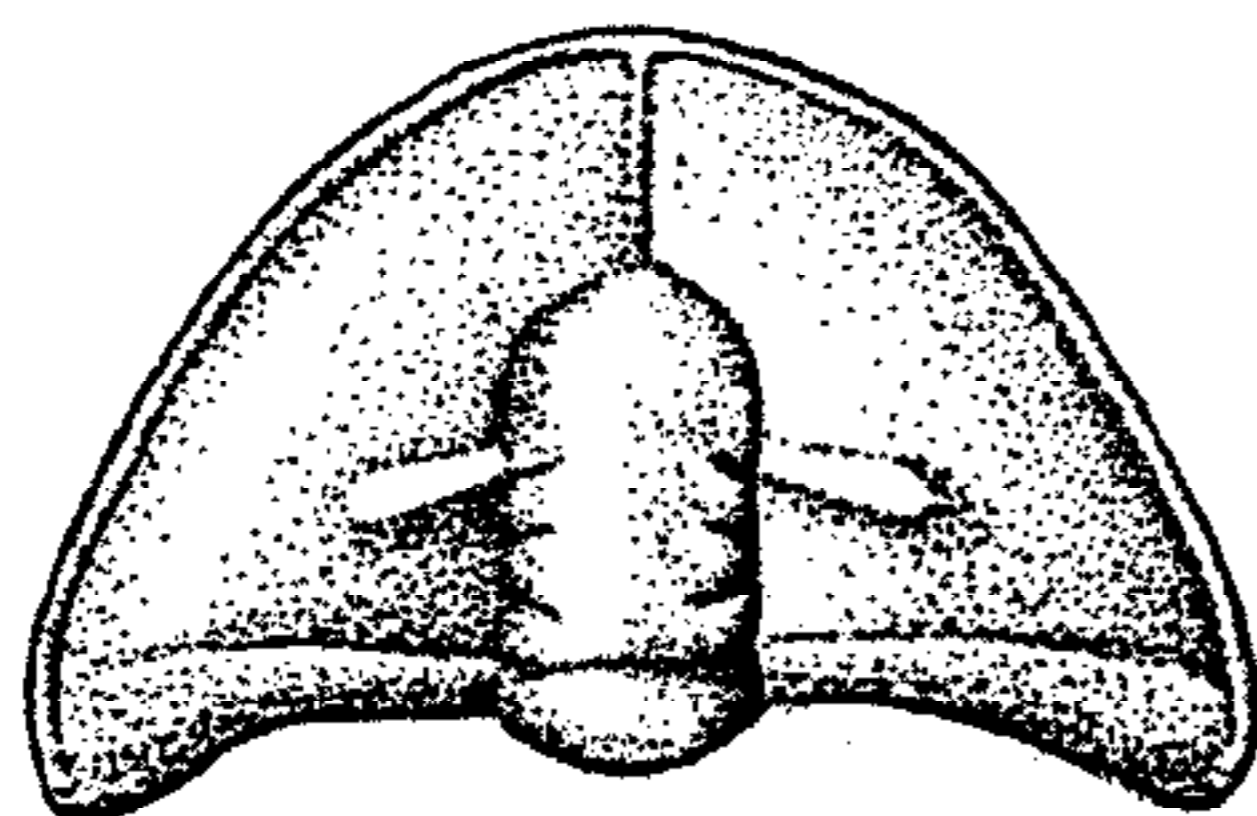

3

Myinda

FIG. 405. Diceratocephalidae (p. 0334), Sarkiidae (p. 0512), Myindidae (p. 0512).

medium in size and confluent with wide, oblique eye ridges. Librigenae with short spines. Thoracic pleurae with well-developed spines. Pygidium small; axis with 2 rings and end lobe. Surface of exoskeleton granulose. *Up.L.Cam.*, E.Sib.—FIG. 406.3. **J. quadriceps* (RJONSNITSKY); ceph., reconstr., $\times 1$ (433) (HE).

Jangudaspis OGJENKO, 1956 [**P. princeps*]. *Up.L.Cam.*, USSR (HE).

Judaicella LERMONTOVA, 1951 [**J. vernicula*]. *L.Cam.*, Sib. (LB).

Kueichowia LU, 1942 [**K. liui*]. *L.Cam.*, China (HE).

Kuanyangia HUPÉ, 1953 [**Redlichia pustulosa* LU, 1941] [= *Kuanyangia* HUPÉ, 1953 (obj.)]. *L.Cam.*, Yunnan (HE).

Meneghinella BORNEMANN, 1891 [**M. serrata*]. *L.Cam.*, Sard. (HE).

Metisaspina SIVOV, 1955 [**M. anomala*]. *Low.U.Cam.*, Salair, USSR (HE).

Namanoia LERMONTOVA, 1951 [**N. namandensis*]. [Family Namanoiidae LERMONTOVA, 1951]. *Up.L.Cam.*, E.Sib. (HE).

Paragraulos LU, 1941 [**P. kunmingensis*]. *L.Cam.*, China.—FIG. 406.2. **P. kunmingensis*; incomplete ceph., $\times 4$ (136). (HE).

Protypus WALCOTT, 1886 [**Angelina hitchcocki* WHITFIELD, 1884] [= *Bicaspis* RESSER, 1938].

Glabella large, prominent, pear-shaped, unfurrowed, reaching anterior border; occipital ring simple; fixigenae downsloping; palpebral lobes of medium length, curved; palpebral furrows shallow; anterior facial sutures slightly divergent; posterior sections defining moderately long (*tr.*), rounded posterior areas. Thorax of 12 segments, with prominent axis, pleurae bluntly terminated. Pygidium wide and short, much smaller than cephalon, with sharp anterior angles; marginal furrow and border indistinct. Possibly related to Ellipsocephalidae. *L.Cam.*, N.Am.—FIG. 406.1. *P. marginatus* RASETTI, Que.; 1a, b, cran., lat., and dors., views, $\times 2.25$; 1c, pyg., $\times 1.5$ (448n) (RA).

MIDDLE CAMBRIAN GENERA

Amgaspis CHERNYSHEVA, 1956 [**A. medius*]. *Low.M.Cam.*, USSR (HE).

Amginouyia CHERNYSHEVA, 1956 [**A. elegans*]. *Low.M.Cam.*, USSR (HE).

Chakasskia POLETAEVA, 1936 [**C. minusensis*].

Glabella elongate, sides tapering to broadly rounded front, with 3 pairs of lateral furrows, posterior 2 pairs complete, chevron-shaped, posterior pair touching occipital furrow; narrow eye ridges, palpebral rims and furrows prominent; no preglabellar field; anterior border furrow runs into axial furrow at sides; anterior border narrow; eyes of medium size, near mid-length of glabella; fixigenae convex, horizontal, with palpebral areas 0.7 of glabellar width, posterior areas broadly (*exsag.*) triangular, 0.7 of length (*tr.*) of occipital ring; librigenae, thorax and pygidium unknown. Outer surface granulose (102). *Low.M.Cam.*, Sib. (W. Sayan Mtns.) (LB).

Chittidilla KING, 1941 [**C. plana*]. Preglabellar area convex, sloping evenly to front margin; occipital ring with short blunt spine; palpebral lobes small, with ocular ridge reaching point near front of glabella, which bears 3 pairs of faint furrows. *M.Cam.*, S.Asia.—FIG. 408.2. **C. plana*, Magnesian Sandstone, Pak.; cran., $\times 3.6$ (418) (RA).

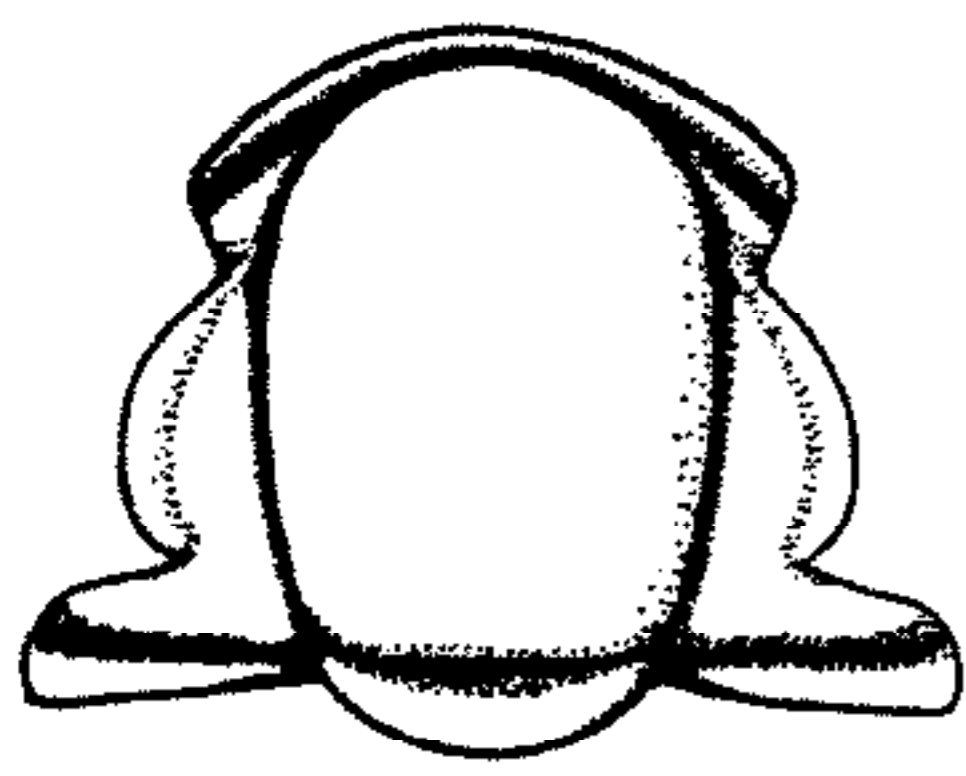

1a



1b

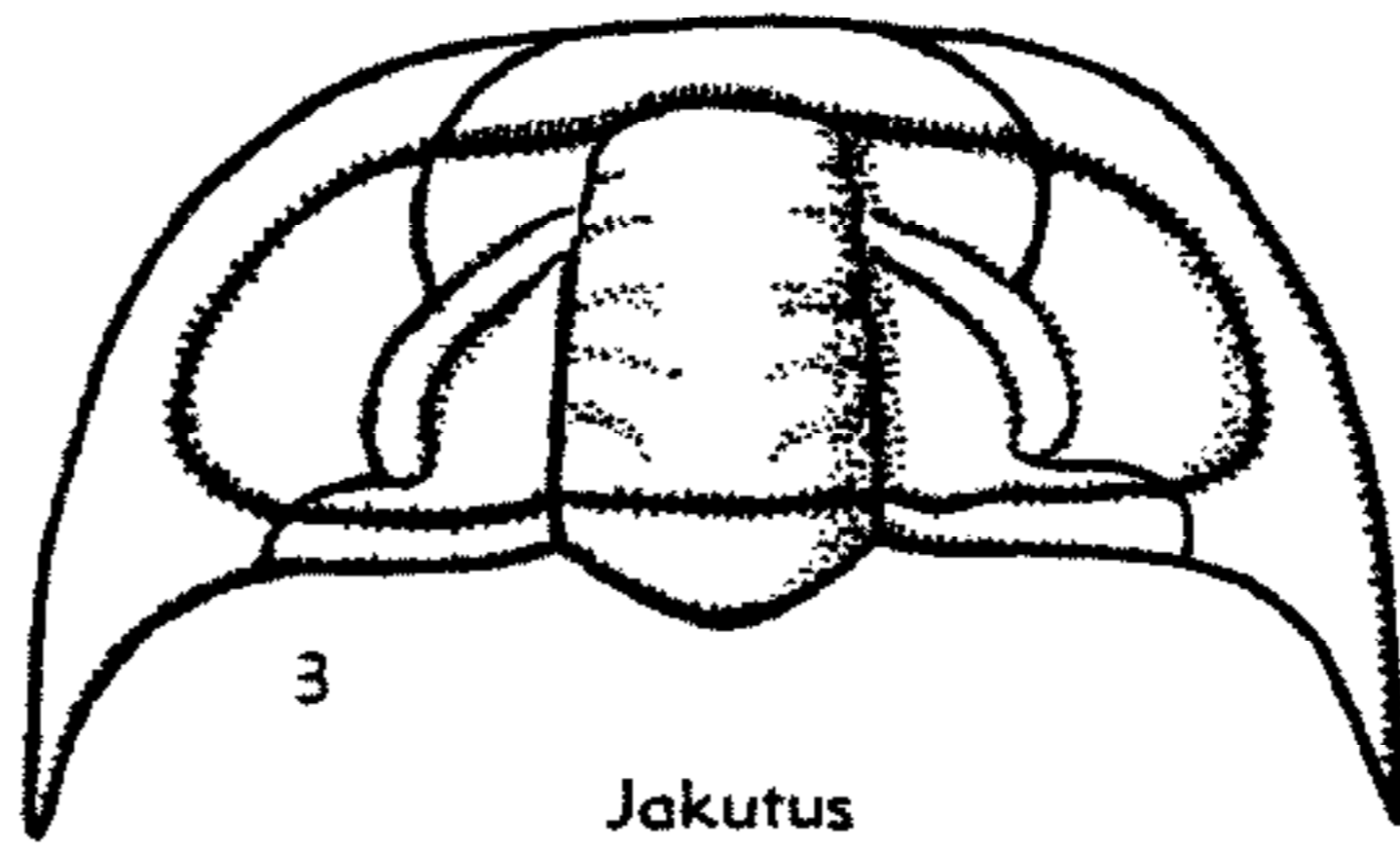

3

Jakutus



1c

Protypus



2

Paragraulos

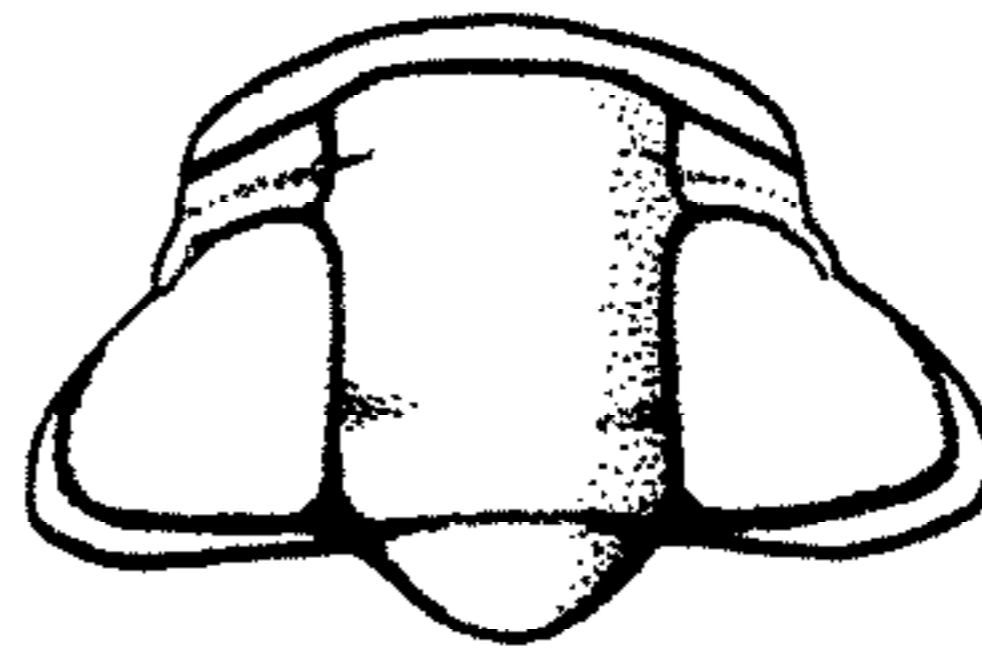

4

Avalonia

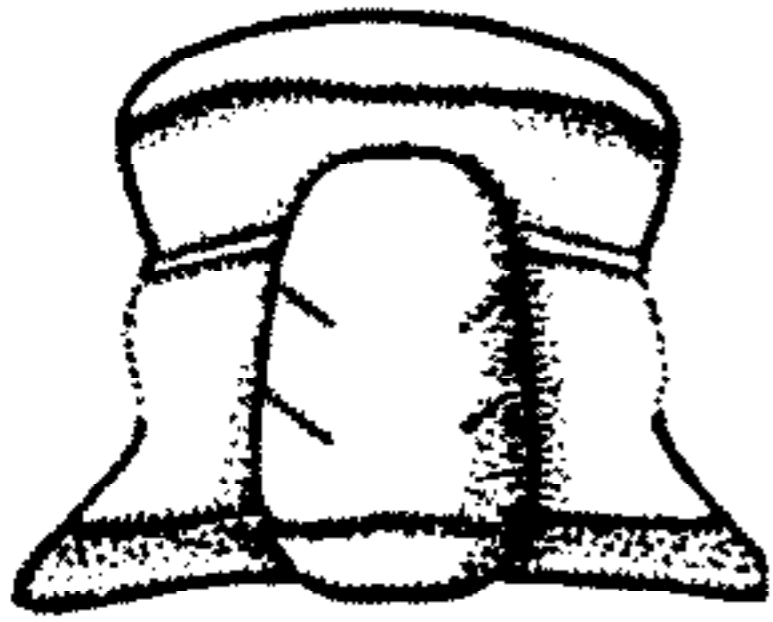

5

Agraulopsis



6

Metagraulos

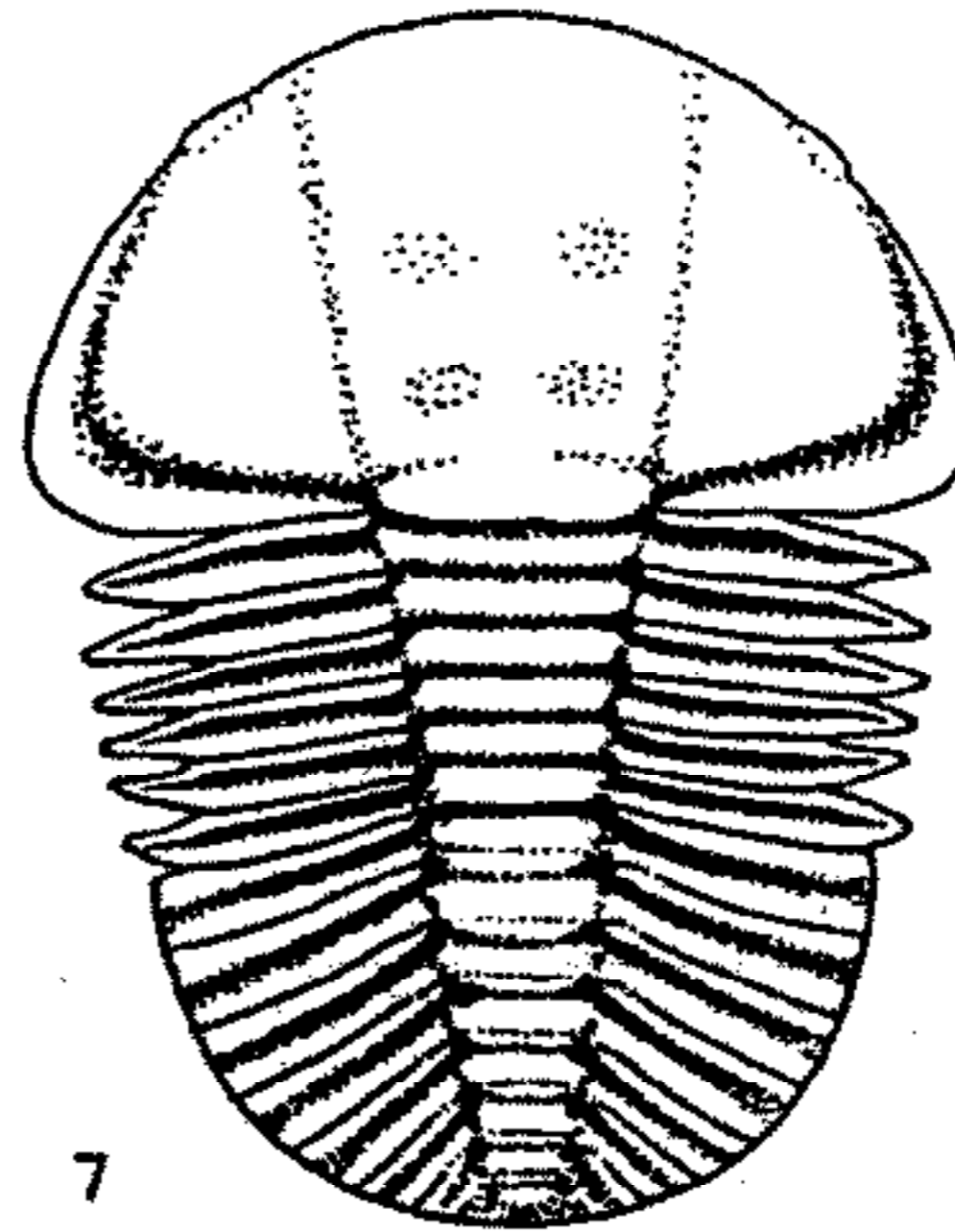

7

Hanburia

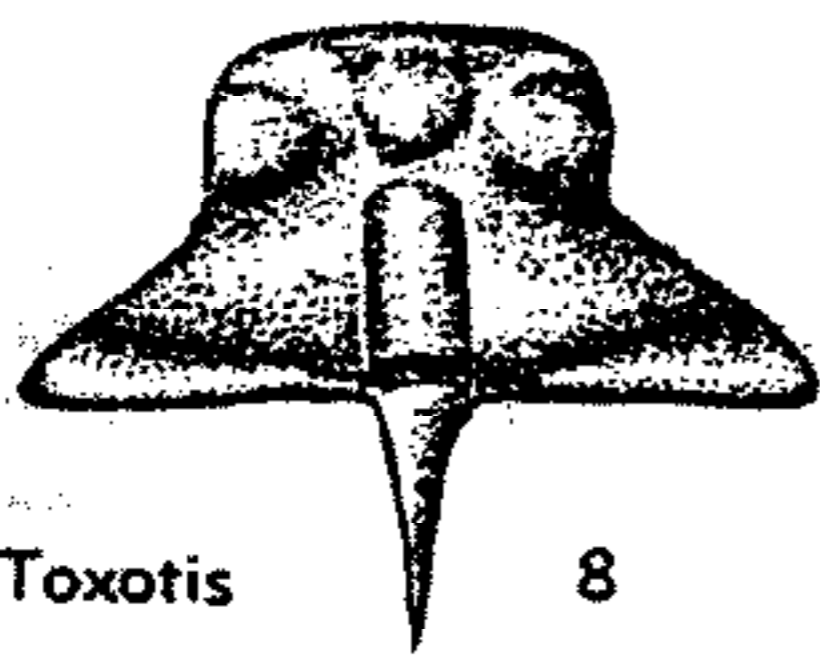

Toxotis

8

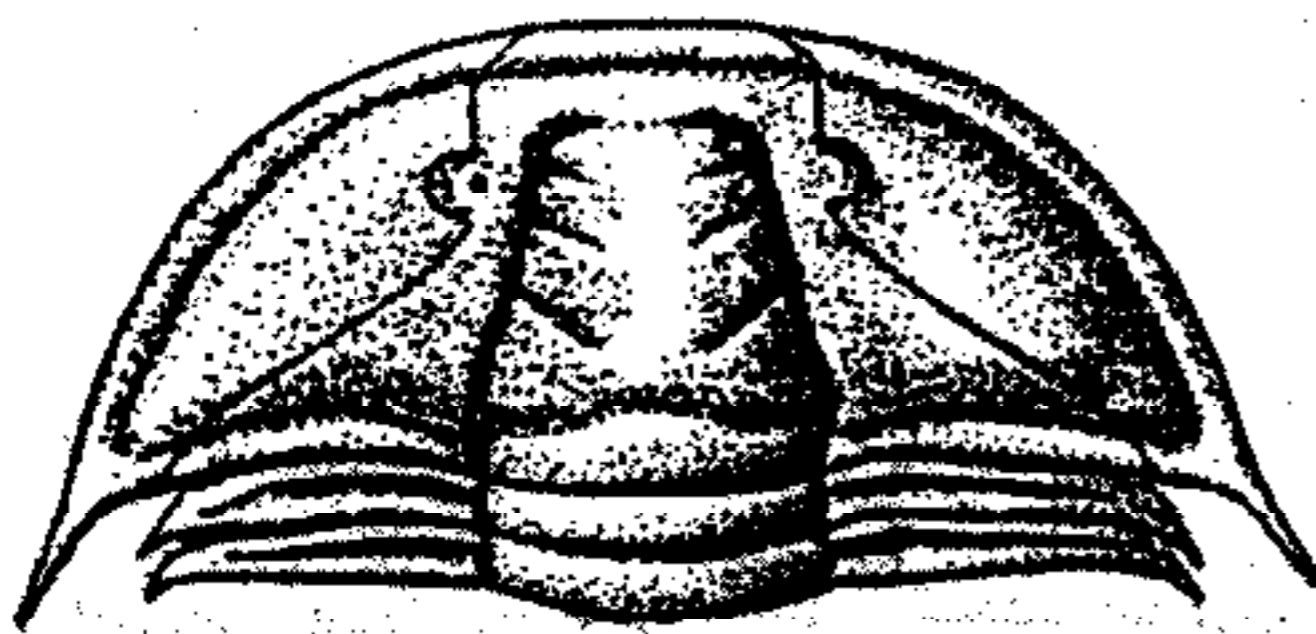

9

Ullospis

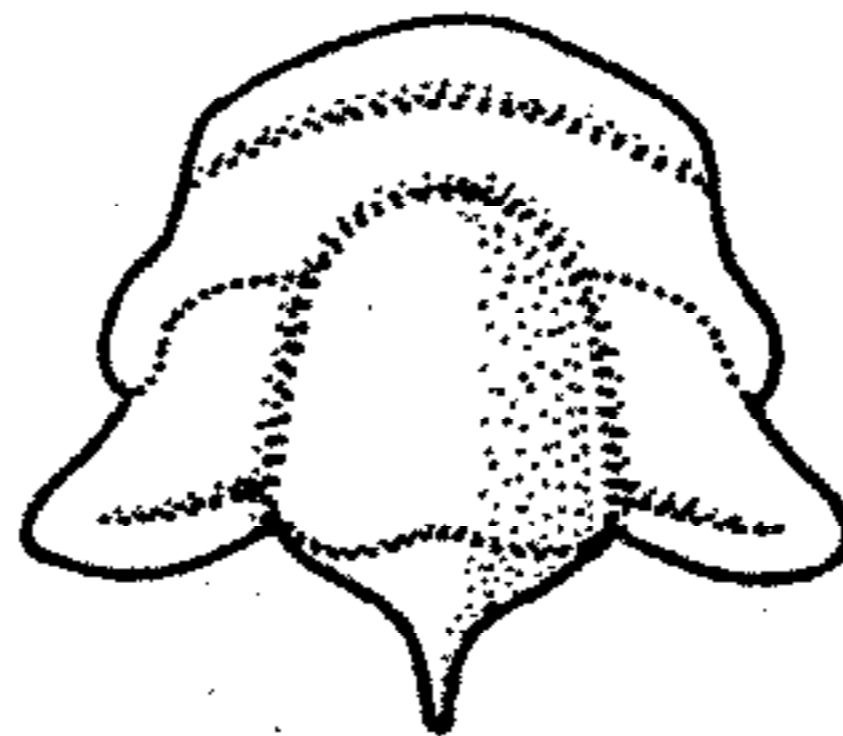

10a

Chondroparia

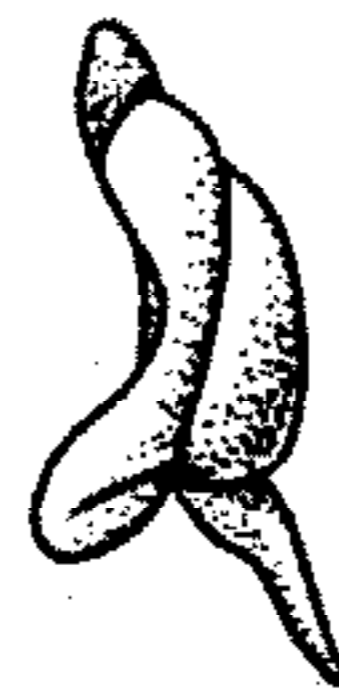

10b

FIG. 406. Incertae sedis. Lower and Middle Cambrian genera (p. 0512-0516; *Agraulopsis*, p. 0234).

Chondragraulos LERMONTOVA, 1940 [**C. minusensis*]. *M.Cam.*, Sib. (HE).

Chondroparia LORENZ, 1906 [**Agraulos? pusillus* MATTHEW, 1897]. Cephalon small, elliptical, regularly convex; glabella tapering, with rounded front, 3 pairs of short, faint lateral furrows; eye ridges very faint; short occipital spine may be present; preglabellar area downsloping; anterior border furrow narrow, anterior border convex; palpebral lobes small, slightly anterior to center of glabella; fixigenae with palpebral areas slightly downsloping, 0.5 to 0.3 of glabellar width, posterior areas broadly (*sag.*) triangular, 0.7 of length (*tr.*) of occipital ring; librigenae, thorax and pygidium unknown. Outer surface may be finely granulose. *Up.M.Cam.*, E.Can.—FIG. 406, 10a,b. **C. pusilla* (MATTHEW), N.B.; 10a,b, cran., $\times 4$ (429) (LB).

Conoides HOWELL, 1937 [**C. edsoni*]. *Up.M.Cam.*, E.U.S.A. (Vt.) (LB).

Edelsteinaspis LERMONTOVA, 1940 [**E. ornata*]. Glabella elongate, rectangular, front converging very slightly, rounded, with 3 pairs of chevron-shaped complete lateral furrows; with distinct eye ridges, palpebral lobes and furrows; no preglabellar field, anterior border furrow curves into preglabellar furrow, narrow, rimlike anterior border; eyes large, slightly posterior to center of glabella; fixigenae of medium width, slightly upsloping, with arcuate palpebral areas, not quite 0.5 of glabellar width, posterior areas narrow (*exsag.*), straplike, long; librigenae rectangular, with shallow marginal furrows, and short rounded genal spine. Thorax of 10 or 11 segments; axis convex; pleurae low, flat, wider (*tr.*) than axis, with deep pleural furrow. Pygidium semicircular, axis narrow, convex, tapered 0.8 of its length to narrow, rounded end, with 6 axial rings and terminal; pleural fields wider, convex, pleurae 5, separated by narrow interpleural grooves and crossed by deep pleural furrows that fade at inner edge of medium wide flat border, no border furrow. Outer surface finely granulose. *Low.M.Cam.*, Sib.—FIG. 407. **E. ornata*, Minusinsky Basin; exoskel., $\times 1.7$ (423) (LB).

Eilura RESSER & ENDO, in ENDO & RESSER, 1937 [**E. typa*]. *M.Cam.*, Manch. (37) (LB).

Fabulaspis IVSHIN, 1953 [**F. famosus*]. *M.Cam.*, Kazakhstan (HE).

Hanburia WALCOTT, 1916 [**H. gloriosa*]. Cranium semicircular in outline; glabella expanded forward, poorly defined, reaching margin of cephalon; librigenae presumably narrow and marginal; existence of palpebral lobes and eyes doubtful. Thorax of 6 segments; pleurae furrowed, slightly curved forward. Pygidium almost as large as cephalon, semicircular, with distinct furrows and grooves, no marginal furrow or border. Size small. *M.Cam.*, N.Am.—FIG. 406, 7. **H. gloriosa*,

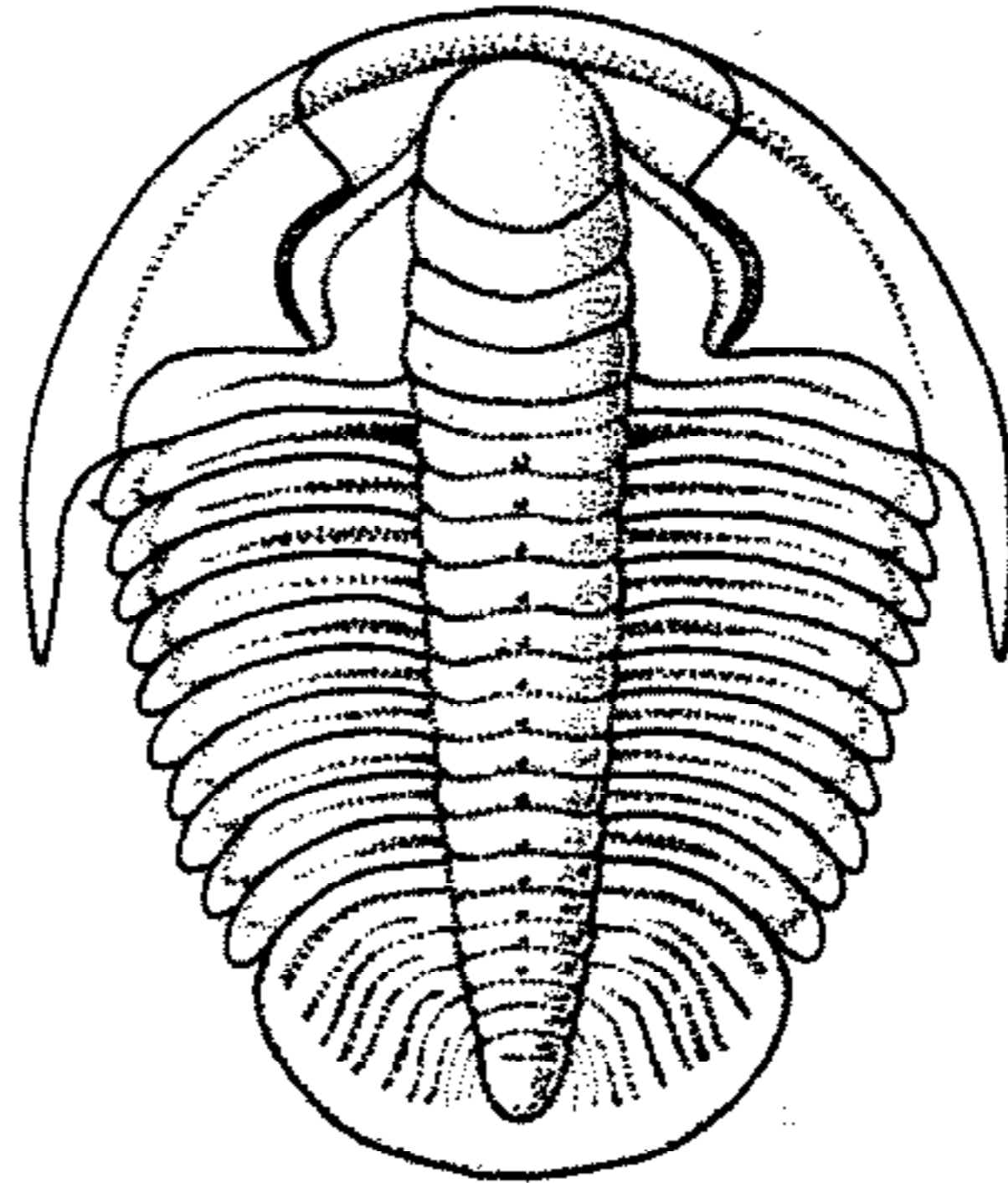

FIG. 407. **Edelsteinaspis ornatus* LERMONTOVA (Incertae sedis), *M.Cam.*, exoskel. (reconstr.), ornamentation omitted, $\times 1.7$ (423).

osa, B.C.; exoskel., restoration of cephalon uncertain, $\times 2$ (448n) (RA).

Inouyina POLETAeva, 1936 [**I. quadratica*]. Glabella convex, rectangular, sides parallel to slightly rounded front, with 4 pairs of lateral furrows, anterior 3 pairs short, straight, posterior pair complete, curving back to touch occipital furrow on mid-length; eye ridges narrow, palpebral rims and furrows distinct; no preglabellar field; narrow anterior border furrow curves into preglabellar furrow; anterior border medium wide, convex, downsloping; eyes of medium size, near mid-length of glabella; fixigenae convex, horizontal, with palpebral areas 0.7 of glabellar width, posterior areas broadly (*exsag.*) triangular, more than 0.7 of length of occipital ring; librigenae, thorax and pygidium unknown. Outer surface granulose (102). *Low.M.Cam.*, Sib. (W. Sayan Mts.) (95) (LB).

Kolpura RESSER & ENDO, in ENDO & RESSER, 1937 [**Pterocephalus? liches* WALCOTT, 1911]. Cephalon and thorax unknown. Pygidium semicircular; axis convex, tapered 0.5 of its length to broad rounded end, with postaxial ridge continuing to notched posterior margin, 4 axial rings and terminal; pleural fields low, same in width as axis, pleurae 4 or 5, with interpleural grooves very faint anteriorly or obsolete, 4 broad shallow pleural furrows curved abruptly backward, crossing border nearly to margin, no border furrow, border of medium width, flat, anterior 2 segments ending in short flat spines, posterior pleurae fused to form a broad, flat notched pseudospine. Outer surface finely granulose. *M.Cam.*, E.Asia.—FIG. 408, 1. **K. liches* (WALCOTT), China (Shantung); pyg., $\times 1.3$ (488) (LB).



1

Kolpura



2

Chittidillo

FIG. 408. Incertae sedis. Middle Cambrian genera (p. 0513-0515).

Levisia WALCOTT, 1911 [**Agraulos agenor* WALCOTT, 1905], *M.Cam.*, China (Shantung) (LB).

Megagraulos KOBAYASHI, 1935 [**M. coreanicus*]. *M.Cam.*, NE.Asia (LB).

Metagraulos KOBAYASHI, 1935 [**Agraulos nitida* WALCOTT, 1906]. *M.Cam.*, China.—FIG. 406,6.

**Metagraulos nitida* (WALCOTT); cran., $\times 3$ (488) (HE).

Orloviella SIVOV, 1955 [**O. typica*]. *M.Cam.-U. Cam.*, Sib. (HE).

Pararania KOBAYASHI, 1942 [**Dolichometopus tatei* WOODWARD, 1884]. *M.Cam.*, S.Austral. (HE).

Plagiura RESSER, 1935 [**Ptychoparia? cercops* WALCOTT, 1917] [= *Plagiurella* RESSER, 1937]. Glabella subconical, unfurrowed in adult; palpebral lobes small, close to glabella, anterior in position; frontal area poorly differentiated into preglabellar field and border; anterior sections of facial sutures directed straight forward; posterior sections long, almost straight, defining large, triangular, furrowed posterior area; genal angles rounded. Thorax of 15 segments; pleurae furrowed at geniculation, sharply pointed distally. Pygidium wide and short; axis long, prominent; pleural fields furrowed; anterior angles sharp; border furrow indistinct, border downturned. *M. Cam.*, N.Am.—FIG. 409,1. **P. cercops* (WALCOTT), Mt. Whyte F., Alba; a, cran., $\times 2$, b, pyg., $\times 3$ (448n) (RA).

Prohedineella SIVOV, 1955 [**P. erbiensis*]. Cranidium resembles *Welleraspis*. *M.Cam.*, Sib. (HE).

Pseudoliostracina KOBAYASHI, 1938 [**Lioparia blautoeides* LORENZ, 1906]. *M.Cam.*, China (HE).

Schistometopus RESSER, 1938 [**S. typicalis*]. Glabella tapered, well defined, with 4 pairs of furrows occupying with occipital ring most of cranial length; fixigenae half as wide as glabella at palpebral lobes; eye ridges strong; palpebral lobes about 0.25 of length of glabella, at level of glabellar mid-point; anterior border convex; preglabellar field reduced or lacking; anterior border furrow with a pair of backward inbends corresponding to axial furrows; anterior sections of facial sutures slightly divergent in front of palpebral lobes; posterior sections curving outward and backward; posterior area deeply furrowed. *M.Cam.*, N.Am.—FIG. 409,2. *S. convexus* RASETTI, Mt. Whyte F., B.C.; cran., $\times 3$ (448n) (RA).

Toxotis WALLERIUS, 1895 [**T. pusilla*]. Minute, subtrapezoidal cranidium having short, very narrow, parallel-sided glabella delimited by shallow axial furrows, occipital ring with long, stout, backward-directed spine, effaced lateral furrows; long preglabellar field occupied by boss; narrow, indistinctly defined anterior border; wide anterior and palpebral regions of fixigenae occupied by boss, very wide posterior areas, usually effaced eye-ridges; converging course of anterior sections of facial sutures from eyes to anterior margin, wide, shallow, distinctly marked posterior border furrow, and finely punctate outer surface of preglabellar field and anterior genal area; other parts of exoskeleton unknown (336). *M.Cam.*, Swed.—FIG. 406,8. **T. pusilla*; cran., $\times 15$ (336) (PO).

Trinia POLETAEVA, 1956 [**T. bella*]. [Family Triniidae POLETAEVA, 1956]. *Up.M.Cam.*, USSR (HE).

Ullaspis WESTERGÅRD, 1948 [**U. conifrons*]. Fairly small, opisthoparian, ovate, moderately convex exoskeleton having tapering, anteriorly truncated glabella, 3 pairs of well-defined lateral furrows; short preglabellar field; narrow, well-defined cephalic border; narrow anterior and palpebral and wide posterior areas of fixigenae, indistinctly defined eye-ridges, small eyes situated fairly close to anterior corners of glabella; slightly diverging, almost subparallel course of anterior sections of facial sutures from eyes to anterior border, almost straight posterior sections crossing posterior border close to genal angle; genal spines. Thorax of more than 10 segments with continuously tapering axis, furrowed pleurae, and short pleural spines. Surface smooth (336). *M.Cam.*, Swed.—FIG. 406,9. **U. conifrons*; ceph. with 2 attached thoracic segs., restored, $\times 1.6$ (336) (PO).

Yorkella KOBAYASHI, 1942 [**Conocephalites australis* WOODWARD, 1884]. *M.Cam.*, S.Austral. (HE).

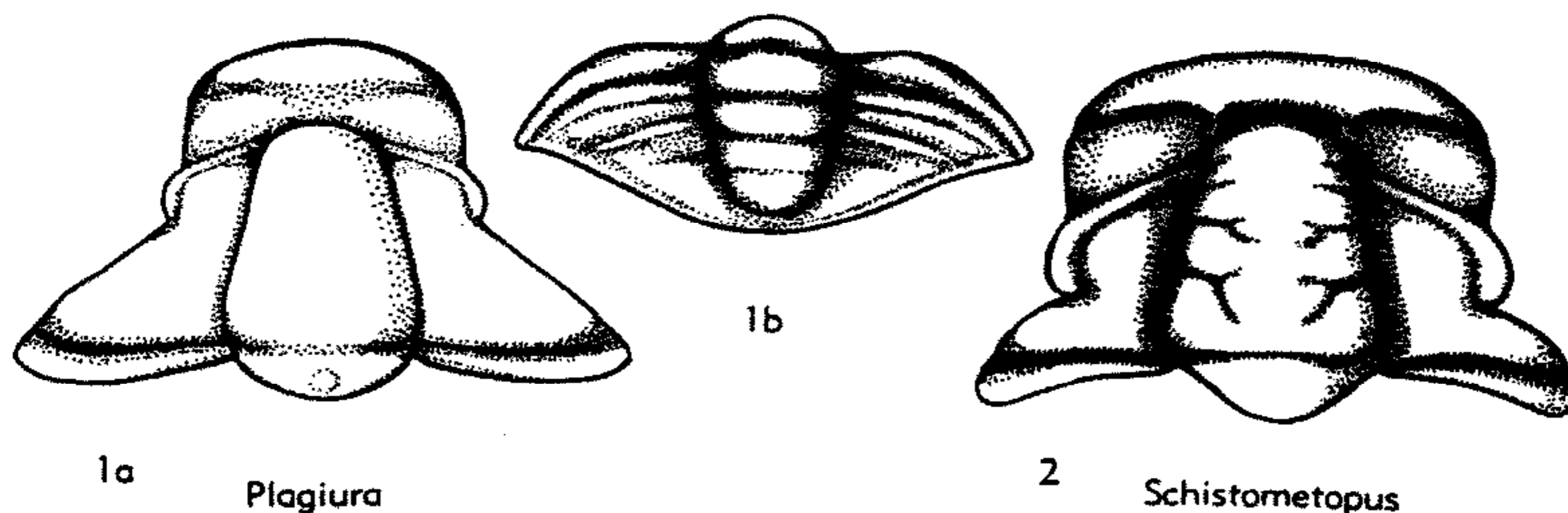

FIG. 409. Incertae sedis. Middle Cambrian genera (p. 0516).

UPPER CAMBRIAN GENERA

Abakanopleura SIVOV, 1955 [**A. kenensis*]. *Low. U.Cam.*, Sib. (HE).

Acantholenus MATTHEW, 1898 [**Leptoplastus spiniger* MATTHEW, 1889]. *U.Cam.*, E.Can.(N.B.) (HE).

Acheilops ULRICH, in BRIDGE, 1930 [**A. dilatatus*]. Glabella expanded forward, reaching front margin of cephalon; occipital ring short and simple; palpebral lobes long, narrow, curved, close to glabella, reaching axial furrow at anterior end; fixigenae lacking in front of eyes; posterior areas very slender, slanting backward. Size small. Cranium suggests *Corynexochidae*, resemblance possibly due to homeomorphy. *U.Cam.(Trempeal.)*, N.Am.—FIG. 410,3. **A. dilatatus*, Mo.; cran., $\times 2$ (448n) (RA).

Acrohybus RAYMOND, 1937 [**A. argutus*]. *U.Cam.(Dresbach.)*, E.USA(Vt.). (LB).

Aidarella LERMANTOVA, 1951 [**A. vigilans*]. *U.Cam.*, NE.Kazakhstan (HE).

Bowmania WALCOTT, 1925 [**Arethusina americana* WALCOTT, 1886]. Glabella almost parallel-sided, prominent, rounded in front, with two pairs of short, lateral furrows; occipital furrow straight, occipital ring short (*sag.*) and simple; width of palpebral area about 0.7 of glabellar width; eye ridges straight, slanting backward; palpebral lobes small, slightly posterior to glabellar mid-point; anterior sections of facial suture directed straight outward-forward to margin; preglabellar field long (*sag.*); border convex, narrow (*sag.*); posterior sections of facial sutures not well known. *U.Cam.(Trempeal.)*, N.Am.—FIG. 410,4. **B. americana* (WALCOTT), Nev.; cran., $\times 4$ (448n) (RA).

Bridgeia LOCHMAN, 1944 [**B. mirabila*]. Glabella narrowly tapering, strongly convex, with median ridge, no lateral furrows; no preglabellar area; wide, deep anterior border furrow runs into preglabellar furrow; anterior border wide (*sag.*), strongly convex; eyes small, opposite anterior 0.3 of glabella; fixigenae slightly upsloping, with

palpebral areas 0.75 of glabellar width, posterior areas long (*tr.*); librigenae unknown. Thoracic segments, number unknown, axis and pleurae subequal in width. Pygidium ovate; axis wide, convex, nearly full length, 1 axial ring; pleurae steeply sloping, unfurrowed, narrow, flat border (132). *U.Cam.(Dresbach.)*, W.USA.—FIG. 410, 6. **B. mirabilis*, Mont.; 6a,b, cran.; 6c, thoracic segments and pyg.; all $\times 7.5$ (132) (LB).

Cryptoderaspis RASETTI, 1946 [**C. metisensis*]. Glabella extremely prominent, ovate, unfurrowed; occipital ring short, hidden by glabella in dorsal view; fixigenae downsloping; frontal area convex, undifferentiated; palpebral lobes small; posterior areas triangular, unfurrowed. Size small. *U.Cam.(Dresbach.)*, N.Am.—FIG. 410,7. **C. metisensis*, Que.; 7a-b, cran., dors. and lat. views, $\times 3$ (448n) (RA).

Ellipsocephaloides KOBAYASHI, 1935 [**Ellipsocephalus curtus* WHITFIELD, 1878]. Entire cranium of low convexity; glabella parallel-sided, rounded in front; lateral furrows as pairs of pits that may be connected across glabella; occipital ring simple; frontal area narrow (*sag.*), convex, undifferentiated; eye ridges and palpebral lobes forming long, continuous, thick band; fixigenae horizontal, of variable width; posterior areas not extending much farther than palpebral lobes. Pygidium with short, pointed axis and fanlike pleural regions extended into several pairs of flat spines. Size small. No relationship to *Ellipsocephalus*. *U.Cam.(Francon.)*, N.Am.—FIG. 410, 5c. *E. silvestris* RESSER, Okla.; pyg., $\times 8$ (239). —FIG. 410,5a,b. *E. monensis* RESSER, Alba.; cran., $\times 5$; pyg., $\times 3$ (239) (RA).

Eosaukia LU, 1954 [**E. latilimbata*]. *Low.U.Cam.*, SW.China (HE).

Esseigania KOBAYASHI, 1944 [**E. tolli*]. *Up.U.Cam.*, Sib.(Chatanga-Anabar Basin) (LB).

Goycoia RUSCONI, 1950 [**G. tellicheai*]. *U.Cam.*, Arg.(Mendoza) (LB).

Hamashania KOBAYASHI, 1942 [**H. pulchera*]. Cephalon and thorax unknown. Pygidium elongate ovoid; axis convex, tapered probably 0.83 of

length to narrow rounded end, may be postaxial ridge, 7 or more axial rings and terminal; pleural regions about same width as axis, low, with 8 or more pleurae, without pleural furrows but shallow posteriorly curved interpleural grooves reach nearly to margin; no border furrow or well-defined border, low slope continues to margin. Outer sur-

face smooth. *U.Cam.*(Fengshanian), E.Asia.—
FIG. 411,6. **H. pulchra*, Manch.; incompl. pyg.,
×3 (419) (LB).

Hanivella SIVOV, 1955 [**H. primaeva*]. *U.Cam.*,
Salair, USSR (HE).

Jubileia KOBAYASHI, 1938 [*]. *grandifrons*. *U.Cam.*
(Francon.), Can.(B.C.) (LB).

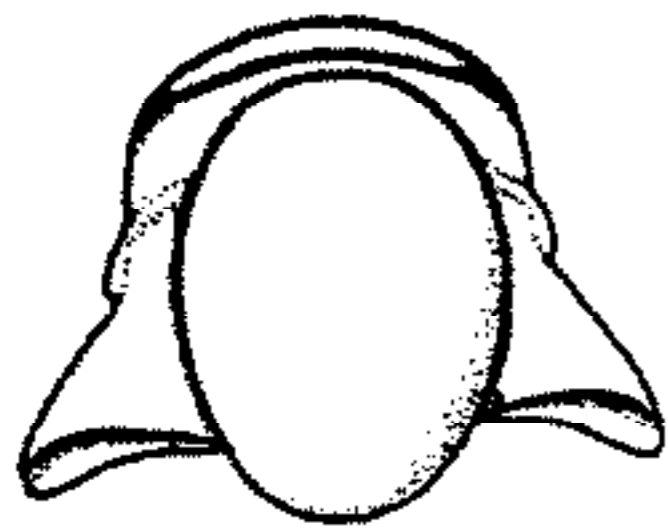

1a



1b

Onchonotopsis



2a

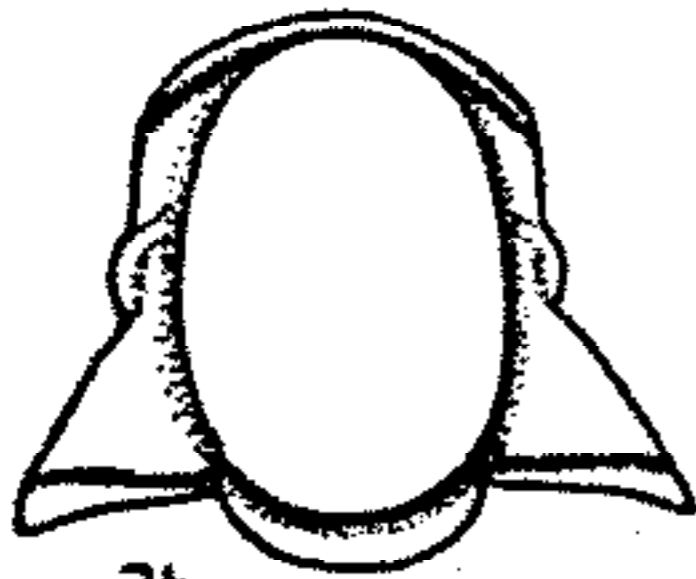

2b

Matania

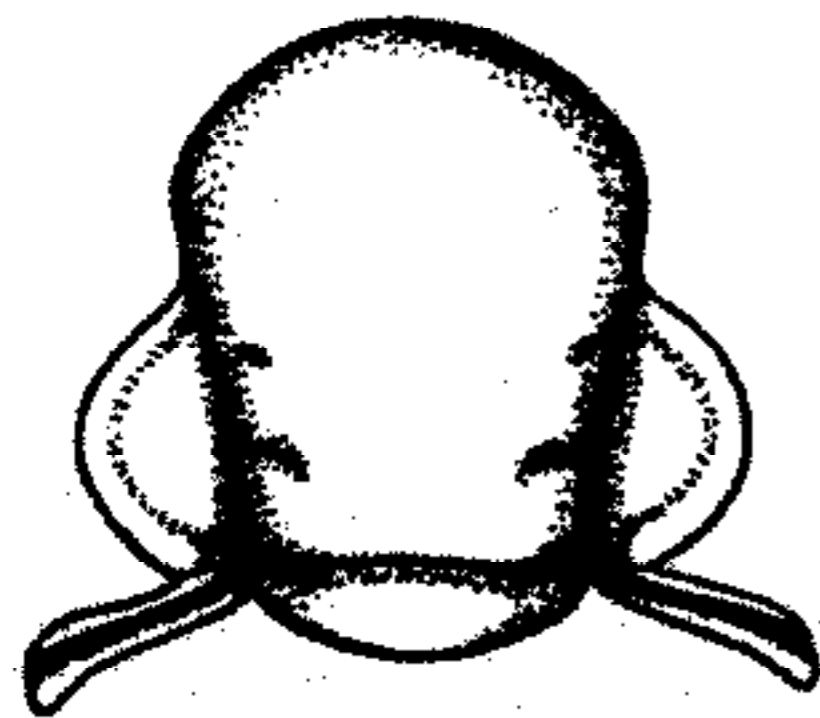

3

Acheilops

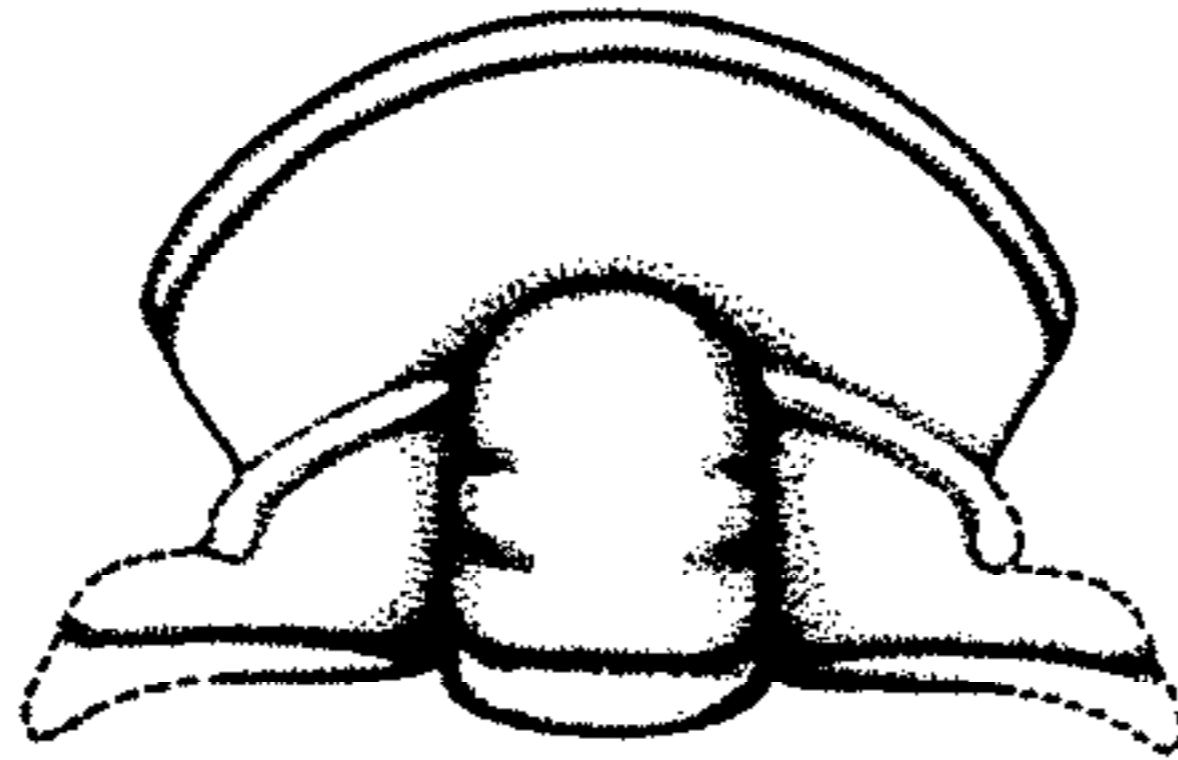

4

Bowmania



5a

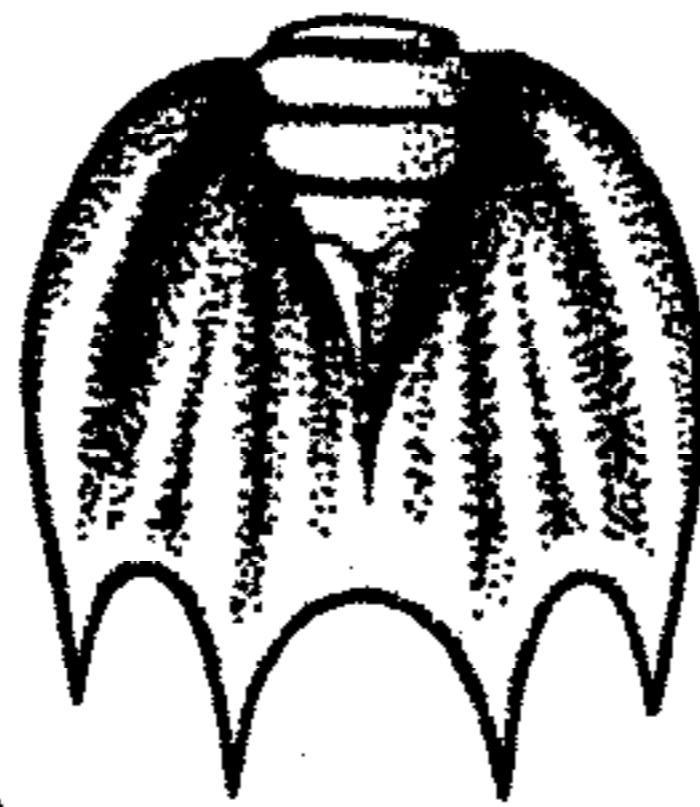

5b

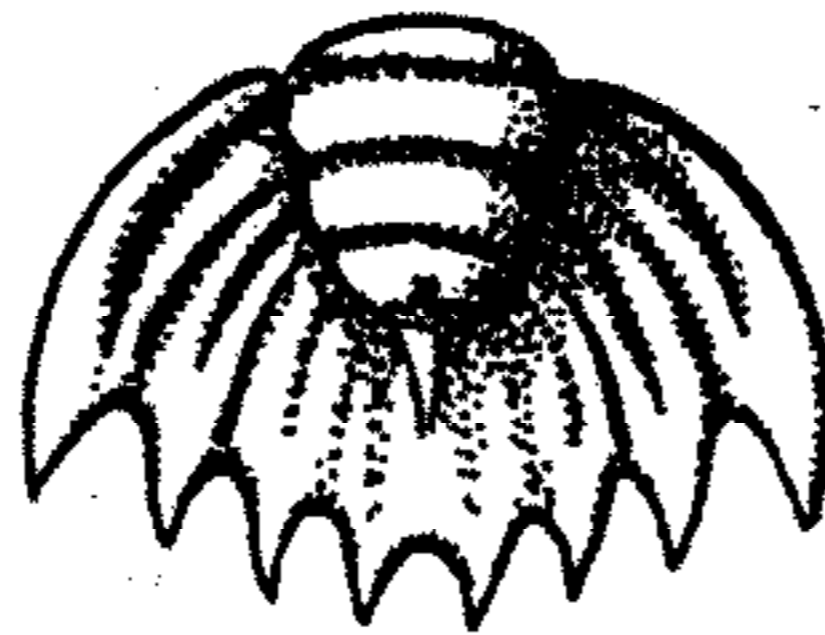

5c

Ellipsocephaloïdes

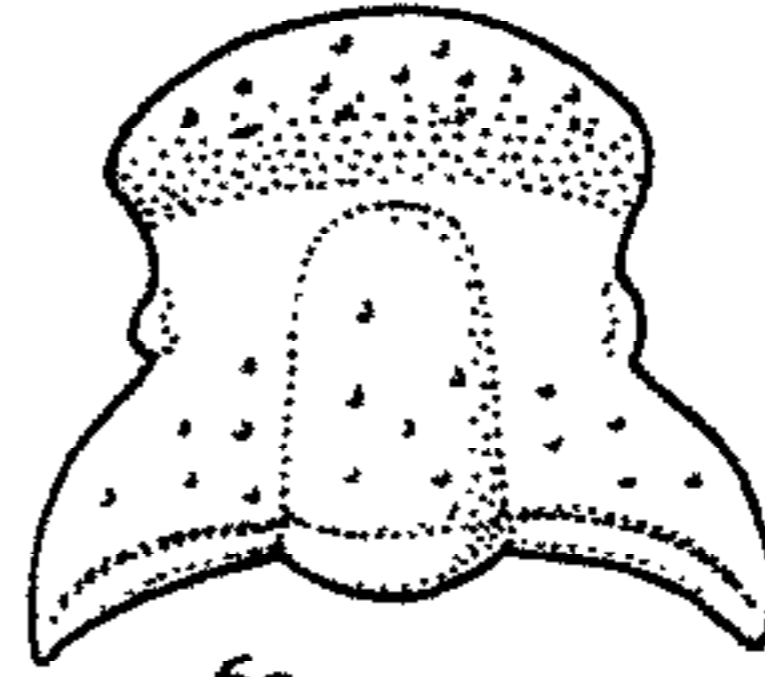

6a

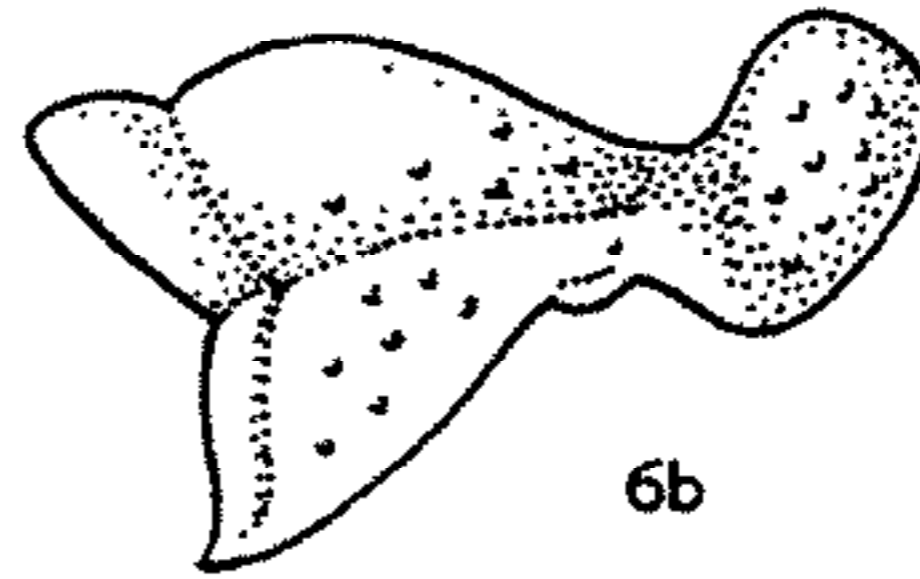

6b

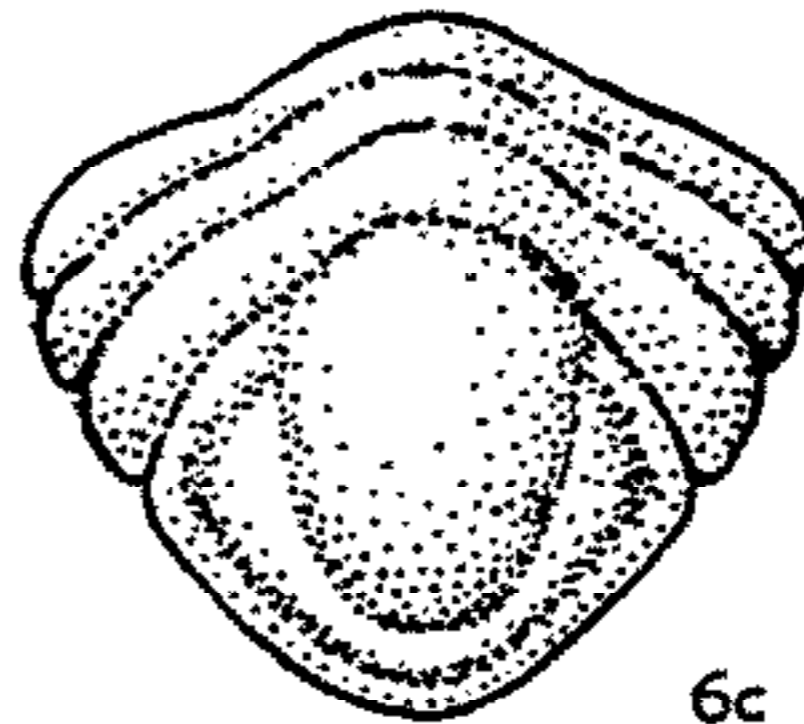

6c

Bridgeia

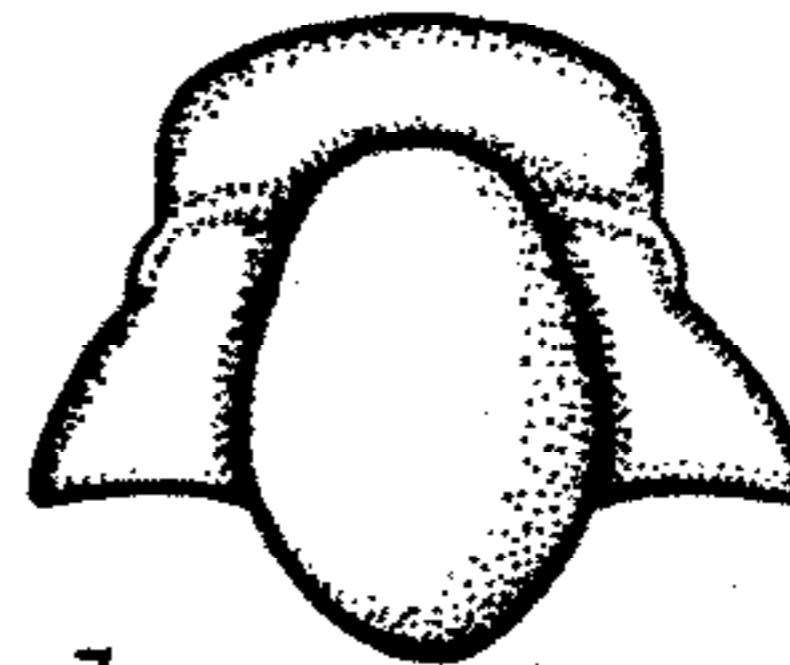

7a



7b

Cryptoderaspis

FIG. 410. Incertae sedis. Upper Cambrian genera (p. 0517-0519).

- [*Kaniniella* SIVOV, 1955 [**K. alata*]. *Low.U.Cam.*, Sib. (HE). Invalid homonym; see *Kaniniella* KOBAYASHI, 1938 (p. 0290)].
- Kazellina* SIVOV, 1955 [**K. amsassiensis*]. *U.Cam.*, USSR (HE).
- Knechtelia* LOCHMAN, 1950 [**K. ann*]. Glabella truncate-tapering, with 3 pairs of faint lateral furrows, preglabellar area narrow, flat; anterior border wide, rimlike, convex; eye ridges faint, eyes small, posterior to front of glabella; fixigenae convex, horizontal, with palpebral areas about 0.75 of glabellar width, posterior areas subrectangular, long (*tr.*). Librigenae, thorax and pygidium unknown (129). *Up.M.Cam.-U.Cam.* (*Dresbach.*), W.N.Am. (LB).
- Koldinia* WALCOTT & RESSER, 1924 [**K. typa*] [= *Kolodinia* KOBAYASHI, 1943]. Glabella low, broadly tapering, without lateral furrows; all other furrows narrow, very faint on exterior, faint on interior; anterior border rimlike, eye ridges narrow, diagonal; eyes below medium size, posterior to center of glabella; fixigenae downsloping, with palpebral areas about 0.3 of glabellar width, posterior areas short (*tr.*), triangular. Pygidium subtriangular; axis low, tapered 0.75 of its length to pointed end, with narrow postaxial ridge extending to margin, axis wider than pleural fields, with 5 axial rings and terminal; interpleural grooves and pleural furrows very faint, border of medium width (102). *U.Cam.* (*Francon.*), Arct. Eurasia.—FIG. 411,2. *K. microphthalmia* KOBAYASHI, Sib.; *3a,b*, cran.; *c*, pyg., $\times 2$ (207) (LB).
- Koldiniella* SIVOV, 1955 [**K. mitella*]. *U.Cam.*, Salair, USSR (HE).
- Kujandina* IVSHIN, 1956 [**K. taskudukensis*]. *U.Cam.*, E.Sib. (LB).
- Mareda* KOBAYASHI, 1942 [**M. mukazegata*]. Glabella low, subquadrate, sides converging slightly, front straight, with 2 pairs of lateral furrows, posterior pair complete, 2nd pair diagonal, well defined; no preglabellar field; anterior border furrow obsolete; anterior border narrow; eyes just above medium size slightly behind mid-length of glabella; eye ridges absent, palpebral rims prominent, palpebral furrows arcuate; fixigenae horizontal, narrow, with arcuate palpebral areas, about 0.3 of glabellar width, posterior areas narrow, apparently short; librigenae unknown. Pygidium elongate, multisegmented; axis narrow, convex, tapering about 0.75 of its length, may have narrow postaxial ridge, 12 axial rings and very small terminal; pleural regions twice width of axis, no border; 10 to 12 pleurae, curved abruptly backward and remaining distinct at margin, interpleural grooves shallow, parallel pleural furrows deeper. Outer surface finely granulose. *U.Cam.*, NE.Asia-C.N.Am.—FIG. 411,3. *M. mukazegata*, Fengshanian, China (Chansi Basin); pyg., $\times 1.5$ (419) (LB).
- Matania* RASETTI, 1946 [**M. ovata*]. Glabella large, prominent, ovate, unfurrowed, reaching anterior border; occipital ring short, simple; fixigenae narrow; palpebral lobes small, at level of glabellar mid-point; anterior facial sutures directed straight forward, posterior sections almost straight, directed outward and backward; posterior areas furrowed. Size small. *U.Cam.* (*Dresbach.*), N.Am.—FIG. 410,2. *M. ovata*, Que.; *2a,b*, cran., dors., lat. views, $\times 5$ (448n) (RA).
- Mataninella* SIVOV, 1955 [**M. escharoida*]. *U.Cam.*, USSR (HE).
- Meisterella* IVSHIN, 1953 [**M. meisteri*]. *U.Cam.*, Kazakhstan (LB).
- Neoacrocephalites* SIVOV, 1955 [**N. togensis*]. *U.Cam.*, USSR (HE).
- Ninaspis* IVSHIN, 1956 [**N. ischernyshevae*]. *U.Cam.*, E.Sib. (LB).
- Oligometopus* RESSER, 1936 [**Ptychoparia* (*Solenopleura?*) *breviceps* WALCOTT, 1884]. *U.Cam.* (*Francon.*), Nev. (LB).
- Onchonotopis* RASETTI, 1946 [**O. pergibba*]. Similar to *Matania*, with glabella greatly elevated posteriorly, overhanging occipital ring; preglabellar field present. Size small. *U.Cam.* (*Dresbach.*), N.Am.—FIG. 410,1. *O. pergibba*, Que.; *1a,b*, cran., dors., and lat. views, $\times 4$ (448n) (RA).
- Parakoldinioidia* ENDO, in ENDO & RESSER, 1937 [**P. typicalis*]. Glabella convex, faintly keeled, rectangular, sides diverging very slightly at rounded front, with 3 pairs of short lateral furrows; eye ridges narrow diagonal; palpebral furrows and palpebral rims narrow, no preglabellar field or anterior border furrow; narrow, convex triangular border; eyes below medium size, somewhat behind center of glabella; fixigenae upsloping, with palpebral areas 0.75 of glabellar width, posterior areas short, triangular; librigenae narrow, rectangular, with short genal spine. ?Pygidium semicircular; axis convex, narrower than pleural fields, tapered 0.66 of its length to narrow rounded end, with 4 axial rings and terminal; pleurae 4, crossed by broad pleural furrows, interpleural grooves obsolete; with shallow border furrow and narrow flat border. Outer surface granulose (37). *U.Cam.* (*Fengshanian*), N.E.Asia.—FIG. 411,1. *P. typicalis*, Manch.; *1a*, ceph., $\times 4$; *1b*, pyg., $\times 1$ (37) (LB).
- Phoreotropis* RAYMOND, 1924 [**P. puteatus*]. Small trilobite. Cranidium of low convexity; glabella parallel-sided, narrow and long, defined laterally, anteriorly merging with convex, undifferentiated anterior area of fixigenae; occipital furrow distinct; palpebral lobes small, lacking palpebral furrows, somewhat anterior to glabellar mid-point; anterior sections of facial sutures directed forward and slightly inward, posterior sections fairly straight to posterior margin. *U.Cam.* (*Trempeal.*), N.Am.—FIG. 411,5. *P. puteatus*, E.USA (Vt.), cran., $\times 10$ (448n) (RA).
- Phylacterus* RAYMOND, 1924 [**P. saylesi*]. *U.Cam.* (*Trempeal.*), E.USA (Vt.) (LB).

Pseudosalteria RAYMOND, 1924 [**P. laevis*]. Small trilobite. Cranidium of low convexity, semicircular; glabella subovate, with faint furrows represented by pairs of pits; palpebral lobes, if present, small and anteriorly located; border lacking. *U.Cam. (Trempeal.)*, N.Am.—FIG. 411,8. **P. laevis*, E. USA (Vt.); cran., partly restored, X6 (448n) (RA).

Pseudosaukia RASETTI, 1944 [**Dikelocephalus sesostris* BILLINGS, 1865]. *U.Cam. (Trempeal.)*, Que. (Levis) (LB).

Resseria HOWELL, 1945 [**Pseudosalteria welleri* RAYMOND, 1924]. *U.Cam.*, N.Am. (N.J.) (HE).

Tingocephalus SUN, 1935 [**T. granulatus*]. Glabella moderately convex, subrectangular, front slightly rounded, with 3 pairs of short, deep di-

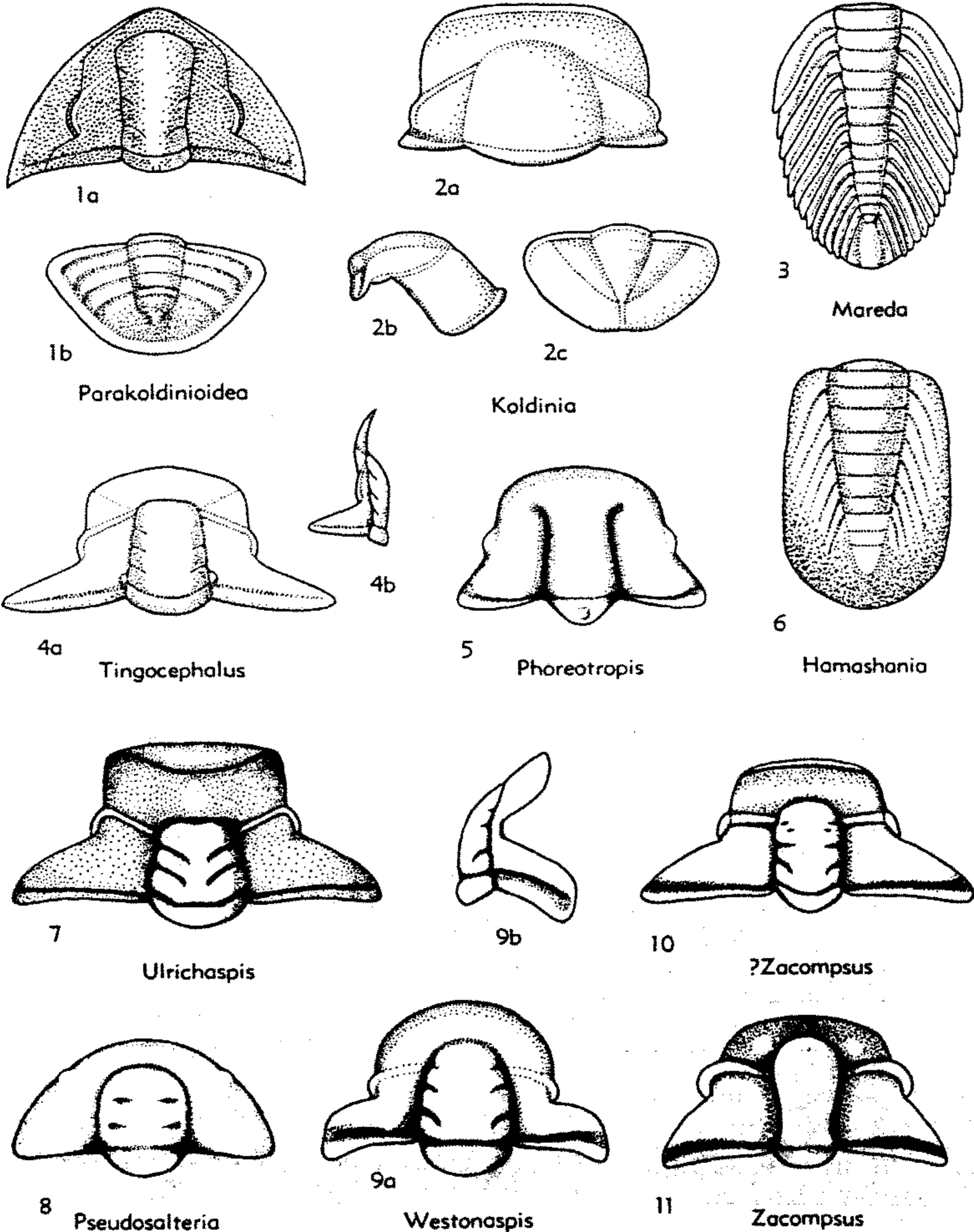

FIG. 411. Incertae sedis. Upper Cambrian genera (p. 0517-0521).

agonal lateral furrows; preglabellar field a broad triangle in front of fixigenae only, anterior border furrow curving into corners of glabella, broad concave anterior border; wide diagonal eye ridges; eyes below medium size, opposite center of glabella; fixigenae horizontal, with palpebral areas about same in width as glabella, posterior areas narrow (*exsag.*), very long (*tr.*). Librigenae, thorax and pygidium unknown. Outer surface granulose (289). *Low.U.Cam.(Changshanian)*, NE.Asia.—FIG. 411,4. **T. granulatus*, China (Shantung); 4a,b, cran., $\times 3$ (289) (LB).

Triarthrella HALL, 1863 [**T. auroralis*]. *U.Cam.(Trempeal.)*, Wis. (LB).

Ulrichaspis RASETTI, 1945 [**U. paradoxa*]. Glabella subtrapezoidal, well defined, with two pairs of deep furrows; anterior area divided into longitudinally convex preglabellar field and transversely arched border; eye ridges strong, directed forward; palpebral lobes small, at level of anterior end of glabella; anterior sections of facial sutures directed forward, posterior sections almost straight backward and outward; posterior area large, subtriangular, with deep border furrow. *U.Cam.(Trempeal.)*, N.Am.—FIG. 411,7. **U. paradoxa*, Que.; cran., partly restored, $\times 1.2$ (448n) (RA).

Volonellus IVSHIN, 1953 [**V. granulatus*]. *U.Cam., Kazakhstan* (LB).

Westonaspis RASETTI, 1945 [**W. laevifrons*]. Small trilobite. Glabella tapered, rounded in front; axial furrow deep laterally, shallow anteriorly; three pairs of lateral furrows; occipital furrow deep, occipital ring rounded; fixigenae downsloping; frontal area undifferentiated, convex, downsloping; palpebral lobes small; anterior sections of facial sutures describing a circular arc; posterior sections directed almost straight outward; posterior area wide (*tr.*), deeply furrowed. *U.Cam.(Trempeal.)*, N.Am.—FIG. 411,9. **W. laevifrons*, Que.; 9a,b, cran., dors. and lat. views, $\times 6$ (448n) (RA).

Zacompsus RAYMOND, 1924 [**Z. clarki*]. Small trilobite. Cranidium of low convexity; glabella elevated, pyriform, narrow and long, unfurrowed in type species; occipital ring short (*sag.*), rounded; fixigenae almost horizontal; anterior border apparently lacking in type species; eye ridges prominent, directed forward; palpebral lobes anterior in position; anterior sections of facial sutures directed forward and inward; posterior sections almost straight outward and backward, delimiting large, subtriangular, deeply furrowed posterior area. *U.Cam.(Trempeal.)*, N.Am.—FIG. 411,11. **Z. clarki*, E.USA(Vt.); cran., $\times 8$.—FIG. 411, 10. *Z.? levisensis* RASETTI, Que., cran., $\times 8$ (448n) (RA).

ORDOVICIAN GENERA

Bodenbenderia HARRINGTON & LEANZA, 1957 [**B. longifrons*]. Cranidium small, slightly wider than long. Glabella long, convex, raised above level of

fixigenae, parallel-sided, rounded anteriorly, with 2 pairs of lateral furrows oblique backward-inward, anterior (2*p*) furrows very faint, pre-occipital stronger. Preglabellar field narrow, depressed; anterior border narrow, convex, raised; anterior margin rounded-subacuminate mesially. Eyes large, close to glabella, posterior. Anterior sections of facial sutures subparallel in front of eyes, intramarginal to mid-line. *L.Ord., Arg.*—FIG. 412,9. **B. longifrons*; cran. (holotype), $\times 8.8$ (59*) (HA).

Brackebuschia HARRINGTON & LEANZA, 1957 [**B. acheila*]. Cranidium small, slightly longer than wide. Glabella long, moderately convex, raised above level of fixigenae, defined by deep axial furrows, subparallel-sided, rounded-subtruncate anteriorly, with 4 pairs of faint lateral furrows oblique backward-inward. Occipital ring of moderate width. Frontal area narrow, depressed, without differentiated anterior border; anterior margin curved forward. Eyes large, moderately near glabella, slightly posterior; palpebral lobes elongated. Anterior sections of facial sutures slightly divergent in front of eyes. Associated pygidium small, semi-elliptical in outline; axis tapering backward, strongly raised above level of pleural regions, with 4 strongly marked rings and small triangular terminal segment; pleural regions with very faint indications of 2 to 3 ribs; border absent. *L.Ord., Arg.*—FIG. 412,2. **B. acheila*; a, cran. (holotype), $\times 7.8$; b, pyg. (paratype), $\times 9.0$ (59*) (HA).

Carmon BARRANDE, 1872 [**Trilobites mutilus* BARRANDE, 1852]. *U.Ord., Boh.* (HE).

Ceratopeltis POULSEN, 1937 [**C. latilimbatus*]. *L.Ord., E.Greenl.* (HE).

Clelandia COSSMANN, 1902 [**Harrisia parabola* CLELAND, 1900] [= *Harrisia* CLELAND, 1900, non ROBINEAU-DESVOIDY, 1830]. *L.Ord., N.Y.* (HE).

Crossoura MOBERG & SEGERBERG, 1906 [**C. parvula*; SD VOGDES, 1925]. *L.Ord.(Tremadoc.)*, Swed. (HE).

Curiaspis SDZUV, 1955 [**C. notabilis*]. Cephalon proparian; glabella with slightly expanded frontal lobe in front of 2 transglabellar furrows (1*p*, 2*p*) and occipital furrow; eyes medium-sized, eye ridges distinct; fixigenae and occipital ring with well-developed spines. No preglabellar field. *L.Ord.(L.Tremadoc.)*, Ger.—FIG. 413,5. **C. notabilis*; 5a,b, cran., $\times 10$ (272) (HE).

Cuyanaspis RUSCONI, 1953 [**Megalaspis emposadensis* RUSCONI, 1953]. *L.Ord., Arg.(Mendoza)* (LB).

Deltacare HARRINGTON & LEANZA, 1957 [**D. prorops*]. Cranidium triangular in outline, wider than long. Glabella long, tapering forward, rounded anteriorly, with 3 pairs of faint lateral furrows. Occipital ring moderately wide. Preglabellar field narrow, depressed; anterior border wider than field, convex, raised, subtriangular;

anterior margin acuminate. Fixigenae with wide triangular posterior areas; genal angles rounded. Eyes small, far forward, moderately far from glabella. Facial sutures proparian; anterior sections convergent in front of eyes, intramarginal to midline. *L.Ord.*, Arg.—FIG. 412,1. **D. prosops*; cran. (holotype), $\times 13$ (59*) (HA).

Ellsaspis RASETTI, 1945 [**E. elliptica*]. Cranidium wide, subelliptical, of uniform convexity; glabella ovate; axial and lateral furrows barely indicated on interior surface; palpebral lobes poorly differentiated from fixigenae; facial sutures showing little change in direction at palpebral lobes; anterior border narrow (*sag.*), flat; border furrow on posterior area well impressed. *L.Ord.*, N.Am.—FIG. 412,5. **E. elliptica*, Que.; cran., partly exfoliated to show furrows on interior surface, $\times 6$ (448n) (RA).

Endoaspis LOCHMAN, 1956 [*pro Wutingia* ENDO, 1935 (*non* MELICHAR, 1926)] [**Wutingia rectangularis* ENDO, 1935]. *L.Ord.*, Manch. (LB).

Etheridgaspis KOBAYASHI, 1940 [**Ptychoparia? carolinensis* ETHERIDGE, ?1919]. *L.Ord.*, Tasm. (HE).

Eulomella KOBAYASHI, 1955 [**E. mckayensis*]. Resembles *Parabolinella*. *L.Ord.*, Can.(B.C.) (HE)

Eulomina RŮŽIČKA, 1931 [**Euloma mitratum* RŮŽIČKA]. Glabella broad, rising above fixigenae, strongly tapered, weakly furrowed; preglabellar field short (*sag.*); border wide (*sag.*), elevated; eyes small; anterior facial sutures divergent. *L.Ord.*, Eu.—FIG. 412,6. **E. mitratum* (RŮŽIČKA), Boh.; 6a,b, cran., dors. and lat. views, $\times 2.5$ (262) (RA).

Gignopeltis RAYMOND, 1924 [**Dolichmetopus? rarus* BILLINGS, 1865]. *L.Ord.*, Can. (HE).

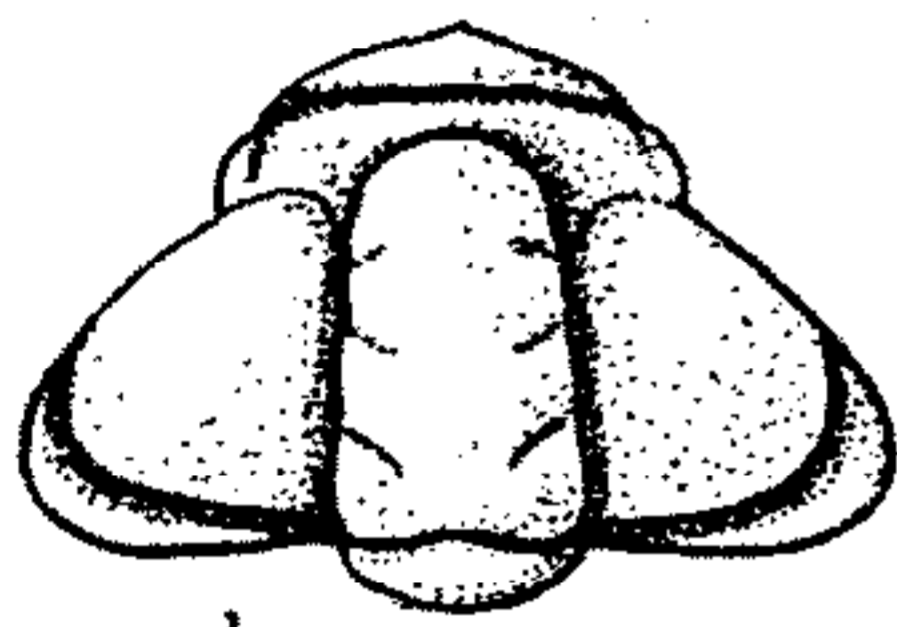

1 Deltacare

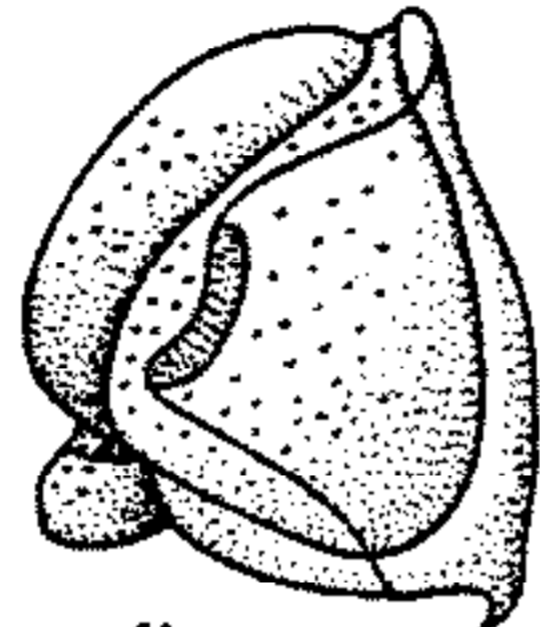

4b

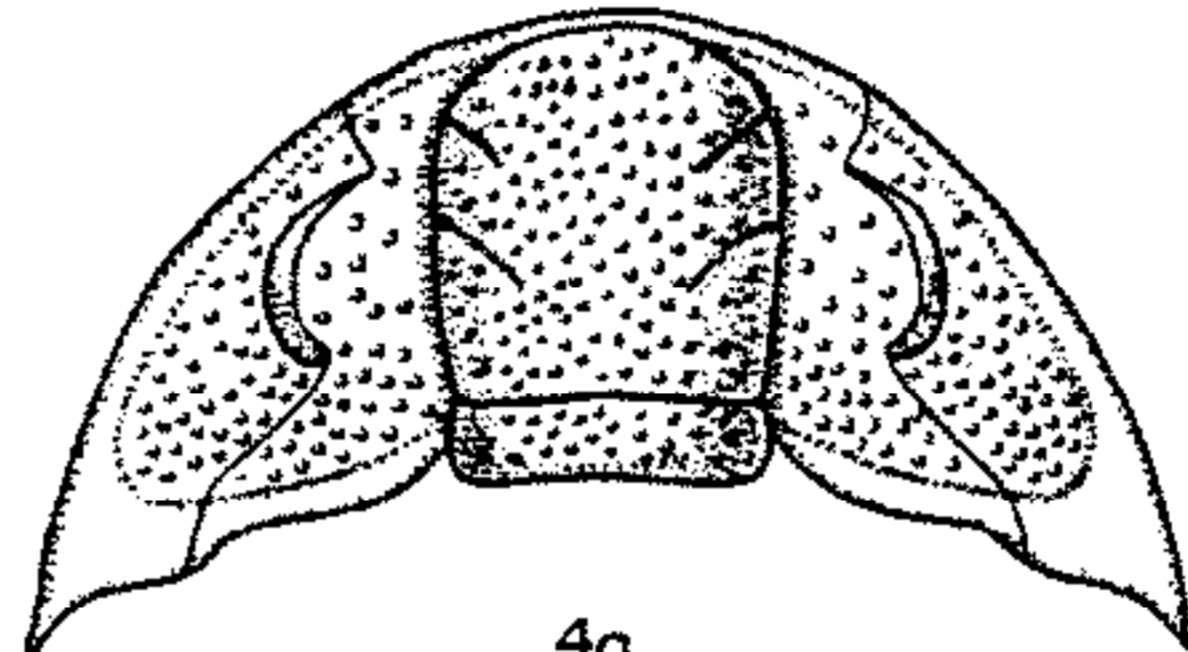

4a

Psephosthenaspis

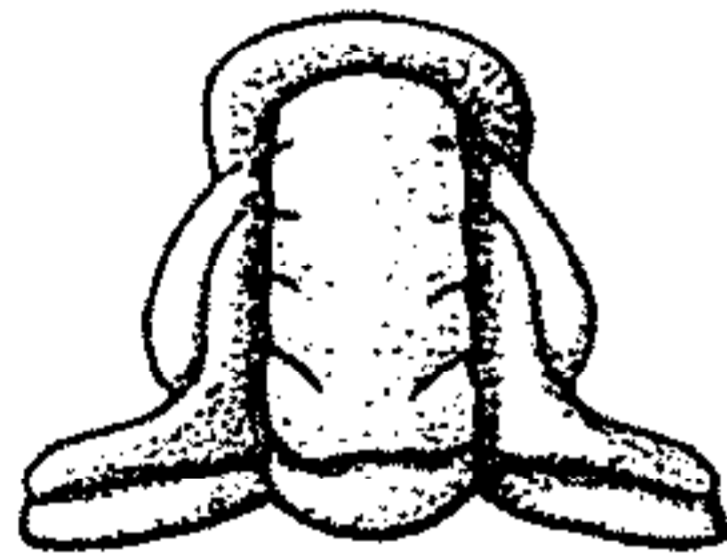

2a

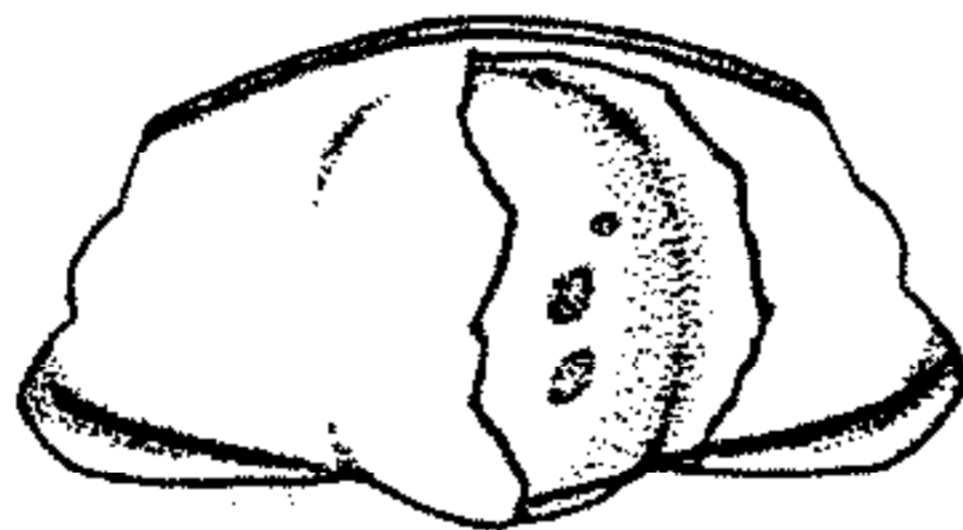

5

Ellsaspis



2b

Brackebuschia

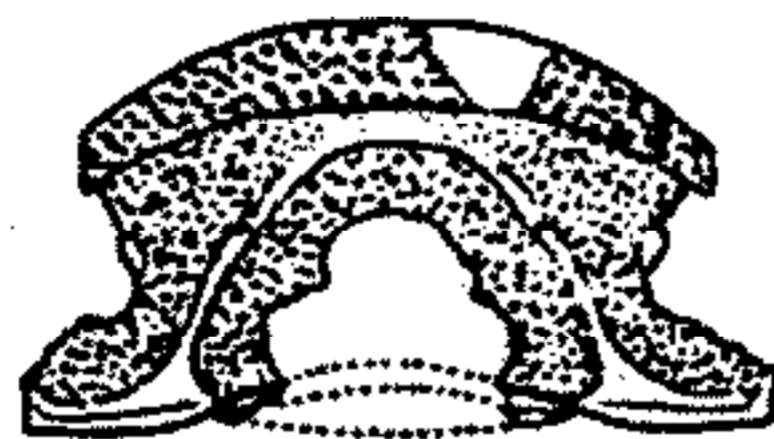

6a

Eulomina



6b

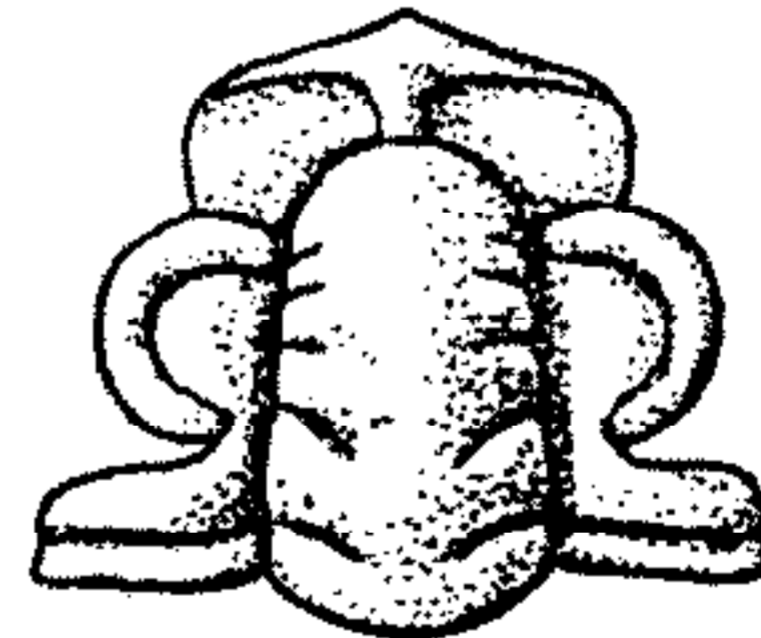

8

Nannopeltis

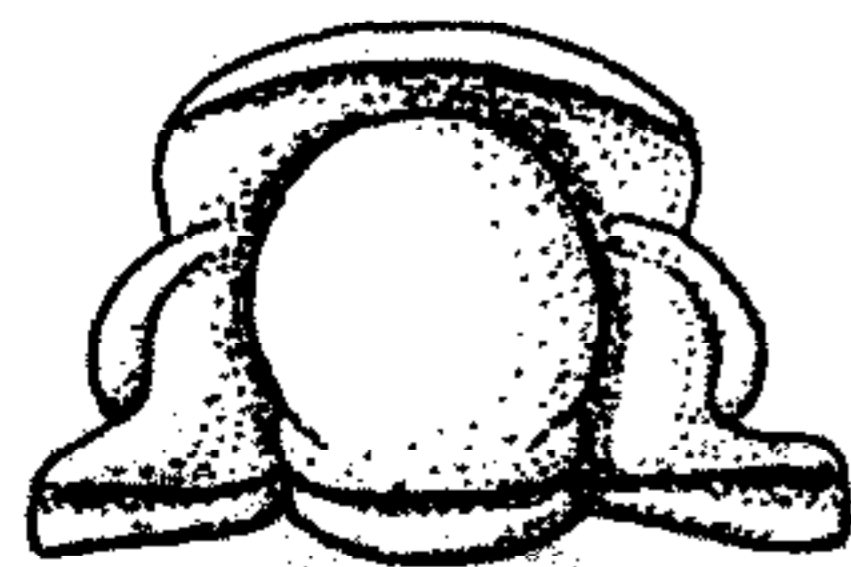

3

Sphaerocare

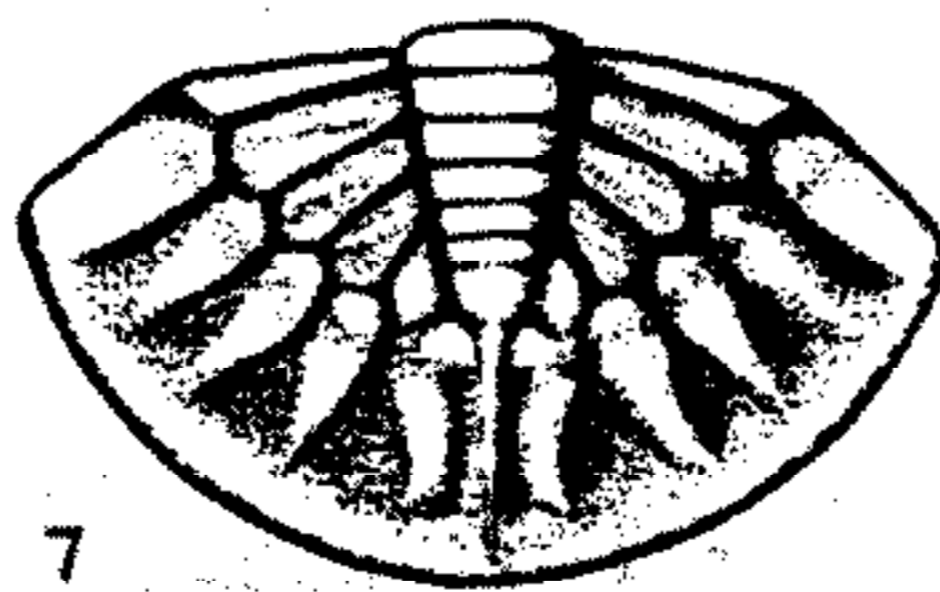

7

Grinnellaspis

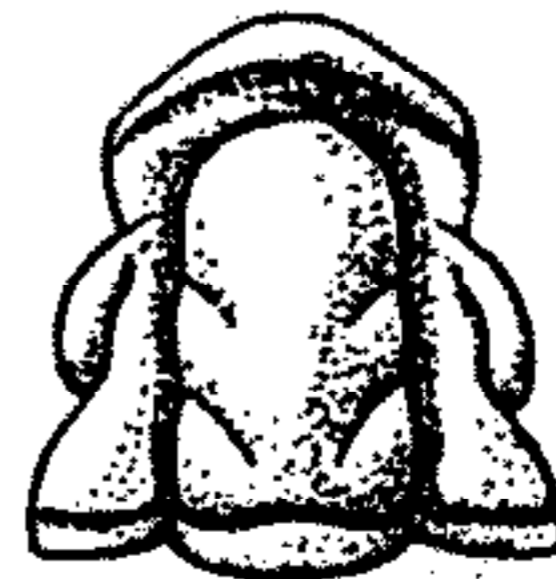

9

Bodenbenderia

FIG. 412. Incertae sedis. Ordovician genera (p. 0521-0524).

Grinnellaspis POULSEN, 1948 [*pro Actinopeltis* POULSEN, 1946, non HAWLE & CORDA, 1847] [**Actinopeltis feildeni* POULSEN]. Pygidium of low convexity, semicircular; axis short, tapering backward, annulated; pleural fields small, deeply furrowed; border wide, slightly concave, with low ribs opposite the pleural furrows. *L.Ord.*, Arctic.—FIG. 412.7. **G. feildeni* (POULSEN), Ellesmere Land: pyg., $\times 2.5$ (175) (RA).

Hyperbolochilus ROSS, 1951 [**H. marginauctum*]. *L.Ord.*, N.Am. (HE).

Idiorhapha WHITTINGTON, 1953 [**Cheirurus solitarius* BILLINGS, 1865]. *L.Ord.* or *Low.M.Ord.*, Can. (HE).

Ischyrotoma RAYMOND, 1925 [**I. twenhofeli*]. *M.Ord.*, N.Am.—FIG. 413.4. **I. twenhofeli*, *M.Ord.*, Que.; ceph., $\times 1.5$ (78) (HE).

Koraipsis KOBAYASHI, 1934 [**K. spinus*] [= *Koraipsis* RICHTER, 1942, *nom. van.*]. *L.Ord.* (*Tremadoc.*), S.Korea.—FIG. 413.2. **K. spinus*; cran., $\times 3$ (96) (HE).

Leptopilus RAYMOND, 1924 [**L. declivis*]. Cephalon 5 mm. in length, convex, no concave border. Glabella about half length (*sag.*) of cephalon, parallel-sided, shallow occipital furrow. Genae confluent with long (*sag.*) preglabellar field, genal spine short. Eye lobes situated close to posterior part of glabella, anterior sections of suture diverge forward, then converge to meet at margin; posterior sections curve out to cross posterior margin at about half width. Placed by RAYMOND (210) in Styginidae, by HUPÉ (78, 79) in Bathyruridae. *L.Ord.* (*Tremadoc.*), E.USA (Vt.) (WH).

Macroculites KOBAYASHI, 1955 [**M. enigmaticus*]. *L.Ord.*, W.Can. (B.C.) (HE).

Nannopeltis HARRINGTON & LEANZA, 1957 [**Hysterolenus modestus* HARRINGTON, 1938]. Cranium very small, wider than long. Glabella large, raised above level of fixigenae, well defined by deep axial furrows, elongated, very slightly tapering forward, rounded anteriorly, with 4 pairs of lateral furrows, 4*p* and 3*p* furrows oblique forward-inward, 2*p* furrows normal to axis, pre-occipital furrows longer, oblique backward-inwards. Occipital furrow disconnected at middle; occipital ring narrow, bent backward mesially. Preglabellar field slightly wider than occipital ring, depressed, with raised mesial ridge; anterior border narrow, raised; anterior margin sharply acuminate. Eyes large, located close to glabella, posterior; palpebral lobes semicircular in outline, with narrow raised rim prolonged anteriorly into short eye ridge normal to axis. Anterior sections of facial sutures divergent in front of eyes, curved forward-inward at border furrow, intramarginal to midline, meeting in acute ogive. *L.Ord.*, Arg.—FIG. 412.8. **N. modesta*; cran., $\times 8.8$ (59*) (HA).

Nesuretus HICKS, 1872 [**N. ramseyensis*; SD VOGDES, 1925]. *L.Ord.* (*Tremadoc.*) (HE).

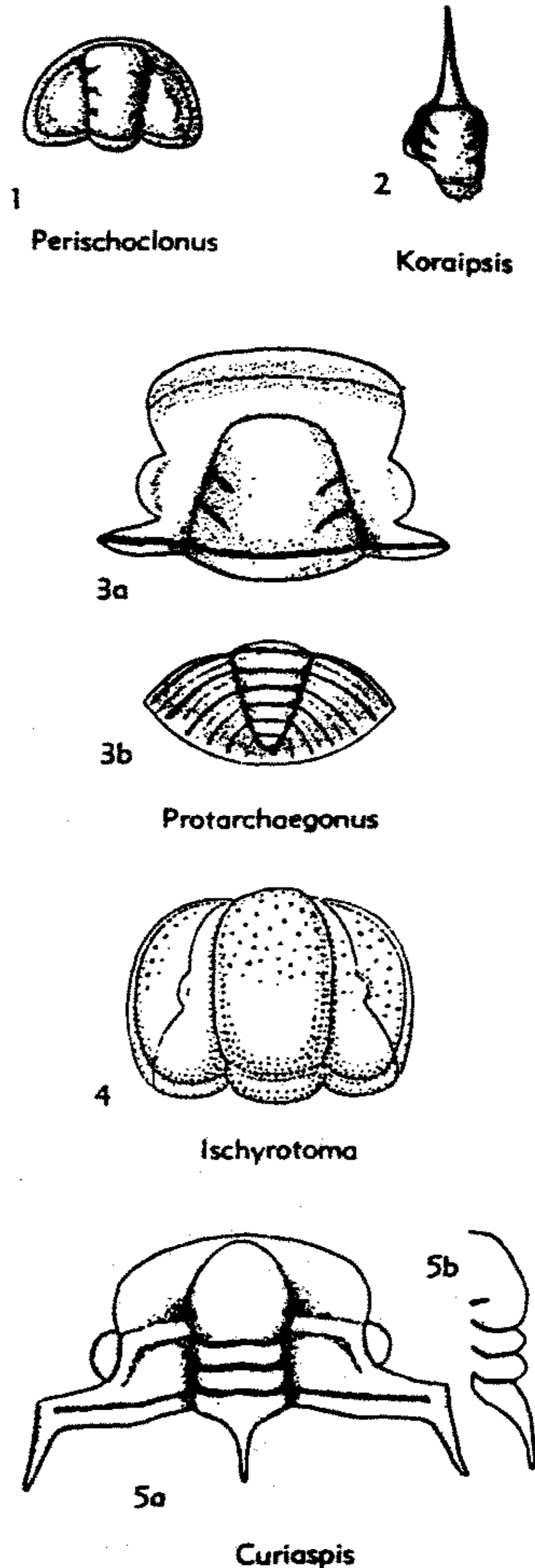

FIG. 413. Incertae sedis. Ordovician genera (p. 0521-0524).

Onchonotus RAYMOND, 1924 [**Menocephalus globosus* BILLINGS, 1860]. *L.Ord.*, Can. (HE).

Perischoclonus RAYMOND, 1925 [**P. capitalis*]. Cephalic axis expanding slightly forward. Three pairs of short lateral glabellar furrows. Small eyes

rather distant from glabella and far back. No genal spines. Course of posterior sections of facial sutures uncertain. Only cephalon known. *M.Ord.*, Newf. —FIG. 413,1. **P. capitalis*; ceph., $\times 2$ (449) (HE).

Platycoryphe FOERSTE, 1919 [**Calymene platycephala* FOERSTE, 1910]. *M.Ord.*(Trenton), N. Am. (HE).

Protarchaeon SDZUY, 1955 [**P. moroffi*]. *L.Ord.*(L.Tremadoc.), Ger.—FIG. 413,3. **P. moroffi*; 3a,b, cran., pyg., $\times 10$ (HE).

Psephosthenaspis WHITTINGTON, 1953 [**Bathyrurus strenuus* BILLINGS, 1865]. Glabella moderately convex, broadly rectangular, rounded in front, with 2 pairs of faint arcuate lateral furrows; preglabellar field very narrow (*sag.*); anterior border narrow, rimlike, dying out laterally; eyes of medium size, slightly behind mid-length of glabella; fixigenae with palpebral areas about 0.25 of glabellar width, upsloping, posterior areas narrow (*exsag.*), of medium length (*tr.*); rostrum short (*sag.*), broad (*tr.*) and convex; librigenae rectangular, with wide vertical ocular platform and short pointed genal spine. Pygidium unknown. Outer surface coarsely granulose (354). ?*Up.L.Ord.*(Chazyan), E.Can.—FIG. 412,4. **P. strenua* (BILLINGS), (*erratic*), Que.; 4a,b, cran., $\times 2$ (354) (LB).

Pseudocelandia ROSS, 1951 [**P. cornupsittaca*]. *L.Ord.*, N.Am. (HE).

Pyraustocranium ROSS, 1951 [**P. orbatum*]. *L.Ord.*, Utah (HE).

Rhamphopyge KOBAYASHI, 1955 [**R. altipolum*]. *L.Ord.*(Tremadoc.), Can.(B.C.) (LB).

Sphaerocare HARRINGTON & LEANZA, 1957 [**S. globifrons*]. Cranidium small, length about 0.7 of width. Glabella slightly longer than wide, very globose, almost hemispherical, rounded anteriorly, with one pair of short lateral furrows. Occipital ring narrow. Preglabellar field narrow, depressed; anterior border slightly wider than field, convex, raised; anterior margin curved forward. Eyes of medium size, located close to glabella, posterior. Anterior sections of facial sutures divergent in front of eyes, intramarginal for short stretch, marginal to mid-line. *L.Ord.*, Arg.—FIG. 412,3. **S. globifrons*; cran. (holotype), $\times 8.8$ (59*) (HA).

Tasmanaspis KOBAYASHI, 1940 [**T. lewisi*]. *L.Ord.*, Tasm. (HE).

Tasmanocephalus KOBAYASHI, 1936 [**Conocephalites? stephensi* R. ETHERIDGE, 1882]. *L.Ord.*, Tasm. (LB).

Thomondia HARPER, 1942 [**T. globosa*]. *U.Ord.* (*Ashgill*), Ire. (HE).

Triarthroides RAYMOND, 1938 [**T. cyclas*]. *L.Ord.* (*Tremadoc.*), E.USA(Vt.) (LB).

DEVONIAN GENERA

Jonotus MEYER, 1848 [*]. *reflexus*. *Dev.*, Ger. (Eifel) (HE).

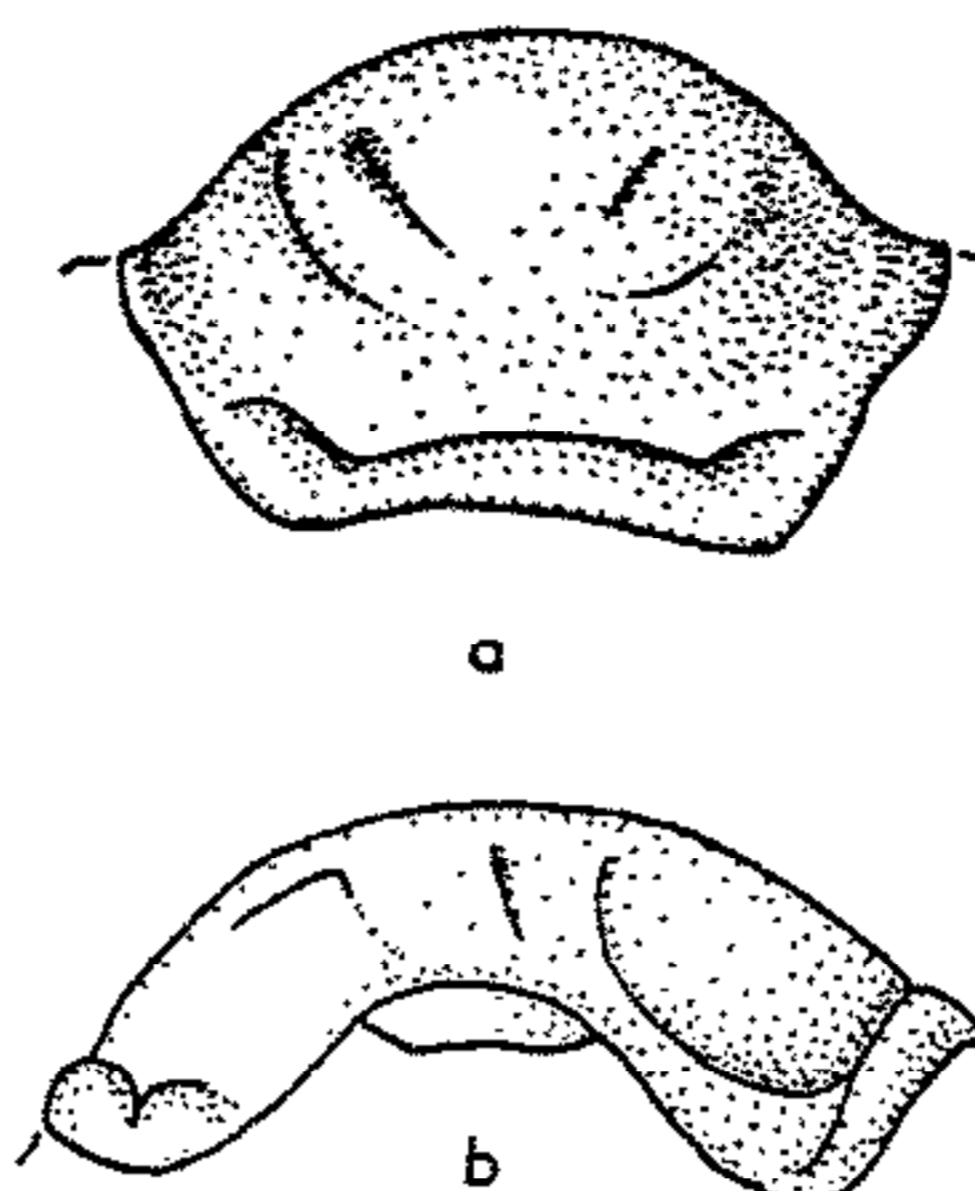

FIG. 414. **Piliolites orioensis* COZZENS (Incertae sedis), M.Dev., Ohio Valley; a,b, ceph., ?front, side, $\times 2.3$ (391a, 1848).

Piliolites COZZENS, 1848 [**Piliolites ohioensis*]. Buckler gibbous, ovate, arched, margined, anterior margin smaller and sloping downward; posterior, thicker and turning up; lateral margins very small. [Author's original description of type species.] *M.Dev.*, Ohio Valley. [Description and figures based on 3 specimens, seemingly from "falls of the Ohio river." VOGDES (1893, 1925) lists genus as synonym of *Proetus*, but it resembles no genus of Proctidae.] —FIG. 414. **P. ohioensis*, M.Dev., Ohio Valley; a,b, "ceph.", ?front, side, $\times 2$, $\times 3$ (391a) (ST).

Unrecognizable genera

- Acheilus* CLARK in RAYMOND, 1924 [**A. levisensis*]. *U.Ord.*, N.Am. (RA).
- Aligerites* HOWELL, 1942 [*pro Aliger* HOWELL, 1937 (*non* THIELE, 1929)] [**Aliger venustus* HOWELL, 1937]. *U.Ord.*, E.USA(Vt.) (LB).
- Alloctops* RAFINESQUE, 1832 [**A. flexuosa*] (HE).
- Annamitella* MANSUY, 1920 [**A. asiatica*] (LB).
- Anthracopeltis* BOULAY, 1880 [**A. crepini*] (HE).
- Arthricocephalus* BERGERON, 1899 [**A. chauveausi*]. Fr. (RA).
- Billingsaspis* RESSER, 1935 [**Conocephalites vulcanus* BILLINGS, 1863]. *L.Ord.*, E.USA(Vt.) (LB).
- Cancapolia* RUSCONI, 1954 [**C. proa*]. *Low.U.Ord.*, Arg.(Mendoza) (HE).
- Canotiana* RUSCONI, 1950 [**C. villavicensis*]. *U.Ord.*, Arg.(Mendoza) (LB).
- Cayastaia* RUSCONI, 1954 [**C. flexuosa*]. *U.Ord.*, Arg.(Mendoza) (LB).
- Changshanocephalus* SUN, 1935 [**C. reedi*] (LB).
- Chosenia* KOBAYASHI, 1934 [**C. laticephala*] (LB).
- Chuangites* HOWELL, 1945 [**C. jerseyensis*]. *U.Ord.* (*Tremadoc.*), E.USA(N.J.) (LB).
- Cobboldites* KOBAYASHI, 1943 [**Microdiscus comleyensis* COBBOLD]. *L.Ord.*, Eng. (RA).
- Conagraulos* HOWELL, 1937 [**C. rarus*]. *Up.M.Ord.*, E.USA(Vt.) (LB).

- Costapyge* HOWELL, 1937 [**C. vermontensis*]. *Up. M. Cam.*, E.USA(Vt.) (LB).
- Cylindrocephalus* TRENKNER, 1868 [non MOT-SCHOULSKY, 1860] [**C. angustus*] (SC).
- Dictyella* KOBAYASHI, 1933 [**D. wuhuensis*] (LB).
- Dipharus* CLARK, 1923 [**D. insperatus*]. *L. Cam.*, N. Am. (RA).
- Diplopsites* RAFINESQUE, 1832 [**D. levis*] (HE).
- Diplozyga* RAYMOND, 1938 [**D. striata*]. *L. Ord.* (*Tremadoc.*). E.USA(Vt.) (LB).
- Exigua* HOWELL, 1937 [**E. quadrata*]. *Up. M. Cam.*, E.USA(Vt.) (LB).
- Fengtienia* ENDO, in ENDO & RESSER, 1937 [**F. peculiaris*] (LB).
- Glabrella* LERMONTOVA, 1940 [**G. ventrosa*] [non SCUDDER, 1882]. *M. Cam.*, USSR (RA).
- Glossicephalus* HOWELL, 1937 [**G. longifrons*]. *Up. M. Cam.*, E.USA(Vt.) (LB).
- Hagiorites* KOBAYASHI, 1951 [**H. omeishanensis*] (LB).
- Hamptonella* RESSER, 1937 [**Ptychoparia? fitchi* WALCOTT, 1887]. *L. Cam.*, E.USA(N.Y.) (RA).
- Hesa* RICHTER & RICHTER, 1941 [**H. problematica*]. *L. Cam.*, Dead Sea (HA).
- Hockspiella* RUSCONI, 1950 [**H. spinosa*]. *M. Cam.*, Arg.(Mendoza) (LB).
- Hsiaella* RESSER & ENDO, in ENDO & RESSER, 1937 [**H. striata*]. *M. Cam.*, Manch. (LB).
- Huaquinchaia* RUSCONI, 1955 [**H. spinosa*]. ?*U. Cam.*, Arg.(Mendoza) (LB).
- Huilichia* RUSCONI, 1955 [**R. trispinata*]. *M. Cam.*, Arg.(Mendoza) (LB).
- Isidreana* RUSCONI, 1955 [**I. tellecheai*]. *L. Ord.*, Arg.(Mendoza) (LB).
- Isidrella* RUSCONI, 1955 [**I. bispinata*]. *M. Cam.*, Arg.(Mendoza) (LB).
- Isoctomesa* RAFINESQUE, 1822 [**Trilobites emarginata*] (HE).
- Leiostegioides* KOBAYASHI, 1934 [**L. raymondi*] (LB).
- Levinia* RUSCONI, 1950 [**L. brachypyge*]. *U. Cam.*, Arg.(Mendoza) (LB).
- Liaotungia* RESSER & ENDO, in ENDO & RESSER, 1937 [**L. puteata*]. *M. Cam.*, Manch. (LB).
- Litocodia* RESSER, 1938 [**L. typicalis*]. *L. Cam.*, USA(Ala.) (RA).
- Mendodiscus* RUSCONI, 1950 [**M. tuberculatus*]. *M. Cam.*, Arg.(Mendoza) (RA).
- Mendogaspis* RUSCONI, 1951 [**M. trispinatus*]. ?*M. Cam.*, Arg.(Mendoza) (LB).
- Mendoparabolina* RUSCONI, 1951 [**M. pirquinensis*]. *U. Cam.*, Arg.(Mendoza) (LB).
- Micragraulos* HOWELL, 1937 [**M. franklini*]. *Up. M. Cam.*, E.USA(Vt.) (LB).
- Mimana* KOBAYASHI, 1935 [= *Mimana* KOBAYASHI, 1934; *nom. nud.*] [**M. eurycephala*] (LB).
- Notocoryphe* RUSCONI, 1950 [**N. andinus*]. *U. Cam.*, Arg.(Mendoza) (LB).
- Orkekeia* RUSCONI, 1955 [**O. ornata*]. ?*M. Cam.*, Arg.(Mendoza) (LB).
- Orimops* RAFINESQUE, 1832 [**Calymene calicephala* GREEN, 1832] (HE).
- Oryctocephalina* LERMONTOVA, 1940 [**O. reticulata*]. *M. Cam.*, USSR (RA).
- Perimetopus* RESSER, 1937 [**Conocephalites arenosus* BILLINGS, 1861]. *L. Cam.*, E.USA(Vt.) (RA).
- Pseudolevinia* RUSCONI, 1951 [**P. macropyge*]. *M. Cam.*, Arg.(Mendoza) (LB).
- Ptychopleurites* KOBAYASHI, 1936 [pro *Ptychopleura* KOBAYASHI, 1936 (non FRITZINGER, 1843)] [**Ptychopleura brevifrons* KOBAYASHI, 1936] (LB).
- Querandinia* RUSCONI, 1954 [**Q. conicephala*]. *Low. U. Cam.*, Arg.(Mendoza) (LB).
- Retusites* RAFINESQUE, 1832 [**R. levis*] (HE).
- Taianocephalus* SUN, 1924 [**T. grabau*] (LB).
- Telesiops* RAFINESQUE, 1832 [**T. leiocephalus*] (HE).
- Tomoligus* RAFINESQUE, 1832 [**Trilobites mimulus*] (HE).
- Vinakainella* RUSCONI, 1953 [**V. asperoensis*]. *L. Cam. or Low. M. Cam.*, Arg.(Mendoza) (RA).
- Wedekindia* SUN, 1935 [non SCHINDEWOLF, 1935, non DUNBAR & HENBEST, 1931] [**W. cylindrica*] (LB).
- Yanquetruzia* RUSCONI, 1955 [**Y. chupina*]. *M. Cam.*, Arg.(Mendoza) (LB).
- Yoyarria* RUSCONI, 1955 [**Y. puelchana*]. *L. Ord.*, Arg.(Mendoza) (LB).

Nomina nuda

Carlopsia LAMONT, 1949. [Introduced as *Cyphoproetus* (*Carlopsia*) *glaudii*. The subgenus *Carlopsia* as well as the species *glaudii* are nomina nuda.] (RR).

"Mesembria" CLARKE, 1913. Does not exist in nomenclature. Mesembria was introduced by CLARKE, 1913 (pp. 141, 151) as a term for a group of genera. Contrary to the originally "synthetic term" *Synphoria* (see there) it has never attained nomenclatorial status, despite the generally accepted opinion. Though thus being available for nomenclature the name should be strictly avoided in order to prevent taxonomic and nomenclatorial confusion (RR).

Particeps REED, 1943 (WE).

SUPPOSED TRILOBITA HERE REJECTED FROM CLASS

Dalmaniopsis GEINITZ, 1862 [**Dalmanites? Kablikae*]. *Perm.* (*Rotliegenden*), Boh. [An arthropod, but no trilobite, according to RICHTER & RICHTER, 1955 (*Senckenbergiana lethae*, vol. 36, no. 3/4, p. 294).] (HE).

Family BOHEMILLIDAE Barrande, 1872

Cephalon composed of median segmented region and lateral cheeks with prominent spines and large

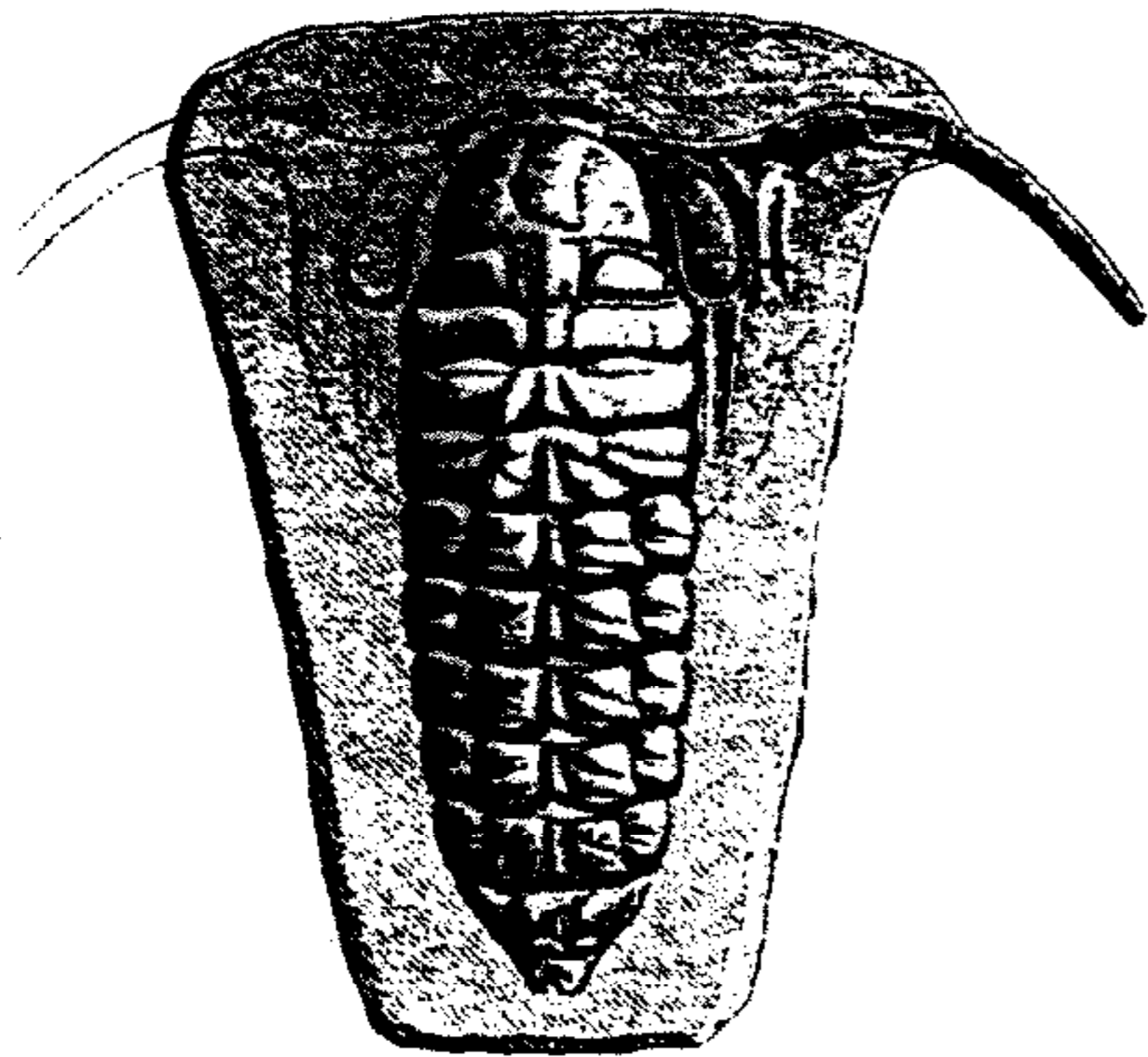

FIG. 415. **Bohemilla stupenda* BARRANDE (Bohemilidae), Ord. (D gamma 2), St. Benigna, Boh.; exoskel. (restored), $\times 3$ (4).

eyes with facets. Facial sutures (if present) undetected. Median segmented region composed of sub-semicircular frontal lobe and 4 segments, separated by furrows and progressively more like the free posterior segments; thus the posterior 3 have a median keel and the hindermost head-segment is divided longitudinally into 3 portions. Six free segments occur posterior to cephalon; if the last is interpreted as pygidium, thorax comprises 5 segments, longitudinally divided into 3 parts; the middle about 0.5 of total width and carrying median keel, separated from lateral parts by oblique and posteriorly directed furrows. The sixth segments is incompletely preserved (in only specimen showing posterior part of exoskeleton), and possesses similar structure; it may represent last thoracic segment, in which case a minute bifid structure at posterior tip may represent fragment of pygidium. [Interpreted by WHITTARD, 1952, as an arthropod other than trilobite.] Ord.

Bohemilla BARRANDE, 1872 [**B. stupenda*]. Characters of family. Ord., Eu.—FIG. 415. **B. stupenda*, D gamma 2, Boh. (St. Benigna); exoskel., $\times 2$ (4) (HE).

REFERENCES

Angelin, N. P.

- (1) 1851-78, *Palaeontologica Scandinavica: Academiae Regiae Scientiarum Suecanae (Holmiae); Pars I. Crustacea formationis transitionis*, p. 1-24, pl. 1-24 [1851]; *Pars II.* [no separate title], p. i-ix, 21-92, pl. 25-41 [1854]; republished in combined and revised form (ed., G. LINDSTRÖM), p. x+96, pl. 1-42 [1878].

Bancroft, B. B.

- (2) 1949, *Upper Ordovician trilobites of zonal value in south-east Shropshire*: Roy. Soc. London, Proc., ser. B., v. 136, p. 291-315, pl. 9-11.

Barrande, Joachim

- (3) 1852, *Système Silurien du Centre de la Bohême: I^{re} Partie, Crustacés, Trilobites*: v. 1, 935 p., 51 pl. (Praha, Paris).
 (4) 1872, *Système Silurien du Centre de la Bohême: I^{re} Partie, Supplément au Vol. I. Trilobites, Crustacés divers et Poissons*: 647 p., 37 pl. (Praha, Paris).

Barrois, Charles

- (5) 1886, *Mémoire sur la faune de Hont-de-Ver (Haute-Barrone)*: Soc. géol. du Nord (Lille), Ann., v. 13.

Barton, D. C.

- (6) 1915, *A revision of the Cheirurinae, with notes on their evolution*: Washington Univ. Studies (St. Louis), v. 3, pt. 1, no. 1, p. 101-152.

Bassler, R. S.

- (7) 1919, *Cambrian and Ordovician*: Maryland Geol. Survey (Baltimore), p. 1-424, pl. 1-58 (Trilobita, p. 332-362, pl. 24-58).

Bell, W. C., Feniak, O. W., & Kurtz, V. E.

- (8) 1952, *Trilobites of the Franconian Formation, southeast Minnesota*: Jour. Paleont. (Tulsa), v. 26, p. 175-198, pl. 29-38, fig. 1.

Beyrich, Ernst

- (9) 1845, *Ueber einige böhmische Trilobiten*: Reimer (Berlin).

Billings, Elkanah

- (10) 1859, *Descriptions of some new species of trilobites from the Lower and Middle Silurian rocks of Canada*: Canadian Naturalist (Ottawa), v. 4, p. 367-383.
 (11) 1860, *On some new species of fossils from the Limestone near Point Levi opposite Quebec*: Same, v. 5, no. 4, p. 301-324.
 (12) 1861-65, *Palaeozoic fossils: v. 1. Containing descriptions and figures of new or little known species of organic remains from the Silurian rocks*: Geol. Survey Can. (Montreal), 426 p. [p. 1-24, Nov. 1861; p. 25-56, Jan. 1862; p. 57-168, June 1862; p. 169-394, Feb. 1865; p. 395-426, Oct. 1865].

Boeck, C.

- (13) 1828, *Notitser til Laeren om Trilobiterne*: Magazin om Naturvidenskaberne (Christiania), Aargang 1827, v. 8, p. 11-44, 1 pl.

Bornemann, J. G.

- (14) 1891, *Die Versteinerungen des cambrischen Schichtensystems der Insel Sardinien, Abt. 2*: Nova Acta K. Leopoldino-Carolinae Akad. Naturforscher (Halle a.S.), v. 56, p. 427-528, pl. 19-28.

Bridge, Josiah

- (15) 1937, *Trilobita* [Cambrian from Texas]: in BRIDGE, JOSIAH & GIRTY, G. H., A redescription of Ferdinand Roemer's Paleozoic types from Texas, U.S. Geol. Survey Prof. Paper 186-M, p. 246-256, pl. 67-69.

———, & Cloud, P. E., Jr.

- (16) 1947, *New gastropods and trilobites critical in the correlation of Lower Ordovician rocks*: Am. Jour. Sci. (New Haven), v. 245, p. 545-559.

Brøgger, W. C.

- (17) 1878, *Om paradoxideskifrene ved Krekling*. Nyt Magazin for Naturvidenskaberne (Oslo), v. 24, p. 18-88, pl. 1-6.
- (18) 1882, *Die silurischen Etagen 2 und 3 im Kristianiagebiet und auf Eker, ihre Gliederung, Fossilien, Schichtenstörungen und Contactmetamorfosen*: Univ.-Programm (Christiania), p. 1-376, pl. 1-12.
- (19) 1886, *Ueber die Ausbildung des Hypostomes bei einigen skandinavischen Asaphiden*: Bihang till K. Svenska (Stockholm), Handl., v. 11, no. 3 [Sveriges Geol. Undersök., ser. C, no. 82].

Brongniart, Alexandre & Desmarest, A. G.

- (20) 1822, *Histoire naturelle des crustacés fossiles, sous les rapports zoologiques et géologiques. Savoir: Les Trilobites*: 154 p., 11 pl., F. G. Levrault (Paris).

Chernysheva, N. E.

- (21) 1956 [New genera of trilobites] in POLETAeva, O. K., & CHERNYSHEVA, N. E., New families and genera [of trilobites], materials of Paleontology, All-Russian Sci. Res. Geol. Inst. (Moscow), new ser., v. 12, p. 145-182, 324-335, pl. 28-33.

Clark, T. H.

- (22) 1923, *New fossils from the vicinity of Boston*: Proc. Boston Soc. Nat. History, v. 36, no. 8, p. 473-485, 2 fig.

Clarke, J. M.

- (23) 1900, *The Oriskany fauna of Becraft Mountain, Columbia County, N. Y.*: N. Y. State Mus. (Albany), Mem., ser. 3, v. 3, p. 1-128, pl. 1-9, 2 figs.
- (24) 1913, *Fossils devonianos do Paraná*: Servico geol. mineral. Brasil (Rio de Janeiro), Mon., v. 1, p. i-xx, 1-353, 27 pl., 27 text figs.

Cobbold, E. S.

- (25) 1931, *Le genre Olenopsis en France*: Soc. géol. France (Paris), Bull., ser. 5, v. 1, no. 5-7, p. 561-571.

Cooper, B. N.

- (26) 1953, *Trilobites from the Lower Champlainian formations of the Appalachian Valley*: Geol. Soc. America (New York), Mem. 55, 1-69 p., 1-19 pl., 2 fig.

———, & Cooper, G. A.

- (27) 1946, *Lower Middle Ordovician stratigraphy of the Shenandoah Valley, Virginia*: Same, Bull., v. 57, p. 35-114, pl. 1-3, fig. 1-9.

Cooper, G. A. & Kindle, C. H.

- (28) 1936, *New brachiopods and trilobites from the Upper Ordovician of Percé, Quebec*: Jour. Paleont. (Tulsa), v. 10, p. 348-372, pl. 51-53.

Dalman, J. W.

- (29) 1827, *Om Palaeaderna eller de så kallade Trilobiterna*: K. Svenska Vetenskapsakademiens (Stockholm), Handl., v. 1, 226-294, pl. 1-6.

Deiss, Charles

- (30) 1939, *Cambrian stratigraphy and trilobites of northwestern Montana*: Geol. Soc. America (New York), Spec. Paper 18, 135 p., 18 pl., 7 fig.

Delgado, J. F.

- (31) 1904, *Faune cambrienne du Haut-Alemtejo (Portugal)*: Comissão Serv. Geol. Portugal (Lisbon), Comunicações, v. 5, p. 307-379.

Delo, D. M.

- (32) 1935, *A revision of the phacopid trilobites*: Jour. Paleont. (Tulsa), v. 9, p. 402-420, fig. 1-45.
- (33) 1940, *Phacopid trilobites of North America*: Geol. Soc. America (New York), Spec. Paper 29, 135 p., 13 pl.

Eichwald, Eduard

- (34) 1825, *Geognostico-zoologicae, per Ingriam Marisque Baltici provincias, nec non de Trilobitis observationes*: 58 p., illus. (Casani).

Emmrich, H. F.

- (35) 1844, *Zur Naturgeschichte der Trilobiten*: Realschul-Programm (Meiningen).
- (36) 1845, *Ueber die Trilobiten*: Neues Jahrb. f. Mineral. (Stuttgart), Band 1845, p. 18-52.

Endo, Riuji, & Resser, C. E.

- (37) 1937, *The Sinian and Cambrian formations and fossils of southern Manchoukuo*: Manch. Sci. Mus. (Mukden), Bull. 1, 474 p., 73 pl.

Erben, H. K.

- (38) 1952, *Trilobiten aus dem älteren Hercyn (Unterdevon) des Unterharzes*: Neues Jahrb. f. Geol. Paläont. (Stuttgart), Abhandl., v. 94, no. 2-3, p. 150-362, pl. 17-24, 64 figs.
- (39) 1952, *Zur Gliederung der Ceratocephalidae* RUD. & E. RICHTER, 1925, emend. PRANTL & PŘIBYL, 1949 (*Tril.*): Same, Monatshefte 7, p. 304-317, figs.

Etheridge, R., Jr.

- (40) 1919, *The Cambrian trilobites of Australia and Tasmania*: Roy. Soc. South Australia (Adelaide), Trans., v. 43.

———, & Mitchell, J.

- (41) 1896, *The Silurian trilobites of New South Wales, Pt. 4. The Odontopleuridae*: Linn. Soc. New South Wales (Sydney), Proc., v. 21, p. 697-721.

Evitt, W. R.

- (42) 1951, *Some Middle Ordovician trilobites of the families Cheiruridae, Harpidae and Lichidae*: Jour. Paleont. (Tulsa), v. 25, p. 587-616, pl. 85-88, fig. 1.
- (43) 1953, *Observations on the trilobite Ceraurus*: Same, v. 27, p. 33-48, pl. 5-8, fig. 1.

———, & Whittington, H. B.

- (44) 1953, *The exoskeleton of Flexicalymene (Trilobita)*: Same, vol. 27, p. 49-55, pl. 9, 10, fig.

Foerste, A. F.

- (45) 1920, *The generic relations of the American Ordovician Lichadidae*: Am. Jour. Sci. (New Haven), ser. 4, v. 49, p. 26-50, pl. 1-4.

Ford, S. W.

- (46) 1872, *Descriptions of some new species of primordial fossils*: Am. Jour. Sci. (New Haven), ser. 3, v. 3, p. 419-422.

Frederickson, E. A.

- (47) 1948, *Upper Cambrian trilobites from Oklahoma*: Jour. Paleont. (Tulsa), v. 22, p. 798-803, pl. 123.
- (48) 1949, *Trilobite fauna of the Upper Cambrian Honey Creek Formation*: Same, v. 23, p. 341-363, pl. 68-72, 1 fig.

Green, Jacob

- (49) 1832, *A monograph of the trilobites of North America*: 93 p. (Philadelphia).
- (50) 1832, *Synopsis of the trilobites of North America*: Monthly Am. Jour. Geol. & Nat. Sci. (Philadelphia), v. 1, no. 12.

Grönwall, K. A.

- (51) 1902, *Bornholms Paradoxides-lag og deres Fauna*: Danm. Geol. Undersøg. (Copenhagen), ser. 2, no. 13, p. 1-230, pl. 1-4.

Gürich, G.

- (52) 1901, *Ueber eine neue Lichas-Art aus dem Devon von Neu-Süd-Wales und über die Gattung Lichas überhaupt*: Neues Jahrb. (Stuttgart), Beil.-Band 14, p. 519-539, pl. 18, 19, fig. 1, 2.

Hall, James

- (53) 1863, *Preliminary notice of the fauna of the Potsdam Sandstone*: New York State Cabinet Nat. History (Albany), 16th Ann. Rept., Appendix D, p. 119-184.

———, & Clarke, J. M.

- (54) 1888, *Palaeontology: Trilobites and other Crustacea*: New York Geol. Survey (Albany), v. 7, 236 p., 36 pl.

Harrington, H. J.

- (55) 1938, *Sobre las faunas del Ordoviciano inferior del norte argentino*: Museo de La Plata (Buenos Aires), Revista, new ser., v. 1, Sección Paleont., p. 109-289, pl. 1-14.
- (56) 1956, *Olenellidae with advanced cephalic spines*: Jour. Paleont. (Tulsa), v. 30, p. 56-61, pl. 15.

———, & Leanza, A. F.

- (57) 1942, *Sobre algunos trilobites nuevos o poco conocidos del ordovicico argentino*: Museo de La Plata (Buenos Aires), Revista, new ser., v. 2, Sección Paleont., p. 131-141, pl. 1-3.
- (58) 1952, *La clasificación de los "Olenidae" y de los "Ceratopygidae"*: Asociación Geológica Argentina (Buenos Aires), Revista, v. 7, no. 3, p. 190-205, pl. 1.
- (59) 1957, *Ordovician Trilobites of Argentina*: Univ. Kansas (Lawrence), Dept. Geol. Spec. Pub. 1, 276 p., 140 fig.

Hawle, Ignaz, & Corda, A. J. C.

- (60) 1847, *Prodrom einer Monographie der böhmischen Trilobiten*: K. Böhm. Gesell. Wiss. (Prague), Abhandl., v. 5, 176 p., 7 pl.

Henningsmoen, Gunnar

- (61) 1957, *The trilobite family Olenidae*: Norske Videnskapsakademien (Oslo), Mat.-Naturv. Kl., Skr., no. 1, 303 p., 31 pl., 19 fig.

Henriksen, K. L.

- (62) 1926, *The segmentation of the trilobite's head*: Dansk Geol. Foren. (Copenhagen), Meddel., v. 7, p. 1-32.

Hintze, L. F.

- (63) 1952, *Lower Ordovician trilobites from western Utah and eastern Nevada*: Utah Geol. Mineral. Survey (Salt Lake City), Bull. 48, vi+249 p., 28 pl., 2 fig.

Holliday, Samuel

- (65) 1942, *Ordovician trilobites from Nevada*: Jour. Paleont. (Tulsa), v. 16, p. 471-478, pl. 73, 74.

Holm, Gerhard

- (66) 1882, *Ueber einigen Trilobiten aus dem Phyllograptusschiefer Dalekarliens*: Bihang till K. Svenska Vetenskapsakademiens (Stockholm), Handl., v. 6, no. 9.
- (67) 1886, *III. Illaeniden*: in SCHMIDT, FR., Revision der Ostbaltischen Trilobiten, Acad. impériale Sci. St. Petersburg, Mém., v. 7, no. 33, 173 p., 12 pl.

Holub, K.

- (68) 1908, *Prispevek kú Poznání fauny pasma Dd 1 γ*: České Akad., Rozpravy, v. 17, no. 10.

- (69) 1911, *Über eine neue Fauna in der Umgebung von Rokycan*: Internat. Acad. Sci. Bohême (Prague), Bull., v. 16, p. 1-4, pl. 1-2.
- Howell, B. F.**
- (70) 1933, *The classification of the trilobite subfamily Centroleurinae*: Dansk Geol. Foren. (Copenhagen), Meddel., v. 8, p. 215-219.
- (71) 1935, *Some New Brunswick Cambrian agnostians*: Wagner Free Inst. Sci. (Philadelphia), Bull., v. 10, p. 13-16, 1 pl.
- (72) 1937, *Cambrian Centroleura vermontensis fauna of northwestern Vermont*: Geol. Soc. America (New York), Bull., v. 48, p. 1147-1210, 6 pl.
- (73) 1945, *Revision of the Upper Cambrian faunas of New Jersey*: Same, Mem. 12, 46 p., 8 pl.
- , & **Duncan, D. C.**
- (74) 1939, *Middle-Upper Cambrian transition faunas of North America*: Wagner Free Inst. Sci. (Philadelphia), Bull., v. 14, no. 1, p. 1-11, pl. 1.
- , & **Stubblefield, C. J.**
- (75) 1950, *A revision of the fauna of the North Welsh Conocoryphe viola beds implying a Lower Cambrian age*: Geol. Mag. (Hertford), v. 87, no. 1, p. 1-16, pl. 1-2.
- Hsü, S. C., & Ma, C. T.**
- (76) 1948, *The I-Changian Formation and the I-Changian fauna*: Natl. Research Inst. Geol., Acad. Sinica (Nanking), Mem., v. 8, p. 18-46.
- Hupé, Pierre**
- (77) 1953, *Contribution à l'étude du Cambrien inférieur et du Précambrien III de l'Anti-Atlas marocain*: Service géol. Maroc (Rabat), Notes et Mém., no. 103, 402 p., 24 pl., 99 fig.
- (78) 1953, *Classification des trilobites*: Ann. Paléont. (Paris), v. 39, p. 61-168 [1-110], fig. 1-92.
- (79) 1955, *Classification des trilobites*: Same, v. 41, p. 91-325 [111-345], fig. 93-247.
- Hutchinson, R. D.**
- (80) 1952, *The stratigraphy and trilobite faunas of the Cambrian sedimentary rocks of Cape Breton Island, Nova Scotia*: Geol. Survey Canada (Ottawa), Mem. 263, p. 1-124, pl. 1-7.
- Ivshin, N. K.**
- (81) 1953, *Middle Cambrian trilobites of Kazakhstan, Pt. 1*: Akad. Nauk Kazakhstan SSSR (Alma Ata), 221 p., 11 pl.
- (82) 1956, *Upper Cambrian trilobites of Kazakhstan*: Same, 98 p., 9 pl.
- Jaekel, Otto**
- (83) 1909, *Ueber die Agnostiden*: Zeitschr. deutsch. geol. Gesell. (Berlin), v. 61, p. 380-401.
- Jaanusson, Valdar**
- (84) 1953, *Untersuchungen über baltoskandische Asaphiden. I. Revision der mittelordovizischen Asaphiden des Siljan-Gebietes in Dalarna*: K. Svenska Vetenskapsakademiens (Stockholm), Arkiv f. Mineral. Geol., no. 14, p. 377-464, illus.
- (85) 1953, *Untersuchungen über baltoskandische Asaphiden. II. Revision der Asaphus (Neoasaphus) Arten aus dem Geschiebe des südbottnischen Gebietes*: Same, v. 1, no. 15, p. 465-499, illus.
- (86) 1954, *Zur Morphologie und Taxonomie der Illaeniden*: Same, v. 1, no. 20, p. 545-583, 3 pl., 19 fig.
- Jegorova, L. I.**
- (87) 1955, [New genera of trilobites]: in CHALIPHINA, L. L., Atlas of guide forms of fossil faunas and floras of western Siberia, v. 1, Western Siberia Geol. Inst. [Tomsk], 501 p., 85 pl., 202 fig.
- Kautsky, Fritz**
- (88) 1945, *Die Unterkambrische Fauna vom Aistjakk in Lappland*: Geol. Fören. i Stockholm, Förhandl., v. 67, p. 129-211, pl. 9-18, fig. 1-5.
- Kegel, W.**
- (89) 1928, *Die obersilurische Trilobiten aus dem Harz und dem rheinischen Schiefergebirge*: Preuss. Geol. Landesanst. (Berlin), Jahrb. für 1927, v. 48, p. 616-647, 2 pl., 8 fig.
- Kiaer, J.**
- (90) 1916, *The Lower Cambrian Holmia fauna at Tømten in Norway*: Videnskapselskapets (Oslo), Mat.-Naturv. Kl., Skr., no. 10, p. 1-140, pl. 1-14.
- Kielan, Zofia**
- (91) 1957, *On the trilobite family Staurocephalidae*: Acta Palaeont. Polonica (Warsaw), v. 2, no. 2-3, p. 155-182, pl. 1-6.
- King, W. B. R.**
- (92) 1930, *Notes on the Cambrian faunas of Persia*: Geol. Mag. (Hertford), v. 67, p. 316-327.
- (93) 1941, *The Cambrian fauna of the Salt Range of India*: Geol. Survey India (Calcutta), Prof. Paper no. 75, p. 1-15, pl. 1-5.
- Klouček, C.**
- (94) 1917, *Über die d1γ-Schichten und ihre Trilobitenfauna*: Internat. Acad. Sci. Bohême (Prague), Bull., p. 231-246, 1 pl.
- Kobayashi, Teiichi**
- (95) 1933, *Upper Cambrian of the Wuhutsui Basin, with special reference to the limit of the Chaumitian (or Upper Cambrian) of eastern Asia, and its subdivisions*: Japan. Jour. Geol. Geog. (Tokyo), v. 2, no. 1-2, p. 55-155, pl. 9-15.

Kobayashi, Teiichi

- (96) 1934, *The Cambro-Ordovician formations and faunas of South Chosen. Palaeontology. Part II. Lower Ordovician faunas*: Jour. Fac. Sci., Imp. Univ. Tokyo, sec. 2, v. 3, pt. 9, p. 521-585, pl. 1-8.
- (97) 1935, *The Cambro-Ordovician formations and faunas of South Chosen. Paleont., Pt. III. Cambrian faunas of South Chosen with special study on the Cambrian trilobite genera and families*: Same, v. 4, pt. 2, p. 49-344.
- (98) 1936, *On the Parabolinaella fauna from the Province Jujuy, Argentina, with a note on the Olenidae*: Japanese Jour. Geol. Geog. (Tokyo), v. 13, p. 85-102, pl. 15-16.
- (99) 1938, *Upper Cambrian fossils from British Columbia*: Same, v. 15, p. 151-192.
- (100) 1939, *On the agnostids (Part I)*: Fac. Sci. Imp. Univ. Tokyo, Jour., sec. 2, v. 5, p. 69-198.
- (101) 1942, *On the Dolichometopinae*: Same, v. 6, pt. 10, p. 141-206, pl. 1-4.
- (102) 1943, *Cambrian faunas of Siberia*: Same, v. 6, pt. 12, p. 271-334.
- (103) 1944, *The Cambrian formation in the middle Yangtze Valley and some trilobites contained. Miscellaneous notes on the Cambro-Ordovician geology and paleontology, no. 15*: Japan. Jour. Geol. Geog. (Tokyo), v. 19, no. 1-4, p. 89-105, pl. 8.
- (104) 1944, *On the Cambrian formations in Yunnan and Haut-Tonkin and the trilobites contained. Miscellaneous notes on the Cambro-Ordovician geology and paleontology, no. 16*: Same, v. 19, no. 1-4, p. 107-138, pl. 9-10.
- (105) 1944, *On the eodiscids*: Fac. Sci., Imp. Univ. Tokyo, Jour., sec. 2, v. 7, pt. 1, p. 1-74.
- (106) 1951, *On the Ordovician trilobites in central China*: Same, v. 8, pt. 1, p. 1-87, pl. 1-5, fig.
- (107) 1952, *On Mansuyia and the Tsinaniidae*: Paleont. Soc. Japan, Trans. Proc., new ser., v. 5, p. 145-154.
- (108) 1955, *The Ordovician fossils from the McKay Group in British Columbia, western Canada, with a note on the Early Ordovician palaeogeography*: Fac. Sci., Univ. Tokyo, Jour. sec. 2, v. 9, pt. 3, p. 355-493, pl. 1-9.

, & Kato, Fujio

- (109) 1951, *On the ontogeny and ventral morphology of Redlichia chinensis with description of Alutella nakamurai, new gen. and sp.*: Same, sec. 2, v. 8, p. 99-143.

Koch, C.

- (110) 1883, *Monographie der Homalonotus-Arten des rheinischen Unterdevon*: Geol. Spezialkarte von Preussen (Berlin), Abhandl., v. 4, pt. 2, p. 1-85, pl. 1-8.

Kozłowski, Roman

- (111) 1923, *Faune dévonienne de Bolivie*: Ann. Paléont. (Paris), v. 12, p. 1-112, pl. 1-10, fig. 1-7.

Kramarenko, N. N.

- (112) 1952, *Nouye trilobity iz Silura Bassejna reki Podkamennaja Tunguska*: Doklady Akad. Nauk SSSR (Moscow), new ser., v. 86, p. 401-404, fig. 1-9.

Lake, Philip

- (113) 1906, *Trilobites from Bolivia, collected by Dr. J. W. Evans in 1901-1902*: Quart. Jour. Geol. Soc. (London), v. 62, p. 425-430, pl. 40.
- (114) 1906-1946, *A monograph of the British Cambrian trilobites*: Palaeontogr. Soc. (London), Mon., p. 1-350, pl. 1-47 [p. 1-28, pl. 1-2, 1906; p. 29-48, pl. 3-4, 1907; p. 49-64, pl. 5-6, 1908; p. 65-88, pl. 7-10, 1913; p. 89-120, pl. 11-14, 1919; p. 121-148, pl. 15-18, 1931; p. 149-172, pl. 19-22, 1932; p. 173-196, pl. 23-25, 1934; p. 197-224, pl. 26-31, 1935; p. 225-248, pl. 32-35, 1937; p. 249-272, pl. 36-39, 1938; p. 273-306, pl. 40-43, 1940; p. 307-332, pl. 44-46, 1942; p. 333-350, pl. 47, addenda, errata, 1946].

Lamont, Archie

- (115) 1941, *Trinucleidae in Eire*: Ann. Mag. Nat. History (London), ser. 11, v. 8, p. 438-469, pl. 5.

Leanza, A. F.

- (116) 1949, *Olenopsis Ameghino, 1889 (un roedor) versus Olenopsis Bonermann [sic], 1891 (un trilobite)*: Asociacion Geol. Argentina (Buenos Aires), Revista, v. 4, no. 1, p. 36.

Lermontova, E. V.

- (117) 1940, *Arthropoda*: in VOLOGDIN, A., Atlas of the leading forms of the fossil faunas of the USSR, 1, Cambrian, State Editorial Office Geol. Literature (Moscow-Leningrad), 194 p., 49 pl.
- (118) 1951, *Lower Cambrian trilobites and brachiopods of eastern Siberia*: All Union (USSR) Sci. Res. Geol. Inst. (Moscow), 221 p., 21 pl.
- (119) 1951, *Upper Cambrian trilobites and brachiopods of Boshche-Kulya (Kazakhstan)*: Same, 49 p., 6 pl.
- (120) 1955, [New genera of trilobites]: in CHALIPHINA, L. L., Atlas of guide forms of fossil faunas and floras of western Siberia, v. 1, Western Siberia Geol. Inst. (Tomsk), 501 p., 85 pl., 202 fig.

Linnarsson, J. G. O.

- (121) 1869, *Om Vestergötlands Cambriska och Siluriska Aflagringar*: K. Svenska Vetenskapsakademiens (Stockholm), *Handl.*, v. 8, no. 2.
- (122) 1879, *Om faunan i kakken med Conocoryphe exsulans ("Coronatuskalken")*: Sveriges Geol. Undersök. (Stockholm), ser. C, no. 35.

Lochman, Christina

- (123) 1936, *New trilobite genera from the Bonnetterre Dolomite (Upper Cambrian) of Missouri*: *Jour. Paleont.* (Tulsa), v. 10, p. 35-43, pl. 9.
- (124) 1938, *Middle and Upper Cambrian faunas from western Newfoundland*: Same, v. 12, p. 461-477, pl. 56, 57, 1 fig.
- (125) 1938, *Upper Cambrian faunas of the Cap Mountain Formation of Texas*: Same, v. 12, p. 72-85, pl. 17-18.
- (126) 1940, *Fauna of the basal Bonnetterre Dolomite (Upper Cambrian) of southeastern Missouri*: Same, v. 14, p. 1-52, pl. 1-5, fig. 1.
- (127) 1940, *Corrections to the basal Bonnetterre fauna*: Same, v. 14, p. 515.
- (128) 1948, *New Cambrian trilobite genera from northwest Sonora, Mexico*: Same, v. 22, p. 451-464, pl. 69, 70.
- (129) 1950, *Upper Cambrian faunas of Little Rocky Mountains, Montana*: Same, v. 24, p. 322-349, pl. 46-51.
- (130) 1952, *Trilobites*: in COOPER, G. A., et al., *Cambrian stratigraphy and paleontology near Caborca, northwestern Sonora, Mexico*, Smithsonian Misc. Coll. (Washington), v. 119, no. 1, p. 60-161.
- (131) 1956, *Stratigraphy and paleogeography of the Elliptocephala asaphoides strata in Cambridge and Hoosick quadrangles, New York*: *Geol. Soc. America (New York), Bull.*, v. 67, p. 1331-1396, pl. 1-10.

—, & Duncan, Donald

- (132) 1944, *Early Upper Cambrian faunas of central Montana*: Same, *Spec. Paper 54*, 181 p., 19 pl.

Lomovitskaja, M. P.

- (133) 1955, [New genera of trilobites]: in CHALIPHINA, L. L., *Atlas of guide forms of fossil faunas and floras of western Siberia*, v. 1, *Western Siberia Geol. Inst. (Tomsk)*, 501 p., 85 pl., 202 fig.

Lorenz, T.

- (134) 1906, *Beiträge zur geologie und palaeontologie von Ostasien, Pt. 2, Palaeontologischer Teil*: *Deutsch. geol. Gesell. (Berlin), Zeitschr.*, v. 58, p. 53-108, pl. 4-6.

Lu, Yen-Hao

- (135) 1940, *On the ontogeny and phylogeny of Redlichia intermedia Lu (sp. nov.)*: *Geol. Soc. China (Peiping), Bull.*, v. 20, no. 3-4, p. 333-342, 1 pl.
- (136) 1941, *Lower Cambrian stratigraphy and trilobite fauna of Kunming, Yunnan*: Same, v. 21, no. 1, p. 71-90, pl. 1, 4 fig.
- (137) 1942, *Some Lower Cambrian trilobites from Chintingshan, North Kueichou*: Same, v. 22, no. 3-4, p. 177-188, pl. 2.
- (138) 1946, *Early Middle Cambrian faunas from Meitan*: Same, v. 25, no. 1-4, p. 185-200, pl. 1.
- (139) 1957, *Trilobita*: reprinted from "Index Fossils of China," *Invertebrata, Part III*, p. 249-294, pl. 137-155; edited by Institute of Palaeontology, Academia Sinica, published by Geol. Press, Peking.

M'Coy, F.

- (140) 1849, *On the classification of some British fossil Crustacea, with notices of new forms in the University collection at Cambridge*: *Ann. Mag. Nat. History (London)*, ser. 2, v. 4, p. 161-179, 392-414.

Maksimova, Z. A.

- (141) 1955, *Trilobity srednego i verkhnego devona Urala i severnykh Mugodzhari*: *Vsesoyuz. Nauk.-Issled. Geol. Inst., Trans.*, new ser., v. 3, p. 1-263, pl. 1-18, fig. 1-44.

Mansuy, H.

- (142) 1916, *Faunes cambriennes de l'extrême-orient méridional*: *Mém. Service Géol. de l'Indochine*, v. 5, fasc. 1.

Matthew, G. F.

- (143) 1882-83, *Illustrations of the fauna of the St. John Group, no. 1, The Paradoxides*: *Roy. Soc. Canada, Trans.*, v. 1, sec. 4, p. 87-108, pl. 9, 1882; v. 1, sec. 4, p. 271-279, pl. 10, 1883.
- (144) 1885, *The fauna of the St. John Group continued: On the Conocoryphe, with further remarks on Paradoxides*: Same, v. 2, sec. 4, p. 99-124, pl. 1.
- (145) 1888, *Illustrations of the fauna of the St. John Group, no. 4, pt. 2, The smaller trilobites with eyes (Ptychoparidae and Elliptocephalidae)*: Same, v. 5, sec. 4, p. 123-166, pl. 1, 2.
- (146) 1896, *Faunas of the Paradoxides beds in eastern North America*: *New York Acad. Sci., Trans.*, v. 15, p. 192-247, pl. 14-17.
- (147) 1897, *Studies of Cambrian faunas*: *Roy. Soc. Canada, Trans.*, ser. 2, v. 3, sec. 4, p. 165-203, pl. 1-4.

Meléndez Meléndez, Bermudo

- (148) 1943, *Los terrenos cámbricos de la península hispánica*: *Trabajos. Inst. Cienc. Nat. (Madrid)*, ser. geol., t. 1, no. 1, 179 p., 45 pl., 15 fig.

Meneghini, G.

- (149) 1888, *Paleontologia dell' Inglese in Sardegna. Fauna Cambriana. Trilobiti*: Memoria per servire alla descrizione della Carta geologica d'Italia (Roma), v. 3.

Miller, B. Maxwell

- (150) 1936, *Cambrian trilobites from northwestern Wyoming*: Jour. Paleont. (Tulsa), v. 10, p. 23-34.

Moberg, J. C.

- (151) 1902, *Bidrag till kannedomen om trilobiternas byggnad*: Geol. Fören. i Stockholm Förhandl., v. 24, pt. 5, p. 295-302, pl. 3.

———, & Möller, H.

- (152) 1898, *Om Acerocarezon*: Same. v. 20, p. 197-290, pl. 10-14.

———, & Segerberg, C. O.

- (153) 1906, *Bidrag till kannedomen om Cera-topygeregionen med särskild hänsyn till dess utveckling i Fogelsångstrakten*: Lunds Univ. Årsskr., new ser., v. 2, pt. 2, no. 7, p. 1-113, pl. 1-7.

Monke, H.

- (154) 1903, *Beiträge zur Geologie von Schantung, I, Obercambrische Trilobiten von Yen-tsy-yai*: K. Preuss. Geol. Landesanst. und Bergakad. (Berlin), Jahrb. für 1902, v. 22, 1903, p. 103-151, pl. 3-9.

Navarese, V.

- (155) 1943, *Sul Cambriano della Sardinia*: Reale Ufficio geol. d'Italia (Roma), Boll., v. 67, no. 3, p. 1-28, pl. 1.

Nelson, C. A.

- (156) 1951, *Cambrian trilobites from the St. Croix Valley*: Jour. Paleont. (Tulsa), v. 25, p. 765-784, pl. 106-110.

Neltner, Louis

- (157) 1938, *Etudes géologiques dans le sud marocain (Haut-Atlas et Anti-Atlas)*: Serv. Mines et Carte géol. Maroc (Rabat), Notes et Mém., no. 42, 298 p., 19 pl., 54 fig.

———, & Poctey, N.

- (158) 1950, *Quelques faunes géorgiennes du Maroc*: Same, no. 74, p. 53-83, illus.

Novák, O.

- (159) 1883, *Zur Kenntnis der böhmischen Trilobiten*: Palaeont. Geol. Österreich-Ungarns, Beitr., v. 3, p. 23-63, pl. 8-12.

Öpik, A. A.

- (160) 1937, *Trilobiten aus Estland*: Acta et Commentationes Univ. Tartuensis, A, Math.-Phys.-Med., v. 32, p. 1-163, pl. 1-26, fig. 1-42.

Palmer, A. R.

- (161) 1951, *Pemphigaspis, a unique Upper Cambrian trilobite*: Jour. Paleont. (Tulsa), v. 25, p. 762-764, pl. 105.

- (162) 1954, *The faunas of the Riley Formation in central Texas*: Same, v. 28, p. 709-786, pl. 76-92, 6 fig.

Pander, C. H.

- (163) 1830, *Beiträge zur Geognosie des russischen Reiches*: 1-165 p., 1-31 pl. (St. Petersburg).

Peach, B. N.

- (164) 1894, *Additions to the fauna of the Olenellus Zone*: Quart. Jour. Geol. Soc. (London), v. 50, p. 661-676, pl. 29-32.

Phleger, F. B., Jr.

- (165) 1936, *Lichadian trilobites*: Jour. Paleont. (Tulsa), v. 10, p. 593-615, fig. 1-83.

- (166) 1937, *Further notes on the Lichadacea*: Same, v. 11, p. 253-256.

- (167) 1937, *New Lichadacea in the collections of the Museum of Practical Zoölogy*: Harvard Univ., Mus. Comp. Zoology (Cambridge), Bull., v. 80, p. 415-425, pl. 1, 2.

Pillet, J.

- (168) 1954, *La classification des Phacopacea (Trilobites)*: Soc. géol. France (Paris), Bull., sér. 6, v. 3, p. 817-839, text-pl. 1-3, fig. 1-3 (non 1953, see *op. cit.*, p. 837).

Poletaeva, O. K.

- (169) 1955, [New genera of trilobites]: in CHALIPHINA, L. L., Atlas of guide forms of the fossil faunas and floras of western Siberia, v. 1, Western Siberia Geol. Inst. (Tomsk), 501 p., 85 pl., 202 fig.

———, & Chernysheva, N. E.

- (170) 1956, *New families and genera [of trilobites]*: Materials of Paleontology, All-Russian Sci. Res. Geol. Inst. (Moscow), new ser., v. 12, p. 145-182, 324-335, pl. 28-33.

Poulsen, Chr.

- (171) 1923, *Bornholms Olenuslag og deres Fauna*: Danm. Geol. Undersøg. (Copenhagen), ser. 2, no. 40, p. 1-83, pl. 1-3.

- (172) 1927, *The Cambrian, Ozarkian and Canadian faunas of Northwest Greenland*: Meddel. om Grønland (Copenhagen), v. 70, no. 2, p. 233-343, pl. 14-21.

- (173) 1932, *The Lower Cambrian faunas of East Greenland*: Same, v. 87, no. 6, p. 1-66, pl. 1-14.

- (174) 1934, *The Silurian faunas of North Greenland, I. The fauna of the Cape Schuchert Formation*: Same, v. 72, no. 1, p. 1-46, pl. 1-3.

- (175) 1946, *Notes on Cambro-Ordovician fossils collected by the Oxford University Ellesmere Land Expedition 1934-35*: Quart. Jour. Geol. Soc. (London), v. 102, p. 299-337.

Prantl, Ferdinand, & Přibyl, Alois

- (176) 1947, *A study of the superfamily Odontopleuracea nov. superfamily (trilobites)*: Czechoslovakia, Státní Geol. Ústav, Rozpravy (Praha), v. 12, 221 p., 11 pl., fig.

- (177) 1947, *Classification and division of the genus Scutellum Pusch, 1833, from the Barrandian (Central Bohemia)*: Internat. Acad. tchèque Sci. (Praha), Bull. (1946), année 47, p. 1-32, pl. 1-7.
- (178) 1947, *Classification of some Bohemian Cheiruridae (Trilobitae)*: Praha, Národní Museum, Sborník, Geol. Paleont., v. 3B, no. 1, p. 1-40, 6 pl.
- (179) 1948, *Classification of the Bohemian Homalonotidae (Trilobitae)*: Internat. Acad. tchèque Sci. (Praha), Bull. (1947), année 48, no. 9, p. 1-24, fig. 1-6, pl. 1-2.
- (180) 1948, *Study of the genus Barrandia McCoy*: Same, no. 5, p. 1-17, pl. 1-2.
- (181) 1950, *A revision of the Bohemian representatives of the family Otarionidae R. & E. Richter (Trilobitae)*: Czechoslovakia, Státní Geol. Ústav, Sborník (Praha), v. 17, Paleont., p. 353-512, illus.
- (182) 1950, *On the genus Symphysurus Goldfuss and allied forms from the Ordovician of Bohemia (Trilobitae)*: Soc. Roy. Lettres et Sci. de Bohême, Classe des Sci. (Praha), Mém. 12, année 1948, p. 1-16, pl. 1-2.
- (183) 1954, *On the Bohemian representatives of the family Harpedidae (Hawle and Corda) (Trilobitae)*: Czechoslovakia, Ústřed. Ústav Geol., Rozpravy (Praha), v. 18, p. 1-170, pl. 1-10.
- Příbyl, Alois**
 (184) 1947, *Aulacopleura and the Otarionidae*: Jour. Paleont. (Tulsa), v. 21, p. 537-545, pl. 80, fig. 1-19.
- , & Erben, H. K.
 (185) 1952, *Über einige neue oder wenig bekannte Acanthopyginae (Tril.) des böhmischen und des deutschen Devons*: Paläont. Zeitschr. (Berlin), v. 26, p. 141-174, pl. 9-12, fig. 1-11.
- Raasch, G. O., & Lochman, Christina**
 (186) 1943, *Revision of three early Upper Cambrian trilobite genera*: Jour. Paleont. (Tulsa), v. 17, p. 221-235, pl. 34-35.
- Rasetti, Franco**
 (187) 1943, *New Lower Ordovician trilobites from Lévis, Quebec*: Jour. Paleont. (Tulsa), v. 17, p. 101-104, pl. 19.
- (188) 1944, *Upper Cambrian trilobites from the Lévis conglomerate*: Same, v. 18, p. 229-258, pl. 36-39.
- (189) 1945, *New Upper Cambrian trilobites from the Lévis conglomerate*: Same, v. 19, p. 462-478, pl. 60-62.
- (190) 1945, *Description supplémentaire de trois genres de trilobites Cambriens*: Naturaliste Canadien (Quebec), v. 72, p. 117-124.
- (191) 1945, *Evolution of the facial sutures in the trilobites Loganopeltoides and Loganopeltis*: Am. Jour. Sci. (New Haven), v. 243, p. 44-50.
- (192) 1946, *Revision of some Late Upper Cambrian trilobites from New York, Vermont, and Quebec*: Same, v. 244, p. 537-546, pl. 1.
- (193) 1946, *Early Upper Cambrian trilobites from western Gaspé*: Jour. Paleont. (Tulsa), v. 20, p. 442-462, pl. 67-70.
- (194) 1948, *Lower Cambrian trilobites from the conglomerates of Quebec (exclusive of the Ptychopariidea)*: Same, v. 22, p. 1-24, pl. 1-6.
- (195) 1948, *Cephalic sutures in Loganopeltoides and the origin of "hypoparian" trilobites*: Same, v. 22, p. 25-29, pl. 7.
- (196) 1948, *Middle Cambrian trilobites from the conglomerates of Quebec*: Same, v. 22, p. 315-339, pl. 45-52.
- (197) 1951, *Middle Cambrian stratigraphy and faunas of the Canadian Rocky Mountains*: Smithsonian Misc. Coll. (Washington), v. 116, no. 5, p. 1-277, pl. 1-34.
- (198) 1952, *Ventral cephalic sutures in Cambrian trilobites*: Am. Jour. Sci. (New Haven), v. 250, p. 885-898.
- (199) 1952, *Revision of the North American trilobites of the family Eodiscidae*: Jour. Paleont. (Tulsa), v. 26, p. 434-451, pl. 51-54.
- (200) 1952, *Cephalic sutures in the Upper Cambrian trilobite Entomaspis*: Same, v. 26, p. 797-802, pl. 117, 5 fig.
- (201) 1954, *Phylogeny of the Cambrian trilobite family Catillicephalidae and the ontogeny of Welleraspis*: Same, v. 28, p. 599-612, pl. 62.
- (202) 1954, *Early Ordovician trilobite faunules from Quebec and Newfoundland*: Same, v. 28, p. 581-587, pl. 60-61.
- (203) 1955, *Lower Cambrian ptychoparid trilobites from the conglomerates of Quebec*: Smithsonian Misc. Coll. (Washington), v. 128, no. 7, p. 1-35, pl. 1-6.
- Raw, Frank**
 (204) 1936, *Mesonacidae of Comley in Shropshire, with a discussion of classification within the family*: Quart. Jour. Geol. Soc. (London), v. 92, p. 236-293, pl. 16-23.
- (205) 1937, *Systematic position of the Olenellidae (Mesonacidae)*: Jour. Paleont. (Tulsa), v. 11, p. 575-597, 1 fig.
- Raymond, P. E.**
 (206) 1905, *Trilobites of the Chazy Limestone*: Ann. Carnegie Mus. (Pittsburgh), v. 3, p. 328-396, pl. 10-14.

Raymond, P. E.

- (207) 1913, *Revision of the species which have been referred to the genus Bathyrurus*: Canada Geol. Survey (Ottawa), Victoria Memorial Mus. Bull. 1, p. 51-69, fig.
- (208) 1913, *Notes on some old and new trilobites in the Victoria Memorial Museum*: Same, p. 33-39, pl. 3-4.
- (209) 1920, *The appendages, anatomy, and relationships of trilobites*: Conn. Acad. Arts & Sci. (New Haven), Mem., v. 7, p. 1-169, pl. 1-11, fig. 1-46.
- (210) 1924, *New Upper Cambrian and Lower Ordovician trilobites from Vermont*: Proc. Boston Soc. Nat. History, v. 37, p. 389-466, pl. 12-14.
- (211) 1925, *Some trilobites of the Lower Middle Ordovician of eastern North America*: Harvard Univ., Mus. Comp. Zoology (Cambridge), Bull., v. 67, p. 3-180, pl. 1-10.
- (212) 1931, *Notes on invertebrate fossils, with descriptions of new species*: Same, v. 55, p. 165-213, pl. 1-5.
- (213) 1937, *Upper Cambrian and Lower Ordovician Trilobita and Ostracoda from Vermont*: Geol. Soc. America (New York), Bull., v. 48, p. 1079-1146, pl. 1-4.

Redlich, K.

- (214) 1899, *The Cambrian fauna of the eastern Salt Range*: Geol. Survey India, Palaeont. Indica (Calcutta), Mem., new ser., no. 1, p. 1-13, pl. 1.

Reed, F. R.

- 215) 1896, *Notes on the evolution of the genus Cheirurus*: Geol. Mag. (Hertford), new ser. 4, v. 3, p. 117-123, 161-167.
- 216) 1902, *Notes on the genus Lichas*: Quart. Jour. Geol. Soc. (London), v. 58, p. 59-82, fig. 1-19.
- 217) 1903, *The Lower Palaeozoic trilobites of the Girvan district, Ayrshire, I*: Palaeontogr. Soc. (London), Mon., p. 1-48, pl. 1-6.
- 218) 1904, *The Lower Palaeozoic trilobites of the Girvan district, Ayrshire, II*: Same, v. 58, p. 49-96, pl. 7-13.
- 219) 1905, *The classification of the Phacopidae*: Geol. Mag. (Hertford), new ser. 5, v. 2, p. 172-178, 224-228.
- 220) 1910, *The Cambrian fossils of Spiti*: Geol. Survey India, Palaeont. Indica (Calcutta), Mem., v. (15)7, pt. 1, p. 1-76.
- 221) 1914, *The Lower Palaeozoic trilobites of Girvan. Supplement*: Palaeontogr. Soc. (London), Mon., v. 67, p. 1-56, pl. 1-8.
- 222) 1917, *Ordovician and Silurian fossils from Yun-Nan*: Geol. Survey India, Palaeont. Indica (Calcutta), Mem., v. 6, pt. 3, p. 1-84, pl. 1-8.

- (223) 1918, *Notes on the genus Homalonus*: Geol. Mag. (Hertford), ser. 6, v. 5, p. 263-276, 314-327.
- (224) 1923, *The subgenera of Lichas*: Same, v. 60, p. 454-462.
- (225) 1925, *Revision of the fauna of the Bokkeveld beds*: South African Mus. (Cape Town), Annals, v. 22, p. 27-225, pl. 4-11.
- (226) 1927, *Recent work on the Phacopidae*: Geol. Mag. (Hertford), v. 64, p. 308-322, 337-353.
- (227) 1928, *Notes on the Family Encrinuridae*: Same, v. 65, p. 51-77.
- (228) 1930, *A review of the Asaphidae*: Ann. Mag. Nat. History (London), ser. 10, v. 5.
- (229) 1934, *Cambrian and Ordovician fossils from Kashmir*: Geol. Survey India, Palaeont. Indica (Calcutta), Mem., new ser., v. 21, no. 2.

Rennie, J. V. L.

- (230) 1930, *Some Phacopidae from the Bokkeveld Series*: Roy. Soc. South Africa (Cape Town), Trans., v. 18, p. 327-360, pl. 9-10, fig. 1.

Resser, C. E.

- (231) 1928, *Cambrian fossils from the Mohave Desert*: Smithsonian Misc. Coll. (Washington), v. 81, no. 2, p. 1-14, pl. 1-3.
- (232) 1935, *Nomenclature of some Cambrian trilobites*: Same, v. 93, no. 5, 1935, p. 1-46.
- (233) 1936, *Second contribution to nomenclature of Cambrian trilobites*: Same, v. 95, no. 4, p. 1-29.
- (234) 1937, *Third contribution to nomenclature of Cambrian trilobites*: Same, v. 95, no. 22, p. 1-29.
- (235) 1938, *Cambrian System (restricted) of the southern Appalachians*: Geol. Soc. America (New York), Spec. Paper 15, 140 p., 16 pl.
- (236) 1939, *The Spence Shale and its fauna*: Smithsonian Misc. Coll. (Washington), v. 97, no. 12, p. 1-29.
- (237) 1939, *The Ptarmigania strata of the northern Wasatch Mountains*: Same, v. 98, no. 24, p. 1-72, pl. 1-14.
- (238) 1942, *Fifth contribution to nomenclature of Cambrian fossils*: Same, v. 101, no. 15, p. 1-58.
- (239) 1942, *New Upper Cambrian trilobites*: Same, v. 103, no. 5, p. 1-136.

———, & Endo, R.

- (240) 1937, *Description of the fossils [mainly trilobites]*: in ENDO, R., & RESSER, C. E., *The Sinian and Cambrian formations and fossils of southern Manchoukuo*: Manch. Sci. Mus. (Mukden), Bull. 1, p. 103-301, pl. 14-64.

- , **Howell, B. F.**
 (241) 1938, *Lower Cambrian Olenellus Zone of the Appalachians*: Geol. Soc. America (New York), Bull., v. 49, p. 195-248, pl. 1-13.
- Richter, Rudolf**
 (242) 1921, *Beiträge zur Kenntnis devonischer Trilobiten. III. Über die Organisation von Harpes, einen Sonderfall unter Crustaceen*: Senckenberg. naturf. Gesell. (Frankfurt a.M.), Abhandl., v. 37, p. 179-218, pl. 16, 17.
 (243) 1923, *Von Bau und Leben der Trilobiten, 4, Die Versteifungen der Schale und daraus hervorgehende Konvergenzen*: Palaeontologia Hungarica (Budapest), v. 1, p. 90-108, fig. 17-37.
 (244) 1926, *Von Bau und Leben der Trilobiten, 3, Die Beziehungen von Glatze und Magen*: Same, v. 1, p. 77-89, fig. 1-16 (not published in 1923).
 (245) 1937, *Von Bau und Leben der Trilobiten, 8, Die "Salter'sche Einbettung" als Folge und Kennzeichen des Häutungs-Vorgangs*: Senckenbergiana (Frankfurt a.M.), v. 19, p. 413-431, fig. 1-3.
- , & **Richter, Emma**
 (247) 1926, *Die Trilobiten des Oberdevons, Beiträge zur Kenntnis devonischer Trilobiten, 4*: Abhandl. preuss. geol. Landesanst. (Berlin), v. 99, p. 1-314, pl. 1-12, fig. 1-18, table A-C.
 (248) 1940, *Studien im Paläozoikum der Mittelmeer-Länder, 5, Die Saukianda-Stufe von Andalusien, eine fremde Fauna im europäischen Ober-Kambrium*: Senckenberg. naturf. Gesell. (Frankfurt a.M.), Abhandl. 450, p. 1-81, pl. 1-5.
 (249) 1941, *Studien im Paläozoikum der Mittelmeer-Länder, 6, Die Fauna des Unter-Kambriums von Cala in Andalusien*: Same, Abhandl. 455, p. 1-90, pl. 1-4.
 (250) 1941, *Studien im Paläozoikum der Mittelmeer-Länder, 7, Das Kambrium am Totem Meer und die älteste Tethys*: Same, Abhandl. 460, p. 1-50, pl. 1-2.
 (251) 1943, *Trilobiten aus dem Devon von Marokko mit einem Anhang über Arten des Rheinlands*: Senckenbergiana (Frankfurt a.M.), v. 26, p. 116-199, pl. 1-8, fig. 1-11.
 (252) 1948, *Studien im Paläozoikum der Mittelmeer-Länder, 8, Zur Frage des Unter-Kambriums in Nordost-Spanien*: Same, v. 29, p. 23-39, pl. 1, fig. 1-5.
 (253) 1949, *Studien im Paläozoikum der Mittelmeer-Länder, 9, Die Frage der Saukianda-Stufe (Kambrium, Spanien)*: Same, v. 30, p. 217-240.
- (254) 1952, *Phacopacea von der Grenze Emsium Eiflium (Tril.)*: Same, v. 33, p. 79-108, pl. 1-4, fig. 1-4.
 (255) 1954, *Die Trilobiten des Ebbe-Sattels und zu vergleichende Arten (Ordovizium, Gotlandium/Devon)*: Senckenberg. naturf. Gesell. (Frankfurt a.M.), Abhandl. 488, p. 1-76, pl. 1-6.
 (256) 1955, *Oberdevonische Trilobiten, Nachträge, 2, Phylogenie der oberdevonischen Phacopidae*: Senckenberg. lethaea (Frankfurt a.M.), v. 36, p. 56-72, fig. 1-2.
 (257) 1956, *Grundlagen für die Beurteilung und Einteilung der Familie Scutelluidae (Tril.)*: Same, v. 37, p. 79-124, pl. 1-7.
- Ross, R. J., Jr.**
 (258) 1951, *Stratigraphy of the Garden City Formation in northeastern Utah, and its trilobite faunas*: Peabody Mus. Nat. Hist., Yale Univ. (New Haven), Bull. 6, p. 1-161, pl. 1-36.
- Rusconi, Carlos**
 (259) 1952, *Fosiles cámbricos del Cerro Aspero, Mendoza*: Museo Historia Natural de Mendoza (Argentina), Revista, v. 6, p. 63-122, pl. 1-6.
 (260) 1954, *Trilobitas cámbricos de la Quebradita Oblicua, Sud del Cerro Aspero*: Same, v. 7, p. 3-59, pl. 1-4.
- Růžicka, R.**
 (261) 1926, *Faune des couches à Euloma du gisement ferrugineux près de Holoubkov (à Ouzký)*: Bull. Internat. Acad. tchéque Sci. (Praha).
 (262) 1931, *Supplément à la faune des couches à Euloma du gisement méallifère près de Holoubkov (à Ouzký)*: Zvláštní otisk z věstníku státního geologického ústavu Csl. Republiky (Praha), Ročník 7, p. 10-20, 1931 (also in Czech, p. 1-9).
 (263) 1938, *New trilobites from the Barrandien*: Bull. Internat. Acad. tchéque Sci. (Praha), p. 1-6, pl. 1.
 (264) 1940, *Trilobiten der ältesten kambrischen Fauna Böhmens von Tejrovic (Kamenna hurka)*: Same, année 40 (1939), p. 201-211, pl. 1-3.
- Saito, Kazuo**
 (265) 1934, *Older Cambrian Trilobita and Conchostraca from northwestern Korea*: Japan. Jour. Geol. Geog. (Tokyo), v. 11, no. 3-9, p. 211-237, pl. 25-27.
- Salter, J. W.**
 (266) 1853, *Figures and descriptions illustrative of British organic remains*: Mem. Geol. Survey Great Britain, decade 7, pl. 1-10.
 (267) 1864, *British fossils*: Same, decade 11.

Salter, J. W.

- (268) 1864-83, *A monograph of the British trilobites*: Palaeontogr. Soc. (London), Mon., p. 1-244, pl. 1-30 [p. 1-80, pl. 1-6, 1864; p. 81-128, pl. 7-14, 1865; p. 129-176, pl. 15-25, 1866; p. 177-214, pl. 26-30, 1867; p. 215-224, 1883; compenda, 1864; errata, 1865; addenda et compenda, 1866].

Schmidt, F.

- (269) 1881, *Revision der ostbaltischen silurischen Trilobiten nebst geognostischer Übersicht des ostbaltischen Silurgebiets, Abtheilung I, Phacopiden, Cheiruriden und Encrinuriden*: Mem. Acad. Imp. Sci. St. Petersbourg, ser. 7, v. 30, no. 1, p. 1-237, pl. 1-16.
- (270) 1888, *Über eine neuentdeckte untercambrische Fauna in Estland*: Same, ser. 7, v. 36, no. 2, p. 1-27, pl. 1-2.
- (271) 1904, *Revision der ostbaltischen silurischen Trilobiten, Abt. V, Lief. III*: Same, ser. 8, v. 14, no. 10.

Sdzuy, Klaus

- (272) 1955, *Die Fauna der Leimitz-schiefer (Tremadoc)*: Senckenberg. naturf. Gesell. (Frankfurt a.M.), Abhandl. 492, p. 1-74, pl. 1-8, fig. 1-48.

Shaw, A. B.

- (273) 1951, *The paleontology of northwestern Vermont, I, New Late Cambrian trilobites*: Jour. Paleont. (Tulsa), v. 25, no. 1, p. 97-114, pl. 21-24.
- (274) 1952, *Paleontology of northwestern Vermont, II, Fauna of the Upper Cambrian Rockledge Conglomerate near St. Albans*: Same, v. 26, no. 3, p. 458-483, 5 fig., pl. 57.

Shirley, Jack

- (275) 1936, *Some British trilobites of the family Calymenidae*: Quart. Jour. Geol. Soc. (London), v. 92, p. 384-422, pl. 29-31, fig.

Sivov, A. G.

- (276) 1955, [New genera of trilobites]: in CHALIPHINA, L. L., Atlas of guide forms of fossil faunas and floras of western Siberia, v. 1, Western Siberia Geol. Inst. (Tomsk), 501 p., 85 pl., 202 fig.

Skjeseth, Steinar

- (277) 1952, *On the lower Didymograptus zone (3B) at Ringsåker, and contemporaneous deposits in Scandinavia*: Norsk Geol. Tidsskr. (Oslo), v. 30, p. 138-182, illus.
- (278) 1955, *The Middle Ordovician of the Oslo region, Norway. 5. The trilobite family Styginidae*: Same, v. 35, p. 9-28, pl. 1-5.

Steinmann, G. & Hoek, H.

- (279) 1912, *Das Silur und Cambrium des Hochlandes von Bolivia und ihre Fauna*: Neues Jahrb. Mineral. Geol. Paläont. (Stuttgart), Beil.-Band 34, p. 176-252, pl. 7-14.

Størmer, Leif

- (280) 1939, *Studies on trilobite morphology. Part I. The thoracic appendages and their phylogenetic significance*: Norsk Geol. Tidsskr. (Oslo), v. 19, p. 143-273, pl. 1-12, fig. 1-35.
- (281) 1940, *Early descriptions of Norwegian trilobites*: Same, v. 20, p. 113-151, pl. 1-3.
- (282) 1942, *Studies on trilobite morphology. Part II. The larval development, the segmentation, and the sutures, and their bearing on trilobite classification*: Same, v. 21, p. 49-164, pl. 1-2.
- (283) 1944, *On the relationship and phylogeny of fossil and recent Arachnomorpha. A comparative study on Arachnida, Xiphosura, Eurypterida, Trilobita, and other fossil Arthropoda*: Norske Videnskaps-Akademi i Oslo, Mat.-Naturv. Kl., Skr., no. 5, 158 p., 30 fig.
- (284) 1951, *Studies on trilobite morphology. Part III. The ventral cephalic structures with remarks on the zoological position of the trilobites*: Norsk Geol. Tidsskr. (Oslo), v. 29, p. 108-158, pl. 1-4, 14 fig.

Struve, Wolfgang

- (285) 1958, *Beiträge zur Kenntnis der Phacopacea (Trilobita): 1. Die Zeliszkelinae. 2. Acastavinae n. subfam. 3. Treveropyge n. gen. und Comura (Delocare) n. subgen. (Asteroptyginae)*: Senckenberg. lethaea (Frankfurt a.M.), v. 39.

Stubblefield, C. J.

- (286) 1942, *Specimens of the trilobite Redlichia from the Cambrian of western Australia*: Geologists' Assoc. (London), Proc., v. 53, p. 107.

—, & Bulman, O. M. B.

- (287) 1927, *The Shineton Shales of the Wrekin district*: Quart. Jour. Geol. Soc. (London), v. 83, pt. 1, p. 96-146, pl. 3-5.

Sun, Y. C.

- (288) 1924, *Contributions to the Cambrian faunas of North China*: Geol. Survey of China, Palaeont. Sinica (Peiping), ser. B, v. 1, fasc. 4, p. 1-110, pl. 1-5.
- (289) 1935, *The Upper Cambrian trilobite faunas of North China*: Same, ser. B, v. 7, fasc. 2, 1935.

Suvorova, N. P.

- (290) 1956, *Cambrian trilobites from eastern Siberian platform*: Akad. Nauk SSSR Trudi, Paleont. Inst. (Moscow), v. 63, p. 1-158, pl. 1-12.

Tasch, Paul

- (291) 1951, *Fauna and paleoecology of the Upper Cambrian Warrior Formation of central Pennsylvania*: Jour. Paleont. (Tulsa), v. 25, p. 275-306, pl. 44-47.

Teixeira, Carlos

- (292) 1953, *La faune cambrienne de Vila Boim au Portugal*: Soc. Geol. Portugal (Lisbon), Bol., v. 10, p. 169-188.

Temple, J. T.

- (293) 1956, *Notes on the Cheiruracea and Phacopacea*: Geol. Mag. (Hertford), p. 418-430.

Thoral, M.

- (294) 1935, *Contribution à l'étude paléontologique del l'Ordovicien inferieur de la Montagne Noire et révision sommaire de la Montagne Noire*: Univ. Paris, Thèse, Faculté des Sci., p. 1-363, pl. 1-35.
- (295) 1946, *Conocoryphidae languedociens*: Univ. Lyon, Sci. naturelles, Ann., v. 4, p. 5-74, pl. 1-9.
- (296) 1948, *Solenopleuridae et Liostracidae languedociens*: Same, v. 6, p. 1-89, pl. 1-6.

Thorslund, Per

- (297) 1940, *On the Chasmops Series of Jemtland and Södermanland (Tvären)*: Sveriges Geol. Undersök. (Stockholm), ser. C., Årsbok 34, no. 6, p. 1-191, pl. 1-15, fig.

Tjernvik, T. E.

- (298) 1955, *Nericiaspis, a new genus of proparian olenids*: Geol. Fören. i Stockholm, Förhandl. v. 77, p. 209-212.
- (299) 1956, *On the Early Ordovician of Sweden*: Geol. Inst. Univ. Uppsala, Bull., v. 36, no. 9, p. 107-284.

Tripp, R. P.

- (300) 1957, *The classification and evolution of the superfamily Lichacea (Trilobita)*: Geol. Mag. (Hertford), v. 94, p. 104-122, fig. 1-8.

Troedsson, G. T.

- (301) 1937, *On the Cambro-Ordovician faunas of western Qurugtagh, eastern T'ien-shan*: Geol. Survey China, Palaeont. Sinica (Peiping), new ser. B, no. 2, p. 1-74, pl. 1-10.

Ulrich, E. O.

- (302) 1930, *Ordovician trilobites of the family Telephidae and concerned stratigraphic correlations*: Proc. U.S. Natl. Mus. (Washington), v. 76, p. 1-101, pl. 1-8.
- (303) 1930, *Trilobita*: in BRIDGE, J., *Geology of the Eminence and Cardareva Quadrangles*: Missouri Bureau Geol. Mines (Rolla), ser. 2, v. 24, p. 212-222, pl. 19, 21.

Vogdes, A. W.

- (304) 1890, *A bibliography of Palaeozoic Crustacea from 1698 to 1889, including a list of North American species and a systematic arrangement of genera*: U.S. Geol. Survey (Washington), Bull. 63, 177 p.
- (305) 1917, *Palaeozoic Crustacea. The publications and notes on the genera and species*

during the past twenty years, 1895-1917: San Diego Soc. Nat. History, Trans., v. 3, no. 1, p. 1-141, pl. 1-5.

- (306) 1925, *Palaeozoic Crustacea. Part II. A list of the genera and subgenera of the Trilobita*: Same, p. 87-115.

Walcott, C. D.

- (307) 1886, *Second contribution to the studies on the Cambrian faunas of North America*: U.S. Geol. Survey (Washington), Bull. 30, 369 p., illus.
- (308-309) 1890, *Fauna of the Lower Cambrian or Olenellus Zone*: Same, 10th Ann. Rept., pt. 1, p. 509-760, pl. 43-98.
- (310) 1905-06, *Cambrian faunas of China*: U.S. Natl. Mus. (Washington), Proc., v. 29, p. 1-106, no illus.; v. 30, p. 563-595, no illus.
- (311) 1908, *Cambrian geology and paleontology, No. 2, Cambrian trilobites*: Smithsonian Misc. Coll. (Washington), v. 53, p. 13-52, pl. 1-6 (Pub. 1805).
- (312) 1910, *Cambrian geology and paleontology, No. 6, Olenellus and other genera of the Mesonacidae*: Same, v. 53, p. 231-422, pl. 23-44 (Pub. 1934).
- (313) 1911, *Cambrian geology and paleontology, II, No. 4, Cambrian faunas of China*: Same, v. 57, p. 69-108, pl. 14-17 (Pub. 2012).
- (314) 1912, *Cambrian geology and paleontology, II, No. 8, The Sardinian Cambrian genus Olenopsis in America*: Same, v. 57, p. 239-249, pl. 36 (Pub. 2076).
- (315) 1913, *The Cambrian faunas of China*: Carnegie Inst. (Washington), Pub. 54, Research in China, v. 3, p. 1-276, pl. 1-24.
- (316) 1916, *Cambrian geology and paleontology, III, No. 3, Cambrian trilobites*: Smithsonian Misc. Coll. (Washington), v. 64, p. 155-258, pl. 24-38 (Pub. 2370).
- (317) 1916, *Cambrian geology and paleontology, III, No. 5, Cambrian trilobites*: Same, v. 64, p. 301-456, pl. 45-67 (Pub. 2420).
- (318) 1917, *Cambrian geology and paleontology, IV, No. 3, Fauna of the Mount Whyte Formation*: Same, v. 67, p. 61-114, pl. 8-13 (Pub. 2480).
- (319) 1918, *Cambrian geology and paleontology, IV, No. 4, Appendages of trilobites*: Same, v. 67, p. 115-216, pl. 14, 42, fig. 1-3 (Pub. 2523).
- (320) 1924, *Cambrian geology and paleontology, V, No. 2, Cambrian and Lower Ozarkian trilobites*: Same, v. 75, p. 51-60, pl. 9-14 (Pub. 2788).
- (321) 1925, *Cambrian geology and paleontology, V, No. 3, Cambrian and Ozarkian trilobites*: Same, v. 75, p. 59-146, pl. 15-24 (Pub. 2823).

Walcott, C. D., & Resser, C. E.

- (322) 1924, *Trilobites from the Ozarkian sandstones of the Island of Novaya Zemlya*: Rept. Sci. Results Norwegian Exped. to Novaya Zemlya, 1921, no. 24, p. 1-14, pl. 1-2.

Warburg, Elsa

- (323) 1925, *The trilobites of the Leptaena Limestone in Dalarne*: Geol. Inst. Univ. Uppsala, Bull., v. 27, p. 1-450, pl. 1-11, fig. 1-23.
- (324) 1939, *The Swedish Ordovician and Lower Silurian Lichidae*: K. Svenska Vetenskaps-akademiens (Stockholm), Handl., v. 17, no. 4, p. 1-162, pl. 1-14.

Weber, V. N.

- (325) 1948, *Trilobites of the Silurian rocks, no. 1, Lower Silurian trilobites*: Mon. Paleont. U.S.S.R. (Moscow), v. 69, p. 1-113, pl. 1-11.

Wedekind, Rud.

- (326) 1912, *Klassifikation der Phacopiden*: Deutsch. geol. Gesell. (Berlin), Zeitschr., v. 63, p. 317-336, pl. 15-16, fig. 1-2, 1 table.
- (327) 1914, *Paläontologische Beiträge zur Geologie des Kellerwaldes*: Preuss. geol. Landesanst. (Berlin), Abhandl., v. 69, p. 1-84, pl. 1-5, fig. 1-26.

Weller, J. M.

- (328) 1936, *Carboniferous trilobites and genera*: Jour. Paleont. (Tulsa), v. 10, p. 704-714, pl. 95.
- (329) 1937, *Evolutionary tendencies in American Carboniferous trilobites*: Same, v. 11, p. 337-346, text fig. 1-4.

Westergård, A. H.

- (330) 1917, *Notiser rörande Dictyograptuskiffern*: Geol. Fören. i Stockholm, Förhandl. v. 39, p. 635-644, pl. 7.
- (331) 1922, *Sveriges Olenidskiffer*: Sveriges. Geol. Undersök. (Stockholm), ser. Ca, no. 18, p. 1-205, pl. 1-16.
- (332) 1936, *Paradoxides oelandicus beds of Öland*: Same, ser. C, no. 394 (Årsbok 30, no. 1), p. 1-66, pl. 1-12.
- (333) 1944, *Borrningar genom Skånes Alunskiffer 1941-42*: Same, ser. C, no. 459, p. 1-45, pl. 1-6.
- (334) 1946, *Agnostidea of the Middle Cambrian of Sweden*: Same, ser. C, no. 477 (Årsbok 40, no. 1), p. 1-140, 1946.
- (335) 1947, *Supplementary Notes on the Upper Cambrian trilobites of Sweden*: Same, ser. C, no. 489, p. 1-34, pl. 1-3.
- (336) 1948, *Non-agnostidean trilobites of the Middle Cambrian of Sweden, pt. 1*: Same, ser. C, no. 498, p. 1-32, pl. 1-4.

- (337) 1950, *Non-agnostidean trilobites of the Middle Cambrian of Sweden, pt. 2*: Same, ser. C, no. 511, p. 1-56, pl. 1-8.

- (338) 1953, *Non-agnostidean trilobites of the Middle Cambrian of Sweden, pt. 3*: Same, ser. C, no. 526, p. 1-58, pl. 1-8.

Whitehouse, F. W.

- (339) 1936, *The Cambrian faunas of North-Eastern Australia*: Queensland Mus., Mem., v. 11, p. 59-112.
- (340) 1939, *The Cambrian faunas of North-Eastern Australia, pt. 3, The polymerid trilobites*: Same, v. 11, p. 179-282, pl. 19-25.

Whittard, W. F.

- (341) 1934, *A revision of the trilobite genera Deiphon and Onychopyge*: Ann. Mag. Nat. History (London), ser. 10, v. 14, p. 505-533, pl. 15, 16, fig. 1-3.
- (342) 1940, *The Ordovician trilobite fauna of the Shelve-Corndon district, West Shropshire. Part 1. Agnostidae, Raphiophoridae, Cheiruridae*: Same, v. 11, pt. 5, p. 153-172, pl. 5-6.
- (343) 1952, *Cyclopygid trilobites from Girvan and a note on Bohemilla*: Brit. Mus. (Nat. Hist.) Geol. 1 (London), Bull. 10, p. 307-321, pl. 32, 33.
- (344) 1955-56, *The Ordovician trilobites of the Shelve Inlier, West Shropshire*: Palaeontogr. Soc. (London), Mon., p. 1-7, pl. 1-9.

Whittington, H. B.

- (345) 1940, *On some Trinucleidae described by Joachim Barrande*: Am. Jour. Sci. (New Haven), v. 238, p. 241-259, pl. 1-4.
- (346) 1941, *The Trinucleidae—with special reference to North American genera and species*: Jour. Paleont. (Tulsa), v. 15, p. 21-41, pl. 5, 6.
- (347) 1941, *Silicified Trenton trilobites*: Same, v. 15, p. 492-522, pl. 72-75, 13 fig.
- (348) 1950, *A monograph of the British trilobites of the family Harpidae*: Palaeontogr. Soc. (London), Mon., p. 1-55, pl. 1-7.
- (349) 1950, *Swedish Lower Ordovician Harpidae and the genus Harpides*: Geol. Fören. i Stockholm, Förhandl., v. 72, p. 301-306, pl. 1.
- (350) 1950, *Sixteen Ordovician genotype trilobites*: Jour. Paleont. (Tulsa), v. 24, p. 531-565, pl. 68-75.
- (351) 1952, *A unique remopleuridid trilobite*: Breviora, Harvard Univ., Mus. Comp. Zoology (Cambridge), no. 4, p. 1-9, 1 pl.
- (352) 1952, *The trilobite family Dionididae*: Jour. Paleont. (Tulsa), v. 26, p. 1-11, pl. 1, 2.

- (353) 1953, *A new Ordovician trilobite from Florida*: Breviora, Harvard Univ., Mus. Comp. Zoology (Cambridge), no. 17, p. 1-6, pl. 1.
- (354) 1953, *North American Bathyruridae and Leiostegiidae (Trilobita)*: Jour. Paleont. (Tulsa), v. 27, p. 647-678, pl. 65-69, 5 fig.
- (355) 1954, *Status of Invertebrate Paleontology, 1953. VI. Arthropoda: Trilobita*: Harvard Univ., Mus. Comp. Zoology (Cambridge), Bull., v. 112, p. 193-200, 2 fig.
- (356) 1954, *Ordovician trilobites from Silliman's Fossil Mount*: in MILLER, A. K., et al., *Ordovician cephalopod fauna of Baffin Island*: Geol. Soc. America (New York), Mem. 62, p. 119-149, pl. 59-63, fig.
- (357) 1956, *Silicified Middle Ordovician trilobites: the Odontopleuridae*: Harvard Univ., Mus. Comp. Zoology (Cambridge), Bull., v. 114, p. 155-288, pl. 1-24.
- (358) 1956, *The trilobite family Isocolidae*: Jour. Paleont. (Tulsa), v. 30, p. 1193-1198, pl. 129-130.
- , & Evitt, W. R.
(359, 360) 1953, *Silicified Middle Ordovician trilobites*: Geol. Soc. America (New York), Mem. 59, 137 p., 33 pl., 27 fig.
- Williams, Alwyn**
(361) 1948, *The Lower Ordovician cryptolithids of the Llandeilo district*: Geol. Mag. (Hertford), v. 85, p. 65-88, pl. 6.
- Wilson, J. L.**
(362) 1949, *The trilobite fauna of the Elvinia Zone in the basal Wilberns Limestone of Texas*: Jour. Paleont. (Tulsa), v. 23, p. 25-44, pl. 9-11, 1 fig.
(363) 1951, *Franconian trilobites of the central Appalachians*: Same, v. 25, p. 617-654, pl. 89-95.
(364) 1954, *Late Cambrian and early Ordovician trilobites from the Marathon Uplift, Texas*: Same, v. 28, p. 249-285, pl. 24-27, 4 fig.
(365) 1956, *Revisions in nomenclature and new species of Cambro-Ordovician trilobites from the Marathon Uplift, West Texas*: Same, v. 30, p. 1341-1349, pl. 146.
- , & Frederickson, E. A.
(366) 1950, *The Irvingella major ("Ptychopleurites") Faunizone of the Upper Cambrian*: Am. Jour. Sci. (New Haven), v. 248, p. 891-902, pl. 1.
- Wiman, C.**
(367) 1908, *Studien über das Nordbaltische Silurgebiete*: Geol. Inst. Univ. Uppsala, Bull., v. 8, p. 73-168, pl. 5-8.

SOURCES OF ILLUSTRATIONS

- | | | |
|----------------------------|-------------------------------------|--|
| (368) Angelin, N. P. | (394) Delgado, J. F. | (420) Kramarenko, N. N. |
| (369) Bancroft, B. B. | (395) Delo, D. M. | (421) Lake, Philip |
| (370) Barrande, Joachim | (396) Diener, Carl | (422) Lamont, Archie |
| (371) Barrois, Charles | (397) Erben, H. K. | (423) Lermontova, E. V. |
| (372) Barton, D. C. | (398) Etheridge, R., & Mitchell, J. | (424) Lindström, G. |
| (373) Bayle, E. | (399) Frederickson, E. A. | (425) Lochman, Christina |
| (374) Beecher, C. E. | (400) ———, & Pollock, J. M. | (426) Lu, Y. H. |
| (375) Begg, J. L. | (401) Goldfuss, A. | (427) McLearn, F. H. |
| (376) Berg, R. R. | (402) Grönwall, K. A. | (428) Mansuy, H. |
| (377) Bergeron, J. M. | (403) Hall, James | (429) Matthew, G. F. |
| (378) Bigot, A. | (404) ———, & Clarke, J. M. | (430) Mitchell, J. |
| (379) Billings, Elkanah | (405) Harrington, H. J. | (431) Moberg, J. C., & Grönwall, K. A. |
| (380) Bornemann, J. G. | (406) Henningsmoen, Gunnar | (432) ———, & Segerberg, C. O. |
| (381) Bradley, J. H. | (407) Hintze, L. F. | (433) Monke, H. |
| (382) Brøgger, W. C. | (408) Holliday, Samuel | (434) Murchison, R. I. |
| (383) Chernyshev, T. | (409) Holm, Gerhard | (435) Nelson, C. A. |
| (384) Chernysheva, N. E. | (410) Howell, B. F. | (436) Newell, N. D. |
| (385) Clark, T. H. | (411) Hupé, Pierre | (437) Novák, O. |
| (386) Clarke, J. M. | (412) Inai, Yutaka | (438) Oehlert, D. P. |
| (387) Cobbold, E. S. | (413) Ivshin, N. K. | (439) Öpik, A. A. |
| (388) ———, & Pocock, R. W. | (414) Jaanusson, Valdar | (440) Palmer, A. R. |
| (389) Coignou, ——— | (415) Kegel, W. | (441) Péneau, J. |
| (390) Cooper, B. N. | (416) Kindle, C. H. | (442) Perner, J. |
| (391) Cooper, G. A. | (417) Kiaer, J. | (443) Poletaeva, O. K. |
| (391a) Cozzens, ——— | (418) King, W. B. R. | (444) Post, A. |
| (392) Cullison, J. S. | (419) Kobayashi, Teiichi | |
| (393) Dames, W. | | |

- (445) Poulsen, Chr.
 (445a) Přibyl, Alois
 (446) Pringle, J., & George,
 T. N.
 (447) Raasch, G. H., &
 Bell, W. C.
 (448) Rasetti, Franco
 (449) Raymond, P. E.
 (450) ———, & Barton, D. C.
 (451) ———, & Narraway,
 J. E.
 (452) Reed, F. R. C.
 (453) Regnéll, Gerhard
 (454) Reimann, I. G.
 (455) Remelé, A.
 (456) Rennie, J. V. L.
 (457) Resser, C. E.
 (458) Richter, Emma
 (459) Richter, Reinhold
 (460) Richter, Rudolf
 (461) ———, & Richter,
 Emma
- (462) Roemer, A.
 (463) Ross, R. J., Jr.
 (464) Růžicka, R.
 (465) Saito, Kazuo
 (466) Salter, J. W.
 (467) Schmidt, Herta
 (468) Schmidt, Fr.
 (469) Schmidt, W. E.
 (470) Sdzuy, Klaus
 (471) Shaw, A. B.
 (472) Shimer, H. W., &
 Shrock, R. R.
 (473) Størmer, Leif
 (474) Struve, Wolfgang
 (475) Stubblefield, C. J.
 (476) Stumm, E. C.
 (477) Sugiyama, Toshio, &
 Okano, Hirosi
 (478) Sun, Y. C.
 (479) Termier, Henri, &
 Termier, Geneviève
 (480) Tesch, Manu
- (481) Thomas, H. H.
 (482) Thomas, Ivor
 (483) Thorai, M.
 (484) Thorslund, Per.
 (484a) Tjernvik, T. E.
 (485) Toumansky, O. G.
 (486) Tripp, R. P.
 (486a) Troedsson, G. T.
 (487) Ulrich, E. O., &
 Resser, C. E.
 (488) Walcott, C. D.
 (489) Warburg, Elsa
 (490) Weber, V.
 (491) Weller, Stuart
 (491a) Westergård, A. H.
 (492) Wheeler, R. R.
 (493) Whitehouse, F. W.
 (494) Whitfield, R. P.
 (495) Whittard, F. W.
 (496) Whittington, H. B.
 (497) Wilson, J. L.
 (498) Woodward, H.

INDEX

Italicized names in the following index are considered to be invalid, those printed in roman type being accepted as valid. Suprafamilial names are distinguished by the use of full capitals and authors' names are set in small capitals with an initial large capital. Page references having chief importance are in boldface type (as O442).

- Abadiella, O205
 Abadiellidae, O151, O151, O205
 Abakanopleura, O517
 abaxial, O117
 abdomen, O9
Abruptae, O262
 Acadagnostus, O184
 Acadoparadoxides, O213
Acanthaloma, O506
Acanthocnemis, O276
Acanthogramma, O276
 Acantholenus, O517
Acantholominae, O152
 Acanthomicmacca, O208
 Acanthoparypha, O89, O128, O138-
 O140, O143, O435
 Acanthoparyphinae, O163, O435
 Acanthopleurella, O245
 Acanthopyge, O503
 Acastava, O475
 Acastavinae, O163, O475
 Acaste, O109, O488
 Acastella, O476
 Acastellina, O476
Acastina, O488
 Acastinae, O152, O163, O487
 Acastoides, O488
 Acerocare, O112, O154, O265
 Acerocarina, O266
 Achatella, O491
 Acheilops, O517
Acheilus, O285, O524
Acidaspidae, O147, O148, O504
 Acidaspides, O510
 Acidaspis, O51, O76, O89, O506
Acidiphorus, O379
 Acmarhachis, O173
 Acontheinae, O151, O161, O227
 Acontheus, O227
 Acrocephalaspis, O276
 Acrocephalina, O276
 Acrocephalites, O276
Acrocephalitidae, O152, O275
 Acrocephalitinae, O162, O275
 Acrocephalops, O304
 Acrohybus, O517
Acrolichas, O498
 acron, O11
Actinobolus, O372
Actinolobus, O372
 Actinopeltis, O434
Actinopeltis, O523
Aculeodiscus, O188
 Adastocephalum, O468
 adaxial, O117
Aeglina, O361
Aeglinidae, O149, O150, O361
Aeglininae, O148
 Aeonina, O384
 Agaso, O261
 aggregate eye, O117
 AGLASPIDA, O13
 Aglaspis (merostome), O28
Agnostacea, O172, O187
 AGNOSTIDA, O41, O45, O48,
 O67, O70, O86, O118, O121,
 O123, O124, O159, O160, O172
 Agnostidae, O141, O147-O151,
 O160, O172
Agnostidea, O172
 AGNOSTINA, O42, O70, O160,
 O172
 AGNOSTINI, O146, O172
 Agnostoidae, O151, O172
 Agnostus, O172
 Agraulidae, O151, O162, O278
Agrauloidae, O151, O274
Agrauloides, O278
 Agraulopsis, O234
 Agraulos, O86, O278
 Aguaraya, O512
 Aidarella, O517
 Akantharges, O503
 ala, O117
 Alanisia, O207
 alar furrow, O117
 Albansia, O275
 Albertella, O72, O227
Albertellidae, O151, O227
Alceste, O373
 Aldanaspis, O276
 Aldonia, O212
 Aldonaiinae, O161, O212
Aldoniinae, O151
Alemtejoia, O190
Aliger, O524
Aligerites, O524
Alloctops, O524
 Alokistocare, O231, O238
 Alokistocarella, O238
 Alokistocaridae, O76, O151,
 O161, O238
Alokistocarinae, O151
Alsataspididae, O428
 Alsataspididae, O67, O92, O156,
 O158, O163, O428
Alsataspis, O428
 Ambonolium, O313
Ambonslium, O313
 Amblyceranium, O278
Amececephalinae, O151
 Amecephalina, O238
Amecephalus, O238
 Ameura, O401
 Amgaspis, O513
 Amginouyia, O513
 Amiaspis, O279
 Amiella, O30
 Amphilichas, O498
Amphion, O439
Amphionidae, O439
 Amphoton, O222
 Amphotonella, O222
 Amphytion, O327
Ampycidae, O148, O426
 AMPYCINI, O146, O419
 Ampyx, O56, O97, O426
Ampyxininae, O152
 Amquia, O299
 Anabaraspis, O211
 Anacheirurus, O441
 Anadoxides, O214
 anaprotaspid stage, O128
 anaprotaspis, O117
 Anataphrus, O340
 Anchiopella, O469
 Anchiopsis, O75
Anchiopsis, O468
 Ancyropyge, O75, O509
Andersonia, O320
 Anderssonella, O320
Anderssonia, O320
Andesaspis, O266
 Andrarina, O261
 Andrarinidae, O162, O260
Aneuacanthus, O227
Aneuacanthus, O227
 ANGELIN, O41
 Angelina, O50, O113, O267
 Anglagnostus, O179
 Angusteva, O207
 Anisonotella, O426
Anisonotus, O426
 Anisopyge, O402
Anisopyginae, O152
 Ankoura, O285
Annamitella, O524
 Annamitia, O238
 ANNELIDA, O4
Anomalocephalus, O239
 Anomocaracea, O162, O286
 Anomocare, O107, O286
 Anomocarella, O290
Anomocarellidae, O151
 Anomocaridae, O150, O152, O162,
 O232, O286
 Anomocarina, O287
 Anomocarioides, O287
 Anomocariopsis, O288
Anopocare, O264
 Anopolenus, O214
 Anoria, O72, O222
Anorina, O355
Antagmidae, O151
 Antagminae, O161, O235
 Antagmus, O235
 Antatlasia, O209
Antatlasidae, O151
 Antatlasinae, O161, O209
 antenna, O77, O117

- antennary pit, O117
ANTENNATA, O15
 antenniform cercus, O84, O117
 antennular pit, O118
 antennule, O10
 anterior area (of fixed cheek), O118
 anterior area (of fixigena), O118
 anterior border, O118
 anterior border furrow (of cephalon), O118
 anterior branch (of facial suture), O118
 anterior flange, O118
 anterior lateral labellar furrow, O118
 anterior lateral glabellar lobe, O118
 anterior limb, O118
 anterior lobe (of glabella), O118
 anterior lobe (of hypostoma), O118
 anterior median process, O118
 anterior pit, O118
 anterior pleural band, O118
 anterior pleural spine, O118
 anterior region (of fixed cheeks), O118
 anterior region (of fixigena), O118
 anterior wing (of hypostoma), O54, O118
Anthes, O264
Anthracopeltis, O524
 Aojia, O311
 Apachia, O278
 Apatokenhalina, O331
 Anatokephalus, O48, O114, O329
Apedopyganus, O304
 Aphelaspis, O256
 Apianurinae, O167, O508
 Apianurus, O509
 apodeme, O6, O70, O94, O118
 apodemal pit, O118
 Aposolenopleura, O306
 appendages, of Trilobitoidea, O26
 appendifer, O118
 appendiferal pit, O118
ARACHNIDA, O13, O15
Araiopleura, O429
Arapahoia, O409
Archaeagnostus, O184
Archaeops, O200
Archegonus, O392
ARCHIASPIDES, O146
 archicerebrum, O9
Arctaspis, O276
Arctinuroides, O496
Arctinurus, O42, O496
Arcuolimbus, O301
 area, O118
Areia, O91, O438
Areiinae, O152, O163, O438
Arellanella, O238
Arethusia, O406
Arethusina, O406
Arethusinidae, O148
Arges, O501
Argatinae, O500
Arion, O278
Arionellus, O278
Arionides, O278
Aristoharpes, O416
Armagnostus, O184
Arnomia, O306
Arraphidae, O415
Arraphus, O416
Arthricocephalus, O524
ARTHROPODA, O3, O4
Arthrorhachinae, O176
Arthrorhachis, O178
ARTICULATA, O4
 articulating boss (and socket), O118
 articulating facet, O73
 articulating furrow, O118
 articulating half ring, O70, O118
 Artokephalus, O331
 Asaphacea, O162, O334
 Asaphellina, O356
 Asaphelloides, O355
 Asaphellus, O56, O346
 asaphid enrollment, O104
 asaphid suture pattern, O67, O158
 Asaphidae, O42, O48, O54, O66-
 O68, O72, O76, O96, O97, O102, O105, O121, O147-O150, O152, O159, O162, O334
ASAPHINA, O162, O231, O334
 Asaphinae, O152, O162, O334
ASAPHINI, O146, O334
Asaphininae, O148
 Asaphiscacea, O162, O290
 Asaphiscidae, O152, O162, O232, O290
 Asaphiscinae, O152, O162, O290
Asaphiscoidae, O152, O290
 Asanhiscus, O44, O290
Asaphoidae, O152
 Asaphopsis, O359
 Asaphopsoides, O359
 Asaphus, O50, O56, O76, O88, O93, O94, O101, O103, O105-O108, O231, O335
Asioptychaspis, O320
 Asperocare, O222
 Asoidagnostus, O173
Aspidaeglina, O361
 associated, O118
Asteraspis, O304
 Asteropyge, O77, O78, O81, O111, O477
 Asteropyginae, O152, O163, O477
 Asthenopsis, O275
 Astroproctus, O395
 Astycoryphe, O398
Astycoryphinae, O152
 Ataktaspis, O315
 Athabaskia, O222
 Athabaskiella, O222
 Atops, O91, O242
Atosidae, O152
Aulacodiscidae, O151
 Aulacodiscus, O91
Aulacodiscus, O148, O188
 Aulacoparia, O335, O336
 Aulacoparina, O336
 Aulacopleura, O406
 Aulacopleuridae, O148, O163, O406
 Aulacopleurina, O407
Aulacopleurinae, O152
 Austinvillia, O235
 Australoharpes, O417
 Australopyge, O354
Autolichas, O496
Autoloxolichas, O498
 auxiliary impressions, O96
 Avalonia, O512
Avonaspis, O281
 Avonina, O233
 Avoninidae, O162, O283
 axial furrow, O46, O73, O118
 axial glabellar furrow, O118
 axial line, O118
 axial lobe, O118
 axial node, O118
 axial region, O118
 axial ring, O70, O73, O118
 axial spine, O118
 axis, O73, O118
 axothorax, O118
 Aysheiaia, O17, O18
Aysheidae, O18
 Aysheiididae, O18
 Babakovia, O219
 Bailiaspis, O157, O242
 Bailiella, O104, O157, O242
Bailiellinae, O152
 Bainella, O484
 Baltagnostus, O184
 BARRANDE, O41, O63, D96, O99, O101, O102, O136, O141, O146
 Barrandia, O101, O357
Barrandia, O192
 BARROIS, O41
 basal lobe (of glabella), O48, O118
 basal furrow, O118
 Basidechenella, O388
Basilicoides, O354
 Basilicus, O336
 Basiliella, O51, O336
 basipod, O8
 basipodite, O118
 Basocephalus, O217
 Bathycheilus, O453
 Bathynotellus, O216
 bathynotid suture pattern, O67, O159
 Bathynotidae, O72, O151, O159, O161, O216
BATHYNOTINA, O161, O216
 Bathynotus, O64, O67, O72, O216
 Bathyracea, O163, O376
Bathyrellinae, O152
 Bathyrellus, O376
 Bathyuridae, O102, O105, O149, O150, O152, O163, O376
 Bathyurina, O376
Bathyurinae, O152
 Bathyuriscellus, O207
Bathyuriscidae, O150, O220
Bathyuriscidea, O150
 Bathyuriscidella, O222

- Bathyriscinae*, O151
Bathyriscus, O110, O224
Bathyrurus, O376
Battoides, O172
Battus, O172
Bavarilla, O455
Bavarillinae, O163, O455
Bayfieldia, O325
 BECKMAN, O88
 BEECHER, O41, O62, O75, O127, O128, O146, O153, O159
Bellaspidella, O252
Bellaspis, O306
Bellefontia, O101, O353
Belovia, O510
Beltella, O266
Beltina, O4, O13
Bemaspis, O306
Benthamaspis, O295
Bergamia, O423
 BERGERON, O41
Bergeronia, O211
Bergeroniaspis, O211
Bergeroniellus, O211
Berkeia, O256
Bernia, O272
Bernicella, O312
Bertillon pattern, O43, O118
Bettonia, O423
Bevanopsis, O448
 BEYRICH, O40
Bicaspis, O513
Bicella, O235
bicomposite glabellar lobe, O118
Bienella, O311
Bienvillia, O267
Bigotina, O51, O212
Bigotininae, O151, O161, O212
Bigotinops, O211
Billingaspis, O524
 BILLINGS, O41, O76
Binodaspis, O512
biramous appendage, O78, O118
Birmanites, O48, O359
Blackwelderia, O317
Blackwelderioides, O317
Blainia, O290
Blainiopsis, O290
Blandicephalus, O256
Blayacina, O211
blind trilobites, O62
blindness, O91
Blountia, O292
Blountiana, O292
Blountidae, O292
Blountiidae, O152
Blountiinae, O162, O292
Blountina, O292
Bodenbenderia, O521
Boeckaspis, O154, O266
Boeckia, O266
Bohemilla, O525
Bohemillidae, O525
Bohemopyge, O350
Bolaspidella, O304
Bolaspidae, O162, O304
Bolaspis, O304
Bolbocephalus, O376
Bollandia, O399
Bondonella, O195
Bonnaria, O217
Bonnaspis, O227
Bonneterrina, O248
Bonnia, O217
Bonniella, O217
Bonniopsis, O217
border, O50, O73, O119
border furrow, O119
border pit, O119
 BORN, O96
Bornemannia, O226
Borogothus, O353
Borthaspidella, O358
Borthaspis, O358
Boschchekulia, O363
Botrioides, O420
Bouleia, O148, O155, O466
Bouleiinae, O152, O163, O466
Bouleinae, O152
Bounyongia, O509
Bowmania, O517
Brachyampyx, O426
Brachyaspidon, O286
Brachyaspis, O355
Brachyaspidis, O286
Brachymetopidae, O152, O163, O406
Brachymetopina, O407
Brachymetopinae, O407
Brachymetopus, O62, O407
Brachypleura, O327
Brackebuschia, O521
Braintreella, O233
branchiae, O13
 BRANCHIOPODA, O16, O28
Brassiccephalus, O48, O299
Brevidiscinae, O151, O187
Brevidiscus, O188
Brevitermierella, O211
Bridgeia, O517
brim, O119
brim prolongation, O119
 BRINK, O88
Briscoia, O254
Bristolia, O154, O192
 BRØGGER, O41
Broeggeria, O422
Broeggerolithus, O422
 BROILI, O41
 BRONGNIART, O40, O146
Brongniartella, O456
Brongniartia, O456
Bronteidae, O147-O150, O367
Bronteides, O367
Bronteopsis, O366
Brontes, O369
Bronteus, O369
Brunswickia, O234
Bucksella, O281
Bulaiaspis, O200
Bumastides, O358
Bumastinae, O152, O163, O374
Bumastoides, O374
Bumastus, O120, O374
Burgessia, O14, O24, O32
BURGESSIDA, O32
Burgessidae, O32
 BURGESSIIDA, O28, O32
Burgessiidae, O28, O32
Burgess Shale, O22, O77, O101
 BURLING, O107
Burlingia, O59, O60, O119, O293
Burlingiacea, O162, O293
Burlingidae, O149, O293
Burlingiidae, O149-O152, O159, O232, O293
Burlingiidea, O150, O293
burlingiiform sutures, O59, O119
Burlingioidae, O152, O293
 BURMEISTER, O40, O146, O148
Burmeisterella, O461
Burmeisteria, O460
Burnetia, O281
Burnetiella, O281
Burnetiidae, O152, O281
butress (of fixed cheek), O119
butress (of fixigena), O119
Buttsia, O285
Bynumia, O286
Bynumiella, O286
Bynumina, O286
Bythicheilus, O238
Caborcella, O233
Cainatops, O242
Calipernurus, O509
Callavia, O57, O193
Callaviinae, O161, O192
Calliops, O492
 CALMAN, O8, O28
Calmonia, O484
Calmoniidae, O163, O483
Calmoniinae, O152, O163, O483
Calmoninae, O483
Calodiscinae, O151, O187
Calodiscus, O188
Calvinella, O323
Calybole, O390
Calymaena, O452
Calymena, O452
Calymenacea, O450
Calymene, O71, O452
Calymenella, O455
Calymenesun, O452
calymenid suture pattern, O159
Calymenidae, O45, O56, O67, O76, O96, O102, O119, O147-O150, O152, O159, O163, O450
Calymenidea, O150, O450
Calymenidius, O279
 CALYMENINA, O149, O163, O231, O450
Calymeninae, O152, O163, O450
Calymenoidae, O152, O450
Calymenopsis, O234, O450
Calymmena, O452
Calymmene, O452
Calymmenidae, O450
Calypaulax, O492
Calypaulax (subgen. A), O492
Calypotomma, O296
Camaraspidae, O256
Camaraspis, O256
Camaraspoides, O257

- Campylopleuri*, O242
Cancapolia, O524
Canotagnostus, O179
Canotiana, O524
Caphyra, O327
 carapace, O43, O119
Carbonocoryphe, O394
Carlopsia, O525
 Carmon, O521
Carnicia, O62, O394
 Carolinites, O295
 CARPENTER, O15
Catadoxides, O214
Catillicephala, O284
Catillicephalidae, O67, O68, O159, O162, O284
Catuniella, O290
 caudal ramus, O119
 caudal shield, O119
 caudal spine, O119
 CAULOGASTRA, O15
Cayastaia, O524
Cedaria, O60, O119, O301
Cedariidae, O152, O301
 cedariiform suture, O60, O119
Cedariinae, O162, O301
Cedarina, O301
Cekovia, O372
Celmidae, O163, O409
Celmus, O409
 central area (of glabella), O47, O119
 central body (of hypostoma), O119
 central region (of glabella), O119
Centropleura, O214
Centropleurinae, O151, O161, O213
 cephalic muscles, O94
 cephalic region, O45, O119
 cephalic spine, O51, O119
 cephalic sutures, O152
Cephalobaena (pentastomid), O17
 CEPHALOCARIDA, O16
Cephalocoelia, O284
Cephalocoeliidae, O284
 cephalon, O9, O43, O45, O119
Ceratagnostus, O178
Ceratarges, O41, O501
Ceratarginae, O163, O500
Ceratevenkaspis, O494
Ceratocephala, O51, O56, O71, O507
Ceratocephalidae, O152, O506
Ceratocephalina, O507
Ceratocephalinae, O152
Ceratolichas, O498
Ceratonurus, O507
Ceratopeltis, O521
Ceratopygacea, O162, O362
Ceratopyge, O48, O75, O363
Ceratopygidae, O48, O150, O152, O158, O159, O160, O363
Ceratopyginae, O152
Ceratopygoidae, O152
Cerauridae, O431
Ceraurinella, O54, O68, O96, O97, O118, O120, O124, O125, O135, O140, O142, O432
Ceraurinus, O432
Cerauroides, O432
Ceraurus, O72, O75, O76, O78, O80, O82-O85, O97, O99, O107, O136, O142, O433
 cercopod, O8
 cercus, O119
 cervical lobe, O119
Chakasskia, O513
Champlainia, O235
Chancia, O238
Changia, O320
Changshania, O247
Changshaniidae, O152, O247
Changshaniinae, O161, O247
Changshaninae, O247
Changshanocephalus, O524
 CHAPMAN, O146
Charchaqua, O354
Charchaquia, O354
Chariocephalus, O297
Chasmopinae, O163, O492
Chasmops, O95, O96, O493
Chasmopsidae, O492
Chattiaspis, O475
Chaunoproetus, O394
 cheek, O119
 cheek area, O119
 cheek lobe, O119
 cheek region, O119
 cheek roll, O119
 cheek roll prolongation, O119
Cheilocephalidae, O162, O312
Cheilocephalus, O312
Cheiropyge, O408
Cheiruracea, O430
Cheiruridae, O45, O56, O67, O72, O76, O89, O91, O92, O96, O100, O102, O118, O147-O150, O152, O159, O163, O431
 CHEIRURINA, O163, O430
Cheirurinae, O152, O163, O431
Cheiruroidae, O152, O430
Cheiruroides, O220
Cheirurus, O56, O93, O154, O431
 CHELICERATA, O4, O11, O15, O28
Chelidonocephalus, O238
 CHELONIPELLIDA, O28, O35
Cheloniellidae, O28, O35
Cheloniellon, O24, O35
Chilometopus, O224
Chilonorria, O224
 CHILOPODA, O10, O14, O16
Chiruridae, O431
Chirurides, O431
Chirurus, O431
Chittidilla, O513
Cholopilus, O313
Chomatopyge, O412
Chondragraulos, O515
Chondranomocarc, O290
Chondroparia, O515
Choneilobarges, O503
Chosenia, O524
Choubertella, O51, O198
Chuagia, O313
Chuangia, O313
Chuangiella, O313
Chuangiopsis, O313
Chuangites, O524
 cicatrization, O107
Ciceragnostus, O45, O184
 circulatory system, of Arthropoda, O13
 circulatory system, of trilobites, O101
 CIRRIPEDIA, O16
Clappaspidinae, O152
Clappaspinae, O152
Clappaspis, O239
Clarella, O214
Clariondia, O201
 CLARKE, O41, O88, O89
 classification, of Arthropoda, O15
 classification, of Trilobita, O42, O160
 classification, of Trilobitoidea, O28
Clavagnostidae, O151, O161, O173
Clavagnostus, O174
Clavaspidella, O224
Clavatellus, O430
Clelandia, O521
Clevelandella, O256
Cliffia, O276
Clypoproetus, O395
Cnemidopyge, O427
 COBBOLD, O41
Cobboldia, O190
Cobboldites, O524
Cobboldus, O193
Coelaspis, O240
Coenaspis, O304
Coignouina, O406
Coleopachys, O250
 COLLEMBOLA, O16
Collyrolenus, O211
 color patterns of trilobites, O107
Colpocoryphe, O456
Colpocoryphinae, O152, O163, O456
Colpocoryphoides, O453
Columbicephalus, O355
Comanchia, O252
Comluella, O207
 composite internal mold, O119
 compound eye, O119
Comura, O479
Conagraulos, O524
Conaspis, O320
Condylopyge, O174
Condylopygidae, O151, O161, O174
 connective suture, O65, O119
Conocephalidae, O242
Conocephalites, O242
Conocephalus, O242
Conocoryphacea, O161, O242
Conocoryphe, O66, O100, O157, O242
 CONOCORYPHIDA, O149, O231, O242
Conocoryphidae, O66, O67, O70, O91, O100, O147, O149, O150, O152, O159, O161, O232, O242
 CONOCORYPHINA, O149, O231, O242
Conocoryphinae, O152

- Conocoryphoidae*, 0151
Conoides, 0515
Conocephalina, 0238
Conocephalinae, 0237
Conocephalinidae, 0152
Conocephalininae, 0161, 0237
Conocephalinoidae, 0152
Conolichas, 0498
Conomicmacca, 0208
Conoparia, 0405
Conophrys, 0245
Continuae, 0262
COOPER, 0143
Coosella, 0309
Coosellidae, 0162, 0309
Coosia, 0309
Coosina, 0310
COPEPODA, 016
Corbinia, 0325
Cordania, 0408
Coreanocephalus, 0320
Coreolenus, 0212
corner furrow, 0119
Cornuproetinae, 0163, 0385
Cornuproetus, 0385
Coronocephalus, 0446
Coronura, 042, 0109, 0110, 0470
Coronurinae, 0468
Corrugatagnostus, 0176
Corycephalus, 0470
Corydocephalus, 0503
corynexochid suture pattern, 067, 0158
CORYNEXOCHIDA, 0161, 0217, 0231
Corynexochidae, 067, 091, 0150, 0151, 0158, 0161, 0226
Corynexochides, 0224
Corynexochina, 0227
Corynexochinae, 0151, 0161, 0226
Corynexochoidae, 0151
Corynexochus, 0227
Costapyge, 0525
Cotalagnostus, 0184
Coulomania, 091, 0157, 0242
coxa, 08, 078, 0119
coxite, 0119
coxopod, 08
coxopodite, 08, 0119
cranidium, 046, 0119
Craspedarges, 0503
Crassifimbria, 0236
Crassiproetus, 0385
crenulation, 0119
Crepiceaphlus, 0248
Crepicepalus, 0248
Crepicephalacea, 0161, 0248
Crepicephalidae, 075, 0152, 0161, 0248
Crepicephalina, 0249
Crepicephalinae, 0152
Crepicephalus, 0248
Crepichilella, 0306
Crepicocephalus, 0248
Crithias, 0276
Croixana, 0272
Cromus, 075, 0447
Crossoura, 0521
Crotalocephalus, 0431
Crotalurinae, 0152
Crotalurus, 0409
Crusoida, 0275
CRUSTACEA, 04, 08, 011, 013, 016
Cryphaeoides, 0485
Cryphaeus, 0480
Cryphina, 0479
Cryphops, 062, 088, 0111, 0463
Cryptoderaspis, 0517
cryptolithid enrollment, 0104
Cryptolithidae, 0120, 0121, 0150, 0151, 0422
Cryptolithidea, 0150, 0419
Crytolithinae, 0152, 0163, 0422
Crytolithoides, 0422
Crytolithus, 026, 056, 064, 066, 076, 078, 082, 092, 096, 097, 0422
Cryptonymus, 0372, 0446
Ctenocephalinae, 0152
Ctenocephalus, 066, 0242
Ctenopyge, 075, 0154, 0159, 0264
Culipagnostus, 0178
Cummingella, 0401
Curiaspis, 0521
cuticula, 06
CUVIER, 04
Cuyanaspis, 0521
Cybele, 095, 0448
Cybelella, 0448
Cybelidae, 0163, 0448
Cybelinae, 0448
Cybelina, 0448
Cybelinae, 0152
Cybelleta, 0448
Cybeloides, 056, 0448
Cybelopsis, 0439
Cyclagnostidae, 0151
Cyclagnostus, 0182
Cyclognathina, 0266
Cyclognathus, 0266
Cyclopagnostidae, 0161, 0174
Cyclopagnostus, 0175
Cyclopygacea, 0162, 0361
Cyclopyge, 0361
Cyclopygidae, 087, 0149, 0150, 0152, 0162, 0361
Cyclopyginae, 0148, 0361
Cylindraspis, 0392
Cylindrocephalus, 0525
Cyphaspidae, 0148, 0150, 0403
Cyphaspidinae, 0406
Cyphaspididinae, 0152
Cyphaspidinae, 0163, 0406
Cyphaspis, 0405
Cyphinioides, 0401
Cyphinium, 0401
Cypholichas, 0498
Cyphoniscus, 0512
Cyphoproetus, 0385
Cyranolichas, 0498
Cyrtodechenella, 0390
Cyrtometopinae, 0152, 0163, 0433
Cyrtometopus, 089, 0434
Cyrtoproetus, 0413
Cyrtosymbole, 0389
Cyrtosymbolidae, 0152, 0389
Cyrtosymbolinae, 0152, 0163, 0389
Cystispina, 0394
Dactylocephalus, 0359
dactylopod, 08
Daguinaspidae, 0151, 0197
Daguinaspididae, 050, 067, 0151, 0161, 0197
Daguinaspis, 049, 063, 0120, 0121, 0198
DALMAN, 040, 0146
Dalmania, 0468
Dalmaniopsis, 0525
Dalmanitacea, 0163, 0468
Dalmanites, 090, 096, 0119, 0468
Dalmanitidae, 042, 056, 067, 077, 096, 0152, 0159, 0163, 0468
dalmanitiform suture, 0119
Dalmanitina, 056, 0135, 0138-0140, 0142, 0475
Dalmanitinae, 0152, 0163, 0468
Dalmanitoides, 0470
Dalmaniturus, 0485
Dalmannia, 0468
Damesella, 057, 0317
Damesellacea, 0162, 0316
Damesellidae, 053, 057, 0152, 0162, 0316
Damesellinae, 0152, 0162, 0317
Dartonaspid, 0295
Dasometopus, 0157, 0242
Dawsonia, 0188
DAWSONIDA, 0187
Dawsoniidae, 0151, 0187
Dawsoniidea, 0187
Deadwoodia, 0306
Decaulion, 0372
Dechenella, 0387
Dechenellidae, 0152
Dechenellinae, 0163, 0387
Deckera, 0281
Decoroproetus, 0398
degree of meraspis period, 0119
Deiocoryphe, 0159
Deiphon, 041, 046, 075, 0436
Deiphoninae, 0152, 0163, 0436
Deiracephalus, 0304
Deissella, 0304
Delaria, 0401
Delgadella, 0190
Delgadodiscus, 0190
Delgadoia, 0190
Delgadoiinae, 0188
Dellea, 0306
Delocare, 0479
Deltacare, 0521
Deltadiscus, 0188
Deltophthalmus, 0304
Denckmannia, 0467
Denckmannites, 0105, 0467
Denemarkia, 0398
Denemarkiinae, 0152

- Denisia*, 0285
Densonella, 0304
 denticle, 0119
Dereimsia, 0463
Desmetia, 0267
Despujolsia, 0204
Despujolsiidae, 0161, 0204
Deuterolichas, 0498
deutocerebrum, 09
Diacalymene, 0452
Diacanthaspis, 0141, 0506
Diacoryphe, 0394
Dianops, 062, 091, 0105, 0111, 0463
Diaphanometopinae, 0163, 0445
Diatemnus, 0267
Dicellocephalidae, 0148
Diceratocephalidae, 0162, 0334
Diceratocephalus, 0334
Diceratopyge, 0363
Dichagnostus, 0174
Dichelepyge, 072, 0363
Dicranactis, 0369
Dicranogmus, 0503
Dicranopeltinae, 0152
Dicranopeltis, 045, 075, 0496
Dicranopeltoides, 0496
Dicranurinae, 0152
Dicranurus, 0507
Dictya, 0356
Dictyella, 0525
Dictyites, 0356
Dictyocephalites, 0418
Dienstina, 0467
 digestive system, of Trilobitoidea, 026
Digonus, 0461
Digrypos, 0424
Dikelocephalacea, 0161, 0251
Dikelocephalidae, 057, 068, 075, 0124, 0148-0150, 0152, 0159, 0162, 0232, 0252
Dikelocephalidea, 0150, 0251
Dikelocephalinae, 0147, 0152
Dikelocephaliniidae, 075
Dikelocephalites, 0258
Dikelocephaloidae, 0152, 0251
Dikelocephalopsis, 0361
Dikelocephalus, 057, 067, 068, 0159, 0254
Dikelocephalina, 0359
Dikelocephalinidae, 0162, 0359
Dikelocephalininae, 0152
Dimastocephalus, 0295
Dimeropyge, 063, 064, 067, 075, 0107, 0109, 0136, 0412
 dimeropygid suture pattern, 067, 0159
Dimeropygidae, 094, 0105, 0122, 0125, 0152, 0159, 0163, 0412
Dimeropygiella, 0412
Dindymene, 091, 0448
Dindymeninae, 0163, 0448
Dinesidae, 0151, 0161, 0230
Dinesus, 0230
Dionide, 041, 046, 066, 071, 0142, 0424
Dionideae, 0148, 0424
Dionidella, 0424
Dionididae, 066, 067, 073, 092, 0100, 0148, 0152, 0163, 0424
Dipharus, 0525
Diplagnostidae, 0151, 0161, 0175
Diplagnostus, 0175
Diplapatokephalus, 0329
Dipleura, 064, 066, 0143, 0460
Dipleuropyge, 0363
Diplolichas, 0503
 DIPLOPODA, 014, 016
Diplopsites, 0525
Diplorrhina, 0186
Diploxyga, 0525
 discoidal enrollment, 0104
 distal, 0119
Distazeris, 0285
Ditomopyge, 048, 049, 0107, 0122, 0401
Ditomopyginae, 0152
Dokimocephalidae, 0152, 0162, 0281
Dokimocephalus, 0281
Dolerasaphus, 0349
Dolerobasilicus, 0354
Dolerolenidae, 0151, 0161, 0205
Dolerolenus, 0207
Dolgaia, 0290
Dolichoharpes, 0417
Dolichometopidae, 067, 072, 0151, 0158, 0161, 0220
Dolichometopinae, 0151
Dolichometopsis, 0224
Dolichometopus, 0221
 dorsal exoskeleton, 043, 0119
 dorsal furrow, 0119
 dorsal shield, 0119
Doryagnostus, 0178
Dorypyge, 057, 0217
Dorypygella, 0248
Dorypygellinae, 0152
Dorypygidae, 057, 067, 076, 0151, 0158, 0161, 0217
Dorypygina, 0217
Dorypyginae, 0151
 double enrollment, 0104
 doublure, 043, 045, 053, 075, 0119
Drabia, 0233
Drepanura, 0317
Drepanurinae, 0152, 0162, 0317
Dresbachia, 0304
Drevermannia, 062, 091, 0393
Drumaspis, 0297
Drummuckaspis, 0508
Dubhglasina, 0418
Ductina, 062, 066, 070, 091, 092, 0156, 0159, 0467
Dudleyaspis, 0506
Dunderbergella, 0290
Dunderbergia, 0238
Dysplanus, 046, 064, 065, 089, 095, 0374
Dytremacephalus, 0258
Ebenezeria, 0194
Eccaparadoxides, 0213
Eccoptychile, 0435
Eccoptychiloides, 0435
 ecdysis, 07, 058, 0111, 0119
Echinolichadinae, 0152
Echinolichas, 0498
Ectenaspis, 0341
Ectenonotus, 0449
Ectillaeninae, 0163, 0374
Ectillaenus, 042, 046, 097, 0374
Edelsteinaspididae, 0151
Edelsteinaspididae, 0151
Edelsteinaspis, 0515
Edgellia, 0420
Edmundsonia, 0427
Egle, 0361
Ehmania, 0238
Ehmaniella, 076, 078, 0239
 EICHWALD, 041, 076
Eiffiarges, 0503
Eilura, 0515
Eirelithus, 0423
Ekeraspis, 0349
Elasmaspis, 0494
Eldoradia, 0305
Eleutherocentrus, 0378
Elkia, 0254
Ellipsocephalacea, 0161, 0207
Ellipsocephalidae, 067, 0148-0151, 0161, 0207
Ellipsocephalidea, 0150, 0207
Ellipsocephalinae, 0151, 0161, 0207
Ellipsocephaloidae, 0152
Ellipsocephaloides, 0517
Ellipsocephaloididae, 0152, 0207
Ellipsocephalus, 0104, 0207
Ellipsostrenua, 0207
Ellipsotaphrus, 087, 0361
Elliptocephala, 0130, 0131, 0194
Elliptocephalinae, 0151, 0161, 0194
Ellsaspis, 0522
Elrathia, 0240
Elrathiella, 049, 0240
Elrathiellinae, 0151
Elrathina, 051, 076, 0240
Elrathinidae, 0151
Elrathininae, 0151
Elvinia, 0296
Elviniidae, 0152, 0162, 0296
Elviniinae, 0152
Elvininae, 0296
Elyx, 0100, 0157, 0243
Embolimus, 0227
Emeraldella, 015, 024, 030
 EMERALDELLIDA, 028, 030
Emeraldellidae, 028, 030
 EMMRICH, 040, 0146, 0148
Emmrichella, 0247
Emmrichellacea, 0161, 0246
Emmrichellidae, 0152, 0161, 0247
Emmrichellinae, 0161, 0247
Emsurina, 0441
Encrinurella, 0449
Encrinuridae, 056, 065, 067, 091, 092, 096, 0118, 0147-0150, 0152, 0159, 0163, 0445
Encrinurinae, 0152, 0163, 0446
Encrinuroides, 0447

- Encrinurus, O50, O446
 endite, O8, O79, O119
 ENDO, O41
 Endoaspis, O522
 endocuticula, O6
Endogramma, O276
 endopodite, O119
Endymion, O427
 Endymionia, O427
Endymionidae, O427
 Endymioniidae, O152, O163, O427
Enetagnostus, O175
Enneacnemis, O276
Enontoura, O410
 enrollment, O102
Entomaspidae, O152, O419
 Entomaspidae, O152, O163, O419
 entomaspidiform sutures, O61, O119
 Entomaspis, O51, O59, O61, O119, O157, O419
 Entomolithus, O146
Entomolithus, O40
 ENTOMOSTRACITES, O40
Eoacidaspidae, O509
 Eoacidaspidae, O167, O508
 Eoacidaspis, O510
 Eoagnostus, O184
 Eoasaphus, O355
Eobronteidae, O367
 Eobronteus, O56, O371
 Eochuangia, O315
 Eochuangiinae, O152, O162, O315
Eochuanginae, O152, O315
Eocorycephalus, O472
 Eocryphops, O103, O463
 Eoectenopve, O264
 Eocyphinium, O75, O399
 Eodaguinaspis, O198
 eodiscid suture pattern, O67
 Eodiscidae, O41, O58, O67, O91, O148, O150, O151, O161, O187
Eodiscidea, O150, O172, O187
Eodiscoidae, O151, O187
 EODISCINA, O161, O187
Eodiscinae, O151
Eodiscini, O187
 Eodiscus, O188
 Eodrevermannia, O394
Eodrevermanniinae, O152
 Eoharpes, O418
 Eohomalonotinae, O152, O163, O455
 Eohomalonotus, O456
 Eoisotelus, O336
 Eomonarachus, O492
Eomonoracheinae, O489
Eopageta, O189
 Eophacops, O463
 Eops, O202
 Eoptychaspis, O322
 Eoptychoparia, O236
 Eorobergia, O329
 Eosaukia, O517
 Eoshumardia, O245
 ephebic stage, O119
 Epidaguinaspis, O198
 epicuticula, O6
 epimera, O119
 EPIPARIA, O150
 epipodite, O8
 epistoma, O119
 epistomal plate, O119
 epistome, O119
 Erbia, O230
 Erbiopsis, O217
 Eremiproetus, O387
 ERIKSON, O83
Erinnys, O244
 Eshelmania, O306
Esmeraldina, O195
 Esseigania, O517
Eteraspis, O290
 Etheridgaspis, O522
 Euagnostus, O184
Euarges, O503
Euarginae, O152
 EUARTHROPODA, O4, O15, O20
Eudechenella, O388
 Eudolatites, O475
 Eugonocare, O258
 Euloma, O119, O234
 Eulomella, O522
 Eulomina, O522
 Eulominae, O161, O234
 EUONYCHOPHORA, O20
Euplethagnostus, O182
Euproetus, O384
Euptychaspidae, O152, O320
Euptychaspidae, O152
 Euptychaspis, O322
 Eurekiidae, O152, O162, O325
 Eurostina, O247
 Eurudagnostus, O179
 Eurycare, O45, O264
 EURYPTERIDA, O14, O15
 EUTRILOBITA, O146
Eutrimerocephalus, O466
 Evansaspis, O313
 Evenkaspis, O494
Exigua, O525
 exite, O8, O119
 Exochops, O399
 exocuticula, O6
 exopodite, O8, O119
 exoskeleton, O4, O119
 exsagittal, O119
 external mold, O120
 external rim, O120
 exuviae, O120
 eye, O87, O120
 eye lappet, O120
 eye list, O120
 eye lobe, O120
 eye platform, O51, O87, O120
 eye ridge, O50, O120
 eyes, of Arthropoda, O12
 eye tubercle, O120
 Eymekops, O288
 Fabulaspis, O515
 facet, O120
 facial suture, O58, O120
 Falanaspis, O428
 Fallagnostus, O173
 Fallotaspidae, O151, O161, O194
 Fallotaspis, O49, O60, O63, O125, O194
Fallotia, O194
 false eye ridge, O120
 Famatinolithus, O48, O423
 FEDOTOV, O15
 femur, O8, O120
Fengshania, O320
 Fengtienia, O102
Fengtienia, O525
 Ferralsia, O211
 Fieldaspis, O59, O64, O93, O227
 FISCHER, O111
 Fissocephalus, O418
 fixed cheek, O50, O120
 fixigena, O50, O120
 fixigenal boss, O120
 fixigenal spine, O120
 flange, O120
 Flexicalymene, O56, O59, O60, O76, O96, O97, O99, O128, O133, O134, O138, O140, O143, O452
Forbestia, O384
 FORD, O41, O62, O130
 Fordaspis, O217
 Formonia, O62, O394
 fossula, O46, O120
 fossular apodeme, O120
 free cheek, O46, O120
 Fremontella, O57, O192
 Fremontia, O192
 fringe, O120
 frontal area, O49, O120
 frontal axial spine, O120
 frontal furrow, O120
 frontal lobe (of glabella), O120
 frontal process, O120
 frontal spine, O120
 front furrow, O120
 fronto-median lobe, O47, O120
 Fuchouia, O222
 fulcral process, O120
 fulcral socket, O120
 fulcrum, O71, O120
 Gallagnostoides, O181
 Gallagnostus, O181
 Gaspelichas, O498
 gena, O121
 genal angle, O51, O120
 genal caeca, O100, O120
 genal field, O120
 genal lobe, O120
 genal region, O46, O120
 genal ridge, O120
 genal roll, O120
 genal roll prolongation, O121
 genal spine, O51, O121, O140
 Genevievella, O301
Genevievellidae, O152, O301
 geniculate, O121
Georgiellus, O194
 Geragnostella, O177
 Geragnostidae, O151, O161, O176
 Geragnostus, O49, O176
 Gerasaphes, O355
Gerasaphus, O355

- Gerastos*, O384
 gerontic stage, O121
Gigantopygidae, O67, O158, O161, O204
Gigantopygus, O204
Gignopeltis, O522
Gigoutella, O215
 gill branch, O8
Giordanella, O512
Giradia, O312
Girandia, O312
 girder, O121
Girvanagnostus, O177
 glabella, O46, O121
 glabellar furrow, O121
 glabellar lobe, O121
 glabellar node, O121
 glabellar tongue, O121
 glabellar tubercle, O121
Glabrella, O525
 GLAESSNER, O112
Gladiatoria, O329
Glaphuridae, O152, O162, O298
Glaphurina, O298
Glaphurus, O51, O298
Glaphyraspis, O279
Glossocoryphus, O240
Globulaspis, O509
Glockeria, O467
Glossicephalus, O525
Glossopleura, O224
Glossopleurinae, O151, O220
Glyphanellus, O290
Glyphaspellus, O290
Glyphaspis, O288
Glyphopeltis, O288
Glyptagnostus, O178
Glyptometopidae, O152
Glyptometopus, O279
 GOLDFUSS, O40, O146
Goldiidae, O367
Goldillaenus, O374
Goldius, O369
 GONATOPARIA, O148
 gonatoparian suture, O59, O121
Goniacanthus, O276
Goniagnostus, O178
Goniodiscus, O188
Goniophrys, O295
Goniopleura, O405
Goniotelina, O379
Gonioteloides, O380
Goniotelus, O379
Goniturus, O379
Gonotelus, O379
Gortania, O463
Gourdonia, O480
Goycoia, O517
Grandagnostus, O181
Grandiocus, O290
Granularia, O512
Granularidae, O512
Granulariidae, O167, O512
 granule, O121
Gravicalymene, O452
 GREEN, O40
Greenops, O480
Greylockia, O250
Griffithides, O126, O399
Griffithidinae, O152
Grinnellaspis, O523
Grinnellaspis, O434
Groenwallia, O261
Guandacolitus, O422
 GÜRICH, O41, O147, O148

Habelia, O31
 HADDING, O107
Hadrohybus, O435
Hadorrachus, O486
Hadorrakos, O486
 HAECKEL, O146
Hagiorites, O525
 half ring, O121
 HALL, O41
 HALL & CLARKE, O109
Hallaspis, O285
Hamashania, O517
Hamatolenus, O211
Hamptonella, O525
Hanburia, O515
Hanburiinae, O151
Hangchungolithus, O423
Hanivella, O518
Haniwa, O288
Haniwoides, O288
 HANSEN, O8
 HANSTRØM, O92, O93
Hapalopleura, O72, O429
 hapalopleurid enrollment, O104
Hapalopleuridae, O104, O158, O163, O428
Haploconus, O412
Hapsiceraurus, O433
Hardyoides, O302
Hardyia, O312
Harpedacea, O415
Harpedidae, O147-O149, O415
Harpes, O90, O104, O142, O147, O415
 harpid enrollment, O104
 harpid suture pattern, O67, O159
Harpidae, O53, O56, O67, O91, O100, O104, O113, O117, O119-O122, O125, O126, O147, O152, O163, O415
Harpidella, O405
Harpides, O48, O418
Harpides, O415
 harpidid suture pattern, O159
Harpididae, O61, O67, O100, O119-O122, O125, O126, O152, O163, O418
 HARPINA, O163, O231, O415
Harpina, O418
Harpoidae, O152, O415
 HARRINGTON, O3
 HARRINGTON & LEANZA, O41, O113, O114
Harrisia, O521
Hartshillia, O242, O244
Hartshillina, O75, O244
Hartshilliinae, O151
Harttella, O242
Hastagnostidae, O151, O161, O178
Hastagnostus, O178
 HAWLE & CORDA, O40, O146
Hausmannia, O468
 head, O121
 head shield, O121
Hebediscidae, O151
Hebediscus, O190
 HEDGPETH, O14
Hedinia, O269
Hedinaspis, O47, O269
 HEEGAARD, O8, O15
Heliocephalus, O470
Heliomera, O438
Heliomerinae, O152, O163, O438
Heliomeroides, O438
Helioproetus, O395
Helmetia, O24, O36
Hemiarges, O503
Hemibarrandia, O358
Hemigyaspis, O346
Hemirhodon, O67, O158, O224
Hemisphaerocoryphe, O438
 HENNINGSMOEN, O2, O96, O112, O147, O151
 HENRIKSEN, O28, O63, O153
Hesa, O525
Hesperaspis, O409
Heterocaryon, O282
Heterocaryoninae, O152, O281
 HETEROPYGIA, O148
 HEXAPODA, O5, O15, O16
 HEYMONDS, O15
Hibbertia, O418
 HICKS, O41
Hicksia, O216
Hicksiidae, O151, O161, O215
Highgatea, O331
Highgatella, O262
Hillyardina, O278
Hindermeyeria, O207
Hintzeia, O444
Hoeferia, O199
Hoekaspiella, O525
Hoekaspis, O97, O346
Hoffetella, O209
Holasaphus, O261
 holaspis, O121
 holaspis period, O121, O127, O141
Holcacephalus, O302
Holdenia, O512
Holia, O75, O89, O141, O143, O435
 HOLM, O96, O107
 HOLMGREN, O153
Holmia, O53, O59, O63, O65, O93, O195
 holmiid suture pattern, O67
Holmiinae, O73, O151, O161, O194
Holocephalina, O244
Holocephalinae, O152
 holochroal eye, O88
 hologlabella, O121
Holomeris, O369
Holotrachelacea, O163, O381
Holotrachelidae, O152, O163, O382
Holotrachelus, O154, O382

- Holstonia*, O248
 Holteria, O218
Holteriinae, O151, O217
Homagnostoides, O177
Homagnostus, O173
 homalonotid suture pattern, O67, O159
Homalonotidae, O42, O54, O56, O65, O67, O72, O125, O148-O150, O152, O159, O163, O454
Homalonotinae, O152, O163, O458
Homalonotus, O56, O458
Homalops, O492
Homalopteon, O352
Homalopyge, O341
Homodictya, O292
Homoglossa, O366
Homolichadinae, O152, O498
Homolichas, O498
Homolichinae, O163, O498
 HOMOPODA, O28
Homotelus, O341
Hoploichas, O498
Hoplolichoides, O498
 horn, O121
 Hospes, O244
Housia, O67, O68, O75, O159, O260
Housiella, O260
Housiidae, O68, O152, O159, O162, O260
 HOWELL, O3
Howellaspida, O151
Howellaspinae, O151
Howellaspis, O304
Hsiuella, O525
Huaquinchaiia, O525
Huarpagnostus, O178
Hugaiidae, O152
Huilichia, O525
Hukasawaia, O331
Humilogriffithides, O401
Hundwarella, O290
Hungaia, O50, O67, O70, O159, O333
Hungaiidae, O70, O152, O159, O162, O332
Hungaiinae, O152
Hungaiinae, O152
Hungioides, O361
Hunnebergia, O346
 HUPÉ, O10, O13, O41, O63, O91, O93, O96, O99, O101, O106, O107, O114, O131, O147, O149, O151, O153, O159
Hupeia, O212
Hyboaspis, O376
Hyboaspis, O376
Hydrocephalus, O213
Hydrolaenus, O374
Hymenocaris, O27
Hypagnostinae, O184
Hypagnostus, O184
Hyperagnostus, O179
Hyperbolochilus, O523
 hyperglabella, O121
Hypermecaspididae, O162, O232, O269
Hypermecaspis, O47, O49, O270
Hypodicranotus, O56, O58, O72, O327
 HYPOPARIA, O147, O150, O151, O231
 hypostoma, O43, O54, O121, O140
 hypostomal suture, O66, O121
 hypostome, O121
 Hypothetica, O61, O419
Hypotheticidae, O152
Hysteroleninae, O152
Hysterolenus, O67, O158, O363
Hystricuridae, O152, O278
Hystricurinae, O162, O278
Hystricurus, O278
 Idahoia, O252
Idahoiidae, O161, O251
 Idamea, O314
 Iddingsia, O282
Idiomesus, O245
Idiorhapha, O523
Illaenacea, O162, O365
Illaenicae, O365
Illaenidae, O42, O43, O56, O67, O72, O96, O97, O100, O102, O105, O149, O150, O152, O163, O372
Illaenides, O365, O372
 ILLAENINA, O162, O231, O365
Illaeninae, O148, O152, O163, O372
Illaenoidae, O152
Illaenoides, O374
Illaenopsis, O48, O358
Illaenuracea, O162, O270
Illaenuridae, O152, O155, O162, O271
Illaenurus, O155, O271
Illaenus, O42, O46, O56, O75, O89, O94, O95, O99, O107, O109, O125, O372
Illaenurus, O271
 Incaia, O423
Inglefieldia, O240
 inner margin (of fringe), O121
 inner margin (of lower lamella), O121
 inner margin (of upper lamella), O121
Inouyella, O288
Inouyia, O247
Inouyina, O515
Inouyops, O247
Inoyellaspis, O207
 INSECTA, O4, O10, O16
 INTEGRICEPHALIDA, O149
 integument, O121
 intercheek suture, O121
 intergenal spine, O53, O121
 internal mold, O121
 internal rim, O121
 interocular spine, O121
 interpleural furrow, O73, O121
 interpleural groove, O121
 intramarginal suture, O121
Iranaspida, O162, O315
Iranaspis, O315
Iranella, O258
Irania, O290
Iraninae, O152
Iranoleesia, O290
Irvingella, O295
Irvingellina, O295
Irvingelloides, O295
 Isalaux, O494
 ISBERG, O107
Isbergia, O385
 ischiopod, O8
Ischyrotoma, O523
Isidreana, O525
Isidrella, O525
Isocolidae, O152, O167, O511
Isocolus, O48, O511
Isotomesa, O525
 ISOPYGLA, O148, O172
 isopygous, O73, O121
Isoteleidae, O339
 isoteliform suture, O61, O121
Isotelinae, O162, O339
Isoteloides, O341
Isotelus, O41, O42, O61, O76, O106, O107, O121, O138, O142, O143, O339
Ithycephalus, O312
Ithyektyphus, O240
Ithyophoridae, O152
Ityophoridae, O163, O430
Ityophorus, O430
 IVANOV, O8, O13, O15
 JAANUSSON, O2, O96
 JACKSON, O146
 JAEKEL, O147-O149, O151, O153
Jakutus, O512
Jalonella, O211
Jangudaspidis, O513
Jeffersonia, O379
Jeholaspis, O322
Jemtella, O449
Jincella, O275
Jonotus, O524
Josephulus, O492
Jubileia, O518
Judaiella, O513
Judomia, O193
Jujuyaspida, O152, O264
Jujuyaspinae, O152
Jujuyaspis, O266
 Kainella, O50, O59, O61, O75, O121, O329
Kainellidae, O329
 kainelliform suture, O61, O121
Kaninia, O290
Kaniniella, O290
Kaniniella, O519
Kanoshia, O56, O444
Kaolishania, O318
Kaolishaniella, O319
Kaolishaniidae, O162, O318
Kaolishaninae, O318
Karlia, O227
Kaskia, O399
Kassinius, O314
Kawina, O435

- KAYSER, O41
 Kayseraspis, O75, O97, O347
 Kayserops, O482
 Kazelia, O258
 Kazellina, O519
 Keidelaspis, O267
 Keidelia, O295
 Keithia, O322
 Keithiella, O322
 Kendallina, O272
 Kerakephalichas, O498
 Kettneraspis, O506
 KIAER, O62, O63, O153
 Kindbladia, O283
 Kingaspidinae, O151, O161, O208
 Kingaspidoides, O208
 Kingaspis, O51, O208
 KINGSLEY, O15
 Kingstonia, O285
 Kingstoniidae, O162, O284
 Kiowaia, O312
 Kirkella, O343
 Kistocare, O240
 Kjerulfia, O63, O65, O193
 Klotziella, O224
 Kloucekia, O489
 Knechtelia, O519
 KNOD, O41
 KOBAYASHI, O41, O151
 Kobayashia, O353
 Kochaspis, O250
 Kochiella, O240
 Kochina, O240
 Kodymaspis, O358
 Koenigia, O458
 Kogenium, O363
 Kokuria, O288
 Koldinia, O519
 Koldiniella, O519
 Koldinioidia, O246
 Kolihapeltis, O369
 Kolodinia, O519
 Koptura, O515
 Komaspidacea, O162, O294
 Komaspidae, O152, O294
 Komaspidella, O314
 Komaspididae, O152, O162, O294
 Komaspis, O295
 Koneprusia, O507
 Kootenia, O76, O79, O80, O83, O218
 Kootenidae, O217
 Kooteniella, O218
 Kooteniellina, O218
 Kooteniidae, O217
 Koptura, O288
 Kopturinae, O152
 Koraispis, O523
 Koreaspis, O523
 Kormagnostus, O185
 Kounamkites, O240
 KOZŁOWSKI, O41
 Krattaspis, O433
 Krejcia, O433
 Kuanyangia, O513
 Kuanyiangia, O513
 Kueichowia, O513
 Kujandaspis, O240
 Kujandina, O519
 Kyphocephalus, O283
 Labiostris, O258
 labium, O121
 Labradoria, O212
 labrum, O121
 Lachnostoma, O64, O341
 Lakaspis, O358
 LAKE, O41, O61, O147
 LAMONT, O96
 Lancastris, O220
 Lancastridae, O151
 LANG, O8
 LANKESTER, O4, O15, O18, O20
 Lannacus, O341
 Lapidaria, O350
 larva, O121
 larval stage, O121
 lateral articulating furrow (of pleura), O121
 lateral border furrow (of cephalon), O122
 lateral border (of cephalon), O122
 lateral glabellar furrow, O47, O122
 lateral glabellar lobe, O47, O122
 lateral line (of fringe), O122
 lateral lobe (of pygidium), O122
 lateral notch (of hypostoma), O54, O122
 lateral occipital lobe, O122
 lateral preoccipital lobe, O122
 lateral tongue furrow, O122
 LATIGASTRA, O15
 Latiredlichia, O49, O200
 Latiredlichidae, O151, O199
 Latoucheia, O211
 Laudonia, O53, O63, O154, O192
 Lauzonella, O67, O70, O159, O331
 Leachoilia, O15, O24, O31
 LEANCHOILIDA, O31
 LEANCHOILIDA, O28, O31
 Leachoiliidae, O28, O31
 Lecanopleura, O306
 Lecanopleurinae, O152
 Lecanopyge, O380
 Lecanopygidae, O70, O159, O163, O380
 Lehua, O433
 Leiagnostidae, O151, O181
 Leiagnostus, O41, O46, O73, O181
 Leimitzia, O361
 Leiobienvillia, O267
 Leiocoryphe, O67, O68, O91, O159, O409
 Leiolichas, O496
 Leiostegiacea, O162, O313
 Leiostegidae, O313
 Leiostegiidae, O152, O162, O313
 Leiostegiinae, O152
 Leiostegina, O458
 Leiosteginae, O313
 Leiostegioides, O525
 Leiostegium, O313
 Leiostegium, O313
 Leiostegium, O313
 Leiostrototropis, O444
 Leiostegium, O313
 Lejopyge, O178
 Lejopygidae, O151
 Leonaspis, O506
 Leptopilus, O523
 Leptoplastidae, O262
 Leptoplastides, O264
 Leptoplastinae, O152, O162, O262
 Leptoplastoides, O111, O133, O135, O136, O140, O142
 Leptoplastus, O263
 Lepidoproetus, O386
 LERMONTOVA, O41
 Lermontovia, O212
 Lermontoviinae, O211
 Levinia, O525
 Levisaspidae, O152
 Levisaspidae, O152
 Levisaspis, O302
 Levisella, O67, O159, O332
 Levisia, O516
 Liaotungia, O525
 librigena, O46, O51
 librigenal spine, O122
 Lichacea, O495
 Lichadacea, O495
 Lichadae, O495
 Lichades, O495
 Lichadidae, O147, O149, O150, O152, O495
 Lichadinae, O152
 Lichadoidae, O152, O495
 Lichakephalidae, O163, O503
 Lichakephalus, O504
 Lichapyge, O331
 Lichas, O56, O93, O94, O496
 Lichasidae, O495
 Lichengia, O323
 LICHIDA, O163, O231, O495
 Lichidae, O42, O48, O53, O56, O118, O120, O122, O147-O150, O163, O495
 Lichinae, O163, O496
 Lichnocephala, O134, O138, O379
 Ligometopus, O492
 limb, O122
 LIMULAVA, O29
 LIMULAVIDA, O28, O29
 Limulus (Merostome), O21
 LINDSTRÖM, O62, O88, O89, O91, O93
 Linguagnostus, O175
 Linguaphillipsia, O401
 LINGUATULIDA, O18
 Linguecephalichas, O498
 Lingukainella, O331
 LINNÉ, O40
 Liobole, O392
 Liobolina, O392
 Liocalymene, O452
 Liocephalus, O242
 Lioharpes, O56, O418
 Lioparella, O291
 Lioparia, O288
 Liosolenopleura, O261
 Liostracina, O248
 Liostracinidae, O152, O161, O248
 Liostracinoides, O248
 Liostracus, O261

- Liparges*, O503
Lisania, O312
Litagnostus, O181
Litocephalus, O259
Litocodia, O525
Llanoaspidella, O300
Llanoaspidinae, O162, O301
Llanoaspininae, O301
Llanoaspis, O301
Lloydia, O48, O313
Lloydidae, O313
Loydiidae, O152, O313
Lloydolithus, O423
 LLWYD, O40
Lobocephalina, O238
Lobocephalus, O238
Lobopyge, O503
 LOCHMAN-BALK, O2, O107
Loganellidae, O70, O159, O162, O331
Loganellus, O67, O70, O159, O331
Loganopeltidae, O100, O152, O418
Loganopeltis, O51, O61, O157, O160, O418
Loganopeltoides, O61, O63, O157, O160, O418
Lonchocephalidae, O152, O162, O278
Lonchocephalus, O279
Lonchodomas, O45, O46, O48, O97, O120, O427
Longianda, O203
 longitudinal glabellar furrow, O122
Lopnorites, O364
Lorentzia, O288
 LORENZ, O41
Lorenzella, O247
Lotagnostus, O178
 lower (external or internal) rim, O122
 lower lamella, O122
Luaspis, O207
Luhops, O213
Lunacrana, O245
 lung books, O13
Lusatiops, O212
Lutesvillia, O379
Luxella, O236
Lyriaspis, O233
Lyrlichas, O498
- Macelloura*, O271
Machairagnostus, O75, O182
Macrobiotus (tardigrade), O17
Macrobole, O392
Macroculites, O523
macropleura, O72, O122
macropleural segment, O122
macropleural spine, O122
Macropyge, O75, O329
MACROPYGA, O148
Macropygidae, O329
Macropyginae, O152
macropygous, O73, O122
macrospine, O70, O122
Macroterolichas, O496
Macrotoxus, O288
macula, O54, O92, O122
- Madarocephalus*, O285
Maiaspis, O275
Maja, O355
Makromuktis, O496
 MALACOSTRACA, O16
Malladaia, O470
Maladaiinae, O152, O325
Maladia, O326
Maladiinae, O152
Maladioidella, O260
Maladioides, O297
Mallagnostidae, O174
Mallagnostus, O174
Malvernia, O470
Manchuriella, O291
Manchurocephalus, O209
 MANDIBULATA, O16
 MANSUY, O41
Mansuyella, O364
Mansuyellinae, O152
Mansuyia, O319
Mansuyiinae, O152
Mansuyiinae, O152, O318
Mapania, O288
Mareda, O519
margin, O122
marginal band, O122
marginal furrow, O122
marginal limb, O122
marginal pit, O122
marginal rim, O122
marginal spine (of cephalon), O53, O122, O156
marginal spine (of pygidium), O75, O122
marginal suture, O66, O122
Marjumi, O75, O306
Marjumiacea, O162, O305
Marjumidae, O305
Marjumiidae, O152, O162, O305
Marrella, O15, O24, O29, O149
 MARRELLIDA, O28, O29
Marrellidae, O28, O29, O149
 MARRELLINA, O29
 MARRELLOMORPHA, O15, O22, O28, O29
Marrolithoides, O423
Marrolithus, O423
Marsaisia, O202
Maryvillia, O292
Mastigopleuridae, O504
Matania, O517
Mataninella, O519
 MATTHEW, O41
Matthewlenus, O211
Maustonia, O272
 M'COY, O40, O146, O153
McNairia, O241
median border spine, O122
median cervical lobe, O122
median lateral glabellar furrow, O122
median lateral glabellar lobe, O122
median lobe (of glabella), O122
median preoccipital lobe, O122
median suture, O65, O122
Meeria, O252
Megadunderbergia, O240
- Megagraulos*, O516
Megalaspidella, O97, O347
Megalaspides, O341
Megalaspis, O347
Megalophthalmus, O290
Megistaspidella, O348
Megistaspis, O42, O56, O107, O110, O347
Meisterella, O519
Mekynophrys, O264
Mendodiscus, O525
Mendogaspis, O525
Mendolaspis, O427
Mendoparabolina, O525
Mendospidella, O224
Meneghinella, O513
 MENECHINI, O41
Menevia, O244
Meneviella, O244
Meneviellinae, O152
Menocephalinae, O152
Menocephalites, O275
Menomonina, O142, O303
Menomonidae, O303
Menomoniidae, O70, O150, O152, O159, O162, O303
Menoparia, O53, O128, O133, O136, O138, O330
Mephiarges, O503
meraspid period, O122, O127, O135
Meraspis, O122
meropod, O8
 MEROSTOMATA, O4, O15, O28
 MEROSTOMOIDEA, O15, O28, O29
Mesagnostus, O186
Mesembria, O525
mesentron, O13
Mesetaia, O208
Mesocrepicephalus, O250
Mesoctenopyge, O264
Mesodema, O200
 MESONACIDA, O149, O150, O190, O191
Mesonacidae, O149, O150, O191
Mesonacis, O192
Mesopagetia, O189
Mesospheniscus, O186
Mesotaphraspis, O136, O413
mesotergite, O43, O70, O122
Metabowmania, O247
Metacalymene, O452
Metacanthina, O482
Metacanthus, O480
metacranial spine, O122
Metacryphaeus, O486
Metadiscus, O188
Metadoxididae, O151
Metadoxides, O214
Metadoxidinae, O161, O214
metafixigenal spine, O53, O122
metagenal spine, O53, O122
Metagnostus, O178
Metagraulos, O516
Metaharpes, O418
*metalibrigen*al spine, O53
Metalichas, O498

- metamere, 07, 0123
 Metanomocare, 0288
 metaparian suture, 060, 062, 0123
Metaphillipsia, 0399
 Metapilekia, 0441
 Metapliomerops, 0441
 metaprotaspid stage, 0128
 metaprotaspis, 0123
 metastoma, 043, 058, 0123
 metastome, 0123
Meteraspis, 0250
 Metroaspis, 0250
 Metisaspina, 0513
 Metisaspis, 0301
Metisia, 0306
Metopias, 0496
 Metopolichas, 0496
 Metoptogyrus, 0355
Mexicaspidae, 0151
Mexicaspinae, 0151, 0227
 Mexicaspis, 057, 0227
 Mexicella, 0240
Miagnostus, 0178
 Micmacca, 0208
 Micmaccopsis, 0207
Micragnostidae, 0151, 0161, 0179
 Micragnostus, 0179
Micragraulidae, 0151
Micragraulos, 0525
Microdiscidae, 0148
Microdiscus, 0188
 Microparia, 0362
Microphthalmus, 0463
Micropyge, 0276
 MICROPYGLA, 0148, 0190
 micropygous, 073, 0123
 microstructure of trilobite exo-
 skeleton, 085
 middle body (of hypostoma), 0123
 middle furrow, 0123
Millardia, 0304
 MILNE EDWARDS, 040, 0146
Mimana, 0525
 MIOMERA, 0151, 0172
Miraspidinae, 0152, 0163, 0506
Miraspidinae, 0152
 Miraspis, 051, 072, 0506
 Missisquoia, 0510
Missisquoidae, 0152, 0167, 0510
 Mitchellaspis, 0447
Mitchellia, 0447
 MOBERG, 062, 096
 Modocia, 0306
 Mohicana, 0208
 Molaria, 026, 031
 Mollisonia, 024, 037
 molting, 07, 058, 0110
Monadina, 0276
 Monkaspis, 0288
 Monocheilus, 0288
 Monodechenella, 0388
Monorachus, 0494
Monorakeidae, 0493
Monorakeinae, 0493
Monorakidae, 0163, 0493
Monorakos, 0494
Monorhachis, 0494
Moosia, 0296
 morphology, of Arthropoda, 04
 morphology, of Euarthropoda, 021
 morphology, of Onychophora, 017
 morphology, of Trilobita, 041
 morphology, of Trilobitoidea, 024
 movable cheek, 0123
 Moxomia, 0267
 muscle scar, 0123
 Myinda, 052, 0512
 Myindidae, 0167, 0512
 MYRIAPODA, 04, 08, 011, 013,
 016
 Myopsoleninae, 0151, 0161, 0211
 Myopsolenus, 0211
 Myopsomicmacca, 0208
 Mytocephala, 0473
 Myttonia, 0423
 Namanoia, 0513
Namanoidae, 0513
 Namuropyge, 0408
 Nanillaenus, 0373
 Nankinolitus, 0423
 Nannopeltis, 0523
 Naraoia, 015, 025, 030
Naraoidea, 030
Naraoiidae, 028, 030
 Nasocephalus, 0308
 Nassovia, 0234
 Nassoviinae, 0161, 0234
Nassovinae, 0234
Nathorstia, 076, 0149
 nauplius, 013
 neanic stage, 0123
 neck furrow, 0123
 neck node (or spine), 0123
 neck ring, 0123
 NECTASPIA, 030
 NECTASPIDA, 028, 030
 Neltneria, 0196
 Neltneriinae, 0151, 0161, 0196
 Neoacrocephalites, 0519
 Neoagnostus, 0173
 Neosaphus, 056, 0103, 0108,
 0336
 Neochilonorria, 0224
 Neocobboldia, 0190
 Neogriffithides, 0401
 Neolenus, 0218
 Neometacanthus, 0480
Neophillipsia, 0401
 Neoprobolium, 0120, 0472
 Neoproetus, 0401
 Neoredlichia, 0120, 0201
 Neoredlichidae, 053, 0151, 0161,
 0201
Neosynphoria, 0472
Neosynphoriinae, 0152
Neosynphorinae, 0468
 Neotaenicephalus, 0308
 neoteny, 0159
 Nepea, 0251
 Nepeacea, 0161, 0250
 Nepeidae, 0151, 0161, 0251
 Nephranomma, 0468
 Nephranops, 088, 091, 0105,
 0111, 0465
 nepionic stage, 0123
 Nericia, 0308
 Nericiaspis, 0148, 0154, 0159,
 0266
 nervous system of trilobites, 0101
 Neseuretus, 0523
 Nevadella, 0196
 Nevadia, 0196
 Nevadiinae, 0151, 0161, 0196
 NIESZKOWSKI, 041
 Nieszkowskia, 072, 0109, 0436
 Nileid suture pattern, 067, 0159
 Nileidae, 054, 056, 066, 067,
 070, 072, 096, 0105, 0150,
 0152, 0159, 0162, 0356
Nileinae, 0148, 0152
 Nileoides, 0341
 Nileus, 056, 064, 071, 0101,
 0109, 0356
 Ninaspis, 0519
 Ningkianolithus, 0423
 Niobe, 061, 0109, 0350
 Niobella, 0350
 Niobides, 0349
 niobiform suture, 061
 Niobina, 0350
 Niobinae, 0162, 0350
Nitidulopyge, 0503
 Nixonella, 0312
 node, 0123
 Norinia, 0350
 Norwoodella, 0303
 Norwoodia, 0302
 Norwoodiacea, 0162, 0301
Norwoodidae, 0151, 0301
Norwoodidea, 0150, 0301
Norwoodiidae, 0150, 0151, 0152,
 0159, 0162, 0232, 0302
Norwoodina, 0302
Norwoodiinae, 0152
 Notasaphus, 0218
Notocoryphe, 0525
 Notopeltis, 095, 0349
 Novák, 041, 096
Novákaspis, 0405
 Novaspidinae, 0152, 0163, 0424
Novaspidinae, 0152, 0424
 Novaspis, 0424
 nuchal furrow, 0123
 nuchal ring, 0123
 nuchal node (or spine), 0123
 Obrucheviaspis, 0309
 occipital furrow, 046, 0123
 occipital lobe, 0123
 occipital node, 0123
 occipital ring, 046, 048, 0123
 occipital spine, 0123, 0140
 Octillaenus, 0373
 Octobronteus, 0372
Octoillaenus, 0373
 ocular band, 0123
 ocular platform, 0123
 ocular ridge, 0123
 Odontocephalus, 0470
 Odontochile, 059, 060, 064, 0471
 Odontopleura, 041, 051, 0122,
 0504
Odontopleuracea, 0504

- ODONTOPLEURIDA, 0149,
 0163, 0231, 0504
 Odontopleuridae, 048, 056, 076,
 094, 0120-0122, 0147-0150,
 0152, 0163, 0504
 Odontopleurinae, 0152, 0163,
 0504
Odontopleuroidea, 0152, 0504
Odontopyge, 0262
Oedicybele, 0449
Oedorhachis, 0185
 OEHLERT, 041, 0110
Ogmasaphus, 0336
Ogygia, 0352
Ogyginus, 0352
Ogygiocarella, 0352
Ogygiocaris, 0352
Ogygiocaridinae, 0152, 0162,
 0334, 0350
Ogygiocarinae, 0152
Ogygites, 0352
Ogygitoides, 0341
Ogygopsidae, 067, 0151, 0161,
 0218
Ogygopsis, 0219
Oidalgnotus, 0175
Olekmaspis, 0211
Olenacea, 0162, 0261
Olenaspella, 0274
Olenellacea, 0191
 OLENELLIDA, 0191
Olenellidae, 053, 054, 057, 059,
 066, 067, 070-073, 76, 086,
 100, 0121, 0122, 0124-0126,
 0148-0151, 0154, 0161, 0191
Olenellidea, 0191
 olenellid suture pattern, 067
 OLENELLINA, 0161, 0191
Olenellinae, 0151, 0161, 0192
Olenelloidea, 0151, 0191
Olenelloides, 053, 0197
Olenelloidinae, 0151, 0161, 0197
Olenellus, 044, 057, 072, 073,
 076, 078, 0192
 olenid mode of molting, 0112
 olenid suture pattern, 067, 0159
Olenidae, 053, 067, 075, 076,
 091, 092, 096, 0100, 0113,
 0147-0150, 0152, 0154, 0159,
 0162, 0232, 0262
Olenidea, 0261
 OLENINA, 0149
Oleninae, 0147, 0152, 0162, 0262
Olenoidea, 0152, 0261
Olenoides, 010, 026, 056, 058,
 076, 078, 080, 082-084, 0117,
 0149, 0218
Olenopsis, 0205
Olenopsis, 0207
Olentella, 0260
Olenus, 0132, 0155, 0262
 OLIGOMERIA, 0148
Oligometopus, 0519
Omeipsis, 0356
 ommatidia, 012
Oncagnostus, 0173
Onchaspis, 0507
Onchocephalus, 0237
Oncholichas, 0496
Onchometopus, 0336
Onchonotopsis, 0519
Onchonotus, 0523
Onchopeltis, 0283
 ONCOPODA, 015, 018
Onnia, 099, 0135, 0138, 0139,
 0422
 ontogeny, of Arthropoda, 013
 ontogeny, of Trilobita, 0127
 ontogeny, of Trilobitoidea, 026
 ONYCHOPHORA, 04, 015, 016
Onychonyge, 0364
Onycopyge, 0438
Opabinia, 014, 024, 032
 OPABINIDA, 032
Opabinidae, 032
 OPABINIIDA, 028, 032
Opabiniidae, 028, 032
 OPIK, 041, 096, 0109, 0160
 OPISTHOPARIA, 0147-0151,
 0231
 opisthoparian suture, 059, 0123,
 0154
 opisthothorax, 070, 0123
Opsidiscus, 0147, 0159, 0188
Ordosia, 0315
Ordosinae, 0313
Orimops, 0452, 0525
Orkekeia, 0525
Orlovia, 0240
Orloviella, 0516
Ormathops, 091, 0473
Orometopidae, 0152, 0163, 0424
Orometopus, 066, 0158, 0424
Orphanaspis, 0508
Orria, 0224
Orriella, 0225
Orrinae, 0151, 0220
Oryctocara, 0220
Oryctocarinae, 0151
Oryctocephalidae, 059, 066, 067,
 0149-0151, 0158, 0161, 0219
 oryctocephalid suture pattern, 067,
 0158
Oryctocephalina, 0525
Oryctocephalinae, 0147, 0151
Oryctocephalites, 0220
Oryctocephalops, 0220
Oryctocephalus, 059, 0220
Orygmaspis, 0272
Oscoelia, 0254
Oscolinae, 0152
Osekaspis, 0433
 OSTRACODA, 016
Otarion, 0122, 0405
Otarionidae, 067, 0148, 0150,
 0152, 0163, 0403
Otarioninae, 0152, 0163, 0404
Ouijania, 0211
Pachyaspis, 0241
Pachycranium, 0278
 PACKARD, 015
Paenebeltella, 0266
Paedeumias, 063, 065, 067, 072,
 0107, 0109, 0114, 0130, 0131,
 0136, 0192
 paedeumiid suture pattern, 067
Pagetia, 049, 051, 058, 067,
 0147, 0159, 0189
Pagetidae, 0188
Pagetides, 0190
Pagetiellus, 0190
Pagetiidae, 058, 059, 067, 0151,
 0159, 0161, 0188
Pagetina, 0189
Pagodia, 0310
Pagodiidae, 0310
Pagodiidae, 0162, 0310
Pagura, 0216
 paired eye ridges, 0123
Paladin, 056, 0401
 PALAEADES, 040
 PALAEANOSTRACA, 028, 032
Palaeocrevicephalus, 0250
Palaeolenidae, 0151
Palaeoleninae, 0151, 0161, 0209
Palaeolenus, 0209
Palaeophillipsia, 0413
Palella, 0288
Paleomerus, 014
 palpebral area (of fixed cheek),
 0123
 palpebral area (of fixigena), 0123
 palpebral furrow, 050, 0123
Palpebralia, 062, 0394
 palpebral lobe, 050, 0123
 palpebral region (of fixed cheek),
 0123
 palpebral region (of fixigena),
 0123
 palpebral rim, 0123
 palpebro-ocular ridge, 051, 0123
Panarchaegonus, 0408
Panderia, 0374
 panderian opening, 0106, 0123
 panderian organ, 0105, 0123
 panderian protuberance, 0105,
 0123
 pander organ, 0123
Papillicalymene, 0452
Papyriaspidae, 0162, 0268
Papyriaspinae, 0152
Papyriaspinae, 0152, 0268
Papyriaspis, 0269
Paraaulacopleura, 0406
Parabailiella, 0244
Parabarrandia, 0358
Parabarrandiinae, 0152
Parabasilius, 0342
Parabellefontia, 0353
Parablackwelderia, 0318
Parabolina, 056, 075, 0113, 0114,
 0262
Parabolina, 047, 0113, 0267
Parabolinites, 0262
Parabolinoidea, 0272
Parabolinoidea, 0162, 0271
Parabolinoidea, 0266
Parabriscoia, 0254
Paracalmonia, 048, 053, 0125,
 0486
Paracedaria, 0300
Paracedariidae, 0152
Paracoosia, 0288

- Paracrepicephalus*, O250
Paracrocephalites, O276
Paracybeloides, O448
Paradalmmites, O484
Paradechenella, O388
Paradiscus, O188
PARADOXIDA, O212
Paradoxidacea, O161, O212
Paradoxidae, O149
Paradoxideae, O148
Paradoxides (family), O212, O213
Paradoxides, O42, O57, O59, O93, O110, O128, O131, O138, O140, O142, O143, O213
Paradoxididae, O42, O53, O57, O59, O66, O67, O71, O148, O151, O158, O161, O213
Paradoxidinae, O151, O213
Paradoxinae, O147, O213
Paradoxidoidea, O151
 parafrontal band, O123
 paraglabellar area, O123
Paragnostus, O174
Paragraulos, O513
Paragriffithides, O401
Paraharpes, O64, O418
Parahomalonotus, O461
Parahystricurus, O278
Parairvingella, O295
Parakinella, O330
Parakoldinioidia, O519
Paralichas, O498
Paralepulus, O369
Paralejurus, O369
Paramansuyella, O319
Paramansuyia, O319
Paramegalaspis, O349
Paramicmacca, O208
Paranorwoodia, O303
Paranileus, O343, O358
Paraolenoides, O218
Paraolenus, O262
Paraorlovia, O292
Paraphillipsia, O401
Parapilekia, O441
Paraplethopeltis, O410
 parapodia, O4
Parapoliella, O221
 paraprotaspid stage, O128
 paraprotaspis, O124
Parararia, O516
Pararedlichia, O200
Pararedlichinae, O151, O161, O200
PARARTHROPODA, O4, O18
Parasolenopleura, O275
Parasolenopleuridae, O151
Parasolenopleuroidea, O151, O274
Paratermiera, O211
Paratollaspis, O230
Paratrinucleus, O420
Pardailhania, O276
Parehmania, O241
Pareops, O201
Pareuloma, O234
Parevenkaspis, O495
aria, O124
 arial spine, O124
Parkaspis, O226
Particeps, O525
 patella, O8, O78, O124
Pateraspis, O435
 pathology, O107
 PAUROPODA, O10, O14, O16
Peachella, O192
Pedinocephalus, O260
Peishania, O292
Peltabellia, O379
Peltocare, O154, O159, O266
Peltoura, O264
Peltura, O72, O89, O139, O154, O155, O159, O264
Pelturina, O266
Pelturinae, O162, O264
Pemphigaspis, O73, O75, O285
Pennaia, O486
Pentagnostus, O185
 PENTASTOMIDA, O4, O15, O18
 perfixigenal spine, O124
 periglabellar area, O124
Perimetopus, O525
Periomma, O237
Periomellinae, O161, O234
Periomella, O234
Perioura, O241
Peripatidae, O20
Peripatopsidae, O20
Peripatus, O17
Perischoelonus, O523
Perischodory, O315
Perliproetus, O387
Permoproetinae, O152
Permoproetus, O401
Perneraspis, O275
Perneria, O275
Peronopsidae, O184
Peronopsis, O186
 perrostral suture, O63, O124
Perunasaspis, O413
Pesaia, O276
Petigurus, O379
Phacopacea, O163, O462
Phacopucea, O461
 PHACOPIDA, O163, O430
Phacopidacea, O461
Phacopidae, O54, O56, O62, O67, O76, O91, O92, O102, O105, O147, O152, O155, O159, O163, O462
Phacopidea, O150, O461
Phacopidella, O105, O111, O467
Phacopidellinae, O126, O152, O163, O467
 phacopid enrollment, O104
Phacopides, O462
Phacopidina, O486
 phacopid mode, of molting, O111
 phacopid suture pattern, O67, O159
 PHACOPINA, O163, O461
Phacopina, O489
Phacopinae, O126, O152, O163, O462
 PHACOPINI, O146, O430
Phacopoidae, O152, O461
Phacops, O44, O48, O56, O58, O62, O76, O78, O81, O82, O85, O86, O88, O90, O103, O105, O111, O120, O154, O463
Phaetonellus, O48, O386
Phaetonides, O396
Phalacroma, O64, O141, O181
Phalacromidae, O151, O161, O181
Phalacromides, O181
Phalagnostus, O181
Phanoptes, O213
Pharostoma, O95, O97, O454
Pharostomidae, O152
Pharostomatinae, O163, O454
 pharostomian scars, O96
Pharostomidae, O152, O454
Pharostomina, O453
Phillibole, O392
Phillipsella, O409
Phillipsia, O107, O109, O126, O399
Phillipsiidae, O56, O152, O163, O399
Phillipsiinae, O152
Phillipsinella, O45, O56, O103, O409
Phillipsinellidae, O56, O67, O152, O163, O408
 phillipsinellid enrollment, O104
Philonyx, O479
Phylsacium, O213
Phoidagnostus, O181
Phoreotropis, O519
Phylacops, O361
Phylacterus, O519
Phyllaspis, O398
 phylogeny, of Arthropoda, O14
Pianaspis, O269
Piazella, O237
Piedmontia, O248
Pilekia, O441
Pilekiidae, O441
Pilekiinae, O163, O441
Pilgrimia, O300
Pilgrimiidae, O299
Piliolites, O524
Piriproetus, O386
Placoparia, O71, O91, O148, O155, O445
Placopariinae, O152, O163, O445
Placoparina, O435
Plaesiacomia, O458
Plagiolaria, O465
Plagiops, O465
Plagiura, O516
Plagiurella, O516
Plagiurinae, O151
Planiscutellum, O369
Plasiaspis, O449
Platagnostidae, O151, O181
Platagnostus, O181
Platuspella, O282
 plate, O15
Platillaenus, O56, O96, O374
Platopolichas, O496
Platyantyx, O379
Platycalymene, O452
Platycolpus, O380
Platycoryphe, O524
Platydiamesus, O380

- Platyharpes*, O418
Platylichadinae, O152
Platylichas, O498
Platymetopus, O498
Platynotus, O496
Platypeltis, O358
Platypeltoidea, O358
Plectasaphus, O336
Plesiomegalaspis, O347
Plesioparabolina, O262
Plethagnostus, O182
Plethometopus, O410
Plethopeltella, O315
Plethopeltidae, O68, O151, O159, O163, O409
Plethopeltis, O49, O409
 pleura, O11, O124
Pleuracanthus, O477
 pleural band, O124
 pleural field, O75, O124
 pleural furrow, O72, O73, O124
 pleural lobe, O124
 pleural platform, O124
 pleural pygidial spine, O124
 pleural region (of pygidium), O124
 pleural rib, O124
 pleural spine, O124
 pleurite, O7
Pleuroctenium, O141, O174
 pleuron, O124
 pleurothorax, O124
Plicatolina, O113, O268
Pliomera, O72, O75, O105, O155, O439
Pliomeraspis, O439
Pliomerella, O445
Pliomerellinae, O163, O445
PLIOMERIA, O148
Pliomeridae, O51, O54, O56, O65, O67, O72, O91, O92, O148, O152, O155, O159, O163, O439
Pliomerillinae, O152
Pliomerina, O439
Pliomerinae, O152, O163, O439
Pliomeroides, O444
Pliomerops, O440
Plusiarges, O503
Plutonia, O213
Plutonides, O213
 podite, O124
 Poliella, O226
Poliellaspis, O226
Poliellina, O226
Polyeres, O508
POLYMERIA, O151
Polyleuraspis, O226
Polytomurus, O424
Pumpeckia, O436
 POMPECKI, O41, O147
 pore, O124
Portentosus, O331
Porterfieldia, O91, O92, O268
 PORTLOCK, O109
Portlockia, O463
 postaxial field, O124
 postaxial furrow, O124
 postaxial keel, O124
 postaxial ridge, O73, O124
 posterior area (of fixed cheek), O124
 posterior area (of fixigena), O124
 posterior band of occipital ring, O124
 posterior border (of cephalon), O124
 posterior border furrow (of cephalon), O124
 posterior branch (of facial suture), O124
 posterior flange, O124
 posterior genal ridge, O124
 posterior limb, O124
 posterior lobe (of glabella), O124
 posterior lobe (of hypostoma), O124
 posterior margin (of cephalon), O124
 posterior pleural band, O124
 posterior pleural spine, O124
 posterior region (of fixed cheek), O124
 posterior region (of fixigena), O124
 posterior section (of facial suture), O59, O124
 posterior spine, O75, O124
 posterior wing (of hypostoma), O54, O124
 posterolateral limb, O124
 posterolateral spine (of pygidium), O124
 post-eyeline, O124
 postocular area (of fixed cheek), O124
 postocular branch (of facial suture), O124
 posterior region (of fixed cheek), O124
 postocular ridge, O124
 postoral plate, O125
 POULSEN, O2, O41, O62, O147, O149, O153, O155
Poulsenia, O237
Pradesia, O512
Praedechenella, O388
 PRANTL & PŘIBYL, O41
Prantlia, O395
 preantenna, O10
 Precambrian arthropods, O4
precoxa, O8, O78, O125
pre-epipodite, O8, O78, O125
prefemur, O8, O78, O125
 preglabellar area, O125
 preglabellar field, O50, O125
 preglabellar furrow, O46, O125
 preglabellar keel, O125
 preglabellar pit, O125
 preglabellar ridge, O125
 preoccipital glabellar furrow, O125
 preoccipital glabellar lobe, O125
 preocular branch (of facial suture), O125
 preocular ridge, O125
Presbynileus, O343
 pretarsus, O8, O78, O125
Prevedoria, O241
Pribylia, O387
Pricyclopyge, O362
 primary suture pattern, O153
Primaspis, O506
Princetonella, O296
Prionocheilus, O454
Prionopeltinae, O152
Prionopeltis, O396
Prionopyge, O364
Prionurides, O382
Prionurus, O396
Proagnostus, O173
Proampyx, O278
PROARTHROPODA, O15, O22
Proasaphiscus, O292
Proaulacopleura, O269
Probolichas, O498
Probolium, O472
Proboloides, O486
Probolops, O486
Probowmania, O247
Proceratocephala, O508
Proceratopyge, O67, O159, O364
PROCHELICERATA, O28, O29, O31
Prochuangia, O319
 procranial spine, O125
 proctodeum, O13
Proerbia, O231
Proerbiidae, O151, O230
Proetacea, O163, O382
Proetidae, O56, O67, O91, O92, O102, O105, O147-O150, O152, O163, O382
Proetidella, O395
Proetidellinae, O152, O163, O395
Proetiden, O382
Proetides, O414
Proetina, O415
Proetinae, O152, O163, O384
Proetoidae, O152, O382
Proetus, O56, O96, O384
 profixigenal spine, O53
 progenal spine, O53
Prohedina, O269
Prokootenia, O219
 prolongation, O125
 prolibrigenal spine, O53, O125
Proliostracus, O237
Promegalaspides, O72, O353
Promegalaspidinae, O162, O352
PROPARIA, O147-O151, O430
 proparian olenid suture pattern, O159
 proparian suture, O60, O125, O154
 propod, O8
Prosaukia, O324
Prosaukiinae, O152
Prosopiscus, O449
Prosymphysurus, O226
Protadelaidia, O4, O13
Protagraulos, O207
Protapatokephalus, O329
Protarchaeogonus, O524
PROTARTHROPODA, O4, O15, O16

- protaspis, O125, O127
 protaspis, O13, O125, O127
 Protelnites, O247
 prothorax, O70, O125
Protillaenus, O292
 protocerebrum, O9
 PROTOLENIDA, O207
 Protolenidae, O50, O151, O161, O210
 Protoleninae, O151, O161, O211
 Protolenus, O211
Protolichas, O503
Protolloydolithus, O423
 PROTONYCHOPHORA, O18
 PROTOPARIA, O149, O150, O191
 Protopeltura, O266
Protopliomerella, O444
Protopliomeropinae, O163, O442
Protopliomerops, O123, O444
Protopliomeropsinae, O152, O442
 protopod, O8
 protopodite, O79, O125
Protopresbynileus, O343
 protopygidium, O125, O128
Protostygina, O367
 PROTRILOBITA, O146
 PROTURA, O16
Protypidae, O151
Protypus, O513
 proximal, O125
Prozacanthoides, O228
Pruvostina, O120, O211
Pruvostinoides, O208
Psalaspis, O273
Psalikilopsis, O278
Psalikilus, O278
Psephosthenaspis, O524
Pseudagnostidae, O161, O182
Pseudagnostus, O182
Pseudanomocarina, O290
 PSEUDANOSTRACA, O31, O32, O35
 pseudantennary pit, O125
Pseudasaphus, O337
Pseudatops, O91, O244
Pseudoasaphus, O337
Pseudobasilicus, O338
Pseudocelandia, O524
Pseudocheirus, O433
 PSEUDOCRUSTACEA, O14, O31
Pseudocryphaeus, O482
Pseudocybele, O56, O128, O134, O444
Pseudogygites, O343
Pseudohysterolenus, O364
Pseudokainella, O75, O114, O330
Pseudolenus, O211
Pseudolevinia, O525
Pseudoliostracina, O516
Pseudolisania, O312
 pseudomegalaspis enrollment, O104
Pseudomegalaspis, O103, O109, O339
Pseudomera, O440
Pseudomonaspis, O506
Pseudonileus, O343, O358
 PSEUDONOTOSTRACA, O15, O22, O28, O31
 pseudopalpebral furrow, O125
Pseudoperonopsis, O186
Pseudophilipsia, O402
Pseudoproetus, O396
 pseudoproparian suture, O60, O125
Pseudoptychoparia, O212
Pseudorhaptagnostus, O183
Pseudosalteria, O520
Pseudosaratogia, O252
Pseudosaukia, O520
Pseudosaukia, O322
Pseudosaukianda, O202
Pseudosphaerexochus, O435
Pseudosolenopleura, O275
Pseudotupolichas, O496
Psilacella, O362
Psilaspis, O290
Psilocephalina, O358
Psychopyge, O483
Ptarmigania, O226
Ptarmiganidae, O220
Ptarmiganiidae, O220
Ptarmiganoides, O226
Pterocephalia, O256
Pterocephalidae, O162, O256
Pterocephalina, O259
Pterocephalops, O260
Pterocephalus, O256
Pterolichas, O496
Pteroparia, O51, O91, O398
Pteropariinae, O152
Pterygometopidae, O163, O489
Pterygometopidella, O468
Pterygometopinae, O152, O163, O489
Pterygometopus, O490
Ptychagnostus, O179
Ptychaspidae, O162, O320
Ptychaspidae, O152, O320
Ptychaspidoidea, O152, O320
Ptychaspis, O320
Ptychocheilus, O350
Ptychometopus, O452
Ptychoparella, O233
Ptychoparia, O48, O59, O61, O100, O125, O157, O159, O233
Ptychopariacea, O161, O233
Ptychopariidae, O149, O150, O233
 ptychopariid suture pattern, O67
 PTYCHOPARIIDA, O161, O231
Ptychopariidae, O67, O100, O149, O151, O159, O161, O233
Ptychopariidea, O150, O233
 ptychopariiform suture, O61, O125
 PTYCHOPARIINA, O150, O161, O231
Ptychopariinae, O151, O161, O233
 PTYCHOPARINA, O149, O231
Ptychoparinae, O233
Ptychoparioidae, O151, O233
Ptychoparoides, O233
Ptychoparopsis, O241
Ptychopleura, O525
Ptychopleurites, O525
Ptychopyge, O109, O339
Ptycephalus, O343
Punctularia, O306
Punctulariidae, O152, O305
 pustule, O125
 PYCNOGONIDA, O4, O13, O16, O125
 pygaxis, O125
 PYGIDATA, O146
 pygidial region, O73, O125
 pygidium, O9, O43, O73, O125
 pygopleura, O125
Pyraustocranium, O524
Quadragnostinae, O184
Quadragnostus, O186
Quadraticephalus, O322
Quebecaspis, O279
 QUENSTEDT, O146, O148
Querandinia, O525
 rachis, O125
Radiaspis, O51, O506
Radiolichas, O503
Rananasus, O379
Raphiophoracea, O419
Raphiophoridae, O56, O66, O67, O92, O96, O148-O152, O159, O163, O426
 raphiophorid suture pattern, O159
Raphiophorinae, O152
Raphiophorus, O47, O48, O426
 RASETTI, O2, O41, O58, O59, O63, O66, O151, O160
Rasettia, O67, O70, O159, O380
 Raw, O63, O91, O111, O127, O141, O153
Rawlinsella, O305
 RAYMOND, O15, O22, O28, O41, O75, O77, O91-O93, O96, O99, O100, O107, O143, O147, O153
 RAYMOND & NARRAWAY, 96
Raymondarges, O496
Raymondaspis, O367
Raymondella, O427
Raymondia, O299
Raymondina, O299
Raymondinacea, O162, O298
Raymondinidae, O152, O162, O299
Raymondininae, O162, O299
Raymondites, O380
Reacalymene, O452
Redlichaspis, O200
Redlichia, O59, O93, O200
Redlichiaea, O161, O198
Redlichidae, O150
 REDLICHIIIDA, O161, O190
Redlichiiidae, O53, O59, O66, O67, O71, O150, O151, O158, O161, O199
Redlichiiidea, O150, O198
 REDLICHIIINA, O150, O161, O198, O231
Redlichinae, O151, O161, O199
Redlichina, O205
Redlichioidea, O151, O198
Redlichops, O201
 REED, O41, O96
Reedia, O466
Reedocalymene, O453
Reedocalymeninae, O152

- Reedolithus, O91, O92, O422
 Reedops, O466
 regeneration, O107
 region, O125
 Remipyga, O433
 Remopleuridacea, O162, O326
Remopleuridae, O149
 Remopleurides, O89, O122, O327
Remopleurides (family), O326
Remopleurididae, O53, O58, O72, O100, O121, O148-O150, O152, O154, O162, O327
Remopleuridiella, O327
Remopleuridinae, O162, O327
 reproductive system, of trilobites, O101
 Reraspis, O95, O435
 respiratory system, O101
 respiratory system, of Arthropoda, O13
 RESSER, O41, O59, O110, O114
 RESSER & ENDO, O102
 Resseraspis, O381
 Resseria, O520
 Resserops, O125, O202
Retusites, O525
 Reuscholithus, O422
 rhabdom, O12
 rhachis, O125
 Rhadinopleura, O430
 Rhamphopyge, O524
 Rhaptagnostus, O183
 Rhenops, O483
Rhinaspis, O347
 Rhodonaspis, O269
Rhodope, O374
 rib, O73, O125
 rib furrow, O125
 Richardsonella, O329
Richardsonellidae, O152
Richardsonellinae, O162, O329
 RICHTER, O2, O59, O63, O83, O91, O96, O111, O147, O150, O153, O156
 RICHTER & RICHTER, O41, O88, O109
Richterarges, O503
 Richterops, O202
 Rimouskia, O276
 Rinconia, O212
 ring, O125
 ring furrow, O125
 ring process, O125
 ring socket, O125
 Robergia, O327
Rogersvillia, O301
 Rollia, O278
 Ross, O110, O128, O134
 Rossaspis, O51, O110, O134, O139, O444
 rostral flange, O125
 rostral plate, O43, O54, O125
 rostral suture, O63, O125
 rostrum, O126
 ROUAULT, O41, O110
Rowia, O241
Rudagnostidae, O184
Rudagnostus, O179
Ruzickaia, O238
 sagittal, O126
 sagittal line, O126
 Saimachia, O288
 Saltaspis, O113, O148, O154, O159, O266
 SALTER, O41, O111, O146, O148
Salteria, O428
Salteria, O244
 Salterian molting, O111
Salterolithus, O423
 Sao, O128, O130, O132, O136, O138, O142, O155, O276
Saoidae, O152, O276
Saoinae, O162, O276
 Saratogia, O252
 Sarkia, O512
Sarkiaidae, O152
Sarkiaidae, O512
Sarkiaidae, O152, O167, O512
 Saukia, O323
 Saukianda, O202
Saukiandidae, O53, O151, O161, O202
 Saukiandiops, O200
 Saukiella, O57, O325
Saukiidae, O56, O152, O162, O232, O322
Saukiinae, O152, O322
 Saukioides, O322
 Scabriscutellum, O369
 Schagonaria, O215
Schantungia, O313
 Scharvia, O415
 Schistocephalus, O215
 Schistometopus, O516
 schizochroal eye, O89, O126
Schizophorus, O336
 Schizoproetus, O48, O49, O118, O389
Schizopyge, O486
 Schizostylus, O487
 Schmalensecia, O293
 SCHMIDT, O2, O41, O107
Schmidtaspis, O295
Schmidtella, O406
Schmidtia, O195
 Schmidtillus, O195
 SCHULTZE, O96
 Scinocephalus, O330
 sclerite, O4, O6, O43, O126
 Scotiella, O489
Scotoharpes, O416
 scrobiculate, O126
Sculptoproetus, O385
Scutellidae, O150, O152, O367
Scutelloidae, O152, O365
Scutelluidae, O152, O367
 Scutellum, O48, O56, O75, O85, O86, O93, O94, O109, O110, O369
 Sdzuy, O2
 segment, O126
 Seisonia, O441
 Seleneceme, O48, O120, O428
Selenecemidae, O152
Selenoharpes, O418
Selenopeltidae, O152, O508
Selenopeltides, O508
Selenopeltinae, O167, O508
Selenopeltis, O508
Selenopeltoides, O508
Selenoptychus, O361
Selenosema, O276
 Semiproetus, O392
Semnocephalus, O306
 Serrodiscus, O188
 seta, O6
 Sevilla, O401
 Shangtungia, O248
Shangtungia, O313
Shantungia, O248, O313
 Shickshockia, O309
 shield, O126
 Shirakiella, O271
Shirakiellidae, O152, O162, O271
 shoulder, O54, O126
 Shumardia, O41, O48, O72, O128, O134-O136, O138, O142, O245
Shumardidae, O149-O151
Shumardiidae, O41, O72, O91, O92, O149-O152, O161, O244
Shumardioidae, O152
 Shumardops, O91, O246
 side lobe, O126
Sidneya, O30
 Sidneyia, O15, O24, O30
Sidneyidae, O29
Sidneyiidae, O28, O29
 SIEGFRIED, O102, O106
 SINCLAIR, O96, O107
 Sinolenus, O212
Sinosaukia, O323
 size, of Trilobita, O41
 Skania, O99
 Skemmatocare, O394
 Skemmatopyge, O394
 Skreiaspis, O279
Sneedvillia, O248
 SNODGRASS, O8, O10, O15, O28
Solenagnostus, O179
Solenoparia, O309
Solenopariidae, O152
Solenopleura, O275
Solenopleuracea, O162, O274
Solenopleurella, O275
Solenopleurellinae, O151
Solenopleuridae, O149, O150, O152, O162, O274
Solenopleurina, O275
Solenopleurinae, O152, O162, O274
Solenopleuroidea, O152, O274
Solenopleuroopsis, O278
 SOLUTA, O15
Somatrikelon, O463
Somatrikopon, O463
 Sombrerella, O237
 somite, O7, O126
Sonoraspis, O224
 spatulate, O126
 Spencia, O275
Sphaeragnostidae, O151, O161, O183
Sphaeragnostus, O183

- Sphaerexochinae, O152, O163, O436
 Sphaerexochus, O46, O75, O89, O139, O140, O436
 Sphaerocare, O524
 Sphaerocoryphe, O53, O125, O438
 spheroidal enrollment, O102
Sphaerometopus, O438
Sphaerophthalmella, O266
Sphaerophthalmoides, O266
Sphaerophthalmus, O53, O89, O264
 Spinagnostidae, O151, O161, O184
 Spinagnostus, O184
 spine, O126
Spinodiscinae, O151, O187
Spinodiscus, O188
 Stapeleyella, O423
 Staurocephalus, O449
 Staurocephalinae, O152, O163, O449
Staurogmus, O276
Stauroholcus, O275
Stenelymus, O301
Stenochilina, O285
Stenocombus, O292
Stenopareia, O46, O56, O95, O96, O374
Stenopilus, O67, O68, O159, O412
Stenorhachis, O343
Stenosaukia, O324
Stephanocare, O317
Stephenaspis, O229
 sternite, O7, O43, O126
 STETHOSTOMATA, O15
Stigmacephalus, O274
Stigmametopus, O245
Stigmaspis, O322
 STØRMER, O3, O8, O15, O22, O28, O41, O62, O77, O79, O83, O92, O93, O99, O128, O131, O139, O147, O150, O153, O155
Stoermeraspis, O372
Stoermeria, O372
 stomodaeum, O9
 STRAND, O155
Strenuaeva, O207
Strenuella, O57, O119, O207
Strenuellinae, O151, O161, O207
Strettonia, O219
Strigigenalis, O381
Strotactinus, O444
Strotocephala, O412
Strotocephalus, O238
Strototropis, O444
 STRUVE, O2
 STUBBLEFIELD, O2, O59, O62, O131, O136, O141, O142, O147, O151, O153, O159
Stubblefieldia, O435
Stygina, O56, O366
 Styginidae, O56, O67, O152, O162, O365
 subcoxa, O126
 subcranial furrow, O126
 submarginal suture, O66
 subocular area, O126
 subocular groove, O126
Sulcatagnostus, O186
Sulcocephalus, O281
 SUN, O41
Sunia, O222
Sunina, O320
 sutural ridge, O126
 suture, O58, O126
 suture patterns, O158
 SUTURICEPHALIDA, O149
Svobodapeltis, O372
 SWINNERTON, O62, O114, O147- O149, O153
 SYMPHYLA, O14, O16
 Symphysops, O87, O88, O362
Symphysuridae, O150, O356
Symphysurina, O75, O353
Symphysurinella, O353
Symphysurininae, O162, O334, O353
Symphysurioides, O353
Symphysurus, O108, O358
 sympod, O8
 sympodite, O126
Synhomalonotus, O453, O456
Synphoria, O472
Synphorinae, O468
Synphorinae, O468
Synphoroides, O472
Syspacephalus, O237
Syspacheilus, O310
Tabatopygellina, O219
Taenicephalina, O309
Taenicephalus, O274
 tagma, O9
Taianocephalus, O525
Taihungshania, O356
Taihungshanidae, O355
Taihungshaniidae, O75, O162, O355
Taihunshaniinae, O152
Taihunshaninae, O152
 tail, O126
 tail shield, O126
Taishania, O297
Taitzuia, O312
Talacomarrolithus, O423
Talbotina, O49, O279
Talbotinidae, O152, O305
 TARDIGRADA, O4, O15, O18
 tarsus, O8, O78, O126
Tasmanaspis, O524
Tasmanocephalus, O524
Tatonaaspis, O271
Tatulaspis, O283
Taxioura, O219
 tegument, O126
 TEICHERT, O107
 Teinistion, O248
Telephidaceae, O294
Telephidae, O152, O297
Telephina, O48, O53, O107, O111, O154, O298
Telephinidae, O53, O162, O232, O297
Telephoidae, O152, O294
Telephus, O298
Telesiops, O525
Tellerina, O325
 telopodite, O78, O126
 telson, O126
Temnoura, O361
Temnura, O361
Temnurus, O361
 TEMPLE, O138
Terataspis, O42, O51, O75, O498
 teratology, O107
Teratorhynchus, O48, O329
 tergite, O7, O43, O126
Termierella, O123, O210
Termierellinae, O151, O161, O210
 terminal axial piece, O73, O126
 terminal axial segment, O126
 terminal axial spine, O75, O126
 terrace lines, O43, O126
Terranovella, O280
Tesselacauda, O56, O441
 test, O126
Tetracnemis, O276
Tetralichadinae, O152, O498
Tetralichas, O498
Tetralichinae, O163, O498
Tetrapsellium, O422
Thaleops, O374
Theamataspidae, O152, O376
Theamataspididae, O152, O376
Theamataspidinae, O163, O376
Theamataspis, O48, O376
Theodenisia, O67, O68, O159, O285
Thomastus, O374
Thomondia, O524
Thompsonaspis, O241
 thoracic region, of Trilobita, O70, O126
 thoracic segment, O126
 THORAL, O41
Thoralaspis, O212
 thorax, O9, O43
 THORSLUND, O3
Thysanopeltidae, O56, O67, O147- O150, O162, O367
Thysanopeltides, O367
Thysanopeltis, O369
Thysanopyge, O42, O75, O354
Thysanopyginae, O162, O354
Tibagya, O486
 tibia, O8, O78, O126
 TIEGS, O10, O14
Tingocephalinae, O152
Tingocephalus, O520
Toernquistia, O413
Toernquistia, O413
Toernquistiidae, O152
Tolanaspis, O219
Tollaspidae, O230
Tollaspis, O231
Tomagnostella, O186
Tomagnostus, O175
Tomoligus, O525
Tomorhachis, O174
Tonkinella, O220
Tonkinellidae, O151
Tonkinellinae, O151
Tontoia, O37
Tostonia, O326
Toxotididae, O152
Toxotis, O516
 tracheae, O13

- Trachycheilus, O241
Trachylichas, O496
 Tramoria, O330
 transglabellar furrow, O47, O126
 transitory pygidium, O126, O135
 transverse, O126
Travelocera, O507
Trematophorus, O336
 Tretaspidinae, O152, O163, O421
Tretaspinae, O152, O421
 Tretaspis, O85, O86, O91, O92, O97, O422
 Treveropyge, O483
 Triangulaspis, O190
Triarthrae, O148
 Triarthrella, O521
Triarthridae, O267
 Triarthrinae, O148, O152, O162, O267
 Triarthroides, O524
 Triarthropsis, O285
 Triarthrus, O26, O58, O75, O83, O85, O113, O114, O267
 tricomposite glabellar lobe, O126
 Tricrepicephalidae, O161, O250
 Tricrepicephalus, O107, O250
Trigonaspis, O384
 Trigonocerca, O343
 Trigonocercella, O343
Trigrypidae, O152
Trigrypos, O424
Trigryposidae, O152
 Trilobagnostus, O179
 TRILOBITA, O4, O11, O15, O22, O38, O160, O172
 TRILOBITAE, O40
 TRILOBITOIDEA, O4, O15, O23, O28
 TRILOBITOMORPHA, O4, O15, O22
Trimerinae, O152, O458
 Trimerocephalus, O62, O91, O92, O95, O111, O466
Trimerolichas, O496
 Trimerus, O42, O72, O75, O460
 Trinia, O516
Triniidae, O516
Trinodidae, O151, O176
 Trinodus, O178
Trinucleacea, O419
Trinucleen, O420
 TRINUCLEI, O40
 TRINUCLEIDA, O149, O231
 Trinucleidae, O56, O66, O67, O76, O91, O100, O104, O112, O119, O120-O122, O126, O147-O152, O158, O163, O420
Trinucleides, O420
 trinucleid suture pattern, O67, O159
 TRINUCLEINA, O163, O231, O419
 Trinucleinae, O152, O163, O420
Trinucleoidae, O152, O419
 Trinucleoides, O425
 Trinucleus, O86, O92, O110, O147, O420
 Triplagnostus, O179
 TRIPP, O2
 tritocerebrum, O9
 trochanter, O8, O79, O126
Trochuridae, O152
Trochurinae, O152
 Trochurus, O503
 tropidia, O126
Tropidocoryphe, O397
Tropidocoryphidae, O152
 Tropidocoryphinae, O152, O163, O397
 Tropidopyge, O270
 Trypaulites, O472
 Tschernyschewiella, O406
Tsiania, O356
Tsinain, O356
 Tsinania, O356
Tsinanidae, O356
 Tsinaniidae, O152, O162, O356
Tsinania, O356
 tubercle, O126
 Tunetzuella, O356
 Turcopyge, O495
 Typhloniscus, O487
 Typhloproetus, O62, O91, O395

Ucebia, O285
 Ullaspis, O516
 ULRICH, O41
 Ulrichaspis, O521
Ulricholithus, O422
 Uncaspis, O250
 Unguliproetus, O385
 upper lamella, O126
 upper rim (external or internal), O126
 Uralichas, O42, O143, O496
 Urbanaspis, O309
 Uromystrum, O380
 uropod, O126
 Utia, O247
Utidae, O152, O247
Utiana, O247
Utidae, O152, O247
Utinae, O247
Utioidea, O152, O246

 VANDEL, O4, O8, O13, O15, O22
 Vanuxemella, O75, O230
Vanuxemellinae, O151, O227
 Varvia, O354
 ventromarginal suture, O126
 Vermilionites, O309
 Vermontella, O235
 Vidria, O402
Vinakainella, O525
 vincular furrow, O105, O126
 Vinicella, O213
Vistoia, O230
 visual surface of eye, O126
 Vogdes, O40
 Vogdesia, O344
 VOLBORTH, O96, O99
Volborthia, O467
 Volonellus, O521

 WALCH, O40
 WALCOTT, O14, O22, O28, O41, O62, O76, O77, O82, O99, O114, O130, O148, O153
 Walcottaspis, O254
 Wanneria, O57, O63, O75, O197
 Wanneriinae, O151, O161, O197
 Waptia, O14, O24, O32
 WAPTIDA, O32
Waptidae, O32
 WAPTIDA, O28, O32
 Waptiidae, O28, O32
 WARBURG, O2, O41, O62, O153
 Warburgaspis, O396
 Warburgella, O396
Warburgella, O367
 Waribole, O392
 "water bears," O16
 WATERLOT, O15
 WEBER, O10
 Weberides, O401
 Weberopeltis, O372
Wedekindia, O525
 Weeksina, O280
 WELLER, O2
 Welleraspis, O128, O133, O134, O138, O139, O141, O156, O281
 WELLS, O107
 Wenkchemnia, O226
 Wentsuia, O288
 WESTERGÅRD, O41, O110, O148
 Westergardia, O76, O78, O266
 Westergardites, O268
 Westonaspis, O521
 Weymouthia, O188
Weymouthiidae, O151, O187
 WHITEHOUSE, O41, O149
Whitfieldina, O302
 WHITTARD, O96
 WHITTINGTON, O2, O41, O96, O106, O156
 WHITTINGTON & EVITT, O63, O89, O93
 Whittingtonia, O508
 Wilbernia, O252
 WILLIAMS, O107
 wing process (of hypostoma), O126
 Wongia, O283
 Woods, O147
 WOODWARD, O41
Wossekia, O374
 Wuhuia, O322
 Wutingaspis, O205
Wutingia, O522

 Xenasaphus, O339
 Xenocheilos, O284
 XENOPODA, O28
 Xenostegium, O75, O353
 Xenusion, O4, O13, O17, O19
 Xiphogonium, O387
 XIPHOSURA, O8, O14, O15
 Xystridura, O214
 Xystridurinae, O151, O161, O214

 Yabeia, O309
Yanquetruzia, O525
 Yinites, O205
 Yinitidae, O75, O151, O205
 Yohoaspis, O233

Yohoia, O14, O24, O36
 Yohoidae, O28, O35
 Yokusenidae, O151
 Yokusenoidae, O151
 Yorkella, O516
 Youngia, O439
 Yoyarrja, O525
 Yuepingia, O350
 Yuknessaspis, O233
 Yukonaspis, O271

Yunnanocephalidae, O151, O161,
 O212
 Yunnanocephalus, O212
 Zacanthoidae, O149, O150, O227
 Zacanthoides, O53, O227
 Zacanthoididae, O53, O57, O59,
 O66, O67, O72, O75, O149,
 O150, O154, O158, O227
 Zacanthoididea, O150
 Zacanthopsis, O230
 Zacompsus, O521
 Zbirovia, O375
 Zdicella, O375
 Zeliszkeella, O473
 Zeliszkeellinae, O152, O163, O473
 Zethus, O435
 Zetillaenus, O374
 Zuninaspis, O354
 ZITTEL-EASTMAN, O147