

*Encyclopedia of*

# Dietary Supplements

*edited by*

*Paul M. Coates*

*Marc R. Blackman*

*Gordon M. Cragg*

*Mark Levine*

*Joel Moss*

*Jeffrey D. White*



*Encyclopedia of*  
Dietary  
Supplements



*Encyclopedia of*  
**Dietary**  
**Supplements**

edited by

**Paul M. Coates**

*Director of the Office of Dietary Supplements  
National Institutes of Health  
Bethesda, Maryland*

**Marc R. Blackman**

*Scientific Director for Clinical Research  
at the National Center for  
Complementary and Alternative Medicine  
National Institutes of Health  
Bethesda, Maryland*

**Gordon M. Cragg**

*Chief of the Natural Products Branch  
of the National Cancer Institute  
National Institutes of Health  
Frederick, Maryland*

**Mark Levine**

*Section Chief of Molecular and Clinical Nutrition  
at the National Institute of Diabetes and Digestive and Kidney Diseases  
National Institutes of Health  
Bethesda, Maryland*

**Joel Moss**

*Chief of the Pulmonary–Critical Care Medicine Branch  
of the National Heart, Lung, and Blood Institute,  
National Institutes of Health  
Bethesda, Maryland*

**Jeffrey D. White**

*Director of the Office of Cancer Complementary  
and Alternative Medicine National Cancer Institute  
National Institutes of Health  
Bethesda, Maryland*



MARCEL DEKKER

NEW YORK



This is intended as a reference work only and is limited by the information available at the time of publication. Neither the Authors, the Editors, the Publisher, nor any of their sponsors or employers, endorse nor recommend the products or recommendations reported herein. Carefully consult the most recent FDA recommendations and a qualified medical professional before prescribing or using any dietary supplement.

**ISBN (Print): 0-8247-5504-9**

**ISBN (Online): 0-8247-5503-0**

**ISBN (Combination): 0-8247-4793-3**

**Library of Congress Cataloging-in-Publication Data**

A catalog record of this book is available from the Library of Congress.

This book is printed on acid-free paper.

**Headquarters**

Marcel Dekker

270 Madison Avenue, New York, NY 10016, U.S.A.

tel: 212-696-9000; fax: 212-685-4540

**World Wide Web**

<http://www.dekker.com>

**Copyright © 2005 by Marcel Dekker (except as noted on the opening page of each article). All Rights Reserved.**

*Cover photo:* Left-hand round detail: Courtesy of Peggy Kessler Duke

Neither this book nor any part may be reproduced or transmitted in any form or by any means, electronic or mechanical, including photocopying, microfilming, and recording, or by any information storage and retrieval system, without permission in writing from the publisher.

Current printing (last digit):

10 9 8 7 6 5 4 3 2 1

**PRINTED IN THE UNITED STATES OF AMERICA**

**Paul M. Coates**  
**Marc R. Blackman**  
**Gordon Cragg**  
**Mark Levine**  
**Joel Moss**  
**Jeffrey D. White**  
**Editors**

*National Institutes of Health,  
Bethesda, Maryland, U.S.A.*

### ***Editorial Advisory Board***

**Gary R. Beecher**

*Beltsville Human Nutrition Research Center,  
USDA-ARS, Beltsville, Maryland, U.S.A.*

**Joseph M. Betz**

*Office of Dietary Supplements, National Institutes of  
Health, Bethesda, Maryland, U.S.A.*

**John H. Cardellina**

*II, Developmental Therapeutics Program,  
National Cancer Institute, Frederick, Maryland, U.S.A.*

**Norman Farnsworth**

*Department of Pharmaceutical Sciences, University of  
Illinois at Chicago, Chicago, Illinois, U.S.A.*

**Donald B. McCormick**

*Department of Biochemistry, Emory University School  
of Medicine, Atlanta, Georgia, U.S.A.*

**Masatoshi Noda**

*Department of Molecular Infectiology,  
Chiba University, Chiba, Japan*

**Robert M. Russell**

*Jean Mayer USDA Human Nutrition Research Center  
on Aging at Tufts University, Boston, Massachusetts,  
U.S.A.*

**Noel W. Solomons**

*CESSIAM Guatemala, Miami, Florida, U.S.A.*

**Roy Upton**

*American Herbal Pharmacopoeia<sup>®</sup>, Scotts Valley,  
California, U.S.A.*

**Steven H. Zeisel**

*School of Public Health, The University of  
North Carolina, Chapel Hill, North Carolina, U.S.A.*



# Reviewers

The Editors wish to thank the outside reviewers, who lent their time, shared their expertise, and volunteered their editorial insights. Please note that some of the following read more than one article and two reviewers requested they remain anonymous.

- Salvatore Alesci, M.D., Ph.D. / *National Institutes of Health, Bethesda, Maryland, U.S.A.*
- Marilyn Barrett, Ph.D. / *Pharmacognosy Consulting Services, San Carlos, California, U.S.A.*
- Melinda A. Beck, Ph.D. / *University of North Carolina at Chapel Hill, Chapel Hill, North Carolina, U.S.A.*
- Joseph M. Betz, Ph.D. / *National Institutes of Health, Bethesda, Maryland, U.S.A.*
- John Beutler, Ph.D. / *National Cancer Institute, Frederick, Maryland, U.S.A.*
- Mark Blumenthal / *American Botanical Council and HerbalGram, Austin, Texas, U.S.A.*
- Richard A. Bone, Ph.D. / *Florida International University, Miami, Florida, U.S.A.*
- Linda S. Brady, Ph.D. / *National Institutes of Health, Bethesda, Maryland, U.S.A.*
- Alan L. Buchman, M.D., M.S.P.H / *Feinberg School of Medicine at Northwestern University, Chicago, Illinois, U.S.A.*
- John H. Cardellina, II, Ph.D. / *National Cancer Institute, Frederick, Maryland, U.S.A.*
- Lucas R. Chadwick, Ph.D. / *UIC/NIH Center for Botanical Dietary Supplements Research in Women's Health, Chicago, Illinois, U.S.A.*
- Yung-Chi Cheng, Ph.D. / *Yale School of Medicine, New Haven, Connecticut, U.S.A.*
- George P. Chrousos, M.D. / *National Institutes of Health, Bethesda, Maryland, U.S.A.*
- G. H. Constantine, Ph.D. / *Oregon State University College of Pharmacy, Corvallis, Oregon, U.S.A.*
- Steven Dentali, Ph.D. / *American Herbal Products Association, Silver Spring, Maryland, U.S.A.*
- Edzard Ernst, M.D., Ph.D., F.R.C.P. / *Peninsula Medical School of the Universities of Exeter & Plymouth, Exeter, Devon, U.K.*
- Norman R. Farnsworth, Ph.D. / *University of Illinois at Chicago, Chicago, Illinois, U.S.A.*
- Guylaine Ferland, Ph.D. / *Université de Montréal, Montreal, Canada*
- Lorraine A. Fitzpatrick, M.D. / *Women's Health Fellowship Mayo Clinic, Rochester, Minnesota, U.S.A.*
- Sherwood L. Gorbach, M.D. / *Tufts University School of Medicine, Boston, Massachusetts, U.S.A.*
- Tory M. Hagen, Ph.D. / *Oregon State University, Corvallis, Oregon, U.S.A.*
- Mary L. Hardy, M.D. / *David Geffen School of Medicine at UCLA, Los Angeles, California, U.S.A.*
- Jane Higdon, Ph.D. / *Oregon State University, Corvallis, Oregon, U.S.A.*
- Richard B. Kreider, Ph.D. / *Baylor University, Waco, Texas, U.S.A.*
- Norman I. Krinsky, Ph.D. / *School of Medicine and Jean Mayer USDA Human Nutrition Research Center on Aging at Tufts University, Boston, Massachusetts, U.S.A.*
- Oran Kwon, Ph.D. / *Korea Food and Drug Administration, Seoul, South Korea*
- Benjamin H.S. Lau, M.D., Ph.D. / *Loma Linda University, Loma Linda, California, U.S.A.*
- Gian Paolo Littarru, M.D. / *Polytechnic University of Marche, Ancona, Italy*
- Yuan Chun Ma, Ph.D. / *Canadian Phytopharmaceuticals Corp., Richmond, British Columbia, Canada*
- Craig J. McClain, M.D. / *University of Louisville, Louisville, Kentucky, U.S.A.*
- Donald B. McCormick, Ph.D. / *Emory University School of Medicine, Atlanta, Georgia, U.S.A.*
- Joshua W. Miller, Ph.D. / *University of California School of Medicine, Davis, California, U.S.A.*
- Richard L. Nahin, Ph.D., M.P.H. / *National Institutes of Health, Bethesda, Maryland, U.S.A.*
- Jac B. Park, Ph.D. / *United States Department of Agriculture, Beltsville, Maryland, U.S.A.*

- Greg Pennyroyal** / *Natural Product Solutions LLC, Temecula, California,*  
**J. David Phillipson, D.Sc., Ph.D.** / *University of London, London, U.K.*  
**William F. Popin, M.S.** / *Young Living Essential Oils, Lehi, Utah, U.S.A.*  
**A. Catharine Ross, Ph.D.** / *The Pennsylvania State University, University Park, Pennsylvania, U.S.A.*  
**Filippo Rossi-Fanelli** / *Universita degli Studia di Roma, Rome, Italy*  
**Norman Salem, Jr., Ph.D.** / *National Institutes of Health, Rockville, Maryland, U.S.A.*  
**Manickam Sugumaran, M.Sc., Ph.D.** / *University of Massachusetts, Boston, Massachusetts, U.S.A.*  
**Ronald S. Swerdloff, M.D.** / *Harbor-UCLA Medical Center and the David Geffen School of Medicine,  
Torrance, California, U.S.A.*  
**Barbara N. Timmermann, Ph.D.** / *University of Arizona College of Pharmacy, Tucson, Arizona, U.S.A.*  
**Roy Upton, Herbalist** / *American Herbal Pharmacopoeia<sup>®</sup>, Scotts Valley, California, U.S.A.*  
**Hildebert Wagner, Ph.D.** / *University of Munich, Munchen, Germany*  
**W. Allan Walker, M.D.** / *Harvard Medical School, Boston, Massachusetts, U.S.A.*

# Contributors

- Steve F. Abcouwer** / *University of New Mexico School of Medicine, Albuquerque, New Mexico, U.S.A.*
- Gianluca Aimaretti** / *University of Turin, Turin, Italy*
- Salvatore Alesci** / *Clinical Neuroendocrinology Branch, National Institute of Mental Health, National Institutes of Health, Bethesda, Maryland, U.S.A.*
- Lindsay H. Allen** / *United States Department of Agriculture—Western Human Nutrition Research Center, University of California, Davis, California, U.S.A.*
- John J.B. Anderson** / *Schools of Public Health and Medicine, University of North Carolina, Chapel Hill, North Carolina, U.S.A.*
- Decio Armanini** / *University of Padua, Padua, Italy*
- Emanuela Arvat** / *University of Turin, Turin, Italy*
- Dennis V.C. Awang** / *MediPlant Consulting Inc., White Rock, British Columbia, Canada*
- Pamela Bagley** / *Biomedical Libraries, Dartmouth College, Hanover, New Hampshire, U.S.A.*
- Matteo Baldi** / *University of Turin, Turin, Italy*
- Rudolf Bauer** / *Institute of Pharmaceutical Sciences, Karl-Franzens-University Graz, Graz, Austria*
- John Beard** / *The Pennsylvania State University, University Park, Pennsylvania, U.S.A.*
- Gary R. Beecher** / *Lothian, Maryland, U.S.A.*
- Joseph M. Betz** / *National Institutes of Health, Bethesda, Maryland, U.S.A.*
- Jens Bielenberg** / *Division of Endocrinology, University of Padua, Padua, Italy*
- Marc R. Blackman** / *Endocrine Section, Laboratory of Clinical Investigation, National Center for Complementary and Alternative Medicine, National Institutes of Health, Bethesda, Maryland, U.S.A.*
- Nancy L. Booth** / *UIC/NIH Center for Botanical Dietary Supplements Research, Program for Collaborative Research in the Pharmaceutical Sciences, College of Pharmacy, University of Illinois at Chicago, Chicago, Illinois, U.S.A.*
- Christelle Bourgeois** / *Institute of Medical Biochemistry, Medical University of Vienna, Vienna, Austria*
- François G. Brackman** / *Fournier Pharma, Garches, France*
- Raymond F. Burk** / *Clinical Nutrition Research Unit, Vanderbilt University School of Medicine, Nashville, Tennessee, U.S.A.*
- Werner R. Busse** / *Dr. Willmar Schwabe GmbH & Co. KG, Karlsruhe, Germany*
- Shenglin Chen** / *Molecular and Clinical Nutrition Section, Digestive Diseases Branch, National Institute of Diabetes and Digestive and Kidney Diseases, National Institutes of Health, Bethesda, Maryland, U.S.A.*
- Emily Y. Chew** / *Division of Epidemiology and Clinical Research, National Eye Institute, National Institutes of Health, Bethesda, Maryland, U.S.A.*
- Carolyn S. Chung** / *Children's Hospital Oakland Research Institute, Oakland, California, U.S.A.*
- Daniel O. Clegg** / *George E. Wahlen Department of Veterans Affairs Medical Center and University of Utah School of Medicine, Salt Lake City, Utah, U.S.A.*
- Dallas L. Cloutre** / *Glykon Technologies Group, L.L.C., Santa Monica, California, U.S.A.*
- Jerry M. Cott** / *Food and Drug Administration, Rockville, Maryland, U.S.A.*
- Edward M. Croom, Jr.** / *School of Pharmacy, University of Mississippi, Oxford, Mississippi, U.S.A.*
- Gustav Dallner** / *Stockholm University, Stockholm, Sweden*

- Pedro Del Corral** / *Clinical Neuroendocrinology Unit, Pediatric Reproductive Endocrinology Branch, National Institutes of Child Health and Human Development, National Institutes of Health, Bethesda, Maryland, U.S.A.*
- Brigit Dietz** / *UIC/NIH Center for Botanical Dietary Supplements Research, College of Pharmacy, University of Illinois at Chicago, Chicago, Illinois, U.S.A.*
- Linda C. Duffy** / *Infectious Diseases Division, University of Buffalo—State University of New York, Women and Children's Health Research Foundation, Women and Children's Hospital/Kaleida Health, Buffalo, New York, U.S.A.*
- Peter Eck** / *Molecular and Clinical Nutrition Section, Digestive Diseases Branch, National Institute of Diabetes and Digestive and Kidney Diseases, National Institutes of Health, Bethesda, Maryland, U.S.A.*
- Alan Edgar** / *Fournier Pharma, Garches, France*
- Memory P.F. Elvin-Lewis** / *Washington University, St. Louis, Missouri, U.S.A.*
- Jan Engle** / *UIC/NIH Center for Botanical Dietary Supplements Research, College of Pharmacy, University of Illinois at Chicago, Chicago, Illinois, U.S.A.*
- Daniel S. Fabricant** / *UIC/NIH Center for Botanical Dietary Supplements Research for Women's Health, Program for Collaborative Research in the Pharmaceutical Sciences, College of Pharmacy (M/C-877), University of Illinois at Chicago, Chicago, Illinois, U.S.A.*
- Norman R. Farnsworth** / *UIC/NIH Center for Botanical Dietary Supplements Research for Women's Health, Program for Collaborative Research in the Pharmaceutical Sciences, College of Pharmacy (M/C-877), University of Illinois at Chicago, Chicago, Illinois, U.S.A.*
- Cristina Fiore** / *University of Padua, Padua, Italy*
- Sanford C. Garner** / *Constella Group, Inc., Durham, North Carolina, U.S.A.*
- Ezio Ghigo** / *University of Turin, Turin, Italy*
- Roberta Giordano** / *University of Turin, Turin, Italy*
- Elizabeth Griffiths** / *Infectious Diseases Division, University of Buffalo—State University of New York, Women and Children's Health Research Foundation, Women and Children's Hospital/Kaleidaz Health, Buffalo, New York, U.S.A.*
- Peter Hadley** / *Delft University of Technology, Delft, FGN, The Netherlands*
- William S. Harris** / *Lipid and Diabetes Research Center, Mid America Heart Institute, Saint Luke's Hospital, Kansas City, Missouri, U.S.A.*
- Robert P. Heaney** / *Creighton University, Omaha, Nebraska, U.S.A.*
- Chi-Tang Ho** / *Cook College, Rutgers, The State University of New Jersey, Piscataway, New Jersey, U.S.A.*
- Curtiss D. Hunt** / *United States Department of Agriculture, Agriculture Research Service, Grand Forks Human Nutrition Research Center, Grand Forks, North Dakota, U.S.A.*
- Christopher G. Jackson** / *University of Utah School of Medicine and George E. Wahlen Department of Veterans Affairs Medical Center, Salt Lake City, Utah, U.S.A.*
- C. Jakobs** / *VU University Medical Center, Clinical Chemistry, Metabolic Unit, Amsterdam, The Netherlands*
- Elizabeth J. Johnson** / *Jean Mayer USDA Human Nutrition Research Center on Aging, Tufts University, Boston, Massachusetts, U.S.A.*
- Katharine M. Jones** / *United States Department of Agriculture—Western Human Nutrition Research Center, University of California, Davis, California, U.S.A.*
- Wiltrud Juretzek** / *Dr. Willmar Schwabe GmbH & Co. KG, Karlsruhe, Germany*
- Chithan Kandaswami** / *State University of New York at Buffalo, Buffalo, New York, U.S.A.*
- Arie Katz** / *Molecular and Clinical Nutrition Section, Digestive Diseases Branch, National Institute of Diabetes and Digestive and Kidney Diseases, National Institutes of Health, Bethesda, Maryland, U.S.A.*
- Kara M. Kelly** / *Division of Pediatric Oncology, Integrative Therapies Program for Children with Cancer, College of Physicians and Surgeons, Columbia University Medical Center, New York, New York, U.S.A.*
- Ikhlas A. Khan** / *National Center for Natural Products Research, Research Institute of Pharmaceutical Sciences, School of Pharmacy, University of Mississippi, University, Mississippi, U.S.A.*
- Janet C. King** / *Children's Hospital Oakland Research Institute, Oakland, California, U.S.A.*
- Marguerite A. Klein** / *Division of Extramural Research and Training, National Center for Complementary and Alternative Medicine, National Institutes of Health, Bethesda, Maryland, U.S.A.*

- Leslie M. Klevay** / *Grand Forks Human Nutrition Research Center, Agricultural Research Service, Grand Forks, North Dakota, U.S.A.*
- Egon Koch** / *Dr. Willmar Schwabe GmbH & Co. KG, Karlsruhe, Germany*
- David J. Kroll** / *Natural Products Laboratory, Research Triangle Institute (RTI International), Research Triangle Park, North Carolina, U.S.A.*
- Oran Kwon** / *Korea Food and Drug Administration, Seoul, Korea*
- Elena Ladas** / *Division of Pediatric Oncology, Integrative Therapies Program for Children with Cancer, College of Physicians and Surgeons, Columbia University Medical Center, New York, New York, U.S.A.*
- Joshua D. Lambert** / *Susan Lehman Cullman Laboratory for Cancer Research, Ernest Mario School of Pharmacy, Rutgers, The State University of New Jersey, Piscataway, New Jersey, U.S.A.*
- Fabio Lanfranco** / *University of Turin, Turin, Italy*
- Benjamin Z. Leder** / *Massachusetts General Hospital and Harvard Medical School, Boston, Massachusetts, U.S.A.*
- Jee-Hyuk Lee** / *Molecular and Clinical Nutrition Section, Digestive Diseases Branch, National Institute of Diabetes and Digestive and Kidney Diseases, National Institutes of Health, Bethesda, Maryland, U.S.A.*
- James E. Leklem** / *Oregon State University, Corvallis, Oregon, U.S.A.*
- Albert Y. Leung** / *Phyto-Technologies, Inc., Woodbine, Iowa, U.S.A.*
- Mark Levine** / *Molecular and Clinical Nutrition Section, Digestive Diseases Branch, National Institute of Diabetes and Digestive and Kidney Diseases, National Institutes of Health, Bethesda, Maryland, U.S.A.*
- Walter H. Lewis** / *Washington University, St. Louis, Missouri, U.S.A.*
- Thomas S.C. Li** / *Agriculture and Agri-Food Canada, Pacific Agri-Food Research Center, Summerland, British Columbia, Canada*
- Tieraona Low Dog** / *University of Arizona Health Sciences Center, Tucson, Arizona, U.S.A.*
- Shelly C. Lu** / *USC Research Center for Liver Diseases, USC-UCLA Alcoholic Liver and Pancreatic Disease Center, The Division of Gastrointestinal and Liver Diseases, Keck School of Medicine, University of Southern California, Los Angeles, California, U.S.A.*
- José M. Mato** / *CIC-Biogune, Metabolomics Unit, Technological Park of Bizkaia, Derio, Bizkaia, Spain*
- Mauro Maccario** / *University of Turin, Turin, Italy*
- Gail B. Mahady** / *UIC/NIH Center for Botanical Dietary Supplements Research, College of Pharmacy, University of Illinois at Chicago, Chicago, Illinois, U.S.A.*
- Irini Manoli** / *Endocrine Section, Laboratory of Clinical Investigation, National Center for Complementary and Alternative Medicine, National Institutes of Health, Bethesda, Maryland, U.S.A.*
- Lisa Marafetti** / *University of Turin, Turin, Italy*
- Valentino Martina** / *University of Turin, Turin, Italy*
- Donald B. McCormick** / *School of Medicine, Emory University, Atlanta, Georgia, U.S.A.*
- Dennis J. McKenna** / *Center for Spirituality and Healing, Academic Health Center, University of Minnesota, Minneapolis, Minnesota, U.S.A.*
- Mark Messina** / *School of Public Health, Loma Linda University, Loma Linda, California, U.S.A.*
- Joanna Michel** / *UIC/NIH Center for Botanical Dietary Supplements Research, College of Pharmacy, University of Illinois at Chicago, Chicago, Illinois, U.S.A.*
- J.A. Milner** / *National Institutes of Health, Bethesda, Maryland, U.S.A.*
- Homan Miraliakbari** / *Memorial University of Newfoundland, St. John's, Newfoundland, Canada*
- Donald M. Mock** / *University of Arkansas for Medical Sciences, Little Rock, Arkansas, U.S.A.*
- Joel Moss** / *National Institutes of Health, NHLBI, Pulmonary-Critical Care Medicine Branch, Bethesda, Maryland, U.S.A.*
- Ilias Muhammad** / *National Center for Natural Products Research, Research Institute of Pharmaceutical Sciences, School of Pharmacy, University of Mississippi, University, Mississippi, U.S.A.*
- Steven M. Musser** / *Office of Scientific Analysis and Support, Center for Food Safety and Applied Nutrition, United States Food and Drug Administration, College Park, Maryland, U.S.A.*
- Koji Nakanishi** / *Columbia University, New York, New York, U.S.A.*



- Brooke K. Norsworthy** / *Clinical Nutrition Research Unit, Vanderbilt University School of Medicine, Nashville, Tennessee, U.S.A.*
- Pearay Ogra** / *Infectious Diseases Division, University of Buffalo—State University of New York, Women and Children’s Health Research Foundation, Women and Children’s Hospital/Kaleida Health, Buffalo, New York, U.S.A.*
- Adewole L. Okunade** / *Washington University, St. Louis, Missouri, U.S.A.*
- Karel Pacak** / *Clinical Neuroendocrinology Unit, Pediatric Reproductive Endocrinology Branch, National Institutes of Child Health and Human Development, National Institutes of Health, Bethesda, Maryland, U.S.A.*
- Sebastian J. Padayatty** / *Molecular and Clinical Nutrition Section, Digestive Diseases Branch, National Institute of Diabetes and Digestive and Kidney Diseases, National Institutes of Health, Bethesda, Maryland, U.S.A.*
- Jae B. Park** / *Phytonutrients Laboratory, BHNRC, ARS, United States Department of Agriculture, Beltsville, Maryland, U.S.A.*
- Cesare Patrini** / *University of Pavia, Pavia, Italy*
- Colleen E. Piersen** / *UIC/NIH Center for Botanical Dietary Supplements Research, Program for Collaborative Research in the Pharmaceutical Sciences, College of Pharmacy, University of Illinois at Chicago, Chicago, Illinois, U.S.A.*
- Gregory A. Plotnikoff** / *Center for Spirituality and Healing, Academic Health Center, University of Minnesota, Minneapolis, Minnesota, U.S.A.*
- Haiping Qiao** / *Infectious Diseases Division, University of Buffalo—State University of New York, Women and Children’s Health Research Foundation, Women and Children’s Hospital/Kaleida Health, Buffalo, New York, U.S.A.*
- Eugenio Ragazzi** / *University of Padua, Padua, Italy*
- Charles J. Rebouche** / *Carver College of Medicine, University of Iowa, Iowa City, Iowa, U.S.A.*
- Gianguido Rindi** / *University of Pavia, Pavia, Italy*
- Richard S. Rivlin** / *Clinical Nutrition Research Unit, Institute for Cancer Prevention, New York, New York, U.S.A.*
- P.J. Rohdewald** / *Institute of Pharmaceutical Chemistry, Westfälische Wilhelms-Universität Münster, Münster, Germany*
- A. Catharine Ross** / *The Pennsylvania State University, University Park, Pennsylvania, U.S.A.*
- Robert K. Rude** / *University of Southern California, Los Angeles, California, U.S.A.*
- Robert M. Russell** / *Jean Mayer USDA Human Nutrition Research Center on Aging, Tufts University, Boston, Massachusetts, U.S.A.*
- Rosalie Sagraves** / *UIC/NIH Center for Botanical Dietary Supplements Research, College of Pharmacy, University of Illinois at Chicago, Chicago, Illinois, U.S.A.*
- G.S. Salomons** / *VU University Medical Center, Clinical Chemistry, Metabolic Unit, Amsterdam, The Netherlands*
- Shengmin Sang** / *Susan Lehman Cullman Laboratory for Cancer Research, Ernest Mario School of Pharmacy, Rutgers, The State University of New Jersey, Piscataway, New Jersey, U.S.A.*
- John Paul SanGiovanni** / *Division of Epidemiology and Clinical Research, National Eye Institute, National Institutes of Health, Bethesda, Maryland, U.S.A.*
- Steven J. Schwartz** / *The Ohio State University, Columbus, Ohio, U.S.A.*
- Mariangela Seardo** / *University of Turin, Turin, Italy*
- Fereidoon Shahidi** / *Memorial University of Newfoundland, St. John’s, Newfoundland, Canada*
- Barry Shane** / *University of California, Berkeley, California, U.S.A.*
- William L. Smith** / *University of Michigan Medical School, Ann Arbor, Michigan, U.S.A.*
- Fabio Soldati** / *Pharmaton SA, Head of Research and Development, Bioggio, Switzerland*
- Jiannan Song** / *School of Public Health and School of Medicine, University of North Carolina, Chapel Hill, North Carolina, U.S.A.*
- Stephen Sporn** / *Springfield, Missouri, U.S.A.*
- Roland Stocker** / *Centre for Vascular Research, School of Medical Sciences, University of New South Wales, Sydney, New South Wales, Australia*

- Kristian Strømgaard** / *The Danish University of Pharmaceutical Sciences, Copenhagen, Denmark*
- J.W. Suttie** / *College of Agricultural and Life Sciences, University of Wisconsin-Madison, Madison, Wisconsin, U.S.A.*
- Lawrence Sweetman** / *Mass Spectrometry Laboratory, Institute of Metabolic Disease, Baylor University Medical Center, Dallas, Texas, U.S.A.*
- Anne L. Thurn** / *Office of Dietary Supplements, National Institutes of Health, Bethesda, Maryland, U.S.A.*
- Maret G. Traber** / *Linus Pauling Institute, Oregon State University, Corvallis, Oregon, U.S.A.*
- Roy Upton** / *American Herbal Pharmacopoeia<sup>®</sup>, Scotts Valley, California, U.S.A.*
- Stine B. Vogensen** / *The Danish University of Pharmaceutical Sciences, Copenhagen, Denmark*
- Yaohui Wang** / *Molecular and Clinical Nutrition Section, Digestive Diseases Branch, National Institute of Diabetes and Digestive and Kidney Diseases, National Institutes of Health, Bethesda, Maryland, U.S.A.*
- Solomon P. Wasser** / *Institute of Evolution, University of Haifa, Mount Carmel, Haifa, Israel*
- Karin Woelkart** / *Institute of Pharmaceutical Sciences, Karl-Franzens-University Graz, Graz, Austria*
- Richard J. Wurtman** / *Massachusetts Institute of Technology, Cambridge, Massachusetts, U.S.A.*
- M. Wyss** / *DSM Nutritional Products Ltd., Basel, Switzerland*
- Chung S. Yang** / *Susan Lehman Cullman Laboratory for Cancer Research, Ernest Mario School of Pharmacy, Rutgers, The State University of New Jersey, Piscataway, New Jersey, U.S.A.*
- Steven H. Zeisel** / *School of Public Health and School of Medicine, University of North Carolina, Chapel Hill, North Carolina, U.S.A.*
- Jianping Zhao** / *National Center for Natural Products Research, Research Institute of Pharmaceutical Sciences, School of Pharmacy, University of Mississippi, University, Mississippi, U.S.A.*



# Contents

<i>Preface</i> . . . . .	xv
<b>S-Adenosylmethionine</b> / José M. Mato and Shelly C. Lu . . . . .	1
<b>Androstenedione</b> / Benjamin Z. Leder . . . . .	7
<b>L-Arginine</b> / Mauro Maccario, Emanuela Arvat, Gianluca Aimaretti, Valentino Martina, Roberta Giordano, Fabio Lanfranco, Lisa Marafetti, Mariangela Seardo, Matteo Baldi, and Ezio Ghigo . . . . .	15
<b>Astragalus</b> / Roy Upton . . . . .	25
<b>Biotin</b> / Donald M. Mock . . . . .	31
<b>Black Cohosh (<i>Cimicifuga racemosa</i>)</b> / Daniel S. Fabricant and Norman R. Farnsworth . . . . .	41
<b>Boron</b> / Curtiss D. Hunt . . . . .	55
<b>Calcium</b> / Robert P. Heaney . . . . .	65
<b>L-Carnitine and Acetyl-L-Carnitine</b> / Charles J. Rebouche . . . . .	73
<b>β-Carotene</b> / Elizabeth J. Johnson and Robert M. Russell . . . . .	81
<b>Cascara Sagrada (<i>Rhamnus purshiana</i>)</b> / Gail B. Mahady . . . . .	89
<b>Chasteberry (<i>Vitex agnus castus</i>)</b> / Gail B. Mahady, Brigit Dietz, Joanna Michel, Jan Engle, and Rosalie Sagraves . . . . .	95
<b>Choline</b> / Jiannan Song and Steven H. Zeisel . . . . .	105
<b>Chondroitin</b> / Christopher G. Jackson and Daniel O. Clegg . . . . .	113
<b>Coenzyme Q<sub>10</sub></b> / Gustav Dallner and Roland Stocker . . . . .	121
<b>Copper</b> / Leslie M. Klevay . . . . .	133
<b>Cranberry (<i>Vaccinium macrocarpon</i>) Aiton</b> / Marguerite A. Klein . . . . .	143
<b>Creatine</b> / G.S. Salomons, M. Wyss, and C. Jakobs . . . . .	151
<b>Dang Gui (<i>Angelica sinensis</i>)</b> / Roy Upton . . . . .	159
<b>Dehydroepiandrosterone (DHEA)</b> / Salvatore Alesci, Irini Manoli, and Marc R. Blackman . . . . .	167
<b>Echinacea</b> / Rudolf Bauer and Karin Woelkart . . . . .	177
<b>Ephedra (Ma Huang)</b> / Anne L. Thurn . . . . .	189
<b>Evening Primrose (<i>Oenothera biennis</i>)</b> / Fereidoon Shahidi and Homan Miraliakbari . . . . .	197
<b>Feverfew (<i>Tanacetum parthenium</i>)</b> / Dennis V.C. Awang and Albert Y. Leung . . . . .	211
<b>Folate</b> / Pamela Bagley and Barry Shane . . . . .	219
<b>Garlic (<i>Allium sativum</i>)</b> / J.A. Milner . . . . .	229
<b>Ginger (<i>Zingiber officinale</i>)</b> / Tieraona Low Dog . . . . .	241
<b>Ginkgo biloba</b> / Kristian Strømgaard, Stine B. Vogensen, and Koji Nakanishi . . . . .	249
<b>Ginseng, American (<i>Panax quinquefolium</i>)</b> / Thomas S.C. Li . . . . .	259
<b>Ginseng, Asian (<i>Panax ginseng</i>)</b> / Fabio Soldati . . . . .	265
<b>Glucosamine</b> / Daniel O. Clegg and Christopher G. Jackson . . . . .	279
<b>Glutamine</b> / Steve F. Abcouwer . . . . .	287
<b>Goldenseal (<i>Hydrastis canadensis</i>)</b> / Dennis J. McKenna and Gregory A. Plotnikoff . . . . .	297
<b>Grape Seed Extract</b> / Dallas L. Cloutre and Chithan Kandaswami . . . . .	309

<b>Green Tea Polyphenols</b> / Shengmin Sang, Joshua D. Lambert, Chi-Tang Ho, and Chung S. Yang . . . . .	327
<b>Hawthorn (<i>Crataegus</i>)</b> / Werner R. Busse, Wiltrud Juretzek, and Egon Koch . . . . .	337
<b>5-Hydroxytryptophan</b> / Pedro Del Corral and Karel Pacak . . . . .	349
<b>Iron</b> / John Beard . . . . .	357
<b>Isoflavones</b> / Mark Messina . . . . .	363
<b>Kava (<i>Piper methysticum</i>)</b> / Steven M. Musser . . . . .	373
<b>Lactobacilli and Bifidobacteria</b> / Linda C. Duffy, Stephen Sporn, Elizabeth Griffiths, Haiping Qiao, and Pearay Ogra . . . . .	381
<b>Licorice (<i>Glycyrrhiza glabra</i>)</b> / Decio Armanini, Cristina Fiore, Jens Bielenberg, and Eugenio Ragazzi . . . . .	391
<b><math>\alpha</math>-Lipoic Acid/Thioctic Acid</b> / Donald B. McCormick . . . . .	401
<b>Lutein</b> / Emily Y. Chew and John Paul SanGiovanni . . . . .	409
<b>Lycopene</b> / Peter Hadley and Steven J. Schwartz . . . . .	421
<b>Maca (<i>Lepidium meyenii</i>)</b> / Ilias Muhammad, Jianping Zhao, and Ikhtlas A. Khan . . . . .	435
<b>Magnesium</b> / Robert K. Rude . . . . .	445
<b>Melatonin</b> / Richard J. Wurtman . . . . .	457
<b>Milk Thistle (<i>Silybum marianum</i>)</b> / Elena Ladas, David J. Kroll, and Kara M. Kelly . . . . .	467
<b>Niacin</b> / Christelle Bourgeois and Joel Moss . . . . .	483
<b>Omega-3 Fatty Acids</b> / William S. Harris . . . . .	493
<b>Omega-6 Fatty Acids</b> / William L. Smith . . . . .	505
<b>Pantothenic Acid</b> / Lawrence Sweetman . . . . .	517
<b>Pau d'Arco or Lapacho (<i>Tabebuia</i>)</b> / Walter H. Lewis, Adewole L. Okunade, and Memory P.F. Elvin-Lewis . . . . .	527
<b>Phosphorus</b> / John J.B. Anderson and Sanford C. Garner . . . . .	537
<b>Pycnogenol<sup>®</sup>, French Maritime Pine Bark Extract</b> / P.J. Rohdewald . . . . .	545
<b>Proanthocyanidins</b> / Gary R. Beecher . . . . .	555
<b><i>Pygeum africanum</i> Extract</b> / François G. Brackman and Alan Edgar . . . . .	569
<b>Quercetin</b> / Jae B. Park . . . . .	577
<b>Red Clover (<i>Trifolium pratense</i>)</b> / Nancy L. Booth and Colleen E. Piersen . . . . .	587
<b>Reishi or Ling Zhi (<i>Ganoderma lucidum</i>)</b> / Solomon P. Wasser . . . . .	603
<b>Riboflavin</b> / Richard S. Rivlin . . . . .	623
<b>Saw Palmetto (<i>Serenoa repens</i>)</b> / Edward M. Croom, Jr. . . . .	635
<b>Selenium</b> / Raymond F. Burk and Brooke K. Norsworthy . . . . .	645
<b>Shiitake (<i>Lentinus edodes</i>)</b> / Solomon P. Wasser . . . . .	653
<b>St. John's Wort (<i>Hypericum perforatum</i>)</b> / Jerry M. Cott . . . . .	665
<b>Thiamin</b> / Gianguido Rindi and Cesare Patrini . . . . .	677
<b>Valerian</b> / Dennis V.C. Awang and Albert Y. Leung . . . . .	687
<b>Vitamin A</b> / A. Catharine Ross . . . . .	701
<b>Vitamin B<sub>6</sub></b> / James E. Leklem . . . . .	715
<b>Vitamin B<sub>12</sub></b> / Lindsay H. Allen and Katharine M. Jones . . . . .	735
<b>Vitamin C</b> / Mark Levine, Arie Katz, Sebastian J. Padayatty, Yaohui Wang, Peter Eck, Oran Kwon, Shenglin Chen, and Jee-Hyuk Lee . . . . .	745
<b>Vitamin E</b> / Maret G. Traber . . . . .	757
<b>Vitamin K</b> / J.W. Suttie . . . . .	771
<b>Yohimbe (<i>Pausinystalia johimbe</i>)</b> / Joseph M. Betz . . . . .	783
<b>Zinc</b> / Carolyn S. Chung and Janet C. King . . . . .	791
<b>Index</b> . . . . .	801

# Preface

Welcome to the *Encyclopedia of Dietary Supplements*, reflecting the combined efforts of more than 100 authors on more than 75 different topics. We expect this work to become a valuable reference for students and researchers of physiology and chemistry, for healthcare providers, and for consumers who are interested in understanding the kind of science that is—or is not—behind the claims that are made for dietary supplements that are sold throughout the world, where standards of government regulation differ from country to country.

In the United States, sales of products in the dietary supplement market approached \$20 billion in 2003. Their form and their labeling are regulated by the Food and Drug Administration (FDA) as a result of legislation passed in 1994 called the Dietary Supplement Health and Education Act (DSHEA). The dietary supplement category in the United States includes vitamins, minerals, and other ingredients that are found in foods, as well as ingredients not ordinarily found in foods—such as extracts of herbs and other natural products—that are used by consumers for their potential health-promoting, disease-preventing, performance-enhancing or healing properties. Many of these are represented in the chapters of this book.

The *Encyclopedia* is not just for consumers in the U.S. market, although we acknowledge that the term “dietary supplements” is an American expression. We are not aware of any other single term that describes all of the substances that we wish to include in this encyclopedia, even though some may not consider it appropriate to certain products not marketed in the United States. Consumers in all parts of the world ingest the substances that we have covered in this reference. Sometimes the claims for benefit of specific products are borne out by well-documented scientific studies. In other cases, they are not, and enthusiasm for their use is based on popular legend or on longstanding patterns of use in traditional healing systems. In this encyclopedia, we hope that readers will be able to examine the types of evidence that have been used to support claims of benefit.

The goal of the *Encyclopedia of Dietary Supplements* is to provide readers with comprehensive, yet accessible, information on the current state of science for individual supplement ingredients or extracts. To this end, each entry reviews the basic information available about the ingredient, including where applicable its chemistry and functions, before detailing the pre-clinical and clinical literature. Articles outline the regulatory status of each substance, and then conclude with references to the relevant literature.

Dietary supplements included for this first edition of this Encyclopedia were selected in large part because of their popularity in the marketplace. It is clear that the level of scientific information available differs markedly among the various entries. For many ingredients, the chemistry and physiology, pre-clinical and clinical information, and mechanism of action are well known. For others, by contrast, some or many pieces of these data are missing. The preparation of some commercial products is of high quality and follows good agricultural, laboratory, and manufacturing practices. Again, by contrast, the preparations for others have not been reliable, making them subject to high variability in content and contamination. As dietary supplement use becomes more widespread, there are growing concerns about the safety of some ingredients, including possible harmful interactions between supplements and prescribed drugs. These issues should form the basis for future research.

The field of dietary supplements is a rich one, and the science related to this large class of ingredients is expanding all the time. Thus, an important feature of this encyclopedia is

that, after this first edition appears in print and online at [www.dekker.com](http://www.dekker.com), future updates will be made online and on a regular basis. Topics that have not been covered in this edition can be included in future online versions. The first online update, for example, will include an article on regulation of these products around the world. Likewise, information that requires, it can be updated promptly via the online updates, without having to wait for a revised printed edition.

Two of the topics in this edition of the *Encyclopedia*—*Ephedra* and *Androstenedione*—were commissioned before their status as dietary supplements in the U.S. market was changed. In February 2004, the FDA announced a ban on ephedra-containing products from the dietary supplement market in the United States (<http://www.cfsan.fda.gov/~lrd/fpephed6.html>). In March 2004, the FDA issued warning letters to companies that market products containing androstenedione (<http://www.cfsan.fda.gov/~dms/andltr.html>). The regulatory status of these products as dietary supplements is therefore in question. Nevertheless, until recently, both ephedra and androstenedione were widely consumed in the United States. We felt, therefore, that discussion of the science of these ingredients was important.

We express our thanks to the authors of the individual articles. This is a challenging and somewhat controversial field, but we believe that our authors have provided a balanced and current view of the literature. We also acknowledge with gratitude the hard work and guidance of Marcel Dekker's editorial staff, particularly Jinnie Kim, Sapna Maloor, and Oona Schmid.

Finally, we wish to emphasize that the inclusion of articles on particular dietary supplements in this *Encyclopedia* does not imply that we endorse them.

Paul M. Coates  
Marc R. Blackman  
Gordon M. Cragg  
Mark Levine  
Joel Moss  
Jeffrey D. White







# S-Adenosylmethionine

**José M. Mato**

*CIC-Biogune, Metabolomics Unit, Technological Park of Bizkaia, Derio, Bizkaia, Spain*

**Shelly C. Lu**

*USC Research Center for Liver Diseases, USC-UCLA Alcoholic Liver and Pancreatic Disease Center, The Division of Gastrointestinal and Liver Diseases, Keck School of Medicine, University of Southern California, Los Angeles, California, U.S.A.*

## INTRODUCTION

S-Adenosyl-L-methionine (SAME) has been shown to regulate key cell functions. Abnormalities in SAME content have been linked to the development of liver disease and to depression. This article reviews the biochemistry and functions of SAME, its deficiency in liver disease and depression, and SAME treatment in liver disease, depression, and osteoarthritis.

## COMMON AND SCIENTIFIC NAME

S-Adenosyl-L-methionine—also known as 5'-[(3-amino-3-carboxypropyl)-methylsulfonio]-5'-deoxyadenosine and *S*-(5'-desoxyadenosin-5-yl)-methionine—has the chemical formula  $[C_{15}H_{23}N_6O_5S]^+$ . It is abbreviated in the scientific literature as AdoMet, SAM, or SAME. In the early literature, before the identification of its structure, SAME was known as “active methionine.”

## GENERAL DESCRIPTION

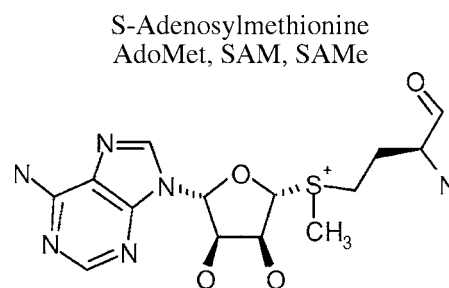
SAME was discovered by Giulio Cantoni in 1953 and since then has been shown to regulate key cellular functions such as differentiation, growth, and apoptosis. Abnormal SAME content has been linked to the development of experimental and human liver disease, and this has led to the examination of the effect of SAME supplementation in a variety of animal models

of liver disease and in patients with liver disease. Both serum and cerebrospinal fluid (CSF) levels of this methionine metabolite have been reported to be low in depressed patients; the possibility of SAME therapy has therefore been considered in this condition. The effect of SAME in the treatment of other diseases, such as osteoarthritis, has also been investigated.

## BIOCHEMISTRY AND FUNCTIONS

### Discovery

Though SAME was discovered 50 years ago, its story begins in 1890 with Wilhelm His. When he fed pyridine to dogs, he was able to isolate *N*-methylpyridine from the urine—His emphasized the need to demonstrate both the origin of the methyl group as well as the mechanism of its addition to the pyridine (reviewed in Ref.<sup>[1]</sup>). Both questions were addressed by Vincent du Vigneaud, who, during the late 1930s, demonstrated that the sulfur atom of methionine was transferred to cysteine through the “trans-sulfuration” pathway, and discovered the “transmethylation” pathway, that is, the exchange of methyl groups between methionine, choline, betaine, and creatine. In 1951, Cantoni demonstrated that a liver homogenate supplemented with ATP and methionine converted nicotinamide to *N*-methylnicotinamide. Two years later, he established



**Fig. 1** Structure of SAME.

*José M. Mato, Ph.D.*, is Professor and Director at CIC-Biogune, Metabolomics Unit, Technological Park of Bizkaia, Derio, Bizkaia, Spain.

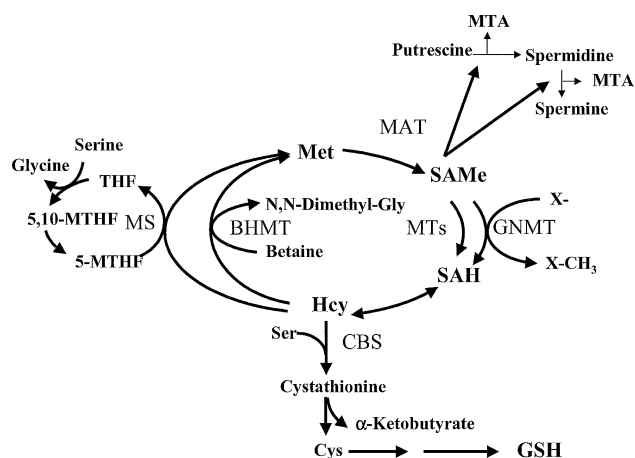
*Shelly C. Lu, M.D.*, is Professor at USC Research Center for Liver Diseases, USC-UCLA Alcoholic Liver and Pancreatic Disease Center, The Division of Gastrointestinal and Liver Diseases, Department of Medicine, Keck School of Medicine, University of Southern California, Los Angeles, California, U.S.A.

that methionine and ATP reacted to form a product, which he originally called “active methionine,” capable of transferring its methyl group to nicotinamide or guanidoacetic acid to form *N*-methylnicotinamide or creatine in the absence of ATP. After determination of its structure, he called it AdoMet (Fig. 1). Subsequently, Cantoni and his colleagues discovered methionine adenosyltransferase (MAT)—the enzyme that synthesizes SAME, *S*-adenosylhomocysteine (SAH)—the product of the transmethylation reactions, and SAH-hydrolase—the enzyme that converts SAH to adenosine and homocysteine (Hcy). At about the same time, Peter Bennett discovered that folate and vitamin B<sub>12</sub> could replace choline as a source of methyl groups in rats maintained on diets containing Hcy in place of methionine, a finding that led to the discovery of methionine synthase (MS). In 1961, John Tabor demonstrated that the propylamino moiety of SAME is converted via a series of enzymatic steps to spermidine and spermine. In the biosynthesis of polyamines, 5′-deoxy-5′-methylthioadenosine (MTA) was identified as an end product. Thus, by the beginning of the 1960s, Laster’s group could finally provide an integrated view, similar to that depicted in Fig. 2, combining the transmethylation and trans-sulfuration pathways with polyamine synthesis.

Since then, SAME has been shown to donate: 1) its methyl group to a large variety of acceptor molecules, including DNA, RNA, phospholipids, and proteins; 2) its sulfur atom, via a series of reactions, to cysteine and glutathione (GSH), a major cellular antioxidant; 3) its propylamino group to polyamines, which are required for cell growth; and 4) its MTA moiety, via a complex set of enzymatic reactions known as the “methionine salvage pathway,” for the resynthesis of this amino acid. These reactions can affect a wide spectrum of biological processes ranging from metal detoxication and catecholamine metabolism to membrane fluidity, gene expression, cell growth, differentiation, and apoptosis (reviewed in Ref.<sup>[2]</sup>), to establish what Cantoni called the “AdoMet empire.”

## Synthesis

In mammals, there are three distinct enzymes that synthesize SAME: MATI, MATII, and MATIII. MATI and MATIII are the gene products of *MAT1A*, while MATII is the gene product of *MAT2A* (reviewed in Ref.<sup>[2]</sup>). In adults, *MAT1A* is expressed exclusively in the liver and pancreas, whereas *MAT2A* is expressed in all tissues, including the liver. In fetal rat liver, *MAT1A* expression increases progressively from day 20 of gestation, increases 10-fold immediately after birth, and reaches a peak at 10 days of age, decreasing slightly by adulthood. Conversely, *MAT2A* expression



**Fig. 2** Hepatic metabolism of SAME. Methionine (Met) is converted to homocysteine (Hcy) via *S*-adenosylmethionine (SAME) and *S*-adenosylhomocysteine (SAH). The conversion of Met to SAME is catalyzed by methionine adenosyltransferase (MAT). After decarboxylation, SAME can donate the remaining propylamino moiety attached to its sulfonium ion to putrescine to form spermidine and methylthioadenosine (MTA) and to spermidine to form spermine and a second molecule of MTA. SAME donates its methyl group in a large variety of reactions catalyzed by dozens of methyltransferase (MTs), the most abundant in the liver being glycine-*N*-methyltransferase (GNMT). The SAH thus generated is hydrolyzed to form Hcy and adenosine through a reversible reaction catalyzed by SAH hydrolase. Hcy can be remethylated to form methionine by two enzymes: methionine synthase (MS) and betaine methyltransferase (BHMT). In the liver, Hcy can also go through the trans-sulfuration pathway to form cysteine via a two-step enzymatic process. In the presence of serine, Hcy is converted to cystathionine in a reaction catalyzed by cystathionine  $\beta$ -synthetase (CBS). Cystathionine is then hydrolyzed by cystathionase to form cysteine, a precursor for the synthesis of glutathione (GSH). In tissues other than the liver, kidney, and pancreas, cystathionine is not converted to GSH due to the lack of expression of one or more enzymes of the trans-sulfuration pathway. The expression of BHMT is also limited to the liver. All mammalian tissues convert Met to Hcy, via SAME and SAH, and remethylate Hcy to Met via the MS pathway. Other abbreviations in this figure: THF, tetrahydrofolate; 5,10-MTHF, methylenetetrahydrofolate; 5-MTHF, methyltetrahydrofolate; Ser, serine; Gly, glycine; X, methyl acceptor molecule; X-CH<sub>3</sub>, methylated molecule.

decreases after birth, increases threefold in the newborn, and decreases further in postnatal life, reaching a minimum in the adult liver (about 5% that of *MAT1A*). Due to differences in the regulatory and kinetic properties of the various MATs, MATII cannot maintain the same high levels of SAME compared to the combination of MATI and MATIII (reviewed in Ref.<sup>[2]</sup>). Consequently, in *MAT1A* knockout mice, despite a significant increase in *MAT2A* expression,

the liver content of S<sub>A</sub>Me is reduced about threefold from birth, when the switch from *MAT2A* to *MAT1A* takes place.<sup>[3]</sup>

## DEFICIENCY

### In Liver Disease

Mice lacking *MAT1A* have hepatic hyperplasia and spontaneously develop nonalcoholic steatohepatitis (NASH) and hepatocellular carcinoma (HCC).<sup>[3,4]</sup> It is also well known that when rats and mice are fed a diet deficient in methyl groups (choline, methionine, folate, and vitamin B<sub>12</sub>), the liver develops steatosis within a few days (reviewed in Refs.<sup>[5,6]</sup>). If the diet continues, NASH, fibrosis of the liver, and cirrhosis result, with some animals developing HCC. Numerous nutritional studies have shown that dietary methyl deficiency causes a decrease in the hepatic content of S<sub>A</sub>Me, an increase in the concentration of SAH, and an elevation of plasma Hcy levels. It has been demonstrated, for example, that disruption of the gene encoding for 5,10-methylenetetrahydrofolate reductase (*MTHFR*), which synthesizes 5-methyltetrahydrofolate, required by methionine synthase to remethylate Hcy to methionine (see Fig. 2), results in elevated plasma Hcy levels, and reduced content of hepatic betaine, glycerophosphocholine, and phosphocholine, the intracellular storage forms of choline, as well as increased content of SAH and reduced S<sub>A</sub>Me.<sup>[7]</sup> Plasma Hcy decreased and hepatic phosphocholine increased in *MTHFR* knockout mice fed a diet supplemented with betaine; while knockout mice fed a control diet developed severe steatosis, those on a diet supplemented with betaine had only moderate or mild steatosis.<sup>[7]</sup>

The observation that *MAT1A* knockout mice have hepatic hyperplasia, are more susceptible to develop liver injury in response to a choline-deficient diet, and spontaneously develop NASH and HCC<sup>[3,4]</sup> strongly suggests that shortage of S<sub>A</sub>Me may be a key component of the mechanism by which a deficiency in methyl groups causes hepatic lesions. Microarray and proteomic experiments using liver from *MAT1A* knockout mice<sup>[3,4,8]</sup> indicate that S<sub>A</sub>Me regulates the expression of a large and diverse set of genes, including many metabolic genes that are affected in 3-mo-old knockout mice long before the appearance of any sign of histological lesion. This surprising result suggests that abnormal S<sub>A</sub>Me levels may cause liver injury and cancer through perturbation of multiple metabolic pathways in the cell. The medical implications of these observations are obvious, since cirrhotic patients, independent of the etiology of their disease, have impaired metabolism of methionine, reduced hepatic synthesis of S<sub>A</sub>Me

(caused by both inactivation of the enzyme and reduced expression of *MAT1A* due to the spontaneous methylation of the gene promoter) and are predisposed to develop HCC.<sup>[9,10]</sup>

A

### In Depression

Major depression has been associated with a deficiency in methyl groups (folate, vitamin B<sub>12</sub>, and S<sub>A</sub>Me) (reviewed in Ref.<sup>[11]</sup>). Thus, depressed patients often have low plasma folate and vitamin B<sub>12</sub>, and reduced S<sub>A</sub>Me content in the CSF. Moreover, patients with low plasma folate appear to respond less well to antidepressants. The mechanism by which low S<sub>A</sub>Me concentrations may contribute to the appearance and evolution of depression is, however, not well known. S<sub>A</sub>Me-dependent methylation reactions are involved in the synthesis and inactivation of neurotransmitters, such as noradrenaline, adrenaline, dopamine, serotonin, and histamine, and the administration of drugs that stimulate dopamine synthesis, such as L-dihydroxyphenylalanine, causes a marked decrease in S<sub>A</sub>Me concentration in rat brain, and in plasma and CSF in humans. Moreover, various drugs that interfere with monoaminergic neurotransmission, such as imipramine and desipramine, reduce brain S<sub>A</sub>Me content in mice (reviewed in Ref.<sup>[11]</sup>). As in the liver, these results suggest that abnormally low S<sub>A</sub>Me levels may cause depression through perturbation of multiple metabolic pathways in the brain.

## INDICATIONS AND USAGE

### Treatment in Animal Models of Liver Disease

The importance of the metabolism of methyl groups in general, and S<sub>A</sub>Me in particular, to normal hepatic physiology, coupled with the convincing body of evidence linking abnormal S<sub>A</sub>Me content with experimental and human liver disease, led to the study of the effect of S<sub>A</sub>Me supplementation in a variety of animal models of liver disease. S<sub>A</sub>Me administration to alcohol-fed rats and baboons reduced GSH depletion and liver damage (reviewed in Ref.<sup>[12]</sup>). It improved survival in animal models of galactosamine-, acetaminophen-, and thioacetamide-induced hepatotoxicity, and in ischemia-reperfusion-induced liver injury (reviewed in Ref.<sup>[13]</sup>). S<sub>A</sub>Me treatment also lowered liver fibrosis in rats treated with carbon tetrachloride (reviewed in Ref.<sup>[13]</sup>), and reduced neoplastic hepatic nodules in animal models of HCC (reviewed in Ref.<sup>[14]</sup>).

## Treatment of Human Diseases

SAMe has been used in humans for the past 20 years for the treatment of osteoarthritis, depression, and liver disease. In 2002, the Agency for Healthcare Research and Quality (AHRQ) reviewed 101 individual clinical trials of SAMe.<sup>[15]</sup> Of these, 47 focused on depression, 14 on osteoarthritis, and 40 on liver disease. Of the 41 studies on liver disease, 9 were for cholestasis of pregnancy, 12 for other causes of cholestasis, 7 for cirrhosis, 8 for chronic hepatitis, and 4 for various other chronic liver diseases.

### Pharmacokinetics

Orally administered SAMe has low bioavailability, presumably due to a significant first-pass effect (degradation in the gastrointestinal tract) and rapid hepatic metabolism. Plasma concentrations obtained with an enteric-coated tablet formulation are dose related, with peak levels of 0.5–1 mg/L achieved 3–5 hr after single doses ranging from 400 to 1000 mg.<sup>[15]</sup> The levels decline to baseline within 24 hr. One study showed a significant gender difference in bioavailability, with women showing three- to sixfold greater peak plasma values than men.<sup>[15]</sup> Plasma–protein binding of SAMe is no more than 5%. SAMe crosses the blood–brain barrier, with slow accumulation in the CSF. Unmetabolized SAMe is excreted in urine and feces.

Parenterally administered SAMe has much higher bioavailability. However, this form is currently not approved for use in the United States.

### Liver disease

Of the 40 studies on liver disease analyzed by the AHRQ, 8 were included in a meta-analysis of the efficacy of SAMe in relieving pruritus and decreasing elevated serum bilirubin levels associated with cholestasis of pregnancy.<sup>[15]</sup> Compared to placebo, treatment with SAMe was associated with a significant decrease in pruritus and serum bilirubin levels. Similar results were obtained when 6 studies were included in a meta-analysis of the efficacy of SAMe in relieving pruritus and decrease bilirubin levels associated with cholestasis caused by a variety of liver diseases.

In 2001, the Cochrane Hepato-Biliary Group analyzed 8 clinical trials of SAMe treatment of alcoholic liver disease involving 330 patients.<sup>[16]</sup> This meta-analysis found that SAMe decreased total mortality [odds ratio (OR) = 0.53, 95% confidence interval (CI) = 0.22–1.29] and liver-related mortality (OR = 0.63, 95% CI = 0.25–1.58). However, since many of the studies were small and their quality varied greatly, the Cochrane Group concluded, “SAMe should not be used for alcoholic liver disease outside

randomized clinical trials.”<sup>[16]</sup> The AHRQ reached a similar conclusion: “For liver conditions other than cholestasis, additional smaller trials should be conducted to ascertain which patient populations would benefit more from SAMe, and what interventions (dose and route of administration) are most effective.”<sup>[15]</sup> The Cochrane Hepato-Biliary Group also concluded that only 1 trial involving 123 patients with alcoholic cirrhosis used adequate methodology and reported clearly on mortality and liver transplantation. In this study,<sup>[17]</sup> mortality decreased from 30% in the placebo group to 16% in the SAMe group ( $p = 0.077$ ). When patients with more advanced cirrhosis (Child score C) were excluded from the analysis (a total of 8 patients), the mortality was significantly less in the SAMe group (12%) compared to the placebo group (25%,  $p = 0.025$ ). In this study, 1200 mg/day was administered orally.

### Depression

Of the 40 studies on depression analyzed by the AHRQ, 28 were included in a meta-analysis of the efficacy of SAMe in decreasing symptoms of depression.<sup>[15]</sup> Compared to placebo, treatment with SAMe was associated with an improvement of approximately 6 points in the score of the Hamilton Rating Scale for Depression measured at 3 weeks (95% CI = 2.2–9.0). This degree of improvement was statistically as well as clinically significant. However, compared to treatment with conventional antidepressant pharmacology, treatment with SAMe was not associated with a statistically significant difference in outcomes. With respect to depression, the AHRQ report concluded: “Good dose-escalation studies have not been performed using the oral formulation of SAMe for depression.”<sup>[15]</sup> The AHRQ report also concluded that “additional smaller clinical trials of an exploratory nature should be conducted to investigate uses of SAMe to decrease the latency of effectiveness of conventional antidepressants and to treat postpartum depression.”<sup>[15]</sup>

### Osteoarthritis

Of the 13 studies on osteoarthritis analyzed by the AHRQ, 10 were included in a meta-analysis of the efficacy of SAMe in decreasing pain of osteoarthritis.<sup>[15]</sup> Compared to placebo, one large randomized clinical trial showed a decrease in the pain of osteoarthritis with SAMe treatment. Compared to treatment with nonsteroidal anti-inflammatory medications, treatment with oral SAMe was associated with fewer adverse effects while being comparable in reducing pain and improving functional limitation.

## Adverse effects

The risks associated with SAME are minimal. It has been used in Europe for 20 years and is available under prescription in Italy, Spain, the United Kingdom, and Canada, and over the counter as a dietary supplement in the United States. The most common side effects of SAME are nausea and gastrointestinal disturbance, which occur in less than 15% of treated subjects.

## Interactions with herbs, supplements, and drugs

Theoretically, SAME might increase the effects and adverse effects of products that increase serotonin levels, which include herbs and supplements such as Hawaiian baby woodrose, St. John's wort, and L-tryptophan, as well as drugs that have serotonergic effects. These drugs include tramadol (Ultram<sup>®</sup>), pentazocine (Talwin<sup>®</sup>), clomipramine (Anafranil<sup>®</sup>), fluoxetine (Prozac<sup>®</sup>), paroxetine (Paxil<sup>®</sup>), sertraline (Zoloft<sup>®</sup>), amitriptyline (Elavil<sup>®</sup>), and many others. It is also recommended that SAME be avoided in patients taking monoamine oxidase inhibitors or within 2 weeks of discontinuing such medication.

## CONCLUSIONS

Although evidence linking abnormal SAME content with the development of experimental and human liver disease is very convincing, the results of clinical trials of SAME treatment of liver disease are not conclusive. Consequently, SAME should not be used outside clinical trials for the treatment of liver conditions other than cholestasis. A new clinical study enrolling a larger number of patients should be carried out to confirm that SAME decreases mortality in alcoholic liver cirrhosis. This is important because if SAME improves survival, it will become the only available treatment for patients with alcoholic liver cirrhosis.

Although depression has been associated with a deficiency in SAME, it is not yet clear whether this is a consequence or the cause. To clarify this point, more basic research and the development of new experimental models are needed. Clinical trials indicate that SAME treatment is associated with an improvement of depression. Dose studies using oral SAME should be performed to determine the best dose to be used. New studies should also be carried out in which the efficacy of SAME is compared with that of conventional antidepressants.

With respect to osteoarthritis, as of now, there is no evidence associating a deficiency in SAME with the appearance of the disease. Moreover, the efficacy of SAME in the treatment of osteoarthritis is also not convincing at present.

## ACKNOWLEDGMENTS

This work was supported by NIH grants DK51719 (to S.C. Lu), AA12677, AA13847, and AT-1576 (to S.C. Lu and J.M. Mato), and Plan Nacional de I + D 2002-00168 (to J.M. Mato).

## REFERENCES

1. Finkelstein, J.D. Homocysteine: a history in progress. *Nutr. Rev.* **2000**, *58* (7), 193–204.
2. Mato, J.M.; Corrales, F.J.; Lu, S.C.; Avila, M.A. S-Adenosylmethionine: a control switch that regulates liver function. *FASEB J.* **2002**, *16* (1), 15–26.
3. Lu, S.C.; Alvarez, L.; Huang, Z.Z.; Chen, L.X.; An, W.; Corrales, F.J.; Avila, M.A.; Kanel, G.; Mato, J.M. Methionine adenosyltransferase 1A knockout mice are predisposed to liver injury and exhibit increased expression of genes involved in proliferation. *Proc. Natl. Acad. Sci. U.S.A.* **2001**, *98* (10), 5560–5565.
4. Martínez-Chantar, M.L.; Corrales, F.J.; Martínez-Cruz, A.; García-Trevijano, E.R.; Huang, Z.Z.; Chen, L.X.; Kanel, G.; Avila, M.A.; Mato, J.M.; Lu, S.C. Spontaneous oxidative stress and liver tumors in mice lacking methionine adenosyltransferase 1A. *FASEB J.* **2002**, *16* (10), 1292–1294.
5. Shivapurkar, N.; Poirier, L.A. Tissue levels of S-adenosylmethionine and S-adenosylhomocysteine in rats fed methyl-deficient, amino acid-defined diets for one to five weeks. *Carcinogenesis* **1983**, *4* (8), 1051–1057.
6. Koteish, A.; Diehl, A.M. Animal models of steatohepatitis. *Best Pract. Res. Clin. Gastroenterol.* **2002**, *16* (5), 679–690.
7. Schwahn, B.C.; Chen, Z.; Laryea, M.D.; Wendel, U.; Lussier-Cacan, S.; Genest, J., Jr.; Mar, M.H.; Zeisel, S.H.; Castro, C.; Garrow, T.; Rozen, R. Homocysteine–betaine interactions in a murine model of 5,10-methylenetetrahydrofolate reductase deficiency. *FASEB J.* **2003**, *17* (3), 512–514.
8. Santamaría, E.; Avila, M.A.; Latasa, M.U.; Rubio, A.; Martín-Duce, A.; Lu, S.C.; Mato, J.M.; Corrales, F.J. Functional proteomics of non-alcoholic steatohepatitis: mitochondrial proteins as targets of S-adenosylmethionine. *Proc. Natl. Acad. Sci. U.S.A.* **2003**, *100* (6), 3065–3070.
9. Duce, A.M.; Ortiz, P.; Cabrero, C.; Mato, J.M. S-Adenosyl-L-methionine synthetase and phospholipid methyltransferase are inhibited in human cirrhosis. *Hepatology* **1988**, *8* (1), 65–68.

10. Avila, M.A.; Berasain, C.; Torres, L.; Martin-Duce, A.; Corrales, F.J.; Yang, H.P.; Prieto, J.; Lu, S.C.; Caballeria, J.; Rodes, J.; Mato, J.M. Reduced mRNA abundance of the main enzymes involved in methionine metabolism in human liver cirrhosis and hepatocellular carcinoma. *J. Hepatol.* **2000**, *33* (6), 907–914.
11. Bottiglieri, T. S-Adenosyl-L-methionine (SAME): from the bench to the bedside—molecular basis of a pleiotropic molecule. *Am. J. Clin. Nutr.* **2002**, *76* (5), 1151S–1157S.
12. Tsukamoto, H.; Lu, S.C. Current concepts in the pathogenesis of alcoholic liver injury. *FASEB J.* **2001**, *15* (8), 1335–1349.
13. Mato, J.M.; Alvarez, L.; Ortiz, P.; Pajares, M.A. S-Adenosylmethionine synthesis: molecular mechanisms and clinical implications. *Pharmacol. Ther.* **1997**, *73* (3), 265–280.
14. Pascale, R.M.; Simile, M.M.; De Miglio, M.R.; Feo, F. Chemoprevention of hepatocarcinogenesis: S-adenosyl-L-methionine. *Alcohol* **2002**, *27* (3), 193–198.
15. Agency for Healthcare Research and Quality. *S-Adenosyl-L-methionine for Treatments of Depression, Osteoarthritis, and Liver Disease*, Evidence Report/Technology Assessment No. 64. <http://www.ahrq.gov/clinic/tp/sametp.htm> (accessed 2002).
16. Rambaldi, A.; Gluud, C. S-Adenosyl-L-methionine for alcoholic liver disease. *Cochrane Database Syst. Rev.* **2001**, *4*, CD002235.
17. Mato, J.M.; Cámara, J.; Fernández de Paz, J.; Caballería, L.; Coll, S.; Caballero, A.; García-Buey, L.; Beltrán, J.; Benita, V.; Caballería, J.; Solà, R.; Moreno-Otero, R.; Barrao, F.; Martin-Duce, A.; Correa, J.A.; Parés, A.; Barrao, E.; García-Magaz, I.; Puerta, J.L.; Moreno, J.; Boissard, G.; Ortiz, P.; Rodés, J. S-Adenosylmethionine in alcoholic liver cirrhosis: a randomized placebo-controlled, double-blind, multicentre trial. *J. Hepatol.* **1999**, *30* (6), 1081–1089.

# Androstenedione

**Benjamin Z. Leder**

*Massachusetts General Hospital and Harvard Medical School, Boston, Massachusetts, U.S.A.*

## INTRODUCTION

Androstenedione (chemical name: 4-androsten-3,17-dione) is a steroid hormone produced primarily in the reproductive system and adrenal glands in men and women. It circulates in the bloodstream and is the immediate precursor to the potent anabolic/androgenic hormone testosterone in the steroid synthesis pathway. Despite this well-known physiologic classification, as well as a growing body of evidence demonstrating that orally administered androstenedione is converted to more potent steroid hormones, the United States Food and Drug Administration has classified the hormone as a “dietary supplement.” As such, it is available to the general public without a prescription and can be easily purchased in health clubs, nutrition stores, and over the Internet.

## GENERAL DESCRIPTION

The seemingly contradictory classification above is based on the definition set forth in the 1994 Dietary Supplement Health and Education Act (DSHEA). According to the DSHEA, a substance is defined as a dietary supplement if it is a “product (other than tobacco) intended to supplement the diet that bears or contains one or more of the following dietary ingredients: a vitamin, mineral, amino acid, herb or other botanical... or a concentrate, metabolite, constituent, extract, or combination of any ingredient described above.” Hence, because androstenedione can be synthesized from plant products, it falls under that umbrella. Furthermore, the DSHEA specifies that the Department of Justice cannot bring action to remove a product unless it is proven to pose “a significant or unreasonable risk of illness or injury” when used as directed. Not surprisingly, since the passing of the DSHEA, the use of dietary supplements has increased dramatically. In fact, by 1999, the dietary supplement industry in the United States was generating annual sales of 12 billion dollars.<sup>[1]</sup>

Initially, androstenedione use was primarily confined to athletes in strength and endurance-related sports, an interest that seems to have sprung from reports of its use in the official East German Olympic athlete doping program. The event that most dramatically sparked widespread curiosity in androstenedione, however, was the media report that the St. Louis Cardinals baseball player Marc McGwire had used androstenedione in the 1999 season (during which he broke the record for most home runs in a season). The publicity that surrounded this supplement also prompted an increased interest in related “prohormones,” such as norandro stenedione and androstenediol. This then led to a proliferation of claims concerning the potential benefits of andro stenedione use. Presently, manufacturers credit it not only with promoting muscle growth and improving athletic performance, but also with increasing energy, libido, sexual performance, and general quality of life. Additionally, androstenedione is now often packaged in combination with other substances as part of an intensive nutritional approach to performance enhancement. An example of such a combination is shown in Fig. 1. Clearly, the use of androstenedione and related compounds is currently outpacing the accumulation of data that may or may not eventually provide a rational basis for their use.


## BIOCHEMISTRY AND PHYSIOLOGY

Androstenedione is a steroid hormone that is produced primarily in the adrenals, testes, and ovaries. It is classified as a “weak androgen” because it binds to the body’s receptor for androgen hormones in a much less potent fashion than classic anabolic/androgenic steroids such as testosterone.<sup>[2]</sup> It is synthesized from the precursor hormone dehydroepiandrosterone (DHEA—itself a dietary supplement) and is the direct precursor to testosterone. In normal physiologic circumstances, androstenedione can also be converted to potent feminizing hormones such as estrone and estradiol (both members of the “estrogen” class of hormones). The relationship between androstenedione, other steroid hormones, and the enzymes

---

*Benjamin Z. Leder, M.D.*, is Assistant Professor, Endocrine Unit at Massachusetts General Hospital and Harvard Medical School, Boston, Massachusetts, U.S.A.





**PROHORMONE FACTORS**  
 4-Androstenedione: 100 mg  
 19-Nor-5-Androstenedione: 50 mg  
 5-Androstenediol: 50 mg  
 DHEA: 50 mg

**GH/IGF FACTORS**  
 L-Arginine Pyroglutamate: 2500 mg  
 L-Ornithine Alpha-Ketoglutarate: 1250 mg  
 Taurine: 750 mg  
 Colostrum: 250 mg

**LH BOOSTER**  
 Tribulus: 250 mg  
 Acetyl-L-Carnitine: 250 mg  
 L-Carnitine: 100 mg

**DHT BLOCKERS**  
 Saw Palmetto: 200 mg  
 Beta Sitosterol: 200 mg  
 Pygeum Africanum: 50 mg

**ESTROGEN BLOCKERS**  
 Kudzu: 100 mg  
 Chrysin : 250 mg

**Fig. 1** A typical combination dietary supplement product.

involved in the conversion of androstenedione to testosterone and estrogens is shown in Fig. 2.

Importantly, the enzymes that convert androstenedione to potent hormones like testosterone and estradiol are active not only in endocrine glands, but also in many peripheral body tissues such as muscle, bone, liver, and brain.<sup>[3]</sup> Thus, if orally administered androstenedione has biological activity, it may act either directly or by conversion to these more potent agents.

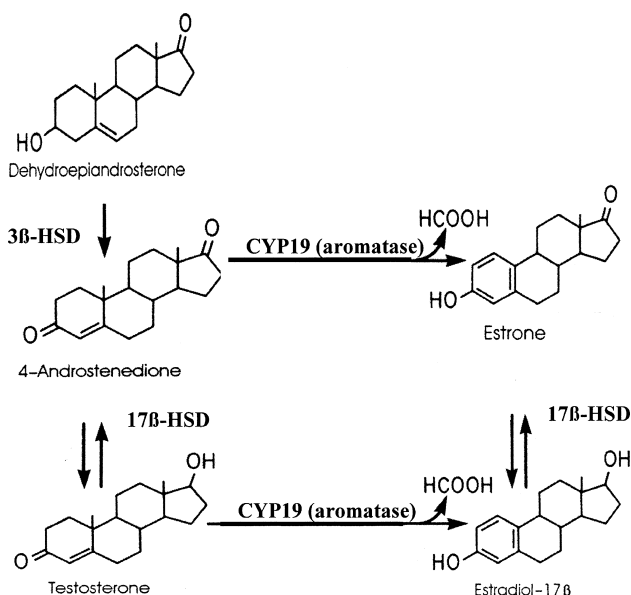
## ANDROSTENEDIONE USE

There are no precise data concerning the prevalence of androstenedione use in the general population. Our best estimates are based on industry sales figures and extrapolations from data on classic anabolic/androgenic steroid use in specific populations. For example, in 1997, it was estimated that 4.9% of male and 2.4% of female adolescents in the United States had used illegal anabolic steroids.<sup>[4]</sup> Because these substances are so readily available, there is concern that androstenedione use in this particularly susceptible population might greatly exceed these numbers. Recently, in fact, a study was published that seems to validate these concerns. In this study, a survey was administered in five health clubs in Boston, Massachusetts, and the results revealed that 18% of men and 3% of women respondents had used androstenedione or other adrenal hormone dietary supplements at least

once. These percentages suggest that as many as 1.5 million U.S. health club members alone have used these substances.<sup>[5]</sup>

## PHARMACOKINETICS AND HORMONAL EFFECTS OF ANDROSTENEDIONE IN MEN

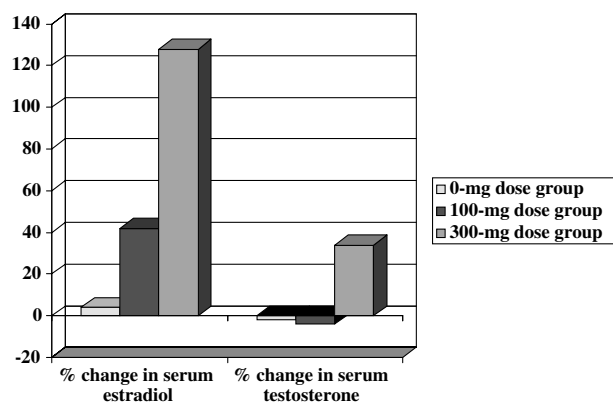
Because so many of the claims that surround androstenedione are based on the premise that oral administration increases serum testosterone levels, it may be surprising to some that prior to 1999, there was only a single published study investigating the ability of orally administered androstenedione to be converted to more potent steroid hormones.<sup>[6]</sup> In this study, 2 women were given a single dose of androstenedione, and the levels were subsequently measured over the next several hours. Since 1999, however, numerous small studies (mostly in men) have investigated the effects of the supplement.<sup>[6-16]</sup> In general, these studies report that serum androstenedione levels increase dramatically after oral administration and thus confirm that a significant portion of the supplement is absorbed through the gastrointestinal tract after ingestion. However the answer to the more important question, namely, whether it is then converted to more potent steroid hormones such as testosterone and estradiol, appears to be complex. In general, these studies suggest that the ability of oral androstenedione to increase estrogen and testosterone levels in men is dose



**Fig. 2** Androstenedione's relationship to other steroid hormones. Enzyme abbreviations: 3 $\beta$ -HSD, 3 $\beta$ -hydroxysteroid dehydrogenase; 17 $\beta$ -HSD, 17 $\beta$ -hydroxysteroid dehydrogenase.

dependent and is possibly related to the age of the study population as well. Specifically, the bulk of the research indicates that when androstenedione is administered to men in individual doses between 50 and 200 mg, serum estrogen levels increase dramatically. However, larger individual doses (e.g., 300 mg) are required to increase serum testosterone levels.

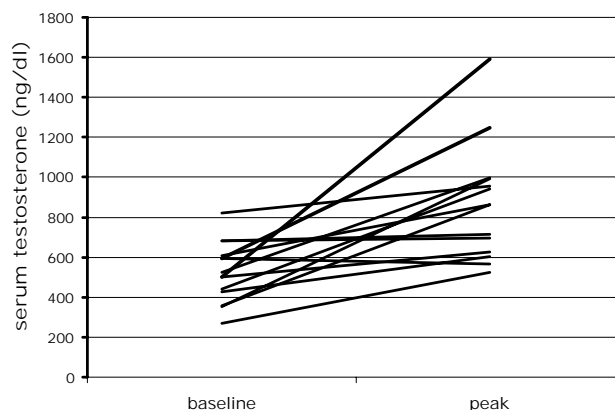
For example, King and colleagues studied the effects of a single 100-mg oral dose of androstenedione in 10 men between the ages of 19 and 29 and reported that while serum androstenedione and estradiol levels increased significantly, testosterone levels did not change.<sup>[13]</sup> These investigators then specifically measured the portion of circulating testosterone that is not bound to protein and considered the "bioactive" portion (called free testosterone) and similarly saw no effect of the supplement. In a separate study, Leder and colleagues gave 0, 100, or 300 mg of androstenedione to normal healthy men between the ages of 20 and 40 for 7 days and took frequent blood samples on days 1 and 7.<sup>[14]</sup> As in the study by King, they also found that men receiving both the 100- and 300-mg dose of androstenedione experienced dramatic increases in serum estradiol that were often well above the normal male range. Another similarity was that 100 mg did not affect serum testosterone levels. As shown in Fig. 3, however, the novel finding of this study was that 300 mg of androstenedione increased serum testosterone levels significantly, albeit by only a modest amount (34%).



**Fig. 3** Percentage change in serum testosterone and estradiol in healthy men after a single androstenedione dose (as measured by 8 hr of frequent blood sampling). (Adapted from Ref.<sup>[14]</sup>) (View this art in color at [www.dekker.com](http://www.dekker.com).)

Leder and colleagues further observed that there was a significant degree of variability among men with regard to their serum testosterone response after androstenedione ingestion. As shown in Fig. 4, some subjects, even in the 300-mg dose group, experienced relatively little change in testosterone levels, whereas serum testosterone levels doubled in other men. This finding suggests that there may be individual differences in the way androstenedione is metabolized that could impact any one person's physiological response to taking the supplement.

Brown and colleagues investigated the hormonal response in a group of men between the ages of 30 and 56.<sup>[10]</sup> In this study, subjects consuming 100 mg of androstenedione three times daily experienced



**Fig. 4** Individual variability in the peak serum testosterone level achieved after a single 300-mg dose of androstenedione in men. Each line represents one study subject. (Adapted from Ref.<sup>[14]</sup>.)

increases in serum estrogens but not serum testosterone. However, unlike in the study by King and colleagues discussed above, free testosterone did increase significantly (albeit again by only a small amount).

Finally, several studies have compared the hormonal effects of androstenedione with those of other “prohormone” dietary supplements. Broeder and colleagues studied the results of a 100-mg twice-daily dose of oral androstenedione, androstenediol (a closely related steroid hormone), or placebo in men between the ages of 35 and 65.<sup>[7]</sup> They found that both compounds increased estrogen levels but neither affected total serum testosterone levels. Similarly, Wallace and colleagues studied the effects of 50-mg twice-daily doses of androstenedione and DHEA in normal men and reported no increases in serum testosterone levels with either.<sup>[16]</sup>

### **EFFECTS ON MUSCLE SIZE AND STRENGTH IN MEN**

The results of the studies discussed above suggest that androstenedione use in men would be less likely to promote the muscle building and performance enhancing effects associated with testosterone use and more likely to induce the undesirable feminizing effects associated with estrogens. Several studies have assessed the ability of androstenedione (with or without exercise) to increase muscle size and strength and have been uniformly disappointing.<sup>[7,9,13,15,16]</sup> For example, Broeder and colleagues, in the study described above, also measured changes in body composition and strength in subjects taking 100 mg androstenedione twice daily in combination with a 12-week intensive weight-training program.<sup>[7]</sup> Despite using sensitive methods that can detect small changes in body composition, they found no differences in muscle mass, fat mass, or strength in the subjects receiving androstenedione compared to those receiving a placebo tablet. Importantly, however, in this study as well as all of these studies referenced above, the supplement was given in doses that were not sufficient to increase testosterone levels. It thus remains unknown whether doses of androstenedione sufficient to increase testosterone levels will enhance muscle mass or athletic performance. This issue is particularly important because it is likely that many ingest doses that far exceed those used in research investigating “high” dose androstenedione. Additionally, the issue of whether androstenedione can increase muscle mass or strength has important regulatory ramifications. If androstenedione is shown to build muscle, it could be classified as an “anabolic steroid” under the 1990 Anabolic Steroid Control Act and regulated as a

controlled substance by the United States Drug Enforcement Agency.

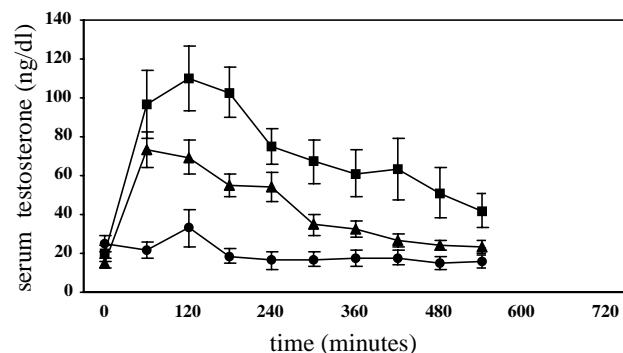
### **METABOLISM OF ANDROSTENEDIONE IN MEN**

One of the consistent findings of the various androstenedione studies in men is the inefficiency of conversion of the supplements to testosterone. Leder and colleagues explored this issue further by investigating the pattern of androstenedione metabolism in healthy men.<sup>[17]</sup> Specifically, they measured the concentration of inactive testosterone metabolites (also called conjugates) in the urine of subjects ingesting androstenedione and found an increase of over 10-fold compared to their baseline levels. This finding was in direct contrast to the much more modest changes in serum testosterone they had observed. It suggests that while much of the androstenedione that is absorbed after oral administration is converted to testosterone, it is then immediately further metabolized to inactive compounds in the liver. The investigators confirmed this hypothesis by directly measuring the concentration of one of these inactive metabolites (testosterone glucuronide) in the serum of these subjects. As expected, they found that testosterone glucuronide levels increased by 500–1000% (as opposed to the 34% increase in biologically active serum testosterone after a single 300-mg dose of oral androstenedione). Together, these findings demonstrate the effectiveness of the liver in inactivating steroid molecules when taken orally.

### **PHARMACOKINETICS AND HORMONAL EFFECTS OF ANDROSTENEDIONE IN WOMEN**

Since the initial report of androstenedione administration in 2 women in 1962,<sup>[6]</sup> research into the effects of the supplement has focused largely on the hormonal response to oral administration in young men. Between 2002 and 2003, however, two studies on women were published. The first of these studies examined the effects of a single dose of either 0, 50, or 100 mg of androstenedione in postmenopausal women.<sup>[18]</sup> The findings of this study were surprising. In contrast to the effects observed in men, even these low doses increased testosterone levels significantly in women (Fig. 5).

Also, unlike the results seen in men, estradiol levels were unaffected by androstenedione administration. In the other study, 100 mg of androstenedione was administered to young, premenopausal, healthy women. Similar to postmenopausal women, these subjects experienced significant increases in serum testosterone levels after androstenedione administration



**Fig. 5** Serum testosterone levels during 12 hr of frequent blood sampling in postmenopausal women. Circles represent control subjects receiving no supplement, triangles those receiving 50 mg of androstenedione, and squares those receiving 100 mg. (Adapted from Ref.<sup>[18]</sup>)

(estradiol was not measured).<sup>[19]</sup> Importantly, in both of these studies, the peak testosterone levels achieved by the older and younger women taking androstenedione were often significantly above the normal range. Together, these results predict that the physiological effects of the supplement may be different in men and women, as might their potential toxicities. To date, however, there have been no published reports investigating the long-term physiological effects in women.

## ADVERSE EFFECTS AND TOXICITY

Ever since the publicity surrounding androstenedione exploded in 1999, many reports in the lay press have focused on the potential dangerous side effects. Nonetheless, with the exception of a single case description of a man who developed 2 episodes of priapism in the setting of androstenedione ingestion,<sup>[20]</sup> there have been no published reports of androstenedione-associated serious adverse events. This fact should be only partially reassuring, however, because androstenedione's classification as a dietary supplement (as opposed to a drug) allows manufacturers to avoid responsibility for rigorously monitoring any potential toxicity of their product.

It is well known that oral administration of certain testosterone derivatives can cause severe liver diseases, and anabolic steroid use in general is associated with anecdotal reports of myocardial infarction, sudden cardiac death, and psychiatric disturbances ("roid rage"). Nonetheless, despite androstenedione's close chemical similarity to these substances, it is important to note that it is not a potent anabolic steroid; nor does it have a chemical structure similar to those specific compounds that cause liver problems. Thus, the

potential of androstenedione to cause these particular serious side effects appears to be limited. Of more pressing concern to clinicians are the possible long-term effects in specific populations. In clinical trials, the supplement was generally well tolerated, though several studies did report that it reduces high-density lipoprotein (HDL, or "good cholesterol") levels in men. Importantly, however, even the longest of these studies lasted only several months. It thus remains quite possible that androstenedione use, especially at high doses, could cause subtle physiologic changes over prolonged periods that could directly lead to adverse health consequences. In men, for example, the dramatic increase in estradiol levels observed with androstenedione administration could, over time, lead to gynecomastia (male breast enlargement), infertility, and other signs of feminization. In women, because the supplement increases testosterone levels above the normal range, it could cause hirsutism (excess body hair growth), menstrual irregularities, or male-like changes in the external genitalia. In children, increases in both testosterone and estrogen levels could cause precocious puberty or premature closure of growth plates in bone, thereby compromising final adult height.

## PURITY OF COMMERCIALY AVAILABLE ANDROSTENEDIONE

Androstenedione is available from multiple manufacturers and can be purchased as a tablet, capsule, sublingual tablet, or even nasal spray. Often, it is combined with other products that claim to limit its potential side effects (such as chrysin, for example, which is purported to decrease androstenedione's conversion to estrogens). Because the manufacture of dietary supplements is not subject to the same regulations as are pharmaceuticals, the purity and labeling of androstenedione-containing products may not be accurate. Catlin and colleagues, for example, reported the surprise finding that urine samples from men treated with androstenedione contained 19-norandrosterone, a substance not associated with androstenedione metabolism, but rather with the use of a specific banned anabolic steroid.<sup>[21]</sup> Further investigation revealed that the androstenedione product used contained a tiny amount of the unlabeled steroid "19-norandrostenedione." Though the amount of 19-norandrostenedione was not physiologically significant, it was enough to cause a "positive" urine test for illegal anabolic steroid use when tested in the standard fashion. In fact, it is precisely this type of contamination that may explain the recent increase in competitive athletes testing positive for 19-norandrosterone and other banned substances in well-known standard testing methods.

Catlin and colleagues also analyzed nine common brands of androstenedione and showed that there was considerable variation among products in terms of both purity and content (see Table 1).

Thus, it is obvious that some brands of androstenedione are grossly mislabeled. Furthermore, this mislabeling adds to the considerable uncertainty that already exists regarding the long-term effects of androstenedione use.

## REGULATORY STATUS AND DETECTION

As mentioned previously, androstenedione is currently available over-the-counter in the United States due to its classification as a dietary supplement. There is a good possibility, however, that this classification may soon change as legislation has now been introduced in the United States Congress aimed at reclassifying “prohormone” steroid supplements (including androstenedione) as controlled substances. In the meantime, many sports organizations, including the National Football League (NFL), the National Collegiate Athletic Association (NCAA), and the International Olympic Committee (IOC) have banned androstenedione use due to concerns that it may offer some athletes a competitive advantage. Despite these prohibitions, detection of androstenedione has not been standardized. Specifically, the method used most often to detect testosterone use, measurement of the urinary testosterone-to-epitestosterone ratio, has not proven to be reliable in establishing androstenedione use.<sup>[22]</sup> Further study will clearly be needed to define novel testing procedures that are able to detect androstenedione use reliably.

**Table 1** Analysis of nine common brands of androstenedione supplements

Amount of androstenedione listed (in mg)	Amount of androstenedione found (in mg)
100	93
100	83
100	103
100	90
100	88
100	85
50	35
50	0 (no steroid compounds identified)
250	168 (10 mg of testosterone was also present)

(From Ref.<sup>[21]</sup>)

## CONCLUSIONS

Androstenedione is a steroid hormone and a popular over-the-counter dietary supplement. It is marketed as a legal alternative to traditional anabolic steroids and is purported to increase strength, athletic performance, libido, sexual performance, energy, and general quality of life. Studies indicate that when taken orally by men, small doses are converted to potent estrogens and larger doses to both testosterone and estrogens. Comparatively, there appears to be a much more physiologically important increase in estrogens compared with testosterone in men. In women, the effects are reversed. Studies have thus far failed to confirm any effect on muscle size or strength, though the dosing regimens were modest. While documentation of adverse side effects among users of androstenedione is scarce, there is considerable concern over potential long-term toxicity, especially in women and adolescents. Finally, the lack of purity in androstenedione-containing products introduces a further level of potential concern over these long-term health effects.

## REFERENCES

1. Anonymous. Herbal treatments: the promises and pitfalls. *Consumer Reports* **1999**, *64*, 44–48.
2. Orth, D.N.; Kovacs, W.J. The adrenal cortex. In *Williams Textbook of Endocrinology*; Wilson, J.D., Foster, D.W., Kronenberg, H.M., Larsen, P.R., Eds.; W.B. Saunders Company: Philadelphia, PA, 1998; 517–664.
3. Labrie, F.; Simard, J.; Luu-The, V.; Pelletier, G.; Belghmi, K.; Belanger, A. Structure, regulation and role of 3 beta-hydroxysteroid dehydrogenase, 17 beta-hydroxysteroid dehydrogenase and aromatase enzymes in the formation of sex steroids in classical and peripheral intracrine tissues. *Baillieres Clin. Endocrinol. Metab.* **1994**, *8* (2), 451–474.
4. Yesalis, C.E.; Barsukiewicz, C.K.; Kopstein, A.N.; Bahrk, M.S. Trends in anabolic-androgenic steroid use among adolescents. *Arch. Pediatr. Adolesc. Med.* **1997**, *151*, 1197–1206.
5. Kanayama, G.; Gruber, A.J.; Pope, H.G., Jr.; Borowiecki, J.J.; Hudson, J.I. Over-the-counter drug use in gymnasiums: an underrecognized substance abuse problem? *Psychother. Psychosom.* **2001**, *70* (3), 137–140.
6. Mahesh, V.B.; Greenblatt, R.B. The in vivo conversion of dehydroepiandrosterone and androstenedione to testosterone in the human. *Acta Endocrinol.* **1962**, *41*, 400–406.
7. Broeder, C.E.; Quindry, J.; Brittingham, K.; Panton, L.; Thomson, J.; Appakondou, S.; Breuel,

- K.; Byrd, R.; Douglas, J.; Earnest, C.; Mitchell, C.; Olson, M.; Roy, T.; Yarlalagadda, C. The Andro Project: physiological and hormonal influences of androstenedione supplementation in men 35 to 65 years old participating in a high-intensity resistance training program. *Arch. Intern. Med.* **2000**, *160* (20), 3093–3104.
8. Brown, G.A.; Vukovich, M.D.; Martini, E.R.; Kohut, M.L.; Franke, W.D.; Jackson, D.A.; King, D.S. Effects of androstenedione-herbal supplementation on serum sex hormone concentrations in 30- to 59-year-old men. *Int. J. Vitam. Nutr. Res.* **2001**, *71* (5), 293–301.
  9. Brown, G.A.; Vukovich, M.D.; Reifenrath, T.A.; Uhl, N.L.; Parsons, K.A.; Sharp, R.L.; King, D.S. Effects of anabolic precursors on serum testosterone concentrations and adaptations to resistance training in young men. *Int. J. Sport. Nutr. Exerc. Metab.* **2000**, *10* (3), 340–359.
  10. Brown, G.A.; Vukovich, M.D.; Martini, E.R.; Kohut, M.L.; Franke, W.D.; Jackson, D.A.; King, D.S. Endocrine responses to chronic androstenedione intake in 30- to 56-year-old men. *J. Clin. Endocrinol. Metab.* **2000**, *85* (11), 4074–4080.
  11. Earnest, C.P.; Olson, M.A.; Broeder, C.E.; Breuel, K.F.; Beckham, S.G. In vivo 4-androstene-3,17-dione and 4-androstene-3 beta,17 beta-diol supplementation in young men. *Eur. J. Appl. Physiol.* **2000**, *81* (3), 229–232.
  12. Ballantyne, C.S.; Phillips, S.M.; MacDonald, J.R.; Tarnopolsky, M.A.; MacDougall, J.D. The acute effects of androstenedione supplementation in healthy young males. *Can. J. Appl. Physiol.* **2000**, *25* (1), 68–78.
  13. King, D.S.; Sharp, R.L.; Vukovich, M.D.; Brown, G.A.; Reifenrath, T.A.; Uhl, N.L.; Parsons, K.A. Effect of oral androstenedione on serum testosterone and adaptations to resistance training in young men. *J. Am. Med. Assoc.* **1999**, *281* (21), 2020–2028.
  14. Leder, B.Z.; Longcope, C.; Catlin, D.H.; Ahrens, B.; Schoenfeld, D.A.; Finkelstein, J.S. Oral androstenedione administration and serum testosterone concentrations in young men. *J. Am. Med. Assoc.* **2000**, *283* (6), 779–782.
  15. Rasmussen, B.B.; Volpi, E.; Gore, D.C.; Wolfe, R.R. Androstenedione does not stimulate muscle protein anabolism in young healthy men. *J. Clin. Endocrinol. Metab.* **2000**, *85* (1), 55–59.
  16. Wallace, M.B.; Lim, J.; Cutler, A.; Bucci, L. Effects of dehydroepiandrosterone vs. androstenedione supplementation in men. *Med. Sci. Sports Exerc.* **1999**, *31* (12), 1788–1792.
  17. Leder, B.Z.; Catlin, D.H.; Longcope, C.; Ahrens, B.; Schoenfeld, D.A.; Finkelstein, J.S. Metabolism of orally administered androstenedione in young men. *J. Clin. Endocrinol. Metab.* **2001**, *86* (8), 3654–3658.
  18. Leder, B.Z.; Leblanc, K.M.; Longcope, C.; Lee, H.; Catlin, D.H.; Finkelstein, J.S. Effects of oral androstenedione administration on serum testosterone and estradiol levels in postmenopausal women. *J. Clin. Endocrinol. Metab.* **2002**, *87* (12), 5449–5454.
  19. Kicman, A.T.; Bassindale, T.; Cowan, D.A.; Dale, S.; Hutt, A.J.; Leeds, A.R. Effect of androstenedione ingestion on plasma testosterone in young women; a dietary supplement with potential health risks. *Clin. Chem.* **2003**, *49* (1), 167–169.
  20. Kachhi, P.N.; Henderson, S.O. Priapism after androstenedione intake for athletic performance enhancement. *Ann. Emerg. Med.* **2000**, *35* (4), 391–393.
  21. Catlin, D.H.; Leder, B.Z.; Ahrens, B.; Starcevic, B.; Hatton, C.K.; Green, G.A.; Finkelstein, J.S. Trace contamination of over-the-counter androstenedione and positive urine test results for a nandrolone metabolite. *J. Am. Med. Assoc.* **2000**, *284* (20), 2618–2621.
  22. Catlin, D.H.; Leder, B.Z.; Ahrens, B.D.; Hatton, C.K.; Finkelstein, J.S. Effects of androstenedione administration on epitestosterone metabolism in men. *Steroids* **2002**, *67* (7), 559–564.



# L-Arginine

A

**Mauro Maccario**  
**Emanuela Arvat**  
**Gianluca Aimaretti**  
**Valentino Martina**  
**Roberta Giordano**  
**Fabio Lanfranco**  
**Lisa Marafetti**  
**Mariangela Seardo**  
**Matteo Baldi**  
**Ezio Ghigo**

*University of Turin, Turin, Italy*

## INTRODUCTION

Arginine was first isolated in 1895 from animal horn. It is classified as a nonessential amino acid even if occurring in newborns, young children, or other circumstances characterized by accelerated tissue growth (e.g., infection, sepsis, trauma) when its production may be too slow and not sufficient to meet the requirements. Thus, in these conditions, arginine may be classified as “semiessential.”<sup>[1]</sup> Arginine participates in protein synthesis in cells and tissues. It is essential for the synthesis of urea, creatine, creatinine, and pyrimidine

bases. It also strongly influences hormonal release and has an important role in vasculature dynamics, participating in the synthesis of nitric oxide (NO).

## BIOCHEMISTRY

Dietary arginine is particularly abundant in wheat germ and flour, buckwheat, oatmeal, dairy products (cottage cheese, ricotta cheese, nonfat dry milk, skimmed yogurt), chocolate, beef (roasts, steaks), pork, nuts (coconut, pecans, walnuts, almonds, hazel nuts, peanuts), seeds (pumpkin, sesame, sunflower), poultry (chicken, turkey), wild game (pheasant, quail), seafood (halibut, lobster, salmon, shrimp, snails, tuna), chick peas, and soybeans.<sup>[2]</sup>

L-Arginine, delivered via the gastrointestinal tract, is absorbed in the jejunum and ileum of the small intestine. A specific amino acid transport system facilitates the process and is also responsible for assisting with the transport of the other basic amino acids, L-lysine and L-histidine. About 60% of the absorbed L-arginine is metabolized by the gastrointestinal enterocytes, and only 40% reaches the systemic circulation intact.

Deficient intake of arginine produces symptoms of muscle weakness, similar to muscular dystrophy.<sup>[3]</sup> Deficiency of arginine impairs insulin secretion, glucose production, and liver lipid metabolism.<sup>[4]</sup> Conditional deficiencies of arginine or ornithine are associated with the presence of excessive ammonia in the blood, excessive lysine, rapid growth, pregnancy, trauma, or protein deficiency and malnutrition. Arginine deficiency is also associated with rash, hair loss and hair breakage, poor wound healing, constipation, fatty liver, hepatic cirrhosis, and hepatic coma.<sup>[4]</sup>

Depending on nutritional status and developmental stage, normal plasma arginine concentrations in

---

*Mauro Maccario, M.D.*, is Associate Professor at the Division of Endocrinology, Dept. of Internal Medicine, University of Turin, Turin, Italy.

*Emanuela Arvat, M.D.*, is Associate Professor at the Division of Endocrinology, Dept. of Internal Medicine, University of Turin, Turin, Italy.

*Gianluca Aimaretti, M.D., Ph.D.*, is at the Division of Endocrinology, Dept. of Internal Medicine, University of Turin, Turin, Italy.

*Valentino Martina, M.D.*, is Researcher at the Division of Endocrinology, Dept. of Internal Medicine, University of Turin, Turin, Italy.

*Roberta Giordano, M.D.*, is at the Division of Endocrinology, Dept. of Internal Medicine, University of Turin, Turin, Italy.

*Fabio Lanfranco, M.D.*, is at the Division of Endocrinology, Dept. of Internal Medicine, University of Turin, Turin, Italy.

*Lisa Marafetti, M.D.*, is at the Division of Endocrinology, Dept. of Internal Medicine, University of Turin, Turin, Italy.

*Mariangela Seardo, M.D.*, is at the Division of Endocrinology, Dept. of Internal Medicine, University of Turin, Turin, Italy.

*Matteo Baldi, M.D.*, is at the Division of Endocrinology, Dept. of Internal Medicine, University of Turin, Turin, Italy.

*Ezio Ghigo, M.D.*, is Professor at the Division of Endocrinology, Dept. of Internal Medicine, University of Turin, Turin, Italy.



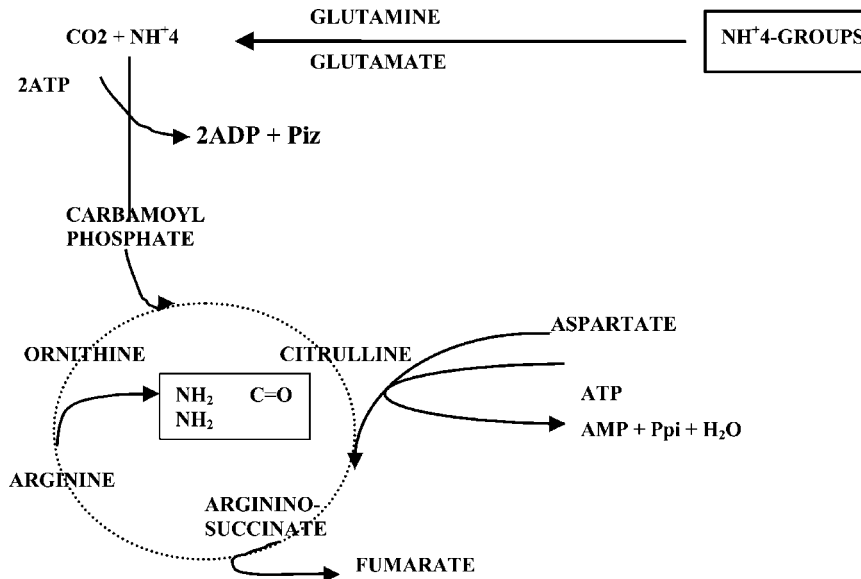


Fig. 1 L-Arginine and Krebs cycle in the renal tubule.

humans and animals range from 95 to 250 μmol/L. Toxicity and symptoms of high intake are rare, but symptoms of massive dosages may include thickening and coarsening of the skin, muscle weakness, diarrhea, and nausea.

The proximal renal tubule accounts for much of the endogenous production of L-arginine from L-citrulline. In the tubule, arginine reacts via the Krebs cycle with the toxic ammonia formed from nitrogen metabolism, producing the nontoxic and readily excretable urea

(Fig. 1).<sup>[5]</sup> Without this effective mechanism to handle the byproducts of metabolism and without an appropriate L-arginine intake, ammonia would accumulate rapidly, resulting in hyperammonemia.

L-Arginine undergoes different metabolic fates. NO, L-citrulline, L-ornithine, L-proline, L-glutamate, and polyaminelike putrescine are formed from L-arginine. Moreover, the high-energy compound NO-creatinine phosphate, essential for sustained skeletal muscle contraction, is also formed from L-arginine (Fig. 2).

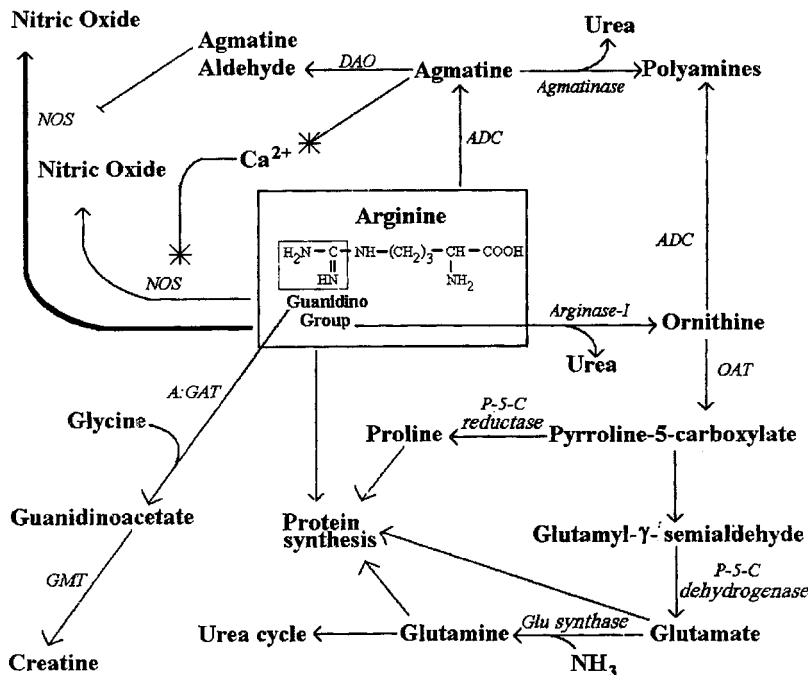


Fig. 2 L-Arginine metabolites (ADC, arginine decarboxylase; A:GAT, arginine: glycine amidinotransferase; DAO, diamine oxidase; Glu synthase, glutamine synthase; GMT, guanidinoacetate-N-methyltransferase; NOS, nitric oxide synthase; OAT, ornithine aminotransferase; P-5-C dehydrogenase, pyrroline-t-carboxylate dehydrogenase; P-5-C reductase, pyrroline-5-carboxylate reductase).

L-Arginine, its precursors, and its metabolites are deeply involved in the interaction of different metabolic pathways and interorgan signaling. The amino acid influences the internal environment in different ways: disposal of protein metabolic waste; muscle metabolism; vascular regulation; immune system function; healing and repair of tissue; formation of collagen; and building of new bone and tendons.

A leading role for arginine has been shown in the endocrine system, vasculature, and immune response.

## PHYSIOLOGY

### Endocrine Actions

L-Arginine functions as a secretagogue of a number of important hormones, which include pituitary, pancreatic, and adrenal hormones. The effects on growth hormone, prolactin, corticotrophin, and insulin secretion will be discussed in detail.

#### Growth hormone (GH) secretion

Among the various factors modulating somatotropin function, arginine is well known to play a primary stimulatory influence. Arginine has been shown to increase basal GH levels and to enhance the GH responsiveness to growth hormone releasing hormone (GHRH) in both animals and humans throughout their lifespans<sup>[6–9]</sup>; its GH-stimulating activity is present after both intravenous and oral administration and is dose dependent; 0.1 and 0.5 g/kg are the minimal and the maximal i.v. effective doses, respectively. Moreover, a low orally administered arginine dose has been shown to be as effective as a high i.v. dose in enhancing the GH response to GHRH in both children and elderly subjects.<sup>[10,11]</sup>

Increasing evidence favors the hypothesis that arginine, directly or indirectly via NO, acts by inhibiting hypothalamic somatostatin (SS) release. It has been shown that arginine—but not isosorbide-dinitrate and molsidomine, two NO donors—stimulates GH secretion,<sup>[12,13]</sup> suggesting that it does not exert its effects through the generation of NO. Otherwise, arginine does not modify either basal or GHRH-induced GH increase from rat anterior pituitary.<sup>[14]</sup> On the contrary, it potentiates the GH response to the maximal GHRH dose in humans. Arginine can elicit a response when it has been inhibited by a previous GHRH administration, which reflects an SS-mediated negative GH autofeedback mechanism.<sup>[7,8,15]</sup> Moreover, arginine counteracts the GH-inhibiting effect of neuroactive substances, acting by stimulating SS release; it does not modify the GH-releasing activity of stimuli acting via SS reduction.<sup>[8]</sup> Again, favoring

an SS-mediated mechanism is also the evidence that ornithine, the active form of arginine, is unable to modify plasma GHRH levels in humans.<sup>[16]</sup> Moreover, arginine fails to potentiate the increased spontaneous nocturnal GH secretion, which is assumed to reflect circadian SS hyposecretion and GHRH hypersecretion, respectively.<sup>[8]</sup> Arginine does not influence the strong GH-releasing action of ghrelin, the natural ligand of GH secretagogues (GHS), which is supposed to act as a functional antagonist of SS at both pituitary and hypothalamic level.<sup>[17,18]</sup>

The GH-releasing activity of arginine is sex- but not age-dependent, being higher in females than in males but similar in children, youth, and elderly subjects.<sup>[8,19–23]</sup> Moreover, it has been clearly demonstrated that arginine totally restores the low somatotrope responsiveness to GHRH observed in aging, in which a somatostatinergic hyperactivity has been hypothesized.<sup>[20–23]</sup> This evidence, besides stressing an SS-mediated mechanism for arginine, clearly indicates that the maximal secretory capacity of somatotrophic cells does not vary with age and that the age-related decrease in GH secretion is due to hypothalamic impairment.<sup>[20–23]</sup> This also points out the possible clinical usefulness of this substance to rejuvenate the GH/insulinlike growth factor-I (IGF-I) axis in aging—in fact, the reduced function of the GH/IGF-I axis in aging may account for the changes in body composition and structure function. In agreement with this assumption, it has been reported by some, but not all, authors that elderly subjects would benefit from treatment with rhGH to restore IGF-I levels within the young range.<sup>[21,24]</sup> As it has been demonstrated that the GH releasable pool in the aged pituitary is basically preserved and that the age-related decline in GH secretion mostly reflects hypothalamic dysfunction,<sup>[21,23]</sup> the most appropriate, i.e., “physiological,” approach to restore somatotroph function in aging would be a treatment with neuroactive substances endowed with GH-releasing action. Among these GH secretagogues, arginine received considerable attention. In fact, the coadministration of arginine (even at low oral doses) with GHRH (up to 15 days) enhanced the GH responsiveness to the neurohormone in normal aged subjects.<sup>[11]</sup> However, the efficacy of long-term treatment with oral arginine to restore the function of the GH/IGF-I axis in aging has never been shown in elderly subjects.

Following the evidence that, when combined with arginine, GHRH becomes the most potent and reproducible stimulus to diagnose GH deficiency throughout lifespan,<sup>[25]</sup> GHRH + arginine is, at present, one of the two gold standard tests for the diagnosis of GH deficiency.<sup>[25,26]</sup> In fact, the GH response to a GHRH + arginine test is approximately threefold higher than the response to classical tests and does

not vary significantly with age.<sup>[25,26]</sup> Due to its good tolerability and its preserved effect in aging, the GHRH + arginine test is today considered the best alternative choice to the insulin-induced tolerance test (ITT) for the diagnosis of GH deficiency throughout the lifespan.<sup>[25]</sup>

### Prolactin (PRL) secretion

Among the endocrine actions of arginine, its PRL-releasing effect has been shown both in animals and in humans after intravenous but not after oral administration.<sup>[10,27]</sup> Though present, the PRL response to arginine is markedly lower than to the classical PRL secretagogues, such as dopaminergic antagonists or thyrotropin releasing hormone (TRH),<sup>[6]</sup> but higher than that observed after secretion of GH and other modulators of lactotrope function.<sup>[17]</sup>

The mechanisms underlying the stimulatory effect of arginine on PRL secretion are largely unknown, but there is evidence that it is not mediated by galanin, a neuropeptide with PRL-releasing effect. In fact, galanin has been shown to potentiate PRL response to arginine, suggesting different mechanisms of action for the two substances.<sup>[28]</sup>

### ACTH secretion

Although some excitatory amino acids and their agonists have been demonstrated to differently modulate corticotropin releasing hormone (CRH) and arginine vasopressin (AVP) release in vitro and influence both sympathoadrenal and hypothalamo-pituitary-adrenal (HPA) responses to hypoglycemia in animals,<sup>[29,30]</sup> little is known about arginine influences on HPA axis in humans. Many studies have shown that mainly food ingestion influences spontaneous and stimulated adrenocorticotrophic hormone (ACTH)/cortisol secretion in normal subjects and that central  $\alpha_1$ -adrenergic-mediated mechanisms are probably involved.<sup>[31]</sup> At present, however, no data exist regarding the effect of each nutrient component on HPA function. Previous studies demonstrated that arginine is unable to exert an ACTH-stimulatory effect in humans via generation of NO<sup>[12]</sup> and our preliminary data (unpublished results) failed to demonstrate a significant effect of arginine (30 g i.v.) on either ACTH or cortisol secretion in normal subjects.

### Insulin secretion

Arginine is the most effective insulin secretagogue known and it is used clinically to determine a patient's capacity to secrete insulin. In stimulating insulin release, arginine acts synergistically with glucose, and to a much lesser extent with serum fatty acids.

In humans, a synergistic effect of arginine and glucose upon insulin secretion has been shown,<sup>[32,33]</sup> and combined administration of these two stimuli has been studied in an attempt to probe  $\beta$ -cell secretory capacity in diabetic patients.<sup>[34]</sup>

A protein meal leads to a rapid increase in both plasma insulin and glucagon levels.<sup>[35]</sup> Administration of arginine has a similar effect. An arginine transport system is present in the  $\beta$  cell plasma membrane.<sup>[36]</sup> When arginine enters into the  $\beta$  cell, it causes ionic changes that depolarize the  $\beta$  cell and trigger  $\text{Ca}^{2+}$  uptake and exocytosis of insulin-containing granules.

Several mechanisms for arginine-induced  $\beta$ -cell stimulation have been proposed. These include the metabolism of L-arginine leading to the formation of ATP,<sup>[37,38]</sup> the generation of NO,<sup>[39,40]</sup> and the direct depolarization of the plasma membrane potential due to the accumulation of the cationic amino acid.<sup>[41-43]</sup>

A sustained  $\text{Ca}^{2+}$  influx is directly related to insulin secretion following arginine uptake by  $\beta$  cells. The arginine-induced increase in  $\text{Ca}^{2+}$  concentration is inhibited by the activation of ATP-sensitive potassium (K-ATP) channels with diazoxide and seems dependent on the nutritional status. These observations suggest that the K-ATP channels, when fully open, act to prevent membrane depolarization caused by arginine. The presence of a nutrient, such as glucose, produces sufficient closure of K-ATP channels to allow arginine-induced membrane depolarization and activation of the voltage-activated  $\text{Ca}^{2+}$  channels.<sup>[36]</sup>

## Nonendocrine Actions

### Cardiovascular system

Recently, increasing interest has been focused on NO. This mediator, which is synthesized from L-arginine<sup>[44]</sup> by nitric oxide synthases (NOS),<sup>[45]</sup> is a potent vasodilator<sup>[46]</sup> and inhibitor of platelet adhesion and aggregation.<sup>[47]</sup> Three isoforms of NOS are described. The isoform found in endothelium (eNOS) is constitutive (cNOS) and is responsible for a consistent vasodilator tone; eNOS and cNOS represent the same enzyme. Also, the isoform found in the platelets is constitutive. Although constitutive, eNOS can be regulated by endothelial shear stress<sup>[48]</sup> and substances such as acetylcholine, histamine, serotonin, thrombin, bradykinin, and catecholamines. Calcium is required for eNOS activation.<sup>[49]</sup> NO production is mainly dependent on the availability of arginine and NOS is responsible for the biochemical conversion of L-arginine to NO and citrulline in the presence of cofactors such as reduced nicotinamide adenine dinucleotide phosphate (NADPH), tetrahydrobiopterin (BH4), flavin mononucleotide, and flavin adenine nucleotide.

Reduced NO production, leading to vasoconstriction and increases in adhesion molecule expression, platelet adhesion and aggregation, and smooth muscle cell proliferation has been demonstrated in atherosclerosis, diabetes mellitus, and hypertension<sup>[50–52]</sup>—conditions known to be associated with an increased mortality due to cardiovascular disease. Taken together, these observations lead to the concept that interventions designed to increase NO production by supplemental L-arginine might have therapeutic value in the treatment and prevention of the endothelial alterations of these diseases. Besides numerous actions exerted mainly through NO production, arginine also has a number of NO-independent properties, such as the ability to regulate blood and cellular pH, and the effect on the depolarization of endothelial cell membranes.

The daily consumption of arginine is normally about 5 g/day. Arginine supplementation is able to increase NO production, although the  $K_m$  for L-arginine is 2.9  $\mu\text{mol}$  and the intracellular concentration of arginine is 0.8–2.0 mmol. To explain this biochemical discrepancy, termed “arginine paradox,” there are theories that include low arginine levels in some diseases (e.g., hypertension, diabetes mellitus, and hypercholesterolemia), and/or the presence of enzymatic inhibitors,<sup>[53]</sup> in particular the asymmetric dimethyl arginine (ADMA), and/or the activity of the enzyme arginase (which converts arginine to ornithine and urea, leading to low levels of arginine). Several studies demonstrated that L-arginine infusion in normal subjects and patients with coronary heart disease,<sup>[54]</sup> hypercholesterolemia,<sup>[55]</sup> and hypertension<sup>[56]</sup> is able to improve the endothelial function, but the results, although encouraging, are not conclusive because of the short-term effects of intravenous arginine. However, arginine does not affect endothelial function in patients with diabetes mellitus. On the other hand, oral L-arginine has a longer half-life and longer-term effects than L-arginine given intra-arterially or intravenously,<sup>[57]</sup> so that, in the setting of long-term health maintenance or symptom management rather than acute administration, the oral route would be preferred. Studies in animals documented that oral L-arginine supplementation is able to reduce the progression of atherosclerosis, preserving endothelium function<sup>[58]</sup> and inhibiting circulating inflammatory cells<sup>[59]</sup> and platelets<sup>[60]</sup> in animals with hypercholesterolemia, and to decrease blood pressure and wall thickness in animals with experimental hypertension.<sup>[61]</sup> On the other hand, studies in humans in vivo are not so widely positive as the animal experimental data. Actually, although the majority of the data is in normal subjects, individuals with a history of cigarette smoking and patients with hypercholesterolemia and claudication demonstrate beneficial effects of oral L-arginine administration on platelet adhesion and

aggregation, monocyte adhesion, and endothelium-dependent vasodilation.<sup>[62,63]</sup> Other studies do not show any benefit,<sup>[64,65]</sup> so that no definitive conclusions can be made. Taken together, the studies show a major effect when L-arginine supplementation was given in subjects with hypercholesterolemia, probably due to an increase in NO production via reduction of the ADMA intracellular concentration, which is increased in the presence of LDL hypercholesterolemia.

In conclusion, despite the numerous beneficial effects on intermediate endpoints especially in hypercholesterolemic patients, there is no evidence of clinical benefit in the treatment or prevention of cardiovascular disease. More data, derived from large-scale prospective studies evaluating the effect of long-term treatment with L-arginine, are needed.

### Immune system

Many studies, in animals as well as in humans, have shown that arginine is involved in immune modulation. In fact, this amino acid is a component of most proteins, and the substrate for several nonprotein, nitrogen-containing compounds acting as immune modulators.

There is clear evidence that arginine participates in the cell-mediated immune responses of macrophages and T lymphocytes in humans through the production of NO by inducible nitric oxide synthase (iNOS), which occurs mostly in the macrophage,<sup>[66,67]</sup> and through the modulation of T lymphocyte function and proliferation.<sup>[68,69]</sup> At intracellular levels, arginine is metabolized by two different enzymatic pathways: the arginase pathway, by which the guanidino nitrogen is converted into urea to produce ornithine; and the NOS pathway, which results in oxidation of the guanidino nitrogen to produce NO and other substances.<sup>[70,71]</sup>

It has been shown that macrophage superoxide production, phagocytosis, protein synthesis, and tumoricidal activity are inhibited by high levels of arginine in vitro and that sites of inflammation with prominent macrophage infiltration, such as wounds and certain tumors, are deficient in free arginine.<sup>[72]</sup> In particular, a decrease in arginine availability due to the activity of macrophage-derived arginase rather than the arginine/NO pathway may contribute to the activation of macrophages migrating at inflammatory sites.<sup>[72]</sup> Arginine metabolism in the macrophages is activity dependent: At rest, macrophages exhibit minimal utilization of arginine and lower iNOS expression or arginase activity, whereas in activated cells, arginine is transported into the cell, and iNOS expression and arginase are induced by cytokines and other stimuli.<sup>[73]</sup> The types of stimuli that induce iNOS and arginase are quite different; in vitro and

in vivo studies demonstrated that iNOS is induced by T-helper I cytokines (IL-1, TNF, and  $\gamma$ -interferon) produced during activation of the cellular immune response, such as severe infections or sepsis,<sup>[66,67]</sup> while arginases are induced by T-helper II cytokines (IL-4, IL-10, and IL-13) and other immune regulators aimed at inducing the humoral immune response.<sup>[74,75]</sup> Thus, in disease processes, where inflammatory response predominates, iNOS expression and NO production prevail. Under biological circumstances where T-helper II cytokine expression is prevalent, arginase activity and the production of ornithine and related metabolites would predominate.

In vitro studies in animals demonstrated depressed lymphocyte proliferation in cultures containing low levels of arginine and maximal proliferation when arginine is added at physiologic plasma concentration.<sup>[69,76]</sup> However, the mechanism by which in vivo arginine supplementation may enhance in vitro lymphocyte proliferation is still unknown.

It has also been shown that supplemental arginine increased thymic weight in rodents due to increased numbers of total thymic T lymphocytes. On the other hand, in athymic mice, supplemental arginine increased the number of T cells and augmented delayed-type hypersensitivity responses, indicating that it can exert its effects on peripheral lymphocytes and not just on those within the thymus.<sup>[68]</sup>

The immunostimulatory effects of arginine in animal studies have suggested that this amino acid could be an effective therapy for many pathophysiological conditions in humans, able to positively influence the immune response under some circumstances by restoring cytokine balance and reducing the incidence of infection.

In healthy humans, oral arginine supplementation shows many effects on the immune system, including increase in peripheral blood lymphocyte mitogenesis, increase in the T-helper–T-cytotoxic cell ratio and, in macrophages, activity against micro-organisms and tumor cells.<sup>[77]</sup> Furthermore, the delayed-type hypersensitivity response as well as the number of circulating natural killer (NK) and lymphokine-activated killer cells are increased.<sup>[77–79]</sup> Therefore, it has been hypothesized that arginine could be of benefit to patients undergoing major surgery after trauma and sepsis and in cardiovascular diseases, HIV infection, and cancer.<sup>[80]</sup> In fact, short-term arginine supplementation has been shown to maintain the immune function during chemotherapy; arginine supplementation (30 g/day for 3 days) reduced chemotherapy-induced suppression of NK cell activity, lymphokine-activated killer cell cytotoxicity, and lymphocyte mitogenic reactivity in patients with locally advanced breast cancer.<sup>[81]</sup> It must be noted that chronic administration of arginine has also been shown to promote cancer growth by

stimulating polyamine synthesis in both animal and human studies.<sup>[82]</sup>

These data clearly indicate the involvement of arginine in immune responses in both animals and humans. The clinical application and efficacy of this amino acid in human diseases are also suggested but need to be confirmed in large clinical trials.

## CONCLUSIONS

From an endocrinological point of view, the classification of arginine simply as an amino acid involved in peripheral metabolism is no longer acceptable. Besides other nonendocrine actions, it has been clearly demonstrated that arginine plays a major role in the neural control of anterior pituitary function, particularly in the regulation of somatotrophin secretion. One of the most important concepts regarding arginine is the likely existence of “argininergic” neurons at the CNS level, where this amino acid represents the precursor of NO, a gaseous neurotransmitter of major importance. On the other hand, NO does not necessarily mediate all the neuroendocrine or the peripheral arginine actions. The understanding of the arginine/NO system remains to be clarified particularly from a neuroendocrine point of view, and this will attract great interest in the near future. Similarly, the potential clinical implications for arginine have also never been appropriately addressed and could provide unexpected results either in the endocrine or in the cardiovascular field.

## REFERENCES

1. Reyes, A.A.; Karl, I.E.; Klahr, S. Role of arginine in health and in renal disease. *Am. J. Physiol.* **1994**, *267*, F331–F346.
2. Cooper, H.K. *Advanced Nutritional Therapies*; Cooper, H.K., Ed.; Nelson T.: Nashville, 1996; 87–94.
3. Braverman, E.R.; Blum, K.; Smayda, R.; Pfeiffer, C.C. *The Healing Nutrients Within*; Braverman, E.R., Ed.; McGraw Hill–NTC Inc.: New York, 1997; 180–229.
4. Balch, M.D.; James, F.; Balch, C.N.C.; Phyllis, A. *Prescription for Nutritional Healing*; 2nd Ed.; Avery Publishing Group: Garden City Park, NY, 1997; 35–36.
5. Peters, H.; Noble, N.A. Dietary L-arginine in renal disease. *Semin. Nephrol.* **1996**, *16*, 567–575.
6. Muller, E.E.; Nisticò, G. Neurotransmitter regulation of the anterior pituitary. In *Brain Messengers*

- and the Pituitary*; Muller, E.E., Nisticò, G., Eds.; Academic Press: San Diego, 1989; 404–537.
7. Casanueva, F.F. Physiology of growth hormone secretion and action. In *Endocrinology of Metabolism Clinic of North America*; Melmed, S., Ed.; Saunders: Philadelphia, 1992; Vol. 21, 483–492.
  8. Ghigo, E. Neurotransmitter control of growth hormone secretion. In *Regulation of Growth Hormone and Somatic Growth*; De La Cruz, L.F., Ed.; Elsevier Science: Amsterdam, 1992; 103–136.
  9. Frohman, L.A.; Jansson, J.O. Growth hormone releasing hormone. *Endocr. Rev.* **1996**, *7*, 223–231.
  10. Bellone, J.; Bartolotta, E.; Cardinale, G.; Arvat, E.; Cherubini, V.; Aimaretti, G.; Maccario, M.; Mucci, M.; Camanni, F.; Ghigo, E. Low dose orally administered arginine is able to enhance both basal and growth hormone-releasing hormone-induced growth hormone secretion in normal short children. *J. Endocrinol. Invest.* **1993**, *16*, 521–525.
  11. Ghigo, E.; Ceda, G.P.; Valcavi, R.; Goffi, S.; Zini, M.; Mucci, M.; Valenti, G.; Cocchi, D.; Muller, E.E.; Camanni, F. Low doses of either intravenously or orally administered arginine are able to enhance growth hormone response to growth hormone releasing hormone in elderly subjects. *J. Endocrinol. Invest.* **1994**, *17*, 113–122.
  12. Korbonits, M.; Trainer, P.J.; Fanciulli, G.; Oliva, O.; Pala, A.; Dettori, A.; Besser, M.; Delitala, G.; Grossman, A.B. L-Arginine is unlikely to exert neuroendocrine effects in humans via the generation of nitric oxide. *Eur. J. Endocrinol.* **1996**, *135*, 543–547.
  13. Maccario, M.; Oleandri, S.E.; Procopio, M.; Grottoli, S.; Avogadri, E.; Camanni, F.; Ghigo, E. Comparison among the effects of arginine, a nitric oxide precursor, isosorbide dinitrate and molsidomine, two nitric oxide donors, on hormonal secretions and blood pressure in man. *J. Endocrinol. Invest.* **1997**, *20*, 488–492.
  14. Alba-Roth, J.; Albrecht Muller, O.; Schopohl, J.; Von Werder, K. Arginine stimulates GH secretion by suppressing endogenous somatostatin secretion. *J. Clin. Endocrinol. Metab.* **1988**, *67*, 1186–1192.
  15. Ghigo, E.; Arvat, E.; Valente, F.; Nicolosi, M.; Boffano, G.M.; Procopio, M.; Bellone, J.; Maccario, M.; Mazza, E.; Camanni, F. Arginine reinstates the somatotrope responsiveness to intermittent growth hormone-releasing hormone administration in normal adults. *Neuroendocrinology* **1991**, *54*, 291–294.
  16. Evain-Brion, D.; Donnadieu, M.; Liapi, C. Plasma GHRH levels in children: physiologically and pharmacologically induced variation. *Hormone Res.* **1986**, *24*, 116–118.
  17. Ghigo, E.; Arvat, E.; Muccioli, G.; Camanni, F. Growth hormone-releasing peptides. *Eur. Endocrinol.* **1997**, *136*, 445–460.
  18. Broglio, F.; Gottero, C.; Benso, A.; Prodam, F.; Destefanis, S.; Gauna, C.; Maccario, M.; Deghenghi, R.; van der Lely, A.J.; Ghigo, E. Effects of ghrelin on the insulin and glycemic responses to glucose, arginine, or free fatty acids load in humans. *J. Clin. Endocrinol. Metab.* **2003**, *88*, 4268–4272.
  19. Ghigo, E.; Bellone, J.; Mazza, E.; Imperiale, E.; Procopio, M.; Valente, F.; Lala, R.; De Sanctis, C.; Camanni, F. Arginine potentiates the GHRH but not the pyridostigmine-induced GH secretion in normal short children. Further evidence for a somatostatin suppressing effect of arginine. *Clin. Endocrinol.* **1990**, *32*, 763–767.
  20. Ghigo, E.; Goffi, S.; Nicolosi, M.; Arvat, E.; Valente, F.; Mazza, E.; Ghigo, M.C.; Camanni, F. Growth hormone (GH) responsiveness to combined administration of arginine and GH-releasing hormone does not vary with age in man. *J. Clin. Endocrinol. Metab.* **1990**, *71*, 1481–1485.
  21. Corpas, E.; Harman, S.M.; Blackman, S. Human growth hormone and human aging. *Endocr. Rev.* **1993**, *14*, 20–39.
  22. Muller, E.E.; Cocchi, D.; Ghigo, E.; Arvat, E.; Locatelli, V.; Camanni, F. Growth hormone response to GHRH during lifespan. *J. Pediatr. Endocrinol. Metab.* **1993**, *6*, 5–13.
  23. Ghigo, E.; Arvat, E.; Gianotti, L.; Ramunni, J.; Di Vito, L.; Maccagno, B.; Grottoli, S.; Camanni, F. Human aging and the GH/IGF-I axis. *J. Pediatr. Endocrinol. Metab.* **1996**, *9*, 271–278.
  24. Rudman, D.; Feller, A.G.; Nagraj, H.S.; Gergans, G.A.; Lalitha, P.Y.; Goldberg, A.F.; Schlenker, R.A.; Cohn, L.; Rudman, I.W.; Mattson, D.E. Effects of human growth hormone in men over 60 years old. *N. Engl. J. Med.* **1990**, *323*, 1–6.
  25. Aimaretti, G.; Bellone, S.; Baffoni, C.; Corneli, G.; Origlia, C.; Di Vito, L.; Rovere, S.; Arvat, E.; Camanni, F.; Ghigo, E. Short procedure of GHRH plus arginine test in clinical practice. *Pituitary* **2001**, *4*, 129–134.
  26. Ghigo, E.; Aimaretti, G.; Gianotti, L.; Bellone, J.; Arvat, E.; Camanni, F. New approach to the diagnosis of growth hormone deficiency in adults. *Eur. J. Endocrinol.* **1996**, *134*, 352–356.
  27. Davis, S.L. Plasma levels of prolactin, growth hormone and insulin in sheep following the infusion of arginine, leucine and phenylalanine. *Endocrinology* **1972**, *91*, 549–555.
  28. Ghigo, E.; Maccario, M.; Arvat, E.; Valetto, M.R.; Valente, F.; Nicolosi, M.; Mazza, E.; Martina, V.;

- Cocchi, D.; Camanni, F. Interaction of galanin and arginine on growth hormone, prolactin, and insulin secretion in man. *Metabolism* **1992**, *41*, 85–89.
29. Patchev, V.K.; Karalis, K.; Chrousos, G.P. Effects of excitatory amino acid transmitters on hypothalamic corticotropin-releasing hormone (CRH) and arginine-vasopressin (AVP) release in vitro: implication in pituitary–adrenal regulation. *Brain Res.* **1994**, *633*, 312–316.
  30. Molina, P.E.; Abumrad, N.N. Contribution of excitatory amino acids to hypoglycemic counter regulation. *Brain Res.* **2001**, *899*, 201–208.
  31. Al-Damluji, S.; Iveson, T.; Thomas, J.M.; Pendlebury, D.J.; Rees, L.H.; Besser, G.M. Food induced cortisol secretion is mediated by central alpha-1 adrenoceptor modulation of ACTH secretion. *Clin. Endocrinol. (Oxford)* **1987**, *26*, 629–636.
  32. Floyd, J.C.; Fagans, J.R.; Pek, S.; Tiffualt, C.A.; Knopf, R.F.; Conn, J.W. Synergistic effect of essential amino acids and glucose upon insulin secretion in man. *Diabetes* **1970**, *19*, 109–115.
  33. Levin, S.R.; Karam, J.H.; Hane, S.; Grodsky, G.M.; Fosham, P.H. Enhancement of arginine induced insulin secretion in man by prior administration of glucose. *Diabetes* **1971**, *20*, 171–176.
  34. Ward, W.K.; Bolgiano, D.C.; McKnight, B.; Halter, J.B.; Porte, D. Diminished  $\beta$ -cell secretory capacity in patients with non-insulin-dependent diabetes mellitus. *J. Clin. Invest.* **1984**, *74*, 1318–1328.
  35. van Loon, L.J.C.; Saris, W.H.M.; Verhagen, H.; Wagenmakers, A.J.M. Plasma insulin responses after ingestion of different amino acid or protein mixtures with carbohydrate 1–3. *Am. J. Clin. Nutr.* **2000**, *72*, 96–105.
  36. Weinhaus, A.J.; Poronnik, P.; Tuch, B.E.; Cook, D.I. Mechanisms of arginine-induced increase in cytosolic calcium concentration in the beta-cell line NIT-1. *Diabetologia* **1997**, *40*, 374–382.
  37. Malaisse, W.J.; Blachier, F.; Mourtada, A.; Camara, J.; Albor, A.; Valverde, I.; Sener, A. Stimulus-secretion coupling of arginine-induced insulin release: metabolism of L-arginine and L-ornithine in tumoral islet cells. *Mol. Cell. Endocrinol.* **1989**, *67*, 81–91.
  38. Malaisse, W.J.; Blachier, F.; Mourtada, A.; Camara, J.; Albor, A.; Valverde, I.; Sener, A. Stimulus-secretion coupling of arginine-induced insulin release. Metabolism of L-arginine and L-ornithine in pancreatic islets. *Biochim. Biophys. Acta* **1989**, *1013*, 133–143.
  39. Schmidt, H.H.H.W.; Warner, T.D.; Ishiim, K.; Sheng, H.; Murad, F. Insulin secretion from pancreatic B cells caused by L-arginine-derived nitrogen oxides. *Science* **1992**, *255*, 721–723.
  40. Jansson, L.; Sandler, S. The nitric oxide synthase II inhibitor NG-nitro-L-arginine stimulates pancreatic islet insulin release in vitro, but not in the perfused pancreas. *Endocrinology* **1991**, *128*, 3081–3085.
  41. Charles, S.; Tamagawa, T.; Henquin, J.C. A single mechanism for the stimulation of insulin release and  $86\text{Rb}^+$  efflux from rat islets by cationic amino acids. *J. Biochem.* **1982**, *208*, 301–308.
  42. Sener, A.; Blachier, F.; Rasschaert, J.; Mourtada, A.; Malaisse-Lagae, F.; Malaisse, W.J. Stimulus-secretion coupling of arginine-induced insulin release: comparison with lysine-induced insulin secretion. *Endocrinology* **1989**, *124*, 2558–2567.
  43. Blachier, F.; Mourtada, A.; Sener, A.; Malaisse, W.J. Stimulus-secretion coupling of arginine induced insulin release. Uptake of metabolized and nonmetabolized cationic amino acids by pancreatic islets. *Endocrinology* **1989**, *124*, 134–141.
  44. Palmer, R.M.; Rees, D.D.; Ashton, D.S. L-Arginine is the physiological precursor for the formation of nitric oxide in endothelium-dependent relaxation. *Biochem. Biophys. Res. Commun.* **1988**, *153*, 1251–1256.
  45. Palmer, R.M.; Moncada, S. A novel citrulline-forming enzyme implicated in the formation of nitric oxide by vascular endothelial cells. *Biochem. Biophys. Res. Commun.* **1989**, *158*, 348–352.
  46. Moncada, S.; Radomski, M.W.; Palmer, R.M. Endothelium derived relaxing factor: identification as nitric oxide and role in the control of vascular tone and platelet function. *Biochem. Pharmacol.* **1988**, *37*, 2495–2501.
  47. Radomski, M.W.; Palmer, R.M.; Moncada, S. Endogenous nitric oxide inhibits human platelet adhesion to vascular endothelium. *Lancet* **1987**, *2*, 1057–1058.
  48. Cooke, J.P.; Rossitch, E., Jr.; Andon, N.A.; Loscalzo, J.; Dzau, V.J. Flow activates an endothelial potassium channel to release an endogenous nitrovasodilator. *J. Clin. Invest.* **1991**, *88*, 1663–1671.
  49. Wever, R.M.F.; Luscher, T.F.; Cosentino, F.; Rabelink, T.J. Atherosclerosis and the two faces of endothelial nitric oxide synthase. *Circulation* **1998**, *97*, 108–112.
  50. Napoli, C.; Ignarro, L.J. Nitric oxide and atherosclerosis. *Nitric Oxide* **2001**, *5*, 88–97.
  51. Martina, V.; Bruno, G.A.; Trucco, F.; Zumpano, E.; Tagliabue, M.; Di Bisceglie, C.; Pescarmona, G.P. Platelet cNOS activity is reduced in patients

- with IDDM and NIDDM. *Thromb. Haemost.* **1998**, *79*, 520–522.
52. Taddei, S.; Virdis, A.; Ghiadoni, L.; Sudano, I.; Solvetti, A. Endothelial dysfunction in hypertension. *J. Cardiovasc. Pharmacol.* **2001**, *38* (Suppl. 2), S11–S14.
  53. Goumas, G.; Tentoularis, C.; Tousoulis, D.; Stefanadis, C.; Toutouzas, P. Therapeutic modification of the L-arginine–eNOS pathway in cardiovascular disease. *Atherosclerosis* **2001**, *127*, 1–11.
  54. Tousoulis, D.; Davies, G.; Tentolouris, C.; Crake, T.; Toutouzas, P. Coronary stenosis dilatation induced by arginine. *Lancet* **1997**, *349*, 1812–1813.
  55. Creager, M.A.; Gallagher, S.J.; Girerd, X.J.; Coleman, S.M.; Dzau, V.J.; Cooke, J.P. L-Arginine improves endothelium-dependent vasodilation in hypercholesterolic humans. *J. Clin. Invest.* **1992**, *90*, 1248–1253.
  56. Panza, J.A.; Casino, P.R.; Badar, D.M.; Quiumi, A.A. Effect of increased availability of endothelium-dependent vascular relaxation in normal subjects and in patients with essential hypertension. *Circulation* **1993**, *87*, 1475–1481.
  57. Blum, A.; Porat, R.; Rosenschein, U.; Keren, G.; Roth, A.; Laniado, S.; Miller, H. Clinical and inflammatory effects of dietary L-arginine in patients with intractable angina pectoris. *Am. J. Cardiol.* **1999**, *83*, 1488–1490.
  58. Cooke, J.P.; Singer, A.H.; Tsao, P.; Zera, P.; Rowan, R.A.; Billingham, M.E. Antiatherogenic effect of L-arginine in the hypercholesterolemic rabbit. *J. Clin. Invest.* **1992**, *90*, 1168–1172.
  59. Brandes, R.P.; Brandes, S.; Boger, R.H.; Bode-Boger, S.M.; Mugge, A. L-Arginine supplementation in hypercholesterolemic rabbits normalizes leukocyte adhesion to non-endothelial matrix. *Life Sci.* **2000**, *66*, 1519–1524.
  60. Coreaux, D.; Tourneau, T.; Ezekowitz, M.D.; McFadden, E.P.; Meurice, T.; Asseman, P.; Bauters, C.; Jude, B. Enhanced monocyte tissue factor response after experimental balloon angiography in hypercholesterolemic rabbits: inhibition with L-arginine. *Circulation* **1998**, *98*, 1176–1182.
  61. Sun, Y.P.; Zu, P.Q.; Browne, A.E.M.; Gao, L.R.; Chou, T.M.; Chatterjee, K.; Sudhir, K.; Parmodej, W.W. L-Arginine decreases blood pressure and left ventricular hypertrophy in rats with experimental aortic coarctation. *J. Am. Coll. Cardiol.* **1998**, *31* (Suppl. Aj), 501A pp.
  62. Adams, M.R.; Mc Credie, M.R.; Jessup, W.; Robinson, J.; Sullivan, D.; Celmayer, D.S. Oral L-arginine improves endothelium-dependent dilation and reduces monocyte adhesion to endothelial cells in young men with coronary artery disease. *Atherosclerosis* **1997**, *129*, 261–270.
  63. Lerman, A.; Burnett, J.C.; Higano, S.T.; McKinley, L.J.; Holmes, D.T., Jr. Long term arginine supplementation improves small vessel coronary endothelial function in humans. *Circulation* **1998**, *97*, 2123–2128.
  64. Blum, A.; Hathaway, L.; Mincemoyer, R.; Schenke, W.H.; Kirby, M.; Csako, G.; Waclawiw, M.A.; Panza, J.A.; Cannon, R.O. Effects of oral L-arginine on endothelium-dependent vasodilation and markers of inflammation in healthy postmenopausal women. *J. Am. Coll. Cardiol.* **2000**, *35*, 271–276.
  65. Chin-Dusting, J.P.F.; Kaye, G.M.; Lefkovits, J.; Wong, J.; Bergin, P.; Jennongs, J.L. Dietary supplementation with L-arginine fails to restore endothelial function in forearm resistance arteries in patients with severe heart failure. *J. Am. Coll. Cardiol.* **1996**, *27*, 1207–1213.
  66. Hibbs, J.B., Jr.; Taintor, R.R.; Vavrin, Z.; Rachlin, E.M. Nitric oxide: a cytotoxic activated macrophage effector molecule. *Biochem. Biophysiol. Res. Commun.* **1988**, *157*, 87–94.
  67. Nathan, C.F.; Hibbs, J.B., Jr. Role of nitric oxide synthesis in macrophage antimicrobial activity. *Curr. Opin. Immunol.* **1991**, *3*, 65–70.
  68. Barbul, A.; Sisto, D.A.; Wasserkrug, H.L. Arginine stimulates lymphocyte immune response in healthy humans. *Surgery* **1981**, *90*, 244–251.
  69. Ochoa, J.B.; Strange, J.; Kearney, P.; Gellin, G.; Endean, E.; Fitzpatrick, E. Effects of L-arginine on the proliferation of T lymphocyte subpopulations. *J. Parenter. Enteral Nutr.* **2001**, *25*, 23–29.
  70. Kepka-Lenhart, D.; Mistry, S.K.; Wu, G.; Morris, S.M., Jr. Arginase I a limiting factor for nitric oxide an polyamine synthesis by activated macrophages? *Am. J. Physiol. Regul. Integr. Comp. Physiol.* **2000**, *279*, R2237–R2242.
  71. Taheri, F.; Ochoa, J.B.; Faghiri, Z.; Culotta, K.; Park, H.J.; Lan, M.S.; Zea, A.H.; Ochoa, A.C. Arginine regulates the expression of the T-cell receptor zeta chain (CD3zeta) in jurkat cells. *Clin. Cancer Res.* **2001**, *7*, 958s–965s.
  72. Albina, J.E.; Caldwell, M.D.; Henry, W.L., Jr.; Mills, C.D. Regulation of macrophage functions by L-arginine. *J. Exp. Med.* **1989**, *169*, 1021–1029.
  73. Kakuda, D.K.; Sweet, M.J.; MacLeod, C.L.; Hume, D.A.; Markovich, D. CAT2-mediated L-arginine transport and nitric oxide production in activated macrophages. *Biochem. J.* **1999**, *340*, 549–553.
  74. Modolell, M.; Corraliza, I.M.; Link, F.; Soler, G.; Eichmann, K. Reciprocal regulation of the nitric



- oxide synthase–arginase balance in mouse bone marrow-derived macrophages by TH1 and TH2 cytokines. *Eur. J. Immunol.* **1995**, *25*, 1101–1104.
75. Hesse, M.; Modolell, M.; La Flamme, A.C.; Scito, M.; Fuentes, J.M.; Cheever, A.W.; Pearce, E.J.; Wynn, T.A. Differential regulation of nitric oxide synthase-2 and arginase-1 by type 1/type 2 cytokines in vivo: granulomatous pathology is shaped by the pattern of L-arginine metabolism. *J. Immunol.* **2001**, *167*, 6533–6544.
76. Kobayashi, T.; Yamamoto, M.; Hiroi, T.; McGhee, J.; Takeshita, Y.; Kiyono, H. Arginine enhances induction of T helper 1 and T helper 2 cytokine synthesis by Peyer's patch alpha beta T cells and antigen-specific mucosal immune response. *Biosci. Biotechnol. Biochem.* **1998**, *62*, 2334–2340.
77. Barbul, A.; Fishel, R.S.; Shimazu, S.; Wasserkrug, H.L.; Yoshimura, N.N.; Tao, R.C.; Efron, G.J. Intravenous hyperalimentation with high arginine levels improves wound healing and immune function. *J. Surg. Res.* **1985**, *38*, 328–334.
78. Daly, J.M.; Reynolds, J.; Thom, A.; Kinsley, L.; Dietrick-Gallagher, M.; Shou, J.; Ruggieri, B. Immune and metabolic effects of arginine in the surgical patient. *Ann. Surg.* **1988**, *208*, 512–523.
79. Park, K.G.; Hayes, P.D.; Garlick, P.J.; Sewell, H.; Eremin, O. Stimulation of lymphocyte natural cytotoxicity by L-arginine. *Lancet* **1991**, *337*, 645–646.
80. Appleton, J. Arginine: clinical potential of a semi-essential amino acid. *Altern. Med. Rev.* **2002**, *7*, 512–522.
81. Brittenden, J.; Heys, S.D.; Ross, J.; Park, K.G.; Eremin, O. Natural cytotoxicity in breast cancer patients receiving neoadjuvant chemotherapy: effects of L-arginine supplementation. *Eur. J. Surg. Oncol.* **1994**, *20*, 467–472.
82. Park, K.G. The immunological and metabolic effect of L-arginine in human cancer. *Proc. Nutr. Soc.* **1993**, *52*, 387–401.

# Astragalus

Roy Upton

American Herbal Pharmacopoeia<sup>®</sup>, Scotts Valley, California, U.S.A.

A

## INTRODUCTION

Astragalus root (*Astragalus membranaceus* and *Astragalus mongholicus*) (Fig. 1; flowers are shown in Fig. 2) is one of the most important plant products used in traditional Chinese medicine for supporting immune resistance. While there have been few clinical trials regarding its use, numerous preclinical studies suggest immune modulation activity.

## BIOCHEMISTRY AND FUNCTION

### Pharmacokinetics

No human pharmacokinetics data have been reported in English language publications on astragalus, its crude extracts, or its derived directly constituents.

### Pharmacodynamics

The majority of research on astragalus has focused on its immunostimulatory activity and its purported ability to restore the activity of a suppressed immune system. Reviews of a limited number of clinical trials and pre-clinical data provide some evidence for its usefulness in the prevention of the common cold and as an adjunct to cancer therapies. There is limited proof for benefit to the cardiovascular system, with improvement in clinical parameters associated with angina, congestive heart failure, and acute myocardial infarct. There is some indication from animal studies supporting its use in the treatment of hepatitis.

As with much of the literature regarding Chinese herbs, there are few clinical data of high methodological quality available for astragalus, and publication bias regarding the Chinese literature has been reported.<sup>[1]</sup> There are relatively strong preclinical

data of pharmacological mechanisms that provide support for the putative immunomodulatory effects.

## Immunomodulatory Effects

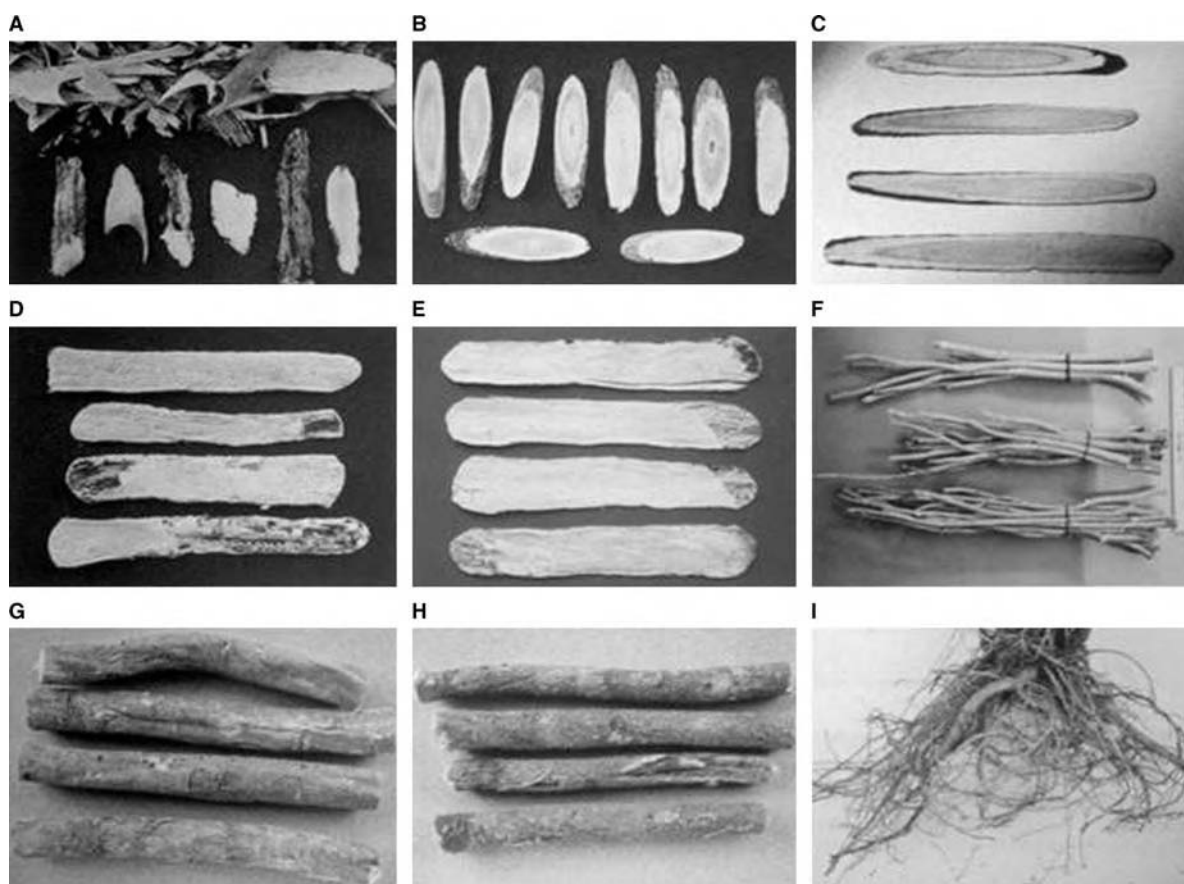
The clinical data regarding the putative immunomodulatory effects of astragalus are limited and weak. According to one English language review of the Chinese literature, a prophylactic effect against the common cold was reported in an epidemiological study in China involving 1000 subjects. Administration of astragalus, given either orally or as a nasal spray, reportedly decreased the incidence of disease and shortened the length of its course. Studies exploring this protective effect found that oral administration of the preparation to subjects for 2 weeks enhanced the induction of interferon by peripheral white blood cells. Levels of immunoglobulin A (IgA) and IgG antibodies in nasal secretions were reported to be increased following 2 mo of treatment.<sup>[2]</sup> The effect of astragalus on the induction of interferon was studied in a placebo-controlled study involving 28 people. Fourteen volunteers were given an extract equivalent to 8 g of dried root per day and the rest were supplied placebos. Blood samples were drawn before treatment, then 2 weeks and 2 mo after treatment. Interferon production by leukocytes was statistically increased after both time periods ( $P < 0.01$ ).<sup>[3]</sup> In another study, astragalus was shown to potentiate the effects of interferon [recombinant  $\alpha$ -interferon-1 (rIFN- $\alpha$ 1)] in patients with chronic cervicitis.<sup>[4]</sup> No further details of these studies were available for review.

In China, astragalus is widely used in the treatment of cancer, both as a primary treatment and as an adjunct to conventional therapies. It is most often combined with other similar acting immune-enhancing plants. A number of randomized prospective clinical studies of cancer patients were conducted using a combination of astragalus and ligustrum (*Ligustrum lucidum*) (undisclosed quantities) with positive results.<sup>[5]</sup> However, these effects are considered to be due to the cumulative effects of the two botanicals and cannot be presumed to occur with astragalus alone.

In one of the available reviews of a clinical trial, it was reported that 53 cases of chronic leukopenia responded favorably to an astragalus extract (1 : 1; 2 ml daily intramuscularly for 1–2 weeks). Improvements in

Roy Upton is at the American Herbal Pharmacopoeia<sup>®</sup>, Scotts Valley, California, U.S.A.

This review has been summarized with permission from the Astragalus monograph of the American Herbal Pharmacopoeia<sup>®</sup>, Scotts Valley, California.



**Fig. 1** Different forms and quality of astragalus on the American market. (Photographs by Roy Upton, Soquel, CA.) (*View this art in color at [www.dekker.com](http://www.dekker.com).*)

symptoms and white blood cell counts were observed, but specific data were lacking. Similar prophylaxis against flu and modulation of endogenously produced interferon have been reported in several animal studies utilizing astragalus alone.<sup>[2]</sup>

Immunomodulatory effects have been demonstrated in numerous preclinical studies. The most relevant



**Fig. 2** Astragalus flowers. (*View this art in color at [www.dekker.com](http://www.dekker.com).*)

of these was a series of investigations conducted by researchers at the M.D. Andersen Cancer Center, who found that astragalus extract restored to normal the immune response of patients' mononuclear cells that were grafted into rats immunocompromised by cyclophosphamide. These scientists concluded that astragalus and its polysaccharide fraction reversed the immunosuppressive effect of this drug.<sup>[6-10]</sup> In other studies, astragalus and its various fractions were shown to stimulate macrophage phagocytosis<sup>[11,12]</sup> and hematopoiesis.<sup>[13]</sup>

Astragalus was also studied for its ability to affect natural killer (NK) cell activity using an enzyme-release assay. The NK cell activity of peripheral blood mononuclear cells (PBMC) from 28 patients with systemic lupus erythematosus (SLE) was increased after in vitro incubation with an undefined astragalus preparation. Low levels of NK cell activity were correlated with disease activity. PBMC from patients with SLE had significantly decreased NK cell activity as compared to those from healthy donors. The extent of stimulation by the astragalus preparation was related to the dose and length of the preincubation period.<sup>[14]</sup>

The ability of an astragalus fraction to potentiate the effects of recombinant interleukin-2 (rIL-2) has similarly been demonstrated in *in vitro* assays. Lymphokine-activated-killer (LAK) cells were treated with a combination of the astragalus fraction and 100 units/ml of interleukin-2 (IL-2). The combination therapy produced the same amount of tumor-cell-killing activity as that generated by 1000 units/ml of rIL-2 on its own, thus suggesting that the astragalus fraction elicited a 10-fold potentiation of rIL-2 in this *in vitro* model.<sup>[10]</sup> These findings were confirmed in a follow-up study by the same group of researchers using LAK cells from cancer and AIDS patients. In this study, the cytotoxicity of a lower dose of 50 µg/ml of rIL-2 given with the astragalus fraction was comparable to that of a higher dose of 500 µg/ml of rIL-2 alone against the Hs294t melanoma cell line of LAK cells. With the combination, the effector–target cell ratio could be reduced to one-half to obtain a level of cytotoxicity that was equivalent to the use of rIL-2 alone. Additionally, the astragalus fraction was shown to increase the responsiveness of peripheral blood lymphocytes that were not affected by rIL-2. In this study, and in another by the same researchers, it was concluded that the fraction potentiated the activity of LAK cells and allowed for the reduction of rIL-2, thus minimizing the toxicity of rIL-2 therapy.<sup>[15,16]</sup> Almost identical findings (a 10-fold potentiation) were reported by other researchers, who concluded that astragalus is effective in potentiating IL-2 generated LAK cell cytotoxicity *in vitro*.<sup>[17,18]</sup> It was also found to enhance the secretion of tumor necrosis factor (TNF) from human PBMC. A polysaccharide fraction (molecular weight 20,000–25,000) increased secretion of TNF $\alpha$  and TNF $\beta$  after isolation of adherent and nonadherent mononuclear cells from PBMC.<sup>[19]</sup>

### Cardiovascular Effects

Various cardioactive properties have been reported in the literature. In one study, 92 patients with ischemic heart disease were given an unidentified preparation of astragalus. Marked relief from angina pectoris and some improvements as measured by electrocardiogram (EKG) and impedance cardiogram were reported. Improvement in the EKG index was reported as 82.6%. Overall improvement was significant as compared to the control group ( $P < 0.05$ ).<sup>[20]</sup> A similar result in cardiac performance was reported by other groups of researchers. In one study, 43 patients were hospitalized within 36 hr of acute myocardial infarct. After administration of an astragalus preparation (undefined profile), the ratio of pre-ejection period/left ventricular ejection time (PEP/LVET) was decreased, the antioxidant activity of superoxide

dismutase (SOD) of red blood cells was increased, and the lipid peroxidation (LPO) content of plasma was reduced.<sup>[21]</sup> In another experiment, 20 patients with angina pectoris were given an undefined astragalus preparation. Cardiac output, as measured by Doppler echocardiogram (DEC), increased from  $5.09 \pm 0.21$  to  $5.95 \pm 0.18$  L/min 2 weeks after administration of astragalus ( $P < 0.01$ ). In this study, neither improvement in left ventricular diastolic function nor inhibition of adenosine triphosphate was observed.<sup>[22]</sup> Intravenous administration (undefined preparation) was also reported to significantly shorten the duration of ventricular late potentials in cardiac patients ( $39.8 \pm 3.3$  ms vs.  $44.5 \pm 5.9$  ms;  $P < 0.01$ ).<sup>[23]</sup>

Patients with congestive heart failure were treated for 2 weeks with injections (unspecified amount) of astragaloside IV, a primary triterpene of astragalus. There was an improvement in symptoms, such as tightness in the chest, difficulty in breathing, and exercise capacity. Radionuclide ventriculography showed that left ventricular modeling improved and left ventricular end-diastolic and left ventricular end-systolic volume diminished significantly. The authors concluded that astragaloside IV is an effective positive inotropic agent.<sup>[24]</sup>

In animal studies, astragalus or its compounds were reported to elicit antioxidant,<sup>[25]</sup> mild hypotensive, and both positive (50–22 µg/ml) and negative (30 µg/ml) inotropic activity.<sup>[26]</sup> Antioxidant,<sup>[27]</sup> calcium channel blocking,<sup>[28]</sup> and thrombolytic activity<sup>[29]</sup> have been reported in *in vitro* studies.<sup>[30]</sup>

### Hepatoprotective Effects

In China, astragalus is widely used in the treatment of chronic hepatitis where reductions in elevated liver enzymes and improvements in symptoms in humans have been reported. This activity is stated to be associated with polysaccharides that increase interferon production. Hepatoprotective effects against numerous hepatotoxic agents (e.g., acetaminophen, carbon tetrachloride, and *E. coli* endotoxin) have been reported in both animal and *in vitro* studies. In these experiments, improvement in histological changes in hepatic tissue, including fatty infiltration, vacuolar degeneration, and hepatocellular necrosis was reported. These effects may be associated with saponin fractions.<sup>[31]</sup>

### CONCLUSIONS

There is some evidence to support the oral administration of astragalus for the prevention of colds and upper respiratory infections, and as supplement to cancer therapies. These are very common indications for which astragalus is applied by herbal practitioners.

For its use in cancer therapies, there are no definitive guidelines. The modern experience of practitioners together with the limited clinical and preclinical data pointing to an immunomodulatory effect suggests that there may be some value for these indications. However, more investigation in this area is needed.

Restoration of immune function, increased stem cell generation of blood cells and platelets, lymphocyte proliferation, rise in numbers of antibody-producing and spleen cells, potentiation of rIL-2 and rIFN- $\alpha$ 1 and recombinant  $\alpha$ -interferon-2 (rIFN- $\alpha$ 2) immunotherapy, and enhancement in phagocytic activity by macrophages and leukocytes, as well as increased cytotoxicity by NK cells, are cited as potential mechanisms of action.

Potential benefits to cardiovascular health, including relief from angina and congestive heart failure, and improvement in clinical parameters following acute myocardial infarct, have been reported. These gains may be in part due to antioxidant properties.

## INDICATIONS

Astragalus is most commonly used as a general tonic and specifically for immune enhancement. It has been used for the prevention and treatment of the common cold and upper respiratory tract infections. Astragalus potentiates rIL-2 and rIFN- $\alpha$ 1 and -2 immunotherapy and by lowering the therapeutic thresholds, may reduce the side effects normally associated with these therapies. However, it is not known if any negative interaction can occur. It is useful as a complementary treatment during chemotherapy and radiation therapy, and in immune deficiency syndromes.

In traditional Chinese medicine and Western clinical herbal medicine, astragalus is most commonly used in combination with other botanicals and is very seldom used as a single agent.

## DOSAGES

- Crude drug: 9–30 g daily to be prepared as a decoction.<sup>[32]</sup>
- Decoction: 0.5–1 L daily (up to 120 g of whole root per liter of water).

## SAFETY PROFILE

### Side Effects

None cited in the literature.

### Contraindications

None cited in the literature.

## Precautions

May not be appropriate for the treatment of autoimmune diseases or in conjunction with immunosuppressive therapies. Since immunostimulating polysaccharides may stimulate histamine release, allergic symptoms may be aggravated by the use of astragalus.

## Interactions

Potentiates the effects of acyclovir,<sup>[33]</sup> IL-2,<sup>[10]</sup> and rIFN- $\alpha$ 1 and -2 therapies.<sup>[3,4]</sup> May be incompatible with immunosuppressive agents in general.

## Pregnancy, Mutagenicity, and Reproductive Toxicity

Specific data are lacking. According to one review, astragalus is reported to have no mutagenic effects.<sup>[34]</sup>

## Lactation

Specific data are lacking. Based on a review of the available pharmacologic and toxicologic literature, no limitation is to be expected.

## Carcinogenicity

Specific data are lacking.

## Influence on Driving

Specific data are lacking. Based on the available pharmacologic and toxicologic literature, no limitation is to be expected.

## Overdose

Specific data are lacking.

## Treatment of Overdose

Specific data are lacking.

## Toxicology

Based on a review of the available data and the experience of modern practitioners, astragalus can be considered as a very safe herb even when taken within its large dosage range. However, traditional Chinese

medicine suggests that it should not be used during infectious conditions. Investigations of specific fractions similarly show little toxicity.<sup>[10]</sup>

## REGULATORY STATUS

Regulated as a dietary supplement.

## REFERENCES

- Vickers, A.; Goyal, N.; Harland, R.; Rees, R. Do certain countries produce only positive results? A systematic review of controlled trials. *Controlled Clin. Trials* **1998**, *19*, 159–166.
- Pharmacology and Applications of Chinese Materia Medica*; Chang H.M., But, P.H., Eds.; World Scientific: Singapore, 1987.
- Hou, Y.; Zhang, Z.; Su, S.; Duan, S. Interferon induction and lymphocyte transformation stimulated by *Astragalus membranaceus* in mouse spleen cell cultures. *Zhonghua Weisheng Wuxue Hemian Yixue Zazhi* **1981**, *1* (2), 137–139.
- Qian, Z.W.; Mao, S.J.; Cai, X.C.; Zhang, X.L.; Gao, F.X.; Lu, M.F.; Shao, X.S.; Li, Y.Y.; Yang, X.K.; Zhuo, Y.A. Viral etiology of chronic cervicitis and its therapeutic response to  $\alpha$ -recombinant interferon. *Chin. Med. J.* **1990**, *103*, 647–651.
- Morazzoni, P.; Bombardelli, P. *Astragalus membranaceus* (Fisch) Bunge; Scientific Documentation 30; Indena SpA: Milan, Italy, 1994; 1–18.
- Sun, Y.; Hersh, E.M.; Talpaz, M.; Lee, S.L.; Wong, W.; Loo, T.L.; Mavligit, G.M. Immune restoration and/or augmentation of local graft-versus-host reaction by traditional Chinese medicinal herbs. *Cancer* **1983**, *52* (1), 70–73.
- Chu, D.T.; Wong, W.L.; Mavligit, G.M. Immunotherapy with Chinese medicinal herbs I: immune restoration of local xenogeneic graft-versus-host reaction in cancer patients by fractionated *Astragalus membranaceus* in vitro. *J. Clin. Lab. Immunol.* **1988**, *25* (3), 119–123.
- Chu, D.T.; Wong, W.L.; Mavligit, G.M. Immunotherapy with Chinese medicinal herbs II: reversal of cyclophosphamide-induced immune suppression by administration of fractionated *Astragalus membranaceus* in vivo. *J. Clin. Lab. Immunol.* **1988**, *25*, 125–129.
- Chu, D.T.; Sun, Y.; Lin, J.R. Immune restoration of local xenogeneic graft-versus-host reaction in cancer patients in vitro and reversal of cyclophosphamide-induced immune suppression in the rat in vivo by fractionated *Astragalus membranaceus*. *Chin. J. Integr. Trad. West. Med.* **1989**, *9* (6), 326–354.
- Chu, D.T.; Lepe-Zuniga, J.; Wong, W.L.; LaPushin, R.; Mavligit, G.M. Fractionated extract of *Astragalus membranaceus*, a Chinese medicinal herb, potentiates LAK cell cytotoxicity generated by low dose of recombinant interleukin-2. *J. Clin. Lab. Immunol.* **1988**, *26* (3), 183–187.
- Shimizu, N.; Tomoda, M.; Kanari, M.; Gonda, R. An acidic polysaccharide having activity on the reticuloendothelial system from the root of *Astragalus mongholicus*. *Chem. Pharm. Bull.* **1991**, *39* (11), 2969–2972.
- Tomoda, M.; Shimizu, N.; Ohara, N.; Gonda, R.; Ishii, S.; Otsuki, H. A reticuloendothelial system-activating glycan from the roots of *Astragalus membranaceus*. *Phytochemistry* **1992**, *31* (1), 63–66.
- Rou, M.; Renfu, X. The effect of *radix Astragali* on mouse marrow hemopoiesis. *J. Trad. Chin. Med.* **1983**, *3* (3), 199–204.
- Zhao, X.Z. Effects of *Astragalus membranaceus* and *Tripterygium hypoglaucum* on natural killer cell activity of peripheral blood mononuclear in systemic lupus erythematosus. *Zhongguo Zhongxi Yixue* **1992**, *12* (11), 645, 669–671.
- Chu, D.T.; Sun, Y.; Lin, J.R.; Wong, W.L.; Mavligit, G.M. F3, a fractionated extract of *Astragalus membranaceus*, potentiates lymphokine-activated killer cell cytotoxicity generated by low dose recombinant interleukin-2. *Chin. J. Integr. Trad. West. Med.* **1990**, *10* (1), 34–36.
- Chu, D.T.; Lin, J.R.; Wong, W.L. The in vitro potentiation of LAK cell cytotoxicity in cancer and AIDS patients induced by F3, a fractionated extract of *Astragalus membranaceus*. *Chung Hua Chung Liu Tsa Chih* **1994**, *16* (3), 167–171.
- Wang, Y.; Qian, X.J.; Hadley, H.R.; Lau, B.H. Phytochemicals potentiate interleukin-2 generated lymphokine-activated killer cell cytotoxicity against murine renal cell carcinoma. *Mol. Biother.* **1992**, *4* (3), 143–146.
- Zhou, S.; Lu, Z.; Wang, Y.; Yuan, S.; Chen, S.; Liu, W. Study on the antineoplastic activity of astragalus polysaccharide. *Yaowu Shengwu Jishu* **1995**, *2* (2), 22–25.
- Zhao, K.W.; Kong, H.Y. Effect of astragalin on secretion of tumor necrosis factors in human peripheral blood mononuclear cells. *Chung Kuo Chung Hsi I Chieh Ho Tsa Chih* **1993**, *13* (5), 263–265.
- Li, S.Q.; Yuan, R.X.; Gao, H. Clinical observation on the treatment of ischemic heart disease with *Astragalus membranaceus*. *Chung Kuo Chung Hsi I Chieh Ho Tsa Chih* **1995**, *15* (2), 77–80.

21. Chen, L.X.; Liao, J.Z.; Guo, W.Q. *Astragalus membranaceus* on left ventricular function and oxygen free radical in acute myocardial infarction patients and mechanism of its cardiotoxic action. *Chung Kuo Chung Hsi I Chieh Ho Tsa Chih* **1995**, *15* (3), 141–143.
22. Lei, Z.Y.; Qin, H.; Liao, J.Z. Action of *Astragalus membranaceus* on left ventricular function of angina pectoris. *Chung Kuo Chung Hsi I Chieh Ho Tsa Chih* **1994**, *14* (4), 199–202.
23. Shi, H.M.; Dai, R.H.; Wang, S.Y. Primary research on the clinical significance of ventricular late potentials (VLPs), and the impact of mexiletine, lidocaine, and *Astragalus membranaceus* on VLPs. *Chung Hsi I Chieh Ho Tsa Chih* **1991**, *11* (5), 265–267.
24. Luo, H.M.; Dai, R.H.; Li, Y. Nuclear cardiology study on effective ingredients of *Astragalus membranaceus* in treating heart failure. *Chung Kuo Chung Hsi I Chieh Ho Tsa Chih* **1995**, *15* (12), 707–709.
25. Lei, C.; Yue, H.; Chen, Y.; Lu, W.; Sun, H.; Yang, S. Effects of astragalus saponins on ischemic scope, epicardial ECG, myocardial enzymes in acute myocardial infarcted dog heart. *Baiqiuwen Yike Daxue Xuebao* **1995**, *21* (2), 111–113.
26. Wang, Q.; Li, Y.; Qi, H.; Sun, X.; Zhang, W.; Jiang, Y. Inotropic action of *Astragalus membranaceus* Bunge saponins and its possible mechanism. *Zhongguo Zhongyao Zazhi* **1993**, *17* (9), 557–559.
27. Sun, C.; Zhong, G.; Zhan, S.; Jaing, Y.; Wei, Y.; An, Z. Study on antioxidant effect of astragalus polysaccharide. *Zhongguo Yaolixue Tongbao* **1996**, *12* (2), 161–163.
28. Guo, Q.; Peng, T.; Yang, Y.; Gu, Q.; Zhao, J. Effect of drugs on  $Ca^{2+}$  influx and CVB3-RNA replication in cultured rat heart cells infected with CVB3. *Viol. Sin.* **1996**, *11* (1), 40–44.
29. Zhang, W.J.; Wojta, J.; Binder, B.R. Regulation of the fibrinolytic potential of cultured human umbilical vein endothelial cells: astragaloside IV downregulates plasminogen activator inhibitor-1 and upregulates tissue-type plasminogen activator expression. *J. Vascul. Res.* **1997**, *34* (4), 273–280.
30. Zhong, G.; Jiang, Y.; Wei, Y.; An, Z.; Sun, X.; Li, Y. Positive inotropic action of *Astragalus membranaceus* saponins on isolated working heart. *Baiqiuwen Yike Daxue Xuebao* **1994**, *20* (5), 448–449.
31. *Astragalus Root Monograph*; Upton, R., Graf, A., Eds.; American Herbal Pharmacopoeia: Santa Cruz, CA, 1999.
32. Radix Astragali (huangqi). In *Pharmacopoeia of the People's Republic of China*; English Ed.; Chemistry and Industry Press: Beijing, 1997; Vol. 1, 442 p.
33. Zuo, L.; Dong, X.; Sun, X. The curative effects of *Astragalus membranaceus* Bunge (A-6) in combination with acyclovir on mice infected with HSV-1. *Viol. Sin.* **1995**, *10* (2), 177–179.
34. Wagner, H.; Bauer, R.; Peigen, X.; Jianming, C.; Michler, H. *Radix Astragali [Huang Qi]: Chinese Drug Monographs and Analysis*; Verlag für Ganzheitliche Medizin Dr Erich Wühr GmbH: Bayer, Wald, 1997; Vol. 1 (8), 18 p.

# Biotin

Donald M. Mock

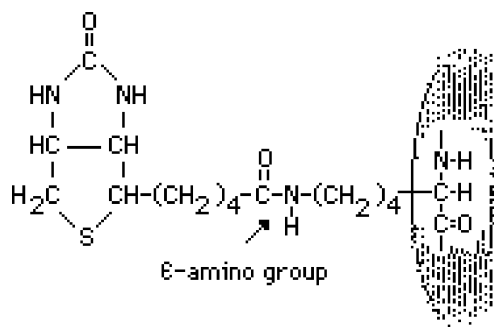
University of Arkansas for Medical Sciences, Little Rock, Arkansas, U.S.A.

## INTRODUCTION

Biotin is usually classified as a B-complex vitamin. This is by far the most widely used term for this vitamin. However, its discovery by different approaches has also led to it being named Bios IIB, protective factor X, vitamin H, coenzyme R, factor S, factor W, and vitamin B<sub>W</sub>. This entry generally reviews the biochemistry of biotin and surveys the clinical findings. Readers are encouraged to use the references for further information.

## SCIENTIFIC NAMES AND STRUCTURE

The molecular weight of biotin is 244.31 Da. Its structure was elucidated independently by Kogl and du Vigneaud in the early 1940s and is shown in Fig. 1.<sup>[1]</sup> Biotin is a bicyclic compound. The imidazolidone contains a ureido group (–N–CO–N–). The tetrahydrothiophene ring contains sulfur and has a valeric acid side chain attached to the C2 carbon of the sulfur-containing ring. This chain has a cis configuration with respect to the ring that contains the nitrogen atoms. The two rings are fused in the cis configuration, producing a boat-like structure. With three asymmetric



**Fig. 1** Protein-bound biotin with arrow showing the amide bond to the  $\epsilon$ -amino acid.

Donald M. Mock, M.D., Ph.D., is Professor at the Departments of Biochemistry and Molecular Biology and Pediatrics, University of Arkansas for Medical Sciences, Little Rock, Arkansas, U.S.A.

carbons, eight stereoisomers exist; only one [designated D-(+)-biotin or, simply, biotin] is found in nature and is enzymatically active. Biocytin ( $\epsilon$ -N-biotinyl-L-lysine) is about as active as biotin on a molar basis in mammalian growth studies.

Goldberg/Sternbach synthesis or a modification thereof is the method by which biotin is synthesized commercially.<sup>[1]</sup> Additional stereospecific methods have been published.<sup>[2,3]</sup>

## HISTORY

Biotin was discovered in nutritional experiments that demonstrated a factor in many foodstuffs capable of curing scaly dermatitis, hair loss, and neurologic signs induced in rats fed dried egg white. Avidin, a glycoprotein found in egg white, binds biotin very specifically and tightly. From an evolutionary standpoint, avidin probably serves as a bacteriostat in egg white. Consistent with this hypothesis is the observation that the protein is resistant to a broad range of bacterial proteases in both free and biotin-bound form. Because it is also resistant to pancreatic proteases, dietary avidin binds to dietary biotin (and probably any biotin from intestinal microbes) and prevents absorption, carrying the biotin on through the gastrointestinal tract.

Biotin is definitely synthesized by intestinal microbes; however, the contribution of microbial biotin to absorbed biotin, if any, remains unknown. Cooking denatures avidin, rendering this protein susceptible to digestion and unable to interfere with the absorption of this vitamin.

## BIOCHEMISTRY

Biotin acts as an essential cofactor for five mammalian carboxylases. Each has the vitamin covalently bound to a polypeptide chain. For monomeric carboxylases, this chain is the apoenzyme. For the dimeric carboxylases, this chain is designated the  $\alpha$  chain. The covalent attachment of biotin to the apocarboxylase protein is a condensation reaction catalyzed by holocarboxylase synthetase (EC 6.3.4.10). An amide bond is formed



between the carboxyl group of the valeric acid side chain of biotin and the  $\epsilon$ -amino group of a specific lysyl residue in the apocarboxylase. These apocarboxylase regions contain sequences of amino acids that tend to be highly conserved within and between species for the individual carboxylases.

All five of the mammalian carboxylases catalyze the incorporation of bicarbonate as a carboxyl group into a substrate and employ a similar catalytic mechanism. In the carboxylase reaction, the carboxyl moiety is first attached to biotin at the ureido nitrogen opposite the side chain. Then the carboxyl group is transferred to the substrate. The reaction is driven by the hydrolysis of ATP to ADP and inorganic phosphate. Subsequent reactions in the pathways of the five mammalian carboxylases release  $\text{CO}_2$  from the product of the enzymatic reaction. Thus, these reaction sequences rearrange the substrates into more useful intermediates but do not violate the classic observation that mammalian metabolism does not result in the net fixation of carbon dioxide.<sup>[4]</sup>

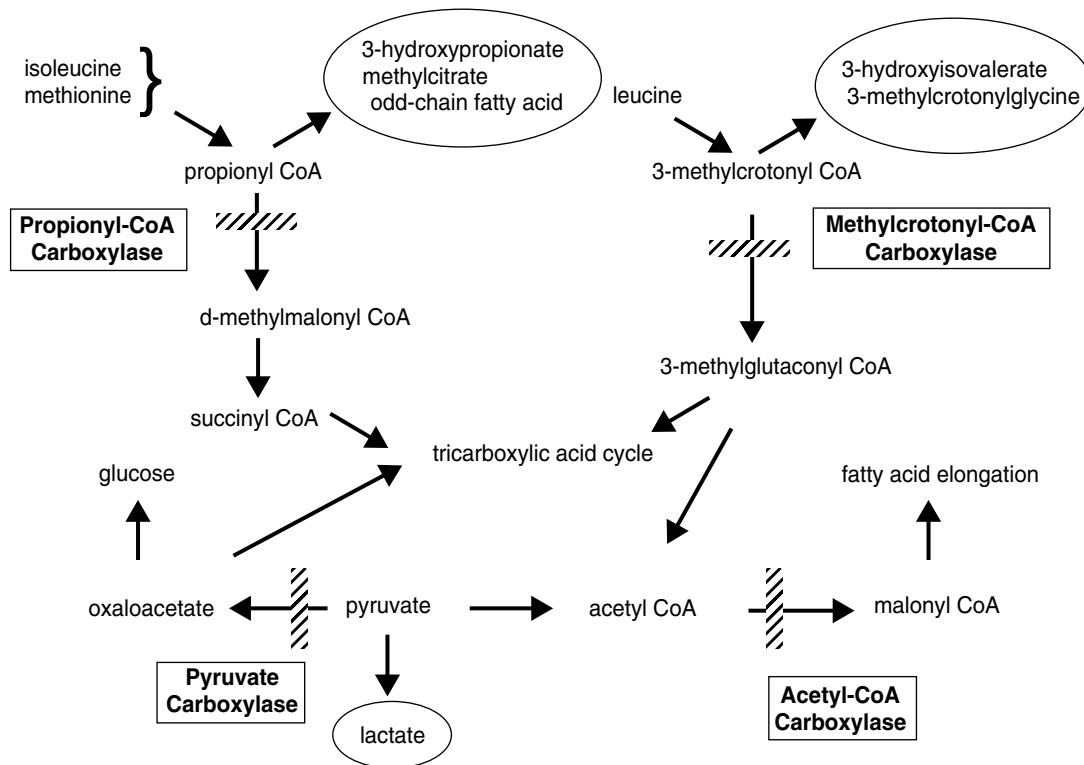
The five carboxylases are pyruvate carboxylase (EC 6.4.1.1), methylcrotonyl-CoA carboxylase (EC 6.4.1.4), propionyl-CoA carboxylase (EC 6.4.1.3), and two isoforms of acetyl-CoA carboxylase (EC 6.4.1.2), denoted I and II, which are also known as  $\alpha$  ACC and

$\beta$  ACC. Each carboxylase catalyzes an essential step in intermediary metabolism (Fig. 2).

Pyruvate carboxylase mediates in the incorporation of bicarbonate into pyruvate to form oxaloacetate, an intermediate in the Krebs tricarboxylic acid cycle. Thus, it catalyzes an anaplerotic reaction. In gluconeogenic tissues (i.e., liver and kidney), the oxaloacetate can be converted to glucose. Deficiency of this enzyme (denoted by a block in the metabolic pathway) is likely the cause of the lactic acidosis and hypoglycemia observed in biotin deficient animals and humans.

Methylcrotonyl-CoA carboxylase catalyzes an essential step in the degradation of the branch-chained amino acid leucine. Deficient activity of this enzyme leads to metabolism of 3-methylcrotonyl CoA to 3-hydroxyisovaleric acid and 3-methylcrotonylglycine by an alternate pathway. Thus, increased urinary excretion of these abnormal metabolites reflects deficient activity of this carboxylase.

Propionyl-CoA carboxylase serves the purpose of catalyzing the incorporation of bicarbonate into propionyl CoA to form methylmalonyl CoA, which undergoes isomerization to succinyl CoA and enters the tricarboxylic acid cycle. In a fashion analogous to methylcrotonyl-CoA carboxylase deficiency, inadequacy of this enzyme leads to increased urinary excretion



**Fig. 2** Pathways involving biotin-dependent carboxylases. Deficiencies (hatched bar) of pyruvate carboxylase, propionyl-CoA carboxylase, methylcrotonyl-CoA carboxylase, and acetyl-CoA carboxylase lead to increased blood concentrations and urinary excretion of characteristic organic acids denoted by ovals.

of 3-hydroxypropionic acid and 3-methylcitric acid and enhanced accumulation of odd-chain fatty acids C15:0 and C17:0. The mechanism is likely the substitution of propionyl CoA for acetyl CoA during fatty acid elongation. Although the proportional increase is large (e.g., 2- to 10-fold), the absolute composition relative to other fatty acids is quite small (<1%) and likely produces little or no functional consequences.

Acetyl-CoA carboxylase helps in catalyzing the incorporation of bicarbonate into acetyl CoA to form malonyl CoA. Isoform I of this enzyme is located in the cytosol and produces cytosolic malonyl CoA, which is rate limiting in fatty acid synthesis (elongation). Isoform II is present on the outer mitochondrial membrane. It controls fatty acid oxidation in mitochondria through the inhibitory effect of malonyl CoA on fatty acid transport into mitochondria.

In the normal turnover of cellular proteins, holocarboxylases are degraded to biocytin or biotin linked to an oligopeptide containing at most a few amino acid residues. Because the amide bond between biotin and lysine (Fig. 1) is not hydrolyzed by cellular proteases, the specific hydrolase biotinidase [biotin amide hydrolase (EC 3.5.1.12)] is required to release biotin for recycling.

Biotin exists in free and bound pools within the cell that are responsive to changes in its status.<sup>[5]</sup> The pool size is likely determined by a balance between cellular uptake, cellular release, incorporation into apocarboxylases and histones, release from these biotinylated proteins during turnover, and catabolism to inactive metabolites. Regulation of intracellular mammalian carboxylase activity by biotin remains to be elucidated.

Genetic deficiencies of holocarboxylase synthetase and biotinidase cause the two distinct types of multiple carboxylase deficiency that were previously designated the neonatal and juvenile forms. The genes for holocarboxylase synthetase and human biotinidase have been cloned, sequenced, and characterized.<sup>[6]</sup> Biotinidase deficiency is particularly relevant to understanding biotin inadequacy because the clinical manifestations appear to result largely from a secondary biotin shortage.

## PHYSIOLOGY

### Digestion of Protein-Bound Biotin

The content of free and protein-bound forms of biotin in foods is variable, but the majority in meats and cereals appears to be protein bound via an amide bond between biotin and lysine. Neither the mechanisms of intestinal hydrolysis of protein-bound biotin nor the determinants of bioavailability have been clearly delineated. Wolf et al.<sup>[7]</sup> have postulated that biotinidase plays a critical role in the release of biotin

from covalent binding to protein. Doses of free biotin that do not greatly exceed the estimated dietary intake (e.g., 50–150 mg per day) appear adequate to prevent the symptoms of biotinidase deficiency. This suggests that biotinidase inadequacy in patients causes biotin deficiency, at least in part, through impaired intestinal digestion of protein-bound biotin.

### Intestinal Absorption

At physiologic pH, the carboxylate group of biotin is negatively charged. Thus, the vitamin is at least modestly water soluble and requires a transporter to cross membranes of, for example, enterocytes for intestinal absorption, somatic cells for utilization, and renal tubule cells for reclamation from the glomerular filtrate.

An excellent in-depth review of intestinal uptake of biotin has been published recently.<sup>[8]</sup> In intact intestinal preparations such as loops and everted gut sacks, biotin transport exhibits two components.<sup>[9]</sup> One of these is saturable at a  $K_m$  of approximately 10 mM biotin—this observation is consistent with a biotin transporter. The other is not saturable even at very large concentrations of biotin—this being in agreement with passive diffusion. Absorption of biocytin, the biotinyl-lysine product of intraluminal protein digestion, is inefficient relative to biotin,<sup>[10]</sup> thus conforming with the inference that biotin must be released from dietary protein by biotinidase.<sup>[11]</sup> The biotin transporter is present in the intestinal brush border membrane.<sup>[8]</sup> The transport is very structurally specific, temperature dependent,  $\text{Na}^+$  coupled, and electroneutral. In the presence of a sodium ion gradient, it occurs against a concentration gradient.<sup>[8]</sup>

In rats, biotin transport is upregulated with maturation and by biotin deficiency.<sup>[8]</sup> Carrier-mediated transport of the vitamin is most active in the proximal small bowel of the rat. However, absorption from the proximal colon is still significant, supporting the potential nutritional significance of biotin synthesized and released by enteric flora.<sup>[8]</sup> Clinical studies have provided some evidence that biotin is absorbed from the human colon.<sup>[9]</sup> In contrast, more rigorous studies in swine indicate that biotin absorption from the hindgut is much less efficient than that from the upper intestine. Further, biotin synthesized by enteric flora is probably not present at a location or in a form in which bacterial biotin contributes importantly to absorbed biotin.

Exit of biotin from the enterocyte (i.e., transport across the basolateral membrane) is also carrier mediated.<sup>[8]</sup> However, basolateral transport is independent of  $\text{Na}^+$ , is electrogenic, and does not accumulate biotin against a concentration gradient.

## Transport in Blood

Biotin is relocated in blood from the site of absorption in the intestine to the peripheral tissues and the liver.<sup>[1]</sup> Wolf et al.<sup>[12]</sup> originally hypothesized that biotinidase might serve as a biotin-binding protein in plasma or perhaps even as a carrier protein for the movement of biotin into the cell. Based on protein precipitation and equilibrium dialysis using <sup>3</sup>H-biotin, Chauhan and Dakshinamurti<sup>[13]</sup> concluded that biotinidase is the only protein in human serum that specifically binds biotin. However, using <sup>3</sup>H-biotin, centrifugal ultrafiltration, and dialysis to assess reversible binding in plasma from the rabbit, pig, and human, Mock and Lankford<sup>[14]</sup> found that less than 10% of the total pool of free plus reversibly bound biotin is reversibly bound to plasma protein; the biotin binding observed could be explained by binding to human serum albumin. Using acid hydrolysis and <sup>3</sup>H-biotinyl-albumin, Mock and Malik<sup>[15]</sup> found additional biotin covalently bound to plasma protein. The percentages of free, reversibly bound, and covalently bound biotin in human serum are approximately 81%, 7%, and 12%. The role of plasma proteins in the transport of biotin remains to be definitively established.

Biotin concentrations in erythrocytes are equal to those in plasma (D.M. Mock, unpublished observation). However, transport into erythrocytes is very slow, consistent with passive diffusion.<sup>[16]</sup>

## Uptake by the Liver

Studies in a variety of hepatic cell lines indicate that uptake of free biotin by the liver is similar to intestinal uptake.<sup>[17,18]</sup> Transport is mediated by a specialized carrier system that is Na<sup>+</sup> dependent, electroneutral, and structurally specific for a free carboxyl group. At large concentrations, movement is carried out by diffusion. Metabolic trapping, e.g., biotin bound covalently to intracellular proteins, is also important. After entering the hepatocyte, biotin diffuses into the mitochondria via a pH-dependent process.

Two biotin transporters have been described: 1) a multivitamin transporter present in many tissues; and 2) a biotin transporter identified in human lymphocytes. The first biotin transporter was discovered in 1997 by Prasad et al.<sup>[19]</sup> in human placental choriocarcinoma cells. This Na<sup>+</sup>-coupled, saturable, structurally specific transporter can also transfer pantothenic acid and lipoic acid as well as biotin. This transporter has been named sodium-dependent multivitamin transporter (SMVT) and is widely expressed in human tissues.<sup>[20]</sup> Recent studies by Said and coworkers<sup>[8]</sup> using RNAi specific for SMVT provide strong evidence that biotin uptake by Caco-2 and HepG2

cells occurs via SMVT. Thus, intestinal absorption and hepatic uptake are likely mediated by it.

The biotin transporter identified in lymphocytes is also Na<sup>+</sup> coupled, saturable, and structurally specific.<sup>[21]</sup> Recent studies by Zemleni and coworkers provide evidence in favor of monocarboxylate transporter 1 (MCT1) as the lymphocyte biotin transporter.<sup>[22]</sup>

A child with biotin dependence due to a defect in the lymphocyte biotin transporter has been reported.<sup>[16]</sup> The child became acutely encephalopathic at the age of 18 mo. Urinary organic acids indicated deficiency of several biotin-dependent carboxylases. Symptoms improved rapidly following biotin supplementation. Serum biotinidase activity and biotinidase gene sequence were normal. Activities of biotin-dependent carboxylases in lymphocytes and cultured skin fibroblasts were normal, excluding biotin holocarboxylase synthetase deficiency as the cause. Despite extracellular biotin sufficiency, biotin withdrawal caused recurrence of abnormal organic aciduria, indicating intracellular biotin deficiency. Biotin uptake rates into fresh lymphocytes from the child and into his lymphocytes transformed with Epstein–Barr virus were about 10% of normal fresh and transformed control cells, respectively. For fresh and transformed lymphocytes from his parents, biotin uptake rates were consistent with heterozygosity for an autosomal recessive genetic defect. SMVT gene sequence was normal. These investigators speculate that lymphocyte biotin transporter is expressed in additional tissues such as the kidney and may mediate some critical aspect of biotin homeostasis.

Ozand et al.<sup>[23]</sup> recently described several patients in Saudi Arabia with biotin-responsive basal ganglia disease. Symptoms include confusion, lethargy, vomiting, seizures, dystonia, dysarthria, dysphagia, seventh nerve paralysis, quadriplegia, ataxia, hypertension, chorea, and coma. A defect in the biotin transporter system across the blood–brain barrier was postulated.

The relationship of these putative biotin transporters to each other is unclear. Their relative roles in intestinal absorption, transport into various organs, and renal reclamation remain to be elucidated.

## Renal Handling

Specific systems for the reabsorption of water-soluble vitamins from the glomerular filtrate may contribute importantly to conservation of these vitamins.<sup>[24]</sup> Animal studies using brush border membrane vesicles from human kidney cortex indicate that biotin is reclaimed from the glomerular filtrate against a concentration gradient by a saturable, Na<sup>+</sup>-dependent, structurally specific system.<sup>[25]</sup> Subsequent egress of biotin from the tubular cells occurs via a basolateral membrane transport system that is not dependent

on  $\text{Na}^+$ . Biocytin does not inhibit tubular reabsorption of biotin.<sup>[25]</sup> Studies in patients with biotinidase deficiency suggest that there may be a role for biotinidase in the renal handling of biotin.<sup>[26,27]</sup>

### Transport into the Central Nervous System

A variety of animal and human studies suggest that biotin is transported across the blood–brain barrier.<sup>[1,28,29]</sup> The transporter is saturable and structurally specific for the free carboxylate group on the valeric acid side chain. Transport into the neuron also appears to involve a specific transport system as well as subsequent trapping of biotin by covalent binding to brain proteins, presumably the biotin-dependent carboxylases and histones.

### Placental Transport

Biotin concentrations are 3- to 17-fold greater in plasma from human fetuses compared to their mothers in the second trimester, consistent with active placental transport.<sup>[30]</sup> Specific systems for transport of biotin from the mother to the fetus have been reported recently.<sup>[20,31–33]</sup> The microvillus membrane of the placenta contains a saturable transport system for biotin that is  $\text{Na}^+$  dependent and actively accumulates biotin within the placenta, consistent with SMVT.<sup>[20,31–33]</sup>

### Transport into Human Milk

More than 95% of the biotin is free in the skim fraction of human milk.<sup>[34]</sup> The concentration of biotin varies substantially in some women<sup>[35]</sup> and exceeds that in serum by one to two orders of magnitude, suggesting that there is a transport system into milk. The biotin metabolite bisnorbiotin (see discussion of metabolism under the section “Pharmacology”) accounts for approximately 50%. In early and transitional human milk, the biotin metabolite biotin sulfoxide accounts for about 10% of the total biotin plus metabolites.<sup>[36]</sup> With postpartum maturation, the biotin concentration increases, but the bisnorbiotin and biotin sulfoxide concentrations still account for 25% and 8% at 5 weeks postpartum. Current studies provide no evidence for a soluble biotin-binding protein or any other mechanism that traps biotin in human milk.

## PHARMACOLOGY

Studies in which pharmacologic amounts of biotin were administered orally and intravenously to experimental subjects and tracer amounts of radioactive

**Table 1** Normal range of urinary excretion of biotin and major metabolites (nmol/24 h;  $n = 31$  males and females)

Biotin	Bisnorbiotin	Biotin sulfoxide
18–77	11–39	8–19

biotin were administered intravenously to animals show that biotin in pure form is 100% bioavailable when administered orally. Using bioassays, it was found that the preponderance of biotin in foodstuffs is bound to macromolecules. It is likely that biotin is bound to carboxylases and perhaps to histones. The bioavailability of biotin from foodstuffs is not known, whereas that from animal feeds varies but can be well below 50%. After intravenous administration, the vitamin disappears rapidly from plasma; the fastest phase of the three-phase disappearance curve has a half-life of less than 10 min.

An alternate fate to being incorporated into carboxylases or unchanged excretion is catabolism to an inactive metabolite before excretion in urine.<sup>[4]</sup> About half of biotin undergoes metabolism before excretion. Two principal pathways of biotin catabolism have been identified in mammals. In the first pathway, the valeric acid side chain of biotin is degraded by  $\beta$ -oxidation. This leads to the formation of bisnorbiotin, tetranorbiotin, and related intermediates that are known to result from  $\beta$ -oxidation of fatty acids. The cellular site of this  $\beta$ -oxidation of biotin is uncertain. Nonenzymatic decarboxylation of the unstable  $\beta$ -keto-biotin and  $\beta$ -keto-bisnorbiotin leads to formation of bisnorbiotin methylketone and tetranorbiotin methylketone, which appear in urine. In the second pathway, the sulfur in the thiophane ring of biotin is oxidized, leading to the formation of biotin L-sulfoxide, biotin D-sulfoxide, and biotin sulfone. Combined oxidation of the ring sulfur and  $\beta$ -oxidation of the side chain lead to metabolites such as bisnorbiotin sulfone. In mammals, degradation of the biotin ring to release carbon dioxide and urea is quantitatively minor.

On a molar basis, biotin accounts for approximately half of the total avidin-binding substances in human serum and urine (Table 1). Biocytin, bisnorbiotin, bisnorbiotin methylketone, biotin sulfoxide, and biotin sulfone form most of the balance. Biotin metabolism is accelerated in some individuals by anticonvulsants and during pregnancy, thereby increasing the ratio of biotin metabolites to biotin excreted in urine.

## OCCURRENCE AND DIAGNOSIS OF BIOTIN DEFICIENCY

The fact that normal humans have a requirement for biotin has been clearly documented in two

situations: prolonged consumption of raw egg white, and parenteral nutrition without biotin supplementation in patients with short-gut syndrome and other causes of malabsorption.<sup>[1]</sup> Deficiency of this member of the vitamin B group also has been clearly demonstrated in biotinidase deficiency.<sup>[6]</sup>

The clinical findings and biochemical abnormalities in cases of biotin deficiency include dermatitis around body orifices, conjunctivitis, alopecia, ataxia, and developmental delay.<sup>[1]</sup> The progression of clinical findings in adults, older children, and infants is similar. Typically, the symptoms appear gradually after weeks to several years of egg-white feeding or parenteral nutrition. Thinning of hair progresses to loss of all hair, including eyebrows and lashes. A scaly (seborrheic), red (eczematous) skin rash was present in the majority of reports. In several, the rash was distributed around the eyes, nose, mouth, and perineal orifices. The appearance of the rash was similar to that of cutaneous candidiasis; *Candida albicans* could often be cultured from the lesions. These manifestations on skin, in conjunction with an unusual distribution of facial fat, have been dubbed "biotin deficiency facies." Depression, lethargy, hallucinations, and paresthesias of the extremities were prominent neurologic symptoms in the majority of adults, while infants showed hypotonia, lethargy, and developmental delay.

In cases severe enough to produce the classic cutaneous and behavioral manifestations of biotin deficiency, urinary excretion rates and plasma concentrations of biotin are frankly decreased. Urinary excretion of the organic acids discussed in the "Biochemistry" section and shown in Fig. 2 is frankly increased. The increase is typically 5- to 20-fold or more. However, such a severe degree of biotin deficiency has never been documented to occur spontaneously in a normal individual consuming a mixed general diet.

Of greater current interest and debate are the health consequences, if any, of marginal biotin deficiency. Concerns about the teratogenic effects have led to studies of biotin status during human gestation.<sup>[37]</sup> Recent research on biotin status<sup>[38,39]</sup> and of biotin supplementation during pregnancy<sup>[40]</sup> provides evidence that a marginal degree of deficiency develops in at least one-third of women during normal pregnancy. Although the degree of this vitamin's deficiency is not severe enough to produce overt manifestations, it is severe enough to produce metabolic derangements. A similar marginal degree of biotin shortage causes high rates of fetal malformations in some mammals.<sup>[41-43]</sup> Moreover, data from a multivitamin supplementation study provide significant, albeit indirect, evidence that the marginal degree of deficiency that occurs spontaneously in normal human gestation is teratogenic.<sup>[37]</sup>

Valid indicators of marginal biotin deficiency have been reported. Asymptomatic biotin shortage was induced in normal adults housed in a general clinical research center by egg-white feeding. Decreased urinary excretion of biotin, increased urinary excretion of 3-hydroxyisovaleric acid, and decreased activity of propionyl-CoA carboxylase in lymphocytes from peripheral blood were early and sensitive indicators of biotin deficiency.<sup>[44-46]</sup> Based on a study of only five subjects, it was found that 3-hydroxyisovaleric acid excretion in response to a leucine challenge may be even more sensitive than normal 3-hydroxyisovaleric acid excretion.<sup>[45]</sup> The plasma concentration of biotin and the urinary excretion of methylglycine, 3-hydroxypropionic acid, and 3-methylcitric acid were not found to be good indicators of marginal biotin deficiency.<sup>[47]</sup> In a biotin repletion study, the resumption of a mixed general diet produced a trend toward normalization of biotin status within 7 days. This was achieved if the supplement was started immediately at the time of resuming a normal diet.

Based on decreased lymphocyte carboxylase activities and plasma biotin levels, Velazquez et al.<sup>[48]</sup> have reported that biotin deficiency occurs in children with severe protein-energy malnutrition. These investigators have speculated that the effects of biotin inadequacy may be responsible for part of the clinical syndrome of protein-energy malnutrition.

Long-term treatment with a variety of anticonvulsants appears to be associated with marginal biotin deficiency severe enough to interfere with amino acid metabolism.<sup>[49-51]</sup> The mechanism may involve both accelerated biotin breakdown<sup>[51-53]</sup> and impairment of biotin absorption caused by the anticonvulsants.<sup>[54,55]</sup>

Biotin deficiency has also been reported or inferred in several other circumstances including Leiner's disease,<sup>[56-58]</sup> sudden infant death syndrome,<sup>[59,60]</sup> hemodialysis,<sup>[61-65]</sup> gastrointestinal diseases and alcoholism,<sup>[1]</sup> and brittle nails.<sup>[66]</sup> Additional studies are needed to confirm or refute an etiologic link of these conditions to the vitamin's deficiency.

The mechanisms by which biotin deficiency produces specific signs and symptoms remain to be completely delineated. However, several studies have given new insights on this subject. The classic assumption for most water-soluble vitamins is that the clinical findings of deficiency result directly or indirectly from deficient activities of the vitamin-dependent enzymes. On the basis of human studies on deficiency of biotinidase and isolated pyruvate carboxylase, as well as animal experiments regarding biotin deficiency, it is hypothesized that the central nervous system effects of biotin deficiency (hypotonia, seizures, ataxia, and delayed development) are likely mediated through deficiency of brain pyruvate carboxylase and the attendant central nervous system lactic acidosis rather than by

disturbances in brain fatty acid composition.<sup>[67–69]</sup> Abnormalities in metabolism of fatty acids are likely important in the pathogenesis of the skin rash and hair loss.<sup>[70]</sup>

Exciting new work has provided evidence for a potential role for biotin in gene expression. These findings will likely provide new insights into the pathogenesis of biotin deficiency.<sup>[11,71]</sup> In 1995, Hymes and Wolf discovered that biotinidase can act as a biotinyl transferase; biocytin serves as the source of biotin, and histones are specifically biotinylated.<sup>[6]</sup> Approximately 25% of total cellular biotinidase activity is located in the nucleus. Zempleni and coworkers have demonstrated that the abundance of biotinylated histones varies with the cell cycle, that these histones are increased approximately twofold compared to quiescent lymphocytes, and are debiotinylated enzymatically in a process that is at least partially catalyzed by biotinidase.<sup>[72–74]</sup> These observations suggest that biotin plays a role in regulating DNA transcription and regulation.

Although the mechanisms remain to be elucidated, biotin status has been shown to affect gene expression. Cell culture studies suggest that cell proliferation generates an increased demand for biotin, perhaps mediated by increased synthesis of biotin-dependent carboxylases.<sup>[73]</sup> Velazquez and coworkers have reported that biotin deficiency in rats reduces messenger RNA levels of holocarboxylase synthetase, but has differential effects on the amount of mRNA and enzyme protein for the various carboxylases.<sup>[75,76]</sup>

Studies have been conducted in diabetic humans and rats that support an effect of biotin status on carbohydrate metabolism. Genes studied include glucokinase, phosphoenolpyruvate carboxykinase (PEPCK), and expression of the asialoglycoprotein receptor on the surface of hepatocytes.<sup>[77–79]</sup> The effect of biotin status on PEPCK expression was particularly striking when diabetic rats were compared to nondiabetic rats. However, most studies have been performed on rats in which metabolic pathways have been perturbed prior to administration of biotin. Thus, the role of the vitamin in regulation of these genes during normal biotin status remains to be elucidated.

## INDICATIONS AND USAGE

In 1998, the United States Food and Nutrition Board of the National Academy of Sciences reviewed the recommendations for biotin intake.<sup>[80]</sup> The committee concluded that the data were inadequate to justify setting an estimated average requirement (EAR). However, adequate intake (AI) was formulated (Table 2). The AI for infants was based on an empirical determination of the biotin content of human milk. Using the

**Table 2** Adequate intake for biotin consumption

Age	Amount (µg/day)
0–6 mo	5
7–12 mo	6
1–3 yr	8
4–8 yr	12
9–13 yr	20
14–18 yr	25
19–>70 yr	30
Pregnancy	30
Lactation	35

Values for males and females in all age groups were combined because they do not differ.

(From Ref.<sup>[80]</sup>.)

value for free biotin determined microbiologically (6 µg/L) and an average consumption of 0.78 L/day by infants of age 0–6 mo, an AI of 5 µg/day was calculated. The AI for lactating women has been increased by 5 µg/day to allow for the amount of biotin secreted in human milk. Using the AI for 0–6 mo infants, the reference body weight ratio method was used to extrapolate AIs for other age groups (see Table 2).

## TREATMENT OF BIOTIN DEFICIENCY

If biotin deficiency is confirmed, biotin supplementation should be undertaken and effectiveness should be documented. Doses between 100 µg and 1 mg are likely to be both effective and safe on the basis of studies supplementing biotin deficiency during pregnancy, chronic anticonvulsant therapy, and biotinidase deficiency.

## TOXICITY

Daily doses up to 200 mg orally and up to 20 mg intravenously have been given to treat biotin-responsive inborn errors of metabolism and acquired biotin deficiency. Toxicity has not been reported.

## REFERENCES

1. Mock, D.M. Biotin. In *Present Knowledge in Nutrition*, 7th Ed.; Ziegler, E.E., Filer, L.J., Jr., Eds.; International Life Sciences Institutes—Nutrition Foundation: Washington, DC, 1996; 220–235.
2. Miljkovic, D.; Velimirovic, S.; Csanadi, J.; Popsavin, V. Studies directed towards

- stereospecific synthesis of oxybiotin, biotin, and their analogs. Preparation of some new 2,5, anhydro-xylitol derivatives. *J. Carbohydr. Chem.* **1989**, *8*, 457–467.
3. Deroose, F.D.; DeClercq, P.J. Novel enantioselective syntheses of (+)-biotin. *J. Org. Chem.* **1995**, *60*, 321–330.
  4. Mock, D.M. Biotin. In *Modern Nutrition in Health and Disease*, 9th Ed.; Shils, M.E., Olson, J.A., Shike, M., Ross, A.C., Eds.; Williams & Wilkins: Baltimore, MD, 1999; 459–466.
  5. Lewis, B.; Rathman, S.; McMahan, R. Dietary biotin intake modulates the pool of free and protein-bound biotin in rat liver. *J. Nutr.* **2001**, *131*, 2310–2315.
  6. Wolf, B. Disorders of biotin metabolism. In *The Metabolic and Molecular Basis of Inherited Disease*, 8th Ed.; Scriver, C.R., Beaudet, A.L., Sly, W.S., Valle, D., Eds.; McGraw-Hill, Inc.: New York, 2001; Vol. 3, 3151–3177.
  7. Wolf, B.; Heard, G.; McVoy, J.R.S.; Raetz, H.M. Biotinidase deficiency: the possible role of biotinidase in the processing of dietary protein-bound biotin. *J. Inherit. Metab. Dis.* **1984**, *7* (Suppl. 2), 121–122.
  8. Said, H.M. Recent advances in carrier-mediated intestinal absorption of water-soluble vitamins. *Annu. Rev. Physiol.* **2004**, *66*, 419–446. <http://arjournals.annualreviews.org/doi/abs/10.1146/annurev.physiol.66.032102.144611>: on-line, 2003 (accessed March 8, 2004).
  9. Mock, D.M. Biotin. *Present Knowledge in Nutrition*; 6th Ed.; International Life Sciences Institute—Nutrition Foundation: Blacksburg, VA, 1990; 189–207.
  10. Said, H.M.; Redha, R. A carrier-mediated system for transport of biotin in rat intestine in vitro. *Am. J. Physiol.* **1987**, *252* (1), G52–G55.
  11. McMahan, R.J. Biotin in metabolism and molecular biology. *Annu. Rev. Nutr.* **2002**, *22*, 221–239.
  12. Wolf, B.; Grier, R.E.; McVoy, J.R.S.; Heard, G.S. Biotinidase deficiency: a novel vitamin recycling defect. *J. Inherit. Metab. Dis.* **1985**, *8* (Suppl. 1), 53–58.
  13. Chauhan, J.; Dakshinamurti, K. Role of human serum biotinidase as biotin-binding protein. *Biochem. J.* **1988**, *256*, 265–270.
  14. Mock, D.M.; Lankford, G. Studies of the reversible binding of biotin to human plasma. *J. Nutr.* **1990**, *120*, 375–381.
  15. Mock, D.M.; Malik, M.I. Distribution of biotin in human plasma: most of the biotin is not bound to protein. *Am. J. Clin. Nutr.* **1992**, *56*, 427–432.
  16. Mardach, R.; Zempleni, J.; Wolf, B.; Cress, S.; Boylan, J.; Roth, S.; Cederbaum, S.; Mock, D. Biotin dependency due to a defect in biotin transport. *J. Clin. Invest.* **2002**, *109* (12), 1617–1623.
  17. Bowers-Komro, D.M.; McCormick, D.B. Biotin uptake by isolated rat liver hepatocytes. In *Biotin*, Dakshinamurti, K., Bhagavan, H.N., Eds.; New York Academy of Sciences: New York, 1985; Vol. 447, 350–358.
  18. Said, H.M.; Ma, T.Y.; Kamanna, V.S. Uptake of biotin by human hepatoma cell line, Hep G(2): a carrier-mediated process similar to that of normal liver. *J. Cell Physiol.* **1994**, *161* (3), 483–489.
  19. Prasad, P.D.; Ramamoorthy, S.; Leibach, F.H.; Ganapathy, V. Characterization of a sodium-dependent vitamin transporter mediating the uptake of pantothenate, biotin and lipoate in human placental choriocarcinoma cells. *Placenta* **1997**, *18*, 527–533.
  20. Prasad, P.D.; Wang, H.; Kekuda, R.; Fujita, T.; Fei, Y.J.; Devoe, L.D.; Leibach, F.H.; Ganapathy, V. Cloning and functional expression of a cDNA encoding a mammalian sodium-dependent vitamin transporter mediating the uptake of pantothenate, biotin, and lipoate. *J. Biol. Chem.* **1998**, *273*, 7501–7506.
  21. Zempleni, J.; Mock, D.M. Uptake and metabolism of biotin by human peripheral blood mononuclear cells. *Am. J. Physiol.* **1998**, *275*, C382–C388 (*Cell Physiol.* 44).
  22. Daberkow, R.L.; White, B.R.; Cederberg, R.A.; Griffin, J.B.; Zempleni, J. Monocarboxylate transporter 1 mediates biotin uptake in human peripheral blood mononuclear cells. *J. Nutr.* **2003**, *133*, 2703–2706.
  23. Ozand, P.T.; Gascon, G.G.; Al Essa, M.; Joshi, S.; Al Jishi, E.; Bakheet, S.; Al Watban, J.; Al-Kawi, Z.; Dabbagh, O. Biotin-responsive basal ganglia disease: a novel entity. *Brain* **1999**, *121*, 1267–1279.
  24. Bowman, B.B.; McCormick, D.B.; Rosenberg, I.H. Epithelial transport of water-soluble vitamins. *Annu. Rev. Nutr.* **1989**, *9*, 187–199.
  25. Baur, B.; Baumgartner, E.R. Na(+)-dependent biotin transport into brush-border membrane vesicles from human kidney cortex. *Pflugers Arch.—Eur. J. Physiol.* **1993**, *422*, 499–505.
  26. Baumgartner, E.R.; Suormala, T.; Wick, H. Biotinidase deficiency: factors responsible for the increased biotin requirement. *J. Inherit. Metab. Dis.* **1985**, *8* (Suppl. 1), 59–64.
  27. Baumgartner, E.R.; Suormala, T.; Wick, H. Biotinidase deficiency associated with renal loss of biocytin and biotin. *J. Inherit. Metab. Dis.* **1985**, *7* (Suppl. 2), 123–125.

28. Spector, R.; Mock, D.M. Biotin transport through the blood–brain barrier. *J. Neurochem.* **1987**, *48*, 400–404.
29. Spector, R.; Mock, D.M. Biotin transport and metabolism in the central nervous system. *Neurochem. Res.* **1988**, *13* (3), 213–219.
30. Mantagos, S.; Malamitsi-Puchner, A.; Antsaklis, A.; Livaniou, E.; Evangelatos, G.; Ithakissios, D.S. Biotin plasma levels of the human fetus. *Biol. Neonate* **1998**, *74*, 72–74.
31. Karl, P.I.; Fisher, S.E. Biotin transport in microvillous membrane vesicles, cultured trophoblasts and the isolated perfused cotyledon of the human placenta. *Am. J. Physiol.* **1992**, *262*, C302–C308.
32. Schenker, S.; Hu, Z.; Johnson, R.F.; Yang, Y.; Frosto, T.; Elliott, B.D.; Henderson, G.I.; Mock, D.M. Human placental biotin transport: normal characteristics and effect of ethanol. *Alcohol. Clin. Exp. Res.* **1993**, *17* (3), 566–575.
33. Hu, Z.-Q.; Henderson, G.I.; Mock, D.M.; Schenker, S. Biotin uptake by basolateral membrane of human placenta: normal characteristics and role of ethanol. *Proc. Soc. Biol. Exp. Med.* **1994**, *206* (4), 404–408.
34. Mock, D.M.; Mock, N.I.; Langbehn, S.E. Biotin in human milk: methods, location, and chemical form. *J. Nutr.* **1992**, *122*, 535–545.
35. Mock, D.M.; Mock, N.I.; Dankle, J.A. Secretory patterns of biotin in human milk. *J. Nutr.* **1992**, *122*, 546–552.
36. Mock, D.M.; Stratton, S.L.; Mock, N.I. Concentrations of biotin metabolites in human milk. *J. Pediatr.* **1997**, *131* (3), 456–458.
37. Zempleni, J.; Mock, D.M. Marginal biotin deficiency is teratogenic. *Proc. Soc. Exp. Biol. Med.* **2000**, *223* (1), 14–21.
38. Mock, D.M.; Stadler, D.; Stratton, S.; Mock, N.I. Biotin status assessed longitudinally in pregnant women. *J. Nutr.* **1997**, *127* (5), 710–716.
39. Mock, D.M.; Stadler, D.D. Conflicting indicators of biotin status from a cross-sectional study of normal pregnancy. *J. Am. Coll. Nutr.* **1997**, *16*, 252–257.
40. Mock, D.M.; Quirk, J.G.; Mock, N.I. Marginal biotin deficiency during normal pregnancy. *Am. J. Clin. Nutr.* **2002**, *75*, 295–299.
41. Mock, D.M.; Mock, N.I.; Stewart, C.W.; LaBorde, J.B.; Hansen, D.K. Marginal biotin deficiency is teratogenic in ICR mice. *J. Nutr.* **2003**, *133*, 2519–2525.
42. Watanabe, T.; Endo, A. Teratogenic effects of maternal biotin deficiency in mouse embryos examined at midgestation. *Teratology* **1990**, *42*, 295–300.
43. Watanabe, T.; Endo, A. Biotin deficiency per se is teratogenic in mice. *J. Nutr.* **1991**, *121*, 101–104.
44. Mock, N.I.; Malik, M.I.; Stumbo, P.J.; Bishop, W.P.; Mock, D.M. Increased urinary excretion of 3-hydroxyisovaleric acid and decreased urinary excretion of biotin are sensitive early indicators of decreased status in experimental biotin deficiency. *Am. J. Clin. Nutr.* **1997**, *65*, 951–958.
45. Mock, D.M.; Henrich, C.L.; Carnell, N.; Mock, N.I. Indicators of marginal biotin deficiency and repletion in humans: validation of 3-hydroxyisovaleric acid excretion and a leucine challenge. *Am. J. Clin. Nutr.* **2002**, *76*, 1061–1068.
46. Mock, D.M.; Henrich, C.L.; Carnell, N.; Mock, N.I.; Swift, L. Lymphocyte propionyl-CoA carboxylase and accumulation of odd-chain fatty acid in plasma and erythrocytes are useful indicators of marginal biotin deficiency. *J. Nutr. Biochem.* **2002**, *13* (8), 462–470.
47. Mock, D.M.; Henrich-Shell, C.L.; Carnell, N.; Stumbo, P.; Mock, N.I. 3-Hydroxypropionic acid and methylcitric acid are not reliable indicators of marginal biotin deficiency. *J. Nutr.* **2004**, *134*, 317–320.
48. Velazquez, A.; Martin-del-Campo, C.; Baez, A.; Zamudio, S.; Quiterio, M.; Aguilar, J.L.; Perez-Ortiz, B.; Sanchez-Ardines, M.; Guzman-Hernandez, J.; Casanueva, E. Biotin deficiency in protein–energy malnutrition. *Eur. J. Clin. Nutr.* **1988**, *43*, 169–173.
49. Krause, K.-H.; Berlit, P.; Bonjour, J.-P. Impaired biotin status in anticonvulsant therapy. *Ann. Neurol.* **1982**, *12*, 485–486.
50. Krause, K.-H.; Berlit, P.; Bonjour, J.-P. Vitamin status in patients on chronic anticonvulsant therapy. *Int. J. Vitam. Nutr. Res.* **1982**, *52* (4), 375–385.
51. Mock, D.M.; Dyken, M.E. Biotin catabolism is accelerated in adults receiving long-term therapy with anticonvulsants. *Neurology* **1997**, *49* (5), 1444–1447.
52. Wang, K.-S.; Mock, N.I.; Mock, D.M. Biotin biotransformation to bisnorbiotin is accelerated by several peroxisome proliferators and steroid hormones in rats. *J. Nutr.* **1997**, *127* (11), 2212–2216.
53. Mock, D.M.; Mock, N.I.; Lombard, K.A.; Nelson, R.P. Disturbances in biotin metabolism in children undergoing long-term anticonvulsant therapy. *J. Pediatr. Gastroenterol. Nutr.* **1998**, *26* (3), 245–250.
54. Said, H.M.; Redha, R.; Nylander, W. Biotin transport and anticonvulsant drugs. *Am. J. Clin. Nutr.* **1989**, *49*, 127–131.
55. Said, H.M.; Redha, R.; Nylander, W. Biotin transport in the human intestine: inhibition by anticonvulsant drugs. *Am. J. Clin. Nutr.* **1989**, *49*, 127–131.



56. Nisenson, A. Seborrheic dermatitis of infants and Leiner's disease: a biotin deficiency. *J. Pediatr.* **1957**, *51*, 537–548.
57. Nisenson, A. Seborrheic dermatitis of infants: treatment with biotin injections for the nursing mother. *Pediatrics* **1969**, *44*, 1014–1015.
58. Erlichman, M.; Goldstein, R.; Levi, E.; Greenberg, A.; Freier, S. Infantile flexural seborrheic dermatitis. Neither biotin nor essential fatty acid deficiency. *Arch. Dis. Child.* **1981**, *567*, 560–562.
59. Johnson, A.R.; Hood, R.L.; Emery, J.L. Biotin and the sudden infant death syndrome. *Nature* **1980**, *285*, 159–160.
60. Heard, G.S.; Hood, R.L.; Johnson, A.R. Hepatic biotin and the sudden infant death syndrome. *Med. J. Aust.* **1983**, *2* (7), 305–306.
61. Yatzidis, H.; Koutsicos, D.; Alaveras, A.G.; Papastephanidis, C.; Francos-Plemenos, M. Biotin for neurologic disorders of uremia. *N. Engl. J. Med.* **1981**, *305* (13), 764.
62. Livaniou, E.; Evangelatos, G.P.; Ithakissios, D.S.; Yatzidis, H.; Koutsicos, D.C. Serum biotin levels in patients undergoing chronic hemodialysis. *Nephron* **1987**, *46*, 331–332.
63. DeBari, V.; Frank, O.; Baker, H.; Needle, M. Water soluble vitamins in granulocytes, erythrocytes, and plasma obtained from chronic hemodialysis patients. *Am. J. Clin. Nutr.* **1984**, *39*, 410–415.
64. Yatzidis, H.; Koutsicos, D.; Agroyannis, B.; Papastephanidis, C.; Frangos-Plemenos, M.; Delatola, Z. Biotin in the management of uremic neurologic disorders. *Nephron* **1984**, *36*, 183–186.
65. Braguer, D.; Gallice, P.; Yatzidis, H.; Berland, Y.; Crevat, A. Restoration by biotin in the in vitro microtubule formation inhibited by uremic toxins. *Nephron* **1991**, *57*, 192–196.
66. Colombo, V.E.; Gerber, F.; Bronhofer, M.; Floersheim, G.L. Treatment of brittle fingernails and onychoschizia with biotin: scanning electron microscopy. *J. Am. Acad. Dermatol.* **1990**, *23*, 1127–1132.
67. Sander, J.E.; Packman, S.; Townsend, J.J. Brain pyruvate carboxylase and the pathophysiology of biotin-dependent diseases. *Neurology* **1982**, *32*, 878–880.
68. Suchy, S.F.; Rizzo, W.B.; Wolf, B. Effect of biotin deficiency and supplementation on lipid metabolism in rats: saturated fatty acids. *Am. J. Clin. Nutr.* **1986**, *44*, 475–480.
69. Suchy, S.F.; Wolf, B. Effect of biotin deficiency and supplementation on lipid metabolism in rats: cholesterol and lipoproteins. *Am. J. Clin. Nutr.* **1986**, *43*, 831–838.
70. Mock, D.M. Evidence for a pathogenic role of  $\omega 6$  polyunsaturated fatty acid in the cutaneous manifestations of biotin deficiency. *J. Pediatr. Gastroenterol. Nutr.* **1990**, *10*, 222–229.
71. Zempleni, J. Biotin. In *Present Knowledge in Nutrition*, 8th Ed.; Bowman, B.B., Russel, R.M., Eds.; International Life Sciences Institutes—Nutrition Foundation: Washington, DC, 2001.
72. Zempleni, J.; Mock, D.M. Chemical synthesis of biotinylated histones and analysis by sodium dodecyl sulfate–polyacrylamide gel electrophoresis/streptavidin-peroxidase. *Arch. Biochem. Biophys.* **1999**, *371* (1), 83–88.
73. Zempleni, J.; Mock, D.M. Chemical synthesis of biotinylated histones and analysis by SDS-PAGE/streptavidin peroxidase. *Biomol. Eng.* **2000**, *16* (5), 181.
74. Stanley, J.S.; Griffin, J.B.; Zempleni, J. Biotinylation of histones in human cells: effects of cell proliferation. *Eur. J. Biochem.* **2001**, *268*, 5424–5429.
75. Rodriguez-Melendez, R.; Perez-Andrade, M.E.; Diaz, A.; Deolarte, A.; Camacho-Arroyo, I.; Ciceron, I.; Ibarra, I.; Velazquez, A. Differential effects of biotin deficiency and replenishment on rat liver pyruvate and propionyl-CoA carboxylases and on their mRNAs. *Mol. Genet. Metab.* **1999**, *66*, 16–23.
76. Rodriguez-Melendez, R.; Cano, S.; Mendez, S.T.; Velazquez, A. Biotin regulates the genetic expression of holocarboxylase synthetase and mitochondrial carboxylases in rats. *J. Nutr.* **2001**, *131* (7), 1909–1913.
77. Chauhan, J.; Dakshinamurti, K. Transcriptional regulation of the glucokinase gene by biotin in starved rats. *J. Biol. Chem.* **1991**, *266*, 10,035–10,038.
78. Dakshinamurti, K.; Desjardins, P.R. Lipogenesis in biotin deficiency. *Can. J. Biochem.* **1968**, *46*, 1261–1267.
79. Collins, J.C.; Pajetta, E.; Green, R.; Morell, A.G.; Stockert, R.J. Biotin-dependent expression of the asialoglycoprotein receptor in HepG2. *J. Biol. Chem.* **1988**, *263* (23), 11,280–11,283.
80. National Research Council. Dietary reference intakes for thiamin, riboflavin, niacin, vitamin B-6, folate, vitamin B-12, pantothenic acid, biotin, and choline. In *Recommended Dietary Allowances*, 11th Ed.; Food and Nutrition Board Institute of Medicine, Ed.; National Academy Press: Washington, DC, 1998, 374–389.

# Black Cohosh (*Cimicifuga racemosa*)

Daniel S. Fabricant

Norman R. Farnsworth

UIC/NIH Center for Botanical Dietary Supplements Research for Women's Health,  
Program for Collaborative Research in the Pharmaceutical Sciences, College of Pharmacy  
(M/C-877), University of Illinois at Chicago, Chicago, Illinois, U.S.A.

## INTRODUCTION

Native to the eastern United States, black cohosh has been a mainstay of Native American ethnomedicine for many years. Recently, its popularity has increased, primarily for relief of menopausal symptoms because of the potential toxicity of hormone replacement therapies. A thorough description of black cohosh, its current uses and effects, and a full review of clinical studies to date are presented.

## BOTANICAL NOMENCLATURE

*Actaea racemosa* L. syn. *Cimicifuga racemosa* (L.) Nutt. (Ranunculaceae—buttercup family).

## GENERAL DESCRIPTION

Black cohosh represents the thick, knotted roots/rhizomes of *C. racemosa* (L.) Nutt. (appropriate botanical identification methods are described later). The plant is native to the eastern United States, with a rich tradition of ethnomedical use by Native Americans. It has been used clinically for relief of climacteric symptoms for almost 50 years, and its popularity has increased in recent years due to the potential toxicity of classical hormone therapy (equine estrogens + progestin). While its mechanism of action remains unclear, evidence is surfacing to indicate that black cohosh does not operate through classical endocrine pathways, i.e., estrogen receptors (ERs), to alleviate climacteric symptoms; recent data suggest action

through neurotransmitter regulation of hypothalamic function.

## CHEMISTRY

Fifty-seven triterpene glycosides (Fig. 1) have been reported from the roots/rhizomes of *C. racemosa*,<sup>[1]</sup> of which 23-*epi*-26-deoxyactein is generally recognized as the major component. Evaluation of 23-*epi*-26-deoxyactein (formerly 27-deoxyactein), cimicifugoside F, and cimicifugoside, and their respective aglycons, for binding affinity toward ER- $\beta$  revealed no significant affinity.<sup>[2]</sup> The roots/rhizomes also contain 18 aromatic acids.<sup>[1]</sup> Of these, caffeic acid has shown pregnant mare antigonadotropin activity,<sup>[3-5]</sup> rat uterine antispasmodic activity,<sup>[6]</sup> and smooth muscle relaxant/antispasmodic activity in the rat ileum<sup>[7]</sup> and guinea pig ileum.<sup>[8]</sup> Ferulic acid has demonstrated luteinizing hormone (LH) release inhibition,<sup>[9]</sup> follicle stimulating hormone (FSH) release stimulation,<sup>[9]</sup> antiestrogenic activity,<sup>[10]</sup> prolactin stimulation in cows<sup>[11]</sup> and inhibition in rats,<sup>[9]</sup> and uterine relaxant/antispasmodic activity in rats.<sup>[12]</sup> Fukinolic acid has an estrogenic effect on MCF-7 cells with reference to estradiol.<sup>[13]</sup> These activities may correlate with, or prove useful in the determination of, the mechanism of action of black cohosh. Additionally a number of plant sterols and fatty acids generally regarded as ubiquitous in the plant kingdom, are contained in the roots/rhizomes, the biological activities of which, in all probability, do not relate to the mechanism of action.<sup>[1]</sup>

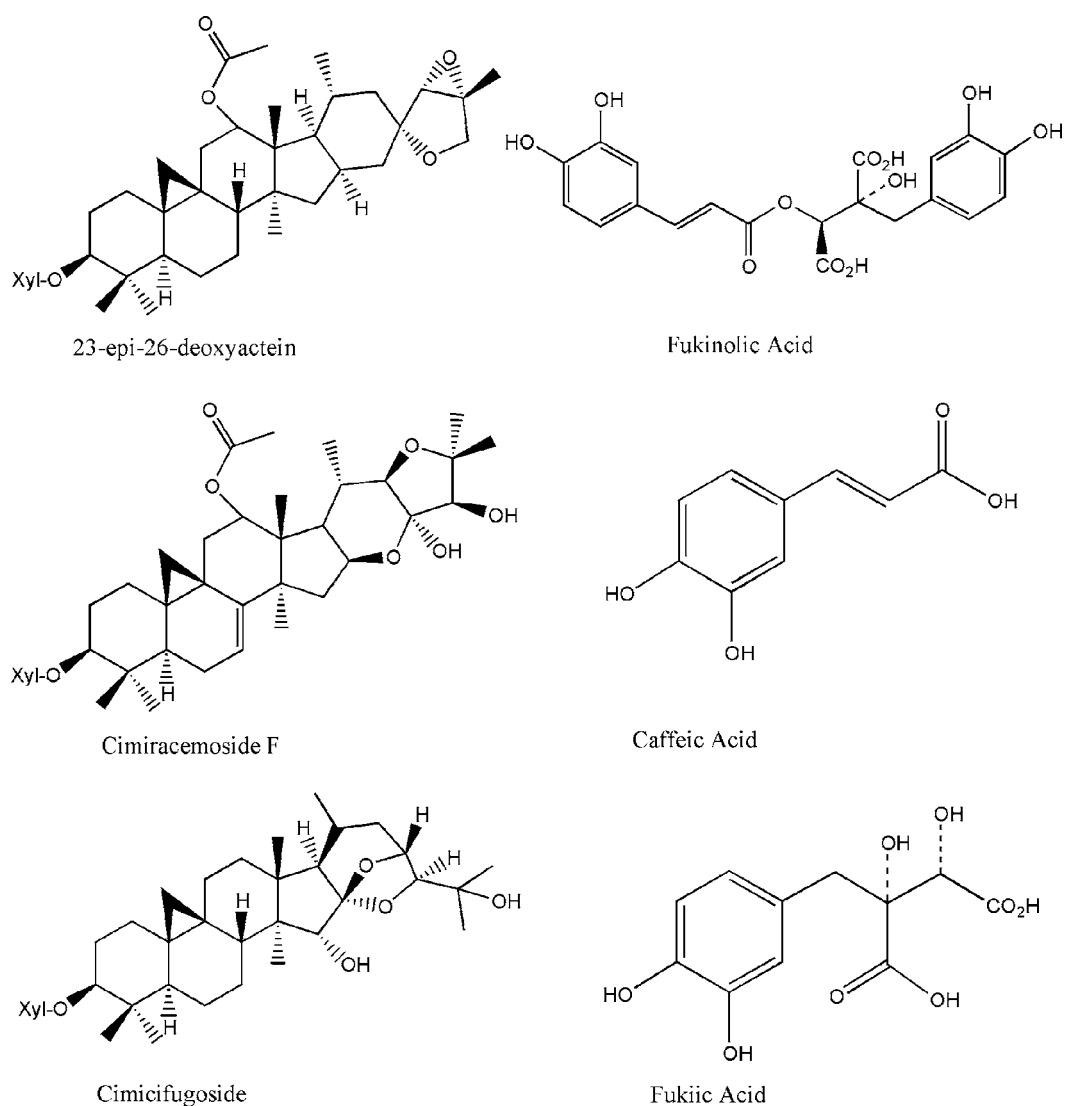
The weakly estrogenic formononetin has been reported in the plant.<sup>[14]</sup> However, recent studies using plant material collected from different sites in the eastern United States at different times of the year indicate that the plant does not contain formononetin.<sup>[15,16]</sup>

## BOTANICAL DESCRIPTION

*C. racemosa* is an erect, smooth-stemmed, perennial 1–2.5 m in height. Large compound leaves are alternately arranged and triternate on short, clasping petioles. Basal leaf petioles are grooved in young

Daniel S. Fabricant, Ph.D., is at the UIC/NIH Center for Botanical Dietary Supplements Research for Women's Health, Program for Collaborative Research in the Pharmaceutical Sciences, College of Pharmacy (M/C-877), University of Illinois at Chicago, Chicago, Illinois, U.S.A.

Norman R. Farnsworth, Ph.D., is at the UIC/NIH Center for Botanical Dietary Supplements Research for Women's Health, Program for Collaborative Research in the Pharmaceutical Sciences, College of Pharmacy (M/C-877), University of Illinois at Chicago, Chicago, Illinois, U.S.A.



**Fig. 1** Triterpenes and phenolics of biological interest.

specimens. This shallow, narrow sulcus disappears as the petiole enlarges, whereas it remains present throughout life in the related eastern North American species *C. rubifolia* Kearney and *C. americana* Michx.<sup>[17]</sup> Terminal leaflets are acute and glabrous with sharp serrated margins often trilobate and occasionally bilobed. Fruits are ovoid follicles occurring sessile on the pedicel. The flowering structure, the raceme, is a long, wandlike structure with showy white flowers (Fig. 2). The flowers possess numerous characteristic stamens having slender filaments with distinctive white anthers.<sup>[18]</sup> The roots/rhizomes have the following features: branched and knotted structure; dark brown exterior; white and mealy or brown and waxy interior; upper surface with several buds and numerous large stem bases terminated, frequently, by deep, cup-shaped, radiating scars, each of which shows a radiate structure, or less frequently, by fibrous

strands; lower and lateral surfaces with numerous root scars and a few short roots; horny fracture; slight odor; bitter and acrid taste.<sup>[19]</sup>

#### EFFECTS ON CLIMACTERIC SYMPTOMS RELATED TO MENOPAUSE

With a history spanning almost 50 years of clinical study, mainly in Europe,<sup>[20]</sup> black cohosh is one of the more popular alternatives to hormone replacement therapy (HRT). Most of the clinical research has been performed on the commercially available Remifemin<sup>®</sup>. The formulation and dosage of Remifemin used in human studies has changed over time, as shown in Table 1. However, other commercial formulations are available, as evident in Table 2. Most have still not been clinically studied.



**Fig. 2** Black cohosh raceme. (View this art in color at [www.dekker.com](http://www.dekker.com).)

The results of clinical studies have been measured using a variety of parameters. Self-assessments, physician assessments, and physiological parameters are usually used in tandem when designing such studies to measure psychological, neurovegetative, somatic, and physiological markers of menopause or, in the case of the treatment groups, relief from its climacteric symptoms.

More significant when evaluating studies is the study design: More weight should be placed on studies following good clinical practice. The gold standard is a randomized, double-blind, multicenter, placebo-controlled study design. With that in mind, three studies on black cohosh have been randomized, double blinded and placebo controlled.<sup>[25,32,40]</sup> The findings of the Jacobson study, spanning only 60 days of treatment, may be limited by the time factor.<sup>[32]</sup> Additionally, the study participants all had a history of breast cancer. The outcome of the study was that the median

number of hot flashes decreased 27% in both placebo and black cohosh groups. No significant differences were observed between groups. Thus, black cohosh, on the basis of this study, was no more effective than placebo in the treatment of hot flashes. The source and formulation of the extract used in this study was not specified. A more recent open-labeled study using breast cancer survivors, treated with either tamoxifen or a combination of BNO 1055 (a proprietary hydroalcoholic black cohosh extract) with tamoxifen, suggests a satisfactory reduction in the number and severity of hot flashes in the combination treatment group.<sup>[33]</sup>

In another randomized, double-blinded, and placebo-controlled clinical study, for a duration of 12 weeks, black cohosh was compared with standard conjugated estrogen (CE) therapy (0.625 mg daily). Patients' physical and psychological symptoms were measured every 4 weeks. The end result of the study was that the patients treated with black cohosh had a statistically significant lower index score compared with those on placebo, with both the Kupperman menopausal (KM) and the Hamilton menopausal (HAM-A) scales, indicating a decrease in severity and frequency of hot flashes. Additionally, this study showed an increase in the number of estrogenized cells in the vaginal epithelium.<sup>[40]</sup>

In 2003, a similar and confusing study compared two different preparations of BNO 1055 extract to CE therapy (0.6 mg daily).<sup>[25]</sup> The study parameters were: patient self-assessment [diary and menopause rating scale (MRS)], CrossLaps (to measure bone resorption), bone-specific alkaline phosphatase (marker of bone formation), and endometrial thickness (measured by ultrasound). Both BNO 1055 extracts were equipotent to CE therapy and significantly better than placebo at reducing climacteric complaints. Additionally, the study showed that both BNO 1055 preparations had beneficial effects on bone metabolism in serum, specifically an increase in bone-specific alkaline phosphatase, and no reduction in bone resorption, thus leading to an increase in bone formation. No change in endometrial thickness was observed in the BNO 1055 treatment groups, but it was significantly increased with CE therapy. However, an increase in superficial vaginal cells was observed in both CE and BNO 1055 treatment groups. The authors of this study hypothesized that the impact of the BNO 1055 preparations was similar to the effects of selective estrogen receptor modulating (SERM), e.g., Raloxifene<sup>®</sup>, therapy on bone and neurovegetative climacteric symptoms, without any uterotrophic effects.<sup>[25]</sup>

A recent double-blinded, randomized study compliant with good clinical practice used two dosages (low: 39 mg; high: 127 mg) of an unspecified hydroalcoholic

Table 1 Black cohosh clinical studies

Author	Year	Extract, formulation, and dosage	Study length	n	Outcome measure/result	Study design
Hernandez-Munoz et al.	2003	BNO 1055	12 mo	136	Combination therapy with tamoxifen (20 mg) reduced severity and incidence of hot flashes	Open, randomized, patient self-assessment
Baier-Jagodinski	1995	Cimisan® T, drops, variable dose	4–8 weeks	157		Open, uncontrolled
Wuttke et al.	2003	Klimadynon®/BNO1055	3 mo	62	Equipotent to 0.6 CE for relief of climacteric complaints and for bone resorption. No effect on endometrial thickness	Randomized, double-blinded, placebo-controlled, multicenter, MRS
Schotten	1958	Remifemin®, 20 drops	3–4 weeks	22	Alleviation of neurovegetative and psychic complaints associated with menopause and premenopause	Case series
Kesselkaul	1957	Remifemin, 60 drops	2 weeks	63	Alleviation of climacteric complaints in 95% of patients	Case series
Nesselhut et al.	1999	Remifemin, tablets, equivalent to 136 mg dried herb/day	3 mo	28	Good to very good alleviation of 10 menopausal symptoms in 80% of study participants	Open, postmarket surveillance
Foldes	1959	Remifemin, 3 tablets/day	Unknown	41	Thirty-one patients of the verum group responded to the treatment with a decrease in menopausal complaints	Placebo-controlled, open, crossover, patient self-assessment
Starfinger	1960	Remifemin, 3–20 drops/day	1 yr	105	Decreased climacteric complaints without incidence of side effects or resulting in nonphysiological bleeding	Case series
Liske et al.	2000	Remifemin, equivalent to 39 or 127 mg dried herb/day	6 mo	57	Alleviation of symptoms in both groups. Results similar after 3 mo	Double-blinded, randomized, good-clinical-practice compliant, KMI, SDS, CGI
Schlide	1964	Remifemin, fluidextract, 60 drops/day	Variable	135		Case series
Daiber	1983	Remifemin, fluidextract, 80 drops/day	12 weeks	36	Alleviation of climacteric complaints (hot flashes, insomnia, sweating, and restlessness)	Open CGI

Stolze	1982	Remifemin, fluidextract, 80 drops/day	6–8 weeks	629	Alleviation of neurovegetative and psychological menopausal symptoms in 80% of patients	Open, physician and patient self-assessment
Vorberg	1984	Remifemin, fluidextract, 80 drops/day	12 weeks	50	Significant or highly significant alleviation of menopausal (neurovegetative and psychic) complaints. Study included subjects contraindicated for hormone therapy	Randomized, open, KMI, CGI, POMS
Warnecke	1985	Remifemin, fluidextract 80 drops/day	12 weeks	20	Significant alleviation of symptoms (psychic and neurovegetative) in the black cohosh, conjugated estrogen, and diazepam groups. Vaginal cytology of treatment group was comparable to that in estrogenic stimulation	Randomized, open, KMI, HAM-A, SDS, CGI, karyopyknosis index, eosinophil index
Heizer	1960	Remifemin, tablets, 3–6/day	2–18 mo	66	Alleviation of menopausal (neurovegetative and psychic) complaints in 47% of patients with intact uteri and 35% with hysterectomies	Case series
Jacobson et al.	2001	Remifemin, tablets, equivalent to 40 mg dried herb/day	60 days	42 <sup>a</sup>	No change in median number or intensity of hot flashes	Double-blinded, randomized, placebo-controlled, patient self-assessment, VAS, MSS
Duker et al.	1991	Remifemin, tablets, equivalent to 40 mg dried herb/day	2 mo	110	LH suppression	In vitro study using blood from menopausal women taking black cohosh
Stoll	1987	Remifemin, tablets, equivalent to 8 mg extract/day	12 weeks	26	Significant alleviation of climacteric symptoms (vaginal atrophy, neurovegetative and psychic complaints) in comparison with estrogen and placebo groups	Double-blinded, randomized, placebo-controlled, KMI, HAM-A, VMI (vaginal epithelium)
Lehman-Willenbrock et al.	1988	Remifemin, tablets, equivalent to 8 mg extract/day	6 mo	15	Significant alleviation of climacteric symptoms in black cohosh and drug treatment groups. No significant change in gonadotropin (FSH, LH) levels <sup>sq</sup>	Randomized, open, KMI

(Continued)

Table 1 Black cohosh clinical studies (Continued)

Author	Year	Extract, formulation, and dosage	Study length	n	Outcome measure/result	Study design
Petho	1987	Remifemin, tablets, unspecified dose	6 mo	50	KMI decreased significantly from 17.6 to 9.2, correlates with a significant reduction in neurovegetative symptoms. Severity of subjects' physical and psychological symptoms decreased according to subjective self assessments	Open, KMI, patient self-assessment
Gorlich	1962	Remifemin, tablets, variable dose	Variable	41 (258) <sup>b</sup>	Alleviation of climacteric and vascular symptoms in 85% of patients	Case series
Brucker	1960	Remifemin, tablets, variable dose	Variable	87 (517) <sup>b</sup>	Alleviation of menopausal complaints	Case series
Mielnik	1997	Uncharacterized extract, 4 mg daily	6 mo	34	Alleviation of climacteric (neurovegetative) symptoms in 76% of patients after 1 mo	Open, KMI
Georgiev	1997	Uncharacterized extract, unspecified dose	3 mo	50	Alleviation of climacteric symptoms in 90% of patients. Increase in vaginal cell proliferation (VMI) in 40% of treated women	Open, KMI, HAM-A, VMI
Liske et al.	2000	Unique <i>C. racemosa</i> preparation, equivalent to 39 or 127.3 mg/day	6 mo	152	No direct systemic estrogenic effect on serum levels of FSH, LH, SHBG, prolactin, and 17- $\beta$ -estradiol. No change in vaginal cytology. Higher dose had a more significant reduction in KMI index after 6 mo. Significant reduction of neurovegetative and psychic complaints with both doses	Drug equivalence trial, KMI, SDS, CGI

CGI, Clinician's global impression scale; HAM-A, Hamilton anxiety scale; KMI, Kupperman menopausal index; VMI, vaginal maturity index; SDS, self-assessment depression scale; POMS, profile of mood states scale; MSS, unspecified menopausal index using the Likert scale; VAS, visual analog scale; open, open-labeled.

<sup>a</sup>All with breast cancer history.

<sup>b</sup>Numbers in parentheses represent number enrolled in the study. Either their diagnostics were not measured or they were disqualified from the study. (Adapted from Refs.<sup>[20-39,67,70]</sup>)

Table 2 Commercially available products<sup>a</sup>

Name	Delivery form	Effective ingredients	Indications	Manufacturer (country)
Cefakliman <sup>®</sup> mono	Capsules	Concentrated extract from <i>Cimicifuga</i> root	Menopausal and premenstrual symptoms; dysmenorrhea	Cefak (Germany)
Cefakliman mono	Solution	Ethanolic extract from <i>Cimicifuga</i> root	Menopausal and premenstrual symptoms; dysmenorrhea	Cefak
Cimipure-PE <sup>®</sup> 2.5	Capsules	Dried hydroalcoholic extract	Climacteric symptoms related to menopause	Pure World (United States)
Cimisan/-T	Blister pack	Concentrated extract from <i>Cimicifuga</i> root	Premenstrual and dysmenorrheic as well as neurovegetative symptoms from menopause	APS (Germany)
Cimisan/-T	Drops	Liquid extract	Premenstrual and dysmenorrheic as well as neurovegetative symptoms from menopause	APS
Femilla <sup>®</sup> /Tincture	Tincture	Hydroalcoholic extract from <i>Cimicifuga</i> root	Neurovegetative symptoms with painful menstruation (dysmenorrhea) as well as during menopause	Steigerwald (Germany)
Klimadynon/ Menofem/ BNO1055	Blister pack	Concentrated extract from <i>Cimicifuga</i> root	Menopause-related neurovegetative symptoms	Bionorica (Germany)
Klimadynon/ Menofem/ BNO1055	Solution	Liquid extract	Menopause-related neurovegetative symptoms	Bionorica
Remifemin Plus <sup>®</sup>	Dragees	Extract of <i>Hypericum</i> (aerial parts) and <i>Cimicifuga</i> root	Menopausal symptoms such as hot flashes, sweating, depressive moods, and psychovegetative problems such as despondency, inner tension, irritability, lack of concentration, insomnia, fear, and/or nervousness; premenstrual vegetative symptoms	Schaper & Brümmer (Germany); marketed in the United States through GlaxoSmithKline)
Remifemin	Tablets	Concentrated extract from <i>Cimicifuga</i> root	Menopausal symptoms; mild dysfunction after ovariectomy or hysterectomy; to aid treatment with sexual steroids; premenstrual neurovegetative and emotional problems; juvenile menstrual irregularities	Schaper & Brümmer
Remifemin	Solution	Percolate extract of <i>Cimicifuga</i> root	Menopausal symptoms; mild dysfunction after ovariectomy or hysterectomy; to aid treatment with sexual steroids; premenstrual neurovegetative and emotional problems; juvenile menstrual irregularities	Schaper & Brümmer

<sup>a</sup>Independent confirmation as to the identity and/or quality of formulations is not publicly available.



Remifemin extract. Their effectiveness was measured using KM index, self-assessment depression scale (SDS), clinical global impression scale (CGI), serum levels of luteinizing hormone (LH), follicle stimulating hormone (FSH), sex hormone binding globulin (SHBG), prolactin, and 17- $\beta$ -estradiol, and vaginal cytology. Reductions in the KM and SDS indices were significant. CGI was scored as good to very good in 80%<sup>[41]</sup> and 90% (high) of the patients in the treatment groups. No effect on serum hormone levels or vaginal cytology was shown, prompting the authors of the study to suggest that black cohosh does not have a direct estrogenic effect on the serum hormone levels or vaginal epithelium.<sup>[22]</sup> Two recent open studies using unspecified types of extracts showed reduced KM index scores. One of the studies reported a significant reduction in 1 mo.<sup>[23]</sup> The other, using the HAM-A scale, also recorded a 90% improvement in climacteric symptoms in menopausal women after 3 mo of black cohosh administration.<sup>[34]</sup>

More details of each of the human studies are presented in Table 1. Recently, an analysis interpreting the safety data from published clinical trials, case studies, postmarketing surveillance studies, spontaneous report programs, and phase I studies was performed.<sup>[42]</sup> The data, obtained from over 20 studies, including over 2000 subjects, suggest that adverse ones occurrence with black cohosh is rare. The events are mild and reversible, the most common reported being gastrointestinal upsets and rashes.<sup>[42]</sup>

## BIOCHEMISTRY AND FUNCTIONS

Despite the aforementioned extensive clinical research, the mechanism of action of black cohosh remains unclear. Most of the older literature suggests a direct estrogenic effect; more recent proposals have targeted an effect on the limbic system (hypothalamus) or an effect on the neurotransmitters involved in regulation of this system as being responsible for the activity of black cohosh. Data fall into the following categories.

### ER Competitive Binding

The first report of ER binding pointed toward clarifying the mechanism of action of black cohosh.<sup>[43]</sup> Additional studies were carried out to further substantiate endocrine activity.<sup>[44,45]</sup> One significant factor regarding black cohosh that was frequently overlooked in these studies is the lipophilic nature of the extract used in this determination. Extracts and fractions displaying ER binding activity are of a significantly different chemical nature than the typical hydroalcoholic extracts available for human use.

A lipophilic extract of the plant showed relatively weak (35  $\mu\text{g}/\text{ml}$ ) ER binding on rat uteri.<sup>[43]</sup> One study also confirmed the ER binding activity of an unspecified lipophilic subfraction on ovariectomized (ovx) rat uterine cells, with no binding activity seen with a hydroalcoholic extract.<sup>[44]</sup>

Recent reports have contradicted the estrogen binding affinity of black cohosh extracts.<sup>[46-48]</sup> Using a root extract in an in vitro competitive cytosolic ER (from ovx rat livers) binding assay with diethylstilbestrol (DES), an inhibitor of estrogen binding, a significant inhibition of estradiol binding was shown in the presence of DES.<sup>[46]</sup> No binding was demonstrated with the extract alone. A hydroalcoholic extract (50% aqueous ethanol) was assayed for ER binding to intact human breast cancer cell lines MCF-7 and T-47-D. No binding affinity was shown. However, binding activity was evident for other hydroalcoholic plant extracts.<sup>[47]</sup> Using a methanol extract of black cohosh at a high concentration (200  $\mu\text{g}/\text{ml}$ ) on recombinant diluted ER- $\alpha$  and ER- $\beta$ , no binding activity was evident.<sup>[48]</sup> A recent study using BNO 1055 (formulation) showed contrasting results.<sup>[49]</sup> The extract displayed dose-dependent competition with radiolabeled estradiol in both porcine and human endometrial cytosolic estrogen receptor ligand binding assay (ER-LBA) systems. By comparison, the extract did not displace human recombinant ER- $\alpha$  and ER- $\beta$ . These findings prompted the authors to suggest that their product contains estrogenic compounds that have binding affinity for a putative ER- $\gamma$ .

### Receptor Expression

As with the receptor binding assays, the nature of the extract or fraction is a decisive factor in the expression of ERs. Using a lipophilic and hydrophilic *C. racemosa* extract, luciferase expression in an MCF-7 ER- $\alpha$  and ER- $\beta$  expressing subclone was studied.<sup>[50]</sup> At 35  $\mu\text{g}/\text{ml}$ , the lipophilic extract was able to activate transcription of the estrogen-regulated genes; the hydrophilic extract showed no such activity. A recent study measuring an extract at a low concentration (4.75  $\mu\text{g}/\text{L}$ ) reported increased ER levels, an effect also produced by estradiol, in human MCF-7 cells.<sup>[51]</sup> An unspecified black cohosh extract tested in a transient gene expression assay using HeLa cells cotransfected with an estrogen-dependent reporter plasmid in the presence of human ER- $\alpha$  and ER- $\beta$  cDNA failed to show transactivation of the gene.<sup>[52]</sup>

### Plasma Hormone Levels

The effect of black cohosh on serum concentrations of FSH and LH has been studied extensively. Crude

alcoholic extracts suppressed plasma LH, with no effect on FSH in ovx rats.<sup>[43,45]</sup> Further fractionation of the crude fraction showed that the activity resided in the lipophilic fraction, with the aqueous soluble fractions devoid of this activity.<sup>[43]</sup> A later study in rats using lipophilic and hydrophilic extracts at high doses (140 and 216 mg/rat, i.p.) resulted only in LH suppression with a single injection administration of the lipophilic extract.<sup>[44]</sup> Another study reported LH suppression in ovx rats with an unspecified dose and extract type of *C. racemosa*.<sup>[53]</sup> A recent study compared the effect of *C. racemosa* (BNO 1055) with that of estradiol on LH levels.<sup>[50]</sup> Reduced levels were reported for the black cohosh treated animals at 60 mg/day administered subcutaneously for 7 days. However, another study reported no estrogen agonistic effects on FSH, LH, or prolactin levels in ovx rats (DMBA model) with daily administration for 7 weeks of a 40% isopropanolic extract (Remifemin).<sup>[54]</sup>

### Hormonal Secretion

The effect on prolactin secretion in pituitary cell cultures was assayed using an unspecified ethanolic extract of *C. racemosa*.<sup>[55]</sup> Basal and TRH-stimulated prolactin levels were reduced significantly at doses of 10 and 100 µg/ml. This effect was reversed by the addition of haloperidol (D-2 antagonist) to the cell cultures, suggesting dopaminergic regulation of hormone secretion by *C. racemosa*.

### Osteopenia Inhibition

The BNO 1055 black cohosh extract (60 mg/rat, s.c.) has been shown to increase the expression of collagen I and osteocalcin in rats to a level equivalent to that in ovx rats treated with estradiol (8 µg).<sup>[50]</sup> An additional study using the BNO 1055 extract demonstrated an osteoprotective effect—a reduced loss of bone mineral density in rat tibia after 3 mo of administration.<sup>[56]</sup> A study using an unspecified isopropanol extract of *C. racemosa* showed reduced urinary parameters of bone loss. The authors of this study suggested that this action was similar to that of the SERM Raloxifene.<sup>[57]</sup> A follow-up study using BNO 1055 vs. CE therapy showed beneficial effects of the extract on bone metabolism in humans, specifically an increase in bone-specific alkaline phosphatase in serum.<sup>[25]</sup> While no direct correlation between species has been established, it is of note that studies on Asian species of *Cimicifuga* have demonstrated similar activity and may be of importance for further investigation of this biological activity.<sup>[58,59]</sup>

### Uterine Weight/Estrus Induction

Uterine and ovarian weight increase, cell cornification, and an increased duration of estrus are generally considered evidence of endometrial estrogenic activity. However, it has recently been debated that uterine weight is a poor marker for endometrial effects.<sup>[60]</sup> Three studies demonstrating that black cohosh extracts increased the uterine weight of ovx rats have been reported,<sup>[20,53,61]</sup> two of which used an undetermined root extract.<sup>[53,61]</sup> One study on immature mice reported similar findings.<sup>[20]</sup> By contrast, two studies on ovx rats,<sup>[50,62]</sup> as well as four studies on immature mice, reported the converse.<sup>[50,52,54,63]</sup> One of these studies found that despite no increase in uterine or ovarian weight, the duration of estrus was significantly increased by black cohosh.<sup>[63]</sup> A study by the authors and collaborators demonstrated no attenuation in uterine weight at variable doses (4, 40, and 400 mg/kg day) of a 40% isopropanol extract in ovx rats.<sup>[64]</sup>

### Cell Proliferation

An unspecified black cohosh extract failed to induce growth of MCF-7 cells significantly when compared to untreated control cells.<sup>[52]</sup> A study using isopropanolic and ethanolic extracts also failed to demonstrate growth of MCF-7 cells.<sup>[65]</sup>

### CNS Effects and Neurotransmitter Binding

A study using an unspecified extract (25–100 mg/kg, orally) to measure effects on mice body temperature and ketamine-induced sleep time, using bromocriptine (D-2 agonist) pretreated with sulpiride (D-2 blocker) as a positive control, suggested a receptor mediated dopaminergic effect.<sup>[55]</sup> A further study was carried out to characterize neurotransmitter levels in the striatum and hippocampus after pretreatment in mice with the extract for 21 days.<sup>[66]</sup> Serotonin and dopamine metabolic levels in the striatum were substantially lower in comparison with the control group. These studies have helped lead to the hypothesis that it is dopaminergic action, rather than estrogenlike activity, that is responsible for the success of black cohosh in reducing climacteric symptoms.<sup>[67]</sup> A study by the authors and collaborators has pointed to the effects of black cohosh being mediated by serotonin (5-HT) receptors.<sup>[64]</sup> Three different extracts (100% methanol, 40% isopropanol, 75% ethanol) bound to the 5-HT<sub>7</sub> receptor subtype at IC<sub>50</sub> ≤ 3.12 µg/ml. The 40% isopropanol extract inhibited [<sup>3</sup>H]-lysergic acid diethylamide (LSD), binding to the 5-HT<sub>7</sub> receptor with

greater potency than the synthetic [<sup>3</sup>H]-8-hydroxy-2-(di-*N*-propylamino)tetralin to rat 5-HT<sub>1A</sub>. Analysis of ligand binding data suggests that the methanol extract functioned as a mixed competitive ligand of the 5-HT<sub>7</sub> receptor. Further testing of the methanol extract in 293T-5-HT<sub>7</sub> transfected HEK cells revealed elevated cAMP levels; these levels were reversed in the presence of the 5-HT antagonist methiothepin, indicating a receptor mediated process and possible agonist activity local to the receptor.<sup>[64]</sup>

### Miscellaneous

A black cohosh methanol extract protected S30 breast cancer cells against menadione-induced DNA damage at variable concentrations, and scavenged DPPH free radicals at a concentration of 99 μM.<sup>[68]</sup>

### USE IN PREGNANT/LACTATING WOMEN

Despite an absence of mutagenic effects reported to date, the use of black cohosh during pregnancy is contraindicated according to WHO suggestions.<sup>[69]</sup> Data are inconclusive regarding the effects on lactation. Additionally, the American Herbal Products Association (AHPA) assigned black cohosh 2a and 2b classifications, which state that the herb is not to be used during pregnancy or nursing unless otherwise directed by an expert qualified in the use of the described substance.<sup>[70]</sup> However, experimental data are not available to confirm these warnings.

### DOSAGE<sup>a[69,70]</sup>

- Dried rhizome and root: One gram up to 3 times daily.
- Tincture (1:10): 0.4 ml daily (40–60% alcohol v/v).
- Fluidextract (1:1): Twenty drops twice daily (60% ethanol v/v, equivalent to 40 mg dried herb).<sup>b</sup>
- Tablet equivalence: Two tablets a day (equivalent to 40 mg dried fluid extract).

### ADVERSE EFFECTS

A majority of adverse event reports (AERs) for black cohosh have been for Remifemin products because of

widespread use. Thus, the data are more regarding the safety of this particular product, rather than that of black cohosh unspecified extracts. In clinical trials, minor cases of nausea, vomiting, dizziness, and headache have been reported.<sup>[69]</sup> A recent review of AERs concluded that, for black cohosh preparations, the events are rare, mild, and reversible.<sup>[42]</sup> Furthermore, case reports citing acute hepatitis, convulsions, and cardiovascular and circulatory insult have been reviewed.<sup>[42]</sup> In these reports, no effort was made to positively identify the botanical used as black cohosh. This, combined with underreporting, is a common factor with respect to AERs for botanical dietary supplements.<sup>[71]</sup>

### COMPENDIAL/REGULATORY STATUS

Black cohosh products are regulated and marketed in the United States as dietary supplements under the provisions of the Dietary Supplement Health and Education Act (DSHEA) of 1994 (U.S.C. Sec. 321). Dried roots/rhizomes, whole, powdered, and as extracts, are now officially included in the *United States Pharmacopeia—National Formulary*.<sup>[72]</sup> In the European Union, they are approved as nonprescription phytomedicines administered orally in compliance with the *German Commission E Monographs*.<sup>[73]</sup>

### CONCLUSIONS

With the current fear of side effects related to classical hormone therapy, modulation of certain climacteric symptoms of menopause by both dopaminergic and serotonergic drugs is becoming a viable and frequent treatment option. A review of the clinical trials associated with black cohosh leads to the conclusion that women using hydroalcoholic extracts of the rhizomes/roots of this plant gain relief from climacteric symptoms (e.g., hot flashes) in comparison with placebo. Confounding the review of these clinical trials are the different types of extracts administered. Early in vitro studies tended to report that black cohosh extracts acted on ERs, or have some sort of direct estrogenic effect. It is, however, becoming clearer now that, at least in humans, the beneficial effects in reducing hot flashes relate, at least in part, to serotonergic or dopaminergic mechanisms regulating hypothalamic control, possibly mediating estrogenic mechanisms. Again, the controversy surrounding a potential direct estrogenic mechanism of action may also be due to variance in the extracts assayed. Full safety evaluations, either in animals or in humans, have not been conducted to date. However, side effects reported in clinical trials seem to be minimal.

<sup>a</sup>The *Commission E Monographs* also recommend that usage not be extended for more than 6 mo due to a lack of long-term safety data. Experimental data are not available to validate this 6-mo limit.

<sup>b</sup>There appears to be confusion whether 40 mg refers to extract or herb. Correspondence with Remifemin manufacturers by the authors has not clarified this matter.

## REFERENCES

1. Farnsworth, N.R. *NAPRALERT Database*; University of Illinois at Chicago: Chicago, Illinois, 2003.
2. Onorato, J.; Henion, J.D. Evaluation of triterpene glycoside estrogenic activity using LC/MS and immunoaffinity extraction. *Anal. Chem.* **2001**, *73* (19), 4704–4710.
3. Gumbinger, H.G.; Winterhoff, H.; Sourgens, H.; Kemper, F.H.; Wylde, R. Formation of compounds with antigonadotropic activity from inactive phenolic precursors. *Contraception* **1981**, *23* (6), 661–666.
4. Winterhoff, H.; Gumbinger, H.G.; Sourgens, H. On the antigonadotropic activity of *Lithospermum* and *Lycopus* species and some of their phenolic constituents. *Planta Med.* **1988**, *54* (2), 101–106.
5. Andary, C. Caffeic acid glucoside esters and their pharmacology. In *Polyphenolic Phenomena*; Scalbert, A., Ed.; INRA Editions: Paris, 1993; 237–245.
6. Ortiz de Urbina, J.J.; Martin, M.L.; Sevilla, M.A.; Montero, M.J.; Carron, R.; San Roman, L. Antispasmodic activity on rat smooth muscle of polyphenol compounds caffeic and protocatechic acids. *Phytotherapy Research* **1990**, *4* (2), 71–76.
7. Saturnino, P.C. Anna; Saturnino, Carmela; De Martino, Giovanni; Reyes, Nancy Lozano; Aquino, Rita. Flavonol glycosides from *Aristeguietia discolor* and their inhibitory activity on electrically-stimulated guinea pig ileum. *International Journal of Pharmacognosy* **1997**, *35* (5), 305–312.
8. Trute, A.; Gross, J.; Mutschler, E.; Nahrstedt, A. In vitro antispasmodic compounds of the dry extract obtained from *Hedera helix*. *Planta Med.* **1997**, *63* (2), 125–129.
9. Okamoto, R.; Sakamoto, S.; Noguchi, K. Effects of ferulic acid on FSH, LH and prolactin levels in serum and pituitary tissue of male rats (author's transl). *Nippon Naibunpi Gakkai Zasshi* **1976**, *52* (9), 953–958.
10. de Man, E.; Peeke, H.V. Dietary ferulic acid, biochanin A, and the inhibition of reproductive behavior in Japanese quail (*Coturnix coturnix*). *Pharmacol. Biochem. Behav.* **1982**, *17* (3), 405–411.
11. Gorewit, R.C. Pituitary and thyroid hormone responses of heifers after ferulic acid administration. *J. Dairy Sci.* **1983**, *66* (3), 624–629.
12. Ozaki, Y.; Ma, J.P. Inhibitory effects of tetramethylpyrazine and ferulic acid on spontaneous movement of rat uterus in situ. *Chem. Pharm. Bull. (Tokyo)* **1990**, *38* (6), 1620–1623.
13. Kruse, S.O.; Lohning, A.; Pauli, G.F.; Winterhoff, H.; Nahrstedt, A. Fukiic and piscidic acid esters from the rhizome of *Cimicifuga racemosa* and the in vitro estrogenic activity of fukinolic acid. *Planta Med.* **1999**, *65* (8), 763–764.
14. Struck, D.; Tegtmeier, M.; Harnischfeger, G. Flavones in extracts of *C. racemosa*. *Planta Med.* **1997**, *63*, 289.
15. Kennelly, E.J.; Baggett, S.; Nuntanakorn, P.; Ososki, A.L.; Mori, S.A.; Duke, J.; Coletton, M.; Kronenberg, F. Analysis of thirteen populations of black cohosh for formononetin. *Phytomedicine* **2002**, *9* (5), 461–467.
16. Fabricant, D.; Li, W.; Chen, S.N.; Graham, J.; Fitzloff, J.; Fong, H.H.S.; Farnsworth, N.R. Geographical and diurnal variations of chemical constituents of *C. racemosa* (L.) Nutt. *ASP & CRN Botanical Dietary Supplements: Natural Products at a Crossroads*; Asilomar, CA, 2001.
17. Ramsey, G.W. A comparison of vegetative characteristics of several genera with those of the genus *Cimicifuga* (Ranunculaceae). *SIDA* **1988**, *13* (1), 57–63.
18. Ramsey, G.W. Morphological considerations in the North American *Cimicifuga* (Ranunculaceae). *Castanea* **1987**, *52* (2), 129–141.
19. Youngken, H. *A Textbook of Pharmacognosy*, 4th Ed.; P. Blakiston's Son and Co.: Philadelphia, 1936; Vol. xiv, 924.
20. Foldes, J. The actions of an extract of *C. racemosa*. *Arzneimittelforschung* **1959**, *13*, 623–624.
21. Baier-Jagodinski, G. Praxisstudie mit Cimisan bei klimakterischen Beschwerden, prämenstruellen Syndrom und Dysmenorrhoe. *Natur Heilpraxis Naturmedizin* **1995**, *48*, 1284–1288.
22. Liske, E.; Hanggi, W.; Henneicke-von Zepelin, H.H.; Boblitz, N.; Wustenberg, P.; Rahlfs, V.W. Physiological investigation of a unique extract of black cohosh (*Cimicifugae racemosae rhizoma*): a 6-month clinical study demonstrates no systemic estrogenic effect. *J. Womens Health Gen Based Med.* **2002**, *11* (2), 163–174.
23. Mielnik, J. *Cimicifuga racemosa* in the treatment of neurovegetative symptoms in women in the perimenopausal period. *Maturitas* **1997**, *27* (Supplement), 215.

24. Stoll, W. Phytotherapeutikum beeinflusst atrophisches Vaginalepithel Doppelblindversuch *Cimicifuga* vs. östrogenpräparat. *Therapeutikon* **1987**, *1*, 23–31.
25. Wuttke, W.; Seidlova-Wuttke, D.; Gorkow, C. The *Cimicifuga* preparation BNO 1055 vs. conjugated estrogens in a double-blind placebo-controlled study: effects on menopause symptoms and bone markers. *Maturitas* **2003**, *44* (Suppl. 1), S67–S77.
26. Schlidge, E. Essay on the treatment of premenstrual and menopausal mood swings and depressive states. *Ringelh. Biol. Umsch.* **1964**, *19* (2), 1822.
27. Stefan, H. An essay on the manifestations and therapy of hormone related female biopathic syndrome. *Ringelh. Biol. Umsch.* **1959**, *10*, *11*, 149–152, 157–162.
28. Vorberg, G. Therapy of climacteric complaints. *Zeitschrift für Allgemeinmedizin* **1984**, *60*, 626–629.
29. Warnecke, G. Influence of a phytopharmaceutical on climacteric complaints. *Meizinische Welt* **1985**, *36*, 871–874.
30. Stolze, H. Der andere Weg, klimakterische Beschwerden zu behandeln. *Gyne* **1982**, *3*, 14–16.
31. Liske, E. Therapeutic efficacy and safety of *Cimicifuga racemosa* for gynecologic disorders. *Adv. Ther.* **1998**, *15* (1), 45–53.
32. Jacobson, J.S.; Troxel, A.B.; Evans, J.; Klaus, L.; Vahdat, L.; Kinne, D.; Lo, K.M.; Moore, A.; Rosenman, P.J.; Kaufman, E.L.; Neugut, A.I.; Grann, V.R. Randomized trial of black cohosh for the treatment of hot flashes among women with a history of breast cancer. *J. Clin. Oncol.* **2001**, *19* (10), 2739–2745.
33. Hernandez Munoz, G.; Pluchino, S. *Cimicifuga racemosa* for the treatment of hot flashes in women surviving breast cancer. *Maturitas* **2003**, *44* (Suppl. 1), S59–S65.
34. Georgiev, D.B.; Iordanova, E. Phytoestrogens—the alternative approach [abstract]. *Maturitas* **1997**, *27* (Suppl.), P309.
35. Daiber, W. Klimakterische Beschwerden: ohne Hormone zum Erfolg. *Arzt Prax.* **1983**, *35*, 1946–1947.
36. Brucker, A. Essay on the phytotherapy of hormonal disorders in women. *Med. Welt* **1960**, *44*, 2331–2333.
37. Borrelli, F.; Ernst, E. *Cimicifuga racemosa*: a systematic review of its clinical efficacy. *Eur. J. Clin. Pharmacol.* **2002**, *58* (4), 235–241.
38. Heizer, H. Criticism on *Cimicifuga* therapy in hormonal disorders in women. *Med. Klin.* **1960**, *55*, 232–233.
39. Petho, A. Klimakterische Beschwerden. Umstellung einer Hormonbehandlung auf ein pflanzliches Gynäkologikum möglich? *Arzt Prax.* **1987**, *38*, 1551–1553.
40. Stoll, W. Phytopharmakon beeinflusst atrophisches vaginales Epithel: Doppelblindstudie—*Cimicifuga* vs. östrogenische Substanzen. *Therapeutikon* **1987**, *1*, 23–31.
41. Russell, L.; Hicks, G.S.; Low, A.K.; Shepherd, J.M.; Brown, C.A. Phytoestrogens: a viable option? *Am. J. Med. Sci.* **2002**, *324* (4), 185–188.
42. Huntley, A.; Ernst, E. A systematic review of the safety of black cohosh. *Menopause* **2003**, *10* (1), 58–64.
43. Jarry, H.; Harnischfeger, G.; Duker, E. The endocrine effects of constituents of *Cimicifuga racemosa*. 2. In vitro binding of constituents to estrogen receptors. *Planta Med.* **1985**, *51* (4), 316–319.
44. Duker, E.M.; Kopanski, L.; Jarry, H.; Wuttke, W. Effects of extracts from *Cimicifuga racemosa* on gonadotropin release in menopausal women and ovariectomized rats. *Planta Med.* **1991**, *57* (5), 420–424.
45. Jarry, H.; Harnischfeger, G. Endocrine effects of constituents of *Cimicifuga racemosa*. 1. The effect on serum levels of pituitary hormones in ovariectomized rats. *Planta Med.* **1985**, *51* (1), 46–49.
46. Eagon, C.L.; Elm, M.S.; Eagon, P.K. Estrogenicity of traditional Chinese and Western herbal remedies. *Proceeding of the American Association for Cancer Research* **1996**, *37*, 284.
47. Zava, D.T.; Dollbaum, C.M.; Blen, M. Estrogen and progestin bioactivity of foods, herbs, and spices. *Proc. Soc. Exp. Biol. Med.* **1998**, *217* (3), 369–378.
48. Liu, J.; Burdette, J.E.; Xu, H.; Gu, C.; van Breemen, R.B.; Bhat, K.P.; Booth, N.; Constantinou, A.I.; Pezzuto, J.M.; Fong, H.H.; Farnsworth, N.R.; Bolton, J.L. Evaluation of estrogenic activity of plant extracts for the potential treatment of menopausal symptoms. *J. Agric. Food Chem.* **2001**, *49* (5), 2472–2479.
49. Jarry, H.; Metten, M.; Spengler, B.; Christoffel, V.; Wuttke, W. In vitro effects of the *Cimicifuga racemosa* extract BNO 1055. *Maturitas* **2003**, *44* (Suppl. 1), S31–S318.
50. Jarry, H.; Leonhardt, S.; Duls, C.; Popp, M.; Christoffel, V.; Spengler, B.; Theiling, K.;

- Wuttke, W. Organ specific effects of *C. racemosa* in brain and uterus. 23rd International LOF-Symposium on Phyto-Oestrogens, Belgium, 1999.
51. Liu, Z.P.; Yu, B.; Huo, J.S.; Lu, C.Q.; Chen, J.S. Estrogenic effects of *Cimicifuga racemosa* (black cohosh) in mice and on estrogen receptors in MCF-7 cells. *J. Med. Food* **2001**, *4* (3), 171–178.
  52. Amato, P.; Christophe, S.; Mellon, P.L. Estrogenic activity of herbs commonly used as remedies for menopausal symptoms. *Menopause* **2002**, *9* (2), 145–150.
  53. Eagon, P.K.; Tress, N.B.; Ayer, H.A.; Wiese, J.M.; Henderson, T.; Elm, M.S.; Eagon, C.L. Medicinal botanicals with hormonal activity. *Proceeding of the American Association for Cancer Research* **1999**, *40*, 161–162.
  54. Freudenstein, J.; Dasenbrock, C.; Nisslein, T. Lack of promotion of estrogen-dependent mammary gland tumors in vivo by an isopropanolic *Cimicifuga racemosa* extract. *Cancer Res.* **2002**, *62* (12), 3448–3452.
  55. Lohning, A.; Verspohl, E.; Winterhoff, H. Pharmacological studies on the dopaminergic activity of *C. racemosa*. 23rd International LOF-Symposium on Phyto-Oestrogens, Belgium, 1999.
  56. Seidlova-Wuttke, D.; Jarry, H.; Becker, T.; Chritoffel, V.; Wuttke, W. Pharmacology of *Cimicifuga racemosa* extract BNO 1055 in rats: bone, fat and uterus. *Maturitas* **2003**, *44* (Suppl. 1), S39–S50.
  57. Nisslein, T.; Freudenstein, J. Effects of black cohosh on urinary bone markers and femoral density in an ovx-rat model. *Osteoporosis International* 2000, (abstract 504).
  58. Li, J.X.; Kadota, S.; Li, H.Y.; Miyahara, T.; Wu, Y.W.; Seto, H.; Namba, T. Effects of *Cimicifugae rhizoma* on serum calcium and phosphate levels in low calcium dietary rats and bone mineral density in ovariectomized rats. *Phytomedicine* **1997**, *3* (4), 379–385.
  59. Li, J.X.; Kadota, S.; Li, H.Y.; Miyahara, T.; Namba, T. The effect of traditional medicines on bone resorption induced by parathyroid hormone (PTH) in tissue culture: a detailed study on *cimicifuga rhizoma*. *J. Trad. Med.* **1996**, *13*, 50–58.
  60. Johnson, E.B.; Muto, M.G.; Yanushpolsky, E.H.; Mutter, G.L. Phytoestrogen supplementation and endometrial cancer. *Obstet. Gynaecol.* **2001**, *98* (5 Pt 2), 947–950.
  61. Eagon, C.L.; Elm, M.S.; Teepe, A.G.; Eagon, P.K. Medicinal botanicals: estrogenicity in rat uterus and liver. *Proceeding of the American Association for Cancer Research* **1997**, *38*, 293.
  62. Einer-Jensen, N.; Zhao, J.; Andersen, K.P.; Kristoffersen, K. *Cimicifuga* and *Melbrosia* lack oestrogenic effects in mice and rats. *Maturitas* **1996**, *25* (2), 149–153.
  63. Liu, Z.; Yang, Z.; Zhu, M.; Huo, J. Estrogenicity of black cohosh (*Cimicifuga racemosa*) and its effect on estrogen receptor level in human breast cancer MCF-7 cells. *Wei Sheng Yan Jiu* **2001**, *30* (2), 77–80.
  64. Burdette, J.E.; Liu, J.; Chen, S.-N.; Fabricant, D.S.; Piersen, C.E.; Barker, E.L.; Pezzuto, J.M.; Mesecar, A.; van Breemen, R.B.; Farnsworth, N.R.; Bolton, J.L. Black cohosh acts as a mixed competitive ligand and partial agonist of the serotonin receptor. *J. Agric. Food Chem.* **2003**, *51* (19), 5661–5670.
  65. Zierau, O.; Bodinet, C.; Kolba, S.; Wulf, M.; Vollmer, G. Antiestrogenic activities of *Cimicifuga racemosa* extracts. *J. Steroid Biochem. Mol. Biol.* **2002**, *80* (1), 125–130.
  66. Lohning, A.; Winterhoff, H. Neurotransmitter concentrations after three weeks treatment with *Cimicifuga racemosa* (abstract). *Phytomedicine* **2000**, *7* (Suppl. 2), 13.
  67. Borrelli, F.; Izzo, A.A.; Ernst, E. Pharmacological effects of *Cimicifuga racemosa*. *Life Sci.* **2003**, *73* (10), 1215–1229.
  68. Burdette, J.E.; Chen, S.N.; Lu, Z.Z.; Xu, H.; White, B.E.; Fabricant, D.S.; Liu, J.; Fong, H.H.; Farnsworth, N.R.; Constantinou, A.I.; Van Breemen, R.B.; Pezzuto, J.M.; Bolton, J.L. Black cohosh (*Cimicifuga racemosa* L.) protects against menadione-induced DNA damage through scavenging of reactive oxygen species: bioassay-directed isolation and characterization of active principles. *J. Agric. Food Chem.* **2002**, *50* (24), 7022–7028.
  69. Mahady, G.B.; Fong, H.H.S.; Farnsworth, N.R. *Botanical Dietary Supplements: Quality, Safety and Efficacy*; Swets & Zeitlinger: Lisse, 2001; 350.
  70. Black cohosh—standards of analysis, quality control and therapeutics. In *American Herbal Pharmacopoeia and Therapeutic Compendium*; Upton, R., Ed.; AHP: Santa Cruz, 2002, 37 p.
  71. Barnes, J.; Mills, S.Y.; Abbot, N.C.; Willoughby, M.; Ernst, E. Different standards for reporting

ADRs to herbal remedies and conventional OTC medicines: face-to-face interviews with 515 users of herbal remedies. *Br. J. Clin. Pharmacol.* **1998**, *45* (5), 496–500.

72. *Pharmacological Forum*, **2002**, *28* (5).

73. *The Complete German Commission E Monographs: Therapeutic Guide to Herbal Medicines*; Blumenthal, M., Busse, W., Hall, T., Goldberg, A., Grunwald, J., Riggins, C.W., Rister, R.S., Eds.; Integrative Medicine Communications: Boston, 1998; 685.

#### FURTHER READINGS

Lehmann-Willenbrock, E.; Riedel, H. H. Clinical and endocrinologic studies of the treatment of ovarian

insufficiency manifestations following hysterectomy with intact adnexa. *Zentralbl. Gynäkol.* **1988**, *110* (10), 611–618.

Kesselkaul, O. Treatment of climacteric disorders with Remifemin. *Med. Monatsschr.* **1957**, *11* (2), 87–88.

Starfinger, W. A contribution to the therapy of the psychovegetative syndrome. *Dtsch. Med. J.* **1960**, *11*, 308–309.

Schotten, E. Experience with the *Cimicifuga* preparation, Remifemin. *Landarzt* **1958**, *34* (11), 353–354.

Nesselhut, T.; Liske, E. Pharmacological measures in postmenopausal women with an isopropanolic aqueous extract of *Cimicifugae racemosae* rhizome. *Menopause* **1999**, *6*, 331.

Gorlich, N. Treatment of ovarian disorders in general practice. *Arztl. Prax.* **1962**, *14*, 1742–1743.

# Boron

**Curtiss D. Hunt**

*United States Department of Agriculture, Agriculture Research Service, Grand Forks Human Nutrition Research Center, Grand Forks, North Dakota, U.S.A.*

## INTRODUCTION

The element boron is essential for all higher plants and at least some organisms in each of the other phylogenetic kingdoms Eubacteria, Stramenopila (brown algae and diatoms), and Fungi. Physiologic concentrations of the element are needed to support metabolic processes in several species in Animalia. For example, embryological development in fish and frogs does not proceed normally in the absence of boron. There is evidence that higher vertebrates, e.g., chickens, rats, and pigs, require physiological amounts to assist normal biologic processes including immune function and bone development. In humans, boron is under apparent homeostatic control and is beneficial for immune function.

## COMMON CHEMICAL FORMS

Boron is the fifth element in the periodic table, with a molecular weight of 10.81, and is the only nonmetal in Group III. Only organoboron compounds are apparently important in biological systems during normal physiological conditions and they are defined for this discussion as those organic compounds that contain B–O bonds.<sup>[1]</sup> B–N compounds form a part of organoboron compounds, because B–N is isoelectronic with C–C. These complexes are present in plants, and most likely in human tissues.

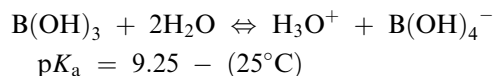
## BORON SPECIATION

### Environmental Forms

Boron does not naturally occur free or bind directly to any element other than oxygen, but for certain exceptions, e.g., NaBF<sub>4</sub> (ferrucite) and (K,Cs)BF<sub>4</sub> (avogadrite).<sup>[1]</sup> Its average concentration in the oceans is 4.6 mg/L, and it is the 10th most abundant element

in oceanic salts.<sup>[2]</sup> Weathering of clay-rich sedimentary rock is the major source of total boron mobilized into the aquatic environment.<sup>[3]</sup> Undissociated boric acid (orthoboric acid) is the predominant species of boron in most natural freshwater systems,<sup>[3]</sup> where most concentrations are below 0.4 mg/L and are not lowered by typical treatments for drinking water. The most common commercial compounds are anhydrous, pentahydrate, and decahydrate (tincal) forms of disodium tetraborate (borax, Na<sub>2</sub>B<sub>4</sub>O<sub>7</sub>), colemanite (2CaO·3B<sub>2</sub>O<sub>3</sub>·5H<sub>2</sub>O), ulexite (Na<sub>2</sub>O·2CaO·5B<sub>2</sub>O<sub>3</sub>·16H<sub>2</sub>O), boric acid (H<sub>3</sub>BO<sub>3</sub>), and monohydrate and tetrahydrate forms of sodium perborate (NaBO<sub>3</sub>).<sup>[4]</sup>

At typical physiological concentrations ( $6.0 \times 10^{-7}$  to  $\sim 9.0 \times 10^{-3}$  mol/L) in plants, animals, or humans, inorganic boron is essentially present only as the monomeric species boric acid, i.e., B(OH)<sub>3</sub>, and borate, i.e., B(OH)<sub>4</sub><sup>-</sup>.<sup>[5]</sup> Polyborate species can form near neutral physiological conditions (pH  $\sim 7.4$ ), when borate concentrations exceed  $\sim 0.025$  mol/L,<sup>[6]</sup> an unusually high boron concentration in biological systems, but still lower than that found in the snap bean leaf (0.1 mol/L).<sup>[7]</sup> Within the normal pH range of the gut and kidney, B(OH)<sub>3</sub> would prevail as the dominant species (pH 1:  $\sim 100\%$  B(OH)<sub>3</sub>; pH 9.3: 50%; pH 11:  $\sim 0\%$ ).<sup>[8]</sup> Boric acid is an exclusively monobasic acid and is not a proton donor. Rather, it accepts a hydroxyl ion (a Lewis acid) and leaves an excess of protons to form the tetrahedral anion B(OH)<sub>4</sub><sup>-</sup>.<sup>[9]</sup>

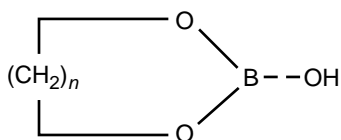


### Biochemical Forms

Many biomolecules contain one or more hydroxyl groups, and those with suitable molecular structures can react with boron oxo compounds to form borate esters, an important class of biologically relevant boron species. Several types of boron esters exist. Boric acid reacts with suitable dihydroxy compounds to form corresponding boric acid monoesters (“partial” esterification) (e.g., Fig. 1) that retain the trigonal-planar configuration and no charge.

*Curtiss D. Hunt, Ph.D.*, is at the United States Department of Agriculture, Agriculture Research Service, Grand Forks Human Nutrition Research Center, Grand Forks, North Dakota, U.S.A.





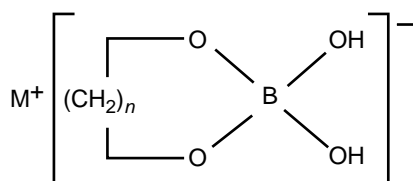
**Fig. 1** Boric acid may complex with a suitable dihydroxy ligand to form a boric acid monoester (“partial” esterification) that retains a trigonal-planar configuration and no charge.

In turn, a boric acid monoester can form a complex with a ligand containing a suitable hydroxyl to create a borate monoester (“partial” esterification; monocyclic) (Fig. 2), but with a tetrahedral configuration and a negative charge. A compound of similar configuration and charge is also formed when borate forms a complex with a suitable dihydroxy compound. The two types of boromonoesters can react with another suitable dihydroxy compound to give a corresponding spiro-cyclic borodiester (“complete” esterification) that is a chelate complex with a tetrahedral configuration and negative charge (Fig. 3).<sup>[10]</sup> A partially esterified tridentate cleisto complex (Fig. 4) may be formed when a ligand contains three suitably cis-oriented hydroxyl groups.<sup>[11]</sup> A variety of important biological complexes are formed when nitrogen acts as an electron-pair donor to fill the vacant boron  $p_z$  orbital. For example, the  $N^{\delta 2}$  of histidine-57 of  $\alpha$ -lytic protease and the boron atom of a peptide boronic acid interact to form a covalent bond and give rise to a reversible complex (Fig. 5).

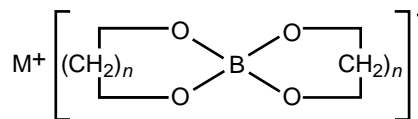
Boric acid and boric acid-like structures, instead of borate, are most likely the species reactive with biological ligands, because it is probably easier for a diol to substitute for a relatively loosely bound water molecule associated with boric acid or a boric acid-like structure than it is for the diol to substitute for a hydroxyl ion in borate or a borate-like structure of differences in charge.<sup>[10]</sup>

### Prokaryotes

Boron is an integral component of several biomolecules, where it is thermodynamically stabilized



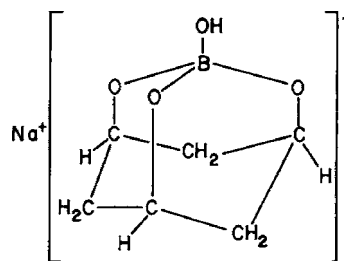
**Fig. 2** Borate may complex with a suitable dihydroxy ligand to form a borate monoester (“partial” esterification; monocyclic) with a tetrahedral configuration and a negative charge.



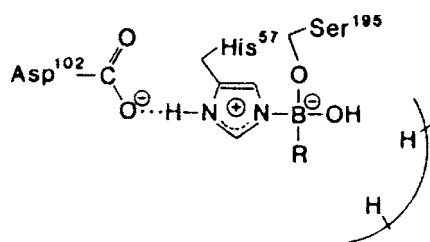
**Fig. 3** Boric acid monoesters or borate monoesters can combine with a suitable dihydroxy compound to form a corresponding spiro-cyclic borodiester (“complete” esterification) that is a chelate complex with a tetrahedral configuration and negative charge.

in a covalent bond<sup>[12–15]</sup> or a boroster.<sup>[16]</sup> Presence in these molecules is essential; in its absence, they no longer perform their normal physiologic functions. The element is a structural component of certain antibiotics produced by certain myxobacteria, a distinct and unusual group of bacteria. For example, tartrolon B (Fig. 6) is characterized by a single boron atom in the center of the molecule.<sup>[13]</sup> Recently, another related antibiotic, boromycin, was discovered to be potent against human immunodeficiency virus (HIV).<sup>[17]</sup> It strongly inhibits the replication of the clinically isolated HIV-1 strain and apparently, by unknown mechanisms, blocks release of infectious HIV particles from cells chronically infected with HIV-1.

One more new finding was that of a boron-containing biomolecule produced by a bacterium that is not an antibiotic,<sup>[15]</sup> but rather a cell-to-cell communication signal. Communication between bacteria is accomplished through the exchange of extracellular signaling molecules called autoinducers (AIs). This process, termed “quorum sensing,” allows bacterial populations to coordinate gene expression for community cooperative processes such as antibiotic production and virulence factor expression. AI-2 is produced by a large number of bacterial species and contains one boron atom per molecule. Not surprisingly, it is derived from the ribose moiety of biomolecule *S*-adenosylmethionine (SAM). The gliding bioluminescent marine bacterium, *Vibrio harveyi* (phylum Proteobacteria), produces and also binds AI-2. In *V. harveyi*, the primary receptor and sensor for AI-2 is the protein LuxP, which consists of two similar domains



**Fig. 4** A partially esterified tridentate cleisto complex may be formed when a ligand contains three cis-oriented hydroxyl groups.

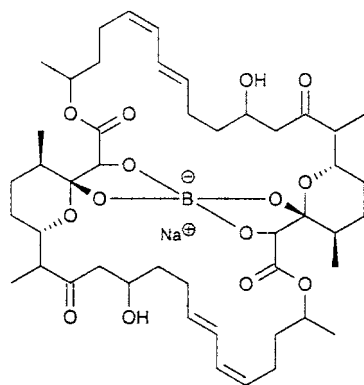


**Fig. 5** Boron reversibly inhibits all tested serine proteases by binding to the available serine residue and nitrogen at the active catalytic site of the enzyme.

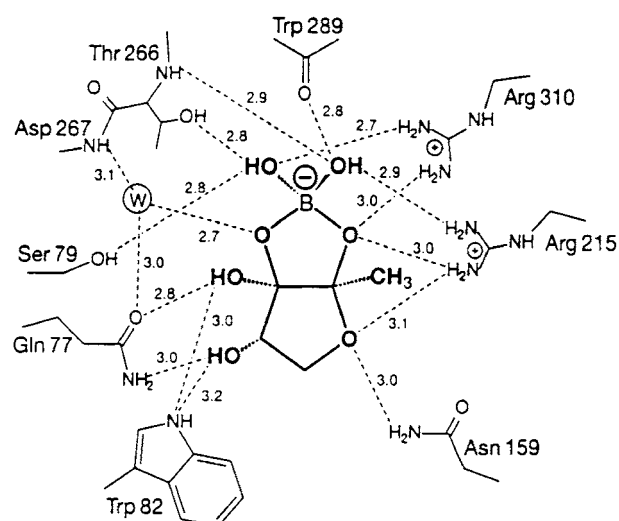
connected by a three-stranded hinge. The AI-2 ligand binds in the deep cleft between the two domains to form a furanosyl borate diester complex (Fig. 7).<sup>[15]</sup>

### Animal and Human Tissues

Only meager information is available on the speciation of boron in animal and human tissues. However, animal and human biocompounds with vicinal *cis*-diol moieties bind boron; those without these moieties typically do not. Of the animal and human biocompounds examined, SAM has the highest known affinity for boron.<sup>[18]</sup> It is the predominant methyl donor in biological methylations and is therefore a versatile cofactor in a variety of physiologic processes.<sup>[19]</sup> NAD<sup>+</sup>, an essential cofactor for five subclasses of oxidoreductase enzymes, also has a strong affinity for boron. The di-adenosine phosphates (Ap<sub>n</sub>A) are structurally similar to NAD<sup>+</sup>. Boron binding by Ap<sub>4</sub>A, Ap<sub>5</sub>A, and Ap<sub>6</sub>A is greatly enhanced compared to NAD<sup>+</sup> but is still less than that of SAM. The Ap<sub>n</sub>A molecules are present in all cells with active protein synthesis and reportedly regulate cell proliferation, stress response, and DNA repair.<sup>[20]</sup> At physiologic pH, the adenine moieties of Ap<sub>n</sub>A are driven together by hydrophobic



**Fig. 6** Tartrolon B, an example of certain antibiotics produced by certain myxobacteria that require the presence of a single atom of boron for functionality.

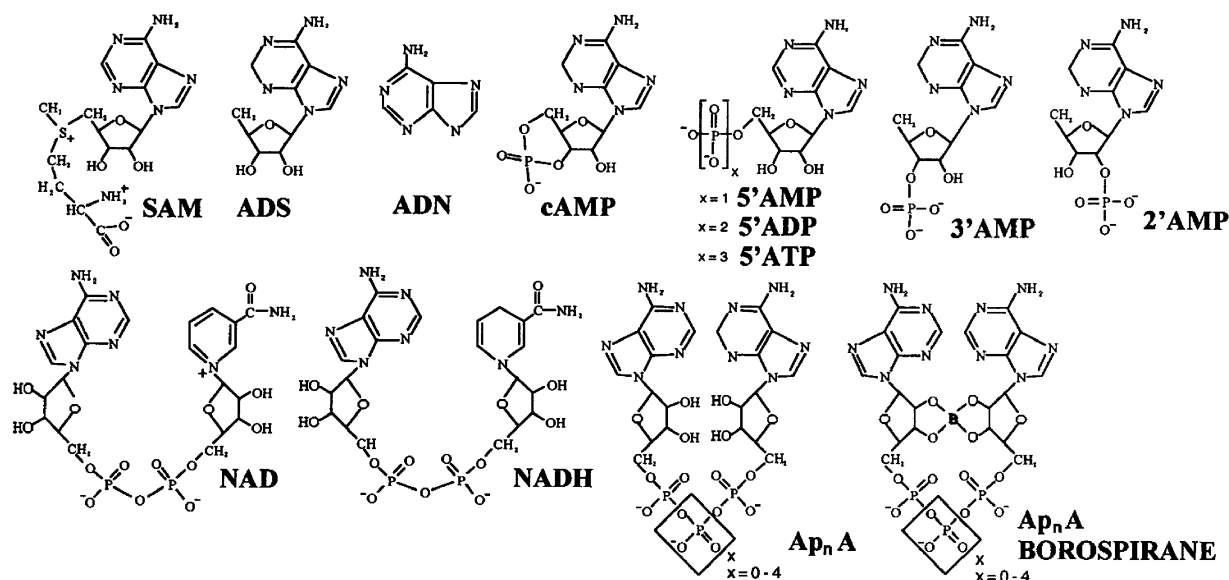


**Fig. 7** The autoinducer AI-2, with its integral boron atom, is stabilized by a hydrogen network in the binding site of the receptor. The O–O or O–N distances for potential hydrogen bonds are shown in angstroms. (From Ref.<sup>[15]</sup>)

forces and stack interfacially.<sup>[21]</sup> Stacking of the terminal adenine moieties brings their adjacent ribose moieties into close proximity, a phenomenon that apparently potentiates cooperative boron binding between the opposing riboses (Fig. 8).

### Plant-Based Foods

All higher plants require boron and contain organo-boron complexes. There may have been considerable evolutionary pressure exerted to select carbohydrate energy sources that do not interact with boron. Sugars often form intramolecular hemiacetals: Those with five-membered rings are called furanoses and those with six-membered rings are known as pyranoses. In cases where either five- or six-membered rings are possible, the six-membered ring usually predominates for unknown reasons.<sup>[22]</sup> In general, compounds in a configuration where there are *cis*-diols on a furanoid ring (e.g., ribose, apiose, and erythritan) form stronger complexes with boron than those configured to have *cis*-diols predominately on a pyranoid ring (e.g., the pyranoid form of  $\alpha$ -D-glucose). D-Glucose reacts with boric acid,<sup>[23]</sup> but the near absence (<0.5%) of an  $\alpha$ -furanose form of D-glucose in aqueous solutions<sup>[22]</sup> suggests that glucose was selected as the aldose for general energy metabolism because of its lower reactivity with boric acid. On the other hand, ribose may have been selected as part of the chemistry of nucleic acid and nucleotide function and apiose for, rather than against, its extraordinary borate-complexing capability.



**Fig. 8** Experimental data indicate that biochemical species with vicinal *cis*-diols bind strongly to boron: *S*-adenosylmethionine (SAM)  $\equiv$  diadenosine hexophosphate (Ap<sub>6</sub>A)  $\equiv$  Ap<sub>5</sub>A > Ap<sub>4</sub>A > Ap<sub>3</sub>A  $\equiv$  NAD<sup>+</sup> > Ap<sub>2</sub>A > NADH  $\equiv$  5'-ATP > 5'-ADP > 5'-AMP > adenosine (ADS). Species without these moieties do not bind boron well: 3'-AMP  $\equiv$  2'-AMP  $\equiv$  cAMP  $\equiv$  adenine (ADN).

Recent evidence suggests that the predominant place of boron function in plants is in the primary cell walls, where it cross-links rhamnogalacturonan II (RG-II) (Fig. 9), a small, structurally complex polysaccharide of the pectic fraction. RG-IIs have an atom of boron that cross-links two RG-II dimers at the site of the apiose residues to form a borodiester.<sup>[24]</sup> However, this function is not adequate to explain all boron deficiency signs in plants. Boron oxo compounds also form stable ionic complexes with the polyol ligands mannitol, sorbitol, and fructose in liquid samples of celery phloem sap and vascular exudate and phloem-fed nectaries of peach.<sup>[25]</sup> In fact, current data suggest that no free boric acid or borate is present in these phloem saps or vascular exudates.

### Dietary Supplements

Boron speciation in dietary supplements varies widely,<sup>[26]</sup> as does the relevant information provided by various dietary supplement manufacturers. It is sometimes listed only in a general manner (e.g., “borates” or “boron”), and occasionally in a more specific way (e.g., “sodium borate” or “sodium tetraborate decahydrate”). Several commercially available forms (e.g., “boron amino acid chelate,” “boron ascorbate,” “boron aspartate,” “boron chelate,” “boron citrate,” “boron gluconate,” “boron glycerborate,” “boron glycinate,” “boron picolinate,” “boron proteinate,” and “boron bonded with niacin”) are not well characterized in the scientific literature. Most often,

dietary boron supplements are provided in conjunction with other nutrient supplements.

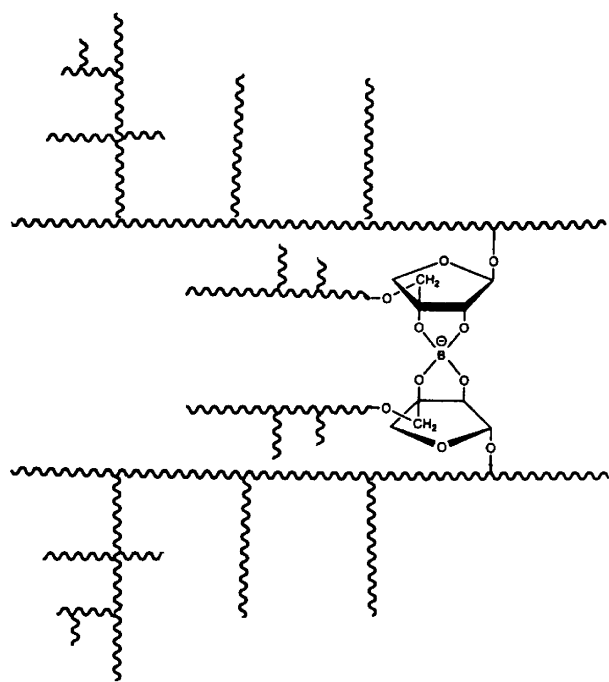
### BIOAVAILABILITY AND EXCRETION

If plant and animal boron absorption mechanisms are analogous, the organic forms of the element per se are probably unavailable.<sup>[27]</sup> However, the strong association between boron and polyhydroxyl ligands (described below) is easily and rapidly reversed by dialysis, change in pH, heat, or the excess addition of another low-molecular polyhydroxyl ligand.<sup>[23]</sup> Thus, within the intestinal tract, most ingested boron is probably converted to orthoboric acid (common name: boric acid), B(OH)<sub>3</sub>, the normal end product of hydrolysis of most boron compounds.<sup>[1]</sup> Gastrointestinal absorption of inorganic boron and subsequent urinary excretion<sup>[28]</sup> is near 100%. In humans, lack of boron accumulation and relatively small changes in blood boron values during a substantial increase in dietary boron support the concept of boron homeostasis.<sup>[28]</sup>

### DIETARY BORON SOURCES AND INTAKES

#### Dietary Recommendations

The tolerable upper intake level (UIL) for boron varies by life stage (Table 1).<sup>[29]</sup> No estimated average requirement, recommended dietary allowance, or adequate intake has been established for any age–sex group.



**Fig. 9** Schematic representation of two monomers of the pectic polysaccharide rhamnogalacturonan-II cross-linked by an atom of boron at the site of the apiose residues to form a borodiester. Multiple cross-links form a supramolecular network. (From Ref.<sup>[6]</sup>)

### Dietary Supplements

For adults, the amount of boron commonly provided in a single dietary boron supplement is 0.15 mg.<sup>[26]</sup> However, the quantity supplied by one dose may be as low as 0.15 mg or as high as 40.0 mg.<sup>[30]</sup> The mean usual intake of boron (mg/day) from dietary supplements for children (1–8 yr), adolescents (9–15 yr), males (19+ yr), females (19+ yr), and pregnant/lactating women is 0.269, 0.160, 0.174, 0.178,

**Table 1** Upper limits for boron set by the 2001 Food and Nutrition Board of the National Academy of Sciences

Life stage group	Age (yr)	Upper limit (mg/day)
Children	1–3	3
	4–8	6
	9–13	11
Adolescents	14–18	17
Adults	19–70	20
	>70	20
Pregnancy	≤18	17
	19–50	20
Lactation	≤18	17
	19–50	20

(From Ref.<sup>[29]</sup>.)

and 0.148, respectively. The median intake from supplements in the U.S. population is approximately 0.135 mg/day.<sup>[29]</sup>

### Nonfood Personal Care Products

Boron is a notable contaminant or ingredient of many nonfood personal care products. For example, an antacid was found to have a high boron concentration (34.7 µg/g)<sup>[31]</sup> such that the maximum recommended daily dose would provide 2.0 mg/B/day, two times the estimated daily boron consumption for the overall adult U.S. population.

### Dietary Sources and Intakes

Ten representative foods with the highest boron concentrations (µg/g) are distributed among several food categories<sup>[32]</sup>: raw avocado (14.3), creamy peanut butter (5.87), salted dry roasted peanuts (5.83), dry roasted pecans (2.64), bottled prune juice (5.64), canned grape juice (3.42), sweetened chocolate powder (4.29), table wine (12.2% alcohol) (3.64), prunes with tapioca (3.59), and granola with raisins (3.55). Several fruit, bean, pea, and nut products contain more than 2 µg B/g. Foods derived from meat, poultry, or fish have relatively low concentrations.

Infant foods supply 47% of their boron (B) intake. For toddlers, consumption from fruits and fruit juices combined is twice that from milk/cheese (38% vs. 19%). For adolescents, milk/cheese foods are the single largest source of boron (18–20%), and for adults and senior citizens, it is beverages (mainly represented by instant regular coffee) (21–26%). For all groups (except infants), 7–21% of boron intake is contributed by each of the vegetable, fruit, and fruit drink products. Infants, toddlers, adolescent girls and boys, adult women and men, and senior women and men are estimated to consume (mg/day) the following amounts of boron: 0.55, 0.54, 0.59, 0.85, 0.70, 0.91, 0.73, and 0.86, respectively.

### INDICATIONS AND USAGE

#### Boron and Mineral Metabolism

Boron supplementation (3 mg B/day) of a low-boron diet (0.36 mg B/day) led to a decrease in the percentage of dietary calcium lost in the urine in postmenopausal volunteers fed marginal amounts of magnesium (109 mg Mg/day), but increased it in volunteers fed adequate amounts of magnesium (340 mg Mg/day), a relation that may be important in understanding metabolic mineral disorders that perturb calcium

balance.<sup>[28]</sup> A similar phenomenon occurred in either free-living sedentary or athletic premenopausal women consuming self-selected typical Western diets: boron supplementation increased urinary calcium loss.<sup>[33]</sup>

### Boron and Cartilage and Bone Structure

Findings at the microscopic level indicate that physiological amounts of boron function to modify mineral metabolism in vitamin D deficiency through suppression of bone anabolism in magnesium deficiency and bone catabolism in magnesium adequacy in the chick model. The effects of boron on cartilage calcification are apparently beneficial in both magnesium deficiency and adequacy because vitamin D deficiency-induced mortality was substantially reduced by dietary boron. Furthermore, supplemental boron alleviated distortion of the marrow sprouts, a distortion characteristic of vitamin D deficiency. In addition, physiological supplements of boron to a low-boron diet increased chondrocyte density in the proliferative zone of the growth plate in vitamin D-deficient chicks.<sup>[34]</sup>

### Boron and Insulin and Glucose Metabolism

Dietary boron influences energy substrate metabolism in a wide variety of biological species including humans. At the molecular level, the element influences the activities of at least 26 enzymes,<sup>[35]</sup> with many of these enzymes being essential in energy substrate metabolism. For example, in plants, a serious outcome of boron deficiency is the accumulation of starch in chloroplasts and acceleration of the pentose phosphate cycle.<sup>[36]</sup>

There is evidence that dietary boron directly affects insulin metabolism. For example, hyperinsulinemia was reported in vitamin D-deprived rats that were concurrently deprived of boron.<sup>[37]</sup> This effect is independent of other dietary factors. For example, in the rat model (with overnight fasting), boron deprivation increased plasma insulin but did not change glucose concentrations regardless of vitamin D<sub>3</sub> or magnesium status. In the chick model, deprivation increased in situ peak pancreatic insulin release regardless of vitamin D<sub>3</sub> nutriture. These results suggest that physiological amounts of the element may help reduce the amount of insulin needed to maintain plasma glucose.

In the vitamin D-deficient chick, dietary boron decreases the abnormally elevated plasma concentrations of pyruvate,  $\beta$ -hydroxybutyrate, and triglycerides that are typically associated with this inadequacy.<sup>[34]</sup> Vitamin D-deprived rats exhibited significant decreases in plasma triglyceride concentrations and increases in plasma pyruvate concentrations when they were not given boron.<sup>[37]</sup> In older volunteers (men and women)

fed a low-magnesium, marginal-copper diet, dietary boron deprivation induced a modest but significant increase in fasting serum glucose concentrations.<sup>[38]</sup>

It has been demonstrated repeatedly in the chick model that physiological amounts of dietary boron can attenuate the rise in plasma glucose concentration induced by vitamin D deficiency.<sup>[34,39,40]</sup> However, it is not understood how boron deprivation perturbs energy substrate metabolism in humans and animal models, particularly when other nutrients are provided in suboptimal amounts.

### Boron and Immune Function

There is evidence that dietary boron helps control the normal inflammatory process. The serine proteases are major proteolytic enzymes (i.e., elastase, chymase, and cathepsin G) released by activated leukocytes that, in addition to degrading structural proteins, have many essential regulatory roles in normal inflammation, including control of the blood fibrinolytic system (e.g., thrombin) and the coagulation system (e.g., coagulation factor Xa).<sup>[41]</sup> Boron reversibly inhibits these enzymes (Fig. 5). For example, nanomolar concentrations of certain synthetic peptide boronic acids, including MeO-Suc-Ala-Ala-Pro-acetamido-2-phenylethane boronic acid, effectively inhibit chymotrypsin, cathepsin G, and both leukocyte and pancreatic elastase in vitro.<sup>[42]</sup>

In the antigen-induced arthritis rat model, physiological supplements of boron (as boric acid) reduced paw swelling and circulating neutrophil concentrations.<sup>[43]</sup> Perimenopausal women who excreted <1.0 mg B/day during the placebo period exhibited an increased percentage of polymorphonuclear leukocytes during the boron (as sodium borate) supplementation period.<sup>[44]</sup> Certain boron-containing RG-IIs from *Panax ginseng* leaves enhanced the expression of Fc receptor (which internalizes antigen-antibody complexes and thus induces efficient processing of antigens into peptides presented by major histocompatibility complex class II molecules<sup>[45]</sup>) and interleukin-6 (IL-6) production activity of mouse macrophages.<sup>[46]</sup> Dietary boron may serve as a signal suppressor that downregulates specific enzymatic activities typically elevated during inflammation at the inflammation site. Suppression, but not elimination, of these enzyme activities is hypothesized to reduce the incidence and severity of inflammatory disease.

### Boron and Steroid Metabolism

There is clear evidence that dietary boron affects steroid metabolism. In particular, circulating concentrations of vitamin D metabolites are sensitive to

boron nutriture. Findings from animal models indicate that dietary boron enhances the efficacy of vitamin D, but cannot substitute for the vitamin. In volunteers (men and women on or not on estrogen therapy), boron supplementation after consumption of a low-boron diet increased serum 25-hydroxycholecalciferol ( $62.4 \pm 7.5$  vs.  $44.9 \pm 2.5$  mmol/L, mean  $\pm$  SEM),<sup>[47,48]</sup> an effect that may be especially important during the winter months, when those concentrations normally range between 35 and 105 mmol/L.<sup>[49]</sup>

The circulating concentrations of  $17\beta$ -estradiol also respond to boron nutriture. Perimenopausal women who excreted  $<1.0$  mg B/day during the placebo period exhibited increased serum concentrations of estradiol after supplementation (2.5 mg B/day) of self-selected diets.<sup>[44]</sup> In a separate study, postmenopausal women on estrogen therapy, but not men or postmenopausal women not ingesting estrogen, also exhibited increased serum concentrations of estradiol after boron supplementation (3 mg B/day) of a low-boron diet (0.25 mg B/2000 kcal).<sup>[48]</sup> However, plasma estradiol, but not testosterone, concentrations increased in young male volunteers when their self-selected diets were supplemented with ample amounts of the element (10 mg/day).<sup>[50]</sup>

## OVERDOSAGE

As with all other elements, boron produces toxicity in all tested biological organisms when excessive amounts are absorbed. The toxicity signs associated with boric acid when used as an antiseptic in lieu of antibiotics on abraded epithelium (i.e., surgical wounds and diaper rash) were overlooked for many years even though signs of poisoning were reported soon after its introduction into clinical use. Boron is more bacteriostatic than bactericidal, and thus may suppress bacterial growth.

Deaths can occur at doses totaling between 5 and 20 g of boric acid for adults and below 5 g for infants<sup>[51]</sup> (in Ref.<sup>[52]</sup>). Potential lethal doses are usually cited as 3–6 g for infants and 15–20 g for adults. However, an independent examination of 784 cases of boric acid ingestion found minimal or no toxicity at these intake levels or higher.<sup>[53]</sup> Signs of acute boron toxicity, regardless of route of administration, include nausea, vomiting, headache, diarrhea, erythema, hypothermia, restlessness, weariness, desquamation, renal injury, and death from circulatory collapse and shock. Autopsy may reveal congestion and edema of brain, myocardium, lungs, and other organs, with fatty infiltration of the liver. Chronic heavy borax dust occupational exposure (average air concentration:  $4.1$  mg/m<sup>3</sup>; range:  $1.2$ – $8.5$  mg/m<sup>3</sup>) may manifest as eye irritation, nosebleeds, chest tightness, sore throat, dry mouth,

and productive cough.<sup>[52]</sup> Chronic boron toxicity symptoms include poor appetite, nausea, weight loss, decreased sexual activity, seminal volume, sperm count and motility, and increased seminal fructose. At present, death from boron poisoning is exceptionally rare, probably because of the emphasis placed on maintaining electrolytic balance and supporting kidney function during the worst part of the illness. Depending upon boron blood levels, treatment ranges from observation to gastric lavage to dialysis.

## CONCLUSIONS

Boron is ubiquitous in the environment, and daily dietary intakes of adult American males, for example, are slightly less than 1.0 mg. The evidence to date suggests that higher animals<sup>[43,54]</sup> and humans<sup>[28,48,55]</sup> probably require the element to support normal biological functions. Despite the progress made in studies of boron essentiality for plants, animals, and man, the biochemical mechanisms responsible for its beneficial physiologic effects across the phylogenetic spectrum are poorly understood. However, the unique nature of the element's biochemistry suggests specific lines of investigation. In particular, further characterization of the various cell signaling molecules that form complexes with boron under physiological conditions should provide insights into its specific biochemical function(s) in humans.

## REFERENCES

1. Greenwood, N.N.; Earnshaw, A. *Chemistry of the Elements*; Pergamon Press: Oxford, U.K., 1984.
2. Argust, P. Distribution of boron in the environment. *Biol. Trace Elem. Res.* **1998**, *66*, 131–143.
3. Butterwick, L.; de Oude, N.; Raymond, K. Safety assessment of boron in aquatic and terrestrial environments. *Ecotoxicol. Environ. Saf.* **1989**, *17*, 339–371.
4. Woods, W.G. An introduction to boron: history, sources, uses, and chemistry. *Environ. Health Perspect.* **1994**, *102* (Suppl. 7), 5–11.
5. Weser, U. Chemistry and structure of some borate polyol compounds of biochemical interest. In *Structure and Bonding*; Jorgensen, C., Neilands, J., Nyholm, R., Reinen, D., Williams, R., Eds.; Springer-Verlag: New York, 1967; Vol. 2, 160–180.
6. Power, P.P.; Woods, W.G. The chemistry of boron and its speciation in plants. *Plant Soil* **1997**, *193*, 1–13.
7. Dugger, W.M.; Humphreys, T.E.; Calhoun, B. The influence of boron on starch phosphorylase

- and its significance in translocation of sugars in plants. *Plant Physiol.* **1957**, *32* (4), 364–370.
8. Spivack, A.J.; Edmond, J.M. Boron isotope exchange between seawater and the oceanic crust. *Geochim. Cosmochim. Acta* **1987**, *51*, 1033–1043.
  9. Greenwood, N.N. Boron. In *Comprehensive Inorganic Chemistry*, 1st Ed.; Bailar, J.J., Emeléus, H., Nyholm, R., Trotman-Dickenson, A., Eds.; Pergamon Press Ltd.: Oxford, 1973; Vol. 1, 665–990.
  10. Van Duin, M.; Peters, J.A.; Kieboom, A.P.G.; Van Bekkum, H. Studies on borate esters I. The pH dependence of the stability of esters of boric acid and borate in aqueous medium as studied by  $^{11}\text{B}$  NMR. *Tetrahedron* **1984**, *40* (15), 2901–2911.
  11. Bell, C.F.; Beauchamp, R.D.; Short, E.L. A study of the complexes of borate ions and some cyclitols using  $^{11}\text{B}$ -N.M.R spectroscopy. *Carbohydr. Res.* **1986**, *147*, 191–203.
  12. Sato, K.; Okazaki, T.; Maeda, K.; Maeda, K.; Okami, Y. New antibiotics, aplasmomycins B and C. *J. Antibiot. (Tokyo)* **1978**, *31*, 632–635.
  13. Schummer, D.; Irschik, H.; Reichenbach, H.; Höfle, G. Antibiotics from gliding bacteria, LVII. Tartrolons: new boron-containing macrodiolides from *Sorangium cellulosum*. *Liebigs Ann. Chem.* **1994**, *1994*, 283–289.
  14. Dunitz, J.D.; Hawley, D.M.; Miklos, D.; White, D.N.J.; Berlin, Y.; Marusic, R.; Prelog, V. Structure of boromycin. *Helv. Chim. Acta.* **1971**, *54* (6), 1709–1713.
  15. Chen, X.; Schauder, S.; Potier, N.; Van Dorselaer, A.; Pelczer, I.; Bassler, B.L.; Hughson, F.M. Structural identification of a bacterial quorum-sensing signal containing boron. *Nature* **2002**, *415* (6871), 545–549.
  16. O'Neill, M.A.; Warrenfeltz, D.; Kates, K.; Pellerin, P.; Doco, T.; Darvill, A.G.; Albersheim, P. Rhamnogalacturonan-II, a pectic polysaccharide in the walls of growing plant cells, forms a dimer that is covalently cross-linked by a borate ester. *J. Biol. Chem.* **1996**, *271*, 22,923–22,930.
  17. Kohno, J.; Kawahata, T.; Otake, T.; Morimoto, M.; Mori, H.; Ueba, N.; Nishio, M.; Kinumaki, A.; Komatsubara, S.; Kawashima, K. Boromycin, an anti-HIV antibiotic. *Biosci. Biotechnol. Biochem.* **1996**, *60* (6), 1036–1037.
  18. Ralston, N.V.C.; Hunt, C.D. Diadenosine phosphates and *S*-adenosylmethionine: novel boron binding biomolecules detected by capillary electrophoresis. *Biochim. Biophys. Acta* **2001**, *1527*, 20–30.
  19. Kozarich, J.W. *S*-Adenosylmethionine-dependent enzyme activation. *Biofactors* **1988**, *1*, 123–128.
  20. McLennan, A.G. Dinucleoside phosphates—an introduction. In *Ap<sub>4</sub>A and Other Dinucleoside Polyphosphates*, McLennan, A.G., Ed.; CRC Press: Boca Raton, 1992; 1–9.
  21. Kolodny, N.H.; Collins, L.J. Proton and phosphorus-31 NMR study of the dependence of diadenosine tetraphosphate conformation on metal ions. *J. Biol. Chem.* **1986**, *261*, 14,571–14,577.
  22. Zubay, G. *Biochemistry*; Macmillan: New York, 1988.
  23. Zittle, C.A. Reaction of borate with substances of biological interest. In *Advances in Enzymology*, Ford, F., Ed.; Interscience Publishers: New York, 1951; Vol. 12, 493–527.
  24. Albersheim, P.; An, J.; Freshour, G.; Fuller, M.S.; Guillen, R.; Ham, K.S.; Hahn, M.G.; Huang, J.; O'Neill, M.; Whitcombe, A. et al. Structure and function studies of plant cell wall polysaccharides. *Biochem. Soc. Trans.* **1994**, *22* (2), 374–378.
  25. Hu, H.; Penn, S.G.; Lebrilla, C.B.; Brown, P.H. Isolation and characterization of soluble B-complexes in higher plants. *Plant Physiol.* **1997**, *113*, 649–655.
  26. *Physicians' Desk Reference for Nonprescription Drugs and Dietary Supplements*; Medical Economics Co.: Montvale, NJ, 1999.
  27. Gupta, U.C.; James, Y.W.; Campbell, C.A.; Leyshon, A.J.; Nicholaichuk, W. Boron toxicity and deficiency: a review. *Can. J. Soil Sci.* **1985**, *65* (3), 381–409.
  28. Hunt, C.D.; Herbel, J.L.; Nielsen, F.H. Metabolic response of postmenopausal women to supplemental dietary boron and aluminum during usual and low magnesium intake: boron, calcium, and magnesium absorption and retention and blood mineral concentrations. *Am. J. Clin. Nutr.* **1997**, *65*, 803–813.
  29. Food and Nutrition Board: Institute of Medicine. *Dietary Reference Intakes for Vitamin A, Vitamin K, Arsenic, Boron, Chromium, Copper, Iodine, Iron, Manganese, Molybdenum, Nickel, Silicon, Vanadium, and Zinc*; Academic Press: Washington, DC, 2001.
  30. Innovative liquid cal/mag 32 oz, Vol. 2001, FoodandVitamins.com (accessed 2001).
  31. Hunt, C.D.; Shuler, T.R.; Mullen, L.M. Concentration of boron and other elements in human foods and personal-care products. *J. Am. Diet. Assoc.* **1991**, *91*, 558–568.
  32. Hunt, C.D.; Meacham, S.L. Aluminum, boron, calcium, copper, iron, magnesium, manganese, molybdenum, phosphorus, potassium, sodium, and zinc: concentrations in common Western foods and estimated daily intakes by infants, toddlers, and male and female adolescents, adults, and seniors in the United States. *J. Am. Diet. Assoc.* **2001**, *101*, 1058–1060, Table, [http://www.eatright.com/images/journal/0901/hunt\\_tables.pdf](http://www.eatright.com/images/journal/0901/hunt_tables.pdf).

33. Meacham, S.L.; Taper, L.J.; Volpe, S.L. Effect of boron supplementation on blood and urinary calcium, magnesium, and phosphorus, and urinary boron in athletic and sedentary women. *Am. J. Clin. Nutr.* **1995**, *61*, 341–345.
34. Hunt, C.D.; Herbel, J.L.; Idso, J.P. Dietary boron modifies the effects of vitamin D<sub>3</sub> nutriture on indices of energy substrate utilization and mineral metabolism in the chick. *J. Bone Miner. Res.* **1994**, *9*, 171–181.
35. Hunt, C.D. Regulation of enzymatic activity. One possible role of dietary boron in higher animals and humans. *Biol. Trace Elem. Res.* **1998**, *66*, 205–225.
36. Goldbach, H.E. A critical review on current hypotheses concerning the role of boron in higher plants: suggestions for further research and methodological requirements. *J. Trace Microprobe Tech.* **1997**, *15* (1), 51–91.
37. Hunt, C.D.; Herbel, J.L. Boron affects energy metabolism in the streptozotocin-injected, vitamin D<sub>3</sub>-deprived rat. *Magnes. Trace Elem.* **1991–1992**, *10*, 374–386.
38. Nielsen, F.H. Dietary boron affects variables associated with copper metabolism in humans. In *6th International Trace Element Symposium 1989*; Anke, M., Baumann, W., Bräunlich, H., Brückner, C., Groppe, B., Grün, M., Eds.; Karl-Marx-Universität and Friedrich-Schiller-Universität: Leipzig and Jena, Germany, 1989; Vol. 4, 1106–1111.
39. Hunt, C.D. Dietary boron modified the effects of magnesium and molybdenum on mineral metabolism in the cholecalciferol-deficient chick. *Biol. Trace Elem. Res.* **1989**, *22*, 201–220.
40. Hunt, C.D.; Herbel, J.L. Physiological amounts of dietary boron improve growth and indicators of physiological status over a 20-fold range in the vitamin D<sub>3</sub>-deficient chick. In *Trace Element Metabolism in Man and Animals*, Anke, M., Meissner, D., Mills, C., Eds.; Verlag Media Touristik: Gersdorf, Germany, 1993; Vol. 2, 714–718.
41. Kettner, C.A.; Bone, R.; Agard, D.A.; Bachovchin, W.W. Kinetic properties of the binding of alpha-lytic protease to peptide boronic acids. *Biochemistry* **1988**, *27*, 7682–7688.
42. Kettner, C.A.; Shenvi, A.B. Inhibition of the serine proteases leukocyte elastase, pancreatic elastase, cathepsin G, and chymotrypsin by peptide boronic acids. *J. Biol. Chem.* **1984**, *259* (24), 15,106–15,114.
43. Hunt, C.D.; Idso, J.P. Dietary boron as a physiological regulator of the normal inflammatory response: a review and current research progress. *J. Trace Elem. Exp. Med.* **1999**, *12*, 221–233.
44. Nielsen, F.H.; Penland, J.G. Boron supplementation of peri-menopausal women affects boron metabolism and indices associated with macromineral metabolism, hormonal status and immune function. *J. Trace Elem. Exp. Med.* **1999**, *12*, 251–261.
45. Amigorena, S.; Bonnerot, C. Fc receptor signaling and trafficking: a connection for antigen processing. *Immunol. Rev.* **1999**, *172*, 279–284.
46. Shin, K.-W.; Kiyohara, H.; Matsumoto, T.; Yamada, H. Rhamnogalacturonan II from the leaves of *Panax ginseng* C.A. Meyer as a macrophage Fc receptor expression-enhancing polysaccharide. *Carbohydrates Res.* **1997**, *300*, 239–249.
47. Nielsen, F.H.; Mullen, L.M.; Gallagher, S.K. Effect of boron depletion and repletion on blood indicators of calcium status in humans fed a magnesium-low diet. *J. Trace Elem. Exp. Med.* **1990**, *3*, 45–55.
48. Nielsen, F.H.; Gallagher, S.K.; Johnson, L.K.; Nielsen, E.J. Boron enhances and mimics some effects of estrogen therapy in postmenopausal women. *J. Trace Elem. Exp. Med.* **1992**, *5*, 237–246.
49. Tietz, N.W. *Textbook of Clinical Chemistry*; W.B. Saunders: Philadelphia, 1986.
50. Naghii, M.R.; Samman, S. The effect of boron supplementation on its urinary excretion and selected cardiovascular risk factors in healthy male subjects. *Biol. Trace Elem. Res.* **1997**, *56*, 273–286.
51. Stokinger, H.E. Boron. In *Patty's Industrial Hygiene and Toxicology*; 3rd Ed.; Clayton, G.D., Clayton, F.E., Eds.; John Wiley and Sons: New York, 1981; Vol. 2B, 2978–3005.
52. WHO Task Group on Environmental Health Criteria for Boron. *Environmental Health Criteria 204: Boron*; World Health Organization: Geneva, 1998.
53. Litovitz, T.L.; Klein-Schwartz, W.; Oderda, G.M.; Schmitz, B.F. Clinical manifestations of toxicity in a series of 784 boric acid ingestions. *Am. J. Emerg. Med.* **1988**, *6*, 209–213.
54. Armstrong, T.A.; Spears, J.W.; Crenshaw, T.D.; Nielsen, F.H. Boron supplementation of a semi-purified diet for weanling pigs improves feed efficiency and bone strength characteristics and alters plasma lipid metabolites. *J. Nutr.* **2000**, *130*, 2575–2581.
55. Travers, R.L.; Rennie, G.C.; Newnham, R.E. Boron and arthritis: the results of a double-blind pilot study. *J. Nutr. Med.* **1990**, *1*, 127–132.





# Calcium

Robert P. Heaney

Creighton University, Omaha, Nebraska, U.S.A.

## INTRODUCTION

Calcium is an alkaline earth, divalent, cationic element, abundant in the biosphere and widely distributed in nature. It exhibits intermediate solubility. As a solid, calcium forms crystalline minerals with a variety of anions, thereby making up the bulk of limestone, marble, gypsum, coral, pearls, seashells, bones, and antlers. In solution, its ionic radius (0.99 Å units) allows it to fit snugly into the folds of protein molecules.

## ACTIONS AND PHARMACOLOGY/PHYSIOLOGY

Calcium is unusual—perhaps unique—among the nutrients in that its intake (whether from foods or supplements) is not related to its primary intracellular, metabolic function. Rather, calcium nutrition is centered almost exclusively on the secondary functions of the nutrient. Accordingly, the primary functions are described here for completeness, but only briefly. More information can be found in standard textbooks of cell physiology or reviews of calcium signaling.<sup>[1]</sup>

### Primary Metabolic Functions

Calcium acts as a second messenger within cells, linking external stimuli acting on cells to the specific, internal responses a cell is able to make (e.g., nerve signals and muscle contraction). By forming up to 8–12 coordination bonds with oxygen atoms in amino acid side chains, calcium stabilizes the tertiary structure of numerous catalytic and structural proteins. Cytosolic calcium ion levels are normally maintained at very low concentrations [3–4 orders of magnitude below extracellular fluid (ECF) levels]. The second messenger response occurs when calcium ions flood into critical cytosolic compartments in response to first message stimuli. Additionally, dissolved calcium in the circulating blood and ECF of all vertebrates supports such diverse functions as blood clotting and neuromuscular signal transmission.

Calcium is not consumed in the exercise of these metabolic functions.

ECF  $[Ca^{2+}]$  is tightly maintained at  $\sim 4.4$ – $5.2$  mg/dl (1.1–1.3 mmol/L). The regulatory apparatus behind this constancy consists of parathyroid hormone (PTH), calcitonin, and 1,25-dihydroxyvitamin D [ $1,25(OH)_2D$ ], acting jointly through control of intestinal calcium absorption efficiency, bone resorption, and the renal excretory threshold for calcium.

### Secondary Functions

Effects on the size and strength of the nutrient reserve (bone mass)

Calcium is lost continuously from the body through shed skin, hair, nails, sweat, and excreta. For this reason, land-living vertebrates, needing a continuous supply of calcium, have evolved an internal reserve, in the form of bone. Because bone also serves structural/mechanical functions, the reserve has become far larger than would be needed solely to protect calcium's primary functions. It is for this reason that the main functions themselves are not threatened by deficient calcium intake, or enhanced by calcium repletion.

The bony reserves are accessed by a process termed “bone remodeling.” Bony tissue is continuously renewed by first resorbing pre-existing volumes of bone and then subsequently replacing them with new bone. Mineralization of the new bone occurs at a rate that is the integral of the prior several days of osteoblast activity, and for that reason tends to be relatively constant over the short term. By contrast, osteoclastic bone resorption is controllable minute by minute. Thus, by modulating bone resorption, the body can, in effect, withdraw calcium from, or cause it to be taken up by, bone whenever ECF  $[Ca^{2+}]$  departs from optimal levels.

When daily absorbed calcium intake is less than that needed to offset daily calcium losses, resorption exceeds formation and the bony reserves are depleted. This occurs by net destruction of microscopic volumes of the bony tissue and scavenging of the calcium released in the process. Such decrease in skeletal mass results in a corresponding reduction in strength. Additionally, bone remodeling itself directly contributes to

Robert P. Heaney, M.D., is John A. Creighton University Professor, Creighton University, Omaha, Nebraska, U.S.A.

bony structural weakness,<sup>[2]</sup> insofar as the remodeling locus is, for the several months of its life cycle, depleted of its normal complement of bony material.

The principal purpose of calcium intake during growth is to support the accumulation of the skeletal mass called for in the genetic program, i.e., the building of a large calcium reserve. During the adult years, intake serves to: 1) offset daily losses, thus preventing unbalanced withdrawals from the skeletal reserves, with their inevitable, associated reduction in bony strength, and 2) reduce the level of bone remodeling to the minimum needed for optimum structural maintenance.<sup>[2]</sup> These two effects are the basis for the protective effect of calcium with respect to osteoporosis.

#### Intraluminal effects of unabsorbed dietary calcium

Net absorption efficiency for ingested calcium is of the order of 10–15% (see below). Accordingly, up to 90% of dietary and supplemental calcium remains in the intestinal lumen and is excreted as a component of the feces. At high calcium intakes, unabsorbed calcium amounts to 1000 mg (25 mmol) per day or more. This unabsorbed calcium complexes with other constituents of the digestive residue, blocking their absorption or neutralizing their luminal actions.<sup>[3]</sup> This occurs, for example, with oxalic acid, which may be either present in ingested plant foods, or produced by bacterial degradation of unabsorbed food fatty acids. Calcium oxalate formation in the gut reduces oxalate absorption and hence the renal oxalate load. It thereby reduces the risk of kidney stones. Similarly, calcium complexes directly with free fatty acids and bile acids in the digestate, which, in their free form, act as mucosal irritants. In colon cancer-prone individuals, these irritants would otherwise serve as cancer promoters. These actions are the basis for the protective effects of high calcium intakes on risks of renal stone disease and colon cancer.

Additionally, calcium complexes with dietary phosphorus, also blocking its absorption to some extent. This is the basis for the use of calcium salts as a part of the control of hyperphosphatemia in patients with end-stage renal disease (ESRD). Every 500 mg of ingested calcium (whether from foods or supplements) binds ~166 mg of coingested phosphorus, preventing its absorption.<sup>[4]</sup>

#### “Off-loop” effects of alterations in calcium homeostasis

When calcium intake is low, PTH is secreted to improve renal calcium conservation and intestinal absorption efficiency, the latter through 1- $\alpha$ -hydroxyl-

ation of 25(OH)D to 1,25(OH)<sub>2</sub>D in the kidney. The calcium-conserving effects of these hormones are part of a classical negative feedback loop, in the sense that 1,25(OH)<sub>2</sub>D, by increasing calcium absorptive extraction from food, counteracts to some extent the original stimulus to PTH secretion and 1,25(OH)<sub>2</sub>D synthesis.

In addition to these functions within the feedback control loop, 1,25(OH)<sub>2</sub>D binds to membrane receptors in many tissues not directly involved in calcium regulation.<sup>[3]</sup> These include vascular smooth muscle cells and adipocytes. These effects are termed “off-loop,” since they occur as a result of reduced ECF [Ca<sup>2+</sup>] but do not act to change that level. Hence, they do not influence the signals that caused them in the first place, i.e., they are not a part of the regulatory feedback loop. The cell membrane receptors are linked to calcium channels that open and let calcium ions into the cytosol, where they may trigger their usual second messenger function (but without the normal first messenger). The presence of high cytosolic calcium levels when dietary calcium is low has given rise to the term “calcium paradox disease.” In individuals with limited control of cytosolic [Ca<sup>2+</sup>], this rise in cytosolic calcium triggers inappropriate, tissue-specific cell activity, e.g., smooth muscle contraction in arterioles and adipogenesis in fat cells. These relationships are the basis for the protective effects of high calcium intake against hypertension and obesity, and probably for premenstrual syndrome and polycystic ovary syndrome as well.<sup>[3]</sup>

#### The Internal Calcium Economy

The adult human body contains approximately 1000–1300 g (25,000–32,500 mmol) of calcium, with more than 99% being locked up in bones and teeth. Low hydration of bone, together with the insolubility of hydroxyapatite (the principal form of calcium phosphate in mineralized tissues), means that most body calcium is effectively exterior to the ECF and accessible only by cellular action (e.g., osteoclastic bone resorption).

The ECF, which is the locus of all body calcium traffic, contains about 1 g (25 mmol) calcium (i.e., ~0.1% of total body calcium). Soft tissues contain another 7–8 g (175–200 mmol), mostly locked up in intracellular vesicles, which store calcium for its critical, second messenger function. The calcium homeostatic regulatory apparatus functions solely to maintain the constancy of the concentration of the ~1 g of calcium in the ECF. In healthy midlife adults, ECF calcium turns over at a rate of approximately 650 mg/day (~10 mg/kg/day), with bone mineralization and resorption accounting for half to two-thirds of that traffic.

Fig. 1 displays the principal organs involved in the transfers that comprise the traffic of the calcium economy, together with the sizes of those transfers in and out of the system. The values shown are typical of the calcium economy of a middle-aged woman. In considering the magnitudes of these transfers, it is important to recognize that they do not vary independent of one another. An increase in absorption, for example, produces an immediate decrease in bone resorption. This linkage is mediated by the PTH-calcitonin-vitamin D regulatory apparatus.

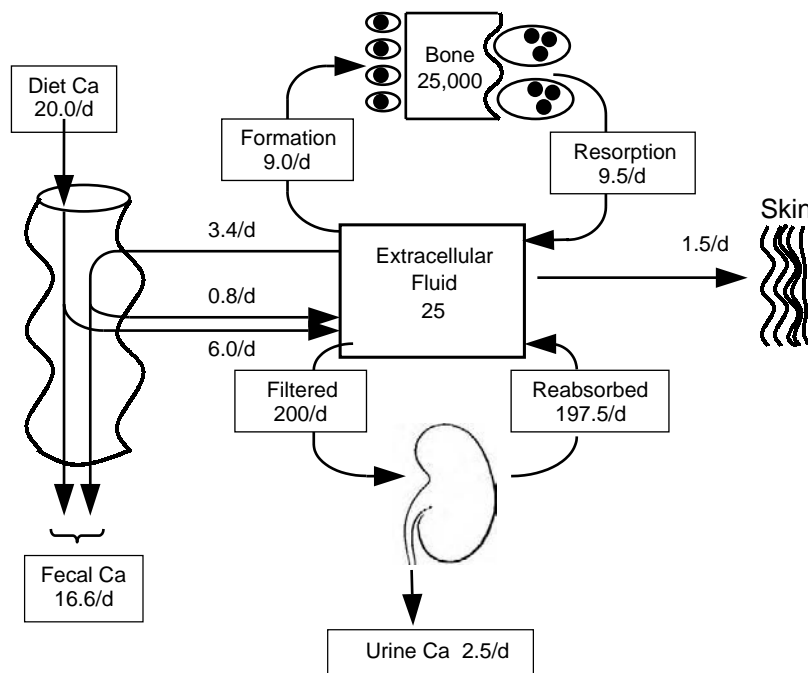
## Absorption

Calcium is absorbed mainly from the small intestine by a combination of active, transcellular transport and passive, paracellular diffusion. The active transport component is mediated by a vitamin D-dependent calcium binding protein (“calbindin”) that shuttles calcium ions from the luminal brush border to basolateral portions of the cell membrane, where calcium is released into the ECF. Calbindin activity is highest in the duodenum and drops along the length of the remaining bowel (including the colon). Accordingly active transport capacity is greatest in the duodenum. However, the residence time of the digestate in the duodenum is short, and most of the actual transport occurs in the jejunum and ileum, where it is longer.

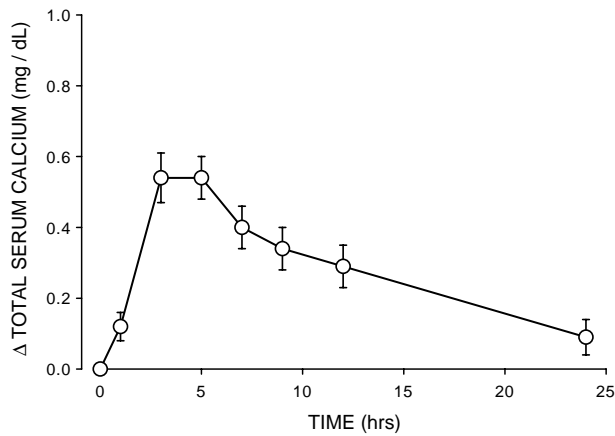
Fig. 2 shows the calcemic rise above baseline in healthy adults for a 500 mg calcium supplement source

ingested as part of a low-calcium breakfast. It illustrates a number of features of calcium absorption: 1) a delay of about 30 min before serum calcium begins to rise, reflecting gastric residence time; 2) peak calcemia at 3–5 hr after ingestion, indicating continuing absorptive input throughout that period of time; 3) a degree of calcemia approximating a 1% rise for every 100 mg calcium ingested, i.e., a perturbation that is within the usual normal range for serum calcium and hence effectively undetectable outside of a research context; and 4) gradual return to baseline by 9–10 hr. Tracer studies show that calcium absorption is effectively complete by 5 hr after ingestion,<sup>[5]</sup> and the slow fall to baseline after the peak reflects offsetting declines in other inputs into the ECF.

It is commonly considered that calcium salts must be dissociated to be absorbed, and hence that solubility predicts absorbability. However, this is probably incorrect. The pH of the digestate in the small intestine is close to neutral, and it is likely that most of the digestate calcium is complexed with prevailing anions in the digestate. Aqueous solubility of calcium salts spanning 4–5 orders of magnitude has been shown to have little or no effect on absorbability if the calcium source is coingested with food.<sup>[6]</sup> Double-tracer studies have demonstrated absorption of insoluble calcium complexes *without prior dissociation*.<sup>[7]</sup> Thorough dispersion of calcium salts among food particulates is probably more important than actual solubilization. Additionally, continuous



**Fig. 1** Principal routes of calcium entry into and exit from the extracellular fluid of an adult human. The values for bone and ECF are total masses (mmol); transfer rates are given in mmol/day and represent typical values. (To convert to milligrams, multiply values shown by 40.) Total body balance in this illustration is  $-0.5$  mmol/day. (Copyright Robert P. Heaney, 1996, 2004; used with permission.)

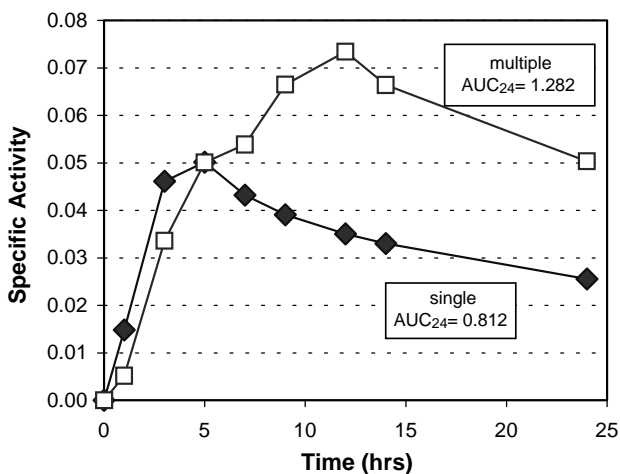


**Fig. 2** Time course of the rise in serum calcium following a single oral dose of a commercial calcium carbonate preparation (containing 500 mg calcium) taken as part of a light, low-calcium breakfast. Error bars are 1 SEM. (Copyright Robert P. Heaney, 2001, 2004; used with permission.)

slow release from the stomach, exposing the duodenal mucosa to only small amounts of calcium at a time, substantially improves absorption (Fig. 3).<sup>[8]</sup>

## Excretion

Calcium leaves the body through unabsorbed digestive secretions, through sweat and shed skin, hair, and nails, and through urine (see Fig. 1). In nonexercising



**Fig. 3** Time course of serum calcium tracer concentration following oral dosing of 1000 mg tracer-labeled calcium, either as a single bolus dose (“single”) or as 17 divided doses of 59 mg each (“multiple”) given over an 8-hr period. “Specific activity” is a measure of tracer concentration in the calcium contained in a serum sample. (Copyright Robert P. Heaney, 2002; used with permission.) (View this art in color at [www.dekker.com](http://www.dekker.com).)

adult humans with typical calcium intakes, digestive calcium losses amount to about 120 mg/day, cutaneous losses to around 60 mg/day, and urinary losses to about 120 mg/day, with great individual variability around these figures. Only the urinary loss is physiologically regulated by the system controlling calcium homeostasis, and much of even the urinary calcium represents obligatory loss, i.e., excretion determined by forces outside of the calcium regulatory system,<sup>[9]</sup> such as salt intake and net endogenous acid production (as, for example, from metabolism of S-containing amino acids). On average, urine calcium rises by about 45 mg (1.1 mmol) for every 1000 mg (25 mmol) increase in calcium intake. This increase is a reflection of the small absorptive calcemia (see Fig. 2), which produces a corresponding rise in the filtered load of calcium.

In adults, the primary purpose served by ingested calcium is the offsetting of obligatory excretory losses, thus protecting the skeletal reserves and thereby preserving their structural integrity. Ingested calcium, thus, does not so much “go” to bone as prevents net efflux of calcium out of bone.

## INDICATIONS AND USAGE

Calcium is a nutrient and would normally be ingested as a component of food. However, except for dairy foods, modern diets, especially seed-based plant foods (which are the basis of most contemporary diets), are calcium poor. Hence, for many individuals, achieving an adequate calcium intake may be difficult without recourse to supplements or calcium-fortified foods. (The latter are effectively equivalent to taking a supplement along with the otherwise unfortified food.)

## Supplementation to Achieve Recommended Intake Levels

Diets free of dairy foods typically contain no more than 200–300 mg calcium, far below currently recommended intakes (Table 1). Supplementation (or fortification) may be required to meet optimal intake objectives.

Since absorption efficiency is inversely proportional to the logarithm of the ingested load,<sup>[11]</sup> absorption is maximized by a divided dose regimen (e.g., 3× per day; see also Fig. 3). Also, because delivery of calcium to the absorptive sites in the upper small intestine is optimized under meal conditions, it is best to take calcium supplements with meals. (N.B.: Fortified foods tend, automatically, to meet both objectives.)

**Table 1** Estimated average requirements (EARs) for calcium and the corresponding RDAs (mg/day)

Age range	EAR	RDA <sup>a</sup>
Infants, 7–12 mo	270	350
Children		
1–3 yr	500	600
4–8 yr	800	1000
Boys and girls, 9–18 yr	1300	1550
Men and women		
19–50 yr	1000	1200
>50 yr	1200	1450

<sup>a</sup>Using an estimated 10% coefficient of variation of individual requirements around the population mean. (From Ref.<sup>[10]</sup>.)

### Preparations

The nutritional preparations of calcium include mainly salts with such anions as carbonate, citrate, phosphate, lactate, and citrate–malate (CCM). Additionally, salts with gluconic acid may occasionally be found, and calcium chelates with amino acids are also marketed. The calcium content (i.e., “elemental” calcium) varies from 40% for the carbonate salt to ~13% for CCM. For phosphate binding in ESRD, the acetate salt is more commonly used. In the United States, most preparations come in the form of swallowable or chewable tablets, with calcium contents ranging from 200 to 600 mg per tablet.

Bioavailability is approximately the same for all the leading salts, although CCM and the chelates tend toward the high end of the range and the gluconic acid salts toward the low end. Absorbability of the salt is only very weakly related to solubility, and gastric acid is not necessary for calcium absorption if the supplement is taken (as recommended) with meals. The most extensive, side-by-side comparisons have involved the carbonate and citrate salts, and the bulk of the evidence there indicates approximately equal absorbability for the two sources, with perhaps a slight edge for the carbonate salt.<sup>[12]</sup> Poor pharmaceutical formulation will impede disintegration and hence prevent absorption, a problem encountered with many generic calcium supplement products sold in the 1980s and early 1990s.<sup>[13]</sup> For this reason, preference should be given to supplements that meet United States Pharmacopeia (USP) disintegration standards, and even better, to those that have demonstrated bioavailability.

A growing variety of fortified foods have been available since about 1999. As noted, fortification tends to improve the nutritional value of low-calcium foods and, to some extent, it can be thought of as equivalent to taking supplements with meals. However, interactions between added calcium and various food

constituents during food processing and storage may alter the absorbability characteristics of the former. For example, it was noted during the early days of juice supplementation that CCM was well absorbed from orange and grapefruit juices, and even better from apple juice, but poorly from lemon juice. These differences could not have been predicted from what was known of food chemistry. Hence, with fortified foods as with supplements, actual bioavailability of the product reaching the consumer should be demonstrated.

When calcium is added to beverages (such as orange juice or soy beverage), an additional problem arises. Solubility of the principal calcium salts is relatively low, and serving size portions of such beverages would not sustain in solution more than a small fraction of the calcium content of, say, a comparable serving of milk. Hence, such fortification almost always requires physical suspension of a particulate. In some beverages, this suspension is so poor that the calcium settles as a dense sludge at the bottom of the beverage container and may, accordingly, not be ingested at all.<sup>[14]</sup>

### Supportive Therapy as a Part of Antiosteoporosis Pharmacotherapy

Current antiosteoporosis pharmacotherapy includes bisphosphonates, selective estrogen receptor modulators (SERMs), estrogen, and anabolic agents such as the fluoride salts and PTH derivatives, including teriparatide. All have as their goal at least stabilization of bone mass. Some of them, such as the bisphosphonates, can lead to slow steady state bone gain (0.5–1.0% per year), and the anabolic agents can produce as much as 10–15% bone gain per year. To support this increase, especially for the anabolic agents, calcium intake from diet must usually be augmented by supplements. Optimal doses for calcium during pharmacotherapy have not been established. However, all the bisphosphonates and SERMs have been tested only with 500–1000 mg supplemental calcium, while fluoride has been shown to produce bone hunger calling for as much as 2500 mg Ca/day. Only estrogen has been studied with and without supplemental calcium, and here the evidence is very clear: Bony effects of estrogen are augmented two- to threefold, and estrogen dose can be reduced if calcium intake is above 1000 mg/day.<sup>[15,16]</sup> With the more potent anabolic agents, a calcium phosphate preparation may be preferable, so as to ensure an adequate intake of both of the components of bone mineral and to compensate for the intestinal binding of diet phosphorus by high dose calcium supplementation.

### Ancillary Therapy for Prevention or Treatment of Miscellaneous Disorders

Hypertension, pre-eclampsia, colon cancer, renolithiasis, premenstrual syndrome, polycystic ovary syndrome, and obesity—all multifactorial disorders—have each been shown to have a calcium-related component,<sup>[3]</sup> and for several of them, calcium supplementation has been shown in randomized controlled trials to reduce incidence and/or expression. Optimal calcium intake for this protection has not been established for any of the disorders concerned, but several threads of evidence indicate that total intakes of 1200–1800 mg of Ca per day may be sufficient. The role of calcium in these disorders has been described above (see sections “Intraluminal Effects” and “Off-Loop Effects”). Specific pharmacotherapy of any of the disorders concerned should always be accompanied by an adequate calcium intake, using supplements if necessary.

### CONTRAINDICATIONS

There are few, if any, true contraindications to calcium supplementation. In general, supplementation moves contemporary intakes into the range that would have been the Paleolithic standard, and hence helps to normalize modern diets. However, patients receiving calcitriol therapy or suffering from disorders such as sarcoidosis, in which calcium absorption may be high, should not take supplements except under medical supervision.

### PRECAUTIONS AND ADVERSE REACTIONS

Calcium supplements may bind with tetracycline antibiotics and hence reduce their absorbability. The element has also been reported to interfere slightly with thyroxin absorption. Hence, a person requiring both calcium and thyroid replacements should take them at different times of the day or have plasma thyroxin and thyroid stimulating hormone (TSH) levels checked to ensure that the thyroid dose produces the desired therapeutic effect. Both calcium salts and high calcium foods reduce absorption of nonheme iron ingested at the same meal in unprepared subjects. However, chronic supplementation studies show no long-term deterioration in iron status in adults and no interference with augmenting iron status during growth.<sup>[17]</sup> The single-meal tests that are used to demonstrate this interference could not have detected physiological upregulation of iron absorption.

Adverse reactions tend to be extremely rare and mostly idiosyncratic. Although constipation is often

said to be a consequence of taking calcium carbonate, the evidence is scant,<sup>[18]</sup> and in several randomized controlled trials, the difference in degree of constipation between the calcium- and placebo-treated groups has generally been small and usually not statistically significant.

### OVERDOSAGE

In its 1997 recommendations, the Food and Nutrition Board of the Institute of Medicine set a tolerable upper intake level (TUIL) for calcium of 2500 mg/day.<sup>[9]</sup> However, it is important to note that there has never been a reported case of overdosage of calcium from food sources, even at continuing intakes over 6000 mg/day. Supplement intakes above 2500 mg/day are occasionally associated with a syndrome similar to the milk alkali syndrome. The pathogenesis of the hypercalcemia seen in this condition is complex, but there is usually hypoperfusion of both the kidneys and skeleton, the two most important internal regulatory organs for calcium. The condition can usually be managed by giving attention to adequate hydration and maintenance of blood flow to these critical organs. Except as support for the most potent osteoporosis pharmacotherapy, or in management of the hyperphosphatemia of ESRD, there is no known reason to use supplements at a dose above 2500 mg Ca/day.

### REGULATORY STATUS

Calcium supplements are regulated as foods in the United States. Bioavailability is not a regulated characteristic of marketed supplement products. Nevertheless, because of pharmaceutical formulation and food matrix effects on absorbability, bioavailability of different preparations of the same salt (e.g., calcium carbonate) may vary over a twofold range.

### REFERENCES

1. Awumey, E.M.; Bukoski, R.D. Cellular functions and fluxes of calcium. In *Calcium and Human Health*; Weaver, C.M., Heaney, R.P., Eds.; Humana: Totowa, NJ. 2005.
2. Heaney, R.P. Is the paradigm shifting? *Bone* **2003**, *33*, 457–465.
3. Heaney, R.P. Ethnicity, bone status, and the calcium requirement. *Nutr. Res.* **2002**, *22* (1–2), 153–178.
4. Heaney, R.P.; Nordin, B.E.C. Calcium effects on phosphorus absorption: implications for the

- prevention and co-therapy of osteoporosis. *J. Am. Coll. Nutr.* **2002**, *21* (3), 239–244.
5. Barger-Lux, M.J.; Heaney, R.P.; Recker, R.R. Time course of calcium absorption in humans: evidence for a colonic component. *Calcif. Tissue Int.* **1989**, *44*, 308–311.
  6. Heaney, R.P.; Recker, R.R.; Weaver, C.M. Absorbability of calcium sources: the limited role of solubility. *Calcif. Tissue Int.* **1990**, *46*, 300–304.
  7. Hanes, D.A.; Weaver, C.M.; Heaney, R.P.; Wastney, M. Absorption of calcium oxalate does not require dissociation in rats. *J. Nutr.* **1999**, *129*, 170–173.
  8. Heaney, R.P.; Berner, B.; Louie-Helm, J. Dosing regimen for calcium supplementation. *J. Bone Miner. Res.* **2000**, *15* (11), 2291.
  9. Nordin, B.E.C.; Polley, K.J.; Need, A.G.; Morris, H.A.; Marshall, D. The problem of calcium requirement. *Am. J. Clin. Nutr.* **1987**, *45*, 1295–1304.
  10. Food and Nutrition Board, Institute of Medicine. *Dietary Reference Intakes for Calcium, Magnesium, Phosphorus, Vitamin D, and Fluoride*; National Academy Press: Washington, DC, 1997.
  11. Heaney, R.P.; Weaver, C.M.; Fitzsimmons, M.L. The influence of calcium load on absorption fraction. *J. Bone Miner. Res.* **1990**, *11* (5), 1135–1138.
  12. Heaney, R.P.; Dowell, M.S.; Barger-Lux, M.J. Absorption of calcium as the carbonate and citrate salts, with some observations on method. *Osteoporosis Int.* **1999**, *9*, 19–23.
  13. Shangraw, R.F. Factors to consider in the selection of a calcium supplement. Proceedings of the 1987 Special Topic Conference on Osteoporosis. Public Health Report 1989, S104, 46–49.
  14. Heaney, R.P.; Rafferty, K.; Bierman, J. Not all calcium-fortified beverages are equal. *Nutr. Today* **2005**.
  15. Nieves, J.W.; Komar, L.; Cosman, F.; Lindsay, R. Calcium potentiates the effect of estrogen and calcitonin on bone mass: review and analysis. *Am. J. Clin. Nutr.* **1998**, *67*, 18–24.
  16. Recker, R.R.; Davies, K.M.; Dowd, R.M.; Heaney, R.P. The effect of low dose continuous estrogen and progesterone therapy with calcium and vitamin D on bone in elderly women: a randomized controlled trial. *Ann. Intern. Med.* **1999**, *130*, 897–904.
  17. Ilich-Ernst, J.Z.; McKenna, A.A.; Badenhop, N.E.; Clairmont, A.C.; Andon, M.B.; Nahhas, R.W.; Goel, P.; Matkovic, V. Iron status, menarche, and calcium supplementation in adolescent girls. *Am. J. Clin. Nutr.* **1998**, *68*, 880–887.
  18. Clemens, J.D.; Feinstein, A.R. Calcium carbonate and constipation: a historical review of medical mythopoeia. *Gastroenterology* **1977**, *72*, 957–961.





# L-Carnitine and Acetyl-L-Carnitine

**Charles J. Rebouche**

*Carver College of Medicine, University of Iowa, Iowa City, Iowa, U.S.A.*

## INTRODUCTION

L-Carnitine [known chemically as *R*(-)-β-hydroxy-γ-(*N,N,N*-trimethylammonio)butyrate; molecular weight 161.2 g/mol] is a water-soluble quaternary amine that facilitates lipid metabolism. Only the L isomer is biologically active. Humans acquire varying amounts of L-carnitine from dietary sources, but a dietary requirement has not been established. The goal of this entry is to survey the literature on the clinical findings on L-carnitine, but due to space constraints, it is not an exhaustive review of the literature. Readers are directed to the references for more information.

## BIOCHEMISTRY AND FUNCTIONS

The human body synthesizes L-carnitine from the essential amino acids lysine and methionine in amounts that are limited but adequate for the maintenance of normal health.<sup>[1]</sup> L-Carnitine participates in a reversible transesterification reaction, in which an acyl group is transferred from coenzyme A to the hydroxyl group of L-carnitine (Fig. 1). Acetyl-L-carnitine [*R*(-)-β-acetoxy-γ-(*N,N,N*-trimethylammonio)butyrate; molecular weight 204.2 g/mol] is biosynthesized in this manner. Carnitine and acetyl-L-carnitine are also obtained in varying amounts from the diet.<sup>[1]</sup>

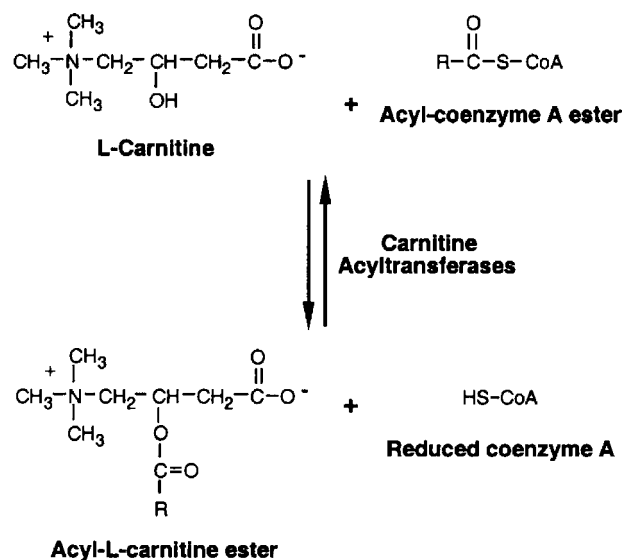
### Transfer of Long-Chain Fatty Acids from Cytoplasm into Mitochondria

Long-chain fatty acids, as free acids or coenzyme A esters, cannot cross the mitochondrial inner membrane. In contrast, long-chain acylcarnitine esters rapidly cross this membrane, facilitated by a carrier protein, carnitine–acylcarnitine translocase (CACT).<sup>[2]</sup> In the cytoplasm, transesterification of long-chain fatty acids from coenzyme A to L-carnitine is catalyzed by carnitine palmitoyltransferase I (CPT I), an integral

protein of the mitochondrial outer membrane. This enzyme serves as the primary regulator in partitioning fatty acids towards oxidation in mitochondria or triglyceride synthesis, and its activity is regulated principally through inhibition by malonyl-CoA.<sup>[3]</sup> On the matrix side of the mitochondrial inner membrane, the acyl group of the carnitine ester is transferred to intramitochondrial coenzyme A and carnitine is released.<sup>[2]</sup> This reaction is catalyzed by carnitine palmitoyltransferase II (CPT II), an enzyme bound to the surface of the membrane.<sup>[2]</sup> L-Carnitine, either nonesterified or as a short-chain acyl ester, may then exit the mitochondrion via CACT (Fig. 2).

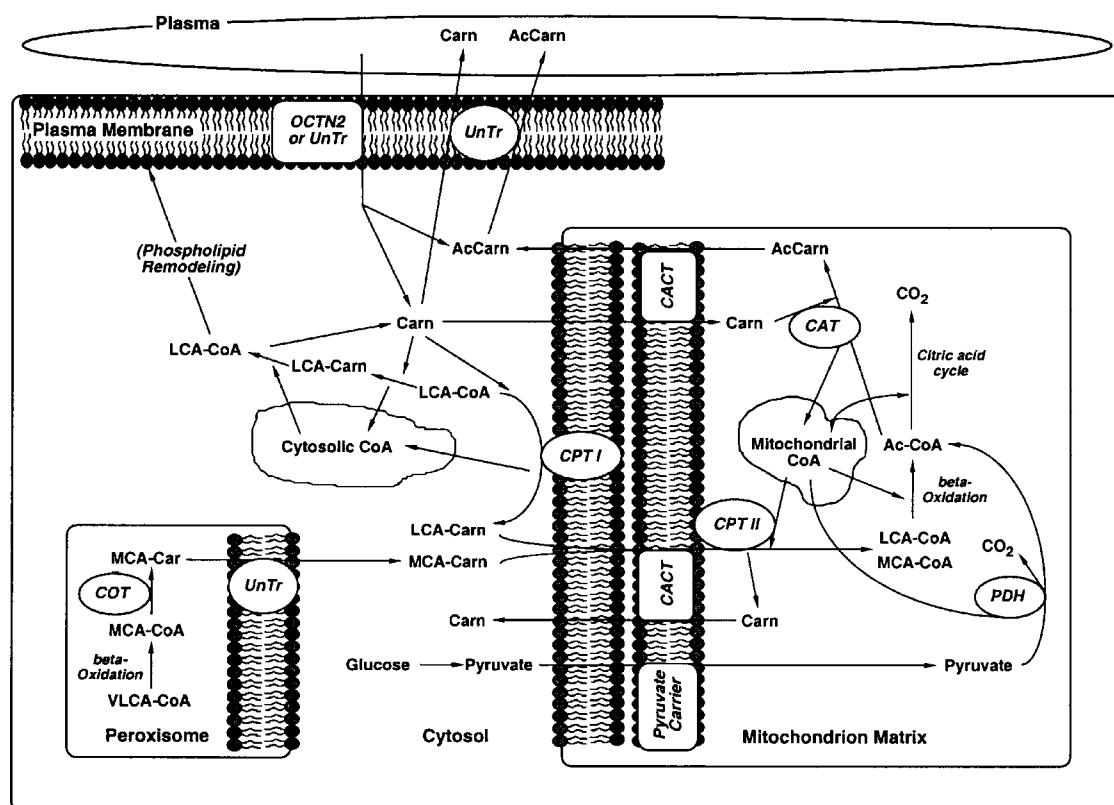
### Transfer of Chain-Shortened Fatty Acids from Peroxisomes to Mitochondria

Very-long-chain fatty acids are not metabolized in the mitochondria. Instead, they enter peroxisomes and undergo several β-oxidation cycles, leading to the generation of medium-chain acyl-CoA. These acyl groups are then transesterified by carnitine octanoyltransferase for export.<sup>[2]</sup> Medium-chain acylcarnitine



**Fig. 1** Transesterification reaction between L-carnitine and coenzyme A.

*Charles J. Rebouche, Ph.D.*, is at the Carver College of Medicine, University of Iowa, Iowa City, Iowa, U.S.A.



**Fig. 2** L-Carnitine and acetyl-L-carnitine transport and function. Abbreviations: Carn, L-Carnitine; AcCarn, acetyl-L-carnitine; OCTN2, organic cation transporter 2; UnTr, unidentified transporter(s); LCA-CoA, long-chain acyl-coenzyme A; MCA-CoA, medium-chain acyl-coenzyme A; VLCA-CoA, very-long-chain acyl-coenzyme A; LCA-Carn, long-chain acylcarnitine esters; MCA-Carn, medium-chain acylcarnitine esters; Ac-CoA, acetyl-coenzyme A; CPT I, carnitine palmitoyltransferase I; CPT II, carnitine palmitoyltransferase II; CAT, carnitine acetyltransferase; COT, carnitine octanoyltransferase; CACT, carnitine-acylcarnitine translocase; PDH, pyruvate dehydrogenase complex.

esters exported from peroxisomes are transported into mitochondria by CACT, and the acyl moieties are transesterified to coenzyme A and oxidized (Fig. 2).<sup>[2]</sup>

### Modulation of the Acyl-CoA/CoA Ratio in Cellular Compartments

Coenzyme A participates in many metabolic processes in the cellular cytoplasm and organelles. However, neither coenzyme A nor its thioesters can cross the membranes separating these compartments. Thus, in each compartment, sufficient nonesterified coenzyme A must be made available to maintain metabolic activities in that part of the cell. Because of its ability to be transported across organelle membranes and undergo rapid transesterification with coenzyme A, L-carnitine facilitates availability of adequate amounts of the deacylated coenzyme. In mitochondria, the amount of acetyl-CoA generated from rapid  $\beta$ -oxidation of fatty acids or carbohydrate utilization may exceed the

capacity of the citric acid cycle to release the coenzyme. Transesterification of acetyl units to L-carnitine, catalyzed by carnitine acetyltransferase (CAT), frees intramitochondrial coenzyme A for participation in subsequent cycles of substrate utilization.<sup>[3,4]</sup> Lowering of the acetyl-CoA/CoA ratio stimulates pyruvate oxidation, secondary to an increase in pyruvate dehydrogenase complex activity.<sup>[4]</sup> Acetyl-L-carnitine can be removed from the mitochondrion via CACT for use in the cytoplasm, for export and use in other cells or tissues, or to be excreted.<sup>[3,4]</sup> This function has long been viewed primarily as a means to dispose of acetyl units from mitochondria. However, export of acetyl-L-carnitine from some cells and tissues (e.g., liver and kidney) may be important for supply of this metabolite to other tissues (e.g., brain), where it may have specific functions in addition to its use as a substrate for energy production. Moreover, by modulating the intramitochondrial acetyl-CoA/CoA ratio, L-carnitine plays a significant role in regulating glucose metabolism in skeletal muscle and heart.<sup>[4]</sup>

## Membrane Phospholipid Remodeling

L-Carnitine and extramitochondrial CPT are important modulators of long-chain fatty acid utilization for membrane phospholipid biosynthesis and remodeling. L-Carnitine acts as a reservoir of long-chain fatty acids for incorporation into erythrocyte membrane phospholipids during repair after oxidative insult,<sup>[2]</sup> and for use in the synthesis of dipalmitoylphosphatidylcholine, the major component of surfactant, in lung alveolar cells.<sup>[2]</sup>

## Other Reported Actions of L-Carnitine and/or Acetyl-L-Carnitine

L-Carnitine may mimic some of the actions of glucocorticoids in vivo. In HeLa cells, L-carnitine reduced glucocorticoid receptor- $\alpha$  affinity for its steroid ligand, and triggered nuclear translocation of the receptor.<sup>[5]</sup> It suppressed glucocorticoid receptor-mediated tumor necrosis factor- $\alpha$  and interleukin-12 release by human primary monocytes stimulated with lipopolysaccharide ex vivo.<sup>[5]</sup> All of these effects of L-carnitine were concentration dependent. In rats and mice, L-carnitine markedly suppressed liposaccharide-induced cytokine production, improving their survival during cachexia and septic shock.<sup>[5]</sup> In humans, L-carnitine supplementation of surgical and AIDS patients decreased serum tumor necrosis factor- $\alpha$  concentration.<sup>[5]</sup> Glucocorticoids also increase the expression and activity of urea cycle enzymes. Hyperammonemia associated with chronic valproic acid therapy and with several inborn errors of metabolism, including CACT deficiency and medium-chain acyl-CoA dehydrogenase deficiency, is attenuated by L-carnitine administration. Experimentally, L-carnitine supplementation protects against lethal ammonia intoxication in mice.<sup>[6]</sup> One suggested mechanism for these effects of L-carnitine is increased synthesis and activity of urea cycle enzymes, a process also responsive to glucocorticoids.

L-Carnitine is a peripheral antagonist of thyroid hormone action in some tissues.<sup>[7]</sup> It inhibits thyroid hormone entry into cell nuclei. In a controlled clinical trial, L-carnitine was shown to reverse or prevent some symptoms of hyperthyroidism.<sup>[7]</sup>

Acetyl-L-carnitine may directly or indirectly reverse age-associated mitochondrial decay.<sup>[8]</sup> It acts as a chaperone to protect macromolecules, including carnitine acetyltransferase, from structural alteration and/or loss of function. Acetyl-L-carnitine partially reverses age-associated loss of mitochondrial membrane potential and decline in membrane cardiolipin concentration, and protects against oxidative damage to mitochondrial DNA.<sup>[8]</sup> In aging rats, it improves brain function and ambulatory activity.<sup>[8]</sup>

## PHYSIOLOGY

### Dietary Intake and Biosynthesis

Meat, fish, chicken, and dairy products are rich sources of dietary L-carnitine.<sup>[1]</sup> Plant derived foods contain very small amounts of the substance. Most commercially available infant formulas contain L-carnitine, either provided from the milk component, or supplemented, as in the case of soy-protein-based formulas. There is no recommended dietary allowance or dietary reference intake for L-carnitine.

In mammals, L-carnitine is synthesized from  $\epsilon$ -*N*-trimethyllysine, which is derived from post-translationally methylated lysine residues in proteins, and protein turnover.<sup>[1]</sup> In normal humans, the rate of synthesis is estimated to be about 1.2  $\mu$ mol/kg body weight/day.<sup>[1]</sup> The rate of L-carnitine biosynthesis is regulated by the availability of  $\epsilon$ -*N*-trimethyllysine. Thus, conditions that increase protein methylation and/or protein turnover may increase the rate of L-carnitine biosynthesis.<sup>[1]</sup>

### Bioavailability

Dietary L-carnitine may be absorbed through active or passive mechanisms. Evidence from several in vivo and in vitro studies indicates that L-carnitine is actively transported from the small intestinal lumen into enterocytes.<sup>[9]</sup> However, the preponderance of data suggests that intracellular L-carnitine in the intestinal mucosa does not cross serosal membranes by an active transport mechanism. Absorption of dietary L-carnitine and L-carnitine supplements appears to occur primarily by passive diffusion.<sup>[9]</sup> In humans, approximately 54–87% of dietary L-carnitine is absorbed, depending on the amount in the diet. The bioavailability of dietary supplements (0.6–4 g/day) is 15–20%.<sup>[9,10]</sup> Unabsorbed L-carnitine is degraded by micro-organisms in the large intestine. Major metabolites identified are trimethylamine oxide in urine and  $\gamma$ -butyrobetaine in feces.<sup>[9,10]</sup> Bioavailability of oral acetyl-L-carnitine has not been studied in normal healthy humans.

### Distribution in Tissues, Fluids, and Cells

L-Carnitine and acylcarnitine esters are present in all tissues. In most tissues and cells, they are present in higher concentration than in the circulation. For example, in human skeletal muscle and liver, respectively, nonesterified L-carnitine is concentrated 76-fold

and 50-fold from that in serum (estimated from data in Ref.<sup>[11]</sup>).

### Tissue Accumulation

L-Carnitine and acetyl-L-carnitine are concentrated in most tissues via the high-affinity,  $\text{Na}^+$ -dependent organic cation transporter OCTN2.<sup>[12]</sup>  $K_t$  for L-carnitine binding is 3–5  $\mu\text{M}$ ; OCTN2 binds acetyl-L-carnitine and propionyl-L-carnitine with comparable affinity. This protein is highly expressed in heart, placenta, skeletal muscle, kidney, pancreas, testis, and epididymis and weakly expressed in brain, lung, and liver. L-Carnitine entry into the liver occurs via a low-affinity ( $K_t = 5 \text{ mM}$ ) transporter, probably distinct from OCTN2. Several other L-carnitine transporters have been identified, including OCTN1, OCTN3, and  $\text{ATB}^{0,+}$ .<sup>[2]</sup> Specific roles for these transporters in carnitine metabolism in humans have not been determined.

### Homeostasis, Renal Reabsorption, and Excretion

Circulating L-carnitine concentrations are maintained at a fairly constant level of around 50  $\mu\text{M}$ , predominantly through efficient reabsorption by the kidney.<sup>[9]</sup> At a filtered load of 50  $\mu\text{mol/L}$ , the efficiency of L-carnitine and acylcarnitine ester reabsorption is 90–98%. However, as the filtered load of L-carnitine increases, as, for example, after consumption of a dietary supplement or after intravenous infusion, the efficiency of reabsorption declines rapidly. Physiologically, the efficiency of L-carnitine reabsorption is sensitive to the amount in the diet and to differences in the macronutrient content of the diet. Clearance of acylcarnitine esters is often higher than that of non-esterified L-carnitine. Experimental studies have shown that in rats and humans, kidneys are able to synthesize acetyl-L-carnitine from L-carnitine and either acetoacetate or  $\beta$ -hydroxybutyrate, and that L-carnitine, acetyl-L-carnitine, and  $\gamma$ -butyrobetaine (also synthesized in human kidneys) are secreted from mucosal cells into the tubular lumen.<sup>[9]</sup> Because the kinetics of transport of these metabolites by the sodium-dependent L-carnitine transporter are not different, the relative proportions appearing in urine reflect not only those in the glomerular filtrate, but also those in the renal tubular epithelium that are secreted into the lumen. Thus, under conditions of rapid intracellular synthesis of acylcarnitine esters or direct accumulation from the circulation, secretion of these species will lead to a higher proportion of acylcarnitine esters in urine compared to that in the circulation. By inference, kidneys may be substantially involved in the regulation of circulating acylcarnitine ester concentrations.<sup>[9]</sup>

## L-CARNITINE DEFICIENCIES

L-Carnitine deficiency is defined biochemically as abnormally low concentration (less than 20  $\mu\text{M}$ ) of nonesterified L-carnitine in plasma.<sup>[2]</sup> A concentration ratio of acylcarnitine esters/nonesterified L-carnitine of 0.4 or greater in plasma is also considered abnormal. Nutritional L-carnitine deficiency has not been shown to occur in the absence of other mitigating factors.<sup>[2]</sup>

Primary L-carnitine deficiency occurs as a result of defects in the gene coding for the plasma membrane L-carnitine transporter OCTN2.<sup>[13]</sup> Characteristic features of this disease are cardiomyopathy, hypoketotic hypoglycemia, and muscle weakness. Secondary deficiency occurs in genetic diseases of organic acid metabolism and fatty acid oxidation defects, end-stage renal disease requiring chronic hemodialysis, and chronic use of several drugs (including pivalic acid-containing prodrugs, valproic acid, cisplatin, ifosfamide, and zidovudine), and due to other genetic and iatrogenic factors.<sup>[14–17]</sup>

## INDICATIONS AND USAGE

L-Carnitine, acetyl-L-carnitine, and/or propionyl-L-carnitine may be used for replacement therapy to restore normal carnitine concentrations and/or a normal nonesterified-to-esterified carnitine ratio. They may be used as supplements to increase the carnitine load of the body and/or increase the flux of carnitine among compartments. In some conditions, both replacement therapy and supplementation are appropriate. For primary and some secondary carnitine deficiencies (see above), L-carnitine is used for replacement therapy.

### L-Carnitine Replacement Therapy and Supplementation in End-Stage Renal Disease

Regular L-carnitine supplementation in hemodialysis patients can improve lipid metabolism, antioxidant status, and anemia requiring erythropoietin, and may reduce incidence of intradialytic muscle cramps, hypotension, asthenia, muscle weakness, and cardiomyopathy.<sup>[17,18]</sup> The recommended dosage is 50 mg/kg body weight/day, to a maximum of 3 g/day.

### L-Carnitine and Propionyl-L-Carnitine Supplementation for Cardiac Ischemia, Congestive Heart Failure, Cardiomyopathy, and Peripheral Artery Disease

Experimental studies have shown L-carnitine to be an effective antianginal agent that reduces ST segment

depression and left ventricular end-diastolic pressure during stress in patients with coronary artery disease.<sup>[19]</sup> Cardioprotective effects of L-carnitine have been observed following aorto-coronary bypass grafting and following acute myocardial infarction. Carnitine administration initiated early after acute myocardial infarction attenuated left ventricular dilation and resulted in smaller left ventricular volumes.<sup>[19]</sup>

L-Carnitine deficiency syndromes sometimes present with dilated cardiomyopathy and are often effectively treated with L-carnitine.<sup>[20]</sup> Thus, it was suggested that cardiomyopathy progressing to congestive heart failure but not associated with inherited L-carnitine deficiency might respond to L-carnitine supplementation. A large scale clinical trial of L-carnitine supplementation versus placebo in 574 patients with heart failure produced promising results with regard to improvement in maximum duration of exercise, but other endpoints, including death and hospital admissions during the follow-up period, were not different between treatment groups.<sup>[20]</sup> Use of L-carnitine supplements for congestive heart failure not associated with inherited L-carnitine deficiency remains debatable.<sup>[20,21]</sup>

Peripheral arterial disease is a common manifestation of atherosclerosis and is associated with reduced arterial circulation in the lower extremities. Propionyl-L-carnitine supplementation (2 g/day) for 6 mo improved treadmill exercise performance and enhanced functional status in patients with claudication associated with peripheral arterial disease.<sup>[22]</sup>

### **L-Carnitine Supplementation for Exercise Performance and Weight Reduction**

L-Carnitine supplementation has been suggested to improve exercise performance in healthy humans. Proposed mechanisms include enhanced muscle fatty acid oxidation, altered glucose homeostasis, enhanced acylcarnitine production, modification of training responses, and altered muscle fatigue resistance.<sup>[23]</sup> A review of published studies has led to the conclusion that L-carnitine supplements do not improve exercise performance in healthy humans.<sup>[23–26]</sup> On the other hand, in conditions where the nonesterified L-carnitine concentration of skeletal muscle may be significantly reduced, such as in peripheral arterial disease and end-stage renal disease, L-carnitine supplementation has produced some benefit to muscle function and exercise performance.<sup>[26]</sup>

Because of its role in facilitating fatty acid oxidation, L-carnitine has been suggested to aid in weight loss regimes. Two facts argue against this. First, there is no evidence that it facilitates, directly or indirectly, mobilization of fatty acids from adipose tissue. Second, in normal humans, the intracellular concentration of

L-carnitine is sufficiently high for it not to be limiting for transesterification of fatty acids by CPT I. Adding an increment of L-carnitine will not increase the rate at which this reaction occurs. There is no scientific evidence that L-carnitine supplements facilitate weight loss in humans.

### **L-Carnitine and Acetyl-L-Carnitine Replacement Therapy and Supplementation for Chronic Fatigue**

As a dietary supplement, acetyl-L-carnitine may improve symptoms of fatigue in humans. Use of the cancer chemotherapeutic agents cisplatin and ifosfamide is associated with fatigue. In a prospective study, improvement of symptoms of fatigue was observed in 50 nonanemic patients following L-carnitine supplementation to the chemotherapeutic regimen of cisplatin or ifosfamide.<sup>[27]</sup> L-Carnitine may also attenuate the nephrotoxicity associated with cisplatin treatment.<sup>[28]</sup>

Chronic fatigue syndrome (CFS) in humans was found to be associated with low circulating acetyl-L-carnitine concentration and decreased accumulation in several brain regions.<sup>[29]</sup> It has been suggested that acetyl-L-carnitine helps to maintain neuronal metabolic activity by promoting glucose and lactate uptake and utilization through its role as a precursor of glutamate in neurons.<sup>[30]</sup> In a randomized, open-label study of 30 patients with CFS, acetyl-L-carnitine and propionyl-L-carnitine showed beneficial effects on fatigue and attention concentration.<sup>[31]</sup>

### **Acetyl-L-Carnitine Supplementation for Depression and Cognitive Function in the Elderly**

Acetyl-L-carnitine appears to have specific and perhaps unique roles in brain metabolism. Animal studies and in vitro experiments suggest that this agent has promise in slowing or reversing memory and cognition decline and the decline in physical performance that normally occurs in the process of aging. In studies of the elderly, patients with depressive syndrome scored significantly lower on the Hamilton Rating Scale for Depression (modified for the elderly) following supplementation with acetyl-L-carnitine.<sup>[32]</sup> Elderly subjects with mild mental impairment had improved scores on cognitive performance tests following such supplementation.<sup>[33]</sup> A meta-analysis of the efficacy of acetyl-L-carnitine in mild cognitive impairment and mild Alzheimer's disease included all identified double-blind, placebo-controlled, prospective, parallel-group studies using treatment doses of 1.5–3.0 g/day of acetyl-L-carnitine that were conducted between 1983 and 2000.<sup>[34]</sup> This analysis showed a significant advantage for acetyl-L-carnitine compared to placebo, with

beneficial effects observed on both clinical scales and psychometric tests. The benefit was observed by 3 mo of supplement use, and it increased over time. The typical usage recommended by vendors is 1–3 g/day.

### L-Carnitine Supplementation in Liver Dysfunction with Hyperammonemia

Hyperammonemia occurs in some inborn errors of metabolism and as a result of drug- or toxicant-induced hepatotoxicity. Mortality and metabolic consequences of acute ammonium intoxication in mice are reduced by pharmacologic administration of L-carnitine.<sup>[6]</sup> The mechanism for this effect may have two components. L-Carnitine administration normalizes the redox state of the brain (perhaps by increasing the availability of  $\beta$ -hydroxybutyrate and/or acetyl-L-carnitine to the brain), and it increases the rate of urea synthesis in the liver, perhaps in part by activation of the glucocorticoid receptor. At least part of the protective effect is associated with flux through the carnitine acyltransferases, as analogs of L-carnitine that are competitive inhibitors of carnitine acyltransferases enhance the toxicity of acute ammonium administration.<sup>[6]</sup> Thus, it has been proposed that L-carnitine increases urea synthesis in the liver by facilitating fatty acid entry into mitochondria, leading to increased flux through the  $\beta$ -oxidation pathway, an increase of intramitochondrial reducing equivalents, and enhancement of ATP production.<sup>[6]</sup> Carnitine supplementation may benefit individuals with hepatic dysfunction due to inborn errors of metabolism or chemical intoxication.

### L-Carnitine and Acetyl-L-Carnitine Replacement Therapy and Supplementation in Diabetes

L-Carnitine infusion improves insulin sensitivity in insulin-resistant diabetic patients.<sup>[35]</sup> Glucose oxidation is increased during L-carnitine administration, concurrent with lower plasma concentration of lactate. These observations suggest that L-carnitine activates normally depressed pyruvate dehydrogenase activity in insulin-resistant patients.<sup>[35]</sup> Intravenous administration of acetyl-L-carnitine increases glucose disposal in Type 2 diabetic patients.<sup>[36]</sup> Such administration appears to promote storage of glucose as glycogen, rather than increase glucose oxidation.<sup>[36]</sup>

### L-Carnitine and Acetyl-L-Carnitine Replacement Therapy and Supplementation in Human Immunodeficiency Virus (HIV) Infection

L-Carnitine and acyl-L-carnitine ester concentrations are below normal in some HIV-infected patients

undergoing antiretroviral therapy.<sup>[37]</sup> L-Carnitine administration as part of antiretroviral therapy with either zidovudine or didanosine reduced lymphocyte apoptosis and oxidant stress compared to the antiretroviral regimens without L-carnitine.<sup>[38]</sup>

### ADVERSE EFFECTS

Transient diarrhea, nausea, vomiting, abdominal cramps, and/or “fish-odor syndrome” have been noted in rare cases after consumption of 2–6 g of L-carnitine.<sup>[39]</sup>

### COMPENDIAL/REGULATORY STATUS

L-Carnitine is approved as a pharmaceutical by the U.S. Food and Drug Administration for treatment of primary systemic carnitine deficiency, and for acute and chronic treatment of patients with inborn errors of metabolism that result in secondary carnitine deficiency (e.g., medium-chain acyl-CoA dehydrogenase deficiency, glutaric aciduria, Type 2 diabetes, methylmalonic aciduria, and propionic acidemia).<sup>[39]</sup> L-Carnitine is also approved as a pharmaceutical by the U.S. Food and Drug Administration for the prevention and treatment of carnitine deficiency in patients with end-stage renal disease who are undergoing dialysis.<sup>[39]</sup>

### REFERENCES

1. Rebouche, C.J. Carnitine function and requirements during the life cycle. *FASEB J.* **1992**, *6* (15), 3379–3386.
2. Rebouche, C.J. Carnitine. In *Modern Nutrition in Health and Disease*, 10th Ed.; Shils, M.E., Shike, M., Ross, A.C., Caballero, B., Weinsier, R.L., Cousins, R.J., Eds.; Lippincott, Williams & Wilkins: Baltimore. *in press*.
3. Eaton, S. Control of mitochondrial  $\beta$ -oxidation flux. *Prog. Lipid Res.* **2002**, *41* (3), 197–239.
4. Lopaschuk, G.D. Carnitine and myocardial glucose metabolism. In *Carnitine Today*; De Simone, C., Famularo, G., Eds.; R.G. Landis Co.: Austin, 1997; 71–93.
5. Alesci, S.; De Martino, M.U.; Mirani, M.; Benvenga, S.; Trimarchi, F.; Kino, T.; Chrousos, G.P. L-Carnitine: a nutritional modulator of glucocorticoid receptor functions. *FASEB J.* **2003**; express article 10.1096/fj.02-1024fje, published online June 17, 2003 (accessed online August 2003).

6. O'Connor, J.-E.; Costell, M.; Grisolia, S. Protective effect of L-carnitine on hyperammonemia. *FEBS Lett.* **1984**, *166* (2), 331–334.
7. Benvenega, S.; Ruggeri, R.M.; Russo, A.; Lapa, D.; Campenni, A.; Trimarchi, F. Usefulness of L-carnitine, a naturally occurring peripheral antagonist of thyroid hormone action, in iatrogenic hyperthyroidism: a randomized, double-blind, placebo-controlled clinical trial. *J. Clin. Endocrinol. Metab.* **2001**, *86* (8), 3579–3594.
8. Liu, J.; Atamna, H.; Kuratsune, H.; Ames, B.N. Delaying brain mitochondrial decay and aging with mitochondrial antioxidants and metabolites. *Ann. N. Y. Acad. Sci.* **2002**, *959*, 133–166.
9. Rebouche, C.J.; Seim, H. Carnitine metabolism and its regulation in microorganisms and mammals. *Annu. Rev. Nutr.* **1998**, *18*, 39–61.
10. Rebouche, C.J. Kinetics, pharmacokinetics and regulation of L-carnitine and acetyl-L-carnitine metabolism. *Ann. N. Y. Acad. Sci.* **2004**, *1033*, 30–41.
11. Rebouche, C.J.; Engel, A.G. Carnitine metabolism and deficiency syndromes. *Mayo Clin. Proc.* **1983**, *58* (8), 533–540.
12. Ramsay, R.R.; Gandour, R.D.; van der Leij, F.R. Molecular enzymology of carnitine transfer and transport. *Biochim. Biophys. Acta* **2001**, *1546* (1), 21–43.
13. Tein, I. Carnitine transport: pathophysiology and metabolism of known molecular defects. *J. Inherited Metab. Dis.* **2003**, *26* (2), 147–169.
14. Bøhmer, T. Drug-induced carnitine deficiency. In *Carnitine. Pathobiochemical Basics and Clinical Applications*; Seim, H., Löster, H., Eds.; Ponte Press: Bochum, 1996; 167–176.
15. Famularo, G.; Matricardi, F.; Nucera, E.; Santini, G.; De Simone, C. Carnitine deficiency: primary and secondary syndromes. In *Carnitine Today*; De Simone, C., Famularo, G., Eds.; R.G. Landis Co.: Austin, 1997; 119–161.
16. Scaglia, F.; Longo, N. Primary and secondary alterations of neonatal carnitine metabolism. *Semin. Perinatol.* **1999**, *23* (2), 152–161.
17. Sundberg, E. The role of L-carnitine in treating anemia hyporesponsive to erythropoietin. *Dial. Transplant.* **2004**, *33* (6), 326–333.
18. Bellinghieri, G.; Santoro, D.; Calvani, M.; Mallamace, A.; Savica, V. Carnitine and hemodialysis. *Am. J. Kidney Dis.* **2003**, *41* (1, Suppl. 1), S116–S122.
19. Stanley, W.C.; Lopaschuk, G.D.; Hall, J.L.; McCormack, J.G. Regulation of myocardial carbohydrate metabolism under normal and ischaemic conditions. *Cardiovasc. Res.* **1997**, *33* (2), 243–257.
20. Atar, D.; Spiess, M.; Mandinova, A.; Cierpka, H.; Noll, G.; Lüscher, T.F. Carnitine—from cellular mechanisms to potential clinical applications in heart disease. *Eur. J. Clin. Invest.* **1997**, *27* (12), 973–976.
21. Arsenian, M.A. Carnitine and its derivatives in cardiovascular disease. *Prog. Cardiovasc. Dis.* **1997**, *40* (3), 265–286.
22. Hiatt, W.R.; Regensteiner, J.G.; Creager, M.A.; Hirsch, A.T.; Cooke, J.P.; Olin, J.W.; Gorbunov, G.N.; Isner, J.; Lukjanov, Y.V.; Tsitsiashvili, M.S.; Zabelskaya, T.F.; Amato, A. Propionyl-L-carnitine improves exercise performance and functional status in patients with claudication. *Am. J. Med.* **2001**, *110* (8), 616–622.
23. Brass, E.P. Supplemental carnitine and exercise. *Am. J. Clin. Nutr.* **2000**, *72* (2, Suppl. S), 618S–623S.
24. Wächter, S.; Vogt, M.; Kreis, R.; Boesch, C.; Bigler, P.; Hoppeler, H.; Krähenbühl, S. Long-term administration of L-carnitine to humans: effect on skeletal muscle carnitine content and physical performance. *Clin. Chim. Acta* **2002**, *318* (1–2), 51–61.
25. Heinonen, O.J. Carnitine and physical exercise. *Sports Med.* **1996**, *22* (2), 109–132.
26. Brass, E.P.; Hiatt, W.R. The role of carnitine and carnitine supplementation during exercise in man and in individuals with special needs. *J. Am. Coll. Nutr.* **1998**, *17* (3), 207.
27. Graziano, F.; Bissoni, R.; Catalano, V.; Silva, R.; Rovidati, S.; Mencarini, E.; Ferraro, B.; Canestrari, F.; Baldelli, A.M.; De Gaetano, A.; Giordani, P.; Testa, E.; Lai, V. Potential role of levocarnitine supplementation for the treatment of chemotherapy-induced fatigue in non-anemic cancer patients. *Brit. J. Cancer* **2002**, *86* (12), 1854–1857.
28. Chang, B.; Nishikawa, M.; Sato, E.; Utsumi, K.; Inoue, M. L-Carnitine inhibits cisplatin-induced injury of the kidney and small intestine. *Arch. Biochem. Biophys.* **2002**, *405* (1), 55–64.
29. Kuratsune, H.; Yamaguti, K.; Lindh, G.; Evengård, B.; Hagberg, G.; Matsumura, K.; Iwase, M.; Onoe, H.; Takahashi, M.; Machii, T.; Kanakura, Y.; Kitani, T.; Långström, B.; Watanabe, Y. Brain regions involved in fatigue sensation: reduced acetylcarnitine uptake into the brain. *NeuroImage* **2002**, *17* (3), 1256–1265.
30. Tanaka, M.; Nakamura, F.; Mizokawa, S.; Matsumura, A.; Matsumura, K.; Watanabe, Y. Role of acetyl-L-carnitine in the brain: revealed by Bioradiography. *Biochem. Biophys. Res. Commun.* **2003**, *306* (4), 1064–1069.
31. Vermeulen, R.C.; Scholte, H.R. Exploratory open label, randomized study of acetyl- and propionyl-carnitine in chronic fatigue syndrome. *Psychosom. Med.* **2004**, *66* (2), 276–282.



32. Tempesta, E.; Casella, L.; Pirrongelli, C.; Janiri, L.; Calvani, M.; Ancona, L. L-Acetylcarnitine in depressed elderly subjects. A cross-over study vs. placebo. *Drugs Exp. Clin. Res.* **1987**, *XII* (7), 417–423.
33. Salvioli, G.; Neri, M. L-Acetylcarnitine treatment of mental decline in the elderly. *Drugs Exp. Clin. Res.* **1994**, *XX* (4), 169–176.
34. Montgomery, S.A.; Thal, L.J.; Amrein, R. Meta-analysis of double blind randomized controlled clinical trials of acetyl-L-carnitine versus placebo in the treatment of mild cognitive impairment and mild Alzheimer's disease. *Clin. Psychopharmacol.* **2003**, *18* (2), 61–71.
35. Mingrone, G.; Greco, A.V.; Capristo, E.; Benedetti, G.; Giancaterini, A.; De Gaetano, A.; Gasbarrini, G. L-Carnitine improves glucose disposal in type 2 diabetic patients. *J. Am. Coll. Nutr.* **1999**, *18* (1), 77–82.
36. Giancaterini, A.; De Gaetano, A.; Mingrone, G.; Gniuli, D.; Liverani, E.; Capristo, E.; Greco, A.V. Acetyl-L-carnitine infusion increases glucose disposal in type 2 diabetic patients. *Metabolism* **1999**, *49* (6), 704–708.
37. Vilaseca, M.A.; Artuch, R.; Sierra, C.; Pineda, J.; Lopez-Vilches, M.A.; Munoz-Almagro, C.; Fortuny, C. Low serum carnitine in HIV-infected children on antiretroviral treatment. *Eur. J. Clin. Nutr.* **2000**, *53* (10), 1317–1322.
38. Moretti, S.; Famularo, G.; Marcellini, S.; Boschini, A.; Santini, G.; Trinchieri, V.; Lucci, L.; Alesse, E.; De Simone, C. L-Carnitine reduces lymphocyte apoptosis and oxidant stress in HIV-1-infected subjects treated with zidovudine and didanosine. *Antioxid. Redox Signal.* **2002**, *4* (3), 391–403.
39. *Physician's Desk Reference*, 57th Ed.; Thompson PDR: Montclair, NJ, 2003; 3152–3155.

## FURTHER READINGS

- Carnitine Today*; De Simone, C., Famularo, G., Eds.; R.G. Landis Co.: Austin, 1997.
- Liu, J.; Atamna, H.; Kuratsune, H.; Ames, B.N. Delaying brain mitochondrial decay and aging with mitochondrial antioxidants and metabolites. *Ann. N. Y. Acad. Sci.* **2002**, *959*, 133–166.
- Pettigrew, J.W.; Levine, J.; McClure, R.J. Acetyl-L-carnitine in mood, aging, and disease. In *Diet-Brain Connections: Impact of Memory, Mood, Aging and Disease*; Mattson, M.P., Ed.; Kluwer: Norwell, MA, 2002; 159–178.

# β-Carotene

Elizabeth J. Johnson

Robert M. Russell

Jean Mayer USDA Human Nutrition Research Center on Aging, Tufts University,  
Boston, Massachusetts, U.S.A.

## INTRODUCTION

β-Carotene (molecular formula  $C_{40}H_{56}$ ) is a fat soluble plant pigment found in red, orange, and yellow vegetables and fruits. β-Carotene is converted to vitamin A (retinal, retinol, retinoic acid), when the body is in short supply. It is an antioxidant—a compound that blocks the action of activated oxygen molecules that can damage cells. Dietary intake of foods containing β-carotene has been associated with cancer prevention. However, there is not enough evidence to support this. In fact, β-carotene supplementation may increase the risk of lung cancer among people already at high risk, such as smokers.

## BIOCHEMISTRY AND FUNCTIONS

β-Carotene belongs to a large class of plant pigments referred to as carotenoids. It is made up of eight isoprene units that are cyclized at each end of the molecule. β-Carotene functions in plants and in photosynthetic bacteria as an accessory pigment in photosynthesis, and protects against photosensitization in animals, plants, and bacteria. In humans, the only known function of β-carotene is its vitamin A activity. Other possible actions in humans include antioxidant activity, immunoenhancement, inhibition of mutagenesis and transformation, inhibition of pre-malignant lesions, and decreased risk of some cancers and some cardiovascular events. In the skin, β-carotene has been suggested to be protective against solar radiation damage.

## ABSORPTION AND METABOLISM

Because it is fat soluble, β-carotene follows the same intestinal absorption pathway as dietary fat.

Release from the food matrix and dissolution in the lipid phase are the important initial steps in the absorption process. β-Carotene is thought to be absorbed by the small intestinal mucosa via a passive, diffusion process. It is taken up by the mucosa of the small intestine and packaged into triacylglycerol-rich chylomicrons, and is partly converted to vitamin A by a specific enzyme, β-carotene 15,15'-oxygenase, in the intestinal mucosa. Both β-carotene and vitamin A (primarily as retinyl esters) are incorporated into chylomicrons and secreted into lymph for transport to the liver. Additional random cleavage at several double bonds in the polyene chain of β-carotene can occur when there is not an adequate supply of antioxidants, e.g., vitamin E. However, enzymatic central cleavage plays the major role in β-carotene breakdown under normal conditions. In conditions of oxidative stress (e.g., smoking or diseases associated with oxidative stress) or when high blood or tissue concentrations of β-carotene are present, both central and random cleavage may occur (Fig. 1).<sup>[1]</sup>

The delivery of β-carotene to extrahepatic tissue is accomplished through the interaction of lipoprotein particles with receptors and the degradation of lipoproteins by extrahepatic enzymes such as lipoprotein lipase. β-Carotene is present in a number of human tissues, including adipose, liver, kidney, adrenal gland, and testes, and is one of the major carotenoids in human diet, serum, and tissues.

In fasting serum, β-carotene is found primarily in low density lipoproteins (LDL), but appreciable amounts are also found in high density lipoproteins (HDL).<sup>[2–4]</sup> β-Carotene, being lipophilic, is located in the core of lipoproteins, which may explain why there is little transfer among them.

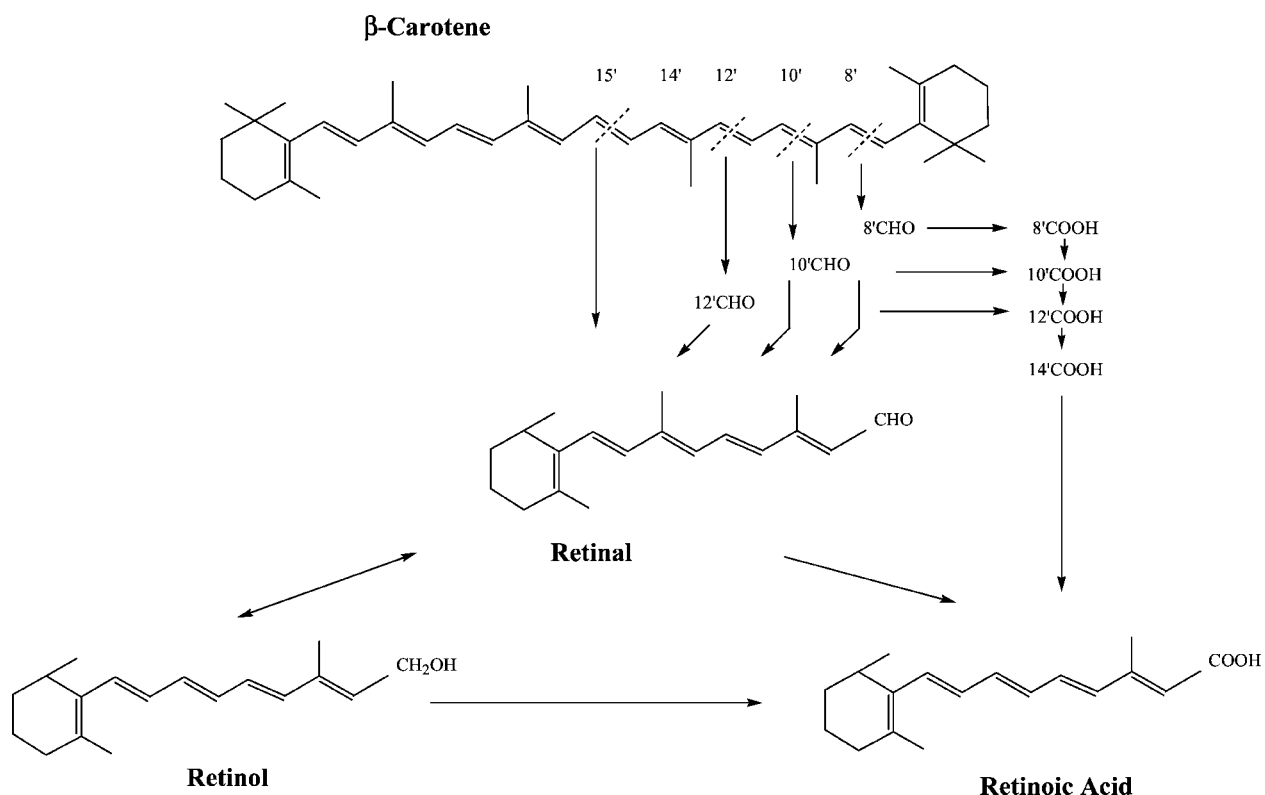
The concentration of β-carotene in human serum is highly variable and depends on a number of factors, including β-carotene intake, efficiency of absorption, and other components of the diet.

## BIOAVAILABILITY

The bioavailability of a carotenoid is considered to be the fraction of ingested carotenoid utilized for normal

Elizabeth J. Johnson, Ph.D., is a Research Scientist, Jean Mayer USDA Human Nutrition Research Center on Aging, and Assistant Professor, Tufts University, Boston, Massachusetts, U.S.A.

Robert M. Russell, M.D., is Director, Jean Mayer USDA Human Nutrition Research Center on Aging, and Professor, Tufts University, Boston, Massachusetts, U.S.A.



**Fig. 1** β-Carotene conversion to vitamin A (retinal, retinol, retinoic acid). Central cleavage between bonds 15 and 15' forms retinal directly. Cleavage at other bonds forms apo-carotenals (CHO). Apo-carotenals may be oxidized to apo-carotenoic acids (–COOH), which could form retinoic acid.

physiological functions or storage. Information on carotenoid bioavailability is based largely on serum levels after ingestion. The bioavailability of β-carotene from food, concentrated extracts, or synthetic products is quite variable. Several human studies have reported that the serum response of β-carotene from foods is more varied than the response from β-carotene supplements. Factors that affect β-carotene bioavailability include vehicle type (supplement vs. food; processed vs. unprocessed food) and dietary factors (amount of β-carotene, fat, and fiber).<sup>[5]</sup>

Compared with carrots (a source of β-carotene), supplements suspended in oil or in water from gelatin-stabilized beadlets (the form used in the major clinical trials) raise the plasma concentration approximately sixfold. This may be because a pure form of β-carotene does not need to be released from a food matrix for intestinal absorption. β-Carotene may have twice the bioavailability from fruits compared with green leafy vegetables. The percentage absorption of a single dose of β-carotene (45 μg to 39 mg) has been reported to range from 9% to 22%,<sup>[6–8]</sup> but the absorption efficiency decreases as the amount of carotenoids in the diet increases.<sup>[9–12]</sup> Absorption of β-carotene at dosages greater than 20–30 mg is limited because of factors such as solubility.<sup>[13]</sup>

Cooking and mechanical homogenization increase the bioavailability of carotenoids from foods. The mechanism by which this occurs is most likely the disruption of the food matrix to release the carotenoid from the matrix and from protein complexes. For example, the plasma response of β-carotene has been reported to be three times greater in spinach and carrots that were pureed and thermally processed than it was when these vegetables were consumed in raw, large pieces.<sup>[14]</sup>

Although dietary fat facilitates the absorption of β-carotene, the amount of dietary fat does not affect the postprandial increases in plasma β-carotene concentrations.<sup>[15]</sup> However, when β-carotene is given in the absence of fat, no detectable change in serum level occurs.<sup>[16]</sup>

Studies involving daily supplementation with high-dose β-carotene on plasma concentrations of other carotenoids for several years find no overall adverse effect on plasma concentrations of other carotenoids.<sup>[17]</sup>

The β-carotene: vitamin A (retinol) equivalency ratio of a low dose (<2 mg) of purified β-carotene in oil is approximately 2 : 1. The water miscible form of β-carotene is presumed to be better absorbed than the carotenoid in oil and, therefore, may have a more efficient (i.e., lower) conversion ratio. However, the

efficiency of absorption of β-carotene in food is lower than that of β-carotene in oil. The Institute of Medicine of the National Academy of Sciences proposed that 12 μg β-carotene in food has the same vitamin A activity as 1 μg retinol.<sup>[18]</sup>

## INDICATIONS AND USAGE

### Food Sources

β-Carotene is the most widely studied carotenoid and is one of the major carotenoids in our diet and in human blood and tissues.<sup>[19,20]</sup> Major sources of dietary β-carotene include green leafy vegetables as well as orange and yellow fruits and vegetables (Table 1).<sup>[21]</sup> However, the bioavailability of β-carotene from green leafy vegetables such as spinach is thought to be low.<sup>[22]</sup> Factors other than food vehicle are thought to be important in the bioavailability of β-carotene. These include cooking, chopping, and the presence of dietary fat, all of which improve the bioavailability.<sup>[14,23]</sup> Of the 50 different carotenoids that can be metabolized into vitamin A, β-carotene has the highest provitamin A activity. Typical dietary intakes of β-carotene in the United States are 0.5–6.5 mg/day.<sup>[24–26]</sup> However, intakes much higher than this are possible through over-the-counter supplements that are commonly available in health food stores in doses of 3–20 mg/capsule.

### Recommended Intakes

Although no dietary reference intakes (DRIs) are proposed for β-carotene at present,<sup>[27]</sup> existing

**Table 1** β-Carotene content of foods

Food	Content (mg/100 g wet wt) <sup>a</sup>
Carrots, raw	7.9
Carrots, cooked	9.8
Apricots, raw	3.5
Apricots, dried	17.6
Cantaloupe, raw	3.0
Kale	4.7
Pepper, red	2.2
Pumpkin	3.1
Spinach, raw	4.1
Spinach, cooked	5.5
Sweet potato, cooked	8.8
Winter squash, cooked	2.4

<sup>a</sup>Edible portion.  
(From Ref.<sup>[21]</sup>.)

recommendations for increased consumption of carotenoid-rich fruits and vegetables are supported. Based on evidence that β-carotene supplements have not been shown to provide any benefit for the prevention of major chronic diseases and may cause harm in certain subgroups (e.g., smokers and asbestos workers), it is concluded that β-carotene supplements are not advisable other than as a provitamin A. If there is adequate retinol in the diet, there are no known clinical effects of consuming diets low or moderate in β-carotene. β-Carotene is widely used in vitamin and mineral supplements at levels ranging from 0.4 to 20 mg/day. It is given medicinally in doses of up to 6 mg/day for dietary deficiency of vitamin A and up to 300 mg/day for the reduction of photosensitivity in individuals with erythropoietic protoporphyria.

Although no safe upper level of intake for β-carotene has been established in the United States, the European Expert Group on Vitamins and Minerals has established a safe upper level of β-carotene intake of 7 mg/day.<sup>[28]</sup> The safe upper level applies only to the general population, i.e., nonsmokers and those not exposed to asbestos. This safe upper level applies to β-carotene supplements only, given that there is no evidence to suggest that current levels of β-carotene intake from foods are harmful.

Excessive dietary intake of preformed vitamin A has been associated with reduced bone mineral density and increased risk of hip fractures. β-Carotene may be a safe source of vitamin A in osteoporotics given that it is not associated with bone demineralization.<sup>[29]</sup>

### Cancer Prevention

Observational epidemiologic studies have been very consistent in showing that people who consume higher dietary levels of fruits and vegetables have a lower risk of certain types of cancer.<sup>[30]</sup> The consistency of the results is particularly strong for lung cancer, where carotenoid and/or fruit and vegetable intake has been associated with reduced risk in all of 8 prospective studies and in 18 of 20 retrospective studies.<sup>[31]</sup> However, in 3 large randomized clinical trials using high-dose β-carotene supplements (20 mg/day, 30 mg/day, or 50 mg given every other day) for 4–12 yr, no protection was reported with respect to lung cancer or any other cancer.<sup>[32–34]</sup> In fact, in two of these studies, there was an increased risk of lung cancer in heavy smokers and asbestos workers with β-carotene supplementation<sup>[33,34]</sup> (see “Contraindications”). Thus, the high β-carotene levels in the epidemiologic studies may have reflected a diet high in fruits and vegetables, with many putative anticarcinogenic substances.

## Cardiovascular Disease

A body of evidence indicating that the oxidation of LDL plays an important role in the development of atherosclerosis has led investigators to consider a preventive role for  $\beta$ -carotene. Early in vitro studies of LDL oxidation showed that  $\beta$ -carotene carried in LDL is oxidized before the onset of oxidation of LDL polyunsaturated fatty acids, suggesting a possible role in delaying LDL oxidation. Epidemiologic studies, including descriptive, cohort, and case-control studies, suggest that  $\beta$ -carotene-rich diets are associated with a reduced risk of cardiovascular disease.<sup>[35–37]</sup> Furthermore, inverse association between serum or adipose  $\beta$ -carotene levels and cardiovascular outcomes has also been observed. However, in a meta-analysis of 8  $\beta$ -carotene treatment trials involving 138,113 subjects, a dose range of 15–50 mg/day and follow-up range from 1.4 to 12.0 yr, it was found that  $\beta$ -carotene supplementation led to a small but significant increase in all-cause mortality and a slight but significant increase in cardiovascular death.<sup>[38]</sup>

## Erythropoietic Protoporphyrin

Erythropoietic protoporphyria is an inborn defect of ferrochelatase resulting in an increase in the protoporphyrin content of the erythrocytes, plasma, and feces. The disease is characterized clinically by photosensitivity, which generally appears within the first few years of life. These patients experience a burning sensation of the skin within a few minutes or hours of exposure to sunlight, followed by edema, erythema, and purpura.  $\beta$ -Carotene is used therapeutically for the treatment of erythropoietic protoporphyria.<sup>[39]</sup> This is based on the observation that carotenoids prevent photosensitivity in bacteria. On treatment of the condition with extremely high doses (180 mg/day) of  $\beta$ -carotene, a marked improvement in skin photosensitivity has been reported in some, but not all, patients. No toxic effects have been

observed from this treatment in the limited number of patients reported.

## CONTRAINDICATIONS

The epidemiologic observations of possible protective effects of high  $\beta$ -carotene intakes against cancer, along with what is known about carotenoid biochemical functions, led to further study of the effect of  $\beta$ -carotene on cancer risk. Long-term large randomized intervention trials were designed to test the efficacy of high doses of  $\beta$ -carotene (20–30 mg/day) in the prevention of cancer (Table 2). Surprisingly, the results from two trials provide possible evidence of harm from  $\beta$ -carotene supplements in relation to cancer among high-risk individuals, such as smokers and asbestos workers,<sup>[32,33]</sup> but no effect (either beneficial or detrimental) in a generally well-nourished population.<sup>[34]</sup> However, in the Linxian (Chinese) Cancer Prevention Study,<sup>[40]</sup> it was found that supplementation with  $\beta$ -carotene doses, vitamin E, and selenium led to a significant reduction in total mortality (9%), especially from cancer (13%) and particularly stomach cancer (21%) (Table 3). The positive results of the Chinese study probably reflect the correction of a vitamin A deficiency in this study population. A number of mechanisms have been proposed to account for the association between  $\beta$ -carotene supplementation and lung cancer in smokers and asbestos workers, including an imbalance of other carotenoids or antioxidants, a pro-oxidant activity of  $\beta$ -carotene at the high oxygen tensions found in the lungs, induction of P450 enzymes, and the production of damaging  $\beta$ -carotene oxidation products by components of cigarette smoke.<sup>[41]</sup>

The epidemiologic studies that led to these intervention studies reported a relationship between diet and/or blood  $\beta$ -carotene levels and cancer prevention. It is probable that  $\beta$ -carotene serves as a marker of increased fruit and vegetable intake and, therefore, of all components that have cancer prevention potential,

**Table 2**  $\beta$ -Carotene supplementation trials: Study designs

Study (Ref.)	Population	Intervention	Duration
ATBC <sup>[32]</sup>	29,133 Finnish male smokers (50–69 yr of age)	$\beta$ -Carotene, 20 mg/day + vitamin E, 50 mg/day	5–8 yr
CARET <sup>[33]</sup>	18,314 men and women and asbestos workers (45–74 yr of age)	$\beta$ -Carotene, 30 mg/day + vitamin A, 25,000 IU	<4 yr
PHS <sup>[34]</sup>	22,071 male physicians (40–84 yr of age)	$\beta$ -Carotene, 50 mg on alternate days	12 yr
Linxian <sup>[40]</sup>	29,584 men and women, vitamin and mineral deficient (40–69 yr)	$\beta$ -Carotene, 15 mg/day; selenium, 50 $\mu$ g/day; $\alpha$ -tocopherol, 30 mg/day	5 yr

**Table 3** β-Carotene supplementation trials: Cancer outcomes

Study (Ref.)	Cancer outcome
ATBC <sup>[32]</sup>	18% increase in lung cancer; 8% increase in mortality
CARET <sup>[33]</sup>	28% increase in lung cancer; 17% increase in deaths
PHS <sup>[34]</sup>	No effect of supplementation on incidence of cancer
Linxian <sup>[40]</sup>	13% decrease in total cancers; 9% decrease in overall deaths

e.g., vitamin C, folic acid, other carotenoids, and polyphenols.

### TOXICITY/ADVERSE EFFECTS

β-Carotene obtained from eating fruits and vegetables is considered safe. β-Carotene first became available as a pharmaceutical product in the early 1970s. It can be purified from natural sources such as green plants or algae, or it can be manufactured synthetically. Purity of β-carotene may be a problem when derived from plant or algal sources. Preparations of crystalline β-carotene in oil are widely available. Although not harmful, high doses of β-carotene (from foods and supplements) can result in a skin condition known as carotenoderma, in which the skin turns a yellow-orange color due to an elevation of plasma and tissue carotene concentrations. Carotenoderma is harmless and reversible when β-carotene ingestion is discontinued. This condition has been reported in adults taking supplements containing 20–30 mg/day or more of β-carotene for long periods of time or consuming high levels of carotenoid-rich foods such as carrots,<sup>[42]</sup> and is the primary effect of excess carotenoid intake noted in infants, toddlers, and young children.<sup>[43]</sup> Carotenoderma is distinguished from jaundice in that the ocular sclera are yellowed in jaundiced subjects, but not in those with carotenoderma.

In the treatment of erythropoietic protoporphyria (180 mg/day), no toxic effects have been observed.<sup>[39]</sup> However, the numbers studied have been small. There is no evidence that β-carotene is teratogenic, mutagenic, or carcinogenic in long-term bioassays in experimental animals.<sup>[44]</sup> In humans, there have been no reports of reproductive toxicity or teratogenicity associated with high β-carotene intake, either before or during pregnancy. In addition, long-term supplementation with β-carotene to persons with adequate vitamin A status does not increase the concentration of serum retinol, as the metabolic conversion is regulated by vitamin A status.<sup>[17]</sup>

Doses of 20–30 mg/day of β-carotene for 4–12 yr have been associated with an increased risk of lung cancer in high-risk groups (i.e., smokers and asbestos-exposed workers). Similar to the results in human intervention studies, β-carotene supplementation [2.4 mg/kg body weight (bw) per day with exposure of animals to cigarette smoke] was associated with the development of squamous cell metaplasia in the lungs of ferrets.<sup>[45]</sup> The development of squamous cell metaplasia was also observed in animals supplemented with β-carotene (2.4 mg/kg bw/day) without exposure to smoke, although the metaplasia was less prominent. Whether high, chronic doses of β-carotene in low-risk groups, e.g., nonsmokers, would have toxic effects is not known at this time.

### COMPENDIAL/REGULATORY STATUS

β-Carotene is in the generally recognized as safe (GRAS) list issued by the Food and Drug Administration.

### REFERENCES

1. Yeum, K.J.; Russell, R.M. Carotenoid bioavailability and bioconversion. *Annu. Rev. Nutr.* **2002**, *22*, 483–504.
2. Erdman, J.W.; Bierer, T.L.; Gugger, E.T. Absorption and transport of carotenoid. *Ann. N.Y. Acad. Sci.* **1993**, *691*, 76–85.
3. Cornwell, D.G.; Kruger, F.A.; Robinson, H.B. Studies on the absorption of beta-carotene and the distribution of total carotenoid in human serum lipoproteins after oral administration. *J. Lipid Res.* **1962**, *3*, 65–70.
4. Krinsky, N.I.; Cornwell, D.G.; Oncley, J.L. The transport of vitamin A and carotenoids in human plasma. *Arch. Biochem. Biophys.* **1958**, *73*, 223–246.
5. Johnson, E.J. Human studies on bioavailability and serum response of carotenoids. In *CRC Handbook of Antioxidants*, 2nd Ed.; Cadenas, E., Packer, L., Eds.; Marcel Dekker, Inc., 2001.
6. Blomstrand, R.; Werner, B. Studies on the intestinal absorption of radioactive beta-carotene and vitamin A in man. Conversion of beta-carotene into vitamin A. *Scand. J. Clin. Lab. Invest.* **1967**, *19*, 339–345.
7. Goodman, D.S.; Blomstrand, R.; Werner, B.; Huang, H.S.; Shiratori, T. The intestinal absorption and metabolism of vitamin A and beta-carotene in man. *J. Clin. Invest.* **1999**, *45*, 1615–1623.

8. Novotny, J.A.; Dueker, S.R.; Zech, L.A.; Clifford, A.J. Compartmental analysis of the dynamics of  $\beta$ -carotene metabolism in an adult volunteer. *J. Lipid Res.* **1993**, *36*, 1825–1838.
9. Brubacher, G.B.; Weiser, H. The vitamin A activity of beta-carotene. *Int. J. Vitam. Nutr. Res.* **1985**, *55*, 5–15.
10. Tang, G.; Dolnikowski, G.G.; Russell, R.M. Vitamin A equivalence of beta-carotene in a woman as determined by a stable isotope reference method. *Eur. J. Nutr.* **2000**, *39*, 7–11.
11. Brown, E.D.; Micozzi, M.S.; Craft, N.E.; Bieri, J.G.; Beecher, G.; Edwards, B.K.; Rose, A.; Taylor, P.R.; Smith, J.C., Jr. Plasma carotenoids in normal men after a single ingestion of vegetables or purified beta-carotene. *Am. J. Clin. Nutr.* **1989**, *49*, 1258–1265.
12. Erdman, J. The physiology chemistry of carotenes in man. *Clin. Nutr.* **1988**, *7*, 101–106.
13. Borel, P.; Grolier, P.; Armand, M.; Partier, A.; Lafont, H.; Lairon, D.; Azais-Braesco, V. Carotenoids in biological emulsions: solubility, surface-to-core distribution, and releases from lipid droplets. *J. Lipid Res.* **1996**, *37*, 250–261.
14. Rock, C.L.; Lovalvo, J.L.; Emenhiser, C.; Ruffin, M.T.; Flatt, S.W.; Schwartz, S.J. Bioavailability of  $\beta$ -carotene is lower in raw than in processed carrots and spinach in women. *J. Nutr.* **1998**, *128*, 913–916.
15. Roodenburg, A.J.C.; Leenen, R.; Van het Hof, K.H.; Weststrate, J.A.; Tijburg, L.B.M. Amount of fat in the diet affects bioavailability of lutein esters but not of  $\alpha$ -carotene,  $\beta$ -carotene and vitamin E in humans. *Am. J. Clin. Nutr.* **2000**, *71*, 1187–1193.
16. Prince, M.R.; Friscoli, J.K. Beta-carotene accumulation in serum and skin. *Am. J. Clin. Nutr.* **1993**, *57*, 175–181.
17. Nierenberg, D.W.; Dain, B.J.; Mott, L.S.; Baron, J.A.; Greenberg, E.R. Effect of 4 years of oral supplementation with  $\beta$ -carotene on serum concentrations of retinol, tocopherol, and five carotenoids. *Am. J. Clin. Nutr.* **1997**, *66*, 315–319.
18. Institute of Medicine, Food and Nutrition Board. *Dietary Reference Intakes for Vitamin A, Vitamin K, Arsenic, Boron, Chromium, Copper, Iodine, Iron, Manganese, Molybdenum, Nickel, Silicon, Vanadium, and Zinc*, 1st Ed.; National Academy Press: Washington, DC, 2001.
19. Enger, S.M.; Longnecker, M.P.; Shikany, J.M.; Swenseid, M.E.; Chen, M.J.; Harper, J.M.; Haile, R.W. Questionnaire assessment of intake of specific carotenoids. *Cancer Epidemiol. Biomarkers Prev.* **1995**, *4*, 201–205.
20. Schmitz, H.H.; Poor, C.L.; Wellman, R.B.; Erdman, J.W., Jr. Concentrations of selected carotenoids and vitamin A in human liver, kidney and lung tissue. *J. Nutr.* **1991**, *121*, 1613–1621.
21. Mangels, A.R.; Holden, J.M.; Beecher, G.R.; Forman, M.R.; Lanza, E. Carotenoid content of fruits and vegetables: an evaluation of analytic data. *J. Am. Diet. Assoc.* **1993**, *93*, 284–296.
22. Castenmiller, J.J.; West, C.E.; Linssen, J.P.; Van het Hof, K.H.; Voragen, A.G. The food matrix of spinach is a limiting factor in determining the bioavailability of beta-carotene and to a lesser extent of lutein in humans. *J. Nutr.* **1999**, *129*, 349–355.
23. Van het Hof, K.H.; Gartner, C.; West, C.E.; Tijburg, L.B.M. Potential of vegetable processing to increase the delivery of carotenoids to man. *Int. J. Vitam. Res.* **1998**, *68*, 366–370.
24. Henderson, C.T.; Mobarhan, S.; Bowen, P.; Stacewicz-Sapuntzakis, M.; Langenberg, P.; Kiani, R.; Lucchesi, P.; Sugarman, S. Normal serum response to oral beta-carotene in humans. *J. Am. Coll. Nutr.* **1989**, *8*, 625–635.
25. Witschi, J.C.; Houser, H.B.; Littell, A.S. Preformed vitamin A, carotene, and total vitamin A activity in usual adult diets. *J. Am. Diet. Assoc.* **1970**, *57*, 13–16.
26. Yeum, K.-J.; Booth, S.L.; Sadowski, J.A.; Liu, C.; Tang, G.; Krinsky, N.I.; Russell, R.M. Human plasma carotenoid response to the ingestion of controlled diets high in fruits and vegetables. *Am. J. Clin. Nutr.* **1996**, *64*, 594–602.
27. <http://image.guardian.co.uk/sys-files/Guardian/documents/2003/05/08/vitmin2003.pdf>, May, 2003.
28. Institute of Medicine, Food and Nutrition Board. *Dietary Reference Intakes for Vitamin C, Vitamin E, Selenium, and Carotenoids. A Report of the Panel on Dietary Antioxidants and Related Compounds, Subcommittees on Upper Reference Levels of Nutrients and Interpretation and Uses of Dietary Reference Intakes, and the Standing Committee on the Scientific Evaluation of Dietary Reference Intakes*, 1st Ed.; National Academy Press: Washington, DC, 2000.
29. Michaelsson, K.; Lithell, H.; Vessby, B.; Melhus, H. Serum retinol levels and the risk of fractures. *N. Engl. J. Med.* **2003**, *348*, 287–294.
30. Block, G.; Patterson, B.; Subar, A. Fruit, vegetables and cancer prevention: a review of the epidemiological evidence. *Nutr. Cancer* **1992**, *18*, 1–29.
31. Ziegler, R.G.; Mayne, S.T.; Swanson, C.A. Nutrition and lung cancer. *Cancer Causes Control* **1996**, *7*, 157–177.

32. The Alpha-Tocopherol Beta-Carotene Cancer Prevention Study Group. The effect of vitamin E and beta carotene on the incidence of lung cancer and other cancers in male smokers. *N. Engl. J. Med.* **1994**, *330*, 1029–1035.
33. Omenn, G.S.; Goodman, G.E.; Thornquist, M.D.; et al. Effects of a combination of beta carotene and vitamin A on lung cancer and cardiovascular disease. *N. Engl. J. Med.* **1996**, *334*, 1150–1155.
34. Hennekens, C.H.; Buring, J.E.; Manson, J.E.; et al. Lack of effect of long-term supplementation with beta-carotene on the incidence of malignant neoplasms and cardiovascular disease. *N. Engl. J. Med.* **1996**, *334*, 1483–1491.
35. Gaziano, J.M.; Hennekens, C.H. The role of beta-carotene in the prevention of cardiovascular disease. *Ann. N.Y. Acad. Sci.* **1993**, *691*, 148–155.
36. Kohlmeier, L.; Hastings, S.B. Epidemiologic evidence of a role of carotenoids in cardiovascular disease prevention. *Am. J. Clin. Nutr.* **1995**, *62*, 1370S–1376S.
37. Manson, J.E.; Gaziano, J.M.; Jonas, M.A.; Hennekens, C.H. Antioxidants and cardiovascular disease: a review. *J. Am. Coll. Nutr.* **1993**, *12*, 426–432.
38. Vivekananthan, D.P.; Penn, M.S.; Sapp, S.K.; Hsu, A.; Topol, E.J. Use of antioxidant vitamins for the prevention of cardiovascular disease; meta-analysis of randomized trials. *Lancet* **2003**, *361*, 2017–2023.
39. Matthews-Roth, M.M. Beta-carotene therapy for erythropoietic protoporphyria and other photosensitivity diseases. *Biochimie* **1986**, *68*, 875–884.
40. Blot, W.J.; Lu, J.Y.; Taylor, P.R.; et al. Nutrition intervention trials in Linxian, China: Supplementation with specific vitamin/mineral combinations, cancer incidence, and disease-specific mortality in the general population. *J. Natl. Cancer Inst.* **1993**, *66*, 1191–1208.
41. Wang, X.-D.; Russell, R.M. Procarcinogenic and anticarcinogenic effects of beta-carotene. *Nutr. Rev.* **1999**, *57*, 263–272.
42. Bendich, A. The safety of beta-carotene. *Nutr. Cancer* **1988**, *11*, 207–214.
43. Lascari, A.D. Carotenemia. A review. *Clin. Pediatr.* **1981**, *20*, 25–29.
44. Heywood, R.; Palmer, A.K.; Gregson, R.L.; Hummler, H. The toxicity of beta-carotene. *Toxicology* **1985**, *36*, 91–100.
45. Wang, X.-D.; Liu, C.; Bronson, R.T.; Smith, D.E.; Krinsky, N.I.; Russell, R.M. Retinoid signaling and activator protein-1 expression in ferrets given beta-carotene supplements and exposed to tobacco smoke. *J. Natl. Cancer Inst.* **1999**, *91*, 60–66.

#### FURTHER READINGS

- Kritchevsky, S.B. Beta-carotene, carotenoids and the prevention of cardiovascular disease. *J. Nutr.* **1999**, *129*, 5–8.
- Pryor, W.A.; Stahl, W.; Rock, C. Beta-carotene: from biochemistry to clinical trials. *Nutr. Rev.* **2000**, *58*, 39–53.
- Van Poppel, G. Epidemiological evidence for beta-carotene in prevention of cancer and cardiovascular disease (review). *Eur. J. Clin. Nutr.* **1996**, *50*, S57–S61.





# Cascara Sagrada (*Rhamnus purshiana*)

## Gail B. Mahady

Program for Collaborative Research in the Pharmaceutical Sciences,  
UIC/NIH Center for Botanical Dietary Supplements Research, College of Pharmacy,  
University of Illinois at Chicago, Chicago, Illinois, U.S.A.

## INTRODUCTION

*Rhamnus purshiana* De Candolle (Rhamnaceae) is an evergreen shrub or small tree native to the Pacific Northwest United States and southwestern Canada.<sup>[1–4]</sup> *Rhamnus* is the generic name for buckthorn, and the species name, *purshiana*, was given in honor of the German botanist Friedrich Pursh.<sup>[4]</sup> Its primary usage is as a laxative.

## GENERAL DESCRIPTION

The shrub or small tree of *Rhamnus purshiana* De Candolle has elliptical leaves, greenish flowers, and black berries. It ranges in height from 4.5 to 10 m and has a reddish-brown bark commonly referred to as cascara sagrada (Spanish for “sacred bark”). Most of the commercial production comes from Oregon, Washington, and southern British Columbia. The bark is collected in spring (April/May) and early summer by stripping from wild trees scattered throughout the native forests. It is removed by making longitudinal incisions and peeling off sections, which tend to roll into large quills. Trees are also felled and the bark is removed from the larger branches. The bark is then air dried, with the inner surface protected from the sun in order to preserve its yellow color. The dried bark is allowed to mature for 1 or 2 yr before use in commercial preparations.<sup>[4]</sup> The fresh bark contains chemical constituents that act as a gastrointestinal (GI) irritant and emetic; thus, the bark must be aged for at least 1 yr prior to human use. Cascara bark and its preparations have been used for centuries by the Pacific Northwest Native Americans, as well as the European settlers, and cascara preparations are now used worldwide as a laxative.<sup>[5]</sup>

Commercial preparations of cascara (Cortex Rhamni Purshianae) consist of the dried, whole, or

fragmented bark of *R. purshiana*. The bark and its preparations are official in the pharmacopeias of many countries.<sup>[1,6–9]</sup> Cascara was first listed in the U.S. Pharmacopeia (USP) in 1890 as a laxative mild enough for use in treating the elderly and children. The official listing of cascara in USP 25<sup>[9]</sup> defines it as the dried bark (at least 1 yr old) of *R. purshiana*, yielding not less than 7.0% of total hydroxyanthracene derivatives calculated as cascaroside A on a dried basis. Not less than 60% of the total hydroxyanthracene derivatives consists of cascarosides, calculated as cascaroside A.<sup>[9]</sup> Currently official in the USP are cascara sagrada extract, fluidextract, aromatic fluidextract, and tablets.

## CHEMISTRY

The chemistry of cascara has been extensively investigated, and numerous quinoid constituents are reported to be present in the bark.<sup>[1]</sup> Much of the chemical and pharmacological research on cascara was performed over 50 years ago, and anthraquinone glycosides were established as the active constituents of the bark.<sup>[5]</sup> Hydroxyanthracene glycosides make up 6–9% of the bark, of which 70–90% is C-10 glycosides, with aloins A and B and desoxyaloins A and B (=chrysaloins) accounting for 10–30%.<sup>[1]</sup> The cascarosides A and B, and C and D, are diastereoisomeric pairs derived from 8- $\beta$ -*O*-glucosides of aloin A and B and 8-*O*-glucosyl-11-desoxyaloin, respectively, and constitute 60–70% of the total glycosides.<sup>[1]</sup> Hydrolysis of the cascarosides cleaves the *O*-glycosidic bonds to yield aloins (barbaloin and chrysaloin). The cascarosides are not bitter, whereas most of their hydrolysis products (the aloins) are very bitter. Both the USP and the European Pharmacopoeia recognize the cascarosides and aloin as the active constituents of cascara and have chemical assay procedures for determining these glycosides.<sup>[7–9]</sup>

Other major hydroxyanthracene glycosides include the hydroxyanthraquinones chrysophanol-8-*O*-glucoside and aloe-emodin-8-*O*-glucoside at a

---

Gail B. Mahady, Ph.D., is Assistant Professor at the Department of Pharmacy Practice, Program for Collaborative Research in the Pharmaceutical Sciences, UIC/NIH Center for Botanical Dietary Supplements Research, College of Pharmacy, University of Illinois at Chicago, Chicago, Illinois, U.S.A.

concentration of 10–20%.<sup>[10]</sup> In the fresh bark, anthraquinones are present in the reduced form, and are converted by oxidation from their corresponding parent anthraquinone glycosides during drying and storage.<sup>[3]</sup>

## PHARMACOLOGY AND USES

### Laxative Effects

Cascara sagrada is an anthraquinone laxative and is used for short-term treatment of occasional constipation.<sup>[1,11,12]</sup> The laxative effects of cascara are primarily due to the anthraquinone glycosides, the cascariosides A–D.<sup>[1,5]</sup> Other anthranoid derivatives that may be active include emodin anthrone-6-*O*-rhamnoside (franguloside), and physcion and chrysophanol in glycosidic and aglycone forms.<sup>[13,14]</sup> Anthraquinone laxatives are prodrugs in that after oral administration, the hydroxyanthracene glycosides are poorly absorbed in the small intestine, but are hydrolyzed in the colon by intestinal bacteria to pharmacologically active metabolites, which are partly absorbed there<sup>[11,13]</sup>; this acts as a stimulant and irritant to the GI tract.<sup>[12]</sup> The mechanism of action of cascara is similar to that of senna in that the action is twofold: 1) stimulation of colonic motility, resulting in augmented propulsion, and accelerated colonic transit (which reduces fluid absorption from the fecal mass); and 2) an increase in the paracellular permeability across the colonic mucosa, probably due to an inhibition of Na<sup>+</sup>, K<sup>+</sup>-adenosine triphosphatase or an inhibition of chloride channels,<sup>[13,15]</sup> which results in an increase in the water content in the large intestine.<sup>[11,15]</sup> The laxative effect of cascara is generally not observed before 6–8 hr after oral administration. The hydroxyanthracene glycosides are excreted predominantly in the feces but to some extent in urine as well, producing an orange color; anthrones and anthranols also pass into breast milk.<sup>[13]</sup>

### Toxicity

Anthraquinone laxatives may produce an excessive laxative effect and abdominal pain. The major symptoms of overdose are griping and severe diarrhea, with consequent losses of fluid and electrolytes.<sup>[12]</sup> Treatment should be supported with generous amounts of fluid. Electrolytes should be monitored, particularly potassium. This is especially important in children and the elderly. Renal excretion of the compounds may cause abnormal coloration of urine (yellow-brown to reddish depending on the pH of the urine). Large

doses may cause nephritis. Melanotic pigmentation of the colonic mucosa (pseudomelanosis coli) has been observed in individuals who abuse anthraquinone laxatives. Pigmentation is usually benign and reverses within 4–12 mo of discontinuation of the products.<sup>[12]</sup>

Emodin is one of the naturally occurring anthraquinones present in cascara. Its toxicology was recently assessed by the National Toxicology Program and published in 2001.<sup>[16]</sup> Due to reports that 1,8-dihydroxyanthraquinone, a commonly used laxative ingredient, caused tumors in the GI tract of rats, the effects of emodin were studied, as it is structurally similar and was reported to be mutagenic in bacteria. The acute and chronic toxicity of emodin was investigated in rodents exposed to emodin in feed for 16 days, 14 weeks, or 2 yr. In the 16-day study, rodents were fed diets containing average daily doses of approximately 50, 170, 480, 1400, or 3700 mg/kg body weight for males and 50, 160, 460, 1250, or 2000 mg/kg body weight for females. The results showed that the mean body weights of males and females exposed to 480 mg/kg or greater were significantly lower than those of the controls. Macroscopic lesions were observed in the gallbladder and kidney of rats exposed to the highest doses of 1400 or 3700 mg/kg. In the 14-week study, rats were fed diets containing approximately 20, 40, 80, 170, or 300 mg/kg for males and females. Mean body weights of males exposed to 170 mg/kg or greater and females exposed to 80 mg/kg or greater were significantly lower than those of the controls. In rats exposed to 170 or 300 mg/kg of emodin, increases in platelet counts and decreases in total serum protein and albumin concentrations were observed. Relative kidney weights of rats exposed to 80 mg/kg or greater and relative lung and liver weights of rats exposed to 40 mg/kg or greater were significantly increased compared to the control groups. The incidences and severities of nephropathy were increased in males and females exposed to 40 mg/kg or greater. In the chronic toxicity study (2 yr), groups of 65 male and 65 female rats were fed diets containing emodin at an equivalent to average daily doses of approximately 110, 320, or 1000 mg/kg to males and 120, 370, or 1100 mg/kg to females for 105 weeks. Survival of exposed males and females was similar to that of the controls. There were negative trends in the incidences of mononuclear cell leukemia in both male and female rats, and incidences in the group fed 1000 mg/kg were significantly decreased. At the 12-mo interim evaluation, nephropathy was slightly higher.

In terms of genetic toxicology, emodin was mutagenic in *Salmonella typhimurium* strain TA100 in the presence of S9 activation; no mutagenicity was detected in strain TA98, with or without S9. Chromosomal aberrations were induced in cultured Chinese

hamster ovary cells treated with emodin, with or without metabolic activation by S9. In the rat bone marrow micronucleus test, administration of emodin by three intraperitoneal injections gave negative results. Results of acute-exposure (intraperitoneal injection) micronucleus tests in bone marrow and peripheral blood erythrocytes of male and female mice were also negative. In a peripheral blood micronucleus test on mice from the 14-week study, negative results were seen in male mice, but a weak positive response was observed in similarly exposed females.

The results of these investigations show no evidence of carcinogenic activity of emodin in male F344/N rats in the 2-yr study. There was equivocal evidence of carcinogenic activity of emodin in female F344/N rats and male B6C3F1 mice. There was no such evidence in female B6C3F1 mice exposed to 312, 625, or 1250 ppm.<sup>[16]</sup>

Other investigations of the carcinogenic potential of cascara have been carried out in rodents. In one study, the effects of the laxative bisacodyl (4.3 and 43 mg/kg) and cascara (140 and 420 mg/kg) on the induction of azoxymethane (AOM)-induced aberrant crypt foci (ACF) and tumors in rats were investigated.<sup>[17]</sup> Animals were treated with AOM and laxatives (alone or in combination) for 13 weeks. The results demonstrated that bisacodyl (4.3 and 43 mg/kg), given alone, did not induce the development of colonic ACF and tumors. However, bisacodyl (4.3 mg/kg) coupled with AOM increased the number of crypts per focus, but not the number of tumors. Bisacodyl (43 mg/kg) significantly increased the number of crypts per focus and tumors. Cascara (140 and 420 mg/kg) did not induce the development of colonic ACF and tumors and did not modify the number of AOM-induced ACF and tumors.<sup>[18]</sup> Results from another study were similar. Dietary exposure to high doses of these glycosides for 56 successive days did not induce the appearance of ACF or increase in incidence of ACF induced by 1,2-dimethylhydrazine (DMH). However, in rats treated with both DMH and the highest dose of glycosides, the average number of aberrant crypts per focus, considered a consistent predictor of tumor outcome, was higher than that in rats given DMH alone.<sup>[17]</sup>

## HUMAN USE

### Contraindications and Precautions

Products containing cascara should only be used if no effect can be obtained through a change of diet or use of bulk-forming laxatives. Patients should also be warned that certain constituents of the drug are

excreted by the kidney and may color the urine (harmless). Rectal bleeding or failure to have a bowel movement after the use of a laxative may indicate a serious condition. Laxatives containing anthraquinone glycosides should not be used for periods longer than 1–2 weeks.<sup>[12]</sup> Decreased intestinal transit time may result in reduced absorption of orally administered drugs.<sup>[1]</sup> Electrolyte imbalances such as increased loss of potassium may potentiate the effects of cardiotonic glycosides (e.g., digitalis). Existing hypokalemia resulting from long-term laxative abuse can also potentiate the effects of antiarrhythmic drugs that affect potassium channels to change sinus rhythm, such as quinidine. The induction of hypokalemia by drugs such as thiazide diuretics, adrenocorticosteroids, or liquorice root may be enhanced, and electrolyte imbalance may be aggravated.<sup>[11]</sup>

Chronic use (>2 weeks) may cause dependence and need for increased doses, and an atonic colon with impaired function.<sup>[12]</sup> It may also lead to pseudomelanosis coli (harmless), and to an aggravation of constipation with dependence and possible need for increased dosages. Chronic abuse with diarrhea and consequent fluid and electrolyte losses (mainly hypokalemia) may cause albuminuria and hematuria, and may result in cardiac and neuromuscular dysfunction.<sup>[1]</sup>

Anthraquinone laxatives, such as cascara, should not be administered to patients with intestinal obstruction and stenosis, atony, severe dehydration states with water and electrolyte depletion, or chronic constipation.<sup>[1,12]</sup> Cascara should not be administered to patients with inflammatory intestinal diseases, such as appendicitis, Crohn's disease, ulcerative colitis, and irritable bowel syndrome, or in children under 12 yr of age.<sup>[1,12]</sup> As with other stimulant laxatives, cascara is contraindicated in patients with cramps, colic, hemorrhoids, nephritis, or any undiagnosed abdominal symptoms such as pain, nausea, or vomiting.<sup>[12]</sup>

Due to the pronounced action on the large intestine and insufficient toxicological investigations, products containing cascara should not be administered to pregnant women.<sup>[19,20]</sup> Furthermore, anthranoid metabolites are excreted into breast milk. Thus, cascara should not be used during lactation, due to insufficient data available to assess the potential for pharmacological effects in the breast-fed infant.<sup>[20]</sup>

### Adverse Reactions

In single doses, cramp-like discomfort of the gastrointestinal tract may occur, which may require a reduction of dosage. Overdose can lead to colicky abdominal spasms and pain, as well as the formation

of thin, watery stools. Long-term laxative abuse may lead to electrolyte disturbances (hypokalemia, hypocalcemia), metabolic acidosis, malabsorption, weight loss, albuminuria, and hematuria.<sup>[21,22]</sup> Weakness and orthostatic hypotension may be exacerbated in elderly patients when stimulant laxatives are used repeatedly. Secondary aldosteronism may occur due to renal tubular damage after aggravated use. Steatorrhea and protein-losing gastroenteropathy with hypoalbuminemia have also been reported in laxative abuse.<sup>[23]</sup> Melanotic pigmentation of the colonic mucosa (pseudomelanosis coli) has been observed in individuals taking anthraquinone laxatives for extended time periods.<sup>[12,22–24]</sup> The pigmentation is clinically harmless and usually reversible within 4–12 mo after the drug is discontinued.<sup>[22,24–26]</sup> Conflicting data exist on other toxic effects such as intestinal–neuronal damage after long-term use.<sup>[22]</sup> Use of the fresh drug may cause severe vomiting, with possible spasms.<sup>[13]</sup>

Cases of allergic respiratory diseases after occupational exposure to cascara have been reported.<sup>[27]</sup> Cascara sagrada is an etiologic agent of IgE-mediated occupational asthma and rhinitis. One case of cholestatic hepatitis, complicated by portal hypertension, has been attributed to the ingestion of cascara in one patient who was also known to abuse alcohol and take a number of other prescription medications.<sup>[28]</sup>

### Current Regulatory Status

Prior to June 1998, cascara sagrada was recognized by the Food and Drug Administration (FDA) as a category I over-the-counter (OTC) preparation (monograph). The agency has reclassified cascara ingredients to category II (nonmonograph) and is adding them to the list of stimulant laxative ingredients for which the data are inadequate to establish general recognition of safety and effectiveness (GRAS).<sup>[29]</sup> The FDA has now issued a final rule stating that the stimulant laxative ingredients aloe (including aloe extract and aloe flower extract) and cascara sagrada (including casanthranol, cascara fluidextract aromatic, cascara sagrada bark, cascara sagrada extract, and cascara sagrada fluidextract) in OTC drug products are not generally recognized as safe and effective or are misbranded. According to the FDA, products containing aloe and cascara sagrada ingredients must be reformulated or discontinued; the stimulant laxatives must therefore be deleted or replaced. Reformulated products will also need to be relabeled. This final rule is part of FDA's ongoing OTC drug product review. These decisions were based on lack of data and information and the failure of interested persons to submit any new data from carcinogenicity studies.<sup>[29]</sup>

### Dosage Forms and Dose

Cascara sagrada is available as extracts, fluidextracts, and tablets.<sup>[9]</sup> The average daily dose (taken at bedtime, or one-half dose in the morning and at bedtime) of standardized preparations is 20–30 mg of hydroxyanthracene derivatives calculated as cascarioside A (dried aged bark, 0.25–1 g).<sup>[1]</sup> Do not exceed recommended dose and do not use for more than 1–2 weeks continuously.

### REFERENCES

1. Farnsworth, N.R.; Fong, H.H.S.; Mahady, G.B. *Cortex Rhamni Purshianae*; WHO Monographs on Selected Medicinal Plants; WHO Publications: Geneva, Switzerland, 2001; Vol. 2.
2. Gathercoal, E.N.; Wirth, E.H. *Pharmacognosy*; Lea and Febiger: Philadelphia, 1947; 411–416.
3. Tyler, V.E.; Bradley, L.R.; Robbers, J.E. *Pharmacognosy*, 9th Ed.; Lea and Febiger: Philadelphia, 1988; 62–63.
4. Youngken, H.W. Rhamnaceae (buckthorne family). *Textbook of Pharmacognosy*; The Blakiston Company: Philadelphia, 1950; 543–549.
5. Leung, A.Y. Cascara sagrada—new standards are needed. *Drug Cosmetic Ind.* **1977**, *12*, 42.
6. *Rhamnus purshiana* DC. *African Pharmacopoeia*, 1st Ed.; Organization of African Unity, Scientific, Technical & Research Commission: Lagos, Nigeria, 1985; 192–194.
7. *European Pharmacopoeia*, 2nd Ed.; Council of Europe: Strasbourg, 2002; 549.
8. *Pharmacopée Française*; Adrapharm: Paris, 1996; 1–5.
9. *The United States Pharmacopeia 25*; The United States Pharmacopeia Convention Inc.: Rockville, MD, 2002; 281–282.
10. Bruneton, J. *Pharmacognosy, Phytochemistry, Medicinal Plants*; Lavoisier: Paris, 1995; 360–361.
11. *Cascara Sagrada Bark*; Blumenthal, M. et al., Eds.; The Complete German Commission E Monographs; American Botanical Council: Austin, TX, 1998.
12. *Goodman & Gilman's The Pharmacological Basis of Therapeutics*, 9th ed.; Hardman, J., Ed.; McGraw-Hill: New York, 2001.
13. Bradley, P.R. Cascara sagrada. *British Herbal Medicine*; British Herbal Compendium: Dorset, 1992; Vol. 1, 52–54.
14. Westendorf, J. Anthranoid derivatives—*Rhamnus* species. In *Adverse Effects of Herbal Drugs*; De Smet, P.A.G.M. et al., Eds.; Springer-Verlag: Heidelberg, 1993; Vol. 2, 70.

15. de Witte, P. Metabolism and pharmacokinetics of the anthranoids. *Pharmacology* **1993**, *47* (Suppl. 1), 86–97.
16. National Toxicology Program. *NTP Toxicology and Carcinogenesis Studies of EMODIN (CAS NO. 518-82-1) Feed Studies in F344/N Rats and B6C3F1 Mice*. National Toxicology Program Technical Reports Series 2001; 493, 1–278.
17. Mereto, E.; Ghia, M.; Brambilla, G. Evaluation of the potential carcinogenic activity of senna and cascara glycosides for the rat colon. *Cancer Lett.* **1996**, *101*, 79–83.
18. Borrelli, F.; Mereto, E.; Capasso, F.; Orsi, P.; Sini, D.; Izzo, A.A.; Massa, B.; Boggio, M.; Mascolo, N. Effect of bisacodyl and cascara on growth of aberrant crypt foci and malignant tumors in the rat colon. *Life Sci.* **2001**, *69*, 1871–1877.
19. Lewis, J.H.; Weingold, A.B. The use of gastrointestinal drugs during pregnancy and lactation. *Am. J. Gastroenterol.* **1985**, *80*, 912–923.
20. *Physician' Desk Reference*; Medical Economics: Montvale, 1998.
21. Godding, E.W. Therapeutics of laxative agents with special reference to the anthraquinones. *Pharmacology* **1976**, *14* (Suppl. 1), 78–108.
22. Muller-Lissner, S.A. Adverse effects of laxatives: facts and fiction. *Pharmacology* **1993**, *47* (Suppl. 1), 138–145.
23. Heizer, W.D. Protein-losing gastroenteropathy and malabsorption associated with factitious diarrhoea. *Ann. Intern. Med.* **1968**, *68*, 839–852.
24. Loew, D. Pseudomelanosis coli durch Anthra-noide. *Z. Phytother.* **1994**, *16*, 312–318.
25. Patel, P.M. et al. Anthraquinone laxatives and human cancer. *Postgrad. Med. J.* **1989**, *65*, 216–217.
26. Kune, G.A. Laxative use not a risk for colorectal cancer: data from the Melbourne colorectal cancer study. *Z. Gastroenterol.* **1993**, *31*, 140–143.
27. Giavina-Bianchi, P.F., Jr.; Castro, F.F.; Machado, M.L.; Duarte, A.J. Occupational respiratory allergic disease induced by *Passiflora alata* and *Rhamnus purshiana*. *Ann. Allergy Asthma Immunol.* **1997**, *79*, 449–454.
28. Nadir, A.; Reddy, D.; Van Thiel, D.H. Cascara sagrada-induced intrahepatic cholestasis causing portal hypertension: case report and review of herbal hepatotoxicity. *Am. J. Gastroenterol.* **2000**, *95*, 3634–3637.
29. Food and Drug Administration, Department of Health and Human Services. Status of certain additional over-the-counter drug category II and III active ingredients. Final rule. *Federal Register* **2002**, *67*, 31125–31127.



# Chasteberry (*Vitex agnus castus*)

Gail B. Mahady  
Brigit Dietz  
Joanna Michel  
Jan Engle  
Rosalie Sagraves

UIC/NIH Center for Botanical Dietary Supplements Research, College of Pharmacy,  
University of Illinois at Chicago, Chicago, Illinois, U.S.A.

## INTRODUCTION

*Vitex agnus castus* L. (Verbenaceae), commonly referred to as chaste tree or chasteberry, is a small shrubby tree, approximately 1–6 m in height and native to the Mediterranean region and Asia.<sup>[1,2]</sup> The tree is also widely cultivated in warm temperate regions of the world. The name chasteberry is thought to be derived from the traditional belief that the plant promoted chastity.<sup>[3]</sup> The fruit of *V. agnus castus* (VAC) was used in ancient Greece and Rome, as well as by the monks of the Middle Ages to suppress sexual desire.<sup>[4,5]</sup> In the past, extracts of VAC have been used for the treatment of gynecological disorders, such as endometrial hyperplasia, hypermenorrhea, and secondary amenorrhea, as well as endocrine-dependent dermatoses (dermatitis dysmenorrhea symmetrica, acne vulgaris, eczema, and acne rosacea).<sup>[6–8]</sup>

Today, extracts of the dried ripe fruits of VAC are regulated in the United States as dietary supplements under the 1994 Dietary Supplement Health and Education Act. They are widely used as a botanical dietary supplement for the management of female

gynecological disorders including corpus luteum insufficiency,<sup>[9,10]</sup> premenstrual syndrome (PMS),<sup>[12–14]</sup> menstrual problems,<sup>[15,16]</sup> cyclic mastalgia,<sup>[17–19]</sup> as well as to treat hormonally induced acne.<sup>[20]</sup> In addition, vitex has been traditionally used to treat fibroid cysts and infertility, stop miscarriages caused by progesterone insufficiency,<sup>[21]</sup> and treat indigestion.<sup>[3]</sup>

## CHEMISTRY

Commercial products of VAC are prepared from the dried, ripe fruit, containing not less than 0.4% (v/w) of volatile oil and at least an 8% water-soluble extractive.<sup>[1,22]</sup> To date, although the active constituents of VAC remain unknown, the *European Pharmacopoeia* recommends a minimum content of 0.08% casticin in the dried plant material.<sup>[23]</sup> Two compounds are currently used as marker compounds for quality control, the iridoid glycoside *agnuside* and the flavonol *casticin*.<sup>[24]</sup> Most vitex preparations used in European medicine are nonstandardized fluid extracts, tinctures, and/or native dry extracts. The “native” or “total” extract is an approximate 10:1 (w/w) drug-to-extract ratio containing 0.6–1.0% casticin.<sup>[2]</sup>

The ripe, dried vitex fruit yields 0.4–0.7% (v/w) essential oil, depending on distillation time and comminution size. The oil is mainly composed of bornyl acetate, 1,8-cineole, limonene,  $\alpha$ - and  $\beta$ -pinene,  $\beta$ -caryophyllene, and  $\alpha$ -terpinyl acetate.<sup>[25]</sup> Flavonoids, iridoids, and diterpenes represent major groups of secondary constituents also found in the fruit.<sup>[2]</sup> Casticin (up to 0.2%) is considered to be the major flavonoid, with chrysopenetin, chrysosplenol D, cynaroside, 5-hydroxy-3,4',6,7-tetramethoxyflavone, 6-hydroxykaempferol, isorhamnetin, luteolin, and luteolin 6-C-glycoside derivatives being other compounds of this class.<sup>[25–27]</sup> Major iridoids found include agnuside (*p*-hydroxybenzoylaucubin, 0.0014%) and aucubin (0.0013%). Diterpene constituents include vitexilactone (0.001–0.004%), 6 $\beta$ ,7 $\beta$ -diacetoxy-13-hydroxy $\lambda$ -8,14-diene, rotundifuran, vitexlabdines

---

*Gail B. Mahady, Ph.D.*, is Assistant Professor at the Department of Pharmacy Practice, UIC/NIH Center for Botanical Dietary Supplements Research, College of Pharmacy, University of Illinois at Chicago, Chicago, Illinois, U.S.A.

*Brigit Dietz, Ph.D.*, is Research Associate at the Department of Medicinal Chemistry and Pharmacognosy, UIC/NIH Center for Botanical Dietary Supplements Research, College of Pharmacy, University of Illinois at Chicago, Chicago, Illinois, U.S.A.

*Joanna Michel* is Research Assistant at the Department of Medicinal Chemistry and Pharmacognosy, UIC/NIH Center for Botanical Dietary Supplements Research, College of Pharmacy, University of Illinois at Chicago, Chicago, Illinois, U.S.A.

*Jan Engle, Pharm. D.*, is Clinical Professor at the Department of Pharmacy Practice, UIC/NIH Center for Botanical Dietary Supplements Research, College of Pharmacy, University of Illinois at Chicago, Chicago, Illinois, U.S.A.

*Rosalie Sagraves, Pharm. D.*, is Dean at the Department of Pharmacy Practice, UIC/NIH Center for Botanical Dietary Supplements Research, College of Pharmacy, University of Illinois at Chicago, Chicago, Illinois, U.S.A.



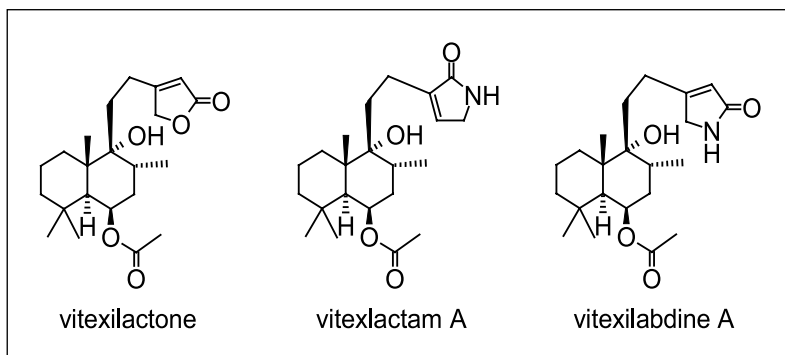


Fig. 1 Compounds from *Vitex agnus castus* fruits.

A–D, and vitexlactam A.<sup>[25,26]</sup> The structures of the above-mentioned components are presented in Fig. 1.

### THERAPEUTIC INDICATIONS

Extracts from VAC fruits are primarily used for the symptomatic management of corpus luteum insufficiency, hyperprolactinemia,<sup>[9,10]</sup> PMS,<sup>[11–14,25,28]</sup> cyclic mastalgia.<sup>[17–19]</sup> A few clinical studies have also indicated that VAC may also be a potential treatment for infertility due to hyperprolactinemia and luteal-phase defect,<sup>[29]</sup> insufficient lactation, and to prevent miscarriages due to progesterone insufficiency.<sup>[21]</sup>

### CLINICAL STUDIES

Since the 1950s, over 32 human or clinical studies have assessed the safety and efficacy of various VAC extracts and tinctures (53–70% ethanol) for the treatment of acne, corpus luteum insufficiency, cyclic breast pain, hyperprolactinemia, menopausal symptoms, increasing lactation, PMS, uterine bleeding disorders, and miscellaneous menstrual irregularities. Most of these investigations are open, uncontrolled studies assessing the effects of VAC on menstrual cycle-irregularities or PMS. The results from randomized, controlled clinical trials are also published.

#### Premenstrual Syndrome

PMS refers to the regular occurrence of affective symptoms, such as depressive moods, irritability, anxiety, confusion, and social withdrawal, as well as somatic symptoms including breast tenderness or heaviness and breast pain (mastalgia), abdominal bloating, cravings, fatigue, and headache.<sup>[30]</sup> The syndrome affects approximately 30–40% of menstruating women and is one of the most frequent complaints noted in gynecology practice.<sup>[28]</sup> Approximately 12

clinical trials have assessed the safety and efficacy of VAC extracts for the symptomatic treatment of PMS.<sup>[11–13,15,28,31–37]</sup> Of these investigations, only three were randomized, controlled trials and two were double blinded.<sup>[28,36,37]</sup>

The Schellenberg study was a randomized, placebo-controlled trial.<sup>[36]</sup> In this study, patients with PMS symptoms were treated with either a VAC extract ( $n = 86$ ; one tablet daily) or a placebo ( $n = 84$ ) for three consecutive menstrual cycles. A PMS diagnosis was made according to the *Diagnostic and Statistical Manual for Mental Disorders* (DSM-III). The main efficacy variable was change from baseline to endpoint (end of cycle 3) in the patient's self-assessment (PSA) of six PMS symptoms (irritability, mood alteration, anger, headache, breast fullness, and other indications including bloating). The secondary efficacy variable used was a change in the Clinical Global Impressions (CGI) score for the severity of condition, global improvement, and risk/benefit. Mean improvement in PSA was significantly greater in the treatment group compared with placebo ( $P < 0.001$ ). CGI scores for each of the three factors also revealed significant superiority of the treatment relative to placebo ( $P < 0.001$ ). The observed response rate (>50% reduction in symptoms) was 52% and 24% for the treatment and placebo groups, respectively. Adverse events reported included treatment ( $n = 4$ ): acne, multiple abscesses, intermenstrual bleeding, urticaria; placebo ( $n = 3$ ): acne, early menstrual period, and gastric upset.<sup>[36]</sup>

A randomized, double-blind, placebo-controlled trial involving 217 women with self-diagnosed PMS according to a modified version of the Menstrual Distress Questionnaire (MDQ), a rating scale covering most of the important PMS symptoms, assessed the efficacy of the fruit in treating the syndrome.<sup>[37]</sup> Subjects were treated with either a powder of VAC (300 mg tablets; two tablets three times daily;  $n = 105$ ) or a soy-based placebo ( $n = 112$ ) for a period of 3 mo, after which they all completed the modified MDQ again. Other than a statistically significant difference in effect

between the active powder and the soy placebo for the symptom of “feeling jittery and restless” ( $P = 0.05$ ), no other significant results were reported.<sup>[37]</sup> Unfortunately, soy was a poor choice for a placebo in this study, as it is not considered to be biologically inert.

A multicenter, randomized, double-blind, controlled clinical trial compared the activity of a dried ethanol extract of the fruit with that of pyridoxine (vitamin B<sub>6</sub>) treatment of women with PMS.<sup>[28]</sup> The intent-to-treat population included 127 women: 61 subjects were given one capsule of extract plus one placebo capsule daily for three cycles, while 66 were given one capsule of placebo twice daily on days 1–15 of their cycle, followed by one capsule (100 mg) of pyridoxine twice daily on days 16–35. Therapeutic response was assessed using the Premenstrual Tension Syndrome (PMTS) scale, the CGI scale, and by recording six characteristic symptoms of PMS (breast tenderness, edema, inner tension, headache, constipation, and depression). Therapeutic efficacy was assessed by both patients and physicians, at the end of the trial. Initial mean PMTS scores were higher in the chaste tree group (15.2) compared to the pyridoxine group (11.9). By the end of therapy, the mean absolute change in PMTS score in each group was 5.1, representing a reduction of 10.1 and 6.8, for the chaste tree and pyridoxine groups, respectively ( $P < 0.038$ , both groups, 95% CI  $-6.4261$  to  $-0.1670$ ). Therefore, no difference could be found between the two treatment groups. The CGI scale showed that 77.1% (chasteberry) and 60.6% (pyridoxine) of patients showed improvement. Adverse events were rare, but included gastrointestinal complaints, skin reactions, and transient headache.<sup>[28]</sup>

Six postmarketing studies assessed the safety and efficacy of various extracts of the fruit in 8391 female patients with menstrual abnormalities or PMS symptoms.<sup>[11,12,15,32,33,35]</sup> Three open (uncontrolled) studies also assessed efficacy.<sup>[13,31,34]</sup> The dose used ranged from 40 to 42 drops or one capsule daily, for 1 day to 9 yr and the outcomes measured included the physician’s assessment and PSA. Elimination of symptoms was observed in 29–42% of patients improvement in 51–59%, and no change in 1–10%. Adverse events were reported in 1–5% of patients but were generally not stated to be serious. The difficulty with these studies includes the lack of a control group, besides most of them not distinguishing between PMS and other menstrual disorders.<sup>[13,31,34]</sup>

An open (uncontrolled) clinical trial involving 50 women (43 completed) with late-luteal phase dysphoric disorder (DSM-III) assessed the effect of an ethanol fruit extract on the management of PMS.<sup>[31]</sup> Thirteen of the subjects were concurrently taking oral contraceptives. After 2 mo of baseline observation, one tablet of the extract was administered daily for three

cycles, followed by a post-treatment phase that lasted three cycles. Treatment effectiveness was evaluated using both the MDQ and the visual analogue scale (VAS). The MDQ was filled out by patients at the end of the first cycle and during cycles 3 and 6. The VAS was completed twice per cycle, once in the late-luteal phase when symptoms peaked and the other after menstruation during the follicular phase. By the end of the third cycle, the MDQ scores were reduced by 42.5% ( $P < 0.001$ ), with a 50% reduction in the score in 20/43 patients. By the end of the post-treatment period, the scores remained approximately 20% below baseline ( $P < 0.001$ ). The main symptoms that improved following treatment were breast tenderness, behavioral changes, negative feelings, and edema. The average late-luteal phase VAS score was reduced by 47.2% during the 3 mo treatment phase ( $P < 0.01$ ), and remained at 21.7% below baseline ( $P < 0.001$ ) during the post-treatment phase. By contrast, the follicular phase score did not significantly change. The number of days with PMS symptoms was reduced from 7.5 to 6 days ( $P < 0.001$ ), and the concomitant use of oral contraceptives had no significant effect on any of the parameters investigated. Twenty patients (47%) reported 37 adverse events during the treatment and post-treatment periods.<sup>[31]</sup>

An open (uncontrolled) study involving 36 women with PMS, assessed the effect of a 58% ethanol extract of the fruit for the management of PMS symptoms.<sup>[13]</sup> The subjects were treated with 40 drops of the extract daily over three cycles and the outcomes measured were a reduction in physical symptoms such as headache, swollen breasts, breast tenderness, bloating, fatigue, and psychological changes such as increased appetite, sugar craving, nervousness and restlessness, anxiety, irritability, lack of concentration, depression, crying spells, mood changes, and aggressiveness. The duration of the luteal phase was also determined. After 3 mo of treatment, 69% of women had a reduction in physical symptoms, where 80% showed a decrease in psychological symptoms ( $P < 0.05$ ). The duration of the luteal phase lengthened from 5.4 to 11.4 days.<sup>[13]</sup>

## Mastalgia

Breast pain (mastalgia) is a common complaint and is usually classified as cyclical (associated with the menstrual cycle) or noncyclical (not related to the menstrual cycle). Mild premenstrual breast discomfort, lasting for 1–4 days prior to menstruation that resolves upon initiation, is considered cyclic mastalgia, and is a symptom of PMS. In addition to the experiments reported above, a number of open studies<sup>[38–44]</sup> and three randomized controlled clinical trials<sup>[17,19,45]</sup> have

assessed the safety and efficacy of VAC extracts for the treatment of cyclic mastalgia.

A randomized, double-blind, placebo-controlled clinical trial involving 104 women with cyclic breast pain (for at least three cycles) assessed the efficacy of a VAC tincture (10 g tincture containing 2 g of crude drug in 53% ethanol VAC) in treating it.<sup>[45]</sup> The patients were treated with placebo, VAC tincture (30 drops twice daily), or VAC tablets (one tablet twice daily) for three cycles. The subjects assessed the intensity of breast pain once per cycle using a VAS, and recorded the presence of menstrual bleeding and the intensity of pain in a diary. Prolactin levels were measured during the premenstrual week of cycles 1 and 3. At the end of the third treatment cycle, a significant reduction in breast pain was observed in the treated patients as compared with placebo (VAC solution,  $P = 0.006$ ; VAC tablets,  $P = 0.007$ ). A significant decrease in prolactin levels ( $P = 0.039$ ) was also noted in the treatment groups as compared with placebo.<sup>[45]</sup>

A second randomized, placebo-controlled, double-blind study with a similar design compared VAC solution (30 drops twice daily for three cycles) with placebo in the treatment of 100 women (50 per group) who had breast pain at least 5 days prior to menses in the last cycle before the study.<sup>[17]</sup> The treatment phase lasted three menstrual cycles ( $2 \times 30$  drops/day = 1.8 ml of VAC or placebo). Mastalgia for at least 5 days of the cycle before the treatment was the strict inclusion condition. For assessment of the efficacy, VAS was used. Altogether 97 patients were included in the statistical analysis (VAC:  $n = 48$ , placebo:  $n = 49$ ). Intensity of breast pain diminished quicker in the VAC group. This study design and duration were similar to that of Wuttke et al.<sup>[45]</sup> The results of this experiment showed a decrease in the VAS scores in both the treatment and placebo groups. However, as compared with the placebo, the treatment group had significantly lower VAS values at the end of each cycle ( $P = 0.018, 0.006, \text{ and } 0.064$  for cycles 1, 2, and 3, respectively).

In a randomized, placebo-controlled trial, the effects of VAC solution and placebo (double-blind) were compared with that of gestagen (Lynestrol<sup>®</sup>) in 160 women with mastalgia.<sup>[19]</sup> A complete remission or improvement of symptoms was reported in 82.1%, 74.5%, and 36.8% of the patients in the Lynestrol, VAC, and placebo groups, respectively. The difference in effect between treatment groups and placebo was significant ( $P < 0.01$ ), but no significant discrepancy was found between the two treatment groups.<sup>[19]</sup>

Open studies have been used to assess the effectiveness of VAC solution for the treatment of over 1700 women with mastalgia.<sup>[38–44]</sup> All these investigations assessed the efficacy of one VAC solution, at a dose of 45–75 drops per day for 1–6 cycles. Two of

these studies compared VAC treatment with Lynestrol (5 mg daily on days 12–24 of each cycle). Elimination of symptoms was observed in 46–81.5% of the treated women, improvement in 12–39.6%, and no effect in 6.5–29%. Collective reported adverse events from these studies included circulatory disturbances, acne, and weight gain.<sup>[38–44]</sup>

### Menstrual Cycle Irregularity and Infertility

Since 1954, at least 17 investigations have assessed the efficacy of VAC extracts for the treatment of menstrual cycle disorders including amenorrhea, oligomenorrhea, polymenorrhea, corpus luteum insufficiency, and infertility.<sup>[2]</sup> Two double-blind placebo-controlled clinical trials and several observational studies have investigated the effect of various fruit extracts on corpus luteal-phase dysfunction and infertility.<sup>[10,29,46]</sup> The products tested were ethanol extracts (53–70% ethanol), and the dose administered was 20 drops twice daily, 15 drops three times daily, 30 drops twice daily, or one to two tablets or capsules daily.

In the first randomized, double-blind, placebo-controlled trial, the efficacy of a dried VAC fruit extract was assessed in infertile women.<sup>[10]</sup> The objective of this study was to determine if elevated pituitary prolactin levels could be reduced by treatment with VAC, and if the deficits observed in the luteal-phase length and luteal-phase progesterone synthesis could be normalized. Blood was obtained for hormone analysis on days 5, 8, and 20 of the menstrual cycle, both before and after 3 mo of VAC therapy. Latent hyperprolactinemia was analyzed by monitoring prolactin release 15 and 30 min after intravenous administration of 200  $\mu\text{g}$  of thyroid hormone. Thirty-seven cases (placebo:  $n = 20$ , treatment:  $n = 17$ ) were included in the statistical analysis. After 3 mo of treatment, prolactin release was reduced, a significant increase in the length of the luteal phase (10.5 days;  $P < 0.05$ ) was observed, and deficits in luteal progesterone synthesis were decreased. These changes only occurred in the treatment group and were not observed in the placebo group. All other hormonal parameters did not change with the exception of  $17\beta$ -estradiol, which was observed to increase during the luteal phase in the treatment group. The overall length of the menstrual cycles did not change, suggesting that there was a corresponding shortening of the follicular phase. Two women in the extract group became pregnant by the end of the study. No adverse events were reported.<sup>[10]</sup>

In a second randomized, double-blind, placebo-controlled trial, the efficacy of a VAC fruit extract was assessed in 96 infertile women.<sup>[29]</sup> The outcome criteria measured included pregnancy or menstrual bleeding in women with secondary amenorrhea or

improved luteal hormone concentrations. The subjects were administered 30 drops of the extract twice daily for 3 mo. Sixty-six patients completed the study, and positive outcomes were observed in 47% of women overall, with 61% in the treatment group and 38% in the placebo group, although the results did not reach statistical significance ( $P = 0.069$ ). In women with amenorrhea or luteal-phase dysfunction, pregnancy resulted twice as often in the treatment group (15%) versus the placebo group (7%); however, no statistical analysis was reported.<sup>[29]</sup>

In open (uncontrolled) trials involving 48 (45 completed) infertile women (due to luteal-phase dysfunction), the efficacy of a VAC fruit extract for the normalization of progesterone concentrations was determined.<sup>[46]</sup> Inclusion criteria were normal prolactin levels (below 20 ng/ml), normal results in prolactin and thyroid stimulating stimulation (TSH) tests, and an abnormally low serum progesterone level below 12 ng/ml on the 20th day of the cycle. Treatment consisted of a fruit extract, 40 drops daily, without any other medication for 3 mo. Forty-five patients completed the studies (three were excluded because of concurrent hormone use). The outcome of therapy was assessed by the normalization of the midluteal progesterone concentration and correction (lengthening) of any pre-existing shortening of the phases of the cycle. Treatment was deemed successful in 39 out of the 45 women. Seven subjects became pregnant. In 25 patients, serum progesterone was restored to normal ( $>12$  ng/ml), and in seven cases there was a trend toward normalization of progesterone levels. However, no statistical analysis was performed on the resultant data.<sup>[46]</sup>

Two larger postmarketing trials, involving 479 women, assessed the safety and efficacy of a VAC fruit extract for the treatment of oligomenorrhea or polymenorrhea.<sup>[47]</sup> The subjects were treated with 30 drops of the extract twice daily and the outcome measured was the bleeding-free interval. A lengthening of the

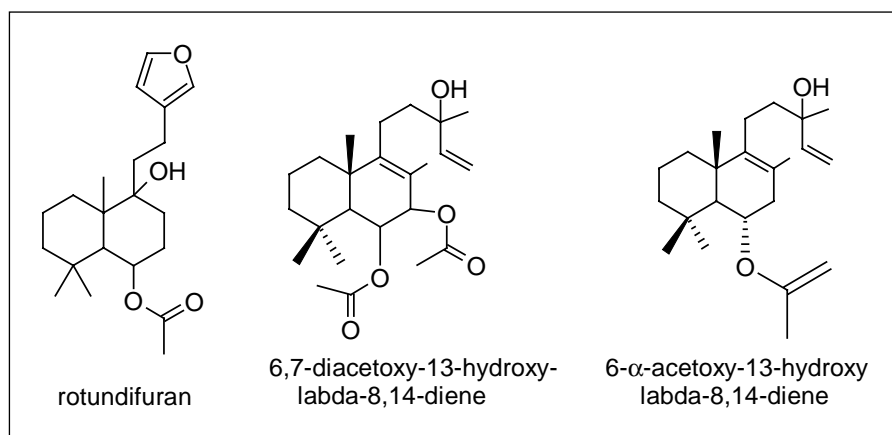
bleeding-free interval was observed for 35 days in 187/287 women receiving treatment for oligomenorrhea and 26 days in 139/192 patients being treated for polymenorrhea.<sup>[47]</sup>

### Endocrine-Dependent Dermatoses

Two uncontrolled clinical studies and one observational report have assessed the effects of a VAC fruit extract on acne caused by a hormone imbalance.<sup>[6–8]</sup> In one open study, 118 cases of acne were treated with a VAC extract (20 drops twice daily for 4–6 weeks, then 15 drops twice daily for 1–2 yr) and compared with conventional acne treatments.<sup>[8]</sup> Patients treated with the fruit extract reported a more rapid healing rate after 6 weeks and after 3 mo of therapy, while 70% of subjects taking the VAC extract stated complete healing.

### MECHANISM OF ACTION

Several potential mechanisms of action have been proposed to explain the activity of VAC extracts, including inhibition of prolactin secretion,<sup>[48–50]</sup> dopaminergic,<sup>[51–53]</sup> and estrogenic effects.<sup>[50,54–56]</sup> Extracts have been shown to act as a dopamine agonist in vitro and in vivo. The binding of an ethanol VAC extract and various fractions of the extract to the dopamine  $D_2$  and other receptors was evaluated by both radio-ligand binding studies and by superfusion experiments.<sup>[52]</sup> The extract bound to the dopamine  $D_2$  and opioid ( $\mu$  and  $\kappa$  subtype) receptors with a median inhibitory concentration ranges between 20 and 70  $\mu$ g/ml. Binding was not observed for the histamine  $H_1$ , benzodiazepine and OFQ receptors, or the serotonin transporter. Two diterpenes, isolated from a hexane fraction of the extract, rotundifuran and 6 $\beta$ ,7 $\beta$ -diacetoxy-13-hydroxy-labda-8,14-diene (Fig. 2),



**Fig. 2** 2- $\alpha$ -Acetoxy-13-hydroxylabdadiene, rotundifuran, and 6 $\beta$ ,7 $\beta$ -diacetoxy-13-hydroxy-labda-8,14-diene.

exhibited inhibitory actions on dopamine D<sub>2</sub> receptor binding with a median inhibitory concentration of 45 and 79 µg/ml, respectively.<sup>[27,52]</sup> While lipophilic fractions of the extract bound to the µ and κ opioid receptors, binding to delta opioid receptors was inhibited primarily by an aqueous fraction of the extract. In superfusion experiments, the aqueous fraction of a methanol extract inhibited the release of acetylcholine in a concentration-dependent manner. In addition, the D<sub>2</sub> receptor antagonist spiperone antagonized the effect of the extract suggesting a dopaminergic action mediated by D<sub>2</sub> receptor activation. A labdane diterpene, α-acetoxy-13-hydroxylabdadiene (Fig. 2), isolated from a fruit extract, was found to displace <sup>125</sup>I-sulpiride from recombinant human D<sub>2</sub> receptor binding sites in a dose-dependent manner.<sup>[57]</sup> This group also demonstrated that rotundifuran, at a concentration of 100 µM, significantly (*P* < 0.05) inhibited the secretion of prolactin from cultured rat pituitary cells.

Several groups have demonstrated that extracts bind to the estrogen receptor and have weak estrogenic effects, suggesting that chasteberry may also affect the estrogen/progesterone balance.<sup>[50,54–56]</sup> A methanol extract of the fruit bound to both ERα and ERβ, induced the expression of estrogen-dependent genes, progesterone receptor (PR), and presenelin-2 (pS2) in Ishikawa cells.<sup>[56]</sup> Significant binding affinity for both ERα and ERβ was observed, with a median inhibitory concentration of 46.3 and 64.0 µg/ml, respectively. However, the binding affinity of the extract for ERα and ERβ was not significantly different.<sup>[56]</sup> Based on bioassay-guided isolation, the “estrogenic” component from the fruit extract was identified as linoleic acid (LA), which also bound to ERα and ERβ.<sup>[58]</sup> Similar to the extract, LA also induced the expression of the PR mRNA in Ishikawa cells, at a concentration of 1 µg/ml, indicating that binding produced a biological estrogenic effect *in vitro*. In addition, low concentrations of the extract or LA (10 µg/ml) upregulate the expression of ERβ mRNA in the ER+ hormone-dependent T47D:A18 cell line, a further indication of estrogenic activity.<sup>[58]</sup>

## ADVERSE EFFECTS

In general, VAC products and extracts appear to be very well tolerated and there have been few accounts of adverse reactions (ARs). A review of 30 human studies, involving 11,506 subjects, reported a total of 246 adverse events, thus representing an AR rate of approximately 2%.<sup>[2]</sup> The major ARs included acne, cycle changes, dizziness, gastrointestinal distress, increased menstrual flow, nausea, skin reactions,

urticaria, and weight gain.<sup>[2]</sup> Minor side effects include fatigue, hair loss, increased intraocular pressure, palpitations, polyurea, sweating, and vaginitis.<sup>[2,45]</sup> One case of multiple follicular development was reported in a female patient after self-medication with a VAC-containing product for infertility.<sup>[59]</sup>

Although the potential estrogenic effects of VAC extracts are weak,<sup>[56,58]</sup> its use during pregnancy or in women with estrogen-dependent breast cancer should not be recommended. In addition, patients with a feeling of tension and swelling of the breasts or other menstrual disturbances should consult a healthcare provider for medical diagnosis.<sup>[60]</sup> Although there are no drug interactions reported, the potential dopaminergic effects of VAC extracts may reduce the efficacy of dopamine-receptor antagonists.<sup>[24,53]</sup> Furthermore, because of possible hormonal effects, VAC may interfere with the effectiveness of oral contraceptives and hormone therapy.<sup>[2]</sup>

## PRODUCTS AND DOSAGE

There is a wide range of VAC extracts and products available to consumers. The following examples are a general list of products used in clinical trials and listed in reference texts. This list is not complete, and is not intended as a recommendation of one product over another. The dose as listed is intended for adults, and the products are not recommended for children.

- Dry native extracts, 8.3–12.5:1 (w/w), ca. 1.0% casticin: one tablet, containing 2.6–4.2 mg native extract. The tablets should be swallowed whole with some liquid each morning.
- Dry native extract, 9.58–11.5:1 (w/w): one tablet containing 3.5–4.2 mg native extract each morning with some liquid.<sup>[28]</sup>
- Dry native extract, 6.0–12.0:1 (w/w), ca. 0.6% casticin: PMS: one tablet containing 20 mg native extract daily with water upon awaking or just before bedtime, before from meals.
- Fluid extract: 1:1 (g/ml), 70% alcohol (v/v): 0.5–1.0 ml.
- Fluid extract: 1:2 (g/ml): 1.2–4.0 ml.
- Tinctures, alcohol 58 vol% (100 g of aqueous-alcoholic solution contains 9 g of 1:5 tincture): 40 drops, one time daily with some liquid each morning.
- Tinctures, ethanol 19% v/v (100 g of aqueous-alcoholic solution contains 0.192–0.288 g extractive corresponding to 2.4 g dried fruit): 40 drops, once daily.
- Hydroalcoholic extracts (50–70% v/v): corresponding to 30–40 mg dried fruit.<sup>[2,60]</sup>

## REFERENCES

1. WHO Publications.. *Fructus Agnus castii. WHO Monographs on Selected Medicinal Plants*; WHO Publications: Geneva Switzerland, 2004; Vol. 4. *in press*.
2. *Chaste Tree Fruit, American Herbal Pharmacopoeia and Therapeutic Compendium*; Upton, R., Ed.; American Herbal Pharmacopoeia: Santa Cruz, CA, 2001.
3. Christie, S.; Walker, A.F. *Vitex agnus-castus* L.: (1) A review of its traditional and modern therapeutic use: (2) Current use from a survey of practitioners. *Eur. J. Herbal Med.* **1997**, *3*, 29–45.
4. Winterhoff, H.; Münster, C.; Gorkow, C. Die Hemmung der Laktation bei Ratten als indirekter Beweis für die Senkung von Prolaktin durch *Agnus castus*. *Z. Phytother.* **1991**, *12*, 175–179.
5. Winterhoff, H. *Vitex agnus castus* (chaste tree) pharmacological and clinical data. In *Phyto-medicines of Europe: Chemistry and Biological Activity*; Lawson, L.D., Bauer, R., Eds.; American Chemical Society: Washington, DC, 1998; 299–308. The National Osteoporosis Foundation. Physician's Guide to Prevention and Treatment of Osteoporosis, 1994; 1–43.
6. Amann, W. Acne vulgaris and *Agnus castus* (Agnolyt®). *Z. Allgemeinmed.* **1975**, *51*, 1645–1648.
7. Bleier, W. Phytotherapy in irregular menstrual cycles or bleeding periods and other gynecological disorders of endocrine origin. *Zentralbl. Gynäkol.* **1959**, *81*, 701–709.
8. Giss, G.; Rothenberg, W. Phytotherapeutische Behandlung der Akne. *Z. Haut Geschl. Kr.* **1968**, *43*, 645–647.
9. Merz, P.G.; Gorkow, C.; Schroedter, A.; Rietborch, S.; Sieder, C.; Loew, D.; Dericks-Tan, J.S.E.; Taubert, H.D. The effects of a special *Agnus castus* extract (BP1095E1) on prolactin secretion in healthy male subjects. *Exp. Clin. Endocrinol. Diab.* **1996**, *104*, 447–453.
10. Milewicz, A.; Gejdel, E.; Sworen, H.; Sienkiewicz, K.; Jedrzejak, J.; Teucher, T.; Schmitz, H. *Vitex agnus-castus* Extrakt zur Behandlung von Regeltempoanomalien infolge latenter Hyperprolaktinämie: Ergebnisse einer randomisierten Plazebo-kontrollierten Doppelblindstudie. *Arzneimittel-Forschung* **1993**, *43*, 752–756.
11. Loch, E.G.; Selle, H.; Bobbitz, N. Treatment of premenstrual syndrome with a phytopharmaceutical formulation containing *Vitex agnus-castus*. *J. Women's Health Gender Based Med.* **2000**, *9*, 315–320.
12. Dittmar, F.W.; Böhnert, K.J.; Peeters, M.; Albrecht, M.; Lamentz, M.; Schmidt, U.; Prämenstruelles Syndrom: Behandlung mit einem Phytopharmakon. *TW Gynäkol.* **1992**, *5*, 60–68.
13. Coeugnet, E.; Elek, E.; Kühnast, R. Das prämenstruelle Syndrom (PMS) und seine Behandlung. *Ärztz. Naturheilverfahr.* **1986**, *27*, 619–622.
14. Wuttke, W.; Gorkow, C.; Jarry, H. Dopaminergic compounds in *Vitex agnus castus*. In *Phytopharmaka in Forschung und klinischer Anwendung*; Lowe, D., Rietbrock, N., Eds.; Darmstadt: Steinkopff, 1995; S81–S91.
15. Loch, E.G.; Böhnert, K.J.; Peeters, M. Die Behandlung von Blutungsstörungen mit *Vitex-agnus-castus*-Tinktur. *Frauenarzt* **1991**, *32*, 867–870.
16. Loch, E.G.; Kaiser, E. Diagnostik und Therapie dysgonadaler Blutungen in der Praxis. *Gynäkol. Prax.* **1990**, *14*, 489–495.
17. Halaska, M.; Beles, P.; Gorkow, C.; Sieder, C. Treatment of cyclical mastalgia with a solution containing an extract of *Vitex agnus-castus*: recent results of a placebo-controlled double-blind study. *Breast* **1999**, *8*, 175–181.
18. Kress, D.; Thanner, E. Behandlung der Mastopathie: möglichst Risikoarm. *Med. Klin.* **1981**, *76*, 566–567.
19. Kubista, E.; Müller, G.; Spona, J. Behandlung der Mastopathie mit zyklischer Mastodynrie: klinische Ergebnisse und Hormonprofile. *Gynäkol. Rundsch.* **1986**, *26*, 65–79.
20. Amann, W. Amenorrhoe-günstige Wirkung von *Agnus castus* (Agnolyt®) auf Amenorrhoe. *Z. Allgemeinmed.* **1982**, *58*, 228–231.
21. McGuffin, M.; Hobbs, C.; Upton, R.; Goldberg, A. *Botanical Safety Handbook*; CRC Press: Boca Raton, 1997; 231 pp.
22. *British Herbal Pharmacopoeia*; 4th Ed.; British Herbal Medicine Association: Exeter: UK, 1996.
23. *European Pharmacopoeia*, 4th Ed.; Strasbourg, Directorate for the Quality of Medicines of the Council of Europe (EDQM), 2001: Strasbourg, 2002.
24. Abel, G.; Goetz, C.; Wolf, H. *Vitex*. In *Hagers Handbuch der pharmazeutischen Praxis*; Hänsel, R., Keller, K., Rimpler, H., Schneider, G., Eds.; Springer: Berlin, 1994; Vol. 6 (P–Z), 1183–1196.
25. Meier, B.; Hoberg, E. Agni-casti fructus. New findings on quality and effectiveness. *Z. Phytother.* **1999**, *20* (3), 140–158.

26. Hoberg, E.; Meier, B.; Sticher, O. Quantitative high performance liquid chromatography analysis of casticin in the fruits of *Vitex agnus-castus*. *Pharmaceut. Biol.* **2001**, *39*, 57–61.
27. Hoberg, E.; Orjala, J.; Meier, B.; Sticher, O. Diterpenoids from the fruits of *Vitex agnus-castus*. *Phytochemistry* **1999**, *52*, 1555–1558.
28. Lauritzen, C.; Reuter, H.D.; Repges, R.; Bohnert, K.J.; Schmidt, U. Treatment of premenstrual tension syndrome with *Vitex agnus-castus*; controlled double-blind study versus pyridoxine. *Phytomedicine* **1997**, *4*, 183–189.
29. Gerhard, I.; Patek, A.; Monga, B.; Blank, A.; Gorkow, C. Mastodynon bei weiblicher Sterilität: randomisierte plazebokontrollierte klinische Doppelblindstudie. *Forsch. Komplementarmed.* **1998**, *20*, 272–278.
30. Chuong, C.J.; Coulam, C.B. Current views and the beta-endorphin hypothesis. In *The Premenstrual Syndrome*; Gise, L.H., Kase, N.G., Berkowith, R.L., Eds.; Churchill Livingstone: New York, 1988; 75–95.
31. Berger, D.; Schaffner, W.; Schrader, E.; Meier, B.; Brattstrom, A. Efficacy of *Vitex agnus castus* L. extract Ze 440 in patients with premenstrual syndrome (PMS). *Arch. Gynecol. Obstet.* **2000**, *264*, 150–153.
32. Feldman, H.U.; Albrecht, M.; Lamertz, M.; Bohnert, K.J. Therapie bei gelbkörperschwäche bzw. prämenstruellem Syndrom mit *Vitex-agnus-castus*-Tinktur. *Gyne* **1990**, *11*, 421–425.
33. Liebl, A. Behandlung des prämenstruellen Syndroms: *Agnus-castus*-haltiges Kombinationsarzneimittel im Test. *TW Gynäkol.* **1992**, *5*, 147–154.
34. Meyl, C. Therapie des prämenstruellen Syndroms. Vergleich einer kombinierten Behandlung von Mastodynon und Vitamin E mit der Vitamin E-Monotherapie. *Therapeutikon* **1991**, *5*, 518–525.
35. Peters-Welte, C.; Albrecht, M. Regeltempostörungen und PMS: *Vitex agnus-castus* in einer Anwendungsbeobachtung. *TW Gynäkol.* **1994**, *7*, 49–50.
36. Schellenberg, R.; Kunze, G.; Pfaff, E.R.; Massing, A.; Wältner, H.; Kirschbaum, M.; Boedecker, R.H.; Dudeck, J. Pre-menstrual syndrome treatment with *Agnus castus* extract: a randomised, placebo-controlled study. *Br. Med. J.* **2001**, *322*, 134–137.
37. Turner, S.; Mills, S. A double-blind clinical trial on a herbal remedy for premenstrual syndrome: a case study. *Complement. Ther. Med.* **1993**, *1*, 73–77.
38. Fersizoglou, N.E. Hormonale und thermographische Veränderungen unter konservativer Therapie der Mastopathie. Vergleich von Danazol, Tamoxifen, Lisurid, Lynestrenol und einem Phytopharmakon [dissertation]; Universitäts-Frauenklinik Heidelberg: Heidelberg, 1989. Available from: Universitäts-Fraunklinik Heidelberg.
39. Fikentscher, H. Ätiologie, Diagnose und Therapie der Mastopathie und Mastodynie. Erfahrungen bei der Behandlung mit Mastodynon®. *Med. Klin.* **1977**, *72*, 1327–1330.
40. Fournier, D.; Grumbrecht, C. Behandlung der Mastopathie, Mastodynie und des prämenstruellen Syndroms. Vergleich medikamentöser Behandlung zu unbehandelten Kontrollen. *Therapiewoche* **1987**, *37* (5), 430–434.
41. Gregl, A. Klinik und Therapie der Mastodynie. *Med. Welt* **1985**, *36*, 242–246.
42. Krapfl, E. Prospektiv randomisierte klinische Therapiestudie zum Wirksamkeitsvergleich von Orgametril®, einem 19 Nor-Testosteron-Derivat, versus Mastodynon®, einem *Agnus castus*-haltigen alkoholischen Pflanzenextrakt, bei schmerzhafter Mastopathie [dissertation]; Universitäts-Frauenklinik Heidelberg: Heidelberg, 1988; 150 pp. Available from: Universitäts Frauenklinik Heidelberg.
43. Opitz, G.; Liebl, A. Zur konservativen Behandlung der Mastopathie mit Mastodynon. *Ther. Gegenwart* **1980**, *119* (7), 804–809.
44. Schwalbe, E. Ein Beitrag zur behandlung der Mastodynie. *Z. Allgemeinmed.* **1979**, *55* (22), 1239–1242.
45. Wuttke, W.; Solitt, G.; Gorkow, C.; Sieder, C. Behandlung zyklusabhängiger Brustschmerzen mit einem *Agnus-castus*-haltigen Arzneimittel. Ergebnisse einer randomisierten plazebokontrollierten Doppelblindstudie. *Geburtshilfe Frauenheilkd.* **1997**, *57* (10), 569–574.
46. Propping, D.; Katzorke, T. Behandlung der Gelbkörperschwäche in der Praxis. *Therapiewoche* **1987**, *38*, 2992–3001.
47. Mergner, R. Zyklusstörungen: Therapie mit einem *Vitex agnus-castus* haltigen Kombinationsarzneimittel. *Kassenarzt* **1992**, *7*, 51–60.
48. Jarry, H.; Leonhardt, S.; Wuttke, W.; Gottingen, B.; Gorkow, C. *Agnus castus* als dopaminerges Wirkprinzip in mastodynon. *Z. Phytother.* **1991**, *12*, 77–82.
49. Jarry, H.; Leonhardt, S.; Gorkow, C.; Wuttke, W. In vitro prolactin but not LH and FSH release is inhibited by compounds in extracts of *Agnus castus*: Direct evidence for a dopaminergic

- principle by the dopamine receptor assay. *Exp. Clin. Endocrinol.* **1994**, *102*, 448–454.
50. Jarry, H.; Kuhn, U.; Ludwig, M.L.; Wuttke, W.; Sprengler, B.; Christoffel, V. Erste Hinweise für estrogen-wirkende Inhaltstoffe im *Vitex agnus-castus*: Effekte auf die in-vitro Steroidsekretion von humanen Granulosa- und porcinen Lutealzellen. *J. Menopause* **2000**, *4*, 12–13.
  51. Jarry, H. Diterpenes isolated from *Vitex agnus castus* BNO 1095 inhibit prolactin secretion via specific interaction with dopamine D2 receptors in the pituitary [abstract]. 10. Jahrestagung der Gesellschaft für Phytotherapie, Münster, Nov 11–13, 1999, Verl. Sci. Data Supp., 3–4.
  52. Meier, B.; Berger, D.; Hoberg, E.; Sticher, O.; Schaffner, W. Pharmacological activities of *Vitex agnus-castus* extracts in vitro. *Phytomedicine* **2000**, *7*, 373–381.
  53. Wuttke, W.; Jarry, H.; Christoffel, V.; Spengler, B.; Seidlova-Wuttke, D. Chaste tree (*Vitex agnus castus*)—pharmacological and clinical indications. *Phytomedicine* **2003**, *10*, 348–357.
  54. Berger, D. *Vitex agnus-castus*: safety and efficacy in the treatment of the premenstrual syndrome, principles and mechanisms of action of a newly developed extract [thesis]. University of Basel: Basel, Switzerland, 1998. Available from: College of Philosophy and Natural Sciences, University of Basel.
  55. Eagon, C.L.; Elm, M.S.; Teepe, A.G.; Eagon, P.K. Medicinal botanicals: estrogenicity in rat uterus and liver. *Proc. Am. Assoc. Cancer Res.* **1997**, *38*, 193
  56. Liu, J.; Burdette, J.; Xu, H.Y.; Bolton, J. Evaluation of estrogenic activity of plant extracts for the potential treatment of menopausal symptoms. *J. Agric. Food Chem.* **2001**, *49*, 2472–2479.
  57. Christoffel, V. Prolactin inhibiting dopaminergic activity of diterpenes from *Vitex agnus-castus*. In *Phytopharmaka V, Forschung und klinische Anwendung*; Loew, D., Blume, H., Dinger, T.H., Eds.; Darmstadt: Steinkopff, 1999.
  58. Burdette, J.; Liu, J. Estrogenic activity of *Vitex agnus-castus* and linoleic acid. *Phytomedicine. in press.*
  59. Cahill, D.J.; Fox, R.; Wardle, P.G.; Harlow, C.R. Multiple follicular development associated with herbal medicine. *Hum. Reprod.* **1994**, *9*, 1469–1470.
  60. *The Complete German Commission E Monographs: Therapeutic Guide to Herbal Medicines*; Blumenthal, M., Ed.; American Botanical Council: Austin, TX, 1998.





# Choline

Jiannan Song  
Steven H. Zeisel

*School of Public Health and School of Medicine, University of North Carolina,  
Chapel Hill, North Carolina, U.S.A.*

## INTRODUCTION

Choline, an essential nutrient for humans, is consumed in many foods. It is a constituent of all cell membranes and is necessary for growth and development. Also, as the major precursor of betaine, it is used by the kidney to maintain water balance and by the liver as a source of methyl groups for the removal of homocysteine in methionine formation. Moreover, choline is used to produce the important neurotransmitter (nerve messenger chemical) acetylcholine, which is involved in memory and other nervous system functions. Maternal diets deficient in choline during the second half of pregnancy in rodents caused decreased neuronal cell growth and increased cell death in the memory center of fetal brains. This resulted in lifelong biochemical, structural, and electrophysiological changes in brains, and permanent behavioral (memory) modifications in the offspring. Dietary deficiency of choline in rodents causes development of liver cancer in the absence of any known carcinogen. In humans, dietary deficiency of choline is associated with fatty liver and liver damage. With the recent availability of a food choline content database, and with new recommended adequate intakes of choline in the human diet, further epidemiological and clinical studies on this nutrient can be expected.

## BIOCHEMISTRY AND RELATION WITH OTHER NUTRIENTS

Choline (Fig. 1) is needed for synthesis of the major phospholipids in cell membranes. Phospholipids are the structural building blocks of membranes and have hydrophilic (water-attracting) properties that create the double layer structure of membranes. Choline is also involved in methyl metabolism, cholinergic

neurotransmission, transmembrane signaling, and lipid-cholesterol transport and metabolism.<sup>[1]</sup> Choline can be acetylated, phosphorylated, oxidized, or hydrolyzed. There are several comprehensive reviews of the metabolism and functions of choline.<sup>[1,2]</sup>

Cells necessarily require choline, and die by apoptosis when deprived of this nutrient. Humans derive choline from foods, and from the *de novo* biosynthesis of choline moiety via the methylation of phosphatidylethanolamine using *S*-adenosylmethionine as the methyl donor (most active in the liver). This ability to form choline means that some of the demand for choline can, in part, be met using methyl groups derived from 1-carbon metabolism (via methyl-folate and methionine). Several vitamins (folate, vitamin B<sub>12</sub>, vitamin B<sub>6</sub>, and riboflavin) and the amino acid methionine interact with choline in 1-carbon metabolism (Fig. 2). There has been renewed interest in these pathways during the past several years, engendered by recent insights that indicate that modest dietary inadequacies of the above-mentioned nutrients, of a degree insufficient to cause classical deficiency syndromes, can still contribute to important diseases such as neural tube defects, cardiovascular disease, and cancer.<sup>[2]</sup>

Perturbing the metabolism of one of these pathways results in compensatory changes in the others.<sup>[1]</sup> For example, methionine can be formed from homocysteine using methyl groups from methyl-tetrahydrofolate (THF), or from betaine that are derived from choline. Similarly, methyl-THF can be formed from 1-carbon units derived from serine or from the methyl groups of choline via dimethylglycine. Choline can be synthesized *de novo* using methyl groups derived from methionine (via *S*-adenosylmethionine). When animals and humans are deprived of choline, they use more methyl-THF to remethylate homocysteine in the liver and increase dietary folate requirements. Conversely, when they are deprived of folate, they use more methyl groups from choline, increasing the dietary requirement for choline.<sup>[3]</sup> The availability of transgenic and knockout mice has made possible additional studies that demonstrate the interrelationship of these methyl sources.<sup>[4]</sup> When considering dietary requirements, it is important to realize that methionine, methyl-THF, and choline can be fungible sources of methyl groups.

---

*Jiannan Song, M.D.*, is at the Department of Nutrition, School of Public Health and School of Medicine, University of North Carolina, Chapel Hill, North Carolina, U.S.A.

*Steven H. Zeisel, M.D., Ph.D.*, is at the Department of Nutrition, School of Public Health and School of Medicine, University of North Carolina, Chapel Hill, North Carolina, U.S.A.

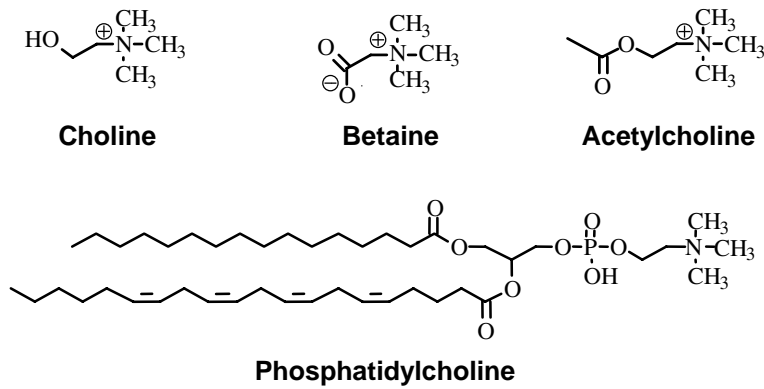


Fig. 1 Chemical structures of choline and related compounds.

As discussed earlier, de novo choline synthesis is catalyzed by phosphatidylethanolamine *N*-methyltransferase (PEMT), which is primarily found in the liver. The PEMT knockout (*pemt*<sup>-/-</sup>) mice developed fatty liver and other signs of choline deficiency. This phenomenon can be reversed by adding extra choline to their diet.<sup>[4]</sup> Another interesting finding is that *pemt*<sup>-/-</sup> females have trouble delivering normal litters without additional choline in their diet (unpublished data). Furthermore, the biochemistry and morphology of the fetal brain was altered in *pemt*<sup>-/-</sup> offspring. Overexpression of the *pemt* gene in cell culture systems downregulated PI3K/Akt signaling and induced apoptosis, perhaps explaining impaired proliferation induced by *pemt2* transfection.<sup>[5]</sup> These results

together with the previous findings that humans are subject to dietary choline deficiency under certain conditions during which endogenous production cannot meet the demand, lead to the postulation that people with a defective PEMT enzyme could be more susceptible to choline deficiency. This enzyme is highly polymorphic: 98 single nucleotide polymorphisms (SNPs) were found in 48 Japanese people.<sup>[6]</sup> Whether any of these would lead to functional outcomes is currently under investigation.

## PHYSIOLOGY

### Choline Metabolism

Choline is found in foods as free choline and as esterified forms such as phosphocholine, glycerophosphocholine, sphingomyelin, and phosphatidylcholine.<sup>[7]</sup> Lecithin is a term often used interchangeably with phosphatidylcholine, whereas the compound is a phosphatidylcholine-rich mixture added as an emulsifying agent in the food industry. Pancreatic enzymes can liberate choline from dietary phosphocholine, glycerophosphocholine, and phosphatidylcholine. Before choline can be absorbed in the gut, some is metabolized by bacteria to form betaine and methylamines (which are not methyl donors).

There is no estimate for percentage absorption of the various forms of choline in humans. The water-soluble choline-derived compounds (choline, phosphocholine, and glycerophosphocholine) are absorbed via the portal circulation, whereas the lipid-soluble compounds (phosphatidylcholine and sphingomyelin) are absorbed as chylomicrons. Lecithin is the most abundant choline-containing compound in the diet. About half of the lecithin ingested enters the thoracic duct, and the remaining is metabolized to glycerophosphocholine in the intestinal mucosa and subsequent to choline in the liver. The liver takes up the majority of choline and stores it in the form of phosphatidylcholine and

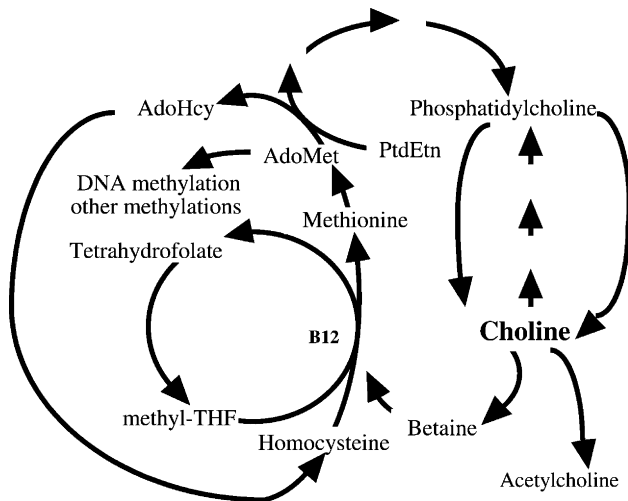


Fig. 2 Pathways of choline metabolism. Choline can be a methyl group donor and interacts with methionine and folate metabolism. It can be acetylated to form the neurotransmitter, acetylcholine, and can be phosphorylated to form membrane phospholipids such as phosphatidylcholine (lecithin). Abbreviations: AdoHcy—S-adenosylhomocysteine; AdoMet—S-adenosylmethionine; PtdEtn—phosphatidylethanolamine; THF—tetrahydrofolate.

sphingomyelin. Kidney and brain also accumulate choline. Although some free choline is excreted with urine, most is oxidized in the kidney to form betaine, which is responsible for maintaining the osmolarity in kidney. A specific carrier is needed for the transport of free choline across the blood–brain barrier, and the capacity is especially high in neonates.

## CHOLINE DEFICIENCY AND ORGAN FUNCTION

Many animal species, including the baboon, fed a choline-deficient diet deplete choline stores and develop liver dysfunction. Within hours of a choline-deficient diet, fat accumulation can be detected in the rat liver. Prolonged choline deficiency may result in liver cirrhosis. Renal dysfunction is another major choline deficiency sign in animal models. Massive tubular necrosis and interstitial hemorrhage are usually followed by complete renal failure. Animals fed a choline-deficient diet may also develop growth retardation, bone abnormalities, neural tube defects, and pancreatic damage. However, supplementation of choline to poultry reduced bird's liver fat and enhanced immune function.<sup>[8]</sup>

Some humans (male and female) fed total parenteral nutrition (TPN) solutions devoid of choline, but adequate for methionine and folate, have significantly lower levels of plasma-free choline and develop fatty liver and hepatic aminotransferase abnormalities. However, liver damage resolves when a source of dietary (or intravenous) choline is provided.<sup>[9]</sup> Fatty liver occurs because choline is required to make the phosphatidylcholine portion of the VLDL lipoprotein particle. In the absence of choline, VLDL is not secreted, and triglyceride accumulates in hepatic cytosol.

## Choline and Cardiovascular Disease

The choline-containing phospholipid phosphatidylcholine has been used as a treatment to lower the cholesterol concentrations because lecithin–cholesterol acyltransferase has an important role in the removal of cholesterol from tissue. Betaine, the oxidized product of choline, has been used to normalize the plasma homocysteine and methionine levels in patients with homocystinuria, a genetic disease caused by 5,10-methylenetetrahydrofolate reductase deficiency. Therefore, dietary choline intake might be correlated with cardiovascular disease risk. Many epidemiologic studies have examined the relationship between dietary folic acid and cancer or heart disease. It may be helpful to also consider choline intake as a confounding factor because folate and choline methyl donation can be interchangeable.<sup>[7]</sup>

## Choline Deficiency and Cancer

An interesting effect of dietary choline deficiency in rats and mice has never been studied in humans. Deficiency of this nutrient in rodents causes development of hepatocarcinomas in the absence of any known carcinogen.<sup>[10]</sup> Choline is the only single nutrient for which this is true. It is interesting that choline-deficient rats not only have a higher incidence of spontaneous hepatocarcinoma, but also are markedly sensitized to the effects of administered carcinogens. Several mechanisms are suggested for the cancer-promoting effect of a choline-devoid diet. These include increased cell proliferation related to regeneration after parenchymal cell death occurs in the choline-deficient liver, hypomethylation of DNA (alters expression of genes), reactive oxygen species leakage from mitochondria with increased lipid peroxidation in liver, activation of protein kinase C signaling due to accumulation of diacylglycerol in liver, mutation of the fragile histidine triad (FHIT) gene, which is a tumor suppressor gene, and defective cell-suicide (apoptosis) mechanisms.<sup>[10]</sup> Loss of PEMT function may also contribute to malignant transformation of hepatocytes.<sup>[5]</sup>

## CHOLINE AND BRAIN

### Choline and Adult Brain Function

Acetylcholine is one of the most important neurotransmitters used by neurons in the memory centers of the brain (hippocampus and septum). Choline accelerates the synthesis and release of acetylcholine in nerve cells. Choline used by brain neurons is largely derived from membrane lecithin, or from dietary intake of choline and lecithin. Free choline is transported across the blood–brain barrier at a rate that is proportional to serum choline level, while lecithin may be carried into neurons as part of an ApoE lipoprotein. Choline derived from lecithin may be especially important when extracellular choline is in short supply, as might be expected to occur in advanced age because of decreased brain choline uptake.<sup>[11]</sup>

Single doses of choline or lecithin in adult humans may enhance memory performance in healthy individuals, perhaps with greatest effect in individuals with the poorest memory performance. Studies in students showed that lecithin or choline treatment improved memory transiently for hours after administration.<sup>[12]</sup> In humans with Alzheimer-type dementia, some studies report enhanced memory performance after treatment with lecithin,<sup>[13]</sup> while other studies did not observe this. Buchman et al.<sup>[14]</sup> recently reported that humans on long-term TPN may have verbal and visual

memory impairment which may be improved with choline supplementation. If lecithin is effective, it is in a special subpopulation in the early stages of the disease. Choline and lecithin have also been effectively used to treat tardive dyskinesia, presumably by increasing cholinergic neurotransmission.<sup>[15]</sup>

### Choline and Brain Development

Maternal dietary choline intake during late pregnancy modulated mitosis and apoptosis in progenitor (stem) cells of the fetal hippocampus and septum and altered the differentiation of neurons in fetal hippocampus.<sup>[16]</sup> Variations in maternal dietary choline intake (choline supplementation or choline deficiency) during late pregnancy also were associated with significant and irreversible changes in hippocampal function in the adult animal, including altered long-term potentiation (LTP) and altered memory.<sup>[17]</sup> More choline (about 4× dietary levels) during days 11–17 of gestation in the rodent increased hippocampal progenitor cell proliferation, decreased apoptosis in these cells, enhanced LTP in the offspring when they were adult animals, and enhanced visuospatial and auditory memory by as much as 30% in the adult animals throughout their lifetimes.<sup>[17]</sup> The enhanced maze performance appears to be due to choline-induced improvements in memory capacity. Indeed, adult rodents decrement in memory as they age, and offspring exposed to extra choline in utero do not show this “senility.”<sup>[18]</sup> In contrast, mothers fed choline-deficient diets during late pregnancy have offspring with diminished progenitor cell proliferation and increased apoptosis in fetal hippocampus, insensitivity to LTP when they were adult animals, and decremented visuospatial and auditory memory.<sup>[17]</sup> Early postnatal choline supplementation significantly attenuated the effects of prenatal alcohol on a learning task, suggesting that early dietary interventions may also influence brain development.<sup>[19]</sup> The mechanisms for these developmental effects of choline are not yet clear. We hypothesize that some of the genes that are regulators of cell cycling are, in turn, regulated by epigenetic events that are modulated by choline.<sup>[20]</sup> Specifically, DNA methylation is an epigenetic event that is required for a proper gene regulation during neurogenesis.<sup>[21]</sup> DNA methylation, especially at the CG sites, is associated with a reduction of gene expression. In brain and other tissues, a choline-methyl-deficient diet directly alters gene methylation. Specifically in CpG islands within specific genes, global DNA was significantly undermethylated in brains of choline-methyl-deficient rats.<sup>[22]</sup> Rats fed a choline-deficient diet showed a poorer retention of nociceptive memory in the passive avoidance task,<sup>[23]</sup>

suggesting that effects on brain may not be limited to the fetal period.

Are these findings in animals likely to be true in humans? We do not know. Human and rat brains mature at different rates. In terms of hippocampal development, the embryonic days 12–18 in the rat correspond to approximately the last trimester of human. Rat brain is comparatively more mature at birth than is the human brain, but human hippocampal development may continue for months or years after birth. A pilot study on prenatal choline supplementation in humans is underway at this time.

### HUMAN REQUIREMENT FOR CHOLINE

Though males have a dietary requirement for choline,<sup>[2]</sup> human studies in women, children, or infants have not been completed. Thus, we do not know whether choline is needed in the diet of these groups. Pregnancy may be a time when dietary supplies of choline are especially limiting.

### Gender and Choline Requirement

Males have higher choline requirement than do females.<sup>[2]</sup> Female rats are less sensitive to choline deficiency than are male rats perhaps because estrogen enhances females' capacity to form the choline moiety *de novo* from *S*-adenosylmethionine.<sup>[24]</sup>

### Pregnancy and Choline Requirement

Though female rats are resistant to choline deficiency, pregnant rats are as vulnerable to deficiency as are males.<sup>[25]</sup> During pregnancy, large amounts of choline are delivered to the fetus across the placenta and this depletes maternal stores. Choline concentration in amniotic fluid is 10-fold greater than that in maternal blood. At birth, humans and other mammals have plasma choline concentrations that are much higher than those in adults.<sup>[26]</sup> This is accompanied by significant depletion of the maternal choline pool. In rats, the liver choline concentrations in late pregnancy decreased to less than one-third that of nonpregnant females. It is not known whether the *de novo* synthesis of choline increases during pregnancy.

### Choline in Milk

Large amounts of choline are required in neonates for rapid organ growth and membrane biosynthesis. Choline administration significantly increased milk

production (and milk choline content) during the first month of lactation in cows, but did not affect fat or protein concentrations in milk.<sup>[27]</sup> Human infants derive much of their choline from milk. Mature human milk contains more phosphocholine and glycerophosphocholine than choline, phosphatidylcholine, or sphingomyelin. Human milk contains 1.5–2 mM choline moiety per liter. The mother's need for choline is likely to be increased during lactation because much must be secreted into milk. Lactating rats are more sensitive to choline deficiency than are nonlactating rats.<sup>[25]</sup>

### Choline in Plasma

Plasma choline concentration varies in response to diet and can rise as much as twofold after a two-egg meal. Fasting plasma choline concentrations vary from 7 to 20  $\mu$ M, with most subjects having concentrations of 10  $\mu$ M. Individuals who have starved for up to 7 days have diminished plasma choline, but levels never drop below 50% of normal. Plasma phosphatidylcholine concentration also decreases in choline deficiency,<sup>[28]</sup> but these values are also influenced by factors that change plasma lipoprotein levels. Fasting plasma phosphatidylcholine concentrations are approximately 1–1.5 mM.

### Food Sources

In foods there are multiple choline compounds that contribute to total choline content (choline, glycerophosphocholine, phosphocholine, phosphatidylcholine, and sphingomyelin).<sup>[29]</sup> Foods highest in total choline concentrations per 100 g were: beef liver (418 mg), chicken liver (290 mg), eggs (251 mg), wheat germ (152 mg), bacon (125 mg), dried soybeans (116 mg), and pork (103 mg). Betaine in foods cannot be converted to choline but can spare the use of choline as a methyl group donor. The foods highest in betaine concentrations per 100 g were: wheat bran (1506 mg), wheat germ (1395 mg), spinach (725 mg), pretzels (266 mg), shrimp (246 mg), and wheat bread (227 mg). Both commercially available infant formulas and bovine milk contain choline and choline-containing compounds.<sup>[30]</sup> Soy-derived infant formulas have lower glycerophosphocholine concentration, but have more phosphatidylcholine than do either human milk or bovine-derived formulas. Free choline is added to infant formulas when they are formulated.

### Adverse Effects

High doses of choline have been associated with excessive cholinergic stimulation, such as vomiting,

salivation, sweating, and gastrointestinal effects. In addition, fishy body odor results from the excretion of trimethylamine, a choline metabolite from bacterial action.<sup>[24]</sup> The tolerable upper limit for choline has been set at 3 g/day.<sup>[2]</sup>

## DIETARY RECOMMENDATIONS

The Institute of Medicine (IOM) recently made recommendations for choline intake in the diet.<sup>[2]</sup> There were insufficient data to derive an estimated average requirement for choline; hence, only an adequate intake (AI) could be estimated. The IOM report cautioned, "this amount will be influenced by the availability of methionine and methyl-folate in the diet. It may be influenced by gender, and it may be influenced by pregnancy, lactation, and stage of development. Although AIs are set for choline, it may be that the choline requirement can be met by endogenous synthesis at some of these stages." The IOM recommendations are given in Table 1.

## CONCLUSIONS

Choline in the diet is important for many reasons. Humans deprived of it develop liver dysfunction. Also, parenterally nourished patients need a source of choline. As our understanding of the importance of folate

**Table 1** IOMs recommended adequate intakes (AIs) of choline for humans

Group	Amount (mg/day)
Infants	
0–6 mo	125, 18 mg/kg
6–12 mo	150
Children	
1–3 yr	200
4–8 yr	250
9–13 yr	375
Males	
14–18 yr	550
19 yr and older	550
Females	
14–18 yr	400
19 yr and older	425
Pregnancy (all ages)	450
Lactation (all ages)	550

(From Ref.<sup>[2]</sup>.)

and homocysteine nutrition increases, there should be increased interest in studying how choline interacts with these compounds. Recent findings about choline in brain development should stimulate comparable studies in humans. The availability of food composition data now makes it possible to examine interactions between choline, folate, and methionine when considering epidemiological data.

## ACKNOWLEDGMENTS

Support was received from the National Institutes of Health (AG09525, DK55865) and by grants from the NIH to the UNC Clinical Nutrition Research Unit (DK56350) and Center for Environmental Health Susceptibility (ES10126). Jiannan Song is a recipient of a Royster Fellowship from the University of North Carolina.

## REFERENCES

1. Zeisel, S.H.; Blusztajn, J.K. Choline and human nutrition. *Ann. Rev. Nutr.* **1994**, *14*, 269–296.
2. Institute of Medicine and National Academy of Sciences USA. In *Dietary Reference Intakes for Folate, Thiamin, Riboflavin, Niacin, Vitamin B<sub>12</sub>, Panthothenic acid, Biotin, and Choline*; National Academy Press: Washington DC, 1998; Vol. 1.
3. Kim, Y.-I. et al. Folate deficiency causes secondary depletion of choline and phosphocholine in liver. *J. Nutr.* **1995**, *124* (11), 2197–2203.
4. Waite, K.A.; Cabilio, N.R.; Vance, D.E. Choline deficiency-induced liver damage is reversible in *Pemt*<sup>(-/-)</sup> mice. *J. Nutr.* **2002**, *132* (1), 68–71.
5. Zou, W. et al. Overexpression of *PEMT2* downregulates the PI3K/Akt signaling pathway in rat hepatoma cells. *Biochim. Biophys. Acta* **2002**, *1581* (1–2), 49–56.
6. Saito, S. et al. Identification of 197 genetic variations in six human methyltransferase genes in the Japanese population. *J. Hum. Genet.* **2001**, *46* (9), 529–537.
7. Zeisel, S.H. et al. Concentrations of choline-containing compounds and betaine in common foods. *J. Nutr.* **2003**, *133* (5), 1302–1307.
8. Swain, B.K.; Johri, T.S. Effect of supplemental methionine, choline and their combinations on the performance and immune response of broilers. *Br. Poult. Sci.* **2000**, *41* (1), 83–88.
9. Buchman, A. et al. Choline deficiency: a cause of hepatic steatosis during parenteral nutrition that can be reversed with intravenous choline supplementation. *Hepatology* **1995**, *22* (5), 1399–1403.
10. Zeisel, S.H. et al. Choline deficiency selects for resistance to p53-independent apoptosis and causes tumorigenic transformation of rat hepatocytes. *Carcinogenesis* **1997**, *18*, 731–738.
11. Cohen, B.M. et al. Decreased brain choline uptake in older adults. An in vivo proton magnetic resonance spectroscopy study. *JAMA* **1995**, *274*, 902–907.
12. Sitaram, N. et al. Choline: Selective enhancement of serial learning and encoding of low imagery words in man. *Life Sci.* **1978**, *22* (17), 1555–1560.
13. Little, A. et al. A double-blind, placebo controlled trial of high-dose lecithin in Alzheimer's disease. *J. Neurol. Neurosurg. Psychiatry* **1985**, *48* (8), 736–742.
14. Buchman, A.L. et al. Verbal and visual memory improve after choline supplementation in long-term total parenteral nutrition: a pilot study. *J. Parenter. Enteral. Nutr.* **2001**, *25* (1), 30–35.
15. Growdon, J.H.; Gelenberg, A.J. Choline and lecithin administration to patients with tardive dyskinesia. *Trans. Am. Neurol. Assoc. (JC:w3w)* **1978**, *103* (95), 95–99.
16. Albright, C.D. et al. Maternal choline availability alters the localization of p15Ink4B and p27Kip1 cyclin-dependent kinase inhibitors in the developing fetal rat brain hippocampus. *Dev. Neurosci.* **2001**, *23* (2), 100–106.
17. Meck, W.H.; Williams, C.L. Choline supplementation during prenatal development reduces proactive interference in spatial memory. *Brain Res. Dev. Brain Res.* **1999**, *118* (1–2), 51–59.
18. Meck, W.H.; Williams, C.L. Metabolic imprinting of choline by its availability during gestation: Implications for memory and attentional processing across the lifespan. *Neurosci. Biobehav. Rev.* **2003**, *27*, 385–399.
19. Thomas, J.D. et al. Neonatal choline supplementation ameliorates the effects of prenatal alcohol exposure on a discrimination learning task in rats. *Neurotoxicol. Teratol.* **2000**, *22* (5), 703–711.
20. Niculescu, M.D.; Yamamuro, Y.; Zeisel, S.H. Choline availability modulates human neuroblastoma cell proliferation and alters the methylation of the promoter region of the

- cyclin-dependent kinase inhibitor 3 gene. *J. Neurochem.* **2004**, *89* (5), 1252–1259.
21. Lachner, M.; Jenuwein, T. The many faces of histone lysine methylation. *Curr. Opin. Cell Biol.* **2002**, *14* (3), 286–298.
  22. Alonso-Aperte, E.; Varela-Moreiras, G. Brain folates and DNA methylation in rats fed a choline deficient diet or treated with low doses of methotrexate. *Int. J. Vitam. Nutr. Res.* **1996**, *66* (3), 232–236.
  23. Nakamura, A. et al. Dietary restriction of choline reduces hippocampal acetylcholine release in rats: In vivo microdialysis study. *Brain Res. Bull.* **2001**, *56* (6), 593–597.
  24. Drouva, S.V. Estradiol activates methylating enzyme(s) involved in the conversion of phosphatidylethanolamine to phosphatidylcholine in rat pituitary membranes. *Endocrinology* **1986**, *119* (6), 2611–2622.
  25. Zeisel, S.H. et al. Pregnancy and lactation are associated with diminished concentrations of choline and its metabolites in rat liver. *J. Nutr.* **1995**, *125*, 3049–3054.
  26. Zeisel, S.H.; Epstein, M.F.; Wurtman, R.J. Elevated choline concentration in neonatal plasma. *Life Sci.* **1980**, *26* (21), 1827–1831.
  27. Pinotti, L. et al. Rumen-protected choline administration to transition cows: Effects on milk production and vitamin E status. *J. Vet. Med.—Ser. A* **2003**, *50* (1), 18–21.
  28. Zeisel, S.H. et al. Choline, an essential nutrient for humans. *FASEB J.* **1991**, *5* (7), 2093–2098.
  29. Zeisel, S.H. et al. Concentrations of choline-containing compounds and betaine in common foods. *J. Nutr.* **2003**, *133* (5), 1302–1307.
  30. Holmes-McNary, M. et al. Choline and choline esters in human and rat milk and infant formulas. *Am. J. Clin. Nutr.* **1996**, *64*, 572–576.





# Chondroitin

## Christopher G. Jackson

University of Utah School of Medicine and George E. Wahlen Department of Veterans Affairs Medical Center, Salt Lake City, Utah, U.S.A.

## Daniel O. Clegg

George E. Wahlen Department of Veterans Affairs Medical Center and University of Utah School of Medicine, Salt Lake City, Utah, U.S.A.

## INTRODUCTION

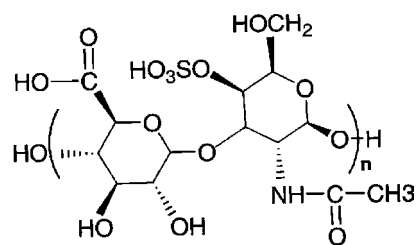
Osteoarthritis (OA) is the most common arthropathy worldwide and a significant cause of morbidity and disability, especially in the elderly.<sup>[1]</sup> Both biomechanical forces and biochemical processes are important in its pathogenesis, which is characterized by progressive deterioration of articular cartilage causing debilitating pain and loss of normal joint motion. Standard therapies can alleviate the symptoms of OA to some extent but have no ability to prevent disease progression. A number of alternative substances, collectively referred to as nutraceuticals, have been touted in the lay press as being beneficial for OA, with particular interest focused on glucosamine and chondroitin sulfate.<sup>[2,3]</sup>

Chondroitin sulfate is a key component of normal cartilage that is substantially reduced in the cartilage of individuals with OA. This observation stimulated interest in its potential role as a therapeutic agent, and continuing investigations have now identified a number of apparent biologic actions. No consensus exists, however, as to its clinical efficacy or utility. While it has gained a measure of acceptance in Europe, physicians in the United States appear to be less convinced by the available clinical data. Nonetheless, the interest of the general population has been piqued, and owing to its universal availability as an over-the-counter supplement, present use of chondroitin sulfate, either with or without standard OA therapy, is not uncommon.<sup>[4]</sup>

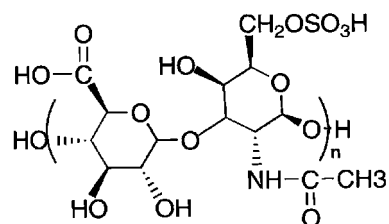
## STRUCTURE, BIOCHEMISTRY, AND PHYSIOLOGY

Chondroitin sulfate is classified as a glycosaminoglycan (GAG) and is present abundantly in articular cartilage as well as in many other tissues, including bone, tendon, intervertebral disk, aorta, cornea, and skin. It is composed of alternating *N*-acetylgalactosamine and *D*-glucuronic acid residues, which form a long, unbranched chain. While the length of the chain is variable, it seldom exceeds 200–250 disaccharide units. Sulfation occurs at the 4 or 6 position of the *N*-acetylgalactosamine residue to produce chondroitin-4-sulfate (chondroitin sulfate A) and chondroitin-6-sulfate (chondroitin sulfate C), respectively, whereas the substitution of *L*-iduronic acid for *D*-glucuronic acid produces dermatan sulfate, formerly known as chondroitin sulfate B (Fig. 1).

Chondroitin sulfate A



Chondroitin sulfate C



**Fig. 1** Structure of chondroitin-4-sulfate (chondroitin sulfate A) and chondroitin-6-sulfate (chondroitin sulfate C).

*Christopher G. Jackson, M.D.*, is Professor of Medicine at the University of Utah School of Medicine and Staff Physician in the Rheumatology Section at the George E. Wahlen Department of Veterans Affairs Medical Center, Salt Lake City, Utah, U.S.A.

*Daniel O. Clegg, M.D.*, is Chief of the Rheumatology Section at the Department of George E. Wahlen Veterans Affairs Medical Center and Professor of Medicine at the University of Utah School of Medicine, Salt Lake City, Utah, U.S.A. He holds the Harold J., Ardella T., and Helen T. Stevenson Presidential Endowed Chair in Rheumatology.

The significance of the sulfation position is not fully understood but appears to be associated with tissue age and location. Sulfation at the 4 position is seen more frequently in deeper, immature cartilage, while older, thinner cartilage is primarily sulfated at the 6 position.<sup>[5]</sup> Additionally, abnormalities in sulfation appear to be present in OA cartilage,<sup>[6]</sup> although their physiologic significance is uncertain.

The chondroitins comprise one of three primary divisions of GAGs, heparins and keratan sulfates being the other two. GAGs are synthesized intracellularly by chondrocytes, synoviocytes, fibroblasts, and osteoblasts. Following synthesis, multiple GAGs attach to a protein core within the Golgi apparatus to form a proteoglycan, which is subsequently secreted into the extracellular matrix.<sup>[7]</sup> The factors that promote and regulate proteoglycan biosynthesis are complex, and it has been estimated that more than 10,000 enzymatic steps may be required.<sup>[8]</sup>

The predominant proteoglycan in human articular cartilage is aggrecan, which contains both chondroitin sulfate and keratan sulfate side chains. Together, these side chains account for 80–90% of the mass of aggrecan. Chondroitin sulfate predominates over keratan sulfate, with more than 100 chondroitin sulfate side chains being present on a single aggrecan molecule. While there is some variability in the core protein, the physical and chemical properties of proteoglycans are largely attributable to the chondroitin sulfate side chains. One important feature of proteoglycans is a marked negative electrical charge, which is created by the ionized sulfate groups within the GAG side chains.

Articular cartilage consists of collagen fibers surrounded by a matrix containing aggregates of aggrecan and hyaluronate. Within the matrix, 100–200 aggrecan molecules bind to a single hyaluronate strand to form a supramolecular structure large enough to be seen by electron microscopy. The tensile strength of articular cartilage is the result of a network of collagen fibers, while the aggrecan–hyaluronate aggregates, which are rich in chondroitin sulfate chains, provide resiliency. Under normal circumstances, water is electrically attracted to cartilage by the negatively charged GAG residues and becomes entrapped within the aggregates. When a deforming force (such as occurs with weight bearing) is applied to the cartilage surface, minimal deformity occurs under normal conditions because the movement of water within cartilage is resisted by: 1) its electrical affinity to the GAG residues, and 2) the physical obstruction created by the bulky aggrecan–hyaluronate aggregates.

In OA, deterioration of articular cartilage is associated with a loss of proteoglycan, with a consequent change in water content and decrease in resilience. The pathogenetic events producing these changes remain uncertain but may result from changes in

proteoglycan catabolism involving matrix metalloproteases, serine proteases, glycosidases, and chondroitinases secreted from chondrocytes and other connective tissue cells.<sup>[9]</sup> Experimental models of OA suggest that synthesis of aggrecan increases early in the degenerative process in an apparent attempt at cartilage repair. The chondroitin sulfate side chains synthesized in this setting, however, are longer and more antigenic, suggesting that important GAG constitutional and/or conformational changes may be involved in the pathogenesis of OA.<sup>[9]</sup> One such change appears to involve the terminal sulfation of chondroitin.<sup>[10]</sup> Further study of the mechanisms that produce changes in GAG synthesis may yet yield a site for therapeutic intervention that might have disease-modifying potential.

## PHARMACOLOGY

The pharmacologic properties of exogenously administered chondroitin sulfate have been examined in a number of animal models and in humans with doses ranging from 60 mg/kg to 2 g/kg. Various routes of administration have been utilized in these studies, including oral, intraperitoneal, subcutaneous, and intravenous.<sup>[11]</sup> In general, chondroitin sulfate appears to be well tolerated, and no significant adverse events have been reported with any route of administration. Determinations of oral bioavailability have yielded estimates of 5–15%, with blood levels reported to peak between 2 and 28 hr<sup>[12,13]</sup> following administration. No significant difference was observed between divided and single day dosing, while sustained dosing yielded serum levels only slightly higher than those seen following a single dose.<sup>[12]</sup> The elimination half-life has been estimated at 6 hr. With a radiolabeled preparation of chondroitin sulfate administered orally to rats, more than 70% of the radioactivity was absorbed and subsequently identified in either the tissues or the urine. Radioactivity was found in every tissue examined at 24 hr, with levels variably diminished at 48 hr except in joint cartilage, the eye, the brain, and adipose tissue, where levels were increased.<sup>[12]</sup> There are very limited data for chondroitin pharmacokinetics when it is administered in conjunction with glucosamine.

The variability in pharmacokinetic derivations reported to date are considerable and appear to be principally due to methodological differences and limitations. Early studies that utilized radioactive forms of chondroitin sulfate (tritiated) in animals were complicated by the production of tritiated water, which introduced error into concentration determinations, while assays utilizing high-performance liquid

chromatography (HPLC) methodology were unable to detect low concentrations of chondroitin. More recent work in humans is similarly problematic due to assay insensitivity, failure to account for endogenous chondroitin sulfate levels, and/or the use of diluents for anticoagulation. Newer technologies now permit the reliable quantitation of GAG at lower levels,<sup>[14]</sup> and a pharmacokinetic study incorporating these techniques is being contemplated in conjunction with the Glucosamine/chondroitin Arthritis Intervention Trial (GAIT).

## CHONDROITIN PREPARATIONS

Chondroitin sulfate is produced by several manufacturers and is readily available worldwide. It is derived by extraction from bovine, porcine, or shark cartilage. Various methods of extraction exist, but the specifics of each process are the proprietary information of the manufacturer. Most processes start with some form of enzymatic digestion followed by a variable number of washings, incubations, and elutions. In contrast to the procedure with prescription medications, the production process is not strictly regulated, and variations in quality and potency can occur from batch to batch and from manufacturer to manufacturer.

In a study conducted to identify a high-quality chondroitin dosage form for use in a clinical trial, three different sources of purified chondroitin were evaluated in a blinded fashion. While each sample exhibited similar disaccharide and glycosaminoglycan content overall, chondroitin potency varied by 15–20%.<sup>[15]</sup>

In the United States, chondroitin sulfate is classified as a nutritional supplement and is widely available without a prescription in pharmacies and health and natural food stores. Not infrequently, it is encapsulated with glucosamine.

## PUTATIVE MECHANISMS OF ACTION

A number of possible mechanisms of action for chondroitin sulfate in the treatment of OA have been suggested from pilot studies in animals and humans. Additional investigations are needed to confirm and extend these preliminary observations.

- a. *Inhibition of matrix proteases and elastases.* Articular cartilage is catabolized by proteinases and elastases that are elaborated from chondrocytes and leukocytes, respectively. In both in vitro and in vivo studies with rodents, a modest decrease in elastase activity was seen following chondroitin administration. A similar chondroitin

effect on neutral proteases has also been observed. The mechanism of this apparent inhibitory effect of chondroitin may be ionic disruption at the catalytic site of the enzyme. Chondroitin-6-sulfate may be more potent than chondroitin-4-sulfate.<sup>[16]</sup>

- b. *Stimulation of proteoglycan production.* Several studies have shown that proteoglycan synthesis in vitro increases when chondroitin is added to cultures of chondrocytes and synovio-cytes.<sup>[17–19]</sup> The mechanism by which this occurs is unknown, but increased RNA synthesis has been observed, as well as TNF- $\alpha$  inhibition and IL-1 $\beta$  antagonism.
- c. *Viscosupplementation.* An increase in synovial fluid viscosity has been reported following the administration of oral chondroitin sulfate to rabbits, rats, and horses.<sup>[17,20,21]</sup> A more viscous synovial fluid may interfere physically with cartilage matrix catabolism, but the mechanism by which chondroitin might increase the viscosity of synovial fluid is uncertain.
- d. *Anti-inflammatory action.* Chondroitin sulfate has been reported to decrease leukocyte chemotaxis, phagocytosis, and lysosomal enzyme release in vitro. When administered orally to rodents, it appeared to decrease granuloma formation in response to sponge implants as well as attenuate the inflammatory response in adjuvant arthritis and carrageenan-induced pleurisy.<sup>[22]</sup>

## CLINICAL STUDIES

Interest in chondroitin sulfate as a therapeutic agent is longstanding and has primarily focused on the treatment of OA. Nearly all of the available clinical data come from trials conducted in Europe, where it is now classified as a “symptomatic slow-acting drug in osteoarthritis” (SYSADOA).<sup>[23]</sup> Some have suggested that it may also have chondroprotective properties and thereby have properties of a “disease modifying antiosteoarthritic drug” (DMOAD). Among physicians in the United States, however, there is considerable skepticism, and its role in the treatment of OA, if any, remains very controversial.

Most of the clinical experience with chondroitin sulfate has been in knee OA, which is an important patient subset due to its prevalence and resulting disability. Radiographic evidence of knee OA is present in about one-third of people older than 65 years, although not all have symptoms. Epidemiologic studies suggest that knee OA increases in frequency with each decade of life and affects women more often.

Obesity, prior trauma, and repetitive occupational knee bending have also been identified as risk factors. The functional consequences of knee OA are considerable, as it produces disability as often as heart and chronic obstructive pulmonary disease.<sup>[24]</sup>

The initial management of OA includes patient education, weight reduction, aerobic exercise, and physical therapy, and these should always be pursued before pharmacologic intervention is considered. Weight reduction and strengthening exercises may be of particular benefit in knee OA. Acetaminophen and nonsteroidal anti-inflammatory drugs (NSAIDs) are the agents most often prescribed when nonpharmacologic measures prove insufficient. Local intervention with intra-articular corticosteroid injections and viscosupplementation may be of benefit in some patients.

Most rheumatologists would agree that present therapies for OA are suboptimal for the majority of patients. This was readily apparent in a representative 2-yr clinical trial comparing an NSAID and acetaminophen in knee OA, in which a majority of subjects in both treatment groups withdrew prior to study completion because of toxicity or lack of efficacy. Given the shortcomings of standard therapy, it is not surprising that more than one-third of patients report that they have experimented with alternative and complementary treatments.<sup>[25]</sup>

Nutraceuticals are produced and distributed in the United States under the authority of the Dietary Supplement Health and Education Act (DSHEA), which was enacted in 1994 as an amendment to the existing Federal Food, Drug, and Cosmetic Act. The provisions of DSHEA broaden the definition of dietary supplements and have removed the more stringent premarket safety evaluations that had been required previously. The act stipulates that the labels of dietary supplements list ingredients and nutritional information and permits manufacturers to describe the supplement's effect on the "structure or function" of the body and the "well-being" that might be achieved through its use. However, representations regarding the use of the supplement to diagnose, prevent, treat, or cure a specific disease are expressly prohibited.

Legislation passed by the U.S. Congress in 1991 and 1993 (P.L. 102-170 and P.L. 103-43, respectively) established an office within the National Institutes of Health "to facilitate the study and evaluation of complementary and alternative medical practices and to disseminate the resulting information to the public." This Office of Alternative Medicine became the forerunner of the present National Center for Complementary and Alternative Medicine (NCCAM), which was formally instituted in February 1999. With a present budget of more than \$113 million, the stated mission of NCCAM is to "explore complementary and alternative

healing practices in the context of rigorous science." One of the first clinical trials to be sponsored by NCCAM is GAIT, an ongoing Phase III evaluation of the efficacy and safety of glucosamine and chondroitin in knee OA.

Most of the clinical experience with chondroitin sulfate suffers from poor study design, possible sponsor bias, inadequate concealment, and lack of intention-to-treat principles. Two recent meta-analyses have reviewed the published literature for randomized, double-blind, placebo-controlled trials of at least 4 weeks' duration and scored them based on quality.<sup>[26,27]</sup> Both prioritized the same eight clinical trials for inclusion in their respective analyses.<sup>[28-35]</sup>

In 1992, Mazieres and colleagues<sup>[32]</sup> randomized 114 patients with OA of the knee or hip to receive 2000 mg chondroitin sulfate or placebo daily for 3 mo followed by a 2-mo observation phase. Kellgren and Lawrence radiographic scores of I-III were required for inclusion as was pain >40 mm on a visual analog scale (VAS). Statistically significant improvement in pain, Lequesne index (LI), and overall patient and physician assessments was demonstrated. The same year, L'Hirondel<sup>[31]</sup> reported on 125 patients with knee OA randomized to treatment with 1200 mg chondroitin sulfate or placebo. After 6 mo, significant improvement in the VAS pain score and LI was demonstrated in the chondroitin-treated group.

Five studies were reported in 1998 that further evaluated chondroitin sulfate against placebo in knee OA. Bucsi and Poor<sup>[29]</sup> treated 85 patients with 800 mg chondroitin sulfate or placebo daily for 6 mo. All patients had Kellgren and Lawrence radiographic scores in the I-III range. Chondroitin treatment led to a significant improvement in LI and pain VAS. A timed 20-m walk evaluated mobility and showed a significant reduction in the chondroitin-treated patients. In a study of longer duration, Conrozier<sup>[34]</sup> reported on 104 patients with Kellgren and Lawrence scores of I-III who were randomized to treatment with 800 mg chondroitin sulfate or placebo daily for 12 mo. Significant improvement in LI was noted in the chondroitin group, in which a suggestion of radiographic improvement was also present. Bourgeois et al.<sup>[28]</sup> compared the effect of single and divided dosing by treating 127 patients with either chondroitin at 1200 mg or 3 × 400 mg per day, or placebo for 90 days. Significant improvement was seen in both chondroitin groups in joint pain, LI, and physicians' and patients' overall pain assessment. No difference in either efficacy or tolerability was seen between the divided and single daily dose treatment groups. Pavelka, Bucsi, and Manopulo<sup>[35]</sup> conducted a 3-mo dose-finding study in which patients were randomized to receive chondroitin sulfate at doses of 1200, 800, or 200 mg or placebo daily. Statistical significance was achieved in LI and

joint pain only for the 800 and 1200 mg treatment groups; no difference in efficacy was demonstrated between these two doses. Uebelhart and colleagues<sup>[36]</sup> studied the efficacy and tolerability of 800 mg chondroitin sulfate daily compared to placebo over 12 mo. There were 23 patients in both the treatment and placebo groups. A significant reduction in pain and comparable improvement in mobility were demonstrated in the chondroitin group. They also reported an apparent stabilization in both joint space narrowing and serum osteocalcin levels, suggesting the possibility of chondroprotection associated with chondroitin therapy.

In 2001, Mazieres et al.<sup>[33]</sup> reported on 63 patients treated with chondroitin sulfate compared to 67 treated with placebo. A 3-mo treatment period was followed by 3 mo of observation. Trends toward significant improvement were seen in LI, pain, and physician's assessment as well as most other efficacy criteria at the end of the treatment period and persisted into the observation period for the chondroitin group.

Both meta-analyses concluded that chondroitin sulfate was likely beneficial in alleviating the symptoms of knee OA to some degree but felt that the magnitude of the clinical effect was most likely less than that reported. No chondroprotective effect was identifiable. These meta-analyses further concluded that problems with design methodology (inadequate allocation concealment and absence of an intention-to-treat approach), industry sponsorship, and publication bias significantly limited the validity of the available data and made the need for more rigorously controlled studies unequivocal.

A single study<sup>[37]</sup> reported in 1995 compared the efficacy of chondroitin sulfate in osteoarthritis to an NSAID. In this randomized, multicenter, double-blind trial, 74 patients were randomized to chondroitin sulfate, while 72 patients were randomized to diclofenac sodium. The diclofenac group was treated with 50 mg per day for the first month of the study and then with placebo for months 2 and 3. The chondroitin group received 400 mg chondroitin sulfate for months 1, 2, and 3. Both groups received only placebo for months 4–6. Patients in the diclofenac group showed prompt improvement with the initiation of therapy. However, their symptoms returned with the discontinuation of treatment at month 2 and increased through month 6. In comparison, the chondroitin group showed a more modest improvement in symptoms with initiation of therapy but continued to improve through month 3. Symptoms reappeared thereafter, but not to the same extent as in the diclofenac cohort. These data suggested that chondroitin might have a gradually progressive benefit in the treatment of OA that may persist following discontinuation of therapy.

Only scant information exists regarding the clinical efficacy of chondroitin sulfate in combination with glucosamine. An animal study has suggested that combination therapy may increase GAG synthesis *in vivo* compared with the use of either agent singly. Symptomatic and anti-inflammatory improvement with combination glucosamine and chondroitin has been reported in horses and dogs.

Under the sponsorship of NCCAM, GAIT is a multicenter, randomized, double-blind, and placebo-controlled trial designed to rigorously evaluate the tolerability and efficacy of glucosamine and chondroitin sulfate in the treatment of knee OA. The five treatment arms employed in this study consist of glucosamine alone, chondroitin sulfate alone, a combination of glucosamine and chondroitin sulfate, celecoxib, and placebo. This trial is a two-part study designed to: 1) compare the efficacy of glucosamine and chondroitin sulfate alone and in combination with that of an active comparator and placebo in alleviating the pain of knee OA over 24 weeks, and 2) determine whether radiographic benefit is evident after 24 mo of treatment.

## SAFETY

Information regarding the safety of chondroitin sulfate is scant, whether as a single agent or in combination with other agents, but the available data do suggest that adverse effects associated with chondroitin use are both minor and infrequent. In the randomized, controlled trials summarized above, the frequency of adverse effects reported in the chondroitin sulfate treatment arms was no greater than that with placebo arms, and dropout rates ranged from 2% to 12%. The pooled data in an earlier meta-analysis showed the frequency of adverse effects to be greater in patients treated with placebo. The side effects reported most often with chondroitin sulfate were epigastric distress, diarrhea, and constipation. Additionally, rashes, edema, alopecia, and extrasystoles have been reported infrequently.

An additional safety concern at present is the potential for transmission of bovine spongiform encephalopathy (BSE, or mad cow disease) from infected beef products. Despite stringent safeguards put in place by the U.S. Department of Agriculture that banned the import of beef products from any at-risk country, a case has now been identified in an American herd. Those who elect to take chondroitin sulfate should be familiar with the animal source from which it has been extracted and, if bovine, assure themselves that it has come from a disease-free herd.

## RECOMMENDATIONS

The published medical literature at present suggests that chondroitin sulfate is well tolerated and may be of benefit in alleviating the symptoms of OA. There is, however, a great need for clinical trials of sufficient size, design, and scientific rigor to: 1) define the frequency and magnitude of clinical improvement, 2) demonstrate whether any effect on disease progression is present, and 3) formally define the tolerability and safety profile of the compound. Such studies are presently in progress, but until they are completed, an evidence-based rationale for the use of chondroitin sulfate in the treatment of OA will not be possible.

## REFERENCES

1. Oliveria, S.A. et al. Incidence of symptomatic hand, hip, and knee osteoarthritis among patients in a health maintenance organization. *Arthritis Rheum.* **1995**, *38* (8), 1134–1141.
2. Theodosakis, J.; Adderly, B. et al. *The Arthritis Cure*; St Martin's Press: New York, 1997.
3. Theodosakis, J.; Adderly, B. et al. *Maximizing the Arthritis Cure*; St. Martin's Press: New York, 1998.
4. Rao, J.K. et al. Use of complementary therapies for arthritis among patients of rheumatologists. *Ann. Intern. Med.* **1999**, *131* (6), 409–416.
5. Bayliss, M.T. et al. Sulfation of chondroitin sulfate in human articular cartilage. The effect of age, topographical position, and zone of cartilage on tissue composition. *J. Biol. Chem.* **1999**, *274* (22), 15892–15900.
6. Burkhardt, D. et al. Comparison of chondroitin sulphate composition of femoral head articular cartilage from patients with femoral neck fractures and osteoarthritis and controls. *Rheumatol. Int.* **1995**, *14* (6), 235–241.
7. Hardingham, T. Chondroitin sulfate and joint disease. *Osteoarthritis Cartilage* **1998**, *6* (Suppl A), 3–5.
8. Bali, J.P.; Cousse, H.; Neuzil, E. Biochemical basis of the pharmacologic action of chondroitin sulfates on the osteoarticular system. *Semin. Arthritis Rheum.* **2001**, *31* (1), 58–68.
9. Caterson, B. et al. Mechanisms of proteoglycan metabolism that lead to cartilage destruction in the pathogenesis of arthritis. *Drugs Today (Barc.)* **1999**, *35* (4–5), 397–402.
10. Plaas, A.H. et al. Glycosaminoglycan sulfation in human osteoarthritis. Disease-related alterations at the non-reducing termini of chondroitin and dermatan sulfate. *J. Biol. Chem.* **1998**, *273* (20), 12642–12649.
11. Conte, A. et al. Metabolic fate of exogenous chondroitin sulfate in man. *Arzneimittelforschung* **1991**, *41* (7), 768–772.
12. Conte, A. et al. Biochemical and pharmacokinetic aspects of oral treatment with chondroitin sulfate. *Arzneimittelforschung* **1995**, *45* (8), 918–925.
13. Volpi, N. Oral bioavailability of chondroitin sulfate (Condrosulf) and its constituents in healthy male volunteers. *Osteoarthritis Cartilage* **2002**, *10* (10), 768–777.
14. Calabro, A.; Hascall, V.C.; Midura, R.J. Adaptation of FACE methodology for microanalysis of total hyaluronan and chondroitin sulfate composition from cartilage. *Glycobiology* **2000**, *10* (3), 283–293.
15. Barnhill, J.G. et al. Product selection for the glucosamine/chondroitin arthritis trial (GAIT): Part 2 chondroitin. *in press*.
16. Marossy, K. Interaction of the chymotrypsin- and elastase-like enzymes of the human granulocyte with glycosaminoglycans. *Biochim. Biophys. Acta* **1981**, *659* (2), 351–361.
17. Nishikawa, H.; Mori, I.; Umemoto, J. Influences of sulfated glycosaminoglycans on biosynthesis of hyaluronic acid in rabbit knee synovial membrane. *Arch. Biochem. Biophys.* **1985**, *240* (1), 146–153.
18. Verbruggen, G.; Veys, E.M. Influence of sulphated glycosaminoglycans upon proteoglycan metabolism of the synovial lining cells. *Acta Rheumatol. Belg.* **1977**, *1* (1–2), 75–92.
19. Schwartz, N.B.; and Dorfman, A. Stimulation of chondroitin sulfate proteoglycan production by chondrocytes in monolayer. *Connect. Tissue Res.* **1975**, *3* (2), 115–122.
20. VidelaDorna, I.; Guerrero, R. Effects of oral and intramuscular use of chondroitin sulphate in induced equine aseptic arthritis. *J. Equine Vet. Sci.* **1998**, *18*, 548–550.
21. Omata, T. et al. Effects of chondroitin sulphate-C on bradykinin-induced proteoglycan depletion in rats. *Arzneimittelforschung* **1999**, *49*, 577–581.
22. Ronca, F. et al. Anti-inflammatory activity of chondroitin sulfate. *Osteoarthritis Cartilage* **1998**, *6* (Suppl A), 14–21.
23. Pendleton, A. et al. EULAR recommendations for the management of knee osteoarthritis: report of a task force of the Standing Committee for International Clinical Studies Including Therapeutic Trials (ESCISIT). *Ann. Rheum. Dis.* **2000**, *59* (12), 936–944.
24. Guccione, A.A. et al. The effects of specific medical conditions on the functional limitations of

- elders in the Framingham Study. *Am. J. Public Health* **1994**, *84* (3), 351–358.
25. Rao, J.K. et al. Rheumatology patients' use of complementary therapies: results from a one-year longitudinal study. *Arthritis Rheum.* **2003**, *49* (5), 619–625.
  26. McAlindon, T.E.; LaValley, M.P.; Felson, D.T. Efficacy of glucosamine and chondroitin for treatment of osteoarthritis. *J. Am. Med. Assoc.* **2000**, *284* (10), 1241
  27. Richey, F. et al. Structural and symptomatic efficacy of glucosamine and chondroitin in knee osteoarthritis: a comprehensive meta-analysis. *Arch. Intern. Med.* **2003**, *163* (13), 1514–1522.
  28. Bourgeois, P. et al. Efficacy and tolerability of chondroitin sulfate 1200 mg/day vs chondroitin sulfate 3×400 mg/day vs placebo. *Osteoarthritis Cartilage* **1998**, *6* (Suppl A), 25–30.
  29. Bucsi, L.; Poor, G. Efficacy and tolerability of oral chondroitin sulfate as a symptomatic slow-acting drug for osteoarthritis (SYSADOA) in the treatment of knee osteoarthritis. *Osteoarthritis Cartilage* **1998**, *6* (Suppl A), 31–36.
  30. Uebelhart, D. et al. Effects of oral chondroitin sulfate on the progression of knee osteoarthritis: a pilot study. *Osteoarthritis Cartilage* **1998**, *6* (Suppl A), 39–46.
  31. L'Hirondel, J. Klinische Doppelblind-studie mit oral verabreichtem Chondroitinsulfat gegen Placebo bei der tibiofemorale Gonarthrose (125 patienten) [Double-blind clinical trial of oral chondroitin sulfate versus placebo for tibio-femoral osteoarthritis (125 patients)]. *Lit. Rheumatol.* **1992**, *14*, 77–84.
  32. Mazieres, B. et al. Chondroitin sulfate in the treatment of gonarthrosis and coxarthrosis. 5-months result of a multicenter double-blind controlled prospective study using placebo. *Rev. Rhum. Mal. Osteoartic.* **1992**, *59* (7–8), 466–472.
  33. Mazieres, B. et al. Chondroitin sulfate in osteoarthritis of the knee: a prospective, double blind, placebo controlled multicenter clinical study. *J. Rheumatol.* **2001**, *28* (1), 173–181.
  34. Conrozier, T. Anti-arthritis treatments: efficacy and tolerance of chondroitin sulfates (CS 4&6). *Presse Med.* **1998**, *27* (36), 1862–1865.
  35. Pavelka, K.; Bucsi, L.; Manopulo, R. Double-blind, dose effect study of oral CS 4&6 1200 mg, 800 mg, 200 mg against placebo in the treatment of femorotibial osteoarthritis. *Eular Rheumatol. Lit.* **1998**, *27* (Suppl 2), 63.
  36. Uebelhart, D. et al. Protective effect of exogenous chondroitin 4,6-sulfate in the acute degradation of articular cartilage in the rabbit. *Osteoarthritis Cartilage* **1998**, *6* (Suppl A), 6–13.
  37. Morreale, P. et al. Comparison of the anti-inflammatory efficacy of chondroitin sulfate and diclofenac sodium in patients with knee osteoarthritis. *J. Rheumatol.* **1996**, *23* (8), 1385–1391.





# Coenzyme Q<sub>10</sub>

**Gustav Dallner**

*Stockholm University, Stockholm, Sweden*

**Roland Stocker**

*Centre for Vascular Research, School of Medical Sciences, University of New South Wales, Sydney, New South Wales, Australia*

## INTRODUCTION

Coenzyme Q is a lipid with broad distribution in nature, present in plants, bacteria, fungi, and all animal tissues. Coenzyme Q refers to a general structure composed of a nucleus, i.e., 2,3-dimethoxy-5-methylbenzoquinone, and, substituted at position 6 of this quinone, a side chain consisting of isoprene units (5 carbons), all in trans configuration and with one double bond. In human tissues, the major part of coenzyme Q is coenzyme Q<sub>10</sub>, which has 10 isoprenoid units; only 2–7% is present as coenzyme Q<sub>9</sub>.

## NAME AND GENERAL DESCRIPTION

Coenzyme Q<sub>10</sub> (C<sub>59</sub>H<sub>90</sub>O<sub>4</sub>) has a molecular weight of 863.3, a melting point of 49°C, and a redox potential of around +100 mV. The lipid is soluble in most organic solvents but not in water. The term coenzyme Q refers to both oxidized and reduced forms.

The oxidized form of coenzyme Q, ubiquinone (CoQ), has an absorption maximum at 275 nm, whereas its reduced form, ubiquinol (CoQH<sub>2</sub>), has a small maximum at 290 nm. The absorption of CoQ at 210 nm is six times higher than that at 275 nm; this reflects the double bonds of the polyisoprenoid moiety and is therefore unspecific. The two major features of the lipid are the quinone moiety and the side chain. The quinone moiety is the basis for the redox function of this coenzyme, allowing continuous oxidation–reduction (Fig. 1) as a result of enzymatic actions. The long polyisoprenoid side chain gives the molecule its highly hydrophobic character and influences its physical properties and arrangement in membranes.

---

*Gustav Dallner, Ph.D.*, is Professor at the Department of Biochemistry and Biophysics, Stockholm University, Stockholm, Sweden.

*Roland Stocker, Ph.D.*, is at the Centre for Vascular Research, School of Medical Sciences, University of New South Wales, Sydney, New South Wales, Australia.

## EXTRACTION AND ANALYSIS

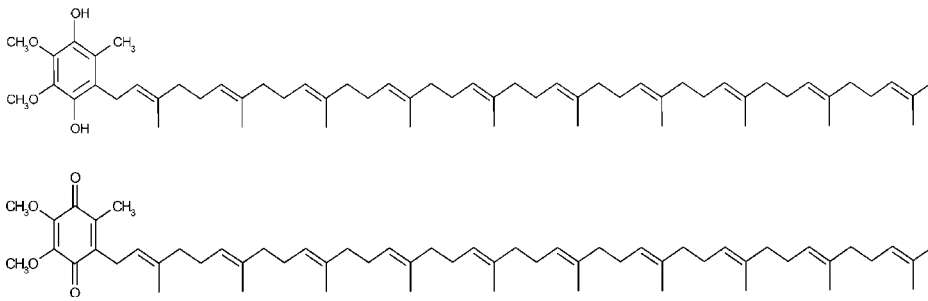
For analysis of the blood and tissue level of coenzyme Q, extraction is usually performed with organic solvents without previous acid or alkaline hydrolysis.<sup>[1]</sup> The simplest procedure is using petroleum ether, hexane, or isopropyl alcohol and methanol. In this system, phase separation occurs, and the methanol phase retains all the phospholipids, which make up more than 90% of the total lipid in most tissues. The separated neutral lipids, among them coenzyme Q, are generally isolated and quantified by reversed phase high-performance liquid chromatography (HPLC) and UV detection. Both the sensitivity and the specificity of the method can be improved greatly by using electrochemical detection. Additionally, this latter procedure makes it possible to analyze—under certain conditions—the ratio of oxidized/reduced coenzyme Q amount, reflecting the *in vivo* situation.

## BIOCHEMISTRY AND FUNCTIONS

### Biosynthesis

The biosynthesis of coenzyme Q in animal and human tissues is unique though the initial section, designated the mevalonate pathway, is identical for the production of coenzyme Q, cholesterol, dolichol, and isoprenylated proteins.<sup>[2]</sup> After the branch point, however, the terminal portions of the biosynthetic pathways for each of the products are specific (Fig. 2).

The mevalonate pathway consists of 8 enzymatic reactions, which lead to the production of farnesyl pyrophosphate, the common initial substrate for all the terminal products mentioned above. The pathway starts with 2 enzymatic steps using 3 molecules of acetyl-CoA, resulting in 3-hydroxy-3-methylglutaryl-CoA (HMG-CoA). The next reaction is a reduction to mevalonate by HMG-CoA reductase. This reaction is considered to be the main regulatory step in the pathway and also in cholesterol synthesis. Statins, drugs very commonly used in the treatment of

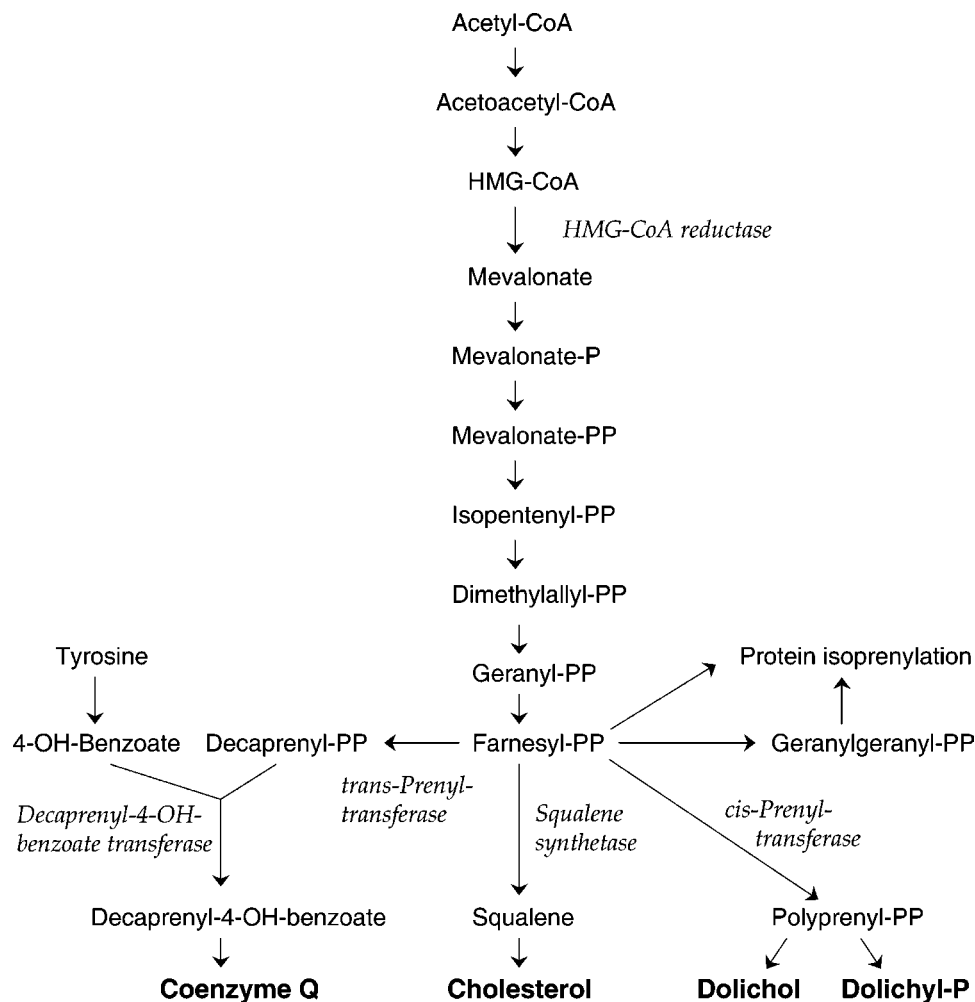


**Fig. 1** Coenzyme Q<sub>10</sub>, shown in its reduced ubiquinol-10 (top) and oxidized ubiquinone-10 (bottom) forms, consists of a long hydrophobic side chain and a substituted benzoquinone ring.

hypercholesterolemia, are competitive inhibitors of HMG-CoA reductase. Mevalonate is phosphorylated in two steps to mevalonate pyrophosphate, which is then decarboxylated to isopentenyl pyrophosphate. Isopentenyl pyrophosphate is not only an intermediate but also the main building block for the synthesis of dolichol and the side chain of coenzyme Q. It is isomerized to dimethylallyl pyrophosphate, the substrate for farnesyl synthase. This enzyme mediates a two-step

reaction, giving rise initially to the enzyme-bound, two-isoprenoid intermediate geranyl pyrophosphate, followed by a new condensation with isopentenyl pyrophosphate to the three-isoprenoid farnesyl pyrophosphate.

The branch-point enzymes, all of them utilizing farnesyl pyrophosphate as substrate, initiate the terminal part of the synthesis. These enzymes are considered overall rate limiting and consequently of utmost



**Fig. 2** The mevalonate pathway, leading to the biosynthesis of coenzyme Q, cholesterol, dolichol, and dolichyl phosphate.

importance in the regulation of the biosynthesis of the lipid in question. In cholesterol synthesis, squalene synthase mediates the head-to-head condensation of 2 molecules of farnesyl-pyrophosphate. *cis*-Prenyltransferase catalyzes the 1'-4 condensation of *cis*-isopentenyl pyrophosphate to all-trans farnesyl pyrophosphate, which, after additional modifications, generates dolichols with chain length between 16 and 23 isoprene units. *trans*-Prenyltransferase mediates a series of addition reactions of isopentenyl pyrophosphate to farnesyl pyrophosphate, resulting in all-trans poly-prenyl pyrophosphate, giving the side chain of coenzyme Q. The chain length varies between different species, and in humans, the chain is mostly decaprenyl pyrophosphate, with some solanesyl pyrophosphate.

The next step in the biosynthesis requires the precursor of the benzoquinone moiety, 4-hydroxybenzoate, which itself is produced from tyrosine and is present in excess amounts. After prenylation of 4-hydroxybenzoate, the ring is modified by C-hydroxylations, decarboxylation, O-methylations, and C-methylation. The sequence of these reactions has been studied so far mainly in bacteria and yeast. In mammalian tissues, only 2 genes have been isolated through complementary recognition with yeast. Isolated enzymes are not available at present, although these will be required for the establishment of the details of coenzyme Q synthesis in animal tissues.

### Enzymatic Reduction of CoQ

A major function of coenzyme Q is to serve as a lipid-soluble antioxidant. This requires its reduced form, CoQH<sub>2</sub>, to be regenerated at different cellular locations. Ascorbate readily reduces benzoquinone in a catalytic process controlled by molecular oxygen, although this reduction is not likely of biological importance, as the benzoquinone moiety of the lipid-soluble CoQ<sub>10</sub>, when localized in biological membranes, is not accessible to the water-soluble vitamin C. Similarly, cytosolic DT-diaphorase, an enzyme proposed for CoQ<sub>10</sub> reduction, is not efficient in reducing benzoquinones containing long isoprenoid side chains. Based on studies with the inhibitors rotenone and dicoumarol, it is suggested that a cytosolic reduced nicotinamide adenine dinucleotide phosphate (NADPH)-dependent CoQ reductase, different from the mitochondrial reductase and DT-diaphorase, is involved. More recently, the flavin adenine dinucleotide (FAD)-containing enzymes lipoamide dehydrogenase and thioredoxin reductase were found to reduce CoQ in vitro with high efficiency. These enzymes are homodimers, have a molecular weight of around 55 kDa, and belong to the family of pyridine nucleotide disulfide oxidoreductases.

### Enzymatic Functions

The most thoroughly studied function of coenzyme Q is its participation in the mitochondrial electron transport chain. The lipid is essential in respiration as it shuttles electrons from NADH dehydrogenase and succinate dehydrogenase (complexes I and II) to the cytochrome system (complex III). During respiration, coenzyme Q is present in the fully oxidized, fully reduced, and semiquinone forms. In the protonmotive Q cycle, there is a cyclic electron transfer pathway through complex III involving semiquinone that accounts for the energy conservation at coupling site 2 of the respiratory chain.

An electron transport system is also present in the plasma membranes of cells for transferring electrons across the membrane.<sup>[3]</sup> The system is composed of a quinone reductase located on the cytosolic side and is thought to reduce CoQ in the presence of NADH. The resulting CoQH<sub>2</sub> then shuttles electrons to an NADH oxidase, located on the external surface of the plasma membrane, that reduces extracellular electron acceptors such as the ascorbyl radical, in this case to ascorbate. This oxidase is not related to the NADPH oxidase of phagocytes, which functions independent of coenzyme Q. The precise function(s) of the NADH oxidase remain(s) to be elucidated, although it has been suggested to be involved in the control of cell growth and differentiation, the maintenance of extracellular ascorbic acid, the regulation of cytosolic NAD<sup>+</sup>/NADH ratio, the induction of tyrosine kinase, and early gene expression.

An electron transport system has also been proposed to be present in lysosomal membranes, transferring electrons from NADH to FAD, cytochrome *b*<sub>5</sub>, CoQ, and molecular oxygen. This system could be involved in the translocation of protons into the lysosomal lumen.

### Nonenzymatic Functions

#### Modulation of mitochondrial pore opening

Ions and solutes may penetrate the inner mitochondrial membrane through specific transporters and ion channels. It has been observed in vitro, during the accumulation of Ca<sup>2+</sup>, that a permeability transition occurs and macromolecules up to the size of 1500 Da cross the membrane as the result of opening of an inner mitochondrial complex, the membrane transition pore. A large number of different compounds can open or close the membrane transition pore. An opening in the inner mitochondrial membrane is highly deleterious as it leads to loss of pyridine nucleotides, hydrolysis of ATP, disruption of ionic status, and

elimination of the protonmotive force. Opening of the membrane transition pore is suggested to be an early event in apoptosis, causing activation of the caspase cascade through release of cytochrome *c*. On the other hand, the membrane transition pore may also have a physiological function by acting as a fast Ca<sup>2+</sup> release channel in mitochondria.

Various coenzyme Q analogs that contain the benzoquinone moiety with or without a short saturated or unsaturated side chain are modulators of the membrane transition pore.<sup>[4]</sup> They can inhibit, induce, or counteract the effects of inhibitors and inducers. Endogenous CoQ<sub>10</sub> may play an important role in preventing the membrane transition pore from opening, as it counteracts several apoptotic events, such as DNA fragmentation, cytochrome *c* release, and membrane potential depolarization.

### Uncoupling protein function

It is well established that the inner mitochondrial membrane possesses uncoupling proteins that translocate protons from the outside to the inside of mitochondria. As a result, the proton gradient established by the respiratory chain is uncoupled from oxidative phosphorylation and heat is produced instead of energy. In human tissues, 5 uncoupling proteins have been identified, but only uncoupling protein 1 has been studied in detail. It is present in brown adipose tissue and participates in thermogenesis. The content of uncoupling proteins in other tissues is low, since uncoupling is not a common event. Uncoupling protein 2 is found in most tissues, and uncoupling protein 3 is abundant in skeletal muscle.

By overexpressing uncoupling proteins 1, 2, and 3 from *E. coli* in liposomes, it was demonstrated that coenzyme Q is an obligatory cofactor for the functioning of uncoupling proteins, with the highest activity obtained with CoQ<sub>10</sub>.<sup>[5]</sup> Uncoupling proteins were able to transport protons only when CoQ<sub>10</sub> was added to the membranes in the presence of fatty acids. Low concentration of ATP inhibited the activity. In this way, a proton is delivered from a fatty acid to the uncoupling protein with the assistance of CoQ<sub>10</sub> in the inner mitochondrial membrane. This is followed by the translocation of a proton to the mitochondrial matrix by the uncoupling protein.

### Antioxidant activity

Approximately 1–2% of the molecular oxygen consumed by mitochondria is converted to superoxide anion radical and hydrogen peroxide. In addition, reactive oxygen species (ROS) are produced by a number of other processes, including autoxidation reactions, and by the action of enzymes such as

NADPH oxidases of phagocytes and other cells, mitochondrial monoamine oxidase, flavin oxidases in peroxisomes, and cytochromes P-450. Furthermore, nitric oxide, generated by nitric oxide synthases, can interact with ROS and give rise to a number of reactive nitrogen species (RNS). These reactive species have the potential to damage lipids, proteins, and DNA, a process generally referred to as “oxidative damage.” Antioxidants are enzymes, proteins, or nonproteinaceous agents that prevent the formation of ROS and RNS, or remove these species or biomolecules that have been oxidatively damaged.

Coenzyme Q is the only lipid-soluble antioxidant synthesized endogenously.<sup>[6]</sup> Its reduced form, CoQH<sub>2</sub>, inhibits protein and DNA oxidation, but it is its effect on lipid peroxidation that has been studied in detail. Ubiquinol inhibits the peroxidation of cell membrane lipids and also that of lipoprotein lipids present in the circulation and in the walls of blood vessels. It has been suggested that CoQH<sub>2</sub> is a more efficient antioxidant than vitamin E, for two reasons. First, its tissue (but not blood) concentration exceeds severalfold that of vitamin E. Second, and similar to vitamin C, CoQH<sub>2</sub> effectively reduces  $\alpha$ -tocopheroxyl radical to  $\alpha$ -tocopherol, and by doing so eliminates the potential pro-oxidant activities of vitamin E. In fact, CoQH<sub>2</sub> has been suggested to act as the first line of nonenzymatic antioxidant defense against lipid-derived radicals. In addition, CoQH<sub>2</sub> can inhibit the initiation of lipid peroxidation by scavenging aqueous radical oxidants.

As a result of its antioxidant action as a one-electron reductant, CoQH<sub>2</sub> is oxidized initially to its semiquinone radical (CoQH•), which itself may be oxidized further to CoQ, with the potential to generate the superoxide anion radical. Regeneration of CoQH<sub>2</sub> is therefore required for coenzyme Q to maintain its antioxidant activity. The effectiveness of cellular reducing systems is suggested by the fact that in most human tissues, the bulk of coenzyme Q is recovered as CoQH<sub>2</sub>.

### Effects on atherosclerosis

Coenzyme Q<sub>10</sub> can theoretically attenuate atherosclerosis by protecting low-density lipoprotein (LDL) from oxidation. Ubiquinol-10 is present in human LDL and, at physiological concentrations, prevents its oxidation in vitro more efficiently than vitamin E. The antiatherogenic effects are demonstrated in apolipoprotein E-deficient mice fed a high-fat diet.<sup>[7]</sup> Supplementation with pharmacological doses of CoQ<sub>10</sub> not only increased aortic CoQ<sub>10</sub> levels but also decreased the absolute concentration of lipoprotein-associated lipid hydroperoxides in atherosclerotic lesions. Most significantly, there was a clear decrease in the size of atherosclerotic lesions in the whole aorta.

Whether these protective effects are solely due to the antioxidant actions of coenzyme Q remains to be established, as the tissue content of other markers of oxidative stress, such as hydroxylated cholesteryl esters and  $\alpha$ -tocopherylquinone, did not decrease.

Oral administration of CoQ<sub>10</sub> to healthy humans results in increased concentrations of CoQ<sub>10</sub>H<sub>2</sub> in circulating lipoproteins,<sup>[8]</sup> with reduction most likely taking place in the intestine. Administration of CoQ<sub>10</sub> also results in uptake of the lipid into monocytes and lymphocytes but not into granulocytes, whereas this dietary treatment increases the vitamin E content in both mononuclear and polymorphonuclear cells.<sup>[9]</sup> The phospholipid composition is modified selectively in mononuclear cells, which display elevated amounts of arachidonic acid. Basal and stimulated levels of  $\beta$ 2-integrin CD11b and complement receptor CD35, distributed on the surface of monocytes, are also decreased by CoQ<sub>10</sub> supplementation. This may contribute to the antiatherogenic effect of dietary CoQ<sub>10</sub>, since CD11b contributes to the recruitment of monocytes to the vessel wall during atherogenesis.

#### Effects on blood flow and pressure

Previous studies have demonstrated a decrease in blood pressure in patients with established hypertension when CoQ<sub>10</sub> is administered alone or in combination with standard antihypertensive drug therapy.<sup>[10]</sup> It is possible that this effect is indirect—perhaps via improved diastolic and endothelial function. Endothelial dysfunction of the arteries has serious consequences and is commonly seen in subjects with established cardiovascular disease or elevated risk factors. Ubiquinone supplementation improves endothelial function measured as flow-mediated dilatation of the brachial artery in patients with uncomplicated type 2 diabetes and dyslipidemia but not in hypercholesterolemic subjects.<sup>[11]</sup> In diabetic patients, CoQ<sub>10</sub> administration has also been found to decrease systolic blood pressure and HbA<sub>1c</sub>, but not F<sub>2</sub>-isoprostanes, suggesting that the protective effects may have been unrelated to decrease of vascular oxidative stress.

## PHYSIOLOGY

### Tissue Distribution

CoQ<sub>10</sub> is present in all human tissues in highly variable amounts (Table 1). The amounts are dependent on several factors, the most important under normal physiological conditions is the age (see Aging). The highest amount is found in the heart (114  $\mu$ g per gram wet weight).<sup>[12]</sup> In the kidney, liver, muscle, pancreas, spleen, and thyroid, the CoQ<sub>10</sub> content is between 25 and 67  $\mu$ g/g, and in the brain, lung, testis, intestine,

**Table 1** Concentration of coenzyme Q<sub>10</sub> in different adult human tissues

Tissue	CoQ <sub>10</sub> ( $\mu$ g/g tissue)
Brain	13
Thyroid	25
Lung	8
Heart	114
Stomach	12
Small intestine	12
Colon	11
Liver	55
Pancreas	33
Spleen	25
Kidney	67
Testis	11
Muscle	40

colon, and ventricle, it is between 8 and 13  $\mu$ g/g. This variation is explained by histological structure, and consequently there are great variations within the same organ. For example, in different regions of the bovine brain, the amount of CoQ<sub>10</sub> varies between 25  $\mu$ g/g (striatum) and 3  $\mu$ g/g (white matter). Rapid extraction and direct measurement by HPLC show that the major part of coenzyme Q<sub>10</sub> in tissues, with the exception of brain and lung, is the reduced form, CoQ<sub>10</sub>H<sub>2</sub>.

### Intracellular Distribution

In rat liver, the highest amount of coenzyme Q<sub>9</sub> is found in outer and inner mitochondrial membranes, lysosomes, and Golgi vesicles (1.9–2.6  $\mu$ g/mg protein); the concentration in plasma membranes is 0.7  $\mu$ g/g, and it is 0.2–0.3  $\mu$ g/g in the nuclear envelope, rough and smooth microsomes, and peroxisomes (Table 2).<sup>[12]</sup> The distribution pattern is quite different from that of other neutral lipids. For example, the major part of dolichol is localized in lysosomes, that of cholesterol in plasma membranes, and that of vitamin E in Golgi vesicles.

Within membranes, coenzyme Q<sub>10</sub> has a specific arrangement, as the decaprenoid side chain is found in the central hydrophobic region, between the double layer of phospholipid fatty acids. The functionally active group, the benzoquinone ring, is located on the outer or inner surface of the membrane depending on the functional requirement. Because of this central localization, coenzyme Q<sub>10</sub> destabilizes membranes, decreases the order of phospholipid fatty acids, and increases permeability. These effects are in contrast to those of cholesterol, which is present adjacent to

**Table 2** Concentration of coenzyme Q<sub>9</sub> in different subcellular organelles of rat liver

Organelle	CoQ <sub>9</sub> ( $\mu\text{g}/\text{mg}$ protein)
Nuclear envelope	0.2
Mitochondria:	1.4
Outer membranes	2.2
Inner membranes	1.9
Microsomes:	0.2
Rough microsomes	0.2
Smooth microsomes	0.3
Lysosomes:	1.9
Lysosomal membranes	0.4
Golgi vesicles	2.6
Peroxisomes	0.3
Plasma membranes	0.7

fatty acids on one side of the bilayer and stabilizes the membrane, increases the order of its lipids, and decreases membrane permeability.

### Transport

While the mevalonate pathway from acetyl-CoA to farnesyl pyrophosphate is mainly cytoplasmic, the terminal parts of coenzyme Q biosynthesis are localized in the mitochondria and endoplasmic reticulum (ER)–Golgi system. The mitochondrial inner membrane probably receives its lipid from the biosynthetic system associated with the matrix–inner membrane space. Newly synthesized very-low-density lipoproteins assembled in the ER–Golgi system also contain *de novo* synthesized coenzyme Q, which has to be synthesized at this location, like the other lipid and protein components of the lipoproteins. It is most probable that the various other cellular membranes also receive their constitutive coenzyme Q from the ER–Golgi system, as is the case with other lipids. Judging by studies in plants *in vivo* and with reconstituted cell-free systems, intracellular transport of coenzyme Q is a vesicle-mediated, ATP-dependent process, and cytosolic carrier proteins may also be involved.

Under normal conditions, all organs and tissues synthesize sufficient coenzyme Q, so that external supply is not required. Coenzyme Q present in small amounts in all circulating lipoproteins is derived from very-low-density lipoprotein newly synthesized and discharged by the liver. It likely functions as an antioxidant and protects lipoproteins, with restricted redistribution among them. In the case of dietary coenzyme Q, lipoproteins are the carriers in the circulation

and interact with at least some types of tissues for cargo delivery. Thus, the situation differs from that of cholesterol, in which case several organs depend on external supply from the diet or the liver.

### Bioavailability

#### Plasma

The uptake of coenzyme Q from the intestine occurs at a low rate, with only ~2–4% of the dietary lipid appearing in the circulation. The uptake mechanism has not been studied so far but is probably similar to that of vitamin E and mediated by chylomicrons. In rats, dietary CoQ<sub>10</sub> appears as CoQ<sub>10</sub>H<sub>2</sub> in mesenteric triacylglycerol-rich lipoproteins, which enter the circulation and are converted by lipoprotein lipase to chylomicron remnants, which are then cleared rapidly by the liver. Some of this diet-derived coenzyme Q reappears in the circulation, perhaps as the result of hepatic synthesis and release of very-low-density lipoprotein. Depending on the diet, in healthy human controls the amounts of coenzyme Q in very-low-density, low-density, and high-density lipoproteins are ~1.2, 1.0, and 0.1 nmol/mg protein, respectively. After dietary supplementation ( $3 \times 100$  mg CoQ<sub>10</sub>/day for 11 days), the amounts are ~3.2, 3.5, and 0.3 nmol/mg protein, respectively.<sup>[8]</sup> These data are consistent with the notion that circulating coenzyme Q redistributes among lipoproteins to protect them against oxidation.

#### Blood cells

Red blood cells contain very small amounts of coenzyme Q. In lymphocytes, the content of CoQ<sub>10</sub> is doubled after 1 week of dietary supplementation with this lipid, and this enhances both the activity of DNA repair enzymes and the resistance of DNA to hydrogen peroxide-induced oxidation.<sup>[13]</sup> Two months of CoQ<sub>10</sub> supply to humans increases the ratio of T4/T8 lymphocytes,<sup>[14]</sup> and an increase in the number of lymphocytes has been noted after 3 mo of dietary supply of this lipid. Ten weeks of CoQ<sub>10</sub> administration to healthy subjects elevated the lipid content by 50% in monocytes, but no increase was observed in polymorphonuclear cells.

#### Tissues

There remains some controversy regarding the bioavailability of dietary coenzyme Q in different tissues. In rats, the liver, spleen, adrenals, ovaries, and arteries take up a sizeable amount of dietary coenzyme Q.<sup>[15]</sup> Under normal physiological conditions, very limited uptake may also occur in the heart, pancreas, pituitary

gland, testis, and thymus. No uptake is apparent in the kidney, muscle, brain, and thyroid gland. However, uptake into rat brain has been reported—possibly the outcome of the specific conditions employed. Similarly, in mice, some, but not all, investigators have reported uptake into tissues. Derivatization of coenzyme Q by succinylation and acetylation increases its uptake into blood but not into various organs.

What is clear is that under normal conditions, the bioavailability of dietary coenzyme Q in most tissues is limited. This may be explained by its distribution and functional requirement. Under normal conditions, all cells synthesize sufficient lipid, so that external supply is not required. Exogenous coenzyme Q taken up by the liver does not appear in mitochondria, which house the bulk of this cellular lipid, but is found mainly in nonmembranous compartments, such as the lysosomal lumen.

The situation is, however, different in states of coenzyme Q deficiency. Genetic modifications causing low levels of coenzyme Q have serious consequences for neuronal and muscular function.<sup>[16]</sup> In children with genetic coenzyme Q deficiency, dietary supplementation greatly alleviates pathological conditions and re-establishes mitochondrial and other functions. Limited studies with biopsy samples from patients with cardiomyopathy also indicate that the cardiac levels of coenzyme Q are decreased and may be increased by dietary supplementation with the lipid. Thus, it appears that uptake and appropriate cellular distribution of coenzyme Q occur if there is a requirement for the lipid.

Direct organ uptake of sizeable amounts is not necessarily the only way of action of coenzyme Q, as other redox-active substances can act by signaling, serving as primary ligands or secondary transducers. Thus, the presence of coenzyme Q in the blood may impact on the vascular system, the production of cytokines, the expression of adhesion molecules, and the production of prostaglandins and leukotrienes. The possibility that metabolites of coenzyme Q influence metabolic processes has not yet been investigated.

### Catabolism

The short half-life of coenzyme Q, ranging between 49 and 125 hr in various tissues (Table 3), indicates that the lipid is subjected to rapid catabolism in all tissues. The main urinary metabolites identified have an unchanged and fully substituted aromatic ring with a short side chain containing 5–7 carbon atoms and a carboxyl group at the  $\omega$ -end.<sup>[17]</sup> Phosphorylated forms of these metabolites are also recovered from nonhepatic tissues. These water-soluble metabolites are transferred to the circulation and are excreted by the kidney to urine. In the liver, the coenzyme Q

**Table 3** Half-life of CoQ<sub>9</sub> in rat tissues

Tissue	Half-life (hr)
Brain	90
Thyroid	49
Thymus	104
Heart	59
Stomach	72
Small intestine	54
Colon	54
Liver	79
Pancreas	94
Spleen	64
Kidney	125
Testis	50
Muscle	50

metabolites become conjugated to glucuronic acid for fecal removal via bile.

### Regulation of tissue coenzyme Q content

In contrast to cholesterol, coenzyme Q does not appear to be subject to dietary or diurnal variations. However, a number of treatments decrease the content of the lipid in experimental systems. Administration of thiouracil, which inhibits thyroid gland function, decreases liver coenzyme Q. Oral administration of vitamin A also lowers hepatic coenzyme Q. In selenium-deficient rats, the coenzyme Q content of the liver is decreased by 50%, and the amount of the lipid is also lowered in the heart and kidney (but not muscle). A protein-free diet for 3 weeks lowers coenzyme Q content in the liver and heart but not in the kidney, spleen, and brain. As indicated earlier, HMG-CoA reductase controls cholesterol synthesis because the branch-point enzyme squalene synthase has a low affinity for farnesyl pyrophosphate, so that its pool size is the main regulatory factor.<sup>[18]</sup> By contrast, the branch-point enzyme of coenzyme Q synthesis, *trans*-prenyltransferase, has a high affinity for farnesyl pyrophosphate, so that a decrease in this substrate does not generally lower the rate of coenzyme Q synthesis. It appears, however, that the doses of statins employed for the treatment of hypercholesterolemia result in inhibition of synthesis, as the coenzyme Q concentration decreases in several tissues.<sup>[19]</sup>

As mentioned above, the bioavailability of dietary coenzyme Q is limited. For this reason, it would be advantageous to find compounds that elevate tissue concentrations of coenzyme Q by increasing its biosynthesis. In rats and mice, treatment with peroxisomal inducers, such as clofibrate, phthalates, and



acetylsalicylic acid, induces coenzyme Q synthesis in most organs and elevates its concentration in all sub-cellular organelles.<sup>[20]</sup> The upregulation takes place by interaction with a nuclear receptor: peroxisomal proliferator receptor- $\alpha$ . This receptor interacts with a number of genes, resulting in the increased synthesis of several enzymes, many of them connected to lipid metabolism. However, peroxisomal proliferator receptor- $\alpha$  is poorly expressed in human tissue, and it is not known to what extent this transcription factor is involved in coenzyme Q metabolism. Agonists or antagonists to various nuclear receptors may be a future approach to the upregulation of coenzyme Q biosynthesis and its concentration in human tissues.

Hormones control coenzyme Q metabolism, but their method of action is not known in detail. Growth hormone, thyroxin, dehydroepiandrosterone, and cortisone elevate coenzyme Q levels in rat liver to various extents. A liver-specific increase of coenzyme Q occurs in rat and mice after 2–3 weeks, stay in the cold room (+4°C). Vitamin A deficiency more than doubles the coenzyme Q level in liver mitochondria and more than trebles that in liver microsomes. Squalestatin 1, an inhibitor of squalene synthase, greatly increases coenzyme Q synthesis by increasing the farnesyl pyrophosphate pool and saturating *trans*-prenyltransferase.

## COENZYME Q<sub>10</sub> DEFICIENCY

### Genetic Disorders

Coenzyme Q deficiency is an autosomal recessive disorder that may present itself in the form of myopathy, encephalopathy and renal disease, or ataxia.<sup>[16]</sup> The myopathic form is characterized by substantial loss of muscle coenzyme Q, muscle weakness, myoglobinuria, ragged-red fibers, and lactic acidosis. Patients with encephalopathy and renal involvement possess a more general disease, with myopia, deafness, renal failure, ataxia, amyotrophy, and locomotor disability. In these cases, coenzyme Q is undetectable or present at very low levels in cultured fibroblasts. In the ataxic form of deficiency, weakness, cerebellar ataxia, cerebellar atrophy, seizures, and mental retardation dominate, and low levels of coenzyme Q are found in the skeletal muscle. Since most of the genes involved in coenzyme Q biosynthesis are as yet unidentified, the direct reason for the described deficiencies has not been established. In one case, a deficiency in *trans*-prenyltransferase was suggested as the probable cause for the low rate of coenzyme Q synthesis. The cases described in the literature probably represent extreme forms of coenzyme Q deficiency, seriously affecting mitochondrial functions. Moderate coenzyme Q deficiency is probably more common, though this requires verification

by appropriate analysis of tissue biopsy samples. Unfortunately, the coenzyme Q content in blood often does not mirror the tissue concentration of the lipid, and it is highly desirable to develop methods to estimate moderate degrees of coenzyme Q deficiency. At present, diagnosis depends on measuring the coenzyme Q content in muscle biopsy samples, cultured fibroblasts, and lymphoblasts, or analyzing mitochondrial respiration and enzymes that require coenzyme Q as intermediate.

### Aging

In human organs, the coenzyme Q content increases three- to fivefold during the first 20 years after birth, followed by a continuous decrease, so that in some tissues the concentration may be lower at 80 years than at birth (Table 4).<sup>[21]</sup> The decrease is less pronounced in the brain, where it mainly takes place between 70 and 90 years, and its extent, between 20% and 60%, depends on the localization. This pattern is different from that seen for other lipids. In most tissues, the content of cholesterol and phospholipids remains unchanged during the whole life period, whereas the amounts of dolichyl phosphate and especially dolichol increase greatly with age. It is unclear whether the decrease in coenzyme Q content is caused by its lowering in all or some selected cellular membranes or, alternatively, by histological changes such as decreased number of mitochondria.

**Table 4** Coenzyme Q<sub>10</sub> content ( $\mu\text{g/g}$ ) with age in (A) human organs and (B) human brain

	2 days	2 years	20 years	41 years	80 years
<b>(A) Human organs</b>					
Lung	2.2	6.4	6.0	6.5	3.1
Heart	36.7	78.5	110.0	75.0	47.2
Spleen	20.7	30.2	32.8	28.6	13.1
Liver	13.9	45.1	61.2	58.3	50.8
Kidney	17.4	53.4	98.0	71.1	64.0
Pancreas	9.2	38.2	21.0	19.3	6.5
Adrenal	17.5	57.9	16.1	12.2	8.5
	34 years	55 years	70 years	90 years	
<b>(B) Human brain</b>					
Nucleus caudatus	11.6	11.7	10.5	6.6	
Gray matter	16.4	16.2	16.0	13.5	
Hippocampus	14.5	13.8	12.6	8.0	
Pons	11.6	11.7	10.5	6.6	
Medulla oblongata	11.1	10.8	10.0	4.7	
White matter	5.0	5.0	4.9	2.0	
Cerebellum	13.2	13.0	12.9	11.0	

## Cardiomyopathy

The uptake of dietary coenzyme Q into heart muscle is low in both rats and humans, but it may increase significantly in various forms of cardiomyopathy.<sup>[22]</sup> A number of clinical trials performed during the last 30 years suggest that heart functional performance may be improved by dietary coenzyme Q supplementation.<sup>[23]</sup> In congestive heart failure, improvements have been reported for ejection fraction, stroke volume, and cardiac output. Patients with angina may respond with improved myocardial efficiency. Reperfusion injury, such as after heart valve replacement and coronary artery bypass graft surgery, includes oxidative damage, and treatment of patients with coenzyme Q prior to surgery may lead to decreased oxidative damage and functional improvement. However, the benefits reported have not been consistent, and despite the existence of a large body of literature, there remains a need for large, long-term, and well-designed trials to establish unambiguously whether CoQ<sub>10</sub> supplements are beneficial in the setting of cardiomyopathy and the failing heart.

## Neurological Disorders

Judging by extensive animal studies, a number of neurological diseases involve mitochondrial dysfunction and oxidative stress. The positive effects obtained with coenzyme Q treatment in these models suggest that supplementation may also be beneficial in humans.<sup>[24]</sup> Patients with early Parkinson's disease were subjected to a trial in which the placebo group was compared with groups supplemented for 16 mo with coenzyme Q up to daily doses of 1200 mg. It was found that coenzyme Q slowed the progressive functional deterioration, with the best results obtained with the highest dose. Platelets from these patients had decreased coenzyme Q content and also showed reduced activity of mitochondrial complex I and complex II/III. The ratio of CoQ<sub>10</sub>H<sub>2</sub> to CoQ<sub>10</sub> was also decreased in these platelets, indicative of the presence of oxidative stress. Upon supplementation, the CoQ<sub>10</sub> content in the platelets increased and complex I activity was also elevated. In Huntington's disease, magnetic resonance spectroscopy detected increased lactate concentration in the cerebral cortex. Administration of CoQ<sub>10</sub> caused a significant decrease in lactate that reversed upon discontinuation of the therapy.

Deficiency of frataxin, a regulator of mitochondrial iron content, causes Friedrich's ataxia. When patients with this disease were treated with coenzyme Q and vitamin E for 6 mo, progression of their neurological deficits was slowed down, associated with an improvement in cardiac and skeletal muscle energy

metabolism.<sup>[25]</sup> Treatment of these patients with idebenone, an analog of coenzyme Q, reduced heart hypertrophy and improved heart muscle function. In several studies, patients with mitochondrial encephalopathy, lactic acidosis, and strokes (MELAS) displayed significant improvement after coenzyme Q or idebenone treatment.<sup>[26]</sup>

## Statin Therapy

Statins are the drugs most commonly used for the treatment of hypercholesterolemia, and, in addition to efficient cholesterol lowering, they also have anti-inflammatory activities. The basis for their use is that inhibition of HMG-CoA reductase decreases the farnesyl pyrophosphate pool to such an extent that squalene synthase, which catalyzes the terminal regulatory step in cholesterol synthesis, is no longer saturated, thereby inhibiting overall synthesis.<sup>[18]</sup> It appears, however, that the extent to which the farnesyl pyrophosphate pool is decreased by therapeutic doses of the drug also affects the saturation of *trans*- and *cis*-prenyltransferases in spite of the fact that these latter enzymes have a higher affinity for farnesyl pyrophosphate. Consequently, synthesis of both coenzyme Q and dolichol is inhibited. Rats treated with statins exhibit decreased levels of coenzyme Q, dolichol, and dolichyl phosphate in heart and muscle, and the same is probably also true in humans. In humans, statin treatment significantly decreases blood coenzyme Q concentration,<sup>[27]</sup> although the clinical significance of this phenomenon remains to be established. Various degrees of myopathy, myalgia, and rhabdomyolysis have been reported in statin-treated patients, and it is possible that these conditions are related to decreased muscle coenzyme Q content. Given the widespread use of statins, it is important that future studies address a possible causal link between these side effects of statin treatment and altered tissue coenzyme Q content.

## Exercise

During endurance exercise training, the coenzyme Q concentration increases in rat muscle on a weight basis due to an increase in mitochondrial mass. After 4 days of high-intensity training, the coenzyme Q content in the exposed muscles of healthy persons is unchanged.<sup>[28]</sup> Supplementation (120 mg/day) doubles the coenzyme Q concentration in the plasma, but there is no change in the muscle content as judged by HPLC analysis of the tissue homogenate and isolated mitochondrial fraction in both control and trained subjects.

## Dosage

So far, no toxic or unwanted side effects have been described for CoQ<sub>10</sub> supplements, not even after ingestion in gram quantities. In most studies, 100–200 mg has been given per day in two doses. In genetic disorders, in the case of adults, the dose may increase to 300 mg/day and in neurological diseases, up to 400 mg/day. In the latter case, in the frame of large multicenter trials, doses up to 1200 mg have been supplied. A patent on the use of statins combined with coenzyme Q has expired recently, although this combined preparation has not been manufactured so far. Now it may be possible for the pharmaceutical industry to introduce capsules containing statins and coenzyme Q in order to decrease the potential for muscle damage. In this case, relatively low doses of CoQ<sub>10</sub> (e.g., 50 or 100 mg/day) appear to be appropriate.

## REFERENCES

- Mosca, F.; Fattorini, D.; Bompadre, S.; Littarru, G.P. Assay of coenzyme Q<sub>10</sub> in plasma by a single dilution step. *Anal. Biochem.* **2002**, *305*, 49–54.
- Grünler, J.; Ericsson, J.; Dallner, G. Branch-point reactions in the biosynthesis of cholesterol, dolichol, ubiquinone and prenylated proteins. *Biochim. Biophys. Acta.* **1994**, *1212*, 259–277.
- Morré, D.J.; Morré, D.M. Cell surface NADH oxidases (ECTO-NOX proteins) with roles in cancer, cellular time-keeping, growth, aging and neurodegenerative diseases. *Free Radic. Res.* **2003**, *37*, 795–808.
- Fontaine, E.; Ichas, F.; Bernardi, P. A ubiquinone-binding site regulates the mitochondrial permeability transition pore. *J. Biol. Chem.* **1998**, *273*, 25,734–25,740.
- Echtay, K.S.; Winkler, E.; Frischmuth, K.; Klingenberg, M. Uncoupling proteins 2 and 3 are highly active H<sup>+</sup> transporters and highly nucleotide sensitive when activated by coenzyme Q (ubiquinone). *Proc. Natl. Acad. Sci. U.S.A.* **2001**, *98*, 1416–1421.
- Stocker, R.; Bowry, V.W.; Frei, B. Ubiquinol-10 protects human low density lipoprotein more efficiently against lipid peroxidation than does  $\alpha$ -tocopherol. *Proc. Natl. Acad. Sci. U.S.A.* **1991**, *88*, 1646–1650.
- Witting, K.; Pettersson, K.; Letters, J.; Stocker, R. Anti-atherogenic effect of coenzyme Q<sub>10</sub> in apolipoprotein E gene knockout mice. *Free Radic. Biol. Med.* **2000**, *29*, 295–305.
- Mohr, D.; Bowry, V.W.; Stocker, R. Dietary supplementation with coenzyme Q<sub>10</sub> results in increased levels of ubiquinol-10 within circulating lipoproteins and increased resistance of human low-density lipoprotein to the initiation of lipid peroxidation. *Biochim. Biophys. Acta.* **1992**, *1126*, 247–254.
- Turunen, M.; Wehlin, L.; Sjöberg, M.; Lundahl, J.; Dallner, G.; Brismar, K.; Sindelar, P.J.  $\beta$ 2-Integrin and lipid modifications indicate a non-antioxidant mechanism for the anti-atherogenic effect of dietary coenzyme Q<sub>10</sub>. *Biochem. Biophys. Res. Commun.* **2002**, *296*, 255–260.
- Burke, B.E.; Neuenschwander, R.; Olson, R.D. Randomized double-blind, placebo-controlled trial of coenzyme Q<sub>10</sub> in isolated systolic hypertension. *South Med. J.* **2001**, *94*, 1112–1117.
- Watts, G.F.; Playford, D.A.; Croft, K.D.; Ward, N.C.; Mori, T.A.; Burke, V. Coenzyme Q<sub>10</sub> improves endothelial dysfunction of the brachial artery in type II diabetes mellitus. *Diabetologia* **2002**, *45*, 420–426.
- Turunen, M.; Olsson, J.; Dallner, G. Metabolism and function of coenzyme Q. *Biochim. Biophys. Acta.* **2004**, *1660*, 171–199.
- Tomasetti, M.; Littarru, G.P.; Stocker, R.; Alleva, R. Coenzyme Q<sub>10</sub> enrichment decreases oxidative DNA damage in human lymphocytes. *Free Radic. Biol. Med.* **1999**, *27*, 1027–1032.
- Folkers, K.; Hanioka, T.; Xia, L.J.; McRee, J.T.; Langsjoen, P. Coenzyme Q<sub>10</sub> increases T4/T8 ratios of lymphocytes in ordinary subjects and relevance to patients having the AIDS related complex. *Biochem. Biophys. Res. Commun.* **1991**, *176*, 786–791.
- Bentinger, M.; Dallner, G.; Chojnacki, T.; Swiezewska, E. Distribution and breakdown of labeled coenzyme Q<sub>10</sub> in rat. *Free Radic. Biol. Med.* **2003**, *34*, 563–575.
- Rustin, P.; Munnich, A.; Rötig, A. Mitochondrial respiratory chain dysfunction caused by coenzyme Q deficiency. *Meth. Enzymol.* **2004**, *382*, 81–86.
- Nakamura, T.; Ohno, T.; Hamamura, K.; Sato, T. Metabolism of coenzyme Q<sub>10</sub>: biliary and urinary excretion study in guinea pigs. *Biofactors* **1999**, *9*, 111–119.
- Faust, J.R.; Brown, M.S.; Goldstein, J.L. Synthesis of delta 2-isopentenyl tRNA from mevalonate in cultured human fibroblasts. *J. Biol. Chem.* **1980**, *255*, 6546–6548.
- Löv, P.; Andersson, M.; Edlund, C.; Dallner, G. Effects of mevinolin treatment on tissue dolichol and ubiquinone levels in the rat. *Biochim. Biophys. Acta.* **1992**, *1165*, 102–109.
- Åberg, F.; Zhang, Y.; Appelkvist, E.L.; Dallner, G. Effects of clofibrate, phthalates and probucol on ubiquinone levels. *Chem. Biol. Interact.* **1994**, *91*, 1–14.

21. Kalen, A.; Appelkvist, E.L.; Dallner, G. Age-related changes in the lipid compositions of rat and human tissues. *Lipids* **1989**, *24*, 579–584.
22. Folkers, K.; Vadahanavikit, S.; Mortensen, S.A. Biochemical rationale and myocardial tissue data on the effective therapy of cardiomyopathy with coenzyme Q<sub>10</sub>. *Proc. Natl. Acad. Sci. U.S.A.* **1985**, *82*, 901–904.
23. Sacher, H.L.; Sacher, M.L.; Landau, S.W.; Kersten, R.; Dooley, F.; Sacher, A.; Sacher, M.; Dietrick, K.; Ichkhan, K. The clinical and hemodynamic effects of coenzyme Q<sub>10</sub> in congestive cardiomyopathy. *Am. J. Ther.* **1997**, *4*, 66–72.
24. Beal, M.F. Coenzyme Q<sub>10</sub> as a possible treatment for neurodegenerative diseases. *Free Radic. Res.* **2002**, *36*, 455–460.
25. Lodi, R.; Hart, P.E.; Rajagopalan, B.; Taylor, D.J.; Crilley, J.G.; Bradley, J.L.; Blamire, A.M.; Manners, D.; Styles, P.; Schapira, A.H.V.; Cooper, J.M. Antioxidant treatment improves in vivo cardiac and skeletal muscle bioenergetics in patients with Friedreich's ataxia. *Ann. Neurol.* **2001**, *49*, 590–596.
26. Abe, K.; Matsuo, Y.; Kadekawa, J.; Inoue, S.; Yanagihara, T. Effect of coenzyme Q<sub>10</sub> in patients with mitochondrial myopathy, encephalopathy, lactic acidosis, and stroke-like episodes (MELAS): evaluation by noninvasive tissue oximetry. *J. Neurol. Sci.* **1999**, *162*, 65–68.
27. Ghirlanda, G.; Oradei, A.; Manto, A.; Lippa, S.; Uccioli, L.; Greco, A.V.; Littarru, G.P. Evidence of plasma CoQ<sub>10</sub>-lowering effect by HMG-CoA reductase inhibitors: a double-blind, placebo-controlled study. *J. Clin. Pharmacol.* **1993**, *33*, 226–229.
28. Svensson, M.; Malm, C.; Tonkonogi, M.; Ekblom, B.; Sjödin, B.; Sahlin, K. Effect of Q<sub>10</sub> supplementation on tissue Q<sub>10</sub> levels and adenine nucleotide catabolism during high-intensity exercise. *Int J. Sport Nutr.* **1999**, *9*, 166–180.



# Copper

**Leslie M. Klevay**

*Grand Forks Human Nutrition Research Center, Agricultural Research Service,  
Grand Forks, North Dakota, U.S.A.*

## INTRODUCTION

Since the discovery in 1928 that copper is an essential nutrient, hundreds of experiments to clarify its function have been conducted with several species of animals and, under very controlled conditions, with adult human volunteers. People respond to copper depletion similar to animals.<sup>[1]</sup>

The earliest experiments involved hematology, which preoccupied nutritional scientists for decades. Gradually, evidence for the adverse effects of copper deficiency on the cardiovascular and skeletal systems accumulated. Cardiovascular research related to copper deficiency, including associated lipid metabolism and cardiovascular physiology, now exceeds that on hematology. Early work on bone structure and function is being collected and extended.

Methods for assessing nutritional status for copper are poorly developed. However, there are a sufficient number of reports of low activities of enzymes dependent on copper and low copper values in important organs to suggest that a considerable number of people may be too low in this element. These data complement measurements of dietary copper suggesting that the Western diet, which is frequently low in copper, may be the source of this abnormal biochemistry. Some people with abnormal gastrointestinal physiology may absorb too little copper as well.

## GENERAL DESCRIPTION

Copper is an essential and versatile nutrient that operates as the active site in 10 to 15 enzymes.<sup>[1-3]</sup> These proteins moderate the chemistry of this metallic element to enhance various metabolic processes related to oxidation. There also are several other copper-binding proteins of physiological importance,<sup>[3]</sup> in addition

to some newly discovered proteins called metallochaperones.<sup>[4]</sup> The latter proteins act in the intracellular transport of metallic elements and help to ensure that free copper ion is nonexistent in the body.<sup>[5,6]</sup>

## ACTIONS, BIOCHEMISTRY, AND PHYSIOLOGY

The essentiality of copper for mammals, including people, was discovered<sup>[7]</sup> when rats fed a milk diet with adequate iron became anemic and grew poorly. Copper proved to be the active material in several foods that were curative and could prevent the condition. All the classic deficiency experiments with animals were done with milk diets. Adequate copper permits normal utilization of dietary iron. In addition to preventing anemia, it assists in blood coagulation,<sup>[8,9]</sup> crosslinking<sup>[2,3,10]</sup> of connective tissues of arteries, bones, and heart, defense against oxidative damage,<sup>[1]</sup> energy transformations, myelination of brain and spinal cord, reproduction, and synthesis of hormones.<sup>[11]</sup> Inadequate copper produces adverse effects<sup>[12-14]</sup> on the metabolism of cholesterol and glucose, blood pressure control and heart function, bone, mineralization, and immunity.

Hypercholesterolemia in copper deficiency has been found in at least 25 independent laboratories,<sup>[13]</sup> most recently by Davis and Feng,<sup>[15]</sup> Fields, Lewis, and Bureau,<sup>[16]</sup> and Wildman and Mao,<sup>[17]</sup> since the original observation.<sup>[18]</sup> Glutathione is an effective regulator of 3-hydroxy-3-methylglutaryl coenzyme A activity.<sup>[19,20]</sup> Copper deficiency disrupts glutathione metabolism,<sup>[21]</sup> leading to increased activity of this enzyme<sup>[22-24]</sup> and contributing to the hypercholesterolemia that occurs. In contrast, decreased activities of lecithin : cholesterol acyltransferase<sup>[25]</sup> and lipoprotein lipase<sup>[26]</sup> also contribute to the hypercholesterolemia of deficiency.

Electrocardiograms of animals deficient in copper reveal human cardiovascular risk factors such as branch block and abnormalities of the ST segment<sup>[13]</sup>; other heart blocks and wave pathologies are numerous.<sup>[13]</sup> The heart blocks are probably caused by decreased activity of an ATPase isoform localized to the conduction system of the heart.<sup>[27]</sup>

Copper deficiency depresses vasodilation via alterations in nitric oxide physiology.<sup>[28,29]</sup> The mechanism

---

*Leslie M. Klevay, M.D., S.D. in Hyg., is Professor at the Department of Internal Medicine, University of North Dakota, North Dakota, U.S.A.*

The U.S. Department of Agriculture, Agricultural Research Service, Northern Plains Area, is an equal opportunity/affirmative action employer and all agency services are available without discrimination.

has been reviewed<sup>[21,30]</sup> and may involve, *inter alia*, guanylate cyclase, which contains copper.<sup>[31]</sup>

There seems to be little doubt that copper deficiency can affect desaturase (and elongase) enzymes, but agreement is lacking on the details and directions of all the changes. Some of the data have been reviewed.<sup>[12,21,32,33]</sup> These enzymes can alter the number of double bonds in a fatty acid and can also increase its length. Prostaglandin metabolism is also affected.<sup>[21]</sup>

## FOOD SOURCES AND SUPPLEMENTATION

As far as is known, food source does not affect copper absorption, in marked contrast to iron and zinc, which are more easily absorbed from animal, than from plant, products. Higher concentrations of copper in many plant foods can compensate if fractional absorption is slightly lower. Vegetarian diets are high in copper.<sup>[34,35]</sup>

Phytates either have no inhibitory effect on copper, or have a markedly smaller effect than that on zinc.<sup>[18,118]</sup> At intestinal pH, copper complexes with phytates are soluble whereas zinc complexes are not. Phytates can thus enhance the utilization of copper.<sup>[36]</sup>

Copper absorption at 55–75% is considerably higher than that of other trace elements; absorption occurs mainly in the upper small intestine, but stomach and colon may absorb the element as well.<sup>[1]</sup> Thus, the concentration of copper in foods is an important characteristic that determines nutritional usefulness. In order of increasing concentration on a weight basis, fats and oils, dairy products, sugar, tuna, and lettuce are low in copper; legumes, mushrooms, chocolate, nuts and seeds, and liver are high in copper.<sup>[37,38]</sup> Bread, potatoes, and tomatoes are consumed in sufficiently large amounts by U.S. adults for these foods to contribute substantially to copper intake, although they are not considered to be high-copper foods.<sup>[39]</sup>

The Western diet typical of the United States, parts of Europe, and wealthy enclaves in the developing world is often low in copper. Approximately one-third of these diets are low in comparison with those used in successful depletion experiments of men and women<sup>[40–44]</sup> under controlled conditions and in comparison to the estimated safe and adequate daily dietary intakes (ESADDI)<sup>[45]</sup> and the newer estimated average requirement (EAR)<sup>[46]</sup> and recommended dietary allowance (RDA) of the National Academy of Sciences (U.S.) (below).

Estimations of dietary copper intakes based on calculations from the amount of copper in individual foods are too high in comparison to chemical analysis of the composite diets<sup>[34,47,48]</sup>; the smallest error from calculation is an excess of 52%.<sup>[48]</sup> It may be that people who provide dietary data report intakes that

are somewhat low, but it is unlikely that they are 50% too low; the reporting error is probably similar across experiments.

The calculated 25th, median, and 75th percentiles for intakes of 51- to 70-yr-old men in a statistical sample of the U.S. population (Table C-15 in Ref.<sup>[49]</sup>) are 1.19, 1.47, and 1.81 mg copper daily. Corrections based on the mean excess in copper found by calculation<sup>[34,47,48]</sup> decrease these estimates to 0.44, 0.64, and 0.87 mg daily. Although younger men seem to eat more copper, women eat less!

Data from several publications on dietary intakes of copper were pooled<sup>[35,38]</sup> and a frequency distribution curve was derived for 849 analyzed diets. Approximately one-third of the diets contained less than 1 mg of copper daily. Further analytical confirmation of diets low in copper is available from men and women randomly selected in Baltimore. Thirty-six percent and 62% of the diets were below the respective dietary reference intakes for copper.<sup>[50]</sup>

Three approaches to supplementation are available. Diets below the EAR and the RDA can be improved by avoiding foods low in copper and by selecting foods high in copper.<sup>[37]</sup> A copper-deficient salad (lettuce, mayonnaise, oil, tuna, etc.) can be improved by adding sunflower seeds, mushrooms, legumes, etc.<sup>[38]</sup> Soy products are increasingly popular and are high in copper,<sup>[51]</sup> as are nuts<sup>[52]</sup> and chocolate.<sup>[53]</sup> Beer enhances the utilization of copper in rats fed a deficient diet, resulting in a sixfold increase in longevity, with less cardiac damage and lower plasma cholesterol.<sup>[54]</sup>

In contrast to iron, fortification of foods with copper is uncommon. Some new snacks and drinks promoted as products with exceptional nutritional properties are fortified with copper. A variety of tablets and capsules containing copper are available commercially.

Copper gluconate is the only copper supplement listed by the United States Pharmacopeial Convention for oral use.<sup>[55]</sup> We have used copper sulfate effectively in experiments with animals<sup>[18,56]</sup> and human volunteers.<sup>[40,42,44]</sup> Others have used copper salts of amino acids.<sup>[57]</sup> It is not easy to identify the chemical form of copper in some of the available supplements.

Cupric oxide is contained in some vitamin–mineral supplements; this form is no longer used in animal nutrition because the copper is utilized poorly.<sup>[58]</sup> Cupric oxide is used in the preparations with many ingredients because of its high concentration of copper, not because of demonstrated efficacy.

## INDICATIONS AND USAGE

The Western diet is associated with rapid growth in infancy, increasingly early sexual maturation, tall

adults, and low rates of infection. This diet is also associated with common diseases of affluence such as cancer, heart disease, obesity, and osteoporosis.<sup>[59]</sup> Numerous anatomical, chemical, and physiological characteristics of people with some of these latter illnesses have been found in several species of animals deficient in copper.<sup>[13,14]</sup>

No single indicator provides an adequate assessment of copper nutriture (nutritional status).<sup>[46]</sup> Indices useful in experiments with animals have sometimes been helpful in depletion studies of people, but most do not seem to be altered by marginal deficiency. Circulating copper may not reflect the actions of enzymes inside cells in various organs where the metabolic processes affected by copper take place. Liver copper, generally impossible to assess in people, is the best indicator in animal experiments.<sup>[56]</sup> Experiments with animals reveal that plasma copper can be normal or increased even though copper in liver or other organs may be low.<sup>[60-68]</sup> Thus, normal or high plasma copper values in people may not be an accurate reflection of copper nutriture.

Data on which to base dietary reference intakes for copper are elusive and, often, absent. Consequently, some of the values in Table 1 are rounded and values for males and females are combined. The adequate intake (AI) values are based on intakes of apparently healthy, full-term infants whose sole source of copper was human milk. Values for pregnancy are based on the amount of copper in the fetus and other products of conception. Those for lactation are the amounts needed to replace the average amount secreted in human milk. EARs are values estimated to meet the requirement of half of the healthy individuals of the group. Copper RDAs are based on the EAR plus an assumed coefficient of variation of 15%, which is larger than the 10% assumed for some other nutrients.<sup>[46]</sup>

It seems clear that there is little or no copper deficiency in the industrialized world if one relies on

traditional criteria of deficiency such as decreased plasma copper or ceruloplasmin. However, these markers are affected by the acute phase response and are easily increased by nondietary variables such as inflammation, oral contraceptives, and pregnancy. Copper depletion experiments with men and women reveal unfavorable alterations in biochemistry and physiology with minimal or no changes in circulating copper and without anemia (above). Copper deficiency is the leading nutritional deficiency of agricultural animals worldwide<sup>[69]</sup>; can people be far behind?

The recent report on dietary reference intakes<sup>[49]</sup> and its predecessors, e.g., Ref.<sup>[45]</sup>, summarize the reasons why people may decide to take (or avoid) nutrient supplements. Growth and function are improved when nutrients are increased above levels just sufficient to prevent deficiency. There is little evidence that small surpluses of nutrients are detrimental, while small deficits will lead to deficiency over time. There is no evidence of unique health benefits from the consumption of a large excess of any one nutrient. Meeting recommended intakes for nutrients will not provide for malnourished individuals.

There seems to be little or no anemia responsive to copper in the United States, although this phenomenon does not seem to have been studied adequately in the last half century. Copper deficiency can masquerade as the myelodysplastic syndrome, however.<sup>[70]</sup> Supplementation of middle-aged Europeans with copper protected their red blood cells from oxidative hemolysis in vitro,<sup>[57]</sup> indicating that extra copper improved the quality of the cells.

Several of the classical risk factors for ischemic heart disease have been produced in animals deficient in copper. Similar changes have been found in more than 30 men and women in successful copper depletion experiments using conventional foods and have been reversed by copper supplementation.<sup>[40-44]</sup> Copper intakes of 0.65–1.02 mg daily in these experiments were insufficient. Criteria of depletion included abnormal electrocardiograms<sup>[40,41]</sup> and blood pressure regulation,<sup>[44]</sup> dyslipidemia,<sup>[43]</sup> glucose intolerance,<sup>[42]</sup> and hypercholesterolemia.<sup>[40]</sup> Two of the experiments were interrupted prematurely with early repletion with copper because of abnormal electrocardiography; all of the metabolic and physiological abnormalities disappeared with copper repletion.

In contrast is a balance experiment using a formula diet that failed to confirm these results.<sup>[71]</sup> Applesauce, cheese, chicken, cornflakes, crackers, lettuce, margarine, milk, orange juice, and rice provided less than 31–34% of dietary energy (calculated at 2400 kcal/day).<sup>[72]</sup> As actual energy intake ranged from 2415 to 3553 kcal,<sup>[71]</sup> the food part of the formula was probably about 26%. Because formula diets are known to lower serum cholesterol,<sup>[73]</sup> the potential increase in

**Table 1** Daily adequate intake (AI), estimated average requirement (EAR), and recommended dietary allowance (RDA) for copper, mg

Age	AI (mg)	EAR (mg)	RDA (mg)
0–6 mo	0.20 or 30 (µg/kg)		
7–12 mo	0.22 or 24 (µg/kg)		
1–3 yr		0.26	0.34
4–8 yr		0.34	0.44
9–13 yr		0.54	0.70
14–18 yr		0.685	0.89
19–70 yr		0.70	0.90
Pregnancy		0.80	1.00
Lactation		1.00	1.30



cholesterolemia from the low copper intake may have been obscured.

Activities of enzymes dependent on copper<sup>[74–80]</sup> and organ copper concentrations<sup>[81–90]</sup> have been found to be decreased in people with cardiovascular (mostly ischemic) diseases. There is a positive correlation between cardiac output and copper in heart tissue of patients with coronary heart disease.<sup>[89]</sup> Decreased copper in organs and decreased enzyme activities are evidence of impaired copper nutriture.<sup>[91–93]</sup>

No long-term copper supplementation has been done in patients with cardiac arrhythmia, dyslipidemia, glucose intolerance, hypercholesterolemia, or hypertension. However, some dietary regimens found to alleviate some of these conditions may have included an increase in copper intake as a hidden variable: for example, the Lifestyle Trial,<sup>[94]</sup> the protective effect of legumes on cholesterol, blood pressure, and diabetes,<sup>[95]</sup> and the benefit of whole grain foods on coronary heart disease.<sup>[96]</sup> Spencer<sup>[97]</sup> described two men and a woman whose premature ventricular beats, which had persisted for years, were thought to be due to coronary heart disease. These premature beats disappeared after they ingested 4 mg of copper (as copper gluconate) per day.

Copper-deficient people have osteoporosis that can be cured with extra copper (reviewed in Ref.<sup>[14]</sup>). This phenomenon has been found mainly in young children. Adults may have skeletal pathology from low copper status as well. Copper is decreased in bone in both osteoarthritis and ischemic necrosis of the femoral head.<sup>[98]</sup> Low serum copper in patients with fractures of the femoral neck<sup>[99]</sup> or decreased lumbar bone density<sup>[12,100,101]</sup> may indicate covert copper deficiency.

There is no epidemiologic evidence that low copper intakes produce the osteoporosis that occurs in late middle age. However, two double-blind, placebo-controlled trials have shown that trace element supplements including copper improved bone mineral density in postmenopausal women.<sup>[102,103]</sup>

Premature infants and people with extensive burns may need extra copper. The former<sup>[104]</sup> are sometimes born before their mothers can load them with copper in the last trimester.<sup>[10]</sup> Enzyme activities or improved physiology are more likely to be useful in assessing benefits of copper therapy than are measurements of circulating copper in prematurity.

In analogy to vitamin B<sub>12</sub> deficiency, any disruption of the gastrointestinal tract has the potential to impair copper nutriture. For example, some people with cystic fibrosis or pancreatic insufficiency may need extra copper.<sup>[105–107]</sup> Copper-dependent enzyme activity and copper concentration have been found to be decreased in ulcerative colitis biopsies.<sup>[108]</sup> Supplementation of people with these conditions should be done under medical supervision. A potential

role for copper supplements in the treatment of rheumatoid arthritis and psoriasis has not been proved.

Though adults may have unmet needs for copper to provide cardiovascular, hematopoietic, or skeletal benefit, neither the dose nor the duration of therapy is clear. People in supplementation trials have tolerated 3–6 mg daily over their usual dietary amounts for weeks or months. There is probably no reason to exceed the tolerable upper intake level (UL) of 10 mg daily (Table 2).

## Potential Toxicity and Precautions

All chemicals, including essential nutrients, are toxic if the dose is excessive. It seems that people have a 50- to 400-fold safety factor for copper considering usual dietary intakes and the tolerance level found with several species of experimental animals.<sup>[109]</sup> The UL connotes an intake that can, with high probability, be tolerated biologically by almost all individuals.

Gastrointestinal signs and symptoms such as nausea are prominent in the setting of this limit. A small, double-blind study has revealed that adults are unaffected in 12 weeks by a daily supplement of 10 mg of copper.<sup>[46]</sup> The UL values in Table 2 are based on this experiment; no value is available for infants less than 1 yr old. van Ravesteyn administered 38 mg of copper daily to people for as long as 14 days; toxicity was not mentioned.<sup>[110]</sup> Copper supplements should be taken with food<sup>[111,112]</sup> and should not be taken by people with biliary disease, liver disease, idiopathic copper toxicosis or Wilson's disease, or by people taking penicillamine or trientine.

Although copper can interfere with zinc utilization, this phenomenon does not seem to be of practical importance to people. In contrast, copper deficiency has been induced in people (and in numerous species of pets and animals in zoos) by the ingestion of

**Table 2** Daily tolerable upper intake level (UL) for copper, mg

Age group	UL (mg)
Children	
1–3 yr	1.00
4–8 yr	3.00
9–13 yr	5.00
Adolescents	
14–18 yr	8.00
Adults	
19–70+ yr	10
Pregnancy	8.00
Lactation	8.00–10.00

recently minted pennies (U.S.), which are almost pure zinc.<sup>[113]</sup> The dose of supplemental zinc that is excessive for adults is ill-defined, but the adult UL for zinc, 40 mg daily, is based on reduced copper nutriture from zinc in food, water, and supplements combined. A case of copper-responsive anemia has been reported in a patient with acrodermatitis enteropathica overtreated with zinc.<sup>[114]</sup> This potential exists for patients with Wilson's disease treated with zinc, particularly children.<sup>[115]</sup> Vitamin C is known to interfere with the utilization of copper, but its UL of 2 g daily is not based on copper effects. Adverse effects on blood pressure regulation and copper utilization were found in women fed 1.5 g vitamin C daily.<sup>[44]</sup> Simple sugars such as fructose, glucose, and sucrose interfere with the utilization of copper<sup>[116,117]</sup>. It should be noted that high-fructose corn syrup is found in many processed foods and beverages. Copper supplements should not be used as emetics.

## CONCLUSIONS

The Western diet often is low in copper. Statements to the contrary are based on dietary calculations, which are falsely high. The best way to ensure an adequate intake of copper is to minimize the intake of foods low in copper and to increase that of foods high in it, such as cereals, grains, legumes, mushrooms, nuts, and seeds. Dietary copper can be increased by using the food pyramid as a guide. Only a few foods are fortified with copper. Copper gluconate is probably the best supplement.

There seems to be little copper deficiency in Western society if one considers anemia as its only sign. However, adults with diseases of the cardiovascular, gastrointestinal, and skeletal systems have repeatedly been found to have low concentrations of copper in important organs and to have low activities of enzymes dependent on copper. These signs are consonant with deficiency. Anemia may therefore not be the most sensitive sign of deficiency in adults. Premature infants may also be deficient in copper. Large intakes of vitamin C or zinc can impair the proper utilization of copper in people.

## REFERENCES

- Linder, M.C. Copper. In *Present Knowledge in Nutrition*, 7th Ed.; Ziegler, E.E., Filer, L.J. Jr., Eds.; ISLI Press: Washington, 1996; 307–319.
- Owen, C.A. Jr. Biochemical aspects of copper. Noyes Publications: Park Ridge, N.J., 1982; 1–205.
- Prohaska, J.R. Biochemical changes in copper deficiency. *J. Nutr. Biochem.* **1990**, *1*, 452–461.
- O'Halloran, T.V.; Culotta, V.C. Metallochaperones, an intracellular shuttle service for metal ions. *J. Biol. Chem.* **2000**, *275*, 25,057–25,060.
- May, P.M.; Linder, P.W.; Williams, D.R. Ambivalent effect of protein binding on computed distributions of metal ions complexed by ligands in blood plasma. *Experientia* **1976**, *32*, 1492–1494.
- May, P.M.; Linder, P.W.; Williams, D.R. Computer simulation of metal-ion equilibria in biofluids: models for the low-molecular-weight complex distribution of calcium(II), magnesium(II), manganese(II), iron(III), copper(II), zinc(II), and lead(II) ions in blood plasma. *J. Chem. Soc. Dalton Trans.* **1977**, 588–595.
- Hart, E.B.; Steenbock, H.; Waddell, J.; Elvehjem, C.A. Iron in nutrition. VII. Copper as a supplement to iron for hemoglobin building in the rat. *J. Biol. Chem.* **1928**, *77*, 797–812.
- Lynch, S.M.; Klevay, L.M. Effects of a dietary copper deficiency on plasma coagulation factor activities in male and female mice. *J. Nutr. Biochem.* **1992**, *3*, 387–391.
- Mann, K.G.; Lawler, C.M.; Vehar, G.A.; Church, W.R. Coagulation factor V contains copper ion. *J. Biol. Chem.* **1984**, *259*, 12,949–12,951.
- Linder, M.C.; Goode, C.A. 6.4 Specific copper components in special tissues. In *Biochemistry of Copper*; Plenum Press: New York, 1991; 212–220.
- Davis, G.K.; Mertz, W. Copper. In *Trace Elements in Human and Animal Nutrition*, 5th Ed.; Mertz, W., Ed.; Academic Press: San Diego, 1986; 301–364.
- Klevay, L.M. Ischemic heart disease: toward a unified theory. In *Role of Copper in Lipid Metabolism*; Lei, K.Y., Carr, T.P., Eds.; CRC Press: Boca Raton, FL, 1990; 233–267.
- Klevay, L.M. Trace element and mineral nutrition in disease: ischemic heart disease. In *Clinical Nutrition of the Essential Trace Elements and Minerals: The Guide for Health Professionals*; Bogden, J.D., Klevay, L.M., Eds.; Humana Press, Inc.: Totowa, NJ, 2000; 251–271.
- Klevay, L.M.; Wildman, R.E. Meat diets and fragile bones: inferences about osteoporosis. *J. Trace Elem. Med. Biol.* **2002**, *16*, 149–154.
- Davis, C.D.; Feng, Y. Dietary copper, manganese and iron affect the formation of aberrant crypts in colon of rats administered 3,2'-dimethyl-4-aminobiphenyl. *J. Nutr.* **1999**, *129*, 1060–1067.
- Fields, M.; Lewis, C.G.; Bureau, I. Aspirin reduces blood cholesterol in copper-deficient rats: a potential antioxidant agent? *Metabolism* **2001**, *50*, 558–561.

17. Wildman, R.E.; Mao, S. Tissue-specific alterations in lipoprotein lipase activity in copper-deficient rats. *Biol. Trace Elem. Res.* **2001**, *80*, 221–229.
18. Klevay, L.M. Hypercholesterolemia in rats produced by an increase in the ratio of zinc to copper ingested. *Am. J. Clin. Nutr.* **1973**, *26*, 1060–1068.
19. Cappel, R.E.; Gilbert, H.F. Thiol/disulfide exchange between 3-hydroxy-3-methylglutaryl-CoA reductase and glutathione. A thermodynamically facile dithiol oxidation. *J. Biol. Chem.* **1988**, *263*, 12,204–12,212.
20. Cappel, R.E.; Gilbert, H.F. Oxidative inactivation of 3-hydroxy-3-methylglutaryl-coenzyme A reductase and subunit cross-linking involve different dithiol/disulfide centers. *J. Biol. Chem.* **1993**, *268*, 342–348.
21. Allen, K.G.; Klevay, L.M. Copper: an antioxidant nutrient for cardiovascular health. *Curr. Opin. Lipidol.* **1994**, *5*, 22–28.
22. Valsala, P.; Kurup, P.A. Investigations on the mechanism of hypercholesterolemia observed in copper deficiency in rats. *J. Biosci.* **1987**, *12*, 137–142.
23. Yount, N.Y.; McNamara, D.J.; Al Othman, A.A.; Lei, K.Y. The effect of copper deficiency on rat hepatic 3-hydroxy-3-methylglutaryl coenzyme A reductase activity. *J. Nutr. Biochem.* **1990**, *1*, 21–27.
24. Kim, S.; Chao, P.Y.; Allen, K.G. Inhibition of elevated hepatic glutathione abolishes copper deficiency cholesterolemia. *FASEB J.* **1992**, *6*, 2467–2471.
25. Lau, B.W.; Klevay, L.M. Plasma lecithin: cholesterol acyltransferase in copper-deficient rats. *J. Nutr.* **1981**, *111*, 1698–1703.
26. Lau, B.W.; Klevay, L.M. Postheparin plasma lipoprotein lipase in copper-deficient rats. *J. Nutr.* **1982**, *112*, 928–933.
27. Huang, W.; Lai, C.; Wang, Y.; Askari, A.; Klevay, L.M.; Chiu, T.H. Altered expressions of cardiac Na/K-ATPase isoforms in copper deficient rats. *Cardiovasc. Res.* **1995**, *29*, 563–568.
28. Saari, J.T. Dietary copper deficiency and endothelium-dependent relaxation of rat aorta. *Proc. Soc. Exp. Biol. Med.* **1992**, *200*, 19–24.
29. Lynch, S.M.; Frei, B.; Morrow, J.D.; Roberts, L.J.; Xu, A.; Jackson, T.; Reyna, R.; Klevay, L.M.; Vita, J.A.; Keaney, J.F., Jr. Vascular superoxide dismutase deficiency impairs endothelial vasodilator function through direct inactivation of nitric oxide and increased lipid peroxidation. *Arterioscler. Thromb. Vasc. Biol.* **1997**, *17*, 2975–2981.
30. Anon. Decreased dietary copper impairs vascular function. *Nutr. Rev.* **1993**, *51*, 188–189.
31. Gerzer, R.; Böhme, E.; Hofmann, F.; Schultz, G. Soluble guanylate cyclase purified from bovine lung contains heme and copper. *FEBS Lett.* **1981**, *132*, 71–74.
32. Cunnane, S.C. Modulation of long chain fatty acid unsaturation by dietary copper. In *Copper Bioavailability and Metabolism*; Kies, C., Ed.; Plenum Press: New York, 1989; 183.
33. Cunnane, S.C. Copper and long chain fatty acid metabolism. In *Role of Copper in Lipid Metabolism*; Lei, K.Y., Carr, T.P., Eds.; CRC Press: Boca Raton, FL, 1990; 161–178.
34. Gibson, R.S.; Scythes, C.A. Trace element intakes of women. *Br. J. Nutr.* **1982**, *48*, 241–248.
35. Klevay, L.M.; Buchet, J.P.; Bunker, V.W.; Clayton, B.E.; Gibson, R.S.; Medeiros, D.M.; Moser-Veillon, P.B.; Patterson, K.Y.; Taper, L.J.; Wolf, W.R. Copper in the Western diet (Belgium, Canada, UK and USA). In *Trace Elements in Man and Animals*, TEMA 8; Anke, M., Meissner, D., Mills, C.F., Eds.; Verlag Media Touristik: Gersdorf, Germany, 1993; 207–210.
36. Klevay, L.M. Hypocholesterolemia due to sodium phytate. *Nutr. Rep. Int.* **1977**, *15*, 587–595.
37. Lurie, D.G.; Holden, J.M.; Schubert, A.; Wolf, W.R.; Miller-Ihli, N.J. The copper content of foods based on a critical evaluation of published analytical data. *J. Food Comp. Anal.* **1989**, *2*, 298–316.
38. Klevay, L.M. Lack of a recommended dietary allowance for copper may be hazardous to your health. *J. Am. Coll. Nutr.* **1998**, *17*, 322–326.
39. Subar, A.F.; Krebs, S.S.; Cook, A.; Kahle, L.L. Dietary sources of nutrients among US adults, 1989 to 1991. *J. Am. Diet. Assoc.* **1998**, *98*, 537–547.
40. Klevay, L.M.; Inman, L.; Johnson, L.K.; Lawler, M.; Mahalko, J.R.; Milne, D.B.; Lukaski, H.C.; Bolonchuk, W.; Sandstead, H.H. Increased cholesterol in plasma in a young man during experimental copper depletion. *Metabolism* **1984**, *33*, 1112–1118.
41. Reiser, S.; Smith, J.C., Jr.; Mertz, W.; Holbrook, J.T.; Scholfield, D.J.; Powell, A.S.; Canfield, W.K.; Canary, J.J. Indices of copper status in humans consuming a typical American diet containing either fructose or starch. *Am. J. Clin. Nutr.* **1985**, *42*, 242–251.
42. Klevay, L.M.; Canfield, W.K.; Gallagher, S.K.; Henriksen, L.K.; Lukaski, H.C.; Bolonchuk, W.; Johnson, L.K.; Milne, D.B.; Sandstead, H.H. Decreased glucose tolerance in two men

- during experimental copper depletion. *Nutr. Rep. Int.* **1986**, *33*, 371–382.
43. Reiser, S.; Powell, A.; Yang, C.Y.; Canary, J.J. Effect of copper intake on blood cholesterol and its lipoprotein distribution in men. *Nutr. Rep. Int.* **1987**, *36*, 641–649.
  44. Lukaski, H.C.; Klevay, L.M.; Milne, D.B. Effects of dietary copper on human autonomic cardiovascular function. *Eur. J. Appl. Physiol.* **1988**, *58*, 74–80.
  45. Anon. In *Recommended Dietary Allowances*; 10th Ed.; National Academy Press: Washington DC, 1989; 284.
  46. Anon. Copper. In *Dietary Reference Intakes for Vitamin A, Vitamin K, Arsenic, Boron, Chromium, Copper, Iodine, Iron, Manganese, Molybdenum, Nickel, Silicon, Vanadium, and Zinc*; National Academy of Sciences: Washington, DC, 2001; 177–204.
  47. Rawson, J.R.; Medeiros, D.M. Macronutrient, copper and zinc intakes of young adult males as determined by duplicate food samples and diet records. *Nutr. Rep. Int.* **1989**, *39*, 1149–1159.
  48. Hunt, J.R.; Vanderpool, R.A. Apparent copper absorption from a vegetarian diet. *Am. J. Clin. Nutr.* **2001**, *74*, 803–807.
  49. Anon. In *Dietary Reference Intakes for Vitamin A, Vitamin K, Arsenic, Boron, Chromium, Copper, Iodine, Iron, Manganese, Molybdenum, Nickel, Silicon, Vanadium, and Zinc*; National Academy of Sciences: Washington, DC, 2001; 773.
  50. Pang, Y.; MacIntosh, D.L.; Ryan, P.B. A longitudinal investigation of aggregate oral intake of copper. *J. Nutr.* **2001**, *131*, 2171–2176.
  51. Klevay, L.M. Soy protein may affect plasma cholesterol through copper. *Am. J. Clin. Nutr.* **1994**, *60*, 300–301.
  52. Klevay, L.M. Copper in nuts may lower heart disease risk. *Arch. Intern. Med.* **1993**, *153*, 401–402.
  53. Klevay, L.M. Copper in legumes may lower heart disease risk. *Arch. Intern. Med.* **2002**, *162*, 1780.
  54. Klevay, L.M.; Moore, R.J. Beer mitigates some effects of copper deficiency in rats. *Am. J. Clin. Nutr.* **1990**, *51*, 869–872.
  55. Anon. In *Drug Information for the Health Care Professional: USP DI*, 20th Ed.; World Color Book Services: Versailles, KY, 2000; 986–988.
  56. Klevay, L.M.; Saari, J.T. Comparative responses of rats to different copper intakes and modes of supplementation. *Proc. Soc. Exp. Biol. Med.* **1993**, *203*, 214–220.
  57. Rock, E.; Mazur, A.; O'Connor, J.M.; Bonham, M.P.; Rayssiguier, Y.; Strain, J.J. The effect of copper supplementation on red blood cell oxidizability and plasma antioxidants in middle-aged healthy volunteers. *Free Radical Biol. Med.* **2000**, *28*, 324–329.
  58. Baker, D.H. Cupric oxide should not be used as a copper supplement for either animals or humans. *J. Nutr.* **1999**, *129*, 2278–2279.
  59. Burkitt, D.P. Western diseases and what they encompass. In *Western Diseases: Their Dietary Prevention and Reversibility*; Temple, N.J., Burkitt, D.P., Eds.; Humana Press: Totowa, NJ, 1994; 15–27.
  60. Evans, G.W.; Cornatzer, N.F.; Cornatzer, W.E. Mechanism for hormone-induced alterations in serum ceruloplasmin. *Am. J. Physiol.* **1970**, *218*, 613–615.
  61. Kincaid, R.L. Toxicity of ammonium molybdate added to drinking water of calves. *J. Dairy Sci.* **1980**, *63*, 608–610.
  62. Klevay, L.M. Metabolic interactions among cholesterol, cholic acid and copper. *Nutr. Rep. Int.* **1982**, *26*, 405–414.
  63. Kennedy, M.L.; Failla, M.L.; Smith, J.C. Jr. Influence of genetic obesity on tissue concentrations of zinc, copper, manganese and iron in mice. *J. Nutr.* **1986**, *116*, 1432–1441.
  64. Clegg, M.S.; Ferrell, F.; Keen, C.L. Hypertension-induced alterations in copper and zinc metabolism in Dahl rats. *Hypertension* **1987**, *9*, 624–628.
  65. Klevay, L.M. Dietary cholesterol lowers liver copper in rabbits. *Biol. Trace Elem. Res.* **1988**, *16*, 51–57.
  66. Vlad, M.; Bordas, E.; Tornus, R.; Sava, D.; Farkas, E.; Uza, G. Effect of copper sulfate on experimental atherosclerosis. *Biol. Trace Elem. Res.* **1993**, *38*, 47–54.
  67. Vlad, M.; Uza, G.; Zirbo, M.; Olteanu, D. Free radicals, ceruloplasmin, and copper concentration in serum and aortic tissue in experimental atherosclerosis. *Nutrition* **1995**, *11*, 588–591.
  68. Xu, H.; Sakakibara, S.; Morifuji, M.; Salamatulla, Q.; Aoyama, Y. Excess dietary histidine decreases the liver copper level and serum alanine aminotransferase activity in Long-Evans Cinnamon rats. *Br. J. Nutr.* **2003**, *90*, 573–579.
  69. Mills, C.F. Changing perspectives in studies of the trace elements and animal health. In *Trace Elements in Man and Animals*, TEMA 5; Mills, C.F., Bremner, I., Chesters, J.K., Eds.; Commonwealth Agricultural Bureaux: Farnham Royal, U.K., 1985; 1–10.
  70. Gregg, X.T.; Reddy, V.; Prchal, J.T. Copper deficiency masquerading as myelodysplastic syndrome. *Blood* **2002**, *100*, 1493–1495.

71. Turnlund, J.R.; Keyes, W.R.; Anderson, H.L.; Acord, L.L. Copper absorption and retention in young men at three levels of dietary copper by use of the stable isotope  $^{65}\text{Cu}$ . *Am. J. Clin. Nutr.* **1989**, *49*, 870–878.
72. Klevay, L.M. Can copper deficiency cause ischemic heart disease? In *Trace Elements in Man and Animals*, TEMA 7; Momcilovic, B., Ed.; Institute for Medical Research and Occupational Health, University of Zagreb: Zagreb, 1991.
73. Hegsted, D.M.; Nicolosi, R.J. Do formula diets attenuate the serum cholesterol response to dietary fats? *J. Vasc. Med. Biol.* **1990**, *2*, 69–73.
74. Vivoli, G.; Bergomi, M.; Rovesti, S.; Pinotti, M.; Caselgrandi, E. Zinc, copper, and zinc- or copper-dependent enzymes in human hypertension. *Biol. Trace Elem. Res.* **1995**, *49*, 97–106.
75. Bergomi, M.; Rovesti, S.; Vinceti, M.; Vivoli, R.; Caselgrandi, E.; Vivoli, G. Zinc and copper status and blood pressure. *J. Trace Elem. Med. Biol.* **1997**, *11*, 166–169.
76. Klevay, L.M. Measured copper and zinc in body fluids. *J. Trace Elem. Med. Biol.* **1998**, *12*, 1.
77. Russo, C.; Olivieri, O.; Girelli, D.; Faccini, G.; Zenari, M.L.; Lombardi, S.; Corrocher, R. Anti-oxidant status and lipid peroxidation in patients with essential hypertension. *J. Hypertens.* **1998**, *16*, 1267–1271.
78. Wang, X.L.; Adachi, T.; Sim, A.S.; Wilcken, D.E. Plasma extracellular superoxide dismutase levels in an Australian population with coronary artery disease. *Arterioscler. Thromb. Vasc. Biol.* **1998**, *18*, 1915–1921.
79. Dubick, M.A.; Keen, C.L.; DiSilvestro, R.A.; Eskelson, C.D.; Ireton, J.; Hunter, G.C. Antioxidant enzyme activity in human abdominal aortic aneurysmal and occlusive disease. *Proc. Soc. Exp. Biol. Med.* **1999**, *220*, 39–45.
80. Landmesser, U.; Merten, R.; Spiekermann, S.; Buttner, K.; Drexler, H.; Hornig, B. Vascular extracellular superoxide dismutase activity in patients with coronary artery disease: relation to endothelium-dependent vasodilation. *Circulation* **2000**, *101*, 2264–2270.
81. Wester, P.O. Trace elements in human myocardial infarction determined by neutron activation analysis. *Acta Med. Scand.* **1965**, *178*, 765–788.
82. Anderson, T.W.; Neri, L.C.; Schreiber, G.B.; Talbot, F.D.; Zdrojewski, A. Ischemic heart disease, water hardness and myocardial magnesium. *Can. Med. Assoc. J.* **1975**, *113*, 199–203.
83. Chipperfield, B.; Chipperfield, J.R. Differences in metal content of the heart muscle in death from ischemic heart disease. *Am. Heart J.* **1978**, *95*, 732–737.
84. Tilson, M.D. Decreased hepatic copper levels. A possible chemical marker for the pathogenesis of aortic aneurysms in man. *Arch. Surg.* **1982**, *117*, 1212–1213.
85. Aalbers, T.G. *Cardiovascular Diseases and Trace Elements*; Drukkerij Blok en Zonen: Dieren, 1984.
86. Penttilä, O.; Neuvonen, P.J.; Himberg, J.J.; Siltanen, P.; Järvinen, A.; Merikallio, E. Auricular myocardial cation concentrations in certain heart diseases in man. *Trace Elem. Med.* **1986**, *3*, 47–51.
87. Zama, N.; Towns, R.L. Cardiac copper, magnesium, and zinc in recent and old myocardial infarction. *Biol. Trace Elem. Res.* **1986**, *10*, 201–208.
88. Kinsman, G.D.; Howard, A.N.; Stone, D.L.; Mullins, P.A. Studies in copper status and atherosclerosis. *Biochem. Soc. Trans.* **1990**, *18*, 1186–1188.
89. Oster, O.; Dahm, M.; Oelert, H. Element concentrations (selenium, copper, zinc, iron, magnesium, potassium, phosphorous) in heart tissue of patients with coronary heart disease correlated with physiological parameters of the heart. *Eur. Heart J.* **1993**, *14*, 770–774.
90. Mielcarz, G.; Howard, A.N.; Mielcarz, B.; Williams, N.R.; Rajput-Williams, J.; Nigdigar, S.V.; Stone, D.L. Leucocyte copper, a marker of copper body status is low in coronary artery disease. *J. Trace Elem. Med. Biol.* **2001**, *15*, 31–35.
91. Dann, W.J.; Darby, W.J. The appraisal of nutritional status (nutriture) in humans; with especial reference to vitamin deficiency disease. *Physiol. Rev.* **1945**, *25*, 326–346.
92. Golden, M.H.N. Severe malnutrition. In *Oxford Textbook of Medicine*, 3rd Ed.; Weatherall, D.J., Ledingham, J.G., Warrell, D.A., Eds.; Oxford University Press: Oxford, 1996; 1278–1296.
93. Klevay, L.M. Advances in cardiovascular-copper research. In *Trace Elements in Nutrition, Health and Disease*, First International Bio-Minerals Symposium, Apr 19, 2001; Schrauzer, G.N., Ed.; Institut Rosell: Montreal, Canada, 2002; 64–71.
94. Klevay, L.M. The Lifestyle Heart Trial. *Nutr. Rev.* **1992**, *50*, 29.
95. Klevay, L.M. Extra dietary copper inhibits LDL oxidation. *Am. J. Clin. Nutr.* **2002**, *76*, 687–688.
96. Klevay, L.M. Dietary copper and risk of coronary heart disease. *Am. J. Clin. Nutr.* **2000**, *71*, 1213–1214.
97. Spencer, J.C. Direct relationship between the body's copper/zinc ratio, ventricular premature

- beats, and sudden coronary death. *Am. J. Clin. Nutr.* **1979**, *32*, 1184–1185.
98. Milachowski, K.A. Investigation of ischaemic necrosis of the femoral head with trace elements. *Int. Orthop.* **1988**, *12*, 323–330.
  99. Conlan, D.; Korula, R.; Tallentire, D. Serum copper levels in elderly patients with femoral-neck fractures. *Age Ageing* **1990**, *19*, 212–214.
  100. Milachowski, K.A.; Matzen, K.A. Mineral- und Spurenelementstoffwechselstörungen bei der Koxarthrose. *Z. Orthop.* **1982**, *120*, 828–832.
  101. Howard, G.; Andon, M.; Bracker, M.; Saltman, P.; Strause, L. Low serum copper, a risk factor additional to low dietary calcium in postmenopausal bone loss. *J. Trace Elem. Exp. Med.* **1992**, *5*, 23–31.
  102. Strause, L.; Saltman, P.; Smith, K.T.; Bracker, M.; Andon, M.B. Spinal bone loss in postmenopausal women supplemented with calcium and trace minerals. *J. Nutr.* **1994**, *124*, 1060–1064.
  103. Eaton-Evans, J.; McIlrath, E.M.; Jackson, W.E.; McCartney, H.; Strain, J.J. Copper supplementation and the maintenance of bone mineral density in middle-aged women. *J. Trace Elem. Exp. Med.* **1996**, *9*, 87–94.
  104. Anon. Copper metabolism in premature and low-birth-weight neonates. *Nutr. Rev.* **1981**, *39*, 333–336.
  105. Percival, S.S.; Bowser, E.; Wagner, M. Reduced copper enzyme activities in blood cells of children with cystic fibrosis. *Am. J. Clin. Nutr.* **1995**, *62*, 633–638.
  106. Percival, S.S.; Kauwell, G.P.; Bowser, E.; Wagner, M. Altered copper status in adult men with cystic fibrosis. *J. Am. Coll. Nutr.* **1999**, *18*, 614–619.
  107. Best, K.; McCoy, K.; Gemma, S.; DiSilvestro, R.A. Copper enzyme activities in cystic fibrosis before and after copper supplementation plus or minus zinc. *Metabolism* **2004**, *53*, 37–41.
  108. Mennigen, R.; Kusche, J.; Streffer, C.; Krakamp, B. Diamine oxidase activities in the large bowel mucosa of ulcerative colitis patients. *Agents Actions* **1990**, *30*, 264–266.
  109. Klevay, L.M. The role of copper, zinc, and other chemical elements in ischemic heart disease. In *Metabolism of Trace Metals in Man*; Rennert, O.M., Chan, W.Y., Eds.; CRC Press: Boca Raton, FL, 1984; 129–157.
  110. van Ravesteyn, A.H. Metabolism of copper in man. *Acta Med. Scand.* **1944**, *118*, 163–196.
  111. Araya, M.; McGoldrick, M.C.; Klevay, L.M.; Strain, J.J.; Robson, P.; Nielsen, F.; Olivares, M.; Pizarro, F.; Johnson, L.A.; Poirier, K.A. Determination of an acute no-observed-adverse-effect level (NOAEL) for copper in water. *Regul. Toxicol. Pharmacol.* **2001**, *34*, 137–145.
  112. Araya, M.; Chen, B.; Klevay, L.M.; Strain, J.J.; Johnson, L.; Robson, P.; Shi, W.; Nielsen, F.; Zhu, H.; Olivares, M.; Pizarro, F.; Haber, L.T. Confirmation of an acute no-observed-adverse-effect and low-observed-adverse-effect level for copper in bottled drinking water in a multi-site international study. *Regul. Toxicol. Pharmacol.* **2003**, *38*, 389–399.
  113. Klevay, L.M. The illness and death of a female hyena poisoned by zinc ingested as pennies. *J. Zoo Wildl. Med.* **2000**, *31*, 289–290.
  114. Hoogenraad, T.U.; Dekker, A.W.; Van den Hamer, C.J. Copper responsive anemia, induced by oral zinc therapy in a patient with acrodermatitis enteropathica. *Sci. Total Environ.* **1985**, *42*, 37–43.
  115. Klevay, L.M. Using zinc to remove copper from pediatric patients with Wilson's disease. *J. Lab. Clin. Med.* **2001**, *138*, 214.
  116. Reiser, S.; Ferretti, R.J.; Fields, M.; Smith, J.C. Jr. Role of dietary fructose in the enhancement of mortality and biochemical changes associated with copper deficiency in rats. *Am. J. Clin. Nutr.* **1983**, *38*, 214–222.
  117. Fields, M.; Ferretti, R.J.; Smith, J.C., Jr.; Reiser, S. The interaction of type of dietary carbohydrates with copper deficiency. *Am. J. Clin. Nutr.* **1984**, *39*, 289–295.
  118. Oberleas, D. Phytates. In *Toxicants Occurring Naturally in Foods*, 2nd Ed.; Strong, F.M., et al., Eds.; National Academy of Sciences: Washington, DC, 1973; 363.

#### FURTHER READINGS

- Kies, C. Copper bioavailability and metabolism. In *Advances in Experimental Medicine and Biology*, 1st Ed.; Plenum Press: New York, 1989; Vol. 258.
- Klevay, L.M.; Medeiros, D.M. Deliberations and evaluations of the approaches, endpoints and paradigms for dietary recommendations about copper. *J. Nutr.* **1996**, *126*, 2419S–2426S.
- Lei, K.Y.; Carr, T.P. *Role of Copper in Lipid Metabolism*; CRC Press: Boca Raton, FL, 1990; 287.



# Cranberry (*Vaccinium macrocarpon*) Aiton

Marguerite A. Klein

Division of Extramural Research and Training, National Center for Complementary and Alternative Medicine, National Institutes of Health, Bethesda, Maryland, U.S.A.

## INTRODUCTION

Cranberry (*Vaccinium macrocarpon* Aiton) is a native plant of North America. Today it is one of the top selling herbal supplements in the U.S. market. Juice and dietary supplements derived from the berry reportedly exhibit various health benefits, including prevention and treatment of bacterial adhesion in urinary tract infections (UTIs) and stomach ulcers, prevention of dental caries, protection against lipoprotein oxidation, and anticancer activity. Some of these biologic effects have been linked to the presence of phenolic compounds. The composition of these compounds in cranberry is beginning to be assessed and quantified; however, their bioavailability and metabolism are for the most part not known. Interpretation of results from research on the efficacy/safety profile of cranberry is confounded by methodologic limitations. More research is needed to conclusively determine its health benefits.

## BACKGROUND

*V. macrocarpon* Aiton, the cultivated species, is a member of the heath family (Ericaceae), which includes blueberry, huckleberry, and bilberry. The wild plants are distributed over eastern United States and Canada. Cranberry was of great economic value to the Native Americans, especially since it was the only edible fruit available late in the season (September–November). Various parts of the plant were used as dyes, food, and medicinals. They used the berries in poultices for treating wounds and blood poisoning, the leaves for urinary disorders, diarrhea and diabetes, and infusion of branches for pleurisy.<sup>[1]</sup> In addition, the European settlers applied cranberries therapeutically for the relief of blood disorders, stomach ailments, liver problems, vomiting, appetite loss, and cancer. Sailors took barrels of the fruit to sea to prevent scurvy. Over 100 years ago, women in Cape Cod were known to use

it for the treatment of dysuria. About four decades back, consumption of the berry for treatment of UTI received attention and support within the medical community.<sup>[2,3]</sup>

Cranberry was first cultivated in the early 19th century. The principal areas of cultivation in North America are Wisconsin, Massachusetts, New Jersey, Oregon, Washington, and parts of Canada. In the 1940s, cranberry juice cocktail became widely available and is the most common form of cranberry consumption today.<sup>[1]</sup> This is a sweetened beverage of about 27% cranberry juice by volume. As a dietary supplement, cranberry ranks among the top 10 selling herbal products in the U.S. market.<sup>[4]</sup>

## CHEMISTRY AND PREPARATION OF PRODUCT

The chemical composition for some constituents of cranberry has been well documented. Raw cranberries are relatively low in sugar content and minerals compared to other small fruits. They are a very good source of vitamin C, have a fair amount of vitamin A, but are relatively low in the B vitamins (Table 1).<sup>[5–7]</sup>

Most of the biologic effects of cranberry have been linked to its high level of phenolic compounds,<sup>[8,9]</sup> higher than 20 other fruits tested.<sup>[10,11]</sup> The major phenolic in the berry are flavonoids and phenolic acids. Chen et al.<sup>[9]</sup> found a total of 400 mg of total flavonoids and phenolic compounds per liter of sample in freshly squeezed cranberry juice. About 44% were phenolic acids and 56% flavonoids.

The term phenolic acid includes the cinnamic acids (C6–C3) and benzoic acids (C7). Cinnamic acids occur naturally in combination with other compounds, usually in the form of esters. The ester of caffeic with quinic acid is a classic example. On the contrary, benzoics usually occur as free acids. Benzoic acid is the major phenolic compound in cranberry.<sup>[9]</sup> The fruits' astringency is attributable to high levels of organic acids, primarily quinic, citric, malic, and benzoic.

Cranberries contain three major classes of flavonoids: flavanols, flavonols, and anthocyanins. Simple phenols consist of one aromatic ring containing at least one hydroxyl group, whereas polyphenols have more than one aromatic ring with each comprising at least

Marguerite A. Klein, M.S., R.D., is Program Director within Division of Extramural Research and Training, National Center for Complementary and Alternative Medicine, National Institutes of Health, Bethesda, Maryland, U.S.A.



**Table 1** Nutrient and flavonoid content of *Vaccinium macrocarpon*

Source (100 g)	Water (g)	Energy (kcal)	Total			Vit. C (mg)	Thiamin (mg)	Riboflavin (mg)	Vit. A (IU)	Vit. E (mg)	Catechin (mg)	Myrecetin (mg)	Quercetin (mg)	
			sugars (g)	Ca (mg)	Mg (mg)									K (mg)
Cranberries, raw	87.13	46	4.04	8	6	85	13.3	0.012	0.020	60	1.2	0.00	4.33	14.02
Cranberry juice cocktail	85.50	57	13.50	3	2	18	35.4	0.009	0.009	4	0.00	0.19	0.27	1.13

IU = International units.  
(From Refs.<sup>[5-7]</sup>)

one hydroxyl group. Flavonoids are a subclass of polyphenols that have a C6–C3–C6 backbone structure. The different classes within the group vary in the number of substituent hydroxyl groups, degree of unsaturation, and level of oxidation of the 3-carbon segment.

Flavanols, also known as flavan-3-ols or catechins, exist in the monomer form (catechin and epicatechin) and the oligomer or polymer form (proanthocyanidins). Proanthocyanidins, also known as condensed tannins, are polymeric compounds, the basic structural elements of which are polyhydroxyflana-3-ol units linked together by carbon–carbon bonds.<sup>[12]</sup> One subclass of proanthocyanidins is procyanidins. Cranberries contain a variety of different procyanidins, mixtures of oligomers and polymers, with the last of these being the dominant procyanidins in cranberry.<sup>[13]</sup> Procyanidins may contribute to organoleptic characteristics.

Flavonols include the glycosides of quercetin, kaempferol, and myrecetin.<sup>[9,14]</sup> Quercetin is the major flavonol in cranberry and is glycosylated mainly at the 3-position with arabinose, galactose, rhamnose, and rhamnose–glucose. Myrecetin also exists and has been identified as conjugates of both arabinose and galactose.<sup>[15]</sup> The wide-ranging flavonol content of cranberry is high, exceeding 150 mg/kg.<sup>[14]</sup>

Anthocyanins are responsible for the fruit's bright red color. Early studies found a somewhat higher content of anthocyanins than flavonols.<sup>[16]</sup> The pigments present are cyanidin-3-galactoside, -3-glucoside, and -3-arabinoside, as well as peonidin-3-galactoside, -3-glucoside, and -3-arabinoside.<sup>[17]</sup> The major anthocyanins in cranberry are 3-galactosides and 3-arabinosides of cyanidin and peonidin.<sup>[18]</sup>

## PRECLINICAL STUDIES

### Bioavailability

The structural diversity of cranberry components has a major influence on their bioavailability. Bioavailability of consumed components influences their biological effects. Many studies have ignored their achievable

plasma concentration after ingestion as well as the possibility of conjugation and metabolism of bioactive components. In general, polyphenols reaching the colon are extensively metabolized by microflora into a wide array of low-molecular weight phenolic acids. The concentration of intact polyphenols (parent compounds and their conjugated forms) in plasma rarely exceeds 1  $\mu\text{mol/L}$  (1  $\mu\text{M}$ ) after consumption of a single compound. However, measurement of plasma antioxidant capacity suggests that more phenolic compounds are present, largely in the form of unknown metabolites, produced either in the tissues or by gut microflora. Their urinary recovery has been found in the range of 1–25% of ingested amount.<sup>[18]</sup>

The bioavailability of the major flavonoids from cranberry has not been studied. However, their bioavailability from other dietary sources (e.g., tea, cocoa or chocolate, red wine, onions, or fruits) has been analyzed. Less is known about absorption and metabolism of the proanthocyanidins than other flavanols, in part due to its complex structure and nonspecific analytic methods to detect it. Higher-molecular weight polymers are considered to have poor absorption.<sup>[19,20]</sup> Proanthocyanidins are degraded to low-molecular weight metabolites by human colonic microflora.<sup>[19]</sup> Although biologic activity is apparent after proanthocyanidin ingestion, only its metabolites have been measured in the urine and plasma.<sup>[21]</sup>

### Urinary Acidification

Cranberries contain quinic acid, which is excreted in the urine as hippuric acid. Early studies attributed the antibacterial nature of the fruit to the urinary acidifying activity due to the excretion of organic acids and increased concentration of hippuric acid.<sup>[22–24]</sup> Other experiments showed no decreased pH nor increased levels of hippuric acid or only a brief effect.<sup>[25–27]</sup> Hippuric acid does have antibacterial effects if present in acidic urine (pH 5.0) and at concentrations of 0.02–0.04 M. However, cranberry juice rarely can achieve the bacteriostatic concentrations by itself without the addition of exogenous hippuric acid to the diet.<sup>[28]</sup>

## Antiadhesion

### Urinary tract infection

More recently, emphasis has been on the role of components that act by interference with bacterial adherence of *Escherichia coli* to uroepithelial cells.<sup>[29–31]</sup> Several studies found antiadherence activity in mouse and human urine.<sup>[29]</sup> Two compounds were identified that inhibited adherence. One was fructose and the other was a nondialyzed polymeric compound. While fructose in vitro inhibits adherence,<sup>[29,31]</sup> it is unlikely to contribute to in vivo antiadhesion activity in urine because it is metabolized before reaching the urinary tract. Later proanthocyanidins were identified as the compounds responsible for preventing uropathogenic *E. coli* from adhering to the urinary tract.<sup>[32]</sup> Their chemical structure was subsequently elucidated.<sup>[12]</sup> Because of the poor bioavailability of this polymer, other mechanisms may be responsible for the antiadhesive effect of cranberry in UTI, dental plaque, and *Helicobacter pylori* infection.

### Dental plaque

Because of cranberry's diverse range of biologically active compounds, it may affect the formation and pathogenicity of dental plaque by: 1) blocking adherence of bacteria to surfaces; 2) inhibiting enzymes associated with the formation of plaque (e.g., preventing biofilm formation); and 3) reducing acid tolerance and viability of cariogenic organisms. To examine the effect of cranberry juice on the coaggregation of oral bacteria, a high-molecular weight nondialyzable material of unknown molecular structure was isolated from the juice.<sup>[33]</sup> In vitro, this nondialyzable material dissociated coaggregates formed by bacteria. It acted preferentially on pairs of bacteria in which one or both members were gram-negative anaerobes. After 42 days, bacterial counts in media selective for *Staphylococcus mutans* from saliva samples of 30 volunteers using a standard mouthwash to which the nondialyzable material was added showed a two order of magnitude reduction in colony forming units in the experimental group compared to the placebo group.

### *Helicobacter pylori*

Adhesins mediate adhesion of *H. pylori* to epithelial cells. Because cranberry or its constituents have been shown to inhibit adherence of *E. coli* to uroepithelial cells in vitro, the hypothesis that it would prevent adhesion of *H. pylori* to gastric mucus and cells was tested.<sup>[34]</sup> A high-molecular weight nondialyzable material from cranberry juice was demonstrated to restrain the adhesion of three strains of *H. pylori* to

immobilized human gastric mucus and erythrocytes via the sialic acid-specific adhesin. Therefore, the authors hypothesized that cranberry or its constituent may inhibit de novo adhesion. In vivo or clinical studies to demonstrate prevention or treatment of *H. pylori* infection have not yet been published in English.

## Antioxidant

Antioxidant capacity is not restricted to a particular class of cranberry components but has been found in a wide range of fractions.<sup>[35]</sup> Polyphenols are reducing agents, and together with others, such as vitamin C, they may protect the body's tissues against oxidative stress. The antioxidant activity of the berry in vivo cannot be accounted for on the basis of increased vitamin C alone.<sup>[36]</sup> Crude cranberry fruit extracts have significant antioxidant activity in vitro.<sup>[37]</sup> The total antioxidant activity of 100 g of cranberry was estimated to be equivalent to that of 3120 mg of vitamin C.<sup>[10]</sup> Isolated polyphenolic compounds from whole cranberries are comparable or superior to that of vitamin E in their activity.<sup>[15]</sup> Cranberry ranks higher than apple, peach, lemon, pear, banana, orange, grapefruit, and pineapple,<sup>[10]</sup> as well as avocado, cantaloupe, melon, nectarine, plum, and watermelon.<sup>[11,38]</sup>

Cranberries contain two phenolics, namely flavonoids and hydroxycinnamic acids, which have antioxidant potential. The contribution of individual phenolics to total antioxidant capacity is generally dependent on their structure and content in the berry. The highest antioxidant activity has been noted in peonidin-3-galactoside (21% of antioxidant capacity). Quercetin-3-galactoside, cyanidin-3-galactoside, and peonidin-3-arabinoside each contribute about 10–11%.<sup>[39]</sup>

Different methods of assessment of antioxidant capacity, varying substrate systems, divergent ways of extraction, length of storage, and differential concentrations of active antioxidants confound the antioxidant activity–chemical structure relationship. Given the diversity and abundance of phenolic antioxidants in cranberry, considerable potential exists for cranberry products to prevent oxidative processes related to cardiovascular disease and cancer at the cellular level and in vivo.

## Atherosclerosis

Consumption of flavonoids may decrease the risk of atherosclerosis.<sup>[40]</sup> One of the possible mechanisms by which they may protect against vascular disease is as antioxidants, which inhibits low-density-lipoprotein (LDL) oxidation.<sup>[15]</sup> Others include: 1) inhibition of platelet aggregation and adhesion; 2) inhibition of the inflammatory response; 3) induction of

endothelium-dependent vasodilation; and 4) increase of reverse cholesterol transport and decrease of total and LDL-cholesterol. Data supporting these methods are preliminary. Evidence to support other ways by which cranberry or its constituents may decrease the risk of atherosclerosis is not available in the literature.

## Cancer

The antioxidant capacity alone of cranberry constituents may not account for the observed effects.<sup>[38,41]</sup> A soluble-free extract had the highest antiproliferative activity and maximum calculated bioactivity index for dietary cancer prevention compared to ten other fruits.<sup>[10]</sup> Given the diversity of molecular structures and bioactivity among the classes of phytochemicals in cranberry, it is likely that they may fight cancer by several different mechanisms. These include: 1) induction of apoptosis; 2) slow initiation, promotion, and progression of tumors<sup>[35,38,41]</sup>; and 3) inhibition of the inflammatory response.<sup>[41]</sup> In vivo carcinogenesis studies will need to be performed to further confirm antitumor promotion activity and identify individual components and mixtures responsible for activity. Cytotoxicity of cranberry or its constituents toward tumor cells has not been reported.

## Safety Studies

No animal toxicology studies have been reported, nor have serious adverse events in humans consuming cranberry products for long periods been reported.

## CLINICAL STUDIES

### Efficacy

#### Urinary tract infection

The use of cranberry to prevent or treat UTI is common. The accumulating evidence from small, non-controlled and controlled clinical trials suggests that the berry may relieve symptoms associated with UTI and may reduce the need for antibiotics. The Cochrane Library<sup>[42,43]</sup> conducted separate reviews of the fruit for the prevention and treatment of UTI. Each review used similar search strategies and selection criteria. These included all randomized or quasirandomized controlled trials. Trials of at least 1 mo to at least 5 days were included for prevention and treatment, respectively. For prevention, seven trials met the inclusion criteria. Meta-analysis performed using data from the two better trials found that when consumed over a year, cranberry juice decreased the number of

symptomatic UTIs in women. For the five trials not included in the meta-analysis, one reported a significant result for symptomatic UTIs in women and another reported a significant result for asymptomatic UTIs in elderly women. For treatment, no trials meeting the inclusion criteria were found; only a few uncontrolled trials were found. The Cochrane Library concluded that there was no good quality or reliable evidence of the effectiveness of cranberry juice or other cranberry products for the treatment of UTI. For both prevention and treatment, the review authors concluded that more research was needed.

Two other studies not included in the Cochrane reviews reported apparently contradictory results. The first was a study of adults with spinal cord injury who demonstrated a reduction in biofilm load,<sup>[44]</sup> but the importance of this effect for frank UTI was not determined. A small study of urostomy patients also found equivocal results.<sup>[45]</sup>

Many of the clinical study reports available in the literature suffer from major limitations. Many trials have not been controlled or randomized, and randomization procedures have not always been described. Crossover designs used in some research may not be appropriate for studies of UTI. Other limitations include no blinding or failed blinding, lack of controlled diets or dietary assessment, use of convenience samples, and small numbers of subjects. Trials have been faulted for the large number of withdrawals. Intention-to-treat analyses were not often applied. Most studies have been conducted in older or elderly patients. Very few have been conducted in younger patients, with or without comorbidities, or in men. Primary outcomes have differed from study to study and have often included urinary pH, as well as rate of bacteriuria, biofilm<sup>a</sup> load, and urinary white and red blood cell counts, rather than UTI. It is also not clear what is the optimum dosage or type of product. There is limited evidence of efficacy or safety for forms of cranberry product other than juice or juice cocktail. Finally, the published articles do not describe the quality and composition of the products tested.

### Adverse Effects

The U.S. Food and Drug Administration granted generally recognized as safe (GRAS) status to cranberry foods and beverages. This means that their safety is well established. The few clinical studies assessing the adverse effects of cranberry juice cocktail have

<sup>a</sup>Biofilms are collection of proteinaceous material that cover the bacterial populations and often render them resistant to sterilization and antimicrobial treatments.

reported no or few side effects other than diarrhea and other gastrointestinal symptoms. The safety of cranberry capsules, tablets, and concentrates, for example, has not been established.

### Observed Drug Interactions and Contraindications

There is insufficient reliable information available on cranberry dietary supplements or juice cocktail to assess their safety or their interaction with other dietary supplements, foods, medications, or laboratory tests. Because of its oxalate levels, cranberry may be a causative factor in nephrolithiasis. The results of three small studies of juice cocktail and tablets are equivocal, showing differences in urine acidification, calcium and oxalate excretion, and other promoters and inhibitors of stone formation.<sup>[46,47]</sup> There is one report of a 4-mo-old infant being hospitalized in Spain for cranberry juice intoxication and acidosis.<sup>[48]</sup> Five unsubstantiated reported cases suggest an interaction between cranberry juice and warfarin.<sup>[49]</sup> Theoretically, the juice could interfere with the copper-reduction glucose test since ascorbic acid (a reducing agent) and hippuric acid have each been reported to cause a false-positive reaction with the copper-reduction glucose determination in vitro. However, the results of two small studies are equivocal and inconclusive indicating that interference may be variable and dependent on the type of reagent strip kit.<sup>[50,51]</sup>

### REGULATORY STATUS

In the United States, cranberry is classified as a food when sold as juice, juice cocktail, and other conventional forms. Cranberry products, such as encapsulated powders, tablets, or tinctures, are regulated as “dietary supplements” in the United States. In Canada, conventional forms are sold as foods, whereas products promoting a health claim are sold as “natural health products.”

### CONCLUSIONS

There is a need for comprehensive chemical analyses of all classes of compounds present in cranberry. Individual structures and composition vary significantly among cranberry products and its isolated constituents. Composition varies by ripeness of the fruit, plant variety, growth conditions, extraction method, and processing. This suggests that bioactivities will also vary. However, quantitation of complex polyphenols has been and continues to be limited because of the

lack of appropriate standardized analytical methods. Consequently, the precise estimation of cranberry constituent intake is hampered. Furthermore, the bioavailability, metabolism, stability, purity, and composition of cranberry products tested in clinical studies have not been established or published. Therefore, the ability to infer epidemiological relationships with health and disease can be confounded.

Evidence for health benefit of cranberry is preliminary and inconclusive. Current evidence from in vitro and clinical studies has been conflicting. This could reflect differences among sources of cranberry or its constituents, form of product consumed, and level of intakes. In addition, clinical studies performed to date have had many methodologic limitations and few have assessed safety. Nevertheless, results of clinical studies are encouraging for the relief of symptoms associated with and the prevention of UTI.

The complex composition of cranberry creates problems in extrapolation of research results on dietary intake of individual constituents to intake of whole fruits or extracts of whole fruits. Synergistic effects of the whole may enhance the health benefits beyond what can be achieved by the individual constituents. The complex mixture of compounds could also protect against side effects. More research on potential synergistic and protective effects among the classes of compounds in cranberry and with other food constituents and pharmaceuticals is necessary.

For these reasons, it is important to understand the composition of cranberry, determine the bioavailability and metabolism of its constituents in isolation and as part of the whole mixture, and rigorously examine the biological effects of cranberry on disease conditions in order to establish its potential for being safe and providing health benefit.

### REFERENCES

1. Henig, Y.S.; Leahy, M.M. Cranberry juice and urinary-tract health: science supports folklore. *Nutrition* **2000**, *16* (7/8), 684–687.
2. Moen, D.V. Observations on the effectiveness of cranberry juice in urinary infections. *Wisconsin Med. J.* **1962**, *61*, 282–283.
3. Papas, P.N.; Bruschi, C.A.; Ceresia, G.C. Cranberry juice in the treatment of urinary tract infections. *Southwest Med.* **1966**, *47* (1), 17–20.
4. Blumenthal, M. Herb sales down in mainstream market, up in natural food stores. *HerbalGram* **2002**, *55*, 60.
5. <http://www.nal.usda.gov/fnic/foodcomp/Data/SR16/sr16.html> (accessed October 27, 2003).
6. <http://www.nal.usda.gov/fnic/foodcomp/Data/Flav/flav.html> (accessed October 27, 2003).

7. <http://www.nal.usda.gov/fnic/foodcomp/> (accessed October 27, 2003).
8. Zuo, Y.; Wang, C.; Zhan, J. Separation, characterization, and quantitation of benzoic and phenolic antioxidants in American cranberry fruit by GC-MS. *J. Agric. Food Chem.* **2002**, *50*, 3789–3794.
9. Chen, H.; Zuo, Y.; Deng, Y. Separation and determination of flavonoids and other phenolic compounds in cranberry juice by high-performance liquid chromatography. *J. Chromatogr. A* **2001**, *913*, 387–395.
10. Sun, J.; Chu, Y.; Wu, X.; Liu, R.H. Antioxidant and antiproliferative activities of common fruits. *J. Agric. Food Chem.* **2002**, *50*, 7449–7454.
11. Vinson, J.A.; Su, X.; Zubik, L.; Bose, P. Phenol antioxidant quantity and quality in foods: fruits. *J. Agric. Food Chem.* **2001**, *49*, 5315–5321.
12. Foo, L.Y.; Lu, Y.; Howell, A.B.; Vorsa, N. The structure of cranberry proanthocyanidins which inhibit adherence of uropathogenic P-fimbriated *Escherichia coli* in vivo. *Phytochemistry* **2000**, *54*, 173–181.
13. Gu, L.; Kelm, M.; Hammerstone, J.F.; Beecher, G.; Cunningham, D.; Vannozzi, S.; Prior, R.L. Fractionation of polymeric procyanidins from lowbush blueberry and quantification of procyanidins in selected foods with an optimized normal-phase HPLC-MS fluorescent detection method. *J. Agric. Food Chem.* **2002**, *50*, 4852–4860.
14. Hakkinen, S.H.; Karenlampi, S.O.; Heinonen, I.M.; Mykkanen, H.M.; Torronen, A.R. Content of the flavonols quercetin, myricetin, and kaempferol in 25 edible berries. *J. Agric. Food Chem.* **1999**, *47*, 2274–2279.
15. Yan, X.; Murphy, B.T.; Hammond, G.B.; Vinson, J.A.; Neto, C.C. Antioxidant activities and anti-tumor screening of extracts from cranberry fruit (*Vaccinium macrocarpon*). *J. Agric. Food Chem.* **2002**, *50*, 5844–5849.
16. Lees, D.H.; Francis, F.J. Quantitative methods for anthocyanins 6. Flavonols and anthocyanins in cranberries. *J. Food Sci.* **1971**, *36* (7), 1056–1060.
17. Hong, V.; Wrolstad, R. Use of HPLC separation/photodiode array detection for characterization of anthocyanins. *J. Agric. Food Chem.* **1990**, *38*, 527–530.
18. Scalbert, A.; Williamson, G. Dietary intake and bioavailability of polyphenols. *J. Nutr.* **2000**, *130*, 2073S–2085S.
19. Deprez, S.; Brezillon, C.; Rabot, S.; Philippe, C.; Miola, I.; Lapierre, C.; Scalpert, A. Polymeric proanthocyanidins are catabolized by human colonic microflora into low-molecular-weight phenolic acids. *J. Nutr.* **2000**, *130*, 2733–2738.
20. Donovan, J.L.; Manach, C.; Rios, L.; Morand, C.; Scalbert, A.; Remesy, C. Procyanidins are not bioavailable in rats fed a single meal containing a grape seed extract or the procyanidin dimer B<sub>3</sub>. *Br. J. Nutr.* **2002**, *87*, 299–306.
21. Koga, T.; Moro, K.; Nakamori, K.; Yamakoshi, J.; Hosoyama, H.; Kataoka, S.; Ariga, T. Increase of antioxidative potential of rat plasma by oral administration of proanthocyanidin-rich extract from grape seeds. *J. Agric. Food Chem.* **1999**, *47*, 1892–1897.
22. Blatherwick, N.R.; Long, M.L. Studies of urinary acidity. II. The increased acidity produced by eating prunes and cranberries. *J. Biol. Chem.* **1923**, *57*, 815–818.
23. Fellers, C.R.; Redmon, B.C.; Parrott, E.M. Effect of cranberries on urinary acidity and blood alkali reserve. **1932**, *6* (5), 455–463.
24. Jackson, B.; Hicks, L.E. Effect of cranberry juice on urinary pH in older adults. *Home Healthcare Nurse* **1997**, *15*, 199–202.
25. Kahn, H.D.; Panariello, V.A.; Saeli, J.; Sampson, J.R.; Schwartz, E. Effect of cranberry juice on urine. *J. Am. Diet. Assoc.* **1967**, *51*, 251–254.
26. Avorn, J.; Monane, M.; Gurwitz, J.H.; Glynn, R.J.; Choodnovskiy, I.; Lipsitz, L.A. Reduction of bacteriuria and pyuria after ingestion of cranberry juice. *J. Am. Med. Assoc.* **1994**, *271*, 751–754.
27. Nahata, M.C.; Cummins, B.A.; McLeod, D.C.; Schondelmeyer, S.W.; Butler, R. Effect of urinary acidifiers on formaldehyde concentration and efficacy with methenamine therapy. *Eur. J. Clin. Pharmacol.* **1982**, *22*, 281–284.
28. Bodel, P.R.; Cotran, R.; Kass, E.H. Cranberry juice and the antibacterial action of hippuric acid. *J. Lab. Clin. Med.* **1959**, *54* (6), 881–888.
29. Zafriri, D.; Ofek, I.; Adar, R.; Pocino, M.; Sharon, N. Inhibitory activity of cranberry juice on adherence of type 1 and type P fimbriated *Escherichia coli* to eucaryotic cells. *Antimicrob. Agents Chemother.* **1989**, *33* (1), 92–98.
30. Ahuja, S.; Kaack, B.; Roberts, J. Loss of fimbrial adhesion with the addition of *Vaccinium macrocarpon* to the growth medium of P-fimbriated *Escherichia coli*. *J. Urol.* **1998**, *159*, 559–562.
31. Ofek, I.; Goldhar, J.; Zafriri, D.; Lis, H.; Adar, R.; Sharon, N. Anti-*Escherichia coli* adhesin activity of cranberry and blueberry juices (letter). *N. Engl. J. Med.* **1991**, *324* (22), 1599.
32. Howell, A.B.; Der Marderosian, A.; Foo, L.Y. Inhibition of the adherence of P-fimbriated *Escherichia coli* to uroepithelial-cell surfaces by proanthocyanidin extracts from cranberries. *N. Engl. J. Med.* **1998**, *339* (15), 1085–1086.

33. Weiss, E.I.; Lev-Dor, R.; Kashamn, Y.; Goldhar, J.; Sharon, N.; Ofek, I. Inhibiting interspecies coaggregation of plaque bacteria with a cranberry juice constituent. *J. Am. Dent. Assoc.* **1998**, *129*, 1719–1723.
34. Burger, O.; Weiss, E.; Sharon, N.; Tabak, M.; Neeman, I.; Ofek, I. Inhibition of *Helicobacter pylori* adhesion to human gastric mucus by a high-molecular-weight constituent of cranberry juice. *Crit. Rev. Food Sci. Nutr.* **2002**, *42* (Suppl.), 279–284.
35. Kandil, F.E.; Smith, M.A.L.; Rogers, R.B.; Pepin, M.-F.; Song, L.L.; Pezzuto, J.M.; Seigler, D.S. Composition of a chemopreventive proanthocyanidin-rich fraction from cranberry fruits responsible for the inhibition of 12-*O*-tetradecanoyl phorbol-13-acetate (TPA)-induced ornithine decarboxylase (ODC) activity. *J. Agric. Food Chem.* **2002**, *50*, 1063–1069.
36. Pedersen, C.G.; Kyle, J.; Jenkinson, A. McE.; Gardner, P.T.; McPhail, D.B.; Duthie, G.G. Effects of blueberry and cranberry juice consumption on the plasma antioxidant capacity of healthy female volunteers. *Eur. J. Clin. Nutr.* **2000**, *54*, 405–408.
37. Wang, S.Y.; Stretch, A.W. Antioxidant capacity in cranberry is influenced by cultivar and storage temperature. *J. Agric. Food Chem.* **2001**, *49*, 969–974.
38. Roy, S.; Khanna, S.; Alessio, H.M.; Vider, J.; Bagchi, D.; Bagchi, M.; Sen, C.K. Anti-angiogenic property of edible berries. *Free Radic. Res.* **2002**, *36* (9), 1023–1031.
39. Zheng, W.; Wang, S.Y. Oxygen radical absorbing capacity of phenolics in blueberries, cranberries, chokeberries, and lingon berries. *J. Agric. Food Chem.* **2003**, *51*, 502–509.
40. Reed, J. Cranberry flavonoids, atherosclerosis and cardiovascular health. *Crit. Rev. Food Sci. Nutr.* **2002**, *42*, 301–316.
41. Murphy, B.T.; MacKinnon, S.L.; Yan, X.; Hammond, G.B.; Vaisberg, A.J.; Neto, C.C. Identification of triterpene hydroxycinnamates with in vitro antitumor activity from whole cranberry fruit (*Vaccinium macrocarpon*). *J. Agric. Food Chem.* **2003**, *51*, 3541–3545.
42. Jepson, R.G.; Mihaljevic, L.; Craig, J. Cranberries for preventing urinary tract infections (Cochrane Review). *The Cochrane Library*; John Wiley & Sons, Ltd.: Chichester, UK, 2004; Issue 1.
43. <http://www.cochranelibrary.com> (accessed May 11, 2001).
44. Reid, G.; Hsiehl, J.; Potter, P.; Mighton, J.; Lam, D.; Warren, D.; Stephenson, J. Cranberry juice consumption may reduce biofilms on uroepithelial cells: pilot study in spinal cord injured patients. *Spinal Cord* **2001**, *39*, 26–30.
45. Tsukada, K.; Tokunaga, K.; Iwama, T.; Mishima, Y.; Tazawa, K.; Fujimaki, M. Cranberry juice and its impact on peri-stomal skin conditions for urostomy patients. *Ostomy/Wound Manag.* **1994**, *40*, 60–67.
46. Kessler, T.; Jansen, B.; Hesse, A. Effect of black-currant-, cranberry- and plum juice consumption on risk factors associated with kidney stone formation. *Eur. J. Clin. Nutr.* **2002**, *56*, 1020–1023.
47. Terris, M.K.; Issa, M.M.; Tacker, J.R. Dietary supplementation with cranberry concentrate tablets may increase the risk of nephrolithiasis. *Urology* **2001**, *57*, 26–29.
48. Garcia-Calatayud, S.; Cordoba, J.J.L.; Lozano de la Torre, M.J. Intoxicacion grave por zumo de arandanos (Cranberry intoxication in a 4-month-old infant). *An. Esp. Pediatr.* **2002**, *56* (1), 72–73.
49. Committee on Safety of Medicines. Possible interaction between warfarin and cranberry juice. *Curr. Prob. Pharmacovigil.* **2003**, *29*, 8 pp.
50. Nahata, M.D.; McLeod, D.C. Lack of effect of ascorbic acid, hippuric acid, and methenamine (urinary formaldehyde) on the copper-reduction glucose test in geriatric patients. *J. Am. Geriatr. Soc.* **1980**, *XXVIII*, 230–233.
51. Kilbourn, J.P. Interference with dipstick tests for glucose and hemoglobin in urine by ascorbic acid in cranberry juice. *Clin. Chem.* **1987**, *33*, 1297.



# Creatine

## G.S. Salomons

VU University Medical Center, Clinical Chemistry, Metabolic Unit,  
Amsterdam, The Netherlands

## M. Wyss

DSM Nutritional Products Ltd., Basel, Switzerland

## C. Jakobs

VU University Medical Center, Clinical Chemistry, Metabolic Unit,  
Amsterdam, The Netherlands

## INTRODUCTION

Creatine (Cr)—methylguanidino acetic acid—is a naturally occurring compound that was first described by Chevreul in 1832. Its name is derived from the Greek word *kreas* (flesh): Creatine is found in abundance in skeletal muscle (red meat) and fish. It is essential in energy transmission and storage via creatine kinase (CK). The daily Cr dosage is obtained by both endogenous synthesis and via nutritional intake, followed by absorption in the intestine.<sup>[1]</sup> Creatine supplementation is widespread among sportspersons because of its documented and/or presumed ergogenic effects.<sup>[2–4]</sup> In addition, supplementation with Cr has proven to be instrumental for the treatment of rare inborn errors of metabolism due to defects in Cr biosynthesis enzymes.<sup>[5–8]</sup>

Creatine is stored in high concentrations in skeletal and heart muscles and to a lesser extent in the brain. It exists in both free and phosphorylated form [phosphocreatine (PCr)], and is important for maintaining high adenosine triphosphate (ATP) : adenosine diphosphate (ADP) ratios. Upon increases in workload, ATP hydrolysis is initially buffered by PCr via the CK reaction. During high-intensity exercise, PCr in muscle is depleted within several seconds. Whether de novo Cr biosynthesis occurs in the brain, or whether Cr is taken up into the brain through the blood–brain barrier is currently a matter of debate.

## DEFICIENCY AND SUPPLEMENTATION

Patients with Cr deficiency syndromes (CDS), i.e., patients with a Cr biosynthesis defect or a Cr transporter defect, have developmental delay and mental retardation (MR), indicating that Cr is crucial for proper brain function. Surprisingly, however, CDS patients do not suffer from muscular or heart problems. Those with a Cr biosynthesis defect, in contrast to Cr transporter deficient subjects, can partly restore their Cr pool in brain upon Cr treatment.<sup>[5–10]</sup>

Creatine supplementation, due to its ergogenic effects, has become a multimillion dollar business.<sup>[3]</sup> In the Western world, Cr has received wide public interest. A simple search on “creatine” in the world wide web using common database search engines results in more than 500,000 entries. Besides the use by sportspersons, Cr supplementation is explored in several animal models of neuromuscular disease (i.e., Huntington’s and Parkinson’s disease, amyotrophic lateral sclerosis), and in human disease.<sup>[3,6,11,12]</sup> A recent study suggests that Cr supplementation increases intelligence and memory performance tasks.<sup>[13]</sup>

The goal of this entry is to provide an overview on Cr and its metabolism in health and disease. The functions of Cr and PCr, Cr biosynthesis, its degradation, tissue distribution, transport and molecular aspects, as well as the benefits and risks of Cr supplementation are discussed. (For in-depth reviews, see Refs.<sup>[2,3,6]</sup>. In these reviews, references to the original studies can be found.)

## BIOCHEMISTRY AND FUNCTION

### Creatine Structure

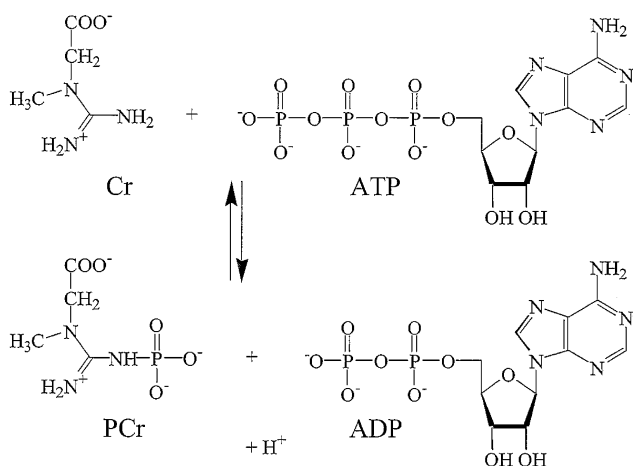
Creatine is a naturally occurring guanidino compound. Its chemical structure is depicted in Fig. 1. Creatine is a

G.S. Salomons, Ph.D., is at the VU University Medical Center, Clinical Chemistry, Metabolic Unit, Amsterdam, The Netherlands.

M. Wyss, Ph.D., is at DSM Nutritional Products Ltd., Basel, Switzerland.

C. Jakobs, Ph.D., is at the VU University Medical Center, Clinical Chemistry, Metabolic Unit, Amsterdam, The Netherlands.





**Fig. 1** Schematic representation of the creatine kinase (CK) reaction, and chemical structures of creatine (Cr) and phosphocreatine (PCr).

hydrophilic, polar molecule. Phosphocreatine is zwitterionic, with negatively charged phosphate and carboxylate groups and a positively charged guanidino group.

## Creatine Synthesis

### Biosynthesis

The transfer of the amidino group of arginine to glycine yielding L-ornithine and guanidinoacetic acid (GAA) represents the first step in the biosynthesis of Cr and is performed by L-arginine:glycine amidinotransferase (AGAT; EC 2.1.4.1). This reaction is reversible and occurs in mitochondria, into which arginine has to be taken up for guanidinoacetate biosynthesis. The human *AGAT* mRNA encodes a 423-amino acid polypeptide including a 37-amino acid mitochondrial targeting sequence. The *AGAT* gene is located on chromosome 15q15.3, is approximately 17 kb long, and consists of 9 exons.

The second step involves the methylation of GAA at the amidino group by S-adenosyl-L-methionine: N-guanidinoacetate methyltransferase (GAMT; EC 2.1.1.2), whereby Cr is formed. The methyl group is provided by S-adenosylmethionine (SAM). The human *GAMT* mRNA encodes a 236-amino acid polypeptide. The gene is located on chromosome 19p13.3, is approximately 12 kb long, and consists of 6 exons.

### Chemical synthesis

Creatine is produced by chemical synthesis, mostly from sarcosine and cyanamide. This reaction is prone to generation of contaminants such as dicyandiamide, dihydrotriazines, or Crn.<sup>[14]</sup> Some manufacturers may

fail to separate these contaminants from Cr. The toxicological profiles of these contaminants are often not known. Dicyandiamide liberates HCN when exposed to strongly acidic conditions (such as in the stomach). For human consumption, only pure preparations of Cr should thus be allowed. Unfortunately, no generally accepted and meaningful quality labels are yet in place that would allow a consumer to judge the origin and quality of Cr in a given commercial product. Moreover, for most studies published so far, it is not possible to correlate the presence or lack of ergogenic, preventive, or adverse side effects with the quality of the many Cr preparations used.

## Creatine Function (CK Reaction)

Creatine is involved in ATP regeneration via the CK reaction. The phosphate group of PCr is transferred to ADP to yield Cr and ATP, the “universal energy currency” in all living cells. The CK reaction serves as an energy and pH buffer and has a transport/shuttle function for high-energy phosphates.

Several CK subunits exist that are expressed in a tissue- and/or spatial-specific manner. In mammals, four CK isoforms exist: the cytosolic M-CK (M for muscle) and B-CK (B for brain) subunits form dimeric molecules, i.e., the MM-, MB-, and BB-CK isoenzymes. The two mitochondrial CK isoforms, ubiquitous Mi-CK and sarcomeric Mi-CK, are located in the mitochondrial intermembrane space and form both homodimeric and homo-octameric, interconvertible molecules.

In fast-twitch skeletal muscles, a sizeable pool of PCr is available for immediate regeneration of ATP, which is hydrolyzed during short periods of intense work. In these muscles, the cytosolic CK activity is high and “buffers” the cytosolic phosphorylation potential that seems to be crucial for the proper functioning of a variety of reactions driven by ATP. Slow-twitch skeletal muscles, the heart, and spermatozoa depend on a more continuous delivery of high-energy phosphates to the sites of ATP utilization. In these tissues, distinct CK isoenzymes are associated with sites of ATP production (e.g., Mi-CK in the mitochondrial intermembrane space) and ATP consumption [e.g., cytosolic CK bound to the myofibrillar M line, the sarcoplasmic reticulum (SR), or the plasma membrane] and fulfill the function of a “transport device” for high-energy phosphates. The  $\gamma$ -phosphate group of ATP, synthesized within the mitochondrial matrix, is transferred by Mi-CK in the mitochondrial intermembrane space to Cr to yield ADP plus PCr. ADP may directly be transported back to the matrix where it is rephosphorylated to ATP. Phosphocreatine leaves the mitochondria and diffuses through the

cytosol to the sites of ATP consumption. There, cytosolic CK isoenzymes locally regenerate ATP and thus warrant a high phosphorylation potential in the vicinity of the respective ATPases. Subsequently, Cr diffuses back to the mitochondria, thereby closing the cycle. According to this hypothesis, transport of high-energy phosphates between sites of ATP production and ATP consumption is achieved mainly by PCr and Cr. The CK system is required to allow most efficient high-energy phosphate transport, especially if diffusion of adenine nucleotides across the outer mitochondrial membrane is limited.

## PHYSIOLOGY

### Tissue Distribution of Creatine and of Its Biosynthesis Enzymes

In a 70-kg man, the total body creatine pool amounts to approximately 120 g.<sup>[1]</sup> Creatine and PCr are found in tissues with high and fluctuating energy demands such as skeletal muscle, heart, brain, spermatozoa, and retina. In skeletal and cardiac muscle, approximately 95% of the total bodily Cr is stored, and the concentration of total creatine may reach up to 35 mM. Intermediate levels are present in brain, brown adipose tissue, intestine, seminal vesicles and fluid, endothelial cells, and macrophages. Low levels are found in lung, spleen, kidney, liver, white adipose tissue, blood cells, and serum (25–100  $\mu$ M).<sup>[2]</sup>

Until recently, GAA biosynthesis was presumed to occur mainly in the kidney (and pancreas), where AGAT is highly expressed, followed by its transport via the blood and uptake of GAA into the liver, the presumed major site of the second reaction, the methylation of GAA by GAMT. Current knowledge suggests that AGAT and GAMT expression is not limited to these organs. Synthesis outside of these organs may allow local supply of Cr (e.g., in brain; see “Creatine Biosynthesis in Mammalian Brain” below) and may to a minor extent contribute to the total Cr content in the body.

### Creatine Accumulation: Transporter-Mediated Creatine Uptake

Cellular transport is of fundamental importance for creatine homeostasis in tissues devoid of Cr biosynthesis. Creatine needs to be taken up against a steep concentration gradient [muscle (mM), serum ( $\mu$ M)]. The Cr transporter gene (*SLC6A8*) (MIM300036) has been mapped to chromosome Xq28. Northern blots indicated that this gene is expressed in most tissues,

with the highest levels in skeletal muscle and kidney, and somewhat lower levels in colon, brain, heart, testis, and prostate. The *SLC6A8* gene product is a member of a superfamily of proteins, which includes the Na<sup>+</sup>- and Cl<sup>-</sup>-dependent transporters responsible for uptake of certain neurotransmitters. The Cr transporter gene spans approximately 8.4 kb, consists of 13 exons, and encodes a protein of 635 amino acids.

### Creatine/Creatinine Clearance

Creatine can be cleared from the blood via either uptake into different organs by the Cr transporter or by excretion via the kidney. There is evidence that tissue uptake of Cr may be influenced by carbohydrates, insulin, caffeine, and exercise and that transporter molecules located in kidney are able to reabsorb Cr. Nevertheless, Cr is found under normal conditions in urine in various amounts. The main route for clearance of Cr is via creatinine excretion. Creatine and PCr are nonenzymatically converted to creatinine. The rate of creatinine formation, which mainly occurs intracellularly, is almost constant (~1.7% per day of the Cr pool). Since muscle is the major site of creatinine production, the rate of creatinine formation is mostly a reflection of the total muscle mass. Creatinine enters the circulation most likely by passive transport or diffusion through the plasma membrane, followed by filtration in kidney glomeruli and excretion in urine.

## CREATINE DEFICIENCY SYNDROMES

Both AGAT and GAMT deficiencies are autosomal recessive inborn errors of metabolism. This is in contrast to the third disorder of Cr metabolism, which is an X-linked inborn error due to a defect in the Cr transporter (Table 1).

### GAMT Deficiency

The first inborn error of Cr biosynthesis, GAMT deficiency (MIM601240), was identified in 1994. The absence of a Cr signal in the <sup>1</sup>H-MR spectrum of brain, the low amounts of urinary creatinine, and the increased levels of GAA in plasma and urine led to the diagnosis of this disease. In addition to creatinine, Cr is also reduced in body fluids. Clinical symptoms are usually noted within the first 8 mo of life. Possibly Cr is provided in high amounts in utero via the umbilical cord and in newborns via the mother's milk, thereby delaying the clinical signs. All patients identified so far have developmental delay, MR to various

**Table 1** Overview of CDS based on the listed number of patients

Deficiency	No. of patients	Trait	Clinical hallmarks	Metabolites	Treatment	References
AGAT (MIM602360 <sup>a</sup> )	3, related	AR	MR Dysphasia Autistiform behavior Epilepsy	Brain: Cr ↓ ↓ in H-MRS Plasma, CSF (urine?): GAA ↓, Cr ↓	Cr supplementation	[8]
GAMT (MIM601240)	20	AR	MR Dysphasia Autistiform behavior Extrapyramidal signs Epilepsy	Brain: Cr ↓ ↓ ↓ in H-MRS Urine, plasma, CSF: GAA ↑↑, Cr ↓	Cr and ornithine supplementation + arginine restriction	[7,8]
SLC6A8 (MIM300036)	>50 (15 families)	X-linked	Males MR Dysphasia Autistiform behavior Epilepsy Female carriers 50%: learning and behavioral disabilities 50%: no clinical signs	Males Brain: Cr ↓ ↓ in H-MRS Urine: Cr/Crn ratio ↑ CSF: Crn ↓? ~50% of female carriers Brain: Cr ↓ in H-MRS Urine: Cr/Crn ratio normal	Cr supplementation: not successful in affected males	[9,10], unpublished

Abbreviations: AR, autosomal recessive; Cr, creatine; Crn, creatinine; H-MRS, proton magnetic resonance spectroscopy; MR, mental retardation.

<sup>a</sup>MIM Victor A. McKusick: Online Mendelian Inheritance in Man: <http://www.ncbi.nlm.nih.gov>.

degrees, expressive speech and language delay, epilepsy, autisticiform behavior, and very mild-to-severe involuntary extrapyramidal movements. The disorder has a highly heterogeneous presentation, varying from very mild signs to severe MR, accompanied by self-injurious behavior.

### AGAT Deficiency

In 2001, the first family with AGAT deficiency (MIM602360) was identified. The two sisters, 4 and 6 yr old, presented with MR, developmental delay from the age of 8 mo on, and speech delay. GAMT deficiency was ruled out because GAA was not increased in urine and plasma. Creatine supplementation (400 mg/kg body weight per day) increased the Cr content in the brain to 40% and 80% of controls within 3 and 9 mo, respectively. A homozygous nonsense mutation in the *AGAT* gene, predicting a truncated dysfunctional enzyme, was finally identified. Lymphoblasts and fibroblasts of the patients indicated impaired AGAT activity. A third related patient was identified with similar clinical presentation. The biochemical hints to detect this disorder are reduced levels of GAA (and creatinine) in plasma, Cerebrospinal fluid (CSF) and possibly urine, together with reduced to undetectable levels of Cr in the brain.

### SLC6A8 Deficiency (Creatine Transporter Deficiency)

Like AGAT deficiency, the X-linked Cr transporter defect was unraveled in 2001. An X-linked Cr transporter (MIM300352) defect was presumed because of: 1) the absence of Cr in the brain as indicated by proton magnetic resonance spectroscopy (MRS); 2) elevated Cr levels in urine and normal GAA levels in plasma, ruling out a Cr biosynthesis defect; 3) the absence of an improvement on Cr supplementation; and 4) the fact that the pedigree suggested an X-linked disease. The hypothesis was proven by the presence of a hemizygous nonsense mutation in the male index patient and by impaired Cr uptake by cultured fibroblasts. The hallmarks of this disorder are MR, expressive speech and language delay, epilepsy, developmental delay, and autisticiform behavior. The age at diagnosis of the affected males identified so far [ $>50$  (Ref.<sup>[9]</sup> and unpublished results)] varies from 2 to 66 yr. In two cases, the disease-causing mutation had arisen de novo. In mothers and sisters who are carriers of the disease, learning and behavioral disabilities are noted in about 50% of the cases. Unfavorable skewed X-inactivation is likely the cause of the difference in severity of the clinical signs in females.

## Intriguing Questions Linked to CDS

### Does a muscle-specific creatine transporter exist?

It is noteworthy that the SLC6A8-deficient patients do not seem to suffer from muscle and/or cardiac failure. This could indicate sufficient endogenous Cr biosynthesis in muscle. Alternatively, Cr uptake is taken over by other transporters, or a yet unknown Cr transporter exists that is specifically expressed in skeletal and cardiac muscle.

### Creatine biosynthesis in mammalian brain

It is a matter of debate whether Cr biosynthesis occurs in mammalian brain. The following findings suggest that it actually does: 1) In rat brain, *AGAT* and *GAMT* mRNA and protein were detected.<sup>[15]</sup> 2) The Cr content in brain of mice treated with guanidinopropionic acid, an inhibitor of the Cr transporter, was—in contrast to muscle tissues—hardly decreased. 3) In contrast to skeletal muscle, Cr supplementation in AGAT- and GAMT-deficient patients requires months to result in an increment in Cr concentration in the brain. These findings make it unlikely that the brain is entirely dependent on Cr biosynthesis in the liver or on its nutritional intake, followed by transport through the blood–brain barrier into the brain.

However, why do Cr transporter deficient patients also reveal Cr deficiency in the brain? One explanation could be that Cr synthesis in the brain, although present, is too low to be relevant physiologically. Alternatively, the expression of AGAT and GAMT may be separated spatially (i.e., AGAT and GAMT molecules may be found in the same or different cell types, but may not be expressed in one and the same cell). This is in line with data of Braissant et al.<sup>[16]</sup> showing such spatial separation in rat brain at both the mRNA and protein level. These findings suggest that GAA needs to be taken up into the appropriate cells prior to GAA methylation, which in case of the transporter defect is not feasible. This would explain the incapability to synthesize Cr in the brain of SLC6A8-deficient patients. Clearly, more thorough investigations are needed to study these discrepancies toward a better understanding of Cr metabolism in the human brain.

### Significance of CDS/relevance for health care

Mental retardation occurs at a frequency of 2–3% in the Western population. In 25% of MR cases, a genetic cause is suspected, of which Down's syndrome and fragile X syndrome are the most common. Mutations in the *SLC6A8* gene may be, together with other

X-linked MR genes, partly responsible for the skewed ratio in sex distribution in MR, autism, and individuals with learning disabilities. SLC6A8 deficiency appears to be a relatively common cause of X-linked MR, though not as common as fragile X. Creatine biosynthesis defects may be less common. Since the damage incurred in these three diseases is irreversible to a large part, but an effective treatment is available at least for the Cr biosynthesis defects, early diagnosis of these patients is highly important.

To date, the clinical phenotype appears to be non-specific and suggests that all MR patients should be tested in diagnostic centers by <sup>1</sup>H-MRS, metabolite screening, and/or sequence analysis of the *SLC6A8* gene. In the case of X-linked MR or X-linked autism due to a genetic, but unknown, cause, the parents are confronted with a risk of recurrence (50% chance that the mother passes the mutant allele on to her child). The diagnosis of SLC6A8 deficiency or a Cr biosynthesis defect allows prenatal diagnosis for subsequent pregnancies.

## CREATINE SUPPLEMENTATION/ THERAPEUTIC USE

### Creatine Sources

Creatine is present in high amounts in meat (4.5 g/kg in beef, 5 g/kg in pork) and fish (10 g/kg in herring, 4.5 g/kg in salmon), which are the main exogenous Cr sources in the human diet. Low amounts of Cr can be found in milk (0.1 g/kg) and cranberries (0.02 g/kg).<sup>[16]</sup> As discussed above, Cr is also synthesized endogenously, which supplies around 50% of the daily requirement of approximately 2 g. This suggests that in vegetarians, who have a low intake of Cr, the bodily Cr content is reduced, unless its endogenous biosynthesis is largely increased. Indeed, in vegetarians, the Cr concentration in muscle biopsies was reported to be reduced.<sup>[17]</sup>

### Dosing as an Ergogenic Aid

Creatine can be obtained as nutritional supplement in the form of various over-the-counter creatine monohydrate products, which are supplied by many manufacturers. Commercial Cr is chemically produced. The majority of consumers are sportspersons, due to Cr's documented and/or presumed ergogenic and muscle mass increasing effects. Usually, a loading phase of 5–7 days of 20 g/day (in 4 portions of 5 g) is recommended, followed by a maintenance phase with 3–5 g Cr per day.

## Benefits

### Benefits in sportspersons

Creatine supplementation is common among cyclists, mountain bikers, rowers, ski-jumpers and tennis, handball, football, rugby, and ice-hockey players. While there is a large body of evidence supporting the ergogenic effects of Cr in high-intensity, intermittent exercise, the situation is more controversial in sports involving single bouts of high-intensity exercise, such as sprint running or swimming.<sup>[2,18]</sup> In endurance exercise, there is currently no reason to believe that Cr supplementation has any benefit. There is a widespread contention that Cr supplementation, by accelerating recovery between exercise bouts, may allow more intensive training sessions. Similarly, supplementation seems to enhance recovery after injury.

In most studies, a significant weight gain has been noted upon Cr supplementation. The underlying basis for this weight gain is still not entirely clear, and may be due to stimulation of muscle protein synthesis or increased water retention. The proportion of fat tends to decrease. Most likely, the increase in body weight reflects a corresponding increase in actual muscle mass and/or volume. Therefore, it is not surprising that Cr use is popular among bodybuilders and wrestlers. On the other hand, in mass-sensitive sports like swimming and running, weight gain due to Cr supplementation may impede the performance, or may at least counteract the ergogenic effects of Cr.

Creatine supplementation may improve muscle performance, especially during high-intensity, intermittent exercise, in four different ways by: increasing PCr stores, which is the most important energy source for immediate regeneration of ATP in the first few seconds of intense exercise; accelerating PCr resynthesis during recovery periods; depressing the degradation of adenine nucleotides and possibly also the accumulation of lactate; and enhancing glycogen storage in skeletal muscle.

### Benefits in neuromuscular disease

Besides its ergogenic effects, supplementary Cr has a neuroprotective function in several animal models of neurological disease, such as Huntington's disease, Parkinson's disease, and amyotrophic lateral sclerosis (ALS).<sup>[2,3,6,11]</sup> The rationale could be that these disorders, due to different causes, hamper cellular energy metabolism in the brain. In animal studies, Cr also protected against hypoxic and hypoxic-ischemic events. Therefore, Cr may be useful in the treatment of a number of diseases, e.g., mitochondrial disorders, neuromuscular diseases, myopathies, and cardiopathies. Currently, the first clinical studies with

Cr supplementation in neuromuscular disease are emerging. In two studies on patients with mitochondrial myopathies or other neuromuscular diseases, Tarnopolsky's group showed increased muscle strength upon Cr supplementation.<sup>[11]</sup> A randomized, double-blind, placebo-controlled trial to determine the efficacy of creatine supplementation did not show a significant beneficial effect on survival and disease progression in a group of 175 ALS patients. These data are in contrast to what was suggested from animal models of ALS and tissue specimens of ALS patients.<sup>[12]</sup> Studies on single subjects and small groups of neuromuscular disease patients have been reported to show both the presence and absence of beneficial effects of Cr supplementation. Recent publications on Cr supplementation in Huntington's disease showed difficulty in proving the effect of Cr on the deterioration of cognitive function.<sup>[19,20]</sup> In Duchenne muscular dystrophy enhanced muscle strength upon treatment was shown, whereas for example in myotonic dystrophy type 2/proximal myotonic myopathy no significant results were seen.<sup>[21,22]</sup> Future studies with enough statistical power are warranted to unravel the relevance of Cr supplementation in these disorders. Clinical trials of patients with ALS, Parkinson's, and other neurological diseases are currently ongoing (<http://clinicaltrials.gov/>).

#### Benefits in creatine biosynthesis disorders

Oral supplementation with 350 mg to 2 g/kg body weight per day has been used in patients with GAMT and AGAT deficiencies. In these patients' brains, the Cr concentration increased over a period of several months.<sup>[5]</sup> In GAMT deficiency, the GAA concentration in plasma, urine, and CSF decreased with Cr supplementation, but still remained highly elevated. Guanidinoacetic acid was found to be toxic in animals and may be partly responsible for some of the clinical signs (i.e., involuntary extrapyramidal movements). Combination therapy of Cr plus ornithine supplementation with protein (arginine) restriction reduced GAA in CSF, plasma, and urine, and almost completely suppressed epileptic seizures.<sup>[7]</sup> In general, all patients with a Cr biosynthesis defect who were treated with Cr alone or in combination therapy showed improvements. Clearly, younger patients will experience the largest benefits, since less irreversible damage is to be expected. However, even older patients showed remarkable improvements.<sup>[7]</sup>

#### Adverse Effects

Weight gain is the only consistent side effect reported. Gastrointestinal distress, muscle cramps, dehydration,

and heat intolerance have been reported repeatedly. Most of these complaints may be due to water retention in muscle during the loading phase of Cr supplementation. Although a causal relationship with fluid intake has not been proven yet, subjects should take care to hydrate properly to prevent these side effects. The French Agency of Medical Security of Food ([www.afssa.fr/ftp/basedoc/2000sa0086.pdf](http://www.afssa.fr/ftp/basedoc/2000sa0086.pdf)) released a statement in January 2001 that the health risk associated with oral Cr supplementation is not sufficiently evaluated, and that Cr may be a potential carcinogen. Since at present there is no scientific basis for the assertion (both Cr and Cr analogs were actually reported to display anticancer activity), this in turn has resulted in a wave of protest from suppliers and defenders of oral Cr supplementation. In fact, based on the current scientific knowledge in healthy individuals, Cr supplementation at the recommended dosages (see "Dosing as an Ergogenic Aid") should be considered safe. Unfortunately, almost nothing is known about the use of Cr in pregnancy, nor are appropriate studies in children available. Furthermore, a potential health hazard is the possible presence of contaminants in some commercial Cr preparations (see "Chemical Synthesis").

#### CONCLUSIONS

Oral Cr supplementation is known or presumed to have a number of favorable effects: For example, it prevents or ameliorates clinical symptoms associated with inherited Cr biosynthesis defects, it may protect against neurological and atherosclerotic disease,<sup>[2,6]</sup> and it increases sports performance, particularly in high-intensity, intermittent exercise. Despite widespread use of Cr as an ergogenic aid, and the significant public interest, the majority of studies on the properties, metabolism, and function of Cr have focused on physiological questions rather than on pharmacokinetics. As yet, the pharmacokinetics are difficult to interpret due to different (and incomplete) study designs. Currently, therefore, it is not adequately known whether Cr supplementation causes any long-term harmful effects. Some precaution is warranted based on the fact that the daily recommended dosage for ergogenic effects (i.e., 20 g during the loading phase, 3–5 g during the maintenance phase) cannot be met by normal food intake.

#### REFERENCES

1. Walker, J. Creatine: biosynthesis, regulation, and function. *Adv. Enzymol.* **1979**, *50*, 117–242.

2. Wyss, M.; Kaddurah-Daouk, R. Creatine and creatinine metabolism. *Physiol. Rev.* **2000**, *80* (3), 1107–1213.
3. Persky, A.M.; Brazeau, G.A. Clinical pharmacology of the dietary supplement creatine monohydrate. *Pharmacol. Rev.* **2001**, *53* (2), 161–176.
4. Greenhaff, P. The nutritional biochemistry of creatine. *Nutr. Biochem.* **1997**, *8*, 610–618.
5. Stöckler, S.; Hanefeld, F.; Frahm, J. Creatine replacement therapy in guanidinoacetate methyltransferase deficiency, a novel inborn error of metabolism. *Lancet* **1996**, *348* (9030), 789–790.
6. Wyss, M.; Schulze, A. Health implications of creatine: can oral creatine supplementation protect against neurological and atherosclerotic disease? *Neuroscience* **2002**, *112* (2), 243–260.
7. Schulze, A.; Bachert, P.; Schlemmer, H.; Harting, I.; Polster, T.; Salomons, G.S.; Verhoeven, N.M.; Jakobs, C.; Fowler, B.; Hoffmann, G.F.; Mayatepek, E. Lack of creatine in muscle and brain in an adult with GAMT deficiency. *Ann. Neurol.* **2003**, *53* (2), 248–251.
8. Stromberger, C.; Bodamer, O.A.; Stöckler-Ipsiroglu, S. Clinical characteristics and diagnostic clues in inborn errors of creatine metabolism. *J. Inher. Metab. Dis.* **2003**, *26* (2–3), 299–308.
9. Salomons, G.S.; van Dooren, S.J.M.; Verhoeven, N.M.; Marsden, D.; Schwartz, C.; Cecil, K.M.; DeGrauw, T.J.; Jakobs, C. X-linked creatine transporter defect: an overview. *J. Inher. Metab. Dis.* **2003**, *26* (2–3), 309–318.
10. deGrauw, T.J.; Salomons, G.S.; Cecil, K.M.; Chuck, G.; Newmeyer, A.; Schapiro, M.B.; Jakobs, C. Congenital creatine transporter deficiency. *Neuropediatrics* **2002**, *33* (5), 232–238.
11. Tarnopolsky, M.A.; Beal, M.F. Potential for creatine and other therapies targeting cellular energy dysfunction in neurological disorders. *Ann. Neurol.* **2001**, *49* (5), 561–574.
12. Groeneveld, J.G.; Veldink, J.H.; van der Tweel, I.; Kalmijn, S.; Beijer, C.; de Visser, M.; Wokke, J.H.; Franssen, H.; van den Berg, L.H.A. Randomized sequential trial of creatine in amyotrophic lateral sclerosis. *Ann. Neurol.* **2003**, *53* (4), 437–445.
13. Rae, C.; Digney, A.L.; McEwan, S.R.; Bates, T.C. Oral creatine monohydrate supplementation improves brain performance: a double-blind, placebo-controlled, cross-over trial. *Proc. R. Soc.: Biol. Sci.* **2003**, *270* (1529), 2147–2150.
14. Benzi, G. Is there a rationale for the use of creatine either as nutritional supplementation or drug administration in humans participating in a sport? *Pharmacol. Rev.* **2000**, *41* (3), 255–264.
15. Braissant, O.; Henry, H.; Loup, M.; Eilers, B.; Bachmann, C. Endogenous synthesis and transport of creatine in the rat brain: An in situ hybridization study. *Brain Res. Mol. Brain Res.* **2001**, *86* (1–2), 193–201.
16. Balsom, P.D.; Söderlund, K.; Ekblom, B. Creatine in humans with special reference to creatine supplementation. *Sports Med.* **1994**, *18* (4), 268–280.
17. Braissant, O.; Villard, A.-M.; Henry, H.; Speer, O.; Wallimann, T.; Bachmann, C. Synthesis and transport of creatine in the central nervous system. In *Clinical and Molecular Aspects of Defects in Creatine and Polyol Metabolism, Symposia Proceedings*; Verhoeven, N.M., Salomons, G.S., Jakobs, C., Eds.; SPS Verlagsgesellschaft mbH: Heilbronn, Germany. *In press*.
18. Burke, D.G.; Chilibeck, P.D.; Parise, G.; Candow, D.G.; Mahoney, D.; Tarnopolsky, M. Effect of creatine and weight training on muscle creatine and performance in vegetarians. *Med. Sci. Sports Exerc.* **2003**, *35* (11), 1946–1955.
19. Verbessem, P.; Lemiere, J.; Eijnde, B.O.; Swinnen, S.; Vanhees, L.; Van Leemputte, M.; Hespel, P.; Dom, R. Creatine supplementation in Huntington's disease: a placebo-controlled pilot trial. *Neurology.* **2003**, *61* (7), 925–930.
20. Tabrizi, S.J.; Blamire, A.M.; Manners, D.N.; Rajagopalan, B.; Styles, P.; Schapira, A.H.; Warner, T.T. Creatine therapy for Huntington's disease: clinical and MRS findings in a 1-year pilot study. *Neurology* **2003**, *61* (1), 141–142.
21. Tarnopolsky, M.A.; Mahoney, D.J.; Vajsar, J.; Rodriguez, C.; Doherty, T.J.; Roy, B.D.; Biggar, D. Creatine monohydrate enhances strength and body composition in Duchenne muscular dystrophy. *Neurology* **2004**, *62* (10), 1771–1777.
22. Schneider-Gold, C.; Beck, M.; Wessig, C.; George, A.; Kele, H.; Reiners, K.; Toyka, K.V. Creatine monohydrate in DM2/PROMM: a double-blind placebo-controlled clinical study. Proximal myotonic myopathy. *Neurology* **2003**, *60* (3), 500–502.

# Dang Gui (*Angelica sinensis*)

Roy Upton

American Herbal Pharmacopoeia®, Scotts Valley, California, U.S.A.

## INTRODUCTION

The root of dang gui (also known as dong quai; *Angelica sinensis*) is one of the primary botanicals used in traditional Chinese medicine (TCM) for the treatment of gynecological conditions. Despite its widespread use among practitioners of TCM, there have been few clinical studies regarding its efficacy.

Dang gui grows at high altitudes in comparatively cold, damp, mountainous regions in China and other parts of East Asia. This fragrant perennial has smooth purplish stems and bears umbrella-shaped clusters of white flowers that come to about 3 ft height. It produces winged fruits in July and September.

The root of *A. sinensis* (Fig. 1) is commonly prepared as a tea, extract, syrup, tablet, or capsule.

## BIOCHEMISTRY AND FUNCTION

### Pharmacokinetics

There are no human pharmacokinetics data in the English language on dang gui, its crude extracts, or its derived constituents. There are limited data on the kinetics of some compounds contained within dang gui, but they offer little insight into its clinical use or efficacy.

### Pharmacodynamics

Dang gui is one of the most widely used of all TCMs. Historically, and in modern Chinese medicine, it has been primarily used as a general blood tonic for the TCM diagnosis of blood deficiency, a syndrome closely, but not exactly, akin to anemia. It has also been used for gynecological indications, although there has been very little research done in these regards. More recently, pharmacological research has focused

on the potential of constituents of dang gui to elicit cardiovascular, hematopoietic, hepatoprotective, antioxidant, antispasmodic, and immunomodulatory effects. Chinese botanicals are most often used in multi-ingredient formulas rather than as single agents. Therefore, there are very few clinical trials on dang gui alone, although some preclinical studies exist. However, due to the lack of primary English language literature, it is difficult or impossible to adequately review the available data. Another difficulty in reviewing the available studies is that many of the investigations are of disease patterns that are unique to TCM and do not have well-defined corresponding Western diagnoses. While these findings are relevant to TCM practitioners, their importance may be ignored or even criticized by non-TCM practitioners. Lastly, it has been reported that up to 99% of studies presented in the Chinese medical literature show results favoring test intervention, suggesting the potential for a publication bias and hence the need for caution in interpreting the available data.<sup>[1]</sup>

The bioactive compounds most studied in dang gui are phthalides, polysaccharides, and ferulic acid. Studies using these compounds have reported a number of therapeutic effects, some of which are consistent with the use of dang gui in TCM and some of which are not. The contribution of ferulic acid to the therapeutic effect of dang gui is unlikely given its low concentration in crude dang gui (0.05–0.09%). The compounds used in pharmacological studies are often administered at doses exceeding those available from typical dosages of dang gui root preparations. While these data are presented, it is not possible to extrapolate results from such studies to clinical efficacy of orally administered crude drug products; hence, the reported findings must be evaluated critically.

### Cardiovascular and Hemorrhheological Effects

Limited clinical studies have investigated the use of dang gui for the treatment of patients with acute ischemic stroke or chronic obstructive pulmonary disease (COPD) with pulmonary hypertension. Results provide fairly weak evidence that dang gui exerts hypotensive and cardioprotective effects. In general, the

---

Roy Upton is at American Herbal Pharmacopoeia®, Scotts Valley, California, U.S.A.





**Fig. 1** Whole dang gui (*Angelica sinensis*) roots. (Photograph by Roy Upton, Soquel, California.) (View this art in color at [www.dekker.com](http://www.dekker.com))

study design of the available reports was poor and the patient populations extremely limited. Preclinical studies using dang gui and some of its constituents suggest actions and mechanisms by which it may exert a cardiovascular effect. These include stimulation of circulation, platelet aggregation inhibition, decrease in myocardial oxygen consumption, and vasorelaxation (measured as a decrease in vascular resistance; see also “Effects on Smooth Muscle”).

One study looked at the effects of dang gui in 60 patients with COPD.<sup>[2]</sup> In the dang gui group, levels of blood endothelin-1, angiotensin II, endogenous digitalis-like factor, mean pulmonary arterial pressure, and pulmonary vascular resistance were decreased significantly ( $P < 0.05$  or  $P < 0.01$ ) compared to those in the controls ( $20 \pm 6\%$ ,  $36 \pm 9\%$ ,  $38 \pm 11\%$ ,  $17 \pm 5\%$ , and  $27 \pm 8\%$ , respectively). Another study showed that dang gui decreased the mean pulmonary arterial pressure in patients with COPD without changing blood pressure and heart rate, suggesting a vasodilatory effect on pulmonary vessels without effect on systemic circulation.

In another study, it was suggested that dang gui and dextran exhibited positive effects on neurological and hemorrhheological symptoms in patients recovering from stroke.<sup>[3]</sup> However, no control group was included, and so any claimed effects are questionable. Other clinical studies with very small numbers of patients<sup>[4,5]</sup> have reported on an ability of dang gui to decrease blood viscosity, an effect consistent with its traditional use. While this effect may be real, the

mechanisms by which this may occur and the constituents involved have not been well articulated.

A number of animal studies and in vitro assays support some of the putative cardiovascular effects of dang gui. These include an increase in myocardial perfusion, decrease in myocardial oxygen consumption, increase in blood flow, decrease in vascular resistance, and inhibition of platelet aggregation, ventricular fibrillation, and arrhythmias. However, it is impossible to extrapolate these findings to humans.

### Hepatoprotective Effects

There is some evidence to suggest that dang gui and its constituents can decrease portal hypertension in patients with liver cirrhosis without affecting systemic hemodynamics. This use is consistent with the traditional actions of dang gui in improving circulation, since portal hypertension is thought to be due to the obstruction of hepatic microcirculation.<sup>[6,7]</sup> Additionally, a number of preclinical studies indicate that dang gui, dang gui polysaccharides, ferulic acid, and sodium ferulate have antioxidant effects that can protect the liver against damage due to chemically induced toxicity. Part of this action is due to the ability of dang gui polysaccharides to reduce the levels of nitric oxide (NO) (24.6%), serum alanine aminotransferase (sALT) (40.8%), and serum glutathione S transferase (18.4%) in animals with acetaminophen- or  $\text{CCl}_4$ -induced liver challenge.<sup>[8-10]</sup>

## Gynecological Effects

Dang gui is one of the most important herbal drugs in TCM for the treatment of menstrual disorders, especially when used in combination with other botanicals. It has traditionally been used to treat conditions associated with the TCM diagnosis of “blood stasis” and “blood vacuity,” which can be correlated with Western syndromes such as amenorrhea, dysmenorrhea, endometriosis, uterine fibroids, and certain forms of infertility. Its efficacy appears to have been demonstrated over the 750-year history of its use for these indications and its continued, and apparent, successful use by modern practitioners of TCM. However, there are few studies substantiating these effects, and those that are available are of very poor methodological quality.<sup>[11,12]</sup>

## Hormonal Effects and Effects on Menopausal Symptoms

Because of the putative effects of dang gui in gynecological imbalances, various studies have investigated its potential for eliciting hormonal effects. In the available human study,<sup>[13]</sup> one of the few double-blind, placebo-controlled trials with dang gui, no statistically significant differences in endometrial thickness, vaginal cell maturation, or menopausal symptoms were observed between subjects taking dang gui and those taking placebo. Several preclinical studies have investigated the estrogenicity of dang gui or ferulic acid, with mixed, but largely negative, results. Some in vitro assays have reported that dang gui extract exhibited a significant dose-dependent inhibition of estrogen receptor binding, indicating that it competed with estradiol for receptor sites.<sup>[14]</sup> In the same study, dang gui extract dose-dependently induced reporter gene expression in estrogen-sensitive rat uterine leiomyoma cells. However, when tested in conjunction with the maximum stimulatory dose of estradiol, the extract inhibited estradiol-induced reporter gene expression, suggesting the possibility that dang gui may act as an estrogen antagonist when in the presence of physiological levels of estradiol. Another group of researchers reported similar findings.<sup>[15]</sup> Using ELISA-type immunoassays of 2 steroid-regulated proteins, presenelin-2 (pS2) and prostate-specific antigen (PSA), in breast carcinoma cell line BT-474, these latter researchers reported that dang gui extract showed “weak” estrogen and androgen antagonistic effects of 50% and 71% blocking activity, respectively, and no progestational activity. In contrast to these findings, another group of researchers found no estrogen receptor binding, cell proliferative, or progestin activity of an aqueous ethanol extract of dang gui.<sup>[16]</sup>

## Effects on Smooth Muscle

Dang gui and its constituents have been shown to relax the smooth muscle tissue of the vascular system, trachea, intestines, and uterus. The spasmolytic effects of dang gui on trachea and uterine tissues are consistent with TCM indications. While the mechanism of the relaxant action has not been fully elucidated, preclinical studies suggest that it may be due, in part, to histamine receptor blocking activity, calcium ion channel effects, or modulation of cholinergic receptors. Both relaxing and stimulating effects on uterine tissue have been reported, with various constituents eliciting different actions. The therapeutic relevance of in vitro findings to humans is unknown given the lack of clinical evidence.

## Hematopoietic Effects

One of the traditional applications of dang gui in TCM is its use in the treatment of “blood vacuity,” which closely, but not completely, corresponds to a Western medical diagnosis of anemia. Limited clinical and preclinical data support this use. One proposed mechanism of action is its reported effect in stimulating hematopoiesis. These actions appear to be primarily associated with the polysaccharide fraction.<sup>[17,18]</sup>

## Antioxidant Effects

There have been numerous studies demonstrating an antioxidant effect of dang gui and its constituents. Much of these have focused on the antioxidant activity of ferulic acid, which is well known for its ability to prevent lipid peroxidation, inhibit superoxide anion radical formation, scavenge free radicals, and protect against radiation damage.<sup>[19–21]</sup> However, dang gui contains only trace amounts of ferulic acid, and so these in vitro findings cannot be extrapolated to the use of crude dang gui preparations.

## Immunomodulatory Effects

Limited animal and in vitro studies have reported on specific immunomodulatory effects of dang gui, including stimulation of phagocytic activity and interleukin-2 (IL-2) production, and an anti-inflammatory effect. There is evidence to suggest that the polysaccharide fraction of dang gui may contribute to these effects. However, there is no clinical evidence supporting these effects, and there appears to be no direct correlation between TCM use of dang gui and immunomodulatory activity.<sup>[22–24]</sup>

## Effects on Bone Cells

Dang gui is traditionally used in formulas for bone and tendon injuries. A recent study investigated the pharmacology behind this indication by testing the in vitro effects of a 1% aqueous extract of dang gui on human osteoprecursor cells.<sup>[25]</sup> Cells were incubated for 5 days in medium with (12.5–1000 µg/ml) and without the extract. Compared to untreated control cell cultures, cell proliferation was enhanced at extract concentrations less than 125 µg/ml ( $P < 0.05$ ), whereas it was inhibited at concentrations greater than 250 µg/ml ( $P < 0.05$  at 1 mg/ml). In addition, the activity of alkaline phosphatase, a protein synthesized by bone cells during osteogenesis, was increased significantly at all concentrations ( $P < 0.05$ ).

## Wound-Healing Effects

One group of researchers found that a crude extract of dang gui (characterization and dosage not available) significantly, accelerated epithelial cell proliferation in wounds.<sup>[9,26,27]</sup> The activity was reportedly associated with an increase in DNA synthesis and epidermal growth factor (EGF) mRNA expression. The same researchers observed direct wound-healing effects of dang gui crude extract, with activity associated with increased ornithine carboxylase activity and increased c-Myc expression. Another study found that dang gui prevented bleomycin-induced acute injury to rat lungs.<sup>[28]</sup> Alveolitis and the production of malondialdehyde (MDA) were all reduced ( $P < 0.01$  or  $P < 0.001$ ), suggesting immunomodulatory and antioxidant effects.

## Analgesic Effects

Two uncontrolled clinical trials were found that addressed the traditional Chinese use of dang gui as an analgesic for pain due to “blood stasis”; both used injectable preparations. In one, an ethanol extract was administered (intramuscularly) on alternate days for a total of 20 doses into the pterygoideus externus of 50 patients with temporomandibular joint syndrome. A 90% cure rate was claimed.<sup>[29]</sup> Thirty cases of refractory interspinal ligament injury were treated by local injection of 2 ml of 5% or 10% dang gui twice weekly for 2–3 weeks. Twenty-four (80%) of these patients reported a disappearance of pain, no tenderness, and the ability to work as usual; 4 (13%) patients reported alleviation of pain; 2 (7%) reported no improvement.<sup>[30]</sup> These uses are consistent with the traditional use of dang gui in TCM. However, the effects of injectable preparations cannot be extrapolated to oral use of dang gui.

## CONCLUSIONS

Dang gui is one of the most important herbal drugs in TCM, primarily being used for blood tonification and the treatment of gynecological disorders. More recently, interest has focused on dang gui’s possible cardiovascular, hepatoprotective, hematopoietic, antioxidant, antispasmodic, and immunomodulatory effects. Despite its long tradition of use and current widespread clinical utility, there has been very little clinical work verifying the therapeutic efficacy of dang gui when used alone, primarily due to the fact that in TCM, botanicals are generally used in combinations rather than as single agents.

Based on the literature available, and keeping many of its limitations for an English readership in mind, there is limited clinical support for the use of dang gui alone for the following indications: pulmonary artery and portal hypertension, acute ischemic stroke, dysmenorrhea, infertility, and pain due to injury or trauma. The use of dang gui for most of these indications is consistent with TCM. One trial on menopausal symptoms found no effect of dang gui on hormonal activity. Most of the trials available are of poor methodological quality.

Clinical and preclinical studies provide some support for a wide variety of actions of dang gui. These include the promotion of circulation, vasodilation/relaxation, and the inhibition of platelet aggregation, all of which are consistent with the “blood quickening” properties ascribed to dang gui in TCM. Similarly, the hematopoietic effect of dang gui is consistent with its use in TCM to “nourish blood.” Its smooth muscle (uterus, vessels, trachea) relaxant effects are consistent with its use for dysmenorrhea, asthma, and coughing. Dang gui may relax or stimulate the uterus depending on a variety of factors: In general, the volatile oil fraction appears to be a uterine relaxant, while the nonvolatile constituents appear to stimulate contractions. There is some support for the traditional use of dang gui as an analgesic and vulnerary. The radiation protective effect of dang gui in animals is most likely due to its antioxidant activity. Assays for an estrogenic effect of dang gui have had mixed, but largely negative, results. The relevancy of many of these actions to the therapeutic use of dang gui in humans has not yet been demonstrated.

## MEDICAL INDICATIONS SUPPORTED BY CLINICAL TRIALS

The clinical data regarding the use of dang gui alone are scarce and of poor methodological quality. Based on the available data, it is best that dang gui be used

within the context of TCM and by qualified TCM practitioners.

## DOSAGES<sup>[31]</sup>

- Crude drug: 6–12g daily to be prepared as a decoction.
- Liquidextract (1 : 1): 3–5 ml three times daily.

## SAFETY PROFILE

### Side Effects

Based on a review of the available traditional and scientific data, dang gui is a very safe herb with a low probability of side effects when used within its normal dosage range. One review article that claimed to cover 200 reports on dang gui pharmacology stated that dang gui had no major side effects.<sup>[32]</sup> Individual case reports regarding the potential of dang gui to promote bleeding have been prepared.

### Contraindications

Based on a review of the available literature and the experience of practitioners, dang gui is contraindicated prior to surgery and in those, generally speaking, with bleeding disorders.

### Precautions

Precautions regarding the use of dang gui and other botanicals used in traditional systems of medicine must be differentiated between those recognized in the scientific literature and those recognized traditionally. There is evidence suggesting an anticoagulant effect for dang gui, and there are two published reports on its ability to enhance the effects of chronic treatment with warfarin (see “Interactions”). A few unpublished case reports suggest that high doses or chronic administration of dang gui alone during pregnancy may be associated with miscarriage. There are also anecdotal reports of dang gui alone causing increased blood flow during menses (Upton, personal communication, unreferenced). Therefore, patients should consult with a qualified health care professional prior to using dang gui if they have bleeding disorders, are using anticoagulant medications, or wish to use it during menses or in the first trimester of pregnancy. It must, however, be noted that in TCM, dang gui is specifically indicated for certain bleeding disorders that are due to an underlying diagnosis of blood stasis and in certain cases of

threatened miscarriage. For such uses, dang gui must be used according to TCM principles under the guidance of a qualified TCM practitioner.

## Interactions

Two reports are available suggesting that dang gui can enhance the effects of the anticoagulant warfarin. According to one of these, a 46-yr-old woman with atrial fibrillation who had been stabilized on warfarin for almost 2 yr (5 mg daily) consumed a dang gui product (Nature’s Way) concurrently for 4 weeks (565–1130 mg daily). She experienced a greater than twofold elevation in prothrombin time (from 16.2 to 27 sec) and international normalized ratio (from 2.3 to 4.9). No other cause for this increase could be determined. Within 1 mo of discontinuing dang gui use, coagulation values returned to acceptable levels.<sup>[33]</sup>

An animal study investigated the interaction of dang gui and a single dose and a steady-state dose of warfarin.<sup>[34]</sup> Six rabbits were administered a single dose of warfarin (2 mg/kg s.c.). Seven days later, the same animals were given an aqueous extract of dang gui (2 g/kg p.o., twice of a 2 g/ml extract daily) for 3 days, after which they were again given a single dose of warfarin. Plasma warfarin concentrations were measured at intervals up to 72 hr after each warfarin dose, and prothrombin time was measured daily during dang gui treatment and after the warfarin doses. Mean prothrombin time did not change significantly during the dang gui treatment period. However, when measured after coadministration of dang gui and warfarin, prothrombin time was significantly lowered at 24, 36, and 48 hr compared to that with warfarin treatment alone ( $P < 0.05$  or  $P < 0.01$ ). No significant variations in the single dose pharmacokinetic parameters of warfarin were observed after treatment with dang gui. Hence, the mechanism of decrease in prothrombin time could not be correlated to the pharmacokinetics of warfarin. Another group of 6 rabbits was given 0.6 mg/kg of warfarin s.c. daily for 7 days; a steady-state plasma concentration was achieved after day 4. On days 4, 5, and 6, the rabbits were treated as above with dang gui. Mean prothrombin time was again significantly increased after coadministration with dang gui ( $P < 0.01$ ) and 2 rabbits died at days 6 and 7 after the dang gui treatment had begun. Plasma warfarin levels did not change after dang gui treatment. The authors suggested that these results indicate that precautionary advice should be given to patients who medicate with dang gui or its products while on chronic treatment with warfarin.

One study reported that dang gui might enhance the antitumor effect of cyclophosphamide in mice with transplanted tumors.<sup>[35]</sup>

### Pregnancy, Mutagenicity, and Reproductive Toxicity

Because of its blood-moving properties, dang gui should only be used in pregnancy while under the supervised care of a qualified health professional. According to TCM practice, dang gui is used in combination with other herbs in various stages of pregnancy.<sup>[12]</sup> Formulae traditionally used in pregnancy are prescribed within the context of specific diagnoses in which the use of dang gui in pregnancy is clearly indicated. In the West, dang gui is often used alone out of this traditional medical context. Because of this, several Western sources consider dang gui to be contraindicated in pregnancy. Data regarding the effect of dang gui preparations on the fetus are lacking.

### Lactation

There are three unpublished case reports of a rash in infants of lactating mothers who were taking dang gui. The rashes reportedly resolved upon discontinuation of the preparation by the mother. Specific details regarding the preparations used were lacking (Romm, 2002, personal communication to AHP, unreferenced). Dang gui is a member of the botanical family Apiaceae, a group of plants that contain many types of photoreactive compounds known to cause rashes.

### Carcinogenicity

Insufficient data are available with which to make a definitive determination regarding the carcinogenicity of dang gui. One animal study identified a possible antitumor effect of dang gui applied to mice with Ehrlich ascites tumors.<sup>[36]</sup> Data are mixed regarding estrogen positive tumors; while one in vitro assay found that dang gui stimulated the growth of MCF-7 breast cancer cell lines 16-fold, with no measurable effect on estrogen receptors,<sup>[37]</sup> another found a possible antitumor effect in T-47D and MCF-7 cell lines.<sup>[38]</sup> Data regarding the potential estrogenic effects of dang gui have been mixed.

### Influence on Driving

No data available. Based on the experience of modern herbal practitioners, no negative effects are to be expected.

### Overdose

No data available.

### Treatment of Overdose

No data available.

### Toxicology

The following LD<sub>50</sub> values have been reported dang gui extract (8:1 or 16:1), 100 g/kg p.o. in rats<sup>[39,40]</sup>; dang gui aqueous extract, 100 g/kg i.v. in mice<sup>[41]</sup>; dang gui 50% ethanol extract, greater than 40 g/kg p.o. in mice<sup>[42]</sup>; dang gui total acids, 1.05 ± 0.49 g/kg i.p. in mice.<sup>[43]</sup> The LD<sub>50</sub> of ferulic acid i.v. in mice was reported to be 856.6 mg/kg,<sup>[44]</sup> and that of ligustilide, approximately 410 mg/kg i.p.<sup>[45]</sup> In a review of the toxicology literature on dang gui, it was reported that i.v. injection of the volatile fraction of dang gui could cause kidney degeneration.<sup>[33]</sup>

### REGULATORY STATUS

Regulated as a dietary supplement (USC 1994).

### REFERENCES

1. Vickers, A.; Goyal, N.; Harland, R.; Rees, R. Do certain countries produce only positive results? A systematic review of controlled trials. *Controlled Clin. Trials Des. Meth. Anal.* **1998**, *19*, 159–166.
2. Xu, J.Y.; Li, B.X.; Cheng, S.Y. Short-term effects of *Angelica sinensis* and nifedipine on chronic obstructive pulmonary disease in patients with pulmonary hypertension. *Zhongguo Zhongxiyi Jiehe Zazhi* **1992**, *12* (12), 707, 716–718.
3. Tu, J.; Huang, H. Effects of *Radix Angelicae sinensis* on hemorrheology in patients with acute ischemic stroke. *Gong Zazhi* **1984**, *4* (3), 225–228.
4. Gao, S.W.; Chen, Z.J. Effects of sodium ferulate on platelet aggregation and platelet thromboxane A<sub>2</sub> in patients with coronary heart disease. *Zhongxiyi Jiehe Zazhi* **1988**, *8* (5), 263–265, 269.
5. Terasawa, K.; Imadaya, A.; Tosa, A.; Mitsuma, T.; Toriizuka, K.; Takeda, K.; Mikage, M.; Hattori, M.; Namba, T. Chemical and clinical evaluation of crude drugs derived from *Angelica acutiloba* and *Angelica sinensis*. *Fitoterapia* **1985**, *56* (4), 201–208.
6. Huang, Z.P.; Liang, K.H. Effect of *Radix Angelicae sinensis* on serum gastrin levels in patients with cirrhosis. *Zhonghua Neike Zazhi* **1994**, *33* (6), 373–375.
7. Huang, Z.P.; Guo, B.; Yuan, S.Y.; Ai, L.; Liang, K.H. Effects of *Radix Angelicae sinensis* on

- systemic and portal hemodynamics in cirrhotics with portal hypertension. *Zhonghua Neike Zazhi* **1996**, *35* (1), 15–18.
8. Xie, F.; Li, X.; Sun, K.; Chu, Y.; Cao, H.; Chen, N.; Wang, W.; Liu, W.; Mao, D. An experimental study on drugs for improving blood circulation and removing blood stasis in treating mild chronic hepatic damage. *J. Trad. Chin. Med.* **2001**, *21* (3), 225–231.
  9. Ye, Y.N.; Liu, E.S.; Li, Y.; So, H.L.; Cho, C.C.; Sheng, H.P.; Lee, S.S.; Cho, C.H. Protective effect of polysaccharides-enriched fraction from *Angelica sinensis* on hepatic injury. *Life Sci.* **2001**, *69* (6), 637–646.
  10. Ding, H.; Peng, R.; Yu, J. Modulation of *Angelica sinensis* polysaccharides on the expression of nitric oxide synthase and Bax, Bcl-2 in liver of immunological liver-injured mice. *Zhonghua Ganzangbing Zazhi* **2001**, *9* (Suppl.), 50–52.
  11. Gao, Y.M.; Zhang, H.K.; Duan, Z.X. Treatment of 112 cases of dysmenorrhea with danggui jingyou pill. *Lanzhou Daxue Xuebao* **1988**, *1*, 36–38.
  12. Fu, Y.F.; Xia, Y.K.; Shi, Y.P. Treatment of 34 cases of infertility due to tubal occlusion with compound danggui injection by irrigation. *Jiangsu Zhongyi* **1988**, *9* (1), 15–16.
  13. Hirata, J.D.; Swiersz, L.M.; Zell, B.; Small, R.; Ettinger, B. Does dong quai have estrogenic effects in postmenopausal women? A double-blind, placebo-controlled trial. *Fertil. Steril.* **1997**, *68* (6), 981–986.
  14. Eagon, P.K.; Hunter, D.S.; Elm, M.S.; Tress, N.B.; Eagon, C.L. Modulation of estrogen action. *Proc. Am. Assoc. Cancer Res.* **2001**, *42* (March), pages unavailable.
  15. Rosenberg Zand, R.S.; Jenkins, D.J.A.; Dimandis, E.P. Effects of natural products and nutraceuticals on steroid hormone-regulated gene expression. *Clin. Chim. Acta* **2001**, *312*, 213–219.
  16. Zava, D.T.; Dollbaum, C.M.; Blen, M. Estrogen and progestin bioactivity of foods, herbs, andspices. *Proc. Soc. Exp. Biol. Med.* **1998**, *217* (3), 369–378.
  17. Ma, L.; Mao, X.; Li, X.; Zhao, H. The effect of *Angelica sinensis* polysaccharides on mouse bone marrow hematopoiesis. *Zhonghua Xueyexue Zazhi* **1988**, *9* (3), 148–149.
  18. Wang, Y.; Zhu, B. The effect of *Angelica* polysaccharide on proliferation and differentiation of hematopoietic precursor cells. *Zhonghua Yixue Zazhi* **1996**, *76* (5), 363–366.
  19. Carbonneau, M.A.; Leger, C.L. Supplementation with wine phenolic compounds increases the antioxidant capacity of plasma and vitamin E of low-density lipoprotein without changing the lipoprotein Cu(2+)-oxidizability: possible explanation by phenolic location. *Eur. J. Clin. Nutr.* **1997**, *51* (10), 682–690.
  20. Graf, E. Antioxidant potential of ferulic acid. *Free Rad. Biol. Med.* **1992**, *13* (45), 435–438.
  21. Ohta, T.; Nakano, T.; Egashira, Y.; Sanada, H. Antioxidant activity of ferulic acid  $\beta$ -glucuronide in the LDL oxidation system. *Biosci. Biotechnol.* **1997**, *61* (11), 1942–1943.
  22. Hirabayashi, T.; Ochiai, H.; Sakai, S.; Nakajima, K.; Terasawa, K. Inhibitory effect of ferulic acid and isoferulic acid on murine interleukin-8 production in response to influenza virus infections in vitro and in vivo. *Planta Med.* **1995**, *61* (3), 221–226.
  23. Hu, H.J.; Hang, B.Q.; Wang, P.S. Anti-inflammatory effect of ferulic acid. *Zhongguo Yaoxue Daxue Zazhi* **1990**, *21* (5), 279–282.
  24. Hu, H.J.; Hang, B.Q.; Wang, P.S. Anti-inflammatory effect of the root of *Angelica sinensis*. *Zhongguo Zhongyao Zazhi* **1991**, *16* (11), 684–686.
  25. Yang, Q.; Populo, S.M.; Zhang, J.Y.; Yang, G.G.; Kodama, H. Effect of *Angelica sinensis* on the proliferation of human bone cells. *Clin. Chim. Acta* **2002**, *324*, 89–97.
  26. Ye, Y.N.; Koo, M.W. *Angelica sinensis* modulates migration and proliferation of gastric epithelial cells. *Life Sci.* **2001**, *68* (8), 961–968.
  27. Ye, Y.N.; Liu, E.S.D. A mechanistic study of proliferation induced by *Angelica sinensis* in a normal gastric epithelial cell line. *Biochem. Pharmacol.* **2001**, *61* (11), 1439–1448.
  28. Xu, Q.Y.; Liu, W.; Lin, Y.H. *Radix Angelica sinensis* prevents bleomycin-induced acute injury in rats lung. *Hubei Yike Daxue Xuebao* **1997**, *18* (1), 20–23.
  29. Tong, Y.F. Treatment of temporomandibular joint dysfunctional syndrome by injection of *Angelica sinensis* extract into pterygoideus externus: clinical analysis of 50 cases. *Zhongyi Zazhi* **1991**, *12* (5), 293.
  30. Cui, L.X. Treatment of interspinal ligament injury with danggui injection. *Shanghai J. Acupunct. Moxibust.* **1989**, *8* (1), 22.
  31. *Pharmacopoeia of the People's Republic of China*; Chemistry and Industry Press: Beijing, 2000; Vol. 1.
  32. Mei, Q.B.; To, J.Y.; Cui, B. Advances in the pharmacological studies of radix *Angelica sinensis* (Oliv.) Diels (Chinese danggui). *Chin. Med. J.* **1991**, *104* (9), 776–781.
  33. Page, R.L.; Lawrence, J.D. Potentiation of warfarin by dong quai. *Pharmacotherapy* **1999**, *19* (7), 870–876.

34. Lo, A.C.T.; Chan, K.; Woo, K.S. Danggui (*Angelica sinensis*) affects the pharmacodynamics but not the pharmacokinetics of warfarin in rabbits. *Eur. J. Drug Metab. Pharmacokin.* **1997**, *20* (1), 55–60.
35. Gao, G.; Yang, J. Synergistic effect of *Angelica sinensis* on cyclophosphamide in treating transplanted tumors of mice. *Zhongguo Yiyuan Yaoxue Zazhi* **1997**, *17* (7), 304–305.
36. Choy, Y.M.; Leung, N.; Cho, C.S.; Wong, C.K.; Pang, P.K.T. Immunopharmacological studies of low molecular weight polysaccharide from *Angelica sinensis*. *Am. J. Chin. Med.* **1989**, *22* (2), 137–145.
37. Amato, P.; Cristophe, S.; Mellon, P.L. Estrogenic activity of herbs commonly used as remedies for menopausal symptoms. *Menopause* **2002**, *9* (2), 145–150.
38. Dixon-Shanies, D.; Shaikh, N. Growth inhibition of human breast cancer cells by herbs and phytoestrogens. *Oncol. Rep.* **1999**, *6* (6), 1383–1387.
39. Mills, S.; Bone, K. *Principles and Practice of Phytotherapy*; Church Livingstone: Edinburgh, 2000.
40. Zhu, D.P.Q. Dong quai. *Am. J. Chin. Med.* **1987**, *15* (3, 4), 117–125.
41. Wei, Z.M. Pharmacological effects of *Angelica sinensis* on the cardiovascular system. *Xinjiang Zhongyiyao* **1987**, *3*, 43–46.
42. Yang, H.Y.; Chen, C.F. Acute toxicity and bioactivity evaluation of commonly used Chinese drugs: analgesic Chinese drugs. *J. Chin. Med.* **1992**, *3* (2), 41–59.
43. Zhu, Y.Z.; Yang, Q.L.; Zhang, P.Y. Antiarrhythmic effect of the total acid of *Angelica sinensis*. *Lanzhou Med. Coll.* **1989**, *15* (3), 125–128.
44. Ozaki, Y.; Ma, J.P. Inhibitory effects of tetramethylpyrazine and ferulic acid on spontaneous movement of rat uterus in situ. *Chem. Pharm. Bull.* **1990**, *38* (6), 1620–1623.
45. Xie, F.X.; Tao, J.Y. Central inhibitory effect of ligustilide of *Angelica sinensis*. *Shanxi Zazhi* **1985**, *14* (8), 59–62.

# Dehydroepiandrosterone (DHEA)

## Salvatore Alesci

*Clinical Neuroendocrinology Branch, National Institute of Mental Health, National Institutes of Health, Bethesda, Maryland, U.S.A.*

## Irini Manoli

*Endocrine Section, Laboratory of Clinical Investigation, National Center for Complementary and Alternative Medicine, National Institutes of Health, Bethesda, Maryland, U.S.A.*

## Marc R. Blackman

*Endocrine Section, Laboratory of Clinical Investigation, National Center for Complementary and Alternative Medicine, National Institutes of Health, Bethesda, Maryland, U.S.A.*

## INTRODUCTION

DHEA is the acronym used to designate the hormone “dehydroepiandrosterone,” also referred to as “prasterone.” The chemical name for DHEA is 5-androsten-3 $\beta$ -ol-17-one (Fig. 1).

As a dietary supplement, it is marketed under different trade names (e.g., Nature’s Blend DHEA, Nature’s Bounty DHEA, DHEA Max, DHEA Fuel, etc.). A pharmaceutical-grade preparation, currently available only for experimental use, has been assigned the trade name Prestara (previously known as Aslera or GL701).

## HISTORICAL OVERVIEW AND GENERAL DESCRIPTION

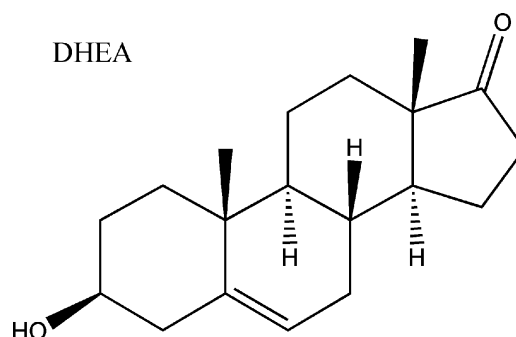
Discovered in 1934, DHEA is the most abundant steroid hormone, and is produced by the adrenal glands in humans and other primates. It acts as a weak androgen and serves as a precursor of other steroids including more potent androgens and estrogens. To date, however, the exact functions of this hormone remain unknown. DHEA is broadly traded on the Internet, under the claim of being a “marvel hormone.” Despite the growing popularity of its use, there is insufficient

scientific evidence supporting the purported potential health benefits, and little information regarding the potential short- and long-term adverse risks of consuming exogenous DHEA. Moreover, variations in quality control and manufacturing practices of dietary supplements result in differences in concentrations and purity of the marketed compounds, and insufficient surveillance for side effects.

## BIOCHEMISTRY AND PHYSIOLOGY

### Biosynthesis and Metabolism

DHEA is primarily produced in the zona reticularis of the adrenal cortex. In healthy women, the adrenal gland is the principal source of this steroid, whereas in men, 10–25% of the circulating DHEA is secreted by the testes.<sup>[1]</sup> It can also be synthesized within the central nervous system (CNS), and can be considered a “neurosteroid.”<sup>[2]</sup> Pregnenolone, the immediate precursor of DHEA, is derived from cholesterol through the action of the cytochrome P450 side-chain cleavage



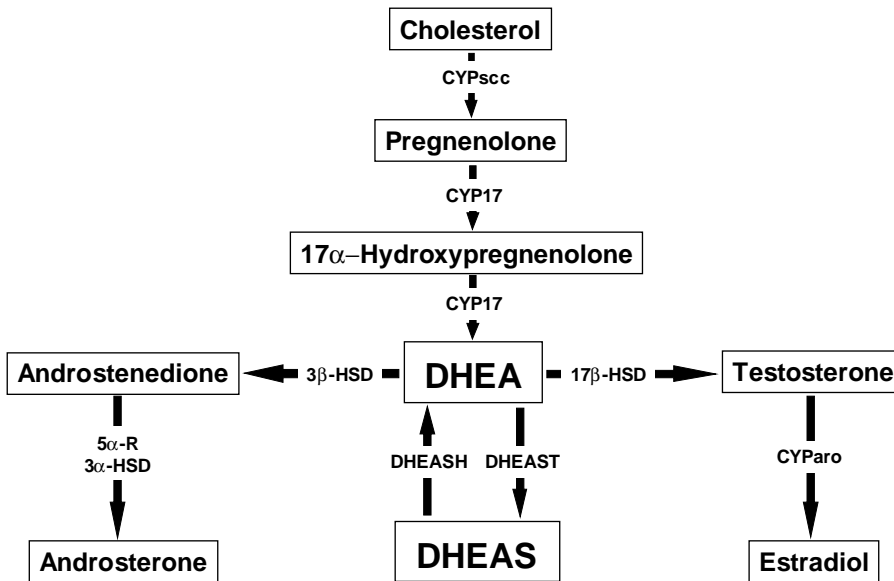
**Fig. 1** Chemical structure of dehydroepiandrosterone (DHEA).

*Salvatore Alesci, M.D., Ph.D.*, is Staff Scientist at the Clinical Neuroendocrinology Branch, National Institute of Mental Health, National Institutes of Health, Bethesda, Maryland, U.S.A.

*Irini Manoli, M.D.*, is Visiting Fellow at the Endocrine Section, Laboratory of Clinical Investigation, National Center for Complementary and Alternative Medicine, National Institutes of Health, Bethesda, Maryland, U.S.A.

*Marc R. Blackman, M.D.*, is Chief at the Endocrine Section, Laboratory of Clinical Investigation, National Center for Complementary and Alternative Medicine, National Institutes of Health, Bethesda, Maryland, U.S.A.





**Fig. 2** Schematic diagram of DHEA/DHEAS biosynthesis and metabolism. Abbreviations: CYPsc, cytochrome P450 side-chain cleavage enzyme; CYP17, cytochrome P450 17- $\alpha$  hydroxylase; 3 $\beta$ /17 $\beta$ /3 $\alpha$ -HSD, 3-beta/17-beta/3-alpha hydroxysteroid dehydrogenase; 5 $\alpha$ -R, 5-alpha reductase; DHEASH, DHEA sulfohydrolase; DHEAST, DHEA sulfotransferase; CYParo, cytochrome P450 aromatase.

enzyme (CYPsc). It is converted into DHEA by cytochrome P450 17 $\alpha$ -hydroxylase (CYP17), while hydroxysteroid sulfotransferase (DHEAST) catalyzes the transformation of DHEA into its 3-sulfated metabolite DHEAS (Fig. 2). This can be converted back to DHEA by the action of sulfohydrolases (DHEASH), located in the adrenal gland and peripheral tissues.

Human plasma contains DHEA-fatty esters (DHEA-FA), which are formed from DHEA by the enzyme lecithin-cholesterol acyltransferase. Newly formed DHEA-FA are incorporated into very-low-density lipoproteins (VLDL) and low-density lipoproteins (LDL) and may be used as substrates for the synthesis of active oxidized and hydroxylated metabolites in the periphery, such as 7 $\alpha$ / $\beta$ -hydroxy-DHEA in the brain, and androstenedione, androstenediol, and androstetriol in the skin and immune organs.<sup>[3,4]</sup>

### Regulation of DHEA Production

Release of DHEA by the adrenals is mostly synchronous with that of cortisol, under the stimulus of the hypothalamic corticotrophic-releasing hormone (CRH) and pituitary adrenocorticotrophic hormone (ACTH). However, the finding of dissociation between DHEA and cortisol secretion during several physiologic and pathophysiologic states suggests that other non-ACTH mediated mechanisms may be involved in the modulation of DHEA secretion (Table 1).

Estrogens, growth hormone, insulin, and prolactin stimulate DHEA secretion by human adrenal cells. However, these findings have not always been replicated in animal or clinical studies. A complex intra-adrenal network involving vascular and nervous

systems, local growth and immune factors, and a "cross-talk" between cells of the cortex and medulla, the other component of the adrenal gland, also regulate DHEA secretion. The existence of a specific "adrenal androgen stimulating hormone" has also been postulated, but remains controversial.<sup>[5]</sup>

**Table 1** Dissociation of cortisol and DHEA/DHEAS secretion during physiological and pathological conditions

Condition	DHEA	DHEAS	Cortisol
Physiological (age-related)			
Fetal stage		↑	N
Birth		↑	N
Infancy and childhood		↓	N
Adrenarche (6–8 yr)	↑	↑	N
Puberty	↑	↑	N
Adrenopause (50–60 yr)	↓	↓	N or ↑
Pathological			
Anorexia nervosa	↓	↓	↑
Chronic/severe illness		↓	↑
Burn trauma		↓	↑
Cushing's disease	N	N	↑
Congenital adrenal hyperplasia		↑	↓
Ectopic ACTH syndrome	N, ↑, or ↓	N, ↑, or ↓	↑
Idiopathic hirsutism		↑	N
Partial hypopituitarism without ACTH deficiency	↓	↓	N
End-stage renal diseases		↓	↑
Stress	↓	↓	↑

N = normal serum levels; ↑ = increased serum levels; ↓ = decreased serum levels.

(From Ref.<sup>[5]</sup>.)

## Adrenarche and Adrenopause

At birth, DHEAS is the predominant circulating steroid. However, a dramatic involution of the fetal adrenal zone, starting in the first postnatal month and continuing through the first year of life, is paralleled by a sudden decrease in DHEA/DHEAS, which remains unchanged for the next 6 yr. By the age of 6–8 yr, the adrenal gland matures, culminating in the creation of the zona reticularis, followed by an abrupt elevation in DHEA and DHEAS concentrations, termed the “adrenarche.”<sup>[6]</sup> Peak concentrations of DHEA (180–800 ng/dl) and DHEAS (45–450 μg/dl) are reached during the third decade of life. Subsequently, there is a progressive 2% decline per year in DHEA and DHEAS secretion and excretion, with concentrations equal to 20% of the peak by the age of 80, and values lower in women than in men.<sup>[5,7]</sup> This marked decline has been termed “adrenopause.” DHEA and DHEAS levels are higher in men than in women at all ages.

## Mechanisms of Action

Despite the identification of high-affinity binding sites for DHEA in rat liver, T-lymphocytes, and endothelial cells, the search for a specific, cognate DHEA receptor has been unsuccessful. Multiple mechanisms of action have been proposed for DHEA. Most important among these are that DHEA can be metabolized into more potent androgens [testosterone and dihydrotestosterone (T and DHT)] and estrogens (estradiol and estrone) in the periphery, which can interact with specific androgen and estrogen receptors. DHEA itself can bind to the androgen and estrogen receptors, but its affinity is extremely low compared with those of the native ligands. It has been estimated that DHEA and DHEAS function as precursors of 50% of androgens in men, 75% of active estrogens in premenopausal women, and 100% of active estrogens in postmenopausal women.<sup>[8]</sup> Lipophilic DHEA, but not hydrophobic DHEAS, can be converted into both androgens and estrogens intracellularly in target tissues, by “intracrine” processes.<sup>[4]</sup> This conversion depends on the levels of different steroidogenic and metabolizing enzymes, and on the hormonal milieu. For example, DHEAS and sulfatase are present in high concentrations in the prostate, and the resultant metabolism of DHEA to DHT accounts for up to one-sixth of the intraprostatic DHT.<sup>[9]</sup>

DHEA can also function as a neurosteroid, by modulating neuronal growth, development, and excitability, the latter via interaction with  $\gamma$ -aminobutyric acid (GABA<sub>A</sub>), *N*-methyl-D-aspartate (NMDA), and sigma receptors.<sup>[10]</sup> It is known to be a potent inhibitor of

glucose-6-phosphate dehydrogenase (G6DPH), thus interfering with the formation of mitochondrial NADP(H) and ribose-6-phosphate and inhibiting DNA synthesis and cell proliferation.<sup>[11]</sup> The steroid hormone has also been proposed to exert antigluco-corticoid, cytokine modulatory, potassium channel and cyclic guanyl monophosphate (cGMP) stimulatory, and thermogenic effects.

## PHARMACOKINETICS

### Absorption and Tissue Distribution

While DHEA is marketed as an oral product, it has also been shown to be absorbed when administered by the transdermal, intravenous, subcutaneous, and vaginal routes. Crystalline and micronized formulations result in higher DHEAS serum concentrations, possibly due to an enhanced rate of absorption.<sup>[12]</sup> After absorption in the small intestine, DHEA is mainly sulfated in the liver. The nonoral route averts first pass liver degradation, resulting in higher serum levels. DHEA concentrations are high in the brain, with a brain-to-plasma ratio of 4–6.5 to 1,<sup>[13]</sup> and plasma, spleen, kidney, and liver concentrations follow in descending order. Cerebrospinal, salivary, and joint fluid levels are directly related to those of serum.

### Bioavailability, Metabolism, and Clearance

Pharmacokinetic studies on DHEA reveal a clearance rate compatible with a two-compartment model. The initial volume of distribution is  $17.0 \pm 3$  L. DHEA disappears from the first compartment in  $17.2 \pm 6.2$  min and from the second in  $60.2 \pm 12.3$  min.<sup>[14]</sup> DHEAS follows a one-compartment model of disappearance. Its volume of distribution is  $4.6 \pm 0.9$  L, while the half-life from that compartment is 13.7 hr.<sup>[15]</sup> In men,  $77.8 \pm 17.3\%$  of the DHEAS that enters the circulation will reappear as DHEA, while in women, it is  $60.5 \pm 8.2\%$ . The opposite conversion of DHEA to DHEAS is much smaller,  $5.2\% \pm 0.7\%$  in men, and  $6.25\% \pm 0.54\%$  in women.

Mean metabolic clearance rates (MCRs) were calculated using the constant infusion technique: The DHEA MCR is  $2050 \pm 160$  L/day in men and  $2040 \pm 160$  L/day in women, whereas the MCR for DHEAS is  $13.8 \pm 2.7$  L/day in men and  $12.5 \pm 1.0$  L/day in women. The differences in the clearance rates of DHEA and DHEAS are partly explained by different binding efficiencies with albumin. Circulating DHEA is primarily bound to albumin, with only minimal binding to sex-hormone

binding globulin (SHBG); the remaining small amount is free. There is no known specific DHEA binding protein. In comparison, DHEAS is strongly bound to albumin but not to SHBG, and an even smaller amount is protein free. Obesity results in increased MCR for DHEA from 2000 to 4000 L/day in women. A rise in MCR is also caused by insulin infusion in men.<sup>[16]</sup>

## Supplementation

Considerations related to the metabolism of DHEA become more complicated when it is administered as a dietary supplement (in the United States) or as a drug (in some other countries). The steroid is usually given orally in a single morning dose, as its constant interconversion to DHEAS and the long half-life of DHEAS make multiple dosing unnecessary. In addition, morning dosing mimics the natural rhythm of DHEA secretion. Doses ranging from 25 to 1600 mg/day have been used in different studies.

After an oral dose, the half-lives of DHEA/DHEAS are longer (24 hr) than those reported in intravenous tracer studies, which may reflect the conversion of DHEAS to DHEA.<sup>[17]</sup> Oral administration of 20–50 mg of DHEA in patients with primary or secondary adrenal insufficiency restores serum DHEA and DHEAS concentrations to the range observed in normal young subjects, while a dose of 100–200 mg/day results in supraphysiological concentrations.

Different metabolic pathways for exogenous DHEA in relation to gender and age have been reported. DHEA levels after oral administration of 25 or 50 mg DHEA for 8 days were persistently higher in women versus men.<sup>[17]</sup> Similarly, oral administration of 200 mg of micronized DHEA in single or multiple doses for 15 days in healthy adult men and women resulted in higher serum concentrations and bioavailability (measured by DHEA  $C_{max}$  and AUC) in women. The net increase in DHEAS levels was 21-fold in women and 5-fold in men.<sup>[18]</sup> The metabolic fate of exogenous DHEA also differs by gender and age. While in pre- and postmenopausal women, DHEA is mostly transformed into androgens, in men it is preferentially metabolized into estrogens. Higher serum concentrations of DHEA, testosterone, and estradiol are achieved in elderly subjects.<sup>[19]</sup>

## THERAPEUTIC APPLICATIONS

### DHEA Replacement in Adrenal Insufficiency

The strongest evidence for a beneficial effect of DHEA replacement is provided by studies of its

administration to patients with primary (Addison's disease) and secondary adrenal insufficiency. In such cases, DHEA deficiency is usually not corrected. Despite optimal glucocorticoid and mineralocorticoid replacement, however, these subjects often experience chronic fatigue, reduced sense of well being, and lack of sexual interest.

Oral administration of 50 mg/day of DHEA for 4 mo to 24 women with adrenal insufficiency increased serum levels of DHEAS, androstenedione, testosterone, and androstenediol glucuronide, and improved overall well being, mood, and sexual activity.<sup>[20]</sup> In another study of 15 men and 24 women with Addison's disease, a 3-mo administration of 50 mg/day of DHEA corrected the hormonal deficiency and improved self-esteem, while it tended to enhance overall well being, mood, and energy.<sup>[21]</sup>

### DHEA Replacement in Adrenopause and Age-Related Disorders

As noted, aging is accompanied by a profound decrease in circulating levels of DHEA and DHEAS in both sexes.<sup>[5,7]</sup> Epidemiological studies suggest an association between DHEA and DHEAS decline and the adverse effects of aging, albeit with gender differences.

One large prospective observational study showed a small, but significant, inverse correlation between serum DHEAS levels and risk of cardiovascular mortality in men at 19 yr of follow-up, whereas in women, high DHEAS levels were associated with an increased risk of cardiovascular death at 12 yr of follow-up, and this trend lost significance at 19 yr of follow-up.<sup>[22]</sup> Similar results were reported in another study of 963 men and 1171 women aged >65yr: all-cause and cardiovascular mortality were highest in men with DHEAS levels in the lowest quartile, whereas no significant association between circulating DHEAS and mortality was found in women.<sup>[23]</sup> Other studies failed to demonstrate this inverse relationship in men.<sup>[24]</sup> Positive correlations between low DHEAS levels and depressed mood and bone loss have been reported in aged women.<sup>[25]</sup> In comparison, DHEAS levels are reduced in men, with noninsulin dependent diabetes mellitus (NIDDM).<sup>[26]</sup> Reports of an association between low DHEA levels and Alzheimer's disease are conflicting.

It remains uncertain as to whether the DHEAS decline is simply a biomarker of aging, or is causally related to morbidity and mortality in the elderly. One study on the effects of a 6-mo oral administration of 50 mg/day of DHEA in 13 men and 17 women aged 40–70yr showed restoration of DHEA and DHEAS

levels to young-adult values, with improvement in physical and psychological sense of well being, but not sexual interest, in both genders. These effects were accompanied by increased serum levels of IGF-I, reduced IGF-I binding protein-1 (IGFBP-1), and a significant decrease in apolipoprotein A1 and HDL-cholesterol in women.<sup>[27]</sup> Another study using 100 mg/day of DHEA for 6 mo in 9 men and 10 women aged 50–65 yr reported decreased fat mass and enhanced muscle strength in men, whereas increased levels of downstream androgens were detected in women.<sup>[28]</sup> In a more recent study of 39 elderly men treated for 3 mo with 100 mg/day of oral DHEA, no treatment effect on body composition or subjective well being was found, whereas a significant reduction in HDL-cholesterol was reported.<sup>[29]</sup>

In 280 men and women aged 60–79 yr treated for 12 mo with 50 mg/day of oral DHEA, a slight but significant increase in bone mineral density (BMD) at the femoral neck and the radius, and an increase in serum testosterone, libido, and sexual function were observed in women.<sup>[30]</sup> Similar changes were reported in 14 women aged 60–70 years who were treated for 12 mo with a 10% DHEA skin cream. In addition to a 10-fold increase in DHEA levels, the authors described increased BMD at the hip, and decreased osteoclastic and increased osteoblastic bone markers. Other changes included improved well being, a reduced skinfold thickness, and lower blood glucose and insulin levels, with no adverse change in lipid profile.<sup>[31]</sup> DHEA replacement did not affect BMD in other studies.<sup>[28]</sup>

Little information is available about the effects of DHEA therapy on cardiovascular function and insulin sensitivity from interventional studies. DHEA facilitated fibrinolysis and inhibited platelet aggregations in humans.<sup>[32]</sup> In one study of 24 middle-aged men, administration of 25 mg/day of oral DHEA for 12 weeks decreased the plasma levels of plasminogen activator inhibitor type 1 (PAI-1), and increased dilatation of the brachial artery after transient occlusion.<sup>[33]</sup>

In rodent models of NIDDM, dietary administration of DHEA consistently induced remission of hyperglycemia and increased insulin sensitivity. Some clinical studies in aged men and women have shown improved insulin sensitivity after DHEA replacement,<sup>[31,34]</sup> whereas others have not confirmed those findings in women.<sup>[27,35]</sup>

There are few studies on the effect of DHEA on cognitive function. DHEA administration improves memory and decreases serum levels of  $\beta$ -amyloid in aging mice. In contrast, treatment with 100 mg of oral DHEA did not improve cognitive performance in patients with Alzheimer's disease.<sup>[36]</sup> Moreover, DHEA replacement did not affect memory in any of the controlled studies in healthy elderly, as previously discussed.

## Potentially Beneficial Effects of DHEA Supplementation

DHEA administration, often in large doses, has been proposed in the management of numerous disorders, including obesity, cancer, autoimmune diseases, AIDS, mood disorders, as well as in enhancing physical performance. The scientific evidence supporting the benefits of DHEA therapy in these conditions is, however, very limited.

Pharmacologic treatment with DHEA in mice genetically predisposed to become obese reduced weight gain and fat cell size. In obese rats, the steroid decreased food intake by 50%. In humans, some observational studies indicate a relationship between circulating DHEA and DHEAS levels, body mass index (BMI) and weight loss, whereas others do not confirm this.<sup>[37]</sup> Similar inconsistencies are encountered in interventional studies. Administration of a high oral dose of DHEA (1600 mg/day) decreased body fat and increased muscle mass, with no net change in body weight, in a small group of healthy young men.<sup>[38]</sup> As mentioned above, a reduction in fat mass was also reported in healthy elderly men after a 6 mo administration of 100 mg/day of DHEA,<sup>[28]</sup> whereas topical application of a 10% DHEA cream for 1 yr decreased femoral fat and skinfold thickness in postmenopausal women.<sup>[31]</sup> Other studies in healthy elderly individuals and in obese men failed to demonstrate changes in body fat after DHEA treatment.<sup>[29,35]</sup>

DHEA has been reported to exhibit chemopreventive activity in mouse and rat models, although it has also been found to be hepatocarcinogenic in rats. Epidemiological research has revealed increased DHEA levels to be associated with a rise in risk of ovarian cancer and breast cancer in postmenopausal women, whereas decreased levels are linked with increased risk of bladder, gastric, and breast cancer in premenopausal women. To date, we are unaware of clinical studies documenting the effects of DHEA intervention on cancer initiation or propagation. Fluorinated DHEA analogs that cannot be converted into androgens or estrogens appear to have antiproliferative effects and have been tested in several preclinical cancers including bowel polyposis<sup>[39]</sup> and used without side effects in doses up to 200 mg/day orally for 4 weeks.<sup>[40]</sup>

Increased antibody production in response to bacterial infections and decreased mortality from endotoxic shock were reported in DHEA-treated mice. In a study of 71 aged individuals, however, DHEA administration did not enhance antibody response to influenza vaccine.<sup>[41]</sup> In contrast, 50 mg/day of oral DHEA increased the activity of natural-killer cells by twofold, with a concomitant decrease in T-helper cells in postmenopausal women.<sup>[42]</sup> In 28 women with mild-to-moderate systemic lupus erythematosus, oral

treatment with 200 mg/day of DHEA for 3–6 mo improved well being and decreased disease activity and prednisone dosage requirements.<sup>[43]</sup> The same DHEA dose administered for 16 mo to patients with rheumatoid arthritis showed no beneficial effects.

Serum DHEA and DHEAS levels in patients infected with HIV are directly associated with CD4 cell counts and the stage and progression of the disease. This observation has stimulated self-administration of DHEA as an adjunct to antiviral treatment by AIDS patients. In the only published placebo-controlled trial of DHEA in patients with advanced HIV disease, treatment with 50 mg/day orally for 4 mo resulted in increased DHEAS levels and improved mental function, with no change in CD4 cell count.<sup>[44]</sup> These results were consistent with those from a previous open-label study in 32 HIV-positive patients treated with DHEA doses of 200–500 mg/day for 8 weeks.<sup>[45]</sup>

Studies in adults and adolescents with major depressive disorders have revealed a blunted DHEA circadian variation, with low DHEA and high cortisol/DHEA ratio at 8:00 A.M. In 22 patients with medication-free or stable major depression, supplementation with 30–90 mg/day of oral DHEA for 6 weeks decreased Hamilton depression scale scores as much as 50%.<sup>[46]</sup> Similar results were reported in a well-controlled study in 15 patients aged 45–63 yr with midlife-onset dysthymia who, after a 3-week administration of 90 mg of DHEA, reported improvements in depressive symptoms.<sup>[47]</sup>

DHEA is a popular dietary supplement among athletes. Nevertheless, at 150 mg/day orally, it did not improve body mass or strength in young male athletes and weight lifters.<sup>[48,49]</sup> In contrast, increased quadriceps and lumbar strength were reported in healthy elderly men on DHEA replacement,<sup>[28]</sup> and an increase in lean

body mass of 4.5 kg was observed in healthy young men taking 1600 mg/day of DHEA for 4 weeks.<sup>[38]</sup>

A summary of the various potential therapeutic applications of DHEA replacement/supplementation is presented in Table 2.

## CLINICAL PHARMACOLOGY AND TOXICOLOGY

### Dietary/NonDietary Sources and Available Preparations

There are no known dietary sources of DHEA, although it was suggested that the supplement chromium picolinate could stimulate endogenous DHEA secretion. The Mexican plant “wild yam” contains some natural DHEA precursors, which cannot be converted into DHEA. However, sterol extracts of “wild yam” (such as diosgenin and dioscorea) are used to produce various forms of synthetic DHEA, including tablets, capsules, injectable esters (Gynodian Depot, Schering), sublingual and vaginal preparations, topical creams, lozenges, and herbal teas. DHEA is usually sold in tablets of 5–50 mg. A pharmaceutical-grade preparation (Prestara) has been developed for potential use as a prescription drug. During the manufacture of DHEA, other steroidlike compounds, like androstenedione, may be produced and could contaminate DHEA. Moreover, the real steroid content of the DHEA preparation sold over the counter may vary from 0% to 150% of the amount claimed.<sup>[50]</sup> In addition, there is a lack of information about comparability or bioequivalence among the many products on the market or information about lot-to-lot variability of any particular product in terms of characterization (content) and standardization (contaminants).

**Table 2** Clinical conditions for which DHEA use has been proposed

Condition	Effect	References
Adrenal Insufficiency	Improved general well being, mood, sexual function	17
	No significant effects	18
Aging	Improved physical well being, bone mineral density or sexual function	24
	Decrease in HDL or no effects	25–27, 33
Autoimmune disease	Improved well being, fatigue, disease activity in SLE patients, enhanced immune response	38–40
	No effect in HIV patients	41, 42
Body composition	Decreased fat- and increased muscle mass	25, 35, 45, 46
	No changes	17, 24, 26, 32, 45, 46
Insulin resistance	Improved insulin sensitivity	28, 31
	No change	24, 32
Depression	Improved mood	43, 44
Alzheimer's disease	No effect on cognitive function	33
Cardiovascular	Improved endothelial function	30

## Dosage and Administration

There is no consensus on a recommended dietary allowance (RDA) or optimal treatment dose for DHEA. Replacement with oral doses of 20–50 mg/day for men and 10–30 mg/day for women appears adequate to achieve DHEA/DHEAS levels similar to those in young adults, as suggested by most studies in subjects with adrenal or age-related DHEA/DHEAS deficiency, though oral doses as low as 5 mg/day have been reported to be effective. Higher DHEA doses may be necessary for patients with very low endogenous DHEA levels secondary to steroid administration or chronic disease. Doses of 200–500 mg and 200 mg/day have been used in patients with HIV and systemic lupus erythematosus, respectively. Serum DHEAS levels and its androgenic and estrogenic metabolites must be closely monitored during replacement, to enable appropriate dose adjustments. Rigorous dose ranging studies are needed to determine the optimal doses to achieve a beneficial effect.

## Adverse Reactions, Long-Term Effects, and Contraindications

DHEA appears to elicit few short-term side effects when used in the recommended doses. Women may experience mild hirsutism, increased facial sebum production, and acneiform dermatitis. Circulating levels of downstream androgens rise above young-adult values in healthy elderly women treated with 100 mg/day DHEA; however, the long-term consequences of this increase are unknown. No significant changes in complete blood count, urinalysis, hepatic, and thyroid indices were found in women after 28 days of treatment with 1600 mg DHEA per day.<sup>[35]</sup> A dose escalation study of 750–2250 mg oral DHEA conducted in 31 HIV-positive men revealed no serious dose-limiting toxicity.<sup>[51]</sup>

Because of its potent androgenic and estrogenic effects, it would appear prudent to avoid DHEA replacement/supplementation in individuals with a personal or family history of breast, ovarian, or prostate cancer. This would seem especially important for postmenopausal women, considering the demonstrated direct correlation between DHEA levels and breast and ovarian cancers in this group,<sup>[39]</sup> and the reported increase with DHEA supplementation in free IGF-1.<sup>[52]</sup> Caution may also be appropriate in HIV patients, since high DHEA levels have been implicated in the pathogenesis of Kaposi's sarcoma. Moreover, increased insulin resistance and decreased cholesterol and high-density lipoproteins after administration of a high dose 1600 mg/day of DHEA for 4 weeks have been reported in aged women.<sup>[35]</sup>

DHEA administration is not recommended for people under 40 yr of age, unless there is a documented deficiency state. It should be avoided during pregnancy, lactation, and in persons younger than 18 yr, since dosage and safety of the treatment under these conditions have not been evaluated.

## Known Drug Interactions

Drugs known to interfere with DHEA and/or DHEAS include various hormone preparations, drugs acting on the CNS, cardiovascular drugs, adrenergic and adrenergic blocking agents, and anti-infective agents. Synthetic glucocorticoids such as dexamethasone are the most potent suppressors of DHEA and DHEAS. DHEA and/or DHEAS levels are known to be decreased in patients taking aromatase inhibitors, oral contraceptives, dopaminergic receptor blockers, insulin, troglitazone, and multivitamins, or fish oil. They are also decreased due to the induction of the cytochrome P450 enzymes, by carbamazepin, phenytoin, or rifampicin. Metformin (a biguanide antihyperglycemic drug) and calcium channel blockers are shown to increase DHEA and DHEAS levels. The effect of alcohol is controversial.<sup>[53]</sup>

## COMPENDIAL/REGULATORY STATUS

In the early 1980s, DHEA was widely advertised and sold in U.S. health food stores as an “antiaging,” “antiobesity,” and “anticancer” nonprescription drug. However, on the basis of unknown potential long-term risks, and following the ban by the International Olympic Committee, in 1985 the U.S. Food and Drug Administration reclassified DHEA as a prescription drug. In October 1994, the U.S. Dietary Supplement Health and Education Act allowed DHEA to be sold again as an over-the-counter dietary supplement, as long as no claims are made regarding therapeutic efficacy.

## CONCLUSIONS

Despite a large amount of research related to DHEA, and its alleged utility to sustain “eternal youth,” several key questions remain unanswered. For example, the physiologic function(s), regulation, and mechanisms of actions of DHEA remain unknown, and a causal link between age-related declines in DHEA and adverse effects of aging has not been proven. Results from clinical studies suggest that DHEA may be beneficial in some patients with adrenal insufficiency, whereas those from intervention studies in healthy aged people have been inconclusive, save for

some modest gender differences in selected outcome measures. Well-characterized and standardized products need to be evaluated for safety and efficacy, starting with dose ranging to determine an optimal dose. Because DHEA can be converted to estrogen and testosterone, its potential adverse effects in patients with breast or prostate cancer need to be determined. Long-term, well-designed clinical studies, with clear end points, will be necessary before the beneficial and/or detrimental effects of "replacement" or "pharmacological" DHEA therapies in human aging and disease can be firmly established.

## REFERENCES

1. Vermeulen, A. Androgen secretion after age 50 in both sexes. *Horm. Res.* **1983**, *18* (1–3), 37–42.
2. Baulieu, E.E.; Robel, P. Dehydroepiandrosterone (DHEA) and dehydroepiandrosterone sulfate (DHEAS) as neuroactive neurosteroids. *Proc. Natl. Acad. Sci. U.S.A.* **1998**, *95* (8), 4089–4091.
3. Alesci, S.; Bornstein, S.R. Neuroimmunoregulation of androgens in the adrenal gland and the skin. *Horm. Res.* **2000**, *54* (5–6), 281–286.
4. Labrie, F.; Luu-The, V.; Labrie, C.; Pelletier, G.; El-Alfy, M. Intracrinology and the skin. *Horm. Res.* **2000**, *54* (5–6), 218–229.
5. Alesci, S.; Bornstein, S.R. Intraadrenal mechanisms of DHEA regulation: a hypothesis for adrenopause. *Exp. Clin. Endocrinol. Diabetes* **2001**, *109* (2), 75–82.
6. Parker, L.N.; Sack, J.; Fisher, D.A.; Odell, W.D. The adrenarche: prolactin, gonadotropins, adrenal androgens, and cortisol. *J. Clin. Endocrinol. Metab.* **1978**, *46* (3), 396–401.
7. Blackman, M.R.; Elahi, D.; Harman, S.M. Endocrinology and aging. In *Endocrinology*, 3rd Ed.; DeGroot, L., Ed.; W.B. Saunders Co.: Philadelphia, 1995, Chapter 147; 2702–2730.
8. Labrie, F.; Belanger, A.; Cusan, L.; Gomez, J.L.; Candas, B. Marked decline in serum concentrations of adrenal C19 sex steroid precursors and conjugated androgen metabolites during aging. *J. Clin. Endocrinol. Metab.* **1997**, *82* (8), 2396–2402.
9. Klein, H.; Bressel, M.; Kastendieck, H.; Voigt, K.D. Quantitative assessment of endogenous testicular and adrenal sex steroids and of steroid metabolizing enzymes in untreated human prostatic cancerous tissue. *J. Steroid Biochem.* **1988**, *30* (1–6), 119–130.
10. Rupprecht, R.; Holsboer, F. Neuroactive steroids: mechanisms of action and neuropsychopharmacological perspectives. *Trends Neurosci.* **1999**, *22* (9), 410–416.
11. Schwartz, A.G.; Pashko, L.L. Mechanism of cancer preventive action of DHEA. Role of glucose-6-phosphate dehydrogenase. *Ann. N. Y. Acad. Sci.* **1995**, *774*, 180–186.
12. Casson, P.R.; Straughn, A.B.; Umstot, E.S.; Abraham, G.E.; Carson, S.A.; Buster, J.E. Delivery of dehydroepiandrosterone to premenopausal women: effects of micronization and nonoral administration. *Am. J. Obstet. Gynecol.* **1996**, *174* (2), 649–653.
13. Robel, P.; Baulieu, E.E. Dehydroepiandrosterone (DHEA) is a neuroactive neurosteroid. *Ann. N. Y. Acad. Sci.* **1995**, *774*, 82–110.
14. Wang, D.Y.; Bulbrook, R.D.; Sneddon, A.; Hamilton, T. The metabolic clearance rates of dehydroepiandrosterone, testosterone and their sulphate esters in man, rat and rabbit. *J. Endocrinol.* **1967**, *38* (3), 307–318.
15. de Peretti, E.; Forest, M.G. Pattern of plasma dehydroepiandrosterone sulfate levels in humans from birth to adulthood: evidence for testicular production. *J. Clin. Endocrinol. Metab.* **1978**, *47* (3), 572–577.
16. Nestler, J.E. Regulation of human dehydroepiandrosterone metabolism by insulin. *Ann. N. Y. Acad. Sci.* **1995**, *774*, 73–81.
17. Legrain, S.; Massien, C.; Lahlou, N.; Roger, M.; Debuire, B.; Diquet, B.; Chatellier, G.; Azizi, M.; Faucounau, V.; Porchet, H.; Forette, F.; Baulieu, E.E. Dehydroepiandrosterone replacement administration: pharmacokinetic and pharmacodynamic studies in healthy elderly subjects. *J. Clin. Endocrinol. Metab.* **2000**, *85* (9), 3208–3217.
18. Frye, R.F.; Kroboth, P.D.; Kroboth, F.J.; Stone, R.A.; Folan, M.; Salek, F.S.; Pollock, B.G.; Linares, A.M.; Hakala, C. Sex differences in the pharmacokinetics of dehydroepiandrosterone (DHEA) after single- and multiple-dose administration in healthy older adults. *J. Clin. Pharmacol.* **2000**, *40* (6), 596–605.
19. Valenti, G.; Banchini, A.; Denti, L.; Maggio, M.; Ceresini, G.; Ceda, G.P. Acute oral administration of dehydroepiandrosterone in male subjects: effect of age on bioavailability, sulfoconjugation and bioconversion in other steroids. *J. Endocrinol. Invest.* **1999**, *22* (Suppl. 10), 24–28.
20. Arlt, W.; Callies, F.; van Vlijmen, J.C.; Koehler, I.; Reincke, M.; Bidlingmaier, M.; Huebler, D.; Oettel, M.; Ernst, M.; Schulte, H.M.; Allolio, B. Dehydroepiandrosterone replacement in women with adrenal insufficiency. *N. Engl. J. Med.* **1999**, *341* (14), 1013–1020.
21. Hunt, P.J.; Gurnell, E.M.; Huppert, F.A.; Richards, C.; Prevost, A.T.; Wass, J.A.; Herbert, J.; Chatterjee, V.K. Improvement in mood and

- fatigue after dehydroepiandrosterone replacement in Addison's disease in a randomized, double blind trial. *J. Clin. Endocrinol. Metab.* **2000**, *85* (12), 4650–4656.
22. Barrett-Connor, E.; Goodman-Gruen, D. The epidemiology of DHEAS and cardiovascular disease. *Ann. N. Y. Acad. Sci.* **1995**, *774*, 259–270.
  23. Trivedi, D.P.; Khaw, K.T. Dehydroepiandrosterone sulfate and mortality in elderly men and women. *J. Clin. Endocrinol. Metab.* **2001**, *86* (9), 4171–4177.
  24. LaCroix, A.Z.; Yano, K.; Reed, D.M. Dehydroepiandrosterone sulfate, incidence of myocardial infarction, and extent of atherosclerosis in men. *Circulation* **1992**, *86* (5), 1529–1535.
  25. Greendale, G.A.; Edelstein, S.; Barrett-Connor, E. Endogenous sex steroids and bone mineral density in older women and men: the Rancho Bernardo study. *J. Bone Miner. Res.* **1997**, *12* (11), 1833–1843.
  26. Barrett-Connor, E. Lower endogenous androgen levels and dyslipidemia in men with non-insulin-dependent diabetes mellitus. *Ann. Intern. Med.* **1992**, *117* (10), 807–811.
  27. Morales, A.J.; Nolan, J.J.; Nelson, J.C.; Yen, S.S. Effects of replacement dose of dehydroepiandrosterone in men and women of advancing age. *J. Clin. Endocrinol. Metab.* **1994**, *78* (6), 1360–1367.
  28. Morales, A.J.; Haubrich, R.H.; Hwang, J.Y.; Asakura, H.; Yen, S.S. The effect of six months treatment with a 100 mg daily dose of dehydroepiandrosterone (DHEA) on circulating sex steroids, body composition and muscle strength in age-advanced men and women. *Clin. Endocrinol. (Oxf.)* **1998**, *49* (4), 421–432.
  29. Flynn, M.A.; Weaver-Osterholtz, D.; Sharpe-Timms, K.L.; Allen, S.; Krause, G. Dehydroepiandrosterone replacement in aging humans. *J. Clin. Endocrinol. Metab.* **1999**, *84* (5), 1527–1533.
  30. Baulieu, E.E.; Thomas, G.; Legrain, S.; Lahlou, N.; Roger, M.; Debuire, B.; Faucounau, V.; Girard, L.; Hervy, M.P.; Latour, F.; Leaud, M.C.; Mokrane, A.; Pitti-Ferrandi, H.; Trivalle, C.; de Lacharriere, O.; Nouveau, S.; Rakoto-Arison, B.; Souberbielle, J.C.; Raison, J.; Le Bouc, Y.; Raynaud, A.; Girerd, X.; Forette, F. Dehydroepiandrosterone (DHEA), DHEA sulfate, and aging: contribution of the DHEAge Study to a sociobiomedical issue. *Proc. Natl. Acad. Sci. U.S.A.* **2000**, *97* (8), 4279–4284.
  31. Labrie, F.; Diamond, P.; Cusan, L.; Gomez, J.L.; Belanger, A.; Candas, B. Effect of 12-month dehydroepiandrosterone replacement therapy on bone, vagina, and endometrium in postmenopausal women. *J. Clin. Endocrinol. Metab.* **1997**, *82* (10), 3498–3505.
  32. Beer, N.A.; Jakubowicz, D.J.; Matt, D.W.; Beer, R.M.; Nestler, J.E. Dehydroepiandrosterone reduces plasma plasminogen activator inhibitor type 1 and tissue plasminogen activator antigen in men. *Am. J. Med. Sci.* **1996**, *311* (5), 205–210.
  33. Kawano, H.; Yasue, H.; Kitagawa, A.; Hirai, N.; Yoshida, T.; Soejima, H.; Miyamoto, S.; Nakano, M.; Ogawa, H. Dehydroepiandrosterone supplementation improves endothelial function and insulin sensitivity in men. *J. Clin. Endocrinol. Metab.* **2003**, *88* (7), 3190–3195.
  34. Lasco, A.; Frisina, N.; Morabito, N.; Gaudio, A.; Morini, E.; Trifiletti, A.; Basile, G.; Nicita-Mauro, V.; Cucinotta, D. Metabolic effects of dehydroepiandrosterone replacement therapy in postmenopausal women. *Eur. J. Endocrinol.* **2001**, *145* (4), 457–461.
  35. Mortola, J.F.; Yen, S.S. The effects of oral dehydroepiandrosterone on endocrine-metabolic parameters in postmenopausal women. *J. Clin. Endocrinol. Metab.* **1990**, *71* (3), 696–704.
  36. Wolkowitz, O.M.; Kramer, J.H.; Reus, V.I.; Costa, M.M.; Yaffe, K.; Walton, P.; Raskind, M.; Peskind, E.; Newhouse, P.; Sack, D.; De Souza, E.; Sadowsky, C.; Roberts, E. DHEA treatment of Alzheimer's disease: a randomized, double-blind, placebo-controlled study. *Neurology* **2003**, *60* (7), 1071–1076.
  37. Williams, J.R. The effects of dehydroepiandrosterone on carcinogenesis, obesity, the immune system, and aging. *Lipids* **2000**, *35* (3), 325–331.
  38. Nestler, J.E.; Barlascini, C.O.; Clore, J.N.; Blackard, W.G. Dehydroepiandrosterone reduces serum low density lipoprotein levels and body fat but does not alter insulin sensitivity in normal men. *J. Clin. Endocrinol. Metab.* **1988**, *66* (1), 57–61.
  39. Johnson, M.D.; Bebb, R.A.; Sirrs, S.M. Uses of DHEA in aging and other disease states. *Ageing Res. Rev.* **2002**, *1* (1), 29–41.
  40. Davidson, M.; Marwah, A.; Sawchuk, R.J.; Maki, K.; Marwah, P.; Weeks, C.; Lardy, H. Safety and pharmacokinetic study with escalating doses of 3-acetyl-7-oxo-dehydroepiandrosterone in healthy male volunteers. *Clin. Invest. Med.* **2000**, *23* (5), 300–310.
  41. Danenberg, H.D.; Ben-Yehuda, A.; Zakay-Rones, Z.; Gross, D.J.; Friedman, G. Dehydroepiandrosterone treatment is not beneficial to the immune response to influenza in elderly subjects. *J. Clin. Endocrinol. Metab.* **1997**, *82* (9), 2911–2914.
  42. Casson, P.R.; Andersen, R.N.; Herrod, H.G.; Stentz, F.B.; Straughn, A.B.; Abraham, G.E.; Buster, J.E. Oral dehydroepiandrosterone in physiologic doses modulates immune function in



- postmenopausal women. *Am. J. Obstet. Gynecol.* **1993**, *169* (6), 1536–1539.
43. Kroboth, P.D.; Salek, F.S.; Pittenger, A.L.; Fabian, T.J.; Frye, R.F. DHEA and DHEA-S: a review. *J. Clin. Pharmacol.* **1999**, *39* (4), 327–348.
  44. Piketty, C.; Jayle, D.; Lepage, A.; Castiel, P.; Ecosse, E.; Gonzalez-Canali, G.; Sabatier, B.; Boule, N.; Debuire, B.; Le Bouc, Y.; Baulieu, E.E.; Kazatchkine, M.D. Double-blind placebo-controlled trial of oral dehydroepiandrosterone in patients with advanced HIV disease. *Clin. Endocrinol. (Oxf.)* **2001**, *55* (3), 325–330.
  45. Rabkin, J.G.; Ferrando, S.J.; Wagner, G.J.; Rabkin, R. DHEA treatment for HIV + patients: effects on mood, androgenic and anabolic parameters. *Psychoneuroendocrinology* **2000**, *25* (1), 53–68.
  46. Wolkowitz, O.M.; Reus, V.I.; Keebler, A.; Nelson, N.; Friedland, M.; Brizendine, L.; Roberts, E. Double-blind treatment of major depression with dehydroepiandrosterone. *Am. J. Psychiatry* **1999**, *156* (4), 646–649.
  47. Bloch, M.; Schmidt, P.J.; Danaceau, M.A.; Adams, L.F.; Rubinow, D.R. Dehydroepiandrosterone treatment of midlife dysthymia. *Biol. Psychiatry* **1999**, *45* (12), 1533–1541.
  48. Wallace, M.B.; Lim, J.; Cutler, A.; Bucci, L. Effects of dehydroepiandrosterone vs. androstenedione supplementation in men. *Med. Sci. Sports Exerc.* **1999**, *31* (12), 1788–1792.
  49. Brown, G.A.; Vukovich, M.D.; Sharp, R.L.; Reifenrath, T.A.; Parsons, K.A.; King, D.S. Effect of oral DHEA on serum testosterone and adaptations to resistance training in young men. *J. Appl. Physiol.* **1999**, *87* (6), 2274–2283.
  50. Parasrampur, J.; Schwartz, K.; Petesch, R. Quality control of dehydroepiandrosterone dietary supplement products. *J. Am. Med. Assoc.* **1998**, *280* (18), 1565.
  51. Dyner, T.S.; Lang, W.; Geaga, J.; Golub, A.; Stites, D.; Winger, E.; Galmarini, M.; Masterson, J.; Jacobson, M.A. An open-label dose-escalation trial of oral dehydroepiandrosterone tolerance and pharmacokinetics in patients with HIV disease. *J. Acquir. Immune Defic. Syndr.* **1993**, *6* (5), 459–465.
  52. Genazzani, A.D.; Stomati, M.; Strucchi, C.; Puccetti, S.; Luisi, S.; Genazzani, A.R. Oral dehydroepiandrosterone supplementation modulates spontaneous and growth hormone-releasing hormone-induced growth hormone and insulin-like growth factor-1 secretion in early and late postmenopausal women. *Fertil. Steril.* **2001**, *76* (2), 241–248.
  53. Salek, F.S.; Bigos, K.L.; Kroboth, P.D. The influence of hormones and pharmaceutical agents on DHEA and DHEA-S concentrations: a review of clinical studies. *J. Clin. Pharmacol.* **2002**, *42* (3), 247–266.

# Echinacea

Rudolf Bauer

Karin Woelkart

Institute of Pharmaceutical Sciences, Karl-Franzens-University Graz,  
Graz, Austria

## INTRODUCTION

*Echinacea* is a herbal medicine that has been used for centuries, customarily as a treatment for common cold, coughs, bronchitis, upper respiratory infections (URIs), and inflammatory conditions. It belongs to Heliantheae tribe of the Asteraceae (Compositae) family, and the nine species of these perennial North American wildflowers have a widespread distribution over prairies, plains, and wooded areas.

## BACKGROUND

Three species of *Echinacea* are used medicinally: *E. purpurea* (Fig. 1), *E. pallida* (Fig. 2), and *E. angustifolia* (Fig. 3). In the United States of America, *Echinacea* preparations have been the best selling herbal products in health food stores. However, an analysis reveals that completely different preparations are sold under the name *Echinacea*.<sup>[1]</sup> The most investigated preparation, which is mainly available on the German market, contains the expressed juice of *E. purpurea* aerial parts. Besides this, hydroalcoholic tinctures of *E. purpurea* aerial parts and roots, as well as from *E. pallida* and *E. angustifolia* roots, can be found.<sup>[2,3]</sup> In North America especially, it is also common to sell encapsulated powders from aerial parts and roots of the three species.

Despite the popularity of the herb and the fact that over 400 scientific papers have been published about its ability to “boost the immune system” both in vitro and in vivo, its molecular mode of action is still not fully understood. At least it is evident that *Echinacea* preparations can enhance phagocytosis and stimulate

the production of cytokines in macrophages, meaning that they preferentially stimulate the nonspecific immune system. It is apparent that the multiplicity and diversity of parts of various plants, methods of extraction, and solvent used, as well as the components on which the extracts have been standardized, have hampered recommendations regarding *Echinacea* usage.

Several reviews on the evidence regarding the effectiveness of orally ingested *Echinacea* extracts in reducing the incidence, severity, or duration of acute URIs have been published. So far, nine controlled treatment trials and four prevention trials have been performed with *Echinacea* preparations. Seven of the treatment trials reviewed by Barrett reported generally positive results, and three of the prevention trials marginal benefit.<sup>[4]</sup> More recently, the clinical effect of a preparation from *E. purpurea*, standardized on alkamides, cichoric acid, and polysaccharides, has been confirmed. It is apparent from this study that early intervention with *Echinacea* could potentially reduce the indirect cost of a cold in terms of workplace absenteeism and performance.<sup>[5]</sup> Clinical efficacy has been approved by the German Commission E for the expressed juice of the aerial parts of *E. purpurea* in the adjuvant therapy of relapsing infections of the respiratory and urinary tracts, as well as for the alcoholic tincture of *E. pallida* roots as adjuvants in the treatment of common cold and flu.<sup>[6]</sup>

The regulatory status of *Echinacea* products is variable. In the United States of America, they are considered as dietary supplements; in Canada, as Natural Health Products (NHPs); and in several European countries, they have drug status.

## HISTORICAL AND BOTANICAL ASPECTS OF ECHINACEA SPECIES

The genus *Echinacea* (Asteraceae) is endemic to North America, where it grows in the Great Plains between the Appalachian Mountains in the east and the Rocky Mountains in the west.<sup>[7]</sup> The medicinal application of *Echinacea* can be traced back to the Native Americans,

Rudolf Bauer, Ph.D., is at the Department of Pharmacognosy, Institute of Pharmaceutical Sciences, Karl-Franzens-University Graz, Graz, Austria.

Karin Woelkart is at the Department of Pharmacognosy, Institute of Pharmaceutical Sciences, Karl-Franzens-University Graz, Graz, Austria.



**Fig. 1** *Echinacea purpurea*. (View this art in color at [www.dekker.com](http://www.dekker.com).)

who regarded it as one of the most favorable remedies for treating wounds, snakebites, headache, and common cold. The territories of the tribes that most frequently used *Echinacea* show a close correspondence with the distribution range of *E. angustifolia*, *E. pallida*, and *E. purpurea*. But, possibly, other *Echinacea* species have also been used.<sup>[8]</sup> In the second half of the

19th century, European settlers took over the use of the plant. When the monograph on *Echinacea* in the National Formulary of the U.S. was published in 1916, the roots of both *E. angustifolia* and *E. pallida* were officially included, with the result that differentiation between these two species was often neglected later on. The use of the aerial parts of *E. purpurea* has primarily become prevalent in Europe over the last 60 yr. The taxonomy of the genus *Echinacea* has been studied intensively by McGregor,<sup>[9]</sup> who accepted nine species and two varieties. Only recently, Binns et al. reported a taxonomic revision of the genus *Echinacea* mainly from a morphological view point.<sup>[10]</sup> The fact that *E. purpurea* is quite different from the other species, led to the creation of a special subgenus “*echinacea*.” In addition, they assigned *E. pallida*, *E. atrorubens*, and *E. laevigata* to the subgenus “*pallida*.” The other species described by McGregor<sup>[9]</sup> have been determined as varieties from *E. pallida* or *E. atrorubens*. However, the new system is not widely accepted, and the taxonomic classification by McGregor is still used.

#### **ACTIVE PRINCIPLES, PHARMACOLOGICAL EFFECTS, AND STANDARDIZATION**

The constituents of *Echinacea*, as in any other plant, cover a wide range of polarity, ranging from the polar polysaccharides and glycoproteins, via the moderately polar caffeic acid derivatives, to the rather lipophilic polyacetylenes and alkamides. This makes it necessary



**Fig. 2** *Echinacea pallida*. (View this art in color at [www.dekker.com](http://www.dekker.com).)



**Fig. 3** *Echinacea angustifolia*. (View this art in color at [www.dekker.com](http://www.dekker.com).)

to study separately the activity of different polar extracts of *Echinacea*, such as aqueous preparations, alcoholic tinctures, and hexane or chloroform extracts.

### **Polysaccharides and Glycoproteins**

Systematic fractionation and subsequent pharmacological testing of the aqueous extracts of the aerial parts of *E. purpurea* led to the isolation of two polysaccharides (PS I and PS II) with immunostimulatory properties. They were shown to stimulate phagocytosis in vitro and in vivo, and enhance the production of oxygen radicals by macrophages in a dose dependent way. Structural analysis showed PS I to be a 4-*O*-methylglucuronarabinoxylan with an average MW of 35,000 Da, while PS II was demonstrated to be an acidic arabinorhamnogalactan of MW 45,000 Da. A xyloglucan, MW 79,500 Da, was isolated from the leaves and stems of *E. purpurea*, and a pectin-like polysaccharide from the expressed juice.<sup>[11]</sup> Polysaccharides from *E. angustifolia* have also been found to possess

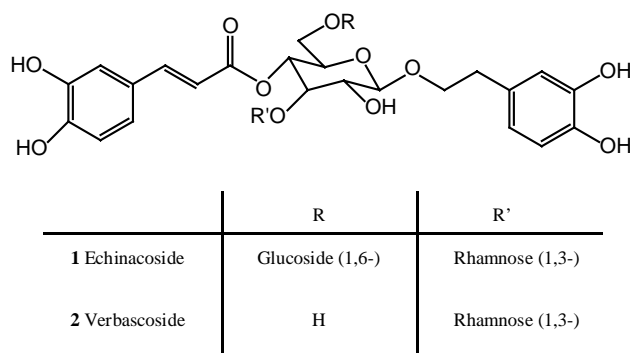
anti-inflammatory activity.<sup>[12]</sup> In a Phase-I clinical trial, a polysaccharide fraction (EPO VIIa), isolated from *E. purpurea* tissue culture and injected at doses of 1 and 5 mg, caused an increase in the number of leukocytes, segmented granulocytes, and TNF- $\alpha$ .<sup>[13]</sup> Three glycoproteins, MW 17,000, 21,000, and 30,000 Da, containing about 3% protein, have been isolated from *E. angustifolia* and *E. purpurea* roots. The dominant sugars were found to be arabinose (64–84%), galactose (1.9–5.3%), and glucosamines (6%). The protein moiety contained high amounts of aspartate, glycine, glutamate, and alanine.<sup>[14]</sup> An ELISA method has been developed for the detection and determination of these glycoproteins in *Echinacea* preparations.<sup>[15]</sup> *E. angustifolia* and *E. purpurea* roots contain similar amounts of glycoproteins, while *E. pallida* has less.<sup>[14]</sup> Purified extracts containing these glycoprotein–polysaccharide complexes exhibited B-cell stimulating activity and induced the release of interleukin-1 (IL-1), TNF- $\alpha$  and interferon- $\alpha,\beta$  (IFN- $\alpha,\beta$ ) in macrophages, which could also be reproduced in vivo in mice.<sup>[14]</sup>

Recently, Alban et al.<sup>[16]</sup> demonstrated stimulation of the classical pathway (CP) and alternative pathway (AP) of the complement system in human serum by an arabinogalactan-protein type II isolated from pressed juice of the aerial parts of *E. purpurea*. In a study performed later, the influence of an oral administration of a herbal product, consisting of an aqueous-ethanolic extract of the mixed herbal drugs *Thujae* summitates, *Baptisiae tinctoriae* radix, *E. purpureae* radix, and *E. pallidae* radix, standardized on *Echinacea* glycoproteins, on cytokine induction and antibody response against sheep red blood cells was investigated by Bodinet et al.<sup>[17]</sup> in mice. This administration caused a significant enhancement of the antibody response against sheep red blood cells, inducing an increase in the numbers of splenic plaque forming cells and the titers of specific antibodies in the sera of the treated animals.<sup>[17]</sup>

The influence of the same extract on the course of Influenza A virus infection in Balb/c mice was also tested. The data show that the oral treatment with this aqueous-ethanolic extract induced a statistically significant increase in the survival rate, prolonged the mean survival time, and reduced lung consolidation and virus titer.<sup>[18]</sup> Recently, Hwang, Dasgupta, and Actor<sup>[19]</sup> showed that macrophages respond to purified polysaccharide and also alkamide preparations. Adherent and nonadherent mouse splenocyte populations were incubated in vitro with *E. purpurea* liquid extract (fresh *Echinacea* root juice, mature seed, fresh leaf, and fresh fruit juice extracted in 40–50% alcohol), or with water or absolute alcohol (25 mg dry powder/ml of solvent) soluble *E. purpurea* dried root and leaf extract preparations. Whole splenocyte populations were capable of producing significant amounts of IL-6 in response to *E. purpurea* water preparations. Likewise, the water soluble extract of *E. purpurea* was able to stimulate nonadherent splenocyte populations to produce tumor necrosis factor- $\alpha$  (TNF- $\alpha$ ), IL-10, and macrophage inflammatory protein-1 $\alpha$  (MIP-1 $\alpha$ ) from nonadherent splenocytes. But only significant concentrations of TNF- $\alpha$  and MIP-1 $\alpha$  mediators were produced from adherent populations at similar dose concentrations. The immune stimulatory ability of components contained within *Echinacea* extracts offers insight into possible therapeutic potential to regulate nonadherent lymphocytes in immune responses and activation events.

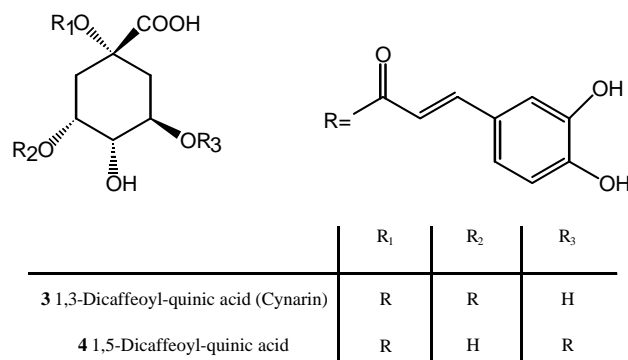
### Caffeic Acid Derivatives

Alcoholic tinctures of *Echinacea* aerial parts and roots are likely to contain caffeic acid derivatives (see Figs. 4–6). Extracts of different species and plant parts of *Echinacea* can be distinguished by thin layer chromatography (TLC) or high-performance liquid



**Fig. 4** Main phenylpropanoid glycosides found in *Echinacea* species.

chromatography (HPLC) analysis.<sup>[2]</sup> Also, capillary electrophoresis [micellar electrokinetic chromatography (MEKC)] has been successfully applied for the analysis of caffeic acid derivatives in *Echinacea* extracts and enables the discrimination of the species.<sup>[20]</sup> The roots of *E. angustifolia* and *E. pallida* have been shown to contain 0.3–1.7% echinacoside (1).<sup>[2]</sup> Both species can be discriminated by the occurrence of 1,3- and 1,5-*O*-dicafeoyl-quinic acids (3, 4), which are only present in the roots of *E. angustifolia*. Echinacoside has antioxidant,<sup>[21]</sup> low antibacterial, and antiviral activity, but does not show immunostimulatory effects.<sup>[11]</sup> It is also reported that echinacoside inhibits hyaluronidase<sup>[22]</sup> and protects collagen type III from free radical induced degradation in vitro.<sup>[23]</sup> The aerial parts of *E. angustifolia* and *E. pallida* have been shown to contain verbascoside (2), a structural analog of echinacoside (1). The roots of *E. purpurea* do not contain echinacoside, but cichoric acid (2*R*,3*R*-dicafeoyl tartaric acid; 6) and caftaric acid (monocaffeoyl tartaric acid; 5). Cichoric acid (6) is also the major polar constituent in the aerial parts of *Echinacea* species. Echinacoside (1) and cichoric acid (6) have also been produced in tissue cultures of *E. purpurea* and *E. angustifolia*.<sup>[11]</sup> The latter acid (6)



**Fig. 5** Quinic acid derivatives from *Echinacea* species.

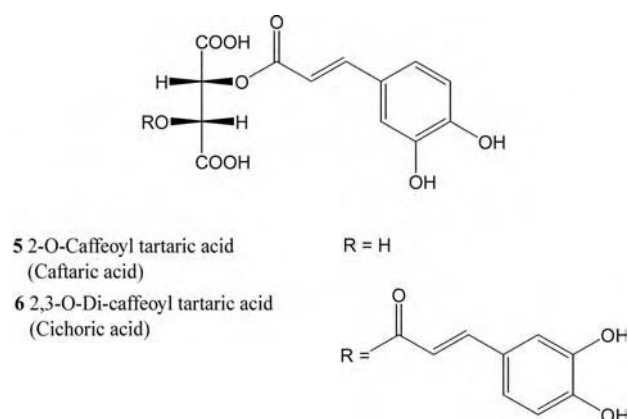


Fig. 6 Tartaric acid derivatives from *Echinacea* species.

has been shown to possess phagocytosis stimulatory activity in vitro and in vivo, while echinacoside (1), verbascoside (2), and 2-caffeoyl-tartaric acid (5) did not exhibit this activity.<sup>[11]</sup> Robinson described cichoric acid as an inhibitor of human immunodeficiency virus type 1 (HIV-1) integrase.<sup>[24]</sup> It is especially abundant in the flowers of all *Echinacea* species and the roots of *E. purpurea* (1.2–3.1% and 0.6–2.1%, respectively). Much less is present in the leaves and stems. *E. angustifolia* contains the lowest amount of cichoric acid.<sup>[2]</sup> The content, however, strongly depends on the season and the stage of development of the plant and is highest at the beginning of the vegetation period and decreases during plant growth.<sup>[25]</sup> It undergoes enzymatic degradation during preparation of alcoholic tinctures and pressed juices of *Echinacea*.<sup>[7]</sup> Nüsslein et al. found that polyphenol oxidases (PPO) are responsible for the oxidative degradation of exogenous and endogenous caffeic acid derivatives.<sup>[26,27]</sup> Apart from cichoric acid, echinacoside (1) and cynarin (3) from *E. angustifolia* roots are also highly susceptible to enzymatic degradation and oxidation in hydroalcoholic solutions during the extraction process. During the 16 days after extraction of *E. angustifolia* roots with 60% (v/v)

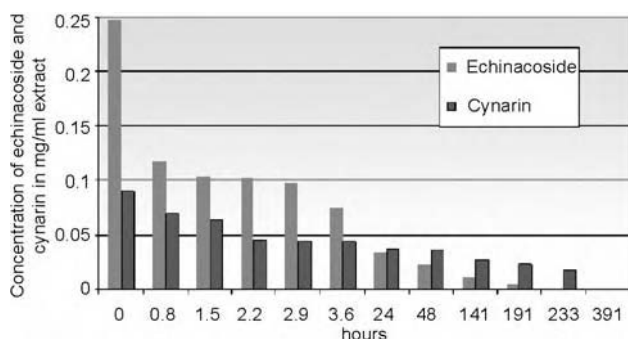


Fig. 7 Content of echinacoside and cynarin in 60% EtOH *E. angustifolia* root extract, during storage at 4°C over 16 days.

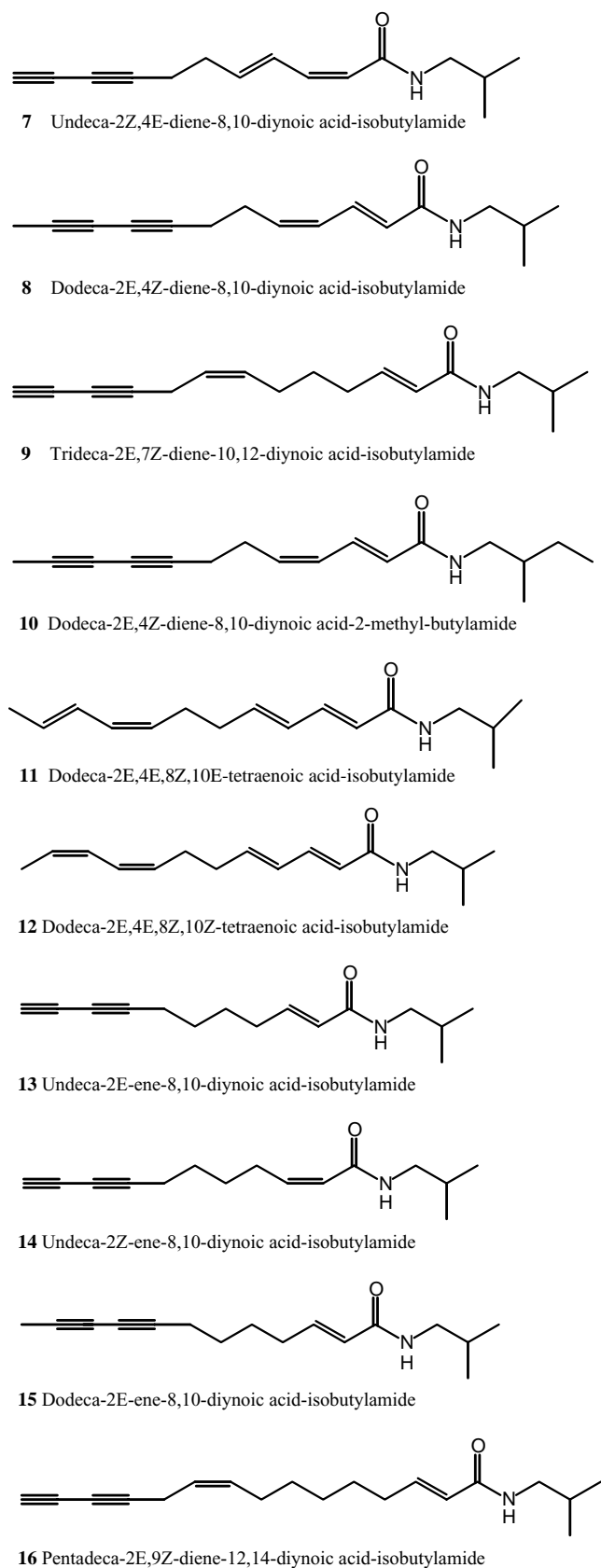
ethanol/water and storage at 4°C, a decline to 0 was observed in the content of echinacoside (1) and cynarin (3) from 0.25 mg/ml extract and 0.09 mg/ml extract, respectively (see Fig. 7).<sup>[28]</sup> In order to standardize *Echinacea* preparations and guarantee a consistent content of caffeic acid derivatives, it is vital to control this enzymatic activity.

## Alkamides

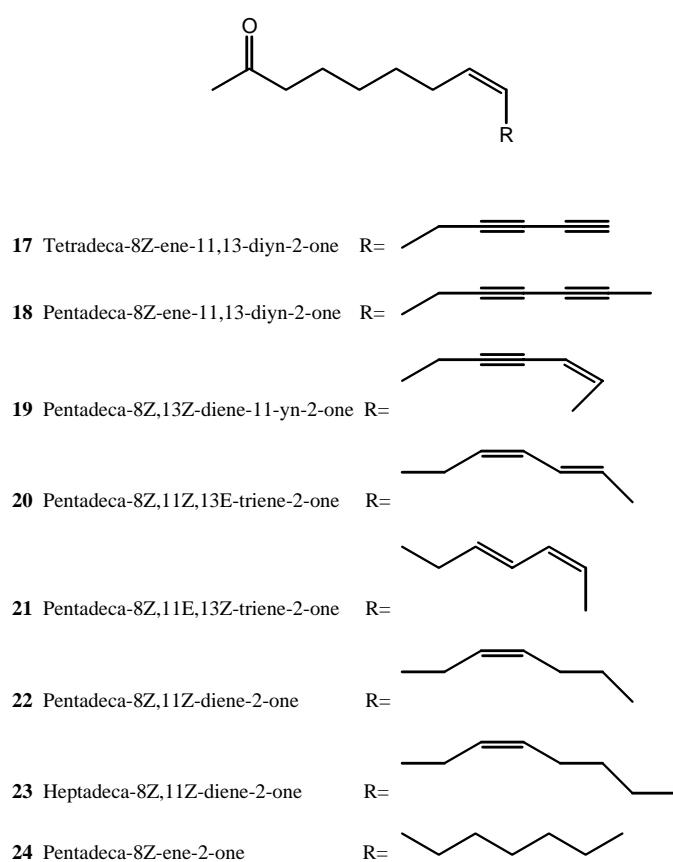
Striking differences have been observed between the lipophilic constituents of *E. angustifolia* (alkamides; see Fig. 8) and *E. pallida* roots (ketoalkynes; see Fig. 9). *E. purpurea* roots also contain alkamides, however, mainly with two double bonds in conjugation to the carbonyl group, while *E. angustifolia* primarily has compounds with a 2-monoene chromophore. The chief lipophilic constituents of *E. pallida* roots have been identified as ketoalkenes and ketoalkynes with a carbonyl group in the 2-position.<sup>[2]</sup> The main components are tetradeca-8Z-ene-11,13-diyn-2-one (17), pentadeca-8Z-ene-11,13-diyn-2-one (18), pentadeca-8Z,13Z-diene-11-yn-2-one (19), pentadeca-8Z,11Z,13E-triene-2-one (20), pentadeca-8Z,11E,13Z-triene-2-one (21), and pentadeca-8Z,11Z-diene-2-one (22). They occur only in trace amounts in *E. angustifolia* and *E. purpurea* roots. Therefore, they are suitable as markers for the identification of *E. pallida* roots. However, it has been observed that these compounds undergo auto-oxidation when the roots are stored in powdered form. Then, the hydroxylated artifacts, 8-hydroxy-9E-ene-11,13-diyn-2-one (25), 8-hydroxy-pentadeca-9E-ene-11,13-diyn-2-one (26), and 8-hydroxy-pentadeca-9E,13Z-diene-11-yn-2-one (27), can be primarily found (see Fig. 10), often with only small residual quantities of the native compounds. Hence, the roots of *E. pallida* are best stored in whole form.

About 15 alkamides have been identified as important lipophilic constituents of *E. angustifolia* roots. They are mainly derived from undeca- and dodecanoic acid, and differ in the degree of unsaturation and the configuration of the double bonds (see Fig. 8). The main structural type is a 2-monoene-8,10-diynoic acid isobutylamide, and some 2'-methyl-butylamides have also been found. In *E. purpurea* roots, 11 alkamides have been identified with the isomeric mixture of dodeca-2E,4E,8Z,10E/Z-tetraenoic acid isobutylamides (11, 12) as the major compounds.<sup>[11]</sup>

The aerial parts of all three *Echinacea* species contain alkamides of the type found in *E. purpurea* roots, and also with dodeca-2E,4E,8Z,10E/Z-tetraenoic acid isobutylamides (11, 12) as the main constituents.<sup>[2]</sup> When testing the alcoholic extracts obtained from the aerial parts and from the roots for phagocytosis stimulating activity, the lipophilic fractions showed the

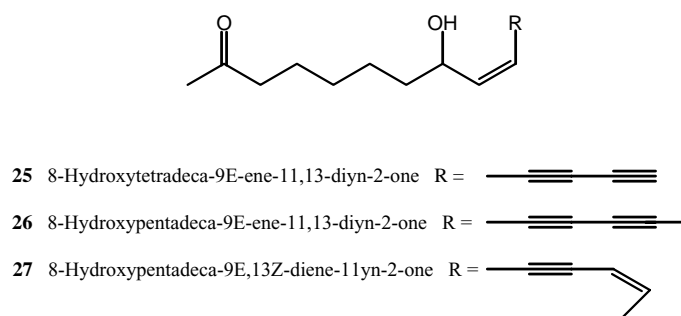


**Fig. 8** Main alkamides found in *Echinacea* aerial parts and *E. purpurea* and *E. angustifolia* roots.



**Fig. 9** Ketoalkenes and ketoalkynes found in *E. pallida* roots.

highest activity, indicating that they represent an active principle. Ethanolic extracts of the aerial parts of *E. angustifolia* and *E. purpurea* displayed immunomodulating activity on the phagocytic, metabolic, and bactericidal activities of peritoneal macrophages in mice.<sup>[11]</sup> Purified fractions from *E. purpurea* and *E. angustifolia* roots were shown to enhance phagocytosis in mice by a factor of 1.5–1.7.<sup>[23]</sup> Alkamides also displayed moderate inhibitory activity in vitro in the 5-lipoxygenase (porcine leukocytes) and cyclo-oxygenase



**Fig. 10** 8-Hydroxy-ketoalkenynes formed via auto-oxidation in powdered *E. pallida* roots.

(microsomes from ram seminal vesicles) assays.<sup>[31]</sup> More recently, Goel et al. conducted an in vivo study to examine the immunomodulatory effects of various dose levels of cichoric acid, polysaccharides, and alkalimides, isolated and purified from *E. purpurea*. Among the components, the alkalimides significantly increased the phagocytic activity as well as phagocytic index of alveolar macrophages from Sprague–Dawley rats. They produced significantly more TNF- $\alpha$  and nitric oxide after stimulation with lipopolysaccharides (LPS) than the other components or the control. These results suggest that the alkalimides are one of the active constituents of *E. purpurea*.<sup>[29]</sup> The immunomodulatory effects appear to be more pronounced in lungs than in spleen.<sup>[30]</sup>

Determination of the alkalimide content (dodeca-2*E*,4*E*,8*Z*,10*E*/*Z*-tetraenoic acid isobutylamides) in the different plant parts showed that it accumulates primarily in the roots and inflorescences, the highest being found in *E. angustifolia*. *E. pallida* roots contain only trace amounts, roots of *E. purpurea* 0.004–0.039%, and those of *E. angustifolia* 0.009–0.151%. The yield in the leaves is 0.001–0.03%.<sup>[11]</sup> In a recent study, 62 commercial dried root and aerial samples of *E. purpurea* grown in eastern Australia were analyzed for the medicinally active constituents. Total concentration in root samples was  $6.2 \pm 2.4$  mg/g, and in aerial samples was  $1.0 \pm 0.7$  mg/g. The proportion of individual alkalimides in root samples was found to be consistent across all samples. The large range in levels suggests that quality standards for the marketing of raw material should be considered.<sup>[32]</sup>

In 2001, Dietz, Heilmann, and Bauer<sup>[33]</sup> reported the presence of dodeca-2*E*,4*E*,8*Z*,10*E*/*Z*-tetraenoic acid isobutylamides (**11**, **12**) in human blood after oral administration of an ethanolic extract of *E. purpurea*. More recently, a study showed that the absorption maximum ( $c_{\max}$ ) of dodeca-2*E*,4*E*,8*Z*,10*E*/*Z*-tetraenoic acid isobutylamides (**11**, **12**) is reached 30 min after oral application. Due to these results, the mucous membrane of the mouth is most likely the major area of absorption.<sup>[34]</sup> Jager et al. investigated the permeability of isobutylamides (**11**, **12**) through Caco-2 monolayers. They found that the alkalimides were almost completely transported from the apical to the basolateral side of the monolayer in 6 hr by passive diffusion and that no significant metabolism occurred.<sup>[35]</sup> Matthias et al.<sup>[36]</sup> investigated the bioavailability of caffeic acid derivatives and alkalimides also using Caco-2-monolayers. The caffeic acid conjugates (caftaric acid, echinacoside, and cichoric acid) permeated poorly through the Caco-2 monolayers although one potential metabolite, cinnamic acid, diffused readily with an apparent permeability ( $P_{\text{app}}$ ) of  $1 \times 10^{-4}$  cm/s, while alkalimides were found to diffuse with  $P_{\text{app}}$  ranging from  $3 \times 10^{-6}$  to  $3 \times 10^{-4}$  cm/s.

Close monitoring of the transport for 6 hr revealed a nearly complete transfer to the basolateral side after 4 hr and no significant metabolism. Transport experiments performed at 4°C showed only a slight decrease, which is a strong hint that dodeca-2*E*,4*E*,8*Z*,10*E*/*Z*-tetraenoic acid isobutylamides (**11**, **12**) cross biological membranes by passive diffusion. These data suggest that alkalimides are more likely than caffeic acid conjugates to pass through the intestinal barrier and thus be available for influencing an immune response.<sup>[36]</sup>

From the above, it is obvious that not a single, but several constituents, like the alkalimides, cichoric acid, glycoproteins, and polysaccharides, are responsible for the immunostimulatory activity of *Echinacea* extracts, and the application of extracts appears to be reasonable. However, conformity of these extracts is a must for generating consistent products and reproducible activity. It is desirable to have products like the preparation from freshly harvested *E. purpurea* plants used in the studies by Goel et al.<sup>[5,29,30,37]</sup> standardized on all groups of compounds, alkalimides, cichoric acid, and polysaccharides.

## CLINICAL EFFICACY

A series of experiments have shown that *E. purpurea* extracts have significant immunomodulatory activities. Among the many pharmacological properties reported, macrophage activation has been demonstrated most convincingly. Phagocytotic indices and macrophage-derived cytokine concentrations have been shown to be responsive to *Echinacea* in a variety of assays. Activation of polymorphonuclear leukocytes and natural killer cells has also been reasonably demonstrated. Changes in the numbers and activities of T- and B-cell leukocytes have been reported, but are less certain. Despite this cellular evidence of immunostimulation, pathways leading to enhanced resistance to infectious disease have not been described adequately. Several dozen human experiments—including a number of blind randomized trials—have reported health benefits of *Echinacea* preparations. So far, clinical efficacy has been studied in randomized controlled clinical trials for cold pressed juice and hydroalcoholic tincture/extract of *E. purpurea* aerial parts, a standardized extract from *E. purpurea* roots (hydroalcoholic tincture/extract), and for the hydroalcoholic extract of *E. pallida* roots. For *E. angustifolia* root tinctures, only a pharmacological study plus a survey on healthy individuals have been performed, but a clinical double-blind experiment is in progress. All of them have used a variety of different *Echinacea* preparations and study designs. Most importantly, the phytochemical profile of the preparations was not determined or not reported in most of the earlier studies. Since different *Echinacea* preparations



have varying phytochemical profiles due to the use of diverse species, plant parts, and extraction procedures, the variation in reported clinical effectiveness may be due to discrepancies in the chemical profile.

The most robust data come from trials testing *E. purpurea* extracts in the treatment for acute URI. Although suggestive of modest benefit, these experiments trials are limited both in size and methodological quality. Hence, while there is a great deal of moderately good quality scientific data regarding pharmacological effects of *E. purpurea*, effectiveness in treating illness is still in discussion.<sup>[4,38]</sup> A recent Cochrane review<sup>[39]</sup> summarized 16 randomized clinical trials of *Echinacea* for upper respiratory tract infection. The authors concluded that evidence is insufficient to recommend a specific *Echinacea* product. From the data, it is seen that *E. purpurea* may especially be efficacious, but they are still weak and inconclusive.

Recently, a formulation prepared from freshly harvested *E. purpurea* plants and standardized on the basis of three known active components, alkamides, cichoric acid, and polysaccharides (Echinilin<sup>TM</sup>), was found to be effective for the treatment of a naturally acquired common cold. This study was conducted to determine the systemic immune response to Echinamide treatment during a cold, particularly to assess its effects on leukocyte distribution and neutrophil function. These effects of *Echinacea* were associated with a significant and sustained increase in the number of circulating total white blood cells, neutrophils, and natural killer cells, and a decrease in lymphocytes. These results suggest that possibly by enhancing the nonspecific immune response and eliciting free radical scavenging properties, this standardized formulation of *Echinacea* may have led to a faster resolution of the cold symptoms.<sup>[37]</sup> A randomized controlled trial of healthy children was performed by Taylor et al. to determine whether an *E. purpurea* pressed juice preparation is effective in reducing the duration and/or severity of URI symptoms and to assess its safety in this population.<sup>[40]</sup> The *E. purpurea* preparation, as dosed in this study, was not effective in treating URI symptoms in patients 2–11 yr old, and its use was associated with an increased risk of rash. In a recent study by Sperber et al., administration of *E. purpurea* pressed juice before and after exposure of healthy subjects to rhinovirus type 39 (RV-39) did not influence the rate of infection. However, because of the small sample size, statistical hypothesis testing had relatively poor power to detect statistically significant differences in the frequency and severity of illness. In this randomized, double-blind, placebo-controlled clinical trial, a total of 92% of *Echinacea* recipients and 95% of placebo recipients were infected. Cold developed in 58% of the former and 82% in the latter.<sup>[41]</sup>

## CLINICAL PARTICULARS

### Dosage Information

For internal use, the daily dose for aerial parts of *E. purpurea* for adults is 6–9 ml of pressed juice or equivalent preparations or 3 × 60 drops of a tincture (1:5, ethanol 55% v/v). For dried roots, the recommended daily dose is 3 × 300 mg. For external use, semisolid preparations with a minimum of 15% of pressed juice are recommended. The dosage for children is a proportion of adult dose according to age or body weight. The duration of administration should not exceed 8 weeks.<sup>[42]</sup> For *E. pallida* roots, the recommended daily dosage of Commission E is tincture 1:5 with 50% (v/v) ethanol from native dry extract (50% ethanol, 7:11:1), corresponding to 900 mg herb.<sup>[6]</sup>

### Adverse Effects and Toxicological Considerations

Clinical reports provide indications of a good tolerability of *Echinacea* preparations. No significant herb–drug interactions with *Echinacea* have been reported. Based on in vitro studies, an ethanolic extract from the roots of *E. angustifolia* may be a mild inhibitor of the cytochrome P450 3A4 enzyme complex system. This tends to increase levels of drugs metabolized by this system, such as itraconazole, fexofenadine, and lovastatin.<sup>[43]</sup> In a recent study by Gorski et al.<sup>[44]</sup> the effect of 400 mg *E. purpurea* root material administered four times daily with water was assessed on cytochrome P450 (CYP) activity in vivo by use of the CYP probe drugs caffeine (CYP1A2), tolbutamide (CYP2C9), dextromethorphan (CYP2D6), and midazolam (hepatic and intestinal CYP3A). The extract reduced the oral clearance of substrates of CYP1A2 but not that of CYP2C9 and CYP2D6. The extract selectively modulated the catalytic activity of CYP3A at hepatic and intestinal sites. Therefore, caution should be exercised when it is coadministered with drugs dependent on CYP3A or CYP1A2 for their elimination.

The German health authorities list the following contraindications and possible side effects of *Echinacea*<sup>[6]</sup>:

Contraindications:

- Allergy against one of the ingredients or against Compositae plants.
- The Commission E warns for general reasons not to use *Echinacea* in case of progressive systemic diseases like tuberculosis, leukoses, collagenoses, multiple sclerosis, and other autoimmune diseases.

- The Commission E warns not to use *Echinacea* in case of AIDS and HIV infection.

#### Side effects:

- In rare cases, hypersensitivity reactions might occur. For drugs with preparations of *Echinacea*, rash, itching, rarely face swelling, shortness of breath, dizziness, and blood pressure drop have been reported.
- In case of diabetes, the metabolic status may worsen.<sup>[6]</sup>

Shivering and other “influenza-like” symptoms have been occasionally observed after intravenous administration. Brief fever can be the result of the secretion of IFN- $\alpha$  and IL-1 (endogenous pyrogen) from macrophages, i.e., it always occurs when macrophages are stimulated. Rarely, acute allergic reactions can occur. Therefore, it can be concluded that there is a very low incidence of side effects associated with *Echinacea* preparations. Also in long-term treatment, the expressed juice of *E. purpurea* was shown to be well tolerated.<sup>[45]</sup>

## CONCLUSIONS

*Echinacea*, one of the most popular botanical supplements in North America, is employed as an immune modulator, antimicrobial, and (topically) antiseptic. So far, the therapeutic activity of *Echinacea* cannot be unambiguously attributed to any particular constituents. However, pharmacological effects related to immune functions have been demonstrated for both high- and low-molecular-weight constituents. Compounds from the classes of caffeic acid derivatives, alkaloids, polysaccharides, and glycoproteins are regarded as the most relevant constituents. Employing diverse species, plant parts, and extraction procedures, procedures results in different *Echinacea* preparations having varied phytochemical profiles. Clinical effectiveness may vary because of discrepancies in the chemical profile. Standardization of botanicals should guarantee that preparations contain therapeutically effective doses of active principles and should assure consistent batch-to-batch composition and stability of the active constituents. Also, clinical trials should be performed only with well-characterized *Echinacea* preparations. In summary, these preparations can be effective for the enhancement of the body’s defense mechanisms. However, further investigations are necessary to find the optimum dosage, the molecular mode of action, and the best application form. Serious adverse effects from the use of *Echinacea* appear to be extremely rare, and the potential for important herb–drug interactions appears to be limited.

## REFERENCES

1. Brevoort, P. The booming U.S. botanical market. *Herbalgram* **1998**, *44*, 33–46.
2. Bauer, R.; Wagner, H. *Echinacea—Ein Handbuch für Ärzte, Apotheker und andere Naturwissenschaftler*; Wissenschaftliche Verlagsgesellschaft: Stuttgart, 1990.
3. Bauer, R.; Wagner, H. *Echinacea* species as potential immunostimulatory drugs. In *Economic and Medicinal Plant Research*; Wagner, H., Farnsworth, N.R., Eds.; Academic Press Limited, 1991; Vol. 5, 253–321.
4. Barrett, B. Medicinal properties of *Echinacea*: a critical review. *Phytomedicine* **2003**, *10* (1), 66–86.
5. Goel, V.; Lovlin, R.; Chang, C.; Slama, J.V.; Barton, R.; Gahler, R.; Bauer, R.; Basu, T.K. Efficacy of a standardized *Echinacea* preparation (Echinilin) for the treatment of the common cold: a randomised, double-blind, placebo controlled trial. *J. Clin. Pharm. Ther.* **2004**, *29* (1), 75–83.
6. Blumenthal, M. *The Complete German Commission E Monographs, Therapeutic Guide to Herbal Medicines*; American Botanical Council: Austin, 1988.
7. Bauer, R. The *Echinacea* story—the scientific development of an herbal immunostimulant. In *Plants for Food and Medicine—Modern Treatments and Traditional Remedies*; Prendergast, H.D.V., Etkin, N.L., Harris, D.R., Houghton, P.J., Eds.; The Royal Botanic Gardens: Kew, 1998; 317–332.
8. Moerman, D.E. *Native American Ethnobotany*; Timber Press: Portland, OR, 1998; 205–206.
9. McGregor, R.L. The taxonomy of the genus *Echinacea* (Compositae). *Univ. Kansas Sci. Bull.* **1968**, *48*, 113–142.
10. Binns, S.E.; Baum, B.R.; Arnason, J.T. A taxonomic revision of *Echinacea* (Asteraceae: Heliantheae). *Syst. Bot.* **2002**, *27*, 610–632.
11. Bauer, R. Chemistry, analysis and immunological investigations of *Echinacea* phytopharmaceuticals. In *Immunomodulatory Agents from Plants*; Wagner, H., Ed.; Birkhäuser Verlag: Basel, Boston; Berlin, 1999; 41–88.
12. Tagni, E.; Galli, C.L.; Tubaro, A.; Del Negro, P.; Della Loggia, R. Anti-inflammatory activity of *Echinacea angustifolia* fractions separated on the basis of molecular weight. *Pharm. Res. Comm.* **1988**, *20* (Suppl. V), 87–90.
13. Melchart, D.; Worku, F.; Linde, K.; Flesche, C.; Eife, R.; Wagner, H. Erste Phase-I-Untersuchung von *Echinacea*-Polysaccharid (EPO VIIa/EPs) bei i.v. Application. *Erfahrungsheilkunde*, **1993**, *42*, 316–323.

14. Beuscher, N.; Bodinet, C.; Willigmann, I.; Egert, D. Immunmodulierende Eigenschaften von Wurzelextrakten verschiedener *Echinacea*-Arten. *Z. Phytother.* **1995**, *16*, 157–166.
15. Egert, D.; Beuscher, N. Studies on antigen specificity of immunoreactive arabinogalactan proteins extracted from *Baptisia tinctoria* and *Echinacea purpurea*. *Planta Med.* **1992**, *58*, 163–165.
16. Alban, S.; Classen, B.; Brunner, G.; Blaschek, W. Differentiation between the complement modulating effects of an arabinogalactan-protein from *Echinacea purpurea* and heparin. *Planta Med.* **2002**, *68*, 1118–1124.
17. Bodinet, C.; Lindequist, U.; Teuscher, E.; Freudenstein, J. Effect of an orally applied herbal immunomodulator on cytokine induction and antibody response in normal and immunosuppressed mice. *Phytomedicine* **2002**, *9* (7), 606–613.
18. Bodinet, C.; Mentel, R.; Wegner, U.; Lindequist, U.; Teuscher, E.; Freudenstein, J. Effect of oral application of an immunomodulating plant extract on influenza virus type A infection in mice. *Planta Med.* **2002**, *68* (10), 896–900.
19. Hwang, S.; Dasgupta, A.; Actor, J.K. Cytokine production by non-adherent mouse splenocyte cultures to *Echinacea* extracts. *Clin. Chim. Acta.* **2004**, *343*, 161–166.
20. Pietta, P.; Mauri, P.; Bauer, R. MEKC analysis of different *Echinacea* species. *Planta Med.* **1998**, *64*, 649–652.
21. Hu, C.; Kitts, D.D. Studies on the antioxidant activity of *Echinacea* root extract. *J. Agric. Food Chem.* **2000**, *48*, 1466–1472.
22. Maffei Facino, R.; Carini, M.; Aldini, C.; Marinello, C.; Arlandini, E.; Franzoi, L.; Colombo, M.; Pietta, P.; Mauri, P. Direct characterization of caffeoyl esters with antihyaluronidase activity in crude extracts from *Echinacea angustifolia* roots by fast atom bombardment tandem mass spectrometry. *Farmaco* **1993**, *48*, 1447–1461.
23. Maffei Facino, R.; Carini, M.; Aldini, G.; Saibene, L.; Pietta, P.; Mauri, P. Echinacoside and caffeoyl conjugates protect collagen from free radical-induced degradation: a potential use of *Echinacea* extracts in the prevention of skin photodamage. *Planta Med.* **1995**, *61*, 510–514.
24. Robinson, W.E. L-Chicoric acid, an inhibitor of human immunodeficiency virus type (HIV-1) integrase, improves on the in vitro anti-HIV-1 effect of Zidovudine plus a protease inhibitor (AG1350). *Antiviral Res.* **1998**, *39*, 101–111.
25. Bauer, R. Chemistry, pharmacology and clinical application of *Echinacea* products. In *Herbs, Botanicals and Teas*; Mazza, G.; Oomah, B.D., Eds. Technomic Publishing Co., 2000; 45–73.
26. Kreis, W.; Sußner, U.; Nüsslein, B. Reinigung und Charakterisierung einer Polyphenoloxidase aus der Arzneidroge *Echinaceae purpureae* Herba (Sonnenhutkraut). *J. Appl. Bot.—Angew. Bot.* **2000**, *74*, 106–112.
27. Nüsslein, B.; Kurzmann, M.; Bauer, R.; Kreis, W. Enzymatic degradation of cichoric acid in *Echinacea purpurea* preparations. *J. Nat. Prod.* **2000**, *63*, 1615–1618.
28. Woelkart, K.; Gangemi, J.D.; Turner, R.B.; Bauer, R. Enzymatic degradation of echinacoside and cynarin in *Echinacea angustifolia* root preparations. *Pharm. Bio.* **2004**, *42*, in press.
29. Goel, V.; Chang, C.; Slama, J.V.; Barton, R.; Bauer, R.; Gahler, R.; Basu, T.K. Alkylamides of *Echinacea purpurea* stimulate alveolar macrophage function in normal rats. *Int. Immunopharmacol.* **2002**, *2*, 381–387.
30. Goel, V.; Chang, C.; Slama, J.V.; Barton, R.; Bauer, R.; Gahler, R.; Basu, T.K. *Echinacea* stimulates macrophage function in the lung and spleen of normal rats. *J. Nutr. Biochem.* **2002**, *13*, 487–492.
31. Müller-Jakic, B.; Brey, W.; Pröbstle, A.; Redl, K.; Greger, H.; Bauer, R. In vitro inhibition of cyclooxygenase and 5-lipoxygenase by alkamides from *Echinacea* and *Achillea* species. *Planta Med.* **1994**, *60*, 7–40.
32. Wills, R.B.H.; Stuart, D.L. Alkylamide and cichoric acid levels in *Echinacea purpurea* grown in Australia. *Food Chem.* **1999**, *67*, 385–388.
33. Dietz, B.; Heilmann, J.; Bauer, R. Absorption of dodeca-2*E*,4*E*,8*Z*,10*E*/*Z*-tetraenoic acid isobutylamides after oral application of *Echinacea purpurea* tincture. *Planta Med.* **2001**, *67*, 863–864.
34. Woelkart, K.; Koidl, C.; Grisold, A.; Gangemi, J.D.; Turner, R.B.; Marth, E.; Bauer, R. Pharmacokinetics and bioavailability of alkamides from the roots of *Echinacea angustifolia* in humans. *Submitted for publication*.
35. Jager, H.; Meinel, L.; Dietz, B.; Lapke, C.; Bauer, R.; Merkle, H.P.; Heilmann, J. Transport of alkamides from *Echinacea* species through Caco-2 monolayers. *Planta Med.* **2002**, *68*, 469–471.
36. Matthias, A.; Blanchfield, J.T.; Penman, K.G.; Toth, I.; Lang, C.-S.; De Voss, J.J.; Lehmann, R.P. Permeability of alkylamides and caffeic acid conjugates from *Echinacea* in the Caco-2 monolayer model: alkylamides but not caffeic acids cross. *J. Clin. Pharm. Ther.* **2004**, *29*, 7–13.
37. Goel, V.; Lovlin, R.; Chang, C.; Slama, J.V.; Barton, R.; Gahler, R.; Goonewardene, L.; Basu, T.K. A proprietary extract from the

- Echinacea plant (*Echinacea purpurea*) enhances systemic immune response during a common cold. *Phytother. Res. in press*.
38. Ernst, E. The risk–benefit profile of commonly used herbal therapies: ginkgo, St. John’s wort, ginseng, *Echinacea*, saw palmetto, and kava. *Ann. Intern. Med.* **2002**, *136*, 42–53.
  39. Melchart, D.; Linde, K.; Fischer, P.; Kaesmayr, J. *Echinacea* for preventing and treating the common cold. *Cochrane Database Syst. Rev.* **2000**, (2), CD000530.
  40. Taylor, J.A.; Weber, W.; Standish, L.; Quinn, H.; Goesling, J.; McGann, M.; Calabrese, C. Efficacy and safety of *Echinacea* in treating upper respiratory tract infections in children. *J. Am. Med. Assoc.* **2003**, *290*, 2824–2830.
  41. Sperber, S.J.; Shah, L.P.; Gilbert, R.D.; Ritchey, T.W.; Monto, A.S. *Echinacea purpurea* for prevention of experimental rhinovirus colds. *Clin. Infect. Dis.* **2004**, *38*, 1367–1371.
  42. ESCOP Monographs. In *The Scientific Foundation for Herbal Medicinal Products*; 2nd Ed.; Thieme: Stuttgart, New York, 2003; 126–141.
  43. Budzinski, J.W.; Foster, B.C.; Vandenhoeck, S.; Arnason, J.T. An in vitro evaluation of human cytochrome P450 3A4 inhibition by selected commercial herbal extracts and tinctures. *Phytomedicine* **2000**, *7*, 273–282.
  44. Gorski, C.; Huang, S.M.; Pinto, A.; Hamman, M.A.; Hilligoss, J.K.; Zaheer, N.A.; Desai, M.; Miller, M.; Hall, S.D. The effect of echinacea (*Echinacea purpurea* root) on cytochrome P450 activity in vivo. *Clin. Pharmacol. Ther.* **2004**, *75*, 89–100.
  45. Parnham, M.J. Benefit–risk assessment of the squeezed sap of the purple coneflower (*Echinacea purpurea*) for long-term oral immunostimulation. *Phytomedicine* **1996**, *3*, 95–102.



# Ephedra (Ma Huang)

Anne L. Thurn

Office of Dietary Supplements, National Institutes of Health,  
Bethesda, Maryland, U.S.A.

## INTRODUCTION

Ephedra (ma huang) is the common name for a herbal product used in traditional Chinese medicine. It comprises the aerial parts of three principal plant species: *Ephedra sinica* Stapf, *E. equisetina* Bunge, and *E. intermedia* var. *tibetica* Stapf.<sup>[1–3]</sup> The plant is a natural source of the alkaloids (–)-ephedrine and (+)-pseudoephedrine.<sup>[1]</sup>

## GENERAL DESCRIPTION

*E. sinica* Stapf is a low evergreen shrub with small scaly leaves. It flowers in June and July and produces fruit late in the summer.<sup>[4]</sup> Approximately 45–50 species of ephedra have been described worldwide, including in the temperate and subtropical regions of Asia, Europe, and the Americas.<sup>[2,5]</sup> Most of those native to North, South, and Central America, such as *E. nevadensis* (used to make Mormon tea), *E. trifurca*, and *E. antisiphilitica*, contain no alkaloids.<sup>[5]</sup>

Most commercial uses of ephedra are based on its content of ephedrine, the main active constituent in the ephedra species known as ma huang.<sup>[1]</sup> Alkaloid content increases as the plant matures, with peak concentrations in the fall.<sup>[6]</sup> No ephedrine-type alkaloids are found in the roots, berries, or seeds of these plants, and the green upper parts of the stems contain significantly more alkaloids than the woody parts.<sup>[6]</sup>

Traditionally, ephedra has been administered as a tea prepared by soaking 2 g dried aerial portions in 8 fluid oz of boiling water for 10 min, ideally resulting in a content of 15–30 mg ephedrine. In commercial products, it is usually a formulation of powdered aerial portions or a dried extract.<sup>[7]</sup> The ephedrine content of such products ranges from 12 to 80 mg per serving, with most of them being in the lower part of the range.<sup>[8]</sup>

In the United States, ephedra was sold as a dietary supplement until April 2004 when the U.S. Food and Drug Administration (FDA) banned the sale of dietary

supplements containing ephedrine alkaloids. As defined by Congress in the Dietary Supplement Health and Education Act, which became law in 1994, a dietary supplement is a product (other than tobacco) that is intended to supplement the diet; contains one or more dietary ingredients (including vitamins, minerals, herbs or other botanicals, amino acids, and other substances) or their constituents; is intended to be taken orally as a pill, capsule, tablet, or liquid; and is labeled on the front panel as being a dietary supplement.

Ephedra-containing dietary supplements are most often promoted as weight loss aids or to improve energy levels and athletic performance, even though there is little or no evidence for their efficacy. A 1998 survey of more than 14,500 people 18 yr or older in five states for weight loss reported that 7% used nonprescription products, while 1% consumed ephedra-containing preparations.<sup>[9]</sup>

## HISTORICAL USE

Ephedra has a history of more than 5000 years of medicinal use in China and India, where it has been used to treat cold, fever, flu, chills, headaches, edema caused by nephritis, nasal congestion, aching joints, coughing, and wheezing and to induce diuresis or perspiration.<sup>[5,6]</sup> Evidence that its use predates even traditional Chinese and Indian medicine comes from the discovery of a species of ephedra found in a Neanderthal grave in Iraq dating from 60,000 B.C.<sup>[8]</sup> Analysis of the plants found in the grave indicated that they contained bioactive ingredients and were presumably used medicinally. There is documentation of its use by Discorides, the renowned Greek herbalist, in the 1st century and in Europe from the 15th to the 19th centuries.<sup>[10]</sup> In the 1600s, Native Americans and Spaniards in the American Southwest used ephedra (the nonalkaloid-containing species) as a treatment for venereal disease.<sup>[10]</sup>

Ephedrine, the principal active ingredient in most species, was first isolated in 1885 by Nagayoshi Nagai, a Japanese chemist trained in Germany.<sup>[10]</sup> Other alkaloids, such as pseudoephedrine, norephedrine, and norpseudoephedrine, with similar but not identical properties, were subsequently found in various ephedra species.<sup>[11]</sup>

Anne L. Thurn, Ph.D., is Director, Evidence-Based Research Program at the Office of Dietary Supplements, National Institutes of Health (NIH), Bethesda, Maryland, U.S.A.

Early studies on the pharmacologic effects of ephedrine were conducted between 1888 and 1917, but it was not until the 1920s during studies of a variety of Chinese traditional herbs that ephedrine alkaloids became known to Western medicine. Ephedra, one of the herbs tested, gave significant results—an extract given intravenously to dogs resulted in a large increase in blood pressure.<sup>[12]</sup> Subsequent publication of a series of studies on the pharmacologic properties helped Western physicians understand its potential usefulness.<sup>[11]</sup> These experiments demonstrated that ephedrine had three advantages over epinephrine: It could be administered orally, was longer acting, and had a lower toxicity.<sup>[3]</sup> As a result, the former alkaloid replaced the latter in the management of children with mild-to-moderate asthma. Subsequently, it became widely used as a nasal decongestant and central nervous system stimulant.<sup>[4]</sup> Its ability to stimulate the central nervous system was recognized by the Japanese military, who administered it by injection to kamikaze pilots during World War II.<sup>[8]</sup>

The herb ephedra was once recognized as an official drug in the United States, but widespread availability of synthetic ephedrine-type alkaloids has virtually eliminated its clinical use.<sup>[13]</sup>

## CONSTITUENTS AND ACTIONS

Ephedra stems contain 0.5–2.5%<sup>[4]</sup> alkaloids, composed mainly of L-ephedrine and D-pseudoephedrine, with ephedrine content ranging from 30% to 90% of total alkaloid content depending on the source. The content of the various ephedra alkaloids varies in commercial preparations, but ephedrine and pseudoephedrine generally make up 90–100%.<sup>[14]</sup> (–)-Ephedrine and five structurally related alkaloids, (+)-pseudoephedrine, (–)-*N*-methylephedrine, (+)-*N*-methylpseudoephedrine, (+)-norpseudoephedrine, and (–)-norephedrine, are responsible for the medicinal properties of these alkaloid-containing ephedra species.<sup>[1]</sup> Ephedrine acts indirectly by stimulating  $\alpha_1$ -,  $\alpha_2$ -,  $\beta_1$ -, and  $\beta_2$ -adrenergic receptors to release norepinephrine from sympathetic nerve endings and directly as a  $\beta_1$ -,  $\beta_2$ -, and possibly  $\beta_3$ -agonist.<sup>[8,15,16]</sup> It promotes bronchodilation by stimulating  $\beta_2$ -receptors in the lungs, which accounts for its effectiveness in treating bronchial asthma.<sup>[12,16]</sup> However, its other adrenergic actions result in the generally undesirable effects of central nervous system stimulation including insomnia, irritability, hyperactivity,<sup>[16]</sup> hypertension,<sup>[14,17]</sup> and gastrointestinal symptoms (nausea and vomiting).<sup>[11]</sup> These side effects have led to the development of selective  $\beta_2$ -agonists and the discontinuation of ephedrine use for bronchodilation.

Ephedrine increases heart rate and therefore cardiac output.<sup>[16]</sup> It also causes peripheral vasoconstriction,

which increases peripheral resistance and can lead to a sustained rise in blood pressure.<sup>[16]</sup> In general, the increase in blood pressure is dose dependent,<sup>[8]</sup> but doses under 50 mg do not always produce such an effect.<sup>[14,17]</sup>

Chronic use of ephedrine for the management of asthma results in tachyphylaxis, making it an unreliable long-term therapeutic agent.<sup>[16]</sup> Frequent doses become less effective as a result of the depletion of norepinephrine stores as well as the release of adenosine into synaptic junctions and increased cellular phosphodiesterase activity, both of which suppress catecholamine release.<sup>[18]</sup> To potentiate the effects of ephedrine, methylxanthines (e.g., caffeine and theophylline), which interfere with the inhibitory effect of adenosine on both norepinephrine release and phosphodiesterase activity, are often combined with ephedra or ephedrine.<sup>[19,20]</sup>

In the United States, ephedra-containing dietary supplements were widely promoted as weight loss aids because of their ephedrine content. The alkaloid has been postulated to do this by two mechanisms. First, by stimulating thermogenesis in laboratory animals<sup>[13,16,21]</sup> and humans,<sup>[15,18]</sup> ephedrine increases energy expenditure. In rats, it has been shown to directly stimulate thermogenesis in brown adipose tissue via  $\beta$ -adrenergic receptors.<sup>[16]</sup> But studies in humans have provided evidence against the role of brown adipose tissue in ephedrine-induced thermogenesis.<sup>[18]</sup> Although the site of action remains unclear, the thermogenic action in humans has been widely confirmed and serves as the major rationale for its use as a weight loss aid. Second, the combination of ephedrine and caffeine acts as an appetite suppressant, reducing food intake. One study showed that about 75% of the effect of this combination on weight loss is the result of its anorectic properties, which may affect the satiety center in the hypothalamus.<sup>[13,22]</sup> Evidence from animal studies and some human experiments shows that the combination reduces body fat but not lean body mass.<sup>[13,23]</sup> However, because the human studies had few participants, larger studies would have to be carried out to confirm this finding.

The use of ephedrine as a nasal decongestant in over-the-counter preparations has been replaced for the most part by more selective  $\beta_2$ -bronchodilators, but it is still included as a component of some pediatric prescription cold and cough medications and is found in a nonprescription medication for asthma.<sup>[16]</sup> The ephedra constituent pseudoephedrine is generally preferred as an oral decongestant because it is less potent and therefore less likely than ephedrine to cause central nervous system stimulation or hypertension.<sup>[16]</sup>

Intravenous ephedrine is still widely used for the prevention and treatment of hypotension caused by

spinal anesthesia, particularly during cesarean section.<sup>[16]</sup> Other uses have included treatment of chronic urticaria, diabetic neuropathic edema, nocturnal enuresis, motion sickness, spastic or hypermotile bowel, and myasthenia gravis.<sup>[24,25]</sup>

In addition to ephedrine alkaloids, some ephedra species contain other nitrogen-containing secondary metabolites with known neuropharmacologic activity.<sup>[5]</sup> These include several cyclopropyl analogs of L-glutamate and methanoproline, and a cyclopropyl analog of L-proline, as well as common amino acids such as L-glutamate, L-glutamine, L-serine, and L-proline.

The stems of some ephedra species also contain kynurenates, derivatives of tryptophan catabolism that may help protect the plant from birds or rodents, but their physiological function is unknown.<sup>[5]</sup> Kynurenates in ephedra stems exhibit antimicrobial activity against some Gram-positive and Gram-negative bacteria, although significantly less than the antibiotic ciprofloxacin.

Nonnitrogenous compounds found in some ephedra species include organic acids, phenolic compounds (flavonoids and tannins), and essential oils primarily composed of terpenoids (38.9%).<sup>[2,5]</sup> The tannin fractions have been shown to inhibit angiotensin converting enzyme activity, although it was much less than that of captopril.

Extracts of the roots contain the spermine-type alkaloids ephedradines A, B, C, and D, feruloylhistamine, and bisflavanols and result in hypotension when administered intravenously.<sup>[2,26]</sup> The roots are not used in commercial dietary supplement products and are only a minor constituent of formulations used in traditional Chinese medicine.

## PHARMACOKINETICS

Ephedrine is well absorbed after oral administration, is excreted largely unchanged in the urine, and has a serum half-life of 2–3 hr.<sup>[14,27]</sup> When ingested in the form of ma huang, it has a  $t_{max}$  (time of occurrence for peak drug concentration) of nearly 4 hr compared with only 2 hr for pure ephedrine.<sup>[17]</sup>

Peak ephedrine blood levels are similar regardless of whether the alkaloid is taken as a herbal preparation or in the pure form. Ingestion of 400 mg ma huang containing 20 mg ephedrine resulted in blood concentrations of 81 ng/ml, which is the same as the peak ephedrine levels observed after administering an equivalent amount of pure ephedrine.<sup>[17]</sup>

## PRECLINICAL STUDIES

Ephedra and its constituents have been studied in animals for a wide range of indications, including ulcer

prevention, reduction of uremic toxins in renal failure, and immune modulation, as well as for their antimicrobial, antidiabetic, anti-inflammatory, antioxidant, and antitussive activity.<sup>[2]</sup> Ephedrine has also been used in preclinical research to examine the efficacy and potential mechanisms of action of ephedra for weight loss.<sup>[2,13]</sup>

## CLINICAL TRIALS

A systematic review of the literature was conducted by RAND for published and unpublished sources of controlled clinical trials on ephedra and ephedrine used for weight loss and athletic performance in humans.<sup>[6]</sup> Fifty-two controlled clinical trials of ephedrine or botanical ephedra used for weight loss or athletic performance enhancement in humans were included.

### Efficacy for Weight Loss

Forty-four controlled trials were identified that assessed ephedra and ephedrine alkaloids used in combination with other compounds for weight loss, and 20 of these met inclusion criteria for the meta-analysis. Five pairs of treatment regimens were compared:

1. Ephedrine vs. placebo (5 studies): Ephedrine was associated with 1.3 lb/mo weight loss greater than placebo for up to 4 mo of use.
2. Ephedrine plus caffeine vs. placebo (12 studies): Ephedrine plus caffeine was associated with 2.2 lb/mo weight loss greater than placebo for up to 4 mo of use.
3. Ephedrine plus caffeine vs. ephedrine (3 studies): Ephedrine plus caffeine was associated with 0.8 lb/mo weight loss greater than ephedrine alone.
4. Ephedrine plus herbs containing ephedra plus caffeine (3 studies): Ephedra plus herbs containing caffeine was associated with 2.1 lb/mo weight loss greater than placebo for up to 4 mo of use.
5. Ephedrine vs. other active weight loss products (2 studies): No conclusions could be drawn about ephedrine vs. other active weight loss products because the sample size in these studies was too small.

Only one study compared an ephedra-containing product without caffeine but with other herbs and a placebo. This product was associated with a weight loss of 1.8 lb/mo, more than that associated with a placebo for up to 3 mo of use.

None of the studies lasted longer than 6 mo; hence long-term weight loss and maintenance could not be



assessed. The results indicate that the use of ephedrine, ephedrine plus caffeine, or dietary supplements containing ephedra plus herbs containing caffeine was associated with a statistically significant increase in weight loss for up to 4 mo.

### Efficacy for Athletic Performance Enhancement

There are no controlled clinical studies for athletic performance enhancement. RAND identified eight controlled trials of the effects of synthetic ephedrine for athletic performance enhancement, usually along with caffeine. The studies could not be pooled for meta-analysis because of the wide variety of interventions used. A few studies assessing the effect of ephedrine plus caffeine showed a modest improvement in very short-term athletic tasks such as weight lifting (1–2 hr after a single dose) and time to exhaustion for aerobic exercises. However, these trials were of very short duration and were done in small numbers of healthy young men, mostly military recruits. The results therefore cannot be generalized to the general public. Because all the studies were done in the same laboratory, the ability of other investigators to confirm the results has not been tested.

## TOXICOLOGY

### In Vitro Toxicity

The toxicity of eight water extracts of ephedra prepared from the entire plant using either ground or whole herb, boiled for 0.5 or 2 hr, and with either one or two extractions, was tested in a human hepatoblastoma cell line (HepG2) and a variety of animal cell lines.<sup>[28]</sup> Of the cell lines tested, only a neuronal cell line (Neuro-2a) showed significant sensitivity to the cytotoxic effects of the extracts. Grinding increased the toxicity of the resulting extracts. Normalizing the results for ephedrine content showed that the toxicity of the ephedra extracts could not be accounted for solely by ephedrine content, indicating the presence of other cytotoxic constituents. Kynurenates and cyclopropyl amino acids, both of which cause central nervous system toxicities and have been isolated from some species of ephedra, could be associated with the additional toxicity.<sup>[5]</sup> However, neurotoxicity is eliminated during the boiling of extracts that are used in commercial products.

In studies performed by the National Toxicology Program (NTP), ephedrine was not mutagenic in four strains of *Salmonella typhimurium* and did not cause chromosomal aberrations in vitro in Chinese hamster ovary cells.<sup>[29]</sup> Other in vitro research of ephedrine or

water or methanol extracts of ephedra have also not demonstrated any mutagenic effects.<sup>[30,31]</sup>

### In Vivo Toxicity

Several studies in mice have determined the oral LD<sub>50</sub> (median lethal dose) of water extracts of ephedra, which ranges from 4000 to 8000 mg/kg depending on the alkaloid content of the species used.<sup>[2]</sup> Based on these measurements, the equivalent range of ephedrine was calculated to be 520–720 mg/kg.

The NTP also evaluated the toxicity of ephedrine in B6C3F1 mice and F344 rats. During 2-yr studies, the animals were given diets containing 0, 125, or 250 ppm ephedrine/day. The mean body weight of the rats and mice receiving diets containing either dose of ephedrine was lower than those of controls, and survival was similar for the controls and exposed animals.<sup>[29]</sup>

A teratogenicity study of ephedrine showed a frequency of 8% malformed chick embryo hearts with exposure to 0.5 μmol ephedrine and 26% for 5.0 μmol.<sup>[32]</sup>

## ADVERSE EVENTS

The safety of ephedra-containing dietary supplements has been a controversial subject, resulting in a high level of interest from regulators, manufacturers, and the public. MedWatch, the Adverse Reaction Monitoring System of the FDA, has recorded many reports of side effects concerning ephedra-containing products.

In 1997, as a result of the increasing number of adverse event reports, the FDA published a proposed rule on the use of dietary supplements containing ephedrine alkaloids.<sup>[33]</sup> It recommended that ephedra-containing dietary supplement products be limited to a total of 8 mg ephedrine per serving, with a daily limit of 24 mg, a duration limit of 7 days, and label warnings. The General Accounting Office audited the methods used by the FDA to develop this rule and reported that because the evidence was from case reports and not controlled clinical trials, it was not sufficient to support the suggested limits on dose and duration.<sup>[34]</sup> As a result, the FDA withdrew the parts of the rule that place limits on the amount of ephedrine-type alkaloids permitted.

Ephedra-containing products were the subject of significant media coverage for quite a few years because of the deaths of several professional athletes who were allegedly taking these products.<sup>[6]</sup> As a result of these safety concerns, ephedra was prohibited by the International Olympic Committee and the National Football League.<sup>[6]</sup>

A review of the adverse effects reported in 50 controlled clinical trials of ephedra, ephedrine with or without caffeine, or botanicals containing caffeine concluded that use of these substances was associated with 2–3 times the risk of nausea, vomiting, psychiatric symptoms, autonomic hyperactivity, and palpitations compared with placebo.<sup>[35]</sup> No serious adverse events such as myocardial infarction, stroke, or death were reported in these studies, but the authors of the review noted that the small total number of patients in these experiments was not adequate to distinguish a serious adverse event rate of 1 in 1000 or higher.

To evaluate the incidence of serious side effects, several research reviewed ephedra-related adverse event reports in MedWatch as well as case reports in the published literature. The latter were evaluated in the RAND review because the total number of participants in the clinical trials was not sufficient to adequately assess the possibility of rare outcomes. Although such adverse event reports are not conclusive evidence of a cause-and-effect relationship, they can indicate the potential for such a relationship.

RAND searched the literature for published case reports and the MedWatch database for cases of serious adverse events that were idiopathic in etiology. If use of ephedra or ephedrine-containing products was well documented, then the possibility that ephedra or ephedrine caused the event was considered. Sentinel events were defined as adverse events associated with ingestion of an ephedra-containing product within 24 hr prior to the event and for which alternative explanations were excluded with reasonable certainty. Possible sentinel events were defined as adverse events that met the first two criteria for sentinel events but for which alternative explanations could not be excluded. RAND reviewed 71 cases reported in the published medical literature, 1820 case reports from the MedWatch database, and more than 18,000 consumer complaints reported to a manufacturer of ephedra-containing dietary supplements. The documentation for most reports was insufficient to support decisions about the relationship between the use of ephedra or ephedra-containing dietary supplements and the adverse event. Only 65 cases from the published literature, 241 from MedWatch, and 43 from a manufacturer of ephedra-containing dietary supplements had documentation sufficient for them to be included in the adverse event analysis. Among these, RAND identified 2 deaths, 3 myocardial infarctions, 9 cardiovascular accidents, 3 seizures, and 5 psychiatric events as sentinel events and 9 deaths, 6 myocardial infarctions, 10 cardiovascular accidents, 9 seizures, and 7 psychiatric events as possible sentinel events.<sup>[35]</sup> About half of the sentinel and possible sentinel events occurred in individuals under 30 yr of age.

Another study identified 140 MedWatch reports of adverse events concerning ephedra-containing products between June 1, 1997 and March 31, 1999 and concluded that 31% were definitely or probably related to use of these products and another 31% were possibly related.<sup>[36]</sup> The events included death, stroke, hypertension, tachycardia, palpitations, and seizures.

A third study reviewed the MedWatch database for stroke, myocardial infarction, or sudden death associated with the use of ephedra-containing products from 1995 to 1997.<sup>[27]</sup> Of 926 cases of adverse event reports concerning the use of ephedra-containing products, 37 serious cardiovascular events were identified as being temporarily associated with the use of these products.

In 2003, on the basis of new information, including the RAND report, the FDA reopened the comment period on the proposed rule for dietary supplements containing ephedrine alkaloids for 30 days. In April 2004, the FDA banned the sale of dietary supplements containing ephedrine alkaloids.

## CONTRAINDICATIONS

Because of the potentially dangerous effects of ephedrine on the heart and central nervous system, individuals with a history of cardiovascular disease; hypertension; hyperthyroidism; seizures; depression or other mental, emotional, or behavioral conditions; glaucoma; or difficulty in urinating because of benign prostatic hypertrophy should avoid taking ephedra-containing products.<sup>[37]</sup>

Ephedrine is often used for intraoperative hypotension and bradycardia, raising concerns about preoperative use of ephedra-containing products. Such application puts people anesthetized with halothane at risk because halothane sensitizes the myocardium to ventricular arrhythmias.<sup>[14]</sup>

The potential for serious side effects rises as serving size and frequency of use is increased.<sup>[33]</sup> These risks may also be enhanced when ephedra-containing products are used with other sources of stimulants such as caffeinated beverages, over-the-counter drugs, and other dietary supplements containing stimulants.

## DRUG INTERACTIONS

Ephedra-containing products should not be taken with, or for 2 weeks, after monoamine oxidase inhibitors or with drugs for Parkinson's disease, obesity, or weight control; methyl dopa; or any product containing ephedrine, pseudoephedrine, or phenylpropanolamine.<sup>[37]</sup>

## FUTURE RESEARCH

To assess the safety of ephedra, a rigorous case-control study of ischemic vascular, cardiovascular, and heat stroke events should be given a high priority.

Other approaches to fill the gaps in knowledge concerning ephedra might include surveys or the addition of questionnaires to existing cohort studies to determine current patterns of ephedra use, including dose, intake of concurrent medications, and characteristics of users. The information retrieved would provide data on events and utilization could be used to plan the design of future studies.

Basic research is needed on pharmacokinetic drug interaction assessments, including identification of interactions with agents such as anabolic steroids or sympathomimetics, and on physiologic responses under conditions such as exercise and thermal stress.

Clinical trials will be necessary to assess the risk-benefit ratio of ephedra for weight loss among overweight and obese individuals. A phase II study could be used to evaluate adverse events, weight loss, physiological responses, and optimal dosing. A randomized clinical trial of adequate sample size could then be used to characterize side effects and evaluate efficacy with regard to moderate or long-term weight loss and maintenance and relevant health outcomes.

The research portfolio described above would be time consuming and expensive but would answer the questions of ephedra safety and efficacy definitively. However, it is likely that as a result of the FDA's ban on dietary supplements containing ephedrine alkaloids that this research will not be done.

## REFERENCES

1. Betz, J.M.; Gay, M.L.; Mossoba, M.M.; Adams, S. Chiral gas chromatographic determination of ephedrine-type alkaloids in dietary supplements containing ma huang. *J. AOAC Int.* **1997**, *80* (2), 303–314.
2. McKenna, D.J.; Jones, K.; Hughes, K. *Botanical Medicines: The Desk Reference for Major Herbal Supplements*, 2nd Ed.; Haworth Herbal Press: New York, 2002; 271–319.
3. Chen, K.K. Half a century of ephedrine. *Am. J. Chin. Med.* **1974**, *2* (4), 359–365.
4. Foster, S.; Tyler, V.E. *Tyler's Honest Herbal: A Sensible Guide to the Use of Herbs and Related Remedies* 4th Ed.; Haworth Herbal Press: New York, 1999; 147–149.
5. Caveney, S.; Charlet, D.A.; Freitag, H.; Maier-Stolte, M.; Starratt, A.N. New observations on the secondary chemistry of world ephedra (Ephedraceae). *Am. J. Bot.* **2001**, *88* (7), 1199–1208.

6. Shekelle, P.; Hardy, M.; Morton, S.; Maglione, M.; Suttorp, M.; Roth, R.; Jungvig, L.; Mojica, W.A.; Gagne, J.; Rhodes, S.; McKinnon, E. *Ephedra and Ephedrine for Weight Loss and Athletic Performance Enhancement: Clinical Efficacy and Side Effects*, Evidence Report/Technology Assessment No. 76 (Prepared by Southern California-RAND Evidence-Based Practice Center, Under Contract No. 290-97-0001). AHRQ Publication No. 03-E022; Agency for Healthcare Research and Quality: Rockville, MD, March 2003.
7. Gurley, B. Extract versus herb: effect of formulation on the absorption rate of botanical ephedrine from dietary supplements containing ephedra (ma huang). *Ther. Drug Monit.* **2000**, *22* (4), 439–445.
8. Karch, S.B. *Toxicology and Clinical Pharmacology of Herbal Products*, Humana Press: New Jersey, 2000; 11–30.
9. Blanck, H.M.; Khan, L.K.; Serdula, M.K. Use of nonprescription weight loss products: results from a multistate survey. *J. Am. Med. Assoc.* **2001**, *286* (8), 930–935.
10. Chen, K.K.; Schmidt, C.F. Ephedrine and related substances. *Medicine* **1930**, *9*, 1–117.
11. Robbers, J.E.; Tyler, V.E. *Tyler's Herbs of Choice*, Haworth Herbal Press: New York, 1999; 112–116.
12. Holmstedt, B. Historical perspective and future of ethnopharmacology. *J. Ethnopharmacol.* **1991**, *32* (1–3), 7–24.
13. Dulloo, A.G.; Miller, D.S. The thermogenic properties of ephedrine/methylxanthine mixtures: animal studies. *Am. J. Clin. Nutr.* **1986**, *43* (3), 388–394.
14. Ang-Lee, M.K.; Moss, J.; Yuan, S.-S. Herbal medicines and perioperative care. *J. Am. Med. Assoc.* **2001**, *286* (2), 208–216.
15. Liu, Y.L.; Toubro, S.; Astrup, A.; Stock, M.J. Contribution of beta3-adrenoreceptor activation to ephedrine-induced thermogenesis in humans. *Int. J. Obes. Relat. Metab. Disord.* **1995**, *19* (9), 678–685.
16. Hoffman, B.B. Catecholamines, sympathomimetic drugs, and adrenergic receptor antagonists. In *Goodman and Gilman's The Pharmacological Basis of Therapeutics*, 10th Ed.; Hardman, J.G., Limbird, L.E., Gilman, A.G., Eds.; Pergamon Press: New York, 1990; 215–268.
17. White, L.M.; Gardner, S.F.; Gurley, B.J.; Marx, M.A.; Wang, P.L.; Estes, M. Pharmacokinetics and cardiovascular effects of ma-huang (*Ephedra sinica*) in normotensive adults. *J. Clin. Pharmacol.* **1997**, *37* (2), 116–122.
18. Dulloo, A.G.; Seydoux, J.; Girardier, L. Potentiation of the thermogenic antiobesity effects of

- ephedrine by dietary methylxanthines: adenosine antagonism or phosphodiesterase inhibition? *Metabolism* **1992**, *41* (11), 1233–1241.
19. Astrup, A.; Toubro, S. Thermogenic, metabolic, and cardiovascular responses to ephedrine and caffeine in man. *Int. J. Obes. Relat. Metab. Disord.* **1993**, *17* (Suppl. 1), S41–S43.
  20. Dulloo, A.G. Ephedrine, xanthines and prostaglandin-inhibitors: actions and interactions in the stimulation of thermogenesis. *Int. J. Obesity* **1993**, *17* (Suppl. 1), S35–S40.
  21. Dulloo, A.G.; Miller, D.S. The thermogenic properties of ephedrine/methylxanthine mixtures: human studies. *Int. J. Obesity* **1986**, *10*, 467–481.
  22. Astrup, A.; Toubro, S.; Christensen, N.J.; Quaade, F. Pharmacology of thermogenic drugs. *Am. J. Clin. Nutr.* **1992**, *55* (Suppl. 1), 246S–248S.
  23. Boozer, C.N.; Daly, P.A.; Homel, P.; Solomon, J.L.; Blanchard, D.; Nasser, J.A.; Strauss, R.; Meredith, T. Herbal ephedra/caffeine for weight loss: a 6-month randomized safety and efficacy trial. *Int. J. Obesity* **2002**, *26* (5), 593–604.
  24. Reynolds, J.E.F. *Martindale. The Extra Pharmacopoeia*, 31st Ed.; Royal Pharmaceutical Society: London, England, 1996; 1575–1577, 1588–1589.
  25. Bierman, C.W.; Pearlman, D.S. *Allergic Diseases from Infancy to Adulthood*, 2nd Ed.; W.B. Saunders Company: Philadelphia, 1988; 1–824.
  26. Hikano, H.; Ogata, K.; Konno, C.; Susumu, S. Hypotensive actions of ephedradines, macrocyclic spermine alkaloids of ephedra roots. *Plant Med.* **1983**, *48*, 290–293.
  27. Samunek, D.; Link, M.S.; Homoud, M.K.; Contreras, R.; Theohardes, T.C.; Want, P.J.; Estes, N.A.M., III Adverse cardiovascular events temporally associated with ma huang, an herbal source of ephedrine. *Mayo Clin. Proc.* **2002**, *77*, 12–17.
  28. Lee, M.K.; Cheng, B.W.H.; Che, C.T.; Hsieh, D.P.H. Cytotoxicity assessment off ma-huang (ephedra) under different conditions of preparation. *Toxicol. Sci.* **2000**, *56*, 424–430.
  29. NTP Toxicology and Carcinogenesis Studies of Ephedrine Sulfate (CAS No. 134-72-5) in F344/N Rats and B6C3F1 Mice (Feed Studies). National Toxicology Program. *Natl. Toxicol. Program Tech. Rep. Ser.* **1986**, *307*, 1–186.
  30. Yin, S.J.; Liu, D.X.; Wang, J.C.; Zhou, Y. A study on the mutagenicity of 102 raw pharmaceuticals used in Chinese traditional medicine. *Mutat. Res.* **1991**, *260* (1), 73–82.
  31. Hilliard, C.A.; Armstrong, M.M.; Bradt, C.I.; Hill, R.B.; Greenwood, S.K.; Galloway, S.M. Chromosome aberrations in vitro related to cytotoxicity of nonmutagenic chemicals and metabolic poisons. *Environ. Mol. Mutagen.* **1998**, *31* (4), 316–326.
  32. Nishikawa, T.; Kasajima, T.; Kanai, T. Potentiating effects of forskolin on the cardiovascular teratogenicity of ephedrine in chick embryos. *Toxicol. Lett.* **1991**, *56* (1–2), 145–150.
  33. Dietary supplements containing ephedrine alkaloids; proposed rule. 21 CFR 111. *Fed. Regist.* **1997**, *63* (107), 30,677–30,724.
  34. United States General Accounting Office. *Dietary Supplements: Uncertainties in Analyses Underlying FDA's Proposed Rule on Ephedrine Alkaloids*. GAO/HEHS/GGD-99-90; July 1999.
  35. Shekelle, P.G.; Hardy, M.L.; Morton, S.C.; Maglione, M.; Mojica, W.W.; Suttrop, M.J.; Rhodes, S.L.; Jungvig, L.; Gagne, J. Efficacy and safety of ephedra and ephedrine for weight loss and athletic performance: a meta-analysis. *J. Am. Med. Assoc.* **2003**, *289* (12), 1437–1545.
  36. Haller, C.A.; Benowitz, N.L. Adverse cardiovascular and central nervous system events associated with dietary supplements containing ephedra alkaloids. *N. Engl. J. Med.* **2000**, *343* (25), 1833–1838.
  37. Jellin, J.M. Therapeutic Research Faculty Staff. Ephedra. In *Natural Medicines Comprehensive Database*; Jellin, J.M., Ed.; 2000; 400–403. Available at <http://www.naturaldatabase.com/default.asp> (accessed October 2003).



# Evening Primrose (*Oenothera biennis*)

Fereidoon Shahidi  
Homan Miraliakbari

Memorial University of Newfoundland,  
St. John's, Newfoundland, Canada

## INTRODUCTION

Intake of dietary fat, particularly essential fatty acids, is known to influence human health and disease status. Evening primrose oil (EPO), a source of  $\gamma$ -linolenic acid, has received much attention for its possible therapeutic effects on inflammatory and cardiovascular diseases, diabetes, and cancer, among others. The beneficial health effects attributed to the oil are thought to be mediated by the desaturated metabolite of  $\gamma$ -linolenic acid, namely dihomo- $\gamma$ -linolenic acid, which is metabolized in the body to produce anti-inflammatory eicosanoids that may reduce the incidence or severity of human disease status and to promote health. EPO is also a source of antioxidative tocopherols. This entry attempts to summarize the effects of EPO in health promotion and disease risk reduction.

## BACKGROUND

Evening primrose (*Oenothera biennis*) is a biennial herb with erect stems reaching 3 ft in height and has fragrant, yellow flowers that bloom at nightfall (evenings). The plant is native to North America but has been naturalized in Europe and parts of the Southern Hemisphere. Following pollination (usually performed by moths), short and cylindrical capsules containing many small seeds are formed.<sup>[1]</sup> The oil extract of evening primrose seeds (evening primrose oil or EPO) is a rich source of the essential polyunsaturated omega-6 (*n*-6) fatty acid, linoleic acid (65–80% of total fatty acids) and its desaturated metabolite  $\gamma$ -linolenic acid (8–14% of total fatty acids).<sup>[2]</sup> EPO is also a good source of  $\alpha$ -tocopherol.<sup>[3]</sup> Several reports show that EPO is beneficial in the promotion of human health and in the treatment of several diseases, including heart diseases, cancer, inflammatory diseases, diabetes, and those related to women's health.<sup>[4]</sup> However, the U.S. Food and Drug Administration has not approved the

use of EPO for any of the health claims attributed to its use.<sup>[5]</sup> Among others, the oil is available as a dietary supplement in North America and Europe. Several moderately to highly refined dietary oil supplements containing EPO have been developed and marketed for specific uses including Efamast<sup>®</sup> for benign breast pain and Epogam<sup>®</sup> for atopic eczema, although no health agencies support these claims.

## Essential Fatty Acids

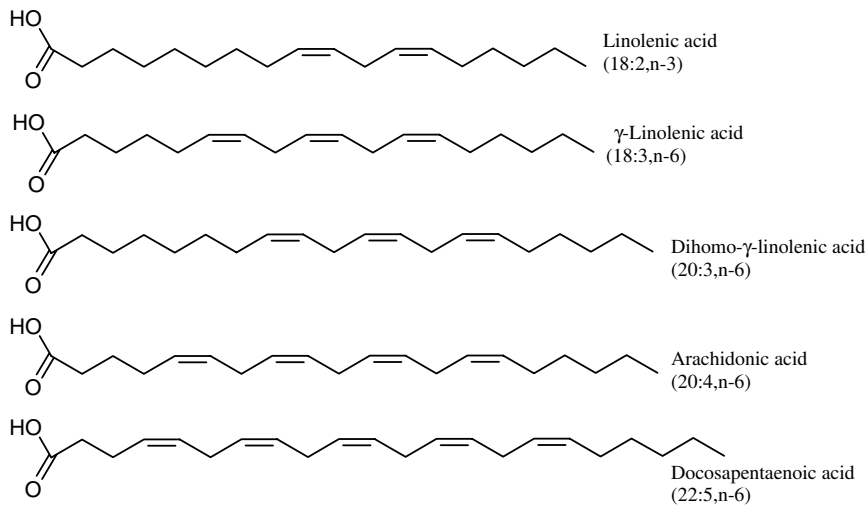
Humans are unable to synthesize polyunsaturated fatty acids (PUFAs), but are able to elongate and desaturate their 18-carbon (C<sub>18</sub>) precursors obtained through the diet.<sup>[6]</sup> In humans, two essential PUFA families, namely, the omega-6 (*n*-6) and the omega-3 (*n*-3) families, are recognized with linoleic acid (18:2, *n*-6), and  $\alpha$ -linolenic acid (18:3, *n*-3), serving as their parent compounds, respectively. The designation *n*-6 and *n*-3 indicates whether the sixth or the third carbon from the methyl terminus is unsaturated. EPO is a rich source of the *n*-6 fatty acid,  $\gamma$ -linolenic acid (18:3, *n*-6), which can be elongated *in vivo* to produce dihomo- $\gamma$ -linolenic acid (20:3, *n*-6), and then desaturated to produce arachidonic acid (20:4, *n*-6). Several putative health benefits of EPO have been attributed to  $\gamma$ -linolenic acid and its metabolites.<sup>[4]</sup>

## Metabolic Functions of Omega-6 Fatty Acids

In humans, linoleic acid (18:2, *n*-6) is the essential fatty acid required in the highest amount, which is estimated to be approximately 1–2% of total caloric intake in adults.<sup>[7]</sup> Dietary linoleic acid can be elongated and desaturated in the body to produce other long-chain *n*-6 fatty acids. If dietary linoleic acid intake is deficient,  $\gamma$ -linolenic acid (18:3, *n*-6), dihomo- $\gamma$ -linolenic acid (20:3, *n*-6), arachidonic acid (20:4, *n*-6), and docosapentaenoic acid (22:5, *n*-6) become essential. Hence, these fatty acids are referred to as conditionally essential (Fig. 1).<sup>[8]</sup> Both *n*-6 and *n*-3 fatty acids are chain elongated through the same biosynthetic pathways. Thus, elongation and desaturation of long-chain *n*-3 and *n*-6 PUFAs are proportional to the dietary

Fereidoon Shahidi is at the Department of Biochemistry, Memorial University of Newfoundland, St. John's, Newfoundland, Canada.

Homan Miraliakbari is at the Department of Biochemistry, Memorial University of Newfoundland, St. John's, Newfoundland, Canada.



**Fig. 1** Essential and conditionally essential fatty acids of the omega-6 (*n*-6) family.

intake of their  $C_{18}$  precursors.<sup>[9]</sup> The efficiency of fatty acid elongation pathways in humans is estimated to be 5–7% under optimal conditions when adequate dietary  $C_{18}$  essential fatty acids are present.<sup>[9]</sup>

The  $C_{18}$  *n*-6 and *n*-3 fatty acids are essential partly because they are the precursors of  $C_{20}$  and  $C_{22}$  lipid-based cytokines or eicosanoids [prostaglandins (PG), thromboxanes (TX), and leukotrienes (LT)]. These lipid mediators play crucial roles in vascular physiology and inflammatory responses, among others.<sup>[10]</sup> The long-chain *n*-6 and *n*-3 fatty acids have also been beneficial in many diseases e.g., cancer,<sup>[11]</sup> cardiovascular diseases, including stroke.<sup>[12]</sup> Therapeutic health effects of EPO have often been attributed to its high content of  $\gamma$ -linolenic acid, which is elongated *in vivo* to dihomogamma-linolenic acid,<sup>[13]</sup> which can then be metabolized via the cyclo-oxygenase or lipoxygenase enzyme families to yield series-1 PG and TX or series-3 LT, respectively. The cyclo-oxygenase and lipoxygenase products of dihomogamma-linolenic acid and hence EPO have been shown to exert anti-inflammatory,<sup>[14]</sup> anti-proliferative,<sup>[15]</sup> and anticarcinogenic<sup>[16]</sup> effects. However, the desaturase product of dihomogamma-linolenic acid, arachidonic acid (20:4, *n*-6), is metabolized to produce proinflammatory PG and LT that may negate the anti-inflammatory potential of dihomogamma-linolenic acid *in vivo*.<sup>[17]</sup>

The long-chain *n*-6 and *n*-3 fatty acids play important roles in maintaining the fluidity or optimal state of cell membranes and are key components in the membranes of highly specialized cells such as neurons, erythrocytes, cardiomyocytes, retinocytes, germ cells, and immune cells.<sup>[18]</sup> Linoleic acid and elongation products thereof have a role in maintaining epidermal integrity. They are essential for the development and maintenance of the skin's water impermeable barrier, the stratum corneum.<sup>[19]</sup> The elongation products of *n*-6 and *n*-3 fatty acids are also required for proper

growth and development of the brain and retina during gestation and infant life,<sup>[20]</sup> and for normal brain function and vision in adults.<sup>[21]</sup> More recently, these products have been shown to affect gene expression, leading to pronounced changes in metabolism, cellular differentiation, and growth.<sup>[22]</sup>

## EPO AND INFLAMMATORY DISEASES

Chronic inflammation associated with diseases such as inflammatory bowel disease, psoriasis, arteriosclerosis, and rheumatoid arthritis may be caused or attenuated by alterations of normal eicosanoid pathways resulting in overproduction of inflammatory cytokines. Many anti-inflammatory drugs act as inhibitors of proinflammatory cytokine production. For example, nonsteroidal anti-inflammatory drugs (NSAIDs) (acetylsalicylic acid or aspirin) irreversibly inactivate cyclo-oxygenase activity, thereby inhibiting proinflammatory PG and TX biosynthesis. EPO may be of use in the treatment and/or management of some inflammatory diseases because it has been shown to reduce proinflammatory eicosanoid biosynthesis, while concomitantly increasing anti-inflammatory biosynthesis both *in vitro* and *in vivo*.<sup>[23]</sup> Currently, there is much research investigating their therapeutic potential for inflammatory diseases.

Several research groups have performed feeding studies with EPO to unravel its effects on proinflammatory cytokine production in cell-based *in vitro* model systems.<sup>[24]</sup> In one recent study,<sup>[25]</sup> 3-week-old male Wistar rats were fed diets supplemented with oils including EPO for 8 weeks. Experimental diets contained 15% EPO, sardine oil, or virgin olive oil by weight, while control diets contained 2% corn oil. After the 8-week feeding period, lymphocytes and other blood cells were obtained from the peritoneal region

of animals from all four groups and were purified to yield a suspension containing approximately 85% polymorphonuclear leukocytes and 15% mononuclear lymphocytes. The leukocyte suspensions were stimulated with the calcium ionophore (A23187) to induce the production of cyclo-oxygenase-derived eicosanoids, which were quantified by radioimmunoassay. In these studies, leukocytes from EPO-fed animals had reduced the production of proinflammatory prostaglandin E<sub>2</sub> (PGE<sub>2</sub>) and thromboxane B<sub>2</sub> (TXB<sub>2</sub>) compared to those from control animals. However, the difference reached significance for PGE<sub>2</sub> only.<sup>[25]</sup> Larger and more important differences were observed for leukocytes from the fish oil-fed animals but not for those with virgin olive oil. These results show that EPO may be an effective anti-inflammatory agent since its long-term dietary presence reduces lymphocyte reactivity, possibly due to its  $\gamma$ -linolenic acid constituent.<sup>[25]</sup>

### EPO and Atopic Dermatitis

Atopic dermatitis, also known as atopic eczema, is an immune-mediated inflammatory skin disorder characterized by redness, itching, and oozing vesicular lesions that become scaly, crusted, or hardened.<sup>[26]</sup> Corticosteroid and antipruritic treatments are common for addressing atopic dermatitis, but concerns regarding the side effects of these drugs have prompted search for alternative natural and less toxic treatments.<sup>[27]</sup> The effects of EPO supplementation on atopic dermatitis have received much attention because the fatty acid composition of the oil may interfere with the production of proinflammatory cytokines, which could potentially reduce the symptoms of this disease.<sup>[28]</sup> Furthermore, low  $\Delta$ -6-desaturase activity leading to  $\gamma$ -linolenic acid deficiency has previously been reported as a contributing factor to atopic dermatitis,<sup>[29]</sup> making EPO (with its high  $\gamma$ -linolenic acid content) the subject of much interest in eczema therapy. Morse et al.<sup>[30]</sup> performed a meta-analysis on nine placebo-controlled studies investigating the efficacy of EPO supplementation in the treatment of atopic dermatitis; the individual studies were performed in eight different centers.<sup>[30]</sup> This analysis included two of the earliest large-scale studies on EPO and eczema as well as seven small ones (14–47 participants). In these studies, patients and doctors assessed the severity of eczema in experimental and placebo groups by scoring measures for skin symptoms including itchiness, dryness, and scalliness. Subjects in the experimental groups were provided with Epogam EPO capsules containing 10%  $\gamma$ -linolenic acid. Results from all studies were pooled together to give a global clinical score for each assessment point. This early meta-analysis showed that

the clinical scores for patients receiving Epogam supplements were significantly better than those for placebo groups, particularly for the symptom of itch ( $P < 0.0001$ ). Furthermore, there was a positive correlation between plasma dihomo- $\gamma$ -linolenic acid levels and clinical score improvement.<sup>[30]</sup> However, the results of this meta-analysis have been questioned by experts for two main reasons: first it did not consider the relatively large study by Bamford, Gibson, and Renier,<sup>[31]</sup> which included 123 participants and did not demonstrate any therapeutic effect of EPO on eczema. Second, this meta-analysis as well as seven of the studies referenced by it were sponsored by Scotia Pharmaceuticals, the manufacturer of Epogam. Some recent studies have failed to reflect the efficacy of EPO as treatment for atopic eczema, as exhibited in the placebo-controlled trial conducted by Hederes and Berg<sup>[32]</sup> that included 60 eczemic children supplemented with Epogam for 16 weeks as well as in the larger placebo-based trial by Berth-Jones and Graham Brown<sup>[33]</sup> that included 123 patients. It has been postulated that EPO treatment may modify immunological parameters associated with atopic dermatitis such as plasma interferon- $\gamma$  (INF- $\gamma$ ) and immunoglobulin-E (IgE) levels.<sup>[34,35]</sup> Recently, Yoon, Leg and Lee<sup>[35]</sup> investigated this possibility in 14 children with atopic dermatitis. A group of 6 children without the disorder were used as normal controls. EPO was administered to participants with atopic dermatitis until their symptom scores remained below 1 for 2 weeks. EPO treatments lasted  $75 \pm 58$  days; all participants receiving EPO exhibited clinical improvements and >42% of this group were completely cleared of symptoms of atopic dermatitis. Before EPO treatments, the mean plasma INF- $\gamma$  levels in the experimental group were significantly lower than that of the control group ( $P < 0.01$ ). But after treatments, INF- $\gamma$  levels in the experimental group increased to a level equal to that of the control group ( $P < 0.01$ ).<sup>[35]</sup> Plasma IgE levels of the experimental group were significantly greater than that of the control group both before and after the treatment. The results of this study imply that EPO is therapeutic in children with atopic dermatitis, and the observed clinical improvements are likely due to the normalization of INF- $\gamma$  levels and perhaps other immunological parameters.<sup>[35]</sup>

Thus, no consensus exists among the results of different studies on the effects of EPO supplementation for atopic dermatitis. The heterogeneous nature of the patients, who can exhibit slight to very serious symptoms, may explain the observed inconsistencies.<sup>[36]</sup> Recent reviews show that the current body of literature is too inconsistent, making it impossible to conclusively link EPO supplementation to improvements in eczema symptoms.<sup>[37,38]</sup> Larger-scale, placebo-controlled studies are needed to provide firm evidence



about the postulated beneficial effects of EPO on atopic dermatitis symptoms.

### EPO and Rheumatoid Arthritis

Arthritis is a degenerative chronic disease that can affect any of the body's joints. The term arthritis refers to the inflammation of a joint, but not all arthritic diseases involve inflammation. One very common type of the disease is rheumatoid arthritis, which is a chronic inflammatory disease involving the body's immune system. According to Health Canada, 4 million Canadians suffer from arthritis. Rheumatoid arthritis is an autoimmune condition that occurs in younger adults and sometimes in children. It is due to the release of inflammatory cytokines into the fluid space between the bones of a joint (synovium), which causes chronic inflammation of the cartilage covering the ends of the bones. The most common symptoms are pain, stiffness, and, if left untreated, bone deformity.<sup>[15]</sup> The Raynaud phenomenon and Sjögren syndrome are two inflammatory diseases commonly seen in rheumatoid arthritis patients.<sup>[39]</sup> Raynaud phenomenon is an immunologic syndrome characterized by vascular spasms and enhanced blood cell aggregation that leads to ischemia of the fingers, toes, ears, and nose and causes severe pain and pallor in the affected extremities.<sup>[40]</sup> Sjögren syndrome is an immunologic disease affecting predominantly women in their 30s and leads to the destruction of exocrine glands. The main symptoms include persistent cough and dry eyes and mouth.<sup>[41]</sup> Ingestion of EPO enhances dihomo- $\gamma$ -linoleic acid levels<sup>[42]</sup> and may promote the production of anti-inflammatory series-1 PG or reduce proinflammatory series-2 PG production, which may be of benefit to rheumatoid arthritis patients. To investigate this possibility, research has been performed on the effects of EPO on rheumatologic conditions.

Two early studies investigating the effect of EPO supplementation on rheumatoid arthritis symptoms were conducted by Brown et al.<sup>[43]</sup> and Hansen et al.<sup>[44]</sup> Both studies involved only 20 or less participants who were supplemented with low daily doses of EPO (<1 g) for 3–4 mo. The tests showed no significant improvements, although a trend toward amelioration was observed in rheumatoid arthritis sufferers in the study by Hansen et al.<sup>[44]</sup> Jantti et al.<sup>[45]</sup> studied the effects of EPO or olive oil administration (approximately 1.4 g per day) for 12 weeks on sufferers. This research was unique because participants were required to abstain from NSAID use for the duration of the study, which could potentially negate the possible therapeutic effects of EPO if they are mediated by the anti-inflammatory PG and TX products of dihomo- $\gamma$ -linolenic acid.<sup>[45]</sup> Compared to baseline,

neither the olive oil nor EPO group exhibited any clinical improvements in rheumatoid arthritis symptoms.<sup>[45]</sup> Although these early studies did not provide evidence of EPO's therapeutic effects, it is possible that the supplementation regimes were insufficient and that higher doses of the oil given over a longer period may improve rheumatoid arthritis symptoms. More recently, Brzeski, Madhok, and Capel<sup>[46]</sup> examined the effects of supplementation of 6 g of EPO or olive oil per day for 6 mo on symptom management in 40 rheumatoid arthritis sufferers. While olive oil supplementation was supposed to act as a placebo, a significant improvement was however noted at the end of the 6-mo evaluation period compared to baseline, similar to that observed for participants in the EPO group. Thus, both olive oil and EPO supplementations were equally effective in improving the clinical scores of rheumatoid arthritis sufferers, and selection of an appropriate placebo must be carefully exercised in such studies so that the possible therapeutic effects of EPO are not masked. Belch et al.<sup>[47]</sup> studied the effects of EPO and EPO plus fish oil (approximately 6 g per day) on rheumatoid arthritis symptoms in 49 participants over a 12-mo supplementation period. In this study, 16 patients were given EPO, 15 EPO plus fish oil, and 18 liquid paraffin as placebo.<sup>[47]</sup> Measures of disease activity and NSAID use were used to assess the effectiveness of the treatments. After the supplementation period, NSAID use was lower in both the EPO and EPO plus fish oil groups. However, no clinical improvements were observed in either treatment group implying that EPO did not serve as a disease-modifying agent for rheumatoid arthritis.<sup>[47]</sup> The results of a similar, but larger, study, including 402 rheumatoid arthritis patients were reported by Darlington and Stone.<sup>[48]</sup> This was a multicenter, double-blind and placebo-controlled trial. Participants were randomized into one of two groups receiving between 2 and 3 g per day of EPO (experimental group) or sunflower oil (placebo), the duration of the treatment period may not have been consistent among the centers. The results of this study did not reveal any therapeutic effects of EPO in sufferers of rheumatoid arthritis.<sup>[48]</sup>

The current body of literature regarding EPO supplementation and rheumatoid arthritis does not provide any clear understanding regarding its therapeutic effects; few studies, however, show a clear improvement in symptoms, but many refute its therapeutic potential, due to the use of faulty designs. Some of these studies have used inappropriate placebos, others have recruited participants exhibiting a wide range of disease symptoms, and many have used treatment doses that were too small to promote clinical improvements in sufferers of rheumatoid arthritis. Larger-scale, placebo-based trials are needed to

conclusively evaluate the effects of EPO on rheumatoid arthritis.

## EVENING PRIMROSE AND CARDIOVASCULAR DISEASE

Cardiovascular disease is the common term for all diseases that affect the heart and circulatory system, including ischemic, nonischemic, hypertensive and valvular heart disease. It is the leading cause of death in the Western societies<sup>[49]</sup> and has been linked to the high fat intake, particularly saturated fat, common in the Western diet.<sup>[50]</sup> Besides high saturated and trans fat intake, other risk factors include diabetes mellitus, smoking, stress, physical inactivity, high sodium intake, and genetic predisposition. The hallmark of cardiovascular disease is cardiac dysfunction, which in most cases is caused by hypertension due to the narrowing of large arteries with atheromatous plaques or the total occlusion of coronary arteries (thrombus) caused by atheromatous blockages leading to myocardial tissue necrosis. Both conditions reduce the heart's ability to pump blood and can result in either chronic or sudden heart failure.

Several reports indicate that ingestion of dietary PUFA reduces the likelihood of cardiovascular disease. Much attention has been paid to the antithrombotic and antiatherogenic effects of *n*-3 fatty acids of fish oils, while oils rich in *n*-6 fatty acids have evoked relatively less interest.<sup>[51]</sup> Arachidonic acid is the major metabolite produced from dietary linoleic acid, and eicosanoids produced from arachidonic acid are known as being proaggregatory. Thus, *n*-6 fatty acids have been speculated to promote thrombosis and atherogenesis.<sup>[52]</sup> However, not all dietary *n*-6 fatty acids become elongated and desaturated into arachidonic acid. For example, dietary  $\gamma$ -linolenic acid is rapidly converted into dihomono- $\gamma$ -linolenic, which is the precursor of the antiaggregatory vasodilator, PGE<sub>1</sub>.<sup>[52]</sup> EPO is a source of antioxidative compounds such as  $\alpha$ -tocopherol,<sup>[53]</sup> which may protect highly oxidizable biomacromolecules such as low-density lipoproteins (LDL) from oxidation in vivo, which is known to precede some aspects of cardiovascular disease, most notably blood vessel damage.<sup>[54]</sup> The fact that EPO is a source of  $\gamma$ -linolenic acid and antioxidative compounds has led researchers to investigate its possible cardioprotective effects. Most of these studies have been conducted using animal models of cardiovascular disease.

Singer et al.<sup>[55,56]</sup> using spontaneously hypertensive rats (SHR), revealed that dietary EPO intake alters blood lipid profiles and systolic pressures, thereby improving cardiovascular risk factors.<sup>[55,56]</sup> The dietary proportions and types of fats consumed can alter

platelet–blood vessel interactions. Long-chain *n*-3 fatty acids and dihomono- $\gamma$ -linolenic acid may exert antithrombotic activity since their eicosanoid metabolites reduce platelet aggregability, a known cardiovascular risk factor.<sup>[57]</sup> De la Cruz et al.<sup>[58]</sup> investigated the ability of EPO to reduce blood platelet aggregation in response to inducers (adenosine diphosphate or collagen) using a total of 40 male white New Zealand rabbits fed normal and atherogenic diets. These researchers also measured platelet thromboxane synthesis and malondialdehyde (MDA) production to assess blood platelet reactivity. Two control groups were used in this study: one group received a low fat diet (2.1%, w/w) with normal lipid composition (normal diet group), while the other was fed a high fat (12.2%, w/w) diet containing primarily saturated fatty acids (atherogenic diet group). The diets of experimental animals were supplemented with EPO to get a total fat content between 19.8% and 20.3%. These feeding trials lasted 6 weeks; on the last day, the animals were anesthetized, and blood samples were obtained for subsequent analysis. Compared to the normal control diet, the atherogenic control diet resulted in hyperlipidemia (hypercholesterolemia and hypertriglyceridemia) with a concomitant decrease in high-density lipoprotein (HDL) levels. Platelet aggregation and platelet production of thromboxane B<sub>2</sub> (TXB<sub>2</sub>) and MDA were several times greater in the atherogenic diet group compared to controls. Supplementation of EPO in normal diets did not alter blood lipid and platelet parameters compared to normal controls. However, EPO significantly reduced total blood cholesterol and triacylglycerols, while increasing HDL levels in animals fed atherogenic diets, and reducing blood lipid aggregation level to that of normal control values ( $P < 0.05$ – $P < 0.01$ ). Treatment also reduced TXB<sub>2</sub> and MDA production by platelets from animals fed atherogenic diets, although these values were still significantly higher than those of the control animals fed on a normal control diet ( $P < 0.05$ – $P < 0.01$ ). Diets rich in saturates promoted the onset of cardiovascular risk factors such as platelet reactivity and aggregation, and EPO treatment normalized these parameters substantially in male New Zealand white rabbits.<sup>[58]</sup> More recently, De la Cruz et al.<sup>[59]</sup> assessed the antioxidant potential of EPO in 40 male white New Zealand rabbits that were fed atherogenic diets (50% fat, w/w) or normolipidic diets (20% fat, w/w) containing 15% EPO (w/w); controls were fed either atherogenic or normolipidic diets without EPO enrichment. The duration of the feeding period was 6 weeks, after which all animals were sacrificed, and samples of liver, brain, heart, aorta, and blood platelets from each animal were collected to test MDA and glutathione levels. The results of this study showed that in normolipidic diets, EPO treatment did not alter MDA production

or glutathione levels. However, atherogenic diets promoted MDA production (both induced and non-induced TBARS) and glutathione oxidation in all tissues and platelets. Meanwhile, tissues of animals receiving atherogenic diets plus EPO exhibited a lesser induction of MDA production and glutathione oxidation ( $P < 0.05$ – $P < 0.01$ ). Thus, EPO supplementation may reduce the production of lipid oxidation products in tissues, which are implicated in the onset of atherosclerosis.<sup>[59]</sup> The cardioprotective effects of EPO may be due to the presence of antioxidative components. Charnock<sup>[60]</sup> recently evaluated the effects of dietary EPO, sunflower oil, borage oil, and saturated fat against ventricular fibrillation in male Hooded-Wistar rats fed normal chow diets supplemented with 6% EPO (w/w) for 32 weeks. At the end of the feeding period, the animals were anesthetized and ventilated, followed by surgical ligation (occlusion) of the left descending coronary artery to induce ventricular fibrillation and cardiac arrhythmia. In this study, incidence and duration of ventricular fibrillation were lowest in the EPO group. Interestingly, EPO exerted a protective effect against ventricular fibrillation, which exceeded that of borage oil (containing three times more  $\gamma$ -linolenic acid than EPO). This implies that  $\gamma$ -linolenic acid may not be the therapeutic component of EPO; some other compounds present in EPO may exert cardioprotective effects in this animal model.<sup>[60]</sup>

Very few investigations on the cardioprotective effects of EPO have been carried out in humans. Abraham et al.<sup>[61]</sup> examined changes in the fatty acid composition of adipose tissue, serum triacylglycerol and cholesterol ester levels, and lipoprotein profiles in men with low dihomo- $\gamma$ -linolenic acid levels supplemented with safflower oil or EPO for four mo. Participants in this study were split into four groups (6–9 men per group) receiving 10, 20, or 30 ml per day of EPO or 20 ml per day of safflower oil. Adipose and blood samples were obtained from participants before and after the treatment period. Treatment with EPO at levels  $\geq 20$  ml per day increased adipose dihomo- $\gamma$ -linolenic acid levels ( $P < 0.01$ ); safflower oil did not increase adipose dihomo- $\gamma$ -linolenic acid content. Within individual participants, similar trends were observed between adipose fatty acid compositions and serum triacylglycerol and cholesterol ester fatty acid compositions. Safflower oil and EPO treatments did not significantly lower LDL or raise HDL levels, implying that EPO may not exert strong antiatherogenic effects in humans, contrary to the findings from the animal models.<sup>[61]</sup> However, Abraham et al.<sup>[61]</sup> used a highly select group of men most likely possessing low  $\Delta$ -6-desaturase activity, which may have affected the outcome of this study. More recently, Khan et al.<sup>[62]</sup> performed a double-blind, placebo-based

study to examine the effects of an 8-mo treatment with food oils on vascular tone and endothelial function in 173 healthy volunteers (118 males and 55 females). The placebo oil used was 25 : 75 (w/w) mixture of soybean oil and coconut oil, administered at 10 g per day to the placebo group. Participants in the EPO group received 5 g EPO plus 5 g placebo oil per day. The results for the EPO group showed that it did not alter the vasodilator responses to acetylcholine (“general endothelial function”) or sodium nitroprusside (“endothelium-independent vasodilation”) in healthy volunteers.<sup>[62]</sup>

The majority of results from human and animal studies exhibit different findings with respect to the cardioprotective effects of EPO, as certain invasive tests cannot be performed on humans. In animal models, specific cardiovascular conditions can be induced, thereby allowing researchers to more accurately measure specific responses to EPO. More research involving human subjects and possibly trials involving recovering cardiovascular disease patients already taking medication need to be done in order to assess whether EPO exerts any cardioprotective effects in medicated patients.

## EPO AND CANCER

Cancer is a general term for more than 100 diseases that are characterized by uncontrolled and abnormal growth of cells (neoplasia) derived from normal tissues. Cancerous cells may develop into tumors that could produce toxins or spread locally or through the bloodstream and lymphatic system to other parts of the body (metastasize). The initial steps that lead to the transformation of normal cells into cancerous cells are not well understood. But many lines of evidence implicate the involvement of mutated genes in cells progressing toward cancer. Cancer cells are incapable of apoptosis, a property that makes them potentially “immortal.”<sup>[63]</sup> Two recognized treatments for cancer are chemotherapy, which is the administration of drugs (alkylating agents, e.g., vinblastine and chlorambucil) and radiation therapy in which cancerous tumors are subjected to ionizing radiation. Both treatments cause irreparable damage to the DNA of cancer cells, thereby promoting cell apoptosis. Currently, much research is being conducted to identify new cancer therapies with less adverse side effects and greater specificity toward cancer cells. Experimental and epidemiological studies have demonstrated that the composition of dietary fat affects the incidence and progression of some cancers.<sup>[64]</sup>

Several cancerous cell lines have been developed from animal and human malignant tumors. They serve as excellent *in vitro* models for cancer studies because

the biochemical processes that occur within these cells are remarkably similar to those within their parent tumors. Early reports using cancerous cell lines have shown that  $\gamma$ -linolenic acid and metabolites of this compound suppress cell proliferation.<sup>[65]</sup> The fact that EPO is a dietary source of  $\gamma$ -linolenic acid has prompted several research groups to investigate its anticancer potential. Gardiner and Duncan<sup>[66]</sup> examined the effects of EPO and safflower oil on the growth of precultured BL6 melanoma tumors implanted in mice. After implantation, the mice were fed diets containing 6% EPO or safflower oil for 4 weeks after which tumor growth and  $\Delta$ -6-desaturase activity were measured in each animal. Results showed that EPO promoted in vivo tumor growth to a greater extent than safflower oil and that the  $\Delta$ -6-desaturase activities of the in vivo BL6 tumors were lower than that of in vitro BL6 tumors. These results collectively imply that BL6 tumor growth in vivo is enhanced in the presence of dietary  $\gamma$ -linolenic acid, which may ameliorate the anti-growth effects of low  $\Delta$ -6-desaturase activity since  $\gamma$ -linolenic acid is a product of this enzyme's activity.<sup>[66]</sup> Ramesh and Das<sup>[67]</sup> examined the effects of topical EPO or fish oil application on skin carcinogenesis in male Swiss albino mice. This study employed a multi-stage skin carcinogenesis model involving two clearly defined steps: initiation and promotion using noxious chemicals topically applied on the skin of mice. Treatments of 10 mg EPO or fish oil were used twice daily for 14 weeks, after which papilloma (benign skin tumors) counts and histopathological assessments of excised skin samples were performed. Both fish oil and EPO significantly reduced papilloma formation compared to the control animals receiving no topical EPO or fish oil treatment ( $P < 0.05$ ). However, neither EPO nor fish oil could influence skin cell proliferation in this model. These results imply that EPO may interfere with the development of papillomas but cannot influence the metastatic properties of skin tumors in this model.<sup>[67]</sup> Booyens et al.<sup>[65]</sup> studied liver cancer cell proliferation in 6 patients taking EPO supplements and reported a decrease in tumor sizes in 3 patients as well as considerable reductions in plasma levels of cancer markers.<sup>[65]</sup> More recently, Kollias et al.<sup>[68]</sup> studied the effects of EPO (4 g per day) on breast fibroadenoma (benign solid growth) in 20 female subjects. The treatment period lasted 6 mo, after which clinical and ultrasound measurements of previously diagnosed fibroadenomas were compared. Results of these measurements showed that EPO treatment did not alter fibroadenoma size compared to matched controls.<sup>[68]</sup>

Data from animal models imply that EPO may exert anticarcinogenic effects when consumed as a dietary component, and some human studies support these findings. However, the subset of studies involving

human subjects has been small scale and is quite prone to errors due to interpatient variability. Larger-scale human studies with subject populations that exhibit similar disease symptoms and severity are needed to provide strong support for the anticarcinogenic potential of EPO.

## EPO AND WOMEN'S HEALTH

Several adverse health effects have consistently been observed in menopausal and postmenopausal women. Menopausal hot flashes, postmenopausal osteoporosis, and chronic breast mastalgia (chronic breast pain) are examples of adverse health states affecting women.<sup>[69]</sup> The etiologies of these conditions are not well understood, but one common factor has been associated with their declining estrogen level.<sup>[70]</sup> It has been speculated that alterations in hypothalamic activity may underline the clinical aspects of adverse menopausal conditions; however, this view is not accepted widely.<sup>[71]</sup> For most women, estrogen replacement therapy (ERT) is an effective treatment for adverse menopausal conditions. But several concerns regarding the long-term safety of ERT have prompted the search for natural, nonhormonal substitutes, and EPO in this regard has received some positive attention.<sup>[2]</sup>

Chenoy et al.<sup>[72]</sup> performed a randomized, double-blind, placebo-based trial to evaluate the effect of oral EPO consumption or paraffin supplementation (4 g per day for 6 mo) in the treatment of hot flashes among 56 menopausal women. Results were based on reports given in diaries of all 56 participants, which showed no significant difference between EPO and placebo treatments despite numerous claims of its efficacy.<sup>[72]</sup> Menopause is known to precede bone mineral density loss leading to osteoporosis that significantly weakens bones making them prone to fractures after light traumas. Adequate premenopausal calcium and vitamin D intakes are negative risk factors for osteoporosis, while smoking and back-to-back pregnancies are promotional risk factors. Bassey et al.<sup>[73]</sup> recently performed a randomized placebo-controlled trial to investigate changes in bone density markers in response to Efacal<sup>®</sup>, an EPO plus eicosapentaenoic acid (EPA), and calcium supplement. This study included 43 pre- and postmenopausal women supplemented with either 4 g Efacal, 1 g calcium per day, or placebo. Final assessments were made after 12 mo. Completed food frequency questionnaires were used to assess background calcium intake. The results of this study showed that Efacal treatments did not significantly alter bone mineral density or any other osteoporosis markers, which may indicate the lack of therapeutic efficacy of Efacal in osteoporosis treatment or the already optimal nutritional state of participants in this

study.<sup>[73]</sup> Breast mastalgia is the most commonly diagnosed breast problem and can lead to severe pain that interferes with daily life. Effective medications are available, but the high frequency of side effect occurrence with these drugs has stemmed interest in alternative remedies for breast mastalgia.<sup>[2]</sup> Recently, Blommers et al.<sup>[74]</sup> investigated the effects of fish oil and EPO on breast mastalgia in 120 premenopausal women. The participants were divided into four groups receiving either 3 g EPO plus 3 g fish oil per day, 3 g EPO plus 3 g corn oil per day, 3 g fish oil plus 3 g corn oil per day, or 6 g corn oil per day (the control group). The treatments were given for 6 mo and symptom questionnaires were sent to participants 3 and 6 mo into the trial and were compiled for subsequent symptom analysis. The results of this study showed no significant differences between the three experimental groups and the control group with respect to the number of days with active mastalgia, indicating that EPO supplementation may not be an effective treatment for breast mastalgia.<sup>[74]</sup>

Premenstrual syndrome affects millions of premenopausal women and exerts a wide variety of symptoms including abdominal pain, breast tenderness, headache, depression, fatigue, and mood swings that usually subside within 72 hr after the onset of menstrual flow.<sup>[75]</sup> The syndrome occurs more frequently in women with atopic allergies<sup>[76]</sup> and in those with a high saturated fat intake,<sup>[77]</sup> which implicates abnormal fatty acid metabolism or dietary PUFA deficiency as promotional factors for premenstrual syndrome. Some reports have indicated that EPO may be effective in the management of premenstrual syndrome symptoms. However, few placebo-controlled trials have been conducted to investigate this possibility. Khoo, Munro, and Battistutta<sup>[78]</sup> examined the therapeutic effectiveness of EPO (Efamol<sup>®</sup>) in the relief of symptoms of premenstrual syndrome. This was a prospective, randomized, double-blind, placebo-controlled trial involving 38 women supplemented with 4 g per day of EPO or placebo for 6 mo (6 menstrual cycles). No significant differences in premenstrual syndrome symptoms were observed between the EPO and placebo groups throughout this study. Yet both groups did exhibit improvements in overall symptoms (psychological, fluid retention, and breast pain) implying that the improvement observed in the EPO group was due to the placebo effect.<sup>[78]</sup> Budeiri, Li-Wan-Po, and Dornan<sup>[79]</sup> analyzed the results of 7 placebo-controlled trials that investigated the effects of EPO on premenstrual syndrome symptoms (meta-analysis). The differences that existed between these studies made a rigorous meta-analysis impossible. EPO was shown to exert moderate beneficial effects compared to placebo for breast pain associated with premenstrual syndrome. Yet, it displayed no overall evidence of

effectiveness in the management of premenstrual syndrome.<sup>[79]</sup>

A link between pregnancy complications and low maternal PUFA status has been established. Marine diets rich in *n*-3 PUFA are known to reduce the incidence of gestation-induced hypertension,<sup>[80]</sup> a condition characterized by increased platelet aggregation and vasoconstriction leading to thrombosis in nonhypertensive women. If in addition to hypertension high urinary protein levels develop (proteinuria), the condition is called pre-eclampsia. Zielinski et al.<sup>[81]</sup> studied the effects of EPO against hypertension development in pregnant rabbits. In this study, pregnant and nonpregnant rabbits were supplemented with 50 mg/kg per day EPO for 10 days. Pregnant and nonpregnant rabbits on regular diets were used as controls. After the supplementation period, angiotensin II, a blood clotting factor, was administered to animals to induce hypertension, and the pressor response (increase in blood pressure) was measured. Results showed that EPO-supplemented pregnant rabbits exhibited a significantly lower systolic and diastolic response to angiotensin II compared to the control pregnant rabbits. No significant difference in the pressor response to angiotensin II existed between nonpregnant rabbits of both groups. These results may be attributable to the high levels of  $\gamma$ -linolenic acid that may have enhanced PGE<sub>1</sub> (antiaggregatory) synthesis. Coadministration of PGE<sub>1</sub> with angiotensin II reduces vascular responsiveness to angiotensin II.<sup>[81]</sup> Moodley and Norman<sup>[82]</sup> performed a randomized, placebo-based trial to study the effects of 4 g/day EPO administration in 47 women with established pre-eclampsia, showing that no difference in pre-eclampsia symptoms (blood pressure, and blood aggregability) existed between the two groups.<sup>[82]</sup> One of the largest clinical trials investigating the effect of EPO treatment on women with pre-eclampsia was performed by D'Almeida et al.<sup>[83]</sup> A total of 150 women in their first trimester of pregnancy were supplemented with a mixture of EPO, EPA, and docosahexaenoic acid (DHA) or placebo for 6 mo. Some were treated with magnesium oxide. Participants supplemented with the EPO mixture exhibited significantly better cardiovascular function (reduced incidence of edema,  $P < 0.004$ ) and reduced pre-eclampsia, implying that EPO in combination with EPA and DHA may be helpful in the prevention of pre-eclampsia.<sup>[83]</sup>

Early studies have shown that EPO is an effective natural remedy for some female specific adverse health conditions.<sup>[2]</sup> But more recent studies disagree with some of these findings, showing that EPO exerts no significant change beyond a placebo effect in controlled human trials. More investigations are needed in order to conclusively resolve these discrepancies. In addition, patient assessments should be based on clinical

evaluations and not on symptom frequency questionnaires in order to reduce the level of uncertainty in results and increase the significance of experimental findings.

### EPO AND DIABETES MELLITUS-INDUCED NEUROPATHY

Insulin is a peptide-based pancreatic hormone that stimulates most body cells to absorb plasma glucose necessary for energy and cellular metabolism. Several mammalian glucose transporters require insulin for activation and cell membrane incorporation (receptor requirement). Diabetes mellitus is a disease caused by a relative or complete lack of insulin action that leads to detrimental alterations in carbohydrate metabolism. "Diabetes mellitus" is Latin for "to flow sweet," which refers to the large volume of urine produced daily with high glucose content. There are two forms of diabetes mellitus: juvenile onset and adult onset diabetes. Juvenile onset diabetes (Type-I diabetes) is a genetic disease believed to be caused by an autoimmune reaction early in life in which the pancreatic  $\beta$ -cells that secrete insulin into the bloodstream become nonfunctional, thereby causing insulin deficiency that can only be treated with insulin injections. Hence the term insulin-dependent diabetes mellitus (IDDM). Adult onset diabetes (Type-II diabetes), by far the most prominent form, is characterized by normal-to-high  $\beta$ -cell activity and insulin levels but markedly decreased insulin sensitivity, and tends to affect obese individuals.<sup>[84]</sup> Both Type-I and Type-II diabetes result in high plasma glucose levels that can alter plasma proteins such as hemoglobin, disrupt microvascular circulation by increasing blood coagulation that may require the amputation of limbs and can lead to neuropathy. Diabetics have been shown to have diminished  $\Delta$ -5- and  $\Delta$ -6-desaturase activity, causing alterations in tissue fatty acid profiles and deficiencies in some long-chain PUFA.<sup>[85]</sup> Membrane fatty acid composition is known to affect the cellular response to insulin. Increases in membrane PUFA levels enhance cellular insulin sensitivity and receptor recruitment, while decreasing the levels has the opposite effect, decreased insulin responsiveness.<sup>[86]</sup> Since essential PUFA are known to improve insulin responsiveness at the cellular level, several studies have been done to investigate whether oils rich in PUFA, such as EPO, can improve diabetes management. Most of the investigations on the effects of EPO on diabetes mellitus have been carried out using animal models in which the administration of diabetogenic agents or pancreatectomy is done to induce the disorder. These models closely resemble Type-I diabetes and are particularly useful in the study of diabetic neuropathy.

Vascular changes that occur during diabetes mellitus may cause reductions in nerve perfusion leading to impaired nerve function and neuropathy. Cameron et al.<sup>[87]</sup> examined whether EPO supplementation could help overcome diabetic nerve conduction deficits in diabetic rats. The animals were treated with streptozotocin (a diabetogenic agent) and fed normal diets for 1 mo to allow for the accumulation of nerve conduction deficits. After this initial feeding period, experimental animals were fed diets supplemented with 10% EPO for 1 mo to assess whether this treatment could reduce the extent of diabetes-induced abnormalities. Control diabetic and nondiabetic rats were fed normal diets for 2 mo. Results of this study showed that after the initial 1 mo feeding period, diabetic rats exhibited deficits in motor and sensory nerve conduction velocity, which were maintained over a 2 mo period. In EPO-treated diabetic rats, deficits in nerve conduction velocity were restored to the level of nondiabetic control rats.<sup>[87]</sup> These findings suggest that EPO is an effective treatment for diabetes-induced neuropathy in this animal model. More recently, the effects of sunflower oil, EPO, and two structured  $\gamma$ -linolenic acid-containing triacylglycerols were examined on nerve conduction deficits in streptozotocin-induced diabetic rats.<sup>[88]</sup> Animals were fed diets supplemented with sunflower oil, EPO, dilinolein mono- $\gamma$ -linoleate (DLMG), or tri- $\gamma$ -linoleate for 6 weeks after diabetes induction to examine whether the stereospecific distribution of  $\gamma$ -linolenic acid in triacylglycerols could influence diabetes-induced neuropathy. All diets were prepared to contain equal amounts of  $\gamma$ -linolenic acid, except for sunflower oil-supplemented diets that served as control diets. Results showed that all three  $\gamma$ -linolenic acid-containing diets restored nerve conduction velocity, while sunflower oil-treated controls showed no such improvements, implying that the stereospecific distribution of  $\gamma$ -linolenic acid in dietary triacylglycerols did not influence its therapeutic effects in this animal model.<sup>[88]</sup> Ford et al.<sup>[89]</sup> examined effects of treatments with EPO,  $\alpha$ -lipoic acid, or sunflower oil on peripheral nerve conduction and vascular parameters in streptozotocin-induced diabetic rats. For 6 weeks after the induction of diabetes mellitus, the animals were fed normal diets; normal untreated rats were placed on the same diet for use as controls. After the initial feeding period, control and diabetic animals were treated daily with 300 mg/kg body weight  $\alpha$ -lipoic acid, 10 g/kg body weight EPO, or 10 g/kg body weight sunflower oil for 27 weeks. EPO treatments for 2 weeks significantly improved both motor and sensory nerve conduction velocity in diabetic rats ( $P < 0.05$  or less) and resulted in the restoration of normal nondiabetic control values in these animals. However, no significant vascular improvements were observed in the EPO-treated

diabetic group.  $\alpha$ -Lipoic acid treatments resulted in significant improvements in both nerve conduction velocities and vascular parameters in diabetic rats ( $P < 0.05$  or less). Sunflower oil-treated diabetic rats showed no significant differences in vascular and neuronal conduction parameters compared to control diabetic rats.<sup>[89]</sup>

Findings from animal models show that EPO is an antineuropathic agent in streptozotocin-induced diabetes and may be of benefit in the prevention of neuropathy in diabetic humans. To date, however, no published trials have investigated the effects of EPO on diabetic neuropathy in humans.

## OTHER HEALTH EFFECTS OF EPO

Animal and human studies have investigated the effects of EPO on mental health,<sup>[90]</sup> inflammatory bowel disease,<sup>[91]</sup> and renal health.<sup>[92]</sup> Joy, Mumby, and Joy<sup>[90]</sup> systematically searched several scientific databases for randomized trials investigating the effects of EPO on schizophrenia. In some trials, EPO supplementation improved symptoms, while others showed no such effects.<sup>[90]</sup> Greenfield et al.<sup>[93]</sup> showed that EPO treatment improved stool frequency in ulcerative colitis patients after 3 mo of supplementation; no such

effects were observed for patients treated with MaxEPA fish oil. Animal studies show that EPO treatments can significantly reduce cyclosporin-A-mediated nephrotoxicity.<sup>[94,95]</sup> Yoshimoto et al.<sup>[96]</sup> showed that EPO treatments significantly improved skin symptoms and abnormal plasma fatty acid compositions of hemodialysis patients. These health effects of EPO seem promising. However, the amount of existing literature is small making it hard to draw clear conclusions about these effects. Furthermore, most of these studies have been small scale with few having more than 40 subjects; large-scale trials involving humans are needed (Table 1).

## CONCLUSIONS

EPO might modify several health factors that could in turn modify the onset of disease states. It may exert therapeutic effects in inflammatory and immune-mediated diseases, cardiovascular diseases, cancer, and some conditions associated with menopause. These effects may in part be due to the oil's  $\gamma$ -linolenic acid constituent that could promote the production of anti-inflammatory dihomogamma-linolenic acid-derived eicosanoids and/or reduce proinflammatory arachidonic acid-derived eicosanoid production, thus affecting

**Table 1** Summary of research findings on the effects EPO in health and disease

Disease/condition studied	Type of evidence (References)	Overall findings
Atopic dermatitis	Small-scale human trials <sup>[30–38]</sup>	EPO may be effective treatment for some clinical symptoms
Rheumatoid arthritis	Small–medium scale human trials <sup>[43–48]</sup>	Inconclusive, several trials possess faults in their study protocol
Cardiovascular disease	Animal studies <sup>[55–60]</sup> and small-scale human studies <sup>[61,62]</sup>	EPO is effective in animals, no evidence suggests effectiveness in humans
Cancer	In vitro/animal studies <sup>[65–68]</sup> and small-scale human trials <sup>[68]</sup>	Animal studies suggest EPO is antiproliferative, some human studies agree
Menopausal hot flashes	Small-scale human trials <sup>[72]</sup>	Inconclusive findings
Osteoporosis	Small-scale human studies <sup>[73]</sup>	Ineffective in reducing bone density loss and other markers of osteoporosis
Breast mastalgia	Small-scale human studies <sup>[74]</sup>	Few studies indicate therapeutic effectiveness
Premenstrual syndrome	Small-scale human trials <sup>[78,79]</sup>	No clinical evidence of effectiveness
Pregnancy-induced hypertension/pre-eclampsia	Animal studies <sup>[81]</sup> and small-scale human trials <sup>[82,83]</sup>	Both animal and human studies implicate EPO as therapeutic
Diabetes mellitus-induced neuropathy	Animal studies <sup>[87–89]</sup>	EPO is an antineuropathic agent in diabetic animal models

several aspects of cellular biology and physiology such as immune hyper-reactivity, vascular function, and cellular proliferation. However, it is quite possible that some other components or group of compounds present in EPO may be responsible for its health effects. Incorporation into normal human diets would provide adequate levels of  $\gamma$ -linolenic acid and vitamin E, thereby reducing the likelihood of their deficiency. Thus, EPO may exert several beneficial effects on human health and disease states. Nonetheless, further studies are needed before any casual relationships between health/disease states and EPO can be made.

## REFERENCES

- Novak, F.A. *The Pictorial Encyclopedia of Plants and Flowers*; Crown Publishers Incorporated: New York, 1966.
- Horner, N.K.; Lampe, J.W. Potential mechanisms of diet therapy for fibrocystic breast conditions show inadequate evidence of effectiveness. *J. Am. Diet. Assoc.* **2000**, *100*, 1368–1380.
- Kleijnen, J. Evening primrose oil. *Br. Med. J.* **1994**, *309*, 824–825.
- Barre, D.E. Potential of evening primrose, borage, blackcurrant and fungal oils in human health. *Ann. Nutr. Metab.* **2001**, *45*, 47–57.
- US Food and Drug Administration Center for Food Safety and Applied Nutritional Health Claims. Available at: <http://vm.cfsan.fda.gov/~dms/flg-6c.html>.
- Abeywardena, M.Y.; Jablonskis, L.T.; Head, R.J. Dietary *n*-3 and *n*-6 polyunsaturated oils and airway contractility. *Prostaglandins Leukot. Essent. Fatty Acids* **2001**, *6*, 281–287.
- Sanders, T.A.B. Essential fatty acid requirements of vegetarians in pregnancy, lactation, and infancy. *Am. J. Clin. Nutr.* **1999**, *70*, 555S–559S.
- Assies, J.; Lieverse, R.; Vreken, P.; Wanders, R.J.A.; Dingemans, P.; Linszen, D.H. Significantly reduced docosahexaenoic and docosapentaenoic acid concentrations in erythrocyte membranes from schizophrenic patients compared with a carefully matched control group. *Biol. Psychiatry* **2001**, *49*, 510–522.
- Brenna, J.T. Efficiency of conversion of alpha-linolenic acid to long chain *n*-3 fatty acids in man. *Curr. Opin. Clin. Nutr. Metab. Care* **2002**, *5*, 127–132.
- Smith, C.J.; Zhang, Y.; Koboldt, C.M.; Muhammad, J.; Zweifel, B.S.; Shaffer, A.; Talley, J.J.; Masferrer, J.L.; Seibert, K.; Isakson, P.C. Pharmacological analysis of cyclooxygenase in inflammation. *Proc. Natl. Acad. Sci.* **1998**, *95*, 13,313–13,338.
- Eberhart, C.E.; Coffey, R.J.; Radhika, A.; Giardiello, F.M.; Ferrenbach, S.; Dubois, R.N. Up-regulation of cyclooxygenase-II gene expression in human colo-rectal adenomas and adenocarcinomas. *Gastroenterology* **1994**, *107*, 1183–1188.
- McLennan, P.; Howe, P.; Abeywardena, M.; Muggli, R.; Raederstorff, D.; Mano, M.; Rayner, T.; Head, R. The cardiovascular protective role of docosapentaenoic acid. *Eur. J. Pharmacol.* **1996**, *300*, 83–89.
- Johnson, M.M.; Swan, D.D.; Surette, M.E.; Stegner, J.; Chilton, T.; Fontech, A.N.; Chilton, F.H. Dietary supplementation with  $\gamma$ -linolenic acid alters fatty acid content and eicosanoid production in healthy humans. *J. Nutr.* **1997**, *127*, 1435–1444.
- Kunkel, S.L.; Ogawa, H.; Conran, P.B.; Ward, P.A.; Zurier, R.B. Suppression of chronic inflammation by evening primrose oil. *Prog. Lipid Res.* **1981**, *20*, 886–888.
- Miller, C.C.; McCreedy, C.A.; Jones, A.D.; Ziboh, V.A. Oxidative metabolism of dihomo- $\gamma$ -linolenic acid by guinea pig epidermis: evidence of generation of anti-inflammatory products. *Prostaglandins* **1988**, *35*, 917–938.
- Cia, J.; Jiang, W.G.; Mansel, R.E. Inhibition of angiogenic factor- and tumor-induced angiogenesis by  $\gamma$ -linolenic acid. *Prostaglandins Leukot. Essent. Fatty Acids* **1999**, *60*, 21–29.
- James, M.J.; Gibson, R.A.; Cleland, L.G. Dietary polyunsaturated fatty acids and inflammatory mediator production. *Am. J. Clin. Nutr.* **2000**, *71*, 343S–348S.
- Sirtori, C.R.; Galli, C. *N*-3 fatty acids and diabetes. *Biomed. Pharmacother.* **2002**, *56*, 397–406.
- Wertz, P.W.; Swartzendruber, D.C.; Abraham, W.; Madison, K.C.; Downing, D.T. Essential fatty acids and epidermal integrity. *Arch. Dermatol.* **1987**, *123*, 1381–1384.
- Simopoulos, A.P.; Koletzko, B.; Anderson, R.E.; Hornstra, G.; Mensink, R.P.; Weksler, B.B.; Harris, W.S.; De Caterina, R.; Muggli, R.; Spercher, H. The 1st Congress of the International Society for the Study of Fatty Acids and Lipids (ISSFAL): fatty acids and lipids from cell biology to human disease. *J. Lipid Res.* **1994**, *35*, 169–173.
- Hibbeln, J.R.; Salem, N. Dietary polyunsaturated fatty acids and depression: when cholesterol does not satisfy. *Am. J. Clin. Nutr.* **1995**, *62*, 1–9.
- Clarke, S.D.; Jump, D.B. Regulation of gene expression by dietary fat. *Ann. Nutr.* **1999**, *19*, 63–90.
- Schalin-Karrila, M.; Matila, L.; Jansen, C.T.; Utila, P. Evening primrose oil in the treatment



- of atopic eczema: effect on clinical status, plasma phospholipid fatty acids and circulating blood prostaglandins. *Br. J. Dermatol.* **1987**, *117*, 11–19.
24. Horrobin, D.F. Nutritional and medicinal importance of gamma-linolenic acid. *J. Lipid Res.* **1992**, *31*, 163–166.
  25. de La Puerta-Vazquez, R.; Martinez-Dominguez, E.; Sanchez-Perona, J.; Ruiz-Gutierrez, V. Effects of different oils on inflammatory mediator generation and fatty acid composition in rat neutrophils. *Metabolism* **2004**, *53*, 59–65.
  26. Hanifin, J.M.; Rajka, G. Diagnostic features of atopic dermatitis. *Acta Derm. Venereol.* **1980**, *92*, 44–47.
  27. Charman, C.R.; Morris, A.D.; Williams, H.C. Topical corticosteroid phobia in patients with atopic eczema. *Br. J. Dermatol.* **2000**, *142*, 931–936.
  28. Lovell, C.R.; Burton, J.L.; Horrobin, D.F. Treatment of atopic eczema with evening primrose oil. *Lancet* **1981**, *1*, 287
  29. Manku, M.S.; Horrobin, D.F.; Morse, N.; Kyte, V.; Jenkins, K.; Wright, S.; Burton, J.L. Reduced levels of prostaglandin precursors in the blood of atopic patients: defective delta-6-desaturase function as a biochemical basis for atopy. *Prostaglandins Leukot. Med.* **1984**, *9*, 615–628.
  30. Morse, P.F.; Horrobin, D.F.; Manku, M.S.; Stewart, J.C.; Allen, R.; Littlewood, S.; Wright, S.; Burton, J.; Gould, J.; Holt, P.J. Meta-analysis of placebo-controlled studies of the efficacy of Epogam in the treatment of atopic eczema. Relationship between plasma essential fatty acid changes and clinical response. *Br. J. Dermatol.* **1989**, *121*, 75–90.
  31. Bamford, J.T.; Gibson, R.W.; Renier, C.M. Atopic eczema unresponsive to evening primrose oil. *J. Am. Acad. Dermatol.* **1985**, *3*, 959–965.
  32. Hederos, C.A.; Berg, A. Epogam evening primrose oil treatment in atopic dermatitis and asthma. *Arch. Dis. Child.* **1996**, *75*, 494–497.
  33. Berth-Jones, J.; Graham-Brown, R.A.C. Placebo-controlled study of essential fatty acid supplementation in atopic dermatitis. *Lancet* **1993**, *341*, 1557–1560.
  34. Kerscher, M.J.; Korting, H.C. Treatment of atopic eczema with evening primrose oil: rational and clinical results. *Clin. Invest.* **1992**, *70*, 167–171.
  35. Yoon, S.; Lee, J.; Lee, S. The therapeutic effect of evening primrose oil in atopic dermatitis patients with dry scaly skin lesions is associated with the normalization of serum gamma-interferon levels. *Skin Pharmacol. Appl. Skin Physiol.* **2002**, *15*, 20–25.
  36. Lee, S.H.; Lee, J.H.; Lee, S.C.; Kim, K.X. Interleukin-4 as a new index of disease severity in atopic dermatitis. *Kor. J. Dermatol.* **1998**, *36*, 95–102.
  37. Williams, H.C. Evening primrose oil for atopic dermatitis. *Br. Med. J.* **2003**, *327*, 1358–1359.
  38. Granlund, H. Treatment of childhood eczema. *Paediatr. Drugs* **2002**, *4*, 729–735.
  39. Belch, J.J.F.; Hill, H. Evening primrose oil and borage oil in rheumatologic conditions. *Am. J. Clin. Nutr.* **2000**, *71*, 352S–356S.
  40. Lau, C.; O'Dowd, A.; Belch, J.J.F. White cell activation in the Raynaud's phenomenon of systemic sclerosis and vibration induced white finger syndrome. *Ann. Rheum. Dis.* **1992**, *51*, 249–252.
  41. Horrobin, D.F. Essential fatty acid metabolism in diseases of connective tissue with special reference to scleroderma and Sjögren's syndrome. *Med. Hypothesis* **1984**, *14*, 233–247.
  42. Martens\_Lobenhoffer, J.; Meyer, F.P. Pharmacokinetic data of gamma-linolenic acid in healthy volunteers after the administration of evening primrose oil. *Int. J. Clin. Pharmacol. Ther.* **1998**, *36*, 363–366.
  43. Brown, J.; Sim, A.K.; De Ceular, K.; McLeod, M.; El-Ghorbary, F.; Dick, W.C. Naudicelle in patients with rheumatoid arthritis. *Therapeutique* **1980**, *50*, 355–357.
  44. Hansen, T.M.; Lershe, A.; Kassis, V.; Lorenzen, I.; Sondergaard, J. Treatment of rheumatoid arthritis with prostaglandin E<sub>1</sub> precursors *cis*-linoleic acid and gamma-linolenic acid. *Scand. J. Rheumatol.* **1983**, *12*, 85–88.
  45. Jantti, J.; Seppala, E.; Vapaatalo, H.; Isomaki, H. Evening primrose oil and olive oil in treatment of rheumatoid arthritis. *Clin. Rheumatol.* **1989**, *8*, 238–244.
  46. Brzeski, M.; Madhok, R.; Capel, H.A. Evening primrose oil in patients with rheumatoid arthritis and side effects of non steroidal anti-inflammatory drugs. *Br. J. Rheumatol.* **1991**, *30*, 370–372.
  47. Belch, J.J.F.; Ansell, D.; Madhok, R.; O'Dowd, A.; Sturrok, R.D. Effects of altering dietary essential fatty acids on requirements for non-steroidal anti-inflammatory drugs in rheumatoid arthritis: a double blind placebo controlled study. *Ann. Rheum. Dis.* **1988**, *47*, 96–104.
  48. Darlington, L.G.; Stone, T.W. Antioxidants and fatty acids in the amelioration of rheumatoid arthritis and related disorders. *Br. J. Nutr.* **2001**, *85*, 251–269.
  49. de Lorgeril, M.; Salen, P.; Laporte, F.; de Leiris, J. Alpha-linolenic acid in the prevention and treatment of coronary heart disease. *Eur. Heart J.* **2002**, *3*, D26–D32.

50. Dolocek, T.A.; Granditis, G. Dietary polyunsaturated fatty acids and mortality in multiple risk factor intervention trial (MRFIT). *World Rev. Nutr. Diet.* **1991**, *66*, 205–216.
51. Calder, P.C. Polyunsaturated fatty acids, inflammation, and immunity. *Lipids* **2001**, *36*, 1007–1024.
52. Tapiero, H.; Nguyen Ba, G.; Couvreur, P.; Tew, K.D. Polyunsaturated fatty acids (PUFA) and eicosanoids in human health pathologies. *Biomed. Pharmacother.* **2002**, *56*, 215–222.
53. Oomah, B.D.; Mazza, G. Health benefits of phytochemicals from selected Canadian crops. *Trends Food Sci. Technol.* **1999**, *10*, 193–198.
54. Coker, S.J.; Parratt, J.R. AH23848, a thromboxane antagonist, suppresses ischemia and reperfusion induced in anaesthetized greyhounds. *Br. J. Pharmacol.* **1985**, *86*, 259–264.
55. Singer, P.; Moritz, V.; Wirth, M.; Berger, I.; Forster, D. Blood pressure and serum lipids from SHR after diets supplemented with evening primrose, sunflower or fish oil. *Prostaglandins Leukot. Essent. Fatty Acids* **1990**, *40*, 17–20.
56. Singer, P.; Berger, I.; Moritz, V.; Forster, D.; Taube, C. N-6 and N-3 PUFA in liver lipids, thromboxane formation and blood pressure from SHR during diets supplemented with evening primrose, sunflower seed or fish oil. *Prostaglandins Leukot. Essent. Fatty Acids* **1990**, *39*, 207–211.
57. Horrobin, D.F. Omega-6 and omega-3 essential fatty acids in atherosclerosis. *Semin. Thromb. Hemost.* **1993**, *19*, 129–137.
58. De la Cruz, J.P.; Martin-Romero, M.; Carmona, J.A.; Villabos, M.A.; Sanchez de la Cuesta, F. Effect of evening primrose oil on platelet aggregation in rabbits fed an atherogenic diet. *Thromb. Res.* **1997**, *87*, 141–149.
59. De la Cruz, J.P.; Quintero, L.; Galvez, J.; Villalobos, M.A.; Sanchez de la Cuesta, F. Antioxidant potential of evening primrose oil administration in hyperlipidemic rabbits. *Life Sci.* **1999**, *65*, 543–555.
60. Charnock, J.S. Gamma-linolenic acid provides additional protection against ventricular fibrillation in aged rats fed linoleic acid rich diets. *Prostaglandins Leukot. Essent. Fatty Acids* **2000**, *62*, 129–134.
61. Abraham, R.D.; Riemsma, R.A.; Elton, R.A.; Macintyre, C.; Oliver, M.F. Effect of safflower oil and evening primrose oil in men with a low dihomogamma-linolenic level. *Atherosclerosis* **1990**, *81*, 199–208.
62. Khan, F.; Elherik, K.; Bolton-Smith, C.; Barr, R.; Hill, A.; Murrie, I.; Belch, J.J.F. The effects of dietary fatty acid supplementation on endothelial function and vascular tone in healthy subjects. *Cardiovasc. Res.* **2003**, *59*, 955–962.
63. Hale, A.J.; Smith, A.C.; Sutherland, L.C.; Stoneman, V.E.A.; Longthorne, V.L.; Culhane, A.C.; Williams, G.T. Apoptosis: molecular recognition of death. *Eur. J. Biochem.* **1996**, *236*, 1–26.
64. Prener, A.; Storm, H.H.; Nielsen, N.H. Cancer of the male genital tract in circumpolar Inuit. *Acta Oncol.* **1996**, *35*, 589–593.
65. Booyens, J.; Engelbrecht, P.; le-Roux, S.; Louwrens, C.C.; Van der Merwe, C.F.; Katzeff, I.E. Some effects of the essential fatty acids linoleic acid, alpha-linolenic acid and their metabolites gamma-linolenic acid arachidonic acid, eicosapentaenoic acid, docosahexaenoic acid and of prostaglandins A1 and E1 on the proliferation of human osteogenic sarcoma cells in culture. *Prostaglandins Leukot. Med.* **1984**, *15*, 15–33.
66. Gardiner, N.S.; Duncan, J.R. Possible involvement of a delta-6 desaturase in control of melanoma growth by gamma-linolenic acid. *Prostaglandins Leukot. Med.* **1991**, *42*, 149–153.
67. Ramesh, G.; Das, U.N. Effect of evening primrose oil and fish oils on two stage skin carcinogenesis in mice. *Prostaglandins Leukot. Essent. Fatty Acids* **1998**, *59*, 155–161.
68. Kollias, J.; Macmillan, D.M.; Sibbering, D.M.; Berrel, H.; Robertson, J.F.R. Effect of evening primrose oil on clinically diagnosed fibroadenomas. *Breast* **2000**, *9*, 35–36.
69. Dove, D.; Johnson, P. Oral evening primrose oil: its effects on length of pregnancy and selected intrapartum outcomes in low nulliparous women. *J. Nurse-Midwifery* **1999**, *44*, 320–324.
70. Erlik, Y.; Meldrum, D.R.; Judd, H.L. Estrogen levels in postmenopausal women with hot flashes. *Obstet. Gynecol.* **1982**, *59*, 403–411.
71. Glazier, M.G.; Bowman, M.A. A review of evidence for the use of phytoestrogens as a replacement for traditional estrogen replacement therapy. *Arch. Int. Med.* **2001**, *161*, 11,161–11,172.
72. Chenoy, R.; Hussain, S.; Tayob, Y.; O’Brean, P.M.S.; Moss, M.Y.; Morse, P.F. Effect of oral gamma-linolenic acid from evening primrose oil on menopausal flushing. *Br. Med. J.* **1994**, *308*, 501–503.
73. Basse, E.J.; Littlewood, J.J.; Rothwell, M.C.; Pye, D.W. Lack of effect of supplementation with essential fatty acids on bone mineral density in pre- and postmenopausal women: two randomized controlled trials of Efacal® v. calcium alone. *Br. J. Nutr.* **2000**, *83*, 629–635.
74. Blommers, J.; de-Lange de Cleric, E.; Kuik, D.J.; Bezemer, P.D.; Meiger, S. Evening primrose oil and fish oil for severe chronic mastalgia: a randomized, double-blind, controlled trial. *Am. J. Obstet. Gynecol.* **2002**, *187*, 1389–1394.

75. Campbell, E.M.; Peterkin, K.; O'Grady, R.; Sanson-Fisher, R. Premenstrual symptoms in general practice. *J. Reprod. Med.* **1997**, *42*, 637–646.
76. Chan, S.; Hanifin, J. Immunopharmacologic aspects of atopic dermatitis. *Clin. Rev. Allergy* **1993**, *11*, 523–541.
77. Be Lieu, R.M. Mastodynia. *Obstet. Gynecol. Clin. North Am.* **1994**, *21*, 461–477.
78. Khoo, S.K.; Munro, C.; Battistutta, D. Evening primrose oil and treatment of premenstrual syndrome. *Med. J. Aust.* **1990**, *153*, 189–192.
79. Budeiri, D.; Li-Wan-Po, A.; Dornan, J.C. Is evening primrose oil of value in the treatment of premenstrual syndrome? *Control. Clin. Trials* **1996**, *17*, 60–68.
80. Bang, H.O.; Dyerberg, J. Lipid metabolism and ischemic heart disease in Greenland Eskimos. *Adv. Nutr. Res.* **1980**, *3*, 1–22.
81. Zielinski, M.; Wojnarski, L.; Celewicz, Z.; Cretti, A. Influence of evening primrose oil on blood pressure and the pressor response to angiotensin II in pregnant and non-pregnant rabbits. *Ginekol. Pol.* **1994**, *65*, 111–114.
82. Moodley, J.; Norman, R.J. Attempts at dietary alteration of prostaglandin pathways in the management of pre-eclampsia. *Prostaglandins Leukot. Essent. Fatty Acids* **1989**, *37*, 145–147.
83. D'Almeida, A.; Carter, J.P.; Anatol, A.; Prost, C. Effects of combination of evening primrose oil (gammalinolenic acid) and fish oil (eicosapentaenoic + docosahexaenoic acid) versus magnesium, and versus placebo in preventing pre-eclampsia. *Women Health* **1992**, *19*, 117–131.
84. Storlein, L.H.; Pan, D.A.; Kriketos, J.; O'Conner, I.D.; Catterson, G.J.; Clooney, A.B.; Jenkins, J.; Baur, L.A. Skeletal muscle lipid membranes and insulin resistance. *Lipids* **1996**, *31*, S262–S265.
85. Cameron, N.E.; Cotter, M.A. The relationship of vascular changes to metabolic functions in diabetes mellitus and their role in the development of peripheral nerve complications. *Diab. Metab. Rev.* **1994**, *10*, 189–224.
86. Dutta-Roy, A.K. Insulin mediated processes and in platelets, erythrocytes and monocytes/macrophages: effects of essential fatty acid metabolism. *Prostaglandins Leukot. Essent. Fatty Acids* **1994**, *51*, 385–399.
87. Cameron, N.E.; Cotter, M.A.; Dines, K.C.; Robertson, S.; Cox, D. The effects of evening primrose oil on nerve function and capillarization in streptozotocin-diabetic rats: modulation by the cyclooxygenase inhibitor flubiprofen. *Br. J. Pharmacol.* **1993**, *109*, 972–979.
88. Dines, K.C.; Cameron, N.E.; Cotter, M.A. Comparison of the effects of evening primrose oil and triglycerides containing gamma-linolenic acid on nerve conduction and blood flow in diabetic rats. *J. Pharmacol. Exp. Ther.* **1995**, *273*, 49–55.
89. Ford, I.; Cotter, M.A.; Cameron, N.E.; Greaves, M. The effects of treatment with alpha-lipoic acid or evening primrose oil on vascular hemostatic and lipid risk factors, blood flow and peripheral nerve conduction in the streptozotocin-diabetic rat. *Metabolism* **2001**, *50*, 868–875.
90. Joy, C.B.; Mumby-Croft, R.; Joy, L.A. Polyunsaturated fatty acid (fish or evening primrose) for schizophrenia. *Cochrane Database Syst. Rev.* **2000**, *2*, CD001257.
91. Endres, S.; Lorenz, R.; Loeschke, K. Lipid treatment of inflammatory bowel disease. *Curr. Opin. Clin. Nutr. Metab. Care* **1999**, *2*, 117–129.
92. Morphake, P.; Bariety, J.; Darlamastos, I.; Tsipas, G.; Gkkias, G.; Hornysh, A.; Papanikolaou, N. Alteration of cyclosporine (CsA)-induced nephrotoxicity by gamma linolenic acid (GLA) and eicosapentaenoic acid (EPA) in Wistar rats. *Prostaglandins Leukot. Essent. Fatty Acids* **1994**, *50*, 29–35.
93. Greenfield, S.M.; Green, A.T.; Teare, J.P.; Jenkins, A.P.; Panchard, N.A.; Ainley, C.C.; Thompson, R.P. A randomized controlled study of evening primrose oil and fish oil in ulcerative colitis. *Aliment. Pharmacol. Ther.* **1993**, *7*, 159–166.
94. Darlamastos, I.E.; Varonos, D.D. Role of prostanoids and endothelins in the prevention of cyclosporine-induced nephrotoxicity. *Prostaglandins Leukot. Essent. Fatty Acids* **2001**, *64*, 231–239.
95. Scholey, J.W.; Mills, D.E. Dietary fatty acids and the glomerular hemodynamic response to cyclosporine in borderline hypertensive rats. *Kidney Int.* **1995**, *47*, 611–617.
96. Yoshimoto-Furuie, K.; Yoshimoto, K.; Tanaka, T.; Saima, S.; Kikuchi, Y.; Shay, J.; Horrobin, D.F.; Echizen, H. Effects of oral supplementation with evening primrose oil for six weeks on plasma essential fatty acids and uremic skin symptoms in hemodialysis patients. *Nephron* **1999**, *81*, 151–159.

# Feverfew (*Tanacetum parthenium*)

**Dennis V. C. Awang**

*MediPlant Consulting Inc., White Rock, British Columbia, Canada*

**Albert Y. Leung**

*Phyto-Technologies, Inc., Woodbine, Iowa, U.S.A.*

## INTRODUCTION

Feverfew (*Tanacetum parthenium*) has been used since antiquity for a variety of medicinal purposes, prominent among them being alleviation of fever, headache, and women's ailments. Claims of efficacy are almost invariably anecdotal. However, over the past two decades, randomized controlled trials have been conducted in the prophylaxis of migraine and treatment of rheumatoid arthritis. While the quality of these trials is varied, there is good evidence of feverfew's potential in migraine: statistically significant reduction in frequency and severity of attacks and degree of nausea and vomiting has been observed following administration of feverfew leaf. While it is said that more people in the U.K. currently self-medicate with feverfew for arthritis than for migraine, no clear benefit has been demonstrated in the single clinical trial conducted with rheumatoid arthritic patients. Neither the constituent(s) of feverfew nor the mechanism(s) of action is/are yet known. Parthenolide, the dominant sesquiterpene lactone (STL) constituent of the clinically tested sesquiterpene chemotype, and long considered the active antimigraine principle, is no longer considered to be a significant contributor in that respect. Also, the latest trial, using a supercritical carbon dioxide extract of feverfew leaf, lends promise to the development of a reliably consistent and effective standardized preparation. No serious adverse reactions have been recorded, although the development of mouth ulcers has caused a small percentage of consumers to discontinue treatment. No drug interactions have been observed so far.

---

*Dennis V. C. Awang, Ph.D.*, is the President at MediPlant Consulting Inc., White Rock, British Columbia, Canada.

*Albert Y. Leung, Ph.D.*, is at Phyto-Technologies, Inc., Woodbine, Iowa, U.S.A.

## BOTANY

### Nomenclature

Following residence in a number of genera, after its original assignment to *Rudbeckia* and then *Matricaria* by Linnaeus, feverfew, a member of the plant family Asteraceae (Compositae), is currently recognized as *Tanacetum parthenium* (L.) Schultz Bip. Today, the only previous synonym occasionally encountered in commerce and the scientific literature is *Chrysanthemum parthenium* (L.) Bernh.<sup>[1]</sup>

The most popular common names of this plant are: bachelor's buttons, featherfew, featherfoil (federfoyl), flintwort, midsummer daisy, nosebleed, *matricaire*, *grande camomille* (French), *mutterkraut* (German), *altamisa*, *Santa Maria*, *manzanilla* (Spanish).<sup>[2]</sup>

The generic term *Tanacetum* is claimed to be derived from the Greek word *athanatos*, meaning immortal (*thanatos*, death), alluding to the ever-lasting nature of the plant's dried flowers. The specific epithet *parthenium* likely originates from the Greek *parthenos*, meaning virgin, apparently in reference to the traditional use by women for menstrual difficulties.<sup>[3]</sup> The common name feverfew is widely held to be a translation of the Latin *febrifugia*, an agent that dispels fever.

### Physical Description

The feverfew plant is a strongly aromatic bushy perennial that can grow to 90 cm high. Its crushed leaves are bitter and have a distinctly camphorous odor. The stems (up to 5 mm in diameter) have yellow-green, deeply divided leaves, 2–5 cm long, that bear characteristic glandular and covering trichomes (hairs). The wild-type feverfew, traditionally used as medicine, has daisylike flowerheads composed of 5–30 functional male and female yellow disc florets, generally 1–2 cm in diameter, surrounded by a single row of female ray florets, each with a white corolla 3–8 mm long, with a 2–7 mm long strap.

Several taxonomic varieties and forms have been recognized based on differences in floral and leaf morphologies. Some of these have two or more rows of ray florets, and at least one is devoid of ray florets<sup>[4]</sup>; two prominent cultivars, *crispum* and *aureum*, have curled leaf edges and decidedly yellow leaves, respectively.<sup>[5]</sup>

Native to the mountains of the Balkan Peninsula, feverfew has spread throughout Europe, to North, Central, and South America, and is now widely cultivated commercially both as a medicinal and as an ornamental plant.<sup>[6]</sup>

Medicinal feverfew is derived mainly from the leaves of the plant, but some countries, such as France, allow inclusion of stalk and flowers.<sup>[7]</sup> Commercial dried feverfew leaf usually contains about 10% of stalk.<sup>[8]</sup> Feverfew leaf extracts are also available.

## HISTORY

### Ancient Uses

The ancient medicinal applications of feverfew have been categorized broadly into three main groups: treatment for fever and headache; use in cases of difficulties in labor, threatened miscarriage, and regulation of menstruation; and relief of stomachache, toothache, and insect bites.<sup>[9]</sup>

Since the time of Dioscorides, the 1st-century Greek physician, feverfew has been used to treat intermittent fevers and has been grown in monastic gardens for that purpose.<sup>[9]</sup> John Gerard(e)'s book, *The Herball*, originally published in 1597,<sup>[10]</sup> claimed that "(Feverfew) is very effectual for all pains in the head coming of a cold cause, the herb being bruised and applied to the crown of the head." Gerard further added that "Feverfew dried and made into powder, and two drams of it taken with hony or sweet wine, purgeth by siege melancholy and flegme; wherefore it is very good for them that are giddie in the head, or which have the turning called vertigo, that is a swimming and turning in the head. Also it is good for such as be melancholic, sad, pensive, and without speech." Also, Gerard claimed that feverfew was "profitable applied to Saint Antonies fire, to all inflammation and hot swellings." Feverfew has been termed "the aspirin of the 18th century."<sup>[11]</sup> Culpeper's *Complete Herbal*, originally printed in 1649,<sup>[12]</sup> recommended feverfew for "ague" (fever with chills): "the decoction drank warm, and the herb bruised, with a few corns of bay-salt, and applied to the wrists before the coming of the ague fits, does take them away." In support of effectiveness against stomachache and insect bites, a very early herbal, Bancke's (1525), is quoted by Berry<sup>[9]</sup>: "This is named Federfoy. His virtue is to conforte a mannus stomake. It is good to asswage

the axes cotydan, ye crampe, and to tempre it that cometh of colde stomackes. Also it is good to lay to a soore that is byten with venymous beestes; it will hele it shortly on it be layde thereto." Regarding toothache, Charles Estienne declares: "Stampt and applied unto the teeth or eare of the side that aketh, it wholly asswageth the paine of the teethe."<sup>[13]</sup>

As noted earlier, the third major area of traditional medicinal application of feverfew deals with "female complaints." Regarding its usefulness as an emmenagogue, assisting and promoting menstrual flow, Gerard<sup>[10]</sup> states: "... it procureth womens sickness with speed, it bringeth forth the afterbirth and the dead child..." According to Culpeper,<sup>[12]</sup> "Venus commands this herb, and has commended it to succour her sisters to be a general strengthener of their wombs, and to remedy such infirmities as a careless midwife has there caused; if they will be pleased to make use of her herb boiled in white wine, and drink the decoction, it cleanses the womb, expels the afterbirth, and does a woman all the good she can desire of a herb."

As a final note on the traditional use of feverfew for headache and claims by some authors as to its ancient use in migraine<sup>[9]</sup> and specifically "for the prevention of migraine" since the time of Dioscorides (50 A.D.),<sup>[14]</sup> the often cited opinion of John Hill, M.D., recorded in 1772 in his book *The Family Herbal* ("In the worst headache this herb exceeds whatever else is known"),<sup>[11]</sup> has been interpreted as a reference to migraine. However, it is highly questionable whether the characteristic features of migraine were appreciated then and whether feverfew's migraine prophylactic potential was recognized. Feverfew's anti-migraine effect was discovered in modern times only in 1973,<sup>[15]</sup> and it has been widely held that feverfew's influence is entirely prophylactic and not in the realm of symptomatic relief. However, a prominent researcher in the field has reported that the housekeeper of a retired British professor of physiology experienced dramatic relief from a migraine attack: within 20–30 min of chewing 5 leaves, "her pain had vanished."<sup>[16]</sup> Of course, any such anecdotal claim of efficacy, whether ancient or modern, cannot be taken as proof of medicinal value.

### Modern Uses

Feverfew is currently widely used to mitigate migraine attacks, as a palliative in arthritis, and for the treatment of psoriasis.<sup>[17]</sup> However, while it is claimed that, since the 16th century, feverfew has been used by more people in the U.K. for arthritis than for migraine,<sup>[11]</sup> most of the research attention has been focused on the latter condition (see later). The dramatic upsurge of interest in feverfew for migraine occurred following

newspaper accounts of favorable responses in sufferers whose condition was resistant to conventional medication.<sup>[11]</sup> The stimulus for this burgeoning attention was the experience of Ann Jenkins, a Welsh doctor's wife, who in 1973 at age 68, upon the suggestion of the elderly father of a friend of her sister's, had begun experimenting with feverfew; the old gentleman, interestingly enough, had found feverfew helpful in treating his arthritis. After increasing the dose from one small leaf to three, after 5 mo, the vomiting associated with the migraine attacks stopped. She also required less of her conventional migraine treatment, ergotamine. After 6 mo, she went for an entire month without a migraine attack, and after 10 mo, the attacks ceased.<sup>[15]</sup>

### The Questionnaire

With the assistance of Mrs. Jenkins, Dr. E. Stewart Johnson, associated with the City of London Migraine Clinic, solicited participants in an epidemiological survey on the use and value of feverfew. A questionnaire was provided inquiring as to whether headaches during use of the herb were less frequent, more frequent, less painful, more painful, or unchanged. Of the roughly 300 responders, 253 were judged to be suffering from true migraine, 93% having been diagnosed by a doctor. Of these, 72% reported reduced frequency of migraine attacks, while 26% felt that their headaches worsened. This success rate was virtually identical for participants whether or not they were suffering from other ailments or taking other medications. A further assessment of 242 patients for actual numbers of attacks each month before and during feverfew treatment revealed that 33% no longer suffered any migraine attacks while taking the herb and 76% had fewer monthly episodes. Eighty percent of those who stopped taking feverfew reported recurrence of severe migraine within a week or two. A polling of feverfew users on their experience with conventional migraine preventive drugs produced very interesting results. Clonidine, the pharmaceutical most commonly tried, was deemed ineffective by 72% of feverfew users, while ergotamine, the most helpful of the other drugs, was judged helpful by 62%. Most of the other drugs were found less than 50% effective. Curiously, about 40% of feverfew users attributed pleasant side effects to the plant: relief from the symptoms of coexisting arthritis, less muscular tension, more restful sleep, and the like. Responders to the questionnaire had been taking feverfew for an average of two-and-a-half years.<sup>[15]</sup> Traditionally, feverfew users take 2–4 small or 1–2 large leaves per day, often in a bread-and-butter sandwich, sometimes mixing honey with the crushed leaves to further mask the bitter taste.<sup>[11]</sup>

### CHEMICAL CONSTITUENTS

The main chemical constituents that have received attention regarding biological activity fall into three categories, namely, essential oil, STLs, and flavonoids. The flavonoids of feverfew are the lipophilic flavonols di- and trimethylethers of 6-hydroxykaempferol and quercetagenin, and the hydrophilic flavone glycosides apigenin-7-glucuronide, luteolin-7-glucuronide, and chrysoeriol-7-glucuronide.<sup>[18]</sup> The trimethylether of 6-hydroxykaempferol, originally named tanetin, and characterized as 3,7,4'-substituted, was later determined to be the known flavonol santin, a 3,6,4'-trimethylether. Santin, 6-hydroxykaempferol-3,6-dimethylether, and quercetagenin-3,6-dimethylether (axillarlin) are the three main flavonol constituents. Two further minor lipophilic flavonols have been identified unequivocally: quercetagenin-3,6,3'-trimethylether (jaceidin) and quercetagenin-3,6,4'-trimethylether (centaureidin).<sup>[19]</sup>

The volatile essential oil is dominated by camphor (43–44%) and chrysanthenyl acetate (24%), accompanied by lesser amounts of spiroketal enol ether diynes, camphene, germacrene-D, *p*-cymene and terpinen-4-ol. The dominant STL, parthenolide, is also released in the volatile oil, as are the ubiquitous phytosterols sitosterol and stigmasterol.<sup>[20–22]</sup> No significant infra-specific variation has been observed in the composition of the volatile oil.<sup>[23]</sup>

STLs have until recently been the prime focus of chemical and biological attention among feverfew constituents. The germacranolide (10-membered carbon ring), parthenolide, dominates the STL chemotype that has been subjected to clinical evaluation. The most comprehensive analysis of the chemical content of feverfew leaf has been conducted by Bohlmann and Zdero.<sup>[24]</sup> Parthenolide comprises more than 80% of the total STL content of this chemotype, in concentrations as high as 2% of dry weight in individual plants.<sup>[25]</sup> At least two other STL chemotypes of feverfew have been recognized, devoid of parthenolide.<sup>[26]</sup> The most prominent STLs accompanying parthenolide in the clinically efficacious STL chemical profile are 3 $\beta$ -hydroxyparthenolide, the isomeric guaianolide (5/7-carbocyclic) *bis*-epoxides, canin ( $\alpha$ ) and artecanin ( $\beta$ ), the endoperoxide precursor of canin, tanaparthin- $\alpha$ -peroxide, and the cyclopentenone *seco*-tanaparthenolide A, all containing an  $\alpha$ -methylene- $\gamma$ -butyrolactone moiety.<sup>[16,27]</sup>

Respecting the historical identification of feverfew STLs, it should be noted that there is a serious question concerning the presence of unusually structured compounds such as chrysanthemomin, chrysanthemolide, and partholide,<sup>[28]</sup> which are not identified elsewhere as feverfew constituents and are likely the result of degradation during protracted refluxing 1 week and subsequent processing; chrysanthemomin, a trisesquiterpene

species, has been described as<sup>[29]</sup> “a novel dimeric germacranolide nucleus, esterified at C-8 by a related esterified sesquiterpenic acid.” Likewise probably artifactual are the chlorine-containing STLs reported from *T. parthenium* extracted from the same material with chlorinated solvent; the two isomeric chlorohydrins in question were not detected by Hylands, at the University of London, who provided the feverfew leaf, and almost certainly resulted from epoxide ring opening by hydrogen chloride present in the chloroform used for extraction.<sup>[30]</sup> One of the two chlorides, characterized by X-ray analysis, is formally an adduct chlorohydrin formed by  $\beta$ -chloride opening of the  $\alpha$ -3,4-epoxy function of canin. The structure of the other isomer, uncrystallized, has not been confirmed, but the proposed C-10 epimerized configuration seems extremely unlikely, not having ever been observed in any feverfew STL.

## CLINICAL STUDIES

### Migraine

Of the six clinical trials reported, results on one<sup>[31]</sup> are available only by way of an abstract, which provides neither information on the nature of the tested material nor adequate details about outcome measures. Nonetheless, a systematic review of these trials has accorded it a rating on the Jadad<sup>[32]</sup> scale of judging quality.<sup>[33]</sup> Of the other 5 trials—3 with dried whole leaf preparations and 2 with extracts—4 are positive. One of the studies that used extract provided a negative result of singular importance.<sup>[34]</sup>

The first of the positive trials, a randomized double-blind and placebo-controlled study,<sup>[35]</sup> involved only 17 patients and has been properly criticized not only on the basis of its small size, but also because the subjects were self-selected, being convinced of the efficacy of feverfew from their history of beneficial self-medication for roughly 3–4 yr and the corresponding expectation of relapse attendant on deprivation of the medicine. In this 4-mo-long study, 8 and 9 subjects, respectively, received a daily dose of 50 mg of freeze-dried feverfew leaf powder or placebo. Those who took placebo had a significant increase in both frequency and severity of migraine attacks as well as of nausea and vomiting during the early months of feverfew withdrawal. Two subsequent trials, conducted in the U.K.<sup>[36]</sup> and Israel,<sup>[37]</sup> used encapsulated air-dried feverfew leaf powder. The British trial was of a randomized, double-blind, placebo-controlled crossover design. After a 1-mo single-blind placebo run in, 60 patients were randomly allocated to a daily capsule of the treatment (70–114 mg; mean 82 mg) or matching placebo (dried cabbage leaves) for 4 mo and then

switched for a further 4 mo. Results on 59 patients were analyzed and revealed feverfew to be associated with a reduction in the mean number and severity of attacks as well as in the degree of vomiting. In the Israeli trial, 57 patients were divided into groups of 30 and 27 after a preliminary 2-mo treatment with feverfew (100 mg daily), following which a double-blind placebo-controlled crossover study was conducted in two phases over 2 mo each. As with the earlier British trial, a significant reduction in pain intensity was observed as compared with placebo—as was a “profound” reduction in typical migraine symptoms such as vomiting, nausea, and sensitivity to noise and light.

Two trials have been conducted with extracts of feverfew leaf, one a failure<sup>[34]</sup> and the other a limited success.<sup>[38]</sup> The earlier trial with 90% ethanol extract was judged to be methodologically of superior quality<sup>[33]</sup> but revealed no difference between placebo and the treatment, which contained roughly twice the level of parthenolide as the feverfew treatment used in the successful Israeli trial.<sup>[37]</sup> These observations impose the unavoidable inference that parthenolide cannot be directly responsible for feverfew’s anti-migraine activity. The ineffectiveness of this extract preparation was likely due to loss or degradation of the active principle(s) as a result of the protracted extraction process, involving stirring in solvent for 19 days at ambient room temperature.<sup>[34]</sup> The final trial employed a proprietary supercritical carbon dioxide extract of feverfew leaf in a randomized, double-blind, placebo-controlled multicenter trial with four parallel groups receiving daily doses of 2.08, 6.25, and 18.75 mg for 12 weeks. While the proprietary preparation failed to exert a significant migraine prophylactic effect in general, it was safe and effective at 6.25 mg thrice daily in a small subgroup of patients with at least four migraine attacks per month. The authors of this last study cautioned that their findings should be regarded with reservation on account of the small number of subjects. These German researchers have completed another trial, which they claim to have been successful, and a manuscript describing it has been submitted for publication.<sup>[39]</sup>

### Arthritis

A single clinical trial in rheumatoid arthritis failed to show any beneficial effect in 40 women treated with 70–86 mg of dried feverfew leaf or placebo for 6 weeks.<sup>[40]</sup> However, considering the continued popularity of the plant for treating the symptoms of this condition, it has been suggested that it may well be of benefit in milder cases of arthritis than that afflicting the women in this trial, who were extremely refractory

cases, unresponsive to all conventional arthritis drugs.<sup>[41]</sup> The authors of the failed trial suggested further that feverfew may be of benefit in osteoarthritis and for soft tissue lesions.<sup>[40]</sup>

### Mechanism of Action

The simplistic mechanism of feverfew action in migraine, involving Michael addition of systemic nucleophiles to  $\alpha,\beta$ -unsaturated lactones such as parthenolide and inhibition of the release of serotonin (5-hydroxytryptamine, or 5-HT) from blood platelets, is now totally discredited.<sup>[42]</sup> It seems likely that the feverfew constituent(s) responsible for its antimigraine activity will be found in the volatile fraction or flavonoid complement of the plant's leaf. However, the relevance of any of the plethora of in vitro pharmacological activities noted in both aqueous and organic extracts of feverfew leaf<sup>[16,17]</sup> has not been established. Nonetheless, inhibition of the release of damaging substances from white blood cells in inflamed joints and skin could account for the claimed benefit of feverfew in arthritis and psoriasis.<sup>[17]</sup>

### SAFETY

#### Adverse Effects

No serious adverse effects have been reported for feverfew consumption. The side effect that has received the most attention is mouth ulceration, the formation of recurrent, so-called aphthous ulcers (commonly referred to as "canker sores"). Interestingly, in the University of Nottingham trial,<sup>[36]</sup> more patients<sup>[16]</sup> in the placebo group reported mouth ulceration than those in the verum group.<sup>[10]</sup> Johnson<sup>[15]</sup> had previously noted that 11.3% of the 253 patients participating in a questionnaire survey admitted to experiencing mouth ulceration when asked but only 6.4% volunteered such information; a parallel situation was obtained for indigestion, with 6.5% and 3.9%, respectively. It is also interesting to note that mouth ulceration from feverfew appears to be a systematic effect that resolves within a week or so of discontinuation of the treatment, but returned on rechallenge. It has been claimed that the mouth ulceration can be alleviated by treatment with tincture of myrrh (normally derived from *Commiphora* species, especially *Commiphora molmol*).<sup>[43]</sup> Nonsteroidal anti-inflammatory drugs (NSAIDs), increasingly used for migraine prophylaxis and arthritis, also produce recurrent aphthous ulceration.<sup>[44]</sup>

Feverfew sometimes induces a more generalized inflammation of the oral mucosa and tongue, with

attendant swelling of lips and loss of taste. This soreness is likely caused by direct contact with leaves during chewing and probably due to the interaction of STLs known to cause contact dermatitis.<sup>[45]</sup>

Feverfew leaf does not appear to affect blood pressure, heart rate, body weight, or the results of hematological and biochemical tests, but rare cases of transient palpitations, colicky abdominal pain, and heavier menstruation have been reported.<sup>[35]</sup>

Also, a "post-feverfew syndrome" has been identified in long-term feverfew users who stopped taking the herb: About one-tenth experienced moderate to severe aches, pains, and stiffness in joints and muscles, along with CNS symptoms of anxiety and poor sleep.<sup>[35]</sup> It has been speculated that such sleep disturbances may be due to withdrawal of melatonin, present in significant quantities in the leaf (2.45  $\mu\text{g/g}$  in fresh; 2.19  $\mu\text{g/g}$  in dried).<sup>[46]</sup>

### Toxicology

While no formal studies have been conducted to assess chronic toxicity in animals, it has been argued that such tests are now superfluous since feverfew has been used by large numbers of people continuously for many years, some for more than 10 yr, without apparent ill effect.<sup>[35]</sup>

A study involving 30 females who had been consuming feverfew for more than 11 mo revealed no differences in the frequency of chromosomal aberrations or the frequency of sister chromatid exchanges compared with a matched set of nonusers.<sup>[47]</sup>

### Contraindications

In view of feverfew's traditional reputation as an emmenagogue, its capacity to induce uterine contraction in full-term women, and its ability to cause abortion in cattle, it would seem prudent for pregnant women to avoid its use. It should also be noted that when feverfew was used to promote menstruation, it was taken in much higher doses than those currently employed for treating migraine and arthritis. Finally, little is known of the effects of feverfew on migraine and arthritis in pregnancy.<sup>[15]</sup>

Feverfew is also contraindicated in persons with recognized hypersensitivity to other members of the Asteraceae, since crossreactivity is common among plants in this family.<sup>[48]</sup>

### Drug Interactions

Feverfew is often indicated by certain scientists as an anticoagulant herb, based on the ability of parthenolide,



only one of its numerous biologically active constituents, to inhibit platelet aggregation. Yet, neither bleeding episodes nor abnormal coagulation tests have been reported from feverfew use.<sup>[49]</sup>

## REFERENCES

- Heywood, V.H. *Tanacetum* L. In *Flora Europaea*; Tutin, T.G., Heywood, V.H., Burges, N.A., Moore, D.M., Valentine, D.H., Walters, S.M., Webb, D.A., Eds.; Cambridge University Press: New York, 1976; Vol. 4, 171.
- Herba Tanacetii Parthenii*. In *WHO Monographs on Selected Medicinal Plants*; World Health Organization: Geneva, Switzerland, 2002; Vol. 2, 317–328.
- Nicholson, G. *Dictionary of Gardening*; L. Upcott Gill: London, 1886–1887; Vol. 5.
- Bailey, L.H. *The Standard Cyclopedia of Horticulture*; Macmillan & Co: New York, 1930.
- Hylands, D.M. How to identify the correct varieties of feverfew. *Migraine Matters* **1984**, 2, 25
- Foster, S. *Herbal Renaissance*; Gibbs Smith Publisher: Salt Lake City, UT, 1993; 93–95.
- Pharmacopée Française*; Adrapharm: Paris, 1996.
- Awang, D.V.C. Feverfew fever: a headache for the consumer. *HerbalGram* **1993**, 29, 34–36, 66.
- Berry, M.I. Feverfew faces the future. *Pharm. J. (U.K.)* **1984**, 232, 611–614.
- Gerarde, J. *The Herball, General Historie of Plantes*; Adams Islip: London, 1597.
- Johnson, E.S. Patients who chew chrysanthemum leaves. *MIMS Mag.* **1983**, 15 (32), 24.
- Culpeper, N. *The English Physician Enlarged*; H. Colbert: Dublin, 1787.
- Clair, C. *Of Herbs and Spices*; Abelard-Shuman Ltd.: London, 1961; 165.
- Feverfew (leaves). In *Botanical Dietary Supplements: Quality, Safety and Efficacy*; Mahady, G.B., Fong, H.H.S., Farnsworth, N.R., Eds.; Swets & Zeitlinger B.V.: Lisse, The Netherlands, 2001; 87.
- Johnson, S. *Feverfew. A Traditional Herbal Remedy for Migraine and Arthritis*; Sheldon Press: London, 1984.
- Heptinstall, S.; Awang, D.V.C. Feverfew: a review of its history, its biological and medicinal properties, and the status of commercial preparations of the herb. In *Phytomedicines of Europe. Chemistry and Biological Activity*; Lawson, L.D., Bauer, R., Eds.; American Chemical Society: Washington, DC, 1998; 159–175.
- Heptinstall, S. Feverfew—an ancient remedy for modern times? *J. Roy. Soc. Med.* **1998**, 81, 373–374 (Editorial).
- Williams, C.A.; Harbourne, J.B.; Geiger, H.; Hoult, J.R. The flavonoids of *Tanacetum parthenium* and *T. vulgare* and their anti-inflammatory properties. *Phytochemistry* **1999**, 51, 417–423.
- Long, C.; Sauleau, P.; David, B.; Lavaud, C.; Cassabois, V.; Ausseil, F.; Massiot, G. Bioactive flavonoids of *Tanacetum parthenium* revisited. *Phytochemistry* **2003**, 64, 567–569.
- DePooter, H.L.; Vermeesch, J.; Schamp, N.M. The essential oils of *Tanacetum vulgare* L. and *Tanacetum parthenium* (L.) Schultz Bip. *J. Essent. Oil Res.* **1989**, 1 (1), 9–13.
- Banthorpe, D.V.; Brown, G.D.; Janes, J.F.; Marr, I.M. Parthenolide and other volatiles in the flowerheads of *Tanacetum parthenium* (L.) Schultz Bip. *Flavour Fragrance J.* **1990**, 5, 183–185.
- Willigmann, I.; Hages, H.; Bramm, A.; Jakob, K.; Puhl, G.; Koppelman, G.; Freudenstein, J. Pharmacognostic and chemotaxonomic investigations of the aerial parts of feverfew (*Herba Tanacetii parthenii*) from different origins. Poster presentation. 46th Annual Congress of the Society for Medicinal Plant Research, Vienna, Austria, 1998. (Abstract book, Symposium Sekundäre Pflanzenstoffe, Jena, 1999).
- Hendriks, H.; Bos, R.; Woerdenbag, H.J. The essential oil of *Tanacetum parthenium* (L.) Schultz-Bip. *Flavour Fragrance J.* **1996**, 11, 367–371.
- Bohlmann, F.; Zdero, C. Sesquiterpene lactones and other constituents from *Tanacetum parthenium*. *Phytochemistry* **1982**, 21, 2543–2549.
- Cutlan, A.R.; Bonilla, L.E.; Simon, J.E.; Erwin, E.J. Intra-specific variability of feverfew: correlations between parthenolide, morphological traits and seed origin. *Planta Med.* **2000**, 66, 612–617.
- Awang, D.V.C. Chemotaxonomy and the regulation of commercial plant products. Identity and standardization. Presentation to the 57th Congress of the French Canadian Association for the Advancement of the Sciences, Montreal, Quebec, May 15–19, 1989.
- Hewlett, M.J.; Begley, M.J.; Groenewegen, W.A.; Heptinstall, S.; Knight, D.W.; May, J.; Salan, U.; Toplis, D. Sesquiterpene lactones from feverfew, *Tanacetum parthenium*: isolation, structural revision, activity against human blood platelet function and implications for migraine therapy. *J. Chem. Soc. Perkin Trans.* **1996**, 1, 1979–1986.
- Hylands, D.M.; Hylands, P.J. New sesquiterpene lactones from feverfew. *Phytochemistry Society of Europe Symposium* **1986**, Abstract Book, P17.
- Hylands, P.J.; Hylands, D.M. The active principle of feverfew. In *Development of Drugs*

- and *Modern Medicines*; Gorrad, J.W., Gibson, G.G., Mitchard, M., Eds.; Ellis Horwood: London, 1986; 100–104.
30. Wagner, H.; Fessler, B.; Lotter, H.; Wray, V. New chlorine-containing sesquiterpene lactones from *Chrysanthemum parthenium*. *Planta Med.* **1999**, *51*, 417–423.
  31. Kuritzky, A.; Elhacham, Z.; Yerushalmi, Z.; Hering, R. Feverfew in the treatment of migraine: its effect on serotonin uptake and platelet activity. *Neurology* **1994**, *44* (Suppl. 2), 293 P (Abstract).
  32. Jadad, A.R.; Moore, R.A.; Carrol, D.; Jenkinson, C.; Reynolds, D.J.M.; Gavaghan, D.J.; McQuay, H.J. Assessing the quality of reports of randomized clinical trials. Is blinding necessary? *Controlled Clin. Trials* **1996**, *17*, 1–12.
  33. Vogler, B.K.; Pittler, M.H.; Ernst, E. Feverfew as a preventive treatment for migraine: a systematic review. *Cephalalgia* **1998**, *18*, 704–708.
  34. De Weerd, C.J.; Bootsma, H.P.R.; Hendriks, H. Herbal medicines in migraine prevention. *Phyto-medicine* **1996**, *3* (3), 225–230.
  35. Johnson, E.S.; Kadam, N.P.; Hylands, D.M.; Hylands, P.J. Efficacy of feverfew as prophylactic treatment of migraine. *Br. Med. J.* **1985**, *291*, 569–573.
  36. Murphy, J.J.; Heptinstall, S.; Mitchell, J.R.A. Randomised double-blind placebo-controlled trial of feverfew in migraine prevention. *Lancet* **1988**, 189–192.
  37. Palevitch, D.; Earon, G.; Carasso, R. Feverfew (*Tanacetum parthenium*) as a prophylactic treatment for migraine: a double-blind placebo-controlled study. *Phytother. Res.* **1997**, *11*, 508–511.
  38. Pfaffenrath, V.; Diener, H.C.; Fischer, M.; Friede, M.; Heinicke-von Zepelin, H.H. The efficacy and safety of *Tanacetum parthenium* (feverfew) in migraine prophylaxis—a double-blind, multicentre, randomized placebo-controlled dose–response study. *Cephalalgia* **2002**, *22*, 523–532.
  39. Friede, M. Personal communication.
  40. Pattrick, M.; Heptinstall, S.; Doherty, M. Feverfew in rheumatoid arthritis: a double blind, placebo controlled study. *Ann. Rheum. Dis.* **1989**, *48*, 547–549.
  41. Heptinstall, S. Personal communication.
  42. Awang, D.V.C. Feverfew effective in migraine prevention. A research review. *HerbalGram* **1998**, *42*, 18.
  43. Gardiner, A. *Medicinal Herbs and Essential Oils*; Promotional Reprint Company Ltd.: London, 1996; 24.
  44. Fenton, D.A.; Young, E.R.; Wilkinson, J.D. Recurrent aphthous ulceration. *Br. Med. J.* **1983**, *286*, 1062 (Letter).
  45. Hausen, B.M. Sesquiterpene lactones—*Tanacetum parthenium*. In *Adverse Effects of Herbal Drugs*; De Smet, P.A.G.M., Keller, K., Hänsel, R., Chandler, R.F., Eds.; Springer-Verlag: Berlin, 1994; Vol. 1.
  46. Murch, S.J.; Simmons, C.B.; Saxena, P.K. Melatonin in feverfew and other medicinal plants. *Lancet* **1997**, *350*, 1598–1599.
  47. Anderson, D.; Jenkinson, P.C.; Dewdney, R.S.; Blowers, S.D.; Johnson, E.S.; Kadam, N. Chromosomal aberrations and sister chromatid exchanges in lymphocytes and urine mutagenicity of migraine patients: a comparison of chronic-feverfew users and matched non-users. *Hum. Toxicol.* **1988**, *7*, 145–152.
  48. Hausen, B.M.; Osmundsen, P.E. Contact allergy to parthenolide in *Tanacetum parthenium* (L.) Schultz Bip. (feverfew, Asteraceae) and cross-reactions to related sesquiterpene lactone containing Compositae species. *Acta Dermatovenerol. (Stockh.)* **1983**, *63*, 308–314.
  49. Awang, D.V.C.; Fugh-Berman, A. Herb–drug interactions in chronic conditions. *Alternative Ther. Women’s Health* **2002**, *4* (8), 57–60.



# Folate

**Pamela Bagley**

*Biomedical Libraries, Dartmouth College, Hanover, New Hampshire, U.S.A.*

**Barry Shane**

*University of California, Berkeley, California, U.S.A.*

## INTRODUCTION

Folate is an essential dietary B-complex vitamin required for human health. It functions as a cofactor in the synthesis of nucleotides required for DNA synthesis and in amino acid metabolism. The classic symptom of folate deficiency is megaloblastic (large cell) anemia, which is a reflection of defective DNA synthesis. Poor folate status is also a risk factor for cancer. The recent finding that periconceptional folate supplementation greatly reduces the incidence of birth defects in humans had led to fortification of the food supply with folic acid in the United States and other countries.

## STRUCTURE AND CHEMISTRY

Folate is used as a generic term for a family of chemically and functionally related compounds based on the folic acid structure (Fig. 1). Folic acid (molecular weight 441.4), also known as pteroylglutamate, is a chemically oxidized, synthetic form of the vitamin and consists of a pterin (2-amino-4-hydroxypteridine) ring linked to *para*-aminobenzoic acid, which is conjugated to a molecule of L-glutamic acid. Folic acid is readily reduced within the cell to the metabolically active 5,6,7,8-tetrahydrofolate form. Folates in tissues act as donors and acceptors of one-carbon units in metabolic reactions known as one-carbon metabolism. These units can be at the oxidation level of methanol (5-methyltetrahydrofolate), formaldehyde (5,10-methylenetetrahydrofolate), or formate (5- or 10-formyltetrahydrofolate or 5,10-methenyltetrahydrofolate). The predominant coenzyme forms are listed in Table 1.

*Pamela Bagley, M.S., Ph.D., is Information and Education Services Librarian at Biomedical Libraries, Dartmouth College, Hanover, New Hampshire, U.S.A.*

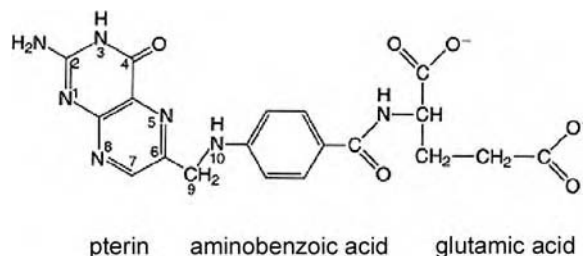
*Barry Shane, Ph.D., is Professor at the Department of Nutritional Sciences and Toxicology, University of California, Berkeley, California, U.S.A.*

Practically all tissue folates are polyglutamate forms in which the glutamate tail is extended through an unusual peptide bond via the gamma-carboxyl of glutamate. Glutamate chain lengths can vary from about 4 to 10 in human tissues. Metabolism of folates to polyglutamate forms is required for their biological activity, as the polyglutamate forms are much more effective substrates for folate-dependent enzymes than are the monoglutamate derivatives, which are the transport forms of the vitamin.<sup>[1]</sup> Conversion of folates to polyglutamates of chain length greater than 3 is also required for effective retention of folate by tissues.<sup>[2]</sup>

## BIOCHEMISTRY AND FUNCTIONS

Folate coenzymes are involved in three major inter-related metabolic cycles in the cytosol of cells. These cycles are required for the synthesis of thymidylate and purines, precursors for DNA and RNA synthesis, and for the synthesis of methionine from homocysteine and the interconversion of serine and glycine (Fig. 2).

5,10-Methylenetetrahydrofolate plays a central role in these cycles as it can be used directly for thymidylate synthesis, or reduced to 5-methyltetrahydrofolate in the methionine synthesis cycle, or oxidized to 10-formyltetrahydrofolate for use in purine synthesis. Although these synthetic cycles are located in the cytosol, mammalian cells also contain a large



**Fig. 1** Structure of folic acid (pteroylglutamate). One-carbon substituents can be at the N-5 and/or N-10 positions of the reduced tetrahydrofolate molecule.

**Table 1** Metabolically active forms of folate<sup>a</sup>

Unsubstituted folates	
7,8-Dihydrofolate (reduced at positions 7 and 8)	
5,6,7,8-Tetrahydrofolate	
Substituted folates	
5-Methyltetrahydrofolate	One-carbon group -CH <sub>3</sub>
5-Formyltetrahydrofolate (folinic acid, leukovorin)	-CHO
5-Formiminotetrahydrofolate	-CHNH
10-Formyltetrahydrofolate	-CHO
5,10-Methylenetetrahydrofolate	-CH <sub>2</sub> -
5,10-Methenyltetrahydrofolate	-CH-

<sup>a</sup>Active forms are polyglutamate derivatives.

mitochondrial folate pool, which is also involved in the provision of one-carbon precursors for cytosolic one-carbon metabolism.<sup>[3,4]</sup>

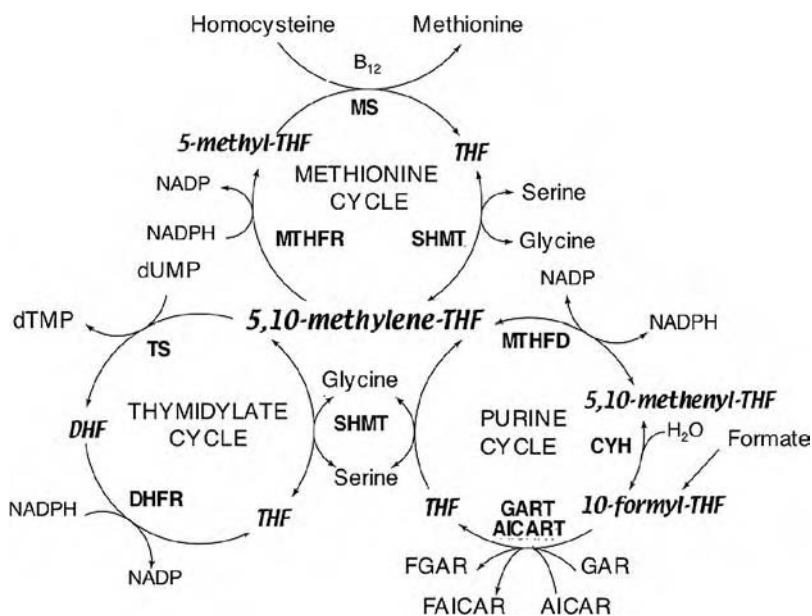
### Serine–Glycine Interconversion

Serine is the major provider of one-carbon units for folate-dependent one-carbon metabolism.<sup>[1]</sup> It donates its  $\beta$ -carbon to tetrahydrofolate to generate glycine and 5,10-methylenetetrahydrofolate. The reaction, which is catalyzed by the pyridoxal phosphate (PLP)-dependent enzyme serine hydroxymethyltransferase (SHMT), is at near equilibrium and can be easily reversed. Mammalian tissues contain two distinct isozymes of SHMT, one cytosolic and one mitochondrial, encoded by different genes.<sup>[5]</sup> Recent studies suggest that the mitochondrial isozyme, which is expressed in all tissues, is responsible for the generation of the

majority of one-carbon units required for cytosolic one-carbon metabolism.<sup>[6]</sup> 5,10-Methylenetetrahydrofolate generated via the mitochondrial SHMT reaction is oxidized to 10-formyltetrahydrofolate and then hydrolyzed to formate. The formate produced exits the mitochondria and is the one-carbon reincorporated into the cytosolic one-carbon pool as 10-formyltetrahydrofolate. 10-Formyltetrahydrofolate can be reduced to 5,10-methylenetetrahydrofolate in the cytosol reversibly by the action of a C1 synthase enzyme. The tissue distribution of the cytosolic isozyme of SHMT is more limited than that of the mitochondrial enzyme; the cytosolic isozyme is highly expressed in liver and kidney and in rapidly replicating cells. A major role of the hepatic cytosolic SHMT enzyme may be to synthesize serine from glycine for use in gluconeogenesis. Mammalian cell mutants that lack mitochondrial SHMT but express cytosolic SHMT are glycine auxotrophs.<sup>[7]</sup>

### Nucleotide Synthesis

Folate is required for the synthesis of thymidylate, a nucleotide required specifically for the synthesis of DNA. Thymidylate synthase catalyzes the transfer of the one-carbon group from 5,10-methylenetetrahydrofolate to the 5'-position of dUMP and its reduction to a methyl group to generate dTMP. The folate molecule also provides the reducing component in this reaction, and the tetrahydrofolate is oxidized to dihydrofolate. The dihydrofolate generated has to be reduced back to tetrahydrofolate before it can be reutilized in one-carbon metabolism in a reaction catalyzed by dihydrofolate reductase (DHFR). Thymidylate synthase



**Fig. 2** The major metabolic cycles of folate-dependent one-carbon metabolism in the cytoplasm of cells. The cycles use reduced tetrahydrofolate (THF) polyglutamates as substrates. SHMT, serine hydroxymethyltransferase; MTHFR, methylenetetrahydrofolate reductase; MS, methionine synthase; TS, thymidylate synthase; DHFR, dihydrofolate reductase; MTHFD, methylenetetrahydrofolate dehydrogenase; CYH, methenyltetrahydrofolate cyclohydrolase; GART, GAR formyltransferase; AICART, AICAR formyltransferase; dUMP, deoxyuridine monophosphate; dTMP, deoxythymidine monophosphate; FAICAR, formylaminoimidazole carboxamide ribonucleotide; AICAR, aminoimidazole carboxamide ribonucleotide; FGAR, formylglycinamide ribonucleotide; B12, vitamin B12 (cobalamin).



is excreted within 24 hr. Although plasma folate levels in excess of 100 times the normal can be achieved, tissue folate levels increase only marginally, often less than two-fold, due to the limited ability of tissues to metabolize these large doses to the polyglutamate forms required for folate retention.

Folate monoglutamate in plasma is transported into tissues via the reduced folate carrier, the same plasma membrane protein responsible for folate transport in the gut.<sup>[13]</sup> For reasons not currently understood, the properties of this protein differ between tissues. The liver carrier effectively transports both oxidized and reduced folate, while the carrier in most peripheral tissues has a very poor affinity for folic acid, and is specific for reduced folates.

A second distinct folate transporter known as folate binding protein or the folate receptor is expressed in a more limited range of tissues. High levels of folate binding protein are expressed in the choroid plexus, kidney proximal tubes, and placenta and in a number of human tumors, while lower levels have been found in a variety of other tissues. This transporter is responsible for reabsorption of folate in the kidney by a receptor mediated endocytotic process and is believed to play a similar role in folate transport in other tissues.<sup>[14]</sup> An additional distinct cellular transporter responsible for the transport of reduced folate monoglutamates into the mitochondrion has recently been identified.<sup>[15]</sup>

### Tissue Retention and Turnover

Folate monoglutamate transported into cells is metabolized to polyglutamate forms by the enzyme folylpolyglutamate synthase. Mammalian cells contain mitochondrial and cytosolic isozymes encoded by a single gene.<sup>[16]</sup> In the cytosol, much of the entering folate is metabolized to the 5-methyltetrahydrofolate derivative, which is a poor substrate for folylpolyglutamate synthase. This has to be metabolized to tetrahydrofolate via the methionine synthase reaction before effective polyglutamylation and tissue retention is achieved. As the flux of 5-methyltetrahydrofolate through the methionine synthase reaction is quite limiting, particularly when the cell contains high levels of 5-methyltetrahydrofolate polyglutamate, much of the newly absorbed folate is not retained by the tissue and appears in the circulation predominantly as 5-methyltetrahydrofolate.

Under normal conditions of dietary intake and status, whole body folate turns over quite slowly, with a half-life in excess of 100 days.<sup>[17]</sup> Urinary excretion of intact folate accounts for only a very small proportion of this turnover. Over 99% of tissue folate is in the polyglutamate form. The actual mechanism of

catabolism is poorly understood but primarily involves cleavage at the C9–N10 bond to generate *p*-aminobenzoylpolyglutamates and a pterin moiety.<sup>[18]</sup> The *p*-aminobenzoylpolyglutamates are hydrolyzed to monoglutamate by a lysosomal glutamylhydrolase and acetylated, and then excreted in urine as *N*-methylaminobenzoylmonoglutamate. The pterin moiety is excreted in bile and appears in the feces.

Feces contain very high levels of folate, but most, if not all, of this arises from bacterial synthesis in the lower gut. Studies in rodents have shown that some of this bacterially synthesized folate is bioavailable.<sup>[19]</sup> Whether folate synthesized by gut bacteria in humans is also bioavailable has not been determined.

## FOLATE DEFICIENCY

### Megaloblastic Anemia

Folate deficiency is usually due to a dietary insufficiency, although it can arise from other causes such as malabsorption syndromes. The classic symptom of folate insufficiency is megaloblastic anemia, a condition reflecting deranged DNA synthesis in the erythropoietic cells. This disorder is fairly common in pregnancy. Blood cells are enlarged and often multinucleated. Megaloblastic changes occur in all fast growing tissues such as the marrow and the gut epithelia. Affected cells contain close to twice the normal DNA content and the DNA is partially fragmented. Many are arrested in the G2 phase just prior to mitosis. Cells that divide often undergo apoptosis. The defect in DNA synthesis in folate deficiency has been ascribed to defective thymidylate synthesis under these conditions, with a resulting increase in uracil misincorporation into DNA. Removal of uracil by the repair enzyme uracil DNA glycosylase, and a decreased repair of the gaps produced by this enzyme, leads to an increase in double-stranded DNA breaks under these conditions.<sup>[20]</sup>

Megaloblastic anemia, or pernicious anemia, is also a classic symptom of impaired B<sub>12</sub> status. This condition, which is quite prevalent in the elderly, is seldom due to a dietary deficiency but usually results from malabsorption of B<sub>12</sub>. However, the anemia that results is identical to that of folate deficiency. In B<sub>12</sub> deficiency, the B<sub>12</sub>-dependent methionine synthase enzyme is inactive, and cytosolic folate is “trapped” as 5-methyltetrahydrofolate at the expense of other folate coenzyme forms required for one-carbon metabolism, such as thymidylate synthesis, leading to a functional folate deficiency in the cell.<sup>[10]</sup> As 5-methyltetrahydrofolate is a poor substrate for folylpolyglutamate synthase, the ability of tissues to accumulate folate is reduced and the functional folate

deficiency is compounded by a drop in cellular folate levels. As the defective DNA synthesis in pernicious anemia due to B<sub>12</sub> deficit is caused by an induced secondary folate deficiency, high levels of folate cause a hematological response in patients. However, folate is ineffective in preventing the severe neurological pathologies associated with B<sub>12</sub> deficiency.

### Vascular Disease

Severe genetic conditions that result in marked hyperhomocysteinemia are associated with a variety of clinical symptoms, including early onset occlusive cardiovascular and cerebrovascular disease. These genetic diseases include deficiency of methylenetetrahydrofolate reductase and cystathionine β-synthase, enzymes involved in the homocysteine remethylation and trans-sulfuration pathways, respectively. Lowering of homocysteine with high doses of folate and betaine improves the clinical picture in these patients, strongly suggesting that homocysteine is the causative agent of these conditions, although the actual mechanism is not known.<sup>[21]</sup>

More recently, epidemiological studies have suggested that chronic mild hyperhomocysteinemia is a risk factor for occlusive vascular disease. In many case control studies, plasma homocysteine concentrations were higher in patients with vascular disease than in matched controls. However, this relationship has not been found consistently in prospective studies. Fasting homocysteine levels have been inversely correlated with both plasma folate and food folate intake, and increased folate intake lowers the mean homocysteine of groups, with the greatest effect on those with the highest plasma homocysteine levels. If mildly elevated homocysteine is a causative risk factor for vascular disease, then it may be that a simple dietary intervention can lower the risk.

A common polymorphism (677C → T, Ala to Val) in the flavoprotein methylenetetrahydrofolate reductase that results in a “heat-labile” enzyme and decreased enzyme activity in tissues has been implicated as one reason for the folate responsiveness of a subset of hyperhomocysteinemic subjects.<sup>[22]</sup> The incidence of the Val/Val homozygosity (around 10% in the U.S. population) is significantly higher in subjects with the highest deciles of homocysteine levels. The valine substitution reduces the affinity of the enzyme for its FAD cofactor, and loss of FAD leads to decreased protein stability. Folate binding “locks” the FAD cofactor in place on the enzyme and stabilizes the protein.<sup>[23]</sup> Comparisons of Val/Val individuals with Ala/Ala subjects have demonstrated that differences between these groups are most obvious in subjects with poor folate and riboflavin status and that

increased dietary folate not only lowers homocysteine in both groups but also eliminates the differences between the genotypes.<sup>[24]</sup> Although elevated homocysteine is associated with increased vascular disease risk and increased folate intake decreases plasma homocysteine levels, it remains to be established whether increased folate intake reduces vascular disease risk.

### Neural Tube Defects

In the early 1990s, double-blind, randomized trials confirmed that supplemental folic acid given prior to conception and during early pregnancy significantly reduced (by over 70%) the incidence of neural tube defects (NTDs), the most common birth defects in humans.<sup>[25,26]</sup> This was most likely not due to correction of a simple folate deficiency. Instead, it is thought that some women and/or their offspring have a higher requirement for folate due to genetic reasons. The current fortification of the food supply with folic acid in the United States and some other countries arose because those individuals at risk of having an NTD child cannot be identified at the moment (see below).

A large number of folate candidate genes have been screened as risk factors for NTDs. Homozygosity of the 677T (Val) allele of methylenetetrahydrofolate reductase has been shown to be a risk factor in a number of studies, with the risk increasing very significantly in comparisons of infants of mothers with poor folate status. However, carrying this particular allele can only account for about 15% of the population-based attributable derived risk.<sup>[27]</sup>

### Cancer

Epidemiological studies have shown that poor folate status is associated with an increased risk for certain types of cancer, including colon cancer.<sup>[28]</sup> The mechanism behind this is not known, but uracil misincorporation arising from defective thymidylate synthesis has been suggested as one possibility. As changes in folate status influence the remethylation of homocysteine to methionine and alter adenosylmethionine-to-adenosylhomocysteine ratios, it has also been proposed that the increased cancer risk in folate deficiency may be due to hypomethylation of DNA and/or histones. Changes in DNA and histone methylation have been observed in many tumors, and it has been demonstrated that methionine deficiency causes hypomethylation of DNA.

Subjects homozygous for the methylenetetrahydrofolate reductase 667T allele demonstrate a decreased cancer risk, which is most pronounced in comparisons with subjects of good folate status. It has been speculated that this polymorphism directs more of the



one-carbon flux into thymidylate synthesis and away from methionine synthesis, although this remains to be proven.

## INDICATIONS AND USAGE

### Supplementation to Achieve Recommended Intake Levels

In 1998, the United States Food and Nutrition Board of the National Academy of Sciences and a joint FAO/WHO Expert Consultation on Human Vitamin and Mineral Requirements reviewed their recommendations for folate intake.<sup>[12]</sup> Both groups used plasma and red blood cell folate concentrations as primary indicators of folate adequacy, and plasma total homocysteine levels as an additional indicator of folate status. Their conclusions appear in Table 2.

The suggested levels represent the daily folate required to ensure adequate nutrition in 95–97.5% of the population and are an overestimation of the level needed by most people in any given group. Individuals who do not routinely consume the suggested level of

folate from foods should be encouraged to supplement their diets with folic acid.

### Treatment of Folate Deficiency

Folate deficiency has traditionally been diagnosed as a low serum or red blood cell folate level (<3 and <160 ng/ml, respectively) in the setting of macrocytic anemia. However, anemia reflects a late stage of folate depletion; earlier stages are often evidenced solely by low blood folate levels and/or elevations in homocysteine levels. Vitamin B<sub>12</sub> deficiency artifactually increases serum folate levels and decreases red blood cell folate levels, and also increases plasma homocysteine levels, which can confound the diagnosis.

After ruling out B<sub>12</sub> deficiency, rapid restoration of a folate-replete state can be achieved by administering 500–1000 µg of folic acid orally per day. There is little evidence that doses greater than 1000 µg convey additional benefit. Once the folate deficiency is resolved, daily intake of folate based on the levels found in Table 2 should be maintained. In cases of severe intestinal malabsorption or an inability to use the gastrointestinal tract, it may be necessary to administer 1 mg of folic acid parenterally via an intravenous or intramuscular route. This dose appears suitable for initial repletion of a folate-deficient state.

**Table 2** RDIs for folate. Recommended dietary allowances<sup>a</sup> and recommended nutrient intakes<sup>b</sup>

RDA		RNI <sup>c</sup>	
Age	DFE <sup>d</sup> (µg/day)	Age	DFE (µg/day)
0–5 mo	65	0–6 mo	80
6–11 mo	80	7–12 mo	80
1–3 yr	150	1–3 yr	160
4–8 yr	200	4–6 yr	200
9–13 yr	300	7–9 yr	300
14 yr and above	400 <sup>e</sup>	10 yr and above	400
Pregnancy	600	Pregnancy	600
Lactation	500	Lactation	500

<sup>a</sup>RDA, 1998 United States Food and Nutrition Board of the Institute of Medicine.

<sup>b</sup>RNI, 1998 Joint FAO/WHO Expert Consultation on Human Vitamin and Mineral Requirements.

<sup>c</sup>Values for males and females in all age groups were combined as they did not differ, and age groups with the same RNI were combined.

<sup>d</sup>Values are given as dietary folate equivalents (DFE). 1 DFE = 1 µg food folate = 0.6 µg synthetic folic acid taken with food = 0.5 µg synthetic folic acid taken on an empty stomach.

<sup>e</sup>In view of evidence linking increased folate intake with reduction of neural tube defects in the fetus, it is recommended that all women capable of becoming pregnant consume 400 µg synthetic folic acid from supplements and/or fortified foods in addition to food folate from a varied diet. The RDA value for pregnancy does not include this additional folate.

### Prevention of Neural Tube Defects

Because the neural tube closes during the 4th week of embryonic life, before many women realize they are pregnant, and the population at risk of this condition cannot be identified, it is recommended that all women planning a pregnancy or are of child-bearing age take 400 µg folic acid, either as a supplement or through fortified foods.<sup>[12]</sup> In addition, women with a family history of NTDs or who have had a previous NTD-affected pregnancy should be encouraged to take a daily supplement containing 4000–5000 µg folic acid during the periconceptional period.

Beginning in 1998, the FDA mandated fortification of the U.S. food supply with folic acid to reduce the incidence of NTDs. Food fortification rather than targeting supplements to women planning pregnancies was deemed necessary because of a perceived failure of public health efforts to influence those most at risk. Fortification was planned at a level expected to achieve an average extra daily folic acid intake of 100 µg, which would be equivalent to about 200 µg of extra food folate because of its higher bioavailability, and with few individuals expected to receive over 1 mg, to limit the possibility of masking of B<sub>12</sub> deficiency. Because of “overage” by food manufacturers, the average

increased folic acid intake in the U.S. population has been closer to 200 µg, and postfortification NTD rates have fallen by about 20%.<sup>[29]</sup> Some argue that increased fortification is required to further decrease NTD rates and point to the 70% reduction observed in the initial intervention trials. However, NTD rates had been falling prior to fortification, and the underlying rate in the United States was quite low compared to that in some other countries. Folate intervention studies in China demonstrated a 70% drop in NTD rates in areas of high prevalence and a much smaller drop in areas of lower prevalence.<sup>[30]</sup> It may be that the current level of fortification has already achieved the maximum effect. Food fortification has exposed the whole population to a very significant increase in folate intake, not just the individuals at risk of NTDs. Concerns have been raised about the possibility of unanticipated side effects, as limited studies have been carried out on the effects of high doses of folate.

Although fortification was initiated to reduce NTD incidence, there may have been other benefits. Plasma and red cell folate levels have increased and the proportion of the population with deficient levels has fallen dramatically. The proportion of the population with elevated plasma homocysteine levels has also fallen by about 50%.<sup>[31]</sup>

### Adverse Effects of Drugs on Folate Status

Treatment with certain drugs may indicate the need for administration of supplemental folate. For instance, many physicians prescribe methotrexate (7.5–15 mg per week) for the treatment of rheumatoid arthritis, asthma, and ulcerative colitis. The side effects of this treatment, including alopecia, stomatitis, pancytopenia, and interstitial pulmonary fibrositis, are thought to be inversely related to serum folate levels at the start of treatment. Daily administration of 1 mg of folic acid to people who take methotrexate appears to significantly reduce the development of side effects, and does not interfere with the efficacy of treatment.

Long-term use of sulfasalazine, an anti-inflammatory that is often administered for the treatment of inflammatory bowel disease and rheumatoid arthritis, is often associated with folate deficiency. Therefore, prophylactic coadministration of folic acid at 400–1000 µg per day is indicated.

Phenytoin, phenobarbital, and primidone have repeatedly been associated with either low serum folate levels or frank folate deficiency. Therefore, chronic administration of these drugs should also prompt prophylactic administration of 400–1000 µg of folic acid per day.

Chronic alcoholism is associated with a considerable risk of folate deficiency. A large part of this effect can

be explained by the fact that the diet of a chronic alcoholic is often folate poor. However, other mechanisms have also been described, including impaired intestinal deconjugation of polyglutamated food folates, increased metabolic turnover or urinary excretion, and cleavage of the folate molecule by acetaldehyde. Since deficiencies of other B-vitamins commonly accompany folate deficiency in this setting, administration of a multivitamin preparation containing 400 µg of folic acid is probably the best approach to avoid development of deficiency.

### Hyperhomocysteinemia

Although it cannot be conclusively stated that homocysteine is a cause of vascular disease, a compelling body of observational studies over the past two decades strongly implicates modest elevations in plasma homocysteine with an increased risk. Because the cost of treating hyperhomocysteinemia with vitamins is exceedingly low, this disorder is a reasonable indication for B-vitamin supplementation. Some contend that this is particularly true for the secondary prevention of cardiovascular disease when other reversible risk factors cannot be identified.

In healthy ambulatory populations, low dietary intake and low blood levels of folic acid, B<sub>12</sub>, and B<sub>6</sub> are the primary determinants of blood homocysteine levels.<sup>[32]</sup> It is clear that daily administration of these three vitamins reduces blood homocysteine levels to those associated with considerably lower cardiovascular risk. Provision of a daily dose of 1000 µg of folic acid often suffices, with two notable exceptions. If hyperhomocysteinemia is due to a deficiency of B<sub>12</sub> or B<sub>6</sub>, folate supplementation will not help. Secondly, the hyperhomocysteinemia that commonly develops in individuals with chronic renal insufficiency and in post-renal-transplant recipients is particularly resistant to low doses of folic acid supplementation.<sup>[33]</sup> It appears that doses of 2500 µg of folic acid per day are necessary for optimal homocysteine reduction in this population. Normalization of homocysteine levels in individuals with end stage renal disease may never occur, even with supraphysiological doses of folic acid.

### Cancer Prevention

Observational studies continue to indicate an inverse relationship between folate intake or folate blood levels and the risk of developing certain common cancers. Although there is no firm evidence that supplemental folate can help prevent colorectal cancer, data from animal experiments and preliminary clinical trials support a true causal relationship. Recent data suggest that daily intakes of >400 µg folate for more than 10 yr constitutes a protective effect.

The appropriate setting for prophylaxis with folic acid for cancer prevention remains inconclusive, in part due to concern about potential risks. In large doses, folate is known to accelerate the growth of existing cancers. Therefore, there is concern that supplemental folate may inadvertently accelerate the growth of a precancerous or cancerous polyp in the colon. For this reason, it is prudent to await further research on this topic before folic acid is used for cancer prevention in individuals at increased risk.

### CONTRAINDICATIONS: VITAMIN B<sub>12</sub> DEFICIENCY

Vitamin B<sub>12</sub> deficiency is often undiagnosed and may affect a substantial percentage of the population, particularly the elderly. It may be associated with hematologic symptoms (megaloblastic anemia) and/or neurologic indications (dementia, paresthesia, and ataxia). People who have or are at risk of vitamin B<sub>12</sub> deficiency should not be given folic acid without concomitant monitoring for and treatment of vitamin B<sub>12</sub> deficiency. One risk of folic acid supplementation is that high doses can “hide” the hematologic manifestations of B<sub>12</sub> deficiency and allow the associated neurologic complications to progress. Furthermore, there is anecdotal evidence suggesting that folic acid supplementation may precipitate or exacerbate the neurologic damage caused by vitamin B<sub>12</sub> deficiency.

### PRECAUTIONS AND ADVERSE REACTIONS

#### Drug Interactions

In large amounts, folic acid has been reported to counteract the antiepileptic effect of phenobarbital, phenytoin, and primidone and increase the frequency of seizures in susceptible individuals. Because of the drug–nutrient interaction between these anticonvulsant drugs and folate, people taking these three drugs are also at risk of folate deficiency.

#### Overdosage

Folic acid doses of up to 15,000 µg in healthy adults without convulsive disorders have not been associated with any reported serious adverse effects. The Food and Nutrition Board of the National Academy of Sciences recommended 1000 µg as an upper limit for folic acid for adults 19 yr and older, including pregnant and lactating women.<sup>[12]</sup> This upper limit was not related to any known toxicity of folate per se. Instead, the concern was the possible masking of B<sub>12</sub> deficiency

**Table 3** Upper limits for folic acid set by the 1998 Food and Nutrition Board of the National Academy of Sciences

Age (yr)	Upper limit (µg/day)
1–3	300
4–8	400
9–13	600
14–18	800
>19	1000

anemia and limited information, primarily anecdotal, that folate might exacerbate the neurology of B<sub>12</sub> deficiency. The Food and Nutrition Board set upper limits for children and adolescents by adjusting the adult limit on the basis of relative body weight. Table 3 gives the upper limits for folic acid by age group. No upper limit was set for infants due to lack of adequate data. The Food and Nutrition Board also recommended that food (or maternal milk) be the only source of folate for infants.

### COMPENDIAL/REGULATORY STATUS

Not applicable.

### REFERENCES

1. Shane, B. Folylpolylglutamate synthesis and role in the regulation of one-carbon metabolism. *Vitam. Horm.* **1989**, *45*, 263–335.
2. Osborne, C.B.; Lowe, K.E.; Shane, B. Regulation of folate and one-carbon metabolism in mammalian cells. I. Folate metabolism in Chinese hamster ovary cells expressing *Escherichia coli* or human folylpoly-gamma-glutamate synthetase activity. *J. Biol. Chem.* **1993**, *268*, 21,657–21,664.
3. Lin, B.F.; Shane, B. Expression of *Escherichia coli* folylpolyglutamate synthetase in the Chinese hamster ovary cell mitochondrion. *J. Biol. Chem.* **1994**, *269*, 9705–9713.
4. Barlowe, C.K.; Appling, D.R. In vitro evidence for the involvement of mitochondrial folate metabolism in the supply of cytoplasmic one-carbon units. *Biofactors* **1988**, *1*, 171–176.
5. Garrow, T.A.; Brenner, A.A.; Whitehead, V.M.; Chen, X.N.; Duncan, R.G.; Korenberg, J.R.; Shane, B. Cloning of human cDNAs encoding mitochondrial and cytosolic serine hydroxymethyltransferases and chromosomal localization. *J. Biol. Chem.* **1993**, *268*, 11,910–11,916.

6. Gregory, J.F.; Cuskelly, G.R.; Shane, B.; Toth, J.P.; Baumgartner, T.G.; Stacpoole, P.W. Primed-constant infusion of [<sup>3</sup>H]serine allows in vivo kinetic measurement of serine turnover, homocysteine remethylation, and transsulfuration processes in human one-carbon metabolism. *Am. J. Clin. Nutr.* **2000**, *72*, 1535–1541.
7. Stover, P.; Chen, L.H.; Suh, J.R.; Stover, D.M.; Keyomarsi, K.; Shane, B. Molecular cloning, characterization and regulation of the human mitochondrial serine hydroxymethyltransferase gene. *J. Biol. Chem.* **1997**, *272*, 1842–1848.
8. Blakley, R.L. Dihydrofolate reductase. In *Folates and Pterins. Chemistry and Biochemistry of Folates*; Blakley, R.L., Benkovic, S.J., Eds.; Wiley: New York, 1984; Vol. 1, 191–244.
9. Santi, D.V.; Danenberg, P.V. Folates in pyrimidine nucleotide biosynthesis. In *Folates and Pterins. Chemistry and Biochemistry of Folates*; Blakley, R.L., Benkovic, S.J., Eds.; Wiley: New York, 1984; Vol. 1, 345–398.
10. Shane, B.; Stokstad, E.L.R. Vitamin B<sub>12</sub>-folate interrelationships. *Annu. Rev. Nutr.* **1985**, *5*, 115–141.
11. Devlin, A.M.; Ling, E.; Peerson, J.M.; Fernando, S.; Clarke, R.; Smith, A.D.; Halsted, C.H. Glutamate carboxypeptidase II: a polymorphism associated with lower levels of serum folate and hyperhomocysteinemia. *Hum. Mol. Genet.* **2000**, *9*, 2837–2844.
12. Food and Nutrition Board, Institute of Medicine. Folate. In *Dietary Reference Intakes for Thiamin, Riboflavin, Niacin, Vitamin B<sub>6</sub>, Folate, Vitamin B<sub>12</sub>, Pantothenic Acid, Biotin and Choline*; National Academy Press: Washington, DC, 2000; 196–305.
13. Chiao, J.H.; Roy, K.; Tolner, B.; Yang, C.H.; Sirotnak, F.M. RFC-1 gene expression regulates folate absorption in mouse small intestine. *J. Biol. Chem.* **1997**, *272*, 11,165–11,170.
14. Birn, H.; Selhub, J.; Christensen, E.I. Internalization and intracellular transport of folate-binding protein in rat kidney proximal tubule. *Am. J. Physiol.* **1993**, *264*, C302–C310.
15. Titus, S.A.; Moran, R.G. Retrovirally mediated complementation of the glyB phenotype. Cloning of a human gene encoding the carrier for entry of folates into mitochondria. *J. Biol. Chem.* **2000**, *275* (47), 36,811–36,817.
16. Chen, L.; Qi, H.; Korenberg, J.; Garrow, T.A.; Choi, Y.J.; Shane, B. Purification and properties of human cytosolic folylpoly-γ-glutamate synthetase and organization, localization, and differential splicing of its gene. *J. Biol. Chem.* **1996**, *271*, 13,077–13,087.
17. Stites, T.E.; Bailey, L.B.; Scott, K.C.; Toth, J.P.; Fisher, W.P.; Gregory, J.F. Kinetic modeling of folate metabolism through the use of chronic administration of deuterium-labeled folic acid in men. *Am. J. Clin. Nutr.* **1997**, *65*, 53–60.
18. Suh, J.; Herbig, A.K.; Stover, P.J. New perspectives on folate catabolism. *Annu. Rev. Nutr.* **2001**, *21*, 255–282.
19. Rong, N.; Selhub, J.; Goldin, B.R.; Rosenberg, I.H. Bacterially synthesized folate in rat large intestine is incorporated into host tissue folylpolyglutamates. *J. Nutr.* **1991**, *121*, 1955–1959.
20. Blount, B.C.; Mack, M.M.; Wehr, C.M.; MacGregor, J.T.; Hiatt, R.A.; Wang, G.; Wickramasinghe, S.N.; Everson, R.B.; Ames, B.N. Folate deficiency causes uracil misincorporation into human DNA and chromosome breakage: implications for cancer and neuronal damage. *Proc. Natl. Acad. Sci. U.S.A.* **1997**, *94*, 3290–3295.
21. Refsum, H.; Ueland, P.M.; Nygard, O.; Vollset, S.E. Homocysteine and vascular disease. *Annu. Rev. Med.* **1998**, *49*, 31–62.
22. Frosst, P.; Blom, H.J.; Milos, R.; Goyette, P.; Sheppard, C.A.; Matthews, R.G.; Boers, G.J.; den Heijer, M.; Kluijtmans, L.A.; van den Heuvel, L.P. et al. A candidate genetic risk factor for vascular disease: a common mutation in methylenetetrahydrofolate reductase. *Nat. Genet.* **1995**, *10*, 111–113.
23. Guenther, B.D.; Sheppard, C.A.; Tran, P.; Rozen, R.; Matthews, R.G.; Ludwig, M.L. The structure and properties of methylenetetrahydrofolate reductase from *Escherichia coli* suggest how folate ameliorates human hyperhomocysteinemia. *Nat. Struct. Biol.* **1999**, *6*, 359–365.
24. Jacques, P.F.; Kalmbach, R.; Bagley, P.J.; Russo, G.; Rogers, G.T.; Wilson, P.W.F.; Rosenberg, I.H.; Selhub, J. The relationship between riboflavin and plasma total homocysteine in the Framingham offspring cohort is influenced by folate status and the C677T transition in the methylenetetrahydrofolate reductase gene. *J. Nutr.* **2002**, *132*, 283–288.
25. MRC Vitamin Study Research Group. Prevention of neural tube defects: results of the Medical Research Council Vitamin Study. *Lancet* **1991**, *338*, 131–137.
26. Scott, J.M.; Weir, D.G.; Kirke, P.N. Folate and neural tube defects. In *Folate in Health and Disease*; Bailey, L.B., Ed.; Marcel Dekker, Inc.: New York, 1995; 329–360.
27. Whitehead, A.S.; Gallagher, P.; Mills, J.L.; Kirke, P.N.; Burke, H.; Molloy, A.M.; Weir, D.G.;

- Shields, D.C.; Scott, J.M. A genetic defect in 5,10-methylenetetrahydrofolate reductase in neural tube defects. *Q. J. Med.* **1995**, *88*, 763–766.
28. Ma, J.; Stampfer, M.J.; Giovannucci, E.; Artigas, C.; Hunter, D.J.; Fuchs, C.; Willett, W.C.; Selhub, J.; Hennekens, C.H.; Rozen, R. Methylenetetrahydrofolate reductase polymorphism, dietary interactions, and risk of colorectal cancer. *Cancer Res.* **1997**, *57*, 1098–1102.
29. Honein, M.A.; Paulozzi, L.J.; Mathews, T.J.; Erickson, J.D.; Wong, L.-Y.C. Impact of folic acid fortification of the US food supply on the occurrence of neural tube defects. *J. Am. Med. Assoc.* **2001**, *285*, 2981–2986.
30. Berry, R.J.; Li, Z.; Erickson, J.D.; Li, S.; Moore, C.A.; Wang, H.; Mulinare, J.; Zhao, P.; Wong, L.Y.; Gindler, J.; Hong, S.X.; Correa, A. Prevention of neural-tube defects with folic acid in China. China–U.S. Collaborative Project for Neural Tube Defect Prevention. *N. Engl. J. Med.* **1999**, *341*, 1485–1490.
31. Jacques, P.F.; Selhub, J.; Bostom, A.G.; Wilson, P.W.; Rosenberg, I.H. The effect of folic acid fortification on plasma folate and total homocysteine concentrations. *N. Engl. J. Med.* **1999**, *340*, 1449–1454.
32. Selhub, J.; Jacques, P.; Wilson, P.; Rush, D.; Rosenberg, I. Vitamin status and intake as primary determinants of homocysteinemia in an elderly population. *J. Am. Med. Assoc.* **1993**, *270*, 2693–2698.
33. Bostom, A.G.; Shemin, D.; Lapane, K.L.; Nadeau, M.R.; Sutherland, P.; Chan, J.; Rozen, R.; Yoburn, D.; Jacques, P.F.; Selhub, J.; Rosenberg, I.H. Folate status is the major determinant of fasting total plasma homocysteine levels in maintenance dialysis patients. *Atherosclerosis* **1996**, *123*, 193–202.

#### FURTHER READINGS

- Bailey, L.B. *Folate in Health and Disease*; Marcel Dekker, Inc.: New York, 1995.
- Blakley, R.L.; Benkovic, S.J. *Folates and Pterins. Chemistry and Biochemistry of Folates*; Wiley: New York, 1984; Vol. 1.
- Blakley, R.L.; Whitehead, V.M. *Folates and Pterins: Nutritional, Pharmacological, and Physiological Aspects*; Wiley: New York, 1986; Vol. 3.
- Brody, T.; Shane, B. Folic acid. In *Handbook of the Vitamins*, 3rd Ed.; Rucker, R.B., Suttie, J.W., McCormack, D.B., Machlin, L.J., Eds.; Marcel Dekker, Inc.: New York, 2001; 427–462.
- Food and Nutrition Board, Institute of Medicine. *Dietary Reference Intakes for Thiamin, Riboflavin, Niacin, Vitamin B<sub>6</sub>, Folate, Vitamin B<sub>12</sub>, Pantothenic Acid, Biotin and Choline*; National Academy Press: Washington, DC, 2000.
- World Health Organization; Food and Agriculture Organization of the United Nations. *Human Vitamin and Mineral Requirements: Report of a Joint FAO/WHO Expert Consultation, Bangkok, Thailand*; FAO, WHO: Rome, 2002.

# Garlic (*Allium sativum*)

J.A. Milner

National Institutes of Health, Bethesda, Maryland, U.S.A.

## INTRODUCTION

Historically, garlic (*Allium sativum*) has been revered as part of a healthful diet. Ancient medical texts from Egypt, Greece, Rome, China, and India prescribed garlic for a number of applications including improving performance, reducing infections, and protection against toxins.<sup>[1]</sup> These medicinal properties, coupled with its savory characteristics, have made garlic a true cultural icon in many parts of the world.

## USAGE

Garlic, a member of the Alliaceae family of plants, has characteristics similar to onions, leeks, and chives (Fig. 1). Its intake is not known with any degree of certainty, since it is not traditionally considered in dietary assessment surveys, and as personal preferences vary considerably. Regardless, consumption varies from region to region, and from individual to individual within a region.<sup>[2,3]</sup> According to recent United States Department of Agriculture (USDA) reports, during any typical day, about 18% of Americans consume at least one food containing garlic. Average intake in the United States has been estimated to be about 0.6 g/week or less,<sup>[2]</sup> while in some parts of China, it may be as great as 20 g/day.<sup>[4,5]</sup> Garlic also continues to be one of the top selling dietary supplements in the United States and in several other parts of the world. A recent study in China provided evidence that a reduction in prostate cancer risk occurred when subjects consumed more than 10 g/day compared to those consuming 2.2 g/day or less.<sup>[6]</sup> While several cellular processes can be modified by garlic or its constituents, it remains unclear who will benefit most from intervention strategies, what factors determine the response, and the minimum quantity and duration needed to bring about a response.

While some appear to be able to tolerate rather large quantities of garlic, e.g., 20 g/day, some may not be as resistant. While a spectrum of adverse reactions has been observed, including contact dermatitis,

respiratory distress, gastrointestinal disturbances, bleeding abnormalities, and anaphylactic shock; the overall incidence is quite low.<sup>[7-9]</sup>

Claims about the health benefits of garlic likely contributed to its clinical usage, especially by individuals flirting with alternative health care strategies. Peng et al.<sup>[10]</sup> found in their study that about 43% of veteran outpatients were taking at least one dietary supplement along with their prescription medication(s). The most common products included vitamins and minerals, garlic, *Ginkgo biloba*, saw palmetto, and ginseng. In a comparable study, Adusumilli et al.<sup>[11]</sup> found that about 57% of patients undergoing elective surgery had used herbal medicine at some point in their life. Echinacea, aloe vera, ginseng, garlic, and *Ginkgo biloba* were among the most common. Interestingly, one in six in this study used herbal supplements during the month of surgery. Stys et al.<sup>[12]</sup> reported that patients with a history of myocardial infarction, coronary revascularization, hyperlipidemia, and a family history of coronary artery disease were more likely to use supplements including multivitamins, vitamin E, vitamin C, vitamin B, folate, garlic, calcium, coenzyme Q10, and ginkgo than those without comparable health concerns. Average low-density lipoprotein (LDL), blood pressure, and glycosylated hemoglobin did not differ significantly between users and nonusers.

## CHEMISTRY OF GARLIC

Garlic's distinctive characteristics arise from sulfur, which constitutes almost 1% of its dry weight.<sup>[13,14]</sup> While garlic does not typically serve as a major source of essential nutrients, it may contribute to several dietary factors with potential health benefits. Carbohydrates constitute only about 33% of garlic's weight, but a significant proportion of these are oligosaccharides, which may influence gastrointestinal flora or gastrointestinal function. Besides having a moderate amount of protein, garlic is also a relatively rich source of the amino acid, arginine. Antioxidant properties associated with carbohydrate-arginine polymers may contribute to some of garlic's proposed health benefits.<sup>[15]</sup> The presence of several other factors including selenium and flavonoids may influence the magnitude of the response to garlic.<sup>[16,17]</sup>

J.A. Milner, Ph.D., is Chief at the National Institutes of Health (NIH), Bethesda, Maryland, U.S.A.



**Fig. 1** While garlic is more than a source of sulfur, a variety of compounds are known to arise when it is peeled and crushed that may have health benefits. (View this art in color at [www.dekker.com](http://www.dekker.com).)

The majority of studies about garlic constituents focus on its sulfur components (Table 1).  $\gamma$ -Glutamyl-*S*-alk(en)yl-L-cysteines and *S*-alk(en)yl-L-cysteine sulfoxides are the primary sulfur-containing constituents. Considerable variation in the *S*-alk(en)ylcysteine sulfoxide content has been reported, ranging between 0.53% and 1.3% of the fresh weight, with alliin (*S*-allyl cysteine sulfoxide) the largest contributor.<sup>[18]</sup> Alliin concentrations can increase during storage as a result of the transformation of  $\gamma$ -glutamylcysteines. In addition to alliin, garlic bulbs contain small amounts of (+)-*S*-methyl-L-cysteine sulfoxide (methiin) and (+)-*S*-(*trans*-1-propenyl)-L-cysteine sulfoxide, *S*-(2-carboxypropyl) glutathione,  $\gamma$ -glutamyl-*S*-allyl-L-cysteine,

$\gamma$ -glutamyl-*S*-(*trans*-1-propenyl)-L-cysteine, and  $\gamma$ -glutamyl-*S*-allyl-mercapto-L-cysteine.<sup>[3,13]</sup>

Alliin is the major thiosulfinate compound (allyl 2-propenethiosulfinate or diallyl thiosulfinate) occurring in garlic and its aqueous extracts. When it is chopped or crushed, allinase enzyme, present in garlic, is activated and acts on alliin (found in the intact garlic) to produce alliin (thio-2-propene-1-sulfinic acid *S*-allyl ester). Since alliin is relatively unstable, it further decomposes to sulfides, ajoene, and dithiins.<sup>[19]</sup> Garlic's characteristic odor arises largely from alliin and its oil-soluble metabolites. Heating denatures allinase and reduces allyl mercaptan, methyl mercaptan, and allyl methyl sulfide. The decreased formation of these metabolites is associated with a reduction in smell and with its anticarcinogenic potential.<sup>[20]</sup> Overall, the method used to process garlic can dramatically influence the sulfur compounds that predominate.<sup>[3,20,21]</sup> New analytical approaches<sup>[14]</sup> may assist in characterizing the impact of production and processing methods on the content of specific allyl sulfur compounds.

While the pharmacokinetics of allyl sulfur compounds in mammals has not been adequately examined, it is unlikely that alliin occurs in a significant proportion once garlic is consumed. If it does, the liver should quickly transform it to diallyl disulfide (DADS) and allyl mercaptan.<sup>[22]</sup> DADS is absorbed and transformed into allyl mercaptan, allyl methyl sulfide, allyl methyl sulfoxide, and allyl methyl sulfone.<sup>[23]</sup> Thus, a host of compounds likely arise from ingestion of the parent compounds found in garlic. While allyl methyl sulfone predominated in tissues, both sulfoxide and sulfone have been identified in urine.

**Table 1** Structures of some biologically active lipid- and water-compounds isolated from garlic

Chemical	Structure
Alliin	$\text{CH}_2=\text{CH}-\text{CH}_2-\overset{\text{O}^-}{\underset{ }{\text{S}^+}}-\text{S}-\text{CH}_2-\text{CH}-\text{CH}_2$
Ajoene	$\text{CH}_2=\text{CH}-\text{CH}_2-\overset{\text{O}^-}{\underset{ }{\text{S}^+}}-\text{CH}_2-\text{CH}=\text{CH}-\text{S}-\text{S}-\text{CH}_2-\text{CH}=\text{CH}_2$
Diallyl sulfide	$\text{CH}_2=\text{CH}-\text{CH}_2-\text{S}-\text{CH}_2-\text{CH}=\text{CH}_2$
Diallyl disulfide	$\text{CH}_2=\text{CH}-\text{CH}_2-\text{S}-\text{S}-\text{CH}_2-\text{CH}=\text{CH}_2$
Diallyl trisulfide	$\text{CH}_2=\text{CH}-\text{CH}_2-\text{S}-\text{S}-\text{S}-\text{CH}_2-\text{CH}=\text{CH}_2$
<i>S</i> -Allylcysteine	$\text{CH}_2=\text{CH}-\text{CH}_2-\text{S}-\text{CH}_2-\overset{\text{NH}_2}{\underset{ }{\text{CH}}}-\text{COOH}$
<i>S</i> -Allylmercaptocysteine	$\text{CH}_2=\text{CH}-\text{CH}_2-\text{S}-\text{S}-\text{CH}_2-\overset{\text{NH}_2}{\underset{ }{\text{CH}}}-\text{COOH}$

## IMPLICATIONS IN HEALTH PROMOTION

Garlic is increasingly being recognized to alter several physiological processes that may influence health, including those associated with heart disease and cancer.<sup>[17,24–27]</sup> Preclinical studies provide some of the most convincing evidence that garlic and its related sulfur components can alter a host of biological processes associated with health.

Some of the health benefits attributed to the consumption of garlic and associated allyl sulfur components are:

- Antibacterial
- Anticarcinogenic
- Antifungal
- Antioxidant
- Antithrombotic
- Antiviral
- Hypolipidemic

While these results generally support earlier views about garlic's medicinal properties, there is admittedly considerable variability in response. Unfortunately, a dearth of clinical studies exists for establishing firm conclusions about who might gain most from enhanced consumption.

### Antimicrobial Effects and Cancer Prevention

Garlic has been used for centuries to preserve foods.<sup>[28]</sup> Its extracts have been demonstrated to suppress the proliferation of microbes including *Salmonella*, *Escherichia coli* O157:H7, and *Listeria*.<sup>[28]</sup> More recently, Lee et al.<sup>[29]</sup> found that garlic was very active against a spectrum of pathogens, including clinical antibiotic-resistant strains such as methicillin-resistant *Staphylococcus aureus* (MRSA), methicillin-resistant *S. epidermidis*, vancomycin-resistant enterococci, and ciprofloxacin-resistant *Pseudomonas aeruginosa*.

Garlic and its components can also serve as potent antifungal agents.<sup>[30,31]</sup> Lemar et al.<sup>[31]</sup> reported that fresh garlic extract was more effective in retarding *Candida albicans* than a powder extract.<sup>[30]</sup> Interestingly, in some cases, the garlic extract was more effective than classical antibiotics.<sup>[32]</sup> The antiyeast activity of garlic oil and onion oil was storage stable and was not influenced by pH.<sup>[30]</sup>

Micro-organisms are not equally sensitive to garlic or its constituents.<sup>[28,33]</sup> Sivam et al.<sup>[33]</sup> reported that while 40 µg of thiosulfinate/ml inhibited *Helicobacter pylori*, it did not influence *S. aureus*. At this point, it is unclear what accounts for this variation, although differences in uptake and/or metabolism of the bioactive component are most likely involved.

Allyl sulfur components likely account for most of its antimicrobial properties. In addition to allicin, compounds including diallyl sulfide (DAS), DADS, *E*-ajoene, *Z*-ajoene, *E*-4,5,9-trithiadeca-1,6-diene-9-oxide (*E*-10-devinylajoene, *E*-10-DA), and *E*-4,5,9-trithiadeca-1,7-diene-9-oxide (*iso*-*E*-10-devinylajoene, *iso*-*E*-10-DA) have been reported to influence microbial growth.<sup>[34,35]</sup> Although there are clear differences in the efficiency by which these compounds alter proliferation, relatively small amounts appear to be effective deterrents. The targets accounting for the antimicrobial effects of allyl sulfur compounds are not really understood. However, the response may reflect alterations in protein sulfhydryls and/or a change in the redox state.

Heating blunts the antimicrobial effectiveness of garlic. Such data suggest that a breakdown product of alliin is needed to bring about an antimicrobial response.<sup>[36]</sup> Since both DAS and DADS are recognized to elicit a dose-dependent depression in *H. pylori* proliferation,<sup>[37,38]</sup> heating may have reduced their formation. More recently, Lee et al.<sup>[29]</sup> found that cooked garlic and commercial garlic pills exhibited no antimicrobial activity against a spectrum of pathogens, again suggesting that alliinase inactivation prevents the formation of the actual active component. Thus, it is not surprising that garlic preparations will vary in their antimicrobial properties. Since most of these products are not standardized to an active component or to a standard protocol, any comparison among sources is virtually impossible. Furthermore, few clinical studies have been undertaken with garlic or its specific allyl sulfides. Until this is accomplished, the physiological importance of garlic for its antibiotic properties will remain an area of considerable controversy.

### Coronary Effects

Historically, garlic has received considerable attention for its possible cardiovascular benefits.<sup>[25,26]</sup> While a number of studies have reported that it lowers cholesterol and several other factors linked with heart disease, numerous inconsistencies in the literature are also noted.<sup>[39,40]</sup> The contradictory results may be due to several factors, including a lack of consistency in the dosage of garlic employed, the standardization of garlic preparations in terms of active components, and the duration of intervention.

Interpretation of the relevance of some of these studies has been challenging because of the relatively large quantities of garlic used to bring about a response, i.e., 7–28 cloves/day. The limited number of experiments using comparable amounts also makes it difficult to arrive at a minimum quantity that might



be most effective. Several years ago, Thomson and Ali<sup>[41]</sup> reported that 3 g of fresh garlic daily for 16 weeks decreased blood cholesterol by about 21%. Since a significant decrease was detected before 4 weeks, there may be minimal exposure time before a response occurs. Thus, not only quantity but also duration of exposure must be considered when evaluating results from garlic intervention studies.

Garlic may influence the genesis and progression of cardiovascular disease through several biological effects including a decrease in total and LDL cholesterol, an increase in HDL cholesterol, a reduction of serum triglyceride and fibrinogen concentrations, a lowered arterial blood pressure, and/or an inhibited platelet aggregation. While some studies have reported that it reduces LDL concentrations, others have not.<sup>[25,42–44]</sup> Determining the true response of garlic on LDL has been made complicated by the variation in the quantity and type of preparation examined, as well as the duration of exposure. McCrindle, Helden, and Conner<sup>[44]</sup> did not detect a significant effect of garlic on lipid levels in children with hypercholesterolemia. Whether this relates to the quantity of garlic (300 mg/day), the duration (8 weeks), or to maturation remains unclear. Nevertheless, several studies provide evidence that garlic can diminish cholesterol and triglyceride concentrations in some, but probably not all, individuals.<sup>[39–41]</sup> Collectively, a reduction in cholesterol in the range of 7–15% is more likely to occur.

LDL oxidation is recognized as one of the several factors involved with the initiation and progression of atherosclerosis.<sup>[45]</sup> It occurs when exposed to free radicals released by surrounding cells such as smooth muscle cells, or monocytes/macrophages. Munday et al.<sup>[46]</sup> reported that oxidation of LDL particles by Cu<sup>2+</sup> from subjects given daily 2.4 g aged garlic extract (AGE) for 7 days was reduced compared to those not supplemented. A similar response was not observed when subjects were given raw garlic (6 g) suggesting again that not all preparations are comparable in bringing about a physiological change. Most recently, Ou et al.<sup>[47]</sup> have compared the abilities of 4 allyl sulfur compounds (DAS, DADS, *S*-ethylcysteine, and *N*-acetylcysteine) for their ability to alter LDL oxidation. While all were effective, there were clear differences in efficacy. It should be noted that water-soluble allyl sulfur compounds like those found in deodorized preparations have also been reported to reduce LDL oxidation.<sup>[48]</sup> Overall, it is unclear if the literature discrepancies about garlic and LDL oxidation relate to the subjects examined, the preparations used, and/or the quantity and duration of exposure. Clearly, additional studies are warranted to resolve this important issue.

Aortic stiffening is another risk factor in cardiovascular morbidity and mortality. This stiffness

coincides with a high systolic blood pressure and augmented pulse pressure. Reuter, Koch, and Lawson<sup>[49]</sup> provided evidence that garlic reduced blood pressure, increased fibrinolytic activity, and inhibited platelet aggregation in humans. However, Isaacsohn et al.<sup>[50]</sup> found no change in blood pressure using another garlic preparation. The dearth of studies, coupled with the wide variation in experimental designs, makes it virtually impossible to evaluate garlic as a modifier of blood pressure. However, preclinical evidence does suggest that a reduction is plausible. Specifically, using a Goldblatt model for hypertension, Al-Qattan et al.<sup>[51]</sup> have found that garlic was effective in exerting a sustained depression in arterial blood pressure possibly by regulating sodium homeostasis. Garlic treatment has also been found to lead to a dose-dependent vasorelaxation in both an endothelium-intact and a mechanically endothelium-disrupted pulmonary arterial ring in vitro model.<sup>[52]</sup> NG-nitro-L-arginine methyl ester, a nitric oxide synthase inhibitor, was found to prevent this vasorelaxation.

The inducible nitric oxide synthase (iNOS) is recognized to occur in human atherosclerotic lesions and is thought to promote the formation of peroxynitrites. Allicin and ajoene have been reported to cause a dose-dependent inhibition of the iNOS system in lipopolysaccharide (LPS)-stimulated RAW 264.7 macrophages.<sup>[53]</sup> Recent studies from this group suggest that NF-kappa B is not a major target of garlic metabolites such as bioactive allyl sulfur compounds.<sup>[54]</sup> Thus, a change in NO concentration may be fundamental to the observed response to garlic and associated sulfur components in modifying blood pressure. Recent studies suggest that allicin may inhibit iNOS activity through a dose-dependent decrease in iNOS mRNA levels and by reducing arginine transport through a downregulation of cationic amino acid transporter-2 (CAT-2) mRNA.<sup>[55]</sup> Kim et al.<sup>[56]</sup> provide evidence that both garlic extracts and *S*-allylcysteine (SAC) have similar behaviors in reducing NO concentrations in macrophages and endothelial cells.

Acute coronary syndromes can occur when an unstable atherosclerotic plaque erodes or ruptures, thereby exposing the highly thrombogenic material inside the plaque to the circulating blood. This triggers a rapid formation of a thrombus that occludes the artery. Campbell et al.<sup>[57]</sup> noted that feeding a deodorized garlic preparation reduced the fatty streak development and vessel wall cholesterol accumulation in rabbits fed a cholesterol fortified diet. Similarly, garlic consumption for 48 weeks in a randomized trial was found to reduce atherosclerotic plaque volumes in both the carotid and femoral arteries by 5–18%.<sup>[58]</sup> More recently, Durak et al.<sup>[59]</sup> observed that providing a diet plus garlic extract (1.5 ml garlic extract/kg/day) was accompanied by an improved antioxidant status and

a reduction in plaque in cholesterol fed rabbits. Experiments by Siegel et al.<sup>[60]</sup> provide evidence that garlic extracts can inhibit  $\text{Ca}^{2+}$  binding to heparan sulfate proteoglycan. Since the ternary proteoglycan receptor/LDL cholesterol/calcium complex is critical for the “nanoplaque” composition and ultimately for the atherosclerotic plaque, these studies provide a biological basis for why some individuals may benefit from garlic intake.

Aggregates of activated platelets also likely have a pivotal role in coronary syndromes. Garlic and some of its organosulfur components have been found to be potent inhibitors of platelet aggregation *in vitro*.<sup>[61]</sup> Boiling garlic retards its ability to inhibit platelet aggregation.<sup>[61]</sup> Unfortunately, few studies have documented that garlic can modify platelet aggregation *in vivo*. Several years ago, Steiner and Li<sup>[42]</sup> did prove that consumption of AGE reduced epinephrine and collagen-induced platelet aggregation, although it failed to influence adenosine diphosphate (ADP)-induced aggregation. Their studies also demonstrated that platelet adhesion to fibrinogen could be suppressed by consumption of this garlic supplement. Recently, ajoene was found to be a powerful inhibitor of platelet aggregation.<sup>[62]</sup> However, its effectiveness disappeared rapidly suggesting that genetic differences in its metabolism/catabolism may determine responsiveness.

### Influence on Multiple Tissues and Processes Related to Cancer

Preclinical models provide rather compelling evidence that garlic and its associated components can reduce the incidence of breast, colon, skin, uterine, esophagus, and lung cancers.<sup>[17,41,63]</sup> The ability to inhibit tumors arising from diverse inducing agents and in different tissues indicates that a generalized cellular event is likely responsible for the change in tumor incidence. Fluctuations in various processes associated with cancer including carcinogen formation, carcinogen bioactivation, DNA repair, tumor cell proliferation and/or apoptosis may account for these observations (Fig. 2). It is likely that several of these processes are modified simultaneously. Specificity in terms of the dose of allyl sulfur needed to bring about a response and the temporality of the change required to cause a phenotypic change calls for additional clarification.

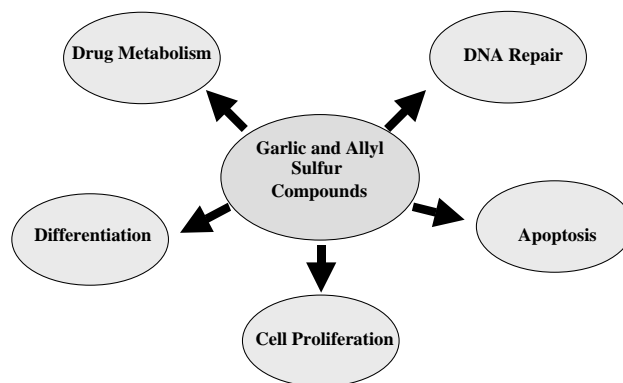
### Nitrosamine formation and metabolism

Suppressed nitrosamine formation continues to surface as one of the most likely mechanisms by which garlic may block cancer. Several studies provide evidence

that allyl sulfur compounds can retard the spontaneous and bacterial mediated formation of nitrosamines.<sup>[17]</sup> Since many of nitrosamines are considered suspect carcinogens in various tissues, this block may be particularly important. Dion, Agler, and Milner<sup>[34]</sup> demonstrated that all allyl sulfur compounds were not equal in impeding nitrosamine formation. The ability of SAC and its nonallyl analog *S*-propylcysteine to retard *N*-nitroso compound (NOC) formation, but not DADS, dipropyl disulfide (DPDS), and DAS reveals the critical role that the cysteine residue has in the inhibition.<sup>[34]</sup>

The reduction in nitrosamine formation may actually arise secondary to increased formation of nitrosothiols. Williams<sup>[64]</sup> suggested almost 20yr ago that several sulfur compounds may reduce nitrite availability for nitrosamine formation by enhancing the formation of nitrosothiols. Since the allyl sulfur content among garlic preparations can vary enormously, commercial preparations will not be equivalent in their ability to retard nitrosamine formation. While *S*-nitrosylation is known to influence health and disease,<sup>[65]</sup> it is unclear how garlic influences this process across various cell types.

Some of the most compelling evidence that garlic depresses nitrosamine formation in humans comes from studies conducted almost 15yr ago by Mei et al.<sup>[5]</sup> They demonstrated that ingesting 5g garlic/day blocked the enhanced urinary excretion of nitrosoproline resulting from exaggerated nitrate and proline intake. The significance of this observation comes from the predictive value that nitrosoproline has as an indicator for the synthesis of other potential carcinogenic nitrosamines.<sup>[66]</sup> Evidence that the garlic can block the formation of other spontaneously formed nitrosamines comes from data of Lin, Liu, and Milner<sup>[67]</sup> and Dion, Agler, and Milner.<sup>[34]</sup>



**Fig. 2** The anticancer effects of garlic may relate to alterations in one or more cancer processes. Each of these processes has been reported to be altered by one or more allyl sulfur compounds that occur in processed garlic.

The anticancer benefits attributed to garlic are also associated with suppressed nitrosamine bioactivation. Evidence from multiple sources points to the effectiveness of garlic to block DNA alkylation, an initial step in nitrosamine carcinogenesis.<sup>[68]</sup> Consistent with this reduction in bioactivation Dion, Agler, and Milner<sup>[34]</sup> found that both water-soluble *S*-allyl sulfide and lipid-soluble DADS retarded nitrosomorpholine mutagenicity in *Salmonella typhimurium* TA100. Aqueous garlic extracts have also been shown to reduce the mutagenicity of ionizing radiation, peroxides, adriamycin, and *N*-methyl-*N'*-nitro-nitrosoguanidine.<sup>[69]</sup>

A block in nitrosamine bioactivation may arise from inactivation of cytochrome P450 2E1 (CYP2E1).<sup>[70]</sup> An autocatalytic destruction of CYP2E1 may account for some of the chemoprotective effects of DAS, and possible other allyl sulfur compounds against nitrosamine carcinogenesis. Fluctuations in the content and overall activity of P450 2E1 may be a key variable in determining the magnitude of the protection provided by garlic and associated allyl sulfur components.

#### Bioactivation and response to other carcinogens

Garlic and several of its allyl sulfur compounds can also effectively block the bioactivation and carcinogenicity of a host of carcinogenic compounds.<sup>[17,41]</sup> This protection, which traverses a diverse array of compounds and cancers occurring in several tissues, again suggests an overarching biological response. Since metabolic activation is required for many of these carcinogens, it is likely that either phase I or II enzymes are altered, or possibly both. Interestingly, little change in cytochrome P450 1A1, 1A2, 2B1, or 3A4 activities has been detected following treatment with garlic or related sulfur compounds.<sup>[71]</sup> However, this lack of responsiveness may relate to the quantity and duration of exposure, the quantity of carcinogen administered, or the methods used to assess cytochrome content or activity. Wu et al.,<sup>[72]</sup> using immunoblot assays, found that the protein content of cytochrome P450 1A1, 2B1, and 3A1 was increased by garlic oil and each of several isolated disulfide compounds. Their data demonstrated that the number of sulfur atoms in the allyl compound was inversely related to the depression in these cytochromes. Thus, phase I enzyme activity changes may account for some of the anticancer properties attributed to garlic.

Changes in bioactivation resulting from a block in cyclo-oxygenase and lipoxygenase may also partially account for the reduction in tumors following treatment with some carcinogens.<sup>[73]</sup> Ajoene has also been demonstrated to interfere with the COX-2 pathway

in LPS-activated RAW 264.7 cells as in a vitro model.<sup>[74]</sup> While limited, there is also evidence that garlic and associated sulfur components can inhibit lipoxygenase activity.<sup>[75]</sup> Several other foods appear to also influence lipoxygenase activity.<sup>[75]</sup> Evidence for the involvement of lipoxygenase in the bioactivation of carcinogens such as 7,12 dimethylbenz(a)anthracene (DMBA) comes from data of Song,<sup>[76]</sup> which demonstrated that feeding the lipoxygenase inhibitor, nordihydroguaiaretic acid (NDGA), was accompanied by a marked reduction in DMBA-induced DNA adducts in rat mammary tissue. Collectively, these studies pose interesting questions about the role of both cyclo-oxygenase and lipoxygenase in not only forming prostaglandins, and therefore modulating tumor cell proliferation and immunocompetence, but also their involvement in the bioactivation of carcinogens.

#### Detoxification and allyl sulfur specificity

Increased activity of several detoxification enzymes including NAD(P)H: quinone oxidoreductase and glutathione *S*-transferase may also partially account for the experimental anticancer properties provided by garlic.<sup>[77]</sup> Not all GST isozymes are influenced equally as proved by Andorfer, Tchaikovskaya, and Listowsky.<sup>[78]</sup> Bose et al.<sup>[79]</sup> demonstrated that mGSTP1 mRNA expression was either unaltered in liver or moderately increased in forestomach following treatment with DPDS, indicated that the allyl group is critical for the mGSTP1-inducing activity of DADS. Munday and Munday<sup>[77]</sup> provided evidence that both DADS and diallyl trisulfide (DATS) were important in the anticancer action of garlic, while dipropenyl sulfide was involved with the anticancer action of onions.

Dietary garlic supplementation has also been found to reduce the incidence of tumors resulting from the treatment with methylnitrosourea (MNU), a known direct acting carcinogen.<sup>[67]</sup> In an animal model, water-soluble SAC (57  $\mu\text{mol/kg}$  diet) and lipid-soluble DADS cause a comparable reduction in MNU-induced O<sup>6</sup>-methylguanine adducts bound to mammary cell DNA.<sup>[80]</sup> Cohen et al.<sup>[81]</sup> did not inhibit MNU-induced mammary tumors when SAC was supplemented to the diet. The reason for this discrepancy remains unclear but may relate to the quantity of lipid in the diet or to the amount of carcinogen provided. While garlic may influence mammary gland terminal end bud formation and/or a change in rates of DNA repair, more research is needed to determine the quantity and duration of supplementation required for these effects.

Rarely have water- and oil-soluble allyl sulfur compounds been compared within the same study.

Nevertheless, available evidence suggests that major differences in efficacy among extracts are not of paramount importance, at least for blocking the initiation phase of carcinogenesis.<sup>[82]</sup> While subtle variations among garlic preparations are likely to occur, quantity rather than source appears to be a key factor influencing the degree of protection.<sup>[3]</sup> Differences that do occur between preparations likely relate to the content and effectiveness of individual sulfur compounds. Nevertheless, the number of sulfur atoms present in the molecule seems to influence the degree of protection with DATS > DADS > DAS.<sup>[83,84]</sup> Likewise, the presence of the allyl group generally enhances protection over that provided by the propyl moiety.<sup>[79,84]</sup>

### Cell proliferation and apoptosis

Several lipid- and water-soluble organosulfur compounds have been examined for their antiproliferative efficacy.<sup>[17,41,85,86]</sup> Some of the more commonly used lipid-soluble allyl sulfur compounds in tumorigenesis research are ajoene, DAS, DADS, and DATS. A breakdown of allicin appears to be necessary for achieving maximum tumor inhibition. Studies by Scharfenberg, Wagner, and Wagner<sup>[87]</sup> found that the ED<sub>50</sub> for lymphoma cells was two times lower for ajoene than for allicin.

Previous studies reported that lipid-soluble DAS, DADS, and DATS (100 μM) were more effective in suppressing canine tumor cell proliferation than isomolar water-soluble SAC, *S*-ethyl-cysteine, and *S*-propyl-cysteine.<sup>[84,85]</sup> While treating human colon tumor cells (HCT-15) with 100 μM DADS completely blocks growth, approximately 200 μM *S*-allyl mercaptocysteine (SAMC) is required to lead to a similar depression.<sup>[85]</sup> No changes in growth were observed with concentrations of SAC up to 500 μM. Undeniably, not all allyl sulfur compounds from garlic are equally effective in retarding tumor proliferation.<sup>[84–86]</sup>

Evidence exists that these allyl sulfur compounds preferentially suppress neoplastic over nonneoplastic cells.<sup>[83,87]</sup> Adding DATS (10 μM) *in vitro* to cultures of A549 lung tumor cells inhibited their proliferation by 47%, whereas it did not influence nonneoplastic MRC-5 lung cells.<sup>[87]</sup> The antiproliferative effects of allyl sulfides are generally reversible, assuming that apoptosis has not occurred.<sup>[83,87]</sup>

SAMC, DAS, and DADS have also been reported to increase the percentage of cells blocked within the G<sub>2</sub>/M phase.<sup>[85,86,88,89]</sup> The ability of garlic to block this phase is not limited to *in vitro* studies. p34<sup>cdc2</sup> kinase is a complex that governs the progression of cells from the G<sub>2</sub> into the M phase of the cell cycle. Activation of this complex promotes chromosomal condensation and cytoskeletal reorganization through

the phosphorylation of multiple substrates, including histone H1. The G<sub>2</sub>/M phase arrest induced by DADS has been found to coincide with the suppression in p34<sup>cdc2</sup> kinase activity.<sup>[90]</sup> Overall, the ability of DADS to inhibit p34<sup>cdc2</sup> kinase activation appears to occur as a result of a decreased p34<sup>cdc2</sup>/cyclin B(1) complex formation and a change in p34<sup>cdc2</sup> hyperphosphorylation.<sup>[90]</sup>

Several of the allyl sulfur compounds from garlic have also been reported to induce apoptosis.<sup>[89,91–93]</sup> DADS, SAMC, and ajoene have been shown to activate caspase-3.<sup>[91,92]</sup> More recently, allicin was claimed to induce the formation of apoptotic bodies, nuclear condensation, and a typical DNA ladder in cancer cells. Furthermore, these studies demonstrated that allicin leads to the activation of caspases-3, -8, and -9 and cleavage of poly(ADP-ribose) polymerase.<sup>[93]</sup>

DADS has been also reported to restrain the growth of H-ras oncogene transformed tumors in nude mice.<sup>[94]</sup> This inhibition correlated with that of p21H-ras membrane association in the tumor tissue. This group also demonstrated the importance of the allyl group in leading to a depression in ras.<sup>[95]</sup> Recently, allicin was found to induce activation of extracellular signal-regulated kinases 1 and 2 (ERK 1 and 2) in human peripheral mononuclear cells, and also in wild-type Jurkat T cells (114). It however failed to activate ERK 1 and 2 in Jurkat T cells that express p21(ras), in which Cys118 was replaced by Ser. Since these cells are not susceptible to redox-stress modification and activation, the authors postulated that the immune stimulatory effect of allicin is mediated by redox-sensitive signaling such as activation of p21(ras).<sup>[96]</sup>

### Cell differentiation

Lea, Randolph, and Patel<sup>[97]</sup> suggest that at least part of the ability of DADS to induce differentiation in DS19 mouse erythroleukemic cells relates to its ability to increase histone acetylation. DADS caused a marked increase in the acetylation of H4 and H3 histones in DS19 and K562 human leukemic cells. Similar results were also obtained with rat hepatoma and human breast cancer cells. In 2002, Lea et al.<sup>[98]</sup> provided evidence that DADS administered to rats could also increase histone acetylation in liver and a transplanted hepatoma cell line. The evidence suggested an increase in the acetylation of core histones and enhanced differentiation. Allyl mercaptan was a more potent inhibitor of histone deacetylase than DADS. In contrast to the effect on histone acetylation, there was a decrease in the incorporation of phosphate into histones when DS19 cells were incubated with 25 μM SAMC.<sup>[98]</sup>

### Dietary Modifiers of Garlic and Allyl Sulfur Efficacy

The influence of garlic on the cancer process cannot be considered in isolation since several dietary components can markedly influence its overall impact. Among the factors recognized to influence the response to garlic are total fat, selenium, methionine, and vitamin A.<sup>[3,99,100]</sup> Selenium supplied either as a component of the diet or as a constituent of the garlic has been reported to enhance the protection against DMBA mammary carcinogenesis over that provided by garlic alone. Suppression in carcinogen bioactivation, as indicated by a reduction in DNA adducts, may partially account for this combined benefit of garlic and selenium. Both selenium and allyl sulfur compounds are recognized to alter cell proliferation and induce apoptosis.

### CONCLUSIONS

Garlic may well have significance in enhancing health. Since it has relatively few side effects in most people, there are few disadvantages associated with its enhanced use, except for its lingering odor. However, odor does not appear to be a prerequisite for many of the health benefits, since preclinical studies indicate water-soluble SAC provides comparable benefits to those compounds that are linked to odor. It is probable that garlic and its associated water- and lipid-allyl sulfur compounds influence several key molecular targets in cancer prevention. While most can savor the culinary experiences identified with garlic, some individuals because of their gene profile and/or environmental exposures may be particularly responsive to more exaggerated intakes.

### REFERENCES

- Rivlin, R.S. Historical perspective on the use of garlic. *J. Nutr.* **2001**, *131* (3s), 951S–954S.
- Steinmetz, K.A.; Kushi, L.H.; Bostick, R.M.; Folsom, A.R.; Potter, J.D. Vegetables, fruit, and colon cancer in the Iowa Women's Health Study. *Am. J. Epidemiol.* **1994**, *139*, 1–15.
- Amagase, H.; Petesch, B.L.; Matsuura, H.; Kasuga, S.; Itakura, Y. Intake of garlic and its bioactive components. *J. Nutr.* **2001**, *131* (3s), 955S–962S.
- Mei, X.; Wang, M.L.; Pan, X.Y. Garlic and gastric cancer I. The influence of garlic on the level of nitrate and nitrite in gastric juice. *Acta Nutr. Sin.* **1982**, *4*, 53–56.
- Mei, X.; Lin, X.; Liu, J.; Lin, X.Y.; Song, P.J.; Hu, J.F.; Liang, X.J. The blocking effect of garlic on the formation of *N*-nitrosoproline in humans. *Acta Nutr. Sin.* **1989**, *11*, 141–145.
- Hsing, A.W.; Chokkalingam, A.P.; Gao, Y.T.; Madigan, M.P.; Deng, J.; Gridley, G.; Fraumeni, J.F., Jr. Allium vegetables and risk of prostate cancer: a population-based study. *J. Natl. Cancer Inst.* **2002**, *94* (21), 1648–1651.
- Brenner, S.; Ruocco, V.; Wolf, R.; de Angelis, E.; Lombardi, M.L. Pemphigus and dietary factors. In vitro acantholysis by allyl compounds of the genus *Allium*. *Dermatology* **1995**, *190* (3), 197–202.
- Perez-Pimiento, A.J.; Moneo, I.; Santaolalla, M.; de Paz, S.; Fernandez-Parra, B.; Dominguez-Lazaro, A.R. Anaphylactic reaction to young garlic. *Allergy* **1999**, *54*, 626–629.
- Munday, R.; Munday, J.S.; Munday, C.M. Comparative effects of mono-, di-, tri-, and tetrasulfides derived from plants of the Allium family: redox cycling in vitro and hemolytic activity and phase 2 enzyme induction in vivo. *Free Radical Biol. Med.* **2003**, *34* (9), 1200–1211.
- Peng, C.C.; Glassman, P.A.; Trilli, L.E.; Hayes-Hunter, J.; Good, C.B. Incidence and severity of potential drug–dietary supplement interactions in primary care patients: an exploratory study of 2 outpatient practices. *Arch. Intern. Med.* **2004**, *164*, 630–636.
- Adusumilli, P.S.; Ben-Porat, L.; Pereira, M.; Roesler, D.; Leitman, I.M. The prevalence and predictors of herbal medicine use in surgical patients. *J. Am. Coll. Surg.* **2004**, *198* (4), 583–590.
- Stys, T.; Stys, A.; Kelly, P.; Lawson, W. Trends in use of herbal and nutritional supplements in cardiovascular patients. *Clin. Cardiol.* **2004**, *27*, 87–90.
- Fenwick, G.R.; Hanley, A.B. The genus *Allium*—Part 3. *Crit. Rev. Food Sci. Nutr.* **1985**, *23* (1), 1–73.
- Arnault, I.; Christides, J.P.; Mandon, N.; Haffner, T.; Kahane, R.; Auger, J. High-performance ion-pair chromatography method for simultaneous analysis of alliin, deoxyalliin, alliin and dipeptide precursors in garlic products using multiple mass spectrometry and UV detection. *J. Chromatogr. A* **2003**, *991*, 69–75.
- Ryu, K.; Ide, N.; Matsuura, H.; Itakura, Y. *N* alpha-(1-deoxy-D-fructos-1-yl)-L-arginine, an antioxidant compound identified in aged garlic extract. *J. Nutr.* **2001**, *131* (3s), 972S–976S.
- Miean, K.H.; Mohamed, S. Flavonoid (myricetin, quercetin, kaempferol, luteolin, and

- apigenin) content of edible tropical plants. *J. Agric. Food Chem.* **2001**, *49* (6), 3106–3112.
17. Milner, J.A. Mechanisms by which garlic and allyl sulfur compounds suppress carcinogen bioactivation. *Garlic and carcinogenesis. Adv. Exp. Med. Biol.* **2001**, *492*, 69–81.
  18. Kubec, R.; Svobodova, M.; Velisek, J. A gas chromatographic determination of *S*-alk(en)yl-cysteine sulfoxides. *J. Chromatogr.* **1999**, *862* (1), 85–94.
  19. Block, E. The chemistry of garlic and onion. *Sci. Am.* **1985**, *252*, 114–119.
  20. Song, K.; Milner, J.A. Heating garlic inhibits its ability to suppress 7,12-dimethylbenz(a)anthracene-induced DNA adduct formation in rat mammary tissue. *J. Nutr.* **1999**, *129* (3), 657–661.
  21. Lawson, L.D.; Ransom, D.K.; Hughes, B.G. Inhibition of whole blood platelet-aggregation by compounds in garlic clove extracts and commercial garlic products. *Thromb. Res.* **1992**, *65*, 141–156.
  22. Egen-Schwind, C.; Eckard, R.; Kemper, F.H. Metabolism of garlic constituents in the isolated perfused rat liver. *Planta Med.* **1992**, *58*, 301–305.
  23. Germain, E.; Auger, J.; Ginies, C.; Siess, M.H.; Teyssier, C. In vivo metabolism of diallyl disulphide in the rat: identification of two new metabolites. *Xenobiotica* **2002**, *32* (12), 1127–1138.
  24. Fleischauer, A.T.; Arab, L. Garlic and cancer: a critical review of the epidemiologic literature. *J. Nutr.* **2001**, *131*, 1032S–1040S.
  25. Dillon, S.A.; Burmi, R.S.; Lowe, G.M.; Billington, D.; Rahman, K. Antioxidant properties of aged garlic extract: an in vitro study incorporating human low density lipoprotein. *Life Sci.* **2003**, *72* (14), 1583–1594.
  26. Rahman, K. Garlic and aging: new insights into an old remedy. *Ageing Res. Rev.* **2003**, *2*, 39–56.
  27. Banerjee, S.K.; Mukherjee, P.K.; Maulik, S.K. Garlic as an antioxidant: the good, the bad and the ugly. *Phytother. Res.* **2003**, *17*, 97–106.
  28. Adler, B.B.; Beuchat, L.R. Death of *Salmonella*, *Escherichia coli* O157:H7, and *Listeria monocytogenes* in garlic butter as affected by storage temperature. *J. Food Prot.* **2002**, *65*, 1976–1980.
  29. Lee, Y.L.; Cesario, T.; Wang, Y.; Shanbrom, E.; Thrupp, L. Antibacterial activity of vegetables and juices. *Nutrition* **2003**, *19*, 994–996.
  30. Kim, J.W.; Kim, Y.S.; Kyung, K.H. Inhibitory activity of essential oils of garlic and onion against bacteria and yeasts. *J. Food Prot.* **2004**, *67* (3), 499–504.
  31. Lemar, K.M.; Turner, M.P.; Lloyd, D. Garlic (*Allium sativum*) as an anti-Candida agent: a comparison of the efficacy of fresh garlic and freeze-dried extracts. *J. Appl. Microbiol.* **2002**, *93* (3), 398–405.
  32. Arora, D.S.; Kaur, J. Antimicrobial activity of spices. *Int. J. Antimicrobial Agents* **1999**, *12* (3), 257–262.
  33. Sivam, G.P.; Lampe, J.W.; Ulness, B.; Swanzy, S.R.; Potter, J.D. *Helicobacter pylori*—in vitro susceptibility to garlic (*Allium sativum*) extract. *Nutr. Cancer* **1997**, *27* (2), 118–121.
  34. Dion, M.E.; Agler, M.; Milner, J.A. *S*-allyl cysteine inhibits nitrosomorpholine formation and bioactivation. *Nutr. Cancer* **1997**, *28* (1), 1–6.
  35. Tsao, S.M.; Yin, M.C. In-vitro antimicrobial activity of four diallyl sulphides occurring naturally in garlic and Chinese leek oils. *J. Med. Microbiol.* **2001**, *50*, 646–649.
  36. Cellini, L.; Di Campli, E.; Masulli, M.; Di Bartolomeo, S.; Allocati, N. Inhibition of *Helicobacter pylori* by garlic extract (*Allium sativum*). *FEMS Immunol. Med. Microbiol.* **1996**, *13* (4), 273–277.
  37. Chung, M.J.; Lee, S.H.; Sung, N.J. Inhibitory effect of whole strawberries, garlic juice or kale juice on endogenous formation of *N*-nitrosodimethylamine in humans. *Cancer Lett.* **2002**, *182* (1), 1–10.
  38. Canizares, P.; Gracia, I.; Gomez, L.A.; Martin de Argila, C.; Boixeda, D.; Garcia, A.; de Rafael, L. Allyl-thiosulfinates, the bacteriostatic compounds of garlic against *Helicobacter pylori*. *Biotechnol. Prog.* **2004**, *20*, 397–401.
  39. Lawson, L.D. Garlic for total cholesterol reduction. *Ann. Intern. Med.* **2001**, *135*, 65–66.
  40. Peleg, A.; Hershcovici, T.; Lipa, R.; Anbar, R.; Redler, M.; Beigel, Y. Effect of garlic on lipid profile and psychopathologic parameters in people with mild to moderate hypercholesterolemia. *Isr. Med. Assoc. J.* **2003**, *5* (9), 637–640.
  41. Thomson, M.; Ali, M. Garlic [*Allium sativum*]: a review of its potential use as an anti-cancer agent. *Curr. Cancer Drug Targets* **2003**, *3*, 67–81.
  42. Steiner, M.; Li, W. Aged garlic extract, a modulator of cardiovascular risk factors: a dose-finding study on the effects of AGE on platelet functions. *J. Nutr.* **2001**, *131*, 980S–984S.
  43. Byrne, D.J.; Neil, H.A.; Vallance, D.T.; Winder, A.F. A pilot study of garlic consumption shows no significant effect on markers of oxidation or sub-fraction composition of low-density lipoprotein including lipoprotein(a) after allowance for non-compliance and the placebo effect. *Clin. Chim. Acta* **1999**, *285*, 21–33.
  44. McCrindle, B.W.; Helden, E.; Conner, W.T. Garlic extract therapy in children with

- hypercholesterolemia. Arch. Pediatr. Adolesc. Med. **1998**, *152*, 1089–1094.
45. Scanu, A.M. Lipoprotein(a) and the atherothrombotic process: mechanistic insights and clinical implications. Curr. Atheroscler. Rep. **2003**, *5* (2), 106–113.
  46. Munday, J.S.; James, K.A.; Fray, L.M.; Kirkwood, S.W.; Thompson, K.G. Daily supplementation with aged garlic extract, but not raw garlic, protects low density lipoprotein against in vitro oxidation. Atherosclerosis **1999**, *143* (2), 399–404.
  47. Ou, C.C.; Tsao, S.M.; Lin, M.C.; Yin, M.C. Protective action on human LDL against oxidation and glycation by four organosulfur compounds derived from garlic. Lipids **2003**, *38*, 219–224.
  48. Ho, S.E.; Ide, N.; Lau, B.H. S-allyl cysteine reduces oxidant load in cells involved in the atherogenic process. Phytomedicine **2001**, *8* (1), 39–46.
  49. Reuter, H.D.; Koch, H.P.; Lawson, L.D. Therapeutic effects of garlic and its preparations. In *Garlic*, 2nd Ed.; Koch, H.P., Lawson, L.D., Eds.; Williams and Wilkins: London, UK, 1996; 135–162.
  50. Isaacsohn, J.L.; Moser, M.; Stein, E.A.; Dudley, K.; Davey, J.A.; Liskov, E.; Black, H.R. Garlic powder and plasma lipids and lipoproteins: a multicenter, randomised, placebo-controlled trial. Arch. Intern. Med. **1998**, *158*, 1189–1194.
  51. Al-Qattan, K.K.; Khan, I.; Alnaqeeb, M.A.; Ali, M. Mechanism of garlic (*Allium sativum*) induced reduction of hypertension in 2K-1C rats: a possible mediation of Na/H exchanger isoform-1. Prostaglandins Leukot. Essent. Fatty Acids **2003**, *69* (4), 217–222.
  52. Ku, D.D.; Abdel-Razek, T.T.; Dai, J.; Kim-Park, S.; Fallon, M.B.; Abrams, G.A. Garlic and its active metabolite allicin produce endothelium- and nitric oxide-dependent relaxation in rat pulmonary arteries. Clin. Exp. Pharmacol. Physiol. **2002**, *29* (1–2), 84–91.
  53. Dirsch, V.M.; Kiemer, A.K.; Wagner, H.; Vollmar, A.M. Effect of allicin and ajoene, two compounds of garlic, on inducible nitric oxide synthase. Atherosclerosis **1998**, *139* (2), 333–339.
  54. Dirsch, V.M.; Keiss, H.P.; Vollmar, A.M. Garlic metabolites fail to inhibit the activation of the transcription factor NF-kappaB and subsequent expression of the adhesion molecule E-selectin in human endothelial cells. Eur. J. Nutr. **2004**, *43* (1), 55–59.
  55. Schwartz, I.F.; Hershkovitz, R.; Iaina, A.; Gnessin, E.; Wollman, Y.; Chernichowski, T.; Blum, M.; Levo, Y.; Schwartz, D. Garlic attenuates nitric oxide production in rat cardiac myocytes through inhibition of inducible nitric oxide synthase and the arginine transporter CAT-2 (cationic amino acid transporter-2). Clin. Sci. (Lond.) **2002**, *102* (5), 487–493.
  56. Kim, K.M.; Chun, S.B.; Koo, M.S.; Choi, W.J.; Kim, T.W.; Kwon, Y.G.; Chung, H.T.; Billiar, T.R.; Kim, Y.M. Differential regulation of NO availability from macrophages and endothelial cells by the garlic component S-allyl cysteine. Free Radical Biol. Med. **2001**, *30* (7), 747–756.
  57. Campbell, J.H.; Efendy, J.L.; Smith, N.J.; Campbell, G.R. Molecular basis by which garlic suppresses atherosclerosis. J. Nutr. **2001**, *131* (3s), 1006S–1009S.
  58. Koscielny, J.; Klussendorf, D.; Latza, R.; Schmitt, R.; Radtke, H.; Siegel, G.; Kiesewetter, H. The antiatherosclerotic effect of *Allium sativum*. Atherosclerosis **1999**, *144* (1), 237–249.
  59. Durak, I.; Ozturk, H.S.; Olcay, E.; Can, B.; Kavutcu, M. Effects of garlic extract on oxidant/antioxidant status and atherosclerotic plaque formation in rabbit aorta. Nutr. Metab. Cardiovasc. Dis. **2002**, *12* (3), 141–147.
  60. Siegel, G.; Malmsten, M.; Pietzsch, J.; Schmidt, A.; Buddecke, E.; Michel, F.; Ploch, M.; Schneider, W. The effect of garlic on arteriosclerotic nanoplaque formation and size. Phytomedicine **2004**, *11* (1), 24–35.
  61. Ali, M. Mechanism by which garlic (*Allium sativum*) inhibits cyclooxygenase activity. Effect of raw versus boiled garlic extract on the synthesis of prostanoids. Prostaglandins Leukot. Essent. Fatty Acids **1995**, *53* (6), 397–400.
  62. Teranishi, K.; Apitz-Castro, R.; Robson, S.C.; Romano, E.; Cooper, D.K. Inhibition of baboon platelet aggregation in vitro and in vivo by the garlic derivative, ajoene. Xenotransplantation **2003**, *10* (4), 374–379.
  63. Kris-Etherton, P.M.; Hecker, K.D.; Bonanome, A.; Coval, S.M.; Binkoski, A.E.; Hilpert, K.F.; Griel, A.E.; Etherton, T.D. Bioactive compounds in foods: their role in the prevention of cardiovascular disease and cancer. Am. J. Med. **2002**, *113* (Suppl. 9B), 71S–88S.
  64. Williams, D.H. S-nitrosation and the reactions of S-nitroso compounds. Chem. Soc. Rev. **1983**, *15*, 171–196.
  65. Foster, M.W.; McMahon, T.J.; Stamler, J.S. S-nitrosylation in health and disease. Trends Mol. Med. **2003**, *9* (4), 160–168.
  66. Ohshima, H.; Bartsch, H. Quantitative estimation of endogenous N-nitrosation in humans by monitoring N-nitrosoproline in urine. Methods Enzymol. **1999**, *301*, 40–49.

67. Lin, X.-Y.; Liu, J.Z.; Milner, J.A. Dietary garlic suppresses DNA adducts caused by *N*-nitroso compounds. *Carcinogenesis* **1994**, *15*, 349–352.
68. Kweon, S.; Park, K.A.; Choi, H. Chemopreventive effect of garlic powder diet in diethylnitrosamine-induced rat hepatocarcinogenesis. *Life Sci.* **2003**, *73* (19), 2515–2526.
69. Knasmuller, S.; de Martin, R.; Domjan, G.; Szakmary, A. Studies on the antimutagenic activities of garlic extract. *Environ. Mol. Mutag.* **1989**, *13* (4), 357–365.
70. Yang, C.S.; Chhabra, S.K.; Hong, J.Y.; Smith, T.J. Mechanisms of inhibition of chemical toxicity and carcinogenesis by diallyl sulfide (DAS) and related compounds from garlic. *J. Nutr.* **2001**, *131* (3s), 1041S–1045S.
71. Le Bon, A.M.; Vernevaux, M.F.; Guenot, L.; Kahane, R.; Auger, J.; Arnault, I.; Haffner, T.; Siess, M.H. Effects of garlic powders with varying alliin contents on hepatic drug metabolizing enzymes in rats. *J. Agric. Food Chem.* **2003**, *51* (26), 7617–7623.
72. Wu, C.C.; Sheen, L.Y.; Chen, H.W.; Kuo, W.W.; Tsai, S.J.; Lii, C.K. Differential effects of garlic oil and its three major organosulfur components on the hepatic detoxification system in rats. *J. Agric. Food Chem.* **2002**, *50* (2), 378–383.
73. Sengupta, A.; Ghosh, S.; Das, S. Modulatory influence of garlic and tomato on cyclooxygenase-2 activity, cell proliferation and apoptosis during azoxymethane induced colon carcinogenesis in rat. *Cancer Lett.* **2004**, *208* (2), 127–136.
74. Dirsch, V.M.; Vollmar, A.M. Ajoene, a natural product with non-steroidal anti-inflammatory drug (NSAID)-like properties? *Biochem. Pharmacol.* **2001**, *61* (5), 587–593.
75. Shobana, S.; Naidu, K.A. Antioxidant activity of selected Indian spices. *Prostaglandins Leukot. Essent. Fatty Acids* **2000**, *62* (2), 107–110.
76. Song, K. Factors Influence on Garlic's Anticancer Properties, Masters thesis. The Pennsylvania State University, 1999.
77. Munday, R.; Munday, C.M. Induction of phase II enzymes by aliphatic sulfides derived from garlic and onions: an overview. *Methods Enzymol.* **2004**, *382*, 449–456.
78. Andorfer, J.H.; Tchaikovskaya, T.; Listowsky, I. Selective expression of glutathione *S*-transferase genes in the murine gastrointestinal tract in response to dietary organosulfur compounds. *Carcinogenesis* **2004**, *25* (3), 359–367.
79. Bose, C.; Guo, J.; Zimniak, L.; Srivastava, S.K.; Singh, S.P.; Zimniak, P.; Singh, S.V. Critical role of allyl groups and disulfide chain in induction of Pi class glutathione transferase in mouse tissues in vivo by diallyl disulfide, a naturally occurring chemopreventive agent in garlic. *Carcinogenesis* **2002**, *23* (10), 1661–1665.
80. Schaffer, E.M.; Liu, J.Z.; Green, J.; Dangler, C.A.; Milner, J.A. Garlic and associated allyl sulfur components inhibit *N*-methyl-*N*-nitrosourea induced rat mammary carcinogenesis. *Cancer Lett.* **1996**, *102* (1–2), 199–204.
81. Cohen, L.A.; Zhao, Z.; Pittman, B.; Lubet, R. *S*-allylcysteine, a garlic constituent, fails to inhibit *N*-methylnitrosourea-induced rat mammary tumorigenesis. *Nutr. Cancer* **1999**, *35* (1), 58–63.
82. Schaffer, E.M.; Liu, J.Z.; Milner, J.A. Garlic powder and allyl sulfur compounds enhance the ability of dietary selenite to inhibit 7,12-dimethylbenz[*a*]anthracene-induced mammary DNA adducts. *Nutr. Cancer* **1997**, *27* (2), 162–168.
83. Sakamoto, K.; Lawson, L.D.; Milner, J. Allyl sulfides from garlic suppress the in vitro proliferation of human A549 lung tumor cells. *Nutr. Cancer* **1997**, *29* (2), 152–156.
84. Sundaram, S.G.; Milner, J.A. Diallyl disulfide inhibits the proliferation of human tumor cells in culture. *Biochim. Biophys. Acta* **1995**, *1315*, 15–20.
85. Knowles, L.M.; Milner, J.A. Possible mechanism by which allyl sulfides suppress neoplastic cell proliferation. *J. Nutr.* **2001**, *131* (3s), 1061S–1066S.
86. Pinto, J.T.; Rivlin, R.S. Antiproliferative effects of allium derivatives from garlic. *J. Nutr.* **2001**, *131* (3s), 1058S–1060S.
87. Scharfenberg, K.; Wagner, R.; Wagner, K.G. The cytotoxic effect of ajoene, a natural product from garlic, investigated with different cell lines. *Cancer Lett.* **1990**, *53*, 103–108.
88. Knowles, L.M.; Milner, J.A. Diallyl disulfide induces ERK phosphorylation and alters gene expression profiles in human colon tumor cells. *J. Nutr.* **2003**, *133* (9), 2901–2906.
89. Xiao, D.; Pinto, J.T.; Soh, J.W.; Deguchi, A.; Gundersen, G.G.; Palazzo, A.F.; Yoon, J.T.; Shirin, H.; Weinstein, I.B. Induction of apoptosis by the garlic-derived compound *S*-allylmercaptocysteine (SAMC) is associated with microtubule depolymerization and c-Jun NH(2)-terminal kinase 1 activation. *Cancer Res.* **2003**, *63* (20), 6825–6837.
90. Knowles, L.M.; Milner, J.A. Diallyl disulfide inhibits p34(cdc2) kinase activity through changes in complex formation and phosphorylation. *Carcinogenesis* **2000**, *21* (6), 1129–1134.
91. Sundaram, S.G.; Milner, J.A. Diallyl disulfide induces apoptosis of human colon tumor cells. *Carcinogenesis* **1996**, *17* (4), 669–673.



92. Kwon, K.B.; Yoo, S.J.; Ryu, D.G.; Yang, J.Y.; Rho, H.W.; Kim, J.S.; Park, J.W.; Kim, H.R.; Park, B.H. Induction of apoptosis by diallyl disulfide through activation of caspase-3 in human leukemia HL-60 cells. *Biochem. Pharmacol.* **2002**, *63* (1), 41–47.
93. Oommen, S.; Anto, R.J.; Srinivas, G.; Karunakaran, D. Allicin (from garlic) induces caspase-mediated apoptosis in cancer cells. *Eur. J. Pharmacol.* **2004**, *485* (1–3), 97–103.
94. Singh, S.V.; Pan, S.S.; Srivastava, S.K.; Xia, H.; Hu, X.; Zaren, H.A.; Orchard, J.L. Differential induction of NAD(P)H: quinone oxidoreductase by anti-carcinogenic organosulfides from garlic. *Biochem. Biophys. Res. Commun.* **1998**, *244* (3), 917–920.
95. Singh, S.V. Impact of garlic organosulfides on p21(H-ras) processing. *J. Nutr.* **2001**, *131* (3s), 1046S–1048S.
96. Patya, M.; Zahalka, M.A.; Vanichkin, A.; Rabinkov, A.; Miron, T.; Mirelman, D.; Wilchek, M.; Lander, H.M.; Novogrodsky, A. Allicin stimulates lymphocytes and elicits an antitumor effect: a possible role of p21ras. *Int. Immunol.* **2004**, *16* (2), 275–281.
97. Lea, M.A.; Randolph, V.M.; Patel, M. Increased acetylation of histones induced by diallyl disulfide and structurally related molecules. *Int. J. Oncol.* **1999**, *15* (2), 347–352.
98. Lea, M.A.; Rasheed, M.; Randolph, V.M.; Khan, F.; Shareef, A.; desBordes, C. Induction of histone acetylation and inhibition of growth of mouse erythroleukemia cells by S-allyl mercaptocysteine. *Nutr. Cancer* **2002**, *43* (1), 90–102.
99. Amagase, H.; Schaffer, E.M.; Milner, J.A. Dietary components modify garlic's ability to suppress 7,12-dimethylbenz(a)anthracene induced mammary DNA adducts. *J. Nutr.* **1996**, *126*, 817–824.
100. Dong, Y.; Lisk, D.; Block, E.; Ip, C. Characterization of the biological activity of gamma-glutamyl-Se-methylselenocysteine: a novel, naturally occurring anticancer agent from garlic. *Cancer Res.* **2001**, *61* (7), 2923–2928.

# Ginger (*Zingiber officinale*)

## Tieraona Low Dog

University of Arizona Health Sciences Center, Tucson, Arizona, U.S.A.

## INTRODUCTION

Ginger is a popular spice and the world production is estimated at 100,000 tons annually, of which 80% is grown in China.<sup>[1]</sup> In addition to its long history of use as a spice, references to ginger as a medicinal agent can be found in ancient Chinese, Indian, Arabic, and Greco-Roman texts. Ginger has been used for a variety of conditions, but it is chiefly known as an antiemetic, anti-inflammatory, digestive aid, diaphoretic, and warming agent. In the year 2000, ginger sales ranked 17th among those of all herbal supplements sold in U.S. mainstream retail stores.<sup>[2]</sup>

## NAME AND GENERAL DESCRIPTION

The Zingiberaceae family consists of 49 genera and 1300 species, of which there are 80–90 species of *Zingiber* and 250 species of *Alpinia*. This entry will focus primarily upon the scraped or unscraped rhizome of common ginger, *Zingiber officinale* Roscoe, a reedlike plant grown in numerous subtropical areas of the world, including Jamaica, India, China, and Africa.<sup>[3]</sup>

## CONSTITUENTS

Ginger rhizome contains 4–10% oleoresin composed of nonvolatile, pungent constituents (phenols such as gingerols and their related dehydration products, shogaols); nonpungent fats and waxes; 1.0–3.3% volatile oils of which 30–70% are sesquiterpenes, mainly  $\beta$ -bisabolene, (–) zingiberene,  $\beta$ -sesquiphellandrene, and (+) arcurcumene; monoterpenes, mainly geranial and neral; 40–60% carbohydrates, mainly starch; 9–10% proteins and free amino acids; 6–10% lipids composed of triglycerides, phosphatidic acid, lecithins, and free fatty acids; vitamin A; niacin; and minerals.<sup>[4]</sup>

---

Tieraona Low Dog, M.D., is Clinical Assistant Professor in the Department of Medicine and Program in Integrative Medicine, University of Arizona Health Sciences Center, Tucson, Arizona, U.S.A.

## PHARMACOKINETICS

Gingerol, when administered intravenously to rats, demonstrated a half-life of 7.23 min.<sup>[5]</sup> It is not clear how this relates to the pharmacokinetics of whole rhizome on oral administration in humans. Scientific studies are currently underway to determine the pharmacokinetics of ginger when administered orally; however, the results from these inquiries have not yet been published.

## PHARMACODYNAMICS

### Antiemetic Activity

Numerous human clinical trials have addressed the antiemetic effects of dried ginger root in the treatment of hyperemesis gravidarum,<sup>[6]</sup> motion sickness,<sup>[7]</sup> postoperative nausea,<sup>[8]</sup> and chemotherapy-induced nausea and vomiting.<sup>[9]</sup> The mechanism of action and constituent(s) responsible for the antiemetic activity of ginger are not completely understood. A class of antiemetics found to be clinically effective in the treatment of chemotherapy-induced and postoperative nausea and vomiting are the 5-hydroxytryptamine (5-HT) antagonists, specifically 5-HT<sub>3</sub>. Several components of ginger, viz., 6-gingerol, 6-shogaol, and galanolactone, have shown anti-5-HT activity in isolated guinea pig ileum. Galanolactone is a competitive antagonist predominantly at ileal 5-HT<sub>3</sub> receptors.<sup>[10]</sup> A study in rats found that an acetone extract of ginger and ginger juice effectively reversed the cisplatin-induced delay in gastric emptying typically seen when the drug is administered. The reversal produced by the ginger acetone extract was similar to the effect seen with the 5-HT<sub>3</sub>-receptor antagonist ondansetron; ginger juice, at doses of 2 and 4 ml/kg orally (p.o.), was superior to the drug.<sup>[11]</sup> Other researchers have demonstrated that ginger increases gastrointestinal motility, reducing the feedback from the gastrointestinal tract to central chemoreceptors,<sup>[11]</sup> though a double-blind crossover trial of 16 healthy volunteers who were randomly allocated to receive either 1 g of dried ginger or placebo found no effect on gastric emptying.<sup>[12]</sup>

## Motion sickness

Human studies evaluating the effects of ginger on experimentally induced motion sickness<sup>[13]</sup> and four human clinical trials evaluating the use of ginger for motion sickness have been published. The first randomized, double-blind, placebo-controlled study was published in 1988. Eighty Danish naval cadets (ages 16–19 yr) were randomized to receive either 1 g of dried ginger powder or placebo. Symptoms of seasickness were evaluated over the four following hours. Participants who received ginger powder experienced less seasickness than those in the control group ( $p < 0.05$ ). No power calculation was included in the report.

A 1994 randomized, double-blind, non-placebo-controlled study of 1475 volunteers (age 16–65 yr) traveling by sea compared the efficacy of 7 antiemetic medications: Touristil<sup>®</sup> (cinnarizine 20 mg, clomperidone 15 mg), Marzine<sup>®</sup> (cyclizine 50 mg), Dramamine<sup>®</sup> (dimenhydrinate 50 mg, caffeine 50 mg), Permesin<sup>®</sup> (meclizine 25 mg, caffeine 20 mg) Stugeron<sup>®</sup> (cinnarizine 20 mg), Scopoderm TTS<sup>®</sup> (scopolamine 0.5 mg) and Zintona<sup>®</sup> (product standardized to minimum 1.4% volatile oils and minimum 2.0 mg gingerols and shogaols in capsule containing 250 mg ginger rhizome). Stugeron and Scopoderm TTS were administered the evening prior to departure, with a second dose of Stugeron being given the morning of sea travel. The other medications were administered 2 hr prior to departure, with Touristil and Zintona being administered again 4 hr later. None of the study medications offered complete protection from seasickness, with all offering similar rates of efficacy. In each treatment group, 4.1–10.2% experienced vomiting and 16.4–23.5% experienced nausea and discomfort. There was no statistical difference between groups. No serious adverse reactions were reported.<sup>[14]</sup> Though interesting, the study did not include a baseline measurement of nausea/vomiting sensitivity.

A 1999 randomized, double-blind drug comparison study found the efficacy of ginger extract (Zintona) and dimenhydrinate to be similar when given to 60 cruise ship passengers (age 10–77 yr) with a history of motion sickness.<sup>[15]</sup> Side effects were significantly less in the ginger group (13.3%) than in those receiving dimenhydrinate (40%). Comorbid conditions were not ruled out and no power calculation was included in the report.

Another 1999 randomized, double-blind study compared the efficacy of a ginger extract (Zintona) and dimenhydrinate in the pediatric population.<sup>[16]</sup> Twenty-eight children, aged 4–8 yr, with a history of motion sickness as determined by questionnaire were enrolled in the trial. Fifteen subjects received ginger and 13 received dimenhydrinate. Subjects (3–6 yr)

in the ginger group received 250 mg of ginger extract 1/2 hr before the trip and, if necessary, 250 mg every 4 hr; children aged 6 and above received 500 mg 1/2 hr before the trip and, if necessary, 500 mg every 4 hr. Children randomized to receive dimenhydrinate took 12.5–25 mg 1/2 hr before the trip and, if necessary, 25 mg every 4 hr. Physicians' rating of the therapeutic effectiveness showed highly significant difference between the treatment groups ( $p < 0.00001$ ). Results were good in 100% of treatment cases in the ginger group, while in the dimenhydrinate group, they were modest in 69.2% and good in only 30.8%. All subjects in the ginger group reported symptom reduction within 30 min of taking the extract, while 69.2% in the dimenhydrinate group reported a reduction in 60 min ( $p < 0.00001$ ). No patient in the ginger group reported any side effects, while most (84.6%) of the dimenhydrinate patients suffered from side effects, including dryness of the mouth (69.23%) and vertigo (23.07%). The difference in the treatment group was highly significant ( $p < 0.001$ ). It is unclear when reading the study whether all of the children traveled by the same mode(s) of transportation. Also, the randomization process did not appear to allow for well-matched groups with regard to severity of motion sickness.

While the studies all show a beneficial effect for ginger on motion sickness, all have methodological shortcomings.

## Nausea and vomiting of pregnancy

Nausea is likely to affect more than 50% of pregnant women, and frequently disrupts family and work routines.<sup>[17]</sup> The most extensively studied botanical for nausea and vomiting of pregnancy is dried ginger rhizome (*Z. officinale*). There are three published placebo-controlled trials addressing the safety and efficacy of ginger for this condition. The 1990 trial by Fischer-Rasmussen et al.<sup>[18]</sup> randomized 30 pregnant women admitted to hospital with hyperemesis gravidarum before the 20th week of gestation to receive either 250 mg of powdered ginger capsules 4 times per day or placebo for a 4 day period followed by a 2 day wash-out and crossover to the other treatment. A scoring system was used to assess the degree of nausea, vomiting, and weight loss prior to onset of the trial and then re-evaluated on Days 5 and 11 (after treatment). The relief scores were greater for ginger than placebo, with a reduced number of vomiting episodes and degree of nausea. Subjective assessment by the women showed that 70.4% preferred the period when they received ginger; only 14.8% preferred placebo. No adverse effects on pregnancy outcome were noted.

Vutyavanich, Kraissarin, and Ruangsri<sup>[19]</sup> conducted a randomized, double-blind, placebo-controlled study of 70 women ( $n = 67$ ) with nausea of pregnancy, with or without vomiting, prior to the 17th week of gestation. The primary outcome was improvement in nausea symptoms. Women received either 250 mg powdered ginger capsules or placebo 4 times daily for a 4 day period. A visual analog scale (VAS) and Likert scale were used as measuring instruments. The VAS scores decreased (improved) significantly in the ginger group compared to placebo ( $p = 0.014$ ). Vomiting episodes were also significantly decreased ( $p < 0.001$ ). At the 1 week follow up visit, 28 of 32 subjects in the ginger group had improvement of nausea symptoms, while only 10 of 35 in the placebo group experienced improvement ( $p < 0.001$ ). Minor side effects were noted in both groups: More heartburn was noted in the ginger group. No adverse effects were noted on pregnancy outcomes.

In 2003, a double-blind, placebo-controlled trial randomized 120 women before the 20th week of gestation, who had experienced morning sickness daily for at least 1 week and had no relief of symptoms through dietary changes, to receive either 125 mg ginger extract (EV.EXT 35; equivalent to 1.5 g dried ginger) or placebo 4 times per day.<sup>[20]</sup> The nausea experience score was significantly lower for the ginger extract group relative to the placebo group after the first day of treatment, and this difference was present for each treatment day. For retching symptoms, the ginger extract group was shown to have significantly lower symptom scores than the placebo group for the first 2 days only. In contrast to the other published studies, there was no significant difference between ginger extract and placebo groups for any of the vomiting symptoms. Twenty-one women were excluded from the final analysis due to insufficient data (12 for adverse events and 9 due to noncompliance). Adverse events included spontaneous abortion ( $n = 4$  women; 3 in the ginger group, 1 in the placebo group), intolerance of the treatment ( $n = 4$ ; all in the ginger group), worsening of treatment requiring further medical assistance ( $n = 3$ ; 1 in the ginger group, 2 in the placebo group), and allergic reaction to treatment ( $n = 1$ ; ginger group). Follow-up of the pregnancies revealed normal ranges of birth weight, gestational age, Apgar scores, and frequencies of congenital abnormalities when the study group infants were compared to the general population of infants born at the Royal Hospital for Women for the year 1999–2000.

Clinical trials suggest that ginger may be considered a useful treatment option for women suffering from morning sickness.

## Chemotherapy-induced nausea and vomiting

Chemotherapy-induced nausea and vomiting significantly reduces patients' quality of life, increases fatigue and anxiety, and increases costs of health care delivery. An abstract published in 1987 reported that of 41 patients with leukemia randomly assigned to receive either oral ginger or placebo after administration of intravenous compazine, there was a significant reduction in nausea in those who received ginger compared with those who received placebo.<sup>[21]</sup> This report was followed by a small open study of 11 patients who were undergoing monthly photopheresis therapy (psoralen and the chemotherapy agent 8-MOP) and regularly complained of nausea as a result.<sup>[22]</sup> Patients were given 1.6 g of powdered ginger 30 min prior to the administration of 8-MOP and then evaluated their nausea on a scale of 0–4. Total score for nausea decreased from 22.5 (individual average 2.045) prior to the trial to 8.0 (individual average 0.727) after administration of ginger. Three patients complained of heartburn. The study suffered from lack of blinding and placebo arm.

In 2003, a more rigorous randomized, prospective, crossover, double-blind study was carried out in 60 patients ( $n = 50$ ) receiving cyclophosphamide in combination with other chemotherapeutic agents.<sup>[9]</sup> Patients with at least 2 episodes of vomiting in the previous cycle were included and randomly assigned to receive 1 of 3 antiemetics: 1 g p.o. dried ginger powder given 20 min prior to chemotherapy and repeated 6 hr after chemotherapy; 20 mg IV metoclopramide 20 min prior to chemotherapy and 10 mg p.o. 6 hr after chemotherapy; or 4 mg IV ondansetron 20 min prior to chemotherapy and 4 mg p.o. 6 hr after chemotherapy. Lactulose capsules and normal saline IV were used where appropriate to maintain blinding. Patients were admitted to the hospital for 24 hr and observed for the incidence of nausea and vomiting, and adverse effects, if any, were recorded. Patients were crossed over to receive the other antiemetic treatments during the two successive cycles of chemotherapy. Complete control of nausea was achieved in 86% with ondansetron, 62% on ginger, and 58% with metoclopramide. Complete control of vomiting was achieved in 86% with ondansetron, 68% of patients on ginger, and 64% with metoclopramide. No adverse effects attributable to ginger were recorded. In summary, the antiemetic effect of ginger was comparable to that of metoclopramide, but ondansetron was found to be better than both.

A double-blind, placebo-controlled, three-armed, randomized clinical trial is being undertaken through the National Institutes of Health to assess the efficacy and safety of 2 dose levels (1000 or 2000 mg orally

per day) of ginger extract (standardized for 5% gingerols) in patients undergoing chemotherapy (cisplatin or adriamycin).<sup>[23]</sup> This type of research is needed to more appropriately assess safety, efficacy, optimal dose, and optimal dosage form.

### Postoperative nausea and vomiting

Postoperative nausea and vomiting (PONV) is one of the most common complaints following anesthesia and surgery. The incidence of PONV is 20–30% during the first 24 hr after anesthesia. As a part of oral premedication, ginger is being studied due to its lack of known relevant side effects (e.g., sedation), high patient acceptance, and low cost.<sup>[24]</sup> Ernst and Pittler<sup>[25]</sup> systematically reviewed trials investigating the antiemetic effect of ginger and performed a meta-analysis of three available studies investigating the herbal remedy in preventing PONV. The most rigorous double-blind, randomized, controlled trial in 108 patients undergoing gynecological laparoscopic surgery under general anesthesia failed to find any significant reduction in PONV with either 0.5 or 1.0 g powdered ginger when compared to placebo.<sup>[26]</sup> This was in contrast to the positive results reported by Bone et al.<sup>[27]</sup> and Phillips, Ruggier, and Hutchinson.<sup>[8]</sup> The authors of the meta-analysis concluded that ginger was a promising antiemetic, but the clinical data were insufficient to draw firm conclusions. Since this publication, two more trials for PONV have been published.

A double-blind, placebo-controlled trial enrolled 80 patients undergoing outpatient gynecological laparoscopy, who were randomly allocated to receive either 1 g powdered ginger 1 hr before surgery or placebo. The visual analog nausea score (VANS) and vomiting time were evaluated at 2, 4, and 24 hr post-operation. The VANS was lower in the ginger group compared to placebo at both 2 and 4 hr ( $p < 0.05$ ), but no difference was found in either group at 24 hr. Incidence and frequency of vomiting were lower in the ginger group but were not statistically different from those of placebo.<sup>[28]</sup>

The double-blind, placebo-controlled study by Eberhart et al.<sup>[29]</sup> randomized 184 ( $n = 175$ ) healthy women undergoing gynecologic laparoscopic surgery to 1 of 3 arms: placebo group: 3 × 2 placebo capsules (2 capsules preoperatively and 3 and 6 hr postoperatively); G<sub>300</sub> group: 3 × 1 verum capsules and 3 × 1 placebo capsules (1 capsule preoperatively and 3 and 6 h postoperatively) (=300 mg of ginger extract); or G<sub>600</sub> group: 3 × 2 verum capsules (2 capsules preoperatively and 3 and 6 hr postoperatively) (=600 mg of ginger extract). One verum capsule contained 100 mg of standardized extract of the rhizome

of ginger (drug extract ratio 10–20 : 1; extraction agent: acetone). Thus, 100–200 mg of this standardized extract is roughly equivalent to 1–2 g of crude ginger. The trial was stopped early according to the prospectively defined protocol due to the results of the interim analysis ( $n = 180$  patients), which found that the observed incidence of PONV was 49% (95% confidence interval: 36–63%) in the placebo group, 58% (95% confidence interval: 44–70%) in the G<sub>300</sub> group, and 53% (39–66%) in the G<sub>600</sub> group ( $p = 0.69$ ).

The data for ginger and PONV are contradictory, with the most rigorous studies not showing any significant benefit over placebo, including the Eberhart study, which used doses up to 6 g crude herb equivalent.

### Anti-inflammatory Activity

In vitro and animal models have shown that ginger inhibits both cyclo-oxygenase and lipo-oxygenase pathways.<sup>[30]</sup> Intraperitoneal administration of crude hydroethanolic ginger reduced rat paw edema induced by carrageenan and inhibited serotonin-induced skin edema.<sup>[31]</sup>

### Osteoarthritis

Present-day therapy for osteoarthritis (OA) is principally directed at symptoms, since there is no well-established disease-modifying therapy. Treatments generally involve a combination of nonpharmacologic and pharmacologic measures, utilizing a combination of analgesia, and anti-inflammatory and intra-articular therapies.<sup>[32]</sup> Srivastava and Mustafa<sup>[33]</sup> published two collections of anecdotal reports on the beneficial effects of ginger on rheumatological complaints more than a decade ago. Two clinical trials have been published since that time. Ginger extract (170 mg/day EV.EXT 33) was compared to placebo and ibuprofen (400 mg/day) in 67 patients ( $n = 56$ ) with osteoarthritis of the hip or knee in a controlled, double-blind, double-dummy, crossover study with a wash-out period of 1 week followed by 3 treatment periods in a randomized sequence, each of 3 weeks duration. Acetaminophen was used as rescue medication throughout the study. The ranking of efficacy was ibuprofen > ginger extract > placebo for VAS scores on pain and the Lequesne index, but no significant difference was seen when comparing ginger extract and placebo directly.<sup>[34]</sup> The lack of positive effects may have been due to inadequate trial length and/or insufficient dose.

A randomized, double-blind, placebo-controlled study enrolled 261 ( $n = 247$ ) patients with OA of

the knee as diagnosed by the American College of Rheumatology classification criteria.<sup>[35]</sup> The primary efficacy variable was the proportion of responders experiencing a reduction in “knee pain on standing,” using an intent-to-treat analysis. A responder was defined by a reduction in pain of  $\geq 15$  mm on a visual analog scale. During the 6-week treatment period, patients ingested 1 capsule twice daily of 255 mg ginger extract (EV.EXT 77, extracted from 2500–4000 mg of dried ginger rhizomes and 500–1500 mg of dried galanga rhizomes) or placebo. The percentage of responders experiencing a reduction in knee pain on standing was superior in the ginger extract group compared with the control group (63% vs. 50%;  $p = 0.048$ ). Analysis of the secondary efficacy variables revealed a consistently greater response in the ginger extract group compared with the control group, when analyzing mean values: reduction in knee pain on standing (24.5 vs. 16.4 mm;  $p = 0.005$ ) and reduction in knee pain after walking 50 ft (15.1 vs. 8.7 mm;  $p = 0.016$ ). One group of adverse events showed a significant difference between treatment groups: Gastrointestinal (GI) adverse events were more common in the ginger extract group [116 events in 59 patients (45%)] compared with the placebo group [28 events in 21 patients (16%)]. None of the GI adverse events were considered serious by the investigators.

Both of these studies suggest the strong need for dose escalation studies that can determine the most efficacious dose that it is still safe and well tolerated. Studies of longer duration are also required before more definitive conclusions can be drawn about the safety, tolerance, and effectiveness of ginger for osteoarthritis.

### Cardiovascular Effects

In vitro research has shown that constituents in ginger have an inhibitory effect upon cholesterol biosynthesis.<sup>[36]</sup> Animal studies have demonstrated lipid-lowering activity via enhancement of the activity of hepatic cholesterol-7 $\alpha$ -hydroxylase, the rate-limiting enzyme in bile acid biosynthesis, thereby stimulating conversion of cholesterol to bile acids, an important mechanism for eliminating cholesterol from the body.<sup>[37]</sup> A study in rabbits found that an orally administered ethanolic extract of ginger (200 mg/kg) reduced lipids after 10 weeks feeding of a cholesterol rich diet. The authors found that, at this dose, ginger produced results similar to those of gemfibrozil.<sup>[38]</sup> In contrast to the in vitro and animal data, a study of patients with coronary artery disease found that 3 mo ingestion of 4 g/day dried ginger powder failed to lower blood lipids.<sup>[39]</sup>

Ginger inhibits platelet aggregation in vitro, acting as a potent inhibitor of arachidonic acid, epinephrine, adenosine diphosphate (ADP), and collagen. A placebo-controlled study of 8 healthy males found that ingestion of 2 g of ginger caused a dose-dependent reduction of thromboxane synthetase and prostaglandin synthetase; however, no differences were found in bleeding time, platelet count, or platelet function between the placebo and control groups.<sup>[40]</sup> In patients with coronary artery disease (CAD), powdered ginger administered in a dose of 4 g/day for 3 mo did not affect ADP- and epinephrine-induced platelet aggregation. However, a single dose of 10 g produced a significant reduction in platelet aggregation induced by the two agonists.<sup>[39]</sup>

### Gastrointestinal Effects

Ginger has long been valued in traditional medicine for a wide variety of gastrointestinal complaints. Researchers are beginning to explore possible scientific explanations for these historical uses. In vitro research indicates that constituents present in ginger have antiulcer activity.<sup>[41]</sup> Animal research demonstrates that ginger reduces the occurrence of gastric ulcers induced by nonsteroidal anti-inflammatory drugs (NSAIDs) and hypothermic restraint stress.<sup>[42]</sup> Chologic activity has been documented in rats with the acetone extract of ginger.<sup>[43]</sup>

*Helicobacter pylori* (HP) is the primary etiological agent associated with dyspepsia, peptic ulcer disease, and development of gastric cancer. Novel, inexpensive, and safe approaches to the eradication of *H. pylori* are currently being sought. A methanol extract of the dried, powdered ginger rhizome, fractions of the extract, and the isolated constituents, 6-, 8-, and 10-gingerol and 6-shogaol, were tested against 19 strains of HP.<sup>[44]</sup> The extract inhibited the growth of all 19 strains in vitro with a minimum inhibitory concentration (MIC) range of 6.25–50  $\mu$ g/ml. One fraction of the crude extract, containing the gingerols, was active and inhibited the growth of all HP strains with a MIC range of 0.78–12.5  $\mu$ g/ml.

### DOSE

As with many botanicals, dosage ranges vary widely in research and, especially, in the marketplace. The following are a few doses (serving sizes) found in the literature:

- Fresh or dried rhizome: 2–4 g daily.<sup>[45]</sup>
- Fluidextract: 1 : 1 (g/ml) 0.25–1.0 ml 3 times daily; tincture 1 : 5 (g/ml) 1.25–5.0 ml 3 times daily.<sup>[45]</sup>

## ADVERSE EFFECTS

Patients treated with ginger have reported increased flatulence and heartburn compared to those on placebo.

## CONTRAINDICATIONS

Due to its cholagogic effect, those with active gallstone disease should avoid ginger.

## HERB-DRUG INTERACTIONS

None are known. There have been anecdotal and speculative warnings about ginger and warfarin; however, there are no documented cases in the literature. Standardized ginger extract had no significant effects on coagulation parameters or on warfarin-induced changes in blood coagulation in rats.<sup>[46]</sup> Though evidence is lacking for a direct interaction between warfarin and ginger,<sup>[47]</sup> it is probably still wise for practitioners and patients alike to be cautious about the use of doses greater than 4 g/day of dried ginger in conjunction with antiplatelet/anticoagulant medications.

## TOXICITY

There is little risk of toxicity when used as a spice. Acute toxicity tests in mice found no mortality or adverse effects when ginger extract was given at doses up to 2.5 g/kg (by lavage) over a 7 day period. Increasing the dose to 3.0–3.5 g/kg resulted in 10–30% mortality.<sup>[48]</sup>

## USE IN PREGNANCY

Two studies have been published examining the effect of ginger in pregnant rats. One found that ginger tea (20 or 50 g/L) administered from gestation days 6–15 and then sacrificed at Day 20 significantly increased early embryonic loss and increased growth in surviving fetuses.<sup>[49]</sup> No gross morphologic malformations were seen in the treated fetuses. Teratogenic studies on ginger extracts at doses of 100–1000 mg/kg failed to observe any toxic effects or early embryonic loss.<sup>[50]</sup>

Researchers at the Hospital for Sick Children in Toronto, Canada, studied 187 pregnant women who used some form of ginger in the first trimester. They report that the risk of these mothers having a baby with a congenital malformation was no higher than that in a control group.<sup>[6]</sup> Of the published human studies, there was 1 spontaneous abortion out of 32

in the ginger group,<sup>[18]</sup> 1 spontaneous abortion of 27 in the crossover design study,<sup>[19]</sup> and 3 spontaneous abortions of 60 in the ginger group,<sup>[20]</sup> although one of these occurred in a woman who had not begun taking the treatment. Though the total number of women in these clinical trials is small, the rate of spontaneous abortion is not any greater than that seen in the general population.

## REFERENCES

- Langner, E.S.; Griefenberg, S.; Gruenwald, J. Ingwer: eine Heilpflanze mit Geschichte [Ginger: a medicinal plant with a history]. *Balance Z. Prax. Wiss. Komplement. Ther.* **1997**, *1*, 5–16.
- Blumenthal, M. Herb sales down 15% in mainstream market. *HerbalGram* **2001**, *51*, 69.
- Evans, W.C. *Trease and Evans Pharmacognosy*, 15th Ed.; W.B: Saunders: London, England, 2002; 277–280.
- British Herbal Pharmacopoeia (BHP)*; British Herbal Medicine Association: Exeter, U.K., 1996.
- Ding, G.H.; Naora, K.; Hayashibara, M.; Katagiri, Y.; Kano, Y.; Iwamoto, K. Pharmacokinetics of [6]-gingerol after intravenous administration in rats. *Chem. Pharm. Bull. (Tokyo)* **1991**, *39*, 1612–1614.
- Portnoi, G.; Chng, L.A.; Karimi-Tabesh, L.; Koren, G.; Tan, M.P.; Einarson, A. Prospective comparative study of the safety and effectiveness of ginger for the treatment of nausea and vomiting in pregnancy. *Am. J. Obstet. Gynecol.* **2003**, *189* (5), 1374–1377.
- Mowrey, D.B.; Clayson, D.E. Motion sickness, ginger, and psychophysics. *Lancet* **1982**, *1*, 655–657.
- Phillips, S.; Ruggier, R.; Hutchinson, S.E. *Zingiber officinale* (ginger)—an antiemetic for day case surgery. *Anesthesia* **1993**, *48* (8), 715–717.
- Sontakke, S.; Thawani, V.; Naik, M.S. Ginger as an antiemetic in nausea and vomiting induced by chemotherapy: a randomized, cross-over, double blind study. *Indian J. Pharmacol.* **2003**, *35*, 32–36.
- Huang, Q.R.; Iwamoto, M.; Aoki, S. et al. Anti-5-hydroxytryptamine-3 effect of galanolactone, diterpenoid isolated from ginger. *Chem. Pharm. Bull. (Tokyo)* **1991**, *39*, 397–399.
- Sharma, S.S.; Gupta, Y.K. Reversal of cisplatin-induced delay in gastric emptying in rats by ginger (*Zingiber officinale*). *J. Ethnopharmacol.* **1998**, *62* (1), 49–55.
- Phillips, S.; Hutchinson, S.; Ruggier, R. *Zingiber officinale* does not affect gastric emptying rate. A randomised, placebo-controlled, crossover trial. *Anaesthesia* **1993**, *48* (5), 393–395.

13. Lien, H.C.; Sun, W.M.; Chen, Y.H.; Kim, H.; Hasler, W.; Owyang, C. Effects of ginger on motion sickness and gastric slow-wave dysrhythmias induced by circularvection. *Am. J. Physiol. Gastrointest. Liver Physiol.* **2003**, *284* (3), G481–G489.
14. Schmid, R.; Schick, T.; Steffen, R.; Tschopp, A.; Wilk, T. Comparison of seven commonly used agents for prophylaxis of seasickness. *J. Travel Med.* **1994**, *1*, 203–206.
15. Riebenfeld, D.; Borzone, L. Randomized, double-blind study comparing ginger (Zintona<sup>®</sup>) and dimenhydrinate in motion sickness. *Healthnotes Rev. Complement. Integr. Med.* **1999**, *6* (2), 98–101 (Reviewed and edited by Fulder, S. and Brown, D.).
16. Carredu, P. Motion sickness in children: results of a double-blind study with ginger (Zintona<sup>®</sup>) and dimenhydrinate. *Healthnotes Rev. Complement. Integr. Med.* **1999**, *6* (2), 102–107.
17. O'Brien, B.; Naber, S. Nausea and vomiting during pregnancy: effects on the quality of women's lives. *Birth* **1992**, *19*, 138–143.
18. Fischer-Rasmussen, W.; Kjaer, S.K.; Dahl, C.; Asping, U. Ginger treatment of hyperemesis gravidarum. *Eur. J. Obstet. Gynecol. Reprod. Biol.* **1990**, *38* (1), 19–24.
19. Vutyavanich, T.; Kraissarin, T.; Ruangsri, R.A. Ginger for nausea and vomiting in pregnancy: randomized double-masked placebo-controlled trial. *Obstet. Gynecol.* **2001**, *97* (4), 577–582.
20. Willetts, K.E.; Eakangaki Abie Eden, J.A. Effect of a ginger extract on pregnancy-induced nausea: a randomised controlled trial. *Aust. N. Z. J. Obstet. Gynaecol.* **2003**, *43* (2), 139–144.
21. Pace, J.C. Oral ingestion of encapsulated ginger and reported self-care actions for the relief of chemotherapy-associated nausea and vomiting. *Dissertations Abstr. Int.* **1987**, *47*, 3297–3298.
22. Meyer, K.; Schwartz, J.; Crater, D.; Keyes, B. *Zingiber officinale* (ginger) used to prevent 8-MOP-associated nausea. *Dermatol. Nurs.* **1995**, *7* (4), 242–244.
23. Trial of encapsulated ginger as a treatment for chemotherapy-induced nausea and vomiting. <http://www.ClinicalTrials.gov>.
24. Skinner, C.M.; Rangasami, J. Preoperative use of herbal medicines: a patient survey. *Br. J. Anaesth.* **2002**, *89*, 792–795.
25. Ernst, E.; Pittler, M.H. Efficacy of ginger for nausea and vomiting: a systematic review of randomized clinical trials. *Br. J. Anaesth.* **2000**, *84*, 367–371.
26. Arfeen, Z.; Owen, H.; Plummer, J.L.; Ilsley, A.H.; Sorby-Adams, R.A.; Doecke, C.J. A double-blind randomized controlled trial of ginger for the prevention of postoperative nausea and vomiting. *Anaesth. Intens. Care* **1995**, *23* (4), 449–452.
27. Bone, M.E.; Wilkinson, D.J.; Young, J.R.; McNeil, J.; Charlton, S. Ginger root—a new antiemetic. The effect of ginger root on postoperative nausea and vomiting after major gynaecological surgery. *Anaesthesia* **1990**, *45* (8), 669–671.
28. Pongrojpraw, D.; Chiamchanya, C. The efficacy of ginger in prevention of post-operative nausea and vomiting after outpatient gynecological laparoscopy. *J. Med. Assoc. Thail.* **2003**, *86* (3), 244–250.
29. Eberhart, L.H.; Mayer, R.; Betz, O. et al. Ginger does not prevent postoperative nausea and vomiting after laparoscopic surgery. *Anesth. Analg.* **2003**, *96* (4), 995–998.
30. Mustafa, T.; Srivastava, K.C.; Jensen, K.B. Drug development: report 9. Pharmacology of ginger, *Zingiber officinale*. *J. Drug Dev.* **1993**, *6*, 25–89.
31. Penna, S.C.; Medeiros, M.V.; Aimbire, F.S.; Faria-Neto, H.C.; Sertie, J.A.; Lopes-Martins, R.A. Anti-inflammatory effect of the hydralcoholic extract of *Zingiber officinale* rhizomes on rat paw and skin edema. *Phytomedicine* **2003**, *10* (5), 381–385.
32. Hochberg, M.C.; Altman, R.D.; Brandt, K.D.; Clark, B.M.; Dieppe, P.A.; Griffin, M.R. et al. Guidelines for the medical management of osteoarthritis: part II. Osteoarthritis of the knee. *Arthritis Rheum.* **1995**, *38*, 1541–1546.
33. Srivastava, K.C.; Mustafa, T. Ginger (*Zingiber officinale*) in rheumatism and musculoskeletal disorders. *Med. Hypotheses* **1992**, *39*, 342–348.
34. Bliddal, H.; Rosetzky, A.; Schlichting, P. et al. A randomized, placebo-controlled, cross-over study of ginger extracts and ibuprofen in osteoarthritis. *Osteoarthritis Cartilage* **2000**, *8* (1), 9–12.
35. Altman, R.D.; Marcussen, K.C. Effects of a ginger extract on knee pain in patients with osteoarthritis. *Arthritis Rheum.* **2001**, *44* (11), 2531–2538.
36. Tanabe, M.; Chen, Y.D.; Saito, K.; Kano, Y. Cholesterol biosynthesis inhibitory component from *Zingiber officinale* Roscoe. *Chem. Pharm. Bull.* **1993**, *41* (4), 710–713.
37. Srinivasan, K.; Sambaiiah, K. The effect of spices on cholesterol 7 alpha-hydroxylase activity and on serum and hepatic cholesterol levels in the rat. *Int. J. Vitam. Nutr. Res.* **1991**, *61* (4), 364–369.
38. Bhandari, U.; Sharma, J.N.; Zafar, R. The protective action of ethanolic ginger (*Zingiber officinale*) extract in cholesterol fed rabbits. *J. Ethnopharmacol.* **1998**, *61* (2), 167–171.
39. Bordia, A.; Verma, S.K.; Srivastava, K.C. Effect of ginger (*Zingiber officinale* Rosc.) and



- fenugreek (*Trigonella foenumgraecum* L.) on blood lipids, blood sugar and platelet aggregation in patients with coronary artery disease. *Prostaglandins Leukot. Essent. Fatty Acids* **1997**, *56* (5), 379–384.
40. Lumb, A.B. Effect of dried ginger on human platelet function. *Thromb. Haemost* **1994**, *71*, 110–111.
  41. Yoshikawa, M.; Yamaguchi, S.; Kunimi, K.; Matsuda, H.; Okuno, Y.; Yamahara, J.; Murakami, N. Stomachic principles in ginger. III. An anti-ulcer principle, 6-gingesulfonic acid, and three monoacyldigalactosylglycerols, ginger-glycolipids A, B, and C, from *Zingiberis Rhizoma* originating in Taiwan. *Chem. Pharm. Bull.* **1994**, *42* (6), 1226–1230.
  42. al-Yahya, M.A.; Rafatullah, S.; Mossa, J.S.; Ageel, A.M.; Parmar, N.S.; Tariq, M. Gastro-protective activity of ginger *Zingiber officinale* Rosc., in albino rats. *Am. J. Chin. Med.* **1989**, *17* (1–2), 51–56.
  43. Yamahara, J.; Miki, K.; Chisaka, T. et al. Chologic effect of ginger and its active constituents. *J. Ethnopharmacol.* **1985**, *13* (2), 217–225.
  44. Mahady, G.B.; Pendland, S.L.; Yun, G.S.; Lu, Z.Z.; Stoia, A. Ginger (*Zingiber officinale* Roscoe) and the gingerols inhibit the growth of Cag A<sup>+</sup> strains of *Helicobacter pylori*. *Anti cancer Res.* **2003**, *23* (5A), 3699–3702.
  45. Blumenthal, M.; Busse, W.R.; Goldberg, A. et al. *The Complete German Commission E Monographs—Therapeutic Guide to Herbal Medicines*; American Botanical Council/Integrative Medicine Communications: Austin, TX/Newton, MA, 2000; 153–159.
  46. Weidner, M.S.; Sigwart, K. The safety of ginger extract in the rat. *J. Ethnopharmacol.* **2000**, *73* (3), 513–520.
  47. Vaes, L.P.; Chyka, P.A. Interactions of warfarin with garlic, ginger, ginkgo, or ginseng: nature of the evidence. *Ann. Pharmacother.* **2000**, *34* (12), 1478–1482.
  48. Mascolo, N.; Jain, R.; Jain, S.C. et al. Ethnopharmacologic investigation of ginger (*Zingiber officinale*). *J. Ethnopharmacol.* **1989**, *27* (1–2), 129–140.
  49. Wilkinson, J.M. Effect of ginger tea on the fetal development of Sprague–Dawley rats. *Reprod. Toxicol.* **2000**, *14*, 507–512.
  50. Weidner, M.S.; Sigwart, K. Investigation of the teratogenic potential of a *Zingiber officinale* extract in the rat. *Reprod. Toxicol.* **2001**, *15*, 75–80.

# Ginkgo biloba

Kristian Strømgaard  
Stine B. Vogensen

The Danish University of Pharmaceutical Sciences, Copenhagen, Denmark

Koji Nakanishi

Columbia University, New York, New York, U.S.A.

## INTRODUCTION

The tree *Ginkgo biloba* L. has a long history of use in traditional Chinese medicine. The ginkgo tree is classified in its own family and order, and holds a special position in evolutionary plant history because it provides a connection between the seedless vascular plants and seed plants. In recent years, the leaf extract of *G. biloba* has become one of the most widely used herbal remedies and is sold as a phytomedicine in Europe and as a dietary supplement worldwide. *G. biloba* extracts are used for the treatment of cerebral dysfunction and circulatory disorders, and have been studied in several animal experiments and clinical trials. There are a wide variety of chemical constituents in the extract, with the principal components being terpenes trilactones (ginkgolides and bilobalide) and flavonoids.

## BACKGROUND

*G. biloba* L., or the maidenhair tree (Fig. 1), is the only surviving member of its family (Ginkgoaceae) and order (Ginkgoales), underscoring its unique phylogenetic status. Fossil records show that the *Ginkgo* genus was present some 180 million years ago. The Ginkgoaceae peaked 130 million years ago, with numerous widespread species, but gradually gave way to modern angiosperms. Today, only one species, *G. biloba*, survives, and it occurs naturally only in

eastern parts of China. The morphology of the ginkgo tree itself appears to have changed very little over 100 million years, and for this reason it is often called a “living fossil.”

The ginkgo tree takes its name from *ginkyo* in Japanese and *yinhsing* in Chinese; both words translate to “silver apricot,” referring to the appearance of the ginkgo nuts. The term “ginkgo” was first used by the German physician and botanist Engelbert Kaempfer in 1712, but Linnaeus provided the terminology “*Ginkgo biloba*” in 1771. The ginkgo tree can grow up to 40 m high, with a stem diameter between 1 and 4 m, and can reach an age of more than 1000 yr. Vertical growth generally slows down with the onset of sexual maturity at around 25 yr. The appearance of the tree varies from slim and conical to full and rounded, with gray bark deeply furrowed on old trees. The ginkgo tree has characteristic green, leathery, fan-shaped leaves that turn golden-yellow in autumn. In young specimens, the leaves are divided into two distinct lobes, and hence the notation *biloba* (from Latin *bi*, double, *loba*, lobes). The *Ginkgo* species is dioecious, having separate male and female trees.

Among seed plants with a reproductive system, the ginkgo is a primitive tree, and its reproductive organs resemble those of seedless vascular plants such as ferns. *G. biloba* provides an important evolutionary connection between seedless vascular plants and seed plants, as discovered by Japanese botanist Sakugoro Hirase more than a hundred years ago. In the spring, before the leaves emerge, male *G. biloba* trees produce catkins rich in pollen, while female trees produce 2–3 mm long ovules. Each ovule secretes a small mucilaginous droplet that catches the airborne pollen and transports it inside the ovule, where multiflagellated spermatozoids are produced. A spermatozoid fertilizes the female egg cell, and the seed is shed from the tree approximately 1 mo after fertilization. Fully mature ginkgo seeds, also known as ginkgo nuts, have a pungent smell due to the presence of butanoic and hexanoic acids in the fleshy sarcotesta surrounding the seed (Fig. 2).<sup>[1]</sup>

---

Kristian Strømgaard, Ph.D., is Associate Professor at the Department of Medicinal Chemistry, The Danish University of Pharmaceutical Sciences, Copenhagen, Denmark.

Stine B. Vogensen, Ph.D., is Currently a Medicinal Chemist at MedChem Aps, Copenhagen, Denmark.

Koji Nakanishi, Ph.D., is Centennial Professor at the Department of Chemistry, Columbia University, New York, New York, U.S.A.



**Fig. 1** A *Ginkgo biloba* tree. (View this art in color at [www.dekker.com](http://www.dekker.com).)

### Cultivation and History of Use

The ginkgo tree has been cultivated in China for several thousand years and, according to some of the earliest written ginkgo tree references dating back to the Song dynasty of the early 11th century, the tree was appreciated for its beauty and for its edible nuts. The tree was introduced into Japan from China in the 12th century, and some 500 years later into Europe and North America. The use of *G. biloba* for medicinal purposes was first mentioned in 1505 A.D. in a book by Liu Wan-Tai. In the Chinese materia medica *Pen Tsao Ching* from 1578, *G. biloba* is described as a treatment for senility in aging members of the royal court. In these old records, it is mainly the use of nuts that is described. Raw ginkgo nuts without the fleshy sarco-testa are described in traditional Chinese medicine as a treatment for a variety of lung-related ailments, including asthma and bronchitis, as well as some kidney and bladder disorders. The use of *G. biloba* leaves has played only a minor role in traditional Chinese medicine, but in the modern Chinese Pharmacopeia, the leaves are considered beneficial for the heart and lungs.

The ginkgo tree can persist in conditions of low light and nutrient scarcity and is highly resistant to bacteria, fungi, and viruses. Furthermore, it is resistant to air pollution; this has made *G. biloba* a popular roadside tree in urban areas of Japan, Europe, and northern America. In China, the ginkgo tree is cultivated partly to meet demands for ginkgo nuts, a delicacy in Chinese and Japanese cuisine alike. The kernel is obtained by boiling the nuts until the hard shell cracks open; this kernel is subsequently boiled with sugar or roasted. Unfortunately, raw ginkgo nuts contain the toxin 4-*O*-methylpyridoxine, which can result in serious food poisoning.

### *Ginkgo biloba* Extract (GBE)

For pharmaceutical purposes, an extract of *G. biloba* leaves was first introduced in Western countries in 1965 by the German company Dr. Willmar Schwabe under the trade name Tebonin. Later, Schwabe established a collaboration with the French company Beaufour-Ipsen, and together they developed a standardized *G. biloba* extract (GBE) termed EGb 761 (Extrait de *Ginkgo biloba* 761), which was sold under trade names such as Tanakan, Rōkan, and Tebonin forte. Other *G. biloba* products have entered the markets, and GBE is now among the best selling dietary supplements worldwide. Rising demand for GBE has spurred the increased harvesting of *G. biloba* leaves, and today, more than 50 million *G. biloba* trees are grown, especially in China, France, and the United States, producing approximately 8000 tons of dried leaves each year. The yellow or green leaves are harvested in mid- to late summer and then dried and pulverized. Through various extraction procedures, the active constituents are concentrated and undesired constituents such as organic acids are discarded. The composition of the leaf extract varies considerably and is related to the age of the plant, growth conditions, and time of harvest. To ensure the quality of GBE, the concentration of flavonoids and terpene trilactones, the presumed active constituents, has been standardized.

### CHEMISTRY AND PREPARATION OF PRODUCT

*G. biloba* contains a wide variety of phytochemicals, including alkanes, lipids, sterols, benzenoids, carotenoids, phenylpropanoids, carbohydrates, flavonoids, and terpenoids, particularly terpene trilactones.<sup>[2]</sup>

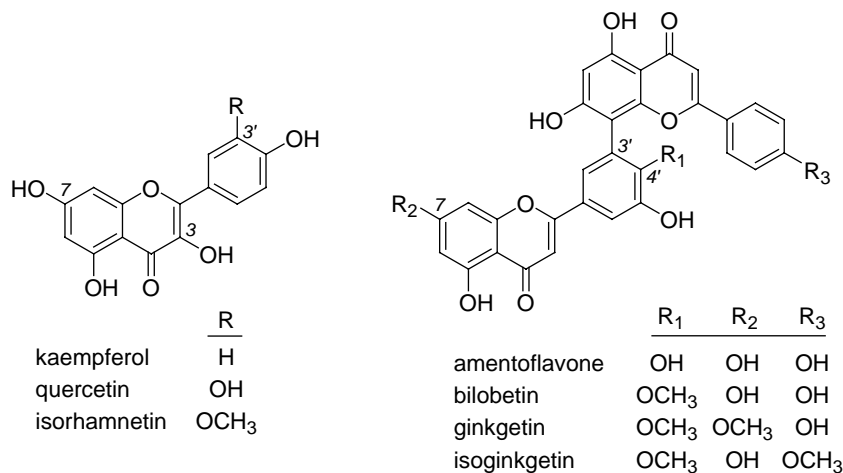


**Fig. 2** Leaves and nuts of *G. biloba*. (View this art in color at [www.dekker.com](http://www.dekker.com).)

The major constituents are flavonoids, polyphenolic compounds that are widely distributed in the plant kingdom and are found in all green plants. Flavonoids are pigments responsible for the colors yellow, orange, and red in autumn leaves and various flowers, and are also present in wine and tea. Currently, more than 30 flavonoids have been found in *G. biloba*; the diversity arises from different glycoside substitutions of the flavonol aglycone. The flavonoids of GBE are almost exclusively flavonol-*O*-acyl-glycosides, including mono-, di-, or triglycosides of the flavonol aglycones quercetin and kaempferol primarily substituted at the 3-position (Fig. 3). Additionally, nonglycosidic

biflavonoids, such as bilobetin, ginkgetin, and isoginkgetin (Fig. 3) and proanthocyanidins such as procyanidin and prodelphinidin have also been isolated from *G. biloba*.

The terpene trilactones (TTLs) comprise 5 diterpenes named ginkgolide A, B, C, J, and M and the sesquiterpene bilobalide (Fig. 4). These compounds have unique structures only found in the ginkgo tree. The ginkgolide cage structure consists of six 5-membered rings, including 3 lactones, a tetrahydrofuran ring, and a spiro[4.4]nonane skeleton. The ginkgolides differ in the positions and numbers of hydroxyl groups on the spiroonane framework. In bilobalide, rings A



**Fig. 3** Structures of flavonoids.

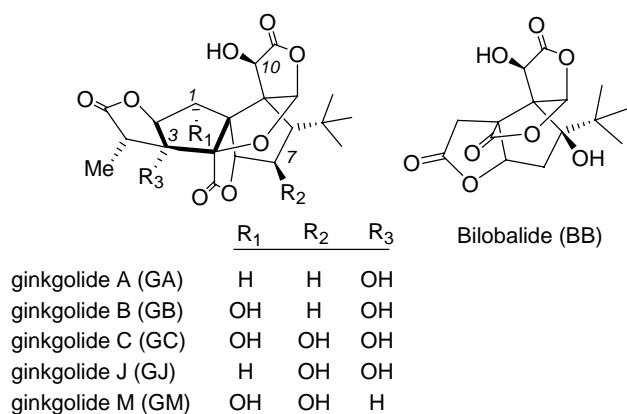


Fig. 4 Structures of ginkgolides and bilobalide.

and F are absent and the tetrahydrofuran ring of the ginkgolides (ring D) is replaced by a lactone (Fig. 4). The ratios of TTLs vary by season and between different parts of the tree.

The TTLs are unique constituents of the ginkgo tree and have attracted great interest due to their complex structures and reported biological activities.<sup>[3]</sup> Ginkgolides were first isolated from the root bark of *G. biloba* by S. Furukawa in 1932, and their structures were elucidated in 1967. The structure of bilobalide was determined in 1972. The ginkgolides have inspired many studies, particularly as targets for complex total synthesis, as templates for structure–activity relationship studies, and as terpenes with a surprising and novel biosynthetic pathway. Prior to these studies, it was thought that all terpenes were biosynthesized through the mevalonate pathway, but by examining the biosynthesis of ginkgolides, Arigoni and coworkers proved that terpenes can be synthesized through the deoxyxylulose phosphate or non-mevalonate pathway.<sup>[4]</sup>

### Formulation and Analysis

Standardized extracts (dry extracts from dried leaves, extracted with acetone and water) contain 22–27% flavone glycosides and 5–7% terpene lactones, of which approximately 2.8–3.4% is ginkgolides A, B, and C and 2.6–3.2% is bilobalide. Qualitative and quantitative determination of flavonoid glycosides is carried out after hydrolysis to the aglycones kaempferol, quercetin, and isorhamnetin. The qualitative presence or absence of biflavones is determined by high-performance liquid chromatography (HPLC). Qualitative and quantitative determination

of terpene trilactones (ginkgolides and bilobalide) is by HPLC or gas–liquid chromatography. Certain commercial products such as EGb 761 do not contain biflavones, and the level of ginkgolic acids should be below 5 mg/kg, because of their allergenic potential. Coated tablets and solutions for oral administration are prepared from these standardized, purified extracts.

### PRECLINICAL STUDIES

A vast number of preclinical studies have investigated the in vitro and in vivo effects of *G. biloba* extract as well as the individual components of GBE, particularly the TTLs ginkgolides and bilobalide. The major components of all GBEs are flavonoids and TTLs, and it is believed that these 2 classes of compounds are responsible for the biological effects of GBE. In most cases, GBE has been investigated in in vitro or in vivo assays, or the extracts have been screened in DNA arrays. The other primary approach has been to investigate single chemical components, such as the flavonoids, ginkgolides, and bilobalide, in a wide variety of assays. Although many biological effects can be explained by the individual components, it has often been suggested that GBE acts by a synergistic mechanism. The effects of GBE can be grouped into 3 related categories: 1) effects related to antioxidant activity; 2) effects on gene expression; and 3) direct effect on protein function, with these effects sometimes being overlapping or related.

The antioxidant effects of GBE are well documented, particularly using in vitro studies. These effects are most likely due to the flavonoids, which are well-known free-radical scavengers and antioxidants. Specifically, it has been shown that GBE can scavenge nitric oxide (NO), protect against lipid peroxidation of low-density lipoproteins (LDL), and inhibit the formation of oxygen radicals. It is believed that numerous disease states are related to free radicals. Therefore, it has been speculated that the antioxidant effects of GBE could be used to treat diseases such as atherosclerosis and cancer, as well as a number of neurodegenerative diseases such as Alzheimer's and Parkinson's disease.

The effects of GBE on gene expression have been the subject of several investigations in recent years, and a general consensus has emerged that this effect is critically important when looking at the clinical effects of GBE.<sup>[5]</sup> Gohil and coworkers used high-density oligonucleotide microarrays to study neuromodulatory effects in mice that had EGb 761-supplemented diets.<sup>[6]</sup> Twelve thousand genes and

expressed gene tags from the hippocampus and cerebral cortex of the mice were analyzed for changes in gene expression, and of these, 10 were found to change more than threefold as a result of EGb 761 administration. Several of these 10 genes may be relevant to neurodegenerative disorders.

In another approach, the expression of peripheral benzodiazepine receptor (PBR), a protein involved in cholesterol transport and many other biological events, was studied.<sup>[7]</sup> It was shown that GBE treatment decreased expression of PBR in a time- and concentration-dependent manner, and that this effect is most likely due to the ginkgolides. The clinical relevance of this result is not entirely clear, but it might be related to cancer or neurodegeneration.<sup>[8]</sup>

Most clinical studies of GBE have looked at effects on various forms of neurodegenerative disease, particularly as potential treatment of Alzheimer's disease (AD). Together with the accumulation of intracellular neurofibrillary tangles, deposition of  $\beta$ -amyloid plaques is the primary indication for AD, and it is believed that an increase of  $\beta$ -amyloid plaques is central to the pathogenesis of AD. Therefore, the recent finding that GBE seems to inhibit  $\beta$ -amyloid aggregation may be significant in explaining the effects of GBE in relation to AD.<sup>[9]</sup>

The two major components of GBE are flavonoids and TTLs, and in contrast to the wealth of studies that have been performed using GBEs, far fewer investigations have looked at the effect of the individual components of these extracts. However, flavonoids and TTLs are thought to be responsible for most of the pharmacological properties of GBEs. An important consideration when looking at the effects on the CNS is the bioavailability, including penetration of the blood-brain barrier (BBB), of these components. It has been assumed that the bioavailability of flavonoids is low, whereas TTLs, in particular the ginkgolides, are nearly completely bioavailable. Very recent studies indicate that ginkgolides can penetrate the BBB, although only in limited amounts. Although such studies cannot predict which of the components of GBE are efficacious, bioavailability is obviously a critical parameter when evaluating the physiological effects of GBE.

Flavonoids possess many biological activities, and they act as antioxidants, free-radical scavengers, enzyme inhibitors, and cation chelators. They also show anti-inflammatory, antiallergic, anti-ischemic, immunomodulatory, and antitumoral action.<sup>[10]</sup> The pharmacological effects of flavonoids in GBE have mainly been attributed to their utility as antioxidants and free-radical scavengers. Since the flavonoids

present in GBE are almost entirely flavonol-glycosides, it is expected that these compounds or their metabolites play a key role in these events; however, as mentioned above, their bioavailability might be a limiting factor.

The number of studies on the biological effects of ginkgolides increased dramatically in 1985, when it was reported that ginkgolides, particularly ginkgolide B (GB), are antagonists of the platelet-activating factor (PAF) receptor. The clinical application of GB (BN 52021) as a PAF receptor antagonist was investigated, but, as is true of all other antagonists of the PAF receptor, GB was never registered as a drug, primarily due to a failure to demonstrate efficacy. The clinical studies, however, showed that GB was well tolerated and showed very few, if any, side effects. A large number of ginkgolide derivatives that have been prepared and tested for their ability to antagonize the PAF receptor and several derivatives showed increased potency in comparison to the native ginkgolides. Together, these studies have led to a clearer understanding of the structural features required for PAF receptor antagonism.<sup>[3]</sup>

Recently, it was found that ginkgolides are potent and selective antagonists of glycine (Gly) receptors. The Gly receptors are found primarily in the spinal cord and brain stem, but also in higher brain regions such as the hippocampus. They are, together with  $\gamma$ -aminobutyric acid (GABA<sub>A</sub>) receptors, the main inhibitory receptors in the CNS. Electrophysiological studies showed that GB antagonizes Gly receptors in neocortical slices<sup>[11]</sup> and hippocampal cells,<sup>[12]</sup> and suggested that GB binds to the central pore of the ion channel, acting as a noncompetitive antagonist. Molecular modeling studies showed a striking structural similarity between picrotoxinin, an antagonist of both GABA<sub>A</sub> and Gly receptors, and ginkgolides.<sup>[11]</sup> Thus, ginkgolides are highly useful pharmacological tools for studying the function and properties of Gly receptors. However, the physiological importance of this antagonism remains to be investigated.

Several studies have shown that ginkgolides, particularly ginkgolide A (GA) and GB can modulate peripheral benzodiazepine (PB) receptors. These receptors are located mainly in peripheral tissues and glial cells in the brain, and are distinct from the benzodiazepine site on GABA<sub>A</sub> receptors. PB receptors are typically located on the outer membranes of mitochondria. The function of PB receptors is not entirely clear, but involvement in steroidogenesis, cell proliferation, and stress and anxiety disorders has been suggested. The primary action of GB is the inhibition of the expression of PB receptors.<sup>[13]</sup>

Several studies have indicated that ginkgolides protect against various damaging CNS events, such as ischemia and other cerebrovascular and traumatic brain injury, as well as inflammation. The mechanisms behind these effects are not entirely clear, and are probably multifaceted.

Bilobalide (BB) is the predominant TTL found in GBE, and although no specific target has been established or pursued, a wealth of pharmacological evidence indicates that BB might be a very important compound when looking at neuromodulatory properties of *G. biloba* constituents. Several studies have shown that BB affects the major neurotransmitters in the brain, glutamate and GABA. Recently, it was demonstrated that BB is an antagonist of GABA<sub>A</sub> receptors; in neocortical rat brain slices, BB was a weak antagonist ( $IC_{50} = 46 \mu\text{M}$ ),<sup>[10]</sup> and at recombinant  $\alpha_1\beta_1\gamma_{2L}$  GABA<sub>A</sub> receptors, BB was reasonably potent ( $IC_{50} = 4.6 \mu\text{M}$ ).<sup>[14]</sup>

Since antagonists of inhibitory receptors, particularly GABA<sub>A</sub> receptors, are known convulsants, the result of BB acting on GABA<sub>A</sub> receptors could pose a risk to patients ingesting GBE. In confirmation, a study of two epileptic patients showed an increased frequency of seizures with GBE administration. This increase was reversed when the patients stopped taking the extract.<sup>[15]</sup> These results indicate that people with a low seizure threshold, such as epileptic patients, should be cautious when taking *G. biloba* extract.

In contrast to these findings, other studies have shown the potential neuroprotective effect of BB in reducing glutamate release and phospholipid breakdown. Potential medicinal applications of BB have been described in patents, including use of BB for the protection of neurons from ischemia, as an anticonvulsant, and for treatment of tension and anxiety. BB inhibits brain phospholipase A<sub>2</sub> activity, leading to a neuroprotective effect, and several studies have shown that BB preserves mitochondrial respiration, especially under ischemic conditions.

## CLINICAL STUDIES

A vast number of clinical trials have been conducted using GBEs and, in most cases, these trials have examined effects related to dementia. Specifically, changes in memory, thinking, and personality in aging people were studied. In almost all of these investigations, the standardized extract EGb 761 was administered and, although various dosing regimens were employed, daily

doses of 120–240 mg EGb 761 were most commonly used.

Generally, clinical studies have shown that GBE can lead to an improvement in the symptoms associated with cerebral insufficiency, such as memory loss, depression, and tinnitus. In Germany, GBE is registered as an herbal medicine to treat cerebral insufficiency. This is a diagnosis covering a range of conditions, as illustrated by the list of indications from the German Commission E: “disturbed performance in organic brain syndrome within the regimen of a therapeutic concept in cases of demential syndromes with the following principal symptoms: memory deficits, disturbances in concentration, depressive emotional condition, dizziness, tinnitus, and headache. The primary target groups are dementia syndromes, including primary degenerative dementia, vascular dementia, and mixed forms of both.”<sup>[16]</sup>

In two seminal clinical studies, a total of 549 AD patients were evaluated for effects of EGb 761 treatment.<sup>[17,18]</sup> In both studies, EGb 761 significantly slowed the loss of cognitive symptoms of dementia, and regression on certain data points was delayed by 7.8 mo, which is comparable to the currently available AD treatments, Aricept (donepezil, 9.5 mo) and Exelon (rivastigmine, 5.5 mo), both acetylcholinesterase inhibitors.

Kleijnen and Knipschild reviewed 40 GBE clinical studies, which examined the efficacy of GBE in cerebral insufficiency.<sup>[19]</sup> In the studies, the standard dose was 120 mg/day for at least 4–6 weeks. Of the 40 trials, only 8 were considered acceptable. The problems with many of the studies included small patient numbers, inadequate description of randomization procedures, inadequate patient characterization, and insufficient data presentation. Essentially, all the 8 trials reported positive results, and no serious side effects were reported. It was concluded that future studies could provide a detailed efficacy assessment of GBE treatment. A more recent review by Knipschild and colleagues summarized 55 additional clinical studies, which also looked at the effect of GBE on cerebral insufficiency. Knipschild reports that although there is good evidence for a GBE effect, this evidence was obtained from an excessively small patient population and further, larger trials are required.<sup>[20]</sup>

A meta-analysis systematically reviewed over 50 clinical studies on GBE for the treatment of dementia and cognitive malfunctions associated with AD. Only 4 of the 50 studies met the inclusion criteria for the evaluation; these 4 studies included more than 400 patients. It was concluded that administration of 120–240 mg of GBE for 3–6 mo had a small but significant effect on objective measures of cognitive function

in AD, without significant adverse effects in formal clinical trials.<sup>[21]</sup>

Recently, two clinical studies have cast doubt on the positive clinical effect of GBE seen in almost all previous investigations. Both of these new studies include a larger number of patients, are carefully designed, and are randomized, double-blind and placebo-controlled. Knipschild et al. completed a clinical trial with 214 patients, who received GBE for 24 weeks. The patients suffered from either dementia or age-associated memory impairment (AAMI), and no GBE treatment-related improvement was seen.<sup>[22]</sup> In another study with 203 people over 60 yr who were given GBE for 6 weeks, no beneficial effect from the GBE treatment was observed<sup>[23]</sup>; the results of this investigation have been heavily debated.

In a very recent evaluation from the Cochrane Library, Birks and Evans have critically reviewed 33 clinical studies, which were all randomized and double-blind.<sup>[24]</sup> The duration of the studies varied from 3 to 52 weeks, although the majority were conducted for 12 weeks. The participants were all diagnosed with either dementia or AAMI, although some of the older studies did not fully verify the diagnoses. In their conclusion, Birks and Evans state that GBE appears to be safe and with no side effects compared to placebo, and that there is promising evidence for improved cognition and function with GBE treatment. However, the authors also note the results of recent trials that did not show GBE-related improvement, and therefore suggest that further clinical trials are required.

Currently, at least two major clinical trials are ongoing. The U.S. National Institutes of Health is sponsoring the Ginkgo Evaluation of Memory (GEM) Study, which has enrolled more than 3000 elderly people from four medical centers in the United States. The goal is to find out whether medicine made from *G. biloba* can prevent or delay the changes in memory, thinking, and personality that can occur as people get older. Doctors refer to these changes as “dementia,” the most well known type being Alzheimer’s disease. Half of the patients are taking pills that contain *Ginkgo biloba*, and the other half are on a placebo. After 5 yr, when the study has been completed, the two groups will be compared to see whether there are differences in how memory, thinking, and personality have changed, and to see whether *G. biloba* has been effective in preventing these changes. In France, the pharmaceutical company Ipsen is sponsoring another clinical trial, the GuidAge study, which aims to examine prevention of Alzheimer’s disease in patients over the age of 70 with memory impairment. The results from these two studies will obviously be of major importance

in evaluating and determining the effects of GBE in relation to dementia.

A primary function of GBE is to improve blood flow and to inhibit platelet aggregation, the latter through inhibition of the PAF receptor by ginkgolides. Therefore, the vascular effects of GBE administration naturally invite examination, and a number of clinical trials have looked at effects of GBE treatment in relation to peripheral vascular conditions. A meta-analysis of clinical trials investigating the effect of GBE on intermittent claudication, an early symptom of peripheral arterial disease, was carried out by Pittler and Ernst.<sup>[25]</sup> Of 12 clinical trials conducted, 8 were included in this analysis, and the authors concluded that GBE is superior to placebo in the symptomatic treatment of intermittent claudication. However, it was noted that the overall magnitude of the treatment effect was modest and its clinical relevance was uncertain.

The effect of GBE on healthy people has also been examined. Several clinical studies indicate improved cognitive functions. This effect is still controversial, as illustrated by a recent evaluation of the clinical trials studying GBE efficacy in healthy persons.<sup>[26]</sup> Canter and Ernst found nine placebo-controlled, double-blind trials, which were generally of acceptable methodological quality. None of these short-term (<31 days) trials indicated consistent positive effects from GBE treatment. The authors conclude that the benefit from GBE on cognitive function is not proven and that there is a particular need for further long-term investigations with healthy subjects.<sup>[26]</sup>

Several studies have looked at the adverse effects and toxicity of GBE. Generally very few, if any, serious side effects from GBE have been found. Studies of acute GBE toxicity in mice and rats showed that doses of up to 10 g/kg did not result in lethal effects, and higher doses could not be administered. In chronic toxicity studies with rats, doses up to 500 mg/kg caused no significant changes that could be observed after sacrificing the animals. In vitro studies and studies in mice and rats showed no mutagenic, carcinogenic, or teratogenic effects. In humans, the toxicity of orally administered GBE is generally considered low, and no significant interactions with other medications have been reported.

In conclusion, there is mounting evidence from clinical studies to suggest that GBE may positively affect a range of cognitive and peripheral vascular conditions. Other recent studies have questioned the benefit of GBE on cognitive disorders, but ongoing clinical trials seek to settle this controversy in the future. There is no evidence for any adverse effects from GBE administration.



## REGULATORY STATUS

In most European countries, GBE is registered as an herbal medicine, whereas it is registered as a dietary supplement in the United States.

## ACKNOWLEDGMENTS

We are grateful to Prof. Per Mølgaard (Copenhagen, Denmark) and Ms. Sonja Krane (New York, U.S.A.) for comments on the manuscript.

## REFERENCES

- Hori, T.; Ridge, R.W.; Tulecke, W.; Del Tredici, P.; Trémouillaux-Guiller, J.; Tobe, H.; Eds. *Ginkgo biloba—A Global Treasure*; Springer-Verlag: Tokyo, 1997.
- Hasler, A. Chemical constituents of *Ginkgo biloba*. In *Ginkgo biloba*; Medicinal and Aromatic Plants—Industrial Profiles; Harwood Academic Publishers: Amsterdam, 2000; Vol. 12, 109–142.
- Strømgaard, K.; Nakanishi, K. Chemistry and biology of terpene trilactones from *Ginkgo biloba*. *Angew. Chem. Int. Ed.* **2004**, *43*, 1640–1658.
- Schwarz, M.; Arigoni, D. Ginkgolide biosynthesis. In *Comprehensive Natural Products Chemistry*; Elsevier: Oxford, 1999; 367–400.
- DeFeudis, F.V. Effects of *Ginkgo biloba* extract (EGb 761) on gene expression: possible relevance to neurological disorders and age-associated cognitive impairment *Drug Dev. Res.* **2002**, *57*, 214–235.
- Watanabe, C.M.H.; Wolffram, S.; Ader, P.; Rimbach, G.; Packer, L. et al. The in vivo neuro-modulatory effects of the herbal medicine *Ginkgo biloba*. *Proc. Natl. Acad. Sci. U.S.A.* **2001**, *98*, 6577–6580.
- Papadopoulos, V.; Kapsis, A.; Li, H.; Amri, H.; Hardwick, M. et al. Drug-induced inhibition of the peripheral-type benzodiazepine receptor expression and cell proliferation in human breast cancer cells. *Anticancer Res.* **2002**, *20*, 2835–2848.
- DeFeudis, F.V.; Papadopoulos, V.; Drieu, K. *Ginkgo biloba* extracts and cancer: a research area in its infancy. *Fund. Clin. Pharmacol.* **2003**, *17*, 405–417.
- Luo, Y.; Smith, J.V.; Paramasivam, V.; Burdick, A.; Curry, K.J. et al. Inhibition of amyloid- $\beta$  aggregation and caspase-3 activation by the *Ginkgo biloba* extract EGb761. *Proc. Natl. Acad. Sci. U.S.A.* **2002**, *99*, 12,197–12,202.
- Rice-Evans, C.A.; Packer, L.; Eds. *Flavonoids in Health and Disease*; Marcel Dekker: New York, 2003.
- Ivic, L.; Sands, T.T.J.; Fishkin, N.; Nakanishi, K.; Kriegstein, A.R. et al. Terpene trilactones from *Ginkgo biloba* are antagonists of cortical glycine and GABA<sub>A</sub> receptors. *J. Biol. Chem.* **2003**, *278*, 49,279–49,285.
- Kondratskaya, E.L.; Lishko, P.V.; Chatterjee, S.S.; Krishtal, O.A. BN52021, a platelet factor antagonist, is a selective blocker of glycine-gated chloride channel. *Neurochem. Int.* **2002**, *40*, 647–653.
- Amri, H.; Ogwuegbu, S.O.; Boujrad, N.; Drieu, K.; Papadopoulos, V. In vivo regulation of the peripheral-type benzodiazepine receptor and glucocorticoid synthesis by the *Ginkgo biloba* extract EGb and isolated ginkgolides. *Endocrinology* **1996**, *137*, 5707–5718.
- Huang, S.H.; Duke, R.K.; Chebib, M.; Sasaki, K.; Wada, K. et al. Bilobalide, a sesquiterpene trilactone from *Ginkgo biloba*, is an antagonist at recombinant  $\alpha_1\beta_1\gamma_{2L}$  GABA<sub>A</sub> receptors. *Eur. J. Pharmacol.* **2003**, *464*, 1–8.
- Granger, A.S. *Ginkgo biloba* precipitating epileptic seizures. *Age Ageing* **2001**, *30*, 523–525.
- Blumenthal, M.; Busse, W.R.; Goldberg, A.; Gruenwald, J.; Hall, T. et al. The complete german commission E monographs. In *Therapeutic Guide to Herbal Medicines*; American Botanical Council: Austin, TX, 1998; 136–137.
- Kanowski, S.; Hermann, W.M.; Stephan, K.; Wierich, W.; Horr, R. Proof of efficacy of *Ginkgo biloba* special extract EGb 761 in outpatients suffering from mild to moderate primary degenerative dementia of the Alzheimer type or multi-infarct dementia. *Pharmacopsychiatry* **1996**, *29*, 47–56.
- Le Bars, P.L.; Katz, M.M.; Berman, N.; Itill, T.M.; Freedman, A.M. et al. A placebo-controlled double-blind, randomized trial of an extract of *Ginkgo biloba* for dementia. North American EGb study group. *J. Am. Med. Assoc.* **1997**, *278*, 1327–1332.
- Kleijnen, J.; Knipschild, P. *Ginkgo biloba*. *Lancet* **1992**, *340*, 1136–1139.

20. van Dongen, M.C.J.M.; van Rossum, E.; Knipschild, P. Efficacy of *Ginkgo biloba* special extracts—evidence from randomized clinical trials. In *Ginkgo biloba*; Harwood Academic Publishers: Amsterdam, 2000; 385–442.
21. Oken, B.S.; Storzbach, D.M.; Kaye, J.A. The efficacy of *Ginkgo biloba* on cognitive function in Alzheimer disease. *Arch. Neurol.* **1998**, *55*, 1409–1415.
22. van Dongen, M.; van Rossum, E.; Kessels, A.; Knipschild, P. Ginkgo for elderly people with dementia and age-associated memory impairment: a randomized clinical trial. *J. Clin. Epidemiol.* **2003**, *56*, 367–376.
23. Solomon, P.R.; Adams, F.; Silver, A.; Zimmer, J.; De Veaux, R. Ginkgo for memory enhancement. A randomized controlled trial. *J. Am. Med. Assoc.* **2002**, *288*, 835–840.
24. Birks, J.; Evans, J.G. *Ginkgo biloba* for cognitive impairment and dementia (Cochrane Review).

In *The Cochrane Library*; John Wiley & Sons, Ltd: Chichester, UK, 2004.

25. Pittler, M.H.; Ernst, E. *Ginkgo biloba* extract for the treatment of intermittent claudication: a meta-analysis of randomized trials. *Am. J. Med.* **2000**, *108*, 276–281.
26. Canter, P.H.; Ernst, E. *Ginkgo biloba*: a smart drug? A systematic review of controlled trials of the cognitive effects of *Ginkgo biloba* extracts in healthy people. *Psychopharmacol. Bull.* **2002**, *36*, 108–123.

#### FURTHER READINGS

- DeFeudis, F.V. *Ginkgo biloba* extract (EGB 761). Ullstein Medical: Wiesbaden, 1998.
- van Beek, T.A.; Ed. *Ginkgo biloba*. Harwood Academic Publishers: Amsterdam, 2000.
- The ginkgo pages, <http://www.xs4all.nl/~kwanten>.



# Ginseng, American (*Panax quinquefolium*)

Thomas S.C. Li

Agriculture and Agri-Food Canada, Pacific Agri-Food Research Center,  
Summerland, British Columbia, Canada

## INTRODUCTION

American ginseng (*Panax quinquefolium* L.), indigenous to North America, is one of the most popular medicinal herbs in the world. While Asian ginseng (*P. ginseng* C.A. Meyer) has been used for thousands of years in China and other parts of Asia as an energy booster, American ginseng has recently attracted considerable attention as a herbal supplement in Western countries due to the discovery of chemical compounds that have nutritional and medicinal values. It has been reported that ginseng has therapeutic effects on immune function, cardiovascular diseases, cancer, sexual function, diabetes, and obesity. American ginseng is considered safe when used orally and appropriately. However, it may interfere with prescription drugs, and interact with food, and diseases or conditions.

## BACKGROUND

American ginseng is a slow-growing perennial, aromatic, shade-loving herb, 60–80 cm tall, belonging to the Araliaceae family. It has a bifurcated root with compound, verticillated, oval-to-oblong leaves. Indigenous to North America, American ginseng was first discovered in Quebec, Canada,<sup>[1]</sup> by Father Lafitau in the early 18th century, and has generated a lot of interest, particularly from China ever since.<sup>[2,3]</sup> Canada is one of the major producers in the world, with an annual yield of approximately 5 million pounds of 4-yr-old ginseng root (personal communication from grower's associations). Besides having adaptogenic effects for increasing resistance to environmental stress, ginseng also has tonic, stimulant, and diuretic effects. Recently, cultivation of American ginseng in China has progressed rapidly due to the public demand for its *yin* (cool) characteristics instead of the *yang* (hot) of Asian ginseng.<sup>[4,5]</sup> Among ginseng species, it has comparable, but different, ginsenoside content, which may account for the different therapeutic effects.<sup>[6,7]</sup> American ginseng has shown

immunostimulation<sup>[8]</sup> and liver-protective activities,<sup>[9]</sup> ability to increase sexual drive,<sup>[10]</sup> memory, and learning and decrease aging,<sup>[11]</sup> and to possess both digestion-regulating<sup>[12]</sup> and liver-protective activities<sup>[13]</sup> in the rat.

There are three kinds of American ginseng available on the market: cultivated (organic and inorganic), simulated wild, and wild. The Chinese prefer wild ginseng, since they believe that it has more potency for health and are willing to pay extra for its value. However, it has been reported that there was no statistical difference in ginsenoside content among these three types.<sup>[14]</sup>

In North America, American ginseng is available as a herbal supplement, in the form of whole root, powders, tinctures, drinks, and teas. In the last few years, researchers have isolated chemical constituents that have potential medicinal value. In addition to adaptogenic and tonic effects on health, it is believed to have ginseng therapeutic effects on immune function,<sup>[15]</sup> cancer,<sup>[16]</sup> cardiovascular diseases,<sup>[17]</sup> and sexual function.<sup>[18]</sup> It may help reduce the healing period required in patients with chronic bronchitis who are taking antibiotic drugs,<sup>[19]</sup> and maintain blood sugar levels in diabetic patients.<sup>[20]</sup>

## CHEMISTRY AND PREPARATION OF PRODUCT

There is considerable literature on the chemical compounds of ginseng.<sup>[21]</sup> However, the major active constituents of American ginseng are now generally accepted to be dammarane saponins, commonly referred to as ginsenosides Ra, Rb<sub>1</sub>, Rb<sub>2</sub>, Rc, Rd, Re, Rf, Rg<sub>1</sub>, Rg<sub>2</sub>, Rg<sub>3</sub>, Rh<sub>1</sub>, and Rh<sub>2</sub>.<sup>[22]</sup> A total of 28 ginsenosides have been extracted from ginseng roots.<sup>[23]</sup> Six major ginsenosides (Rb<sub>1</sub>, Rb<sub>2</sub>, Rc, Rd, Re, and Rg<sub>1</sub>) are present, which are widely regarded as the chemical constituents mainly responsible for its bioactivity.<sup>[4]</sup>

Individual and total ginsenoside contents vary substantially among *Panax* species.<sup>[24]</sup> Soldati and Sticher<sup>[25]</sup> reported a total of 1.71% ginsenosides (Rb<sub>1</sub>, Rb<sub>2</sub>, Rc, Rd, Re, Rf, Rg<sub>1</sub>, and Rg<sub>2</sub>) in the roots of American ginseng (*P. quinquefolium*). Ma et al.<sup>[26]</sup> found that total ginsenosides (Rb<sub>1</sub>, Rb<sub>2</sub>, Rc, Rd, Re,

Thomas, S.C. Li, Ph.D., is a Research Scientist at Agriculture and Agri-Food Canada, Pacific Agri-Food Research Center, Summerland, British Columbia, Canada.

Rf, and Rg<sub>1</sub>) extracted from *P. quinquefolium* root ranged from 1.26% to 8.60%. These compounds also exist in leaves<sup>[27,28]</sup> and berries (Li, unpublished data). In addition to saponins, ginseng contains a high-molecular-weight polysaccharide and many other phytochemicals, including phytosterols, oils, acids, carbohydrates, flavonoids, nitrogen-containing compounds, vitamins A and B<sub>12</sub>, and inorganics.<sup>[29,30]</sup> There are many chemical components, ranging from organic acids, such as maltol (3-hydroxyl-2-methyl-r-pyrone), to glucose, sodium, magnesium, peptidoglycans, and volatile oils.

It was reported that new C<sub>17</sub>- and C<sub>18</sub>-polyacetylenes and two known polyacetylenes, ginsenoyne G and acetylpanxydol, were isolated from dry ginseng roots.<sup>[31,32]</sup> Recently, phytosterols were extracted from American ginseng seed oil,<sup>[29]</sup> which can be used in the manufacture of dietary supplements, or as supplemental ingredients in foods. These sterols can be used to reduce serum cholesterol and low-density-lipid cholesterol levels in normal and mildly hypercholesteremic subjects.<sup>[33]</sup>

## NUTRITIONAL AND MEDICINAL VALUES

American ginseng is a much favored herb, used regularly by millions of healthy people to stimulate and maintain energy levels and achieve a sense of well-being. It was reported that ginseng may be able to help maintain metabolic balance by eliciting a homeostatic effect,<sup>[34]</sup> which may not be effective in the absence of stress, but can return the body processes to normal when there is stress or damage irrespective of the source.<sup>[35]</sup> Yuan and Dey<sup>[36]</sup> conducted a study on the multiple clinical effects of American ginseng on patients with stomach cramps, loss of appetite and weight, hypertension, insomnia, and irregular menstrual cycles. They found that all patients were cured after taking a daily dose of 2 g of American ginseng for 2 weeks.

### Antioxidant Activity (Preclinical)

Extracts of ginsenoside have demonstrated the antioxidant properties of American ginseng. The extracts have been reported to exhibit effective antioxidant activity in lipid and aqueous media by both chelation of metal ions and scavenging of free radicals.<sup>[37]</sup> Ginseng extracts, specifically Rb<sub>1</sub> and Rb<sub>2</sub>, protected human low-density lipoprotein against cupric ion-mediated oxidation. Similar activity was observed against peroxyl radical-induced supercoiled DNA breakage.<sup>[38]</sup>

## Effect on Metabolism (Preclinical and Clinical)

Ginseng is able to lower cholesterol levels in the blood by stimulating either cholesterol transport or an enzyme involved in cholesterol metabolism.<sup>[39]</sup> The decrease may also be due to an increased conversion of cholesterol into bile acids and/or the direct excretion of cholesterol.<sup>[40]</sup>

The effects of saponins and monomer saponins from American ginseng on lipid metabolism were evaluated recently. It was found that at 0.5 mg/L, saponins inhibited the activity of pancreatic lipase by 90%, while at 0.5 mg/ml, ginsenosides Rc, Rb<sub>1</sub>, and Rb<sub>2</sub> prevented it by 100%, 96%, and 97%, respectively. This finding suggests the potential use of saponins as drugs for antiobesity.<sup>[41]</sup> In an evaluation of antihyperglycemic effects of American ginseng berry extracts in diabetic ob/ob mice, Xie et al.<sup>[42]</sup> reported that the extract may prove to be of clinical importance in the prevention and treatment of Type 2 diabetes. Reductions in fasting blood glucose and prolonged elevation of postprandial glycemia (PPG) are important in blood sugar control following meals. Vuksan et al.<sup>[20]</sup> reported that in a placebo study of 10 men and women with Type 2 diabetes, the participants were randomly administered 0, 3, 6, or 9 g of American ginseng root powder 120, 80, 40, or 0 min before a 25 g oral glucose challenge. They concluded that 3 g of ginseng powder administered within 2 hr of the challenge may be sufficient to achieve reductions of PPG in Type 2 diabetic individuals.

### Effect on Memory (Preclinical)

It was reported that ginsenoside Rb<sub>1</sub> could improve memory deficits induced by anticholinergic drug treatment and facilitate acetylcholine release from rat brain hippocampal slices.<sup>[43]</sup> This specific effect of Rb<sub>1</sub> on cholinergic functions may warrant its further study for enhancing short-term memory acquisition and retention in senile dementia.<sup>[44]</sup> It was stated that many patients with amyotrophic lateral sclerosis used natural or traditional therapies of proven benefit. One such therapy is American ginseng root. It improved learning ability and memory in mice.<sup>[45]</sup>

### Effects on Stress and Fatigue (Preclinical)

The effects of ginseng on stress and fatigue have been expounded by Chinese herbalists for millennia. It is well known for its antistress and adaptogenic properties, but only recently have these effects been scientifically examined. Ginseng is traditionally reputed to regularize bodily functions and relieve many ailments resulting from physiological stress. Beneficial effects are thought to be due to a nonspecific influence on

production and use of regulatory hormones. Various compounds in ginseng have been shown to increase nonspecific resistance to physical, chemical, and biological stresses, and relieve fatigue.<sup>[46]</sup> Some of the manifestations include a decrease in body temperature, relaxation of muscle tone, and analgesia.<sup>[17]</sup> Awang<sup>[4]</sup> indicated that the pharmacological profile of American ginseng supported the treatment of stress-related conditions in humans.

### Effect on the Immune System (Preclinical)

Ginseng saponin can act as an immune stimulant or a supportive agent,<sup>[47]</sup> although the mechanisms by which these saponin compounds exert their immunostimulant effects are not well understood. It was reported that ginseng is able to act prophylactically as an anti-inflammatory agent in humans. Ginseng is also able to increase antibody levels, stimulate natural killer cells and the release of the chemical messenger, interferon, which can activate the immune system.<sup>[48]</sup> An aqueous extract, mainly oligosaccharides and polysaccharides from American ginseng, showed immunomodulating activities in vitro, which may be used clinically for the modulation of immune responses in humans.<sup>[49]</sup>

### Effect on Cancer (Preclinical and Clinical)

Potentially significant research has demonstrated recently that ginseng has an inhibitory effect on cancer development. It was suggested that ginseng should be recognized as a functional food for cancer prevention.<sup>[15]</sup> In a case-control study at the Korea Cancer Center Hospital, Yun and Choi<sup>[16]</sup> reported, without mentioning the mechanisms involved, that the risk of oral, pharyngeal, stomach, and liver cancers associated with smoking was reduced with ginseng intake. It is believed that ginseng exhibits a toxic effect against cancer cells by inhibiting the biosynthesis of macromolecules.<sup>[17]</sup> In vitro use of American ginseng and the breast cancer therapeutic agent, estradiol, has been reported to synergistically inhibit cancer cell growth.<sup>[50]</sup> In a study of the antiproliferative activity of ginsenosides using human prostate carcinoma LNCaP cell line, ginsenoside Rg<sub>3</sub> displayed growth inhibitory activity.<sup>[51]</sup>

Many in vitro studies have been conducted recently on the effects of saponins extracted from ginseng on cancer cells,<sup>[52]</sup> and the results indicated that it can inhibit cancer cell proliferation and invasion, usually at 10–180 μM.<sup>[53]</sup> Animal studies have also been conducted on the antitumor effect of saponins, which can decrease tumor growth and metastasis and improve survival.<sup>[54–56]</sup> Oral administration of crude

ginseng extracts, at 50–500 mg/kg body weight, for 10 days significantly reduced tumor growth in melanoma- and sarcoma-bearing mice.<sup>[57]</sup> Jia et al.<sup>[58]</sup> did an intracranial glioma rat model study with a specially formulated ginseng product Careseng<sup>®</sup>, containing over 80% of Rh<sub>2</sub> and Rh<sub>2</sub>-like ginsenosides, against breast, prostate, lung, pancreatic, and brain cancer cell lines in vitro. It was concluded that Careseng<sup>®</sup> has provocative and novel anticancer properties.

A few studies have been conducted with humans using ginseng extracts in China.<sup>[59,60]</sup>

### SAFETY AND POSSIBLE INTERACTION WITH PRESCRIPTION DRUGS

Ginseng has been used by humans for decades, which is a good indication of the safety of this unique herb. Brekhman and Dardymov<sup>[61]</sup> reported that the LD<sub>50</sub> for ginseng ranges from 10 to 30 g/kg body weight in mice. Correct oral ingestion of American ginseng is considered safe.<sup>[62,63]</sup> Daily doses of 0.25–0.5 g and 0.4–0.8 g of dried root were recommended for young and elderly people, respectively.<sup>[64]</sup> Higher levels have been associated with insomnia.<sup>[65]</sup> Siegel<sup>[66]</sup> suggested avoidance of large doses because of possible side effects, e.g., morning diarrhea, skin eruptions, sleeplessness, nervousness, hypertension, euphoria, and edema.<sup>[21]</sup> There are no standards or guidelines set by the National Institute for Occupational Safety and Health (NIOSH or OSHA) for occupational exposure to, or workplace maximum allowable levels of, ginseng ([http://www.ntp-server.niehs.nih.gov/htdocs/chem\\_Background/ExecSumm/Ginseng/](http://www.ntp-server.niehs.nih.gov/htdocs/chem_Background/ExecSumm/Ginseng/)) (accessed March 2004). Ginseng was not on the American Conference of Governmental Industrial Hygienists (ACGIH) list of compounds for which recommendations for a threshold limit value (TLV) or biological exposure index (BEI) are made. The Dietary Supplement Health and Education Act (DSHEA) requires no proof of safety for dietary supplements on the market prior to October 15, 1994, which includes ginseng, since its products have been available for over 30 yr (<http://www.quackwatch.org/02consumerProtection/dshea.html>) (accessed in March 2004).

### Interactions with Drugs

American ginseng can lower blood glucose.<sup>[66]</sup> Theoretically, concomitant use with antidiabetes drugs might enhance blood glucose lowering effects and possibly cause hypoglycemia. It was reported that American ginseng can interfere with antipsychotic and stimulant drugs, and hormone therapy,<sup>[67]</sup> monoamine oxidase inhibitors, and warfarin.<sup>[68,69]</sup>

### Interactions with Food

It has been shared that concomitant use of ginseng can potentiate the stimulant effect of coffee and tea.<sup>[70]</sup> It may also be important to take ginseng with a meal to avoid a hypoglycemic reaction, especially in patients with Type 2 diabetes.<sup>[66]</sup>

### Interactions with Diseases or Conditions

American ginseng has been reported to decrease blood coagulation and adversely affect cardiac conditions,<sup>[14]</sup> increase the risk of hypoglycemic episodes,<sup>[66]</sup> and have estrogenic effects.<sup>[71]</sup>

### QUALITY CONTROL AND REGULATORY STATUS

Quality control of any herbal product is a very important step. This will build up consumer confidence and make the herbal industry sustainable. There are many ginseng products, such as whole or sliced roots, capsules, tablets, teas, liquid extracts, soft gels, cigarettes, chewing gum, candies, and wine, available in the North American market. Consumers have been purchasing ginseng in its various forms for health benefits. However, researchers have long suspected that some of the products claiming to contain ginseng may be misbranded, mislabeled, and/or adulterated.<sup>[72]</sup> In addition, pesticide residues are a major concern due to their great potential of harming humans. To address the seriousness of pesticide abuse in ginseng farms, both the American and the Canadian governments have established a regulation, which allows only registered pesticides to be applied a set number of days before harvest.

International trade in American ginseng is regulated under the provisions of Conventions on International Trade in Endangered Species (CITES), which regulates trade through permit requirements for imports, exports, and re-exports of listed species.

### REFERENCES

1. Evans, B.L. Root of Chinese–Canadian relations. *Can. Hist. Rev.* **1985**, *LXVI*, 1–26.
2. Higby, G. Early history of American ginseng. *Apothecary's Cabinet* **2002**, *Fall* (5), 1–6.
3. Unpublished data.
4. Awang, D.V.C. The anti-stress potential of North American ginseng (*Panax quinquefolius* L.). *J. Herbs, Spices Med. Plants* **1998**, *6*, 87–91.
5. Taylor, D. Getting to the root of ginseng: questions about the herb's health benefits haven't cooled the red-hot market in wild American ginseng. *Smithsonian* **2002**, *33*, 1–5.
6. Liu, C.X.; Xiao, P.G. Recent advances on ginseng research in China. *J. Ethnopharmacol.* **1992**, *36*, 27–38.
7. Kim, Y.R.; Lee, S.Y.; Shin, B.A.; Kim, K.M. *Panax ginseng* blocks morphine-induced thymic apoptosis by lowering plasma corticosterone level. *Gen. Pharmacol.* **1999**, *32*, 647–652.
8. Assinewe, V.A.; Arnason, J.T.; Aubry, A.; Mullin, J.; Lemaire, I. Extractable polysaccharides of *Panax quinquefolius* L. *Phytomedicine* **2002**, *9*, 398–404.
9. Lin, J.H.; Wu, L.S.; Tsai, K.T. Effects of ginseng on the blood chemistry profile of dexamethasone-treated male rats. *Am. J. Chin. Med.* **1995**, *23*, 167–172.
10. Murphy, L.L.; Cadena, R.S.; Chavez, D.; Ferraro, J.S. Effect of American ginseng (*Panax quinquefolium*) on male copulatory behavior in the rat. *Physiol. Behav.* **1998**, *64*, 445–450.
11. Salim, K.N.; McEwen, B.S.; Chao, H. Ginsenoside Rb<sub>1</sub> regulates ChAT, NGF and trkA, mRNA expression in the rat brain. *Brain Res. Mol. Brain Res.* **1997**, *47*, 177–182.
12. Yuan, C.S.; Wu, J.A.; Lowell, T.; Gu, M. Gut and brain effects of American ginseng root on brainstem neuronal activities in rats. *Am. J. Chin. Med.* **1998**, *26*, 47–55.
13. Yoshikawa, M.; Murakami, T.; Yashiro, K. Bioactive saponins and glycosides, XI: structures of new dammarane-type triterpene oligoglycosides, quinquenosides I, II, III, IV, and V, from American ginseng roots of *Panax quinquefolium* L. *Chem. Pharm. Bull.* **1998**, *46*, 647–654.
14. Assinewe, V.A.; Baum, B.R.; Gagnon, D.; Arnason, J.T. Phytochemistry of wild populations of *Panax quinquefolius* L. (North American ginseng). *J. Agric. Food Chem.* **2003**, *51*, 4549–4553.
15. You, J.S.; Hou, D.M.; Chen, K.T.; Huang, H.F. Combined effects of ginseng and radiotherapy on experimental liver cancer. *Phytother. Res.* **1995**, *9*, 331–335.
16. Yun, T.K.; Choi, S.Y. Preventive effect of ginseng intake against various human cancers: a case-control study on 1987 pairs. *Cancer Epidemiol. Biomarkers Prev.* **1995**, *4*, 401–408.
17. Hikino, H. Traditional remedies and modern assessment: the case of ginseng. In *The Medicinal Plant Industry*; Wijesedera, R.O.B., Ed.; CRC Press: London, 1991.
18. Vogler, B.K.; Pittler, M.H.; Ernst, E. The efficacy of ginseng. A systematic review of randomised

- clinical trials. *Eur. J. Clin. Pharmacol.* **1999**, *55*, 567–575.
19. Scaglione, F.; Weiser, K.; Alessandria, M. Effects of the standardised ginseng extract G115 in patients with chronic bronchitis. A nonblinded, randomised comparative pilot study. *Clin. Drug Invest.* **2001**, *21*, 41–45.
  20. Vuksan, V.; Stavro, M.P.; Sievenpiper, J.L.; Beljan-Zdravkovic, U.; Letter, I.A.; Josse, R.G.; Xu, Z. American ginseng helps maintain blood sugar levels in type 2 diabetes. *Diabetes Care* **2000**, *23*, 1221–1226.
  21. Court, W.E. *Ginseng, The Genus Panax*; Harwood Academic Publ.: PA, U.S.A., 2000.
  22. Shibata, S.; Tanaka, O.; Shoji, J.; Saito, H. Chemistry and pharmacology of *Panax*. In *Economic and Medicinal Plant Research*, 1st Ed.; Wagner, H., Hikino, H., Norman, R., Eds.; Academic Press: Tokyo, 1985.
  23. Li, T.S.C. Asian and American ginseng—a review. *HortTechnology* **1995**, *5*, 27–34.
  24. Li, T.S.C.; Wang, L.C.H. Physiological components and health effects of ginseng, Echinacea, and Sea buckthorn. In *Functional Foods—Biochemical and Processing Aspects*; Mazza, G., Ed.; Technomic Publ. Co. Inc.: Lancaster, PA, 1998; 329–356.
  25. Soldati, F.; Sticher, O. HPLC separation and quantitative determination of ginsenosides from *Panax ginseng*, *Panax quinquefolium* and from ginseng drug preparations. *Planta Med.* **1980**, *38*, 348–357.
  26. Ma, Y.C.; Zhu, J.; Benkrima, L.; Luo, M.; Sun, L.; Sain, S.; Kont, K.; Plaut-Carcasson, Y.Y. A comparative evaluation of ginsenosides in commercial ginseng products and tissue culture samples using HPLC. *J. Herbs, Spices Med. Plants* **1995**, *3*, 41–45.
  27. Starratt, A.N.; Hendel, J.G.; Reeleder, R.D. Leaves of North American ginseng, *Panax quinquefolius* L.: a renewable source of certain ginsenosides. *Can. J. Plant Sci.* **2001**, *81*, 65–67.
  28. Li, T.S.C.; Wardle, D. Seasonal fluctuations of leaf and root weight and ginsenoside contents of 2-, 3-, and 4-year-old American ginseng plants. *HortTechnology* **2002**, *12*, 229–232.
  29. Beveridge, T.H.J.; Li, T.S.C.; Drover, J.C.G. Phytosterol content in American ginseng seed oil. *J. Agric. Food Chem.* **2002**, *50*, 744–750.
  30. Choi, K.T. *Panax ginseng* C.A. Meyer: micropropagation and the in vitro production of saponins. In *Medicinal and Aromatic Plant. I. Biotechnology in Agriculture and Forestry*; Bajaj, Y.P.S., Ed.; 1988; 484–500.
  31. Hirakura, K.; Morita, M.; Nakajima, K.; Ikeya, Y.; Mitsuhashi, H. Three acetylated polyacetylenes from the roots of *Panax ginseng*. *Phytochemistry* **1991**, *30*, 4053–4055.
  32. Ahn, B.Z.; Kim, S.I.; Lee, Y.H. Acetylpanaxydol and panaxydolchloroahydrin, two new poleyns from Korean ginseng with cytotoxic activity against L1210 cells. *Arch. Pharm.* **1989**, *322*, 223–226.
  33. Hetherington, M.; Steek, W. Phytosterols from Canadian plants: uses and sources. *Can. Chem. News* **1999**, May 20–21.
  34. Lewis, W.H. Ginseng: a medical enigma. In *Plants in Indigenous Medicine and Diet Biobehavioral Approaches*; Etkin, N.L., Ed.; Redgrave Publ. Co.: New York, 1988; 290–308.
  35. Fulder, S. Ginseng: useless root or subtle medicine? *New Sci.* **1977**, *20*, 158–159.
  36. Yuan, C.S.; Dey, L. Multiple effects of American ginseng in clinical medicine. *Am. J. Chin. Med.* **2001**, *29*, 567–569.
  37. Kitts, D.D.; Wijewickreme, A.N.; Hu, C. Antioxidant properties of a North American ginseng extract. *Mol. Cell. Biochem.* **2000**, *203*, 1–10.
  38. Hu, C.; Kitts, D.D. Free radical scavenging capacity as related to antioxidant activity and ginsenoside composition of Asian and North American ginseng extract. *J. Am. Oil Chem. Soc.* **2001**, *78*, 249–255.
  39. Kao, J.H. The effect of ginseng saponin on the development of experimental atherosclerosis. *Hanyang Uidae Haksulchi* **1983**, *3*, 273–276.
  40. Yamamoto, M.Y.; Uemura, T.; Nakama, S.; Uemiya, M.; Kumagai, A. Serum HDL-cholesterol-increasing and fatty liver improving actions of *Panax ginseng* in high cholesterol diet-fed rats with clinical effect of hyperlipidemia in man. *Am. J. Clin. Med.* **1983**, *11*, 96–100.
  41. Zhang, J.; Zheng, Y.N.; Li, X.G.; Han, L.K. Effects of saponins from *Panax quinquefolium* L. On the metabolism of lipid. *J. Jilin Agric. Univ.* **2002**, *24* (62–63), 87.
  42. Xie, J.T.; Aung, H.H.; Wu, J.A.; Atlele, A.S.; Yuam, C.S. Effects of American ginseng berry extract on blood glucose levels in ob/ob mice. *Am. J. Chin. Med.* **2002**, *30*, 187–194.
  43. Benishin, C.G.; Lee, R.; Wang, L.C.H.; Liu, H.J. Effects of ginsenoside Rb<sub>1</sub> on central cholinergic metabolism. *Pharmacology* **1991**, *42*, 223–229.
  44. Wang, L.C.H. The effect of ginsenoside Rb<sub>1</sub>. Proceedings of the Prairie Medicinal and Aromatic Plants Conference, Alberta Agriculture, Food and Rural Development: Olds, Alta., Canada, 1996; 103–106.
  45. Jiang, F.; DeSilva, S.; Turnbull, J. Beneficial effect of ginseng root in SOD-1 (G93A) transgenic mice. *J. Neurol. Sci.* **2000**, *180*, 52–54.



46. Tsung, S.L.; Chen, C.; Tang, S. The sedative, fatigue relieving and temperature stress-combating effect of *Panax ginseng*. *Acta Physiol. Sin.* **1964**, *27*, 324–328.
47. Boik, J. *Natural Compounds in Cancer Therapy*; Oregon Medical Press: Princeton, MA, 2001.
48. Wang, B.X.; Cui, J.C.; Liu, A.J. The effects of polysaccharides of roots of *Panax ginseng* on the immune function. *Yaoxue Xuebao* **1982**, *17*, 66–67.
49. Wang, M.Q.; Guilbert, L.J.; Ling, L.; Li, J.; Wu, Y.; Xu, S.; Pang, P.; Shan, J.J. Immunomodulating activity of CVT-E002, a proprietary extract from North American ginseng (*Panax quinquefolium*). *J. Pharm. Pharmacol.* **2001**, *53*, 1515–1523.
50. Duda, R.B.; Zhong, Y.; Navas, V.; Li, M.; Toy, B.R.; Alavarez, J.G. American ginseng and breast cancer therapeutic agents synergistically inhibit MCF-7 breast cancer cell growth. *J. Surg. Oncol.* **1999**, *72*, 230–239.
51. Liu, W.K.; Xu, S.X.; Che, C.T. Anti-proliferative effect of ginseng saponins on human prostate cancer cell line. *Life Sci.* **2000**, *67*, 1297–1306.
52. Duda, R.B.; Zhong, Y.; Navas, V. American ginseng and breast cancer therapeutic agents synergistically inhibit MCF-7 breast cancer cell growth. *J. Surg. Oncol.* **1999**, *72*, 230–239.
53. Boik, J. *Natural Compounds in Cancer Therapy*; Oregon Medical Press: MN, U.S.A., 2001.
54. Hasegawa, H.; Uchiyama, M. Antimetastatic efficacy of orally administered ginsenoside Rb<sub>1</sub> in dependence on intestinal bacterial hydrolyzing potential and significance of treatment with an active bacterial metabolite. *Planta Med.* **1998**, *64*, 696–700.
55. Nakata, H.; Kikuchi, Y.; Tode, T. Inhibitory effects of ginsenoside Rh<sub>2</sub> on tumor growth in nude mice bearing human ovarian cancer cells. *Jpn. J. Cancer Res.* **1998**, *89*, 733–740.
56. Wakabayashi, C.; Hasegawa, H.; Murata, J.; Saiki, I. In vivo antimetastatic action of ginseng protopanaxadiol saponins is based on their intestinal bacterial metabolites after oral administration. *Oncol. Res.* **1997**, *9*, 411–417.
57. Chen, X.; Liu, H.; Lei, X. Cancer chemopreventive and therapeutic activities of red ginseng. *J. Ethnopharmacol.* **1998**, *60*, 71–78.
58. Jia, W.; Yan, H.; Bu, X.; Liu, G. Anti cancer pharmacology of careseng, a natural product of ginseng. Proceedings of the American Society of Clinical Oncology Annual Meeting, Chicago, IL, May 31–June 3, abstract no. 3571, 2003; p. 888.
59. Kakizoe, T. Asian studies of cancer chemoprevention, latest clinical results. *Eur. J. Cancer* **2000**, *36*, 1303–1309.
60. Yang, G.; Yu, Y. Effects of ginsenoside on the natural killer cell–interferon–interleukin-2 regulatory network and its tumor inhibiting effect. *J. Tradit. Chin. Med.* **1988**, *8*, 135–140.
61. Brekhman, I.I.; Dardymov, I.V. New substances of plant origin which increase nonspecific resistance. *Ann. Rev. Pharmacol.* **1969**, *9*, 419–430.
62. Lyon, M.R.; Cline, J.C. Effect of herbal extract combination *Panax quinquefolium* and *Ginkgo biloba* on attention–deficit hyperactivity disorder: a pilot study. *J. Psychiatr. Neurosci.* **2001**, *26*, 221–228.
63. McGuffin, M. *Botanical Safety Handbook*; CRC Press: Boston, 1997.
64. Newall, C.A.; Anderson, L.A.; Philpson, J.D. *Herbal Medicine: A Guide for Healthcare Professionals*; The Pharmaceutical Press: London, U.K., 1996.
65. Brown, R. Potential interactions of herbal medicines with antipsychotics, antidepressants and hypnotics. *Eur. J. Herbal Med.* **1997**, *3*, 25–28.
66. Siegel, R.K. Ginseng abuse syndrome, problems with the panacea. *J. Am. Med. Assoc.* **1979**, *241*, 1614–1615.
67. Vuksan, V.; Sievenpiper, J.L.; Vernon, Y.; Koo, Y.; Francis, T.; Beljan-Zdravkovic, U.; Zheny, X.; Vidgen, E. American ginseng (*Panax quinquefolius* L.) Reduces postprandial glycemia in nondiabetic subjects and subjects with type 2 diabetes mellitus. *Arch. Intern. Med.* **2002**, *160*, 1009–1013.
68. Jones, B.D.; Runikis, A.M. Interaction of ginseng with phenelzine. *J. Clin. Psychopharmacol.* **1987**, *7*, 201–202.
69. Janetzky, K. Probable interaction between warfarin and ginseng. *Am. J. Health Syst. Pharm.* **1997**, *54*, 692–693.
70. Newall, C.A.; Anderson, L.A.; Philpson, J.D. *Herbal Medicine: A Guide for Healthcare Professionals*; The Pharmaceutical Press: London, 1996.
71. Amato, P.; Christophe, S.; Mellon, P.L. Estrogenic activity of herbs commonly used as remedies for menopausal symptoms. *Menopause* **2002**, *9*, 145–150.
72. Hall, T.; Lu, Z.; Yat, P.N.; Fitzloff, J.F.; Arnason, J.T.; Awang, D.V.C.; Fung, H.H.S.; Blumenthal, M. An introduction to the ginseng evaluation program. *HerbalGram* **2001**, *52*, 27–30.

# Ginseng, Asian (*Panax ginseng*)

Fabio Soldati

Pharmaton SA, Head of Research and Development, Bioggio, Switzerland

## INTRODUCTION

*Panax ginseng* is one of the most investigated medicinal plants and is cultivated in China and Korea. In the Eastern world, ginseng roots have been used for more than 2000 yr as a tonic and a prophylactic to combat psychophysical tiredness and asthenia. The plant contains more than 200 identified chemical compounds, and among them ginsenosides are considered some of the most pharmacologically important constituents and characteristic markers. The United States Pharmacopeia–National Formulary (USP–NF) describes its attributes. Consistent efficacy and safety require constantly uniform composition, a condition which the raw material (roots) can scarcely fulfill. Standardization is the prerequisite for a constant pharmacological answer. High-performance liquid chromatography (HPLC) methods were developed for the quantification of ginsenosides. Numerous pharmacological studies have been performed on *P. ginseng* roots and extracts. Among other activities, the following are relevant: free radical scavenging effect, immunological effects, action on the central nervous system, and metabolic effects. These studies show not only the activity but also demonstrate that there is a certain relation between dose and response. Moreover, some experiments reveal that by increasing the dose of the extracts or the ginsenosides beyond certain limits, the desired pharmacological effects are reversed. This could explain the sometimes controversial results observed for the *P. ginseng* activity. The ginsenosides are considered prodrugs, and in the acidic medium of the stomach are immediately hydrolyzed; further metabolism occurs in the intestine. In humans, the hydrolysis products were detected in plasma and urine after oral administration.

Toxicological studies (acute, subacute, and chronic toxicity, teratogenic activity) performed in mice, rats, rabbits, pigs, and dogs, and mutagenicity tests (Ames, DNA-repair, mouse-bone micronucleus, chromosomal aberration in human lymphocytes), as well as the safety assessment on the cardiovascular and hormone system,

demonstrate that a standardized *P. ginseng* extract has a very large therapeutic index.

Clinical experiments have shown major activity, particularly in the central nervous system (cognitive function) and on the immune system (stimulation of natural killer (NK) cells, antibody titer, and antiviral activity), but the results of the metabolic effect on physical endurance are controversial. The therapeutic dose of the dried roots is 0.5–2.0 g, and doses of extracts should be calculated accordingly. No contraindications are known. Data from clinical trials suggest that the incidence of adverse side effects with *P. ginseng* preparations is rare. In animals, no effect on fetal development has been observed; but since no human data are available, ginseng should not be used during pregnancy or lactation.

The indications of *P. ginseng* root and standardized extracts supported by clinical data are for the enhancement of mental and physical capacities, and increased resistance against infections, in cases of weakness, exhaustion, tiredness, loss of concentration, and during convalescence. In traditional medicine, it is also used in the treatment of impotence and prevention of hepatotoxicity.

## BACKGROUND

### *Panax ginseng* C.A. Meyer

Vernacular names: Asian, Chinese, Korean, or Oriental ginseng. *P. ginseng* C.A. Meyer; Chinese, Korean, Asian, or Oriental ginseng. This species is a member of the plant family Araliaceae and is widely cultivated in China and Korea. Methods of cultivation, botanical characteristics, and authentication of this medicinal plant have been extensively described.<sup>[1,2]</sup>

### The *Panax ginseng* Root

The ginseng root (described in detail in the USP–NF monograph) is among the most important traditional Chinese medicines. It has been used in China since antiquity to combat fatigue and weakness. The earliest known mention of ginseng in Europe goes back to 1711 when a Jesuit, Father Jartoux, who worked in Chinese missions, sent a letter to the general procurator in Paris,

Fabio Soldati, Ph.D., is at Pharmaton SA, Head of Research and Development, Bioggio, Switzerland.

describing this plant, which he had never seen before, as having immense therapeutic properties. The ginseng plant then remained practically unknown to the scientific Western world until the early 1960s when researchers started to investigate its pharmacological and therapeutic properties. One of the major difficulties was the lack of demonstration of its healing power following protocols accepted by Western medicine, especially since ginseng is not considered to be part of it.<sup>[4]</sup>

Currently, more than 4600 publications on ginseng are referenced in the chemical abstracts. Radix ginseng has been used traditionally in China for the enhancement of mental and physical performance, in case of weakness, exhaustion, tiredness, and during convalescence.<sup>[5]</sup>

## CHEMISTRY AND PREPARATION OF PRODUCTS

### Source Materials

The USP–NF gives a detailed description of the botanical and chemical characteristics as well as the purity criteria of the root in the monograph on Asian ginseng.<sup>[3]</sup>

### Proposed Active Constituents

So far, approximately 200 substances have been isolated and characterized from *P. ginseng*, both from primary and secondary metabolism of the plant. These include 30 ginsenosides, 40 ether-soluble compounds, eight nitrogen-containing compounds, 32 volatile compounds, 13 carbohydrates/polysaccharides, 9 glycans, 56 lipids and fatty acids, and 9 trace elements. The ginsenosides are characteristic substances of ginseng. They are commonly used as chromatographic “markers” in the assessment of chemical content and quality control of ginseng roots. They exert pharmacological activities [free radical scavengers and release of nitric oxide (NO)], but they are not solely responsible for the activities of *P. ginseng*, such as the immunological effects, free radical scavenging effects, action on the central nervous system, and metabolic effects.<sup>[4]</sup>

The ginsenosides are triterpene saponins of the dammarane type, which are derivatives of either protopanaxadiol or protopanaxatriol. Their structures were elucidated by Prof. S. Shibata and Prof. O. Tanaka at the Tokyo university and University of Hiroshima. Examples of protopanaxadiol saponins are ginsenosides Ra<sub>1</sub>, Ra<sub>2</sub>, Ra<sub>3</sub>; Rb<sub>1</sub>, Rb<sub>2</sub>, Rb<sub>3</sub>; Rc and Rd, and malonyl-ginsenosides Rb<sub>1</sub>, Rb<sub>2</sub>, Rc and Rd. Examples of protopanaxatriol saponins are ginsenosides Re, Rf;

20-gluco-ginsenosides Rf, Rg<sub>1</sub>, Rg<sub>2</sub>, and Rh<sub>1</sub>. Ginsenoside Ro is a derivative of oleanolic acid.

The most important of the ginsenosides are considered to be Rb<sub>1</sub>, Rb<sub>2</sub>, Rc, Rd, Re, Rf, Rg<sub>1</sub>, and Rg<sub>2</sub>, with Rb<sub>1</sub>, Rb<sub>2</sub>, Re, and Rg<sub>1</sub> being the most abundant. The total ginsenoside content of a 6-yr-old main root varies between 0.7% and 3%. The lateral roots can contain two to three times more saponins than the main root, while the slender roots can even contain up to 10 times more.<sup>[5]</sup>

### Formulation and Analysis

HPLC methods developed for the quantification of ginsenosides contained in the roots and in the finished products<sup>[6]</sup> are also included in the U.S. Pharmacopoeia and European Pharmacopoeia for the definition of *P. ginseng* roots and *P. ginseng* extracts.

Crude plant materials, powdered herbal drug, and extracts are used in tablets, hard and soft capsules, effervescent tablets, lozenges, and liquid preparations.

The development from a medicinal plant to a phyto-medicine is a long process. In fact, in 1980, analysis of the content of ginsenosides in different products on the market purported to contain roots of *P. ginseng* showed considerable variation from one batch to another of the same product, with none being detected in one product labeled as containing pure *P. ginseng*.<sup>[5]</sup>

The variety of ginseng and the methods of cultivation are very important. There are various species of ginseng that, from a morphological point of view, are similar, but as far as their content of substances is concerned they are not identical. Also, the method of preparation of the roots and their drying procedure can differ considerably. In the Far East, the roots (which in nature are white) are sometimes treated with steam at about 100°C for differing times in order to protect them from microbiological pathogens. This high-temperature treatment results in the reddening of the epidermis of the roots producing the so-called “red ginseng.” Thus, the red ginseng is simply white ginseng, modified by heat treatment. Not only are the sugars in the epidermis of the root caramelized by the heating, but the ginsenosides are also partially chemically modified and/or destroyed.<sup>[7]</sup> In addition, the distribution of the ginsenosides is different in the various parts of the plant, both in total content and in the relative ratio of the different ginsenosides.

In 1984, in cooperation with Prof. O. Tanaka from the University of Hiroshima, we documented a relationship between the age of the plant and the content of ginsenosides. The major development of the roots occurs between the fourth and fifth year of growth, during which time the root doubles its weight, and the optimum yield of ginsenosides occurs at the fifth

year.<sup>[8]</sup> China is the largest producer, but the average yield of ginseng per acre is only two-thirds of what could be reasonably expected, due almost entirely to diseases that attack the crop. Fungal diseases like *Alternaria panax*, *Fusarium* spp., *Phytophthora cactorum*, and *Cylindrocarpon destructans* can devastate ginseng crops. A 5 yr growth span, of course, implies the use of insecticides and pesticides, but thanks to the implementation of controls in the country of origin, and information provided to the farmers (selective and rational use of pesticides), it is possible to lower the pesticide concentrations to safe levels.

As mentioned above, the roots of wild *P. ginseng* are not uniform in their content of ginsenosides (markers and active ingredients of the plant) and the content of pesticides can be too high in some cases, making them unsuitable for the production of pharmaceutical products. Therefore, the use of cultivated plants (with a rational use of pesticides) and standardized extraction methods is basic to ensuring the uniformity of an extract and thus its consistent pharmacological and toxicological effects.

The USP gives a detailed description of the quality of a standardized Asian ginseng extract: "Powdered Asian Ginseng Extract is prepared from Asian Ginseng by maceration, percolation, or both processes performed at room temperature with suitable solvents such as alcohol, methanol, water, or mixtures of these solvents, and by concentrating the fluid extract at temperatures below 50°. The ratio of the starting crude plant material to Powdered Extract is between 3 : 1 and 7 : 1. It contains not less than 3.0 per cent of ginsenosides Rg<sub>1</sub>, Re, Rb<sub>1</sub>, Rc, Rb<sub>2</sub>, and Rd combined, calculated on the anhydrous basis. It may contain other added substances." Moreover, the USP gives detailed information on the methods for identification [thin layer chromatography (TLC)] and content determination (HPLC) of the ginsenosides as well as limits for microbial contamination, water, pesticide residuals, heavy metals, organic volatile impurities, and alcohol content.<sup>[3]</sup>

## PRECLINICAL STUDIES

### Pharmacodynamic Properties

Numerous pharmacological studies have been performed on *P. ginseng* extracts. Among other activities, the following are relevant: free radical scavenging effects, immunological effects, action on the central nervous system, and metabolic effects. The exercise of such a range of pharmacological actions may be attributed to the fact that *P. ginseng* contains more than 200 different compounds that exert different activities. Depending on the method of extraction

and the solvents employed, different extracts can be obtained, which can exert varying pharmacological effects.<sup>[4]</sup> Some of the relevant results from over 4600 published papers are discussed below.

### Free Radical Scavenging Effects

Studies with hearts from rats exposed to hyperbaric oxygen (HBO) and to HBO after treatment with 10 mg/ml ginseng extract in their drinking water showed that ginseng prevents myocardial ischemia/reperfusion damage and the impairment of endothelial functionality induced by reactive oxygen species arising from HBO exposure. These effects may be attributed to antioxidant intervention. In experiments with perfused rabbit lungs, the extract inhibited vasoconstriction induced by the thromboxane analog U46619 or by acetylcholine after exposure to free radicals generated by electrolysis. This effect appears to be due to the release of NO from the pulmonary endothelium. The extract had activities superior to the pure ginsenosides.<sup>[10]</sup>

The extract of *P. ginseng* potentiated the relaxation induced by electrical stimulation or nicotine in monkey cerebral arterial strips denuded of the endothelium and partially contracted with prostaglandin F<sub>2</sub>α. The response to electrical stimulation was blocked by tetrodotoxin, whereas that to nicotine was suppressed by hexamethonium, while NG-nitro-L-arginine blocked both of these effects. Atropine, however, did not alter the potentiating effect of *P. ginseng* extract, and relaxations induced by exogenous NO were unaffected. The enhancement of the neurogenic response appears to be associated with increments in the synthesis or release of NO from the perivascular nerve. Blockage of muscarinic prejunctional inhibition, superoxide scavenging action, and phosphodiesterase inhibition is not involved.<sup>[11]</sup>

A crude and a standardized *P. ginseng* extract of different saponin compositions were tested as to their efficacy in reducing lipid peroxidation, inflammation, and release of myocellular proteins after eccentric contraction exercise on a rat treadmill. Plasma creatine kinase (CK) levels were significantly reduced by approximately 25% after ingestion of both extracts. The two extracts reduced lipid peroxidation by approximately 15% as measured by malondialdehyde levels. Beta-glucuronidase concentrations and glucose-6-phosphate dehydrogenase (G6PDH) levels, which can be considered as markers of inflammation, were also significantly decreased. The values of beta-glucuronidase were increased approximately 40% in vastus and in rectus muscles. The extracts appeared to be equally effective in reducing injuries and inflammation caused by eccentric muscle contractions.<sup>[12]</sup>

To clarify the relationship between the structures of ginsenosides and their properties, 11 individual ginsenosides, along with their core structures, protopanaxadiol, and protopanaxatriol, were used in 2,2'-azobis (2-amidinopropane hydrochloride) (AAPH)-induced hemolysis of human erythrocytes, a good experimental model to determine free radical-induced membrane damage and to evaluate the antioxidative or pro-oxidative activities of various antioxidants.<sup>[13]</sup> It was found that the core structures of ginsenosides, either protopanaxadiol or protopanaxatriol, play a pro-oxidative role in AAPH-induced hemolysis of erythrocytes. As to the individual ginsenosides, if there are no sugar moieties attached to the 20-position of the triterpene dammarane, the ginsenoside acts as a pro-oxidant, as with Rg<sub>3</sub>, Rh<sub>2</sub>, and Rg<sub>2</sub>. A glucose attached to the 6-position instead of the 20-position sugar moieties can make the ginsenoside an antioxidant, as with Rh<sub>1</sub>. The antioxidants among ginsenosides follow two different mechanisms that can be expressed mathematically by the Boltzmann equation, as is the case with Rc and Rb<sub>1</sub>, and a polynomial equation, as with Re, Rd, Rg<sub>1</sub>, Rb<sub>3</sub>, and Rh<sub>1</sub>. The orders of antioxidative ability are Rc > Rb<sub>1</sub> and Re > Rd > Rg<sub>1</sub> > Rb<sub>3</sub> > Rh<sub>1</sub>, respectively.<sup>[13]</sup>

### Immunological Effects

The effect of oral administration of a standardized ginseng extract to mice for four consecutive days (10 mg/day) on immune response was investigated. The extract enhanced antibody plaque forming cell response and circulating antibody titer against sheep erythrocytes. This finding was confirmed by oral administration of an extract with defined ginsenoside content to mice at doses of 10, 50, or 250 mg/kg body weight daily for 5–6 days, which resulted in enhanced immune responses in a battery of six *ex vivo* tests including primary and secondary immune responses against sheep red cells, natural killing activity, mitogen-induced proliferation, interferon production, and T-cell-mediated cytotoxicity.<sup>[14]</sup>

A standardized extract from ginseng roots and several fractions of the extract were found to possess anticomplement and mitogenic activities in mice spleen cell cultures, with the strongest anticomplement activity being observed in the crude polysaccharide fraction. The polysaccharide with the major anticomplement activity consisted of arabinose, galactose, and glucose, and small amounts of galacturonic acid, glucuronic acid, and rhamnose. Its molecular weight was estimated to be  $3.68 \times 10^5$  kDa.<sup>[46,50]</sup>

An acidic polysaccharide fraction containing galactose, arabinose, and uronic acids showed inhibition of *Helicobacter pylori*-induced hemagglutination with a

minimum inhibitory concentration of 250 µg/ml. Digestion of the fraction with pectinase resulted in a lower molecular weight oligosaccharide fraction, which was noninhibitory at a concentration of 4 mg/ml.<sup>[51]</sup>

A high output nitric oxide synthase (iNOS) was shown in mice administered intraperitoneally with the acidic polysaccharide from ginseng. Newly synthesized iNOS protein was also observed in peritoneal macrophages cultured with interferon-gamma and the acidic polysaccharide. Spleen cells from acidic polysaccharide-treated mice did not proliferate in response to concanavalin A, but responsiveness was restored by the cotreatment of NG-monomethyl-L-arginine (NMMA) with concanavalin A. The treatment of mice with aminoguanidine, a specific iNOS inhibitor, alleviated the acidic polysaccharide-induced suppression of antibody response to sheep red blood cells. Present results suggest that the immunomodulating activities of the acidic polysaccharide were mediated by the production of NO.<sup>[15]</sup>

Recently, it was demonstrated that *P. ginseng* extract and purified ginsenosides exert an adjuvant effect on the immune responses against porcine parvovirus, *Erysipelothrix rhusiopathie* and against *Staphylococcus aureus* in dairy cattle.<sup>[16]</sup>

### Action of the Central Nervous System

A study in rats using learning and memory retention tests and determination of <sup>14</sup>C-phenylalanine transport across the blood–brain barrier after oral administration of a standardized ginseng extract was undertaken.<sup>[17]</sup> Learning and memory retention improved (5 of 7 tests) after an oral dose of 20 mg extract/kg for 3 days, but remained unchanged or even decreased after an oral dose of 100 mg extract/kg for 3 days. The <sup>14</sup>C-phenylalanine transport across the blood–brain barrier increased after oral dosing of 30 mg extract/kg or 5 days.

Biochemical analysis of brain stem and brain cortex for concentration of monoamines and 3',5'-cyclic adenosine monophosphate (AMP) and for activity of phosphodiesterase and adenylate cyclase after intraperitoneal injection of the standardized ginseng extract was also studied. The phosphodiesterase activity remained unchanged after intraperitoneal (i.p.) treatment with 50 mg extract/kg for 5 days, while the adenylate cyclase activity (with or without NaF activation) was decreased after i.p. treatment with 30 and 200 mg extract/kg for 5 days, except in the case of 30 mg extract without NaF activation, where adenylate cyclase activity was increased. The 3',5'-Cyclic AMP concentration decreased after i.p. treatment with 200 mg extract/kg body weight intraperitoneally for 5 days. The i.p. treatment with 50 mg extract/kg for

5 days increased the dopamine and noradrenaline concentrations in brain stem, whereas the serotonin concentration was decreased in brain stem and increased in brain. These studies thus revealed the influence of ginseng extract on complex neurological processes such as learning and memory as well as on several aspects of brain metabolism.<sup>[17]</sup>

Using a two-way active avoidance with punishment (electric shock) reinforcement (shuttle box), the effects of a standardized ginseng extract were investigated on learning and memory in 2-, 10-, and 22-mo-old rats and in rats of the same age (5-mo old), which, after preliminary training with the same method, had been classified as “good,” “poor,” or “satisfactory” learners. In experiments on rats of different ages, the extract was administered orally daily for 10 consecutive days before training at increasing doses of 3, 10, 30, and 100 mg/kg. The animals were trained for 5 days, and the retention test was given 14 days after the last administration of the extract (10 days after the last training session). In experiments on rats with different learning capabilities, the extract was administered orally at a dose of 10 mg/kg for 10 days after shuttle box training. The retention test was performed on the day following the last treatment. It was found that the extract exerted the most favorable effects on learning and memory in cases where these processes had decayed as a result of either senescence or individual specificities.<sup>[18]</sup> When the same extract was administered orally at doses of 3, 10, 30, 100, and 300 mg/kg for 10 days to rats using the “shuttle-box” method for active avoidance, the most pronounced effect on learning and memory was obtained at the dose of 10 mg/kg. Using the “step-down” method for passive avoidance, the dose of 30 mg/kg significantly improved retention. In the staircase maze training with positive (alimentary) reinforcement test, only the dose of 10 mg/kg significantly improved learning and memory. The dose of 100 mg/kg greatly increased the locomotor activity of mice. These results show that ginseng at appropriate doses improves learning, memory, and physical capabilities. Bell-shaped dose–effect curves, reported with other nootropic drugs, were obtained.<sup>[18]</sup>

In a study designed to examine the cellular neurotrophic and neuroprotective actions of two pure ginsenosides in two-model systems, PC12 cells were grown in the absence or presence of nerve growth factor (NGF) as a positive control, and different concentrations of Rb<sub>1</sub> or Rg<sub>1</sub>. To assess neurotrophic properties, neurite outgrowth was quantified for representative fields of cells. After 8 days in culture, both ginsenosides enhanced neurite outgrowth in the presence of a suboptimal dose of (2 ng/ml) NGF, but did not significantly stimulate it in the absence of NGF. However, after 18 days in culture, both ginsenosides increased the outgrowth in the absence of NGF.

SN-K-SH cells were grown in the absence or presence of mitochondrial permeability transition pore (MPTP) or beta-amyloid to assess neuroprotection. Both Rb<sub>1</sub> and Rg<sub>1</sub> reversed MPTP-induced cell death. Beta-amyloid-induced cell death was not reversed by either ginsenoside, but Rg<sub>1</sub> produced a modest enhancement of cell death in this model. These results suggest that these two ginsenosides have neurotrophic and selective neuroprotective actions that may contribute to the purported enhancement of cognitive function.<sup>[19]</sup>

In addition, the cognition enhancing effects of ginsenosides Rb<sub>1</sub> and Rg<sub>1</sub> were investigated. Mice were trained in a Morris water maze following injection (i.p.) of Rb<sub>1</sub> (1 mg/kg) or Rg<sub>1</sub> (1 mg/kg) for 4 days. Both Rb<sub>1</sub>- and Rg<sub>1</sub>-injected mice showed enhanced spatial learning compared to control animals. The hippocampus, but not the frontal cortex, of the treated mice contained higher density of a synaptic marker protein, synaptophysin, compared to the control mice. Electrophysiological recordings in hippocampal slices revealed that Rb<sub>1</sub> or Rg<sub>1</sub> injection did not change the magnitude of paired-pulse facilitation or long-term potentiation. The results suggest that Rb<sub>1</sub> and Rg<sub>1</sub> enhance spatial learning ability by increasing hippocampal synaptic density without changing plasticity of individual synapses.<sup>[20]</sup>

### Metabolic Effects

The effect of a standardized ginseng extract on enzymatic activities, myotypological composition, capillaries, and mitochondrial content was studied in the skeletal muscle of male Wistar rats.<sup>[21]</sup> The animals were divided into four groups, and were administered doses of 50 mg/kg, while simultaneously performing exercise for a period of 12 weeks. After 24 h of inactivity, the muscles of the hindlimb were extracted. With regard to the enzymatic activities of the citrate synthase (CS) and lactate dehydrogenase (LDH), CS levels increased with exercise, while the LDH levels showed no major variations, either due to the exercise or the treatment. Treatment with ginseng extract increased the capillary density and the mitochondrial content of the red gastrocnemius muscle. These results suggest that prolonged treatment with the standardized ginseng extract increases the capillary density and the oxidative capacity of the muscles with greater aerobic potential in a manner similar to the performance of physical exercise. When exercise and treatment are combined, the effects that are obtained separately are not potentiated.<sup>[21]</sup>

The effect of prolonged treatment with a standardized *P. ginseng* extract on the antioxidant capacity of the liver was investigated. For this purpose, the extract was orally administered to rats at different doses for

3 mo, and untreated control rats were subjected to exhaustive exercise on a treadmill. A bell-shaped dose-response on running time was obtained, and the results showed that the administration of the extract significantly increases the hepatic glutathione peroxidase (GPX) activity and the reduced glutathione (GSH) levels in the liver, with a dose-dependent reduction of the thiobarbituric acid reactant substances (TBARS). After the exercise, there is reduced hepatic lipid peroxidation, as evidenced by the TBARS levels in both the controls and the treated animals. The GPX and superoxide dismutase (SOD) activities are also significantly increased in the groups receiving the extract, compared with the controls. The hepatic transaminase levels, alanine-amino-transferase (ALT) and aspartate-amino-transferase (AST), in the recuperation phase 48 hr after the exercise, indicate a clear hepatoprotective effect related to the administration of the extract. At the hepatic level, the extract increases the antioxidant capacity, with a marked reduction of the effects of the oxidative stress induced by the exhaustive exercise.<sup>[52]</sup>

The effect of a standardized *P. ginseng* extract on D-glucose uptake by Ehrlich ascites tumor cells was examined. Measurements were carried out using [<sup>3</sup>H]-2-deoxy-D-glucose, a nonmetabolizable glucose analog, and indicated that it was transported from the medium into the cells and phosphorylated, but was neither further metabolized nor eliminated. Thus, the amount taken into the cells was a measure of D-glucose uptake. The results showed that the extract stimulated D-glucose transport, and that the maximum effect was obtained at a concentration of 2.0 µg/ml representing an increase of about 35% above basal activity.<sup>[53]</sup>

A study was performed to determine the effect of ginseng extract and ginsenosides (total saponin, panaxadiol, and panaxatriol) on jejunal crypt survival, endogenous spleen colony formation, and apoptosis in jejunal crypt cells of mice irradiated with high- and low doses of gamma-radiation. The radioprotective effect of ginseng was compared with the effect of diethyl-dithiocarbamate (DDC). The jejunal crypts were protected by pretreatment with ginseng extract (i.p.: 50 mg/kg of body weight at 12 and 36 hr before irradiation,  $p < 0.005$ ). Ginseng extract ( $p < 0.005$ ), total saponin ( $p < 0.01$ ), or panaxadiol ( $p < 0.05$ ) administration before irradiation (i.p.: 50 mg/kg of body weight at 12 and 36 hr before irradiation) resulted in an increase in the formation of the endogenous spleen colony. The frequency of radiation-induced apoptosis in the intestinal crypt cells was also reduced by pretreatment with the extract of whole ginseng ( $p < 0.05$ ), total saponin ( $p < 0.005$ ), or panaxadiol ( $p < 0.05$ ) (i.p. at 12 and 36 hr before irradiation). The radioprotective effect on the jejunal crypts and apoptosis in the DDC-treated group appeared similar

to that in the ginseng-treated groups. Treatment with DDC showed no significant modifying effects on the formation of the endogenous spleen colony. In the experiment on the effect of ginsenosides, the result indicated that panaxadiol might have a major radioprotective effect.<sup>[22]</sup>

In Asia, ginseng is commonly included in herbals used for the treatment of sexual dysfunction. Recent studies in laboratory animals have shown that ginseng enhances libido and copulatory performance. These effects may not be due to changes in hormone secretion, but to direct effects of ginseng, or its ginsenoside components, on the central nervous system and gonadal tissues. Indeed, there is good evidence that ginsenosides can facilitate penile erection by directly inducing the vasodilatation and relaxation of penile corpus cavernosum. Moreover, the effects of ginseng on the corpus cavernosum appear to be mediated by the release and/or modification of release of NO from endothelial cells and perivascular nerves. Recent findings that ginseng treatment decreased prolactin secretion also suggested a direct NO-mediated effect at the level of the anterior pituitary. Thus, animal studies lend growing support for the use of ginseng in the treatment of sexual dysfunction and provide increasing evidence for a role of NO in the mechanism of ginsenosides.<sup>[23]</sup>

### Pharmacokinetics and Metabolism

The performance of studies on pharmacokinetics and metabolism on plant extracts is a very difficult task, since the extracts contain numerous substances. The only possibility is to do such investigations on some active ingredients of the plant extracts. The ginsenosides are considered prodrugs, and in the case of *P. ginseng*, ginsenosides Rg<sub>1</sub> (a representative of the protopanaxatrol derivatives) and Rb<sub>1</sub> (an example of the protopanaxadiol derivatives) are shown to be metabolized at the gastrointestinal level. In the acidic medium of the stomach, they are immediately decomposed into different ginsenoside artifacts whose chemical structures have been partially determined. The same hydrolysis of the ginsenosides also occurs in vitro under milder acidic conditions. At least five metabolites are formed from each ginsenoside. Thus, considering that approximately 13 ginsenosides are contained in the root, at least 65 metabolites are obtained at the gastrointestinal level. The latter are formed in very small quantities and are especially difficult to detect in blood and urine. The amounts of non-metabolized intact Rg<sub>1</sub> and Rb<sub>1</sub> absorbed by the gastrointestinal tract of the rat are about 1.9% and 0.1% of the doses, respectively. Whole-body autoradiography was used to demonstrate the absorption and

distribution of the radioactively labeled ginsenoside Rg<sub>1</sub> and its metabolites after oral administration.

A study performed with mini-pigs showed, after intravenous administration, that the derivatives of protopanaxatriol, such as Rg<sub>1</sub>, have a one-compartment pharmacokinetic profile, and a half-life of about 30 min. On the other hand, for those of protopanaxadiol, such as Rb<sub>1</sub>, the half-life is much longer (about 16 hr), and their pharmacokinetics are described by a two-compartment model.<sup>[4]</sup>

Using a sensitive mass spectrometric method, which is specific for the identification of ginsenosides in complex biological matrices, the degradation pathway of ginsenosides in the gastrointestinal tract of humans could be elucidated following the oral administration of a standardized *P. ginseng* extract. Within the framework of a pilot study, human plasma and urine samples of two subjects were screened for ginsenosides and their possible degradation products. In general, the urine data coincided well with the plasma data, and in both volunteers, the same hydrolysis products, which are not originally present in the extract ingested, were identified. It was shown that two hydrolysis products of the protopanaxatriol ginsenosides, namely G-Rh<sub>1</sub> and G-F<sub>1</sub>, may reach the systemic circulation. In addition, compound-K, the main intestinal bacterial metabolite of the protopanaxadiol ginsenosides, was detected in plasma and urine. These products are probably responsible for the action of ginseng in humans. In contrast to previous reports, G-Rb<sub>1</sub> was identified in the plasma and urine of one subject.<sup>[24]</sup>

### Preclinical Safety Data

The results of several toxicity studies in animals with a *P. ginseng* extract have been reviewed.<sup>[25]</sup>

#### Single dose toxicity

The LD<sub>50</sub> after oral administration is >5 g/kg in the rat, >2 g/kg in the mini-pig, and >1 g/kg in mice, and after i.p. administration, it is >1 g/kg in rats and mice. No noticeable changes of cardiovascular parameters such as electrocardiogram (ECG), pulse, blood pressure, cardiac output, and stroke volume were observed after single dose oral administration of 0.25, 0.5, and 2.0 g/kg in mini-pigs.

#### Repeated dose toxicity

No hematological or histological abnormalities were observed in rats after 20 days of daily oral administration of 4.0 g/kg. Treatment-related hematological or

histopathological effects were not noticed in beagle dogs after oral administration of 1.5, 5.0, and 15 mg/kg for 90 days.

#### Reproduction toxicity

No decrease of growth rate or reproduction and no treatment-related hematological or histopathological findings were seen in rats for 33 weeks in a two-generation study with daily oral administration of 1.5, 5.0, and 15 mg/kg.

#### Embryo, fetal, and perinatal toxicity

No abnormalities of fetal development have been detected in rats after daily oral administration of 40 mg ginseng extract/kg on days 1–15 after mating, or in rabbits after daily oral administration of 20 mg/kg on days 7–15 after mating.

In an in vitro study using whole rat embryo culture model, ginsenoside Rb<sub>1</sub> induced teratogenicity.<sup>[26]</sup> The significance of this study is uncertain due to the concentration of Rb<sub>1</sub> used, and to the fact that it is known that ginsenosides that are not metabolized by the acidic medium and intestinal flora exert hemolytic activities (as is generally observed with saponins).

#### Genotoxicity

No genotoxicity was observed in the hepatocyte-DNA-repair test using concentrations of 0.1–10 mg/ml of ginseng extract with or without ginsenosides or using 1–50 µg/ml of ginsenoside Rg<sub>1</sub>. Neither has mutagenicity been observed in *Salmonella typhimurium* and Chinese Hamster V79 cells.

## CLINICAL STUDIES

### Performance

In a double-blind crossover study, 12 student nurses working night shifts (3–4 consecutive nights followed by 3 days of rest) were given 1.2 g of ginseng roots or placebo for the first three consecutive nights and tested on the morning after the third night. Crossover medication was given after an interval of at least 2 weeks. A third series of tests was carried out during normal daytime working, after no medication and following a good night's sleep (GNS). The subjects assessed their mood, physical well being, and degree of lethargy by means of linear self-rating scales. Two psychophysiological performance tests and hematological tests were also carried out.



The detrimental effects of night shifts were clearly seen. A constant trend in favor of ginseng compared to placebo was noted. Ginseng ratings were favorable for mood criteria, but not for physical well-being symptoms. Ginseng restored blood glucose levels raised by night shift stress. A small but consistent antifatigue activity of ginseng was concluded.<sup>[27]</sup>

Various tests of psychomotor performance were carried out in a cohort of 16 healthy male volunteers given a standardized ginseng extract (100 mg ginseng extract twice a day for 12 weeks) and in a similar group given placebo under double-blind conditions. A favorable effect of ginseng relative to baseline performance was observed in attention (cancellation test), processing (mental arithmetic, logical deduction), integrated sensory-motor function (choice reaction time), and auditory reaction time. However, end performance of the ginseng cohort was only statistically superior ( $p < 0.05$ ) to the placebo group in mental arithmetic. No difference between ginseng and placebo was found in tests of pure motor function (tapping test), recognition (digit symbol substitution), and visual reaction time.<sup>[28]</sup>

In a double-blind, placebo-controlled, crossover study, 43 top triathletes received either placebo or 200 mg of a standardized ginseng extract per day for periods of 10 weeks, respectively. Significant differences ( $p < 0.05$ ) in various endurance parameters were only seen after the second treatment phase. It was concluded that ginseng improves endurance (resistance against end of season stress), but not optimum performance.<sup>[29]</sup>

Twenty top class male athletes received 200 mg standardized ginseng extract per day for 9 weeks. In the bicycle ergometer exercise test lasting 8 min, the post-treatment values were higher for maximal oxygen absorption and lower for blood lactate level and heart rate during exercise compared to pretreatment values. The differences were significant ( $p < 0.001$ ).<sup>[30]</sup>

A double-blind study involved 30 athletes who received daily either placebo ( $n = 10$ ), 200 mg ginseng extract standardized to 7% ginsenosides ( $n = 10$ ), or 400 mg vitamin E and 200 mg ginseng extract standardized to 4% ginsenosides ( $n = 10$ ) for 9 weeks. The same bicycle ergometer test was used and statistically significant variations in heart rate ( $p < 0.05$ ), blood lactate ( $p < 0.01$ ), and maximal oxygen absorption ( $p < 0.01$ ) after exercise between either of the two ginseng preparations and placebo were found. Differences between the two ginseng preparations were not statistically significant. The levels of testosterone and luteinizing hormone in plasma, and free cortisol in urine, were unchanged after all treatment periods.<sup>[31]</sup>

A further double-blind, placebo-controlled study with 28 top class male athletes examined the persistence

of the effects of 9 weeks' treatment (placebo or 200 mg ginseng extract with 4% ginsenosides) beyond the treatment period. Ginseng resulted in a significant improvement of maximal oxygen uptake during exercise ( $p < 0.01$ ), heart rate at maximal exercise ( $p < 0.001$ ), forced expiratory volume ( $p < 0.01$ ), forced vital lung capacity ( $p < 0.05$ ), and visual reaction time ( $p < 0.01$ ) compared with placebo. These positive effects lasted for at least 3 weeks after treatment, and it was concluded that the effects of ginseng are based on clinically relevant metabolic changes that persist for a certain period after treatment.<sup>[32]</sup>

In a double-blind, placebo-controlled study with 50 ambulatory patients suffering from asthenia, depressive syndrome, or neurovegetative disorders, the effects of 8 weeks' treatment with 200 mg/day of a standardized ginseng extract on performance in two psychometric tests and on results from a comprehensive psychological questionnaire (Sandoz Clinical Assessment Geriatric) were studied. Significant improvement ( $p < 0.05$  and  $p < 0.01$ ) was seen in most of the parameters.<sup>[33]</sup>

In a randomized double-blind study, 31 healthy male volunteers received 200 or 400 mg ginseng extract per day for 8 weeks. Ginseng had no effect on oxygen consumption, respiratory exchange ratio, minute ventilation, blood lactic acid concentration, heart rate, and perceived exertion.<sup>[34]</sup>

In another randomized double-blind study, 19 healthy female volunteers received daily 200 mg ginseng extract or placebo for 8 weeks. It had no effect on maximal work performance and resting, exercise, recovery oxygen uptake, respiratory exchange ratio, minute ventilation, heart rate, and blood lactic acid levels.<sup>[35]</sup>

In a double-blind, placebo-controlled, crossover study in 8 healthy volunteers (mean age 25 yr) who regularly practised physical activities, 30 days of daily oral treatment with 400 mg of a standardized ginseng extract did not improve performance at supramaximal exercise (125% of the maximum aerobic power on bicycle ergometer), nor did it influence blood lactate or blood testosterone.<sup>[36]</sup>

In a study on blood oxygenation status of 8 male and 2 female middle aged subjects (average 50 yr old), a significant ( $p < 0.05$ ) increase of resting arterial  $pO_2$  was found after 4 weeks' oral treatment with 200 mg standardized ginseng root extract per day. The resting arterial  $pO_2$  was increased by 4.5 mmHg. In synergy with oxygen treatment, the increase was 10.1 mmHg. Venous  $pO_2$  was decreased (4.3 mmHg).<sup>[37]</sup>

The effects of 400 mg/day of a ginseng extract on a variety of cognitive functions were compared with placebo in a double-blind, randomized study in which 112 healthy volunteers older than 40 yr (55 on ginseng, 57 on placebo) were treated for 8–9 weeks. The ginseng

group showed a tendency to have faster simple reactions and significantly better abstract thinking than the controls. However, there was no significant difference between the two groups in concentration, memory, or subjective experience.<sup>[38]</sup>

A study investigated whether acute administration of standardized ginseng extract had any consistent effect on mood and four aspects of cognitive performance (quality of memory, speed of memory, quality of attention, and speed of attention) that can be derived by factor analysis of the Cognitive Drug Research computerized assessment battery. The study followed a placebo-controlled, double-blind, balanced crossover design. Twenty healthy young adult volunteers received 200, 400, and 600 mg of the extract, and a matching placebo, in counterbalanced order, with a 7 day wash-out period between treatments. Following a baseline cognitive assessment, further test sessions took place 1, 2.5, 4, and 6 hr after the day's treatment. The most striking result was a significant improvement in "quality of memory" and the associated "secondary memory" factor at all time points following 400 mg of ginseng. Both the 200 and 600 mg doses were associated with a significant decrement of the "speed of attention" factor at later testing times only. Subjective ratings of alertness were also reduced 6 hr following the two lowest doses.<sup>[48]</sup>

The effects of a standardized ginseng extract on psychological mood states, and the perceptual response to submaximal and maximal exercise stress were examined in a study with 19 young adult females who received either 200 mg/day of a standardized ginseng root extract ( $n = 10$ ) or placebo ( $n = 9$ ). The results did not support claims of the efficacy of ginseng to alter psychological function characteristics at rest and during exercise stress.<sup>[39]</sup>

The effects of a standardized ginseng extract (300 mg/day) on healthy, untrained male students and on healthy male students who received regular bicycle ergometer training were compared with placebo in an 8 week, randomized, double-blind study ( $n = 41$ ). Ginseng administration at the prescribed dose exhibited training-like effects on  $\text{VO}_2$  max as well as anaerobic power and leg muscle strength. But no synergistic effect on these fitness variables occurred when both ginseng administration and exercise training were combined.<sup>[40]</sup>

The effect of acute administration of standardized ginseng extract was investigated on mood and four aspects of cognitive performance mentioned previously derived from factor analysis of the cognitive drug research computerized test battery. Following a double-blind, placebo-controlled, balanced, crossover design, 30 healthy young adult volunteers received 400 mg of ginseng, and a matching inert placebo, in a counterbalanced order, with a 7 day wash-out period

between treatments. Following baseline evaluation of cognitive performance and mood measures, participants' cognitive performance and mood were assessed again 90 min after drug ingestion. In line with previous research, a fractionation of the effect of ginseng administration was observed. Ginseng significantly improved speed of attention, indicating a beneficial effect on participants' ability to allocate attentional processes to a particular task. However, no significant effect was observed on any other aspect of cognitive performance. In addition, participants' self-reported mood measures did not differ significantly across treatments. It is interesting to note that previous research demonstrated no improvement on attentional processes, but significant improvements on quality of memory following administration of 400 mg of ginseng when participants were tested 1, 2.5, 4, and 6 hr post-ingestion.<sup>[48]</sup> It may be the case that ginseng may offer performance at varying time points. This may be due to different chemical constituents of ginseng displaying several pharmacokinetic properties and psychopharmacological actions.<sup>[49]</sup>

### Immunomodulation

The effects of ginseng root extract (200 mg orally/day) on immune parameters were studied in an 8 week three leg trial involving 60 healthy volunteers of both sexes aged between 18 and 50 yr. Study medication was either a standardized ginseng extract or a nonstandardized aqueous ginseng extract or placebo. The statistically significant differences from baseline that have been observed are listed below. The standardized extract led to an increase in the following: chemotaxis of circulating polymorphonuclear leukocytes ( $p < 0.05$  at week 4 and  $p < 0.001$  at week 8), phagocytosis index and phagocytosis fraction ( $p < 0.001$  at weeks 4 and 8), total lymphocytes (T3) ( $p < 0.05$  at week 4 and  $p < 0.001$  at week 8), T-helper (T4) subset ( $p < 0.05$  at week 4 and  $p < 0.001$  at week 8), helper/suppressor (T4/T8) ratio ( $p < 0.05$  at weeks 4 and 8), induction of blastogenesis in circulating lymphocytes ( $p < 0.05$  at weeks 4 and 8 after induction by concanavalin A and pokeweed mitogen,  $p < 0.001$  at weeks 4 and 8 after induction by lipopolysaccharide) and natural killer cell activity ( $p < 0.05$  at week 4 and  $p < 0.001$  at week 8). With the aqueous extract, a rise was observed in the following: chemotaxis of circulating polymorphonuclear leukocytes ( $p < 0.05$  at week 4 and 8), phagocytosis index and phagocytosis fraction ( $p < 0.05$  at week 8), total (T3) lymphocytes ( $p < 0.05$  at week 4 and  $p < 0.001$  at week 8), T-helper (T4) subset ( $p < 0.05$  at week 8), induction of blastogenesis in circulating lymphocytes ( $p < 0.05$  at week 8 after induction by concanavalin

A and pokeweed mitogen), and natural killer cell activity ( $p < 0.05$  at week 8). With the placebo, only an enhancement in natural killer cell activity was statistically significant ( $p < 0.05$ ) after 8 weeks. It was concluded that ginseng extracts act as an immunostimulant in humans, and that the standardized extract was more active than the aqueous one.<sup>[41]</sup>

Healthy volunteers ( $n = 227$ ) were enrolled in a multicenter, randomized, double-blind, placebo-controlled clinical trial to investigate potential effects of a standardized ginseng extract on resistance against influenza and the common cold. Study duration was 12 weeks and the study medication was either 200 mg standardized ginseng extract ( $n = 114$ ) or placebo ( $n = 113$ ) per day. All participants received an anti-influenza polyvalent vaccine at week 4. Results from examinations at weeks 4, 8, and 12 showed highly significant differences ( $p < 0.0001$ ) between ginseng extract and placebo with regard to the frequency of influenza or colds between weeks 4 and 12 (15 cases in the verum group vs. 42 cases in the placebo group). Antibody titers at week 8 were also much higher after verum (272 units vs. 171 units after placebo) as well as natural killer cell activity which was almost twice as high in the verum group compared to the placebo group.<sup>[42]</sup>

A controlled single-blind study was performed to investigate the effects of standardized ginseng root extract (200 mg/day) in 40 patients suffering from chronic bronchitis. It was shown that the extract significantly ( $p < 0.001$ ) improves alveolar macrophage activity compared to baseline.<sup>[43]</sup>

The effects of a standardized ginseng root extract (200 mg orally per day for 3 mo) were studied in a pilot trial involving 15 patients with severe chronic respiratory diseases. Respiratory parameters, such as vital capacity, expiratory volume and flow, ventilation volume, as well as walking distance, were examined. The results led to the conclusion that the extract improves pulmonary function and oxygenation capacity, which seems to be the reason for improved walking capacity.<sup>[44]</sup>

A study in two equal groups of 10 young healthy males was undertaken to investigate the effects of 8 weeks' administration of a standardized ginseng extract (300 mg/day) in comparison with the effects of placebo. It was concluded that ginseng caused no significant changes in peripheral blood leukocytes and lymphocyte subsets.<sup>[45]</sup>

## INDICATIONS

### Uses Supported by Clinical Data

Radix ginseng is used as a preventive and restorative agent for boosting mental and physical capacities,

immunity against infections, and in subjects experiencing debility fatigue, tiredness, and loss of concentration, and during pregnancy.<sup>[5,46]</sup>

### Uses Described in Pharmacopoeias and in Traditional Systems of Medicine

Radix ginseng is also used in the treatment of impotence, prevention of hepatotoxicity, and gastrointestinal disorders such as gastritis and ulcer.<sup>[5]</sup>

### Uses Described in Folk Medicine, but not Supported by Experimental or Clinical Data

Treatment of liver diseases, coughs, fever, tuberculosis, rheumatism, vomiting during pregnancy, hypothermia, and dyspnea.<sup>[5]</sup>

## POSODOLOGY

Adult daily dose: 0.5–2.0 g dried root; doses of equivalent preparations should be calculated accordingly.<sup>[5,46]</sup>

## CONTRAINDICATIONS

None have been reported.<sup>[5,46]</sup>

## INTERACTIONS AND SIDE EFFECTS

Data from clinical trials suggest that the incidence of adverse events with *P. ginseng* preparations is similar to that with placebo. The most commonly experienced adverse effects are headache, sleep and gastrointestinal disorders. The possibility of more serious side effects is indicated in isolated case reports and data from spontaneous reporting schemes. However, causality is often difficult to determine from the evidence provided. Combination products containing ginseng as one of several constituents have been associated with serious adverse events and even fatalities. Interpretation of these cases is difficult as ingredients other than *P. ginseng* may have caused the problems. Possible drug interactions have been reported between *P. ginseng* and warfarin, phenelzine, and alcohol. Collectively, these data suggest that *P. ginseng* monopreparations are rarely associated with adverse events or drug interactions. The ones that are documented are usually mild and transient. Combined preparations are more often associated with such events, but causal attribution is usually not possible.<sup>[47]</sup>

A study in humans has shown that *P. ginseng* extract after oral administration for 14 days does not induce the cytochrome P450 3A (CYP3A) activity.<sup>[54]</sup>

## PREGNANCY AND LACTATION

In animals, no effect on fetal development has been observed. No human data are available.

In accordance with general medical practice, ginseng should not be used during pregnancy or lactation without medical advice.<sup>[46]</sup>

## OVERDOSE

Critical analysis of a report on a so-called ginseng abuse syndrome has shown that there were no controls or analysis to determine the type of ginseng ingested or the constituents of the preparation taken, and that some of the amounts ingested were clearly excessive (as much as 15 g, whereas the recommended daily dose is 0.5–2 g). The only conclusion that can be validly drawn from the above report is that excessive and uncontrolled intake should be avoided. One case of ginseng-associated cerebral arteritis has been reported in a patient consuming 200 ml of a preparation made from 12.5 g (dry weight) of ginseng and 200 ml of rice wine.<sup>[46]</sup>

## REGULATORY STATUS

Depending on the national legislations: prescription (Rx), over the counter (OTC), or dietary supplement.

## REFERENCES

1. Court, W. *Ginseng, The Genus Panax*; Harwood Academic Publishers: The Netherlands, 2000.
2. Ngan, F.; Shaw, P.; But, P.; Wang, J. Molecular authentication of *Panax* species. *Phytochemistry* **1999**, *50*, 787–791.
3. Asian Ginseng. In *USP–NF*; The United States Pharmacopeial Convention Inc.: Rockville, U.S.A., 2004; 2007–2008.
4. Soldati, F. *Panax ginseng*: standardization and biological activity. In *Biologically Active Natural Products: Pharmaceuticals*; Cutler, S.J., Cutler, H.J., Eds.; CRC Press: Boca Raton, 2000; 209–232.
5. Radix ginseng. In *WHO Monographs on Selected Medicinal Plants*; World Health Organization: Geneva, 1999; Vol. 1, 168–182.
6. Soldati, F.; Sticher, O. HPLC separation and quantitative determination of Ginsenosides from *Panax ginseng*, *Panax quinquefolium* and from ginseng drug preparations. *Planta Med.* **1980**, *39* (4), 348–357.
7. Kitagawa, I.; Taniyama, T.; Shibuya, H.; Noda, T.; Yoshikawa, M. Chemical studies on crude drug processing. On the constituents of Ginseng Radix Rubra: comparison of the constituents of White Ginseng and Red Ginseng prepared from the same *Panax ginseng* root. *Yakugaku Zasshi* **1987**, *107* (7), 495–505.
8. Soldati, F.; Tanaka, O. *Panax ginseng* C.A. Meyer—relation between age of plant and content of ginsenosides. *Planta Med.* **1984**, *51* (4), 351–352.
9. Powdered Asian Ginseng Extract. In *USP–NF*; The United States Pharmacopeial Convention Inc.: Rockville, USA, 2004; 2008–2009.
10. Rimar, S.; Lee-Mengel, M.; Gillis, C.N. Pulmonary protective and vasodilator effects of a standardized *Panax ginseng* preparation after artificial gastric digestion. *Pulm. Pharmacol.* **1996**, *9*, 205–209.
11. Toda, N.; Ayajiki, K.; Fujioka, H.; Okamura, T. Ginsenosides potentiates NO-mediated neurogenic vasodilatation of monkey cerebral arteries. *J. Ethnopharmacol.* **2001**, *76*, 109–113.
12. Cabral de Oliveira, A.C.; Perez, A.C.; Merino, G.; Prieto, J.G.; Alvarez, A.I. Protective effects of *Panax ginseng* on muscle injury and inflammation after eccentric exercise. *Comp. Biochem. Physiol. (C), Pharmacol. Toxicol. Endocrinol.* **2001**, *130*, 369–377.
13. Liu, Z.Q.; Luo, X.Y.; Liu, G.Z.; Chen, Y.P.; Wang, Z.C.; Sun, Y.X. In vitro study of the relationship between the structure of ginsenoside and its antioxidative or prooxidative activity in free radical induced hemolysis of human erythrocytes. *J. Agric. Food Chem.* **2003**, *51* (9), 2555–2558.
14. Jie, Y.H.; Cammisuli, S.; Baggiolini, M. Immunomodulatory effects of *Panax ginseng* C.A. Meyer in the mouse. *Agent Actions* **1984**, *15*, 386–391.
15. Park, K.M.; Kim, Y.S.; Jeong, T.C.; Joe, C.O.; Shin, H.J.; Lee, Y.H.; Nam, K.Y.; Park, J.D. Nitric oxide is involved in the immunomodulating activities of acidic polysaccharide from *Panax ginseng*. *Planta Med.* **2001**, *67*, 122–126.
16. Hu, S.; Concha, C.; Lin, F.; Waller, K.P. Adjuvant effect of ginseng extracts on the immune responses to immunisation against *Staphylococcus aureus* in dairy cattle. *Vet. Immunol. Immunopathol.* **2003**, *91*, 29–37.
17. Petkov, V. Effects of ginseng on the brain biogenic monoamines and the 3',5'-cAMP system.

- Experiments on rats. *Arzneimittelforschung* **1978**, *28*, 388–393.
18. Petkov, V.; Mosharrof, A.H. Effect of standardized Ginseng extract on learning, memory and physical capabilities. *Am. J. Chin. Med.* **1987**, *15*, 19–29.
  19. Rudakewich, M.; Ba, F.; Benishin, C.G. Neurotrophic and neuroprotective actions of ginsenosides Rb1 and Rg1. *Planta Med.* **2001**, *67*, 533–537.
  20. Mook-Jung, I.; Hong, H.S.; Boo, J.H.; Lee, K.H.; Yun, S.H.; Cheong, M.Y.; Joo, I.; Huh, K.; Jung, M.W. Ginsenoside Rb1 and Rg1 improve spatial learning and increase hippocampal synaptophysin level in mice. *J. Neurosci. Res.* **2001**, *63*, 509–515.
  21. Ferrando, A.; Vila, L.; Voces, J.A.; Cabral, A.C.; Alvarez, A.I.; Prieto, J.G. Effects of a standardized *Panax ginseng* extract on the skeletal muscle of the rat: a comparative study in animals at rest and under exercise. *Planta Med.* **1999**, *65*, 239–244.
  22. Kim, S.R.; Jo, S.K.; Kim, S.H. Modification of radiation response in mice by ginsenosides, active components of *Panax ginseng*. In *Vivo* **2003**, *17*, 77–82.
  23. Murphy, L.L.; Lee, T.J. Ginseng, sex behaviour and nitric oxide. *Ann. N.Y. Acad. Sci.* **2002**, *962*, 372–377.
  24. Tawab, M.A.; Bahr, U.; Karas, M.; Wurglics, M.; Schubert-Zsilavecz, M. Degradation of ginsenosides in humans after oral administration. *Drug Metab. Dispos.* **2003**, *31*, 1065–1071.
  25. Soldati, F. Toxicological studies on ginseng. Proceedings of the 4th International Ginseng Symposium, Korea; Ginseng and Tobacco Research Institute: Daejeon, Korea, 1984; 119–126.
  26. Chan, L.Y.; Chiu, P.Y.; Lau, T.K. An in-vitro study of ginsenoside Rb1 induced teratogenicity using a whole rat embryo culture model. *Hum. Reprod.* **2003**, *18*, 2166–2168.
  27. Hallstrom, C.; Fulder, S.; Carruthers, M. Effect of ginseng on the performance of nurses on night duty. *Comp. Med. East West* **1982**, *6*, 277–282.
  28. D'Angelo, L.; Grimaldi, R.; Caravaggi, M.; Marcoli, M.; Perucca, E.; Lecchini, S.; Frigo, G.M.; Crema, A. Double-blind, placebo-controlled clinical study on the effect of a standardized ginseng extract on psychomotor performance in healthy volunteers. *J. Ethnopharmacol.* **1986**, *16*, 15–22.
  29. Van Schepdael, P. Les effets du ginseng G115 sur la capacité physique de sportifs d'endurance. *Acta Ther.* **1993**, *19*, 337–347.
  30. Forgo, I.; Kirchdorfer, A.M. On the question of influencing the performance of top sportsmen by means of biologically active substances. *Aerztliche Praxis* **1981**, *33*, 1784–1786.
  31. Forgo, I. Effects of drugs on physical performance and hormone system of sportsmen. *Munch. Med. Wochenschr.* **1983**, *125*, 822–824.
  32. Forgo, I.; Schimert, G. The duration of effect of the standardized ginseng extract in healthy competitive athletes. *Notabene Med.* **1985**, *15*, 636–640.
  33. Rosenfeld, M.S.; Nachtajler, S.P.; Schwartz, T.G.; Sikorsky, N.M. Evaluation of the efficacy of a standardized ginseng extract in patients with psychophysical asthenia and neurological disorders. *La Semana Méd.* **1989**, *173* (9), 148–154.
  34. Engels, H.J.; Wirth, J.C. No ergogenic effects of ginseng (*Panax ginseng* C.A. Meyer) during graded maximal aerobic exercise. *J. Am. Diet. Assoc.* **1997**, *97* (10), 1110–1115.
  35. Engels, H.J.; Said, J.M.; Wirth, J.C. Failure of chronic ginseng supplementation to affect work performance and energy metabolism in healthy adult females. *Nutr. Res.* **1996**, *16* (8), 1295–1305.
  36. Collomp, K.; Wright, F.; Collomp, R.; Shamari, K.; Bozzolan, F.; Préfaut, C. Ginseng et exercice supramaximal. *Sci. Sports* **1996**, *11*, 250–251.
  37. Von Ardenne, M.; Klemm, W. Measurements of the increase in the difference between the arterial and venous Hb-O<sub>2</sub> saturation obtained with daily administration of 200 mg standardized ginseng extract G115 for four weeks. *Panminerva Med.* **1987**, *29* (2), 143–150.
  38. Sørensen, H.; Sonne, J. A double-masked study of the effects of ginseng on cognitive functions. *Curr. Ther. Res.* **1996**, *57* (12), 959–968.
  39. Smith, K.; Engels, H.J.; Martin, J.; Wirth, J.C. Efficacy of a standardized ginseng extract to alter psychological function characteristics at rest and during exercise stress. *J. Am. Coll. Sports Med.* **1995**, *27* (5), Suppl. 147.
  40. Cherdrungsi, P.; Rungroeng, K. Effects of standardized ginseng extract and exercise training on aerobic and anaerobic exercise capacities in humans. *Kor. J. Ginseng Sci.* **1995**, *19* (2), 93–100.
  41. Scaglione, F.; Ferrara, F.; Dugnani, S.; Falchi, M.; Santoro, G.; Frascini, F. Immunomodulatory effects of two extracts of *Panax ginseng* C.A. Meyer. *Drugs Exp. Clin. Res.* **1990**, *16* (10), 537–542.
  42. Scaglione, F.; Cattaneo, G.; Alessandria, M.; Cogo, R. Efficacy and safety of the standardized ginseng extract G115 for potentiating vaccination against common cold and/or influenza syndrome. *Drugs Exp. Clin. Res.* **1996**, *22* (2), 65–72.
  43. Scaglione, F.; Cogo, R.; Cocuzza, C.; Arcidiano, M.; Beretta, A. Immunomodulatory effects of *Panax ginseng* C.A. Meyer (G115) on alveolar macrophages from patients suffering with chronic

- bronchitis. *Int. J. Immunother.* **1994**, *10* (1), 21–24.
44. Gross, D.; Krieger, D.; Efrat, R.; Dayan, M. Ginseng extract G115 for the treatment of chronic respiratory diseases. *Schweiz. Z. Ganzheitsmed.* **1995**, *1*, 29–33.
45. Srisurapanon, S.; Rungroeng, K.; Apibal, S.; Cherdrugsi, P.; Siripol, R.; Vanich-Angkul, V.; Timvipark, C. The effect of standardized ginseng extract on peripheral blood leukocytes and lymphocytes subsets: a preliminary study in young healthy adults. *J. Med. Assoc. Thai.* **1997**, *80* (S1), S81–S85.
46. Ginseng radix. In *ESCOP Monographs*; ESCOP, Eds.; George Thieme Verlag: Stuttgart, 2003; 211–222.
47. Coon, J.T.; Ernst, E. *Panax ginseng*: a systematic review of adverse effects and drug interactions. *Drug Saf.* **2002**, *25* (5), 323–344.
48. Kennedy, D.O.; Scholey, A.B.; Wesnes, K.A. Dose dependent changes in cognitive performance and mood following acute administration of Ginseng to healthy young volunteers. *Nutr. Neurosci.* **2001**, *4*, 295–310.
49. Sunram-Lea, S.I.; Birchall, R.J.; Wesnes, K.A.; Petrini, O. Acute administration of Ginseng improves speed of attention in healthy young volunteers. Summer Meeting of the British Association for Psychopharmacology, Cambridge, July 20–23, 2003. *J. Psychopharmacol.* **2003**, *17* (3)(Suppl. 1), A63.
50. Yamada, H.; Otsuka, H.; Kiyohara, H. Fractionation and characterization of anticomplementary and mitogenic substances from *Panax ginseng* extract G115. *Phytother. Res.* **1995**, *35*, 264–269.
51. Belogortseva, N.I.; Yoon, Y.Y.; Kim, K.H. Inhibition of *Helicobacter pylori* hemagglutination by polysaccharide fractions from roots of *Panax ginseng*. *Planta Med.* **2000**, *66*, 217–220.
52. Voces, J.; Alvarez, A.I.; Vila, L.; Ferrando, A.; Cabral de Oliveira, C.; Prieto, J.C. Effects of administration of the standardized *Panax ginseng* extract G115 on hepatic antioxidant function after exhaustive exercise. *Comp. Biochem. Physiol.* **1999**, Part C, *123*, 175–184.
53. Yamasaki, K.; Murakami, C.; Ontani, K.; Kasai, R.; Kurakowa, T.; Ishibashi, S.; Soldati, F.; Stöckli, M.; Mulz, D. Effects of the standardized *Panax ginseng* extract G115 on the D-glucose transport by Ehrlich ascites tumor cells. *Phytother. Res.* **1993**, *7*, 200–202.
54. Anderson, G.D.; Rosito, G.; Mohustsy, M.A.; Elmer, G.W. Drug interaction potential of Soy extract and *Panax ginseng*. *J. Clin. Pharmacol.* **2003**, *43*, 643–648.



# Glucosamine

## Daniel O. Clegg

George E. Wahlen Department of Veterans Affairs Medical Center, and  
University of Utah School of Medicine,  
Salt Lake City, Utah, U.S.A.

## Christopher G. Jackson

University of Utah School of Medicine, and  
George E. Wahlen Department of Veterans Affairs Medical Center,  
Salt Lake City, Utah, U.S.A.

## INTRODUCTION

Glucosamine (2-amino-2-deoxy-D-glucose) is a naturally occurring substance derived from the exoskeletons of arthropods. Glucosamine-6-phosphate is a precursor in the biosynthesis of the glycosaminoglycans (GAGs) found in cartilage. Premature loss of cartilage is part of the clinical syndrome recognized as osteoarthritis (OA). The hypothetical role that dietary glucosamine may play in the treatment of osteoarthritis is to delay, halt, or even reverse this degenerative process. There have been a number of interesting clinical experiments suggesting these effects. However, carefully designed, objective trials are needed to confirm them. If glucosamine is shown to have disease-modifying effects on osteoarthritis, more basic studies will be necessary to determine the mechanism of action. Additionally, if it is effective in the treatment of the syndrome development of a rational plan to regulate its manufacture and distribution is imperative, so that the patient can be assured of a reliable and pure product.

## CHEMISTRY AND PHYSIOLOGY

D-Glucosamine (2-amino-2-deoxy-D-glucose) is a naturally available amino sugar (hexosamine) with a molecular weight of 179.17. The chemical structure is shown in Fig. 1.

---

*Daniel O. Clegg, M.D.*, is Chief of the Rheumatology Section at the Department of George E. Wahlen Veterans Affairs Medical Center, and Professor of Medicine at the University of Utah School of Medicine, Salt Lake City, Utah, U.S.A. He holds the Harold J., Ardella T., and Helen T. Stevenson Presidential Endowed Chair in Rheumatology.

*Christopher G. Jackson, M.D.*, is Professor of Medicine at the University of Utah School of Medicine, and staff physician in the Rheumatology Section at the George E. Wahlen Department of Veterans Affairs Medical Center, Salt Lake City, Utah, U.S.A.

When taken up by living cells, glucosamine reacts with ATP to form glucosamine-6-phosphate, the natural precursor of GAGs that contain *N*-acetylglucosamine (keratan sulfate and hyaluronan) and those that have *N*-acetylgalactosamine (heparan sulfate and chondroitin sulfate). These GAGs are polysaccharides composed of hexosamines and monosaccharides (e.g., galactose and glucuronic acid) arranged as a linear chain of repeating disaccharide units (such as the glucuronic acid and *N*-acetylgalactosamine-6-sulfate of chondroitin sulfate). With the exception of hyaluronan, GAGs do not exist alone in nature but are attached to specific “core” proteins, and the composite structures are called proteoglycans (protein-glycosaminoglycans). Both hyaluronan and many different kinds of proteoglycans (such as aggrecan, versican, and syndecan) are abundant throughout the body where they perform diverse functions.<sup>[1]</sup>

The most abundant proteoglycan of adult human articular cartilage is aggrecan, and it is composed of a protein core substituted with about 100 chondroitin sulfate and about 50 keratan sulfate chains. Because of the high fixed charge density (about 4000 sulfate groups per molecule), and its retention by the collagen network of the tissue, aggrecan generates an osmotic gradient, which retains water within the tissue, thereby providing the articular cartilage with high compressive resistance. This property of the cartilage, together with its capacity to generate a mucinlike molecule called

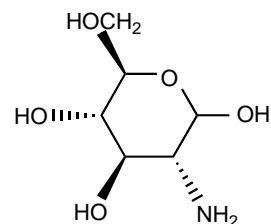
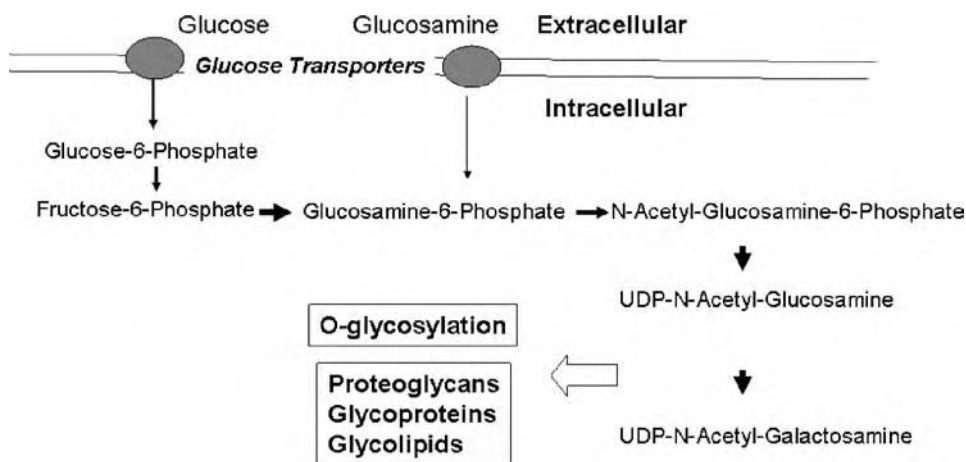


Fig. 1 Chemical structure of glucosamine.





**Fig. 2** Glucosamine production from glucose by the hexosamine pathway and glucosamine uptake by glucose transporters.

lubricin on its surface,<sup>[2]</sup> is critical to the smooth, essentially frictionless motion observed in normally functioning joints. In patients with early osteoarthritis, there is a loss of aggrecan from the cartilage, and this compromises the integrity and function of the tissue, which, if left uncontrolled, leads to advanced joint disease, pain, and disability. Because dietary glucosamine could theoretically increase the production of glucosamine-6-phosphate (if it reaches the joint space and is taken up by cartilage cells) and therefore tissue proteoglycans (including cartilage aggrecan), there has been much interest in the possibility that it might represent a means of preventing cartilage loss in osteoarthritis. However, the pharmacokinetics of dietary glucosamine taken by the general public for this purpose have not been established. In particular, the concentration of that reaches the articular cartilage is unknown, and whether such a level would be sufficient to alter the intracellular concentration of glucosamine-6-phosphate (and aggrecan production) in human cartilage is yet to be determined.

Generally, glucosamine is produced from glucose inside the cell through the hexosamine biosynthetic pathway. Under normal physiological conditions, glucosamine levels in the extracellular fluids are below detection, but if provided in the diet, it is rapidly taken up into cells by glucose transporters,<sup>[3,4]</sup> and is phosphorylated to produce glucosamine-6-phosphate, which enters the hexosamine biosynthetic pathway as such (see Fig. 2 for details).

There have been numerous recent studies directed toward examining how a change in glucosamine concentration (in or around the painful joint) might result in therapeutic benefit. For example, experiments on the effect of glucosamine on chondrocyte or cartilage metabolism have shown how it can inhibit interleukin-1 (IL-1)-induced and aggrecanase-mediated cartilage degradation,<sup>[5,6]</sup> a glucosamine

effect that appears to be due to a blockade of the NFKb signaling pathway.<sup>[7,8]</sup> There are also data demonstrating that glucosamine suppresses the activation of T-lymphoblasts and dendritic cells in vitro as well as allogeneic mixed leukocyte reactivity. Further, glucosamine administration prolonged allogeneic cardiac allograft survival in vivo.<sup>[9]</sup>

All of these studies<sup>[5-9]</sup> have used high concentrations of glucosamine (0.5–10 mM), either administered IV over a short time in in vivo studies or added to cells and tissue cultures in in vitro studies. However, since the pharmacokinetics of human dietary glucosamine have not been described, the importance of these observations at high concentrations remains undetermined.

## PHARMACOLOGY AND PHARMACOKINETICS

Information on the absorption and serum pharmacokinetics for dietary glucosamine is very limited, and in some cases, the available data are contradictory. For example, in one series of studies,<sup>[10-12]</sup> <sup>14</sup>C-glucosamine was given orally to rats, dogs, and humans, and in all cases, the radiolabel was described as “efficiently” absorbed, reaching a plasma peak after about 4 hr. A high percentage of the radiolabel (about 35%) was excreted in the urine, and a similar amount was lost in expired air. On the other hand, the laboratory that conducted this experiment was unable to detect chemical amounts of glucosamine in human serum after a single oral dose at 100 mg/kg (five times the clinical dose) using a chromatographic assay with a limit of detection of about 14  $\mu$ M.<sup>[13]</sup> This suggests that the bioavailable glucosamine in human serum after the normal recommended dosage (20 mg/kg) is well below 10  $\mu$ M.

## USE OF GLUCOSAMINE IN OSTEOARTHRITIS

Glucosamine has acceptance as a symptomatic slow acting drug for osteoarthritis (SYSADOA) in Europe.<sup>[14]</sup> However, its use in the United States has been controversial. It is marketed in the United States as a dietary supplement, which results in availability without prescription. The public's access to glucosamine is regulated under the 1994 Dietary Supplement Health and Education Act (DSHEA), which was enacted for less-rigorous regulation of the manufacture, packaging, and claims requirements for complementary and alternative medicine (CAM) agents compared to traditional drugs. This less-regulated environment can result in the arbitrary promotion or advocacy of CAM products and in unsubstantiated scientific claims or empiric utilization. There has been a great deal of interest and information in the lay press. In his books, Theodosakis, Adderly, and Fox<sup>[15,16]</sup> advocated the use of glucosamine as part of a defined therapeutic approach to osteoarthritis that in addition to the supplements glucosamine and chondroitin, recommends regular exercise, healthy diet, and weight control, "traditional medications" as indicated, and a positive attitude.

Osteoarthritis has been described as "the coming epidemic of arthritis."<sup>[17]</sup> This article estimates the prevalence of osteoarthritis in the United States to be 20 million in 2002, and, assuming current demographics, it will climb to 40 million by 2020. Patients with osteoarthritis frequently seek medical care for improvement in their symptoms. The Arthritis Foundation estimates that there are over 7 million physician visits annually for osteoarthritis. A recent study addressing primary care utilization found that osteoarthritis patient visits accounted for more than one-half of general medical visits that involved rheumatologic complaints.<sup>[18]</sup> Currently, recommended medical therapy includes patient education in joint protection, weight reduction, physical therapy, and analgesia most often with acetaminophen.<sup>[14,19-21]</sup> Often-times, these recommendations fail to meet the patient's expectations, and miscreates a frustrating gap between hopes and reasonably attainable results. In this setting, patients are turning to complementary and/or alternative therapies in an effort to obtain an added measure of improvement. Likewise, physicians are frustrated by the lack of evidence-based information to establish a foundation for the rational use of these therapies. Often, studies attempting to demonstrate the efficacy of CAM have been hampered by serious flaws. Publication bias in the medical literature, even of trials that have been poorly developed and performed, is toward reports of positive results. Consequently, due to a lack of scientifically credible information, both patients and health care practitioners are often

unable to develop rational therapeutic strategies that include CAM.

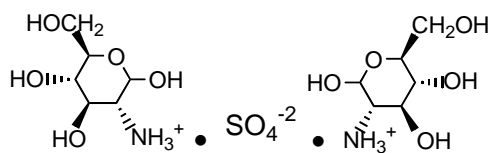
In an effort to encourage rigorously designed scientific trials that address CAM efficacy, the National Institutes of Health (NIH) established the Office of Alternative Medicine and, subsequently, the National Center for Complementary and Alternative Medicine (NCCAM). The stated mission of NCCAM is to "support rigorous research on complementary and alternative medicine, to train researchers in CAM, and to disseminate information to the public and professionals on which CAM modalities work, which do not, and why."<sup>[22]</sup> When the Office of Alternative Medicine was established in 1992, its budget was \$ 2 million. The 2003 budget for NCCAM was \$ 113.4 million.<sup>[23]</sup> In this complex medical/political milieu, the use of glucosamine in the treatment of osteoarthritis has become very popular over the past several years. The *Nutrition Business Journal* estimates that the United States consumes over 3000 t of glucosamine annually worth almost \$ 800 million in consumer spending.<sup>[24]</sup>

## GLUCOSAMINE PREPARATIONS

Glucosamine is prepared commercially by acid hydrolysis of chitin [poly- $\beta$ -(1  $\rightarrow$  4)-*N*-acetyl-D-glucosamine], which is a major component of the shells of Crustacea such as crabs and shrimps. Because it is derived from shellfish hydrolyzates, persons with shellfish allergies should probably avoid exposure, or use with caution. Along with cellulose, chitin is the most widely prevalent natural biopolymer. In shellfish, chitin is clustered with proteins and calcium carbonate. The purification of chitin and its subsequent hydrolysis yields glucosamine. As a weak organic base, glucosamine can be transformed into either a hydrochloride or a sulfate salt form. Commercially available forms of glucosamine include: 1) glucosamine sulfate; 2) cocrystals and coprecipitates of glucosamine sulfate with potassium or sodium chloride; 3) glucosamine hydrochloride; and 4) physical mixtures of glucosamine hydrochloride and potassium or sodium sulfate. Glucosamine is available in highly purified final forms. Details of the various preparations are summarized below.

### Glucosamine Sulfate

The "pure" sulfate salt of glucosamine is intensely hygroscopic, and due to the resultant hydration and subsequently low pH, there is potential for oxidation of the amino group (Fig. 3). Because of these properties, this formulation must be preserved with a



**Fig. 3** Chemical structure of glucosamine sulfate.

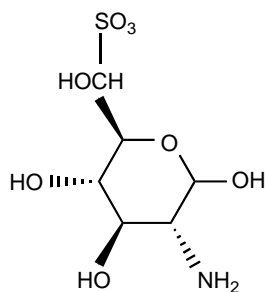
desiccant under extremely controlled conditions and would be prohibitively expensive. For these reasons, commercial manufacture of “pure glucosamine sulfate,” and development of a clinical application of this formulation is not feasible.

### Glucosamine Bonded with Sulfate (Not as a Salt)

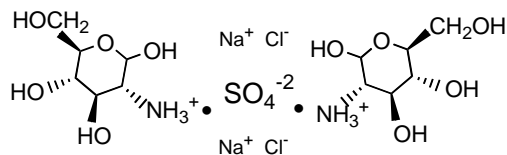
There are other substances available that are sometimes termed “glucosamine sulfate.” These compounds are not the sulfate salts of glucosamine. Rather, they are composed of glucosamine with sulfate groups covalently bonded to the hexosamine at different sites. Examples are D-glucosamine 2,3-disulfate, D-glucosamine 2,6-disulfate, D-glucosamine 3,6-disulfate, and D-glucosamine-6-sulfate. Their structures are available through the International Union of Pure and Applied Chemistry (IUPAC). These molecules are not a component of the so-called “stabilized glucosamine sulfate” (which is a salt form of glucosamine discussed later), nor are they available in oral dosage forms. One example is illustrated in Fig. 4.

### Cocrystals and Coprecipitates of Glucosamine

Because glucosamine hydrochloride was readily available but could not be patented, efforts were directed toward the use of glucosamine sulfate for commercial purposes. However, due to the issues described above, commercial development for mass distribution could not be accomplished. To overcome these obstacles, a process was developed and patented that yielded



**Fig. 4** Glucosamine-6-sulfate (not a salt form; sulfate covalently bonded to structure).



**Fig. 5** Chemical structure of glucosamine sulfate/sodium chloride coprecipitate.

glucosamine sulfate in a cocrystallized matrix with sodium chloride (Fig. 5). This method “stabilized” the glucosamine sulfate, in that addition of sodium chloride led to a reduction in the hygroscopic properties of the compound and made it possible to produce oral dosage forms. This product has since been used in commercially sponsored clinical trials of glucosamine in osteoarthritis.

Subsequent to the award of patent protection for the production of this “stabilized glucosamine sulfate,” there has been commercial promotion alleging that this preparation is therapeutically superior to others, though no clinical studies have been conducted to prove it. In this regard, it is important to recognize that since the biological acid in the stomach is HCl, all dietary glucosamine (independent of the salt form ingested) likely enters the small intestine for absorption as glucosamine HCl. It is also interesting to note that all of the published pharmacokinetic studies on glucosamine in humans have been conducted using  $^{14}\text{C}$  radiolabeled glucosamine hydrochloride mixed with unlabeled “stabilized glucosamine sulfate.”<sup>[11–13]</sup>

At least one other glucosamine stabilization method has been patented. Similar to the process described above, this technique utilizes lyophilization (freeze-drying) to coprecipitate glucosamine sulfate with potassium chloride. This method has also been patented, and the resultant product is commercially available in the United States. In both instances, glucosamine hydrochloride (see below) is the glucosamine substrate that is either cocrystallized or coprecipitated to produce the final “stabilized glucosamine sulfate” salt.

### Glucosamine Hydrochloride

Glucosamine hydrochloride is a much more stable salt form of glucosamine than glucosamine sulfate and is produced from chitin in an acid extraction using hydrochloric acid (Fig. 6). It is available as an extremely (>99%) pure compound that is very stable and has a long shelf life. The material can be certified by the Food and Drug Administration (FDA) as compliant with current Good Manufacturing Practices (cGMP) and can be produced to strict pharmacologic standards.

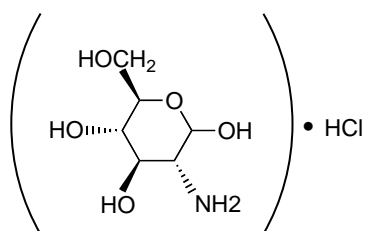


Fig. 6 Chemical structure of glucosamine hydrochloride.

### Physical Mixtures

Because of the patent issues described above, some products marketed as “glucosamine sulfate” are simply a physical combination of glucosamine hydrochloride and a sulfate salt such as potassium sulfate. The rationale for using this combination is the possibility that both glucosamine and ionic sulfate may be therapeutic, or that ionic sulfate may promote glucosamine absorption in the gut.

However, it must be recognized that when the sulfate dissociates from the glucosamine in the gastrointestinal (GI) tract, highly charged anion(s) are generated that do not readily cross GI tract membranes and potentially result in an osmotic diarrhea. In large doses, this is the basis of the mechanism of action for cathartic laxatives that contain sulfate salts. Normal levels of sulfate in the blood (about 0.3 mM) are critical for many cellular functions, including the synthesis of GAGs. However, the pharmacokinetics of dietary sulfate and its potential effect on cartilage metabolism are unknown, though some authors have suggested a role for sulfates in osteoarthritis.<sup>[25,26]</sup>

### Comparison of Salt Forms

As detailed in the subsections above, there are practical therapeutic considerations inherent in the physical characteristics of the various glucosamine preparations. These are summarized in Table 1. The actual quantity of glucosamine found in the preparations varies due to the size of the associated salt form. Thus, as can be seen, in the usual daily dose of 1500 mg/day,

the actual level of glucosamine can range from 895 to 1245 mg/day.

Most often, salt forms of pure substances are prepared to improve solubility characteristics. Hydrochloride salts are among the most commonly used forms of salts of weak organic bases, because chloride is readily available, is found naturally in the human body, and produces salts with good stability characteristics. An additional advantage is that on a molecule-per-molecule basis, these salts are smaller than those made with ions such as citrate, lactate, and sulfate (e.g., the molecular weight of HCl is 36, whereas that of H<sub>2</sub>SO<sub>4</sub> is 101). This is important when considering whether a dose is referenced to the amount of active parent drug or to the quantity of the salt form as seen in Table 1. Finally, therapeutic drug monitoring in patients receiving a salt form of a drug is conducted using blood concentration of the parent drug, not the salt. In the instance of glucosamine, the salt form dissociates when it dissolves in the GI tract. Hence, in performing pharmacokinetics of glucosamine HCl (or H<sub>2</sub>SO<sub>4</sub>), only the glucosamine moiety is measured.

In the case of glucosamine hydrochloride, glucosamine sulfate, and any of its stabilized forms, the dissolution of these molecules will also involve dissociation of the salt. There has been no published evidence, nor have we observed any difference in the rate of dissolution of any of the glucosamine containing preparations.

### CLINICAL TRIALS USING GLUCOSAMINE IN OSTEOARTHRITIS

Many of the controlled clinical trials with glucosamine in osteoarthritis patients have been of marginal quality due to insufficient sample size, lack of statistical rigor, potential for sponsor bias, inadequate concealment, and lack of intention-to-treat principles. One systematic review of published randomized trials whose aim was to determine the effectiveness of glucosamine in osteoarthritis<sup>[27]</sup> identified six studies found to be acceptable for systematic quality assessment.<sup>[28–33]</sup> The authors found that each one of these studies demonstrated a positive effect, and the pooled effect

Table 1 Quantities of glucosamine present in different preparations<sup>a</sup>

Comparative attributes	Glucosamine HCl	Glucosamine SO <sub>4</sub> -2NaCl	Glucosamine SO <sub>4</sub> -2KCl
Purity (as the salt form) (%)	99 +	79.5 (20.5% NaCl)	75 (25% KCl)
Weight percentage as glucosamine	83.1	62.7	59.5
Dose (mg) to yield 1500 mg of glucosamine	1805	2392	2521
Glucosamine content (mg) per 1500 mg of substance	1246.5	940.5	892.5

<sup>a</sup>Does not include comparison of physical mixtures of glucosamine hydrochloride and potassium sulfate because these mixtures can be prepared in varying concentrations.

size was deemed to be moderate. Subsequent to this review, three independently funded studies have been published.<sup>[34–36]</sup> In general, experiments with larger sample sizes and those without industry support tended to have smaller effect sizes.

Two other glucosamine clinical trials merit specific comment. Both of these recently published studies present data from patients who received long term glucosamine therapy with the primary objective being to evaluate progressive loss of joint space in the knee and thus assess the potential for disease modification using standard, serially obtained, antero-posterior, weight-bearing knee X-rays as the outcome measure. Other outcomes were also addressed aimed at evaluating improvement in joint pain over the duration of the trial. Both studies were industry supported.

The first study<sup>[37]</sup> evaluated 212 patients followed for three years on 1500 mg glucosamine per day versus placebo. It assessed change in medial compartment joint space width as determined on standing, weight-bearing antero-posterior knee radiographs as the primary outcome. Symptomatic outcomes were assessed using the WOMAC instrument. The authors reported that the patients taking glucosamine experienced no loss in joint space, while those on placebo continued to show progressive cartilage loss. Glucosamine-treated subjects also experienced improved symptoms in total WOMAC index based on intent-to-treat statistical principles.

In the second study evaluated,<sup>[38]</sup> 202 patients received 1500 mg glucosamine per day or placebo. Once again, radiographic medial joint space narrowing as described in the study above was the primary outcome measure. Symptomatic evaluation was measured using both the WOMAC and Lequesne instruments. The researchers found that patients taking glucosamine showed no progression of medial joint space narrowing, while the placebo-treated subjects experienced progressive joint space narrowing. The study also reported a completer's analysis that demonstrated significant improvement in symptoms based on both the above-mentioned indices.

At least two major concerns have been raised regarding the validity of the selected radiographic outcome measure in these studies. The first is that because of anatomic positioning in the extended AP view of the knee, the joint space width does not actually measure articular cartilage only, but others as well such as the meniscus and status of the collateral ligaments and therefore may not indicate true joint space width. Utilization of standardized radiographic protocols<sup>[39]</sup> or the development and validation of other quantitative measures of articular cartilage will be necessary to demonstrate whether these agents are potentially disease modifying. Secondly, positioning of the joint for

radiography in terms of extension may be influenced by the amount of joint pain at the time the film was taken.<sup>[40]</sup> Thus, patients with less painful knees may have had less guarding and therefore more extension that could give the appearance of wider joint space width. In any event, the possibility of disease modification by glucosamine as determined by altering radiographic evidence of progressive joint space narrowing is an intriguing and important question that warrants further study.

A seemingly overlooked, yet remarkable, finding in both of these trials was the improvement that was seen in joint pain over the years of study follow-up. Sustained lessening in pain of the degree and duration suggested by these trials has never been reported before for any agent in the management of osteoarthritis. This is certainly a puzzling information regarding glucosamine efficacy in a controlled setting.

## SAFETY

The safety profile of glucosamine in the published studies described earlier is uniformly favorable and comparable to placebo. A few minor adverse events have been reported, including GI complaints such as heartburn, diarrhea, constipation, epigastric pain, and nausea.<sup>[41]</sup> One concern about the use of glucosamine is its potential to cause or worsen diabetes. In animal models, increased glucosamine levels in cells have been associated with insulin resistance (a major factor in the genesis of Type 2 diabetes mellitus) and alterations in insulin production.<sup>[42–44]</sup> Whether the doses commonly used in humans are sufficient to cause significant alterations in glucose homeostasis is not clear at this time. A recent study by Scroggie, Albright, and Harris,<sup>[45]</sup> however found that glucosamine treatment of known diabetics did not change either their diabetes management or their diabetes control as assessed by levels of hemoglobin A1c.

## RECOMMENDATIONS

Glucosamine is a natural aminosaccharide present in the exoskeletons of arthropods and is obtained from chitin by acid decomposition. It does not exist as a natural biosynthetic product in cells. Instead, it is generated as glucosamine-6-phosphate by the reaction of fructose-6-phosphate and glutamine (see Fig. 2 pathway for detail). Glucosamine-6-phosphate precedes in the biosynthesis of the GAG component of proteoglycans such as cartilage aggrecan. Loss of cartilage aggrecan due to excessive proteolysis is part of the clinical syndrome identified as osteoarthritis. Dietary glucosamine may slacken, stall, or even counter this

degenerative process. While there have been clinical studies suggesting these effects, meticulous and objective experiments are required to validate them. Even more importantly, if glucosamine has a beneficial effect on osteoarthritis, more basic studies will be necessary to determine its pharmacokinetic profile, establish what the biological mechanism of its effects are (which cells and metabolic pathways are affected), and how such effects could be maximized. Finally, if glucosamine is proven to be effective in the treatment of OA, a feasible plan to regulate its manufacture and distribution will be required. This will assure the patient of a safe and uncontaminated product.

## ACKNOWLEDGMENTS

The authors gratefully acknowledge John D. Sandy, Ph.D., Anna Plaas, Ph.D., and Jamie Barnhill, Ph.D., for their valuable assistance in preparing this manuscript.

## REFERENCES

- Iozzo, R.V. Matrix proteoglycans: from molecular design to cellular function. *Annu. Rev. Biochem.* **1998**, *67*, 609–652.
- Jay, G.D.; Harris, D.A.; Cha, C.J. Boundary lubrication by lubricin is mediated by O-linked beta(1-3)Gal-GalNAc oligosaccharides. *Glycoconj. J.* **2001**, *18* (10), 807–815.
- Wood, I.S.; Trayhurn, P. Glucose transporters (GLUT and SGLT): expanded families of sugar transport proteins. *Br. J. Nutr.* **2003**, *89* (1), 3–9.
- Uldry, M.; Ibberson, M.; Hosokawa, M.; Thorens, B. GLUT2 is a high affinity glucosamine transporter. *FEBS Lett.* **2002**, *524* (1–3), 199–203.
- Sandy, J.D.; Gamett, D.; Thompson, V.; Verscharen, C. Chondrocyte-mediated catabolism of aggrecan: aggrecanase-dependent cleavage induced by interleukin-1 or retinoic acid can be inhibited by glucosamine. *Biochem. J.* **1998**, *335* (Pt. 1), 59–66.
- Orth, M.W.; Peters, T.L.; Hawkins, J.N. Inhibition of articular cartilage degradation by glucosamine-HCl and chondroitin sulphate. *Equine Vet. J. Suppl.* **2002**, (34), 224–229.
- Gouze, J.N.; Bianchi, A.; Becuwe, P.; Dauca, M.; Netter, P.; Magdalou, J. et al. Glucosamine modulates IL-1-induced activation of rat chondrocytes at a receptor level, and by inhibiting the NF-kappa B pathway. *FEBS Lett.* **2002**, *510* (3), 166–170.
- Largo, R.; Alvarez-Soria, M.A.; Diez-Ortego, I.; Calvo, E.; Sanchez-Pernaute, O.; Egido, J. et al. Glucosamine inhibits IL-1beta-induced NF-kappaB activation in human osteoarthritic chondrocytes. *Osteoarthritis Cartilage* **2003**, *11* (4), 290–298.
- Ma, L.; Rudert, W.A.; Harnaha, J.; Wright, M.; Machen, J.; Lakomy, R. et al. Immunosuppressive effects of glucosamine. *J. Biol. Chem.* **2002**, *277* (42), 39,343–39,349.
- Setnikar, I.; Giachetti, C.; Zanolio, G. Absorption, distribution and excretion of radioactivity after a single intravenous or oral administration of [<sup>14</sup>C] glucosamine to the rat. *Pharmatherapeutica* **1984**, *3* (8), 538–550.
- Setnikar, I.; Giacchetti, C.; Zanolio, G. Pharmacokinetics of glucosamine in the dog and in man. *Arzneimittelforschung* **1986**, *36* (4), 729–735.
- Setnikar, I.; Palumbo, R.; Canali, S.; Zanolio, G. Pharmacokinetics of glucosamine in man. *Arzneimittelforschung* **1993**, *43* (10), 1109–1113.
- Setnikar, I.; Rovati, L.C. Absorption, distribution, metabolism and excretion of glucosamine sulfate. A review. *Arzneimittelforschung* **2001**, *51* (9), 699–725.
- Pendleton, A.; Arden, N.; Dougados, M.; Doherty, M.; Bannwarth, B.; Bijlsma, J.W. et al. EULAR recommendations for the management of knee osteoarthritis: report of a task force of the Standing Committee for International Clinical Studies Including Therapeutic Trials (ESCISIT). *Ann. Rheum. Dis.* **2000**, *59* (12), 936–944.
- Theodosakis, J.; Adderly, B.; Fox, B. *The Arthritis Cure*; St. Martin's Press: New York, 1997.
- Theodosakis, J.; Adderly, B.; Fox, B. *Maximizing the Arthritis Cure*; St. Martin's Press: New York, 1998.
- Gorman, C.; Park, A. The age of arthritis. *Time* **2002**.
- Hood, C.; Johnson, J.; Kelly, C. What is the prevalence of rheumatic disorders in general medical inpatients? *Postgrad. Med. J.* **2001**, *77* (914), 774–777.
- Recommendations for the medical management of osteoarthritis of the hip and knee: 2000 update. American College of Rheumatology Subcommittee on Osteoarthritis Guidelines. *Arthritis Rheum.* **2000**, *43* (9), 1905–1915.
- Hochberg, M.C.; Altman, R.D.; Brandt, K.D.; Clark, B.M.; Dieppe, P.A.; Griffin, M.R. et al. Guidelines for the medical management of osteoarthritis. Part II. Osteoarthritis of the knee. American College of Rheumatology. *Arthritis Rheum.* **1995**, *38* (11), 1541–1546.

21. Hochberg, M.C.; Altman, R.D.; Brandt, K.D.; Clark, B.M.; Dieppe, P.A.; Griffin, M.R. et al. Guidelines for the medical management of osteoarthritis. Part I. Osteoarthritis of the hip. American College of Rheumatology. *Arthritis Rheum.* **1995**, *38* (11), 1535–1540.
22. NCCAM. About the National Center for Complementary and Alternative Medicine 2003.
23. NCCAM. NCCAM Funding: Appropriations History 2003.
24. China Dominates Glucosamine Supply. *Nutr. Bus. J.* **2001** (August/September).
25. Cordoba, F.; Nimni, M.E. Chondroitin sulfate and other sulfate containing chondroprotective agents may exhibit their effects by overcoming a deficiency of sulfur amino acids. *Osteoarthritis Cartilage* **2003**, *11* (3), 228–230.
26. Hoffer, L.J.; Kaplan, L.N.; Hamadeh, M.J.; Grigoriu, A.C.; Baron, M. Sulfate could mediate the therapeutic effect of glucosamine sulfate. *Metabolism* **2001**, *50* (7), 767–770.
27. McAlindon, T.E.; LaValley, M.P.; Gulin, J.P.; Felson, D.T. Glucosamine and chondroitin for treatment of osteoarthritis: a systematic quality assessment and meta-analysis. *J. Am. Med. Assoc.* **2000**, *283* (11), 1469–1475.
28. Reichelt, A.; Forster, K.K.; Fischer, M.; Rovati, L.C.; Setnikar, I. Efficacy and safety of intramuscular glucosamine sulfate in osteoarthritis of the knee. A randomised, placebo-controlled, double-blind study. *Arzneimittelforschung* **1994**, *44* (1), 75–80.
29. Rovati, L. The clinical profile of glucosamine sulfate as a selective symptom modifying drug in osteoarthritis: current data and perspectives. *Osteoarthritis Cartilage* **1997**, *5* (Suppl. A), 72.
30. Vajjaradul, Y. Double-blind clinical evaluation of intra-articular glucosamine in outpatients with gonarthrosis. *Clin. Ther.* **1981**, *3* (5), 336–343.
31. Pujalte, J.M.; Llavore, E.P.; Ylescupidéz, F.R. Double-blind clinical evaluation of oral glucosamine sulphate in the basic treatment of osteoarthrosis. *Curr. Med. Res. Opin.* **1980**, *7* (2), 110–114.
32. Houghton, J.B.; McMillan, R.; Wein, C.; Paget-Dellio, S.D. Effect of glucosamine hydrochloride in the treatment of pain of osteoarthritis of the knee. *J. Rheumatol.* **1999**, *26* (11), 2423–2430.
33. Noack, W.; Fischer, M.; Forster, K.K.; Rovati, L.C.; Setnikar, I. Glucosamine sulfate in osteoarthritis of the knee. *Osteoarthritis Cartilage* **1994**, *2* (1), 51–59.
34. Thie, N.M.; Prasad, N.G.; Major, P.W. Evaluation of glucosamine sulfate compared to ibuprofen for the treatment of temporomandibular joint osteoarthritis: a randomized double blind controlled 3 month clinical trial. *J. Rheumatol.* **2001**, *28* (6), 1347–1355.
35. Hughes, R.; Carr, A. A randomized, double-blind, placebo-controlled trial of glucosamine sulphate as an analgesic in osteoarthritis of the knee. *Rheumatology (Oxford)* **2002**, *41* (3), 279–284.
36. Rindone, J.P.; Hiller, D.; Collacott, E.; Nordhaugen, N.; Arriola, G. Randomized, controlled trial of glucosamine for treating osteoarthritis of the knee. *West. J. Med.* **2000**, *172* (2), 91–94.
37. Reginster, J.Y.; Deroisy, R.; Rovati, L.C.; Lee, R.L.; Lejeune, E.; Bruyere, O. et al. Long-term effects of glucosamine sulphate on osteoarthritis progression: a randomised, placebo-controlled clinical trial. *Lancet* **2001**, *357* (9252), 251–256.
38. Pavelka, K.; Gatterova, J.; Olejarova, M.; Machacek, S.; Giacovelli, G.; Rovati, L.C. Glucosamine sulfate use and delay of progression of knee osteoarthritis: a 3-year, randomized, placebo-controlled, double-blind study. *Arch. Intern. Med.* **2002**, *162* (18), 2113–2123.
39. Buckland-Wright, J.C.; Wolfe, F.; Ward, R.J.; Flowers, N.; Hayne, C. Substantial superiority of semiflexed (MTP) views in knee osteoarthritis: a comparative radiographic study, without fluoroscopy, of standing extended, semiflexed (MTP), and schuss views. *J. Rheumatol.* **1999**, *26* (12), 2664–2674.
40. Mazzuca, S.A.; Brandt, K.D.; Lane, K.A.; Katz, B.P. Knee pain reduces joint space width in conventional standing anteroposterior radiographs of osteoarthritic knees. *Arthritis Rheum.* **2002**, *46* (5), 1223–1227.
41. Heyneman, C.A.; Rhodes, R.S. Glucosamine for osteoarthritis: cure or conundrum? *Ann. Pharmacother.* **1998**, *32* (5), 602–603.
42. McClain, D.A.; Crook, E.D. Hexosamines and insulin resistance. *Diabetes* **1996**, *45* (8), 1003–1009.
43. Tang, J.; Neidigh, J.L.; Cooksey, R.C.; McClain, D.A. Transgenic mice with increased hexosamine flux specifically targeted to beta-cells exhibit hyperinsulinemia and peripheral insulin resistance. *Diabetes* **2000**, *49* (9), 1492–1499.
44. Rossetti, L. Perspective: hexosamines and nutrient sensing. *Endocrinology* **2000**, *141* (6), 1922–1925.
45. Scroggie, D.A.; Albright, A.; Harris, M.D. The effect of glucosamine–chondroitin supplementation on glycosylated hemoglobin levels in patients with type 2 diabetes mellitus: a placebo-controlled, double-blinded, randomized clinical trial. *Arch. Intern. Med.* **2003**, *163* (13), 1587–1590.

# Glutamine

Steve F. Abcouwer

University of New Mexico School of Medicine,  
Albuquerque, New Mexico, U.S.A.

## INTRODUCTION

Glutamine is the most abundant amino acid in the body, due to its relatively high concentration in the blood and comparatively large stores of free glutamine in muscle. It is found in all proteins, and thus any protein source provides glutamine in the diet. The free form is also found in meat, milk, fruits, and vegetables. However, glutamine is not an essential amino acid, since it can be readily produced from glutamate in all tissues, with muscle tissue being the primary source of glutamine in the blood. Although there is no dietary reference intake (for under normal conditions, glutamine is not a necessary dietary constituent), during critical illness, severe trauma, intestinal disease, starvation, total parenteral nutrition (intravenous feeding), wasting (excessive loss of lean body mass), and extreme endurance exercise, the body's need and consumption of glutamine can exceed the ability of tissues to produce this amino acid. Under such stress conditions, dietary glutamine is beneficial. Hence, glutamine is referred to as a "conditionally essential" amino acid. It is becoming one of the most popular and profitable nutritional supplements due to claims that consumption can boost immune function and increase muscle mass and volume. However, while glutamine is nontoxic and probably harmless, the benefits of consuming dietary supplements containing this amino acid have not been proven.

## NAME AND GENERAL DESCRIPTION

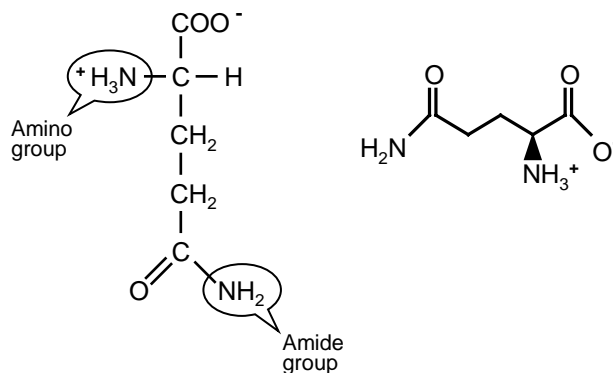
Glutamine (L-glutamine, Gln, Q, CAS Registry number 56-85-9) is a nonessential, neutral, polar amino acid, one of the 20 common amino acids found in proteins. Its molecular weight is 146.15, and its molecular formula is  $C_5H_{10}N_2O_3$ . Unlike most amino acids, glutamine contains two nitrogen molecules: one is part of the "alpha amino" group, and the other is part of an amide or "amido" group of the amino acid side chain (Fig. 1). The addition of the amide

group differentiates glutamine from the closely related amino acid glutamate (L-glutamic acid, Glu, E). The interconversion of glutamine and glutamate by addition and removal of this amide group makes glutamine a convenient nitrogen shuttle and nitrogen donor in many synthetic biochemical reactions. In this way, glutamine can also serve as a source of intracellular glutamate. Because glutamate is a critical intracellular anion, this function is vital for the control of cell volume. Through glutamate, glutamine carbons can also enter the tricarboxylic acid cycle (TCA cycle). Thus, glutamine can serve as an important source of reducing equivalents (e.g., NAD(P)H, FADH<sub>2</sub>) and, ultimately, cellular energy.

## BIOCHEMISTRY AND FUNCTIONS

### Biological Synthesis and Utilization

Glutamine is formed directly from glutamate by the addition of ammonia in an ATP-requiring reaction catalyzed by the enzyme glutamine synthetase (GS, E.C. 6.3.1.2). This enzyme is found in the cell cytoplasm. Its function is solely to form glutamine at the expense of cellular glutamate and energy. The amino acid may



**Fig. 1** The structure of glutamine. Two representations of glutamine: On the left is the structural formula, with the amino nitrogen and amide nitrogen side groups indicated. On the right is a conformational formula. In solution at neutral pH, both the amino and carboxylic acid groups of glutamine are charged.

Steve F. Abcouwer, Ph.D., is Assistant Professor at the Department of Biochemistry and Molecular Biology, University of New Mexico School of Medicine, Albuquerque, New Mexico, U.S.A.



be formed because it is needed for synthetic reactions, ammonia detoxification, or for export to other tissues. Glutamine is readily converted to glutamate by several amidotransferase enzymes and glutaminase enzymes (GA, E.C. 3.5.1.2). The former enzymes transfer the amide nitrogen of glutamine to other molecules in the course of biosynthesis. In this way, glutamine is necessary for the production of other amino acids, purine and pyrimidine bases, amino sugars, and several coenzymes.<sup>[1]</sup> Glutaminase produces glutamate and ammonia. Two GA genes exist: One is expressed exclusively in the liver and is therefore referred to as hepatic glutaminase (hGA), whereas the other is ubiquitously expressed and is referred to as kidney glutaminase (kGA).<sup>[2]</sup> The kidney GA gene gives rise to several isoforms due to alternative splicing of the transcript.<sup>[3]</sup> The functional significance of these GA isoforms is not fully known. However, the expression of one isoform known as GAC is controlled by acidity, which has important implications for the control of chronic metabolic acidosis.<sup>[4]</sup>

### Metabolic Functions

The normal plasma concentration of glutamine is relatively high, whereas the plasma concentration of glutamate is quite low.<sup>[5,6]</sup> Cells also exhibit large capacities for the import of glutamine, much larger than that for glutamate.<sup>[7]</sup> Once inside the cell, glutamine is readily converted into glutamate by the action of amidotransferase and glutaminase enzymes. In fact, in most tissues (with the notable exception of muscle), the intracellular concentration of glutamine is much lower than that of glutamate.<sup>[6,8]</sup> Thus, glutamine represents the primary source of intracellular glutamate (for review see Ref.<sup>[9]</sup>). Glutamate is an important intracellular anion, playing a vital role in maintenance of cell osmolarity and, thus, cell volume.<sup>[10]</sup>

Glutamate formed from glutamine is itself indispensable for many cellular processes (for review, see Refs.<sup>[8,9]</sup>). For example, transamination reactions utilizing the amino nitrogen of glutamate convert certain keto acids to amino acids. In this way, glutamate is central to the cell's amino acid economy. The anion also serves as a precursor for proline synthesis. It supports the synthesis of the tripeptide molecule glutathione, the cell's major store of reducing equivalents.<sup>[11]</sup> Glutamate does this directly by serving as a substrate for glutathione synthesis, and indirectly by providing a means for the cell to import cysteine, another substrate for glutathione synthesis.<sup>[12]</sup> Glutamate is oxidatively deaminated by the enzyme glutamate dehydrogenase (GDH) to form  $\alpha$ -ketoglutarate, with the concurrent reduction of  $\text{NAD}^+$  (or  $\text{NADP}^+$ ) to NADH (or NADPH). As  $\alpha$ -ketoglutarate, the carbon

skeleton of glutamate enters the TCA cycle. In this way, glutamate carbons are utilized for anaplerosis (as carbon donor to replenish the tricarboxylic acid cycle) and are oxidized to  $\text{CO}_2$  making glutamine an important source of cellular energy.<sup>[13]</sup> Oxidation of glutamine carbons to  $\text{CO}_2$  and glutamine to pyruvate (a process referred to as "glutaminolysis" in analogy to glycolysis) produces reducing equivalents in the forms of NADH, NADPH, and  $\text{FADH}_2$ . These reducing equivalents are utilized for ATP synthesis by oxidative phosphorylation, synthetic reactions, and cellular protection against oxidative stress (Fig. 2).<sup>[14]</sup>

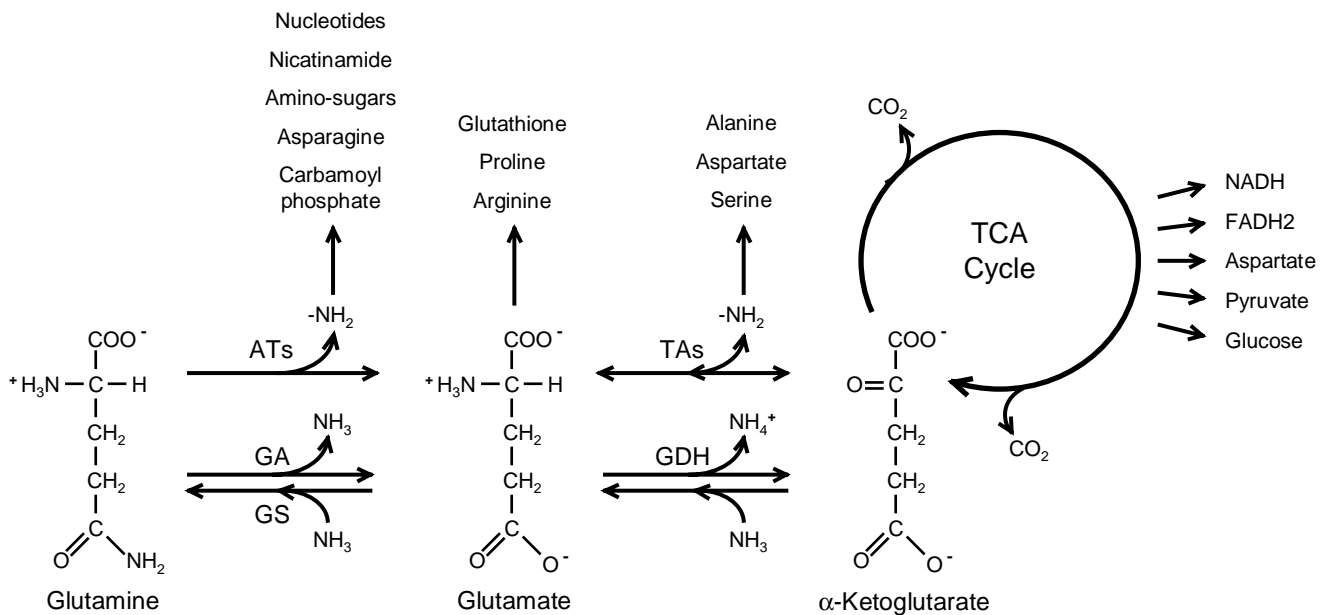
## PHYSIOLOGY

### Cellular Functions

In 1955, Harry Eagle pioneered the growth of mammalian cells in culture. In the course of developing culture media for these cells, he tested the requirements for numerous salts, vitamins, minerals, carbohydrates, and amino acids.<sup>[15]</sup> The scientist discovered that glutamine was necessary to support the growth and viability of cell in culture, and at concentrations greater than that of any other amino acid.<sup>[16]</sup> Eagle and colleagues subsequently determined that both protein synthesis and nucleic acid synthesis were dependent on glutamine.<sup>[17]</sup> Now it is known that nearly all mammalian cell cultures benefit from the addition of glutamine to their media. Thus, cell culture media is almost always supplemented with concentrations of glutamine that are an order of magnitude greater than those of other amino acids. However, during all this time, the exact nature of this dependence on glutamine has not been clarified. Perhaps this is because the metabolic functions of glutamine and glutamate are so varied. Indeed, a supply of glutamine is needed to support numerous cellular processes.

### Support of Cell Proliferation

The need for glutamine is particularly acute for proliferative cells. In the adult, cell proliferation is most active in the intestine, immune system, and during wound healing. Cells within the intestinal epithelium constantly divide to cope with cell loss and renewal. Replacement of damaged epithelial cells through a process of crypt cell proliferation and differentiation along the crypt-villus axis seems to be supported by glutamine.<sup>[18]</sup> In culture, intestinal epithelial cells are avid glutamine consumers, and their growth is glutamine dependent.<sup>[19]</sup> Cell growth and replacement also characterize the immune system. In response to immune challenge, immune cells of



**Fig. 2** Metabolic functions of glutamine. Once inside a cell, glutamine is readily converted to glutamate by glutaminase enzymes (GA) that produce free ammonia, and by several amidotransferase enzymes (ATs) which utilize the amide nitrogen of glutamine to transfer ammonia to other molecules in synthetic reactions (a partial list is shown). Glutamine is formed from glutamate by glutamine synthetase (GS), utilizing ammonia and ATP (not shown). The relatively high intracellular concentration of glutamate makes it an important osmolyte for the control of cell volume. Glutamate is also utilized for synthesis of glutathione (a tripeptide containing glutamate), proline, and arginine. It is oxidatively deaminated to form  $\alpha$ -ketoglutarate and ammonia in a reversible reaction catalyzed by glutamate dehydrogenase (GDH). The forward reaction utilizes  $\text{NAD(P)}^+$  and  $\text{H}_2\text{O}$  (not shown). In the reverse reaction,  $\text{NAD(P)H}$  is oxidized and  $\text{H}_2\text{O}$  is formed. Transaminase enzymes (TAs) transfer the ammonia from the amino group of glutamate to keto acids, forming new amino acids. For example, alanine is formed from pyruvate and aspartate from oxaloacetate in this manner. Other intermediate reactions in the synthesis of amino acids are catalyzed by aminotransferase enzymes utilizing glutamate, for example, in the formation of 3-phosphoserine from 3-hydroxypyruvate during serine synthesis. As  $\alpha$ -ketoglutarate, the carbon skeleton of glutamine enters the tricarboxylic acid cycle (TCA cycle). In this way, these carbons are oxidized to  $\text{CO}_2$ , forming reducing equivalents in the forms of  $\text{NADH}$  and  $\text{FADH}_2$  that are utilized for ATP production. From TCA cycle intermediates, the carbon skeleton of glutamine can provide substrates for formation of many metabolic intermediates, including aspartate, pyruvate, and glucose.

both T and B lineage undergo clonal expansion followed by programmed cell death (apoptosis) when the infection has abided. Immune cells of all types exhibit marked glutamine dependence for both activation and proliferation.<sup>[20]</sup> Glutamine also inhibits cell death caused by several cellular stresses, and thus has been referred to as an “apoptosis suppressor.”<sup>[14]</sup>

## SYSTEMIC METABOLISM

### Glutamine Cycling in Brain and Liver

Glutamine synthetase occurs in all tissues and is especially abundant in brain and liver. In the brain, GS activity is vital for the conversion of glutamate (one of the most important neurotransmitter molecules) to glutamine by astrocytes.<sup>[21]</sup> This serves to prevent the accumulation of glutamate, which is toxic at

high levels, and to detoxify ammonia. Glutamine is then transferred from the astrocytes to neurons, which convert it back to glutamate to be released at synapses in response to stimuli (for review, see Ref.<sup>[22]</sup>).

In the liver, another glutamine–glutamate cycle operates.<sup>[23]</sup> Blood entering the liver from the gut via the portal vein carries waste nitrogen that must be disposed of by conversion to urea. Much of this nitrogen is carried by glutamine. Periportal hepatocytes extract glutamine and convert it to glutamate, producing ammonia that then enters the urea cycle. In addition, the alpha amino nitrogen of glutamine is converted to ammonia by oxidative deamination of glutamate. The alpha amino group of glutamate can also be transferred to oxaloacetate to form aspartate that can enter the urea cycle. Thus, as the blood moves down the liver sinusoids, it is stripped of glutamine. A high level of GS in the liver is concentrated in the pericentral and perivenous hepatocytes.<sup>[24]</sup>

In the perivenous section of the sinusoid, excess ammonia is scavenged and incorporated into glutamine by GS. In this way, ammonia is removed and the concentration of glutamine in the outgoing venous blood is elevated.

### Glutamine Production by Muscle and Lung

The muscle, lung, and adipose tissue are major sources of glutamine in circulation, and these tissues increase glutamine production during catabolic states. The expression of the GS gene in these tissues is increased in response to stress hormones, principally glucocorticoids.<sup>[25]</sup> The human GS gene has not been characterized. However, the rat GS gene includes two regions containing glucocorticoid response elements (GRE), which are responsible for increased transcription in response to glucocorticoid hormones.<sup>[26]</sup> This phenomenon of increased gene expression is particularly evident in muscle and lung tissues.<sup>[25]</sup> Thus, in response to stress hormones, muscle and lung tissues produce increased amounts of GS mRNA that is translated into GS protein.

In addition, the ultimate accumulation of GS protein is regulated by a unique feedback mechanism that responds to the need for glutamine synthesis. Namely, the degradation rate of the GS protein is increased by glutamine.<sup>[27]</sup> Thus, when glutamine is abundant, GS protein is rapidly degraded. When intracellular glutamine is depleted, GS protein degradation slows and the GS level increases. In this way, the amount of GS protein is indexed to the need for glutamine. In times of stress, glucocorticoid hormones increase GS transcription, and the resulting elevated level of GS mRNA leads to increased GS protein production. Nevertheless, GS protein will not appreciably accumulate unless there is a need for increased glutamine production, as signaled by intracellular glutamine depletion.<sup>[27]</sup> Importantly, stress hormones also signal changes that lead to increased glutamine export from cells.<sup>[28]</sup> Thus, as these hormones signal for increased GS expression, the intracellular glutamine stores become depleted. This leads to a synergistic mechanism by which GS protein is produced at an accelerated rate and degraded at a reduced rate. This results in a robust increase in GS activity, until such time that the production of glutamine is sufficient to match the rate of its export.

### Control of Acidosis

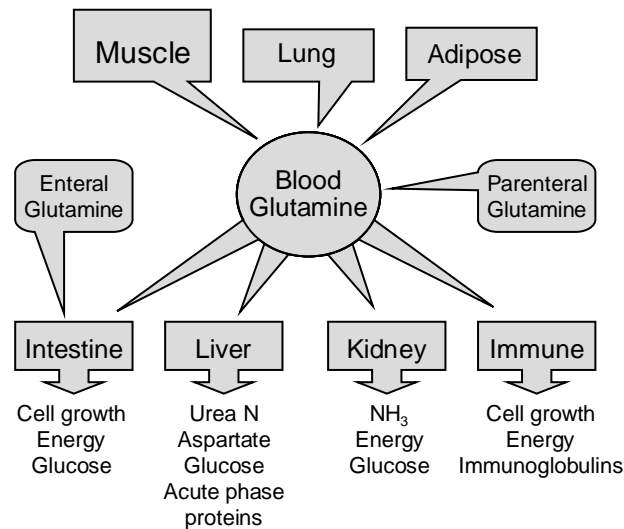
Glutamine utilization by the kidney is essential for controlling the amount of acid in the blood. This is accomplished by ammonia formation by the kidney

enzymes glutaminase and GDH, using glutamine as the source.<sup>[29]</sup> Once GA forms glutamate and ammonia, GDH catalyzes the oxidative deamination of glutamate to form  $\alpha$ -ketoglutarate and ammonia. The ammonia formed from these two reactions binds hydrogen ions to form ammonium ions that are eliminated in the urine along with acid anions. During shock, starvation, uncontrolled type-I diabetes, and severe diarrhea, metabolic acidosis can occur due to the increased production of ketoacids (e.g., acetoacetate and  $\beta$ -hydroxybutyrate) or the loss of bicarbonate ions. To dispose of these extra acid anions, the kidney greatly increases its utilization of glutamine, thereby producing ammonia. This is accomplished by increasing the expression of GA and GDH within the kidney tubules. The expression of GA (the GAC isoform) and GDH in response to acidosis is controlled by a unique mechanism that involves stabilization of these mRNA by zeta-crystallin in response to acidic pH.<sup>[4,30]</sup> The consequence of greater utilization of glutamine by the kidney during acidosis is that the demand for systemic glutamine synthesis is correspondingly increased (Fig. 3).

## ROLE IN CATABOLIC DISEASE

### Catabolic States

Catabolic states describe any metabolic situation in which fat and lean body masses are utilized faster than they are restored. However, the term catabolic state is usually used to describe a pathological state where fat and lean body mass (primarily muscle) is utilized in response to hormonal signals and/or increased metabolic demands that are not being met by nutrient uptake. Severe trauma, burn, infection, starvation, or chronic diseases such as HIV/AIDS and cancer cachexia may cause it. Increased protein turnover during these states produces greater amounts of waste nitrogen and thus requires increased nitrogen shuttling by glutamine.<sup>[31]</sup> These states are also associated with ketosis causing metabolic acidosis. Glutamine demand by the kidney is increased to counter this acidosis. In addition, massive immune activation and expansion may also cause an increased glutamine demand as immune cells consume more of this amino acid. If infection occurs, the liver increases its consumption of glutamine and other amino acids to support acute phase protein synthesis.<sup>[32]</sup> If sustained, catabolic states can lead to severe depletion of lean body mass, thereby diminishing the ability of muscle tissue to produce glutamine and satisfy this increased demand, and ultimately leading to impaired immunity, poor wound healing, and loss of intestinal barrier function.<sup>[33]</sup>



**Fig. 3** Systemic glutamine metabolism. Free glutamine in circulation is derived mainly from muscle, and secondarily from lung and adipose tissue. Glutamine is also obtained from the liver and brain (not shown). Blood glutamine can also be provided directly by parenteral nutrition. Glutamine from the diet and in circulation is extracted by the intestine and is used to support cell growth, energy production, and acts as a substrate for gluconeogenesis. The amino acid extracted by the liver is a major carrier of nitrogen that enters the urea cycle. Aspartate formed from glutamine can also enter the urea cycle, carrying both nitrogen and carbon. Glutamine is also a major substrate for liver gluconeogenesis. In times of infection, it aids acute phase protein synthesis by the liver by supporting amino acid synthesis. The kidney uses glutamine as a source of ammonia to neutralize hydrogen ions and eliminate acid anions, and thus control acidosis. Glutamine also serves as a source of energy and as a gluconeogenic precursor for the kidney. Immune cells, both gut-associated and in circulation, consume glutamine to sustain cell growth and provide cellular energy. It also supports the synthesis of immunoglobulins and other proteins by immune cells. (View this art in color at [www.dekker.com](http://www.dekker.com).)

### Interorgan Transport

During catabolic states, stress hormones trigger an increased rate of muscle protein degradation, while decreasing muscle protein synthesis.<sup>[28]</sup> Thus, free amino acids are produced. The carbon skeletons of branched-chain amino acids are preferentially utilized for oxidative energy production by the muscle, sparing glucose for use by other tissues.<sup>[34]</sup> The muscle releases other amino acids produced from protein degradation, which are then utilized in other tissues, especially those in the intestine, kidney, liver, and immune system. In the muscle, the amino groups from oxidation of branched-chain amino acids ultimately become waste nitrogen in the form of ammonia. In order to dispose of this nitrogen, muscle tissue utilizes glutamine and

alanine as nitrogen carriers.<sup>[35]</sup> Thus, lean body mass is converted into energy, and a mixture of amino acids is released that is dominated by glutamine and alanine.<sup>[36]</sup>

The lung also increases production of glutamine during catabolic states.<sup>[37]</sup> Adipose tissue has also been implicated as a producer of glutamine.<sup>[38]</sup> However, the source of nitrogen to support the production of glutamine by these tissues has not been established. Glutamine may be produced from glutamate and ammonia extracted from blood.<sup>[38]</sup> It is possible that branched-chain amino acids produced in the liver could be extracted by these tissues and used to support glutamine synthesis.<sup>[35]</sup>

Glutamine is an ideal nitrogen shuttle because it can be readily formed from intracellular glutamate, and because each molecule carries two ammonia equivalents. Alanine is ideal as a nitrogen shuttle because it can be readily formed from pyruvate by a single transamination reaction, and as it can then serve as a ready source of energy and glucose when it is converted back to pyruvate. Thus, both glutamine and alanine carry nitrogen and serve as energy sources for visceral tissues. In addition, both serve as major gluconeogenic precursors for the liver, kidney, and intestine.<sup>[39,40]</sup>

Thus, in catabolic states, muscle protein breakdown and conversion of unknown substrates by the lung produce glutamine that is released by these tissues. The kidney, intestine, immune system, and healing tissues utilize this glutamine. The amino acid also serves as a major precursor for glucose formation. Nitrogen carried by glutamine is disposed of as urea produced in the liver and as ammonia produced primarily in the kidney. If a catabolic state persists, loss of lean body mass diminishes the ability of muscle to produce glutamine and maintain interorgan glutamine flux.

## NUTRITIONAL SUPPLEMENTATION

### Total Parenteral Nutrition (TPN)

In severe catabolic states or situations where oral nourishment cannot be tolerated, intravenous feeding, referred to as TPN, is used. Until recently, TPN formulations did not include glutamine. This was in part due to the fact that glutamine is unstable in solution; it slowly decomposes to form ammonia and pyrrolidone-carboxylic acid.<sup>[41]</sup> Lack of enteral feeding during TPN leads to intestinal atrophy.<sup>[42]</sup> Because glutamine is such an important substrate for the intestine, it was reasoned that its inclusion in TPN solutions would alleviate intestinal atrophy. Numerous studies using animal models have confirmed this assumption (for review, see Ref.<sup>[43]</sup>). In addition, many human trials have demonstrated significant benefits in inclusion of glutamine in TPN solutions (for review, see Ref.<sup>[44]</sup>).

Including glutamine-containing dipeptides that are cleaved in the circulation to produce free glutamine solved the problem of glutamine instability.<sup>[45]</sup> However, the inclusion of up to 25 g/day glutamine in TPN solution has very little effect on glutamine concentrations in blood and muscle.<sup>[46]</sup>

In contrast to TPN, the benefits of enteral glutamine supplementation are still being debated.<sup>[47]</sup> In fact, several efforts to reverse wasting and cachexia by glutamine feeding have not been successful.<sup>[48,49]</sup> On the other hand, two recent studies<sup>[50,51]</sup> have shown that a combination of an oral glutamine, arginine, and the leucine metabolite,  $\beta$ -hydroxy- $\beta$ -methylbutyrate, was able to inhibit lean muscle loss during HIV/AIDS wasting and cancer cachexia. This has led to a clinical trial of this nutrient combination entitled "Adjuvant Nutrition for Critically Ill Trauma Patients" being sponsored by the National Institute of Diabetes and Digestive and Kidney Diseases (NIDDK).

### Support of Intestinal Renewal and Function

Glutamine's ability to support intestinal renewal and function has made it a prime candidate for nutritional support of patients with intestinal diseases, including short-bowel syndrome and inflammatory bowel disease, such as Crohn's disease (for review, see Ref.<sup>[52]</sup>). However, most studies showing the benefits of enteral glutamine feeding on intestinal repair and function have been conducted using rats and pigs. Although glutamine is now being routinely incorporated into treatments that include various growth factors and nutrients, there are few clinical data to confirm that it has beneficial effects in humans.<sup>[53,54]</sup> Glutamine feeding is also believed to improve intestinal mucositis caused by chemotherapy or radiation treatment.<sup>[55,56]</sup> Results of studies with animals have suggested that it can accomplish this. However, there are not sufficient controlled clinical data on humans to reach a conclusion.<sup>[57-59]</sup> A recent phase III, randomized, double-blind clinical study conducted by the North Central Cancer Treatment Group found that glutamine feeding had no effect on acute diarrhea in patients receiving pelvic radiation therapy.<sup>[60]</sup>

### Very-Low-Birth Weight Infants

Another group of patients who may benefit from glutamine feeding is very low-birth-weight infants. These babies are born with underdeveloped alimentary systems that make them unable to tolerate oral feedings and render them prone to necrotizing colitis and susceptible to sepsis due to poor barrier function of the intestinal epithelium. Several studies have shown that glutamine feeding of premature infants can

decrease morbidity and reduce hospital costs (for review, see Ref.<sup>[61]</sup>). However, subsequent clinical trials have not demonstrated appreciable benefits of glutamine in this patient group. A trial of glutamine in TPN for very low-birth-weight infants found that glutamine reduced the time until these babies could tolerate full enteral feeding (13 vs. 21 days).<sup>[62]</sup> However, glutamine did not reduce the incidence of sepsis or age at discharge. A clinical trial of glutamine feeding for extremely low-birth-weight babies found that glutamine fed infants did not exhibit greater tolerance of enteral feeding, suffer less necrotizing enterocolitis, or exhibit greater weight gain.<sup>[63]</sup> Another study found that enterally fed glutamine was completely metabolized in the gut of preterm infants and had no effect on whole-body protein and nitrogen kinetics.<sup>[64]</sup> Nevertheless, a clinical trial examining the benefits of nutritional support including glutamine is now being conducted by the National Center for Research Resources entitled "Gluconeogenesis in Very Low Birth Weight Infants who Are Receiving Nutrition by Intravenous Infusion."

### Sickle Cell Disease

It has been suggested that glutamine feeding may alleviate the anemia associated with sickle cell disease. In 1975, a study found that incubation of sickle cells in high concentrations of homoserine, asparagine, and glutamine reduced the sickling of the red blood cells.<sup>[65]</sup> A subsequent study discounted the effects of these amino acids when it was found that they did not restore the deformability of sickle cells and did not raise the minimum gelling concentration of deoxyhemoglobin S, in spite of noticeable morphological effects on the cells.<sup>[66]</sup> On the other hand, recent studies performed at the UCLA School of Medicine found that oral glutamine does improve the redox state of sickle cells, indicated by increased NADH/(NADH + NAD<sup>+</sup>) ratio.<sup>[67]</sup> A clinical trial entitled "L-Glutamine Therapy for Sickle Cell Anemia" is now being sponsored by the FDA Office of Orphan Products Development.

### Athletic Performance Enhancement

Glutamine has recently become one of the most popular dietary supplements. Its use to boost athletic performance and promote muscle gain is based on three observations: 1) Glutamine concentration in the plasma is decreased following extreme endurance exercise, such as marathon running<sup>[68]</sup>; 2) Muscle breakdown leads to release of large amounts of glutamine from the muscle<sup>[36]</sup>; and 3) Glutamine, in its role as

the primary source of glutamate, is vital for the maintenance of cell volume.<sup>[10]</sup> It is rational to believe that consumption of glutamine would prevent depletion of plasma glutamine, even boosting its concentration in the blood. However, studies in animals and humans have shown that enteral consumption of large amounts of glutamine causes only slight and transient increases in blood glutamine levels.<sup>[5]</sup> If the muscle were no longer required to supply glutamine, then increasing glutamine supply might be expected to deter muscle protein breakdown. Although this is seemingly logical, there is no scientific evidence that glutamine supplementation, either by enteral or parenteral routes, can decrease muscle glutamine release or increase muscle glutamine import. Both muscle protein breakdown and glutamine release are hormonally controlled.<sup>[28]</sup> Thus, the balance between anabolic and catabolic hormones is more likely to influence net buildup or loss of lean body mass. Furthermore, increasing plasma glutamine concentration would increase muscle cell glutamate concentration, osmolarity, and cell volume only if muscle glutamine uptake is appreciably increased for sustained periods. There is no evidence to suggest that this can be accomplished by oral glutamine consumption. Though only short-term studies have been performed so far, they do not support the hypothesis that oral glutamine supplementation improves athletic performance.<sup>[69,70]</sup>

### Immune System Enhancement

Because immune cells are dependent upon glutamine, this amino acid has been touted as an “immune booster.” Even juice vendors offer immune booster additions that include glutamine. Several animal studies have found beneficial effects of glutamine feeding on measures of immune function, especially mucosal immune function.<sup>[71]</sup> Because glutamine feeding has minor effects on plasma glutamine concentration, this effect is probably not due to delivery to immune cells in the circulatory system. Oral glutamine may directly affect the proliferation and development of gut-associated lymphoid tissue (GALT). These immune cells mature and expand their numbers while residing in the intestine. They are later associated with mucosal membranes and, therefore, are vital for protection against infection through these barriers.<sup>[72]</sup> In the intestine, these cells are exposed to ingested glutamine, which may stimulate their growth and development.<sup>[71]</sup> Enteral glutamine decreases mortality and infectious morbidity in burn patients, perhaps by reducing intestinal permeability and bacterial translocation.<sup>[73]</sup> Although several small studies suggest that inclusion of glutamine in nutritional formulas may benefit critically ill patients,<sup>[74]</sup> the true utility of glutamine

supplementation as an immune modulator, and the mechanism by which oral glutamine consumption may support immune function have yet to be determined.

### CONCLUSIONS

In conclusion, glutamine is a nitrogen donor in metabolic reactions and the main interorgan nitrogen shuttle. As a source of glutamate, it is essential for maintenance of cellular volume, amino acid economy, glutathione, energy, and reducing equivalents. Glutamine is a conditionally essential amino acid, and several limited studies have suggested that metabolic support of catabolic patients with glutamine may improve their condition and speed their recovery.<sup>[75]</sup> Glutamine, together with other nutrients, may also benefit those with intestinal deficiencies or sickle cell disease. Dietary supplementation is claimed to increase athletic performance, muscle mass buildup, and improve immune function. However, controlled clinical studies have not yet substantiated these claims. Further, several recent clinical studies have not confirmed that the benefits of glutamine feeding observed in animals can be translated to humans.

### REFERENCES

1. Zalkin, H.; Smith, J.L. Enzymes utilizing glutamine as an amide donor. *Adv. Enzymol. Relat. Areas Mol. Biol.* **1998**, *72*, 87–144.
2. Curthoys, N.P.; Watford, M. Regulation of glutaminase activity and glutamine metabolism. *Ann. Rev. Nutr.* **1995**, *15*, 133–159.
3. Elgadi, K.M.; Meguid, R.A.; Qian, M.; Souba, W.W.; Abcouwer, S.F. Cloning and analysis of unique human glutaminase isoforms generated by tissue-specific alternative splicing. *Physiol. Genomics* **1999**, *1* (2), 51–62.
4. Porter, L.D.; Ibrahim, H.; Taylor, L.; Curthoys, N.P. Complexity and species variation of the kidney-type glutaminase gene. *Physiol. Genomics* **2002**, *9* (3), 157–166 (E-published 2002 Apr 16).
5. Valencia, E.; Marin, A.; Hardy, G. Impact of oral L-glutamine on glutathione, glutamine, and glutamate blood levels in volunteers. *Nutrition* **2002**, *18* (5), 367–370.
6. Heuschen, U.A.; Allemeyer, E.H.; Hinz, U.; Langer, K.; Heuschen, G.; Decker-Baumann, C.; Herfarth, C.; Stern, J. Glutamine distribution in patients with ulcerative colitis and in patients with familial adenomatous polyposis coli before and after restorative proctocolectomy. *Int. J. Colorectal Dis.* **2002**, *17* (4), 245–252.

7. Collins, C.L.; Wasa, M.; Souba, W.W.; Abcouwer, S.F. Determinants of glutamine dependence and utilization by normal and tumor-derived breast cell lines. *J. Cell Physiol.* **1998**, *176* (1), 166–178.
8. Tapiero, H.; Mathe, G.; Couvreur, P.; Tew, K.D. LI Glutamine and glutamate. *Biomed. Pharmacother.* **2002**, *56* (9), 446–457.
9. Newsholme, P.; Procopio, J.; Lima, M.M.; Pithon-Curi, T.C.; Curi, R. Glutamine and glutamate—their central role in cell metabolism and function. *Cell Biochem. Funct.* **2003**, *21* (1), 1–9.
10. Dall'Asta, V.; Bussolati, O.; Sala, R.; Parolari, A.; Alamanni, F.; Biglioli, P.; Gazzola, G.C. Amino acids are compatible osmolytes for volume recovery after hypertonic shrinkage in vascular endothelial cells. *Am. J. Physiol.* **1999**, *276* (4 Pt 1), C865–C872.
11. Roth, E.; Oehler, R.; Manhart, N.; Exner, R.; Wessner, B.; Strasser, E.; Spittler, A. Regulatory potential of glutamine—relation to glutathione metabolism. *Nutrition* **2002**, *18* (3), 217–221.
12. Bannai, S.; Ishii, T. A novel function of glutamine in cell culture: utilization of glutamine for the uptake of cysteine in human fibroblasts. *J. Cell Physiol.* **1988**, *137* (2), 360–366.
13. Zielke, H.R.; Zielke, C.L.; Ozand, P.T. Glutamine: a major energy source for cultured mammalian cells. *Fed. Proc.* **1984**, *43* (1), 121–125.
14. Mates, J.M.; Perez-Gomez, C.; Nunez de Castro, I.; Asenjo, M.; Marquez, J. Glutamine and its relationship with intracellular redox status, oxidative stress and cell proliferation/death. *Int. J. Biochem. Cell Biol.* **2002**, *34* (5), 439–458.
15. Eagle, H. Nutrition needs of mammalian cells in tissue culture. *Science* **1955**, *122* (3168), 501–514.
16. Eagle, H.; Oyama, V.I.; Levy, M.; Horton, C.L.; Fleischman, R. The growth response of mammalian cells in tissue culture to L-glutamine and L-glutamic acid. *J. Biol. Chem.* **1956**, *218* (2), 607–616.
17. Eagle, H. Amino acid metabolism in mammalian cell cultures. *Science* **1959**, *130* (3373), 432–437.
18. Klurfeld, D.M. Nutritional regulation of gastrointestinal growth. *Front. Biosci.* **1999**, *4*, D299–D302.
19. Rhoads, J.M.; Argenzio, R.A.; Chen, W.; Rippe, R.A.; Westwick, J.K.; Cox, A.D.; Berschneider, H.M.; Brenner, D.A. L-Glutamine stimulates intestinal cell proliferation and activates mitogen-activated protein kinases. *Am. J. Physiol.* **1997**, *272* (5 Pt 1), G943–G953.
20. Newsholme, P. Why is L-glutamine metabolism important to cells of the immune system in health, postinjury, surgery or infection? *J. Nutr.* **2001**, *131* (Suppl. 9), 2515S–2522S (discussion 2523S–2524S).
21. Broer, S.; Brookes, N. Transfer of glutamine between astrocytes and neurons. *J. Neurochem.* **2001**, *77* (3), 705–719.
22. Cooper, A.J. Role of glutamine in cerebral nitrogen metabolism and ammonia neurotoxicity. *Mental Retard. Dev. Disabil. Res. Rev.* **2001**, *7* (4), 280–286.
23. Watford, M.; Chellaraj, V.; Ismat, A.; Brown, P.; Raman, P. Hepatic glutamine metabolism. *Nutrition* **2002**, *18* (4), 301–303.
24. Haussinger, D. Liver glutamine metabolism. *J. Parenter Enteral Nutr.* **1990**, *14* (Suppl. 4), 56S–62S.
25. Abcouwer, S.F.; Bode, B.P.; Souba, W.W. Glucocorticoids regulate rat glutamine synthetase expression in a tissue-specific manner. *J. Surg. Res.* **1995**, *59* (1), 59–65.
26. Chandrasekhar, S.; Souba, W.W.; Abcouwer, S.F. Identification of glucocorticoid-responsive elements that control transcription of rat glutamine synthetase. *Am. J. Physiol.* **1999**, *276* (2 Pt 1), L319–L331.
27. Labow, B.I.; Souba, W.W.; Abcouwer, S.F. Glutamine synthetase expression in muscle is regulated by transcriptional and posttranscriptional mechanisms. *Am. J. Physiol.* **1999**, *276* (6 Pt 1), E1136–E1145.
28. Hasselgren, P.O.; Fischer, J.E. Counter-regulatory hormones and mechanisms in amino acid metabolism with special reference to the catabolic response in skeletal muscle. *Curr. Opin. Clin. Nutr. Metab. Care* **1999**, *2* (1), 9–14.
29. Curthoys, N.P. Role of mitochondrial glutaminase in rat renal glutamine metabolism. *J. Nutr.* **2001**, *131* (Suppl. 9), 2491S–2495S (discussion 2496S–2497S).
30. Schroeder, J.M.; Liu, W.; Curthoys, N.P. Ph-responsive stabilization of glutamate dehydrogenase mRNA in llc-pk1-f+ cells. *Am. J. Physiol. Renal Physiol.* **2003**, *285* (2), F258–F265 (E-published 2003 Apr 8).
31. Obled, C.; Papet, I.; Breuille, D. Metabolic bases of amino acid requirements in acute diseases. *Curr. Opin. Clin. Nutr. Metab. Care* **2002**, *5* (2), 189–197.
32. Biolo, G.; Toigo, G.; Ciocchi, B.; Situlin, R.; Iscra, F.; Gullo, A.; Guarnieri, G. Metabolic response to injury and sepsis: changes in protein metabolism. *Nutrition* **1997**, *13* (Suppl. 9), 52S–57S.
33. Hadley, J.S.; Hinds, C.J. Anabolic strategies in critical illness. *Curr. Opin. Pharmacol.* **2002**, *2* (6), 700–707.

34. Block, K.P.; Buse, M.G. Glucocorticoid regulation of muscle branched-chain amino acid metabolism. *Med. Sci. Sports Exerc.* **1990**, *22* (3), 316–324.
35. Holecek, M. Relation between glutamine, branched-chain amino acids, and protein metabolism. *Nutrition* **2002**, *18* (2), 130–133.
36. Brosnan, J.T. Interorgan amino acid transport and its regulation. *J. Nutr.* **2003**, *133* (6 Suppl. 1), 2068S–2072S.
37. Souba, W.W.; Herskowitz, K.; Plumley, D.A. Lung glutamine metabolism. *J. Parenter Enteral Nutr.* **1990**, *14* (Suppl. 4), 68S–70S.
38. Kowalski, T.J.; Watford, M. Production of glutamine and utilization of glutamate by rat subcutaneous adipose tissue in vivo. *Am. J. Physiol.* **1994**, *266* (1 Pt. 1), E151–E154.
39. Stumvoll, M.; Perriello, G.; Meyer, C.; Gerich, J. Role of glutamine in human carbohydrate metabolism in kidney and other tissues. *Kidney Int.* **1999**, *55* (3), 778–792.
40. Mithieux, G. New data and concepts on glutamine and glucose metabolism in the gut. *Curr. Opin. Clin. Nutr. Metab. Care* **2001**, *4* (4), 267–271.
41. Ozturk, S.S.; Palsson, B.O. Chemical decomposition of glutamine in cell culture media: effect of media type, pH, and serum concentration. *Biotechnol. Prog.* **1990**, *6* (2), 121–128.
42. Buchman, A.L.; Moukarzel, A.A.; Bhuta, S.; Belle, M.; Ament, M.E.; Eckhert, C.D.; Hollander, D.; Gornbein, J.; Kopple, J.D.; Vijayaraghavan, S.R. Parenteral nutrition is associated with intestinal morphologic and functional changes in humans. *J. Parenter Enteral Nutr.* **1995**, *19* (6), 453–460.
43. Wernerman, J. Glutamine-containing tpn: a question of life and death for intensive care unit-patients? *Clin. Nutr.* **1998**, *17* (1), 3–6.
44. Boelens, P.G.; Nijveldt, R.J.; Houdijk, A.P.; Meijer, S.; van Leeuwen, P.A. Glutamine alimentation in catabolic state. *J. Nutr.* **2001**, *131* (Suppl. 9), 2569S–2577S.
45. Furst, P.; Pogan, K.; Stehle, P. Glutamine dipeptides in clinical nutrition. *Nutrition* **1997**, *13* (7–8), 731–733.
46. Palmer, T.E.; Griffiths, R.D.; Jones, C. Effect of parenteral L-glutamine on muscle in the very severely ill. *Nutrition* **1996**, *12* (5), 316–320.
47. Garcia-de-Lorenzo, A.; Zarazaga, A.; Garcia-Luna, P.P.; Gonzalez-Huix, F.; Lopez-Martinez, J.; Mijan, A.; Quecedo, L.; Casimiro, C.; Usan, L.; del Llano, J. Clinical evidence for enteral nutritional support with glutamine: a systematic review. *Nutrition* **2003**, *19* (9), 805–811.
48. Hall, J.C.; Dobb, G.; Hall, J.; de Sousa, R.; Brennan, L.; McCauley, R. A prospective randomized trial of enteral glutamine in critical illness. *Intensive Care Med.* **2003**, *29* (10), 1710–1716.
49. Gore, D.C.; Wolfe, R.R. Glutamine supplementation fails to affect muscle protein kinetics in critically ill patients. *J. Parenter Enteral Nutr.* **2002**, *26* (6), 342–349(discussion 349–350).
50. Clark, R.H.; Feleke, G.; Din, M.; Yasmin, T.; Singh, G.; Khan, F.A.; Rathmacher, J.A. Nutritional treatment for acquired immunodeficiency virus-associated wasting using beta-hydroxy beta-methylbutyrate, glutamine, and arginine: a randomized, double-blind, placebo-controlled study. *J. Parenter Enteral Nutr.* **2000**, *24* (3), 133–139.
51. May, P.E.; Barber, A.; D'Olimpio, J.T.; Hourihane, A.; Abumrad, N.N. Reversal of cancer-related wasting using oral supplementation with a combination of beta-hydroxy-beta-methylbutyrate, arginine, and glutamine. *Am. J. Surg.* **2002**, *183* (4), 471–479.
52. Ziegler, T.R.; Evans, M.E.; Fernandez-Estivariz, C.; Jones, D.P. Trophic and cytoprotective nutrition for intestinal adaptation, mucosal repair, and barrier function. *Annu. Rev. Nutr.* **2003**, *23*, 229–261.
53. Goh, J.; O'Morain, C.A. Review article: nutrition and adult inflammatory bowel disease. *Aliment. Pharmacol. Ther.* **2003**, *17* (3), 307–320.
54. Zachos, M.; Tondeur, M.; Griffiths, A.M. Enteral nutritional therapy for inducing remission of Crohn's disease. *Cochrane Database Syst. Rev.* **2001**, (3), CD000542.
55. Savarese, D.M.; Savy, G.; Vahdat, L.; Wischmeyer, P.E.; Corey, B. Prevention of chemotherapy and radiation toxicity with glutamine. *Cancer Treat. Rev.* **2003**, *29* (6), 501–513.
56. Duncan, M.; Grant, G. Oral and intestinal mucositis—causes and possible treatments. *Aliment. Pharmacol. Ther.* **2003**, *18* (9), 853–874.
57. El-Malt, M.; Ceelen, W.; Boterberg, T.; Claeys, G.; de Hemptinne, B.; de Neve, W.; Pattyn, P. Does the addition of glutamine to total parenteral nutrition have beneficial effect on the healing of colon anastomosis and bacterial translocation after preoperative radiotherapy? *Am. J. Clin. Oncol.* **2003**, *26* (3), e54–e59.
58. Decker, G.M. Glutamine: indicated in cancer care? *Clin. J. Oncol. Nurs.* **2002**, *6* (2), 112–115.
59. Ward, E.; Picton, S.; Reid, U.; Thomas, D.; Gardener, C.; Smith, M.; Henderson, M.; Holden, V.; Kinsey, S.; Lewis, I.; Allgar, V. Oral glutamine in paediatric oncology patients: a dose finding study. *Eur. J. Clin. Nutr.* **2003**, *57* (1), 31–36.



60. Kozelsky, T.F.; Meyers, G.E.; Sloan, J.A.; Shanahan, T.G.; Dick, S.J.; Moore, R.L.; Engeler, G.P.; Frank, A.R.; McKone, T.K.; Urias, R.E.; Pilepich, M.V.; Novotny, P.J.; Martenson, J.A. North Central Cancer Treatment Group. Phase iii double-blind study of glutamine versus placebo for the prevention of acute diarrhea in patients receiving pelvic radiation therapy. *J. Clin. Oncol.* **2003**, *21* (9), 1669–1674.
61. Neu, J. Glutamine supplements in premature infants: why and how [comment]. *J. Pediatr. Gastroenterol. Nutr.* **2003**, *37* (5), 533–535.
62. Thompson, S.W.; McClure, B.G.; Tubman, T.R. A randomized, controlled trial of parenteral glutamine in ill, very low birth-weight neonates. *J. Pediatr. Gastroenterol. Nutr.* **2003**, *37* (5), 550–553.
63. Poindexter, B.B.; Ehrenkranz, R.A.; Stoll, B.J.; Koch, M.A.; Wright, L.L.; Oh, W.; Papile, L.A.; Bauer, C.R.; Carlo, W.A.; Donovan, E.F.; Fanaroff, A.A.; Korones, S.B.; Laptook, A.R.; Shankaran, S.; Stevenson, D.K.; Tyson, J.E.; Lemons, J.A. Effect of parenteral glutamine supplementation on plasma amino acid concentrations in extremely low-birth-weight infants. *Am. J. Clin. Nutr.* **2003**, *77* (3), 737–743.
64. Parimi, P.S.; Devapatla, S.; Gruca, L.L.; Amini, S.B.; Hanson, R.W.; Kalhan, S.C. Effect of enteral glutamine or glycine on whole-body nitrogen kinetics in very-low-birth-weight infants. *Am. J. Clin. Nutr.* **2004**, *79* (3), 402–409.
65. Rumen, N.M. Inhibition of sickling in erythrocytes by amino acids. *Blood* **1975**, *45* (1), 45–48.
66. Shirahama, K.; Kubota, S.; Yang, J.T. Do amino acids reverse the sickling of erythrocytes containing hemoglobin S? *Hemoglobin* **1980**, *4* (2), 149–155.
67. Niihara, Y.; Zerez, C.R.; Akiyama, D.S.; Tanaka, K.R. Oral L-glutamine therapy for sickle cell anemia: I. Subjective clinical improvement and favorable change in red cell and redox potential. *Am. J. Hematol.* **1998**, *58* (2), 117–121.
68. Castell, L. Glutamine supplementation in vitro and in vivo, in exercise and in immunodepression. *Sports Med.* **2003**, *33* (5), 323–345.
69. Antonio, J.; Sanders, M.S.; Kalman, D.; Woodgate, D.; Street, C. The effects of high-dose glutamine ingestion on weightlifting performance. *J. Strength Cond. Res.* **2002**, *16* (1), 157–160.
70. Candow, D.G.; Chilibeck, P.D.; Burke, D.G.; Davison, K.S.; Smith-Palmer, T. Effect of glutamine supplementation combined with resistance training in young adults. *Eur. J. Appl. Physiol.* **2001**, *86* (2), 142–149.
71. Kudsk, K.A. Effect of route and type of nutrition on intestine-derived inflammatory responses. *Am. J. Surg.* **2003**, *185* (1), 16–21.
72. Kudsk, K.A.; Wu, Y.; Fukatsu, K.; Zarzaur, B.L.; Johnson, C.D.; Wang, R.; Hanna, M.K. Glutamine-enriched total parenteral nutrition maintains intestinal interleukin-4 and mucosal immunoglobulin a levels. *J. Parenter Enteral Nutr.* **2000**, *24* (5), 270–274 (discussion 274–275).
73. Garrel, D. The effect of supplemental enteral glutamine on plasma levels, gut function, and outcome in severe burns. *J. Parenter Enteral Nutr.* **2004**, *28* (2), 123.
74. Andrews, F.J.; Griffiths, R.D. Glutamine: essential for immune nutrition in the critically ill. *Br. J. Nutr.* **2002**, *87* (Suppl. 1), S3–S8.
75. Melis, G.C.; ter Wengel, N.; Boelens, P.G.; van Leeuwen, P.A. Glutamine: recent developments in research on the clinical significance of glutamine. *Curr. Opin. Clin. Nutr. Metab. Care* **2004**, *7* (1), 59–70.

#### FURTHER READINGS

For a comprehensive guide to glutamine and sources of information, see ‘*Glutamine—A Medical Dictionary, Bibliography, and Annotated Research Guide to Internet References*,’ ICON Health Publications, March 2004; ISBN: 0597844399.

For an update on U.S. government sponsored clinical trials of glutamine, see <http://www.clinicaltrials.gov/ct/search?term=Glutamine>.

# Goldenseal (*Hydrastis canadensis*)

Dennis J. McKenna  
Gregory A. Plotnikoff

Center for Spirituality and Healing, Academic Health Center, University of Minnesota,  
Minneapolis, Minnesota, U.S.A.

## INTRODUCTION

Goldenseal (*Hydrastis canadensis* L.) is a plant native to North America and is used in its herbal traditions. A principal active ingredient, the alkaloid berberine, is shared with several medicinal plants used in traditional Asian medicines. Traditional uses include soothing irritated skin and mucous membranes, easing dyspepsia, and reducing debility. Preclinical studies suggest clinically relevant activity for cancer, cardiac diseases, and gastrointestinal and infectious diseases among others. There are no published clinical trials of goldenseal, and most of the available preclinical and clinical data are on the alkaloids berberine and  $\beta$ -hydrastine. Accordingly, much of the information summarized in this entry applies to berberine, and only indirectly to goldenseal, under the assumption that extracts of the plant containing berberine or  $\beta$ -hydrastine will display activities similar to those of the alkaloids. A few clinical trials of berberine support use for cardiac arrhythmias, congestive heart failure, diarrhea, and protozoal infection. Berberine has poor oral absorption, but human pharmacokinetic studies have not been published. Injected, inhaled, or skin-absorbed berberine affects cytochrome P450 metabolism and may displace albumin-bound bilirubin and pharmaceuticals. In a study of 21 commercial ethanolic herbal extracts potentially inhibitory to cytochrome P450 3A4 (CYP3A4), goldenseal displayed the most pronounced activity, at a concentration of 0.03% of the full strength preparation.<sup>[1]</sup> Thus, there is a significant potential for goldenseal extracts to elicit herb/drug or herb/herb interactions in patients concomitantly taking pharmaceutical medications or other herbal supplements that

are metabolized by P450 3A4. Reported adverse reactions to goldenseal or berberine are rare however.<sup>[2]</sup>

## CLASSIFICATION AND NOMENCLATURE

- Scientific name: *Hydrastis canadensis* L.
- Family: Ranunculaceae
- Common names: Goldenseal, yellow root, turmeric root, eye root, Indian dye, yellow puccoon, ground raspberry

*H. canadensis* (Fig. 1) is a perennial herbaceous plant found in rich, shady woods and moist meadows in eastern North America, especially in Ohio, northern Kentucky, Indiana, and Virginia, whereas in Canada, it is restricted to southwestern Ontario.<sup>[3]</sup> The name “goldenseal” comes from the yellow scars left on the rhizome by the stem that bursts forth every spring; these scars look like the imprint of an old-fashioned letter seal. *Hydrastis* is a Greek word meaning “to accomplish with water.”<sup>[3,4]</sup>

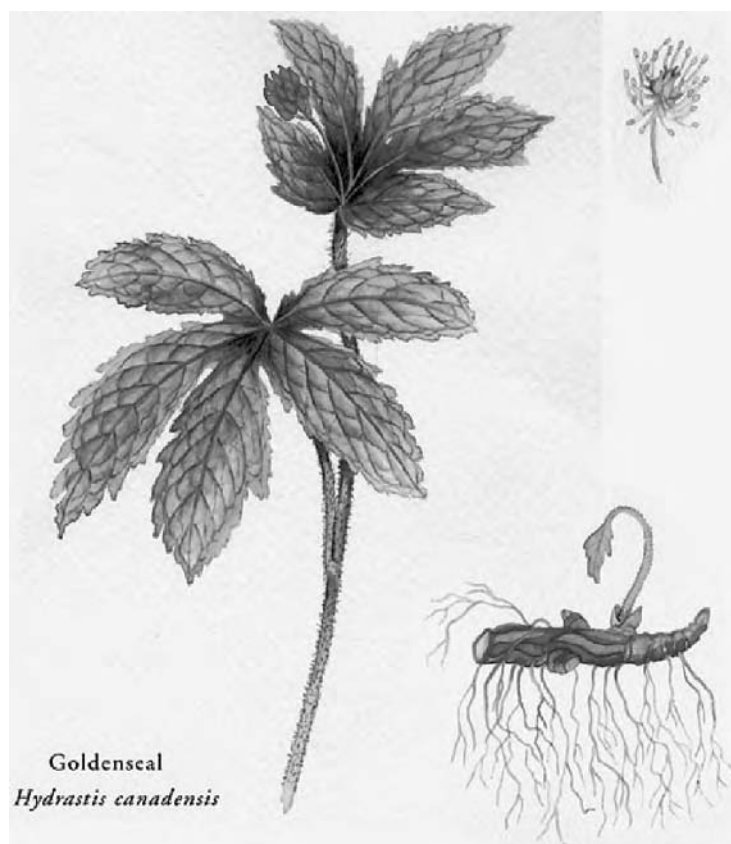
Goldenseal grows to about 30 cm in height with a simple, hairy stem, usually bearing a single-lobed basal leaf and two-lobed cauline leaves near the top. The flower is terminal, solitary, and erect, with small greenish-white sepals and no petals, and blooms in May and June. The fruit is an oblong, compound, orange-red berry containing two black seeds in each carpel. The medicinal rhizome is horizontal, irregularly knotted, bears numerous long slender roots, and is bright yellow with an acrid smell.<sup>[4,6]</sup>

Populations of goldenseal in the wild have been greatly diminished in recent years due to overcollection and habitat loss, which has placed this plant on the endangered species list. Due to concerns about overharvesting and increasing market demand, it is now commercially cultivated across the country, especially in the Blue Ridge Mountains.<sup>[4,6]</sup> Recently, other species of plants purported to be *H. canadensis* have been sold as the bulk dried herb on the U.S. wholesale market. This substitution is due to the high market price goldenseal now commands, and the shortage of cultivated supply. Care must be taken in ascertaining accurate identification of the dried material.<sup>[5,7]</sup>

---

Dennis J. McKenna, Ph.D., is Senior Lecturer and Research Associate at the Center for Spirituality and Healing, Academic Health Center, University of Minnesota, Minneapolis, Minnesota, U.S.A.

Gregory A. Plotnikoff, M.D., M.T.S., is currently a Visiting Research Fellow at the Department of Oriental Medicine, Keio University School of Medicine, Tokyo, Japan.



**Fig. 1** Goldenseal (*Hydrastis canadensis* L.): whole plant, flower, and rhizome. (View this art in color at [www.dekker.com](http://www.dekker.com).)

## HISTORY AND TRADITIONAL USES

Goldenseal has been used as both a dye and a medicine in North America. The root of goldenseal supplied Native Americans with a brilliant yellow dye for coloring their clothing and weapons, as well as for painting their skin.<sup>[4]</sup> Goldenseal's ability to soothe irritated mucous membranes led to its topical and oral use for numerous uncomfortable conditions. Native Americans taught the first European settlers to use goldenseal root to treat skin diseases, ulcers, gonorrhea, and arrow wounds. The Iroquois employed goldenseal for heart troubles, fevers, and tuberculosis.<sup>[8]</sup> The Cherokee utilized it for cancer and general debility.<sup>[9]</sup> Both tribes used the plant for dyspepsia, appetite improvement, and inflammatory dermatoses. Folk use expanded later to include treatments of sore eyes, hepatitis, and menstrual difficulties.

Goldenseal became known as one of the most powerful North American medicinal plants, and was included in the *U.S. Pharmacopoeia* from 1831 to 1936, and then in the *National Formulary* until 1960.<sup>[4,6]</sup> It is now commonly used in the United States as a treatment for canker sores, and sore mouths and throats.<sup>[7]</sup> Many herbal practitioners advise that topical use, such as gargling with a solution of goldenseal for sore throat, is more effective than similar

amounts taken orally in capsules.<sup>[10]</sup> Today, many North American herbal practitioners consider it to be indispensable for its many purported medicinal effects: digestive, antibiotic, immunostimulatory, antispasmodic, sedative, hypotensive, uterotonic, choleric, carminative, antifungal, and antimicrobial.<sup>[11]</sup> No clinical trials have been published to date.

Goldenseal's medicinal effects are primarily attributed to the alkaloid berberine, on which there are the most preclinical data.<sup>[12]</sup> Berberine is also found in barberry or Oregon grape root (*Mahonia aquifolium* Nutt.), another traditional Native American herbal medicine used for similar symptoms.<sup>[12]</sup> Likewise, in traditional Asian medicines, berberine-containing species are used for similar indications as in North America. For example, in traditional Chinese medicine, three species of *Coptis* are used for problems affecting the cardiovascular and gastrointestinal systems.<sup>[13]</sup> They are widely used in China today for treatment of congestive heart failure.<sup>[14]</sup> Kampo, the Japanese herbal medicine tradition, incorporates the berberine-containing Chinese cork tree (*Phellodendron amurense* Rupr.) as a cooling agent for hot illnesses including irritated skin and membranes.<sup>[12]</sup> Ayurveda, a traditional Indian system of herbal medicine, utilizes *Berberis aristata* for intestinal infections. Vietnamese traditional herbal medicine uses

*B. asiatica* Griff. for dyspepsia, dysentery, eye inflammation, and toothache.<sup>[15]</sup>

Some studies have commenced on the other abundant alkaloid,  $\beta$ -hydrastine.<sup>[5]</sup> This is a central nervous system (CNS) stimulant and has direct myocardial and intestinal smooth-muscle-depressant effects.<sup>[12,17]</sup> The *British Herbal Compendium*<sup>[17]</sup> states that the activity of goldenseal is mainly due to  $\beta$ -hydrastine, which is vasoconstrictive, and active on the nervous, reproductive, respiratory, and cardiac systems. Both berberine and  $\beta$ -hydrastine are choleric, spasmolytic, sedative, and antibacterial; canadine is a stimulant to uterine muscle.<sup>[17]</sup>

## CHEMISTRY

### Alkaloids

The primary active constituents of goldenseal are the alkaloids  $\beta$ -hydrastine (1.5–4%) and berberine (0.5–6%). The plant contains lesser amounts of the alkaloids canadine (tetrahydroberberine), berberastine, hydrastindine, isohydrastindine, (*S*)-corypalmine, (*S*)-isocorypalmine, and 1- $\alpha$ -hydrastine (Fig. 2).<sup>[12]</sup>

### Other Constituents

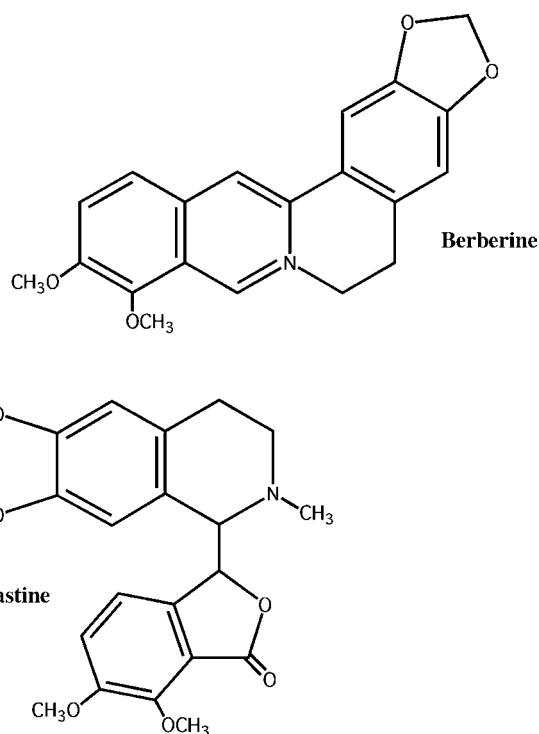
Other constituents include meconin, chlorogenic acid, lipids, resin, starch, sugars, and a small amount of volatile oil.<sup>[12]</sup>

### Formulation and Analysis

High performance liquid chromatography (HPLC) analysis of commercial goldenseal products demonstrates wide variation in berberine,  $\beta$ -hydrastine, alkaloid ratio, and total alkaloid content. Berberine content ranged from 0.82% to 5.86%, while that of  $\beta$ -Hydrastine between 0% and 2.93%.<sup>[18]</sup> HPLC analysis guidelines have been published.<sup>[19]</sup>

## PRECLINICAL STUDIES ON GOLDENSEAL AND BERBERINE

As noted above, there have been no clinical and few preclinical investigations of goldenseal itself, but a rather large number of studies have investigated the activities of its major alkaloid, berberine. In this entry, we have reviewed what little preclinical data have been published on goldenseal itself, and have summarized the preclinical and clinical data on berberine.



**Fig. 2** Structures of berberine and  $\beta$ -hydrastine, the major alkaloids of *Hydrastis canadensis* (goldenseal).

### Cardiovascular and Circulatory Functions (In Vitro, Organ Isolates)

Yao et al.<sup>[20]</sup> reported that berberine could relax 5-hydroxytryptamine-induced muscle contractions. Palmery, Cometa, and Leone<sup>[21]</sup> have shown that an extract of goldenseal exhibits an inhibitory action on adrenaline-induced contractions in rat thoracic aorta in vitro. The constituents responsible were identified as the alkaloids canadine, berberine, and canadine. Including the inactive alkaloid  $\beta$ -hydrastine, the alkaloid mixture showed an  $IC_{50}$  of  $2.86 \times 10^{-7}$  M. Therefore, Palmery, Cometa, and Leone<sup>[21]</sup> concluded that the mixture of active alkaloids, producing a greater adrenolytic action than any one alone, acted synergistically. Moreover, acting in a dose-dependent manner, the total extract of the roots and rhizomes was able to inhibit contractions induced by higher doses of adrenaline, whereas the individual alkaloids did not. The authors concluded that these alkaloids appear to account for the vasoconstrictive activity of goldenseal that has led to its popular use.

### Immune Functions (In Vivo, Male Rats)

Rehman et al.<sup>[22]</sup> examined the effects of continuous treatment with a goldenseal root extract on antigen-

specific immunity in male rats over a 6-week treatment period (6.6 g in glycerin solvent/L drinking water) compared to glycerin-only treated rats. No significant difference was found in the consumption levels of treated and nontreated controls. Rehman and colleagues recorded changes in immunoglobulins G and M (IgG and IgM), finding no significant difference in IgG levels during the first 3 weeks and a trend toward lower levels in the last 3 weeks of treatment compared to the controls that reached significance on day 42 only. IgM levels became significantly higher in the goldenseal group on day 4 and continued to remain so on days 11 and 15. The effect amounted to an accelerated antibody response, which permitted a more rapid increase in levels of IgM, or an enhancement of “the acute primary IgM response.” The authors commented that further studies of immunomodulatory medicinal plants should take the matter of time dependence into consideration to pinpoint times of maximal effects.

### Antimicrobial and Antifungal Activity (In Vitro)

Scazzocchio et al.<sup>[23]</sup> evaluated a “total” standardized extract of goldenseal for relative killing time in a low-density inoculum. The undiluted extract showed the most activity, and there was correspondingly weaker activity at two lower dilutions. The standardized extract and four derivative alkaloids were least effective against *Candida albicans* and *Escherichia coli*. Compared with the alkaloids tested, however, the undiluted standardized extract showed the most potent activity, killing the fungus at 15 sec vs. 1–2 hr for the alkaloids (canadoline, canadine, berberine, and  $\beta$ -hydrastine). Undiluted, berberine was the most potent alkaloid against *C. albicans* (killing time, 1 hr at 3.0 mg/ml), equivalent to the standardized extract at a 50% dilution. Canadoline killed *C. albicans* at over 2 hr. The results suggested that isoquinoline alkaloids with an open C ring, such as canadoline, appear to show greater antimicrobial activity. In most of the micro-organisms tested, canadine also showed more potency than berberine.

Goldenseal is a very weak antibiotic against common bacteria such as the Gram-negative *Pseudomonas aeruginosa* and the Gram-positive *Staphylococcus aureus* and *Streptococcus pyogenes*. For the latter, a weak pathogen, the mean inhibitory concentration of goldenseal was 4000 times higher than that of penicillin.<sup>[24]</sup> Goldenseal's value and potential value lie elsewhere. For example, it demonstrates relevant activity against the oral pathogens *Streptococcus mutans* and *Fusobacterium nucleatum*.<sup>[25]</sup>

### Respiratory and Pulmonary Functions (In Vitro, Organ Isolates)

A relaxing effect was shown from an ethanolic extract of goldenseal roots in carbachol-precontracted guinea pig trachea.<sup>[26]</sup> Complete relaxation of carbachol-precontracted isolated guinea pig trachea was obtained from a total extract of the roots in a cumulative dose of 5 mg/ml. Further studies have shown that the constituents responsible are the alkaloids canadoline, canadine, berberine, and hydrastine (EC<sub>50</sub> 2.4, 11.9, 34.2, 72.8  $\mu$ g/ml, respectively). Although as yet unclear, the activity appears to involve interactions of the alkaloids with adenosine and adrenergic receptors.<sup>[27]</sup>

### PRECLINICAL STUDIES ON BERBERINE

#### Cancer

##### Antiproliferative activity

In vitro antiproliferation of 6 types of esophageal cancer lines was found from coculturing the cells with berberine (ID<sub>50</sub> 0.11–0.90  $\mu$ g/ml).<sup>[28]</sup>

Consecutive intraperitoneal (i.p.) dosing inhibited ascites tumor proliferation in Swiss albino mice and resulted in a 32% increase in life span compared to controls.<sup>[29]</sup>

##### Chemopreventive activity

In vitro, berberine inhibited carcinogenicity of arylamine and its main metabolizing enzyme, *N*-acetyltransferase, in human bladder tumor cell lines,<sup>[30]</sup> colon tumor cells,<sup>[31]</sup> and leukemia cells.<sup>[30]</sup>

Berberine displayed dose-dependent in vivo activity against carcinogenesis induced by 20-methylcholanthrene or *N*-nitrosodiethylamine (NDEA) in mice and rats.<sup>[32]</sup>

Berberine also suppressed tumor induction by proinflammatory tumor promoters teleocidin and 12-*O*-tetradecanoylphorbol-13-acetate (TPA).<sup>[33]</sup>

##### Chemotherapy adjunct activity

Berberine displayed a synergistic effect with radiation treatment and cyclophosphamide in Swiss albino mice implanted with Dalton's lymphoma ascites tumor cells.<sup>[29]</sup>

##### Cytotoxicity

In vitro cytotoxic activity of berberine has been demonstrated in a wide variety of tumor cells including uterine, ovary, and larynx carcinomas,<sup>[34]</sup> gliomas,<sup>[35]</sup> leukemias,<sup>[36]</sup> and hepatomas.<sup>[37]</sup>

## Cardiovascular and Circulatory Functions

### Antiarrhythmic effects

Berberine was shown by Huang et al.<sup>[38]</sup> to inhibit experimental ventricular arrhythmias induced by aconitine, ouabain, and barium chloride in rats by 62%.

### Cardiotonicity; cardioprotection

Berberine significantly reduced creatine phosphokinase release during the reoxygenation period, and ultrastructural damage was reduced.<sup>[39]</sup>

### Congestive heart failure

Berberine and its derivatives have positive inotropic, negative chronotropic, antiarrhythmic, and vasodilator properties, each of which can be beneficial in congestive heart failure.<sup>[40]</sup>

For rats with verapamil-induced cardiac failure, pretreatment with berberine resulted in significantly less severe cardiac failure compared with untreated controls.<sup>[41]</sup> In a rat model of cardiac hypertrophy, berberine administered for 8 weeks, beginning 4 weeks after aortic banding, resulted in significant reductions in whole heart, left ventricular weight, and left ventricular size compared with control aorta-banded rats.<sup>[42]</sup>

### Hypertension

Berberine is reported to have an antihypertensive effect at low concentrations ( $<1 \times 10^{-6}$  M). Denuded aorta and methylene blue pretreated aorta did not demonstrate aortic relaxation at these concentrations. Methylene blue is a direct nitric oxide synthesis inhibitor and a direct inhibitor of guanylyl cyclase. These data indicate that aortic relaxation observed in response to low concentrations of berberine in isolated rat aorta was solely endothelium dependent at these concentrations. Those higher than  $1 \times 10^{-6}$  M induced aortic relaxation regardless of the presence of intact endothelium or methylene blue pretreatment.<sup>[43]</sup>

## Digestive, Hepatic, and Gastrointestinal Functions

### Diarrhea

Berberine sulfate was demonstrated to inhibit the intestinal secretory response induced by *Vibrio cholerae* and *E. coli* by 70% in vivo. However, the drug was effective when given either before or after enterotoxin binding.<sup>[44]</sup> In the human colon (in vitro), berberine

was shown to inhibit ion transport. Based on studies using a human model of intestinal ion transport, the antisecretory activity of berberine appears to be due to a direct action on epithelial cells, possibly through the blockade of potassium channels.<sup>[45]</sup>

### Hepatic functions

Berberine has shown significant pre- and posttreatment hepatoprotective effects in rat models of acetaminophen-induced hepatotoxicity as measured by reduction of serum alkaline phosphatases and serum transaminases. Although the alkaloid does display some ameliorative effects as a pretreatment in CCl<sub>4</sub> induced models of hepatotoxicity, it did not have comparable posttreatment activity. In both instances, berberine was more effective in the animals exposed to acetaminophen than those exposed to CCl<sub>4</sub>.<sup>[46]</sup>

## Endocrine and Hormonal Functions

### Adrenal functions

Berberine has exhibited  $\alpha$ -adrenergic antagonist activities in isolated animal organs.<sup>[20,47]</sup>

## Immunology: Immunopotiation

Berberine alkaloids have displayed potent macrophage-activating activity, in turn inducing cytostatic activity against tumor cells. In mice, and in vitro against human brain tumors, berberine produced an average of 91% tumor inhibition against 6 malignant brain tumor cell lines.<sup>[48]</sup>

## Infectious Diseases

### Fungal infections

The overgrowth of *Candida* on mucous membranes may respond well to the use of goldenseal extract. Berberine sulfate has demonstrated antifungal activity against *C. albicans*, *C. tropicalis*, *Trichophyton mentagrophytes*, *Microsporum gypseum*, *Cryptococcus neoformans*, and *Sporotrichum schenckii*.<sup>[49,50]</sup>

### Microbial infections

Berberine is active against important gastrointestinal pathogens including *Helicobacter pylori* and *Vibrio cholerae*. For the first, a concentration-dependent inhibitory activity was shown from berberine (0.08–160  $\mu$ M) against 21 strains of *H. pylori* obtained from human peptic ulcer patients.<sup>[51]</sup> Further study on

15 strains of *H. pylori* demonstrated that a crude methanol extract of both *H. canadensis* and extracted berberine showed an MIC<sub>50</sub> of just 12.5 µg/ml.<sup>[52]</sup>

For *V. cholerae*, berberine sulfate has exhibited in vitro bactericidal activity with more rapid antibacterial activity in vitro than tetracycline and chloramphenicol.<sup>[49]</sup> On *S. aureus*, at very high concentrations of 35 and 50 mg/ml, achievable only in the intestines, berberine was bacteriostatic.<sup>[49]</sup>

Certain microbial agents can block the adherence of micro-organisms to host cells at doses much lower than those needed to kill cells or inhibit cell growth. Strategies that interrupt the adhesive functions of bacteria before host tissue invasion occurs may be an effective prophylactic approach against bacterial infectious diseases. Berberine caused an eightfold increase in release of lipoteichoic acid, the major ligand responsible for adherence of *Streptococci* to epithelial cells, fibronectin, and hexadecane.<sup>[53]</sup>

### Parasitic infections

Berberine demonstrated antiplasmodial (IC<sub>50</sub>) values less than 1 M for multidrug resistant *Plasmodium falciparum*.<sup>[54]</sup> When derived from *H. canadensis*, it is active against multiple drug resistant *Mycobacterium tuberculosis*.<sup>[55]</sup> It has also demonstrated effectiveness against *Entamoeba histolytica*, *Trichomonas*, *Giardia*, *Leishmania*, and *Echinococcus granulosus*.<sup>[56–60]</sup>

In vitro studies and strong anecdotal evidence indicate that berberine sulfate, berberine hydrochloride, or goldenseal is effective in inhibiting the growth of protozoan parasites such as *E. histolytica*, *Giardia lamblia*, *Trichomonas vaginalis*, and *Leishmania donovani*.<sup>[57,59]</sup> The alkaloid does not have the mutagenic side effects of metronidazole, the current agent of choice for treating these conditions; yet it has in some cases appeared equally effective.<sup>[59]</sup>

The protozoan parasite *L. donovani* and its treatment with berberine chloride were studied in hamsters. Berberine was effective in reducing by 90% the number of parasitic amastigotes formed by the protozoan parasite *L. donovani* in the liver and spleen of hamsters, and was much better tolerated at levels of 50 and 100 mg/kg/day than the medication pentamidine.<sup>[58]</sup> Based on the ability of β-hydrastine to dissolve *E. granulosus* cysts in mice, Ye et al.<sup>[60]</sup> showed that it may be a promising agent for treating hydatidosis.

### Integumentary, Muscular, and Skeletal Functions

#### Connective tissue functions

Berberine-type alkaloids inhibit the activity of elastase, a serine proteinase that degrades elastin, an important

structural component of blood vessels, lung, skin, and other tissues.<sup>[61]</sup> The authors suggest that these alkaloids might therefore be effective in treating certain inflammatory diseases, such as pulmonary emphysema, chronic bronchitis, arthritis, and rheumatoid arthritis.

#### Osteoporosis

Berberine demonstrated inhibition of parathyroid-induced bone resorption in ovariectomized rats.<sup>[62]</sup> When administered orally (10 mg/kg/day for 22 weeks) to male and female senescence-accelerated mice, it resulted in significant increases in bone mineral density compared with controls.<sup>[63]</sup>

### Receptor and Neurotransmitter Mediated Functions

Berberine has shown concentration-dependent non-competitive monoamine oxidase (MAO) inhibitory activity in vitro in mouse brain mitochondria.<sup>[64]</sup>

### Respiratory and Pulmonary Functions

An ethanolic extract of goldenseal roots produced a relaxing effect in carbachol-precontracted guinea pig trachea.<sup>[26]</sup> Despite remaining unclear, the effect seems to involve interactions of the alkaloids with adenosine and adrenergic receptors.<sup>[27]</sup>

## CLINICAL STUDIES

### Cardiovascular and Circulatory Disorders

In a study of 100 patients with ventricular tachyarrhythmias, berberine treatment (dose not specified in summary) resulted in significant reductions in the number of beats per hour (from 452 ± 421.8 to 271 ± 352.7). There were no side effects except for mild gastroenterologic symptoms in some patients.<sup>[48]</sup> In China, berberine is a class III antiarrhythmic agent, with oral berberine (tablets, 1.2 g/day) reportedly of value in the treatment of ventricular premature complexes (VPCs) in patients with congestive heart failure.<sup>[65]</sup> Subjects were administered oral berberine 1.2–2.0 g/day in a randomized, controlled trial of 156 cases with New York Heart Association (NYHA) class II–IV heart failure. Those treated with berberine demonstrated significant improvement in the 6-min walking distance test ( $P = 0.001$ ) and left ventricular ejection fraction ( $P < 0.02$ ). VPCs decreased 84% ( $P < 0.001$ ) and nonsustained ventricular tachycardia decreased 96% ( $P < 0.001$ ) in the treatment groups

with nonsignificant differences in those receiving placebo. Total mortality in the treatment group was 8.8% and 16.4% in the placebo group ( $P < 0.02$ ).<sup>[66]</sup>

### Digestive, Hepatic, and Gastrointestinal Disorders

#### Diarrhea

In a randomized, controlled experiment, the efficacy of berberine sulfate in the treatment of diarrhea due to enterotoxigenic *E. coli* (ETEC) and *V. cholerae* was evaluated in 165 patients. The berberine sulfate group showed significantly reduced stool volumes for 3 consecutive 8-hr periods following treatment. The results suggest that berberine can be an effective and safe antisecretory drug for ETEC diarrhea, but that it has only slight activity against cholera and is not additive with tetracycline.<sup>[67]</sup>

In a study by Khin-Maung-U et al.,<sup>[68]</sup> 400 adults presenting with acute watery diarrhea were entered into a randomized placebo-controlled, double-blind clinical trial of berberine, tetracycline, and a tetracycline plus berberine combination to study the antisecretory and vibriostatic effects of berberine. Of 185 patients with cholera, those given tetracycline or tetracycline plus berberine showed considerably reduced volume and frequency of diarrheal stools, duration of diarrhea, and volume of required intravenous and oral rehydration fluid.

In a trial of 65 children below 5 yr of age affected by acute diarrhea, a superior response was observed in those receiving berberine tannate (25 mg every 6 hr) compared to those receiving standard antibiotic therapy. Berberine tannate was effective against diarrhea caused by *E. coli*, *Shigella*, *Salmonella*, *Klebsiella*, and *Faecalis aerogenes*.<sup>[44]</sup>

In 200 adult patients with acute diarrhea, standard antibiotic treatment in conjunction with berberine hydrochloride (150 mg orally (p.o.)/day) resulted in a faster recovery than in those given antibiotic therapy alone. In addition, in 30 subjects treated with berberine hydrochloride alone, diarrhea was arrested in all with no side effects or toxicity.<sup>[69]</sup>

#### Cirrhosis

In patients with alcohol-related liver cirrhosis, berberine prevented the elevation of serum tyramine following oral tyrosine load by inhibiting bacterial tyrosine decarboxylase in the large intestine. The accumulation of tyramine causes lowering of peripheral resistance, resulting in high cardiac output, reduction in renal function, and cerebral dysfunction.<sup>[70]</sup>

### Parasitic Disease

Pediatric patients 5 mo to 14 yr of age infected with giardiasis were administered berberine (10 mg/kg/day), while a control group received a standard anti-giardial drug (metronidazole). After 10 days, 90% of the berberine group showed negative stools vs. 95% in the metronidazole group; at 1 mo, 83% of the berberine group remained negative compared to 90% of the metronidazole group.<sup>[71]</sup>

### DOSAGE AND TOXICITY

- Dried root as decoction: 0.5–1.0 g, 3× daily.
- Tincture (1 : 10, 60% ethanol): 2–4 ml, 3× daily.
- Fluid extract (1 : 1, 60% ethanol): 0.3–1.0 ml 3× daily.

All of the above formulations and dosages are derived from the recommendations in the *British Herbal Compendium*.<sup>[17,72]</sup> Specific indications are not mentioned, and these dosages therefore represent a range of recommended ones.

Werbach and Murray<sup>[48]</sup> advised the use of 250–500 mg, 3× daily, of a standardized extract containing 5% total alkaloids for indications such as alcoholic liver diseases, infections, and diarrhea. All of the applications cited in this publication, however, are for berberine, and not for goldenseal per se.

### Contraindications

According to Bergner,<sup>[10]</sup> some practitioners recommend that goldenseal not be administered to a child under 2 yr of age. Berberine-containing herbs are contraindicated for the treatment of newborn infants because of the capacity to displace bilirubin from albumin.<sup>[73]</sup> It is also not advisable for children at risk for glucose-6-phosphate-dehydrogenase deficiency. This follows the observation that shortly after administration of berberine-containing herbs, they developed hemolytic anemia and jaundice. After a subsequent ban of berberine-containing herbs by the Government of Singapore in 1979, incidences of jaundice dropped, whereas they remained at a high level among infants in southern China and Hong Kong. Using serum from neonates, in vitro tests of herbal teas rich in berberine showed that bilirubin protein binding was decreased and that the effect was at least partly due to berberine.<sup>[2]</sup> Brinker<sup>[16]</sup> cautions against the local use of goldenseal to treat purulent ear discharge because of a possible underlying rupture in the ear drum. He also lists it as a bitter herb that could ostensibly aggravate gastrointestinal irritations.



## Drug Interactions

In herbal medicine, goldenseal is widely believed to enhance the activity of other botanicals; however, no studies are available to support this contention. There is a theoretical risk that berberine can increase the activity of pharmaceuticals. Yao et al.<sup>[74]</sup> found berberine acted like yohimbine and prazosin in showing competitive blocking activity against  $\alpha_1$ - and  $\alpha_2$ -adrenoreceptors. Therefore, goldenseal may have an additive effect with those agents. Because berberine can displace albumin-bound bilirubin, goldenseal theoretically could displace highly protein-bound pharmaceuticals. This could precipitate significant toxicity.

Goldenseal may also compromise pharmaceutical agents. It has one of the highest inhibitory activities against human cytochrome P450 (CYP) isoforms.<sup>[1,6]</sup> Mice pretreated with berberine (4 mg/kg p.o.) in a single dose showed significantly prolonged phenobarbital-induced (60 mg/kg i.p.) sleeping time and increased toxicity resulting in 100% death from a sublethal dose of strychnine (0.3 mg/kg i.p.). These results strongly suggest inhibition of the hepatic cytochrome P450 drug metabolizing enzymes.<sup>[46]</sup> Among 21 commercial ethanolic herbal extract products sold in Canada, in vitro inhibitory activity on CYP3A4 was found from about 66%. Significant inhibition of CYP3A4 was shown at concentrations less than 10% of their full strength source preparations. An extract of goldenseal (*H. canadensis*, 0.03% full strength) was the most potent inhibitor.<sup>[1]</sup>

In vitro studies using various colon, gastric, and oral cancer cell lines pretreated with berberine (32 mM) 24 hr before treatment with the anticancer drug taxol (paclitaxel) found that the anticancer activity of the agent was compromised.<sup>[75]</sup> Others have made similar observations in murine and human hepatoma cell lines in which berberine compromised the retention of chemotherapy agents (tamoxifen and verapamil) in tumor cells.<sup>[75]</sup> In vivo studies are required to clarify these potential drug interactions with berberine.

Certain pharmaceuticals can elevate serum levels of berberine. Under normal conditions, oral administration demonstrates very poor bioavailability (<5%).<sup>[76]</sup> This means that the risk of toxicity is low. However, in a rat recirculating perfusion model, concomitant use of P-glycoprotein inhibitors, such as cyclosporin A and verapamil, significantly enhanced berberine absorption.<sup>[77]</sup> This 6 $\times$  rise in absorption increases the risk of berberine toxicity.

## Pregnancy and Lactation

Herbs that contain berberine are not recommended for use during pregnancy. Berberine has been shown

to cause uterine contractions in experimental animals.<sup>[2,11,17]</sup> Developmental toxicity evaluation in mice demonstrated no effect on maternal body weight or gravida uterine weight. Maternal liver weight was increased in the absence of histopathologic changes at 12,500 ppm. Prenatal mortality, live litter size, and fetal sex ratio were unaffected. At 50,000 ppm, slight increases in the incidence of cleft palate and exencephaly were documented. Also noted was an 8% reduction in fetal body weight. The developmental toxicity NOAEL was 12,500 ppm, while the LOAEL was 50,000 ppm. These correspond to 75–300 times greater than the estimated human intake.<sup>[78]</sup>

*The Botanical Safety Handbook*<sup>[79]</sup> does not caution use during lactation. No pharmacokinetic studies of goldenseal have been found to confirm to what extent alkaloids cross in breast milk. Use by breastfeeding mothers of babies with jaundice or a deficiency of glucose-6-phosphate-dehydrogenase should be carefully scrutinized (see “Contraindications”). In vitro tests of serum from neonates fed berberine-containing herbal teas showed that bilirubin protein binding was decreased and that the effect was at least partly due to berberine.<sup>[2]</sup> The dose of plant constituents received in direct feeding with herbal teas is many times larger than that possible through breast milk.

## Toxicity

No oral toxic dose has been established for goldenseal. The oral LD<sub>50</sub> in mice of berberine is variously reported from 3.29 mg/10 g to 1000 mg/kg body weight, suggesting that toxicity is extremely low.<sup>[5]</sup> The German Commission E gives the LD<sub>50</sub> of berberine in mice as 24.3 mg/kg i.p.<sup>[80]</sup> Others report that in Swiss albino mice, the acute i.p. LD<sub>50</sub> of berberine is 500 mg/kg, while the chronic LD<sub>50</sub> is 150 mg/kg for 10 days.<sup>[29]</sup> Berberine in adults is well tolerated up to a dose of 500 mg. Above that, side effects have been reported: eye and skin irritation, nephritis and kidney irritation, nose bleed, lethargy, and dyspnea.<sup>[81]</sup> In humans, a massive overdose of berberine would be expected to result in CNS-depressant effects,<sup>[81]</sup> including central paralysis.<sup>[82]</sup>

## Special Precautions

Goldenseal and berberine-containing plants are usually considered nontoxic<sup>[72]</sup> and are generally so at the recommended dosages. However, higher dosages may interfere with vitamin B metabolism.<sup>[4]</sup> Tinctures may cause irritation of the mucous membranes.<sup>[16]</sup> Bergner<sup>[10]</sup> reports that large doses over a long duration can overstimulate and eventually exhaust the mucous membranes. In support of this, he cites the

traditional Chinese medical point of view that bitter herbs taken inappropriately can injure the spleen.

Duke<sup>[4]</sup> warns that topical overdose can cause skin or membrane ulceration, and for that reason advises against its traditional use as a douche. Foster<sup>[6]</sup> counters that this fear is from Millsbaugh's 1887 homeopathic text. Modern studies have been unable to confirm this.

## CONCLUSIONS

Goldenseal has a long history of application in Western phytotherapy and herbalism, as well as in Native American ethnomedicine. Its use as a popular dietary supplement continues to the present, and this has led in part to overharvesting of wild populations such that the species has been placed on the endangered list. Abundant preclinical and clinical evidence on the activity of its major alkaloid, berberine, has shown that the plant potentially has numerous therapeutic indications, especially in microbial, fungal, and parasitic infections, in diarrhea and other gastrointestinal disorders, and in cardiac disorders such as arrhythmias and mild congestive heart failure. Berberine occurs in other plant species, and both the alkaloid itself and extracts of berberine-containing plants have been investigated clinically. Oddly, there have been no published clinical studies on goldenseal itself, despite its popularity and position as a mainstay of Western herbalism. Thus, the possible therapeutic applications of goldenseal are speculations extrapolated from the data on the activities of the alkaloids and other species containing these alkaloids.

## REFERENCES

- Budzinski, J.W.; Foster, B.C.; Vandenhoeck, S.; Arnason, J.T. An in vitro evaluation of human cytochrome P450 3A4 inhibition by selected commercial herbal extracts and tinctures. *Phyto-medicine* **2000**, *7* (4), 273–282.
- De Smet, P.A.G.M. *Adverse Effects of Herbal Drugs*; Springer-Verlag: New York, NY, 1992; Vol. 1.
- Sinclair, A.; Catling, P.M. Status of goldenseal, *Hydrastis canadensis* Ranunculaceae, in Canada. *Can. Field-Nat.* **2000**, *114* (1), 111–120.
- Duke, J.A. *Handbook of Medicinal Herbs*; CRC Press: Boca Raton, FL, 1985, 238–239.
- Snow, J.M. *Hydrastis Canadensis* L. Ranunculaceae. *Protoc. J. Bot. Med.* **1996**, *2* (2), 25–28.
- Foster, S. *Goldenseal*. Botanical Series Leaflet No. 309; American Botanical Council: Austin, TX, 1991.
- Govindan, M.; Govindam, G. A convenient method for the determination of the quality of goldenseal. *Fitoterapia* **2000**, *71* (3), 232–235.
- Herrick, J.W. *Iroquois Medical Botany*. Ph.D. Thesis, State University of New York, Albany, NY, 1977.
- Hamel, P.B.; Chiltoskey, M.U. *Cherokee Plants and Their Uses—A 400-Year History*; Herald Publishing Company: Sylva, NC, 1975.
- Bergner, P. Goldenseal and the common cold: the antibiotic myth. *Med. Herbalism* **1996**, *8* (4), 1–10.
- Murray, M.T. *The Healing Power of Herbs*; Prima Publishing: Rocklin, CA, 1995; 162–172.
- Leung, A.Y.; Foster, S. *Encyclopedia of Common Natural Ingredients Used in Food, Drugs, and Cosmetics*; John Wiley and Son, Inc.: New York, NY, 1996; 282–283.
- Chang, H.M.; But, P.P.H. *Pharmacology and Application of Chinese Materia Medica*; World Scientific: Singapore, 1986.
- Marin-Neto, J.A.; Maciel, B.C.; Secches, A.L.; Gallo, L. Cardiovascular effects of berberine in patients with severe congestive heart failure. *Clin. Cardiol.* **1988**, *11* (4), 253–260.
- Nguyen, V.D. *Medicinal Plants of Vietnam, Cambodia and Laos*; Self published: Santa Monica, CA, 1993; 80–81.
- Brinker, F. *Herb Contraindications and Drug Interactions*, 2nd Ed.; Eclectic Medical Publications: Sandy, OR, 1998; 78.
- Bradley, P.R. *British Herbal Compendium*; British Herbal Medicine Association: Bournemouth, Dorset, England, 1992; 119–120.
- Edwards, D.J.; Draper, E.J. Variations in alkaloid content of herbal products containing goldenseal. *J. Am. Pharm. Assoc.* **2003**, *43* (3), 419–423.
- Abourashed, E.A.; Khan, I.A. High-performance liquid chromatography determination of  $\beta$ -hydrastine and berberine in dietary supplements containing goldenseal. *J. Pharm. Sci.* **2001**, *90* (7), 817–822.
- Yao, W.X.; Fang, D.C.; Xia, G.J.; Jiang, M.X. Blocking action of berberine on various receptors in rat anococcygeus muscle. *J. Tongji Med. Univ.* **1989**, *9* (1), 86–90.
- Palmery, M.; Cometa, M.F.; Leone, M.G. Further studies of the adrenolytic activity of the major alkaloids from *Hydrastis canadensis* L. On isolated rabbit aorta. *Phytother. Res.* **1996**, *10* (S1), S47–S49.
- Rehman, J.; Dillow, J.M.; Carter, S.M.; Chou, J.; Le, B.; Maisel, A.S. Increased production of antigen-specific immunoglobulins G and M following in vivo treatment with medicinal plants *Echinacea angustifolia* and *Hydrastis canadensis*. *Immunol. Lett.* **1999**, *68* (2–3), 391–395.

23. Scazzocchio, F.; Cometa, M.F.; Tomassini, L.; Palmery, M. Antimicrobial activity of *Hydrastis canadensis* extract and its major isolated alkaloids. *Planta Med.* **2001**, *67* (6), 561–564.
24. Knight, S.E. Goldenseal *Hydrastis canadensis* versus penicillin: a comparison of effects on *Staphylococcus aureus*, *Streptococcus pyogenes*, and *Pseudomonas aeruginosa*. *Bios* **1999**, *70* (1), 3–10.
25. Hwang, B.Y.; Roberts, S.K.; Chadwick, L.R.; Wu, C.D.; Kinghorn, A.D. Antimicrobial constituents from goldenseal (the rhizomes of *Hydrastis canadensis*) against selected oral pathogens. *Planta Med.* **2003**, *69* (7), 623–627.
26. Cometa, M.F.; Abdel-Haq, H.; Palmery, M. Spasmolytic activities of *Hydrastis canadensis* L. on rat uterus and guinea pig trachea. *Phytother. Res.* **1998**, *12* (S1), S83–S85.
27. Abdel-Haq, H.; Cometa, M.F.; Palmery, M.; Leone, M.G.; Silvestrini, B.; Saso, L. Relaxant effects of *Hydrastis canadensis* L. and its major alkaloids on guinea pig isolated trachea. *Pharmacol. Toxicol.* **2000**, *87* (5), 218–222.
28. Wu, S.N.; Yu, H.S.; Jan, C.R.; Li, H.F.; Yu, C.L. Inhibitory effects of berberine on voltage- and calcium-activated potassium currents in human myeloma cells. *Life Sci.* **1998**, *62* (25), 2283–2294.
29. Anis, K.V.; Kuttan, G.; Kuttan, R. Role of berberine as an adjuvant response modifier during tumour therapy in mice. *Pharm. Pharmacol. Commun.* **1999**, *5* (12), 697–700.
30. Chung, J.G.; Chen, G.W.; Hung, C.F.; Lee, J.H.; Ho, C.C.; Chang, H.L.; Lin, W.C.; Lin, J.G. Effects of berberine on arylamine *N*-acetyltransferase activity and 2-aminofluorene–DNA adduct formation in human leukemia cells. *Am. J. Chin. Med.* **2000**, *28* (2), 227–238.
31. Lin, J.G.; Chung, J.G.; Wu, L.T.; Chen, G.W.; Chang, H.L.; Wang, T.F. Effects of berberine on arylamine *N*-acetyltransferase activity in human colon tumor cells. *Am. J. Chin. Med.* **1999**, *27* (2), 265–275.
32. Anis, K.V.; Rajeshkumar, N.V.; Kuttan, R. Inhibition of chemical carcinogenesis by berberine in rats and mice. *J. Pharm. Pharmacol.* **2001**, *53* (5), 763–768.
33. Nishino, H.; Kitagawa, K.; Fujiki, H.; Iwashima, A. Berberine sulfate inhibits tumor-promoting activity of teleocidin in two-stage carcinogenesis on mouse skin. *Oncology* **1986**, *43* (2), 131–134.
34. Orfila, L.; Rodriguez, M.; Colman, T.; Hasegawa, M.; Merentes, E.; Arvelo, F. Structural modification of berberine alkaloids in relation to cytotoxic activity in vitro. *J. Ethnopharmacol.* **2000**, *71* (3), 449–456.
35. Korkmaz, S.; Kosar, M.; Baser, K.H.C.; Ozturk, Y. Effects of berberine on C6 glioma and NIH 3T3 fibroblast cell lines. In 3rd International Congress on Phytomedicine, Munich, Germany, October 11–13, 2000. Abstracts in: *Phytomedicine* **7** (S2), 123 abstract P-150.
36. Wu, H.L.; Hsu, C.Y.; Liu, W.H.; Yung, B.Y.M. Berberine-induced apoptosis of human leukemia HL-60 cells is associated with down-regulation of nucleophosmin/B23 and telomerase activity. *Int. J. Cancer* **1999**, *81* (6), 923–929.
37. Fukuda, K.; Hibiya, Y.; Mutoh, M.; Koshiji, M.; Akao, S.; Fujiwara, H. Inhibition of activator protein 1 activity by berberine in human hepatoma cells. *Planta Med.* **1999**, *65* (4), 381–383.
38. Huang, W.M.; Yan, H.; Jin, J.M.; Yu, C.; Zhang, H. Beneficial effects of berberine on hemodynamics during acute ischemic left ventricular failure in dogs. *Chin. Med. J.* **1992**, *105* (12), 1014–1019.
39. Zhou, J.; Xuan, B.; Li, D.X. Effect of tetrahydroberberine on ischemic and reperfused myocardium in rats. *Acta Pharmacol. Sin.* **1993**, *14* (2), 130–133.
40. Lau, C.W.; Yao, X.Q.; Chen, Z.Y.; Ko, W.H.; Huang, Y. Cardiovascular actions of berberine. *Cardiovasc. Drug Rev.* **2001**, *19* (3), 234–244.
41. Zhou, Z.; Xu, J.; Lan, T. Protective effect of berberine on isolated perfused heart in heart failure. *Hua Xi Yi Ke Da Xue Xue Bao* **2001**, *32* (3), 417–418.
42. Hong, Y.; Hui, S.S.; Chan, B.T.; Hou, J. Effect of berberine on regression of pressure-overload induced cardiac hypertrophy in rats. *Am. J. Chin. Med.* **2002**, *30* (4), 589–599.
43. Wong, K.K. Mechanism of the aortic relaxation induced by low concentrations of berberine. *Planta Med.* **1998**, *64* (8), 756–757.
44. Sack, R.B.; Froelich, J.L. Berberine inhibits intestinal secretory response of *Vibrio cholerae* and *Escherichia coli* enterotoxins. *Infect. Immun.* **1982**, *35* (2), 471–475.
45. Taylor, C.T.; Winter, D.C.; Skelly, M.M.; O'Donoghue, D.P.; O'Sullivan, G.C.; Harvey, B.J.; Baird, A.W. Berberine inhibits ion transport in human colonic epithelia. *Eur. J. Pharmacol.* **1999**, *368* (1), 111–118.
46. Janbaz, K.H.; Gilani, A.H. Studies on preventive and curative effects of berberine on chemical-induced hepatotoxicity in rodents. *Fitoterapia* **2000**, *71* (1), 25–33.
47. Ölmez, E.; İlhan, M. Evaluation of the  $\alpha$ -adrenoceptor antagonistic action of berberine in isolated organs. *Arzneimittel-Forsch./Drug Res.* **1992**, *42* (9), 1095–1097.
48. Werbach, M.R.; Murray, M.T. *Botanical Influences on Illness: A Sourcebook of Clinical Research*; Third Line Press: Tarzana, CA, 1994.

49. Amin, A.H.; Subbaiah, T.V.; Abbasi, K.M. Berberine sulfate: antimicrobial activity, bioassay and mode of action. *Can. J. Microbiol.* **1969**, *15* (9), 1067–1076.
50. Park, K.S.; Kang, K.C.; Kim, J.H.; Adams, D.J.; Johng, T.N.; Paik, Y.K. Differential inhibitory effects of protberberines on sterol and chitin biosyntheses in *Candida albicans*. *J. Antimicrob. Chemother.* **1999**, *43* (5), 667–674.
51. Chung, J.G.; Wu, L.T.; Chang, S.H.; Lo, H.H.; Hsieh, S.E.; Li, Y.C.; Hung, C.F. Inhibitory actions of berberine on growth and arylamine *N*-acetyltransferase activity in strains of *Helicobacter pylori* from peptic ulcer patients. *Int. J. Toxicol.* **1999**, *18* (1), 35–40.
52. Mahady, G.B.; Pendland, S.L.; Stoia, A.; Chadwick, L.R. In vitro susceptibility of *Helicobacter pylori* to isoquinoline alkaloids from *Sanguinaria canadensis* and *Hydrastis canadensis*. *Phytother. Res.* **2003**, *17* (3), 217–221.
53. Sun, D.; Courtney, H.S.; Beachey, E.H. Berberine sulfate blocks adherence of *Streptococcus pyogenes* to epithelial cells, fibronectin, and hexadecane. *Antimicrob. Agents Chemother.* **1988**, *32* (9), 1370–1374.
54. Wright, C.W.; Marshall, S.J.; Russell, P.F.; Anderson, M.M.; Phillipson, J.D.; Kirby, G.C.; Warhurst, D.C.; Schiff, P.L. In vitro antiplasmodial, antiamoebic and cytotoxic activities of some monomeric isoquinoline alkaloids. *J. Nat. Prod.* **2000**, *63* (12), 1638–1640.
55. Gentry, E.J.; Jampani, H.B.; Keshavarz-Shokri, A.; Morton, M.D.; Velde, D.; Telikepalli, H.; Mitscher, L.A.; Shawar, R.; Humble, D.; Baker, W. Antitubercular natural products: berberine from the roots of commercial *Hydrastis canadensis* powder. Isolation of inactive 8-oxotetrahydrothalifenidine, canadine,  $\beta$ -hydrastine, and two new quinic acid esters, hyacdinic acid esters-1 and 2. *J. Nat. Prod.* **1998**, *61* (10), 1187–1193.
56. Subbaiah, T.V.; Amin, A.H. Effect of berberine sulphate on *Entamoeba histolytica*. *Nature* **1967**, *215* (100), 527–528.
57. Amin, A.H.; Subbaiah, T.V.; Abbasi, K.M. Berberine sulfate: antimicrobial activity, bioassay and mode of action. *Can. J. Microbiol.* **1969**, *15* (9), 1067–1076.
58. Ghosh, A.K.; Bhattacharyya, F.K.; Ghosh, D.K. *Leishmania donovani*: amastigote inhibition and mode of action of berberine. *Exp. Parasitol.* **1985**, *60* (3), 404–413.
59. Kaneda, Y.; Tanaka, T.; Saw, T. Effects of berberine, a plant alkaloid, on the growth of anaerobic protozoa in axenic culture. *Tokai J. Exp. Clin. Med.* **1990**, *15* (6), 417–423.
60. Ye, Y.C.; Chen, Q.M.; Hai, P.; Chai, F.L.; Zhou, S.X. Effect of  $\beta$ -hydrastine on the ultrastructure of several experimental *Echinococcus granulosus* cyst in mice. *Zhongguo Yao Li Xue Bao* **1989**, *10* (2), 185–187.
61. Tanaka, T.; Metori, K.; Mineo, S.; Hirofani, M.; Furuya, T.; Kobayashi, S. Inhibitory effects of berberine-type alkaloids on elastase. *Planta Med.* **1992**, *59* (3), 200–202.
62. Li, H.; Miyahara, T.; Tezuka, Y.; Namba, T.; Nemoto, N.; Tonami, S.; Seto, H.; Tada, T.; Kadota, S. The effect of Kampo formulae on bone resorption in vitro and in vivo I. Active constituents of Tsu-kan-gan. *Biol. Pharm. Bull.* **1998**, *21* (12), 1322–1326.
63. Li, H.; Miyahara, T.; Tezuka, Y.; Tran, Q.L.; Seto, H.; Kadota, S. Effect of berberine on bone mineral density in SAMP6 as a senile osteoporosis model. *Biol. Pharm. Bull.* **2003**, *26* (1), 110–111.
64. Lee, S.S.; Kai, M.; Lee, M.K. Effects of natural isoquinoline alkaloids on monoamine oxidase activity in mouse brain: inhibition by berberine and palmatine. *Med. Sci. Res.* **1999**, *27* (issue not specified), 749–751.
65. Zeng, X.; Zeng, X. Relationship between the clinical effects of berberine on severe congestive heart failure and its concentration in plasma studied by HPLC. *Biomed. Chromatogr.* **1999**, *13* (7), 422–444.
66. Zeng, X.H.; Zeng, Z.J.; Li, Y.Y. Efficacy and safety of berberine for congestive heart failure secondary to ischemic or idiopathic dilated cardiomyopathy. *Am. J. Cardiol.* **2003**, *92* (2), 173–176.
67. Rabbani, G.H.; Butler, T.; Knight, J.; Sanyal, S.C.; Alam, K. Randomized controlled clinical trial of berberine sulfate therapy for diarrhea due to enterotoxigenic *Escherichia coli* and *Vibrio cholerae*. *J. Infect. Dis.* **1987**, *155* (5), 979–984.
68. Khin-Maung-U; Myo-Khin; Nyunt-Nyunt-Wai; Aye-Kyaw; Tin-U. Clinical trial of berberine in acute watery diarrhoea. *Br. Med. J. (Clin. Res. Ed.)* **1985**, *291* (6509), 1601–1605.
69. Kamat, S.A. Infectious diseases. A review of work done in India. *J. Assoc. Physicians India* **1970**, *18* (4), 449–457, 529.
70. Watanabe, A.; Obata, T.; Nagashima, H. Berberine therapy of hypertyraminemia in patients with liver cirrhosis. *Acta Med. Okayama* **1982**, *36* (4), 277–281.
71. Gupta, S. Use of berberine in the treatment of giardiasis. *Am. J. Dis. Child.* **1975**, *129* (7), 866.
72. Newall, C.A.; Anderson, L.A.; Phillipson, J.D. *Herbal Medicine. A Guide for Health-care*

- Professionals; The Pharmaceutical Press: London, England, 1996; 151–152.*
73. Chan, E. Displacement of bilirubin from albumin by berberine. *Biol. Neonate* **1993**, *63* (4), 201–208.
  74. Yao, W.X.; Fang, D.C.; Cheng, B.; Jiang, M.X. Blocking action of berberine on  $\alpha_2$ - and  $\alpha_1$ -adrenoreceptors in rat vas deferens and anococcygeus muscle. *J. Tongji Med. Univ.* **1987**, *7* (4), 233–238.
  75. Lin, H.L.; Liu, T.Y.; Wu, C.W.; Chi, C.W. Berberine modulates expression of *mdr1* gene product and the responses of digestive track cancer cells to paclitaxel. *Br. J. Cancer* **1999**, *81* (3), 416–422.
  76. Sheng, M.P.; Sun Q.; Wang, H. Studies on the intravenous pharmacokinetics and oral absorption of berberine HCL in beagle dogs. *Sin. Pharmacol. Bull.* **1993**, *9* (issue not specified), 64–67.
  77. Pan, G.Y.; Wang, G.J.; Liu, X.D.; Fawcett, J.P.; Xie, Y.Y. The involvement of P-glycoprotein in berberine absorption. *Pharmacol. Toxicol.* **2002**, *91* (4), 193–197.
  78. Price, C.J.; George, J.D.; Marr, M.C.; Myers, C.B.; Jahnke, G.D. Developmental toxicity evaluation of goldenseal root powder in mice. *Toxicologist* **2003**, *72* (S1), 341
  79. McGuffin, M.; Hobbs, C.; Upton, R.; Goldberg, A. *American Herbal Product Association's Botanical Safety Handbook*; CRC Press: Boca Raton, FL, 1997.
  80. Blumenthal, M.; Busse, W.R.; Goldberg, A.; Gruenwald, J.; Hall, T.; Riggins, C.W.; Rister, R.S. *The Complete German Commission E Monographs*; American Botanical Council: Austin, TX, 1998; 309–310.
  81. Rumack, B.H.; Berberine In: *Poisindex® System. CCIS*; Hall, A.H., Rumack, B.H., Eds.; Thompson Micromedex: Greenwood Village, CO, 2003; 118.
  82. Sax, N.I. *Dangerous Properties of Industrial Materials*, 5th Ed.; Van Nostrand Reinhold: New York, 1979; 412.

# Grape Seed Extract

**Dallas L. Cloutre**

*Glykon Technologies Group, L.L.C., Santa Monica, California, U.S.A.*

**Chithan Kandaswami**

*State University of New York at Buffalo, Buffalo, New York, U.S.A.*

## INTRODUCTION

Grape seed extract (GSE) refers to mixtures of catechin monomers, procyanidin oligomers, and procyanidin polymers extracted from *Vitis vinifera* seeds. These bioactive components are reducing agents and hydrogen-donating antioxidants. Their intrinsic properties are due to their polyphenolic nature. They exert diverse biologic effects in vitro at pharmacologic concentrations and seem to critically influence and modulate cell function, cell activation, cell signal transduction, endothelium-dependent vasodilation, vascular reactivity, inflammatory cascades, immune function, cellular and humoral immunity, cell survival, carcinogenesis, etc., in experimental situations—actions that may be relevant to their potential roles in the prevention of chronic disorders, amelioration of diseases, and maintenance of homeostasis. Grape seed extract also seems to exert a number of specific health-supportive actions clinically.

## DESCRIPTION AND CHEMICAL COMPOSITION

Natural proanthocyanidins, of which procyanidins comprise the most prominent subclass, originate from carbohydrates and occur throughout the plant kingdom. They impart characteristic flavor and “mouth feel” to a wide variety of fruits, juices, and beverages.<sup>[1]</sup> For more details specifically on proanthocyanidins, see the separate entry, since the scope of this article is confined to grape seed extracts, which contain procyanidins.

Grape seed extracts have varying amounts of monomers, oligomers, higher oligomers, and polymers

of catechin, a flavan-3-ol molecule (Fig. 1). Elongation into large polymers in the seeds and other plant sources is reminiscent of the long branches of carbohydrates, the polysaccharides.

Catechin is a three-ring chemical structure characterized by a 15-carbon membered ( $C_6-C_3-C_6 = 6$ -carbon ring, 3-carbon ring, 6-carbon ring) flavan skeleton (Fig. 1), composed of a chromane nucleus ( $C_6-C_3$ ) (rings A and C), also shared by the tocopherols, bonded to an aromatic ring (the B-ring) with hydroxyl group ( $-OH$ ) substitutions. The substitution of  $-OH$ , at carbon-3 (C-ring, Fig. 1) of the flavan confers it the name flavan-3-ol, known by its trivial name catechin (Fig. 3). The condensation of two such flavan molecules by carbon-carbon ( $-C-C-$ ) linkage forms a 30-carbon containing unit, a dimer, the smallest member of the procyanidin class (Fig. 4). The treatment of a procyanidin (or generically, any proanthocyanidin) with mineral acid ruptures the carbon-carbon ( $-C-C-$ ) linkage and generates cyanidin (an anthocyanidin), a brilliant, bright colored pigment associated with colored grape varieties, colored fruits, etc. Hence the name procyanidin (proanthocyanidin).

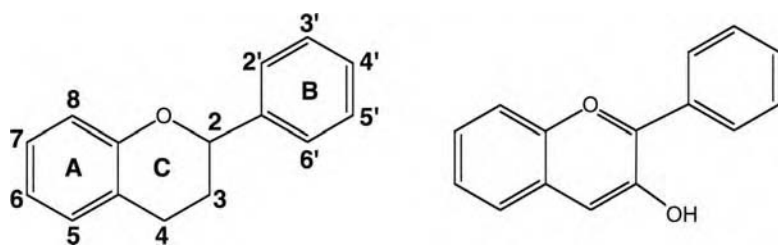
The early name for proanthocyanidins, leucoanthocyanidins (i.e., “colorless” anthocyanidins), includes all monomeric flavans, such as flavan-3,4-diols [flavans with hydroxyl ( $OH-$ ) group substitution at both of the carbons, carbon-3 (C-3) and carbon-4 (C-4) of the C-ring of their flavan nucleus], flavan-4-ols (flavans with  $OH-$  group substitution at C-4 of the C-ring of their flavan nucleus), and others, which yield anthocyanidins on treatment with mineral acid by the cleavage of such carbon-oxygen ( $-C-O$ ) bonds. Those compounds that yield anthocyanidins (Fig. 2) by the fission of a C-C linkage belong to the proanthocyanidin group and comprise monomers, dimers, and polymers. The naming of proanthocyanidins follows a system of nomenclature in vogue for oligosaccharides and polysaccharides by considering the direction in which a C-4 in a given monomer bonds with a carbon atom of a second monomer with which it binds to form a dimer.<sup>[2]</sup>

The relative percentage of polyphenols in the grape seeds vs. their content in the whole grape depends on the varietal and generally appears to be a little above

*Dallas L. Cloutre, Ph.D.*, is Manager at the Glykon Technologies Group, L.L.C., Santa Monica, California, U.S.A.

*Chithan Kandaswami, Ph.D., C.N.S., F.A.C.N.*, is at Advocare International, Carrollton, Texas, U.S.A.

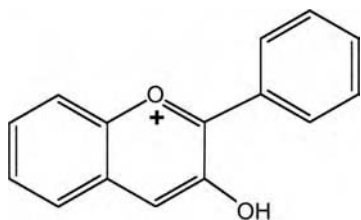
The authors have no pecuniary/proprietary interest in Endotelon or any other company that produces or promotes grape seed products.



**Fig. 1** Flavan skeleton and naming convention. The six carbon atoms that make up each of the “A” and “B” rings (aromatic) of the flavan skeleton are numbered as shown in the illustration so that each “position” can be identified. The rings A and B are linked by a bent bridge (a 3-carbon unit) consisting of carbons 2, 3, and 4 (C-2, C-3, and C-4) plus an oxygen atom, these latter components constituting the “C” (heterocyclic) ring. The basic flavan-3-ol skeleton consists of the flavan nucleus and a hydroxyl (–OH) group attached at C-3 of the C ring. Flavan possesses an unsubstituted C-ring.

4.0% of the total weight. The pulp contains about 10% of the total extractable phenolic substance in the berry. The seeds and the skin constitute two-thirds and one-third, respectively, of the remainder.<sup>[3]</sup> The components that compose the phenolic fraction in the grape seed are essentially all flavonoids, designated as monomeric flavan-3-ols identified as (+)-catechin, (–)-epicatechin, and (–)-epicatechin-3-gallate esterified with a gallic acid residue. The flavan-3-ol repeated molecules show extensive distribution in grape seeds, and considerable chain extensions occur to produce polymers. Fuleki and Da Silva assessed the composition of catechin and procyanidins in 17 different red and white cultivars.<sup>[4]</sup> They isolated and identified 11 different monomers, dimers, and trimers by reverse-phase HPLC. In earlier studies reported in 1994, Prieuer et al., employing gel permeation chromatography and normal-phase HPLC demonstrated that the degree of polymerization of the procyanidin could reach 16.<sup>[5]</sup> A certain amount of higher polymer content may arise from oxidative polymerization of oligomers after extraction from the seeds.

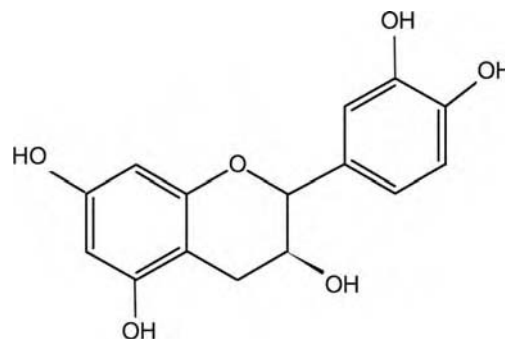
Known by a number of names—leucoanthocyanidins, oligomeric proanthocyanidins (OPC), procyanidin, procyanidolic oligomers (PCO), pycnogenols, and others—GSE first gained widespread



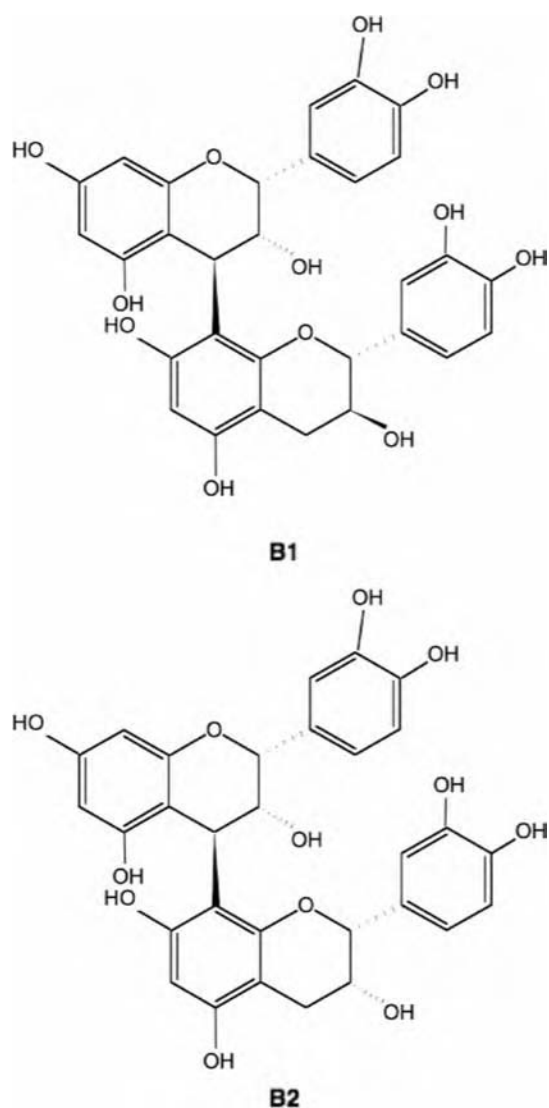
**Fig. 2** Anthocyanidin. The anthocyanidin is an aglycone, i.e., it lacks any attached sugar moiety. The –OH group occurs at several different positions on the A and B rings. Anthocyanins are glycosides, having one or more sugar molecules substituted at the –OH group shown and also occurring at other positions of the flavone ring.

prominence as a nutritional supplement in the work of Masquelier and coworkers.<sup>[6]</sup> Wine is a source of GSE procyanidins, but extraction of the active substances into wine requires extended exposure of the juice to the crushed skins and seeds, something typical only of red wines. In contrast, grape seed extracts are made from many varieties, including white (i.e., green) grapes. Commonly claimed potencies in grape seed extracts range from 60% to 95% polyphenols.

Wine procyanidins originate from grape seed and skin. Of the procyanidins, the B types are the most extensively studied, while the C series has also received attention. The presence of (+)-catechin, (–)-epicatechin, (–)-epicatechin 3-*O*-gallate, procyanidin dimers B1, B2, B3, B4, B5, B6, B7, B8, B2 3'-*O*-gallate, and procyanidin trimers C1 have all been confirmed, depending on the extract (Figs. 3–5).<sup>[7]</sup> Dimers, trimers, and tetramers based on catechin and epicatechin, and the gallates of these constitute the bulk of procyanidins in extracts. Oxidation and other processes can yield extracts with higher amounts of pentamers, hexamers, and heptamers. By employing matrix-assisted laser desorption/ionization time-of-flight mass spectrometry (MALDI-TOF MS), recent studies have demonstrated



**Fig. 3** Catechin. Catechin is the basic flavan-3-ol monomer subunit of procyanidin oligomers and polymers. Procyanidins are proanthocyanidins consisting of catechin and epicatechin extension units. Epicatechin differs from catechin in the configuration of the carbon-3 (3-substituent).



**Fig. 4** Procyanidin B. Epicatechin-(4→8)-catechin (B1) (the linkage is in the direction of C-4 to C-8); epicatechin-(4→8)-epicatechin (B2).

the presence of flavan-3-ols esterified with several residues of gallic acids in procyanidins to yield galloylated procyanidins.<sup>[8]</sup> Most extracts will contain some percentage of monomeric units along with the procyanidins. No consensus exists regarding the optimal ratio of these components inasmuch as oligomers and polymers may have different biologic effects.

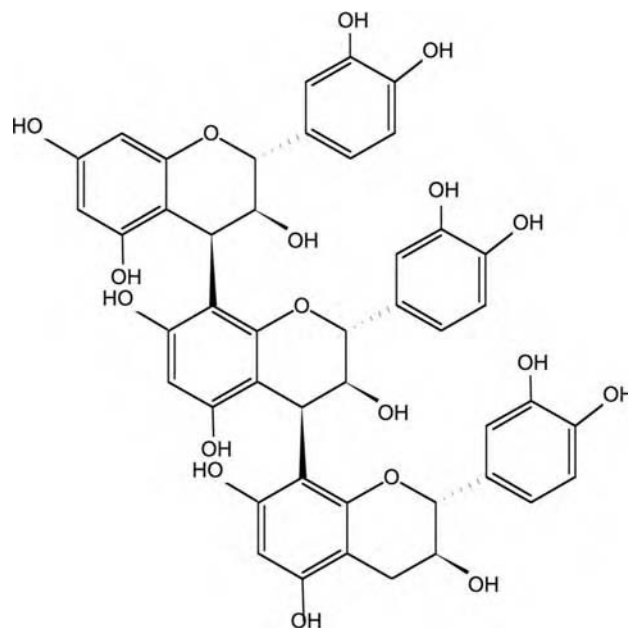
## MECHANISMS OF ACTION

### Antioxidant

Procyanidins, the primary components of GSE, are typical phenolic compounds, are electron acceptors, act as antioxidants, and have the propensity to reduce free radical-mediated damage in cells. Like vitamin C,

they are reducing agents. Moreover, they scavenge oxygen and nitrogen free radicals. They can also bind metal ions and thus diminish metal catalyzed lipid peroxidation. However, metal ions, such as iron and copper, are well sequestered by metal binding proteins (e.g., ferritin) and are stored in human tissues. Hence, the primary antioxidant activity of procyanidins is of more interest than the complexing of metal ions. Procyanidins are chain-breaking antioxidants and, therefore, are capable of reducing lipid peroxidation by this means. Their inhibitory action on oxygen activating enzymes, which could be responsible for much of the effect seen in reducing oxidant and free radical generation in cells, also garners interest. Being primary phenolic compounds, they are hydrogen-donating antioxidants. Nevertheless, their biological properties, pharmacologic actions, bioavailability, antioxidant activity, and specific interactions with enzymes and cellular receptors, are related to their intrinsic molecular structures. Antioxidant-related functions and abilities to modulate enzyme activities, cell activation, and signaling account for only some of the known pharmacologic actions of GSE.

In vitro tests of GSE show it to be a more powerful antioxidant than either vitamin C or E, as assessed by the inhibition of lipid peroxidation and the scavenging of radical species.<sup>[9]</sup> The antioxidant activity of GSE components in the lipid phase decreases with polymerization, whereas that in the aqueous phase increases from monomer to trimer and then decreases from trimer to tetramer. Galloylation of catechin and dimeric procyanidins decreases lipid-phase antioxidant activity, while increasing that of the aqueous phase.<sup>[10]</sup>



**Fig. 5** Procyanidin C.



Numerous studies demonstrate that GSE inhibits radical generation mediated by xanthine oxidase, metal catalysis, and arachidonic acid oxygenation. The inhibition of xanthine oxidase may itself be responsible for the reduction in radicals generated by this enzyme. Polyphenol fractions from grape seed enriched with procyanidin oligomers and polymers intercept both direct  $\text{Cu}^{2+}$  and indirect cell (monocyte)-mediated radical generation systems. Grape seed extract is balanced in its actions in comparison with chlorogenic acid and catechin, taken as archetypes for preventing oxidation partly as a copper complexing agent and as radical scavenger only, respectively.<sup>[11]</sup> Of the different antioxidants tested, including grape skin extracts, GSE is most effective in protecting low-density lipoprotein (LDL) in the peroxy-nitrite generator initiated system and in impairing superoxide production in adherent macrophages.

Procyanidins strongly inhibit superoxide generation and prevent oxidative discharge from activated neutrophils at the site of their adhesion.<sup>[12]</sup> This action may be due to their inhibition of neutrophil NADPH oxidase and protein kinase C. Similarly, they protect cells from peroxy-nitrite damage.<sup>[13]</sup> One recent study indicates that the high condensation rate and the gallate ester moiety in GSE procyanidins might play an important role in nitric acid (NO) scavenging activity. The mechanism of the NO scavenging activity of GSE procyanidins suggested is that NO reacts with phenolic compounds directly to generate phenoxy radicals.<sup>[14]</sup> Another experiment indicated that GSE can protect the mitochondrial membrane from the oxidative damage caused by gas-phase cigarette smoke.<sup>[15]</sup> Yet other mechanisms may be active. Grape seed extract confers cardioprotection against oxidant injury in chick cardiomyocytes induced by exogenous  $\text{H}_2\text{O}_2$  and antimycin. This action does not require protein kinase C, mitochondrial  $\text{K}_{\text{ATP}}$  channel, or NO synthase, presumably because GSE acts by directly binding iron and by scavenging reactive oxygen species (ROS).<sup>[16]</sup>

Grape seed extract inhibits the oxidation of polyunsaturated fatty acid moieties in LDL particles by intercepting free radical propagation of LDL oxidation. In a clinical study, Fuhrman, Lavy, and Aviram reported the specific effect of wine derived polyphenols in reducing the susceptibility of plasma LDL to oxidative modification.<sup>[17]</sup> Procyanidin dimers and trimers isolated from GSE inhibited the oxidation of LDL and prevented early aortic atherosclerosis in hypercholesterolemic golden Syrian hamsters.<sup>[18,19]</sup> Some *in vitro* studies have ascribed an indirect protective role for red wine phenolic compounds. These substances may protect plasma LDL against oxidative degradation by sparing the endogenous  $\alpha$ -tocopherol of LDL.<sup>[20]</sup>

*In vivo* studies generally suggest that sufficient enteric absorption occurs to accomplish a reduction

in plasma indices of oxidant status. Total plasma antioxidant activity and levels of vitamin C increased with procyanidin supplementation in one animal model, although there was a slight decrease in vitamin E in the serum.<sup>[21]</sup> The addition of GSE procyanidins to a vitamin E deficient diet (71 mg/kg of body weight) negated the effects of the oxidative stress induced by both vitamin E deficiency and atherogenic diet.<sup>[22]</sup> The oral administration of GSE procyanidins (250 mg/kg of body weight) increased the antioxidative potential of rat plasma in another study.<sup>[23]</sup>

A recent work has demonstrated an increase in the plasma antioxidant capacity in humans after ingestion of GSE.<sup>[24]</sup> Supplementation with an alcohol-free red wine extract, the source of procyanidins, in volunteers had no effect on plasma vitamins C and E, retinol, or carotenoid concentrations. Nevertheless, there was reduced LDL oxidation.<sup>[25]</sup> A separate investigation similarly found no impact on serum levels of vitamins C and E, yet reported a powerful influence on total antioxidant capacity.<sup>[26]</sup> Supplementation of a meal with GSE minimizes the postprandial oxidative stress by decreasing the oxidants, increasing the antioxidant levels in plasma, and enhancing the resistance to oxidative modification of LDL.<sup>[27]</sup> Supplementation with procyanidin components contained in fractions isolated from dealcoholized extracts of red wine caused a rise in the antioxidant capacity of plasma and vitamin E content of low-density lipoprotein in human subjects in a separate study.<sup>[28]</sup>

Smoking is a model of oxidative stress. A randomized, double-blind crossover study undertaken in 24 healthy male heavy smokers reported the antioxidant potential of GSE.<sup>[29]</sup> The enrolled subjects received 150 mg of GSE per day complexed with lecithin for 4 weeks (phase 1). A wash-out period of 3 weeks was then followed by 4 weeks of placebo treatment (phase 2). Blood samples were taken at baseline and at the end of each phase and assayed for plasma lipids and LDL susceptibility to oxidation. The subjects did not show any significant modification of total cholesterol (TC), triglycerides (TG), high-density lipoprotein-cholesterol (HDL-C), or LDL-C during the GSE treatment. Among oxidative indices, the concentration of thiobarbituric acid reactive substances (TBARS) was significantly reduced in subjects taking the GSE complex compared with that in placebo and with basal values.

### Anti-inflammatory

Grape seed extract significantly suppressed in a dose-dependent manner the expression of the gene for inducible nitric oxide synthase (iNOS) in lipopolysaccharide (LPS) activated peripheral blood mononuclear

cells (PBMC), as determined by iNOS mRNA expression in the cells, an action indicating that GSE may mediate an anti-inflammatory cellular process.<sup>[30]</sup> However, another mechanism may be just as significant. A primary factor in the onset of inflammation is the increased permeability of tissues due to the action of collagenase. Animal experiments show that grape seed oligomers prevent the increased permeability of cerebral capillaries, aorta, and cardiac muscle capillaries induced by collagenase injections.<sup>[31]</sup> Other studies have demonstrated the inhibition of hyaluronidase activation in isolated rat mast mesentery cells.<sup>[32]</sup> Procyanidins bind with biopolymers, such as proteins and carbohydrates; they can bind to collagen and prevent its degradation by elastases.<sup>[33]</sup> In an animal model of inflammation, a naturally occurring procyanidin decreased to a statistically significant extent the magnitude of rat-paw edema induced with serotonin, carrageenan, or prostaglandin E1. In the case of carrageenan-induced edema, this procyanidin was about twice as effective as phenylbutazone.<sup>[34]</sup> Grape seed extract (10–40 mg/kg i.p.) inhibited carrageenan-induced paw edema in rats and croton oil-induced ear swelling in mice in a dose-dependent manner. At 10 mg/kg, it reduced the malondialdehyde (MDA) content in inflamed paws, inhibited *N*-acetyl glucosamine ( $\beta$ -NAG) and NOS activity, and lowered the content of NO, interleukin-1 $\beta$  (IL-1 $\beta$ ), tumor-necrosis factor (TNF- $\alpha$ ), and prostaglandin E2 (PGE2) in exudates from edema paws of rats induced by carrageenan.<sup>[35]</sup>

### Immunostimulatory, Antiviral, and Anticancer

Procyanidins in vitro exert marked antiviral and antitumor effects by inducing production of the Th1-derived cytokine gamma interferon (IFN- $\gamma$ ) by PBMC from healthy donors. Grape seed extract significantly induces the transcription of IFN- $\gamma$  mRNA as demonstrated by reverse transcriptase-polymerase chain reaction (RT-PCR), but has no effect on that of the proinflammatory Th2-derived cytokine, IL-6. In addition to the enhancement in IFN- $\gamma$  expression, there is a concomitant increase in the number of cells with intracytoplasmic IFN- $\gamma$ , as well as in the synthesis and secretion of IFN- $\gamma$ . This demonstrates that the potentially beneficial immunostimulatory effects of GSE may be mediated through the induction of IFN- $\gamma$ .<sup>[36]</sup> In vitro and ex vivo effects seem to be dependent on the molecular size. One study compared the effects of monomers, dimers, and a trimer on NO production, TNF- $\alpha$  secretion, and oxidant-responsive transcription factor, NF- $\kappa$ B. Monomers and dimers depressed NO production, TNF- $\alpha$  secretion, and NF- $\kappa$ B-dependent gene expression induced by interferon- $\gamma$ , whereas the

trimeric procyanidin C2 enhanced these parameters.<sup>[37]</sup> Grape seed extract also downregulates the expression of coentry receptors required by HIV and perhaps other viruses for entry into cells.<sup>[38]</sup>

### Vasodilation

Dysfunctional vasodilation is found in a number of pathogenic conditions. Procyanidins display endothelium-dependent vasorelaxation (EDR) activity in vitro. This EDR enhancing activity involves the release of NO, mediated by endothelial NOS, and subsequent increase in cyclic guanosine monophosphate (GMP) levels in the vascular smooth muscle cells. The activity of isolated procyanidins tends to increase with the degree of polymerization, epicatechin content, and with galloylation.<sup>[39–41]</sup> Cishek et al. clearly established that GSE elicits dose-dependent EDR, whereas monomers derived from grape seeds are inactive.<sup>[41]</sup> Further studies deduced that acute exposure to grape seed extracts elicits an EDR, which was mediated by the release of NO, but did not involve the muscarinic receptors.<sup>[42]</sup> The authors speculated that NO release is either mediated by a series of events initiated by a novel receptor for flavonoids or triggered by a nonreceptor-mediated mechanism.

Administration of GSE (60 mg/kg/day) to New Zealand white rabbits for 7 weeks showed a positive effect on endothelial function by increasing EDR.<sup>[42]</sup> There was impairment of EDR in cholesterol-fed rabbits compared with that from animals fed standard chow. However, in those fed grape seed extracts together with cholesterol, this impairment was attenuated. This finding is significant in that endothelial dysfunction is an integral component of atherosclerosis. Harrison has demonstrated that such dysfunction precedes angiographically recognizable plaques in the coronary arteries.<sup>[43]</sup> Endothelial dysfunction (i.e., loss of EDR) also exists in hypertensives, diabetics, smokers, postmenopausal women, and individuals with hyperlipidemia. These conditions are recognized conventional cardiovascular risk factors.<sup>[44]</sup> Lipid disturbances may not be the common causal factor. da Luz et al. have demonstrated lipid-independent protection by red wine and nonalcoholic wine components (polyphenols) against atherosclerosis development.<sup>[45]</sup> These substances prevented plaque formation in hypercholesterolemic rabbits despite significant increases in LDL. Antiplatelet effect, impairment of the expression of endothelial cell adhesion molecules, and/or EDR (and associated NO stimulation) by polyphenols are likely explanations. Studies have indicated that GSE attenuates the expression of adhesion molecules in human endothelial cells in culture and in human subjects with systemic sclerosis.<sup>[46,47]</sup>

## PHARMACOKINETICS

Relatively few studies address the absorption, distribution, metabolism, and elimination of procyanidins. The information available on the factors that control the disposition of flavonoids in general is limited, and there are few reliable methods for identifying possible metabolites in tissues. Recent experiments concerning the metabolism of flavanol monomers, such as epicatechin and catechin, confirm findings made some 30 yr ago.<sup>[48]</sup> Flavanol monomers seem to be extensively metabolized to *O*-methylated forms and/or conjugated to glucuronides and sulfates during absorption into the circulation, whereas the higher procyanidin oligomers can undergo cleavage to mixtures of monomers and dimers in the stomach that may act to enhance their absorption in the small intestine. Higher oligomers may have very limited absorption. The major bioactive forms of monomers and procyanidins *in vivo* are likely to be metabolites and/or conjugates of epicatechin, such as 3'-*O*-methyl-epicatechin.<sup>[49]</sup>

## Animal and Human Studies

Lappara et al. showed the rapid appearance of small, but still significant, radioactivity in the blood of rats after oral administration of a grape preparation containing radioactive carbon-labeled procyanidin dimers.<sup>[50]</sup> Harmand and Blanquet documented similar results and reported that the amount of radioactivity excreted into the feces increased with the dose.<sup>[51]</sup> Yamakoshi et al. detected procyanidins in the plasma of grape seed extract-fed rabbits 1 hr after administration of the extracts.<sup>[52]</sup> In a subsequent study, these authors reported the occurrence of metabolites of GSE procyanidins in rat plasma 15 min after administration, with three peaks identified by HPLC as gallic acid, (+)-catechin, and (-)-epicatechin.<sup>[23]</sup> Lapidot et al. reported that red wine anthocyanidins were detected in the urine of volunteers, a very surprising finding since they are stable only at very low pH.<sup>[53]</sup> The authors deduced that proanthocyanidins entering the body from the administered red wine in this instance degraded to anthocyanidins in the urine (under its acidic conditions) upon storage.

Animal studies on the metabolism of procyanidins have reported variable results. In one study, catechin, the procyanidin dimer B3, and a grape seed extract containing catechin, epicatechin, and a mixture of procyanidins were fed to rats in a single meal. Subsequently, catechin and epicatechin were found in conjugated forms in both plasma and urine, but no procyanidins or conjugates were detected in the plasma or urine of any rats. According to the authors, the procyanidins did not cleave into bioavailable monomers

and had no significant effects on the plasma levels or urinary excretion of the monomers.<sup>[54]</sup> Yet another study found no monomers or related metabolites from oligomers upon feeding at 1 g/kg body weight.<sup>[55]</sup> In rats fed procyanidins, neither parent compound nor catechin appeared as metabolites, in contrast to animals fed catechin monomers. These latter animals excreted large amounts of catechin and its 3'-*O*-methylated form. Phenolic acids were the metabolites observed.<sup>[56]</sup> The authors concluded that these aromatic acids derived from the scission of the aromatic rings of catechins and procyanidins might also contribute to the biological effects attributed to dietary procyanidins. The *in vivo* formation of such aromatic acids from phenolic compounds has been known for decades.<sup>[57]</sup>

In contradistinction to the above observations, several studies have reported the absorption of procyanidins. Oligomeric proanthocyanidins from grape seed in an early animal study were found to have an affinity for the collagen structures that support the arteries, capillaries, and veins.<sup>[51]</sup> Administration of procyanidin B2 [epicatechin-(4 $\beta$ -8)-epicatechin] to rats resulted in it being excreted in urine, a portion of which was degraded to (-)-epicatechin and to the metabolized conjugated and/or methylated (-)-epicatechin internally.<sup>[58]</sup> Holt et al. found that after acute consumption of a flavanol-rich cocoa, procyanidin dimer B2 [epicatechin-(4 $\beta$ -8)-epicatechin] appeared in human plasma within minutes.<sup>[59]</sup> In another trial with humans, administration of 2.0 g of GSE led to the presence of procyanidin B1 [epicatechin-(4 $\beta$ -8)-catechin] 2 hr later in serum.<sup>[60]</sup> At least one large animal study supports the position that GSE is more active when given in conjunction with grape skin extract.<sup>[61]</sup>

## PHARMACOLOGY

The antioxidant and free radical scavenging actions of GSE procyanidins can explain only some of the biologic effects of GSE. Other factors include the inhibition of collagen degrading enzymes, the upregulation of endothelial nitric oxide synthase (eNOS), and the downregulation of iNOS in circulating blood cells, the modulation of cell activation, cellular protein phosphorylation, and cellular signaling, interference with matrix proteases, etc. Moreover, caution is in order. Many animal studies have involved dietary administrations of 100–300 mg/kg or more of body weight.

## Anticarcinogenic and Anticancer Effects

Animal experiments indicate that GSE interferes with the initiation and promotion of carcinogenesis.

The extract elicits antiproliferative, apoptosis-promoting, and direct cytotoxic actions against prostate and other cancer cell lines in vitro.<sup>[62–64]</sup> In an animal model, the dietary administration of proanthocyanidins from grape seeds prevented photocarcinogenesis in SKH-1 hairless mice. Grape seed proanthocyanidins significantly decreased tissue fat level (24–27%,  $P < 0.05$ ) without changing the total body mass of the animals compared with controls as a result of increased lipolysis or decreased synthesis of fat. The conclusion was that there was a reduction in UVB-induced oxidative damage and tissue fat content.<sup>[65]</sup> Antitumor-promoting actions have been similarly shown with the topical application of GSE in an animal model.<sup>[66]</sup>

Procyanidins from various sources have elicited antitumor-promoter effects in *in vivo* carcinogenesis studies, often with dimers and trimers showing seemingly greater activity.<sup>[67]</sup> In one study, feeding female rats diets containing 0.1–1.0% GSE procyanidins led to 72–88% inhibition of AOM (azoxymethane)-induced aberrant crypt foci formation and a 20–56% prevention of ornithine decarboxylase activity in the distal third of the colon with no effect on the activity of liver cytochrome P-450 2E1.<sup>[68]</sup> 7,12-Dimethylbenz[a]anthracene-induced rat mammary tumorigenesis was not influenced by oral GSE feeding. The authors surmised that this lack of action on mammary tumorigenesis in part might be due to lack of effect of dietary proanthocyanidins on the liver carcinogen-metabolizing enzymes, cytochrome P-450 1A1, and glutathione-S-transferase. However, see “Hepatoprotective, Tissue Protective, and Premenstrual Syndrome Effects”.

### Metabolic, Nutritional, Renal, and Cardioprotective Effects

Antioxidant protection against LDL modification may not be the primary factor by which dietary agents protect against coronary artery disease. Benefits could accrue by way of protection against endothelial dysfunction, changes in cholesterol transport, and so forth. Plasma protein binding studies show that (+)-catechin and procyanidins from GSE mainly bind to a protein of about 80 kDa in rats and 35 kDa in humans. The sequencing indicates that these proteins are apo A-1 in humans and transferrin in rats. The fact that red wine procyanidins bind to both proteins suggests that they may have a role in reverse cholesterol transport and in preventing the oxidizing action of iron.<sup>[69]</sup> In one rat study, administration of GSE procyanidins caused a significant increment of volatile fatty acids (VFA) pool and beneficial effects on lipid disposition.<sup>[70]</sup> Grape seed extract procyanidins appear

to exert an antihypercholesterolemic effect not only by enhancing reverse cholesterol transport, but also by reducing intestinal cholesterol absorption and increasing bile acid excretion in rats.<sup>[71]</sup> Supplementation at the level of 2% in the diet exhibits a hypocholesterolemic effect in high-cholesterol fed rats.<sup>[72]</sup> Similarly, GSE added to the diet exerted a positive effect on serum lipids in rabbits fed with high fat diet.<sup>[73]</sup> At the 0th, 6th and 12th week of the experiment, there was a lower serum TC, TG, LDL-C, and a higher HDL-C in experimental groups in comparison with those in the control group.

Studies with animal and human models have reported that GSE exerts wide-ranging protection against nonlipid factors implicated in cardiovascular disease. Supplementation of the extract in studies has improved postischemic left ventricular function, reduced myocardial infarct size, ventricular fibrillation (VF) and tachycardia, decreased the amount of ROS as detected by electron spin resonance (ESR) spectroscopy, and lessened MDA formation in the heart perfusate.<sup>[74]</sup> In an animal model, there was inhibition of cardiomyocyte apoptosis under ischemia/reperfusion conditions.<sup>[75]</sup>

A 1984 GSE study showed protection against elevations in blood cholesterol and damage to the aorta on a high-cholesterol diet in rabbits.<sup>[76]</sup> A more recent trial in rabbits (0.1% and 1% in the diet) using immunohistochemical analysis revealed a decrease in the number of oxidized LDL-positive macrophage-derived foam cells in atherosclerotic lesions in the aorta of the animals fed a proanthocyanidin-rich extract.<sup>[52]</sup> Clinically, a randomized, double-blind, crossover study undertaken in 24 healthy male heavy smokers indicated a protective effect from GSE (150 mg/day), administered for 4 weeks with a significant reduction in TBARS.<sup>[77]</sup>

The mechanisms underlying cardioprotection against oxidative stress are becoming clearer. In one study, 10 healthy volunteers received a daily dose of 110 mg of GSE procyanidins for 30 days. Fasting venous blood samples were taken before and at the end of the supplementation period and after 7 days of washout. There was no modification in the total antioxidant activity and the plasma concentrations of  $\alpha$ -tocopherol. However, the levels of  $\alpha$ -tocopherol in red blood cell membranes increased significantly from  $1.8 \pm 0.1$  to  $2.8 \pm 0.2$  mg/g. Similarly, oxidized DNA in the lymphocytes was reduced, and red blood cell membrane fatty acid composition was shifted to a higher level of polyunsaturated fatty acids. It was suggested that dietary procyanidins exert their antioxidant protection *in vivo* by sparing lipid soluble vitamin E and reducing DNA oxidative damage.<sup>[78]</sup> The higher polymers of procyanidins appear to interfere with the absorption of fat in human subjects, but

as yet the relation of this to reduced oxidative stress and other results remains unclear.<sup>[79]</sup>

Cardioprotective effects would also be expected from hypotensive effects of GSE. One mechanism explored concerns the inhibition of angiotensin I converting enzyme (ACE) activity. Procyanidolic oligomers from *Vitis vinifera* L. (two fractions), *Cupressus sempervirens* L. (three fractions) and the monomers, (+)-catechin, (-)-epicatechin have been tested for their effects on angiotensin I converting enzyme activity. The oligomers appeared to be the most active (dose IC<sub>50</sub> of 0.08 mg/ml for the fraction A of *Vitis*, the most active substance). Monomers had little activity. Under in vivo conditions, the vasopressive response to angiotensin I was inhibited by approximately 20–40% in the rabbit after administration of procyanidolic oligomers (5 mg/kg i.v.). Angiotensin II was also inhibited, which indicated another action, perhaps due to the formation of compounds between angiotensin I and II and the oligomers.<sup>[80]</sup> Recent in vitro evaluations complement the earlier reported effect of procyanidins in inhibiting ACE.<sup>[81,82]</sup> Isolated procyanidins containing (-)-epicatechin subunits inhibited angiotensin II binding on the human G-protein coupled membrane receptor type 1 (AT1). The degree of inhibition increased with the extent of polymerization of the procyanidin.<sup>[83]</sup> This finding regarding polymerization is in line with that of other studies. Many sources of procyanidins seem to be active in lowering blood pressure.

Protection of renal functions has been demonstrated with procyanidins. Administration of GSE procyanidins resulted in the reversal of experimental myoglobinuric acute renal failure (MAR) induced by glycerol in rats.<sup>[84,85]</sup>

### Hair Growth Effects

Topical application studies of GSE have determined that procyanidin dimers and trimers exhibit higher growth-promoting activity than do the monomers. Procyanidin B2, an epicatechin dimer, exhibits the maximum growth-promoting activity for hair epithelial cells (300% of control). Procyanidin C1, an epicatechin trimer, is second in hair growth promotion (approximately 220% of control). Other fractions display much less efficacy.<sup>[86]</sup> Procyanidin B3 also has potential according to an in vitro study.<sup>[87]</sup> A clinical trial using a topical application of procyanidin B2 produced significant results.<sup>[88]</sup>

### Hepatoprotective, Tissue Protective, and Premenstrual Syndrome Effects

Considerable interest has developed in the hepatoprotective effects of GSE. In one rodent study,

procyanidolic oligomers decreased the activities of cytochrome P-450 1A1 and of other inducible P-450 isozymes, while significantly increasing those of the phase II enzymes generally involved in the detoxification of reactive metabolite intermediates. This demonstrates that GSE can modulate the generation of reactive intermediates mediated by distinct molecular forms of P-450, thus revealing their potential in chemoprevention.<sup>[89]</sup> A wide-ranging study reported that prior oral exposure of mice for a period of 7–10 days afforded near complete protection of GSE against the action of four agents that induced hepatotoxicity, pulmonary toxicity, cardiotoxicity, nephrotoxicity, spleenotoxicity, and neurotoxicity, while significantly reducing DNA damage in various tissues triggered by these agents.<sup>[90]</sup>

Premenstrual syndrome (PMS) is often linked to problems with the clearance of sex hormones and other compounds by the liver, leading to circulatory and other issues. In one uncontrolled clinical study, GSE was judged to offer significant benefits with regard to mammary symptoms, abdominal swelling, pelvic pains, weight variations, and venous problems of the legs.<sup>[91]</sup>

### Inflammation and Allergy Protective Effects

The development of an inflammatory process requires that local endothelial cells become activated and express adhesion molecules on their surface. Exposure of these cells to cytokines such as IL-1, TNF- $\alpha$ , IFN- $\gamma$ , or LPS stimulates the expression of adhesion molecules, such as intercellular adhesion molecule-1 (ICAM-1). These adhesion molecules interact with related molecules on the surface of activated circulating leukocytes, which then stick firmly to the endothelium and migrate into the site of inflammation.<sup>[92]</sup>

Inflammation reactions underlie many of the most common pathologies, including allergies and asthma. One starting point for these reactions is the degranulation of the mast cells. These cells release histamine, serotonin, and bradykinin, which in turn mediate immune responses resulting in the weakening of cell walls, the loss of fluids, and the modulation of immune response. An in vitro study found a tannin (a proanthocyanidin) to be the most inhibitory to isolated hyaluronidase of the different flavonoids tested.<sup>[93]</sup>

In vitro, procyanidins strongly inhibit superoxide generation and release from calcium ionophore activated neutrophils of  $\beta$ -glucuronidase, myeloperoxidase, and elastase. In addition, they dose-dependently inhibit the activity of myeloperoxidase released from calcium ionophore-stimulated cells. To the extent they are absorbed and metabolized, monomers cleaved from them and/or their metabolites may intercept the function of activated human neutrophils by impairing

the expression and/or activity of adhesion molecules. Gabor presented evidence for such a protective effect in 1986.<sup>[94]</sup> (+)-Catechin is far less active than are procyanidins.<sup>[12]</sup>

### Vascular, Postoperative Edema, and Skin and Wound Healing Effects

Procyanidins and flavonoids may be beneficial to connective tissue for several reasons, including the decrement of inflammation and associated tissue degradation, the improvement of local circulation, as well as the promotion of a strong collagen matrix.<sup>[95]</sup> Certain proteins, such as elastins, are important in the interaction of cells and the vascular wall. Procyanidin oligomers appear to be potent inhibitors of elastases, and this has particular implications for vascular protection. They stabilize collagen *in vitro* and *in vivo*. The shorter chains of dimers and trimers are more effective in inhibiting lipid peroxidation and in their antiradical activity, whereas the longer pentamers and hexamers are more effective in inhibiting elastase activity.<sup>[80]</sup> The dimers to pentamers in particular act on the vascular wall, especially on mesenchymal cells, as well as on the extracellular matrix, where they bind to fibrous proteins and prevent the degradation of elastin and collagen.<sup>[96]</sup>

Tixier et al. showed that procyanidins bind to thin elastin fibers when injected intradermally into young rabbits resulting in the resistance of the fibers to hydrolytic attack by porcine pancreatic elastase.<sup>[33]</sup> Catechin-related molecules possess an inherent ability to interact with glycoproteins and crosslink with the  $\epsilon$ -amino groups of prolyl and lysyl residues in polypeptides from biomolecules such as collagen.<sup>[1,97]</sup> Endothelial cells from vein explants from patients with edema placed in a medium containing procyanidins incorporated significantly less glucosamine than those in the control and secreted more into the medium. The greatest impact was on the biosynthesis of glycoprotein and sulfated glycosaminoglycan, which may explain the beneficial effect of procyanidins on vein disorders.<sup>[98]</sup> Similarly, corneas incubated in the presence of collagenase were quickly attacked, and their degradation was practically complete after 24 hr. With a low concentration of procyanidins from grape seeds (0.066 mg/ml), proteolysis was only slightly inhibited. A higher concentration (1 mg/ml) completely prevented collagenolysis, and there was complete preservation of the corneas against proteolytic attack.<sup>[99]</sup>

Procyanidins reduce the activity of bacterial proteases *in vitro*.<sup>[100]</sup> Matrix metalloproteinases (MMPs) and their inhibitors play major roles in the remodeling of the extracellular matrix and in the metastatic properties of malignant tumors. Grape seed

extract procyanidins possess the structural requirements to interact with the activities of matrix proteases and gelatinases.<sup>[101,102]</sup>

One animal study showed that procyanidolic oligomers from GSE have a particular affinity for the cell membranes and that it lodges in the lamina densa of the basal membrane, where it seems to facilitate the formation of collagen microfibrils.<sup>[103]</sup> Experience with human subjects confirms such findings. In a double-blind placebo-controlled clinical trial examining postoperative edema, GSE was administered at the rate of 300 mg/day for 5 days prior to facelift, and then postoperatively days 2 through 6 in 32 female patients. It was judged to be significantly superior to placebo in reducing postoperative swelling.<sup>[104]</sup>

Classically, GSE has had an application in Europe in the treatment of capillary fragility and weakness, also known as peripheral venous insufficiency. In a small placebo-controlled study with 28 active subjects (150 mg of procyanidolic oligomers per day) and 25 controls, capillary resistance rose from  $14.6 \pm 0.98$  to  $18 \pm 3.35$  cmHg ( $P < 0.0005$ ) in the treated group, while no significant variation was observed in the placebo group ( $15.5 \pm 1.3$  vs.  $14.7 \pm 1.3$  cmHg initially).<sup>[105]</sup> In a more recent open-label study involving 4729 patients, GSE was administered at the rate of 150 mg twice per day. Evaluations were carried out at 45 and 90 days of treatment based on factors such as nocturnal cramps, sensation of warmth in the legs, cyanosis, and edema. Heaviness in the legs reduced by 57% of the cases at the first evaluation and in 89.4% of the cases at the second evaluation. Other symptoms improved in 66% of the cases by day 45 and in greater than 79% of cases by the 90-day evaluation.<sup>[106]</sup>

Topical application of GSE showed positive effects on wound healing in one study. There was accelerated wound contraction and closure. Grape seed extract treatment was associated with a more well-defined hyperproliferative epithelial region, higher cell density, enhanced deposition of connective tissue, and improved histological architecture.<sup>[107]</sup> Oral administration has proved effective in lightening the UV-induced pigmentation of guinea pig skin.<sup>[108]</sup> One study selected GSE procyanidins as natural crosslinking agents, which suggests that GSE may be of significant value in the field of tissue engineering.<sup>[109]</sup>

### Visual Effects

Animal trials have indicated protection against cataract formation. Yamakoshi et al. recently reported that GSE prevented and postponed development of cataract formation in rats fed a standard diet containing 0.213% GSE [0.082% procyanidins in the diet (w/w)] for 27 days and suggested the antioxidant role

of larger molecular procyanidins to explain this anti-cataract effect.<sup>[52]</sup> Clinical work seems to support claims for other visual benefits. Two human intervention studies give evidence of significant improvements in visual acuity, response to glare, and in other areas. In one double-blind study, 100 patients were supplemented with 200 mg of GSE/day for 5 weeks, whereas controls received no treatment. Significant improvements occurred in visual performances after glare as well as in visual adaptation to low luminance.<sup>[110]</sup> In another clinical study, 40 myopic patients received either OPC (150 mg/day) or placebo for 30 days. Of 14 patients in the OPC group with low light-emitting-diode (LED) visual evoked potentials (VEPs), 12 demonstrated significant improvement compared to 0/17 in the placebo ( $P < 0.0001$ ). Significant electroretinographic improvements were noted in 8 patients (40%) in the OPC group and 0 patients in the placebo group ( $P < 0.0001$ ).<sup>[111]</sup>

### Obesity Management and Positive Effects on Energy Metabolism

Grape seed extract in vitro shows inhibitory activity on the fat-metabolizing enzymes pancreatic lipase and lipoprotein lipase, thus suggesting that it might be useful as a treatment to limit dietary fat absorption and the accumulation of fat in adipose tissue. The observed reduction in intracellular lipolytic activity of cultured 3T3-L1 adipocytes indicates that such extracts may, in turn, reduce the levels of circulating free fatty acids, which are linked to insulin resistance in obese patients.<sup>[112]</sup> A more complex picture emerges from another in vitro test in which differentiated 3T3-L1 cells were treated with catechin, epicatechin, or procyanidin extracts with varying degrees of polymerization at 150  $\mu$ M for different periods of time (0.5–24 hr). There was an increase in the release of glycerol from stored fat into the medium in 3T3-L1 cells treated with procyanidin extract that reached a plateau after 15 hr exposure. Procyanidins from grape and wine, by implication, affect lipid metabolism, but their monomers (catechin and epicatechin) do not. This effect is more pronounced when the degree of polymerization is higher. Procyanidin extracts cause a time-dependent reduction in the hormone sensitive lipase (HSL) mRNA levels, inhibited triacylglycerol synthesis, and also favored triacylglycerol hydrolysis until the HSL mRNA had reached very low levels.<sup>[113]</sup> In addition, the administration of grape extract has been shown to increase oxygen consumption in isolated guinea pig heart, suggestive of an increased oxidation of energy sources.<sup>[114]</sup>

In vivo work has yielded inconsistent results with regard to weight loss. In one animal trial, supplying

250 mg of GSE procyanidins (equivalent to the procyanidins of 0.5 L of wine/day in humans) in the diet of rats for 12 weeks significantly decreased weight gain with no influence on daily food intake.<sup>[70]</sup> However, two more recent oral toxicity animal trials using much higher intakes of up to 2.5% of diet did not report weight loss.<sup>[115,116]</sup> In a third trial, a significant increase in food consumption without increase in weight gain was observed in male and female rats, provided the grape seed extract diets compared to that of the control rats, especially in male rats consuming 2.0% grape seed extract.<sup>[117]</sup> One trial in humans lasting only 3 days found that giving grape seed extract 30–60 min prior to lunch and dinner reduced energy intake in a small subgroup of the trial population that consumed substantially more calories than did the majority of the study's subjects. But it yielded no significant impact compared with placebo in the subjects as a whole.<sup>[118]</sup>

### USAGE AND DOSAGE

In view of the paucity of data concerning the composition of procyanidins in foodstuffs, the dietary intake of GSE-related components and their metabolic disposition, it is not possible to indicate a dose as a nutritional supplement. Based on French red wine consumption of 180 ml/day, the current daily intake of phenolics was estimated at 400.2 mg/day/resident and catechins (monomers, dimers B1, B2, B3, B4) at 83.2 mg/day/resident, including 40% of monomers for the French population.<sup>[18]</sup> The concentration of GSE used in animal in vivo studies is at pharmacologic and extra-pharmacologic doses. It is unlikely many will achieve such levels of intake using the dietary supplements. More focused human studies are imperative to recommend specific procyanidin-containing supplements at specific doses in human populations. Based on European studies and practices, therapeutic dosages are typically 150–300 mg/day.

### SAFETY AND REGULATORY ISSUES

No significant health hazards have been reported with the use of GSE as directed. The extract was examined for acute and subchronic oral toxicity using Fischer 344 rats and for mutagenic potential by the reverse mutation test using *Salmonella typhimurium*, the chromosomal aberration test using CHL cells, and the micronucleus test using ddY mice.<sup>[116]</sup> No evidence of acute oral toxicity at dosages of 2 and 4 g/kg, and mutagenicity was found. Administration of GSE as a dietary admixture at levels of 0.02%, 0.2%, and 2% (w/w) to the rats for 90 days did not induce noticeable

signs of toxicity. The no-observed-adverse-effect level (NOAEL) of GSE in the subchronic toxicity study was 2% in the diet (equal to 1410 mg/kg of body weight/day in males and 1501 mg/kg of body weight/day in females). A subchronic 3-mo trial found no-observed-adverse-effects at intakes of approximately 1.78 g/kg of body weight/day of grape seed extract or grape skin extract in male rats and 2.15 g/kg of body weight/day in female rats.<sup>[115]</sup> Similarly, researchers elsewhere concluded that administration of the grape seed extract IH636 to male and female Sprague–Dawley rats in the feed at levels of 0.5%, 1.0% for 90 days did not induce any significant toxicological effects.<sup>[117]</sup> One set of researchers did find that grape seed tannins exert a reversible inhibitory effect on rat intestinal alkaline phosphatase (AP), sucrase, and dipeptidyl peptidase IV (DPP IV) activities after dietary supplementation with 2% tannins for 31 days.<sup>[119]</sup> The usual cautions during pregnancy and lactation apply. Infrequent minor side effects include gastric upset, diarrhea, and constipation. These are alleviated by taking the dosage with meals.

In the United States, grape seed and grape skin extracts are generally recognized as safe (GRAS). European regulations vary from country to country, but GSE is commonly allowed in pharmacopeias as a nonprescription herbal drug for the treatment of venous disorders.

## CONCLUSIONS

Grape seed extract components exhibit a wide range of biological effects as modifiers of inflammation and modulators of various enzyme systems. Potential benefits demonstrated in experimental studies include endothelium-dependent relaxation, impact on inflammatory mediator (cytokine) release by cells and on the oxidation of LDL-cholesterol, effects on platelet aggregation and on nitric oxide metabolism. A very large amount of in vitro data exists, but well-controlled animal studies employing physiological and subphysiological concentrations of GSE are fewer. Moreover, the effects noted do not necessarily predict human results because of differences in bacterial and hepatic metabolism among species.

Data from human intervention trials are relatively scant. Furthermore, little is known about the absorption, bioavailability, and bioactivity of GSE associated flavanol oligomers and polymers because of difficulties associated with their reliable quantification in physiological fluids. The small number of adequately controlled human studies generally indicates that sufficient absorption takes place to accomplish transitory changes in the antioxidative capacity of plasma

in humans and to afford cellular protection, even though the identification of the metabolites is elusive. However, none of these studies has adequately considered long-term effects. No clear picture has emerged regarding the appearance of catechin monomers or procyanidin dimers in the plasma of human subjects following GSE ingestion. Metabolites arising through bacterial biotransformation by ring fission may have their own unique pharmacologic effects deemed to be beneficial for health. More well-controlled in vivo and clinical studies are needed to extend the application of these compounds outside the realm of scientific research per se.

## ACKNOWLEDGMENT

The authors wish to thank Daniel E. Clouatre for help with the figures.

## ARTICLE OF FURTHER INTEREST

*Proanthocyanidins*, p. 555.

## REFERENCES

1. Haslam, E. *Plant Phenolics: Vegetable Tannins Revisited*; Cambridge University Press: Cambridge, United Kingdom, 1989.
2. Harborne, J.B. *The Flavonoids: Advances in Research Since 1986*; Chapman & Hall/CRC: Boca Raton, Florida, 1994.
3. Amerine, A.; Joslyn, M.A. Composition of grapes. In *The Table Wines, the Technology of Their Production*, 2nd Ed.; University of California Press: Berkeley, 1967; 234–238 (Chapter 6).
4. Fuleki, T.; Da Silva, J.M.R. Catechin and procyanidin composition of seeds from grape cultivars grown in Ontario. *J. Agric. Food Chem.* **1997**, *45*, 1156–1160.
5. Prieuer, C.; Rigaud, J.; Cheynier, V.; Moutounet, M. Oligomeric and polymeric procyanidins from grape seeds. *Phytochemistry* **1994**, *26*, 781–784.
6. Schwitter, B.; Masquelier, J. *OPC in Practice*, 2nd Ed.; Alfa Omega Editrice: Rome, 1995.
7. Da Silva, J.M.R.; Rigaud, J.; Cheynier, V.; Cheminat, A.; Moutounet, M. Procyanidin dimers and trimers from grape seeds. *Phytochemistry* **1991**, *30* (4), 1259–1264.



8. Krueger, C.G.; Dopke, N.C.; Treichel, P.M.; Folts, J.; Reed, J.D. Matrix-assisted laser desorption/ionization time-of-flight mass spectrometry of polygalloyl polyflavan-3-ols in grape seed extract. *J. Agric. Food Chem.* **2000**, *48*, 1663–1667.
9. Bagchi, D.; Garg, A.; Krohn, R.L.; Bagchi, M.; Tran, M.X.; Stohs, S.J. Oxygen free radical scavenging abilities of vitamins C and E, and a grape seed proanthocyanidin extract in vitro. *Res. Commun. Mol. Pathol. Pharmacol.* **1997**, *95* (2), 179–189.
10. Plumb, G.W.; De Pascual-Teresa, S.; Santos-Buelga, C.; Cheyner, V.; Williamson, G. Antioxidant properties of catechins and proanthocyanidins: effect of polymerisation, galloylation and glycosylation. *Free Radic. Res.* **1998**, *29* (4), 351–358.
11. Shafiee, M.; Carbonneau, M.A.; Urban, N.; Descomps, B.; Leger, C.L. Grape and grape seed extract capacities at protecting LDL against oxidation generated by Cu<sup>2+</sup>, AAPH or SIN-1 and at decreasing superoxide THP-1 cell production. A comparison to other extracts or compounds. *Free Radic. Res.* **2003**, *37* (5), 573–584.
12. Carini, M.; Stefani, R.; Aldini, G.; Ozioli, M.; Facino, R.M. Procyanidins from *Vitis vinifera* seeds inhibit the respiratory burst of activated human neutrophils and lysosomal enzyme release. *Planta Med.* **2001**, *67* (8), 714–717.
13. Aldini, G.; Carini, M.; Piccoli, A.; Rossoni, G.; Facino, R.M. Procyanidins from grape seeds protect endothelial cells from peroxynitrite damage and enhance endothelium-dependent relaxation in human artery: new evidences for cardio-protection. *Life Sci.* **2003**, *73* (22), 2883–2898.
14. Yoshimura, Y.; Nakazawa, H.; Yamaguchi, F. Evaluation of the NO scavenging activity of procyanidin in grape seed by use of the TMA-PTIO/NOC 7 ESR system. *J. Agric. Food Chem.* **2003**, *51* (22), 6409–6412.
15. Gao, J.; Tang, H.; Li, Y.; Liu, H.; Zhao, B. EPR study of the toxicological effects of gas-phase cigarette smoke and the protective effects of grape seed extract on the mitochondrial membrane. *Appl. Magn. Reson.* **2002**, *22* (4), 497–511.
16. Shao, Z.-H.; Becker, L.B.; Vanden Hoek, T.L.; Schumacker, P.T.; Li, C.-Q.; Zhao, D.; Wojcik, K.; Anderson, T.; Qin, Y.; Dey, L.; Yuan, Ch.-S. Grape seed proanthocyanidin extract attenuates oxidant injury in cardiomyocytes. *Pharmacol. Res.* **2003**, *47* (6), 463–469.
17. Fuhrman, B.; Lavy, A.; Aviram, M. Consumption of red wine with meals reduces the susceptibility of human plasma and low-density lipoprotein to lipid peroxidation. *Am. J. Clin. Nutr.* **1995**, *61*, 549–554.
18. Teissedre, P.-L.; Landrault, N. Wine phenolics: contribution to dietary intake and bioavailability. *Food Res. Int.* **2000**, *33*, 461–467.
19. Auger, C.; Caporiccio, B.; Landrault, N.; Teissedre, P.L.; Laurent, C.; Cros, G.; Besancon, P.; Rouanet, J.M. Red wine phenolic compounds reduce plasma lipids and apolipoprotein B and prevent early aortic atherosclerosis in hypercholesterolemic golden Syrian hamsters (*Mesocricetus auratus*). *J. Nutr.* **2002**, *132*, 1207–1213.
20. Deckert, V.; Desrumaux, C.; Athias, A.; Duverneuil, L.; Palleau, V.; Gambert, P.; Masson, D.; Lagrost, L. Prevention of  $\alpha$ -tocopherol consumption, cholesterol oxidation, and vascular endothelium dysfunction by red wine polyphenolic compounds. *Atherosclerosis* **2002**, *165*, 41–50.
21. Facino, R.M.; Carini, M.; Aldini, G.; Berti, F.; Rossoni, G.; Bombardelli, E.; Morazzoni, P. Diet enriched with procyanidins enhances antioxidant activity and reduces myocardial post-ischaemic damage in rats. *Life Sci.* **1999**, *64* (8), 627–642.
22. Tebib, K.; Rouanet, J.M.; Besancon, P. Antioxidant effects of dietary polymeric grape seed tannins in tissues of rats fed a high, cholesterol vitamin E-deficient diet. *Food Chem.* **1997**, *59* (1), 135–141.
23. Koga, T.; Moro, K.; Nakamori, K.; Yamakoshi, J.; Hosoyama, H.; Kataoka, S.; Ariga, T. Increase of antioxidative potential of rat plasma by oral administration of proanthocyanidin-rich extract from grape seeds. *J. Agric. Food Chem.* **1999**, *47*, 1892–1897.
24. Vinson, J.A.; Proch, J.; Bose, P. Megannatural((R)) gold grapeseed extract: in vitro antioxidant and in vivo human supplementation studies. *J. Med. Food* **2001**, *4* (1), 17–26.
25. Chopra, M.; Fitzsimons, P.E.; Strain, J.J.; Thurnham, D.I.; Howard, A.N. Nonalcoholic red wine extract and quercetin inhibit LDL oxidation without affecting plasma antioxidant vitamin and carotenoid concentrations. *Clin. Chem.* **2000**, *46* (8 Pt 1), 1162–1170.
26. Nuttall, S.L.; Kendall, M.J.; Bombardelli, E.; Morazzoni, P. An evaluation of the antioxidant

- activity of a standardized grape seed extract, *Leucoselect. J. Clin. Pharm. Ther.* **1998**, *23* (5), 385–389.
27. Natella, F.; Belelli, F.; Gentili, V.; Ursini, F.; Scaccini, C. Grape seed proanthocyanidins prevent plasma postprandial oxidative stress in humans. *J. Agric. Food Chem.* **2002**, *50* (26), 7720–7725.
  28. Carbonneau, M.A.; Leger, C.L.; Monnier, L.; Bonnet, C.; Michel, F.G.; Dedieu, F.; Descomps, B. Supplementation with wine phenolic compounds increases the antioxidant capacity of plasma and vitamin E of low-density lipoprotein without changing the lipoprotein Cu<sup>2+</sup>-oxidizability: possible explanation by phenolic location. *Eur. J. Clin. Nutr.* **1997**, *51*, 682–690.
  29. Vigna, G.B.; Costantini, F.; Aldini, G.; Carini, M.; Catapano, A.; Schena, F.; Tangerini, A.; Zanca, R.; Bombardelli, E.; Morazzoni, P.; Mezzetti, A.; Fellin, R.; Facino, R.M. Effect of a standardized grape seed extract on low-density lipoprotein susceptibility to oxidation in heavy smokers. *Metabolism* **2003**, *52* (10), 1250–1257.
  30. Nair, M.P.N.; Mahajan, S.; Kandaswami, C.; Schwartz, S.A. Defined grape seed extract proanthocyanidin blend downregulates lipopolysaccharides (LPS) induced nitric oxide synthase (NOS) gene expression by normal peripheral blood mononuclear cells (PBMC). In *Polyphenols, Wine and Health Communications*, Polyphenols, Wine and Health Symposium, Bordeaux, France, April 14–16, 1999; Cheze, C., Vercauteren, J., Eds.; also presented at the Oxygen Club of California 1999 World Congress: Oxidants and Antioxidants in Biology: Santa Barbara, California, March 3–6, 1999.
  31. Robert, L.; Godeau, G.; Gavignet-Jeannin, C.; Groult, N.; Six, C.; Robert, A.M. The effect of procyanidolic oligomers on vascular permeability. A study using quantitative morphology. *Pathol. Biol. (Paris)* **1990**, *38* (6), 608–616 (French).
  32. Kakegawa, H.; Matsumoto, H.; Endo, K.; Satoh, T.; Nonaka, G.; Nishioka, I. Inhibitory effects of tannins on hyaluronidase activation and on the degranulation from rat mesentery mast cells. *Chem. Pharm. Bull. (Tokyo)* **1985**, *33* (11), 5079–5082.
  33. Tixier, J.M.; Godeau, G.; Robert, A.M.; Hornebeck, W. Evidence by in vivo and in vitro studies that binding of pycnogenols to elastin affects its rate of degradation by elastases. *Biochem. Pharmacol.* **1984**, *33* (24), 3933–3939.
  34. Blaszo, G.; Gabor, M. Oedema-inhibiting effect of procyanidin. *Acta Physiol. Acad. Hung., Tomus* **1980**, *65* (2), 235–240.
  35. Li, W.G.; Zhang, X.Y.; Wu, Y.J.; Tian, X. Anti-inflammatory effect and mechanism of proanthocyanidins from grape seeds. *Acta Pharmacol. Sinica* **2001**, *22* (12), 1117–1120.
  36. Nair, N.; Mahajan, S.; Chawda, R.; Kandaswami, C.; Shanahan, T.C.; Schwartz, S.A. Grape seed extract activates Th1 cells in vitro. *Clin. Diagn. Lab. Immunol.* **2002**, *9* (2), 470–476.
  37. Park, Y.C.; Rimbach, G.; Saliou, C.; Valacchi, G.; Packer, L. Activity of monomeric, dimeric, and trimeric flavonoids on NO production, TNF-alpha secretion, and NF-kappaB-dependent gene expression in RAW 264.7 macrophages. *FEBS Lett.* **2000**, *465* (2–3), 93–97.
  38. Nair, M.P.; Kandaswami, C.; Mahajan, S.; Nair, H.N.; Chawda, R.; Shanahan, T.; Schwartz, S.A. Grape seed extract proanthocyanidins down-regulate HIV-1 entry coreceptors, CCR2b, CCR3 and CCR5 gene expression by normal peripheral blood mononuclear cells. *Biol. Res.* **2002**, *35* (3–4), 421–431.
  39. Fitzpatrick, D.F.; Bing, B.; Maggi, D.A.; Fleming, R.C.; O'Malley, R.M. Vasodilating procyanidins derived from grape seeds. *Ann. N. Y. Acad. Sci.* **2002**, *957*, 78–89.
  40. Karim, M.; Kappagoda, C.T. Endothelial nitric oxide synthase activity of polymeric phenolics (flavonoids) derived from grape seed extract. *FASEB J.* **1999**, *13* (4) (Abstract 415.6).
  41. Cishek, M.B.; Galloway, M.T.; Karim, M.; German, J.B.; Kappagoda, C.T. Effect of red wine on endothelium-dependent relaxation in rabbits. *Clin. Sci. (Lond.)* **1997**, *93*, 507–511.
  42. Kappagoda, C.T.; Karim, M.; McCormick, K.; Kandaswami, C.K. Unraveling the French paradox. *C. Chem. Innov.* **2000**, *30*, 26–31.
  43. Harrison, D.G. Endothelial dysfunction in atherosclerosis. *Basic Res. Cardiol.* **1994**, *89* (Suppl 1), 87–102.
  44. D'Agostino, R.B.; Russell, M.W.; Huse, D.M.; Ellison, R.C.; Silbershatz, H.; Wilson, P.W.; Hartz, S.C. Primary and subsequent coronary risk appraisal: new results from the Framingham study. *Am. Heart J.* **2000**, *139* (2 Pt 1), 272–281.
  45. da Luz, P.L.; Serrano, C.V.; Chacra, A.P.; Monteiro, H.P.; Yoshida, V.M.; Furtado, M.; Ferreira, S.; Gutierrez, P.; Pileggi, F. The effect of red wine on experimental atherosclerosis: lipid-independent protection. *Exp. Mol. Pathol.* **1999**, *65*, 150–159.

46. Sen, C.K.; Bagchi, D. Regulation of inducible adhesion molecule expression in human endothelial cells by grape seed proanthocyanidin extract. *Mol. Cell. Biochem.* **2001**, *216*, 1–7.
47. Kalfin, R.; Righi, A.; Del Rosso, A.; Bagchi, D.; Generini, S.; Cerinic, M.M.; Das, D.K. Activin, a grape seed-derived proanthocyanidin extract, reduces plasma levels of oxidative stress and adhesion molecules (ICAM-1, VCAM-1 and E-selectin) in systemic sclerosis. *Free Radic. Res.* **2002**, *36*, 819–825.
48. Das, N.P. Studies on flavonoid metabolism: Absorption and metabolism (+)-catechin in man. *Biochem. Pharmacol.* **1971**, *20*, 3435–3445.
49. Spencer, J.P.; Schroeter, H.; Rechner, A.R.; Rice-Evans, C. Bioavailability of flavan-3-ols and procyanidins: gastrointestinal tract influences and their relevance to bioactive forms in vivo. *Antioxid. Redox Signal.* **2001**, *3* (6), 1023–1039.
50. Lappara, J.; Michaud, J.; Masqualier, J. Pharmacokinetic study of flavanolic oligomers. *J. Plant Med. Phytother.* **1977**, *11*, 133–142.
51. Harmand, M.F.; Blanquet, P. The fate of total flavanolic oligomers (OFT) extracted from *Vitis vinifera* L. in the rat. *Eur. J. Drug Metab. Pharmacokin.* **1978**, *1*, 15–30.
52. Yamakoshi, J.; Kataoka, S.; Koga, T.; Ariga, T. Proanthocyanidin-rich extract from grape seeds attenuates the development of aortic atherosclerosis in cholesterol fed rabbits. *J. Atheroscler.* **1999**, *142*, 139–149.
53. Lapidot, T.; Harel, S.; Granit, R.; Kanner, J. pH dependent forms of red wine anthocyanins as antioxidants. *J. Agric. Food Chem.* **1998**, *46*, 4297–4302.
54. Donovan, J.L.; Manach, C.; Rios, L.; Morand, C.; Scalbert, A.; Remesy, C. Procyanidins are not bioavailable in rats fed a single meal containing a grape seed extract or the procyanidin dimer B3. *Br. J. Nutr.* **2002**, *87* (4), 299–306.
55. Nakamura, Y.; Tonogai, Y. Metabolism of grape seed polyphenol in the rat. *J. Agric. Food Chem.* **2003**, *51* (24), 7215–7225.
56. Gonthier, M.P.; Donovan, J.L.; Texier, O.; Felgines, C.; Remesy, C.; Scalbert, A. Metabolism of dietary procyanidins in rats. *Free Radic. Biol. Med.* **2003**, *35* (8), 837–844.
57. Scheline, R.D. *Handbook of Mammalian Metabolism of Plant Compounds*; CRC Press: Boca Raton, FL, 1991.
58. Baba, S.; Osakabe, N.; Natsume, M.; Terao, J. Absorption and urinary excretion of procyanidin B2 [epicatechin-(4 $\beta$ -8)-epicatechin] in rats. *Free Radic. Biol. Med.* **2002**, *33* (1), 142–148.
59. Holt, R.R.; Lazarus, S.A.; Sullards, M.C.; Zhu, Q.Y.; Schramm, D.D.; Hammerstone, J.F.; Fraga, C.G.; Schmitz, H.H.; Keen, C.L. Procyanidin dimer B2 [epicatechin-(4–8)-epicatechin] in human plasma after the consumption of a flavanol-rich cocoa. *Am. J. Clin. Nutr.* **2002**, *76*, 798–804.
60. Sano, A.; Yamakoshi, J.; Tokutake, S.; Tobe, K.; Kubota, Y.; Kikuchi, M. Procyanidin B1 is detected in human serum after intake of proanthocyanidin-rich grape seed extract. *Biosci. Biotechnol. Biochem.* **2003**, *67* (5), 1140–1143.
61. Shanmuganayagam, D.; Beahm, M.R.; Osman, H.E.; Krueger, C.G.; Reed, J.D.; Folts, J.D. Grape seed and grape skin extracts elicit a greater antiplatelet effect when used in combination than when used individually in dogs and humans. *J. Nutr.* **2002**, *132* (12), 3592–3598.
62. Tyagi, A.; Agarwal, R.; Agarwal, C. Grape seed extract inhibits EGF-induced and constitutively active mitogenic signaling but activates JNK in human prostate carcinoma DU145 cells: possible role in antiproliferation and apoptosis. *Oncogene* **2003**, *22* (9), 1302–1316.
63. Katsuzaki, H.; Hibasami, H.; Ohwaki, S.; Ishikawa, K.; Imai, K.; Date, K.; Kimura, Y.; Komiya, T. Cyanidin 3-O-beta-D-glucoside isolated from skin of black Glycine max and other anthocyanins isolated from skin of red grape induce apoptosis in human lymphoid leukemia Molt 4B cells. *Oncol. Rep.* **2003**, *10* (2), 297–300.
64. Agarwal, C.; Sharma, Y.; Zhao, J.; Agarwal, R. A polyphenolic fraction from grape seeds causes irreversible growth inhibition of breast carcinoma MDA-MB468 cells by inhibiting mitogen-activated protein kinases activation and inducing G1 arrest and differentiation. *Clin. Cancer Res.* **2000**, *6* (7), 2921–2930.
65. Mittal, A.; Elmets, C.A.; Katiyar, S.K. Dietary feeding of proanthocyanidins from grape seeds prevents photocarcinogenesis in SKH-1 hairless mice: relationship to decreased fat and lipid peroxidation. *Carcinogenesis* **2003**, *24* (8), 1379–1388.
66. Zhao, J.; Wang, J.; Chen, Y.; Agarwal, R. Anti-tumor-promoting activity of a polyphenolic fraction isolated from grape seeds in the mouse skin two-stage initiation-promotion protocol and identification of procyanidin B5-3'-gallate as the most effective antioxidant

- constituent. *Carcinogenesis* **1999**, *20* (9), 1737–1745.
67. Gali, H.U.; Perchellet, E.M.; Gao, X.M.; Karchesy, J.J.; Perchellet, J.P. Comparison of the inhibitory effects of monomeric, dimeric, and trimeric procyanidins on the biochemical markers of skin tumor promotion in mouse epidermis in vivo. *Planta Med.* **1994**, *60* (3), 235–239.
68. Singletary, K.W.; Meline, B. Effect of grape seed proanthocyanidins on colon aberrant crypts and breast tumors in a rat dual-organ tumor model. *Nutr. Cancer* **2001**, *39* (2), 252–258.
69. Brunet, M.J.; Blade, C.; Salvado, M.J.; Arola, L. Human apo A-I and rat transferrin are the principal plasma proteins that bind wine catechins. *J. Agric. Food Chem.* **2002**, *50*, 2708–2712.
70. Tebib, K.; Besancon, P.; Rouanet, J.-M. Effects of dietary grape seed tannins on rat cecal fermentation and colonic bacterial enzymes. *Nutr. Res.* **1996**, *16* (1), 105–110.
71. Tebib, K.; Besancon, P.; Rouanet, J.-M. Dietary grape seed tannins affect lipoproteins, lipoprotein lipases and tissue lipids in rats fed hypercholesterolemic diets. *J. Nutr.* **1994**, *124* (12), 2451–2457.
72. Tebib, K.; Bitri, L.; Besancon, P.; Rouanet, J.-M. Polymeric grape seed tannins prevent plasma cholesterol changes in high-cholesterol-fed rats. *Food Chem.* **1994**, *49* (4), 403–406.
73. Yu, H.; Zhao, X.; Xu, G.; Wang, S.E. Effect of grape seed extracts on blood lipids in rabbits model with hyperlipidemia. *Wei Sheng Yan Jiu/J. Hygi. Res.* **2002**, *31* (2), 114–116 (Chinese).
74. Bagchi, D.; Sen, C.K.; Ray, S.D.; Das, D.K.; Bagchi, M.; Preuss, H.G.; Vinson, J.A. Molecular mechanisms of cardioprotection by a novel grape seed proanthocyanidin extract. *Mutat. Res.* **2003**, *523–524*, 87–97.
75. Sato, M.; Bagchi, D.; Tosaki, A.; Das, D.K. Grape seed proanthocyanidin reduces cardiomyocyte apoptosis by inhibiting ischemia/reperfusion-induced activation of JNK-1 and C-JUN. *Free Radic. Biol. Med.* **2001**, *31* (6), 729–737.
76. Wegrowski, J.; Robert, A.M.; Moczar, M. The effect of procyanidolic oligomers on the composition of normal and hypercholesterolemic rabbit aortas. *Biochem. Pharmacol.* **1984**, *33* (21), 3491–3497.
77. Vigna, G.B.; Costantini, F.; Aldini, G.; Carini, M.; Catapano, A.; Schena, F.; Tangerini, A.; Zanca, R.; Bombardelli, E.; Morazzoni, P.; Mezzetti, A.; Fellin, R.; Maffei, F.R. Effect of a standardized grape seed extract on low-density lipoprotein susceptibility to oxidation in heavy smokers. *Metabolism* **2003**, *52* (10), 1250–1257.
78. Simonetti, P.; Ciappellano, S.; Gardana, C.; Bramati, L.; Pietta, P. Procyanidins from *Vitis vinifera* seeds: in vivo effects on oxidative stress. *J. Agric. Food Chem.* **2002**, *50* (21), 6217–6221.
79. Rabovsky, A.; Cuomo, J.; Wentz, M. Inhibition of fat absorption with grape seed antioxidants. *Free Radic. Biol. Med.* **1998**, *25* (Suppl 1) 277.
80. Meunier, M.T.; Villie, F.; Jonadet, M.; Bastide, J.; Bastide, P. Inhibition of angiotensin I converting enzyme by flavanolic compounds: in vitro and in vivo studies. *Planta Med.* **1987**, *53* (1), 12–15.
81. Lacaille-Dubois, F.U.; Wagner, H. Search for potential angiotensin converting enzyme (ACE)-inhibitors from plants. *Phytomedicine* **2001**, *8* (1), 47–52.
82. Actis-Goretta, L.; Ottaviani, J.I.; Keen, C.L.; Fraga, C.G. Inhibition of angiotensin converting enzyme (ACE) activity by flavan-3-ols and procyanidins, *FEBS Lett.* **2003**, *555* (3), 597–600.
83. Caballero-George, C.; Vanderheyden, P.M.; De Bruyne, T.; Shahat, A.A.; Van den Heuvel, H.; Solis, P.N.; Gupta, M.P.; Claeys, M.; Pieters, L.; Vauquelin, G.; Vlietinck, A.J. In vitro inhibition of [<sup>3</sup>H]-angiotensin II binding on the human AT1 receptor by proanthocyanidins from *Guazuma ulmifolia* bark. *Planta Med.* **2002**, *68* (12), 1066–1071.
84. Stefanovic, V.; Savic, V.; Vlahovic, P.; Cvetkovic, T.; Najman, S.; Mitic-Zlatkovic, M. Reversal of experimental myoglobinuric acute renal failure with bioflavonoids from seeds of grape. *Ren. Fail.* **2000**, *22* (3), 255–266.
85. Avramovic, V.; Vlahovic, P.; Mihailovic, D.; Stefanovic, V. Protective effect of a bioflavonoid proanthocyanidin-BP1 in glycerol-induced acute renal failure in the rat: renal stereological study. *Ren. Fail.* **1999**, *21* (6), 627–634.
86. Takahashi, T.; Kamiya, T.; Hasegawa, A.; Yokoo, Y. Procyanidin oligomers selectively and intensively promote proliferation of mouse hair epithelial cells in vitro and activate hair follicle growth in vivo. *J. Invest. Dermatol.* **1999**, *112* (3), 310–316.
87. Kamimura, A.; Takahashi, T. Procyanidin B-3, isolated from barley and identified as a hair-growth stimulant, has the potential to counteract

- inhibitory regulation by TGF-beta1. *Exp. Dermatol.* **2002**, *11* (6), 532–541.
88. Takahashi, T.; Kamimura, A.; Yokoo, Y.; Honda, S.; Watanabe, Y. The first clinical trial of topical application of procyanidin B-2 to investigate its potential as a hair growing agent. *Phytother. Res.* **2001**, *15* (4), 331–336.
  89. Seo, K.; Jung, S.; Park, M.; Song, Y.; Choung, S. Effects of leucocyanidines on activities of metabolizing enzymes and antioxidant enzymes. *Biol. Pharm. Bull.* **2001**, *24* (5), 592–593.
  90. Bagchi, D.; Ray, S.D.; Patel, D.; Bagchi, M. Protection against drug- and chemical-induced multiorgan toxicity by a novel IH636 grape seed proanthocyanidin extract. *Drugs Exp. Clin. Res.* **2001**, *27* (1), 3–15.
  91. Amsellem, M.; Masson, J.M.; Negui, B., et al. Endotelon in the treatment of venolymphatic problems in premenstrual syndrome, a multicentered study on 165 patients. *Tempo Méd.* **1987**, *November*, 282 (French).
  92. Aplin, A.E.; Howe, A.; Alahari, S.K.; Juliano, R.L. Signal transduction and signal modulation by cell adhesion receptors: the role of integrins, cadherins, immunoglobulin-cell adhesion molecules, and selectins. *Pharmacol. Rev.* **1998**, *50* (2), 197–263.
  93. Kuppusamy, U.R.; Khoo, H.E.; Das, N.P. Structure-activity studies of flavonoids as inhibitors of hyaluronidase. *Biochem. Pharmacol.* **1990**, *40* (2), 397–401.
  94. Gabor, M. Anti-inflammatory and anti-allergic properties of flavonoids. *Prog. Clin. Biol. Res.* **1986**, *213*, 471–480.
  95. Middleton, E., Jr.; Kandaswami, C.; Theoharidis, T.C. The impact of plant flavonoids on mammalian biology: implications for inflammation, heart disease and cancer. *Pharmacol. Rev.* **2000**, *52*, 673–751.
  96. Doutremepuich, J.D.; Barbier, A.; Lacheretz, F. Effect of Endotelon (procyanidolic oligomers) on experimental acute lymphedema of the rat hindlimb. *Lymphology* **1991**, *24* (3), 135–139.
  97. Schlebusch, H.; Kern, D. Stabilization of collagen by polyphenols. *Angiologia* **1972**, *9*, 248–256.
  98. Drubaix, I.; Robert, L.; Maraval, M.; Robert, A.M. Synthesis of glycoconjugates by human diseased veins: modulation by procyanidolic oligomers. *Int. J. Exp. Pathol.* **1997**, *78* (2), 117–121.
  99. Robert, A.M.; Robert, L.; Renard, G. Protection of cornea against proteolytic damage. Experimental study of procyanidolic oligomers (PCO) on bovine cornea. *J. Fr. Ophthalmol.* **2002**, *25* (4), 351–355 (French).
  100. Song, S.E.; Choi, B.K.; Kim, S.N.; Yoo, Y.J.; Kim, M.M.; Park, S.K.; Roh, S.S.; Kim, C.K. Inhibitory effect of procyanidin oligomer from elm cortex on the matrix metalloproteinases and proteases of periodontopathogens. *J. Periodontal Res.* **2003**, *38* (3), 282–289.
  101. Sartor, L.; Pezzato, E.; Dell'Aica, I.; Caniato, R.; Biggin, S.; Garbisa, S. Inhibition of matrix-proteases by polyphenols: chemical insights for anti-inflammatory and anti-invasion drug design. *Biochem. Pharmacol.* **2002**, *64* (2), 229–237.
  102. Nair, N.; Chawda, R.; Nair, R.; Aalinkeel, R.; Kandaswami, C.; Schwartz, S. Flavonoids from grape seed extract upregulate tissue inhibitor of metalloproteinase-1 gene expression in a breast adenocarcinoma cell line, MCF-7. *FASEB J.* **2002**, *16* (5) A1003.
  103. Pfister, A.; Simon, M.T.; Gazav, J.M. Fixation sites of procyanidolic oligomers in the blood capillary walls of the lungs of guinea pigs. *Acta Ther.* **1982**, *8*, 223–237 (French).
  104. Baruch, J. Effect of Endotelon in postoperative edema. Results of a double-blind study versus placebo in 32 female patients. *Ann. Chir. Plast. Esthet.* **1984**, *29* (4), 393–395 (French).
  105. Lagrue, G.; Olivier-Martin, F.; Grillot, A. A study of the effects of procyanidol oligomers on capillary resistance in hypertension and in certain nephropathies. *Sem. Hop.* **1981**, *57* (33–36), 1399–1401 (French).
  106. Henriot, J.P. Veno-lymphatic insufficiency 4,729 patients undergoing hormonal and procyanidol oligomer therapy. *Phlebologie* **1993**, *46* (2), 313–325 (French).
  107. Khanna, S.; Venojarvi, M.; Roy, S.; Sharma, N.; Trikha, P.; Bagchi, D.; Bagchi, M.; Sen, C.K. Dermal wound healing properties of redox-active grape seed proanthocyanidins. *Free Radic. Biol. Med.* **2002**, *33* (8), 1089–1096.
  108. Yamakoshi, J.; Otsuka, F.; Sano, A.; Tokutake, S.; Saito, M.; Kikuchi, M.; Kubota, Y. Lightening effect on ultraviolet-induced pigmentation of guinea pig skin by oral administration of a proanthocyanidin-rich extract from grape seeds. *Pigment Cell Res.* **2003**, *16* (6), 629–638.
  109. Han, B.; Jaurequi, J.; Tang, B.W.; Nimni, M.E. Proanthocyanidin: a natural crosslinking reagent for stabilizing collagen matrices. *J. Biomed. Mater. Res.* **2003**, *65A* (1), 118–124.

110. Corbe, C.; Boissin, J.P.; Siou, A. Light vision and chorioretinal circulation Study of the effect of procyanidolic oligomers (Endotelon). *J. Fr. Ophthalmol.* **1988**, *11* (5), 453–460 (French).
111. Proto, F., et al. Electrophysical study of *Vitis vinifera* procyanoside oligomers effects on retinal function in myopic subjects. *Ann. Ott. Clin. Ocul.* **1998**, *114*, 85–93 (French).
112. Moreno, D.A.; Ilic, N.; Poulev, A.; Brasaemle, D.L.; Fried, S.K.; Raskin, I. Inhibitory effects of grape seed extract on lipases. *Nutrition* **2003**, *19* (10), 876–819.
113. Ardevol, A.; Blade, C.; Salvado, M.J.; Arola, L. Changes in lipolysis and hormone-sensitive lipase expression caused by procyanidins in 3T3-L1 adipocytes. *Int. J. Obes. Relat. Metab. Disord.* **2000**, *24*, 319–324.
114. Sahach, V.F.; Shymans'ka, T.V.; Zul'fiharov, O.S.; Ovchynnikova, O.H.; Hozhenko, A.I. The effect of a grape extract on the contractile activity of the myocardium and on the coronary flow of the isolated guinea pig heart. *Fiziol. Zh.* **1999**, *45*, 117–121 (Ukrainian).
115. Bentivegna, S.S.; Whitney, K.M. Subchronic 3-month oral toxicity study of grape seed and grape skin extracts. *Food Chem. Toxicol.* **2002**, *40* (12), 1731–1743.
116. Yamakoshi, J.; Saito, M.; Kataoka, S.; Kikuchi, M. Safety evaluation of proanthocyanidin-rich extract from grape seeds. *Food Chem. Toxicol.* **2002**, *40* (5), 599–607.
117. Wren, A.F.; Cleary, M.; Frantz, C.; Melton, S.; Norris, L. 90-day oral toxicity study of a grape seed extract (IH636) in rats. *J. Agric. Food Chem.* **2002**, *50* (7), 2180–2192.
118. Vogels, N.; Nijs, I.; Westerterp-Plantenga, M.S. Grape seed extract reduced energy intake in overweight humans. *Int. J. Obesity* **2003**, *27* (Suppl. 1), S126.
119. Tebib, K.; Rouanet, J.M.; Besancon, P. Effect of grape seed tannins on the activity of some rat intestinal enzyme activities. *Enzyme Protein* **1994–1995**, *48* (1), 51–60.



# Green Tea Polyphenols

**Shengmin Sang**  
**Joshua D. Lambert**

*Susan Lehman Cullman Laboratory for Cancer Research, Ernest Mario School of Pharmacy, Rutgers, The State University of New Jersey, Piscataway, New Jersey, U.S.A.*

**Chi-Tang Ho**

*Cook College, Rutgers, The State University of New Jersey, Piscataway, New Jersey, U.S.A.*

**Chung S. Yang**

*Susan Lehman Cullman Laboratory for Cancer Research, Ernest Mario School of Pharmacy, Rutgers, The State University of New Jersey, Piscataway, New Jersey, U.S.A.*

## INTRODUCTION

Tea (*Camellia sinensis*, Theaceae) is second only to water in worldwide popularity as a beverage. The three major types of tea, green, oolong, and black, differ in terms of the manufacture and chemical composition. There are numerous studies in humans, animal models, and cell lines to suggest potential health benefits from the consumption of tea, including prevention of cancer and heart disease. Many of the health benefits have been attributed to the polyphenolic components: Epigallocatechin-3-gallate (EGCG) and the related catechins have been the most widely studied in terms of disease prevention and treatment. The present entry summarizes the data concerning the preventive effects of the green tea polyphenols on heart diseases, diabetes, neurodegenerative disorders, and cancer. Greater attention is given to cancer prevention as this area has been most widely studied. Importance is also accorded to the bioavailability and biotransformation of the catechins. Such factors are likely to influence the potential health benefits of tea consumption, and a complete understanding of them will aid in better assessing the beverage's disease preventive activity.

---

*Shengmin Sang, Ph.D.*, is Assistant Research Professor, Dept. of Chemical Biology, at the Susan Lehman Cullman Laboratory for Cancer Research, Ernest Mario School of Pharmacy, Rutgers University, Piscataway, New Jersey, U.S.A.

*Joshua D. Lambert, Ph.D.*, is Research Associate, Dept. of Chemical Biology, at the Susan Lehman Cullman Laboratory for Cancer Research, Ernest Mario School of Pharmacy, Rutgers University, Piscataway, New Jersey, U.S.A.

*Chi-Tang Ho, Ph.D.*, is Professor II, Dept. of Food Science, Cook College, Rutgers University, Piscataway, New Jersey, U.S.A.

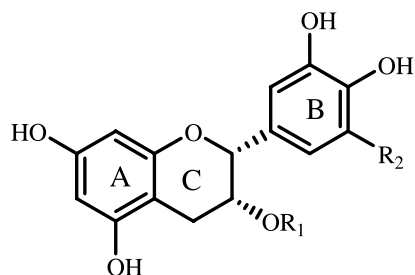
*Chung S. Yang, Ph.D.*, Professor II and Chair, Dept. of Chemical Biology, Ernest Mario School of Pharmacy, Rutgers University, Piscataway, New Jersey, U.S.A.

## BACKGROUND

Tea is one of the most widely consumed beverages in the world; it has been used for medicinal purposes in China and Japan for thousands of years. More than 300 different varieties of tea are produced from the leaves of *C. sinensis* by various manufacturing processes. Generally, tea is divided into three types: green (nonfermented), oolong (semifermented), and black (fermented). Green tea and oolong tea are more popular in China, Japan, Korea, and some African countries, whereas black tea is preferred in India and the Western countries. Experimental and epidemiological studies have linked the consumption of tea to reduced risk of cardiovascular diseases and cancer.<sup>[1]</sup> These effects have been attributed to its polyphenol compounds. Catechins are the most abundant polyphenols in green tea. A typical cup of brewed green tea contains, by dry weight, 30–40% catechins including EGCG, epigallocatechin (EGC), epicatechin-3-gallate (ECG), and epicatechin (EC) (Fig. 1). EGCG is the most abundant catechin in green, oolong, and black teas. Green and oolong teas typically contain 30–130 mg of EGCG per cup (237 ml), whereas black tea may have up to 70 mg of EGCG per cup.<sup>[2]</sup> The main pigments in black tea are theaflavins (Fig. 1) and thearubigins, which are formed by the oxidation and polymerization of catechins during fermentation. The resulting brewed black tea contains 3–10% catechins, 2–6% theaflavins, and more than 20% thearubigins.<sup>[3]</sup>

Green tea and its constituents have been extensively studied both in vitro and in animal models of carcinogenesis.<sup>[1]</sup> Whereas these compounds have been shown to be efficacious in a number of animal models of carcinogenesis, the epidemiological evidence regarding the effects of tea consumption on cancer risk in humans is conflicting. Likewise, the primary cancer preventive



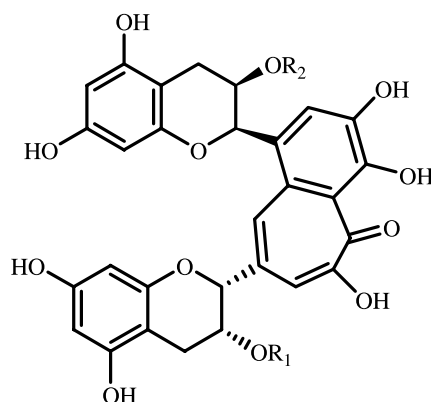


Epicatechin:  $R_1=R_2=H$

Epigallocatechin:  $R_1=H$ ;  $R_2=OH$

Epicatechin 3-gallate:  $R_1=Galloyl$ ;  $R_2=H$

Epigallocatechin 3-gallate:  $R_1=Galloyl$ ;  $R_2=OH$



Theaflavin:  $R_1=R_2=H$

Theaflavin 3-gallate:  $R_1=Galloyl$ ;  $R_2=H$

Theaflavin 3'-gallate:  $R_1=H$ ;  $R_2=Galloyl$

Theaflavin 3,3'-digallate:  $R_1=R_2=Galloyl$

**Fig. 1** Structures of the major tea polyphenols. (Used with permission from Dr. Chung S. Yang.)

mechanisms of tea in animal models remain unclear. Although many of the beneficial effects have been attributed to the strong antioxidative activity of the polyphenols, this mechanism has not been firmly established in animals or humans.<sup>[4,5]</sup> In the present entry, we discuss the disease preventive activities of green tea and tea polyphenols, potential mechanisms by these activities are realized, and the current knowledge of the bioavailability and biotransformation of these compounds.

## CARDIOVASCULAR DISEASE

### Animal Studies

Both animal and human studies have suggested a cardioprotective effect for tea.<sup>[6]</sup> Treatment of nephrectomized rats with 0.25% green tea extract for 4 weeks resulted in attenuation of left ventricular hypertrophy and hypertension.<sup>[7]</sup> Studies with isolated myocytes showed that green tea extract inhibited ouabain-induced reactive oxygen species (ROS) production and cell proliferation. Both green tea and black tea (1–2% in the diet) have been shown to reduce serum cholesterol levels in hypercholesterolemic rats at least in part by inhibiting the absorption of cholesterol from the gut.<sup>[8,9]</sup> Vinson and colleagues have demonstrated that 1.25% green or black tea (as the drinking fluid) reduced cholesterol (20–29% decrease), triglycerides (20–32% decrease), and lipid peroxides (27–49% decrease) in cholesterol fed hamsters after 15 days of treatment.<sup>[6]</sup> Treatment of C57bL/6J apolipoprotein (apo) E-deficient mice with 0.08% green tea extract for 14 weeks reduced the number of atheromatous areas in the aorta by 23% and aortic cholesterol and triglyceride levels by 27% and 50%, respectively.<sup>[10]</sup> By

contrast, 8 weeks of treatment with green tea and black tea had no effect on the incidence of atherosclerotic lesions, low-density lipoprotein (LDL) oxidation, and lipid peroxidation in New Zealand white rabbits.<sup>[11]</sup>

### Human Studies

Studies in humans have yielded mixed results. A Phase II randomized controlled study has shown that consumption of 4 cups/day of green tea but not black tea results in a 31% decrease in the urinary concentrations of 8-hydroxydeoxyguanosine, a marker of oxidative stress, in smokers.<sup>[12]</sup> Hirano et al. have reported that intake of green tea was inversely associated with incidence of myocardial infarction (1–3 cups/day reduced prevalence by 35%), but had no effect on the incidence of coronary artery disease.<sup>[13]</sup> Another study of 512 subjects in Japan suggested that drinking 2–3 or 4 cups/day was inversely associated with the development of coronary atherosclerosis with odds ratios of 0.5 and 0.4, respectively.<sup>[14]</sup>

## NEURODEGENERATIVE DISORDERS

Green tea and its components, especially EGCG, have been shown in some experiments to inhibit the development of Parkinson's disease. In a case-control study in China, consumption of 3 or more cups of tea per day was shown to reduce the risk of developing this disease by 28%.<sup>[15]</sup> Laboratory trials with mice further support a potential protective effect for green tea. Choi et al. reported that oral administration of green tea and EGCG attenuated the development of

1-methyl-4-phenyl-1,2,3,6-tetrahydropyridine (MPTP)-induced Parkinson's disease in mice.<sup>[16]</sup> EGCG prevented the loss of tyrosine hydroxylase positive cells in the substantia nigra and decreased the expression of neuronal nitric oxide synthetase (nNOS).<sup>[16]</sup> Potential mechanisms for the antiparkinsonian effects of EGCG include inhibition of catechol-*O*-methyltransferase (COMT) and of 6-hydroxydopamine-induced neuronal cell death.<sup>[17,18]</sup>

## DIABETES

Obesity and diabetes have become widespread health problems and contribute to increased risk of other diseases, including heart diseases, and cancer. Consumption of 1.5 L of oolong tea for 30 days has been shown to decrease the plasma glucose levels by 30% in individuals with Type II diabetes.<sup>[19]</sup> Likewise, green tea, but not an equivalent amount of caffeine, was shown to increase the 24 h energy expenditure and fat oxidation in healthy human volunteers.<sup>[20]</sup> Sabu, Smitha, and Kuttan have demonstrated that green tea polyphenols [500 mg/kg, intragastric (i.g.)] increased glucose tolerance in normal rats, and daily administration of 50–100 mg/kg, i.g. for 15 days reduced the plasma glucose levels by 29–44% in alloxan-treated rats.<sup>[21]</sup> In vitro, EGCG inhibited interleukin-1 $\beta$  and interferon- $\gamma$ -induced cytotoxicity in insulinoma cells.<sup>[22]</sup> The author suggested that this effect may be beneficial in preventing islet cell death in Type I diabetes as these mediators are important in the pathology of that disease.

## CANCER

### Animal Studies

Green tea has shown cancer chemopreventive activity against ultraviolet-light, chemical-induced, and genetic models of carcinogenesis. The organ sites include the lung, skin, oral cavity, esophagus, stomach, liver, pancreas, bladder, small intestine, colon, and prostate.<sup>[1,23,24]</sup> Chung et al. have demonstrated that 2% green tea inhibits NNK-induced lung tumors per mouse by ~45%. The corresponding amount of EGCG or caffeine inhibits lung tumor multiplicity by 28% or 15%, respectively.<sup>[25]</sup> In the inhibition of intestinal tumorigenesis in Apc<sup>min</sup> mouse model, EGCG is active, but caffeine is not (unpublished data from our laboratory). It appears that the major active constituent of green tea is EGCG in this model.

In addition to polyphenols, caffeine has also been shown to be an important cancer preventive component of tea. For example, Huang et al. have reported that whereas orally administered green tea and black tea

are effective in reducing the incidence and multiplicity of UVB-induced skin tumors, orally administered decaffeinated teas are much less effective. Addition of caffeine restores the activity of the decaffeinated teas.<sup>[26]</sup> A recent study has shown that topical application of caffeine or EGCG to SKH-1 hairless mice that have been pretreated twice weekly with UVB for 20 weeks decreases the multiplicity of skin tumors by 44–72% or 55–66%, respectively. In addition, both compounds have increased the apoptotic index of the tumors by 56–92% as measured by immunohistochemistry for caspase-3 positive cells.<sup>[27]</sup>

### Epidemiological Studies

Although data from animal models of carcinogenesis suggest that tea and its components may be efficacious cancer preventive agents, they are epidemiologically inconclusive. These studies have been extensively reviewed elsewhere.<sup>[1,28,29]</sup> Because of direct contact between tea constituents and the gastrointestinal tract, these organs are most likely to be affected by tea. Prevention of gastric cancer by tea has been suggested by at least six case-control studies. In addition, a nested case-control study of gastric cancer in men of the Shanghai cohort in China with greater than 4 yr follow-up has found an inverse correlation between urinary tea polyphenol positivity and risk of gastric cancer (OR = 0.52; 95% CI = 0.28–0.97).<sup>[30]</sup> Conversely, analysis from two population-based prospective studies in Japan found no association between tea consumption and the risk of gastric cancer over 9- and 7-yr periods.<sup>[31]</sup>

Similarly, whereas Su and Arab have reported that tea consumption by men and women in the United States was significantly inversely associated with the risk of colon cancer,<sup>[32]</sup> a prospective cohort study by The Netherlands Cohort Study on Diet and Cancer found no association between black tea consumption and risk of colorectal, stomach, lung, or breast cancer in men or women.<sup>[33]</sup> Such inconsistent results may be due to a number of confounding factors, including diet, smoking status, age, alcohol consumption, problems quantifying tea consumption, and interindividual differences in cancer susceptibility and in the biotransformation of tea constituents.

### Mechanisms of Cancer Prevention

Numerous potential mechanisms have been proposed for the cancer preventive activity of tea and its constituents based on studies with cancer cell lines. In vitro, tea polyphenols, especially EGCG, have been shown to cause growth inhibition and apoptosis in a number of human tumor cell lines including melanoma, breast

cancer, lung cancer, leukemia, and colon cancer.<sup>[34–37]</sup> The relative importance of any of these mechanisms *in vivo* remains to be determined. In general, biologically important activities that can be modulated by low concentration of an agent are likely to be more relevant *in vivo*. One problem faced by most studies is the relatively high concentrations of tea compounds used in *in vitro* studies. These levels often far exceed those found in animal plasma or tissue following tea consumption.

#### Antioxidant/pro-oxidant activity

EGCG, as well as other tea polyphenols, has been shown to have strong antioxidant activity *in vitro* by scavenging reactive oxygen and nitrogen species and chelating redox-active transition metal ions. They have also been suggested to function indirectly as antioxidants through inhibition of the redox-sensitive transcription factors, nuclear factor- $\kappa$ B (NF $\kappa$ B) and activator protein-1 (AP-1), inhibition of “pro-oxidant” enzymes, such as inducible nitric oxide synthase, lipoxygenases, cyclo-oxygenases and xanthine oxidase, and induction of Phase II and antioxidant enzymes, such as glutathione *S*-transferases and superoxide dismutases.<sup>[38]</sup> Several human intervention studies with green and black teas demonstrate a significant increase in plasma antioxidant capacity in humans  $\sim$ 1 hr after consumption of moderate amounts (1–6 cups/day).<sup>[39]</sup> However, some of the effects are small, and some studies do not demonstrate such an effect. The results now available are insufficient to draw a firm conclusion, and additional human intervention studies with more specific markers are needed.

In contrast to the potential antioxidative activity of tea polyphenols, recent experiments have suggested that the cell-killing activity of these compounds, at least *in vitro*, may be related to their pro-oxidant activity. For example, we have shown that EGCG-induced apoptosis in H661 lung cancer cells and Ras-transformed human bronchial cells is completely or partially blocked by the inclusion of catalase in the medium.<sup>[37,40]</sup> Catalase, however, does not affect the growth inhibitory activity of EGCG. In the presence of HT29 cells in McCoy’s 5A medium, treatment with 50  $\mu$ M EGCG results in the production of up to 23  $\mu$ M H<sub>2</sub>O<sub>2</sub>.<sup>[41]</sup> Both of these observations suggest a role for H<sub>2</sub>O<sub>2</sub> in some of the observed activities of EGCG *in vitro*. It is not known whether this mechanism is relevant *in vivo*.

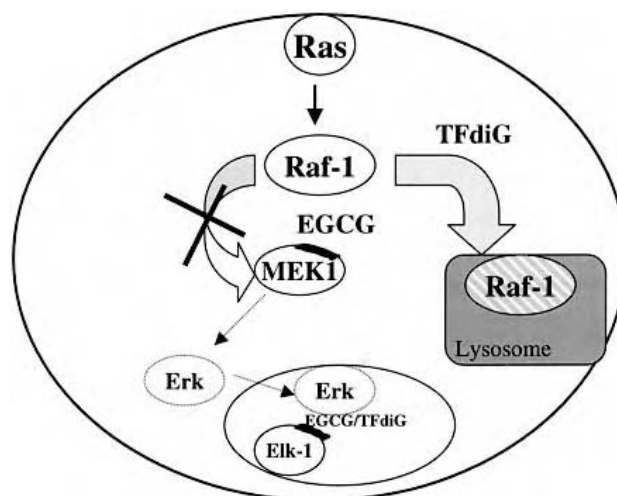
#### Inhibition of protein kinases, transcription factors, and growth factor signaling

Enhanced activities of the transcription factors, AP-1 and NF $\kappa$ B, have been implicated as key events in some carcinogenesis pathways, including UVB-induced skin

tumorigenesis. This enhanced activity can result from activation of one or more mitogen-activated protein kinase (MAPK) pathway.<sup>[42]</sup> EGCG (5–20  $\mu$ M) has been shown to prevent 12-tetradecanoylphorbol-13-acetate (TPA) and epidermal growth factor (EGF)-induced transformation of JB6 mouse epidermal cells in a dose-dependent manner.<sup>[42]</sup> This inhibition is shown to correlate with decreased jun N-terminal kinase (JNK) activation leading to inhibition of AP-1 activity. Topical application of EGCG to B6D2 transgenic mice, which carry a luciferase reporter gene containing the AP-1 binding sequence, results in a 60% inhibition of UVB-induced transcription of the luciferase reporter gene.<sup>[42]</sup>

NF $\kappa$ B activation by both lipopolysaccharide and tumor necrosis factor  $\alpha$  (TNF $\alpha$ ) is restrained by EGCG-mediated inhibition of inhibitor  $\kappa$ B (I $\kappa$ B) phosphorylation and degradation. In cultured intestinal epithelial cells, EGCG is found to be the most potent inhibitor of I $\kappa$ B kinase activity among green tea catechins, with an IC<sub>50</sub> of approximately 18  $\mu$ M.<sup>[43]</sup> Since NF $\kappa$ B is known to be antiapoptotic, its prevention by tea polyphenols is expected to increase apoptosis.

We have demonstrated that EGCG and theaflavin digallate (TFdiG) affect different steps in the Ras–MAP kinase signaling pathway (Fig. 2).<sup>[44]</sup> Treatment of 30.7b Ras 12, Ras-transformed mouse epidermal cells, with 20  $\mu$ M of either compound results in decreased levels of phosphorylated Erk1/2 and MEK1/2. EGCG inhibits the association between Raf-1 (an upstream protein kinase) and MEK1. TFdiG and EGCG can also directly prevent the kinase activity of this protein by competing with Elk-1 for access to



**Fig. 2** Inhibitory mechanism of EGCG and TFdiG on the Ras–MAP kinase pathway (Ref.<sup>[44]</sup>). (Used with permission from Dr. Chung S. Yang.)

the active site. TFdiG, but not EGCG, enhances the degradation of Raf-1.<sup>[44]</sup> Similarly, treatment of Ras-transformed human bronchial cells with EGCG and TFdiG has been shown to restrain c-jun and Erk1/2 phosphorylation as well as the phosphorylation of EIK-1 and MEK1/2, which are downstream and upstream of the MAP kinase cascade, respectively.<sup>[40]</sup>

Overexpression of growth factor and its receptors such as EGF, platelet-derived growth factor (PDGF), and others can result in enhanced proliferation by cancer cells.<sup>[45]</sup> Selective blockade of growth factor receptor-mediated signal transduction, either by competition with ligand or inhibition of kinase activity, has been shown to inhibit cell growth and induce apoptosis. Using in vitro kinase assays, Liang et al. have demonstrated that EGCG potently and selectively inhibits the kinase activity of EGF-R, PDGF-R, and fibroblast growth factor (FGF)-R with IC<sub>50</sub> of 1–2 μM.<sup>[45]</sup> In A431 human epidermoid carcinoma cells, pretreatment with 5 μM EGCG completely abolishes ligand-induced autophosphorylation. The fact that preincubation is required to demonstrate this effect suggests that the auto-oxidation of EGCG may denature the EGF-R, resulting in lower ligand binding and autophosphorylation.

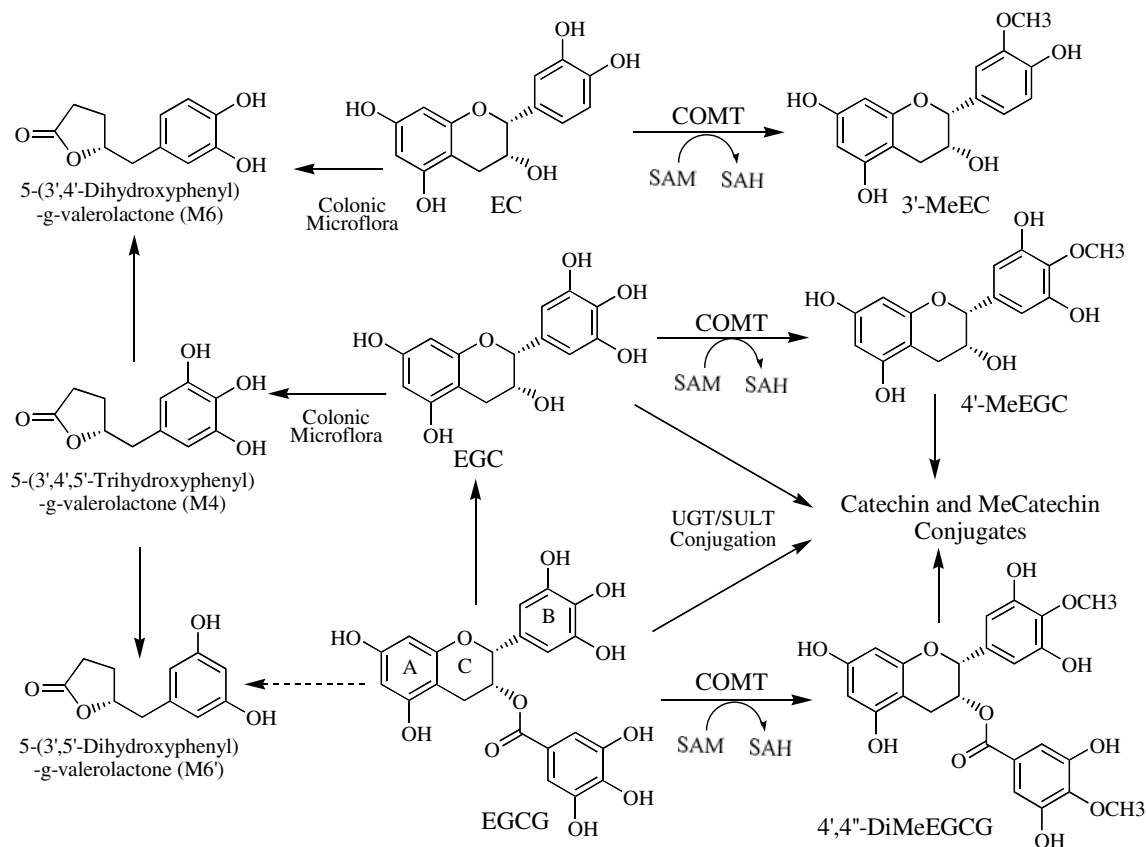
### Other potential mechanisms

EGCG has also been shown to inhibit many enzyme activities that may contribute to the prevention of carcinogenesis (reviewed in Ref.<sup>[46]</sup>). These include the inhibition of: topoisomerase I activity in several human colon carcinoma cell lines (by 3–17 μM EGCG), chymotryptic activity of the 20S proteasome in leukemic, breast cancer, and prostate cancer cell lines (1–10 μM EGCG), and matrix metalloproteinases (MMPs) 2 and 9 (9–13 μM EGCG).

It is evident that different pathways may be involved in the protective effects that tea polyphenols exhibit. The relative importance of each of these potential mechanisms in vivo depends on whether effective tissue concentrations of the tea polyphenols can be achieved. In most cases, this remains to be determined.

### BIOTRANSFORMATION AND BIOAVAILABILITY OF TEA POLYPHENOLS

Tea catechins have been shown to undergo extensive biotransformation and to have low bioavailability (Fig. 3).<sup>[1,46]</sup> Whereas cell-line studies typically require



**Fig. 3** Potential Phase II biotransformation pathways for the tea catechins (Ref.<sup>[46]</sup>). (Used with permission from Dr. Chung S. Yang.)

concentrations of compounds in the 5–100  $\mu\text{M}$  range, such levels are not generally observed systemically. The low bioavailability of the tea polyphenols is likely due to their relatively high molecular weight and the large number of hydroxyl groups, which not only serve as functional handles for Phase II enzymes but may also reduce the absorption of the compounds from the intestinal lumen.<sup>[47]</sup> Correlating mechanistic data *in vitro* with effects *in vivo* should be done with careful consideration of the poor bioavailability of the tea polyphenols.

### Enzymology of Biotransformation

The catechins are subject to extensive biotransformation including methylation, glucuronidation, sulfation, and ring-fission metabolism (Fig. 3). Methylated forms, have been observed in the rat with 4',4''-di-*O*-methyl-EGCG being the major metabolite detected in the bile of the rat following oral EGCG administration.<sup>[48–50]</sup> Rat liver cytosol shows higher COMT activity toward EGCG and EGC than do human or mouse liver cytosol.

In humans, EGC has been detected mainly as the glucuronidated form (57–71%) or sulfated form (23–36%) with only a small amount present as the free form (3–13%).<sup>[51]</sup> Methylation of EGC also occurs in humans leading to the formation of 4'-*O*-methyl EGC, which is present mainly as the glucuronide or sulfate conjugate.<sup>[1]</sup> In contrast, the sulfated form of EC is more abundant (66%) than the glucuronidated form (33%),<sup>[51]</sup> whereas EGCG is present mainly in the free form in plasma.<sup>[52]</sup> Recent work in our laboratory has shown that EGCG is time- and concentration-dependently sulfated by human, mouse, and rat liver cytosol.<sup>[53]</sup> The rat has the greatest activity, followed by the mouse and the human. Further studies are required to determine the structure of these sulfated metabolites.

In addition to these conjugation reactions, the tea catechins undergo metabolism in the gut to form the ring-fission products 5-(3',4',5'-trihydroxyphenyl)- $\gamma$ -valerolactone (M4), 5-(3',4'-dihydroxyphenyl)- $\gamma$ -valerolactone (M6) and 5-(3',5'-dihydroxyphenyl)- $\gamma$ -valerolactone (M6') (Fig. 3).<sup>[54,55]</sup> We have found that these ring-fission products are present in human urine (4–8  $\mu\text{M}$ ) and plasma (0.1–0.2  $\mu\text{M}$ ) approximately 13 hr after oral ingestion of 20 mg/kg decaffeinated green tea.<sup>[54]</sup> M4, M6, and M6' retain the polyphenolic character of the parent compound, and have the addition of a potentially, biologically active valerolactone structure.

### Pharmacokinetics

The pharmacokinetic parameters of the tea catechins have been thoroughly determined in the rat by both

intravenous and *i.g.* routes of administration. The kinetics of *i.v.* EGCG, EGC, and EC fit to a two-compartment model with elimination half-lives of 212, 45, and 41 min, respectively. The absolute bioavailability of EGCG, EGC, and EC following *i.g.* administration of decaffeinated green tea is 0.1%, 14%, and 31%, respectively.<sup>[56]</sup> In another study, the EGCG levels in the tissues and blood correspond to 0.0003–0.45% of the ingested dose, further demonstrating the poor bioavailability of EGCG in the rat.<sup>[57]</sup> Studies with bile duct-cannulated rats have shown that after oral administration of 100 mg EGCG, 3.28% of the dose is recovered in the bile as EGCG (2.65%) and methylated metabolites (0.63%).<sup>[48]</sup> With the exception of 4''-*O*-methyl-EGCG and 4',4''-di-*O*-methyl-EGCG, which were present as the sulfated form, the other metabolites and EGCG are present largely (>58%) as the glucuronidated form.

Studies of [<sup>3</sup>H]-EGCG in both the rat and the mouse have shown that following a single *i.g.* dose, radioactivity is found throughout the body.<sup>[58,59]</sup> After 24 h, 10% of the initial dose (radioactivity) is in the blood with 1% found in the prostate, heart, lung, liver, kidney, and other tissues. Excretion in the feces is the major route of elimination with 25–30% of the total radioactivity excreted after 24 h. In the rat, *i.v.* administration of [<sup>3</sup>H]-EGCG resulted in 77% of the dose being excreted in the bile and only 2% in the urine.<sup>[60]</sup>

Treatment of rats with a green tea polyphenol preparation (0.6% w/v) in the drinking fluid has been shown to result in increasing plasma levels over a 14-day period with levels of EGC and EC being higher than those of EGCG.<sup>[61]</sup> Plasma levels then decrease over the subsequent 14 days suggesting an adaptive effect. EGCG levels have been found to be highest in the rat esophagus, intestine, and colon, which have direct contact with tea catechins, whereas they are lower in the bladder, kidney, colon, lung, and prostate. When the same polyphenol preparation is given to mice, the levels in the plasma, lung, and liver are much higher than in rats. These levels appear to peak on day 4 and then decrease to less than 20% of the peak values in days 8–10.<sup>[61]</sup>

In mice, the absolute bioavailability of EGCG has been found to be higher than that in rats (26.5% vs. 0.1%). Concentrations of EGCG in the small intestine and colon are 45 and 7.9 nmol/g following *i.g.* administration of 75 mg/kg EGCG. The levels in other tissues are less than 0.1 nmol/g. Following *i.v.* administration of EGCG, levels are highest in the liver (3.6 nmol/g), lung (2.7 nmol/g), and small intestine (2.4 nmol/g). While greater than 50% of plasma EGCG is found as the glucuronide, EGCG is found mainly as the free form in the tissues.<sup>[62]</sup>

Several studies of the systemic bioavailability of orally administered green tea and catechins in human

volunteers have been conducted. Most recently, we have shown that oral administration of 20 mg green tea solids/kg body weight results in  $C_{\max}$  in the plasma for EGC, EC, and EGCG of 728.8, 427.6, and 170.1 nM, respectively.<sup>[63]</sup>  $T_{\max}$  has been found to range from 1.3 to 1.6 hr with  $t_{1/2\beta}$  of 3.4, 1.7, and 2 hr for EGCG, EGC, and EC, respectively. Plasma EC and EGC are present mainly in the conjugated form, whereas 77% of the EGCG was in the free form, which is consistent with previous results.<sup>[52,64]</sup> EGC but not EC is also methylated (4'-*O*-methyl-EGC) in humans. Plasma and urine levels of 4'-*O*-methyl-EGC have been shown to exceed those of EGC by 10- and 3-fold, respectively.<sup>[64]</sup> EGCG has also been shown to undergo methylation. The maximum plasma concentration of 4',4''-di-*O*-methyl-EGCG is 20% of that of EGCG, but the cumulative excretion of 4',4''-di-*O*-methyl-EGCG is 10-fold higher (140  $\mu$ g) than that of EGCG (16  $\mu$ g) over 24 hr.<sup>[65]</sup>

Whereas the tea polyphenols have a rather low systemic bioavailability, we have demonstrated that after holding green tea solution (7 mg/ml green tea solids in water) in the mouth without swallowing followed by extensive rinsing, the salivary concentrations of EGCG and EGC are 153 and 327  $\mu$ M, respectively.<sup>[66]</sup> These levels are 400–1000 times greater than those observed in plasma following ingestion of tea. Such locally high levels may support the use of green tea in the prevention of oral cancer and caries. More recently, our laboratory has reported that holding green tea leaves for 2–5 min resulted in high salivary catechin (2–131  $\mu$ M) concentrations, suggesting that tea leaves are a low cost product for sustained delivery of tea polyphenols in the oral cavity.<sup>[67]</sup>

## CONCLUSIONS

Despite the demonstration of cancer prevention by tea in many animal studies, epidemiological trials have yielded mixed results concerning its effectiveness as a cancer chemopreventive agent in humans. This may be due to several factors: 1) the dose of the chemopreventive agent is generally higher in animal studies than is typically consumed by humans; 2) the model of carcinogenesis, especially certain chemical carcinogens, may not be relevant to human carcinogenesis; 3) inter-individual variation in metabolism of tea constituents as well as other confounding factors may mask the effects of tea consumption on cancer. A clearer understanding of the bioavailability of tea polyphenols may resolve some of these confounding factors. These same limitations apply to the current knowledge of the beneficial effects of tea against other chronic diseases. Definitive conclusions on the effectiveness of tea as a preventive agent for chronic human disease will require

well-designed intervention and prospective epidemiological studies.

## REFERENCES

1. Yang, C.S.; Maliakal, P.; Meng, X. Inhibition of carcinogenesis by tea. *Annu. Rev. Pharmacol. Toxicol.* **2002**, *42*, 25–54.
2. Balentine, D.A.; Paetau-Robinson, I. Tea as a source of dietary antioxidants with a potential role in prevention of chronic diseases. In *Herbs, Botanicals, and Teas*; Mazza, G., Oomah, B.D., Eds.; Lancaster Technomic Publishing Co. Inc., 2000; 265–287.
3. Balentine, D.A.; Wiseman, S.A.; Bouwens, L.C. The chemistry of tea flavonoids. *Crit. Rev. Food Sci. Nutr.* **1997**, *37* (8), 693–704.
4. Ahmad, N.; Katiyar, S.K.; Mukhtar, H. Antioxidants in chemoprevention of skin cancer. *Curr. Probl. Dermatol.* **2001**, *29*, 128–139.
5. Cherubini, A.; Beal, M.F.; Frei, B. Black tea increases the resistance of human plasma to lipid peroxidation in vitro, but not ex vivo. *Free Radical Biol. Med.* **1999**, *27* (3/4), 381–387.
6. Vinson, J.A. Black and green tea and heart disease: a review. *Biofactors* **2000**, *13* (1–4), 127–132.
7. Priyadarshi, S.; Valentine, B.; Han, C.; Fedorova, O.V.; Bagrov, A.Y.; Liu, J.; Periyasamy, S.M.; Kennedy, D.; Malhotra, D.; Xie, Z.; Shapiro, J.I. Effect of green tea extract on cardiac hypertrophy following 5/6 nephrectomy in the rat. *Kidney Int.* **2003**, *63* (5), 1785–1790.
8. Hara, Y. The effects of tea polyphenols on cardiovascular diseases. *Prev. Med.* **1992**, *21* (3), 333.
9. Sano, M.; Takahashi, Y.; Yoshino, K.; Shimoi, K.; Nakamura, Y.; Tomita, I.; Oguni, I.; Konomoto, H. Effect of tea (*Camellia sinensis* L.) on lipid peroxidation in rat liver and kidney: a comparison of green and black tea feeding. *Biol. Pharm. Bull.* **1995**, *18* (7), 1006–1008.
10. Miura, Y.; Chiba, T.; Tomita, I.; Koizumi, H.; Miura, S.; Umegaki, K.; Hara, Y.; Ikeda, M.; Tomita, T. Tea catechins prevent the development of atherosclerosis in apoprotein E-deficient mice. *J. Nutr.* **2001**, *131* (1), 27–32.
11. Tijburg, L.B.; Wiseman, S.A.; Meijer, G.W.; Weststrate, J.A. Effects of green tea, black tea and dietary lipophilic antioxidants on LDL oxidizability and atherosclerosis in hypercholesterolaemic rabbits. *Atherosclerosis* **1997**, *135* (1), 37–47.
12. Hakim, I.A.; Harris, R.B.; Brown, S.; Chow, H.H.; Wiseman, S.; Agarwal, S.; Talbot, W. Effect of increased tea consumption on oxidative DNA

- damage among smokers: a randomized controlled study. *J. Nutr.* **2003**, *133* (10), 3303S–3309S.
13. Hirano, R.; Momiyama, Y.; Takahashi, R.; Taniguchi, H.; Kondo, K.; Nakamura, H.; Ohsuzu, F. Comparison of green tea intake in Japanese patients with and without angiographic coronary artery disease. *Am. J. Cardiol.* **2002**, *90* (10), 1150–1153.
  14. Sasazuki, S.; Kodama, H.; Yoshimasu, K.; Liu, Y.; Washio, M.; Tanaka, K.; Tokunaga, S.; Kono, S.; Arai, H.; Doi, Y.; Kawano, T.; Nakagaki, O.; Takada, K.; Koyanagi, S.; Hiyamuta, K.; Nii, T.; Shirai, K.; Ideishi, M.; Arakawa, K.; Mohri, M.; Takeshita, A. Relation between green tea consumption and the severity of coronary atherosclerosis among Japanese men and women. *Ann. Epidemiol.* **2000**, *10* (6), 401–408.
  15. Tan, E.K.; Tan, C.; Fook-Chong, S.M.; Lum, S.Y.; Chai, A.; Chung, H.; Shen, H.; Zhao, Y.; Teoh, M.L.; Yih, Y.; Pavanni, R.; Chandran, V.R.; Wong, M.C. Dose-dependent protective effect of coffee, tea, and smoking in Parkinson's disease: a study in ethnic Chinese. *J. Neurol. Sci.* **2003**, *216* (1), 163–167.
  16. Choi, J.Y.; Park, C.S.; Kim, D.J.; Cho, M.H.; Jin, B.K.; Pie, J.E.; Chung, W.G. Prevention of nitric oxide-mediated 1-methyl-4-phenyl-1,2,3,6-tetrahydropyridine-induced Parkinson's disease in mice by tea phenolic epigallocatechin 3-gallate. *Neurotoxicology* **2002**, *23* (3), 367–374.
  17. Lu, H.; Meng, X.; Yang, C.S. Enzymology of methylation of tea catechins and inhibition of catechol-*O*-methyltransferase by (–)-epigallocatechin gallate. *Drug Metab. Dispos.* **2003**, *31* (5), 572–579.
  18. Jin, C.F.; Shen, S.R., Sr.; Zhao, B.L. Different effects of five catechins on 6-hydroxydopamine-induced apoptosis in PC12 cells. *J. Agric. Food Chem.* **2001**, *49* (12), 6033–6038.
  19. Hosoda, K.; Wang, M.F.; Liao, M.L.; Chuang, C.K.; Iha, M.; Clevidence, B.; Yamamoto, S. Antihyperglycemic effect of oolong tea in type 2 diabetes. *Diabetes Care* **2003**, *26* (6), 1714–1718.
  20. Dulloo, A.G.; Duret, C.; Rohrer, D.; Girardier, L.; Mensi, N.; Fathi, M.; Chantre, P.; Vandermander, J. Efficacy of a green tea extract rich in catechin polyphenols and caffeine in increasing 24-h energy expenditure and fat oxidation in humans. *Am. J. Clin. Nutr.* **1999**, *70* (6), 1040–1045.
  21. Sabu, M.C.; Smitha, K.; Kuttan, R. Anti-diabetic activity of green tea polyphenols and their role in reducing oxidative stress in experimental diabetes. *J. Ethnopharmacol.* **2002**, *83* (1–2), 109–116.
  22. Han, M.K. Epigallocatechin gallate, a constituent of green tea, suppresses cytokine-induced pancreatic beta-cell damage. *Exp. Mol. Med.* **2003**, *35* (2), 136–139.
  23. Katiyar, S.K.; Elmets, C.A. Green tea polyphenolic antioxidants and skin photoprotection (review). *Int. J. Oncol.* **2001**, *18* (6), 1307–1313.
  24. Weisburger, J.H. Tea and health: the underlying mechanisms. *Proc. Soc. Exp. Biol. Med.* **1999**, *220* (4), 271–275.
  25. Chung, F.L.; Schwartz, J.; Herzog, C.R.; Yang, Y.M. Tea and cancer prevention: studies in animals and humans. *J. Nutr.* **2003**, *133* (10), 3268s–3274s.
  26. Huang, M.T.; Xie, J.G.; Wang, Z.Y.; Ho, C.T.; Lou, Y.R.; Wang, C.X.; Hard, G.C.; Conney, A.H. Effects of tea, decaffeinated tea, and caffeine on UVB light-induced complete carcinogenesis in SKH-1 mice: demonstration of caffeine as a biologically important constituent of tea. *Cancer Res.* **1997**, *57* (13), 2623–2629.
  27. Lu, Y.P.; Lou, Y.R.; Xie, J.G.; Peng, Q.Y.; Liao, J.; Yang, C.S.; Huang, M.T.; Conney, A.H. Topical applications of caffeine or (–)-epigallocatechin gallate (EGCG) inhibit carcinogenesis and selectively increase apoptosis in UVB-induced skin tumors in mice. *Proc. Natl. Acad. Sci. U.S.A.* **2002**, *99* (19), 12455–12460.
  28. Zeegers, M.P.; Tan, F.E.; Goldbohm, R.A.; van den Brandt, P.A. Are coffee and tea consumption associated with urinary tract cancer risk? A systematic review and meta-analysis. *Int. J. Epidemiol.* **2001**, *30* (2), 353–362.
  29. Blot, W.J.; Chow, W.H.; McLaughlin, J.K. Tea and cancer: a review of the epidemiological evidence. *Eur. J. Cancer Prev.* **1996**, *5* (6), 425–438.
  30. Sun, C.L.; Yuan, J.M.; Lee, M.J.; Yang, C.S.; Gao, Y.T.; Ross, R.K.; Yu, M.C. Urinary tea polyphenols in relation to gastric and esophageal cancers: a prospective study of men in Shanghai, China. *Carcinogenesis* **2002**, *23* (9), 1497–1503.
  31. Koizumi, Y.; Tsubono, Y.; Nakaya, N.; Nishino, Y.; Shibuya, D.; Matsuoka, H.; Tsuji, I. No association between green tea and the risk of gastric cancer: pooled analysis of two prospective studies in Japan. *Cancer Epidemiol. Biomarkers Prev.* **2003**, *12* (4), 472–473.
  32. Su, L.J.; Arab, L. Tea consumption and the reduced risk of colon cancer—results from a national prospective cohort study. *Public Health Nutr.* **2002**, *5* (3), 419–425.
  33. Goldbohm, R.A.; Hertog, M.G.; Brants, H.A.; van Poppel, G.; van den Brandt, P.A. Consumption of black tea and cancer risk: a prospective cohort study. *J. Natl. Cancer Inst.* **1996**, *88* (2), 93–100.
  34. Chung, L.; Cheung, T.; Kong, S.; Fung, K.; Choy, Y.; Chan, Z.; Kwok, T. Induction of apoptosis

- by green tea catechins in human prostate cancer DU145 cells. *Life Sci.* **2001**, *68* (10), 1207–1214.
35. Lea, M.; Xiao, Q.; Sadhukhan, A.; Cottle, S.; Wang, Z.Y.; Yang, C.S. Inhibitory effects of tea extracts and (–)-epigallocatechin gallate on DNA synthesis and proliferation of hepatoma and erythroleukemia cells. *Cancer Lett.* **1993**, *68* (2–3), 231–236.
  36. Uesato, S.; Kitagawa, Y.; Kamishimoto, M.; Kumagai, A.; Hori, H.; Nagasawa, H. Inhibition of green tea catechins against the growth of cancerous human colon and hepatic epithelial cells. *Cancer Lett.* **2001**, *170* (1), 41–44.
  37. Yang, G.Y.; Liao, J.; Kim, K.; Yurkow, E.J.; Yang, C.S. Inhibition of growth and induction of apoptosis in human cancer cell lines by tea polyphenols. *Carcinogenesis* **1998**, *19* (4), 611–616.
  38. Frei, B.; Higdon, J. Antioxidant activity of tea polyphenols in vivo: evidence from animal studies. *J. Nutr.* **2003**, *133* (10), 3275s–3284s.
  39. Rietveld, A.; Wiseman, S. Antioxidant effects of tea: evidence from human clinical trials. *J. Nutr.* **2003**, *133* (10), 3285s–3292s.
  40. Yang, G.Y.; Liao, J.; Li, C.; Chung, J.; Yurkow, E.J.; Ho, C.T.; Yang, C.S. Effect of black and green tea polyphenols on c-jun phosphorylation and H(2)O(2) production in transformed and non-transformed human bronchial cell lines: possible mechanisms of cell growth inhibition and apoptosis induction. *Carcinogenesis* **2000**, *21* (11), 2035–2039.
  41. Hong, J.; Lu, H.; Meng, X.; Ryu, J.H.; Hara, Y.; Yang, C.S. Stability, cellular uptake, biotransformation, and efflux of tea polyphenol (–)-epigallocatechin-3-gallate in HT-29 human colon adenocarcinoma cells. *Cancer Res.* **2002**, *62* (9), 7241–7246.
  42. Dong, Z. Effects of food factors on signal transduction pathways. *Biofactors* **2000**, *12* (1), 17–28.
  43. Yang, F.; Oz, H.S.; Barve, S.; de Villiers, W.J.; McClain, C.J.; Varilek, G.W. The green tea polyphenol (–)-epigallocatechins-3-gallate blocks nuclear factor-kappa B activation by inhibiting I kappa B kinase activity in the intestinal epithelial cell line IEC-6. *Mol. Pharmacol.* **2001**, *60* (3), 528–533.
  44. Chung, J.Y.; Park, J.O.; Phyu, H.; Dong, Z.; Yang, C.S. Mechanisms of inhibition of the Ras–MAP kinase signaling pathway in 30.7b Ras 12 cells by tea polyphenols (–)-epigallocatechin-3-gallate and theaflavin-3,3'-digallate. *FASEB J.* **2001**, *15* (11), 2022–2024.
  45. Liang, Y.C.; Lin-shiau, S.Y.; Chen, C.F.; Lin, J.K. Suppression of extracellular signals and cell proliferation through EGF receptor binding by (–)-epigallocatechin gallate in human A431 epidermoid carcinoma cells. *J. Cell Biochem.* **1997**, *67* (1), 55–65.
  46. Lambert, J.D.; Yang, C.S. Mechanisms of cancer prevention by tea constituents. *J. Nutr.* **2003**, *133* (10), 3262s–3267s.
  47. Lipinski, C.A.; Lombardo, F.; Dominy, B.W.; Feeney, P.J. Experimental and computational approaches to estimate solubility and permeability in drug discovery and development settings. *Adv. Drug Deliv. Rev.* **2001**, *46* (1), 3–26.
  48. Okushio, K.; Suzuki, M.; Matsumoto, N.; Nanjo, F.; Hara, Y. Identification of (–)-epicatechin metabolites and their metabolic fate in the rat. *Drug Metab. Dispos.* **1999**, *27* (2), 309–316.
  49. Okushio, K.; Suzuki, M.; Matsumoto, N.; Nanjo, F.; Hara, Y. Methylation of tea catechins by rat liver homogenates. *Biosci. Biotech. Biochem.* **1999**, *63* (2), 430–432.
  50. Kida, K.; Suzuki, M.; Matsumoto, N.; Nanjo, F.; Hara, Y. Identification of biliary metabolites of (–)-epigallocatechin gallate in rats. *J. Agric. Food Chem.* **2000**, *48* (9), 4151–4155.
  51. Lee, M.J.; Wang, Z.Y.; Li, H.; Chen, L.; Sun, Y.; Gobbo, S.; Balentine, D.; Yang, C.S. Analysis of plasma and urinary tea polyphenols in human subjects. *Cancer Epidemiol. Biomarkers Prev.* **1995**, *4* (4), 393–399.
  52. Chow, H.H.; Cai, Y.; Alberts, D.S.; Hakim, I.; Dorr, R.; Shahi, F.; Crowell, J.A.; Yang, C.S.; Hara, Y. Phase I pharmacokinetic study of tea polyphenols following single-dose administration of epigallocatechin gallate and polyphenon E. *Cancer Epidemiol. Biomarkers Prev.* **2001**, *10* (1), 53–58.
  53. Lu, H. Mechanistic studies on the Phase II metabolism and absorption of tea catechins. In *Toxicology*; New Brunswick Rutgers, The State University of New Jersey.
  54. Li, C.; Lee, M.J.; Sheng, S.; Meng, X.; Prabhu, S.; Winnik, B.; Huang, B.; Chung, J.Y.; Yan, S.; Ho, C.T.; Yang, C.S. Structural identification of two metabolites of catechins and their kinetics in human urine and blood after tea ingestion. *Chem. Res. Toxicol.* **2000**, *13* (3), 177–184.
  55. Meselhy, M.R.; Nakamura, N.; Hattori, M. Biotransformation of (–)-epicatechin 3-O-gallate by human intestinal bacteria. *Chem. Pharm. Bull. (Tokyo)* **1997**, *45* (5), 888–893.
  56. Chen, L.; Lee, M.J.; Li, H.; Yang, C.S. Absorption, distribution, and elimination of tea polyphenols in rats. *Drug Metab. Dispos.* **1997**, *25* (9), 1045–1050.
  57. Nakagawa, K.; Miyazawa, T. Absorption and distribution of tea catechin, (–)-epigallocate-



- chin-3-gallate, in the rat. *Nutr. Sci. Vitaminol.* **1997**, *43* (6), 679–684.
58. Kohri, T.; Matsumoto, N.; Yamakawa, M.; Suzuki, M.; Nanjo, F.; Hara, Y.; Oku, N. Metabolic fate of (–)-[4-(3H)]epigallocatechin gallate in rats after oral administration. *J. Agric. Food Chem.* **2001**, *49* (8), 4102–4112.
  59. Sukanuma, M.; Okabe, S.; Oniyama, M.; Tada, Y.; Ito, H.; Fujiki, H. Wide distribution of [3H] (–)-epigallocatechin gallate, a cancer preventive tea polyphenol, in mouse tissue. *Carcinogenesis* **1998**, *19* (10), 1771–1776.
  60. Kohri, T.; Nanjo, F.; Suzuki, M.; Seto, R.; Matsumoto, N.; Yamakawa, M.; Hojo, H.; Hara, Y.; Desai, D.; Amin, S.; Conaway, C.; Chung, F.L. Synthesis of (–)-[4-3H]epigallocatechin gallate and its metabolic fate in rats after intravenous administration. *J. Agric. Food Chem.* **2001**, *49* (2), 1042–1048.
  61. Kim, S.; Lee, M.J.; Hong, J.; Li, C.; Smith, T.J.; Yang, G.Y.; Seril, D.N.; Yang, C.S. Plasma and tissue levels of tea catechins in rats and mice during chronic consumption of green tea polyphenols. *Nutr. Cancer* **2000**, *37* (1), 41–48.
  62. Lee, M.J.; Maliakal, P.; Chen, L.; Meng, X.; Bondoc, F.Y.; Prabhu, S.; Lambert, G.; Mohr, S.; Yang, C.S. Pharmacokinetics of tea catechins after ingestion of green tea and (–)-epigallocatechin-3-gallate by humans: formation of different metabolites and individual variability. *Cancer Epidemiol. Biomarkers Prev.* **2002**, *11* (10), 1025–1032.
  63. Yang, C.S.; Chen, L.; Lee, M.J.; Balentine, D.; Kuo, M.C.; Schantz, S.P. Blood and urine levels of tea catechins after ingestion of different amounts of green tea by human volunteers. *Cancer Epidemiol. Biomarkers Prev.* **1998**, *7* (4), 351–354.
  64. Meng, X.; Sang, S.; Zhu, N.; Lu, H.; Sheng, S.; Lee, M.J.; Ho, C.T.; Yang, C.S. Identification and characterization of methylated and ring-fission metabolites of tea catechins formed in humans, mice, and rats. *Chem. Res. Toxicol.* **2002**, *15* (8), 1042–1050.
  65. Lambert, J.D.; Lee, M.J.; Lu, H.; Meng, X.; Ju, J.; Hong, J.; Seril, D.N.; Sturgill, M.G.; Yang, C.S. Epigallocatechin-3-gallate is absorbed but extensively glucuronidated following oral administration to mice. *J. Nutr.* **2003**, *133* (12), 4172–4177.
  66. Lee, M.J.; Lambert, J.D.; Prabhu, S.; Meng, X.; Lu, H.; Maliakal, P.; Ho, C.T.; Yang, C.S. Delivery of tea polyphenols to the oral cavity by green tea leaves and black tea extract. *Cancer Epidemiol. Biomark. Prev.* **2004**, *13* (1), 132–137.
  67. Lee, M.J.; Lambert, J.D.; Prabhu, S.; Meng, X.; Lu, H.; Maliakal, P.; Ho, C.T.; Yang, C.S. Delivery of tea polyphenols to the oral cavity by green tea leaves and black tea extract. *Cancer Epi. Biomark Prev.* **2004**, *13* (1), 132–137.

# Hawthorn (*Crataegus*)

Werner R. Busse

Wiltrud Juretzek

Egon Koch

Dr. Willmar Schwabe GmbH & Co. KG, Karlsruhe, Germany

## INTRODUCTION

Hawthorn is one of the most popular herbal medicines for the heart worldwide. In Europe, particularly in Germany, Austria, and Switzerland, hawthorn preparations are eligible for marketing authorization as drugs for the treatment of mild forms of heart insufficiency. In the United States, hawthorn products are regulated as dietary supplements. Numerous preparations are available, including teas, homeopathic preparations, and tinctures as well as simple and standardized extracts. Different starting materials are used. Extracts are prepared from leaves, flowers, fruits, or leaves and flowers. A substantial number of hawthorn products in the United States consist of comminuted hawthorn leaves, flowers, or fruits.

Over the last decade, the pharmacodynamic action of standardized extracts from leaves and flowers as well as different fractions thereof has been extensively evaluated in in vitro studies and animal experiments. Similarly, the clinical efficacy of hawthorn extracts has been assessed in more than a dozen double-blind, placebo-controlled clinical trials. The results of these studies are reviewed in this entry.

## GENERAL DESCRIPTION

### Plant Description

Hawthorn species (*Crataegus* L.; family Rosaceae) grow as shrubs or trees with hard wood and generally thorny twigs throughout the temperate zones of the world. Leaves are more or less lobed, with margins typically slightly serrated. Flowers are arranged in clusters, and are mostly white and sometimes red.

Werner R. Busse, Ph.D., is Director, International Division, Dr. Willmar Schwabe GmbH & Co. KG, Karlsruhe, Germany.

Wiltrud Juretzek, Ph.D., is at Dr. Willmar Schwabe GmbH & Co. KG, Karlsruhe, Germany.

Egon Koch, Ph.D., is Head of the Department of Pharmacology at Dr. Willmar Schwabe GmbH & Co. KG, Karlsruhe, Germany.

*Encyclopedia of Dietary Supplements* DOI: 10.1081/E-EDS-120022112  
Copyright © 2005 by Marcel Dekker. All rights reserved.

Small false fruits (berries) are formed, and are red, black, or yellow and mealy.

### Starting Material

The starting material consists of collected wild plant parts.

### Leaves and flowers

Hawthorn leaves and flowers consist of the whole or cut, dried, flower-bearing branches of *C. monogyna* Jacq. (Lindm.), *C. laevigata* (Poir.) DC. (*C. oxyacanthoides* Thuill.), or their hybrids or, more rarely, other European *Crataegus* species, including *C. pentagyna* Waldst. et Kit ex Willd., *C. nigra* Waldst. et Kit, and *C. azarolus* L. The preparation should contain not less than 1.5% flavonoids, calculated as hyperoside (C<sub>21</sub>H<sub>20</sub>O<sub>12</sub>; M<sub>r</sub> 464.4), with reference to the dried substance (European Pharmacopoeia; EP).

The United States Pharmacopoeia (USP) only recognizes the first two species. According to the USP, the preparation should contain not less than 0.6% C-glycosylated flavones, expressed as vitexin (C<sub>21</sub>H<sub>20</sub>O<sub>12</sub>), and not less than 0.45% O-glycosylated flavones, expressed as hyperoside (C<sub>21</sub>H<sub>20</sub>O<sub>12</sub>), calculated on a dry basis (USP-NF).

### Fruits (berries)

Hawthorn berries consist of the dried false fruits of *C. monogyna* Jacq. (Lindm.) or *C. laevigata* (Poir.) DC., or their hybrids, or a mixture of these (EP). They should contain not less than 1.0% procyanidins, calculated as cyanidin chloride (C<sub>12</sub>H<sub>11</sub>ClO<sub>6</sub>; M<sub>r</sub> 322.7) with reference to the dried product (EP).

## Constituents of the Starting Material

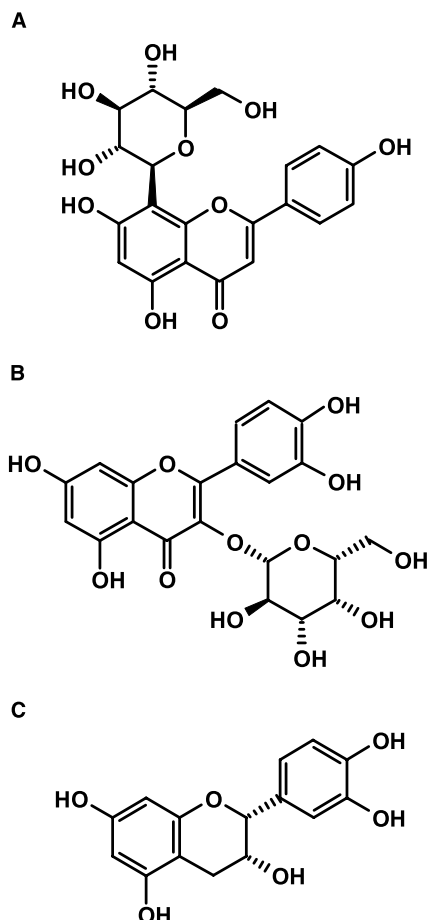
### Leaves and flowers

The major constituents are flavonoids (up to 2%) such as vitexin-2''-O- $\alpha$ -L-rhamnoside, hyperoside, rutin, and vitexin as well as procyanidins formed by the

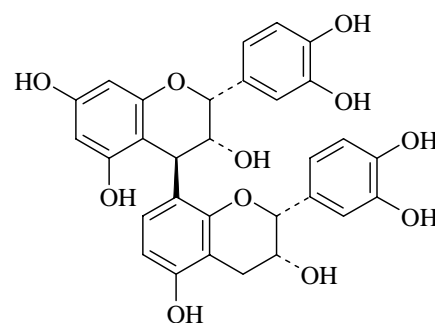
condensation of catechin and/or epicatechin with varying degrees of polymerization (Fig. 1). The most important are oligomeric procyanidins (OPCs) containing 2–8 monomeric units, e.g., the dimeric procyanidin B<sub>2</sub> (Fig. 2). The content of OPCs is approximately 3%.<sup>[1]</sup> Further constituents are triterpenoid acids (approximately 0.6%), e.g., ursolic, oleanolic, and crataegolic acid, and phenol carboxylic acids such as chlorogenic and caffeic acid, as well as various amines.<sup>[2]</sup>

### Fruits (berries)

The fruits contain relatively low levels of flavonoids. The procyanidins contained in the fruits reportedly have a higher degree of polymerization than those in the leaves and flowers. Total procyanidins amount up to 3% of which about 1.9% is OPCs. Triterpenoid acids are also present in the fruit (approximately 0.45%).<sup>[3]</sup>



**Fig. 1** (A) Vitexin [ $\beta$ -D-glucopyranosyl-5,7-dihydroxy-2-(4-hydroxyphenyl)-4H-1-benzopyran-4-one]; (B) hyperoside [2-(3,4-dihydroxyphenyl)-3-( $\beta$ -D-galactopyranosyloxy)-5,7-dihydroxy-4H-1-benzopyran-4-one]; (C) L-epicatechin [(2*R*-*cis*)-2-(3,4-dihydroxyphenyl)-3,4-dihydro-2H-1-benzopyran-3,5,7-triol].



**Fig. 2** Procyanidin B<sub>2</sub>.

### Preparations

Hawthorn extracts from leaves, flowers, and fruits are characterized by different quantitative flavonoid patterns.<sup>[4]</sup>

#### Leaves and flowers

Extracts are produced from the herbal product by a suitable procedure using either water or a hydroalcoholic solvent equivalent in strength to a minimum of 45% ethanol. Aqueous extracts contain a minimum of 2.5% flavonoids and hydroalcoholic extracts a minimum of 6.0% flavonoids expressed as hyperoside (dried extracts) (EP).

Standardized dry extracts are adjusted to 18.75% oligomeric procyanidins (WS<sup>®</sup> 1442; extraction solvent 45% ethanol) or 2.2% flavonoids (LI 132; extraction solvent 70% methanol), with a ratio of starting material to genuine extract (DER) of 4–7:1. The daily recommended dose is currently set at 160–900 mg in 2 or 3 divided doses.<sup>[1,5]</sup>

#### Fruits (berries)

Extracts are produced either from dried fruits, in compliance with the European Pharmacopoeia using alcohol (25–60%, v/v), or from fresh fruits. To date, no official monograph is available advocating the use of preparations from hawthorn fruits. Water extracts, water–alcohol extracts, wine infusions, and fresh juice from hawthorn fruits have been utilized traditionally to strengthen and invigorate heart and circulatory function.<sup>[6]</sup>

### ACTION AND PHARMACOLOGY

Pharmacological investigations with *Crataegus* preparations have been reported in a great number of publications. Unfortunately, many of these studies have been performed with insufficiently characterized

extracts: Information on plant species, plant parts, and solvent and production conditions, for example, is not provided. Moreover, the applied pharmacological models and experimental details are frequently ill defined. Thus, formation of a clear judgment on the pharmacological activities of many of these products is not possible.

Almost all clinical studies reported until now have been performed with two different extracts, prepared from leaves and flowers of selected *Crataegus* species with either 70% methanol (LI 132) or 45% ethanol (WS<sup>®</sup> 1442).<sup>\*</sup> The present entry will mainly review the pharmacological actions of these well-defined preparations.

### Positive Inotropic Action

At concentrations between 30 and 180 µg/ml, LI 132 was found to raise the contraction amplitude of isolated cardiomyocytes of rats by up to 53%<sup>[7]</sup> and to improve oxygen utilization in comparison to β-adrenergic agonists or the cardiac glycoside ouabain. It is supposed that the inotropic action of LI 132 may be due to enhanced intracellular Ca<sup>2+</sup> sensitivity. An increase of contraction amplitude was also observed in electrically stimulated canine papillary muscles.<sup>[8]</sup>

In isolated, electrically stimulated left ventricular muscle strips of human failing myocardium, WS 1442 significantly augmented force of contraction by about 30% (50 µg/ml) and improved the frequency-dependent force generation.<sup>[9]</sup> In normal human myocardial tissue, WS 1442 raised the Ca<sup>2+</sup> gradient as well as the force generation and displaced bound <sup>3</sup>H-ouabain from cell membranes. As the extract did not influence the activity of adenylate cyclase, the pharmacological mechanism of WS 1442 is suggested to be similar to the cAMP-independent positive inotropic action of cardiac glycosides. However, this conclusion is weakened by the fact that an extract fraction enriched for water-soluble low molecular weight constituents displaced <sup>3</sup>H-ouabain but did not elicit any inotropic effect.

Likewise, a significant dose-dependent effect of WS 1442 on the shortening of isolated and electrically stimulated myocytes isolated from right atria and left ventricles of failing human hearts has been reported.<sup>[10]</sup>

Using an isolated guinea pig heart preparation, two independent research groups<sup>[11,12]</sup> observed a maximal increase of contraction force between about 10 and 20% at concentrations of 10 µg/ml LI 132.

### Increase of Coronary Flow and Vasorelaxing Effects

An increase of coronary flow has repeatedly been reported after perfusion of isolated hearts with medium containing ill-defined hawthorn extracts. These earlier observations were confirmed by a comprehensive study investigating the influence of LI 132 on different functional parameters in isolated guinea pig hearts. At a concentration of 3 µg/ml, LI 132 maximally enhanced coronary flow by 64%. A similar effect was brought about by amrinone and milrinone, while epinephrine had only a marginal effect, and digoxin concentration-dependently reduced coronary perfusion.<sup>[11]</sup> Since the nitric oxide synthase (NOS) inhibitor *N*-nitro-L-arginine and the soluble guanylyl cyclase inhibitor ODQ completely abolished the increase in coronary flow induced by WS 1442 in the isolated rat heart, it has been concluded that *Crataegus* extracts increase the endothelial release of NO.<sup>[13]</sup> Endothelium-dependent NO-mediated relaxation induced by an extract from hawthorn fruits has also been observed in rat mesenteric arteries<sup>[14]</sup> and by another extract and a procyanidin-enriched fraction in the rat aorta.<sup>[15]</sup> Siegel et al.<sup>[8]</sup> proposed that dilatation of normal and arteriosclerotic human coronary arteries mediated by LI 132 could be due to the opening of K<sup>+</sup> channels, an action compatible with enhanced NO synthesis. Therefore, relaxation of the noradrenalin-precontracted rat aorta has been proposed as a bioassay to investigate the pharmacological equivalence of different hawthorn extracts.<sup>[16]</sup>

In unanesthetized dogs, the effect of oral (p.o.) treatment with WS 1442 on local blood flow in the myocardium of the left ventricle was measured by means of chronically implanted heat-conduction probes. WS 1442 led to a dose-dependent temporary rise in blood flow, and repeated application caused a sustained increase of basal blood flow.<sup>[17]</sup>

In a pilot study, the effect of LI 132 on the microcirculation in the mesenteric vessels of rats was compared with those of β-acetyldigoxin by intravital microscopy. Compared with digitalis, the *Crataegus* extract improved the erythrocyte flow rate in all investigated vessel types, and reduced both leukocyte adhesion to the endothelium and leukocyte diapedesis.<sup>[18]</sup>

### Antiarrhythmic Effects

Evidence for an antiarrhythmic potential of LI 132 was provided by Poepping et al.,<sup>[7]</sup> who observed a prolongation of the refractory period in isolated rat cardiac myocytes. Similarly, in isolated guinea pig hearts, an increase in left ventricular pressure and coronary flow was obtained, while at the same time, the duration of the refractory period was prolonged.<sup>[11]</sup> This combination

<sup>\*</sup>WS<sup>®</sup> 1442 is a registered trademark.

of effects was unique among inotropic drugs, as epinephrine, amrinone, milrinone, and digoxin shortened the effective refractory period in a concentration-dependent manner.

In guinea pig papillary muscles, LI 132 was observed to significantly increase action potential duration and time required for recovery of the maximum upstroke velocity of the action potential. These effects indicate class III and class I antiarrhythmic effects, respectively.<sup>[12]</sup> Using the patch-clamp technique, the researchers who conducted this experiment subsequently obtained evidence that the prolongation of the action potential duration in isolated guinea pig ventricular myocytes is due to a weak blockade of both the delayed and the inward rectifier potassium current.<sup>[12]</sup> These investigators also attempted to get information on the mechanism responsible for the positive inotropic action of LI 132. As no influence on the L-type calcium current was detected, an inhibition of phosphodiesterase or a  $\beta$ -sympathomimetic action, which had previously been proposed to account for the cardiogenic action of hawthorn extracts, can be excluded.

In vivo, antiarrhythmic effects of *Crataegus* extract WS 1442 were investigated in a rat model of ischemia/reperfusion-induced arrhythmia. Oral treatment for 7 days (100 mg/kg/day) effectively protected animals from reperfusion-induced arrhythmias, mortality, and hypotensive crisis following 7 min of occlusion of the left coronary artery. Treatment with the extract, however, did not modify the elevated plasma creatine kinase concentrations during reperfusion.<sup>[19]</sup>

The influence of intake of a diet containing 2% LI 132 for 3 mo on the incidence of reperfusion arrhythmias was also studied ex vivo in isolated rat hearts after global no-flow ischemia. Depending on the duration of ischemia, the average prevalence of malignant arrhythmias was significantly reduced by up to 83% in hearts of treated animals.<sup>[20]</sup> However, in a recent publication, no protection against reperfusion-induced arrhythmias in isolated hearts was reported after 8 weeks' treatment (0.5 g/kg/day) of Wistar rats with LI 132.<sup>[21]</sup>

### Cardioprotective Effects

Besides protecting against arrhythmias, hawthorn extracts have also been shown to prevent the leakage of intracellular enzymes upon ischemic injury. For this investigation, male Wistar rats were fed for 3 mo with a diet containing 2% *Crataegus* extract LI 132. As an index of myocardial cell damage, the concentration of lactate dehydrogenase (LDH) was determined in the perfusate of the isolated heart. LDH activity increased slightly during occlusion of the left coronary artery and was elevated dramatically after reperfusion.

However, in treated animals, LDH release was suppressed significantly (control:  $3795 \pm 512$  mU/min; LI 132:  $1777 \pm 452$  mU/min).<sup>[22]</sup>

Fractionation of WS 1442 established that its cardioprotective effect is almost exclusively due to its standardized content of 18.75% OPC. A subfraction of WS 1442 enriched for OPCs was found to exert potent antioxidative action and to inhibit the enzymatic activity of neutrophil elastase.<sup>[23]</sup> Since restoration of blood flow into a previously ischemic tissue is associated with the formation of oxygen free radicals as well as the accumulation and activation of leukocytes, it has been suggested that these activities may contribute to protection against reperfusion injury.

Since ischemia lasting for more than 20–30 min causes irreversible tissue damage and cell death, Veveris, Koch, and Chatterjee<sup>[24]</sup> now evaluated whether treatment of rats with WS 1442 also improves cardiac function and prevents myocardial infarction during prolonged ischemia and reperfusion lasting for 240 and 15 min, respectively. Oral administration of WS 1442 (10 or 100 mg/kg/day) for 7 days before ligation of the left coronary artery dose-dependently suppressed the decrease of the pressure rate product. Treatment also attenuated the elevation of the ST segment in the ECG, diminished the incidence of ventricular fibrillations, and reduced the mortality rate. Furthermore, the area of myocardial infarction within the ischemic zone was significantly smaller in treated rats when compared with controls. It is suggested that these pharmacological effects are accounted for by the combined antioxidative, leukocyte elastase-inhibiting, and endothelial NO synthesis-enhancing properties of WS 1442.

### Other Pharmacological Activities

Koch and Chatterjee<sup>[25]</sup> investigated the effects of WS 1442 in a rat model of endotoxin shock, in which the observed cardiovascular pathologies are suggested to be mediated by an excessive formation of oxygen-derived free radicals and enhanced production of NO by inducible NO synthase. Oral treatment (100 mg/kg) 1 hr before injection of endotoxin significantly inhibited the endotoxin-induced deterioration of cardiac output and prevented an increase in peripheral resistance. As WS 1442 had no effect on heart rate and mean arterial blood pressure, the increased cardiac output in treated animals appears to be due to improved ventricular diastolic filling and/or enhanced myocardial contractility. The beneficial effects of WS 1442 in endotoxin shock may also be related to its positive effects on endothelial NO synthesis and/or its antioxidative properties.

Platelet-derived growth factor (PDGF) has been reported to play an important role in the pathogenesis

of atherosclerosis as well as restenosis after angioplasty. Since polyphenols have been reported to inhibit tyrosine phosphorylation of the PDGF receptor beta (PDGFR- $\beta$ ) and *Crataegus* extracts are rich in these constituents, the effect of WS 1442 on the PDGF signal transduction pathway and neointimal formation were investigated in a rat balloon angioplasty model. WS 1442 concentration-dependently inhibited phosphorylation of the human PDGFR- $\beta$  (IC<sub>50</sub> 1.4  $\mu$ g/ml). In PDGF-stimulated NIH3T3 fibroblasts, auto phosphorylation of PDGFR- $\beta$  and DNA synthesis were suppressed half-maximally at concentrations of 31 and 3.1  $\mu$ g/ml, respectively. Oral treatment (300 mg/kg) of rats from day 2 before to day 13 after carotid artery balloon angioplasty significantly reduced neointimal formation and increased the luminal area in parallel. These results provide evidence that WS 1442 may also have therapeutic potential for the prevention of restenosis in humans.<sup>[26]</sup>

Hypocholesterolemic activity of different hawthorn extracts has been reported by two research teams. In one study, rats fed with an atherogenic diet were treated for 6 weeks with a tincture prepared from the fruits of *C. oxyacantha*. In the treated animals, the total as well as the low-density-, very-low-density-, and high-density-lipoprotein (LDL-, VLDL-, and HDL)-cholesterol concentrations were significantly reduced. Detailed investigations revealed that application of the tincture enhanced cholesterol uptake into the liver by an elevated expression of LDL receptors. However, accumulation of cholesterol in the liver was prevented by suppression of cholesterol biosynthesis as well as increased cholesterol degradation.<sup>[27]</sup> The same authors reported that under identical experimental conditions, the tincture reduced lipid peroxidation and precluded atherosclerotic changes in the aorta of treated rats. In addition, decrease of the glutathione and  $\alpha$ -tocopherol content of the liver, aorta, and heart was inhibited.<sup>[28]</sup> The total serum cholesterol and triacylglycerol concentrations were also decreased in hamsters that were fed for 4 weeks with a hypercholesterolemic diet containing an ethanolic extract from the fruits of *C. pinnatifida* (0.5%). Treatment with the extract led to greater excretion of both neutral and acidic sterols. Enzymatic tests indicated that the hypocholesterolemic activity may be mediated by upregulation of hepatic cholesterol-7 $\alpha$ -hydroxylase and downregulation of intestinal acyl-CoA:cholesterol acyltransferase.<sup>[29]</sup>

Other pharmacological effects reported for different hawthorn extracts include stimulation of superoxide dismutase activity in erythrocytes of treated mice,<sup>[30]</sup> inhibition of thromboxane A<sub>2</sub> (TXA<sub>2</sub>) synthesis and a stimulation of prostaglandin I<sub>2</sub> (PGI<sub>2</sub>) production,<sup>[31]</sup> and inhibition of angiotensin converting enzyme.<sup>[32]</sup>

## Pharmacokinetics

The absorption and distribution of <sup>14</sup>C-labeled catechins tri- and higher polymeric procyanidins, and OPC total fraction have been determined in mice after oral administration. Total radioactivity was measured in blood and different organs without determination of individual metabolites. As early as 1 hr after oral administration, absorption of radioactivity could be detected for all labeled substances. The absorption rate for the OPC total fraction was about 31%, and those for individual substances ranged from 16% to 40%. The accumulation of radioactivity was higher after repeated oral administration than after a single dose.<sup>[33]</sup>

## TOXICOLOGY

Doses of up to 3000 mg/kg of WS 1442 were given to rats and mice by the oral route without any sign of toxicity. Following intraperitoneal injection, LD<sub>50</sub> values of 1170 and 750 mg/kg were calculated in mice and rats, respectively. No abnormalities in the general state of health as well as clinical, chemical, hematological, gross morphological, and histological findings were observed after oral treatment of rats and dogs at doses of 30, 90, or 300 mg/kg/day for 26 weeks. Similarly, in a battery of genotoxicity assays, no evidence of mutagenic or clastogenic action was obtained.<sup>[34]</sup> While reports on carcinogenicity studies with *Crataegus* extracts are not available, animal as well as clinical and postmarketing surveillance studies do not indicate any carcinogenic potential.

Oral application of WS 1442 at doses up to 1600 mg/kg body weight to rats and rabbits did not induce teratogenic effects. Furthermore, this extract affected neither the peri- and postnatal development nor the fertility of treated male and female rats and their F1 descendants (Schlegelmilch, personal communication).

## INDICATIONS AND USAGE

Hawthorn extracts from leaves and flowers are recommended as an oral treatment option for chronic heart failure (CHF),<sup>[35]</sup> e.g., declining cardiac performance corresponding to functional stage II of the New York Heart Association (NYHA).<sup>[1,5,6,36]</sup> Stage II NYHA heart failure is characterized by freedom from symptoms at rest and a slight limitation of physical activity; ordinary physical activity results in fatigue, palpitations, dyspnea, or anginal pain. The majority of clinical studies have been performed with standardized

hydroalcoholic extracts of hawthorn leaves and flowers (extract designations WS 1442, LI 132) (Table 1).

In mainly placebo-controlled, double-blind studies, a statistically significant reduction in subjective discomfort and an improvement in cardiac performance due to an increase in left ventricular ejection fraction (LVEF), more efficient cardiac work (reduction in pressure–rate product), and an increase in physical stress tolerance (increase in exercise tolerance, elevation of anaerobic threshold) have been demonstrated in CHF NYHA II patients treated with hawthorn extracts.<sup>[35,36]</sup>

In a placebo-controlled, double-blind study of 40 patients with CHF NYHA II resulting from coronary heart disease, an increase in LVEF of approximately 1.5%, measured during bicycle ergometric loading, was found with WS 1442 (daily dose 480 mg p.o.; 4 weeks), whereas the LVEF in the placebo group dropped by around 0.2% ( $p = 0.0002$ ). At rest, the LVEF increased by about 2.5% with WS 1442 and decreased by about 0.3% with placebo ( $p = 0.0001$ ).<sup>[37]</sup> In another placebo-controlled, double-blind study of 136 patients with CHF NYHA II, WS 1442 (daily dose 160 mg; 8 weeks) led to a reduction in the pressure–rate products (difference 50 W load vs. resting) of approximately 6.2, whereas no effect was observed with placebo ( $p = 0.018$ ).<sup>[38]</sup>

In a double-blind, comparative study of 132 patients with CHF NYHA II, LI 132 (daily dose 900 mg; 7 weeks) was shown to be as effective as the angiotensin-I converting enzyme (ACE) inhibitor captopril (daily dose 37.5 mg; 7 weeks). The work tolerance determined during bicycle exercise increased in the *Crataegus* group from 83 to 97 W, whereas in the captopril group it increased from 83 to 99 W; in both groups, the frequency and severity of the symptoms decreased by about 50%.<sup>[39]</sup>

A recent placebo-controlled, double-blind study of 209 patients with CHF stage NYHA III investigated the efficacy of WS 1442 (daily dose 1800 or 900 mg; 16 weeks) as an add-on therapy to the basic treatment with a diuretic (daily dose 50 mg triamterene/25 mg hydrochlorothiazide). After therapy with 1800 mg WS 1442, the maximal tolerated workload during bicycle exercise showed a statistically significant increase in comparison to both placebo ( $p = 0.013$ ) and 900 mg WS 1442 ( $p = 0.01$ ). Typical heart failure symptoms as rated by the patients were reduced to a greater extent by WS 1442 than by placebo (1800 mg:  $p = 0.004$ ; 900 mg:  $p = 0.04$ ).<sup>[40]</sup>

Table 1 provides an overview of 13 clinical trials on the efficacy of *Crataegus* extracts with a total of 1080 patients, of whom 871 were suffering from CHF NYHA II and 209 from CHF NYHA III. Duration of treatment lasted between 4 and 16 weeks (mean 7.9 weeks). In CHF NYHA II studies performed with

the standardized extract of leaves and flowers (WS 1442, LI 132), the daily doses ranged from 160 to 900 mg extract. In the CHF NYHA III study, daily doses of 900 and 1800 mg WS 1442 were used.

## CONTRAINDICATIONS

Contraindications for the use of hawthorn extracts have not been reported.<sup>[1,5,6]</sup>

## PRECAUTIONS AND ADVERSE REACTIONS

### Precautions

A physician must be consulted in cases where symptoms continue unchanged for longer than 6 weeks or when fluid accumulates in the legs. Medical intervention is absolutely necessary when pain occurs in the region of the heart, spreading out to the arms, upper abdomen, or the area around the neck, or in cases of dyspnea.<sup>[1,5,6]</sup>

### Adverse Effects

Adverse effects of *Crataegus* extracts are not known.<sup>[1,5,6]</sup> In a 16-week placebo-controlled, double-blind study of 209 patients with CHF NYHA III (daily dose 900 or 1800 mg WS 1442 as add-on therapy to pre-existing diuretic treatment), no adverse effects related to the extract were observed, even with the higher daily dose of 1800 mg. The tolerability of the treatment was rated best in the 1800 mg WS 1442 group by both patients and investigators. The incidence of adverse events was also lowest in this group, particularly with respect to dizziness and vertigo. Of the placebo patients, 10% complained of dizziness or vertigo, whereas only 4.3% of the patients treated with 900 mg WS 1442 and 1.4% of those treated with 1800 mg WS 1442 had these complaints.<sup>[40]</sup>

### Drug Interactions

No interactions with other drugs are known to date.

A randomized, crossover trial with 8 healthy volunteers was performed to evaluate the effect of WS 1442 on digoxin pharmacokinetic parameters. Subjects were randomized into one of two groups: digoxin 0.25 mg/day alone for 10 days or digoxin 0.25 mg/day with 900 mg WS 1442/day for 21 days. There were no statistically significant differences in any measured pharmacokinetic parameters. This suggests that WS 1442 and digoxin, in the doses and dosage forms studied, may be coadministered safely.<sup>[41]</sup>

**Table 1** Clinical studies with hawthorn extracts

Author(s) [reference]; type of study	No. of patients/ indication	Daily oral dose and preparation (duration of therapy)	Efficacy
<i>Standardized hydroalcoholic extracts from leaves and flowers<sup>a</sup></i>			
Tauchert; <sup>[40]</sup> double-blind, placebo-controlled (add-on therapy to pre-existing diuretic treatment)	209/NYHA III	<ul style="list-style-type: none"> <li>• 1800 mg WS 1442 + 50 mg triamterene/25 mg hydrochlorothiazide</li> <li>• 900 mg WS 1442 + 50 mg triamterene/25 mg hydrochlorothiazide</li> <li>• Placebo + 50 mg triamterene/25 mg hydrochlorothiazide (16 weeks)</li> </ul>	<p><i>Maximal tolerated workload</i> WS 1442 1800 mg: increase (<math>p = 0.013</math> vs. placebo; <math>p = 0.01</math> vs. 900 mg)</p> <p><i>Symptoms of heart failure and complaints reported by patients</i> WS 1442 1800 mg: decrease in typical symptoms of heart failure (<math>p = 0.004</math> vs. placebo) and in complaints (<math>p = 0.03</math> vs. placebo) WS 1442 900 mg: decrease in typical symptoms of heart failure (<math>p = 0.004</math> vs. placebo) and in complaints (<math>p = 0.03</math> vs. placebo)</p> <p><i>Left ventricular ejection fraction</i> During exercise: WS 1442: +1.5%; placebo: -0.2% (<math>p = 0.0002</math>) At rest: WS 1442: +2.5%; placebo: -0.3% (<math>p = 0.0001</math>)</p> <p><i>Exercise tolerance</i> WS 1442: +10.8%; placebo: -16.9% (<math>p = 0.06</math>)</p> <p><i>Pressure-rate product</i> WS 1442: -26.8% placebo: -2.7%</p> <p><i>Exercise tolerance</i> LI 132: +13 W; placebo: +3 W (<math>p = 0.143</math>)</p> <p><i>Pressure-rate product, symptom score</i> No statistically significant difference between therapy groups</p> <p><i>Exercise tolerance</i> LI 132: +28 W; placebo: +5 W (<math>p &lt; 0.001</math>)</p> <p><i>Pressure-rate product</i> Significant group difference in favor of LI 132 (<math>p &lt; 0.05</math>)</p> <p><i>Symptom score</i> Significant group difference in favor of LI 132 (<math>p &lt; 0.001</math>)</p> <p><i>Ergospirometry</i> LI 132: improved O<sub>2</sub> uptake (<math>p &lt; 0.05</math>), and the anaerobic threshold was reached later (<math>p &lt; 0.05</math>)</p> <p><i>Symptom score</i> LI 132: improvement in 86% of patients; placebo: improvement in 47% of patients (<math>p &lt; 0.01</math>)</p> <p><i>Exercise tolerance</i> LI 132: increase from 83 to 97 W; captopril: increase from 83 to 99 W. No difference between therapy groups</p> <p><i>Pressure-rate product</i> Downwards trend in both therapy groups</p> <p><i>Symptom score</i> Reduction in frequency and severity in both therapy groups by approximately 50%</p>
Eichstaedt et al.; <sup>[37]</sup> double-blind, placebo-controlled	40/NYHA II	480 mg WS 1442 (4 weeks)	
Zapfe G [Phytomedicine 2001, 8 (4), 262–266]; double-blind, placebo-controlled	40/NYHA II	240 mg WS 1442 (12 weeks)	
Boedigheimer K, Chase D [Muench. Med. Wochenschr. 1994, 136 (Suppl. 1), 7–11]; double-blind, placebo-controlled	85/NYHA II	300 mg LI 132 (4 weeks)	
Schmidt U, et al. [Phytomedicine 1994, 7, 17–24]; double-blind, placebo-controlled	78/NYHA II	600 mg LI 132 (8 weeks)	
Foerster A, et al. [Muench. Med. Wochenschr. 1994, 136 (Suppl. 1), 21–26]; double-blind, placebo-controlled	72/NYHA II	900 mg LI 132 (8 weeks)	
Tauchert, Ploch, and Huebner <sup>[39]</sup> ; double-blind, comparison of hawthorn and captopril	132/NYHA II	900 mg LI 132; 37.5 mg captopril (7 weeks)	

(Continued)



Table 1 Clinical studies with hawthorn extracts (Continued)

Author(s) [reference]; type of study	No. of patients/ indication	Daily oral dose and preparation (duration of therapy)	Efficacy
Weigl et al. <sup>[38]</sup> ; double-blind, placebo-controlled	136/NYHA II	160 mg WS 1442 (8 weeks)	<i>Pressure-rate product</i> WS 1442: -6.2; placebo: +0.1 ( $p = 0.018$ ) <i>Main symptoms</i> WS 1442: improvement in 59% of patients; placebo: improvement in 44% of patients ( $p = 0.05$ ) <i>Pressure-rate product</i> WS 1442: -11.6; placebo: -4.9 ( $p < 0.05$ ) <i>Complaints</i> WS 1442: -16.5; placebo: -4 ( $p < 0.05$ ) <i>Left ventricular ejection fraction</i> Increase from 29.8% to 40.4%
Leuchtgens H (Fortschr. Med. 1993, 111, 352-354); double-blind, placebo-controlled	30/NYHA II	160 mg WS 1442 (8 weeks)	
Weigl A, Noh HS (Herz GefäÙsse 1992, 11, 516-524); open	7/NYHA III	240 mg WS 1442 (4 weeks)	
Eichstaedt H, et al. (Therapiewoche 1989, 39, 3288-3296); open	20/NYHA II	480 mg WS 1442 (4 weeks)	<i>Left ventricular ejection fraction</i> During exercise: +5.05% At rest: +3.32% <i>Exercise tolerance</i> : +10% <i>Subjective condition</i> Improvement in 65% of patients according to the patients themselves and in 75% according to the doctor
<i>Extracts from fresh berries</i>			
Degenring FH, et al. (Phytomedicine 2003, 10, 363-369); double-blind, placebo-controlled	143/NYHA II	3 × 30 drops ethanolic (49% v/v) extract of fresh berries (drug-extract ratio 1 : 3.2) (8 weeks)	<i>Exercise tolerance</i> Difference between the treatment groups: 8.3 W in favour of the extract ( $p = 0.045$ ) <i>Pressure-rate product, cardiac symptoms</i> No statistically significant difference between the treatment groups <i>Total exercise time</i> Extract: increase of 38.9 sec vs. placebo <i>Minnesota Questionnaire total score</i> Extract: decrease from 44.1 to 30.6 (31%); placebo: decrease from 42.4 to 34.6 (18%) <i>Dyspnea-Fatigue Index total score</i> Extract: increase from 8.37 to 9.41 (12%); placebo: increase from 8.26 to 8.92 (8%) <i>Dyspnea (visual analog scale)</i> Extract: decrease from 56.6 to 50.5 mm (11%); placebo: decrease from 57.3 to 54.8 mm (4%)
Rietbroek N, et al. (Arzneimittel-Forschung 2001, 51, 793-798); double-blind, placebo-controlled	88/NYHA II	3 × 25 drops ethanolic (60% v/v) extract of fresh berries (drug-extract ratio 1 : 1.3-1.5) (12 weeks)	

<sup>a</sup>WS 1442: standardized to contain 18.75% oligomeric procyanidins; LI 132: standardized to contain 2.2% flavonoids.

In a placebo-controlled, double-blind study of patients with CHF NYHA III, no interactions were seen between WS 1442 (daily dose 900 or 1800 mg) and a diuretic used as basic medication (combination triamterene/hydrochlorothiazide).<sup>[40]</sup>

## OVERDOSAGE

Symptoms of overdosage have not been reported.

## CONCLUSIONS

Extracts from different parts of *Crataegus* species are used commonly throughout the world as herbal remedies for the treatment of mild forms of heart insufficiency. The majority of pharmacological, toxicological, and clinical studies have been performed with standardized hydroalcoholic extracts from leaves and flowers (WS 1442, LI 132). These extracts have been demonstrated to possess cardiogenic as well as cardio-protective activities. Clinical trials, many of them conducted in accordance with the highest standards of good clinical practice, have confirmed that these extracts can be used as an alternative in early CHF and as an adjunct in the therapy of later stages of chronic heart failure. The evidence for the efficacy and safety of other hawthorn preparations needs to be evaluated on a case-by-case basis. Promising results from pharmacological studies on vasoprotective effects of hawthorn extracts warrant further clinical trials in the prophylaxis and treatment of other cardiovascular diseases.

**Table 2** Regulatory status of hawthorn

Australia	Listed in Australian Register of Therapeutic Goods
Austria	Authorized as prescription (Rx) or over-the-counter (OTC) drug
Belgium	Authorized as OTC drug
Canada	Available without restriction; not suitable for self-medication of cardiac diseases
Denmark	Authorized as herbal medicinal product
France	Authorized as traditional herbal medicine
Germany	Authorized as OTC drug
Poland	Authorized as OTC drug
Switzerland	Authorized as OTC drug
United Kingdom	Not included in general sales list
United States	Regulated as dietary supplement

**Table 3** Compendial status of hawthorn

European Pharmacopoeia	Hawthorn leaf and flower, 2003 Hawthorn leaf and flower dry extract, 2003 Hawthorn fruits, 2003
British Pharmacopoeia	Hawthorn fruits, 1998
U.S. Pharmacopoeia–National Formulary	Hawthorn leaf with flower, 2003 Powdered hawthorn leaf with flower, 2003
American Herbal Pharmacopoeia	Hawthorn leaf with flower, 1999
ESCOP monograph	Hawthorn leaf and flower, 1999
WHO monograph	Folium cum Flore Crataegi, 2001

## COMPENDIAL/REGULATORY STATUS

The regulatory and compendial status of hawthorn are summarized in Tables 2 and 3.

## REFERENCES

1. *Crataegi cum Flore (Hawthorn Leaf and Flower)*; ESCOP Monographs on the Medicinal Uses of Plant Drugs; European Scientific Cooperative on Phytotherapy, October 1999, Fascicule 6, 1–11 (ISBN 1-9019604-06-X).
2. Upton, R. *Hawthorn Leaf with Flower—Crataegus spp. Analytical, Quality Control, and Therapeutic Monograph*; American Herbal Pharmacopoeia and Therapeutic Compendium (Series 1), 1999; 1–29.
3. Blumenthal, M. *The ABC Clinical Guide to Herbs*; American Botanical Council: Austin, TX, 2003.
4. Wagner, H.; Elbl, G.; Lotter, H.; Guinea, M. Evaluation of natural products as inhibitors of angiotensin-I-converting enzyme (ACE). *Pharm. Pharmacol. Lett.* **1991**, *1*, 15–18.
5. *Folium cum Flore Crataegi*. WHO Monographs on Selected Medicinal Plants. World Health Organization: Geneva, 2002; 66–82.
6. Hawthorn leaf with flower. In *The Complete German Commission E Monographs*; Blumenthal, M., Busse, W., Goldberg, A., Gruenwald, J., Hall, T., Riggins, C.W., Rister, R.S., Eds.; Integrative Medicine Communications: Boston, 1998; 142–144.
7. Poepping, S.; Rose, H.; Ionescu, I.; Fischer, Y.; Kammermeier, H. Effect of a hawthorn extract on contraction and energy turnover of isolated

- rat cardiomyocytes. *Arzneimittel-Forschung Drug Res.* **1995**, *45*, 1157–1161.
8. Siegel, G.; Casper, U.; Schnalke, F.; Hetzer, R. Molecular physiological effector mechanisms of hawthorn extract in cardiac papillary muscle and coronary vascular smooth muscle. *Phytother. Res.* **1996**, *10*, S195–S198.
  9. Schwinger, R.H.G.; Pietsch, M.; Frank, K.; Brixius, K. *Crataegus* special extract WS<sup>®</sup> 1442 increases force of contraction in human myocardium cAMP-independently. *J. Cardiovasc. Pharmacol.* **2000**, *35*, 700–707.
  10. Schmidt-Schweda, S.; Burstin, J.V.; Möllmann, H.; Wollner, S.; Holubarsch, Ch. Der positiv inotrope Effekt des *Crataegus* Spezialextrakts WS<sup>®</sup> 1442 in isolierten Myozyten aus menschlichem Vorhof- und Ventrikelmuskard wird vorwiegend durch oligomere Procyanidine vermittelt. *Z. Kardiologie* **2000**, *98* (Suppl.), 164
  11. Joseph, G.; Zhao, Y.; Klaus, W. Pharmakologisches Wirkprofil von *Crataegus*-Extrakt im Vergleich zu Epinephrin, Amrinon, Milrinon und Digoxin am isoliert perfundierten Meerschweinchenherzen. *Arzneimittel-Forschung/Drug Res.* **1995**, *45*, 1261–1265.
  12. Müller, A.; Linke, W.; Zhao, Y.; Klaus, W. *Crataegus* extract prolongs action potential duration in guinea-pig papillary muscle. *Phyto-medicine* **1996**, *3*, 257–261.
  13. Koch, E.; Chatterjee, S.S. *Crataegus* extract WS<sup>®</sup>-1442 enhances coronary flow in the isolated rat heart by endothelial release of nitric oxide. *Naunyn-Schmiedeberg's Arch. Pharmacol.* **2000**, *361* (Suppl.), R48.
  14. Chen, Z.Y.; Zhang, Z.S.; Kwan, K.Y.; Zhu, M.; Ho, W.K.K.; Huang, Y. Endothelium-dependent relaxation induced by hawthorn extracts in rat mesenteric artery. *Life Sci.* **1998**, *63*, 1983–1991.
  15. Kim, S.H.; Kang, K.W.; Kim, K.W.; Kim, N.D. Procyanidins in *Crataegus* extract evoke endothelium-dependent vasorelaxation in rat aorta. *Life Sci.* **2000**, *67*, 121–131.
  16. Vierling, W.; Brand, N.; Gaedcke, F.; Sensch, K.H.; Schneider, E.; Scholz, M. Investigation of the pharmaceutical and pharmacological equivalence of different hawthorn extracts. *Phyto-medicine* **2003**, *10*, 8–16.
  17. Mävers, W.H.; Hensel, H. Veränderungen der lokalen Myokarddurchblutung nach oraler Gabe eines *Crataegus*extraktes bei nichtnarkotisierten Hunden. *Arzneimittel-Forschung/Drug Res.* **1974**, *24*, 783–785.
  18. Ernst, F.D.; Reuther, G.; Walper, A. Hämodynamische und hämorheologische Wirkungen von *Crataegus*-Extrakt. *Muench. Med. Wochenschr.* **1994**, *1/136*, 57–60.
  19. Krzeminski, T.; Chatterjee, S.S. Ischemia and reperfusion induced arrhythmias: beneficial effects of an extract of *Crataegus oxyacantha* L. *Pharm. Pharmacol. Lett.* **1993**, *3*, 45–48.
  20. Al Makdessi, S.; Sweidan, H.; Dietz, K.; Jacob, R. Protective effect of *Crataegus oxyacantha* against reperfusion arrhythmias after global no-flow ischemia in the rat heart. *Basic Res. Cardiol.* **1999**, *94*, 71–77.
  21. Rothfuß, M.A.; Pascht, U.; Kissling, G. Effect of long-term application of *Crataegus oxyacantha* on ischemia and reperfusion induced arrhythmias in rats. *Arzneimittel-Forschung/Drug Res.* **2001**, *51*, 24–28.
  22. Al Makdessi, S.; Sweidan, H.; Müller, S.; Jacob, R. Myocardial protection by pretreatment with *Crataegus oxyacantha*. *Arzneimittel-Forschung/Drug Res.* **1996**, *46*, 25–27.
  23. Chatterjee, S.S.; Koch, E.; Jaggy, H.; Krzeminski, T. In-vitro- und in-vivo-Untersuchungen zur kardioprotektiven Wirkung von oligomeren Procyanidinen in einem *Crataegus*-Extrakt aus Blättern mit Blüten. *Arzneimittel-Forschung Drug Res.* **1997**, *47*, 821–825.
  24. Veveris, M.; Koch, E.; Chatterjee, S.S. *Crataegus* special extract WS<sup>®</sup> 1442 improves cardiac function and reduces infarct size in a rat model of prolonged coronary ischemia and reperfusion. *Life Sci.* **2004**, *74*, 1945–1955.
  25. Koch, E.; Chatterjee, S.S. *Crataegus* extract WS<sup>®</sup> 1442 compensates the decrease of cardiac output in endotoxemic rats. *Eur. Cytokine Network* **2000**, *11*, 527
  26. Koch, E.; Spörl-Aich, G.; Zirrgiebel, U.; Trotzke, F. Inhibition of PDGF receptor-beta signal transduction and intimal hyperplasia in a rat carotid artery balloon angioplasty model by oral treatment with the standardized *Crataegus* extract WS<sup>®</sup> 1442. *Naunyn-Schmiedeberg's Arch. Pharmacol.* **2004**, *369*, R96.
  27. Rajendran, S.; Deepalakshmi, P.D.; Parasakthy, K.; Devaraj, H.; Devaraj, S.N. Effect of tincture of *Crataegus* on the LDL-receptor activity of hepatic plasma membrane of rats fed an atherogenic diet. *Atherosclerosis* **1996**, *123*, 235–241.
  28. Shanthi, R.; Parasakthy, K.; Deepalakshmi, P.D.; Niranjali, D.S. Protective effect of tincture of *Crataegus* on oxidative stress in experimental atherosclerosis in rats. *J. Clin. Biochem. Nutr.* **1996**, *20*, 211–223.
  29. Zhang, Z.; Ho, W.K.K.; Huang, Y.; Chen, Z.Y. Hypocholesterolemic activity of hawthorn fruit is mediated by regulation of cholesterol-7 $\alpha$ -hydroxylase and acyl CoA : cholesterol acyltransferase. *Food Res. Int.* **2002**, *35*, 885–891.

30. Dai, Y.R.; Gao, C.M.; Tian, Q.L.; Yin, Y. Effect of extracts of some medicinal plants on superoxide dismutase activity in mice. *Planta Med.* **1987**, *53*, 309–310.
31. Vibes, J.; Lasserre, B.; Gleye, J. Effect of a methanolic extract from *Crataegus oxyacantha* blossoms on TXA2 and PGI2 synthesising activities of cardiac tissue. *Med. Sci. Res.* **1993**, *21*, 435–436.
32. Lacaille-Dubois, M.A.; Franck, U.; Wagner, H. Search for potential angiotensin converting enzyme (ACE)-inhibitors from plants. *Phyto-medicine* **2001**, *81*, 47–52.
33. Hecker-Niediek, A.E. *Untersuchungen zur Biogenese, Markierung und Pharmakokinetik der Procyanidine aus Crataegus-Spezies*. Marburg University: Marburg, 1983 (dissertation).
34. Schlegelmilch, R.; Heywood, R. Toxicity of *Crataegus* (hawthorn) extract (WS<sup>®</sup> 1442). *J. Am. Coll. Toxicol.* **1994**, *13*, 103–111.
35. Pittler, M.H.; Schmidt, K.; Ernst, E. Hawthorn extract for treating chronic heart failure: meta-analysis of randomized trials. *Am. J. Med.* **2003**, *114*, 665–674.
36. Loew, D. Phytotherapy in heart failure. *Phyto-medicine* **1997**, *4*, 276–271.
37. Eichstaedt, H.; Stoerk, T.; Moeckel, M.; Danne, O.; Funk, P.; Koehler, S. Wirksamkeit und Verträglichkeit von *Crataegus*-Extrakt WS<sup>®</sup> 1442 bei herzinsuffizienten Patienten mit eingeschränkter linksventrikulärer Funktion. *Perfusion* **2001**, *14*, 212–217.
38. Weigl, A.; Assmus, K.D.; Neukum-Schmidt, A.; Schmitz, J.; Zapfe, G.; Noh, H.S.; Siegrist, J. *Crataegus*-Spezialextrakt WS<sup>®</sup> 1442. Objektiver Wirksamkeitsnachweis bei Patienten mit Herzinsuffizienz (NYHA II). *Fortschr. Med.* **1996**, *114*, 291–296.
39. Tauchert, M.; Ploch, M.; Huebner, W.-D. Wirksamkeit des Weissdorn-Extraktes LI 132 im Vergleich mit Captopril. *Muench. Med. Wochenschr.* **1994**, *1* (Suppl.), 27–33.
40. Tauchert, M. Efficacy and safety of *Crataegus* extract WS<sup>®</sup> 1442 in comparison with placebo in patients with chronic stable New York Heart Association class-III heart failure. *Am. Heart J.* **2002**, *143*, 910–915.
41. Tankanow, R.; Tamer, H.R.; Streetman, D.S.; Smith, S.G.; Welton, J.L.; Annesley, T.; Aaronson, K.D.; Bleske, B.E. Interaction study between digoxin and a preparation of hawthorn (*Crataegus oxyacantha*). *J. Clin. Pharmacol.* **2003**, *43*, 637–642.



# 5-Hydroxytryptophan

**Pedro Del Corral**

**Karel Pacak**

*Clinical Neuroendocrinology Unit, Pediatric Reproductive Endocrinology Branch, National Institutes of Child Health and Human Development, National Institutes of Health, Bethesda, Maryland, U.S.A.*

## INTRODUCTION

5-Hydroxytryptophan (5-HTP) is the immediate precursor for the neurotransmitter, serotonin. It is available for purchase over the counter in food supplement stores and via the internet. Because 5-HTP crosses the blood–brain barrier and readily converts to serotonin, it is thought that 5-HTP may be taken orally to boost serotonin levels. Hence, the precursor may be used to modulate physiological processes mediated by serotonin (see Fig. 1). 5-HTP is produced commercially by extraction from the seeds of *Griffonia simplicifolia*, an African plant, and as of the Fall of 2003, it was sold in the United States for ~US\$ 14–16 for 45–60 capsules of 50 mg. The entry will review the literature on 5-HTP; particular interest will be on studies performed on humans using 5-HTP for therapeutic purposes. Trials using animal models will be referenced when no available information was found in human studies.

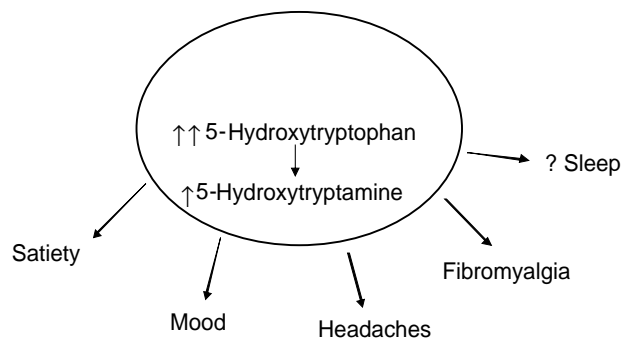
This article gives an overview of pharmacokinetics and metabolism of 5-HTP; then it covers several clinical areas in which 5-HTP has been suggested to be at least partially therapeutic. First, we discuss studies on depression, from the early studies of the 1960s, which provided the first indications that 5-HTP could have an antidepressant property to a meta-analysis published in 2002. The use of combination/augmentation therapy (5-HTP + antidepressants) will also be addressed. Second, we study the utilization of 5-HTP for its purported anorectic effect and potential application in obese individuals. Third, we examine the use of 5-HTP in several neurological disorders including different kinds of headaches, and its controversial use in

cerebellar ataxias. Fourth, we assess the side effect profile of 5-HTP, its frequency, severity, and duration, including the infrequent but potentially lethal condition, eosinophilia-myalgia syndrome. The entry ends with a summary and recommendations on the use of 5-HTP.

## PHARMACOKINETICS AND METABOLISM

5-Hydroxytryptophan is the immediate precursor for 5-hydroxytryptamine (serotonin) synthesis (see Fig. 2). Serotonin does not cross the blood–brain barrier. Therefore, the neuronal availability of serotonin is highly dependent on tryptophan uptake, which uses a transporter to cross the blood–brain barrier to get intracellular access before it is metabolized by tryptophan hydroxylase, the rate limiting step to produce serotonin from 5-HTP. Importantly, this is a saturable process in which tryptophan competes with other amino acids, suggesting that their elevated levels could inhibit/diminish tryptophan transport rates into the neuron. Conversely, it may be taken as a dietary supplement, which does not require a transporter system, and crosses the blood–brain barrier. Studies in rodents indicate that ~7% of <sup>14</sup>C labeled 5-HTP from the arterial circulation is extracted by the brain.<sup>[1]</sup>

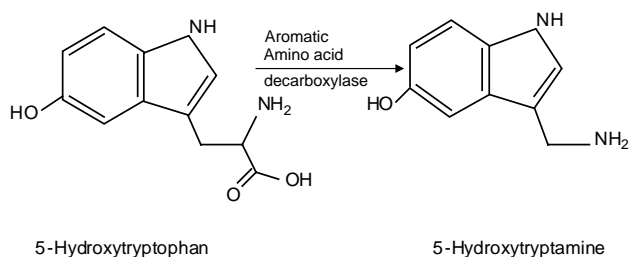
Following 5-HTP administration, a dose-dependent serotonin release that could last for more than 2 hr



**Fig. 1** Possible therapeutic uses of 5-HTP in clinical medicine.

*Pedro Del Corral, Ph.D., M.D., is at the Clinical Neuroendocrinology Unit, Pediatric Reproductive Endocrinology Branch, National Institutes of Child Health and Human Development, National Institutes of Health, Bethesda, Maryland, U.S.A.*

*Karel Pacak, M.D., D.Sc., is at the Clinical Neuroendocrinology Unit, Pediatric Reproductive Endocrinology Branch, National Institutes of Child Health and Human Development, National Institutes of Health, Bethesda, Maryland, U.S.A.*



**Fig. 2** Chemical structure of 5-hydroxytryptophan and conversion to 5-hydroxytryptamine.

after administration has been reported.<sup>[2,3]</sup> Subsequent to oral intake of 5-HTP, the peak plasma concentration is observed at 2–3 hr, and the bioavailability is ~50–70%.<sup>[4,5]</sup> The former may be substantially increased by pretreatment with carbidopa, a peripheral aromatic amino acid decarboxylase inhibitor. For example, a single dose of 5-HTP with carbidopa resulted in a 15-fold higher plasma peaks than did 100 mg without carbidopa,<sup>[5–7]</sup> suggesting that if carbidopa is coadministered with 5-HTP, smaller doses of the later may be used. Additionally, subject-to-subject variability in 5-HTP plasma half-life ranges from 2½ to 7 hr after a single dose of 200 mg.<sup>[5]</sup>

Little is known about intracerebral 5-HTP and the effects of carbidopa on brain concentration of 5-HTP in humans. The development of positron emission tomography (PET) and new tracers has emerged as the dominant methodology to assess neurotransmission in humans. In the early 1990s, Ågren et al.<sup>[8]</sup> at Uppsala University, Sweden, were the first to use PET and demonstrate <sup>11</sup>C-labeled 5-HTP uptake across the blood–brain barrier in eight healthy volunteers, with most of the tracer accumulating in the striatum and in the prefrontal cortex. The authors suggested that after intravenous injection, <sup>11</sup>C-5-HTP crosses through the blood–brain barrier by a simple diffusion mechanism prior to subsequent decarboxylation to <sup>11</sup>C-serotonin. In a subsequent study, the same investigators<sup>[9]</sup> showed that administration of the peripheral L-aromatic amino acid decarboxylase (AADC) inhibitor benzeride is an efficient method to raise levels of intracerebral 5-HTP uptake.

## CLINICAL USE OF 5-HTP

### Obesity

It has been long known that brain serotonin systems contribute to the modulation of food intake and satiety.<sup>[10]</sup> An increase of intrasynaptic serotonin tends to reduce food consumption. Thus, one might consider that individuals taking 5-HTP might experience increase satiety and weight loss over a period of time.

There are few studies on the effects of 5-HTP on obesity, and they suggest an anorectic effect of 5-HTP.<sup>[11–13]</sup>

For instance, a 5-week, double blind, crossover study, without any dietary modification, found that oral administration of 300 mg of 5-HTP before meals (i.e., 900 mg/day) led to mild decrease of food intake and weight loss in obese subjects.<sup>[11]</sup> A second study<sup>[12]</sup> from the same group followed obese patients for 6 weeks while treated with placebo or the same 5-HTP dose + no dietary restriction, followed by an additional 6 weeks in which the patients continued placebo or 5-HTP treatment plus dietary restriction diet of 1200 cal. The cohort receiving 5-HTP during the first 6 weeks experience a small but significant weight loss compared with the group receiving placebo. However, during the second 6 weeks, the patients on 5-HTP experienced further weight loss compared with first 6 weeks and the placebo group plus dietary restriction. Food records indicated that subjects on 5-HTP reduced their carbohydrate intake by about 50% by the end of the first 6 weeks, and a questionnaire revealed that early satiety was reported by 100% and 90% of the patients receiving 5-HTP during the first 6 weeks and the second 6 weeks, respectively. Nausea was reported by 80% of the treatment group during the first 6 weeks and 20% during the second 6 weeks. The authors argued that the episodic nausea was unlikely to have been a major contributor to weight loss since it declined substantially over time as the weight reduction was enhanced.

The authors suggested that optimal adherence to dietary prescription observed in these patients receiving 5-HTP resulted in early satiety and reduced carbohydrate intake.<sup>[12]</sup> In a third study,<sup>[13]</sup> this group extended their findings to noninsulin dependent overweight diabetics. The authors postulated that low brain serotonin levels may contribute to excess energy intakes of diabetic patients. Importantly, this study was only 2 weeks long and based on their previous studies, one might wonder whether there would have been further benefits with an additional 4–6 weeks. Thus, it remains to be established whether longer periods of time would lead to greater weight loss and declines in glycosylated hemoglobin.

### Depression

The hypothesis that 5-HTP was involved in the pathogenesis of depression was based on observations of lowered concentrations of 5-hydroxyindoleacetic acid (5-HIAA, a metabolite of serotonin) in cerebrospinal fluid of depressed patients. Therefore, it seemed reasonable to consider that exogenous administration of 5-HTP could increase endogenous brain serotonin synthesis, presumably boosting synaptic serotonin

activity.<sup>[14]</sup> Its use in depression has been studied for at least 40 yr.<sup>[15,16]</sup> Initial success was reported in treating some depressed patients with small amounts of intravenous 5-HTP combined with a monoamine inhibitor. However, in a subsequent study, these results were not replicated.

Preliminary data collected during the 1960s and 1970s showed some evidence suggesting a possible antidepressant effect. There were a few well-conducted studies in the following years. Van Praag et al.<sup>[17]</sup> published the results of the first double blind placebo controlled study of 5-HTP in depressed patients. Three out of five patients responded compared to zero out of five receiving placebo. In an open label study, Sano<sup>[18]</sup> administered 5-HTP (50–300 mg) to 107 depressed individuals and found 70% response rate, suggesting beneficial effects in the treatment group. Other studies (see Ref.<sup>[14]</sup> for review) were plagued by methodological issues, such as low number of patients, lack of adequate controls, including placebo treatment, and coadministration of other antidepressant agents, such as monoamine oxidase inhibitors. During the 1980s, Van Praag and de Haan<sup>[19]</sup> reported that 200 mg of oral 5-HTP given with 150 mg of carbidopa was more effective than placebo in preventing relapses in formerly depressed unipolar and bipolar patients during a 12-mo period. Specifically, during placebo treatment, 17/20 patients experienced relapse compared with 6/20 taking 5-HTP. The authors concluded that 5-HTP plus a peripheral decarboxylase inhibitor may be an effective prophylactic agent to prevent recurrent depression in unipolar and bipolar patients.

Van Hiele<sup>[20]</sup> performed a clinical study of 5-HTP (50–600 mg dosing, mean was 200 mg) plus 150 mg of carbidopa in 99 depressed patients who had previously failed to respond to psychotherapy, tricyclics, lithium, and electroconvulsive therapy. During the experimental period, many of the patients continued treatment with tricyclics, lithium, or other neuroleptics. Although the author reported that 51% of the patients underwent partial or complete recovery, it is not possible to know whether the recovery from depression was due to the experimental treatment or to the combination with the agents the patients were already taking before the study. Interestingly, the author stated that some of the responders had been followed on 5-HTP and peripheral decarboxylase inhibitor for up to 3 yr.

In a recent review of the literature, most studies of the 1980s were short in duration, had small sample sizes, and used a wide range of oral doses from 200 to 3000 mg/day.<sup>[21]</sup> Despite these limitations, a careful evaluation of the literature reviewed by several investigators suggests a 25–50% efficacy of 5-HTP in alleviating depression.<sup>[14,21,22]</sup> The treatment response does not appear to be dose (100–300 mg/day) dependent, and there is no evidence that the use of decarboxylase

inhibitor increased the efficacy of 5-HTP.<sup>[20–22]</sup> A recent meta-analysis reviewed the literature on 5-HTP and depression from 1966 to 2000.<sup>[23]</sup> The authors found that 5-HTP was more effective than placebo at alleviating depression. In this review, a large body of evidence was subjected to very basic criteria for assessing reliability and validity, and was found to be largely of insufficient quality to inform clinical practice. The small size of the studies and the large number of inadmissible, poorly executed trials cast doubt on the result from potential publication bias, and suggest that they are insufficiently evaluated to assess their effectiveness. The authors suggested that well-designed studies are required before the true efficacy of 5-HTP is known.

Less is known about the pathophysiological mechanisms by which serotonin synthesis is reduced in depression. Several investigators have examined whether brain 5-HTP uptake in depression is different from that in healthy controls.<sup>[8]</sup> The PET study showed that 5-HTP uptake across the blood–brain barrier was about 30% lower in depressed patients compared with that in healthy volunteers. This study described lower 5-HTP uptake in depressed patients, but the nature of this anomaly remains elusive. Although one might consider 5-HTP to mediate its effects through serotonin, there is evidence hinting to the possible stimulation of dopaminergic activity. For instance, Takahashi, Kondo, and Kato<sup>[24]</sup> administered 300 mg of oral 5-HTP daily for 2 weeks to 24 depressed patients, and CSF 5-HIAA and HVA levels were measured. The authors reported significant increases in CSF 5-HIAA in responders and nonresponders, whereas rise in HVA was seen only in responders (30% of the patients). This suggested that 5-HTP dosing may alter serotonergic and dopaminergic turnover, and that only those patients who experience increases in both CSF metabolites could expect antidepressant effects from 5-HTP. This is consistent with the earlier observations that dopaminergic and noradrenergic neurons possess transport sites for 5-HTP.<sup>[25]</sup>

The efficacy of 5-HTP to treat depression has been found to be similar to that of imipramine and clomipramine.<sup>[21,22]</sup> The therapeutic effects of the tricyclic antidepressant clomipramine and of the monoamine oxidase nialamide are potentiated by 5-HTP in combination with carbidopa.<sup>[21,22]</sup> It is unknown whether this potentiating effect is observed with other antidepressants.<sup>[22]</sup> It has been reported<sup>[26]</sup> that patients resistant to fluvoxamine treatment, a serotonin reuptake inhibitor, fail to respond to subsequent 5-HTP. This should not have been an unexpected finding since both agents target the same neurotransmitter. Perhaps the next step would be to crossover patients responsive to serotonin reuptake inhibitors to 5-HTP, a positive response would extend the findings of Nolen et al.<sup>[26]</sup>



and would suggest that serotonin sensitive depressed patients could be tried on 5-HTP.

## Headaches

The hypothesis that serotonin might be involved in the mechanisms of chronic primary headaches was set forward in the late 1950s.<sup>[27]</sup> By the 1970s, a study using 200 mg/day of oral 5-HTP for 2 mo in 20 patients reported improved migraine headaches comparable to the therapeutic effect of methysergide, an ergot alkaloid.<sup>[28]</sup> A double blind trial on a group of 80 patients suffering from common or classic migraine were pretreated with placebo for 30 days and then randomized to groups receiving 1.4 mg/day of pizotifen (a serotonin antagonist and antihistamine) or 5-HTP (400 mg/day), respectively, for 60 days. The authors assessed headache severity by a 4-degree analog scale. The 5-HTP treatment group showed a significant improvement in the most severe headache subgroups (i.e., degrees 3 and 4) compared with placebo. The prophylactic effects were similar to those of pizotifen.<sup>[29]</sup> In a subsequent study,<sup>[30]</sup> the same group of researchers set to identify and describe responsive subgroups to 5-HTP treatment in 100 patients within similar categories of primary headaches. The subjects ingested 100 mg of 5-HTP at meal times for 4 mo. Responders were defined as exhibiting a 60% or greater reduction in the Pain Total Index (a composite of pain severity and pain duration). The study found 74% of the patients improved with treatment, and the effect became noticeable by the second month. Personal history of depression, age of onset less than 20 yr, and previous positive response to pizotifen were identified as having significant prevalence in the responder group. Additionally, the responders were more likely to present with throbbing and anterior pain, whereas the nonresponders presented with generalized and posterior headaches.

Other investigators<sup>[31,32]</sup> could not reproduce the therapeutic effects of 5-HTP to the same extent. For example, in one study,<sup>[31]</sup> there was 48% response rate in patients, which was not statistically significant, probably because of the relatively large and prolonged placebo effect in the patients with chronic primary headaches. This small discrepancy might be explained by the shorter duration (2 vs. 4 mo) of the latter study compared to the former, and by the fact that 82% of the patient population had very frequent, severe, and long lasting headaches refractory to previous prophylactic agents. A recent parallel, randomized, double blind study found 5-HTP and placebo equally effective in patients treated for chronic tension headaches during an 8 week period.<sup>[32]</sup> Less is known about the effects of 5-HTP on the management of

headaches in children. One study<sup>[33]</sup> has reported 70% effectiveness compared with a 10% placebo response in children and adolescents with recurrent headaches and parasomnias.

## Sleep Aid

In adults, there is an association between sleep and the serotonergic system. In the 1960s, there were reports on the effect of 5-HTP intravenously on sleep. One study was a case report of a single individual in whom progressive increases in the dosages of intravenous 5-HTP from 50 to 150 mg augmented the percentage of the night spent in REM sleep from 22% to 30%.<sup>[34]</sup> Another trial administered 40 mg of intravenous 5-HTP and reported a shortened period from sleep onset to the first REM period in one of six patients.<sup>[35]</sup> Yet another examined the effects of 600 and 200 mg of 5-HTP administered orally to healthy volunteers during a five night period, while electroencephalograms were performed throughout the night. Increases in REM sleep ranged from 5% to 53% for both patients receiving the 200 and 600 mg dose.<sup>[36]</sup> During the last three decades, little new information has been reported in humans. Animal models have shown that the destruction of the raphe nuclei or the administration of the serotonin synthesis inhibitor *p*-chlorophenylalanine induces insomnia that is selectively antagonized/reversed by 5-HTP.<sup>[37]</sup> Future studies in humans should explore the possible sleep-inducing effect of 5-HTP, and if so, the dose-response.

## Fibromyalgia

This syndrome is characterized by chronic aching of skeletal muscles, multiple tender joints, fatigue, morning stiffness, and disturbed sleep. There are also reports of reduced blood serotonin levels in this patient population.<sup>[38]</sup> In a 30-day double blind trial, Caruso et al.<sup>[39]</sup> found 100 mg of oral 5-HTP three times a day more effective than placebo in patients with fibromyalgia. In a subsequent study,<sup>[40]</sup> the authors were interested in examining the efficacy and tolerability of long term orally administered 5-HTP at the same dose. Good clinical improvement was found in 50% of the patients as early as the 15th day and retained to up to the 90th day of treatment; it was well tolerated and its side effects were mild and transient.

## Neurological Disorders

There is some evidence that 5-HTP at doses of about 10 mg/kg/day for 4 mo can improve postural equilibrium, dysarthria in patients with various inherited

and acquired cerebellar ataxias, and particularly in those with lesions located precisely in the anterior lobe vermis.<sup>[41]</sup> Improvements in coordination have been reported in patients with Friedreich's ataxia; however, the effect is only partial and not clinically major.<sup>[42]</sup>

A recent report<sup>[43]</sup> described a group of five boys between ages 1 and 5 yr presenting with floppiness in infancy followed by motor delay, hypotonic-ataxic syndrome, learning disability, and short attention span. All patients had 51–65% reduction of CSF 5-HIAA compared with age-matched median values, as well as decrease in urinary 5-HIAA excretion. The levels of tryptophan in CSF and serum were normal. Urine and CSF serotonergic metabolites were unaltered by tryptophan loading, but normalized following 5-HTP treatment. The authors stated that this new neurodevelopmental syndrome responsive to treatment with 5-HTP and carbidopa might result from an overall reduced capacity of serotonin production due to tyrosine hydroxylase gene regulatory defect/inactivation or selective loss of serotonergic neurons.

## ADVERSE SIDE EFFECTS

The most common side effects are nausea, vomiting, fatigue/sleepiness. Adverse events appear to be dose related to some degree. Studies using higher doses of 5-HTP are more likely to see side effects.<sup>[21]</sup> Coadministration of L-aromatic amino acid decarboxylase inhibitors prevents the conversion of 5-HTP to serotonin in the periphery, which in turn increases the plasma concentration of 5-HTP, associating it to a higher incidence of nausea.<sup>[7]</sup> In 1994, the dietary supplement industry was deregulated by passage of the Dietary Supplement and Health Education Act. As a consequence, the purity, safety, and efficacy of dietary supplements are not evaluated by the U.S. Food and Drug Administration. The potential dangers of ingesting dietary supplements were demonstrated in 1989 with the outbreak of eosinophilia-myalgia syndrome, which affected more than 1500 people and caused about 30 deaths.<sup>[44]</sup>

Eosinophilia-myalgia like syndrome has been described in individuals taking 5-HTP.<sup>[45]</sup> The compound thought to cause this syndrome was structurally characterized as a 6-hydroxy-1-methyl-1,2,3,4-tetrahydro- $\beta$ -carboline.<sup>[45]</sup> The quantity of contaminant per dosage of 5-HTP varies between preparations, and a threshold to prevent eosinophilia-myalgia syndrome may not be established. It is conceivable that high doses of 5-HTP could increase serotonin levels excessively, and theoretically it could lead to serotonin syndrome, which is characterized by altered mental status, autonomic dysfunction, and neuromuscular abnormalities. To our knowledge, there are no published cases of

serotonin syndrome linked to 5-HTP consumption. Administration of 5-HTP to individuals without known affective disorders may cause mood elevation, and at times mania.<sup>[21]</sup>

## CONCLUSIONS

The serotonin precursor, 5-HTP, is commercially available over the counter in food supplement stores and via the internet. It is sold in the United States for ~US\$ 15–20 for 45–60 capsules of 50 mg. Following oral administration of 5-HTP, plasma concentration peaks are observed at 2–3 hr and can be raised by prior treatment with an L-aromatic amino acid decarboxylase inhibitors. Brain PET scans indicate most 5-HTP accumulates in the striatum and in the prefrontal cortex. Individuals taking the supplement might experience increased satiety and weight loss over a period of time. The literature suggests that 200–300 mg of 5-HTP three times a day with meals exerts an anorectic effect, which leads to weight loss in obese individuals, even without any dietary modification. 5-Hydroxytryptophan seems to preferentially reduce carbohydrate intake by as much as 50% in overweight/obese and noninsulin dependent overweight diabetics. There is reasonable evidence to suggest that gradual individually titrated dose of 50–300 mg/day taken with meals may reverse/attenuate depression in about 50% of patients. The treatment response does not appear to be dose dependent, and there is no evidence that the use of decarboxylase inhibitor increases the efficacy of 5-HTP. Of note, it is acknowledged that most studies were plagued by methodological issues, and further studies are necessary before appropriate clinical recommendations can be established.

Moderate-to-severe primary chronic headaches may be alleviated in patients receiving oral 5-HTP at 100 mg three times a day, particularly in patients presenting with anterior throbbing pain. Children may also respond well to treatment. The therapeutic effect takes several months before a clear response is observed. 5-Hydroxytryptophan at 100 mg three times a day may also be useful in about 50% of patients with fibromyalgia. Other possible therapeutic effects of 5-HTP on inducing sleep, treating selected forms of ataxias, and treating inborn errors of serotonin metabolism have not been well studied. More studies are warranted before any recommendation can be made. Nausea, vomiting, fatigue/sleepiness are the most common side effects of 5-HTP and appear to be somewhat dose related. The most serious side effect, albeit uncommon, is eosinophilia-myalgia syndrome. Its incidence is associated to the presence of a contaminant acquired during the commercial synthesis of 5-HTP. Therefore, it is recommended that individuals choosing to take

5-HTP be alert to the development of myalgias or cognitive/motor changes, and make arrangements with their primary care physicians to follow eosinophil counts regularly.

## COMPENDIAL/REGULATORY ISSUES

Not applicable.

## REFERENCES

1. Oldendorf, W.M. Brain uptake of radiolabelled amino acids, amines, and hexoses after arterial injection. *Am. J. Physiol.* **1971**, *221*, 1629–1639.
2. Gartside, S.E.; Cowen, P.J.; Sharp, T. Effect of 5-hydroxy-L-tryptophan on the release of 5-HT on rat hypothalamus in vivo as measured by microdialysis. *Neuropharmacology* **1992**, *31*, 9–14.
3. Perry, K.W.; Fuller, R.W. Extracellular 5-hydroxytryptamine concentration in rat hypothalamus after administration of fluoxetine plus 5-hydroxytryptophan. *J. Pharm. Pharmacol.* **1993**, *45*, 759–761.
4. Magnussen, I.; Nielson-Nudsk, F. Bioavailability and related pharmacokinetics in man of orally administered 5-hydroxytryptophan in steady state. *Acta Pharmacol. Toxicol.* **1980**, *46*, 257–262.
5. Westenberg, H.G.M.; Gerritsen, T.W.; Meijer, B.A.; Van Praag, H.M. Kinetics of L-5-hydroxytryptophan in healthy subjects. *Psychiatr. Res.* **1982**, *7*, 373–385.
6. Magnussen, I.; Jensen, T.; Rand, J.H.; Van Woert, M.H. Plasma accumulation and metabolism of orally single dose administered L-5-hydroxytryptophan in man. *Acta Pharmacol. Toxicol.* **1981**, *49*, 184–189.
7. Gijssman, H.J.; Van Gerven, J.M.A.; De Kam, M.L.; Schoemaker, R.C.; Pieters, M.S.M.; Weemaes, M.; De Rijk, R.; Van Der Post, J.; Cohen, A.F. Placebo controlled comparison of three dose-regimens of 5-hydroxytryptophan challenge test in healthy volunteers. *J. Clin. Psychopharmacol.* **2002**, *22*, 183–189.
8. Ågren, H.; Reibring, L.; Hartvig, P.; Tedroff, J.; Bjurling, P.; Hörnfeldt, K.; Andersson, Y.; Lundqvist, H.; Långström, B. Low brain uptake of L-[11C]5-hydroxytryptophan in major depression: a positron emission tomography study on patients and healthy volunteers. *Acta Psychiatr. Scand.* **1991**, *83*, 449–455.
9. Reibring, L.; Ågren, H.; Hartvig, P.; Tedroff, J.; Lundqvist, H.; Bjurling, P.; Kihlberg, T.; Långström, B. Uptake and utilization of [beta-11C] 5-hydroxytryptophan in human brain studied by positron emission tomography. *Psychiatr. Res. Neuroimaging* **1992**, *45*, 215–225.
10. Wurtman, J.J.; Wurtman, R.J.; Growdon, J.H.; Henry, P.; Lipscomb, M.A.; Zeisel, S.H. Carbohydrate craving in obese people: suppression by treatments affecting serotonergic transmission. *Int. J. Eat. Disord.* **1981**, *1*, 2–15.
11. Ceci, F.; Cangiano, C.; Cairella, M.; Cascino, A.; Del Ben, M.; Muscaritoli, M.; Sibilila, L.; Rossi-Fanelli, F. The effects of oral 5-hydroxytryptophan on feeding behavior in obese adults female subjects. *J. Neural Transm.* **1989**, *76*, 109–117.
12. Cangiano, C.; Ceci, F.; Cascino, A.; Del Ben, M.; Laviano, A.; Muscaritoli, M.; Antonucci, F.; Rossi-Fanelli, F. Eating behavior and adherence to dietary prescriptions in obese adults subjects treated with 5-hydroxytryptophan. *Am. J. Clin. Nutr.* **1992**, *56*, 863–867.
13. Cangiano, C.; Laviano, A.; Del Ben, M.; Preziosa, I.; Angelico, F.; Cascino, A.; Rossi-Fanelli, F. Effect of oral 5-hydroxytryptophan on energy intake and macronutrient selection in non-insulin dependent diabetic patients. *Int. J. Obes. Relat. Metab. Disord.* **1998**, *22*, 648–654.
14. D'Elia, G.; Hanson, L.; Raotma, H. L-Tryptophan and 5-hydroxytryptophan in the treatment of depression. A review. *Acta Psychiatr. Scand.* **1978**, *57*, 239–252.
15. Kline, N.S.; Sacks, W. Relief from depression within one day using an M.A.O. inhibitor and intravenous 5-HTP. *Am. J. Psychiatr.* **1963**, *120*, 274–275.
16. Kline, N.S.; Sacks, W.; Simpson, G.M. Further studies on: one day treatment of depression with 5-HTP. *Am. J. Psychiatr.* **1964**, *121*, 379–380.
17. Van Praag, H.M.; Korf, J.; Dols, L.C.W.; Schut, T. A pilot study of the predictive value of the probenecid test in application of 5-hydroxytryptophan as antidepressant. *Psychopharmacologia* **1972**, *25*, 24–21.
18. Sano, I. L-5-Hydroxytryptophan (L-5-HTP) therapy. *Folia Psychiatr. Neurol. Jpn.* **1972**, *26*, 7–17.
19. Van Praag, H.; de Haan, S. Depression vulnerability and 5-hydroxytryptophan prophylaxis. *Psychiatr. Res.* **1980**, *3*, 75–83.
20. Van Hiele, L.J. L-5-Hydroxytryptophan in depression: the first substitution therapy in psychiatry? *Neuropsychobiology* **1980**, *6*, 230–240.
21. Byerley, W.F.; Judd, L.L.; Reimherr, F.W.; Grosser, B.I. 5-Hydroxytryptophan: a review of its antidepressant efficacy and adverse effects. *J. Clin. Psychopharmacol.* **1987**, *7*, 127–137.
22. Van Praag, H.M. Serotonin precursors in the treatment of depression. In *Serotonin in*

- Biological Psychiatry*; Ho, B.T., et al., Eds.; Raven Press: New York, 1982.
23. Shaw, K.; Turner, J.; Del Mar, C. Are tryptophan and 5-hydroxytryptophan effective treatments for depression? A meta-analysis. *Aust. N. Z. J. Psychiatr.* **2002**, *36*, 488–491.
  24. Takahashi, S.; Kondo, H.; Kato, N. Effect of L-5-hydroxytryptophan on brain monoamine metabolism and evaluation of its clinical effect in depressed patients. *J. Psychiatr. Res.* **1975**, *12*, 177–187.
  25. Lichensteiger, W.; Mutzner, V.; Langeman, H. Uptake of 5-hydroxytryptamine and 5-hydroxytryptophan by neurons of the central nervous system normally containing catecholamines. *J. Neurochem.* **1967**, *14*, 489–497.
  26. Nolen, W.A.; Van De Putte, J.J.; Dijken, W.A.; Kamp, J.S. L-5HTP in depression resistant to re-uptake inhibitors. An open comparative study with tranlycypromine. *Br. J. Psychiatr.* **1985**, *147*, 16–22.
  27. Ostfeldt, A.M. Some aspects of cardiovascular regulation in man. *Angiology* **1959**, *10*, 34–42.
  28. Sicuteri, F. 5-Hydroxytryptophan in the prophylaxis of migraine. *Pharmacol. Res. Comm.* **1972**, *4*, 213–218.
  29. Bono, G.; Criscuoli, M.; Martignoni, E.; Salmon, S.; Nappi, G. Serotonin precursors in migraine prophylaxis. In *Advances in Neurology*; Critchley, M., et al., Eds.; Raven Press: New York, 1982; Vol. 33, 357–363.
  30. Bono, G.; Micieli, G.; Sances, G.; Calvani, M.; Nappi, G. L-5-HTP treatment in primary headaches: an attempt to clinical identification of responsive patients. *Cephalalgia* **1984**, *4*, 159–165.
  31. De Benedittis, G.; Massei, R. Serotonin precursors in chronic primary headache. A double blind cross-over study with L-5-hydroxytryptophan vs. placebo. *J. Neurosurg. Sci.* **1985**, *29*, 239–248.
  32. Fontes Ribeiro, C.A. L-5-Hydroxytryptophan in the prophylaxis of chronic type-tension headache: a double blind, randomized, placebo-controlled study. *Headache* **2000**, *40*, 451–456.
  33. De Giorgis, G.; Miletto, R.; Iannuccelli, M.; Camuffo, M.; Scerni, S. Headache in association with sleep disorders in children: a psychodiagnostic evaluation and controlled clinical study—L-5HTP versus placebo. *Drugs Exptl. Clin. Res.* **1987**, *13*, 425–433.
  34. Mandell, M.P.; Mandell, A.J.; Jacobson, A. Biochemical and neurophysiological studies of paradoxical sleep. *Recent Adv. Biol. Psychiatr.* **1965**, *7*, 115–122.
  35. Oswald, I.; Ashcroft, G.W.; Berger, R.J.; Eccleston, D.; Evans, J.I.; Thacore, V.R. Some experiments of chemistry of normal sleep. *Br. J. Psychiatr.* **1966**, *112*, 391–399.
  36. Wyatt, R.J.; Zarcone, V.; Engelman, K.; Dement, W.C.; Snyder, F.; Sjoerdsma, A. Effects of 5-hydroxytryptophan on the sleep of normal human subjects. *Electroenceph. Clin. Neurophysiol.* **1971**, *30*, 505–509.
  37. Adrien, J. The serotonergic system and sleep-wakefulness regulation. In *The Pharmacology of Sleep*; Kales, A., Ed.; Springer-Verlag: Berlin, 1995; 91–116.
  38. Russel, I.J.; Michalek, J.E.; Vipraio, G.A.; Fletcher, E.M.; Javors, M.A.; Boden, C.A. Platelet <sup>3</sup>H-imipramine uptake receptor density and serum serotonin levels in patients with fibromyalgia/fibrositis syndrome. *J. Rheumatol.* **1992**, *19*, 104–109.
  39. Caruso, I.; Sarzi Puttini, P.; Cazzola, M.; Azzolini, V. Double-blind study of 5-hydroxytryptophan versus placebo in the treatment of primary fibromyalgia syndrome. *J. Int. Med. Res.* **1990**, *18*, 201–209.
  40. Sarzi Puttini, P.; Caruso, I. Primary fibromyalgia syndrome and 5-hydroxytryptophan: a 90 day open study. *J. Int. Med. Res.* **1992**, *20*, 182–189.
  41. Trouillas, P.; Brudon, F.; Adeleine, P. Improvements of cerebellar ataxia with levorotatory form of 5-hydroxytryptophan. *Arch. Neurol.* **1988**, *45*, 1217–1222.
  42. Trouillas, P.; Serratrice, G.; Laplane, D.; Rascol, A.; Augustin, P.; Barroche, G.; Clanet, M.; Degos, C.F.; Desnuelle, C.; Dumas, R.; Michel, D.; Viallet, F.; Warter, J.M.; Adeleine, P. Levorotatory form of 5-hydroxytryptophan in Friedreich's ataxia. *Arch. Neurol.* **1995**, *52*, 456–460.
  43. Raemaekers, V.Th.; Senderek, J.; Häusler, M.; Häring, M.; Abeling, N.; Zerres, K.; Bergmann, C.; Heimann, G.; Blau, N. A novel neurodevelopmental syndrome responsive to 5-hydroxytryptophan and carbidopa. *Mol. Genet. Metab.* **2001**, *73*, 179–187.
  44. Silver, R.M.; Heyes, M.P.; Maize, J.C.; Quearry, B.; Vionnet Fausset, M.; Sternberg, E.M. Scleroderma, fasciitis, and eosinophilia associated with the ingestion of tryptophan. *N. Engl. J. Med.* **1990**, *327*, 874–881.
  45. Michelson, D.; Page, S.W.; Casey, R.; Trucksess, M.W.; Love, L.A.; Miltien, S.; Wilson, C.; Massaquoi, S.G.; Crofford, L.J.; Hallet, M.; Gold, P.W.; Sternberg, E.M. An eosinophilia myalgia syndrome related disorder associated with exposure to L-5-hydroxytryptophan. *J. Rheumatol.* **1994**, *21*, 2261–2265.



# Iron

**John Beard**

*The Pennsylvania State University, University Park, Pennsylvania, U.S.A.*

## INTRODUCTION

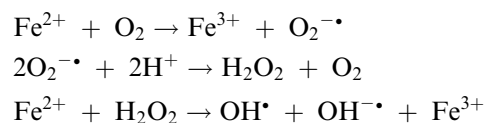
Iron is one of the essential micronutrients, and, as such, is required for growth, development, and normal cellular functioning. In contrast to some other micronutrients such as water soluble vitamins, there is a significant danger of toxicity if excessive amounts of iron accumulate in the body. However, a finely tuned feedback control system limits absorption of iron. We discuss here viable supplementation approaches and compounds as well as the risks associated with supplementation in some individuals.

## COMMON AND SCIENTIFIC NAME

Iron is element number 26 in the periodic table and has an atomic weight of 55.85. It is the fourth most abundant element and the second most abundant metal in the Earth's crust. In simple aqueous solutions, iron exists in two principal oxidation states, ferrous ( $\text{Fe}^{2+}$ ) and ferric ( $\text{Fe}^{3+}$ ).

## GENERAL DESCRIPTION

The two forms of iron in solution can be interchanged by the addition or subtraction of an electron. Many common reducing agents (ascorbic acid, for example) convert ferric iron to ferrous iron, while simple exposure to oxygen in solution converts ferrous back to ferric iron. The amount of "free" iron within cells or in the fluid spaces of the body is quite low since iron can easily participate in redox reactions that underlie the inherent toxicity of excess free iron within cells. This well-known Haber–Weiss–Fenton reaction is illustrated below:



---

*John Beard* is Professor of Nutrition at the Department of Nutritional Sciences, The Pennsylvania State University, University Park, Pennsylvania, U.S.A.

The hydroxyl radical,  $\text{OH}^{\cdot}$ , is capable of attacking most proteins, nucleic acids, and carbohydrates, and initiating lipid peroxidation reactions.<sup>[1]</sup> The vast majority of iron within cells of plants and animals is: 1) stored within large complex proteins such as hemoglobin or ferritin; 2) contained as an essential component with proteins and enzymes and is critical for their functioning; or 3) contained in proteins of iron transport that move iron from one cellular organelle to another, from one cell to another cell, or between organs (transferrin is an example of this iron protein complex). Certain forms of iron salts are highly insoluble in aqueous solutions, especially at neutral pH.

A number of different forms of iron salts are used as fortificants or supplements and vary greatly in their solubility and availability for absorption by enterocytes. A brief list is included in Table 1.

The choices that manufacturers face related to which form of iron to use in their preparations are those of not only cost, but also the chemical properties of each form of iron, and what other chemical or food components are also present in the preparation.<sup>[2]</sup> The highly soluble sources of iron generally have a high bioavailability, but they are also more likely to participate in oxidation reactions with fats to form color reaction products and have a metallic taste. On the other hand, the less soluble forms of

**Table 1** Iron supplements frequently used and their relative bioavailability

Iron source	Iron content	Relative bioavailability
Freely water soluble		
Ferrous sulfate	20	100
Ferrous gluconate	12	89
Ferrous lactate	19	100
Slowly soluble		
Ferric citrate	17	31
Ferric sulfate	22	34
Poorly soluble		
Ferrous fumarate	33	100
Ferrous citrate	24	74
Nearly insoluble		
Ferric orthophosphate	25	31
Elemental iron	97	13–90

Data are expressed as mean percentages.

iron have fewer organoleptic “problems” in general, but their bioavailability is quite variable.

## DIETARY FORMS

Dietary iron occurs in two fundamental forms in the human diet: heme and nonheme iron.<sup>[3]</sup> Heme iron refers to all forms from plant and animal sources in which the iron molecule is tightly bound within the porphyrin ring structure, as is found in both myoglobin and hemoglobin. Nonheme iron refers to all other forms. Contaminant iron that is derived from dust and soil iron are relatively unavailable to the absorptive cells, but may constitute a significant amount of iron intake in developing countries. There is substantial information that demonstrates that nearly all nonheme dietary iron mixes together in a luminal “pool” of iron in the upper gastrointestinal (GI) tract as a result of acidification in the stomach and subsequent exposure to pancreatic and GI enzymes. Inorganic iron is solubilized and ionized by gastric acid juice, reduced to the ferrous form, and kept soluble in the upper GI tract by chelation to compounds such as citrate and ascorbic acid. The type and amount of other materials such as ascorbic acid that can chelate iron to keep it in solution also determine the amount of nonheme iron in a soluble luminal pool. The number of “inhibitors” of nonheme iron absorption is substantial, with phytate, polyphenols, and tannins leading the list. These inhibitors typically bind either ferric or ferrous iron in a tight complex in the lumen of the gut and make it unavailable for the absorptive proteins. Thus, it should be clear that a diet containing a large amount of unrefined grains, nondigestible fibers, etc. will have poor iron bioavailability. In contrast, a diet that is highly refined has little roughage, and substantial portions of meat will have a greater iron bioavailability regardless of other factors. The American diet typically obtains about 50% of its iron intake from grain products, in which the iron concentration is between 0.1 and 0.4 mg per serving. Some fortified cereals, however, may contain as much as 24 mg of iron in a single serving. Heme iron is more highly bioavailable than nonheme iron, and its bioavailability is less affected by other components of the diet. Only about 10% of total dietary iron intake is represented by heme iron in many Western countries.

## Regulation of Absorption

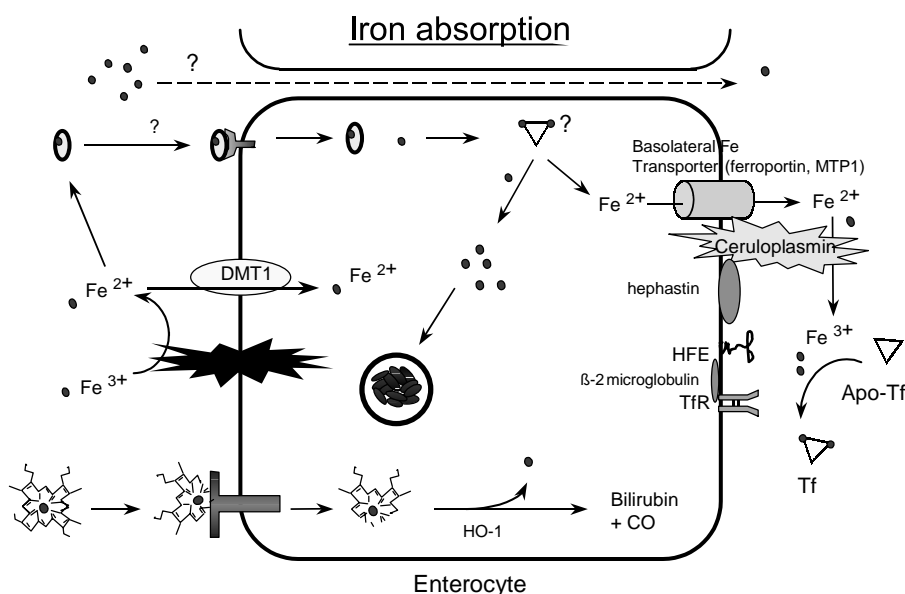
There are two fundamental regulators or determinants of the amount of iron absorbed in humans. The first is the total amount and form of iron compounds ingested (discussed above), and the second is the iron status of

the individual.<sup>[4]</sup> Thus, individuals with a high iron status will absorb proportionally less of any amount of iron consumed than will an iron-deficient individual, and individuals with a lower iron status will absorb more of any dietary intake. This process of selective absorption is the fundamental mechanism whereby humans regulate iron balance.<sup>[5]</sup> The mechanism of this regulation is still not entirely clear, but current research demonstrates that crypt endothelial cells receive a signal from the iron storage “pools,” which then establishes this set point for iron absorption.<sup>[6]</sup> This putative signal peptide, hepcidin, is released from hepatocytes into the plasma pool, with the crypt endothelial cell as one of its targets. Fig. 1 shows that there are a number of routes of iron movement into the enterocyte from the GI lumen. Mostly, these pathways converge on the small “labile iron pool” within the cytoplasmic space of the enterocyte. The exact mechanism of regulation of absorption relates to the expression of specific iron transport proteins such as divalent metal transport (DMT-1), ferroportin [also called metal transport protein-1 (MTP-1)], transferrin receptor (TfR1), and, finally, the hemochromatosis gene product “HFE.”<sup>[4]</sup>

The DMT-1 protein acts primarily at the level of iron movement out of a recycling endosome in the cytosol of the cell and utilizes an associated proton pump and acidification of the endosome. On the opposite side of the cell, MTP-1 acts as an iron exporter through a transmembrane “pore” to move iron to the exterior of the cell in close proximity to copper-containing redox enzymes that allow the production of the necessary ferric iron for binding to transferrin. When there is excess dietary or supplemental iron exposed to the microvillus enterocyte, the excess iron can be stored in the form of ferritin within the enterocyte. The amount of ferritin that is synthesized by the enterocyte is under the regulation of the mRNA-binding protein, IRP, which binds with high affinity at an iron response element (IRE) located in the 5' untranslated end of the ferritin mRNA. There is also a similar set of IREs on the 3' end of the mRNA for TfR and DMT-1 that allows for a reciprocal regulation of iron storage and iron uptake. This IRE-IRP system of regulation, however, is also susceptible to oxidative stress, since nitric oxide may alter the affinity of this regulator of protein translation.<sup>[4]</sup> In situations of very high iron salt intakes, it is likely that an increased oxidative stress within these enterocytes will lead to altered iron storage and absorption.<sup>[7]</sup>

## ACUTE EFFECTS OF HIGH IRON

Acute high doses of iron salts may also lead to diffusion gradient movement of iron in a pericellular



**Fig. 1** Putative mechanism for the absorption of iron in enterocytes of the upper GI tract in humans. On the left side of the diagram is a putative heme iron transporter, the DMT-1, divalent metal transporter mediated uptake coupled to a ferr-oxidase, and a poorly described non-heme iron transporter independent of DMT-1. Soluble intracellular iron can be inserted into ferritin (center of the cell) or exported through the MTP-1 shuttle system located in close proximity to copper-containing hephaestin or ceruloplasmin. The hemochromatosis gene product, HFE, is likely to exert its influence at this site of iron export from the absorptive cell.

mechanism in which the normal regulatory machinery is bypassed. Near toxic intakes of iron salts such as ferrous sulfate, ferrous gluconate, and ferric chloride are known to cause erosion of the enterocyte, cell death, increased flux of iron across the mucosa, very rapid increases in vascular iron, and iron accumulation in liver cells with subsequent liver pathology.<sup>[5,7]</sup> An oral dose of iron in excess of 180 mg per kilogram of body weight is usually associated with mortality that is preceded by vomiting and diarrhea. If the normal cellular and extracellular mechanisms are overwhelmed, free iron will immediately be available for participation in redox-coupled reactions that are associated with cellular damage to proteins and lipids.<sup>[1]</sup> Symptoms of excess iron accumulation become evident in some individuals when as little as 10–20 mg Fe/kg is consumed, with GI upset and constipation as the most common symptoms. These GI effects appear to be highly “case-sensitive” at lower doses, with some individuals being more affected by the absence of food in the stomach and others by the particular form of iron that is taken in the iron supplement. As the dose increases, however, an increasingly greater proportion of individuals report GI effects of increasing severity.

High iron supplement use appears to reduce zinc absorption and plasma zinc concentrations.<sup>[8,9]</sup> This effect is most frequently seen when the molar ratio approaches 25:1<sup>[10]</sup> and is lost if the absorption rate of zinc is measured in the presence of other food items (i.e., during a meal). Fortification of grains and cereals, infant foods, and weaning foods does not appear to affect zinc absorption.<sup>[11]</sup>

## IRON OVERLOAD

Iron overload diseases have received much attention in the last decade, especially in the last five years, with the discovery of the gene associated with hereditary hemochromatosis. Approximately one in 200–400 individuals of Anglo-Saxon ancestry is affected by an autosomal recessive gene mutation that results in this iron overload disease.<sup>[4]</sup> The gene mutation of the HFE gene in position C282Y accounts for the vast majority of the cases of hemochromatosis in individuals of Celtic origin. Various other mutations have also been described, and, in most cases, the mutations are associated with a failure of the HFE protein to bind effectively with the β-2 microglobular protein and the TfR1 protein at the plasma membrane. The failure of the association is related to the lack of control of iron flux across the enterocyte. Hereditary hemochromatosis is thus characterized by a failure to control iron absorption in the enterocyte, with a resulting accumulation of iron in iron storage pools, primarily in cells of the reticuloendothelial system (RES). Clinical signs of iron toxicity occur in homozygous individuals without treatment in the fourth decade of life, or earlier, at which time their total body iron content is more than 20 g. Lack of treatment by chelation and phlebotomy results in cirrhosis of the liver, hepatocellular carcinoma, myocardial pathology, and damage to pancreatic function.<sup>[12]</sup> This accumulation of iron in the liver and the accompanying hepatic fibrosis and cirrhosis appear to be causal in nature. The evidence for iron accumulation in heterozygous individuals is less clear, and the role



of dietary iron bioavailability in body iron accumulation in these individuals is still being debated.<sup>[13]</sup> At the time, it appears prudent for known heterozygous individuals to limit their consumption of iron supplements.

Other forms of iron overload due to chronic excessively high iron intakes have been reported, but these intakes of approximately 200–1200 mg Fe/day for long periods of time are unusual. Bantu siderosis in Africa is an additional example of iron toxicity due to excessively high iron intakes for prolonged periods of time.<sup>[5]</sup> Home brewing of beer in large iron pots is associated with an intake of iron in excess of 50–100 mg Fe/day, with a resulting iron overload disease. There is some evidence as well that there is a genetic component to this disease.<sup>[5]</sup>

Transfusional iron overload may result from the accumulation of iron after senescent transfused red cells are metabolized in the RES. Since each unit of blood contains approximately 225 mg of Fe, there is a real danger of hepatic iron overload with repeated transfusions. Individuals with disorders in effective erythropoiesis who receive transfusions have the additional iron burden of excessive iron absorption. That is, iron accumulation in the RES occurs due to high rates of red cell turnover and iron absorption.

## INDICATIONS AND USAGE

### Supplementation

In 2001, the United States Food and Nutrition Board of the National Academy of Sciences released the current evaluation of recommended intakes and upper limits (ULs) of safe intakes.<sup>[13]</sup> The committee had the perspective that functional consequences of iron deficiency occur only when there are depleted iron stores and there is insufficient delivery of iron to the essential iron pools in all tissues. The erythroid mass has the largest essential iron pool in the form of hemoglobin, with bone marrow uptake responsible for >70% of the plasma iron turnover on a daily basis. In the evaluation of assessment of iron status, the review panel utilized the following indicators: 1) serum or plasma ferritin for iron storage pool size; 2) plasma soluble transferrin receptor for adequacy of iron delivery to rapidly growing cells; 3) plasma or serum transferrin saturation for iron transport; and 4) hemoglobin concentration, hematocrit, or red cell counts for the existence of anemia. The need to utilize all of these indicators is well justified given the impact that acute and chronic infections have on the evaluation of iron status.<sup>[5,7]</sup> The sTfR is relatively new, but is not sensitive to inflammation. Hence, there is great promise that it will prove to be a valuable indicator

of iron status in complicated clinical and nutritional diagnosis.

The suggested levels of intake shown in Table 2 represent the required intakes to insure adequate nutrition in 95–97.5% of the population and are an overestimation of the level needed for most people in any given group. Individuals who do not routinely consume the suggested level of iron from foods should be encouraged to supplement their diets with iron compounds.

### Treatment of Iron Deficiency

Iron deficiency has traditionally been separated into iron deficiency anemia and tissue iron deficiency, also referred to as “depleted iron stores.” Iron deficiency anemia is diagnosed as a low serum transferrin saturation (<15%), a low serum ferritin concentration (<12 µg/L), and an elevated soluble TfR (>6 mg/dl) in the setting of microcytic anemia. However, anemia reflects a later stage of iron depletion, with earlier stages often evidenced by low serum ferritin and slightly elevated TfR levels. Since both serum ferritin and serum iron concentrations are acute phase reactants to inflammatory cytokines, the presence

**Table 2** Recommended dietary allowances (RDA)<sup>a</sup> and estimated average requirements (EAR) for iron consumption (in mg Fe/day)

Age	EAR	RDA
0–6 mo <sup>b</sup>		
7–12 mo	6.9	11
1–3 yr	2.9	7
4–8 yr	4.1	9
Boys		
9–13 yr	6.6	11
14–18 yr	7.8	11
Girls		
9–13 yr	6.4	11
14–18 yr	8.3	16
Men	6	8
Women		
19–50 yr <sup>c</sup>	8.1	19
>51 yr	5	8
Pregnancy <sup>d</sup>	22.6	27
Lactation	6.3	9

<sup>a</sup>RDA, 2001 United States Food and Nutrition Board of the Institute of Medicine.

<sup>b</sup>Only adequate intakes could be estimated in this age group. The AI was estimated as 0.27 mg/day.

<sup>c</sup>Values are given as estimates for reproductive age women.

<sup>d</sup>This is an overall estimate throughout pregnancy though iron requirements clearly vary greatly by trimester. In addition, this estimate is slightly higher for teenage pregnancy (EAR of 22.8 mg and RDA of 27 mg Fe/day).

of inflammation must be considered in a diagnosis of iron deficiency.<sup>[13]</sup>

After the diagnosis of true iron deficiency, rapid restoration of an iron-replete state can be achieved by administering 125–250 mg of ferrous sulfate orally per day. This dose of the salt will deliver 39–72 mg of highly bioavailable iron per day. There is some evidence that doses greater than 250 mg ferrous sulfate convey additional benefits, and it is still common practice in severe anemia of pregnancy to administer this dose twice per day. This, however, results in a high prevalence of complaints of GI distress, constipation, and blackened stools. Thus, compliance with these high doses drops considerably from prescribed amounts. Once the iron deficiency is resolved, daily intake of iron based on the levels indicated in Table 2 should be maintained.

### Preventative Iron Supplementation

One of the great concerns regarding iron deficiency anemia is the adequacy of iron intake during pregnancy.<sup>[14]</sup> There is evidence that poor iron status in the first trimester of pregnancy is associated with prematurity, low birth weight, and small-for-gestational-age newborns. Since many women in developing and underdeveloped countries are not even aware that they are pregnant prior to the 10th to 12th week of pregnancy, there is a need to insure that women “enter” pregnancy in an iron-adequate state. This has led to a re-evaluation of the concept of “daily iron supplements”.<sup>[15,16]</sup> At issue is the relative effectiveness of daily therapeutic doses of iron compared to the administration of lower “preventative intermittent iron” doses. The concept is this: since the GI enterocyte will “reset” its set point for iron absorption every 3–4 days as a new crop of crypt cells migrate up to the tip of the villus, the large doses of iron given on days 2 and 3 are wasted and may in fact result in oxidative damage and mucosal injury. To test this hypothesis, a number of studies in developing countries have compared the efficacy of daily doses to an intermittent dose in correcting iron deficiency anemia in children, adolescents, reproductive age women, and pregnancy.<sup>[15]</sup> The daily dosage approach had a faster response, but with lower compliance, than did the intermittent oral iron dose. The end result in terms of correcting the anemia was similar in nearly all studies, with the exception of pregnancy, where daily iron therapy clearly provided a greater benefit.<sup>[17]</sup>

### Adverse Effects of Drugs on Iron Status

Iron balance is largely regulated at the level of the duodenal enterocyte. Hence, any clinical condition or

administered drug that significantly alters the integrity of these enterocytes has great potential to alter iron requirements and metabolism. Thus, antiulcer drugs such as Prevacid and Prilosec may reduce iron absorption by a reduction in the amount of acidification of the stomach contents. In addition, a number of antibiotics with structures similar to those of doxycycline and tetracycline have been related to decreased absorption of iron due to their ability to chelate iron in the upper bowel. In a similar fashion, biliary excretion of iron is the manner in which most iron is excreted from the body. Hence, drugs known to alter enterohepatic circulation are likely to increase iron requirements. For example, the popular antilipidemic drug cholestyramine interferes with iron absorption and enterohepatic circulation. Clearly, blood loss from the body is the single largest cause of increased or altered iron requirements. Bleeding ulcers, lesions, and leaking inflammatory states in the gut are all associated with a decreased iron status due to increased rates of blood and iron loss.

The administration of Epogen<sup>®</sup>, the recombinant form of erythropoietin, leads to a rapid increase in red cell production and is of course related to an increase in iron requirements as iron is cleared from the plasma pool at a much greater rate. Thus, it is usually essential that patients also receive a supplemental supply of highly available iron to meet this increased demand.

### Contraindications

Individuals with a demonstrated or suspected HFE gene mutation are clearly more at risk of iron overload pathology than they are of needing exogenous iron supplements. A family history is sufficient to warrant a thorough evaluation of iron status and possible genetic mutations. Interventions early in the iron accumulation process are effective in reducing pathology associated with iron accumulation. Similarly, a diagnosis of hemolytic or hemorrhagic anemia is a clear signal to avoid administration of iron. These anemias often lead to a dramatic increase in iron absorption and total body iron early in life due to both transfusional iron overload and the increased iron absorption.<sup>[5]</sup>

### PRECAUTIONS AND ADVERSE REACTIONS

Doses of iron above 180 mg may be lethal in adults.<sup>[18]</sup> As described earlier, high acute intakes of iron may be associated with necrotizing gastritis and enteritis, pallor, lassitude, and frequent diarrhea. A rapid rise in the plasma iron concentration within 60 min to

levels in excess of 500 µg/dl is common and is likely related to the pathology. Rapid treatment with iron chelators, like desferrioxamine, will rapidly decrease plasma iron concentration, and gastric lavage has improved recovery rates.<sup>[5]</sup>

In 2001, the Food and Nutrition Board of the National Academy of Sciences recommended 45 mg as the UL for iron for adults 19 yr and older, including pregnant and lactating women. An uncertainty factor of 1.5 was selected to extrapolate from a lowest observed adverse effect level (LOAEL) to a now observed adverse effect level (NOAEL) using GI side effects as the outcome for adverse effects. ULs for infants and young children were estimated from an NOAEL of 40 mg/day and a UF of 1.0, with a resulting UL of 40 mg/day. This UL remains for children 1–3, 4–8, and 9–13 yr old, primarily due to a lack of data to suggest otherwise. As noted previously in the “Contraindications” section, individuals or subpopulations may be at special risk of iron overload when it is consumed at these UL levels and would not be protected by these ULs. Importantly, the committee did not feel there was compelling evidence to utilize either cardiovascular disease or cancer as dependent variables for setting the UL.

## COMPENDIAL/REGULATORY STATUS

Not applicable.

## CONCLUSIONS

A number of iron compounds exist in the marketplace that can effectively and safely supplement dietary iron to bring individuals back into iron balance. There is risk, however, that overzealous use of supplements can lead to GI distress and, in some individuals with genetic mutations, toxic iron overload, and even death. New understanding of the genetic causality of iron overload syndromes will provide greater avenues for preventing accidental iron overload in the near future.

## REFERENCES

- Gutteridge, J.M.; Halliwell, B. Free radicals and antioxidants in the year 2000. A historical look to the future. *Ann. N. Y. Acad. Sci.* **2000**, *899*, 136–147.
- Hurrell, R. Improvement of trace element status through food fortification: technological, biological and health aspects. *Bibl. Nutr. Dieta* **1998**, *54*, 40–57.
- Conrad, M.E. Iron absorption and transport—an update. *Am. J. Hematol.* **2000**, *64*, 287–298.
- Aisen, P.; Enns, C.; Wessling-Resnick, M. Chemistry and biology of eukaryotic iron metabolism. *Int. J. Biochem. Cell Biol.* **2001**, *33*, 940–959.
- Bothwell, T.; Charlton, R.; Cook, J.; Finch, C.E. *Iron Metabolism in Man*; Blackwell Scientific: Oxford, U.K., 1979.
- Fleming, R.E.; Sly, W.S. Heparin: a putative iron-regulatory hormone relevant to hereditary hemochromatosis and the anemia of chronic disease. *Proc. Natl. Acad. Sci. U.S.A.* **2001**, *98* (15), 8160–8162.
- Schuman, K. Safety aspects of iron in food. *Ann. Nutr. Metab.* **2001**, *45*, 91–101.
- Fung, E.B.; Ritchie, L.D.; Woodhouse, L.R.; Roehl, R.; King, J.C. Zinc absorption in women during pregnancy and lactation: a longitudinal study. *Am. J. Clin. Nutr.* **1997**, *66* (1), 80–88.
- Solomons, N.W. Competitive interactions of iron and zinc in the diet. Consequences for human nutrition. *J. Nutr.* **1986**, *110*, 927–934.
- Sandstrom, B.; Davidsson, L.; Cederblad, A.; Lonnerdal, B. Oral iron, dietary ligands and zinc absorption. *J. Nutr.* **1985**, *115* (3), 411–414.
- Davidsson, L.; Almgren, A.; Sandstrom, B.; Jurell, R.F. Zinc absorption in adult humans: the effect of iron fortification. *Br. J. Nutr.* **1995**, *74*, 417–425.
- Bothwell, T.H.; MacPhail, A.P. Hereditary hemochromatosis: etiologic, pathologic, and clinical aspects. *Semin. Hematol.* **1998**, *35*, 55–71.
- National Academy of Science—Institute of Medicine Panel on Micronutrients. *Dietary Reference Intakes for Vitamin A, Vitamin K, Arsenic, Boron, Chromium, Copper, Iodine, Iron, Manganese, Molybdenum, Nickel, Silicon, Vanadium, and Zinc*. National Academy Press: Washington, DC, 2001.
- Allen, L.H. Anemia and iron deficiency: effects on pregnancy outcome. *Am. J. Clin. Nutr.* **2000**, *71*, 1280–1284.
- Beard, J.L. Weekly iron intervention: the case for intermittent iron supplementation. *Am. J. Clin. Nutr.* **1998**, *68* (2), 209–212.
- Hallberg, L. Combating iron deficiency: daily administration of iron is far superior to weekly administration. *Am. J. Clin. Nutr.* **1998**, *68* (2), 213–217.
- Beaton, G.H.; McCabe, G.P. *Efficacy of Intermittent Iron Supplementation in the Control of Iron Deficiency Anemia in Developing Countries: An Analysis of Experience*; Micronutrients Initiative Report: Ottawa, 1999.
- Iron. Medical Toxicology*; Ellenhorn, M.J., Barceloux, D.G., Eds.; Elsevier: New York, 1988; 1023–1030.

# Isoflavones

Mark Messina

School of Public Health, Loma Linda University, Loma Linda, California, U.S.A.

## INTRODUCTION

Isoflavones are a subclass of the rather ubiquitous flavonoids but by comparison have a much more limited distribution in nature. The primary dietary sources of isoflavones are soybeans and soyfoods. It is often stated in the literature that many legumes and fruits and vegetables contain isoflavones; however, although these statements are technically correct they are misleading, because the amount in these foods is so small as to be nutritionally irrelevant.<sup>[1]</sup>

In contrast to many phytoalexins (substances that are formed by host tissue in response to physiological stimuli, infectious agents, or their products and that accumulate to levels that inhibit the growth of microorganisms), isoflavones are always present in significant quantities in soybeans, because one of their primary functions is to stimulate nodulation genes in soil bacteria called *Rhizobium*.<sup>[2]</sup> Rhizobia have the ability to induce the formation of nodules on soybean roots, which are required for the reduction of atmospheric nitrogen to ammonia, which the soybean can then use as a source of nitrogen for growth.

In total, there are 12 different soybean isoflavone isomers. These are the three aglycones genistein (4',5,7-trihydroxyisoflavone), daidzein (4',7-dihydroxyisoflavone), and glycitein (7,4'-dihydroxy-6-methoxyisoflavone), their respective  $\beta$ -glycosides genistin, daidzin, and glycitin, and three  $\beta$ -glucosides each esterified with either malonic or acetic acid (Figs. 1 and 2).

Typically, there is somewhat more genist(e)in than daidz(e)in in soybeans and soyfoods, whereas glycit(e)in comprises only 5–10% of the total isoflavone content.<sup>[3]</sup> In soybeans and in nonfermented soyfoods, isoflavones are present primarily as glycosides, whereas in fermented soy products, due to micro-organism-induced fermentation and hydrolysis, much of the isoflavones is present in aglycone form.

Red clover (*Trifolium pratense*) also contains a rich supply of isoflavones and, along with soybeans, is used as a source for the production of isoflavone supplements. The plant is common throughout North

America, Europe, and Central and northern Asia. The two predominant isoflavones in red clover are the methylated isoflavones formononetin (4'-methoxy-7-hydroxyisoflavone) and biochanin-A (4'-methoxy-5,7-hydroxyisoflavone).

Unfortunately, there is no uniform method for expressing isoflavone content, and molar concentrations are generally not used as information intended for the consumer. Consequently, there is some ambiguity regarding the biologically active amount of isoflavones in a product even when total isoflavone content is indicated. Since the molecular weight of the aglycone is approximately 60% that of the glycoside, 100 mg isoflavones can actually refer to between approximately 60 and 100 mg of biologically active isoflavone.

## ISOFLAVONE CONTENT OF SOYFOODS

Isoflavones are rather heat stable, as baking or frying at high temperature alters total isoflavone content very little or not at all. The isoflavone content (aglycone weight) of raw soybeans is approximately 1.0 mg/g, with a range of about 0.4–2.4 mg/g. Traditional soyfoods typically provide 0.2–0.4 mg/g of fresh weight product, and about 2–4 mg/g protein. One serving (e.g., 3–4 oz. of tofu or 1 cup soy beverage) of a

R1	R2	Chemical Name	M.W.
OH	H	4',5,7-Trihydroxyisoflavone (Genistein)	270
H	H	4',7-Dihydroxyisoflavone (Daidzein)	254
H	OCH <sub>3</sub>	4',7-Dihydroxy-6-methoxyisoflavone (Glycitein)	284

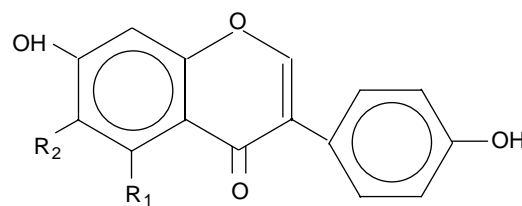
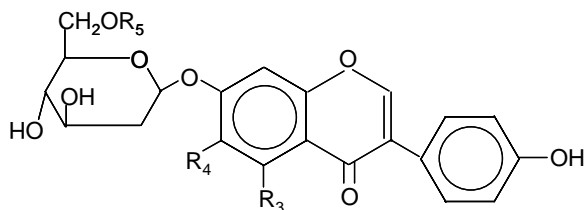


Fig. 1 Chemical formulas and molecular weights of the soybean isoflavone aglycones.

Mark Messina, Ph.D., is at the Department of Nutrition, School of Public Health, Loma Linda University, Loma Linda, California, U.S.A.

R3	R4	R5	Chemical Name	M.W.
OH	H	H	Genistein, 7-O- $\beta$ -D-glucopyranoside (Genistin)	432
OH	H	COCH <sub>3</sub>	6"-O-Acetylgenistin	474
OH	H	COCH <sub>2</sub> COOH	6"-O-Malonylgenistin	518
H	H	H	4',7-Dihydroxyisoflavone, 7-O- $\beta$ -D-glucopyranoside (Daidzin)	416
H	H	COCH <sub>3</sub>	6"-O-Acetyldaidzin	458
H	H	COCH <sub>2</sub> COOH	6"-O-Malonyldaidzin	502
H	OCH <sub>3</sub>	H	Glycitein, 7-O- $\beta$ -D-glucopyranoside (Glycitin)	446
H	OCH <sub>3</sub>	COCH <sub>3</sub>	6"-O-Acetylglycitin	488
H	OCH <sub>3</sub>	COCH <sub>2</sub> COOH	6"-O-Malonylglycitin	532



**Fig. 2** Chemical formula and molecular weights of the soybean isoflavone glycosides.

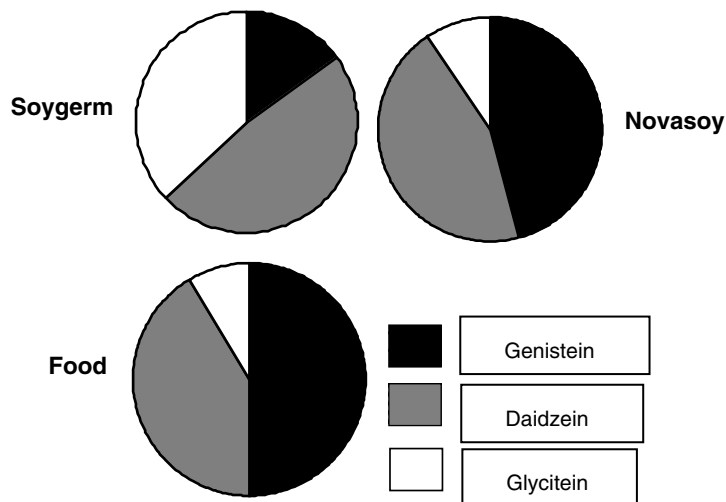
traditional soyfood provides approximately 20–35 mg of isoflavones. Isolated soy proteins vary in isoflavone content (range 0.5–2.0 mg/g), although the average is about 1 mg/g. As a result of processing losses, the isoflavone content of alcohol-washed soy protein concentrates, the most common type of concentrate, is only 5–20% that of the water-washed concentrates. The United States Department of Agriculture, in conjunction with Iowa State University, has recently established an online database (<http://www.nal.usda.gov/fnic/foodcomp/Data/isoflav/isoflav.html>) of the isoflavone content of foods.

In addition to soyfoods and supplements, isoflavones are used as food fortificants, being added to both soy and non-soy products. One brand of isoflavones, Novasoy<sup>®</sup>, which is produced by the Archer Daniels Midland Company, has achieved GRAS status

through self-affirmation and review by an outside panel of experts. It can be added to adult single meal replacements, and health beverages and bars. Novasoy is an example of a supplement that is derived from soybean molasses (distilled ethanol extract from soy flakes) and that reflects the isoflavone profile of soyfoods (Fig. 3).

In contrast, a second source of isoflavone supplements, which is commonly referred to as soygerm, is derived from the hypocotyl portion of the soybean and in comparison to soyfoods is very low in genistein and high in glycitein.<sup>[4]</sup>

As is the case with many types of supplements, a recent analysis found that there is frequently a discrepancy between the isoflavone content and the amount listed on the product label, as only about half of the supplements analyzed were found to contain within



**Fig. 3** Relative isoflavone profiles of different sources of isoflavones.

20% of the stated amount.<sup>[5]</sup> Most supplements contain the amount of isoflavones found in 1 serving of a traditional soyfood.

## ASIAN ISOFLAVONE INTAKE

Older values reported in the literature for Asian isoflavone intake are exaggerations. There are quite good data on Asian soy consumption, especially for Japan. In fact, the Ministry of Health and Welfare in Japan has conducted a national household survey (NHHS) of food intake since 1946. The NHHS was conducted on a quarterly basis between 1946 and 1963 and has been done on an annual basis thereafter.<sup>[6]</sup> It includes randomly selected prefectures comprising 10,000–20,000 subjects of all ages.

Substantial data now indicate that Japanese adult intake is approximately 50 mg/day.<sup>[7–9]</sup> Intake in China, including Hong Kong, is generally similar to or lower than that in Japan. For example, a Chinese prospective study published in 2003 that included nearly 65,000 women from Shanghai found daily median soy protein intake to be only 7.36 g/day.<sup>[10]</sup> Smaller studies conducted in Shanghai reported both lower (3.5 g soy protein/day)<sup>[11]</sup> and higher ( $\approx$ 11 g soy protein/day)<sup>[12]</sup> intakes. The findings from three studies from Hong Kong are quite variable; daily soy protein intakes for women were reported to be 2.5 g,<sup>[13]</sup> 4.9 g,<sup>[14]</sup> and 7.9 g.<sup>[15]</sup> Traditional soyfoods have an isoflavone (mg):protein (g) ratio of approximately 3.5:1. Thus, it is clear that mean isoflavone intake is  $\leq$ 50 mg/day. Few people in Asia consume  $\geq$ 100 mg isoflavones/day.<sup>[10,15]</sup>

## ISOFLAVONE METABOLISM

Plasma isoflavone levels do increase in relation to the amount ingested. Some evidence, but not all, suggests that there is a curvilinear relationship between the area under the plasma curve and isoflavone dose.<sup>[16,17]</sup> Plasma isoflavone levels among Asians are approximately 500 nmol/l,<sup>[18]</sup> but since measurements are typically taken after an overnight fast and the plasma half-life of daidzein and genistein is relative short (generally observed to be between 5 and 10 hr<sup>[19]</sup>), fasting levels are much lower than postprandial levels. In response to the consumption of approximately 50–100 mg of isoflavones (the amount found in approximately 2–4 servings of traditional soyfoods, peak serum isoflavone levels can be expected to be approximately 5  $\mu$ M.<sup>[19]</sup> For the highest sustained plasma levels, it is best to consume isoflavones throughout the day rather than at one sitting.

Most of the isoflavones absorbed are excreted from the body within 24 hr after a single ingestion. Studies suggest that  $<$ 50% of the isoflavone dose ingested is absorbed, but definitive data are not available. Isoflavones circulate in plasma mostly in the conjugated form, bound primarily to glucuronic acid; less than 3% circulates in the free form. Conjugation occurs in both the small intestine and the liver. Isoflavones are thought to undergo enterohepatic circulation.<sup>[19]</sup> Approximately 60% of the methylated isoflavones formononetin and biochanin-A, which are found in red clover, are converted by the liver to daidzein and genistein, respectively. Daidzein is metabolized primarily to equol and *O*-desmethylangolensin, whereas genistein is metabolized to dihydrogenistein and a number of other oxidative metabolites.

Overall, the evidence indicates that whether isoflavones are present in foods as glycosides or aglycones appears not to be critically important in regard to potential health effects, since the glycosides, although not absorbed intact, can be hydrolyzed in vivo.<sup>[20]</sup> Initially, some data suggested that aglycones are absorbed to a greater extent than isoflavone glycosides, but more recent work shows that this is not the case.<sup>[5,17]</sup>

## PHYSIOLOGICAL PROPERTIES

Isoflavones bind to estrogen receptors and affect estrogen-regulated gene products, although their binding affinity is much lower than that of 17 $\beta$ -estradiol. For this reason, isoflavones are often referred to as phytoestrogens. It is, however, probably more accurate to refer to the estrogenlike, rather than estrogenic, properties of isoflavones. Isoflavones have traditionally been considered to be weak estrogens, but for several reasons, it is difficult to arrive at a single estimate of the relative overall estrogenicity of isoflavones. Most importantly, isoflavones bind with much greater affinity to estrogen receptor beta (ER $\beta$ ) than estrogen receptor alpha (ER $\alpha$ ) and are much more potent at triggering transcriptional activity when bound to ER $\beta$  in comparison to ER $\alpha$ .<sup>[21–23]</sup> Since these receptors have different tissue distributions, isoflavone estrogenicity can vary markedly from tissue to tissue.

The different tissue distributions of ER $\alpha$  and ER $\beta$  and the greater binding affinity of isoflavones for ER $\beta$  than ER $\alpha$  have led to speculation that isoflavones are natural selective estrogen receptor modulators (SERMs).<sup>[24]</sup> SERMs such as the breast cancer drug tamoxifen and the osteoporosis drug raloxifene have estrogenlike effects in some tissues but either no effects or antiestrogenic effects in other tissues. The ideal SERM would seemingly have estrogenlike effects on the bones, coronary vessels, and brain, and antiestrogenic effects on the breast and endometrial tissue.

There is evidence that indeed isoflavones are SERMs. For example, isoflavones enhance arterial compliance<sup>[25]</sup> as does estrogen, but unlike estrogen, isoflavones do not stimulate endometrial cell proliferation.<sup>[26]</sup> As evidence of the difference between isoflavones and estrogen is an Australian study that found that in postmenopausal women, isoflavone-rich soy protein did not affect any of the estrogen-regulated proteins examined.<sup>[27]</sup>

Even categorizing isoflavones as SERMs does not fully describe their likely physiological effects, however, as isoflavones, especially genistein, affect signal transduction pathways by inhibiting the activity of many enzymes (e.g., tyrosine protein kinase, mitogen activated kinase, DNA topoisomerase, etc.) and regulating cellular factors that control the growth and differentiation of cells.<sup>[28]</sup> Also, isoflavones demonstrate antioxidant activity *in vitro*<sup>[29]</sup> and in humans,<sup>[30–32]</sup> although the effects in humans have been very inconsistent.

Arguably, the nonhormonal properties of isoflavones are responsible for more of the interest in these compounds than the hormonal effects. This is especially true with regard to genistein and anticancer effects.<sup>[28]</sup> The nonhormonal properties also account for why isoflavones are being studied in connection with such diseases as malaria, diabetes, cystic fibrosis, and alcoholism. Not surprisingly, given the disappointing results of the Women's Health Initiative (WHI), there has been particular interest in isoflavones functioning as possible alternatives to conventional hormone replacement therapy (HRT).<sup>[33]</sup>

Finally, it is important to recognize that isoflavones differ markedly from estrogen in many respects; recent research shows that isoflavones affect the expression of many genes differently from estrogen.<sup>[34]</sup> Consequently, it is not prudent to draw conclusions about their health effects—good or bad—on the basis of what estrogen is thought to do.

## CHRONIC DISEASE PREVENTION AND TREATMENT

### Cancer

Genistein inhibits the growth of a wide range of both hormone-dependent and-independent cancer cells *in vitro*.<sup>[28]</sup> The *in vitro* concentrations required to inhibit cancer growth are typically much higher than serum isoflavone levels, but animal data suggest that the *in vitro* anticancer effects are relevant.<sup>[35]</sup> In fact, it appears that the *in vitro* studies underestimate the *in vivo* anticancer activity of isoflavones since, as cited below, many studies have found that tumor inhibition occurs in response to the ingestion of amounts of isoflavones that produce serum levels that are much

lower than the concentration needed to inhibit the growth of cancer cells *in vitro*. Also, Dalu et al. found that genistein affected signal transduction pathways in the prostate of rats even though genistein prostate concentrations only reached the low nanomolar range.<sup>[36]</sup>

In rodents, isoflavone administration has been shown to inhibit the growth of several types of cancers, including bladder,<sup>[37]</sup> skin,<sup>[38]</sup> prostate,<sup>[39]</sup> and mammary<sup>[40]</sup> tumors. However, most focus has been on the latter two, in part because of the low rates of these cancers in soy-consuming countries.<sup>[41]</sup> Recently, an international group of experts suggested that isoflavones inhibit the progression of latent prostate cancer to the more advanced stages of this disease.<sup>[42]</sup>

Research in animals generally shows that isoflavone-rich soy protein and isolated isoflavones inhibit prostate tumors induced by several different methods, and several epidemiologic studies lend support to the animal experiments, although the design of these epidemiologic studies limits the value of the findings.<sup>[43]</sup> In one, consuming tofu at least five times a week was associated with a 65% reduction in risk ( $p = 0.054$ ) among Japanese Hawaiians.<sup>[44]</sup> In another, consuming soy milk more than once a day was associated with a 70% reduced risk among Seventh-day Adventists.<sup>[45]</sup> These intake levels are quite modest. However, the design of both these prospective studies limits the value of their findings. Most notably, not only did few men actually develop prostate cancer, but importantly, neither study actually presented total soy intake.

The only epidemiologic study that did find soy intake to be protective against prostate cancer.<sup>[46]</sup> In this study, risk was reduced by approximately 50% in Chinese men in the fourth quartile of soy intake. The mean intake for the fourth quartile was not reported, but the cutoff for total soyfoods was a rather modest >111.8 g/day. The authors reported the intake cutoffs for the fourth quartile for genistein and daidzein as >62.0 and >36.3 mg/day, respectively.

In contrast to the data on prostate cancer and soy, the epidemiologic data generally do not show that adult soy intake reduces postmenopausal breast cancer risk, although there are many possible mechanisms by which it can do so. For example, soy increases the length of the menstrual cycle, which is associated with protection against breast cancer.<sup>[47]</sup>

A very intriguing hypothesis is that exposure to isoflavones when young reduces breast cancer risk markedly later in life.<sup>[48]</sup> In support of this hypothesis is a large Chinese case-control study that found that women who consumed soy during their teenage years were about half as likely to develop breast cancer as adults as were Chinese women who consumed little soy during this period.<sup>[49]</sup> Exposure to genistein causes breast tissue differentiation and reduces the number of terminal end buds, the anatomical structure within the

rodent mammary gland that is the likely site of tumor development.<sup>[48,50]</sup> There is evidence that these kinds of changes are also important in humans.<sup>[51]</sup>

### Coronary Heart Disease

In 1999, the U.S. Food and Drug Administration (FDA) approved a health claim for the cholesterol-lowering effects of soy protein.<sup>[52]</sup> The FDA does not require that soy protein contain isoflavones to qualify for the health claim. Data do not indicate that isoflavones by themselves lower cholesterol, although they may slightly raise high-density-lipoprotein (HDL)-cholesterol levels.<sup>[53]</sup> In any event, there are intriguing, but still speculative, data suggesting that independent of effects on cholesterol, isoflavones reduce coronary heart disease risk through multiple mechanisms. For example, some data indicate that isoflavones inhibit low-density-lipoprotein (LDL)-cholesterol oxidation,<sup>[31]</sup> enhance systematic arterial compliance<sup>[25]</sup> and flow mediated dilation,<sup>[54]</sup> reduce platelet aggregation,<sup>[55]</sup> and inhibit smooth muscle cell proliferation.<sup>[56]</sup> These effects, if confirmed, will likely prove to be of greater clinical value than the cholesterol-lowering effects of soy protein.

In support of the possible coronary benefits of isoflavones is a recent prospective study involving nearly 65,000 women from Shanghai, which found that those in the highest quartile of soy protein intake were 86% less likely to have a nonfatal heart attack in comparison to women who consumed relatively little soy protein.<sup>[10]</sup> These results suggest that soy has effects on heart disease risk far beyond the modest cholesterol-lowering properties of soy protein.

### Osteoporosis

Conventional HRT is no longer being recommended for long-term use because results from the WHI showed that the harm of HRT outweighed the benefits.<sup>[33]</sup> However, this trial also found that HRT reduces bone loss and fracture risk in postmenopausal women.<sup>[33]</sup> Isoflavones have been posited to reduce bone resorption in perimenopausal and postmenopausal women in a manner similar to that of estrogen. While still speculative, there is *in vitro*, animal, and clinical support for this hypothesis and for the potential for isoflavones to not only inhibit bone resorption but stimulate bone formation.<sup>[57,58]</sup> For example, Italian researchers found that over the course of one year, daily consumption of 54 mg genistein increased bone mineral density at both the spine and hip to a similar extent as conventional HRT.<sup>[59]</sup> More recently, in a 1-yr study, Chen et al.<sup>[82]</sup> reported that in comparison

to placebo, isoflavone supplements (80 mg/day) reduced bone loss at the hip.

In contrast to these favorable findings, a few studies have failed to show that isoflavones or isoflavone-rich soy protein affect bone mineral density. Also of possible relevance is a 3-trial involving 500 women, which found that the synthetic isoflavone ipriflavone failed to favorably affect bone mineral density (BMD).<sup>[60]</sup> Furthermore, most of the isoflavone trials have involved relatively few subjects and have been relatively short ( $\leq 1$  yr) in duration. Thus, despite the overall encouraging data, and most clinical studies showing beneficial effects, results from long-term trials are needed before definitive conclusions about the skeletal effects of isoflavones can be drawn.

### Menopausal Symptoms

Pioneering isoflavone researcher Herman Adlercreutz from the University of Helsinki was the first to formally hypothesize that isoflavones alleviate hot flashes.<sup>[61]</sup> This hypothesis was based on the estrogenlike effects of isoflavones in combination with the low reported frequency of hot flashes in Japan.<sup>[62]</sup>

Recently, Messina and Hughes reviewed 19 trials involving over 1700 women that examined the effects of soyfoods and isoflavone supplements on menopausal symptoms.<sup>[63]</sup> Six trials were excluded from their analysis, two involving breast cancer patients, two that reported data on severity but not frequency, one that was not blinded, and one that did not include a control group. They found that there was a statistically significant ( $p = 0.01$ ) relationship between initial hot flash frequency and treatment efficacy in the remaining 13 trials.

More specifically, the correlation suggests that hot flash frequency will decrease about 5% (above placebo or control effects) for every additional initial hot flash/day in women whose initial hot flash frequency is  $\geq 5$ /day. In practical terms this means that in theory women with eight hot flashes per day who experience a typical placebo response of 25% will experience a 40% overall improvement by consuming soy or isoflavones; thus, hot flashes would decrease from eight per day to 4–5 per day.

### Cognitive Function

The possibility that estrogen may prevent declines in cognitive function and reduce risk of Alzheimer's disease has spurred investigation into the effects of isoflavones in this regard. The limited rodent data are quite encouraging, and thus far, three clinical trials involving young adults in one and postmenopausal women in two that were conducted for 10,<sup>[64]</sup> 12,<sup>[65]</sup>



and 24<sup>[66]</sup> weeks' duration have found that a high-soy diet and/or isoflavone supplements improved various aspects of cognitive function and memory. In contrast, a prospective study found that tofu consumption was associated with poorer cognitive function in Japanese men and women.<sup>[67]</sup> At this point, despite the encouraging short-term clinical data, the evidence is too preliminary to draw conclusions about the relationship between isoflavones and cognitive function, especially considering that the effects of estrogen on cognitive function are unclear.<sup>[68]</sup>

## CONTROVERSIAL AREAS

### Soy Consumption by Infants

An estimated 22 million infants have used soy formula since 1960. Unquestionably, properly formulated soy infant formula promotes normal growth and development. Still, the estrogenlike properties of isoflavones have raised concerns about the effects of soy formula on sexual development and other processes affected by estrogen. It is worth noting that even cow-milk-based formulas exhibit estrogenic activity in some studies.

Until recently, long-term data on the safety of soy formula were lacking; however, a recent retrospective study of adults aged 20–34 yr who, as infants, participated in controlled feeding studies found little difference in a wide range of physiological and reproductive measures between those who were fed soy infant formula and those given cow's milk.<sup>[69]</sup> Thus, there is little reason to think that soy infant formula is unsafe, although it should be acknowledged that in the retrospective study cited above, the cohort was likely too small to detect any differences in the incidence of rare adverse events.

### Soy Consumption by Breast Cancer Patients

In spite of the many proposed mechanisms by which soy/isoflavones might reduce breast cancer risk, there is concern that the estrogenlike effects of isoflavones could be detrimental to breast cancer survivors. This is a complex and yet unresolved issue, but recent data support the safety of isoflavones.<sup>[40,70]</sup> For example, studies do not show that conventional hormone replacement therapy decreases the survival of breast cancer patients. Furthermore, recent observational data indicate that it is the combination of estrogen and progestin, rather than estrogen alone, that is associated with an increased risk of developing breast cancer.<sup>[71]</sup> This suggests that isoflavones, because they do not contain progesterone activity, are unlikely to

be harmful to breast cancer patients. Nevertheless, some data in animals and humans suggest that isoflavones and soy have estrogenlike effects on breast tissue.<sup>[72–74]</sup> A reasonable perspective until further research is available is for breast cancer patients who currently use soyfoods to not stop using them, but for patients who do not currently consume soy to not begin doing so solely for the purpose of preventing tumor recurrence and/or enhancing survival.

### Soy and Thyroid Function

Isoflavones have been shown *in vitro* and *in vivo* in animals to partially inactivate thyroid peroxidase, an enzyme required for the synthesis of thyroid hormones. However, even in rats, which are extremely sensitive to thyroid insults, soy-containing diets allow normal thyroid function.<sup>[75]</sup> Furthermore, most human studies indicate that isoflavone-rich soy protein has little effect on thyroid function in healthy subjects, and a recent 6-mo study of older healthy postmenopausal women found no ill effects of isoflavone supplements.<sup>[26,76]</sup> If isoflavones do modestly adversely affect thyroid function, they are likely to do so only in individuals consuming inadequate amounts of iodine, or in those in whom thyroid function is already compromised. However, soy protein has been shown to increase the dose of synthetic thyroid hormone needed to maintain therapeutic levels in hypothyroid patients, but whether this effect is due to isoflavones is unclear.<sup>[77]</sup> To circumvent any potential unwanted interaction, thyroid medication use should be temporally separated from the ingestion of isoflavones.

### Soy and Reproduction

Isoflavones have been identified as causing infertility in some animal species (cheetah and sheep), but animal breeders feed isoflavone-rich soy meal to rodents with much success.<sup>[78]</sup> There are differences in isoflavone metabolism among species that make generalizations about likely biological effects in humans difficult. One report did indicate that soy consumption delayed ovulation by 2–3 days, but all women in this study ovulated, and several other studies found no effects of soy on ovulation.<sup>[79]</sup> Although concerns have also been raised about the effect of soy on the reproductive abilities of men, a recent study found no observable effect on hormone measurements, testicular volume, or semen parameters in healthy men who consumed an isoflavone supplement (40 mg/day) for 2 mo.<sup>[80]</sup> It is worth noting that the rodent fetus is exposed to relatively low endogenous levels of estradiol in comparison to humans; thus, any estrogenlike effects of isoflavones may be exaggerated in rodents when compared to

humans.<sup>[81]</sup> Thus, studying the reproductive effects of isoflavones in rodents may not provide insight into likely effects in men or women.

## RECOMMENDED INTAKES

Japanese isoflavone intake from soyfoods is approximately 50 mg/day, and approximately 5% of the population consumes as much as 100 mg of isoflavones daily. The latter figure represents the amount of isoflavones found in approximately 3 servings of traditional soyfoods. Although speculative, epidemiologic studies suggest that 1–2 servings of soy may be sufficient to reduce risk of certain forms of cancer, coronary heart disease, and osteoporosis. Clinical studies in which subjects have been administered soyfoods with varying amounts of isoflavones or isoflavone supplements suggest that 40–90 mg of isoflavones per day is needed for beneficial effects. Long-term safety studies have not been conducted, but studies 1–2 yr in duration have not found isoflavone intakes as high as 100 mg/day to be associated with adverse effects. Short-term studies find no ill effects at levels manyfold higher than this amount. Although no intake recommendations have been issued by established health organizations, considerable evidence suggests that a reasonable target intake to derive the hypothesized benefits of isoflavones is 50–75 mg/day with an upper limit of 100–125 mg/day.

## REFERENCES

1. Franke, A.A.; Custer, L.J.; Wang, W.; Shi, C.Y. HPLC analysis of isoflavonoids and other phenolic agents from foods and from human fluids. *Proc. Soc. Exp. Biol. Med.* **1998**, *217*, 263–273.
2. Long, S.R. *Rhizobium*–legume nodulation: life together in the underground. *Cell* **1989**, *56*, 203–214.
3. Murphy, P.A.; Song, T.; Buseman, G. et al. Isoflavones in retail and institutional soy foods. *J. Agric. Food Chem.* **1999**, *47*, 2697–2704.
4. Song, T.; Lee, S.O.; Murphy, P.A.; Hendrich, S. Soy protein with or without isoflavones, soy germ and soy germ extract, and daidzein lessen plasma cholesterol levels in golden Syrian hamsters. *Exp. Biol. Med. (Maywood)* **2003**, *228*, 1063–1068.
5. Setchell, K.D.; Brown, N.M.; Desai, P. et al. Bioavailability of pure isoflavones in healthy humans and analysis of commercial soy isoflavone supplements. *J. Nutr.* **2001**, *131*, 1362S–1375S.
6. Kobayashi, S. Trends in national survey of Japan. *Nutr. Health* **1992**, *8*, 91–96.
7. Wakai, K.; Egami, I.; Kato, K. et al. Dietary intake and sources of isoflavones among Japanese. *Nutr. Cancer* **1999**, *33*, 139–145.
8. Nagata, C.; Takatsuka, N.; Kawakami, N.; Shimizu, H. Soy product intake and premenopausal hysterectomy in a follow-up study of Japanese women. *Eur. J. Clin. Nutr.* **2001**, *55*, 773–777.
9. Arai, Y.; Watanabe, S.; Kimira, M.; Shimoi, K.; Mochizuki, R.; Kinae, N. Dietary intakes of flavonols, flavones and isoflavones by Japanese women and the inverse correlation between quercetin intake and plasma LDL cholesterol concentration. *J. Nutr.* **2000**, *130*, 2243–2250.
10. Zhang, X.; Shu, X.O.; Gao, Y.T. et al. Soy food consumption is associated with lower risk of coronary heart disease in Chinese women. *J. Nutr.* **2003**, *133*, 2874–2878.
11. Yuan, J.M.; Wang, Q.S.; Ross, R.K.; Henderson, B.E.; Yu, M.C. Diet and breast cancer in Shanghai and Tianjin, China. *Br. J. Cancer* **1995**, *71*, 1353–1358.
12. Dai, Q.; Franke, A.A.; Jin, F. et al. Urinary excretion of phytoestrogens and risk of breast cancer among Chinese women in Shanghai. *Cancer Epidemiol. Biomarkers Prev.* **2002**, *11*, 815–821.
13. Lee, H.P.; Gourley, L.; Duffy, S.W.; Esteve, J.; Lee, J.; Day, N.E. Dietary effects on breast-cancer risk in Singapore. *Lancet* **1991**, *337*, 1197–2000.
14. Ho, S.C.; Woo, J.L.; Leung, S.S.; Sham, A.L.; Lam, T.H.; Janus, E.D. Intake of soy products is associated with better plasma lipid profiles in the Hong Kong Chinese population. *J. Nutr.* **2000**, *130*, 2590–2593.
15. Ho, S.C.; Woo, J.; Lam, S.; Chen, Y.; Sham, A.; Lau, J. Soy protein consumption and bone mass in early postmenopausal Chinese women. *Osteoporosis Int.* **2003**, *14*, 835–842.
16. Setchell, K.D.; Faughnan, M.S.; Avades, T. et al. Comparing the pharmacokinetics of daidzein and genistein with the use of <sup>13</sup>C-labeled tracers in premenopausal women. *Am. J. Clin. Nutr.* **2003**, *77*, 411–419.
17. Setchell, K.D.; Brown, N.M.; Desai, P.B. et al. Bioavailability, disposition, and dose-response effects of soy isoflavones when consumed by healthy women at physiologically typical dietary intakes. *J. Nutr.* **2003**, *133*, 1027–1035.
18. Morton, M.S.; Arisaka, O.; Miyake, N.; Morgan, L.D.; Evans, B.A. Phytoestrogen concentrations in serum from Japanese men and women over forty years of age. *J. Nutr.* **2002**, *132*, 3168–3171.
19. Rowland, I.; Faughnan, M.; Hoey, L.; Wahala, K.; Williamson, G.; Cassidy, A. Bioavailability of

- phyto-oestrogens. *Br. J. Nutr.* **2003**, *89* (Suppl. 1), S45–S58.
20. Setchell, K.D.; Brown, N.M.; Zimmer-Nechemias, L. et al. Evidence for lack of absorption of soy isoflavone glycosides in humans, supporting the crucial role of intestinal metabolism for bioavailability. *Am. J. Clin. Nutr.* **2002**, *76*, 447–453.
  21. An, J.; Tzagarakis-Foster, C.; Scharschmidt, T.C.; Lomri, N.; Leitman, D.C. Estrogen receptor beta-selective transcriptional activity and recruitment of coregulators by phytoestrogens. *J. Biol. Chem.* **2001**, *276*, 17,808–17,814.
  22. Kuiper, G.G.; Carlsson, B.; Grandien, K. et al. Comparison of the ligand binding specificity and transcript tissue distribution of estrogen receptors alpha and beta. *Endocrinology* **1997**, *138*, 863–870.
  23. Kuiper, G.G.; Lemmen, J.G.; Carlsson, B. et al. Interaction of estrogenic chemicals and phytoestrogens with estrogen receptor beta. *Endocrinology* **1998**, *139*, 4252–4263.
  24. Brzezinski, A.; Debi, A. Phytoestrogens: the “natural” selective estrogen receptor modulators?. *Eur. J. Obstet. Gynecol. Reprod. Biol.* **1999**, *85*, 47–51.
  25. Nestel, P.J.; Yamashita, T.; Sasahara, T. et al. Soy isoflavones improve systemic arterial compliance but not plasma lipids in menopausal and perimenopausal women. *Arterioscler. Thromb. Vasc. Biol.* **1997**, *17*, 3392–3398.
  26. Duncan, A.M.; Merz, B.E.; Xu, X.; Nagel, T.C.; Phipps, W.R.; Kurzer, M.S. Soy isoflavones exert modest hormonal effects in premenopausal women. *J. Clin. Endocrinol. Metab.* **1999**, *84*, 192–197.
  27. Teede, H.J.; Dalais, F.S.; McGrath, B.P. Dietary soy containing phytoestrogens does not have detectable estrogenic effects on hepatic protein synthesis in postmenopausal women. *Am. J. Clin. Nutr.* **2004**, *79*, 396–401.
  28. Sarkar, F.H.; Li, Y. Soy isoflavones and cancer prevention. *Cancer Invest.* **2003**, *21*, 744–757.
  29. Ruiz-Larrea, M.B.; Mohan, A.R.; Paganga, G.; Miller, N.J.; Bolwell, G.P.; Rice-Evans, C.A. Antioxidant activity of phytoestrogenic isoflavones. *Free Radical Res.* **1997**, *26*, 63–70.
  30. Djuric, Z.; Chen, G.; Doerge, D.R.; Heilbrun, L.K.; Kucuk, O. Effect of soy isoflavone supplementation on markers of oxidative stress in men and women. *Cancer Lett.* **2001**, *172*, 1–6.
  31. Wiseman, H.; O’Reilly, J.D.; Adlercreutz, H. et al. Isoflavone phytoestrogens consumed in soy decrease F(2)-isoprostane concentrations and increase resistance of low-density lipoprotein to oxidation in humans. *Am. J. Clin. Nutr.* **2000**, *72*, 395–400.
  32. Hodgson, J.M.; Puddey, I.B.; Beilin, L.J.; Mori, T.A.; Croft, K.D. Supplementation with isoflavonoid phytoestrogens does not alter serum lipid concentrations: a randomized controlled trial in humans. *J. Nutr.* **1998**, *128*, 728–732.
  33. Writing Group for the Women’s Health Initiative Investigators. Risks and benefits of estrogen plus progestin in healthy postmenopausal women: principal results from the Women’s Health Initiative randomized controlled trial. *J. Am. Med. Assoc.* **2002**, *288*, 321–333.
  34. Naciff, J.M.; Jump, M.L.; Torontali, S.M. et al. Gene expression profile induced by 17alpha-ethynyl estradiol, bisphenol A, and genistein in the developing female reproductive system of the rat. *Toxicol. Sci.* **2002**, *68*, 184–199.
  35. Dalu, A.; Blaydes, B.; Bryant, C.; Latendresse, J.; Weis, C.; Barry Delclos, K. Estrogen receptor expression in the prostate of rats treated with dietary genistein. *J. Chromatogr. B Anal. Technol. Biomed. Life Sci.* **2002**, *777*, 249.
  36. Dalu, A.; Haskell, J.F.; Coward, L.; Lamartiniere, C.A. Genistein, a component of soy, inhibits the expression of the EGF and ErbB2/Neu receptors in the rat dorsolateral prostate. *Prostate* **1998**, *37*, 36–43.
  37. Zhou, J.R.; Mukherjee, P.; Gugger, E.T.; Tanaka, T.; Blackburn, G.L.; Clinton, S.K. Inhibition of murine bladder tumorigenesis by soy isoflavones via alterations in the cell cycle, apoptosis, and angiogenesis. *Cancer Res.* **1998**, *58*, 5231–5238.
  38. Wei, H.; Bowen, R.; Zhang, X.; Lebwohl, M. Isoflavone genistein inhibits the initiation and promotion of two-stage skin carcinogenesis in mice. *Carcinogenesis* **1998**, *19*, 1509–1514.
  39. Zhou, J.R.; Yu, L.; Zhong, Y.; Blackburn, G.L. Soy phytochemicals and tea bioactive components synergistically inhibit androgen-sensitive human prostate tumors in mice. *J. Nutr.* **2003**, *133*, 516–521.
  40. Zhou, J.R.; Yu, L.; Mai, Z.; Blackburn, G.L. Combined inhibition of estrogen-dependent human breast carcinoma by soy and tea bioactive components in mice. *Int. J. Cancer* **2004**, *108*, 8–14.
  41. Pisani, P.; Parkin, D.M.; Bray, F.; Ferlay, J. Estimates of the worldwide mortality from 25 cancers in 1990. *Int. J. Cancer* **1999**, *83*, 18–29.
  42. Griffiths, K. Estrogens and prostatic disease. International Prostate Health Council Study Group. *Prostate* **2000**, *45*, 87–100.
  43. Messina, M. Emerging evidence on the role of soy in reducing prostate cancer risk. *Nutr. Rev.* **2003**, *61*, 117–131.
  44. Severson, R.K.; Nomura, A.M.; Grove, J.S.; Stemmermann, G.N. A prospective study of demographics, diet, and prostate cancer among

- men of Japanese ancestry in Hawaii. *Cancer Res.* **1989**, *49*, 1857–1860.
45. Jacobsen, B.K.; Knutsen, S.F.; Fraser, G.E. Does high soy milk intake reduce prostate cancer incidence? The Adventist Health Study (United States). *Cancer Causes Control* **1998**, *9*, 553–557 (see comments).
  46. Lee, M.M.; Gomez, S.L.; Chang, J.S.; Wey, M.; Wang, R.T.; Hsing, A.W. Soy and isoflavone consumption in relation to prostate cancer risk in china. *Cancer Epidemiol. Biomarkers Prev.* **2003**, *12*, 665–668.
  47. Kurzer, M.S. Hormonal effects of soy in premenopausal women and men. *J. Nutr.* **2002**, *132*, 570S–573S.
  48. Lamartiniere, C.A.; Zhao, Y.X.; Fritz, W.A. Genistein: mammary cancer chemoprevention, in vivo mechanisms of action, potential for toxicity and bioavailability in rats. *J. Women's Cancer* **2000**, *2*, 11–19.
  49. Shu, X.O.; Jin, F.; Dai, Q. et al. Soyfood intake during adolescence and subsequent risk of breast cancer among Chinese women. *Cancer Epidemiol. Biomarkers Prev.* **2001**, *10*, 483–488.
  50. Rowlands, J.C.; Hakkak, R.; Ronis, M.J.; Badger, T.M. Altered mammary gland differentiation and progesterone receptor expression in rats fed soy and whey proteins. *Toxicol. Sci.* **2002**, *70*, 40–45.
  51. Russo, J.; Lareef, H.; Tahin, Q.; Russo, I.H. Pathways of carcinogenesis and prevention in the human breast. *Eur. J. Cancer* **2002**, *38* (Suppl. 6), S31–S32.
  52. Food and Drug Administration. Food labeling, health claims, soy protein, and coronary heart disease. *Fed. Register.* **1999**, *57*, 699–733.
  53. Clifton-Bligh, P.B.; Baber, R.J.; Fulcher, G.R.; Nery, M.L.; Moreton, T. The effect of isoflavones extracted from red clover (Rimostil) on lipid and bone metabolism. *Menopause* **2001**, *8*, 259–265.
  54. Squadrito, F.; Altavilla, D.; Crisafulli, A. et al. Effect of genistein on endothelial function in postmenopausal women: a randomized, double-blind, controlled study. *Am. J. Med.* **2003**, *114*, 470–476.
  55. Schoene, N.W.; Guidry, C.A. Genistein inhibits reactive oxygen species (ROS) production, shape change, and aggregation in rat platelets. *Nutr. Res.* **2000**, *20*, 47–57.
  56. Pan, W.; Ikeda, K.; Takebe, M.; Yamori, Y. Genistein, daidzein and glycitein inhibit growth and DNA synthesis of aortic smooth muscle cells from stroke-prone spontaneously hypertensive rats. *J. Nutr.* **2001**, *131*, 1154–1158.
  57. Arjmandi, B.H. The role of phytoestrogens in the prevention and treatment of osteoporosis in ovarian hormone deficiency. *J. Am. Coll. Nutr.* **2001**, *20*, 398S–402S; Discussion 417S–420S.
  58. Messina, M.; Gugger, E.T.; Alekel, D.L. Soy protein, soybean isoflavones, and bone health: a review of the animal and human data. In *Handbook of Nutraceuticals and Functional Foods*; Wildman, R., Ed.; CRC Press LLC: Boca Raton, 2001; 77–98.
  59. Morabito, N.; Crisafulli, A.; Vergara, C. et al. Effects of genistein and hormone-replacement therapy on bone loss in early postmenopausal women: a randomized double-blind placebo-controlled study. *J. Bone. Miner. Res.* **2002**, *17*, 1904–1912.
  60. Alexandersen, P.; Toussaint, A.; Christiansen, C. et al. Ipriflavone in the treatment of postmenopausal osteoporosis: a randomized controlled trial. *J. Am. Med. Assoc.* **2001**, *285*, 1482–1488.
  61. Adlercreutz, H.; Hamalainen, E.; Gorbach, S.; Goldin, B. Dietary phyto-oestrogens and the menopause in Japan. *Lancet* **1992**, *339*, 1233.
  62. Lock, M. Menopause in cultural context. *Exp. Gerontol.* **1994**, *29*, 307–317.
  63. Messina, M.; Hughes, C. Efficacy of soyfoods and soybean isoflavone supplements for alleviating menopausal symptoms is positively related to initial hot flush frequency. *J. Med. Food* **2003**, *6*, 1–11.
  64. File, S.E.; Jarrett, N.; Fluck, E.; Duffy, R.; Casey, K.; Wiseman, H. Eating soya improves human memory. *Psychopharmacology (Berl.)* **2001**, *157*, 430–436.
  65. Duffy, R.; Wiseman, H.; File, S.E. Improved cognitive function in postmenopausal women after 12 weeks of consumption of a soya extract containing isoflavones. *Pharmacol. Biochem. Behav.* **2003**, *75*, 721–729.
  66. Kritz-Silverstein, D.; Von Muhlen, D.; Barrett-Connor, E.; Bressel, M.A. Isoflavones and cognitive function in older women: the SOy and Postmenopausal Health In Aging (SOPHIA) Study. *Menopause* **2003**, *10*, 196–202.
  67. White, L.R.; Petrovitch, H.; Ross, G.W. et al. Brain aging and midlife tofu consumption. *J. Am. Coll. Nutr.* **2000**, *19*, 242–255.
  68. Yaffe, K. Hormone therapy and the brain: deja vu all over again? *J. Am. Med. Assoc.* **2003**, *289*, 2717–2719.
  69. Strom, B.L.; Schinnar, R.; Ziegler, E.E. et al. Follow-up study of a cohort fed soy-based formula during infancy. Presented at Experimental Biology 2000, San Diego, CA, April 15–18, 2000; Abstract LB39 (Endocrinology and metabolism), 7 (Program addendum late breaking abstracts).
  70. Messina, M.J.; Loprinzi, C.L. Soy for breast cancer survivors: a critical review of the literature. *J. Nutr.* **2001**, *131*, 3095S–3108S.

71. Pritchard, K.I. Hormonal replacement therapy in breast cancer. *Ann. Oncol.* **2002**, *13* (Suppl. 4), 73–80.
72. Hargreaves, D.F.; Potten, C.S.; Harding, C. et al. Two-week dietary soy supplementation has an estrogenic effect on normal premenopausal breast. *J. Clin. Endocrinol. Metab.* **1999**, *84*, 4017–4024.
73. Allred, C.D.; Allred, K.F.; Ju, Y.H.; Virant, S.M.; Helferich, W.G. Soy diets containing varying amounts of genistein stimulate growth of estrogen-dependent (mcf-7) tumors in a dose-dependent manner. *Cancer Res.* **2001**, *61*, 5045–5050.
74. Allred, C.D.; Ju, Y.H.; Allred, K.F.; Chang, J.; Helferich, W.G. Dietary genistin stimulates growth of estrogen-dependent breast cancer tumors similar to that observed with genistein. *Carcinogenesis* **2001**, *22*, 1667–1673.
75. Chang, H.C.; Doerge, D.R. Dietary genistein inactivates rat thyroid peroxidase in vivo without an apparent hypothyroid effect. *Toxicol. Appl. Pharmacol.* **2000**, *168*, 244–252.
76. Bruce, B.; Messina, M.; Spiller, G.A. Isoflavone supplements do not affect thyroid function in iodine-replete postmenopausal women. *J. Med. Food* **2003**, *6*, 309–316.
77. Bell, D.S.; Ovalle, F. Use of soy protein supplement and resultant need for increased dose of levothyroxine. *Endocr. Pract.* **2001**, *7*, 193–194.
78. Brown, N.M.; Setchell, K.D. Animal models impacted by phytoestrogens in commercial chow: implications for pathways influenced by hormones. *Lab. Invest.* **2001**, *81*, 735–747.
79. Cassidy, A.; Bingham, S.; Setchell, K. Biological effects of isoflavones in young women: importance of the chemical composition of soyabean products. *Br. J. Nutr.* **1995**, *74*, 587–601.
80. Mitchell, J.H.; Cawood, E.; Kinniburgh, D.; Provan, A.; Collins, A.R.; Irvine, D.S. Effect of a phytoestrogen food supplement on reproductive health in normal males. *Clin. Sci. (Lond.)* **2001**, *100*, 613–618.
81. Safford, B.; Dickens, A.; Halleron, N.; Briggs, D.; Carthew, P.; Baker, V. A model to estimate the oestrogen receptor mediated effects from exposure to soy isoflavones in food. *Regul. Toxicol. Pharmacol.* **2003**, *38*, 196–209.
82. Chen, Y.M.; Ho, S.C.; Lam, S.S.; Ho, S.S.; Woo, J.L. Soy isoflavones have a favorable effect on bone loss in Chinese postmenopausal women with lower bone mass: a double-blind, randomized, controlled trial. *J. Clin. Endocrinol. Metab.* **2003**, *88* (10), 4740–4747.

# Kava (*Piper methysticum*)

Steven M. Musser

Office of Scientific Analysis and Support, Center for Food Safety and Applied Nutrition,  
United States Food and Drug Administration, College Park, Maryland, U.S.A.

## INTRODUCTION

Kava, the common name of the plant *Piper methysticum* Forst. f., is native to many South Pacific islands. While the traditional beverage prepared from its roots is known as kava kava, the dietary supplement extracts are called awa. The conventional method of preparing kava for human consumption is to make an aqueous extract of the ground roots. Although some supplements are made in this manner, the majority are prepared through large-scale commercial extraction processes using organic solvents or supercritical fluid (CO<sub>2</sub>) extraction. While the method of extraction changes the relative proportion and concentration of the chemical components responsible for kava's therapeutic action, the components themselves remain the same and are generally referred to as kava lactones or, more correctly, as kava pyrones.

No records exist for the actual discovery of the ceremonial and medicinal use of kava by native populations. However, knowledge of its medicinal properties must have become common hundreds of years prior to Cook's second voyage to the region in 1772, since by that time, it was already being cultivated and used in trade by the native population. In the South Pacific where kava is a native plant, it was, and still is, used ceremonially for its relaxing, mood calming effects and has long been utilized to promote dispute resolution in group settings. Once introduced into the scientific community in Europe, it became the subject of intense study and was soon adapted for use in the medical community. The most notable of kava's medicinal qualities is its anxiolytic effects and, in higher concentrations, its inebriating effects.

Kava preparations have been consumed for decades, and while modern clinical trials have not been conducted, few adverse health effects have been reported. Over a 12-yr period between 1990 and 2002, a number of cases of hepatotoxicity, some involving liver transplant, were associated with kava consumption. These reports prompted a number of

countries to withdraw drug registrations related to kava and/or ban its sale. The causality of case reports of liver toxicity associated with kava consumption is still a matter of scientific debate and has been the subject of numerous scientific meetings and publications. Despite a significant history of efficacy, as well as tolerability, consumption should not be necessarily considered safe, since the possibility exists for rare, serious adverse health effects.

## BACKGROUND

A member of the Piperaceae family, kava is a long-lived, slow-growing shrub that can grow to more than 6 m in height. Its roots can be harvested after the plant reaches 2–3 yr in age and grows to a height of approximately 2–3 m. It does not produce seeds and is generally propagated by planting of its stalks. Consequently, varieties or cultivars with specific properties have been carefully selected and developed for ceremonial, medicinal, and commercial purposes. More than 100 distinct cultivars have been identified. Often, these differ not only in their physical appearance, but also in their medicinal properties. Physical differences include the shade of leaf color, and, more importantly, for taxonomic purposes, the color of the stem (purple to brown) and internode space between stem joints (Fig. 1). Desirable medicinal properties range from appropriate for daily consumption to limited use only for specific symptoms.

Where kava is cultivated for human consumption, it is the roots that are used to prepare beverages and extracts. Root stock is currently harvested for commercial purposes in a number of locations, including the islands of Fiji, Hawaii, Samoa, Tonga, and Vanuatu. In these regions, aqueous extracts have been used for ceremonial and medicinal purposes for thousands of years. An extensive review on the ceremonial and traditional history of use of kava is provided by Singh.<sup>[1]</sup> Interestingly, the conventional method of preparing kava beverages involved chewing the freshly harvested roots and spitting them into a bowl. The mixture was then diluted with a small amount of water, divided, and served. However, that practice has given way to soaking the finely ground root with water or coconut milk for several hours, followed by filtering prior to

---

Steven M. Musser, Ph.D., is at the Office of Scientific Analysis and Support, Center for Food Safety and Applied Nutrition, United States Food and Drugs Administration, College Park, Maryland, U.S.A.



**Fig. 1** Photographs of two different cultivars of kava. Note the differences in stem color, internode distance, and pattern of markings on stem. Picture courtesy of Trish Flaster, Botanical Liaisons. (View this art in color at [www.dekker.com](http://www.dekker.com).)

consumption. Since the active constituents are more soluble in organic solvents, commercial preparations are generally obtained by extracting the roots with alcohol, acetone, or supercritical carbon dioxide.

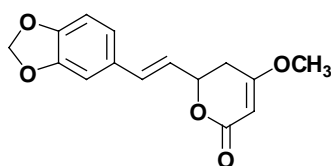
The interest in kava extracts in Western medicine began following its description by naturalist Johann George Forester. Forester, then 18 yr old, and his father Johann Reinhold Forester, served as naturalists aboard the H.M.S. *Resolution* during Captain James Cook's second voyage to the South Pacific from 1772 to 1775. Within 4 mo of Cook's return to England, the younger Forester's description of kava and its medicinal effects were published and broadly circulated in the scientific community of Europe. These reports generated a significant number of scientific studies related to the pharmacological properties and chemical constituents of kava. The first extensive research into the active constituents was conducted by the French scientists Goble (1860) and Cuzent (1861). By the early 1900s, pills, extracts, and tinctures derived from kava were widely available in Europe, and in 1914, it was included in the *British Pharmacopoeia*.

## CHEMISTRY

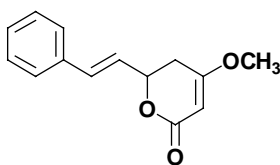
More than 40 different chemical compounds have been isolated or identified in *P. methysticum*.<sup>[2]</sup> Isolated compound classes include alcohols, alkaloids, chalcones, steroids, and long-chained fatty acids. However, only six chemicals have been demonstrated to have pharmacological activity associated with those

observed when consuming the traditional beverage (Fig. 2). The compounds are correctly referred to as substituted alpha-pyrone, although they are often called kava lactones. While Goble and Cuzent had been able to isolate independently an active constituent in the mid-1800s, it was not until the early 1900s that the complete chemical structures of the active constituents were described. Borsche and coworkers published more than a dozen articles describing the structure and isolation of the active kava constituents.<sup>[3]</sup> The six primary chemical constituents were identified as kavain, dihydrokavain, methysticin, dihydromethysticin, yangonin, and desmethoxy-yangonin. It was not until 1950 that the correct chemical structure of yangonin was published by Macierewicz.<sup>[4]</sup> While more than 18 different pyrones have been identified, the complete spectroscopic data of the nine most abundant have only been recently published.<sup>[5]</sup>

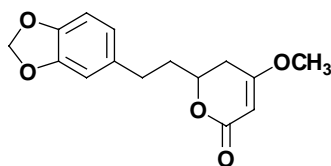
The dried rhizome can contain kava pyrone levels of up to 17%, but ranges of 3–7% are more typical.<sup>[6]</sup> Of the total lipid extract, more than 96% is made up by the six primary kava pyrones. The relative proportion of the six principal pyrones varies considerably from cultivar to cultivar (Fig. 3), and this has been used to develop a chemotaxonomic coding scheme by which different cultivars could be identified.<sup>[7]</sup> In addition to the cultivar type, the nature of the solvent used to extract the raw root material has a dramatic effect on both the amount and proportion of kava pyrones present in the extract.<sup>[8]</sup> For example, extraction with water yields primarily kavain and dihydrokavain with very small amounts of methysticin and yangonin.



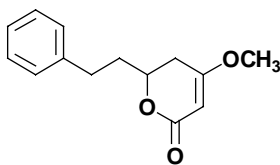
Methysticin (M), m.w. 274



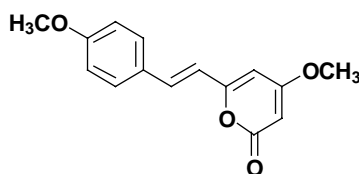
Kavain (K), m.w. 230



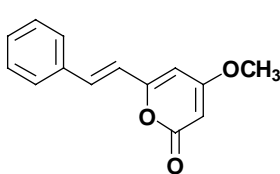
Dihydromethysticin (DM), m.w. 276



Dihydrokavain (DK), m.w. 232



Yangonin (Y), m.w. 258



Desmethoxyyangonin (DY), m.w. 228

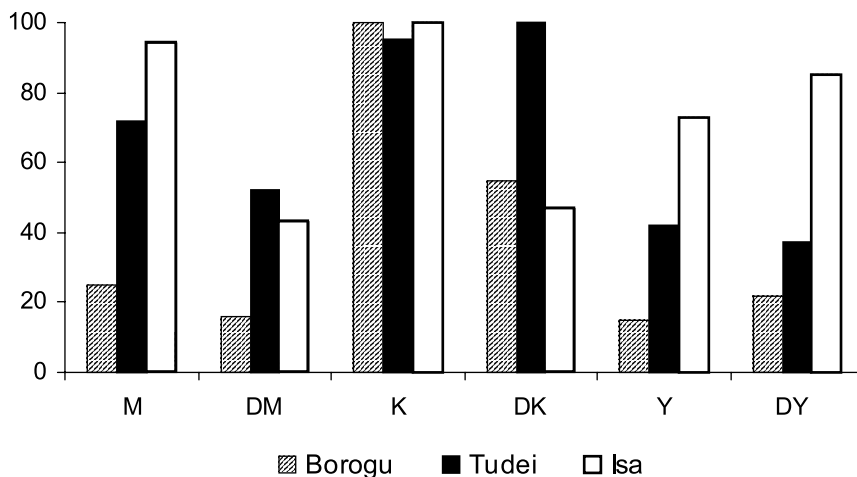
**Fig. 2** Chemical structures of the most abundant active components isolated from kava.

However, if it is performed with an organic solvent, such as acetone, quantitative recovery of all the major kava pyrones can be achieved.

Several studies describe significant differences in the concentration and ratio of pyrones present in the stems, leaves, and roots.<sup>[9,10]</sup> These reports generally agree that overall kava pyrone levels are at the highest in the roots and lowest in the leaves. Also, kavain and methysticin are present in greater quantity in the roots, while the leaves contain more of dihydrokavain and dihydromethysticin. However, a recent analysis of roots, stumps, and stems from a number of different cultivars indicated that both the relative ratio and

amount of pyrone present in the extract were comparable.<sup>[11]</sup> Furthermore, while cultivar type was found to have the largest effect on kava pyrone composition, cultivar age, up to plant maturity at 2–3 yr, and seasonal variations were also found to affect its chemical composition.

Since the six major kava pyrones comprise over 96% of the active components in an extract, accurate measurement is important for quality control of manufactured products containing kava root extracts. Recognizing this need, analysis of the individual pyrones along with other chemical components has been an ongoing scientific endeavor since Forester first



**Fig. 3** Percentage of relative composition of the six primary kava pyrones in three different cultivars. Cultivars Borogu and Tudei were obtained from Vanuatu, while the Isa cultivar was from Hawaii.



disclosed its medicinal properties. As a result, numerous chromatographic methods have been applied to the separation of the active constituents. The first successful demonstration of a mechanism capable of separating all the six primary kava pyrones employed thin layer chromatography with UV detection.<sup>[12]</sup> Although gas chromatography (GC) can be used to successfully separate and quantitate the abundant kava pyrones, it must be performed carefully to avoid decomposition of methysticin in the hot injection port.<sup>[13]</sup> In part because of the possibility of decomposition of the components during GC analysis and need for a more convenient sample preparation method, high performance liquid chromatography (HPLC) has become the preferred analytical method for the quantitation of kava pyrones.<sup>[14,15]</sup> The complete analysis, including the separation of 12 kava pyrones, can be accomplished in under 20 min using the appropriate combination of solvent, column, and column temperature.

## PRECLINICAL STUDIES

While the intoxicating, sedative qualities of kava extracts were obvious from Forester's description of kava's traditional use, it was not until the early 1900s that serious investigations into the pharmacological properties were made.<sup>[16,17]</sup> These early studies clearly demonstrated that the active components of kava extracts existed in the lipophilic portions. Although aqueous extracts had similar activity, they were much less potent. Because the traditional method of preparing kava involved extensive chewing of the root, Schübel and many others postulated that enzymatic activity in the saliva was required to increase the potency of the extracts. However, this has since been proven incorrect, since the chewing action merely creates an emulsion that aids in the extraction of the lipophilic components. Van Veen was able to demonstrate that both the lipophilic extract and the purified form of dihydrokavain caused pigeons and monkeys to become sleepy.<sup>[17]</sup> At high doses, the animals lost control of their limb and quickly entered into long periods of sleep. These results, in addition to loss of righting reflex, were confirmed by Meyer et al., following oral administration of dihydromethysticin and dihydrokavain to mice, rats, rabbits, and cats.<sup>[18]</sup> As a result of the continued study, Meyer found that both kava extracts and individual pure chemical constituents produced centrally acting smooth muscle relaxation and antagonized strychnine-induced convulsions.<sup>[19]</sup> Interestingly, none of the individual kava pyrones exhibited an equivalent potency as that induced by extracts, causing a number of investigators to propose a synergistic action of the natural combination of compounds.

The increasing interest in the use of kava not only for its well-documented effects as a sleeping aid, but also for its anxiolytic qualities, has prompted numerous investigations into its effectiveness as a treatment for anxiety disorders and mild forms of depression. Neuropharmacological trials of the binding of individual kava pyrones to gamma-amino butyric acid (GABA) and benzodiazepine receptors in isolated rat and mouse synaptosomal membranes found only weak binding to GABA<sub>A</sub> receptors and no significant binding to GABA<sub>B</sub> or benzodiazepine receptors.<sup>[20]</sup> The weak receptor binding of the individual kava pyrones and kava extract did not correlate with the observed centrally acting pharmacological properties of kava in animal and human studies. Although this study is widely cited as providing the molecular level mechanism of action of kava pyrones, it does in fact conclude the opposite. Other experiments suggest the mechanism of action to involve sodium- and calcium-gated channels along with inhibition of noradrenalin uptake.<sup>[21,22]</sup> Another evaluation indicates that central nervous system receptor binding of indicated components other than kava pyrones may be responsible for the anxiolytic activity in kava extracts. Leaf and stem extracts contained components with potent binding to GABA<sub>A</sub>, dopamine D<sub>2</sub>, opioid, and histamine receptors, which were unrelated to the concentration of kava pyrones.<sup>[23]</sup>

A number of animal studies have been carried out to examine the metabolism of kava pyrones. In rats, metabolism was extensive and consisted primarily of hydroxylation of the benzene ring and hydrolysis of the pyrone ring.<sup>[24]</sup> Analysis of human urine following ingestion of a traditionally prepared kava beverage detected the known kava pyrones along with a complex mixture of hydroxylated metabolites.<sup>[25]</sup> Other metabolism included the demethylation of the methoxy substituent on the pyrone ring, as well as reduction of the 3,4-double bond of the pyrone ring.

Although kava had not previously been shown to be hepatotoxic, recent reports of liver failure associated with consumption of kava-containing products have prompted new studies related to its metabolism. Since one well-known pathway by which natural products and drugs can cause hepatotoxicity is through the inhibition or modulation of cytochrome P450 (Cyp450) enzymes, the ability of individual kava pyrones to inhibit specific Cyp450 enzymes was investigated. Although kavain was associated with little or no inhibition, methysticin, dihydromethysticin, and desmethoxy-yangonin were all found to cause significant inhibition of the isozymes Cyp2C9, Cyp2C19, and Cyp3A4.<sup>[26]</sup> More importantly, this study showed that methysticin and dihydromethysticin form irreversible metabolic complexes following incubation with these Cyp450 isozymes. Since the affected enzyme systems

are responsible for the metabolism of more than 90% of all drugs, there is a significant risk of adverse reaction associated with kava consumption and conventional drug therapy. This would not be unexpected since drug/natural product combinations have been associated with adverse reactions involving a number of natural products, such as grapefruit juice and St. John's wort.

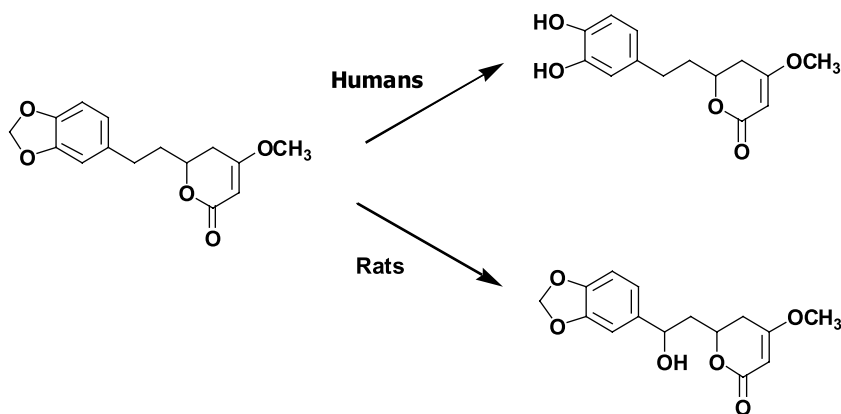
The delayed onset and low incidence of hepatotoxicity associated with kava products suggested an idiosyncratic reaction similar to those observed for some drug products. In many cases, these reactions are often associated with bioactivation to reactive electrophilic metabolites. Further study into the chemical reactivity of the principal chemical constituents of kava extracts was conducted to evaluate their ability to generate reactive metabolites in the presence of human liver microsomes and hepatocytes. The results of these investigations showed significant and extensive formation of glutathione reactive metabolites with several of the kava pyrones.<sup>[27]</sup> Characterization of the glutathione conjugates pointed to a mechanism involving the generation of *ortho*-quinones as the reactive intermediates. Although it is often difficult to link reactive metabolite formation to a specific toxicity, identification of the reactive metabolites has provided important mechanistic insights for future toxicological studies. For example, should toxicity be mediated through this mechanism, rats could not be used since they do not have the ability to metabolize methysticin and dihydromethysticin to the same reactive metabolite observed in humans (Fig. 4).

Since cases of hepatitis similar to those reported for kava extracts have often been associated with the direct action of a chemical contaminant on the liver, numerous studies are underway to evaluate other chemical constituents present for the same activity. One such investigation into direct acting hepatotoxic contaminants present in kava extracts has identified an epoxide form of pipermethystine.<sup>[28]</sup> The epoxide

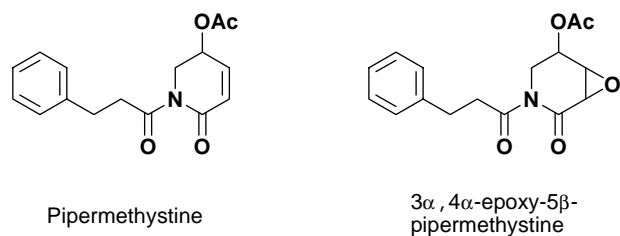
(Fig. 5) was isolated from the outer stem peelings of a kava cultivar from Papua New Guinea known as Isa. Peelings from 10 other cultivars, including another variety from Papua New Guinea, were also included in the analysis, but they did not have detectable levels of the epoxide. This new chemical compound was found to be toxic in in vitro cell cultures of hepatocytes. Since stem peelings are not used traditionally, and have only been recently used to fill the enormous demand for kava, the authors speculate that this alkaloid may be responsible for some of the observed hepatotoxicity. Some support for this hypothesis may be found in the data generated from the Port Import/Export Reporting Service (PIERS), which records more than 100 tn of kava root peelings being imported to the United States prior to the year 2001, presumably for use in kava preparations. While the toxicity of the pipermethystine epoxide remains to be proven, it would not explain the hepatotoxicity observed with a patient taking only kavain, implying that there may be multiple pathways of hepatotoxicity.

## CLINICAL STUDIES

Although there are a number of potential medicinal uses for kava root extracts, the principal purpose is for the relaxing, anxiolytic effects. Its pharmacological properties have led to a continuous, worldwide increase in use as an over-the-counter dietary supplement or a medicinal herbal preparation. The German Commission E monographs permit daily doses of 60–120 mg of total kava pyrones for the treatment of anxiety, stress, and restlessness. While the mechanism of action may not be completely understood, a recent review of clinical trials conducted on the effectiveness of kava for treating depression and anxiety disorders clearly suggests efficacy in comparison to placebo treatment.<sup>[29]</sup>



**Fig. 4** Schematic representation of the difference in primary metabolism of dihydromethysticin and methysticin in rats and humans. Demethylation of methysticin and dihydromethysticin can lead to the formation of a reactive *ortho*-quinone species.



**Fig. 5** Chemical structures of possible contaminants of kava extracts, pipermethystine and the *in vitro* hepatotoxic epoxide form of pipermethystine.

The review included meta-analysis of data collected from seven double-blinded randomized clinical trials. One of the most recent clinical trials included in the meta-analysis was that conducted by Volz and Kieser.<sup>[30]</sup> It included 101 patients and employed a carefully formulated dose of kava equivalent to 210 mg of kava pyrones per day. Using the Hamilton Anxiety Scale as a measure of efficacy, the study found a significant improvement over the control group following 8 weeks of treatment. Although adverse events were reported, they were confined to relatively minor complaints including headache, restlessness, and drowsiness.

Kava has been used, and even abused for its intoxicating properties, for centuries with little but isolated or circumstantial reference to human toxicity. Prior to numerous recent reports of hepatotoxicity, reported human toxicity was limited to a scaly dermatopathy observed with chronic, high consumption rates. This condition is believed to result from inhibition of cholesterol metabolism.<sup>[31]</sup> Clinical observations on an Australian Aboriginal community described greatly increased levels of gamma-glutamyl transferase, along with decreased levels of bilirubin, plasma protein, and urea in all frequent kava users.<sup>[32]</sup> Although many of the individuals in this study consumed very high levels of kava, with most exceeding 100 g/week and some exceeding 400 g/week, no reports of hepatotoxicity were observed. A number of other epidemiological investigations have also been conducted on the carcinogenicity of kava extracts. However, no study has shown any causal link with cancer.

The toxicity of kava extracts to humans is a matter of fierce debate. Prior to 2000, kava was among the top 10 best selling botanical supplements in the United States, and worldwide millions of doses were consumed annually. However, based on a number of reported cases of severe hepatotoxicity, some involving liver transplant, sales have been banned in a number of countries including Germany, Switzerland, and United Kingdom. In a summary of 29 cases of kava-implicated hepatotoxicity reported in Germany between 1990 and 2002,<sup>[33]</sup> nine people developed fulminant liver failure,

and eight of them received liver transplants. There seemed to be no correlation between illness and a particular brand of kava. Additionally, hepatitis was reported in patients consuming kava extracts prepared with acetone and alcohol, implying that the method of extraction had little to do with the associated toxicity. It is also noteworthy to mention that many of the individuals exceeded the German Commission E recommended daily dose of 120 mg.

So far, a definitive mechanism for kava-induced hepatotoxicity has not been identified, but it could include both idiosyncratic and immunoallergenic mechanisms. The most likely mechanism of toxicity could be related to individual metabolic idiosyncratic reaction, since the affected individuals generally demonstrated a long latency period and rarely showed evidence of autoimmune response. A recent study of the metabolic profiles of kava-sensitive individuals showed that subjects with Cyp2D6 deficiency seemed to be at risk for developing kava-related hepatotoxicity.<sup>[34]</sup> Although those with this deficiency are known to be sensitive to a broad range of drugs, there is insufficient evidence to come to this conclusion.

Another traditional use has been for the relief of pain and inflammation associated with arthritis, chronic gout, menstruation, and toothache. Extracts have been shown to produce both short acting local anesthetic action, as well as longer lasting pain relief. The former effect has been likened to that produced by lidocaine,<sup>[35]</sup> and has not been attributed to the individual kava pyrones but to other components present in the extract. The individual kava pyrones have been found to produce analgesic action similar to aspirin. An investigation into the mechanism of the anti-inflammatory response to the kava pyrones found that all six of the primary kava pyrones, in addition to flavokawain, had inhibitory effects on cyclo-oxygenase (COX) enzymes COX-1 and COX-2.<sup>[36]</sup> Since the mechanism of action of nonsteroidal anti-inflammatory drugs, like ibuprofen, is attributed to their ability to inhibit the COX enzymes, the finding that kava pyrones, in particular dihydrokawain and yangonin, also perform a similar function is a likely explanation for their activity.

Kava has a long history of use as a treatment for urinary tract infections and gonorrhea. It was widely believed that drinking the extract would not only relieve the symptoms associated with gonorrhea, but ultimately result in a cure.<sup>[1]</sup> Some supporting scientific evidence for this traditional use is found with the observed broad spectrum of antimicrobial and antifungal effects of kava extracts.<sup>[37]</sup>

Finally, kava extracts have also long been used as a natural remedy for the relief of symptoms associated with menopause. Indeed, clinical evaluation of the extract for the treatment of menopausal symptoms

does conclude that some efficacy is observed.<sup>[38]</sup> One study evaluated the combined effectiveness of hormone replacement therapy along with a daily dose of 100 mg kava extract containing 55% kavain.<sup>[39]</sup> Results of this trial found considerable relief of psychological symptoms associated with menopause when kava was combined with traditional hormone replacement therapy.

## CONCLUSIONS

Kava extracts have a well-documented, effective pharmacological action in inducing sleep and reducing mild cases of anxiety. They are also used extensively as a substitute for alcohol, and numerous kava bars are present in Hawaii and elsewhere in the South Pacific and United States. Despite the implied, broadly accepted safety of consuming kava extracts, there appears to be a sufficient amount of evidence to support a significant risk of severe hepatotoxicity when consuming these products. Since the time required to solve the mechanism of toxicity and conduct appropriate animal studies is likely to take many years, extreme caution should be urged when consuming kava-containing products.

## REFERENCES

- Singh, Y.N. Kava: an overview. *J. Ethnopharmacol.* **1992**, *37*, 13–45.
- Parmar, V.S.; Jain, S.C.; Bisht, K.S.; Jain, R.; Taneja, P.; Jha, A.; Tyagi, O.D.; Prasad, A.K.; Wengel, J.; Olsen, C.E.; Boll, P.M. Phytochemistry of the genus *Piper*. *Phytochemistry* **1997**, *64*, 597–673.
- Borsche, W.; Blount, B.K. Research on the composition of the roots of kava. XIII. Report on a new compound with experimental part (German). *Chem. Ber.* **1933**, *66*, 803–806.
- Macierewicz, Z. Synthesis of the mother substance of yangonin. *Roczniki Chem.* **1950**, *24*, 144–166.
- Dharmaratne, H.R.; Nanayakkara, N.P.; Khan, I.A. Kavalactones from *Piper methysticum*, and their <sup>13</sup>C NMR spectroscopic analyses. *Phytochemistry* **2002**, *59*, 429–433.
- Lebot, V.; Levesque, J. The origin and distribution of kava (*Piper methysticum* Forst f., Piperaceae): a phytochemical approach (National Tropical Botanical Garden, Hawaii). *Allertonia* **1989**, *5*, 223–380.
- Lebot, V.; Levesque, J. Evidence for conspecificity of *Piper methysticum* Forst f. and *Piper wichmannii* C. DC. *Biochem. Syst. Ecol.* **1996**, *24*, 775–782.
- Kubatova, A.; Miller, D.J.; Hawthorne, S.B. Comparison of subcritical water and organic solvents for extracting kava lactones from kava root. *J. Chromatogr. A* **2001**, *923*, 187–194.
- Smith, R.M.; Thakrar, H.; Arowolo, T.A.; Safi, A.A. High performance liquid chromatography of kava lactones from *Piper methysticum*. *J. Chromatogr.* **1984**, *283*, 303–308.
- Smith, R.M. Kava lactones in *Piper methysticum* from Fiji. *Phytochemistry* **1983**, *22*, 1055–1056.
- Simeoni, P.; Lebot, V. Identification of factors determining kavalactone content and chemotype in kava (*Piper methysticum* Forst f.). *Biochem. Syst. Ecol.* **2002**, *30*, 413–424.
- Young, R.L.; Hylin, J.W.; Plucknett, D.L.; Kawano, Y.; Nakayama, R.T. Analysis for kava pyrones in extracts of *Piper methysticum*\*1. *Phytochemistry* **1966**, *5*, 795–798.
- Duve, R.N. Gas-liquid chromatographic determination of the major constituents of *Piper methysticum*. *Analyst* **1981**, *106*, 160–165.
- Shao, Y.; He, K.; Zheng, B.; Zheng, Q. Reversed-phase high-performance liquid chromatographic method for quantitative analysis of the six major kavalactones in *Piper methysticum*. *J. Chromatogr. A* **1998**, *825*, 1–8.
- Schmidt, A.H.; Molnar, I. Computer-assisted optimization in the development of a high-performance liquid chromatographic method for the analysis of kava pyrones in *Piper methysticum* preparations. *J. Chromatogr. A* **2002**, *948*, 51–63.
- Schubel, K. The chemistry and pharmacology of kawa-kawa (*Piper methysticum*, Rauschpfeffer) (German). *Naunyn-Schmiedeberg's Arch. Exp. Pathol. Pharmacol.* **1924**, *102*, 250–282.
- Van Veen, A.G. On the intoxicating substance from kawakawa of wati-plant (*Piper methysticum*) (Dutch). *Geneeskd. Tijdschr. Ned.* **1938**, *78*.
- Meyer, H.J.; Oberdorf, A.; Seifan, E. Investigations on the active substances in kawa-kawa (*Piper methysticum*). *Naunyn-Schmiedeberg's Arch. Exp. Pathol. Pharmacol.* **1960**, *238*.
- Meyer, H.J. Pharmacology of kava 1. *Psychopharmacol. Bull.* **1967**, *4*, 10–11.
- Davies, L.P.; Drew, C.A.; Duffield, P.; Johnston, G.A.; Jamieson, D.D. Kava pyrones and resin: studies on GABAA, GABAB and benzodiazepine binding sites in rodent brain. *Pharmacol. Toxicol.* **1992**, *71*, 120–126.
- Magura, E.I.; Kopanitsa, M.V.; Gleitz, J.; Peters, T.; Krishtal, O.A. Kava extract ingredients, (+)-methysticin and (+/-)-kavain inhibit voltage-operated Na(+)-channels in rat CA1 hippocampal neurons. *Neuroscience* **1997**, *81*, 345–351.

22. Seitz, U.; Schule, A.; Gleitz, J. [3H]-Monoamine uptake inhibition properties of kava pyrones. *Planta Med.* **1997**, *63*, 548–549.
23. Dinh, L.D.; Simmen, U.; Bueter, K.B.; Bueter, B.; Lundstrom, K.; Schaffner, W. Interaction of various *Piper methysticum* cultivars with CNS receptors in vitro. *Planta Med.* **2001**, *67*, 306–311.
24. Rasmussen, A.K.; Scheline, R.R.; Solheim, E.; Hansel, R. Metabolism of some kava pyrones in the rat. *Xenobiotica* **1979**, *9*, 1–16.
25. Duffield, A.M.; Jamieson, D.D.; Lidgard, R.O.; Duffield, P.H.; Bourne, D.J. Identification of some human urinary metabolites of the intoxicating beverage kava. *J. Chromatogr.* **1989**, *475*, 273–281.
26. Mathews, J.M.; Etheridge, A.S.; Black, S.R. Inhibition of human cytochrome P450 activities by kava extract and kavalactones. *Drug Metab. Dispos.* **2002**, *30*, 1153–1157.
27. Johnson, B.M.; Qiu, S.X.; Zhang, S.; Zhang, F.; Burdette, J.E.; Yu, L.; Bolton, J.L.; van Breemen, R.B. Identification of novel electrophilic metabolites of *Piper methysticum* Forst. (kava). *Chem. Res. Toxicol.* **2003**, *16*, 733–740.
28. Dragull, K.; Yoshida, W.Y.; Tang, C.-S. Piperidine alkaloids from *Piper methysticum*. *Phytochemistry* **2003**, *63*, 193–198.
29. Pittler, M.H.; Ernst, E. Efficacy of kava extract for treating anxiety: systematic review and meta-analysis. *J. Clin. Psychopharmacol.* **2000**, *20*, 84–89.
30. Volz, H.P.; Kieser, M. Kava-kava extract WS 1490 versus placebo in anxiety disorders—a randomized placebo-controlled 25-week outpatient trial. *Pharmacopsychiatry* **1997**, *30*, 1–5.
31. Norton, S.A.; Ruze, P. Kava dermatopathy. *J. Am. Acad. Dermatol.* **1994**, *31*, 89–97.
32. Mathews, J.D.; Riley, M.D.; Fejo, L.; Munoz, E.; Milns, N.R.; Gardner, I.D.; Powers, J.R.; Ganygulpa, E.; Gununuwawuy, B.J. Effects of the heavy usage of kava on physical health: summary of a pilot survey in an aboriginal community. *Med. J. Aust.* **1988**, *148*, 548–555.
33. Stickel, F.; Baumuller, H.-M.; Seitz, K.; Vasilakis, D.; Seitz, G.; Seitz, H.K.; Schuppan, D. Hepatitis induced by kava (*Piper methysticum rhizoma*). *J. Hepatol.* **2003**, *39*, 62–67.
34. Russmann, S.; Lauterburg, B.H.; Helbling, A. Kava hepatotoxicity. *Ann. Intern. Med.* **2001**, *135*, 68–69.
35. Singh, Y.N. Effects of kava on neuromuscular transmission and muscle contractility. *J. Ethnopharmacol.* **1983**, *7*, 267–276.
36. Wu, D.; Yu, L.; Nair, M.G.; DeWitt, D.L.; Ramsewak, R.S. Cyclooxygenase enzyme inhibitory compounds with antioxidant activities from *Piper methysticum* (kava kava) roots. *Phyto-medicine* **2002**, *9*, 41–47.
37. Locher, C.P.; Burch, M.T.; Mower, H.F.; Berestecky, J.; Davis, H.; Van Poel, B.; Lasure, A.; Berghe, D.A.V.; Vlietinck, A.J. Anti-microbial activity and anti-complement activity of extracts obtained from selected Hawaiian medicinal plants. *J. Ethnopharmacol.* **1995**, *49*, 23–32.
38. Huntley, A.L.; Ernst, E. A systematic review of herbal medicinal products for the treatment of menopausal symptoms. *Menopause* **2003**, *10*, 465–476.
39. De Leo, V.; la Marca, A.; Morgante, G.; Lanzetta, D.; Florio, P.; Petraglia, F. Evaluation of combining kava extract with hormone replacement therapy in the treatment of postmenopausal anxiety. *Maturitas* **2001**, *39*, 185–188.

# Lactobacilli and Bifidobacteria

## Linda C. Duffy

Infectious Diseases Division, University of Buffalo—State University of New York, Women and Children’s Health Research Foundation, Women and Children’s Hospital/Kaleida Health, Buffalo, New York, U.S.A.

## Stephen Sporn

Springfield, Missouri, U.S.A.

## Elizabeth Griffiths

### Haiping Qiao

### Pearay Ogra

Infectious Diseases Division, University of Buffalo—State University of New York, Women and Children’s Health Research Foundation, Women and Children’s Hospital/Kaleida Health, Buffalo, New York, U.S.A.

## INTRODUCTION

Lactic acid bacteria are found naturally in the human and animal gastrointestinal tract, mouth, and vagina. *Lactobacillus acidophilus* is the most well studied of the lactic acid bacteria, which are important in the fermentation of milk products, fruits, and vegetables. Lactobacilli and a related genus comprising bifidobacteria produce organic compounds (lactic and/or acetic acid) that increase acidity (pH 4–5) of the intestine and vagina, and favorably alter the balance of intestinal microflora.<sup>[1]</sup> Typical lactobacilli (e.g., *L. acidophilus* and *L. casei*) ferment lactic acid, whereas bifidobacteria are considered heterofermenters of acetic and lactic acid. Each genus and species of lactic acid bacteria are generally rod-shaped, Gram-positive prokaryotes, but may differ considerably in their pleomorphic and anaerobic properties (Fig. 1).

---

*Linda C. Duffy, Ph.D.*, is Professor of Pediatrics and Epidemiology/Biostatistics at Women and Children’s Hospital, University of Buffalo, Buffalo, New York, U.S.A.

*Stephen Sporn, N.D.*, is Doctor of Naturopathy, Springfield, Missouri, U.S.A.

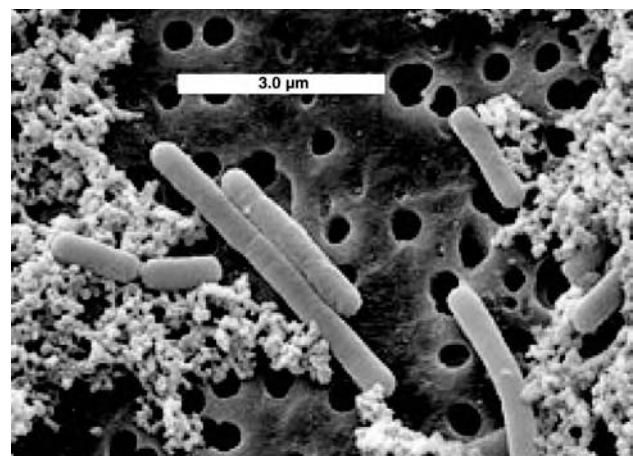
*Elizabeth Griffiths, Ph.D.*, is Research Associate at the Department of Pediatrics, Infectious Diseases Division, UB—SUNY, Women and Children’s Health Research Foundation, Women and Children’s Hospital/Kaleida Health, Buffalo, New York, U.S.A.

*Haiping Qiao, M.D.*, is Research Associate at the Department of Pediatrics, Infectious Diseases Division, UB—SUNY, Women and Children’s Health Research Foundation, Women and Children’s Hospital/Kaleida Health, Buffalo, New York, U.S.A.

*Pearay Ogra, M.D.*, is Professor at the Department of Pediatrics, Infectious Diseases Division, UB—SUNY, Women and Children’s Health Research Foundation, Women and Children’s Hospital/Kaleida Health, Buffalo, New York, U.S.A.

## GENERAL DESCRIPTION

Lactobacilli and bifidobacteria are considered commensal “beneficial” bacteria that have been shown in extensive studies to inhibit growth of harmful pathogens, reduce toxin production, promote good digestion by increasing bioavailability of some nutrients, boost innate immune function, and increase resistance to gastrointestinal and vaginal infections (Fig. 2). In addition, selected strains have been shown to reduce serum cholesterol levels. Less evidence is available regarding their anticarcinogenic effects.



**Fig. 1** *Lactobacillus casei* are Gram-positive, facultatively anaerobic, nonmotile and nonspore-forming, rod-shaped [cell size range = (0.7 – 1.1) × (2.0 – 4.0) μm] members of the industrially important lactic acid bacteria. (Photo courtesy of Jeff Broadbent, Utah State University.) (View this art in color at [www.dekker.com](http://www.dekker.com).)

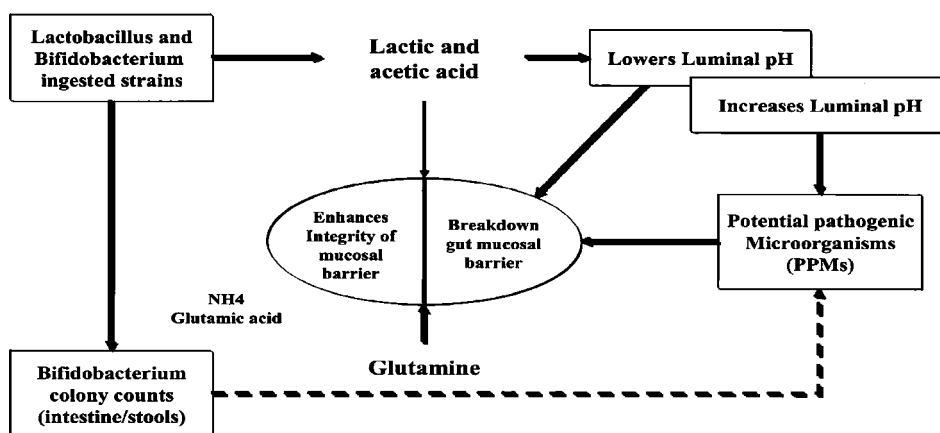


Fig. 2 The relationship between the ingestion of lactic acid bacteria and protective effects against overgrowth of potentially pathogenic micro-organisms.

## BIOAVAILABILITY

Autochthonous *L. acidophilus* and bifidobacteria strains in humans may remain stable lifelong. With lactobacilli particularly, some succession of strains may be caused by transient species derived from food or from the oral cavity.<sup>[2]</sup> Multiple combinations of lactobacilli and bifidobacteria abound in the intestinal tracts of breast-feeding infants, and persist in substantially lower logarithmic quantities in adults to promote gastrointestinal health. They are greatly influenced by food and alcohol consumption habits, antibiotic use, and host physiology.<sup>[3]</sup> *L. acidophilus*, and only a few strains of bifidobacteria, grow well in the vagina and urethra.<sup>[4]</sup>

While multiple strains of commensal bacteria coexist in large quantities in the ileum and large bowel, lactic acid bacteria use lactose as their main source of carbon to produce energy. *L. acidophilus* is a rich source of lactase, the enzyme needed to digest milk sugar. Fructo-oligosaccharides (FOS) are naturally occurring carbohydrates that cannot be digested or absorbed by humans. They support the growth of bifidobacteria in the lower colon, where the bifidobacteria thrive on vegetable fiber, and complex sugars, that are included in garlic, onion, artichoke, asparagus, and chicory root.<sup>[5]</sup> By matching host carbohydrate synthesis with the capacity of these commensal bacteria to produce glycosidases, oligosaccharide outer chains in mammalian glycans may help prime colonization of the developing intestine.

## Proprietary and Probiotic Strains

The adaptive tolerance of commensal bacteria to live in host gastrointestinal niches provides the rationale for giving biologically active supplements (probiotics) as prophylactic and therapeutic agents. Probiotic bacteria are generally, though not exclusively, lactic acid

bacteria and include single or combined strains of *L. acidophilus*, *L. casei* (*rhamnosis*), *L. bulgaricus*, *L. plantarum*, *L. salivarius*, *L. reuteri*, *L. brevis*, *L. paracasei*, *L. johnsonii*, *L. lactis*, *L. fermentum*, *L. gasseri*, *Bifidobacterium bifidum*, *B. longum*, *B. infantis*, *B. lactis*, *B. breve*, *B. adolescentis*, and *Streptococcus thermophilus*. Proprietary strains are generally recognized as safe (GRAS) and are used in the production of yogurt, various fermented milk products, and dietary supplements. The claimed health benefits of probiotic bacteria include: increased nutritional value (improved digestion and increased absorption of vitamins and minerals), promotion of intestinal lactose digestion, positive influence on intestinal and urogenital flora (antibiotics and radiation-induced colitis, yeast infections and vaginitis in women), prevention and reduction of intestinal tract infections (bacteria or virus induced, *Candida enteritis*, and *Helicobacter pylori*), regulation of gut motility (constipation and irritable bowel syndrome), decreased incidence and duration of diarrhea (antibiotic associated, *Clostridium difficile*, travelers, rotavirus), maintenance of gut mucosal integrity, improvement of immune system function, prevention of colon cancer, reduction of catabolic products eliminated by the kidney and liver, prevention of osteoporosis, better development (growth), anticarcinogenic, antimutagenic, and anti-allergic activities (Fig. 3).<sup>[3,6]</sup>

Lactobacilli and selected bifidobacteria strains have been consumed in fermented food products for hundreds of years without serious side effects. Single and combined cultures are increasingly used as probiotics (live microbial supplements) in pharmaceuticals and as dietary supplements. Enhanced viability and strain-specific effects have produced variable results, and are the subject of on-going studies in the emerging field of probiotic biology.<sup>[6]</sup> Probiotic strains of *L. acidophilus* have been the most studied, although an increasing number of probiotic bifidobacteria strains have demonstrated beneficial effects in animal models.<sup>[7,8]</sup> Probiotic

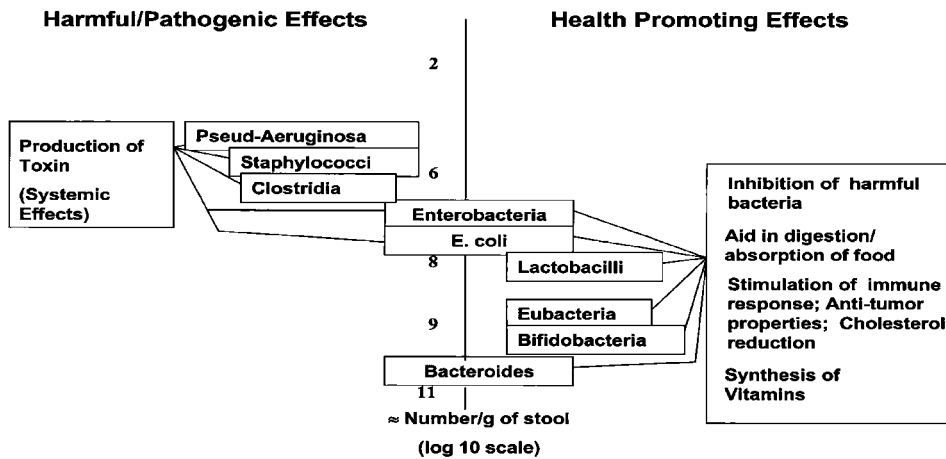


Fig. 3 Dichotomy of microflora based on potentially toxic or beneficial properties. (From Ref.<sup>[6]</sup>; adapted from Ref.<sup>[3]</sup>.)

strains require additional safety and efficacy testing. Yet evidence-based results suggest that they may enhance production of antibacterial products and reduce pathogen attachment to epithelia, which can cause intestinal inflammation, toxin production, and clinical disease. Among the most promising strain-specific effects are their potential roles as adjuvants in stimulating immunoprotective responses.<sup>[9]</sup> Probiotics represent an important, yet unproven, alternative to conventional antimicrobials, to which pathogenic micro-organisms may develop resistance.

## ACTION AND PHARMACOLOGY

Although best known for their ability to reimplant and balance the intestinal microflora, lactic acid bacteria also possess antibacterial activity (bacteriocins). Numerous species, including *L. acidophilus* and bifidobacteria, are involved in the production of short-chain fatty acids and amino acids (arginine, cysteine, and glutamine). *L. acidophilus* and selected bifidobacteria strains produce lactase, an enzyme important in the digestion of milk, and both are involved in vitamin K and vitamin B synthesis (niacin, folic acid, biotin, vitamin B6, and pyridoxine). Colonization by indigenous microflora induces expression of fucosylated glycoconjugates on the host intestinal epithelium. Resistance to colonization by enteric pathogens interacting with gut commensal flora prevents large inoculums of pathogens that lead to pathogenesis and clinical symptoms (Fig. 4).<sup>[10]</sup>

## Mechanisms of Host Defense

Various mechanisms of action for commensal strains have been postulated to explain the reported beneficial effects following their consumption. An intact and functional gut mucosal surface is key to the maintenance of intestinal health, and the intestinal microflora

play an important role. Among the possible methods of probiotic action is the promotion or maintenance of the gut defense barrier, and this may occur through both immunologic and nonimmunologic pathways.<sup>[11]</sup> When pathogenic micro-organisms, antibiotics, chemicals, radiation therapy, or even dietary antigens perturb either the intestinal epithelium or the normal microflora, causing inflammation and increased intestinal permeability, the host's gut defense can be compromised, and this leads to disease.

Lactic acid-producing strains can stabilize the intestinal barrier by virtue of their ability to survive and colonize the intestinal tract. The ability of lactic acid bacteria to adhere to the intestinal epithelium may provide the niche from which they compete successfully with pathogenic bacteria in preventing the latter's attachment to and penetration of the mucosa.<sup>[6]</sup> Adherence to intestinal cells may be nonspecific in nature or may involve interaction with specific receptors. Once the strains succeed in colonizing and multiplying, even if transiently within the gut milieu, they may also

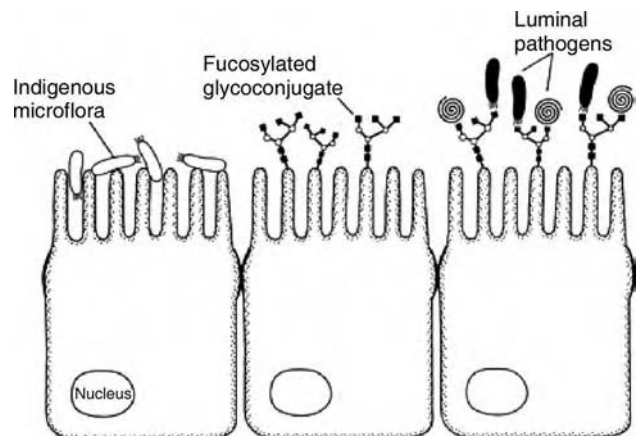


Fig. 4 Crosstalk between intestinal bacteria and the host epithelium. (From Ref.<sup>[10]</sup>; adapted from Schauer, D.B. Paving the way for pathogens. *Curr. Biol.* 1997, 7 (2), R75-77.)



influence composition of the microflora by the secretion of bacteriocins (antimicrobial substances that may kill or inactivate certain disease causing bacteria). They may also provide stability to the gut intestinal barrier by means of immunomodulatory activities especially stimulation of specific secretory immunoglobulin A (IgA) production, resulting in immune exclusion or immune elimination of pathogenic invaders. Both in vitro and in vivo studies have measured the effect of lactic acid strains on cytokine production and the role played in the inflammatory and immune responses to various antigens. The results, which show stimulation of certain cytokines and downregulation of others, suggest that one benefit of oral probiotic therapy may be in controlling the balance between proinflammatory and anti-inflammatory cytokines, and this, in itself, may be influenced by the immunologic state of the host, e.g., healthy vs. allergic.<sup>[11]</sup> In addition, there is evidence that lactic acid bacterial enzymes can modify foreign dietary antigens to render them less immunogenic, which could have clinical applications in the treatment of allergic infants.<sup>[12]</sup>

Recent evidence suggests that stimulation of specific and nonspecific immunity may be important mechanisms by which lactic acid strains can impart protective immunity. The underlying mechanisms of immunoregulation are not well understood, but specific cell wall components may act as adjuvants and increase humoral immune responses. Commensal strains tested in animal models and in a variety of small controlled human trials have generally been shown to be safely tolerated and effective in mediating acute diarrhea and gastrointestinal inflammation. Survival under conditions of gastric acidity and the ability to adhere to intestinal cells have been substantiated in vitro and in vivo for *L. acidophilus* and other probiotic strains.<sup>[13]</sup> The combined findings to date indicate that the mechanisms by which lactic acid bacteria modulate host immunity are complex. Much less is known about the safety and efficacy of other commensal, probiotic strains including *L. acidophilus* Gilliland,<sup>[14]</sup> which may have the potential to reduce serum cholesterol.

In vivo observations in the oral cavity strongly support the notion that the growth of natural flora in

biofilm type plaques may attenuate inflammatory cellular responses. Nutrient exchange in the gut could occur through biofilms, although biofilm plaque has only been reliably reported in the oral cavity. Additionally, there have been a number of interesting observations made recently with *L. acidophilus* in the production of mucous by stimulating mucous genes in its inhibition of apoptosis induced by cytokine production and in its interaction with toll-like receptors.

### Implications for Vaccine Development

Nonpathogenic bacteria may directly influence the intestinal epithelium of the host to limit immune activation. One aspect of probiotic modulation of the immune response is through its effects on cytokine production. Cytokines and their regulation of the immune system have been studied intensively in the last several years in cell lines and primary cells of both rodents and humans. Several experiments have shown that cytokine production can be favorably altered by probiotic use (Table 1).<sup>[15]</sup> There is mounting evidence that commensals acquired postnatally are essential for the development of tolerance to luminal antigens.<sup>[16]</sup> Immune responses are attenuated if there has been prior exposure to gut antigens. This observation suggests an element of tolerance induced by the mucosal immune system. In healthy hosts, the mucosal immune system must be efficient in downregulating overactive responses to dietary antigens and commensal flora, yet differentiate and mount effective protective responses to pathogenic organisms.

The search for suitable carrier organisms for the development of live oral vaccines has been concentrated on attenuated mucosal pathogens. The use of commensal bacterial strains and encoded genes might allow better control, prevent reversion to virulence and thus, optimization of expression systems to be used in live oral vaccines. Work with probiotic carrier strains performed in mouse infection models and optimized model antigens will help to reveal the efficacy and safety of this approach. While genetic manipulation of probiotic strains might also lead to

**Table 1** Probiotic effects on cytokine production

Probiotics	Species	Assessment	Effect
<i>Lactobacillus casei</i> , oral (dry)	Human	Serum IFN $\gamma$	Increased
<i>Lactobacillus</i> GG, oral (live)	Human	TNF $\alpha$ in patients with food allergy	Decreased fecal TNF $\alpha$
<i>Lactobacillus</i> , <i>Bifidobacterium</i> , and streptococcus (several strains), oral (live)	Rodent	Mitogen-induced IL-6, IL-12, IFN $\gamma$ , and TNF $\alpha$ production by intestinal lymphoid cells	Enhanced IL-6 and IL-12 ( <i>L. casei</i> and <i>L. acidophilus</i> ). Enhanced IFN $\gamma$ and NO ( <i>L. acidophilus</i> )

IFN, interferon; TNF, tumor necrosis factor; IL, interleukin; NO, nitric oxide. (From Ref.<sup>[15]</sup>.)

promising results, human immunodeficient states might introduce limitations to vaccination strategies with live carrier vaccines.<sup>[17]</sup>

## PREPARATION

Commercially available fermented foods, although of high nutritional value and shown to have benefit in countering antibiotic-induced and traveler's diarrhea, can be unreliable sources of delivering optimal quantities of these commensal bacteria, since the acid and peroxide production may kill the strains themselves, if concentrations of these natural byproducts become excessive. A variety of alternative delivery systems and biotherapeutic approaches are underway, including expression of heterologous proteins of lactobacilli and bifidobacteria strains.<sup>[18]</sup>

Antigen delivery systems in development require more precise identification of mechanisms of action including liposomal and microparticle components and biofilm plaques, immune adjuvancy, and the potential for use of these commensal organisms as live attenuated vectors. Live vectors are highly immunogenic in themselves, and there may be potential danger for their use in immunocompromised individuals.

Lactobacilli and bifidobacteria can be found in natural health foods and fermented dairy products (sweet acidophilus milk and yogurt). Supplementary sources can also be taken in powder, liquid extract, capsule, and tablet form. Tablet manufacture generates heat, which can reduce the number of viable organisms. Some manufacturers have incorporated a low-temperature tableting process to increase viability. Most strains in tablet form should be freeze-dried, packaged, and stored in opaque, glass, and moisture-proof containers in the refrigerator. Another technique to enhance product viability includes "flushing" the container with nitrogen gas.

Studies with unheated and heated homogenates indicate that candidate strains of lactobacilli and bifidobacteria possess a heat-stable antiproliferative component(s). The potential for generating microbiologically nonviable, yet immunologically active, dietary supplements that are easier to store also warrants further investigation.<sup>[19]</sup>

Fig. 5 depicts a typical manufacturing process for both sweet and fermented acidophilus milk.<sup>[20]</sup> The production of kefir and yogurt also follows, a similar production pattern.

## INDICATIONS AND USAGE

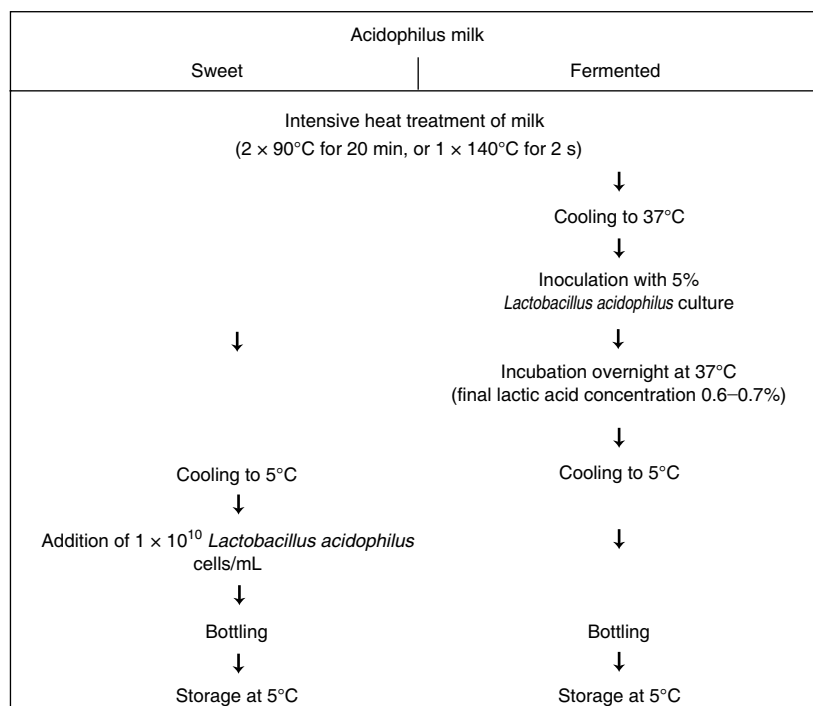
It is possible to manipulate the composition of the gastrointestinal tract microflora in adults through dietary supplementation with probiotics. An effective probiotic

dietary supplement should be of human origin, be nonpathogenic and nontoxic, contain a large number of viable cells, be capable of surviving and metabolizing in the gut, remain viable during storage and use, remain active in the presence of antibiotics, be antagonistic to pathogens, and, most important, exert beneficial effects on the host. In addition, the probiotic ideally should be readily available through regular retail suppliers and be affordable to the consumer. Probiotic strains of bacteria consumed as dietary supplements (or in dairy products) are measured by the amount of viable colony forming units (CFUs) per dosage. Dosage regimens may differ from individual to individual. It is debatable how often or whether probiotics should be ingested regularly in order to enhance persistent health effects. Generally, it is suggested to gradually increase the dosage over time.

When the primary reason for supplementation is to aid digestion, lactobacilli and/or bifidobacteria tablets should be consumed with meals. If, however, the primary goal is to increase the population of these organisms in the lower intestinal tract, then dosing in-between meals with a full glass of water is recommended. A combination of both dosing approaches could also be used to maximize the potential benefits of supplementation. Many practitioners suggest "dosing away" from antibiotic regimens to decrease risk of potential side effects. Daily recommended usage varies, with general consumption levels indicated at between 1 and 10 billion bacteria daily; more may cause gastrointestinal irritation. One to 2 billion CFUs per day of *L. acidophilus* is considered to be the minimal amount necessary for the healthy maintenance of intestinal ecology. It is primarily available in 470–1000 mg capsules that contain 2.5–10 billion live bacteria. Bifidobacteria supplements are less available in health food stores. Limited research has recommended bifidobacteria consumption at 8 g per day. However, some studies indicate that 4 g per day appears sufficient to increase bifidobacteria levels in the gastrointestinal tract. Alternative recommendations to regular use suggest probiotic levels have strain-specific effects and should be used only for 1–2 weeks a year. Since oral antibiotics kill normal populations of microbial flora, consuming an acidophilus preparation for up to a month beyond the antibiotic treatment period is recommended as safe. Studies are also underway to determine whether combinations of lactobacilli and bifidobacteria reimplant better or have enhanced antibacterial or immunoprotective effects.<sup>[21]</sup>

## Labeling

Several reports of misleading labeling of dietary supplements have been published. Labeling has been



**Fig. 5** The manufacturing process for acidophilus milk, both sweet and fermented. (From Ref.<sup>[20]</sup>; reproduced with permission © American Society for Clinical Nutrition.)

criticized for overstating the level of viable bacteria, for inaccurately indicating the species of probiotic bacteria present, and for the presence of species of bacteria not listed on the label (e.g., *Enterococcus* spp.).<sup>[22]</sup> In commercial yogurt, the number of *L. acidophilus* cells does not currently appear on the labels because their concentrations cannot be accurately measured in the presence of other cultures, particularly *L. bulgaricus* and *S. thermophilus*, which are the bacteria that convert milk into yogurt. Species identification of a bank of commercial probiotic strains was attempted using partial 16S rDNA sequencing, carbohydrate fermentation analysis, and cellular fatty acid methyl ester analysis. Results using these methods indicated discrepancies between species designations for 26 out of 58 strains tested, including two ATCC *Lactobacillus* strains (*L. acidophilus* and *L. casei*). Accurate labeling is critical to standardizing and establishing uses and recommendations for specific probiotic strains.<sup>[23]</sup>

### Dose–Range Effects

In general, in the United States, food products containing probiotic bacteria make no mention of the numbers of bacteria present in the product per serving. Most list bacterial genera and species added as live cultures, but not levels. California and Oregon are unique in that they legislate a minimum requirement for acidophilus-containing fluid milk products (10<sup>6</sup>/ml). In the United States, yogurt is not required to contain any viable cultures. Dose–range escalation studies are

urgently needed to establish optimum dose schedules in target groups. There are several reports of disease prevention or enhancement of immune function resulting from the oral administration of probiotics such as *Lactobacillus* and *Bifidobacterium* species.<sup>[24]</sup> When ingested in large enough quantities (1 × 10<sup>15</sup>/L) and for long enough periods (≥2 weeks), these bacteria can be incorporated into the resident gut flora.

### ADVERSE EFFECTS

Lactobacilli and bifidobacteria are extremely rare causes of infection in humans. In the general literature, they have been estimated to represent only 0.05–0.4% of infective endocarditis and bacteremia cases.<sup>[25]</sup> This lack of pathogenicity extends across all age groups and to immunocompromised individuals. Most of the rare cases of infection with lactobacilli occur in patients with predisposing conditions; lactobacillemia is a frequent marker of a serious or fatal underlying disease.<sup>[25]</sup> Recent evidence confirms that the increasing consumption of probiotic lactobacilli and bifidobacteria has not led to an increase in opportunistic infection in consumers. In addition, while immunocompromised patients are at a higher risk for opportunistic infections than the general population, consumption of probiotic products containing lactobacilli or bifidobacteria has not been shown to increase the risk of infections due to these organisms in such individuals.<sup>[26]</sup>

Side effects from consumption of probiotic strains that may indicate allergic reactions include: breathing problems or tightness in throat or chest, chest pain, skin hives, rash, itchy, or swollen skin. Other possible adverse events may include nausea, diarrhea (loose stools), burping, hiccups, or gas.

## DRUG INTERACTIONS/SAFETY

Certain medications may theoretically interact with lactobacilli and bifidobacteria. Gut bacteria may be depleted by use of the contraceptive pill, antibiotics, and diets high in sugar and refined carbohydrates. Lactobacilli and bifidobacteria should be considered safe; however, some restrictions need to be placed on probiotic formulations. Bacteria used should not contain genes encoding transmissible resistance to antibiotics. They should not produce biogenic amines (e.g., histamine, tyrosine, or phenylethylamine), and should not degrade mucin. The assessment of clinical value should probably include an absence of potential to deconjugate bile salts, induce platelet aggregation, and bind to fibrinogen and fibronectine.<sup>[27]</sup>

## CONCLUSIONS

### Research Summary

A large body of research over the past 100 yr demonstrates the health benefits of fermenting lactobacilli and bifidobacteria in the gastrointestinal tracts of breast-feeding infants and adults. Tannock's<sup>[28]</sup> recent compendium of probiotic species of lactobacilli and bifidobacteria summarizes the evidence for their ability

to increase host resistance to gastrointestinal and vaginal infections, effectiveness in treating antibiotic-induced diarrhea, reduction of serum cholesterol and blood pressure, treatment of allergy and inflammatory skin conditions, stimulation of phagocytosis, anti-tumor effects, and adjuvant properties for passive immunity and new generation vaccine delivery. Confirmation of clinical results for most candidate strains of lactobacilli and bifidobacteria is still lacking, with the exception of acute diarrhea or antibiotic-induced diarrhea (Table 2).<sup>[12]</sup> Genetically engineered commensals may, in the future, be used as platforms for delivering drugs, antimicrobials, and live vaccines to defined host sites. Product development in the field of probiotic biology requires interdisciplinary expertise from epidemiologists, microbiologists, gastroenterologists, immunologists, nutritionists, computational scientists, and food technologists. Comparative studies with germfree, knockout, and conventional animals, given advances in new molecular biotechnology, will also help to establish a more accurate concept of host-microbial relationships, in attempts to standardize what constitutes a safe and efficacious, probiotic dose of these organisms.

### Compendial/Regulatory Status

Choice of strain selection with proven safety and probiotic efficacy, appropriate inoculum, incubation conditions, microbial interactions, viability and delivery systems are imminent in establishing health claims and promoting product manufacture of these prophylactic and therapeutic agents. For successful transfer of candidate strains of lactic and acetic acid-producing bacteria from the laboratory scale to industrial production, graphical optimization methods relying on

**Table 2** Important studies for the safety assessment of probiotic lactic acid bacteria and other bacteria

Type of property studied	Safety factor to be assessed
Intrinsic properties of lactic acid bacteria	Adhesion factors, antibiotic resistance, existence of plasmids and plasmid transfer potential, harmful enzyme profile
Metabolic products	Concentrations, safety, and other effects
Toxicity	Acute and subacute effects of ingestion of large amounts of tested bacteria
Mucosal effects	Adhesion, invasion potential, intestinal mucus degradation, infectivity in immunocompromised animals (e.g., following lethal irradiation)
Dose-response effects	Dose-response studies by oral administration in volunteers
Clinical assessment	Potential for side-effects, careful evaluation in health volunteers and disease-specific studies
Epidemiological studies	Surveillance of large populations following introduction of new strains and products

(From Ref.<sup>[12]</sup>.)

statistical standards are essential in process research.<sup>[29]</sup> Continuing challenges include conclusive evidence for probiotic-mediated responses to support purported health claims. To fully explore immunomodulatory mechanisms, further studies on the relative immunogenicity of strain-specific effects and “broken immune tolerance” in inflammatory bowel disorders are critically needed. Live oral vaccines and use of probiotic adjuvants offer several benefits over conventional vaccine delivery and represent a top priority in modern vaccinology.

## REFERENCES

- Mitsuoka, T. The human gastrointestinal tract. In *The Lactic Acid Bacteria: The Lactic Acid Bacteria in Health and Disease*; Wood, B.J.B., Ed.; Elsevier Science Pub. Ltd.: Essex, England, 1992; Vol. 1, 69–114.
- Reuter, G. The lactobacillus and bifidobacterium microflora of the human intestine: composition and succession. *Curr. Issues Intest. Microbiol.* **2001**, 2 (2), 43–53.
- Gibson, G.R.; Roberfroid, M.B. Dietary modulation of the human colonic microbiota: introducing the concept of prebiotics. *J. Nutr.* **1995**, 125 (6), 1401–1412.
- Stark, P.L.; Lee, A. The microbial ecology of the large bowel of breast-fed and formula-fed infants during the first year of life. *J. Med. Microbiol.* **1982**, 15 (2), 189–203.
- Fuller, R. Probiotic foods: current use and future developments. *Int. Food Ingredients* **1993**, 3, 23–26.
- Walker, W.A.; Duffy, L.C. Diet and bacterial colonization: role of probiotics and prebiotics. *J. Nutr. Biochem.* **1998**, 9 (12), 668–675.
- Qiao, H.; Duffy, L.C.; Griffiths, E.; Dryja, D.; Leavens, A.; Rossman, J.; Rich, G.; Riepenhoff-Talty, M.; Lochniskar, M. Immune responses in rhesus rotavirus-challenged BALB/c mice treated with bifidobacteria and prebiotic supplements. *Pediatr. Res.* **2002**, 51 (6), 750–755.
- Duffy, L.C.; Zielezny, M.A.; Riepenhoff-Talty, M.; Dryja, D.; Sayahthari-Altaie, S.; Griffiths, E.; Ruffin, D.; Barrett, H.; Rossman, J.; Ogra, P.L. Effectiveness of *Bifidobacterium bifidum* in mediating the clinical course of murine rotavirus diarrhea. *Pediatr. Res.* **1994**, 35 (6), 690–695.
- Gill, H.S. Stimulation of the immune system by lactic cultures. *Int. Dairy J.* **1998**, 8, 535–544.
- Lu, L.; Walker, W.A. Pathologic and physiologic interactions of bacteria with the gastrointestinal epithelium. *Am. J. Clin. Nutr.* **2001**, 73 (6), 1124S–1130S.
- Isolauri, E.; Sutas, Y.; Kankaanpaa, P.; Arvilommi, H.; Salminen, S. Probiotics: effects on immunity. *Am. J. Clin. Nutr.* **2001**, 73 (2 Suppl.), 444S–450S.
- Salminen, S.; Isolauri, E.; Salminen, E. Clinical uses of probiotics for stabilizing the gut mucosal barrier: successful strains and future challenges. *Antonie van Leeuwenhoek* **1996**, 70, 347–358.
- Conway, P.L.; Gorbach, S.L.; Goldin, B.R. Survival of lactic acid bacteria in the human stomach and adhesion to intestinal cells. *J. Dairy Sci.* **1987**, 70 (1), 1–12.
- Gilliland, S.E.; Nelson, C.R.; Maxwell, C. Assimilation of cholesterol by *Lactobacillus acidophilus*. *Appl. Environ. Microbiol.* **1985**, 49 (2), 377–381.
- Erickson, K.L.; Hubbard, N.E. Probiotic immunomodulation in health and disease. *J. Nutr.* **2000**, 130 (2S), 403S–409S.
- Moreau, M.C.; Corthier, G. Effect of the gastrointestinal microflora on induction and maintenance of oral tolerance to ovalbumin in C3H/HeJ mice. *Infect. Immun.* **1988**, 56 (10), 2766–2768.
- Autenrieth, I.B.; Schmidt, M.A. Bacterial interplay at intestinal mucosal surfaces: implications for vaccine development. *Trends Microbiol.* **2000**, 8 (10), 457–464.
- Kullen, M.J.; Klaenhammer, T. Genetic modification of intestinal lactobacilli and bifidobacteria. In *Probiotics: A Critical Review*; Tannock, G., Ed.; Scientific Press: Wymondham, UK, 1996; 65–83.
- Kaila, M.; Isolauri, E.; Saxelin, M.; Arvilommi, H.; Vesikari, T. Viable versus inactivated lactobacillus strain GG in acute rotavirus diarrhoea. *Arch. Dis. Child.* **1995**, 72 (1), 51–53.
- Heller, K.J. Probiotic bacteria in fermented foods: product characteristics and starter organisms. *Am. J. Clin. Nutr.* **2001**, 73 (2S), 374S–379S.
- Marteau, P.; Salminen, S. Safety of probiotics. In *Probiotics, Other Nutritional Factors and Intestinal Microflora. Nestle Nutrition Workshop Series*; Hanson, L., Yolken, R., Eds.; Lippincott Raven Pub.: Philadelphia, PA, 1999; Vol. 42, 259–269.

22. Sanders, M.E. Considerations for use of probiotic bacteria to modulate human health. *J. Nutr.* **2000**, *130* (2S), 384S–390S.
23. Yeung, P.S.; Sanders, M.E.; Kitts, C.L.; Cano, R.; Tong, P.S. Species-specific identification of commercial probiotic strains. *J. Dairy Sci.* **2002**, *85* (5), 1039–1051.
24. Gill, H.S.; Rutherfurd, K.J.; Cross, M.L.; Gopal, P.K. Enhancement of immunity in the elderly by dietary supplementation with the probiotic *Bifidobacterium lactis* HN019. *Am. J. Clin. Nutr.* **2001**, *74* (6), 833–839.
25. Gasser, F. Safety of lactic-acid bacteria and their occurrence in human clinical infections. *Bull. L'Inst. Pasteur* **1994**, *92*, 45–67.
26. Borriello, S.P.; Hammes, W.P.; Holzapfel, W.; Marteau, P.; Schrezenmeir, J.; Vaara, M.; Valtonen, V. Safety of probiotics that contain lactobacilli or bifidobacteria. *Clin. Infect. Dis.* **2003**, *36* (6), 775–780.
27. Hammes, W.P. Safety assessment of lactic acid bacteria and probiotics. *Monatsschr. Kinderheilkunde* **1998**, *146* (8S), S31–S38.
28. Tannock, G.W. *Probiotics: A Critical Review*; Horizon Scientific Press: Wymondham, UK, 1996.
29. Report of a FAO/WHO Consultation. *Food Consumption and Exposure Assessment of Chemicals*; February 10–14, 1997, WHO/FSF/FOS 97.5, 1998, World Health Organization.

#### FURTHER READINGS

<http://www.academyhealth.com/abbif.html>.

<http://www.flora-source-probiotics.com>.

<http://www.horizonpress.com/hsp/abs/abspro.html>.

<http://www.pubmedcentral.nih.gov>.

<http://www/usda.gov>



# Licorice (*Glycyrrhiza glabra*)

Decio Armanini  
Cristina Fiore  
Jens Bielenberg  
Eugenio Ragazzi

Division of Endocrinology, University of Padua, Padua, Italy

## INTRODUCTION

Licorice (*Glycyrrhiza glabra* and other related species) is one of the most widely used medicinal plants, employed in traditional formulas since antiquity. It is a perennial herb native to the Mediterranean region and central and southwestern Asia, and is now cultivated in temperate and subtropical regions of the world. The extract is obtained from the dried roots and stolons of the plant. Present-day uses of licorice include applications in medicine and food products. Licorice is commonly utilized in foods as a natural flavoring agent. It is reported to possess soothing, anti-inflammatory, and antitussive properties, and is used to treat respiratory and gastric diseases and primary adrenocortical insufficiency. Activity against bacteria and several viruses (including hepatitis, HIV, and SARS-associated coronavirus) has been reported too.

Triterpene saponins constitute the major chemical components of licorice. Key among these is glycyrrhizin. This glycoside gives licorice root its sweet taste. The other compounds vary from species to species and depending on the provenance of the plant. Several flavonoids, as well as other phenolic constituents, are found in licorice; amines, amino acids, sterols, sugars, and starch are also present.

Individuals vary in their sensitivity to licorice. Generally, undesirable symptoms (such as hypokalemic

hypertension) appear only on long-term consumption of moderate to large quantities, and casual use does not produce side effects. However, even small amounts over short periods of time may lead to adverse consequences in some.

## BACKGROUND

- Family: Fabaceae (Leguminosae)
- Genus: *Glycyrrhiza*
- Species: *Glycyrrhiza glabra*: *G. glabra* L. var. *typica* Regel & Herd. (Italian licorice, Spanish licorice), *G. glabra* L. var. *glandulifera* (Waldst. & Kit) Regel & Herd. (Russian licorice), *G. glabra* L. var. *violacea* (Boiss. & Noe) Boiss. (Persian licorice)
- Other species: *G. uralensis* Fischer (Chinese licorice), *G. inflata* Batalin, *G. lepidota* Pursh (American licorice)

## *Glycyrrhiza glabra*

*G. glabra* grows to a height of 1–2 m. It has pinnate leaves with pairs of narrow leaflets (Fig. 1), pea-like purple-blue flowers, and short and flat pods (1–3 cm long by 6 mm wide) containing small, reniform seeds. The root system presents highly developed stoloniferous roots and rhizomes that spread out just under the soil surface. The parts used for medicinal and food purposes are the dried unpeeled roots and stolons (underground stems). Cultivated roots are harvested after 3–4 yr of growth.<sup>[1]</sup>

The varieties of *G. glabra* yielding most of the commercial material are *G. glabra* var. *typica* (Italian licorice, Spanish licorice), which is grown in Italy, Spain, U.K., France, Germany, and the United States, *G. glabra* var. *glandulifera* (Russian licorice), abundant as a wild plant in Russia, and *G. glabra* var. *violacea* (Persian licorice), a wild variety from Iran and Iraq. Other commercially available species are *G. uralensis* (Chinese licorice), a perennial herb

Decio Armanini, M.D., is Professor of Endocrinology at the Department of Medical and Surgical Sciences, University of Padua, Padua, Italy.

Cristina Fiore, Ph.D., is Assistant Professor of Endocrinology at the Department of Medical and Surgical Sciences, University of Padua, Padua, Italy.

Jens Bielenberg, Ph.D., is a Pharmacologist at the Department of Medical and Surgical Sciences, University of Padua, Padua, Italy.

Eugenio Ragazzi, M.D., is a Professor at the Department of Pharmacology and Anaesthesiology, University of Padua, Padua, Italy.





**Fig. 1** *Glycyrrhiza glabra*: leaves (left), dried roots (top right), and the typical aspect on fibrous fracture of the dried root (bottom right).

30–100 cm high found in northern China, Mongolia, and Siberia, and *G. inflata* (from China). *G. lepidota* (American licorice) is a wild species native to North America and is found from western Ontario to Washington and south to Missouri, Texas, and Mexico.

Typical licorice roots consist of straight pieces 14–20 cm or more in length and 5–20 mm in diameter (Fig. 1). The unpeeled root has a brownish-grey cork, while the peeled root presents a yellow fibrous exterior. The fracture is fibrous (Fig. 1), the odor is characteristic, and the taste is sweet (the name licorice is derived from the Greek *glükos*, “sweet,” and *ρίζα*, “root”).

### Historical Notes

The first documented use of licorice dates back to Assyrian and Egyptian times—about 2500 years ago. The plant was used in ancient Greece, and the Greek

botanist Theophrastus (IV–III century B.C.) reported its use as a remedy for dry cough, asthma, and other respiratory diseases. Among the Romans, Pliny the Elder (I century A.D.) mentioned the properties of licorice in reducing hunger and thirst and its efficacy against asthma and sterility in women. During the Middle Ages, licorice root was used in Arab medicine. The famous *Canon* of Avicenna (980–1037 A.D.), considered to be an important recapitulation of the medicine of Hippocrates and Galen as well as the philosophy of Aristotle, reports licorice as a remedy for wounds and ulcers and for diseases of the respiratory tract, stomach, kidneys, and bladder. Avicenna also summarized the art of use of licorice root extracts, developed in Oriental medicine. In the traditional Chinese *Materia Medica* as well as in Tibetan medicine, licorice has been used against respiratory irritative diseases and for gastrointestinal spasms. In India, licorice has been used in traditional Ayurvedic medicine.

## Uses of Licorice

Licorice is widely available and is used in food applications and medicine. The Council of Europe indicates that it can be added to foodstuffs in small amounts as a flavoring agent, and in the United States, it is listed as “generally recognized as safe.”<sup>[3]</sup> Pharmacopeias and traditional medicine describe licorice as a demulcent, anti-inflammatory, and expectorant, and it is used in cases of bronchial disease, gastritis, peptic ulcer, and primary adrenocortical insufficiency.<sup>[4]</sup>

Excessive ingestion of licorice may produce unwanted and potentially harmful side effects. For example, it can cause pseudohyperaldosteronism, which is characterized by hypertension, edema, and hypokalemia (see “Adverse Side Effects”).<sup>[5,6]</sup> The European Union’s Scientific Committee on Food recommends an upper limit of 100 mg/day for regular ingestion. This is considered to provide a safe quantity of the main active constituent of licorice, glycyrrhizic acid.

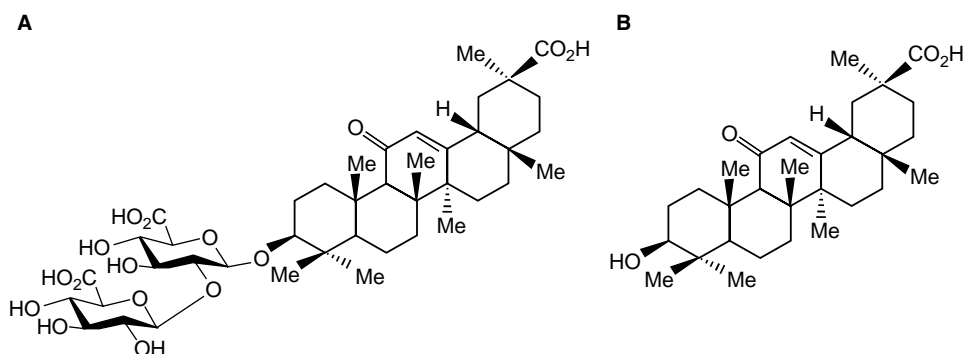
## CHEMISTRY AND PREPARATION OF PRODUCTS

The main chemical constituents of licorice are triterpene saponins, of which glycyrrhizin is the major component. It is present in amounts ranging from 1% to 24%.<sup>[1,7]</sup> Glycyrrhizin is a glycoside (Fig. 2), occurring as a mixture of calcium, sodium, and potassium salts of glycyrrhizinic acid (also called glycyrrhizic acid). On hydrolysis, it releases 2 molecules of D-glucuronic acid and the aglycone 18-β-glycyrrhetic acid (GLA) (otherwise known as glycyrrhetic acid), a pentacyclic triterpene derivative of the β-amyrin type.<sup>[1]</sup> Glycyrrhizin is considered the most important constituent of licorice root and is responsible for its sweet taste: Its sweetness is about 50 times that of sucrose.<sup>[6]</sup> Upon hydrolysis, the glycoside loses its sweet taste. Hydroxy- and deoxytriterpenoid acids related to glycyrrhetic acid, such as liquiritic acid (a C-20 epimer of GLA), licoric acid,

glycyrrhetol, glabrolide, and isoglabrolide,<sup>[7]</sup> have been described. Other components are dependent on species and geographical location. Several flavonoids are present in licorice (about 1%), including liquiritin, liquiritigenin (aglycone of liquiritin), isoliquiritin, isoliquiritigenin (aglycone of isoliquiritin), rhamnoliquiritin, rhamnoisoliquiritin, isoliquiritoside, licoflavonol, licoisoflavones A and B, licoisoflavanone, genistein, licofuranone, licoricidin, glabrin, glabrol, glabrone, glyzarin, glisoflavone, and glycyrrhisoflavone.<sup>[1,7]</sup> Other phenolic constituents (such as coumarin compounds glycyrol, glycyrin, glycoumarin, herniarin, umbelliferone, licopyranocoumarin, licoaryl coumarin, and licocoumarone), amines (1–2%: asparagine, betaine, and choline), amino acids, sterols (stigmasterol and β-sitosterol), and sugars (5–15% as glucose, sucrose, and mannitol; starch can represent about 20% of the dried root) are also found.<sup>[1]</sup>

## Formulations

- *Licorice root liquid extract*: It is an aqueous extract containing 10–20% glycyrrhizinic acid,<sup>[8]</sup> obtained from licorice root with boiling water after maceration. An alcoholic extract (ethanol 70% v/v) is also described,<sup>[9]</sup> containing 3–5% glycyrrhizinic acid.
- *Succus liquiritiae*: It is a dried aqueous extract obtained from the roots of licorice, containing 15% glycyrrhizinic acid.
- *Dried aqueous extract, or block juice*: It is obtained by boiling the roots of licorice in water and evaporating the liquid to dryness. It contains 4–25% glycyrrhizinic acid.<sup>[6]</sup> Also available as spray-dried powder.
- *Powdered licorice extract*: It is prepared from comminuted licorice extracted with water, or solvents (alcohol, water, or mixtures), containing not less than 6% glycyrrhizinic acid.<sup>[8]</sup>
- *Enzymatically hydrolyzed licorice extract (EHLE)*: It is used as a sweetener in Japan.



**Fig. 2** Chemical structure of glycyrrhizic acid (A) and glycyrrhetic acid (B).

- *Deglycyrrhized licorice (DGL)*: This has been developed to obtain some of the therapeutic effects of licorice, with a reduced risk of side effects.<sup>[1]</sup>
- *Licorice root*: It consists of unpeeled, dried roots, rhizomes, and stolons. The content of glycyrrhizic acid must be not less than 2.5%<sup>[8]</sup> or 4.0%<sup>[9]</sup> calculated on a dry weight basis.
- *Powdered licorice*: This comprises dried and ground roots of licorice,<sup>[8]</sup> reduced to a fine or very fine powder, containing not less than 2.5% glycyrrhizic acid.
- *Ammoniated glycyrrhizin*: It is prepared from the water extract of licorice root by acid precipitation followed by neutralization with diluted ammonia.

### Analysis

Chemical assay of glycyrrhizin (glycyrrhizic acid or glycyrrhizic acid) can be done by liquid chromatography<sup>[9]</sup> or thin-layer chromatography.<sup>[8,9]</sup>

## PRECLINICAL AND CLINICAL STUDIES

### Mineralocorticoid Activity

Prolonged administration of licorice is associated with side effects such as hypertension, sodium and water retention, and potassium depletion. Clinically, these symptoms can be seen in the framework of apparent mineralocorticoid excess (AME) syndromes.<sup>[6,10,11]</sup> Glycyrrhizic acid and glycyrrhetic acid have been reported to bind to mineralocorticoid receptors (or type 1 corticosteroid receptors). The affinity of glycyrrhizic acid for the receptors is 4 orders of magnitude lower than that of aldosterone, but it is sufficient to explain, at least in part, the mineralocorticoidlike side effects when large amounts of licorice are consumed.<sup>[12]</sup>

In the kidney, licorice produces a significant change in cortisol metabolism, indicating a strong competitive block (with  $K_i$  5–10 nM)<sup>[13]</sup> of 11 $\beta$ -hydroxysteroid dehydrogenase (11 $\beta$ -HSD) type 2, the enzyme that converts cortisol (active as mineralocorticoid) to cortisone (inactive)<sup>[2,12,13]</sup> by blocking the cortisol–cortisone “shuttle.” Glycyrrhetic acid is 200–1000 times more potent an inhibitor of 11 $\beta$ -HSD than glycyrrhizic acid.<sup>[14]</sup> Hepatic  $\Delta$ -4,5- $\beta$ -steroid reductase, which inactivates glucocorticoids and mineralocorticoids, is also inhibited by glycyrrhetic acid.<sup>[11]</sup> Licorice constituents may also displace cortisol from its binding to transcortin.<sup>[15]</sup> Plasma aldosterone and renin levels in serum may be reduced by suppression of the renin–angiotensin system.<sup>[12]</sup>

### Glucocorticoid and Antiglucocorticoid Activity

Several authors have reported the usefulness of licorice and of glycyrrhizic acid in the treatment of Addison’s disease.<sup>[11]</sup> This effect is evident when even a small amount of cortisol is produced by the adrenals. In these clinical studies, the authors found that licorice can enhance the action of cortisone in the treatment of Addison’s disease and concluded that licorice is safe, effective, and free of undesirable side effects, in addition to being convenient, palatable, and inexpensive. The mechanism for its action was clarified after demonstration of the effect of licorice in blocking 11 $\beta$ -HSD type 2, allowing more cortisol to be available at the level of target tissues.

A measurable affinity of glycyrrhetic and glycyrrhizic acid for kidney glucocorticoid receptors was found in kidney cytosol, demonstrating a direct glucocorticoid activity.<sup>[2,12]</sup> Chronic fatigue syndrome was successfully treated with licorice through enhancement of glucocorticoid action.<sup>[16]</sup>

Glucocorticoids play a crucial role in regulating the distribution and function of adipose tissue. The activity of cortisol in fat cells is modulated by 11 $\beta$ -HSD type 1, which catalyzes the conversion of hormonally inactive cortisone to active cortisol. This enzyme is expressed in both adipocytes and stromal cells (preadipocytes). Glycyrrhetic acid inhibits its activity and consequently reduces the local availability of cortisol and the accumulation of lipids in adipocytes. This mechanism can partially explain the antiglucocorticoid activity of glycyrrhetic acid in adipose tissue. Oral consumption of licorice reduces the total fat mass in healthy subjects; topical application of glycyrrhetic acid could be used for the treatment of local fat excess.<sup>[17]</sup>

### Activity on Sex Hormones

#### Estrogenic activity

Licorice roots are rich in flavonoids and isoflavans, which exhibit estrogenlike activity because of their structural similarity to endogenous estrogens. This configuration could enable them to bind to and activate estrogen receptors.<sup>[2]</sup>

Glycyrrhizin and glycyrrhetic acid have a very weak affinity for estrogen receptors, and appear to possess an antiestrogenic effect. Licorice has been demonstrated to influence estrogen metabolism, with opposite effects depending on estrogen concentrations (inhibition at high and enhancement at low concentrations). An estrogenic effect has been reported for the isoflavone components of licorice.

### Antiandrogen activity

Studies in vivo and in vitro have demonstrated that glycyrrhetic acid blocks 17-hydroxysteroid dehydrogenase and 17,20-lyase in the ovary. This effect could partially explain the usefulness of licorice in the treatment of sterility and excess of androgens as in polycystic ovary syndrome.<sup>[2]</sup> An antiandrogenic effect has been documented in healthy male subjects.<sup>[18]</sup> Licorice causes increase of 17OH-progesterone and decrease of testosterone levels probably by inhibiting 17-HSD and 17,20-lyase as mentioned, reducing the conversion of 17OH-progesterone to androstenedione and androstenedione to testosterone. Mean testosterone values have been shown to decrease by 26% after 1 week of treatment. Licorice can also affect 5 $\alpha$ -reductase, thus inhibiting the transformation of testosterone into dihydrotestosterone (DHT). Glycyrrhetic acid also binds sex-hormone-binding globulin (SHBG), thus increasing free testosterone concentration. It has however been shown that the reduction of testosterone is partially blunted by the increase of luteinizing hormone (LH). Another mechanism involved in the regulation of testosterone during licorice consumption is the inhibitory action of glycyrrhetic acid on 11 $\beta$ -hydroxysteroid dehydrogenase type 1 (11 $\beta$ -HSD1) in Leydig cells.

Chronic use of licorice can also cause hyperprolactinemia.<sup>[2]</sup>

### Antiulcer Activity

Licorice extracts reduce gastric secretion and inhibit gastric ulcer formation in ulcer models in rats.<sup>[19]</sup> Glycyrrhizin and the aglycone glycyrrhetic acid show anti-inflammatory activity on gastric mucosa and increase mucus secretion. Also, deglycyrrhizinated licorice is able to heal ulcers induced in animals and humans.<sup>[20]</sup> The mechanism of the antiulcer activity is reported to be increased mucus secretion and increased synthesis of glycoprotein in the gastric mucosa, together with antipepsin action.<sup>[19]</sup> Clinical studies with deglycyrrhizinated licorice have suggested that its cytoprotective effect may be helpful for patients with gastric ulcer.<sup>[20,21]</sup>

### Anti-inflammatory Activity

Licorice exerts anti-inflammatory and antiallergic effects<sup>[22]</sup> due to the corticosteroidlike activity of its constituents, which enhance (indirectly) the effects of corticosteroids.<sup>[23]</sup>

### Antitumoral Activity

Licorice and its constituents or derivatives may protect against carcinogen-induced DNA damage and may be tumor-suppressive agents as well.<sup>[24]</sup> Glycyrrhizic acid may exert antitumoral activity because it is an inhibitor of lipoxygenase, cyclo-oxygenase, and protein kinase C and downregulates the epidermal growth factor receptor.

Polyphenols contained in licorice induce apoptosis in cancer cells.<sup>[24]</sup> Recently, licorice flavonoids have been shown to inhibit the growth of prostate cancer in vitro. This is probably related to an estrogenic effect.<sup>[25]</sup> More recently, we have demonstrated that glycyrrhetic acid, when added to rat liver mitochondria at micromolar concentrations, induces swelling, loss of membrane potential, pyridine nucleotide oxidation, and release of cytochrome *c* and apoptosis inducing factor. All these observations indicate that glycyrrhetic acid is a potent inducer of mitochondrial permeability transition and can trigger the proapoptotic pathway. These observed nongenomic effects can be involved in the antitumoral effect of licorice.<sup>[26]</sup>

### Antimicrobial Activity

The antibacterial activity of licorice is due to the saponin fraction with glycyrrhizin and glycyrrhetic acid, as well as the flavonoid fraction. The flavonoids glabridin, 3-hydroxyglabrol, 4-*O*-methylglabridin, hispaglabridin A, and glabrol showed activity against *Staphylococcus aureus* and *Mycobacterium smegmatis*, with minimum inhibitory concentrations (MICs) of a few micrograms per milliliter. The coumarin derivatives glycyrol and glycyrin exhibited strong antibacterial activity against *Streptococcus mutans*. Glycycoumarin and licocoumarone inhibited the growth of Gram-positive bacteria.<sup>[27]</sup> The isoflavone licoricidin exhibited inhibitory activity against upper respiratory tract bacteria such as *Streptococcus pyogenes*, *Haemophilus influenzae*, and *Moraxella catarrhalis*. Three coumarin derivatives, glycyrol, glycyrin, and glycycoumarin, also showed antibacterial activity.<sup>[27]</sup> Glabridin from *G. glabra*, licochalcone A from *G. inflata*, and licoricidin and glyasperin D from *G. uralensis* exhibited activity against methicillin-sensitive and resistant *S. aureus*.<sup>[28]</sup>

### Anti-*Helicobacter pylori* Activity

The positive effect of licorice on peptic ulcer might be due in part to its inhibition of *H. pylori*. Among the many chemical constituents of licorice, the flavonoids glabridin and glabrene from *G. glabra*, licochalcone A from *G. inflata*, and licoricidin and licoisoflavone

B from *G. uralensis* suppressed the growth of *H. pylori*, including clarithromycin- and amoxicillin-resistant strains.<sup>[29]</sup> Also, glycyrrhizin, glycyrrhetic acid, and the lipophilic acetylated derivative glycyrrhetic acid monoglucuronide showed bactericidal activity against *H. pylori* (including clarithromycin- and metronidazole-resistant strains).<sup>[29]</sup>

### Antiviral Effects

Screening investigations with licorice extracts have revealed that glycyrrhizin and glycyrrhizic acid are active against several viruses. In hepatitis B, the virustatic effect depends on inhibition of intrahepatic transport and sialylation of the hepatitis B virus antigen.

In Japan, a formulation containing glycyrrhizin (SNMC, composed of 40 mg glycyrrhizinic acid, 20 mg L-cysteine, and 400 mg glycine) has been used for treating chronic hepatitis C, in particular in patients without response to  $\alpha$ -interferon. The mechanism by which glycyrrhizin reduces the progression of liver disease without clearing the virus is unknown. A few in vitro and animal (rat) studies suggest that glycyrrhizin inhibits lipid peroxidation, thereby protecting the hepatocytes.<sup>[30]</sup> It has been shown that glycyrrhizin inhibits immunomediated cytotoxicity towards hepatocytes and murine NF $\kappa$ B activity in liver injury induced by CCl<sub>4</sub>-ethanol.

It is suggested that the anti-HIV-1 effect of glycyrrhizin may be involved in the selective inhibition of the human casein kinase II-mediated stimulation of HIV-1 reverse transcriptase at the cellular level. The antiviral effects of glycyrrhizin may depend on interferon gamma and members of cellular signaling pathways, such as protein kinase II and casein kinase II, and transcription factors such as activator protein 1 and nuclear factor NF $\kappa$ B.<sup>[31]</sup>

Glycyrrhizin, albeit at high concentrations, inhibits SARS-associated coronavirus (SARS-CV) replication.<sup>[31]</sup> In addition to reducing virus replication, glycyrrhizin inhibits adsorption and penetration during the early steps of the virus replicative cycle. The mechanism of activity of glycyrrhizin against SARS-CV is unclear. Besides affecting several cellular signaling pathways, glycyrrhizin upregulates the expression of nitric oxide synthase, leading to increased production of nitric oxide, which correlates with the inhibition of virus replication.<sup>[31]</sup>

### Effect on Oxidative Stress

In a recent study, Calò et al.<sup>[32]</sup> have demonstrated that incubation of mononuclear leukocytes with aldosterone or glycyrrhetic acid enhances the protein

expression of genes involved in oxidative stress, as well as plasminogen activator inhibitor-1 (PAI-1) and the subunit of NADPH oxidase (p22<sup>phox</sup>). This effect is genomic, since it is blocked by incubation with aldosterone receptor antagonist canrenone.

### PHARMACOKINETICS

Glycyrrhizinic acid is mainly absorbed after pre-systemic hydrolysis as glycyrrhetic acid.<sup>[14,33]</sup> Since glycyrrhetic acid is as much as 1000 times more potent an inhibitor of 11 $\beta$ -hydroxysteroid dehydrogenase than glycyrrhizinic acid, the pharmacological and toxicological aspects of its kinetics should be carefully considered.<sup>[14,33]</sup> Following the administration of glycyrrhetic acid (130 mg/day for 5 days), a twofold increase in the cortisol/cortisone ratio in 24-h urine was observed, as a consequence of inhibition of 11 $\beta$ -hydroxysteroid dehydrogenase. The ratio remained elevated for 4 days after cessation of treatment.

After absorption, glycyrrhetic acid is transported to the liver, where it is metabolized to glucuronide and sulfate conjugates,<sup>[14,33]</sup> which are transported to bile. After outflow of the bile into the duodenum, the conjugates are hydrolyzed to glycyrrhetic acid by intestinal bacteria, and glycyrrhetic acid is reabsorbed, thus reducing its plasmatic clearance.<sup>[14,33]</sup> The gastrointestinal transit rate largely influences the reabsorption of glycyrrhetic acid conjugates. In subjects with prolonged gastrointestinal transit times, glycyrrhetic acid might accumulate on repeated licorice consumption, thus increasing the health risk to this specific subgroup.<sup>[14,33]</sup> The established relationship between the pharmacokinetics of glycyrrhetic acid and its inhibitory effect on 11 $\beta$ -HSD, evidenced by the urinary cortisol/cortisone ratio, suggests that this ratio might serve as a noninvasive marker to identify individuals at risk for excessive glycyrrhizinic acid consumption.

### EFFICACY

Licorice is considered safe for use as a flavoring and sweetening agent.<sup>[3]</sup> The root is available as a herbal supplement; according to pharmacopeias and traditional medicine, it has demulcent and expectorant properties, and it has been used in cough preparations.<sup>[34]</sup> Licorice has ulcer-healing and cytoprotective properties,<sup>[20]</sup> which may result from stimulation of mucus synthesis. Deglycyrrhized licorice has a low mineralocorticoid activity and has been used, in combination with antacids, for the treatment of peptic ulcer disease.<sup>[21]</sup> Some clinical studies, however, have reported that the capsule formulation of deglycyrrhized licorice may have poor bioavailability,<sup>[21]</sup> and

other studies have suggested that the product's efficacy in ulcer healing is not superior to that of placebo.<sup>[35]</sup> In recent years, with the advent of powerful specific antiulcer drugs, licorice formulations are no longer used in the treatment of peptic ulcer.

As reported previously, licorice has mild anti-inflammatory and mineralocorticoid properties associated with the presence of glycyrrhizic acid and its metabolite glycyrrhetic acid, which is an inhibitor of cortisol metabolism. However, no evidence for clinically rational mineralocorticoid use is available at present.

The clinical evidence for most of the beneficial and detrimental effects of licorice extracts is contradictory, which is in part due to the individual sensitivity of subjects to the different components of the root, the varying content of components other than glycyrrhizic acid in the roots of different species, and the individual metabolism of these components. Clearer data have been obtained using pure glycyrrhetic acid to study potential wanted and unwanted effects; these are more homogeneous. Glycyrrhetic acid is actually the subject of several studies for its potential in blocking type 1 and type 2 11 $\beta$ -HSD and other enzymes involved in steroidogenesis.

## ADVERSE SIDE EFFECTS

In evaluating the undesirable symptoms induced by the consumption of licorice, the purity and concentration of the active ingredient must be considered. Another common and important aspect that needs to be kept in mind is the great variability in sensitivity to licorice among individuals.<sup>[14]</sup> In most cases, it is necessary to consume large or moderately large amounts of licorice for a prolonged period of time to induce unwanted effects. Certain subjects, though, express these effects at low doses consumed over relatively limited time periods. Generally, the sporadic consumption of licorice does not produce side effects.

In this regard, it is important to underline the rapid reversibility (1–2 weeks) of these effects following suspension of licorice consumption. Yet, sometimes, after prolonged use, persistent hypertension remained after stoppage of use, even in cases with normalized serum potassium, renin, and aldosterone levels.<sup>[12]</sup>

A daily dose of 10 g of pure licorice dry extract (containing about 7% glycyrrhizic acid) can lead to significant side effects (principally hypertension and fatigue), but even 7 g, which constitutes normal consumption, can bring about nontrivial unwanted effects.<sup>[12]</sup> The most frequent complication of chronic ingestion of licorice is acquired apparent mineralocorticoid excess syndrome,<sup>[6,10,11,36–38]</sup> which is characterized by retention of sodium and fluids, edema,

headache, abdominal pain, depletion of potassium, weakness, nausea, cardiac irregularities, and cramps.

## Observed Drug Interactions

Several drugs can produce interact adversely with licorice.<sup>[39]</sup>

- Concurrent use of licorice and thiazide diuretics may cause increased risk of hypokalemia and reduced effectiveness of the diuretic.<sup>[40,41]</sup>
- Combination of licorice with corticosteroids may result in enhanced and prolonged effect of the latter due to inhibition of their metabolism and delay in their excretion.<sup>[42,43]</sup>
- Patients taking licorice with oral contraceptives may present an increased risk of elevated blood pressure and fluid retention.<sup>[41,44]</sup> Licorice itself contains flavonoids with estrogenic activity.
- Licorice may enhance the effect of mineralocorticoids.
- Simultaneous use of licorice and potassium supplements may result in reduced effectiveness of the latter.
- Licorice can reduce the effectiveness of antihypertensive drugs.
- Pharmacokinetic interactions may occur when licorice is taken together with other commonly used drugs, such as warfarin, ibuprofen, aspirin, and deoxycholic acid.
- Flavonoids, such as those found in grapefruit juice, inhibit 11 $\beta$ -HSD type 2, and therefore licorice can enhance the mineralocorticoidlike effect of grapefruit.<sup>[45]</sup>

Licorice consumption is thus dangerous in patients with hypertension, a family history of hypertension, or diseases of the cardiovascular system, bile tract, kidney, or adrenal gland. It is also unsafe in hyperaldosteronism (primary and secondary), in untreated hypothyroidism in association with oral contraceptives, during pregnancy, and in diabetic patients.

## CONCLUSIONS

Licorice is one of the most used plants, having been utilized since ancient times, and is now increasingly considered to have potential for the treatment of some clinical diseases. Studies using the pure principal component, glycyrrhetic acid, have been supported by clinical and research studies both in vivo and in vitro. The recent evidence on the blocking of 11 $\beta$ -HSD has inspired further research on the physiological importance of the two isoforms of this enzyme. Glycyrrhetic acid has made possible the evaluation of the

mechanism of action of aldosterone in the kidney and in the genesis of pseudohyperaldosteronism. Data also point to the involvement of glycyrrhetic acid in the metabolism of fat and its putative use in reducing triglyceride accumulation in adipocytes. Most surprising are the positive effects on viral infections, particularly hepatitis and SARS.

Studies using root extracts do have some limitations due to differences in components in different species of the plant and in particular in the content of flavanoids and other minor components. The interactions between glycyrrhizic acid and these other components, which sometimes could have opposing effects, make validation of the clinical evidence and the scientific studies on licorice difficult.

## REFERENCES

1. Blumenthal, M.; Goldberg, A.; Brinckmann, J.; Foster, S. Licorice root. *Herbal Medicine—Expanded Commission E Monographs*; American Botanical Council: Austin, TX, 2000; 233–239.
2. Armanini, D.; Fiore, C.; Matterello, M.J.; Bielenberg, J.; Palermo, M. History of the endocrine effects of licorice. *Exp. Clin. Endocrinol. Diabetes* **2002**, *110* (6), 257–261.
3. Food and Drug Administration (FDA). Licorice and licorice derivatives. In *Code of Federal Regulations, Title 21—Food and Drugs (Chapter I, Section 184.1408)*; Department of Health and Human Services, 2003.
4. World Health Organization (WHO). Radix Glycyrrhizae. In *Monographs on Selected Medicinal Plants*; WHO: Geneva, 1999; Vol. 1, 183–194.
5. Armanini, D.; Scali, M.; Zennaro, M.C.; Karbowski, I.; Wallace, C.; Lewicka, S.; Vecsei, P.; Mantero, F. The pathogenesis of pseudohyperaldosteronism from carbenoxolone. *J. Endocrinol. Invest.* **1989**, *12* (5), 337–341.
6. Størmer, F.C.; Reistad, R.; Alexander, J. Glycyrrhizic acid in liquorice—evaluation of health hazard. *Food Chem. Toxicol.* **1993**, *31* (4), 303–312.
7. Barnes, J.; Anderson, L.A.A.; Phillipson, J.D. Liquorice. *Herbal Medicines*, 2nd Ed.; Pharmaceutical Press: London, 2002; 325–329.
8. Official Monographs: Licorice, licorice fluidextract, powdered licorice, powdered licorice extract. In *USP 26—United States Pharmacopeia*, 26th Ed.; The United States Pharmacopeial Convention: Rockville, MD, 2002; 2782–2783.
9. Directorate for the Quality of Medicines of the Council of Europe. Licorice ethanolic liquid extracts, standardized, and liquorice root. *European Pharmacopeia*, 4th Ed.; Council of Europe: Strasbourg Cedex, France, 2001; 1477–1479.
10. Quinkler, M.; Stewart, P.M. Hypertension and the cortisol–cortisone shuttle. *J. Clin. Endocrinol. Metab.* **2003**, *88* (6), 2384–2392.
11. Armanini, D.; Calò, L.; Semplicini, A. Pseudohyperaldosteronism: pathogenetic mechanisms. *Crit. Rev. Clin. Lab. Sci.* **2003**, *40* (3), 295–335.
12. Armanini, D.; Lewicka, S.; Pratesi, C.; Scali, M.; Zennaro, M.C.; Zovato, S.; Gottardo, C.; Simoncini, M.; Spigariol, A.; Zampollo, V. Further studies on the mechanism of the mineralocorticoid action of licorice in humans. *J. Endocrinol. Invest.* **1996**, *19* (9), 624–629.
13. Stewart, P.M.; Krozowski, Z.S. 11 $\beta$ -Hydroxysteroid dehydrogenase. *Vitam. Horm.* **1999**, *57*, 249–324.
14. Ploeger, B.; Mensinga, T.; Sips, A.; Seinen, W.; Meulenbelt, J.; DeJongh, J. The pharmacokinetics of glycyrrhizic acid evaluated by physiologically based pharmacokinetic modeling. *Drug Metab. Rev.* **2001**, *33* (2), 125–147.
15. Forslund, T.; Fyhrquist, F.; Froseth, B.; Tikkanen, I. Effects of licorice on plasma atrial natriuretic peptide in healthy volunteers. *J. Intern. Med.* **1989**, *225*, 95–99.
16. Baschetti, R. Liquorice and chronic fatigue syndrome. *N. Z. Med. J.* **1995**, *108* (1002), 259.
17. Armanini, D.; De Palo, C.B.; Mattarello, M.J.; Spinella, P.; Zaccaria, M.; Ermolao, A.; Palermo, M.; Fiore, C.; Sartorato, P.; Francini-Pesenti, F.; Karbowski, I. Effect of licorice on the reduction of body fat mass in healthy subjects. *J. Endocrinol. Invest.* **2003**, *26*, 646–650.
18. Armanini, D.; Bonanni, G.; Palermo, M. Reduction of serum testosterone in men by licorice. *N. Engl. J. Med.* **1999**, *341* (15), 1158.
19. Dehpour, A.R.; Zolfaghari, M.E.; Samadian, T.; Kobarfard, F.; Faizi, M.; Assari, M. Antiulcer activities of liquorice and its derivatives in experimental gastric lesion induced by ibuprofen in rats. *Int. J. Pharm.* **1995**, *119* (2), 133–138.
20. Glick, L. Deglycyrrhizinated liquorice for peptic ulcer. *Lancet* **1982**, *2* (8302), 817.
21. Morgan, A.G.; Pacsoo, C.; McAdam, W.A. Comparison between ranitidine and ranitidine plus Caved-S in the treatment of gastric ulceration. *Gut* **1985**, *26* (12), 1377–1379.
22. Finney, R.S.H.; Somers, G.F. Anti-inflammatory activity of glycyrrhetic acid and derivatives. *J. Pharm. Pharmacol.* **1958**, *10*, 613–620.
23. Stewart, P.M.; Wallace, A.M.; Valentino, R.; Burt, D.; Shackleton, C.H.; Edwards, C.R. Mineralocorticoid activity of liquorice: 11-beta-hydroxysteroid dehydrogenase deficiency comes of age. *Lancet* **1987**, *2* (8563), 821–824.

24. Wang, Z.Y.; Nixon, D.W. Licorice and cancer. *Nutr. Cancer* **2001**, *39* (1), 1–11.
25. Rafi, M.M.; Vastano, B.C.; Zhu, N.; Ho, C.T.; Ghai, G.; Rosen, R.T.; Gallo, M.A.; DiPaola, R.S. Novel polyphenol molecule isolated from licorice root (*Glycyrrhiza glabra*) induces apoptosis, G2/M cell cycle arrest, and Bcl-2 phosphorylation in tumor cell lines. *J. Agric. Food Chem.* **2002**, *50* (4), 677–684.
26. Salvi, M.; Fiore, C.; Armanini, D.; Toninello, A. Glycyrrhetic acid-induced permeability transition in rat liver mitochondria. *Biochem. Pharmacol.* **2003**, *66* (12), 2375–2379.
27. Tanaka, Y.; Kikuzaki, H.; Fukuda, S.; Nakatani, N. Antibacterial compounds of licorice against upper airway respiratory tract pathogens. *J. Nutr. Sci. Vitaminol.* **2001**, *47* (3), 270–273.
28. Fukai, T.; Marumo, A.; Kaitou, K.; Kanda, T.; Terada, S.; Nomura, T. Antimicrobial activity of licorice flavonoids against methicillin-resistant *Staphylococcus aureus*. *Fitoterapia* **2002**, *73* (6), 536–539.
29. Fukai, T.; Marumo, A.; Kaitou, K.; Kanda, T.; Terada, S.; Nomura, T. Anti-*Helicobacter pylori* flavonoids from licorice extract. *Life Sci.* **2002**, *71* (12), 149–163.
30. Van Rossum, T.G.J.; Vulto, R.A.; de Man, R.A.; Brouwer, J.T.; Schalm, S.W. Glycyrrhizin as a potential treatment for chronic hepatitis C. *Alim. Pharmacol. Ther.* **1998**, *12* (3), 199–205.
31. Cinatl, J.; Morgenstern, B.; Bauer, G.; Chandra, P.; Rabenau, H.; Doerr, H.W. Glycyrrhizin, an active component of liquorice root, and replication of SARS-associated coronavirus. *Lancet* **2003**, *361* (9374), 2045–2046.
32. Calò, L.A.; Zaghetto, F.; Pagnin, E.; Davis, P.A.; De Mozzi, P.; Sartorato, P.; Martire, G.; Fiore, C.; Armanini, D. Effect of aldosterone and glycyrrhetic acid on the protein expression of PAI-1 and p22<sup>phox</sup> in human mononuclear leukocytes. *J. Clin. Endocrinol. Metab.* **2004**, *89* (4), 1973–1976.
33. Ploeger, B.; Mensinga, T.; Sips, A.; Meulenbelt, J.; DeJongh, J.A. Human physiologically-based model for glycyrrhizic acid, a compound subject to presystemic metabolism and enterohepatic cycling. *Pharm. Res.* **2000**, *17*, 1516–1525.
34. *British Herbal Compendium*; Bradley, P.R.; British Herbal Medicine Association: Bournemouth, 1992; Vol. 1, 145–148.
35. Feldman, H.; Gilat, T. A trial of deglycyrrhizinated liquorice in the treatment of duodenal ulcer. *Gut* **1971**, *12* (6), 449–451.
36. Conn, J.W.; Rovner, D.R.; Cohen, E.L. Licorice-induced pseudoaldosteronism. Hypertension, hypokalemia, aldosteronopenia, and suppressed plasma renin activity. *J. Am. Med. Assoc.* **1968**, *205*, 492–496.
37. Shibata, S. A drug over the millennia: pharmacognosy, chemistry, and pharmacology of licorice. *Yakugaku Zasshi* **2000**, *120* (10), 849–862.
38. Olukoga, A.; Donaldson, D. Liquorice and its health implications. *J. R. Soc. Health* **2000**, *120* (2), 83–89.
39. Fugh-Berman, A. Herb–drug interactions. *Lancet* **2000**, *355*, 134–138.
40. Walker, B.R.; Edwards, C.R.W. Licorice-induced hypertension and syndromes of apparent mineralocorticoid excess. *Endocrinol. Metab. Clin. North Am.* **1994**, *23* (2), 359–377.
41. Bernardi, M.; D’Intino, P.E.; Trevisani, F.; Cantelli-Forti, G.; Raggi, M.A.; Turchetto, E.; Gasbarrini, G. Effects of prolonged ingestion of graded doses of licorice by healthy volunteers. *Life Sci.* **1994**, *55* (11), 863–872.
42. Teelucksingh, S.; Mackie, A.D.; Burt, D.; McIntyre, M.A.; Brett, L.; Edwards, C.R. Potentiation of hydrocortisone activity in skin by glycyrrhetic acid. *Lancet* **1990**, *335* (8697), 1060–1063.
43. Chen, M.F.; Shimada, F.; Kato, H.; Yano, S.; Kanaoka, M. Effect of oral administration of glycyrrhizin on the pharmacokinetics of prednisolone. *Endocrinol. Jpn.* **1991**, *38* (2), 167–174.
44. deKlerk, G.; Neiuwenhuis, M.; Beutler, J. Hypokalemia and hypertension associated with use of liquorice flavoured chewing gum. *Br. Med. J.* **1997**, *314* (7082), 731–732.
45. Lee, Y.S.; Lorenzo, B.J.; Koufis, T.; Reidenberg, M.M. Grapefruit juice and its flavonoids inhibit 11 beta-hydroxysteroid dehydrogenase. *Clin. Pharmacol. Ther.* **1996**, *59* (1), 62–71.





# $\alpha$ -Lipoic Acid/Thioctic Acid

Donald B. McCormick

School of Medicine, Emory University, Atlanta, Georgia, U.S.A.

## INTRODUCTION

Lipoic acid, also called thioctic acid, has been known as an essential growth factor for certain microorganisms for half a century and for most of this time, identified as a covalently linked cofactor for  $\alpha$ -keto acid decarboxylating enzymes. With humans and other animals that biosynthesize lipoate from fatty acid, it is known that mitochondrial dehydrogenase complexes exist wherein there are lipoyl transacylases which receive acyl moieties from the thiamin pyrophosphate-dependent decarboxylase subunits and vector the acyl group to coenzyme A. A more recent variation of this is the similar function of a lipoyl residue within the glycine decarboxylating system that vectors an aminomethyl function. The dihydrolipoyl enzyme subunits generated in the foregoing cases are then reoxidized to the lipoyl enzymes by FAD-dependent lipoyl dehydrogenase subunits that generally couple with  $\text{NAD}^+$  and electron-to-oxygen transfers.

Within the past quarter century, a greater understanding of the antioxidant properties of  $\alpha$ -lipoate and its natural dihydro form has led to commercial use of lipoate in supplements, which are purported to insure better health, including protection against oxidant stress conditions that may be associated with certain diseases. It is the intent of this entry to examine reports that relate the supplement and therapeutic uses in the human, as have been derived from and relate to antioxidant as well as cofactor functions of lipoate. Most literature bearing on the subject occurs within the past 25 yr, with a fairly rapid expansion of reports in the last decade.

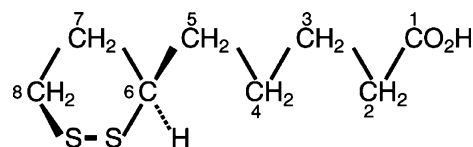
## CHEMISTRY

$\alpha$ -Lipoic (thioctic) acid is chemically recognized as a 1,2-dithiolane-3-pentanoic acid or 6,8-dithiooctanoic acid. The asymmetric carbon at position 6, using the

latter chemical name, is found in nature only as the *R*-(+)-enantiomer, shown in Fig. 1, though a racemate of both *R*-(+)- and *S*-(-)-stereoisomers is the result of usual chemical synthesis before resolution as optically active base salts. The polar carboxyl and, to some extent, the disulfide groups allow moderate water solubility of this compound, which is soluble in common organic solvents as usual for fatty acids. The sulfurs within the dithiolane ring provide reactive nucleophilic centers such that electrons in the  $p_z$  orbitals readily react with electrophilic functions. Addition to a sulfur with concomitant breaking of the disulfide bond results in covalent adducts that serve as intermediates in transfer of acyl or less frequently alkyl groups. Oxidative attack on the dithionyl sulfurs occurs readily to form monoxides and even dioxides. The disulfide function of lipoate is an effective scavenger for hydroxyl radicals. It is also readily reduced to dihydrolipoate, which is the 6,8-mercapto- (or 6,8-dithio)octanoate. The oxidation–reduction (redox) potential for the disulfide–disulfhydryl interconversion is  $-0.32\text{ V}$ , which is well poised to function within a range of biological redox systems. The  $\text{p}K_a$  of lipoic acid is 5.4, so that it is the salt form that occurs at physiological pH. Both lipoate and its dihydro form are fairly effective chelators of divalent metal ions, some of which are toxic to most organisms.

## METABOLISM AND DYNAMICS

Biosynthesis of lipoate involves a nonheme iron-containing synthase capable of inserting S atoms into positions 6 and 8 of octanoate for the dithiolane ring system.<sup>[1]</sup> Lipoate is fairly readily absorbed *in vivo* even at therapeutic levels. Single oral doses of 200 or

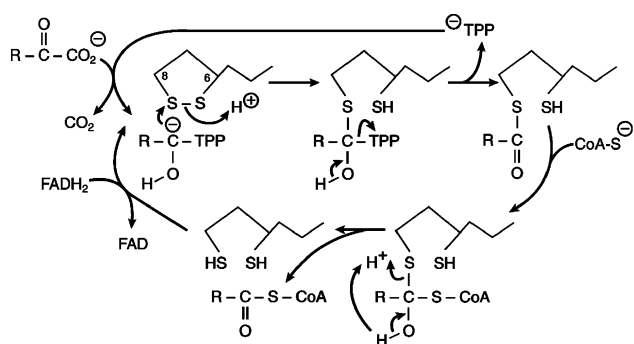


**Fig. 1** Structure of  $\alpha$ -lipoic acid (with numbering as 6,8-dithiooctanoic acid).

Donald B. McCormick, Ph.D., is at the Department of Biochemistry, School of Medicine, Emory University, Atlanta, Georgia, U.S.A.

600 mg of racemic lipoate or 200 mg intravenously were given to 12 healthy subjects.<sup>[2]</sup> The area under the curve following oral and intravenous administration of the 200 mg doses was approximately 47 and 158  $\mu\text{g min/ml}$ , respectively; after the 600 mg dose, it was also about 159. There was no significant difference in mean half-time for plasma concentrations. An absolute bioavailability of 29% was determined after the 200 mg dose. The lack of difference in total plasma clearance indicates nonsaturable kinetics. Another study in which 50–600 mg of the racemate was given orally to healthy volunteers showed that maximal plasma concentrations of the natural *R*-(+)-enantiomer were 40–50% higher than those of the *S*-(-)-enantiomer.<sup>[3]</sup>

A metabolic event that occurs with lipoate in humans as well as most organisms is that uptake at cellular level results in much being reduced to the dihydro form. The reduction of free lipoate (and lipoamide) at rather high levels has been attributed mainly to NADPH-dependent thioredoxin reductase.<sup>[4]</sup> The subsequent fate of both lipoate and dihydrolipoate is summarized in Fig. 2. Some essential lipoate is routed through lipoyl-AMP to form lipoylated holoproteins wherein the attachment is at the  $\epsilon$ -amino function of lysyl residues. The two reactions involved are catalyzed in mammals by separate mitochondrial enzymes. The gene for the second enzyme, lipoyl transferase, has been shown to be located on chromosome 2q11.2 in the human.<sup>[5]</sup> It has been reported that the lethal syndrome of metabolic acidosis found in an infant reflected suppression of the mitochondrial dehydrogenases for pyruvate,  $\alpha$ -ketoglutarate, and branched-chain keto acids.<sup>[6]</sup> The decreased activities were



**Fig. 2** Function of the lipoyl moiety covalently attached to enzymes involved in transacylations following  $\alpha$ -keto acid decarboxylations. In multienzyme dehydrogenase complexes in which lipoyl residues function, there is transfer of an acyl moiety from an  $\alpha$ -hydroxyalkyl-thiamin pyrophosphate to the lipoyl group of a transacylase core and thence to CoA. This results in formation of the dihydrolipoyl group, which is cyclically reoxidized by the FAD-dependent (dihydro) lipoyl dehydrogenase.

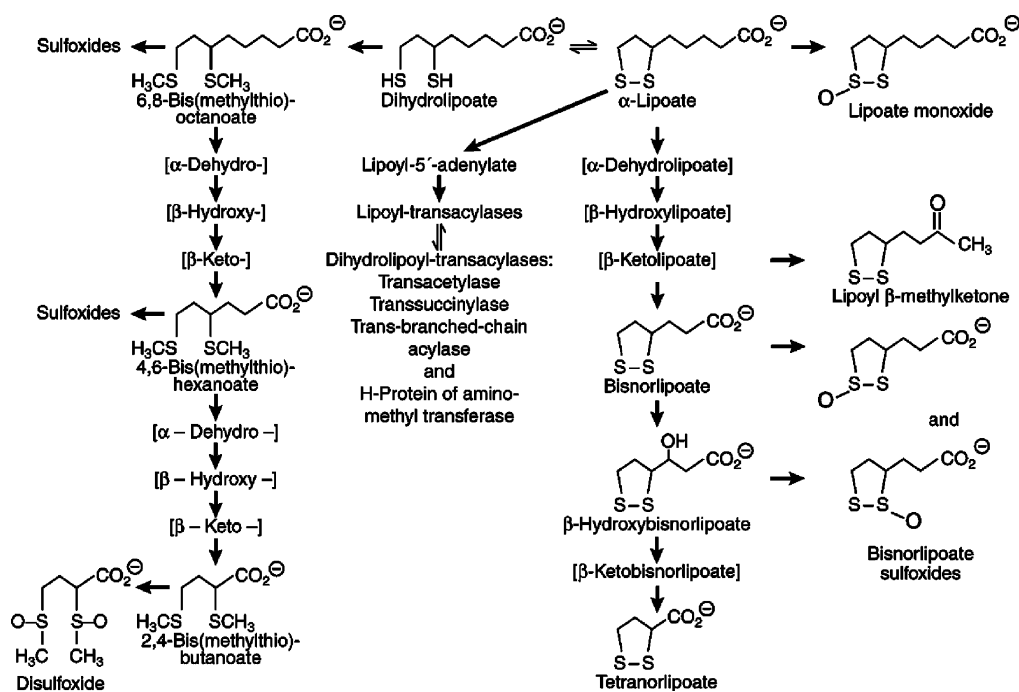
attributable to inability to normally utilize lipoate as cofactor, since addition of lipoate to a medium containing the patient's fibroblasts markedly improved conversions of leucine and valine. A severe acidosis found in an 8-mo-old boy was attributed to a deficiency of lipoyl dehydrogenase, which was improved by oral administration of 25–50 mg/kg of lipoate.<sup>[7]</sup> Less clear is the case of primary biliary cirrhosis in which antimitochondrial antibodies are reported to be present against the transacetylase of the pyruvate dehydrogenase complex.<sup>[8]</sup>

Catabolic events with  $\alpha$ -lipoate, elucidated in microbes and mammals,<sup>[9]</sup> are noted in Fig. 3, as are the more recently discovered catabolites of dihydrolipoate, which are the methylated and sulfoxidized compounds found in plasma and urine after high oral intakes of lipoate.<sup>[10,11]</sup>

## SUPPLEMENT USES AND CLAIMS

Investigations and reviews of the noncofactor nature of  $\alpha$ -lipoate have burgeoned in the past dozen years. The focus has been on the antioxidant, generally thiol, nature of the lipoate–dihydrolipoate interconversion in cells. In most cases, a therapeutic effect, real or potential, is stated. For example, a review, "The pharmacology of the antioxidant lipoic acid,"<sup>[12]</sup> lists four antioxidant properties of lipoate including its metal chelating capacity, its ability to scavenge reactive oxygen species (ROS), regenerate endogenous antioxidants, and repair oxidative damage. Dihydrolipoate, formed by the reduction of lipoate, has the capacity to regenerate the antioxidants vitamins C and E as well as glutathione. It can also provide peptide methionine sulfoxide reductase with reducing equivalents. Other reviews on thiol-based antioxidants suggest therapeutic potential for *N*-acetyl-L-cysteine and lipoate but point out that an advantage of the latter is that it is readily recycled in the cell.<sup>[13,14]</sup> Interestingly, some proponents of the use of lipoate as an antioxidant also recognize the pro-oxidant activities of lipoate and dihydrolipoate.<sup>[15]</sup>

Among effects reported for lipoate is that it inhibits the *in vitro* glycation of albumin by glucose.<sup>[16]</sup> The decrease in advanced glycation end-products (AGEs) has been extended by studies of lipoate with endothelial cells<sup>[17,18]</sup> and erythrocytes.<sup>[19]</sup> Incubation of lipoate with Jurkat T (human leukemic T-lymphocyte) cells was reported to inhibit nuclear factor kappaB (NF- $\kappa$ B) activation.<sup>[20]</sup> Lipoate treatment of these cells also potentiates caspase 3 activation, which leads to Fas-mediated apoptosis.<sup>[21]</sup> The myeloperoxidase-dependent activation of caspase and apoptosis in human HL-60 leukemic cells is protected against by



**Fig. 3** Metabolic conversions of α-lipoate. Intermediates in brackets, i.e., the α-dehydro-, β-hydroxy-, and β-keto-compounds are transitory, and in-line-metabolites that must exist with β-oxidation; other compounds and enzymes named have been isolated and/or chemically identified/synthesized.

incubation with lipoate as well as dehydroascorbic acid, both of which act via their reduced forms, viz. dihydrolipoate and ascorbate, respectively.<sup>[22]</sup> Reduction of NF-κB activity, which regulates production of many inflammatory cytokines and adhesion factors, occurred when lipoate was incubated with Mono Mac6 (a human monocyte) cells.<sup>[23]</sup> Such inhibition of NF-κB was also reported for lipoate with human aortic endothelial cells.<sup>[24]</sup> Given the presumption of the investigators in these studies of NF-κB that it is the activation by ROS that is sequestered by lipoate, it is of interest that recent analyses have questioned the role of oxidative stress in activation of NF-κB.<sup>[25]</sup> Further along lines of the antioxidant potential of lipoate with cells, there have been reports of it leading to an increase in glutathione biosynthesis by improving cystine utilization in several cell types.<sup>[26]</sup> Nitric oxide synthesis in human aortic endothelial cells is stimulated by lipoate as well as vitamin C independent of glutathione status.<sup>[27]</sup> In a comparison of the effects of α-lipoate and α-tocopherol given in high oral doses (600 mg/day lipoate; 400 IU/day α-tocopherol) to healthy adults for 2 mo separately and then 2 mo in combination, it was determined that lipoate functions as an antioxidant, because it decreases plasma- and LDL-oxidation and urinary isoprostanes. However, no additional benefit was seen with the combination of lipoate plus vitamin E.<sup>[28]</sup>

In connecting lipoate (and other antioxidants) with the ability to decrease such reactive oxygen intermediates as are thought to cause “oxidative stress,” including that in aging, some reviewers have suggested lipoate to be “a highly promising thiol antioxidant supplement”.<sup>[29]</sup> Generally, the amounts currently available in over-the-counter or over-the-net sales are in the 30–200 mg range.

### THERAPEUTIC USES AND CLAIMS

The therapeutic uses of lipoate, in part stimulating the use of supplements, range over several diseases and disorders. One of the prime uses of high-dose (usually 600 mg/day or greater) lipoate is with diabetics, particularly those evidencing neuropathy. Use of lipoate as an adjunct therapy in diabetes has been in practice in Germany for a generation. One of the earlier groups (in Düsseldorf) reporting benefit from administration of lipoate to Type 2 diabetics with polyneuropathy reviewed 15 clinical trials in a multicenter study and concluded that doses of 600 mg/day or greater given for weeks to months caused some improvement of neuropathic deficits.<sup>[30]</sup> However, in reporting a 7-mo, multicenter, randomized, control trial involving 509 outpatients,<sup>[31]</sup> the conclusion reached by the Düsseldorf group was: “Findings indicate that a 3-week

intravenous treatment with alpha-lipoic acid, followed by a 6-mo oral treatment, had no effect on neuropathic symptoms distinguishable from placebo to a clinically meaningful degree.” Yet the surmise was that this treatment was associated with a favorable effect on neuropathic deficits without causing significant adverse reactions. Ongoing reviews of the literature on lipoate therapy of diabetics include the overviews of reported improvement in insulin sensitivity attributable to intravenous infusions<sup>[32]</sup> and lessening of the impact of oxidative damage caused by dysregulation of glucose metabolism.<sup>[33]</sup> In a recent review of botanicals and dietary supplements available in the putative treatment of the peripheral neuropathy of diabetics, lipoate is considered with other components that continue to receive attention. However, a concluding statement is that “further studies are needed to confirm their efficacy.”<sup>[34]</sup>

Among other reports of possible benefit from lipoate therapy are effects seen with: *liver disease*, where success was sometimes claimed for *Amanita* (mushroom) poisoning, metal toxicity, carbon tetrachloride toxicity, and alcohol-induced damage,<sup>[35]</sup> though the last had already been refuted by a randomized, double-blind trial;<sup>[36]</sup> *hepatitis C*, where 3 patients treated with a combination of three “antioxidants,” i.e., lipoate, silymarin, and selenium, seemingly recovered;<sup>[37]</sup> *cancers*, where functional defects were improved in peripheral blood mononuclear cells from advanced stage patients,<sup>[38]</sup> growth was suppressed in head and neck squamous cells,<sup>[39]</sup> and levels of ROS were decreased in advanced cancer patients with tumors at different sites;<sup>[40]</sup> *mitochondrial enzyme defects*, where cases of infantile acidosis due to a defect in lipoamide (lipoyl) dehydrogenase were improved specifically<sup>[7]</sup> and energy levels in brain and skeletal muscle improved in a progressive external ophthalmoplegia due to a mitochondrial cytopathy;<sup>[41]</sup> *burning mouth syndrome*, which is an idiopathic dysgeusia, may be ameliorated;<sup>[42–44]</sup> *smell dysfunction following viral infection*, where there may be modest benefit but, as pointed out by the authors, “the outcome of double-blind, placebo-controlled studies in large groups of patients must be awaited.”<sup>[45]</sup> Other suggestions for therapeutic use of lipoate, largely based on its ability to decrease some oxidative stress due to ROS, are in HIV infection,<sup>[46]</sup> though no effect on cognitive function in AIDS patients was found,<sup>[47]</sup> in ataxia–telangiectasia, based on cell studies,<sup>[48]</sup> and in genetic anemias.<sup>[49]</sup> The possible benefit of lipoate as a protective agent against cardiovascular disease has been considered based on work with experimental animals.<sup>[50]</sup> However, any benefit that may accrue to humans must be weighed against the lack of knowledge regarding most appropriate form, dose, and method of administration as well as stage of disease.

One very recent finding that should instill caution in those who would promulgate the use of lipoate and perhaps other micronutrients well beyond the nutritional requirement levels is the report of the enhancement of pathogenicity of organisms that depend on the host for the nutrient. Specifically, *Listeria monocytogenes*, a Gram-positive intracytosolic pathogen that causes severe disease in pregnant and immunocompromised individuals, depends on host-derived lipoate, which may be critical for in vivo replication of this pathogen.<sup>[51]</sup>

## CONCLUSIONS

In consideration of over a hundred publications retrieved electronically, which cover the relatively current knowledge base on lipoic (thioctic) acid use, it is apparent that many are collations derived from studies in vitro, that some of the studies in vivo (particularly with a clinical aim) lack optimal controls, and that a number of these publications are simply reviews that sometimes cite suggestions and suppositions as if they were facts. Nevertheless, the extent and weight of evidence is that there is an additional, noncofactor role of lipoate that may be useful in suppression of “oxidative stress” as encountered in certain diseases. It is less clear whether or not supplement use for otherwise healthy individuals confers any benefit, including delay of aging. More carefully controlled scientific studies with larger numbers of subjects over longer periods will be needed to clarify the possibility that the sale of this compound is justified on a nutritional basis.

## REFERENCES

1. Jordan, S.W.; Cronan, J.E., Jr. Biosynthesis of lipoic acid and posttranslational modification with lipoic acid in *Escherichia coli*. In *Methods in Enzymology, Vitamins and Coenzymes*; McCormick, D.B., Suttie, J.W., Wagner, C., Eds.; Academic Press, Inc.: New York, 1997; Vol. 279, Part I, 176–183.
2. Teichert, J.; Kern, J.; Tritschler, H.J.; Ulrich, H.; Preiss, R. Investigations on the pharmacokinetics of alpha-lipoic acid in healthy volunteers. *Int. J. Clin. Pharmacol. Ther.* **1998**, *36* (12), 625–628.
3. Breithaupt-Grogler, K.; Niebch, G.; Schneider, E.; Erb, K.; Hermann, R.; Blume, H.H. Dose-proportionality of oral thioctic acid—coincidence of assessments via pooled plasma and individual data. *Eur. J. Pharm. Sci.* **1999**, *8* (1), 57–65.
4. Arner, E.S.; Nordberg, J.; Holmgren, A. Efficient reduction of lipoamide and lipoic acid by

- mammalian thioredoxin reductase. *Biochem. Biophys. Res. Commun.* **1996**, *225* (1), 268–274.
5. Fujiwara, K.; Suzuki, M.; Okumachi, Y.; Okamura-Ikeda, K.; Fujiwara, T.; Takahashi, E.; Motokawa, Y. Molecular cloning, structural characterization and chromosomal localization of human lipoyltransferase gene. *Eur. J. Biochem.* **1999**, *260* (3), 761–767.
  6. Yoshida, I.; Sweetman, L.; Kulovich, S.; Nyhan, W.L.; Robinson, B.H. Effect of lipoic acid in a patient with defective activity of pyruvate dehydrogenase, 2-oxoglutarate dehydrogenase, and branched-chain dehydrogenase. *Pediatr. Res.* **1990**, *27* (1), 75–79.
  7. Matalon, R.; Stumpf, D.A.; Michals, K.; Hart, R.D.; Parks, J.K.; Goodman, S.I. Lipoamide dehydrogenase deficiency with primary lactic acidosis: favorable response to treatment with oral lipoic acid. *J. Pediatr.* **1984**, *104* (1), 65–69.
  8. Quinn, J.; Diamond, A.G.; Palmer, J.M.; Bassendine, M.F.; James, O.F.; Yeaman, S.J. Lipoylated and unlipoylated domains of human PDC-E2 as autoantigens in primary biliary cirrhosis: significance of lipoate attachment. *Hepatology* **1993**, *18* (6), 1384–1391.
  9. McCormick, D.B. Some aspects of the metabolism of sulfur-containing heterocyclic cofactors: lipoic acid, biotin, and 8 $\alpha$ -(S-L-cysteinyl)riboflavin. In *Natural Sulfur Compounds. Novel Biochemical and Structural Aspects*; Cavallini, D., Gaull, G.E., Zappia, V., Eds.; Plenum Press: New York, 1979; 423–434.
  10. Schupke, H.; Hempel, R.; Peter, G.; Hermann, R.; Wessel, K.; Engel, J.; Kronbach, T. New metabolic pathways of alpha-lipoic acid. *Drug Metab. Disposition* **2001**, *29* (6), 855–862.
  11. Teichert, J.; Preiss, R. High-performance liquid chromatographic assay for alpha-lipoic acid and five of its metabolites in human plasma and urine. *J. Chromatogr. B: Anal. Technol. Biomed. Life Sci.* **2002**, *769* (2), 269–281.
  12. Biewenga, G.P.; Haenen, G.R.; Bast, A. The pharmacology of the antioxidant lipoic acid. *Gen. Pharmacol.* **1997**, *29* (3), 315–331.
  13. Sen, C.K. Redox signaling and the emerging therapeutic potential of thiol antioxidants. *Biochem. Pharmacol.* **1998**, *55* (11), 1747–1758.
  14. Sen, C.K. Cellular thiols and redox-regulated signal transduction. *Curr. Top. Cell. Regul.* **2000**, *36*, 1–30.
  15. Moini, H.; Packer, L.; Saris, N.E. Antioxidant and prooxidant activities of alpha-lipoic acid and dihydrolipoic acid. *Toxicol. Appl. Pharmacol.* **2002**, *182* (1), 84–90.
  16. Suzuki, Y.J.; Tsuchiya, M.; Packer, L. Lipoate prevents glucose-induced protein modifications. *Free Radical Res. Commun.* **1992**, *17* (3), 211–217.
  17. Bierhaus, A.; Chevion, S.; Chevion, M.; Hofmann, M.; Quehenberger, P.; Illmer, T.; Luther, T.; Berentshtein, E.; Tritschler, H.; Muller, M.; Wahl, P.; Ziegler, R.; Nawroth, P.P. Advanced glycation end product-induced activation of NF-kappaB is suppressed by alpha-lipoic acid in cultured endothelial cells. *Diabetes* **1997**, *46* (9), 1481–1490.
  18. Kunt, T.; Forst, T.; Wilhelm, A.; Tritschler, H.; Pfeutzner, A.; Harzer, O.; Engelbach, M.; Zschaebitz, A.; Stofft, E.; Beyer, J. Alpha-lipoic acid reduces expression of vascular cell adhesion molecule-1 and endothelial adhesion of human monocytes after stimulation with advanced glycation end products. *Chem. Sci.* **1999**, *96* (1), 75–82.
  19. Jain, S.K.; Lim, G. Lipoic acid decreases lipid peroxidation and protein glycosylation and increases (Na<sup>+</sup> + K<sup>+</sup>)- and Ca<sup>++</sup>-ATPase activities in high glucose-treated human erythrocytes. *Free Radical Biol. Med.* **2000**, *29* (11), 1122–1128.
  20. Suzuki, Y.J.; Aggarwal, B.B.; Packer, L. Alpha-lipoic acid is a potent inhibitor of NF-kappaB activation in human T cells. *Biochem. Biophys. Res. Commun.* **1992**, *189* (3), 1709–1715.
  21. Sen, C.K.; Sashwati, R.; Packer, L. Fas mediated apoptosis of human Jurkat T-cells: intracellular events and potentiation by redox-active alpha-lipoic acid. *Cell Death Differ.* **1999**, *6* (5), 481–491.
  22. Myzak, M.C.; Carr, A.C. Myeloperoxidase-dependent caspase-3 activation and apoptosis in HL-60 cells: protection by the antioxidants ascorbate and (dihydro)lipoate. *Redox Rep.* **2002**, *7* (1), 47–53.
  23. Lee, H.A.; Hughes, D.A. Alpha-lipoic acid modulates NF-kappaB activity in human monocytic cells by direct interaction with DNA. *Exp. Gerontol.* **2002**, *37* (2–3), 401–410.
  24. Zhang, W.J.; Frei, B. Alpha-lipoic acid inhibits TNF-alpha-induced NF-kappaB activation and adhesion molecule expression in human aortic endothelial cells. *FASEB J.* **2001**, *15* (13), 2423–2432.
  25. Bowie, A.; O'Neill, L.A. Oxidative stress and nuclear factor-kappaB activation: a reassessment of the evidence in the light of recent discoveries. *Biochem. Pharmacol.* **2002**, *59*, 13–23.
  26. Han, D.; Handelman, G.; Marcocci, L.; Sen, C.K.; Roy, S.; Kobuchi, H.; Tritschler, H.J.; Flohe, L.;

- Packer, L. Lipoic acid increases de novo synthesis of cellular glutathione by improving cystine utilization. *Biofactors* **1997**, *6* (3), 321–338.
27. Visioli, F.; Smith, A.; Zhang, W.; Keaney, J.F., Jr.; Hagen, T.; Frei, B. Lipoic acid and vitamin C potentiate nitric oxide synthesis in human aortic endothelial cells independently of cellular glutathione status. *Redox Rep.* **2002**, *7* (4), 223–227.
  28. Marangon, K.; Devaraj, S.; Tirosh, O.; Packer, L.; Jialal, I. Comparison of the effect of alpha-lipoic acid and alpha-tocopherol supplementation on measures of oxidative stress. *Free Radical Biol. Med.* **1999**, *27* (9–10), 1114–1121.
  29. Sen, C.K. Uptake on thiol status and supplements in physical exercise. *Can. J. Appl. Physiol.* **2001**, *26* (Suppl.), 4S–12S.
  30. Ziegler, D.; Reljanovic, M.; Mehnert, H.; Gries, F.A. Alpha-lipoic acid in the treatment of diabetic polyneuropathy in Germany: current evidence from clinical trials. *Exp. Clin. Endocrinol. Diabetes* **1999**, *107* (7), 421–430.
  31. Ziegler, D.; Hanefeld, M.; Ruhnau, K.J.; Hasche, H.; Lobisch, M.; Schutte, K.; Kerum, G.; Malessa, R. Treatment of symptomatic diabetic polyneuropathy with the antioxidant alpha-lipoic acid: a 7-month multicenter randomized controlled trial (ALADIN III Study). ALADIN III Study Group. Alpha-lipoic acid in diabetic neuropathy. *Diabetes Care* **1999**, *22* (8), 1296–1301.
  32. Evans, J.L.; Goldfine, I.D. Alpha-lipoic acid: a multifunctional antioxidant that improves insulin sensitivity in patients with type 2 diabetes. *Diabetes Technol. Ther.* **2000**, *2* (3), 401–413.
  33. Ruhe, R.C.; McDonald, R.B. Use of antioxidant nutrients in the prevention and treatment of type 2 diabetes. *J. Am. Coll. Nutr.* **2001**, *20* (Suppl. 5), 363S–383S, discussion 381S–383S.
  34. Halat, K.M.; Dennehy, C.E. Botanicals and dietary supplements in diabetic peripheral neuropathy. *J. Am. Board Fam. Pract.* **2003**, *16* (1), 47–57.
  35. Bustamante, J.; Lodge, J.K.; Marcocci, L.; Tritschler, H.J.; Packer, L.; Rihn, B.H. Alpha-lipoic acid in liver metabolism and disease. *Free Radical Biol. Med.* **1998**, *24* (6), 1023–1039.
  36. Marshall, A.W.; Graul, R.S.; Morgan, M.Y.; Sherlock, S. Treatment of alcohol-related liver disease with thioctic acid: a six month randomized double-blind trial. *Gut* **1982**, *23* (12), 1088–1093.
  37. Berkson, B.M. A conservative triple antioxidant approach to the treatment of hepatitis C. Combination of alpha lipoic acid (thioctic acid), silymarin, and selenium: three case histories. *Med. Klin.* **1999**, *94* (Suppl. 3), 84S–89S.
  38. Mantovani, G.; Maccio, A.; Melis, G.; Mura, L.; Massa, E.; Mudu, M.C. Restoration of functional defects in peripheral blood mononuclear cells isolated from cancer patients by thiol antioxidants alpha-lipoic acid and *N*-acetyl cysteine. *Int. J. Cancer* **2000**, *86* (6), 842–847.
  39. Krishna, S.; Brown, N.; Faller, D.V.; Spanjaard, R.A. Differential effects of short-chain fatty acids on head and neck squamous carcinoma cells. *Laryngoscope* **2002**, *112* (4), 645–650.
  40. Mantovani, G.; Maccio, A.; Madeddu, C.; Mura, L.; Gramignano, G.; Lusso, M.R.; Murgia, V.; Camboni, P.; Ferreli, L.; Mocci, M.; Massa, E. The impact of different antioxidant agents alone or in combination on reactive oxygen species, antioxidant enzymes and cytokines in a series of advanced cancer patients at different sites: correlation with disease progression. *Free Radical Res.* **2003**, *37* (2), 213–223.
  41. Barbiroli, B.; Medori, R.; Tritschler, H.J.; Klopstock, T.; Seibel, P.; Reichmann, H.; Iotti, S.; Lodi, R.; Zaniol, P. Lipoic (thioctic) acid increases brain energy availability and skeletal muscle performance as shown by in vivo <sup>31</sup>P-MRS in a patient with mitochondrial cytopathy. *J. Neurol.* **1995**, *242* (7), 472–477.
  42. Femiano, F. Burning mouth syndrome (BMS): an open trial of comparative efficacy of alpha-lipoic acid (thioctic acid) with other therapies. *Minerva Stomatol.* **2002**, *51* (9), 405–409.
  43. Femiano, F.; Scully, C.; Gombos, F. Idiopathic dysgeusia: an open trial of alpha lipoic acid (ALA) therapy. *Int. J. Oral Maxillofac. Surg.* **2002**, *31* (6), 625–628.
  44. Femiano, F.; Scully, C. Burning mouth syndrome (BMS): double blind controlled study of alpha-lipoic acid (thioctic acid) therapy. *J. Oral Pathol. Med.* **2002**, *31* (5), 267–269.
  45. Hummel, T.; Heilmann, S.; Huttenbriuk, K.B. Lipoic acid in the treatment of smell dysfunction following viral infection of the upper respiratory tract. *Laryngoscope* **2002**, *112* (11), 2076–2080.
  46. Merin, J.P.; Matsuyama, M.; Kira, T.; Baba, M.; Okamoto, T. Alpha-lipoic acid blocks HIV-1 LTR-dependent expression of hygromycin resistance in THP-1 stable transformants. *FEBS Lett.* **1996**, *394* (1), 9–13.

47. Anonymous. A randomized, double-blind, placebo-controlled trial of deprenyl and thioctic acid in human immunodeficiency virus-associated cognitive impairment. Dana Consortium on the Therapy of HIV Dementia and Related Cognitive Disorders. Comment in: *Neurology* **1999**, *52* (9), 1920–1921.
48. Gatei, M.; Shkedy, D.; Khanna, K.K.; Uziel, T.; Shiloh, Y.; Pandita, T.K.; Lavin, M.F.; Rotman, G. Ataxia–telangiectasia: chronic activation of damage responsive functions is reduced by alpha-lipoic acid. *Oncogene* **2001**, *20* (3), 289–294.
49. Chan, A.C.; Chow, C.K.; Chiu, D. Interaction of antioxidants and their implication in genetic anemia. *Proc. Soc. Exp. Biol. Med.* **1999**, *222* (3), 274–282.
50. Wollin, S.D.; Jones, P.J.H. Alpha-lipoic acid and cardiovascular disease. *J. Nutr.* **2003**, *133* (11), 3327–3330.
51. O’Riordan, M.; Moors, M.A.; Portnoy, D.A. *Listeria* intracellular growth and virulence require

host-derived lipoic acid. *Science* **2003**, *302* (5644), 462–464.

#### FURTHER READINGS

- McCormick, D.B.; Wright, L.D. Section III. Lipoic acid and lipoamide. In *Methods in Enzymology, Vitamins and Coenzymes*; Academic Press: New York, 1970; Vol. 18, Part A.
- McCormick, D.B.; Wright, L.D. Section III. Lipoic acid and derivatives. In *Methods in Enzymology, Vitamins and Coenzymes*; Academic Press: New York, 1979; Vol. 62, Part D.
- McCormick, D.B.; Suttie, J.W.; Wagner, Section III. Lipoic (thioctic) acid. In *Methods in Enzymology, Vitamins and Coenzymes*; Academic Press, Inc.: New York, 1997; Vol. 279, Part I.
- Rucker, R.B.; Suttie, J.W.; McCormick, D.B.; Machlin, L.J. *Handbook of Vitamins*, 3rd Ed.; Marcel Dekker, Inc.: New York, 2001.





# Lutein

Emily Y. Chew

John Paul SanGiovanni

Division of Epidemiology and Clinical Research, National Eye Institute,  
National Institutes of Health, Bethesda, Maryland, U.S.A.

## INTRODUCTION

Lutein [(3*R*,3'*R*,6'*R*)-β,ε-caroten-3,3'-diol] is a polar lipophilic dihydroxycarotenoid with a molecular weight of 568.871. It contains a conjugated polyene chain and two hydroxylated ionone rings. The compound is biosynthesized by hydroxylation of α-carotene in plants, photosynthetic algae, and some bacteria and fungi. The major function of lutein within these organisms is as an antiphotosensitizing agent and accessory photosynthetic pigment. Lutein is a main constituent of retinal macular pigment and acts as a filter of light at wavelengths capable of inducing photochemical damage and generating reactive oxygen intermediates (ROIs). Lutein intake is associated with decreased likelihood of age-related macular degeneration (AMD), cataract, heart disease, and certain cancers. It may modulate processes or factors involved in immune response. Humans do not have the capacity for de novo biosynthesis of lutein and are thus dependent on dietary sources.

## BIOCHEMISTRY, BIOPHYSICS, FUNCTIONS, AND ACTIONS

Of approximately 600 carotenoids identified in nature,<sup>[1]</sup> 50 in the human diet,<sup>[1]</sup> and 20 in human serum,<sup>[2]</sup> only two forms of dietary xanthophylls, lutein and zeaxanthin [(3*R*,3'*R*,6'*R*)-β,β-caroten-3,3'-diol], are present in human macular pigment.<sup>[3]</sup> *meso*-Zeaxanthin [(3*R*,3'*S*)-β,β-caroten-3,3'-diol] is the third major macular xanthophyll.<sup>[4]</sup> Fig. 1 shows the chemical structures of these compounds. Lutein represents approximately 36% of all retinal carotenoids; zeaxanthin and *meso*-zeaxanthin each represent about 18%. We have applied the term *macular xanthophyll* to represent these three compounds when discussing ocular structure and

function; elsewhere, it represents 3*R*, 3'*R* lutein and 3*R*, 3'*R* zeaxanthin.

The food sources, metabolism, and tissue storage of lutein and zeaxanthin are similar. Separation and quantitation of carotenoids are most frequently achieved through high-performance liquid chromatography (HPLC) and spectrophotometric detection with peak integration. The topographical distribution of macular xanthophylls has been determined by spectrophotometry, a microdissection technique with HPLC, heterochromatic flicker photometry, orthogonal comparison of polarized light extinction, lipofuscin fluorescence, and Raman spectroscopy.<sup>[5]</sup>

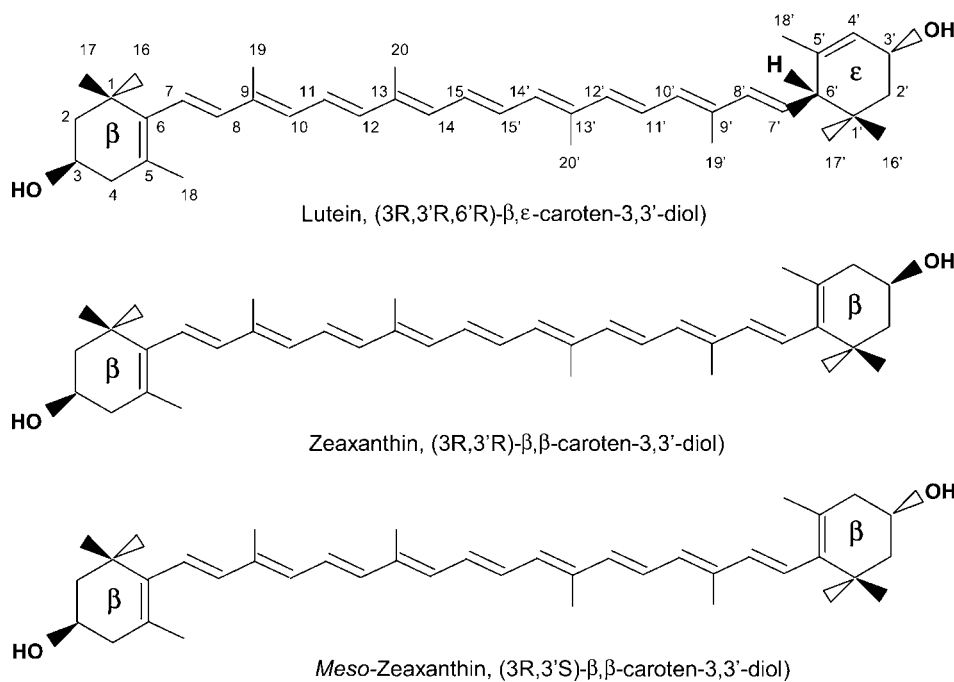
Most major carotenoids in the human diet and serum are internally symmetrical, with one or two cyclic rings at the terminals of a conjugated carbon chain. These compounds can be characterized by the formula C<sub>40</sub>H<sub>56</sub>O<sub>*n*</sub>; *n* ranges from 0 to 6. Xanthophylls are carotenoids with one or more oxygen atoms. The chemical formula for lutein is C<sub>40</sub>H<sub>56</sub>O<sub>2</sub>. Carotenes, or hydrocarbon carotenoids (e.g., lycopene and α- and β-carotene), do not contain oxygen.

Lutein contains an allylic hydroxyl group at the 3' carbon of an ε-ionone ring (double bond at C4'-C5') and a secondary hydroxyl group at the 3 carbon of a β-ionone ring (double bond at C5-C6). The ionone rings are connected to the conjugated polyenic hydrocarbon chain at the 6' and 6 carbons, as they are for zeaxanthin and most other dietary carotenoids. Zeaxanthin differs from lutein in that it contains two β-ionone rings and thus an additional conjugated bond. There are eight stereoisomeric forms of lutein and three of zeaxanthin.<sup>[7]</sup> In retinal tissue and commonly consumed fruits and vegetables, these xanthophylls exist mainly in a single isomeric (all-trans) configuration. This suggests that tissue stores may be of dietary origin. Within the central macula, *meso*-zeaxanthin exists in concentrations equal to those of all-trans zeaxanthin, but it is virtually absent in plants of the human food supply. The relatively lower concentration of lutein within the central retina has led to speculation that *meso*-zeaxanthin may be metabolized from oxidized lutein via a cone-photoreceptor-specific enzyme.<sup>[7-10]</sup>

The natural tissue distribution and biochemical and biophysical characteristics of lutein provide

Emily Y. Chew, M.D., is at the Division of Epidemiology and Clinical Research, National Eye Institute, National Institutes of Health, Bethesda, Maryland, U.S.A.

John Paul San Giovanni, Sc.D., is at the Division of Epidemiology and Clinical Research, National Eye Institute, National Institutes of Health, Bethesda, Maryland, U.S.A.



**Fig. 1** Chemical structures of major macular xanthophylls. (Adapted with permission from *Ann. Rev. Nutr.* 23, © 2003 by Annual Reviews.)

a reasonable basis for speculating that this nutrient acts in biological systems as: 1) an important structural molecule within cell membranes; 2) a short-wavelength light filter; 3) a modulator of intra- and extracellular reduction–oxidation (redox) balance; and 4) a modulator in signal transduction pathways.

### Structural Interactions with Membrane Phospholipids and Transmembrane Proteins

Lutein and zeaxanthin interact with lipids and transmembrane proteins as structural molecules in bioactive phospholipid membranes. The unique hydroxyl moieties of these carotenoids are responsible for their polar properties and affect solubility, aggregation, and reactivity in membranes. Macular xanthophylls are most soluble in nonpolar or dipolar solvents.<sup>[6]</sup> In primates, xanthophylls are preferentially accreted in lipophilic tissue, but may align within hydrophilic aspects of phospholipid molecules in areas adjacent to the aqueous compartment of cells.<sup>[11]</sup>

The stereochemical configuration of lutein results in orientation of the ε-hydroxyl group with the equatorial plane of its ionone ring; the β-hydroxyl group is oriented in an axial direction relative to its ring plane. For zeaxanthin, both β-hydroxyl groups are oriented in an axial direction relative to the ring structures. The stereochemical configuration of zeaxanthin thus constrains the C5–C6 and C5'–C6' double bonds to ~40° at the plane of the conjugated polyene chain. The functional implication of this condition is that the ionone ring system can operate independent of the polyene chain.<sup>[6,7]</sup>

Structural differences in the orientation of the hydroxyl groups in lutein and zeaxanthin impart specific stereochemical properties to each of these xanthophylls and may affect their recognition by transmembrane and binding proteins.<sup>[12]</sup> In model liposomal membrane systems, lutein has been observed to exist in orientations orthogonal and parallel to the membrane surface.<sup>[13]</sup> Zeaxanthin exists mainly in an orthogonal orientation.<sup>[14,15]</sup>

Lutein binds to β-tubulin, a cytoskeletal protein involved in maintenance of cell shape. It has been suggested that this structural complex may stabilize the dynamic volatility of tubulin within the retina.<sup>[16,17]</sup>

### Absorption and Attenuation of Short-Wavelength Radiation

Lutein acts as a filter of short-wavelength light associated with photochemical damage and the generation of ROIs.<sup>[18]</sup> Photochemical retinal injury induced by short-wavelength light (~440 nm) affects retinal photoreceptor outer segments and the retinal pigment epithelium (RPE), a layer of the retina that supports the photoreceptors. Photic damage is maximized at irradiation levels between 400 and 450 nm. At 440 nm, the intensity of light energy required to produce retinal damage is 1/20 that required around 533 nm.<sup>[19]</sup> Macular pigment has a peak spectral absorbance of 460 nm, a range of absorption from approximately 390 to 515 nm, and may filter 40–90% of incident “blue” light.<sup>[6]</sup>

The number of conjugated double bonds in the polyene chain and characteristics of the ionone rings

determine the peak spectral absorption of a carotenoid. Lutein contains 10 conjugated double bonds; zeaxanthin contains 11. In both of these compounds, nine of the bonds are fully conjugated.<sup>[7]</sup> Subtle differences in the interaction of unsaturated bonds within the polyene hydrocarbon chain with those of the ionone rings lead to stereochemical differences in these compounds; such relationships are manifested as differences in the spectral absorption parameters. The wavelength of maximum absorption for lutein is 445 nm. For zeaxanthin, the value is 451 nm (Fig 2).

Lutein may act against the effects of photochemical retinal injury in its capacity to operate as: 1) a biochemical filter of electromagnetic energy in the inner retina;<sup>[13]</sup> and 2) a sink for ROIs generated through acute or chronic tissue irradiation within the photoreceptors and RPE.<sup>[20]</sup> In the first case, lutein would attenuate the rate of short-wavelength-induced radical generation, and the subsequent potential for peroxy-radical-propagated reactions. In the second, it may reduce the potential for short-wavelength-induced photosensitization and subsequent generation of singlet oxygen.

### Oxidative Stress and Balance of Cellular Reduction–Oxidation

Lutein has the capacity to act as an electron donor to ROIs. Its specific distribution within the macula has led to the speculation that it may operate there to scavenge oxidants and re-reduce oxidized macromolecules.<sup>[21]</sup> Xanthophylls have the capacity to quench triplet excited states of photosensitizers and singlet oxygen through electronic energy transfer to the triplet state of the xanthophylls. Subsequently, this abundant energy is thermally dispersed. Xanthophylls exhibit the

capacity to neutralize peroxy radicals and nitric dioxide by forming resonance-stabilized carbon-centered radical adducts and then reacting with vitamin E or vitamin C. The structural characteristics of these xanthophyll-radical cations provide the potential to accept unpaired electrons, thereby possibly conferring pro-oxidant properties to the compound. Under physiological conditions, lutein and other carotenoids are more likely to demonstrate antioxidant properties. Recent reviews provide detailed commentary on these issues.<sup>[21,22]</sup>

*With the exception of their ability to quench singlet oxygen, there is a paucity of evidence demonstrating an in vivo antioxidant function of carotenoids...*<sup>[6]</sup> While there is biological plausibility for the idea that lutein and zeaxanthin act as macular antioxidants, the oxidation products of these xanthophylls that are found in macula<sup>[9]</sup> may be a result of high oxidant stress.<sup>[11]</sup>

Key factors that may affect the anti- or pro-oxidant activities of carotenoids in biological systems include: molecular structure and form; site of action within the cell; concentration; interaction with dietary antioxidants; and partial pressure of oxygen.<sup>[22]</sup>

### Molecular structure

The conjugated polyenic system on the carotenoid hydrocarbon chain facilitates electron-transfer reactions and quenching of singlet oxygen. The polyene chain length allows the position of the excited molecular state to shift to a less reactive configuration within the carotenoid radical. The position of the hydroxyl groups on the ionone rings affects the xanthophyll's ability to react with molecular O<sub>2</sub> as well as its positioning within the membrane. Lutein shares electron-quenching potential with other carotenoids, but the stereoconfiguration of its OH moiety may increase chemical quenching potency.

### Cellular site of action

Carotenoids exist in biological systems strongly bound within protein or lipoprotein complexes. This alters the absorption spectrum relative to those of monomeric (free) xanthophyll chromophores. The nature of a membrane and its composition affects carotenoid interactions and thus influences thermostability and membrane fluidity. The orientation of xanthophylls that span the membrane allows reactions with the polyene chain across its depth. Such a configuration would affect penetration of reactive oxygen metabolites to the highly susceptible fatty acid domain of the membrane. The two orientations of lutein would place the nutrient in close contact with the aqueous and lipid-dense compartments of the cell and allow

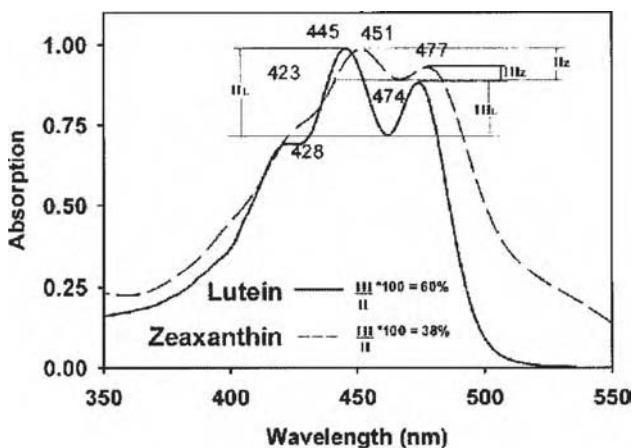


Fig. 2 Absorption spectra of lutein and zeaxanthin in ethanol. (From Ref.<sup>[7]</sup>, with permission from Elsevier.)

interaction with both water- and lipid-soluble compounds involved in attenuating oxidative stress.

### Interaction

Carotenoids may re-reduce oxidized vitamins that have the capacity to modulate redox state.<sup>[23]</sup> Xanthophylls interact with vitamins C and E *in vitro*. The polar nature of xanthophylls may permit a more effective interaction with vitamin C than that of  $\beta$ -carotene, since they have the capacity to bind closely to membrane phosphate head groups at the aqueous interface of the cell. There may be a synergistic response between carotenoid-radical cations and carotenoids. In this capacity, lutein seems to work most effectively with other carotenoids, but  $\beta$ -carotene is unable to reduce lutein or zeaxanthin cations.

### Partial pressure of oxygen

Carotenoid radicals may react in the presence of high molecular  $O_2$  to form carotenoid-peroxyl radicals through autoxidation. These compounds may then react readily with unsaturated fatty acids within cell membranes. Lutein is less sensitive to  $O_2$  tension than  $\beta$ -carotene and is less likely to react with this type of radical. Carotenoids may also react with the lipid-peroxyl radicals ( $ROO^\bullet$ ) via addition to any area within the polyene chain. This reaction yields a resonance-stabilized carbon-centered  $ROO$ -carotenoid $^\bullet$  adduct with the capacity to inhibit the chain-propagating step in lipid peroxidation. Adduct formation is an  $O_2$ -dependent process, and at high partial  $O_2$  pressure, there is a risk of reversible reaction with molecular  $O_2$  to yield secondary peroxyl radicals. Carotenoids may react via electron transfer from the polyene chain to a radical that subsequently may yield carotenoid cation, anion, or alkyl radicals. The carotenoid cation radical has the capacity to react with ascorbate<sup>[7]</sup> to re-reduce the carotenoid to its original form. This provides the basis for suggesting that carotenoids may prevent irreversible oxidation of proteins, nucleic acids, and unsaturated fatty acids. Also, carotenoids may react via allylic hydrogen abstraction to yield carotenoid radicals.<sup>[6,21]</sup>

Lutein may exert an antioxidant capacity against  $ROO^\bullet$  and singlet oxygen molecules.<sup>[7]</sup> It may react with  $ROO^\bullet$  by direct electron addition to generate a more stable carotenoid radical. This less reactive radical is more likely to exist long enough to react with reducing agents (e.g., vitamin E, vitamin C) within the tissue. Lutein may also interact with singlet oxygen and convert, via energy transfer, to a triplet state carotenoid that "is able to harmlessly relax through vibrational transitions and collision without destructive bond breaking."

## Signal Transduction Cascades—Interactions with Signaling Molecules

Xanthophylls may modulate key factors and processes in cell signaling pathways.<sup>[12]</sup> Lutein has been suggested to influence expression of the connexin gene. This gene codes for signaling molecules involved in intercellular gap junctional communication, a process that modulates cellular proliferation in human tumor systems. Xanthophylls also bind with lipocalin proteins. Certain lipocalin proteins have been implicated as immunomodulators.

## PHYSIOLOGY

### Tissue Distribution

Lutein is a major carotenoid of serum and some lipophilic tissues. Approximately 90% of all carotenoids in the body is stored in tissues; less than 10% is found in circulation.<sup>[24]</sup> Lutein is circulated nonpreferentially by high-density lipoprotein (HDL) and low-density lipoprotein (LDL).<sup>[25]</sup> Transport in the fasted state is conducted mainly by HDL, with a smaller amount carried by very-low-density lipoprotein (VLDL).<sup>[1]</sup> Table 1 displays the concentration range of lutein within a number of tissue types. Liver, adrenal, adipose, pancreas, kidney, and breast tissue usually contain higher levels than most other tissues. Of these, adipose has the highest proportion of total carotenoids as lutein and zeaxanthin. Interindividual variation in tissue stores is substantial and has been attributed to demographic, environmental (diet- and life-style-based), and genetic factors.<sup>[26]</sup>

There is a selective accretion of lutein and zeaxanthin in the retina,<sup>[6]</sup> and specific binding proteins

**Table 1** Concentration range of lutein within various tissues

Tissue	$\mu\text{mol/L}$ (serum) / $\mu\text{mol/g}$ (tissue) <sup>a</sup>	$\mu\text{g/dl}$ (serum) / $\mu\text{g/g}$ (tissue) <sup>b</sup>
Serum	0.10–1.2	0.10–0.66
Adrenal	—	0.28–5.73
Adipose	—	0.29–2.70
Pancreas	—	0.08–1.21
Liver	0.10–3.0	0.10–0.66
Kidney	0.04–2.1	0.02–0.06
Lung	0.10–2.3	—
Outer segments	100	—
Retina	100–1000	—

<sup>a</sup>From Ref.<sup>[6]</sup>

<sup>b</sup>From Ref.<sup>[52]</sup>

are now under investigation.<sup>[27]</sup> The concentration is approximately 1 mM in the human fovea (the cone-photoreceptor-dense area of the central macula that processes fine pattern information). Retinal concentrations may be 1000 times higher than those in serum and other tissue (Table 1). The macula also contains the highest proportion of lutein and zeaxanthin as total carotenoids. Within the macula, the cellular distribution of lutein is believed to be highest in photoreceptor axons and interneurons of the inner plexiform layer.<sup>[28]</sup> In eccentric retinal areas, lutein is believed to be present mainly in the rod photoreceptor outer segments.<sup>[20,29]</sup>

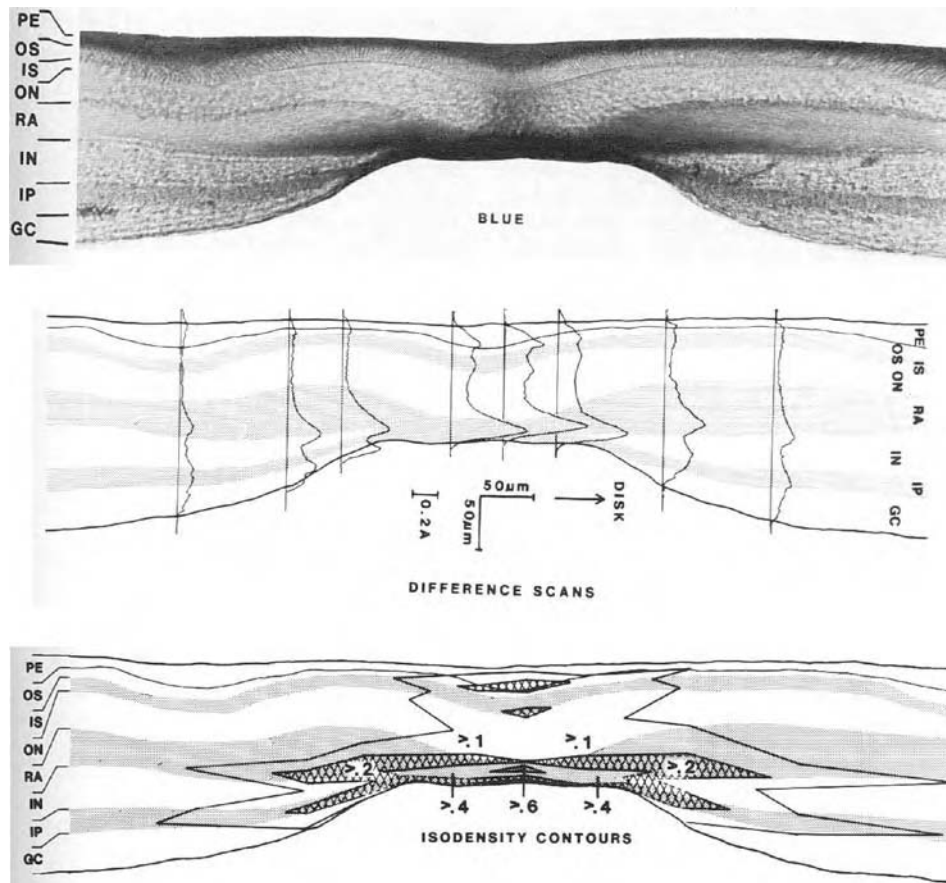
The distribution of total and individual macular xanthophylls varies with retinal eccentricity.<sup>[7,8,10]</sup> The average mass of lutein and zeaxanthin per unit retinal area was 1.33 and 0.81 ng/mm<sup>2</sup> at the foveal center and at an eccentricity of 1.6–2.5 mm, respectively. The lutein:zeaxanthin ratio at 0–5° was 1.0:1.6 in one study. At 5–19°, the ratio was 1.4:1.0. At 19–38°, it

was 2.0:1.0. Research groups examining the distribution of macular xanthophylls have observed similar patterns, with relatively more zeaxanthin in the fovea.<sup>[29]</sup> The distribution of xanthophylls may have implications for light processing and tissue protection, as subtle differences in the structure and physical form of lutein and zeaxanthin lead to positional differences in phospholipid membranes.

Snodderly and others have examined the distribution of macular xanthophylls in nonhuman primates.<sup>[28,30,31]</sup> Fig. 3 shows the macaque retina in cross-section and the distribution of macular pigment within layers, relative to the fovea.

### Plasma, Serum, Cell, and Macular Concentrations

Lutein and zeaxanthin are among the six carotenoids that contribute 60–70% of total plasma carotenoids



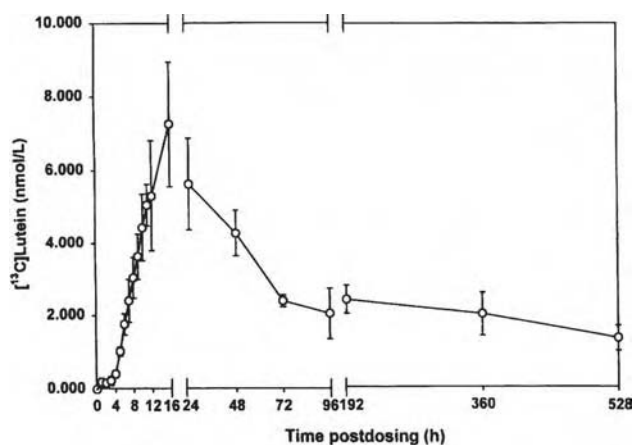
**Fig. 3** Distribution of macular pigment within layers of the macaque retina. Top panel: Photograph of a 45- $\mu$ m section through the fovea of a female macaque in blue light. Middle panel: Graphs of macular pigment density by retinal layer and eccentricity. Units are absorbance units relative to green light. The scale bar represents 0.2 absorbance units. Bottom panel: Isodensity contours with values of absorbance relative to those produced by green light. The highest pigment density within the macular region was observed in the nerve fiber layers. PE = retinal pigment epithelium, OS = photoreceptor outer segments, IS = photoreceptor inner segments, ON = outer nuclear layer, RA = photoreceptor axons, IN = inner nuclear layer, IP = inner plexiform layer, GC = ganglion cell layer. (From Ref.<sup>[28]</sup>, with permission from The Association for Research in Vision and Ophthalmology.)

under fasting conditions. These xanthophylls are commonly reported as a single value, since their elution profiles are similar; when grouped as such, they follow lycopene to represent the second highest concentration of carotenoids within total plasma composition. The plasma lutein:zeaxanthin ratio is 4 or 5:1.

Landrum and Bone<sup>[7]</sup> present the current knowledge on serum response to lutein and zeaxanthin: Serum lutein and zeaxanthin levels of people consuming common Western diets are substantially lower than those attainable with supplementation; higher serum concentrations of lutein and zeaxanthin metabolites are found with supplementation; *meso*-zeaxanthin may be produced from lutein; within the central macula, *meso*-zeaxanthin attains highest concentrations and represents approximately half of the zeaxanthin present in this region.

In experimental populations fed a low-carotenoid diet, plasma carotenoid levels decreased at a rate proportional to the concentration of nutrient in the diet for 2–4 weeks. Thereafter, the rate declined slowly to a plateau. Initial half-lives of lutein/zeaxanthin were 12 days in a 30-day feeding study and 19 days in a 64-day study.<sup>[24]</sup> The mean plasma depletion half-life of lutein/zeaxanthin is estimated to be between 33 and 61 days from a metabolic ward study on a 13-week vitamin C-free diet providing 0.4 mg carotenoids/day.<sup>[32]</sup> Serum concentrations were approximately 45–50% of baseline in 68- and 90-day feeding studies using low-carotenoid diets.<sup>[32,33]</sup>

Stable isotopes have been used to characterize xanthophyll plasma response across a 528-hr period. <sup>13</sup>C-Labeled lutein was fed as part of a low-carotenoid meal and showed a rapid serum response, with a unimodal distribution peaking at 16 hr.<sup>[34]</sup> Fig. 4 shows



**Fig. 4** Plasma response to [<sup>13</sup>C]lutein across a 528 hr period in subjects consuming a 3-mg oral dose of per-labeled [<sup>13</sup>C]lutein. Values are mean  $\pm$  SEM;  $n = 4$ . (From Ref.<sup>[34]</sup>, with permission from the American Oil Chemists' Society Press.)

the results from this study. It is important to note that the 3-mg (5.3- $\mu$ mol) lutein dose was dissolved in high-oleic safflower oil and represented a physiological level attainable through diet. A monophasic 16-hr peak was also reported in a feeding study of an ethyl acetate form of lutein in tocopherol-free corn oil (0.5  $\mu$ mol/kg body weight, 3.84 mmol/L) with samples taken across an 840-hr period.<sup>[35]</sup>

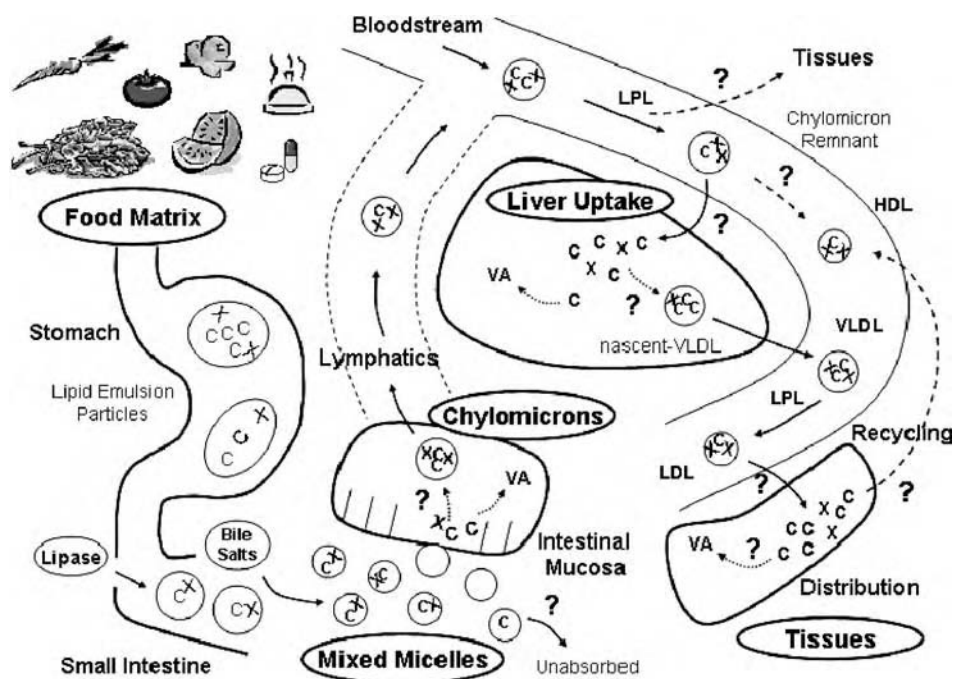
A number of intervention studies with lutein supplements and/or feeding regimens have been developed to characterize plasma and serum lutein responsiveness. While ability to compare across studies is constrained by differences in study design, implementation, and analysis, a number of consistencies emerge in the results: The serum or plasma response to nearly equal intakes of lutein was approximately two times higher in the groups receiving lutein in supplement form; and diets with  $\leq 2$  mg lutein/day had negligible effects on serum and plasma responses across study periods ranging from 1 week to 1 yr.

A number of studies have demonstrated macular tissue response to dietary lutein and zeaxanthin intake. In a 140-day supplementation study on two subjects consuming 30 mg lutein/day, macular pigment increased 21% in one subject and 39% in the other.<sup>[36]</sup> In a carotenoid-rich-food-based intervention, nine of 13 subjects responded to the diet with an average 20% increase in macular pigment density.<sup>[37]</sup> Quantification of macular xanthophylls is possible with a number of in vivo imaging technologies.<sup>[6,7]</sup>

## Bioavailability

Bioavailability is the fraction of a consumed nutrient available for use in normal physiological functions or storage.<sup>[38]</sup> Deming and Erdman<sup>[25]</sup> present the current knowledge on fundamental pathways of carotenoid absorption and metabolism in mammalian species. Fig. 5 displays the pathway of carotenoid absorption and metabolism.

Xanthophylls must first be released from the food matrix; this is the major factor modulating bioavailability of carotenoids. Bioavailability of xanthophylls from dark-green leafy vegetables is low. Most lutein from such sources is sequestered and noncovalently bound in protein-oxycarotenoid complexes within chloroplasts and organelle matrices. It is present within a matrix of fiber, digestible polysaccharides, and proteins. Prior to absorption through the mucosal cells into the portal or lymph systems, esterified xanthophylls must be hydrolyzed. Dietary lipids are essential for solubilization of lutein esters, as well as sufficient secretion of pancreatic esterases and lipases. As a diester, lutein has stronger hydrophobic properties than the monoester form, and is thus more difficult to solubilize.



**Fig. 5** Pathways of carotenoid absorption and metabolism in mammals. HDL = High density lipoprotein, LDL = low density lipoprotein, VLDL = very low density lipoprotein, LPL = lipoprotein lipase. C = carotenes, X = xanthophylls (lutein and zeaxanthin), VA = vitamin A. (From Ref.<sup>[25]</sup>, with permission from IUPAC.) (View this art in color at [www.dekker.com](http://www.dekker.com).)

Mild heating or grinding may enhance bioavailability by dissociation of these protein complexes. At this stage in the pathway, the stereochemical properties of the xanthophyll may also hinder the efficiency of nutrient release. Bioavailability of lutein from food is half to two-thirds that from dietary supplements.<sup>[39]</sup> Once released from the carrier matrix, xanthophylls are transferred to and incorporated within lipid micelles in the small intestine. The polar nature of xanthophylls results in micelle surface binding. Xanthophylls are then absorbed via passive diffusion to the intestinal mucosa, where they are incorporated into chylomicrons.

The orientation and alignment of xanthophylls on micelle surfaces are thought to lead to more efficient enterocyte processing than that of the nonpolar hydrocarbon carotenoids. In a carotenoid feeding study, lutein was present in chylomicrons at 2 hr postconsumption, while  $\beta$ -carotene and lycopene were observed at 4–6 hr. Xanthophylls contained in human chylomicrons may exist exclusively in a hydrolyzed form and are believed to occupy space near the surface of the structures. As chylomicrons are secreted into the lymphatic system en route to the liver, they are transformed into remnants by lipoprotein lipase. Once processed by the liver, the xanthophylls are circulated on the surface of VLDL. The surfaced-based positioning of the xanthophylls increases the potential for exchange across lipoprotein classes. Under normal conditions, there is nonpreferential binding of xanthophylls with LDL and HDL. These lipoproteins then transport xanthophylls to lipophilic tissue, where they

bind to cell-surface receptors and are degraded by lipoprotein lipase. The mechanism of lutein uptake in the retina has not been fully elucidated, although a specific mammalian retinal receptor has been identified.<sup>[27]</sup> Transport to retinal tissue also may occur via passive disposition.

In most dietary intake studies, lutein bioavailability ranged between 30% and 45% (appendix of Ref.<sup>[40]</sup>). In a study using supplements, the bioavailability was approximately 80%. There are no standardized or validated methods for quantitative assessment of carotenoid bioavailability. Castenmiller and West<sup>[40]</sup> suggest that whole plasma pharmacokinetic studies are limited in their ability to represent bioavailability, since values produced represent carotenoid exchange from tissue storage and excretion, in addition to dietary carotenoid absorption. Postprandial carotenoid levels in chylomicrons of triglyceride-rich lipoprotein plasma fraction are considered a more appropriate measure of bioavailability, as they reflect uptake of newly absorbed carotenoids. This marker has been used for lutein determination.<sup>[41]</sup>

Castenmiller and West<sup>[40]</sup> provide an extensive review of theory and research on nine key factors that may influence carotenoid bioavailability. These include: carotenoid species (configurational or geometrical isomers, xanthophylls or hydrocarbon moieties); molecular linkage (free vs. esterified moieties); amount of carotenoid ingested; food or supplement matrix containing the carotenoid; compounds operating as effectors of absorption (nutrients, bioactive compounds, gastric pH); nutrient status of the individual; genetic



factors influencing intake and status; host-related factors affecting postabsorption metabolism (sex, age, general health status, health-related behaviors); and synergistic effects. We discuss selected factors below.

### Species

Hydroxylated carotenoids appear to be more bioavailable than carotenes. When the area under the absorption curve (AUC) for plasma is used to estimate relative rates of absorption, lutein appears to be absorbed two times as well as  $\beta$ -carotene.<sup>[24]</sup> The relative bioavailability of carotenoids has also been assessed through chylomicron response to a natural carotenoid supplement. The proportion of lutein in chylomicrons was substantially higher than that of other carotenoids relative to carotenoid composition of the supplement.<sup>[42]</sup>

### Linkage

Circulating carotenoids are noncovalently bound to lipoproteins and not homeostatically controlled; as such, plasma concentrations are highly dependent on intake.<sup>[24]</sup> Xanthophylls must be de-esterified (hydrolyzed) prior to absorption. The natural form of most xanthophylls is that of esters with long-chain fatty acids or as glycosides. Supplemental formulations of lutein exist in suspended crystalline and esterified forms. Bioavailability from supplements has been estimated to be twice that from food sources.

### Amount

When ingested at levels normally present in the Western diet, carotenoids do not exhibit selective inhibition of bioavailability. Highly concentrated carotenoid supplement intake may affect the plasma response of xanthophylls and carotenes.<sup>[43]</sup>

### Matrix/effectors

The bioavailability of lutein is reduced in the presence of certain forms of fiber, sucrose polyester (a dietary fat substitute), and pharmacological levels of  $\beta$ -carotene. Dietary fiber has been shown to reduce bioavailability by approximately 40–75%;<sup>[44]</sup> the mechanism of action in this case has been linked to lipid metabolism pathways. Higher intake of dietary fiber is associated with increased fecal excretion of bile acids; this reduces the absorption of lipids and lipid-soluble compounds.

Dietary fat is required for the transfer of xanthophylls to lipid micelles in the small intestine. More than 3 g of dietary fat consumed simultaneous with lutein esters was required for the solubilization and induction of pancreatic enzymes that mediate the process of

de-esterification.<sup>[45]</sup> Likewise, dietary lipid analogs, phytosterols, and pharmaceuticals that alter lipid absorption all reduce carotenoid uptake. Plasma lutein/zeaxanthin response to intake of 6 mg of carotenoids was 17% lower in a group of women consuming 30 g alcohol/day, for three menstrual periods, relative to levels during a similar period in which alcohol was not consumed.

### Nutrient status

Plasma lutein is lower in children with falciparum malaria when compared with age-matched peers. Malnutrition negatively affects carotenoid absorption, possibly through its effects on lipid absorption.

### Host-based factors

Smokers have concentrations of carotenoids of the order of approximately 20–30% less than nonsmokers.<sup>[46]</sup> Other important factors have been discussed by Rock, Thornquist, and Neuhoser.<sup>[47]</sup>

### Potential Variable Factors

Serum response to lutein may be influenced by: nutrient interactions with dietary carotenoids, fat, and fiber, and alcohol; food source; variability in food lutein content; and food processing/preparation techniques (Table 2). When carotenoids are consumed at physiological levels, there are no significant interactions affecting absorption, distribution, metabolism, or excretion. Pharmacological doses of  $\beta$ -carotene lower the bioavailability of lutein. Carotenoid interactions in human supplementation studies are reviewed by Van den Berg.<sup>[43]</sup>

## INDICATIONS AND USAGE

### Food Sources

Lutein is most highly concentrated in dark-green leafy vegetables. Some commonly consumed sources of lutein in the Western diet are broccoli, spinach, collard greens, kale, corn, and peas. Release 16 of The United States Department of Agriculture (USDA) National Nutrient Database for Standard Reference contains detailed information on lutein/zeaxanthin content on a wide variety of foods and is available online at [www.nal.usda.gov/fnic/cgi-bin/nut\\_search.pl](http://www.nal.usda.gov/fnic/cgi-bin/nut_search.pl). USDA also provides reports of the USDA-NCC Carotenoids Database of Foods containing lutein/zeaxanthin at [www.nal.usda.gov/fnic/foodcomp/Data/SR16/wtrank/sr16w338.pdf](http://www.nal.usda.gov/fnic/foodcomp/Data/SR16/wtrank/sr16w338.pdf). Table 3 lists values of selected foods

**Table 2** Predictors of lutein/zeaxanthin intake and lutein tissue status

Factor	Lutein/ zeaxanthin intake	Lutein tissue status
<i>Demographic</i>		
Higher age	↑	↑
Female sex	↑	↑
Non-White race	↑	↑
Higher education	↑	↑
<i>Diet-based</i>		
Total energy intake	↑	↓
Body mass index	↓	↓
Lutein/zeaxanthin intake		↑
Lipid intake		↑
Alcohol intake		↓
Fiber intake		↓
<i>Biomedical</i>		
Serum cholesterol		↑
Diseases affecting lipid metabolism		↓
Tx lipid storage and metabolism		↓
<i>Health-related behaviors</i>		
Exercise	↑	
Smoking	↓	↓
Sun exposure	↑	

Note: Regression coefficients reported in Ref.<sup>[47]</sup>. Tx = “treatment for conditions affecting.”

from this resource. Sommerburg et al.<sup>[48]</sup> report the lutein content of foods; in this sample, relative to total carotenoids, corn had the highest proportion (60%). Approximately, half of all carotenoids is lutein in kiwi-fruit, zucchini, and pumpkin. The ratio of dietary lutein to dietary zeaxanthin in Western diets is 7:1 to 4:1.<sup>[7]</sup> There is some evidence to suggest that esterified lutein in food may be absorbed as well as or better than free lutein.

Lutein is commercially available in free or diesterified forms as nutritional supplement. The main source of the nutrient is marigold (*Tagetes erecta*). Concentrations usually range from 6 to 25 mg/capsule. A list of commercially available lutein-containing supplements, the nutrient composition of these supplements, and the supplement manufacturers is present at the Natural Medicines Comprehensive Database (<http://www.naturaldatabase.com/>). As this work went to press, this database listed 102 products.

### Actions in Relation to Concentration

Tissue concentrations required to support the blue light absorption and attenuation action of xanthophylls are not currently known. This capacity and those related to redox balance may be dependent upon coexistence of vitamins E and C. In vitro, higher

**Table 3** Amount of lutein/zeaxanthin (in mg) per 100 g in selected foods

USDA-NCC #	Food	Amount
11236	Kale, frozen, cooked	19.70
11234	Kale, fresh, cooked	18.25
11464	Spinach, frozen, cooked	15.69
11457	Spinach, fresh, raw	12.20
11458	Spinach, fresh, cooked	11.31
11164	Collards, frozen, cooked	10.90
11313	Peas, frozen, cooked	2.40
11642	Summer squash, cooked	2.25
20112	Spinach egg noodles, cooked	2.23
11477	Zucchini, raw	2.13
11090	Broccoli, fresh, raw	1.69
11101	Brussels sprouts, frozen, cooked	1.54
11091	Broccoli, fresh, cooked	1.52
11093	Broccoli, frozen cooked	1.50
11423	Pumpkin, cooked	1.01
09148	Kiwifruit, raw	0.12
11912	Corn, frozen, cooked	0.05

(From the USDA-NCC Nutrient Database for Standard Reference, Release 16.)

concentrations of  $\beta$ -carotene were associated with increased risk of autoxidation and generation of ROIs. This was not the case for zeaxanthin.

### Possible Benefits of Lutein Consumption

Mares-Perlman et al.<sup>[26]</sup> have reviewed evidence on the relationship of lutein and zeaxanthin with health and chronic disease. Consistent protective associations of these nutrients in high- vs. low-intake categories were observed for prevalence of nuclear cataract and cataract extraction. Protective relationships were also observed between dietary intake and certain forms of age-related macular degeneration, although such associations were not observed in all studies. While existing evidence is insufficient to establish a diet–disease relationship, the distribution, composition, and concentration of macular xanthophylls give strong basis for speculation.

Research on lutein intake and immune function is equivocal. In one case, a 15-mg supplement given for 26 days was ineffective in increasing monocyte surface molecules. In another, diets of 0.4% and 0.04% lutein/zeaxanthin decreased short-wavelength-light-induced cellular proliferation and acute inflammation in hairless mice fed for 2 weeks. Kim and colleagues used lutein feeding regimens in canine<sup>[49]</sup> (0–20 mg lutein/day for 12 weeks) and feline<sup>[50]</sup> (0–10 mg lutein/day) populations to demonstrate that this nutrient is

capable of stimulating aspects of cell-mediated humoral immune responses.

Protective associations of higher levels of dietary and serum lutein with cardiovascular risk have been reported in large epidemiological studies.<sup>[26]</sup> In vitro studies demonstrate the capacity of lutein to affect the dynamics of cell adhesion molecules operating within key pathogenic pathways of atherosclerosis. Since lutein coexists with other carotenoids and macromolecules sharing antioxidant and vasoregulatory properties, it is difficult to attribute an independent effect to this compound.

The evidence for a xanthophyll–cancer relationship is suggestive for premenopausal breast cancer, colon cancer, and skin cancer, although the question of whether carotenoids or components of carotenoid-rich foods confer benefit is still in question.<sup>[26]</sup> This argument can be made for any of the carotenoid–disease relationships.

### DRI/Prevention of Deficiency

The Food and Nutrition Board (FNB) of the U.S. National Academy of Sciences does not consider existing scientific evidence on the relationship of carotenoids with health and disease in vivo systems to be strong enough to establish DRIs.

Humans lack the capacity to biosynthesize carotenoids. As such, macular xanthophyll tissue status is modifiable by and dependent upon intake of the preformed compounds. The FNB has not issued a statement defining carotenoid or xanthophyll deficiency. The mean intake of lutein/zeaxanthin was 3.8 mg/day among the 25% of The Third National Health and Nutrition Examination Survey (NHANES III) participants who were consuming the number of vegetable servings recommended by *The Dietary Guidelines for Americans*.

Mares-Perlman, Fisher, and Klein<sup>[51]</sup> have investigated habitual patterns of lutein/zeaxanthin intake in NHANES III. Median intake of lutein/zeaxanthin ranged from 0.32 mg/day in the lowest quintile to 9.7 mg/day in the highest. Average intake was 1–2 mg/day. Other groups have reported averages of 2–4 mg/day. Median serum levels ranged from 0.19  $\mu\text{mol/L}$  in the lowest quintile to 0.79  $\mu\text{mol/L}$  in the highest.

Because lutein and zeaxanthin values from food are commonly represented within food composition databases as a composite value, it has been difficult to determine the relative proportions of each compound within a typical intake pattern. Schalch, Dayhaw-Barker, and Barker<sup>[5]</sup> cite studies in European populations with values of 0.1 and 0.3 mg/day for zeaxanthin and 1.0 and 2.3 mg/day for lutein. Based upon results of epidemiological studies on age-related eye diseases, a number of commercial-sector groups have suggested that 6 mg/day of

lutein/zeaxanthin is associated with a decreased risk of AMD and cataracts.

### ADVERSE EFFECTS

The FNB reports that chronic exposure to carotenoids is not associated with teratogenic, mutagenic, or carcinogenic effects in experimental animals. Kruger et al.<sup>[39]</sup> concluded likewise in a review of a crystalline lutein product. The only known adverse effect of high lutein intake from diet is carotenoderma, a benign and reversible condition characterized by change in skin color. A public document from the U.S. Food and Drug Administration (FDA) references a report from the Cognis Corporation stating that existing studies “show no toxic or adverse effects from the consumption of lutein esters and that long-term consumption of lutein esters is well tolerated.” The reference to the Cognis report describes a 112-day study in which participants consuming a mixed lutein ester product of 30 mg/person/day developed carotenoderma. A 90-day study at doses of 40 mg/person/day did not result in carotenoderma among study participants ([www.cfsan.fda.gov/~rdb/opa-g110.html](http://www.cfsan.fda.gov/~rdb/opa-g110.html)).

Two randomized clinical trials testing pharmacological levels of  $\beta$ -carotene intake have been terminated early due to increased incidence of adverse events among subjects receiving the active agent. In model systems, high concentrations of hydrocarbon carotenoids have led to autoxidation of the polyene chain and a targeting of lipid membranes by subsequently generated radical species. Within model membranes, the biophysical and biochemical properties of xanthophylls may allow membrane stabilization that prevents lipid-peroxyl radical chain propagation and preserves membrane integrity.<sup>[12,21,22]</sup> Higher cellular concentrations of zeaxanthin were associated with decreasing amounts of DNA damage.

### COMPENDIAL/REGULATORY STATUS

Certain lutein products have been considered as substances generally recognized as safe (GRAS) in accordance with the FDA-proposed regulation (62 FR 18938). Independent, private GRAS panels have reviewed a lutein ester product in Xangold<sup>®</sup> (Cognis Corporation, LaGrange, Illinois, U.S.A.) and a crystalline product in FloraGLO<sup>®</sup> (Kemin, Des Moines, Iowa, U.S.A.). Cognis states that the acceptable daily intake of the lutein ester product, for its intended purposes, is 40 mg/person/day (GRAS Notice No. GRN 000110). Kemin states that the level for the inclusion of its product in medical foods is 20 mg/person/day.

## REFERENCES

1. *Dietary Reference Intakes for Vitamin C, Vitamin E, Selenium, and Carotenoids*; National Academy Press: Washington, DC, 2000.
2. Khachik, F.; Spangler, C.J.; Smith, J.C., Jr.; Canfield, L.M.; Steck, A.; Pfander, H. Identification, quantification, and relative concentrations of carotenoids and their metabolites in human milk and serum. *Anal. Chem.* **1997**, *69* (10), 1873–1881.
3. Bone, R.A.; Landrum, J.T.; Tarsis, S.L. Preliminary identification of the human macular pigment. *Vis. Res.* **1985**, *25* (11), 1531–1535.
4. Bone, R.A.; Landrum, J.T.; Hime, G.W.; Cains, A.; Zamor, J. Stereochemistry of the human macular carotenoids. *Invest. Ophthalmol. Vis. Sci.* **1993**, *34* (6), 2033–2040.
5. Schalch, W.; Dayhaw-Barker, P.; Barker II, F.M. The carotenoids of the human retina. In *Nutritional and Environmental Influences on the Eye*; Taylor, A., Ed.; CRC Press: Washington, DC, 1999; 215–250.
6. Krinsky, N.I.; Landrum, J.T.; Bone, R.A. Biologic mechanisms of the protective role of lutein and zeaxanthin in the eye. *Annu. Rev. Nutr.* **2003**, *23*, 171–201.
7. Landrum, J.T.; Bone, R.A. Lutein, zeaxanthin, and the macular pigment. *Arch. Biochem. Biophys.* **2001**, *385* (1), 28–40.
8. Bone, R.A.; Landrum, J.T.; Friedes, L.M. et al. Distribution of lutein and zeaxanthin stereoisomers in the human retina. *Exp. Eye Res.* **1997**, *64* (2), 211–218.
9. Khachik, F.; Bernstein, P.S.; Garland, D.L. Identification of lutein and zeaxanthin oxidation products in human and monkey retinas. *Invest. Ophthalmol. Vis. Sci.* **1997**, *38* (9), 1802–1811.
10. Bone, R.A.; Landrum, J.T.; Fernandez, L.; Tarsis, S.L. Analysis of the macular pigment by HPLC: retinal distribution and age study. *Invest. Ophthalmol. Vis. Sci.* **1988**, *29* (6), 843–849.
11. Krinsky, N.I. Possible biologic mechanisms for a protective role of xanthophylls. *J. Nutr.* **2002**, *132* (3), 540S–542S.
12. Demmig-Adams, B.; Adams III, W.W. Antioxidants in photosynthesis and human nutrition. *Science* **2002**, *298* (5601), 2149–2153.
13. Bone, R.A.; Landrum, J.T. Macular pigment in Henle fiber membranes: a model for Haidinger's brushes. *Vis. Res.* **1984**, *24* (2), 103–108.
14. Sujak, A.; Gabrielska, J.; Grudzinski, W.; Borc, R.; Mazurek, P.; Gruszecki, W.I. Lutein and zeaxanthin as protectors of lipid membranes against oxidative damage: the structural aspects. *Arch. Biochem. Biophys.* **1999**, *371* (2), 301–307.
15. Gabrielska, J.; Gruszecki, W.I. Zeaxanthin (dihydroxy-beta-carotene) but not beta-carotene rigidifies lipid membranes: a <sup>1</sup>H-NMR study of carotenoid-egg phosphatidylcholine liposomes. *Biochim. Biophys. Acta* **1996**, *1285* (2), 167–174.
16. Crabtree, D.V.; Ojima, I.; Geng, X.; Adler, A.J. Tubulins in the primate retina: evidence that xanthophylls may be endogenous ligands for the paclitaxel-binding site. *Bioorg. Med. Chem.* **2001**, *9* (8), 1967–1976.
17. Bernstein, P.S.; Balashov, N.A.; Tsong, E.D.; Rando, R.R. Retinal tubulin binds macular carotenoids. *Invest. Ophthalmol. Vis. Sci.* **1997**, *38* (1), 167–175.
18. Snodderly, D.M. Evidence for protection against age-related macular degeneration by carotenoids and antioxidant vitamins. *Am. J. Clin. Nutr.* **1995**, *62* (6 Suppl.), 1448S–1461S.
19. Ham, W.T.; Muller, W.A. The photopathology and nature of the blue-light and near-UV retinal lesion produced by lasers and other optical sources. In *Laser Applications in Medicine and Biology*; Wolbarsht, M.L., Ed.; Plenum Press: New York, 1989; 191–246.
20. Rapp, L.M.; Maple, S.S.; Choi, J.H. Lutein and zeaxanthin concentrations in rod outer segment membranes from perifoveal and peripheral human retina. *Invest. Ophthalmol. Vis. Sci.* **2000**, *41* (5), 1200–1209.
21. Krinsky, N.I.; Yeum, K.J. Carotenoid-radical interactions. *Biochem. Biophys. Res. Commun.* **2003**, *305* (3), 754–760.
22. Young, A.J.; Lowe, G.M. Antioxidant and pro-oxidant properties of carotenoids. *Arch. Biochem. Biophys.* **2001**, *385* (1), 20–27.
23. Truscott, T.G. Beta-carotene and disease: a suggested pro-oxidant and anti-oxidant mechanism and speculations concerning its role in cigarette smoking. *J. Photochem. Photobiol. B.* **1996**, *35* (3), 233–235.
24. Olson, J.A. Carotenoids. In *Modern Nutrition in Health and Disease*, 9th Ed.; Ross, A.C., Ed.; Lippincott, Williams & Wilkins: Philadelphia, 1999; 525–541.
25. Deming, D.M.; Erdman, J.W. Mammalian carotenoid absorption and metabolism. *Pure Appl. Chem.* **1999**, *71* (12), 2213–2223.
26. Mares-Perlman, J.A.; Millen, A.E.; Ficek, T.L.; Hankinson, S.E. The body of evidence to support a protective role for lutein and zeaxanthin in delaying chronic disease. Overview. *J. Nutr.* **2002**, *132* (3), 518S–524S.
27. Yemelyanov, A.Y.; Katz, N.B.; Bernstein, P.S. Ligand-binding characterization of xanthophyll carotenoids to solubilized membrane proteins derived from human retina. *Exp. Eye Res.* **2001**, *72* (4), 381–392.

28. Snodderly, D.M.; Auran, J.D.; Delori, F.C. The macular pigment. II. Spatial distribution in primate retinas. *Invest. Ophthalmol. Vis. Sci.* **1984**, *25* (6), 674–685.
29. Sommerburg, O.G.; Siems, W.G.; Hurst, J.S.; Lewis, J.W.; Klinger, D.S.; van Kuijk, F.J. Lutein and zeaxanthin are associated with photoreceptors in the human retina. *Curr. Eye Res.* **1999**, *19* (6), 491–495.
30. Snodderly, D.M.; Handelman, G.J.; Adler, A.J. Distribution of individual macular pigment carotenoids in central retina of macaque and squirrel monkeys. *Invest. Ophthalmol. Vis. Sci.* **1991**, *32* (2), 268–279.
31. Snodderly, D.M.; Brown, P.K.; Delori, F.C.; Auran, J.D. The macular pigment. I. Absorbance spectra, localization, and discrimination from other yellow pigments in primate retinas. *Invest. Ophthalmol. Vis. Sci.* **1984**, *25* (6), 660–673.
32. Rock, C.L.; Swendseid, M.E.; Jacob, R.A.; McKee, R.W. Plasma carotenoid levels in human subjects fed a low carotenoid diet. *J. Nutr.* **1992**, *122* (1), 96–100.
33. Daudu, P.A.; Kelley, D.S.; Taylor, P.C.; Burri, B.J.; Wu, M.M. Effect of a low beta-carotene diet on the immune functions of adult women. *Am. J. Clin. Nutr.* **1994**, *60* (6), 969–972.
34. Yao, L.; Liang, Y.; Trahanovsky, W.S.; Serfass, R.E.; White, W.S. Use of a <sup>13</sup>C tracer to quantify the plasma appearance of a physiological dose of lutein in humans. *Lipids* **2000**, *35* (3), 339–348.
35. Kostic, D.; White, W.S.; Olson, J.A. Intestinal absorption, serum clearance, and interactions between lutein and beta-carotene when administered to human adults in separate or combined oral doses. *Am. J. Clin. Nutr.* **1995**, *62* (3), 604–610.
36. Landrum, J.T.; Bone, R.A.; Joa, H.; Kilburn, M.D.; Moore, L.L.; Sprague, K.E. A one year study of the macular pigment: the effect of 140 days of a lutein supplement. *Exp. Eye Res.* **1997**, *65* (1), 57–62.
37. Hammond, B.R., Jr.; Johnson, E.J.; Russell, R.M. Dietary modification of human macular pigment density. *Invest. Ophthalmol. Vis. Sci.* **1997**, *38* (9), 1795–1801.
38. Jackson, M.J. The assessment of bioavailability of micronutrients: introduction. *Eur. J. Clin. Nutr.* **1997**, *51* (Suppl. 1), S1–S2.
39. Kruger, C.L.; Murphy, M.; DeFreitas, Z.; Pfannkuch, F.; Heimbach, J. An innovative approach to the determination of safety for a dietary ingredient derived from a new source: case study using a crystalline lutein product. *Food Chem. Toxicol.* **2002**, *40* (11), 1535–1549.
40. Castenmiller, J.J.; West, C.E. Bioavailability and bioconversion of carotenoids. *Annu. Rev. Nutr.* **1998**, *18*, 19–38.
41. O'Neill, M.E.; Thurnham, D.I. Intestinal absorption of beta-carotene, lycopene and lutein in men and women following a standard meal: response curves in the triacylglycerol-rich lipoprotein fraction. *Br. J. Nutr.* **1998**, *79* (2), 149–159.
42. Gartner, C.; Stahl, W.; Sies, H. Preferential increase in chylomicron levels of the xanthophylls lutein and zeaxanthin compared to beta-carotene in the human. *Int. J. Vitam. Nutr. Res.* **1996**, *66* (2), 119–125.
43. Van den Berg, H. Carotenoid interactions. *Nutr. Rev.* **1999**, *57* (1), 1–10.
44. Riedl, J.; Linseisen, J.; Hoffmann, J.; Wolfram, G. Some dietary fibers reduce the absorption of carotenoids in women. *J. Nutr.* **1999**, *129* (12), 2170–2176.
45. Roodenburg, A.J.; Leenen, R.; van het Hof, K.H.; Weststrate, J.A.; Tijburg, L.B. Amount of fat in the diet affects bioavailability of lutein esters but not of alpha-carotene, beta-carotene, and vitamin E in humans. *Am. J. Clin. Nutr.* **2000**, *71* (5), 1187–1193.
46. Dietrich, M.; Block, G.; Norkus, E.P. Smoking and exposure to environmental tobacco smoke decrease some plasma antioxidants and increase gamma-tocopherol in vivo after adjustment for dietary antioxidant intakes. *Am. J. Clin. Nutr.* **2003**, *77* (1), 160–166.
47. Rock, C.L.; Thornquist, M.D.; Neuhouser, M.L. Diet and lifestyle correlates of lutein in the blood and diet. *J. Nutr.* **2002**, *132* (3), 525S–530S.
48. Sommerburg, O.; Keunen, J.E.; Bird, A.C.; van Kuijk, F.J. Fruits and vegetables that are sources for lutein and zeaxanthin: the macular pigment in human eyes. *Br. J. Ophthalmol.* **1998**, *82* (8), 907–910.
49. Kim, H.W.; Chew, B.P.; Wong, T.S. Dietary lutein stimulates immune response in the canine. *Vet. Immunol. Immunopathol.* **2000**, *74* (3–4), 315–327.
50. Kim, H.W.; Chew, B.P.; Wong, T.S. Modulation of humoral and cell-mediated immune responses by dietary lutein in cats. *Vet. Immunol. Immunopathol.* **2000**, *73* (3–4), 331–341.
51. Mares-Perlman, J.A.; Fisher, A.I.; Klein, R. Lutein and zeaxanthin in the diet and serum and their relation to age-related maculopathy in the third national health and nutrition examination survey. *Am. J. Epidemiol.* **2001**, *153* (5), 424–432.
52. Kaplan, L.A.; Lau, J.M.; Stein, E.A. Carotenoid composition, concentrations, and relationships in various human organs. *Clin. Physiol. Biochem.* **1990**, *8* (1), 1–10.

# Lycopene

L

**Peter Hadley**

*Delft University of Technology, Delft, FGN, The Netherlands*

**Steven J. Schwartz**

*The Ohio State University, Columbus, Ohio, U.S.A.*

## INTRODUCTION

Observational and experimental evidence strongly implicates dietary variables as critical determinants of human health and disease risk. Among the many dietary variables concerning the promotion of optimal health, a diet rich in a variety of fruits and vegetables appears to be a major contributing factor. Much of the evidence derived from human epidemiological studies suggests that an increased intake of fruits and vegetables is associated with a lower risk of cardiovascular diseases<sup>[1,2]</sup> and many types of cancer.<sup>[3–5]</sup> Modern epidemiologic techniques employing detailed diet assessment tools have allowed investigators to further define the potential health benefits of specific fruits and vegetables suggested by observational epidemiologic studies and laboratory investigations. Numerous epidemiological studies have shown that the consumption of tomatoes and tomato-based foods or lycopene is inversely associated with the risk for certain cancers<sup>[6]</sup> and cardiovascular diseases.<sup>[7]</sup> There are numerous phytochemicals in these foods that are hypothesized to be responsible for the potential health benefits observed in these studies; however, the focus has been on lycopene.

## DIETARY AND SUPPLEMENT SOURCES

It is estimated that more than 80% of lycopene consumed in the United States is derived from tomato-based products,<sup>[8]</sup> although apricot, guava, watermelon, papaya, and pink grapefruit also provide a dietary source (Table 1).<sup>[9–11]</sup> The presence of lycopene in human plasma and tissues primarily results from the consumption of tomatoes and a variety of

tomato-based products, such as spaghetti sauce, salsa, tomato soup, and ketchup. The lycopene content of tomatoes can vary considerably with variety and ripening stage. Concentrations in the red strains approach 50 mg/kg compared with only 5 mg/kg in yellow varieties.<sup>[9]</sup>

Although the vast majority of lycopene consumption is from dietary sources, supplements provide an additional vehicle. Recently, the pigment has been added to vitamin/mineral supplements, including Centrum (Wyeth, Madison, New Jersey, U.S.A.) and One-A-Day Men's Health (Bayer, Leverkusen, Germany). The amount contained in one pill of these products is 300 and 600 µg, respectively. Interestingly, these levels are nearly 50–100 times lower than that contained in a single can of condensed tomato soup (i.e., approximately 30 mg). In addition, supplemental forms such as LycoVit<sup>®</sup> 10% (BASF, Ludwigshafen, Germany), Lyc-O-Mato<sup>®</sup> (LycoRed Natural Products Ltd, Beer-Sheva, Israel), and Lacto-lycopene<sup>™</sup> (Nestle, Vevey, Switzerland) are available. LycoVit 10% contains synthetic lycopene, whereas Lyc-O-Mato has lycopene and other carotenoids. Each of these supplements delivers lycopene as gelatin beadlets and/or soft-gel capsules. Alternatively, Lacto-lycopene is provided with whey proteins as carriers.

## CHEMISTRY AND BIOCHEMISTRY

Carotenoids are natural pigments synthesized by plants and micro-organisms. The most established natural roles of carotenoids are to protect cells against photo-oxidation and to serve as light-absorbing pigments during photosynthesis.<sup>[14]</sup> Approximately 700 carotenoids have been characterized and share common structural features, such as the polyisoprenoid structure and a series of centrally located conjugated double bonds (Fig. 1).<sup>[15–17]</sup> The color and photochemical properties of each one are determined by its structure.<sup>[16,17]</sup> Lycopene is responsible for the characteristic red color of tomatoes and tomato-based foods. The structure also contributes to the chemical reactivity of carotenoids toward free radicals and oxidizing

*Peter Hadley, Ph.D.*, is at Delft University of Technology, Delft, FGN, The Netherlands.

*Steven J. Schwartz, Ph.D.*, is Professor and Carl E. Haas Endowed Chair at the Food Science and Nutrition Department, The Ohio State University, Columbus, Ohio, U.S.A.

**Table 1** Common food sources of lycopene

Food	Type	Amount per serving		Serving size
		(mg/100 g wet wt.)	(mg)	
Apricot	Fresh	0.005 <sup>a</sup>	0.007	140 g
Apricot	Canned, drained	0.065 <sup>a</sup>	0.091	140 g
Apricot	Dried	0.86 <sup>a</sup>	0.34	40 g
Chili	Processed	1.08–2.62 <sup>a</sup>	1.40–3.41	130 g
Grapefruit	Pink, fresh	3.36 <sup>a</sup>	4.70	140 g
Guava	Pink, fresh	5.40 <sup>a</sup>	7.56	140 g
Guava juice	Pink, processed	3.34 <sup>a</sup>	8.35	240 ml (~250 g)
Ketchup	Processed	16.60 <sup>a</sup>	3.32	1 tbsp. (~20 g)
Papaya	Red, fresh	2.00–5.30 <sup>b</sup>	2.8–7.42	140 g
Pizza sauce	Canned	12.71 <sup>a</sup>	15.89	125 g
	From pizza	32.89 <sup>c</sup>	9.867	Slice (~30 g)
Rosehip puree	Canned	0.78 <sup>a</sup>	0.47	60 g
Salsa	Processed	9.28 <sup>d</sup>	3.71	2 tbsp. (~40 g)
Spaghetti sauce	Processed	17.50 <sup>d</sup>	21.88	125 g
Tomato	Red, fresh	3.1–7.74 <sup>c</sup>	4.03–10.06	130 g
	Whole, peeled, processed	11.21 <sup>c</sup>	14.01	125 g
Tomato juice	Processed	7.83 <sup>c</sup>	19.58	240 ml (~250 g)
Tomato paste	Canned	30.07 <sup>c</sup>	9.02	30 g
Tomato soup	Canned, condensed	3.99 <sup>c</sup>	9.77	245 g
Vegetable juice	Processed	7.28 <sup>c</sup>	17.47	240 ml (~250 g)
Watermelon	Red, fresh	4.10 <sup>a</sup>	11.48	280 g

<sup>a</sup>USDA 1998. USDA–NCI Carotenoid Database for U.S. Foods. Nutrient Data Laboratory, Agricultural Research Service, U.S. Department of Agriculture, Beltsville Human Nutrition Research Center, Riverdale, Maryland.

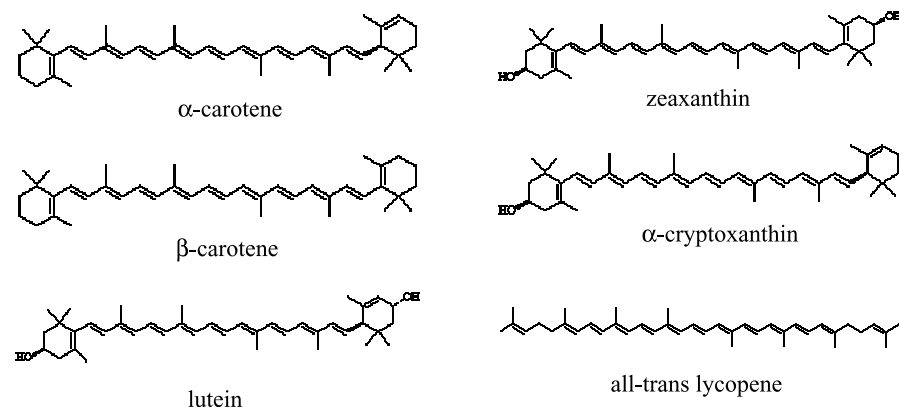
<sup>b</sup>From Ref.<sup>[10]</sup>.

<sup>c</sup>Nguyen and Schwartz.<sup>[12]</sup>

<sup>d</sup>Nguyen and Schwartz.<sup>[13]</sup>

agents, which may be relevant to in vivo biological functions in animals.<sup>[16,17]</sup> Lycopene is a 40-carbon (C<sub>40</sub>H<sub>56</sub>) acyclic carotenoid with 11 linearly arranged conjugated double bonds. Because of the highly conjugated nature of lycopene, it is particularly subject to

oxidative degradation and isomerization. Chemical and physical factors known to degrade other carotenoids, including exposure to light, oxygen, elevated temperature, extremes in pH, and active surfaces, apply to lycopene as well.<sup>[18,19]</sup>

**Fig. 1** Representative structure of common carotenoids.

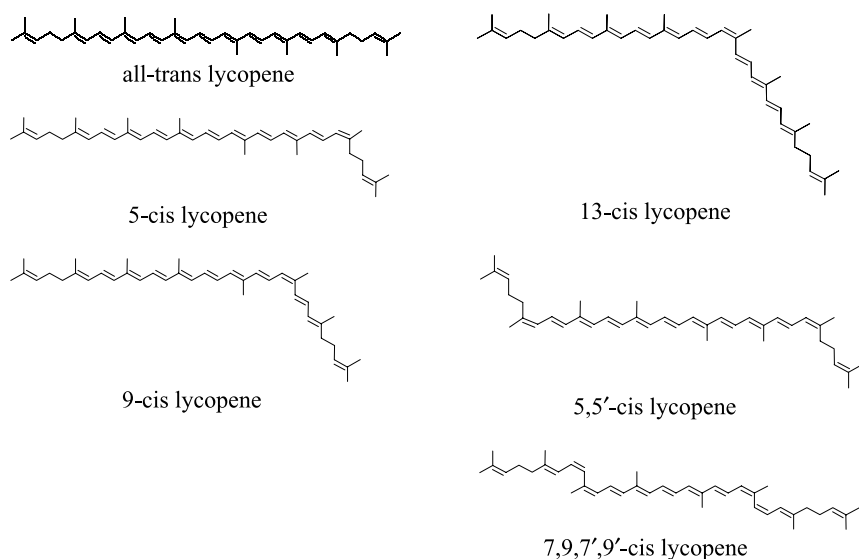
Some dietary carotenoids, such as  $\beta$ -carotene, provide an important source of vitamin A. The presence of a  $\beta$ -ionone ring structure contributes to the provitamin A activity of various carotenoids. Lycopene, however, lacks the  $\beta$ -ionone ring structure and is therefore devoid of provitamin A activity.

With very few exceptions, lycopene from natural plant sources exists primarily in the all-trans form, which is the most thermodynamically stable configuration.<sup>[20–22]</sup> As a polyene, lycopene readily undergoes a cis–trans isomerization. As a result of the 11 conjugated carbon–carbon double bonds in its backbone, lycopene can be theoretically arranged in 2048 different geometrical configurations (Fig. 2). Although a large number of geometrical isomers are theoretically possible for all-trans lycopene, Pauling<sup>[23]</sup> and Zechmeister et al.<sup>[20]</sup> have found that only certain ethylenic groups of a lycopene molecule can participate in cis–trans isomerization reactions because of steric hindrance. Interconversion of isomers is thought to take place with exposure to thermoenergy, absorption of light, or by involvement in specific chemical reactions. Cis isomers of lycopene have chemical and physical characteristics distinctly different from those of their all-trans counterparts. Some of these differences include lower melting point, decreased color intensity, a shift in the  $\lambda_{\text{max}}$ , smaller extinction coefficient, and the appearance of a new maximum in the ultraviolet spectrum.<sup>[24]</sup> To avoid underestimating the quantitative measurement of lycopene cis isomers, the appropriate wavelength maximum and molar absorptivity values should be applied. Because of the difficulty in identifying individual cis forms, quantitative data for isomer content of biological samples are generally estimated values.

## ANALYTICAL ADVANCES AND ISOMER CHARACTERIZATION

High performance liquid chromatography (HPLC) is the most commonly used method for the separation, quantitation, and identification of carotenoids found in plasma and biological tissues. Lycopene is generally separated from other carotenoids using HPLC with reversed-phase  $C_{18}$  columns. Compared with conventional  $C_{18}$  reversed-phase and silica normal-phase columns, reversed-phase  $C_{30}$  columns are frequently used to achieve superior selectivity of lycopene isomers.<sup>[25,26]</sup> The polymerically synthesized  $C_{30}$  columns not only provide excellent separation of the all-trans lycopene isomers from the cis counterpart, but also display extraordinary selectivity among the individual cis isomers.<sup>[26,27]</sup> An HPLC method using multiple columns in series has also been shown to resolve cis and trans lycopene isomers.<sup>[28]</sup> Variations in the properties of the silica packing material in terms of carbon load, particle size, porosity, end-capping technique, and polymerization can also significantly alter the selectivity and sensitivity of lycopene analysis.<sup>[25,29–31]</sup>

Similarities in the structural characteristics of carotenoids cause difficulty when trying to adequately identify individual carotenoids using only fixed wavelength or retention time data. The use of photodiode array detection, allowing for the collection of spectral data across a wide range of wavelengths, has improved our ability to more accurately characterize individual carotenoids. Measurements of retention time, peak resolution, and spectral data for individual absorbing species, and the use of authentic standards for comparison of UV/VIS spectra and retention times are required.<sup>[32]</sup>



**Fig. 2** Structure of selected lycopene isomers.



Our ability to detect very low levels of carotenoids in biological samples has been somewhat limited by methodology and detection that does not adequately quantify carotenoid concentrations. The development of a C<sub>30</sub> reversed-phase gradient HPLC method coupled with a coulometric electrochemical (EC) array detector provides a much lower detection limit and a unique opportunity to quantify low levels of carotenoids in tissue samples and in plasma chylomicron fractions.<sup>[33]</sup> The improved sensitivity of this HPLC–EC method (1–10 fmol) also allows for detection and quantification of compounds from extremely small sample sizes.

Mass spectrometric and tandem mass spectrometric analyses, which provide molecular weight and characteristic fragmentation patterns, provide additional information that increases our confidence in the identification of various carotenoids.<sup>[32]</sup> Both electron impact and fast atom bombardment have also been used in mass spectrometric analysis of carotenoids.<sup>[34–36]</sup>

Identification and structure elucidation of isomeric carotenoids have been facilitated with the aid of high-resolution nuclear magnetic resonance (NMR) spectroscopy. Hengartner, Bernhard, and Meyer<sup>[37]</sup> reported the use of H- and C-NMR, and UV/VIS, mass, and infrared (IR) spectroscopy to fully characterize 15 (*E/Z*)-isomeric forms of lycopene. In addition, the use of HPLC–MS with atmospheric pressure chemical ionization allows lutein stereoisomers to be distinguished from zeaxanthin stereoisomers during one chromatographic run with detection in the picogram range. In contrast, HPLC–NMR coupling provides unequivocal identification of each stereoisomer with a concentration in the nanogram range.<sup>[38]</sup>

The rapid improvement in analytical technology will significantly impact future investigations designed to elucidate the biological impact of lycopene and its isomers on tissues and organs. Investigators ranging from epidemiologists and clinical scientists to those involved in animal studies will be able to more precisely quantitate lycopene and its isomers in extremely small biological samples.

## STABILITY AND ISOMERIZATION

Consumers use the intensity of the red color as an index of quality for tomato products. Therefore, reducing the loss of lycopene throughout the production process and during storage has always been an important issue for the food processing industry. Exposure to thermal treatments during food-processing operations causes well-documented changes in the physiochemical stability of carotenoids. Boskovic<sup>[39]</sup> and Cano et al.<sup>[40]</sup> observed that processing and extended storage of dehydrated tomato products resulted in a loss of

all-trans lycopene content by up to 20%. Food-processing techniques, such as canning and freezing, led to a significant reduction in lycopene and total carotenoid content in papaya slices. In contrast, many studies have found that hydrocarbon carotenoids such as lycopene,  $\alpha$ -carotene, and  $\beta$ -carotene in processed fruits and vegetables are fairly heat resistant.<sup>[41,44]</sup> According to Khachik et al.,<sup>[41]</sup> most of these carotenoids remain stable after bench-top food preparation. Additionally, no major changes in phytofluene, phytoene, and  $\zeta$ -carotene were observed during the processing of tomatoes.<sup>[43]</sup> Saini and Singh<sup>[44]</sup> reported that thermal processing had no effect on the lycopene content in juices made from several high-yield tomato hybrids. Zanori et al.<sup>[45]</sup> reported that despite the oxidative and thermal severity of the drying process, reflected in the 5-hydroxymethyl-2-furfural and ascorbic acid values, lycopene displayed high stability during drying of tomato halves. Additionally, Nguyen and Schwartz<sup>[12]</sup> reported that processing does not have a significant effect on the stability of lycopene, independent of product type, moisture content, container type, tomato variety, and severity of heat treatments.

Although lycopene may be fairly stable during standard food-processing procedures, less is known about the impact of heat on isomerization. Studies have shown that heating tomato juice and bench-top preparation of a spaghetti sauce from canned tomatoes increases *cis* isomer concentrations.<sup>[28,46]</sup> In contrast, Khachik et al.<sup>[42]</sup> observed that common heat treatments during food preparation, such as microwaving, steaming, boiling, and stewing, did not significantly change the distribution of carotenoids in tomatoes and green vegetables. Other studies have also reported low levels of lycopene *cis* isomers in thermally processed tomato products.<sup>[14,27]</sup> Nguyen, Francis, and Schwartz<sup>[48]</sup> reported that during typical cooking of tomatoes, factors such as genotypic differences in the overall carotenoid composition, the presence of oil, and physical changes to tomato tissues did not influence the thermal isomerization of all-trans lycopene, all-trans  $\delta$ -carotene, all-trans  $\gamma$ -carotene, or prolycopene. Observations in our laboratory indicate that lycopene is quite stable in its native matrix within tomato tissue. However, extensive physical and thermal processing that disrupts cell wall constituents can expose lycopene to degradative reactions. In addition, food products containing lipids or supplements formulated with oil will partially solubilize lycopene, leading to isomerization reactions. Further heating such as cooking of foods in the presence of oils and fats will facilitate solubilization, isomerization, and oxidation reactions. Difference in formulation and the extent of processing treatments may account for discrepancies in literature reports on the stability and isomerization susceptibility of lycopene. In addition, once extracted

into organic solvents, lycopene is very labile, and analysis should take place immediately without exposure to heat, light, or oxygen. Additional information needs to be gathered on the thermal behavior of lycopene before definitive answers can be offered regarding its physical state and stability during processing and cooking. Nevertheless, it is evident that the pigment is more stable in native tomato fruit matrices than in isolated or purified form due to the protective effects of cellular constituents such as water.<sup>[49]</sup>

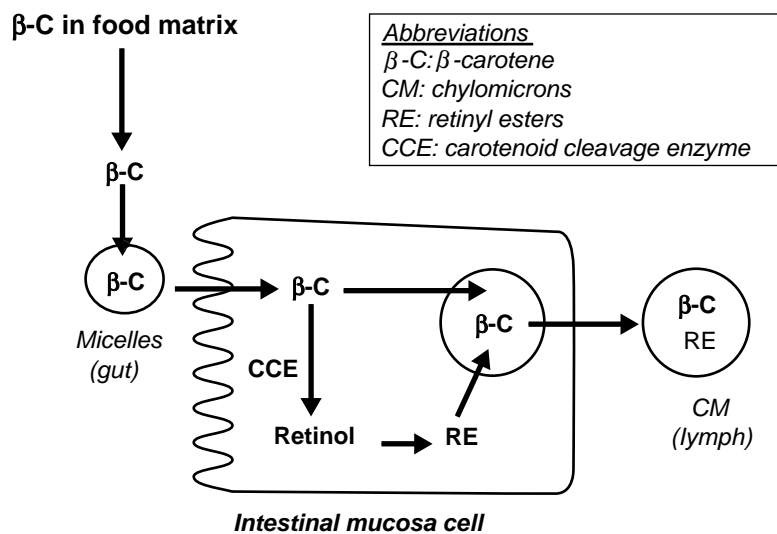
## BIOAVAILABILITY

Phytochemicals present in tomatoes and tomato-based products must be readily bioavailable for absorption to mediate their hypothesized beneficial health effects. Bioavailability is defined as the fraction of an ingested nutrient that is accessible to the body through absorption for use in normal physiological functions and for metabolic processes.<sup>[50]</sup> Carotenoids are strongly bound to intracellular macromolecules in many foods, and absorption may therefore be limited unless they are released from the food matrix.<sup>[51]</sup> Differences in the bioavailability of lycopene may account, in part, for the relatively poor correlation between blood lycopene concentrations and estimated dietary intake.

Carotenoid absorption involves micelle formation, intestinal uptake, and chylomicron transfer via the lymphatics to the bloodstream (Fig. 3).<sup>[53]</sup> Little is known about how lycopene in chylomicrons is subsequently accumulated by the liver and other tissues, repackaged in lipoproteins, and returned to the circulation. Lycopene is carried in the plasma entirely by lipoproteins, and no other lycopene-specific binding or carrier proteins have been identified thus far.<sup>[53,54]</sup>

Details of how hepatocytes, the initial source of circulating lipoproteins, transfer lycopene into specific secreted lipoproteins, and how this process may be regulated are unclear. However, it is likely that dietary and pharmacologic agents that influence lipoprotein metabolism will impact circulating lycopene concentrations also. It is hypothesized that highly lipophilic carotenoids, such as lycopene, are present within the hydrophobic core of the lipoprotein particle.

Several studies have evaluated the bioavailability of the lipophilic carotenoids found in tomatoes and tomato-based products. Heating tomato juice was shown to improve the uptake of lycopene in humans.<sup>[46]</sup> These observations seem to be the result of thermal weakening and disruption of lycopene-protein complexes, rupturing of cell walls, and/or dispersion of crystalline carotenoid aggregates. Likewise, various food-processing operations such as chopping and pureeing, which result in a reduction in physical size of the food particle, will also enhance lycopene bioavailability.<sup>[55,56]</sup> Lycopene bioavailability was studied after a single dose of fresh tomatoes or tomato paste by measuring concentrations of lycopene in the chylomicron fraction of the systemic circulation.<sup>[57]</sup> Each source of lycopene (23 mg) was consumed with 15 g corn oil. Tomato paste was found to yield a 2.5-fold greater total all-trans lycopene peak concentration and a 3.8-fold greater postprandial response area under the curve than fresh tomatoes. When compared with fresh tomatoes, tomato paste resulted in a significantly higher area under the curve for *cis*-lycopene isomers. In addition, van het Hof et al.<sup>[58]</sup> studied the effect of mechanical homogenization and heating on the bioavailability of multiple carotenoids from canned tomatoes. Interestingly, homogenization enhanced triglyceride-rich layer (TRL) and plasma lycopene response (TRL fraction: 31% and 62% higher for



**Fig. 3** Intestinal absorption of carotenoids. (From Ref. <sup>[52]</sup>.)

mildly and severely homogenized tomatoes, respectively, vs. no homogenization; plasma: 16% and 21% higher, respectively;  $P < 0.05$ ). Additional heating also increased lycopene responses in TRL ( $P = 0.14$ ) and plasma ( $P = 0.17$ ). Interestingly, similar effects were found for  $\beta$ -carotene. These observations support the conclusion that food processing, homogenization, and cooking enhance lycopene bioavailability. When compared to these food matrix effects, microencapsulation and solubilization in oleoresin may provide a more bioavailable form of most carotenoids. However, in studies measuring the plasma response to lycopene intake from supplement sources vs. processed tomato-based foods, lycopene bioavailability does not appear to be statistically different.<sup>[59,60]</sup>

Digestive processes will also certainly influence carotenoid bioavailability. Several factors affect initial carotenoid release from the physical food matrix and transfer and distribution into lipid droplets within the stomach and proximal duodenum.<sup>[61]</sup> Pancreatic lipases and bile salts act upon the carotenoid-containing lipid droplets entering the duodenum and form multilamellar lipid vesicles containing the carotenoids.<sup>[53]</sup> The transfer of lycopene, like that of other carotenoids, from the micelle into the mucosal cells appears to occur via passive diffusion.<sup>[62,63]</sup>

Perhaps of major importance, dietary lipids appear to serve a critical role in the dissolution and subsequent absorption of very hydrophobic carotenoids (e.g., lycopene). Factors such as structural features, dietary fat content, fatty acid patterns, fiber, and other food components may influence the carotenoid content of micelles and subsequent mucosal transfer.<sup>[53]</sup> In addition, drugs that interfere with cholesterol absorption<sup>[64]</sup> and nonabsorbable fat analogs, such as sucrose polyesters,<sup>[65]</sup> have been reported to reduce carotenoid absorption.

## PLASMA AND TISSUE DISTRIBUTION

Serum lycopene levels can range from 50 to 900 nmol/L. It is well known that between 10 and 20 cis isomer peaks are typically observed in human blood and together account for the majority of lycopene in serum.<sup>[47,66]</sup> Interestingly, we observed that the ratio of cis:trans lycopene isomers changes in those on a lycopene-free diet. According to Allen et al.,<sup>[67]</sup> plasma lycopene isomer concentrations exhibit a 61:39 ratio for cis:trans at the start of a lycopene-free diet, whereas after 2 weeks, the ratio shifts to 70:30, which was highly significant. In a study by Hadley, Schwartz, and Clinton,<sup>[68]</sup> the percentage of cis:trans lycopene isomers increased from 58:42 to 62:38 following a 1-week washout phase. Studies suggest that the all-trans lycopene content of serum is maintained through

continuous dietary intake and that mobilization of all-trans lycopene from liver or other tissues, or reconversion of cis isomers to trans, cannot maintain the cis:trans ratio. In addition, it is plausible to hypothesize that there is a biological preference for certain lycopene isomers to be cleared from serum, distributed to tissues, or participate in reactions that cause degradation.

Although data are still limited, it is apparent that carotenoids are not uniformly and equally dispersed in human tissues.<sup>[46,69–71]</sup> The tissue-specific carotenoid patterns reported thus far suggest a process whereby certain carotenoids may exert unique biologic effects in one tissue but not in another (Table 2). Presently, there is no evidence for a specific receptor or enzymatic process that mediates lycopene uptake by the tissue. We must therefore assume that uptake in the tissue is related to lipoprotein metabolism.

Lycopene has been shown to exist in over 15 different geometrical configurations in human prostate tissue, where the cis isomer content is even greater (at 80–90%) than that observed in serum.<sup>[47]</sup> The chemical and physiological processes that account for the high proportion of cis isomers in tissue remain speculative. An intriguing hypothesis is that isomerization reflects the participation of lycopene in antioxidant reactions within the prostate. Isomerization changes the structure of lycopene in a fashion that could alter its intracellular distribution within organelles and membrane structures that in turn could influence biological processes. These are hypotheses that will need additional investigation.

## ROLE IN CHRONIC DISEASE

Multiple mechanisms of action for lycopene's purported beneficial health effects have been proposed. As reviewed by Heber and Lu,<sup>[77]</sup> the pigment has been shown to display antioxidant, antiproliferative, and prodifferentiation activities. In addition, other potential methods such as stimulation of xenobiotic metabolism, modulation of cyclo-oxygenase pathways, and inhibition of cholesterolgenesis and/or inflammation are discussed. Although these may participate collectively to impart lycopene's health benefits, much of the focus has been on its antioxidant activity.

It has been widely postulated that oxidation may contribute to the damage of cellular DNA, proteins, and lipids that initiate or enhance the progression of cancer. Recent research has focused on the role of reactive oxygen species (ROS) or free radicals that are produced from exogenous and endogenous factors. Mammals have developed multiple defenses against reactive oxygen. Nutritional substances such as vitamin E, vitamin C, selenium, and carotenoids<sup>[78]</sup> are thought to be important complements to other cellular

**Table 2** Lycopene concentrations in human tissue

Tissue	Concentration (nmol/g wet wt.)				
	Kaplan, Lau, and Stein <sup>[69]</sup>	Schmitz et al. <sup>[70]</sup>	Nierenberg and Nann <sup>[71]</sup>	Stahl and Sies <sup>[46]</sup>	Others
Adipose	1.30			0.20	
Adrenal	21.60			1.90	
Brain					2.55 <sup>a</sup>
Breast			0.78		0.43 <sup>b</sup>
Cervix					0.18 <sup>b</sup>
Colon			0.31		
Kidney	0.39	0.62		0.15	
Liver	2.45	5.72		1.28	0.65 <sup>b</sup>
Lung		0.57	0.22		0.56 <sup>b</sup>
Ovary	0.28			0.25	
Prostate					0.12 <sup>c</sup> , 0.24 <sup>d</sup> , 0.36 <sup>e</sup> , 0.53 <sup>c</sup> , 0.63 <sup>f</sup>
Skin			0.42		
Stomach					0.20 <sup>g</sup>
Testes	21.36			4.34	

<sup>a</sup>Craft et al.<sup>[72]</sup>.

<sup>b</sup>Khachik et al.<sup>[73]</sup>.

<sup>c</sup>Rao, Fleshner, and Agarwal.<sup>[74]</sup>

<sup>d</sup>Freeman et al.<sup>[75]</sup>.

<sup>e</sup>Kucuk et al.<sup>[76]</sup>.

<sup>f</sup>Clinton et al.<sup>[47]</sup>.

<sup>g</sup>Clinton.<sup>[66]</sup>

systems, such as antioxidant enzymes (glutathione peroxidase, catalase, CuZn- and Mn-superoxide dismutase) and antioxidant quenchers (ceruloplasmin, transferrin, ferritin, Cd/Hg/Zn/Cu: metallothioneins), which participate in the free radical defense system and provide protection against oxidative damage. Many of the proposed biological effects and health benefits of tomatoes and tomato-based products are hypothesized to be associated with the ability of certain phytochemicals such as lycopene to enhance the endogenous defense system by protecting against *in vivo* oxidative damage.

The ability of lycopene to act as an antioxidant and scavenger of free radicals is considered by most investigators as the most likely mechanism that could account for the hypothesized beneficial effects on human health.<sup>[79–81]</sup> As a result of having an extensive chromophore system of conjugated carbon–carbon double bonds, lycopene can accept energy from various electronically excited species. This characteristic gives lycopene the ability to quench singlet oxygen<sup>[80]</sup> formed by energy transfer from a metastable excited photosensitizer.<sup>[82]</sup> Singlet oxygen (<sup>1</sup>O<sub>2</sub>) is a very reactive high-energy and short-lived oxygen species produced in biologic systems that can react with biomolecules.

Lycopene may also interact with ROS such as hydrogen peroxide and nitrogen dioxide.<sup>[83–85]</sup>

## CANCER

In recent decades, we have seen an accumulated body of evidence strongly supporting the conclusion that diets rich in fruits and vegetables are associated with a lower risk of many malignancies. A comprehensive review of the epidemiological evidence regarding lycopene-containing tomatoes and tomato-based products and cancer risk was published by Giovannucci.<sup>[6]</sup> Nearly 80% of the 72 studies reported in the review revealed evidence of a protective association between consumption of tomatoes, tomato-based products, or carotenoids provided by these foods and the risk of cancer at several sites. In more than 60% of these trials, the inverse associations were statistically significant. The observed inverse relationship was strongest for lung, stomach, and prostate cancer and was supportive for cervical, breast, oral cavity, pancreatic, colorectal, and esophageal cancer. In addition, epidemiologic investigations of colon,<sup>[86]</sup> upper aerodigestive,<sup>[87]</sup> prostate,<sup>[88–91]</sup> and lung cancer<sup>[92]</sup> further support the

concept that lycopene-containing tomato products have cancer-preventive properties.

Prostate cancer is the most common noncutaneous malignancy in American men, and is the second leading cause of cancer-related deaths.<sup>[93]</sup> Although an association with prostate cancer has not been as strong in comparison with other malignancies, epidemiologic studies have shown that an increase in lycopene consumption as well as serum lycopene concentrations is inversely correlated with the risk for prostate cancer. In 1991, Le Marchand et al.<sup>[94]</sup> studied a multiethnic Hawaiian cohort and found no association between estimated lycopene intake and prostate cancer risk. However, in one of the largest and most comprehensive ongoing epidemiologic studies in adult men, Giovannucci et al.<sup>[95]</sup> investigated the relationship between the risk of prostate cancer and estimated intake of various fruits, vegetables, retinol, and carotenoids in nearly 48,000 men in the Health Professionals' Follow-up Study (HPFS). Dietary intake of lycopene (80% of which was derived from tomatoes and tomato products) was inversely related to risk when the highest quartile (>6.4 mg lycopene/day) was compared with the lowest quartile (<2.3 mg lycopene/day, RR = 0.79, 95% CI = 0.64–0.99,  $P = 0.04$  for trend). A few years later, a case-control study of 797 men in New Zealand found a weak, nonsignificant trend between lycopene intake and prostate cancer incidence when comparing the lowest quartile (<663  $\mu\text{g}/\text{day}$ ) of lycopene intake to the highest quartile (>1994  $\mu\text{g}/\text{day}$ ) (OR = 0.76, 95% CI = 0.53–1.26,  $P = 0.30$  for trend; Ref.<sup>[90]</sup>). Interestingly, in this study, the estimated median intake of lycopene was less than half of the median in the HPFS cohort (1.2 vs. 3.4–4.6 mg lycopene/day, respectively). Recently, updated data from the HPFS for the period from 1992 through 1998 confirmed the earlier findings. Lycopene intake was associated with a decreased risk for prostate cancer (RR = 0.84 for high compared to low quintiles; 95% CI = 0.73–0.96;  $P = 0.003$  for trend; Ref.<sup>[96]</sup>).

Several reports have investigated the relationship between blood concentrations of lycopene and prostate cancer risk. In a study conducted at the Memorial Sloan-Kettering Cancer Center from 1993 to 1997, Lu et al.<sup>[88]</sup> showed that when plasma carotenoid levels from men in the highest and lowest quartiles were compared, inverse associations for prostate cancer risk were statistically significant for plasma lycopene, zeaxanthin, lutein, and  $\beta$ -cryptoxanthin levels. Hsing et al.<sup>[97]</sup> evaluated serum obtained in 1974 from 25,802 persons in Washington County, Maryland, and reported lower mean serum lycopene concentrations in prostate cancer cases compared to controls. A 50% reduction in the relative risk for prostate cancer was observed when cases in the highest serum lycopene quartile were compared to more in the lowest quartile. A study

conducted by Nomura et al.<sup>[98]</sup> in a cohort of 6860 Japanese-American men examined from 1971 to 1975, however, showed no association between several plasma micronutrients and carotenoids, and prostate cancer risk. A nested case-control investigation was undertaken, which involved the analysis of carotenoids in blood samples from men enrolled in the Physicians' Health Study (a randomized, placebo-controlled trial of aspirin and  $\beta$ -carotene). In this study, subjects in the highest quintile (>580.1 ng/ml) of serum lycopene levels had a significantly lower risk of prostate cancer compared with those in the lowest quintile ( $\leq 261.7$  ng/ml, OR = 0.56, 95% CI = 0.34–0.92,  $P = 0.05$ ). The inverse association between serum lycopene and aggressive prostate cancer was particularly significant for men who were not consuming  $\beta$ -carotene supplements (OR = 0.40 for highest quintile vs. lowest quintile, 95% CI = 0.19–0.84,  $P = 0.006$  for trend; Ref.<sup>[99]</sup>).

Several laboratories have conducted studies on lycopene and prostate carcinogenesis in rodents. An investigation using the DMAB and PhIP-induced rat prostate cancer models failed to detect a chemopreventive effect of lycopene provided as an extract of 99.9% purity from LycoRed.<sup>[100]</sup> In another study, two different doses of a lycopene-rich tomato oleoresin were fed to *lacZ* mice to study the effects on short-term benzo[a]pyrene (BaP)-induced and long-term spontaneous *in vivo* mutagenesis in the colon, prostate, and lungs.<sup>[101]</sup> Spontaneous mutagenesis was inhibited in prostate and colon tissue at the higher dose of tomato oleoresin. In addition, BaP-induced mutagenesis in the prostate was also slightly inhibited in mice fed tomato oleoresin. Boileau et al.<sup>[102]</sup> completed a large rat study evaluating the ability of lycopene or freeze-dried tomato powder to inhibit survival in the *N*-nitrosomethylurea-androgen-induced prostate cancer model. In this system, a very small beneficial trend for lycopene and a significant benefit of tomato powder were reported.

There are few human intervention studies investigating the role of lycopene on processes that are related to the development of prostate cancer. The most provocative observations have been published by Kucuk et al.<sup>[76]</sup> The study involved 26 men diagnosed with presumed localized prostate cancer who were scheduled to undergo a radical prostatectomy. The subjects were randomized to consume 30 mg of lycopene per day from two tomato oleoresin capsules (Lyc-O-Mato; LycoRed Natural Products Industries) or to continue their normal diet for 3 weeks prior to surgery. Postsurgical prostate tissue specimens were then compared between the two groups. Men consuming the lycopene supplement had 47% higher prostatic tissue lycopene levels than the control group ( $0.53 \pm 0.03$  ng/g vs.  $0.36 \pm 0.06$  ng/g,  $P = 0.02$ ).

However, plasma lycopene levels were not significantly different between the groups, nor did they change significantly within each group. Those who consumed the lycopene supplement were less likely to have involvement of surgical margins (73% vs. 18% of subjects,  $P = 0.02$ ). Additionally, they were less frequently found to have high-grade prostatic intraepithelial neoplasia (HGPIN) in the prostatectomy specimen (67% vs. 100%,  $P = 0.05$ ). The neoplasia is considered to be a premalignant lesion predisposing men to prostate cancer. Furthermore, the intervention group was found to have smaller tumors, a greater reduction in prostate-specific antigen (PSA) over the 3-week study period, and a higher expression of connexin 43. However, none of these differences were statistically significant.

## CARDIOVASCULAR DISEASE

Epidemiologic studies investigating the relationship between lycopene exposure and the risk for vascular diseases are beginning to emerge. Tissue and serum concentrations of lycopene have been found to be correlated with a reduced risk for coronary heart disease (CHD) in several case-control studies. A multicenter case-control study was conducted to evaluate the relationship between adipose tissue concentration of antioxidants (i.e.,  $\alpha$ - and  $\beta$ -carotene and lycopene) and acute myocardial infarction.<sup>[103]</sup> Cases and control subjects were recruited from 10 European countries to ensure maximum variability in exposure. Upon simultaneous analyses of the carotenoids and adjustment for other variables, lycopene was the only carotenoid found to be protective (OR = 0.52 when the 10th and 90th percentiles were compared, 95% CI = 0.33–0.82,  $P = 0.005$  for trend). Similarly, lower serum lycopene concentrations were found to be related to an increased risk of and mortality from CVD in a concomitant cross-sectional study evaluating Swedish and Lithuanian populations displaying diverging mortality rates from CHD ( $n = 210$ ).<sup>[104]</sup> Klipstein-Grobusch et al.<sup>[105]</sup> investigated the relationship between serum concentrations of the major carotenoids (i.e.,  $\alpha$ -carotene,  $\beta$ -carotene,  $\beta$ -cryptoxanthin, lutein, lycopene, and zeaxanthin) and aortic atherosclerosis as determined by the presence of calcified plaques of the abdominal aorta. A subsample of the elderly population of the Rotterdam Study consisting of 108 subjects with aortic atherosclerosis and controls was used for the case-control analysis. A 45% reduction (OR = 0.55, 95% CI = 0.25–1.22,  $P = 0.13$  for trend) in the risk of atherosclerosis was observed for the highest vs. the lowest quartile of serum lycopene. When adjustments for smoking status were made, the inverse association was greatest for current and former smokers (OR = 0.35, 95% CI = 0.13–0.94,  $P = 0.04$

for trend). No associations were observed with any of the other serum carotenoids studied. A report on men (aged 46–64 yr;  $n = 725$ ) from the Kuopio Ischaemic Heart Disease Risk Factor Study (KIHD) indicated that those in the lowest serum lycopene quarter had a 3.3-fold (95% CI = 1.7–6.4;  $P < 0.001$ ) increased risk of acute coronary events or stroke when compared to the others.<sup>[106]</sup> In addition, subjects in the lowest quarter of serum lycopene had a significant increment in both mean intima-media thickness of common carotid artery wall (CCA-IMT) ( $P < 0.006$  for difference) and maximal CCA-IMT ( $P = 0.002$ ) as compared with others. In a cross-sectional analysis of 520 men and women from the Antioxidant Supplementation in the Atherosclerosis Prevention Study (ASAP), low plasma lycopene levels were associated with an 18% increase in IMT in men when compared to those with plasma lycopene levels higher than the median ( $P = 0.003$  for difference; Ref.<sup>[107]</sup>).

## SAFETY AND ADVERSE EFFECTS

Safety assessment of phytochemicals from fruits and vegetables or supplements is necessary to ensure efficacy without toxicity in future trials. The safety of multiple doses of lycopene was studied by Diwadkar-Navsariwala et al.<sup>[108]</sup> A Phase I study in healthy male subjects, using a physiological pharmacokinetic model, was conducted to study the disposition of lycopene, administered as a tomato beverage in five graded doses (10, 30, 60, 90, or 120 mg). The subjects reported no signs of toxicity for any level of intake. However, long-term consumption of these doses was not evaluated.

Consumption of extreme amounts of lycopene or lycopene-containing tomatoes and/or tomato-based products over an extended period of time can have adverse effects. La Placa, Pazzaglia, and Tosti<sup>[109]</sup> described a case study of a 19-yr-old Italian girl who had consumed 4–5 large red tomatoes and pasta with tomato sauce daily for 3 yr. She displayed yellow-orange discoloration of the skin and abdominal pain. Upon investigation of the abdominal pain, the hepatic ultrasound revealed a digitate area that was relatively hypoechogenic, measuring 2 cm in diameter, in the upper portion of the parenchyma, consisting of deposits of lycopene. These clinical features and dietary history suggested the diagnosis of lycopopenemia.

Additional studies are required to assess the safety of varying levels of lycopene from multiple sources for long periods of time. These experiments will enable future scientists to identify the optimum combination of intake and time to maximize the benefits without adverse effects. Therefore, caution should be exercised when recommending sources and amounts of this carotenoid.

## WHOLE FOODS VS. SUPPLEMENTS

Although lycopene has received a great deal of attention as an important phytochemical from tomatoes and tomato-based foods, it is premature to suggest that lycopene alone is responsible for the reported beneficial health effects of these foods. As briefly discussed above, a study was conducted by Boileau et al.<sup>[102]</sup> to evaluate the effects of tomato powder or lycopene beadlet consumption on prostate carcinogenesis in *N*-methyl-*N*-nitrosourea (NMU)- and testosterone-treated rats. This investigation showed that consumption of tomato powder but not lycopene inhibited prostate carcinogenesis, suggesting that tomato products contain compounds in addition to lycopene that modify prostate cancer development and/or progression. Care should be taken not to make the assumption that all the health benefits brought about by fruit and vegetable consumption are attributed to a single component such as lycopene. Additional studies are needed to determine the differences between lycopene supplement and lycopene-containing diets on biological processes related to chronic disease.

## REFERENCES

- Bazzano, L.A.; Serdula, M.K.; Liu, S. Dietary intake of fruits and vegetables and risk of cardiovascular disease. *Curr. Atheroscler. Rep.* **2003**, *5*, 492–499.
- van't Veer, P.; Jansen, M.C.; Klerk, M.; Kok, F.J. Fruits and vegetables in the prevention of cancer and cardiovascular disease. *Public Health Nutr.* **2000**, *3*, 103–107.
- Smith-Warner, S.A.; Spiegelman, D.; Yaun, S.S. et al. Fruits, vegetables and lung cancer: a pooled analysis of cohort studies. *Int. J. Cancer* **2003**, *107*, 1001–1011.
- Malin, A.S.; Qi, D.; Shu, X.O.; Gao, Y.T.; Friedman, J.M.; Jin, F.; Zheng, W. Intake of fruits, vegetables and selected micronutrients in relation to the risk of breast cancer. *Int. J. Cancer* **2003**, *105*, 413–418.
- Chan, J.M.; Giovannucci, E.L. Vegetables, fruits, associated micronutrients, and risk of prostate cancer. *Epidemiol. Rev.* **2001**, *23*, 82–86.
- Giovannucci, E. Tomatoes, tomato-based products, lycopene, and cancer: review of the epidemiologic literature. *J. Natl. Cancer Inst.* **1999**, *91*, 317–331.
- Sesso, H.D.; Liu, S.; Gaziano, J.M.; Buring, J.E. Dietary lycopene, tomato-based food products and cardiovascular disease in women. *J. Nutr.* **2003**, *133*, 2336–2341.
- U.S. Department of Agriculture. Agricultural Research Service. USDA Nutrient Database for Standard Reference, Release 14. Retrieved from <http://www.nal.usda.gov/fnic/foodcomp> (accessed May 2002).
- Scott, K.J.; Hart, D.J. Development and evaluation of an HPLC method for the analysis of carotenoids in foods, and the measurement of the carotenoid content of vegetables and fruits commonly consumed in the UK. *Food Chem.* **1995**, *54*, 101–111.
- Mangels, A.R.; Holden, J.M.; Beecher, G.R. et al. Carotenoid content of fruits and vegetables: an evaluation of analytic data. *J. Am. Diet. Assoc.* **1993**, *93*, 284–296.
- Nguyen, M.L.; Schwartz, S.J. Carotenoid geometrical isomers in fresh and thermally processed fruits and vegetables. *Proceedings of the 2nd Karlsruhe Nutrition Symposium, Karlsruhe, Germany, 1997.*
- Nguyen, M.L.; Schwartz, S.J. Lycopene stability during food processing. *Proc. Soc. Exp. Biol. Med.* **1998**, *218*, 101–105.
- Nguyen, M.L.; Schwartz, S.J. Lycopene: chemical and biological properties. *Food Technol.* **1999**, *53*, 38–45.
- Demmig-Adams, B.; Gilmore, A.M.; Adams, W.W. In vivo functions of carotenoids in higher plants. *FASEB J.* **1996**, *10*, 403–412.
- Olson, J.A.; Krinsky, N. Introduction: the colorful, fascinating world of the carotenoids: important physiologic modulators. *FASEB J.* **1995**, *9*, 1547–1550.
- Britton, G. Structure and properties of carotenoids in relation to function. *FASEB J.* **1995**, *9*, 1551–1558.
- Fraser, P.D.; Bramley, P.M. The biosynthesis and nutritional uses of carotenoids. *Prog. Lipid Res.* **2004**, *43*, 228–265.
- Moss, G.P.; Weedon, B.C.L. Chemistry of the carotenoids. In *Chemistry and Biochemistry of Plant Pigments*, 2nd Ed.; Goodwin, T.W., Ed.; Academic Press: New York, 1976; Vol. 1, 149–224.
- Henry, L.K.; Catignani, G.L.; Schwartz, S.J. Oxidative degradation kinetics of lycopene, lutein, 9-cis and all-trans beta carotene. *J. Am. Oil Chem. Soc.* **1998**, *75*, 823–829.
- Zechmeister, L.; Le Rosen, A.L.; Went, F.W.; Pauling, L. Prolycopene, a naturally-occurring stereoisomer of lycopene. *Proc. Natl. Acad. Sci. U.S.A.* **1941**, *27*, 468–474.
- Wilberg, V.C.; Rodriguez-Amaya, D.B. HPLC quantitation of major carotenoids of fresh and processed guava, mango, and papaya. *Lebensm. Wiss. Technol.* **1995**, *28*, 474–480.

22. Emehiser, C.; Sander, L.C.; Schwartz, S.J. Capability of a polymeric C30 stationary phase to resolve cis-trans carotenoid isomers in reversed-phase liquid chromatography. *J. Chromatogr. A* **1995**, *707*, 205–216.
23. Pauling, L. Recent work on the configuration and electronic structure of molecules with some applications to natural products: isomerism and the structure of carotenoids. *Fortschr. Chem. Org. Naturst.* **1939**, *3*, 227–229.
24. Zechmeister, L.; Polgar, A. Cis-trans isomerization and cis-peak effect in the alpha carotene set and in some other stereoisomeric sets. *J. Am. Chem. Soc.* **1944**, *66*, 137–144.
25. Sander, L.C.; Sharpless, K.E.; Craft, N.E.; Wise, S.A. Development of engineered stationary phases for the separation of carotenoid isomers. *Anal. Chem.* **1994**, *66*, 1667–1674.
26. Emehiser, C.; Simunovic, N.; Sander, L.C.; Schwartz, S.J. Separation of geometric isomers in biological extracts using a polymeric C30 column in reversed-phase liquid chromatography. *J. Agric. Food Chem.* **1996**, *44*, 3887–3893.
27. Rouseff, R.; Raley, L.; Hofsommer, H.J. Application of diode array detection with a C30 reversed phase column for the separation and identification of saponified orange juice carotenoids. *J. Agric. Food Chem.* **1996**, *44*, 2176–2181.
28. Schierle, J.; Bretzel, W.; Buhler, I.; Faccin, N.; Hess, D.; Steiner, K.; Schuep, W. Content and isomeric ratio of lycopene in food and human blood plasma. *Food Chem.* **1997**, *96*, 459–465.
29. Sander, L.C.; Wise, S.A. Effect of phase length on column selectivity for the separation of polycyclic aromatic hydrocarbons by reversed-phase liquid chromatography. *Anal. Chem.* **1987**, *59*, 2309–2313.
30. Craft, N.E. Carotenoid reversed-phase high-performance liquid chromatography methods: reference compendium. *Meth. Enzymol.* **1992**, *213*, 185–205.
31. Epler, K.S.; Sander, L.C.; Ziegler, R.G.; Wise, S.A.; Craft, N.E. Evaluation of reversed-phase liquid chromatographic columns for recovery and selectivity of selected carotenoids. *J. Chromatogr.* **1992**, *595*, 89–101.
32. Van Breemen, R.B. Electrospray liquid chromatography-mass spectrometry of carotenoids. *Anal. Chem.* **1995**, *67*, 2004–2009.
33. Ferruzzi, M.G.; Sander, L.C.; Rock, C.L.; Schwartz, S.J. Carotenoid determination in biological microsamples using liquid chromatography with a coulometric electrochemical array detector. *Anal. Biochem.* **1998**, *256*, 74–81.
34. Schmitz, H.H.; van Breemen, R.B.; Schwartz, S.J. Fast-atom bombardment and continuous-flow fast-atom bombardment mass spectrometry in carotenoid analysis. *Meth. Enzymol.* **1992**, *213*, 322–337.
35. Van Breemen, R.B.; Schmitz, H.H.; Schwartz, S.J. Continuous-flow fast atom bombardment liquid chromatography/mass spectrometry of carotenoids. *Anal. Chem.* **1993**, *65*, 965–969.
36. Van Breemen, R.B.; Schmitz, H.H.; Schwartz, S.J. Fast atom bombardment tandem mass spectrometry of carotenoids. *J. Agric. Food Chem.* **1995**, *43*, 384–389.
37. Hengartner, U.; Bernhard, K.; Meyer, K. Synthesis, isolation, and NMR-spectroscopic characterization of fourteen (Z)-isomers of lycopene and of some acetylenic-, didehydro-, and tetra-dehydrolycopenes. *Helv. Chim. Acta* **1992**, *75*, 1848–1865.
38. Dachtler, M.; Glaser, T.; Kohler, K.; Albert, K. Combined HPLC-MS and HPLC-NMR online coupling for the separation and determination of lutein and zeaxanthin stereoisomers in spinach and in retina. *Anal. Chem.* **2001**, *73*, 667–674.
39. Boskovic, M.A. Fate of lycopene in dehydrated tomato products: carotenoid isomerization in food system. *J. Food Sci.* **1979**, *44*, 84–86.
40. Cano, M.P.; Ancos, B.; Lobo, G.; Monreal, M.; De-Ancos, B. Effects of freezing and canning of papaya slices on their carotenoid composition. *Z. Lebensm. Unters. Forsch.* **1996**, *202*, 279–284.
41. Khachik, F.; Beecher, G.R.; Lusby, W.R.; Smith, J.C. Separation and identification of carotenoids and their oxidation products in the extracts of human plasma. *Anal. Chem.* **1992**, *64*, 2111–2122.
42. Khachik, F.; Goli, M.B.; Beecher, G.R.; Holden, J.; Lusby, W.R.; Tenorio, M.D.; Barrera, M.R. Effect of food preparation on qualitative and quantitative distribution of major carotenoid constituents of tomatoes and several green vegetables. *J. Agric. Food Chem.* **1992**, *40*, 390–398.
43. Takeoka, G.R.; Dao, L.; Flessa, S. et al. Processing effects on lycopene content and antioxidant activity of tomatoes. *J. Agric. Food Chem.* **2001**, *49*, 3713–3717.
44. Saini, S.P.S.; Singh, S. Thermal processing of tomato juice from new hybrids. *Res. Ind.* **1993**, *38*, 161–164.
45. Zanori, B.; Peri, C.; Nani, R.; Lavelli, V. Oxidative heat damage of tomato halves as affected by drying. *Food Res. Int.* **1998**, *31*, 395–401.



46. Stahl, W.; Sies, H. Uptake of lycopene and its geometrical isomers is greater from heat-processed than from unprocessed tomato juice in humans. *J. Nutr.* **1992**, *122*, 2161–2166.
47. Clinton, S.K.; Emenhiser, C.; Schwartz, S.J.; Bostwick, D.G.; Williams, A.W.; Moore, B.J.; Erdman, J.W. Cis–trans lycopene isomers, carotenoids, and retinal in the human prostate. *Cancer Epidemiol. Biomarkers Prev.* **1996**, *5*, 823–833.
48. Nguyen, M.L.; Francis, D.; Schwartz, S.J. Thermal isomerisation susceptibility of carotenoids in different tomato varieties. *J. Sci. Food Agric.* **2001**, *81*, 910–917.
49. Simpson, K.L.; Lee, T.C.; Rodriguez, D.B.; Chichester, C.O. Metabolism in senescent and stored tissues. In *Chemistry and Biochemistry of Plant Pigments*, 2nd Ed.; Goodwin, T.W., Ed.; Academic Press: New York, 1976; Vol. 1, 779–842.
50. Shi, J.; Le Maguer, M. Lycopene in tomatoes: chemical and physical properties affected by food processing. *Crit. Rev. Biotechnol.* **2000**, *20*, 293–334.
51. Zhou, J.R.; Gugger, E.T.; Erdman, J.W., Jr. The crystalline form of carotenes and the food matrix in carrot root decrease the relative bioavailability of beta and alpha carotene in the ferret model. *J. Am. Coll. Nutr.* **1996**, *15*, 84–91.
52. Harrison, E.; During, A. Personal Communication, 2004.
53. Parker, R.S. Absorption, metabolism, and transport of carotenoids. *FASEB J.* **1996**, *10*, 542–551.
54. Krinsky, N.I.; Cornwell, D.G.; Oncley, J.L. The transport of vitamin A and carotenoids in human plasma. *Arch. Biochem. Biophys.* **1958**, *73*, 233–246.
55. Erdman, J.W.; Poor, C.L.; Dietz, J.M. Factors affecting the bioavailability of vitamin A, carotenoids, and vitamin E. *Food Technol.* **1988**, *42*, 214–221.
56. Rock, C.L.; Lovalvo, J.L.; Emenhiser, C.; Ruffin, M.T.; Flatt, S.W.; Schwartz, S.J. Bioavailability of beta-carotene is lower in raw than in processed carrots and spinach in women. *J. Nutr.* **1998**, *128*, 913–916.
57. Gartner, C.; Stahl, W.; Sies, H. Lycopene is more bioavailable from tomato paste than from fresh tomatoes. *Am. J. Clin. Nutr.* **1997**, *66*, 116–122.
58. Van het Hof, K.H.; de Boer, B.C.; Tijburg, L.B. et al. Carotenoid bioavailability in humans from tomatoes processed in different ways determined from the carotenoid response in the triglyceride-rich lipoprotein fraction of plasma after a single consumption and in plasma after four days of consumption. *J. Nutr.* **2000**, *130*, 1189–1196.
59. Richelle, M.; Bortlik, K.; Liardet, S. et al. A food-based formulation provides lycopene with the same bioavailability to humans as that from tomato paste. *J. Nutr.* **2002**, *132*, 404–408.
60. Hoppe, P.P.; Kramer, K.; van den Berg, H.; Steenge, G.; van Vliet, T. Synthetic and tomato-based lycopene have identical bioavailability in humans. *Eur. J. Nutr.* **2003**, *42*, 272–278.
61. Erdman, J.W.; Bierer, T.L.; Gugger, E.T., Jr. Absorption and transport of carotenoids. In *Carotenoids in Human Health*; Canfield, L.M., Krinsky, N.I., Olson, J.A., Eds.; New York Academy of Sciences: New York, 1993; Vol. 691, 76–85.
62. El-Gorab, M.I.; Underwood, B.A.; Loerch, J.D. The roles of bile salts in the uptake of  $\beta$ -carotene and retinol by rat everted gut sacs. *Biochim. Biophys. Acta* **1975**, *401*, 265–277.
63. Hollander, D.; Ruble, P.E.; Beta-carotene intestinal absorption: bile fatty acid, pH, and flow rate effects on transport. *Am. J. Physiol.* **1978**, *235*, E686–E691.
64. Elinder, L.S.; Hadell, K.; Johansson, J.; Holme, J.M.; Olsson, A.G.; Walldius, G. Probuco treatment decreases serum concentrations of diet-derived antioxidants. *Arterioscler. Thromb. Vasc. Biol.* **1995**, *15*, 1057–1063.
65. Westrate, J.A.; van het Hof, K. Sucrose polyester and plasma carotenoid concentrations in healthy subjects. *Am. J. Clin. Nutr.* **1995**, *62*, 591–597.
66. Clinton, S.K. Lycopene: chemistry, biology, and implications for human health and disease. *Nutr. Rev.* **1998**, *56*, 35–51.
67. Allen, C.M.; Schwartz, S.J.; Craft, N.E.; Giovannucci, E.L.; De Groff, V.L.; Clinton, S.K. Changes in plasma and oral mucosal lycopene isomer concentrations in healthy adults consuming standard servings of processed tomato products. *Nutr. Cancer* **2003**, *47*, 48–56.
68. Hadley, C.W.; Schwartz, S.J.; Clinton, S.K. The consumption of processed tomato products enhances plasma lycopene concentrations in association with a reduced lipoprotein sensitivity to oxidative damage. *J. Nutr.* **2003**, *133*, 727–732.
69. Kaplan, L.A.; Lau, J.M.; Stein, E.A. Carotenoid composition, concentrations, and relationships in various human organs. *Clin. Physiol. Biochem.* **1990**, *8*, 1–10.
70. Schmitz, H.H.; Poor, C.L.; Wellman, R.B.; Erdman, J.W. Concentrations of selected carotenoids and vitamin A in human liver, kidney and lung tissue. *J. Nutr.* **1991**, *121*, 1613–1621.

71. Nierenberg, D.W.; Nann, S.L. A method for determining concentration of retinal, tocopherol, and five carotenoids in human plasma and tissue samples. *Am. J. Clin. Nutr.* **1992**, *56*, 417–426.
72. Craft, N.E.; Garnett, K.; Hedley-Whyte, E.T.; Fitch, K.; Haitema, T.; Dorecy, C.K. Carotenoids, tocopherols and vitamin A in human brain, part 2. *FASEB J.* **1998**, *12*, AS601.
73. Khachik, F.; Spangler, C.J.; Smith, J.C., Jr.; Canfield, L.M.; Steck, A.; Pfander, H. Identification, quantification, and relative concentrations of carotenoids and their metabolites in human milk and serum. *Anal. Chem.* **1997**, *69*, 1873–1881.
74. Rao, A.V.; Fleshner, N.; Agarwal, S. Serum and tissue lycopene and biomarkers of oxidation in prostate cancer patients: a case-control study. *Nutr. Cancer* **1999**, *33*, 159–164.
75. Freeman, V.L.; Meydani, M.; Yong, S.; Pyle, J.; Wan, Y.; Arvizu-Durazo, R.; Liao, Y. Prostatic levels of tocopherols, carotenoids and retinol in relation to plasma levels and self-reported usual dietary intake. *Am. J. Epidemiol.* **2000**, *151*, 109–118.
76. Kucuk, O.; Sarkar, F.H.; Wackr, W. et al. Phase II randomized clinical trial of lycopene supplementation before radical prostatectomy. *Cancer Epidemiol. Biomarkers Prev.* **2001**, *10*, 861–868.
77. Heber, D.; Lu, Q.Y. Overview of mechanisms of action of lycopene. *Exp. Biol. Med. (Maywood)* **2002**, *227*, 920–923.
78. Krinsky, N.I. Mechanism of action of biological antioxidants. *Proc. Soc. Exp. Biol. Med.* **1992**, *200*, 248–254.
79. Gerster, H. The potential role of lycopene for human health. *J. Am. Coll. Nutr.* **1997**, *16*, 109–126.
80. Di Mascio, P.; Kaiser, S.; Sies, H. Lycopene as the most efficient biological carotenoid singlet oxygen quencher. *Arch. Biochem. Biophys.* **1989**, *274*, 532–538.
81. Halliwell, B. Free radicals and antioxidants: a personal view. *Nutr. Rev.* **1994**, *52*, 253–265.
82. Krinsky, N.I. Overview of lycopene, carotenoids, and disease prevention. *Proc. Soc. Exp. Biol. Med.* **1998**, *218*, 95–97.
83. Bohm, F.; Tinkler, J.H.; Truscott, T.G. Carotenoids protect against cell membrane damage by the nitrogen dioxide radical. *Nat. Med.* **1995**, *1*, 98–99.
84. Lu, Y.; Etoh, H.; Watanabe, N. et al. A new carotenoid, hydrogen peroxide oxidation products from lycopene. *Biosci. Biotechnol. Biochem.* **1995**, *59*, 2153–2155.
85. Woodall, A.A.; Lee, S.W.; Weesie, R.J. et al. Oxidation of carotenoids by free radicals: relationship between structure and reactivity. *Biochem. Biophys. Acta (Netherlands)* **1997**, *1336*, 33–42.
86. Slattery, M.L.; Benson, J.; Curtin, K.; Ma, K.; Schaeffer, D.; Potter, J.D. Carotenoids and colon cancer. *Am. J. Clin. Nutr.* **2000**, *71*, 575–582.
87. De Stefani, E.; Oreggia, F.; Boffetta, P.; Deneo-Pellegrini, H.; Ronco, A.; Mendilaharsu, M. Tomatoes, tomato-rich foods, lycopene and cancer of the upper aerodigestive tract: a case-control in Uruguay. *Oral Oncol.* **2000**, *36*, 47–53.
88. Lu, Q.Y.; Hung, J.C.; Heber, D. et al. Inverse associations between plasma lycopene and other carotenoids and prostate cancer. *Cancer Epidemiol. Biomarkers Prev.* **2001**, *10*, 749–756.
89. Tzonou, A.; Signorello, L.B.; Lagiou, P.; Wu, J.; Trichopoulos, D.; Trichopoulou, A. Diet and cancer of the prostate: a case-control study in Greece. *Int. J. Cancer* **1999**, *80*, 704–708.
90. Norrish, A.E.; Jackson, R.T.; Sharpe, S.J.; Skeaff, C.M. Prostate cancer and dietary carotenoids. *Am. J. Epidemiol.* **2000**, *151*, 119–123.
91. Giovannucci, E.; Rimm, E.B.; Liu, Y.; Stampfer, M.J.; Willet, W.C. A prospective study of tomato products, lycopene, and prostate cancer risk. *J. Natl. Cancer Inst.* **2002**, *94*, 391–398.
92. Brennan, P.; Fortes, C.; Butler, J. et al. A multi-center case-control study of diet and lung cancer among non-smokers. *Cancer Causes Control* **2000**, *11*, 49–58.
93. Jemal, A.; Tiwari, R.C.; Murray, T.; Samuels, A.; Samuels, A.; Ward, E. et al. Cancer statistics, 2004. *Cancer J. Clin.* **2004**, *54*, 8–29.
94. Le Marchand, L.; Hankin, J.H.; Kolonel, L.N.; Wilkins, L.R. Vegetable and fruit consumption in relation to prostate cancer risk in Hawaii: a reevaluation of the effect of dietary beta-carotene. *Am. J. Epidemiol.* **1991**, *133*, 215–219.
95. Giovannucci, E.; Ascherio, A.; Rimm, E.B.; Stampfer, M.J.; Colditz, G.A.; Willett, W.C. Intake of carotenoids and retinol in relation to risk of prostate cancer. *J. Natl. Cancer Inst.* **1995**, *87*, 1767–1776.
96. Giovannucci, E. A review of epidemiologic studies of tomatoes, lycopene, and prostate cancer. *Exp. Biol. Med.* **2002**, *227*, 852–859.
97. Hsing, A.W.; Comstock, G.W.; Abbey, H.; Polk, B.F. Serologic precursors of cancer. Retinol, carotenoids, and tocopherol and risk of prostate cancer. *J. Natl. Cancer Inst.* **1990**, *82*, 941–946.
98. Nomura, A.M.Y.; Stemmermann, G.N.; Lee, J.; Craft, N.E.; Serum micronutrients and prostate cancer in Japanese Americans in Hawaii. *Cancer Epidemiol. Biomarkers Prev.* **1997**, *6*, 487–491.

99. Gann, P.H.; Ma, J.; Giovannucci, E.; Willett, W.; Sacks, F.M.; Hennekens, C.H.; Stampfer, M.J. Lower prostate cancer risk in men with elevated plasma lycopene levels: results of a prospective analysis. *Cancer Res.* **1999**, *59*, 1225–1230.
100. Imaida, K.; Tamano, S.; Kato, K. et al. Lack of chemopreventive effects of lycopene and curcumin on experimental rat prostate carcinogenesis. *Carcinogenesis* **2001**, *22*, 467–472.
101. Guttenplan, J.B.; Chen, M.; Kosinska, W.; Thompson, S.; Zhao, Z.; Cohen, L.A. Effects of a lycopene-rich diet on spontaneous and benzo[a]pyrene-induced mutagenesis in prostate, colon and lungs of the *lacZ* mouse. *Cancer Lett.* **2001**, *164*, 1–6.
102. Boileau, T.W.; Liao, Z.; Kim, S.; Lemeshow, S.; Erdman, J.W., Jr.; Clinton, S.K. Prostate carcinogenesis in *N*-methyl-*N*-nitrosourea (NMU)-testosterone-treated rats fed tomato powder, lycopene, or energy-restricted diets. *J. Natl. Cancer Inst.* **2003**, *95*, 1578–1586.
103. Kohlmeier, L.; Clark, J.D.; Gomez-Gracia, E. et al. Lycopene and myocardial infarction risk in the EURAMIC study. *Am. J. Epidemiol.* **1997**, *146*, 618–626.
104. Kristenson, M.; Zieden, B.; Kucinskiene, Z. et al. Antioxidant state and mortality from coronary heart disease in Lithuanian and Swedish men: concomitant cross sectional study of men aged 50. *Br. Med. J.* **1997**, *314*, 629–633.
105. Klipstein-Grobusch, K.; Launer, L.J.; Geleijnse, J.M.; Boeing, H.; Hofman, A.; Witteman, J.C.M. Serum carotenoids and atherosclerosis. The Rotterdam Study. *Atherosclerosis* **2000**, *148*, 49–56.
106. Rissanen, T.H.; Voutilainen, S.; Nyssonen, K. et al. Low serum lycopene concentration is associated with an excess incidence of acute coronary events and stroke: the Kuopio Ischaemic Heart Disease Risk Factor Study. *Br. J. Nutr.* **2001**, *85*, 749–754.
107. Rissanen, T.H. Lycopene and cardiovascular disease. 13th International Carotenoid Symposium 2002, *45* (abstract).
108. Diwadkar-Navsariwala, V.; Novotny, J.A.; Gustin, D.M. et al. A physiological pharmacokinetic model describing the disposition of lycopene in healthy men. *J. Lipid Res.* **2003**, *44*, 1927–1939.
109. La Placa, M.; Pazzaglia, M.; Tosti, A. Lycopenaemia. *J. Eur. Acad. Dermatol. Venereol.* **2000**, *14*, 311–312.

# Maca (*Lepidium meyenii*)

Ilias Muhammad  
Jianping Zhao  
Ikhlas A. Khan

National Center for Natural Products Research, Research Institute of Pharmaceutical Sciences,  
School of Pharmacy, University of Mississippi, University, Mississippi, U.S.A.

## INTRODUCTION

Maca is a dietary supplement derived from the processed tuberous root of *Lepidium meyenii* Walpers (family Brassicaceae; synonyms: *L. peruvianum* G. Chacon de Popovici; common names: Peruvian ginseng, maka, mace, maca-maca, maino, ayak chichira, ayuk willku, pepperweed). The genus *Lepidium* contains approximately 150–175 species.<sup>[1,2]</sup> This plant was first described by Gerhard Walpers in 1843 and domesticated in the Andean mountain at altitudes from 3500 to 4450 m above sea level in the *puna* and *suní* ecosystems.<sup>[3]</sup> It is arguably the highest-altitude plant in cultivation. The genus probably originated in the Mediterranean region, where most of the diploid species are found;<sup>[1,2]</sup> information about its origin and distribution are sketchy. Maca is an important staple for the Andean Indians and indigenous peoples, and was domesticated during the pre-Inca Arcaica period sometime around 3800 B.C. It is the only species cultivated as a starch crop<sup>[4]</sup> and is rich in sugars, protein, starches, and essential minerals, especially iodine and iron.

Based on a long history of traditional use of maca in Peru and elsewhere, a wide array of commercial maca products have gained popularity as dietary supplements throughout the world for aphrodisiac purposes, and to increase fertility and stamina. Limited research has been carried out during the past two to three

decades by academia and the industry, including isolation and identification of several potential constituents, as well as evaluation of biological activities, mainly focused on its aphrodisiac and nutritional properties. Here, we present a comprehensive review of the published literatures on maca, which includes morphological descriptions, traditional uses, nutritional status, chemical constituents, biological activities, cosmetic uses, and standardization.

## CLASSIFICATION

*L. meyenii* (Fig. 1) is a herb or subshrub belonging to the Brassicaceae family.<sup>[3–6]</sup> Chacon recommended changing its name to *L. peruvianum*, because herbarium



**Fig. 1** Dried tuberous root and above ground parts of maca (*Lepidium meyenii*). (View this art in color at [www.dekker.com](http://www.dekker.com).)

---

*Ilias Muhammad, Ph.D.*, is Research Assistant Professor at the National Center for Natural Products Research, Research Institute of Pharmaceutical Sciences, School of Pharmacy, University of Mississippi, University, Mississippi, U.S.A.

*Jianping Zhao, M.S.*, is at the National Center for Natural Products Research and Department of Pharmacognosy, Research Institute of Pharmaceutical Sciences, School of Pharmacy, University of Mississippi, University, Mississippi, U.S.A.

*Ikhlas A. Khan, Ph.D.*, is Research Associate Professor and Assistant Director at the National Center for Natural Products Research and Department of Pharmacognosy, Research Institute of Pharmaceutical Sciences, School of Pharmacy, University of Mississippi, University, Mississippi, U.S.A.

specimens from Bolivia and Argentina were classified as *L. meyenii* but had no resemblance in shape to maca in many cases.<sup>[7]</sup> It has been suggested that the cultivated maca of today is not *L. meyenii* but the new species, *L. peruvianum*. While most maca sold in commerce is still referred to as *L. meyenii*, it is *L. peruvianum*.

## CULTIVATION

Unlike many other tuberous plants, *L. meyenii* is propagated by seed, and 7–9 mo is required to produce the harvested root. It is cultivated on rocky soil on rough Andean terrain under intense sunlight, high wind, and fluctuating temperatures between  $-20^{\circ}\text{C}$  and  $20^{\circ}\text{C}$ . The soil used for cultivation is acidic clay or limestone with a relative humidity of approximately 70%, and the plant can grow without shade or in semishade. Maca is sown from September to October at the beginning of the rainy season, and harvesting starts from May to July after a vegetative phase of 260–280 days. The yield is variable, from 2 to 16 t/ha depending on the cultivation practices, fertilization, and pest control. Well-formed hypocotyls are selected and transplanted to fertilized seed beds for seed production. After a 100–120 day generative phase, seeds are harvested.<sup>[4,8]</sup> Maca seeds represent centuries of cumulative selection by indigenous farmers, but it is only recently that scientists and governments have been growing out, testing, and saving them. The plantation area for maca has expanded drastically because of the increased demand, both domestically and for export. In 1994, less than 50 ha of maca was cultivated in Peru; by 1999, production had increased 24-fold to 1200 ha, and it now stands at more than 2000 ha.

## TRADITIONAL AND MEDICINAL USES

Maca was grown for food by the Pumpush, Yaros, and Ayarmaca Indians. Conquistadors fed the baked or boiled root powder to animals for fertility problems at high altitudes, and the Chinchaycochas Indians used it in bartering. Maca was also used to make beverages, to which hallucinogenic products were also added, that were consumed during dances and religious ceremonies. The tuberous root of maca is generally consumed fresh or dried, and has a tangy taste and an aroma similar to butterscotch. Dried roots are brown, soft, and sweet, with a musky flavor, and retain their flavor for at least 2 yr, and a 7-yr-old root still has 9–10% protein. In South America, the sweet aromatic porridge of dried maca is consumed under the name

mazamorra. In Huancayo, Peru, maca jam and pudding are popular, and maca is often made into a sweet, fragrant, fermented drink called maca chichi.

According to folk belief, maca can enhance male sexual drive and female fertility in humans and domestic animals. The Spanish conquerors found “well-fed babies and tall adults” in the high Andes, which they attributed to a diet based on maca.<sup>[3]</sup> It is also reputed to regulate hormonal secretion, stimulate metabolism, and improve memory, and is touted for antidepressant and anticancer properties, as well as for curing anemia, leukemia, and AIDS. However, these properties have not been substantiated by scientific research. Due to its wide spectrum of putative qualities, maca is also known as Peruvian ginseng.<sup>[3,8]</sup> In Peruvian herbal medicine, it has been used as an immunostimulant, for anemia, tuberculosis, menstrual disorders, menopause symptoms, stomach cancer, and sterility, and for other reproductive and sexual disorders, as well as to enhance memory.

## CHEMICAL STUDIES

### Nutritional Constituents

Maca is very nutritious, with 60–75% carbohydrates, 10–14 % protein, 8.5% fiber, and 2.2% lipids<sup>[9,10]</sup> (Table 1). The dried root contains about 13–16% protein and is rich in essential amino acids, while the fresh root is unusually high in iodine and iron. It contains about 250 mg of calcium, 2 g of potassium, and 15 mg of iron in 100 g of dried root, and sterols (0.05–0.1%), minerals, and vitamins. Maca contains 3.72% fatty acids, including caprylic acid, capric acid, lauric acid, myristic acid, palmitic acid, palmitoleic acid, stearic acid, oleic acid, linoleic acid, and linolenic acid.<sup>[11]</sup> In addition, a new acyclic keto acid, 5-oxo-6*E*,8*E*-octadecadienoic acid (**1**) has been isolated from the tubers.<sup>[12]</sup> Yellow maca has been found to have higher lipid and carbohydrate content compared to the red and black varieties. Evaluation of the nutritional property of maca in albino Swiss mice has shown that the serum values for content of total proteins and albumin are statistically higher for mice eating cooked maca than for those consuming raw maca, with no sign of malnutrition or overweight in any of the groups.<sup>[13]</sup>

### Secondary Metabolites

The major secondary metabolites present in *L. meyenii* can be classified into four groups: a) essential oils;

**Table 1** Nutritional profile and important constituents of maca

Components <sup>a</sup>	
Protein	1–1.4 g
Carbohydrates	6–7.5 g
Fats (lipids)	220 mg
Fiber	850 mg
Ash	490 mg
Sterols	5–10 mg
Calories	32.5
Minerals <sup>a</sup>	
Calcium	25 mg
Copper	0.6 mg
Manganese	80 µg
Potassium	205 mg
Sodium	1.9 mg
Zinc	380 µg
Minerals <sup>b</sup>	
Iodine	52 µg
Iron	1.5 mg
Amino acids <sup>a</sup>	
Alanine	63.1 mg
Arginine	99.4 mg
Aspartic acid	91.7 mg
Glutamic acid	156.5 mg
Glycine	68.3 mg
Histidine	41.9 mg
Hydroxyproline	26.0 mg
Isoleucine	47.4 mg
Leucine	91.0 mg
Lysine	54.5 mg
Methionine	28.0 mg
Proline	0.5 mg
Phenylalanine	55.3 mg
Sarcosine	0.7 mg
Serine	50.4 mg
Threonine	33.1 mg
Tryptophan	4.9 mg
Tyrosine	30.6 mg
Valine	79.3 mg
Fatty acids <sup>c</sup>	
Linoleic acid	32.6%
Palmitic acid	23.8%
Oleic acid	11.1%
Vitamins <sup>b</sup>	
B2	39 µg
B6	114 µg
C	28.6 mg
Niacin	565 µg

<sup>a</sup>Contents per 10 g dried maca tuber.<sup>[9,10]</sup>

<sup>b</sup>Contents per 10 g dried maca tuber.<sup>[37]</sup>

<sup>c</sup>Ref.<sup>[9]</sup> Number of fatty acids: 20. Three major acids are given. Values are in percentage of total fatty acid.

b) glucosinolates; c) alkaloids; and d) macamides. In addition, the presence of malic acid and its benzoate ester (**2**),<sup>[14]</sup> as well as five sterols<sup>[9]</sup> and catechins, is also reported (Table 2 and Fig. 2).

## Essential oils

A total of 53 essential oil components have been identified, using retention indexes and mass spectral data.<sup>[15]</sup> Among the constituents, phenylacetoneitrile (85.9%), benzaldehyde (3.1%), and 3-methoxyphenylacetoneitrile (2.1%) are the major components of the steam-distilled oil.

## Glucosinolates

The glucosinolates are a class of secondary metabolites found in 15 botanical families of dicotyledonous plants, notably including the Brassicaceae. Over 100 have been reported to date from plant sources. Glucosinolates are present at approximately 1% in fresh *L. meyenii* root, but no novel ones have been reported so far in maca. The presence of two main glucosinolates, glucotropolin (**3**) and *m*-methoxybenzylglucosinolate (**4**), have been reported from maca,<sup>[14,16,17]</sup> and their combined presence in *L. meyenii* may be used as a chemotaxonomic marker, since the combination of **3** and **4** does not occur in other members of the Brassicaceae.<sup>[16]</sup> Glucosinolates and their derived products have received increasing attention due to their biological activities; examination of glucosinolate degradation products in the hexane extract has revealed the presence of benzyl isothiocyanate (**5**) and its *m*-methoxy derivative (**6**),<sup>[17]</sup> the former reported to be present in the range of 0.1–0.15% in standardized maca product.<sup>[11]</sup>

Several maca products derived from processed hypocotyls of *L. peruvianum* and other organs have been assessed by high performance liquid chromatography (HPLC) for glucosinolate content. The most abundant glucosinolates were found to be **3** and **4** in fresh and dry hypocotyls and leaves. The richest sources of glucosinolates are seeds, fresh hypocotyls, and sprouts, in that order. Maca seeds and sprouts differ in profile from hypocotyls and leaves due to the presence of several modified benzylglucosinolates, including 5-methylsulfinylpentylglucosinolate (**7**), indolyl-3-methylglucosinolate (**8**), pent-4-enylglucosinolate, 4-methoxyindolyl-3-methylglucosinolate, glucolepigramin, and 4-hydroxybenzylglucosinolate, while the liquor and tonic contain sinigrin (**9**).<sup>[14]</sup>

## Alkaloids

Qualitative detection of alkaloid like compounds in *L. meyenii* was first reported by Dini et al.,<sup>[9]</sup> and a further detailed chemical analysis of the tubers by Muhammad et al.<sup>[12]</sup> reported the benzylated derivative of 1,2-dihydro-*N*-hydroxypyridine, named macaridine (**10**). From the methanol extract of the tuber, (1*R*,3*S*)-1-methyltetrahydro- $\beta$ -carboline-3-carboxylic

**Table 2** Compounds isolated from and identified in maca

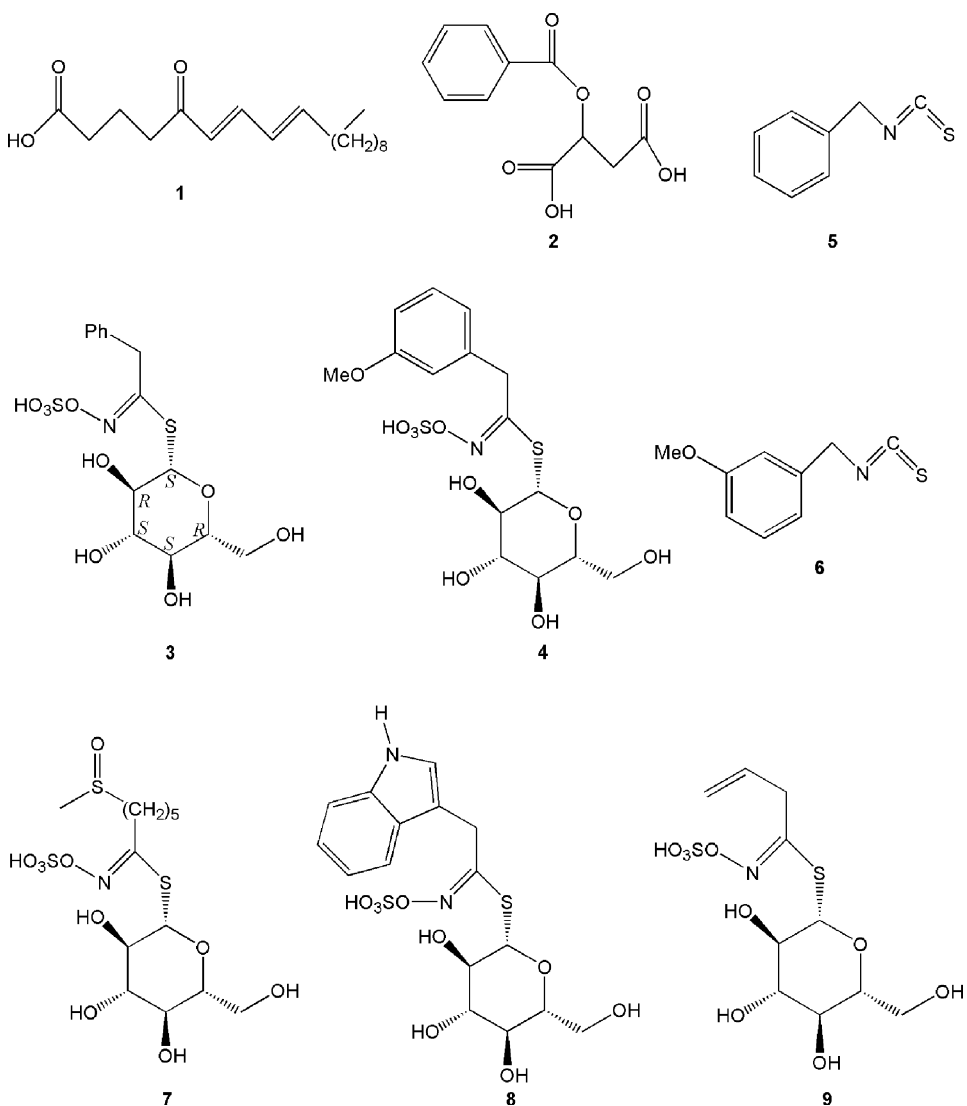
Class	Constituents	Feature	Reference
Macamides	<i>N</i> -Benzyloctanamide (macamide A)	n	[11]
	<i>N</i> -Benzyl-16-hydroxy-9-oxo-10 <i>E</i> ,12 <i>E</i> ,14 <i>E</i> -octadecatrienamide (macamide B)	n	[11]
	<i>N</i> -Benzyl-9,16-dioxo-10 <i>E</i> ,12 <i>E</i> ,14 <i>E</i> -octadecatrienamide (macamide C)	n	[11]
	<i>N</i> -Benzyl-5-oxo-6 <i>E</i> ,8 <i>E</i> -octadecadienamide ( <b>15</b> )	n	[12]
	<i>N</i> -Benzylhexadecanamide ( <b>16</b> )	n	[12]
Organic acids	Caprylic acid, capric acid, lauric acid, myristic acid, palmitic acid, palmitolic acid, stearic acid, oleic acid, linoleic acid, linolenic acid		[9, 11]
	5-Oxo-6 <i>E</i> ,8 <i>E</i> -octadecadienoic acid ( <b>1</b> )	n	[12]
	Malic acid		[17]
	Malic acid benzoate ( <b>2</b> )		[17]
Alkaloids	Macaridine ( <b>10</b> )	n	[12]
	(1 <i>R</i> ,3 <i>S</i> )-1-Methyltetrahydro- $\beta$ -carboline-3-carboxylic acid ( <b>11</b> )		[17]
	1,3-Dibenzyl-4,5-dimethylimidazolium chloride (lepidiline A) ( <b>13</b> )	n	[18]
	1,3-Dibenzyl-2,4,5-trimethylimidazolium chloride (lepidiline B) ( <b>14</b> )	n	[18]
Glucosinolates	Benzylglucosinolate (glucotropeolin) ( <b>3</b> )		[14, 16, 17]
	<i>m</i> -Methoxybenzylglucosinolate ( <b>4</b> )		[14, 17]
	<i>p</i> -Methoxybenzylglucosinolate		[14]
	5-Methylsulfinylpentylglucosinolate (glucoalyscin) ( <b>7</b> )		[14]
	<i>p</i> -Hydroxybenzylglucosinolate (glucosinalbin)		[14]
	<i>m</i> -Hydroxybenzylglucosinolate (tentative identification)		[14]
	Pent-4-enylglucosinolate (glucobrassicinapin)		[14]
	Indolyl-3-methylglucosinolate (glucobrassicin) ( <b>8</b> )		[14]
	4-Methoxyindolyl-3-methylglucosinolate (4-methoxyglucobrassicin)		[14]
Sinigrin ( <b>9</b> )		[14]	
Isothiocyanates	Benzyl isothiocyanate ( <b>5</b> )		[15, 17]
	<i>m</i> -Methoxybenzyl isothiocyanate ( <b>6</b> )		[17]
Sterols	Sitosterol		[9]
	Campesterol		[9]
	Ergosterol		[9]
	Brassicasterol		[9]
	$\Delta^{7,22}$ -Ergostadienol		[9]
Essential oil	Phenylacetonitrile (85.9%), benzaldehyde (3.1%), 3-methoxyphenylacetonitrile (2.1%), and others		[15]
Others	Uridine ( <b>12</b> )		[17]
	Catechins		[32]
	Polysaccharide		[11]

n = New compound.

acid (**11**), and uridine (**12**) and its benzoyl derivative have been isolated.<sup>[17]</sup> Recently, two new 1,3-dibenzylimidazolium chloride derivatives have been isolated from root extracts and identified as lepidiline A (**13**) and lepidiline B (**14**)<sup>[18]</sup> (Fig. 2).

### Macamides

Maca contains novel polyunsaturated acids and their amides, called macaene and macamide by Zheng et al.<sup>[11]</sup> From purified standardized products of



**Fig. 2** Selected structures of compounds isolated from maca. (Continued next page)

maca, three new macamides, *N*-benzyloctamide, *N*-benzyl-16-hydroxy-9-oxo-10*E*,12*E*,14*E*-octadecatrienamide, and *N*-benzyl-9,16-dioxo-10*E*,12*E*,14*E*-octadecatrienamide, have been isolated and identified by HPLC.<sup>[11]</sup> In addition, 17 other analog of macamide and macaene have been reported, but their chemical identity has not been disclosed. Two additional alkamides, *N*-benzyl-5-oxo-6*E*,8*E*-octadecadienamide (**15**) and *N*-benzylhexadecanamide (**16**), have been isolated from tubers.<sup>[12]</sup>

## BIOLOGICAL STUDIES

The following sections include discussions of the results of both preclinical (in vitro and/or animal) and clinical (human patients) studies. While these studies suggest potential beneficial effects of maca, demonstration of efficacy in humans requires the

conduct of clinical trials utilizing randomized, double blind, placebo controlled protocols.

## Fertility-Enhancing and Aphrodisiac Activities

The aphrodisiac activities of maca have been reported by several research groups. Oral administration of the purified lipid extract decreased the latent period of erection (LPE) in male rats with erectile dysfunction, as well as enhanced the sexual function of mice and rats by increasing the number of complete intromissions and the number of sperm-positive females in normal mice.<sup>[11]</sup> Gonzales et al.<sup>[19,20]</sup> reported that maca does not affect serum reproductive hormone levels in adult men, but rather improves sperm motility and sperm production in a dose-dependent manner. In a similar protocol, Gonzales et al.<sup>[21]</sup> demonstrated the improvement of sexual desire after 8 weeks of treatment. Maca demonstrated an effect



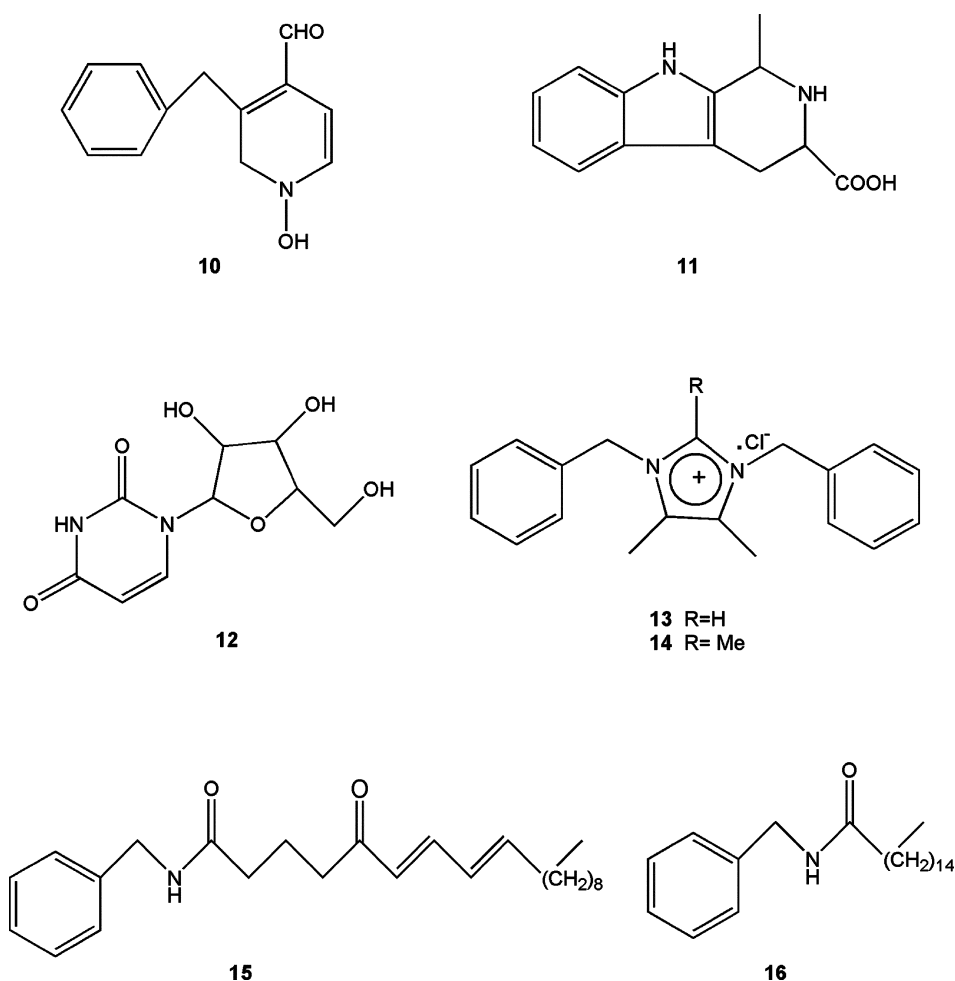


Fig. 2 Continued.

on sexual desire at 8 and 12 weeks of treatment, and this effect was independent of Hamilton depression and anxiety scores as well as serum testosterone and estradiol levels.<sup>[21]</sup> The subacute oral administration of a lipophilic hexane extract improved sexual performance parameters most effectively in sexually inexperienced male rats.<sup>[22,23]</sup> Oral administration of an aqueous extract of maca roots resulted in an increase in the weights of the testis and epididymis, but not seminal vesicle weight, and the root invigorated spermatogenesis in male rats by acting on the initial portions of the seminiferous tubules, where mitosis occurs.<sup>[24]</sup> An international patent has been granted for a “composition and method for improving sexual desire and overall sexual vitality.” The mixture contains maca extract 6:1, *Epimedium sagittatum*, zinc monomethionine aspartate, and yohimbe extract 10:1 and is administered orally to a patient over a period of time.<sup>[25]</sup> In a related study, an investigation of the energy-enhancing action of aqueous root extracts on the behavior of mice was carried out using the forced swimming test.<sup>[26]</sup> The study showed that an increase in swim time was directly related to the

polysaccharide content of the extracts. The fertility-enhancing properties of maca could be due to the presence of biologically active aromatic isothiocyanates derived from the hydrolysis of glucosinolates, and especially due to the formation of benzyl isothiocyanate (5) and *p*-methoxybenzyl isothiocyanate.<sup>[27]</sup> The putative aphrodisiac powers of maca can also be attributed to the presence of prostaglandins and steroids in the hypocotyls.<sup>[9]</sup>

### Cytotoxic and Chemopreventive Activities

Glucosinolates appear to have little biological impact by themselves. However, release of biologically active products such as isothiocyanates, organic cyanides, oxazolidinethiones, and ionic thiocyanate ( $\text{SCN}^-$ ) upon enzymatic degradation by myrosinase, which is typically present in cruciferous plants as well as in the gut microflora of mammals,<sup>[28]</sup> is responsible for the observed activities. Natural isothiocyanates derived from glucosinolate are effective chemoprotective agents that detoxify carcinogens and prevent

several types of cancer in rodent models. Isothiocyanates apparently induce mammalian Phase 1 and 2 drug-metabolizing enzymes and their coding genes, resulting in decreased carcinogen–DNA interactions.<sup>[29]</sup> Benzyl isothiocyanates, most importantly, have been reported to be potent cancer inhibitors of mammary gland and stomach cancers<sup>[30]</sup> and of liver cancer<sup>[31]</sup> in rats treated with carcinogens. The above mentioned work suggests that the type of glucosinolate and total concentration have important implications with respect to overall biological activity, including chemoprevention, in both human and animal nutrition.

### Other Biological Activities

Maca has the capacity to scavenge free radicals and protect cells from oxidative stress. The antioxidant activity of maca was assessed, and the IC<sub>50</sub> values for scavenging  $\alpha,\alpha$ -diphenyl-2-picrylhydrazyl (DPPH) and peroxy radicals were found to be 0.61 and 0.43 mg/ml, respectively.<sup>[32]</sup> Deoxyribose protection by maca (1–3 mg/ml) against hydroxyl radicals was of the order of 57–74%. Maca (1 mg/ml) protected RAW 264.7 cells against peroxynitrite-induced apoptosis and increased ATP production in cells treated with H<sub>2</sub>O<sub>2</sub> (1 mM).

The oil of *L. meyenii* was selectively toxic towards the cyanobacterium *Oscillatoria perornata*, a blue-green alga that causes off-flavor in commercial catfish production, compared to the green alga *Selenastrum capricornutum*, with complete growth inhibition at 100  $\mu$ g/ml.<sup>[15]</sup> Mortality of the Formosan subterranean termite, *Coptotermes formosanus*, was numerically, but not significantly, higher in tests conducted on filter paper treated with maca oil. At 1% (wt./wt.), maca oil appeared to act as a feeding deterrent to termites. Several minor components of the essential oil, including 3-methoxyphenylacetonitrile and benzyl thiocyanate, were significantly active against the termite.<sup>[15]</sup>

### COSMETIC USES

There are patent claims that compositions containing papain-treated papaya (*Carica papaya*) powders, papain-treated maca (*L. meyenii*) powders, papain, and substantially water-free powders or oils<sup>[33]</sup> are useful as face cleansers, packs, and bath preparations that show skin-conditioning effects.<sup>[33]</sup> A face cleanser has been prepared from mannitol 50.0, soap 30.0, kaolin 10.0, talc 3.0, olive oil 1.0, papain 2.0, papain-treated papaya powder 2.0, and papain-treated maca powder 2.0 wt.%. Addition of polyols, mucopolysaccharides, sugars, and/or amino acids to the extract is claimed

to improve the skin-moisturizing effect.<sup>[34]</sup> Water-extracted maca is a desirable hygroscopic material, probably because it exhibits relatively good hygroscopic properties under conditions of varying humidity and has high moisture retention capacity even in dry silica gel desiccators.<sup>[34]</sup> Interestingly, a water extract of *L. meyenii* inhibited tyrosinase, a key enzyme in the production of the skin pigment melanin, with an IC<sub>50</sub> of 150  $\mu$ g/ml.<sup>[35]</sup>

### COMMERCIAL PREPARATIONS AND STANDARDIZATION

A wide array of commercial products, including soft drinks, pills, and capsules, are currently processed and distributed by various companies throughout the world. These products are sold in markets and drug stores in South America, including Peru, and many of these are exported abroad. Today, maca is advertised as an aphrodisiac, stamina builder, and fertility promoter in the world market and is available for purchase through the World Wide Web as a dietary supplement.

Ganzer et al.<sup>[36]</sup> have reported an analytical method for the determination of the main macamides and macaenes of *L. meyenii*. The analysis of several commercially available maca products reveals a similar qualitative pattern for macamides and macaenes, but significant differences in the quantitative composition. The purified standardized product of maca has been analyzed by HPLC,<sup>[11]</sup> and three new macamides and 17 other analogs of macamide and macaene have been reported. Several products (such as pills, capsules, flour, liquor, tonic, and mayonnaise) derived from processed maca (*L. peruvianum*) have also been analyzed and profiled by HPLC for glucosinolate content.<sup>[14]</sup>

### CONCLUSIONS

Maca has been established as a nutritionally valuable food and food supplement through decades of research. The commercial activity of maca has grown explosively with the passing of the Dietary Supplement Health and Education Act (DSHEA) in 1994. As with other herbal dietary products, quality, safety, and efficacy have been the critical concern for the consumer and industry. Furthermore, the rapid expansion of demand and diversity of products has created critical problems, as the scientific base of the industry has failed to keep pace. Further studies are required for the accurate authentication of raw plant material, including *L. meyenii* (maca), prior to commercial use. The quality of the tuberous root may depend upon

the cultivation of maca using good agricultural practice. This include selection of maca-specific habitat areas (typically highlands), soil and climatic conditions, seed stock, and correct storage of tubers. The presence of herbicides, pesticides, and heavy metal residues needs to be analyzed during the quality control of raw material to insure the safety of the products. Secondly, extraction, preparation, and standardization of commercial maca products should be carried out using validated analytical methods, including the chemical profiling of marker compounds.<sup>[36]</sup> The secondary metabolites of maca, including alkaloids, glucosinolates, macamides, and sterols, are just some of the marker constituents that may provide desirable nutritional, biological, and therapeutic (such as fertility-enhancing, aphrodisiac, and chemopreventive) leads. Future research efforts should be directed toward the isolation of the active constituents and the study of their mechanisms of action. Finally, more clinical studies should be directed to ensure safety, including from side effects and toxicity, and efficacy.

#### ACKNOWLEDGMENTS

We are indebted to Dr. Hala ElSohly and Dr. D. Chuck Dunbar, NCNPR, School of Pharmacy, University of Mississippi, for critical reading of the manuscript, and to Dr. Vaishali C. Joshi for assistance in preparing the graphic of maca tuber and editorial assistance on its morphological description. This work was supported in part by the USDA Agricultural Research Service Specific Cooperative Agreement No. 58-6408-2-0009.

#### REFERENCES

- Thellung, A. Die Gattung *Lepidium* (L.) R. Br. Eine monographische Studie. *Allgem. Schweiz. Naturforsch. Ges.* **1906**, *41*, 1–340.
- Mummenhoff, K.; Hurka, H.; Bandelt, H.J. Systematics of Australian *Lepidium* species (Brassicaceae) and implications of their origin: evidence from IEF analysis of Rubisco. *Plant Syst. Evol.* **1992**, *183*, 99–112.
- Maca. In *Guide to Popular Natural Products*; DerMarderosian, A., Ed.; Fact and Comparison, a Wolters Kluwer Company: St. Louis, 2001; 157–158.
- Quiros, C.F.; Cardenas, R.A. Maca (*Lepidium meyenii* Walp.). In *Andean Roots and Tubers: Ahipa, Arracacha, Maca and Yacon*; Hermann, M., Heller, J., Eds.; International Plant Genetic Resources Institute: Rome, 1997; 173–198.

- <http://www.cfsn.com/maca.html> (accessed August 2003).
- Toledo, J.; Dehal, P.; Jarrin, F.; Hu, J.; Hermann, M.; Al-Shehbaz, I.; Quiros, C.F. Genetic variability of *Lepidium meyenii* and other Andean *Lepidium* species (Brassicaceae) assessed by molecular markers. *Ann. Botany (Lond.)* **1998**, *82* (4), 523–530.
- Chacon, G. La maca (*Lepidium peruvianum* Chacon sp. nov.) y su hábitat. *Rev. Peru. Biol.* **1990**, *3*, 171–272.
- Rea, J. Raices andinas: maca. In *In Cultivos Marginados, Otra Perspectiva de 1492*; Hernandez Bermejo, J.E., Leon, J.E., Eds.; FAO: Rome, 1992; 163–166.
- Dini, A.; Migliuolo, G.; Rastrelli, L.; Saturnino, P.; Schettino, O. Chemical composition of *L. meyenii*. *Food Chem.* **1994**, *49* (4), 347–349.
- Comas, M.; Miquel, X.; Arias, G.; de la Torre, M.C. Bromatological studies on *Lepidium meyenii*. *Alimentaria* **1997**, *286*, 85–90.
- Zheng, B.L.; He, K.; Kim, C.H.; Rogers, L.; Shao, Y.; Huang, Z.Y.; Lu, Y.; Yan, S.J.; Qien, L.C.; Zheng, Q.Y. Effect of a lipidic extract from *Lepidium meyenii* on sexual behavior in mice and rats. *Urology* **2000**, *55* (4), 598–602.
- Muhammad, I.; Zhao, J.; Dunbar, D.C.; Khan, I.A. Constituents of *Lepidium meyenii* (maca). *Phytochemistry* **2002**, *59* (1), 105–110.
- Canales, M.; Aguilar, J.; Prada, A.; Marcelo, A.; Huaman, C.; Carbajal, L. Nutritional evaluation of *L. meyenii* (maca) in albino mice and their descendants. *Arch. Latinoam. Nutr.* **2000**, *50* (2), 126–133.
- Li, G.; Ammermann, U.; Quiros, C.F. Glucosinolate contents in maca (*Lepidium peruvianum* Chacon) seeds, sprouts, mature plants and several derived commercial products. *Econ. Bot.* **2000**, *55* (2), 255–262.
- Tellez, M.R.; Khan, I.A.; Kobaisy, M.; Schrader, K.K.; Dayan, F.E.; Osbrink, W. Composition of the essential oil of *Lepidium meyenii* Walp. *Phytochemistry* **2002**, *61* (2), 149–155.
- Dini, I.; Tenore, G.C.; Dini, A. Glucosinolates from maca (*Lepidium meyenii*). *Biochem. Syst. Ecol.* **2002**, *30* (11), 1087–1090.
- Piacente, S.; Carbone, V.; Plaza, A.; Zampelli, A.; Pizza, C. Investigation of the tuber constituents of maca (*Lepidium meyenii* Walp.). *J. Agric. Food Chem.* **2002**, *50* (20), 5621–5625.
- Cui, B.; Zheng, B.L.; He, K.; Zheng, Q.Y. Imidazole alkaloids from *Lepidium meyenii*. *J. Nat. Prod.* **2003**, *66* (8), 1101–1103.
- Gonzales, G.F.; Cordova, A.; Vega, K.; Chung, A.; Villena, A.; Gonez, C. Effect of *Lepidium meyenii* (maca), a root with

- aphrodisiac and fertility-enhancing properties on serum reproductive hormone levels in adult healthy men. *J. Endocrinol.* **2003**, *176* (1), 163–168.
20. Gonzales, G.F.; Cordova, A.; Gonzales, C.; Chung, A.; Vega, K.; Villena, A. *Lepidium meyenii* (maca) improved semen parameters in adult men. *Asian J. Androl.* **2001**, *3* (4), 301–303.
  21. Gonzales, G.F.; Cordova, A.; Vega, K.; Chung, A.; Villena, A.; Gonez, C.; Castillo, S. Effect of *Lepidium meyenii* (MACA) on sexual desire and its absent relationship with serum testosterone levels in adult healthy men. *Andrologia* **2002**, *34* (6), 367–372.
  22. Cicero, A.F.; Piacente, S.; Plaza, A.; Sala, E.; Arletti, R.; Pizza, C. Hexanic Maca extract improves rat sexual performance more effectively than methanolic and chloroformic maca extracts. *Andrologia* **2002**, *34* (3), 177–179.
  23. Cicero, A.F.; Bandieri, E.; Arletti, R. *Lepidium meyenii* Walp. improves sexual behaviour in male rats independently from its action on spontaneous locomotor activity. *J. Ethnopharmacol.* **2001**, *75* (2–3), 225–229.
  24. Gonzales, G.F.; Ruiz, A.; Gonzales, C.; Villegas, L.; Cordova, A. Effect of *Lepidium meyenii* (maca) roots on spermatogenesis of male rats. *Asian J. Androl.* **2001**, *3* (3), 231–233.
  25. Haygood, D.P. Composition and method for improving sexual desire and overall sexual vitality. PCT International Application, July 2003.
  26. Zheng, B.L.; He, K.; Hwang, Z.Y.; Lu, Y.; Yan, S.J.; Kim, C.H.; Zheng, Q.Y. Effect of aqueous extract from *Lepidium meyenii* on mouse behavior in forced swimming test. In *Quality Management of Nutraceuticals*; ACS Symposium Series, American Chemical Society, 2002; Vol. 803, 258–268.
  27. Johns, T. The anu and maca. *J. Ethnobiol.* **1981**, *1*, 208–212.
  28. Farnham, M.W.; Stephenson, K.; Fathey, J.W. Capacity of broccoli to induce a mammalian chemoprotective enzyme varies among inbred lines. *J. Am. Soc. Hortic. Sci.* **2000**, *125*, 482–488.
  29. Gross, H.B.; Dalebout, T.; Grubb, C.D.; Abel, S. Functional detection of chemopreventive glucosinolates in *Arabidopsis thaliana*. *Plant Sci.* **2000**, *159*, 265–272.
  30. Watterberg, L.W. Inhibition of carcinogen induced neoplasia by sodium cyanate, *tert*-butyl isocyanate, and benzyl isothiocyanate administered subsequent to carcinogen exposure. *Cancer Res.* **1981**, *41*, 2991–2994.
  31. Sugie, S.; Okumura, A.; Yoshimi, N.; Guo, J.; Tanaka, T.; Mori, H. Inhibitory effects of benzyl thiocyanate (BTC) and benzyl isothiocyanate (BITC) on diethylnitrosamine (DEN)-induced hepatocarcinogenesis in rats. *Proc. Am. Assoc. Cancer Res.* **1992**, *33*, 160.
  32. Sandoval, M.; Okuhama, N.N.; Angeles, F.M.; Melchor, V.V.; Condezo, L.A.; Lao, J.; Miller, M.J. Antioxidant activity of the cruciferous vegetable maca (*Lepidium meyenii*). *Food Chem.* **2002**, *79* (2), 207–213.
  33. Arita, J.; Hirao, K. Cosmetic Compositions Containing Papain-Treated Papaya and Maca Powders. Japanese Patent 2,003,155,213, May, 2003.
  34. Hiroshi, S.; Ikukatsu, S.; Yoshihiko, F. Studies on hygroscopic abilities of the water-extracted maca. *Kiyo—Suzuka Kogyo Koto Senmon Gakko* **2003**, *36*, 131–134.
  35. Mitsuma, T.; Hirao, K. Skin-Lightening, Rough Skin-Treating, and Moisturizing Cosmetics Containing Extract of *Lepidium* Plant (Cruciferae), Japanese Patent 2,001,039,854, February, 2001.
  36. Ganzera, M.; Zhao, J.; Muhammad, I.; Khan, I.A. Chemical profiling and standardization of *Lepidium meyenii* (maca) by reversed phase high performance liquid chromatography. *Chem. Pharmac. Bull.* **2002**, *50* (7), 988–991.

#### ADDITIONAL READINGS

- [http://mobot.mobot.org/cgi-bin/search\\_vast](http://mobot.mobot.org/cgi-bin/search_vast) (accessed August 2003).
- Leon, J. The “maca” (*Lepidium meyenii*), a little-known food plant of Peru. *Econ. Bot.* **1964**, *18* (2), 122–127.
- Facciola, S. *Cornucopia—A Source Book of Edible Plants*; Kampong Publications, 1990, ISBN 0-9628087-0-9.
- National Research Council. *Lost Crops of the Incas: Little-Known Plants of the Andes with Promise for Worldwide Cultivation*, Report of an Ad Hoc Panel of the Advisory Committee on Technical Innovation, Board on Science and Technology for International Development; National Academy Press: Washington, DC, 1989.
- Castro de Leon, M. Un cultivo Andino en extinción: el caso de la maca. *Pero Indig.* **1990**, *12*, 85–94.
- <http://www.rain-tree.com/macac.htm> (accessed August 2003).
- <http://www.herbmed.org/Herbs/Herb51.htm> (accessed October 2004).
- Valentová, K.; Ulrichová, J. *Smilax* and *Lepidium meyenii*—prospective andean crops for the prevention of chronic diseases. *Biomed. Papers* **2003**, *147*, 119–130.



# Magnesium

**Robert K. Rude**

*University of Southern California, Los Angeles, California, U.S.A.*

## INTRODUCTION

Magnesium (Mg) is an essential nutrient and is vital for numerous biological processes. This entry reviews the biochemistry, physiology, and homeostasis of Mg. Dietary intake and requirements as well as current recommendations are discussed. Causes of and risk factors for the element's deficiency are reviewed along with the clinical manifestations of moderate-to-severe depletion. Possible complications of deficiency such as hypertension, cardiovascular disease, and osteoporosis when dietary Mg intake falls below the recommended daily allowance (RDA) are discussed.

## BIOCHEMISTRY AND PHYSIOLOGY

Magnesium is the fourth most abundant cation in the body and the second most prevalent intracellular cation. Most intracellular Mg binds to ribosomes, membranes, and other macromolecules in the cytosol and nucleus.<sup>[1]</sup> The nutrient provides specific structure and catalytic activity for enzymes.

## Enzyme Interactions

Magnesium is involved in more than 300 vital metabolic reactions.<sup>[2]</sup> Essential for many enzymatic reactions, magnesium has two general interactions: a) It binds to substrate, thereby forming a complex with which the enzyme interacts, as in the reaction of kinases with MgATP; and b) It binds directly to the enzyme and alters its structure and/or serves a catalytic role. Overall, the predominant action of the nutrient is related to utilization of adenosine triphosphate (ATP), which provides high-energy phosphate and exists in all cells primarily as MgATP. Thus, it is imperative for the function of the glycolytic cycle, citric acid cycle, protein kinases, RNA and DNA polymerases, lipid metabolism, and amino acid activation,

besides playing a critical role in the cyclic adenosine monophosphate and phospholipase C second messenger systems.

## Structural Modification of Nucleic Acids and Membranes

Another important role of Mg is its ability to form complexes with nucleic acids. The negatively charged ribose phosphate structure of nucleic acids has a high affinity for Mg. The resulting stabilization of numerous ribonucleotides and deoxyribonucleotides induces important physicochemical changes, which affect DNA maintenance, duplication, and transcription.<sup>[2]</sup> Magnesium, calcium (Ca), and some other cations react with hydrophilic polyanionic carboxylates and phosphates of the membrane components to stabilize the membrane, thereby affecting fluidity and permeability, which influences ion channels, transporters, and signal transducers.

## Ion Channels

Ion channels constitute a class of proteins in the cell membrane, which allow passage of ions into or out of cells when the channels are open. They are classified according to the type of ion they allow to pass, such as sodium (Na), potassium (K), or Ca.<sup>[3]</sup> Magnesium plays an important role in the function of a number of such channels. A deficit of Mg results in cellular K depletion.<sup>[4]</sup> Magnesium is necessary for the active transport of K out of cells by Na, K-ATPase. Another mechanism for the K loss is its increased efflux from cells via other Mg-sensitive K channels, as has been seen in skeletal muscle and in heart muscle. Therefore, a deficiency in the nutrient leads to diminution of intracellular K. The arrhythmogenic effect of Mg deficiency, as discussed below, may be related to its effect on maintenance of intracellular K.

Magnesium has been called nature's physiological Ca channel blocker.<sup>[3]</sup> During Mg depletion, intracellular Ca rises. This may be due to both an increase from extracellular Ca and release from intracellular Ca stores. Magnesium decreases the inward Ca flux through slow Ca channels. In addition, it decreases Ca transport out of the sarcoplasmic reticulum into the cell cytosol.

---

*Robert K. Rude, M.D., is Professor at the Department of Medicine, University of Southern California, Los Angeles, California, U.S.A.*

There is an inverse ability of inositoltriphosphate to release Ca from intracellular stores in response to changes in Mg concentrations, which would also allow greater rise in intracellular Ca during a fall in the latter.

## BODY COMPOSITION AND HOMEOSTASIS

### Composition

The distribution of Mg in various body compartments of apparently healthy adult individuals is summarized in Table 1. Approximately 50–60% is in the skeleton, of which two-thirds is within the hydration shell and one-third on the crystal surface<sup>[5]</sup> and may serve as a reservoir for maintaining extracellular and intracellular Mg. Except for 1% in the extracellular fluid, the rest is intracellular.

### Cellular Mg Homeostasis

Significant amounts of Mg are found in the nucleus, mitochondria, the endoplasmic and sarcoplasmic reticulum, and the cytoplasm.<sup>[1,6]</sup> Total cell concentration ranges between 5 and 20 mM. In the cytosol, 90–95% is bound to ATP, adenosine diphosphate (ADP), citrate, proteins, and nucleic acids. The remainder is free, constituting 1–5% of the total cellular Mg. The concentration of free ionized form in the cytoplasm is 0.2–1.0 mM. Concentration in the cytoplasm is maintained relatively constant due to limited permeability of the plasma membrane to Mg and to the operation of Mg transport systems. Transport into or out of cells requires the presence of carrier-mediated transport systems. Efflux of Mg from the cell is coupled to Na transport and requires extrusion of sodium by Na, K-ATPase. There is also evidence for a Na-independent efflux of Mg. Influx is linked to Na transport, but by

a mechanism other than efflux. The molecular characteristics of Mg transport proteins have not been described. Studies in prokaryotes, however, have identified four separate transport proteins.

The processes that maintain or modify the relationships between total and ionized internal and external Mg are incompletely understood. Its transport is influenced by hormonal and pharmacological factors. Magnesium efflux is stimulated by  $\alpha$ - and  $\beta$ -agonists and permeant cAMP in heart, liver, and thymocytes. Activation of protein kinase C by diacyl glycerol or by phorbol esters stimulates influx but not efflux. Epidermal growth factor has been shown to increase transport into a vascular smooth muscle cell line. Insulin and dextrose increase Mg uptake in a number of tissues, including skeletal and cardiac muscle. The mechanism of insulin-induced Mg transport is likely due to an effect on protein kinase C. It is hypothesized that this hormonally regulated uptake system controls intracellular Mg concentration in cellular subcytoplasmic compartments. Its concentration in these compartments would then serve to regulate the activity of Mg-sensitive enzymes.

## BODY HOMEOSTASIS

Homeostasis of the individual with respect to a mineral depends on the amounts ingested, the efficiency of intestinal and renal absorption and excretion, and all other factors affecting them. A schema for Mg balance is given in Fig. 1.

### Dietary Intake

Magnesium is widely distributed in plant and animal sources but in differing concentrations. In terms of major food sources,<sup>[7]</sup> vegetables, fruits, grains, and animal products account for approximately 16% each; dairy products contribute 20% in adolescents and 10% beyond the third decade. The 1994 U.S. Department of Agriculture Continuing Survey of Food Intakes by Individuals (CSFII) indicated that the mean daily intake was 323 mg in males and 228 mg in females, which was similar to that reported in the Third National Health and Nutrition Examination Survey (NHANES III). These values fall below the current RDA recommendation of approximately 420 mg for males and 320 mg for females.<sup>[8]</sup> It has been suggested that 75% of subjects in the United States have dietary Mg intake that is below the recommended one.

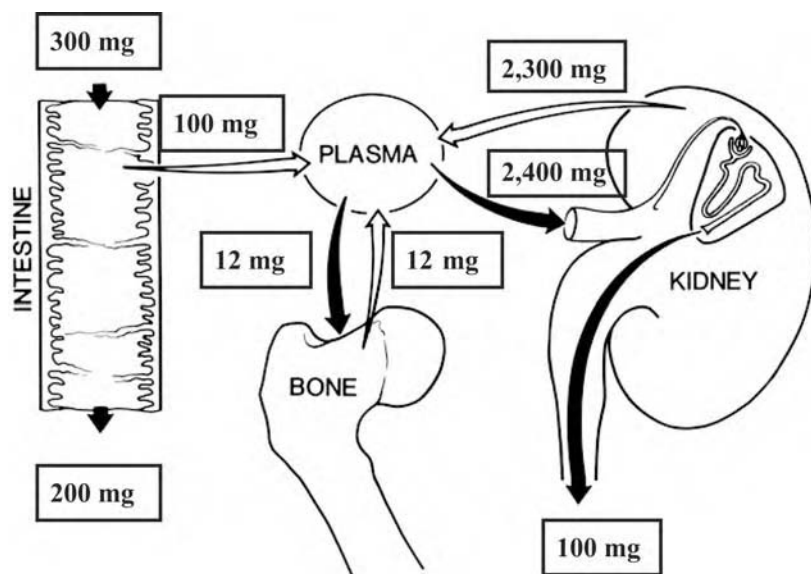
### Intestinal Absorption

In humans, the primary sites of intestinal Mg absorption are the jejunum and ileum.<sup>[9]</sup> With a normal dietary

**Table 1** Distribution and concentrations of magnesium (Mg) in a healthy adult (total body: 833–1170 mmol, or 20–28 g)

Site	Percentage of total body Mg	Concentration/content
Bone	53	0.5% of bone ash
Muscle	27	9 mmol/kg wet weight
Soft tissue	19	9 mmol/kg wet weight
Adipose tissue	0.012	0.8 mmol/kg wet weight
Erythrocytes	0.5	1.65–2.73 mmol/L
Serum	0.3	0.88 $\pm$ 0.06 mmol/L
Mononuclear		2.91 $\pm$ 0.6 fmol/cell
Platelets		2.26 $\pm$ 0.29 mmol/L

1 mmol = 2 mEq = 24.3 mg.



**Fig. 1** Magnesium homeostasis in humans. A schematic representation of magnesium metabolism indicating a) its absorption from the alimentary tract, b) its distribution into bone, and c) its dependence on the kidney for excretion. Homeostasis depends upon the integrity of intestinal and renal absorptive processes.

Mg intake, 30–40% is absorbed. There exist both a passive paracellular mechanism and an active transport process for Mg absorption. The former is dependent on transcellular potential difference generated by sodium transport and accounts for about 90% of intestinal Mg absorption. A Mg-specific transport protein/channel, which is not yet well defined, accounts for the remainder of absorption.<sup>[10]</sup> Net absorption increases with increasing intake. However, fractional Mg absorption falls. Absorption fell progressively from approximately 65% with an intake of 36 mg down to 14% for 1000 mg consumption.<sup>[11]</sup>

No hormone or factor has been described that regulates intestinal Mg absorption, although vitamin D and its metabolites may increase this activity.<sup>[9]</sup> 1,25(OH)<sub>2</sub>-vitamin D enhances intestinal absorption of both Ca and Mg in normal human subjects and patients with chronic renal failure. In balance studies, vitamin D accelerated intestinal Mg absorption but much less than Ca, and mean Mg balance was not affected. In contrast to Ca, there is no significant correlation between serum 1,25(OH)<sub>2</sub>-vitamin D and Mg absorption.

### Bioavailability: Influence of Other Dietary Factors

Absorption of ingested Mg is influenced by its dietary concentration as well as dietary components inhibiting or promoting its absorption.<sup>[8]</sup> Studies in healthy individuals, for the most part, indicate that increasing oral Ca intake does not significantly affect Mg absorption or retention. On the other hand, increased dietary Mg has been associated with either decreased Ca absorption or no effect. High levels of dietary phosphate are reported to impair Mg absorption in some

but not all studies. Increased dietary Mg decreases phosphate absorption, perhaps secondary to formation of insoluble Mg phosphate. A rise in intake of dietary fiber reduces Mg utilization in humans, presumably by decreasing absorption. High dietary zinc intake lessens Mg absorption and balance, while vitamin B<sub>6</sub> depletion was associated with negative Mg balance. The presence of excessive amounts of free fatty acids and oxalate may also impair Mg absorption.

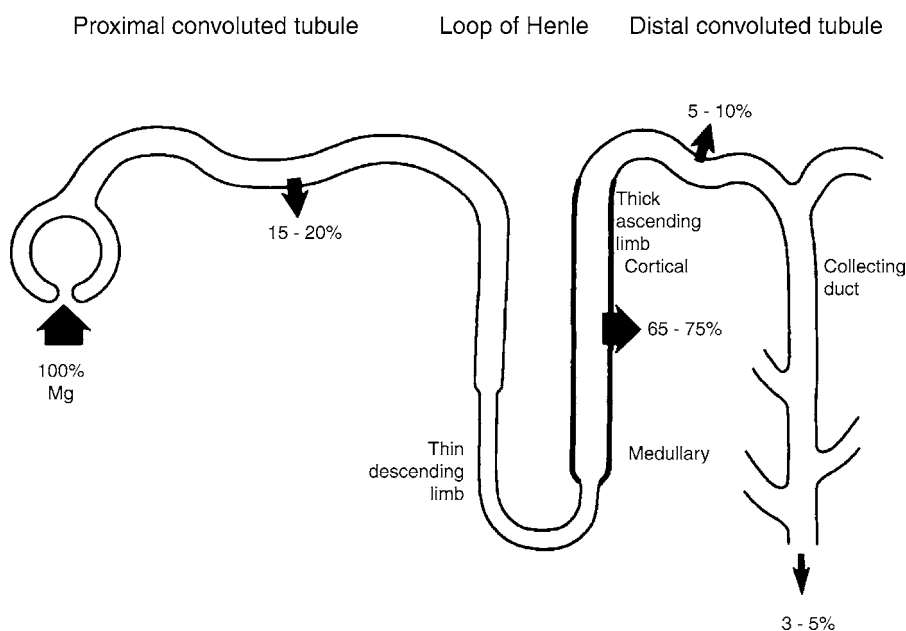
### Bioavailability of Mg Salts

Many salts of Mg are available as oral dietary supplements including oxide, hydroxide, citrate, chloride, gluconate, lactate, aspartate, aspartate hydrochloride, and glycinate. The fractional absorption of a salt depends on its solubility in intestinal fluids and the amounts ingested.<sup>[11]</sup> Absorption of enteric-coated Mg chloride is 67% less than that of the acetate in gelatin capsules. Magnesium citrate has higher solubility than the oxide form. In humans, the former was observed to have better absorption than the latter in one study.<sup>[11]</sup> Little difference in absorption has been demonstrated among other salts however.

### Renal Mg Regulation

The kidney is the critical organ regulating Mg homeostasis, which involves a filtration/reabsorption process.<sup>[12]</sup> About 2400 mg of Mg is normally filtered daily through the glomeruli in the healthy adult. Of this, only about 5% is excreted in the urine. The fractional absorption of the filtered load in the various segments of the nephron is summarized in Fig. 2. Approximately 15–20% of the filtered Mg is





**Fig. 2** Fractional segmental reabsorption of filtered Mg in the nephron. The percentage absorption of filtered Mg has been determined by micropuncture techniques in various laboratory animals as the Mg proceeds through the nephron. Approximately 15–20% of the Mg is reabsorbed in the proximal convoluted tubule. The major site for Mg reabsorption is the thick ascending limb of the loop of Henle, primarily in its cortical portion. Here, 65–75% of Mg leaves the lumen. In the distal convoluted tubule, 5–10% of Mg is reabsorbed. (From Cole, D.E.C.; Quamme, G.A. *J. Am. Soc. Nephrol.* **2000**, *11*, 1937–1947, with permission.)

reabsorbed in the proximal convoluted tubule, presumably by a paracellular mechanism. The majority (65–75%) is reclaimed in the cortical thick ascending limb of Henle. The mechanism also appears to be paracellular transport. A recently described gene, paracellin-1, has been shown to encode for a protein thought to mediate Mg transport at this site. The distal convoluted tubule reabsorbs 5–10% of filtered Mg via an active transcellular pathway.

No hormone or factor has been described that regulates renal Mg homeostasis. Micropuncture studies in rodents show that vasopressin, glucagon, calcitonin, and parathyroid hormone (PTH), when added to segments of the cortical thick ascending limb of loop of Henle and/or the distal convoluted tubule, significantly increased Mg absorption.<sup>[12]</sup> The physiological significance of these observations, however, is unclear.

A number of conditions affect absorption, principally in the ascending thick limb. Inhibition occurs with hypermagnesemia and hypercalcemia.<sup>[12]</sup> This is thought to occur because these cations bind to a calcium-sensitive receptor on the basolateral aspect of these tubular cells and decrease transepithelial voltage, thereby decreasing paracellular absorption of both Mg and Ca. Decreased Mg intake in experimental animals and humans rapidly reduces Mg excretion, even before plasma Mg levels fall below the normal range, suggesting an adaptation of the kidney to Mg insufficiency.

### Tissue Sources

Extracellular, intracellular, and bone Mg fall during depletion. Bone may serve as an important reservoir

for Mg, as human iliac crest content fell an average of 18% with depletion.<sup>[5]</sup>

## MAGNESIUM REQUIREMENTS

### Assessment

For healthy older children, adolescents, and adults, the primary approach for assessing dietary Mg requirement has been the dietary balance study. For infants and young children, figures are based on estimates of intakes through milk and other foods that allow good development. Such data have been transmuted into the dietary reference intakes (DRI) in the United States.<sup>[8]</sup> The U.S. reference intakes are given in Table 2. These are estimates that meet the needs of 97–98% of healthy individuals.

The balance study poses some problems. Laboratory analysis of foods revealed a Mg content 115–124% greater than those calculated by tables of food composition.<sup>[13]</sup> A critique of previous RDA for Mg noted that most published balance data often did not meet the criteria for acceptable methodology.<sup>[13]</sup> The balance studies were usually short term, done mostly in adolescents and younger adults, and data presented for pregnant women were less than adequate. Published information about the elderly was meager. The need was pointed out for improved definition of acceptable standards. While the database of the 1997 reference values (Table 2) has eliminated the poorer experiments, a question remains as to the accuracy of many balance studies in terms of adherence to acceptable methodology.

**Table 2** Recommendations for daily intakes of Mg (mg)

Age (yr)	Male	Female
0–0.5	30	30
0.5–1.0	75	75
1–3	80	80
4–8	130	130
9–13	240	240
14–18	410	360
19–30	400	310
31–50	420	320
51–70	420	320
>70	420	320
<i>Pregnancy</i>		
<18		400
19–30		350
31–50		360
<i>Lactation</i>		
<18		360
19–30		310
31–50		320

### Dietary Intake

Estimates of Mg intakes in NHANES III (1988–1991) indicated that children 2–11 yr grouped by gender, age, and race/ethnicity had median intakes well above their RDA. Those aged 1–5 yr in the lower fifth percentile took in about 90% of the recommendation. On the other hand, males and females from 12 to more than 60 yr, grouped by race and ethnicity, with the exception of non-Hispanic white males, had low median intakes. The Third Report on Nutrition Monitoring in the United States (1995) analyzed intake in relation to the RDA for age and gender. It concluded that Mg presents a potential public health issue requiring further study. One reason given was that the medium intakes from food were lower than the RDA in various population groups. Other than for balance study, assessment of status at various dietary Mg intakes has not been performed. It is, therefore, not possible to accurately estimate what level of intake would place one at risk for a Mg-deficiency-associated problem.

## ASSESSING Mg STATUS

### Analytic Procedures

As Mg is mostly within cells or in bone, assessment of its status is most difficult. A number of laboratory techniques are utilized in clinical and research investigations. Atomic absorption spectrophotometry has been widely used to determine Mg content/concentration. This is the reference method as it

provides greatest accuracy and precision,<sup>[14]</sup> although a number of metallochromic indicators and dyes are commonly used in automated methods. Ion-selective electrodes (ISE) can measure ionized Mg in serum, plasma, and whole blood. Ca and lipophilic cations interfere with determination of ionized Mg however. Literature indicates that ISE from various manufacturers differ in accuracy from each other and from atomic adsorption spectrophotometry (AAS) and may give misleading results in sera with low Mg concentrations.

Other techniques to assess intracellular Mg concentration include nuclear magnetic resonance spectroscopy and fluorescent indicators.<sup>[14]</sup> These methods are research tools. Magnesium isotopes have been used as biologic tracers to follow the absorption, distribution, and excretion of the ion. The radioisotope <sup>28</sup>Mg has been used in human studies. Its value is limited by its radioactivity, its short half-life of 21.3 hr, and its short supply.

### Assessment Tests

Total serum Mg is the only readily available test for clinicians to assess the nutrient's status. Hypomagnesemia is frequently seen in Mg deficiency. However, normal serum levels have been reported in some cases despite low intracellular values. Consequently, total serum Mg values in such situations may not be reliable indicators of depletion. The level of serum ionized Mg may be more relevant under certain circumstances than that of the total one. As discussed earlier, there exist intermethod differences for ionized Mg, and therefore reference ranges must be present for each analyzer and may not be comparable to those of a different manufacturer.

Erythrocyte and blood mononuclear cell Mg content have been measured in cases of deficiency and suggest that these measurements are more accurate than the serum Mg in assessing Mg status. These are not commercially available.

Assessing urine may be useful, as a reduction in dietary Mg results in a rapid decrease in urinary Mg. Low urine Mg would not indicate whether the dietary Mg deficits were acute or chronic or if Mg depletion exists however. In situations in which renal Mg wasting occurs, the resulting hypomagnesemia is associated with excessive urinary Mg excretion (>1 mmol/day). Such a relationship would suggest renal tubular dysfunction as the cause of the hypomagnesemia.

The intravenous Mg retention test provides an estimate of the proportion of infused Mg that is retained over a given period. Persons retaining more than the percentage retained by Mg-replete individuals (e.g., 20–25%) are considered to have some body depletion. A suggested clinical protocol that has been

tested in hypomagnesemic patients, chronic alcoholics, and normal controls has been published.<sup>[15]</sup> It is an invasive, time-consuming, nonstandardized, and expensive test, requiring hospitalization or other close supervision for the partial or full 24 hr after infusion, with careful urine collection for laboratory analysis.

## RISK FACTORS/CAUSES OF DEFICIENCY

### Prevalence

The many risk factors for Mg depletion (Table 3) suggest that this condition may not be a rare occurrence. Up to 11% of hospitalized patients having routine Mg determinations are hypomagnesemic.<sup>[16]</sup> The true prevalence of the condition is not known because this ion is not included in routine electrolyte testing in many clinics or hospitals. Similar high rates have been reported in studies of intensive care unit (ICU) patients.

### Gastrointestinal Disorders

Gastrointestinal disorders (Table 3) may lead to Mg depletion.<sup>[16]</sup> As its content of upper intestinal tract

**Table 3** Causes of Mg deficiency

- 
- |    |  |
|----|--|
| 1. | Gastrointestinal disorders                     |
| a. | Prolonged nasogastric suction/vomiting         |
| b. | Acute and chronic diarrhea                     |
| c. | Intestinal and biliary fistulas                |
| d. | Malabsorption syndromes                        |
| e. | Extensive bowel resection or bypass            |
| f. | Acute hemorrhagic pancreatitis                 |
| g. | Primary intestinal hypomagnesemia              |
| 2. | Renal loss                                     |
| a. | Chronic parenteral fluid therapy               |
| b. | Osmotic diuresis (glucose, urea, and mannitol) |
| c. | Hypercalcemia                                  |
| d. | Alcohol  |
| e. | Diuretics (e.g., furosemide)                   |
| f. | Aminoglycosides                                |
| g. | Cisplatin                                      |
| h. | Cyclosporin                                    |
| i. | Amphotericin B                                 |
| j. | Pentamidine                                    |
| k. | Tacrolimus                                     |
| l. | Primary renal hypomagnesemia                   |
| 3. | Endocrine and metabolic disorders              |
| a. | Diabetes mellitus (glycosuria)                 |
| b. | Phosphate depletion                            |
| c. | Primary hyperparathyroidism                    |
| d. | Hypoparathyroidism                             |
| e. | Primary aldosteronism                          |
| f. | Hungry bone syndrome                           |
| g. | Excessive lactation                            |
- 

fluids is approximately 1 mEq/L, vomiting and nasogastric suction may cause depletion. The Mg content of diarrheal fluids and fistulous drainage is much higher (up to 15 mEq/L), and consequently, depletion is common in acute and chronic diarrhea, regional enteritis, ulcerative colitis, and intestinal and biliary fistulas. Malabsorption syndromes may also result in this deficiency. Steatorrhea and resection or bypass of the small bowel, particularly the ileum, often results in intestinal Mg loss or malabsorption. Acute severe pancreatitis is associated with hypomagnesemia, which may be due to the clinical problem causing the pancreatitis, such as alcoholism, or to saponification of Mg in necrotic parapancreatic fat. A defect in intestinal Mg absorption, presenting early in life with hypomagnesemia, hypocalcemia, and seizures, is an autosomal recessive disorder linked to chromosome 9q22. This disorder appears to be caused by mutations in TRPM6, which expresses a protein involved with active intestinal Mg transport.<sup>[10]</sup>

### Renal Disorders

Excessive excretion of Mg into the urine may cause depletion of the nutrient (Table 3).<sup>[12,17]</sup> Renal Mg reabsorption is proportional to tubular fluid flow and Na and Ca excretion. Therefore, chronic parenteral fluid therapy, particularly with saline, and volume expansion states such as primary aldosteronism and hypercalcemic states may result in depletion. Hypercalcemia has been shown to decrease renal Mg reabsorption, probably mediated by Ca binding to the Ca-sensing receptor in the thick ascending limb of Henle and decreasing transepithelial voltage. Osmotic diuresis due to glucosuria will result in urinary Mg wasting.

Many pharmaceutical drugs cause renal Mg wasting and depletion. Diuretics such as furosemide result in wasting. Aminoglycosides have been shown to induce renal lesions that result in hypermagnesuria and hypomagnesemia. Amphotericin B, cisplatin, cyclosporin, tacrolimus, and pentamidine therapy has been reported to show a similar effect. As blood alcohol rises, hypermagnesuria develops and is one factor contributing to Mg depletion in chronic alcoholism. Hypomagnesemia may accompany a number of other disorders including metabolic acidosis, phosphate depletion, and the hungry bone syndrome.<sup>[16]</sup>

Several genetic renal Mg wasting disease have been described. One autosomal recessive form results from mutations in the paracellin-1 gene on chromosome 3. This is characterized by low serum Mg as well as hypercalcemia and nephrocalcinosis. Another autosomal dominant form of isolated renal Mg wasting and hypomagnesemia has been linked to chromosome

11q23 and has been identified as a mutation on the Na<sup>+</sup>, K<sup>+</sup>-ATPase  $\gamma$ -subunit of gene FXYD2. Gitelman's syndrome (familial hypokalemia–hypomagnesemia syndrome) is an autosomal recessive disorder due to a genetic defect of the thiazide-sensitive NaCl cotransporter gene on chromosome 12.

### Diabetes Mellitus

Diabetes mellitus is the most common disease associated with Mg deficiency.<sup>[18]</sup> The mechanism is thought to be due to renal Mg wasting secondary to osmotic diuresis generated by hyperglycosuria. Dietary Mg intake also falls below the RDA in diabetics. Deficiency of this nutrient has been reported to result in impaired insulin secretion as well as insulin resistance.<sup>[19,20]</sup> The mechanism is unclear but may be due to abnormal glucose metabolism, a decrease in tyrosine kinase activity at the insulin receptor, and impaired insulin secretion by the beta cells. Diabetics given Mg therapy appear to have improved diabetes control. Recently, two studies have reported that the incidence of type 2 diabetes is significantly greater in people on a low Mg diet.<sup>[19,20]</sup> Magnesium status should therefore be assessed in patients with diabetes mellitus.

### CLINICAL PRESENTATION OF DEFICIENCY

As Mg plays an essential role in a wide range of fundamental biologic reactions, it is not surprising that its deficiency may lead to serious clinical symptoms.<sup>[16]</sup> Indications and signs of deficiency are given in Table 4. Since deficiency occurs in a number of disease states, the clinical presentation of Mg deficiency may coexist or be masked by the signs and symptoms of the primary disorder.

#### Moderate-to-Severe Deficiency

When Mg deficiency is recognized in the clinical setting, it is usually of moderate-to-severe depletion. Biochemical, neuromuscular, and cardiac complications are the most prevalent findings in the Mg-deficient patient.

#### Hypocalcemia

Calcium is the major regulator of PTH secretion. Magnesium modulates PTH secretion via the Ca-sensing receptor in a manner similar to Ca.<sup>[21]</sup> Magnesium deficiency, however, perturbs Ca homeostasis.<sup>[21]</sup> When it becomes moderate to severe, symptomatic hypocalcemia develops. Impaired PTH secretion is suggested as most patients with hypocalcemia have low

**Table 4** Manifestations of Mg depletion

I. Bone and mineral metabolism
A. Hypocalcemia
1. Impaired PTH secretion
2. Renal and skeletal resistance to PTH
3. Resistance to vitamin D
B. Osteoporosis (putative)
II. Neuromuscular
A. Positive Chvostek's and Trousseau's sign
B. Spontaneous carpal–pedal spasm
C. Seizures
D. Vertigo, ataxia, nystagmus, athetoid, and choreiform movements
E. Muscular weakness, tremor, fasciculation, and wasting
F. Psychiatric: depression, psychosis
III. Potassium homeostasis
A. Hypokalemia
1. Renal potassium wasting
2. Decreased intracellular potassium
IV. Cardiovascular
A. Cardiac arrhythmia
1. EKG: prolonged P–R interval and Q–T interval, U waves
2. Atrial tachycardia, premature contractions, and fibrillation
3. Junctional arrhythmias
4. Ventricular premature contractions, tachycardia, fibrillation
5. Sensitivity to digitalis intoxication
6. Torsades de pointes
B. Myocardial ischemia/infarction (putative)
C. Hypertension (putative)
D. Atherosclerotic vascular disease (putative)

or inappropriately normal serum PTH levels. Administration of Mg will result in an immediate rise in the serum PTH. Normal or elevated serum PTH in the face of hypocalcemia in some patients suggests an end-organ resistance to PTH as well. Skeletal and renal resistance to PTH in hypocalcemic Mg-deficient patients has been described.

The mechanism for impaired PTH secretion and action in Mg deficiency remains unclear, although a defect in the second messenger systems is suggested. Adenylate cyclase requires Mg for cyclic AMP generation. The PTH has also been shown to activate the phospholipase C second messenger system. Magnesium depletion could perturb this system, as a Mg-dependent guanine nucleotide regulating protein is involved in activation of phospholipase C, and the nutrient has also been shown to be a noncompetitive inhibitor of IP<sub>3</sub>-induced Ca release.

Magnesium is also important in vitamin D metabolism and/or action.<sup>[21]</sup> Patients with hypocalcemia and Mg deficiency are resistant to vitamin D, 1 $\alpha$ -hydroxyvitamin D, and 1,25(OH)<sub>2</sub>-vitamin D. In addition,

serum concentrations of 1,25(OH)<sub>2</sub>-vitamin D are low or low normal in most hypocalcemic Mg-deficient patients. Since PTH is a major trophic for 1,25(OH)<sub>2</sub>-vitamin D formation, the low serum PTH concentrations could explain the low levels. Magnesium deficiency may directly impair the ability of the kidney to synthesize 1,25(OH)<sub>2</sub>-vitamin D as the element supports the 25-hydroxy-1 $\alpha$ -hydroxylase in vitro.

### Hypokalemia

A common feature of Mg depletion is hypokalemia.<sup>[22]</sup> Experimental human Mg deficiency demonstrated a negative K balance resulting from increased urinary K loss. During depletion, there is also loss of intracellular K. Attempts to replete the K deficit with K therapy alone are not successful without simultaneous Mg therapy. The reason for this disrupted K metabolism may be related to Mg dependence of the Na, K-ATPase. Also, intracellular Na and Ca rise, while Mg and K fall. Magnesium also appears to be important in the regulation of K channels in cardiac cells that are characterized by inward rectification. This biochemical feature may be a contributing cause of the electrocardiographic findings and cardiac dysrhythmias discussed later.

### Neuromuscular manifestations

Neuromuscular hyperexcitability is a common complaint of a patient with Mg deficiency.<sup>[16]</sup> Latent tetany, as elicited by positive Chvostek's and Trousseau's sign, or spontaneous carpal-pedal spasm may be present. Seizures may also occur. Although hypocalcemia contributes to the neurologic signs, deficiency without hypocalcemia has been reported to result in neuromuscular hyperexcitability. Other signs occasionally seen include vertigo, ataxia, nystagmus, and athetoid and choreiform movements. Muscular tremor, fasciculation, wasting, fatigue, and weakness may be present. Reversible psychiatric aberrations have also been reported.

There may be several mechanisms underlying these neuromuscular problems. Magnesium has been shown to stabilize the nerve axon. Lowering its serum concentration decreases the threshold of axonal stimulation and increases nerve conduction velocity. It also has been shown to influence the release of neurotransmitters, such as glutamate, at the neuromuscular junction by competitively inhibiting the entry of Ca into the presynaptic nerve terminal. It is likely that a decrease of extracellular Mg would allow a greater influx of Ca into the presynaptic nerves and the subsequent release of a greater quantity of neurotransmitters, resulting in hyper-responsive neuromuscular activity.

### Cardiovascular manifestations

**Dysrhythmias.** Cardiac dysrhythmias are an important consequence of Mg deficiency. Electrocardiographic abnormalities of such shortage in humans include prolonged P-R interval and Q-T interval. Intracellular K depletion and hypokalemia are complicating features and may contribute to these abnormalities. Magnesium-deficient patients with cardiac dysrhythmias have been treated successfully by administration of the nutrient.<sup>[23]</sup> Supraventricular dysrhythmias including premature atrial complexes, atrial tachycardia, atrial fibrillation, and junctional arrhythmias have been described. Ventricular premature complexes, ventricular tachycardia, and ventricular fibrillation are more serious complications. Such dysrhythmias may be resistant to usual therapy. As intracellular Mg depletion may be present despite a normal serum Mg concentration, deficiency always must be considered as a potential factor in cardiac dysrhythmias.

**Acute Myocardial Infarction.** Acute myocardial infarction (AMI) is the leading cause of death in the United States. Magnesium deficiency may be a risk factor as it has been shown to play a role in systemic and coronary vascular tone, in cardiac dysrhythmias as mentioned above, and by inhibiting steps in the coagulation process and platelet aggregation. Over the past decade, debate has arisen over the clinical utility of adjunctive Mg therapy for AMI. While several small controlled trials suggested that adjunctive Mg therapy reduced mortality from AMI by 50%, three major trials define our understanding regarding Mg therapy in AMI.<sup>[24]</sup> Leicester Intravenous Magnesium Intervention Trial (LIMIT-2) was the first study involving large numbers of participants. Magnesium treatment showed an approximately 25% lower mortality rate. The Fourth International Study of Infarct captopril, nitrates, and Mg on AMI. Unlike LIMIT-2, the mortality rate in the Mg-treated group was not significantly different from that in the control group. It was suggested that the ISIS-4 design masked the benefits of Mg therapy. Two major criticisms involved the timing of the therapy and the severity of patient illness. The recently published magnesium in coronaries (MAGIC) trial was designed to address the issues regarding ISIS-4 study design—namely, early intervention in higher risk patients would more likely show the benefit of Mg therapy.<sup>[24]</sup> Over a 3 yr period, 6213 participants were studied. The Mg-treated group mortality at 30 days was not significantly different from that of placebo. The overall evidence from clinical trials does not support the routine application of adjunctive Mg therapy in patients with AMI at this time.

## Chronic Latent Deficiency

Although the diets ordinarily consumed by healthy Americans fall below the RDA with respect to Mg levels,<sup>[8]</sup> they do not appear to lead to symptomatic depletion of the nutrient. A number of clinical disorders, however, have been associated with a low Mg diet. It has been suggested that milder degrees of inadequacy may contribute to disease states such as hypertension, coronary artery disease, and osteoporosis.

## Hypertension

A number of studies have demonstrated an inverse relationship between dietary Mg intake and blood pressure.<sup>[25]</sup> Hypomagnesemia and/or reduction of intracellular Mg have also been inversely correlated with blood pressure. Patients with essential hypertension were found to have reduced free Mg concentrations in red blood cells (RBCs). The Mg levels were inversely related to both systolic and diastolic blood pressure. Intervention studies with Mg therapy in hypertension have led to conflicting results. Several have shown a positive blood-pressure-lowering effect of supplements, while others have not. Other dietary factors may also play a role. Recently, a diet of fruits and vegetables, which increased Mg intake from 176 to 423 mg/day (along with an increase in potassium), significantly lowered blood pressure.<sup>[26]</sup> The addition of nonfat dairy products that increased Ca intake as well further lowered blood pressure. The mechanism by which Mg deficit may affect blood pressure is not clear but may involve decreased production of prostacyclin, increased production of thromboxane A<sub>2</sub>, and enhanced vasoconstrictive effect of angiotensin II and norepinephrine.

## Atherosclerotic vascular disease

Another potential complication of Mg deficiency is the development of atheromatous disease.<sup>[27]</sup> Lipid alterations have been reported in hypomagnesemic human subjects. However, they are often complicated by factors related to underlying lipoprotein abnormalities occurring in diabetes, coronary artery disease, myocardial infarction, and other diseases. Epidemiological studies have related water hardness (Ca and Mg content) inversely to cardiovascular death rates. Mg inhibits platelet aggregation, and platelet hyperactivity is a risk factor in the development of cardiovascular diseases. Diabetic patients with Mg depletion have been shown to have increased platelet aggregation. Mg therapy in these subjects returns the response toward normal. The antiplatelet effect may be related

to the finding that Mg inhibits the synthesis of thromboxane A<sub>2</sub> and 12-HETE, eicosanoids thought to be involved in platelet aggregation. It also inhibits the thrombin-induced Ca influx in platelets as well as stimulates synthesis of prostaglandin I<sub>2</sub> (PGI<sub>2</sub>), the potent antiaggregatory eicosanoid.

## Pre-eclampsia and eclampsia

Pre-eclampsia, which complicates 1 in 2000 pregnancies in developed countries, is responsible for over 50,000 maternal deaths per year. Magnesium therapy has been utilized in the management of pre-eclampsia and eclampsia for decades and contributes to the very low mortality rate in developed countries.<sup>[28]</sup> A large randomized trial (the MAGPIE trial) examined the efficacy of Mg therapy in preventing eclampsia.<sup>[28]</sup> MgSO<sub>4</sub> showed a lower risk (0.8%), as compared with nimodipine, a specific cerebral arterial vasodilator (2.6%) for eclampsia. Documentation of deficiency in women with pre-eclampsia has been difficult to establish. No difference was found in the plasma Mg levels of women with pre-eclampsia and those of healthy pregnant women. However, women with pre-eclampsia had a decreased RBC Mg level. In another study, those with pre-eclampsia or preterm labor had no differences in ionized or total serum Mg levels. While subtle deficits in total body Mg may contribute to hypertension during pregnancy, its role may relate more to the stabilizing neuronal and vascular effects rather than to the correction of an electrolyte deficit. Magnesium therapy is clearly indicated for women with pre-eclampsia. It has been shown to decrease the incidence of eclampsia, and likely to reduce overall mortality. There is also evidence of better fetal outcomes—less low birth weight—from fetal growth retardation or preterm delivery.

## Osteoporosis

Dietary Mg depletion in animals has been shown to lead to a decrease in skeletal growth and increased skeletal fragility.<sup>[13]</sup> A decrease in osteoblastic bone formation and an increase in osteoclastic bone resorption are implicated as the cause in decreased bone mass. In humans, epidemiologic studies suggest a correlation between bone mass and dietary Mg intake.<sup>[29]</sup> Few studies have been conducted assessing Mg status in patients with osteoporosis. Low serum and RBC Mg concentrations as well as high retention of parenterally administered Mg has suggested a deficit. Low skeletal Mg content has been observed in some, but not all, studies. The effect of supplements on bone mass has generally led to an increase in bone mineral density, although study design limits useful information.

Larger long-term placebo-controlled double-blind investigations are required.

There are several potential mechanisms that may account for a decrease in bone mass in Mg deficiency. Magnesium is mitogenic for bone cell growth, which may directly result in a decrease in bone formation. It also affects crystal formation; a lack results in a larger, more perfect crystal, which may affect bone strength. Inadequacy results in a fall in both serum PTH and 1,25(OH)<sub>2</sub>-vitamin D as discussed above. Since both hormones are trophic for bone, impaired secretion or skeletal resistance may result in osteoporosis. Low 1,25(OH)<sub>2</sub>-vitamin D may also result in decreased intestinal Ca absorption. An increased release of inflammatory cytokines may result in activation of osteoclasts and increased bone resorption in rodents.<sup>[29]</sup>

## MANAGEMENT OF DEPLETION

Seizures, acute arrhythmias, and severe generalized spasticity require immediate intravenous infusion. One to two grams of MgSO<sub>4</sub>•7H<sub>2</sub>O (8.2–16.4 mEq Mg) may be infused over 5–10 min, followed by continuous infusion of 6 g over 24 hr or until the condition is controlled. Correction of electrolytes (especially K) should accompany the Mg therapy. Serum Mg and other electrolytes should be determined twice daily.

Less severe manifestations (e.g., paresthesias with latent or active tetany) are likewise best treated by the intravenous route. When renal function is good, 6 g (48 mEq) of Mg sulfate may be given intravenously over 24 hr. This may be continued for 3–5 days until the signs and symptoms and/or electrolyte abnormalities are corrected. When this route cannot be used, intramuscular injections can be given, although these are painful. The dosages given must always exceed the daily losses as indicated by serum levels and urinary excretion. The return to the normal or slightly higher range of serum Mg levels with any of these schedules is relatively rapid. However, repletion of Mg lost from bone and other tissues requires more prolonged therapy.

When intestinal absorption is normal and renal Mg wasting is present, supplements should be added to the usual diet to tolerance (onset of diarrhea) to maintain normal serum levels. In some instances, oral supplementation may not be sufficient, and intramuscular and/or intravenous Mg may be required. Those with continuing severe Mg and K losses in the urine (as in cisplatin nephrotoxicity) may require long-term supplements by intravenous infusion via an indwelling central catheter for home administration.

When depletion is modest and persistent, initial efforts should be directed to increased intake of

Mg-rich foods. When necessary and feasible, oral supplementation may be taken. Quantities of 300–600 mg may be given in divided doses 3–6 times/day.

## CONCLUSIONS

In conclusion, Mg is a vital nutrient necessary for essential biological processes. Despite its rigid homeostasis by the body, deficiency is not uncommon due to numerous diseases, disorders, and medications that impair the normal metabolism of Mg. The relatively low dietary intake compounds this problem in many patients. Indeed, even the reduction in suggested dietary Mg may contribute to chronic disease states in otherwise healthy individuals. It is clear that education is necessary for the general population to increase awareness of the importance of Mg in maintaining health. In addition, further research efforts in both basic science and clinical science are needed to clarify the role of Mg deficiency in disease states.

## REFERENCES

- Maguire, M.E.; Cowan, J.A. Magnesium chemistry and biochemistry. *Biometals* **2002**, *15*, 203–210.
- Cowan, J.A. Structural and catalytic chemistry of magnesium-dependent enzymes. *Biometals* **2002**, *15*, 225–235.
- Ackerman, M.J.; Clapham, D.E. Ion channels—basic science and clinical disease. *N. Engl. J. Med.* **1997**, *336*, 1575–1586.
- Dorup, I. Magnesium and potassium deficiency. *Acta Physiol. Scand.* **1994**, *150*, 7–46.
- Wallach, S. Availability of body magnesium during magnesium deficiency. *Magnesium* **1988**, *7*, 262–270.
- Romani, A.; Marfella, C.; Scarpa, A. Cell magnesium transport and homeostasis: role of intracellular compartments. *Miner. Electrolyte Metab.* **1993**, *19*, 282–289.
- Pennington, J.A.T.; Young, B. Total diet study nutritional elements. *J. Am. Diet. Assoc.* **1991**, *91*, 179–183.
- Food and Nutrition Board, Institute of Medicine. *In Dietary Reference Intakes for Calcium, Phosphorus, Mg, Vitamin D, and Fluoride*; National Academy Press: Washington, DC, 1997.
- Kerstan, D.; Quamme, G.A. Physiology and pathophysiology of intestinal absorption of magnesium. In *Calcium in Internal Medicine*; Massry, S.G., Morii, H., Nishizawa, Y., Eds.; Springer-Verlag London Ltd.: Surrey, U.K., 2002; 171–183.
- Voets, T.; Nilius, B.; Hoefs, S.; van der Kemp, A.W.C.M.; Droogmans, G.; Bindels, R.J.M.;

- Hoenderop, J.G.J. TRPM6 forms the Mg influx channel involved in intestinal and renal Mg absorption. *J. Biol. Chem.* **2004**, *279*, 19–25.
11. Fine, K.D.; Santa Ana, C.A.; Porter, J.L. et al. Intestinal absorption of magnesium from food and supplements. *J. Clin. Invest.* **1991**, *88*, 396–402.
  12. Quamme, G.A.; de Rouffignac, C. Epithelial magnesium transport and regulation by the kidney. *Front. Biosci.* **2000**, *5*, 694–711.
  13. Shils, M.E.; Rude, R.K. Deliberations and evaluations of the approaches, endpoints and paradigms for magnesium dietary recommendations. *J. Nutr.* **1996**, *126*, 2398S–2403S.
  14. Endres, D.; Rude, R.K. Mineral and bone metabolism. In *Tietz Fundamentals of Clinical Chemistry*, 5th Ed.; Burtis, C.A., Ashwood, E.R., Eds.; W.B. Saunders: Philadelphia, PA, 2001; 795–821.
  15. Ryzen, E. Magnesium homeostasis in critically ill patients. *Magnesium* **1989**, *8*, 201–212.
  16. Rude, R.K. Magnesium homeostasis. In *Principles of Bone Biology*, 2nd Ed.; Bilezikian, J.B., Raisz, L., Rodan, G., Eds.; Academic Press: San Diego, 2001; 339–358.
  17. Quamme, G.A. Renal magnesium handling: new insights in understanding old problems. *Kidney Int.* **1997**, *52*, 1180–1195.
  18. McNair, P.; Christensen, M.S.; Christiansen, C. et al. Development of bone mineral loss in insulin-treated diabetes: a 1 and 1/2 years follow-up in sixty patients. *Eur. J. Clin. Invest.* **1982**, *12*, 81–85.
  19. Song, Y.; Buring, J.E.; Manson, J.E., et al. Dietary magnesium intake in relation to plasma insulin levels and risk of type 2 diabetes in women. *Diab. Care* **2004**, *27*, 59–65.
  20. Lopez-Ridaura, R.; Stampfer, M.J.; Wjollett, W.C., et al. Magnesium intake and risk of type 2 diabetes in men and women. *Diab. Care* **2004**, *27*, 134–140.
  21. Rude, R.K. Magnesium deficiency in parathyroid function. In *The Parathyroids*, 2nd Ed.; Bilezikian, J.P., Ed.; Raven Press: New York, 2001; 763–777.
  22. Whang, R.; Hampton, E.M.; Whang, D.D. Magnesium homeostasis and clinical disease of magnesium deficiency. *Ann. Pharmacother* **1994**, *28*, 220–226.
  23. Zehender, M.; Meinertz, T.; Faber, T., et al. Antiarrhythmic effect of increasing the daily intake of magnesium and potassium in patients with frequent ventricular arrhythmias. *J. Am. Coll. Cardiol.* **1997**, *29*, 1028–1034.
  24. Antman, E.; Cooper, H.; Domanski, M. et al. Early administration of intravenous magnesium to high-risk patients with acute myocardial infarction in the magnesium coronaries (MAGIC) trial: a randomized controlled trial. *Lancet* **2002**, *360*, 1189–1196.
  25. Touyz, R.M. Role of magnesium in the pathogenesis of hypertension. *Mol. Aspects Med.* **2003**, *24*, 107–136.
  26. Appel, L.J.; Moore, T.J.; Obarzanek, E. et al. A clinical trial of the effects of dietary patterns on blood pressure. DASH Collaborative Research Group. *N. Engl. J. Med.* **1997**, *336*, 1117–1124.
  27. Maier, J.A.M. Low magnesium and atherosclerosis an evidenced based link. *Mol. Aspects Med.* **2003**, *24*, 137–146.
  28. Belfort, M.A.; Anthony, J.; Saade, G.R. et al. A comparison of magnesium sulfate and nimodipine for the prevention of eclampsia. *N. Engl. J. Med.* **2003**, *348*, 302–311.
  29. Tong, G.; Rude, R.K. The role of dietary magnesium deficiency in osteoporosis. In *Nutrition Aspects of Bone Health*; New, S.A., Ponjour, J.P., Eds.; The Royal Society of Chemistry: Cambridge, 2003; 339–350.

#### FURTHER READINGS

- Cowan, J.A. Introduction to the biological chemistry of magnesium. In *The Biological Chemistry of Magnesium*; Cowan, J.A., Ed.; VCH Publishers: New York, 1995; 1–24.
- Touyz, R.M. Magnesium in clinical medicine. *Front. Biosci.* **2004**, *9*, 1278–1293.
- Laires, M.J.; Monteiro, C.P.; Bicho, M. Role of cellular magnesium in health and human disease. *Front. Biosci.* **2004**, *9*, 262–276.
- Shils, M.E. Magnesium. In *Handbook of Nutritionally Essential Mineral Elements*; O'Dell, B.L., Sunde, R.A., Eds.; Marcel Dekker: New York, 1997; 117–152.





# Melatonin

**Richard J. Wurtman**

*Massachusetts Institute of Technology, Cambridge, Massachusetts, U.S.A.*

## INTRODUCTION

Melatonin is a hormone, like the estrogens and testosterone: It is synthesized in the pineal gland and secreted into the blood and cerebrospinal fluid. It conveys signals to distant organs, principally the brain, which affect the synthesis of second messengers and, ultimately, sleep and circadian rhythms. However, unlike the estrogens and testosterone, melatonin is marketed in the United States as a dietary supplement, which implies that people normally obtain this compound from the diet and that melatonin pills simply supplement that which the diet provides. No food has ever been found to elevate plasma melatonin levels; nor is there acceptable evidence that any food actually contains more than trace amounts of the hormone. This entry describes the history of our knowledge of melatonin, the hormone's synthesis, metabolism, and physiologic regulation, the factors that affect plasma melatonin levels, the known effects of endogenous and exogenous (oral) melatonin, and melatonin's present usage.

## HISTORY OF MELATONIN

Few people would now doubt that the human pineal gland is an important structure, and that it transmits signals to the brain and other organs by secreting a unique hormone, melatonin. However this consensus is only a few decades old: For most of the 20th century, the pineal was generally dismissed as a "vestige"—a "third eye" in certain lower vertebrates, which, in humans, died and became calcified early in life. Tumors of the pineal gland were known sometimes to be associated with a reproductive disorder—precocious puberty, especially in boys—and some scientists attributed this phenomenon to the destruction of functioning pineal tissue. However, most concluded that

the accelerated sexual maturation simply resulted from increased intracranial pressure.

The modern history of the pineal gland probably began with the discovery, in 1917,<sup>[1]</sup> that extracts of cow pineals could lighten the skin of frogs. The physiological significance of this relationship seemed obscure, inasmuch as bovine pineal extracts had no effect on pigmentation in bovines (or humans), and frog pineals lacked detectable skin-lightening ability. However, the finding did indicate that the pineal contained a compound with at least some biological activity, and it provided a way of identifying the active compound, using assays based on the ability of purified extracts to aggregate the melanin granules in the frog's pigment cells. In 1958, Lerner et al.<sup>[2]</sup> discovered the compound's chemical structure to be 5-methoxy-*N*-acetyltryptamine and named it melatonin.

Around that time, scientists made four seemingly unrelated discoveries, which became coherent, like a partly completed crossword puzzle, once melatonin was identified. In chronologic sequence, these were: 1) the demonstration, by Kitay and Altschule, that surgical removal of the rat's pineal accelerated the growth of the ovaries, while administration of bovine pineal extracts had the opposite effect;<sup>[3]</sup> 2) Fiske's observation that housing rats in a continuously lit environment led to decrease in the weights of their pineals;<sup>[4]</sup> 3) Ariens-Kappers' discovery<sup>[5]</sup> that, though the pineal gland originates embryologically as part of the brain, it loses most or all of its CNS connections by birth, and instead receives its innervation from peripheral sympathetic nerves; and 4) the demonstration that both pinealectomy and prolonged light exposure accelerate the growth of the rat's ovaries to an equal extent, and that both responses are blocked by administering pineal extracts.<sup>[6]</sup> In 1963–1964, it was shown that melatonin is a true hormone in rats, that it is the gonad-inhibiting substance previously described in pineal extracts,<sup>[7]</sup> and that its synthesis in the pineal gland is suppressed when rats are exposed continuously to light, the light acting not directly, as on a "third eye," but indirectly, via the animal's eyes and sympathetic nerves.<sup>[8]</sup> (The chemical that mediates the sympathetic nervous signals was shown to be norepinephrine,<sup>[9]</sup> which stimulates pineal beta-receptors and increases cyclic-AMP production.<sup>[10]</sup>) The rates at which the rat's pineal synthesizes

---

*Richard J. Wurtman, M.D.*, is Cecil H. Green Distinguished Professor at the Department of Brain and Cognitive Sciences, Massachusetts Institute of Technology, Cambridge, Massachusetts, U.S.A.

serotonin and melatonin were soon shown to vary with circadian rhythms, and the melatonin rhythm was ultimately found to be generated by intrinsic circadian signals emanating from the suprachiasmatic nucleus (SCN) of the brain,<sup>[11]</sup> which were controlled primarily by the light–dark cycle.

Finally, in 1975, it was shown that melatonin production in humans also exhibits a pronounced circadian rhythm,<sup>[12]</sup> causing nocturnal plasma melatonin levels to be at least tenfold higher than those observed in the daytime. Moreover, this rhythm was not simply a response to the environmental light–dark cycle, since if people were suddenly placed in an environment that was dark between 11 A.M. and 7 P.M. (instead of the usual 11 P.M. to 7 A.M.), it took their melatonin rhythms 5–7 days to re-entrain. The view thus became canonized that the pineal is a “neuroendocrine transducer”<sup>[13]</sup> that tells all mammals when it is dark outside by raising plasma melatonin levels. The uses to which the body puts this information vary considerably among species: In diurnal, but not nocturnal, animals, melatonin promotes sleep onset and maintenance; in animals that breed seasonally, melatonin influences the choice of breeding season (i.e., spring or fall); and in those like humans and rats, which breed throughout the year, melatonin’s reproductive effects can be minimal.

Much subsequent pineal research has concerned the human brain’s responses to melatonin. The most compelling evidence now available supports two such uses, discussed below: the involvement of nocturnal melatonin secretion in initiating and maintaining sleep, and control by the day/night melatonin rhythm of the timing of other 24 hr rhythms. It is melatonin’s effect on sleep that underlies most of its current use as a “dietary supplement.” Some additional possible benefits of melatonin supplementation have been proposed (e.g., as an antioxidant, or to slow aging, or to suppress cancer growth and hypertension). However, evidence supporting these effects is sparse.

Evidence is even more sparse that there is any rational basis for calling melatonin a “dietary supplement.” For melatonin to earn this appellation, it would have to be shown that at least some of the melatonin in human plasma derives from food sources, and that “supplementary” exogenous melatonin simply adds to what the foods provide. But as described below, there is no satisfactory evidence, based on contemporary analytic techniques, that any actual foods contain more than trace amounts of melatonin—if that—and no evidence at all that eating any food elevates human plasma melatonin levels. Melatonin is a *hormone*, like thyroxine and estrogens, and should be labeled and regulated as such. Only its extraordinary lack of overt toxicity apparently keeps the FDA from insisting that it undergo such regulation.

## MELATONIN SYNTHESIS AND METABOLISM: NEURAL AND PHOTIC CONTROL

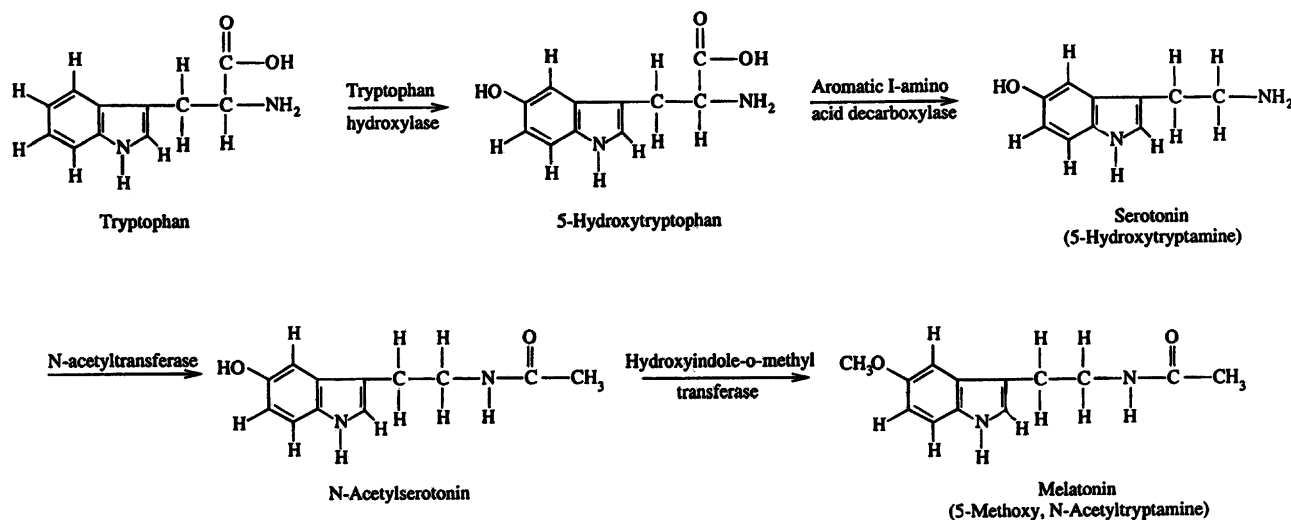
Almost all the melatonin formed in mammals is synthesized within the pineal gland, starting with the uptake of the amino acid tryptophan from the plasma. Since the pineal lies outside the blood–brain barrier, this process—in contrast to tryptophan’s uptake into the brain—is not subject to competition from other circulating neutral amino acids. The tryptophan is first 5-hydroxylated (by the enzyme tryptophan hydroxylase) and then decarboxylated (by the enzyme aromatic L-amino acid decarboxylase) to form 5-hydroxytryptamine or serotonin (Fig. 1).<sup>[9]</sup>

During daylight hours, the serotonin in pinealocytes tends to be stored, and is unavailable to enzymes (monoamine oxidase and the melatonin-forming enzymes) that would otherwise act on it. With the onset of darkness, postganglionic sympathetic outflow to the pineal increases, and the consequent release of norepinephrine onto pinealocytes causes stored serotonin to become accessible for intracellular metabolism. At the same time, the norepinephrine activates the enzymes [especially serotonin-*N*-acetyltransferase (SNAT), but also hydroxyindole-*O*-methyltransferase (HIOMT)] that convert serotonin to melatonin (Fig. 1).<sup>[9,11]</sup> Consequently, pineal melatonin levels rise manyfold. (Pineal levels of 5-methoxytryptophol, the corresponding deaminated and *O*-methylated metabolite of serotonin, also rise<sup>[14]</sup> even though formation of this compound is independent of SNAT.)

The melatonin then diffuses out of the pineal gland into the blood stream and cerebrospinal fluid,<sup>[15]</sup> rapidly raising human plasma melatonin levels from about 2–10 to 100–200 pg/ml.<sup>[12]</sup> Melatonin is highly lipid soluble, because both the ionizable groups in serotonin—the hydroxyl and the amine—have been blocked by its *O*-methylation and *N*-acetylation (Fig. 1). Thus, it diffuses freely across cell membranes into all tissues, and travels in the blood largely bound to albumin.

Most of the melatonin in the circulation is inactivated in the liver, where it is first oxidized to 6-OH-melatonin by a P450-dependent microsomal oxidase and then largely conjugated to sulfate or glucuronide before being excreted into the urine or feces.<sup>[16]</sup> About 2–3% is excreted unchanged into the urine or saliva, enabling measurements of urinary or salivary melatonin to be used as rough estimates of plasma melatonin levels. (Salivary melatonin apparently corresponds to the 25–30% of blood melatonin that is not bound to albumin.)

Studies using radioactively labeled melatonin of high specific activity have identified three probable melatonin receptors, two of which have been cloned using human sources.<sup>[17]</sup> These macromolecules are



**Fig. 1** Metabolism of tryptophan to melatonin in the pineal gland. (Reproduced with permission from Zhdanova, I.V.; Wurtman, R.J. In *Endocrinology: Basic and Clinical Principles*; Conn, P.M., Melmed, S., Eds.; Humana Press, Inc.: Totowa, NJ, 1997; 281.)

concentrated, respectively, within the suprachiasmatic nucleus of the hypothalamus, the pars tuberalis of the pituitary, and cardiac blood vessels ( $mt_1$ ), in the retina and hippocampus ( $MT_2$ ), and in kidney, brain, and various peripheral organs ( $MT_3$ ). Their affinities for melatonin are enhanced by several G-proteins. Activation of the  $mt_1$  and  $MT_2$  receptors by melatonin suppresses cAMP production. The  $MT_3$  site shares 95% homology with a detoxifying enzyme, quinone reductase 2; its effects on specific signal transduction pathways await identification. Because of melatonin's unusual lipid solubility, its receptors could be located intracellularly, in contrast to the plasma membrane receptors characteristic of neurotransmitters; indeed, a nuclear binding site has been identified. The  $mt_1$  receptors in the SCN allow melatonin to inhibit the firing of SCN neurons during the night—an action that might contribute to melatonin's sleep-promoting effects. The SCN's  $MT_2$  receptors apparently mediate melatonin's effects on the SCN's own circadian rhythms, as well as on other rhythms that this brain region controls.

In all species examined thus far, melatonin secretion manifests a characteristic circadian rhythm, causing plasma levels to be low during the daylight hours, ascend after the onset of darkness, peak in the middle of the night between 11 P.M. and 3 A.M., and then fall sharply before the time of light onset. (It is interesting that high nocturnal plasma melatonin levels characterize *both* diurnally active species, in which these levels promote sleep onset and maintenance, and nocturnally active ones, in which melatonin has no obvious relationship to sleep.) While this rhythm is normally

tightly entrained to the environmental light cycle, it does persist when people are placed for a few days in a dark room, and it does not immediately phase-shift when the light schedule is altered, indicating that it is not simply generated by the light–dark cycle but also by cyclic endogenous signals, probably from the SCN.<sup>[11]</sup> These reach the pineal via a retinohypothalamic tract, the superior cervical ganglia, and postganglionic sympathetic fibers that re-enter the cranial cavity.<sup>[5]</sup> In certain fish, birds, and reptiles, pineal glands also contain true photoreceptors, and denervated (or even cultured) glands can sustain circadian rhythms in melatonin synthesis that can be entrained by the light–dark cycle; in contrast, light has no known direct effects on melatonin synthesis in humans and other mammals.

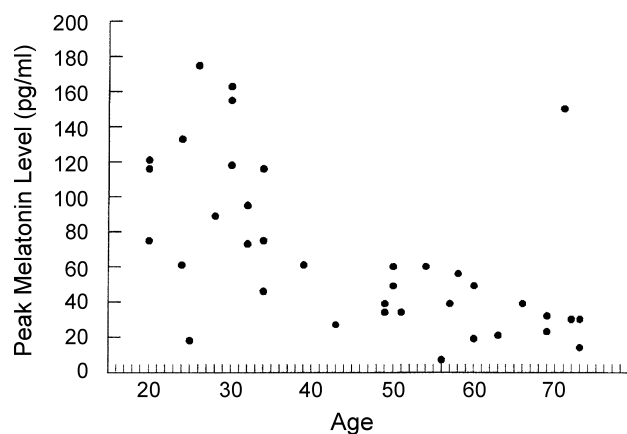
## PLASMA MELATONIN LEVELS

Plasma melatonin normally reflects the amounts secreted by the pineal gland, the flux of melatonin into and out of tissues, melatonin's destruction in the liver, and its secretion into urine and saliva. Since melatonin is now also available as a dietary supplement, plasma levels can reflect consumption of the exogenous compound as well. Available evidence does not support the view that humans derive any plasma melatonin from foods. Several laboratories have described a compound in dietary fruits or vegetables (e.g., tomato<sup>[18,19]</sup>) that they concluded was melatonin. But in only one of these studies<sup>[19]</sup> was the identity of the melatonin unambiguously confirmed by gas

chromatography–spectrometry (GCMS), and in that study, the melatonin concentrations determined by GCMS were very low (less than 20 ng per kg of fruit), and the “... concentrations... indicated by RIA were 6–100-fold higher than... by GCMS for the same extracts, suggesting... contamination by an immunological interference...” Of perhaps greater relevance, no investigator has ever presented evidence that feeding any amount of any food to humans can raise plasma melatonin levels.

Usually, the principal factor affecting plasma melatonin levels is its rate of secretion, which varies with the circadian rhythm described above and as a function of age (Fig. 2). Nocturnal melatonin levels are also affected by drugs that interfere with the transmission of neurotransmitter signals to pineal cells (like propranolol, a beta-blocking agent<sup>[20]</sup>), those that inhibit melatonin’s metabolism (like 8-methoxypsoralen<sup>[21]</sup>), and a few drugs that lack clear links to melatonin’s synthesis or metabolism (e.g., caffeine, ethanol,<sup>[22]</sup> ibuprofen, and indomethacin, which decrease melatonin). Nocturnal melatonin secretion is also suppressed by exposure to environmental lighting,<sup>[23]</sup> even by a relatively dim 100–200 lx, when pupils are dilated.

Melatonin secretion by the human pineal gland exhibits a pronounced age dependence (Fig. 2). Secretion is minimal in newborns, starts during the third or fourth months of life (coincident with the consolidation of sleeping at night<sup>[24]</sup>), increases rapidly at ages 1–3 yr, and then declines slightly to a plateau that persists through early adulthood. Nocturnal melatonin secretion then starts a marked continuing decline in most people, with peak nocturnal levels in most 70-yr-olds being only a quarter or less of what they are



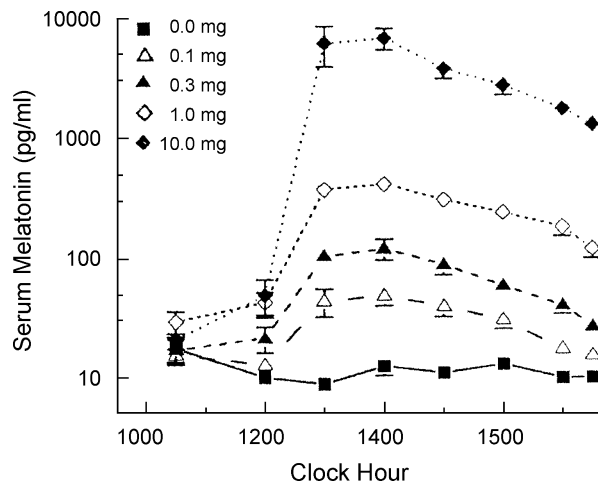
**Fig. 2** Night-time peak serum melatonin levels in subjects of different ages (years). (Reproduced with permission from Zhdanova, I.V.; Wurtman, R.J. In *Endocrinology: Basic and Clinical Principles*, 2nd Ed.; Conn, P.M., Melmed, S., Eds.; Humana Press, Inc.: Totowa, NJ, 2004; *in press*.)

in young adults.<sup>[25]</sup> This decline may reflect the progressive unexplained but ubiquitous calcification of the pineal gland and resulting loss of secretory tissue. Obviously, one strategy in using supplemental melatonin is to administer to older people doses that are just sufficient to compensate for this age-related decline.

The first person to examine the effects of exogenous melatonin was the scientist who discovered it, Aaron Lerner; he explored its actions (and possible toxicities) by giving himself 200 mg intravenously per day for five consecutive days. Lerner described feeling “relaxed.” Neither he nor the investigators who subsequently gave it (in doses of 10 mg–6.6 g) to 96 other subjects prior to 1977 measured its effects on plasma melatonin levels. However since most administered doses in excess of 1 g, it can be assumed that massive increases in plasma melatonin ensued. When Waldhauser et al.<sup>[26]</sup> administered 80 mg doses to two male volunteers in 1987, plasma levels increased more than 1000-fold, and serum prolactin levels rose significantly—an effect not observed with physiologic melatonin doses.

In 1993, Dollins et al. examined the effects of 10, 20, 40, or 80 mg melatonin on various behavioral indices (auditory vigilance; self-reported fatigue, confusion, and sleepiness; reaction times), body temperature, and plasma melatonin levels. All the doses tested produced similar changes in the behavioral assays and in body temperature. And all raised plasma melatonin levels to at least 5000 pg/ml—well beyond the normal nocturnal range of 100–200 pg/ml.<sup>[27]</sup> Hence, the study was repeated using much lower doses (0.1–10 mg orally).<sup>[28]</sup> The authors found that oral doses as low as 0.1–0.3 mg caused dose-related decreases in sleep latency and increases in sleep duration and self-reported sleepiness and fatigue, but without reducing body temperature or elevating plasma melatonin levels beyond their normal nocturnal range (Fig. 3). This suggested that nocturnal melatonin secretion—which produces plasma melatonin levels similar to those seen after the 0.3 mg dose—has a physiologic effect on sleep. It also identified the dosage range that investigators needed to use if they wanted to examine melatonin’s physiologic effects.

It should be noted that there is considerable person-to-person variability in the bioavailability of melatonin: In one study using single 80 mg doses, there were 25-fold variations in areas under the curve (AUCs) in the five subjects studied. In another, using 0.5 mg oral doses, peak plasma melatonin levels among four subjects varied from 480 to 9200 ng/L.<sup>[29]</sup> Melatonin’s bioavailability was relatively poor—10% to 56%—, which the authors attributed to person-to-person differences in first-pass hepatic extraction. Perhaps reflecting such differences in hepatic function, older subjects given a 0.3 mg oral dose of melatonin exhibit considerably greater increments in plasma melatonin



**Fig. 3** Mean serum melatonin profiles of 20 subjects sampled at intervals after ingesting 0.1, 0.3, 1.0, and 10 mg of melatonin or placebo at 11:45 A.M. (Reproduced with permission from Ref.<sup>[28]</sup>.)

levels, with correspondingly greater variability, than young adults receiving that dose.

These findings all suggest that while a 0.3 mg dose given to young subjects during the daytime, or to older insomniacs at night, can, on average, produce normal nocturnal plasma melatonin levels, some individuals may need a little more, or a lot less, melatonin to attain this effect. The pharmacokinetic properties of any oral dosage of melatonin can also vary depending on the lipid solubility of the inert ingredients that accompany it: A preparation containing corn oil plus 0.05 mg melatonin elevated plasma melatonin levels to as high a peak (from 4 to 118 pg/ml<sup>[30]</sup>), though for a shorter period, as one containing 0.3 mg melatonin plus microcrystalline cellulose (15–105 pg/ml<sup>[28]</sup>).

## EFFECTS OF MELATONIN

Because melatonin is available as a dietary supplement and is relatively nontoxic, physicians, researchers, and even consumers are able to administer or consume doses that elevate its plasma levels to hundreds or even thousands of times those ever occurring normally.<sup>[26,31]</sup> Indeed, even the 1–10 mg doses most commonly marketed raise these levels to 3–60 times their normal peaks (Fig. 3).<sup>[28]</sup> Not surprisingly, such concentrations produce biological effects, for example, sleepiness, which might or might not also occur physiologically. Does the demonstration that a pharmacologic dose of melatonin produces such an effect indicate that the effect also occurs at normal night-time plasma melatonin levels? Or, by extension, that a deficiency in melatonin (e.g., in older people) can

contribute to a related disease process? Alas, no: Enormous melatonin concentrations inhibit the aggregation of A-beta peptides to form amyloid in vitro;<sup>[32]</sup> however, this no more means that the age-related decline in plasma melatonin causes Alzheimer's disease than that poison ivy dermatitis—which can be treated with cortisone—is a sign of adrenocortical insufficiency.

What evidence must be adduced before one can propose that some effect of a melatonin megadose also occurs in response to secreted melatonin? First, that the effect occurs when plasma melatonin levels rise or fall within their normal range. Second, that administering melatonin in the daytime, in doses that increase plasma melatonin concentrations to—but not beyond—peak night-time levels, also produces the effect. This type of study can sometimes be done in vitro: If melatonin were found to suppress beta-amyloid aggregation at concentrations found nocturnally in plasmas of young people (up to about 1 nM), but not in concentrations more typical of many older people (less than 0.3 nM), this would indeed be suggestive.

Using these criteria, two probably physiologic effects have been associated with melatonin administration—the promotion of sleep onset and maintenance,<sup>[28]</sup> and the phase-shifting of circadian rhythms, including the rhythm in melatonin itself.<sup>[33]</sup> Both are produced by physiologic doses, i.e., 0.1–0.3 mg for sleep and 0.5 mg for phase-shifting. Melatonin's actions on sleep include both a *direct* action (which decreases sleep latency, increases sleep efficiency, and increases total sleep time) and an *indirect* effect on the daily rhythm in the phasing of sleep onset.

## Sleep

A 1997 review<sup>[34]</sup> on melatonin's hypnotic effects listed 24 papers, almost all of which described sedation, fatigue, decreased alertness, increased reaction time, shortened sleep latency (i.e., number of minutes needed to fall asleep), increased sleep efficiency (i.e., percentage of the total sleep period actually spent sleeping), and/or increased total sleep time. A recent (2005) meta-analysis<sup>[35]</sup> of all the 17 studies (e.g., Refs.<sup>[36–43]</sup>), involving 284 subjects, that satisfied inclusion criteria demonstrated a significant decrease in sleep latency and significant increases in sleep efficiency and total sleep duration. The inclusion criteria were that a study include at least six subjects, all adults, be randomized and double-blinded, involve placebo-controlled clinical trials, and use objective measures of sleep evaluation. Studies could utilize crossover or parallel group designs; however, case reports were excluded. Statistical significance was obtained in spite of considerable variations among the studies in melatonin doses and

routes of administration, the general health of the subjects, and the measures used to evaluate sleep.

The effects of exogenous melatonin on sleep have been examined under three types of experimental conditions in relation to the onset or offset of endogenous melatonin secretion.

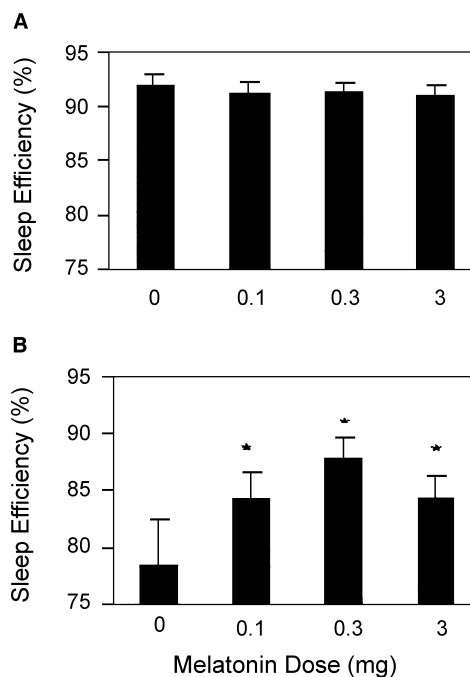
In some studies, the hormone was administered during the daily light period, such that blood melatonin levels would be transiently elevated but would then return to baseline before the initiation of nocturnal melatonin secretion. Such experiments were used to demonstrate that melatonin decreases sleep latency at any time in the afternoon or evening, and that this effect is independent of an action on sleep rhythms (since no treatment can immediately shift the phase of a circadian rhythm by 8–10 hr).

In others, the hormone was given close enough to the onset of darkness for blood melatonin levels to still be elevated when nocturnal melatonin secretion started. The period during which plasma melatonin levels were continuously elevated would thus be prolonged. Such experiments reflected the use of melatonin to decrease sleep latency and maintain continuous sleep in, for example, a shift-worker or eastbound world traveler who needed to start sleeping earlier.

In yet others, the hormone was given at the end of the light period to older insomniacs with low nighttime plasma melatonin levels. The intent was to prolong the portion of the night during which their plasma melatonin concentrations would be in the same range as those of noninsomniac young adults.

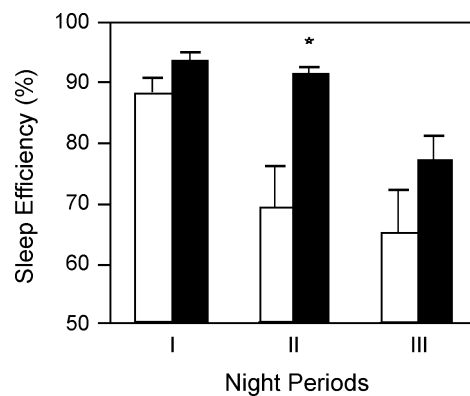
In all these situations, oral melatonin decreased sleep latency and, when tested, increased sleep duration and sleep efficiency. A 0.3 mg dose was either as effective as, or more effective than,<sup>[44]</sup> higher doses, particularly when the hormone was administered for several days. This dose had no effect on body temperature, affirming that, while pharmacologic doses can cause hypothermia, melatonin's ability to promote sleep is not mediated by such a change, as had been suggested. The hormone had no consistent effect on sleep architecture (e.g., REM time). Its effects differed from those of most hypnotic drugs, since after receiving melatonin, subjects could readily keep from falling asleep if they so chose, and their cognitive abilities the next morning were unchanged or improved.

In a relatively large ( $N = 30$ ) study<sup>[44]</sup> on people who were 50 yr old or older and did or did not suffer from clinically significant insomnia (i.e., sleep efficiencies of 70–80% in the insomniacs vs. 92% in controls), melatonin was found to produce statistically and clinically significant improvements in sleep efficiency among insomniacs (Fig. 4). A 0.3 mg dose caused the greatest effect ( $P < 0.0001$ ), particularly during the middle portion of the nocturnal sleep period (Fig. 5).

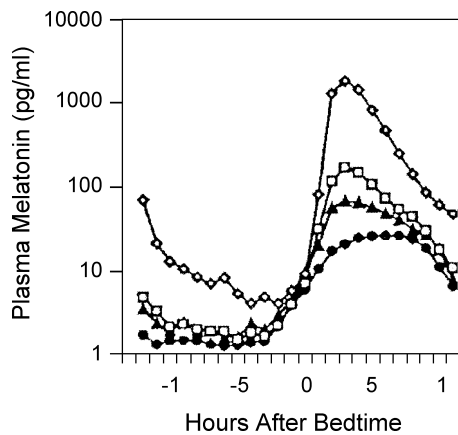


**Fig. 4** Sleep efficiency in subjects with normal sleep (A) and age-related insomnia (B) following melatonin or placebo treatment. \* $P < 0.05$ . (Reproduced with permission from Ref.<sup>[44]</sup>.)

No effects were noted in subjects without insomnia, or in latency to sleep onset (which is not abnormal in this population). Dose-related increases in plasma melatonin levels were observed (Fig. 6), the 0.3 mg dose causing peak levels in the range usually observed nocturnally among young adults. When subjects received a higher dose (3.0 mg) but not 0.3 mg, plasma melatonin levels remained significantly elevated during much of



**Fig. 5** Sleep efficiency in insomniacs during three consecutive parts (I, II, and III) of the night, following placebo (light bar) or melatonin (0.3 mg, dark bar) treatment. \* $P < 0.05$ . (Reproduced with permission from Ref.<sup>[44]</sup>.)

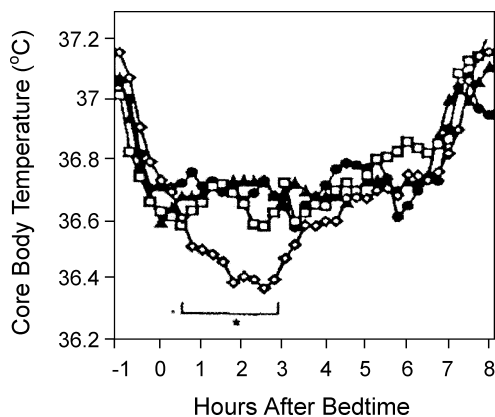


**Fig. 6** Mean group ( $n = 30$ ) plasma melatonin profiles after melatonin or placebo treatment 30 min before bedtime. Circles, placebo; triangles, 0.1 mg; squares, 0.3 mg; diamonds, 3 mg. (Reproduced with permission from Ref.<sup>[44]</sup>)

the following day, and the subjects exhibited hypothermia (Fig. 7).

### Circadian Rhythms: Phase-Shifting and Jet Lag

The ability of exogenous melatonin to synchronize and shift the phases of various human circadian rhythms is generally accepted. As little as 0.5 mg of pure melatonin,<sup>[33]</sup> or 0.05 mg of melatonin in corn oil<sup>[30]</sup> (which causes earlier peaks in plasma melatonin levels), advanced the onset of nocturnal melatonin secretion when administered at 5 P.M.,<sup>[30]</sup> and larger doses caused greater phase advances. (The hormone was also able to shift the core body temperature rhythm. However, a statistically significant effect was found only after a dose that elevated plasma melatonin levels well beyond



**Fig. 7** Core body temperature profiles following melatonin or placebo treatment. Circles, placebo; triangles, 0.1 mg; squares, 0.3 mg; diamonds, 3 mg. \* $P < 0.05$ . (Reproduced with permission from Ref.<sup>[44]</sup>.)

their normal range, i.e., to 1327 pg/ml.<sup>[30]</sup>) As described above, melatonin can also control the timing of sleep and sleepiness rhythms—an effect readily demonstrated among blind people with free-running melatonin and sleep rhythms<sup>[45]</sup> but also among sighted individuals.

Melatonin's ability to phase-shift circadian rhythms underlies its common use to prevent or treat “jet lag”—particularly that associated with eastbound travel (possibly because the melatonin can be taken while the traveler is still awake): A 1999 review<sup>[46]</sup> cited nine placebo-controlled field studies on this use; in seven, subjective measures of sleep and alertness improved. Adequate data are not available on the relationship between the ability of a particular melatonin dose to treat jet lag and to raise plasma melatonin levels. Some investigators recommend taking the melatonin at a specific time (e.g., at 2 A.M. in the traveler's new geographic environment); others simply propose “. . . a . . . pre-flight early evening treatment before an eastbound flight, followed by treatment at bedtime for four days after arrival . . .”<sup>[46]</sup> Westbound, the traveler is advised to take the melatonin late in the evening, to sustain nocturnal plasma melatonin levels for as long into the night as possible.

### Other Reported Effects

It has been suggested<sup>[47]</sup> that melatonin is a potent antioxidant, and that supplements of the hormone may protect against such age-related diseases as atherosclerosis, cancer, and Alzheimer's disease. None of these proposed uses has been tested in a controlled clinical trial and all remain controversial because of lack of confirmation, the enormosity of the melatonin concentrations or doses needed to produce the effect, the failure of the investigators to provide data on actual blood or tissue melatonin concentrations after treatment, and the lack of studies comparing melatonin's effects with those of known antioxidants such as vitamins C or E.<sup>[31,48]</sup> It has usually been possible to demonstrate antioxidant or free radical scavenger effects in vitro; however, these have generally required melatonin concentrations 1000–100,000 times those ever occurring in vivo.<sup>[31]</sup> Similarly, while high doses of melatonin (10–450 mg/kg body weight parenterally) have sometimes elicited antioxidant effects in experimental animals in vivo, neither their long-term safety nor their effects on the animals' blood melatonin levels have been characterized. In humans—if not in nocturnally active laboratory rodents—such megadoses might ultimately impair sleep or various circadian rhythms, perhaps by downregulating melatonin receptors.

Only one study<sup>[31]</sup> has described careful dose-response studies on the ability of melatonin to protect



against auto-oxidation and compared melatonin, with known antioxidants. That study, by Duell et al.<sup>[31]</sup> examined the cell-mediated (by human macrophages) and cell-free (by copper sulfate) oxidation of low density lipoproteins (LDL), a process believed to contribute to atherosclerosis. Melatonin did exhibit weak antioxidant activity, but only at 10,000–100,000-fold physiologic concentrations. In contrast, a vitamin E preparation (alpha-tocopherol) was 50–100-fold more potent than melatonin, and was efficacious at physiologic concentrations. Similarly, vitamin C (ascorbic acid) and tryptophan, melatonin's indolic circulating precursor (Fig. 1), were significantly more potent than melatonin and were active at physiologic concentrations.

Some investigators suggest—based on small studies on laboratory rodents—that melatonin “maintains juvenile conditions” and is a “geroprotector.” There is no evidence that melatonin has any “antiaging” actions in humans.

In several small studies, melatonin was found to reduce blood pressure when given to normotensive men or women in daytime or the early evening, or to patients with essential hypertension. This possible effect should be explored further.

## PRESENT USAGE OF MELATONIN

In the United States, the hormone melatonin is sold, without regulation by the FDA, as a dietary supplement. In most of the rest of the world, it is not sold at all, because it is regulated as a drug and no pharmaceutical company has presented an appropriate regulatory body with a successful new drug application (NDA) for its use. Some countries allow very low doses—less than 100 mg—to be sold without regulatory approval.

Why is melatonin not subject to FDA approval and oversight, while other hormones are subject to such regulation? This is a consequence of the way the Dietary Supplement Health and Education Act of 1994 (Public Law 103–147) has been implemented. That act exempts from FDA regulation a product that is “...intended to supplement the diet that... contains one or more of the following dietary ingredients...,” a list that includes “(D) an amino acid” (e.g., tryptophan), and “(F)...a metabolite...of any ingredient described in clause...(D)” (e.g., melatonin). Not exempted are products like L-dopa that have been “...approved as a new drug...” or “...authorized for investigation as a new drug...” Thyroxine, estrogens, and testosterone had also been approved as drugs prior to passage of the 1994 Dietary Supplement Act, while melatonin had not; thus, melatonin is treated as a dietary supplement, even though there is virtually

no “dietary melatonin” for the “dietary supplement” to supplement.

What have been the consequences of melatonin not being regulated by the FDA? Apparently no deaths to date; if melatonin-related deaths had occurred, the 1994 Act would have allowed the FDA to investigate, and then perhaps to start regulating it. In fact, few serious side effects have been described: A 2001 article described a 35 yr search (1966–2000) of reports on melatonin toxicity using the Medline database. Nine articles were found to describe adverse effects of melatonin; in all cases, the doses administered were in the pharmacologic range (1–36 mg). Individual patients exhibited, autoimmune hepatitis, confusion, optic neuropathy, a psychotic episode, headache, or nystagmus. Four suffered fragmented sleep, four described seizures, and two exhibited skin eruptions. Obviously, no clear pattern of side effects emerges from this review.

In the absence of FDA regulation, companies are able to sell melatonin of uncertain purity, at dosages that are many times those needed for promoting sleep or shifting rhythms, or for restoring normal nocturnal plasma melatonin levels in older people. These dosages can elevate plasma melatonin to levels thousands of times greater than those that ever occur normally, and produce mild but not benign side effects like hypothermia and “hangovers.” Paradoxically, they also may, through receptor downregulation, exacerbate the insomnia that the consumer was trying to treat.

## CONCLUSIONS

This entry describes melatonin, a hormone that is presently marketed as a dietary supplement. Melatonin is synthesized at night in the human pineal gland and released into the blood and cerebrospinal fluid. It acts on the brains of humans to promote sleep, and also influences the phasing of sleep and various other circadian rhythms. During the day, plasma melatonin levels are low; at night, they rise 10–100-fold or more in young adults, but by considerably less in older people—who often may have frequent nocturnal awakenings as a consequence. Very small oral doses of melatonin—about 0.3 mg or less—raise daytime plasma melatonin to night-time levels, thus making it easier for people to fall asleep in the afternoon or evening. Such doses can also help older people remain asleep during the night. Melatonin has also occasionally been claimed to confer other medical benefits—e.g., preventing such age-related diseases as atherosclerosis, cancer, and Alzheimer's disease. The evidence in support of such claims is sparse.

## ACKNOWLEDGMENTS

The author acknowledges with thanks the contributions of Dr. Irina Zhdanova, which included discussing this article before it was written and making useful suggestions for the finished product. Some of the data in this article were obtained with support from an NIH grant to MIT-MGH Clinical Center (5MO1RR01066-26) and a grant from the Center for Brain Sciences and Metabolism Charitable Trust.

## REFERENCES

- McCord, C.P.; Allen, F.P. Evidences associating pineal gland function with alterations in pigmentation. *J. Exp. Zool.* **1917**, *23*, 207–224.
- Lerner, A.B.; Case, J.D.; Takahashi, Y.; Lee, T.H.; Mori, W. Isolation of melatonin, the pineal gland factor that lightens melanocytes. *J. Am. Chem. Soc.* **1958**, *80*, 2587.
- Kitay, J.I.; Altschule, M.D. Effects of pineal extract administration on ovary weight in rats. *Endocrinology* **1954**, *55*, 782–784.
- Fiske, V.M.; Bryant, K.; Putnam, J. Effect of light on the weight of pineal in the rat. *J. Endocrinol.* **1960**, *66*, 489–491.
- Ariens-Kappers, J. Innervation of the epiphysis cerebri in the albino rat. *Anat. Rec.* **1960**, *136*, 220–221.
- Wurtman, R.J.; Roth, W.; Altschule, M.D.; Wurtman, J.J. Interactions of the pineal and exposure to continuous light on organ weights of female rats. *Acta Endocrinol.* **1961**, *36*, 617–624.
- Wurtman, R.J.; Axelrod, J.; Chu, E.W. Melatonin, a pineal substance: effect on the rat ovary. *Science* **1963**, *141* (3577), 277–278.
- Wurtman, R.J.; Axelrod, J.; Fischer, J.E. Melatonin synthesis in the pineal gland: effect of light mediated by the sympathetic nervous system. *Science* **1964**, *143* (3612), 1328–1330.
- Axelrod, J.; Shein, H.M.; Wurtman, R.J. Stimulation of C<sup>14</sup>-melatonin synthesis from C<sup>14</sup>-tryptophan by noradrenaline in rat pineal in organ culture. *Proc. Natl. Acad. Sci. U.S.A.* **1969**, *62*, 544–549.
- Wurtman, R.J.; Shein, H.M.; Larin, F. Mediation by  $\beta$ -adrenergic receptors of effect of norepinephrine on pineal synthesis of [<sup>14</sup>C]serotonin and [<sup>14</sup>C]melatonin. *J. Neurochem.* **1971**, *18*, 1683–1687.
- Klein, D.C.; Moore, R.Y. Pineal N-acetyltransferase and hydroxyindole-O-methyltransferase: control by a retinohypothalamic tract and the suprachiasmatic nucleus. *Brain Res.* **1979**, *174*, 245–262.
- Lynch, H.J.; Wurtman, R.J.; Moskowitz, M.A.; Archer, M.C.; Ho, M.H. Daily rhythm in human urinary melatonin. *Science* **1975**, *187*, 169–171.
- Wurtman, R.J.; Axelrod, J. The pineal gland. *Sci. Am.* **1965**, *213* (1), 50–60.
- Skene, D.J.; Vivien-Roels, B.; Sparks, D.L.; Hunsaker, J.C.; Pevey, P.; Ravid, D.; Swaab, D.F. Daily variation in the concentration of melatonin and 5-methoxytryptophol in the human pineal gland: effects of age and Alzheimer's disease. *Brain Res.* **1990**, *528* (1), 170–174.
- Tricoire, H.; Locatelli, A.; Chemineau, P.; Malpoux, B. Melatonin enters the cerebrospinal fluid through the pineal recess. *Endocrinology* **2002**, *143* (1), 84–90.
- Kopin, I.J.; Pare, C.M.; Axelrod, J.; Weissbach, H. 6-Hydroxylation, the major metabolic pathway for melatonin. *Biochim. Biophys. Acta* **1960**, *40*, 377–378.
- Witt-Enderby, P.A.; Bennett, J.; Jarzynka, M.J.; Firestine, S.; Melan, M.A. Melatonin receptors and their regulation: biochemical and structural mechanisms. *Life Sci.* **2003**, *72*, 2183–2198.
- Hattori, A.; Migitaka, H.; Iigo, M.; Itoh, M.; Yamamoto, K.; Ohtani-Kaneko, R.; Hara, M.; Suzuki, T.; Reiter, R.J. Identification of melatonin in plants and its effects on plasma melatonin levels and binding to melatonin receptors in vertebrates. *Biochem. Mol. Biol. Int.* **1995**, *35* (3), 627–634.
- Van Tassel, D.L.; Roberts, N.; Lewy, A.; O'Neill, S.D. Melatonin in plant organs. *J. Pineal Res.* **2001**, *31*, 8–15.
- Mayeda, A.; Mannon, S.; Hofstetter, J.; Adkins, M.; Baker, R.; Hu, K.; Nurnberger, J. Jr. Effects of indirect light and propranolol on melatonin levels in normal human subjects. *Psychiatry Res.* **1998**, *81*, 9–17.
- Garde, E.; Micic, S.; Knudsen, K.; Angelo, H.R.; Wulf, H.C. 8-Methoxypsoralen increases daytime plasma melatonin levels in humans through inhibition of metabolism. *Photochem. Photobiol.* **1994**, *60* (5), 475–480.
- Ekman, A.C.; Leppaluoto, J.; Huttunen, P.; Aranko, K.; Vakkuri, O. Ethanol inhibits melatonin secretion in healthy volunteers in a dose-dependent randomized double blind cross-over study. *J. Clin. Endocrinol. Metab.* **1993**, *77* (3), 780–783.
- Lewy, A.J.; Wehr, T.A.; Goodwin, F.K.; Newsome, D.A.; Markey, S.P. Light suppresses melatonin secretion in humans. *Science* **1980**, *210*, 1267–1269.
- Kennaway, D.J.; Stamp, G.E.; Goble, F.C. Development of melatonin production in infants and the impact of prematurity. *J. Clin. Endocrinol. Metab.* **1992**, *75*, 367–369.

25. Waldhauser, F.; Lynch, H.J.; Wurtman, R.J. Melatonin in human body fluids: clinical significance. In *The Pineal Gland. Comprehensive Endocrinology*; Reiter, R.J., Ed.; Raven Press: New York, 1984; 345–370.
26. Waldhauser, F.; Lieberman, H.R.; Lynch, H.J.; Waldhauser, M.; Herkner, K.; Frisch, H.; Vierhapper, H.; Waldhausl, W.; Schemper, M.; Wurtman, R.J.; Crowley, W.F. A pharmacological dose of melatonin increases PRL levels in males without altering those of GH, LH, FSH, TSH, testosterone or cortisol. *Neuroendocrinology* **1987**, *46*, 125–130.
27. Dollins, A.B.; Lynch, H.J.; Wurtman, R.J.; Deng, M.H.; Kischka, K.U.; Gleason, R.E.; Lieberman, H.R. Effect of pharmacological daytime doses of melatonin on human mood and performance. *Psychopharmacology* **1993**, *112*, 490–496.
28. Dollins, A.B.; Zhdanova, I.V.; Wurtman, R.J.; Lynch, H.J.; Deng, M.H. Effect of inducing nocturnal serum melatonin concentrations in daytime on sleep, mood, body temperature, and performance. *Proc. Natl. Acad. Sci. U.S.A.* **1994**, *91*, 1824–1828.
29. Di, W.-L.; Kadva, A.; Johnston, A.; Silman, R. Variable bioavailability of oral melatonin. *N. Engl. J. Med.* **1997**, *336* (14), 1028–1029.
30. Deacon, S.; Arendt, J. Melatonin-induced temperature suppression and its acute phase-shifting effects correlate in a dose-dependent manner in humans. *Brain Res.* **1995**, *688*, 77–85.
31. Duell, P.B.; Wheaton, D.L.; Shultz, A.; Nguyen, H. Inhibition of LDL oxidation by melatonin requires supraphysiologic concentrations. *Clin. Chem.* **1998**, *44*, 9.
32. Pappolla, M.; Bozner, P.; Soto, C.; Shao, H.; Robakis, N.K.; Zagorski, M.; Frangione, B.; Ghiso, J. Inhibition of Alzheimer beta-fibrillogenesis by melatonin. *J. Biol. Chem.* **1998**, *273*, 7185–7188.
33. Lewy, A.J.; Ahmed, S.; Latham Jackson, J.M.; Sack, R.L. Melatonin shifts human circadian rhythms according to a phase-response curve. *Chronobiol. Int.* **1992**, *9* (3), 380–392.
34. Zhdanova, I.V.; Wurtman, R.J. Efficacy of melatonin as a sleep-promoting agent. *J. Biol. Rhythms* **1997**, *12* (6), 644–650.
35. Brzezinski, A.; Vangel, M.G.; Wurtman, R.J.; Norrie, G.; Zhdanova, I.; Ben-Shushan, A.; Ford, I. Effect of exogenous melatonin on sleep: A meta-analysis. *Sleep Med. Revs.* **2005**, *9* (1), doi: 10.1016/j.smr.2004.06.004.
36. James, S.P.; Sack, D.A.; Rosenthal, N.E.; Mendelson, W.B. Melatonin administration in insomnia. *Neuropsychopharmacology* **1990**, *3* (1), 19–23.
37. Waldhauser, F.; Saletu, B.; Trinchard-Lugan, I. Sleep laboratory investigations on hypnotic properties of melatonin. *Psychopharmacology* **1990**, *100*, 222–226.
38. Dahlitz, M.; Alvarez, B.; Vignau, J.; English, J.; Arendt, J.; Parkes, J.D. Delayed sleep phase syndrome response to melatonin. *Lancet* **1991**, *337*, 1121–1124.
39. Haimov, I.; Lavie, P.; Laudon, M.; Herer, P.; Vigder, C.; Zisapel, N. Melatonin replacement therapy of elderly insomniacs. *Sleep* **1995**, *18* (7), 598–603.
40. Garfinkel, D.; Laudon, M.; Nof, D.; Zisapel, N. Improvement of sleep quality in elderly people by controlled-release melatonin. *Lancet* **1995**, *346*, 541–544.
41. Attenburrow, M.E.; Cowen, P.J.; Sharpley, A.L. Low dose melatonin improves sleep in healthy middle-aged subjects. *Psychopharmacology* **1996**, *126*, 179–181.
42. Shamir, E.; Laudon, M.; Barak, Y.; Anis, Y.; Rotenburg, V.; Elizur, A.; Zisapel, N. Melatonin improves sleep quality of patients with chronic schizophrenia. *J. Clin. Psychiatry* **2000**, *61*, 373–377.
43. Singer, S.; Tractenberg, R.E.; Kaye, J.; Schafer, K.; Gamst, A.; Grundman, M.; Thomas, R.; Thal, L.J. A multicenter placebo-controlled trial of melatonin for sleep disturbance in Alzheimer's disease. *Sleep* **2003**, *26*, 1–7.
44. Zhdanova, I.V.; Wurtman, R.J.; Regan, M.M.; Taylor, J.A.; Shi, J.P.; Leclair, O.U. Melatonin treatment for age-related insomnia. *J. Clin. Endocrinol. Metab.* **2001**, *86* (10), 4727–4730.
45. Arendt, J.; Aldhous, M.; Wright, J. Synchronisation of a disturbed sleep-wake cycle in a blind man by melatonin treatment. *Lancet* **1988**, *i*, 772–777.
46. Arendt, J. Jet-lag and shift work: (2). Therapeutic use of melatonin. *J. R. Soc. Med.* **1999**, *92* (8), 402–405.
47. Rodriguez, C.; Mayo, J.C.; Sainz, R.M.; Antolin, I.; Herrera, F.; Martin, V.; Reiter, R.J. Regulation of antioxidant enzymes: a significant role for melatonin. *J. Pineal Res.* **2004**, *36*, 1–9.
48. Bonn, D. Melatonin's multifarious marvels: miracle or myth? *Lancet* **1996**, *347*, 184.

# Milk Thistle (*Silybum marianum*)

## Elena Ladas

Division of Pediatric Oncology, Integrative Therapies Program for Children with Cancer, College of Physicians and Surgeons, Columbia University Medical Center, New York, New York, U.S.A.

## David J. Kroll

Natural Products Laboratory, Research Triangle Institute (RTI International), Research Triangle Park, North Carolina, U.S.A.

## Kara M. Kelly

Division of Pediatric Oncology, Integrative Therapies Program for Children with Cancer, College of Physicians and Surgeons, Columbia University Medical Center, New York, New York, U.S.A.

## INTRODUCTION

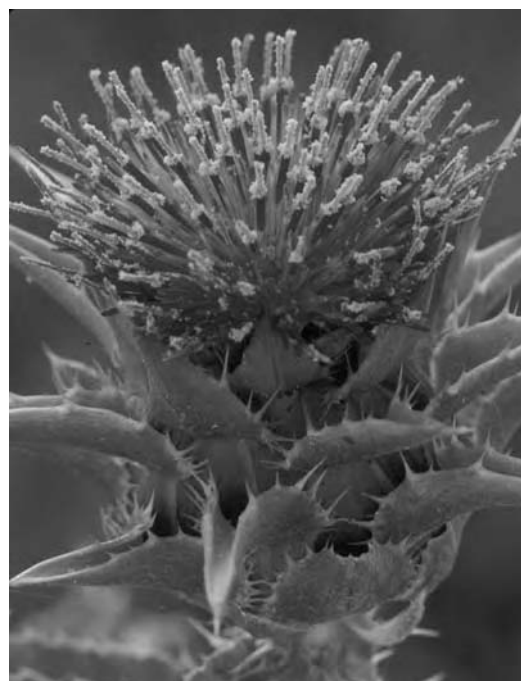
Milk thistle [*Silybum marianum* (L.) Gaertn. (Asteraceae); also *Carduus marianus* L.] (Fig. 1) is a herb widely used in Europe for the treatment of liver and biliary disorders. Although milk thistle is the most commonly used name for the herb, other names include silymarin, holy thistle, St. Mary thistle, Mary thistle, Marian thistle, Mariendistel, and lady's thistle. The plant is indigenous to Europe but can be found in the western and southwestern United States. In ancient times, the leaves of milk thistle were used as part of the European diet. The medicinal properties of the herb reside in its seeds (Fig. 2). The primary active component, silymarin, is a potent antioxidant mixture composed of several related flavonolignans.

## HISTORY

### Use in Historical Times

Milk thistle has been used medicinally for over 2000 years, primarily as a treatment for liver dysfunction. In ancient Greece, Dioscorides recommended the herb

as a treatment for serpent bites.<sup>[1]</sup> Subsequently, Pliny the Elder (23–79 A.D.) prescribed milk thistle for “carrying off bile.”<sup>[1,2]</sup> In the Middle Ages Culpepper reported it to be effective for relieving obstructions of the liver.<sup>[1,2]</sup> In 1898, the eclectic physicians Felter and Lloyd stated that the herb was good for congestion of the liver, spleen, and kidneys.<sup>[1,2]</sup>



**Fig. 1** Milk thistle (*Silybum marianum*). Herbal supplements from this plant are most commonly made from organic extracts of the fruits/seeds present at the base of the spiny tuft. (View this art in color at [www.dekker.com](http://www.dekker.com).)

---

*Elena Ladas* is at the Division of Pediatric Oncology, Integrative Therapies Program for Children with Cancer, College of Physicians and Surgeons, Columbia University Medical Center, New York, New York, U.S.A.

*David J. Kroll* is at the Natural Products Laboratory, Research Triangle Institute (RTI International), Research Triangle Park, North Carolina, U.S.A.

*Kara M. Kelly, M.D.*, is Associate Professor of Clinical Pediatrics at the Department of Pediatrics, Division of Pediatric Oncology, Integrative Therapies Program for Children with Cancer, College of Physicians and Surgeons, Columbia University Medical Center, New York, New York, U.S.A.



**Fig. 2** Milk thistle seeds. The seeds of the thistle are relatively large (5–6 mm in length) and, when hulled, should contain 1–2% (w/w) silybins. The most common crude extract, silymarin, is an off-white to yellow powder composed primarily of seven flavonolignans and the flavonoid taxifolin (dihydroquercetin). Selective extraction of silymarin yields silibinin, once thought to be a pure compound but now known to be a mixture of two silybins (see Table 1 for comparison). (View this art in color at [www.dekker.com](http://www.dekker.com).)

### Current Use

Native Americans use milk thistle to treat boils and other skin diseases. Homeopathic practitioners utilize preparations from the seeds in the treatment of jaundice, gallstones, peritonitis, hemorrhage, bronchitis, and varicose veins.<sup>[1]</sup> Currently, the German Commission E recommends its use for dyspeptic complaints, toxin-induced liver damage, and hepatic cirrhosis, and as a supportive therapy for chronic inflammatory liver conditions.<sup>[3]</sup>

### CHEMISTRY

Although the chemical composition of milk thistle seed extracts has been studied since the 1950s, a precise nomenclature for the biologically active constituents has been evasive until very recently. Historically, the terms “silymarin” and “silibinin,” or “silybinin,” have been used interchangeably<sup>[4]</sup> to denote the content of standardized milk thistle extracts. However, none of these terms refers to a single pure compound (Table 1).

Many of the primary active compounds in milk thistle extracts are classified as flavonolignans, each derived from the biosynthetic condensation of taxifolin, a flavonoid, and coniferyl alcohol, a precursor of lignins and lignans. The terms *silymarin*, *silymarin group*, and *silymarin complex* have all been used to refer to the group of flavonolignans present in organic

**Table 1** Compounds present in silymarin and silibinin

Silibinin <sup>a</sup>	Silymarin <sup>b</sup>	
Silybin A	Silybin A	Silychristin
Silybin B	Silybin B	Isosilychristin
	Isosilybin A	Silydianin
	Isosilybin B	Taxifolin

<sup>a</sup>Approximately a 1 : 1 mixture of silybin A and B.

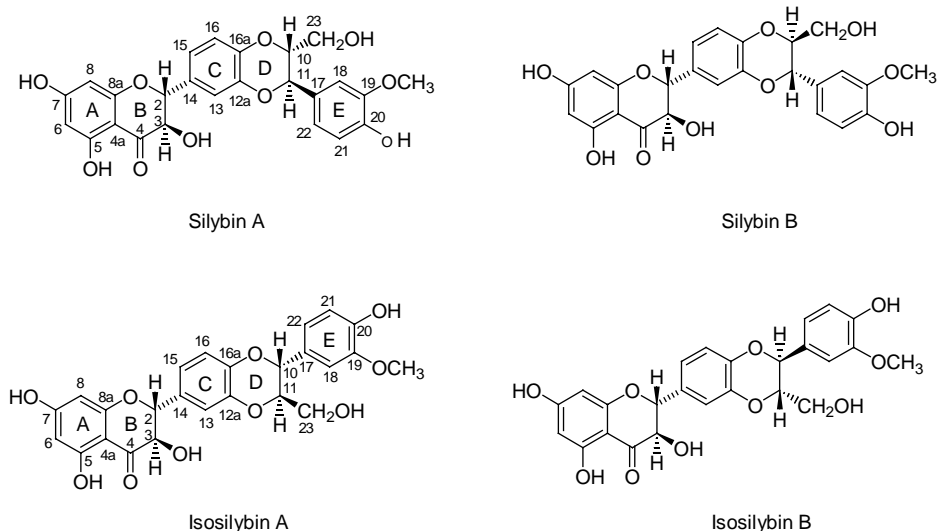
<sup>b</sup>The major part (65–80%), of silymarin is a variable mixture of these eight compounds; 20–35% is accounted for by other polyphenolics and undefined compounds. Some milk thistle extracts are incorrectly labeled as standardized for 65–80% silymarin. With the exception of the small percentage of taxifolin, a more accurate term for these extracts would be 65–80% silibinin equivalents, since the other seven compounds share the same chemical formula. Milk thistle products, especially those used in clinical trials, should be analyzed for the composition of each of these compounds and manufacturers should be encouraged to provide these data to consumers for each lot.<sup>[104]</sup>

extracts of dried milk thistle seeds. The primary flavonolignan present in silymarin is silibinin, a 1 : 1 diastereomeric mixture of silybin A and silybin B (Fig. 3).<sup>[5]</sup> Silymarin also contains several other flavonolignans, each with a formula weight of 482. Isosilybin is a 1 : 1 diastereomeric mixture of isosilybin A and isosilybin B, each of which differs from its corresponding silybin only in the interchange of substituents at the C-10 and C-11 positions (Fig. 3).<sup>[5]</sup> The other flavonoid compounds found in the seed of milk thistle are shown in Table 1, and these remaining structures have been known for quite some time. The resolution of these eight compounds was accomplished in 2003,<sup>[5]</sup> and the stereochemical assignment of the silybins and isosilybins was confirmed thereafter (Fig. 4).<sup>[6]</sup>

The relative biological importance of each of these flavonolignans likely depends on the therapeutic indication. For example, in preclinical studies of human prostate cancer, silibinin is comparable in its growth-inhibitory and antitumor effects to silymarin.<sup>[7]</sup> In contrast, silymarin is 8-fold more potent than silibinin in scavenging free radicals in vitro.<sup>[8]</sup> Consistent with this observation, silydianin and silychristin (present only in silymarin) are 2- to 10-fold more potent than silibinin.<sup>[8]</sup> Therefore, future biological studies will be aided by the recent advances in milk thistle flavonolignan chemistry in determining whether different product formulations are better suited for specific indications.

### ABSORPTION AND TRANSPORT

Silymarin is not water soluble; therefore it is used primarily in capsule rather than in tea (aqueous decoction) form. To facilitate absorption, silibinin bound to a phosphatidylcholine complex is used in

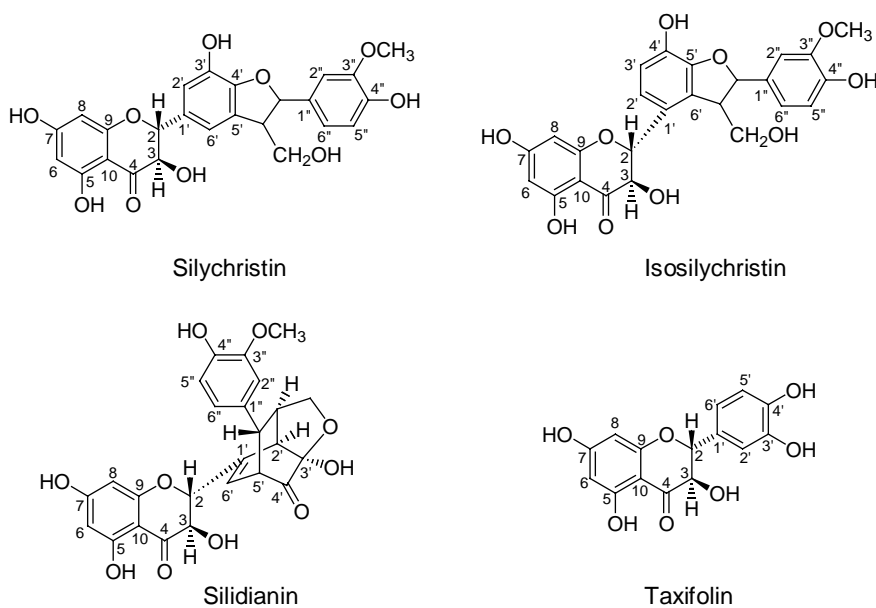


**Fig. 3** Structures of silybins and isosilybins. Silibinin is a 1 : 1 diastereomeric mixture of the two enantiomers silybin A and silybin B but contains no other flavonolignans. In contrast, silymarin is composed of the two silybins as well as varying concentrations of isosilybins A and B and other compounds. (Adapted from Ref.<sup>[5]</sup>.)

most human trials, The bioavailability of this complex is on average 4.6 times higher than that of free silibinin,<sup>[9]</sup> and in patients post cholecystectomy, biliary bioavailability of silibinin–phosphatidylcholine was 4.2-fold greater than that of a similar dose of silymarin.<sup>[10]</sup> Studies suggest that silibinin is absorbed directly by the portal pathway from the intestinal tract. It then undergoes extensive metabolism, as evidenced by the presence of sulfate and/or glucuronide conjugates in the blood.<sup>[9,11]</sup> Once in the liver, silibinin may be packaged into lipid micelles and transported to extrahepatic tissues, a hypothesis supported by the observation of radiolabeled silibinin in micelles in increasing quantities according to their lipophilicity, with the highest concentrations in triglycerides and

very low density lipoproteins. Approximately 80% of silibinin is excreted in bile, with only 3% excreted in urine.<sup>[12]</sup>

Pharmacokinetic studies in humans have found absorption to be rapid, with peak plasma levels occurring within 2 hr after a single dose and within 1 hr after multiple doses.<sup>[9,11]</sup> The pharmacokinetics of single and multiple doses exhibit superimposable curves, although secondary peaks have been observed in multiple dose studies.<sup>[9,11]</sup> This may be due to extensive enterohepatic cycling.<sup>[12]</sup> Following a single dose of silibinin–phosphatidylcholine (80 mg silibinin equivalents), conjugated silybins are observed at 2.5-fold greater concentrations than free silybins, with a mean residence time of nearly 7 hr.<sup>[13]</sup> Pharmacokinetic studies



**Fig. 4** Structures of silychristin, isosilychristin, silydianin and taxifolin. The three flavonolignans and the flavonoid, taxifolin, are present only in silymarin. Silychristin, isosilychristin, and silidianin share the same chemical formula and formula weight (482) as the silybins and isosilybins in Fig. 3. Despite this similarity, silidianin is the most potent free radical scavenger of the class. (Adapted from Ref.<sup>[5]</sup>.)

in humans have shown that steady-state levels are achieved within 4 days of dosing with the complex.<sup>[9,11]</sup> The median peak plasma level of unconjugated flavonolignans (usually expressed as silibinin equivalents, with molar values relative to flavonolignan, which has a formula weight of 482.1) found in multiple human studies is 185 ng/ml, or 0.38  $\mu$ M (range 67–3787 ng/ml; 0.14–7.8  $\mu$ M), with high interindividual variability.<sup>[9,11,14]</sup> However, the interpretation of existing pharmacokinetic studies is hampered by varying dosing regimens with numerous products, and only one study has attempted to examine the differential pharmacokinetics of individual flavonolignan isomers.<sup>[15]</sup> Adverse effects have not correlated with higher plasma levels of free or free and conjugated silibinin.<sup>[16]</sup> This is possibly due to its short half-life (approximately 2–6 hr). Human studies have found similar pharmacokinetic patterns in studies of patients with cirrhosis of the liver.<sup>[17,18]</sup>

Studies have found that the silibinin–phosphatidylcholine form and silymarin are more concentrated in the bile relative to plasma. In nine cholecystectomy patients administered a single oral dose of either silibinin–phosphatidylcholine or silymarin (120 mg silibinin equivalents), peak biliary concentrations reached 116 and 29  $\mu$ g/ml, or 240 and 60  $\mu$ M, respectively.<sup>[10]</sup> Mean residence time for both preparations was in excess of 10 hr.<sup>[10]</sup>

## ACTION AND PHARMACOLOGY

### Milk Thistle as an Antioxidant

Silibinin demonstrates potent antioxidant effects *in vitro* and *in vivo*. As with other flavonolignans, this mixture has been found to be a free radical scavenger, to mildly chelate metals, and to inhibit lipid peroxidation.<sup>[19–22]</sup> Silibinin is an effective scavenger of OH $\cdot$  and HOCl species, but has not exhibited any affinity towards H<sub>2</sub>O<sub>2</sub> and O<sub>2</sub><sup>-</sup> radicals.<sup>[23]</sup> It inhibits lipid peroxidation induced by ADP/Fe<sub>2</sub><sup>+</sup>,<sup>[19]</sup> Fe<sup>11</sup>,<sup>[22]</sup> *tert*-butyl hydroperoxide,<sup>[24]</sup> and phenylhydrazine,<sup>[25]</sup> as measured by effects on malondialdehyde (MDA) production. Silymarin has also been found to be effective in decreasing lipid peroxidation in human platelets in a dose-dependent manner.<sup>[26]</sup> Despite their common chemical formulas, the flavonolignan isomers vary substantially in their *in vitro* potency for sequestering 1,1-diphenyl-2-picrylhydrazyl radical (DPPH).<sup>[8]</sup> Silydianin and silychristin are 2- to 10-fold more potent than the silybins or isosilybins, and this may account for the 8-fold greater potency of silymarin compared to the silybins.<sup>[8]</sup>

*In vitro* data suggest that silibinin affects enzymes involved with phase I detoxification through its effects

on intracellular glutathione concentrations and glutathione-S-transferase enzymes. It stimulates enzyme transcription and the activity of glutathione-S-transferase enzymes and has been found to prevent a decrease in glutathione in the liver cells of rats treated with acetaminophen.<sup>[27–29]</sup> This mechanism is agent specific, as treatment with buthionine sulfoximine, a glutathione-depleting agent, failed to prevent the depletion of intracellular glutathione in rat hepatocytes.<sup>[20]</sup>

In addition, pretreatment with silymarin [Legalon<sup>®</sup> (10  $\mu$ g/ml, 0.1 mg/ml, and 15 mg/ml)] had no effect on MDA production or glutathione or glutathione peroxidase activity in human erythrocytes exposed to doxorubicin or acetaminophen.<sup>[30]</sup> The significance of these antioxidant effects in the intact organism is uncertain.

### Effects on Liver Cells

By acting on protein synthesis, silymarin may accelerate liver regeneration and production of hepatocytes through its actions on DNA-dependent-RNA polymerase I and 5.8S, 18S, and 28S ribosomal RNA.<sup>[31,32]</sup> These hypotheses were later supported in one clinical trial that found improvements in liver histology in patients with acute and subacute liver disease.<sup>[33]</sup> Silymarin has also been found to protect the liver from toxic substances, presumably through alteration of hepatocyte membrane permeability. *In vitro* studies demonstrate that silymarin exerts a protective effect in hepatocytes exposed to *tert*-butyl hydroperoxide, phenylhydrazine, acetaminophen, and carbon tetrachloride.<sup>[22,24,25,34]</sup> This protective effect has been supported by human case reports as well.<sup>[35]</sup> Silymarin may also affect phospholipid metabolism in the liver. Silibinin has been shown to inhibit alcohol-induced phospholipid synthesis,<sup>[36]</sup> by decreasing the rate of glycerol incorporation into phospholipids.<sup>[37]</sup> Investigations in rat liver Kupffer cells indicate that it inhibits leukotriene B<sub>4</sub> formation with an IC<sub>50</sub> of 15  $\mu$ M. This significant inhibition is also observed with as little as 5  $\mu$ M, a concentration achievable in the liver.<sup>[31]</sup> The relevance of this effect in the prevention of fibrotic liver disease continues to be studied.

Silymarin has been found to inhibit signals that promote fibrosis of the liver tumor necrosis factor (TNF)- $\alpha$  and nuclear factor (NF)- $\kappa$ B involved in the development of cirrhosis.<sup>[38,39]</sup> Silibinin inhibited intrahepatic activation of NF- $\kappa$ B and inhibited intrahepatic expression of TNF, interferon- $\gamma$ , interleukin (IL)-4, IL-2, and inducible nitric oxide synthase (iNOS) in mice at doses of 25 mg/kg.<sup>[40]</sup> Interleukin-2 and -4 were expressed in mice fed 10 mg/kg of silymarin, but significant increases were not observed at doses of 50 or 250 mg/kg. Expression of TNF- $\alpha$  and proinflammatory cytokines (IL-6, IL-1 $\beta$ , iNOS) was

stimulated in mice treated with 50 and 250 mg/kg of silymarin. The antioxidant effects of silymarin may also account for its ability to prevent or slow the progression of liver disease.

### Antilipidemic Effects

Silymarin may be an effective hypocholesterolemic drug (Table 2).<sup>[41]</sup> Preliminary research suggests that silymarin on its own or in combination with other polyphenolic compounds found in milk thistle may inhibit absorption of lipids from the gastrointestinal tract, decrease synthesis of lipids in the liver, inhibit enzymes involved in lipid neogenesis, and prevent oxidation of low density lipoprotein (LDL) vesicles.

Silibinin and silibinin–phosphatidylcholine complex do not prevent the accumulation of cholesterol in the liver.<sup>[42,43]</sup> However, silymarin in combination with other milk thistle flavonoids decreased cholesterol absorption from the small intestine in rats fed a high fat diet, through an action similar to bile-acid sequestrants. Taxifolin, a flavonoid compound found in milk thistle, has also been found to inhibit cholesterol absorption.<sup>[44]</sup> This suggests that other components of the herb besides silibinin are responsible for its anticholesterolemic effects.

Silymarin inhibits key enzymes involved in cholesterol biosynthesis. Silibinin inhibits 3-hydroxy-3-methylglutaryl-CoA (HMG-CoA) reductase activity in a dose-dependent manner in cell lines, but this has not been observed in rat liver microsomes.<sup>[45]</sup> Silymarin decreases the concentration of cholesterol in very low density lipoproteins (VLDL),<sup>[41,43,44]</sup> but its effect on plasma cholesterol levels is uncertain. An inverse relationship between plasma cholesterol levels and silymarin was seen in one study,<sup>[42]</sup> but another study has not found an association.<sup>[44,46]</sup>

The effects of silymarin on plasma triglycerides, VLDL, LDL, and high density lipoproteins (HDL) has been evaluated. It lowers plasma VLDL<sup>[42-44]</sup> but has no effect on plasma LDL.<sup>[42,44]</sup> Silymarin and silibinin increase HDL.<sup>[42,44]</sup> The mechanisms through which silymarin may exert these effects is unknown, but its antioxidant properties may be responsible for inhibition of LDL oxidation.<sup>[43]</sup>

### Anticancer Effects

The effects of silymarin and silibinin have been investigated in various cancer models (Table 3). The two mixtures have been evaluated for their ability to exert direct cytotoxic effects, mitigate the toxicity of certain anticancer agents, and enhance the efficacy of chemotherapeutic agents. These effects have been most extensively investigated in prostate cancer cell lines

(DU 145, LNCaP, PC-3)<sup>[47-51]</sup> and a mouse skin cancer model.<sup>[52-57]</sup> Other in vitro studies have investigated their properties in breast cancer (MDA-MB 468, MCF-7)<sup>[7,58,59]</sup> hepatic cancer (HepG2),<sup>[60,61]</sup> epidermoid cancer (A431),<sup>[61]</sup> colon cancer (Caco-2),<sup>[62]</sup> ovarian cancer (OVCA 433, A2780),<sup>[63]</sup> histiocytic lymphoma (U-937),<sup>[64]</sup> and leukemia (HL-60)<sup>[65,66]</sup> cells. Silymarin and silibinin have been investigated in animal tumor models of skin<sup>[52-56]</sup> tongue cancer<sup>[53-57,67]</sup> bladder cancer,<sup>[68]</sup> and adenocarcinoma of the colon<sup>[69,70]</sup> and small intestine.<sup>[69]</sup>

Silymarin and silibinin have activity against prostate cancer. They can inhibit growth factors and cell-to-cell signaling that stimulate cell growth,<sup>[47,48,50,51]</sup> promote cell cycle arrest in G<sub>1</sub>,<sup>[49,50]</sup> and inhibit anti-apoptotic activity.<sup>[71]</sup> Silymarin (75 µg/ml of medium) inhibits epidermal growth factor B1 and subsequent signaling processes leading to growth inhibition of DU 145 cells.<sup>[49]</sup> In LNCaP cells, the G<sub>1</sub> arrest caused by silibinin appears to be mediated by an increase in complex formation between the retinoblastoma gene product, Rb, and members of the E2F transcription factor family. Administration of silibinin in the diet to nude mice significantly lowered tumor volume and wet tumor weight.<sup>[48]</sup> These effects on human prostate cancer xenografts correlated with plasma levels of 14–27 µM. Importantly, the investigators monitored food consumption and found that mice ingested 1.8–3.5 mg silibinin/day. Using typical allometric scaling to a 70 kg human, this correlates to a daily silibinin dose of 650–1300 mg. While this is higher than the dose recommended for hepatic protection, the low toxicity of silibinin and silymarin should make it possible to increase the dose to achieve a therapeutically relevant anticancer concentration of the flavonolignans.

Silymarin and silibinin have also been extensively investigated in the SENCAR mouse nonmelanoma skin cancer model.<sup>[52,53,55-57,72-74]</sup> Silymarin treatment significantly reduced tumor incidence, multiplicity, and volume in cells treated with ultraviolet B to induce tumor promotion, but not in cells treated with UVB to induce tumor initiation.<sup>[53]</sup> Silymarin (6 mg dose in 0.2 ml of acetone) inhibits TNF-α mRNA in the mouse epidermis, possibly by inhibiting tumor promotion.<sup>[75]</sup>

Silymarin and silibinin have chemopreventive effects in breast (MDA-MB-468) and cervical (A431) cancer cell lines.<sup>[7]</sup> In male F344 rats with azoxymethane-induced colon cancer, supplementation with silymarin (100, 500, and 1000 ppm in the diet) resulted in a reduction of colon tumorigenesis and a decrease in multiplicity of tumor growth.<sup>[70]</sup> Pretreatment of human promyelocytic leukemia (HL-60) cells with silibinin resulted in inhibition of cell growth and differentiation. Silymarin interferes with cell-to-cell signaling in breast cancer cell lines (MDA-MB-468),<sup>[59]</sup> histiocytic lymphoma (U-937),<sup>[64]</sup> and hepatoma cell



Table 2 Summary of laboratory studies: Antilipidemic effects

Reference	Model	Treatment (concentration)	Results
105	Rat liver homogenates	Silibinin ( $7.5 \times 10^{-6}$ mol/L)	Inhibition of precursors of cholesterol synthesis
45	Rats	Silibinin (100 mg/kg; 50 mg/kg)	↓ Biliary CHO and phospholipid concentration at higher dose only No effect on liver CHO Inhibition of HMG-CoA reductase activity
106	Rat liver microsomes	Silymarin and silibinin (100 mg/kg)	↓ Turnover of phospholipids only in vitro. (findings not confirmed in vivo)
36	Rats	Silibinin (100 mg/kg IV)	Inhibition of EtOH-induced phosphosynthesis
37	Rat hepatocytes	Silibinin (1 or 0.1 mM)	↓ Incorporation of glycerol in TG synthesis ↓ TG production in the liver
107	Rat liver removed after IP administration (liver homogenates)	Silibinin ( $7.5 \times 10^{-6}$ to $7.5 \times 10^{-4}$ mol/L)	Stimulation of phosphatidylcholine synthesis
42	Hypercholesterolemic rats	Silymarin	↑ Choline phosphate cytidyltransferase ↓ Liver and plasma CHO, VLDL, phospholipids ↑ HDL
43	Rats	Silibinin Silymarin	No effect on TG No effect ↓ Liver and Plasma VLDL ↑ HDL
44	Rats	IdB 1016 Silymarin	Not effective ↓ Liver CHO, TG ↓ Plasma VLDL, TG ↓ Concentration of CHO in VLDL ↑ HDL
108	Rabbits	Silymarin-phospholipid complex Silymarin alone	No effect on plasma CHO and LDL ↓ CHO in liver homogenates ↓ CHO in liver microsomes No significant effect

CHO, cholesterol; EtOH, ethanol; HDL, high density lipoprotein; HMG-CoA reductase, 3-hydroxy-3-methylglutaryl-CoA reductase; IP, intraperitoneal; IV, intravenous; TG, triglyceride; VLDL, very low density lipoproteins; ↑ increase; ↓ decrease.

**Table 3** Summary of laboratory studies: Anticancer effects

Cancer type	Main findings/target of action
<i>Cell lines</i>	
Leukemia <sup>[65]</sup> (HL-60)	Inhibited cell proliferation; induced cell differentiation
Breast <sup>[58,59]</sup> (MCF-7, MDA-MB-468)	Inhibited VEGF (25, 50, 100 µg/ml) Exerted antiangiogenic properties by inhibiting VEGF Inhibited cell growth, cell proliferation, and CDK expression Inhibited VEGF
Prostate <sup>[47,49-51,58,71,105,106]</sup> (DU145, PC-3, LNCaP)	Inhibits erbB1; induced CDK1s; induced cell cycle arrest Stimulated IGF1R-3 Inhibited intracellular PSA and cell growth Inhibited EGF, erbB1, ERK1/2 Inhibited NF-κB, p65, p50; Increased IκBα levels; sensitized cells of TNFα Inhibited Rb phosphorylation; induced G <sub>1</sub> arrest Exerted antiangiogenic properties by inhibiting VEGF secretion
Hepatic <sup>[61]</sup> (HepG2)	Inhibited binding and expression of NF-κB Decreased APAP-induced toxicity
<i>Other</i>	
Testicular <sup>[76]</sup> (H12.1, 577LM, 1777NR Cl-A)	No interference in antitumor effects in cisplatin- and ifosfamide-treated cells
Gynecologic <sup>[79]</sup> (A2780, OVCA 433)	Enhanced efficacy of cisplatin; no stimulation of tumor growth by IdB 1016
Histiocytic lymphoma <sup>[64]</sup> (U-937)	Inhibited transcription of NF-κB. inhibited phosphorylation and degradation of IκBα no effect on AP-1
<i>Animal models</i>	
Colon <sup>[69,70]</sup> (male F344 rats; Sprague-Dawley rats)	Reduced incidence and multiplicity of chemical-induced colon cancer of (dietary silymarin; 100, 500, 1000 ppm in diet) Decrease frequency of adenocarcinoma (silymarin flavonolignans; 0.10%)
Skin <sup>[52,53,72,73,75]</sup> (SENCAR mice)	Inhibited activity and mRNA of ODC Inhibited mRNA of TNFα Inhibited tumor promotion; no effect on tumour initiation Inhibited ligand binding of EGFR, cell cycle arrest, DNA synthesis Inhibited lipid peroxidation and proinflammatory cytokines; prevented depletion of antioxidant enzymes Inhibited MAPK/ERK 1/2, stimulated SAPK/JNK 1/2 and p38 MAPK
<i>Other</i>	
Bladder <sup>[68]</sup> (male ICR mice)	Inhibited initiation and proliferation of tumor cells
Prostate (DU145) <sup>[48]</sup> (athymic male nude mice)	Inhibited tumor volume; induced IGF1R-3
Tongue <sup>[67]</sup> (F344 rats)	Inhibited tumor initiation and promotion

APAP, acetaminophen; CDK1, cyclin-dependent kinase inhibitor; EGF, epidermal growth factor; EGFR and erbB1, epidermal growth factor receptor; IGF1R-3, insulinlike growth factor binding protein 3; IκBα, inhibitory subunit of NF-κB; MAPK/ERK1/2, mitogen-activated protein kinase/extracellular signal-regulated protein kinase; NF-κB, nuclear factor kappa B; ODC, ornithine deoxycarboxylase; PSA, prostate specific antigen; Rb, retinoblastoma; SAPK/JNK1/2, stress-activated protein kinase/jun NH<sub>2</sub>-terminal kinase; TNF-α, tumor necrosis factor α; VEGF, vascular endothelial growth factor.

lines.<sup>[60]</sup> It may also have a chemopreventive role in tongue and bladder carcinogenesis.<sup>[67,68]</sup>

Silymarin has also been investigated as a possible adjunctive agent in mitigating some of the toxicity associated with chemotherapeutic agents. Silibinin and silychristin exerted a protective effect on monkey kidney cells and rats exposed to vincristine or cisplatin chemotherapy.<sup>[76–78]</sup> In germ cell tumors, silibinin did not interfere with the antineoplastic effects of cisplatin or ifosfamide. It potentiated the cytotoxic effect of cisplatin and doxorubicin in breast cancer and ovarian cell lines.<sup>[63,79]</sup> The flavonolignan mixture may increase the chemosensitivity of DU145 prostate cancer cells resistant to chemotherapy.<sup>[71]</sup> The clinical significance of these investigations in humans as well as the effective dose, timing, and duration of treatment with silymarin in humans with cancer needs further investigation.

## INDICATIONS AND USAGE

### Liver Disorders

Although research has been conducted in humans with silymarin and a variety of diseases of the liver, its mechanisms of action are largely unknown. Some human studies suggest that silymarin may be more effective in the earlier stages of liver disease.<sup>[33]</sup> This may be explained by its ability to prevent toxins from entering the hepatocyte, thereby preventing initial damage to the cell (Table 4). The studies investigating silymarin in humans with liver disease are described below.

#### Cirrhosis

Three double-blind, randomized, controlled trials utilizing similar dosing regimens have investigated milk thistle in the treatment of alcohol-induced cirrhosis. The studies have reported mixed results (Table 4). Ferenci et al. followed patients with alcohol- and non-alcohol-induced cirrhosis for two years and found increased survival in patients supplemented with 420 mg/day of silymarin. However, no effects on measurements of liver function were found. A later study utilizing a similar dosing regimen and duration found that silymarin had no effect on survival.<sup>[80]</sup> In a smaller study, patients with alcohol-induced cirrhosis were supplemented with 150 mg/day of silymarin. Significant increases in glutathione levels and decreased malondialdehyde levels were observed.<sup>[81]</sup> No significant effects on measurements of liver function tests were found.

#### Alcoholic or virus-induced hepatitis

Five studies have investigated the effect of silymarin in the treatment or prevention of progression of alcohol-

or virus-induced hepatitis.<sup>[16,82–85]</sup> Variations in the form and dosage of silymarin make comparisons difficult. In the only double-blind placebo-controlled trial, 59 subjects were randomly assigned to Legalon or placebo.<sup>[86]</sup> Substantial increases in aspartate aminotransferase (AST), alanine aminotransferase (ALT), and bilirubin were noted, but *p* values were not reported.

#### Subacute or acute liver disease

Two double-blind, randomized, controlled trials and one observational study have investigated silymarin in the treatment of patients with liver disease.<sup>[33,86,87]</sup> In a large observational study (*n* = 2637), subjects with liver disease of various etiologies and severity were supplemented for 8 weeks with a mean Legalon dose of 267 + 103.6 mg. Considerable decreases in ALT, AST, and  $\gamma$ -glutamyl transferase (GGT) and a decrease in the number of patients with hepatomegaly were noted, but *p* values were not reported. In the two double-blind, placebo-controlled trials, significant decreases in ALT, AST, and GGT were observed.

#### Primary biliary cirrhosis

In a nonrandomized pilot study (*n* = 27), silymarin (140 mg three times daily) was administered to patients with primary biliary cirrhosis nonresponsive to standard medical care.<sup>[88]</sup> No noteworthy changes were observed.

#### Lipidemia

One study suggests that silymarin may be a potential therapeutic agent in the prevention of atherosclerosis.<sup>[89]</sup> Oxidation of LDL particles plays an important role in the development of atherosclerosis. Silymarin may reduce atherosclerosis through its effects on apolipoproteins A-I and A-II. Apolipoproteins reside on the surface of HDL and activate lecithin:cholesterol acyltransferase (LCAT), thereby clearing cholesterol from extrahepatic tissues. Apolipoprotein A-I facilitates uptake of cholesterol into cells. A small trial of 12 weeks' silymarin supplementation in 14 adults with Type-II hyperlipidemia resulted in significant reduction in apolipoprotein A-I levels, thereby showing that silymarin is not beneficial in this condition. Significant decreases in apolipoprotein A-II levels were also observed. However, the role of apolipoprotein A-II in atherosclerosis is not well defined.<sup>[90]</sup> As apolipoprotein A-II is inversely associated with insulin resistance and plasma triglycerides, silymarin may be useful in both atherosclerosis and diabetes. Further study is needed.

**Table 4** Summary of human studies

Reference	Type of study/sample size	Type of disease	Formulation/dosage	Duration of study	Results
<i>Hepatitis</i>					
16	Phase II randomized open trial/60	Viral or alcoholic hepatitis	IdB 1016/80–120 mg b.i.d./t.i.d.	2 weeks	↓ ALT, GGT
82	Controlled, randomized trial/52	Viral hepatitis B	Silymarin/210 mg	5 weeks	No significant findings
83	Double-blind trial/59	Acute viral hepatitis	Legalon/70 mg	21–28 days	Improvements in bilirubin, AST, ALT, (significance NR)
84	DBRCT/45	Chronic hepatitis	Silymarin/ Legalon/420 mg	NR	“Recuperation” was faster among patients with “normal” evolution of disease
85	DBRCT/77	Acute viral hepatitis			
<i>Cirrhosis</i>					
111	DBRCT/170	Cirrhosis	Silymarin/140 mg t.i.d.	2 yr	↑ Survival
80	DBRCT/200	Alcohol-induced cirrhosis	Silymarin/150 mg t.i.d.	2 yr	No significant findings
81	DBRCT/60	Alcohol-induced cirrhosis	Silymarin (MZ-80)/150 mg t.i.d.	6 mo	Significant increases in erythrocyte glutathione
					↓ Platelet MDA values
					No significant differences in liver function tests
<i>Other liver diseases</i>					
33	DBRCT/106	Acute and subacute liver disease	Legalon/420 mg	4 weeks	↓ LFTs
86	Observational study/2637	Toxic liver pathology (unspecified)	Silymarin/267 mg (±103 mg)	8 weeks	Improved histology ↓ ALT, AST, GGT (significance NR)
87	DBRCT/66	Liver damage (unspecified etiology)	NR	28 days	↓ Number of patients with enlarged liver (significance NR) ↓ AST (p < 0.1) ALT (p < 0.05), GGT (p < 0.05)
<i>Primary biliary cirrhosis</i>					
88	Noncontrolled, open trial/27	Primary biliary cirrhosis	Silymarin/140 mg t.i.d.	1 yr	No significant findings
<i>Lipid</i>					
89	Nonrandomized/14	Hyperlipoproteinemia type II	Legalon/420 mg	3 mo	↓ CHO, HDL, Apo AI/AII
					No effect on TG, CHO

ALT, alanine aminotransferase; Apo AI, apolipoprotein AI; Apo AII, apolipoprotein AII; AST, aspartate transaminase; CHO, cholesterol; GGT,  $\gamma$ -glutamyl transpeptidase; HDL, high density lipoprotein; LFT, liver function test; MDA, malondialdehyde; NR, not reported; TG, triglycerides; ↑ increase; ↓ decrease.

## Cancer

Silymarin may have a therapeutic role in the treatment of certain malignancies. However, no clinical trials have reported the safety or efficacy of silymarin in combination with cancer treatment. Two case studies have reported the use of silymarin in humans with cancer in combination with cancer therapy. Silymarin was used as an adjunctive treatment in a 34-year-old woman with elevated liver enzyme content undergoing chemotherapy. A daily dose of 800 mg was associated with reductions in AST and ALT and thereby enabled the patient to receive the prescribed chemotherapy.<sup>[91]</sup> Spontaneous regression of hepatocellular carcinoma has been reported in a 52-year-old man taking silymarin.<sup>[92]</sup>

## Other

*Amanita phalloides* is a mushroom that, upon ingestion, causes amatoxin (a-amanitin) poisoning. This toxin damages both liver and kidney by irreversibly binding to RNA polymerase II. This leads to hepatic failure and often results in death. Intravenous administration of silymarin is the only treatment.<sup>[35]</sup> Histochemical investigations in rat hepatocytes demonstrate that silymarin stabilizes cell membranes.<sup>[93]</sup> Silibinin may also inhibit absorption of the toxin from the gut through its extensive enterohepatic cycling.<sup>[93]</sup> The effectiveness of silibinin depends on the dose and timing of administration after amatoxin exposure.<sup>[93]</sup>

Silymarin has been administered to pregnant women with cholestasis without any teratogenic effects on the fetus.<sup>[94]</sup> Milk thistle has also been used as a lactagogue. Herbalists have also used milk thistle for the treatment of psoriasis. No clinical studies have been reported for these indications.

## AVAILABLE DOSAGES/FORMS

Capsules and extracts of milk thistle are usually quantified as 65–80% silibinin or silibinin equivalents, with the remaining 20–35% consisting of less defined polyphenolic compounds and fatty acids. Most of the clinical trials have used capsules standardized to silibinin content (Table 5). However, the composition of the capsules can vary. The relatively straightforward selective precipitation of the silybins from milk thistle extracts has led to the widespread marketing of silibinin as the purified active principle component of silymarin. Analysis of a representative lot of Legalon (sold in Germany as Legalon and imported into the United States as Thisilyn<sup>®</sup>) revealed 66.1% flavonolignans in the proportions of 30.1% silybin, 9.1% isosilybin, 14.9% silychristin, and 12% silydianin.<sup>[4,8]</sup> Another preparation, Siliphos<sup>®</sup> or Silipide<sup>®</sup> (1dB 1016), is a silibinin preparation sold by Indena S.p.A. and is a patented mixture of 33% silibinin and 66% soy lecithin (phosphatidylcholine). An intravenous preparation of milk thistle extract is sold in Europe as silibinin hemisuccinate in aqueous solution to be given for acute *A. phalloides* poisoning

**Table 5** Formulations and suppliers of silymarin and silibinin

Brand name	Formulation <sup>a</sup>	Manufacturer
Legalon MZ-80	One tablet contains 35, 70, or 140 mg of silymarin. Standardized to silymarin content	Madaus A.G., Ostmerheimer Strasse 198, Cologne, Germany
Thisilyn, Thisilyn Pro <sup>TM</sup>	One capsule contains 175 mg of 80% silymarin (140 mg silymarin)	Manufactured in Germany by Madaus A.G. for US distribution by Nature's Way Products, Inc., Springville, Utah, [also doing business as Murdock Madaus Schwabe Professional Products (MMS Pro), Inc., 10 Mountain Springs Parkway, Springville, Utah 84663]
1dB 1016	One capsule contains 150 mg of a 1:2 ratio of silibinin complexed with soy-derived phosphatidylcholine	Indena S.p.A. Viale Ortles 12, Milan 20139, Italy
Silipide <sup>®</sup> Siliphos <sup>®</sup>		

<sup>a</sup>The information on formulations was supplied by the manufacturers of the product and has not been subject to confirmation by an outside agency.

**NOTE:** The regulatory status of herbal medicine varies between countries. For more information on the regulatory status of herbal therapies in selected countries, refer to: *Legal Status of Traditional Medicine and Complementary/Alternative Medicine: A Worldwide Review*; WHO/EDM/TRM/2001.2: WHO, Geneva, 2001; 189 p. (ISBN 92-4-154548-8; Swiss Fr. 35).

(20 mg/kg total silibinin per day given in four 5 mg/kg infusions of 2 hr each). Silibinin (S-0417) as sold by Sigma-Aldrich (St. Louis, Missouri) is the most commonly used source of milk thistle extract for preclinical studies and comprises nearly identical proportions of silybin A and silybin B.

An average dose of 200–400 mg/day in divided doses has been used in most of the studies investigating silymarin for hepatic disorders and antilipidemic effects. Teas made from the crushed seed are used for mild gastrointestinal disorders<sup>[95]</sup>; however, due to its lipophilic properties, only a small percentage of silymarin is found in aqueous solution.<sup>[2,95]</sup> A list of formulations and suppliers is described in Table 5.

## CONTRAINDICATIONS/ADVERSE REACTIONS

Few side effects are reported when silymarin and silibinin are used within the recommended dose ranges.<sup>[3,95]</sup> Rare cases of a mild laxative effect have been described. One human dose escalation study reported nausea, heartburn, and dyspepsia in subjects treated with 160 mg/day, dyspepsia in patients treated with 240 mg/day, and postprandial nausea and meteorism in patients treated with 360 mg/day. None of these side effects were dose related. At doses greater than 1500 mg/day, mild allergic reactions have been reported. Episodes of sweating and gastrointestinal distress have been associated with the use of milk thistle.<sup>[96]</sup> The symptoms resolved upon discontinuation of the supplement, but it is unknown whether these effects were due to milk thistle or contamination of the capsule.

## DRUG INTERACTIONS

Interactions between milk thistle (silymarin) and medications or other herbal remedies are largely unknown. Silymarin inhibits CYP3A4 and UDP-glucuronyltransferase UGT1A6/9 in cultured human hepatocytes, and silibinin inhibits CYP2C9 and some activities of CYP3A4 in isolated human liver microsomes.<sup>[97,98]</sup> However, the concentration at which inhibition is observed is high (100–500  $\mu$ M in hepatocyte studies) and not achievable with oral intake of silymarin.<sup>[99]</sup> However, the biliary concentrations of flavonolignans can be greater than plasma levels by an order of magnitude or more: Single 120 mg doses of silymarin or silibinin–phosphatidylcholine result in maximum mean biliary concentrations of 60 and 240  $\mu$ M, respectively.<sup>[10]</sup> The observation that patients with HIV often use milk thistle to prevent or manage hepatitis or protect the liver from hepatotoxic drugs led to clinical trials investigating the

potential for interactions with the HIV protease inhibitor indinavir and CYP3A4. Two independent trials of coadministration of milk thistle and indinavir within the recommended dosages in healthy individuals found no interference with indinavir pharmacokinetics.<sup>[100,101]</sup> These findings are also consistent with the observation that a 2 day exposure of isolated human hepatocytes to 10  $\mu$ M silymarin has no effect on CYP3A4 gene expression.<sup>[102]</sup>

Theoretically, its antioxidant and free radical scavenging properties suggest that silymarin may interact with any free radical generating medication, such as the anthracycline chemotherapy agent doxorubicin. This has not yet been investigated in human or laboratory studies.

## OVERDOSAGE

No reports of overdose have been documented. Silymarin has been well tolerated in high doses. Intravenous administration of silibinin (20–50 mg/kg body weight) in the treatment of humans with *A. phalloides* poisoning resulted in no adverse effects. No toxicity has been observed in rats and mice when it is given in doses as high as 5000 mg/kg. Rats and dogs have received silymarin at doses of 50–2500 mg/kg for a 12 mo period. Investigations including post-mortem analyses showed no evidence of toxicity.<sup>[103]</sup> The Merck Index lists no LD<sub>50</sub> value in any species for silibinin or silymarin.

## REGULATORY STATUS

Milk thistle is classified in the United States as a dietary supplement under the Dietary Supplement Health and Education Act (DSHEA) 1994 and cannot be marketed for the treatment of any disease. In Germany, the Commission E approves the internal use of crude milk thistle fruit preparations for dyspeptic complaints. Formulations consisting of an extract of 70–80% silymarin are also approved for toxic liver damage and for supportive treatment in chronic inflammatory liver disease and hepatic cirrhosis.

The U.S. Pharmacopoeia and National Formulary (USP–NF) monographs dictate that milk thistle seeds (with pappus removed) used for extraction contain not less than 2% (w/w) silymarin, expressed as silybin, using a USP spectrophotometric assay method and botanical identification confirmed by thin-layer chromatography and macroscopic and microscopic examinations (USP 24–NF 19, 1999), German pharmacopoeial-grade milk thistle should also contain not less than 1.5% (*Deutsches Arzneibuch/DAB*, 1997).

## CONCLUSIONS

Milk thistle is a herbal plant that has a long history of use in the treatment of a variety of illnesses. Laboratory and clinical research suggests that silymarin, a complex of active components from milk thistle, may be a possible agent in the prevention or treatment of cancer, atherosclerosis, hepatitis, and cirrhosis. The use of milk thistle for these indications has been further reviewed elsewhere.<sup>[1–3,94]</sup> The low toxicity profile of silymarin makes it an attractive agent for further studies. Future investigations are needed to determine the effective dose, duration, and formulation so that standardized recommendations can be developed.

## REFERENCES

1. Flora, K.; Hahn, M.; Rosen, H.; Benner, K. Milk thistle (*Silybum marianum*) for the therapy of liver disease. *Am. J. Gastroenterol.* **1998**, *93* (2), 139–143.
2. Foster, S. *Milk Thistle Silybum marianum*, 2nd Ed.; American Botanical Council: Austin, TX, 1996. PamphLet.
3. *PDR for Herbal Medicine*, 2nd Ed.; Fleming, T. et al. Eds.; Medical Economics Company: Montvale, NJ, 2000.
4. Simanek, V.; Kren, V.; Ulrichova, J.; Vicar, J.; Cvak, L. Silymarin: what is in the name...? An appeal for a change of editorial policy. *Hepatology* **2000**, *32* (2), 442–444.
5. Kim, N.C.; Graf, T.N.; Sparacino, C.M.; Wani, M.C.; Wall, M.E. Complete isolation and characterization of silybins and isosilybins from milk thistle (*Silybum marianum*). *Org. Biomol. Chem.* **2003**, *1* (10), 1684–1689.
6. Lee, D.Y.; Liu, Y. Molecular structure and stereochemistry of silybin A, silybin B, isosilybin A, and isosilybin B, isolated from *Silybum marianum* (milk thistle). *J. Nat. Prod.* **2003**, *66* (9), 1171–1174.
7. Bhatia, N.; Zhao, J.; Wolf, D.M.; Agarwal, R. Inhibition of human carcinoma cell growth and DNA synthesis by silibinin, an active constituent of milk thistle: comparison with silymarin. *Cancer Lett.* **1999**, *147* (1–2), 77–84.
8. Dvorak, Z.; Kosina, P.; Walterova, D.; Simanek, V.; Bachleda, P.; Ulrichova, J. Primary cultures of human hepatocytes as a tool in cytotoxicity studies: cell protection against model toxins by flavanolignans obtained from *Silybum marianum*. *Toxicol. Lett.* **2003**, *137* (3), 201–212.
9. Barzaghi, N.; Crema, F.; Gatti, G.; Pifferi, G.; Perucca, E. Pharmacokinetic studies on 1dB 1016, a silybin–phosphatidylcholine complex, in healthy human subjects. *Eur. J. Drug Metab. Pharmacokinet.* **1990**, *15* (4), 333–338.
10. Schandalik, R.; Perucca, E. Pharmacokinetics of silybin following oral administration of silipide in patients with extrahepatic biliary obstruction. *Drugs Exp. Clin. Res.* **1994**, *20* (1), 37–42.
11. Barzaghi, N.; Perucca, E.; Pifferi, G.; Crema, A. Pharmacokinetics of a new flavanolignan complex (1dB1016) following single and multiple doses in man. In *Flavonoids in Biology & Medicine III: Current Issues in Flavonoid Research*; National University of Singapore, 1990; 551–556.
12. Schandalik, R.; Gatti, G.; Perucca, E. Pharmacokinetics of silybin in bile following administration of silipide and silymarin in cholecystectomy patients. *Arzneimittelforschung* **1992**, *42* (7), 964–968.
13. Gatti, G.; Perucca, E. Plasma concentrations of free and conjugated silybin after oral intake of a silybin–phosphatidylcholine complex (silipide) in healthy volunteers. *Int. J. Clin. Pharmacol. Ther.* **1994**, *32* (11), 614–617.
14. Barzaghi, N.; Perucca, E.; Pifferi, G.; Crema, A. Single-dose pharmacokinetic study of 1dB 1016, a new flavanolignan complex in man. *Eur. J. Pharmacol.* **1989**, *36*, Abstract.
15. Weyhenmeyer, R.; Mascher, H.; Birkmayer, J. Study on dose-Linearity of the pharmacokinetics of silibinin diastereomers using a new stereospecific assay. *Int. J. Clin. Pharmacol. Ther. Toxicol.* **1992**, *30* (4), 134–138.
16. Vailati, A.; Aristia, L.; Sozze, E.; Milani, F.; Inglese, V.; Galenda, P. et al. Randomized open study of the dose–effect relationship of a short course of 1dB 1016 in patients with viral or alcoholic hepatitis. *Fitoterapia* **1993**, *LXIV* (3), 219–228.
17. Orlando, R.; Fragasso, A.; Lampertico, M.; Marena, C. Silybin kinetics in patients with liver cirrhosis: A comparative study of a silybin–phosphatidylcholine complex and silymarin. *Med. Sci. Res.* **1990**, *18*, 861–863.
18. Orlando, R.; Fragasso, A.; Lampertico, M.; Marena, C. Pharmacokinetic studies of silybin–phosphatidylcholine complex (1dB 1016) in liver cirrhosis after multiple doses. *Med. Sci. Res.* **1991**, *19*, 827–828.
19. Bosisio, E.; Benelli, C.; Pirola, O. Effect of the flavanolignans of *Silybum marianum* L. on lipid peroxidation in rat liver microsomes and freshly isolated hepatocytes. *Pharmacol. Res.* **1992**, *25* (2), 147–154.
20. Garrido, A.; Arancibia, C.; Campos, R.; Valenzuela, A. Acetaminophen does not induce oxidative stress in isolated rat hepatocytes: its

- probable antioxidant effect is potentiated by the flavonoid silybin. *Pharmacol. Toxicol.* **1991**, *69* (1), 9–12.
21. Letteron, P.; Labbe, G.; Degott, C.; Berson, A.; Fromenty, B.; Delaforge, M. et al. Mechanism for the protective effects of silymarin against carbon tetrachloride-induced lipid peroxidation and hepatotoxicity in mice. Evidence that silymarin acts both as an inhibitor of metabolic activation and as a chain-breaking antioxidant. *Biochem. Pharmacol.* **1990**, *39* (12), 2027–2034.
  22. Mira, L.; Silva, M.; Manso, C.F. Scavenging of reactive oxygen species by silibinin dihemisuccinate. *Biochem. Pharmacol.* **1994**, *48* (4), 753–759.
  23. Mira, M.L.; Azevedo, M.S.; Manso, C. The neutralization of hydroxyl radical by silibin, sorbinil and bendazac. *Free Radic. Res. Commun.* **1987**, *4* (2), 125–129.
  24. Farghali, H.; Kamenikova, L.; Hynie, S.; Kmonickova, E. Silymarin effects on intracellular calcium and cytotoxicity: a study in perfused rat hepatocytes after oxidative stress injury. *Pharmacol. Res.* **2000**, *41* (2), 231–237.
  25. Valenzuela, A.; Guerra, R.; Garrido, A. Silybin dihemisuccinate protects rat erythrocytes against phenylhydrazine-induced lipid peroxidation and hemolysis. *Planta Med.* **1987**, *53* (5), 402–405.
  26. Koch, H.P.; Loffler, E. Influence of silymarin and some flavonoids on lipid peroxidation in human platelets. *Meth. Find. Exp. Clin. Pharmacol.* **1985**, *7* (1), 13–18.
  27. Zhao, J.; Agarwal, R. Tissue distribution of silibinin, the major active constituent of silymarin, in mice and its association with enhancement of phase II enzymes: implications in cancer chemoprevention. *Carcinogenesis* **1999**, *20* (11), 2101–2108.
  28. Valenzuela, A.; Aspillaga, M.; Vial, S.; Guerra, R. Selectivity of silymarin on the increase of the glutathione content in different tissues of the rat. *Planta Med.* **1989**, *55* (5), 420–422.
  29. Campos, R.; Garrido, A.; Guerra, R.; Valenzuela, A. Acetaminophen hepatotoxicity in rats is attenuated by silybin dihemisuccinate. *Prog. Clin. Biol. Res.* **1988**, *280*, 375–378.
  30. Altorjay, L.; Dalmi, L.; Sari, B.; Imre, S.; Balla, G. The effect of silibinin (Legalon) on the free radical scavenger mechanisms of human erythrocytes in vitro. *Acta Physiol. Hung.* **1992**, *80* (1–4), 375–380.
  31. Dehmlow, C.; Erhard, J.; de Groot, H. Inhibition of Kupffer cell functions as an explanation for the hepatoprotective properties of silibinin. *Hepatology* **1996**, *23* (4), 749–754.
  32. Sonnenbichler, J.; Zetl, I. Biochemical effects of the flavonolignane silibinin on RNA, protein and DNA synthesis in rat livers. *Prog. Clin. Biol. Res.* **1986**, *213*, 319–331.
  33. Salmi, H.A.; Sarna, S. Effect of silymarin on chemical, functional, and morphological alterations of the liver. A double-blind controlled study. *Scand. J. Gastroenterol.* **1982**, *17* (4), 517–521.
  34. Campos, R.; Garrido, A.; Guerra, R.; Valenzuela, A. Silybin dihemisuccinate protects against glutathione depletion and lipid peroxidation induced by acetaminophen on rat liver. *Planta Med.* **1989**, *55* (5), 417–419.
  35. Hruby, K.; Csomos, G.; Fuhrmann, M.; Thaler, H. Chemotherapy of *Amanita phalloides* poisoning with intravenous silibinin. *Hum. Toxicol.* **1983**, *2* (2), 183–195.
  36. Castigli, E.; Montanini, I.; Roberti, R.; Porcellati, G. The activity of silybin on phospholipid metabolism of normal and fatty liver in vivo. *Pharmacol. Res. Commun.* **1977**, *9* (1), 59–69.
  37. Corazzi, L.; Arienti, G.; Tocchi, L.; Montanini, I.; Porcellati, G. The effect of silybin on lipid synthesis in ethanol-intoxicated rat hepatocytes in primary cultures. *Ph. Farmaco Sci.* **1982**, *37*, 123–132.
  38. Iredale, J.P. Cirrhosis: new research provides a basis for rational and targeted treatments. *Br. Med. J.* **2003**, *327* (7407), 143–147.
  39. Schuppan, D.; Hahn, E.G. Clinical studies with silymarin: fibrosis progression is the end point. *Hepatology* **2001**, *33* (2), 483–484.
  40. Schumann, J.; Prockl, J.; Kiemer, A.K.; Vollmar, A.M.; Bang, R.; Tiegs, G. Silibinin protects mice from T cell-dependent liver injury. *J. Hepatol.* **2003**, *39* (3), 333–340.
  41. Skottova, N.; Krecman, V. Silymarin as a potential hypocholesterolaemic drug. *Physiol. Res.* **1998**, *47* (1), 1–7.
  42. Krecman, V.; Skottova, N.; Walterova, D.; Ulrichova, J.; Simanek, V. Silymarin inhibits the development of diet-induced hypercholesterolemia in rats. *Planta Med.* **1998**, *64* (2), 138–142.
  43. Skottova, N.; Krecman, V.; Vana, P.; Chmela, Z.; Ulrichova, J.; Simanek, V. Effect of silymarin and silibinin–phosphatidylcholine complex on plasma and lipoprotein cholesterol, and oxidation of LDL in rats fed on high cholesterol diet supplemented with currant oil. *Acta Univ. Palacki. Olomuc. Fac. Med.* **2000**, *144*, 55–58.
  44. Skottova, N.; Vecera, R.; Urbanek, K.; Vana, P.; Walterova, D.; Cvak, L. Effects of polyphenolic fraction of silymarin on lipoprotein profile in rats fed cholesterol-rich diets. *Pharmacol. Res.* **2003**, *47* (1), 17–26.



45. Nassuato, G.; Lemmolo, R.M.; Strazzabosco, M.; Lirussi, F.; Deana, R.; Francesconi, M.A. et al. Effect of silibinin on biliary lipid composition. Experimental and clinical study. *J. Hepatol.* **1991**, *12* (3), 290–295.
46. Nassuato, G.; Iemmolo, R.M.; Lirussi, F.; Orlando, R.; Giacom, L.; Venuti, M. et al. Effect of silybin on biliary lipid composition in rats. *Pharmacol. Res. Commun.* **1983**, *15* (4), 337–346.
47. Sharma, Y.; Agarwal, C.; Singh, A.K.; Agarwal, R. Inhibitory effect of silibinin on ligand binding to erbB1 and associated mitogenic signaling, growth, and DNA synthesis in advanced human prostate carcinoma cells. *Mol. Carcinogen.* **2001**, *30* (4), 224–236.
48. Singh, R.P.; Dhanalakshmi, S.; Tyagi, A.K.; Chan, D.C.; Agarwal, C.; Agarwal, R. Dietary feeding of silibinin inhibits advance human prostate carcinoma growth in athymic nude mice and increases plasma insulin-like growth factor-binding protein-3 levels. *Cancer Res.* **2002**, *62* (11), 3063–3069.
49. Zi, X.; Grasso, A.W.; Kung, H.J.; Agarwal, R. A flavonoid antioxidant, silymarin, inhibits activation of erbB1 signaling and induces cyclin-dependent kinase inhibitors, G1 arrest, and anticarcinogenic effects in human prostate carcinoma DU145 cells. *Cancer Res.* **1998**, *58* (9), 1920–1929.
50. Zi, X.; Agarwal, R. Silibinin decreases prostate-specific antigen with cell growth inhibition via G1 arrest, leading to differentiation of prostate carcinoma cells: implications for prostate cancer intervention. *Proc. Natl. Acad. Sci. U.S.A.* **1999**, *96* (13), 7490–7495.
51. Zi, X.; Zhang, J.; Agarwal, R.; Pollak, M. Silibinin up-regulates insulin-like growth factor-binding protein 3 expression and inhibits proliferation of androgen-independent prostate cancer cells. *Cancer Res.* **2000**, *60* (20), 5617–5620.
52. Agarwal, R.; Katiyar, S.K.; Lundgren, D.W.; Mukhtar, H. Inhibitory effect of silymarin, an anti-hepatotoxic flavonoid, on 12-o-tetradecanoylphorbol-13-acetate-induced epidermal ornithine decarboxylase activity and mRNA in SENCAR mice. *Carcinogenesis* **1994**, *15* (6), 1099–1103.
53. Katiyar, S.K.; Korman, N.J.; Mukhtar, H.; Agarwal, R. Protective effects of silymarin against photocarcinogenesis in a mouse skin model. *J. Nat. Cancer Inst.* **1997**, *89* (8), 556–566.
54. Lahiri-Chatterjee, M.; Katiyar, S.K.; Mohan, R.R.; Agarwal, R. A flavonoid antioxidant, silymarin, affords exceptionally high protection against tumor promotion in the SENCAR mouse skin tumorigenesis model. *Cancer Res.* **1999**, *59* (3), 622–632.
55. Singh, R.P.; Tyagi, A.K.; Zhao, J.; Agarwal, R. Silymarin inhibits growth and causes regression of established skin tumors in SENCAR mice via modulation of mitogen-activated protein kinases and induction of apoptosis. *Carcinogenesis* **2002**, *23* (3), 449–510.
56. Zhao, J.; Sharma, Y.; Agarwal, R. Significant inhibition by the flavonoid antioxidant silymarin against I 12-O-tetradecanoylphorbol 13-acetate-caused modulation of antioxidant and inflammatory enzymes, and cyclooxygenase 2 and interleukin-1alpha expression in SENCAR mouse epidermis: implications in the prevention of stage I tumor promotion. *Mol. Carcinogen.* **1999**, *26* (4), 321–333.
57. Zhao, J.; Lahiri-Chatterjee, M.; Sharma, Y.; Agarwal, R. Inhibitory effect of a flavonoid antioxidant silymarin on benzoyl peroxide-induced tumor promotion, oxidative stress and inflammatory responses in SENCAR mouse skin. *Carcinogenesis* **2000**, *21* (4), 811–816.
58. Jiang, C.; Agarwal, R.; Lu, J. Anti-angiogenic potential of a cancer chemopreventive flavonoid antioxidant, silymarin: inhibition of key attributes of vascular endothelial cells and angiogenic cytokine secretion by cancer epithelial cells. *Biochem. Biophys. Res. Commun.* **2000**, *276* (1), 371–378.
59. Zi, X.; Feyes, D.K.; Agarwal, R. Anticarcinogenic effect of a flavonoid antioxidant, silymarin, in human breast cancer cells MDA-MB 468: induction of G1 arrest through an increase in Cip1/p21 concomitant with a decrease in kinase activity of cyclin-dependent kinases and associated cyclins. *Clin. Cancer Res.* **1998**, *4* (4), 1055–1064.
60. Saliou, C.; Rihn, B.; Cillard, J.; Okamoto, T.; Packer, L. Selective inhibition of NF-kappaB activation by the flavonoid hepatoprotector silymarin in HepG2. Evidence for different activating pathways. *FEBS Lett.* **1998**, *440* (1–2), 8–12.
61. Shear, N.H.; Malkiewicz, I.M.; Klein, D.; Koren, G.; Randor, S.; Neuman, M.G. Acetaminophen-induced toxicity to human epidermoid cell line A431 and hepatoblastoma cell line Hep G2, in vitro, is diminished by silymarin. *Skin Pharmacol.* **1995**, *8* (6), 279–291.
62. Duthie, S.J.; Johnson, W.; Dobson, V.L. The effect of dietary flavanoids on DNA damage (strand breaks and oxidized pyrimidines) and growth in human cells. *Mutat. Res.* **1997**, *390*, 141–151.

63. Scambia, G.; De Vincenzo, R.; Ranelietti, F.O.; Panici, P.B.; Ferrandina, G.; D'Agostino, G. et al. Antiproliferative effect of silybin on gynaecological malignancies: synergism with cisplatin and doxorubicin. *Eur. J. Cancer* **1996**, *32A* (5), 877–882.
64. Manna, S.K.; Mukhopadhyay, A.; Van, N.T.; Aggarwal, B.B. Silymarin suppresses TNF-induced activation of NF- $\kappa$ B, c-Jun N-terminal kinase, and apoptosis. *J. Immunol.* **1999**, *163*, 6800–6809.
65. Kang, S.N.; Lee, M.H.; Kim, K.M.; Cho, D.; Kim, T.S. Induction of human promyelocytic leukemia HL-60 cell differentiation into monocytes by silibinin: involvement of protein kinase C. *Biochem. Pharmacol.* **2001**, *61* (12), 1487–1495.
66. Clinton, S.K. The dietary antioxidant network and prostate carcinoma. *Cancer* **1999**, *86* (9), 1629–1631.
67. Yanaida, Y.; Kohno, H.; Yoshida, K.; Hirose, Y.; Yamada, Y.; Mori, H. et al. Dietary silymarin suppresses 4-nitroquinoline 1-oxide-induced tongue carcinogenesis in male F344 rats. *Carcinogenesis* **2002**, *23* (5), 787–794.
68. Vinh, P.Q.; Sugie, S.; Tanaka, T.; Hara, A.; Yamada, Y.; Katayama, M. et al. Chemopreventive effects of a flavonoid antioxidant silymarin on *N*-butyl-*N*-(4-hydroxybutyl)nitrosamine-induced urinary bladder carcinogenesis in male ICR mice. *Jpn. J. Cancer Res.* **2002**, *93* (1), 42–49.
69. Gershbein, L.L. Action of dietary trypsin, pressed coffee oil, silymarin and iron salt on 1,2-dimethylhydrazine tumorigenesis by gavage. *Anticancer Res.* **1994**, *14*, 1113–1116.
70. Kohno, H.; Tanaka, T.; Kawabata, K.; Hirose, Y.; Sugie, S.; Tsuda, H. et al. Silymarin, a naturally occurring polyphenolic antioxidant flavonoid, inhibits azoxymethane-induced colon carcinogenesis in male F344 rats. *Int. J. Cancer* **2002**, *101*, 461–468.
71. Dhanalakshmi, S.; Singh, R.P.; Agarwal, C.; Agarwal, R. Silibinin inhibits constitutive and TNF $\alpha$ -induced activation of NF- $\kappa$ B and sensitizes human prostate carcinoma DU145 cells to TNF $\alpha$ -induced apoptosis. *Oncogene* **2002**, *21* (11), 1759–1767.
72. Ahmad, N.; Gali, H.; Javed, S.; Agarwal, R. Skin cancer chemopreventive effects of a flavonoid antioxidant silymarin are mediated via impairment of receptor tyrosine kinase signaling and perturbation in cell cycle progression. *Biochem. Biophys. Res. Commun.* **1998**, *247* (2), 294–301.
73. Chatterjee, M.L.; Agarwal, R.; Mukhtar, H. Ultraviolet B radiation-induced DNA lesions in mouse epidermis: an assessment using a novel 32P-postlabelling technique. *Biochem. Biophys. Res. Commun.* **1996**, *229* (2), 590–595.
74. Zi, X.; Agarwal, R. Modulation of mitogen-activated protein kinase activation and cell cycle regulators by the potent skin cancer preventive agent silymarin. *Biochem. Biophys. Res. Commun.* **1999**, *263* (2), 528–536.
75. Zi, X.; Mukhtar, H.; Agarwal, R. Novel cancer chemopreventive effects of a flavonoid antioxidant silymarin: inhibition of mRNA expression of an endogenous tumor promoter TNF $\alpha$ . *Biochem. Biophys. Res. Commun.* **1997**, *239* (1), 334–339.
76. Bokenmeyer, C.; Fels, L.; Dunn, T.; Voigt, W.; Gaedeke, J.; Schmoll, H.-J. et al. Silibinin protects against cisplatin-induced nephrotoxicity without compromising cisplatin or ifosfamide anti-tumor activity. *Br. J. Cancer* **1996**, *74*, 2036–2041.
77. Gaedeke, J.; Fels, L.M.; Bokenmeyer, C.; Mengs, U.; Stolte, H.; Lentzen, H. Cisplatin nephrotoxicity and protection by silibinin. *Nephrol. Dial. Transplant.* **1996**, *11*, 55–62.
78. Sonnenbichler, J. Fortunato SSIWR. Stimulatory effects of silibinin and silicristin from the milk thistle *Silybum marianum* on kidney cells. *J. Pharmacol. Exp. Ther.* **1999**, *290*, 1375–1383.
79. Giacomelli, S.; Gallo, D.; Apollonio, P.; Ferlini, C.; Distefano, M.; Morazzoni, P. et al. Silybin and its bioavailable phospholipid complex (1dB 1016) potentiate in vitro and in vivo the activity of cisplatin. *Life Sci.* **2002**, *70* (12), 1447–1459.
80. Pares, A.; Planas, R.; Torres, M.; Caballeria, J.; Viver, J.M.; Acero, D. et al. Effects of silymarin in alcoholic patients with cirrhosis of the liver: results of a controlled, double-blind, randomized and multicenter trial. *J. Hepatol.* **1998**, *28* (4), 615–621.
81. Lucena, M.I.; Andrade, R.J.; de la Cruz, J.P.; Rodriguez-Mendizabal, M.; Blanco, E.; Sanchez, d. I. C. Effects of silymarin MZ-80 on oxidative stress in patients with alcoholic cirrhosis. Results of a randomized, double-blind, placebo-controlled clinical study. *Int. J. Clin. Pharmacol. Ther.* **2002**, *40* (1), 2–8.
82. Flisiak, R.; Prokopowicz, D. Effect of misoprostol on the course of viral hepatitis B. *Hepato-gastroenterology* **1997**, *44* (17), 1419–1425.
83. Magliulo, E.; Gagliardi, B.; Fiori, G.P. Results of a double blind study on the effect of silymarin in the treatment of acute viral hepatitis, carried out at two medical centres (author's transl). *Med. Klin.* **1978**, *73* (28–29), 1060–1065.
84. Kiesewetter, E.; Leodolter, I.; Thaler, H. The results of two double blind studies on the

- efficacy of silymarin in chronic hepatitis. *Leber Magen Darm* **1977**, *7*, 318–323.
85. Plomteux, G.; Albert, A.; Heusghem, C. Hepato-protector action of silymarin in human acute viral hepatitis. *Int. Res. Commun. Syst.* **1977**, *5*, 259.
  86. Albrecht, M.; Frerick, H. Therapy of toxic liver pathologies with Legalon. *Z. Klin. Med.* **1992**, *47*, 87–92.
  87. Fintelmann, V.; Albert, A. Demonstration of the therapeutic efficacy of Legalon® in toxic liver diseases in a double blind trial. *Therapiewoche* **1980**, *30*, 5589–5594.
  88. Angulo, P.; Patel, T.; Jorgensen, R.A.; Therneau, T.M.; Lindor, K.D. Silymarin in the treatment of patients with primary biliary cirrhosis with a suboptimal response to ursodeoxycholic acid. *Hepatology* **2000**, *32* (5), 897–900.
  89. Somogyi, A.; Ecsedi, G.G.; Blazovics, A.; Miskolczi, K.; Gergely, P.; Feher, J. Short term treatment of type II hyperlipoproteinaemia with silymarin. *Acta Med. Hung.* **1989**, *46* (4), 289–295.
  90. Allayee, H.; Castellani, L.W.; Cantor, R.M.; de Bruin, T.W.; Lusic, A.J. Biochemical and genetic association of plasma apolipoprotein A-II levels with familial combined hyperlipidemia. *Circ. Res.* **2003**, *92* (11), 1262–1267.
  91. Invernizzi, R.; Bernuzzi, S.; Ciani, D.; Ascari, E. Silymarin during maintenance therapy of acute promyelocytic leukemia. *Haematologica* **1993**, *78* (5), 340–341.
  92. Grossman, M.; Hoerman, R.; Weiss, M.; Jauch, K.W.; Oertel, H.; Staebler, A. et al. 52-year old man with biopsy-confirmed hepatocellular carcinoma resolved spontaneously. *Am. J. Gastroenterol.* **1995**, *90* (9), 1500–1503.
  93. Enjalbert, F.; Rapior, S.; Nougier-Soule, J.; Guillon, S.; Amouroux, N.; Cabot, C. Treatment of amatoxin poisoning: 20-year retrospective analysis. *J. Toxicol. Clin. Toxicol.* **2002**, *40* (6), 715–757.
  94. Hernandez, R.; Nazar, E. Effect of silymarin in intrahepatic cholestasis of pregnancy. *Rev. Chil. Obstet. Ginecol.* **1982**, *47* (1), 22–29.
  95. Blumenthal, M. Milk thistle. In *The ABC Clinical Guide to Herbs*; Goldberg, A., Kunz, T., Dinda, K., Eds.; Thieme New York: Austin, 2003; 287–295.
  96. Adverse Drug Reactions Advisory Committee. *Med. J. Aust.* **1999**, *170*, 218–219.
  97. Beckmann-Knopp, S.; Rietbrock, S.; Weyhenmeyer, R.; Bocker, R.H.; Beckharts, K.T.; Lang, W. et al. Inhibitory effects of silibinin on cytochrome P-450 enzymes in human liver microsomes. *Pharmacol. Toxicol.* **2000**, *86* (6), 250–256.
  98. Venkataraman, R.; Ramachandran, V.; Komoroski, B.J.; Zhang, S.; Schiff, P.L.; Strom, S.C. Milk thistle, a herbal supplement decreases the activity of CYP3A4 and uridine diphosphoglucuronosyl transferase in human hepatocyte cultures. *Drug Metab. Dispos.* **2000**, *28* (11), 1270–1273.
  99. Zuber, R.; Modriansky, M.; Dvorak, Z.; Rohovsky, P.; Ulrichova, J.; Simanek, V. et al. Effect of silybin and its congeners on human liver microsomal cytochrome P450 activities. *Phytother. Res.* **2002**, *16* (7), 632–638.
  100. Piscitelli, S.C.; Formentini, E.; Burstein, A.H.; Alfaro, R.; Jagannatha, S.; Falloon, J. Effect of milk thistle on the pharmacokinetics of indinavir in healthy volunteers. *Pharmacotherapy* **2002**, *22* (5), 551–556.
  101. DiCenzo, R.; Shelton, M.; Jordan, K.; Koval, C.; Forrest, A.; Reichman, R. et al. Coadministration of milk thistle and indinavir in healthy subjects. *Pharmacotherapy* **2003**, *23* (7), 866–870.
  102. Raucy, J.L. Regulation of CYP3A4 expression in human hepatocytes by pharmaceuticals and natural products. *Drug Metab. Dispos.* **2003**, *31* (5), 533–539.
  103. The milk thistles. *Lawrence Rev. Nat. Prod.* **1985**, *6* (1), 1–3.
  104. Kroll, D.; Oberlies, N. The impact of newly proposed dietary supplement manufacturing guidelines on patient safety and clinical trials outcomes. *Focus Complement. Altern. Med.* **2003**, *8*, 301–305.
  105. Tyagi, A.K.; Singh, R.P.; Agarwal, C.; Chan, D.C.; Agarwal, R. Silibinin strongly synergizes human prostate carcinoma DU145 cells to doxorubicin-induced growth inhibition, G2-M arrest, and apoptosis. *Clin. Cancer Res.* **2002**, *8* (11), 3512–3519.
  106. Zhu, W.; Zhang, J.S.; Young, C.Y. Silymarin inhibits function of the androgen receptor by reducing nuclear localization of the receptor in the human prostate cancer cell line LNCaP. *Carcinogenesis* **2001**, *22* (9), 1399–1403.

# Niacin

## Christelle Bourgeois

Institute of Medical Biochemistry, Medical University of Vienna, Vienna, Austria

## Joel Moss

National Institutes of Health, NHLBI, Pulmonary–Critical Care Medicine Branch, Bethesda, Maryland, U.S.A.

## INTRODUCTION

Niacin, also designated vitamin B<sub>3</sub>, is found mostly in meat, grains, milk, and eggs. In the United States, “niacin” means nicotinic acid, and the amide form, nicotinamide, is called niacinamide. Elsewhere, “niacin” denotes nicotinic acid and/or nicotinamide. Deficiency of this vitamin causes pellagra, a disease characterized by dermatitis, diarrhea, and dementia that is endemic today in parts of India and China, and may result in death in severe cases. As a precursor of pyridine nucleotides (nicotinamide adenine dinucleotide [NAD] and nicotinamide adenine dinucleotide phosphate [NADP]), niacin participates in the function of numerous enzymatic pathways, which are critical for normal cell metabolism, involving, for example, redox reactions and those that consume NAD. Discovery of the antihyperlipidemic properties of pharmacological doses of nicotinic acid has renewed interest in this vitamin in developed countries.

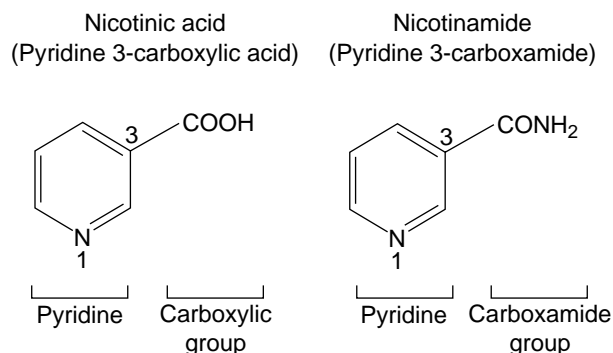
## GENERAL DESCRIPTION

The structures of nicotinic acid and nicotinamide are shown in Fig. 1. They consist of a pyridine ring substituted in position 3 with a carboxylic group in nicotinic acid, and with a carboxamide group in nicotinamide. Niacin was initially studied because of its association with pellagra, a nutritional deficiency disease, symptoms of which are dermatitis, diarrhea, and dementia, with death as the eventual outcome. Pellagra was first documented by Casal as “mal de la rosa” in 1735, but was linked to niacin deficiency only about two centuries later, on the occasion of an epidemic in the southern United States (reviewed in Ref.<sup>[1]</sup>). The disease was

initially thought to be of infectious origin, until Goldberg and Tanner observed its association with poor nutrition, inadequate meat and milk intake, and use of corn as the principal constituent of the diet. In 1922, they suggested that pellagra was an amino acid deficiency. Five years later, it was demonstrated that nicotinic acid cured pellagra and, in 1949 that tryptophan reversed the symptoms. In 1961, Goldsmith quantified the conversion of tryptophan to nicotinic acid by monitoring such nicotinic acid metabolites as *N*<sup>1</sup>-methyl-5-carboxamide-2-pyridone. Elucidation of the biochemical pathway for conversion of tryptophan to nicotinic acid mononucleotide (Fig. 2) took more than 10 years—from 1950, when Knox and Mehler showed that the first step in the biodegradation of tryptophan to *N*-formylkynurenine was catalyzed by tryptophan pyrrolase, to 1963, when work by Nishizuka and Hayaishi revealed that quinolinic acid reacts with phosphoribosepyrophosphate (PRPP) to form nicotinic acid mononucleotide, a reaction catalyzed by the enzyme quinolinic acid phosphoribosyltransferase.

## ACTIONS AND PHARMACOLOGY

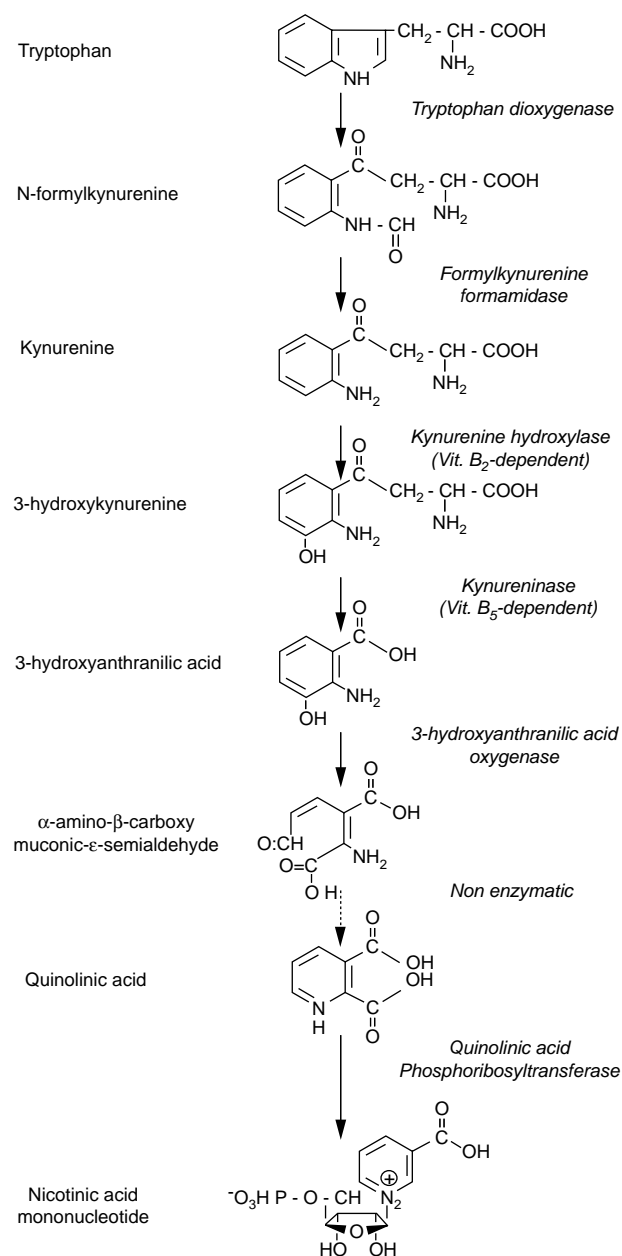
The major dietary sources of niacin are meats, poultry, and fish, followed by dairy and grain products.<sup>[2]</sup> Preformed niacin exists in foods as nicotinamide, nicotinic acid, or the pyridine nucleotide coenzymes, NAD and



**Fig. 1** Structure of nicotinic acid and nicotinamide.

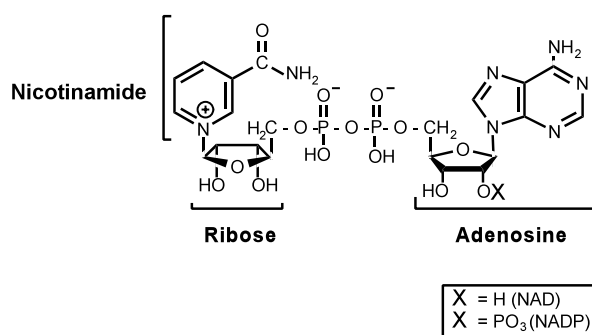
Christelle Bourgeois, Ph.D., is Post-Doctoral Fellow at the Institute of Medical Biochemistry, Medical University of Vienna, Vienna, Austria.

Joel Moss, M.D., Ph.D., is at the National Institutes of Health, NHLBI, Pulmonary–Critical Care Medicine Branch, Bethesda, Maryland, U.S.A.



**Fig. 2** Conversion of tryptophan to nicotinic acid mononucleotide; “de novo” synthesis pathway.

NADP (Fig. 3). L-Tryptophan, the in vivo precursor of nicotinamide (Fig. 2), also contributes to the total niacin-equivalent (NE) content of foods and should be taken into account when calculating the vitamin intake. Eggs and milk, for instance, with their high tryptophan content, are a significant source of NE. Niacin intake is, therefore, generally expressed in NE. It is estimated that 60 g of the amino acid is converted to 1 g of the vitamin, with a variation of about 30% (standard deviation) among individuals. The efficiency of tryptophan conversion to nicotinic acid depends on nutritional history and hormonal factors.<sup>[3]</sup>



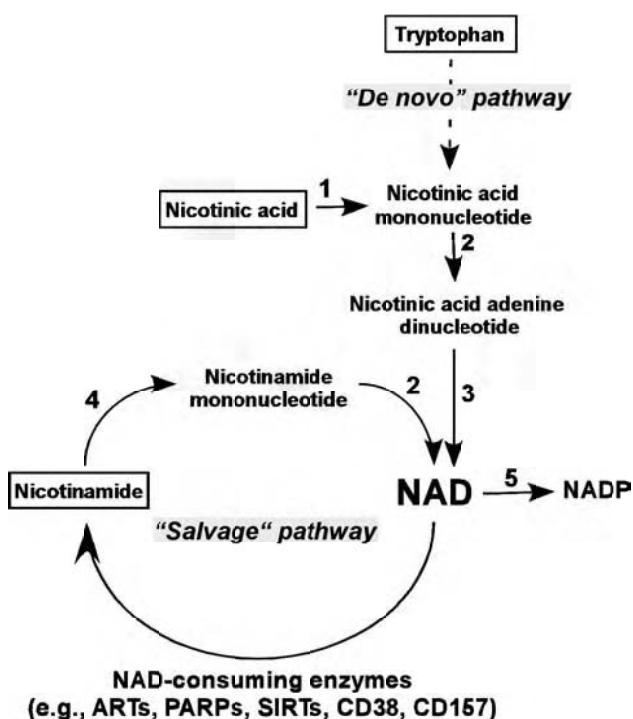
**Fig. 3** Structure of the pyridine coenzymes.

Quantitatively, tryptophan is primarily used for protein biosynthesis, even in conditions of niacin deficiency.

Estimation of dietary niacin content should also consider another factor: bioavailability. Indeed, in certain cereal grains, such as corn, it is largely present as niacytin, a polysaccharide/glycopeptide/polypeptide-bound form, most of which is unavailable for intestinal absorption. In maize, for instance, 70% is in a biologically unavailable form.<sup>[4]</sup> Niacin availability can be improved, however, by specific processes such as the alkali treatment of corn used in the preparation of tortillas.<sup>[3]</sup> Otherwise, absorption of nicotinic acid and its amide by the gastric and intestinal mucosa is very efficient, proceeding via sodium ion-dependent facilitated diffusion at low concentrations, and passive diffusion at high concentrations. In the gut, NAD and NADP are degraded by glycohydrolase and pyrophosphatase activities into nicotinamide and nicotinamide ribonucleotide, which are bioavailable sources of the vitamin.

Tissues absorb free nicotinic acid as well as nicotinic acid bound to proteins. Metabolic trapping, in which nicotinic acid and nicotinamide are converted to NAD, accounts for retention of these vitamins.<sup>[3]</sup> Nicotinic acid and, to a lesser extent, nicotinamide are lipid-soluble molecules, and adipose tissue is responsible for the rapid clearance of nicotinic acid after an intravenous dose. In addition, receptor-mediated uptake has been reported for nicotinamide.<sup>[3]</sup> In liver, nicotinic acid and nicotinamide can be converted to NAD and NADP or metabolized for clearance. Nicotinic acid is eliminated as a glycine conjugate, nicotinuric acid, whereas the main metabolites of nicotinamide are N<sup>1</sup>-methylnicotinamide and its oxidized products, 2- and 4-pyridones.<sup>[5]</sup> Nicotinic acid and nicotinamide metabolites are then excreted in urine; quantification of this excretion is useful in evaluating niacin nutritional status.

Nicotinic acid, nicotinamide, and tryptophan are precursors of NAD and NADP (Fig. 4). These nucleotides can be synthesized “de novo,” using tryptophan from the diet to generate nicotinic acid mononucleotide (Fig. 1), or through the “salvage pathway” (Fig. 4),



**Fig. 4** General pathways of NAD metabolism. In liver, NAD may be synthesized from dietary nicotinic acid, nicotinamide, tryptophan (“de novo” pathway), or readily absorbed from foods. NAD may also be synthesized through the “salvage pathway,” which is fueled by the nicotinamide resulting from the activity of NAD-consuming enzymes (e.g., PARPs, polyadenosine diphosphate ribosylpolymerases; ARTs, mono-ADP-ribosyltransferases; SIRTs, Sir2-like protein deacetylases). NAD, nicotinamide adenine dinucleotide; 1, nicotinic acid phosphoribosyltransferase; 2, (nicotinamide/nicotinic acid) mononucleotide adenosine-5'-triphosphate adenylyltransferase (NMNAT/NaMNAT); 3, NAD synthase; 4, nicotinamide phosphoribosyltransferase; 5, NAD kinase.

using nicotinic acid and nicotinamide absorbed from nutrients, or nicotinamide recycled from signaling reactions that involve NAD catabolism.<sup>[6]</sup> Tryptophan metabolism, initiated by tryptophan-2,3-dioxygenase, a tryptophan-inducible enzyme, occurs primarily in liver. Since quinolinic acid phosphoribosyltransferase activity in mammals was detected only in liver and kidney, other tissues rely mostly on an exogenous supply of nicotinic acid/nicotinamide for NAD biosynthesis; hence the role of nicotinic acid and nicotinamide as essential nutrients. The last step of NAD synthesis is catalyzed by nicotinamide/nicotinic acid mononucleotide adenylyltransferases (NMNAT1–3, in humans),<sup>[7–9]</sup> which use both nicotinamide mononucleotide and nicotinic acid mononucleotide as targets for the adenylyl-transfer reaction. In yeast, genes of the “de novo” synthesis pathway are silenced by an NAD-dependent histone deacetylase, which functions as a sensor of

levels in nuclear NAD pools.<sup>[10]</sup> NADP is formed directly from NAD by phosphorylation catalyzed by a specific kinase present in most tissues except skeletal muscle.<sup>[11]</sup>

These pyridine nucleotides are involved in numerous reactions, ranging from energy metabolism to cell signaling. As coenzymes, they are required in most of the metabolic redox processes of the cell, in which dehydrogenases use NAD/P(H) as coenzymes to oxidize or reduce substrates. NADP dehydrogenases are preferentially involved in anabolic reactions (e.g., synthesis of fatty acids and cholesterol).<sup>[12]</sup> In contrast, NAD is used in catabolic reactions to transfer the potential free energy stored in macronutrients such as carbohydrates, lipids, and proteins to NADH, which is then used to form ATP, the primary energy currency of the cell.

Besides its well-known role in energy transduction, NAD is also substrate for four other classes of enzymes, the mono-ADP-ribosyltransferases (ARTs), the poly-ADP-ribosyltransferases (PARPs), the ADP-ribosylcyclases (e.g., CD38, CD157), and the Sir2-like protein deacetylases (SIRTs). ARTs and PARPs catalyze the activation of the beta-*N*-glycosylic bond of NAD and transfer of the ADP-ribose moiety to acceptor proteins or another ADP-ribose in the case of PARPs. Many of the ARTs also demonstrate NAD glycohydrolase activities, in which water is the ADP-ribose acceptor, as do ADP-ribosylcyclases. The latter, in addition, catalyze the formation of potent calcium-mobilizing second messengers, cyclic ADP-ribose (cADPR) and nicotinic acid adenine dinucleotide (NAAD) from NAD, as well as cyclic ADP-ribose phosphate (cADPRP), and nicotinic acid adenine dinucleotide phosphate (NAADP) from NADP. In contrast, SIRTs utilize NAD as an acceptor of the acetyl group that is removed from proteins, thereby generating 2'-*O*-acetyl-ADP-ribose.

Mono-ADP-ribosyltransferases transfer a single ADPR moiety per specific acceptor amino acid (e.g., arginine, cysteine, asparagine, or histidine). In general, the purpose of this covalent modification is to alter the biological activity of the acceptor protein (reviewed in Ref.<sup>[13]</sup>). The known vertebrate ARTs (ART1–7) are secreted or glycosylphosphatidylinositol-anchored proteins. Their enzymatic activities have been implicated in the regulation of diverse cell processes including myocyte differentiation and modulation of immune cell functions (e.g., T lymphocyte cytotoxicity and neutrophil chemotaxis).<sup>[14]</sup> The well-established modulatory properties of mono-ADP-ribosylation on intracellular targets (e.g., G proteins, chaperone proteins, cytoskeleton, and Golgi components) suggest that additional ARTs are yet to be identified.<sup>[13]</sup>

PARPs synthesize highly negatively charged ADP-ribose polymers on themselves and/or target proteins,

thereby affecting protein folding and, hence, protein function (for review, see Ref.<sup>[15]</sup>). This post-translational modification is transient as the polymers are rapidly metabolized by two enzymes, poly-ADP-ribose glycohydrolase and lyase. Poly-ADP-ribosylation is involved in the regulation of many vital cellular events, e.g., DNA replication and repair, chromatin structure, transcription, apoptosis, and regulation of telomere length.<sup>[16,17]</sup> In general, members of the PARP family are nuclear DNA-binding proteins that catalyze the polymerization and branching of ADPR chains on target proteins. The most extensively studied member, PARP1, is markedly activated at sites of single-strand DNA breaks. Overactivation of PARP1 after extensive DNA damage leads to rapid depletion of NAD and ATP and ultimately cell death. Since niacin contributes to maintaining the NAD levels for PARP, niacin deficiency could compromise DNA repair and increase the risk of cancer. Alternatively, the inhibitory effect of niacin on PARP1 activity should also be taken into account; an excess of niacin could also impair DNA repair. For this reason perhaps, experimental and epidemiological data regarding any relationship between niacin status and genomic stability have been so far conflicting.<sup>[15]</sup>

The third group of enzymes, the NAD-glycohydrolase/ADP-ribosylcyclases, includes CD38 and CD157, and G-protein controlled enzymes in mammals.<sup>[18–20]</sup> These membrane proteins use NAD and NADP to generate signaling molecules, cADPR and cADPRP, by cyclization, and NAADP by transglycosidation. These pyridine derivatives have critical signaling functions in the mobilization of intracellular calcium stores via modulation of the Ca<sup>2+</sup>-releasing channel ryanodine receptors. As shown by targeted gene inactivation in mice, CD38 is required for appropriate cell-dependent antibody and innate immune responses to bacterial pathogens,<sup>[21]</sup> whereas CD157 participates in the regulation of the humoral T cell-independent immune and mucosal thymus-dependent responses.<sup>[22]</sup> Both cyclases have been implicated in the development of autoimmune disorders, although their role(s) is (are) not well established. CD38 has been proposed as a mediator of glucose-induced insulin secretion from pancreatic  $\beta$  cells via the increase of intracellular Ca<sup>2+</sup> concentration and may be involved in the pathogenesis of autoimmune diabetes.<sup>[18,23]</sup> It has been postulated that upregulation of CD157 expression in some patients with rheumatoid arthritis may contribute to the development of this autoimmune disease.<sup>[19]</sup>

Sir2-like proteins are related to the yeast silent information regulator (Sir2), an enzyme required for life span expansion in conditions of nutrient scarcity in yeast and worm.<sup>[24]</sup> In humans, SIRT1, the most closely related to yeast Sir2, deacetylates p53, thereby

inhibiting apoptosis in response to DNA damage.<sup>[25,26]</sup> In mice, absence of SIRT1 leads to p53 hyperacetylation, impaired development, a shortened life span, and sterility.<sup>[27]</sup> Thus, in several species, SIRT1 and homologs appear to regulate diverse pathways that have one common feature, i.e., their impact on aging.<sup>[24]</sup> Because nicotinamide is a potent inhibitor of SIRT activity, it has been proposed to serve as a physiologic regulator,<sup>[28]</sup> whose level would be controlled by the rate of its conversion to nicotinic acid through the NAD<sup>+</sup> salvage pathway, and/or to *N*-methyl nicotinamide, by the excretion pathway.<sup>[29]</sup> Whether a decrease in nicotinamide, or an increase in NAD levels, is responsible for the increased activity of Sir2 during caloric restriction is still debated.<sup>[29,30]</sup> Thus, NAD-consuming enzymes, by their activities, link the nutritional and metabolic status of the cell to the regulation of essential cell functions, such as gene silencing, maintenance of genome integrity, and innate immunity. Many of these reactions yield nicotinamide in addition to other molecules, thus fueling the NAD “salvage pathway” for NAD resynthesis.

## INDICATIONS AND USAGE

### Supplementation to Achieve Recommended Intake Levels

The recommended dietary allowance (RDA), as defined in the report of the Standing Committee on the Scientific Evaluation of Dietary Reference Intakes and its Panel on Niacin,<sup>[4]</sup> is summarized in Table 1. These values were established according to the doses required to prevent pellagra (11.3–13.3 mg of NE/day). The tryptophan content of a reasonable dietary protein intake is itself likely to provide at least 13.2 mg/day NE (based on a 2000 kcal/day diet). There are no relevant data concerning niacin requirements in pregnancy and lactation. Thus, requirements were estimated based on an average increase in energy expenditure of 300 kcal/day during pregnancy and an average daily secretion of 1.4 mg of NE during lactation.<sup>[4]</sup> Since numerous NAD-dependent enzymes (e.g., PARPs and SIRTs) can influence genomic stability, insufficient nicotinic acid intake is likely to increase the risk of cancer and other diseases attributable to increased DNA damage.<sup>[31–33]</sup> It has been suggested that maintenance of adequate NAD levels would, in the long term, prevent or retard the multistage process of carcinogenesis and age-related diseases. Several lines of evidence in yeast and in rodents support this hypothesis.<sup>[34,35]</sup> Furthermore, studies in rats suggest that niacin supplementation could decrease the risk for development of chemotherapy-related malignancies in cancer patients with compromised nutritional status.<sup>[36,37]</sup> According

**Table 1** Recommended dietary allowances of niacin<sup>a</sup>

Age (yr)	RDA (mg) <sup>b</sup>
Infants	
0–0.5	2 <sup>c</sup>
0.5–1.0	4 <sup>c</sup>
Children	
1–3	6 <sup>d</sup>
4–8	8 <sup>d</sup>
Males	
9–13	12 <sup>d</sup>
14–18	16 <sup>d</sup>
19 and above	12
Females	
9–13	12 <sup>d</sup>
14–18	14 <sup>d</sup>
19 and above	14
Pregnancy	
14–50	17
Lactation	
14–50	18

<sup>a</sup>RDA, 1998 United States Food and Nutrition Board of the Institute of Medicine.

<sup>b</sup>One milligram niacin = 60 mg tryptophan = niacin equivalent (NE).

<sup>c</sup>For infants, given values correspond to the adequate intake (AI) level, which is based on the observed mean intake of preformed niacin by infants fed with human milk.

<sup>d</sup>No data being available for these ranges of age, RDAs were estimated by extrapolation from adult values.

to preliminary experimental data linking niacin status and genomic stability, the doses required to prevent pellagra would not be sufficient to promote genomic stability.<sup>[38]</sup>

Niacin nutriture has been assessed in several ways by a variety of methods (for review, see Ref.<sup>[39]</sup>). Dowex-1 formate chromatography is used to separate pyridine nucleotides and *N*<sup>1</sup>-methylnicotinamide. Measurement of the latter and its 2-pyridone derivative in urine is most commonly used. Excretion of *N*<sup>1</sup>-methylnicotinamide below 0.8 mg/day indicates niacin deficiency.<sup>[39]</sup> A ratio of *N*<sup>1</sup>-methyl-5-carboxamide-2-pyridone to *N*<sup>1</sup>-methylnicotinamide of 1.3–2.0 is considered normal; in niacin deficiency, it is less than 1.0. Niacin status can also be assessed by measuring its physiologically active forms, NAD(H)/NADP(H). A method devised by Lowry et al. in 1961, and modified by Slater and Sawyer in 1962 and Nisselbaum and Green in 1969, utilizes appropriate dehydrogenases specific for either NAD or NADP and thiazolyl blue, which, when reduced by NADH and NADPH, forms purple formazan in an amount proportional to the concentration of the coenzymes (oxidized and reduced). This assay is used to measure pyridine nucleotides in tissue and blood. Assays of NAD/NADP

in erythrocytes and cultured cells suggest that the intracellular NAD level may reflect niacin status, whereas NADP levels do not. Measurement of NAD/NADP content and tryptophan level in erythrocytes has been proposed to evaluate niacin deficiency.<sup>[3]</sup>

### Treatment of Niacin Deficiency

In humans, the combination of inadequate intakes of tryptophan and niacin leads to pellagra. This name was given by Frapolli in 1771, from the Italian words “pelle” for “skin” and “agra” for “rough” to describe the roughened, sunburned-like appearance of the skin of niacin-deficient patients exposed to sunlight. Other symptoms include diarrhea and neuropathy.<sup>[40]</sup> In its most acute form, deficiency can lead to death. Maize-based diets predispose to pellagra because of the limited bioavailability of the niacin contained in this grain and its low tryptophan level. Niacin bioavailability can be improved, however, by alkaline treatment. In Central America, where corn that is used for the preparation of tortillas is first soaked in lime solution, the incidence of pellagra is very low, despite the corn-based staple diet.<sup>[3]</sup> Today, this disease seems to be endemic mostly in parts of India, China, and Africa.<sup>[40]</sup> Advanced stages of pellagra can be cured with nicotinamide in intramuscular doses of 50–100 mg three times a day for 3–4 days, followed by similar quantities orally, supplemented with 100 g of proteins daily.

Other factors can also influence the appearance of pellagra (reviewed in Ref.<sup>[3]</sup>). Vitamins B6 and B2 (riboflavin) are coenzymes required for the efficient conversion of tryptophan to niacin (Fig. 2). Hence, an inadequate intake of these vitamins is likely to predispose to pellagra. An excess of leucine also impairs tryptophan bioconversion by competing for transport and by inhibiting kynureninase, resulting in decreased NAD formation.

There are several reports of a higher incidence of pellagra in women than in men. This difference may have several causes, including cultural factors that determine food intake, metabolic stresses due to repeated pregnancies, and lactation. In addition, estrogen metabolites can inhibit kynureninase and kynurenine hydroxylase activity. When the intake of preformed niacin and tryptophan is low, inhibitory effects of estrogens on tryptophan bioconversion could contribute to a greater susceptibility of women to pellagra.

Inborn disorders of tryptophan metabolism can cause nondietary pellagra (reviewed in Ref.<sup>[41]</sup>). In Hartnup’s syndrome (an autosomal recessive disorder), decreased absorption and/or increased excretion



of tryptophan lead to inadequate conversion of this essential amino acid to niacin. The symptoms of niacin deficiency can be alleviated by large doses of the vitamin (40–250 mg/day).

### Treatment of Hyperlipidemia

In pharmacological doses (2–6 g/day), nicotinic acid, but not nicotinamide, significantly reduces atherosclerotic cardiovascular disease and mortality. The benefits of nicotinic acid treatment are due to its anti-hyperlipidemic effects at high doses. It decreases the levels of plasma low-density lipoproteins (LDLs), very low-density lipoproteins (VLDLs), and triglycerides (TGs), and increases the high-density lipoproteins (HDLs), thus reducing the LDL/HDL ratio. The mechanism of action of nicotinic acid on lipoprotein metabolism has not been completely elucidated (reviewed in Ref.<sup>[42]</sup>). Available data suggest that nicotinic acid decreases the formation of LDL and VLDL by inhibiting the lipolysis of TG in adipose tissue and TG synthesis in liver. In adipose tissue, the antilipolytic effect is mediated by niacin activation of a recently characterized Gi/o protein-coupled high-affinity receptor that causes inhibition cAMP-stimulated lipolysis.<sup>[43,44]</sup> On the other hand, nicotinic acid promotes the synthesis of HDL by preventing the catabolism of a major protein component of HDL apolipoprotein AI (apoAI), but not of cholesterol esters from HDL. It has been proposed that an increase in the amount of apoAI available for HDL synthesis would augment reverse cholesterol transport, facilitating the removal of excess cholesterol from peripheral tissues and thereby lowering the risk of atherosclerotic cardiovascular disease.

When nicotinic acid monotherapy does not lower the blood cholesterol level sufficiently, combination with other lipid-lowering drugs that act through different mechanisms (e.g., bile acid-binding resins and statins) has proved successful for some patients.<sup>[45]</sup>

### Prevention of Oxidant-Induced Cell Injury in Pathological Conditions

At high doses (up to 3.5 g/day), nicotinamide is protective against cell death and inhibits the production of inflammatory mediators in animal and in “in vitro” models of oxidant-induced cell injury. In addition to these effects, which are consistent with PARP1 inhibition, nicotinamide exhibits PARP1-independent actions<sup>[15]</sup> that may be attributable to its inhibition of other signaling pathways (e.g., SIRT6) and its function as a precursor of pyridine nucleotides.<sup>[46]</sup> Nicotinamide has been proposed as a possible means of increasing the survival of pancreatic  $\beta$ -cells after

diagnosis of Type I diabetes (insulin-dependent diabetes mellitus, IDDM), or to prevent onset of the disease in high-risk individuals (reviewed in Ref.<sup>[15]</sup>). This latter notion was not confirmed, however, by the recently published European Nicotinamide Diabetes Intervention Trial (ENDIT), a large-scale evaluation of nicotinamide benefits in first-degree relatives of Type I diabetic patients.<sup>[47]</sup> The present state of knowledge suggests that specific inhibition of PARP1 would be needed for effective preventive action.

### Adverse Effect of Drugs on Niacin Status

Isoniazid, which is commonly used to treat tuberculosis, causes vitamin B6 depletion and hence may lower the efficiency of the “de novo” synthesis pathway that converts tryptophan into nicotinic acid, thereby predisposing to pellagra.<sup>[3]</sup>

### CONTRAINDICATIONS

Because of its potential side effects, antihyperlipidemic treatment with nicotinic acid is contraindicated in patients with active peptic ulcer or frequent gout attacks. Until recently, those with Type II diabetes mellitus were also considered at risk, but new clinical data seem to indicate that nicotinic acid can be used safely to treat diabetic dyslipidemia.<sup>[45]</sup>

### PRECAUTIONS AND ADVERSE REACTIONS

Prostaglandin-mediated flushing is the major specific side effect experienced by users of pharmacological doses of nicotinic acid in the initial days of treatment. Symptoms can be reduced by ingestion of the drug with food and/or by gradually increasing the dose. Tolerance develops with continued use in most patients. Flushing has been documented in patients using immediate-release nicotinic acid (IR-nicotinic acid) and sustained-release forms, as well as by some subjects on extended-release nicotinic acid (ER-nicotinic acid). However, in general, the extended-release formulation achieves the efficacy of the immediate-release form with a reduced incidence of flushing and without the hepatic problems caused by sustained-release nicotinic acid.<sup>[48]</sup> Other reported adverse effects of nicotinic acid treatment include pruritis, nausea, gastrointestinal upset, hypotension, tachycardia, and elevated serum blood glucose and uric acid levels. Because of potential hepatic toxicity, liver enzymes (aminotransferases and/or alkaline phosphatase) should be monitored before the initiation of therapy, 6 weeks after initiation and/or any change of dose,

and two or three times a year thereafter. If liver enzymes exceed three times the upper limit of normal, treatment should be discontinued. To avoid liver toxicity, it is recommended that the starting dose not exceed 250–300 mg/day with monthly increments not greater than 250–300 mg/day until a maximum of 3 g/day is reached for IR-nicotinic acid and 1.5–2 g/day for the sustained-release form. To circumvent the hepatic effects of oral intake of nicotinic acid, pro-niacin formulations (e.g., esters of nicotinic acid) have been developed for topical application.<sup>[49,50]</sup> Following conversion of the esterified form by skin  $\alpha$ -naphthyl-acetate-esterase activity, a slower systemic delivery through the skin is accomplished, with lower concentrations of drug, and sustained benefits of nicotinic acid.<sup>[48]</sup>

Nicotinic acid may cause insulin resistance, which requires compensatory insulin secretion, and, in patients with dysfunctional pancreatic  $\beta$ -cells, it may trigger hyperglycemia. Those with diabetes mellitus, therefore, require special monitoring during niacin treatment. No adverse effects of the pharmacological doses of nicotinamide used during the ENDIT study were reported.<sup>[47]</sup> There has been concern, however, that saturation of the nicotinamide excretion pathway may divert methylation equivalents required for anabolic pathways to nicotinamide methylation and lead to growth retardation in children. Furthermore, as a strong inhibitor of SIRT6, nicotinamide might interfere with cell survival.<sup>[29]</sup> Thus, more data are needed on the long-term effects of therapeutic doses of nicotinamide.

## OVERDOSAGE

No adverse events of the consumption of naturally occurring niacin in food have been reported. Side effects have been widely recognized in patients treated for hyperlipidemia with high doses (3–9 g/day) of pharmaceutical preparations of nicotinic acid for periods of months to years.<sup>[42]</sup> Symptoms of nausea and vomiting and signs of liver toxicity with intake of more than 3000 mg/day of nicotinamide or 1500 mg/day of nicotinic acid have been reported. Most frequently, patients develop jaundice and increased levels of serum transaminases. In the most severe cases, liver dysfunction and fulminant hepatitis can result.

## CONCLUSIONS

Meat, cereals, eggs, and milk are the main sources of vitamin B3, the general term to designate niacin (nicotinic acid and nicotinamide) and NE (tryptophan). Deficiency, which may be caused by poor dietary

intake or inherited disorders (e.g., Hartnup's syndrome), results in pellagra. The diversity of pellagra symptoms is representative of the wide spectrum of pathways that require adequate niacin intake to function. The molecular mechanisms by which insufficient niacin uptake causes these symptoms are ill understood. Some may reflect primarily the role of the vitamin as a precursor of NAD and NADP, others to its requirement, as coenzyme or substrate in many enzymatic reactions. Niacin nutritional status may have consequences for cellular functions as diverse as immunity, genomic stability, and energy supply. In addition to its role as a niacin source, nicotinic acid is well established, and widely employed therapeutically, because of its efficacy as an antihyperlipidemic agent. Risks of hepatotoxicity and other side effects have decreased with the development of new niacin formulations that improve drug delivery, and are better tolerated by patients. The recent characterization of different types of nicotinic acid receptors may help in the development of more specific agonists with fewer side effects. Nicotinamide is the niacin source of choice to treat pellagra. Trials of other pharmacological applications of nicotinamide have produced mixed results. It did not seem effective in preventing the development of autoimmune diabetes or for protection against oxidant-induced cell death. This may be due to the several roles of nicotinamide as both an NAD precursor and an inhibitor of several relevant enzymes (e.g., SIRT6 and PARPs). Recent studies suggest that, by sustaining adequate NAD levels, pharmacological doses of niacin could contribute to the prevention or delay of age-related diseases in healthy individuals and protect cancer patients against secondary effects of anticancer therapy. However, because of their multiple functions, more studies are necessary to evaluate the benefits and consequences of pharmacological doses of nicotinamide and nicotinic acid.

## ACKNOWLEDGMENTS

We thank Dr. Martha Vaughan and Dr. Vincent Manganiello for helpful discussions and critical review of the manuscript.

## REFERENCES

1. Weiner, M.; Van Eys, J. The discovery of nicotinic acid as a nutrient. In *Nicotinic Acid: Nutrient-Cofactor-Drug*; Weiner, M., Ed.; Marcel Dekker: New York, NY, 1983; Vol. 1, 3–16.
2. Bates, C.J. Niacin: physiology, dietary sources and requirement. In *Encyclopedia of Human Nutrition*; Sadler, M.J., Strain, J.J., Caballero,

- B., Eds.; Academic Press: San Diego, CA, 1999; 1290–1297.
3. Cervantes-Laurean, D.; McElvaney, G.; Moss, J. Niacin. In *Modern Nutrition in Health and Disease*, 9th Ed.; Shils, M.E., Olson, J.A., Shike, M., Ross, A.C., Eds.; Williams & Wilkins: Philadelphia, PA, 1999; 401–411.
  4. US Institute of Medicine. Niacin. In *Dietary Reference Intakes for Thiamin, Riboflavin, Niacin, Vitamin B6, Folate, Vitamin B12, Pantothenic acid, Biotin, and Choline*; National Academy Press: Washington, DC, 1998; 123–149.
  5. Shibata, K. Fate of excess nicotinamide and nicotinic acid differs in rats. *J. Nutr.* **1989**, *119* (6), 892–895.
  6. Rongvaux, A.; Andris, F.; Van Gool, F.; Leo, O. Reconstructing eukaryotic NAD metabolism. *Bioessays* **2003**, *25* (7), 683–690.
  7. Raffaelli, N.; Sorci, L.; Amici, A.; Emanuelli, M.; Mazzola, F.; Magni, G. Identification of a novel human nicotinamide mononucleotide adenylyl transferase. *Biochem. Biophys. Res. Commun.* **2002**, *297* (4), 835–840.
  8. Zhang, X.; Kurnasov, O.V.; Karthikeyan, S.; Grishin, N.V.; Osterman, A.L.; Zhang, H. Structural characterization of a human cytosolic NMN/NaMN adenylyltransferase and implication in human NAD biosynthesis. *J. Biol. Chem.* **2003**, *278* (15), 13,503–13,511.
  9. Emanuelli, M.; Carnevali, F.; Saccucci, F.; Pierella, F.; Amici, A.; Raffaelli, N.; Magni, G. Molecular cloning, chromosomal localization, tissue mRNA levels, bacterial expression, and enzymatic properties of human NMN adenylyltransferase. *J. Biol. Chem.* **2001**, *276* (1), 406–412.
  10. Bedalov, A.; Hirao, M.; Posakony, J.; Nelson, M.; Simon, J.A. NAD<sup>+</sup>-dependent deacetylase Hst1p controls biosynthesis and cellular NAD<sup>+</sup> levels in *Saccharomyces cerevisiae*. *Mol. Cell. Biol.* **2003**, *23* (19), 7044–7054.
  11. Lerner, F.; Niere, M.; Ludwig, A.; Ziegler, M. Structural and functional characterization of human NAD kinase. *Biochem. Biophys. Res. Commun.* **2001**, *288* (1), 69–74.
  12. Nelson, D.L.; Cox, M.M. Principles of bioenergetics. In *Lehninger Principles of Biochemistry*, 3rd Ed.; Worth Publishers: New York, NY, 2000; 490–526.
  13. Corda, D.; Di Girolamo, M. Functional aspects of protein mono-ADP-ribosylation. *EMBO J.* **2003**, *22* (9), 1953–1958.
  14. Corda, D.; Di Girolamo, M. Mono-ADP-ribosylation: a tool for modulating immune response and cell signaling. *Sci. STKE* **2002**, (163), E53.
  15. Virag, L.; Szabo, C. The therapeutic potential of poly(ADP-ribose) polymerase inhibitors. *Pharmacol. Rev.* **2002**, *54* (3), 375–429.
  16. Kraus, W.L.; Lis, J.T. PARP goes transcription. *Cell* **2003**, *113* (6), 677–683.
  17. Tong, W.M.; Cortes, U.; Wang, Z.Q. Poly(ADP-ribose) polymerase: a guardian angel protecting the genome and suppressing tumorigenesis. *Biochim. Biophys. Acta* **2001**, *1552* (1), 27–37.
  18. Okamoto, H.; Takasawa, S. Recent advances in the Okamoto model: the CD38-cyclic ADP-ribose signal system and the regenerating gene protein (Reg)-Reg receptor system in beta-cells. *Diabetes* **2002**, *51* (Suppl. 3), S462–S473.
  19. Ortolan, E.; Vacca, P.; Capobianco, A.; Armando, E.; Crivellin, F.; Horenstein, A.; Malavasi, F. CD157, the Janus of CD38 but with a unique personality. *Cell Biochem. Funct.* **2002**, *20* (4), 309–322.
  20. Ceni, C.; Muller-Steffner, H.; Lund, F.; Pochon, N.; Schweitzer, A.; De Waard, M.; Schuber, F.; Villaz, M.; Moutin, M.J. Evidence for an intracellular ADP-ribosyl cyclase/NAD<sup>+</sup>-glycohydrolase in brain from CD38-deficient mice. *J. Biol. Chem.* **2003**, *278* (42), 40,670–40,678.
  21. Partida-Sanchez, S.; Randall, T.D.; Lund, F.E. Innate immunity is regulated by CD38, an ecto-enzyme with ADP-ribosyl cyclase activity. *Microbes Infect.* **2003**, *5* (1), 49–58.
  22. Itoh, M.; Ishihara, K.; Hiroi, T.; Lee, B.O.; Maeda, H.; Iijima, H.; Yanagita, M.; Kiyono, H.; Hirano, T. Deletion of bone marrow stromal cell antigen-1 (CD157) gene impaired systemic thymus independent-2 antigen-induced IgG3 and mucosal TD antigen-elicited IgA responses. *J. Immunol.* **1998**, *161* (8), 3974–3983.
  23. Marchetti, P.; Antonelli, A.; Lupi, R.; Marselli, L.; Fallahi, P.; Nesti, C.; Baj, G.; Ferrannini, E. Prolonged in vitro exposure to autoantibodies against CD38 impairs the function and survival of human pancreatic islets. *Diabetes* **2002**, *51* (Suppl. 3), S474–477.
  24. Hekimi, S.; Guarente, L. Genetics and the specificity of the aging process. *Science* **2003**, *299* (5611), 1351–1354.
  25. Cheng, H.L.; Mostoslavsky, R.; Saito, S.; Manis, J.P.; Gu, Y.; Patel, P.; Bronson, R.; Appella, E.; Alt, F.W.; Chua, K.F. Developmental defects and p53 hyperacetylation in Sir2 homolog (SIRT1)-deficient mice. *Proc. Natl. Acad. Sci. U.S.A.* **2003**, *100* (19), 10,794–10,799.
  26. Luo, J.; Nikolaev, A.Y.; Imai, S.; Chen, D.; Su, F.; Shiloh, A.; Guarente, L.; Gu, W. Negative control of p53 by Sir2alpha promotes cell survival under stress. *Cell* **2001**, *107* (2), 137–148.

27. McBurney, M.W.; Yang, X.; Jardine, K.; Hixon, M.; Boekelheide, K.; Webb, J.R.; Lansdorp, P.M.; Lemieux, M. The mammalian SIR2alpha protein has a role in embryogenesis and gametogenesis. *Mol. Cell. Biol.* **2003**, *23* (1), 38–54.
28. Bitterman, K.J.; Anderson, R.M.; Cohen, H.Y.; Latorre-Esteves, M.; Sinclair, D.A. Inhibition of silencing and accelerated aging by nicotinamide, a putative negative regulator of yeast sir2 and human SIRT1. *J. Biol. Chem.* **2002**, *277* (47), 45,099–45,107.
29. Anderson, R.M.; Bitterman, K.J.; Wood, J.G.; Medvedik, O.; Sinclair, D.A. Nicotinamide and PNC1 govern lifespan extension by calorie restriction in *Saccharomyces cerevisiae*. *Nature* **2003**, *423* (6936), 181–185.
30. Lin, S.J.; Guarente, L. Nicotinamide adenine dinucleotide, a metabolic regulator of transcription, longevity and disease. *Curr. Opin. Cell Biol.* **2003**, *15* (2), 241–246.
31. Ames, B.N. DNA damage from micronutrient deficiencies is likely to be a major cause of cancer. *Mutat. Res.* **2001**, *475* (1–2), 7–20.
32. Hageman, G.J.; Stierum, R.H. Niacin, poly(ADP-ribose) polymerase-1 and genomic stability. *Mutat. Res.* **2001**, *475* (1–2), 45–56.
33. Kirkland, J.B. Niacin and carcinogenesis. *Nutr. Cancer* **2003**, *46* (2), 110–118.
34. Anderson, R.M.; Bitterman, K.J.; Wood, J.G.; Medvedik, O.; Cohen, H.; Lin, S.S.; Manchester, J.K.; Gordon, J.I.; Sinclair, D.A. Manipulation of a nuclear NAD<sup>+</sup> salvage pathway delays aging without altering steady-state NAD<sup>+</sup> levels. *J. Biol. Chem.* **2002**, *277* (21), 18,881–18,890.
35. Spronck, J.C.; Kirkland, J.B. Niacin deficiency increases spontaneous and etoposide-induced chromosomal instability in rat bone marrow cells in vivo. *Mutat. Res.* **2002**, *508* (1–2), 83–97.
36. Boyonoski, A.C.; Spronck, J.C.; Gallacher, L.M.; Jacobs, R.M.; Shah, G.M.; Poirier, G.G.; Kirkland, J.B. Niacin deficiency decreases bone marrow poly(ADP-ribose) and the latency of ethylnitrosourea-induced carcinogenesis in rats. *J. Nutr.* **2002**, *132* (1), 108–114.
37. Spronck, J.C.; Bartleman, A.P.; Boyonoski, A.C.; Kirkland, J.B. Chronic DNA damage and niacin deficiency enhance cell injury and cause unusual interactions in NAD and poly(ADP-ribose) metabolism in rat bone marrow. *Nutr. Cancer* **2003**, *45* (1), 124–131.
38. Fenech, M. Micronutrients and genomic stability: a new paradigm for recommended dietary allowances (RDAs). *Food Chem. Toxicol.* **2002**, *40* (8), 1113–1117.
39. Sauberlich, H.E. Niacin. In *Laboratory Tests for the Assessment of Nutritional Status*, 2nd Ed.; CRC Press: Boca Raton, FL, 1999; 161–174.
40. Karthikeyan, K.; Thappa, D.M. Pellagra and skin. *Int. J. Dermatol.* **2002**, *41* (8), 476–481.
41. Levy, H.L. Chapter 193: Hartnup disorder. In *The Metabolic and Molecular Basis of Inherited Diseases*; Scriver, C.R., Beaudet, A.L., Sly, W.S., Valle, D., Eds.; McGraw-Hill: New York, NY, 2003, Online: <http://genetics.accessmedicine.com/index.html>.
42. Ganji, S.H.; Kamanna, V.S.; Kashyap, M.L. Niacin and cholesterol: role in cardiovascular disease (review). *J. Nutr. Biochem.* **2003**, *14* (6), 298–305.
43. Tunaru, S.; Kero, J.; Schaub, A.; Wufka, C.; Blaukat, A.; Pfeffer, K.; Offermanns, S. PUMA-G and HM74 are receptors for nicotinic acid and mediate its anti-lipolytic effect. *Nat. Med.* **2003**, *9* (3), 352–355.
44. Wise, A.; Foord, S.M.; Fraser, N.J.; Barnes, A.A.; Elshourbagy, N.; Eilert, M.; Ignar, D.M.; Murdock, P.R.; Steplewski, K.; Green, A.; Brown, A.J.; Dowell, S.J.; Szekeres, P.G.; Hassall, D.G.; Marshall, F.H.; Wilson, S.; Pike, N.B. Molecular identification of high and low affinity receptors for nicotinic acid. *J. Biol. Chem.* **2003**, *278* (11), 9869–9874.
45. Miller, M. Niacin as a component of combination therapy for dyslipidemia. *Mayo Clin. Proc.* **2003**, *78* (6), 735–742.
46. Klaidman, L.; Morales, M.; Kem, S.; Yang, J.; Chang, M.L.; Adams, J.D., Jr. Nicotinamide offers multiple protective mechanisms in stroke as a precursor for NAD<sup>+</sup>, as a PARP inhibitor and by partial restoration of mitochondrial function. *Pharmacology* **2003**, *69* (3), 150–157.
47. Gale, E.A. Intervening before the onset of Type 1 diabetes: baseline data from the European Nicotinamide Diabetes Intervention Trial (ENDIT). *Diabetologia* **2003**, *46* (3), 339–346.
48. Van den Berg, H. Bioavailability of niacin. *Eur. J. Clin. Nutr.* **1997**, *51* (Suppl. 1), S64–S65.
49. Sugibayashi, K.; Hayashi, T.; Hatanaka, T.; Ogihara, M.; Morimoto, Y. Analysis of simultaneous transport and metabolism of ethyl nicotinate in hairless rat skin. *Pharm. Res.* **1996**, *13* (6), 855–860.
50. Realdon, N.; Ragazzi, E.; Dal Zotto, M. Influence of ointment formulation on skin erythema induced by nicotinate esters. *Pharmazie* **1995**, *50* (9), 603–606.



# Omega-3 Fatty Acids

**William S. Harris**

*Lipid and Diabetes Research Center, Mid America Heart Institute,  
Saint Luke's Hospital, Kansas City, Missouri, U.S.A.*

## INTRODUCTION

Long-chain, highly unsaturated fatty acids (HUFA) of the omega-3 ( $\omega$ -3 or  $n$ -3) family include eicosapentaenoic acid (EPA), docosapentaenoic acid (DPA), and docosahexaenoic acid (DHA). EPA and DPA are 20- and 22-carbon molecules, respectively, with five double bonds  $\Delta$ 5,8,11,14,17, while DHA is a 22-carbon and six double-bond molecule  $\Delta$ 5,8,11,14,17,20. All fatty acids (FA) in the  $\omega$ -3 family are characterized by having their first double bond at the 3rd position counting from the terminal ( $\omega$  or  $n$ th) methyl group in the molecule (Fig. 1). As with the omega-6 family,  $\omega$ -3 FA cannot be synthesized de novo by mammals and must be obtained from the diet.

## BIOCHEMISTRY AND FUNCTIONS

### Synthesis of EPA and DHA

EPA and DHA are natural constituents of the lipids of most marine and many freshwater animals. These FA are originally synthesized by microalgae at the base of the marine food chain.<sup>[1]</sup> They move up the chain via phytoplankton, zooplankton, and small fish to larger fish and marine mammals.

Biosynthesis, once assumed to be relatively straightforward, *vis-à-vis* moving up in chain length and desaturation in a natural progression (C18–C22; 3–6 double bonds), has now been shown to be more complicated and involves two separate organelles (Fig. 1).<sup>[2,3]</sup> The parent  $\omega$ -3 FA,  $\alpha$ -linolenic acid (ALA), is elongated and desaturated (via  $\Delta$ 6 and  $\Delta$ 5 desaturases) to C24:6 in the endoplasmic reticulum (ER). This FA is then translocated to the peroxisome where it is  $\beta$ -oxidized to 22:6,<sup>[4]</sup> and then returned to the ER for incorporation into glycerophospholipids for export. It has been shown that feeding pure EPA

raises DPA but not DHA levels in plasma lipids, whereas pure DHA raises EPA levels.<sup>[5–7]</sup> Presumably, supplemental DHA is able to enter the peroxisome and be degraded to EPA. But the latter FA is apparently not able to enter the proper compartment in the ER in order to be elongated and desaturated to DHA.

### Efficiency of Conversion of ALA to EPA and DHA

In the adult human, the only known role for ALA is to serve as a precursor of DHA, but conversion is exceedingly slow. Reported rates vary from a low of far less than 1%<sup>[8,9]</sup> to 3–6% in young men,<sup>[10]</sup> 9% for young women,<sup>[11]</sup> and even 15%<sup>[10]</sup> depending on the methods used to assess conversion. One of the primary reasons why ALA is poorly converted to the longer-chain EPA and DHA is because it is mostly (about 75%) shunted to  $\beta$ -oxidization.<sup>[12]</sup>

### Tissue Distribution of EPA and DHA

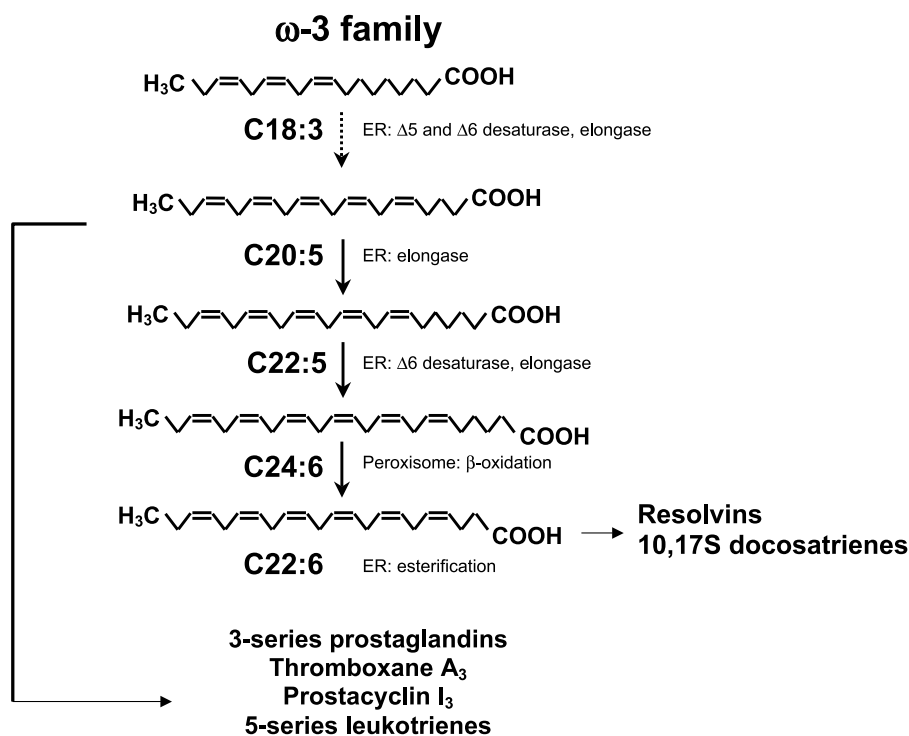
EPA and DHA are found esterified predominantly in membrane phospholipids of tissues, circulating cells, and plasma lipoproteins.<sup>[17,18]</sup> The distribution within plasma differs by lipid class (Fig. 2), with phospholipids carrying by far the most  $\omega$ -3 FA. With respect to cell membranes, the erythrocyte may be used as a model. Omega-3 FA typically constitute about 4–6% of total red blood cell (RBC) phospholipid FA in Western diet where fish intake is sparse. In Japan where EPA and DHA intake is approximately 5–10 higher, RBC EPA + DHA is approximately twice as high.<sup>[13,14]</sup> Certain tissues are particularly rich in DHA. Spermatozoa contain between 6 and 8% DHA,<sup>[15]</sup> and rod outer segments of the retinal epithelium can have up to 30% DHA.<sup>[16]</sup>

### Functions of EPA and DHA

In tissues undergoing physiological stresses, phospholipase A<sub>2</sub> becomes activated by a G-protein mediated pathway, liberating the HUFA at position 2 of membrane phospholipids.<sup>[17,19]</sup> Once cleaved, these HUFA

---

*William S. Harris, Ph.D.*, is Professor at the Department of Medicine, University of Missouri-Kansas City, Missouri, U.S.A.



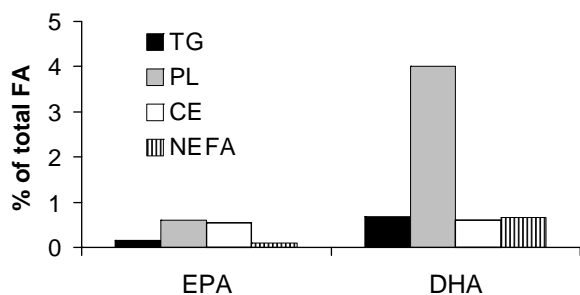
**Fig. 1** The three principal FA in the  $\omega$ -3 family. ALA is derived from plant oils such as flaxseed, soybean, and canola. EPA and DHA are generally derived from marine organisms. There is limited conversion of ALA to EPA and DHA. There is retroconversion of ingested DHA to EPA, but very little DHA is produced from ingested EPA. EPA is the precursor for a wide variety of eicosanoids including the 2-series prostaglandins, and the 5-series leukotrienes. ER, endoplasmic reticulum.

are available for conversion into eicosanoids (20-carbon moieties) and docosanoids (22-carbon moieties). The principal 20-carbon tri-, tetra-, and pentaenoic HUFA are dihomo- $\gamma$ -linolenic acid (DGLA; C20:3 *n*-6), arachidonic acid (AA; C20:4 *n*-6) and EPA. The eicosanoids made from each substrate include a bewildering range of molecular species including prostaglandins, thromboxanes, prostacyclins, lipoxins, leukotrienes, hydroxy acids (metabolites of P-450 enzymes), etc.<sup>[20]</sup> These three substrates give rise to three classes of eicosanoids: DGLA to the 1-series prostaglandins and the 3-series leukotrienes, AA to

the 2- and 4-series, and EPA to the 3-series and 5-series, respectively.<sup>[21]</sup>

With regard to biochemical potency, the eicosanoids produced from AA are generally more potent mediators of inflammation, vasoconstriction, and platelet aggregation than those from EPA<sup>[22]</sup> or DGLA.<sup>[23]</sup> AA is the predominant HUFA in tissue membranes in Western cultures where intakes of EPA and DHA are very low. In platelets, for example, AA constitutes about 25% of total FA and DGLA about 1.5% in subjects consuming Japanese<sup>[24]</sup> and Western<sup>[25]</sup> diets, whereas EPA can vary from <0.5% in the latter to over 2% in the former. The relative proportions of these precursor molecules present in the membranes determine to some degree, which eicosanoids are ultimately produced. Accordingly, a higher EPA content (which produces a correspondingly lower AA content) in membrane HUFA has the potential to diminish the biochemical and, thus, physiological responses to stress.

Docosanoids are a newly discovered group of bioactive molecules similar to eicosanoids but derived from DHA. There are two classes currently known: resolvins, di- and tri-hydroxy derivatives of DHA that are formed by cyclooxygenase-2 in the presence of aspirin and may play a messenger role in the resolution phase of an acute inflammatory response; and 10,17S-docosatriene formed via the 15-lipoxygenase pathway.<sup>[26,27]</sup> Both of these compounds appear to



**Fig. 2** The distribution of AUFA in plasma lipid classes. DHA is particularly predominant in the phospholipid class whereas EPA is found mostly in phospholipids and cholesteryl esters.

limit brain injury during ischemic episodes, so much so that the latter has been termed “neuroprotectin D-1”.<sup>[28]</sup>

### Membrane Ion Channels

The presence of  $\omega$ -3 FA, especially DHA, in biological membranes appears to play an important role in homeostasis.<sup>[29]</sup> As an example, these FA alter the activity of certain ion channels. Original observations in experimental myocardial infarction from Lands' laboratory,<sup>[30]</sup> as well as later studies by McLennan et al.<sup>[31–33]</sup> in rats and monkeys, suggested that  $\omega$ -3 FA may have a direct protective effect on the heart itself independent of effects on serum lipids and platelets. In a dog model of ventricular tachyarrhythmia,<sup>[34]</sup> infused  $\omega$ -3 FA reduced the number of potentially fatal arrhythmias. This led to investigations in isolated cardiac myocytes revealing that EPA and DHA could prolong the refractory state of these cells by interaction with fast-acting sodium channels and L-type calcium channels.<sup>[35,36]</sup> This antiarrhythmic effect is believed to be due to the release of EPA and DHA from myocardial membrane phospholipids by ischemia-activated phospholipase A<sub>2</sub>, and the subsequent interaction of the free acids with ion channels.<sup>[37]</sup> As noted below, the evidence for an antiarrhythmic effect of the relatively low doses of EPA + DHA associated with reduced risk for CHD death (about 500–1000 mg/day) is relatively sparse. A pilot study in 10 patients undergoing cardiac electrophysiological testing reported beneficial effects of an infused,  $\omega$ -3 FA-rich emulsion on the susceptibility of the myocardium to dysrhythmias.<sup>[38]</sup> Tissue levels of EPA + DHA achieved by supplementation with 1 g/day increase from about 1.7% to 2.9% of total cardiac FA.<sup>[39]</sup> It is unknown whether this level of tissue enrichment with EPA + DHA produces the same biophysical effects on membrane function than the higher levels produced in experimental settings in cells, animals, or humans.

### FOOD SOURCES

Fish are the primary source of the  $\omega$ -3 FA. The content per serving can vary markedly depending on the species (Table 1 A and B). Higher-fat fish such as salmon, mackerel, albacore tuna, herring, and sardines are excellent sources of EPA and DHA, whereas low-fat fish such as bass, perch, and cod are poor ones. Commercially available dietary supplements providing EPA and DHA are made with refined fish oils obtained from the high-fat species and others such as menhaden and anchovy. Fish oils are also derived from fish liver;

indeed, for centuries cod liver oil was (and continues to be) the most widely utilized fish oil in the world. A variety of fortified foods have reached the market in which deodorized  $\omega$ -3 rich oils are incorporated into breads, spreads, salad dressings, milk products, frozen desserts, etc. Efforts to increase the  $\omega$ -3 content of traditional foods have included feeding fish oils or flaxseed oil to pigs and chickens.<sup>[40]</sup> With the recent demonstration that transgenic mice carrying the fat-1 gene from *C. elegans* are able to convert  $\omega$ -6 FA into  $\omega$ -3 FA and thereby enrich mouse tissues with EPA and DHA,<sup>[41]</sup> beef, pork, and chicken may some day be engineered so as to join fish as major sources of  $\omega$ -3 FA.

Recognizing that fish contain  $\omega$ -3 FA only because their food has them, and that harvesting fish to obtain these FA cannot be sustained forever, interest has turned to micro-organisms, the ultimate sources of these FA in the marine food chain. A number of species of algae, fungi, and bacteria have been discovered which, under specific environmental conditions, synthesize either DHA<sup>[42]</sup> or EPA.<sup>[43]</sup> Omega-3 fatty acids derived from microbial sources are free of the “fishy” flavors characteristic of most fish oil supplements, and are uncontaminated by any lipid-soluble pollutants (as are the refined fish oils). Organic solvents are, however, used for the recovery of cellular lipids and must be quantitatively removed. At this point, cost issues have largely prohibited their wide-scale use in supplements, but increased demand may bring more “single cell oils” to the market.

### SAFETY OF $\omega$ -3 FATTY ACIDS

Omega-3 fatty acids have been a part of the human diet for thousands of years with no known toxicity. The apparent safety of these FA has been underscored by a 1997 U.S. Food and Drug Administration (FDA) ruling given in response to a request that menhaden oil (a very common fish oil) be granted Generally Recognized as Safe (GRAS) status. The FDA ruled that intakes of up to 3 g/day of marine  $\omega$ -3 FA should be considered GRAS for inclusion in the diet. Thus, the safety of  $\omega$ -3 FA up to this level of intake is not in serious question. The extensive (tablespoon amounts) use of fish *liver* oils (cod and shark) is ill-advised, however, owing to their high levels of fat soluble vitamins (A and D). Although safety is apparently not an issue, there are side effects of supplementation. Perhaps the most common (seen in about 50% of subjects) is a “fishy” belch occurring soon after the capsules are taken. This can be minimized by bedtime consumption of supplements or enteric coating.

In controlled trials such as the GISSI Prevention Study (see below) in which  $\omega$ -3 and vitamin E capsules



**Table 1A** Approximate levels of EPA + DHA in fish and the amounts required to provide about 1 g/day of EPA + DHA

Fish	EPA + DHA g/3 oz serving (edible portion)	Ounces/day required to provide ≈ 1 gm of EPA + DHA per day
Tuna		
Light, canned in water, drained	0.26	12
White, canned in water, drained	0.73	4
Fresh	0.24–1.28	2.5–12
Sardines	0.98–1.70	2–3
Salmon		
Sockeye or Pink	1.05	3
Chinook	1.48	2
Coho, farmed	1.09	3
Coho, wild	0.91	3
Atlantic, farmed	1.09–1.83	1.5–2.5
Atlantic, wild	0.9–1.56	2–3.5
Mackerel	0.34–1.57	2–8.5
Herring		
Pacific	1.81	1.5
Atlantic	1.71	2
Trout, rainbow		
Farmed	0.98	3
Wild	0.84	3.5
Cod		
Atlantic	0.13	23
Pacific	0.24	12.5
Catfish		
Farmed	0.15	20
Wild	0.2	15
Flounder/Sole	0.42	7
Oyster		
Pacific	1.17	2.5
Eastern	0.47	6.5
Lobster	0.07–0.41	7.5–42.5
Crab, Alaskan King	0.35	8.5
Shrimp, mixed species	0.27	11
Clam	0.24	12.5
Scallop	0.17	17.5

were tested in a postmyocardial infarction population of 11,324 patients, less than 5% cited side effects as their reason for discontinuing therapy. Gastrointestinal disturbances were the most common. In another study in which 6.9 g of EPA + DHA (in 10 capsules) was given for 6 mo to 221 patients, there was no difference in adverse event rates between the fish oil group and a control group given corn oil placebos.<sup>[44]</sup> Gastrointestinal

**Table 1B** Approximate levels of EPA + DHA in fish oils and the amounts required to provide about 1 g/day of EPA + DHA

Fish oil capsules	ω-3 Fatty acids (g)/oil (g)	Oil/day (g)
Cod liver oil <sup>a</sup>	0.19	5
Standard fish body oil	0.30	3
Omega-3 FA concentrate	0.50	2
Highly concentrated ω-3 FA	0.7–0.9	1

Fish intakes (oz/d) are only estimates since EPA + DHA content can vary markedly with season, diet, age, and storage/preparation methods. (Values derived from literature<sup>[99,100]</sup> and the USDA Nutrient Data Laboratory, <http://www.nal.usda.gov/fnic/foodcomp/>.)

<sup>a</sup>This amount of cod liver oil would provide the recommended dietary allowance of vitamin A and twice that of vitamin D.

upset was reported by 7% of the former and 8% of the latter. Finally, although refined and concentrated ω-3 FA products are very low in organochloride contaminants, less well-controlled preparations can contain detectable amounts.<sup>[45]</sup> Nevertheless the risk–benefit ratio for these products continues to be very favorable.<sup>[46]</sup>

## POTENTIAL HEALTH BENEFITS OF OMEGA-3 FATTY ACIDS

In early 2004, the first of a series of United States government-mandated Evidence-Based Reviews on ω-3 FA and a wide variety of disease conditions were released by the Agency for Health Care and Policy Research (AHCPR), now known as the Agency for Healthcare Research and Quality. These studies examined the existing medical literature in 12 disease categories. At the time of this writing (June 2004), reports had been issued for coronary heart disease (CHD), asthma, inflammatory/autoimmune diseases, and glycemic control in diabetes. These will be summarized first.

### Coronary Heart Disease

The first three reviews published focused on the effects of ω-3 FA on cardiovascular disease (CVD): 1) clinical endpoints; 2) risk factors; and 3) possible arrhythmogenic mechanisms. The first concluded that the evidence for CVD benefit from consumption of fish or fish oil supplements was strong (<http://www.ahcpr.gov/clinic/epcsums/o3cardsum.htm>). The second found a

consistent beneficial effect of EPA + DHA on serum triglyceride levels, but beyond that, the benefits of  $\omega$ -3 FA on CVD risk are not well explained by their effects on CV risk factors (<http://www.ahcpr.gov/clinic/o3crrinv.htm>). The third came to the conclusion that EPA and/or DHA “might” have antiarrhythmic effects but that the data were not conclusive (<http://www.ahcpr.gov/clinic/o3arrinv.htm>). Some of the effects on membrane function and ion channel activity were discussed above and have recently been reviewed<sup>[37]</sup> as has the evidence for effects on serum lipids.<sup>[47]</sup> The strongest support for a CHD benefit from increased  $\omega$ -3 FA intake comes not from effects on surrogate risk markers but from studies on event rates themselves. These are summarized below and in a recent scientific statement from the American Heart Association.<sup>[48]</sup>

### Epidemiological studies

Data indicating that  $\omega$ -3 FA may protect against CHD began to accumulate in the 1970s when Danish investigators found that acute myocardial infarction rates were significantly lower in Greenland Inuits than in age- and sex-matched Danes.<sup>[49]</sup> On further investigation, a strong link between the  $\omega$ -3 FA in their diets and their apparent protection from heart attacks began to emerge.<sup>[50]</sup> In studies of other fish-eating populations such as the Japanese,  $\omega$ -3 FA intakes were also associated with lower rates of CHD.<sup>[51]</sup>

In three U.S. epidemiological studies,  $\omega$ -3 biomarkers were related to risk.<sup>[52–54]</sup> Siscovick et al.<sup>[52]</sup> obtained blood samples from 80 adults experiencing primary cardiac arrest in the Seattle area and from 108 healthy matched controls. The cases did not have known CHD at the time of their events. The EPA + DHA content of RBC membranes was determined in these samples and related to risk for primary cardiac arrest. The multivariable-adjusted odds ratios for primary cardiac arrest in the highest quartile was about 10% of that in the lowest quartile (95% confidence interval (CI), 0.1–0.4).

Albert et al.<sup>[54]</sup> reached the same conclusion using data from the Physicians' Health Study. In this study, 14,916 healthy male physicians were screened for a wide variety of risk factors and provided baseline blood samples between 1982 and 1984. Over the next 17 years, 94 men experienced sudden cardiac death. Whole blood long-chain  $\omega$ -3 FA (i.e., percentage of total FA as EPA + DHA + DPA) in these cases was compared to that of 184 age- and smoking-status-matched controls. As in the Seattle study, risk for sudden cardiac death was reduced by about 90% in those subjects with the highest blood  $\omega$ -3 levels compared with those with the lowest levels.

A third study to examine the relationship between a blood measure of  $\omega$ -3 FA and risk for CHD death was reported by Lemaitre et al.<sup>[53]</sup> utilizing data from the Cardiovascular Health Study. These investigators found a strong, protective relationship between serum phospholipid EPA + DHA and risk for fatal ischemic heart disease. The odds ratio associated with a one-standard deviation increase in this biomarker was 0.30 (95% CI, 0.12–0.76). Four other analyses<sup>[55–58]</sup> found strong inverse relationships between CHD events and other biomarkers of EPA + DHA intake (coronary artery, serum cholesteryl ester, or total plasma FA). One study reported no relationship between plasma  $\omega$ -3 FA and the 5-yr risk of myocardial infarction.<sup>[59]</sup>

### Randomized clinical trials

The strongest evidence for  $\omega$ -3 FA benefit in CHD has come from randomized, controlled clinical trials with “hard” CHD endpoints such as total mortality, fatal and nonfatal stroke, and/or myocardial infarction. The first was the Diet And Reinfarction Trial (DART) that reported a 29% reduction in all-cause mortality over a 2-yr period in male myocardial infarction survivors advised to increase their intake of oily fish. This provided an additional 500–800 mg of  $\omega$ -3 FA per day.<sup>[60]</sup> The greatest benefit in DART was seen in fatal myocardial infarctions suggesting an antiarrhythmic effect. A post hoc analysis of DART in capsule users suggested that the protective effect was attributable to  $\omega$ -3 fatty acids in the fish.<sup>[61]</sup>

Burr et al.<sup>[62]</sup> conducted a second study similar to DART in patients with stable angina. In this trial, as with the original, a recommendation to increase the intake of oily fish was given. National Health Service records were followed for up to 8-yr to determine the effects of this advice on death from any cause. The authors found no benefit from fish advice, and disturbingly, in a subset randomized to fish oil capsules, a significant increase in the risk for death. There were many weaknesses of and caveats to this study (funding interruption, no confirmation of compliance past 6-mo, possible “risk compensation,” or avoidance of heart medicines in favor of fish oil capsules, etc.). Thus its findings, although disquieting, do not at this point outweigh the evidence for beneficial effects.

The largest study to test the efficacy of  $\omega$ -3 FA for secondary prevention of CHD was the GISSI-Prevenzione Study.<sup>[63,64]</sup> Patients who had survived a heart attack ( $n = 11,324$ ) were randomized to either 300 mg of vitamin E, 850 mg of  $\omega$ -3 FA ethyl esters, both, or usual care alone. After 3.5 yr, the group given the  $\omega$ -3 FA alone experienced a 20% reduction in

all-cause mortality ( $p = 0.01$ ), and a 45% reduction in sudden death ( $p < 0.05$ ) compared to the usual care group. Vitamin E provided no additional benefit. This trial, although very large and carried out in a relatively “real-life” setting, did not include a placebo arm, and dropout rates were high (>25%) in both the  $\omega$ -3 and vitamin E groups. Thus, there remains a need for further research to determine the efficacy, optimal dose, and mechanism of action of  $\omega$ -3 FA supplements for the prevention of CHD death.

#### Blood $\omega$ -3 FA as a CHD risk factor

Given the evidence summarized above, blood biomarkers of EPA + DHA are independently associated with increased risk of death from CHD. This suggests that they might serve as a new risk marker or factor. We have proposed that the content of (i.e., percentage of total FA as) EPA + DHA in RBC membranes (the “Omega-3 Index”) be considered such a risk factor.<sup>[65]</sup> Based on clinical studies in our laboratory and a review of the literature, we proposed that an Omega-3 Index of 8–10% was associated with the greatest cardioprotection, whereas an index of less than 4% was associated with the least. Although further work will be needed to thoroughly validate and refine such a marker, the Omega-3 Index may represent a novel, physiologically relevant, easily modified, independent, and graded risk factor for death from CHD that could have significant clinical utility.

#### Asthma

The rationale for hypothesizing an effect on asthma (and other inflammatory diseases) is based on the previously discussed competition between AA- and EPA-derived eicosanoids. There has also been evidence presented pointing to beneficial effects of  $\omega$ -3 FA on inflammatory cytokines.<sup>[22]</sup> The Evidence-Based Review on  $\omega$ -3 FA and asthma concluded: “Aside from an acceptable safety profile, it is impossible to definitively conclude anything with respect to the value of using omega-3 FA supplementation in asthma...” (<http://www.ahcpr.gov/clinic/o3asminv.htm>).

#### Diabetes (Lipids and Glycemic Control), Arthritis and Inflammatory Diseases

This report concluded that relatively high intakes of  $\omega$ -3 FA (e.g., 3 g/day) had beneficial effects on serum triglycerides in patients with Type II diabetes mellitus without altering glycemic control. With regard to inflammatory conditions including rheumatoid arthritis, inflammatory bowel disease (IBD), immunoglobulin

A (IgA) nephropathy, and systemic lupus erythematosus (SLE), the Evidence Based Review concluded, “There appears to be no effect on most clinical outcomes in rheumatoid arthritis, although tender joint counts appear to be reduced. There are insufficient data to draw conclusions about IBD, renal disease, SLE, bone density or fractures, requirement for anti-inflammatory or immunosuppressive drugs” (<http://www.ahcpr.gov/clinic/epcsums/o3lipidsum.htm>).

#### Other Conditions

The impact of  $\omega$ -3 FA on other conditions is the subject of ongoing evidence-based reviews. The reader is encouraged to consult the AHRQ website at <http://www.ahcpr.gov/> where future reviews will be posted. A summary of the effects of  $\omega$ -3 FA in cancer, neurological and psychological diseases, and human development will be presented.

#### Cancer

While there is growing evidence that  $\omega$ -3 FA may play a palliative role in certain cancers, the data are still largely epidemiologic or derived from animal or cell culture studies.<sup>[66,67]</sup> Randomized controlled trials have, to date, focused on high-risk biomarkers for cancer, not on cancer incidence or mortality itself. The cancers that may be modified by  $\omega$ -3 FA include those of the prostate and digestive tract, especially the colon. A 30-yr study among 6272 Swedish men examined the relationship between fish intake and prostate cancer incidence and death.<sup>[68]</sup> They found that, compared to men consuming “moderate” amounts of fish, those reporting little or no fish intake had twice the incidence and three times the death rate from prostate cancer. Similar findings were reported from a biomarker-based study from New Zealand.<sup>[69]</sup> Clinical trials examining the effects of  $\omega$ -3 FA supplementation on large bowel epithelial cell proliferation (a cancerous precursor) in patients at high risk for colon cancer found that proliferation was significantly reduced.<sup>[70]</sup> Other studies have suggested a beneficial effect of  $\omega$ -3 FA on cancer-induced cachexia.<sup>[71,72]</sup> Finally, research with cancer cells in culture has examined potential mechanisms driving the apparent beneficial effects of  $\omega$ -3 FA.<sup>[73]</sup> For example, EPA inhibited the expression of genes for matrix metalloproteinases, enzymes that digest extracellular matrix and allow tumors to grow.<sup>[74]</sup> Using Jurkat leukemic cells as a model, others have shown that DHA induced programmed cell death (apoptosis), whereas arachidonic and oleic acids did not.<sup>[75]</sup> Considerably more work

will be needed before the role of  $\omega$ -3 FA in cancer prevention and treatment becomes as clear as it is with CHD.

### Neurological and psychological conditions

DHA is a major component of nerve tissue with the brain and retina being particularly enriched in this FA. This observation led researchers to hypothesize that DHA plays either a structural or metabolic role in neural tissue. The possibility thus exists that deficiencies in brain DHA contribute to psychological pathologies such as depression, bipolar disorder, and schizophrenia. Studies in which patients with a variety of mental illnesses were found to have below normal  $\omega$ -3 FA levels in circulating cells, usually erythrocytes, have also been published.<sup>[76–78]</sup> Others have demonstrated that depression is more common in persons with reduced blood levels of  $\omega$ -3 FA,<sup>[79]</sup> and cross-cultural studies suggest that postpartum depression may also be associated with low  $\omega$ -3 levels.<sup>[80]</sup> Better evidence comes from prospective interventions in which patients with cognitive disorders were treated with  $\omega$ -3 FA. These have generally, but not unanimously, shown improvements in patients with bipolar disorder,<sup>[81]</sup> dyspraxia,<sup>[82]</sup> schizophrenia,<sup>[82]</sup> and attention-deficit-hyperactivity disorder.<sup>[83]</sup> Hostility and aggression<sup>[84]</sup> and borderline personality disorder<sup>[85]</sup> may even be diminished by increased  $\omega$ -3 FA intakes. The opportunities for fruitful research into the role of these FA in cognitive disorders are plentiful.

### Human Development (Cognitive, Behavioral, and Visual)

The presence of DHA in breast milk suggests that it is also necessary for early development. Early evidence for this hypothesis came from animal studies where the ability to learn mazes was correlated with  $\omega$ -3 FA levels in tissues.<sup>[86]</sup> Human I.Q. at 4 yr of age has been correlated with maternal EPA + DHA intake.<sup>[87]</sup> Based on the various studies that have examined the need for  $\omega$ -3 FA in early development, the current consensus is that formulas intended for term infants need only contain ALA (because the synthetic systems for conversion to DHA are reasonably well developed at birth), but those meant for preterm infants should have preformed DHA (since metabolic conversion from shorter-chain precursors is not sufficiently developed in these infants).<sup>[88]</sup> While there are theoretical reasons why pregnant women and nursing mothers should increase their intake of DHA, convincing evidence demonstrating clear benefit to their children is presently lacking.

## RECOMMENDED INTAKES

In the US, there are currently (2004) no specific, federally endorsed dietary recommendations for the long-chain  $\omega$ -3 FA. In 2002, the National Academy's Institute of Medicine recommended intakes of ALA of up to 1.2% of energy based on median intakes of healthy individuals in the United States.<sup>[89]</sup> Although the report noted that up to 10% of the ALA target could be supplied as EPA and DHA (about 300 mg), it did not make a specific recommendation per se for these FA. A number of expert panels from around the world have recommended intakes of 200–800 mg/day of EPA + DHA.<sup>[90–94]</sup> The American Heart Association<sup>[48]</sup> currently recommends that for patients with known CHD, an intake of about 1 g of EPA + DHA appears to be prudent, and for those without known CHD, two (preferably oily) fish meals per week. This would translate into an intake of about 500 mg/day of EPA + DHA, an amount that has been associated with the lowest rates of death from CHD observed in major epidemiological trials conducted in the United States.<sup>[52,95–98]</sup>

## CONCLUSIONS

There is tantalizing evidence suggesting that increased intakes of  $\omega$ -3 FA may contribute to the prevention of various diseases, most notably CVD. Although dietary sources should continue to be the first line approach to increasing intakes of  $\omega$ -3 FA, growing concerns about the safety of the fish supply will undoubtedly lead many to consider using supplements that carry a lower risk for contamination. Since an apparent cardioprotective intake is about 0.5–1 g/day, and as most capsules contain at least 300 mg of EPA + DHA per 1-g capsule, only 2–3 capsules may be needed to confer benefit. There is no evidence to date that such an intake would have any adverse health effects, or interact negatively with any known drugs. Consequently, interest in and utilization of  $\omega$ -3 FA for health promotion is likely to continue to grow.

## REFERENCES

1. Yazawa, K. Production of eicosapentaenoic acid from marine bacteria. *Lipids* **1996**, *31* (Suppl.), S297–S300.
2. Sprecher, H.; Luthria, D.L.; Mohammed, B.S.; Baykousheva, S.P. Reevaluation of the pathways for the biosynthesis of polyunsaturated fatty acids. *J. Lipid Res.* **1995**, *36*, 2471–2477.

3. Sprecher, H. The roles of anabolic and catabolic reactions in the synthesis and recycling of polyunsaturated fatty acids. *Prostaglandins Leukot. Essent. Fatty Acids* **2002**, *67*, 79–83.
4. Ferdinandusse, S.; Denis, S.; Dacremont, G.; Wanders, R.J. Studies on the metabolic fate of *n*-3 polyunsaturated fatty acids. *J. Lipid Res.* **2003**, *44*, 1992–1997.
5. Mori, T.A.; Burke, V.; Puddey, I.B.; Watts, G.F.; O'Neal, D.N.; Best, J.D.; Beilin, L.J. Purified eicosapentaenoic and docosahexaenoic acids have differential effects on serum lipids and lipoproteins, LDL particle size, glucose, and insulin in mildly hyperlipidemic men. *Am. J. Clin. Nutr.* **2000**, *71*, 1085–1094.
6. Rambjor, G.S.; Walen, A.I.; Windsor, S.L.; Harris, W.S. Eicosapentaenoic acid is primarily responsible for the hypotriglyceridemic effect of fish oil in humans. *Lipids* **1996**, *31*, S45–S49.
7. Hamazaki, T.; Sawazaki, S.; Asaoka, E.; Itomura, M.; Mizushima, Y.; Yazawa, K.; Kuwamori, T.; Kobayashi, M. Docosahexaenoic acid-rich fish oil does not affect serum lipid concentrations of normolipidemic young adults. *J. Nutr.* **1996**, *126*, 2784–2789.
8. Pawlosky, R.J.; Hibbeln, J.R.; Novotny, J.A.; Salem, N.J. Physiological compartmental analysis of alpha-linolenic acid metabolism in adult humans. *J. Lipid Res.* **2001**, *42*, 1257–1265.
9. Pawlosky, R.J.; Hibbeln, J.R.; Lin, Y.; Goodson, S.; Riggs, P.; Sebring, N.; Brown, G.L.; Salem, N.J. Effects of beef- and fish-based diets on the kinetics of *n*-3 fatty acid metabolism in human subjects. *Am. J. Clin. Nutr.* **2003**, *77*, 565–572.
10. Emken, E.A.; Adlof, R.O.; Gulley, R.M. Dietary linoleic acid influences desaturation and acylation of deuterium-labeled linoleic and linolenic acids in young adult males. *Biochim. Biophys. Acta.* **1994**, *1213*, 277–288.
11. Burdge, G.C.; Wootton, S.A. Conversion of alpha-linolenic acid to eicosapentaenoic, docosapentaenoic and docosahexaenoic acids in young women. *Br. J. Nutr.* **2002**, *88*, 411–420.
12. Brenna, J.T. Efficiency of conversion of alpha-linolenic acid to long chain *n*-3 fatty acids in man. *Curr. Opin. Clin. Nutr. Metab. Care* **2002**, *5*, 127–132.
13. Kamada, T.; Yamashita, T.; Baba, Y.; Kai, M.; Setoyama, S.; Chuman, Y.; Otsuji, S. Dietary sardine oil increases erythrocyte membrane fluidity in diabetic patients. *Diabetes* **1986**, *35*, 604–611.
14. Terano, T.; Hirai, A.; Hamazaki, T.; Kobayashi, S.; Fujita, T.; Tamura, Y.; Kumagai, A. Effect of oral administration of highly purified eicosapentaenoic acid on platelet function, blood viscosity and red cell deformability in healthy human subjects. *Atherosclerosis* **1983**, *46*, 321–331.
15. Conquer, J.A.; Martin, J.B.; Tummon, I.; Watson, L.; Tekpetey, F. Effect of DHA supplementation on DHA status and sperm motility in asthenozoospermic males. *Lipids* **2000**, *35*, 149–154.
16. Nishizawa, C.; Wang, J.Y.; Sekine, S.; Saito, M. Effect of dietary DHA on DHA levels in retinal rod outer segments in young versus mature rats. *Int. J. Vitam. Nutr. Res.* **2003**, *73*, 259–265.
17. Zhou, L.; Nilsson, A. Sources of eicosanoid precursor fatty acid pools in tissues. *J. Lipid Res.* **2001**, *42*, 1521–1542.
18. Spector, A.A.; Yorek, M.A. Membrane lipid composition and cellular function. *J. Lipid Res.* **1985**, *26*, 1015–1035.
19. Brown, W.J.; Chambers, K.; Doody, A. Phospholipase A2 (PLA2) enzymes in membrane trafficking: mediators of membrane shape and function. *Traffic* **2003**, *4*, 214–221.
20. Tapiero, H.; Ba, G.N.; Couvreur, P.; Tew, K.D. Polyunsaturated fatty acids (PUFA) and eicosanoids in human health and pathologies. *Biomed. Pharmacother* **2002**, *56*, 215–222.
21. Arm, J.P. Leukotriene generation and clinical implications. *Allergy Asthma Proc.* **2004**, *25*, 37–42.
22. Blok, W.L.; Katan, M.B.; van der Meer, J.W. Modulation of inflammation and cytokine production by dietary (*n*-3) fatty acids. *J. Nutr.* **1996**, *126*, 1515–1533.
23. Fan, Y.Y.; Chapkin, R.S. Importance of dietary gamma-linolenic acid in human health and nutrition. *J. Nutr.* **1998**, *128*, 1411–1414.
24. Kamida, H.; Matsuzawa, Y.; Tarui, S. Lipid composition of platelets from patients with atherosclerosis: effect of purified eicosapentaenoic acid ethyl ester administration. *Lipids* **1988**, *23*, 917–923.
25. Li, D.; Turner, A.; Sinclair, A.J. Relationship between platelet phospholipid FA and mean platelet volume in healthy men. *Lipids* **2002**, *37*, 901–906.
26. Serhan, C.N.; Hong, S.; Gronert, K.; Colgan, S.P.; Devchand, P.R.; Mirick, G.; Moussignac, R.L. Resolvins: a family of bioactive products of omega-3 fatty acid transformation circuits initiated by aspirin treatment that counter proinflammation signals. *J. Exp. Med.* **2002**, *196*, 1025–1037.

27. Marcheselli, V.L.; Hong, S.; Lukiw, W.J.; Tian, X.H.; Gronert, K.; Musto, A.; Hardy, M.; Gimenez, J.M.; Chiang, N.; Serhan, C.N.; Bazan, N.G. Novel docosanoids inhibit brain ischemia-reperfusion-mediated leukocyte infiltration and pro-inflammatory gene expression. *J. Biol. Chem.* **2003**, *278*, 43,807–43,817.
28. Mukherjee, P.K.; Marcheselli, V.L.; Serhan, C.N.; Bazan, N.G. From the cover: neuroprotectin D1: a docosahexaenoic acid-derived docosatriene protects human retinal pigment epithelial cells from oxidative stress. *Proc. Natl. Acad. Sci. USA* **2004**, *101*, 8491–8496.
29. Salem, N., Jr.; Litman, B.; Kim, H.Y.; Gawsisch, K. Mechanism of action of docosahexaenoic acid in the nervous system. *Lipids* **2001**, *36*, 945–959.
30. Culp, B.R.; Lands, W.E.M.; Lucchesi, B.R.; Pitt, B.; Romson, J. The effect of dietary supplementation of fish oil on experimental myocardial infarction. *Prostaglandins* **1980**, *20*, 1021–1031.
31. McLennan, P.L.; Bridle, T.M.; Abeywardena, M.Y.; Charnock, J.S. Comparative efficacy of *n*-3 and *n*-6 polyunsaturated fatty acids in modulating ventricular fibrillation threshold in marmoset monkeys. *Am. J. Clin. Nutr.* **1993**, *58*, 666–669.
32. McLennan, P.L.; Abeywardena, M.Y.; Charnock, J.S. Dietary fish oil prevents ventricular fibrillation following coronary artery occlusion and reperfusion. *Am. Heart J.* **1988**, *116*, 709–717.
33. McLennan, P.L. Relative effects of dietary saturated, monounsaturated, and polyunsaturated fatty acids on cardiac arrhythmias in rats. *Am. J. Clin. Nutr.* **1993**, *57*, 207–212.
34. Billman, G.E.; Kang, J.X.; Leaf, A. Prevention of sudden cardiac death by dietary pure  $\omega$ -3 polyunsaturated fatty acids in dogs. *Circulation* **1999**, *99*, 2452–2457.
35. Kang, J.X.; Xiao, Y.F.; Leaf, A. Free, long-chain, polyunsaturated fatty acids reduce membrane electrical excitability in neonatal rat cardiac myocytes. *Proc. Natl. Acad. Sci. USA* **1995**, *92*, 3997–4001.
36. Leaf, A. The electrophysiologic basis for the antiarrhythmic and anticonvulsant effects of *n*-3 polyunsaturated fatty acids: heart and brain. *Lipids* **1992**, *36* (Suppl.), S107–S110.
37. Leaf, A.; Kang, J.X.; Xiao, Y.F.; Billman, G.E. Clinical prevention of sudden cardiac death by *n*-3 polyunsaturated fatty acids and mechanism of prevention of arrhythmias by *n*-3 fish oils. *Circulation* **2003**, *107*, 2646–2652.
38. Schrepf, R.; Limmert, T.; Claus, W.P.; Theisen, K.; Sellmayer, A. Immediate effects of *n*-3 fatty acid infusion on the induction of sustained ventricular tachycardia. *Lancet* **2004**, *363*, 1441–1442.
39. Harris, W.S.; Sands, S.A.; Windsor, S.L.; Ali, H.A.; Stevens, T.L.; Magalski, A.; Porter, C.B.; Borkon, A.M. Omega-3 fatty acids in cardiac biopsies from heart transplant patients: correlation with erythrocytes and response to supplementation. *Circulation* **2004**, *110*, 1645–1649.
40. Howe, P.R.; Downing, J.A.; Grenyer, B.F.; Grigonis-Deane, E.M.; Bryden, W.L. Tuna fishmeal as a source of DHA for *n*-3 PUFA enrichment of pork, chicken, and eggs. *Lipids* **2002**, *37*, 1067–1076.
41. Kang, J.X.; Wang, J.; Wu, L.; Kang, Z.B. Transgenic mice: fat-1 mice convert *n*-6 to *n*-3 fatty acids. *Nature* **2004**, *427*, 504.
42. Ratledge, C.; Kanagachandran, K.; Anderson, A.J.; Grantham, D.J.; Stephenson, J.C. Production of docosahexaenoic acid by *Cryptocodinium cohnii* grown in a pH-auxostat culture with acetic acid as principal carbon source. *Lipids* **2001**, *36*, 1241–1246.
43. Yu, R.; Yamada, A.; Watanabe, K.; Yazawa, K.; Takeyama, H.; Matsunaga, T.; Kurane, R. Production of eicosapentaenoic acid by a recombinant marine cyanobacterium *Synechococcus sp.* *Lipids* **2000**, *35*, 1061–1064.
44. Leaf, A.; Jorgensen, M.B.; Jacobs, A.K.; Cote, G.; Schoenfeld, D.A.; Scheer, J.; Weiner, B.H.; Slack, J.D.; Kellett, M.A.; Raizner, A.E.; Weber, P.C.; Mahrer, P.R.; Rossouw, J.E. Do fish oils prevent restenosis after coronary angioplasty?. *Circulation* **1994**, *90*, 2248–2257.
45. Ebel, J.G., Jr.; Eckerlin, R.H.; Maylin, G.A.; Gutenmann, W.H.; Lisk, D.J. Polychlorinated biphenyls and p,p'-DDE in encapsulated fish oil supplements. *Nutr. Rept. Intl.* **1987**, *36*, 413–417.
46. Sidhu, K.S. Health benefits and potential risks related to consumption of fish or fish oil. *Regul. Toxicol. Pharmacol.* **2003**, *38*, 336–344.
47. Harris, W.S. *n*-3 Fatty acids and serum lipoproteins: human studies. *Am. J. Clin. Nutr.* **1997**, *65* (Suppl.), 1645S–1654S.
48. Kris-Etherton, P.M.; Harris, W.S.; Appel, L.J. Fish consumption, fish oil, omega-3 fatty acids, and cardiovascular disease. *Circulation* **2002**, *106*, 2747–2757.
49. Bang, H.O.; Dyerberg, J. Lipid metabolism and ischemic heart disease in Greenland Eskimos **1980**, *3*, 1–22.

50. Dyerberg, J.; Bang, H.O.; Stoffersen, E.; Moncada, S.; Vane, J.R. Eicosapentaenoic acid and prevention of thrombosis and atherosclerosis?. *Lancet* **1978**, *II*, 117–119.
51. Kagawa, Y.; Nishizawa, M.; Suzuki, M.; Miyatake, T.; Hamamoto, T.; Goto, K.; Motonaga, E.; Izumikawa, H.; Hirata, H.; Ebihara, A. Eicosapolyenoic acids of serum lipids of Japanese islanders with low incidence of cardiovascular diseases. *J. Nutr. Sci. Vitaminol* **1982**, *29*, 441–453.
52. Siscovick, D.S.; Raghunathan, T.E.; King, I.; Weinmann, S.; Wicklund, K.G.; Albright, J.; Bovbjerg, V.; Arbogast, P.; Smith, H.; Kushi, L.H.; Cobb, L.A.; Copass, M.K.; Psaty, B.M.; Lemaitre, R.; Retzlaff, B.; Childs, M.; Knopp, R.H. Dietary intake and cell membrane levels of long-chain *n*-3 polyunsaturated fatty acids and the risk of primary cardiac arrest. *J. Am. Med. Assoc.* **1995**, *274*, 1363–1367.
53. Lemaitre, R.N.; King, I.B.; Mozaffarian, D.; Kuller, L.H.; Tracy, R.P.; Siscovick, D.S. *N*-3 polyunsaturated fatty acids, fatal ischemic heart disease and non-fatal myocardial infarction in older adults. The cardiovascular health study. *Am. J. Clin. Nutr.* **2002**, *76*, 319–325.
54. Albert, C.M.; Campos, H.; Stampfer, M.J.; Ridker, P.M.; Manson, J.E.; Willett, W.C.; Ma, J. Blood levels of long-chain *n*-3 fatty acids and the risk of sudden death. *N. Engl. J. Med.* **2002**, *346*, 1113–1118.
55. Luostarinen, R.; Boberg, M.; Saldeen, T. Fatty acid composition in total phospholipids of human coronary arteries in sudden cardiac death. *Atherosclerosis* **1993**, *99*, 187–193.
56. Hallgren, C.G.; Hallmans, G.; Jansson, J.H.; Marklund, S.L.; Huhtasaari, F.; Schutz, A.; Stromberg, U.; Vessby, B.; Skerfving, S. Markers of high fish intake are associated with decreased risk of a first myocardial infarction. *Br. J. Nutr.* **2001**, *86*, 397–404.
57. Erkkila, A.T.; Lehto, S.; Pyorala, K.; Uusitupa, M.I. *n*-3 fatty acids and 5-y risks of death and cardiovascular disease events in patients with coronary artery disease. *Am. J. Clin. Nutr.* **2003**, *78*, 65–71.
58. Rissanen, T.; Voutilainen, S.; Nyssönen, K.; Lakka, T.A.; Salonen, J.T. Fish oil-derived fatty acids, docosahexaenoic acid and docosapentaenoic acid, and the risk of acute coronary events. The Kuopio ischaemic heart disease risk factor study. *Circulation* **2000**, *102*, 2677–2679.
59. Guallar, E.; Hennekens, C.H.; Sacks, F.M.; Willett, W.C.; Stampfer, M.J. A prospective study of plasma fish oil levels and incidence of myocardial infarction in U.S. Male physicians. *J. Am. Coll. Cardiol.* **1995**, *25*, 387–394.
60. Burr, M.L.; Fehily, A.M.; Gilbert, J.F.; Rogers, S.; Holliday, R.M.; Sweetnam, P.M.; Elwood, P.C.; Deadman, N.M. Effects of changes in fat, fish, and fibre intakes on death and myocardial reinfarction: diet and reinfarction trial (DART). *Lancet* **1989**, *2*, 757–761.
61. Burr, M.L.; Sweetnam, P.M.; Fehily, A.M. Diet and reinfarction. *Eur. Heart J.* **1994**, *15*, 1152–1153.
62. Burr, M.L.; Ashfield-Watt, P.A.; Dunstan, F.D.; Fehily, A.M.; Breay, P.; Ashton, T.; Zotos, P.C.; Haboubi, N.A.; Elwood, P.C. Lack of benefit of dietary advice to men with angina: results of a controlled trial. *Eur. J. Clin. Nutr.* **2003**, *57*, 193–200.
63. GISSI-Prevenzione Investigators. Dietary supplementation with *n*-3 polyunsaturated fatty acids and vitamin E in 11,324 patients with myocardial infarction: results of the GISSI-Prevenzione trial. *Lancet* **1999**, *354*, 447–455.
64. Marchioli, R.; Barzi, F.; Bomba, E.; Chieffo, C.; Di Gregorio, D.; Di Mascio, R.; Franzosi, M.G.; Geraci, E.; Levantesi, G.; Muggioni, A.P.; Mantini, L.; Marfisi, R.M.; Mastrogiuseppe, G.; Mininni, N.; Nicolosi, G.L.; Santini, M.; Schweiger, C.; Tavazzi, L.; Tognoni, G.; Tucci, C.; Valagussa, F. Early protection against sudden death by *n*-3 polyunsaturated fatty acids after myocardial infarction: time-course analysis of the results of the Gruppo Italiano per lo Studio della Sopravvivenza nell'Infarto Miocardico (GISSI)-Prevenzione. *Circulation* **2002**, *105*, 1897–1903.
65. Harris, W.S.; von Schacky, C. The omega-3 index: a new risk factor for sudden cardiac death. *Prev. Med.* **2004**, *23*, 100–109.
66. Terry, P.D.; Rohan, T.E.; Wolk, A. Intakes of fish and marine fatty acids and the risks of cancers of the breast and prostate and of other hormone-related cancers: a review of the epidemiologic evidence. *Am. J. Clin. Nutr.* **2003**, *77*, 532–543.
67. Fernandez, E.; Chatenoud, L.; La Vecchia, C.; Negri, E.; Franceschi, S. Fish consumption and cancer risk. *Am. J. Clin. Nutr.* **1999**, *70*, 85–90.
68. Terry, P.; Lichtenstein, P.; Feychting, M.; Ahlbom, A.; Wolk, A. Fatty fish consumption and risk of prostate cancer. *Lancet* **2001**, *357*, 1764–1766.
69. Norrish, A.E.; Skeaff, C.M.; Arribas, G.L.; Sharpe, S.J.; Jackson, R.T. Prostate cancer risk

- and consumption of fish oils: a dietary biomarker-based case-control study. *Br. J. Cancer* **1999**, *81*, 1238–1242.
70. Huang, Y.C.; Jessup, J.M.; Forse, R.A.; Flickner, S.; Pleskow, D.; Anastopoulos, H.T.; Ritter, V.; Blackburn, G.L. *n*-3 fatty acids decrease colonic epithelial cell proliferation in high-risk bowel mucosa. *Lipids* **1996**, *31* (Suppl.), S313–S317.
  71. Moses, A.W.; Slater, C.; Preston, T.; Barber, M.D.; Fearon, K.C. Reduced total energy expenditure and physical activity in cachectic patients with pancreatic cancer can be modulated by an energy and protein dense oral supplement enriched with *n*-3 fatty acids. *Br. J. Cancer* **2004**, *90*, 996–1002.
  72. Fearon, K.C.; Von Meyenfeldt, M.F.; Moses, A.G.; Van Geenen, R.; Roy, A.; Gouma, D.J.; Giacosa, A.; Van Gossum, A.; Bauer, J.; Barber, M.D.; Aaronson, N.K.; Voss, A.C.; Tisdale, M.J. Effect of a protein and energy dense *N*-3 fatty acid enriched oral supplement on loss of weight and lean tissue in cancer cachexia: a randomised double blind trial. *Gut* **2003**, *52*, 1479–1486.
  73. Larsson, S.C.; Kumlin, M.; Ingelman-Sundberg, M.; Wolk, A. Dietary long-chain *n*-3 fatty acids for the prevention of cancer: a review of potential mechanisms. *Am. J. Clin. Nutr.* **2004**, *79*, 935–945.
  74. McCabe, A.J.; Wallace, J.; Gilmore, W.S.; Strain, J.J.; McGlynn, H. The effect of eicosapentanoic acid on matrix metalloproteinase gene expression. *Lipids* **1999**, *34* (Suppl.), S217–S218.
  75. Siddiqui, R.A.; Janski, L.J.; Neff, K.; Harvey, K.; Kovacs, R.J.; Stillwell, W. Docosahexaenoic acid induces apoptosis in Jurkat cells by a protein phosphatase-mediated process. *Biochim. Biophys. Acta.* **2001**, *1499*, 265–275.
  76. Assies, J.; Lieverse, R.; Vreken, P.; Wanders, R.J.; Dingemans, P.M.; Linszen, D.H. Significantly reduced docosahexaenoic and docosapentaenoic acid concentrations in erythrocyte membranes from schizophrenic patients compared with a carefully matched control group. *Biol. Psychiatry* **2001**, *49*, 510–522.
  77. Maes, M.; Christophe, A.; Delanghe, J.; Altamura, C.; Neels, H.; Meltzer, H.Y. Lowered omega3 polyunsaturated fatty acids in serum phospholipids and cholesteryl esters of depressed patients. *Psychiatry Res.* **1999**, *85*, 275–291.
  78. Conquer, J.A.; Tierney, M.C.; Zecevic, J.; Bettger, W.J.; Fisher, R.H. Fatty acid analysis of blood plasma of patients with Alzheimer's disease, other types of dementia, and cognitive impairment. *Lipids* **2000**, *35*, 1305–1312.
  79. Tiemeier, H.; van Tuijl, H.R.; Hofman, A.; Kiliaan, A.J.; Breteler, M.M. Plasma fatty acid composition and depression are associated in the elderly: the Rotterdam study. *Am. J. Clin. Nutr.* **2003**, *78*, 40–46.
  80. Hibbeln, J.R. Seafood consumption, the DHA content of mothers' milk and prevalence rates of postpartum depression: a cross-national, ecological analysis. *J. Affect. Disord.* **2002**, *69*, 15–29.
  81. Stoll, A.L.; Severus, W.E.; Freeman, M.P.; Rueter, S.; Zboyan, H.A.; Diamond, E.; Cress, K.K.; Marangell, L.B. Omega 3 fatty acids in bipolar disorder: a preliminary double-blind, placebo-controlled trial. *Arch. Gen. Psychiatry* **1999**, *56*, 407–412.
  82. Fenton, W.S.; Dickerson, F.; Boronow, J.; Hibbeln, J.R.; Knable, M. A placebo-controlled trial of omega-3 fatty acid (ethyl eicosapentaenoic acid) supplementation for residual symptoms and cognitive impairment in schizophrenia. *Am. J. Psychiatry* **2001**, *158*, 2071–2074.
  83. Young, G.S.; Maharaj, N.J.; Conquer, J.A. Blood phospholipid fatty acid analysis of adults with and without attention deficit/hyperactivity disorder. *Lipids* **2004**, *39*, 117–123.
  84. Iribarren, C.; Markovitz, J.H.; Jacobs, D.R.; Schreiner, P.J.; Daviglius, M.; Hibbeln, J.R. Dietary intake of *n*-3, *n*-6 fatty acids and fish: relationship with hostility in young adults—the CARDIA study. *Eur. J. Clin. Nutr.* **2004**, *58*, 24–31.
  85. Zanarini, M.C.; Frankenburg, F.R. Omega-3 fatty acid treatment of women with borderline personality disorder: a double-blind, placebo-controlled pilot study. *Am. J. Psychiatry* **2003**, *160*, 167–169.
  86. Goldberg, I.J.; Le, N.A.; Paterniti, J.R.; Ginsberg, H.N.; Lindgren, F.T.; Brown, W.V. Lipoprotein metabolism during acute inhibition of hepatic triglyceride lipase in the cynomolgus monkey. *J. Clin. Invest.* **1982**, *70*, 1184–1192.
  87. Helland, I.B.; Smith, L.; Saarem, K.; Saugstad, O.D.; Drevon, C.A. Maternal supplementation with very-long-chain *n*-3 fatty acids during pregnancy and lactation augments children's IQ at 4 years of age. *Pediatrics* **2003**, *111*, e39–e44.
  88. Forsyth, J.S.; Carlson, S.E. Long-chain polyunsaturated fatty acids in infant nutrition: effects on infant development. *Curr. Opin. Clin. Nutr. Metab. Care* **2001**, *4*, 123–126.



89. National Academy of Sciences. *Dietary Reference Intakes for Energy, Carbohydrates, Fiber, Fat, Protein and Amino Acids (Macronutrients)*. **2002**, 45–46, Chap. 11.
90. Simopoulos, A.P.; Leaf, A.; Salem, N., Jr. Workshop statement on the essentiality of and recommended dietary intakes for omega-6 and omega-3 fatty acids. *Prostag. Leuko. Ess. FAs* **2000**, *63*, 119–121.
91. British Nutrition Foundation. *N-3 Fatty Acids and health*. Briefing Paper. 1999.
92. Department of Health. *Committee on Medical Aspects of Food Policy*, Annual Report. 1994.
93. Simopoulos, A.P. Summary of the NATO advanced research workshop on dietary omega 3 and omega 6 fatty acids: biological effects and nutritional essentiality. *J. Nutr.* **1989**, *119*, 521–528.
94. Health Council of the Netherlands. Dietary reference intakes: energy, proteins, fats, and digestible carbohydrates. **2001**, Report *19*.
95. Hu, F.B.; Bronner, L.; Willett, W.C.; Stampfer, M.J.; Rexrode, K.M.; Albert, C.M.; Hunter, D.; Manson, J.E. Fish and omega-3 fatty acid intake and risk of coronary heart disease in women. *JAMA* **2002**, *287*, 1815–1821.
96. Albert, C.M.; Hennekens, C.H.; O'Donnell, C.J.; Ajani, U.A.; Carey, V.J.; Willett, W.C.; Ruskin, J.N.; Manson, J.E. Fish consumption and risk of sudden cardiac death. *JAMA* **1998**, *279*, 23–28.
97. Dolecek, T.A. Epidemiological evidence of relationships between dietary polyunsaturated fatty acids and mortality in the multiple risk factor intervention trial. *Proc. Soc. Exper. Bio. Med.* **1992**, *200*, 177–182.
98. Mozaffarian, D.; Lemaitre, R.N.; Kuller, L.H.; Burke, G.L.; Tracy, R.P.; Siscovick, D.S. Cardiac benefits of fish consumption may depend on the type of fish meal consumed: the cardiovascular health study. *Circulation* **2003**, *107*, 1372–1377.
99. Ackman, R.G. Nutritional composition of fats in seafoods. *Prog. Food. Nutr. Sci.* **1989**, *13*, 161–289.
100. Hepburn, F.N.; Exler, J.; Weihrauch, J.L. Provisional tables on the content of omega-3 fatty acids and other fat components of selected foods. *J. Am. Diet. Assoc.* **1986**, *86*, 788–793.

# Omega-6 Fatty Acids

William L. Smith

University of Michigan Medical School,  
Ann Arbor, Michigan, U.S.A.

## INTRODUCTION

The term “essential fatty acids” (EFAs) applies to those fatty acids that are necessary for human health and required in the diet. There are two different types of EFA deficiencies characterized by a lack of either omega-6 ( $\omega 6$ ) fatty acids or  $\omega 3$  fatty acids. Both  $\omega 3$  and  $\omega 6$  EFAs originate from plants and photosynthetic algae, and thus, are found throughout the food chain. The two best known  $\omega 6$  EFAs are linoleic acid (LA; 9Z, 12Z-octadecadienoic acid) and arachidonic acid (AA; 5Z, 8Z, 11Z, 14Z-eicosatetraenoic acid). The most common  $\omega 3$  EFAs are  $\alpha$ -linolenic acid (ALA; 9Z, 12Z, 15Z-octadecatrienoic acid), eicosapentaenoic acid (EPA; 5Z, 8Z, 11Z, 14Z, 17Z-eicosapentaenoic acid), and docosahexaenoic acid (DHA; 4Z, 7Z, 10Z, 13Z, 16Z, 19Z-docosahexaenoic acid). The average intake of  $\omega 6$  EFAs in the United States is about 7 energy% (en%) with a ratio of almost 8:1  $\omega 6$  EFA/ $\omega 3$  3 EFA. Linoleic acid and AA serve as precursors for the formation by cells of oxygenated fatty acid products called eicosanoids. At least some of the requirements for  $\omega 6$  EFA can be accounted for by eicosanoids. Those derived from AA promote inflammatory responses and thrombosis. There are arguments that significant decreases in inflammatory and cardiovascular diseases would occur were the ratio of the intake of  $\omega 6$  EFA/ $\omega 3$  3 EFA reduced to less than 4.0, which would decrease the formation of eicosanoids.

## STRUCTURES, BIOSYNTHESIS, AND DIETARY SOURCES OF EFAs

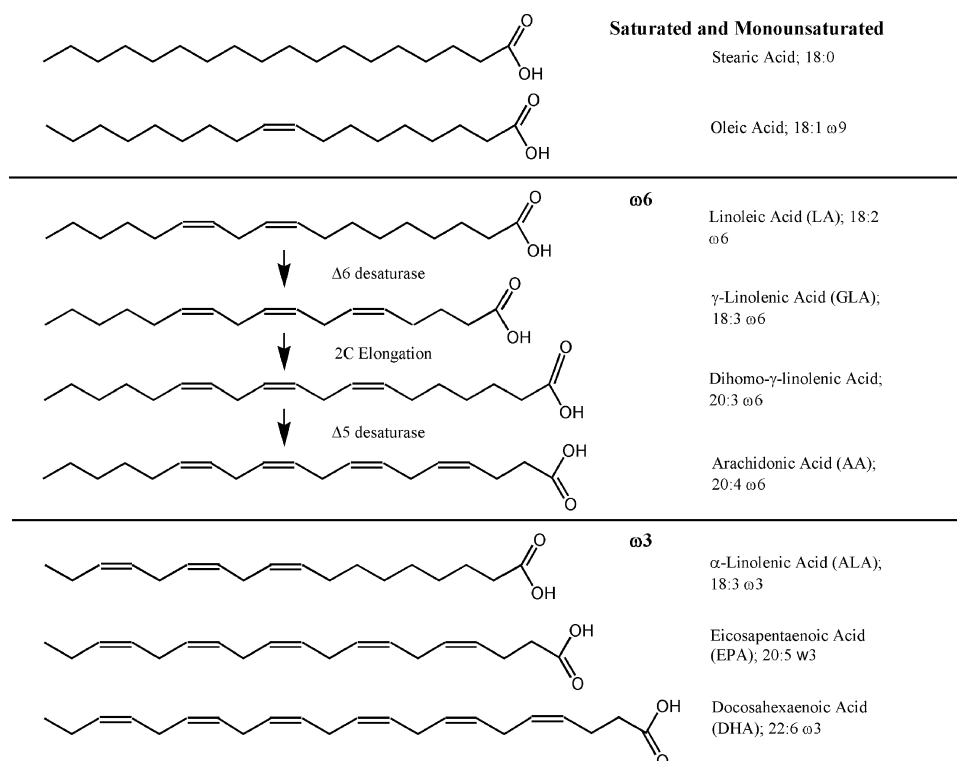
Fig. 1 shows the structures of some common saturated and monounsaturated fatty acids as well as the  $\omega 3$  and  $\omega 6$  polyunsaturated fatty acids (PUFAs). Fatty acids containing two or three double bonds and 18 carbons are commonly referred to as PUFAs—examples are

LA and ALA. Those having three or more double bonds and 20 or more carbon atoms are called highly unsaturated fatty acids (HUFAs)—examples are AA, EPA, and DHA.<sup>[1,2]</sup>

Saturated fatty acids like stearic acid (Fig. 1) can be formed through the combined actions of acetyl CoA carboxylase and the fatty acid synthetase multienzyme complex by sequential addition of two carbons to the carboxyl end of the growing fatty acid carbon chain.<sup>[3]</sup> In other words, C-1 and C-2 of stearic acid are the last two atoms added during biosynthesis. Monounsaturated fatty acids such as oleic acid can be formed from saturated fatty acids by oxidation involving molecular oxygen and a desaturase;<sup>[4–6]</sup> in the case of oleic acid, this is the  $\Delta 9$  desaturase. The PUFAs can be synthesized from monounsaturated fatty acids like oleic acid by the actions of other desaturases acting at different positions along the carbon chain to form methylene-interrupted cis double bonds ( $-\text{CH}=\text{CH}-\text{CH}_2-\text{CH}=\text{CH}-$ ) characteristic of biological systems. The HUFAs can be formed by two carbon chain elongation of PUFAs, followed typically by another desaturation step.<sup>[4,5]</sup> The formation of AA from LA is illustrated in Fig. 1, which shows the  $\Delta 6$  desaturase, two carbon chain elongation, and  $\Delta 5$  desaturase steps.

Animals can form saturated and monounsaturated fatty acids but do not have  $\Delta 12$  or  $\Delta 15$  desaturases. Hence, they are unable to introduce double bonds nearer than nine carbons from the methyl end of the chain (e.g., oleic acid in Fig. 1).<sup>[4,5]</sup> The EFAs of the  $\omega 3$  and  $\omega 6$  families have double bonds located three and six carbons from the methyl end of the chain, respectively (Fig. 1). Plants have variable amounts of  $\Delta 12$  and  $\Delta 15$  desaturases and thus are able to synthesize the 18 carbon fatty acids LA and ALA that have double bonds at these positions.<sup>[4]</sup> The LA and ALA come from plants. Diatoms, which are the photosynthetic algae of phytoplankton, some fungi and moss, and the worm *C. elegans* can form LA and ALA and can also elongate and desaturate PUFAs such as ALA to form HUFAs.<sup>[5,7]</sup> For example, in diatoms, up to 30% of the fatty acid pool can comprise EPA. Finally, it should be noted again that while species containing  $\Delta 12$  and  $\Delta 15$  desaturases can form  $\omega 3$  fatty acids from  $\omega 6$  fatty acids, animals are not able

William L. Smith, Ph.D., is Professor and Chair in the Department of Biological Chemistry, University of Michigan Medical School, Ann Arbor, Michigan, U.S.A.



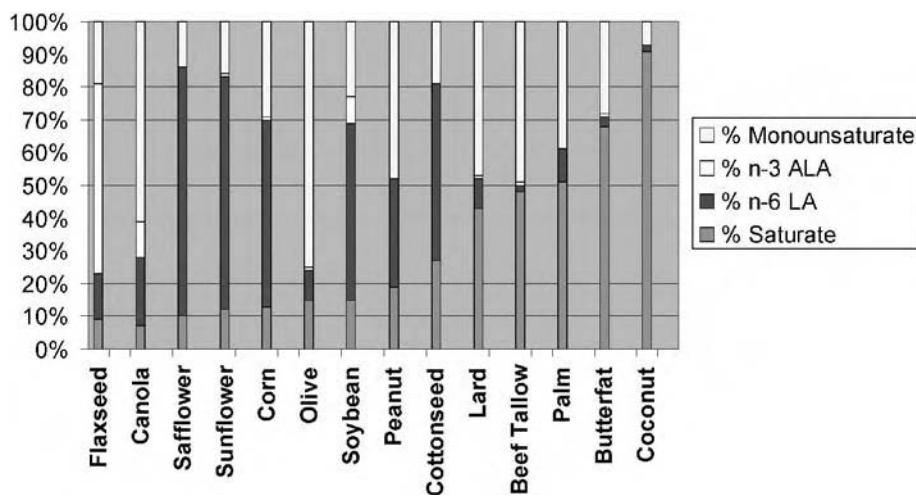
**Fig. 1** The structures and biosynthetic inter-relationships of saturated and monounsaturated fatty acids and the most important  $\omega$ 6 and  $\omega$ 3 fatty acids.

to perform either of these conversions. Hence, they need both  $\omega$ 3 and  $\omega$ 6 fatty acids in their diets.

A major source of  $\omega$ 3 and  $\omega$ 6 fatty acids for humans is plant-based cooking oils, which are primarily mixtures of triglycerides of different compositions. The relative proportions of saturated fatty acids, monounsaturated fatty acids (primarily oleic acid), LA, and ALA vary widely in oils from plants (and animal sources) (Fig. 2).<sup>[8]</sup> Safflower, sunflower, and corn oils contain the highest percentages of LA. Olive oil is

particularly high in oleic acid, while the highest percentage of ALA is in Flaxseed oil. Corn oil is a major cooking oil in the United States.

Meats consumed in the United States except fish contain relatively high proportions of the  $\omega$ 6 fatty acids LA plus AA, and low proportions of the  $\omega$ 3 fatty acids ALA, EPA, and DHA. This is primarily because animals are farm raised on diets containing corn and soybeans; a part of the LA that is consumed is converted to AA (Fig. 1). Freshwater and saltwater fish



**Fig. 2** The percentages of saturated fatty acids (blue), monounsaturated fatty acids (aqua), LA (*n*-6, red), and ALA (*n*-3, yellow) comprising the triglycerides (oil fraction) of various seeds, lard, and beef. (View this art in color at [www.dekker.com](http://www.dekker.com).)

contain relatively high levels of the 20 and 22 carbon  $\omega$ 3 fatty acids EPA and DHA and low levels of  $\omega$ 6 fatty acids. Farm-raised fish contain comparatively higher levels of  $\omega$ 6 fatty acids than wild fish, again because of the former's diets. The National Institutes of Health maintains a web page that provides many details about the relative proportions of various fatty acids in all types of foods (<http://efaeducation.nih.gov/sig/ods.html>).

## **PATHOLOGIES ASSOCIATED WITH EFA DEFICIENCIES**

Studies in the late 1920s and early 1930s showed that rats fed chow diets that had been extracted with organic solvents to eliminate fats exhibited a syndrome manifested grossly by: a) reproductive difficulties, most obviously with parturition; b) scaly skin, which was associated with excessive water loss; and c) a general failure to grow and thrive.<sup>[9]</sup> This syndrome is called EFA deficiency. Although most studies on EFA deficiencies have been performed with rodents, there is also evidence that it can afflict humans who are treated in hospitals, nursing homes, or maintained on artificial milk diets that lack EFAs.<sup>[10]</sup>

The gross abnormalities of EFA deficiency in rodents can be overcome by including an  $\omega$ 6 fatty acid such as LA or AA in the diet. Either LA<sup>[9,11]</sup> or AA<sup>[11]</sup> is effective. The  $\omega$ 3 fatty acid ALA is less effective<sup>[9]</sup> or ineffective.<sup>[11]</sup> It has been recognized over the last 20 yr that there is a distinct  $\omega$ 3 fatty acid deficiency that manifests itself in the form of various neurological deficits and most likely results from a reduction in DHA in various neurons.<sup>[12]</sup> This inadequacy cannot be overcome with  $\omega$ 6 fatty acids.<sup>[1,12]</sup>  $\omega$ 3 fatty acids as a subject is treated elsewhere in this encyclopedia.

As noted above (Fig. 1), AA can be synthesized from LA, and it is generally believed that AA is the key  $\omega$ 6 EFA.<sup>[1,13]</sup> Certainly, in the case of problems with parturition seen in EFA deficiency, it is an AA metabolite, a prostanoid, which is involved. Indeed, the descriptions of the difficulties in parturition seen in EFA-deficient rats<sup>[11]</sup> and in cyclo-oxygenase-1 knockout mice<sup>[14]</sup> are strikingly similar. As discussed in more detail below, prostaglandin endoperoxide H synthases (known generically as cyclo-oxygenases) catalyze the committed step in the conversion of AA to oxygenated metabolites called prostanoids.<sup>[15]</sup> The growth retardation and failure-to-thrive abnormalities characteristic of EFA deficiency may also be dependent on AA. It has been proposed that the latter abnormalities result from a lack of oxygenated metabolites of AA, which are involved in regulating hypothalamic/pituitary hormone secretions.<sup>[16,17]</sup> Early studies involving ALA feeding indicated that

ALA, presumably because it can be converted to EPA and its oxygenated metabolites, can support body weight growth.<sup>[9]</sup>

Interestingly, the scaly skin syndrome of EFA deficiency can be ameliorated by LA and does not require AA or its oxygenated metabolites. *Felinae* have only low levels of the  $\Delta$ 6 desaturase involved in the first step in converting LA to longer chain, more HUFAs (Fig. 1), but dietary LA will resolve the scaly skin problems of EFA-deficient cats.<sup>[18]</sup> The LA (or AA) may function in skin to form *O*-acylated sphingolipids such as 1-*O*-linoleoyl-ceramide<sup>[19]</sup> or hydroxy fatty acids such as 13-hydroxy-9Z,13E-octadecadienoic acid (13-HODE).<sup>[20]</sup> However, related ceramide or hydroxyl fatty acid metabolites of AA (instead of LA) may also function to relieve the scaly skin problem, which is the reason why AA can resolve this abnormality as well as LA.

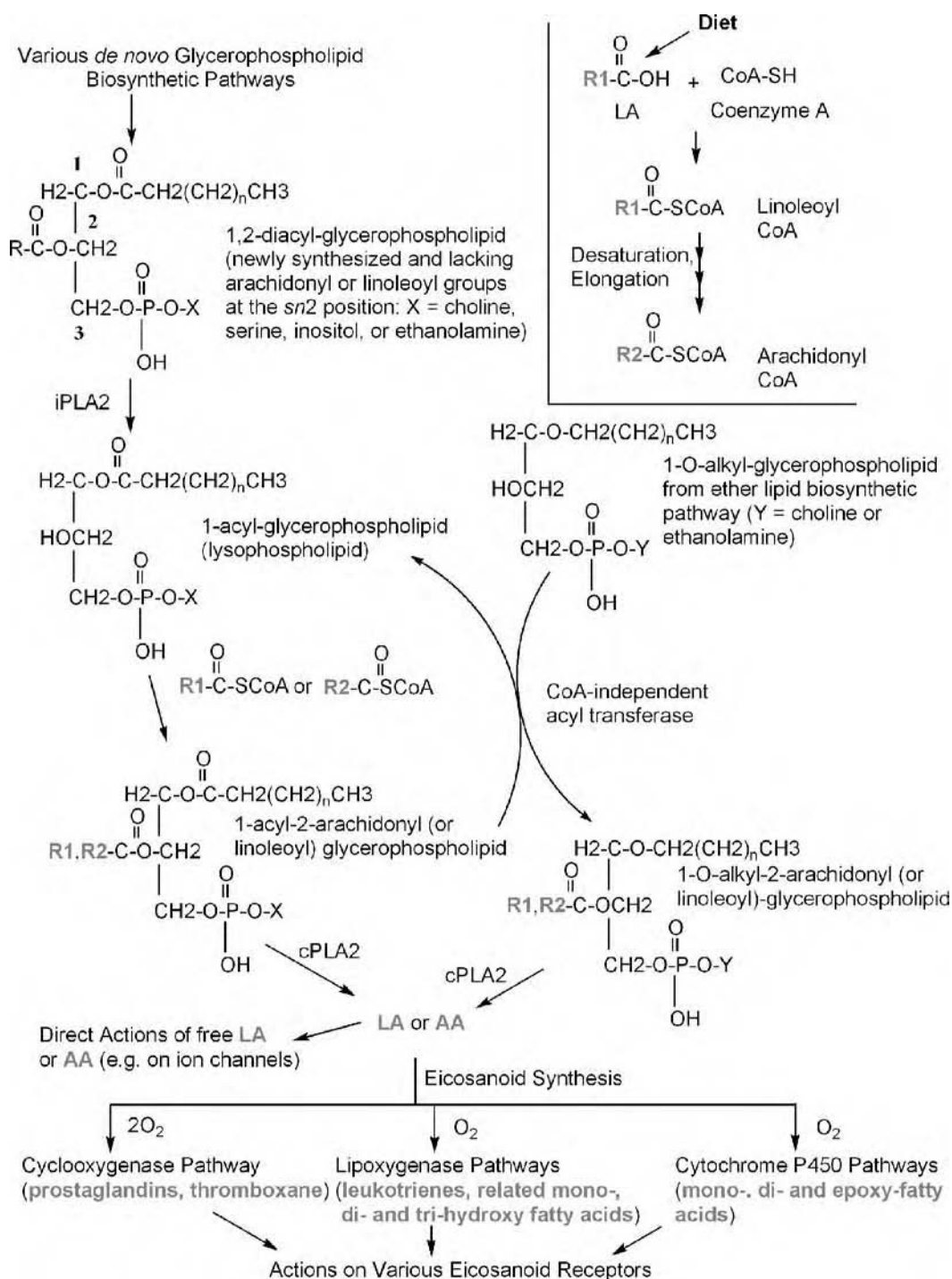
## **METABOLISM OF EFAs TO COMPLEX LIPIDS**

### **Distribution of $\omega$ 6 EFAs in Different Types of Lipids**

The AA and LA are found in cells as a free fatty acid and in many different forms in which the carboxylate group is modified but the carbon chain remains unaltered (Fig. 3). These include: a) arachidonyl- and linoleoyl CoAs (i.e., thioesters); b) arachidonyl and linoleoyl esters in which the acyl chain is esterified at the *sn*2 position of glycerophospholipids (i.e., phosphatidylcholine, phosphatidylserine, phosphatidylinositol, or phosphatidylethanolamine) that comprise cell membranes; c) phospholipid degradation products in which arachidonyl and linoleoyl chains are esterified at the *sn*2 position of metabolic or signaling intermediates such as: i) Phosphatidic acid formed from phosphatidyl inositol derivatives by the action of phospholipase D; ii) 1,2-Diacylglycerol formed by the action of phospholipase C; iii) 2-Arachidonyl glycerol formed by sequential actions of phospholipase C and diglyceride lipase; and iv) perhaps 2-acyl-glycerophospholipids formed via phospholipase A1; d) as arachidonyl ethanolamide (anandamide); and e) 1-*O*-acyl sphingolipids.

### **$\omega$ 6 EFAs in Membrane Phospholipids**

In humans of normal weight, the largest fraction of the total EFA pool is found in membrane glycerophospholipids. The major membrane glycerophospholipids in eukaryotes are phosphatidylethanolamine and phosphatidylcholine with smaller amounts of phosphatidylserine and phosphatidylinositol (Fig. 3).<sup>[21,22]</sup> All of



**Fig. 3** Major pathways involved in the metabolism of LA and AA into various phospholipids and eicosanoids. The *sn*1, 2, and 3 positions of the glycerol backbone are denoted on the structure shown on the top left. (View this art in color at [www.dekker.com](http://www.dekker.com).)

these four classes appear in the form of diacyl derivatives with acyl groups esterified to the *sn*1 and *sn*2 positions of the glycerol backbone. Ethanolamine- and choline-containing phospholipids also occur in abundance as ether lipids having 1-*O*-alkyl or 1-*O*-alkenyl groups and acyl groups at the *sn*2 position (Fig. 3).<sup>[22]</sup>

The 1,2-diacyl glycerophospholipids contain saturated and monounsaturated fatty acids at the *sn*1 position and monounsaturated fatty acids, PUFAs, and HUFAs esterified at the *sn*2 position.<sup>[21]</sup> Similarly, the ether lipids have a saturated or monounsaturated chain at the 1-position and monounsaturated fatty

acids, PUFAs, and HUFAs at the *sn2* position.<sup>[22]</sup> In diacyl glycerophospholipids, about 60% of the fatty acids at the *sn1* position are saturated fatty acids and 40% are monounsaturated fatty acids; the *sn2* position contains about 15% monounsaturated fatty acids and 85% either as PUFAs [mainly LA (18:2  $\omega$ 6)] or HUFAs [mainly AA (20:4  $\omega$ 6) with some  $\omega$ 3 fatty acids mostly EPA and DHA].<sup>[21]</sup> Curiously, phosphatidylethanolamine generally contains 3–4 times more AA than LA, while phosphatidylcholine has 3–4 times more LA than AA. Glycerophospholipids having AA at the *sn2* position most frequently have stearic acid (or an 18 carbon, ether-linked chain) at the *sn1* position; those with LA at the *sn2* position most commonly have palmitic acid, a 16 carbon saturated fatty acid (or a C-16 ether-linked chain) at the *sn1* position. Phosphatidylinositol and its more highly phosphorylated forms such as phosphatidylinositol-4,5-*bis* phosphate that are precursors of important intracellular signaling molecules contain almost exclusively stearic acid and AA at the *sn1* and *sn2* positions, respectively. Finally, it should be noted that different tissues and organs have different phospholipid compositions. The biological rationale for these various differences in tissue phospholipid compositions and in fatty acid compositions among different phospholipids is not known.

### Biosynthesis of Membrane Phospholipids Containing $\omega$ 6 EFAs

Free fatty acids are found in plasma bound to serum albumin, whereas lipoproteins serve to transport triglycerides, cholesterol esters, and phospholipids. These acids can enter cells by simple diffusion or be generated by hydrolysis of triglycerides or phospholipids associated with lipoproteins that have been taken up by cells. There are no known specificities for their uptake. However, once inside the cell, HUFAs such as AA are preferential substrates for long chain acyl CoA ligase, which has a relatively low  $K_M$  toward AA; this serves to sequester free HUFAs in cells.<sup>[6]</sup>

Fatty acyl chains can be introduced into the *sn2* position of 1,2-diacyl-glycerophospholipids at one of two different steps in metabolism (Fig. 3). One is during de novo glycerophospholipid biosynthesis from glycerophosphate when an acyl group from an acyl CoA becomes esterified at the *sn2* position of 1-acyl-glycerophosphate. The second is during phospholipid “retailoring” when a newly formed glycerophospholipid such as phosphatidylethanolamine is hydrolyzed by  $Ca^{2+}$ -independent phospholipase  $A_2$  (iPLA<sub>2</sub>) to yield 1-acyl-glycero-3-phosphorylethanolamine, which, in turn, is acylated in a transferase reaction in which an acyl CoA is the acyl donor. It is thought that the bulk of the PUFAs and HUFAs are introduced into

phospholipids during “retailoring” (Fig. 3).<sup>[6,21]</sup> Finally, an  $\omega$ 6 fatty acyl chain esterified to the *sn2* position of a diacyl glycerophospholipid can be transferred to 1-*O*-alkyl-glycerol-3-phosphate or 1-*O*-alkyl-glycero-3-phosphorylcholine (or -phosphorylethanolamine) by transesterification via a CoA independent transacylase.<sup>[22]</sup> This is an important process because hydrolysis of ether lipids such as 1-*O*-alkyl-2-arachidonyl-phosphatidylcholine by a phospholipase  $A_2$  can provide the AA used for the synthesis of eicosanoids. At the same time, it generates 1-*O*-alkyl-glycero-3-phosphorylcholine, which is the immediate precursor for the acetyl transferase that generates the hormone, platelet-activating factor (1-*O*-alkyl-2-acetyl-phosphatidylcholine; Fig. 3). It should be noted that the transacylation is relatively specific for AA, although LA is also shown as being transferred in Fig. 3.<sup>[6,22]</sup>

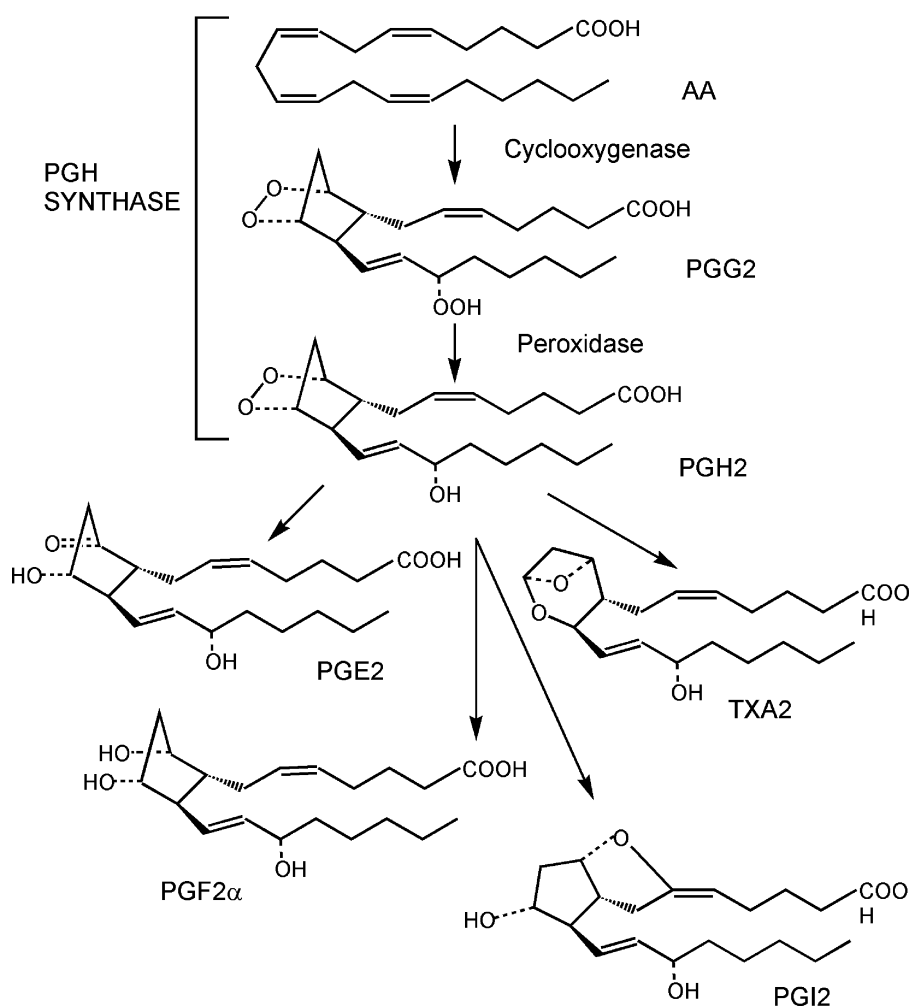
### TRANSFORMATION OF $\omega$ 6 EFAs INTO EICOSANOIDS

Free AA can be transformed to a group of compounds collectively known as eicosanoids: prostanoids, leukotrienes (LTs), and related hydroxyl fatty acids and epoxides (Figs. 3–6).<sup>[15]</sup> The LA can also be converted to some oxygenated products, which although containing only 18 carbons, are also generally referred to as eicosanoids.

### Biosynthesis and Actions of Prostaglandins

The structures and biosynthetic inter-relationships of the most important prostanoids are shown in Fig. 4. PG is the abbreviation for prostaglandin, and TX for thromboxane. Letters after PG denote the nature and location of the oxygen-containing substituents present in the cyclopentane ring. Prostanoids with a subscript “2” are formed from AA.

The PGs are synthesized and released rapidly by cells in response to certain hormones and physical stimuli.<sup>[15]</sup> The pathway for stimulus-induced prostanoid formation involves three stages (Fig. 4): a) mobilization of free AA from membrane phospholipids through the action of cytosolic (c) PLA<sub>2</sub>; b) conversion of AA to prostaglandin endoperoxide H<sub>2</sub> (PGH<sub>2</sub>) by a prostaglandin endoperoxide H synthase (PGHS; also known as cyclo-oxygenase or COX); and c) isomerization of PGH<sub>2</sub> to one of the major prostanoids by a specific synthase (e.g., TXA synthase). Frequently, specific prostanoids are formed by specific cells types; for example, TXA<sub>2</sub> is composed almost exclusively by platelets, whereas PGI<sub>2</sub> is mainly made of vascular endothelial cells.



**Fig. 4** Pathway for the biosynthesis of various prostaglandins (PGs) from AA. PGH<sub>2</sub> is converted to PGE<sub>2</sub>, PGF<sub>2α</sub>, PGI<sub>2</sub>, and TXA<sub>2</sub> by specific synthases.

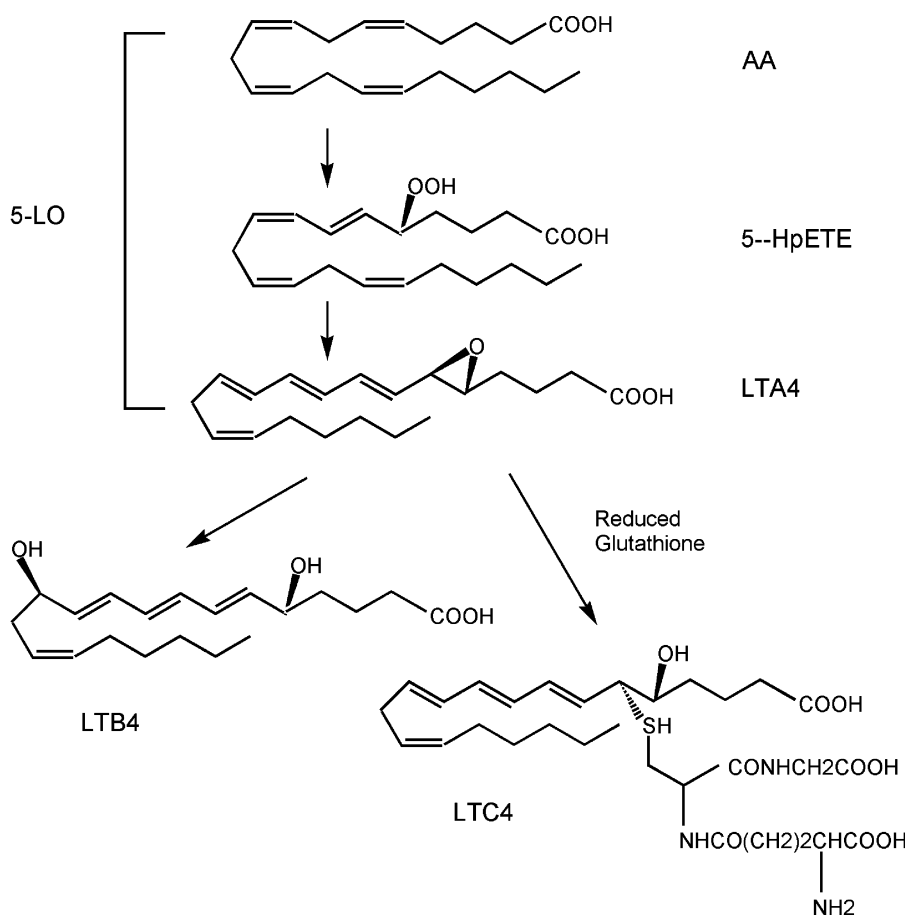
There are two isoforms of PGHSs known as PGHS-1 and -2 or COX-1 and -2.<sup>[23]</sup> The enzymes are encoded by separate genes. In general, PGHS-1 is expressed constitutively, whereas PGHS-2 is induced in response to growth factors, cytokines, and inflammatory stimuli. Both enzymes are inhibited by nonsteroidal anti-inflammatory drugs such as aspirin, ibuprofen, and naprosyn; COX-2 specific inhibitors (e.g., celecoxib and rofecoxib) are available commercially. It should be noted that in addition to being able to use AA as its substrate, PGHS-2 can convert 2-arachidonoyl-glycerol to 2-PGH<sub>2</sub>-glycerol efficiently, and this intermediate can be converted to 2-prostanoyl-glycerol derivatives (with the exception of TXA<sub>2</sub>).<sup>[24]</sup> The importance of these 2-prostanoyl-glycerol derivatives in the actions of PGHS-2 is unknown.

There are specific G protein-linked receptors for each of the known prostanoids.<sup>[25]</sup> These receptors interact with downstream effectors such as adenylate cyclase and phospholipase C to modulate the formation of second messengers such as cAMP, Ca<sup>2+</sup>, and diglyceride. There may also be specific receptors for at least some of the 2-prostanoyl-glycerol derivatives.

Prostaglandins are made by many cells and tissues, hence it has been difficult to study their biology. However, the recent availability of specific knockout mice for most of the various biosynthetic enzymes and prostanoid receptors, specific enzyme inhibitors, and specific receptor agonists and antagonists has been facilitating these studies.<sup>[15,26]</sup>

There are some situations in which the actions of prostanoids are understood reasonably well. For example, TXA<sub>2</sub> formed by platelets is involved in thrombosis. Platelets utilize PGHS-1 to produce PGH<sub>2</sub>, which is then converted to TXA<sub>2</sub>. Low doses of aspirin are used to block platelet PGHS-1 (and thus prevent PGH<sub>2</sub> formation) and ameliorate thrombotic conditions.<sup>[27]</sup> PGHS-2 is the relevant enzyme involved in producing prostanoids that are involved in many inflammatory conditions, and accordingly, COX-2 inhibitors are marketed to alleviate inflammation and associated pain. There also seems to be a link between COX-2 levels in the colon and colon carcinogenesis.<sup>[28]</sup>

It should also be pointed out that AA esterified at the *sn*2 position of any phospholipids can be oxidized nonenzymatically to yield a complex racemic mixture



**Fig. 5** Pathway for the biosynthesis of leukotrienes. LTB<sub>4</sub> is formed from LTA<sub>4</sub> by LTA<sub>4</sub> hydrolase. LTC<sub>4</sub> is formed from LTA<sub>4</sub> by a glutathione-S-transferase called LTC<sub>4</sub> synthase.

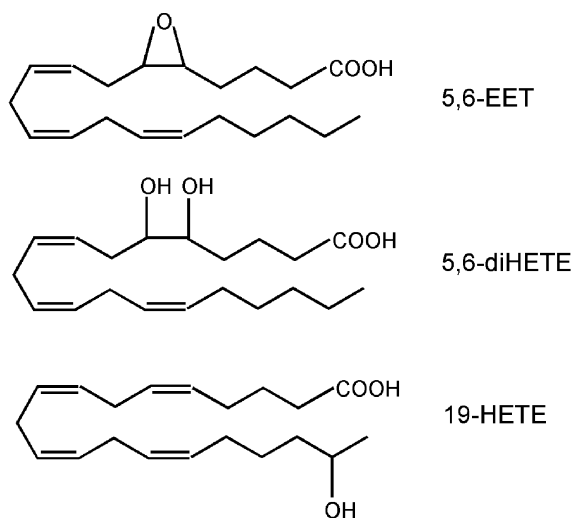
of esterified “isoprostanes,” which are then mobilized presumably through the actions of a phospholipase A<sub>2</sub>.<sup>[29]</sup> Isoprostanes are formed in abundance, particularly under conditions where tissue free radical

damage occurs. Some of them have potent biological activities.<sup>[30]</sup>

**Biosynthesis of LTs and Related Hydroxy Fatty Acids from ω6 EFAs**

The biosynthetic pathway for the formation of LTs is shown in Fig. 5.<sup>[15]</sup> Like prostanoids, LTs are formed in response to cellular stimuli which mobilize free AA from phospholipids by activating cPLA<sub>2</sub>. The LTs are produced from AA by the action of 5-lipo-oxygenase (5-LO), which both forms 5-hydroperoxy-6,8,11,14-(E,Z,Z,Z)-eicosatetraenoic acid (5-HpETE) and then dehydrates this product to form LTA<sub>4</sub>. LTA<sub>4</sub> hydrolase hydrolyzes LTA<sub>4</sub> to produce LTB<sub>4</sub>, while LTA<sub>4</sub> synthase catalyzes the addition of glutathione to C-6 of LTA<sub>4</sub> to create the peptidoleukotriene called LTC<sub>4</sub>. The cellular sites of LTB<sub>4</sub> and LTC<sub>4</sub> are limited and specific. Human neutrophils produce LTB<sub>4</sub>, while mast cells and eosinophils form LTC<sub>4</sub>.

During the search for pharmacological antagonists of LT biosynthesis, a protein called 5-lipo-oxygenase-activating protein (FLAP) was discovered. This protein is important for the efficient production of



**Fig. 6** Examples of AA metabolites formed through the actions of various cytochrome P450s.



LTs by cells, but it is not clear how it functions. It may serve as a protein that transfers AA to 5-LO.<sup>[15]</sup>

LTB<sub>4</sub> is a potent chemotactic and chemokinetic agent for the human polymorphonuclear leukocyte. LTC<sub>4</sub> constricts bronchial smooth muscle and mediates leakage of vascular fluid in the process of edema. The biological activities of both LTB<sub>4</sub> and LTC<sub>4</sub> are mediated by specific G-protein coupled receptors.<sup>[15,31]</sup> LTC<sub>4</sub> receptor antagonists (e.g., montelukast, pranlukast, and zafirlukast) and a 5-LO inhibitor zileuton are commercially available to treat asthma.

There are lipo-oxygenases other than 5-LO, including 8-, 12- and 15-lipo-oxygenases, which introduce oxygen at different positions in the AA chain.<sup>[32]</sup> Certain of these lipo-oxygenases (e.g., 15-LO) will utilize LA as a substrate such as in the formation of 13-HODE, which, as noted above, may be able to ameliorate the scaly skin of EFA-deficient animals.<sup>[20]</sup>

### P450 Hydroxylase Pathways That Lead to Oxygenated Products of AA

The AA can be hydroxylated by specific cytochrome P450 isoforms leading to epoxyeicosatrienoic acids (EETs; Fig. 6).<sup>[15,33]</sup> These can be hydrolyzed to yield dihydroxy acids. Arachidonic acid can also be oxidized at its  $\omega$ -1 or  $\omega$  position to produce 19- and 20-HETE, respectively. Relatively little is known about the physiology or overall biological importance of the P450 hydroxylation products, but some of these products have potent vasoactivity in the renal and other vascular beds.

### BIOLOGICAL ACTIONS OF FREE AA

In addition to being able to function in an oxygenated or otherwise chemically modified form, AA may exert some actions as a free acid. It will activate NADPH oxidase,<sup>[34]</sup> serve as an activating ligand for peroxisomal proliferator-activated receptors ( $\omega$ -hydroxylated epoxy fatty acids and certain prostanoids may also activate PPARs)<sup>[35]</sup> activate ion channels such as a two-pore domain K<sup>+</sup> channel,<sup>[36]</sup> and stimulate apoptosis.<sup>[37]</sup>

### BIOCHEMICAL SELECTIVITY FOR AA AND LA

Identifying the biochemical basis as to why  $\omega$ 6 or  $\omega$ 3 methylene-interrupted cis double bond systems perform their critical biology is of obvious importance. Selectivity or specificity is often claimed for various biological actions of PUFAs, but careful examination of the data frequently reveals that the specificity is modest (e.g., 1.5–3-fold) and thus unlikely to have significant biological consequences.

The enzymic specificities of various lipo-oxygenases toward C-18 and C-20 fatty acids have been studied in some detail.<sup>[13,38]</sup> A methylene-interrupted cis double bond system is required in all cases. Most lipo-oxygenases utilize AA in preference to LA. When this aspect was examined, it was found that most lipo-oxygenases preferentially utilize  $\omega$ 6 vs.  $\omega$ 3 fatty acids and do not function with  $\omega$ 9 fatty acids. This is most notable in the case of 5-lipo-oxygenase and LT formation. Also of importance is the finding that LTs derived from EPA have about one-tenth the biological activity of those formed from AA.<sup>[15,39]</sup>

The substrate specificities of PGHS-1 and -2 have been examined in detail.<sup>[23,40]</sup> AA is the most efficient substrate for both PGHS-1 and -2. EPA is a particularly poor one for PGHS-1 and DHA is not a one. Indeed, EPA and DHA essentially serve as inhibitors of the oxygenation of AA by PGHS-1.<sup>[40,41]</sup> EPA is a much better substrate for PGHS-2, and DHA can also be oxygenated by PGHS-2. Moreover, neither of these fatty acids is an effective inhibitor of AA oxygenation by PGHS-2. LA can be converted to 9- or 13-HODE by PGHS-1 and -2 at about one-fourth the efficiency of AA. The degree to which oxygenation of LA by PGHS occurs and has biological importance is still not known, although 13-HODE formed via a 15-LO<sup>[42]</sup> has been implicated as an effector of cell growth.

The efficacy of prostanoids formed from  $\omega$ 6 vs.  $\omega$ 3 fatty acids (i.e., AA vs. EPA) is an understudied area. The information available indicates that products derived from AA are about 10 times more active on prostanoid receptors than those from EPA.<sup>[43]</sup>

cPLA<sub>2</sub> is the only phospholipase that exhibits significant specificity toward the nature of the acyl chain at the *sn*2 position of phospholipids. It has a marked preference for AA over LA or oleic acid. Surprisingly, the enzyme also appears to discriminate against phosphatidylethanolamine species with DHA at the *sn*2 position.<sup>[44]</sup> It has also been reported that DHA and AA are released from phospholipids by two separate isoforms of PLA<sub>2</sub>.<sup>[45]</sup>

Another enzyme showing some specificity toward AA-containing phospholipids is the CoA independent transacylase involved in forming 1-*O*-alkyl-2-acylglycerophosphate from 1-*O*-alkyl-glycerol-3-phosphate and a diacyl phospholipid donor.<sup>[22]</sup>

Finally, it should be noted that the K<sup>+</sup> channel TRESK is relatively specifically inhibited by AA vs. HUFAs, PUFAs, and saturated fatty acids. Half-maximal inhibition occurs with 5–10  $\mu$ M AA.<sup>[36]</sup>

### WHY PLANTS HAVE LA AND ALA

Why these products are made by plants and a few fungi is neglected in the discussion of EFAs. The question

has been addressed with the model plant *Arabidopsis* that is able to form both LA and ALA because it has both  $\Delta 12$  and  $\Delta 15$  desaturases. LA is found at high concentrations in chloroplast membranes and is essential for photosynthesis.<sup>[46]</sup>  $\alpha$ -Linolenic acid seems not to be critical for photosynthesis but is essential for the synthesis of plant hormones such as jasmonic acid.<sup>[47]</sup>

### HEALTH CONSEQUENCES OF EXCESS DIETARY $\omega$ -6 FATTY ACIDS

Although an absence of LA or AA in the diet can be manifested as EFA deficiency, diets in the United States, Europe, and highly developed countries in the Far East (e.g., Japan) contain high levels of LA. For example, 60% of the mass of corn oil, the most widely used cooking oil in the United States, is LA (Fig. 2). It is estimated that in the average American diet, the percentage of calories derived from fat (i.e., fatty acids) are about 35% and that 7% of caloric intake comes from  $\omega 6$  fatty acids.<sup>[2]</sup> The actual requirement is estimated to be 1–3%.<sup>[2]</sup> This apparently excessive intake of  $\omega 6$  fatty acids does correlate with mortality from cardiovascular deaths in various human populations. It is argued that AA-derived eicosanoid products are an important causative factor in cardiovascular mortality.<sup>[2]</sup> Thus, while eicosanoids are essential for reproduction and perhaps other important biological activities, their overproduction, resulting in part from excessive intake of  $\omega 6$  fatty acids, is now occurring in human diets and may have deleterious consequences.

### CONCLUSIONS

The major  $\omega 6$  EFAs are LA and AA. LA is required in the diets of humans for growth, health, and reproduction. While humans are able to synthesize saturated and monounsaturated fatty acids and convert LA to AA, they are unable to synthesize LA itself. LA is found in plants, whereas both LA and AA are present in meat. The biochemical basis for the need for  $\omega 6$  EFAs is only partially understood. AA is converted to prostanoids that are essential for reproduction. However,  $\omega 6$  EFAs can be converted to other metabolic products that may be responsible for other required actions of  $\omega 6$  EFAs. Excessive intake occurs in diets in industrialized countries and may have deleterious health consequences. Harmful effects of excessive intake may be attenuated by decreasing the dietary intake of  $\omega 6$  EFAs and increasing the dietary intake of  $\omega 3$  EFAs such as EPA and DHA, the fish oil fatty acids.

### ACKNOWLEDGMENTS

William E. M. Lands from College Park, Maryland, and John Ohlrogge from Michigan State University provided important guidance in the preparation of this entry.

### ARTICLE OF FURTHER INTEREST

*Omega-3 Fatty Acids*, p. 493.

### REFERENCES

1. Spector, A.A. Essentiality of fatty acids. *Lipids* **1999**, *34* (Suppl.), S1–S3.
2. Lands, W. Diets could prevent many diseases. *Lipids* **2003**, *38*, 317–321.
3. Rangan, V.S.; Smith, S. Fatty acid synthesis in eukaryotes. In *Biochemistry of Lipids, Lipoproteins and Membranes*; Vance, D.E., Vance, J.E., Eds.; Elsevier: Amsterdam, 2002; 151–180.
4. Cook, H.W.; McMaster, C.R. Fatty acid desaturation and chain elongation in eukaryotes. In *Biochemistry of Lipids, Lipoproteins and Membranes*; Vance, D.E., Vance, J.E., Eds.; Elsevier: Amsterdam, 2002; 181–204.
5. Pereira, S.; Leonard, A.; Mukerji, P. Recent advances in the study of fatty acid desaturases from animals and lower eukaryotes. *Prostaglandins Leukot. Essent. Fatty Acids* **2003**, *68*, 97–106.
6. Zhou, L.; Nilsson, A. Sources of eicosanoid precursor fatty acid pools in tissues. *J. Lipid Res.* **2001**, *42*, 1521–1542.
7. Domergue, F.; Lerchl, J.; Zahringer, U.; Heinz, E. Cloning and functional characterization of *Phaeodactylum tricornutum* front-end desaturases involved in eicosapentaenoic acid biosynthesis. *Eur. J. Biochem.* **2002**, *269*, 4105–4113.
8. Schmid, K.M.; Ohlrogge, J.B. Lipid metabolism in plants. In *Lipids, Lipoproteins and Membranes*; Vance, D.E., Vance, J.E., Eds.; Elsevier: Amsterdam, 2002; 93–126.
9. Burr, G.O.; Burr, M.M. On the nature and role of the fatty acids essential in nutrition. *J. Biol. Chem.* **1930**, *86*, 587–621.
10. Hansen, A.; Wiese, H.; Boelsche, A.; Haggard, M.; Adam, D.; Davis, H. Role of linoleic acid in infant nutrition; clinical and chemical study of 428 infants fed on milk mixtures varying in kind and amount of fat. *Pediatrics* **1963**, *31*, 171–192.
11. Quackenbush, F.W.; Kummerow, F.A.; Steenbock, H. The effectiveness of linoleic,

- arachidonic, and linolenic acids in reproduction and lactation. *J. Nutr.* **1942**, *24*, 213–224.
12. Moriguchi, T.; Salem N., Jr. Recovery of brain docosahexaenoate leads to recovery of spatial task performance. *J. Neurochem.* **2003**, *87*, 297–309.
  13. Brash, A.R. Arachidonic acid as a bioactive molecule. *J. Clin. Invest.* **2001**, *107*, 1339–1345.
  14. Langenbach, R.; Loftin, C.D.; Lee, C.; Tiano, H. Cyclooxygenase-deficient mice: a summary of their characteristics and susceptibilities to inflammation and carcinogenesis. *Ann. N. Y. Acad. Sci.* **1999**, *889*, 52–61.
  15. Smith, W.L.; Murphy, R.C. The eicosanoids: cyclooxygenase, lipoxygenase and epoxygenase pathways. In *Biochemistry of Lipids, Lipoproteins and Membranes*; Vance, D.E., Vance, J.E., Eds.; Elsevier Science B.V.: Amsterdam, 2002; 341–372.
  16. Lands, W. Biochemistry and physiology of n-3 fatty acids. *FASEB J.* **1992**, *6*, 2530–2536.
  17. Lands, W.; Libelt, B.; Morris, A.; Kramer, N.; Prewitt, T.; Bowen, P.; Schmeisser, D.; Davidson, M.; Burns, J. Maintenance of lower proportions of (n-6) eicosanoid precursors in phospholipids of human plasma in response to added dietary (n-3) fatty acids. *Biochim. Biophys. Acta* **1992**, *1180*, 147–162.
  18. Innis, S. Essential fatty acids in growth and development. *Prog. Lipid Res.* **1991**, *30*, 39–103.
  19. Bowser, P.; Nugteren, D.; White, R.; Houtsmuller, U.; Prottey, C. Identification, isolation and characterization of epidermal lipids containing linoleic acid. *Biochim. Biophys. Acta* **1985**, *834*, 419–428.
  20. Ziboh, V.; Miller, C.; Cho, Y. Significance of lipoxygenase-derived monohydroxy fatty acids in cutaneous biology. *Prostaglandins Other Lipid Mediat.* **2000**, *63*, 3–13.
  21. Vance, D.E. Phospholipid biosynthesis in eukaryotes. In *Lipids, Lipoproteins and Membranes*; Vance, D.E., Vance, J.E., Eds.; Elsevier: Amsterdam, 2002; 205–232.
  22. Snyder, F.; Lee, T.-C.; Wykle, R.L. Ether-linked lipids and their bioactive species. In *Lipids, Lipoproteins and Membranes*; Vance, D.E., Vance, J.E., Eds.; Elsevier: Amsterdam, 2002; 233–262.
  23. Smith, W.L.; DeWitt, D.L.; Garavito, R.M. Cyclooxygenases: structural, cellular and molecular biology. *Annu. Rev. Biochem.* **2000**, *69*, 149–182.
  24. Kozak, K.R.; Crews, B.C.; Ray, J.L.; Tai, H.-H.; Morrow, J.D.; Marnett, L.J. Metabolism of prostaglandin glycerol esters and prostaglandin ethanolamides in vitro and in vivo. *J. Biol. Chem.* **2001**, *276*, 30,072–30,077.
  25. Narumiya, S.; FitzGerald, G.A. Genetic and pharmacological analysis of prostanoid receptor function. *J. Clin. Invest.* **2001**, *108*, 25–30.
  26. Smith, W.L.; Langenbach, R. Why there are two cyclooxygenases. *J. Clin. Invest.* **2001**, *107*, 1491–1495.
  27. Patrono, C.; Patrignani, P.; García Rodríguez, L.A. Cyclooxygenase-selective inhibition of prostanoid formation: transducing biochemical selectivity into clinical read-outs. *J. Clin. Invest.* **2001**, *108*, 7–13.
  28. Marnett, L.; DuBois, R. COX-2 a target for colon cancer prevention. *Annu. Rev. Pharmacol. Toxicol.* **2002**, *42*, 55–80.
  29. Yin, H.; Havrilla, C.M.; Gao, L.; Morrow, J.D.; Porter, N.A. Mechanisms for the formation of isoprostane endoperoxides from arachidonic acid. “Dioxetane” intermediate versus beta-fragmentation of peroxy radicals. *J. Biol. Chem.* **2003**, *278*, 16,720–16,725.
  30. Yin, H.; Morrow, J.D.; Porter, N.A. Identification of a novel class of endoperoxides from arachidonate autoxidation. *J. Biol. Chem.* **2004**, *279*, 3766–3776.
  31. Brink, C.; Dahlen, S.-E.; Drazen, J.; Evans, J.F.; Hay, D.W.P.; Nicosia, S.; Serhan, C.N.; Shimizu, T.; Yokomizo, T. International Union of Pharmacology XXXVII. Nomenclature for leukotriene and lipoxin receptors. *Pharmacol. Rev.* **2003**, *55*, 195–227.
  32. Conrad, D.J. The arachidonate 12/15 lipoxygenases. A review of tissue expression and biological function. *Clin. Rev. Allergy Immunol.* **1999**, *17*, 71–89.
  33. Capdevila, J.H.; Falck, J.R.; Harris, R.C. Cytochrome P450 and arachidonic acid bioactivation. Molecular and functional properties of the arachidonate monooxygenase. *J. Lipid Res.* **2000**, *41*, 163–181.
  34. Pessach, I.; Leto, T.L.; Malech, H.L.; Levy, R. Essential requirement of cytosolic phospholipase A2 for stimulation of NADPH oxidase-associated diaphorase activity in granulocyte-like cells. *J. Biol. Chem.* **2001**, *276*, 33,495–33,503.
  35. Cowart, L.A.; Wei, S.; Hsu, M.-H.; Johnson, E.F.; Krishna, M.U.; Falck, J.R.; Capdevila, J.H. The CYP4A isoforms hydroxylate epoxyeicosatrienoic acids to form high affinity peroxisome proliferator-activated receptor ligands. *J. Biol. Chem.* **2002**, *277*, 35,105–35,112.
  36. Sano, Y.; Inamura, K.; Miyake, A.; Mochizuki, S.; Kitada, C.; Yokoi, H.; Nozawa, K.; Okada, H.; Matsushime, H.; Furuichi, K.A. A novel two-pore domain K<sup>+</sup> channel, TRESK, is localized in the spinal cord. *J. Biol. Chem.* **2003**, *278*, 27,406–27,412.

37. Cao, Y.; Pearman, A.T.; Zimmerman, G.A.; McIntyre, T.M.; Prescott, S.M. Intracellular unesterified arachidonic acid signals apoptosis. *Proc. Natl. Acad. Sci.* **2000**, *97*, 11,280–11,285.
38. Kuhn, H.; Sprecher, H.; Brash, A. On singular or dual positional specificity of lipoxygenases. The number of chiral products varies with alignment of methylene groups at the active site of the enzyme. *J. Biol. Chem.* **1990**, *265*, 16,300–16,305.
39. Lee, T.; Mencia-Huerta, J.; Shih, C.; Corey, E.; Lewis, R.; Austen, K. Effects of exogenous arachidonic, eicosapentaenoic, and docosahexaenoic acids on the generation of 5-lipoxygenase pathway products by ionophore-activated human neutrophils. **1984**, *74*, 1922–1933.
40. Laneuville, O.; Breuer, D.K.; Xu, N.; Huang, Z.H.; Gage, D.A.; Watson, J.T.; Lagarde, M.; DeWitt, D.L.; Smith, W.L. Fatty acid substrate specificities of human prostaglandin-endoperoxide H synthase-1 and -2. Formation of 12-hydroxy-(9Z, 13E/Z, 15Z)-octadecatrienoic acids from alpha-linolenic acid. *J. Biol. Chem.* **1995**, *270*, 19,330–19,336.
41. Lands, W.E.M.; LeTellier, P.R.; Rome, L.H.; Vanderhoek, J.Y. Inhibition of prostaglandin biosynthesis. *Adv. Biosci.* **1973**, *9*, 15–28.
42. Hsi, L.C.; Wilson, L.C.; Eling, T.E. Opposing effects of 15-lipoxygenase-1 and -2 metabolites on MAPK signaling in prostate. Alteration in peroxisome proliferator-activated receptor gamma. *J. Biol. Chem.* **2002**, *277*, 40,549–40,556.
43. Bagga, D.; Wang, L.; Farias-Eisner, R.; Glaspy, J.A.; Reddy, S.T. Differential effects of prostaglandin derived from omega-6 and omega-3 polyunsaturated fatty acids on COX-2 expression and IL-6 secretion. *Procl. Natl. Acad. Sci.* **2003**, *100*, 1751–1756.
44. Kramer, R.M.; Sharp, J.D. Structure, function and regulation of Ca<sup>2+</sup>-sensitive cytosolic phospholipase A2 (cPLA2). *FEBS Lett.* **1997**, *410*, 49–53.
45. Strokin, M.; Sergeeva, M.; Reiser, G. Docosahexaenoic acid and arachidonic acid release in rat brain astrocytes is mediated by two separate isoforms of phospholipase A2 and is differently regulated by cyclic AMP and Ca<sup>2+</sup>. *Br. J. Pharmacol.* **2003**, *139*, 1014–1022.
46. Mcconn, M.; Browse, J. Polyunsaturated membranes are required for photosynthetic competence in a mutant arabidopsis. *Plant J.* **1998**, *15*, 521–530.
47. Mcconn, M.; Browse, J. The critical requirement for linolenic acid is pollen development, not photosynthesis, in an arabidopsis mutant. *Plant Cell* **1996**, *8*, 402–416.



# Pantothenic Acid

**Lawrence Sweetman**

*Mass Spectrometry Laboratory, Institute of Metabolic Disease, Baylor University Medical Center, Dallas, Texas, U.S.A.*

## INTRODUCTION

Pantothenic acid is a water soluble B vitamin (vitamin B<sub>5</sub>) that is not synthesized by animals but is widely available in the diet. Pantothenic acid is metabolized to two important cofactors for enzymes: coenzyme A (CoA) and acyl carrier protein (ACP). Both cofactors contain a sulfhydryl group (–SH), which reacts with carboxylic acids to form thioesters. ACP has a central role in the synthesis of fatty acids. CoA forms thioesters with a very wide range of metabolic intermediates and has been estimated to be a cofactor for about 4% of all known enzymes.<sup>[1]</sup> It is also involved with fatty acid synthesis but has broader functions in fatty acid oxidation, ketone body metabolism, oxidative metabolism of pyruvate via pyruvate dehydrogenase and the citric acid cycle, and in the metabolism of a wide variety of organic acids, including those in catabolic pathways of amino acid metabolism.

## MICROBIAL SYNTHESIS

Micro-organisms synthesize pantoic acid (pantoate) from  $\alpha$ -ketoisovaleric acid, the keto acid derived from the amino acid valine.<sup>[1]</sup> A hydroxymethyl group is attached to  $\alpha$ -ketoisovaleric acid, and the keto group is reduced to a hydroxy group to form pantoic acid. Beta-alanine produced by the decarboxylation of the amino acid aspartate is condensed with pantoic acid to form pantothenic acid (pantothenate) (Fig. 1). This synthesis does not occur in humans or in other animals, which must obtain pantothenic acid from the diet. Pantothenic acid is quite widely distributed in foods, giving rise to its name from the Greek word pan- (also panto-) meaning all or every. Liver, meats, milk, whole grain cereals, and legumes are good sources. It is contained in foods in various bound forms, including CoA and CoA esters, ACP, and as a glucoside in tomatoes.

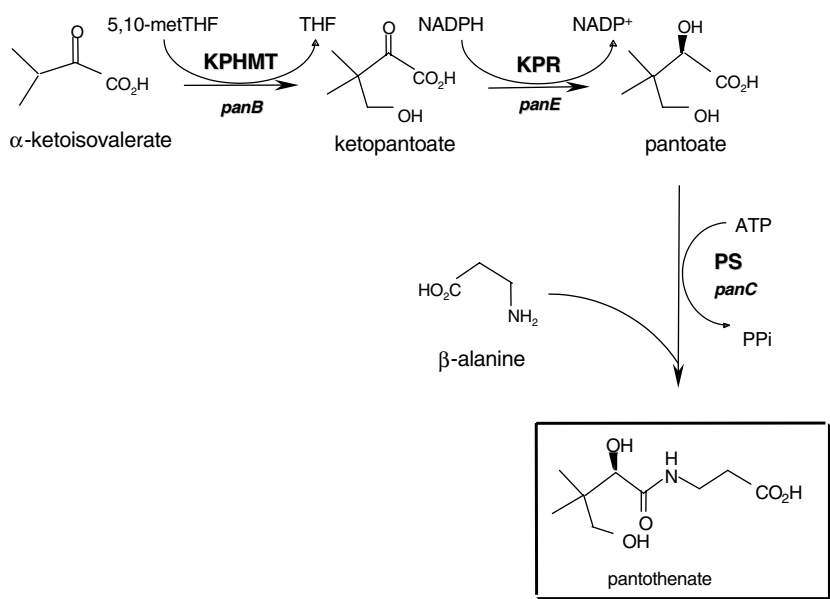
---

*Lawrence Sweetman, Ph.D., is Director, Mass Spectrometry Laboratory at the Institute of Metabolic Disease, Baylor University Medical Center, Dallas, Texas, U.S.A.*

## COFACTOR SYNTHESIS

### Coenzyme A Synthesis

Within cells, pantothenic acid is metabolized to CoA in the cytosol (Fig. 2). The initial reaction is phosphorylation of the hydroxyl group of the pantoic acid portion of pantothenic acid with ATP, catalyzed by pantothenate kinase, to form 4'-phosphopantothenate. This is the rate-limiting step for synthesis of CoA, and regulation of pantothenate kinase activity is the primary control of the rate of CoA synthesis. The activity of pantothenate kinase is strongly inhibited by acetyl CoA and malonyl CoA and activated by free CoA.<sup>[2]</sup> It is also inhibited by the intermediates 4'-phosphopantothenate and dephospho-CoA as well as CoA in other studies.<sup>[3]</sup> Carnitine protects from the inhibition by CoA and acyl CoA by competing with them for their binding to pantothenate kinase. The human genes for the last four enzymes of CoA synthesis have been cloned, expressed, purified, and reconstituted in vitro to synthesize CoA.<sup>[4]</sup> 4'-Phosphopantothenate is the substrate for 4'-phosphopantothenoylcysteine synthetase, which couples ATP hydrolysis with the formation of an amide bond between the carboxyl of 4'-phosphopantothenate and the amino group of the sulfur amino acid, cysteine. The product, 4'-phosphopantothenoylcysteine, is decarboxylated by 4'-phosphopantothenoylcysteine decarboxylase to form 4'-phosphopantetheine. A bifunctional protein with adenylyltransferase activity adds the 5'-AMP group of ATP to the 4'-phospho group of 4'-phosphopantetheine to form dephospho-CoA, and a kinase activity catalyzes the final step in the synthesis of CoA, the phosphorylation of the 3'-hydroxyl of dephospho-CoA utilizing ATP. The adenylyltransferase may be a secondary point of control of the biosynthesis of CoA. All the enzymes in the CoA biosynthetic pathway are present in the cytosol, but the last two enzymes can also be found in mitochondria. Notable features of the structure of CoA are the 3'-phospho-AMP moiety linked with the pantoate portion, and the reactive sulfhydryl group at the end of the long flexible chain derived from  $\beta$ -alanine and cysteine. CoA is often abbreviated as CoASH to illustrate this reactive sulfhydryl group, while thioesters of organic acids with CoASH are often referred to as acyl-SCoA.



**Fig. 1** Pantothenic acid structure and biosynthetic pathway in micro-organisms. (Reproduced with permission from Ref. [26].)

### Coenzyme A Subcellular Location

The majority of the CoA in cells is found within the mitochondria with about 75% of liver CoA in mitochondria and 95% of heart CoA in mitochondria. This is consistent with the mitochondria being the major cellular organelle involved in fatty acid oxidation and in the final oxidative steps in the catabolism of all fuels; CoA plays a major role in these processes. Because the mitochondria represent only a small fraction of the cellular volume, the concentration of CoA here (2.2 mM) is 40–150 times that in the cytosol (0.015–0.05 mM). This large difference is maintained by the transport of the negatively charged CoA into the mitochondria, which is driven by the membrane electrical gradient.<sup>[5]</sup> CoA is also involved in the oxidation of very-long-chain fatty acids in peroxisomes, but little is known about how it enters these organelles. In the cytoplasm, CoA is also utilized for the synthesis of the ACP domain of the fatty acid synthase enzyme, which catalyzes fatty acid synthesis.

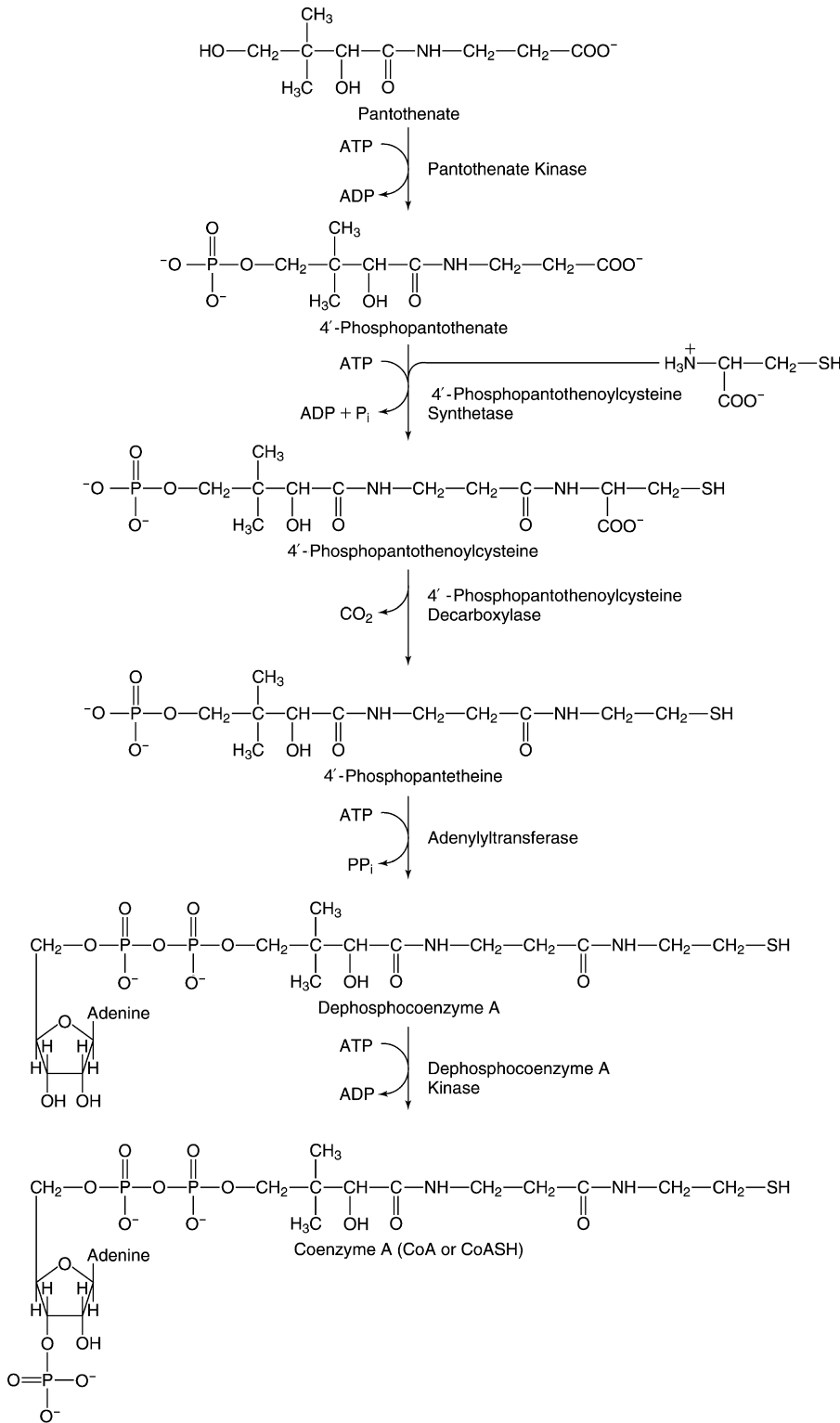
### Acyl Carrier Protein Synthesis

There are several ACPs known in yeast and bacteria, but the ACP domain of fatty acid synthase is the most important and best studied. Fatty acid synthase is the only mammalian enzyme complex containing the ACP domain that has been well characterized. It is a single, homodimeric, multifunctional protein with seven enzymatic activities required for fatty acid synthesis.<sup>[6]</sup> The synthase is synthesized with the ACP domain as an enzymatically inactive apoprotein lacking the prosthetic group. But after covalent attachment of the

phosphopantetheine group, it becomes the enzymatically active holoacyl carrier protein (holo-ACP).<sup>[7]</sup> This reaction, catalyzed by 4'-phosphopantetheinyl transferase, utilizes CoA to form a phosphoester bond between the 4'-phosphopantetheine portion of CoA and a specific serine residue of the ACP, with the release of the 3',5'-ADP moiety of CoA (Fig. 3). Note that as in CoA, the reactive sulfhydryl group of ACP is at the end of the long chain derived from  $\beta$ -alanine and cysteine.

### COFACTOR DEGRADATION

The intermediates in the degradation of CoA are the reverse of those in the synthesis but involve different enzymes. CoA does not appear to be degraded in the mitochondria, but in the lysosomes, the 3'-phosphate group is removed by nonspecific phosphatases to form dephospho-CoA. This is degraded to 4'-phosphopantetheine and 5'-AMP by a nucleotide pyrophosphatase located in the plasma membrane fraction. CoA is also degraded by this enzyme but at a much lower rate and with a much higher  $K_m$ . Surprisingly, acyl CoAs are also readily degraded to 4'-phosphopantetheine. There is an ACP hydrolase that releases 4'-phosphopantetheine from holo-ACP to reform apo-ACP. Interestingly, the combined action of the ACP hydrolase and synthetase results in the rapid turnover of the 4'-phosphopantetheine of ACP with a half-life measured in hours compared to that of the fatty acid synthase, which is measured in days in rat tissues.<sup>[8]</sup> Whether 4'-phosphopantetheine is derived from the degradation of CoA or from the turnover of ACP, the phosphate is removed by phosphatases to give pantetheine. This is hydrolyzed to



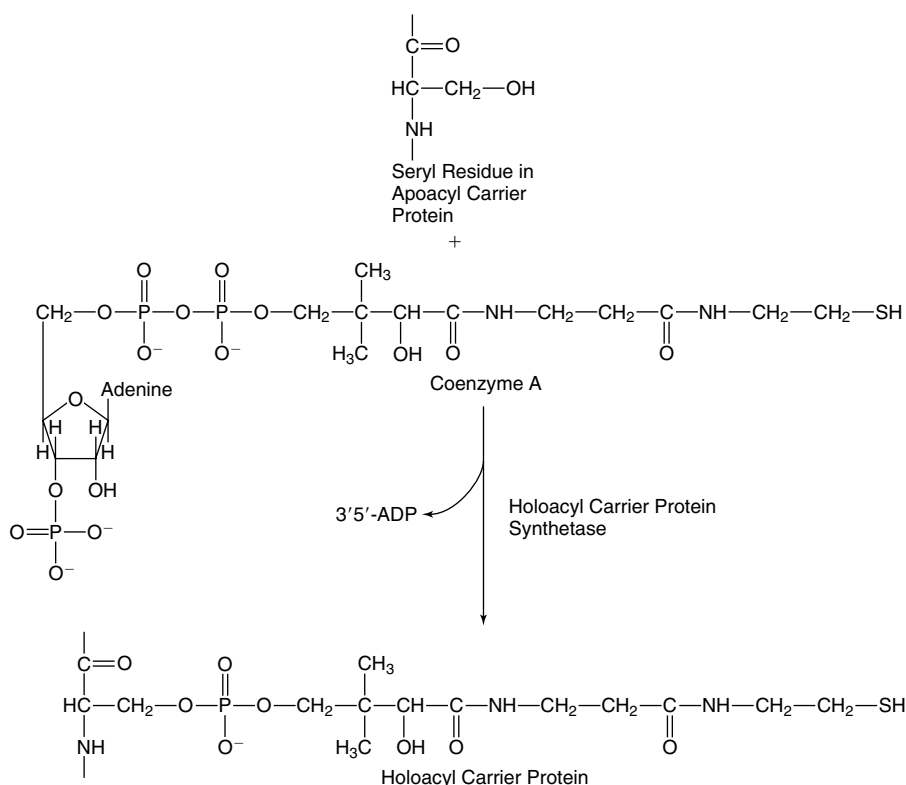
**Fig. 2** CoA synthesis and structure: CoA is synthesized from pantothenic acid, the amino acid cysteine, and ATP in mammalian cells. (Reproduced with permission from Ref.<sup>[27]</sup>.)

pantothenic acid and cysteamine by pantetheinase, which is found in both the microsomal and lysosomal fractions of rat liver and kidney. The pantothenic acid can be excreted or used for resynthesis of CoA. The cysteamine is oxidized to hypotaurine and further oxidized to taurine, which may be excreted in the urine.

**METABOLIC ROLE**

CoA has many functions in metabolism including its role in the formation of ACP. Both CoA and ACP are used to form thioesters with carboxylic acid groups of fatty acids and other compounds. Much of the





**Fig. 3** Acyl carrier protein synthesis: CoA is cleaved to form 3',5'-ADP and attach 4'-phosphopantetheine as a phosphate ester of the hydroxyl of a serine residue in apo-ACP to form holo-ACP, a component of fatty acid synthetase. (Reproduced with permission from Ref.<sup>[27]</sup>.)

metabolism of fatty acids and certain amino acid derivatives, as well as a number of amphibolic steps in metabolism, occurs using CoA thioester substrates and producing CoA thioester products.

### Acyl Carrier Protein and Coenzyme A in Fatty Acid Synthesis

Both CoA and ACP are essential for the synthesis of fatty acids in the cytosol. Acetyl CoA, the substrate for fatty acid synthesis, is generated from citrate and CoA by citrate lyase in the cytosol. The citrate is transported out of the mitochondria where it was formed in the tricarboxylic acid cycle from acetyl CoA produced by the oxidation of pyruvate. Acetyl transacylase transfers the acetyl group from acetyl CoA to the pantetheine sulfhydryl of ACP, releasing free CoA in the process. These two carbons from acetyl CoA form the methyl end of the fatty acid that will be synthesized. A biotin containing enzyme, acetyl CoA carboxylase, utilizes bicarbonate and ATP to convert acetyl CoA to malonyl CoA. Fatty acid synthetase utilizes this malonyl CoA to sequentially add two carbon units to the acetyl or acyl ACP, with the liberation of the third carbon of malonyl CoA as  $\text{CO}_2$ . This process results in the synthesis of even-numbered fatty acids of 16 or 18 carbons. When the synthesis of a fatty acid is complete, a thioesterase hydrolyzes the ACP-fatty acid thioester, releasing the

fatty acid and regenerating the ACP sulfhydryl. The rate of fatty acid synthesis is primarily regulated by the concentration of malonyl CoA, which is determined by regulation of the activity of acetyl CoA carboxylase.

### Coenzyme A in Oxidative Decarboxylation

A key role for CoA in fuel metabolism is its function in  $\alpha$ -keto acid dehydrogenase complexes that catalyze the oxidative decarboxylation of keto acids. In the metabolism of carbohydrates, the end product of the glycolytic pathway for glucose is the simple three-carbon  $\alpha$ -keto acid, pyruvate. In order for pyruvate to be completely oxidized via the tricarboxylic acid cycle and oxidative phosphorylation, it is oxidatively decarboxylated to acetyl CoA [with release of  $\text{CO}_2$  and reduction of nicotinamide adenine dinucleotide (NAD)] by the pyruvate dehydrogenase complex. This complex reaction involves five coenzymes (four of them derived from vitamins): thiamine pyrophosphate (TPP), NAD, flavine adenine dinucleotide (FAD), lipolate, and CoA. In the decarboxylation of pyruvate, the two-carbon aldehyde unit is attached to TPP, oxidized, transferred to a lipoyl enzyme, and then to CoA to form acetyl CoA. Acetyl CoA is a central compound in metabolism, having several catabolic as well as anabolic fates. The CoA is eventually released as free CoA as further metabolism of acetyl CoA progresses.

Two other enzyme complexes catalyze the oxidative decarboxylation of keto acids with the formation of acyl CoA products. The  $\alpha$ -ketoglutarate dehydrogenase in the tricarboxylic acid cycle converts  $\alpha$ -ketoglutarate to succinyl CoA. The CoA is released from succinyl CoA in the next step of the tricarboxylic acid cycle. The branched-chain  $\alpha$ -keto acid dehydrogenase complex, again in a series of reactions analogous to those of pyruvate dehydrogenase, catalyzes the first committed step in the catabolic pathway for the branched-chain amino acids. The  $\alpha$ -keto acids from transamination of valine, isoleucine, and leucine are oxidatively decarboxylated to form branched-chain acyl CoA products with one less carbon in the chain. These are metabolized in a number of different steps as CoA esters and ultimately yield simple acyl CoA products, such as acetyl CoA and propionyl CoA, which enter general metabolism.

### Coenzyme A in Fatty Acid $\beta$ -Oxidation

CoA plays a major role in the  $\beta$ -oxidation of fatty acids in the mitochondria, which may result in the complete degradation of fatty acids to acetyl CoA that can be further oxidized in the tricarboxylic acid cycle. Most of the fatty acids consumed in dietary triglycerides (fat or oils) or obtained from adipose tissue stores have chains of 16 or 18 carbons. These long-chain fatty acids require a carrier system for their transport from the cytosol into the mitochondria. In the cytosol, the free long-chain fatty acids are activated to CoA thioesters by acyl CoA synthetases that couple ATP hydrolysis with thioester formation. These fatty acyl CoAs are transesterified to carnitine to form "energy-equivalent" acyl carnitines, which can be transported across the mitochondrial inner membrane. On the outer mitochondrial membrane, the enzyme carnitine palmitoyl transferase I (CPT I) converts the fatty acyl CoA to acyl carnitine and free CoA. A carnitine/acyl carnitine translocase moves the acyl carnitines into the mitochondria and free carnitine out of the mitochondria. Carnitine palmitoyl transferase II (CPT II) on the inner mitochondrial membrane regenerates fatty acyl CoA in the mitochondria, freeing up carnitine for transport out of the mitochondria. In the  $\beta$ -oxidation, two-carbon segments of the fatty acyl CoA are sequentially removed as acetyl CoA. The series of reactions for each cycle are dehydrogenation to the unsaturated acyl CoA, hydration to 3-hydroxyacyl CoA, dehydrogenation to the 3-ketoacyl CoA, and thiolitic cleavage by CoA to release acetyl CoA and a fatty acyl CoA with two less carbons. There are multiple dehydrogenases with overlapping chain length specificities that favor acyl CoAs with very long, long, medium or short chains. Reducing

equivalents generated in the various dehydrogenation steps are funneled into the electron transport chain. Although most tissues other than the brain can use fatty acids as fuel, cardiac muscle and skeletal muscle are especially dependent on fatty acid oxidation for energy. The rate of fatty acid oxidation is controlled by the rate of transport of fatty acids into the mitochondria. The rate of transport is controlled largely by the activity of CPT I, which is strongly inhibited by malonyl CoA. When fatty acid synthesis is increased by insulin activation of acetyl CoA carboxylase to produce more malonyl CoA as substrate for fatty acid synthetase, the increased malonyl CoA inhibits CPT I, decreasing fatty acid transport into the mitochondria, and thus preventing the reoxidation of newly synthesized fatty acids. Increased glucagon enhances fatty acid  $\beta$ -oxidation indirectly by inhibiting acetyl CoA carboxylase, decreasing the synthesis of malonyl CoA and fatty acids, and reducing malonyl CoA inhibition of CPT I so that fatty acids enter the mitochondria for  $\beta$ -oxidation.

### Coenzyme A in Ketone Body Metabolism

Ketone bodies are an important source of fuel derived from fat metabolism when glucose is limiting as in starvation. Acetoacetate and its reduction product, 3-hydroxybutyrate, were called ketone bodies because some acetoacetate is spontaneously decarboxylated to acetone, a ketone. Ketone bodies are synthesized in the liver from acetoacetyl CoA and acetyl CoA produced via  $\beta$ -oxidation of fatty acids. Acetoacetyl CoA is condensed with acetyl CoA to form 3-hydroxy-3-methylglutaryl CoA and free CoA by mitochondrial 3-hydroxy-3-methylglutaryl CoA (HMG CoA) synthetase. This is then cleaved by HMG CoA lyase to form free acetoacetate and acetyl CoA. The net result of this cycle is the conversion of acetoacetyl CoA to acetoacetate and free CoA, but there is no enzyme that directly catalyzes this hydrolysis. Acetoacetate and 3-hydroxybutyrate are interconverted by 3-hydroxybutyrate dehydrogenase with NAD and NADH, with 3-hydroxybutyrate being the major form. Acetoacetate and 3-hydroxybutyrate are released from the liver into the blood and are then taken up by other tissues that are able to use them as fuels. In the extrahepatic tissues, the acetoacetate is converted to a CoA ester using succinyl CoA as the CoA donor. The acetoacetyl CoA can then be metabolized to acetyl CoA (last step of  $\beta$ -oxidation) and further oxidized by the tricarboxylic acid cycle and oxidative phosphorylation. The brain, which cannot utilize fatty acids for energy, can use the ketone bodies produced from fatty acids by the liver.

## Coenzyme A in Organic Acid Metabolism

CoA is also involved in the mitochondrial metabolism of a large number of other carboxylic acids as CoA thioesters. The catabolism of many amino acids involves the removal of the amino group, leaving a carboxyl group that can be esterified to CoA for further metabolism. As described earlier, the branched-chain  $\alpha$ -keto acids derived from valine, isoleucine, and leucine are oxidatively decarboxylated to form acyl CoA derivatives. Leucine is catabolized to HMG CoA, which is cleaved to acetoacetate (a ketone body) and acetyl CoA by the lyase involved in ketone body synthesis. Valine and isoleucine are metabolized via pathways involving acyl CoAs to form propionyl CoA and propionyl CoA plus acetyl CoA. The amino acids threonine and methionine are also metabolized to propionyl CoA. The propionyl CoA is converted to succinyl CoA and enters the tricarboxylic acid cycle. The amino acids lysine, hydroxylysine and tryptophan are catabolized to acetoacetyl CoA. In addition to catabolic pathways, acyl CoAs are involved in many synthetic reactions. The CoA ester of 3-hydroxy-3-methylglutarate (HMG CoA), formed in the cytosol, is the starting material for the synthesis of isoprenoids, cholesterol, and steroids. Acetyl CoA is a substrate for the acetylation of amino and hydroxyl groups of many compounds. Another role for CoA is the detoxification of drugs and other exogenous compounds. An example is the conversion of aspirin to a CoA ester, then transfer to the amino group of glycine to form salicylurate for excretion.

### Carnitine interrelations

The esters of CoA and carnitine have very similar energy contents. They are maintained in equilibrium by carnitine acyl CoA transferases. The carnitine palmitoyl CoA transferases and their role in transporting long-chain fatty acids into mitochondria for fatty acid  $\beta$ -oxidation have already been described. In addition, carnitine acetyl CoA transferase catalyzes the interconversion of a number of short-chain carnitine esters and CoA thioesters. Additional transferases act on medium-chain length acids. Free carnitine and carnitine esters act as a buffer to maintain free CoA and acyl CoA levels. If acyl CoAs accumulate as that occurring in inherited disorders of fatty acid oxidation or metabolism of some organic acids, free CoA could be depleted below the levels needed for its essential roles in metabolism. The conversion of some acyl CoAs to acyl carnitines frees up CoA and maintains a more normal ratio of free-to-esterified CoA. In addition, acyl CoAs are inhibitors of a number of enzymes, and decreasing their concentration by converting them to acyl carnitines reduces this inhibition. The acyl

carnitines can also be translocated out of the mitochondria, enter the blood circulation, and be excreted by the kidneys as a means of removing accumulated esters of CoA that may be toxic. A side effect of this is that in inherited disorders in which acyl carnitines are excreted in large amounts, carnitine itself may become depleted in tissues and this, in turn, will decrease the transport of fatty acids into the mitochondria.

## PHYSIOLOGY

### Absorption

CoA and ACP from the diet are enzymatically degraded in the intestine to release free pantothenic acid.<sup>[9]</sup> CoA, dephospho-CoA, and phosphopantetheine are not absorbed by the intestine and must be digested to pantothenic acid before absorption. Uptake of pantothenic acid is mediated by a saturable  $\text{Na}^+$ -dependent transporter utilizing the  $\text{Na}^+$  electrochemical gradient for active transport with the highest rate of transport in the jejunum.<sup>[10]</sup> This multivitamin transporter, which also transports biotin and lipoic acid, has been cloned from human intestinal cells.<sup>[11]</sup> Pantetheine is also absorbed by the intestine but is hydrolyzed to pantothenic acid in the intestinal cells. The absorbed pantothenic acid is transported by the blood, primarily as bound forms in red blood cells. How this is made available to tissues is unclear, and it may be that the low concentration of free pantothenic acid in plasma (0.06–0.08 mg/L as compared with 1.0–1.8 mg/L in whole blood) is the form taken up by tissues.<sup>[3]</sup>

### Transport

Pantothenic acid (pantothenate) is transported into mammalian cells by the saturable  $\text{Na}^+$ -dependent multivitamin transporter, which also transports biotin and lipoic acid.<sup>[12]</sup> The transport across the blood–brain barrier is also saturable but does not appear to be  $\text{Na}^+$ -dependent.<sup>[3]</sup>

### Excretion

In the kidney tubules, pantothenic acid is largely reabsorbed at physiological concentrations by a  $\text{Na}^+$ -dependent process.<sup>[3]</sup> At higher concentrations, there is tubular secretion of pantothenic acid (excretion of a higher concentration in the urine than is present in the plasma). As a result, there is a positive correlation between dietary intake of pantothenic acid and its excretion in the urine. There are no known catabolites

of pantothenic acid; only pantothenic acid is excreted in urine.

### DIETARY SOURCES

Pantothenic acid is widely distributed in plant and animal sources, existing both free and bound as ACP and CoA. Total pantothenic acid in foods is determined by hydrolysis of the bound forms to free pantothenic acid and quantitation of the released pantothenic acid by microbiological growth assays, radioimmune assays, or more recently, stable isotope dilution mass spectrometric assays.<sup>[13]</sup> There is considerable loss of pantothenic acid in highly processed foods.<sup>[3]</sup> The average dietary intake of pantothenic acid in the composite Canadian diet is about 5–6 mg/day, with somewhat lower intake in the elderly and young children.<sup>[14]</sup> Another study of mixed total diet composites of young adults in the United States found a mean pantothenic acid intake of 5.88 mg  $\pm$  0.50 standard deviation.<sup>[15]</sup> There is limited information about the bioavailability of pantothenic acid.<sup>[16]</sup> From studies of dietary intake and urinary excretion, it is estimated that only about 50% of dietary pantothenic acid is available.

### RECOMMENDED INTAKES

No recommended daily allowance has been determined for pantothenic acid. Ingestion of 1.7–7 mg/day, depending on age, is considered adequate dietary reference intake (Table 1). Pantothenic acid is included in most multivitamin supplements, generally in the amount of 10 mg.

### DEFICIENCY

Because of the wide distribution of pantothenic acid in foods, no spontaneous deficiency has been reported. Deficiency has been induced in a small number of human volunteers with a pantothenic acid-free diet. There were no clinical symptoms at 9 weeks, even though urinary excretion of pantothenic acid had decreased by 75%, but the volunteers appeared listless and complained of fatigue.<sup>[17]</sup> Others fed a diet deficient in pantothenic acid together with an antagonist ( $\omega$ -methylpantothenic acid) to block pantothenic acid utilization developed headaches, fatigue, a sensation of weakness and numbness, and burning sensations in hands and feet.<sup>[18,19]</sup> Additional symptoms included personality changes, sleep disturbances, impaired motor coordination, and gastrointestinal disturbances. All symptoms were reversed by stopping the antagonist and giving pantothenic acid.

**Table 1** Adequate intakes of pantothenic acid

Group	Amount (mg/day)
Infants	
0–6 mo	1.7
7–12 mo	1.8
Children	
1–3 yr	2
4–8 yr	3
9–13 yr	4
Males	
>13 yr	5
Females	
>13 yr	5
Pregnancy	6
Lactation	7

(From The Institute of Medicine. *Dietary Reference Intakes for Thiamine, Riboflavin, Niacin, Vitamin B6, Folate, Vitamin B12, Pantothenic Acid, Biotin, and Choline*; National Academy Press: Washington, DC, U.S.A., 1998.)

### SUPPLEMENTATION

The effect of supplementation with very high levels of pantothenic acid and thiamin derivatives on physiology and performance of trained cyclists was compared to placebo in a randomized double-blind study.<sup>[20]</sup> There was no difference in any of the physiological parameters or in time trials. Pantothenic acid together with ascorbic acid may improve wound healing, giving more solid and resistant scars, by affecting the trace metal concentrations.<sup>[21]</sup> Exposure of rats to gamma radiation lowers liver CoA, glutathione, cholesterol and phospholipid levels and causes lipid peroxidation. Administration of pantothenol, which is readily converted to pantothenic acid, prevented these effects, presumably by maintaining CoA levels.<sup>[22]</sup> Patients with fatty liver and hypertriglyceridemia treated with large amounts of pantethine show decreased fat in liver and the viscera, but increased subcutaneous fat.<sup>[23]</sup>

In the dietary supplement marketplace, there are many more claims for a wide range of beneficial health effects of very large doses of 500–1000 mg of pantothenic acid. These amounts are hundreds of times the adequate daily intake, considered to be about 5 mg/day for adults. No data on toxicity of pantothenic acid in humans at these or higher doses have been reported, and only minor gastrointestinal effects occur at even higher doses. Although there appears to be no risk of toxicity with gram quantities of pantothenic acid, there is very little evidence to support the health claims for clinical benefits of pantothenic acid. The broad health

claims include increased energy and athletic ability, a cure for acne, decreased symptoms in arthritis, increased immunity, prevention of hair loss and graying, anti-aging, activation of the adrenal glands, synthesis of the neurotransmitter acetylcholine, lowering cholesterol and triglyceride levels, and improved wound healing. The claims are often based on a single or a very few old studies with a small number of subjects, and well controlled double-blind clinical studies with a larger numbers of subjects have not been done to validate the claims.

## INHERITED DISORDER

An inherited disorder, Hallervorden–Spatz syndrome, has been shown to be due to mutations in a pantothenate kinase gene, PANK2.<sup>[24]</sup> This disorder is an autosomal recessive neurodegenerative disorder with iron accumulation in the basal ganglia of the brain, onset in childhood, and a progressive course with early death. There are four different PANK genes in humans, with different expressions in different tissues. PANK1 is most expressed in heart, liver, and kidney, PANK3 in liver, PANK4 in muscle, and PANK2 in most tissues, including basal ganglia. A mutation in PANK2, which resulted in low activity of pantothenate kinase in those tissues, where it is the major expressed pantothenate kinase, would be expected to affect CoA levels since this enzyme is rate limiting for the synthesis of CoA. In a large study of patients with Hallervorden–Spatz syndrome, all those with the classic syndrome showing early onset with rapid progression had mutations in PANK2, most often resulting in protein truncation.<sup>[25]</sup> Only about a third of patients with atypical disease (often with prominent speech-related and psychiatric symptoms) had PANK2 mutations, and these generally caused an amino acid change. Some of these patients with residual activity of pantothenate kinase may benefit from treatment with large doses of pantothenic acid. The classic and atypical disease due to PANK2 abnormalities is now generally referred to as pantothenate kinase-associated neurodegeneration.

## REFERENCES

- Begley, T.P.; Kinsland, C.; Strauss, E. The biosynthesis of coenzyme A in bacteria. *Vitam. Horm.* **2001**, *61*, 157–171.
- Rock, C.O.; Calder, R.B.; Karim, M.A.; Jackowski, S. Pantothenate kinase regulation of the intracellular concentration of coenzyme A. *J. Biol. Chem.* **2000**, *275*, 1377–1383.
- Tahiliani, A.G.; Beinlich, C.J. Pantothenic acid in health and disease. *Vitam. Horm.* **1991**, *46*, 165–228.
- Daugherty, M.; Polanuyer, B.; Farrell, M.; Scholle, M.; Lykidis, A.; de Crecy-Lagard, V.; Osterman, A. Complete reconstitution of the human coenzyme A biosynthetic pathway via comparative genomics. *J. Biol. Chem.* **2002**, *277*, 21,431–21,439.
- Tahiliani, A.G. Dependence of mitochondrial coenzyme A uptake and the membrane electrical gradient. *J. Biol. Chem.* **1989**, *264*, 18,426–18,432.
- Smith, S.; Witkowski, A.; Joshi, A.K. Structural and functional organization of the animal fatty acid synthase. *Prog. Lipid Res.* **2003**, *42*, 289–317.
- Joshi, A.K.; Zhang, L.; Rangan, V.S.; Smith, S. Cloning, expression, and characterization of human 4'-phosphopantetheinyl transferase with broad substrate specificity. *J. Biol. Chem.* **2003**, *278*, 33,142–33,149.
- Tweto, J.; Liberati, M.; Larrabee, A.R. Protein turnover and 4-phosphopantetheine exchange in rat liver fatty acid synthetase. *J. Biol. Chem.* **1971**, *246*, 2468–2471.
- Shibata, K.; Gross, C.J.; Henderson, L.M. Hydrolysis and absorption of pantothenate and its coenzymes in the rat small intestine. *J. Nutr.* **1983**, *113*, 2107–2115.
- Fenstermacher, D.K.; Rose, R.C. Absorption of pantothenic acid in rat and chick intestine. *Am. J. Physiol.* **1986**, *250*, G155–G160.
- Prasad, P.D.; Wang, H.; Huang, W.; Fei, Y.J.; Leibach, F.H.; Devoe, L.D.; Ganapathy, V. Molecular and functional characterization of the intestinal Na<sup>+</sup>-dependent multivitamin transporter. *Arch. Biochem. Biophys.* **1999**, *366*, 95–106.
- Prasad, P.D.; Ganapathy, V. Structure and function of mammalian sodium-dependent multivitamin transporter. *Curr. Opin. Clin. Nutr. Metab. Care* **2000**, *3*, 263–266.
- Rychlik, M. Pantothenic acid quantification by stable isotope dilution assay based on liquid chromatography-tandem mass spectrometry. *Analyst* **2003**, *128*, 831–837.
- Hoppner, K.; Lampi, B.; Smith, D.C. An appraisal of the daily intakes of vitamin B<sub>12</sub>, pantothenic acid and biotin from a composite Canadian diet. *Can. Inst. Food Sci. Technol. J.* **1978**, *11*, 71–74.
- Iyengar, G.V.; Wolf, W.R.; Tanner, J.T.; Morris, E.R. Content of minor and trace elements, and organic nutrients in representative mixed total diet composites from the USA. *Sci. Total Environ.* **2000**, *256*, 215–226.
- van den Berg, H. Bioavailability of pantothenic acid. *Eur. J. Clin. Nutr.* **1997**, *51* (Suppl. 1), S62–S63.

17. Fry, P.C.; Fox, H.M.; Tao, H.G. Metabolic response to a pantothenic acid deficient diet in humans. *J. Nutr. Sci. Vitaminol.* **1976**, *22*, 339–346.
18. Bean, W.B.; Hodges, R.E. Pantothenic acid deficiency induced in human subjects. *Proc. Soc. Exp. Biol. Med.* **1954**, *86*, 693–698.
19. Hodges, R.E.; Ohlson, M.A.; Bean, W.B. Pantothenic acid deficiency in man. *J. Clin. Invest.* **1958**, *37*, 1642–1657.
20. Webster, M.J. Physiological and performance responses to supplementation with thiamin and pantothenic acid derivatives. *Eur. J. Appl. Physiol.* **1998**, *77*, 486–491.
21. Vaxman, F.; Olender, S.; Lambert, A.; Nisand, G.; Grenier, J.F. Can the wound healing process be improved by vitamin supplementation? *Eur. Surg. Res.* **1996**, *28*, 306–314.
22. Slyshenkov, V.S.; Omelyanchik, S.N.; Moiseenok, A.G.; Trebukhina, R.V.; Wojtczak, L. Pantothenol protects rats against some deleterious effects of gamma radiation. *Free Radical Biol. Med.* **1998**, *24*, 894–899.
23. Osono, Y.; Hirose, N.; Nakajima, K.; Hata, Y. The effects of pantethine on fatty liver and fat distribution. *J. Atheroscler. Thromb.* **2000**, *7*, 55–58.
24. Zhou, B.; Westaway, S.K.; Levinson, B.; Johnson, M.A.; Gitschier, J.; Hayflick, S.J. A novel pantothenate kinase gene (PANK2) is defective in Hallervorden–Spatz syndrome. *Nat. Gene.* **2001**, *28*, 345–349.
25. Hayflick, S.J.; Westaway, S.K.; Levinson, B.; Zhou, B.; Johnson, M.A.; Ching, K.H.L.; Gitschier, J. Genetic, clinical and radiographic delineation of Hallervorden–Spatz syndrome. *N. Eng. J. Med.* **2003**, *348*, 33–40.
26. Jones, C.E.; Brook, J.M.; Buck, D.; Abell, C.; Smith, A.G. Cloning and sequencing of the *Escherichia coli panB* gene, which encodes ketopantoate hydroxymethyltransferase, and overexpression of the enzyme. *J. Bacteriol.* **1993**, *175*, 2125–2130.
27. Sweetman, L. Pantothenic acid and biotin. In *Biochemical and Physiological Aspects of Human Nutrition*; Stipanuk, M.H., Ed.; W.B. Saunders Co.: Philadelphia, 2000; 519–540.

#### FURTHER READING

- Tahiliani, A.G.; Beinlich, C.J. Pantothenic acid in health and disease. *Vitam. Horm.* **1991**, *46*, 165–228.



# Pau d'Arco or Lapacho (*Tabebuia*)

Walter H. Lewis

Adewole L. Okunade

Memory P.F. Elvin-Lewis

Washington University, St. Louis, Missouri, U.S.A.

## INTRODUCTION

Pau d'arco and lapacho are the Portuguese and Spanish names used to identify about 26 species of shrubs and trees of the genus *Tabebuia* (Bignoniaceae). These species are indigenous to the American tropics from Mexico to southern South America, with the majority of species found in Brazil and neighboring countries. They possess numerous bioactive compounds, with core activity in the naphthaquinones, particularly lapachol and  $\alpha$ - and  $\beta$ -lapachones. Other classes of compounds include the anthraquinones, flavonoids, iridoids, lignans, and terpenoids, all less well known or active than the more prevalent naphthaquinones. The stem bark and trunk or heartwood of *T. impetiginosa* (Mart. ex DC.) Standl. (synonym *T. avellanadae* Lor.), *T. rosea* (Bertol.) DC., and *T. serratifolia* (Vahl) Nichols. are the materials and species most commonly used in the preparation of botanicals and traditional and herbal medicines, and for research and clinical purposes.

Historical uses of pau d'arco species are most commonly reported for the treatment of syphilis, fevers, malaria, cutaneous infections, and stomach disorders. With a research impetus starting in the 1960s in Brazil, which led to preliminary clinical claims of efficacy in treating cancers, fresh interest in the significance of pau d'arco and its bioreactive compounds has arisen, both regarding basic and clinical research and among the general public.

## BACKGROUND

Widely used historically and currently in South America to treat a variety of infections and diseases, pau

d'arco became known in North America and Europe in the early 1980s. Acceptance of this botanical has been rapid, however, for the bark or wood prepared as an infusion or decoction is ingested regularly by at least one million people.<sup>[1]</sup> In 1995, it was listed among the top 25 selling herbs in the United States, and it represented 1.7% of herb sales in U.S. health food stores in 1996.<sup>[2]</sup>

One of the most important sources of pau d'arco inner bark and heartwood is *T. impetiginosa* (Fig. 1), a large tree up to 30 m tall, with deep pink to purple flowers, found from Mexico and Central America to tropical South America south to northern Argentina and Bolivia. Significant also is the large tree *T. rosea*, with pink to purple flowers, found from Mexico to northern South America, and *T. serratifolia* (Fig. 2), having yellow flowers, which occurs from Colombia to the Guyana and south to Brazil and Bolivia. These and a majority of the remaining 23 species of *Tabebuia* tested contain lapachol or related compounds, each with varying concentrations in the inner stem bark, heartwood, and leaves.

For medicinal purposes, indigenous people prefer the inner bark, although the heartwood is considered more potent. Leaves and flowers are less frequently used, and the roots rarely so.



**Fig. 1** Flowering branch of *Tabebuia impetiginosa*, a 30-m tree common in tropical South America. (Photograph by Al Gentry, courtesy of the Missouri Botanical Garden.) (View this art in color at [www.dekker.com](http://www.dekker.com).)

Walter H. Lewis, Ph.D., is Professor Emeritus at the Department of Biology, Washington University, St. Louis, Missouri, U.S.A.

Adewole L. Okunade, Ph.D., is Research Scientist at the Department of Biology, Washington University, St. Louis, Missouri, U.S.A.

Memory P.F. Elvin-Lewis, Ph.D., is Professor, Biomedicine in Microbiology and Ethnobotany at the Department of Biology, Washington University, St. Louis, Missouri, U.S.A.





**Fig. 2** Flowering branch of *Tabebuia serratifolia*, a 30-m tree common in Amazonian Brazil. (Photograph by Al Gentry, courtesy of the Missouri Botanical Garden.) (View this art in color at [www.dekker.com](http://www.dekker.com).)

Reports of traditional medicinal uses of *Tabebuia* species can be found on herbarium labels and in the literature, and they provide useful anecdotal evidence of prior use. Some examples are:

- *T. impetiginosa* to treat impetigo in Brazil around 1843.<sup>[3]</sup>
- *T. rosea* bark preparation drunk to treat malaria (Steiermark 51372, F); bark to treat rabies in Guatemala (Ruano 425, US); decoction of flowers, leaves, and roots taken internally and also applied externally for treating snakebites in Costa Rica; bark decoction prepared as a remedy for fevers, colds, and headaches;<sup>[4]</sup> bark infusion or decoction as a gargle in Colombia to treat throat ailments and fevers, and as an astringent.<sup>[5]</sup>
- *T. serratifolia* bark as a medicinal for the stomach among the Panará of Venezuela (Boom and Grillo 6209, MO).

Sometimes, such information is difficult to separate from neo-Western herbalism<sup>[6]</sup> when those practicing domestic medicine adopt new uses reported in popular press releases based on limited research. This is particularly evident in reports involving anticancer uses published in Brazil since 1960; no primary herbarium material or literature reference of traditional antineoplastic use can be found prior to this date. Thus, the citation of Schunke 14259 (MO) in 1998 reporting that bark infusions of *T. impetiginosa* are drunk by Peruvian natives to cure diabetes, malignant tumors, leukemia, other cancers, anemia, and Parkinson's disease is undoubtedly an instance of recent incorporation into indigenous pharmacopeia. Use of *T. rosea* bark by the Maya of Mexico against cancer can likewise be traced to the year 1985.<sup>[7]</sup> Similarly, the utilization of *T. serratifolia* bark in Colombia as an anticancer

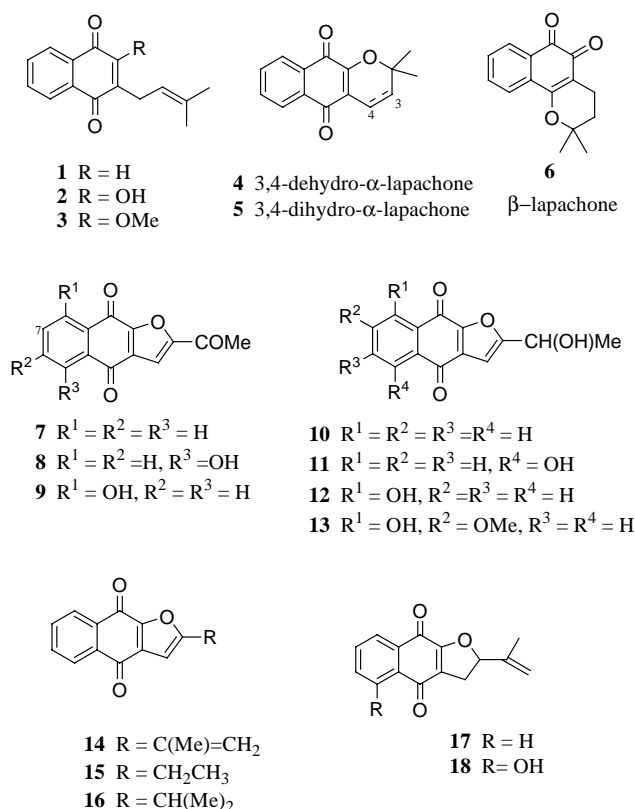
infusion or decoction can be attributed to Brazilian research of the 1960s and 1970s.<sup>[5]</sup>

All species known as pau d'arco should not be considered equivalent in toxicity or efficacy. The purple-flowered species are considered less toxic than the yellow-flowered ones, and the former are preferred. However, the bark and heartwood are routinely collected and used without regard to taxonomic identification, chemical composition, or biological activity.

## CHEMISTRY

Of the 26 species of *Tabebuia* known as pau d'arco, the secondary metabolic chemistry of about half has been well documented. Most contain naphthaquinone derivatives, but only *T. impetiginosa* also contains anthraquinones. In addition, some species possess flavonoids, iridoids, lignans, triterpenes, and other classes of compounds.

The naphthaquinones (Fig. 3) are the most prevalent class of compounds in *Tabebuia*. While a few species lack lapachol (**2**), it is commonly found in the three most important species, *T. impetiginosa*, *T. rosea*, and *T. serratifolia*. The derivatives prenylnaphthaquinone (**1**) and lapachol methylether (**3**) are also found in *T. impetiginosa*. Other prenylnaphthaquinones found



**Fig. 3** Naphthaquinones from *Tabebuia* spp.

in these species include dehydro- $\alpha$ -lapachone (**4**), dihydro- $\alpha$ -lapachone (**5**), and  $\beta$ -lapachone (**6**). In addition, the furanonaphthaquinone derivatives **7–18** are common in *T. impetiginosa*. The majority of these (**2**, **4–7**, **10–12**, **17**, and **18**) have been found in the inner bark.<sup>[8]</sup> The anthraquinone–naphthaquinol dimer, tabebuina (**22**) has also been reported in this species.<sup>[9]</sup> In addition to lapachol, **4**, **7**, **11**, and **14** have been isolated from the root, bark, and heartwood of *T. rosea*,<sup>[10]</sup> along with dehydrotectol (**19**) and the tecomaquinones **20**, **21**, **23**, and **24** from its heartwood (Fig. 4).<sup>[11]</sup> *T. serratifolia* also contains the constituents **2**, **4**, **5**, **11–13**, and **15**, obtained from extracts from the trunk's heartwood.<sup>[12]</sup>

Most pharmacological research has focused on lapachol; however, this is only one of the N-factors (naphthaquinones) responsible for the pharmacological activities of pau d'arco.<sup>[13]</sup> Lapachol is obtained in gram quantities from these species, in amounts ranging from 2% to 7% from the heartwood,<sup>[14]</sup> a level confirmed by Linardi,<sup>[15]</sup> who obtained 3.2% of the compound from petroleum and methanol extracts of finely powdered wood of *T. impetiginosa*. It was also obtained as a minor constituent from nonaqueous extracts of its inner bark,<sup>[8]</sup> but was not detectable in aqueous extracts. In an early publication (1914),

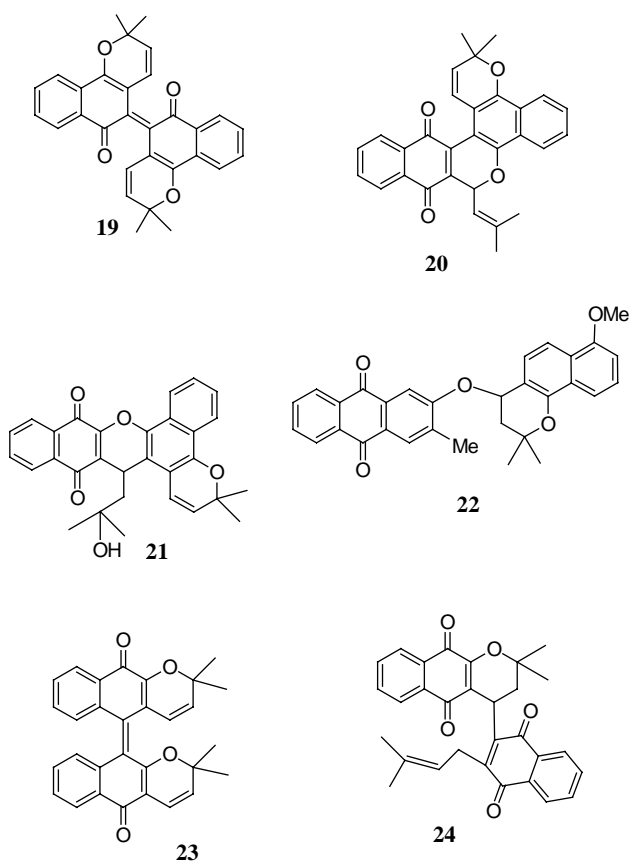


Fig. 4 Dimeric naphthaquinones from *Tabebuia* spp.

*T. serratifolia* wood was reported to have 7.64% lapachol.<sup>[16]</sup> Lapachol and  $\beta$ -lapachone are readily synthesized from 2-hydroxy-1,4-naphthaquinone at high yields.<sup>[17]</sup>

## BOTANICAL PRODUCTS, USES, AND ADVERSE REACTIONS

### Products

Pau d'arco is available as capsules, tablets, skin salves, extracts, and tea bags. Products with lapacho as a component are sold under such names as Advance Defense System Tablets, Brazilian Herbal Tea, Candistroy, Cat's Claw Defense Complex, Cellguard Coq 10 Nac, Healthgard with Echinacea, Immuno-Nourish, Ipe Roxo, Lapacho, Pau d'Arco, Pau d'Arco Inner Bark, Taheebo, and many others.

Powdered inner bark and/or heartwood are often prepared in the United States as decoctions, with one cup taken two to eight times per day. A decoction is prepared by boiling one teaspoon of powdered bark/heartwood for each cup of water for 5–10 min.<sup>[18]</sup> In other examples 2–3 teaspoons of inner bark is simmered in 500 ml of water for 15 min and taken three times a day.<sup>[19]</sup> In a more specific example using 460 mg capsules of inner bark/heartwood orally, 1–2 are ingested at meals with water twice daily, or 3–4 three times daily for no more than 7 days, depending on use.

In a study of 15 commercial products of pau d'arco obtained in Canada, naphthaquinones were detected in all samples except two, although no naphthaquinones were found in the three concentrates examined. Lapachol was detected in only two of these products. However, of two Brazilian products studied, one wood and the other a concentrate, both contained lapachol and related compounds.<sup>[20]</sup>

### Antifungal Use

As an example of herbal medicinal use, pau d'arco tea is drunk or applied vaginally as a douche to treat *Candida*, or an extract-soaked tampon is used to treat this and similar infections, often with associated inflammations.<sup>[21]</sup> Such extracts are also part of a patented nail varnish formulation for the treatment of human onychomycosis and paronychia.<sup>[22]</sup>

### Toxicity, Side Effects, and Interactions

Drinking extracts of yellow-flowered *T. umbellata* or *T. pedicellata* can cause abnormal swellings similar to burns and skin pustules to form. Only weak teas

made from 1 part bark to 10 parts water should be drunk.<sup>[1]</sup> Pau d'arco should be avoided when pregnant, breast-feeding, or taking anticoagulants, and by persons having severe liver disease, von Willebrand's disease, or thrombocytopenia. Its use may cause anemia, nausea, pinkish urine, unusual or excessive bleeding or vomiting, and diarrhea.<sup>[23]</sup>

### Allergic Reactions and Irritation

Exposure to wood dusts may cause skin and mucosal symptoms associated with allergic dermatitis. In the timber trade, allergic reactions to pau d'arco sawdust are common.<sup>[1]</sup>

## PRECLINICAL STUDIES

### In Vitro Studies

#### Antibacterial activity

Both Gram positive and negative microorganisms are affected by certain naphthaquinones through the generation of superoxide anions and hydrogen peroxide,<sup>[24]</sup> by the uncoupling of oxidative phosphorylation, and through electron transfer inhibition.<sup>[25]</sup> Of relevance to traditional uses for skin and gastrointestinal infections are the inhibitory activities of lapachol,  $\beta$ -lapachone,  $\alpha$ -xyloidone, and related compounds against *Staphylococcus aureus*,<sup>[25]</sup> including methicillin resistant strains,<sup>[26]</sup> and *Salmonella*.<sup>[21]</sup> Susceptibility of other organisms has also been demonstrated.<sup>[27]</sup>

#### Anticancer activity

The use of pau d'arco in Brazilian remedies to treat cancers has led to the identification of pau d'arco's active components, the production of some derivatives, partial elucidation of their mechanisms of action, and the conduct of preclinical and clinical evaluations in the treatment of carcinomas and leukemias.<sup>[28–30]</sup>

Current in vitro studies have provided a better understanding of the antiproliferative and immunosuppressive effects observed originally.<sup>[30]</sup> The naphthaquinones inhibit enzymes critical to cellular DNA replication, and other cellular functions, resulting in cell death. Their effects occur at macromolecular levels and result in the selective killing of certain cancer cell lines (colon, lung, prostate, breast, ovary) in unique ways that suggest that lapachol derivatives have the potential for use in therapies for specific cancers, e.g., breast and prostate.<sup>[31]</sup> Some also have increased cytotoxicity,<sup>[32]</sup> and others are effective in drug resistant cell lines.<sup>[33]</sup> Also, in lower doses, they are effective

radiosensitizers. They act by specifically and synergistically enhancing the cytotoxic effects of DNA-damaging agents and the effects of X-rays following prolonged drug exposures. These lapachol derivatives are not responsible for the molecular damage incurred by irradiation, but they prevent repair from occurring.<sup>[34]</sup> Because taxol and  $\beta$ -lapachone affect different phases of the cell division cycle, they can act synergistically by exploiting cell death "collisions," and thus have potential in the treatment of cancers such as multiple myeloma.<sup>[29]</sup>

#### Antifungal activity

Pau d'arco extracts and their components lapachol and  $\beta$ -lapachone are active against more than one known infection of the skin (ringworm) and nails,<sup>[25]</sup> and pathogenic yeasts such as *Candida* and *Cryptococcus neoformans*.<sup>[25]</sup> Activities of these naphthaquinones differ in that lapachol activity is comparable to that of ketoconazole, while  $\beta$ -lapachone is superior.<sup>[25]</sup>

#### Antimalarial activity

Early antimalarial studies claimed that lapachol was almost as active as quinine.<sup>[35]</sup> However, when tested recently, its activity against *Plasmodium falciparum* proved disappointing,<sup>[36]</sup> although several analogs of lapachol show enhanced bioreactivity.<sup>[37]</sup>

#### Antioxidant activity

The antioxidant activity of volatile constituents of the dried inner bark of *T. impetiginosa* is comparable to that of the antioxidants  $\alpha$ -tocopherol and butylated hydroxytoluene.<sup>[38]</sup>

#### Antipsoriatic activity

Lapachol from the inner bark of *T. impetiginosa* and several synthetic analogs have activities similar to those of the antipsoriatic drug anthralin.<sup>[8]</sup>

#### Antiviral activity

Studies indicate that lapachol,  $\beta$ -lapachone, and certain of their derivatives possess broad-spectrum antiviral capacities in vitro. Of those DNA viruses affected, lapachol inhibits replication of members of the herpesvirus group including HHV1, HHV2<sup>[39,40]</sup> and HHV4 (Epstein-Barr virus, or EBV).<sup>[41]</sup> Inhibitory effects against representative RNA viruses,<sup>[42]</sup> including HIV-1, have also been demonstrated.<sup>[43,44]</sup> The ability of  $\beta$ -lapachone to inhibit regulatory proteins, including tat, which affects the viral switch from

latency to active replication, is the subject of several current patents.<sup>[43]</sup>

### Antitrypanosomal activity

Chagas' disease, or American trypanosomiasis, is a devastating disease in South America, and transmission through blood transfusion is a serious concern. In vitro and in vivo inhibitory effects on *Trypanosoma cruzi* of lapachol,  $\beta$ -lapachone, and several 1,2-naphthaquinone derivatives<sup>[45,46]</sup> have led to the development of oxazolic, imidazolic,<sup>[47]</sup> and phenazine<sup>[48]</sup> derivatives, which have the potential to replace crystal violet as blood sterilants.

### Neurodegenerative effects

Lapachol and other naphthaquinones modulate the tau aggregation of proteins, and thus are assumed to effect the treatment or prophylaxis of neurodegenerative diseases and/or clinical dementias, such as Alzheimer's disease.<sup>[49]</sup>

### Snakebites

*T. rosea* bark has demonstrated 100% neutralization of the minimum hemorrhagic dose of *Bothrops atrox* venom in vitro. This correlates with traditional healers' statements from northwestern Colombia that *T. rosea* has antihemorrhagic properties.<sup>[50]</sup>

## In Vivo Studies

### Anticancer activity (rodents)

Crude extracts and lapachol were tested in implanted rodents against Walker 256 carcinosarcoma. Lapachol showed highly significant antitumor activity especially when administered orally, with relatively little effect on host body weight.<sup>[51]</sup> In this model, a 92% reduction in tumor growth occurred, and lapachol's tetra-acetylglucoside derivative increased lifespan by 80% in mice with lymphocytic leukemia P-388.<sup>[15]</sup>

Treatment with  $\beta$ -lapachol following exposure to irradiation optimized the effects of delayed tumor growth in mice with RKO (colorectal cancer cells) induced tumors.<sup>[52]</sup> In human ovarian and prostate tumor prexenografted mouse models, a synergistic cytotoxic effect was demonstrated using taxol and  $\beta$ -lapachone.<sup>[53]</sup>

### Antischistosomiasis activity (mice)

Oral administration of lapachol protected mice from topical infection with *Schistosoma mansoni* cercariae

and also significantly reduced the trematode burden in infected mice.<sup>[54]</sup> Topical application of other naphthaquinones also prevented cercarial penetration,<sup>[55]</sup> with highest activities found when lapachol and its 0-alkyl and 9-acetyl derivatives or  $\beta$ -lapachone were used. Molluscicidal activity was also elicited using other naphthaquinones.<sup>[56]</sup>

### Cancer chemopreventive action (Mice)

1,4-Furanonaphthaquinones with an OH group on the dihydrofuran ring, such as avicequinone-A and avicenol-A, showed the highest bioreactivities in the EBV early activation model and in a chemoprovocative tumor-inducing mouse model.<sup>[57]</sup>

### Toxicity in vivo (rodents, dogs, monkeys)

Lapachol from the bark of *T. ochracea* was tested during rat fetogenesis from days 17 to 20 of pregnancy. While lapachol was not toxic to rat mothers, it was fetotoxic, leading to intrauterine growth retardation of pups compared to untreated controls ( $P < 0.01$ ). There was also significant weight reduction ( $P < 0.01$ ) in lungs, livers, and kidneys of treated pups. Putative effects in women cannot be ignored.<sup>[58,59]</sup>

In oral toxicity tests using lapachol, rodents, dogs, and monkeys developed moderate to severe anemia during the first 2 weeks of treatment, but recovery was evident at 4 weeks of treatment. Monkeys receiving up to 0.25 g/kg/day completed the treatment and recovery periods, with those receiving higher doses developing infrequent emesis, anorexia, pallor of mucous membranes, and periods of diarrhea. Dogs and rats were able to tolerate much larger doses of lapachol than either monkeys or mice. A gender difference was also evident in mice: males tolerated less lapachol than females.<sup>[60]</sup>

## CLINICAL TRIALS

### Anticancer Efficacy

Promising anticancer reports in humans were widely disseminated in South America in the popular press and the medical literature in the 1960s<sup>[21]</sup> and later, and these elicited the U.S. National Cancer Institute's (NCI) attention.<sup>[61]</sup> However, according to NCI evaluations' they did not fulfill the criteria for further development in that studies with the *Tabebuia* constituent lapachol were disappointing, and clinically it induced nausea, vomiting, and prolonged prothrombin times due to its anti-vitamin K action.<sup>[28]</sup> Because lapachol targets vitamin K dependent reactions, such as the

reversible activation of ligand for the axl receptor tyrosine kinase, this compound, like warfarin, may have value in cases where axl is overexpressed. Consequently, lapachol may have value in the treatment of small cell carcinoma, metastatic colon cancer, and adenocarcinomas of the colon.<sup>[62]</sup> To overcome its insolubility, use of  $\beta$ -lapachone as a second anticancer agent alone or in combination with radiation therapy requires the development of pharmaceutically acceptable and solubilizing carrier molecules.<sup>[63]</sup>

Anecdotal reports of lapachol's antitumor effects continue to accumulate, possibly because additional early studies indicated that lapachol had a selective affinity for tumor cells that impeded their respiration, resulting in the evolution of free oxygen radicals and destruction of nucleic acid. In addition to lapachol, other naphthaquinones and bioreactive compounds in these extracts may be contributing to the positive clinical effects being elicited.<sup>[28]</sup>

### Anticervicitis/Antivaginitis

Twenty Brazilian patients suffering from cervicitis and cervico-vaginitis caused by *Trichomonas vaginalis* or *Candida albicans* were evaluated for the effectiveness of daily changes of tampons soaked with extracts of *T. impetiginosa* heartwood.<sup>[64]</sup> After 5–29 days, successful treatment was considered complete, with re-epithelialization of inflamed areas. No patient reported adverse side effects.

### REGULATORY STATUS

In Canada, pau d'arco bark is classified as a "new drug," and at least till 1993, its sale was prohibited throughout the country. Pau d'arco is not listed in either *The Complete German Commission E Monographs* (1998) or the *Herbal Medicine Supplement* (2000), which provide the standards for use of botanicals and phytomedicines in Germany.<sup>[65]</sup> There is no specific regulation of pau d'arco in the United States.

### CONSERVATION

Since it became popular as a medicinal in the 1960s, many populations of *Tabebuia* species have been destroyed indiscriminately. Timber use is also impacting the availability of *T. angustatus* and *T. heterophylla* in the West Indies, *T. heptaphylla* and *T. rosea* wherever native, and *T. billbergii* and *T. chrysantha* in Ecuador.<sup>[1]</sup> A program to conserve these and other members of the Bignoniaceae is sorely needed throughout the Neotropics.

### ACKNOWLEDGMENTS

We appreciate the personal communications from Dr. Lúcia Lohmann, Brazilian researcher of the Bignoniaceae, at the Missouri Botanical Garden, St. Louis, Missouri, and thank Gayle Engels of the American Botanical Council, Austin, Texas, and Natasha Y. Hall of the American Herbal Products Association, Silver Spring, Maryland, for documents on pau d'arco.

### REFERENCES

1. Jones, K. *Pau d'Arco: Immune Power from the Rain Forest*; Healing Arts Press: Rochester, VT, 1995.
2. Arenas, P.; Moreno Azorero, R. Plants of common use in Paraguayan folk medicine for regulating fertility. *Econ. Bot.* **1977**, *31* (2), 298–301.
3. Martius, C.F. *Systema Materiae Medicae Vegetabilis Brasiliensis*. 1843.
4. Morton, J.F. *Atlas of Medicinal Plants of Middle America*; Charles C., Thomas, Ed.; Springfield: IL, 1981; 827–829.
5. García Barriga, H. *Flora Medicinal de Colombia*; Instituto de Ciencias: Naturales, Bogota, 1975; Vol. 3.
6. Elvin-Lewis, M. Should we be concerned about herbal remedies? *J. Ethnopharmacol.* **2001**, *75*, 141–164.
7. Dominguez, X.A.; Alcorn, J.B. Screening of medicinal plants used by the Huastec Mayans of northeastern Mexico. *J. Ethnopharmacol.* **1985**, *13*, 139–156.
8. Müller, K.; Sellmer, A.; Wiegrebe, W. Potential antipsoriatic agents: lapacho compounds as potent inhibitors of HaCaT cell growth. *J. Nat. Prod.* **1999**, *62* (8), 1134–1136.
9. Burnett, A.R.; Alan, R.; Thompson, R.H. Naturally occurring quinones. X. Quinonoid constituents of *Tabebuia avellanadae*. *J. Chem. Soc. C: Organic* **1967**, *21*, 2100–2104.
10. Jain, S.; Chauhan, P.; Singh, P. Quinonoid constituents from some Bignoniaceae plants. *J. Indian Chem. Soc.* **2002**, *79* (12), 946–948.
11. Sharma, P.K.; Khanna, R.N.; Rajinder, N.; Rohatgi, B.K.; Thomson, R.H. Tecomaquinone III: a new quinone from *Tabebuia pentaphylla*. *Phytochemistry* **1988**, *27* (2), 632–633.
12. Vidal-Tessier, A.M.; Delaveau, P.; Champion, B.; Jacquemin, H. Lipophilic quinones of the trunk

- wood of *Tabebuia serratifolia* (Vahl.) Nichols. Ann. Pharm. Fr. **1988**, 46 (1), 55–57.
13. Mowry, D.B. Ancient herb, modern miracle. <http://www.pau-d-arco.com/Dr.Mowry.html> (accessed 2003).
  14. Steinert, J.; Khalaf, H.; Rimpler, M. High-performance LC separation of some naturally occurring naphthaquinones and anthraquinones. J. Chromatogr. A **1996**, 723 (1), 206–209.
  15. Linardi, M.da.C.F.; de Oliveira, M.M.; Sampaio, M.R.P. A lapachol derivative active against mouse lymphocytic leukemia P-388. J. Med. Chem. **1975**, 18 (11), 1159–1161.
  16. Matthies, H.; Schreiber, E. Poisonous woods. Ber. Dtsch. Pharm. Ges. **1914**, 24, 385–444.
  17. Jiang, Z.; Hogeland, J. The synthesis of  $\beta$ -lapachone and its intermediates. US Patent 6,458,974, 2002.
  18. Murray, T.M. A guide to medicinal herbs. In *Natural Alternatives to Over-the-Counter and Prescription Drugs*; William Morrow and Company: New York, 1994; 304–305.
  19. Foster, S. *Herbs for Your Health*; Interweave Press: Loveland, CO, 1996; 70–71.
  20. Awang, D.V.C.; Dawson, B.A.; Ethier, J.-C.; Gentry, A.H.; Girard, M.; Kindack, D. Naphthaquinone constituents of commercial lapacho/pau d'arco/taheebo products. J. Herbs Spices Med. Plants **1994**, 2 (4), 27–43.
  21. de Santana, C.F.; de Lima, O.G.; d'Albuquerque, I.L.; Lacerda, A.L.; Martins, D.G. Antitumoral and toxicological properties of extracts of bark and various wood components of pau d'arco (*Tabebuia avellanedae*). Rev. Inst. Antibiot. **1968**, 8 (1), 89–94 (in Portuguese); Kustrak, D. Taheebo–lapacho–*Tabebuia impetiginosa* (syn. *Tabebuia avellanedae*). Farm. Glasnik **2001**, 57 (6), 215–222.
  22. Strauss, R. Nail evulsion compositions for treatment of nail bed infections. US Patent 5,993,790, 1999.
  23. Festrow, C.W.; Avila, J.R. *The Complete Guide to Herbal Medicine*; Springhouse Corp.: Springhouse, PA, 1999; 368–369; Pierce, A. *The American Pharmaceutical Association Practical Guide to Natural Medicines*; William Morrow and Co.: New York; 1999, 491–493.
  24. Cruz, F.S.; Docampo, R.; Boveris, A. Generation of superoxide anions and hydrogen peroxide from beta-lapachone in bacteria. Antimicrob. Agents Chemother. **1978**, 14 (4), 630–633.
  25. Guiraud, P.; Steiman, R.; Campos-Takaki, G.M.; Seigle-Murandi, F.; Simeon de Buochberg, M. Comparison of antibacterial and antifungal activities of lapachol and beta-lapachone. Planta Med. **1994**, 60 (4), 373–374.
  26. Machado, T.B.; Pinto, A.V.; Pinto, M.C.F.R.; Leal, I.C.R.; Silva, M.G.; Amaral, A.C.F.; Kuster, R.M.; Netto-dos Santos, K.R. In vitro activity of Brazilian medicinal plants, naturally occurring naphthoquinones and their analogues, against methicillin-resistant *Staphylococcus aureus*. Int. J. Antimicrob. Agents **2003**, 21 (3), 279–284.
  27. Gafner, S.; Wolfender, J.-L.; Nianga, M.; Stoeckli-Evans, H.; Hostetmann, K. Antifungal and antibacterial naphthoquinones from *Newbouldia laevis* roots. Phytochemistry **1996**, 42 (5), 1315–1320.
  28. Oswald, E.H. Review of lapacho (pau d'arco). Br. J. Phytother. **1993/1994**, 3, 112–117.
  29. Pardee, A.B.; Li, Y.Z.; Li, C.J. Cancer therapy with beta-lapachone. Curr. Cancer Drug Targets **2002**, 2 (3), 227–242.
  30. da Silva, M.N.; Ferreira, V.F.; de Souza, M.C.B.V. An overview of the chemistry and pharmacology of naphthoquinones with emphasis on  $\beta$ -lapachone and derivatives. Quim. Nova **2003**, 26 (3), 407–416.
  31. Liao, S.; Hiipakka, R.A. Methods and compositions for regulation of 5-alpha reductase activity. PCT Int. Appl. **1999**, 48.
  32. Oliveira, M.F.; Lemos, T.G.; de Mattos, M.C.; Segundo, T.A.; Santiago, G.M.; Braz-Filho, R. New enamine derivatives of lapachol and biological activity. Ann. Acad. Bras. Cienc. **2002**, 74 (2), 211–221.
  33. Dolan, M.E.; Frydman, B.; Thompson, C.B.; Diamond, A.M.; Garbiras, B.J.; Safa, A.R.; Beck, W.T.; Marton, L.J. Effects of 1,2-naphthoquinones on human tumor cell growth and lack of cross-resistance with other anticancer agents. AntiCancer Drugs **1998**, 9 (5), 437–448.
  34. Boothman, D.A.; Trask, D.; Pardee, A.B. Inhibition of potentially lethal DNA damage repair in human tumor cells by  $\beta$ -lapachone, an activator of topoisomerase I. Cancer Res. **1989**, 49 (3), 605–612.
  35. Fieser, L.F. Hooker's researches on lapachol in relation to new developments in the field of chemotherapy. Rec. Chem. Prog. **1946**, 7 (3/4), 26–45.
  36. Carvalho, L.H.; Rocha, E.M.; Raslan, D.S.; Oliveira, A.B.; Krettli, A.U. In vitro activity of natural and synthetic naphthoquinones against

- erythrocytic stages of *Plasmodium falciparum*. Braz. J. Med. Bio. Res. **1988**, *21* (3), 485–487.
37. Kapadia, G.J.; Azuine, M.A.; Balasubramanian, V.; Sridhar, R. Aminonaphthoquinones—a novel class of compounds with potent antimalarial activity against *Plasmodium falciparum*. Pharmacol. Res. **2001**, *43* (4), 363–367.
  38. Park, B.-S.; Lee, K.-G.; Shibamoto, T.; Lee, S.-E.; Takeok, G.R. Antioxidant activity and characterization of volatile constituents of taheebo (*Tabebuia impetiginosa* Martius ex DC.). J. Agric. Food Chem. **2003**, *51* (1), 295–300.
  39. Lagrota, M.H.; do, C.; Wigg, M.D.; Pereira, L.O.B.; Fonseca, M.E.F.; Pereira, N.A.; Guimaraes, J.C. Antiviral activity of lapachol. Rev. Microbiol. **1983**, *14* (1), 21–26.
  40. da Silva, A.J.; Buarque, C.D.; Brito, F.V.; Aurelian, L.; Macedo, L.F.; Malkas, L.H.; Hickey, R.J.; Lopes, D.V.; Noel, F.; Murakami, Y.L.; Silva, N.M.; Melo, P.A.; Caruso, R.R.; Castro, N.G.; Costa, P.R. Synthesis and preliminary pharmacological evaluation of new (+/–) 1,4-naphthoquinones structurally related to lapachol. Bioorg. Med. Chem. **2002**, *10* (8), 2731–2738.
  41. Ueda, S.; Umemura, T.; Dohguchi, K.; Matsuzaki, T.; Tokuda, H.; Nishino, H.; Iwashima, A. Production of anti-tumor-promoting furanonaphthoquinones in *Tabebuia avellanedae* cell cultures. Phytochemistry **1994**, *36* (2), 323–325.
  42. Pinto, A.V.; Pinto, M.C.; Lagrota, M.H.; Wigg, M.D.; Aguiar, A.N. Antiviral activity of naphthoquinones. I. Lapachol derivatives against enteroviruses. Rev. Latinoam. Microbiol. **1987**, *29* (1), 15–20.
  43. Li, C.J.; Zhang, L.J.; Dezube, B.J.; Crumpacker, C.S.; Pardee, A.B. Three inhibitors of type 1 human immunodeficiency virus long terminal repeat-directed gene expression and virus replication. Proc. Natl. Acad. Sci. U.S.A. **1993**, *90* (5), 1839–1842.
  44. Min, B.-S.; Miyashiro, H.; Hattori, M. Inhibitory effects of quinones on RNase H activity associated with HIV-1 reverse transcriptase. Phytother. Res. **2002**, *16* (2), S57–S62.
  45. Boveris, A.; Docampo, R.; Turrens, J.F.; Stoppani, A.O. Effect of beta-lapachone on superoxide anion and hydrogen peroxide production in *Trypanosoma cruzi*. Biochem. J. **1978**, *175* (2), 431–439.
  46. Goncalves, A.M.; Vasconcellos, M.E.; Docampo, R.; Cruz, F.S.; de Souza, W.; Leon, W. Evaluation of the toxicity of 3-allyl-beta-lapachone against *Trypanosoma cruzi* bloodstream forms. Mol. Biochem. Parasitol. **1980**, *1* (3), 167–176.
  47. Santos, A.F.; Ferraz, P.A.; de Abreu, F.C.; Chiari, E.; Goulart, M.O.; Santa Ana, A.E. Molluscicidal and trypanocidal activities of lapachol derivatives. Planta Med. **2001**, *67* (1), 92–93.
  48. Neves, P.C.; Malta, V.R.; Pinto, M.C.; Santos, R.H.; de Castro, S.L.; Pinto, A.V. A trypanocidal phenazine derived from beta-lapachone. J. Med. Chem. **2002**, *45* (10), 2112.
  49. Wischik, D.M.; Horsley, D.; Rickard, J.E.; Harrington, C.R. Naphthaquinone derivatives as inhibitors of tau aggregation for the treatment of Alzheimer's and related neurodegenerative disorders. International Patent Application 2003, 66.
  50. Otero, R.; Núñez, V.; Barona, J.; Fonnegra, R.; Jiménez, S.L.; Osorio, R.G.; Saldarriaga, M.; Díaz, A. Snakebites and ethnobotany in the northwest region of Colombia, Part III. J. Ethnopharmacol. **2000**, *73* (1–2), 233–241.
  51. Rao, K.V.; McBride, T.J.; Oleson, J.J. Recognition and evaluation of lapachol as an antitumor agent. Cancer Res. **1968**, *28*, 1952–1954.
  52. Choi, E.; Kim, Y.; Ahn, S.; Lee, S.; Park, H.; Song, C. Synergistic effect of ionizing radiation and  $\beta$ -lapachone against tumor in vitro and in vivo. Int. J. Radiat. Oncol. Biol. Phys. **2003**, *57* (2S), S351.
  53. Li, Y.; Sun, X.; LaMont, J.T.; Pardee, A.B.; Li, C.J. Selective killing of cancer cells by  $\beta$ -lapachone: direct checkpoint activation as a strategy against cancer. Proc. Natl. Acad. Sci. U.S.A. **2003**, *100* (5), 2674–2678.
  54. Austin, F.G. *Schistosoma mansoni* chemoprophylaxis with dietary lapachol. Am. J. Trop. Med. Hyg. **1974**, *23* (3), 412–419.
  55. Pinto, A.V.; Pinto, M.D.; Gilbert, B.; Pellegrino, J.; Mello, R.T. *Schistosomiasis mansoni*: blockage of cercarial skin penetration by chemical agents: I. naphthoquinones and derivatives. Trans. R. Soc. Trop. Med. Hyg. **1977**, *71* (2), 133–135.
  56. Lima, N.M.F.; dos Santos, A.F.; Porfirio, Z.; Goulart, M.O.F.; Sant'Ana, A.E.G. Toxicity of lapachol and isolapachol and their potassium salts against *Biomphalaria glabrata*, *Schistosoma mansoni* cercariae, *Artemia salina* and *Tilapia nilotica*. Acta Trop. **2002**, *83* (1), 43–47.
  57. Itoigawa, M.; Ito, C.; Tan, H.T.-W.; Okuda, M.; Tokuda, H.; Nishino, H.; Furukawa, H. Cancer

- chemopreventive activity of naphthoquinones and their analogs from *Avicennia* plants. *Cancer Lett.* **2001**, *174* (2), 135–139.
58. Felício, A.C.; Chang, C.V.; Brandão, M.A.; Peters, V.M.; Guerra, M.O. Fetal growth in rats treated with lapachol. *Contraception* **2002**, *66*, 289–293.
59. Guerra, M.O.; Mazoni, A.S.B.; Brandão, M.A.F.; Peters, V.M. Interceptive effect of lapachol in rats. *Contraception* **1999**, *60* (5), 305–307.
60. Morrison, R.K.; Brown, D.E.; Oleson, J.J.; Cooney, D.A. Oral toxicology studies with lapachol. *Toxicol Appl. Pharmacol.* **1970**, *17*, 1–11.
61. Block, J.B.; Serpick, A.A.; Miller, W.; Wiernik, P.H. Early clinical studies with lapachol (NSC-11905). *Cancer Chemother. Rep. Part 2*, **1974**, *4* (4), 27–28.
62. Dinnen, R.D.; Ebisuzaki, K. The search for novel anticancer agents: a differentiation-based assay and analysis of a folklore product. *Anticancer Res.* **1997**, *17* (2A), 1027–1033.
63. Miyamoto, S.; Huang, T.T.; Wuerzberger-Davis, S.; Bornmann, W.G.; Pink, J.J.; Tagliarino, C.; Kinsella, T.J.; Boothman, D.A. Cellular and molecular responses to topoisomerase I poisons. Exploiting synergy for improved radiotherapy. *Ann. N. Y. Acad. Sci.* **2000**, *922*, 274–292.
64. Wanick, M.C.; Bandeira, J.A.; Fernandes, R.V. Antiinflammatory and cicatrizing activities of aqueous–alcohol extracts from pau d'arco rôxo (*Tabebuia avellanedae*) in patients having cervicitis and cervico-vaginitis. *Rev. Inst. Antibiot. Recife* **1970**, *10* (1/2), 41–46 (in Portuguese).
65. Blumenthal, M.; Goldberg, A.; Brinckmann, J. *Herbal Medicine: Expanded Commission E Monographs*; Integrative Medicine Communications: Newton, MA, 2000; 519.





# Phosphorus

## John J.B. Anderson

Schools of Public Health and Medicine, University of North Carolina, Chapel Hill, North Carolina, U.S.A.

## Sanford C. Garner

Constella Group, Inc., Durham, North Carolina, U.S.A.

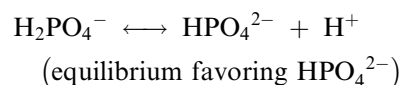
## INTRODUCTION

Phosphorus (P) is the name of element number 32 of the periodic table. It does not exist in nature as such; rather, it is present almost exclusively as phosphate anions in food. Most of these anions are inorganic, but some are derived from pre-existing organic molecules that contain phosphate groups (see below).

In the biological sciences, the term phosphate is used rather than phosphorus.

## GENERAL DESCRIPTION

The two major anionic forms of phosphate are  $\text{HPO}_4^{2-}$  (metaphosphate) and  $\text{H}_2\text{PO}_4^-$  (orthophosphate), which are interconvertible by the addition or removal of a hydrogen ion and an electron. A third form,  $\text{PO}_4^{3-}$ , exists, but it is quite rare in biological tissues: it is the anion of phosphoric acid ( $\text{H}_3\text{PO}_4$ ). In human body fluids (pH 7.4), the usual ratio is 4  $\text{HPO}_4^{2-}$  ions to 1  $\text{H}_2\text{PO}_4^-$  ion. The relationship between the two major biological phosphate anions at equilibrium is as follows:



Phosphorus, primarily in the form of phosphates, has three major dietary sources: 1) foods containing natural phosphates; 2) foods containing phosphate additives; and 3) supplements containing phosphates. Although some amount of phosphorus is present in

all foods, foods high in protein are typically also high in phosphorus. Milk, eggs, meat, poultry, and fish contain the highest amounts of phosphorus, whereas fruits and vegetables have relatively less of the element. Sixty percent of the daily phosphorus intake of North Americans comes from milk and meat against only 10% from fruits and fruit juices.<sup>[1]</sup> Legumes, cereals, and grains are also good sources of phosphorus and contribute almost 20% of the dietary intake. Phosphorus consumption from foodstuffs is increasing, despite an overall decline in the consumption of red meat and milk, because of the steady rise in consumption of cheese (especially processed types), poultry, and fish.<sup>[2]</sup>

Phosphate additives, the most rapidly growing source of phosphorus in the U.S. diet, may contribute to as much as 30% of overall phosphorus intake.<sup>[3]</sup> This source of the mineral remains largely unnoticed by consumers because details of the phosphate content of a food product are not required on the label. Many salts containing phosphorus are used by the food industry to preserve moisture or color, as emulsifiers and sequestrants, or to enhance and stabilize frozen foods. Such processing of foods, now commonplace in the United States, adds significant amounts of phosphate to daily intakes—an estimated minimum of 200–300 mg/day. Approximately 125 phosphorus-containing additives on the generally recognized as safe (GRAS) list are commonly used; those with up-to-date toxicology information are listed in Table 1. Common foods that contain phosphate additives are soft drinks, processed cheese, luncheon meat, products with leavening agents (like waffles), frozen foods (like pizza with added flavorings), and fast food items. As an increasing number of phosphate-containing additives enter the food supply, largely unnoticed, the effects of lower calcium to phosphorus ratios in the diet need to be considered.

Many dietary supplements now contain phosphorus. One such supplement commonly used by athletes is creatine phosphate. This substance, found naturally in muscle fibers, can be used to generate ATP and serves as a “quick energy” source. Advanced as a means of increasing muscle strength during

*John J.B. Anderson, Ph.D.*, is at the Department of Nutrition, Schools of Public Health and Medicine, University of North Carolina, Chapel Hill, North Carolina, U.S.A.

*Sanford C. Garner, Ph.D.*, is at Constella Group, Inc., Durham, North Carolina, U.S.A.

**Table 1** Commonly used phosphate-containing food additives

Ammonium phosphate
Mono-/diglyceride derivatives
Sodium aluminum pyrophosphate
Calcium phosphate
Phosphoric acid
Sodium acid pyrophosphate
Dipotassium phosphate
Potassium phosphate
Sodium phosphate
Ferric phosphate
Potassium pyrophosphate
Sodium tripolyphosphate
Magnesium phosphate
Potassium tripolyphosphate
Modified food starches, distarch phosphate

workouts, creatine phosphate is commonly used by athletes and bodybuilders. Health professionals do not promote the product, since research has failed to show any real beneficial effects. Many other “muscle-building” formulas, e.g., Ripped Fuel<sup>®</sup>, are also high in phosphorus because they contain large amounts of animal protein.

Nutritional supplements such as Ensure<sup>®</sup> and Boost<sup>®</sup>, consumed predominately by older individuals and nutritionally balanced in macronutrients and micronutrients, contain calcium and phosphorus at a ratio of approximately 1:1. Infant formulas have a ratio greater than 1:1. These products are not likely to contribute to excessive phosphorus intakes.

The recommended intakes of phosphorus for U.S. and Canadian citizens have been revised recently.<sup>[4]</sup> The dietary reference intake (DRI) of phosphorus for men and women over the age of 19 yr is 700 mg/day (Table 2). Phosphorus is usually consumed with the protein fraction of food. Generally, every gram of protein consumed contains 15 mg of phosphorus. The rate of intestinal phosphorus absorption, 50–70% on average, is high in relation to the rates for other minerals.

**Table 2** Dietary reference intake (DRI) for phosphorus (mg/day)

Life stage group	Males	Females
9–18 yr	1250	1250
19–>70 yr	700	700

(From Ref.<sup>[4]</sup>.)

## OVER-THE-COUNTER (OTC) PHOSPHATE SUPPLEMENTS

The *Physician's Desk Reference*<sup>[5]</sup> includes a few entries of phosphate salts, but these are typically combined with other nutrients, particularly calcium. Common OTC supplements generally contain little or no phosphate.

## INTESTINAL ABSORPTION OF PHOSPHORUS AS PHOSPHATE IONS

The intestinal absorption of phosphorus as inorganic phosphate ( $P_i$ ) is highly efficient, particularly in infants, in whom up to 80–90% of  $P_i$  may be absorbed. The efficiency is lower in adults but may still be in the range of 50–60% or even higher. In contrast, the intestinal absorption of calcium is usually considered to be between 25% and 30% in adults.

The absorption of organic phosphorus present in phospholipids and other molecules may take place in the intestines, but phosphate groups are typically split up in the gut lumen or on cell surfaces by phosphatases and phospholipases, which are either secreted by the pancreas or exist on the surface of intestinal absorbing cells.

## BLOOD CONCENTRATIONS OF PHOSPHATE IONS

Phosphorus circulates in the blood both as a component of organic molecules, primarily phospholipids, and as inorganic phosphate. Inorganic phosphate can exist in several different ionization states, including  $PO_4^{3-}$ ,  $HPO_4^{2-}$ , and  $H_2PO_4^-$ . Because of the relative solubility of its different forms, approximately 44% of total  $P_i$  is in the form of free  $H_2PO_4^-$ , while 10% is present as free  $HPO_4^{2-}$ . The remaining 46% is bound to either serum proteins (12%) or cations (34%), primarily calcium.

## PHOSPHATE HOMEOSTASIS

Serum  $P_i$  concentration is regulated by the same processes that regulate serum ionized calcium. However, the homeostasis of serum  $P_i$  is not as rigorous as that of calcium. The hormonal regulation of serum  $P_i$  primarily involves parathyroid hormone (PTH), calcitonin, and 1,25-dihydroxyvitamin D, but many other hormones, including insulin, glucagons, growth hormone, estrogens, adrenaline, and adrenal corticosteroids, also affect  $P_i$  homeostasis. Although a direct feedback mechanism has been proposed for  $P_i$

concentration in the regulation of 1,25-dihydroxyvitamin D synthesis, most of the regulatory feedback for PTH and calcitonin is believed to involve the concentration of serum ionized calcium. The use of calcium ion concentration in regulation is understandable given the well-known tendency of serum phosphate and ionized calcium to move in opposite directions. Since phosphate and calcium ions readily form a complex with each other, an increase in phosphate will decrease the concentration of ionized calcium, while a decrease in the phosphate concentration will allow more calcium to circulate in its free or ionized form. Thus, regulation of  $P_i$  in serum is mediated through changes in ionized calcium.

Phosphate homeostatic mechanisms primarily involve renal regulation. If the kidneys decline in function, as in chronic renal failure, phosphate cannot be efficiently excreted and the serum phosphate concentration increases, perhaps even to levels twice as high as the serum calcium concentration.

### URINARY PHOSPHATE EXCRETION

A major regulatory mechanism for the control of serum  $P_i$  concentration is renal excretion. Free  $P_i$  from serum passes freely through the glomeruli as part of the urinary filtrate. The reabsorption process, which is under the control of PTH, can return most of the filtered  $P_i$  to the serum. Parathyroid hormone reduces the efficiency of the reabsorption and increases the excretion of  $P_i$ , thus lowering the circulating serum  $P_i$  concentration even when the efflux from bone is increased. Because renal excretion of  $P_i$  is the major regulatory mechanism controlling the concentration of this ion, the decrease in glomerular filtration rate during the development of renal failure results in a characteristic increase in serum  $P_i$  concentration. As the increased serum  $P_i$  complexes more ionized calcium in the serum, the resulting hypocalcemia stimulates secretion of PTH, contributing to an increased movement of calcium and phosphate from bone into serum. The increased load of  $P_i$  acts to worsen the hyperphosphatemia. Eventually, the chronic elevation of PTH can cause a high-bone-turnover lesion known as osteitis fibrosa. The formation of such bone lesions and others resulting from chronic renal failure is referred to as renal osteodystrophy.

An important aspect of treating chronic renal failure is the control of the elevated serum  $P_i$ . The usual approaches to this control are decreased dietary  $P_i$  intake and treatment with phosphate binders, such as calcium carbonate. Aluminum-based phosphate binders, such as aluminum hydroxide, were often used in the past, but the toxic effects of aluminum on bone

and the nervous system have greatly restricted their use. Newer phosphate binders, such as sevelamer, a non-absorbable gel, are more effective and less toxic.

### ACTIONS OF PHOSPHATES

The widespread biological use of phosphate groups makes these anions essential for both organic and inorganic components within cells and in extracellular structural tissues such as bones and teeth. About 600 g (19.4 mol) of phosphorus is present in the adult human body—85% in the skeleton, 14% in the soft tissues, and 1% in the extracellular fluids, intracellular structures, and cell membranes. The small amount of phosphate ions in extra- and intracellular fluids serves as the compartment to which dietary phosphorus is first added and from which the kidneys clear phosphate ions. Excretion of these ions permits additional hydrogen ions to be secreted by renal tubules, which acidifies the urine. Phosphate ions that are resorbed from bone also enter this fluid compartment. The concentration of phosphorus in adult plasma ranges from 2.5 to 4.5 mg/dl (0.81–1.45 mmol/L), but this concentration declines gradually with age.<sup>[6]</sup> Phosphate anions participate in numerous cellular reactions and physiological processes and are key components of essential molecules such as phospholipids, adenosine triphosphate (ATP), and nucleic acids.

Phosphate ions interact with calcium ions in the body and thereby influence the secretion of PTH. Excessive absorption of phosphate lowers the serum calcium ion concentration, which in turn signals the parathyroid glands to increase PTH secretion. If PTH secretion remains elevated continuously because of a low dietary calcium-to-phosphorus ratio, bone resorption may also be continuously upregulated, which may, over a period of months to years, lead to a significant reduction in bone mass and density. This potential scenario of low calcium–high phosphate has only been observed experimentally for short periods, up to as long as a month, with a continuous elevation of PTH in healthy young adult women.<sup>[7]</sup>

High phosphate intakes contribute to acid generation and acidic urine. Such an increase in dietary acid load may require buffering by bone,<sup>[8]</sup> which may result in the loss of bone mass and density.

Phosphate ions are essential to life due to both their cellular roles and their extracellular uses, such as in the mineralization of bones and teeth. Excessive amounts of dietary phosphorus plus a low calcium intake may have adverse effects on skeletal retention of mineral and, therefore, on strength.

## PHOSPHATE IN BONE MINERALIZATION

Phosphate ions move in and out of the bone fluid compartment from the extracellular fluid, including blood, in large amounts over a 24-hr period. These bidirectional fluxes relate to bone formation and resorption. In the growth phases of life, especially in children, a net gain of phosphate occurs as bone mass increases; in late life, when resorption predominates over formation, the phosphate flux out of bone is greater. Both phosphate ions and calcium ions are required for the mineralization of the bone matrix, and the skeletal ratio of the two remains constant throughout life.

## PHOSPHORYLATION REACTIONS INVOLVED IN CELL REGULATION

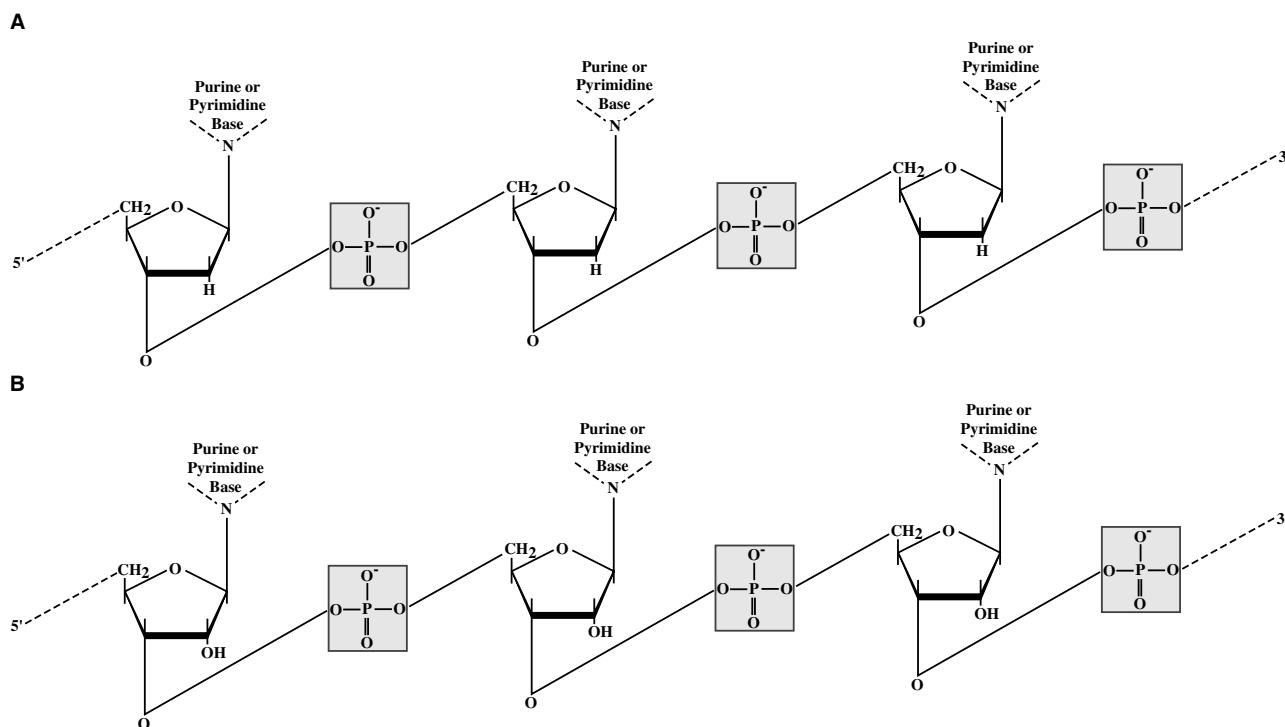
The phosphorylation of specific intracellular protein molecules plays a large role in the cellular regulation of many functions, including transcription, translation, and cell signaling. Serine and threonine are two amino acids commonly phosphorylated by phosphorylase enzymes because of their side-chain hydroxyl groups. These same amino acids may have phosphate groups removed by phosphatase enzymes. Tyrosine kinases are especially important in the removal of phosphate groups from regulatory proteins. Thus, the on and

off states involving phosphates are critical for many cellular regulatory activities.

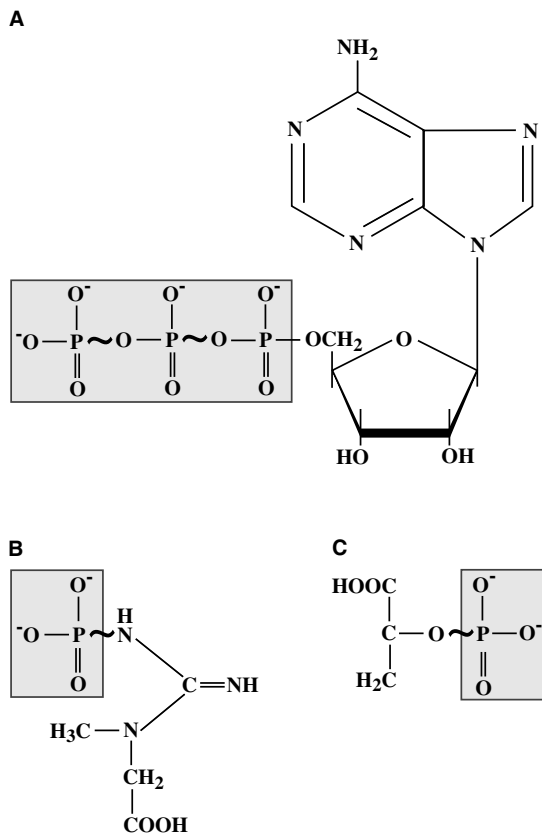
Besides proteins, a number of other molecules incorporate phosphate groups in their structures. These molecules include nucleotides and nucleic acids (DNA and RNA) (Fig. 1), ATP and other energy-storing molecules (Fig. 2), enzyme cofactors (Fig. 3), phospholipids, and others.

## INDICATIONS AND USAGE

Limited therapeutic uses of phosphates exist. Treatment with phosphate salts is not recommended except in a few clinical situations. Premature babies or failure-to-thrive infants who are deficient in phosphorus, as measured by serum inorganic phosphate, need phosphate salts to survive. [A single plasma  $P_i$  measurement of less than 6.0 mg/dl would require a confirmatory measurement to establish deficiency (the acceptable lower limit for newborns and infants within 6 mo of age is 7.0 mg/dl).] Management of any type of adult phosphate depletion, e.g., abuse of aluminum-containing antacids, vitamin D-resistant hypophosphatemic rickets, or osteomalacia, would also require oral phosphate supplementation and possibly intravenous therapy.<sup>[9]</sup> The same may be stated for a patient who is hypercalcemic; here,



**Fig. 1** Nucleic acids. Phosphate groups (in the shaded boxes) serve to link the deoxyribose and ribose sugar molecules in (A) deoxyribonucleic acid (DNA) and (B) ribonucleic acid (RNA).



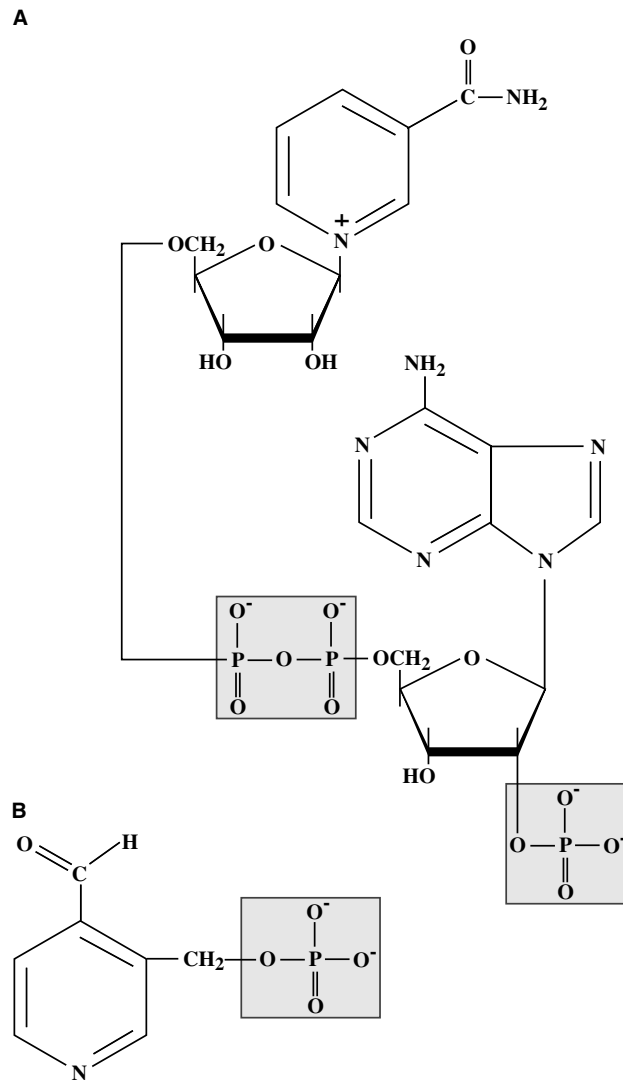
**Fig. 2** Energy-storing molecules. Phosphate groups (in the shaded boxes) provide the high-energy bonds in (A) adenosine triphosphate (ATP), (B) creatine phosphate, and (C) phosphoenol pyruvate, which are used to store energy in a bioavailable form.

phosphate salt administration and plasma calcium concentrations need to be carefully monitored.

Although phosphate deficiency remains rare in the United States, it may be present in approximately 5% of the elderly,<sup>[10]</sup> who may be truly undernourished with respect to protein, energy, and most micronutrients. The need for additional phosphates is complicated by the requirement for practically all macronutrients and micronutrients. These individuals should therefore be provided increased amounts of nutrient-rich foods before considering phosphate supplementation, much as undernourished prisoners of war have been rehabilitated in the past. The elderly may also lose phosphate ions because of renal “leakage.” A postulated scenario of low phosphate dietary status leading to renal phosphate leakage and bone loss is illustrated in Fig. 4.

### CONTRAINDICATIONS

Phosphate supplementation as salts is generally not recommended because of concern about the

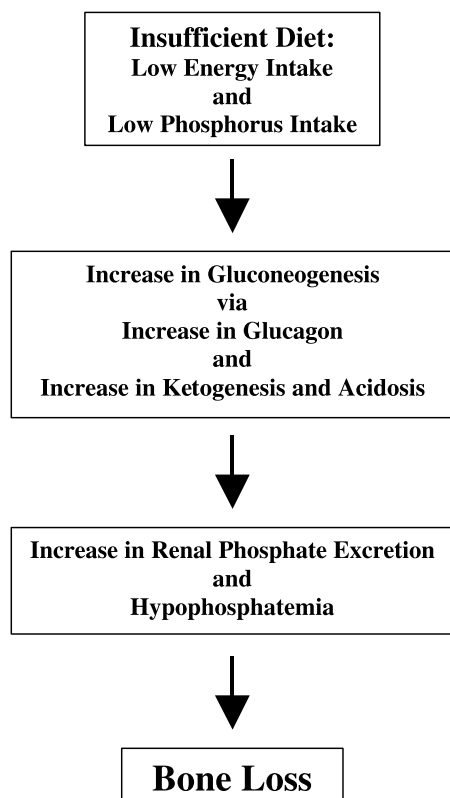


**Fig. 3** Enzyme cofactors. The enzyme cofactors (A) nicotinamide adenine dinucleotide phosphate (NADP) and (B) pyridoxal phosphate each contain one or more phosphate groups (in the shaded boxes).

calcium-to-phosphorus ratio of the diet and the potential increase in PTH. With the exception of appropriate medical use of supplementary phosphate, this statement applies throughout life.

### PRECAUTIONS AND ADVERSE REACTIONS

Subjects supplementing their dietary phosphorus intake with creatine phosphate (used as an ergogenic aid by athletes) may consume excessive amounts of phosphorus in a day over a considerable time period. Reports of adverse reactions due to high phosphorus intakes have been very few, but the Food and Drug Administration (FDA) has been concerned about potential deleterious actions of creatine phosphate.



**Fig. 4** The postulated sequence of events leading to the renal leakage of phosphate ions.

Creatine phosphate is therefore currently on the “watch” list for potential adverse effects.

## OVERDOSAGE

The upper limit (UL) for phosphorus is 4 g/day for adults up to 70 yr of age, but it is very difficult to achieve this level without taking supplements, such as creatine phosphate. The total daily intakes for adults from foods, both naturally occurring phosphates and phosphate additives, are approximately 1300–1800 mg in males and 900–1300 mg in females (Table 3). Therefore, adult intakes without supplements should not come anywhere near the UL of 4000 mg.

## COMPENDIAL/REGULATORY STATUS

Phosphorus, as phosphate salts, is on the GRAS list of FDA additives. Because of the long-standing safe use of phosphate additives, they appropriately belong to this list, but concern about excessively low calcium-to-phosphorus intake ratios makes it desirable for the FDA and other federal agencies to review the status of phosphate additive use vis-à-vis low calcium

**Table 3** Calcium and phosphorus intakes, with calcium : phosphorus ratio at 50th percentile

Life stage	Calcium (mg)	Phosphorus (mg)	Ca : P ratio
<i>All</i>	742	1164	0.64 : 1
<i>Males and females</i>			
0–6 mo	457	322	1.42 : 1
7–12 mo	703	612	1.15 : 1
1–3 yr	766	926	0.83 : 1
4–8 yr	808	1059	0.76 : 1
<i>Males</i>			
9–13 yr	980	1359	0.72 : 1
14–18 yr	1094	1582	0.69 : 1
19–30 yr	954	1613	0.59 : 1
31–50 yr	857	1484	0.58 : 1
51–70 yr	708	1274	0.55 : 1
>70 yr	702	1176	0.60 : 1
<i>Females</i>			
9–13 yr	889	1178	0.75 : 1
14–18 yr	713	1097	0.65 : 1
19–30 yr	612	1005	0.61 : 1
31–50 yr	606	990	0.61 : 1
51–70 yr	571	966	0.59 : 1
>70 yr	517	859	0.60 : 1
Pregnancy	1154	1581	0.73 : 1
Lactation	1050	1483	0.70 : 1

(From Ref.<sup>[10]</sup>.)

intakes. If the calcium : phosphorus ratio falls below 1 : 4 (i.e., 0.25) on a chronic dietary pattern, a chronic increase in PTH will certainly follow and contribute to an increase in bone resorption and the loss of bone mass and density.

## CONCLUSIONS

In general, phosphate supplements are not needed because the diet provides sufficient amounts of phosphate anions. On the contrary, healthy individuals who take phosphate supplements may be at risk for hyperphosphatemia because of the downward regression of the calcium : phosphorus ratio. When the ratio of a typical dietary pattern is reduced to 1 : 4 (or 0.25), excessive parathyroid secretion may lead to bone loss sufficient to compromise skeletal integrity.

If phosphate supplements are deemed by a physician to be essential to correct for phosphate deficiency, such supplements are truly indicated. Such supplementation is clearly rare, and a physician’s diagnosis of phosphate deficiency must be documented. Self-supplementation by individuals may place them at risk because of the potential for chronic elevation of PTH and bone loss. So,

phosphate supplementation, while rare, should only result from a clinical diagnosis of established deficiency.

## ACKNOWLEDGMENTS

We look like to acknowledge three people who helped us in preparation of the article: Mary Lee Sell, Mona Calvo, and Philip Klemmer.

## REFERENCES

1. Anderson, J.J.B.; Garner, S.C. *Calcium and Phosphorus in Health and Disease*; CRC Press: Boca Raton, FL, 1996.
2. Anderson, J.J.B.; Sell, M.L.; Garner, S.C.; Calvo, M.S. Phosphorus. In *Present Knowledge in Nutrition*, 8th Ed.; Russell, R.M., Bowman, B.R., Eds.; ILSI Press: Washington, 2002.
3. Calvo, M.S.; Park, Y.K. Changing phosphorus content of the U.S. diet: potential for adverse effects on bone. *J. Nutr.* **1996**, *126*, 1168S–1180S.
4. Institute of Medicine (IOM). Committee on Dietary Reference Intakes. *Dietary Reference Intakes for Calcium, Phosphorus, Magnesium, Vitamin D, and Fluoride*; National Academy Press: Washington, DC, 1997.
5. *Physician's Desk Reference*, 57th Ed.; Medical Economics: Oradell, NJ, 2003.
6. Burtis, C.A.; Ashwood, E.R. *Tietz Textbook of Clinical Chemistry*, 3rd Ed.; Saunders: Philadelphia, 1999.
7. Calvo, M.S.; Kumar, R.; Heath III, H., Persistently elevated parathyroid hormone secretion and action in young women after four weeks of ingesting high phosphorus, low calcium diets. *J. Clin. Endocrinol. Metab.* **1990**, *70*, 1334–1340.
8. Barzel, U.S. The skeleton as an ion exchange system: implications for the role of acid–base imbalance in the genesis of osteoporosis. *J. Bone Miner. Res.* **1995**, *10*, 1431–1434.
9. Hardman, J.G.; Limbird, L.E. *Goodman & Gilman's The Pharmacologic Basis of Therapeutics*, 9th Ed.; McGraw-Hill: New York, 1996.
10. *Continuing Survey of Food Intake of Individuals (CSFII)*; US Department of Agriculture; Washington, DC, 1994.





# Pycnogenol<sup>®</sup>, French Maritime Pine Bark Extract

**P.J. Rohdewald**

*Institute of Pharmaceutical Chemistry, Westfälische Wilhelms-Universität Münster, Münster, Germany*

## INTRODUCTION

Pycnogenol<sup>®</sup> is the registered trade name for a special standardized extract from the bark of the French maritime pine (*Pinus pinaster* ssp. *atlantica*), distributed by Horphag Research, U.K. The spray-dried, powdered extract is marketed worldwide as a food supplement, a herbal medicine, an ingredient in cosmetics, and as a food additive.

The traditional use of pine bark was in the treatment of scurvy and wound healing. Currently, Pycnogenol is used to restore capillary integrity in cases of gingivitis, retinopathy, or edema formation. Other fields of application are directed to protection of the circulation by inhibiting platelet aggregation, lowering of cholesterol levels, and high blood pressure. The procyanidins, in particular, have shown anti-inflammatory and radical-scavenging activity, leading to treatment of melasma and prevention of ultraviolet (UV)-induced damage of the skin. The application of Pycnogenol in reducing menstrual cramps and pain is probably caused by the spasmolytic activity of the phenolic acids. Very recently, a glucose lowering effect of Pycnogenol has been shown. Safety of Pycnogenol is documented by its generally recognized as safe (GRAS) status in the United States. Unwanted effects are mild and transient, and no interactions with drugs have been reported.

## BACKGROUND

Raw material:

- Family: Pinaceae.
- Genus: *Pinus*.
- Species: *Pinus pinaster* Aiton, ssp. *atlantica* D. del Villar.
- Part used: Outer bark.

*P. pinaster* ssp. *atlantica*, the Atlantic maritime pine, is cultivated in large monocultures in South

Western France in the Biscay area (Fig. 1). It is distinguished from other species by the thick, deeply fissured, reddish bark, representing a geographic race adapted to harsh climate and sandy soil. Trees are cut for timber production after cultivation for 30–50 yr, and the fresh outer bark is used for extraction throughout the year. The bark pieces are 1–3 cm thick, and they are formed from up to 50 mussel-shaped, deep red or light brown layers. The inner side of the bark is slightly concave and plane, while the outer part is irregular with deep cut V-shaped fissures.

Traditionally, preparations from pine bark had been used in the Middle Ages for wound healing, as



**Fig. 1** Forest of French maritime pine trees.

---

*P.J. Rohdewald, Ph.D.*, is Professor Emeritus at the Institute of Pharmaceutical Chemistry, Westfälische Wilhelms-Universität Münster, Münster, Germany.

referred to in the *Thesaurus Medicaminum* of the Zurich pharmacist H. Minner (1479). Also, in North America, Native Americans used bark from conifers for wound healing, and to treat scurvy.<sup>[1]</sup>

## CHEMISTRY AND PRODUCTION

### Composition

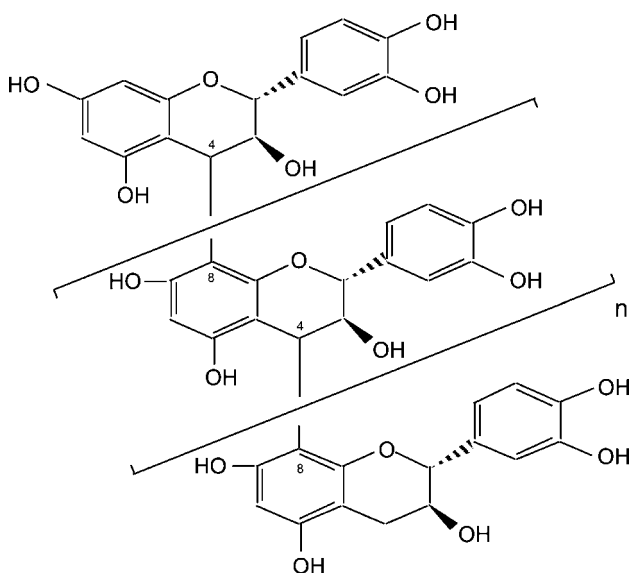
Pycnogenol represents a concentrate of phenolic compounds, consisting of phenolic acids, catechin, taxifolin, and procyanidins.<sup>[2]</sup>

The phenolic acids are derivatives of benzoic acid—*p*-hydroxybenzoic acid, protocatechic acid, vanillic acid and gallic acid—or of cinnamic acid, *p*-cumaric acid, caffeic acid, and ferulic acid. Glycosides and glucose esters of these phenolic acids have been identified.

Catechin is found as the main monomeric procyanidin in Pycnogenol, while epicatechin is present in traces. Another flavonoid, taxifolin, is available in free form and as taxifolin glucoside.

The main constituents of Pycnogenol are procyanidins, biopolymers consisting of catechin and epicatechin subunits (Fig. 2). Chain lengths from dimers up to 12 monomeric units are present. The catechin–epicatechin units can be linked by C4–C8 bonds or by C4–C6 bonds, with the C4–C8 linked isomers predominating.

As inorganic ions, calcium, potassium, and iron are present, together with traces of manganese, zinc, and copper.<sup>[3]</sup>



**Fig. 2** Procyanidin with type 4–8 bonds. Monomers could be catechin or epicatechin units.

### Production

The extract is prepared from fresh sorted, cleaned, and crushed bark. The patented extraction process chain uses ethanol and water as solvents in a multistep process. The purified aqueous extract is spray dried and represents a very fine, brownish-colored powder with an aromatic smell and astringent taste. It is soluble in water, methanol, and ethanol, and insoluble or sparingly soluble in oils. One thousand kilogram bark is needed to produce 1 kg Pycnogenol.

### Formulations

Pycnogenol is available as tablets or capsules of 20–100 mg. For oral health care, a mouth spray delivering 2 mg per actuation and a chewing gum containing 5 mg Pycnogenol are available. In concentrations between 100 and 170 mg/L, it is formulated as an aromatized water. A wide range of cosmetic products containing the extract is sold worldwide.

### Analysis

The quality of the bark of *P. pinaster* is controlled according to the monograph “Maritime Pine” of the *National Formulary of the US Pharmacopoeia*.<sup>[4]</sup>

The standardized extract, Pycnogenol, corresponds to the monograph: “Maritime Pine Extract” of the *National Formulary of the US Pharmacopoeia*<sup>[4]</sup> in terms of identity and purity using thin layer chromatography (TLC) and high-performance liquid chromatography (HPLC). The content of procyanidins (between 65% and 75%) is quantified colorimetrically after oxidative hydrolysis.

### Stability

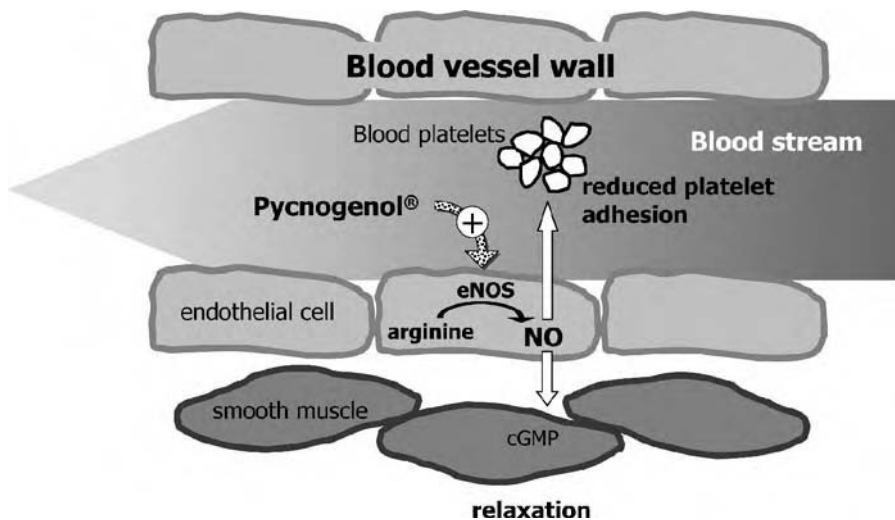
Pycnogenol, stored and protected from light and humidity in well-closed containers at room temperature, is stable over a period of 3 yr.

## PRECLINICAL STUDIES

### Circulatory Function

#### Stimulation of e-NOS

Pycnogenol stimulates the activity of endothelial nitric oxide synthase (e-NOS) *in vitro* and *in vivo* (Fig. 3).



**Fig. 3** Scheme for enhanced NO production by increasing synthesis of endothelial NOS.

In isolated aortic rings from rats<sup>[2]</sup> as well as in human sperms,<sup>[5]</sup> it stimulated endothelial NO production from natural substrate L-arginine by e-NOS. Nitric oxide (NO) initiates release of cGMP in smooth muscle cells and leads to vasorelaxation. Furthermore, NO reacts with blood platelets and prevents their aggregation.

#### Inhibition of adrenaline-induced vasoconstriction

Adrenaline as well as noradrenaline are very potent vasoconstrictors. In experiments with isolated aortic rings from rats, Pycnogenol inhibited the vasoconstriction induced by these stress hormones. The effect was dose dependent and could not be observed after removal of the endothelium.<sup>[2]</sup>

#### Antihypertensive effect

In vitro, Pycnogenol inhibits the angiotensin-converting enzyme (ACE), while in rats, blood pressure could be reduced significantly after i.v. injection.<sup>[2]</sup>

#### Capillary Integrity

##### Protein binding

Procyanidins, the main constituents of Pycnogenol, belong to the class of nonhydrolyzable tannins and have a high affinity to proteins. Pycnogenol binds selectively to collagen, elastin, and skin powder, whereas binding to egg albumin is low.<sup>[6]</sup> Also, the interaction with enzymes is specific, as a result of the

differing IC<sub>50</sub> values<sup>[3]</sup> for inhibition of various enzymes. Stabilization of membranes of erythrocytes via protein binding may be the cause of prevention of hemolytic injury in glucose-6-phosphate dehydrogenase deficient human erythrocytes.<sup>[7]</sup>

##### Capillary sealing

Spontaneous hypertensive rats show a pathologically high leakage of capillaries. Feeding with Pycnogenol produced a long-lasting, dose-dependent increase of capillary resistance against a topically applied vacuum.<sup>[2]</sup>

#### Anti-inflammatory Activity

##### Radical-scavenging activity

In several in vitro models, Pycnogenol inactivated superoxide- and hydroxy-radicals as well as inhibited the formation of singlet oxygen and nitric oxide-radicals.<sup>[2,3]</sup> The superior capacity of procyanidins in radical scavenging is based on their ability to retain scavenging activity by intramolecular rearrangements.<sup>[2]</sup> The lifetime of the ascorbyl-radical is prolonged by Pycnogenol to a greater extent than by other bioflavonoids,<sup>[3]</sup> and the oxidation of low density lipoprotein (LDL) was inhibited in vitro.<sup>[3]</sup> DNA was protected against iron/ascorbate-induced strand breaks by Pycnogenol.<sup>[3]</sup> Toxicity of free radical producing antitumor drugs was reduced by pre-treatment of mice with Pycnogenol without reducing the anticancer activity of doxorubicin and cyclophosphamide.<sup>[8]</sup>

### Antioxidative effects in biological systems

Incubation with Pycnogenol protected  $\alpha$ -tocopherol in endothelial cells against oxidation by peroxynitrite,<sup>[3]</sup> protected nerve cells against  $\beta$ -amyloid- or glutamate-induced toxicity,<sup>[2,3]</sup> and inhibited peroxidation of retinal lipids more efficiently than vitamins E and C.<sup>[2]</sup> Neurons were protected from amyloid- $\beta$ -peptide-induced apoptosis.<sup>[9]</sup>

### Stimulation of synthesis of antioxidative substances

Pycnogenol incubation doubles the concentrations of antioxidative enzymes in vascular endothelial cells.<sup>[2]</sup> Synthesis of proteins in macrophages is increased, and activity of antioxidative enzymes, like catalase or superoxide dismutase, is dose dependently enhanced.<sup>[2]</sup>

### Interaction with NF- $\kappa$ B

In a murine macrophage cell line, preincubation with Pycnogenol blocked the activation of nuclear factor kappa B (NF- $\kappa$ B) and the activator protein (AP-1), major transcription factors centrally involved in inflammatory processes.<sup>[10]</sup> In a human lymphocyte cell line, the extract inhibited the transcription factors NF-AT and AP-1.<sup>[10]</sup> It also prevented the UV-induced activation of transcriptional factors NF- $\kappa$ B and AP-1 in human cell lines from fibroblasts and keratinocytes.<sup>[2]</sup> In human endothelial cells, pretreatment with Pycnogenol suppressed the activation of NF- $\kappa$ B by tumor necrosis factor- $\alpha$  (TNF- $\alpha$ ).<sup>[2]</sup> These results indicate that proinflammatory responses can be inhibited by Pycnogenol early in the biochemical reaction chain at the transcriptional level.

### Inhibition of inflammatory mediators

At the level of cytokines, Pycnogenol blocks production of interleukins 1, 2,<sup>[10]</sup> 6, and 10.<sup>[2]</sup> Synthesis of inducible nitric oxide synthase is blocked by preincubation of macrophages with Pycnogenol,<sup>[3]</sup> and the release of histamine from mast cells is inhibited in vitro.<sup>[2]</sup>

### Inhibition of adhesion molecules

Intercellular adhesion molecules are necessary for tissue invasion of leukocytes in inflammatory processes. Pycnogenol pretreatment downregulates expression of

intercellular adhesion molecule-1 (ICAM-1) and vascular cell adhesion molecule-1 (VCAM-1).<sup>[2]</sup>

### Inhibition of matrix metalloproteases

Matrix metallo-proteases (MMPs) destroy collagen and elastin. Pycnogenol and its metabolites inhibit MMP1, MMP2, and MMP9, and furthermore prevent the release of MMP9 from human monocytes.<sup>[6]</sup>

### Inhibition of UV-induced damage

Topical application of a Pycnogenol-containing gel significantly prevented erythema formation after UV radiation<sup>[2]</sup> and inhibited photocarcinogenesis.<sup>[11]</sup> Wound healing was accelerated and scar formation reduced following application of 1–2% Pycnogenol in gels.<sup>[12]</sup>

## Age-Related Degenerative Processes

### Stimulation of immune system

Incubation with Pycnogenol augmented phagocytosis in macrophages.<sup>[13]</sup> Feeding of the extract to immunosuppressed mice provided protection against protozoal infection,<sup>[14]</sup> and to senescence-accelerated mice restored levels of progenitor cells and  $\beta$ - and T-lymphocytes in a dose-dependent manner.<sup>[2]</sup> Oral administration of Pycnogenol to retrovirus infected mice<sup>[2]</sup> or mice inoculated with cancer cells<sup>[15]</sup> showed enhanced natural killer cell activity.

### Enhancement of cognitive function

Administration of Pycnogenol to senescence-accelerated mice significantly enhanced the memory retention rate in a dose-dependent manner compared to non-supplemented mice in step-through and step-down tests. The treatment also significantly improved the cognitive behavior in the shuttle box test.<sup>[2]</sup>

### Antiaging effects

The life span of mice was prolonged after oral administration of a Pycnogenol-containing combination of antioxidants.<sup>[16]</sup> That of drosophila was increased after feeding the extract.<sup>[17]</sup>

## Spasmolytic Activity

Phenolic constituents of Pycnogenol, ferulic acid and caffeic acid, possess spasmolytic activity as demonstrated in vivo on the isolated rat uterus<sup>[2]</sup> as well as in vivo in experiments with rats.<sup>[2]</sup>

## Blood Glucose Lowering

In streptozotocin-induced diabetic rats, Pycnogenol feeding lowered blood glucose concentrations and enhanced concentrations of antioxidative substances in blood.<sup>[18]</sup>

## Proposed Mechanisms of Action

Based on the support of nitric oxide production, Pycnogenol offers a range of pharmacological effects on the vascular system, such as increased microcirculation, improvement of erectile function, antihypertensive effects, and inhibition of platelet aggregation. The enhancement of capillary integrity results in an antiedema effect and prevents microbleedings. Its radical-scavenging potency may contribute to the anti-inflammatory actions and beneficial effects in degenerative diseases. The spasmolytic activity of phenolic acids contained in Pycnogenol is probably related to its activity in reducing premenstrual cramps and pain. The lowering of blood glucose in streptozotocin-induced diabetic rats points to an antidiabetic effect.

## Safety Studies (On File at Horphag Research Ltd., U.K.)

### Animal toxicology

The *absence of mutagenic* effects has been shown using the Ames test, the chromosome aberration assay in human lymphocytes and the micronucleus test in mice.

*Acute toxicity* is very low. Fourteen acute toxicity tests had been performed using three different species and oral, subcutaneous, intraperitoneal, and intravenous routes of administration. LD50 data varied after oral administration from 1000 to 4000 mg/kg.

*Chronic toxicity* had been tested in three species after oral administration. The no-adverse-effects' level (NOAEL) was established as 100 mg/kg/day.

In six *reproduction toxicity* studies with three species no teratogenic effects were detected, no signs of perinatal toxicity or negative effects on fertility were noted.

*Tolerance after topical application* was tested in several models. Skin and eye irritation tests in rabbits and contact hypersensitivity test in guinea pigs showed that Pycnogenol is nonirritating. In human volunteers, no skin irritation was found with the patch-occlusion test.

### Absorption and metabolism

After oral intake, four metabolites could be found in the urine of a human volunteer. Taxifolin and ferulic acid were excreted as glucuronides or sulfates after 1–4 hr.<sup>[2]</sup> Another investigation found a maximum excretion of ferulic acid after intake of Pycnogenol at 17 hr.<sup>[3]</sup> Procyanidins had been metabolized to valerolactones, which are excreted as glucuronides after 8–15 hr.<sup>[2]</sup>

## CLINICAL STUDIES

### Circulatory Function

#### Improved microcirculation

By microscopic observation of blood capillaries through fingernails it was found that the capillary diameter was increased significantly compared to placebo following intake of Pycnogenol. Supplementation of 60 cardiovascular patients with the extract for 1 mo improved microcirculation significantly as a result of increased vasodilation. The rate of cardiovascular events diminished significantly in the Pycnogenol group compared to placebo.<sup>[2]</sup>

#### Antihypertensive effect

In a double-blind, placebo-controlled crossover study with 11 patients, supplementation with 200 mg Pycnogenol normalized blood pressure of patients with mild hypertension and lowered thromboxane levels.<sup>[2]</sup> In another double-blind, placebo-controlled trial with 58 subjects, intake of 100 mg allowed to reduce significantly the dosage of the calcium channel blocker nifedipine required for treatment of patients with hypertension. Plasma levels of endothelin-1 were reduced, and concentrations of prostacyclin were elevated.<sup>[19]</sup>

#### Inhibition of platelet aggregation

Smoking produces an activation and aggregation of blood platelets. This platelet aggregation was inhibited

in smokers dose dependently by Pycnogenol,<sup>[2]</sup> and the effect persisted over several days. In another group of smokers, thromboxane levels were decreased in blood in addition to the inhibition of platelet aggregation.<sup>[2]</sup> Also, in cardiovascular patients, platelet aggregation was inhibited following intake of the extract.<sup>[2]</sup>

### Improved erectile function

A double-blind, placebo-controlled study demonstrated a significant improvement of erectile function following supplementation with Pycnogenol in men with mild erectile dysfunction.<sup>[20]</sup> Supplementation with L-arginine, the substrate for NO production, led to no significant improvement of erectile function in another clinical study with patients of similar condition.<sup>[21]</sup> However, if the same subjects were given Pycnogenol in addition to L-arginine, the percentage of those with completely restored sexual function increased dramatically. Continuation of treatment with the combination of L-arginine and Pycnogenol in a higher dose yielded a response rate of 80%. Intensity and duration of erectile function were quite significantly improved.<sup>[21]</sup>

### Cholesterol lowering

In an open, controlled study with 25 volunteers, LDL was lowered significantly after 4 weeks supplementation with 150 mg Pycnogenol, while high density lipoprotein (HDL) as well as overall radical absorbance capacity of blood was increased.<sup>[22]</sup> A double-blind, placebo-controlled study with 21 patients showed significant reduction of total cholesterol and LDL after intake of 120 mg Pycnogenol.<sup>[20]</sup> In a comparative, controlled study, total cholesterol and LDL were significantly lowered.<sup>[23]</sup>

### Capillary Integrity

#### Gingival bleeding

In a placebo-controlled study with dental students, a Pycnogenol-containing chewing gum reduced gingival bleeding and plaque formation compared to regular sugar-free chewing gum.<sup>[24]</sup>

#### Effects in vascular retinopathy

Diabetic microangiopathy causes leakage of retinal capillaries. Two open-case experiments, two double-

blind, placebo-controlled trials, and a multicenter field study with a total number of 1289 patients showed unequivocally that Pycnogenol retained progressions of retinopathy and partly improved visual acuity. It restored capillary integrity and reduced leakage of blood into the retina.<sup>[25]</sup>

### Inhibition of edema formation

Chronic venous insufficiency is associated with edema formation in the lower legs, leading to the feeling of heavy legs, swelling, cramps, and pain. In five placebo-controlled, double-blind studies and three double-blind, controlled experiments, these symptoms had been significantly reduced.<sup>[2]</sup> Findings could be objectivated by measuring the circumference of lower limbs<sup>[23]</sup> and demonstrated superior activity compared to a commercial horse chestnut seed extract, a remedy for venous disorders.<sup>[23]</sup>

### Prevention of deep vein thrombosis

In a double-blind, placebo-controlled, randomized trial with 198 passengers, 400 mg Pycnogenol prevented thrombus formation after long-haul flights in the verum group. In the placebo-group, 5 cases of thrombosis were observed, and none in the verum group.<sup>[26]</sup>

### Anti-inflammatory Activity

#### Reduction of asthma symptoms

The anti-inflammatory effects of Pycnogenol also contribute to its beneficial action on asthma patients. In a placebo-controlled, double-blind, crossover study, asthma symptom scores of 22 patients were significantly lower and lung function parameters higher in the Pycnogenol-treated group, while leukotriene levels decreased.<sup>[2]</sup> In a double-blind, placebo-controlled study with 60 children, the extract improved pulmonary function and asthma symptoms and reduced use of rescue inhalations. Leukotriene levels in urine were significantly lowered.<sup>[27]</sup>

### Immune modulation

Following supplementation with 60 mg Pycnogenol, apoptosis of lymphocytes and formation of DNA-antibodies were downregulated in patients with lupus erythematosus.<sup>[2]</sup>

### Improvement of quality of sperms

Lack of antioxidants has been connected with malformed sperms. Quality of sperms of 19 subfertile men was significantly improved in terms of morphology and mobility after supplementation with 200 mg Pycnogenol for 90 days.<sup>[28]</sup> Supplementation with Pycnogenol + L-arginine aspartate and vitamin E or testosterone improved dramatically motility, concentration, and quality of sperms.<sup>[5]</sup>

### Inhibition of UV-induced damages

Oral intake of Pycnogenol strengthens the antioxidative defense system against UV radiation. The minimum erythema doses were significantly increased after intake of 1.11 mg/kg body weight of the extract in 21 volunteers and further enhanced after a larger dose of 1.66 mg/kg.<sup>[2]</sup> In a study with 30 women, taking 75 mg Pycnogenol for 1 mo,<sup>[29]</sup> the UV-induced discoloration of sun-exposed skin areas, melasma, could be reduced with respect to size of the affected area and intensity of discoloration.

### Antidiabetic Effects

In patients with diabetes type II, Pycnogenol lowers dose dependently fasting and postprandial blood levels and improves endothelial function by lowering endothelin-1 levels and increasing prostacyclin concentrations in blood.<sup>[30]</sup> Results were confirmed in a placebo-controlled, double-blind study with diabetic patients showing significant decreases of blood glucose and endothelin-1 and increases of prostacyclin after supplementation with 100 mg Pycnogenol.<sup>[31]</sup>

### Reduction of Menstrual Cramps and Pain

Administration of 30–60 mg Pycnogenol to 39 patients with endometriosis and menstrual pain was reported to reduce symptoms in 70% of the subjects in an open clinical study.<sup>[2]</sup> Supplementation with 60 mg Pycnogenol reduced intake of analgesics, number of days with pain and intensity of low back pain and abdominal pain in 42 patient suffering from menstrual pain.<sup>[32]</sup>

### Efficacy

Pycnogenol has demonstrated antiedema effect in several clinical studies as well as efficacy in inhibiting the

progression of retinopathy. Other clinical investigations support the application of the extract to protect the circulation by inhibition of platelet aggregation, lowering of cholesterol, and an antihypertensive effect. An enhanced radical absorbing capacity after intake of Pycnogenol is probably related to protection against UV radiation and inflammatory diseases. The antidiabetic effect and antispasmodic activity has to be confirmed by further clinical and mechanistic studies.

### Optimum Intake

Clinical studies suggest an optimum dose range between 40 and 100 mg Pycnogenol/day or 1 mg/kg body weight. Pycnogenol should be taken together with breakfast to minimize gastrointestinal troubles.

### Side Effects

The evaluation of clinical studies with more than 2500 patients revealed no serious adverse events related to intake of Pycnogenol. The rate of mild side effects is low, and unwanted effects such as gastrointestinal troubles, dizziness, nausea, headache, or skin sensations were mild and transient in most cases.

### Contraindications

To date, no contraindications have been seen.

### Observed Drug Interactions

No drug interactions have been reported until now.

### Use in Pregnancy and for Children

Despite the fact that teratogenicity tests showed no teratogenic effects, the intake of Pycnogenol during the first 3 mo of pregnancy and during breast feeding should be avoided as a general precaution. Children under 12 should not take Pycnogenol because no clinical experience is available with young children.

### REGULATORY STATUS

In most countries, for example, in the United States, Australia, the United Kingdom, Belgium, the Netherlands, Finland, Italy, Thailand, Taiwan, P.R.



China, and Japan, Pycnogenol is used as a food supplement. In the United States, Pycnogenol has the status of GRAS. In Greece, Switzerland, Colombia, and Venezuela, it is a nonprescriptional herbal drug.

## REFERENCES

- Chandler, F.; Freeman, L.; Hooper, S.N. Herbal remedies of the Maritime Indians. *J. Ethnopharmacol.* **1979**, *1*, 49–68.
- Rohdewald, P. A review of the French maritime pine bark extract (Pycnogenol<sup>®</sup>), a herbal medication with a diverse clinical pharmacology. *Int. J. Clin. Pharm. Ther.* **2002**, *40* (4), 158–168.
- Packer, L.; Rimbach, G.; Virgili, F. Antioxidant activity and biologic properties of a procyanidin-rich extract from pine (*Pinus maritima*) bark, Pycnogenol. *Free Radical Biol. Med.* **1999**, *27* (5–6), 704–724.
- USP C 2003, Inc. Official: 8/1/03–12/31/03.
- Stanislavov, R.; Nikolova, V. Testosterone undecanoate and Pycnogenol<sup>®</sup> in the treatment of reproductive and sexual problems of male infertility. Unpublished results.
- Grimm, T.; Schäfer, A.; Högger, P. Antioxidant activity and inhibition of matrix metalloproteinases by metabolites of maritime pine bark extract (Pycnogenol<sup>®</sup>). *Free Radic. Biol. Med.* **2004**, *36* (6), 811–822.
- Sharma, S.C.; Sharma, S.; Gulati, O. Pycnogenol<sup>®</sup> prevents haemolytic injury in G6PD deficient human erythrocytes. *Phytother. Res.* **2003**, *17* (1), 671–674.
- Feng, W.H.; Wei, H.L.; Liu, G.T. Effect of Pycnogenol<sup>®</sup> on the toxicity of heart, bone marrow and immune organs as induced by antitumor drugs. *Phytomedicine* **2002**, *9*, 414–418.
- Peng, Q.L.; Buz'Zard, A.R.; Lau, B.H.S. Pycnogenol<sup>®</sup> protects neurones from amyloid  $\beta$ -peptide-induced apoptosis. *Mol. Brain Res.* **2002**, *104*, 55–65.
- Cho, K.-J.; Yun, C.-H.; Packer, L.; Cheng, A.-S. Inhibition mechanisms of bioflavonoids extracted from the bark of *Pinus maritima* on the expression of proinflammatory cytokines. *Ann. N. Y. Acad. Sci.* **2002**, 141–156.
- Sime, S.; Reeve, V.E. Protection from inflammation, immunosuppression and carcinogenesis induced by UV radiation in mice by topical Pycnogenol<sup>®</sup>. *Photochem. Photobiol.* **2004**, *79* (2), 193–198.
- Blazsó, G.; Gábor, M.; Schönlau, F.; Rohdewald, P. Pycnogenol<sup>®</sup> accelerates wound healing and reduces scar formation. *Phytother. Res.* **2004**, *18*, 579–581.
- Shah, V.; Bayeta, E.; Lau, B.H.S. Pycnogenol<sup>®</sup> augments macrophage phagocytosis and cytokine secretion. *Pak. J. Nutr.* **2002**, *1*, 196–201.
- Kim, H.C.; Healey, J.M. Effects of pine bark extract administered to immunosuppressed adult mice infected with *Cryptosporidium parvum*. *Am. J. Chin. Med.* **2002**, *29* (3–4), 469–475.
- Chen, S.-W.; Liu, C.; Zhang, J. Effect of pycnogenol in tumor and non-specific immune system. *Henan J. Prev. Med.* **2003**, *14* (1), 16–18.
- Veurink, G.; Liu, D.; Taddei, K.; Perry, G.; Smith, M.A.; Robertson, T.A.; Hne, E.; Groth, D.M.; Atwood, C.S.S.; Martins, R.N. Reduction of inclusion body pathology in ApoE-deficient mice fed a combination of antioxidant. *Free Radic. Biol. Med.* **2003**, *34* (8), 1070–1077.
- Shuguang, L.; Xinwen, Z.; Sihong, X.; Gulati, O.P. Role of Pycnogenol<sup>®</sup> in aging by increasing the *Drosophila's* life-span. *Eur. Bull. Drug Res.* **2003**, *11* (3), 39–45.
- Maritim, A.; Dene, B.A.; Sanders, R.A.; Watkins, J.B. Effect of Pycnogenol<sup>®</sup> treatment on oxidative stress in streptozotocin-induced diabetic rats. *J. Biochem. Mol. Toxicol.* **2003**, *17*, 193–199.
- Liu, X.; Wei, J.; Fengsen, T.; Shengming, Z.; Würthwein, G.; Rohdewald, P. Pycnogenol<sup>®</sup>, French maritime pine bark extract, improves endothelial function of hypertensive patients. *Life Sci.* **2004**, *74*, 855–862.
- Durackova, Z.; Trebaticky, B.; Novotny, V.; Zitnanova, J.; Breza, J. Lipid metabolism and erectile function improvement by Pycnogenol<sup>®</sup>, extract from the bark of *Pinus pinaster* in patients suffering from erectile dysfunction—a pilot study. *Nutr. Res.* **2003**, *23*, 1189–1198.
- Stanislavov, R.; Nikolova, V. Treatment of erectile dysfunction with Pycnogenol<sup>®</sup> and L-arginine. *J. Sex Marital Ther.* **2003**, *29* (3), 207–213.
- Devaray, S.; Kaul, N.; Schönlau, F.; Rohdewald, P.; Jialal, I. Supplementation with a pine bark extract rich in polyphenols increases plasma antioxidant capacity and alters plasma

- lipoprotein profile. *Lipids* **2002**, *37* (10), 931–934.
23. Koch, R. Comparative study of Venostasin<sup>®</sup> and Pycnogenol<sup>®</sup> in chronic venous insufficiency. *Phytother. Res.* **2002**, *16*, 1–5.
  24. Kimbrough, C.; Chun, M.; Dela Roca, G.; Lau, B.H.S. Pycnogenol<sup>®</sup> chewing gum minimizes gingival bleeding and plaque formation. *Phyto-medicine* **2002**, *9*, 410–413.
  25. Schönlau, F.; Rohdewald, P. Pycnogenol<sup>®</sup> for diabetic retinopathy: a review. *Int. Ophthalmol.* **2002**, *24*, 161–171.
  26. Belcaro, G. et al. Prevention of venous thrombosis and thrombophlebitis in long-haul flights with Pycnogenol<sup>®</sup>. *Appl. Thromb. Hemost.* **2004**, *10* (4), 373–377.
  27. Lau, B.H.S.; Riesen, S.K.; Truong, K.P.; Lau, E.W.; Barreta, R.A. Pycnogenol<sup>®</sup> in the management of asthma. *J. Asthma*, *in press*.
  28. Roseff, S.J. Improvement in sperm quality and function with French maritime pine tree bark extract. *J. Reprod. Med.* **2002**, *47*, 821–824.
  29. Ni, Z.; Mu, Y.; Gulati, O. Treatment of melasma with Pycnogenol<sup>®</sup>. *Phytother. Res.* **2002**, *16*, 567–571.
  30. Liu, X.; Ha-Jun, Z.; Rohdewald, P. French maritime pine bark extract Pycnogenol<sup>®</sup> lowers glucose dose-dependently in patients with diabetes type II. *Diabetes Care* **2003**, *27* (3), 839.
  31. Liu, X.; Wei, J.; Tan, F.; Zhou, S.; Würthwein, G.; Rohdewald, P. Antidiabetic effect of Pycnogenol<sup>®</sup> French maritime pine bark extract in patients with diabetes type II. *Life Sci.* **2004**, *75* (21), 2505–2513.
  32. Kohama, T.; Suzuki, N.; Ohno, S.; Inou, M. Analgesic efficacy of Pycnogenol<sup>®</sup> in dysmenorrhea. An open clinical trial. *J. Reprod. Med.* **2004**, *49*, 828–832.



# Proanthocyanidins

Gary R. Beecher

Lothian, Maryland, U.S.A.

## INTRODUCTION

Proanthocyanidins, also called condensed tannins, are oligomers and polymers of monomeric flavonoids. More specifically, they are polyflavans, condensed molecules of those flavonoids with a saturated “C” ring (Fig. 1A). Fifteen subclasses of proanthocyanidins have been identified,<sup>[1]</sup> however, only a few are prominent in foods and supplements of plant origin. The various subclasses are named based on the conversion of the “interior” monomeric units (M) to the corresponding anthocyanidin during acid catalyzed depolymerization. Hence, this broad class of polymers is named *proanthocyanidins*. Examples include conversion of (epi)catechin to *cyanidin* (*procyanidins*) and (epi)gallocatechin to *delphinidin* (*prodelphinidins*). In these tannins, the monomeric units are primarily linked through single 4→6 or 4→8 carbon-carbon bonds (B linkages), or through 4→8 carbon-carbon and 2→7 ether bonds (A linkages) (Fig. 1). Other linkages have also been identified, but have been isolated from nonfood plants or constitute minor compounds of foods such as cocoa.<sup>[1]</sup> Proanthocyanidins range in size from dimers through very large polymers and are found in many plant based foods and several dietary supplements.

## BIOCHEMISTRY

Proanthocyanidins are considered secondary metabolites of plants, i.e., they are not required for the structural or metabolic integrity of the organism. However, they have several biological activities that protect plants from harmful intruders such as microbes, fungi, etc. These properties of proanthocyanidins and other plant components are currently being investigated to determine whether these compounds can be used as “natural” sources of drugs for the treatment of infectious and other vector-borne diseases.<sup>[2]</sup>

One of the earliest biochemical properties of proanthocyanidins to be recognized was their ability

to bind to and denature proteins, especially those rich in proline and hydroxyproline, such as collagen. Their use in the conversion of animal hides into leather, a process called tanning (protein denaturation), led to the generic name of tannins for these compounds. The adverse effect of the binding of proanthocyanidins to protein, fiber, and other carbohydrates, in terms of animal nutrition and human health, is discussed later.

The unique polyhydroxyphenolic nature of proanthocyanidins and the resulting electronic configuration allows relatively easy release of protons, and, as a result, they have substantial antioxidant activity. Employing antioxidant systems ranging from biological to model compounds to instrumental techniques, investigators have shown that proanthocyanidins have high antioxidant and radical scavenging activity,<sup>[3,4]</sup> usually greater than that of vitamins C and E, the “gold standards.” These unique chemical structures also bind divalent cations, such as iron and copper, which contributes to their antioxidant activity by decreasing their availability for such oxidative reactions as the Fenton reaction. Conversely, the role that proanthocyanidin-cation binding has on the bioavailability of such minerals as copper, iron, or aluminum is uncertain.<sup>[5]</sup>

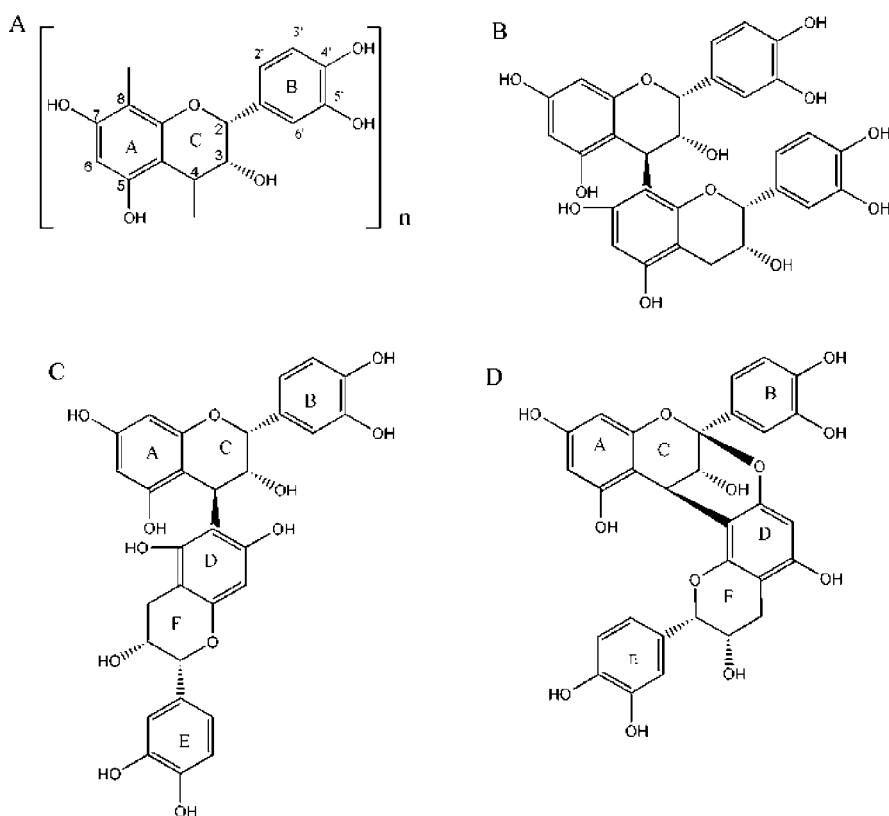
## PHYSIOLOGY

One of the first responses when a food or supplement containing high levels of proanthocyanidins is consumed is an astringent sensation. This is due in part to the binding of these dietary constituents to proline-rich salivary proteins as described above.<sup>[5]</sup> Although binding of proanthocyanidins to digestive enzymes has been a concern in animal nutrition, where dietary concentrations of these components may be as high as a few percent, human foods contain much lower levels and, as a result, interference with digestive enzymes is of little concern.<sup>[5]</sup> However, the gastrointestinal (GI) metabolism and absorption of proanthocyanidins per se have been of interest relative to human health.

Studies with a wide variety of laboratory animals have given mixed results relative to absorption of specific proanthocyanidins.<sup>[3]</sup> However, when absorption

---

Dr. Gary R. Beecher is from Lothian, Maryland, U.S.A.



**Fig. 1** Representative linkages within proanthocyanidin molecules. A) Monomeric representation, (–)-epicatechin, with carbon 4 and 8 shown as potential linkages,  $n=1$ ;  $n$  may equal 2 (dimer) to  $\sim 50$ . B) Example of B-type ( $4 \rightarrow 8$ ) linkage. Specific compound is procyanidin B2 (dimer), epicatechin-( $4\beta \rightarrow 8$ )-epicatechin. C) Example of B-type ( $4 \rightarrow 6$ ) linkage. Specific compound is procyanidin B5 (dimer), epicatechin-( $4\beta \rightarrow 6$ )-epicatechin. D) Example of A-type ( $4 \rightarrow 8$ ,  $2 \rightarrow 7$ ) linkage. Specific compound is procyanidin A2 (dimer), epicatechin-( $2\beta \rightarrow 7$ ,  $4\beta \rightarrow 8$ )-epicatechin.

studies were conducted with Caco-2 cells, a cell line derived from human intestinal cells, dimers and trimers of proanthocyanidins were readily transported across the cell monolayers, whereas higher polymers [degree of polymerization (Dp), Dp6] were adsorbed onto the epithelial cells and permeability was greatly reduced.<sup>[6]</sup> Experiments with human subjects have corroborated these results, showing that dimeric proanthocyanidins, but not higher polymers, were identified in plasma after consumption of flavanol-rich cocoa (containing primarily large polymers) or proanthocyanidin-rich grape seed extract.<sup>[7,8]</sup>

It is difficult to ascribe the positive effects on health biomarkers to the relatively low (nanomolar concentrations) and transient plasma levels of only proanthocyanidin dimers, when foods or supplements containing high levels of proanthocyanidins are consumed. Metabolism of monomeric polyphenols by microflora of the lower GI tract has been recognized for many years.<sup>[9]</sup> The same concept has recently been applied to the metabolism of proanthocyanidins. In vitro experiments employing human colonic microflora demonstrated that semipurified proanthocyanidins, free of monomers, dimers, and trimers, were almost totally degraded after 48 hr of incubation.<sup>[10]</sup> The primary products of these incubations were monohydroxylated derivatives (meta and para isomers) of phenylacetic, phenylpropionic, and phenylvaleric acids,<sup>[10]</sup> which were similar to

those resulting from the metabolism of monomeric flavonoids.<sup>[9]</sup>

Studies with human subjects showed that cocoa proanthocyanidins were stable during transit through the high-acid environment of the stomach,<sup>[11]</sup> but subsequently increased the urinary excretion of several phenolic acids (many of the same as above), suggesting extensive metabolism in the lower GI tract.<sup>[12]</sup> Additional trials with human beings identified the circulating forms of these phenolic acids as glucuronides, which were in much higher concentrations than the intact monomeric polyphenols that were fed.<sup>[13]</sup> Presumably, the glucuronides, along with sulfates and *O*-methyl derivatives of the phenolic acids, are the primary urinary products of proanthocyanidins,<sup>[14,15]</sup> although a dearth of clinical observations limits verification of these assumptions. Collectively, these early observations suggest that metabolic cleavage products of polyphenols and proanthocyanidins should be given consideration as physiologically relevant bioactive components.

One of the shortcomings of many of the investigations on proanthocyanidins has been the lack of purified individual oligomers and polymers. As a result, foods, supplements, and medicinal plant preparations, which contain proanthocyanidins, have been tested for effectiveness. Unfortunately, these materials often contain a host of other compounds that may also alter

various biological responses, e.g., terpene trilactones of *Ginkgo biloba* with neuromodulatory properties.<sup>[16]</sup> Nonetheless, results employing these dietary materials give an indication of the potential proanthocyanidins may have in the beneficial alteration of disease markers. Typical natural product preparations that have been employed in such experiments include *Eriobotrya japonica* (loquat) leaf and seed extracts, grape seed extract, *G. biloba*, pycnogenol (extract of French maritime pine bark), red alder bark extract, and witch hazel (extract of *Hamamelis virginiana* L. bark). Foods and spices that often have been examined for their health-promoting activity and that contain proanthocyanidins include cinnamon, cranberry, cocoa powder and dark chocolate, and red grapes and their wines.

### ALTERATION OF BIOLOGICAL MARKERS ASSOCIATED WITH CHRONIC AND OTHER DISEASES

#### Free Radicals, Human Diseases, and Proanthocyanidins as Antioxidants

Although much has been written about life processes that generate free radicals and other reactive species [reactive oxygen species (ROS), reactive nitrogen species (RNS)] as well as their contribution to human disease pathophysiology,<sup>[17]</sup> the specific role of proanthocyanidins in removal of these damaging species and reversal of health degradative processes has not been elucidated.<sup>[18]</sup> Antioxidant activities are routinely measured *in vitro*,<sup>[19]</sup> but without knowledge of the specific metabolites of proanthocyanidins that are absorbed and distributed to cells in the human body, little connection can be made between these measurements and health promotion.

#### Cancer

Many *in vitro* and *in vivo* systems have been employed to investigate the role of proanthocyanidins on markers associated with cancer processes. However, many *in vitro* experiments have been conducted without regard to the limited knowledge that only proanthocyanidin dimers or smaller metabolites are absorbed by human beings. Therefore, only those studies that may be relevant to human beings are reviewed here.

Procyanidin B2 (dimer), isolated from loquat leaves, was found to inhibit the 12-*O*-tetradecanoylphorbol-13-acetate (TPA)-induced activation of Epstein-Barr virus early antigen in Raji cells.<sup>[20]</sup> *In vivo* studies with mice indicated that pretreatment with dietary grape

seed proanthocyanidin extract (GSPE) greatly reduced TPA-induced lipid peroxidation and DNA fragmentation in brain and hepatic tissues.<sup>[21]</sup> In addition, production of ROS by peritoneal macrophages was significantly decreased in GSPE-prefed and TPA-treated mice, as evidenced by decreased cytochrome *c* reduction and chemiluminescence response. The responses of the biological markers were dose dependent with respect to dietary GSPE levels, and were also greater than the response when vitamin C or E, or beta-carotene, was fed at similar concentrations.

#### Cytotoxicity

A number of studies have examined the cytotoxicity of proanthocyanidins and proanthocyanidin-rich natural products on transformed and normal cells. The 3,3'-di-*O*-gallate derivative of procyanidin B2 was active against human leukemic cells (HL-60) and a melanoma cell line, but was inactive toward several other tumor cell lines.<sup>[3]</sup> Several other galloylated procyanidin dimers were also shown to inhibit the growth of human lung and colon carcinoma cell lines. However, several nongalloylated dimers, dimers and trimers containing A-type linkages, and a galloylated pentamer were less active.<sup>[3]</sup>

The influence of proanthocyanidins has been investigated on biological markers for cancer in several animal models. When fed as a condensed tannin extract of red alder bark or as GSPE, they significantly inhibited the multiplicity, size, and distribution of chemically induced colonic aberrant crypt foci in mice and rats.<sup>[22,23]</sup> Interestingly, one of the most effective forms of administration of red alder bark proanthocyanidins was via drinking water. Experiments showed that proanthocyanidins isolated from cacao liquor and fed to Sprague-Dawley rats substantially inhibited the initiation of 2-aminomethyl-6-phenylimidazo[4,5-*b*]pyridine (PhIP)-induced pancreatic carcinogenesis.<sup>[24]</sup> Feeding proanthocyanidins extracted from grape seeds to SKH-1 hairless mice also decreased both UVB-induced skin carcinogenesis and malignant transformation in terms of incidence, multiplicity, and size.<sup>[25]</sup> Grape seed proanthocyanidins fed to mice or rats, however, were not effective in curtailing chemically induced mammary tumorigenesis.<sup>[23,24]</sup> Several foods also contain them; however, there is a paucity of observations on their effect on carcinogenic processes. Although black and green teas have been extensively investigated for their anticancer activity, the latter contain only limited proanthocyanidins,<sup>[26]</sup> while the former have substantial concentrations of derived tannins (theaflavins, thearubigins, etc.), which are a heterogeneous mixture of oxidation products of monomeric flavonoids, and structurally different from proanthocyanidins.<sup>[27]</sup>

## Mechanisms of action

Investigators have suggested several mechanisms of action for proanthocyanidins toward inhibition of carcinogenic processes. Foremost among these are their antioxidant or ROS scavenging activities,<sup>[28]</sup> based primarily on findings from cell culture and *ex vivo* experiments. Studies with laboratory animals indicated that GSPE provided protection against chemically induced hepato- and nephrotoxicity, increased bcl-X<sub>L</sub> expression in liver tissue, and antagonized both necrotic and apoptotic liver cell death.<sup>[28]</sup> Further attempts to elucidate the antiapoptotic and antinecrotic mechanism suggested that cytochrome P450 2E1 activity, responsible for the metabolism of drugs and chemicals, was substantially decreased by GSPE feeding in livers of mice<sup>[28]</sup> but not in the same organ of rats.<sup>[23]</sup> Also, cytochrome P450 1A and glutathione-S-transferase activities (carcinogen metabolism) were unaltered by a similar feeding regimen in rats.

## Atherosclerosis

Atherosclerosis is an inflammatory disease process.<sup>[29]</sup> One of the first events in this process is the development of endothelial dysfunction, presumably caused by such phenomena as hypertension, diabetes, oxidatively modified low-density lipoproteins (LDL), and elevated levels of homoserine. The injured endothelium becomes more permeable and attracts monocytes and other inflammatory and immune cells by secreting specific cytokines and growth factors. At the same time, upregulation of a series of adhesion molecules increases the adhesiveness of endothelium, platelets, and leukocytes. All of these events promote the formation of atherosclerotic plaques, which results in constriction of the blood vessel. The injured endothelium, in turn, may also have decreased ability to dilate as a result of diminished capacity to produce nitric oxide (NO). Proanthocyanidins and/or their metabolic products may ameliorate several of the steps in this complex process.

## Inhibition of liposome and LDL oxidation

Experiments with synthetic liposomes and proanthocyanidins isolated from cocoa revealed that oxidation was effectively inhibited by flavan-3-ol monomers, and proanthocyanidin dimers and trimers.<sup>[30]</sup> Elucidation of the antioxidant mechanism suggested that proanthocyanidins interacted with the phospholipid "head" groups of the liposome, which restricted both access of oxidants to the membrane surface and movement of oxidants through the internal hydrophobic region of the membrane.<sup>[31]</sup>

Relative to oxidation of LDL, many *in vitro* studies have been conducted with isolated LDL particles, chemical oxidants, and various individual isolated procyanidins or natural products rich in proanthocyanidins.<sup>[32]</sup> It is difficult to interpret results with polymeric proanthocyanidins in terms of biological activity, because studies to date suggest that oligomers greater than Dp<sub>2</sub> are only minimally absorbed in human beings. Nonetheless, experiments with a cellular system (endothelial cell-mediated LDL oxidation), which may have relevance to *in vivo* conditions, showed a preference of antioxidants for monomeric catechin and dimers rather than higher polymers of procyanidin.<sup>[33]</sup>

A highly controlled, double-blind randomized crossover human study demonstrated that proanthocyanidin-containing cocoa powder and chocolate were effective in decreasing LDL oxidation susceptibility, and slightly increasing total serum antioxidant capacity as well as high-density lipoprotein (HDL)-cholesterol levels.<sup>[34]</sup> The diets of this study were based on an average American diet and identical in content except for daily addition of 16 g dark chocolate and 22 g of cocoa powder to the test diet. Similar results of cocoa ingestion on LDL oxidation susceptibility were observed in additional studies for which dietary control was less rigorous.<sup>[35]</sup>

Pycnogenol (150 mg/day) fed to healthy individuals for 6 weeks did not alter LDL oxidizability, but reduced LDL-cholesterol and increased HDL-cholesterol levels in the plasma of two-thirds of the subjects.<sup>[36]</sup> However, the same extract (360 mg/day) given to patients with chronic venous insufficiency decreased total blood cholesterol and LDL-cholesterol values, but did not alter HDL-cholesterol levels.<sup>[37]</sup> Addition of GSPE to the diet for 8 weeks to hypercholesterolemic subjects substantially reduced the level of antibodies to oxidized LDL (measure of oxidized LDL), compared to results of the placebo control group.<sup>[38]</sup>

## Inhibition of inflammatory response

As noted above, atherosclerosis is an inflammatory response of the intima of the vessel wall that involves such immune cells as macrophages and T-lymphocytes.<sup>[32]</sup> A cascade of biochemical events, beginning with metabolism of arachidonic acid to such cytokines as leukotriene and prostacyclin, occurs prior to the recruitment of immune cells to the injured endothelium. Alteration of any of the steps in this cascade that changes the favorable ratio and levels of these cytokines may reduce the severity of the resulting atherosclerotic event.

Short-term (6 hr) *in vivo* experiments with human subjects fed high-proanthocyanidin-containing chocolate resulted in increased plasma levels of prostacyclin, decreased concentrations of leukotrienes, and

a decreased leukotriene/prostacyclin ratio, a measure of the proinflammatory/anti-inflammatory eicosanoid balance.<sup>[39]</sup> Longer-term studies (4 and 6 weeks) with subjects consuming a combination of cocoa powder and dark chocolate daily, in addition to an average American diet or a low-flavonoid diet, failed to alter the urinary excretion of F<sub>2</sub> isoprostane, or thromboxane B<sub>2</sub> (stable metabolite of proaggregatory thromboxane production), 6-keto-prostaglandin F<sub>1α</sub> (prostacyclin stable metabolite), or their ratio.<sup>[34,40]</sup> Consumption of purple grape juice, but not several other juices or coffee devoid of proanthocyanidins, significantly increased 6-keto-prostaglandin F<sub>1α</sub> at 2 hr postconsumption.<sup>[41]</sup>

Pycnogenol (200 mg/day) consumption reduced thromboxane B<sub>2</sub> levels in smokers compared to those in nonsmokers, but did not alter levels in nonsmokers.<sup>[42]</sup> Intake of *G. biloba* extract (120 mg/day, 3 mo) by healthy subjects reduced excretion of both 11-dehydrothromboxane B<sub>2</sub> and prostacyclin, but had no effect in Type 2 diabetics, which suggested a differential modulation of cyclo-oxygenases depending on their cellular location (platelets or endothelial cells).<sup>[43]</sup>

Endothelial dysfunction causes increased expression of cellular adhesion molecules (CAMs), e.g., ICAM-1 (intracellular CAM), VCAM-1 (vascular CAM), and E-selectin, which mediate the recruitment of monocytes and their subsequent differentiation into phagocytic macrophages.<sup>[32]</sup> Many *in vitro* studies have been conducted employing cultured and isolated cells, treated with several sources of proanthocyanidins, both purified and products, as effectors of CAM metabolism. The results of these experiments are difficult to relate to *in vivo* conditions because of the mixture or size of the proanthocyanidins that was tested. However, an *in vitro* study with peripheral blood mononuclear cells (PBMCs), isolated from human subjects who had low production of transforming growth factor beta-1 (TGFβ-1), showed that its production was greatly stimulated by dimeric proanthocyanidins isolated from cocoa.<sup>[44]</sup> In contrast, TGFβ-1 secretion from high-producing PBMCs at baseline was inhibited by the same dimers. Notwithstanding these observations, a 6-week study with human subjects who received a combination of dark chocolate and cocoa powder (~650 mg procyanidins per day) in addition to a low-flavonoid diet failed to alter the response of several markers of inflammation, including interleukin-1β, interleukin-6, TNFα-1, C-reactive protein, and P-selectin.<sup>[40]</sup>

### Decreased platelet aggregation

Platelets are small cells of the blood system that are normally recruited to participate in the healing of capillary walls when damage occurs.<sup>[32]</sup> Healthy

vascular endothelium that produces adequate NO and prostacyclin, both inhibitors of platelet adhesion, does not attract platelets. However, atherosclerotic events, including damage to the endothelium and plaque deposits, may result in recruitment and adhesion of platelets at the site of injury. In the case of a highly stenosed region of a coronary or cerebral artery, aggregated platelets may cause cessation of blood flow, resulting in a myocardial infarct or transient ischemic attack. Therefore, knowledge of components of foods and dietary supplements that downregulate platelet activity may reduce the risk of stroke and heart attacks.

Both short-term (2–6 hr) studies and a long-term (28 day) experiment with human subjects demonstrated that consumption of proanthocyanidin-rich cocoa beverage lowered P-selectin expression and platelet aggregation.<sup>[42–48]</sup> The effects observed were qualitatively similar to those of aspirin, but less profound.<sup>[47]</sup> Other food sources of proanthocyanidins such as purple grape juice, and combined extracts of grape seeds and grape skins, but not citrus juices, were also active in the reduction of platelet aggregation when administered to dogs, monkeys, or human beings.<sup>[32,49]</sup> Extract of *G. biloba* (120 mg/day for 3 mo) fed to healthy volunteers modulated collagen-, but not platelet activating factor (PAF)-mediated platelet aggregation.<sup>[43]</sup> However, giving the same extract to subjects with Type 2 diabetes mellitus decreased platelet aggregation stimulated by both systems.

An *in vivo* model based on cyclic flow reductions caused by platelet aggregation in the partially occluded circumflex coronary artery of anesthetized dogs has been employed to test platelet activity and platelet–vessel wall interactions.<sup>[32]</sup> Several dietary sources of proanthocyanidins (e.g., red wine and purple grape juice) were active in preventing thrombus formation in this model. A similar model, based on experimental venous thrombosis in spontaneously normolipidemic rats fed a cholesterol-rich diet, demonstrated that alcohol-free red wine added to the diet reversed the prothrombotic effect of the hyperlipidemic factors.<sup>[50]</sup>

### Animal models and human studies

Several animal models have been developed to study environmental effects on the progression of atherosclerosis. Golden Syrian hamsters, when fed diets of high cholesterol and coconut oil for 10 weeks, have a lipid profile similar to hypercholesterolemic human beings. This treatment also results in the formation of foam cells on aorta walls, the extent of which has been used as a biomarker of the early stages of atherosclerosis (atherosclerotic index).<sup>[38]</sup> Addition of GSPE to a hypercholesterolemic hamster diet (50 or 100 mg/kg body weight) resulted in a substantial



and significant reduction of the atherosclerotic index. In addition, total plasma cholesterol and triglyceride levels were also significantly reduced in the GSPE-fed animals.

New Zealand white rabbits fed hypercholesterolemic diets respond with high total plasma cholesterol levels (400+ mg/dl) and the formation of Sudan-positive stained lesions (fatty streaks) on the walls of their aorta.<sup>[51]</sup> The extent of the Sudanophilic lesions of the aortic arch of these animals also serves as a biomarker of atherosclerosis potential. Addition of GSPE (Leucoselect-Phytosome) to hypercholesterolemic diets of a group of rabbits reduced aortic arch lesions to nearly control levels (3%), whereas atherosclerotic diets alone resulted in lesions that covered 18% of the vessel wall.

Studies with proanthocyanidin-rich cranberry juice powder fed to familial hypercholesterolemic pigs significantly lowered total plasma cholesterol and LDL, and slightly raised HDL.<sup>[32]</sup> However, the same powder fed to normocholesterolemic pigs did not alter levels of circulating cholesterol fractions. Grape seed proanthocyanidins fed to rats, along with high-cholesterol diets, also reduced serum cholesterol levels compared to non-proanthocyanidin-fed controls.<sup>[3]</sup>

Studies with human beings who consumed a combination of cocoa powder and dark chocolate for relatively long periods (4 and 6 weeks) revealed that this only slightly, but significantly, increased HDL levels in one experiment, but did not remarkably alter plasma cholesterol, triglyceride, or other lipoprotein concentrations.<sup>[34,40]</sup> In contrast, cinnamon, which contains a series of unique trimeric and tetrameric procyanidins with A-type linkages,<sup>[52]</sup> significantly decreased plasma levels of triglycerides and total and LDL cholesterol, when administered (1–6 g/day) just for 20 days.<sup>[53]</sup>

### NO-dependent vasodilation

Impairment of vasodilation is characteristic of atherosclerosis and related circulatory diseases.<sup>[32]</sup> Endothelium-dependent vasodilation is mediated through the release of NO by endothelial cells. The enzyme, nitric oxide synthase (NOS), uses L-arginine and oxygen as substrates to produce NO, which diffuses to smooth muscle cells to stimulate vasorelaxation.

Two noninvasive in situ systems have been developed to test the efficacy of various dietary components, drugs, and environmental conditions on vasodilation. A study showed that patients with coronary artery disease had improved flow-mediated vasodilation of the brachial artery (FMD) when purple grape juice was consumed compared to beverages that did not contain proanthocyanidins.<sup>[32]</sup> A similar experiment with subjects who had at least one cardiovascular risk factor and who consumed a high-proanthocyanidin cocoa

beverage demonstrated a significant increase in FMD response (4 hr postconsumption) relative to response at baseline and after consumption of low-proanthocyanidin cocoa drink.<sup>[54]</sup> In addition, plasma NO concentrations paralleled FMD response, supporting the concept that improved endothelial function, in part, may be due to a favorable modulation of NO bioavailability. Employing pulsatile artery dilation in a fingertip, healthy subjects who consumed proanthocyanidin-rich cocoa for 4 days had consistent and striking peripheral vasodilation compared to baseline.<sup>[55]</sup> Consumption of test cocoa on day 5 gave an additional significant acute vasodilation response, whereas infusion of *N*<sup>G</sup>-nitro-L-arginine methylester (L-NAME), an NOS inhibitor, completely reversed the cocoa-induced vasodilation.

A surgical in situ system was employed to assess the response of cerebral microcirculation of rats to the intake of an extract of *G. biloba* leaves (EGb 761).<sup>[56]</sup> Normotensive and spontaneously hypertensive (SHR) rats were fed EGb 761 for 9 days, after which several parameters of cerebral circulation were compared with those of control animals. The most significant and dramatic changes observed in EGb 761-fed SHR rats were a blood pressure decrease of nearly 30%, and increased numbers of open capillaries and circulating endothelial cells, compared to SHR controls. Only minor changes were observed (increased cerebral blood flow velocity) in EGb 761-treated normotensive animals.

In vitro studies demonstrated that red wine and pycnogenol, both rich in proanthocyanidins, but not white wine, improved vasodilation and simultaneously increased endothelial NO production.<sup>[32]</sup> Characterization of proanthocyanidin fractions isolated from red wine showed that vasodilation activity was greatest in the presence of low-molecular-weight oligomers (Dp2–3), whereas higher polymers were inactive.<sup>[32]</sup> Examination of the mechanism of increased NO production with rat aorta ring strips and *G. biloba* extract suggested inhibition of Ca<sup>2+</sup> influx through Ca<sup>2+</sup> channels, thereby activating NO release.<sup>[57]</sup>

### Vasoconstriction

Angiotensin II is a vasoconstrictor that is produced in the pulmonary capillaries by angiotensin converting enzyme (ACE) and can be involved in the development of hypertension and atherosclerosis.<sup>[32]</sup> Several proanthocyanidins and preparations containing them inhibited ACE activity in both in vitro and in vivo experiments. These included pycnogenol, proanthocyanidins isolated from red grapes, extracts of *Erythroxylum laurifolium* (endemic species on Reunion Island in the Indian Ocean), and fruits of *Cupressus sempervirens* L. (Italian cypress). These observations suggest another role for proanthocyanidins in the amelioration of adverse vascular phenomena.

## Reperfusion

Induced ischemia–reperfusion studies in hearts isolated from laboratory animals simulate myocardial infarction and recovery in human beings. This model permits investigation of various dietary interventions, and other environmental and circulatory alterations on the recovery of hearts postischemia. Hearts from GSPE-, red wine-, or red wine proanthocyanidin-fed rats were more resistant to ischemia–reperfusion injury than those from control animals.<sup>[38]</sup> Blood flow parameters were improved, whereas infarct size, formation of hydroxyl radicals, and malondialdehyde levels of heart perfusate were all modulated as a result of feeding animals proanthocyanidins or proanthocyanidin-containing ingredients. These same dietary treatments also reduced the levels of proapoptotic factors JNK and c-Jun, as well as the proportion of apoptotic cardiomyocytes.

## Other Metabolic Alterations

### Bacterial antiadhesion

Anecdotal observations and recent critical evaluation of scientific literature indicate that consumption of cranberry or its products is effective in the prevention of urinary tract infections.<sup>[58,59]</sup> Although the therapeutic effect was long thought to be increased urinary acidity due to hippuric acid excretion,<sup>[60]</sup> it is now attributed to a family of unique proanthocyanidins and/or their metabolites,<sup>[61]</sup> which have been characterized as containing a high proportion of A-type linkages.<sup>[62]</sup> In the case of urinary tract infection, the primary effect is inhibition of cellular adherence of P-type (mannose-resistant) uropathogenic strains of *Escherichia coli*.<sup>[60,63]</sup> In addition, evidence has been presented for similar responses with *Helicobacter pylori* to gastric epithelial cells<sup>[64]</sup> and a host of organisms commonly found in the oral cavity.<sup>[65]</sup>

### Diabetes, and glucose and insulin metabolism

Impaired glucose uptake and insulin resistance are subtle but common metabolic alterations that may be general etiologies to several age-related disorders and chronic diseases.<sup>[66]</sup> Thus, identification of dietary components and natural products that have the potential to maintain these metabolisms throughout life has a highly favorable risk/benefit ratio. Several foods, botanical materials, and synthetic preparations, such as tea, several spices, and GSPE, have been found to be effective.<sup>[66–68]</sup> Relative to proanthocyanidins, an extract of cinnamon, which contained a series of two trimers and a tetramer of flavan-3-ols, each with an

A-type linkage,<sup>[52]</sup> was effective in significantly reducing fasting blood glucose in a group of Type 2 diabetics.<sup>[53]</sup> Although elucidation of mechanism of action suggested that cinnamon extracts altered the activity of several phosphorylation/phosphatase reactions of insulin receptors in isolated rat epididymal adipocytes,<sup>[69,70]</sup> it is uncertain as to which proanthocyanidins were absorbed and the precise mechanism in vivo.

Cataract formation and occurrence of retinopathy are two complications of Type 2 diabetes. Cocoa-derived proanthocyanidins fed to diabetes-induced (streptozotocin-treated) rats almost completely inhibited cataract formation.<sup>[71]</sup> In control animals, lens opacity was first detected at 5 weeks after start of diabetes induction, and was prevalent in a majority of lenses at 10 weeks of treatment. Although lenses of proanthocyanidin-fed animals revealed some focal hyperplasia of the epithelium and liquefaction of cortical fibers at 10 weeks of dietary treatment, opacity of lens was undetectable.

A review of five clinical trials involving nearly 1300 patients, in which pycnogenol was tested for treatment and prevention of retinopathy, unequivocally showed diminished progression of the disease and partial recovery of visual acuity in subjects ingesting the supplement.<sup>[72]</sup> Pycnogenol treatment effectively improved capillary resistance, reduced blood leakages into the retina, and was as efficacious as the drug calcium dobesilate.

### Immune function

Response of the immune system is one of the first lines of defense of the body to a host of environmental challenges. Many dietary components and drugs stimulate this system to an elevated level of preparedness. Besides those components of the immune system associated with atherosclerosis, the effect of proanthocyanidins has also been tested, in vitro, in several cell culture and isolated human cell systems. Unfortunately, these studies have employed isolated proanthocyanidin fractions or preparations for which confirmation of absorption has not been demonstrated. Thus, the applicability of the results to in vivo conditions is in question.

## DIETARY SOURCES AND INTAKE

### Dietary Sources

#### Foods

A wide variety of analytical procedures have been employed for the bulk measurement of proanthocyanidins.<sup>[73]</sup> Although individual dimers and trimers have

been traditionally quantified with reversed-phase high-performance liquid chromatography (HPLC) systems, only recently have normal-phase HPLC techniques been coupled with sophisticated detection instrumentation for the quantification of individual proanthocyanidin oligomers ( $Dp \leq 12$ ) as well as bulk measurement of higher molecular weight components.<sup>[74–76]</sup>

Employing these normal-phase HPLC procedures, a large number of food samples, selected on the basis of market share and demographics within the United States, were analyzed for proanthocyanidin content.<sup>[77]</sup> These data and others have been combined into a database of values for foods available online from the USDA Nutrient Data Laboratory (<http://www.nal.usda.gov/fnic/foodcomp>). Data for the proanthocyanidin content of selected foods are tabulated in Table 1. The information for red grapes reported in this table are for seedless “eating” grapes, whereas cultivars of red wine grapes and their wines have higher proanthocyanidin contents.<sup>[78,79]</sup> This is reflected in the data for several red wines common in Spain, which contained dimers through polymers Dp13 and represented 77–84% of total flavanols.<sup>[79]</sup> In general, a large number of vegetables, many spices, and some fruits, particularly citrus, had undetectable levels of proanthocyanidins.<sup>[77]</sup> Fifty-six different kinds of common Spanish foods have been analyzed for flavanols, including dimers and trimers, but not higher oligomers.<sup>[80]</sup> Results indicated that procyanidin B2 was the most abundant dimer or trimer, and flavanols were at very low levels or undetected in most vegetables.

## Supplements

Qualitative and quantitative data on the proanthocyanidin content of dietary supplements, botanicals,

and herbals are less precise than those for foods, as these dietary components have not been subjected to the same rigorous sampling and analysis programs. In *G. biloba*, a fraction was isolated, which contained monomeric and polymeric flavonoids, and accounted for 24–36% of the mass depending on the method of extraction.<sup>[81,82]</sup> This fraction contains many flavanol glycosides, biflavones, and proanthocyanidins.<sup>[83]</sup>

Grape seed proanthocyanidins are unique in that they contain a high level of galloyl derivatives, about one per each monomeric unit.<sup>[84,85]</sup> Estimates of masses of these components range from monomers through Dp17–28 depending on the analytical method employed.<sup>[84–86]</sup> Relative to quantification, one report indicated that monomers (catechin and epicatechin) constituted about 15% of the mass, galloylated monomers, dimers, trimers, and tetramers approximately 80%, and pentamers, hexamers, heptamers, and their galloylates around 5%.<sup>[87]</sup>

Pycnogenol has been characterized as having proanthocyanidins that range from monomers of catechin and taxifolin to oligomers or higher.<sup>[88]</sup> Witch hazel (extract of bark of *H. virginiana*) contains about 5% proanthocyanidins, characterized by polymers of Dp17–29 as measured by thiolysis and Dp11–20 when gel permeation chromatography was employed.<sup>[89]</sup> A unique characteristic of these compounds was complete 3-*O*-galloylation of chain extension units. Extracts of loquat (*E. japonitca*) leaves contained procyanidin B2 as one active ingredient,<sup>[20]</sup> whereas *Crataegus sinaica* isolates were characterized as having a series of dimers through pentamers, some of which had A-type interflavan linkages.<sup>[90]</sup> Preparations from *Ecdysanthera utilis* contained two procyanidin trimers that each had an A-type linkage between monomeric unit T (top) and M (interior)

**Table 1** Proanthocyanidin content of selected foods (mg/100 g food)

Food/spice	Dimers <sup>a</sup>	Dp3–10 <sup>a</sup>	Dp > 10 <sup>a</sup>	Total	Type <sup>b</sup>
Apples, red delicious, with peel	14	64	38	116	B, PC
Blueberries	7	40	129	176	B, PC
Chocolate, baking	207	680	551	1438	B, PC
Chocolate, milk	26	105	33	164	B, PC
Cinnamon, ground	256	5319	2509	8084	A, B, PC, PP
Cranberries	26	152	234	412	A, B, PC
Grape seed (dry)	417	1354	1100	2871	B, PC
Grapes, red	2	19	59	80	B, PC
Pecans	42	211	223	476	B, PC, PD
Plums, black	16	100	115	231	A, B, PC

<sup>a</sup>Dimers—Dp2; Dp3–10—trimers through decamers summed; Dp > 10 indicates values for polymers larger than decamers which eluted as a single chromatographic peak.

<sup>b</sup>Linkage type (A, B) and proanthocyanidin subclasses (PC—procyanidin, PD—prodelphinidin, PP—propelargonidin) identified.

(Adapted from Ref.<sup>[77]</sup>.)

as well as several common procyanidin dimers (A1, A2, B2).<sup>[91]</sup>

## Dietary Intake

### Foods

Based on proanthocyanidin content for over 60 U.S. foods and daily food intake data [USDA Continuing Survey of Food Intakes by Individuals (CSFII) for 1994–1996], consumption by individuals in the United States has been calculated.<sup>[77]</sup> The mean intake for all ages (>2 yr old) was estimated at 54 mg/day/person for all proanthocyanidins of  $D_p \geq 2$ . Proanthocyanidin consumption among adults ranged from 46 mg/day (20–39 yr, female) to 66 mg/day (>60 yr, male). As outlined above, these data do not include proanthocyanidins that might be included in the consumption of red wines or other commonly consumed foods that have substantial polymer content but were not analyzed. Nonetheless, these results provide the scientific community with the first estimates of proanthocyanidin consumption.

### Supplements

Because of the dearth of analytical data for the proanthocyanidin content of supplements, botanicals, and herbals, data on levels of intakes from these dietary sources are not available. A recent survey of over 23,000 women in the United States indicated that nearly one-sixth took at least one herbal supplement (including *G. biloba*) in the year 2000.<sup>[92]</sup> Based on this study, those women characterized as more likely to consume herbal supplements were non-Hispanic white, were more educated, had higher income, had residence in South and West, and had functional limitations and chronic conditions. Plans and approaches have been discussed for future inclusion of nutrients and health-related components provided by all supplements into U.S. National Nutrition Surveys.<sup>[93]</sup>

## ADVERSE BIOLOGICAL EFFECTS

Traditionally, condensed tannins (proanthocyanidins) have been considered antinutrients in animal nutrition due to their astringency (reduced feed intake) and ability to bind several macronutrients, thus reducing their digestion and absorption.<sup>[5,94]</sup> However, specific digestive advantages, e.g., reduced incidence of bloating in ruminants, have been realized for some of the unique chemical traits of proanthocyanidins (protein binding), which are now being pursued.<sup>[94,95]</sup> Although

pycnogenol has been shown to bind selected purified intracellular enzymes,<sup>[96]</sup> the precise role of these polymers in the alteration of the metabolic equilibrium in the GI tract of human beings is unknown. Toxicological studies on long-term (90 days) oral administration of GSPE to rats established a no-observed-adverse-effect level (NOAEL) of 1.4 g/kg body weight (BW)/day for males and 1.5 g/kg BW/day for females.<sup>[97]</sup> Similarly, the  $LD_{50}$  of a single oral dose of grape seed extract IH636 was greater than 5 g/kg BW for both male and female rats.<sup>[98]</sup> Feeding IH636 at the rate of 100 mg/kg/day to male B6C3F1 mice for a year or 500 mg/kg/day to female mice for 6 mo had no detectable adverse effects on the pathologies of vital organs or on serum chemistries. In terms of dermal irritation, IH636 was rated as moderately irritating and the no-observed-effect level (NOEL) for systemic toxicity was set at 2 g/kg for male and female albino rats.<sup>[98]</sup> Observations in both rats and human subjects consuming FastOne, a herbal supplement containing extracts of kola nut, grape, green tea, and *G. biloba*, suggested an increased risk of colorectal cancers as substantiated by the induced activity of cytochrome P450 1A2.<sup>[99]</sup>

In a review of potential drug–dietary supplement interactions, about one-half of patients taking prescription medication and at least one dietary supplement had potential for an “interaction of significance”.<sup>[100]</sup> Of these patients, only 6% had the potential of a severe interaction. Spontaneous bleeding in the anterior chamber of the eye (hyphema) has been reported, which was resolved when consumption of *G. biloba* was stopped.<sup>[101]</sup> Review of several clinical trials that investigated pycnogenol indicated that tolerance of the supplement was very good, with only rare side effects, most referring to gastric discomfort.<sup>[72]</sup> Similar observations were reported for Enzogenol, a combination of an extract of *Pinus radiata* bark and vitamin C.<sup>[102]</sup>

## COMPENDIAL/REGULATORY STATUS

Not applicable.

## REFERENCES

1. Porter, L.J. Flavans and proanthocyanidins. In *The Flavonoids: Advances in Research Since 1986*; Harborne, J.B., Ed.; Chapman and Hall: London, 1994; 23–55.
2. Cowan, M.M. Plant products as antimicrobial agents. *Clin. Microbiol. Rev.* **1999**, *12*, 564–582.
3. Santos-Buelga, C.; Scalbert, A. Proanthocyanidins and tannin-like compounds—nature, occurrence,

- dietary intake and effects on nutrition and health. *J. Sci. Food Agric.* **2000**, *80*, 1094–1117.
4. Bors, W.; Foo, L.Y.; Hertkorn, N.; Michel, C.; Stettmaier, K. Chemical studies of proanthocyanidins and hydrolysable tannins. *Antioxid. Redox Signal.* **2001**, *3*, 995–1008.
  5. Salunkhe, D.K.; Chavan, J.K.; Kadam, S.S. *Dietary Tannins: Consequences and Remedies*; CRC Press, Inc.: Boca Raton, FL, 1989.
  6. Deprez, S.; Mila, I.; Huneau, J.F.; Tome, D.; Scalbert, A. Transport of proanthocyanidin dimer, trimer, and polymer across monolayers of human intestinal epithelial Caco-2 cells. *Antioxid. Redox Signal.* **2001**, *3*, 957–967.
  7. Holt, R.R.; Lazarus, S.A.; Sullards, M.C.; Zhu, Q.Y.; Schramm, D.D.; Hammerstone, J.F.; Fraga, C.G.; Schmitz, H.H.; Keen, C.L. Procyanidin dimer B2 [epicatechin-(4 $\beta$ -8)-epicatechin] in human plasma after the consumption of flavanol-rich cocoa. *Am. J. Clin. Nutr.* **2002**, *76*, 798–804.
  8. Sano, A.; Yamakoshi, J.; Tokutake, S.; Tobe, K.; Kubota, Y.; Kikuchi, M. Procyanidin B1 is detected in human serum after intake of proanthocyanidin-rich grape seed extract. *Biosci. Biotechnol. Biochem.* **2003**, *67*, 1140–1143.
  9. De Eds, F. Physiological effects and metabolic fate of flavonoids. In *The Pharmacology of Plant Phenolics*; Fairbairn, J.W., Ed.; Academic Press: London, 1959; 91–102.
  10. Deprez, S.; Brezillon, C.; Rabot, S.; Philippe, C.; Mila, I.; Lapiere, C.; Scalbert, A. Polymeric proanthocyanidins are catabolized by human colonic microflora into low-molecular-weight phenolic acids. *J. Nutr.* **2000**, *130*, 2733–2738.
  11. Rios, L.Y.; Bennett, R.N.; Lazarus, S.A.; Remesy, C.; Scalbert, A.; Williamson, G. Cocoa procyanidins are stable during gastric transit in humans. *Am. J. Clin. Nutr.* **2002**, *76*, 1106–1110.
  12. Rios, L.Y.; Gonthier, M.P.; Remesy, C.; Mila, I.; Lapiere, C.; Lazarus, S.A.; Williamson, G.; Scalbert, A. Chocolate intake increases urinary excretion of polyphenol-derived phenolic acids in healthy human subjects. *Am. J. Clin. Nutr.* **2003**, *77*, 912–918.
  13. Rechner, A.R.; Kuhnle, G.; Bremner, P.; Hubbard, G.P.; Moore, K.P.; Rice-Evans, C.A. The metabolic fate of dietary polyphenols in humans. *Free Radical Biol. Med.* **2002**, *33*, 220–235.
  14. Scalbert, A.; Morand, C.; Manach, C.; Rémésy, C. Absorption and metabolism of polyphenols in the gut and impact on health. *Biomed. Pharmacother.* **2002**, *56*, 276–282.
  15. Duweler, K.G.; Rohdewald, P. Urinary metabolites of French maritime pine bark extract in humans. *Pharmazie* **2000**, *55*, 364–368.
  16. Stromgaard, K.; Nakanishi, K. Chemistry and biology of terpene trilactones from *Ginkgo biloba*. *Angew. Chem. Int. Ed. Engl.* **2004**, *43*, 1640–1658.
  17. Bagchi, D.; Bagchi, M.; Stohs, S.J.; Das, D.K.; Ray, S.D.; Kuszynski, C.A.; Joshi, S.S.; Pruess, H.G. Free radicals and grape seed proanthocyanidin extract: importance in human health and disease prevention. *Toxicology* **2000**, *148*, 187–197.
  18. Halliwell, B.; Gutteridge, J.M.C.; Cross, C.E. Free radicals, antioxidants, and human disease: where are we now? *J. Lab. Clin. Med.* **1992**, *199*, 598–620.
  19. Prior, R.L.; Cao, G. Variability in dietary antioxidant related natural product supplements: the need for methods standardization. *J. Am. Nutraceut. Assoc.* **1999**, *2* (2), 46–56.
  20. Ito, H.; Kobayashi, E.; Li, S.H.; Hatano, T.; Sugita, D.; Kubo, N.; Shimura, S.; Itoh, Y.; Tokuda, H.; Nishino, H.; Yoshida, T. Antitumor activity of compounds isolated from leaves *Eriobotrya japonica*. *J. Agric. Food Chem.* **2002**, *50*, 2400–2403.
  21. Bagchi, D.; Garg, A.; Krohn, R.L.; Bagchi, M.; Bagchi, D.J.; Balmoori, J.; Stohs, S.J. Protective effects of grape seed proanthocyanidins and selected antioxidants against TPA-induced hepatic and brain lipid peroxidation and DNA fragmentation, and peritoneal macrophage activation in mice. *Gen. Pharmacol.* **1998**, *30*, 771–776.
  22. Gali-Muhtasib, H.U.; Younes, I.H.; Karchesy, J.J.; el-Sabban, M.E. Plant tannins inhibit the induction of aberrant crypt foci and colonic tumors by 1,2-dimethylhydrazine in mice. *Nutr. Cancer* **2001**, *39*, 108–116.
  23. Singletary, K.W.; Meline, B. Effect of grape seed proanthocyanidins on colon aberrant crypts and breast tumors in a rat dual-organ tumor model. *Nutr. Cancer* **2001**, *39*, 252–258.
  24. Yamagishi, M.; Natsume, M.; Osakabe, N.; Nakamura, H.; Furuka, F.; Imazawa, T.; Nishikawa, A.; Hirose, M. Effects of cacao liquor proanthocyanidins on PhIP-induced mutagenesis in vitro, and in vivo mammary and pancreatic tumorigenesis in female Sprague-Dawley rats. *Cancer Lett.* **2002**, *185*, 123–130.
  25. Mittal, A.; Elmets, C.A.; Katiyar, S.K. Dietary feeding of proanthocyanidins from grape seed prevents photocarcinogenesis in SKH-1 hairless mice: relationship to decreased fat and lipid

- peroxidation. *Carcinogenesis* **2003**, *24*, 1379–1388.
26. Lakenbrink, C.; Engelhardt, U.H.; Wray, V. Identification of two novel proanthocyanidins in green tea. *J. Agric. Food Chem.* **1999**, *47*, 4621–4624.
27. Beecher, G.R. Overview of dietary flavonoids: nomenclature, occurrence and intake. *J. Nutr.* **2003**, *133*, 3248S–3254S.
28. Bagchi, D.; Bagchi, M.; Stohs, S.; Ray, S.D.; Sen, C.K.; Preuss, H.G. Cellular protection with proanthocyanidins derived from grape seeds. *Ann. N.Y. Acad. Sci.* **2002**, *957*, 260–270.
29. Kris-Etherton, P.M.; Lefevre, M.; Beecher, G.R.; Gross, M.D.; Keen, C.L.; Etherton, T.D. Bioactive compounds in nutrition and health—research methodologies for establishing biological function: the antioxidant and anti-inflammatory effects of flavonoids on atherosclerosis. *Annu. Rev. Nutr.* **2004**, *24*, 511–538.
30. Lotito, S.B.; Actis-Goretta, L.; Renart, M.L.; Caligiuri, M.; Rein, D.; Schmitz, H.H.; Steinberg, F.M.; Keen, C.L.; Fraga, C.G. Influence of oligomer chain length on the antioxidant activity of procyanidins. *Biochem. Biophys. Res. Commun.* **2000**, *276*, 945–951.
31. Verstraeten, S.; Keen, C.L.; Schmitz, H.H.; Fraga, C.G.; Oteiza, P. Flavan-3-ols and procyanidins protect liposomes against lipid oxidation and disruption of the bilayer structure. *Free Radical Biol. Med.* **2003**, *34*, 84–92.
32. Reed, J. Cranberry flavonoids, atherosclerosis and cardiovascular health. *Crit. Rev. Food Sci. Nutr.* **2002**, *42* (Suppl.), 301–316.
33. Pearson, D.A.; Schmitz, H.H.; Lazarus, S.A.; Keen, C.L. Inhibition of in vitro low-density lipoprotein oxidation by oligomeric procyanidins present in chocolate and cocoa. *Methods Enzymol.* **2001**, *335*, 350–360.
34. Wan, J.; Vinson, J.A.; Etherton, T.D.; Proch, J.; Lazarus, S.A.; Kris-Etherton, P.M. Effects of cocoa powder and dark chocolate on LDL oxidative susceptibility and prostaglandin concentrations in humans. *Am. J. Clin. Nutr.* **2001**, *74*, 596–602.
35. Steinberg, F.M.; Bearden, M.M.; Keen, C.L. Cocoa and chocolate flavonoids: implications for cardiovascular health. *J. Am. Diet. Assoc.* **2003**, *103*, 215–223.
36. Devaraj, S.; Vega-Lopez, S.; Kaul, N.; Schonlau, F.; Rohdewald, P.; Jialal, I. Supplementation with a pine bark extract rich in polyphenols increases plasma antioxidant capacity and alters the plasma lipoprotein profile. *Lipids* **2002**, *37*, 931–934.
37. Koch, R. Comparative study of venostasin and pycnogenol in chronic venous insufficiency. *Phytother. Res.* **2002**, *16* (Suppl. 1), S1–S5.
38. Bagchi, D.; Sen, C.K.; Ray, S.D.; Das, D.K.; Bagchi, M.; Preuss, H.G.; Vinson, J.A. Molecular mechanisms of cardioprotection by a novel grape seed proanthocyanidin extract. *Mutat. Res.* **2003**, *523–524*, 87–97.
39. Schramm, D.D.; Wang, J.F.; Holt, R.R.; Ensunsa, J.L.; Gonsalves, J.L.; Lazarus, S.A.; Schmitz, H.H.; German, J.B.; Keen, C.L. Chocolate procyanidins decrease the leukotriene–prostacyclin ratio in humans and human aortic endothelial cells. *Am. J. Clin. Nutr.* **2001**, *73*, 36–40.
40. Mathur, S.; Devaraj, S.; Grundy, S.M.; Jialal, I. Cocoa products decrease low density lipoprotein oxidative susceptibility but do not affect biomarkers of inflammation in humans. *J. Nutr.* **2002**, *132*, 2663–2667.
41. Polagruto, J.A.; Schramm, D.D.; Wang-Polagruto, J.F.; Lee, L.; Keen, C.L. Effects of flavonoid-rich beverages on prostacyclin synthesis in humans and human aortic endothelial cell association with ex vivo platelet function. *J. Med. Foods* **2003**, *6*, 301–308.
42. Araghi-Niknam, M.; Hosseini, S.; Larson, D.; Rohdewald, P.; Watson, R.R. Pine bark extract reduces platelet aggregation. *Integr. Med.* **2000**, *2*, 73–77.
43. Kudolo, G.B.; Dorsey, S.; Blodgett, J. Effect of ingestion of *Ginkgo biloba* extract on platelet aggregation and urinary prostanoid excretion in healthy and Type 2 diabetic subjects. *Thromb. Res.* **2002**, *108*, 151–160.
44. Mao, T.; Van de Water, J.; Keen, C.L.; Schmitz, H.H.; Gershwin, M.E. Cocoa flavonols and procyanidins promote transforming growth factor-beta1 homeostasis in peripheral blood mononuclear cells. *Exp. Biol. Med.* (Maywood) **2003**, *228*, 93–99.
45. Rein, D.; Paglieroni, T.G.; Pearson, D.A.; Wun, T.; Schmitz, H.H.; Gosselin, R.; Keen, C.L. Cocoa and wine polyphenols modulate platelet activation and function. *J. Nutr.* **2000**, *130* (8S Suppl.), 2120S–2126S.
46. Rein, D.; Paglieroni, T.G.; Wun, T.; Pearson, D.A.; Schmitz, H.H.; Gosselin, R.; Keen, C.L. Cocoa inhibits platelet activation and function. *Am. J. Clin. Nutr.* **2000**, *72*, 30–35.
47. Pearson, D.A.; Paglieroni, T.G.; Rein, D.; Wun, T.; Schramm, D.D.; Wang, J.F.; Holt, R.R.; Gosselin, R.; Schmitz, H.H.; Keen, C.L. The effects of flavonol-rich cocoa and aspirin on ex vivo platelet function. *Thromb. Res.* **2002**, *106*, 191–197.

48. Murphy, K.J.; Chronopoulos, A.K.; Singh, I.; Francis, M.A.; Moriarty, H.; Pike, M.J.; Turner, A.H.; Mann, N.J.; Sinclair, A.J. Dietary flavonols and procyanidin oligomers from cocoa (*Theobroma cacao*) inhibit platelet function. *Am. J. Clin. Nutr.* **2003**, *77*, 1466–1473.
49. Shanmuganayagam, D.; Beahm, M.R.; Osman, H.E.; Krueger, C.G.; Reed, J.D.; Folts, J.D. Grape seed and grape skin extracts elicit a greater antiplatelet effect when used in combination than when used individually in dogs and humans. *J. Nutr.* **2002**, *132*, 3592–3598.
50. De Gaetano, G.; De Curtis, A.; Di Castelnuovo, A.; Donati, M.B.; Iacoviello, L.; Rotondo, S. Antithrombotic effect of polyphenols in experimental models: a mechanism of reduced vascular risk by moderate wine consumption. *Ann. N.Y. Acad. Sci.* **2002**, *957*, 174–188.
51. Ursini, F.; Sevanian, A. Wine polyphenols and optimal nutrition. *Ann. N.Y. Acad. Sci.* **2002**, *957*, 200–209.
52. Anderson, R.A.; Broadhurst, C.L.; Polansky, M.M.; Schmidt, W.F.; Khan, A.; Flanagan, V.P.; Schoene, N.W.; Graves, D.J. Isolation and characterization of polyphenol type-A polymers from cinnamon with insulin-like biological activity. *J. Agric. Food Chem.* **2004**, *52*, 65–70.
53. Khan, A.; Safdar, M.; Khan, A.; Khattak, K.N.; Anderson, R.A. Cinnamon improves glucose and lipids of people with type 2 diabetes. *Diabetes Care* **2003**, *26*, 3215–3218.
54. Heiss, C.; Dejam, A.; Kleinbongard, P.; Schewe, T.; Sies, H.; Kelm, M. Vascular effects of cocoa rich in flavan-3-ols. *J. Am. Med. Assoc.* **2003**, *290*, 1030–1031.
55. Fisher, N.D.L.; Hughes, M.; Gerhard-Herman, M.; Hollenberg, N.K. Flavonol-rich cocoa induces nitric-oxide-dependent vasodilation in healthy humans. *J. Hypertens.* **2003**, *21*, 2281–2286.
56. Zhang, J.; Fu, S.; Liu, S.; Mao, T.; Xiu, R. The therapeutic effect of *Ginkgo biloba* extract in SHR rats and its possible mechanisms based on cerebral microvascular flow and vasomotion. *Clin. Hemorheol. Microcirc.* **2000**, *23*, 133–138.
57. Nishida, S.; Satoh, H. Mechanisms for the vasodilation induced by *Ginkgo biloba* extract and its main constituent, bilobide in rat aorta. *Life Sci.* **2003**, *72*, 2659–2667.
58. Leahy, M.; Roderick, R.; Brilliant, K. The cranberry—promising health benefits, old and new. *Nutr. Today* **2001**, *36*, 254–265.
59. Jepson, R.; Mihaljevic, L.; Craig, J. Cranberries for preventing urinary tract infections. *Cochrane Database Syst. Rev.* **2004**, *1*, CD001321.
60. Howell, A.B. Cranberry proanthocyanidins and the maintenance of urinary health. *Crit. Rev. Food Sci. Nutr.* **2002**, *42* (Suppl.), 273–278.
61. Winston, D.; Graff, A.; Brinckmann, J.; Länger, R.; Turner, A.; Reich, E.; Bieber, A.; Howell, A.; Romm, A.J. Cranberry fruit. In *American Herbal Pharmacopoeia and Therapeutic Compendium*; Upton, R., Ed.; American Herbal Pharmacopoeia: Santa Cruz, CA, 2002.
62. Foo, L.Y.; Howell, A.B.; Vorsa, N. A-type proanthocyanidin trimers from cranberry that inhibit adherence of uropathogenic P-fimbriated *Escherichia coli*. *J. Nat. Prod.* **2000**, *63*, 1225–1228.
63. Sharon, N.; Ofek, I. Fighting infectious diseases with inhibitors of microbial adhesion to host tissues. *Crit. Rev. Food Sci. Nutr.* **2002**, *42* (Suppl.), 267–272.
64. Burger, O.; Weiss, E.; Sharon, N.; Tabak, M.; Neeman, I.; Ofek, I. Inhibition of *Helicobacter pylori* adhesion to human gastric mucus by a high-molecular weight constituent of cranberry juice. *Crit. Rev. Food Sci. Nutr.* **2002**, *42* (Suppl.), 279–284.
65. Weiss, E.I.; Lev-Dor, R.; Sharon, N.; Ofek, I. Inhibitory effect of a high-molecular weight constituent of cranberry on adhesion of oral bacteria. *Crit. Rev. Food Sci. Nutr.* **2002**, *42* (Suppl.), 285–292.
66. Preuss, H.G.; Bagchi, D.; Bagchi, M. Protective effects of a novel niacin-bound chromium complex and a grape seed proanthocyanidin extract on advancing age and various aspects of syndrome X. *Ann. N.Y. Acad. Sci.* **2002**, *957*, 250–259.
67. Anderson, R.A.; Polansky, M.M. Tea enhances insulin activity. *J. Agric. Food Chem.* **2002**, *50*, 7182–7186.
68. Broadhurst, C.L.; Polansky, M.M.; Anderson, R.A. Insulin-like biological activity of culinary and medicinal plant aqueous extracts in vitro. *J. Agric. Food Chem.* **2000**, *48*, 849–852.
69. Imparl-Radosevich, J.; Deas, S.; Polansky, M.M.; Baedke, D.A.; Ingebritsen, T.S.; Anderson, R.A.; Graves, D.J. Regulation of PTP-1 and insulin receptor kinase by fractions from cinnamon: implications for cinnamon regulation of insulin signaling. *Hormone Res.* **1998**, *50*, 177–182.
70. Jarvill-Taylor, K.J.; Anderson, R.A.; Graves, D.J. A hydroxychalcone derived from cinnamon functions as a mimetic for insulin in 3T3-L1 adipocytes. *J. Am. Coll. Nutr.* **2001**, *20*, 327–336.
71. Osakabe, N.; Yamagishi, M.; Natsume, M.; Yasuda, A.; Osawa, T. Ingestion of proantho-

- cyanidin derived from cacao inhibits diabetes-induced cataract formation in rats. *Exp. Biol. Med.* (Maywood) **2004**, *229*, 33–39.
72. Schonlau, F.; Rohdewald, P. Pycnogenol for diabetic retinopathy. A review. *Int. Ophthalmol.* **2001**, *24*, 161–171.
73. Cunningham, D.G.; Vannozzi, S.; O’Shea, E.; Turk, R. Analysis and standardization of cranberry products. In *Quality Management of Nutraceuticals*; Ho, C.-T., Zheng, Q.Y., Eds.; ACS Symposium Series 803; American Chemical Society: Washington, DC, 2002; 151–166.
74. Hammerstone, J.F.; Lazarus, S.A.; Mitchell, A.E.; Rucker, R.; Schmitz, H.H. Identification of procyanidins in cocoa (*Theobroma cacao*) using high performance liquid chromatography (HPLC)/mass spectrometry (MS). *J. Agric. Food Chem.* **1999**, *47*, 490–496.
75. Gu, L.; Kelm, M.; Hammerstone, J.F.; Beecher, G.R.; Cunningham, D.G.; Vannozzi, S.; Prior, R.L. Fractionation of polymeric procyanidins from lowbush blueberry and quantification of procyanidins in selected foods with an optimized normal-phase HPLC–MS fluorescent detection method. *J. Agric. Food Chem.* **2002**, *50*, 4852–4860.
76. Gu, L.; Kelm, M.A.; Hammerstone, J.F.; Beecher, G.R.; Holden, J.; Haytowitz, D.; Prior, R.L. Screening of foods containing proanthocyanidins and their structural characterization using LC–MS/MS and thiolytic degradation. *J. Agric. Food Chem.* **2003**, *51*, 7513–7521.
77. Gu, L.; Kelm, M.A.; Hammerstone, J.F.; Beecher, G.; Holden, J.; Haytowitz, D.; Gebhardt, S.; Prior, R.L. Concentrations of proanthocyanidins in common foods and estimations of normal consumption. *J. Nutr.* **2004**, *134*, 613–617.
78. Sanchez-Moreno, C.; Cao, G.; Ou, B.; Prior, R.L. Anthocyanin and proanthocyanidin content in selected white and red wines. Oxygen radical absorbance capacity comparison with nontraditional wines obtained from highbush blueberry. *J. Agric. Food Chem.* **2003**, *51*, 4889–4896.
79. Monagas, M.; Gomez-Cordoves, C.; Bartolome, B.; Laureano, O.; Ricardo da Silva, J.M. Monomeric, oligomeric, and polymeric flavan-3-ol composition of wines and grapes from *Vitis vinifera* L. Cv. Craciano, Tempranillo, and Cabernet Sauvignon. *J. Agric. Food Chem.* **2003**, *51*, 6475–6481.
80. de Pascual-Teresa, S.; Santos-Buelga, C.; Rivas-Gonzalo, J.C. Quantitative analysis of flavan-3-ols in Spanish foodstuffs and beverages. *J. Agric. Food Chem.* **2000**, *48*, 5331–5337.
81. Christen, Y.; Maixent, J.M. What is *Ginkgo biloba* extract EGb 761? An overview—from molecular biology to clinical medicine. *Cell. Mol. Biol.* **2002**, *48*, 601–611.
82. Yang, C.; Yang, Y.R.; Yao, W.X. Extraction of pharmaceutical components from *Ginkgo* leaves using supercritical carbon dioxide. *J. Agric. Food Chem.* **2002**, *50*, 846–849.
83. van Beek, T.A. Chemical analysis of *Ginkgo biloba* leaves and extracts. *J. Chromatogr. A* **2002**, *967*, 21–55.
84. Krueger, C.C.; Dopke, N.C.; Treidchel, P.M.; Folts, J.; Reed, J.D. Matrix-assisted laser desorption/ionization time-of-flight mass spectrometry of polygalloyl polyflavan-3-ols in grape seed extract. *J. Agric. Food Chem.* **2000**, *48*, 1663–1667.
85. Hayasaka, Y.; Waters, E.J.; Cheynier, V.; Herderich, M.J.; Vidal, S. Characterization of proanthocyanidins in grape seeds using electrospray mass spectrometry. *Rapid Commun. Mass Spectrom.* **2003**, *17*, 9–16.
86. Labarbe, B.; Cheynier, V.; Brossaud, F.; Souquet, J.M.; Moutounet, M. Quantitative fractionation of grape proanthocyanidins according to their degree of polymerization. *J. Agric. Food Chem.* **1999**, *47*, 2719–2723.
87. Gabetta, B.; Fuzzati, N.; Griffini, A.; Lolla, E.; Pace, R.; Ruffilli, T.; Peterlongo, F. Characterization of proanthocyanidins from grape seed. *Fitoterapia* **2000**, *71*, 162–175.
88. Rohdewald, P. A review of the French maritime pine bark extract (Pycnogenol), a herbal medication with a diverse clinical pharmacology. *Int. J. Clin. Pharmacol. Ther.* **2002**, *40*, 158–168.
89. Dauer, A.; Rimpler, H.; Hensel, A. Polymeric proanthocyanidins from the bark of *Hamamelis virginiana*. *Planta Med.* **2003**, *69*, 89–91.
90. Shahat, A.A.; Cos, P.; De Bruyne, T.; Apers, S.; Hammouda, F.M.; Ismail, S.I.; Azzam, S.; Claeys, M.; Goovaerts, E.; Pieters, L.; Vanden Bergh, D.; Vlietinck, A.J. Antiviral and antioxidant activity of flavonoids and proanthocyanidins from *Crataegus sinaica*. *Planta Med.* **2002**, *68*, 539–541.
91. Lin, L.C.; Kuo, Y.C.; Chou, C.J. Immunomodulatory proanthocyanidins from *Ecdysanthera utilis*. *J. Nat. Prod.* **2002**, *65*, 505–508.
92. Yu, S.M.; Ghandour, R.M.; Huang, S.J. Herbal supplement use among US women. *J. Am. Med. Women’s Assoc.* **2004**, *59*, 17–24.
93. Dwyer, J.; Picciano, M.F.; Raiten, D.J. Members of Steering Committee. Food and dietary supplement databases for what we eat in



- America—NHANES. *J. Nutr.* **2003**, *133*, 624S–634S.
94. Reed, J.D. Nutritional toxicology of tannins and related polyphenols in forage legumes. *J. Anim. Sci.* **1995**, *73*, 1516–1528.
95. Dixon, R.A.; Sumner, L.W. Legume natural products: understanding and manipulating complex pathways for human and animal health. *Plant Physiol.* **2003**, *131*, 878–885.
96. Moini, H.; Guo, Q.; Packer, L. Enzyme inhibition and protein-binding action of the procyanidin-rich French maritime pine bark extract, pycnogenol: effect on xanthine oxidase. *J. Agric. Food Chem.* **2000**, *48*, 5630–5639.
97. Yamakoshi, J.; Saito, M.; Kataoka, S.; Kikuchi, M. Safety evaluation of proanthocyanidin-rich extract from grape seeds. *Food Chem. Toxicol.* **2002**, *40*, 599–607.
98. Ray, S.; Bagchi, D.H.; Lim, P.M.; Bagchi, M.; Gross, S.M.; Kothari, S.C.; Preuss, H.G.; Stohs, S.J. Acute and long-term safety evaluation of a novel IH636 grape seed proanthocyanidin extract. *Res. Commun. Mol. Pathol. Pharmacol.* **2001**, *109*, 165–197.
99. Ryu, S.D.; Chung, W.G. Induction of the pro-carcinogen-activating CYP1A2 by herbal dietary supplement in rats and humans. *Food Chem. Toxicol.* **2003**, *41*, 861–866.
100. Peng, C.C.; Glassman, P.A.; Trilli, L.E.; Hayes-Hunter, J.; Good, C.B. Incidence and severity of potential drug–dietary supplement interactions in primary care patients: an exploratory study of 2 outpatient practices. *Arch. Intern. Med.* **2004**, *164*, 630–636.
101. Schneider, C.; Bord, C.; Misse, P.; Arnaud, B.; Schmitt-Bernard, C. Spontaneous hyphema caused by *Ginkgo biloba* extracts. *J. Fr. Ophthalmol.* **2002**, *25*, 731–732 (Article in French, information taken from English abstract).
102. Shand, B.; Strey, C.; Scott, R.; Morrison, Z.; Gieseg, S. Pilot study on the clinical effects of dietary supplementation with Enzogenol, a flavonoid extract of pine bark and vitamin C. *Phytother. Res.* **2003**, *17*, 490–494.

# Pygeum africanum Extract

François G. Brackman

Alan Edgar

Fournier Pharma, Garches, France

## INTRODUCTION

*Pygeum africanum* (also called *Prunus africana*) is a tree belonging to the Rosaceae family. It grows in tropical and humid equatorial mountain zones, at altitudes between 1000 and 2400 m. The tree is commonly found in countries such as Cameroon, Kenya, Madagascar, Congolese Democratic Republic, Equatorial Guinea, Uganda, Tanzania, Angola, South Africa, Ethiopia, Burundi, Rwanda, Malawi, and Nigeria.

The origin of the use of *P. africanum* bark is documented back to at least the early 19th century. The ground bark was used in a water, tea, or milk mixture as a drug, the use being triggered by its flavoring effects (hydrocyanic acid). The bark was used by the Zulus, who had observed beneficial effects on urinary symptoms. Other tribes from Africa and Madagascar used it for the relief of symptoms such as gastric pain, urinary disorders, and also for aphrodisiac properties. Such uses are, however, poorly documented, and are based on extracts whose contents and properties might differ both between modes of extraction and from the pharmaceutical standardized extract.

The standardized *P. africanum* extract is used to alleviate lower urinary tract symptoms (LUTS) including those accompanying benign prostatic hyperplasia (BPH).

Recent pharmacological and clinical studies have demonstrated that *P. africanum* extract quantitatively and qualitatively improves bladder as well as prostate-related parameters and symptoms causing micturitional disorders.

*P. africana* is featured in the Convention on International Trade in Endangered Species of Wild Fauna and Flora (CITES) II list of endangered species, imposing strict regulations on its harvest and trade. The exploitation of the bark is done within the frame of durable development. Only adult trees, with a diameter of at least 30 cm, undergo partial bark harvest

(opposite quarters) that does not compromise the tree's survival. Reforestation and forest enrichment could contribute to conservation and sustainability.

## PHARMACEUTICAL DESCRIPTION

Since the origin of the *P. africanum* bark and the extraction and standardization processes play a role in the final quality and content of the extract, results obtained with a given preparation might not necessarily apply to others. Most investigations performed and published were done using a standardized extract, which allows easier comparison of results.

This extract is obtained by a process of maceration and lixiviation of the *P. africanum* bark in organic solvent. The solvent is eliminated, and the extract is purified. The extract has a soft-to-hard consistency, dark brown color, and very strong aromatic odor. It is freely soluble in chloroform and is insoluble in water.

The *P. africanum* bark extract features numerous constituents, including saturated and unsaturated fatty acids (C12–C22), phytosterols ( $\beta$ -sitosterol,  $\beta$ -sitosteryl glucoside, and  $\beta$ -sitosterone), pentacyclic triterpenoids (ursolic acid, 2 $\alpha$ -hydroxyursolic acid, and oleanolic acid), alcohols (*n*-tetracosanol and *n*-docosanol), carbohydrates (triacontane and nonacosane). The pharmaceutical properties are documented in the *European Pharmacopoeia* (Monograph no. 07/2002: 1986). The *American Pharmacopoeia* mentions *P. africanum* bark, extract, and capsules in its Projects Pharmacopeum Forum 29 (4) July–August 2003.

## CLINICAL STUDIES

### Benign Prostatic Hyperplasia

Benign prostatic hyperplasia is a very common finding in aging men. Its prevalence above the age of 50 varies from 50% to 75% in most cases. Transurethral and open surgical adenomectomy are the most widely used treatments for BPH patients with severe symptoms. However, because of the clinically significant incidence of complications such as blood loss, urinary tract

Dr. François G. Brackman, M.D., is Vice President, Department of Global Development and Medical Affairs at Fournier Pharma, Garches, France.

Alan Edgar, Ph.D., is Head of Pharmacology Studies, Department of Drug Discovery at Fournier Pharma, Garches, France.

infections, urethral stenosis, incontinence, impotence, and the need for reintervention after prostatic surgery,<sup>[1]</sup> the management of BPH and LUTS has been rapidly changing. In addition, a large proportion of patients with LUTS do not have prostate enlargement and do not need surgical intervention.

Medical approaches used in the treatment of BPH include  $\alpha$ -adrenoceptor-blockers, 5- $\alpha$ -reductase inhibitors, and plant extracts.

$\alpha$ -Blockers partially alleviate symptoms of BPH<sup>[2]</sup> by reducing the  $\alpha$ -adrenergic tone of the smooth muscle. However, they may have significant cardiovascular side effects that may limit their therapeutic application.

5- $\alpha$ -Reductase inhibitors result from an elegant series of medicinal chemistry studies, and through a reduction in prostate size, are supposed to act on symptoms by a direct effect on the mechanical component of obstruction. However there is certain delay in the onset of the improvement (6–12 mo) and an important incidence of side effects, in particular, on sexual function.<sup>[3]</sup> The limitations of 5- $\alpha$ -reductase inhibitors and  $\alpha$ -blockers in treating bladder outlet obstruction (BOO) might be related to the importance of the functional and structural remodeling of the bladder that also develops as the disease progresses. Benign prostatic hyperplasia is largely considered to be pathologically a disease of the prostate, while being symptomatically a disease of the bladder. While the analogy of the enlarged prostate impinging upon bladder function still holds true in general, numerous individuals see no improvement in urinary function in spite of objective reduction in prostate size. Still others see clear improvement in LUTS independent of any discernable change in prostate size.<sup>[4]</sup> Modifications in the prostate do not necessarily evolve in parallel with bladder remodeling. The efficacy of the various treatment options depends, in part, on the judicious use of the appropriate treatment corresponding to the stage of advancement of the disease. Treatment directed at improving bladder function may be more efficacious in older individuals, while that designed to solely affect the prostate may be more beneficial in relatively younger patients. Benign prostatic hyperplasia results from progressive enlargement of the transition zone of the prostate and involves both glandular and stromal prostate tissue. Stromal elements contain smooth muscle, and contraction is mediated by  $\alpha$ -1-adrenergic receptors. Hyperplasia of the transition zone is responsible for the organ enlargement. Prostate enlargement also mechanically and physically affects bladder dysfunction by a progressive denervation via damage to intramural nerves and synapses as seen in animal models and in obstructive dysfunction in men.<sup>[5–7]</sup> The involvement of specific bladder components indicates that effective treatment should not

solely target the prostate, but must also be directed at the bladder. Still, the origin of the modification of bladder function in BPH remains the prostate, as witnessed by the paucity of symptoms in castrated individuals.<sup>[8]</sup>

More than 2000 patients were enrolled in clinical trials with *P. africanum* extract.<sup>[9]</sup> These studies were conducted either in a double-blind placebo-controlled manner<sup>[10–12]</sup> or as open-labeled studies.<sup>[13]</sup>

There are 18 published randomized controlled trials comparing preparations of *P. africanum* with placebo or medical therapy for >30 days in men with symptomatic BPH. Thirteen trials included comparison of *P. africanum* extract with placebo.<sup>[14,15]</sup> Most often, the treatment regimen was 100 mg/day (50 mg twice a day) for 1–2 mo. The persistence of the effect and the long-term safety profile over more than 5 yr have been investigated in an observational study.<sup>[16]</sup>

The effects observed in those studies were convergent with:

- More than 67% of patients reported “excellent,” “very good,” or “good” results.
- Mean maximum urinary flow rate was improved in all studies in which it was measured.
- Nocturia was improved in 50–100% of the patients in whom it was measured.
- Daytime frequency was improved in 50–95% of patients in whom it was measured.
- Hesitancy, urgency, weak stream, and dysuria were improved in the majority of studies.
- Quality of life scores were improved.
- Standardized assessment scores such as International Prostate Symptoms Score (IPSS) confirmed these results.
- Both clinical and urodynamic improvements were maintained during long-term treatment in a high proportion of patients.
- Both clinical and urodynamic improvements were maintained after 12 mo of treatment.

The most frequently used dosage of *P. africanum* extract is 50 mg b.i.d. One prospective clinical trial<sup>[12,17]</sup> demonstrated the equivalence of effects of the extract 100 mg/day given either as 50 mg twice daily, or as a single daily dose of 100 mg in men with moderate-to-severe urinary symptoms associated with BPH. Both daily dosage modalities of *P. africanum* extract (100 mg/day and 50 mg twice daily) decreased the total IPSS according to an equivalent pattern and to a similar extent (41% and 37.5%, respectively). Mean maximum flow rate increased after 2 mo of treatment by 16% in the 50 mg b.i.d. group and by 18.5% in the 100 mg q.d. group. Similar effects were observed on all components of the condition and on quality of life scores.

## MECHANISM OF ACTION

### Effects on In Vitro and In Vivo Growth Factor-Mediated Prostate Growth

Normal prostate growth is controlled by an orchestration of growth factor-mediated autocrine and paracrine communication acting on epithelial and stromal prostatic tissue. Mutually distinct biochemical and suborganelle perturbations within the prostate can predispose toward BPH or prostatic carcinoma.<sup>[18]</sup> The BPH affects predominantly stromal and glandular cell growth, where basic fibroblast growth factor (bFGF) and epidermal growth factor (EGF) are major regulators along with insulinlike growth factor (IGF). Keratinocyte growth factor (KGF) is expressed in epithelial tissue and has a paracrine effect on stromal cells, whereas transforming growth factor- $\beta$ 1 (TGF- $\beta$ 1) has been shown to inhibit prostatic fibroblast proliferation. Finally, testosterone via dihydrotestosterone (DHT) has a causal role in controlling prostate growth and affects the expression of the aforementioned growth factors and their receptors indirectly. In advanced BPH, the role of androgens may be no more than permissive, while in prostatic carcinoma, androgen receptor signaling is not strictly a function of DHT levels. Furthermore, in men 50 yr old or more, the role of testosterone relative to estrogen appears to diminish.<sup>[19]</sup>

Following an initial observation of an effect of *P. africanum* extract on bFGF- and EGF-mediated proliferation of 3T3 fibroblasts in vitro,<sup>[20]</sup> a detailed series of experiments were performed comparing the potential of the extract to affect prostatic stromal cell proliferation mediated by various prostate-derived growth factors in rats.<sup>[21]</sup> At concentrations devoid of cytotoxicity, *P. africanum* extract was shown in vitro to affect stromal fibroblast cell proliferation induced by EGF, bFGF, and IGF-I as well as with protein kinase C activators, but not by KGF. Furthermore, the inhibition of cell proliferation was observed with IC<sub>50</sub> values in the range of 10  $\mu$ g/ml. The similarity of the individual IC<sub>50</sub> values of *P. africanum* extract on the various growth factors suggests that a locus common to the three growth factors was being affected.<sup>[22]</sup> Furthermore, the in vitro studies demonstrated that stromal fibroblast proliferation was inhibited via a site that converged near the level of protein kinase C.

The results were not limited to rodent prostatic cells, as *P. africanum* extract was also shown to inhibit proliferation of fibroblasts from human hyperplastic prostate and bladder as well.<sup>[23]</sup>

The precise molecular component(s) of *P. africanum* extract responsible for the in vitro effects is not known. Therefore, these results cannot infer in vivo activity per se, as it is not possible to establish a correlation

between the in vitro IC<sub>50</sub> value with a C<sub>max</sub> value for the same metabolite following oral administration.

Therefore, in an attempt to confront this problem, subsequent in vivo studies<sup>[24]</sup> focusing on the rat ventral prostate, which is approximately equivalent to the transition zone of the human prostate, showed that *P. africanum* extract affected adenylyl cyclase-mediated cross talk in cell signaling pathways also at the level of protein kinase C. Finally, ventral prostate hyperplasia induced by DHT treatment in vivo in rats was reversed by oral administration of the extract, while the latter had no effect on dorsal prostate enlargement.<sup>[25]</sup>

The molecular mechanism(s) underlying the in vitro and the in vivo effects of *P. africanum* extract are similar. The extract exhibited an effect on in vitro fibroblast proliferation of both rodent as well as human cells, which correlated with a growth factor profile signature corresponding to stromal cell proliferation, and this was paralleled by a preferential in vivo effect of *P. africanum* extract on ventral (stromal) prostate hyperplasia in rodents.

### Effects on Bladder Function

In man as well as in select animal models, bladder obstruction induced by enlargement of the prostate or partial outlet obstruction of the urethra leads to a progressive increase in urethral resistance. The latter is initially compensated by an increase in bladder wall thickness, increased pressure generation, and alterations in flow parameters that limit the immediate deterioration in bladder function. This phase of compensated bladder function is slowly, though inexorably, followed by a decompensated bladder with a marked loss of contractility. The initial phase displays impaired detrusor smooth muscle function characterized by neuronal degeneration leading to reduced postsynaptic innervation, mitochondrial dysfunction, and loss of intracellular Ca<sup>2+</sup> homeostasis that collectively compromise myosin contractility.

The preceding section described in vitro data corroborated by in vivo results that demonstrated an effect of *P. africanum* extract on molecular aspects of prostate growth mediated by prostate-derived growth factors. Growth factor-mediated fibroblast proliferation is common to both the hyperplastic prostate as well as the hypertrophic bladder secondary to BOO<sup>[26,27]</sup> similarly involving bFGF, EGF, and TGF- $\beta$ . This common link was the rationale for investigating the effect of *P. africanum* extract in various models of impaired bladder function.<sup>[28]</sup> Indeed, initial results showed that the extract inhibited bFGF-stimulated fibroblast proliferation originating from

obstructed bladder in vitro<sup>[23]</sup> and modestly reduced bladder weight in vivo in a preliminary study that was further confirmed in larger subsequent studies.

Pretreatment of rabbits with *P. africanum* extract prior to partial outlet obstruction dose- and time-dependently reduced contractile dysfunction determined by measuring the contractile responses to field stimulation, bethanechol and KCl. At the dose of 100 mg/kg, it improved the response to field stimulation by 50% and to KCl by 70%, and completely normalized the response to bethanechol when subsequently determined 3 weeks following partial outlet obstruction. Of the three parameters measured, partial outlet obstruction affects to a greater extent field stimulation, reflecting marked deterioration of synaptic function. Therefore, the initial experiment was complemented by a series of investigations that first determined the time course of the effects of *P. africanum* extract and correlated this to specific perturbations in synaptic and postsynaptic membranes coupled to alterations in key mitochondrial enzymes and calcium homeostasis. The results of the time course study indicated that *P. africanum* extract was able to normalize the response to field stimulation after 2 weeks of treatment. These results were superior to those obtained after 3 weeks and may indicate a reduced efficacy of *P. africanum* extract after prolonged obstruction or an unrepaired deterioration of synaptic function over time in this model.

In an attempt to mimic the clinical situation, wherein bladder function is already compromised when treatment is initiated, it was then shown that the efficacy of *P. africanum* extract was maintained when administered only after the application of partial outlet obstruction. Specifically, the effects of *P. africanum* extract in restoring the contractile response to field stimulation, carbachol and KCl were qualitatively identical when administered before or after partial outlet obstruction.<sup>[28,29]</sup>

Contractile dysfunction ultimately results in reduced force generation and alterations in myosin isoforms. In parallel with the improved contractile dysfunction, *P. africanum* extract was able to partially normalize the expression of myosin isoforms in line with improved contractility. These studies were based on the observation that alternative post-transcriptional splicing of myosin mRNA generates two isoforms of myosin, SM-A and SM-B, with lower and greater actin-activated adenosine triphosphate (ATP) hydrolysis, respectively, and hence force generation. Following obstruction, detrusor smooth muscle SM-A myosin isoform expression increases threefold corresponding to reduced force generation, while treatment with *P. africanum* extract normalizes the SM-B/SM-A ratio in parallel with the improvement in field stimulation.<sup>[30]</sup>

Contractile dysfunctions of the obstructed bladder are directly related to ischemia (reduced blood flow) and detrusor hypoxia.<sup>[31]</sup> Thus, short-term ischemia is a relevant model that recapitulates pathological aspects of contractile dysfunction inherent in partial outlet obstruction originating surgically or via prostatic enlargement. In this model, unilateral ischemia provokes direct and irrevocable ischemic insult to one side of the bladder, while partially compromising the nonischemic side. In agreement with what was observed following partial outlet obstruction, *P. africanum* extract pretreatment protected the nonischemic side of the bladder from the development of contractile dysfunction. This protective effect was further correlated to an enhanced expression of Hsp70 and c-myc.

The clinical pharmacological relevance of these animal data was established by Valentini et al.,<sup>[32]</sup> who demonstrated in a blinded clinical study that *P. africanum* extract improved detrusor contractile function after 2 mo of treatment.

The contractile dysfunctions induced by partial outlet obstruction in animal models, and by BPH-induced obstructive dysfunction in men, are secondary to denervation, mitochondrial dysfunction, and calcium-storage dysfunction, which in turn is mediated partially by ischemia-generated free radicals and calcium-activated hydrolytic enzymes. One hypothesis is that *P. africanum* extract acts in part by protecting neuronal and subcellular membranes from ischemia-induced damage, and by this means protects the contractile function of the bladder.<sup>[7,33]</sup>

Testosterone, in addition to its well-known action on stimulating prostate growth, also affects the bladder, and in the rat, administration of DHT significantly affects urodynamic parameters including frequency and volume. In DHT-stimulated rats, *P. africanum* extract, in addition to the aforementioned selective effect on ventral prostate growth, also significantly improves bladder frequency and volume.<sup>[34]</sup>

Collectively, these results clearly demonstrate that *P. africanum* extract directly affects bladder function.

Among the limitations of the animal models employed is the lack of a concerted pathophysiology strictly representative of human BPH. The anatomic separation of prostate and bladder function in these models is, nonetheless, an advantage when attempting to demonstrate independent effects of *P. africanum* extract on the two organs. Furthermore, animal studies have the obvious advantage of being devoid of a placebo effect that complicates the design and interpretation of clinical trials in this indication.

Treatment of LUTS is complicated by the multifactorial and multiorganelle origin, the slow evolution of the disease process, as well as the high placebo response in this patient population, which collectively

limit the perceived efficacy of monotherapy in short-term clinical trials.

*P. africanum* extract has demonstrated a reproducible efficacy in a variety of pharmacological studies addressing key aspects of lower urinary tract pathophysiology, thus altering the often encountered perception of plant extracts as poorly defined mixtures acting in an ambiguous manner to that of a reproducible molecular effector.

The precise molecular component(s) responsible for the effects of *P. africanum* extract have not been identified.

A limitation of the animal data described is the use of short-term treatment periods and the rapid instauration of the pathology to investigate what in man is a chronic disease. The treatment duration of most clinical trials has also been limited, and the patient population not always ideally chosen to demonstrate beneficial effects on the bladder. The optimal patient population for showing the efficacy of an  $\alpha$ -blocker, a 5- $\alpha$ -reductase inhibitor and *P. africanum* extract could vary, reflecting different stages of the disease process and related symptoms.

The sum of the in vitro and in vivo pharmacological studies delimits a pharmacological mechanism of action of *P. africanum* extract affecting independently:

- Prostate hyperplasia via a downstream target common to bFGF, EGF, as well as androgen-mediated cell proliferation at or near the level of protein kinase C. The signature of growth factor-mediated inhibition by *P. africanum* extract on in vitro and in vivo prostatic cell proliferation suggests that in vitro results are predictive and correlated to in vivo activity.
- Bladder function with improvement in contractile dysfunction mediated via myosin isoform expression, lessened synaptic denervation, and improved mitochondrial function.

## ADVERSE EFFECTS

Routine preclinical safety trials performed in various animal species by oral and parenteral routes, with single and repeated administrations, studied *P. africanum* at doses greater than 50 times the therapeutic doses. In such studies, no target organ could be identified as to potential toxic effects. *P. africanum* extract is devoid of any mutagenic potential.

Most published open-label and placebo-controlled studies mentioned a good tolerance of the extract.

Of particular note is the absence of any hormone-related adverse effects, confirming that the extract does not exert any hormonal effect. No interactions with concomitant medications such as antihypertensive

agents, lipid lowering agents, or antiarrhythmics were reported. No significant changes were observed in biochemical safety parameters in those published studies where this is documented.<sup>[10,12,13]</sup>

In a recently published review, 13 of 18 randomized controlled trial (RCT) studies provided information on specific adverse events. Side effects due to *P. africanum* were generally mild in nature and similar in frequency to placebo. The most frequently reported were gastrointestinal and occurred among seven men in five trials.<sup>[15]</sup>

In the most recently completed study,<sup>[12]</sup> the type and overall frequency of adverse effects had similar distributions between dosage modalities during the comparative phase and were comparable for both phases of the trial.

Light-to-moderate gastrointestinal effects, such as nausea, constipation, or dyspepsia, which are known as treatment specific, were reported most frequently (5.4% and 9.8% of patients who participated in the comparative and the extension phase, respectively). The majority of the serious adverse effects regarded the urogenital system (1.3% and 3.5% of patients who participated in the comparative and the extension phase, respectively) and appeared more related to the natural evolution of the disease than to the medication itself. It has been observed that very few severe emergent adverse effects (SEAE) appeared during the study, and the risk of presenting an SEAE during the long-term follow up was very low and constant in time. The rate of the SEAE-free patients at 1 yr was 90% with the 95% CI [85%, 95%]. Similar observations were made for the treatment-related emergent adverse events (TREAE), with the rate of the TREAE-free patients at 1 yr equal to 92% [95% CI (88%, 96%)]. Few side effects were responsible for patients' withdrawal from the study (15 patients during the comparative phase and eight patients during the long-term phase).

No significant changes were noted in blood or urine analyses in either group or during the two phases of the study. There was no statistically or clinically significant variation of the prostate-specific antigen (PSA) level at 12 mo compared to the baseline value.

There is no report of any unwanted effect on sexual function with *P. africanum*.

The cardiovascular effects were studied after a trial of 12 mo of treatment with *P. africanum*.<sup>[12]</sup> The treatment was not associated with any unwanted cardiovascular effects in this study.

## PRODUCTS AND DOSAGE

*P. africanum* extracts are available worldwide under various formulations. One of them, *P. africanum* extract V1326, is the most frequent presentation

(50 countries) and is marketed under the Tadenan<sup>TM</sup> trade name, as a prescription drug. Other preparations are available in various countries, containing *P. africanum* extract either as a single component (such as Pronitol<sup>TM</sup>, Bidrolar<sup>TM</sup>, Foudaril<sup>TM</sup>, Kunzle<sup>TM</sup>, Neo Urgenin<sup>TM</sup>, Normobrost<sup>TM</sup>, Normoprost<sup>TM</sup>, Prolitrol<sup>TM</sup>, Provol<sup>TM</sup>, etc.) or in combination with other components such as vitamins or minerals (such as Pro Flow<sup>TM</sup>, Potenza<sup>TM</sup>, Super Prostate Formula<sup>TM</sup>, to name a few).

## REFERENCES

- Mebust, W.K.; Holtgrewe, H.L.; Cockett, A.T.; Peters, P.C. Transurethral prostatectomy: immediate and post operative complications. A cooperative study of 13 participating institutions evaluating 3885 patients. *J. Urol.* **1989**, *141*, 243–247.
- Lowe, F. Alpha-1-adrenoceptor blockade in the treatment of benign prostatic hyperplasia. *Prostate Cancer Prostatic Dis.* **1999**, *2* (3), 110–119.
- Lepor, H.; Williford, W.O.; Barry, M.J.; Brawer, M.K.; Dixon, C.M.; Gormley, G.; Haakenson, C.; Machi, M.; Narayan, P.; Padley, R.J. The efficacy of terazosin, finasteride, or both in benign prostatic hyperplasia. *N. Engl. J. Med.* **1996**, *335*, 533–539.
- Terris, M.K.; Afzal, N.; Kabalin, J.N. Correlation of transrectal ultrasound measurements of prostate and transition zone size with symptom score, bother score, urinary flow rate, and post-void residual volume. *Urology* **1998**, *52* (3), 462–466.
- Levin, R.M.; Longhurst, P.A.; Monson, F.C.; Kato, K.; Wein, A.J. Effect of bladder outlet obstruction on the morphology, physiology, and pharmacology of the bladder. *Prostate Suppl.* **1990**, *3*, 9–26.
- Levin, R.W.; Brading, A.F.; Mills, I.W.; Longhurst, P.A. Experimental models of bladder obstruction. In *Prostatic Disease*; Lepor, H., Ed.; W.B. Saunders Co.: Philadelphia, 2000; 169–196.
- Levin, R.M.; Haugaard, N.; O'Connor, L.; Buttyan, R.; Das, A.; Dixon, J.S.; Gosling, J.A. Obstructive response of human bladder to BPH vs. rabbit bladder response to partial outlet obstruction: a direct comparison. *Neurourol. Urodyn.* **2000**, *19* (5), 609–629.
- Levine, A.C.; Kirschenbaum, A.; Gabrilove, J.L. The role of sex steroids in the pathogenesis and maintenance of benign prostatic hyperplasia. *Mt. Sinai J. Med.* **1997**, *64* (1), 20–25.
- Andro, M.C.; Riffaud, J.P. *Pygeum africanum* extract for the treatment of patients with BPH: a review of 25 years of published experience. *Curr. Ther. Res.* **1995**, *56* (8), 796–817.
- Barlet, A.; Albrecht, J.; Aubert, A.; Fischer, M.; Grof, F.; Grothuesmann, H.G.; Masson, J.C.; Mazeman, E.; Mermon, R.; Reichelt, H.; Schönmetzler, F.; Suhler, A. Efficacy of *Pygeum africanum* extract for the treatment of micturitional disorders due to BPH: evaluation of objective and subjective parameters. A multicentre, placebo-controlled double blind clinical trial. *Wien. Klin. Wochenschr.* **1990**, *102*, 667–673.
- Dufour, B.; Choquet, C.; Revol, M.; Faure, G.; Jorest, R. Traitement symptomatique de l'adénome prostatique. Etude clinique contrôlée des effets de l'extrait de *Pygeum africanum*. *Gaz Med. F.* **1983**, *90*, 2238–2340.
- Chatelain, C.; Autet, W.; Brackman, F. Therapeutic equivalence of efficacy and safety of once and twice daily dosage forms of *Pygeum africanum* extract in patients with symptomatic benign prostatic hyperplasia. A prospective, randomised, double-blind study. *Urology* **1999**, *54* (3), 473–478.
- Breza, J.; Dziurny, O.; Borowka, A.; Hanus, T.; Petrik, R.; Blane, G.; Chadha-Boreham, H. Efficacy and acceptability of Tadenan<sup>®</sup> (*Pygeum africanum* extract) in the treatment of benign prostatic hyperplasia (BPH): a multicentre trial in Central Europe. *Curr. Med. Res. Opin.* **1998**, *14* (3), 127–139.
- Wilt, T.; Ishani, A.; Mac Donald, R.; Rutks, I.; Stark, G. *Pygeum africanum* for benign prostatic hyperplasia (Cochrane review). In *The Cochrane Library*; John Wiley & Sons, Ltd.: Chichester, UK, 2004; Issue 1.
- Ishani, A.; Mac Donald, R.; Nelson, D.; Rutks, I.; Wilt, T. *Pygeum africanum* for benign prostatic hyperplasia: a systematic review and quantitative meta-analysis. *Am. J. Med.* **2000**, *109*, 654–664.
- Moya-Prats, P.P.; Salvá Verd, A.; Crespi Mesquida, G. Valoración estadística de 500 pacientes con hipertrofia prostática benigna, tratados con *Pygeum africanum*, y valorados estadísticamente desde el punto de vista clínico y flujométrico. *Urodinámica Aplicada* **1989**, *1* (4), 150–155.
- Brackman, F.; Autet, W. Once and twice daily dosage regimens of *Pygeum africanum* extract (PA): a double-blind study in patients with benign prostatic hyperplasia. *J. Urol.* **1999**, *161* (Suppl. 4), 361.
- Gomella, L.G.; Godwin, B.W. This month in investigative urology. Apoptosis and benign prostatic hypertrophy. *J. Urol.* **1997**, *158* (1), 2–3.
- Gooren, L.J.; Toorians, A.W. Significance of oestrogens in male (patho)physiology. *Ann. Endocrinol. (Paris)* **2003**, *64* (2), 126–135.

20. Paubert-Braquet, M.; Montboisse, J.-C.; Biochot-Lagente, E.; Friedmann, A.; Delacroix, D.; Cave, A.; Dupont, Ch.; Hocquemiller, R.; Borel, J.P. *Pygeum africanum* extract (Tadenan) inhibits b-FGF and EGF-induced proliferation of 3T3 fibroblasts. *Pharmacologist* **1993**, *35* (3), 173.
21. Yablonsky, F.; Nicolas, V.; Riffaud, J.P.; Bellamy, F. Antiproliferative effect of *Pygeum africanum* extract on rat prostatic fibroblasts. *J. Urol.* **1997**, *157* (6), 2381–2387.
22. Levin, R.M.; Das, A.K. A scientific basis for the therapeutic effects of *Pygeum africanum* and *Serenoa repens*. *Urol. Res.* **2000**, *28* (3), 201–209.
23. Le Brun, G.; Mellah, I.; Aubin, P.; Khatib, A.; Ropiquet, F.; Villette, J.M.; Berthon, P.; Fiet, J.; Cussenot, O. A rationale for the use of *Pygeum africanum* extract during BPH course is suggested by in vitro proliferation control of human prostate and bladder fibroblasts. *Eur. Urol.* **1996**, *30* (Suppl. 2), 98.
24. Solano, R.M.; Garcia-Fernandez, M.O.; Clemente, C.; Querol, M.; Bellamy, F.; Sanchez-Chapado, M.; Prieto, J.C.; Carmena, M.J. Effects of *Pygeum africanum* extract (Tadenan) on vasoactive intestinal peptide receptors, G proteins, and adenylyl cyclase in rat ventral prostate. *Prostate* **2000**, *45* (3), 245–252.
25. Choo, M.S.; Bellamy, F.; Constantinou, C.E. Functional evaluation of Tadenan on micturition and experimental prostate growth induced with exogenous dihydrotestosterone. *Urology* **2000**, *55* (2), 292–298.
26. Buttyan, R.; Jacobs, B.Z.; Blaivas, J.G.; Levin, R.M. Early molecular response to rabbit bladder obstruction. *Neurourol. Urodyn.* **1992**, *11*, 225–238.
27. Buttyan, R.; Chen, M.W.; Monson, F.; Levin, R.M. Molecular control of rabbit urinary bladder hypertrophy. *Biomed. Pharmacother.* **1994**, *48* (Suppl. 1), 27s–34s.
28. Levin, R.M.; Riffaud, J.P.; Bellamy, F.; Rohrmann, D.; Habib, M.; Krasnopolsky, L.; Zhao, Y.; Wein, A.J. Protective effect of Tadenan on bladder function secondary to partial outlet obstruction. *J. Urol.* **1996**, *155* (4), 1466–1470.
29. Levin, R.M.; Hass, M.A.; Bellamy, F.; Horan, P.; Whitbeck, K.; Chow, P.H.; Kung, L.S.; Gosling, J. Effect of oral Tadenan treatment on rabbit bladder structure and function after partial outlet obstruction. *J. Urol.* **2002**, *167* (5), 2253–2259.
30. Gomes, C.M.; Disanto, M.E.; Horan, P.; Levin, R.M.; Wein, A.J.; Chacko, S. Improved contractility of obstructed bladders after Tadenan treatment is associated with reversal of altered myosin isoform expression. *J. Urol.* **2000**, *163* (6), 2008–2013.
31. Levin, R.M.; O'Connor, L.J.; Leggett, R.E.; Whitbeck, C.; Chichester, P. Focal hypoxia of the obstructed rabbit bladder wall correlates with intermediate decompensation. *Neurourol. Urodyn.* **2003**, *22*, 156–163.
32. Valentini, F.A.; Besson, G.R.; Nelson, P.P. Modelised analysis of the effect of Tadenan on the bladder of patients with BPH: blind versus open study of uroflows. 5th International Consultation on BPH, 2000, Paris.
33. Zhao, Y.; Levin, S.S.; Wein, A.J.; Levin, R.M. Correlation of ischemia/reperfusion and partial outlet obstruction induced spectrin proteolysis by calpain with contractile dysfunction in the rabbit bladder. *Urology* **1997**, *49*, 293–300.
34. Yoshimura, Y.; Yamaguchi, O.; Bellamy, F.; Constantinou, C.E. Effect of *Pygeum africanum* tadenan on micturition and prostate growth of the rat secondary to coadministered treatment and post-treatment with dihydrotestosterone. *Urology* **2003**, *61* (2), 474–478.

#### FURTHER READINGS

- Denis, L.J.; et al. The 4th International Consultation on Benign Prostatic Hyperplasia (BPH), Proceedings, Paris, July 2–5, 1997; Health Publication Ltd., 1998.
- Lowe, F.C.; Ku, J.C. Phytotherapy in treatment of benign prostatic hyperplasia: a critical review. *Urology* **1996**, *48*, 12–20.
- Lowe, F.C.; Fagelman, E. Phytotherapy in treatment of benign prostatic hyperplasia. *Curr. Opin. Urol.* **1998**, *8*, 27–29.





# Quercetin

Jae B. Park

Phytonutrients Laboratory, BHNRC, ARS, United States Department of Agriculture, Beltsville, Maryland, U.S.A.

## INTRODUCTION

Quercetin (3',4',5,7-tetrahydroxyflavonol, 3,3',4',5,7-pentahydroxyflavone, 2-(3,4-dihydroxy-phenyl)-3,5,7-trihydroxy-chromen-4-one, 2-(3,4-dihydroxyphenyl)-3,5,7-trihydroxy-4H-1-benzopyran-4-one) is a flavonol, belonging to a class of naturally occurring flavonoids.<sup>[1-4]</sup> It is composed of 3,5,7-trihydroxy-4H-1-benzopyran-4-one (A and C) and a 3,4-dihydroxyphenyl ring (B) (Fig. 1).

Synonyms for quercetin include: C.I. Natural Yellow 10; C.I. 75670; cyanidelonon 1522; flavin meletin; quercetine; quercetol; quertin; quertine; sophoretin; xanthaurine; 3,3',4',5,7-pentahydroxyflavone; 3,5,7,3',4'-pentahydroxyflavone; 2-(3,4-dihydroxyphenyl)-3,5,7-trihydroxy-4H-1-benzopyran-4-one.

## BIOSYNTHESIS AND NATURAL SOURCES

Flavonoids provide flavor, color, and other functions to fruits and vegetables. More than 5000 different flavonoids have been currently isolated. They consist of several classes: flavones (e.g., apigenin, luteolin), flavonols (e.g., quercetin, myricetin), flavanones (e.g., naringenin, hesperidin), flavans (e.g., epicatechin, gallic catechin), anthocyanins (e.g., cyanidin, pelargonidin), and isoflavones (e.g., genistein, daidzein). Quercetin belongs to the flavonol class, due to its hydroxylation at 3-position of the C ring.<sup>[1,2]</sup> It is synthesized in plants via multiple enzymatic processes from phenylalanine and malonyl-CoA. Briefly, 4-coumaroyl-CoA and acetyl-CoA from phenylalanine and malonyl-CoA, respectively, yield chalcone, a precursor for flavonoids including quercetin.<sup>[1,5]</sup> Quercetin present in plants is mainly found conjugated to sugars as glycones.<sup>[1,3]</sup> Besides glycosylation, it is also found modified by prenylation, acetylation, and methylation.<sup>[1,3,6]</sup> This

flavonol is commonly found in dietary sources (onions, apples, black tea, green tea, red wine, beans, grapes, berries, vegetables, and fruits).<sup>[7,8]</sup> Dietary intake is associated with various health benefits.<sup>[9,10]</sup>

## ABSORPTION, METABOLISM, AND BIOAVAILABILITY

There is great interest in the potential health benefits of flavonoids due to their potent antioxidant, free-radical scavenging, and other biological activities observed in vitro.<sup>[9,10]</sup> Quercetin has potent antioxidant and other activities, which contribute beneficial health effects in chronic diseases such as cancer and cardiovascular diseases.<sup>[9-11]</sup> Most beneficial health effects of quercetin would necessitate its absorption into the human body, which is interconnected with its metabolism and bioavailability. Data about these processes are available, but they are yet to be elucidated extensively.

### Absorption

Quercetin occurs as glycones or aglycones, but in plants mainly as glycones such as rutin (quercetin rutinoside). Quercetin aglycone and glycones are quite different in their absorption and pharmacokinetics. Studies indicate that the overall kinetic behavior of quercetin changes following the ingestion of quercetin aglycone or glycones. This includes properties such as

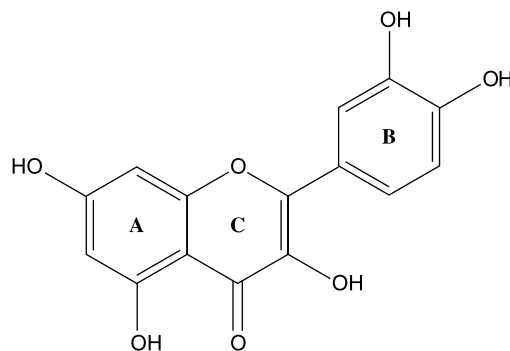


Fig. 1 The chemical structure of quercetin.

Jae B. Park, Ph.D., is at the Phytonutrients Laboratory, BHNRC, ARS, United States Department of Agriculture, Beltsville, Maryland, U.S.A.

$C_{\max}$  (the highest level at a given dose) and  $T_{\max}$  (time to reach  $C_{\max}$ ).<sup>[12]</sup>

Currently, there are two proposed hypotheses on the absorption mechanisms of quercetin glucosides across the small intestine. One is an active uptake of quercetin glucoside by the sodium-dependent glucose transporter (e.g., SGLT1) with subsequent deglycosylation within the enterocyte by cytosolic beta-glucosidase (CBG). The other is the absorption by passive diffusion of quercetin after luminal hydrolysis of its glycones by lactase phlorizin hydrolase (LPH). Both methods seem to be utilized for the uptake of individual quercetin glycones with substrate selectivity. For instance, quercetin-4'-glucoside involves both an interaction with SGLT1 and luminal hydrolysis by LPH, whereas quercetin-3-glucoside appears to be absorbed only following hydrolysis by LPH.<sup>[13]</sup> The deglycosylation step is very critical for the absorption of quercetin glycosides in humans, and is mediated by glucosidases such as LPH and CBG. The significant variation in their activity between individuals was even suggested as a potential cause for differences in flavonoid (quercetin) bioavailability.<sup>[14]</sup> Even though the hydrolysis of the glycoside moiety from quercetin glycones is strongly believed to be a prerequisite process for quercetin absorption, there are also reports indicating that a fraction of quercetin may be absorbed as its glycones via passive diffusion and/or unidentified transporters (which are yet to be isolated).<sup>[15,16]</sup> The discrepancy of absorption patterns between quercetin and its glycones can be accounted for by hydrolysis process of its glycoside and its diverse absorptive processes.

## Metabolism

Quercetin was reported to be metabolized in the liver and the intestine. Absorbed quercetin is mainly metabolized in the liver, while the unabsorbed form is metabolized in the gut by intestinal micro-organisms. *Eubacterium ramulus* was reported as a micro-organism involved in degrading quercetin in the intestine. This strictly anaerobic bacterium can cleave the ring structure of quercetin into 3,4-dihydroxyphenylacetic acid.<sup>[17,18]</sup> Intestinal metabolism of quercetin by the micro-organism may provide an alternative pathway for quercetin absorption in the gut, even though this absorption is likely to be insignificant and irrelevant to quercetin bioavailability. Primary metabolism of quercetin occurs in the liver, even though some minor metabolic processes take place in various human cells. Investigation of metabolites of quercetin in the plasma and urine revealed that the flavonol is metabolized by glucuronidation, hydroxylation, methylation, and sulfonation. Glucuronidation occurs usually during passage across the epithelium as well as in the liver.<sup>[19]</sup>

The enzymes responsible for this process are UDP-glucuronosyltransferases (UGT) such as UGT1A9 (in human liver), and UGT1A1 and UGT1A8 (in intestinal epithelium).<sup>[15,20]</sup> In intestinal epithelial cell, quercetin was reported to metabolize mainly into quercetin-3- and quercetin-7-glucuronides.<sup>[21]</sup> Quercetin glucuronides were also reported to metabolize further via two pathways: first, methylation of the catechol functional group of both quercetin glucuronides by methyltransferases; and second, hydrolysis of the glucuronide by endogenous beta-glucuronidase, followed by sulfation to quercetin-3'-sulfate.<sup>[22,23]</sup> Quercetin is also methylated, sulfonated, and hydroxylated in the liver.<sup>[22,24]</sup> It is often found in plasma as unconjugated quercetin aglycone, even if quercetin glucuronides are considered the main circulating metabolites in humans. Occurrence of the quercetin aglycone within tissues is likely to result from the deconjugation of flavonoid glucuronides by the enzyme beta-glucuronidase. Indeed, some human tissues from the small intestine and liver, and neutrophils, exhibit beta-glucuronidase activity, against quercetin glucuronides.<sup>[25]</sup> Multiple processes of quercetin metabolism may yield quercetin metabolites with different biochemical properties and produce some metabolites with more or less purported beneficial effects.<sup>[26]</sup>

## Bioavailability

Bioavailability is the physiological availability of a compound in a given amount. In other words, it is the proportion of the administered amount that is absorbed into the bloodstream. Therefore, bioavailability is dependent mainly on the initial administered amount, absorption, metabolism, tissue distribution, and excretion. Pharmacokinetic studies are performed using several different doses and routes to determine the bioavailability of an administered compound, which can be used as a good guideline for safe human intake and a valuable criterion for verifying purported effects in *in vitro* studies. However, most pharmacokinetic studies of research quercetin seem fragmentary and require further research to provide complete information regarding quercetin bioavailability.

Originally, quercetin aglycone was thought to be able to pass through the gut wall better than its glycones. However, pharmacokinetic studies suggest that quercetin glycones are absorbed better than its aglycone.<sup>[10,27,28]</sup> The studies also revealed that quercetin glycosides could show significant differences in absorption rate and bioavailability, depending on the glycosylation sites.<sup>[27,28]</sup> Some pharmacokinetic studies of quercetin were performed using quercetin (aglycone) and its glycones to determine bioavailability. In the study using quercetin aglycone, it was reported that

after a single 4 g dose of quercetin administered orally in humans, the flavonol was detected in the plasma. The highest peak plasma concentration ( $C_{\max}$ ) of quercetin was less than 100 ng/ml, and that all quercetins detected in the plasma were in the form of glucuronidated and sulfated quercetins rather than quercetin aglycone.<sup>[1,29]</sup> In the same study, following single intravenous (100 mg) administration of quercetin, the highest peak plasma concentration ( $C_{\max}$ ) of quercetin was around 3000 ng/ml, and the time to reach  $C_{\max}$  ( $T_{\max}$ ) was 10 min.<sup>[1,29]</sup> Human absorption of quercetin can be enhanced by quercetin conjugation with glucose.<sup>[30]</sup> For instance, following ingestion of quercetin glucosides (in fried onions) equivalent to 64 mg of quercetin aglycone,  $C_{\max}$  was reported to be 196 ng/ml after 2.9 hr, which is higher than that following 100 mg of quercetin aglycone.<sup>[31]</sup> The sugar moieties and positions of quercetin *O*-glycosides seem to influence their bioavailability as well.<sup>[32–35]</sup> The difference in bioavailability between quercetin glycosides can also be attributed to the different solubilities influencing their accessibility for absorption and to enzymes involved in the absorption.<sup>[36,37]</sup> Currently, the average human intake of quercetin (glycones and aglycone) is less than 60 mg daily. Based on this amount, the highest concentration achieved in the plasma ( $C_{\max}$ ) is less than 200 ng/ml (0.6  $\mu$ M), which includes quercetin and all its metabolites. In vivo effects of quercetin reflect its bioavailability, which can be changed based on a given dose of the flavonol. Unfortunately, data on bioavailability in multiple doses are currently not available, requiring future investigation.

## CELLULAR AND MOLECULAR ACTIONS

Effects of quercetin in humans are manifested in a dynamic environment. For instance, ingested quercetin (glycone and aglycone) undergoes absorption, metabolism, tissue distribution, and excretion. However, cellular and molecular actions of quercetin reported in in vitro studies are observed in a rather static environment, excluding the key physiological conditions. Also, the quercetin concentrations used in the many experiments discussed below are too high to be achieved by dietary ingestion. Therefore, some biological activities reported in vitro should be regarded as potentials for future application of quercetin in preventing and/or treating purported human diseases, but not a direct interpretation of its beneficial use in disease. Flavonoids (quercetin) were once named vitamin P or vitamin C2, due to their abilities to decrease capillary permeability or spare vitamin C activities.<sup>[2]</sup> Since then, quercetin has been viewed as a compound with both beneficial and harmful effects.<sup>[38–40]</sup> However, it is currently recognized as a compound that is more

helpful than deleterious, because epidemiological, cellular, and molecular studies of quercetin have suggested this.<sup>[41,42]</sup> The antioxidant properties of quercetin are believed to explain its positive effects. The 5,7,3',4'-hydroxyl groups on quercetin are capable of donating electrons to quench various radical oxygen species (ROS) and other radical species,<sup>[43,44]</sup> which have the potential to influence pathogenesis or treatment of chronic human diseases such as cancer and cardiovascular diseases.

## Antioxidant Properties

Oxygen radicals (superoxide, hydrogen peroxide, hydroxyl radicals, and other related radicals) have been reported to be involved in initiating and/or promoting cancer, cardiovascular diseases, aging, and other chronic diseases.<sup>[44]</sup> The radicals are quenched by endogenous antioxidant systems, including antioxidant compounds, which balance cellular redox status involved in cellular processes for cell homeostasis, such as proliferation, signaling transduction, and apoptosis.<sup>[45,46]</sup> Therefore, it is proposed that improper redox balance can contribute to chronic human diseases such as cancer and heart diseases, and adequate intake of antioxidant chemicals from fruits and vegetables may afford significant protection against them. Generally, three criteria are considered to assess the antioxidant activity of flavonoids in vitro: first, B ring with two hydroxyl groups (adjacent), second, C ring with 2,3-double bond, 4-oxo, and 3-hydroxyl group, and third, A ring with 5,7-dihydroxyl groups.<sup>[2]</sup> Quercetin meets all three criteria, indicating stronger antioxidant activity than flavonoids that do not meet the criteria. Accordingly, the flavonol was reported to prevent radicals from damaging carbohydrates, proteins, nucleotides, and lipids.<sup>[47]</sup> Quercetin is metabolized and found in the plasma as quercetin glucuronide conjugates and other metabolites. What about their antioxidant properties? The glucuronide conjugates found in the plasma were also reported to have potent antioxidant activity, indicating that the activity may be retained depending on conjugation positions.<sup>[48]</sup> The antioxidant activity of quercetin is believed to contribute to its beneficial effects.

## Effects on Cancer

Human cancers are caused by numerous oncogenic factors, and oxidative stress is a key factor implicated in the initiation and propagation of cancer. Many epidemiological studies suggest that dietary intake of quercetin may have beneficial effects on various types of human cancers.<sup>[49]</sup> Lately, numerous studies have been performed for elucidating potential anticancer

effects of quercetin in each type of human cancer to bolster findings from epidemiological studies. Deoxy-nucleotide acid (DNA) damage by oxygen radicals can be detrimental for normal cells and can change them into cancer cells. 8-hydroxy-2'-deoxyguanosine and other compounds are routinely used as biomarkers to assess levels of DNA damage. Quercetin was shown to increase resistance of lymphocyte DNA to strand breakage, thereby decreasing the level of urinary 8-hydroxy-2'-deoxyguanosine.<sup>[41]</sup> In several reports, it has been described to have potent anticancer effects against various cancers by inducing programmed cell death (apoptosis). In human myelogenous leukemia cells, quercetin was reported to arrest growth of the cell by an increase in the uptake of vincristine, a chemotherapeutic agent.<sup>[50]</sup> In pancreatic tumor cells, the flavonol was reported to induce cell death via inhibiting epidermal growth factor receptor (EGFR) tyrosine kinase activity, and decreasing protein phosphorylation.<sup>[51]</sup> In prostate cancer cells, quercetin was stated to inhibit cell growth and protein phosphorylation.<sup>[52]</sup> Quercetin was also shown to induce growth inhibition and apoptosis in MCF-7 human breast cancer cells. These data suggest that quercetin may induce growth inhibition and apoptosis in human cancer cells by inhibiting receptor kinases and cell cycle-related kinases.<sup>[53]</sup> Gastrointestinal cancer is a cancer associated with dietary and lifestyle factors. In an animal study, quercetin increased both small and large intestinal UGT enzyme activities, thereby helping detoxify compounds with carcinogenic potentials, and preventing gastrointestinal cancer. There are also several reports indicating that quercetin can have beneficial effects on colon and skin cancers.<sup>[54-56]</sup> Although quercetin seems to have potential as an anticancer agent, future studies are needed, because most studies are based on *in vitro* experiments using high concentrations of quercetin unachievable by dietary ingestion, and because its beneficial effects on cancer are still inconclusive in animal and/or human studies.

### Effects on Cardiovascular Diseases

There are accumulating data indicating that quercetin has beneficial effects on cardiovascular diseases. Some epidemiological studies show that diets rich in flavonoids can decrease incidence of cardiovascular diseases. Quercetin has biological properties consistent with its purported effects on the cardiovascular system. For instance, quercetin has been shown to protect low-density lipoprotein (LDL) from oxidation and prevent platelet aggregation.<sup>[57]</sup> It was also reported to inhibit the proliferation and migration of smooth muscle cells. These findings provide new insights and a rationale for the potential use of quercetin for preventing cardiovascular diseases. Currently, there are numerous reports

supporting beneficial effects of quercetin on cardiovascular diseases. For instance, quercetin was reported to significantly lower the plasma lipid, lipoprotein, and hepatic cholesterol levels, inhibit the production of oxLDL produced by oxidative stress, and protect an enzyme, which can hydrolyze specific lipid peroxides in oxidized lipoproteins and in atherosclerotic lesions.<sup>[58-60]</sup> It was stated to even induce endothelium-dependent vasorelaxation in rat aorta via increasing nitric oxide production.<sup>[61]</sup> These data suggest that the protective effects of quercetin on heart diseases may result from its arterial, venous, and coronary vasodilator effects.<sup>[62]</sup> Quercetin and its glycosides were also reported to inhibit the angiotensin-converting enzyme activity, and Ang II-induced JNK activation inducing vascular smooth muscle cell (VSMC) hypertrophy.<sup>[63,64]</sup> These findings suggest that the positive effects of the flavonol on heart diseases are executed via inhibiting signal transduction pathways leading to the disease.<sup>[65,66]</sup> Quercetin was also reported to inhibit platelet aggregation that can be beneficial for lessening conditions of cardiovascular disease.<sup>[67,68]</sup> Based on all these findings, quercetin seems to have potential in the treatment of cardiovascular diseases. However, some effects may not be feasible or negligible in physiological conditions, because concentrations of quercetin in most studies are too high to be achieved by dietary ingestion of quercetin, and beneficial effects of quercetin on cardiovascular diseases are still inconclusive in human studies. Therefore, future studies are required to test the beneficial effects of quercetin on cardiovascular diseases.

### Effects on Inflammation

Inflammation conditions are often associated with numerous chronic diseases such as coronary heart disease, asthma, and others. Inflammation is highly orchestrated with cytokines, eicosanoids, and other immune factors. Tumor necrosis factor-alpha (TNF-alpha) generated by activated macrophages induces several pathophysiological conditions during acute and chronic inflammation. Quercetin was reported to inhibit TNF-alpha overproduction and attenuate pathophysiological conditions during acute and chronic inflammation.<sup>[69-72]</sup> In asthma, the activation of mast cells and basophils by allergen releases chemical mediators and synthesizes cytokines leading to inflammatory conditions. Among these cytokines, interleukin (IL)-4, IL-13, and IL-5 are the major ones involved in allergic inflammation. Quercetin was reported to inhibit cytokine expression and synthesis by human basophils.<sup>[73]</sup> In one study, a metabolite of quercetin, 3-O-methylquercetin (3-MQ), was reported to provide beneficial effects on asthma by inhibiting cAMP- and

cGMP-phosphodiesterase (PDE).<sup>[74]</sup> All reported effects of quercetin on inflammation are preliminary, necessitating future studies before firm conclusions can be made.

### Other Effects on Human Health

There are some interesting biological effects of quercetin reported during the last 10 yr. One of them is its potential effect on the absorption of glucose, because quercetin-*O*-glycosides were proposed to be transported via the sodium-dependent glucose transporter SGLT1.<sup>[75,76]</sup> Indeed, quercetin glycosides [quercetin-3-glucoside (isoquercitrin) and quercetin-4'-glucoside (spiraeosid)] were reported to inhibit mucosal uptake of the nonmetabolizable glucose analog methyl- $\alpha$ -D-glucopyranoside (MDG).<sup>[76]</sup> In another study, quercetin and several flavonoids were stated to prevent glucose uptake by blocking sodium-independent glucose transporters (Glut-1 and -3).<sup>[77]</sup> In some sense, glucose and dehydroascorbic acid (oxidized vitamin C) uptakes are interconnected, because some sodium-independent glucose transporters are involved in both glucose and dehydroascorbic acid uptake. In HL-60, U937, and Jurkat cells, quercetin was reported to inhibit the intracellular accumulation of ascorbic acid by blocking uptake of both dehydroascorbic acid and ascorbic acid (vitamin C). These data may indicate new understanding of the biological effect of flavonoids on glucose and vitamin C uptake in human cells, and future application of quercetin on diseases involving abnormal glucose utilization.<sup>[78,79]</sup> It was also reported to have great potential to inhibit and/or activate numerous enzymes in human cells.<sup>[80,81]</sup>

### INDICATIONS AND USAGE

Quercetin is widely distributed in plant-derived dietary sources such as onions, apples, black tea, green tea, red wine, beans, and grapes.<sup>[7]</sup> Humans have consumed quercetin (mostly quercetin glycosides) from dietary food sources, and the estimated average daily intake of quercetin by an individual in the United States is estimated to be less than 60 mg. Currently, no dietary recommendations regarding estimated average requirement (EAR), recommended dietary allowance (RDA), adequate intake (AI), and upper limit (UL) have been set for quercetin. Also, epidemiological studies exploring its role in human health are inconclusive.<sup>[82]</sup> Future research is required because of the many biological activities attributed to quercetin, some of which could be beneficial or detrimental depending on the circumstances.

### Potential Uses

Among chronic human diseases, cardiovascular diseases and cancer are believed to get maximum benefit from quercetin intake. Some epidemiological studies revealed that a diet rich in quercetin decreased incidence of cardiovascular diseases, and the flavonol was shown to contain biological properties consistent with its purported effects on the cardiovascular system.<sup>[83]</sup> However, the beneficial effects of quercetin on heart diseases are still inconclusive, and further studies are needed to prove these unambiguously.<sup>[84]</sup> Quercetin was also stated to have antitumor potential through numerous in vitro studies. Epidemiological studies regarding effects of quercetin on cancer are less comprehensive than those on cardiovascular diseases. In some experiments, the positive correlation between quercetin intake and risk of cancer was found, but none was found in others. Therefore, further research is necessary to demonstrate that the risk of cancer can be lowered by quercetin intake. Quercetin was also claimed as a potential compound for other human diseases such as inflammation, diabetes mellitus, and infection. However, these claims have little scientific evidence confirming its efficacy against diseases. In summary, the potential uses discussed herein do not mean that quercetin supplements have therapeutic use for the prevention and treatment of diseases. Its health effects require further study.

### ADVERSE EFFECTS

Although current studies emphasize its beneficial effects on cancer and cardiovascular diseases, high doses of quercetin are believed to have mutagenic and genotoxic activities as demonstrated in in vitro systems.<sup>[85-87]</sup> Even though in vitro experiments indicate that there might be adverse effects, the concentrations in the experiments may have been too high. Uncertainty regarding its side effects was also noticed in animal experiments. The study conducted using F344/N rats fed daily with quercetin (40, 400, and 1900 mg/kg of body weight) indicated no severe toxicity for 1 yr and longer. However, some evidence of carcinogenic activity of quercetin in male rats was reported, based on an increased incidence of renal tubule cell adenomas. But none was found in female rats. Due to the uncertainty, it is suggested that quercetin should be consumed from dietary food sources, and caution should be exercised when taking high doses of quercetin supplement, because its adverse effects are yet to be determined.<sup>[88]</sup>

## COMPENDIAL/REGULATORY STATUS

Not applicable.

## REFERENCES

- Harborne, J.B.; Mabry, T.J. *The Flavonoids*; Chapman and Hall: London, 1982.
- Rice-Evans, C.A.; Packer, L. *Flavonoids in Health and Disease*; Marcel Dekker: New York, 1997.
- Havsteen, B. Flavonoids. A class of natural products of high pharmacological potency. *Biochem. Pharmacol.* **1983**, *32*, 1141–1148.
- Formica, J.V.; Regelson, W. A review of the biology of quercetin and related bioflavonoids. *Food Chem. Toxicol.* **1995**, *33*, 1061–1080.
- Winkel-Shirley, B. Flavonoid biosynthesis. A colorful model for genetics, biochemistry, cell biology, and biotechnology. *Plant Physiol.* **2001**, *126*, 485–493.
- Harborne, J.B.; Williams, C.A. Advances in flavonoid research since 1992. *Phytochemistry* **2000**, *55*, 481–504.
- USDA Database for the Flavonoid Content of Selected Foods*; USDA, 2003.
- Erlund, I.; Marniemi, J.; Hakala, P.; Alfthan, G.; Meririnne, E.; Aro, A. Consumption of black currants, lingonberries and bilberries increases serum quercetin concentrations. *Eur. J. Clin. Nutr.* **2003**, *57*, 37–42.
- Le Marchand, L. Cancer preventive effects of flavonoids—a review. *Biomed. Pharmacother.* **2002**, *56*, 296–301.
- Hollman, P.C.; Katan, M.B. Bioavailability and health effects of dietary flavonols in man. *Arch. Toxicol. Suppl.* **1998**, *20*, 237–248.
- Hertog, M.G.; Hollman, P.C. Potential health effects of the dietary flavonol quercetin. *Eur. J. Clin. Nutr.* **1996**, *50*, 63–71.
- Erlund, I.; Kosonen, T.; Alfthan, G.; Maenpaa, J.; Perttunen, K.; Kenraali, J.; Parantainen, J.; Aro, A. Pharmacokinetics of quercetin from quercetin aglycone and rutin in healthy volunteers. *Eur. J. Clin. Pharmacol.* **2000**, *56*, 545–553.
- Day, A.J.; Gee, J.M.; DuPont, M.S.; Johnson, I.T.; Williamson, G. Absorption of quercetin-3-glucoside and quercetin-4'-glucoside in the rat small intestine: the role of lactase phlorizin hydrolase and the sodium-dependent glucose transporter. *Biochem. Pharmacol.* **2003**, *65*, 1199–1206.
- Nemeth, K.; Plumb, G.W.; Berrin, J.G.; Juge, N.; Jacob, R.; Naim, H.Y.; Williamson, G.; Swallow, D.M.; Kroon, P.A. Deglycosylation by small intestinal epithelial cell beta-glucosidases is a critical step in the absorption and metabolism of dietary flavonoid glycosides in humans. *Eur. J. Nutr.* **2003**, *42*, 29–42.
- Oliveira, E.J.; Watson, D.G.; Grant, M.H. Metabolism of quercetin and kaempferol by rat hepatocytes and the identification of flavonoid glycosides in human plasma. *Xenobiotica* **2002**, *32*, 279–287.
- Day, A.J.; Williamson, G. Biomarkers for exposure to dietary flavonoids: a review of the current evidence for identification of quercetin glycosides in plasma. *Br. J. Nutr.* **2001**, *86*, S105–S110.
- Blaut, M.; Schoefer, L.; Braune, A. Transformation of flavonoids by intestinal microorganisms. *Int. J. Vitam. Nutr. Res.* **2003**, *73*, 79–87.
- Braune, A.; Gutschow, M.; Engst, W.; Blaut, M. Degradation of quercetin and luteolin by *Eubacterium ramulus*. *Appl. Environ. Microbiol.* **2001**, *67*, 5558–5567.
- Gee, J.M.; DuPont, M.S.; Day, A.J.; Plumb, G.W.; Williamson, G.; Johnson, I.T. Intestinal transport of quercetin glycosides in rats involves both deglycosylation and interaction with the hexose transport pathway. *J. Nutr.* **2000**, *130*, 2765–2771.
- Boersma, M.G.; van der Woude, H.; Bogaards, J.; Boeren, S.; Vervoort, J.; Cnubben, N.H.; van Iersel, M.L.; van Bladeren, P.J.; Rietjens, I.M. Regioselectivity of phase II metabolism of luteolin and quercetin by UDP-glucuronosyl transferases. *Chem. Res. Toxicol.* **2002**, *15*, 662–670.
- Gee, J.M.; Susan DuPont, M.; Day, A.J.; Plumb, G.W.; Williamson, G.; Johnson, I.T. Intestinal transport of quercetin glycosides in rats involves both deglycosylation and interaction with the hexose transport pathway. *J. Nutr.* **2000**, *130*, 2765–2771.
- O'Leary, K.A.; Day, A.J.; Needs, P.W.; Mellon, F.A.; O'Brien, N.M.; Williamson, G. Metabolism of quercetin-7- and quercetin-3-glucuronides by an in vitro hepatic model: the role of human beta-glucuronidase, sulfotransferase, catechol-O-methyltransferase and multi-resistant protein 2 (MRP2) in flavonoid metabolism. *Biochem. Pharmacol.* **2003**, *65*, 479–491.
- Sesink, A.L.; O'Leary, K.A.; Hollman, P.C. Quercetin glucuronides but not glucosides are present in human plasma after consumption of quercetin-3-glucoside or quercetin-4'-glucoside. *J. Nutr.* **2001**, *131*, 1938–1941.
- De Santi, C.; Pietrabissa, A.; Mosca, F.; Pacifici, G.M. Methylation of quercetin and fisetin, flavonoids widely distributed in edible vegetables, fruits and wine, by human liver. *Int. J. Clin. Pharmacol. Ther.* **2002**, *40*, 207–212.

25. O'Leary, K.A.; Day, A.J.; Needs, P.W.; Sly, W.S.; O'Brien, N.M.; Williamson, G. Flavonoid glucuronides are substrates for human liver beta-glucuronidase. *FEBS Lett.* **2001**, *503*, 103–106.
26. Breinholt, V.M.; Offord, E.A.; Brouwer, C.; Nielsen, S.E.; Brosen, K.; Friedberg, T. In vitro investigation of cytochrome P450-mediated metabolism of dietary flavonoids. *Food Chem. Toxicol.* **2002**, *40*, 609–616.
27. Mullen, W.; Graf, B.A.; Caldwell, S.T.; Hartley, R.C.; Duthie, G.G.; Edwards, C.A.; Lean, M.E.; Crozier, A. Determination of flavonol metabolites in plasma and tissues of rats by HPLC-radiocounting and tandem mass spectrometry following oral ingestion of [2-(14)C]quercetin-4'-glucoside. *J. Agric. Food Chem.* **2002**, *50*, 6902–6909.
28. Hollman, P.C.; van Trijp, J.M.; Buysman, M.N.; van der Gaag, M.S.; Mengelers, M.J.; de Vries, J.H.; Katan, M.B. Relative bioavailability of the antioxidant flavonoid quercetin from various foods in man. *FEBS Lett.* **1997**, *418*, 152–156.
29. Gugler, R.; Leschik, M.; Dengler, H.J. Disposition of quercetin in man after single oral and intravenous doses. *Eur. J. Clin. Pharmacol.* **1975**, *9*, 229–234.
30. Hollman, P.C.; de Vries, J.H.; van Leeuwen, S.D.; Mengelers, M.J.; Katan, M.B. Absorption of dietary quercetin glycosides and quercetin in healthy ileostomy volunteers. *Am. J. Clin. Nutr.* **1995**, *62*, 1276–1282.
31. Hollman, P.C.; van der Gaag, M.; Mengelers, M.J.; van Trijp, J.M.; de Vries, J.H.; Katan, M.B. Absorption and disposition kinetics of the dietary antioxidant quercetin in man. *Free Radical Biol. Med.* **1996**, *21*, 703–707.
32. Graefe, E.U.; Wittig, J.; Mueller, S.; Riethling, A.K.; Uehleke, B.; Drewelow, B.; Pforte, H.; Jacobasch, G.; Derendorf, H.; Veit, M. Pharmacokinetics and bioavailability of quercetin glycosides in humans. *J. Clin. Pharmacol.* **2001**, *41*, 492–499.
33. Olthof, M.R.; Hollman, P.C.; Vree, T.B.; Katan, M.B. Bioavailabilities of quercetin-3-glucoside and quercetin-4'-glucoside do not differ in humans. *J. Nutr.* **2000**, *130*, 1200–1203.
34. Walle, T.; Otake, Y.; Walle, U.K.; Wilson, F.A. Quercetin glucosides are completely hydrolyzed in ileostomy patients before absorption. *J. Nutr.* **2000**, *130*, 2658–2661.
35. Morand, C.; Manach, C.; Crespy, V.; Remesy, C. Respective bioavailability of quercetin aglycone and its glycosides in a rat model. *Biofactors* **2000**, *12*, 169–174.
36. Khaled, K.A.; El-Sayed, Y.M.; Al-Hadiya, B.M. Disposition of the flavonoid quercetin in rats after single intravenous and oral doses. *Drug Dev. Ind. Pharm.* **2003**, *29*, 397–403.
37. Shimoi, K.; Yoshizumi, K.; Kido, T.; Usui, Y.; Yumoto, T. Absorption and urinary excretion of quercetin, rutin, and alphaG-rutin, a water soluble flavonoid, in rats. *J. Agric. Food Chem.* **2003**, *51*, 2785–2789.
38. Ross, J.A.; Kasum, C.M. Dietary flavonoids: bioavailability, metabolic effects, and safety. *Annu. Rev. Nutr.* **2002**, *22*, 19–34.
39. Vrijsen, R.; Michotte, Y.; Boeye, A. Metabolic activation of quercetin mutagenicity. *Mutat. Res.* **1990**, *232*, 243–248.
40. Nakayasu, M.; Sakamoto, H.; Terada, M.; Nagao, M.; Sugimura, T. Mutagenicity of quercetin in Chinese hamster lung cells in culture. *Mutat. Res.* **1986**, *174*, 79–83.
41. Boyle, S.P.; Dobson, V.L.; Duthie, S.J.; Kyle, J.A.; Collins, A.R. Absorption and DNA protective effects of flavonoid glycosides from an onion meal. *Eur. J. Nutr.* **2000**, *39*, 213–223.
42. Duthie, S.J.; Collins, A.R.; Duthie, G.G.; Dobson, V.L. Quercetin and myricetin protect against hydrogen peroxide-induced DNA damage (strand breaks and oxidised pyrimidines) in human lymphocytes. *Mutat. Res.* **1997**, *393*, 223–231.
43. Rice-Evans, C. Flavonoid antioxidants. *Curr. Med. Chem.* **2001**, *8*, 797–807.
44. Uddin, S.; Ahmad, S. Antioxidants protection against cancer and other human diseases. *Compr. Ther.* **1995**, *21*, 41–45.
45. Jacob, R.A.; Burri, B.J. Oxidative damage and defense. *Am. J. Clin. Nutr.* **1996**, *63*, 985S–990S.
46. Moran, L.K.; Gutteridge, J.M.; Quinlan, G.J. Thiols in cellular redox signalling and control. *Curr. Med. Chem.* **2001**, *8*, 763–772.
47. Feng, Q.; Kumagai, T.; Torii, Y.; Nakamura, Y.; Osawa, T.; Uchida, K. Anticarcinogenic antioxidants as inhibitors against intracellular oxidative stress. *Free Radical Res.* **2001**, *35*, 779–788.
48. Day, A.J.; Bao, Y.; Morgan, M.R.; Williamson, G. Conjugation position of quercetin glucuronides and effect on biological activity. *Free Radical Biol. Med.* **2000**, *29*, 1234–1243.
49. Lopez-Lazaro, M. Flavonoids as anticancer agents: structure–activity relationship study. *Curr. Med. Chem. Anti-Cancer Agents* **2002**, *2*, 691–714.
50. Ikegawa, T.; Ohtani, H.; Koyabu, N.; Juichi, M.; Iwase, Y.; Ito, C.; Furukawa, H.; Naito, M.; Tsuruo, T.; Sawada, Y. Inhibition of P-glycoprotein by flavonoid derivatives in adriamycin-resistant human myelogenous leukemia (K562/ADM) cells. *Cancer Lett.* **2002**, *177*, 89–93.
51. Lee, L.T.; Huang, Y.T.; Hwang, J.J.; Lee, P.P.; Ke, F.C.; Nair, M.P.; Kanadaswam, C.



- Lee, M.T. Blockade of the epidermal growth factor receptor tyrosine kinase activity by quercetin and luteolin leads to growth inhibition and apoptosis of pancreatic tumor cells. *Anticancer Res.* **2002**, *22*, 1615–1627.
52. Huynh, H.; Nguyen, T.T.; Chan, E.; Tran, E. Inhibition of ErbB-2 and ErbB-3 expression by quercetin prevents transforming growth factor alpha (TGF- $\alpha$ )- and epidermal growth factor (EGF)-induced human PC-3 prostate cancer cell proliferation. *Int. J. Oncol.* **2003**, *23*, 821–829.
53. Choi, J.A.; Kim, J.Y.; Lee, J.Y.; Kang, C.M.; Kwon, H.J.; Yoo, Y.D.; Kim, T.W.; Lee, Y.S.; Lee, S.J. Induction of cell cycle arrest and apoptosis in human breast cancer cells by quercetin. *Int. J. Oncol.* **2001**, *19*, 837–844.
54. Gee, J.M.; Hara, H.T. Suppression of intestinal crypt cell proliferation and aberrant crypt foci by dietary quercetin in rats. *Nutr. Cancer* **2002**, *43*, 121–126.
55. Pawlikowska-Pawlega, B.; Jakubowicz-Gil, J.; Rzymowska, J.; Gawron, A. The effect of quercetin on apoptosis and necrosis induction in human colon adenocarcinoma cell line LS180. *Folia Histochem. Cytobiol.* **2001**, *39*, 217–218.
56. Bhatia, N.; Agarwal, C.; Agarwal, R. Differential responses of skin cancer-chemopreventive agents silibinin, quercetin, and epigallocatechin 3-gallate on mitogenic signaling and cell cycle regulators in human epidermoid carcinoma A431 cells. *Nutr. Cancer* **2001**, *39*, 292–299.
57. Formica, J.V.; Regelson, W. Review of the biology of quercetin and related bioflavonoids. *Food Chem. Toxicol.* **1995**, *33*, 1061–1080.
58. Bok, S.H.; Park, S.Y.; Park, Y.B.; Lee, M.K.; Jeon, S.M.; Jeong, T.S.; Choi, M.S. Quercetin dihydrate and gallate supplements lower plasma and hepatic lipids and change activities of hepatic antioxidant enzymes in high cholesterol-fed rats. *Int. J. Vitam. Nutr. Res.* **2002**, *72*, 161–169.
59. Pal, S.; Ho, N.; Santos, C.; Dubois, P.; Mamo, J.; Croft, K.; Allister, E. Red wine polyphenolics increase LDL receptor expression and activity and suppress the secretion of ApoB100 from human HepG2 cells. *J. Nutr.* **2003**, *133*, 700–706.
60. Fuhrman, B.; Aviram, M. Preservation of paraoxonase activity by wine flavonoids: possible role in protection of LDL from lipid peroxidation. *Ann. N. Y. Acad. Sci.* **2002**, *957*, 321–324.
61. Taubert, D.; Berkels, R.; Klaus, W.; Roesen, R. Nitric oxide formation and corresponding relaxation of porcine coronary arteries induced by plant phenols: essential structural features. *J. Cardiovasc. Pharmacol.* **2002**, *40*, 701–713.
62. Ibarra, M.; Perez-Vizcaino, F.; Cogolludo, A.; Duarte, J.; Zaragoza-Arnaez, F.; Lopez-Lopez, J.G.; Tamargo, J. Cardiovascular effects of isorhamnetin and quercetin in isolated rat and porcine vascular smooth muscle and isolated rat atria. *Planta Med.* **2002**, *68*, 307–310.
63. Hackl, L.P.; Cuttle, G.; Dovichi, S.S.; Lima-Landman, M.T.; Nicolau, M. Inhibition of angiotensin-converting enzyme by quercetin alters the vascular response to bradykinin and angiotensin I. *Pharmacology* **2002**, *65*, 182–186.
64. Melzig, M.F.; Escher, F. Induction of neutral endopeptidase and angiotensin-converting enzyme activity of SK-N-SH cells in vitro by quercetin and resveratrol. *Pharmazie* **2002**, *57*, 556–558.
65. Yoshizumi, M.; Tsuchiya, K.; Kirima, K.; Kyaw, M.; Suzuki, Y.; Tamaki, T. Quercetin inhibits Shc- and phosphatidylinositol 3-kinase-mediated c-Jun N-terminal kinase activation by angiotensin II in cultured rat aortic smooth muscle cells. *Mol. Pharmacol.* **2001**, *60*, 656–665.
66. Yoshizumi, M.; Tsuchiya, K.; Suzuki, Y.; Kirima, K.; Kyaw, M.; Moon, J.H.; Terao, J.; Tamaki, T. Quercetin glucuronide prevents VSMC hypertrophy by angiotensin II via the inhibition of JNK and AP-1 signaling pathway. *Biochem. Biophys. Res. Commun.* **2002**, *293*, 1458–1465.
67. Pignatelli, P.; Pulcinelli, F.M.; Celestini, A.; Lenti, L.; Ghiselli, A.; Gazzaniga, P.P.; Violi, F. The flavonoids quercetin and catechin synergistically inhibit platelet function by antagonizing the intracellular production of hydrogen peroxide. *Am. J. Clin. Nutr.* **2000**, *72*, 1150–1155.
68. Di Santo, A.; Mezzetti, A.; Napoleone, E.; Di Tommaso, R.; Donati, M.B.; De Gaetano, G.; Lorenzet, R. Resveratrol and quercetin down-regulate tissue factor expression by human stimulated vascular cells. *J. Thromb. Haemost.* **2003**, *1*, 1089–1095.
69. Manthey, J.A. Biological properties of flavonoids pertaining to inflammation. *Microcirculation* **2000**, *7*, S29–S34.
70. Miller, A.L. The etiologies, pathophysiology, and alternative/complementary treatment of asthma. *Altern. Med. Rev.* **2001**, *6*, 20–47.
71. Manjeet, K.R.; Ghosh, B. Quercetin inhibits LPS-induced nitric oxide and tumor necrosis factor- $\alpha$  production in murine macrophages. *Int. J. Immunopharmacol.* **1999**, *21*, 435–443.
72. Bito, T.; Roy, S.; Sen, C.K.; Shirakawa, T.; Gotoh, A.; Ueda, M.; Ichihashi, M.; Packer, L. Flavonoids differentially regulate IFN gamma-induced ICAM-1 expression in human keratinocytes: molecular mechanisms of action. *FEBS Lett.* **2002**, *520*, 145–152.
73. Higa, S.; Hirano, T.; Kotani, M.; Matsumoto, M.; Fujita, A.; Suemura, M.; Kawase, I.; Tanaka, T.

- Fisetin, a flavonol, inhibits TH2-type cytokine production by activated human basophils. *J. Allergy Clin. Immunol.* **2003**, *111*, 1299–2306.
74. Ko, W.C.; Chen, M.C.; Wang, S.H.; Lai, Y.H.; Chen, J.H.; Lin, C.N. *O*-Methylquercetin more selectively inhibits phosphodiesterase subtype 3. *Planta Med.* **2003**, *69*, 310–315.
75. Gee, J.M.; DuPont, M.S.; Rhodes, M.J.; Johnson, I.T. Quercetin glucosides interact with the intestinal glucose transport pathway. *Free Radical Biol. Med.* **1998**, *25*, 19–25.
76. Ader, P.; Block, M.; Pietzsch, S.; Wolfram, S. Interaction of quercetin glucosides with the intestinal sodium/glucose co-transporter (SGLT-1). *Cancer Lett.* **2001**, *162*, 175–180.
77. Park, J.B. Flavonoids are potential inhibitors of glucose uptake in U937 cells. *Biochem. Biophys. Res. Commun.* **1999**, *260*, 568–574.
78. Park, J.B.; Levine, M. Intracellular accumulation of ascorbic acid is inhibited by flavonoids via blocking of dehydroascorbic acid and ascorbic acid uptakes in HL-60, U937 and Jurkat cells. *J. Nutr.* **2000**, *130*, 1297–1302.
79. Song, J.; Kwon, O.; Chen, S.; Daruwala, R.; Eck, P.; Park, J.B.; Levine, M. Flavonoid inhibition of sodium-dependent vitamin C transporter 1 (SVCT1) and glucose transporter isoform 2 (Glut2), intestinal transporters for vitamin C and glucose. *J. Biol. Chem.* **2002**, *277*, 15,252–15,260.
80. Marchetti, F.; De Santi, C.; Vietri, M.; Pietrabissa, A.; Spisni, R.; Mosca, F.; Pacifici, G.M. Differential inhibition of human liver and duodenum sulphotransferase activities by quercetin, a flavonoid present in vegetables, fruit and wine. *Xenobiotica* **2001**, *31*, 841–847.
81. Ho, P.C.; Saville, D.J.; Wanwimolruk, S. Inhibition of human CYP3A4 activity by grapefruit flavonoids, furanocoumarins and related compounds. *J. Pharm. Sci.* **2001**, *4*, 217–227.
82. Mouria, M.; Gukovskaya, A.S.; Jung, Y.; Buechler, P.; Hines, O.J.; Reber, H.A.; Pandol, S.J. Food-derived polyphenols inhibit pancreatic cancer growth through mitochondrial cytochrome C release and apoptosis. *Int. J. Cancer* **2002**, *98*, 761–769.
83. Formica, J.V.; Regelson, W. Review of the biology of Quercetin and related bioflavonoids. *Food Chem. Toxicol.* **1995**, *33*, 1061–1080.
84. Knekt, P.; Isotupa, S.; Rissanen, H.; Heliovaara, M.; Jarvinen, R.; Hakkinen, S.; Aromaa, A.; Reunanen, A. Quercetin intake and the incidence of cerebrovascular disease. *Eur. J. Clin. Nutr.* **2000**, *54*, 415–417.
85. Ishikawa, M.; Oikawa, T.; Hosokawa, M.; Hamada, J.; Morikawa, K.; Kobayashi, H. Enhancing effect of quercetin on 3-methylcholanthrene carcinogenesis in C57Bl/6 mice. *Neoplasma* **1985**, *32*, 435–441.
86. Toxicology and carcinogenesis studies of quercetin (CAS No. 117-39-5) in F344 rats (Feed Studies). *Natl. Toxicol. Program Tech. Rep. Ser.* **1992**, *409*, 1–171.
87. Canada, A.T.; Watkins, W.D.; Nguyen, T.D. The toxicity of flavonoids to guinea pig enterocytes. *Toxicol. Appl. Pharmacol.* **1989**, *99*, 357–361.
88. Skibola, C.F.; Smith, M.T. Potential health impacts of excessive flavonoid intake. *Free Radical Biol. Med.* **2000**, *29*, 375–383.



# Red Clover (*Trifolium pratense*)

Nancy L. Booth  
Colleen E. Piersen

UIC/NIH Center for Botanical Dietary Supplements Research, Program for Collaborative Research in the Pharmaceutical Sciences, College of Pharmacy, University of Illinois at Chicago, Chicago, Illinois, U.S.A.

## INTRODUCTION

Red clover (RC) is a herbaceous perennial plant that inhabits temperate and subtropical areas throughout the world. Native Americans traditionally valued RC for treatment of external skin problems and lung, nervous, and reproductive system ailments. Herbalists have employed it as a blood cleanser, expectorant, alterative, and sedative. With the recognition of its high content of mildly estrogenic isoflavones, the plant has gained popularity as a treatment for menopausal symptoms. Clinical evidence is presently lacking to support the efficacy of semipurified RC isoflavone extracts for alleviation of vasomotor and prostate cancer/benign prostatic hyperplasia (BPH) symptoms. Limited evidence suggests possible efficacy in prevention of osteoporosis and improvement of arterial compliance, a risk factor for atherosclerosis. Current RC isoflavone products do not contain a protein fraction, which precludes analogous comparison with isoflavone studies utilizing dietary soy [*Glycine max* (L.) Merr.] or soy protein isolates (SPIs) for various clinical outcomes. RC isoflavone extract preparations may also differ from soy isoflavone extracts in content of minor chemicals, many of which have not yet been identified, quantified, or tested for biological activity. The need for long-term studies of RC isoflavone supplements is great, as placebo effects, especially for menopausal symptoms, may persist several weeks. Also, thyroid disease and cancer patients may face a potential, yet undefined, risk from long-term exposure to isoflavones and other compounds in RC.

---

Nancy L. Booth, M.S., is at the UIC/NIH Center for Botanical Dietary Supplements Research, Program for Collaborative Research in the Pharmaceutical Sciences, Department of Medicinal Chemistry and Pharmacognosy, College of Pharmacy, University of Illinois at Chicago, Chicago, Illinois, U.S.A.

Colleen E. Piersen, Ph.D., M.B.A., is a Program Coordinator at the UIC/NIH Center for Botanical Dietary Supplements Research, Program for Collaborative Research in the Pharmaceutical Sciences, Department of Medicinal Chemistry and Pharmacognosy, College of Pharmacy, University of Illinois at Chicago, Chicago, Illinois, U.S.A.

*Encyclopedia of Dietary Supplements* DOI: 10.1081/E-EDS-120022126  
Copyright © 2005 by Marcel Dekker. All rights reserved.

## BOTANICAL NAME

*Trifolium pratense* L. (Fabaceae or Leguminosae).

## COMMON NAMES

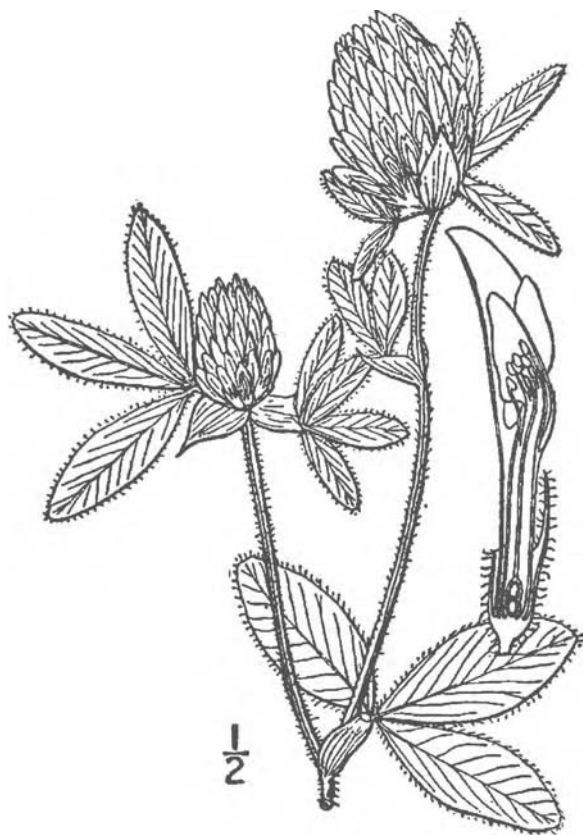
Bee bread, cleaver grass, clover-grass, clover rose, cow clover, creeping clover, honeysuckle, klevler lugovoi, ladies' posy, meadow clover, meadow trefoil, purple clover, red clover, rozheva konyushina, sweet clover, three-leaved grass, treboil, trefoil, trevor, wild clover, and wild red clover (Fig. 1).

## BOTANICAL DESCRIPTION

*T. pratense* L. is a low-growing perennial herb that originated in the Mediterranean area and is now widespread around the globe. It has been cultivated since the 4th century A.D. and is used as livestock fodder and sometimes as green fertilizer, to replenish the soil. Consumption as a food is not widespread, except occasionally as young sprouts or cooked greens.

The general habit of RC is described as having "several stems arising from the same root, ascending, somewhat hairy, and varying much in its height. The leaves are ternate; the leaflets oval or obovate, entire, nearly smooth, often notched at the end, and lighter colored in the center. Stipules ovate and mucronate."<sup>[1]</sup> Flowers occur "in short, dense, ovate, sessile spikes or heads. Corollas unequal, monopetalous; lower tooth of the calyx longer than the four others, which are equal, and all shorter than the rose-red corolla."<sup>[1]</sup> Flower heads are "globose or ovoid, from 1.5 to 3 cm in length, consisting of numerous purplish red or pinkish brown papilionaceous flowers, about 10 mm in length; calyx pubescent, and with subulate teeth shorter than the corolla; odor fragrant; taste somewhat sweetish and bitter."<sup>[2]</sup>

*T. pratense* should not be confused with the similarly named yellow or white "sweet clovers," *Melilotus officinalis* (L.) Pall. and *Melilotus alba* Medikus. The flowers of *M. officinalis* "are in small spike-like



**Fig. 1** Drawing of RC. (From the USDA-NRCS PLANTS Database; Britton, N.L.; Brown, A. *Illustrated Flora of the Northern States and Canada*; 1913; Vol. 2, 355.)

racemes with a papilionaceous corolla and about 3 mm in length and when fresh, yellow, but on drying, a yellowish brown. The odor is fragrant, resembling coumarin and the taste slightly bitter and pungent.”<sup>[2]</sup> *M. alba* has white flowers and is similar in appearance to *M. officinalis*.

## FOLKLORIC, HISTORIC, AND ETHNOMEDICAL USES

### External

Red clover blossoms were incorporated into ointments or decocted to make compresses for “ulcers,” believed to be cancerous lesions or growths by more recent authors. These preparations are also used to treat burns, bites, wounds, gout, and fungal infections. The expressed juice has been used for eye diseases.

### Internal

Cherokee Indians made a tea of the flowers or above-ground parts to treat fevers, “Bright’s disease”

(nephritis), and leukorrhea.<sup>[3]</sup> The Iroquois referred to it as a “blood medicine.” The Ute of Nevada used a decoction as an abortifacient. Tea or tincture was utilized for the spasmodic coughs of whooping cough, measles, bronchitis, laryngitis, and tuberculosis in the 19th and 20th centuries.<sup>[1]</sup> Red clover cigarettes were a treatment for asthma according to the *National Formulary*. Decoctions and infusions are still used as expectorants, alteratives, sedatives, and remedies for rheumatism, ulcers, and skin conditions. Less frequently, its utility for normalization of menses, lactagogue action, or as a fertility tonic has been reported.

In 1900, a product named “Extract of *Trifolium* Compound,” produced by the Wm. S. Merrell Chemical Company (Cincinnati, Ohio, U.S.A.), contained potassium iodide plus extracts of the following plants: *T. pratense* L., *Stillingia sylvatica* L., *Lappa minor* Hill, *Phytolacca decandra* L., *Cascara amarga*, *Berberis aquifolium* Pursh, *Podophyllum peltatum* L., and *Xanthoxylum carolinianum*.<sup>[1]</sup> This preparation was recommended for treatment of syphilis, scrofula, chronic rheumatism, and glandular and various skin afflictions.

The formula for the Hoxsey internal cancer remedy has likely changed over time and been customized for individual patients. However, it has probably contained, at one time or another, the following plants (plus potassium iodide): *Phytolacca americana* L., *Arctium lappa* L., *B. vulgaris* L., *Rhamnus frangula* L., *S. sylvatica* L., *Zanthoxylum americanum* Mill., *C. sagrada* and/or *C. amarga*, *Glycyrrhiza glabra* L., *Medicago sativa* L., and *T. pratense* L.

Flor-Essence<sup>TM</sup>, currently manufactured by Flora, Inc. (Lynden, Washington, U.S.A.) and Flora Manufacturing & Distributing, Ltd. (Burnaby, British Columbia, Canada), is sometimes used by cancer patients and contains the following plant extracts: *A. lappa* L., *T. pratense* L., *Cnicus benedictus* L., *Ulmus rubra* Muhl., *Rumex acetosella* L., *Rheum palmatum* L., *Laminaria digitata* Lmx., and *Nasturtium officinale* R. Br.

## CHEMICAL CONSTITUENTS

Red clover contains several general classes of compounds (Table 1) but is particularly rich in isoflavones, flavones, and flavonols. Both soy and RC contain the isoflavones genistein and daidzein, and soy may contain small amounts of formononetin and biochanin A. However, RC contains substantially more formononetin and biochanin A, relative to genistein and daidzein, when compared to soy.

Under storage conditions of >13% moisture, RC may become contaminated with the fungus *Rhizoctonia legumicola*, which produces the indolizidine

**Table 1** Listing of compound classes found in RC

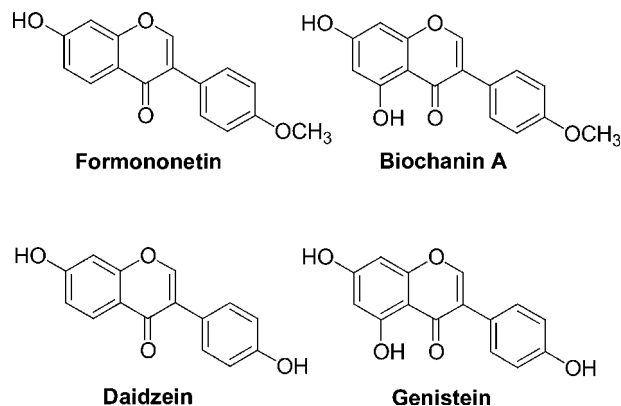
Alkaloid	Flavone
Alkanal	Flavonoid
Alkane	Flavonol
Alkanol	Isoflavonoid
Alkanone	Lipid
Alkenal	Monoterpene
Alkene	Oxygen heterocycle
Alkenol	Phenylpropanoid
Alkenone	Protein
Benzenoid	Sesquiterpene
Carbohydrate	Steroid
Coumarin	Triterpene

(From NAPRALERT<sup>SM</sup> database, University of Illinois at Chicago, Chicago, Illinois, U.S.A.)

alkaloids slaframine and swainsonine. The latter alkaloid causes lysosomal storage disease and may precipitate “locoism” (i.e., weakness, lack of coordination, trembling, and partial paralysis) in livestock. Slaframine is activated by liver metabolism to form a ketoimine that stimulates muscarinic receptors, causing excessive salivation, lacrimation, frequent urination, diarrhea, bradycardia, and bradypnea in livestock.

### Compounds Used for Standardization

The isoflavones genistein, daidzein, formononetin, and biochanin A are currently used to standardize chemical content of commercial RC products (Fig. 2). Standardization is based on the rationale that these four compounds exhibit significant *in vitro* estrogenic activity. However, RC contains various other isoflavones and compounds from distinct structural classes, some with unknown biological activity.



**Fig. 2** Chemical structures of the four isoflavones used in standardization of RC products.

## PHARMACOKINETICS AND METABOLISM

The RC isoflavones exist in the plant primarily as inactive glucosides (genistin, daidzin, ononin, and sissotrin) or malonated glucoside forms. Microflora in the digestive tract hydrolyze these conjugates to their bioactive, aglycone counterparts, which are readily absorbed from the intestine. Formononetin and biochanin A are demethylated to daidzein and genistein, respectively (Fig. 3). Prunetin, a minor component of RC, may also be converted to genistein. Only 30–40% of individuals can metabolize (+/–)-dihydrodaidzein, a daidzein metabolite, to the potent estrogen equol. Hepatic phase II enzymes form isoflavone glucuronides and sulfates. Human hepatic microsomal enzymes, like gut bacteria, demethylate the 4'-O-methylated isoflavones *in vitro*.

Isoflavones circulate in the plasma mainly as conjugates and then are excreted in urine or bile, or undergo enterohepatic circulation. Data on the tissue and fluid distribution of isoflavones in humans are limited, but isoflavones are present in prostatic fluid and secreted into breast milk. Interindividual variability is substantial, but it is estimated that isoflavone (98–99% conjugated) plasma concentrations will reach 1  $\mu$ M in a 70 kg individual who has consumed a single 50 mg dose.<sup>[4]</sup> The pharmacokinetic parameters associated with long-term administration of RC isoflavones suggest that once-daily dosing is adequate.

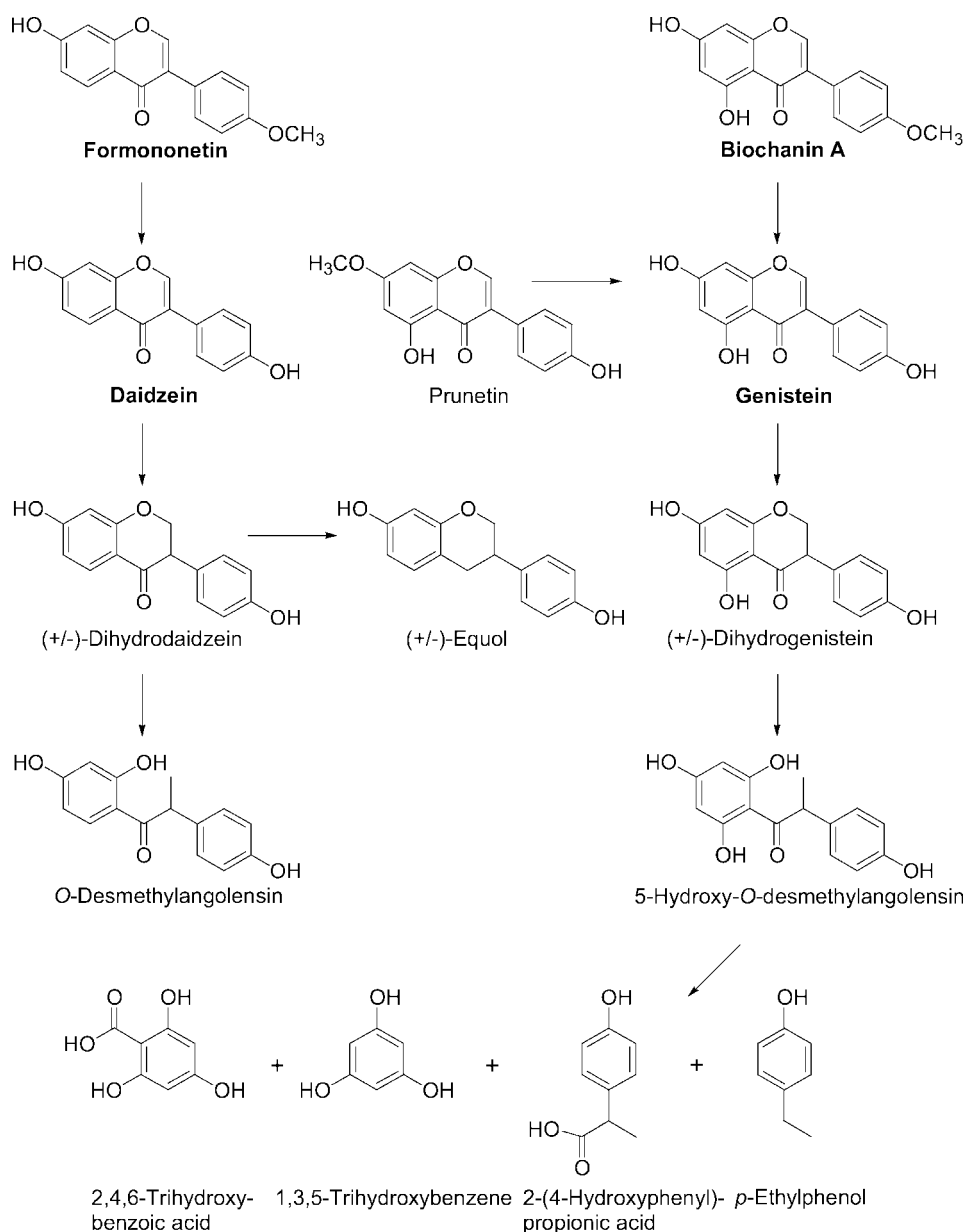
## PHARMACOLOGICAL ACTIVITY

### Hormonal Effects

#### Estrogen receptor dependent

Research into RC mechanism of action has largely focused on interactions with estrogen receptors (ER) ER- $\alpha$  and ER- $\beta$ . Crude, hydroalcoholic extracts of RC inhibit binding of <sup>3</sup>H-17 $\beta$ -estradiol to endogenous and purified, recombinant ER in a number of test systems. Components of RC extracts bind preferentially to ER- $\beta$  over ER- $\alpha$ , earning RC its categorization as natural selective estrogen receptor modulator (SERM). Isoflavone standards also bind preferentially to ER- $\beta$  but exhibit competitive binding at both receptor subtypes with the same rank order of potency: genistein > daidzein > biochanin A ~ prunetin > formononetin.

Pike et al.<sup>[5]</sup> resolved the crystal structure of genistein bound to the ER- $\beta$  ligand-binding domain. The ER- $\beta$ :17 $\beta$ -estradiol structure remains unsolved, but the ER- $\alpha$ :17 $\beta$ -estradiol complex is often used as a basis of comparison to deduce the mode of binding of genistein with ER- $\beta$ . Comparison of the ER- $\beta$ :genistein



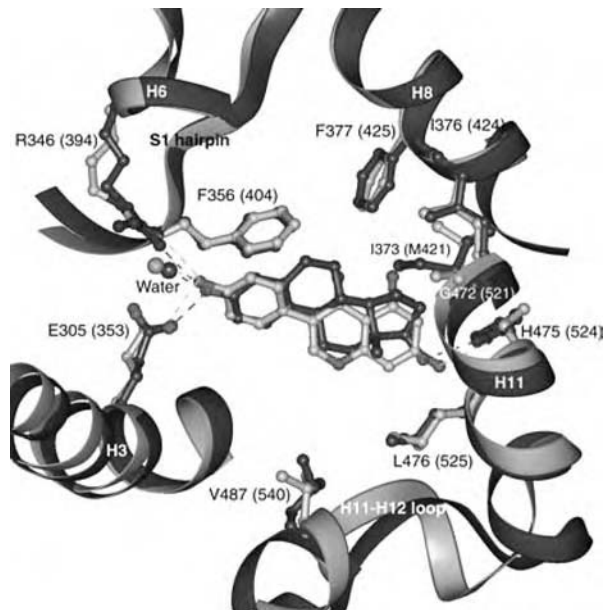
**Fig. 3** Structures and metabolism of the main isoflavones in RC.

structure with the previously published ER- $\alpha$ :genistein structure enabled identification of two conservative amino acid changes, which may contribute to isoflavones' ER- $\beta$  selectivity. The new structure also revealed the partial agonist character of genistein. Like 17 $\beta$ -estradiol, genistein is buried within the hydrophobic core of the binding cavity, but Helix 12 adopts an antagonist orientation similar to that seen for raloxifene. Fig. 4 illustrates the ligand binding modes of genistein and 17 $\beta$ -estradiol coupled to the ligand binding domains of ER- $\beta$  and ER- $\alpha$ , respectively.

Red clover exhibits a complex array of (anti)estrogenic activities in various *in vitro* test systems.<sup>[6]</sup> Crude extracts of RC upregulate the estrogen-inducible genes for progesterone receptor (PR) and the trefoil peptide

(TFF1/*pS2*) and induce alkaline phosphatase (AP) activity in various cell lines. RC downregulates ER levels in T-47D (ER+/PR+) breast cancer cells, an effect that cannot be reversed in the presence of RU486. Preparations of RC and purified isoflavones usually stimulate the proliferation of ER+ breast cancer cells in steroid-depleted media yet inhibit steroid-stimulated growth at midrange to high micromolar concentrations. Modulation of bone cell homeostasis by isoflavones is believed to occur via ER-dependent mechanisms.

*In vivo* animal studies generally support the picture of RC as a weak estrogenic agent with tissue-dependent effects. A survey of various clover and alfalfa fodders associated content of biochanin A



**Fig. 4** Comparison of hER- $\beta$ -LBD:genistein and hER- $\alpha$ -LBD:17 $\beta$ -estradiol ligand binding modes. Crystal structures of genistein in the human (h) ER- $\beta$  ligand binding domain (LBD) (hER- $\beta$ -LBD:genistein, light grey) and 17 $\beta$ -estradiol in the ER- $\alpha$ -LBD (hER- $\alpha$ -LBD:17 $\beta$ -estradiol, dark grey) are superimposed. Hydrogen bonds are drawn as dotted lines. Primary protein residue labels correspond to the hER- $\beta$ -LBD sequence. The corresponding hER- $\alpha$ -LBD sequence number and residue, if different, is provided in parentheses. [This figure was kindly prepared by Barbara Calamini and Andrew Mesecar (University of Illinois at Chicago, Illinois).] (View this art in color at [www.dekker.com](http://www.dekker.com).)

and formononetin with uterotrophic activity in the immature rat model. Exposure of ovariectomized ewes and heifers to formononetin and RC silage, respectively, caused enlargements in teat, vulval, and uterine size and production of milky fluid by the mammae. More recently, a standardized RC extract proved weakly estrogenic by affecting uterotrophic and vaginotrophic outcomes in the ovariectomized rat model, but it did not stimulate breast cell proliferation. In a rat model of endometrial cancer, genistein upregulated estrogen-responsive genes but did not promote tumor growth. Consistent with ER- $\beta$  selectivity, isoflavone preparations improve bone density and protect against cardiovascular disease in most ovariectomized rat and prepubertal rhesus monkey models, although bone results may vary with concentration, timing, and length of exposure.

Isoflavone concentrations in humans routinely exceed endogenous estradiol concentrations. Yet RC is not overtly estrogenizing, suggesting that alternate molecular targets must mediate the clinical actions of the isoflavones.

## Other receptor dependent

In addition to weak estrogenic activity, RC extracts exert weak antiprogesterone and antiandrogenic activities. A 50% hydroethanolic extract did not stimulate, but instead almost completely blocked, progesterin-induced AP activity in T-47 cells.<sup>[7]</sup> More recently, antiandrogenic action of a 5% RC extract appeared responsible for reduction in benign prostate enlargement in aromatase knockout mice. Affinity constants for the four major isoflavones at the progesterone and androgen receptors fall in the millimolar range and adhere to the same rank order of potency for both steroid receptors: biochanin A  $\sim$  genistein > daidzein > formononetin.

## Receptor independent

A number of receptor-independent mechanisms of action influence hormone status. Isoflavones tend to lower steroid hormone levels in part through inhibition of several enzymes involved in steroid biosynthesis:<sup>[8]</sup> aromatase (biochanin A > genistein), 5- $\alpha$ -reductase type 2 (genistein, daidzein, and biochanin A), and 17- $\beta$ -hydroxysteroid dehydrogenase (coumestrol, biochanin A, and genistein). Daidzein sulfates inhibit the sulfatase and sulfotransferase enzymes that: 1) regulate sulfation of endogenous and environmental estrogens; 2) help determine the availability of hormones to tumors; and 3) have been hypothesized to minimize bioactivation of xenobiotic procarcinogens. All four isoflavones—biochanin A being the most potent—expedite the elimination of inactive hormone conjugates through stimulation of UDP-glucuronosyltransferase. Genistein stimulates the production of sex hormone binding globulin (SHBG) in human hepatocarcinoma cells. Equol producers exhibit enhanced urinary ratios of 2-hydroxyestrone to 16 $\alpha$ -hydroxyestrone, a metabolic measure that is negatively correlated with breast cancer risk.

## Cancer-Related Effects

### Antioxidant

Crude RC extracts display antioxidant activity in several experimental systems. Known antioxidant compounds in RC include genistein, daidzein (equol), biochanin A, genistin, daidzin, formononetin, clovamide, and texasin. In addition to exerting their influence through direct chemical interactions, isoflavones lower oxidative stress via indirect mechanisms such as induction of antioxidant scavenging enzymes. In certain biological environments, genistein may act as



a pro-oxidant with potential mutagenic and/or genotoxic consequences.

### Antiproliferative

At pharmacological doses, isoflavones inhibit the proliferation of both hormone-dependent and hormone-independent cancer cells. This phenomenon has been differentially attributed, in part or in whole, to a wide range of ER-independent effects:<sup>[9]</sup> the inhibition of enzymes such as tyrosine kinase (genistein, biochanin A) and DNA topoisomerases I and II (genistein, biochanin A, equol, and orobol); regulation of growth factors and their receptors (genistein); effects on cell cycle regulatory proteins (genistein and biochanin A); regulation of stress response genes (genistein); apoptosis (genistein); and inhibition of nitric oxide synthesis (biochanin A). Biochanin A is largely responsible for the inhibition by RC of benzo(*a*)pyrene metabolism in hamster embryo cell culture. The isoflavones generally exert a chemoprotective effect if administered to rodents before puberty, although genistein will stimulate or suppress tumor growth depending on the cancer model employed.

### Other

Tumor progression and metastasis may be checked by the following actions of genistein: inhibition of angiogenesis, cell adhesion effects; tyrosine phosphorylation of membrane proteins that mediate cellular invasion; and collagenases/metalloproteases.

### Inflammation and Immune Function

Several lines of evidence suggest that the isoflavonoids in RC modulate inflammatory<sup>[10]</sup> and immune responses.<sup>[11]</sup> In the ovariectomized mouse model, genistein in the diet or by injection induces thymic atrophy and suppresses cell-mediated immunity. Injected genistein also decreases humoral immunity. In the hairless mouse model, genistein, equol, isoequol, and dihydroequol protect against UV-induced inflammation and immunosuppression. An aqueous extract of RC strongly inhibited (82% at 0.25 mg/ml) platelet activating factor-induced exocytosis in human neutrophils. The isoflavones modulate anti-inflammatory responses in animal models of chronic ileitis, inflammation-induced corneal neovascularization, and ischemic reperfusion injury.

### Thyroid Function

Speculation that the isoflavones, and RC by extension, trigger thyroid disease has been based on both in vitro

and in vivo findings.<sup>[12]</sup> In vitro, genistein and daidzein competitively inhibit thyroid peroxidase (TPO) to form iodinated isoflavones and irreversibly inhibit the enzyme in the absence of iodide, albeit at IC<sub>50</sub>s above typical circulating levels of free isoflavones. Rat studies have confirmed the relevance of these in vitro findings. Dietary exposure of Sprague–Dawley rats to genistein that achieved serum concentrations comparable to those seen in humans caused intrathyroidal accumulation of genistein and inactivation of TPO. Paradoxically, the rodents did not present as hypothyroid. Thyroxine, tri-iodothyronine (T3), and thyroid stimulating hormone levels remained unchanged; and thyroid sections revealed no pathologies. In the ovariectomized ewe model, however, exposure to RC silage resulted in elevated free and total T3 levels, increased thyroid follicle size, and thyroid gland immunoreactivity to ER- $\alpha$ .

### Glucose and Lipid Metabolism

Isoflavone supplements and RC extracts have been postulated to benefit obesity and diabetes mellitus, and in vitro and in vivo experiments provide some support for this contention. Genistein increases glucose-induced insulin release from either pancreatic  $\beta$ -cells or insulinoma cell lines. Also contributing to the antidiabetic effect, genistein and, to a lesser extent, daidzein inhibit insulin-stimulated glucose uptake from the intestine and other cells, and isoflavones protect against glucose-induced oxidation of low-density lipoproteins (LDL). Anabolic effects of RC isoflavonoids have been observed in mice, rats, and cattle.

At least three rabbit studies have demonstrated beneficial effects of isoflavones or RC<sup>[13]</sup> on lipid metabolism and/or progression of atherosclerosis, although reduced LDL peroxidation rather than changes in serum lipids was hypothesized to account for improvements in one study. Genistein exerts lipolytic/antilipogenic effects in ovariectomized mice.

### Other Biological Activities of RC Compounds

Genistein weakly antagonizes the A1, A2a, and A3 adenosine receptors at low micromolar concentrations. Genistein and daidzein inhibit GABA<sub>A</sub> receptor-mediated chloride currents. The two isoflavones, and certain structural analogues, also block calcium channels in human platelets, inhibiting thrombin-induced [Ca<sup>2+</sup>]<sub>i</sub> elevation. The isoflavone actions at ligand-gated ion channels occur independent of tyrosine kinase inhibition at low- to midrange micromolar concentrations. The RC isoflavones serve as effective antimicrobials (genistein, daidzein, biochanin A, and formononetin) and fungicides (genistein, biochanin

A, and formononetin). See Table 2 for a noncomprehensive list of selected RC compounds with interesting biological activity.

## USAGE

### Human Clinical Studies

#### Caveats

Inferences about RC based on soy isoflavone studies may not be valid. Red clover and soy not only differ in their balance of individual isoflavones, but soy foods and SPIs also contain a unique protein fraction that is not present in RC semipurified isoflavone extracts. To date, no reports have been published regarding the clinical activity of RC protein. Research of dietary soy isoflavone effects on hormone status is complicated by the relative amounts of fiber and nonstarch carbohydrates in the diet, as these influence the gut flora populations responsible for metabolism of isoflavones

in the colon. Additionally, it is currently assumed that the isoflavones are the only “active” constituents present in RC extracts. This may or may not eventually be shown to be true, as 20 or more minor compounds may be present in the semipurified extracts used in clinical trials. Studies reviewed here are limited to clinical trials of RC isoflavone supplements and/or pure isoflavones, and the abovementioned caveats should be borne in mind when interpreting the results presented. Refer to Table 3 for details regarding specific RC isoflavone products.

#### Menopause

Studies administering semipurified RC preparations to women to relieve menopausal hot flashes have generally been of short duration ( $\leq 12$  weeks) and effects, when present, take 8 weeks to manifest. Trials broadly demonstrate a significant placebo effect during the first 4 weeks that may persist throughout the investigation. More recent ones have incorporated a 2- or 4-week

**Table 2** A noncomprehensive listing of compounds found in RC. Selected biological activities of potential interest are presented

Compound (compound class)	Selected biological activities of potential interest
Calycosin (isoflavonoid)	Antiandrogenic, cell differentiation induction, hemoglobin induction
Caryophyllene (sesquiterpene)	Antispasmodic, ambulatory behavior stimulation, choleric
Citrulline (amino acid)	DNA damage prevention, prolactin inhibition
Coumestrol (coumarin)	Prolactin stimulation, estrogenic and antiestrogenic effects in vivo, bone resorption inhibition, apoptosis induction
Daphnoretin (coumarin)	Protein kinase C stimulation, platelet aggregation inhibition
Fraxidin (coumarin)	Negative chronotropism
Glycitein (isoflavone)	Antiestrogenic in vivo, nitric oxide synthesis inhibition, osteocalcin stimulation, prostaglandin E <sub>2</sub> inhibition
Glycitin (isoflavone glucoside)	Bone resorption inhibition
Hyperoside (flavonol)	Anti-ischemic, Ca <sup>2+</sup> uptake inhibition, antihemorrhagic, positive chronotropism, coronary vasodilator, negative inotropism
Medicarpin (pterocarpan)	Apoptosis induction, cell differentiation, hemoglobin induction
Orobol (flavonol)	15-lipo-oxygenase inhibition, topoisomerase II induction
Pectolarigenin (flavone)	Antiatherosclerotic, antihyperlipemic, Ca <sup>2+</sup> -ATPase inhibition
Pratensein (isoflavonoid)	Antihypercholesterolemic
Prunetin (isoflavone)	Antihypercholesterolemic, aromatase inhibition, estrogenic in vivo
Scoparol (flavonol)	Antispasmodic, cAMP inhibition, lipo-oxygenase inhibition, platelet aggregation inhibition, tumor necrosis factor $\alpha$ release inhibition
Scopoletin (coumarin)	Bronchodilator, CNS depressant, platelet aggregation inhibition, uterine relaxant, negative chronotropism/inotropism
Texasin (isoflavonoid)	Lipid peroxidation inhibition
Trigonelline (alkaloid)	Analgesic, antimutagenic, cell cycle disruption, neuron sprouting
Xanthotoxol (coumarin)	Antiarrhythmic, antispasmodic, cell differentiation, negative chronotropism, neural transmission inhibition

(From NAPRALERT<sup>SM</sup> database, University of Illinois at Chicago, Chicago, Illinois, U.S.A.)

Table 3 Table of RC products<sup>a</sup> evaluated in clinical trials

Product name	Delivery form and dosage	Effective ingredients	Isoflavone ratio (genistein + biochanin A: daidzein + formononetin)	Indications
Promensil <sup>b</sup>	Tablet; 40 mg total isoflavones (genistein + daidzein + formononetin + biochanin A)	Dried aqueous alcoholic extract of <i>T. pratense</i>	1.9	Relief of menopausal symptoms such as hot flushes and night sweats; maintenance of bone and cholesterol health; general well being
Trinovin <sup>b</sup>	Tablet; 40 mg total isoflavones (genistein + daidzein + formononetin + biochanin A)	Dried aqueous alcoholic extract of <i>T. pratense</i>	1.9	Maintain normal prostate and urinary function. May assist in the relief of medically diagnosed benign prostatic hypertrophy
Rimostil <sup>b</sup>	Tablet; 57 mg total isoflavones (genistein + daidzein + formononetin + biochanin A)	Dried aqueous alcoholic extract of <i>T. pratense</i>	0.15	Maintain bone and cholesterol health in postmenopausal women
P-07 <sup>c</sup> (not commercially available)	Tablet; 40 mg total isoflavones (genistein + daidzein + formononetin + biochanin A)	Dried aqueous alcoholic extract of <i>T. pratense</i> ; principal isoflavone is biochanin A	3.8	N/A
P-07(b) <sup>c</sup> (not commercially available)	Tablet; 40 mg total isoflavones (genistein + daidzein + formononetin + biochanin A)	Dried aqueous alcoholic extract of <i>T. pratense</i> ; principal isoflavone is biochanin A	3.5	N/A
P-083 <sup>c</sup> (not commercially available)	Tablet; 40 mg total isoflavones (genistein + daidzein + formononetin + biochanin A)	Dried aqueous alcoholic extract of <i>T. pratense</i> ; principal isoflavone is formononetin	0.2	N/A

<sup>a</sup>RC manufacturer: Novogen Ltd.<sup>b</sup>Content has been independently verified. (See Setchell et al. Bioavailability of pure isoflavones in healthy humans and analysis of commercial soy isoflavone supplements. *J. Nutr.* **2001**, *131*, 1362S–1375S and Howes et al. Content of isoflavone-containing preparations. *Med. J. Aust.* **2002**, *176*, 135–136.)<sup>c</sup>Content is per manufacturer's claim and has not been independently verified.

run-in period to assess this placebo effect. Evidence for RC efficacy in reduction of hot flashes is not compelling; nor have any studies directly compared RC to a pharmaceutical proven to alleviate hot flashes. The only long-term study to date administered Promensil™ (1 mg genistein, 0.5 mg daidzein, 16 mg formononetin, 26 mg biochanin A) daily for 1 yr to 117 women aged 49–65 yr and found no statistically significant changes in mean number of hot flashes or menopausal symptoms compared to placebo.<sup>[14]</sup> Another<sup>[15]</sup> demonstrated similar percent reductions in hot flashes at the end of 12 weeks for treatment (Promensil, 82 mg isoflavones/day, high genistein + biochanin A; Rimostil™, 57 mg isoflavones/day, high daidzein + formononetin; Novogen Ltd., Australia) and placebo groups. Both treatment groups showed higher response in women with body mass index (BMI) greater than 25.1. A double-blind randomized placebo-controlled study in Dutch postmenopausal women showed efficacy for Promensil (80 mg isoflavones/day) compared to placebo after 12 weeks, although the mean BMI values for cohorts differed.<sup>[16]</sup> These results suggest possible effects of isoflavones on metabolism, insulin, and/or changes in stores of hormones in fat depots. Racial or ethnic differences may influence phytoestrogen intake in the background diet. A small 6-mo randomized, placebo-controlled trial in postmenopausal women found no significant short-term effects of daily RC tablets (2 tablet dose; 25 mg formononetin, 2.5 mg biochanin A, <1 mg daidzein + genistein per tablet) on memory.<sup>[40]</sup>

### Breast cancer

No studies have directly evaluated the effects of RC isoflavone supplements in breast cancer patients. In a study of high-risk women, 177 subjects (49–65 yr) with Wolfe P2/DY mammographic breast patterns received Promensil daily for 1 yr and exhibited no statistically significant changes in estradiol, follicle stimulating hormone (FSH) or luteinizing hormone (LH) levels.<sup>[14]</sup> Differences between densities of breast patterns were not significant between treatment and placebo groups. Effects of RC on the hormonal status of premenopausal women are unknown.

Excretion of daidzein, genistein, and equol (from dietary sources, including soy) is reduced in women with breast cancer compared to case controls. Equol production is associated with lower concentrations of testosterone, androstenedione, dihydroxyepiandrosterone (DHEA), DHEA sulfate, and higher levels of SHBG, regardless of isoflavone consumption. Female equol producers tend to have lower midluteal phase plasma estrone, estrone sulfate, and progesterone and higher FSH levels vs. nonproducers.

### Cyclical mastalgia

A study for relief of cyclical mastalgia first admitted subjects to a two-menstrual cycle placebo run-in period. Those with <30% average decrease in pain compared to baseline levels were randomized and administered 40 or 80 mg RC isoflavones (Promensil) over three menstrual cycles.<sup>[17]</sup> A 3-day increase in menstrual cycle length was noticed in the 80 mg group compared to the placebo group. Breast pain was significantly reduced in the 40 mg group compared to placebo.

### Endometrial effects

A 3-mo study of 50 mg RC isoflavones/day (product P-07, Novogen Ltd.) in perimenopausal women found no change in the Ki-67 proliferative index of endometrial biopsies taken during the late follicular phase; nor was there change in plasma estradiol, FSH, progesterone, or endometrial thickness.<sup>[18]</sup> A recent study<sup>[19]</sup> discovered a significant inverse association between endometrial cancer risk and dietary consumption of daidzein and total isoflavones, especially at 1.2–1.7 mg isoflavones/day. Doses up to 85.5 mg/day of Rimostil in postmenopausal women for 6 mo did not cause increased endometrial thickness or breakthrough bleeding.

### Prostate cancer

It is currently unclear what role, if any, serum and tissue levels of isoflavones play in prostate cancer and BPH. One study found that prostate cancer patients had higher serum levels of isoflavones compared to cancer-free controls. However, there were more equol producers in the control group vs. the cancer group. Another experiment collected plasma and prostatic tissue specimens from BPH patients and bladder cancer patients with normal prostates. Prostatic genistein was lower in the BPH group, while equol and daidzein concentrations were similar across both groups. Plasma isoflavone concentrations were similar for both cohorts.

Three clinical studies have examined the effect of RC extracts on male prostate health. The first study, unpublished but described in another report, administered 40 or 80 mg RC isoflavones/day for 3 mo to BPH patients (exact product and methodology not provided). The International Prostate Symptom Score decreased 23.3%, urinary flow rate increased 9.8%, and quality of life improved 17% for both treatment groups. A study<sup>[20]</sup> of Trinovin™ (Novogen Ltd.) administered four 40 mg tablets daily to men with prostate cancer for 7–54 days before radical prostatectomy. Apoptosis of prostate cancer cells was more

common in tissues from the treatment group, and was especially evident in regions of low-to-moderate grade cancer. No differences were seen pre- and post-treatment for serum prostate-specific antigen (PSA), Gleason score (grade of cancer severity), or serum testosterone. A study in healthy men using Trinovin as above showed no effects on plasma testosterone, androstenedione, dehydroepiandrosterone sulfate, androsterone, epiandrosterone sulfate, cortisol, or SHBG, but dihydrotestosterone levels increased, which is possibly a detrimental change.

### Osteoporosis prevention and treatment

Results from clinical studies of RC in prevention and treatment of osteoporosis are promising but complicated by varying length of bone remodeling cycles in individuals and the biphasic effects of isoflavones. Background hormonal milieu in the body also plays a role, as does basal metabolic index, which is inversely related to rate of bone loss in postmenopausal women.

Five studies have examined the effects of RC on bone. Refer to Table 4 for a summary of these studies. Three trials in postmenopausal women observed favorable effects in terms of preservation of bone mineral density (BMD). One year of treatment with Promensil (43.5 mg total isoflavones) significantly decreased the loss of lumbar spine BMD in pre- and perimenopausal women.<sup>[21]</sup> There was no effect in postmenopausal women, nor was there an effect on hip BMD for any group. A 6-mo study documented increased BMDs of the proximal forearm (2.9%, 4.1%, 3.0% increases, respectively), but not the distal forearm, for 25, 50, or 75 mg RC isoflavones/day (Rimostil), after a 1-mo placebo run-in period.<sup>[22]</sup> Another 6-mo study found increases in BMD of the proximal radius and ulna in postmenopausal women taking Rimostil at 57 or 85 mg RC isoflavones/day.<sup>[23]</sup> The fourth study reported no measured changes in N-telopeptide and osteocalcin bone markers in perimenopausal women taking 50 mg RC isoflavones/day (product P-07, Novogen Ltd.) for 3 mo.<sup>[18]</sup> The last study also reported no effect of either Promensil or Rimostil on serum osteocalcin and urinary N-telopeptide levels after daily use for 12 weeks by menopausal women.<sup>[41]</sup>

Early postmenopausal women taking 54 mg genistein/day showed increased bone AP, bone Gla protein levels, and increased BMD in the femur and lumbar spine.

### Cardiovascular disease risk

**Vascular Effects.** a) *Arterial compliance:* Arterial stiffness is related to the presence of atherosclerotic plaques, and this parameter has been evaluated in two studies of RC. The first<sup>[24]</sup> administered 40 mg

Promensil (4 mg genistein, 3.5 mg daidzein, 8.0 mg formononetin and 24.5 mg biochanin A; reported content differs from manufacturer specifications) daily for 5 weeks. The dose was then doubled to 80 mg/day for 5 more weeks. Treatment groups (both doses) showed increases in arterial compliance, the magnitude of which was comparable to results seen in studies of hormone replacement therapy. A 6-week randomized, double-blind crossover, placebo-controlled study<sup>[25]</sup> administered two tablets of each of two different products to men and women daily: One significantly enriched in biochanin A [P-07(b)] or another in formononetin (P-083). Isoflavone treatment resulted in significant improvements in systemic arterial compliance (SAC) and pulsed wave velocity (PWV) compared to placebo. However, the formononetin-enriched product had a stronger adjusted trend toward favorable effect on SAC compared to the biochanin A-enriched product.

b) *Vascular endothelial function:* After 6 weeks in the previously mentioned study,<sup>[25]</sup> plasma levels of vascular cellular adhesion molecule-1 (VCAM-1) were reduced in the group receiving 80 mg/day of the formononetin-enriched RC extract (P-083). Administration of up to 85.5 mg/day isoflavones (Rimostil) to postmenopausal women for 6 mo did not result in altered levels of serum factor V, VII, VIII, antithrombin III, or fibrinogen.<sup>[26]</sup> An unpublished study observed no adverse changes in intravascular coagulation (factor VIIc), platelet activation (P-selectin), or endothelial activation (von Willebrand factor), compared to placebo, after 5 weeks of treatment with 40 mg/day of RC isoflavones (product unspecified), although no details were provided about the patients. A small trial in postmenopausal type 2 diabetics demonstrated a drop in mean daytime systolic and diastolic blood pressures with 50 mg RC isoflavones (2.5 mg biochanin A, 25 mg formononetin, <1 mg daidzein + genistein) daily for 4 mo, plus increased forearm vascular resistance in response to L-NMMA. However, another trial in peri- and postmenopausal women taking 43.5 mg RC isoflavones daily did not demonstrate an effect on systolic or diastolic blood pressure.

Despite the mechanisms by which RC extracts act on the vasculature remaining unknown, studies on pure isoflavone compounds yield interesting clues. Orally administered genistein caused increased vasodilation in postmenopausal women, presumably via increasing basal nitric oxide (NO) levels and reducing levels of the vasoconstrictor endothelin-1 (ET-1). Two trials support this hypothesis. The first administered 54 mg genistein/day for 6 mo, and plasma levels of breakdown products of NO nearly doubled compared to either the placebo group or baseline levels. Endothelin-1 levels dropped by ~50%. Forearm blood flow and brachial artery diameter were significantly

**Table 4** Summary of studies evaluating effects of RC extracts on bone in women

Reference	Product and dosage	Study length (mo)	No. of subjects	Significance	Study design
Novogen Ltd. Patent: Ref. <sup>[22]</sup> WO 00/64438; PCT/AU00/00384	Not stated (1.5:1 to 2:1 ratio of formononetin to the sum of daidzein + genistein + biochanin A); 25, 50, or 75 mg total isoflavones given	6	50	50 mg group had 4.1% increase in proximal forearm BMD; 25 and 75 mg groups had 2.9% and 3.0% increase. No significant effect seen on distal forearm BMD	Postmenopausal women; 1-mo placebo run-in followed by isoflavone tablet(s) daily for 6 mo
Clifton-Bligh et al. <sup>[23]</sup>	Rimostil, 28.5, 57, 85.5 mg isoflavones (daidzein + genistein + formononetin + biochanin A)	6	46	57, 85.5 mg groups showed significant (4.1%, 3.0%, respectively) increase in proximal radius and ulna; no significant response in 28.5 mg group	Perimenopausal women; 1-mo run-in period followed by 1-mo placebo period, then double-blind treatment for 6 mo
Hale et al. <sup>[18]</sup>	50 mg of Novogen Ltd.'s P-07 RC isoflavone formulation containing high amount of biochanin A	3	30	No changes in <i>N</i> -telopeptide or osteocalcin bone markers	Pre- and perimenopausal women; double-blind, randomized, placebo-controlled
Atkinson et al. <sup>[21]</sup>	43.5 mg total isoflavones (26 mg biochanin A, 16 mg formononetin, 1 mg genistein, 0.5 mg daidzein)	12	205; 177 completed trial	Reduced loss of lumbar spine bone mineral content and BMD in treatment group; significant increase in bone-specific AP and <i>N</i> -propeptide of collagen type I; no significant effect on hip BMD/ mineral content or boneresorption markers	Pre-, peri- and postmenopausal women; double-blind, randomized, placebo-controlled
Schult et al. <sup>[41]</sup>	Promensil, 41 mg isoflavones (24.5 mg biochanin A, 8 mg formononetin, 4 mg genistein, 5 mg daidzein) and Rimostil, 28.6 mg isoflavones (2 mg biochanin A, 25 mg formononetin, trace amount genistein + daidzein)	3	252; 245 completed trial	No changes in urinary <i>N</i> -telopeptide or serum osteocalcin bone markers	Peri- and postmenopausal women; double-blind, randomized, placebo-controlled

increased during reactive hyperemia after genistein treatment. The second administered the same genistein regimen or 17 $\beta$ -estradiol/norethisterone acetate (1 mg/0.5 mg) for 1 yr. Genistein again improved brachial artery flow-mediated dilation, and improvements in NO breakdown products and ET-1 in the genistein group were of similar magnitude as the results for the hormone group. It remains to be seen whether these vascular effects will also be observed for RC extracts.

**Lipid Effects.** Several studies have investigated the effects of RC preparations on serum lipoprotein levels. In premenopausal women, consumption of 86 mg RC isoflavones per day (product P-07, Novogen Ltd., 51.4 mg biochanin A, 18.6 mg formononetin, 8.6 mg genistein, 7.4 mg daidzein; reported content differs from the manufacturer's claim) for two menstrual cycles had no effect on total cholesterol or triacylglycerol levels. A second study using the same product (P-07, Novogen Ltd.) and dosing regimen over three menstrual cycles found no effects on total cholesterol, LDL, high-density lipoprotein (HDL), triacylglycerol, lipoprotein(a), glucose, or insulin levels. A 1-mo placebo-controlled crossover study in pre- and postmenopausal women taking two Promensil tablets (43 mg isoflavones/tablet, 25 mg biochanin A, 8 mg formononetin, 4 mg genistein, 5 mg daidzein) had a significant effect on HDL in postmenopausal women, but no effect on insulin-like growth factor (IGF) in either group.<sup>[42]</sup>

Postmenopausal women receiving 40 mg and then 80 mg Promensil for 5 weeks/dose had no change in HDL, LDL, triglyceride, or total cholesterol levels. A randomized double-blind ascending dose study administered one or two tablets (26 mg biochanin A, 16 mg formononetin, 0.5 mg daidzein, and 1 mg genistein/tablet; Promensil; content differs slightly from the manufacturer's specifications) for 4 weeks/dose and also found no effect on plasma lipids.<sup>[27]</sup> A 3-mo study in peri- and postmenopausal women taking 2 tablets Promensil (24.5 mg biochanin A, 8 mg formononetin, 4 mg genistein, 5 mg daidzein/tablet) or Rimostil (2 mg biochanin A, 25 mg formononetin, trace genistein + daidzein/tablet) had no effect on plasma lipids, but did decrease triglycerides in women with high baseline levels.<sup>[41]</sup> Another study administered 28.5, 57, or 85.5 mg of RC isoflavones/day as Rimostil for 6 mo. High-density lipoprotein for all treatment groups increased at least 15%. Apolipoprotein B declined in all groups by at least 9%. One-year treatment with 43.5 mg RC isoflavones daily decreased triglycerides and plasminogen activator inhibitor type I (PAI-1) in perimenopausal but not in postmenopausal women.<sup>[43]</sup> Differences between RC extract

formulations may account for some of the observed clinical variation.

A recent randomized, placebo-controlled, parallel crossover, double-blind trial in men and postmenopausal women compared effects of a biochanin A-enriched RC product (P-07(b), Novogen Ltd.) vs. a formononetin-enriched one (P-083, Novogen Ltd.).<sup>[28]</sup> The former, but not the latter, lowered LDL by 9.5% in men compared to baseline levels. Neither product affected plasma lipids in the postmenopausal group.

When 54 mg/day of pure genistein was administered to postmenopausal women for 6 mo, no effects on serum lipids were observed.

## Dosage and Extract Preparation

Current standardized preparations of RC are based on total aglycone content of the main four isoflavones. Typical products incorporate dried aqueous alcoholic extracts of RC to deliver  $\geq 40$  mg isoflavones per dose recommended on the label. These extracts may be hydrolyzed during processing for greater isoflavone aglycone content. Standardized products are available in tablet and capsule form, and clinical doses generally range from 40 to 160 mg isoflavones per day, given in a single dose. Isoflavone doses  $> 80$  mg/day are considered to be higher than isoflavone exposure received by eating a diet containing soyfoods and isoflavone-containing legumes.

## SAFETY, TOXICITY, AND ADVERSE EFFECTS

### Adulteration Issues

#### Heavy metal contamination and pesticide residues

Although RC does not have a particular tendency to preferentially absorb heavy metals under normal conditions, when it is grown on contaminated soil, it can accumulate high levels of Cd, Cu, Pb, As, and Zn to varying amounts, depending on soil pH and metal solubility. It is recommended that source material and/or any resultant extracts be assayed for presence and level of Pb, As, Cd, and Hg, and the country of origin be required to provide quality control documentation. Imported products containing the ingredients realgar (arsenic) and cinnabar (mercury) should be avoided.<sup>[29,30]</sup> The first supplement to the *U.S. Pharmacopoeia/National Formulary 2003* recommends a limit of not more than 10 ppm of heavy metals be present in RC products.

The following pesticides have been designated by the United Nations as hazardous and are banned by some

countries, including the United States: aldrin/dieldrin, chlordane, dichloro diphenyl trichloroethane (DDT), heptachlor, lindane, malathion, and parathion. These chemicals were used on RC fields in the United States during the 1950s and 1960s. Residues persist in the soil for extended periods of time and are still present in everyday foods at low but detectable levels. It is unknown whether proprietary extraction processes may concentrate these residues in the botanical extracts used to make dietary supplements. Some of these pesticides remain in use in other countries, and are a potential contaminant of imported plant material and extracts. Limits (mg/kg) of 34 specific organophosphorus, organochlorine, and pyrethroid pesticides for RC are given in Table 3 under method section <561> of the *U.S. Pharmacopoeia/National Formulary 2004*.<sup>[31]</sup>

### Botanical misidentification

*T. pratense* shares the common name “sweet clover” with the plants *M. alba* Medikus and *M. officinalis* (L.) Pall. This shared common name is unfortunate but physical misidentification is avoidable; the flowers of RC are pinkish-purple, while those of *M. alba* and *M. officinalis* are white and yellow, and can be easily distinguished from one another. See the “Botanical description” section for more botanical characteristics of *M. officinalis*.

### Presence of Coumarins

There are over 3400 naturally occurring coumarins present throughout at least 160 plant families. Many do not have anticoagulant effects *in vivo*; many more have unknown effects. RC has been reported to contain some coumarins, but it has never been evaluated for long-term anticoagulant effects, or herb–drug interactions with blood-thinning drugs such as warfarin. Usual clinical doses of RC extracts are such that exposure to any particular coumarin present would likely be below the threshold where any (hypothetical) clinical anticoagulant effects should manifest.

Dicoumarol, a 4-hydroxycoumarin derivative that is known to inhibit blood coagulation, was isolated in 1941 from *M. alba* Medikus and/or *M. officinalis* (L.) Pall.<sup>[32]</sup> It is a fungal metabolite formed by *Penicillium* species growing in diseased *M. alba* and *M. officinalis*. Although *Melilotus* and *Trifolium* species are closely related, there are no reports of dicoumarol occurring in *Trifolium* species. Coumestrol, daphnoretin, fraxidin, xanthotoxol, medicagol, and scopoletin are present in trace amounts in some RC extracts ( $\leq 100$  ppm).

### Inhibition of Cytochrome P450 (CYP450) Enzymes

*In vitro* experiments with human microsomes have shown that RC extracts exhibit selective inhibition of CYP2C9, marginal inhibition of CYP1A2 and CYP3A4, and nominal inhibition of CYP2A6 and CYP2D6. Genistein and daidzein, as well as genistin and daidzin, inhibit CYP1A1 as measured by reduction of enzyme activity in a mouse hepatoma cell culture system. In other experiments, genistein and equol did not cause significant induction of xenobiotic-metabolizing enzymes in mouse (ethoxyresorufin *O*-deethylase, *p*-nitrophenol oxidase, glutathione *S*-transferase, CYP1A2, CYP2E1, or CYP3A1) or human hepatic cells (CYP1A1, glutathione *S*-transferase  $\lambda$ a, or xenobiotic response elements). There are no reports of clinically significant RC : drug interactions.

### Thyroid Function

Red clover products are used by menopausal women, a group that is prone to hypothyroidism and autoimmune thyroiditis and could be particularly susceptible to the antithyroid actions of the isoflavones. Individuals in this patient population on chronic RC regimens should be monitored for thyroid function. In terms of potential benefit, the San Francisco Bay Area Thyroid Cancer Study recently concluded that isoflavone intake is associated with reduced thyroid cancer risk in both pre- and postmenopausal women.<sup>[33]</sup>

### Safety for Cancer Patients

While RC and the isoflavones exhibit anticancer activities *in vitro* and affect SERM-like effects *in vivo*, insufficient evidence exists to support their use by patients with active cancer, at elevated risk for ER+ cancer, or recovering from cancer. RC has not been rigorously tested in cancer populations, and the theoretical possibility remains that isoflavone supplementation could promote or progress hormone-dependent tumors. The isoflavones also have the potential to compete with antiestrogenic chemotherapeutic agents, and their antioxidant properties may interfere with radiation and chemotherapies. Significant *in vivo* CYP450 interactions appear unlikely but could prove problematic in the context of chemotherapy.

### Safety for Pregnant Women and Children

The safety of RC or isoflavone supplements for pregnant or (the children of) lactating women has not been established, although RC is considered a class



2b herb by the American Herbal Products Association and as such is contraindicated during pregnancy.<sup>[34]</sup> Red clover supplementation is also discouraged for those less than 18 yr old as the long-term consequences, if any, of high isoflavone consumption early in life have not yet been elucidated.

### Adverse Effects Reported in Clinical Trials

Because the exact chemical content of commercial RC isoflavone products is proprietary, and total isoflavone content (or a ratio of summed isoflavone content) is often reported rather than individual chemical content, it is difficult to estimate clinical doses of individual isoflavones. This vague content labeling hinders correlation of clinical effects with specific RC compounds. More trials involving chronic exposure of large patient populations to RC isoflavone extracts are needed to assess long-term risk.

Novogen Ltd. provides a list of side effects, occurring at doses as low as 40 mg isoflavones/day, in their online clinical monograph of Promensil. These effects include breast tenderness, swollen neck glands, increased thyroid function, migraine/headache, dizziness, vertigo, tremor, hypertension, acne, rash, pruritus, psoriasis, bloating, constipation, diarrhea, nausea, mouth ulcer, sore throat, myalgia, osteoarthritis, bronchitis, low platelets, reflux (80 mg), epistaxis (80 mg), menstrual bleeding (80 mg), urinary tract infection (120 mg), and vaginal thrush (80 mg).

Additional adverse events reported in two trials orally administering 54 mg/day genistein included the following: (symptomatic) hypotension, vertigo, paresthesiae, temporary return of abbreviated menses, vaginal bleeding, hot flushes, and endometrial thickness greater than 5 mm.

Compounds and mechanisms responsible for triggering adverse events are currently unknown. Use of the lowest RC dose possible for treatment, with upward titration as necessary, is recommended to decrease the probability of side effects occurring.

### COMPENDIAL/REGULATORY STATUS

Red clover is included on the U.S. FDA generally recognized as safe (GRAS) list and "RC isoflavones" is an approved herbal components name (HCN) designated by the Therapeutic Goods Administration of Australia.<sup>[35]</sup> The flower heads are listed in the *British Herbal Compendium*,<sup>[36]</sup> the *British Herbal Pharmacopoeia*,<sup>[37]</sup> and in *Martindale: The Extra Pharmacopoeia*.<sup>[38]</sup> It appears in the UK's General Sale List, Schedule 1 of Statutory Instrument 1994 No. 2410.<sup>[39]</sup>

### ACKNOWLEDGMENTS

The authors are grateful to Norman Farnsworth for his guidance and suggestions regarding this manuscript. They thank Barbara Calamini and Andrew Mesecar for preparation of Fig. 4. The NAPRALERT<sup>SM</sup> database was searched to prepare Tables 1 and 2. Product information for Tables 3 and 4 and some regulatory status information was provided by Novogen Ltd. Research within the UIC Botanical Center is supported by NIH grant P50 AT00155 jointly funded by the Office of Dietary Supplements, the National Center for Complementary and Alternative Medicine, the National Institute for General Medical Sciences, and the Office for Research on Women's Health. Nancy Booth also receives support from NCCAM NRSA fellowship F31 AT00804. The contents of this chapter are solely the responsibility of the authors and do not necessarily represent the views of the funding agencies.

### REFERENCES

1. Felton, H.W.; Lloyd, J.U. *King's American Dispensatory*; 18th Ed.; 3rd Rev.; The Ohio Valley Company: Cincinnati, 1900; Vol. II, 1995–1996.
2. Gathercoal, E.N.; Wirth, E.H. *Pharmacognosy*; Lea & Febiger: Philadelphia, 1936; 372–373.
3. Hamel, P.B.; Chiltoskey, M.U. *Cherokee Plants: Their Uses—A 400 Year History*; Herald Publishing Company: Sylva, NC, 1975; 29.
4. Barnes, S. Phyto-oestrogens and osteoporosis: what is a safe dose? *Br. J. Nutr.* **2003**, *89* (Suppl. 1), S101–S108.
5. Pike, A.C.; Brzozowski, A.M.; Hubbard, R.E.; Bonn, T.; Thorsell, A.G.; Engstrom, O.; Ljunggren, J.; Gustafsson, J.A.; Carlquist, M. Structure of the ligand-binding domain of oestrogen receptor beta in the presence of a partial agonist and a full antagonist. *EMBO J.* **1999**, *18* (17), 4608–4618.
6. Pierson, C.E. Phytoestrogens in botanical dietary supplements: implications for cancer. *Int. Cancer Ther.* **2003**, *2* (2), 120–138.
7. Zava, D.T.; Dollbaum, C.M.; Blen, M. Estrogen and progestin bioactivity of foods, herbs, and spices. *Proc. Soc. Exp. Biol. Med.* **1998**, *217* (3), 369–378.
8. Kirk, C.J.; Harris, R.M.; Wood, D.M.; Waring, R.H.; Hughes, P.J. Do dietary phytoestrogens influence susceptibility to hormone-dependent cancer by disrupting the metabolism of endogenous oestrogens? *Biochem. Soc. Trans.* **2001**, *29* (Part 2), 209–216.

9. Adlercreutz, H. Phyto-oestrogens and cancer. *Lancet Oncol.* **2002**, *3* (6), 364–373.
10. Ren, M.Q.; Kuhn, G.; Wegner, J.; Chen, J. Isoflavones, substances with multi-biological and clinical properties. *Eur. J. Nutr.* **2001**, *40* (4), 135–146.
11. Yellayi, S.; Zakroczymski, M.A.; Selvaraj, V.; Valli, V.E.; Ghanta, V.; Helferich, W.G.; Cooke, P.S. The phytoestrogen genistein suppresses cell-mediated immunity in mice. *J. Endocrinol.* **2003**, *176* (2), 267–274.
12. Doerge, D.R.; Chang, H.C. Inactivation of thyroid peroxidase by soy isoflavones, in vitro and in vivo. *J. Chromatogr. B Analyt. Technol. Biomed. Life Sci.* **2002**, *777* (1–2), 269–279.
13. Vaskilenko, Y.K.; Dorofeenko, G.N.; Kazakov, A.L.; Lisevitskaya, L.I.; Leont'eva, T.P.; Mezheritskii, V.V.; Parfent'eva, E.P.; Shinkarenko, A.L. Effects of red clover flavonoids and some of their synthetic analogs on lipid metabolism indexes in animals with experimental arteriosclerosis. *Izvestiya Severo-Kavkazskogo Nauchnogo Tsentra Vyshei Shkoly, Estestvennye Nauki* **1978**, *6* (4), 99–101.
14. Atkinson, C.; Warren, R.M.L.; Sala, E.; Dowsett, M.; Dunning, A.M.; Healey, C.S.; Runswick, S.; Day, N.E.; Bingham, S.A. Red-clover derived isoflavones and mammographic breast density: A double-blind, randomized, placebo-controlled trial. *Breast Cancer Res.* **2004**, *6*, R170–R179.
15. Tice, J.A.; Ettinger, B.; Ensrud, K.; Wallace, R.; Blackwell, T.; Cummings, S.R. Phytoestrogen supplements for the treatment of hot flashes: the Isoflavone Clover Extract (ICE) Study, a randomized controlled trial. *JAMA* **2003**, *290* (2), 207–214.
16. van de Weijer, P.H.M.; Barentsen, R. Isoflavones from red clover (Promensil®) significantly reduce menopausal hot flush symptoms compared with placebo. *Maturitas* **2002**, *42*, 187–193.
17. Ingram, D.M.; Hickling, C.; West, L.; Mahe, L.J.; Dunbar, P.M. A double-blind randomized controlled trial of isoflavones in the treatment of cyclical mastalgia. *Breast* **2002**, *11*, 170–174.
18. Hale, G.E.; Hughes, C.L.; Robboy, S.J.; Agarwal, S.K.; Bievre, M. A double-blind randomized study on the effects of red clover isoflavones on the endometrium. *Menopause* **2001**, *8*, 338–346.
19. Horn-Ross, P.L.; John, E.M.; Canchola, A.J.; Stewart, S.L.; Lee, M.M. Phytoestrogen intake and endometrial cancer risk. *J. Natl. Cancer Inst.* **2003**, *95*, 1158–1164.
20. Jarred, R.A.; Keikha, M.; Dowling, C.; McPherson, S.J.; Clare, A.M.; Husband, A.J.; Pedersen, J.S.; Frydenberg, M.; Risbridger, G.P. Induction of apoptosis in low to moderate-grade human prostate carcinoma by red clover-derived dietary isoflavones. *Cancer Epidemiol. Biomarkers Prev.* **2002**, *11*, 1689–1696.
21. Atkinson, C.; Compston, J.E.; Day, N.E.; Dowsett, M.; Bingham, S.A. The effects of phytoestrogen isoflavones on bone density in women: A double-blind, randomized, placebo-controlled trial. *Am. J. Clin. Nutr.* **2004**, *79*, 326–333.
22. Kelly, G.E.; Husband, A.J. Cardiovascular and bone treatment using isoflavones. PCT Int. Appl. WO 00/64438, PCT/AU00/00384, 2000.
23. Clifton-Bligh, P.B.; Baber, R.J.; Fulcher, G.R.; Nery, M.-L.; Moreton, T. The effect of isoflavones extracted from red clover (Rimostil) on lipid and bone metabolism. *Menopause* **2001**, *8*, 259–265.
24. Nestel, P.J.; Pomeroy, S.; Kay, S.; Komesaroff, P.; Behrsing, J.; Cameron, J.D.; West, L. Isoflavones from red clover improve systemic arterial compliance but not plasma lipids in menopausal women. *J. Clin. Endocrinol. Metab.* **1999**, *84* (3), 895–898.
25. Teede, H.J.; McGrath, B.P.; DeSilva, L.; Cehun, M.; Fassoulakis, A.; Nestel, P.J. Isoflavones reduce arterial stiffness: a placebo-controlled study in men and postmenopausal women. *Arterioscler. Thromb. Vasc. Biol.* **2003**, *23*, 1066–1071.
26. Baber, R.; Bligh, P.C.; Fulcher, G.; Liberman, D.; Nery, L.; Moreton, T. The effect of an isoflavone dietary supplement (Rimostil™) on serum lipids, forearm bone density and endometrial thickness in post-menopausal women, 10th Annual Meeting of the North American Menopause Society, Sept 23–25, 1999; The North American Menopause Society: New York, NY, 1999.
27. Howes, J.B.; Sullivan, D.; Lai, N.; Nestel, P.; Pomeroy, S.; West, L.; Eden, J.A.; Howes, L.G. The effects of dietary supplementation with isoflavones from red clover on the lipoprotein profiles of post menopausal women with mild to moderate hypercholesterolemia. *Atherosclerosis* **2000**, *152*, 143–147.
28. Nestel, P.; Cehun, M.; Chronopoulos, A.; DaSilver, L.; Teede, H.; McGrath, B. A biochanin-enriched isoflavone from red clover lowers LDL cholesterol in men. *Eur. J. Clin. Nutr.* **2004**, *58*, 403–408.
29. Ko, R.J. Adulterants in Asian patent medicines. *N. Engl. J. Med.* **1998**, *339*, 847
30. Au, A.M.; Ko, R.; Boo, F.O.; Hsu, R.; Perez, G.; Yang, Z. Screening methods for drugs and heavy metals in Chinese patent medicines. *Bull. Environ. Contam. Toxicol.* **2000**, *65*, 112–119.
31. General Chapter: chemical tests and assays. In *The United States Pharmacopeia Revision 27—The National Formulary Edition 22*; United States Pharmacopoeial Convention, Inc.; Rockville, MD, 2003; 2233–2239.

32. Stahmann, M.A.; Huebner, C.F.; Link, K.P. Studies on the hemorrhagic sweet clover disease: V. Identification and synthesis of the hemorrhagic agent. *J. Biol. Chem.* **1941**, *138*, 513–527.
33. Horn-Ross, P.L.; Hoggatt, K.J.; Lee, M.M. Phytoestrogens and thyroid cancer risk: The San Francisco bay area thyroid cancer study. *Cancer Epidemiol. Biomarkers Prev.* **2002**, *11*, 43–49.
34. American Herbal Products Association's Botanical Safety Handbook; McGuffin, M., Hobbs, C., Upton, R., Goldberg, A., Eds.; CRC Press: New York, 1997; 117.
35. <http://www.tga.health.gov.au/docs/html/tganews/news28/chem.htm> (accessed April 2004).
36. British Herbal Compendium; Bradley, P.R., Ed.; British Herbal Medicine Association; Biddles, Ltd., Guilford and King's Lynn: Great Britain, 1992; Vol. 1, 183–184.
37. British Herbal Pharmacopoeia; 4th Ed.; British Herbal Medicine Association; Biddles, Ltd., Guilford and King's Lynn: Great Britain, 1996; 160–161.
38. Martindale: The Extra Pharmacopoeia; 30th Ed.; Reynolds, J.E.F., Ed.; The Pharmaceutical Press: London, 1993; 1872.
39. [http://www.legislation.hmso.gov.uk/si/si1994/Uksi\\_19942410\\_en\\_1.htm#tcon](http://www.legislation.hmso.gov.uk/si/si1994/Uksi_19942410_en_1.htm#tcon) (accessed April 2004).
40. Howes, J.B.; Bray, K.; Lorenz, L.; Smerdely, P.; Howes, L.G. The effects of dietary supplementation with isoflavones from red clover on cognitive function in postmenopausal women. *Climacteric* **2004**, *7*, 70–77.
41. Schult, T.M.K.; Ensrud, K.E.; Blackwell, T.; Ettinger, B.; Wallace, R.; Tice, J.A. Effect of isoflavones on lipids and bone turnover markers in menopausal women. *Maturitas* **2004**, *48*, 209–218.
42. Campbell, M.J.; Woodside, J.V.; Honour, J.W.; Morton, M.S.; Leatham, A.J.C. Effect of red clover-derived isoflavone supplementation on insulin-like growth factor, lipid and antioxidant status in healthy female volunteers: a pilot study. *Eur. J. Clin. Nutr.* **2004**, *58*, 173–179.
43. Atkinson, C.; Oosthuizen, W.; Scollen, S.; Loktionov, A.; Day, N.E.; Bingham, S.A. Modest protective effect of isoflavones from a red clover-derived dietary supplement on cardiovascular disease risk factors in perimenopausal women, and evidence of an interaction with ApoE genotype in 49–65 year-old women. *J. Nutr.* **2004**, *134*, 1759–1764.

# Reishi or Ling Zhi (*Ganoderma lucidum*)

Solomon P. Wasser

Institute of Evolution, University of Haifa, Mount Carmel, Haifa, Israel

## INTRODUCTION

*Ganoderma lucidum* (reishi mushroom, Ling Zhi) has been an economically important species, particularly in the Far East countries (China, Japan, Korea, etc.), for over 4000 years. It is widely grown on a commercial scale and is commonly purchased for its medicinal and spiritual properties.

## NAME AND GENERAL DESCRIPTION

In Latin, *lucidum* means shiny or brilliant and aptly describes this mushroom's fruiting body, which has a modeled, sculptured, varnished appearance. The Chinese and Koreans know it as Ling Zhi (mushroom of herb and immortality), whereas the Japanese call this mushroom reishi or mannentake (10,000 year mushroom). The virtues of *G. lucidum* extracts, handed down from generation to generation, include it as a "cancer cure" and a symbol of happy augury, good fortune, good health, longevity, and even immortality. Beginning with the Yuan Dynasty (1280–1368 A.D.), *G. lucidum* has been endlessly represented in art—in paintings, carvings of jade and deer's antlers, furniture and carpet designs, balustrades, jewelry, women's hair combs, perfume bottles—in short, wherever an artistic urge found an outlet. The earliest mention of Ling Zhi was in the era of the first emperor of China, Shing-huang of the Ch'in Dynasty (221–207 B.C.). Subsequently, depictions of this fungus proliferated through Chinese literature and art. The mushroom is known by many in North America and Europe as one of the "artist's conk" fungi (the true artist conk is *Ganoderma applanatum*).

A detailed description of the reishi mushroom and its taxonomy can be found in Refs.<sup>[3,10]</sup> (Fig. 1).

## Habitat

This annual mushroom grows on a wide variety of dead or dying trees, e.g., deciduous trees especially oak, maple, elm, willow, sweet gum, magnolia,

and locust (*Quercus*, *Acer*, *Alnus*, *Betula*, *Castanea*, *Corylus*, *Fagus*, *Fraxinus*, *Populus*, *Pyrus*, *Magnolia*, *Tilia*). *G. lucidum* is less frequently found on coniferous trees (e.g., *Larix*, *Picea*, *Pinus*) in Europe, Asia, and North and South America (in temperate rather than subtropical regions). In the Orient, it grows primarily on plum trees. It is also found on stumps, generally near the soil surface, and occasionally on soils arising from buried roots.

## Edibility

The mushroom is too tough to be edible.

## RELATED SPECIES AND ARTIFICIAL CULTIVATION

Ling Zhi encompasses several *Ganoderma* species, which are widely used for medicinal purposes, e.g., *G. lucidum*, *G. luteum* Steyaert, *G. atrum* Zhao, Xu and Zhang, *G. tsugae* Murrill, *G. applanatum* (Pers.: Wallr.) Pat., *G. australe* (Fr.) Pat., *G. capense* (Lloyd) Teng, *G. tropicum* (Jung.) Bres., *G. tenue* Zhao, Xu and Zhang, and *G. sinense* Zhao, Xu and Zhang. According to two famous Chinese plant medical books, *Shen Nong Ben Cao Jing* (25–220 A.D., Eastern Han Dynasty) and *Ben Cao Gang Mil* by Li Shi-Zhen (1590 A.D., Ming Dynasty), six Ling Zhi species/varieties were known in China at that time. Worldwide, more than 250 *Ganoderma* species have been described.<sup>[2,3]</sup> However, in therapeutic practices and literature citations, *Ganoderma* usually refers to the species of *G. lucidum*.

Besides being treasured for its medicinal value in China for more than 1000 yr, the lack of availability of *G. lucidum* was also largely responsible for it being so highly cherished and expensive. During ancient times in China, any person who picked the mushroom from the natural environment and presented it to a high-ranking official was usually well rewarded. Even in the early 1950s, it was presented to Chinese leaders in Mainland China and Taiwan, following the occasional discovery in the wild. In the past, *G. lucidum* grew in small quantities only in the wild; therefore, it was very expensive.

Artificial cultivation of this valuable mushroom was successfully achieved in the early 1970s, and since

Solomon P. Wasser is at the Institute of Evolution, University of Haifa, Mount Carmel, Haifa, Israel.

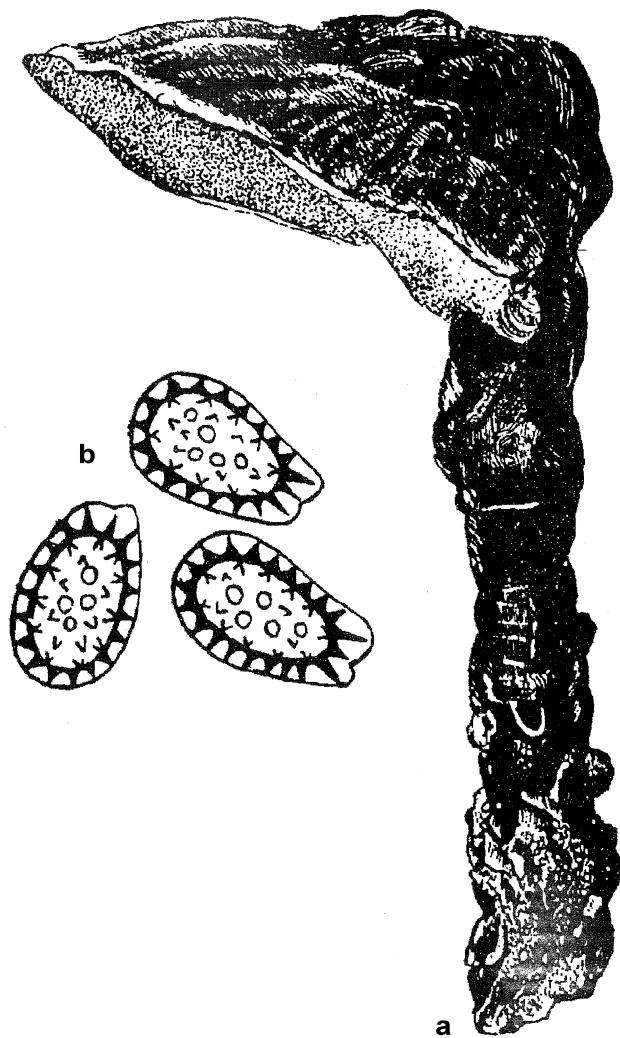


Fig. 1 *Ganoderma lucidum*: (a) fruit body, (b) spores.

1980, production of *G. lucidum* has developed rapidly, particularly in China. The process of producing *G. lucidum* fruiting bodies is the same as for other cultivated edible mushrooms and can be divided into two major stages. The first involves the preparation of the fruiting culture, stock culture, mother spawn, and planting spawn, while the second entails the preparation of growth substrates for mushroom cultivation. Currently, the methods most widely adopted for commercial production are the wood log, short wood segment, tree stump, sawdust bag, and bottle procedures (for cultivation details, see Refs.<sup>[4,5]</sup>).

## HISTORY AND TRADITIONAL USES

*G. lucidum* has been used in folk medicine of China and Japan, especially in the treatment of hepatopathy,

chronic hepatitis, nephritis, hypertension, arthritis, neurasthenia, insomnia, bronchitis, asthma, and gastric ulcers.<sup>[6,8-11]</sup> In China, *G. lucidum* has been cherished for over 4000 yr as a longevity-promoting tonic.<sup>[6]</sup> According to Hikino,<sup>[12]</sup> “the most important elixirs in the Orient” are ginseng (*Panax ginseng* C.A. Meyer) and the fruit bodies of *G. lucidum*.

Fascination with *Ganoderma* began under the name of *ling chih*, later transliterated to *reishi* in Japanese. The fungus first appeared in Chinese literature during the Han Dynasty (206 B.C.–220 A.D.). Emperor Wu associated growth of the fungus in an inner chamber of the Imperial Palace with a plant of immortality—known simply as the *chih* plant or *chih* fungus.<sup>[1]</sup> The Han Dynasty chronicler, Pan Ku, wrote a poem using the term *ling chih*.<sup>[1]</sup> However, the association between the original *chih* fungus and *G. lucidum* had clearly derived from legends of an earlier mysterious *chih* fungus or *chih* plant of immortality recorded in India. Indeed, versions of Indian legends concerning this mushroom are found later, in almost identical form in the Chinese literature, in reference to what would be *ling chih* (*reishi*), while the identity of the true *chih* plant or fungus of immortality remains in dispute.<sup>[1]</sup> In addition to its medicinal properties, *reishi* has been used in the Orient as a talisman to protect a person or home against evil.<sup>[6]</sup>

Medicinal uses of *G. lucidum* in ancient Far East countries included the treatment of neurasthenia, debility from prolonged illness, insomnia, anorexia, dizziness, chronic hepatitis, hypercholesterolemia, mushroom poisoning (antidote), coronary heart disease, hypertension, prevention of altitude sickness, treatment of “deficiency fatigue,” carcinoma, and bronchial cough in the elderly.<sup>[3,6,7,9-11]</sup> Chinese research during the past decade has focused on much the same uses, whether in the fields of antiaging/life prolongation, brain ischemia/reperfusion injury, chronic viral hepatitis, male sexual dysfunction, hypercholesterolemia, immunological function in the elderly, chemotherapy-induced toxicity, narcotic-induced immunosuppression, anticarcinogenic and antitumor activity, and immunostimulation.<sup>[6,8,13-18,55]</sup> Different types of *G. lucidum*, according to Traditional Chinese Medicine (TCM), have different tastes and thus affect different organs. Based on their color, six different types of *G. lucidum* have been classified,<sup>[19]</sup> each with different uses (Table 1).

## General Nutritional Components of *Ganoderma lucidum*

*G. lucidum* contains mainly protein, fat, carbohydrate, and fiber. Artificially cultivated variety has similar contents of nutritional components compared with

**Table 1** The six types of reishi

Color	Taste	Japanese name	Use
Blue	Sour	Aoshiba	Improves eyesight and liver function; calms nerves
Red <sup>a</sup>	Bitter	Akashiba	Aids internal organs; improves memory; enhances vitality
Yellow	Sweet	Kishiba	Strengthens spleen function; calms the “spirit” (shen)
White	Hot (or pungent)	Shiroshiba	Improves lung function; gives courage and strong will
Black	Salty	Kuroshiba	Protects kidneys
Purple	Sweet	Murasakishiba	Enhances function of ears, joints, muscles; helps complexion

<sup>a</sup>The red-colored variety of *G. lucidum* is generally regarded as the most potent and medicinal.<sup>[19]</sup>

wild types, and the extraction significantly increases the amounts of crude protein and carbohydrates and deleted crude fiber. Mizuno<sup>[20]</sup> reported the composition of *G. lucidum* extract (% of dry weight), which consisted of folin-positive material (68.9%), glucose (11.1%), protein (7.3%), and metals (10.2%) (K, Mg, and Ca are the major components with Ge having the 5th highest metal concentration at 489 µg/g). These results generally agree with those reported by other authors.<sup>[4,5,10]</sup> However, there are qualitative and quantitative differences in the chemical composition of *G. lucidum* products depending on the strain, origin, extracting process, and cultivation conditions.<sup>[3,5,10,11,20]</sup>

### Major Bioactive Constituents

Over 300 reports have been published concerning the chemical constituents of *G. lucidum* and related species. The fruiting body, mycelia, and spores of *G. lucidum* contain approximately 400 different bioactive compounds, which mainly include triterpenoids, polysaccharides, nucleotides, sterols, steroids, fatty acids, proteins/peptides, and trace elements.<sup>[11,16,20,21,55]</sup>

## TERPENOID COMPOUNDS

### Triterpenes

At least 140 different triterpenes have been identified in *G. lucidum*.<sup>[3,6,10,11,20,21]</sup> The majority are bitter tasting and largely occur as ganoderic acid.<sup>[21]</sup> A new triterpenoid, named ganosporeric acid A, was recently isolated from the ether-soluble fraction of the spores.<sup>[22]</sup> Min et al.<sup>[23]</sup> reported the isolation of six new lanostane-type triterpenes, and also from the spores (ganoderic acids  $\gamma$ ,  $\delta$ ,  $\epsilon$ ,  $\zeta$ ,  $\eta$ , and  $\theta$ ). Preliminary studies indicate that the spores contain considerably higher contents of ganoderic acids than other parts of the fungus and that triterpene composition of the fruit body varies according to the area in which it is grown.<sup>[22]</sup> The

spores also contain triterpene lactones,<sup>[21]</sup> and documented triterpenoids have been divided into 10 groups based on the structural similarities and known biological and medicinal properties (Fig. 2).

## CARBOHYDRATES

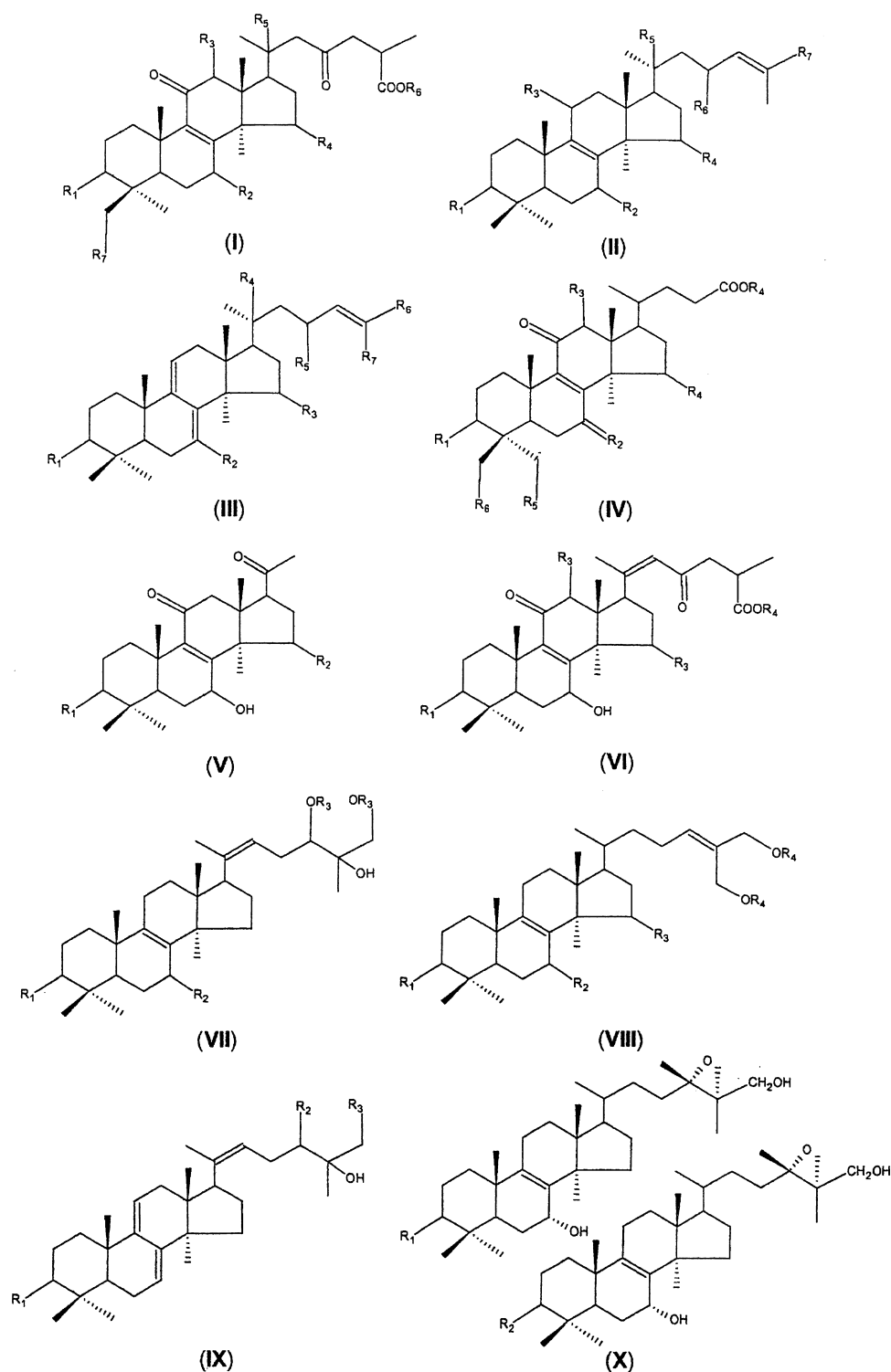
### Polysaccharides

More than 100 types of polysaccharides have been isolated from the fruiting body, spores, and mycelia, or separated from the broth of a submerged liquid culture of *G. lucidum*. Most have a molecular weight ranging from  $4 \times 10^5$  to  $1 \times 10^6$  in the primary structure. They comprise one of the major sources of *G. lucidum*'s pharmacologically active compounds.

*G. lucidum* polysaccharides such as  $\beta$ -D-glucans, heteropolysaccharides, and glycoprotein have been isolated and characterized and are considered the major contributors of bioactivity of the mushroom.  $\beta$ -D-glucans consist of a linear backbone of  $\beta$ -(1  $\rightarrow$  3)-linked D-glucopyranosyl groups with varying degrees of branching from the C6 position. In addition to water-soluble  $\beta$ -D-glucans,  $\beta$ -D-glucans also exist with heteropolysaccharide chains of xylose, mannose, galactose, uronic acid, and  $\beta$ -D-glucans-protein complexes that are present at 10–50% in dry *G. lucidum*.<sup>[16,24–26]</sup> Some protein-bound polysaccharides and fucose-containing glycoprotein with bioactivity have been isolated.<sup>[18,27,28]</sup>

## PROTEINS

Some proteins with bioactivity have also been isolated from *G. lucidum*. The LZ-8 is one such protein isolated from *G. lucidum*, which was shown, by sequencing studies, to be similar to the variable region of the immunoglobulin heavy chain in its sequence and in its predicted secondary structure. Major biological activities of LZ-8 resemble those of lectins, with mitogenic capacity toward mouse spleen cells and human peripheral lymphocytes



**Fig. 2** The lanostane-type triterpenoids of *Ganoderma lucidum*. These triterpenoids are divided into ten groups based on structural similarity.

and agglutination of sheep red blood cells in vitro. Neither was inhibited by the mono- or dimeric sugars examined, indicating that LZ-8 is not a lectin per se. It did not agglutinate human red blood cells but could

function as a potent suppressor of bovine serum albumin-induced anaphylaxis in CFW mice in vitro. It appears to be related to an ancestral protein of the immunoglobulin superfamily.<sup>[29]</sup>

## NITROGENOUS COMPOUNDS

### Nucleotides and Nucleosides

Nucleosides include adenosine and 5-deoxy-5' methyl-sulfinylad-nosine.<sup>[20]</sup>

## OTHER CONSTITUENTS

Reishi also contains sterols, amino acids, soluble proteins, oleic acid, cyclo-octasulfur, an ergosterol peroxide (5,8-epidioxy-ergosta-6,22*E*-dien-3-ol), and the cerebrosides (4*E'*,8*E*)-*N*-*D*-2'-hydroxystearoyl-1-*O*- $\beta$ -*D*-glucopyranosyl-9-methyl-4-8-sphingadienine, and (4*E*,8*E*)-*N*-*D*-2'-hydroxypamitoyl-1-*O*- $\beta$ -*D*-glucopyranosyl-9-methyl-4-8-sphingadienine.<sup>[3,11,17,18,20]</sup>

Regarding the inorganic ions, the mushroom contains Mg, Ca, Zn, Mn, Fe, Cu, and Ge. The spores themselves contain choline, betaine, tetracosanoic acid, stearic acid, palmitic acid, ergosta-7, 22-dien-3-ol, nonadecanoic acid, behenic acid, tetracosane, hentriacontane, ergosterol, and  $\beta$ -sitosterol. One of the lipids isolated from *G. lucidum* is pyrophosphatidic acid.<sup>[13,17,20]</sup>

## THERAPEUTIC APPLICATIONS

### Preclinical and Clinical Studies

*G. lucidum* has been reported to have a number of pharmacological effects including immunomodulating, antiatherosclerotic, anti-inflammatory, analgesic, chemopreventive, antitumor, radioprotective, sleep-promoting, antibacterial, antiviral (including anti-HIV), hypolipidemic, antifibrotic, hepatoprotective, diabetic, antioxidative and radical-scavenging, anti-aging, hypoglycemic, and anti-ulcer properties.<sup>[3,6,9–11,16,25,30,55]</sup>

Reishi has now become recognized as an alternative adjuvant in the treatment of leukemia, carcinoma, hepatitis, and diabetes.<sup>[9–11,14–18,25,30,55]</sup> Clinical studies, to date, lack the controls needed to make a scientific assessment of its efficacy in a given application, a situation expected to change with increasing interest from Western scientific communities. It was only since the last decade that clinical trials on the use of *G. lucidum* preparation used to treat cancer and other diseases have been reported in international peer-reviewed journals.

### ANTITUMOR EFFECT

Polysaccharides ( $\beta$ -*D*-glucans, heteropolysaccharides, and glycoproteins) isolated from *G. lucidum* demonstrated antitumor activity against Sarcoma 180 in

mice.<sup>[3,10,11,13,14,16,20,25,27,28,30]</sup> Triterpenoids, such as ganoderic acids T–Z isolated from *G. lucidum*, showed cytotoxic activity in vitro on hepatoma cells.<sup>[31]</sup> A lanostanoid, 3 $\beta$ -hydroxyl-26-oxo-5 $\alpha$ -lanosta-8,24-dien-11-one, and a steroid, ergosta-7,22-diene-3 $\beta$ ,3 $\alpha$ ,9 $\alpha$ -triol, isolated from fruiting bodies of *G. lucidum*, demonstrated potent inhibitory effects on KB cells and human PLC/PRF/5 cells in vitro.<sup>[32]</sup>

The polysaccharide-mediated potentiation of immune function is thought to be the major mechanism of antitumor action by *G. lucidum*. Among the multiple polysaccharides, active  $\beta$ -*D*-glucans are responsible for the antitumor effect.<sup>[3,10,11,13,20,28,30]</sup> This polysaccharide appears to act by binding to leukocyte surfaces or serum-specific proteins leading to activation of macrophages, T-helper, natural killer (NK) and other effector cells.<sup>[33–35]</sup> All of these increase the production of cytokines such as tumor necrosis factor (TNF- $\alpha$ ) interleukins (IL) and interferon (IFN), nitric oxide (NO), and antibodies by the activated effector cells. Tumor regression in various animal models can be ascribed to vascular damage to tumor blood flow and necrosis caused by T cells and local TNF- $\alpha$  production.

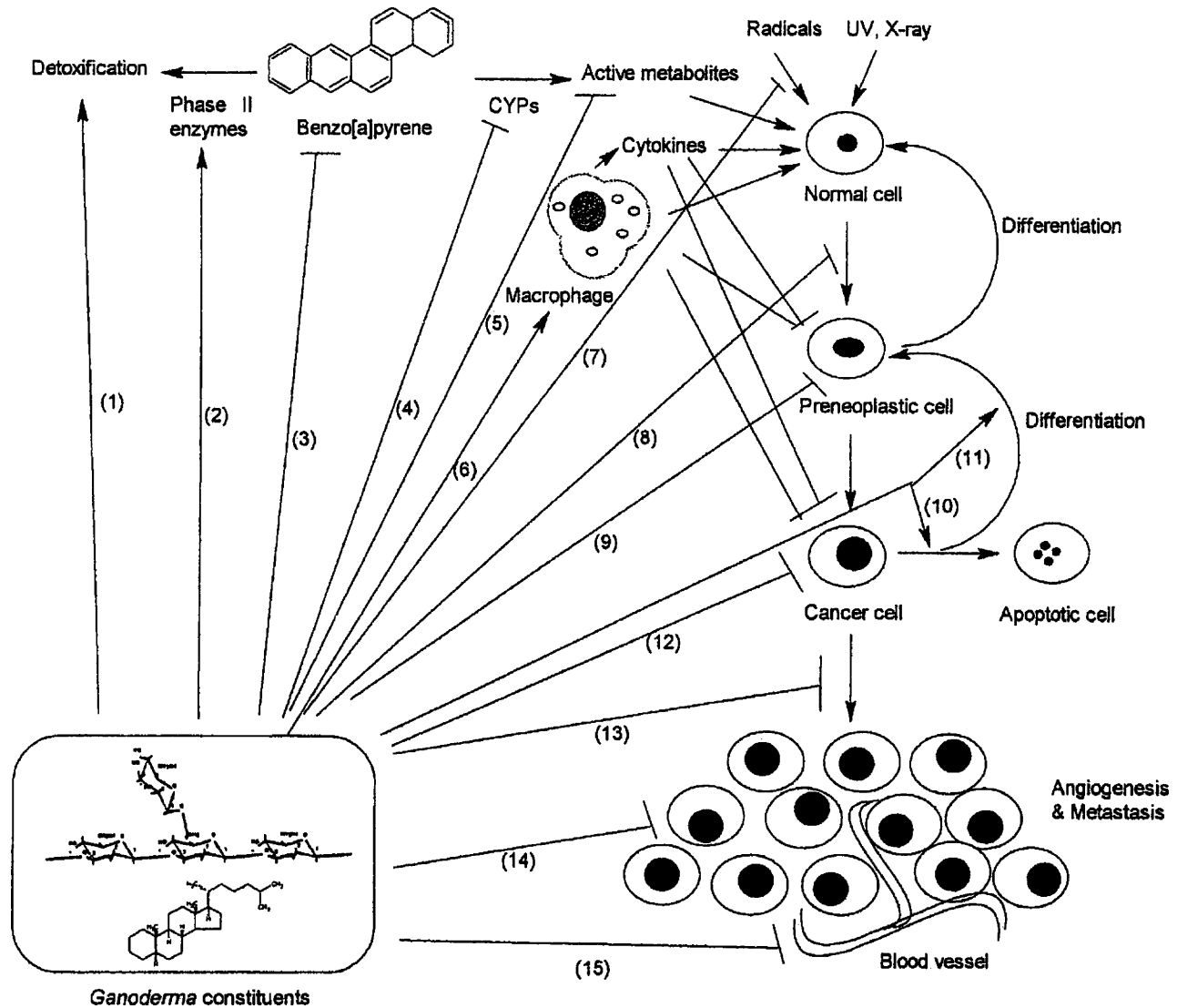
In addition to host defense potentiation, other mechanisms are also involved in the antitumor effect. A compound from *G. lucidum* suppressed the growth of K562 leukemic cells in a dose- and time-dependent manner and induced their differentiation into more mature erythrocytic cells.<sup>[36]</sup> The conditioned medium from PS-stimulated human blood mononuclear cells (PSG-MNC-CM) significantly inhibited the growth of U937 cells and induced their differentiation into mature monocytes/macrophages, which had functions of phagocytosis and producing cytoplasmic superoxide.<sup>[37]</sup> Inhibition of DNA polymerase and posttranslational modification of oncoproteins may contribute to the antitumor activity of reishi.<sup>[38]</sup> The organic germanium may also contribute to its antitumor activity.<sup>[39]</sup> The mechanisms for tumor prevention and antitumor effect of *G. lucidum* are shown in Fig. 3.

In clinical studies, *G. lucidum* products have been widely used as a single agent or in combination with other herbal medicines or chemotherapeutic drugs for many years, mainly in Asian countries. However, randomized, placebo-controlled and multicancer clinical studies using reishi alone have rarely been reported.

### *Ganoderma lucidum* as a Single Agent

In a randomized, placebo-controlled clinical study, 143 patients with advanced previously treated cancer were given an oral *G. lucidum* polysaccharide extract (Ganopoly) of 1800 mg three times daily for 12 weeks.<sup>[16]</sup> Twenty-seven patients were not assessable





**Fig. 3** The mechanisms for the tumor preventive and antitumor effect of *G. lucidum*. Active constituents from *G. lucidum* may operate through several mechanisms including enhancement of detoxification of carcinogens (line 1), increased expression and activity of Phase II enzymes (line 2), inhibition of organ exposure of carcinogens due to reduced absorption or increased excretion (line 3), decreased expression and activity of Phase I (e.g., CYPs) enzymes (line 4), decreased formation of toxic metabolites and adduct formation with macromolecules (line 5), enhanced host immune responses (e.g., activation of macrophages, T lymphocytes, and natural killers producing various cytokines such as TNF- $\alpha$ , IFNs, and ILs, which improve immunosurveillance and kill preneoplastic and cancer cells) (line 6), antioxidative and radical-scavenging effects (line 7), antipromotion effect (line 8), antiproliferation (line 9), apoptosis induction of tumor cells (line 10), induction of differentiation (line 11), direct cytotoxicity, induction of cell-cycle arrest, antiproliferation and modulation of signaling transduction molecules (line 12), antiproliferation and tumor growth inhibition (line 13), antimetastasis (line 14), and anti-angiogenesis (line 15).<sup>[16]</sup>

for response and toxicity, because they were lost in the follow-up or refused further therapy before the 12 weeks of treatment. Of the 100 fully assessable patients, 46 (32.2%) had progressive disease before or at the 6-week evaluation point (range: 5 days–6 weeks).

Sixteen subjects (11.2%) developed progressive disease between 6 and 12 weeks of therapy. No objective (partial or complete) responses were observed, but 38

of 143 cases (26.6%) had stable disease for 12 weeks or more (range: 12–50 weeks). There was no significant change in the Functional Assessment of Cancer Therapy-General (FACT-G) scores in 85 assessable patients. However, palliative effects on cancer-related symptoms, such as sweating and insomnia, have been observed in many subjects. In the group with stable disease, FACT-G scores improved in 23 patients, were

unchanged in five, and declined in one. Within this group, the median change from the baseline score to the 6- and 12-week score was +7.6 and +10.3, both statistically significant ( $P < 0.05$ ). For the 38 patients with SD, the median change from the baseline score was  $28.1 \pm 10.2$  weeks. The prostate-specific antigen (PSA) levels in the five prostate cancer patients were reduced significantly ( $P < 0.05$ ) during SD. Ganopoly was well tolerated with five moderate adverse events recorded. The results indicate that Ganopoly may have an adjunct role in the treatment of patients with advanced cancer although objective responses were not observed in this study.

### ***Ganoderma lucidum*-Containing Herbal Mixture: PC-SPES**

PC-SPES has been used as an alternative in the treatment of prostate cancer.<sup>[47]</sup> Several clinical trials have been completed with patients having advanced prostate cancer.<sup>[48,49]</sup> Small et al.<sup>[49]</sup> included 70 subjects with androgen-dependent ( $n = 33$ ) and androgen-independent ( $n = 37$ ) disease, which was refractory to surgery, radiotherapy, and hormone therapy. Treatment of PC-SPES at a dose of 3 capsules (320 mg/capsule) orally resulted in  $\geq 80\%$  decrease in PSA levels in all 32 patients with androgen-dependent cancer, while it was undetectable in 26 patients (81%). The median duration of PSA response was 57 weeks. In the 35 patients with androgen-independent cancer, 19 (54%) had a PSA decrease of  $\geq 50\%$  with median duration of PSA response of 18 weeks. The study by Pfeifer et al.,<sup>[48]</sup> which included only 16 patients with androgen-independent disease for just a 20-week follow-up, showed an improvement in quality of life for the patients. PC-SPES was generally well tolerated by prostate cancer patients, but they exhibited a dose-dependent toxicity similar to that of diethylstilboestrol.<sup>[49]</sup> Side effects include reduced libido, hot flashes, diarrhea, dyspepsia, leg cramps, nipple tenderness, and gynecomastia.<sup>[48,49]</sup> More life-threatening adverse events are pulmonary emboli in 4–5% of patients and deep vein thrombosis in 2% of patients. Overall, the clinical responses to PC-SPES compare favorably with second-line hormonal therapy with agents, such as estrogens and ketoconazole.<sup>[50]</sup> However, it must be noted that the adulteration of PC-SPES products has become a serious problem. Further details may be obtained at the website of the NIH National Center for Complementary and Alternative Medicine at <http://nccam.nih.gov/health/alerts/spes/>.

In summary, animal studies have demonstrated the antitumor activity of *G. lucidum* administered by different routes at different stages of tumor growth.<sup>[3,10,16,20]</sup> Polysaccharides and triterpenoids

are the major contributors to the anticancer effect of *G. lucidum*, but other constituents, such as proteins, also play a role (Fig. 4).<sup>[20]</sup> Several recently published reports have found that *G. lucidum* or *G. lucidum*-containing herbal mixtures (PC-SPES) had biological activities (e.g., cancer biomarker alteration) and beneficial effects (e.g., palliative effects in cancer patients) although striking objective responses were not observed.<sup>[16,47]</sup>

### **CHEMO- AND RADIOPREVENTIVE EFFECTS**

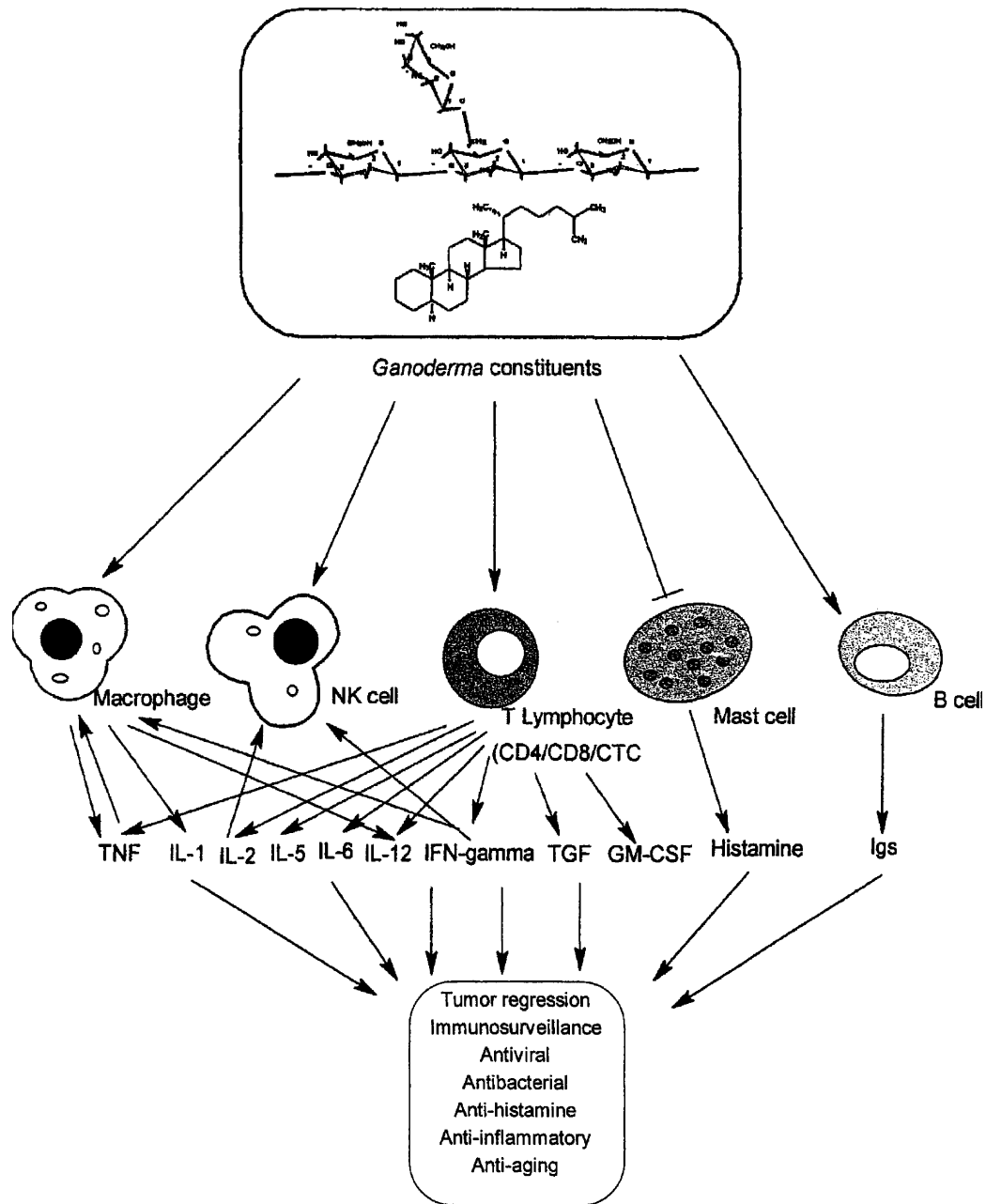
The chemo- and radiopreventive effect of *G. lucidum* may result from its effects on the immune system. *Ganoderma* polysaccharides restored the TNF- $\alpha$  production inhibited by cyclophosphamide to normal levels in mice. Both the *G. lucidum* extract and krestin (protein-bound  $\beta$ -glucan isolated from *Trametes versicolor*) were beneficially effective in the recovery of cellular immunocompetence, measured by [<sup>3</sup>H] thymidine incorporation with splenic cells stimulated through mitogenes, such as phytohemagglutinin (PHA) and concanavalin A. The extract (400 mg/day/kg body weight) appears more effective than krestin (500 mg/day/kg body weight) in repairing the damage of subset T cells in the spleens of  $\gamma$ -irradiated mice, as the relative thymus weight and CD4 and CD8 splenocytes were higher in *G. lucidum* extract-treated mice compared with krestin-treated mice.<sup>[16]</sup>

In morphine-dependent mice, a polysaccharide peptide from *G. lucidum* could restore several immunologic parameters depressed by morphine treatment to normal levels or even beyond.<sup>[40]</sup> Both *c-myc* and *c-myc* mRNA expression in splenocytes of repetitive morphine-treated mice was significantly decreased, and the polysaccharide peptide could induce the expression of these genes indicating that the one from *G. lucidum* could be of a potential application in controlling abuse of opiate-induced immunodeficiency.

### **ENZYME-INHIBITING ACTIVITY**

Triterpenoids of *G. lucidum* have been reported to exert various enzyme inhibitory activities. Inhibitors of farnesyl protein transferase (FTP) have been demonstrated to inhibit Ras-dependent cell transformation and thus represent a potential therapeutic strategy for the treatment of human cancers. Ganoderic acids A and C were identified to be inhibitors of FTP.<sup>[41]</sup> Ergosterol peroxide, 5,8-epidioxy-5 $\alpha$ , 8 $\beta$ -ergosta-6,22E-dien-3 $\beta$ -ol, from *G. lucidum*, was reported to selectively enhance the inhibitory effect of linoleic acid on DNA polymerase- $\beta$ , but not on the type  $\alpha$  enzyme. Ergosterol peroxide itself was





**Fig. 5** The immune-modulating effects of *G. lucidum*. The major immunomodulating effects of active substances derived from *G. lucidum* include mitogenicity and activation of immune effector cells such as T lymphocytes, macrophages, and NK cells leading to the production of cytokines including ILs, TNF- $\alpha$ , and IFNs. Other effects, such as inhibition of mast cells, activation of B lymphocytes, and the complement system have also been reported.<sup>[15]</sup>

**EFFECTS ON IMMUNE EFFECTOR CELLS**

**Splenocytes**

In vitro and in vivo studies in mice indicated that *G. lucidum* water extract stimulates the production of IL-2 by splenocytes in the presence of hydrocortisone.<sup>[3,7,10,11]</sup>

**T Cells**

Extracts from *G. lucidum* are potent activators of T cells, inducing the production of a number of cytokines, in particular IL-2. In human PBMC (primarily T cells) in vitro, the crude *G. lucidum* water extract induced the expression of cytokines including IL-10 and TNF- $\alpha$ , IL-1 $\beta$ , IL-6, and IL-2.<sup>[43]</sup> Crude

polysaccharide fractions isolated from fresh fruiting bodies potentiated the release of IFN- $\gamma$  from human T cells.<sup>[37]</sup> A polysaccharide fraction (GL-B) promoted the production of IL-2 in a dose-dependent manner and markedly enhanced the cytotoxicity of cytotoxic T lymphocytes, which was increased by 100% at a concentration of 200  $\mu\text{g/ml}$ . GL-B also restored the mixed lymphocyte response to alloantigen, automatic proliferation, and IL-2 production of splenocytes in aged mice declined as compared with that in young adult mice in vitro.

LZ-8 is also a potent T-cell activator mediating its effects via cytokine regulation of integrin expression. Stimulation of human peripheral blood lymphocytes with LZ-8 resulted in the production of IL-2 and a corresponding upregulation of IL-2 receptor expression.<sup>[44]</sup> In addition to T-cell proliferation, microscopic examination of LZ-8-stimulated peripheral blood lymphocytes revealed that LZ-8 induced cellular aggregate formation. This formation correlated with a dramatic rise in ICAM-1 expression and an increased production of IFN- $\gamma$ , TNF- $\alpha$ , and IL-1 $\beta$ , molecules associated with regulation of ICAM-1 expression. Both the aggregate formation and the proliferative effects of LZ-8 were blocked by the addition of a monoclonal antibody to either CD18 or CD11a, the counter-receptor complex components for ICAM-1. Furthermore, addition of neutralizing antibodies to both IL-2 receptor and TNF- $\alpha$  blocked aggregate formation, cellular proliferation, and ICAM-1 expression.

### Natural Killer (NK) Cells

A water-extracted polysaccharide fraction from *G. lucidum* enhanced the cytotoxicity of splenic NK cells in tumor-bearing mice.<sup>[3,16,37]</sup>

### Macrophages

Macrophages are responsible for killing pathogens in the body. Activation of macrophages by substances from *G. lucidum* results in the release of cytokines, NO, and other mediators.<sup>[37,45]</sup> All of these responses are associated with the antitumor, antimicrobial, and anti-inflammatory effects of *G. lucidum*.

Polysaccharides from *G. lucidum*, in particular  $\beta$ -D-glucans, are potent stimulators of murine and human macrophages in vitro and in vivo.<sup>[37,45]</sup> CR3 receptors on macrophages are bound by  $\beta$ -D-glucans and internalized, priming a series of molecular events. Crude water-extracted polysaccharides isolated from fresh fruiting bodies of *G. lucidum* potentiated the production of cytokines including IL-1 $\beta$ , IL-6, IFN- $\gamma$ , and TNF- $\alpha$  by human macrophages, which

were antiproliferative, differentiated and apoptosis inductive to the HL-60 and the U937 leukemic cells.<sup>[37]</sup> IFN- $\gamma$  and TNF- $\alpha$  released from macrophages act synergistically to inhibit the growth of leukemic cells as shown by the antibody-neutralization studies. GLB7, a *G. lucidum* polysaccharide, decreased the production of oxygen-free radicals and antagonized the respiratory burst induced by PMA in murine peritoneal macrophages. These observations suggest that GLB7-decreased production of oxygen-free radicals in murine peritoneal macrophages plays an important role in the anti-aging effect of *G. lucidum* polysaccharides.<sup>[45]</sup>

Ganoderan (GAN), a  $\beta$ -D-glucan isolated from *G. lucidum*, enhanced the production of NO in the RAW 264.7 macrophages.<sup>[45]</sup> The ability of GANs to produce NO was based on differences in the chemical composition of GANs obtained from the mycelium on various carbon sources and mycelial fractionation. The highest NO production was observed in the polysaccharide, which was extracted from the mycelial wall. Partial removal of the protein in the extracellular GAN by TCA treatment did appreciably reduce its capacity to secrete NO. The cell proliferation of GAN-treated RAW 264.7 cell lines was inhibited compared to its control. Of the culture supernatant of macrophage activated by this glycan, the percentage of cytotoxicity against mouse leukemia L1210 cells was slightly dependent on the amount of NO in the culture supernatants of the activated macrophages. These results indicate that the  $\beta$ -glucan-related polysaccharides of the higher fungus activate macrophages and release NO, which is an important chemical messenger for the induction of many biological responses.

A protein-polysaccharide fraction (GLB) from the growing tips of *G. lucidum* is a strong stimulator to the macrophages.<sup>[46]</sup> When analyzed using a flow cytometer, GLB (100  $\mu\text{g/ml}$ ) increased the phagocytic activity of the BALB/c mouse peritoneal macrophages as well as chicken macrophage BM2CL cells against FITC-labeled *Candida albicans* by 55.2% and 21.2%, respectively. It also enhanced the spreading and expression of MHC class II molecules of BM2CL cells as well as the mouse peritoneal macrophages.

### Mast Cells

Some substances from *G. lucidum* can act on mast cells. A water extract of the fruit body had inhibitory activity on histamine release from rat peritoneal mast cells, induced by compound 48/80 or antigen (egg white albumin)-antibody reaction and on passive cutaneous anaphylaxis reaction in guinea pigs and rats. Two ganoderic acids (C and D) isolated from the fruit body by methanol inhibited the histamine release from

rat mast cells, induced by compound 48/80 and concanavalin A. A chloroform extract from *G. lucidum* broth also significantly inhibited histamine release from rat peritoneal mast cells induced by A-23187 and compound 48/80. The mechanism for the inhibitory activity on histamine release from mast cells was further studied. Palmitic acid, stearic acid, oleic acid, and linoleic acid were isolated from the active fractions. Of these, oleic acids induced membrane stabilization in model membrane systems. Cyclo-octasulfur extracted from the culture medium of *G. lucidum* may decrease calcium uptake from the extracellular medium by a disulfide exchange reaction in the cell membrane leading to inhibition of histamine release from mast cells.<sup>[3,10,11,14,16]</sup>

### COMPLEMENT SYSTEM

An alkali extract isolated from cultured mycelium of *G. lucidum* activated classical and alternative pathways of a complement system. Activated complement C3 was observed by crossed immunoelectrophoresis in mice. This fraction also activated the reticulo-endothelial system of mice in the carbon clearance test and increased hemolytic plaque forming cells of the spleen. The alkali extract consisted of 10% carbohydrate and 49% proteins. A clinical study in elderly patients with insomnia and palpitations recently showed that taking *G. lucidum* essence for 4–6 weeks increased their serum C3 levels.<sup>[3,10,20]</sup>

### HISTAMINE RELEASE INHIBITION

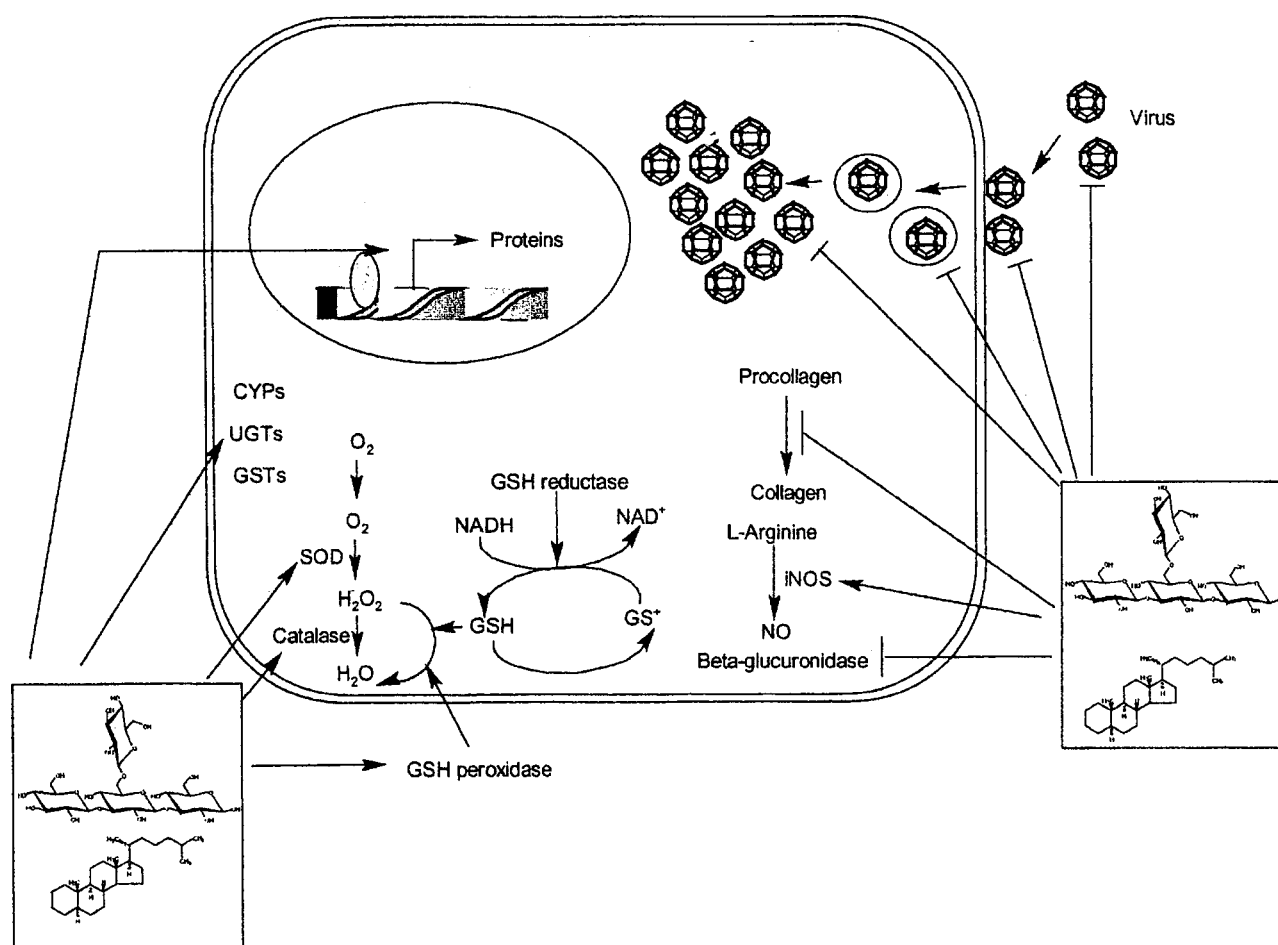
The fruiting bodies have been traditionally used as anti-inflammatory agents for the treatment of asthma or allergy. In the course of a screening test for the inhibition of histamine release from rat mast cells, it was found for the first time that ganoderic acids C and D inhibited histamine release from rat mast cells (that were induced by compound 48/80 and concanavalin A). Other than the triterpenoid compounds, cyclo-octasulfur from this fungus also effectively inhibited histamine release from rat peritoneal mast cells and interacted with membrane proteins to inhibit Ca uptake causing a blockade of histamine release.<sup>[7,13,55]</sup>

### HEPATOPROTECTIVE ACTIVITY

*G. lucidum* has been widely used for the treatment of chronic hepatopathy of various etiologies. Data from

in vitro and animal studies indicate that *G. lucidum* extracts (mainly polysaccharides or triterpenoids) exhibit protective activities against liver injury induced by toxic chemicals (e.g., CCl<sub>4</sub>) and Bacillus Calmette-Guerin (BCG) plus lipopolysaccharide (LPS). Reishi also showed antihepatitis B-virus (HBV) activity in a duckling study. Recently, a randomized placebo-controlled clinical study<sup>[15,17]</sup> showed that treatment with *G. lucidum* polysaccharides for 12 weeks reduced hepatitis B e antigen (HBeAg) and HBV DNA in 25% (13/52) patients with HBV infection. The mechanisms of the hepatoprotective effects of *G. lucidum* have been largely undefined. However, accumulating evidence suggests several possible mechanisms. These include antioxidant and radical-scavenging activity, modulation of hepatic Phase I and II enzymes, inhibition of  $\beta$ -glucuronidase, antifibrotic and antiviral activity, modulation of NO production, maintenance of hepatocellular calcium homeostasis, and immunomodulating effects (Fig. 6). The mushroom could represent a promising approach for the management of various chronic hepatopathies. Further studies are needed to explore the kinetics and mechanisms of action of its constituents with hepatoprotective activities.

The polysaccharide fractions and triterpenes isolated from *G. lucidum* have shown protective effects on the liver in animal and human studies. Ninety patients with chronic hepatitis B, hepatitis B viral (HBV) DNA positivity, and aminotransferase elevation were included in this multicenter prospective randomized Phase I/II study. Subjects were randomized to be given Ganopoly ( $n = 60$ ) or a placebo ( $n = 30$ ) for 12 weeks, then followed up for 13 weeks. Effect of therapy on levels of HBV DNA and aminotransferase activities in serum and HBeAg status were investigated. There were 78 assessable patients who entered the trial for efficacy and safety; 13 of 52 (25%) receiving Ganopoly responded by reducing HBeAg and HBV DNA compared to 10 of 26 (4%) patients in the control group ( $P < 0.05$ ). Among those with serum aspartate aminotransferase (AST) values  $<100$  U/L ( $n = 29$ ), 41% (12/29) responded, and among those with AST values  $>100$  U/L ( $n = 23$ ), 65% (15/23) responded. Within the 6-mo study period, 33% (17/52) of treated patients had normal aminotransferase (ALT) values, and 13% (7/52) had cleared hepatitis B surface antigen (HBsAg) from serum, whereas none of the controls had normal ALT values or had lost HBsAg. Eight of the 60 patients in the Ganopoly group and 4 of the 30 in the controls were unable to be followed up due to loss or withdrawal. Our study indicates that Ganopoly is well tolerated and appears to be active against HBV patients with chronic hepatitis B.<sup>[3,10,15,17]</sup>



**Fig. 6** Possible mechanisms for the hepatoprotective effects of *G. lucidum*. These include antioxidative and radical-scavenging effects, downregulation of activating enzymes, and upregulation of detoxifying enzymes, antiviral activities, inhibition of  $\beta$ -glucuronidase, enhanced hepatic nucleic acid and protein synthesis, inhibition of hepatic collagen synthesis, immunomodulating effects, and modulation of nitric oxide (NO) production. GSH = glutathione; GSSG = oxidized glutathione; INOS = inducible NO synthase; SOD = superoxide dismutase; CYP = cytochrome P450; UGT = uridine diphosphate glucuronosyl-transferases. (From Ref.<sup>[17]</sup>)

## ANTIDIABETIC EFFECT

Animal studies have demonstrated that the polysaccharide fractions of *G. lucidum* have potential hypoglycemic and hypolipidemic activities.

A water extract of reishi reduced the increase in blood glucose and blood insulin levels in rats (50 mg p.o.) following oral glucose test. Following adrenaline (i.v.) or oral glucose in rats, the mushroom inhibited increases in blood glucose without raising blood insulin levels. Glycans (ganoderans B and D) have shown significant hypoglycemic activity in mice.

A clinical study aimed at evaluating the efficacy and safety of polysaccharide fractions extracted from *G. lucidum* (Ganopoly) by a patented technique<sup>[18]</sup> in 71 patients with confirmed type II diabetes mellitus (DM) was carried out. Eligibility criteria included

type II DM of >3 mo duration during which patients did not receive insulin; age >18 yr; normal vital signs for age and disease state; normal electrocardiogram (ECG); and fasting plasma glucose (FPG) level of 8.9–16.7 mmol/L in sulfonylurea-naïve patients or an FPG < 10 mmol/L before washout in sulfonylurea-treated patients. They were randomly grouped and given either Ganopoly or an oral placebo of 1800 mg three times daily for 12 weeks. The subjects underwent 4 weeks of dose adjustment, followed by 8 weeks of dose maintenance. Fasting and stimulated glycosylated hemoglobin (HbA<sub>1c</sub>), plasma glucose, insulin, and C-peptide were monitored at predetermined intervals. Adverse events and hypoglycemic episodes were recorded. Treatment with Ganopoly significantly decreased the mean HbA<sub>1c</sub> from 8.4% at baseline to 7.6% at 12 weeks. Significant changes in mean FPG

and PPG levels at the last visit paralleled the changes in mean HbA<sub>1c</sub> levels. At baseline, the mean FPG and PPG values for patients treated with Ganopoly were 12.0 and 13.6 mmol/L, respectively. At week 12, mean PPG values had decreased to 11.8 mmol/L. However, these parameters did not change or slightly increased for patients receiving placebos. The between-group difference in PPG levels at week 12 was significant ( $P < 0.05$ ). Changes in fasting insulin, 2-hr postprandial insulin, fasting C-peptide, and 2-hr postprandial C-peptide were consistent with the between-group differences in these end points being significant at the last visit. Overall, Ganopoly was well tolerated. This study demonstrated that Ganopoly is efficacious and safe in lowering blood glucose concentrations.<sup>[18]</sup>

A 2-mo open label comparative clinical study of a reishi powder extract (1g t.i.d.) for eight diabetic patients (four with NIDD and four with IDDM) found hypoglycemic effects comparable to those found in controls who were administered insulin (100 IU/ml for 60 days) or oral hypoglycemic agents (250 mg/day for 60 days).<sup>[3,10,11,18]</sup>

## CARDIOVASCULAR AND CIRCULATORY FUNCTIONS

### Cholesterol and Lipid Metabolism

The powdered mycelium of reishi, at 5% of the diet of spontaneously hypertensive rats for 4 weeks, caused plasma total cholesterol to decrease significantly (by 18.6%) compared to controls. Total liver triglyceride and total liver cholesterol levels were also significantly lower in the reishi-fed group (by approximately 46% and 56%, respectively).<sup>[51,52]</sup>

### Hypertension

A water extract of the mycelium administered to rats and rabbits (3–30 mg/kg i.v.) produced significant hypotensive effects; an activity the researchers suggested is secondary to the primary effect that suppresses sympathetic outflow of the central nervous system.<sup>[53]</sup> The powdered mycelium of reishi, at 5% of the diet of spontaneously hypertensive rats for 4 weeks, caused systolic blood pressure to be significantly lower (approximately 10 mmHg) without causing a significant difference in the heart rate.<sup>[51]</sup> Jin et al.<sup>[54]</sup> conducted a double-blind, placebo-controlled clinical study of *G. lucidum* in 54 patients with primary stage-II hypertension who had not responded to previous drug treatment (captopril 25 mg t.i.d. or nomodipine 20 mg t.i.d.). In the group which was

administered administrated *G. lucidum* extract tablets (2 tablets b.i.d. or 220 mg/day), systemic blood pressure significantly improved in 82.5%, with capillary and arterial blood pressure showing significant improvements in as little as 14 days. No changes of any significance were found in the placebo group. According to Soo<sup>[52]</sup> in treating hypertension, *G. lucidum* was shown to be highly effective in a very large number of treated cases. In the more successful cases, blood pressure was back to normal within 2 mo, and in some cases, within 2 weeks.

## ANTIBACTERIAL AND ANTIVIRAL VALUE

### Antibacterial Effect of *Ganoderma lucidum* on Gram-Positive and Gram-Negative Bacteria

Recently, more studies demonstrated that *G. lucidum* contained antibacterial constituents that are able to inhibit gram-positive and/or gram-negative bacteria.<sup>[3,5,10,11,17,55,56]</sup> The aqueous extract from the carpophores of *G. lucidum* inhibited 15 types of gram-positive and gram-negative bacteria. Further studies indicate that the antimicrobial combinations of *G. lucidum* extract with four antibiotics (ampicillin, cefazolin, oxytetracycline, and chloramphenicol) resulted in additive effects in most instances: synergism in two instances when combined with cefazolin against *Bacillus subtilis* and *Klebsiella oxytoca*,<sup>[57]</sup> and antagonism in two instances.

### *Helicobacter pylori*

*Helicobacter pylori* is associated with human gastroduodenal diseases such as gastritis, peptic ulcer, and gastric carcinoma. The extracts of many mushrooms inhibited the growth of this bacterium.<sup>[17,58]</sup> The extract of *G. lucidum* and some other species of higher Basidiomycetes arrested the growth of this pathogen. When their extracts were fractionated, the ether fractions of *G. lucidum* and *Agaricus bisporus* (J. Lge) Imbach were the most effective. Among seven components separated from the ether fraction of *G. lucidum* extract by silica gel column chromatography, P3 was the most potent with a minimum inhibitory concentration of 200 µg/ml.

It appears that some constituents such as ganomycin, triterpenoids, and aqueous extracts from *Ganoderma* species have a broad spectrum of in vitro antibacterial activity against gram-positive and gram-negative bacteria and *H. pylori*. Thus, it is possible that the antibacterial activity of *Ganoderma* species may be beneficial for those patients with chronic infection (e.g., chronic bronchitis) and those with *H. pylori*-positive



peptic ulcer diseases, though clinical studies are required to confirm this.

### Antihuman Immunodeficiency Virus (HIV) Activity

HIV was isolated as an etiological agent of acquired immunodeficiency disease syndrome in 1983.<sup>[59]</sup> Acquired immunodeficiency syndrome caused by HIV infection has recently become an important social and medical problem. Anti-HIV therapy by nucleoside analogues, such as 3'-azido-thymidine, is the major effective approach for the treatment of acquired immunodeficiency syndrome.<sup>[60]</sup> These agents are potent inhibitors of HIV reverse transcriptase (RT) and protease.<sup>[61]</sup> However, the emergence of drug-resistant variants of HIV and toxicities severely limits the long-term effectiveness of these drugs. Recent studies have indicated that many natural products are active as anti-HIV agents. These compounds belong to a wide range of different structural classes, e.g., coumarins, flavonoids, tannins, alkaloids, lignans, terpenes, naphtho- and anthraquinones, and polysaccharides.<sup>[62]</sup>

In vitro studies indicate that various triterpenoids from *G. lucidum* had potent inhibitory activity against HIV. Lucidenic acid O and lucidenic lactone, isolated from the fruiting body of *G. lucidum*, not only inhibited the activities of calf DNA polymerase- $\alpha$  and rat DNA polymerase- $\beta$ , but also those of HIV-1 RT.<sup>[17]</sup> Ganoderiol F and ganodermanontriol isolated from the fruiting bodies of *G. lucidum* are active against HIV-1 growth with an IC<sub>100</sub> of 7.8  $\mu$ g/ml.<sup>[10,11,17]</sup> Ganoderic acid B and ganoderiol B showed potent inhibitory effect on HIV protease with an IC<sub>50</sub> value of 0.17 mM. Other triterpenoids including ganoderic acid C1, 3 $\beta$ -5 $\alpha$ -dihydroxy-6 $\beta$ -methoxyergosta-7,22-diene, ganoderic acid- $\alpha$ , ganoderic acid H, and ganoderiol A had moderate activity against HIV-1 protease with IC<sub>50</sub> values of 0.17–0.23 mM.<sup>[10,11,17,50]</sup> In addition, ganoderic acid- $\beta$ , lucidumol B, ganodermanontriol, ganodermanontriol, and ganolucidic acid A showed significant anti-HIV-1 protease activity with IC<sub>50</sub> values of 20, 59, 90, 70, and 70  $\mu$ M, respectively.<sup>[22]</sup> Ganoderic acid A, B, and C1 had minor inhibitory activity against HIV protease with IC<sub>50</sub> values of 140–430  $\mu$ M. It appears that there is a structure–activity relationship for triterpenoid showing anti-HIV protease activity. The C3, C24, or C25 atoms are vital for the anti-HIV activity.<sup>[22]</sup>

The aqueous low-molecular-weight fraction extracted from *G. lucidum* also exhibited anti-HIV activity using the XTT [2,3-bis (2-methoxy-4-nitro-5-sulphophenyl)-5-[(phenylamino) carbonyl]-2H-tetrazolium hydroxide] antiviral assay, which can quantitatively measure cytopathic effects of HIV-1 on CEM cells,

a human T lymphoblastoid cell line.<sup>[63]</sup> The IC<sub>50</sub> and EC<sub>50</sub> values were 125 and 11  $\mu$ g/ml, respectively, resulting in a therapeutic index of 11.4. This aqueous low-molecular-weight extract was further fractionated to eight subfractions by methanol: GLA (methanolic extract), GLB (hexane soluble), GLC (acetic ether soluble), GLD (water soluble), GLE (neutral), GLF (acidic), GLG (alkaline), and GLH (amphoteric). All subfractions except GLD, GLF, and GLH exhibited anti-HIV activity with IC<sub>50</sub> and EC<sub>50</sub> values of 22–44  $\mu$ g/ml and 14–44  $\mu$ g/ml, respectively. GLC and GLG inhibited HIV RT. Showing consistency, incubation of GLC at 50  $\mu$ g/ml or GLG (100  $\mu$ g/ml) with Jurkat T cells gave a 75% and 66% inhibition of HIV growth, respectively. However, the high-molecular-weight fraction did not inhibit any HIV-induced cytopathic effect. Both low-molecular-weight and high-molecular-weight fractions from *G. lucidum* had negligible toxicities to CEM cells. The results indicate that the aqueous low-molecular-weight fraction from the fruiting bodies of *G. lucidum*, and the neutral and alkaline subfractions from the methanolic extract might contain small molecular weight polysaccharides.

### Epstein-Barr Virus

Virus-induced carcinogenesis is considered a complicated process with multiple steps involving a number of cellular signaling pathways. A few polyoxygenated lanostanoid triterpenes isolated from *G. applanatus* inhibited the 12-*O*-tetradecanoylphorbol-13-acetate induced Epstein–Barr virus early antigen in Raji cells. Similar effects have been observed with *Zingiberaceae rhizomes*, a commonly used traditional medicine in Malaysia. These results indicate that herbal medicines, such as *Ganoderma* species, may behave as antitumor promoters.<sup>[17]</sup>

### Other Viruses

The antiviral effects of two water-soluble substances (GLhw and GLlw) and eight methanol-soluble substances (GLMe-1-8) isolated from the carpophores of *G. lucidum*, were investigated on influenza A virus strains and vesicular stomatitis virus Indiana and New Jersey in vitro. These activities were evaluated by the cytopathic effect inhibition assay and plaque reduction assay using Vero and HEp-2 cells. Five substances, GLhw, GLMe-1, -2, -4, and -7 significantly inhibited the cytopathic effects of vesicular stomatitis virus. GLMe-4 did not exhibit cytotoxicity up to 1000  $\mu$ g/ml, while it displayed potent antiviral activity on the vesicular stomatitis virus New Jersey strain with a therapeutic index of more than 5.43.<sup>[64,65]</sup>

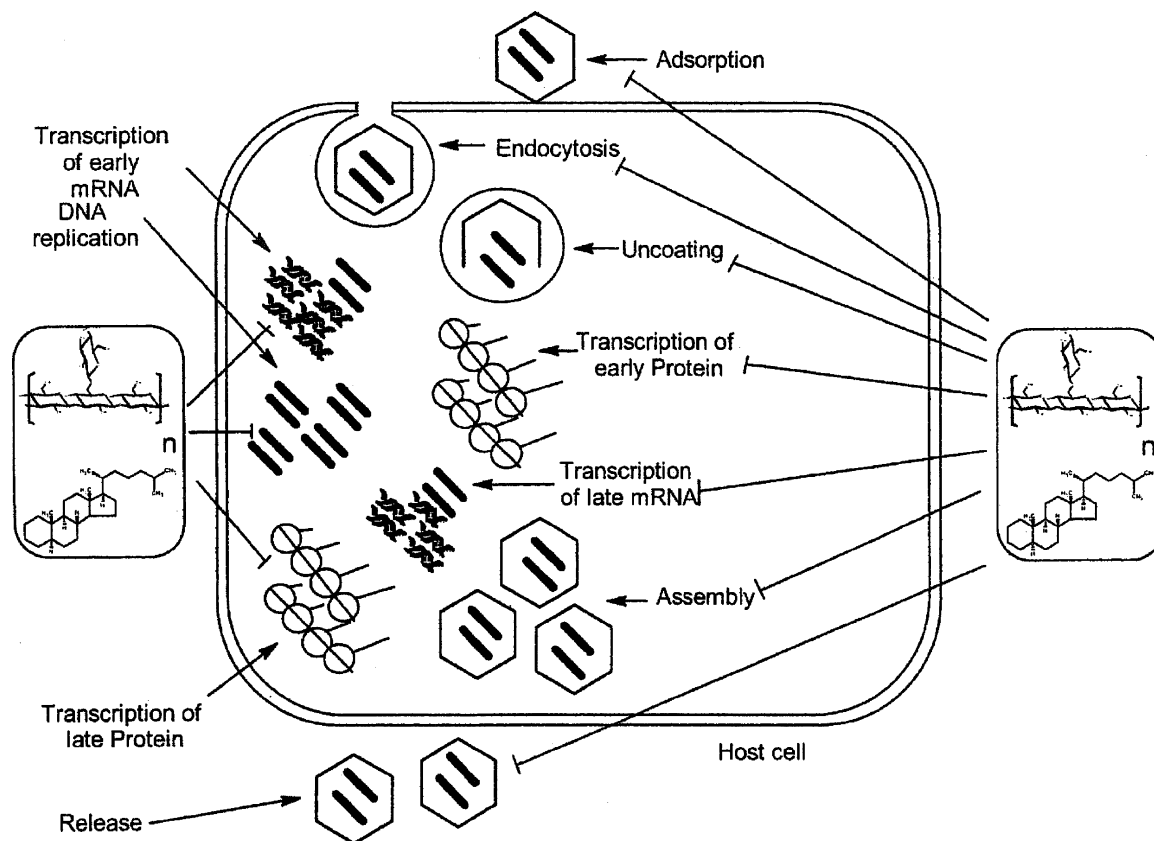
## Mechanism Consideration

The mechanisms for the antibacterial and antiviral activity of *Ganoderma* species are largely undefined. Gao et al.<sup>[17]</sup> suggest that multiple mechanisms may be involved. For example, the *Ganoderma* species constituents (e.g., polysaccharides and triterpenoids) may inhibit viral replication of HSV, HBV, HIV, and other types of viruses by interfering with their adsorption, virus–hepatocyte fusion and endocytosis, viral integration, assembly, and release (Fig. 7).

Data from in vitro studies indicate that *Ganoderma* polysaccharides have direct anti-HBV activity through inhibition of HBV DNA polymerase. The extract from *G. lucidum* inhibited the HBV DNA polymerase activity in PLC/PRF/5 cells by 80%, 70%, and 60%, respectively, with a 28–41% decrease in HBV DNA contents. Some constituents isolated from *G. lucidum* showed inhibitory effect on eukaryotic DNA polymerase. For example, two cerebrosides from the fruiting bodies selectively inhibited the activities of replicative DNA polymerases (especially the  $\alpha$  and  $\delta$  type) with a  $IC_{50}$  of 12–57  $\mu$ M. However, these

cerebrosides hardly influenced the activities of DNA polymerase- $\beta$ , prokaryotic DNA polymerases, terminal deoxynucleotidyl transferase, HIV RT, RNA polymerase, deoxyribonuclease I, and ATPase. Linoleic acid from *G. lucidum* inhibited the activities of mammalian DNA polymerases.<sup>[38,66]</sup>

Immunomodulating effects of *G. lucidum* are considered to play a role in antimicrobial activity.<sup>[15,17]</sup> Activation of immune effector cells (e.g., T cells, macrophages, and natural killer cells) by both pathogen infection and *G. lucidum* administration caused an enhanced production of cytokines, radicals, and NO facilitating the killing of viruses and bacteria. For example, activation of Kupffer cells by *G. lucidum* polysaccharides and triterpenoids within the liver facilitate the killing of HBV. In addition, a study of the mouse indicates that a proteoglycan with a carbohydrate protein ratio of 11.5:1 isolated from *G. lucidum* stimulated the proliferation of mouse spleen lymphocytes, resulting in a three-to-four fold increase in the percentage of B cells. These B cells were enlarged, expressed CD71 and CD25 on the cell surface, and showed an increase in the production of



**Fig. 7** Possible mechanisms for the antiviral effects of *G. lucidum*. Polysaccharides and triterpenoids may inhibit viral replication of HSV, HBV, HIV, and other types of viruses by interfering with their adsorption, and virus–hepatocyte fusion and endocytosis, viral integration, assembly, and release. (From Ref.<sup>[17]</sup>.)

immunoglobulins. Therefore, *Ganoderma* species may stimulate B cells in vivo, producing immunoglobulins, which can neutralize HBV.<sup>[15,17]</sup>

Furthermore, the immunosuppressive activity of *G. lucidum* constituents may decrease tissue and cellular damage following infection. Ling-Zhi-8 at 8 and 12 mg/kg by intraperitoneal injection significantly blocked the production of antibody to HBsAg (83.3–96.8% inhibition) in mice treated with twice the sensitization of the antigen. As Ling-Zhi-8 did not alter the mitogen responsibility of spleen cells and the T-cell subset population in mice, and prevented systemic anaphylaxis and Arthus reactions, these immunosuppressive activities may be ascribed to the blocking of antigen-specific antibody production. The immunosuppressive effect might ameliorate the immune response to HBV infection.<sup>[15,17]</sup>

#### Potential role in the treatment of HBV infection in combination with antiviral nucleoside analogues

Further studies are required to identify the molecular targets of *G. lucidum* constituents for viruses and bacteria. Herbal medicines often contain multiple active substances with individual constituents possibly contributing to the bioactivity observed in vitro and in vivo. Therefore, multiple important molecules might be the targets of a herbal medicine. The identification of these targets may provide molecular evidence of the pharmacological activity and toxicity of herbs.<sup>[67]</sup> *G. lucidum* may play an adjunct role in the management of infectious diseases. However, further experimental clinical studies are needed to identify mechanisms of action, optimal dosing, efficacy, and safety, alone or in combination with chemotherapeutic agents.

#### DOSAGE FORMS

*G. lucidum* is usually prescribed in various forms. It may be injected as a solution of powdered spore. It may be ingested as a soup, syrup, tea, tablets, capsules, tincture, or bolus (powdered medicine in honey). The dose in tincture form (20%) is 10 ml three times daily, that of tablet is 1 g tablets three times daily, and syrup is 4–6 ml/day. As an antidote for ingestion of poisonous mushrooms, dried *G. lucidum* (120–200 g) is decocted in water and given as a drink 3–5 times daily.<sup>[3,5,10,11]</sup>

#### SAFETY PROFILE

Contraindications. None known.

#### Drug Interactions

Because reishi potentiates the immune system, caution is advised for those receiving immunosuppressive therapies.

#### SIDE EFFECTS

In oral dosages of 1.5–9 g/day, some patients, when initially taking a powder extract of reishi, have experienced temporary symptoms of sleepiness, thirst, rashes, bloating, frequent urination, abnormal sweating, and loose stools.<sup>[52]</sup> Large oral doses of vitamin C (6–12 g/day) taken at the same time as reishi powder extract (2–10 g/day) reportedly counteracted loose stools.<sup>[9,10,11,52]</sup>

The inhibition of platelet aggregation by *G. lucidum*<sup>[3,10,11]</sup> may present an additive effect in those taking blood thinning medications such as daily aspirin or warfarin.

Synergistic antimicrobial activity was shown with an aqueous extract of *G. lucidum* in combination with cefazolin against *Klebsiella oxytoca* ATCC 8724 and *Bacillus subtilis* ATCC 6603, *Staphylococcus aureus* ATCC 25923, *Escherichia coli* ATCC 25933, and *Salmonella typhi* ATCC 6509.<sup>[57]</sup>

#### TOXICITY

In animal experiments, *G. lucidum* extracts showed a very low toxicity.<sup>[3,5,10,11]</sup> There are few reported data on the long-term adverse effects on *G. lucidum* and its derivatives.

The aqueous extract of reishi administered to mice (5 g/kg p.o. for 30 days) produced no changes in body weight, organ weight, or hematological parameters. The polysaccharide fraction at the same dosage produced no lethal or serious effects.<sup>[21]</sup> The mushroom produced no changes in the estrus cycles of ovariectomized mice from a dosage of 10 g/kg p.o. and no increase in the weight of levator cavernosa and testicles in male mice from the same dosage. The LD<sub>50</sub> in mice of the reflux percolate was 38.3 ± 1.048 g/kg i.g. No organ toxicity was found in rabbits taking a syrup preparation of reishi (progressively dosed with 4–140 ml/kg p.o. daily for 10 days), or in dogs (2 ml/kg and 4 ml/kg p.o. daily for 10 days). An alcoholic extract (1.2 and 12 g/kg i.g. daily for 30 days) produced no signs of toxicity in young rats in DCG, major organs, hepatic function, growth, or development. Toxic reactions were absent in dogs administered an alcoholic extract (12 g/kg i.g. daily for 15 days and at 24 g/kg i.g. daily for 13 days); however, they did display lethargy.<sup>[10,11]</sup>

**Table 2** Current biomedical applications of *G. lucidum*

Applications	Observed effects
A. Cosmonaut training in Russia	<ol style="list-style-type: none"> <li>1. Improves work capacity</li> <li>2. Rapid recovery of normal physiology</li> </ol>
B. Usage with conventional treatment in cancer therapy	<ol style="list-style-type: none"> <li>1. Maintains leukocyte counts</li> <li>2. Enhances the immune system</li> <li>3. Reduces chemotherapy toxicity and elimination of induced leucopenia (low blood leukocytes) by chemotherapy and radiation</li> <li>4. Accelerates postsurgical recovery</li> <li>5. Sedation, pain relief and reduction of morphine dependence in terminal cancer patients</li> <li>6. Usage during remission to prevent relapses</li> </ol>
C. Cardiovascular disorders including	<ol style="list-style-type: none"> <li>1. Coronary dilation and increasing coronary circulation</li> <li>2. Increases frequency and amplitude of heart contraction</li> <li>3. Blood pressure regulation together with other medication</li> <li>4. Antihyperlipidemic, antihypoglycemic and antiplatelet aggregation (blood clots)</li> <li>5. Relief from oxygen deprivation</li> </ol>
D. Immunomodulation effects	<ol style="list-style-type: none"> <li>1. Anticancer</li> <li>2. Antiviral (e.g., anti-HIV)</li> <li>3. Antibacterial</li> <li>4. Anti-inflammatory</li> <li>5. Therapy of autoimmune disorders</li> <li>6. Inhibition of histamine release in allergy and prevention of anaphylactic shock</li> </ol>
E. Usage during remission of cancer and hepatitis B treatment	
F. Enhancing oxygen utilization	<ol style="list-style-type: none"> <li>1. Relief from discomfort of high-altitude stress, headaches, dizziness, nausea, and insomnia</li> <li>2. Relief of oxygen deprivation caused by coronary arteries blocked by atheromas, spasms, or clots</li> <li>3. Tolerance to hypobaric (low pressure) conditions</li> </ol>
G. Other examples	<ol style="list-style-type: none"> <li>1. Usage in combination with other medication</li> <li>2. Anti-aging, antioxidant free radical scavenger</li> <li>3. Antidiabetic</li> </ol>

(From Refs.<sup>[3,5,10,11,15–18,68]</sup>.)

To test the toxicity of wild reishi, fruit bodies harvested in a rural area of Hong Kong were prepared as a freeze-dried powder extract (yield: 1 g/20 g of freeze-dried fruit bodies and 50 ml of extract solution/100 g of freeze-dried fruit bodies). Examining acute toxicity, the extract solution (0.9259/kg) was administered to male mice at a dosage equivalent to the one commonly recommended by manufacturers of commercial concentrated extracts. Neither evidence of acute toxicity was found, nor was serum contents of

urea, GOT, or GPT significantly different compared to controls. No abnormalities were found in histological examinations of livers and kidneys, organ weights (liver, kidney, heart, lung, and spleen), or organ/body weight ratios compared to the control.<sup>[39]</sup>

Summarized data about *G. lucidum* biomedical applications are shown in Table 2. The observed effects include both clinical and preclinical observations, and the reader should refer to the preceding discussion of the various applications for more details.

## REFERENCES

1. Wasson, R.G. *Soma: Divine Mushroom of Immortality*; Harcourt Brace Jovanovich, Inc.: Los Angeles, CA, USA, 1968; 80–92.
2. Moncalvo, J.-M.; Ryvarden, L. *A Nomenclatural study of the Ganodermataceae Donk*; Synopsis Fungorum 11; Fungiflora: Oslo, Norway, 1997; 114.
3. Wasser, S.P.; Weis, A.L. *Medicinal Mushrooms. Ganoderma lucidum, (Curtis: Fr.), P. Karst*; Nevo, E., Eds.; Peledfus Publ House: Haifa, Israel, 1997; 39.
4. Chen, A.W. Cultivation of the medicinal mushroom *Ganoderma lucidum* (Curtis: Fr.), P. Karst (Reishi) in North America. *Int. J. Med. Mushrooms* **1999**, *1* (3), 263–282.
5. Stamets, P. *Growing Gourmet and Medicinal Mushrooms*, 3rd Ed.; Ten Speed Press: CA, USA, 2000.
6. Chang, S.T.; Buswell, J.A. *Ganoderma lucidum* (Curt.: Fr.) P. Karst. (Aphyllphoromycetideae)—a mushrooming medicinal mushroom. *Int. J. Med. Mushrooms* **1999**, *1* (2), 139–146.
7. Zhou, Sh.; Gao, Y. The immunomodulating effects of *Ganoderma lucidum* (Curt.: Fr.) P. Karst. (Ling Zhi, reishi mushroom) (Aphyllphoromycetideae). *Int. J. Med. Mushrooms* **2002**, *4* (1), 1–11.
8. Ying, J.; Mao, X.; Ma, Q.; Zong, Z.; Wen, H. *Icons of Medicinal Fungi from China*; Yuehan, X., Ed.; Science Press: Beijing, 1987. Translated.
9. Jong, S.C.; Birmingham, J.M. Medicinal benefits of the mushroom *Ganoderma*. *Adv. Appl. Microbiol.* **1992**, *37*, 101–134. Translated.
10. Hobbs, Ch. *Medicinal Mushrooms: An Exploration of Tradition, Healing, and Culture*, 2nd Ed.; Botanica Press, Inc.: Santa Cruz, CA, USA, 1995.
11. McKenna, D.J.; Jones, K.; Hughes, K. *Reishi Botanical Medicines. The Desk reference for Major Herbal Supplements*, 2nd Ed.; The Haworth Herbal Press: New York, London, Oxford, 2002; 825–855.
12. Hikino, H. Traditional remedies and modern assessment: the case of ginseng. In *The Medicinal Plant Industry*; Wijesekera, R.O.B., Ed.; CRC Press: Boca Raton, FL, USA; 149–166.
13. Liu, G.T. Recent advances in research of pharmacology and clinical applications of *Ganoderma* P. Karst. species (Aphyllphoromycetideae) in China. *Int. J. Med. Mushrooms* **1999**, *1* (1), 63–68.
14. Zhou, Sh.; Kestell, P.; Baguley, B.C.; Paxton, J.W. 5,6-Dimethylxanthenone-4-acetic acid: a novel biological response modifier for cancer therapy. *Invest. New Drugs* **2002**, *20*, 281–295.
15. Zhou, Sh.; Gao, Y.; Chen, G.; Dai, X.; Ye, J.; Gao, H. A phase I/II study of a *Ganoderma lucidum* (Curt.: Fr.) P. Karst. (Ling Zhi, reishi mushroom) extract in patients with chronic hepatitis B. *Int. J. Med. Mushrooms* **2002**, *4* (4), 321–328.
16. Gao, Y.; Zhou, Sh.; Chen, G.; Dai, X.; Ye, J. A phase I/II study of a *Ganoderma lucidum* (Curt.: Fr.) P. Karst. extract (ganopoly) in patients with advanced cancer. *Int. J. Med. Mushrooms* **2002**, *4* (3), 207–214.
17. Gao, Y.; Zhou, Sh.; Huang, M.; Xu, A. Antibacterial and antiviral value of the genus *Ganoderma* P. Karst. species (Aphyllphoromycetideae): a review. *Int. J. Med. Mushrooms* **2003**, *5* (3), 235–246.
18. Gao, Y.; Lan, J.; Dai, X.; Ye, J.; Zhou, Sh. A phase I/II study of Ling Zhi mushroom *Ganoderma lucidum*. (W. Curt.: Fr.) Lloyd (Aphyllphoromycetideae) extract in patients with type II diabetes mellitus. *Int. J. Med. Mushrooms* **2004**, *6* (1).
19. Hsu, H.Y., Chen, Y.P., Shen, S.J., Hsu, C.S., Chen, C.C., Chang, H.C., Eds.; *Oriental Materia Medica: A Concise Guide*, Oriental Healing Arts Institute: Long Beach, CA, USA, 1985; 640–641.
20. Mizuno, T. Reishi, *Ganoderma lucidum* and *Ganoderma tsugae*: bioactive substances and medicinal effects. *Food Rev. Int.* **1995**, *11* (1), 151–166.
21. Kim, H.W.; Kim, B.K. Biomedical triterpenoids of *Ganoderma lucidum* (Curt.: Fr.) P. Karst. (Aphyllphoromycetideae). *Int. J. Med. Mushrooms* **1999**, *1* (2), 121–138.
22. Min, B.S.; Nakamura, N.; Miyashiro, H.; Bae, K.W.; Hattori, M. Triterpens from the spores of *Ganoderma lucidum* and their inhibitory activity against HIV-1 protease. *Chem. Pharm. Bull.* **1999**, *46*, 1607–1612.
23. Min, B.S.; Gao, J.J.; Nakamura, N.; Hattori, M. Triterpenes from the spores of *Ganoderma lucidum* and their cytotoxicity against meth-A and LLC tumor cells. *Chem. Pharm. Bull.* **2000**, *48*, 1026–1033.
24. Chen, J.H.; Zhou, J.P.; Zhang, L.N.; Nakamura, Y.; Norisuye, T. Chemical structure of the water-insoluble polysaccharide isolated from the fruiting body of *Ganoderma lucidum*. *Poly. J.* **1998**, *30*, 838–842.
25. Wasser, S.P.; Weis, A.L. Medicinal properties of substances occurring in higher Basidiomycetes mushrooms: current perspectives (review). *Int. J. Med. Mushrooms* **1999**, *1* (1), 31–62.
26. Cheong, J.; Jung, W.; Park, W. Characterization of an alkali-extracted peptidoglycan from Korean *Ganoderma lucidum*. *Arch. Pharm. Res.* **1999**, *22*, 515–519.

27. Ooi, V.E.C.; Liu, F. Immunomodulation and anti-cancer activity of polysaccharide-protein complexes. *Curr. Med. Chem.* **2000**, *7*, 715–729.
28. Wang, Y.Y.; Khoo, K.H.; Chen, S.T.; Lin, C.C.; Wong, C.H.; Lin, C.H. Studies on the immunomodulating and antitumor activities of *Ganoderma lucidum* (Reishi) polysaccharides: functional and proteomic analyses of a fucose-containing glycoprotein fraction responsible for the activities. *Bioorg. Med. Chem.* **2002**, *10*, 1057–1062.
29. Kawagishi, H.; Mitsunaga, S.; Yamawaki, M.; Ido, M.; Shimada, A.; Kinoshita, T.; Murata, T.; Usui, T.; Kimura, A.; Chiba, S. A lectin from mycelia of the fungus *Ganoderma lucidum*. *Phytochemistry* **1997**, *44*, 7–10.
30. Wasser, S.P. Medicinal mushrooms as a source of antitumor and immunomodulating polysaccharides. *Appl. Microbiol. Biotechnol.* **2002**, *60*, 258–274.
31. Toth, J.O.; Luu, B.; Ourisson, G. Ganoderic acid T and Z: cytotoxic triterpenes from *Ganoderma lucidum* (Polyporaceae). *Tetrahedron Lett.* **1983**, *24*, 1081–1084.
32. Lin, C.N.; Tome, W.P.; Won, S.J. Novel cytotoxic principles of Formosan *Ganoderma lucidum*. *J. Nat. Prod.* **1991**, *54*, 998–1002.
33. Konopski, Z.; Smedsrod, B.; Seljelid, R.; Eskelend, T. A novel immunomodulator soluble aminated  $\beta$ -1,3-D-glucan: binding characteristics to mouse peritoneal macrophages. *Biochim. Biophys. Acta Mol. Cell. Res.* **1994**, *1221*, 61–65.
34. Battle, J.; Ha, T.Z.; Li, C.F.; Dellabeffa, V.; Rice, P.; Kalbfleisch, J.; Browder, W.; Williams, D. Ligand binding to the (1,3)-beta-D-glucan receptor stimulates NF-kappa B activation, but not apoptosis in U937 cells. *Biochem. Biophys. Res. Commun.* **1998**, *249*, 499–504.
35. Mueller, A.; Raptis, J.; Rice, P.J.; Kalbfleisch, J.H.; Stout, R.D.; Ensley, H.E.; Browder, W.; Williams, D.L. The influence of glucan polymer structure and solution conformation on binding to (1,3)-beta-D-glucan receptors in a human monocyte-like cell line. *Glycobiology* **2000**, *10*, 339–346.
36. Zhong, L.; Jiang, D.Z.; Wang, Q.R. Effects of *Ganoderma lucidum* (Leyss ex Fr.) Karst. compound on the proliferation and differentiation of K652 leukemic cells. *J. Hunan Med. Univ.* **1999**, *24*, 521–524.
37. Wang, S.Y.; Hsu, M.L.; Hsu, H.C.; Tzeng, H.C.; Lee, S.S.; Shiao, M.S.; Ho, C.K. The anti-tumor effect of *Ganoderma lucidum* is mediated by cytokines released from activated macrophages and T lymphocytes. *Int. J. Cancer* **1997**, *70*, 699–705.
38. Mizushina, Y.; Hanashima, L.; Yamaguchi, T.; Takemura, M.; Sugawara, F.; Saneyoshi, M.; Matsukage, A.; Yoshida, S.; Sakagushi, K. A mushroom fruiting body-inducing substance inhibits activities of replicative DNA polymerases. *Biochem. Biophys. Res. Commun.* **1998**, *249*, 17–22.
39. Chiu, S.W.; Wang, Z.M.; Leung, T.M.; Moore, D. Nutritional value of *Ganoderma* extract and assessment of its genotoxicity and antigenotoxicity using comet assays of mouse lymphocytes. *Food Chem. Toxicol.* **2000**, *38*, 173–178.
40. Lu, Z.W. Psychoneuroimmunological effects of morphine and the immunoprotection of *Ganoderma* polysaccharides peptide in morphine-dependent mice. *Chin. J. Physiol.* **1995**, *26*, 45–49.
41. Lee, S.; Park, S.; Oh, J.W.; Yang, C.H. Natural inhibitors for protein prenyltransferase. *Planta Med.* **1998**, *54*, 303–308.
42. Van der Hem, L.G.; van der Vliet, J.A.; Bocken, C.F.; Kino, K.; Hoitsma, A.J.; Tax, W.J. Ling Zhi-8: studies of a new immunomodulating agent. *Transplantation* **1995**, *60*, 438–443.
43. Mao, T.; van De Water, J.; Keen, C.L.; Stern, J.S.; Hackman, R.; Gershwin, M.E. Two mushrooms, *Grifola frondosa* and *Ganoderma lucidum*, can stimulate cytokine gene expression and proliferation in human T lymphocytes. *Int. J. Immunother.* **1999**, *15*, 13–22.
44. Haak-Frendscho, M.; Kino, K.; Sone, T.; Jardieu, P. Ling Zhi-8: a novel T cell mutagen induces cytokine production and upregulation of ICAM-1 expression. *Cell Immunol.* **1993**, *150*, 101–113.
45. Han, M.D.; Lee, E.S.; Kim, Y.K.; Lee, J.W.; Jeong, H.; Yoon, K.H. Production of nitric oxide in RAW 264.7 macrophages treated with ganoderan, the beta-glucan of *Ganoderma lucidum*. *Korean J. Mycol.* **1998**, *26*, 246–255.
46. Oh, J.Y.; Cho, K.J.; Chung, S.H.; Kim, J.H.; Lillehoj, H.S.; Chung, K.S. Activation of macrophages by GLB, a protein-polysaccharide of the growing tips of *Ganoderma lucidum*. *Yakhak Hoeji* **1998**, *42*, 302–306.
47. Pandha, H.S.; Kirby, R.S. PC-SPES: phytotherapy for prostate cancer. *Lancet* **2002**, *359*, 2213–2215.
48. Pfeifer, B.L.; Pirani, J.F.; Hamann, S.R.; Klippel, K.F. PC-SPES, a dietary supplement for the treatment of hormone-refractory prostate cancer. *BJU Int.* **2000**, *85*, 481–485.
49. Small, E.J.; Frohlich, M.W.; Bok, R.; Shinohara, K.; Grossfield, G.; Rozenblat, Z.; Kelly, W.K.; Corry, M.; Reese, D.M. Prospective trial of the herbal supplement PC-SPES in patients with progressive prostate cancer. *J. Clin. Oncol.* **2000**, *18*, 3595–3603.

50. Smith, D.C.; Redman, B.G.; Flaherty, L.E.; Li, L.; Strawderman, M.; Pienta, K.J. A phase II trial of oral diethylstilbesterol as a second line hormonal agent in advanced prostate cancer. *Urology* **1998**, *52*, 257–260.
51. Kabir, Y.; Kimura, S.; Tamura, T. Dietary effect of *Ganoderma lucidum* mushroom on blood pressure and lipid levels in spontaneously hypertensive rats (SHR). *J. Nutr. Sci. Vitaminol.* **1988**, *34*, 433–438.
52. Soo, T.S. Effective dosage of the extract of *Ganoderma lucidum* in the treatment of various ailments. In *Mushroom Biology and Mushroom Products*; Royse, Ed.; The Pennsylvania State University, 1996; 177–185.
53. Lee, S.Y.; Rhee, H.M. Cardiovascular effects of mycelium extract of *Ganoderma lucidum*: inhibition of sympathetic outflow as a mechanism of its hypotensive action. *Chem. Pharm. Bull. (Tokyo)* **1990**, *38*, 1359–1364.
54. Jin, H.; Zhang, G.; Cao, X.; Zhang, M.; Long, J.; Luo, B.; Chen, H.; Qian, S.; Mori, M.; Wang, Z. Treatment of hypertension by Linzhi combined with hypotensor and its effects on arterial, arteriolar and capillary pressure microcirculation. In *Microcirculatory Approach to Asian Traditional Medicine: Strategy for the Scientific Evaluation*; Excerpta Medica, International Congress Series 1117; Elsevier: Amsterdam, NY, 1996; 131–138.
55. Smith, J.; Rowan, N.; Sullivan, R. *Medicinal Mushrooms. Their Therapeutic Properties and Current Medical Usage with Special Emphasis on Cancer Treatment*; Special Report Commissioned by Cancer Research UK; The University of Strathclyde in Glasgow, 2002; 256.
56. Suay, I.; Arenal, F.; Asensio, F.J.; Basilio, A.; Cabello, M.A.; Diez, M.T.; Garcia, J.B.; del Val, A.G.; Corrochategui, J.; Hernandez, P.; Pelaez, F.; Vicente, M.F. Screening of Basidiomycetes for antimicrobial activities. *Antonie van Leeuwenhoek* **2000**, *78*, 129–139.
57. Yoon, S.Y.; Eo, S.K.; Kim, Y.S.; Lee, C.K.; Han, S.S. Antimicrobial activity of *Ganoderma lucidum* extract alone and in combination with some antibiotics. *Arch. Pharm. Res.* **1994**, *17*, 438–442.
58. Kim, D.H.; Bae, E.A.; Jang, I.S.; Han, M.J. Anti-*Helicobacter pylori* activity of mushrooms. *Arch. Pharm. Res.* **1996**, *19*, 447–449.
59. Barre-Sinoussi, F.; Chermann, J.C.; Rey, F.; Nugeyre, M.T.; Chamaret, S.; Gruest, J.; Dauguet, C.; Axler-Blin, C.; Vezinet-Brun, F.; Rouzioux, C.; Rozenbaum, W.; Montagnier, L. Isolation of a T-lymphotropic retrovirus from a patient at risk for acquired immune deficiency syndrome (AIDS). *Science* **1983**, *220*, 868–971.
60. Matsushita, S.; Kimura, T. Advance in treatment strategy and immune reconstruction against HIV1 infection. *Microbiol. Immunol.* **2002**, *46*, 231–239.
61. Menendez-Arias, L. Targeting HIV: antiretroviral therapy and development of drug resistance. *Trends Pharmacol. Sci.* **2002**, *23*, 381–388.
62. Vermani, K.; Garg, S. Herbal medicines for sexually transmitted diseases and AIDS. *J. Ethnopharmacol.* **2002**, *80*, 49–66.
63. Kim H.W.; Shim, M.J.; Choi, E.C.; Kim, B.K. Inhibition of cytopathic effect of human immunodeficiency virus-1 by water-soluble extract of *Ganoderma lucidum*. *Arch. Pharm. Res.* **1997**, *20*, 425–431.
64. Eo, S.K.; Kim, Y.S.; Lee, C.K.; Han, S.S. Antiherpetic activities of various protein bound polysaccharides isolated from *Ganoderma lucidum*. *J. Ethnopharmacol.* **1999**, *68*, 175–181.
65. Eo, S.K.; Kim, Y.S.; Lee, C.K.; Han, S.S. Possible mode of antiviral activity of acidic protein bound polysaccharide isolated from *Ganoderma lucidum* on herpes simplex viruses. *J. Ethnopharmacol.* **2000**, *72*, 475–481.
66. Mizushima, Y.; Takahashi, N.; Hanashima, L.; Koshino, H.; Esumi, Y.; Uzawa, J.; Sugawara, F.; Sakagushi, K. Lucidenic acid O and lactone, new terpene inhibitors of eukaryotic DNA polymerases from a basidiomycete, *Ganoderma lucidum*. *Bioorg. Med. Chem.* **1999**, *7*, 2047–2052.
67. Wills, R.B.H.; Bone, K.; Morgan, M. Herbal products: active constituents, modes of action and quality control. *Nutr. Res. Rev.* **2000**, *13*, 47–77.
68. Chen, A.W.; Miles, Ph. Biomedical research and the application of mushroom nutraceuticals from *Ganoderma lucidum*. In *Mushroom Biology and Mushroom Products*; Royse, Ed.; 1996, 161–175.

# Riboflavin

**Richard S. Rivlin**

*Clinical Nutrition Research Unit, Institute for Cancer Prevention, New York, New York, U.S.A.*

## INTRODUCTION

Vitamins were discovered more than a hundred years ago and their specific chemical composition identified during the first half of the 20th century, but we are still defining their mechanisms of action at the molecular, physiological, and clinical levels. In particular, we are just beginning to learn how vitamins may play a role in chronic diseases, such as cancer, cardiovascular disease, metabolic bone disorders, inflammation, and infections.

## BACKGROUND

These considerations are particularly relevant to riboflavin, which was discovered in the early part of the 20th century<sup>[1-3]</sup>. Its structure was later identified,<sup>[4,5]</sup> its synthesis achieved,<sup>[6,7]</sup> and its coenzyme derivatives described in 1937<sup>[8]</sup> and 1938.<sup>[9]</sup> More recently, the role of this vitamin in homocysteine metabolism has become more widely appreciated.<sup>[10]</sup> Acting in concert with folic acid, vitamin B6, and vitamin B12, it lowers serum levels of homocysteine.

Riboflavin deficiency, when it occurs, has traditionally been attributed to a daily diet that contains inadequate amounts of this vitamin. In our view, insufficient attention has been paid to the many factors, both physiological and pathological, that influence the utilization of this vitamin in health and disease. Thus, a physiological state of riboflavin deficiency can result from the effects of certain drugs, hormones, and other factors in addition to a poor diet.

## BIOCHEMISTRY AND FUNCTIONS

Chemically, riboflavin is 7,8-dimethyl-10-(1'-D-ribityl)-isoalloxazine. The isoalloxazine ring is a planar structure that is also shared by the two major coenzyme derivatives formed from riboflavin, namely flavin

mononucleotide or riboflavin-5'-phosphate (FMN) and flavin adenine dinucleotide (FAD). These structures are shown in Fig. 1.

A small proportion of the flavin coenzymes are linked covalently with tissue proteins,<sup>[11]</sup> including some vital enzymes, such as sarcosine dehydrogenase, succinic dehydrogenase, and monoamine oxidase. Unlike humans, who cannot synthesize ascorbic acid from its precursors, some species of mammals have large amounts of the microsomal ascorbic-acid-synthesizing enzyme, L-gulonolactone oxidase, which contains covalently bound flavins.

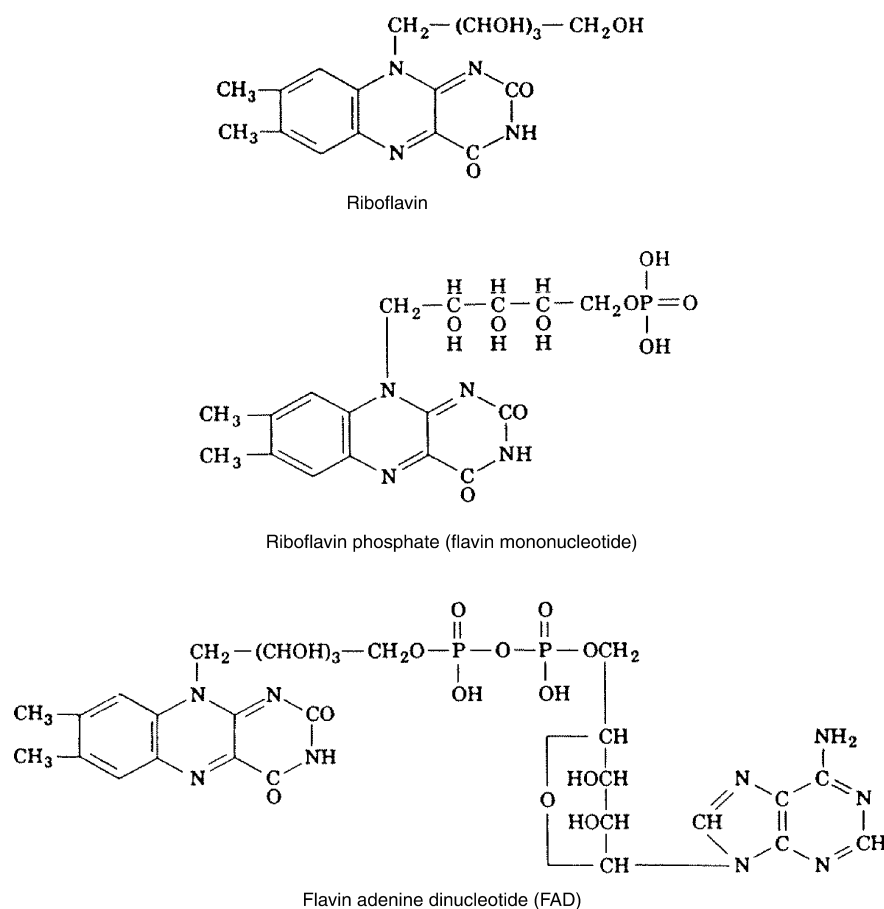
The sequence of events in the synthesis of the flavin coenzymes from riboflavin is that the first biosynthetic enzyme, flavokinase, catalyzes the initial phosphorylation of riboflavin by ATP to FMN (Fig. 2). A fraction of FMN is directly utilized in this form as a coenzyme. The largest fraction, however, combines with a second molecule of ATP to form FAD, the predominant tissue flavin, in a reaction catalyzed by FAD synthetase, also known as FAD pyrophosphorylase. The covalent attachment of flavins to specific tissue proteins occurs after FAD has been synthesized.<sup>[12,13]</sup> A sequence of phosphatases reconverts FAD to FMN and FMN, in turn, to riboflavin.<sup>[14]</sup> Most flavoproteins utilize FAD rather than FMN as coenzyme for a wide variety of metabolic reactions. Microsomal NADPH-cytochrome P450 reductase is highly unusual in containing both FMN and FAD in equimolar ratios.

Riboflavin is yellow and has a high degree of natural fluorescence when excited by UV light, a property that can be utilized conveniently in its assay. There are a number of variations in structure of the naturally occurring flavins. Riboflavin and its coenzymes are sensitive to alkali and acid, particularly in the presence of UV light. Under alkaline conditions, riboflavin is photodegraded to yield lumiflavin (7,8,10-trimethyl-isoalloxazine), which is inactive biologically. Riboflavin is degraded by light to form lumichrome (7,8-dimethylalloxazine) under acidic conditions, a product that is also biologically inactive.<sup>[10]</sup>

Thus, an important physical property of riboflavin and its derivatives is their sensitivity to UV light, resulting in rapid inactivation. Therefore, prolonged phototherapy of neonatal jaundice and of certain skin disorders may promote the development of systemic riboflavin deficiency. The structure-function

*Richard S. Rivlin, M.D.*, is at the Clinical Nutrition Research Unit, Institute for Cancer Prevention, New York, New York, U.S.A.





**Fig. 1** Structures of riboflavin, riboflavin-5'-phosphate (flavin mononucleotide, FMN), and flavin adenine dinucleotide (FAD).

relationships of the various biologically active flavins have been comprehensively reviewed.<sup>[13]</sup> One physical property of riboflavin needs emphasis, namely, its very limited water solubility, which greatly restricts its use as a parenteral supplement and as an oral supplement as well.

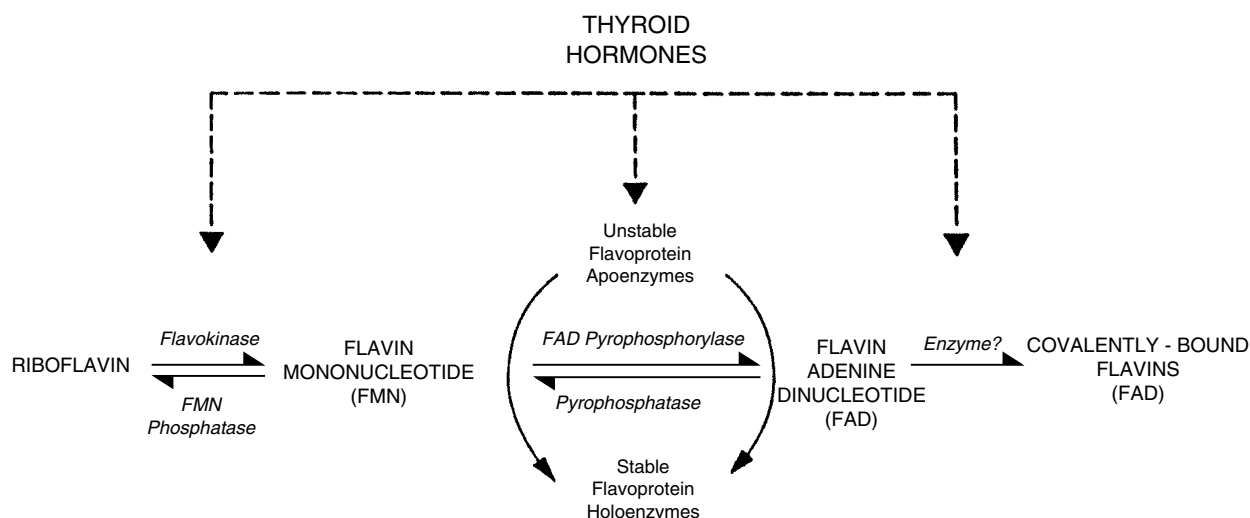
The flavin coenzymes FMN and FAD, as well as the fraction of flavins bound covalently to tissue proteins, function in a wide array of processes in intermediary metabolism, most notably in oxidation-reduction reactions. FAD is an inherent component of the respiratory chain and therefore is closely involved in the generation of energy. Flavin coenzymes participate in drug and steroid metabolism together with the cytochrome P450 enzymes. Flavins have critical roles in fat metabolism. One-electron transfers and two-electron transfers from substrate to FMN and FAD constitute the major redox functions of these flavin coenzymes.<sup>[10]</sup> Other reactions catalyzed by flavoproteins include dehydrogenation, oxidative decarboxylation, dioxygenation, and reduction of oxygen to hydrogen peroxide.

## RIBOFLAVIN DEFICIENCY

With the onset of riboflavin deficiency, there are a number of metabolic adaptations that occur to con-

serve the limited reserves. One of the adaptations is a fall in the small hepatic pool of free riboflavin to nearly undetectable levels, with a relative sparing of the pools of FMN and FAD.<sup>[15]</sup> These coenzymes are needed to fulfill critical metabolic functions, whereas the vitamin itself has little biological activity. Another adaptation to deficiency in its early stages is an increased de novo synthesis of reduced glutathione (GSH) from its amino acid precursors. This effect may occur in response to the diminished reconversion of oxidized glutathione (GSSG) to its reduced form. In riboflavin deficiency, the activity of glutathione reductase, a key FAD-requiring enzyme, is greatly lessened. Reduced glutathione levels may be maintained if the increased capacity to synthesize GSH de novo is adequate to meet the mounting needs.

There is increasing evidence for the emerging concept that dietary inadequacy is not the only cause of deficiency and that certain endocrine abnormalities, such as adrenal and thyroid hormone insufficiency, certain drugs, and diseases may interfere significantly with vitamin utilization.<sup>[16,17]</sup> Psychotropic drugs, such as chlorpromazine, antidepressants (including imipramine and amitriptyline<sup>[18]</sup>), cancer chemotherapeutic drugs (e.g., adriamycin), and some antimalarial agents (e.g., quinacrine<sup>[19]</sup>) impair riboflavin utilization by



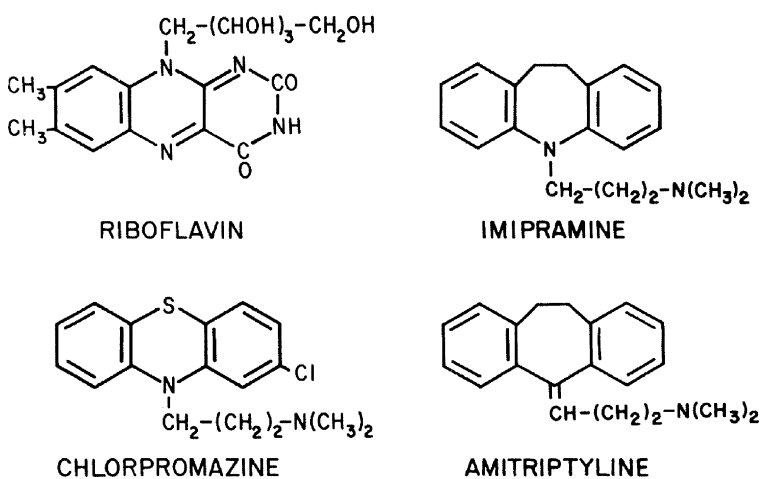
**Fig. 2** Sequence of events in the formation of FMN, FAD, and covalently bound flavins from riboflavin and its regulation by thyroid hormones. Thyroid hormones stimulate the activity of flavokinase and FAD pyrophosphorylase as well as the formation of covalently bound flavins. The combination of unstable apoenzymes with their flavin cofactors converts them into stable flavoprotein holoenzymes.

inhibiting the conversion of this vitamin into its active coenzyme derivatives. Fig. 3 shows the structural similarities among riboflavin, imipramine, chlorpromazine, and amitriptyline.

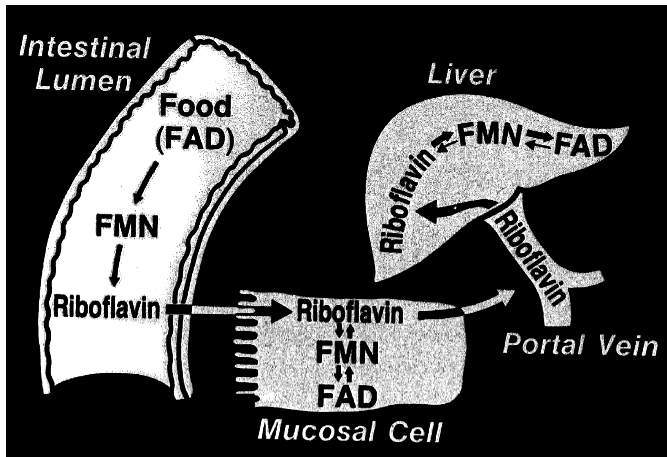
Riboflavin deficiency commonly occurs in patients who abuse alcohol chronically. Alcohol causes shortage of the vitamin by inhibiting both its digestion from dietary sources, which are largely in the form of FAD, and its intestinal absorption (Fig. 4).<sup>[20]</sup> These findings suggest that improvement of the riboflavin nutrition of alcoholics can be accomplished more rapidly and effectively by administering vitamins in pure form, as in supplements, rather than entirely from food sources. Furthermore, in riboflavin-deficient animals, decreased GSH concentrations as well as decreased activities of

GSH peroxidase, glutathione reductase, and glucose-6-phosphate dehydrogenase (G6PD) occur. These findings strongly indicate that the combination of riboflavin deficiency and alcohol administration not only lowers hepatic GSH concentrations, but also inhibits enzymes controlling GSH metabolism and therefore may intensify the hepatic injury induced by excessive alcohol consumption. The consequences of a poor diet in a patient abusing alcohol may be exacerbated by the use of certain drugs for prolonged periods.

In experimental animals, hepatic architecture is markedly disrupted in riboflavin deficiency. Mitochondria in riboflavin-deficient mice increase greatly in size, and cristae increase in both number and size.<sup>[21]</sup> These structural abnormalities may disturb energy



**Fig. 3** Structural similarities among riboflavin, chlorpromazine, imipramine, and amitriptyline.



**Fig. 4** Digestion of food sources of flavins to riboflavin, which is transported across the intestinal mucosa and rephosphorylated in the mucosal cell. Riboflavin bound to serum proteins is transferred to the liver, where it is rephosphorylated to FMN and FAD.

metabolism by interfering with the electron transport chain and metabolism of fatty acids. Villi decrease in number in the rat small intestine; villus length increases, as does the rate of transit of developing enterocytes along the villus.<sup>[22]</sup> These findings of structural abnormalities together with accelerated rate of intestine cell turnover<sup>[23]</sup> may help to explain why dietary riboflavin deficiency leads to both decreased iron absorption and increased iron loss from the intestine.

Deficiency has many other effects on intermediary metabolism, particularly on lipid, protein, and vitamin metabolism. Of particular relevance to vitamin metabolism is the fact that the conversion of vitamin B6 to its coenzyme derivative, pyridoxal-5'-phosphate, may be impaired.<sup>[24]</sup> Riboflavin deficiency has been studied in many animal species and has several consequences, foremost of which is failure of growth. Additional effects include loss of hair, skin disturbances, degenerative changes in the nervous system, and impaired reproduction. Congenital malformations occur in the offspring of female rats that are riboflavin deficient. The conjunctiva becomes inflamed, the cornea is vascularized and eventually opaque, and cataract may result.<sup>[25]</sup>

Changes in the skin consist of scaliness and incrustation of red-brown material consistent with changes in lipid metabolism. Alopecia may develop, lips become red and swollen, and filiform papillae on the tongue deteriorate. During late deficiency, anemia develops. Fatty degeneration of the liver occurs. Important metabolic changes occur, so that deficient rats require 15–20% more energy than control animals to maintain the same body weight. In all species studied to date, riboflavin deficiency causes profound structural and functional changes in an ordered sequence. Early changes are very readily reversible. Later anatomical changes, such as formation of cataract, are largely irreversible despite treatment with riboflavin.<sup>[25]</sup>

Clinically, riboflavin deficit is not detectable at the bedside by any unique or characteristic physical features. The classical symptoms of glossitis, angular stomatitis, and dermatitis are not specific to riboflavin deficiency and may be observed in other vitamin deficiencies as well. When dietary deficiency of riboflavin occurs, it is almost invariably associated with multiple nutrient deficits.<sup>[26]</sup>

The syndrome of dietary riboflavin deficiency in humans has many similarities to that in animals, with one notable exception. The spectrum of congenital malformations observed in rodents with maternal riboflavin deficiency has not been clearly identified in humans.<sup>[27]</sup>

## ANTIOXIDANT POTENTIAL

As a precursor to FMN and FAD, riboflavin is a significant contributor to antioxidant activity. Riboflavin itself has little inherent antioxidant action, but the glutathione redox cycle<sup>[28]</sup> has a major protective role against lipid peroxides. Glutathione peroxidase degrades reactive lipid peroxides. This enzyme requires GSH as a substrate, which is regenerated *in vivo* by reduction from its oxidized form (GSSG) by glutathione reductase, a well-recognized FAD-containing enzyme, as noted above.

It is for this reason that riboflavin deficiency is expected to lead to reduced antioxidant defense capabilities, as has been demonstrated in several independent studies.<sup>[29,30]</sup> Increased lipid peroxidation has been reported in experimental riboflavin deficiency, with a return towards normal after supplementation with this vitamin.<sup>[29,32]</sup> Both basal and stimulated lipid peroxidation are increased in deficiency of the vitamin.<sup>[33]</sup>

Furthermore, the reducing equivalents provided by NADPH, the other substrate required by glutathione

reductase, are primarily generated by an enzyme of the pentose monophosphate shunt, glucose-6-phosphate dehydrogenase. Taniguchi and Hara,<sup>[31]</sup> as well as our laboratory,<sup>[32]</sup> have found that the activity of this enzyme is significantly diminished during riboflavin deficiency. This observation provides an additional mechanism to explain the diminished glutathione reductase activity in vivo during riboflavin deficiency and the eventual decrease in antioxidant capacity.

## HOMOCYSTEINE METABOLISM

There is much contemporary interest in the increasingly persuasive evidence that homocysteine has a role in the pathogenesis of vascular disease, including cardiovascular, cerebrovascular, and peripheral vascular disorders.<sup>[34]</sup> A simplified sequence of homocysteine metabolism is shown in Fig. 5, illustrating the sites of action of vitamins B<sub>6</sub> and B<sub>12</sub>, folic acid, and riboflavin. Blood levels of folic acid sensitively determine serum homocysteine concentrations.<sup>[35]</sup> *N*-5-Methyltetrahydrofolate is a cosubstrate with homocysteine in its inactivation by conversion to methionine. Methylcobalamin is also a coenzyme in this enzymatic reaction. Vitamin B<sub>6</sub> is widely recognized for its importance in the inactivation of homocysteine by serving as coenzyme of two degradative enzymes, cystathionine- $\beta$ -synthase and cystathioninase.

However, in our view, there is insufficient appreciation of the fact that riboflavin also plays a vital role in homocysteine metabolism. The flavin coenzyme FAD is required by methylenetetrahydrofolate reductase (MTHFR), the enzyme responsible for converting *N*-5,10-methylenetetrahydrofolate to *N*-5-methyltetrahydrofolate. Thus, the efficient utilization of dietary folic acid requires adequate riboflavin nutrition. As expected, therefore, riboflavin deficiency reduces the

activity of MTHFR and inhibits folic acid metabolism in rats.<sup>[36]</sup> As a consequence of this effect, plasma homocysteine levels rise.<sup>[37]</sup> In a large cohort of subjects in the Framingham Offspring Study, the more deficient the individual as measured by the erythrocyte glutathione reductase activity coefficient (EGRAC), the higher the serum homocysteine concentration, particularly in those with compromised folate status.<sup>[38]</sup>

It is relevant to note in this context that there is a genetic variant of the methylenetetrahydrofolate reductase gene (677  $\rightarrow$  T) that is common in the Caucasian population.<sup>[39]</sup> Individuals homozygous (TT) for this gene have approximately half the normal activity of the enzyme and are predisposed to develop elevated serum concentrations of homocysteine.<sup>[37]</sup> It is of interest that one group of investigations found an inverse correlation between plasma homocysteine and plasma riboflavin in individuals both with and without the genetic variation.<sup>[40]</sup> Further research is required to determine whether the serum levels of homocysteine and the prevalence of vascular disease can be correlated directly with indices of riboflavin nutrition, and whether effects of marginal as well as overt deficiency of riboflavin are clinically significant with respect to vascular disease.

## FAT METABOLISM

The vital role of riboflavin in fat metabolism has been highlighted by recent demonstrations that in certain rare inborn errors, administration of the vitamin may be therapeutic. In acyl-CoA dehydrogenase deficiency, infants present with recurrent hypoglycemia, lipid storage myopathy, and increased urinary excretion of organic acids. Clinical improvement has occurred rapidly after riboflavin supplementation.<sup>[41,42]</sup> Three varieties of the disorder occur, all of which involve flavoproteins of various types. Several patients with a

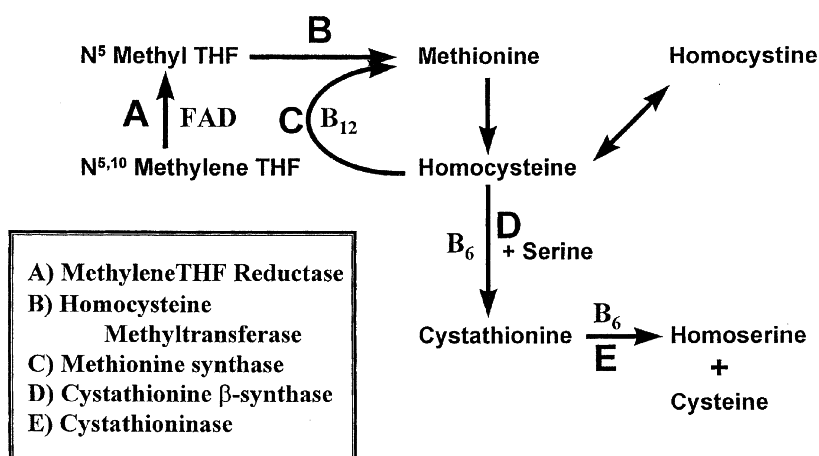


Fig. 5 Simplified representation of homocysteine metabolism to illustrate the sites of action of vitamins B<sub>6</sub>, B<sub>12</sub>, folic acid and riboflavin.

mitochondrial disorder associated with NADH dehydrogenase deficiency showed improvement with riboflavin treatment.<sup>[43]</sup>

In patients with HIV infection, riboflavin administered together with thiamin has been noted to prevent elevation of levels of lactic acid and lactic acidosis.<sup>[44]</sup> In other studies of patients with HIV, riboflavin has potential in managing lactic acidosis induced by treatment of the underlying disease with nucleoside analog.<sup>[45,46]</sup> In addition, riboflavin has benefited Asian cases of ethylmalonic acid encephalopathy.<sup>[47]</sup> Therefore, this vitamin as a supplement has a role in the management of certain rare inborn errors of fat metabolism.

## ANEMIA

Anemia is a characteristic feature in many vitamin deficiencies, and it is usually multifactorial in pathogenesis. Nevertheless, there appears to be a relatively specific anemia occurring in riboflavin-deficient individuals that responds to supplementation with the vitamin.<sup>[48]</sup> The anemia is associated with erythroid hypoplasia, and as a consequence, there is diminished reticulocytosis.

A major effect of riboflavin deficiency in the pathogenesis of anemia appears to be that on iron metabolism.<sup>[49]</sup> It influences tissue mobilization of iron from ferritin, particularly in the gastrointestinal mucosa.<sup>[50]</sup> In addition, it now appears that the deficiency leads to a decrease in the intestinal absorption of the element<sup>[51]</sup> as well as an increase in its loss from the gastrointestinal tract.<sup>[52]</sup>

These mechanisms have been elucidated in rodents. Their relevance to the pathogenesis of anemia in humans remains to be firmly established. It is evident, nevertheless, that riboflavin supplementation does improve hematological function in humans, and likely has an effect on improving the metabolism of iron.<sup>[49]</sup>

## CARCINOGENESIS

More recent studies<sup>[53]</sup> confirm earlier reports<sup>[54]</sup> that riboflavin deficiency may favor cancer formation by increasing the activation of certain carcinogens, particularly nitrosamines. The flavin vitamin may possibly provide protection against the damage to DNA caused by a number of carcinogens through its action as a coenzyme with a variety of cytochrome P450 enzymes. Furthermore, deficiency enhances the covalent binding of carcinogens to DNA.<sup>[55]</sup>

It is important to establish more firmly the potential role of riboflavin as a dietary factor capable of preventing carcinogenesis while at the same time determining

the full implications of the photosensitizing actions of flavins on mutagenesis and carcinogenesis. There are reports from China<sup>[56,57]</sup> and Russia<sup>[58]</sup> raising the possibility that deficient riboflavin nutritional status, together with shortages of other vitamins, may possibly enhance development of precancerous lesions of the esophagus.

Due to their photodynamic actions, flavins may have potential efficacy as adjuncts in cancer treatment. Blue light has been reported to inhibit the proliferation of B16 melanoma cells grown in culture, as well as those transplanted to rodent models.<sup>[59]</sup> It has both cytostatic and cytotoxic properties.

Riboflavin is the only vitamin that has been observed to increase the degree of cell necrosis induced by blue light. The efficacy of riboflavin is concentration dependent and antagonized by catalase. Ohara et al. have postulated that riboflavin, by reacting with blue light to form active oxygen intermediate, may cause a greater degree of cell necrosis than blue light alone.<sup>[59]</sup>

These considerations suggest that riboflavin deficiency may play a role in carcinogenesis. Clearly, more research needs to be done before this vitamin can be recommended for cancer prevention for large populations at risk.

## ASSESSMENT AND DIETARY RECOMMENDATIONS

A variety of methods are available for the analysis of riboflavin and its coenzyme derivatives. Fluorometric procedures take advantage of the inherent fluorescent properties of flavins.<sup>[60]</sup> Some degree of purification of the urine or tissues may be required before analysis is undertaken. There is often significant interference by other natural substances that leads to quenching of fluorescence and methodological artifacts. Riboflavin can be measured by competitive protein binding which is applicable to studies in human urine.<sup>[61]</sup> Riboflavin binds specifically to the avian egg white riboflavin-binding protein<sup>[62]</sup> and thereby provides the basis for quantitative analysis. Currently, procedures using high-performance liquid chromatography (HPLC) have been widely applied as they have a high degree of precision and can be utilized for the analysis of riboflavin in pure form as well as in biological fluids and tissues.<sup>[63]</sup> HPLC is the method most widely employed for the determination of flavins in the blood and in other tissues.

In clinical studies that involve individual patients as well as population groups, the status of riboflavin nutrition is generally evaluated by determining the urinary excretion of riboflavin and EGRAC.<sup>[64]</sup> Urinary riboflavin determinations may be done in the basal

state, in random samples, in 24-hr collections, or after a riboflavin load test. Normal excretion in the urine is approximately 120  $\mu\text{g/g}$  creatinine per 24 hr or higher.<sup>[64]</sup> It is useful to express the value in terms of creatinine to verify the completeness of the collection and to relate excretion to this biological parameter. Expressed in terms of the total amount, riboflavin excretion in the normal adult is about 1.5–2.5 mg/day, which is very close to the recommended dietary allowance (RDA) of the National Academy of Sciences.<sup>[65]</sup> In deficient adult individuals, outflow with urine is reduced to about 40  $\mu\text{g/g}$  creatinine per 24 hr.

Individuals deficient in riboflavin have reduced urinary excretion, reflecting diminished dietary intake and depleted body stores. Excretion is reduced with age and is stimulated by elevated body temperature as well as treatment with certain drugs, and by various stressful conditions associated with negative nitrogen balance.<sup>[64]</sup> Data from urine analysis must therefore be interpreted with these factors in mind. Another potential drawback to utilizing urinary riboflavin excretion as an assessment of nutritional status of this vitamin is that the amount excreted reflects recent intake very sensitively. Thus, if an individual has been depleted for a long time but consumes food items high in riboflavin, the level of the vitamin in urine as determined a few hours later may not be in the deficient range, but is likely to be normal or even elevated.

It is important, therefore, to utilize assessment techniques that more accurately reflect long-term riboflavin status. The method most widely employed and that largely meets these needs is assay of EGRAC. The principle of the method is that the degree of saturation of the apoenzyme with its coenzyme, FAD, reflects the body stores of the latter. In deficient individuals, relative unsaturation of the apoenzyme leads to decreased basal activity of the enzyme. Therefore, the addition of FAD to the enzyme contained in a fresh erythrocyte hemolysate from deficient individuals will increase activity *in vitro* to a greater extent than that observed in preparations from well-nourished individuals, in whom the apoenzyme is relatively more saturated with the coenzyme. The EGRAC is the ratio of enzyme activity with to that without addition of FAD *in vitro*. In general, most studies indicate that an activity coefficient of 1.2 or less indicates adequate riboflavin status, 1.2–1.4 borderline-to-low status, and greater than 1.4 riboflavin deficiency.<sup>[64]</sup>

It must be kept in mind that a number of physiological variables influence the results of this determination as well. In the inherited disorder of glucose-6-phosphate dehydrogenase deficiency associated with hemolytic anemia, the apoenzyme has a higher affinity for FAD than that of the normal erythrocyte, which will affect the measured EGRAC. Thyroid function

affects glutathione reductase activity, the coefficient being elevated in hypothyroidism. This disorder has many biochemical features in common with those of riboflavin deficiency.<sup>[66]</sup>

The latest RDA for riboflavin issued by the Food and Nutrition Board<sup>[65]</sup> calls for adult males aged 31–50 yr to consume 1.3 mg/day and those 51–70 yr of age, 1.1 mg/day. Adult females from 31 to 50 yr of age should consume 1.1 mg/day and the same from 51 to 70 yr of age as well. It is recommended that in women aged 19–50 yr intake be increased to 1.4 mg/day during pregnancy and 1.6 mg/day during lactation.

There has been some concern as to whether these figures are applicable to other population groups around the world. The Chinese tend to excrete very little riboflavin, and their RDA may be lower than that of Americans.<sup>[67]</sup> Adults in Guatemala appear to have a similar RDA in individuals older than 60 compared to those 51 yr or younger.<sup>[68]</sup> This finding may not necessarily be relevant to populations of other countries. The RDAs of various national groups require further study. Environmental factors, protein–calorie intake, physical activity, and other factors may have an impact on riboflavin status. More research is needed on the requirements of the extremely old, who form an increasingly large proportion of the population. They are also the group that consumes the largest number of prescribed and over-the-counter medications.

A point of interest is whether riboflavin requirements are elevated in individuals who exercise compared to those who are sedentary. In women aged 50–67 who exercised vigorously for 20–25 min/day, 6 days a week, both a decrease in riboflavin excretion and a rise in the EGRAC were noted, findings consistent with a marginal riboflavin-deficient state.<sup>[69]</sup> Supplementation with riboflavin did not, however, improve exercise performance. These investigators observed compromised riboflavin status in young women exercising vigorously as well.<sup>[70]</sup> Similarly reduced urinary riboflavin excretion and elevated EGRAC were observed in young Indian males who exercised actively.<sup>[71]</sup>

To determine whether the status of riboflavin nutrition influences metabolic responses to exercise, blood lactate levels were determined in a group of physically active college students from Finland before and after the exercise period. A number of the students were initially in a state of marginal riboflavin deficiency. Following supplementation with vitamins, including riboflavin, that produced improvement in the elevated EGRAC, the blood lactate levels were unaffected and were related only to the degree of exercise.<sup>[72]</sup>

Thus, to date, while it is known that exercise may lead to biochemical abnormalities in riboflavin metabolism, it has not been shown that these abnormalities lead to impaired performance; nor has it been shown

that riboflavin supplementation improves exercise performance.

## SAFETY AND ADVERSE EFFECTS

There is general agreement that dietary riboflavin intake at many times the RDA is without demonstrable toxicity.<sup>[10,73,74]</sup> Because riboflavin absorption is limited to a maximum of about 25 mg at any one time,<sup>[10]</sup> the consumption of megadoses of this vitamin would not be expected to increase the total amount absorbed. Furthermore, classical animal investigations showed an apparent upper limit to the tissue storage capacity of flavins that cannot be exceeded under ordinary circumstances.<sup>[75]</sup> This storage capacity is probably limited by the availability of proteins providing binding sites for flavins. These protective mechanisms prevent tissue accumulation of excessive amounts of the vitamin. Because riboflavin has very low solubility, even intravenous administration of the vitamin would not introduce large amounts into the body. FMN is more water soluble than riboflavin but is not ordinarily available for clinical use.

Nevertheless, the photosensitizing properties of riboflavin raise the possibility of some potential risks. Phototherapy in vitro leads to degradation of DNA and increase in lipid peroxidation, which may have implications for carcinogenesis and other disorders. Irradiation of rat erythrocytes in the presence of FMN increases potassium loss.<sup>[76]</sup> Topical administration of riboflavin to the skin may increase melanin synthesis by stimulation of free-radical formation. Riboflavin forms an adduct with tryptophan and accelerates the photo-oxidation of this amino acid.<sup>[77]</sup> Further research is needed to explore the full implication of the photosensitizing capabilities of riboflavin and its phosphorylated derivatives.

A case from Taiwan was described by the authors as constituting anaphylaxis to riboflavin.<sup>[78]</sup> This case report bears careful scrutiny, as to our knowledge true anaphylaxis to riboflavin has not been demonstrated previously. A 15-yr-old child developed severe symptoms following ingestion of a soft drink and a single multivitamin tablet, both of which contained riboflavin. Positive results were observed after intradermal tests with riboflavin. In our opinion, the symptoms could have been caused by an additive or contaminant in the riboflavin sample and do not definitely implicate riboflavin as a cause of the reaction.

## ACKNOWLEDGMENTS

Research was supported in part by Clinical Nutrition Research Unit Grant 1-PO1-CA 29502 from the

National Institutes of Health, and by grants from The American Institute for Cancer Research, the Ronald and Susan Lynch Foundation, the Sunny and Abe Rosenberg Foundation, and an industrial agreement with Wakunaga of America Co., Ltd.

## REFERENCES

1. McCollum, E.V.; Kennedy, C. The dietary factors operating in the production of polyneuritis. *J. Biol. Chem.* **1916**, *24*, 491.
2. Emmett, A.D.; Luros, G.O. Water soluble vitamins. I. Are the antineuritic and the growth-promoting water-soluble B vitamins the same? *J. Biol. Chem.* **1920**, *43*, 265.
3. Warburg, O.; Christian, W. Über ein neues Oxydationsferment und sein Absorptionsspektrum. *Biochem. Z.* **1932**, *254*, 438–458.
4. Stern, K.G.; Holiday, E.R. Zur Konstitution des Photo-flavins; Versuche in der Alloxazine-Reihe. *Ber. Dtsch. Chem. Ges.* **1934**, *67*, 1104.
5. Theorell, H. Reindarstellung (Kristallisation) des gelben Atmungsfermentes und die reversible Spaltung desselben. *Biochem. Z.* **1934**, *272*, 155.
6. Kuhn, R.; Reinemund, K.D.; Kaltschmitt, H.; Strobele, R.; Trischmann, H. Synthetisches 6,7-Dimethyl-9-D-riboflavin. *Naturwissenschaften* **1935**, *23*, 260.
7. Karrer, P.; Scopp, K.; Benz, F. Synthesis of flavins IV. *Helv. Chim. Acta* **1935**, *18*, 426.
8. Theorell, H. Die freie Eiweisskomponente des gelben Ferments und ihre Kupplung mit Lactoflavinphosphorsäure. *Biochem. Z.* **1937**, *290*, 293.
9. Warburg, O.; Christian, W. Co-Ferment der D-Aminosäure-Deaminase. *Biochem. Z.* **1938**, *295*, 261.
10. McCormick, D.B. In *Riboflavin in Modern Nutrition in Health and Disease*, 8th Ed.; Shils, M.E., Olson, J.A., Shike, M., Eds.; Lea and Febiger: Philadelphia, 1994; 366–375.
11. Yagi, K.; Nakagawa, Y.; Suzuki, O.; Ohishi, N. Incorporation of riboflavin into covalently-bound flavins in rat liver. *J. Biochem.* **1976**, *79*, 841–843.
12. Pinto, J.T.; Rivlin, R.S. Regulation of formation of covalently bound flavins in liver and cerebrum by thyroid hormones. **1979**, *194*, 313–320.
13. Merrill, A.H., Jr.; Lambeth, J.D.; Edmondson, D.E.; McCormick, D.B. Formation and mode of action of flavoproteins. *Annu. Rev. Nutr.* **1981**, *1*, 281–317.
14. Rivlin, R.S. Medical progress: riboflavin metabolism. *N. Engl. J. Med.* **1970**, *283*, 463–474.
15. Fass, S.; Rivlin, R.S. Regulation of riboflavin-metabolizing enzymes in riboflavin deficiency. *Am. J. Physiol.* **1969**, *217*, 988–991.

16. Rivlin, R.S. Medical aspects of vitamin B2. In *Chemistry and Biochemistry of Flavins*; Muller, F., Ed.; CRC Press: Boca Raton, FL, 1991; 201–214.
17. Cimino, J.A.; Jhangiani, S.; Schwartz, E.; Cooperman, J.M. Riboflavin metabolism in the hypothyroid human adult. *Proc. Soc. Exp. Biol. Med.* **1987**, *184*, 151–153.
18. Pinto, J.T.; Huang, Y.P.; Rivlin, R.S. Inhibition of riboflavin metabolism in rat tissues by chlorpromazine, imipramine and amitriptyline. *J. Clin. Invest.* **1981**, *67*, 1500–1506.
19. Dutta, P.; Pinto, J.T.; Rivlin, R.S. Antimalarial effects of riboflavin deficiency. *Lancet* **1985**, *2*, 1040–1043.
20. Pinto, J.T.; Huang, J.P.; Rivlin, R.S. Mechanisms underlying the differential effects of ethanol upon the bioavailability of riboflavin and flavin adenine dinucleotide. *J. Clin. Invest.* **1987**, *79*, 1343–1348.
21. Tandler, B.; Erlandson, R.A.; Wynder, E.L. Riboflavin and mouse hepatic cell structure and function. I. Ultrastructural alterations in simple deficiency. *Am. J. Pathol.* **1968**, *52*, 69–96.
22. Williams, E.A.; Rumsey, R.D.E.; Powers, H.J. Cytokinetic and structural responses of the rat small intestine to riboflavin depletion. *Br. J. Nutr.* **1996**, *75*, 315–324.
23. Powers, H.J.; Weaver, S.; Austin, S.; Beresford, J.K. A proposed intestinal mechanism for the effect of riboflavin deficiency on iron loss in the rat. *Br. J. Nutr.* **1993**, *69*, 553–561.
24. McCormick, D.B. Two interconnected B vitamins: riboflavin and pyridoxine. *Physiol. Rev.* **1989**, *69*, 1170–1198.
25. Goldsmith, G.A. Riboflavin deficiency. In *Riboflavin*; Rivlin, R., Ed.; Plenum Press: New York, 1975; 221–244.
26. Rivlin, R.S. Vitamin deficiency. In *Conns' Current Therapy*; Rakel, R.E., Ed.; W.B. Saunders: Philadelphia, 1994; 551–559.
27. Rivlin, R.S. Disorders of vitamin metabolism: deficiencies, metabolic abnormalities and excesses. In *Cecil Textbook of Medicine*, 19th Ed.; Wyngaarden, J.H., Smith, L.H., Jr., Bennett, J.C., Plum, F., Eds.; W.B. Saunders: Philadelphia, 1991; 1170–1183.
28. Dutta, P. Disturbances in glutathione metabolism and resistance to malaria: current understanding and new concepts. *J. Soc. Pharm. Chem.* **1993**, *2*, 11.
29. Miyazawa, T.; Tsuchiya, K.; Kaneda, T. Riboflavin tetrabutryate: an antioxidative synergist of alpha-tocopherol as estimated by hepatic chemiluminescence. *Nutr. Rep. Int.* **1984**, *29*, 157–166.
30. Miyazawa, T.; Sato, C.; Kaneda, T. Antioxidative effects of  $\alpha$ -tocopherol and riboflavin-butyrate in rats dosed with methyl linoleate hydroperoxide. *Agric. Biol. Chem.* **1983**, *47*, 1577–1582.
31. Taniguchi, M.; Hara, T. Effects of riboflavin and selenium deficiencies on glutathione and related enzyme activities with respect to lipid peroxide content of rat liver. *J. Nutr. Vitaminol.* **1983**, *29*, 283–292.
32. Dutta, P.; Seirafi, J.; Halpin, D.; Pinto, J.T.; Rivlin, R.S. Acute ethanol exposure alters hepatic glutathione metabolism in riboflavin deficiency. *Alcohol* **1995**, *12*, 43–47.
33. Rivlin, R.S.; Dutta, P. Vitamin B2 (riboflavin). Relevance to malaria and antioxidant activity. *Nutr. Today* **1995**, *20*, 62–67.
34. Graham, I.A.; Daly, L.E.; Refsum, H.M.; Robinson, K.; Brattstrom, L.E.; Ueland, P.M.; Palma-Reis, R.J.; Boers, G.H.; Sheahan, R.G.; Israelsson, B.; Uiterwaal, C.S.; Meleady, R.; McMaster, D.; Verhoef, P.; Wittelman, J.; Rubba, P.; Bellet, H. et al. Plasma homocysteine as a risk factor for vascular disease. The European Concerted Action Project. *J. Am. Med. Assoc.* **1997**, *277*, 1775–1781.
35. Boushey, C.J.; Beresford, S.A.A.; Omenn, G.S.; Motulsky, A.G. A quantitative assessment of plasma homocysteine as a risk factor for vascular disease. *J. Am. Med. Assoc.* **1995**, *274*, 1049–1057.
36. Bates, C.J.; Fuller, N.J. The effect of riboflavin deficiency on methylenetetrahydrofolate reductase (NADPH) (EC 1.5.1.20) and folate metabolism in the rat. *Br. J. Nutr.* **1986**, *55*, 455–464.
37. Hustad, S.; Ueland, P.M.; Vollset, S.E.; Zhang, Y.; Bjorke-Monsen, A.L.; Schneede, J. Riboflavin as a determinant of plasma total homocysteine: effect modification by the methylenetetrahydrofolate reductase C677T polymorphism. *Clin. Chem.* **2000**, *46*, 1065–1071.
38. Jacques, P.F.; Kalmbach, R.; Bagley, P.J.; Russo, G.T.; Rogers, G.; Wilson, P.W.; Rosenberg, I.H.; Selhub, J. The relationship between riboflavin and plasma total homocysteine in the Framingham Offspring cohort is influenced by folate status and the C677T transition in the methylenetetrahydrofolate reductase gene. *J. Nutr.* **2002**, *132*, 283–288.
39. Frosst, P.; Blom, H.J.; Milos, R.; Goyette, P.; Sheppard, C.A.; Matthews, R.G.; Boers, G.J.; den Heijer, M.; Kluijtmans, L.A.; van den Heuvel, L.P. et al. A candidate genetic risk factor for vascular disease: a common mutation in methylenetetrahydrofolate reductase. *Nat. Genet.* **1995**, *10*, 111–113.
40. Moat, S.J.; Ashfield-Watt, P.A.L.; Powers, H.J.; Newcombe, R.G.; McDowell, I.F.W. Effect of



- riboflavin status on the homocysteine-lowering effect of folate in relation to the MTHFR (C677T) genotype. *Clin. Chem.* **2003**, *49*, 295–302.
41. Uziel, G.; Garavaglia, B.; Ciceri, E.; Moroni, L.; Rimoldi, M. Riboflavin-responsive glutaric aciduria type II presenting as a leukodystrophy. *Pediatr. Neurol.* **1995**, *13*, 333–335.
  42. Bernsen, P.L.J.A.; Gabreels, F.J.M.; Ruitenbeek, W.; Hamburger, H.L. Treatment of complex I deficiency with riboflavin. *J. Neurol. Sci.* **1993**, *118*, 181–187.
  43. Walker, U.A.; Byrne, E. The therapy of respiratory chain encephalomyopathy: a critical review of the past and present perspective. *Acta Neurol. Scand.* **1995**, *92*, 273–280.
  44. McComsey, G.A.; Lederman, M.M. High doses of riboflavin and thiamine may help in secondary prevention of hyperlactatemia. *AIDS Read.* **2002**, *12*, 222–224.
  45. Dalton, D.S.; Rahimi, A.R. Emerging role of riboflavin in the treatment of nucleoside analogue-induced type B lactic acidosis. *AIDS Patient Care STDs.* **2001**, *15*, 611–614.
  46. Posteraro, A.F., III; Mauriello, M.; Winter, S.M. Riboflavin treatment of antiretroviral induced lactic acidosis and hepatic steatosis. *Conn. Med.* **2001**, *65*, 387–390.
  47. Yoon, H.R.; Hahn, S.H.; Ahn, Y.M.; Jang, S.H.; Shin, Y.J.; Lee, E.H.; Ryu, K.H.; Eun, B.L.; Rinaldo, P.; Yamaguchi, S. Therapeutic trial in the first three Asian cases of ethylmalonic encephalopathy: response to riboflavin. *J. Inher. Metab. Dis.* **2001**, *24*, 870–873.
  48. Foy, H.; Kondi, A. A case of true red cell aplastic anemia successfully treated with riboflavin. *J. Pathol. Bacteriol.* **1953**, *65*, 559–564.
  49. Powers, H.J. Riboflavin (vitamin B-2) and health. *Am. J. Clin. Nutr.* **2003**, *77*, 1352–1360.
  50. Powers, H.J.; Wright, A.J.A.; Fairweather-Tait, S.J. The effect of riboflavin deficiency in rats on the absorption and distribution of iron. *Br. J. Nutr.* **1988**, *59*, 381–387.
  51. Powers, H.J.; Weaver, L.T.; Austin, S.; Wright, A.J.A.; Fairweather-Tait, S.J. Riboflavin deficiency in the rat: effects on iron utilization and loss. *Br. J. Nutr.* **1991**, *65*, 487–496.
  52. Powers, H.J. Investigation into the relative effects of riboflavin on iron economy in the weanling rat and the adult. *Ann. Nutr. Metab.* **1986**, *29*, 261–266.
  53. Webster, R.P.; Gawde, M.D.; Bhattacharya, R.K. Modulation of carcinogen-induced DNA damage and repair enzyme activity by dietary riboflavin. *Cancer Lett.* **1996**, *98*, 129–135.
  54. Rivlin, R.S. Riboflavin and cancer: a review. *Cancer Res.* **1973**, *33*, 1977–1986.
  55. Pangrekar, J.; Krishnaswamy, K.; Jagadeesan, V. Effects of riboflavin deficiency and riboflavin administration on carcinogen–DNA binding. *Food Chem. Toxicol.* **1993**, *85*, 1483–1492.
  56. Munoz, N.; Wahrendorf, J.; Bang, L.J.; Crespi, M.; Grassi, A. Vitamin intervention on precancerous lesions of the esophagus in a high-risk population in China. *Ann. N. Y. Acad. Sci.* **1988**, *534*, 618–619.
  57. Wahrendorf, J.; Munoz, N.; Lu, J.B.; Thurnham, D.I.; Crespi, M.; Bosch, F.X. Blood retinol and zinc riboflavin status in relation to precancerous lesions of the esophagus: findings from a vitamin intervention trial in the People's Republic of China. *Cancer Res.* **1988**, *48*, 2280–2283.
  58. Zaridze, D.G.; Bukin, J.U.; Orlov, Y.N. Relationship between esophageal mucosa pathology and vitamin deficit in population with high frequency of esophageal cancer. *Vopr. Onkol.* **1989**, *35*, 939–945.
  59. Ohara, M.; Fujikura, T.; Fujiwara, H. Augmentation of the inhibitory effect of blue light on the growth of B16 melanoma cells by riboflavin. *Int. J. Oncol.* **2003**, *22*, 1291–1295.
  60. Bessey, O.A.; Lowry, O.H.; Love, R.H. Fluorometric measure of the nucleotides of riboflavin and their concentration in tissues. *J. Biol. Chem.* **1949**, *180*, 755.
  61. Fazekas, A.G.; Menendez, C.E.; Rivlin, R.S. A competitive protein binding assay for urinary riboflavin. *Biochem. Med.* **1974**, *9*, 167–176.
  62. Kim, M.J.; Kim, H.J.; Kim, J.M.; Kim, B.; Han, S.H.; Cha, G.S. Homogeneous assays for riboflavin mediated by the interaction between enzyme–biotin and avidin–riboflavin conjugates. *Anal. Biochem.* **1995**, *231*, 400–406.
  63. Chastain, J.L.; McCormick, D.B. Flavin catabolites: identification and quantitation in human urine. *Am. J. Clin. Nutr.* **1987**, *46*, 830–834.
  64. Sauberlich, H.E.; Judd, J.H.; Nicholds, G.E.; Broquist, H.P.; Darby, W.J. Application of the erythrocyte glutathione reductase assay in evaluating riboflavin nutritional status in a high school student population. *Am. J. Clin. Nutr.* **1972**, *25*, 756–762.
  65. Food and Nutrition Board, National Research Council. In *Dietary Reference Intakes*; National Academy Press: Washington, DC, 1997; 244.
  66. Menendez, C.E.; Hacker, P.; Sonnenfeld, M.; McConnell, R.; Rivlin, R.S. Thyroid hormone regulation of glutathione reductase activity in rat erythrocytes and liver. *Am. J. Physiol.* **1974**, *226*, 1480–1483.
  67. Brun, T.A.; Chen, J.; Campbell, T.C. Urinary riboflavin excretion after a load test in rural

- China as a measure of possible riboflavin deficiency. *Eur. J. Clin. Nutr.* **1990**, *44*, 195–206.
68. Boisvert, W.A.; Mendoza, I.; Castenada, C. Riboflavin requirement of healthy elderly humans and its relationships to macronutrient composition of the diet. *J. Nutr.* **1993**, *123*, 915–925.
69. Trebler Winters, L.R.; Yoon, J.-S.; Kalkwarf, H.J.; Davies, J.C.; Berkowitz, M.G.; Haas, J.; Roe, D.A. Riboflavin requirements and exercise adaptation in older women. *Am. J. Clin. Nutr.* **1992**, *56*, 526–532.
70. Belko, A.Z.; Obarzanek, E.; Roach, R.; Rotter, M.; Urban, G.; Weinberg, S.; Roe, D.A. Effects of aerobic exercise and weight loss on riboflavin requirements of moderately obese, marginally deficient young women. *Am. J. Clin. Nutr.* **1984**, *40*, 553–561.
71. Soares, M.J.; Satyanarayana, K.; Bamji, M.S.; Jacobs, C.M.; Ramana, Y.V.; Rao, S.S. The effect of exercise on the riboflavin status of adult men. *Br. J. Nutr.* **1993**, *69*, 541–551.
72. Fogelholm, M.; Ruokenen, I.; Laakso, J.T.; Vuorimaa, T.; Himberg, J.-J. Lack of association between indices of vitamin B1, B2 and B6 status and exercise-induced blood lactate in young adults. *Int. J. Sport Nutr.* **1993**, *3*, 165–176.
73. Rivlin, R.S. Effect of nutrient toxicities (excess) in animals and man: riboflavin. In *Nutritional Disorders*; Recheigl, M., Jr., Ed.; CRC Handbook Series in Nutrition and Food Section E; CRC Press: West Palm Beach, FL, 1978; Vol. 1, 25–27.
74. Cooperman, J.M.; Lopez, R.; Riboflavin, R. *In Handbook of Vitamins: Nutritional, Biochemical and Clinical Aspects*; Machlin, L.J., Ed.; Marcel Dekker: New York, 1984; 299–327.
75. Burch, H.B.; Combs, A.M.; Lowry, O.H.; Padilla, A.M. Effects of riboflavin deficiency and re-implantation on flavin enzymes of tissues. *J. Biol. Chem.* **1956**, *223*, 29–45.
76. Ghazy, F.S.; Kimura, T.; Muranishi, S.; Sezaki, H. The photodynamic action of riboflavin on erythrocytes. *Life Sci.* **1977**, *21*, 1703–1708.
77. Salim-Hanna, M.; Edwards, A.M.; Silva, E. Obtention of a photo-induced adduct between a vitamin and an essential amino acid. Binding of riboflavin to tryptophan. *Int. J. Vitam. Nutr. Res.* **1987**, *57*, 155–159.
78. Ou, L.S.; Kuo, M.L.; Huang, J.L. Anaphylaxis to riboflavin (vitamin B2). *Ann. Allergy Asthma Immunol.* **2001**, *87*, 430–433.



# Saw Palmetto (*Serenoa repens*)

Edward M. Croom, Jr.

School of Pharmacy, University of Mississippi, Oxford, Mississippi, U.S.A.

## INTRODUCTION

Saw palmetto fruit extracts are frequently consumed for relief of the lower urinary tract symptoms associated with benign prostatic hyperplasia (BPH). The most scientifically researched hexane and CO<sub>2</sub> extracts have been shown in clinical trials to be superior to placebo and to have fewer side effects than  $\alpha$ -blocker and 5 $\alpha$ -reductase inhibitor drugs for relief of symptoms in men with mild to moderate BPH. Because there are no current Food and Drug Administration (FDA) guidelines or regulations on the labeling of saw palmetto products regarding efficacy in improving prostate health, consumers and health care professionals must learn the scientific basis for their safety and effectiveness claims to make an informed product choice.

## BOTANY

- Saw palmetto: *Serenoa repens* (W. Bartram) Small
- Palm family: Arecaceae (also known as Palmaceae, Palmae)

## Botanical Synonyms

*Corypha repens* W. Bartram; *Brahea serrulata* (Michaux) H. Wendland; *Chamaerops serrulata* Michaux; *Corypha obliqua* W. Bartram; *Sabal serrulata* (Michaux) Nuttall ex Schultes & Schultes f.; *Serenoa serrulata* (Michaux) G. Nicholson.

## Botanical Description

The stems of the palm are usually prostrate, branched, and sometimes upright to a length of 3 m or more. The stiff, fan-shaped leaves range in color from yellow-green to green and grayish green to silver-green (Fig. 1). The saw-toothed (serrate) petioles are from 0.5 to 1 m long and have fine to coarse teeth that account for the common name of this shrub-like, branching palm. The flower stalks are approximately

the same length as the petioles. The small (4–5 mm), fragrant, spring flowers are creamy white, with three petals and six stamens. The pulpy, one-seeded fruits ripen from green to orange to black or bluish black (Fig. 2). Mature fruits are approximately 2 cm long and 1 cm in diameter, with some fruits being similar in shape and size to commercial black olives, having a large hard seed inside the pulp. Flowering and fruit production are highly variable each year; most fruits mature in August and September. Saw palmetto is an important wild plant providing food and cover for many animals. The fruits are consumed by black bears, white-tailed deer, raccoons, foxes, opossums, fish, and many species of birds.<sup>[1–3]</sup>

## Ecological Distribution

Saw palmetto is endemic to the southeastern United States. The native range is from the coastal plain of southeast South Carolina to Georgia, throughout the state of Florida, including the Florida Keys, and to the coastal plains of Alabama, Mississippi, and southeast Louisiana. Saw palmetto is a major understory plant, sometimes forming dense thickets in pinelands, dunes, sand pine scrub, mesic hummocks, and woodlands (Fig. 3). The plant is one of the most abundant in Florida and is reported to be very well adapted to surviving fires.<sup>[1–3]</sup>

## PRIMARY USE

The main medicinal use of saw palmetto is for prostate health and relief of symptoms of the lower urinary tract that are associated with BPH, a condition that is common in men over 50 yr of age. The only saw palmetto fruit extracts that have been subjected to multiple clinical trials in BPH are those produced under highly standardized conditions, by extraction with hexane or under hypercritical CO<sub>2</sub> conditions. They have a chemical content of 85–95% fatty acids, and have been stability tested to assure throughout the shelf life that the chemical contents are sufficient and that the capsules will disintegrate in conditions that mimic the acidity of the stomach. Clinical trials generally evaluated the ingestion of two 160 mg soft gel capsules or one 320 mg capsule per day. The most recent structured, evidence-based meta-analysis of

Edward M. Croom, Jr., Ph.D., is Adjunct Associate Professor at the School of Pharmacy, University of Mississippi, Oxford, Mississippi, U.S.A.



**Fig. 1** Saw palmetto leaves. (Photograph courtesy of Renato Iguera.) (View this art in color at [www.dekker.com](http://www.dekker.com).)

clinical trials of standardized lipophilic saw palmetto extracts has shown that they provide good symptomatic relief, with few side effects, in men with mild to moderate BPH symptoms at doses of 320 mg/day.<sup>[4]</sup> Although saw palmetto may give relief as early as 4–6 weeks, 3 mo or more of therapy may be required for some patients before the effects are felt.

### HISTORICAL USES

Saw palmetto leaves, stems, roots, and fruits have had a variety of historical uses. Fans, baskets, roof thatching,

straw hats, and dolls have been made from the leaves, upholstery stuffing from the leaves and stem fibers, and scrubbing brushes from the tough, fibrous roots.<sup>[3]</sup> In the late 1800s, saw palmetto fruits were “lauded as the ‘old man’s friend,’ giving relief from the many annoyances commonly attributed to enlarged prostate.” Felter and Lloyd, writing in the *King’s American Dispensatory* in 1898, went on to comment that “We would rather regard it a remedy for *prostatic irritation* and *relaxation* of tissue than for a hypertrophied prostate.” As authorities of the eclectic school of medicine, they begin their discussion of saw palmetto with “Saw palmetto appears, from clinical



**Fig. 2** Saw palmetto fruits. (Photograph courtesy of Renato Iguera.) (View this art in color at [www.dekker.com](http://www.dekker.com).)



**Fig. 3** Saw palmetto habitat, south Florida. (Photograph courtesy of Renato Iguera.) (View this art in color at [www.dekker.com](http://www.dekker.com).)

reports, to be a nutritive tonic.” Indeed, at that time, saw palmetto was used as a tonic to treat a variety of maladies of the male and female reproductive organs and various irritations of the mucous membranes, including coughs due to different medical disorders.<sup>[5]</sup>

## CHEMISTRY

The dried drupelike fruit is the plant part that has most frequently been used in traditional and allopathic medicine. The fruit consists of approximately 36% outer rind, 16% flesh, 10% seed shell, and 38% seed. The fleshy part contains large quantities of lipids, starches, polysaccharides, sugars and mannitol, and small quantities of ceramides and sphingolipids. The lipid content has been reported to consist of approximately 75% free fatty acids and 25% neutral fats. During the ripening and drying of the fruit, a lipase splits triglycerides into fatty acids. From the oil obtained by pressing fruits preserved in alcohol, C6–C18 fatty acids have been identified.<sup>[6]</sup> Oleic, lauric, and myristic acids are the predominant ones, while palmitic, caproic, caprylic, and capric acids have been reported in smaller quantities in both 90% ethanol and CO<sub>2</sub> extracts.<sup>[6,7]</sup> The characteristic smell of the oil has been attributed to the secondary formation in the fruit of ethylesters of several of the fatty acids present.<sup>[6]</sup> A systematic evaluation of the total fatty acids of fruits at different stages of ripeness, the seed, fruit pulp, fruit powder, and extracts, as well as mixtures, has shown that each product has a characteristic fatty acid profile that can be used for identification and standardization of products.<sup>[8]</sup>

Currently, lipophilic extracts of saw palmetto are widely used in BPH therapy. The most documented extracts, from a pharmacological and clinical point of view, are those obtained by two different extraction processes. The first process involves extraction from dried and finely ground fruits with hexane in an inert gas atmosphere and in the presence of an antioxidant such as ascorbic palmitate, and the second process extracts with carbon dioxide in hypercritical conditions. This latter method directly, produces a pharmaceutical product, which can be used without further purification.<sup>[6]</sup>

In the United States, common saw palmetto products include ethanol and CO<sub>2</sub> extracts. In Germany, fruit extracts obtained with 90% ethanol are very popular, and a hexane extract is a registered pharmaceutical. An analysis of two commercial saw palmetto extracts produced using 90% ethanol vs. under an optimized CO<sub>2</sub> condition found that although the relative composition of free fatty acids and total fatty acids was very similar (Table 1, Ref.<sup>[7]</sup>), the absolute percentage of free fatty acids was 69% in the ethanol extract vs. 90% in the CO<sub>2</sub> extract.<sup>[13]</sup> When the two lipophilic extracts were derivatized with sulfuric acid in methanol to measure total fatty acids (including free fatty acids, esters, and other chemically bonded acids), the quantities were very similar and therefore were not adequate to accurately characterize the exact form of the fatty acids being consumed. A second major difference found was that the ethanol extract contained a large amount of ethylesters that were not present in the CO<sub>2</sub> extract.<sup>[7]</sup>

Upon investigation, a CO<sub>2</sub> extract was found to contain free fatty acids as well as their methyl- and

**Table 1** Relative composition of free and total fatty acids in saw palmetto ethanolic and CO<sub>2</sub> extracts

Fatty acid (FA)	Free FA		Total FA	
	Ethanol	CO <sub>2</sub>	Ethanol	CO <sub>2</sub>
Caproic	2.15	1.39	0.29	0.19
Caprylic	2.06	2.33	0.88	0.82
Capric	1.78	2.74	1.45	1.86
Lauric	30.20	32.84	27.60	29.24
Myristic	13.39	12.34	13.14	12.14
Palmitic	9.84	9.13	10.40	9.78
Linoleic	3.36	6.42	4.43	10.45
Linolenic	0.90	0.98	4.04	3.29
Oleic	34.84	29.96	36.60	29.85
Stearic	1.48	1.87	1.17	2.38
Total	100.00	100.00	100.00	100.00

(Adapted from Ref.<sup>[7]</sup>.)

ethylesters,  $\beta$ -sitosterol,  $\beta$ -sitosterol-3-O- $\beta$ -D-glucoside, campesterol, stigmasterol, lupeol, cycloartenol, 24-methylene-cycloartanol, long-chain saturated and unsaturated alcohols, including farnesol, phytol, and alcohols with C22, C23, C24, C26, and C28 chain lengths, and polyprenolic alcohols. Carotenoids, which give a marked orange color to the oily extracts, have also been isolated.<sup>[6]</sup>

Flavonoids, including rutin, isoquercitrin, kaempferol-3-O-glucoside, and apigenin-7-O-rhamnoglucoside, and anthranilic acid have been reported in alcohol extracts of the fruits. Polysaccharide fractions from aqueous extracts have shown anti-inflammatory and immunomodulatory activities. Some of the polysaccharides found in saw palmetto are galactose, arabinose, xylose, mannose, rhamnose, glucose, and glucuronic acid.<sup>[6]</sup>

The chemistry of the other plant parts has not been thoroughly investigated. Hydrolysis of the petioles and the stem has yielded vanillin, syringaldehyde, *p*-hydroxybenzaldehyde, acetovanillone, acetosyringone, and vanillic, and syringic, *p*-hydroxybenzoic, and ferulic acids.<sup>[6]</sup>

## BENIGN PROSTATIC HYPERPLASIA (BPH)

Benign prostatic hyperplasia is a noncancerous enlargement of the prostate that is associated with bothersome and irritative lower urinary tract symptoms (LUTS), including increased urgency and frequency, nocturia (arising from sleep at night to urinate), dribbling, hesitancy, straining, and incomplete bladder emptying.<sup>[4]</sup> In the United States, most men over 60 yr of age have LUTS, which results in over 1.7 million

visits to the physician annually and over 300,000 prostate operations.<sup>[4]</sup>

## Saw Palmetto and Other Botanical Treatments

Plant derived agents account for over 90% of all prescriptions for BPH in Germany and Austria and approximately half of all therapeutic agents used for treating BPH in Italy.<sup>[4]</sup> Saw palmetto is sold in the United States as a dietary supplement through many sales channels, including the mass market (grocery stores, discount stores, and pharmacies), mail order, direct sales, and multilevel marketing, as well as specialty retail and health food stores. In 2001, saw palmetto was the fifth leading botanical in total consumer sales through all types of market channels, with a turnover of \$123 million.<sup>[9]</sup> In the United States and Europe, other popular phytotherapies and natural remedies include  $\beta$ -sitosterol (from the tuber of the South African plant *Hypoxis rooperi*), a grass pollen mixture (92% rye, 5% timothy, and 3% corn), stinging nettle root, pumpkin seed oil, and *Pygeum* bark.<sup>[10]</sup> Saw palmetto is the most popular botanical used for mild to moderate LUTS associated with BPH and has shown an advantage over standard  $\alpha$ -blockers and 5 $\alpha$ -reductase inhibitors of having fewer significant side effects such as impotence, ejaculatory disorders, and dizziness.

## Current Medical Treatment

The American Urological Association (AUA) has published guidelines on the diagnosis and treatment of BPH.<sup>[11]</sup> This common term is not always used to denote changes in the prostate but is mostly employed to describe a cluster of bothersome LUTS that increase in frequency and severity as men age. Associated mortality and even serious complications such as complete urinary retention are uncommon. Since some of the symptoms associated with BPH may also be due to urinary tract infections, bladder stones, bladder cancer, prostate cancer, and other serious medical conditions that cannot be rationally treated by saw palmetto, men should have a thorough diagnostic evaluation by a physician before and during any use of saw palmetto to be certain that BPH and not a different disease is the source of the symptoms. The AUA treatment guidelines include the patient answering questions concerning the severity and frequency of the main symptoms, which gives the AUA Symptom Index [identical to the 7 questions of the International Prostate Symptom Score (IPSS) questionnaire]. The score on the IPSS or AUA Symptom Score questionnaire is used to classify the severity of BPH as mild (0–7), to moderate (8–19), or severe (20–35). Since some individuals may chose no

therapy (“watchful waiting”) and others with the same symptom score may be sufficiently bothered to seek relief by pharmaceuticals or surgical intervention, there exists a wide latitude in the treatment of choice by the physician and patient for a condition that mainly concerns quality of life. The medical drug therapies evaluated by the AUA include  $\alpha$ -adrenergic blockers, 5 $\alpha$ -reductase inhibitors, combination therapies, and phytotherapy. The AUA considered the  $\alpha$ -blockers to be equal in relief provided but to have slightly different side effect profiles. Recommendation for using 5 $\alpha$ -reductase inhibitor therapies alone or in combination with  $\alpha$ -blockers was limited to men with evidence of prostatic enlargement. The AUA did not recommend the use of saw palmetto and other phytotherapies because of such factors as variations of product consistency, lack of identification of the active compound, and absence of a well documented mechanism of action. In addition, the AUA cited the lack of testing in multicenter, randomized clinical trials with independent data monitoring as a factor in their lack of recommendation of saw palmetto and other phytotherapies.<sup>[11]</sup>

#### **EFFICACY IN CONTROL OF SYMPTOMS RELATED TO BPH**

As mentioned, lipophilic saw palmetto fruit extracts made to European drug standards have been found effective in the most recent evidence-based meta-analysis.<sup>[4]</sup> Clinical trials have demonstrated reasonable improvement of urinary symptoms and urine flow rates in patients that is superior to that provided by placebo and comparable to that by the drug Proscar<sup>®</sup> (finasteride), but with fewer adverse events, including impotence.<sup>[4]</sup> In a recent 12 mo, double-blind, controlled clinical trial, a proprietary hexane lipophilic extract sold as a drug in Europe at a dose of 320 mg/day was compared to the  $\alpha$ -blocker tamsulosin (0.4 mg/day) for efficacy. The head-to-head comparison found that, in the 542 patients who completed the trial, the efficacy in treating irritative and obstructive symptoms as well as improving urine flow was the same for both agents. Both saw palmetto and tamsulosin led to improvement of symptoms by 3 mo, with the former showing a slower initial response; both agents caused an overall improvement of symptoms at 2 mo of 27% (which was a decrease of 4.4 of the total IPSS score). The only meaningful difference in side effect profiles of the two agents was the 4.2% ejaculation disorders reported for tamsulosin as against 0.6% for saw palmetto.<sup>[12]</sup> What is unknown from clinical trials is the long-term safety and efficacy in the prevention of progression of BPH, including: 1) serious, although uncommon, complications such as recurrent urinary tract infections and complete urinary retention

in untreated BPH; and 2) the need for more expensive and invasive therapies such as surgery for the relief of severe symptoms.<sup>[4]</sup>

#### **SAFETY**

In the meta-analysis of the safety of European saw palmetto products used in clinical trials, no major side effects were found, with mild gastrointestinal (GI) complaints, comparable in frequency to placebo, being the most common.<sup>[4]</sup> In comparison to the 5 $\alpha$ -reductase inhibitor drug Proscar, saw palmetto had fewer adverse events, including impotence, the most frequent side effect for Proscar.<sup>[4]</sup> Although not available for independent scientific review, hexane/CO<sub>2</sub> extracts of saw palmetto that have been registered as drugs in Europe have had to undergo the same preclinical safety studies as drugs in the United States. The specific extracts and final pharmaceutical products registered would have been tested in vitro and in vivo for oral toxicity, teratogenicity, mutagenicity, peri- and postnatal toxicity, estrogenic activity, and effect on fertility. In the United States, saw palmetto products as dietary supplements are sold in combination with other plant products that have not undergone the safety, quality, and clinical efficacy testing required of drugs in Europe. Because saw palmetto products sold in the United States could have a different safety profile than those sold in Europe, their safety has been reviewed as a monograph by a special committee of the Food and Nutrition Board and the Board on Life Sciences [part of the Institute of Medicine (IOM) and National Research Council of the National Academies of Science]. Considering the weight of the current scientific evidence, the report concludes that the consumption of saw palmetto fruit (powders and extracts) does not pose a safety risk for men at the currently recommended doses.<sup>[13]</sup> The report notes that the toxicity of combination products (including the 8-herb combination product PC-SPEs, which was removed from commerce because of adulteration with drugs, including the anticoagulant warfarin) was evaluated only in relation to the saw palmetto component.<sup>[13]</sup> The IOM report notes that no drug interactions have been documented with saw palmetto, but that more systematic drug interaction studies are needed.<sup>[13]</sup> There is one published case report of prolonged bleeding time during surgery in a subject using saw palmetto, and there have been a few other adverse event reports submitted to the FDA. Although concerned about the prolonged bleeding time report, no clear causal relationship was found by the IOM Committee review of these reports.<sup>[13]</sup>

The safe use of saw palmetto by pregnant and lactating women is more questionable, since drugs like



finasteride that block the conversion of testosterone to dihydrotestosterone could impair the development of male genitalia in the fetus or feeding infant.<sup>[13]</sup> The World Health Organization (WHO) monograph on saw palmetto states that "Owing to its effects on androgen and estrogen metabolism, the use of *Fructus Serenoae Repentis* during pregnancy or lactation and in children under the age of 12 years is contraindicated."<sup>[14]</sup> Since the safety and efficacy of all botanicals is based on the specific extract and final product formulation as the "active" ingredient, it is worth noting that, although rarely used today by women and children, the hexane and CO<sub>2</sub> extracts and final products registered as prescription drugs in Europe would have been tested like all drugs for potential detrimental effects on the fetus in animal models of fertility and teratogenicity. All chemical compounds that have been reported from saw palmetto are generally nontoxic in the quantities consumed from commercial products.<sup>[13]</sup>

Overall, standardized lipophilic saw palmetto extracts at doses of 320 mg/day have proven risk-free in long-term clinical use in many European countries and in controlled clinical trials from 6 to 48 weeks. In the United States, saw palmetto, consumed at current levels in commercially available products, has also been very safe to use. For men, it should only be used to treat mild to moderate BPH after a complete medical examination to rule out more serious disorders. Saw palmetto products sold as dietary supplements have not undergone standard animal tests for teratogenicity and effects on fertility and therefore are contraindicated for use by pregnant or lactating women.

## PHARMACOLOGY

Saw palmetto fruits have been used in both traditional and homeopathic medicine for the treatment of urological symptoms associated with prostate hypertrophy. In the United States, at the beginning of the 20th century, alcohol extracts of the fruit made as tinctures and alcohol based fluidextracts were popular remedies for prostatitis and prostate hypertrophy. Although the plant was popular and was listed in the *United States Pharmacopeia* (USP) from 1906 to 1916 and in the *National Formulary* (NF) from 1926 to 1950, it is the more recent successful development of European pharmaceutical products that has stimulated more detailed studies on its pharmacology and potential mechanisms of action.<sup>[6,15]</sup>

Saw palmetto research concerning potential mechanisms of action related to the treatment of symptoms associated with BPH has included 5 $\alpha$ -reductase inhibitor activity, inhibition of  $\alpha_1$  adrenoceptors ( $\alpha$ -blocker activity), anti-inflammatory activity, and factors related to prostate cell growth. In studies with

cultured genital skin fibroblasts, the lipophilic extract of saw palmetto inhibits the enzymatic conversion of testosterone to dihydrotestosterone (DHT) by 5 $\alpha$ -reductase and of DHT to androstanediol by 3 $\alpha$ -hydroxysteroid dehydrogenase. Extracts of saw palmetto have inhibited the 5 $\alpha$ -reductase activity in rat prostate tissue, with an IC<sub>50</sub> value of 88  $\mu$ g/ml. An alcohol extract that was devoid of androgen receptor binding activity inhibited 5 $\alpha$ -reductase in homogenates of human genital skin fibroblasts, and a CO<sub>2</sub> extract had an IC<sub>50</sub> inhibition value of 25  $\mu$ g/ml. Various pharmaceutical proprietary products had IC<sub>50</sub> 5 $\alpha$ -reductase inhibition values from 5.6 to 40  $\mu$ g/ml. A lipophilic extract has been reported as a noncompetitive inhibitor of 5 $\alpha$ -reductase type 1 isoenzyme with an IC<sub>50</sub> of 4  $\mu$ g/ml.<sup>[6]</sup> Recently, it was reported that biopsy cores from patients receiving a saw palmetto combination product should DHT levels in the prostate tissues reduced by 32% from 6.49 to 4.40 ng/g, while the levels in men receiving placebo exhibited no significant change.<sup>[18]</sup>

In a detailed study of the 5 $\alpha$ -reductase inhibiting activity of a CO<sub>2</sub> extract and fractions made from it, as well as individual fatty acids, none was found in the fractions that contain the plant sterols, triterpenes, and fatty alcohols. The activity for the entire extract and the main fatty acid components was comparable, with high IC<sub>50</sub> values, including the CO<sub>2</sub> extract at 44.7 mg/ml, lauric acid at 31.1 mg/ml, linoleic acid at 23.6 mg/ml, and linolenic acid at 27.3 mg/ml.<sup>[19]</sup> In comparison to saw palmetto extracts and the most active individual fatty acids, synthetic steroidal 5 $\alpha$ -reductase inhibitors such as finasteride show much greater inhibitory activity, competing with testosterone for the active binding site at nanomolar concentrations.<sup>[19]</sup> Since fatty acids (especially fatty acid esters) are consumed in Western diets at many times the levels found in a standard dose of saw palmetto, the question arises as to how the addition of a relatively small amount of free fatty acids from saw palmetto could have a physiological effect on the symptoms associated with BPH.<sup>[19]</sup> Since 5 $\alpha$ -reductase activity has been shown to be influenced by the lipid environment of the enzyme, Niederprüm hypothesized that the high percentage of free fatty acids from saw palmetto might sufficiently change the lipid environment to control the 5 $\alpha$ -reductase enzyme activity.<sup>[19]</sup>

Saw palmetto has been reported to inhibit the binding of [<sup>3</sup>H]dihydrotestosterone to androgen receptors by some authors, but others have reported to the contrary.<sup>[6]</sup>

Saw palmetto extracts can influence the synthesis of inflammatory metabolites of arachidonic acid. A CO<sub>2</sub> extract was found in vitro to be a dual inhibitor of the cyclo-oxygenase (IC<sub>50</sub>-value: 28.1  $\mu$ g/ml) and 5-lipoxygenase (IC<sub>50</sub> value: 18.0  $\mu$ g/ml) pathways.

By alkaline hydrolysis, ether extraction, and preparative thin layer chromatography, the extract was separated into three fractions containing acid lipophilic compounds, fatty alcohols, and sterols as the main components. The acid lipophilic fraction inhibited the biosynthesis of cyclo-oxygenase and 5-lipoxygenase metabolites at the same intensity as the native CO<sub>2</sub> extract, while the fraction with fatty alcohols and that with sterols, including  $\beta$ -sitosterol, had no inhibitory effect on either enzyme of the arachidonic acid pathway.<sup>[16]</sup>

Among the most abundant of the free fatty acids in saw palmetto lipophilic extracts is oleic acid. This comprises approximately 30–35% of the free and total fatty acids in extracts obtained using 90% ethanol or hypercritical CO<sub>2</sub>.<sup>[7]</sup> Concentrations of fatty acids in prostatic tissue of patients with benign or malignant prostatic disease are different, with a significant reduction in arachidonic acid and docosapentaenoic acid in malignant prostatic tissue phospholipids. It has been suggested that the decrease in arachidonic acid concentration may be due to its increased metabolism via the cyclo-oxygenase and/or lipoxygenase pathways to produce eicosanoids such as prostaglandins and leukotrienes.<sup>[20]</sup> In one study, malignant prostatic tissue converted radiolabeled arachidonic acid to prostaglandin PGE<sub>2</sub> at an almost 10-fold higher rate than BPH tissue. PGE<sub>2</sub> production from [<sup>3</sup>H]arachidonic acid by malignant prostatic tissue was investigated in the presence of oleic acid, eicosapentaenoic acid, docosahexaenoic acid, dihomo- $\gamma$ -linolenic acid, eicosatetraenoic acid, and ketoprofen. Oleic acid was found to be the most effective inhibitor.<sup>[20]</sup>

Saw palmetto extract, when administered orally in rodents, has shown antiedematous activity in a diversity of animal models, including centrifugation-induced tail edema in mice, histamine- and dextran-induced increase in microvascular permeability and edema in rats, IgE-dependent passive cutaneous anaphylaxis in rats, and UV erythema in guinea pigs. Since the antiedematous activity was also observed in an adrenalectomized rat model, glucocorticoids cannot be the source of activity.<sup>[6]</sup>

Extracts of saw palmetto have shown potent non-competitive inhibition of human prostatic  $\alpha_1$  adrenoceptors in vitro.<sup>[15]</sup> Studies performed on isolated organs, including the rat deferential duct, and guinea pig ileum and bladder, have shown the extracts to have both  $\alpha$  adrenoceptor antagonistic and calcium blocking properties.<sup>[6]</sup> Despite these in vitro reports, the typical side effects of  $\alpha$ -blocker drug therapy do not seem to be frequently reported in clinical trials of saw palmetto.

The peripheral antiandrogenic activity of the saw palmetto extracts has been studied in vivo in mice and prepubertal rats. The animals underwent

castration to remove the source of endogenous testosterone and were then given a subcutaneous (s.c.) injection of the hormone. Saw palmetto extract given orally for 12 days (300 mg/mouse) antagonized the stimulant effect of exogenous testosterone, reducing the weights of the ventral prostate and seminal vesicles by 46% and the weight of the preputial glands by 24% in comparison to the control mice treated only with testosterone. Rats given saw palmetto extract (200 mg/animal) orally for 6 days showed similar results. The body weight and the weights of the levator ani muscle, thymus, adrenal glands, and spleen were unaffected by the extract. In prepubertal mice and rats treated with gonadotropin, orally administered saw palmetto extract (200 mg/animal for 3 days) antagonized the effect of androgens on the weight of the ventral prostate, seminal vesicles, and preputial glands. No effect was observed on the weight of the testicles, thymus, or adrenal glands.<sup>[6]</sup> The antiandrogenic activity in castrated rats treated orally for 10 days with 150 and 300 mg of a saw palmetto extract has been shown to depend on both the temperature and pressure conditions used for the CO<sub>2</sub> extraction of the fruits and the dose of the extract (Table 2).<sup>[17]</sup>

The absence of estrogenic properties has been demonstrated by studying the effect of saw palmetto extract on the growth of the prepubertal female mouse uterus and on the changes in the estrus cycle of adult female mice. The absence of progestational activity has been investigated in ovariectomized female mice that were sensitized with estrone and treated daily with 100–400 mg saw palmetto extract orally or 100  $\mu$ g of progesterone subcutaneously. On day 10 of treatment, histamine was administered in one of the uterine horns. In contrast to progesterone, the extract of saw palmetto did not cause an increase in the weight of the uterus.<sup>[6]</sup>

Antispasmodic activity has been reported in vitro for saw palmetto extracts. A 90% ethanol extract reduced norepinephrine-induced contractions of rat deferential duct, and potassium chloride-induced contractions of guinea pig ileum and bladder smooth muscle tissue. Both lipid and saponifiable fractions of saw palmetto reduced norepinephrine-induced contractions of rat aorta, in vitro as well as potassium chloride-induced contractions of rat uterus. Vanadate-induced contractions of the rat uterus have also been reduced by a lipophilic (90% ethanol) saw palmetto extract.<sup>[14]</sup>

Saw palmetto has both individual compounds and specific extracts with pharmacological activity that could be related to mechanisms that would provide symptomatic relief for LUTS associated with BPH. The lack of systemic hormonal and  $\alpha$ -blocker activity should be important for the safe use of saw palmetto and points to the need for more detailed research on

**Table 2** Effect of orally administered (10 days) hypercritical CO<sub>2</sub> *S. repens* fruit extract in castrated prepuberal rats

Treatment	>Dose (mg/day)	Body weight (g)		Prostate weight (mg)
		Initial	Final	
Normal control (olive oil)	—	58.1 ± 2.6	91.1 ± 3.2	20.6 ± 2.4
Castrated control (olive oil)	—	56.2 ± 1.8	87.2 ± 2.2	3.0 ± 1.2 <sup>a</sup>
TP (olive oil)	—	62.3 ± 3.1	95.2 ± 2.5	17.4 ± 1.8
TP + Extract A	300	65.1 ± 2.7	92.3 ± 2.5	11.7 ± 1.3
TP + Extract B	150	63.1 ± 2.7	94.2 ± 2.5	11.9 ± 1.6 <sup>b</sup>
	300	64.1 ± 1.7	93.6 ± 2.4	6.5 ± 1.2 <sup>c</sup>
TP + Extract C	300	66.2 ± 2.2	94.1 ± 2.5	11.1 ± 1.1 <sup>b</sup>

TP = testosterone proptonate (15 mg/day, s.c.). Extract A: 35°C/250 bar; B: 45°C/220 bar; C: 50°C/280 bar.

Values are mean ± S.E.; *n* = 15.

<sup>a</sup>*P* < 0.01 vs. normal control.

<sup>b</sup>*P* < 0.05.

<sup>c</sup>*P* < 0.01 vs. TP; Duncan's test.

(Adapted from Ref.<sup>[17]</sup>.)

activity in prostate cells, tissues, and animals, as well as in humans, to determine whether multiple mechanisms of action are working in synergy or whether the main mechanism of action has yet to be discovered.

## PHARMACOKINETICS

Unlike pharmacodynamic studies that measure physiological changes, pharmacokinetic studies in humans with saw palmetto are difficult to conduct because the most active compounds that would logically be measured are fatty acids and sterols that are common in the normal Western diet. The pharmacokinetics has been investigated in an open, randomized, cross-over study of 12 healthy males who ingested one 320 mg capsule or two 160 mg capsules per day. The extract was absorbed rapidly, with a peak time (*t*<sub>max</sub>) of 1.50–1.58 hr and peak plasma levels (*C*<sub>max</sub>) of 2.54–2.67 µg/ml. The area under curve value (AUC) ranged from 7.99 to 8.42 µg hr/ml. Since the plasma concentration–time profiles of both preparations were very similar, the preparations were considered bioequivalent, but the validity of the methodology has been questioned.<sup>[6,14]</sup>

In another study, the bioavailability and pharmacokinetic profile of a rectal formulation containing 640 mg of *S. repens* extract were determined in 12 healthy male volunteers. The rectal formulation was similar to the oral one but showed a slower absorption, with a *t*<sub>max</sub> of 2.96 hr.<sup>[6]</sup>

In a study of the administration of a radioactive lipophilic sterol extract of saw palmetto in rats, tissue concentrations of lauric acid, oleic acid, and β-sitosterol were highest in abdominal fat tissue, the prostate, and the skin with lower concentrations in the liver and urinary bladder.<sup>[13]</sup>

## REGULATORY STATUS

Saw palmetto products are regulated in the United States as dietary supplements since the passage of the Dietary Supplement Health and Education Act (DSHEA) in 1994. Under the regulations of DSHEA, saw palmetto is sold without FDA premarket approval since dietary supplements are sold as a category of food. Although clinical testing is not required for inclusion in the *United States Pharmacopeia* or *National Formulary*, identity, chemical content, and quality standards for saw palmetto fruits, powders, extracts, and capsules have recently been reintroduced into the dietary supplement section of the USP27–NF22.<sup>[21]</sup> Saw palmetto products sold as dietary supplements are not allowed to make a drug claim (such as for the treatment of urological symptoms associated with BPH) but are allowed to make structure function claims (such as “to support prostate health” or “support healthy prostate function”). Saw palmetto is included in the *Homeopathic Pharmacopoeia of the United States* and as such may be sold as a homeopathic over-the-counter (OTC) drug at strength of 1×, which is similar to a full strength alcoholic (65%) extract.<sup>[22]</sup>

The Federal Trade Commission, the US government agency that regulates advertising claims for all products, has issued a guidance document on truthful and nonmisleading advertising claims for dietary supplements that includes opinions from experts in botanical medicine and the claim being made.<sup>[23]</sup>

Saw palmetto is sold in Canada as a natural health product that must be manufactured to pharmaceutical standards and meet other monograph standards, including the amount of the product to be taken and the form of the product that can be used, and is sold with labels that can state the more accurate claim

“helps relieve the urologic symptoms associated with benign prostatic hyperplasia”<sup>[24]</sup> In France, it is a prescription drug reimbursable by the national health insurance. In Italy, a lipophilic hexane extract is sold as a prescription drug. The dried fruit, simple galenical preparations, and lipophilic extracts are approved as nonprescription drugs in Germany. In Belgium, saw palmetto is a prescription adjuvant for BPH, while in Sweden, it is sold as a natural remedy for self-medication after premarketing authorization. In Switzerland, it is sold without a prescription, but sales are limited to pharmacies, and in the United Kingdom, saw palmetto is a herbal medicine on the *General Sales List* that requires full product licensing.<sup>[15]</sup>

## CONCLUSIONS

Saw palmetto fruits and extracts, based on the known chemistry, pharmacology, clinical trial data, and the low number of adverse event reports, appear to be very safe for men to consume in the amounts used in clinical trials and available in dietary supplement products on the market. Mild nausea or mild GI upset appear to be the most frequent side effects from ingesting amounts currently consumed as dietary supplements or as drugs. Saw palmetto products that have not been tested for systemic estrogen and androgen effects pose a theoretical risk to the proper development of the fetus and infants; their use is therefore contraindicated in the WHO monograph for pregnant or lactating women and children under 12 yr of age.

Specific lipophilic saw palmetto hexane and CO<sub>2</sub> extracts produced to high quality manufacturing and chemical content standards have been shown in clinical trials to be safe and effective for lower urinary tract symptoms associated with BPH. Although saw palmetto is popular as self-treatment in the United States, a large majority of the products on the market have not been evaluated in clinical trials for efficacy.

## ACKNOWLEDGMENTS

Thanks to Renato Iguera and Indena S.p.A., Milan, Italy, for the photographs of saw palmetto. Thanks to Tom Aarts for permission to include the saw palmetto sales figures in 2001 from the *Nutrition Business Supplement Business Report*.

## REFERENCES

1. *Magnoliophyta: Alismatidae, Arecidae, Commelinidae (in Part), and Zingiberidae*. Flora of North America North of Mexico; Flora of North America Editorial Committee, Eds.; Oxford University Press: New York and Oxford, 2000; Vol. 22. Flora of North America Online: [http://flora.huh.harvard.edu:8080/flora/browse.do?flora\\_id=1&taxon\\_id=222000361&key\\_no=1](http://flora.huh.harvard.edu:8080/flora/browse.do?flora_id=1&taxon_id=222000361&key_no=1) (accessed May 20, 2004).
2. Godfrey, R.K. *Trees, Shrubs, and Woody Vines of Northern Florida and Adjacent Georgia and Alabama*; University of Georgia Press: Athens, 1988.
3. Bennett, B.C.; Hicklin, J.R. Uses of saw palmetto (*Serenoa repens*, Arecaceae) in Florida. *Econ. Bot.* **1998**, *52* (4), 381–393.
4. Wilt, T.; Ishani, A.; MacDonald, R. *Serenoa repens* for benign prostatic hyperplasia (Cochrane Review). In *The Cochrane Library*, Issue 2; John Wiley & Sons, Ltd.: Chichester, UK, 2000.
5. Felter, H.W.; Lloyd, J.U. *Serenoa*. In *King's American Dispensatory*; 18th Ed.; 3rd revision; 1898; Vol. 2, 1750–1752 [Reprinted by Eclectic Medical Publications: Sandy, Oregon, 1983 (1993 printing)].
6. Bombardelli, E.; Morazzoni, P. *Serenoa repens* (Bartram) J.K. Small. *Fitoterapia* **1997**, *69* (2), 99–113.
7. Ganzera, M.; Croom, E.M.; Khan, I.A. Determination of fatty acid content of Pumpkin seed, *Pygeum*, and Saw Palmetto. *J. Med. Food* **1999**, *2* (1), 21–27.
8. Peng, T.-S.; Popin, W.F.; Huffman, M. Systematic investigation of quality management of saw palmetto products. In *Quality Management of Nutraceuticals*; American Chemical Society Symposium Series, No. 803; American Chemical Society: Washington, DC, 2002.
9. Supplement Business Report. *Nutr. Bus. J.* **2002**, 3–6.
10. Schulz, V.; Hansel, R.; Tyler, V.E. *Rational Phytotherapy*, 3rd Ed.; Springer: Berlin, 1998.
11. AUA Practice Guidelines Committee. AUA guideline on management of benign prostatic hyperplasia (2003). Chapter 1: Diagnosis and treatment recommendations. *Urology* **2003**, *170*, 530–547.
12. Debruyne, F.; Koch, G.; Boyle, P.; Calais da Silva, F.; Gillenwater, J.G.; Hamdy, F.C.; Perrin, P.; Teillac, P.; Vela-Navarrete, R.; Raynaud, J.P.; PERMAL Study Group. Comparison of a phytotherapeutic agent (Permixon) with an alpha-blocker (tamsulosin) in the treatment of benign prostatic hyperplasia: a 1-year randomized international study. *Eur. Uro.* **2002**, *41* (5), 497–507.
13. Committee on the Framework for Evaluating the Safety of Dietary Supplements, Food and Nutrition Board, Board on Life Sciences. Dietary

- supplement ingredient prototype monographs developed as examples for the report, saw palmetto. *Dietary Supplements: A Framework for Evaluating Safety*; National Academies Press: Washington, DC, 2004. <http://www.iom.edu/subpage.asp?id=19554> (accessed May 21, 2004).
14. World Health Organization. *Fructus Serenoae Repentis*; WHO Monographs on Selected Medicinal Plant. 2001. [www.who.int/medicines/library/trm/medicinalplants/vol2/285to299.pdf](http://www.who.int/medicines/library/trm/medicinalplants/vol2/285to299.pdf) (accessed May 31, 2004).
  15. Brinckmann, J.; Wollschlaeger, B. Saw palmetto. In *The ABC Clinical Guide to Herbs*; Blumenthal, M., Hall, T., Goldberg, A., Kunz, T., Dinda, K., Eds.; American Botanical Council: Austin, TX, 2003; 311–319.
  16. Breu, W.; Hagenlocher, M.; Redl, K.; Tittel, G.; Stadler, F.; Wagner, H. Anti-inflammatory activity of sabal fruit extracts prepared with supercritical carbon dioxide. In vitro antagonists of cyclooxygenase and 5-lipoxygenase metabolism. *Arzneimittelforschung* **1992**, *42* (4), 547–551.
  17. Cristoni, A.; Morazzoni, P.; Bombardelli, E. Chemical and pharmacological study on hypercritical CO<sub>2</sub> extracts of *Serenoa repens* fruits. *Fitoterapia* **1997**, *68* (4), 355–358.
  18. Marks, L.S.; Hess, D.L.; Dorey, F.J.; Luz Macairan, M.; Cruz Santos, P.B.; Tyler, V.E. Tissue effects of saw palmetto and finasteride: use of biopsy cores for in situ quantification of prostatic androgens. *Urology* **2001**, *57* (5), 999–1005.
  19. Niederprüm, H.-J.; Schweikert, H.-U.; Zänker, K.S. Testosterone 5  $\alpha$ -reductase inhibition by free fatty acids from *Sabal serrulata* fruits. *Phyto-medicine* **1994**, *1*, 127–133.
  20. Chaudry, A.A.; Wahle, K.W.; McClinton, S.; Moffat, L.E. Arachidonic acid metabolism in benign and malignant prostatic tissue in vitro: effects of fatty acids and cyclooxygenase inhibitors. *Int. J. Cancer* **1994**, *57* (2), 176–180.
  21. Saw palmetto monographs. In *United States Pharmacopeia 27–National Formulary 22*, USP 27th revision. United States Pharmacopeial Convention, Inc.: Rockville, MD, 2004; 2034–2037.
  22. *Homeopathic Pharmacopoeia of the United States Official Compendium*; Pharmacopoeia Convention of the American Institute of Homeopathy: Boston, MA, 1997.
  23. *Dietary Supplements: An Advertising Guide for Industry*; United States Federal Trade Commission. <http://www.ftc.gov/bcp/conline/pubs/buspubs/dietsupp.htm> (accessed May 31, 2004).
  24. *Saw Palmetto Monograph*; Health Canada, Natural Health Products Directorate. [http://www.hc-sc.gc.ca/hpfb-dgpsa/nhpd-dpsn/mono\\_saw\\_palmetto\\_e.html](http://www.hc-sc.gc.ca/hpfb-dgpsa/nhpd-dpsn/mono_saw_palmetto_e.html) (accessed May 31, 2004).

# Selenium

**Raymond F. Burk**

**Brooke K. Norsworthy**

*Clinical Nutrition Research Unit, Vanderbilt University School of Medicine, Nashville, Tennessee, U.S.A.*

## INTRODUCTION

Selenium is an essential micronutrient that is incorporated into the primary structure of proteins in the form of selenocysteine. Selenoproteins facilitate redox reactions that underlie a number of biochemical processes. Among them are protection against oxidative damage, metabolism of thyroid hormones, support of DNA synthesis, and regulation of transcription factors. Selenium deficiency occurs in China and some other countries but not in the United States. The recommended dietary allowance (RDA) for selenium is 55 µg/day for adults.

## BACKGROUND

Selenium was discovered by Berzelius in 1817 as a by-product of sulfuric acid production. Its importance in biology was established in the 1930s, when it was identified as the toxic principle in plants that poisoned grazing animals in certain parts of the Great Plains of the United States. In response to this problem, the U.S. Department of Agriculture (USDA) mapped the selenium content of forage from all regions of the United States and produced a “selenium map” to help farmers avoid grazing their animals in areas that might produce toxicity.<sup>[1]</sup> In addition, the metabolism of the nutrient was studied over the next two decades with the aim of determining its mechanism of toxicity. Studies carried out during that period established that its metabolism was intertwined with that of sulfur.<sup>[2]</sup>

The essentiality of selenium in animals was recognized in 1957, when provision of the element to rats fed a yeast-based diet was shown to prevent the

development of dietary liver necrosis.<sup>[3]</sup> Vitamin E could also prevent the condition, and this fact has linked these two nutrients since that time. A number of naturally occurring animal diseases are caused by combined selenium and vitamin E deficiency. They include mulberry heart disease, nutritional muscular dystrophy, and nutritional liver necrosis of swine, exudative diathesis of chickens, and white muscle disease of sheep. Reference to the selenium map produced by the USDA shows that these conditions occur in areas where plant selenium concentrations are low.<sup>[1]</sup>

Geological studies led to the recognition that selenium is distributed irregularly in soil. Soils derived from volcanic rock are generally poor in selenium, as are those subject to leaching from high rainfall. Alkaline soils yield their selenium, and acid soils withhold it from plants. Thus, alkaline soils derived from sedimentary rock that are in arid regions tend to transmit high levels of selenium to plants. Plants grown on acidic soil or volcanic soil tend to have low selenium content. One of the areas of low selenium in the United States is the Pacific Northwest, and grazing animals require selenium supplementation there. The South Island of New Zealand and much of Scandinavia also have low soil selenium levels.

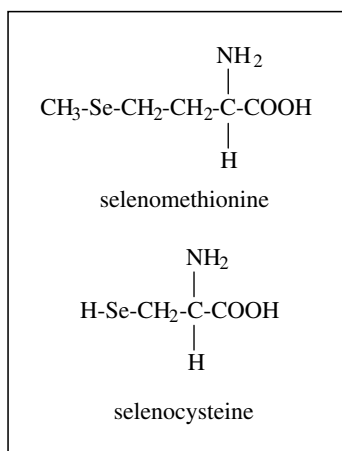
Human selenium deficiency was firmly demonstrated in 1979, when Chinese scientists provided evidence that a cardiomyopathy occurred only in selenium-deficient children living in regions of China where the nutrient content in plants was very low. Blood and hair selenium content of inhabitants of regions where Keshan disease was found were the lowest levels reported in human beings.<sup>[4]</sup> Thus, selenium is an essential nutrient for human beings.

In recent years, supplementation of selenium in pharmacological doses has been touted for a variety of health purposes. These include chemoprevention of cancer, delay of aging, and prevention of heart disease. These potential actions do not appear to relate to its nutritional effects. This brief review will focus on nutritional (physiological) functions of selenium. Other uses of the element will be addressed only briefly.

---

*Raymond F. Burk, M.D.*, is Professor at the Division of Gastroenterology, Department of Medicine and Pathology, Clinical Nutrition Research Unit, Vanderbilt University School of Medicine, Nashville, Tennessee, U.S.A.

*Brooke K. Norsworthy, M.Sc.*, is Research Assistant at the Division of Gastroenterology, Department of Medicine, Clinical Nutrition Research Unit, Vanderbilt University School of Medicine, Nashville, Tennessee, U.S.A.



**Fig. 1** The amino acid forms of selenium that account for most of the element in the body.

## CHEMICAL FORMS

Selenium occupies a spot in the periodic table of elements just below sulfur and shares many chemical properties with that element. Its chemistry is covalent in biological systems.

Most selenium in biological material is present in amino acids (Fig. 1). Plants are not known to require selenium and incorporate the element nonspecifically into selenomethionine. A major source of selenium in the diet is selenomethionine. Once ingested by an animal, it enters the methionine pool and is not distinguished from methionine. Thus, much of the selenium in animal tissues is selenomethionine that is nonspecifically incorporated in proteins at methionine positions. When selenomethionine is catabolized, its selenium becomes available to the selenium metabolic pool. Thus, selenomethionine apparently has no biological function related to selenium other than serving as a dietary source of the element.

Selenocysteine is present in stoichiometric amounts in selenoproteins and is necessary for their function. This is synthesized from the selenium present in the metabolic pool. It is often considered to be a "supercysteine" because its hydrogen is dissociated at physiological pH, making it very reactive. Presence of selenocysteine at active sites of enzymes such as glutathione peroxidases increases their activities several orders of magnitude above that when cysteine is present.

The urinary metabolites of selenium that have been identified are trimethylselenonium ion and a methylated selenosugar.<sup>[5]</sup> They are synthesized in the liver and kidney to regulate whole-body selenium.

Inorganic forms of selenium such as selenite and selenate are biologically available and are often used to supplement selenium intakes. They are well tolerated and inexpensive.

## BIOCHEMISTRY AND FUNCTION

### Selenoprotein Synthesis

Animal selenoproteins contain stoichiometric amounts of selenocysteine in their primary structures. The selenocysteine that is used for this process is synthesized in the cell by modification of a serine residue that has already been ligated to tRNA<sup>[ser]sec</sup>. The resulting selenocysteinyl-tRNA<sup>[ser]sec</sup> recognizes a UGA in the open reading frame of the selenoprotein mRNA with the aid of at least two trans-acting proteins. The process of selenoprotein synthesis is complex and costly to the organism. It requires at least 5 gene products in addition to the ones normally used for protein synthesis. Reviews describing selenoprotein synthesis are available.<sup>[6,7]</sup>

### Selenoproteins and Their Functions

Twenty-five genes that code for selenoproteins have been identified in the human genome.<sup>[8]</sup> Because some genes produce more than one protein product, the number of selenoproteins in humans is probably between 25 and 50. While most of these selenoproteins have not been characterized, a few of them have been subjected to considerable study (Table 1).

**Table 1** Human selenoproteins<sup>a</sup>

Group/name	Abbreviation
<i>Selenoproteins involved in thiol redox reactions</i>	
Glutathione peroxidases	
Cellular glutathione peroxidase	GPX1
Gastrointestinal glutathione peroxidase	GPX2
Extracellular glutathione peroxidase	GPX3
Phospholipid hydroperoxide glutathione peroxidase	GPX4
Odorant metabolizing glutathione peroxidase	GPX6
Thioredoxin reductases	
Cytosolic thioredoxin reductase	TrxR1
Mitochondrial thioredoxin reductase	TrxR2
Testicular thioredoxin reductase	TrxR3
Methionine sulfoxide reductase B	MsrB
<i>Selenoproteins involved in thyroid hormone metabolism</i>	
Type I iodothyronine deiodinase	D1
Type II iodothyronine deiodinase	D2
Type III iodothyronine deiodinase	D3
<i>Selenoprotein involved in selenium supply to the brain and testes</i>	
Selenoprotein P	Se-P

<sup>a</sup>For other selenoproteins, see Ref.<sup>[8]</sup>.

### Selenoproteins involved in thiol redox reactions

There are two major systems that regulate thiol redox status in cells: The glutathione and the thioredoxin systems. Both of them depend on NADPH for their reducing equivalents and contain selenoproteins as components.

The glutathione peroxidases utilize reduced glutathione (GSH) to catabolize hydroperoxides of various kinds. The active sites of these enzymes typically contain selenocysteine, although some of them function with cysteine in the active site. Of the 6 glutathione peroxidase genes in the human genome, 5 code for selenoproteins. At least one of these genes produces 3 different protein products by the use of alternative translation start sites.

Two glutathione peroxidase genes have been knocked out in mice without obvious effects on health and reproduction.<sup>[9,10]</sup> Only when these knockout mice are stressed do they show increased injury compared with wild-type animals.<sup>[11]</sup> A knockout of another glutathione peroxidase, phospholipid hydroperoxide glutathione peroxidase, causes embryonic lethality.<sup>[12]</sup> One isoform of this latter enzyme has structural functions in spermatozoa.<sup>[13]</sup> The considerations above-mentioned indicate that these enzymes have a variety of biological functions and each will have to be evaluated separately. A full discussion of this enzyme family is beyond the scope of this review and can be found elsewhere.<sup>[14]</sup>

Thioredoxin reductases maintain thioredoxin and some other substances, including ascorbate, in a reduced state. These enzymes contain selenium in mammals, but lower life forms sometimes have cysteine homologs. Thioredoxin is responsible for providing reducing equivalents to ribonucleotide reductase and to a number of other enzymes and transcription factors. Therefore, this family is important for gene expression, signaling, and oxidant defenses.<sup>[15,16]</sup> Knockout of thioredoxin in mice causes embryonic lethality.<sup>[17]</sup>

### Selenoproteins involved in thyroid hormone metabolism

Thyroxine, or T4, is the hormone produced by the thyroid gland. It must be converted to triiodothyronine, or T3, to exert biological activity. T3 is inactivated by conversion to T2. All these reactions are carried out by 3 selenoproteins known as deiodinases.<sup>[18]</sup>

In animals, selenium deficiency leads to decreased activity of the deiodinases, but this is compensated for by a rise in T4 levels. When T4 production is compromised by iodine deficiency, the addition of selenium deficiency is not well tolerated.<sup>[19]</sup> There have been

reports of cretinism occurring in infants living in areas where combined selenium and iodine deficiency is found.<sup>[20]</sup>

### Selenium transport

Recently, selenoprotein P has been shown to have selenium transport properties. This extracellular selenoprotein contains 10 selenocysteine residues in its full-length form. It is produced in most tissues, but selenoprotein P in plasma appears to originate largely in liver.

Mice with selenoprotein P knocked out have been produced.<sup>[21,22]</sup> Males have abnormal spermatozoa and have sharply reduced fertility. Both males and females develop neurological impairment when fed a diet containing normal amounts of selenium. They can be rescued by provision of a high-selenium diet.<sup>[22]</sup> These studies appear to indicate that the brain and testes rely on selenoprotein P for their supply of selenium.

### Other selenoproteins

Most of the other selenoproteins appear to be present in low abundance. They will have to be studied individually to determine their biological functions.

### Antioxidant Properties of Selenium

Several lines of investigation indicate that selenium has antioxidant properties. Already mentioned is the relationship with vitamin E, which is a free radical scavenger. When rats that are vitamin E deficient are also made selenium deficient, they undergo massive lipid peroxidation and liver necrosis.<sup>[23]</sup> This indicates that selenium-dependent functions, presumably reactions catalyzed by selenoproteins, partially compensate for the lack of vitamin E, but that loss of both nutrients leads to severe oxidative damage in the liver.

A number of oxidant defense enzymes that do not contain selenium become induced in selenium deficiency. These include glutathione transferases, glutamate-cysteine ligase, NAD(P)H quinone reductase, and heme oxygenase-1.<sup>[24]</sup> Loss of thioredoxin reductase activity appears to be the cause of induction of heme oxygenase-1,<sup>[25]</sup> and this selenoprotein might be responsible for many of the oxidant defense properties of selenium.

### Cancer Chemoprevention

A great deal of attention has been directed to the use of selenium to prevent cancer. The first data suggesting a correlation between low selenium intake and increased



cancer incidence were presented in the 1970s. Since then, other observational studies have supported this correlation. However, they were unable to isolate selenium as the only factor responsible for the lower cancer incidence.

Intervention studies have attempted to evaluate the effect of selenium administration on cancer incidence. One such study was carried out in China.<sup>[26]</sup> An overall reduction in cancer mortality of 13% was achieved in a rural population by giving combined supplements of selenium, vitamin E, and carotene. Unfortunately, no subjects were given selenium alone; so the protection cannot be ascribed to it.

Another study using high-selenium yeast that provided 200 µg of selenium per day was carried out in subjects who had a nonmelanoma skin cancer.<sup>[27]</sup> The primary endpoint was development of another skin cancer. Secondary endpoints of other cancers were introduced after the study had been initiated.

The initial analysis (10 yr of supplementation) of the primary endpoint showed no effect of the high-selenium yeast on skin cancer development, but it showed a decrease of 37% in overall cancer development. The diagnosis of prostate cancer was decreased 63% in the high-selenium yeast group. Concern was raised recently by a report on the entire blinded period (12 yr) of high-selenium yeast supplementation.<sup>[28]</sup> It showed that the supplemented group had a higher incidence of squamous cell carcinoma of the skin than did the placebo group.

The initial report of this study stimulated a great deal of interest in selenium as a chemoprevention agent. A very large trial of selenium and vitamin E administration against the development of prostate cancer has been initiated with NIH support.

Because of the uncertainty that exists about the effect of pharmacologic amounts of selenium on cancer development, selenium supplementation cannot be recommended at present to prevent cancer. Studies that are in progress and planned should provide guidance in this matter.

## METABOLISM

Selenium has chemical properties that account for its function in selenoproteins. Because these can also lead to catalysis of unwanted reactions, homeostatic control of selenium in the organism is necessary.

The major dietary forms of selenium are selenomethionine derived from plants and selenocysteine from animal selenoproteins. Both amino acids appear to be virtually completely absorbed by the mechanisms used for absorption of their sulfur analogs. The inorganic forms that are often used for supplementation, selenite and selenate, are also well absorbed.

Thus, absorption of selenium is very high and not subject to regulation by selenium status.

The selenium pool in the liver appears to be the site of homeostatic regulation. Absorbed selenium is removed from the portal blood by the liver, and selenomethionine is catabolized there by transsulfuration, releasing its selenium to the selenium metabolic pool.

Liver selenium is used to synthesize liver selenoproteins and selenoprotein P for export. Selenium in excess of that needed for these processes appears to be converted into excretory metabolites (trimethylselenonium ion and a methylated selenosugar) that appear in the urine. When toxic amounts of selenium are present, dimethyl selenide appears in the breath. Thus, excretion is responsible for regulating the selenium content of the body.

The only transport form of selenium that has been identified is selenoprotein P.<sup>[21,22]</sup> However, other form(s) must exist, because knockout of selenoprotein P does not affect selenium levels of many tissues.

Selenium storage is accomplished through two mechanisms. One is unregulated and consists of selenomethionine that is present in the methionine pool. As selenomethionine is catabolized, its selenium is fed into the selenium metabolic pool. The other storage mechanism relates to the most abundant glutathione peroxidase enzyme. This protein contains a greater fraction of whole-body selenium than any other selenoprotein. When selenium is in short supply, the mRNA of this glutathione peroxidase is degraded more rapidly, reducing synthesis of this selenoenzyme. This allows selenium to be directed to other selenoproteins that are presumably more important for survival.

In summary, selenium homeostasis is maintained by excretion of the element when it is present in amounts greater than what can be utilized for selenoprotein synthesis. When insufficient selenium is present for synthesis of all selenoproteins, hepatic cytosolic glutathione peroxidase is downregulated so that selenium can be directed to other selenoproteins.

## DIETARY INTAKE AND DEFICIENCY

### Sources and Regional Variation of Selenium

The amount of selenium in plants depends on the availability in the soil on which the plants are grown. This fact leads to a single food plant such as wheat having a selenium content that can vary by a factor of 10 or more, depending on where it is grown. This variation renders food tables for selenium in plants of little value.

Animals, on the other hand, require selenium and have homeostatic mechanisms to maintain predictable concentrations in their tissues. Thus, foods of animal

origin are more reliable sources of selenium. In areas where the soil is poor in selenium, animal foods contain more selenium than plant foods.

The lowest and the highest intakes of selenium in the world have been reported in China. They vary from less than 10 µg/day to over 1 mg/day.<sup>[29]</sup> The cause of this wide variation is the reliance of the population on plant foods and the extreme variation in available soil selenium in different regions.

Intakes in other countries generally vary from around 30 µg/day in New Zealand and parts of Scandinavia to around 100 µg/day in North America. Intakes in Europe are in the range of 30–60 µg/day.

### Keshan Disease

The only human disease that has been clearly linked to selenium deficiency is Keshan disease. It is a childhood cardiomyopathy that occurs in low-selenium regions of China, where the intake of the element is approximately 10 µg/day. A double-blind placebo-controlled study that was carried out in the 1970s showed that selenium supplementation could prevent the development of Keshan disease.<sup>[4]</sup> Because not all selenium-deficient children developed Keshan disease, a second stress was considered. Subsequent studies in mice have suggested that the second stress might be a viral infection.<sup>[30]</sup>

The incidence of Keshan disease has declined in the last few decades and it is now rare. This is likely due to the improvement of the Chinese economy, with increased meat intake and exchange of foodstuffs between regions.

### Assessment of Selenium Status

The endpoint usually used to set recommended intake of selenium is optimization of selenoprotein concentrations. This is based on the assumption that full expression of selenoproteins will promote optimal physiological function and health. Inadequate dietary supply of selenium limits selenoprotein synthesis and results in depressed selenoprotein concentrations. When selenoproteins are optimized, provision of additional selenium will not cause their concentrations to increase. Instead, the additional selenium is excreted. Thus, optimization of the plasma selenoproteins (as representatives of all selenoproteins) has been used to determine the selenium requirement.

There are two selenoproteins in plasma, selenoprotein P and extracellular glutathione peroxidase. When optimized, these proteins contain 6.4 and 1.7 µg of selenium per 100 ml of plasma, respectively.<sup>[31]</sup> Thus, the total selenium in the plasma selenoproteins is approximately 8 µg per 100 ml of plasma.

A third pool of selenium is present in plasma proteins. It is selenomethionine distributed nonspecifically in the methionine pool. In the United States, the amount of selenium in this form ranges from 1 to 12 µg per 100 ml of plasma. This leads to the total plasma selenium concentration in the United States varying from about 9 to 20 µg per 100 ml. The mean serum selenium level of 18,597 persons reported by the Third National Health and Nutrition Examination Survey (NHANES III, 1988–1994) was 12.5 µg per 100 ml, with 5th and 95th percentiles of 10 and 15 µg per 100 ml, respectively.<sup>[32]</sup>

Based on these results, plasma or serum selenium concentrations of 8 µg per 100 ml or higher in healthy people should indicate optimization of the plasma selenoproteins. Concentrations greater than this merely indicate that the subjects are consuming selenomethionine. People with diseases may have alterations in their selenoprotein concentrations caused by their conditions,<sup>[33]</sup> so this value may not apply to them.

For reference purposes, plasma concentrations of selenium in low-selenium regions of China are generally 2 µg per 100 ml or less. In New Zealand, they are 5–8 µg per 100 ml, and in Europe, 5–10 µg per 100 ml. Concentrations greater than 50 µg per 100 ml of plasma occur in high-selenium regions of China.

### Dietary Reference Intakes

Estimates of the human selenium requirement have been based on two studies. One was performed in China in the early 1980s.<sup>[34]</sup> Men with a dietary intake of 11 µg of selenium per day were supplemented with selenium as selenomethionine for several months. The group that received a supplement of 30 µg of selenium per day optimized its plasma glutathione peroxidase activity. Thus, a total intake (diet plus supplement) of 41 µg/day optimized plasma selenoproteins.

The other study was carried out in New Zealand in a group with a dietary selenium intake of 28 µg/day. Its results were more difficult to interpret because of the high basal selenium intake. However, results indicated a similar requirement for optimization to that found in China.

In 2000, based on these two studies, the Institute of Medicine set the RDA for selenium at 55 µg/day for adults of both sexes.<sup>[35]</sup> Table 2 shows the corresponding values for other subjects as well. These recommendations are for healthy people and are meant to satisfy the biochemical selenium requirements of the body. Further research will be necessary to determine whether there are special populations that need a greater selenium intake. Also, this RDA does not take into consideration the possible pharmacologic use of selenium.

**Table 2** Recommended dietary allowances (RDAs) for selenium

Group	Amount ( $\mu\text{g}/\text{day}$ )
Children	
1–3 yr old	20
4–8 yr old	30
9–13 yr old	40
Adolescents (14–18 yr old)	55
Adults ( $\geq 19$ yr old)	55
Pregnant women	60
Lactating women	70

(From Ref.<sup>[35]</sup>.)

## SUPPLEMENTATION

Several forms of selenium are available for use as supplements. The two inorganic forms, selenite and selenate, are often used in animal experimental diets because they cannot be converted to selenomethionine, and therefore tissue selenium concentrations reflect only selenoproteins. These forms have similar bioavailability (50–90%), but selenite is subject to reaction with intestinal contents. Also, selenite is an oxidant and can be quite damaging when given in large quantities. Selenite is added to salt in some selenium-deficient regions of China and to fertilizer in Finland. Both these methods of supplementation have been shown to be effective in improving the selenium status of human populations.

Selenomethionine makes up a large fraction of the normal dietary selenium. It is virtually completely bioavailable. It is less likely to cause acute toxicity than are the inorganic forms, although its toxicity is approximately the same as that of those forms under steady state conditions. Administration of selenium as selenomethionine can complicate interpretation of tissue selenium levels, and it is more expensive than the inorganic forms.

High-selenium yeast preparations are available for selenium supplementation. These are proprietary products in which yeast is grown in high-selenium medium. Much of the selenium in the yeast is in the form of selenomethionine, but many minor forms are also present in variable amounts. Because of the relatively uncharacterized nature of the selenium in these yeast products, their usefulness in scientific experiments is minimal. Producers and marketers of these yeast preparations make various claims, but there is no good evidence for their special efficacy. These are often expensive.

All these forms of selenium are effective as supplements in delivering selenium to human beings and animals. The inorganic forms have the advantage of being inexpensive. Selenomethionine allows the person to incorporate surplus selenium into protein. Because

high-selenium yeast contains selenomethionine, it shares this property.

Scientific experiments generally use inorganic selenium or selenomethionine, depending on the design of the experiment.

Research is being performed on other forms of selenium such as Se-methylselenocysteine to evaluate their chemoprevention activity. Such forms are not generally available at present and cannot be recommended except for research purposes.

## Toxicity

Selenium can be toxic. Manifestations range from severe acute multiorgan failure after ingestion of milligram-to-gram quantities of selenious acid (selenite) to loss of hair and nails caused by chronic ingestion of more than a milligram of selenium per day for long periods.

Studies carried out in a high-selenium region of China indicated that brittle nails and hair loss did not occur at intakes below 1 mg/day. Based on this result, the Institute of Medicine set a safe upper limit of 400  $\mu\text{g}/\text{day}$  for chronic selenium intake for adults.<sup>[35]</sup> In practical terms, this is about 300  $\mu\text{g}$  above the dietary intake of selenium in the United States. Thus, it allows room for supplements to be taken by those who believe they might be efficacious.

## CONCLUSIONS

Selenium is an essential element that has a variety of biochemical functions. It is lacking in the food supply of many countries, but there is no such evidence in North America. There is a need for research into the effects of marginal selenium intakes such as those in New Zealand, Scandinavia, and Europe. Also, studies are needed to determine whether genetic and/or disease conditions raise the selenium requirement. Finally, claims have been made that ingestion of pharmacologic amounts of selenium can prevent cancer. Studies are underway to assess that possibility.

## ACKNOWLEDGMENTS

The authors are grateful to Kristina E. Hill, Ph.D., for helpful discussions. The work of the authors is supported by NIH grant DK58765.

## REFERENCES

1. Allaway, W.H. An overview of distribution patterns of trace elements in soils and plants. *Ann. N. Y. Acad. Sci.* **1972**, *199*, 17–25.

2. Painter, E.P. The chemistry and toxicity of selenium compounds, with special reference to the selenium problem. *Chem. Rev.* **1941**, *28*, 179–213.
3. Schwarz, K.; Foltz, C.M. Selenium as an integral part of factor 3 against dietary necrotic liver degeneration. *J. Am. Chem. Soc.* **1957**, *79*, 3292–3293.
4. Keshan Disease Research Group. Observations on effect of sodium selenite in prevention of Keshan disease. *Chin. Med. J.* **1979**, *92*, 471–476.
5. Kobayashi, Y.; Ogra, Y.; Ishiwata, K.; Takayama, H.; Aim, N.; Suzuki, K.T. Selenosugars are key and urinary metabolites for selenium excretion within the required to low-toxic range. *Proc. Natl. Acad. Sci. U.S.A.* **2002**, *99*, 15,932–15,936.
6. Driscoll, D.M.; Copeland, P.R. Mechanism and regulation of selenoprotein synthesis. *Annu. Rev. Nutr.* **2003**, *23*, 17–40.
7. Lescure, A.; Fagegaltier, D.; Carbon, P.; Krol, A. Protein factors mediating selenoprotein synthesis. *Curr. Protein Pept. Sci.* **2002**, *3*, 143–151.
8. Kryukov, G.V.; Castellano, S.; Novoselov, S.V.; Lobanov, A.V.; Zehtab, O.; Guigo, R.; Gladyshev, V.N. Characterization of mammalian selenoproteomes. *Science* **2003**, *300*, 1439–1443.
9. Ho, Y.-S.; Magnenat, J.-L.; Bronson, R.T.; Cao, J.; Gargano, M.; Sugawara, M.; Funk, C.D. Mice deficient in cellular glutathione peroxidase develop normally and show no increased sensitivity to hyperoxia. *J. Biol. Chem.* **1997**, *272*, 16,644–16,651.
10. Chu, F.F.; Doroshov, J.H.; Esworthy, R.S. Expression, characterization, and tissue distribution of a new cellular selenium-dependent glutathione peroxidase, GSHPx-GI. *J. Biol. Chem.* **1993**, *268*, 2571–2576.
11. Cheng, W.-H.; Ho, Y.S.; Valentine, B.A.; Ross, D.A.; Combs, G.F., Jr.; Lei, X.G. Cellular glutathione peroxidase is the mediator of body selenium to protect against paraquat lethality in transgenic mice. *J. Nutr.* **1998**, *128*, 1070–1076.
12. Imai, H.; Hirao, F.; Sakamoto, T.; Sekine, K.; Mizukura, Y.; Saito, M.; Kitamoto, T.; Hayasaka, M.; Hanaoka, K.; Nakagawa, Y. Early embryonic lethality caused by targeted disruption of the mouse PHGPx gene. *Biochem. Biophys. Res. Commun.* **2003**, *305*, 278–286.
13. Ursini, F.; Heim, S.; Kiess, M.; Maiorino, M.; Roveri, A.; Wissing, J.; Flohé, L. Dual function of the selenoprotein PHGPx during sperm maturation. *Science* **1999**, *285*, 1393–1396.
14. Arthur, J.R. The glutathione peroxidases. *Cell Mol. Life Sci.* **2000**, *57*, 1825–1835.
15. Mustacich, D.; Powis, G. Thioredoxin reductase. *Biochem. J.* **2000**, *346*, 1–8.
16. Arnér, E.S.J.; Holmgren, A. Physiological functions of thioredoxin and thioredoxin reductase. *Eur. J. Biochem.* **2000**, *267*, 6102–6109.
17. Matsui, M.; Oshima, M.; Oshima, H.; Takaku, K.; Maruyama, T.; Yodoi, J.; Taketo, M.M. Early embryonic lethality caused by targeted disruption of the mouse thioredoxin gene. *Dev. Biol.* **1996**, *178*, 179–185.
18. Bianco, A.C.; Salvatore, D.; Gereben, B.; Berry, M.J.; Larsen, P.R. Biochemistry, cellular and molecular biology, and physiological roles of the iodothyronine selenodeiodinases. *Endocr. Rev.* **2002**, *23*, 38–89.
19. Beckett, G.J.; Nicol, F.; Rae, P.W.; Beech, S.; Guo, Y.; Arthur, J.R. Effects of combined iodine and selenium deficiency on thyroid hormone metabolism in rats. *Am. J. Clin. Nutr.* **1993**, *57*, 240S–243S.
20. Vanderpas, J.B.; Contempre, B.; Duale, N.L.; Goossens, W.; Bebe, N.; Thorpe, R.; Ntambue, K.; Dumont, J.; Thilly, C.H.; Diplock, A.T. Iodine and selenium deficiency associated with cretinism in northern Zaire. *Am. J. Clin. Nutr.* **1990**, *52*, 1087–1093.
21. Schomburg, L.; Schweizer, U.; Holtmann, B.; Flohe, L.; Sendtner, M.; Kohrle, J. Gene disruption discloses role of selenoprotein P in selenium delivery to target tissues. *Biochem. J.* **2003**, *370*, 397–402.
22. Hill, K.E.; Zhou, J.; McMahan, W.J.; Motley, A.K.; Atkins, J.F.; Gesteland, R.F.; Burk, R.F. Deletion of selenoprotein P alters distribution of selenium in the mouse. *J. Biol. Chem.* **2003**, *278*, 13,640–13,646.
23. Hafeman, D.G.; Hoekstra, W.G. Lipid peroxidation in vivo during vitamin E and selenium deficiency in the rat as monitored by ethane evolution. *J. Nutr.* **1977**, *107*, 666–672.
24. Burk, R.F. Biological activity of selenium. *Annu. Rev. Nutr.* **1983**, *3*, 53–70.
25. Mostert, V.; Hill, K.E.; Burk, R.F. Loss of activity of the selenoenzyme thioredoxin reductase causes induction of hepatic heme oxygenase-1. *FEBS Lett.* **2003**, *541*, 85–88.
26. Taylor, P.R.; Li, B.; Dawsey, S.M.; Li, J.Y.; Yang, C.S.; Guo, W.; Blot, W.J. Prevention of esophageal cancer: the nutrition intervention trials in Linxian, China Linxian Nutrition Intervention Trials Study Group. *Cancer Res.* **1994**, *54*, 2029s–2031s.
27. Clark, L.C.; Combs, G.F., Jr.; Turnbull, B.W.; Slate, E.H.; Chalker, D.K.; Chow, J.; Davis, L.S.; Glover, R.A.; Graham, G.F.; Gross, E.G.; Krongrad, A.; Leshner, J.L., Jr.; Park, H.K.; Sanders, B.B., Jr.; Smith, C.L.; Taylor, J.R. Effects of selenium supplementation for cancer

- prevention in patients with carcinoma of the skin. A randomized controlled trial. Nutritional prevention of cancer study group. *J. Am. Med. Assoc.* **1996**, *276*, 1957–1963.
28. Duffield-Lillico, A.J.; Slate, E.H.; Reid, M.E.; Turnbull, B.W.; Wilkins, P.A.; Combs, G.F., Jr.; Park, H.K.; Gross, E.G.; Graham, G.F.; Stratton, M.S.; Marshall, J.R.; Clark, L.C. Selenium supplementation and secondary prevention of nonmelanoma skin cancer in a randomized trial. *J. Natl. Cancer Inst.* **2003**, *95*, 1477–1481.
  29. Combs, G.F., Jr.; Spallholz, J.E.; Levander, O.A.; Oldfield, J.E. In *Selenium in Biology and Medicine*; AVI: New York, 1987.
  30. Beck, M.A.; Kolbeck, P.C.; Rohr, L.H.; Shi, Q.; Morris, V.C.; Levander, O.A. Benign human enterovirus becomes virulent in selenium-deficient mice. *J. Med. Virol.* **1994**, *43*, 166–170.
  31. Burk, R.F.; Hill, K.E.; Motley, A.K. Plasma selenium in specific and non-specific forms. *Biofactors* **2001**, *14*, 107–114.
  32. Niskar, A.S.; Paschal, D.C.; Kieszak, S.M.; Flegal, K.M.; Bowman, B.; Gunter, E.W.; Pirkle, J.L.; Rubin, C.; Sampson, E.J.; McGeehin, M. Serum selenium levels in the US population: third national health and nutrition examination survey, 1984–1994. *Biol. Trace Elem. Res.* **2003**, *91*, 1–10.
  33. Burk, R.F.; Early, D.S.; Hill, K.E.; Palmer, I.S.; Boeglin, M.E. Plasma selenium in patients with cirrhosis. *Hepatology* **1998**, *27*, 794–798.
  34. Yang, G.-Q.; Zhu, L.-Z.; Liu, S.-J.; Gu, L.-Z.; Qian, P.-C.; Huang, J.-H.; Lu, M.-D. Human selenium requirements in China. In *Selenium in Biology and Medicine*; Combs, G.F., Jr., Spallholz, J.E., Levander, O.A., Oldfield, J.E., Eds.; AVI: New York, 1987; 589–607.
  35. Institute of Medicine. In *Dietary Reference Intakes for Vitamin C, Vitamin E, Selenium, and Carotenoids*; National Academy Press: Washington, DC, 2000.

#### FURTHER READINGS

- Burk, R.F.; Levander, O.A. Selenium. In *Modern Nutrition in Health and Disease*, 9th Ed.; Shils, M.E., Olson, J.A., Shike, M., Ross, A.C., Eds.; Lea and Febiger: Philadelphia, 1999; 265–276.
- Sunde, R.A. Selenium. In *Present Knowledge in Nutrition*, 8th Ed.; Bowman, B.A., Russell, R.M., Eds.; ISLI Press: Washington, DC, 2001; 352–365.

# Shiitake (*Lentinus edodes*)

Solomon P. Wasser

University of Haifa, Mount Carmel, Haifa, Israel

## INTRODUCTION

Shiitake mushroom, the common Japanese name for *Lentinus edodes* (Fig. 1), derives from the mushroom associated with the shii tree (*Castanopsis cuspidate* Schottky) and *take*, the Japanese word for mushroom (Table 1). Because Japan is the world leader in production of this type of mushroom, the mushroom is now widely known by this name. These mushrooms are renowned in Far East countries (e.g., Japan, China, Korea) as a food and medicine for thousands of years. In the year 199 A.D., Kyusuyu, a native tribe of Japan, offered the Japanese Emperor Chuai a shiitake mushroom. Even older documents record its use in ancient China, where it was referred to as “ko-ko” or “hoang-mo.”<sup>[1]</sup> The cultivation of this mushroom has been practiced for a thousand years, with its cultivation originating in China during the Sung Dynasty (960–1127). Both history and legend credit Wu San Kwung as the originator of shiitake cultivation. Almost every mushroom-growing village in China has a temple in his honor.<sup>[2]</sup> In 1313, Chinese author Wang Cheng recorded shiitake-growing techniques in his *Book of Agriculture*. He described how to select a suitable site, choose appropriate tools, and cut down the trees on which one could cultivate the mushrooms. He outlined the basic methods as follows: Cut the bark with a hatchet and cover the logs with soil. After 1 yr, top the soil and water frequently. Beat the logs with a wooden club to induce mushroom production. The mushrooms will appear after a rain.<sup>[2,3]</sup>

Shiitake mushroom cultivation techniques were probably introduced to Japanese farmers by the Chinese between 1500 and 1600 A.D.<sup>[4]</sup>

At present, shiitake is one of the five most cultivated edible mushrooms in the world.<sup>[5]</sup> Its production (2 million tons) is second only to button mushroom *Agaricus bisporus*. Grown mainly in East Asia, shiitake is now arousing interest worldwide.<sup>[5–8]</sup> Increasing markets have been spawned, partly by the exotic and well-appreciated taste of shiitake, and partly by advances in research that has demonstrated its significant medicinal properties. Shiitake mushroom is becoming

popular in nutritional and medicinal products throughout Asia, Europe, and North America.

## HABITAT AND DISTRIBUTION

Gregarious on fallen wood of a wide variety of deciduous trees, especially shii, oak, chestnut, beech, maple, sweet gum, poplar (aspen, cottonwood), alder, hornbeam, ironwood, chinquapin, mulberry (*Castanopsis cuspidate*, *Quercus*, *Castanea*, *Fagus*, *Acer*, *Liquidamber*, *Populus*, *Diospyros*, *Alnus*, *Carpinus*, *Morus*) in a warm, moist climate. Most of these are raised for artificial cultivation of shiitake mushroom.

*L. edodes* occurs naturally throughout Southeast Asia. It has been reported from China, Japan, Korea, Vietnam, Thailand, Burma, North Borneo, the Philippines, Taiwan, and Papua New Guinea.<sup>[7,8]</sup>

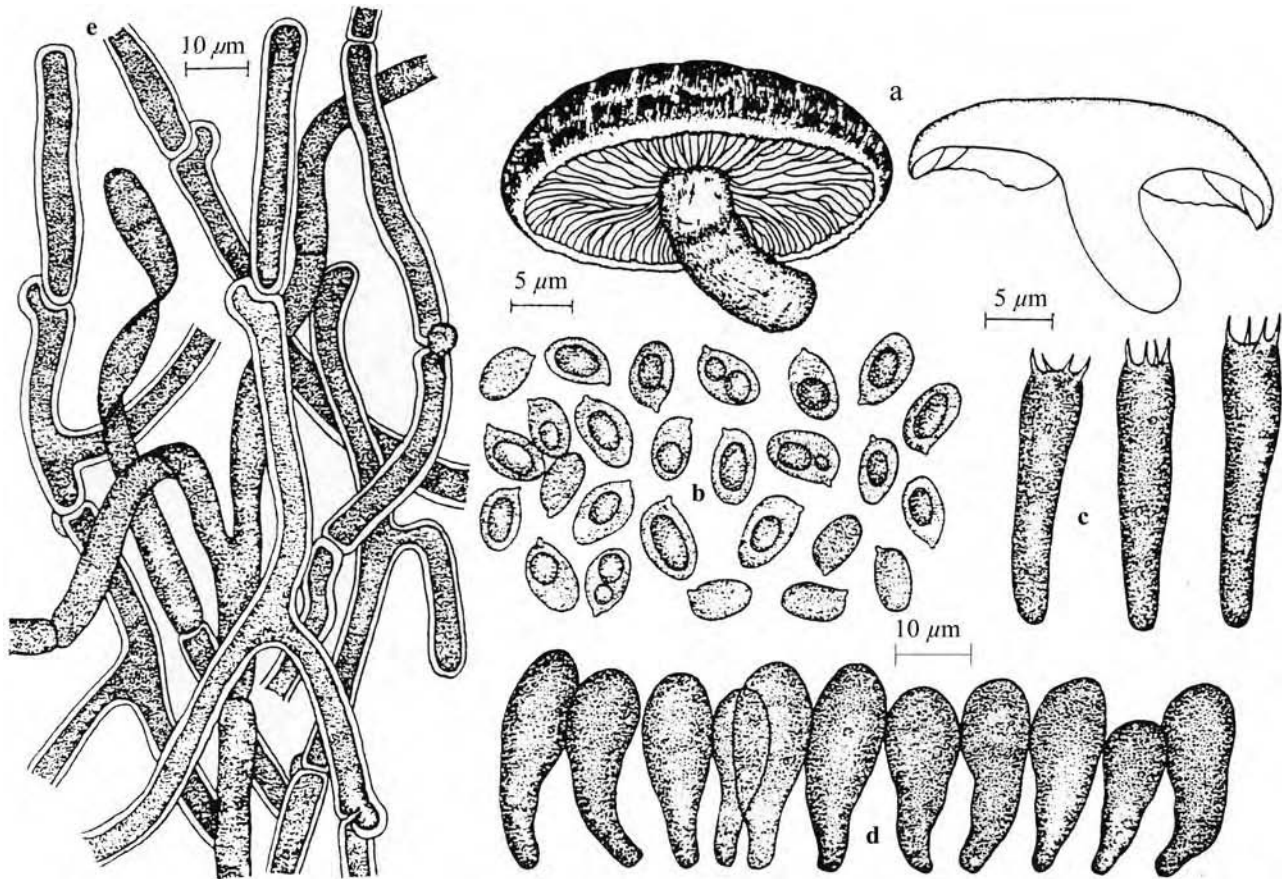
## EDIBILITY AND NUTRITIONAL VALUE

Shiitake are traditionally well-known edible mushrooms of high nutritious value. Raw or dried forms, used in Chinese curative powers of shiitake mushroom, are legendary. It was stated in *Ri Youg Ben Cao*, Vol. 3 (1620), written by Wu-Rui of the Ming Dynasty, “shiitake accelerates vital energy, wards off hunger, cures colds, and defeats body fluid energy.” In later years, it was found that the mushroom contained various important nutrients. Moreover, recent scientific investigations have isolated many compounds and have found evidence of their health promotion activities.<sup>[1,7–10]</sup>

Shiitake mushrooms have excellent nutritional value. Their raw fruit bodies include 88–92% water, protein, lipids, carbohydrates as well as vitamins and minerals. It should be noted that amounts of nutrients and biologically active compounds differ in various strains and are affected by substrate, fruiting conditions, and methods of cultivation. On a dry weight basis, they have a relatively high nutritional value when compared to commonly consumed vegetables.

Dried shiitake mushrooms are rich in carbohydrates and protein. They contain 58–60% carbohydrates, 20–23% protein (digestibility of 80–87%), 9–10% fiber, 3–4% lipids, and 4–5% ash. The mushroom is a good source of vitamins, especially provitamin D<sub>2</sub>

Solomon P. Wasser is at the University of Haifa, Mount Carmel, Haifa, Israel.



**Fig. 1** Shiitake mushroom [*L. edodes* (Berk.) Singer]. a—fruit body, b—spores, c—basidia, d—cheilocystidia, e—elements of pileal cuticle.

(ergosterol), 325 mg%, which under ultraviolet (UV) light and heat yields calciferol (vitamin D<sub>2</sub>). It also contains B vitamins, including B<sub>1</sub> (thiamine), B<sub>2</sub> (riboflavin), B<sub>12</sub> (niacin), and pantothenic acid.<sup>[1,3,9,10]</sup> Minerals found include Fe, Mn, K, Ca, Mg, Cd, Cu, P, and Zn. Analysis of dried cultured shiitake mycelium gives the following mineral concentrations (in mg/g of dry weight): K, 15.1; Ca, 22; Mg, 44–78; Mn, 1.2; Cd, 0.96; Fe, 2.36; Ni, 52.5; Cu, 89.1; P, 281; Zn, 282; Ge, 3; Br, 11.4; and Sr, 164.

Water-soluble polysaccharides amount to 1–5% of the dry weight of the shiitake mushroom. In addition to glycogen-like polysaccharides, (1-4)-, (1-6)- $\alpha$ -D-glucans and antitumor polysaccharides, lentinan, (1-3)-, (1-6)- $\beta$ -bonded heteroglucans, heterogalactans, heteromannans, xyloglucans, etc., have been identified. The mushrooms' indigestible polysaccharides, which serve as dietary fiber, include heteroglycan, polyuronide,  $\beta$ -glucan as well as chitin. Among the free sugars present are trehalose, glycerol, mannitol, arabitol, mannose, and arabinose.<sup>[1,7–10]</sup>

In shiitake mushrooms, dietary fiber consists of water-soluble materials such as  $\beta$ -glucan and protein and water-insoluble substances extractable only with

salts, acids, and alkalies such as polyuronide (acidic polysaccharide), hemicellulose,  $\beta$ -glucan with heterosaccharide chains, lignin, and chitin present as cell wall constituents.

The fatty acids account for 3.38% of the total lipids.<sup>[9,16]</sup> Their composition is as follows: linoleic acid (18:2), 72.8%; palmitic acid (16:0), 14.7%; oleic acid (18:1), 3.0%; tetradecenoic acid (14:1), 1.6%; stearic acid (18:0), 0.9%; and myristic acid (14:0), 0.1%.

The aroma components include alcohols, ketones, sulfides, alkanes, fatty acids, etc. The major volatile flavor contributors are *matsutakeol* (octen-1-ol-3) and ethyl-*n*-amyl ketone. The characteristic aroma of shiitake mushrooms was identified as 1,2,3,5,6-pentathiepane. According to Mizuno,<sup>[9]</sup> the components responsible for the delicious flavor are monosodium glutamate, 5'-nucleotides, free amino acids, lower molecular weight peptides, organic acids, and sugars. Their relative ratios are responsible for the variation in flavor naturally seen in this mushroom. Organic acids contributing to the flavor of shiitake mushroom include malic acid, fumaric acid,  $\alpha$ -keto-glutaric acid, oxalic acid, lactic acid, acetic acid, formic acid, and glycolic acid.

**Table 1** Mycological data for shiitake

Basidiomycotina	
Homobasidiomycetes	
Agaricomycetiae	
Agaricales	
Family: Pleurotaceae	
Genus: <i>Lentinus</i>	
<i>Lentinus edodes</i> (Berk.) Singer, Mycologia, 1941 33, 451 (Fig. 1)	
Basionym	<i>Agaricus edodes</i> Berk., J. Linn. Soc. Bot. 1877, 16, 50.
Synonyms	<i>Collybia shiitake</i> Schroet., Garenfl. 1886, 35, 105. <i>Armillaria edodes</i> (Berk.) Sacc., Syll. Fung. 1887, 5, 79. <i>Agaricus russaticeps</i> (Berk.) apud Cooke, Grevillea 1889, 16, 106. <i>Lepiota shiitake</i> (Schroet.) Tanaka, Japan Bot. Mag. 1889, 3, 159. <i>Lentinus tonkinensis</i> Pat., J. Bot. Paris 1890, 4, 14. <i>Mastaleuomyces edodes</i> (Berk.) O. Kuntze, Rev. Gen. Pl. 1891, 2, 861. <i>Pleurotus russaticeps</i> (Berk.), Sacc., Syll. Fung. 1891, 9, 48. <i>Cortinellus shiitake</i> (Schroet.) P. Henn., Not. Knigl. Bot. Gard. Mus. Berl. 1899, 2, 385. <i>Tricholoma shiitake</i> (Schroet.) Singer, Ann. Mycol. 1936, 34, 332. <i>Cortinellus edodes</i> (Berk.) S. Ito et Imai, Journ. Fax. Agr. Hokkaido Imp. Univ. 1938, 43, 55. <i>Lentinula edodes</i> (Berk.) Pegler, Kavaka 1975, 3, 20.
English names	Black forest mushroom, black oak mushroom, golden oak mushroom, snake butter, pasania mushroom, oakwood mushroom, Japanese forest mushroom
Japanese name	Shiitake
Chinese names	Shiang-gu, Shing ku, Hua Gu, Xiang, Hoang-mo

A detailed description of the shiitake mushroom can be found in Refs.<sup>[1,4,7]</sup>.

## RELATED SPECIES

### Artificial Cultivation

The shiitake mushroom is commonly considered as a species of the genus *Lentinus* Fr. As noted in the below synonymy, *L. edodes* has at various times been assigned to 10 genera (*Agaricus*, *Collybia*, *Armillaria*, *Lepiota*, *Lentinus*, *Mastaleuomyces*, *Pleurotus*, *Cortinellus*, *Tricholoma*, and *Lentinula*). While specialists in medicinal mushrooms and cultivation are familiar with shiitake mushrooms as *L. edodes*, some alternative taxonomic classifications are discussed in Refs.<sup>[11–15]</sup> Although the mushroom had been grown in Asian countries for centuries, the interest there, as well as in the Western countries, has increased rapidly since World War II, especially in the last 15–20 yr. Its cultivation is now a worldwide multimillion dollar industry.

The process for producing shiitake mushroom fruiting bodies (Fig. 2) is the same as for other cultivated edible mushrooms and can be divided into two major

stages. The first stage involves the preparation of the fruiting culture, stock culture, mother spawn, and planting spawn, and the second stage entails the preparation of the growth substrates for cultivation. Currently, the methods most widely adopted for commercial production are wood log and synthetic sawdust bag.<sup>[3,6–8,16]</sup> A discussion of the cultivation methods used is beyond the scope of this review. Interested readers may refer to the references cited above; growth parameters for cold- and warm-weather strains are given in Ref.<sup>[8]</sup>

## PRECLINICAL STUDIES

### Therapeutic Applications

This section mainly discusses preclinical in vitro and in vivo (animal) studies.

Shiitake is one of the best-known and best-characterized mushrooms used in medicine. It is the source of several well-studied preparations with proven pharmacological properties, especially the polysaccharide



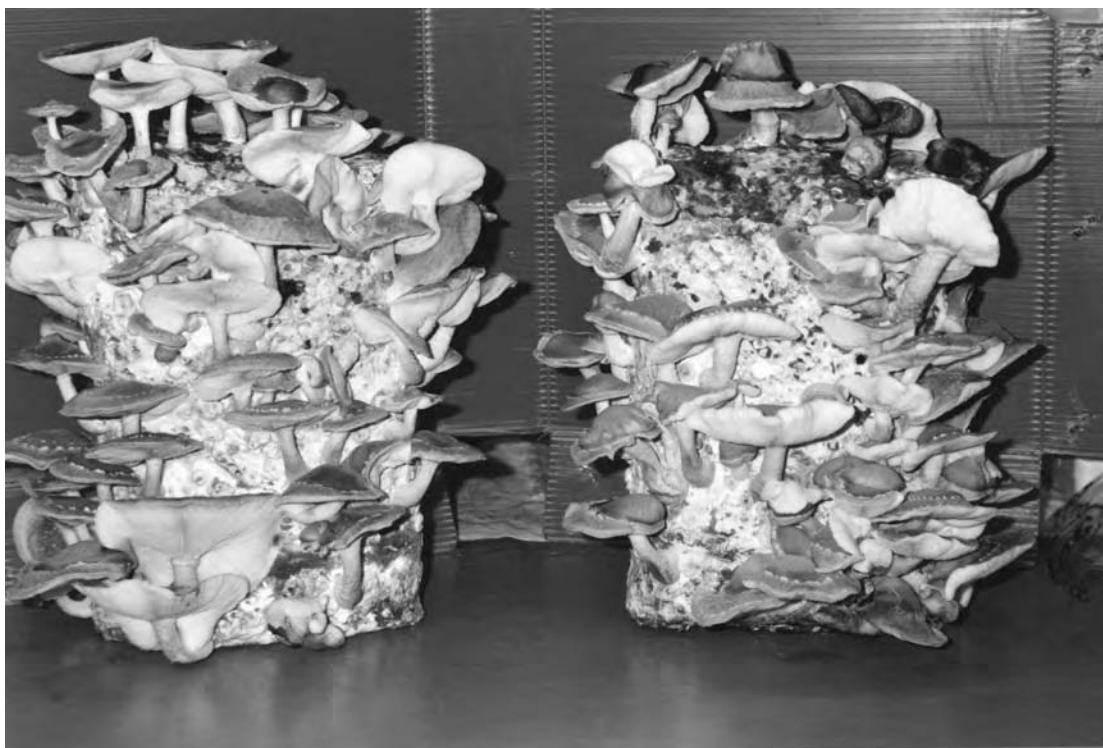


Fig. 2 Shiitake mushroom [*L. edodes* (Berk.) Singer]: cultivated fruiting bodies.

lentinan, shiitake mushroom mycelium, and culture media extracts (LEM, LAP and KS-2).<sup>[7,9,16–19]</sup>

### Anticarcinogenic and Antitumor Effects

Using methods of fractionation and purification of polysaccharides, Chihara et al.<sup>[20–22]</sup> isolated a water-soluble antitumor polysaccharide from fruiting bodies of shiitake, which was named “lentinan” after the genus *Lentinus* to which the shiitake mushroom belongs. Chihara was one of the first to report on the antitumor properties of the mushroom, stating that lentinan “was found to almost completely regress the solid type tumors of Sarcoma 180 and several kinds of tumors including methylchloranthrene-induced fibrosarcoma in synergic host–tumor system A.”<sup>[21,22]</sup> The antitumor effect of lentinan was originally confirmed by using Sarcoma 180 transplanted in CD-1/ICD mice.<sup>[20]</sup> Later, it showed prominent antitumor activity not only against allogenic tumors such as Sarcoma 180, but also against various synergic and autochthonous tumors, and it prevented chemical and viral oncogenesis.<sup>[23]</sup> The molecular formula of  $\beta$ -D-glucan lentinan is  $(C_6H_{10}O_5)_n$ , and the mean molecular weight is about one million ( $-5 \times 10^5$  Da);  $[\alpha]_D + 20-22^\circ$  (NaOH). Its structure was confirmed as  $\beta$ -(1-3)-D-glucopyranan with a branched chain of  $\beta$ -(1-6)-monoglycosyl (branching degree: 2.5°), showing

a right-handed triple helix.<sup>[7,9,17,18]</sup> It is water soluble, heat stable, and alkali labile. That is,  $\beta$ -D-glucan binds to lymphocyte surfaces or serum-specific proteins, which activate macrophage, T-helper cells, natural killer (NK) cells, and other effector cells. All these increase the production of antibodies as well as interleukins (IL-1, IL-2) and interferon (IFN- $\gamma$ ) released upon activation of effector cells.<sup>[19,24]</sup> Thus, the carcinostatic effect of lentinan results from the activation of the host’s immune system. In animal testing of carcinostatic activity, intraperitoneal (i.p.) administration is used, but oral administration (p.o.) is occasionally effective.

The purified polysaccharide has been shown in animal studies to produce strong tumor regression and even the disappearance of sarcoma tumors in 5 weeks, ascite hepatoma 134,<sup>[18,19,25]</sup> and Ehrlich carcinoma as well as a number of other experimentally induced cancers in allogenic, syngeneic, and autologous hosts. It also exhibits preventive activity against chemical carcinogenesis. Injections of lentinan into mice produced either an 80% reduction in tumor size or complete regression in most of the animals tested. Moreover, an intact immune system and a functioning thymus gland were found to be requisite for its anticancer effect.<sup>[11,12]</sup> When immunosuppressive agents such as  $\beta$ -benzylthioguanosine or X-radiation were given with lentinan, the antitumor effect decreased. The polysaccharide has also been found to restore the enzyme

activity of X-prolyl-dipeptidyl-aminopeptidase, which can be depressed in cancer patients and in mice with implanted tumors.<sup>[26]</sup>

Laboratory tests seem to indicate a role for the adrenal-pituitary axis and central peripheral nervous system including serotonin, 5HT, histamine, and catecholamines in lentinan's antitumor activity.<sup>[1,10,17,24]</sup>

The oral administration of the polysaccharide to AKR mice exerted strong antitumor activity resulting in raised levels of lymphocytokines, such as IFN- $\gamma$ , tumor necrosis factor (TNF- $\alpha$ ) and IL-1  $\alpha$ . Tissue cultures of murine macrophages CRL-2019, B-lymphocytes HB-284, and T-lymphocytes DRL-8179, which were treated with lentinan, showed high levels of activation using flow cytometry. Lentinan-activated immunocytes, particularly the T-helper cells, might render the physiological constitutions of the host highly cancer- and infection resistant. Adoptive immunotherapy of the immunodeficient mice such as the nude (athymic) mice, B-cell deficient mice, and severe combined immunodeficient (SCID) mice via the transfer of the lentinan-activated immunocytes resulted in the inhibition of tumor growth. Lentinan appeared to represent a unique class of host defense potentiators (HDP), protecting the hosts from the side effects of conventional therapeutic measures and improving various kinds of immunological parameters with no toxic side effects in animal models.<sup>[19,24,27,28]</sup>

### LEM and LAP Extracts from Shiitake Mushroom Mycelium and Culture Media

*L. edodes* mycelium (LEM) is prepared from an extract of the powdered mycelia of the shiitake mushroom. Its yield is about 6–7 g/kg of medium. The precipitate obtained from a water solution of the mycelium by adding four volumes of ethanol was named LAP. The yield of LAP is  $\approx 0.3$  g/g of LEM.

*L. edodes* mycelium and LAP are glycoproteins containing glucose, galactose, xylose, arabinose, mannose, and fructose.<sup>[9]</sup> The former also contains various nucleic acid derivatives, vitamin B compounds especially B<sub>1</sub> (thiamine), B<sub>2</sub> (riboflavin), and ergosterol.<sup>[7,8]</sup>

In 1990, an immunoactive substance, EP3, was obtained by fractionation of LEM. EP3 is a lignin complex composed of about 80% lignin, 10% carbohydrates, and 10% protein. After removal of the last two components, biological activity was not affected, but when lignin is removed, activity was reduced. Therefore, the active substance is believed to be a water-soluble lignin containing numerous carboxyl groups.<sup>[9,16]</sup>

Both LEM and LAP have demonstrated strong antitumor activities orally and by injection to animals and humans. They were shown to act by activating the

host's immune system and are also useful for the treatment of hepatitis B.<sup>[9,14–16]</sup>

### KS-2- $\alpha$ -Mannan Peptide

Polysaccharide KS-2 (MW 6–9.5  $\times 10^4$  [ $\alpha$ ]<sub>D</sub> + 62°; C = 0.5, water) was obtained by extraction of cultured mycelia of shiitake mushroom (strain KSLE 007) with hot water, followed by precipitation with ethanol.<sup>[9,16,29]</sup> The product is an  $\alpha$ -mannan peptide containing the amino acids serine, threonine, alanin, and proline (as well as residual amounts of the other amino acids). The polysaccharide was shown<sup>[29]</sup> to be effective on Sarcoma 180 and Ehrlich's carcinoma, either i.p. or p.o., and to act via interferon-inducing activity. The acute LC<sub>50</sub> of KS-2 was found to be extremely low in mice, more than 12,500 mg/kg when administered orally.

The mechanism of action of KS-2 is not yet clear, but the results showed no direct KS-2 cytotoxic effect against the tumor cells in vitro. Its antitumor activity was observed to be higher at the lower inoculum size of tumor cells, regardless of the routes of KS-2 administration (60% survival rate at 5  $\times 10^3$  tumor cells/mouse, 10% survival at 1  $\times 10^6$  tumor cells/mouse). The results also showed that the antitumor activity of KS-2 in mice was always accompanied by the induction of interferon in the sera. Furthermore, preliminary findings indicated that macrophages obtained from KS-2 treated mice exhibited tumoricidal activity,<sup>[10,16,30]</sup> and it was reported that macrophage activation became tumoricidal when incubated in vitro with interferon. Considering these findings, the antitumor activity of KS-2 may be explained by macrophage activation with or without interferon induced by KS-2.

### Immune-Modulating Effects

As was stated earlier, lentinan and other polysaccharides from shiitake mushrooms do not attack cancer cells directly, but produce their antitumor effects by activating different immune responses in the host. Lentinan, for example, appears to act as an HDP, which is able to restore or augment the responsiveness of host cells to lymphocytokines, hormones, and other biologically active substances by stimulating maturation, differentiation, or proliferation of cells involved in host defense mechanisms.<sup>[19,24]</sup> Host defense potentiators are functionally different from biological response modifiers. Thus, lentinan is able to increase host resistance against various kinds of cancer and infectious diseases, including acquired immunodeficiency syndrome (AIDS).<sup>[7,28]</sup>

The initial interactions of lentinan in the human body or animals are not presently known. However,

there is a transitory but notable increase in several serum protein components in the  $\alpha$ - and  $\beta$ -globulin region, namely, complement C3, hemopexin, and ceruloplasmin.<sup>[7,10,19,24]</sup>

Lentianan stimulates various kinds of NK cell-, T cell-, B cell-, and macrophage-dependent immune reactivities. Its antitumor effect is abolished by neonatal thymectomy and decreased by the administration of antilymphocyte serum, supporting the concept that the polysaccharide requires immunocompetent T-cell compartments. The effect of lentianan was also inhibited by antimacrophage agents, e.g., carrageenan. Unlike other well-known immunostimulants, lentianan is in a unique class of distal tubular (DT)-cell-oriented assistant, in which macrophages play some part.<sup>[7,10,19,24]</sup>

For example, lentianan can activate NK cells in vitro in the same concentrations that are achieved in the blood plasma of patients treated clinically with lentianan.<sup>[10,16,24]</sup> Natural killer-cell activity is involved in tumor suppression, and while these cells do not stimulate T-killer cell activity or do so only under certain conditions, they are strong T-helper cell stimulants both in vitro and in vivo.<sup>[1,7,10,16,19,24]</sup> Using the blood of healthy donors and cancer patients, some authors have shown that the polysaccharide is able to stimulate peripheral blood lymphocytes in vitro to increase IL-2-mediated lymphokine-activated killer cell (LAK-cell) and NK cell activity at levels achievable in vivo by administration of clinical doses of lentianan. It has been shown to inhibit suppressor T cell activity in vivo and to increase the ratio of activated T cells and cytotoxic T-cells in the spleen when administered to gastric cancer patients undergoing chemotherapy.<sup>[7,10,24]</sup>

Many interesting biological activities of lentianan have been reported including: a) an increase in the activation of nonspecific inflammatory responses such as acute phase protein (APP) production, b) vascular dilation and hemorrhage in vivo, c) activation and generation of helper and cytotoxic T-cells, d) augmentation of immune mediators like IL-1 and IL-3, colony stimulating factor(s), and migration inhibitory factor, and e) increasing the capacity of peripheral blood mononuclear (PBM) cells of patients with gastric cancer and producing IL-1 $\alpha$ , IL-1 $\beta$ , and a TNF- $\alpha$ .<sup>[7,10,19,24,27]</sup>

In an in vivo study of rats with peritonitis, combined lentianan-gentamicin treatment had a significantly better survival rate than the controls. Lentianan activated the peritoneal macrophages' secretory activity of active oxygen and produced cytokines, thus enhancing the ability of polymorphonuclear leukocytes (PMNs) to produce active oxygen, which has a bactericidal effect.<sup>[31]</sup> It also increases peritoneal macrophage cytotoxicity against metastatic tumor cells in mice, but not against a highly metastatic tumor type.<sup>[32]</sup> Some patients treated with lentianan for carcinomatous pleuritis or carcinomatous peritonitis have improved with

the disappearance of malignancy, while in another group their condition deteriorated or diminished.<sup>[33]</sup> The polysaccharide can activate the normal and alternative pathways of the complement system and can split C3 into C3a and C3b enhancing macrophage activation.<sup>[34]</sup>

Many biological reactions are accelerated and induced by lentianan, including the very important phenomenon of infiltration of eosinophils, neutrophils, and granulocytes around target tissues. Fig. 3 shows early responses initiated by it and possible pathways for inflammatory reactions.

Lentianan's immune-activating ability may be linked with its modulation of hormonal factors, which are known to play a role in tumor growth. Aoki<sup>[34]</sup> showed that the antitumor activity of lentianan is strongly reduced by administration of thyroxin or hydrocortisone. It can also restore tumor-specific antigen-directed delayed-type hypersensitivity reaction (DTHR).

Lentianan is not formally included among the non-specific immunostimulants (RES stimulants), but it augments the induction of antigen-specific cytotoxic T-lymphocytes, macrophages, and other nonspecific immune responses.

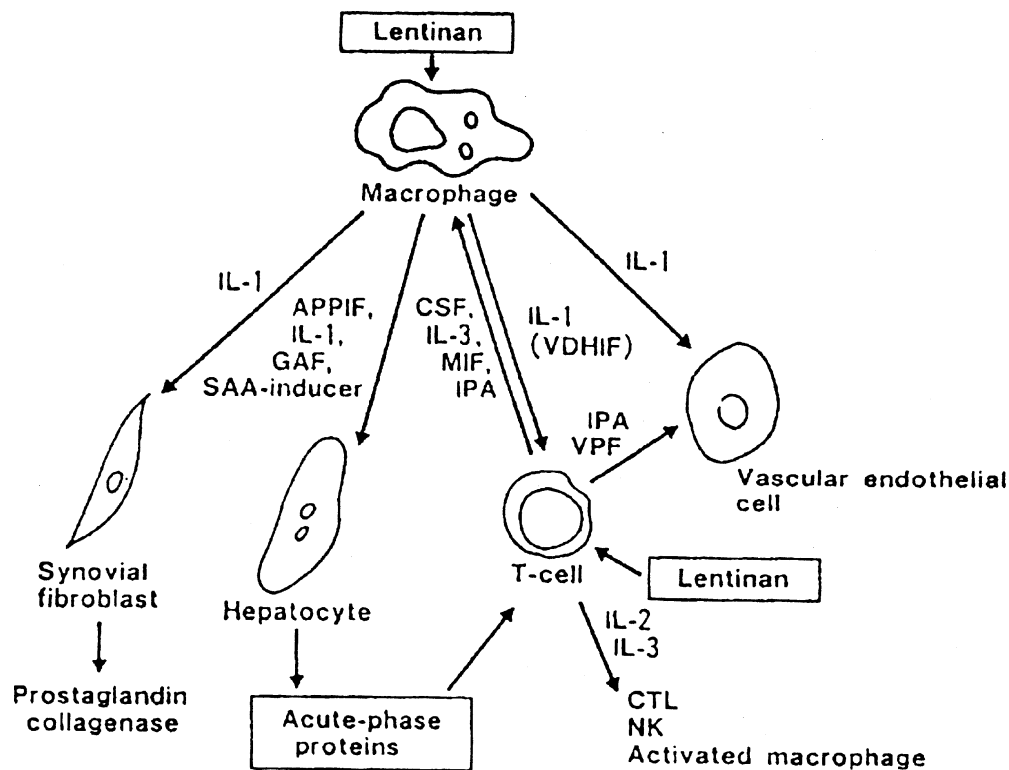
Possible immune system regulating actions of lentianan were summarized by Chihara et al.<sup>[23]</sup> and are seen in Fig. 4.

### Cardiovascular Effects

The major cause of death in Western countries is coronary artery disease, a primary risk factor for which hypercholesterolemia is a factor contributing to hardening of the arteries. In humans, 50% or more of the total cholesterol is derived from de novo synthesis.<sup>[18,35,36]</sup>

It is known that shiitake mushroom is able to lower blood serum cholesterol (BSC) via a factor known as eritadenine (also called "lentinacin" or "lentysine").

Apparently, eritadenine reduces BSC in mice, not by the inhibition of cholesterol biosynthesis, but by the acceleration of the excretion of ingested cholesterol and its metabolic decomposition. It has been shown to lower blood levels of cholesterol and lipids in animals. When added to the diet of rats, eritadenine (0.005%) caused a 25% decrease in total cholesterol in as little as one week. The cholesterol-lowering activity of this substance is more pronounced in rats fed a high-fat diet than in those on a low-fat diet. Although feeding studies with humans have indicated a similar effect, further research is needed. Hobbs<sup>[1,10]</sup> and Yang et al.<sup>[36]</sup> have shown that shiitake mushrooms lowered BSC levels. Various studies have confirmed<sup>[1,7,10,16]</sup> that the mushroom can lower blood pressure and free cholesterol in plasma, as well as accelerate the accumulation of lipids in the liver by removing them from circulation.



**Fig. 3** Early responses initiated by lentinan and a possible pathway for inflammatory reactions. APPIF, acute phase protein-inducing factor; VDHIF, vascular dilatation and hemorrhage-inducing factor; CSF, colony stimulating factor; MIF, migration inhibitory factor; GAF, glucocorticoid antagonizing factor; SAA, serum amyloid A; IPA, plasminogen activator inducer; VPF, vascular permeability factor; CTL, cytotoxic T-lymphocytes; NK, natural killer cells.<sup>[16]</sup>

### Hepatoprotective Effects

The injection of LEM slowed the growth of cancerous liver tumor in rats.<sup>[16,18,37]</sup> A polysaccharide fraction from shiitake mushrooms demonstrated liver protection in animals as well as the ability to improve liver function and enhance the production of antibodies to hepatitis B.<sup>[7,35]</sup>

Lentinan improved serum glutamic pyruvic transaminase (SGPT) and completely restored GPT levels in the livers of mice with toxic hepatitis. Crude extracts of shiitake mushroom cultures have demonstrated liver-protecting actions.<sup>[10,16,18,35]</sup>

### Antiviral, Antibacterial, and Antiparasitic Effects

Lentinan and its derivatives are effective against various kinds of bacterial, viral (including AIDS), and parasitic infections.<sup>[7,10,18,28]</sup> An important area of this polysaccharide research deals with its ability to mobilize the body's humoral immunity to ward off bacterial infections resistant to antibiotics.<sup>[7]</sup> Many cancer and AIDS patients die of opportunistic infections due to immunodysfunction.<sup>[7,27]</sup> It is extremely

important to protect AIDS patients from these various infections. According to Ref.<sup>[39]</sup>, in vitro studies show that lentinan, when used in combination with azidothymidine (AZT), suppressed the surface expression of human immunodeficiency virus (HIV) on T cells more so than did AZT alone. Lentinan and the sulfated form exhibited potent in vitro anti-HIV activity resulting in inhibition of viral replication and cell fusion. AIDS therapy must include a strategy to enhance the immune system. Among the various therapeutic approaches used, prevention of the development of AIDS symptoms in carriers should be stressed. Based on these in vitro studies, it is possible that such prevention may be realized by the use of HDPs such as lentinan or its related substances. For example, LEM is also useful in the treatment of AIDS. It has been shown to inhibit HIV infections of cultured human T cells, and it potentiates the effects of AZT against viral replication in vitro. The mechanism of its action is not known for certain, but the extract was found to activate macrophages and stimulate the production of IL-1.<sup>[7,10,36,39]</sup>

Water-soluble lignins from EP3 and EPS4 from shiitake mushroom mycelium have shown antiviral and immunomodulating effects.<sup>[40]</sup> A water-soluble extract

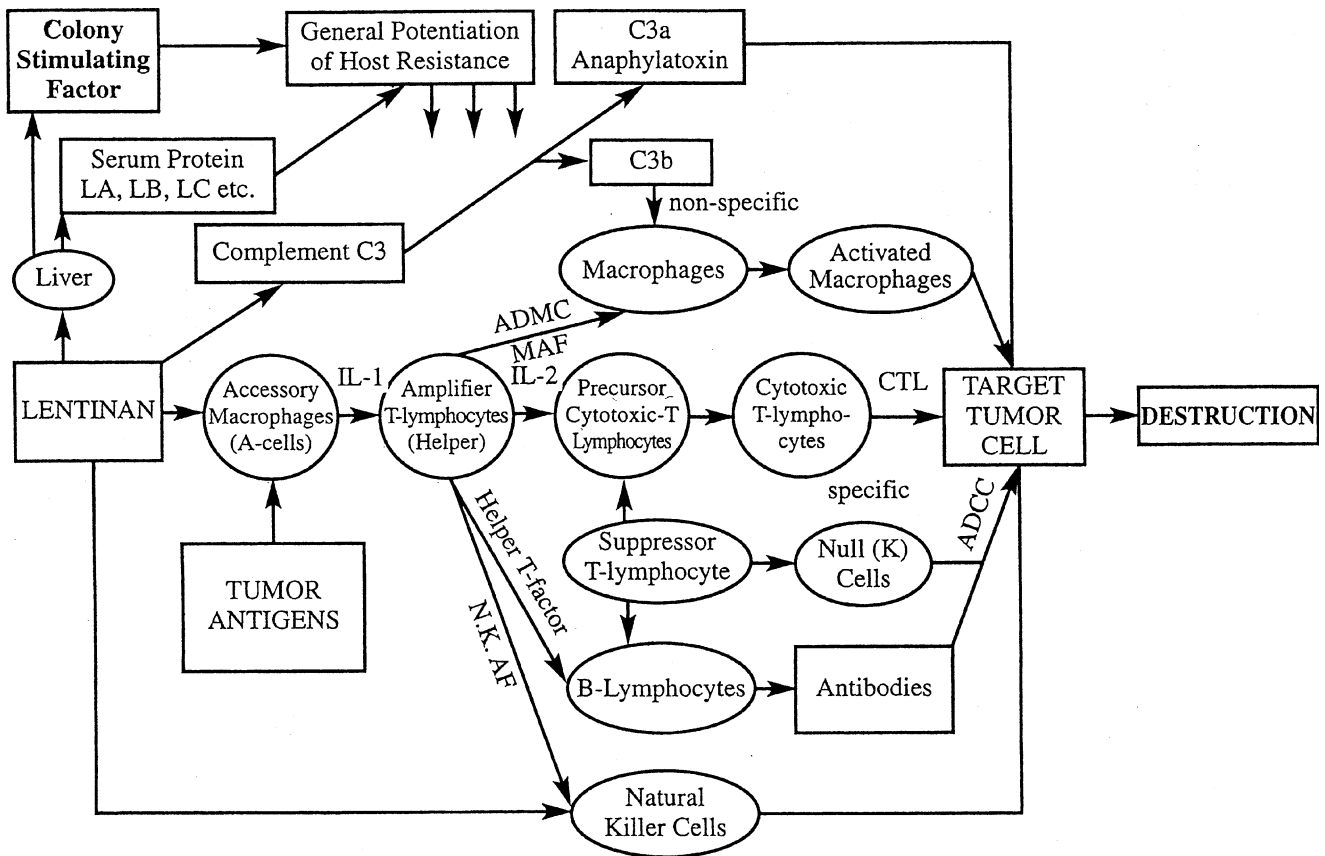


Fig. 4 Possible mode of action of lentinan as HDP. (From Ref.<sup>[23]</sup>.)

of mycelium known as JLS and JLS-18 has the ability to block the release of *herpes simplex* virus type 1 in animals JLS-18-consisting of 65–75% lignin, 15–30% polysaccharides, and 10–20% protein has inhibited the herpes virus both in vitro and in vivo.<sup>[41]</sup>

In addition, lentinan has shown: a) antiviral activity in mice against vesicular stomatitis virus (VSV) encephalitis virus, Abelson virus, and adenovirus type 12; b) stimulated nonspecific resistance against respiratory viral infections in mice; c) conferred complete protection against an LD75 challenge dose of virulent mouse influenza A/SW15; d) enhanced bronchoalveolar macrophage activity; e) increased resistance against the parasites *Schistosoma japonicum* and *S. mansoni*; f) exhibited activity against *Mycobacterium tuberculosis* bacilli resistant to antituberculosis drugs, *Bacillus subtilis*, *Staphylococcus aureus*, *Micrococcus luteus*, *Candida albicans*, and *Saccharomyces cerevisiae*; and h) increased host resistance to infections with the potentially lethal *Listeria monocytogenes*. Antibacterial polyacetylene compounds, centinamycin A and B, have also been identified in shiitake mushroom. Eritadenine, a compound that affects cholesterol metabolism, also processes antiviral properties.<sup>[7,10,35]</sup>

It should be noted that a protein fraction of shiitake mushroom fruiting bodies, labeled fruiting body protein (FBP), prevented the infection of plants with tobacco mosaic virus (TMV). The binding of the virus to the plant cells was inhibited by FBP.<sup>[7,9,16]</sup>

## HUMAN CLINICAL STUDIES AND MEDICINAL USES

In the last 15–20 yr, shiitake mushroom has been subject to various clinical studies in humans and is thought to be beneficial for a wide variety of disorders including different types of cancer, heart disease, hyperlipidemia (including high blood cholesterol), hypertension, infectious disease, and hepatitis. The mushroom is used medicinally for diseases involving depressed immune function (including AIDS), cancer, environmental allergies, fungal (especially *Candida*) infection, frequent flu and colds, bronchial inflammation, and regulating urinary incontinence.

It was shown that the success of immune adjuvant in therapy depends on the type of cancer (location) being treated, the individual's general health,

immunological and hormonal status as well as the individual's constitution.

Lentinan was demonstrated to have antitumor activity as well as to increase the survival time of patients with inoperable gastric cancer<sup>[10]</sup> and women with recurrent breast cancer following surgical therapy (for details on protocols, see Refs.<sup>[7,10,18]</sup>). According to Refs.<sup>[42,43]</sup>, when the polysaccharide is administered once or twice a week with chemotherapy to a patient with progressive cancer but with no serious liver, kidney, or bone marrow dysfunction, it produced a statistically significant improvement in immune and anticancer activity when compared to chemotherapy alone. Two hundred seventy-five patients with advanced or recurrent gastric cancer were given one of two kinds of chemotherapy (mitomycin C with 5-fluorouracil or tegafur) either alone or with lentinan injections. Statistically, the best results were obtained when lentinan was administered prior to chemotherapy and in patients with a basis of prolongation of life, regression of tumors or lesions, and the improvement of immune responses.

According to Ref.<sup>[44]</sup>, lentinan was injected into malignant peritoneal and/or pleural effusions of a group of 16 patients with advanced cancer. Eighty percent of the lesions showed probable clinical responses, with an improvement in performance demonstrated in seven subjects. The survival time for those who responded immunologically to the treatment was 129 days and 45 days for those who did not respond.

Shiitake mushrooms have cancer-preventative properties and can be a beneficial dietary supplement. Compounds that block the formation of carcinogenic *N*-nitroso compounds from nitrates (which occur in vegetables and meats) are produced in dried and heated mushrooms.<sup>[7,8,10]</sup> The uncooked form contains no detectable amounts of the nitrite-scavenging compound thiazolidine-4-carboxylic acid, while the dried variety has 134 mg/100 g (dry weight basis) of this compound, and the boiled form holds 850 mg/100 g.

In vitro studies have indicated that LEM from shiitake mushroom may be more effective than AZT in the treatment of AIDS (see discussions in the section on "Preclinical studies"), because it inhibits the cytopathic effect of giant cell formation in a cell-free system with MT-4 cells, or a cell-to-cell infection system with MOLT-4 cells, both of which induce multinucleated giant cells very efficiently. *L. edodes* mycelium may work by blocking the initial stages of HIV infection.<sup>[39]</sup> Azidothymidine inhibits cell-free infection of HIV, but it is ineffective in preventing the formation of multinucleated giant cells. It is also expensive and is known to cause severe bone marrow toxicity and a host of other side effects. Furthermore, it may become less effective during long-term use or may not offer any long-term survival advantages even with early use. Mycelium

extract, however, is nontoxic and less expensive. Its encapsulated form is recommended as a daily dietary supplement primarily for prevention of disease and maintenance of health. It must be stressed that more clinical trials will be necessary to assess the long-term benefit of the extract for HIV and AIDS. Another use is to boost the immune response in AIDS patients.<sup>[7,10,18]</sup> When it was used to treat HIV-positive patients with AIDS symptoms, the T-cell count rose from a baseline of 1250/mm<sup>3</sup> after 30 days up to 2550/mm<sup>3</sup> after 60 days. An improvement in clinical symptoms was also noted.

Lentinan has shown favorable results in treating chronic persistent hepatitis and viral hepatitis B.<sup>[10]</sup> Forty patients with chronic viral hepatitis B and seropositive for Hbe antigenemia were given 6 g of LEM daily (orally) for 4 mo. The study focused on the number of patients seroconverting from Hbe antigen positive to antiHbe positive, which was 25% after LEM therapy, and was higher in patients with chronic active hepatitis (36.8%). In addition, 17 patients (43%) became seronegative for Hbe antigen. Liver function tests improved even for patients who remained seropositive, and they had raised plasma albumin, and adjusted protein metabolism.

Dried shiitake mushroom (9 g/day) decreased 7–10% serum cholesterol in patients suffering with hypercholesterolemia. For many patients 60 years of age or older with hyperlipidemia, consuming fresh shiitake mushroom (90 g/day in 7 days) led to a decrease in total cholesterol blood level by 9–12% and triglyceride level by 6–7%.<sup>[10,36]</sup> Lentin, a novel protein isolated from shiitake mushroom, exerted an inhibitory activity on HIV-1 reverse transcriptase and proliferation of leukemia cells.<sup>[27,28]</sup>

### Antifungal Activity

From the fruiting bodies of the shiitake mushroom, a novel protein designated lentin with potent antifungal activity was isolated in 2003.<sup>[28]</sup> It was unadsorbed on DEAE-cellulose, and adsorbed on Affi-gel blue gel and Mono S. The N-terminal sequence of the protein manifested similarity to endoglucanase. Lentin, which had a molecular mass of 27.5 kDa, inhibited mycelia growth in a variety of fungal species including *Physalospora piricola*, *Botrytis cinerea*, and *Mycosphaerella arachidicola*.<sup>[28]</sup>

### Toxicity and Side Effects

Shiitake mushroom is edible, but some individuals may experience minor side effects or allergic reactions.

Literature describes<sup>[7,10,18,45]</sup> cases of shiitake-induced toxicodermis and shiitake dermatitis. Allergic reactions to the spores of shiitake mushrooms have been reported in workers picking mushrooms indoors, who are prone to an immune reaction to spores called “mushroom worker’s lung.” Symptoms include fever, headache, congestion, coughing, sneezing, nausea, and general malaise.<sup>[46]</sup> A water extract of the fruiting body was found<sup>[47]</sup> to decrease the effectiveness of blood platelets in initiating coagulation. So people who bleed easily or who take blood thinners should be closely monitored when under long-term treatment with shiitake mushroom or its water-soluble fractions.

*L. edodes* mycelium has shown no evidence of being acutely toxic, even in massive doses of over 50 mg/day for 1 week, though mild side effects such as diarrhea and skin rash may occur.<sup>a</sup> As a rule, symptoms disappear after a short period, when the body has adapted to the extract. Lentinan has no known serious side effects. However, in clinical trials of patients with advanced cancer, minor side reactions occurred such as a slight increase in glutamate-oxaloacetate transaminase (GOT) and GPT liver enzymes and a feeling of mild pressure on the chest. But these changes disappeared after lentinan administration was stopped.<sup>[34]</sup>

## COMMERCIAL PREPARATIONS OF SHIITAKE MUSHROOMS

### Dosage and Preparation

Shiitake mushroom is prescribed in various forms. It may be injected as a solution (1 mg/vial) or ingested as a sugar-coated tablet, capsule, concentrate, powdered extract, syrup, tea, wine, and/or as a medicinal dish. Lentinan’s anticancer effect is highly dose-dependent. The standard dose of the dried fruiting body in tea or in mushroom dishes is given as 6–16 g, equivalent to about 90 g of fresh fruiting body. As a tablet, the dosage is usually in the form of 2 g tablets 2–4×/day.

Commercial preparations can be found in many countries in health food stores and supermarkets. The tablets are usually made from a dried water-extract of the mycelia or fruiting bodies because drying concentrates the lentinan and other active principals. Standardized extracts are also available, and they are preferred because the amount of lentinan present is certified and clearly stated on the bottle.

Although the fresh form can be a valuable dietary supplement, the quantities one would require for

therapeutic doses are so great that its consumption could cause digestive upset. That is why LEM, which is concentrated and easily absorbed, is preferred for medicinal use.<sup>[7,8,10]</sup>

Fresh and dried shiitake mushrooms are used in medicinal mushroom dishes (“Yakuzen”). Certain medicinal effects have been recently studied<sup>[16]</sup> and found to reduce the ill effects of certain gourmet diets. These dishes can be prepared in many ways, limited only by one’s ingenuity: boiled, grilled, skewered, or on aluminum foil with different types of seasoning. To obtain a concentrate, whole fruit bodies or powdered mushrooms are boiled in water. The extract is then concentrated, and is used as a drink. It can also be consumed as a tea: canned “shiitake tea,” which contains a concentrated extract, or many other shiitake “healthy tea” products sold as mushroom containing tea bags.

Shiitake mushroom concentrate can be freeze-dried or spray-dried to form a granular powder. There are many products containing powdered shiitake mushroom extract, such as a mixture of this powder with vitamin C crystals or with medicinal plants such as ginseng. In Eastern countries, the mushroom is mainly used as a concentrate when extracted with boiling water. Residues from these processes still contain substantial amounts of useful polysaccharide substances, including those effective as antitumor compounds such as  $\beta$ -glucans, nucleic acids, dietary fiber, etc.

An alcohol extraction product is obtained by preserving fresh or dried shiitake mushroom in alcohol, which has been mixed with sugar or molasses. Some products, including “healthy shiitake wine,” are sold as a nightcap or as a tonic drink.<sup>[8,9]</sup>

### Drug Interactions

A watery extract of the whole fruiting body of *L. edodes* is reported to lessen the effectiveness of the blood platelets during the process of coagulation. People who bleed easily or who take blood thinners should use caution when chronically using *L. edodes* extracts in therapeutic amounts or in its water-soluble fractions (LEM).<sup>[10,47]</sup>

For cancer patients, smaller doses of intravenous and intramuscular lentinan are more effective than larger ones (e.g., 1 mg per injection is considered safe, whereas 10 mg may produce marked depression in the host immune response). Aoki<sup>[34]</sup> notes that what is considered an excessive dosage intravenously may be a favorable dosage when using oral administration.

For treating the initial stages of AIDS or chronic hepatitis, the best oral dose of LEM is between 2 and 6 g/day in 2–3 divided doses. If the disease is stable, the dosage may be decreased to 0.5–1 g/day.<sup>[7,10]</sup>

<sup>a</sup>The author does not consider these massive doses.

## REFERENCES

1. Hobbs, Ch. *Medicinal Mushrooms: An Exploration of Tradition, Healing, and Culture*, 2nd Ed.; Botanica Press, Inc.: Santa Cruz, CA, USA, 1995.
2. Miles, P.G.; Chang, S.T. *Mushroom Biology: Concise Basics and Current Development*; World Scientific: Singapore, 1997; 193.
3. Przybylowicz, P.; Donoghue, J. *Shiitake Grower's Handbook: The Art and Science of Mushroom Cultivation*; Hunt Publ. Co.: Dubugue, Kendall, 1990; 199.
4. Singer, R.; Harris, B. *Mushrooms and Truffles: Botany, Cultivation, and Utilization*, 2nd Ed.; Koeltz Sci. Books: Koenigstein, 1987.
5. Chang, S.T. World production of cultivated edible and medicinal mushrooms in 1997 with emphasis on *Lentinus edodes* (Berk.) Sing. in China. *Int. J. Med. Mushr.* **1999**, *1*, 387–409.
6. Royse, D. Specialty mushrooms and their cultivation. *Horticult. Rev.* **1997**, *19*, 59–97.
7. Wasser, S.P.; Weis, A.L. *Medicinal Mushrooms. Lentinus edodes* (Berk.) Singer; Nevo, E., Ed.; Peledfus Publ. House: Haifa, Israel, 1997; 95.
8. Stamets, P. *Growing Gourmet and Medicinal Mushrooms*, 3rd Ed.; Ten Speed Press: CA, USA, 2000.
9. Mizuno, T. Shiitake, *Lentinus edodes*: functional properties for medicinal and food purposes. *Food Rev. Int.* **1995**, *11*, 7–21.
10. Hobbs, Ch. Medicinal value of *Lentinus edodes* (Berk.) Sing. A literature review. *Int. J. Med. Mushr.* **2000**, *2*, 287–302.
11. Pegler, D. The classification of the genus *Lentinus* Fr. (Basidiomycota). *Kavaka.* **1975**, *3*, 11–20.
12. Earle, F.S. The genera of the North American gill-fungi. *Bull. N. Y. Bot. Gard.* **1909**, *5*, 373–451.
13. Murrill, W.A. Additions to Florida fungi. 1. *Bull. Torrey Bot. Club* **1939**, *66*, 29–37.
14. Singer, R. *The Agaricales in Modern Taxonomy*, 4th Ed.; Koeltz Sci. Books: Koenigstein, 1986.
15. Pegler, D. The genus *Lentinula* (Tricholomataceae tribe Collybiaeae). *Sydowia* **1983**, *36*, 227–239.
16. Mizuno, T. A development of antitumor polysaccharides from mushroom fungi. *Food Food Ingrid. J. Jpn.* **1996**, *167*, 69–85.
17. Wasser, S.P. Medicinal mushrooms as a source of antitumor and immunomodulating polysaccharides. *Appl. Microbiol. Biotechnol.* **2002**, *60*, 258–274.
18. Smith, J.; Rowan, N.; Sullivan, R. *Medicinal mushrooms. Their therapeutic properties and current medical usage with special emphasis on cancer treatment*; Special Report Commissioned by Cancer research UK. The University of Strathclyde in Glasgow, 2002; 256.
19. Yap, A.T.; Ng, M.L. Immunopotentiating properties of lentinan (1-3)- $\beta$ -D-glucan extracted from culinary-medicinal shiitake mushroom *Lentinus edodes* (Berk.) Singer (Agaricomycetidae). *Int. J. Med. Mushr.* **2003**, *5*, 352–372.
20. Chihara, G.; Maeda, Y.Y.; Hamuro, J.; Sasaki, T.; Fukuoka, F. Inhibition of mouse Sarcoma 180 by polysaccharides from *Lentinus edodes* (Berk.). *Sing. Nature* **1969**, *222*, 687–688.
21. Chihara, G.; Hamuro, J.; Maeda, Y.Y.; Arai, Y.; Fukuoka, F. Antitumor polysaccharide derived chemically from natural glucan (pachyman). *Nature (London)* **1970**, *225*, 943–944.
22. Chihara, G.; Hamuro, J.; Maeda, Y.Y.; Arai, Y.; Fukuoka, F. Fractionation and purification of the polysaccharides with marked antitumor activity, especially lentinan, from *Lentinus edodes* (Berk.) Sing. (an edible mushroom). *Cancer Res.* **1970**, *30*, 2776–2781.
23. Chihara, G.; Hamuro, J.; Maeda, Y.Y.; Shiio, T.; Suga, T.; Takasuka, N.; Sasaki, T. Antitumor and metastasis-inhibitory activities of lentinan as an immuno-modulator: an overview. *Cancer Detect. Rev. Supp.* **1987**, *1*, 423–443.
24. Yap, A.T.; Ng, M.L. An improved method for the isolation of lentinan from the edible and medicinal shiitake mushroom, *Lentinus edodes* (Berk.) Sing. (Agaricomycetidae). *Int. J. Med. Mushr.* **2001**, *3*, 9–20.
25. Moriyama, M. et al. Anti-tumor effect of polysaccharide lentinan on transplanted ascites hepatoma-134 in C3H/He mice. In *Manipulation of Host Defence Mechanisms*, International Congress Series 576; Excerpta Media: Amsterdam, 1981.
26. Mori, K.; Toyomasu, T.; Nanba, H.; Kuroda, H. Antitumor activity of fruit bodies of edible mushrooms orally administrated to mice. *Mushr. J. Trop.* **1987**, *7*, 121–126.
27. DeVere White, R.W.; Hackman, R.M.; Soares, S.E.; Beckett, L.A.; Sun, B. Effect of a mushroom mycelium extract on the treatment of prostate cancer. *Urology* **2002**, *60*, 640–644.
28. Ngai, P.H.K.; Ng, T.B. Lentin, a novel and potent antifungal protein from shiitake mushroom with inhibitory effects on activity of human immunodeficiency virus-1 reverse transcriptase and proliferation of leukemia cells. *Life Sci.* **2003**, *73*, 3363–3374.
29. Fujii, T.; Maeda, H.; Suzuki, K.; Ishida, N. Isolation and characterization of a new antitumor polysaccharide, KS-2, extracted from culture mycelia of *Lentinus edodes*. *J. Antibiot.* **1978**, *31*, 1079–1090.



30. Suzuki, C. Killing activity of experimental tumor cells given to macrophage by new antitumor immunopotentiator, KS-2. *Japan J. Bacter.* **1978**, *33*, 78–85.
31. Kurashige, S.; Akusawa, Y.; Endo, F. Effects of *Lentinus edodes*, *Grifola frondosa*, and *Pleurotus ostreatus* administration on cancer outbreak, and activities of macrophages and lymphocytes in mice treated with a carcinogen, *N*-butyl-*N*-butanolnitrosoamine. *Immunopharm. Immunotoxicol.* **1997**, *19*, 175–183.
32. Ladanyi, A.; Timar, J.; Lapis, K. Effect of lentinan on macrophage cytotoxicity against metastatic tumour cells. *J. Cancer Immunol. Immunother.* **1993**, *36*, 123–126.
33. Yoshino, S.; Tabata, T.; Hazama, S.; Iizuka, N.; Yamamoto, K.; Hirayama, M.; Tangoku, A.; Oka, M. Immunoregulatory effects of the antitumour polysaccharide lentinan on Th1/Th2 balance in patients with digestive cancers. *Anticancer Res.* **2000**, *20*, 4707–4711.
34. Aoki, T. Lentinan. In *Immune, Modulation Agents and Their Mechanisms*; Fenichel, R.L., Chirgis, M.A., Eds.; Immunol Studies, 1984; 25, 62–77.
35. Wasser, S.P.; Weis, A.L. Medicinal properties of substances occurring in higher Basidiomycetes mushrooms: current perspectives (review). *Int. J. Med. Mushr.* **1999**, *1*, 31–62.
36. Yang, B.K.; Kim, D.H.; Jeong, S.Ch.; Das, S.; Choi, Y.S.; Shin, J.S.; Lee, S.Ch.; Song, Ch.H. Hypoglycemic effect of a *Lentinus edodes* exopolymer produced from a submerged mycelial culture. *Biosci. Biotechnol. Biochem.* **2002**, *66*, 937–942.
37. Amagase, H. Treatment of hepatitis B patients with *Lentinus edodes* mycelium. *Proceedings of the XII International Congress of Gastroenterology*, Lisbon; 1987, 197.
38. Suay, I.; Arenal, F.; Asensio, F.J.; Basilio, A.; Cabello, M.A.; Diez, M.T.; Garcia, J.B.; del Val, A.G.; Corrochategui, J.; Hernandez, P.; Pelaez, F.; Vicente, M.F. Screening of Basidiomycetes for antimicrobial activities. *Antonie van Leeuwenhoek* **2000**, *78*, 129–139.
39. Tochikura, T.S. et al. Inhibition (in vitro) of replication and of the cytopathic effect of human immunodeficiency virus by an extract of the culture medium of *Lentinus edodes* mycelia. *Med. Microbiol. Immunol.* **1988**, *177*, 235–244.
40. Hanafusa, T. et al. Intestinal absorption and tissue distribution of immunoactive and antiviral water-soluble [<sup>14</sup>C] lignins in rats. *Yakubutsu Dotai.* **1990**, *5*, 409–436.
41. Sarkar, S. et al. Antiviral effect of the extract of culture medium of *Lentinus edodes* mycelia on the replication of herpes simplex virus type 1. *Antiviral Res.* **1993**, *20*, 293–303.
42. Taguchi, T. et al. Clinical trials on lentinan (polysaccharide). In *Immunomodulation by Microbial Products and Related Synthetic Compounds*; Yamamura, Y. et al., Ed.; Elsevier Science: New York, 1982; 467–475.
43. Taguchi, T. et al. Clinical efficacy of lentinan on patients with stomach cancer: end point results of a four-year follow-up survey. *Cancer Detect. Prev.* **1987**, *1*, 333–349.
44. Oka, M. et al. Immunological analysis and clinical effects of intra-abdominal and intrapleural injection of lentinan for malignant ascites and pleural effusion. *Biotherapy* **1992**, *5*, 107–112.
45. Ueda, A. et al. Allergic contact dermatitis in shiitake (*Lentinus edodes* (Berk.) Sing.) growers. *Contact Dermatitis* **1992**, *26*, 228–233.
46. Van Leon, P.C. Mushroom worker's lung. Detection of antibodies against Shii-take (*Lentinus edodes*) spore antigens in Shii-take workers. *J. Occup. Med.* **1992**, *34*, 1097–1101.
47. Yang, Q.Y.; Jong, S.C. Medicinal mushrooms in China. *Mushr. Sci. XII.* **1989**, 631–642.

# St. John's Wort (*Hypericum perforatum*)

**Jerry M. Cott**

Food and Drug Administration, Rockville, Maryland, U.S.A.

## INTRODUCTION

St. John's wort (SJW) is one of the best known yet least understood of the modern herbals. Though clearly a favorite medicinal among herbalists and European physicians, its reputation has been sullied by reports of drug interactions and lack of efficacy in two U.S. trials. Safe use of this herb requires some familiarity with its effects on intestinal P450 enzymes and *p*-glycoprotein. Understanding the efficacy data requires a critical analysis of depression trials that have been performed with this antidepressant and an appreciation of why clinical studies fail. SJW is a well-studied botanical extract that appears to have a clinically significant therapeutic activity in mild-to-moderate major depressive disorder. While side effects are rare and mild, interactions with other medications may occur, particularly with those that are substrates of both intestinal cytochrome P450 3A4 (CYP3A4) and the *p*-glycoprotein transporter.

## BACKGROUND

*Hypericum perforatum* L. Hypericaceae (St. John's wort; SJW) has been used for millennia for its many medicinal properties, including wound healing, treatment for kidney and lung ailments, insomnia, and depression (Fig. 1). The SJW has become increasingly popular in Germany where it is approved for use in the treatment of mild-to-moderate depression, and has remained a first-line treatment for many years. It is named for its flowering time at the end of June, around the birth day of John the Baptist. Originally brought from Europe to North America, the plant can be found growing wild along roadsides and in fields and pastures. Current uses are primarily in treating central nervous system (CNS) indications such as depression, anxiety, and insomnia. Oil-based preparations are used for stomach upsets and are also applied topically to treat bruises, muscle aches, and first-degree burns.<sup>[1]</sup> A cream-based formulation was recently shown to be more effective than the vehicle

for atopic dermatitis.<sup>[2]</sup> In 2002, SJW was the seventh best-selling herbal supplement (at just under US\$15 million) in mainstream retail stores in the United States, though sales have declined somewhat in recent years (down 18% from 2001).<sup>[3]</sup> Causal factors may include reports of poor quality control, herb–drug interactions, and concern that SJW may be ineffective due to the publication of the first “negative” clinical trial data in the *Journal of the American Medical Association*.<sup>[4,5]</sup>

## CHEMISTRY AND PREPARATION OF PRODUCTS

SJW has long been known to contain red pigments that have been postulated to be the primary active



**Fig. 1** St. John's wort. (Compliments of Peggy Duke.)  
(View this art in color at [www.dekker.com](http://www.dekker.com))

*Jerry M. Cott, Ph.D.*, is a Pharmacologist at the Center for Drug Evaluation and Research, Food and Drug Administration, Division of Anesthetic, Critical Care & Addiction Drug Products, Rockville, Maryland, U.S.A.

constituent(s) in this plant genus, though there is insufficient evidence for this assumption. They are the naphthodianthrones hypericin and pseudohypericin (Fig. 2), and other derivatives that make up approximately 0.1–0.15% by weight. It also contains flavonoids and flavonols (2–4%) such as hyperoside, quercitrin, isoquercitrin, quercetin, biapigenin, rutin, and the biflavonoid, amentoflavone; and the phloroglucinols, primarily hyperforin (2–4%) (Fig. 3). Other constituents include volatile oils, tannins (6.5–15%), and caffeic acid derivatives. While originally believed to be a necessary component for antidepressant activity, hypericin is considered a marker compound for purposes of botanical identification.

The early SJW studies from Germany examining the antidepressant activity were based on extracts standardized to hypericin only. More recent research suggested that hyperforin might also be important, and that this constituent may degrade (oxidize) under normal manufacturing conditions. Therefore, some companies began to stabilize their formulations to prevent oxidation and standardize the hyperforin content at 3–5%. The necessity for this was called into question when the relatively hyperforin-free (<0.2%) formulation, Ze117, showed clinical antidepressant efficacy in major depression (see below). There are reports that the majority of SJW products failed to provide within 10% of stated naphthodianthrones.<sup>[6]</sup> However, virtually all products in the United States and Europe are characterized by the 0.3% marker using a calculation of total naphthodianthrones from the spectrophotometric method of the *German Pharmaceutical Codex* (DAC) and the *U.S. Pharmacopoeia* (USP). This method yields considerably different results from the more accurate and specific liquid chromatography (LC) and mass spectrophotometric (MS) methods. Nevertheless, it is the USP standard analytical method and should be the one used when referring to the accuracy of individual product labeling. Should there be concern about a possible lack of efficacy due to differences of analytical standard? If these constituents, particularly hypericin and hyperforin, are not crucial for efficacy, how much emphasis should really be placed on their precise standardization? Certainly,

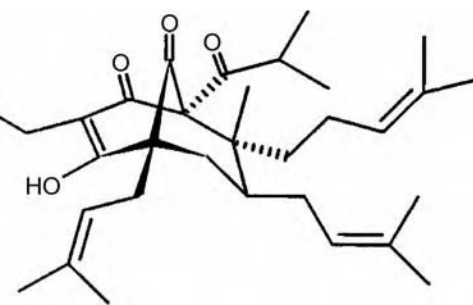
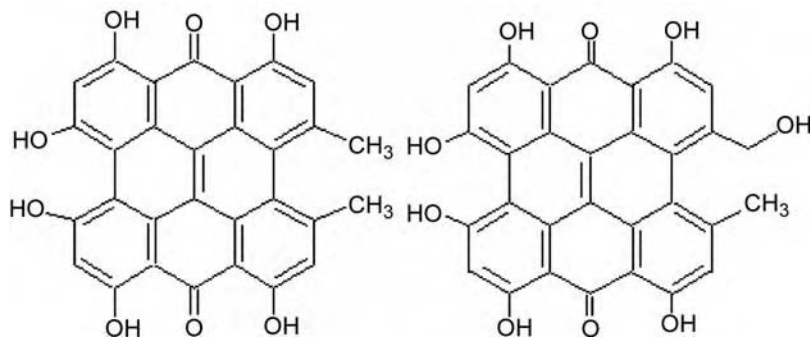


Fig. 3 Hyperforin.

constituents listed on a product label should portray an accurate representation of the ingredients of the product, and how those values—i.e., by what analytical method—were determined.

An additional problem is one of dissolution. Not only must the herbal products contain the correct constituents in their proper concentrations, but they must also release them either in the stomach or in small intestine. Specific tests of dissolution with a USP method (with paddle stirring of simulated gastric fluid at 37°C), with or without the addition of bile components, were carried with several different preparations of SJW.<sup>[7]</sup> Results suggest that the hydrophilic flavonoids are released by most formulations, but the more lipophilic hypericins and hyperforin are poorly released. While Jarsin<sup>®</sup> 300 (LI160; Lichtwer Pharma AG, Berlin, Germany) has shown antidepressant activity in many trials, and was used in the two American studies, it released less than 25% of its hyperforin and 50% of its flavonoids within 4 hr. Other experiments indicate that the stability of SJW preparations—especially under conditions of high humidity—may be of concern.<sup>[8]</sup>

## PRECLINICAL STUDIES

Receptor binding studies with reasonable concentrations of the crude extract have shown little affinity for any of the standard neurotransmitter receptors, with the exception of gamma-aminobutyric acid (GABA) (both types A and B).<sup>[9]</sup> Many individual

Fig. 2 The naphthodianthrones hypericin and pseudohypericin.

components of SJW have been evaluated in binding assays, and a review of these data is presented in recent papers by Butterweck et al.<sup>[10,11]</sup> As this author explains, these data are made difficult to interpret due to the constituents' presence in the extract at several orders of magnitude lower than the  $K_i$ , occasional solubility problems, and lack of functional activity studies.

SJW has been reported to share a mechanism (uptake inhibition) with synthetic antidepressants, but this may not really be the case. Although it has been reported to affect the serotonin (5HT) "uptake" process, the concentrations required are unrealistically high (approximately 1000 times less potent than synthetic uptake inhibitors). In addition to 5HT, every other neurotransmitter that has been measured appears to have its uptake inhibited. This lack of specificity is not the profile of a true pharmacologic effect. In addition, the side effects of SJW are not at all similar to 5HT uptake inhibitors. Hyperforin is the constituent identified as the primary "uptake inhibitor." However, recent studies suggest that neither SJW nor hyperforin is a true uptake inhibitor since they do not bind to the 5HT uptake site. Rather, they appear to release monoamines and other transmitter substances from synaptosomes, yielding the same net effect in the *in vitro* assay. This "pseudo" uptake inhibition has been suggested to be a nonselective transmitter release that is related to increasing intracellular sodium concentrations, calcium mobilization, and ion channel modulation. Treatment with SJW also fails to inhibit uptake in human depressed patients, unlike the tricyclic and selective serotonin reuptake inhibitor (SSRI) antidepressants. In addition, the relatively hyperforin-free formulation, Ze117<sup>[12]</sup> (250 mg, twice daily), shows clinical antidepressant efficacy when compared with placebo<sup>[13]</sup> and has equivalence to 20 mg/day fluoxetine<sup>[14]</sup> and 150 mg/day imipramine<sup>[15]</sup> in major depression. This supports the Butterweck hypothesis that flavonoids are at least partly responsible for the therapeutic efficacy of SJW extracts.<sup>[16]</sup> Table 1 summarizes some of the controversies regarding the importance of hyperforin, while Table 2 describes various proposed mechanisms of the action of SJW.

**Table 1** Uptake inhibition and hyperforin

Hyperforin claimed activity	Reference
Primary constituent linked to "uptake inhibition"	Chatterjee et al. (1998); Müller et al. (1998)
Does not bind uptake site	Singer et al. (1999); Jensen et al. (2001)
Causes monoamine release	Gobbi et al. (1999)
Release related to intracellular sodium concentration	Singer et al. (1999)
Release related to calcium mobilization	Koch and Chatterjee (2001)
Release related to ion channel modulation	Krishtal et al. (2001)
No uptake inhibition occurs in humans	Uebelhack and Franke (2001)
SJW side effects unlike uptake inhibitors	Woelk et al. (1994)

Although SJW demonstrates very weak monoamine oxidase (MAO) inhibition *in vitro*, *in vivo* administration (intraperitoneal) of SJW to rats shows no effect on MAO. This is supported by the absence of reported cases of monoamine oxidase inhibitor (MAOI)-associated hypertension in patients using SJW.

Pharmacokinetic studies have been performed with the standardized SJW extract, LI 160, in normal volunteers. The peak plasma concentrations of components analyzed thus far include hypericin and pseudohypericin at around 8 and 6 ng/ml (~16 and 12 nM), respectively, at steady state<sup>[17]</sup> and hyperforin at 150 ng/ml (280 nM).<sup>[18]</sup> However, intravenous (i.v.) doses of hypericin as high as 2 mg/kg in monkeys cannot be detected in the cerebrospinal fluid, suggesting that direct central effects are unlikely.<sup>[19]</sup>

Surprisingly, rat atrial tissue preparations showed SJW extracts to have 5HT antagonist activity and negative chronotropic and inotropic actions.<sup>[20]</sup> Amentoflavone has been acknowledged to bind with high affinity to benzodiazepine receptors, and efforts have been made to show that it may be able to cross the blood-brain barrier.<sup>[21]</sup> However, intravenous administration to mice failed to affect <sup>3</sup>H-flunitrazepam binding to brain benzodiazepine receptors,<sup>[22]</sup> making it a doubtful candidate for therapeutic activity. Thus, the true mechanism(s) of antidepressant action for SJW is yet to be determined.<sup>[23,24]</sup> It is possible that more sophisticated neuropharmacologic techniques of the future will reveal novel and marvelously subtle pharmacologic activities for herbal medicines that current research methods fail to uncover.

## CLINICAL STUDIES

### Depression

The efficacy of SJW in the treatment of mild-to-moderate major depressive disorder is well established. With the notable exception of the two American trials,<sup>[4,5]</sup> other clinical studies and meta-analyses have found SJW to be better than placebo or comparable to

**Table 2** Other proposed mechanisms of antidepressant action

Antidepressant mechanism	Probable relevance	Reason	Reference
MAO inhibition	—	Very weak effect	Cott <sup>[9]</sup>
	—	No effect in vivo	Bladt and Wagner (1994)
	—	No MAOI side effects	Woelk et al. (1994)
Inhibition of dopamine- $\beta$ -hydroxylase	—	Requires 21 $\mu$ M	Kleber et al. (1999)
Direct neurotransmitter release	—	No current examples	Chatterjee et al. (2001)
Alteration of neuronal membrane fluidity	?	Insufficient data	Eckert and Müller (2001)
Adenosine receptor antagonism	—	Requires 0.1–0.5 mg/ml	Reith et al. (2000)
CRF <sub>1</sub> antagonism	—	Requires 30-fold higher plasma levels	Simmen et al. (2003)
Inhibition of free radical production	?	Insufficient evidence; high concentrations?	Hunt et al. (2001)
Combination of other mechanisms	—	No evidence	Bennett et al. (1998)

standard synthetic antidepressants. In a recent meta-analysis by Linde and Mulrow,<sup>[25]</sup> 27 trials including a total of 2291 patients met the criteria for inclusion. Seventeen trials with 1168 patients were placebo controlled (16 were single preparations and one was a combination with four other plant extracts). Ten trials (eight single preparations, two combinations of SJW and valerian) with 1123 patients compared SJW with other antidepressants or sedative drugs. Most trials were 4–6 weeks long. Participants usually had “neurotic depression” (if diagnosed according to ICD-9) or “mild-to-moderately severe depressive disorders” (when based on the ICD-10, DSM-III, or DSM-IV). Severity, based on the Hamilton Depression Score, varied from 12.4 to 29.5 with a mean score of 20.8. Severity is not always directly correlated to score, since the scale itself is subjective, and there are versions of the scale having more than the 17 original items. Most outcome measures included percentage of patients responding to treatment (Hamilton score of 10 or less and/or a 50% decrease from baseline). Duration of illness was not available. The SJW preparations were significantly better than placebo and similarly effective as standard antidepressants. The reviewers concluded that the extracts are more effective than placebo for the short-term treatment of mild-to-moderately severe depression.

An updated analysis by the same researchers<sup>[26]</sup> was performed on the efficacy of SJW extracts in depression in nine reviews (total number of trials: 29). While the studies differed considerably, the conclusions were very similar: the extracts were superior to placebo in mild-to-moderate depressive disorders.

Schulz<sup>[27]</sup> recently reviewed 34 clinical trials conducted since 1990. Eleven were placebo controlled, and in nine cases, the SJW extract was shown to be significantly superior. Comparative results with SJW were as good or even better than with imipramine or

fluoxetine, while amitriptyline was significantly superior to SJW after 6 weeks of therapy. There were no significant differences in treatment outcome between SJW and other synthetics (maprotiline and sertraline) or light therapy. The results of the trials conducted up to 2002 showed no major differences in efficacy among the various methanol or ethanol extracts.

Whiskey, Werneke, and Taylor<sup>[28]</sup> updated and expanded previous meta-analyses of SJW. Twenty-two randomized controlled trials were identified. Entry criterion for severity was most often  $\geq 16$  or  $\geq 17$ . Two were  $\geq 18$  and one<sup>[4]</sup> was  $\geq 20$ . Information related to duration of illness was not provided. Meta-analysis showed that SJW was significantly more effective than placebo but not remarkably different in efficacy from active antidepressants. A subanalysis of six placebo-controlled trials and four active comparator trials that met stricter methodological criteria also showed SJW to be more effective than placebo and similar to standard antidepressants. There was no evidence of publication bias.

Kim, Shreltzer, and Goebert<sup>[29]</sup> performed a meta-analysis utilizing only well-controlled, double-blind studies with strictly defined depression criteria. There were six randomized double-blind trials, which included a total of 651 outpatients. As with the other meta-analyses, there was little mention of such factors as mean duration of depression, family history of affective disorders, previous episodes of depression, and exclusion of bipolar illness. The trials appear to have been performed in psychiatric and general practice sites. Five of the studies were carried out in Germany, and Hamilton scores ranged from 15 to 24. SJW was found to be 1.5 times more likely to result in an antidepressant response than placebo and was equivalent to tricyclic antidepressants (TCAs).

Most clinical trials (including the two recent American studies) were performed with a standardized

SJW extract such as LI160. This is one of the several officially recognized formulations in Germany for the treatment of depression. SJW remains a first-line treatment for mild-to-moderate depression in Europe.<sup>[30]</sup> So, why did the two clinical trials conducted in the United States [Shelton et al.<sup>[4]</sup> (funded by Pfizer); and the Hypericum Depression Trial Study Group,<sup>[5]</sup> (funded by the National Institutes of Health, NIH)] fail to show efficacy? Was there something different about these trial designs from other trials conducted with SJW? While both studies were purported to be the first rigorous and definitive studies of the herb, a closer examination reveals a shared weakness. The primary difference in these experiments is their departure from standard entry criteria for patient inclusion into a depression trial. While most previous studies of SJW targeted patients with “mild-to-moderate” depression [approximately 15–20 on the 17-item Hamilton Depression Scale (HAM-D)], both of these trials required a score of at least 20. In the final demographics, the mean severity score for both studies was greater than 22; this is more toward the “moderate-to-severe” range of severity. Although it is commonly believed that more severely depressed patients will be less likely to respond to placebo—and that their inclusion in a clinical trial would increase the power to detect a true drug effect—published data do not support this.<sup>[31]</sup> Antidepressant trials performed by the pharmaceutical industry routinely use a severity score of approximately 17 on the 17-item Hamilton scale as a criterion for entry to trials. For example, Walsh et al.<sup>[31]</sup> recently reported a mean Hamilton entry score of 16.7 for published depression trials. Given that 50% of industry antidepressant trials fail to show a significant therapeutic effect,<sup>[32]</sup> it is clearly in the corporate interest to design studies with adequate statistical power. To do otherwise would not make economic sense. In the 40-plus years of experience in designing and implementing antidepressant trials, it seems doubtful that the pharmaceutical industry would have overlooked such an easy fix (increasing severity scores required for entry). Thus, the use of a more severely depressed population is unlikely to improve the quality of a study, and may even contribute to its failure.

Of perhaps greater significance for these studies than the severity of the patients' symptoms was the duration of their illness. The average length of the current depressive episode in both these trials was quite long, often greater than 2 yr. It seems likely that this patient population would be relatively unresponsive to any brief treatment within a clinical trial setting. While both trials claimed to exclude “treatment refractory” patients, it is doubtful that this was the case. The failure of sertraline to improve mood scores in the NIH study is consistent with this notion. The Pfizer study contained no active comparison, and thus no conclu-

sions regarding efficacy can be drawn from it. In order to determine efficacy, there must be a statistically significant difference between two groups on the primary outcome measure. Failure to show a difference could simply mean that the trial lacked the sensitivity to detect a difference (as with the Pfizer study). This is certainly the case for the NIH study where sertraline failed to differentiate from placebo on either of the primary efficacy endpoints. Thus, the two American trials are not useful for determination of efficacy. Safety information might reasonably be derived from them however, and is considered in a later section.

## Anxiety Disorders

SJW has also shown efficacy in placebo-controlled trials in somatoform disorders (medical conditions that appear to be psychological in origin).<sup>[33]</sup> The authors found a pronounced and relatively rapid onset of activity and a notable lack of adverse effects when compared to other treatments of somatoform disorders. They also noted that efficacy was not dependent on the presence of depressive symptoms, since patients without significant depression improved as much as those who did. The National Institute of Mental Health (NIMH) is currently supporting a placebo-controlled trial of SJW in social phobia in Madison. This same group has previously reported success in treating obsessive-compulsive disorder (OCD) in an open-label trial with SJW.<sup>[34]</sup> There is also a case report of three patients with generalized anxiety disorder (GAD) who responded to treatment with SJW.<sup>[35]</sup>

## Adverse Effects

Tolerability of SJW has been found to be very good with few adverse drug reactions (ADRs) reported (Table 3). The extensive use in Germany has not resulted in any serious drug interactions or overdose toxicity. While SJW is often said to be contraindicated in severe depression, this may have more to do with the need for medical supervision and the inappropriateness of self-treatment rather than a true lack of efficacy.

In their meta-analysis of 22 trials, Whiskey, Werneke, and Taylor<sup>[28]</sup> reported that adverse effects occurred more frequently with standard antidepressants than with SJW. The meta-analysis by Kim, Streltzer, and Goeber<sup>[29]</sup> showed that there was a higher dropout rate due to side effects in the tricyclic groups and that these drugs were nearly twice as likely to cause side effects—including those that were more severe—than did SJW. Linde and Mulrow<sup>[25]</sup> report that extensive use of SJW in Germany has thus far not resulted in published cases of serious drug interactions or toxicity after overdose.

**Table 3** Incidence of adverse events

Adverse event rate	Type of study	Reference
26% SJW; 45% standard drug	Meta-analysis	Linde and Mulrow <sup>[25]</sup>
4% SJW; 4.8% PBO 20% SJW; 36% standard drug	Meta-analysis	Linde et al. (1996)
3% SJW	Review	Kasper (2001)
1–3% SJW; photosensitivity ~1 in 300,000	Review	Schulz <sup>[57]</sup>
26% SJW; 47% TCAs	Meta-analysis	Kim, Streltzer, and Goebert <sup>[29]</sup>
18% SJW; 16% PBO 28% SJW, 47% standard drug	Meta-analysis	Whiskey, Werneke, and Taylor <sup>[28]</sup>
Common ADRs: gastrointestinal symptoms, dizziness/confusion, tiredness/sedation	Review	Ernst et al. (1998)
Insomnia, vivid dreams, restlessness, anxiety, agitation, irritability, dry mouth, headache	Review	Upton et al. (1997), Schulz, <sup>[57]</sup> Anon <sup>[41]</sup>
Mania in bipolar disorder	Case reports	Nierenberg (1999)

The two American trials found SJW to be well tolerated. In the NIH study, the number of withdrawals due to side effects was 2 for SJW, 3 for placebo, and 5 for sertraline. Patients reaching the maximum dose during the trial were 54% for SJW and placebo and 36% for sertraline ( $p < 0.005$ ). The significant side effects of sertraline were diarrhea (38%), nausea (37%), anorgasmia (32%), forgetfulness (12%), frequent urination (21%), and sweating (29%). Those of SJW were anorgasmia (25%), frequent urination (27%), and swelling (19%). While the adverse events reported for sertraline are very consistent with literature reports, those for SJW are not. Specifically, anorgasmia has not been reported to occur in any of the German studies. Since this side effect is one of the most common complaints associated with SSRIs, it is tempting to speculate that it might have somehow “contaminated” the side effect profile of SJW. No explanation was provided by the authors. Finally, both the patients and the physicians correctly guessed the sertraline treatment in the majority of patients, while placebo and SJW were correctly guessed by no more than chance.

In the Pfizer study, headache was the only adverse event that occurred with greater frequency in the SJW group (41%) than with placebo (25%). Patients discontinuing due to adverse events comprised only 1% in both the placebo and SJW groups. There were no reports of anorgasmia.

### Photosensitivity

The potentially serious adverse effect, photosensitivity, occurs very rarely. Photosensitivity from SJW preparations appears to be due to the naphthodianthrone, hypericin and pseudohypericin. These compounds are photoactive quinones that produce singlet oxygen and free radicals when exposed to light. For most people receiving high doses of SJW, the extent of photosensitivity is a slight reduction in the minimum

tanning dose. This was demonstrated in a randomized, placebo-controlled clinical trial in which fair-skinned subjects who burned easily were given metered doses of SJW extract (LI160), and exposed to UVA and UVB irradiation.<sup>[36]</sup> Volunteers received placebo or 900, 1800, or 3600 mg SJW extract, containing 0, 2.8, 5.6, and 11.3 mg of total hypericin prior to testing. Sensitivity to selective UVA light was increased slightly (~20%) after the highest dose of SJW. Another group received multiple dosing at twice the recommended dose [600 mg three times a day (t.i.d.)]. In the SJW group, there was a slight increase in SSI (both UVA and B) sensitivity (~9%), and a larger increase to UVA light (~21%). The authors concluded that photosensitization was without clinical relevance at the recommended dosages. While the German Commission E notes that photosensitization is possible, especially in fair-skinned individuals, it concludes that animal and human research indicates that photosensitization is not likely to occur at recommended dosages.<sup>[1]</sup>

### Reproduction

The potential cognitive effects of prenatal exposure of SJW were tested in mice. SJW or a placebo was given in food bars (estimated to contain ~182 mg/kg/day) for 2 weeks before mating and throughout gestation. The SJW did not affect body weight, body length, or head circumference measurements; physical milestones (teeth eruptions, eye opening, external genitalia); reproductive capability, perinatal outcomes, or growth and development of the second-generation offspring.<sup>[37]</sup> In an identically designed study,<sup>[38]</sup> one offspring per gender from each litter (SJW: 13; placebo: 12) was tested on various learning and memory tests. In the majority of the tests, there were no differences between groups. Occasional minor discrepancies were found in favor of placebo-treated mice, but the authors questioned whether this was biologically significant.

The safety of SJW to nursing mothers and their infants was examined in a Canadian study.<sup>[39]</sup> Thirty-three breastfeeding women receiving SJW were followed between May 1999 and April 2001 and compared with matched controls. There were no statistically significant differences found in maternal or infant demographics or maternal adverse events. None was observed in the frequency of maternal report of decreased milk production, or in infant weight over the first year of life.

A mother with postnatal depression was admitted to a healthcare center in Germany. Her pharmacist had recommended taking an SJW preparation three times a day (LI160). Four breast milk samples during an 18-hr period were analyzed for hypericin and hyperforin. Only hyperforin was excreted into breast milk at sufficient levels to enable detection (0.6–18 ng/ml). Neither was found in the infant's plasma. No side effects were seen in the mother or infant.<sup>[40]</sup>

### Mutagenicity

The mutagenic potential of SJW was determined in an Ames test and the unscheduled DNA synthesis (UDS) assay. High concentrations of the extracts showed an increase in the number of revertants, both with and without metabolic activation. The authors ascribed the mutagenic effects to the flavonols found in SJW. Of the substances present in SJW, quercetin has generated the most controversy with respect to mutagenic potential. The genotoxicity of a standardized aqueous ethanolic extract (Psychotonin M) was examined in different *in vivo* and *in vitro* test systems with mammalian cells. The *in vitro* investigations were performed with the hypoxanthine guanine phosphoribosyl transferase (HGPRT) test, UDS test, and the cell transformation test using Syrian hamster embryo (SHE) cells. In these studies, both the *in vitro* tests as well as the *in vivo* tests—fur spot test of the mouse and the chromosome aberration test with the Chinese hamster bone marrow cells—were negative. Thus, there was mixed evidence regarding the mutagenic potential of SJW (see Ref.<sup>[41]</sup> for review).

### Drug Interactions

Studies have shown that SJW can reduce plasma levels of several drugs.<sup>[24]</sup> Current knowledge regarding the metabolism of these drugs indicates that the liver cytochrome P450 drug metabolizing enzyme systems cannot, by itself, account for these effects. There is fairly substantial evidence that SJW induces both intestinal CYP3A4 and the P-glycoprotein (Pgp) trans-membrane pump after chronic administration.<sup>[42,43]</sup> While drugs that are substrates of only one of these systems may show a measurable decrease,

these are not generally clinically relevant. However, medications with a narrow therapeutic index that are substrates of both CYP3A4 and Pgp (e.g., cyclosporine and indinavir) are of concern due to the possibility that SJW may result in substantial decreases in plasma concentrations.<sup>[24]</sup>

While anecdotal reports have suggested that other medications or enzyme systems may be affected, these studies must be carefully evaluated in light of the specific methodology and the total body of evidence. For example, Obach<sup>[44]</sup> reported that crude SJW methanolic extracts showed inhibition of all CYP enzymes when tested at very high concentrations [50% enzyme inhibition ( $IC_{50}$ ) ranged from 10 to 1000  $\mu\text{g/ml}$ ]. Hyperforin inhibited 2D6, 2D9, and 3A4 with  $IC_{50}$  of 1.6, 4.4, and 2.3  $\mu\text{M}$ , respectively. The significance of these data is uncertain since the concentrations were higher than those attained clinically, e.g., hyperforin maximum plasma level ( $C_{\text{max}}$ ) was reported to be approximately 280 nM (150 ng/ml).<sup>[18]</sup> In addition, the activities of isolated chemical constituents may not be relevant to whole or crude plant extracts. However, within physiologically relevant concentrations, the SJW constituent, hyperforin, induces CYP3A4 in hepatocyte cells via the pregnane X nuclear receptor ( $K_i = 27 \text{ nM}$ )<sup>[45]</sup> and the steroid X receptor.<sup>[46]</sup>

Artificially high concentration of test substances in *in vitro* assays can result in false positives. Direct (*in vivo*) evidence of interaction with CYP450 is more useful for predicting clinical interactions. Clinical trials designed specifically to test for CYP450 enzymes show induction of CYP3A4 but not of other major enzymes, CYP1A2 and 2D6.<sup>[47–51]</sup>

SJW has recently been reported to induce Pgp as well as CYP3A4. The administration of the extract to rats or humans for 14 days resulted in a 3.8-fold and 1.4-fold increase, respectively, of intestinal Pgp expression.<sup>[42]</sup> This would explain the report that SJW reduces the plasma levels of digoxin,<sup>[42,51]</sup> which is not a substrate of P450 enzymes, but rather of Pgp. Of possible importance to this discussion, the low-hyperforin, low-hypericin formulation, Ze117, lacks interaction potential with digoxin (Table 4).<sup>[52]</sup> Hypericin has been reported to induce Pgp, though not as markedly as the whole extract.<sup>[53]</sup>

Reduced levels of phenprocoumon (an anticoagulant closely related to warfarin) in 10 subjects were suggested to be caused by an interaction between SJW and CYP2C9 (the primary liver enzyme associated with warfarin metabolism) although there was no direct evidence for this. Another possible explanation for the interaction is reduced intestinal absorption due to induction of Pgp. In support of this possibility, rats treated orally with SJW did not show changes in liver enzyme activity but did exhibit reduced plasma



**Table 4** Drugs reported to interact with SJW based on solid (pharmacokinetic) data

Drug (subjects)	SJW treatment	Effect	Reference
Indinavir ( <i>n</i> = 8)	300 mg t.i.d. 14 days	57% ↓ AUC	Piscitelli et al. (2000)
Cyclosporine ( <i>n</i> = 2)	300 mg t.i.d. 21 days Li160	~50% ↓ AUC	Ruschitzka et al. (2000)
Digoxin ( <i>n</i> = 13)	900 mg/day 10 days Li160	25% ↓ AUC	Johne et al. <sup>[51]</sup>
Digoxin ( <i>n</i> = 8)	300 t.i.d. 14 days	18% ↓ AUC	Dürr et al. <sup>[42]</sup>
Digoxin ( <i>n</i> ~ 8)	250 mg b.i.d. 14 days (Ze 117)	No effect	Brattström <sup>[52]</sup>
Phenprocoumon ( <i>n</i> = 10)	300 mg t.i.d. 11 days Li160	17% ↓ AUC	Maurer et al. (1999)
3-Ketodesogestrel ( <i>n</i> = 3/17)	600/900 mg/day 2 cycles Li160	42–44% ↓ AUC	Pfrunder et al. <sup>[55]</sup>
Norethindrone/ethinyl estradiol ( <i>n</i> = 12)	300 mg t.i.d. 2 cycles (Rexall-Sundown)	14% ↑ clearance/ 48% ↓ <i>t</i> <sub>1/2</sub>	Hall et al. (2003)
3-Ketodesogestrel/ethinylestradiol ( <i>n</i> = 16)	250 mg b.i.d. 14 days (Ze117)	No effect	Brattström <sup>[52]</sup>
Carbamazepine ( <i>n</i> = 5)	300 mg t.i.d. 14 days	No effect	Burstein et al. <sup>[56]</sup>
Amitriptyline ( <i>n</i> = 12)	900 mg/day 14 days Li160	22% ↓ AUC	Johne et al. (2002)

levels of orally administered warfarin.<sup>[54]</sup> These data also suggest (in rats at least) that the warfarin induction by SJW takes place in the intestine, rather than in the liver.

Intermenstrual bleeding has been reported in women who had been taking long-term oral contraceptives and recently started taking SJW. Induction of 3A4 by SJW could be responsible, since steroids are known substrates of CYP3A4. A recent study<sup>[55]</sup> on the pharmacokinetics of ethinylestradiol and 3-ketodesogestrel found no evidence of ovulation during low-dose oral contraceptive and SJW combination therapy. There were no significant changes in follicle maturation, serum estradiol, or progesterone concentrations when compared with oral contraceptive treatment alone. There was, however, an increase in intracyclic bleeding episodes and a decrease in serum 3-ketodesogestrel concentrations, suggesting that SJW might increase the risk of unintended pregnancies. The hyperforin-poor formulation, Ze117, did not have this effect on 3-ketodesogestrel or ethinylestradiol, however (Table 4).

Another study examined the effects of SJW on the anticonvulsant, carbamazepine.<sup>[56]</sup> There were no significant differences before and after the administration of SJW in carbamazepine concentrations at peak, trough, or AUC. This suggests that SJW is either not a particularly powerful CYP3A4 inducer or that it cannot induce carbamazepine metabolism beyond the extent to which it induces itself.

The concern about interactions of SJW with other antidepressants probably stems from reports about its inhibition of MAO and 5HT uptake. The theory suggests that combination of an antidepressant and an MAOI could cause in a hypertensive crisis, and combination with an uptake inhibitor could result in

5HT syndrome. There have been no reports suggesting that side effects resembling MAOIs have occurred with SJW. This is consistent with current evidence suggesting that MAO inhibition may be an *in vitro* artifact.<sup>[9]</sup> There are a few case reports of “5HT syndrome” in the United States that implicate SJW. However, there have been none in Europe where SJW has been used extensively for many years.<sup>[57]</sup> One case report concerned four elderly patients described as having “mild 5HT syndrome” but were consistent with exaggerated side effects of sertraline, namely nausea, vomiting, and restlessness.<sup>[58]</sup> All of them were stable on sertraline and experienced these effects within 3–4 days of adding SJW. There are many conflicting literature references to drug metabolism, and sertraline is certainly an example. While most references do not list sertraline as a substrate of CYP3A4, there is a case report of a 12-yr-old boy on sertraline who experienced a 5HT syndrome when erythromycin, a known CYP3A4 inhibitor, was added.<sup>[59]</sup> There is evidence that acute doses of SJW have a mild inhibiting action on CYP3A4. Since all these patients were stable on sertraline at the time they initiated SJW, this response can be explained by an increase in sertraline plasma levels—a pharmacokinetic effect, rather than a pharmacodynamic effect. A fifth elderly patient in the Lantz, Buchalter, and Giambanco<sup>[58]</sup> report was stable on nefazodone when she added SJW. A similar exaggerated serotonergic response resulted that is consistent with increased blood levels of nefazodone due to acute inhibition of CYP3A4.<sup>[59]</sup> The opposite effect could be predicted if the SJW had been started first, followed by the antidepressant. This is in fact the result of a clinical trial of amitriptyline and SJW (Table 4). In this study, 12 depressed patients received 900 mg SJW extract along with 75 mg twice daily of amitriptyline

for 14 days. Reductions in AUC of 21.7% were seen for amitriptyline and 40.6% for nortriptyline. Levels of amitriptyline and its metabolite continuously decreased over the 14 day period, consistent with enzyme induction. Amitriptyline is another drug for which considerable contradiction exists in the literature regarding its metabolism. David Flockhart (<http://medicine.iupui.edu/flockhart/>) lists amitriptyline as a substrate for CYP1A2, 2C19, 2C9, and 2D6, while Feucht and Weissman<sup>[60]</sup> also describe it as a substrate for CYP3A4 and glucuronyl transferase.

Recent studies have included the previously unstudied enzyme, CYP2E1. It was found that chronic treatment with SJW in both mice<sup>[61]</sup> and humans<sup>[62]</sup> leads to induction of this enzyme. The most commonly associated substrate for CYP2E1 is ethanol, but anesthetic gases also use this route of elimination (<http://medicine.iupui.edu/flockhart/>).

Thus, SJW is capable of weak inhibition of CYP3A4 acutely, and moderate induction of intestinal CYP3A4 and CYP2E1 activity after repeated dosing. Chronic administration of SJW also induces the drug transporter protein, Pgp. Drugs that are substrates of both systems (e.g., indinavir and cyclosporine) are of particular concern as they would be predicted to be doubly affected by SJW. While the currently popular constituent, hyperforin, appears to be responsible for the enzyme induction, it may not be necessary for the therapeutic effect. This is evidenced by the low hyperforin, low hypericin formulation, Ze117, showing efficacy in major depression.<sup>[63]</sup> Of particular interest in this context is that clinical pharmacokinetic studies have shown this formulation to lack interaction potential with either the CYP3A4 system or the Pgp transporter.<sup>[52]</sup> More in vivo data are needed to make sense of the plentiful, but often contradictory, in vitro data.

Of interest in the context of herb–drug and food–drug interaction is a recent report showing that red wine causes metabolic effects comparable to SJW on the pharmacokinetics of cyclosporine. In a randomized, two-way crossover study of 12 healthy individuals, red wine caused a 50% increase in the oral clearance of cyclosporine. Systemic exposure as measured by the area under the concentration-vs.-time curve (AUC) and peak concentration ( $C_{max}$ ) was significantly decreased by red wine. However, half-life was not affected, suggesting that the wine decreased cyclosporine absorption.<sup>[64]</sup>

## REFERENCES

1. Blumenthal, M.; Goldberg, A.; Brinckmann, J. *Herbal Medicine: Expanded Commission E Monographs*; Integrative Medicine Communications: Newton, MA, 2000.
2. Schempp, C.M.; Windeck, T.; Hezel, S.; Simon, J.C. Topical treatment of atopic dermatitis with St. John's wort cream—a randomized, placebo controlled, double blind half-side comparison. *Phytomedicine* **2003**, *10* (Suppl. 4), 31–37.
3. Blumenthal, M. Herbs continue slide in mainstream market: sales down 14 percent. *HerbalGram* **2003**, *58*, 71.
4. Shelton, R.C.; Keller, M.B.; Gelenberg, A.J. et al. Effectiveness of St. John's wort in major depression: a randomized controlled trial. *J. Am. Med. Assoc.* **2001**, *285* (15), 1978–1986.
5. Hypericum Depression Trial Study Group. Effect of *Hypericum perforatum* (St. John's wort) in major depressive disorder. *J. Am. Med. Assoc.* **2002**, *287*, 1807–1814.
6. Draves, A.H.; Walker, S.E. Analysis of the hypericin and pseudohypericin content of commercially available St. John's wort preparations. *Can. J. Clin. Pharmacol.* **2003**, *10* (3), 114–118.
7. Westerhoff, K.; Kaunzinger, A.; Wurglics, M.; Dressman, J.; Schubert-Zsilavecz, M. Biorelevant dissolution testing of St. John's wort products. *J. Pharm. Pharmacol.* **2002**, *54* (12), 1615–1621.
8. Kopleman, S.H.; NguyenPho, A.; Zito, W.S.; Muller, F.X.; Augsburg, L.L. Selected physical and chemical properties of commercial *Hypericum perforatum* extracts relevant for formulated product quality and performance. *AAPS PharmSci.* **2001**, *3* (4), E26.
9. Cott, J.M. In vitro receptor binding and enzyme inhibition by *Hypericum perforatum* extract. *Pharmacopsychiatry* **1997**, *30* (Suppl. II), 108–112.
10. Butterweck, V.; Nahrstedt, A.; Evans, J.; Hufeisen, S.; Rauser, L.; Savage, J.; Popadak, B.; Ernsberger, P.; Roth, B.L. In vitro receptor screening of pure constituents of St. John's wort reveals novel interactions with a number of GPCRs. *Psychopharmacol. (Berl.)* **2002**, *162* (2), 193–202.
11. Butterweck, V. Mechanism of action of St. John's wort in depression: what is known? *CNS Drugs* **2003**, *17* (8), 539–562.
12. Wurglics, M.; Westerhoff, K.; Kaunzinger, A.; Wilke, A.; Baumeister, A.; Dressman, J.; Schubert-Zsilovecz, M. Batch-to-batch reproducibility of St. John's wort preparations. *Pharmacopsychiatry* **2001**, *34* (Suppl. 1), S152–S156.
13. Schrader, E.; Meier, B.; Brattström, A. Hypericum treatment of mild–moderate depression in a placebo-controlled study. A prospective, double blind, randomised, placebo controlled, multicentre study. *Hum. Psychopharmacol.* **1998**, *13*, 163–169.
14. Schrader, E. Equivalence of St. John's wort extract (Ze 117) and fluoxetine: a randomised, controlled study in mild to moderate depression. *Int. Clin. Psychopharm.* **2000**, *15*, 61–68.

15. Woelk, H. Comparison of St. John's wort and imipramine for treating depression: randomised controlled trial. *Br. Med. J.* **2000**, *321* (7260), 536–539.
16. Butterweck, V.; Christoffel, V.; Nahrstedt, A.; Peterleit, F.; Spengler, B.; Winterhoff, H. Step by step removal of hyperforin and hypericin: activity profile of different *Hypericum* preparations in behavioral models. *Life Sci.* **2003**, *73* (5), 627–639.
17. Staffeldt, B.; Kerb, R.; Brockmoller, J.; Ploch, M.; Roots, I. Pharmacokinetics of hypericin and pseudohypericin after oral intake of the *Hypericum perforatum* extract LI 160 in healthy volunteers. *J. Geriatr. Psychiatry Neurol.* **1994**, *7*, S47–S53.
18. Biber, A.; Fischer, H.; Romer, A.; Chatterjee, S.S. Oral bioavailability of hyperforin from hypericum extracts in rats and human volunteers. *Pharmacopsychiatry* **1998**, *31* (Suppl. 1), 36–43.
19. Fox, E.; Murphy, R.F.; McCully, C.L.; Adamson, P.C. Plasma pharmacokinetics and cerebrospinal fluid penetration of hypericin in nonhuman primates. *Cancer Chemother. Pharmacol.* **2001**, *47* (1), 41–44.
20. Straumann, D.; Chatterjee, S.; Statkow, P. Comparison of the effects of an alcoholic St. John's wort extract on various isolated organs. *Pharmacopsychiatry* **2001**, *34*, S143–S145.
21. Gutmann, H.; Bruggisser, R.; Schaffner, W.; Bogman, K.; Botomino, A.; Drewe, J. Transport of amentoflavone across the blood–brain barrier in vitro. *Planta Med.* **2002**, *68* (9), 804–807.
22. Nielsen, M.; Frokjaer, S.; Braestrup, C. High affinity of the naturally occurring biflavonoid, amentoflavon, to brain benzodiazepine receptors in vitro. *Biochem. Pharmacol.* **1988**, *37* (17), 3285–3287.
23. Gobbi, M.; Moia, M.; Pirona, L.; Morizzoni, P.; Mennini, T. In vitro binding studies with two hypericum perforatum extracts—hyperforin, hypericin and biapigenin—on 5-HT<sub>6</sub>, 5-HT<sub>7</sub>, GABA(A)/benzodiazepine, sigma, NPY-Y1/Y2 receptors and dopamine transporters. *Pharmacopsychiatry* **2001**, *34* (Suppl. 1), S45–S48.
24. Cott, J. Herb–drug interactions: focus on pharmacokinetics. *CNS Spectr.* **2001**, *6* (10), 1–7.
25. Linde, K.; Mulrow, C.D. St. John's wort for depression (Cochrane Review). *The Cochrane Library* **1998**, *93* (4), 1131–1135.
26. Linde, K.; Ter Riet, G.; Hondras, M.; Vickers, A.; Saller, R.; Melchart, D. Systematic reviews of complementary therapies—an annotated bibliography. Part 2: herbal medicine. *BMC Complement. Altern. Med.* **2001**, *1* (1), 5.
27. Schulz, V. Clinical trials with hypericum extracts in patients with depression—results, comparisons, conclusions for therapy with antidepressant drugs. *Phytomedicine* **2002**, *9* (5), 468–474.
28. Whiskey, E.; Werneke, U.; Taylor, D.A. A systematic review and meta-analysis of *Hypericum perforatum* in depression: a comprehensive clinical review. *Int. Clin. Psychopharmacol.* **2001**, *16* (5), 239–252.
29. Kim, H.L.; Streltzer, J.; Goebert, D. St John's wort for depression: a meta-analysis of well-defined clinical trials. *J. Nerv. Ment. Dis.* **1999**, *187* (9), 532–538.
30. Di Carlo, G.; Borrelli, F.; Izzo, A.A.; Ernst, E. St. John's wort: Prozac from the plant kingdom. *Trends Pharmacol. Sci.* **2001**, *22* (6), 292–297.
31. Walsh, B.T.; Seidman, S.N.; Sysko, R.; Gould, M. Placebo response in studies of major depression: variable, substantial, and growing. *J. Am. Med. Assoc.* **2002**, *287* (14), 1840–1847.
32. Robinson, D.S.; Rickels, K. Concerns about clinical drug trials. *J. Clin. Psychopharmacol.* **2000**, *20* (6), 593–596.
33. Volz, H.P.; Murck, H.; Kasper, S.; Moller, H.J. St. John's wort extract (LI 160) in somatoform disorders: results of a placebo-controlled trial. *Psychopharmacol. (Berl.)* **2002**, *164* (3), 294–300.
34. Taylor, L.; Kobak, K.A. An open-label trial of St. John's wort (*Hypericum perforatum*) in obsessive–compulsive disorder. *J. Clin. Psychiatry* **2000**, *61*, 575–578.
35. Davidson, J.R.T.; Connor, K.M. St. John's wort in generalized anxiety disorder: 3 case reports. *J. Clin. Psychopharmacol.* **2001**, *21* (6), 635–636.
36. Brockmoller, J.; Reum, T.; Bauer, S.; Kerb, R.; Hubner, W.D.; Roots, I. Hypericin and pseudohypericin: pharmacokinetics and effects on photosensitivity in humans. *Pharmacopsychiatry* **1997**, *30* (Suppl. 2), 94–101.
37. Rayburn, W.F.; Gonzalez, C.L.; Christensen, H.D.; Stewart, J.D. Effect of prenatally administered hypericum (St. John's wort) on growth and physical maturation of mouse offspring. *Am. J. Obstet. Gynecol.* **2001**, *184* (2), 191–195.
38. Rayburn, W.F.; Gonzalez, C.L.; Christensen, H.D.; Harkins, T.L.; Kupiec, T.C. Impact of hypericum (St.-John's-wort) given prenatally on cognition of mice offspring. *Neurotoxicol. Teratol.* **2001**, *23* (6), 629–637.
39. Lee, A.; Minhas, R.; Matsuda, N.; Lam, M.; Ito, S. The safety of St. John's wort (*Hypericum perforatum*) during breastfeeding. *J. Clin. Psychiatry* **2003**, *64* (8), 966–968.
40. Klier, C.M.; Schafer, M.R.; Schmid-Siegel, B.; Lenz, G.; Mannel, M. St. John's wort (*Hypericum perforatum*)—is it safe during breastfeeding? *Pharmacopsychiatry* **2002**, *35* (1), 29–30.
41. Anon. Final report on the safety assessment of *Hypericum perforatum* extract and *Hypericum perforatum* oil. *Int. J. Toxicol.* **2001**, *20*, 31–39.

42. Dürr, D.; Stieger, B.; Kullak-Ublick, G.A.; Rentsch, K.M.; Steinert, H.C.; Meier, P.J.; Fattinger, K. St. John's wort induces intestinal P-glycoprotein/MDR1 and intestinal and hepatic CYP3A4. *Clin. Pharmacol. Ther.* **2000**, *68* (6), 598–604.
43. Wang, Z.; Gorski, J.C.; Hamman, M.A.; Huang, S.M.; Lesko, L.J.; Hall, S.D. The effects of St. John's wort (*Hypericum perforatum*) on human cytochrome P450 activity. *Clin. Pharmacol. Ther.* **2001**, *70* (4), 317–326.
44. Obach, R.S. Inhibition of human cytochrome P450 enzymes by constituents of St. John's wort, an herbal preparation used in the treatment of depression. *J. Pharmacol. Exp. Ther.* **2000**, *294* (1), 88–95.
45. Moore, L.B.; Goodwin, B.; Jones, S.A.; Wisely, G.B.; Serabjit-Singh, C.J.; Willson, T.M. et al. St. John's wort induces hepatic drug metabolism through activation of the pregnane X receptor. *Proc. Natl. Acad. Sci. USA* **2000**, *97* (13), 7500–7502.
46. Wentworth, J.M.; Agostini, M.; Love, J.; Schwabe, J.W.; Chatterjee, V.K. St. John's wort, a herbal antidepressant, activates the steroid X receptor. *J. Endocrinol.* **2000**, *166* (3), R11–R16.
47. Roby, C.A.; Anderson, G.D.; Kantor, E.; Dryer, D.A.; Burstein, A.H. St. John's wort: effect on CYP3A4 activity. *Clin. Pharmacol. Ther.* **2000**, *67* (5), 451–457.
48. Markowitz, J.S.; Donovan, J.L.; DeVane, C.L.; Taylor, R.M.; Ruan, Y.; Wang, J.S.; Chavin, K.D. Effect of St. John's wort on drug metabolism by induction of cytochrome P450 3A4 enzyme. *J. Am. Med. Assoc.* **2003**, *290* (11), 1500–1504.
49. Ereshefsky, B.; Gewertz, N.; Lam, Y.W.F.; Vega, L.M.; Ereshefsky, L. Determination of SJW differential metabolism at CYP2D6 and CYP3A4 using dextromethorphan probe technology. Abstracts from Annual Meeting, New Clinical Drug Evaluation Unit, Boca Raton, June 1999; 130.
50. Gewertz, N.; Ereshefsky, B.; Lam, Y.W.F.; Benavides, R.; Ereshefsky, L. Determination of differential effects of St. John's wort on the CYP1A2 and NAT2 metabolic pathways using caffeine probe technology. Abstracts from 39th Annual Meeting, New Clinical Drug Evaluation Unit, Boca Raton, June 1999; 131.
51. Johne, A.; Brockmöller, J.; Bauer, S.; Maurer, A.; Langheinrich, M.; Roots, I. Pharmacokinetic interaction of digoxin with an herbal extract from St. John's wort (*Hypericum perforatum*). *Clin. Pharmacol. Ther.* **1999**, *66* (4), 338–345.
52. Brattström, A. Der Johanniskrautextrakt Ze117. *DAZ* **2002**, *142* (30), 3695–3699.
53. Perloff, M.D.; von Moltke, L.L.; Stormer, E.; Shader, R.I.; Greenblatt, D.J. Saint John's wort: an in vitro analysis of P-glycoprotein induction due to extended exposure. *Br. J. Pharmacol.* **2001**, *134* (8), 1601–1608.
54. Nöldner, M.; Chatterjee, S. Effects of two different extracts of St. John's wort and some of their constituents on cytochrome P450 activities in rat liver microsomes. *Pharmacopsychiatry* **2001**, *34* (Suppl. 1), S108–S110.
55. Pfrunder, A.; Schiesser, M.; Gerber, S.; Haschke, M.; Bitzer, J.; Drewe, J. Interaction of St. John's wort with low-dose oral contraceptive therapy: a randomized controlled trial. *Br. J. Clin. Pharmacol.* **2003**, *56* (6), 683–690.
56. Burstein, A.H.; Horton, R.L.; Dunn, T.; Alfaro, R.M.; Piscitelli, S.C.; Theodore, W. Lack of effect of St. John's wort on carbamazepine pharmacokinetics in healthy volunteers. *Clin. Pharmacol. Ther.* **2000**, *68* (6), 605–612.
57. Schulz, V. Incidence and clinical relevance of the interactions and side effects of *Hypericum preparations*. *Phytomedicine* **2001**, *8* (2), 152–160.
58. Lantz, M.S.; Buchalter, E.; Giambanco, V. St. John's wort and antidepressant drug interactions in the elderly. *J. Geriatr. Psychiatry Neurol.* **1999**, *12* (1), 7–10.
59. Lee, D.O.; Lee, C.D. Serotonin syndrome in a child associated with erythromycin and sertraline. *Pharmacotherapy* **1999**, *19* (7), 894–896.
60. Feucht, C.L.; Weissman, S.B. Psychiatric and antiretroviral agents: associated drug interactions. *Trends in Evidence-Based Neuropsychiatry* **2000**, *2* (11), 69–73.
61. Bray, B.J.; Brennan, N.J.; Perry, N.B.; Menkes, D.B.; Rosengren, R.J. Short term treatment with St. John's wort, hypericin or hyperforin fails to induce CYP450 isoforms in the Swiss Webster mouse. *Life Sci.* **2002**, *70* (11), 1325–1335.
62. Gurley, B.J.; Gardner, S.F.; Hubbard, M.A.; Williams, D.K.; Gentry, W.B.; Cui, Y.; Ang, C.Y.W. Cytochrome P450 phenotypic ratios for predicting herb–drug interactions in humans. *Clin. Pharmacol. Ther.* **2002**, *72*, 276–287.
63. Käufeler, R.; Meier, B.; Brattström, A. Efficacy and tolerability of Ze 117 St. John's wort extract in comparison with placebo, imipramine and fluoxetine for the treatment of mild to moderate depression according to ICD-10. An overview. *Pharmacopsychiatry* **2001**, *34*, S49–S50.
64. Tsunoda, S.M.; Harris, R.Z.; Christians, U.; Velez, R.L.; Freeman, R.B.; Benet, L.Z.; Warshaw, A. Red wine decreases cyclosporine bioavailability. *Clin. Pharmacol. Ther.* **2001**, *70* (5), 462–467.

## ADDITIONAL READINGS

- Bennett, D.A., Jr.; Phun, L.; Polk, J.F.; Voglino, S.A.; Zlotnik, V.; Raffa, R.B. Neuropharmacology of St. John's wort (*Hypericum*). *Ann. Pharmacother.* **1998**, *32* (11), 1201–1208.
- Bladt, S.; Wagner, H. Inhibition of MAO by fractions and constituents of hypericum extract. *J. Geriatr. Psychiatry Neurol.* **1994**, *7* (Suppl 1), S57–S59.
- Chatterjee, S.S.; Biber, A.; Weibezahn, C. Stimulation of glutamate, aspartate and gamma-aminobutyric acid release from synaptosomes by hyperforin. *Pharmacopsychiatry* **2001**, *34* (Suppl 1), S11–S19.
- Chatterjee, S.S.; Nolder, M.; Koch, E.; Erdelmeier, C. Antidepressant activity of *Hypericum perforatum* and hyperforin: the neglected possibility. *Pharmacopsychiatry* **1998**, *31* (Suppl 1), 7–15.
- Eckert, G.P.; Müller, W.E. Effects of hyperforin on the fluidity of brain membranes. *Pharmacopsychiatry* **2001**, *34* (Suppl 1), S22–S25.
- Ernst, E.; Rand, J.I.; Barnes, J.; Stevinson, C. Adverse effects profile of the herbal antidepressant St. John's wort (*Hypericum perforatum* L.). *Eur. J. Clin. Pharmacol.* **1998**, *54* (8), 589–594.
- Gobbi, M.; Valle, F.D.; Ciapparelli, C.; Diomedea, L.; Morazzoni, P.; Verotta, L. et al. *Hypericum perforatum* L. extracts does not inhibit 5-HT transporter in rat brain cortex. *Naunyn Schmiedebergs Arch. Pharmacol.* **1999**, *360* (3), 262–269.
- Hall, S.D.; Wang, Z.; Huang, S.-M.; Hamman, M.A.; Vasavada, N.; Adigun, A.Q.; Hilligoss, J.K.; Miller, M.; Gorski, J.C. The interaction between St. John's wort and an oral contraceptive. *Clin. Pharmacol. Ther.* **2003**, *74*, 525–535.
- Hunt, E.J.; Lester, C.E.; Lester, E.A.; Tackett, R.L. Effect of St. John's wort on free radical production. *Life Sci.* **2001**, *69* (2), 181–190.
- Jensen, A.G.; Hansen, S.H.; Nielsen, E.O. Adhyperforin as a contributor to the effect of *Hypericum perforatum* L. in biochemical models of antidepressant activity. *Life Sci.* **2001**, *68* (14), 1593–1605.
- Johne, A.; Schmider, J.; Brockmoller, J.; Stadelmann, A.M.; Stormer, E.; Bauer, S.; Scholler, G.; Langheinrich, M.; Roots, I. Decreased plasma levels of amitriptyline and its metabolites on comedication with an extract from St. John's wort (*Hypericum perforatum*). *J. Clin. Psychopharmacol.* **2002**, *22* (1), 46–54.
- Kasper, S. *Hypericum perforatum*—a review of clinical studies. *Pharmacopsychiatry* **2001**, *34* (Suppl 1), S51–S55.
- Kleber, E.; Oby, T.; Hippeli, S.; Schneider, W.; Elstner, E.F. Biochemical activities of extracts from *Hypericum perforatum* L. 1st communication: inhibition of dopamine-beta-hydroxylase. *Arzneimittelforschung* **1999**, *49* (2), 106–109.
- Koch, E.; Chatterjee, S.S. Hyperforin stimulates intracellular calcium mobilisation and enhances extracellular acidification in DDTI-MF2 smooth muscle cells. *Pharmacopsychiatry* **2001**, *34* (Suppl 1), S70–S73.
- Krishtal, O.; Lozovaya, N.; Fisunov, A.; Tsintsadze, T.; Pankratov, Y.; Kopanitsa, M.; Chatterjee, S.S. Modulation of ion channels in rat neurons by the constituents of *Hypericum perforatum*. *Pharmacopsychiatry* **2001**, *34* (Suppl 1), S74–S82.
- Linde, K.; Ramirez, G.; Mulrow, C.; Pauls, A.; Weidenhammer, W.; Melchart, D. St John's wort for depression—an overview and meta-analysis of randomised clinical trials. *Br. Med. J.* **1996**, *313*, 253–258.
- Maurer, A.; Johne, A.; Bauer, S.; Brockmoller, J.; Donath, F.; Roots, I. et al. Interaction of St. John's wort extract with phenprocoumon. *Eur. J. Clin. Pharmacol.* **1999**, *55* (3), A22.
- Müller, W.E.; Singer, A.; Wonnemann, M.; Hafner, U.; Rolli, M.; Schafer, C. Hyperforin represents the neurotransmitter reuptake inhibiting constituent of *Hypericum* extract. *Pharmacopsychiatry* **1998**, *31* (Suppl 1), 16–21.
- Nierenberg, A.A.; Burt, T.; Matthews, J.; Weiss, A.P. Mania associated with St. John's wort. *Biol. Psychiatry* **1999**, *46* (12), 1707–1708.
- Piscitelli, S.C.; Burstein, A.H.; Chaitt, D.; Alfaro, R.M.; Falloon, J. Indinavir concentrations and St. John's wort. *Lancet* **2000**, *355* (9203), 547–548.
- Reith, U.; Frank, B.; Müller, C.E. Constituents of *Hypericum perforatum* (St. John's wort) as ligands of human adenosine receptors. *Drug Dev. Res.* **2000**, *50*, 66, (Abstract 69).
- Ruschitzka, F.; Meier, P.J.; Turina, M.; Luscher, T.F.; Noll, G. Acute heart transplant rejection due to Saint John's wort. *Lancet* **2000**, *355* (9203), 548–549.
- Simmen, U.; Bobirnac, I.; Ullmer, C.; Lubbert, H.; Berger, B.K.; Schaffner, W.; Schoeffler, P. Antagonist effect of pseudohypericin at CRFI receptors. *Eur. J. Pharmacol.* **2003**, *458* (3), 251–256.
- Singer, A.; Wonnemann, M.; Müller, W.E. Hyperforin, a major antidepressant constituent of St. John's wort, inhibits serotonin uptake by elevating free intracellular Na<sup>+</sup>. *J. Pharmacol. Exp. Ther.* **1999**, *290* (3), 1363–1368.
- Uebelhack, R.; Franke, L. In vitro effects of St. John's wort extract and hyperforin on 5 HT uptake and efflux in human blood platelets. *Pharmacopsychiatry* **2001**, *34* (Suppl 1), S146–S147.
- Upton, R.; Graff, A.; Williamson, E.; Bunting, D.; Gatherum, D.M.; Walker, E.B.; Cott, J. *Hypericum perforatum*: quality control, analytical and therapeutic monograph. American Herbal Pharmacopoeia and Therapeutic Compendium on St. John's Wort. *Herbal Gram* **1997**, *40* (Suppl.), 1–32.
- Woelk, H.; Burkard, G.; Grünwald, J. Benefits and risks of the hypericum extract LI 160: drug monitoring study with 3250 patients. *J. Geriatr. Psychiatry Neurol.* **1994**, *7* (Suppl 1), S34–S38.

# Thiamin

Gianguido Rindi  
Cesare Patrini

University of Pavia, Pavia, Italy

## INTRODUCTION

Thiamin (aneurin or vitamin B<sub>1</sub>) is a water-soluble vitamin of the B group. In animal tissues, it is present mainly in phosphorylated form, with thiamin pyrophosphate being the most abundant. The pyrophosphate form is a coenzyme of five different enzymes involved in carbohydrate and lipid metabolism. Aneurin is absorbed by the small intestine by a specific, easily saturable mechanism, which can be impaired by alcohol, and by synthetic or natural thiamin antagonists present in food.

Severe thiamin deficiency causes beriberi, a disease that can lead to extensive neurological and cardiovascular damage. In developed countries, where beriberi is rare, clinical (Wernicke–Korsakoff's syndrome) or sub-clinical manifestations of this deficiency can be induced by chronic alcoholism. Congenital disorders may lead to serious and often fatal diseases. Even in more developed countries, because of a wrong or unbalanced diet, there may be a deficiency of this vitamin, which can be easily resolved by administering a dietary supplement.

## NAME AND GENERAL DESCRIPTION

Thiamin, 3-[(4-amino-2-methyl-5-pyrimidinil) methyl]-5-(hydroxyethyl)-4-methylthiazolium chloride, is a water-soluble micronutrient essential for human health, though not produced by the human body. It has a molecular weight of 300.81 as a base or 327.17 as a hydrochloride and consists of two rings (one pyrimidine and one thiazole), linked by a methylene bridge (Fig. 1).

In 1911, C. Funk, who coined the term “vitamin,” isolated a crystalline compound from the rice polishing process that prevented polyneuritis in chickens fed only polished rice. In 1936, R.R. Williams published the correct structure of the thiamin molecule and its synthesis.

---

*Gianguido Rindi, M.D., Ph.D.*, is Emeritus Professor of Physiology at the Department of Experimental Medicine, Human Physiology Section, University of Pavia, Pavia, Italy.

*Cesare Patrini, B.M., B.Sc.*, is Scientific Area Engineer at the Department of Experimental Medicine, Human Physiology Section, University of Pavia, Pavia, Italy.

## BIOCHEMISTRY AND FUNCTIONS

In animal tissues, thiamin is present in four different forms: free (T), mono- (TMP), pyro- (TPP), and tri- (TTP) phosphate, with TPP corresponding to about 80% of total thiamin (Fig. 1). Thiamin compounds can be enzymatically interconverted (Fig. 2). Some thiamin phosphates can be absent (Table 1) from a number of products. It is noteworthy that polished rice lacks thiamin, while rice bran and germ are very rich.

In general, the spread of thiamin content values between the poorest and the richest sources is not too large (20- to 40-fold). This underscores the widespread functional role of vitamin B<sub>1</sub> in both animal and plant cellular metabolism.

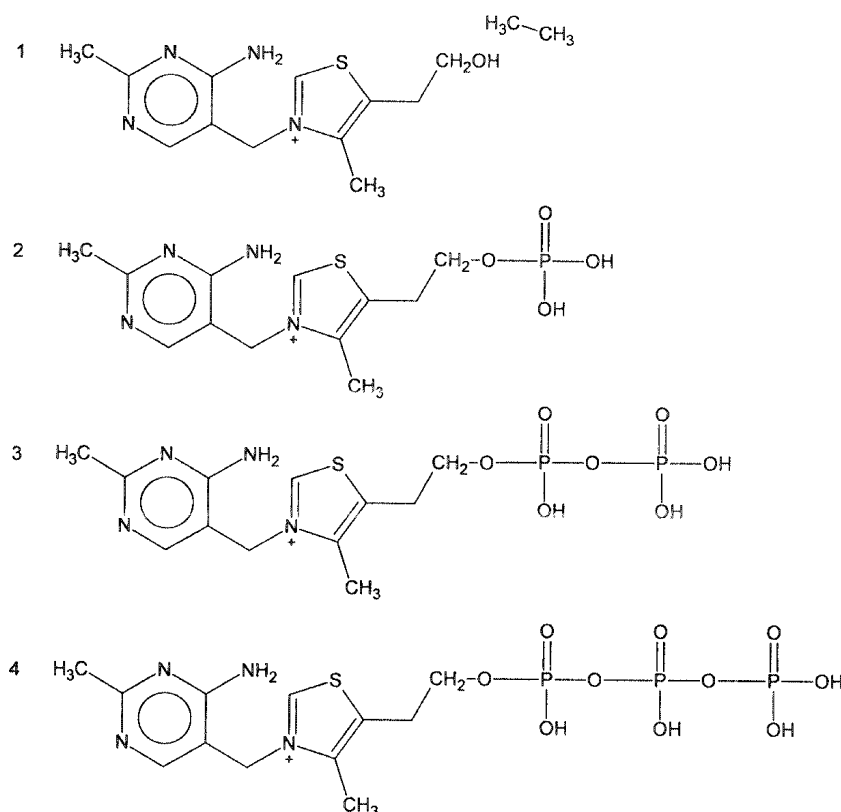
### Coenzymatic Function

Thiamin pyrophosphate is the coenzymatic form of thiamin. Its enzymatic synthesis requires ATP, Mg<sup>2+</sup>, and thiamin pyrophosphokinase.

TPP is the coenzyme for three separate mitochondrial dehydrogenases, one cytosolic transketolase, and one recently characterized peroxisomal lyase. The dehydrogenases are multienzyme complexes involved in carbohydrate and lipid metabolism. They participate in the oxidative decarboxylation of pyruvate, oxoglutarate, and branched-chain oxoacids. The transketolase intervenes in the pentose phosphate cycle and allows the reversible interconversion of three-, four-, five-, six-, and seven-carbon sugars by transfer of either two or three carbon moieties. This metabolic pathway supplies pentose phosphate for nucleotide synthesis, as well as reduced nicotinamide adenine dinucleotide phosphate (NADP) for various other syntheses, e.g., steroid hydroxylation and fatty acid synthesis. Lyase is required to shorten 3-methyl-branched fatty acids by  $\alpha$ -oxidation (Fig. 3).

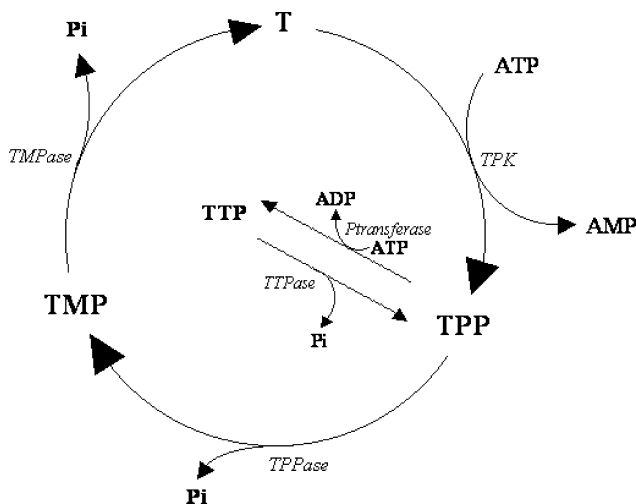
### Non-Coenzymatic Function

Thiamin triphosphate certainly has not an enzymatic function, but it is involved in a non-coenzymatic process, since it can control the number of functional maxi-Cl channels (and perhaps other ion channels



**Fig. 1** Thiamin and its phosphate esters. 1, Thiamin (free base); 2, thiamin monophosphate; 3, thiamin pyrophosphate; 4, thiamin triphosphate.

as well) in nervous tissues (Fig. 3). It may also induce a reaction to physiological stress enhancing cell survival, possibly through the phosphorylation of some target cellular proteins.



**Fig. 2** Enzymatic interconversion of thiamin compounds. T, free thiamin; TMP, thiamin monophosphate; TPP, thiamin pyrophosphate; TTP, thiamin triphosphate; Pi, inorganic phosphate; TPK, thiamin pyrophosphokinase; P-transferase, ATP:ADP phosphatetransferase; TMPase, thiamin monophosphatase; TPPase, thiamin pyrophosphatase; TTPase, thiamin triphosphatase.

## PHYSIOLOGY

### Absorption and Transport

After a meal, thiamin is found in the intestinal lumen in free form, its phosphates being completely hydrolyzed by a variety of intestinal phosphatases. In humans, the intraluminal concentration of aneurin has been estimated at less than 530  $\mu\text{g/L}$  (2  $\mu\text{mol/L}$ ). At these very low concentrations, active transport occurs by a saturable transmembrane process. In humans, single oral doses above 2.5–5 mg are largely unabsorbed.

The absorption process, studied in human tissue in vitro, involves two mechanisms. At concentrations of less than 1  $\mu\text{mol/L}$ , thiamin is absorbed mainly by an active carrier-mediated system that entails phosphorylation and is age related. At higher concentrations, passive diffusion prevails (Fig. 4).<sup>[3]</sup>

In blood, thiamin is transported both inside the erythrocytes, which contain free thiamin and its phosphates,<sup>[4]</sup> and in plasma, which contains only free thiamin and TMP.<sup>[5]</sup> Total thiamin concentration in the whole blood of humans is about 0.1  $\mu\text{M}$  (30  $\mu\text{g/L}$ ) 10 times less than that of several other animal species, and it is unevenly distributed among different cells (15% in leucocytes, 75% in erythrocytes) and plasma (10%).

**Table 1** Thiamin (T), thiamin mono-, pyro-, and triphosphate (TMP, TPP, and TTP) content of tissues from animals of various species and of various materials

Species	N	Content, µg/g fresh tissue										
		T total	T	TMP	TPP	TTP	T total	T	TMP	TPP	TTP	
				<i>Brain</i>				<i>Heart</i>				
Mouse	2 <sup>a</sup>	2.63	0.11	0.25	2.74	0.11	9.28	0.33	1.08	9.65	0.28	
Rat	5 <sup>b</sup>	2.92	0.16	0.27	3.03	0.14	5.98	0.34	0.52	4.94	0.30	
Guinea pig	3	1.64	0.11	0.22	1.61	0.04	5.01	0.13	0.32	5.56	0.24	
Rabbit	3	1.67	0.10	0.22	1.64	0.07	4.92	0.17	0.40	5.16	0.24	
Cat	2	0.96	0.20	0.06	0.99	0.08	2.06	0.16	0.11	1.93	0.25	
Dog	1	0.86	0.39	0.00	0.54	0.06	1.23	0.37	0.00	0.93	0.18	
Pig	3	0.81	0.26	0.00	0.62	0.07	3.40	0.41	0.12	3.13	0.58	
Pigeon	2	1.55	0.06	0.21	1.56	0.06	3.08	0.03	0.18	3.44	0.21	
Chicken	2	1.35	0.13	0.26	1.00	0.26	1.52	0.15	0.04	1.48	0.23	
Turkey	2	1.95	0.30	0.02	1.84	0.25	1.41	0.10	0.10	1.38	0.18	
				<i>Liver</i>				<i>Kidney</i>				
Mouse	2 <sup>a</sup>	8.95	0.61	0.82	9.15	0.40	6.21	0.45	0.80	5.99	0.31	
Rat	5 <sup>b</sup>	9.14	0.59	0.93	9.55	0.22	4.81	0.28	0.34	5.16	0.15	
Guinea pig	3	3.73	0.18	0.37	3.92	0.12	5.05	0.10	0.34	5.40	0.49	
Rabbit	3	1.88	0.09	0.14	2.02	0.07	4.55	0.26	0.47	4.65	0.19	
Cat	2	1.34	0.07	0.10	1.31	0.19	1.34	0.09	0.08	1.26	0.18	
Dog	1	0.78	0.24	0.00	0.50	0.21	0.88	0.18	0.05	0.72	0.12	
Pig	3	1.70	0.25	0.02	1.63	0.20	1.99	0.22	0.12	1.78	0.34	
Pigeon	2	3.00	0.22	0.68	2.61	0.06	3.82	0.32	0.44	3.80	0.07	
Chicken	2	2.83	0.52	0.30	2.30	0.31	2.71	0.25	0.27	2.43	0.39	
Turkey	2	0.93	0.08	0.05	0.93	0.09	1.93	0.11	0.12	1.97	0.19	
<b>Materials</b>												
Raw rice	4	1.590	1.530	0.0	0.053	0.017						
Rice bran	3	2.440	2.440	0.0	0.0	0.0						
Rice germ	5	37.29	36.00	0.0	0.55	0.45						
Polished rice	4	Traces										
Wheat germ	2	4.83	4.56	0.0	0.33	0.00						
Baker's yeast	2	4.44	0.80	0.49	3.92	0.05						
Fresh cow's milk <sup>c</sup>	3	0.27	0.27	0.0	0.0	0.0						
Pig's red blood cells <sup>d</sup>	2	0.147	0.049	0.006	0.094	0.025						
Pig's sciatic nerve	2	0.215	0.075	0.025	0.110	0.039						

T total = T + TMP + TPP + TTP; T is expressed as chloride hydrochloride and its phosphates as such. In pigs and dogs, the gray matter of the brain and the apex of the heart were only studied.

<sup>a</sup>Each determination was on tissues pooled from 12 animals.

<sup>b</sup>Each determination was on pooled tissues from 6 animals.

<sup>c</sup>Freshly drawn, µg/ml content.

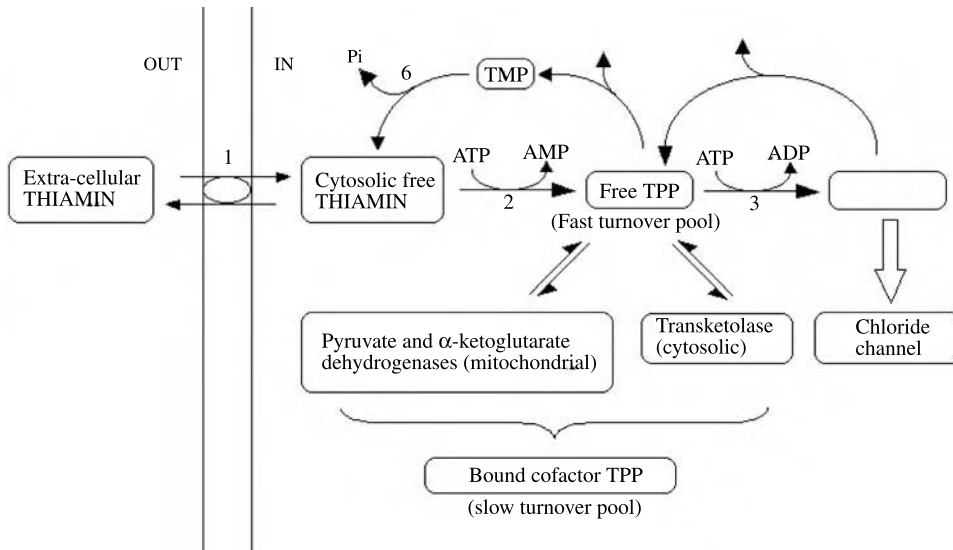
<sup>d</sup>Trichloroacetic acid was removed by ether extraction before chromatography.

(From Ref.<sup>[1]</sup>. Courtesy of IJVNR.)

Only free thiamin and TMP are present in cerebrospinal fluid (Table 2).<sup>[4,6]</sup> Vitamin B<sub>1</sub> transport across the blood-brain barrier, like that across the intestine, involves two different mechanisms: saturable

(carrier mediated) and nonsaturable. However, in this case, the TMP transport rate is 5–10 times lower than that of thiamin (rat). In the brain, thiamin uptake rate is 10 times the maximal rate of thiamin loss.





**Fig. 3** Thiamin metabolism in neurons. 1, High-affinity thiamin transporter; 2, thiamin pyrophosphokinase; 3, ATP:ADP phosphotransferase; 4, thiamin triphosphatase; 5, thiamin pyrophosphatase; 6, thiamin monophosphatase. (From Ref.<sup>[2]</sup>. Courtesy of Kluwer Academic/Plenum Publishers and L. Bettendorff.)

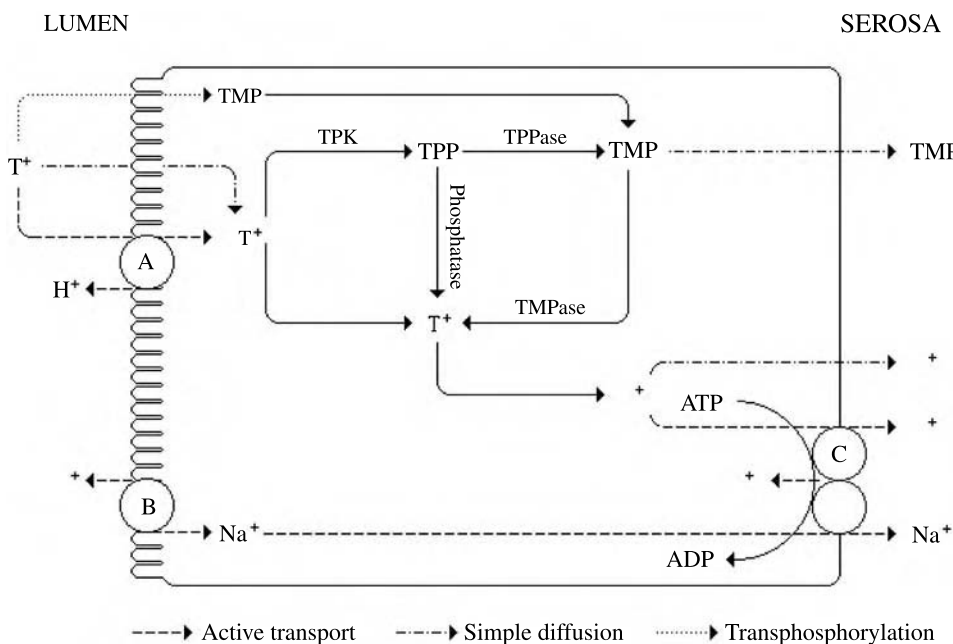
**Renal Excretion**

In adult humans, total thiamin content is estimated at approximately 30mg, with a biological half-life of 9.5–18.5 days. Normal urinary excretion of the vitamin varies widely from 16.3 to 72.2 mg for 24 hr, and there is a highly significant correlation between its oral dose (up to 2.25 mg) and urinary excretion (Fig. 5). The relationship between thiamin stores and urinary excretion has been used to determine aneurin status and requirements. In urine, besides the free form, TMP, and small amounts of TPP, different thiamin catabolites and 20–30 breakdown products have also been found. When intact vitamin B<sub>1</sub> is no longer

measurable in the urine but the total excretion of thiamin metabolites exceeds the thiamin intake, a state of deficiency arises.

**Placental Transport**

Thiamin, like other vitamins, is transported through the human placenta. In the placenta, thiamin transport is an active process, possibly carrier mediated, and travels preferentially from the mother to fetus, rather than vice versa. In the placenta, thiamin is more highly concentrated compared to maternal and fetal levels. In the umbilical cord, plasma thiamin is about 2.5-fold higher



**Fig. 4** Transcellular thiamin transport by rat enterocytes: an updated model. The entry of T is largely by exchange with H<sup>+</sup> (A) and very little through enzymatic transphosphorylation to TMP. Cellular crossing is associated with enzymatic phosphorylation to TPP. The exit is directly dependent on the activity of Na<sup>+</sup>-K<sup>+</sup> ATPase (C). T: thiamin; TMP, TPP: thiamin mono-, pyrophosphate; TPK: thiamin pyrophosphokinase; TMPase, TPPase: thiamin mono-, pyrophosphatase; (A), T/H<sup>+</sup> antiport; (B), Na<sup>+</sup>/H<sup>+</sup> antiport; (C), Na<sup>+</sup>-K<sup>+</sup> ATPase. (From Ref.<sup>[3]</sup>. Courtesy of Society for Experimental Biology and Medicine.)

**Table 2** Thiamin (T), thiamin monophosphate (TMP), and thiamin pyrophosphate (TPP) in plasma, whole blood,<sup>a</sup> and in cerebrospinal fluid (CSF)

Parameter	Concentration (nmol/L)						
	Plasma T	Plasma TMP	Blood T	Blood TMP	Blood TPP	CSF T	CSF TMP
Mean	7.1	5.8	24	5.7	85	17	28
SD	1.6	2.6	11	2.2	18.1	8.3	8.6
95% CI	0.7	1.2	4.9	1	8.5	2.5	2.6
Geometric mean	6.9	5.4	22	5.3	83	15	27
Range	4.5–11	2.8–11	8.6–56	2.4–12	55–125	5.7–40	15–50

<sup>a</sup>Concentrations of thiamin, TMP, and TPP in 34 healthy subjects, and of T and TMP in CSF in 44 healthy subjects. Mean, standard deviation (SD), 95% confidence interval (95% CI), geometric mean, and corresponding range calculated as the antilog of  $[\log \text{mean} \pm (2 \log \text{SD})]$  are given. (From Ref.<sup>[4]</sup>, with permission from Elsevier and C.M.E. Tallaksen.)

than that in maternal plasma, and its concentration in the umbilical cord arteria is significantly lower than that in cord vein, indicating massive retention by the fetus.

### PHARMACOKINETICS OF THIAMIN

By using different doses of thiamin, it has been possible to evaluate some kinetic parameters in humans. The distribution phase is characterized by a half-time,  $t_{1/2}$ , of ca. 5–10 min. The distribution volume increases from an initial value similar to that in extracellular space to one much higher than body water volume, indicating a rapid tissue uptake.

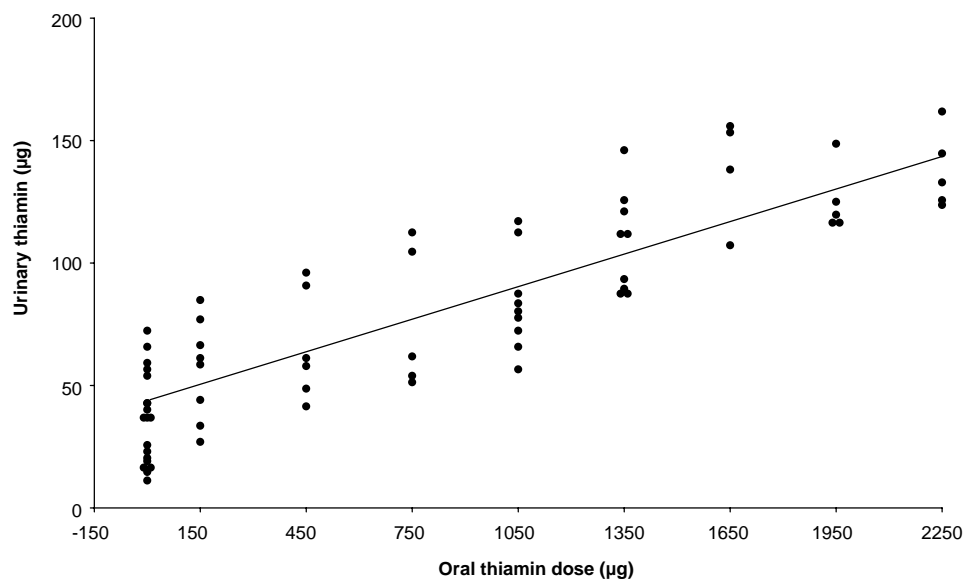
Thiamin can be resorbed and secreted by the kidney, and its renal disposition varies with the dose. At low doses, only a small portion of the dose appears in the urine. When increased, this fraction rapidly reaches 100% due to the saturation of nonrenal clearance processes (active tissue uptake by rapid

intracellular phosphorylation to TPP and binding to specific sites).

After a high dose, only the nonsaturated tubular secretion remains efficient, allowing most of the dose to be eliminated. Following a low dose, however, nonrenal clearance is unsaturated, and tubular reabsorption takes up a larger portion of the vitamin so that the thiamin bypasses the kidney.

### BIOAVAILABILITY

Factors influencing the availability of thiamin in food are pH, temperature, radiation, oxidation, and thiamin antagonists. The vitamin is very stable at acidic pH, but is rapidly destroyed at pH above 8. It is susceptible to destruction by X-rays,  $\gamma$ -rays, and UV irradiation, and sulfite treatment. Oxidation to thiochrome and other oxidation products also inactivate thiamin.



## Thiamin Antagonists

Two types of thiamin antagonists are known: synthetic structural analogs and natural antithiamin compounds.<sup>[8]</sup> Several structural analogs including pyrithiamin, oxythiamin, amprolium (a chick anticoccidial drug), and chloroethylthiamin have been chemically synthesized and used for experiments both in vivo and in vitro to study different aspects of thiamin physiology.

Natural antithiamin compounds are found in plant and animal tissues, and act by modifying thiamin structure. An inhibitor of thiamin synthesis in germs has recently been described.<sup>[9]</sup>

Two enzymes causing thiamin degradation are known: a) thiaminase I, present in the intestine of carp and other fish, in ferns (*Pteridium aquilinum*), and in *Bacillus thiaminolyticus*, which cleaves the thiamin molecule through an exchange reaction with a nitrogen base or thiol compound; b) thiaminase II, present chiefly in intestinal bacteria (*B. thiaminolyticus* and *Clostridium thiaminolyticum*), which catalyzes the hydrolysis of thiamin to pyrimidine and thiazole rings. Ferns and some other plants (especially blueberry, red chicory, black currant, red beetroot, Brussels sprouts, and red cabbage) contain certain polyhydroxyphenols (caffeic acid, chlorogenic acid, and tannins), which inactivate thiamin through an oxyreductive process.

Natural antithiamin factors can induce severe thiamin deficiency leading to death in horses, oxen, sheep, and pigs fed with rhizomes and fern leaves, which are commonly found in forage. The resulting disease in sheep and oxen is known as polyencephalomalacia (cerebrocortical disease). Fish-based feeds containing antithiamin factors can produce neurological signs of thiamin deficiency in farm bred silver foxes (Chastek paralysis) and minks, not to mention domestic cats as well. Tea leaves and tea infusions can deplete thiamin body stores in humans, because of their high polyhydroxyphenol content. In Thailand, thiamin deficiency is higher in the northern provinces, where people chew fermented tea leaves and eat raw fermented fish, both containing antithiamin factors. In such situations thiamin supplementation is recommended.

## Lipid-Soluble Thiamin Analogs

In 1951, it was observed that the treatment of thiamin with a garlic extract (*Allium sativum*) transformed it into a compound that did not produce the chemical reactions of thiamin, but remained very active biologically. This was called allithiamin, and was shown to be a mixed thiamin allyldisulfide, where thiamin is in the thiol form (i.e., it contains an open thiazole ring) (Fig. 6). Since then, several thiolic forms have been

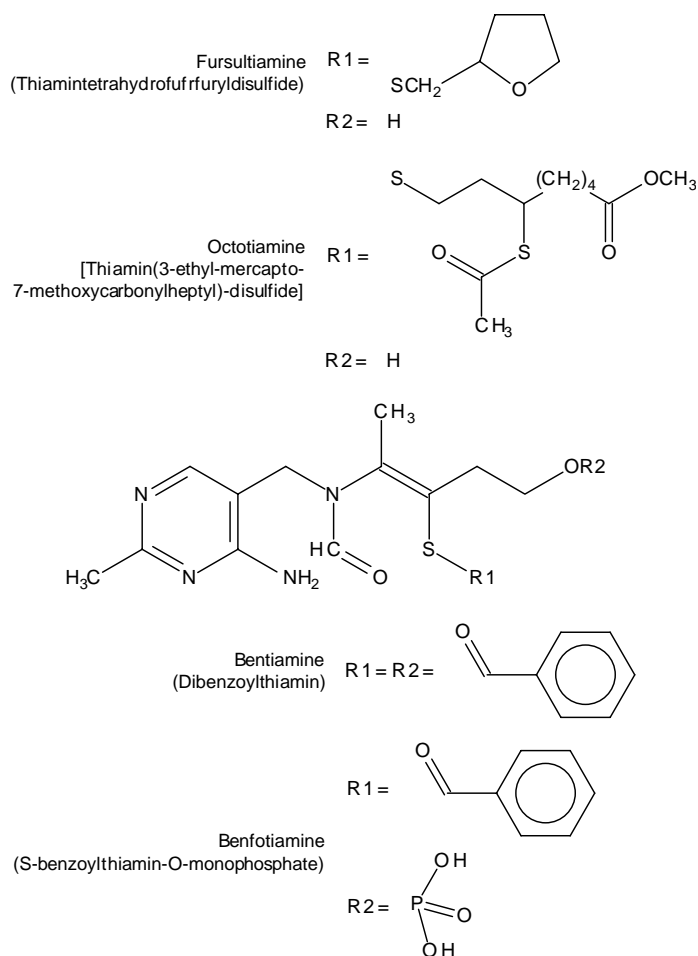


Fig. 6 Synthetic lipid-soluble thiamin derivatives.

prepared including thiamin propyldisulfide, thiamin tetrahydrofurfuryldisulfide, *O*-benzoylthiamin disulfide, and *S*-benzoylthiamin-*O*-monophosphate (Fig. 6). These forms are recommended for a dietary supplementation, having the general property of being lipid soluble. Hence, they easily pass through intestinal walls via diffusion and are quickly and completely transformed into thiamin in tissues by closure of the thiazole ring. Consequently, their oral administration produces thiamin levels in blood and tissues that are much higher than those obtainable under the same conditions with thiamin.

## THIAMIN STATUS

Thiamin status is assessed mainly with three types of tests: determination of erythrocyte transketolase activity, urinary excretion before and after thiamin administration, and blood or serum thiamin compound levels.

Transketolase activity is measured in hemolyzed erythrocytes, thiamin deficiency being associated with

the depressed basal activity of this enzyme with increased activation after TPP addition: The higher the activation value, the greater the degree of thiamin deficiency.<sup>[10]</sup>

Urinary excretion of thiamin acts as an index of recent dietary intake, and thiamin status can be determined using a thiamin loading test. Four hours after a 5-mg dose of thiamin, a 24-day urinary excretion value of less than 2 mg is indicative of thiamin deficiency.<sup>[10]</sup>

Measurement of thiamin concentration in the whole blood and erythrocytes is probably the current method of choice, given the recent development of techniques exploiting sensitive and easily standardizable high-performance liquid chromatography.<sup>[4]</sup> In contrast, in some cases of Wernicke's encephalopathy, blood thiamin and its phosphate level are drastically reduced, and TMP content appears to be a more sensitive marker of thiamin deficiency.<sup>[11]</sup>

## THIAMIN DEFICIENCY

In underdeveloped countries, the main cause of severe thiamin deficiency is inadequate intake, ultimately leading to beriberi. In industrialized countries, however, the most common cause is alcoholism.

There is concern about persisting borderline thiamin nutritional status even in developed countries. In the subclinical range, thiamin deficiency may be accompanied by irritability, headache, unusual fatigue, and loss of appetite. However, if antithiamin agents are introduced into the diet or illness restricts thiamin intake, the major risk with borderline status is beriberi onset.

In ancient Chinese literature, beriberi was recorded as far back as 2600 B.C. The term "beriberi," as noted by Bontius (1630), a Dutch physician who lived in Java, means "sheep" because "those whom this same disease attacks, with their knees shaking and the legs raised up, walk like sheep." The disease affects people almost exclusively fed on polished rice. Unlike raw rice, the grains of this type of rice are deprived of their external coating membranes, which hold almost all thiamin content (see Table 1).

Three main types of beriberi are recognized: "dry" or neuritic, "wet" or edematous, and "infantile" or acute. The first occurs chiefly in older adults, and is characterized by marked wasting, with less cardiac involvement. The second involves the heart more markedly, leading to edema of its lower extremities, which progresses upwards until it causes heart failure. The third occurs more frequently in breast-fed infants (2–6 mo of age): It has a very rapid onset and a fulminating course, which may result in death in a matter of hours. The acute fulminating type of beriberi is sometimes referred to by the Japanese term "shoshin."

The main manifestations of beriberi in humans concern the cardiovascular and nervous systems, with heart hypertrophy and right ventricle dilatation, tachycardia, respiratory distress, and edema of the legs. Neurological signs include exaggeration of tendon reflexes, polyneuritis, and sometimes paralysis typically affecting the lower extremities. At a later stage, the upper extremities are affected with muscle weakness and pain and convulsions. With severe deficiency, cardiovascular and neurological signs may be present simultaneously, and may be fatal. As mentioned above, in developed countries, subclinical inadequacy is fairly common.

In the human central nervous system, aneurin deficiency may lead to Wernicke's encephalopathy and Korsakoff's psychosis. Both conditions are typical of alcoholics and manifest as the Wernicke-Korsakoff syndrome. Wernicke's encephalopathy, which can also occur after persistent vomiting and during a hunger strike, is characterized by confusion, ataxia, confabulation, and coma. The total blood level of thiamin compounds, especially TMP, is very low.<sup>[11]</sup> Korsakoff's psychosis is an amnesic disorder, considered to be the psychotic component of Wernicke's disease. Autoptic findings show abnormalities mainly in the midbrain and lower brain regions. Administration of thiamin results in a dramatic clinical improvement in these cases.

In alcoholism, most of the peripheral and central nervous system abnormalities are considered to be a consequence of thiamin deficiency. Alcoholics are deficient in thiamin due to its low intake, its impaired intestinal absorption and utilization, and possibly increased excretion. In addition, they are often affected by liver disease, which worsens the situation.

In children born to alcoholic mothers, thiamin deficiency may be present and is termed "fetal alcoholic syndrome." This is characterized by intrauterine growth retardation,<sup>[12]</sup> congenital malformations, and psychomotor abnormalities.

## POTENTIAL VARIABLE FACTORS

Thiamin body stores are rather small, and any condition interrupting continuous intake and/or any loss of the vitamin will engender the development of a state of deficiency. Thus, up to 80% of heavy alcoholics have been found to be thiamin deficient.

Aging is associated with low intake and decreased activation of thiamin: up to 50% of the elderly have been found to have thiamin deficit. Chronic diseases, hospitalization, and dialysis institutionalization contribute to the risk of deficiency. In these cases supplementation is recommended.

Diuretics have been reported as having a thiamin-losing effect leading to the risk of thiamin

deficiency.<sup>[13]</sup> Moreover, oxidative stress (the abnormal metabolism of free radicals) is believed to cause abnormalities in thiamin-dependent processes and thiamin homeostasis ultimately leading to nerve degeneration.<sup>[14]</sup>

## CONGENITAL DISORDERS

Several congenital disorders of thiamin metabolism have been described. They include maple syrup urine disease (branched-chain disease), Leigh's disease, lactate acidosis, and thiamin responsive megaloblastic anemia.

In maple syrup urine disease, there is an enzyme missing, the branched-chain  $\alpha$ -oxoacid dehydrogenase complex. The urine of the patient smells like maple syrup, because the  $\alpha$ -oxoacid cannot be degraded and is found in high concentrations both in the serum and urine. The disease, which affects neonates, is characterized by acidosis seizures in the early neonatal period.

Leigh's disease (subacute necrotizing encephalomyelopathy) is a fatal disease that develops in infancy and early childhood. It is associated with weakness, anorexia, difficulties in speech and eye motion, and cessation of growth. High oral doses of thiamin, especially its lipid-soluble form, are efficacious here.

Congenital lactate acidosis is a group of different inborn defects found mainly in children and characterized by lactic and pyruvate acidosis, neurological abnormalities, and development delay. There is likely to be a defect in the pyruvate dehydrogenase complex in these patients, who definitely improve after administration of high doses of thiamin.<sup>[15]</sup>

Thiamin responsive megaloblastic anemia (TRMA; Roger's syndrome) is a rare disease of infancy and childhood characterized by megaloblastic anemia associated with sensorineural deafness and diabetes mellitus. Cardiac abnormalities may also be present. The patients respond to thiamin therapy, especially to lipid-soluble thiamins, but their hearing recovers only partially.<sup>[16]</sup> The disease is a consequence of a state of thiamin deficiency due to the mutation of a gene producing a membrane protein that transports thiamin.<sup>[17]</sup>

## REQUIREMENTS AND ALLOWANCES

Thiamin requirements are related to total caloric intake, especially to carbohydrate intake.<sup>[18]</sup> The recommended dietary allowance (RDA) (by definition, the intake levels of essential nutrients scientists consider sufficient to satisfy the requirements of practically all healthy persons) for a thiamin level consistent with

good health is: 0.5 mg/1000 kcal (4200 kJ). Assuming that an adult expends 2000 kcal/day and thiamin losses for cooking are about 20%, the recommended daily allowances are 1.4 and 1.1 mg for adult men and women, respectively. During pregnancy and lactation, intake should be 1.5 and 1.6 mg/day.<sup>[19]</sup>

## SOURCES

Thiamin is widespread in foods, but its content is relatively low. This emphasizes the necessity of its dietary supplementation.

In animal products, vitamin B<sub>1</sub> occurs mostly in its phosphorylated form, while in plant products, it is also present in its unphosphorylated form (Fig. 7).

The most important dietary sources of thiamin for humans are grain products, which provide about 40% of vitamin requirements. The highest sources are dried baker's yeast, cereal whole grains, nuts, and dried legumes. A significant contribution to its intake may come from meat products, especially pork liver and muscle (27.1%), vegetables (11.7%), milk and milk products (8.1%), legumes and fruits (9.8%), and eggs (20%).<sup>[21]</sup>

The average thiamin intake of adult men in United States in 1998 was 1.75 mg/day.<sup>[19]</sup> The corresponding consumption for adult women and children 1–5 yr of age was 1.05 and 1.12 mg, respectively.

Presently, in more developed countries, disease due to consumption of junk food lacking in thiamin seems to be increasing. This deficiency can be resolved by specific dietary supplements.

## TOXICITY

In humans, even very high oral doses of thiamin have been found to have no toxic effects. Large parenteral doses (up to 100–500 mg) in single and repeated injections by different routes are also generally well tolerated. In relatively rare instances, thiamin has provoked symptoms resembling anaphylactic shock in humans. All these reactions have occurred exclusively on parenteral administration, and followed by injection within a few minutes. In addition, parenterally injected thiamin may also induce an allergic reaction that becomes negative over time.<sup>[22]</sup>

## CONCLUSIONS

Thiamin, one of the earliest-recognized water-soluble vitamins, is widely available in foods, albeit at low concentrations. It is essential for human good health and can be introduced through a balanced diet or a

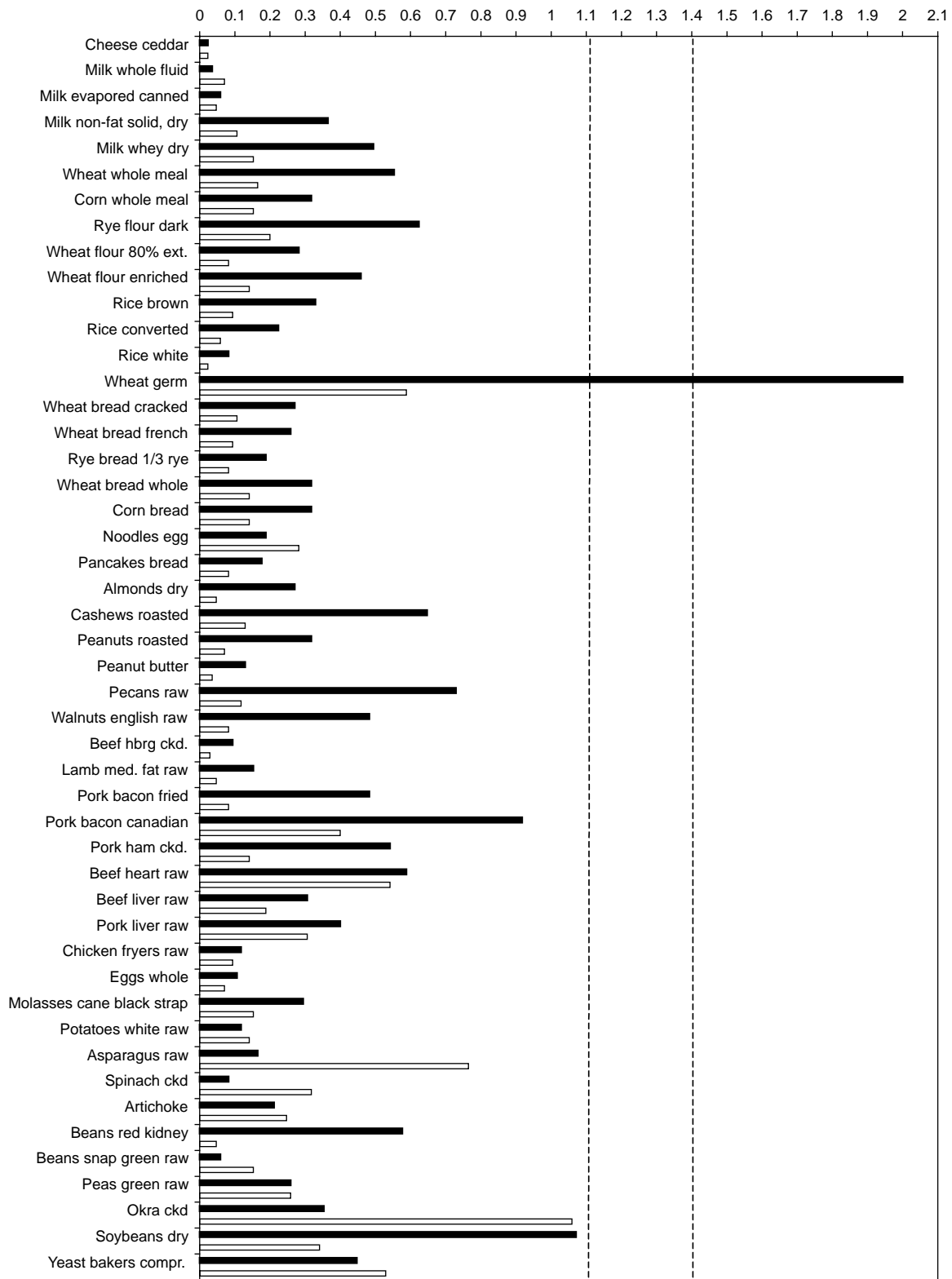


Fig. 7 Thiamin contents of selected foods: ■, mg/100 g; □, mg/100 cal. (From Ref.<sup>[20]</sup>. Courtesy of Marcel Dekker, Inc.)

dietary supplement. Low intake or chronic alcoholism can lead to severe thiamin deficiency diseases, including beriberi and the Wernicke–Korsakoff syndrome. In its pyrophosphate form, aneurin has an essential coenzymatic function in carbohydrate and lipid metabolism. Hence, it is vital to correct any possible lack of thiamin by specific dietary supplements as soon as possible to avoid the development of the above-mentioned pathologies. The function of thiamin triphosphate, however, needs further research. Studies of the molecular and genetic aspects of congenital and acquired thiamin disorders are still in progress.

## REFERENCES

- Rindi, G.; de Giuseppe, L. The content of thiamine and its mono-, di- and triphosphoric esters in different biological materials. *Int. Rev. Vitam. Res.* **1961**, *31* (3), 321–326.
- Bettendorff, L. Thiamine in excitable tissues: reflections on a non-cofactor role. *Metab. Brain Dis.* **1994**, *9* (3), 183–209.
- Rindi, G.; Laforenza, U. Thiamine intestinal transport and related issues: recent aspects. *Proc. Soc. Exp. Biol. Med.* **2000**, *224* (4), 246–255.
- Tallaksen, C.M.E.; Bømer, T.; Karlsen, J.; Bell, H. Determination of thiamine and its phosphate esters in human blood, plasma and urine. In *Methods in Enzymology*; McCormick, D.B., Suttie, J.W., Wagner, C., Eds.; 1997; Vol. 279 (part I), 67–74.
- Rindi, G.; de Giuseppe, L.; Sciorelli, G. Thiamine monophosphate, a normal constituent of rat plasma. *J. Nutr.* **1968**, *94* (4), 447–454.
- Rindi, G.; Patrini, C.; Poloni, M. Monophosphate, the only phosphoric ester of thiamin in the cerebrospinal fluid. *Experientia* **1981**, *37* (9), 975–976.
- Bayliss, R.M.; Brookes, L.; McCulloch, J.; Kuyl, J.M.; Metz, J. Urinary thiamine excretion after physiological oral doses of the vitamin. *Int. J. Vitam. Nutr. Res.* **1984**, *54* (2), 161–164.
- Somogyi, J. Biochemical aspects of the antimetabolites of thiamine. *Bibl. Nutr. Dieta* **1966**, *8* (1), 74–96.
- Reddick, J.J.; Saha, S.; Lee, J.; Melnick, J.S.; Perkins, J.; Begley, T.P. The mechanism of bacimethrin, a naturally occurring thiamine antimetabolite. *Bioorg. Med. Chem. Lett.* **2001**, *11* (17), 2245–2248.
- Finglas, P.M. Thiamin. *Int. J. Vitam. Nutr. Res.* **1994**, *63* (4), 270–274.
- Tallaksen, C.M.E.; Bell, H.; Bømer, T. Thiamine and thiamine phosphate esters deficiency assessed by high performance liquid chromatography in four clinical cases of Wernicke encephalopathy. *Alcohol. Clin. Exp. Res.* **1993**, *17* (4), 712–716.
- Butterworth, R.F. Maternal thiamine deficiency: a factor in intrauterine growth retardation? *Ann. N. Y. Acad. Sci.* **1993**, *678*, 375–379.
- Suter, P.M.; Vetter, W. Diuretics and vitamin B<sub>1</sub>: are diuretics a risk for thiamine malnutrition? *Nutr. Rev.* **2000**, *58* (10), 319–323.
- Gibson, G.E.; Zhang, H. Interactions of oxidative stress with thiamine homeostasis promote neurodegeneration. *Neurochem. Int.* **2002**, *400* (6), 493–504.
- Robinson, B.H. Lactacidemia. *Biochim. Biophys. Acta* **1993**, *1182* (3), 231–244.
- Rindi, G.; Patrini, C.; Laforenza, U.; Mandel, H.; Berant, M.; Viana, M.B.; Poggi, V.; Zarra, A.N.F. Further studies of erythrocyte thiamin transport and phosphorylation in seven patients with thiamin-responsive megaloblastic anemia. *J. Inher. Metab. Dis.* **1994**, *17* (6), 667–677.
- Neufeld, E.J.; Fleming, J.C.; Tartaglino, E.; Steinkamp, M.P. Thiamine-responsive megaloblastic anemia syndrome: a disorder of high affinity thiamine transport. *Blood Cells Mol. Dis.* **2001**, *27* (1), 135–138.
- Elmadfa, J.; Majchrzak, D.; Rust, P.; Genser, D. The thiamine status of adult humans depends on carbohydrate intake. *Int. J. Vitam. Nutr. Res.* **2001**, *71* (4), 217–221.
- Institute of Medicine. *Dietary Reference Intakes for Thiamin, Riboflavin, Niacin, Vitamin B<sub>6</sub>, Folate, Vitamin B<sub>12</sub>, Panthotenic Acid, Biotin, and Cholin*; National Academy Press: Washington, DC, U.S.A., 1998; 58–86. Available from [www.nap.edu](http://www.nap.edu), 2001.
- Gubler, C.J. Thiamin. In *Handbook of Vitamins—Nutritional, Biochemical, and Clinical Aspects*; Machlin, L.J., Ed.; Marcel Dekker Inc: New York, 1984; 266–267.
- Sauberlich, H.E.; Kretch, M.J.; Johnson, H.L.; Nelson, R.A. *Animal Products in Human Nutrition*; Beitz, D.C., Hansen, R. C., Eds.; Academic Press: New York, 1982; 339 pp.
- Fernández, M.; Barceló, M.; Muñoz, C.; Torrecillas, M.; Blanca, M. Anaphylaxis to thiamine (vitamin B<sub>1</sub>). *Allergy* **1997**, *52* (9), 958–960.

# Valerian

**Dennis V.C. Awang**

*MediPlant Consulting Inc., White Rock, British Columbia, Canada*

**Albert Y. Leung**

*Phyto-Technologies, Inc., Woodbine, Iowa, U.S.A.*

## INTRODUCTION

Valerian or valerian root consists of the underground organs (root and rhizome, with or without stolons) of *Valeriana officinalis* L. and a number of other *Valeriana* species (family Valerianaceae). It has been used by people of different cultures since antiquity for a number of conditions, including insomnia, migraine, hysteria, neurasthenia, fatigue, and stomach cramps. In the West, valerian is best known for its use as a mild sedative and hypnotic for nervous unrest and sleep disturbances. It is a major component of dietary supplements and herbal remedies marketed directly to consumers for treating these conditions. Over the past several decades, valerian has undergone rather extensive chemical, pharmacological, and clinical studies. Its aqueous extract has been found to be mostly responsible for its sleep-inducing effect, while the volatile oil (mainly valerenic acid) and the valepotriates (through their degradation products) are major contributors to its sedative effects. Current data also indicate the valepotriates to be responsible for the antianxiety or tranquilizing effect of valerian. No serious toxic side effects associated with the clinical use of valerian have been reported.

## HISTORY/ETYMOLOGY/TRADITIONAL USES

*Valeriana* species have been used medicinally since early Greek and Roman times, and were termed “*Phu*” (*Fu*) by such ancients, as Pliny the Elder (23–79 A.D.), Pedianos Dioscorides (40–80 A.D.), and the Greek physician Galen (ca. 131–208 A.D.) who prescribed it for insomnia.<sup>[1]</sup> *Phu*, retained as *V. phu* L., synonymous with *V. dioscorides*,<sup>[2]</sup> apparently refers to the strong disagreeable odor associated with the

dried roots or crushed plant. However, the scent in some Asian species was regarded as pleasant, and the roots in earlier times were used to perfume linen.<sup>[3]</sup> The genus name *Valeriana* was introduced around the 10th century, from which time it was used synonymously with *Phu* or *Fu* and *Amantilla*.<sup>[4]</sup> It is claimed that the ancient *Phu* related to species other than *V. officinalis*, which was introduced just over 1000 yr ago.<sup>[5]</sup> The name valerian is held to be derived either from the Latin *valere*, meaning “to be healthy” or to honor the Roman emperor Publius A.L. Valerianus (not Valerius) (253–260 A.D.).<sup>[4]</sup>

Use of valerian as a medicine is said to have been first documented by Hippocrates (460 to about 370 B.C.).<sup>[6]</sup> Theophrastus of Lesbos (370–286 B.C.) mentioned valerian use as a perfume and Dioscorides apparently used several members of the valerian family for treating digestive disorders, flatulence and nausea, as well as liver and urinary tract problems. The Greeks also used these plants as antiperspirant, poison antidote, emmenagogue, and for vaginal infections. The use of valerian for nervous disorders was not firmly established until the late 16th century, thereafter being widely used for hysteria and epilepsy. It is also recorded that preparations of the plant were used to treat soldiers suffering from shell shock during the First World War.<sup>[7]</sup> European authorities subsequently indicated general application as antispasmodic, anthelmintic, diuretic, and diaphoretic.<sup>[6]</sup>

The underground organs, i.e., roots and rhizomes, with and without stolons, carefully dried under 40°C, constitute the pharmacopeial drug, which is the main focus of this entry. The therapeutic applications approved by the German Commission E and other European regulatory agencies are generally sedative, sleep aid and antianxiety in nature.<sup>[1]</sup>

## TAXONOMY

Many of the approximately 250 species of *Valeriana* (family Valerianaceae) occurring worldwide,<sup>[8]</sup> generally termed “valerian,” have been used as traditional medicines in different cultures.<sup>[6]</sup> Today, the best

*Dennis V.C. Awang, Ph.D.*, is President of MediPlant Consulting Inc., White Rock, British Columbia, Canada.

*Albert Y. Leung, Ph.D.*, is at Phyto-Technologies, Inc., Woodbine, Iowa, U.S.A.



known and most thoroughly researched species is *V. officinalis* L. *s.l.* (*sensu lato*). It consists of many morphologically diversified subspecies and varieties, including diploid, tetraploid and octaploid, as well as transitional types.<sup>[9]</sup> *V. officinalis*, common or “official” valerian, is native to Europe and Asia and naturalized in North America.<sup>[10]</sup> Other prominent common names for this species are all-heal, amantilla, *baldrian* (Ger.), Belgian valerian (recognizing the premier commercial supplier of the cultivated plant), capon’s tail, cat’s love/valerian, Fragrant valerian, St. George’s herb, setwall, spikenard, and vandal root.<sup>[10]</sup>

The most popular medicinal valerian species worldwide are: Mexican valerian—*V. edulis* Nutt. ex Torr. and A. Gray ssp. *procera* (Kunth or H.B.K.) F.G. Meyer or *V. mexicana* DC [syn. *V. sorbifolia* H.B.K. var. *mexicana* (DC) F.G. Meyer]; Indian valerian—*V. wallichii* DC [syn. *V. jatamansi* Jones]; Chinese/Japanese (Kesso) valerian—*V. fauriei* Briquet, formerly *V. latifolia*, *V. officinalis* var. *latifolia* Miq., syn. *V. angustifolia* Tausch., formerly *V. officinalis* var. *angustifolia* Miq.<sup>[8,11]</sup> The American *Valeriana* species next in prominence to *V. edulis* is *V. sitchensis* Bong., particularly ssp. *scouleri* Rydb., or Pacific valerian, which is native to N. W. America, and considered by the Russians to be the most powerful of all species.<sup>[4]</sup> This latter species should not be confused with American “valerian,” an entirely different genus, *Cypripedium pubescens* Willd. or *C. parviflorum* Salisb.<sup>[4]</sup>

## BOTANICAL DESCRIPTION OF *VALERIANA OFFICINALIS*

*V. officinalis* is a perennial herbaceous plant, which bears short simple rhizomes, sometimes producing stolons (horizontal stems/runners), the buds of which lead to new plants. The usually robust, solitary, vertically grooved stalks, cylindrical and hollow, are simple or slightly branched, more or less hairy, especially at the base,<sup>[4]</sup> and attain a height of up to 2 m. The leaves are arranged in pairs, with clasping petioles, united at their bases. Each leaf bears, as a rule, 6–10 pairs of more or less opposite (pinnate or pinnatisect) leaflets of varying breadth, broader when fewer. Leaflets are linear, lanceolate, or elliptical, entire, dentate–serrate (notched or toothed).<sup>[4,6,10,12]</sup> The compound inflorescence consists of cymes (broad, flattened clusters), with flowers ranging in color from white through flesh-colored to pink, and sometimes lavender or red.<sup>[6]</sup> The flowers are hermaphrodite, with a tubular five-lobed corolla 2.5–5 mm long,<sup>[13]</sup> often spurred at the base, with three stamens. The limb of the calyx at first inrolled expands to a feathery pappus crowning

the inferior ovary.<sup>[4]</sup> The fruit, 2–5 mm long, is a hairy or glabrous capsule containing one oblong compressed seed.<sup>[4,13]</sup>

## PHARMACOPEIAL STATUS

Valerian was official in the *United States Pharmacopeia* (USP) from 1820 to 1942, the *U.S. National Formulary* from 1888 to 1946, and the *British Pharmacopoeia* until 1980. It was reintroduced to the *U.S. National Formulary* by the USP Convention in 1998.<sup>[7]</sup> Today, valerian is official in the national pharmacopeias of Austria, France, Germany, Great Britain, Hungary, Russia, Switzerland, and in the *European Pharmacopoeia*, among others;<sup>[1]</sup> according to the *European Pharmacopoeia*, the crude drug *Valerianae Radix* contains no less than 0.5% (v/m) of essential oil.

Japanese valerian root (*V. fauriei*) is official in the national pharmacopoeia of Japan. Also, *V. edulis* has been incorporated into the *Mexican Pharmacopoeia*, but *V. wallichii*, included in the 2nd edition of the *Indian Pharmacopoeia* (1996), was excluded from the 3rd edition.

## Dosage Forms

In Germany, where more than 100 over-the-counter (OTC) tranquilizers and sleep aids contain valerian, some of which are specifically formulated for children,<sup>[14]</sup> preparations are available as crude dried root and rhizome, loose or encapsulated, for aqueous infusion, preparation of tinctures or for extraction with alcohol, hydroalcoholic or aqueous media, the latter often alkaline, for use in tableted formulations. Straight ethanol is generally used to maximize extraction of valepotriates and essential oil. “Standardized extracts” are usually standardized for valerianic acid content, mostly to 0.8%.<sup>[15]</sup> Commercial branded German and U.S. products are listed in a recent publication.<sup>[16]</sup> A broad variety of combination valerian products are also available, including purported standardized extracts in combination with other sedative herbs, notably hops (*Humulus lupulus* L.), lemon balm (*Melissa officinalis* L.), passionflower (*Passiflora incarnata* L.), and lavender (*Lavandula angustifolia* Miller).<sup>[14]</sup>

## Dosage

In the treatment of restlessness and sleep disorders, in 1995 the German Commission E recommended 1–3 g of dried root and rhizome, daily,<sup>[15]</sup> 450 mg of extract,

taken at least 1 hr before bedtime, and for symptomatic treatment of anxiety, 200–300 mg of extract in the morning,<sup>[17]</sup> tincture (1 : 5, 70% ethanol), 1–3 ml, taken once to several times daily,<sup>[4]</sup> or an infusion of 2–3 g dried root and rhizome per cup, up to several times daily.<sup>[14]</sup>

## CHEMICAL CONSTITUENTS

### Volatile Oil

Most of the research emphasis, both chemically and pharmacologically, has been placed on two major groups of valerian constituents, namely, the volatile oil, composed of a mixture of monoterpenes and sesquiterpenes, and the iridoids or valepotriates (valerian epoxy triesters).

The content of volatile oil of *V. officinalis* is quite variable, dependent upon subspecies and influenced notably by soil conditions, age, and time of harvesting. A number of percentage ranges have been recorded: 0.4–1.4,<sup>[18]</sup> 0.1–2,<sup>[19]</sup> 0.2–2.8,<sup>[10]</sup> 0.5–2.<sup>[20]</sup> The literature reports that *V. officinalis* mainly contains valerenic acid and its derivatives (0.1–0.5%) as well as valepotriates (0.8–1.7%), whereas the other major species, *V. wallichii* and *V. edulis*, contain considerably higher percentages of valepotriates, 2.8–3.5 and 8–12, respectively.<sup>[21]</sup> Fresh root of *V. thalictroides* Graebn. may contain as much as 14.5% valepotriates (Fig. 1).<sup>[22]</sup>

Stoll, Seebeck, and Stauttacher<sup>[23]</sup> identified 12 monoterpenes and 17 sesquiterpenes in the essential oil of European *V. officinalis*. The monoterpenes are dominated by bornyl acetate and bornyl isovalerate. The major sesquiterpenes include valerenic acid and its derivatives, acetoxyvalerenic acid and hydroxyvalerenic acid, the structurally related valerenal, valeranone, and elemol (Fig. 1). Examination of the oils of a wide selection of *V. officinalis* plants grown in the Netherlands identified broadly three chemical races. Two of the three types contain no kessyl alcohols, one also devoid of valeranone, while the third has moderate quantities of the alcohols, along with elemol, valerenal, and relatively high levels of valeranone; the two nonkessyl types have, respectively, high levels of valerenal accompanied by moderate amounts of elemol and valeranone, and elevated levels of elemol and valerenal.<sup>[24]</sup>

*V. officinalis* is the only valerian species in which valerenic acids have been identified. The parent valerenic acid is the major of the three acid constituents, and hydroxyvalerenic acid is generally either present in very low quantities or not present at all. Some regard hydroxyvalerenic acid as the artifactual product of hydrolysis of acetoxyvalerenic acid.<sup>[25]</sup>

### Valepotriates

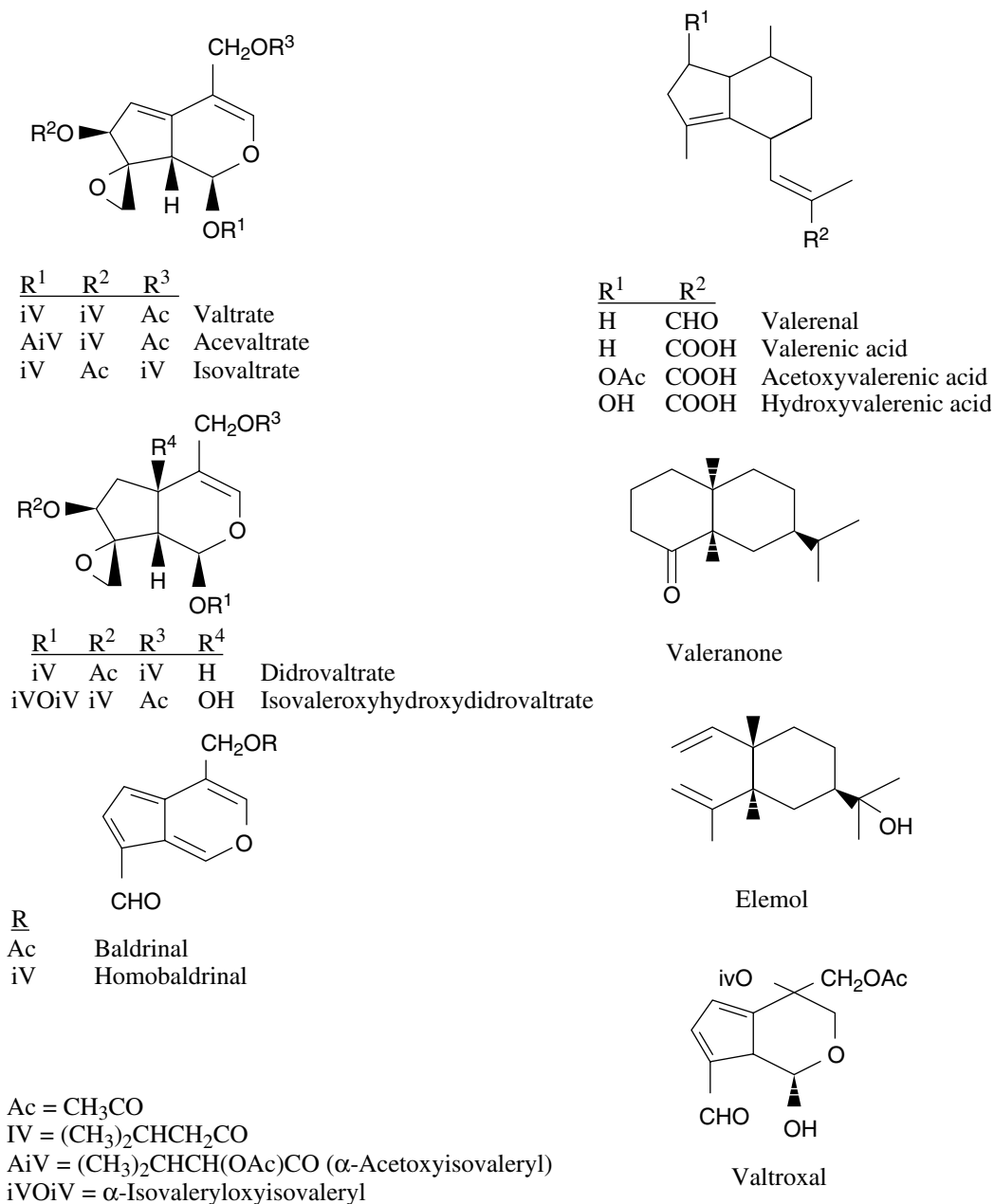
Valepotriates are of two basic types, diene and monoene, the former, e.g., valtrate, bearing an olefinic double bond in each of the two fused rings, while the latter, e.g., didrovaltrate (dihydrovaltrate), has a single double bond in the six-membered ring.

Three nonglycosidic water-insoluble iridoids, generally termed “valepotriates,” were first isolated by Thies from *V. wallichii*. Two were the dienes, valtrate and acevaltrate, and the third, the monoene didrovaltrate.<sup>[26]</sup> The full range of valepotriate variety has been catalogued by Houghton,<sup>[19]</sup> including their chief decomposition products, baldrinal, homobaldrinal, valtroxal,<sup>[13]</sup> and isovaltral (Fig. 2).<sup>[21]</sup>

A glucosylated valepotriate, valerosidate, is also present<sup>[27]</sup> and chlorine containing valepotriates, valechlorine and valeridine, have been reported.<sup>[28]</sup> However, the latter pair are likely artifactual hydrogen chloride adducts to the valepotriate epoxy function, resulting from degraded chloroform used for extraction.

Valepotriates are highly unstable in aprotic solvents as well as in mineral acid and alkali, more so at higher temperatures. In aqueous media, the diene valepotriates rapidly degrade to baldrinals: baldrinal from valtrate and acevaltrate; homobaldrinal and isovaltral from isovaltrate.<sup>[21]</sup> Consequently, valepotriate formulations can only be produced effectively in solid dosage forms, preferably enteric-coated,<sup>[29]</sup> such as the German proprietary standardized extract, Valmane<sup>®</sup>, consisting of 80% didrovaltrate, 15% valtrate, and 5% acevaltrate.

Valepotriates are only efficiently extracted using concentrations of alcohol greater than 70%. Bos et al.<sup>[21]</sup> investigated the stability of the monoene valepotriates, valtrate, and isovaltrate, in ethanol and 70% ethanol, at 4, 20 and 36°C against a control of freshly prepared *V. officinalis* tincture at –20°C. Also analyzed were film-coated tablets prepared from *V. officinalis* and *V. wallichii*, as well as capsules of extracts prepared from *V. officinalis* and *V. edulis* ssp. *procera*. Neither valepotriates nor baldrinals could be detected in tinctures or in film-coated tablets of extracts. Baldrinals, which are not products of the dominant valepotriate, didrovaltrate, were also not detected in Valmane. The ethanol solution of the two monoene valepotriates gave no indication of decomposition, remaining colorless with no detectable levels of baldrinals. By contrast, in 70% ethanol, the concentration of valepotriates was reduced to 30% of the initial concentration after 2 weeks at 20°C and virtually nothing after 3–4 weeks; baldrinal content increased from 5%, after 2 weeks, to 85%, after 3–4 weeks, the solution rapidly becoming yellow. At 36°C, the valepotriate content of the tincture also



**Fig. 1** Major active constituents and degradation products of *V. officinalis*.

rapidly declined but baldrinals were not detected, speculatively because of interaction with as yet unknown co-constituents. These observations indicate that water is necessary for decomposition of valepotriates to baldrinals and that the rate and course of decomposition are strongly temperature dependent.

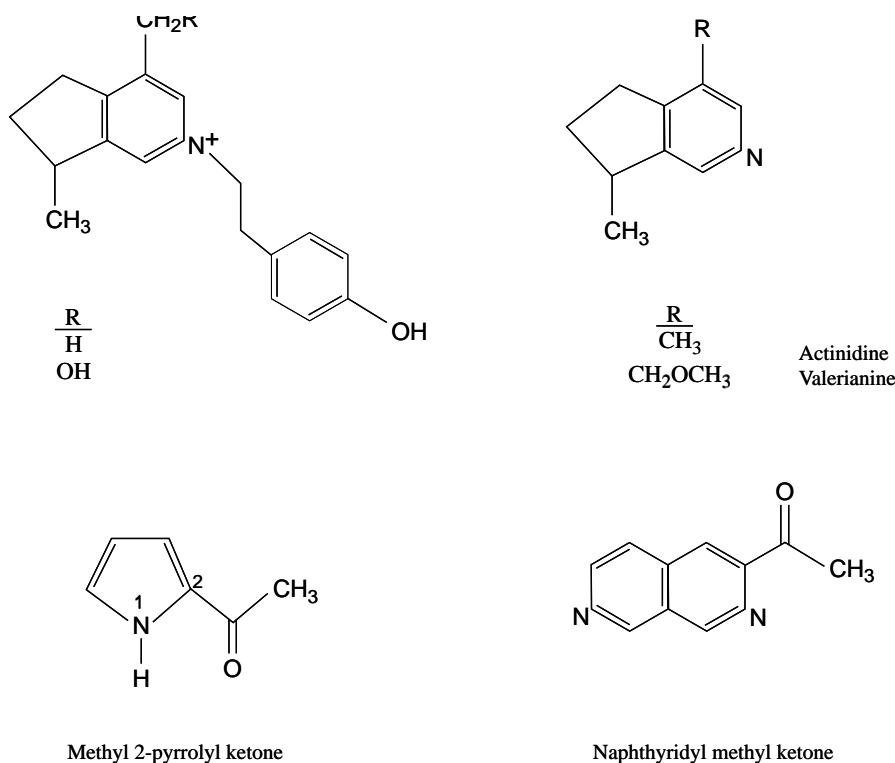
In addition, both monoterpenic and valepotriate carboxylic esters are susceptible to hydrolysis, mainly enzymatic, yielding free carboxylic acids. Prominent among hydrolysis products is isovaleric acid, generated

from bornyl isovalerate and isovaleryl valepotriates, and responsible for valerian's disagreeable odor.

### Other Constituents

Small amounts of pyridine alkaloids have been reported to be present in *V. officinalis*.<sup>[30-34]</sup>

Also, substantial quantities of free amino acids have been found in aqueous extracts of valerian underground organs,<sup>[15]</sup> notably gamma-aminobutyric acid



**Fig. 2** Alkaloids isolated from *Valeriana officinalis*.

(GABA) along with glutamine, potentially metabolizable to GABA, both considered as possibly responsible for the sedative activity of such extracts.<sup>[35]</sup> However, doubt has been expressed over the ability of orally ingested amino acids to reach the central nervous system (CNS).<sup>[36]</sup> Also, the amount of amino acids extracted is reduced by increasing alcoholic strength of hydroalcoholic solvents.<sup>[36]</sup> A group of four closely related furanofuran lignans, derivatives of pinosresinol, have been reported.<sup>[37]</sup> *V. officinalis* also contains small amounts of flavonoids and phenolic acids.<sup>[38]</sup> Isovaleramide, a mild anxiolytic and sedative, has also been reported as a constituent of valerian.<sup>[11,38]</sup>

## PHARMACOLOGICAL ACTIVITY

So far, research into valerian constituents and their mechanisms of action strongly suggests a variety of activities associated with different chemical compounds. The sedative effects, characterized by relaxant and CNS-depressant actions, are likely due to the combined influence of the volatile oil (mainly valerenic acid), the valepotriates—through their degradation products, baldrinals, and valtroxals—and possibly lignans. The valepotriates seem mainly responsible for the antianxiety or tranquilizing effect. The sleep-inducing effect, most pronounced in aqueous extracts of

valerian, has not been conclusively associated with an obviously polar constituent, but GABA and glutamine are prominent candidates.

## Total Extracts

The improvement of sleep characteristics by aqueous extracts of valerian (see later) suggests that the observed *in vitro* effects on GABA-A receptors are of therapeutic significance, involving an as yet unidentified water-soluble compound or compounds. An aqueous extract also displaced GABA from receptors in rat brain cortex tissue; a similar extract of valerian was also found to perform the same activity in rat brain cortex synaptosomes,<sup>[39]</sup> and also to displace melatonin from such receptors,<sup>[38]</sup> both actions consistent with sedative effect. However, the lipophilic fraction of a hydroalcoholic extract, as well as valerenic acid and valepotriate constituents, showed no affinity with GABA-A receptors, but, rather, affinity for barbiturate receptors—as did didrovaltrate—and to a lesser extent for the peripheral or mitochondrial benzodiazepine receptors.<sup>[40]</sup> These observations strongly indicate that the sleep-inducing properties of valerian reside in the water-soluble element, while the more generalized sedative effects are likely due to the combined actions of different constituents, including valerenic acid

derivatives and possibly also valepotriates, chiefly via activities at the GABA-A and barbiturate receptors in the CNS.

### Alkaloids

It is widely regarded that the content of valerian alkaloids is too low to contribute significantly to valerian's overall pharmacological effects.<sup>[19]</sup> However, it has been postulated that actinidine is responsible for the animal attractant properties of valerian, which is claimed to stimulate cats, as well as rodents and dogs.<sup>[41]</sup> The structure of actinidine, also a constituent of cat-attractant *Actinidia*, is judged as similar to those of the closely related monoterpene lactones matatabilactone<sup>[30]</sup> and nepetalactone from catnip (*Nepeta cataria* L.) reported to have the same effect in cats.<sup>[41,42]</sup> The latter lactone, interestingly, has been found to be a minor constituent of the essential oil of *V. celtica* L.<sup>[43]</sup> It has also been noted that isovaleric acid, responsible for valerian's characteristic odor, is a component of the anal gland secretion of some members of the cat family and associated with mating behavior.<sup>[44]</sup> Most of the research into valerian's pharmacological effects has been concentrated on the volatile oil and the nonvolatile valepotriates.

### Volatile oil

Early 20th century investigation indicated that the sedative effect of valerian tinctures was due to its volatile oil content. However, it appeared from subsequent research that the volatile oil could be only partially responsible for the sedation observed in animal tests.<sup>[19]</sup> Of the volatile oil constituents of *V. officinalis*, most attention has been focused on the sesquiterpenes, particularly valerenic acid and valeranone.

Valerenic acid effected a significant decrease in motility of mice<sup>[45]</sup> and increased pentobarbital-induced sleeping time somewhat less effectively than chlorpromazine and diazepam.<sup>[46]</sup> A central rather than peripheral mechanism of action was indicated, and the compound was found to inhibit the enzyme system responsible for breakdown of GABA in the brain.<sup>[47]</sup> The resultant increased level of GABA is expected to contribute to sedation and decreased CNS activity.

Valeranone is not regarded as important as valerenic acid.<sup>[19]</sup> The ketone also prolongs barbitone-induced sleeping time and decreases motility in mice, attributed to reduced levels of 5-hydroxytryptamine (5-HT, serotonin) and noradrenaline in the brain.<sup>[45]</sup> It has been noted though that the calculated corresponding effective doses of valeranone in humans would not likely be attained in standard valerian

preparations.<sup>[19]</sup> Valeranone has been shown to exert primarily a spasmolytic effect rather than acting on the CNS as does valerenic acid.<sup>[48]</sup>

Also reported to inhibit binding of 5-HT to its receptor is one of the four furanofuran lignans, 1-hydroxypinoresinol.<sup>[37]</sup>

### Valepotriates

Following the identification of valepotriates in valerian,<sup>[25]</sup> much attention was devoted to their pharmacology. Their presence seemed to explain apparent discrepancies in activity of tinctures with low volatile oil content, which, nonetheless, displayed relatively high sedative/tranquilizing activity. Experiments with a high valepotriate content—as much as 8% total containing 80% didrovaltrate—preparation from Mexican valerian (*V. edulis* ssp. *procera*) showed lessened spontaneous motility in mice.<sup>[49]</sup> Tests with cats revealed no decrease in reactivity but a reduction in aggressiveness, anxiety, and restlessness. In another experiment, Von Eickstedt<sup>[50]</sup> compared the effect of alcohol coadministered with chlorpromazine, diazepam, or an extract with a high valepotriate content: unlike the two prescription drugs, valepotriates diminished the effects of alcohol.

The valepotriates are readily susceptible to decomposition, and their major decomposition products, such as homobaldrinal from valtrate<sup>[51]</sup> and valtroxal from didrovaltrate,<sup>[52]</sup> have been found to have more potent antimotility activity than their parent valepotriates. It has been proposed that such decomposition processes take place in the intestines under the agency of bacterial flora.<sup>[51]</sup>

The mechanisms underlying the sedative/anxiolytic effects of the valepotriates remain unclear. A strong spasmolytic effect has been observed at doses well below those at which a direct CNS effect can be detected,<sup>[53]</sup> and binding to dopamine receptors may inhibit the CNS stimulant effect of endogenous dopamine.<sup>[54]</sup> Moreover, there still remains concern over the question of oral bioavailability of valepotriates and their degradation products such as valtroxal and baldrinals, which are more active intraperitoneally than orally, probably due to partial hydrolytic deactivation in the gut and/or poor absorption.<sup>[19]</sup>

### Toxicology of valepotriates

The valepotriates have shown alkylating, mutagenic, and cytotoxic properties in vitro. Braun et al.<sup>[55]</sup> demonstrated the alkylating ability common to epoxides evinced by valtrate and didrovaltrate at the same rate as the epoxide epichlorohydrin, and the chlorinated tertiary amine, *N,N*-dimethyl-*N*-(2-chloroethyl) amine.

An assessment of their effect on DNA synthesis in cultured hepatoma cells<sup>[56]</sup> indicated that the diene valtrate had a rapid and extensive inhibitory effect on incorporation of 3H-thymidine and 3H-leucine and that the monoenes, didrovaltrate, and deoxydidrovaltrate, while being less active, nonetheless exhibited considerable cytotoxicity. Structure–activity considerations indicated that the C5–C6 (cyclopentenyl) double bond was important for cytotoxic activity but that the epoxide group is not essential.

A later comparative evaluation of valepotriate toxicity showed that the diene types were about 2–3 times more toxic than the monoenes. The decomposition products of diene valepotriates baldrinal and homobaldrinal were 10–30 times less toxic than their parent compounds, while isovaltral, like homobaldrinal a product of isovaltrate, was more cytotoxic than its parent. Monoene valepotriates were found to be remarkably stable under storage, while dienes, as noted earlier, are very labile.<sup>[57]</sup> However, in vitro observations of valepotriate cytotoxicity against mouse bone marrow cells<sup>[58]</sup> could not be replicated in vivo on the same type of cell, whether orally or intraperitoneally.<sup>[59]</sup> These results indicate that human in vivo toxicity is likely considerably less than that observed in in vitro experiments, probably as a result of poor absorption and/or distribution and metabolism of these iridoids. It has been discovered that valepotriates and baldrinals, the latter likely produced in the gastrointestinal (GI) tract, are rapidly absorbed in the body, the latter more so. Baldrinal glucuronide esters have been isolated, which did not give positive reactions in both the Ames test and the SOS chromotest.<sup>[60]</sup> At most, the administration of valepotriates would seem to pose only a slight but potential genotoxic risk to the GI tract and liver.<sup>[29]</sup> However, until this is confirmed by long-term in vivo studies in humans, it would be prudent for children<sup>[14]</sup> as well as for adults not interested in the antianxiety effect to avoid consumption of valepotriates. Tinctures of *Valeriana* species stored at ambient room temperature for 2 mo were found to have lost most of their valepotriate content, a recommended precautionary treatment for reducing valepotriate toxicity.<sup>[61]</sup>

## CLINICAL STUDIES

Most of the clinical studies with valerian relate to sleep disorders, mainly in treatment of insomnia. Those trials have generally employed valepotriate-free aqueous extracts of root/rhizome, although hydroalcoholic extracts with substantial sesquiterpene content and very low content in valepotriates have also been tested. Combinations of extracts of valerian root with extracts of hop flowers, lemon balm leaves, and passionflower aerial parts have also been evaluated.

A much smaller number of clinical trials have been conducted with valepotriate-rich extracts for treatment of generalized anxiety disorder (GAD) and affective disorders.

## Sleep Disorders

More than a dozen double-blind placebo-controlled trials of valerian have been conducted, most also randomized and/or of crossover design. The results of those studies have been summarized in great detail in the second edition of *Botanical Medicines*;<sup>[15]</sup> a summary of salient details of the most recent rigorously designed trials is presented in Table 1. Generally, 400–450 mg of an aqueous extract taken at bedtime produced a significant decrease in subjectively evaluated sleep-onset latency, as well as improved sleep quality of poor or irregular sleepers, without causing any hangover the following morning.<sup>[61,62]</sup> The earlier of these two studies<sup>[61]</sup> compared the effects of an aqueous extract of valerian to those of a commercial preparation (Hova<sup>®</sup>) of combined valerian root and hop flower extract, against placebo. Hova affected neither sleep latency nor sleep quality but generated a marked increase in reports of feeling more sleepy than usual upon awakening. The reason for the inferiority of the commercial preparation cannot be speculated upon without knowledge of the details of its preparation. A much later study with Hova compared its effects to those of the benzodiazepine, bromazepam, in 37 middle-aged women and 9 men with nonpsychiatric/nonchronic sleep disorders;<sup>[63]</sup> the randomized, double-blind, placebo-controlled, parallel-group designed trial found that the health of patients improved only after 2 weeks and that the valerian–hop combination product was equally effective as the benzodiazepine, therefore presenting a sensible alternative to the latter. A combination concentrated standardized valerian–lemon balm extract was compared with triazolam, another benzodiazepine, and placebo in 20 healthy volunteers, poor sleepers aged 30–50.<sup>[64]</sup> Both treatment groups showed a significant increase in sleep efficiency especially those in the subcategory of “bad” sleepers. In contrast to the triazolam group, however, no daytime sedation, impairment of concentration, or performance capabilities were observed in the valerian/lemon balm group.

Interestingly, a proprietary 70% alcohol extract of valerian root (Lichter AG, LI 156) produced significant improvement in sleep characteristics only after 2 weeks of treatment.<sup>[65]</sup>

Kamm-Kohl, Jansen, and Brockmann,<sup>[66]</sup> in a randomized placebo-controlled double-blind study with 80 hospitalized elderly patients with sleep disturbances and/or rapid fatigue, investigated the efficacy of an

**Table 1** Selected randomized controlled trials of *V. officinalis* root extracts for sleep disorders

Treatment	Sample size	Results	Comments	References
<p>Single-night study assessed with questionnaires</p> <ul style="list-style-type: none"> <li>• 400 mg of a freeze-dried aqueous extract; 400 mg of combined aqueous valerian and hop flower extracts (in 2:1 ratio) in a proprietary preparation (Hova); placebo (brown sugar). Sealed in opaque capsules, the three coded samples were taken in a crossover design for 9 nonconsecutive nights.</li> <li>• Each preparation was taken 1 h before retiring and the postsleep questionnaire filled the following morning.</li> </ul>	128	<ul style="list-style-type: none"> <li>• The nonproprietary extract significantly reduced sleep latency, pronounced in the elderly (<math>p &lt; 0.05</math>), as well as improving sleep quality, particularly in poor sleepers, especially women, the young, and smokers (<math>p &lt; 0.01</math>)</li> <li>• Dream recall, night awakening, and sleepiness the next morning were not significantly altered. Hova did not influence ratings for sleep latency and sleep quality but caused a marked increase in reports of feeling more sleepy than usual the next morning (<math>p &lt; 0.01</math>), likely due to the hop extract.</li> </ul>	<ul style="list-style-type: none"> <li>• Total sleep time is not a reliable measure without baseline reference.</li> <li>• It is doubtful whether the distinctive odor of valerian was effectively masked to prevent identification from the ground brown sugar placebo.</li> <li>• Reliability of subject responses is difficult to assess.</li> </ul>	61
<p>Sleep laboratory evaluation of EEG parameters</p> <ul style="list-style-type: none"> <li>• 400 mg extract; placebo.</li> <li>• Preparations taken in crossover design for 4 nights and questionnaires filled out the morning after each EEG night.</li> </ul>	10	<ul style="list-style-type: none"> <li>• The small scale parallel sleep laboratory study revealed no significant changes in either EEG parameters or subjective measures. These results were likely influenced by the test population being exclusively young good sleepers, found to be unaffected by valerian in the parallel study with a larger, more diverse population.</li> </ul>	<ul style="list-style-type: none"> <li>• The variability of the EEG likely masked any potential but small effects on sleep physiology.</li> </ul>	

<ul style="list-style-type: none"> <li>• 45 mg aqueous extract 3–9 times daily for 14 days.</li> </ul>	80 elderly	<ul style="list-style-type: none"> <li>• Statistically significant improvements were seen on both a subjective well-being (mood) scale (von Zarassen) and the Nurse's Objective Rating Scale for Inpatient Evaluations (NOISE) (<math>p &lt; 0.01</math>); patients treated with the extract reported improved ability to fall asleep and to sleep throughout the night, as well as reduced feelings of fatigue.</li> </ul>	<ul style="list-style-type: none"> <li>• Feelings of rapid fatigue were assumed to be related to sleep disturbances.</li> </ul>	66
<ul style="list-style-type: none"> <li>• 450 and 900 mg aqueous extract, 30 min before retiring, on 4 nights during the week for 3 weeks.</li> </ul>	7	<ul style="list-style-type: none"> <li>• The 450 mg treatment produced decreased sleep latency; there was a positive correlation between sleep quality measured by wrist-worn activity meters and questionnaires; no further improvements were noted with the 900 mg treatment, which made subjects feel more sleepy the next morning.</li> <li>• No influence on total sleep time or total sleep time movements was observed.</li> </ul>	<ul style="list-style-type: none"> <li>• The use of activity meters to assess sleep quality is unconventional and of questionable reliability.</li> <li>• As noted above, the use of brown sugar as placebo is not completely satisfactory on account of distinctive valerian odor.</li> <li>• Very small study group.</li> </ul>	62
<ul style="list-style-type: none"> <li>• 400 mg of standardized valerian extract, virtually valepotriate-free, combined with hops flowers and lemon balm extract. The placebo contained a full complement of hops and lemon balm but only 4 mg valerian extract. Preparations taken for 2 nights.</li> </ul>	27	<ul style="list-style-type: none"> <li>• 24 of 27 (89%) reported improved sleep with the test preparation; 21 of 27 (78%) rated the test preparation superior to control (<math>p &lt; 0.0001</math>); 12 of 27 (44%) reported "perfect sleep," with the preparation.</li> </ul>	<ul style="list-style-type: none"> <li>• Very limited duration of study.</li> <li>• Both valerian botanical accompaniments are known to have sedative properties.</li> </ul>	70

(Continued)



**Table 1** Selected randomized controlled trials of *V. officinalis* root extracts for sleep disorders (*Continued*)

Treatment	Sample size	Results	Comments	References
600 mg of a 70% alcoholic extract (Sedonium, Lichtwer Pharma, Berlin).	121	Increase in clinical global impression, rating of sleep quality, and in subjective rating on the von Zarassen well-being scale. Physicians and patients judged the effect of the valerian treatment as “very good” or “good” in 61.0% and 66.1%, respectively. By contrast, placebo was judged as such in only 25.9% of cases.	Placebo, stated to be indistinguishable from verum, not described further.	65
Sedonium, 600 mg/night for 14 nights.	16	In objective measures, using polysomnographic tests, valerian decreased slow-wave sleep (SWS) latency (21.3 vs. 13.5 min) compared to placebo, as well as increasing the duration of SWS compared to baseline. By subjective assessment, the time to sleep onset was reduced (45 vs. 60 min) by valerian compared to placebo.	Relatively small patient population.	68
Sedonium: 600 mg extract in short term (single dose) or long term (14 days with multiple dosage). Patients underwent 9 polysomnographic nights: 1 control before and 8 nights during the study, the latter scheduled in two trial periods separated by a washout period of 13 days.	16	Single-dose valerian treatment exerted no observable effects on sleep structure and subjective sleep assessment. After multiple-dose treatment, sleep efficiency showed significant increase for both placebo and verum in comparison with baseline polysomnography. However, significant differences were noted in parameters describing slow-wave sleep between valerian- and placebo-treated subjects.	The treatment chosen represents the high end of the recommended dose of natural valerian drug for treatment of sleep disturbances. While valerian is unlikely to be effective in the treatment of patients with acute, reactive sleep disturbances because of its slight and delayed influence, it can be recommended for patients with mild psychophysiological insomnia.	69

aqueous extract of valerian root over 14 days (45 mg, 3–9 times daily). Statistically significant improvements were observed in both subjective well being and behavioral disturbances in the treated group, but not in the placebo group. Patients in the verum group reported improved ability to fall asleep and sleep through the night, as well as reduced feeling of fatigue.

More recently, three trials were conducted with the commercial preparation, Sedonium<sup>®</sup>, in the form of coated tablets each containing 300 mg of a dry extract of valerian root.<sup>[67–69]</sup> Each study involved 16 patients in a randomized double-blind, placebo-controlled, crossover design. The first of these<sup>[67]</sup> examined the effects on electroencephalogram (EEG) in single (1.2 g) and multiple-dose (600 mg/night) for 2 weeks; the observed changes in EEG approximated those produced by psychosedative anxiolytic drugs. The second<sup>[68]</sup> used polysomnographic tests to measure slow-wave sleep (SWS) and SWS latency, among other parameters. In objective measurements, valerian decreased SWS latency, compared to placebo, while increasing the duration of SWS compared to baseline; subjectively, the time to sleep onset was reduced by valerian as compared to placebo. The third<sup>[69]</sup> assessed the short-term (single dose of 2 × 300 mg tablets) and long-term (14 days with multiple dosage) treatment being administered 1 hr before bedtime. No effects on sleep structure and subjective sleep assessment were observed after a single dose of valerian. After the multidose treatment, however, as in the second trial, significant differences were noted in SWS and SWS latency between verum and placebo groups. Interestingly, polysomnographic comparisons with baseline values indicated significant increases in sleep efficiency for both placebo and multiple-dose treatment groups.

Lindahl and Lindwall<sup>[70]</sup> conducted a randomized double-blinded crossover comparison of two combination preparations. The first, a commercial product (Valeriana Natt) containing valerian extract equivalent to 400 mg of root, standardized to and containing primarily sesquiterpenes, and with only traces of valepotriates, combined with hop and lemon balm extracts. The second contained valerian extract equivalent to only 4 mg of root, combined with “a full dose of *Flores humuli* and *Lemon melissa*.” Any observed differences would be attributed to the difference in valerian content. Eighty-nine percent of the 27 subjects reported improved sleep and 44% “perfect sleep” from Valeriana Natt. No side effects were reported, nor nightmares, which had been experienced with customary sedatives.

## SAFETY

In all the clinical trials of valerian preparations conducted so far, only mild side effects such as stomach

upset, headaches and itching have occasionally been noted.<sup>[71]</sup> No subchronic or chronic toxicity data are available. A recent case report, involving consumption of more than 20 times the recommended dose of powdered valerian root by an 18-yr-old female college student, in an apparent suicide attempt, revealed only mild symptoms, all of which resolved within 24 hr.<sup>[72]</sup> The symptoms noted were fatigue, abdominal cramping, chest tightness, lightheadedness, and foot and hand tremor. A study aimed at assessing possible delayed adverse effects of valerian overdose treated 10 males and 14 females after allegedly taking an overdose of a purported valerian-containing OTC product, Sleep-Qik, a valerian dry extract combined with hyoscyne hydrobromide and cyproheptadine hydrochloride.<sup>[73]</sup> No clinical evidence of acute hepatotoxicity or subclinical liver damage was detected, and delayed liver and other adverse effects were judged unlikely. Concern for valerian hepatotoxicity has been misdirected and misguidedly associated in its indictment, along with skullcap (*Scutellaria lateriflora*), in a case of hepatotoxicity,<sup>[74]</sup> almost certainly due to german-der (*Teucrium chamaedrys*) substituted for skullcap. The case of a high-output cardiac failure, in a 58-yr-old man who had been consuming a plethora of medications including protracted high dosage valerian, following withdrawal of valerian was suspected to be a “benzodiazepine-like withdrawal syndrome.”<sup>[75]</sup> However, while a causal association could not be established, similarities of mechanism of action between valerian and benzodiazepines strike a cautionary note.

Studies of valerian’s influence on vigilance have revealed no effects that would impair coordination or decrease alertness.<sup>[76]</sup> However, while alcohol does not potentiate the effects of valerian,<sup>[77]</sup> as do many synthetic tranquilizers, because of additive effect caution should be exercised with joint consumption during driving and operating heavy machinery.

## Contraindications and Drug Interactions

European clinical monographs list no contraindications to its use in pregnancy or during lactation. Also, studies with pregnant rats indicate no deleterious effects of oral consumption of valepotriates.<sup>[78]</sup> Nonetheless, erring on the side of caution, ingestion of appreciable quantities of valepotriates is generally disavowed, recommending either removal by extraction or sufficient length of storage to promote degradation of the iridoids (see earlier).

While no drug interactions have been reported in humans, studies in rodents indicate a potential for reaction with barbiturates and benzodiazepines.<sup>[79]</sup> In mice, sleeping time induced by thiopental was extended and thiopental anesthesia prolonged, after treatment

with both aqueous and alcoholic extracts of valerian, perhaps contraindicating valerian while undergoing treatment with barbiturates. On the other hand, the demonstrated affinity of valerian extracts and valepotriates for GABA and benzodiazepine receptor sites, as well as the diminution of diazepam withdrawal effects observed in rats treated intraperitoneally with valepotriates, suggests that valepotriate-rich preparations may be helpful in easing withdrawal from benzodiazepines.

## REFERENCES

1. *Herbal Medicine: Expanded Commission E Monographs*; Blumenthal, M., Goldberg, A., Brinckmann, J., Eds.; Integrative Medicine Communications: Newton, MA, 2000; 394–400.
2. Dweck, A.C. 1. An introduction to valerian. *Valeriana officinalis* and related species. In *Valerian. The Genus Valeriana*; Houghton, P.J., Ed.; Harwood Academic: Amsterdam, The Netherlands, 1997; 4–10.
3. Coon, N. *Using Plants for Healing*; Rodale Press: Emmaus, PA, 1979; 203 pp.
4. Grieve, M. *A Modern Herbal*; Dover Publications, Inc.: New York, 1971; 824–830.
5. Flückiger, F.A.; Hanbury, D. *Pharmacographia, A History of the Principal Drugs of Vegetable Origin*; Macmillan & Co.: London, 1879; 803 pp.
6. Hobbs, C. Valerian: a literature review. *Herbal-Gram* **1989**, 21, 19–34.
7. Howard, M. *Traditional Folk Remedies*; Century Hutchinson Ltd.: London, 1987; 217 pp.
8. Hocking, G.M. *A Dictionary of Natural Products*; Plexus Publishing, Inc.: Medford, NJ, 1997; 836–837.
9. Bernáth, J. Cultivation of valerian. In *Valerian: The Genus Valeriana*; Houghton, P.J., Ed.; Harwood Academic: Amsterdam, The Netherlands, 1997; 77–100.
10. Anon. *Radix Valerianae. WHO Monographs on Selected Medicinal Plants*; WHO Publications: Geneva, Switzerland, 1999; 267–268.
11. *Valerian Root, Valeriana officinalis: Analytical Quality Control and Therapeutic Monograph*; Upton, R., Ed.; American Herbal Pharmacopoeia: Santa Cruz, CA, 1999; 25 pp.
12. *Flora Europea*; Tutin, T.G., Heywood, V.H., Burges, N.A., Moore, D.M., Valentine, D.H., Walters, S.M., Webb, D.A., Eds.; Cambridge University Press: London, 1970; Vol. 4, 53 pp.
13. Morazzoni, P.; Bombardelli, E. *Valeriana officinalis*: traditional use and recent evaluation of activity. *Fitoterapia* **1995**, 66, 99–112.
14. Schilcher, H. *Phytotherapy in Paediatrics*; Medpharm Scientific Publishers: Stuttgart, Germany, 1997; 59–62.
15. McKenna, D.J.; Jones, K.; Hughes, K. *Botanical Medicines: The Desk Reference for Major Herbal Supplements*; 2nd Ed.; The Haworth Press Inc.: New York, 2002; 1007–1037.
16. *The ABC Clinical Guide to Herbs*; Blumenthal, M., Goldberg, A., Kunz, T., Dinda, K., Eds.; American Botanical Council: Austin, TX, 2003; 357–358.
17. Mahady, G.B.; Fong, H.H.S.; Farnsworth, N.R. *Botanical Dietary Supplements: Quality, Safety and Efficacy*; Swets and Zeitlinger: Lisse, The Netherlands, 2001; 270 pp.
18. *British Herbal Compendium*; Bradley, P.R., Ed.; British Herbal Medicine Association: Bournemouth, Dorset, England, 1993; Vol. 1, 214–217.
19. Houghton, P.J. The biological activity of valerian and related plants. *J. Ethnopharmacol* **1988**, 22, 121–142.
20. Leung, A.; Foster, S. *Encyclopedia of Common Natural Ingredients Used in Food, Drugs and Cosmetics*; 2nd Ed.; John Wiley & Sons, Inc.: New York, 1996; 507–510.
21. Bos, R.; Woerdenbag, H.J.; Hendriks, H.; Zwaving, J.H.; De Smet, P.A.G.M.; Tittel, G.; Wikstrom, H.V.; Scheffer, J.C. Analytical aspects of phytotherapeutic valerian preparations. *Phytochem. Anal.* **1996**, 7, 143–151.
22. Becker, H.; Chavadev, S.; Webbling, F. Valepotriates in *Valeriana thalictroides*. *Planta Med.* **1983**, 49, 64–67.
23. Stoll, A.; Seebeck, E.; Stauffacher, D. New investigations on valerian. *Schweiz. Apotheker-Zeitung* **1957**, 95, 115–120.
24. Hazelhoff, B.; Smith, D.; Malingré, T.M.; Hendriks, H. The essential oil of *Valeriana officinalis* L.s.l. *Pharm. Weekblad Sci. Ed.* **1979**, 144, 443–449.
25. Gobbato, S.; Lolla, E.A. New HPLC method for the analysis of valerenic acid in *Valeriana officinalis* extracts. *Fitoterapia* **1996**, 67, 159–162.
26. Thies, P.W. Über die Wirkstoffe des Baldrians 2: Zur Konstitution der Isovaleriansaureester Valepotriat, Acetoxyvalepotriat und Dihydrovalepotriat. *Tetrahedron Letters* **1966**, 1163–1170.
27. Inouye, H.; Ueda, S.; Usato, S.; Shingu, T.; Thies, P.W. Die absolute Konfiguration von Valerosidatum und von Didrovaltratum. *Tetrahedron* **1974**, 30, 2317–2225.
28. Popov, S.; Handjieva, N.; Marekov, N. Halogen containing valepotriates isolated from *Valeriana officinalis* roots. *Dokl. Bolgarskoi Akad. Nauka* **1973**, 26, 913–915.

29. Schulz, V.; Hänsel, R.; Tyler, V.E. *Rational Phytotherapy*; 4th Ed.; Springer-Verlag: New York, 2001; 87–97.
30. Torssell, K.; Wahlberg, K. Isolation, structure and synthesis of alkaloids from *Valeriana officinalis* L. *Acta Chem. Scand.* **1967**, *21*, 53–62.
31. Franck, B.; Petersen, U.; Hüper, F. Valerianine, a tertiary monoterpene alkaloid from valerian. *Angew. Chem. (Int. Ed.)* **1970**, *9*, 891.
32. Johnson, R.; Waller, G. Isolation of actinidine from *Valeriana officinalis*. *Phytochem. Rep.* **1971**, *10*, 3334–3335.
33. Janot, M.-M.; Guilhem, J.; Contz, O.; Venera, G.; Ciongo, E. Contribution à l'étude des alcaloïdes de la valériane (*Valeriana officinalis* L.); actinidine et naphtyridylméthylacétone, nouvel alcaloïde. *Ann. Pharm. Fr.* **1979**, *37*, 413–420.
34. Houghton, P.J. The chemistry of *Valeriana*. In *Valerian The Genus Valeriana*; Houghton, P.J., Ed.; Harwood Academic: Amsterdam, The Netherlands, 1997; 43 pp.
35. Santos, M.S.; Ferreira, F.; Faro, C.; Pires, E.; Carvalho, A.P.; Cunha, A.P.; Macedo, T. The amount of GABA present in aqueous extracts of valerian is sufficient to account for [<sup>3</sup>H] GABA release in synaptosomes. *Planta Med.* **1994**, *60*, 475–476.
36. Houghton, P.J. The scientific basis for the reputed activity of valerian. *J. Pharm. Pharmacol.* **1999**, *51*, 505–512.
37. Bodesheim, U.; Hölzl, J. Isolierung, Strukturaufklärung und Radiorezeptorassays von Alkaloiden und Lignanen aus *Valeriana officinalis* L. *Pharmazie* **1997**, *52*, 386–391.
38. Balandrin, M.F.; Van Wagenen, B.C. inventors. Use of Isovaleramide as a Mild Anxiolytic and Sedative Agent; NPS Pharmaceuticals, Inc.: Salt Lake City, UT. U.S. patent 5,506,268 April 9, 1996.
39. Santos, M.S.; Ferreira, F.; Cunha, A.P.; Carvalho, A.P.; Macedo, T. An aqueous extract of valerian influences the transport of GABA in synaptosomes. *Planta Med.* **1994**, *60*, 278–279.
40. Mennini, T.; Bernasconi, P.; Bombardelli, E.; Morazzoni, P. In vitro study on the interaction of extracts and pure compounds from *Valeriana officinalis* roots with GABA, benzodiazepine and barbiturate receptors in rat brain. *Fitoterapia* **1993**, *64* (4), 291–300.
41. Hölzl, J. The pharmacology and therapeutics of *Valeriana*. In *Valerian; The Genus Valeriana*; Houghton, P.J., Ed.; Harwood Academic: Amsterdam, The Netherlands, 1997; 69 pp.
42. Tucker, A.O.; Tucker, S.S. Catnip and the catnip response. *Econ. Bot.* **1988**, *42*, 214–231.
43. Bicchi, C.; Sandra, P.; Schelfaut, M.; Verzele, M. Studies on the essential oil of *Valeriana celtica* L. *J. High Resolution Chromatogr. Chromatogr. Commun.* **1983**, *6*, 213–215.
44. Lissák, K. Olfactory-induced sexual behavior in female cats. In *22nd International Congress of Physiological Sciences; Lectures and Symposia II*; Leiden, Netherlands, 1962; 653–656.
45. Hendriks, H.; Bos, R.; Allersma, D.P.; Malingré, T.M.; Koster, A.S. Pharmacological screening of valerenal and some other components of the essential oil of *Valeriana officinalis*. *Planta Med.* **1981**, *42*, 62–68.
46. Hendriks, H.; Bos, R.; Woerdenbag, H.J.; Koster, A.S. Central nervous system depressant activity of valerenic acid in the mouse. *Planta Med.* **1985**, *51*, 28–31.
47. Riedel, E.; Hansel, R.; Ehrke, G. Hemmung des  $\gamma$ -Aminobuttersäureabbaus durch Valerensäure-derivate. *Planta Med.* **1982**, *46*, 219–220.
48. Hazelhoff, B.; Malingré, T.M.; Maijer, D.K.F. Antispasmodic effects of valerian compounds: an in-vivo and in-vitro study on the guinea-pig ileum. *Arch. Int. Pharmacodyn.* **1982**, *257*, 274–287.
49. Von Eickstedt, K.-W.; Rahman, S. Psychopharmakologische Wirkungen von Valepotriaten. *Arzneim. Forsch.* **1969**, *19*, 316–319.
50. Von Eickstedt, K.-W. Die Beeinflussung der Alkohol—Wirkung durch Valepotriate. *Arzneim. Forsch.* **1989**, *19*, 995–997.
51. Wagner, H.; Jurcic, K.; Schaeffe, R. Vergleichende Untersuchungen über die sedierende Wirkung von Baldrianextraketen Valepotriaten und ihren Abbauprodukten. *Planta Med.* **1980**, *38*, 358–365.
52. Veith, J.; Scheneider, G.; Lemmer, B.; Willems, M. Einfluss einiger abbauprodukte von Valepotriaten auf die Motilität Licht–Dunkel synchronisierter Mäuse. *Planta Med.* **1986**, *47*, 179–183.
53. Wagner, H.; Jurcic, K. Über die spasmolytische Wirkung des Baldrians. *Planta Med.* **1979**, *37*, 84–86.
54. Godau, P. Analytik von Inhaltsstoffen aus *Valeriana officinalis* und deren pharmakologischen Testung mit RBS. Dissertation, University of Marburg, 1991.
55. Braun, R.; Dittmar, W.; Machut, M.; Weickman, S. Valepotriate mit Epoxidstruktur-beatliche Alkylantein. *Dtsch. Apotheker-Zeitung* **1982**, *122*, 1109–1113.
56. Bounthanh, C.; Richert, L.; Beck, J.P.; Haag-Berrurier, M.; Anton, R. The action of valepotriates on the synthesis of DNA and proteins of cultured hepatoma cells. *Planta Med.* **1983**, *49*, 138–142.

57. Bos, R.; Hendriks, H.; Scheffer, J.J.C.; Woerdenbag, H.J. Cytotoxic potential of valerian constituents and valerian tinctures. *Phyto-medicine* **1998**, *5*, 219–225.
58. Tortarola, M.; Braun, R.; Huebner, G.E.; Maurer, H. In-vitro effects of epoxide-bearing valepotriates on mouse early hematopoietic progenitor cells and human T-lymphocytes. *Arch. Toxicol.* **1982**, *51*, 37–41.
59. Braun, R.; Dieckmann, H.; Machut, M.; Echarti, C.; Maurer, H.R. Untersuchungen zum Einfluss von Baldrianalen auf hämatopoetische Zellen in vitro, auf die metabolische Aktivität der Leber in vivo sowie zum Gehalt in Fertigarzneimitteln. *Planta Med.* **1986**, *52*, 446–450.
60. Dieckmann, H. Untersuchungen zur Pharmakokinetik, Metabolismus und Toxikologie von Baldrianalen. Ph.D. Thesis, Freie Universität Berlin, 1988.
61. Leathwood, P.D.; Chauffard, F.; Heck, E.; Munoz-Box, R. Aqueous extract of valerian root (*Valeriana officinalis* L.) improves sleep quality in man. *Pharmacol Biochem. Behav.* **1982**, *17*, 65–71.
62. Leathwood, P.D.; Chauffard, F. Aqueous extract of valerian reduced latency to fall asleep in man. *Planta Med.* **1985**, *51*, 144–148.
63. Schmitz, M.; Jäckel, M. Vergleichsstudie zur Untersuchung der Lebensqualität von Patienten mit exogenen Schlafstörungen (vorübergehenden Ein- und Durchschlafstörungen) unter Therapie mit einem Hopfen-Baldrian-Präparat und einem Benzodiazepin-Präparat. *Wien. Med. Wochenschr.* **1998**, *148*, 291–298.
64. Dressing, H.; Reimann, D.; Löw, H.; Schredl, M.; Reh, C.; Laux, P.; Müller, W.E. Baldrian-Melisse-Kombinationen versus Benzodiazepin; Beischlafstörungen gleichwertig? *Therapiewoche* **1992**, *42*, 726–736.
65. Vorbach, E.U.; Gortelmeyer, R.; Bruning, J. Therapie von Insomnien: Wirksamkeit und Verträglichkeit eines Baldrianpräparats. *Psychopharmacotherapie* **1996**, *3*, 109–115.
66. Kamm-Kohl, A.V.; Jansen, W.; Brockmann, P. Modern valerian therapy of nervous disorders in elderly patients. *MedWelt* **1984**, *35*, 1450–1454.
67. Donath, F.; Roots, I. Effects of valerian extract (Sedonium<sup>®</sup>) on EEG power spectrum in male healthy volunteers after single and multiple application. *Eur. J. Clin. Pharmacol.* **1996**, *50*, 541 (abstract).
68. Quispe Bravo, S.; Diefenbach, K.; Donath, F.; Fietze, I.; Roots, I. The influence of valerian on objective and subjective sleep in insomniacs. *Eur. J. Clin. Pharmacol.* **1997**, *52* (Suppl.), A 170 (abstract 548).
69. Donath, F.; Quispe, S.; Diefenbach, K.; Maurer, A.; Fietze, I.; Roots, I. Critical evaluation of the effect of valerian extract on sleep structure and sleep quality. *Pharmacopsychiatry* **2000**, *33*, 47–53.
70. Lindahl, O.; Lindwall, L. Double-blind study of a valerian preparation. *Pharmacol. Biochem. Behav.* **1989**, *32*, 1065–1066.
71. Schmidt-Voigt, J. Treatment of nervous sleep disorders and unrest with a sedative of purely vegetable origin. *Therapiewoche* **1986**, *36*, 663–667.
72. Willey, L.B.; Mady, S.P.; Cobaugh, D.J.; Wax, P.M. Valerian overdose: a case report. *Vet. Hum. Toxicol.* **1996**, *37* (4), 364–365.
73. Chan, T.Y.K. An assessment of the delayed effects associated with valerian overdose. *J. Clin. Pharmacol. Ther.* **1998**, *36* (10), 569 (Letter).
74. Mac Gregor, F.B.; Abernethy, V.E.; Dahabra, S.; Cobden, I.; Hayes, P.C. Hepatotoxicity of herbal remedies. *Br. Med. J.* **1989**, *229*, 1156–1157.
75. Garges, H.P.; Varia, I.; Doraiswamy, P.M. Cardiac complications and delirium associated with valerian root withdrawal. *J. Am. Med. Assoc.* **1998**, *280* (18), 1566–1567 (Letter).
76. Gerhardt, U.; Linnenbrink, N.; Georghiadou, Ch. Effects of two plant-based sleep remedies on vigilance. *Schweiz. Rundsch. Med. Prax.* **1996**, *85*, 473–481.
77. Von Eickstedt, K.-W. Die Beeinflussung der Alkohol—Wirkung durch Valepotriate. *Arzneim Forsch.* **1996**, *19*, 995–997.
78. Tufik, S.; Fujita, K.; de Lourdes, M.; Seabra, V.; Lobo, L.L. Effects of prolonged administration of valepotriates in rats on the mothers and their offspring. *J. Ethnopharmacol.* **1994**, *41*, 39–44.
79. Brinker, F. *Herb Contraindications and Drug Interactions*, 2nd Ed.; Eclectic Medical Publications: Sandy, OR, 1998; Vol. 134, 162–163.

# Vitamin A

## A. Catharine Ross

The Pennsylvania State University,  
University Park, Pennsylvania, U.S.A.

## INTRODUCTION

Vitamin A (all-*trans*-retinol, vitamin A alcohol) is the parent molecule of a family of compounds with shared biological activities. Collectively, these compounds are essential for visual functions and for the maintenance of healthy epithelial tissues (skin, immune system organs, gastrointestinal tract, reproductive organs, lungs, and others). The nutritional term vitamin A encompasses both preformed vitamin A and provitamin A. Preformed vitamin A (retinol and its esters) occurs naturally in foods of animal origin and is added in the preparation of some fortified foods and nutritional supplements. Provitamin A compounds ( $\beta$ -carotene,  $\alpha$ -carotene, and  $\beta$ -cryptoxanthin), which are synthesized by plants as accessory photosynthetic pigments, can be metabolized by humans and animals to retinol. The essential metabolites of vitamin A include 11-*cis*-retinaldehyde, the form required for vision, and all-*trans*-retinoic acid (RA), which functions as a hormone and an essential regulator of gene transcription.

## NAME AND GENERAL DESCRIPTION

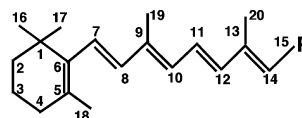
Retinol is a fat-soluble compound,  $C_{20}H_{30}O$ , molecular weight 286.44, which can be converted in vivo to all of the other essential forms of vitamin A. The structure of retinol includes a methyl-substituted cyclohexenyl ( $\beta$ -ionone) ring and a conjugated tetraene side chain ending in a terminal hydroxyl group (Fig. 1). The predominant retinyl ester in foods as well as in most human tissues is retinyl palmitate. The retinol in supplements is usually of synthetic origin and is often esterified with palmitic or acetic acid for greater product stability. Vitamin A<sub>2</sub> (3,4-didehydroretinol) is a minor variant found in some freshwater fishes. Its biological activity is qualitatively similar to that of retinol, but quantitatively about half as much.<sup>[1]</sup>

Retinol in the diet serves as a precursor for the regulated production of several essential metabolites. Among these are 11-*cis*-retinaldehyde, the form of vitamin A that is essential for vision, and all-*trans*-RA, the form that is most potent in cell and tissue differentiation assays. However, numerous other retinoids (cis-*trans* isomers, ring-oxidized derivatives, and conjugated forms) have been isolated from plasma, tissues, bile, and excreta. It is likely that several dozen different natural retinoids exist, many with some detectable biological activity. Some of these can best be categorized as precursors ( $\beta$ -carotene, retinol) that may give rise to active metabolites (11-*cis*-retinaldehyde, RA), and some are mainly catabolic end products (ring-oxidized retinoids; conjugated water-soluble forms). However, there are exceptions; for example, retinoyl- $\beta$ -glucuronide, a water-soluble conjugated form present in bile, shows bioactivity in some assays, perhaps as a result of the release of RA.

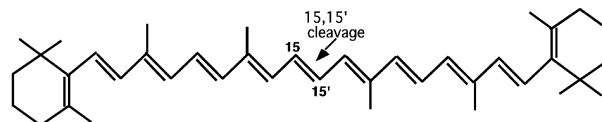
$\beta$ -Carotene is a fat-soluble hydrocarbon,  $C_{40}H_{56}$ , molecular mass 536 g/mol, with two  $\beta$ -ionone rings (identical to those in retinol) connected by a methyl-substituted polyene chain (Fig. 1B). During absorption, the molecule is cleaved either centrally at the

### A. Retinol (all-*trans*)

R = CH<sub>2</sub>OH, retinol  
R = CH<sub>2</sub>O-fatty acyl group, retinyl ester  
R = CHO, retinaldehyde  
R = COOH, retinoic acid



### B. All-*trans*- $\beta$ -Carotene



**Fig. 1** (A) Retinol. R indicates the various substituents at carbon 15 giving rise to retinol, retinyl esters, retinaldehyde, and retinoic acid. Some of these molecules also exist naturally in several isomeric forms, such as 9-*cis*, 11-*cis*, and 13-*cis* isomers. (B)  $\beta$ -Carotene. The position of central (symmetrical) cleavage at the 15,15' double bond is shown.

A. Catharine Ross, Ph.D., is Professor at the Department of Nutritional Sciences, The Pennsylvania State University, University Park, Pennsylvania, U.S.A.

15,15' bond (see figure) or off-center (eccentrically) to yield up to two, but often only one, molecule(s) of retinol. The efficiency with which humans convert the  $\beta$ -carotene contained in supplements or foods to retinol varies considerably among subjects (see section on "Intestinal Vitamin A Absorption"). The provitamin A carotenoids  $\alpha$ -carotene and  $\beta$ -cryptoxanthin, each having a single  $\beta$ -ionone ring, have about half the bioactivity of  $\beta$ -carotene. Several carotenoids that are relatively abundant in foods (lutein, zeaxanthin, lycopene, phytofluene) lack the  $\beta$ -ionone structure, which is crucial to the functions of vitamin A.

## BIOCHEMISTRY AND FUNCTION

### Activation

Neither retinol nor  $\beta$ -carotene is directly bioactive. Both compounds must be metabolized to generate the bioactivity of vitamin A.<sup>[2]</sup>

Key reactions in the conversion of retinyl esters and  $\beta$ -carotene to retinol, and in the oxidation of retinol to RA, are shown in Fig. 2. Biosynthesis and catabolism are both important as a means for controlling the cellular levels of retinoids, especially hormonally active forms such as RA. For most of the reactions shown, several enzymes have been described. It is uncertain at this time which of them are critical and which may serve ancillary or redundant functions. As shown in Fig. 2, the oxidation of retinaldehyde to RA is irreversible. The regulatory enzymes involved in these steps, and how they differ in different tissues, are being investigated intensively because they may determine the capacity of various tissues to use retinol *in vivo*.

### Hormonal Functions

The hormonal functions of vitamin A are mediated mostly, if not entirely, by RA, which acts both as a

classical endocrine hormone that is transported from its sites of origin to its target organs through plasma, and as a locally produced paracrine or autocrine regulator. Tissues must maintain an appropriate level of RA for many processes, including normal embryogenesis and the maintenance of differentiated epithelial cells throughout the life cycle. Proper differentiation, in turn, affects the health of the skin, immune system, reproductive organs, and other organ systems.

Retinoic acid exists in at least three isomeric forms: all-*trans*-RA, 9-*cis*-RA, and 13-*cis*-RA. All-*trans*-RA, the most potent form in most cell differentiation assays, is a specific ligand for the nuclear retinoic acid receptor, RAR (described below). 9-*cis*-RA binds to both RAR and retinoid X receptor (RXR), although its main physiological target is considered to be the activation of the RXRs. 13-*cis*-RA is an enigmatic retinoid—while it is present in human plasma, possesses bioactivity in some assays, and is used clinically, this isomer has not been shown to be a significant ligand for nuclear retinoid receptors. It is possible that it undergoes slow conversion to all-*trans*- or 9-*cis*-RA and therefore acts as a precursor.

### Nuclear Receptors

The RARs and RXRs are members of the steroid/thyroid hormone receptor superfamily. There are three genes in each family, alpha, beta, and gamma, and their gene products are differentially expressed in various tissues. Nearly all cell types express at least one form of RAR and RXR. Each RAR and RXR protein has a DNA-binding domain (DBD) that interacts with specific DNA sequences (response elements) present in retinoid-responsive genes. Each receptor also has a ligand-binding domain (LBD) capable of binding all-*trans*-RA (the RARs) or 9-*cis*-RA (principally the RXRs). Binding of a retinoid ligand induces a conformational change in the receptor protein that

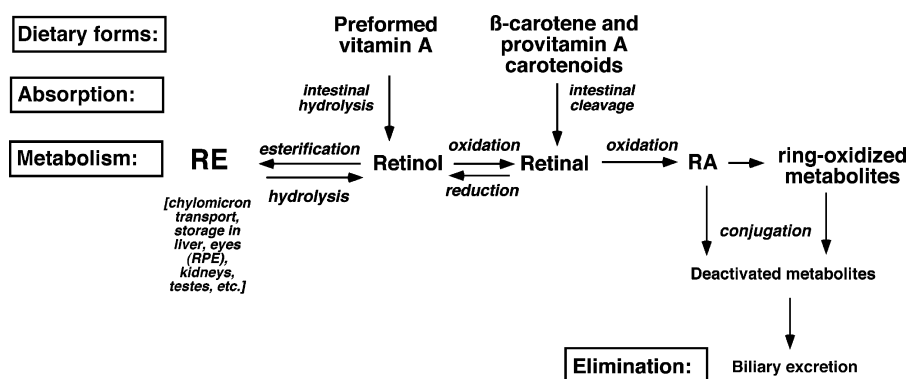


Fig. 2 Schematic summary of the major forms of vitamin A in the diet, their conversion to active metabolites by cellular metabolism, and their elimination from the body. RE, retinyl ester; RA, retinoic acid.

facilitates the formation of RAR–RXR heterodimers and also facilitates their interaction with DNA response elements and additional coactivator or corepressor molecules. Three modes of regulation have been described. Ligand-activated gene transcription is the mode of regulation that seems to apply to most retinoid-responsive genes. However, active antagonism (opposition against the binding of other transcription factors, such as to AP-1 sites) and transcriptional repression (sometimes involving unliganded receptors) have also been described. Which of these outcomes occurs appears to depend on specific features of the gene's promoter region binding elements, and/or on the recruitment of other specific transcription factors and general coactivator or corepressor proteins to the RAR–RXR complex.<sup>[3,4]</sup> A large number of synthetic retinoid analogs have been shown to possess agonistic or antagonistic actions on gene expression. Compounds that selectively bind to RXRs are known as “rexinoids.” These have the potential to affect multiple hormonal pathways in which RXR plays a role, because RXR also serves as the heterodimeric partner of the vitamin D receptor, thyroid hormone receptor, peroxisome proliferator activator receptors (PPARs), lipid-activated receptors (LXR, FXR), and xenobiotic-activated receptors (PXR).<sup>[5]</sup>

## Development

Retinoic acid signaling is first observable soon after gastrulation and appears to be critical for the establishment of the body's axes and overall pattern. Genes of the Hox family that are involved in establishing the anterior–posterior body axis are regulated directly or indirectly by RA. The development of tissues of neural crest origin, as well as the development of the limbs, cardiovascular system, sensory organs, and other organ systems, is affected by either a nutritional deficiency of vitamin A or an excess of either vitamin A or acidic retinoids during critical periods of gestation.<sup>[6]</sup> The types of birth defects seen in the offspring of women unintentionally exposed to an excess of RA during early gestation have been produced experimentally in retinoid-treated animals.

Studies of early mouse and avian embryos have shown the presence of cellular retinoid-binding proteins, nuclear retinoid receptors, and certain enzymes involved in RA production (RALDH2) and catabolism (CYP26) at early stages of gestation. RA levels appear to be closely regulated by the embryo's own tissues from the very early stages of development, based on the expression of biosynthetic and catabolic enzymes. However, it is possible for these autonomous mechanisms to be overwhelmed if the supply of retinol is either too little or too much.

## Differentiation

Biological retinoids, particularly all-*trans*-RA, and synthetic retinoids are capable of controlling cell growth and inducing cell differentiation. In stem cells, cancer cells, and hyperplastic cells, a reduction in proliferation often precedes or appears to occur concomitantly with a shift to the expression of genes characteristic of the mature cell phenotype. In susceptible cells, retinoids may also induce programmed cell death (apoptosis). The ability of retinoids to control the proliferation of certain cell types has led to extensive clinical testing and the development of successful treatments (e.g., for acute promyelocytic leukemia and psoriasis). Numerous novel synthetic retinoids have been synthesized in an effort to achieve greater efficacy and reduce the toxicity inherent to natural retinoids.

A large number of genes contain response elements capable of binding RAR and RXR. These genes fall into diverse groups—some code for structural proteins and others for enzymes, receptors, growth factors and cytokines, and regulatory factors. Essentially all organ systems depend on retinoids for their integrity, but some, such as epithelial tissues (skin, respiratory tract, the immune system, the reproductive systems, etc.), are especially sensitive and are often the first tissues to exhibit changes during the onset of vitamin A deficiency or hypervitaminosis A.<sup>[7]</sup>

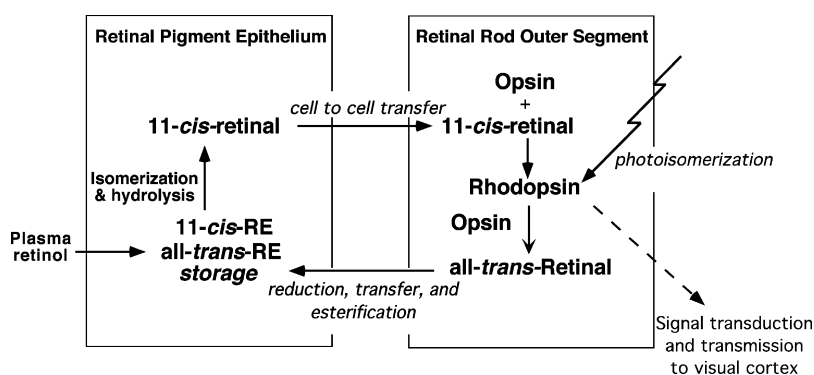
## Ocular Functions

Vitamin A plays two distinct roles in the eyes. In the retina, 11-*cis*-retinaldehyde functions as part of the visual pigment that absorbs light and is critical for phototransduction. In the cornea and conjunctival membranes (and probably in other cell types in the eye), RA is necessary for the proper maintenance of cells, including the mucus-secreting goblet cells (see section on “Cornea and Conjunctiva”).

## Retina

The retinal pigment epithelium (RPE) is a continuous single layer of epithelial cells lining the retina that plays multiple roles with respect to vitamin A metabolism: The RPE cells take up retinol from the blood, store it in the form of retinyl esters, and convert retinol to 11-*cis*-retinaldehyde, the form of vitamin A that is essential for the production of the visual pigments present in the rods and cones (Fig. 3). Moreover, RPE cells are necessary to maintain the nearby photoreceptor cells—the rods and cones—whose outer segment regions contain the photosensitive proteins (also known as visual pigments) rhodopsin and iodopsin,





**Fig. 3** Processes and reactions of the visual cycle. The interplay of the retinal pigment epithelium cell layer and the adjacent photoreceptor cells (rods and cones) is crucial to vision.

respectively. Rod cells are ideally suited for the detection of motion and for vision in dim light, while the less numerous color-sensitive cones, which are present in the retina of humans, but not in all vertebrates, are distributed mostly in the fovea.<sup>[8]</sup> Molecules of 11-*cis*-retinaldehyde that are formed in the RPE must be transported to the rod and cone outer segments, where they then become covalently bound, each to a molecule of opsin protein, forming rhodopsin and iodopsin. The process of vision is initiated when light, striking the 11-*cis*-retinaldehyde moiety of rhodopsin, catalyzes its photoisomerization. This change in molecular conformation triggers a neuronal signaling pathway to the visual cortex. For vision to continue without interruption, the all-*trans*-retinaldehyde produced by photoisomerization must be converted back to 11-*cis*-retinaldehyde. A series of reactions known as the visual cycle occurs in the photoreceptor cells together with the RPE to regenerate 11-*cis*-retinaldehyde. When the level of vitamin A stored in the RPE is low (for example, during the onset of vitamin A deficiency) the visual cycle is slowed. This results in impaired dark adaptation, known clinically as night blindness.

### Cornea and conjunctiva

Progressive change in the conjunctival and corneal membranes (xerophthalmia) is one of the earliest recognized manifestations of vitamin A deficiency. The cornea, an avascular tissue, obtains retinol from holo-retinol-binding protein (holo-RBP) in tear secretions. This retinol seems to be oxidized locally, producing RA, which functions in the maintenance of the corneal epithelium. The mucus-secreting goblet cells of the conjunctiva are disrupted in vitamin A deficiency, contributing to dryness (xerosis) and the formation of Bitôt's spots (foamy patches, usually located on the outer quadrants of the eye, that contain dead cells and bacteria). As vitamin A deficiency progresses, the cornea may become soft (keratomalacia). Remarkably, this progression can be halted and

vision rescued by providing a high dose of vitamin A (typically 60 mg or more), even at this late stage of deficiency.<sup>[9]</sup> Without treatment, the lens undergoes ulceration, resulting in irreversible blindness.

## PHYSIOLOGY

### Transport and Binding Proteins

#### Retinol-binding protein (RBP)

The RBP gene, located on human chromosome 10q23–24, encodes an open reading frame for a 199-amino acid proprotein from which a 16-amino acid signal peptide is removed cotranslationally, forming the mature 183-amino acid RBP. Whereas RBP mRNA is relatively abundant in hepatocytes and the liver is likely to be the primary site of RBP synthesis, it is also present at lower levels (5–10% of liver levels) in the kidney and several other organs,<sup>[10]</sup> indicating that they also may produce RBP. Retinol-binding protein contains a single high-affinity binding site for one molecule of retinol. When newly synthesized apo-RBP binds retinol, holo-RBP is formed. In plasma, 90–95% of vitamin A is in the form of holo-RBP. The binding of retinol to RBP is further stabilized by the binding of RBP to another transport protein, transthyretin (TTR, also known as prealbumin).<sup>[11]</sup>

#### Cellular retinoid-binding proteins

Several different intracellular retinoid-binding proteins have been isolated. In general, they are similar in structure (several belong to the same gene superfamily) but preferentially bind either retinol or RA. They also differ in their distribution in organs and cell types. The functions of these proteins appears to be twofold: They provide aqueous solubility to their lipid-soluble retinoids, and they act as chaperones to direct their retinoid “cargo” to specific enzymes that catalyze

retinol esterification or oxidation, or RA oxidation.<sup>[12]</sup> Additionally, cellular retinoic acid-binding proteins may regulate the distribution of RA between the cytoplasm and the nucleus of cells and affect gene transcription. Despite abundant evidence that the cellular retinoid-binding proteins are important in retinoid metabolism, studies of mice lacking one or more of these binding proteins have shown the animals to be viable and to lack a serious phenotype. Mice lacking cellular retinol-binding protein did, however, develop vitamin A deficiency very rapidly when they were fed a low vitamin A diet.<sup>[13]</sup> This result implies that the cellular retinoid-binding proteins may have evolved to facilitate the conservation of vitamin A.

## Metabolism

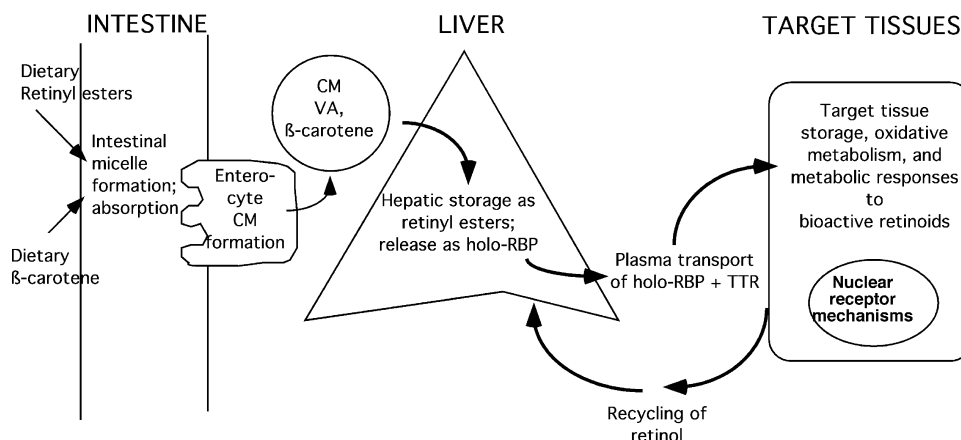
### Intestinal vitamin A absorption

**Preformed Vitamin A.** Dietary retinyl esters must be hydrolyzed in the lumen prior to absorption. Several retinyl ester hydrolases (REHs) are secreted in pancreatic juice or are present on the brush border of enterocytes in the duodenum and jejunum (Fig. 4). Both bile salts and products of lipid digestion are necessary for micelle formation, which is essential for the uptake of retinol into enterocytes. Therefore, sufficient bile must be produced and the diet must contain an adequate quantity of fat (generally >5%) for the maximal absorption of vitamin A. Any condition that impairs the luminal digestion and emulsification of dietary fat is likely to simultaneously reduce the absorption of vitamin A. The efficiency of retinol absorption into the body is quite high, about 70–90%.<sup>[14]</sup> Moreover, absorption is not downregulated when intake is elevated. The highly efficient

absorption of retinol, even when intake is very high, is considered part of the etiology of vitamin A toxicity. Once retinol is absorbed into the enterocyte, about 95% of it is re-esterified with long-chain fatty acids. These newly formed retinyl esters are then incorporated into the lipid core of nascent chylomicrons, which, after secretion into the lymphatic system, enter the blood stream.

**Carotenoids.** Provitamin A carotenoids in fruits and vegetables are much less bioavailable because they are, to a significant extent, bound to the food matrices, from which they must be liberated by digestion. It appears that the release of carotenoids from the food matrices of many fruits and especially from fibrous vegetables is relatively inefficient (see section on “Dietary Reference Intakes”). Although pure  $\beta$ -carotene in oily solution is already free from the food matrices, it must still be incorporated into micelles prior to uptake. Overall, the efficiency of utilization of  $\beta$ -carotene is substantially lower and much more variable than that of retinol. Furthermore, the percentage of carotene absorbed tends to fall as the mass of carotene present in the lumen rises.<sup>[14]</sup>

Of the relatively small fraction of provitamin A carotenoid that is actually absorbed and metabolized in enterocytes, most undergoes cleavage by carotenoid oxygenase enzymes. The cloning of a  $\beta$ -carotene mono-oxygenase capable of cleaving the central 15,15' double bond and an asymmetric carotene cleavage enzyme has helped to elucidate how different dietary carotenoids are processed in the small intestines. Because a yield of nearly two molecules of retinal from each molecule of oil-dissolved  $\beta$ -carotene has been obtained in vivo, it is thought that the predominant mechanism is central cleavage. The products of carotene cleavage, retinaldehyde and  $\beta$ -apocarotenals, must



**Fig. 4** Physiology of interorgan vitamin A transfer. The role of the liver in the uptake of chylomicron (CM) vitamin A (VA) from the intestine, the storage of retinyl esters in the liver (mainly in stellate cells), and the recycling of retinol from extrahepatic tissues are emphasized. RBP, retinol binding protein; TTR, transthyretin.

both undergo further metabolism. Of the absorbed carotene that is further metabolized, most is converted to retinol, esterified, and absorbed into lymph as retinyl esters, as described above for vitamin A. A minor portion of the retinaldehyde produced by  $\beta$ -carotene cleavage is oxidized to RA and released into the portal vein. While other provitamin A carotenoids, principally  $\alpha$ -carotene and  $\beta$ -cryptoxanthin, appear to be metabolized in the same way as  $\beta$ -carotene is, they yield only half as much vitamin A activity. This is because they have only one  $\beta$ -ionone ring, a feature essential for retinol. Some foods (notably seaweed and certain algae) contain 9-*cis*- $\beta$ -carotene. However, its fate is less well studied than that of all-*trans*- $\beta$ -carotene. It may in part undergo isomerization to form all-*trans*-derivatives, or it may be used in the formation of 9-*cis*-retinoids.<sup>[15]</sup> Several non-provitamin A carotenoids that are common in the diet, such as lycopene, lutein, and zeaxanthin, can be absorbed and are found in human plasma. However, since they lack a  $\beta$ -ionone ring, they have no provitamin A activity.

A significant proportion ( $\sim 1/3$ ) of the  $\beta$ -carotene absorbed by human enterocytes is incorporated into chylomicrons without undergoing cleavage, whereas most vertebrates convert nearly all of their absorbed  $\beta$ -carotene to retinol. In one clinical study,  $\beta$ -carotene metabolism occurred over an extended period of time after absorption (up to 53 days after feeding<sup>[16]</sup>).

#### Storage and metabolism in liver and extrahepatic tissues

The majority of chylomicron vitamin A is taken up by the liver. Smaller proportions are taken up by adipose and other tissues. Within hours of uptake, these newly assimilated retinyl esters are hydrolyzed and, thereafter, new molecules of retinyl ester are formed by esterification. In the vitamin A-adequate condition,  $>90\%$  of total body vitamin A is present as retinyl esters stored in the liver, most of it in perisinusoidal stellate cells.<sup>[14]</sup>  $\beta$ -Carotene is stored in liver and in fat at relatively low concentrations.

When vitamin A is needed, retinol is released from storage by hydrolysis. The released retinol is bound to newly synthesized RBP, as has been shown in cultured hepatocytes, and then secreted into plasma. If a person's intake of vitamin A is inadequate, nearly all of the liver's vitamin A stores can be mobilized. Once the liver's reserves of vitamin A are exhausted, plasma and tissue retinoid levels fall rapidly, and symptoms of deficiency begin to appear.

Several enzymes in the liver can oxidize retinol to RA. The liver also contains at least one cytochrome P450 enzyme (and possibly more) capable of forming 4-oxo-RA. CYP26A1, a form that is induced by

RA, is relatively abundant in the liver. Numerous retinoid metabolites, which include oxidation products in unconjugated form, as well as conjugates such as retinoyl- $\beta$ -glucuronide, are secreted into bile. Fecal excretion is the major route by which vitamin A is eliminated from the body. In general, the oxidation of the retinoid ring at carbon-4 serves as an initial deactivating reaction and the retinoid formed is then further metabolized, for example, by glucuronidation, which results in the formation of water-soluble retinoids. How these processes are regulated by nutritional factors is not well understood. However, in a study in rats, an enzyme, LRAT, that catalyzes retinol esterification and CYP26 were both elevated in vitamin A-supplemented animals compared to controls, and reduced in animals fed a vitamin A-marginal diet.<sup>[17]</sup> These observations suggest the existence of homeostatic mechanisms capable of keeping the concentrations of retinol and RA within close bounds.

Many extrahepatic tissues, including the eyes, kidneys, lungs, and endocrine organs, store vitamin A as retinyl esters. Except in the retina, the levels are usually 5–10% of those in the liver. Many of these organs also form bioactive retinoids, including RA. These organs may also catabolize retinoids and release the products into plasma. Ultimately, the majority of catabolized vitamin A is excreted into the biliary tract and eliminated in feces.<sup>[18]</sup>

#### Plasma transport

Vitamin A is present in plasma as retinyl esters transported in chylomicrons during absorption, and as retinol bound to RBP, which circulates at a nearly constant level throughout the day. After ingestion, chylomicron vitamin A peaks in lymph and plasma at about 2–6 hr; the magnitude of the peak is directly related to the quantity of vitamin A ingested. Chylomicrons are cleared from plasma with a half-life of  $<20$  min.<sup>[19]</sup>

Except after meals,  $>95\%$  of plasma vitamin A is in the form of retinol bound to RBP-TTR. Fasting plasma concentrations are normally about 60 and 50  $\mu\text{g}$  retinol/dl (2 and 1.7  $\mu\text{M}$ ) in adult males and females, respectively.<sup>[20]</sup> The concentration of RBP is slightly higher, such that RBP is about 90% saturated. In the National Health and Nutrition Examination Surveys (NHANES), retinol levels were shown to increase from childhood to adolescence, and to be higher in adult males than in premenopausal females (30–60 yr). From age 70 yr, the levels were nearly equal in males and females.<sup>[21]</sup>

A significant aspect of retinol physiology is its recycling among organs. Each molecule of retinol is taken up by tissues, esterified and stored, hydrolyzed and

mobilized, and then returned to plasma several times before it undergoes irreversible degradation. Using model-based compartmental analysis of plasma retinol in a healthy young man who had consumed 105  $\mu\text{mol}$  of retinyl palmitate, it was calculated that 50  $\mu\text{mol}$  of retinol passed through his plasma each day, although only 4  $\mu\text{mol}/\text{day}$  was degraded.<sup>[22]</sup> Overall, the body's capacity for vitamin A storage is high, whereas its ability to degrade and eliminate the vitamin seems to be quite limited. These features of metabolism help to explain the propensity for retinyl esters to accumulate in tissues when vitamin A intake exceeds needs.

The relationship between the concentrations of plasma retinol and liver vitamin A is far from linear; in fact, plasma retinol is maintained at a nearly constant level over a wide range of liver vitamin A concentrations.<sup>[20]</sup> Only when liver vitamin A stores are nearly exhausted (<20–30  $\mu\text{g}/\text{g}$ ) and the secretion of holo-RBP is compromised does plasma retinol fall.<sup>[20]</sup> Because of this, plasma retinol is not a good predictor of liver vitamin A reserves, except when it is obviously low. However, it is still used as a provisional indicator of vitamin A status. Values of <0.35, <0.70, <1.05, and >1.05  $\mu\text{mol}$  retinol/L are often interpreted as indicating severe deficiency, marginal deficiency, subclinical low status, and vitamin A adequacy, respectively. Plasma retinol is depressed in states of inflammation and fever, due to a reduction in RBP synthesis,<sup>[23,24]</sup> which further confounds the assessment of vitamin A status during illness. However, as long as tissue vitamin A reserves are adequate, plasma retinol will return to the normal range when inflammation subsides.

When liver vitamin A levels are very high (above  $\sim 300 \mu\text{g}$  total retinol/g liver), plasma total retinol may rise. However, this increase is due not to unesterified retinol, but rather to the presence of unmetabolized retinyl esters in chylomicrons and other plasma lipoproteins. Elevated fasting retinyl esters are a sign of hypervitaminosis A (see later section).

Plasma  $\beta$ -carotene levels tend to reflect recent carotenoid intake. They may, however, vary considerably among similarly treated subjects due to intraindividual differences in absorptive efficiency.

Several acidic retinoids are present in plasma in low (nanomolar) concentrations. These include all *trans*- and 13-*cis*-RA, which circulate bound to albumin, not RBP. In pharmacokinetic studies of the clearance of RA from the plasma of nonhuman primates given high doses of all-*trans*-RA or 9-*cis*-RA, the half-lives were of the order of <1–2 hr, although clearance did not necessarily follow first-order kinetics.<sup>[25]</sup>

### Renal loss

Only a relatively small fraction of retinol and its metabolites is excreted in urine. Studies have shown

that RBP is filtered in the glomerulus and that the complex of RBP–TTR ( $\sim 75 \text{ kDa}$ ) is less susceptible to urinary loss than is the smaller apo-RBP ( $\sim 21 \text{ kDa}$ ). A multiligand membrane receptor, megalin, has been implicated in the recovery of RBP from the renal filtrate. Mice lacking megalin excreted more RBP and retinol in urine than normal mice.<sup>[26]</sup> The kidneys are known to express RBP mRNA, and the production of new RBP by the kidneys may be important for the recovery of retinol from the renal filtrate and its recycling in plasma.

## VITAMIN A DEFICIENCY

Insufficient vitamin A is still a public health problem in large parts of the developing world. Foods containing vitamin A may be scarce, or they may be present but not considered appropriate for feeding to the most vulnerable groups. Young children after weaning and women of reproductive age, especially pregnant women,<sup>[27,28]</sup> are most susceptible to becoming vitamin A deficient. For example, night blindness is most common in preschool-age children and pregnant women<sup>[29]</sup> (see section on “Ocular Functions”).

Vitamin A deficiency is also manifest by various systemic effects, including dryness of the skin (follicular hyperkeratosis), loss of mucus-secreting goblet cells in the trachea and respiratory tract, and a generalized metaplasia of epithelial tissues throughout the body. Immune system functions, especially those involving T cells, are often impaired in vitamin A-deficient animals and humans.<sup>[24,30]</sup>

No specific deficiency of  $\beta$ -carotene is known and no essential function has been described for it other than being a precursor of retinol.<sup>[31]</sup> As long as the sum of dietary  $\beta$ -carotene and retinal is adequate, the body's needs for vitamin A can be met. Nonetheless, carotenoids are widely thought of as lipid-soluble antioxidants and may have functions apart from their role as vitamin A.

## FOOD SOURCES, INDICATIONS, AND USE

### Food Sources

Vitamin A is contained in foods of both animal and plant origin, albeit in different chemical forms (Table 1). Individuals with widely differing dietary patterns (omnivorous, vegetarian, vegan) can obtain adequate vitamin A from their preferred type of diet. Prefomed vitamin A is present in highest concentrations in liver and fish oils. Milk and egg yolks contain prefomed vitamin A as well as some provitamin A. Provitamin A is the only form present in fruits and vegetables. Most provitamin A is consumed in leafy

**Table 1** Food sources of vitamin A

Sources	%DV <sup>a</sup>
<i>Animal sources of preformed vitamin A</i>	
Liver, beef, cooked, 3 oz	610
Liver, chicken, cooked, 3 oz	280
Fat free milk, fortified with vitamin A, 1 cup	10
Cheese pizza, 1/8 of a 12 in. diameter pie	8
Milk, whole, 3.25% fat, 1 cup	6
Cheddar cheese, 1 oz	6
Whole egg, 1 medium	6
<i>Plant sources of <math>\beta</math>-carotene and other provitamin A carotenoids</i>	
Carrot, 1 raw (7-1/2 in. long)	410
Carrots, boiled, sliced, 1/2 cup	380
Sweet potatoes, canned, drained solids, 1/2 cup	140
Spinach, frozen, boiled, 1/2 cup	150
Mango, raw, sliced, 1 cup	130
Vegetable soup, canned, chunky, ready-to-serve, 1 cup	115
Cantaloupe, raw, 1 cup	100
Kale, frozen, boiled, 1/2 cup	80
Spinach, raw, 1 cup	40
Apricot nectar, canned, 1/2 cup	35
Tomato juice, canned, 6 oz	20
Apricots, with skin, juice pack, 2 halves	10
Pepper, sweet, red, raw, 1 ring, 3 in. diameter, 1/4 in. thickness	10
Peach, raw, 1 medium	10
Papaya, raw, cubed, 1 cup	8

<sup>a</sup>%DV = Daily value. DVs are reference numbers based on the recommended dietary allowance (RDA). Daily values are set by the government and reflect current nutrition recommendations for a 2000 cal reference diet (<http://www.fda.gov/fdac/special/foodlabel/dvs.html>). The DV is not a unit of bioactivity. It is, however, a useful tool for quickly comparing the vitamin A contents of various foods. The DV for vitamin A is 5000 IU (1500  $\mu$ g retinol = 1500 RAE). %DVs are based on a 2000 cal diet.

(From <http://www.nal.usda.gov/fnic/foodcomp>.)

green and yellow vegetables; tomato products; colored fruits such as mangoes, oranges, and apricots; and some vegetable oils such as corn oil. In the United States, milk, cereals, and infant formulas may be fortified with vitamin A. Based on a U.S. survey from 1994 to 1996, the major contributors of vitamin A were vegetables and fruits (~55%), followed by dairy products and meats (~30%).<sup>[14]</sup> The median adult intake in the U.S. NHANES III survey was equivalent to ~687  $\mu$ g retinol activity equivalent (RAE)/day (see Table C-8 in Ref.<sup>[14]</sup>). The contents of bioactive retinoids such as retinal and RA in foods are inconsequential. These compounds must be formed in vivo from vitamin A.

### Units of Activity

Due to differences in the composition and bioavailability of vitamin A present in various foods, it has been necessary to adopt average equivalency factors for the purpose of estimating the total amount (bioactivity) of vitamin A contained in a particular food or in

a person's diet. Over the years, several units have been defined. Table 2 summarizes the relationship between these units. The newest unit, the retinol activity equivalent (RAE) unit, is used to express the dietary reference intake (DRI) values for vitamin A (see following section).<sup>[14]</sup> The labels on most pharmaceutical preparations and the values in food tables before 2001 show vitamin A expressed in older units [international units (IU) or retinol equivalents (RE)]. The change to RAE from the RE unit that was used for the 1989 recommended dietary allowances (RDAs) was necessitated by a re-evaluation of the nutritional equivalency of carotenoids in foods, compared to retinol. Because isotope dilution studies had shown that the utilization (bioconversion and absorption) of carotenoids in fruits and vegetables is lower and more variable than had previously been thought, a new set of conversion values was needed.<sup>[14]</sup> Significant interindividual variations have been observed in the response to oral doses of pure  $\beta$ -carotene in supplements and to carotenoid-containing foods,<sup>[32,33]</sup> which is thought to reflect differences in the efficiency of carotene uptake into the mucosa, intracellular cleavage, postabsorptive

**Table 2** Units of vitamin A activity currently used

Name of unit	Basis of definition	Equivalency (compounds in the all-trans configuration)
International unit (IU)	Comparisons of retinol and $\beta$ -carotene bioactivity, typically made in rat growth assay	1 IU = 0.3 $\mu$ g retinol 0.3 $\mu$ g RE (see below) 0.0105 $\mu$ mol retinol 3 IU $\beta$ -carotene 1.8 $\mu$ g $\beta$ -carotene 3.6 $\mu$ g other provitamin A carotenoids
Retinol equivalent (RE)	Based on IU system but redefined and expanded to include equivalencies for provitamin A carotenoids in foods	1 RE = 1 $\mu$ g retinol 0.00349 $\mu$ mol retinol 2 $\mu$ g $\beta$ -carotene (pure, in oil) 6 $\mu$ g $\beta$ -carotene in foods 12 $\mu$ g other provitamin A carotenoids
Retinol activity equivalent (RAE) (2001, Institute of Medicine)	Based on RE system but modified to reflect new information showing a lower bioavailability of carotenoids in most foods than estimated previously	1 RAE = 1 $\mu$ g retinol 12 $\mu$ g $\beta$ -carotene (in oil) 12 $\mu$ g $\beta$ -carotene in foods 24 $\mu$ g other provitamin A carotenoids in foods

clearance from plasma, or a combination of these factors.<sup>[16,33]</sup>

### Dietary Reference Intakes

The DRIs are a set of nutrient-based reference values established by expert committees of the U.S. Food and Nutrition Board of the Institute of Medicine (IOM) to provide guidance for planning diets. They extend and expand the concepts previously established for RDAs. For vitamin A, there are four DRI categories: estimated average requirement (EAR), RDA, adequate intake (AI), and tolerable upper intake level (upper level, UL). In practice, the EAR is used to calculate the RDA, which is defined as the average daily dietary intake level that is sufficient to meet the nutrient requirements of nearly all healthy individuals. Recommended dietary allowances are set for life-stage and gender groups.

Dietary reference intake values for vitamin A were established by the IOM in 2001.<sup>[14]</sup> To calculate EAR values, data for adult men and women were used in a computational method that took into account the amount of vitamin A lost per day, minimum acceptable liver vitamin A reserves, organ and body weight factors, and efficiency of tissue storage. The RDA was then calculated as the EAR + 20%. Values for adolescents and children were based on adult values, scaled down on the basis of body weight. Reference values are given in Table 3. The EAR and 2001 RDA are expressed in RAE (see previous section).

For infants, an AI was set based on the average amount of vitamin A in human breast milk that is consumed by infants in these age groups (Table 4). UL recommendations are discussed below in the section on “Adverse Effects.”

### Use in Disease

In economically developed countries with an abundant food supply, there are few, if any, indications for vitamin A supplementation. However, if supplements that

**Table 3** Recommended dietary allowances (RDAs)<sup>a</sup> for vitamin A consumption

Group	RDA ( $\mu$ g RAE/day)	
<i>Children</i>	<i>Boys</i>	<i>Girls</i>
1–3 yr	300	300
4–8 yr	400	400
9–13 yr	600	600
14–18 yr	900	700
<i>Adults</i>	<i>Men</i>	<i>Women</i>
10 yr and older	900	700
<i>Pregnancy</i>		
14–18 yr		750
19–50 yr		770
<i>Lactation</i>		
14–18 yr		1200
19–50 yr		1300

<sup>a</sup>U.S. Food and Nutrition Board of the Institute of Medicine, 2001.

**Table 4** Recommended adequate intakes (AIs)<sup>a</sup> for vitamin A consumption ( $\mu\text{g}$  RAE/day)

Infants	Boys	Girls
0–6 mo	400	400
7–12 mo	400	400

<sup>a</sup>U.S. Food and Nutrition Board of the Institute of Medicine, 2001. 1  $\mu\text{g}$  RAE (retinol activity equivalent) = 1  $\mu\text{g}$  all-*trans*-retinol.

contain vitamin A are used, care should be taken that the total amount of *performed* retinol in food, fortified foods, and supplements does not exceed the UL (see “Adverse Effects”). The majority of nutritional supplements contain either all or at least a part of their vitamin A as retinol or retinyl ester. The amount of vitamin A in various supplements differs widely, from less than the U.S. RDA (<100% DV), to 100% DV or higher. (See Table 1 for representative %DV in foods.)

Vitamin A, as retinol, is used prophylactically to reduce the risk of deficiency and improve child survival in developing countries, where vitamin A deficiency is still prevalent. It has been tested in several studies and found to be consistently efficacious.<sup>[34]</sup> Because the body can efficiently absorb and store a significant amount of vitamin A in the liver, from which retinol can be released slowly over time, it is possible to provide a single large oral dose, usually as retinyl palmitate, at intervals as far as 4–6 mo apart. The safety of high-dose vitamin A was considered a concern, but a number of studies have shown that doses of 100,000–200,000 IU (30–60 mg retinol) can safely be given to children <1 yr and >1 yr, respectively.<sup>[35]</sup> In countries where measles mortality is high, the provision of vitamin A to children with measles is now standard care.<sup>[36]</sup>

$\beta$ -Carotene is sometimes used for purposes other than to provide vitamin A. High doses of  $\beta$ -carotene have been used for long periods of time in patients with the light-sensitive skin disease erythropoietic protoporphyria, without development of retinoid-like toxicity.<sup>[37]</sup> Certain cosmetic changes (e.g., yellow skin complexion, carotenoderma) are associated with consumption of large amounts of  $\beta$ -carotene, but they are considered benign and disappear over time after intake is stopped. Although neither a high intake of carotenoids in the diet nor the use of  $\beta$ -carotene supplements is known to produce toxicity, a “safe range” of intracellular  $\beta$ -carotene has yet to be determined.<sup>[37]</sup>

Several natural and synthetic analogs of RA are approved for use as drugs; these should be used only under the supervision of a physician and are not considered to be dietary supplements. Most synthetic retinoids have been designed to retain the hormonal activity of RA, or to have receptor-selective hormonal effects. However, no effective retinoid has yet been

shown to be without any side effects, and most are potentially teratogenic. Among the retinoids used in dermatology and cancer chemoprevention<sup>[38]</sup> are all-*trans*-RA (tretinoin) and 13-*cis*-RA (isotretinoin, Accutane<sup>®</sup>, and Acitretin<sup>®</sup>). All-*trans*-RA is used in the treatment of acute promyelocytic leukemia.<sup>[39]</sup>

## ADVERSE EFFECTS

### Hypervitaminosis A

An excessive intake of *performed* vitamin A is associated with elevated plasma retinyl esters and saturation of vitamin A storage mechanisms in tissues. This condition is generally referred to as hypervitaminosis A. Although hypervitaminosis A may be due to excess consumption of foods high in retinyl esters (such as liver), it is most often due to the use of high-dose supplements containing preformed vitamin A, or synthetic retinoids. Depending on the length of exposure and dosage, the resulting toxicity may be tolerable, severe, or even lethal. The hallmarks of mild to moderate vitamin A toxicity include dizziness and nausea, changes in cerebrospinal fluid pressure, abnormal liver functions, and pain in weight-bearing bones and joints. These effects may be due to membrane lysis and/or inappropriate gene regulation. An excess of vitamin A or retinoid drugs during pregnancy can be teratogenic, resulting in severe craniofacial abnormalities and other defects, or fetal death.<sup>[40]</sup>

There is no antidote for excess tissue vitamin A, which has a propensity to be retained in fatty tissues. It takes a very long time for tissue vitamin A levels to fall after intake is discontinued, and the liver damage resulting from hypervitaminosis A may be irreversible.

### Upper Levels

Due to the serious and potentially irreversible effects of an excess intake of vitamin A, the IOM report of 2001 established a UL for preformed vitamin A.<sup>[14]</sup> The UL is defined as the highest intake that is likely to pose no risk of adverse health effects in nearly all healthy individuals; it is meant to be a guideline for safe levels of consumption. Due to the body’s capacity to store vitamin A, fluctuations in the day-to-day intake are usually not a cause for concern, but intakes that are elevated over an extended time are potentially detrimental. The UL applies specifically to *performed* vitamin A, whether obtained from foods, fortified foods, or supplements. The UL is not meant to apply to individuals taking vitamin A under medical supervision. The critical adverse effects used to calculate the UL were risk of

**Table 5** Tolerable upper intake levels (ULs)<sup>a</sup> for preformed vitamin A consumption ( $\mu\text{g}$  retinol/day)

Group	UL ( $\mu\text{g}$ retinol/day)	
<i>Infants</i>		
0–6 mo	600	
7–12 mo	600	
<i>Children</i>		
	<i>Boys</i>	<i>Girls</i>
1–3 yr	600	600
4–8 yr	900	900
9–13 yr	1700	1700
14–18 yr	2800	2800
<i>Adults</i>		
	<i>Men</i>	<i>Women</i>
10 yr and older	3000	3000
<i>Pregnancy</i>		
14–18 yr	2800	
19–50 yr	3000	
<i>Lactation</i>		
14–18 yr	2800	
19–50 yr	3000	

<sup>a</sup>U.S. Food and Nutrition Board of the Institute of Medicine, 2001.

birth defects (teratogenesis) in women of reproductive age, and liver abnormalities for males and women over 50 yr. Based on this, a UL of 2800–3000  $\mu\text{g}/\text{day}$  was set for adults. Upper intake level values for children were scaled down based on body weight. Table 5 provides UL values for vitamin A by age groups.<sup>[14]</sup> It is noteworthy that the UL values for vitamin A for some age–sex groups are less than fourfold above the RDA (see Table 3). A person's intake of carotenoids from foods and supplements is *not* included in calculating the UL.

Users of supplements containing retinol or an ester of retinol should evaluate their average *combined* intake from diet (liver, milk, dairy products), fortified foods (e.g., breakfast cereals), and supplements to assure that it does not exceed the UL. Supplements for children should be checked to assure that they are suitable for the child's age. For example, an adult supplement containing 5000 IU as retinol (equal to 1500  $\mu\text{g}$ ) contains more than the UL for children 1–3 and 4–8 yr of age (UL of 600 and 900  $\mu\text{g}$ , respectively; Table 5).

### Contraindications

The teratogenic potential of preformed vitamin A is a significant concern.<sup>[14,40]</sup> Women who could be pregnant should not take high-dose vitamin A supplements, and should avoid total intakes of preformed vitamin A that exceed the UL. Several synthetic retinoids that are prescribed for therapeutic use are known to be teratogenic and contraception is essential

when they are used by women capable of becoming pregnant.

### Interactions

There are relatively few nutritionally significant interactions between vitamin A and other nutrients. Iron deficiency may impair the body's ability to mobilize vitamin A from storage, and vitamin A deficiency may have a similar effect on iron.<sup>[41]</sup> Some drug–nutrient interactions are probable, since vitamin A is itself metabolized by enzymes of the cytochrome P450 family, some of which also metabolize drugs and xenobiotics, including ethanol. The RXR interacts with some receptors involved in drug metabolism, suggesting additional possible interactions. Chronic alcoholism and cirrhosis are associated with markedly reduced levels of liver vitamin A. Nonetheless, retinol and  $\beta$ -carotene have been reported to exacerbate ethanol-induced liver damage, and therefore caution should be exercised regarding the use of vitamin A or  $\beta$ -carotene supplements by alcoholics.<sup>[42]</sup>

### COMPENDIAL/REGULATORY ISSUES

None.

### REFERENCES

- Ross, A.C. Vitamin A and retinoids. In *Modern Nutrition in Health and Disease*, 9th Ed.; Shils, M.E., Olson, J.A., Shike, M., Ross, A.C., Eds.; Williams & Wilkins: Baltimore, 1999; 305–327.
- Ross, A.C.; Zolfaghari, R.; Weisz, J. Vitamin A: recent advances in the biotransformation, transport, and metabolism of retinoids. *Curr. Opin. Gastroenterol.* **2001**, *17*, 184–192.
- Altucci, L.; Gronemeyer, H. Nuclear receptors in cell life and death. *Trends Endocrinol. Metab.* **2001**, *12*, 460–468.
- Wei, L.N. Retinoid receptors and their coregulators. *Annu. Rev. Pharmacol. Toxicol.* **2003**, *43*, 47–72.
- Dawson, M.I.; Zhang, X.K. Discovery and design of retinoic acid receptor and retinoid X receptor class- and subtype-selective synthetic analogs of all-trans-retinoic acid and 9-cis-retinoic acid. *Curr. Med. Chem.* **2002**, *9*, 623–637.
- Clagett-Dame, M.; DeLuca, H.F. The role of vitamin A in mammalian reproduction and embryonic development. *Annu. Rev. Nutr.* **2002**, *22*, 347–381.



7. DeLuca, L.M. Retinoids and their receptors in differentiation, embryogenesis, and neoplasia. *FASEB J.* **1991**, *5*, 2924–2933.
8. Saari, J.C. Biochemistry of visual pigment regeneration. *Invest. Ophthalmol. Vis. Sci.* **2000**, *41*, 337–348.
9. Sommer, A.; West, K.P., Jr. *Vitamin A Deficiency: Health, Survival, and Vision*; Oxford University Press Inc.: New York, 1996.
10. Soprano, D.R.; Blaner, W.S. Plasma retinol-binding protein. In *The Retinoids: Biology, Chemistry and Medicine*, 2nd Ed.; Sporn, M.B., Roberts, A.B., Goodman, D.S., Eds.; Raven Press: New York, 1994; 257–281.
11. Robbins, J. Transthyretin from discovery to now. *Clin. Chem. Lab. Med.* **2002**, *40*, 1183–1190.
12. Dong, D.; Ruuska, S.E.; Levinthal, D.J.; Noy, N. Distinct roles for cellular retinoic acid-binding proteins I and II in regulating signaling by retinoic acid. *J. Biol. Chem.* **1999**, *274*, 23,695–23,698.
13. Ghyselinck, N.B.; Båvik, C.; Sapin, V.; Mark, M.; Bonnier, D.; Hindelang, C.; Dierich, A.; Nilsson, C.B.; Håkansson, H.; Sauvant, P.; Azaïs-Braesco, V.; Frasson, M.; Picaud, S.; Chambon, P. Cellular retinol-binding protein I is essential for vitamin A homeostasis. *EMBO J.* **1999**, *18*, 4903–4914.
14. Institute of Medicine. *Dietary Reference Intakes for Vitamin A, Vitamin K, Arsenic, Boron, Chromium, Copper, Iodine, Iron, Manganese, Molybdenum, Nickel, Silicon, Vanadium, and Zinc*; National Academy Press: Washington, 2001; 82–161.
15. Olson, J.A. Carotenoids. In *Modern Nutrition in Health and Disease*, 9th Ed.; Shils, M.E., Olson, J.A., Shike, M., Ross, A.C., Eds.; Williams & Wilkins: Baltimore, 1999; 525–541.
16. Tang, G.; Qin, J.; Dolnikowski, G.G.; Russell, R.M. Short-term (intestinal) and long-term (post-intestinal) conversion of beta-carotene to retinol in adults as assessed by a stable-isotope reference method. *Am. J. Clin. Nutr.* **2003**, *78*, 259–266.
17. Ross, A.C. Retinoid production and catabolism: role of diet in regulating retinol esterification and retinoic acid oxidation. *J. Nutr.* **2003**, *133*, 291S–296S.
18. Ross, A.C. Hepatic metabolism of vitamin A. In *Hepatology: A Textbook of Liver Disease*, 4th Ed.; Zakim, D., Boyer, T.D., Eds.; Saunders: Philadelphia, 2002; 149–168.
19. Berr, F. Characterization of chylomicron remnant clearance by retinyl palmitate label in normal humans. *J. Lipid Res.* **1992**, *33*, 915–930.
20. Olson, J.A. Serum level of vitamin A and carotenoids as reflectors of nutritional status. *J. Natl. Cancer Inst.* **1984**, *73*, 1439–1444.
21. Life Science Research Office. *Assessment of the Vitamin A Nutritional Status of the U.S. Population Based on Data Collected in the Health and Nutrition Examination Surveys*; FASEB: Bethesda, 1985.
22. Von Reinersdorff, D.; Green, M.H.; Green, J.B. Development of a compartmental model describing the dynamics of vitamin A metabolism in men. *Adv. Exp. Med. Biol.* **1998**, *445*, 207–223.
23. Rosales, F.J.; Ritter, S.J.; Zolfaghari, R.; Smith, J.E.; Ross, A.C. Effects of acute inflammation on plasma retinol, retinol-binding protein, and its mRNA in the liver and kidneys of vitamin A-sufficient rats. *J. Lipid Res.* **1996**, *37*, 962–971.
24. Stephensen, C.B. Vitamin A, infection, and immune function. *Annu. Rev. Nutr.* **2001**, *21*, 167–192.
25. Adamson, P.C.; Murphy, R.F.; Godwin, K.A.; Ulm, E.H.; Balis, F.M. Pharmacokinetics of 9-*cis*-retinoic acid in the rhesus monkey. *Cancer Res.* **1995**, *55*, 482–485.
26. Christensen, E.I.; Moskaug, J.O.; Vorum, H.; Jacobsen, C.; Gundersen, T.E.; Nykjaer, A.; Blomhoff, R.; Willnow, T.E.; Moestrup, S.K. Evidence for an essential role of megalin in trans-epithelial transport of retinol. *J. Am. Soc. Nephrol.* **1999**, *10*, 685–695.
27. Underwood, B.A. Hypovitaminosis A: international programmatic issues. *J. Nutr.* **1994**, *124*, 1467S–1472S.
28. Underwood, B.A. Maternal vitamin A status and its importance in infancy and early childhood. *Am. J. Clin. Nutr.* **1994**, *59*, 517S–524S.
29. Sommer, A. *Nutritional Blindness: Xerophthalmia and Keratomalacia*; Oxford University Press: New York, 1982.
30. Ross, A.C.; Stephensen, C.B. Vitamin A and retinoids in antiviral responses. *FASEB J.* **1996**, *10*, 979–985.
31. Institute of Medicine. *Dietary Reference Intakes for Vitamin C, Vitamin E, Selenium, and Carotenoids*; National Academy Press: Washington, 2000.
32. Hickenbottom, S.J.; Lemke, S.L.; Dueker, S.R.; Lin, Y.; Follett, J.R.; Carkeet, C.; Buchholz, B.A.; Vogel, J.S.; Clifford, A.J. Dual isotope test for assessing beta-carotene cleavage to vitamin A in humans. *Eur. J. Nutr.* **2002**, *41*, 141–147.

33. Lin, Y.; Dueker, S.R.; Burn, B.J.; Neidlinger, T.R.; Clifford, A.J. Variability of the conversion of beta-carotene to vitamin A in women measured by using a double-tracer study design. *Am. J. Clin. Nutr.* **2000**, *71*, 1545–1554.
34. Beaton, G.H.; Martorell, R.; Aronson, K.A.; Edmonston, B.; McCabe, G.; Ross, A.C.; Harvey, B. Vitamin A supplementation and child morbidity and mortality in developing countries. *Food Nutr. Bull.* **1994**, *15*, 282–289.
35. Underwood, B.A.; Smitasiri, S. Micronutrient malnutrition: policies and programs for control and their implications. *Annu. Rev. Nutr.* **1999**, *19*, 303–324.
36. Committee on Infectious Diseases. Vitamin A treatment of measles. *Pediatrics* **1993**, *91*, 1014–1015.
37. Biesalski, H.K.; Obermueller-Jevic, U.C. UV light, beta-carotene and human skin—beneficial and potentially harmful effects. *Arch. Biochem. Biophys.* **2001**, *389*, 1–6.
38. Hansen, L.A.; Sigman, C.C.; Andreola, F.; Ross, S.A.; Kelloff, G.J.; De Luca, L.M. Retinoids in chemoprevention and differentiation therapy. *Carcinogenesis*. **2000**, *21*, 1271–1279.
39. Wang, Z.G.; Delva, L.; Gaboli, M. et al. Role of PML in cell growth and the retinoic acid pathway. *Science* **1998**, *279*, 1547–1551.
40. Soprano, D.R.; Soprano, K.J. Retinoids as teratogens. *Annu. Rev. Nutr.* **1995**, *15*, 111–132.
41. Bloem, M.W. Interdependence of vitamin A and iron: an important association for programmes of anaemia control. *Proc. Nutr. Soc.* **1995**, *54*, 501–508.
42. Leo, M.A.; Lieber, C.S. Alcohol, vitamin A, and  $\beta$ -carotene: adverse interactions, including hepatotoxicity and carcinogenicity. *Am. J. Clin. Nutr.* **1999**, *69*, 1071–1085.



# Vitamin B<sub>6</sub>



**James E. Leklem**

*Oregon State University, Corvallis, Oregon, U.S.A.*

## INTRODUCTION

Vitamin B<sub>6</sub> is unique among the water-soluble vitamins with respect to the numerous functions it serves and its metabolism and chemistry. Within the past few years, the attention this vitamin has received has increased dramatically.<sup>[1–7]</sup>

This entry provides an overview of vitamin B<sub>6</sub> as it relates to human nutrition. Both qualitative and quantitative information is provided in an attempt to indicate the importance of this vitamin within the context of health and disease in humans. The exhaustive literature on the intriguing chemistry of the vitamin is not dealt with in any detail, but readers are encouraged to refer to the citations for further information.

## NAME AND GENERAL DESCRIPTION

As we leave the 20th century behind, there may be a tendency to lose the sense of excitement of discovery that Gyorgy and colleagues experienced when they began to unravel the mystery of the vitamin B complex. Some of the major highlights of the early years of vitamin B<sub>6</sub> research are presented in Table 1. Paul Gyorgy was the first to use the term vitamin B<sub>6</sub>.<sup>[8]</sup> The term was used to distinguish this factor from other hypothetical growth factors B<sub>3</sub>, B<sub>4</sub>, B<sub>5</sub> (and Y).

Since Gyorgy first coined the term, there has been confusion in the terminology of the multiple forms of the vitamin. “Vitamin B<sub>6</sub>” is the recommended generic descriptor for all 3-hydroxy-2-methylpyridine derivatives.<sup>[9]</sup> Fig. 1 depicts the various forms of vitamin B<sub>6</sub>, including the phosphorylated ones. Pyridoxine (once referred to as pyridoxal) is the alcohol form and should not be used as a generic name for vitamin B<sub>6</sub>. The trivial names and abbreviations commonly used for the three principal forms of vitamin B<sub>6</sub>, their phosphoric esters, and analogs are as follows: pyridoxine, PN; pyridoxal, PL; pyridoxamine, PM; pyridoxine-5'-phosphate, PNP; pyridoxal-5'-phosphate, PLP; pyridoxamine-5'-phosphate, PMP; 4-pyridoxic

acid, 4-PA. Other forms of vitamin B<sub>6</sub> exist, particularly bound forms.

The various physical and chemical properties of the phosphorylated and nonphosphorylated forms of vitamin B<sub>6</sub> are given in Table 2. Detailed data on fluorescence<sup>[11]</sup> and ultraviolet<sup>[12]</sup> absorption characteristics of B<sub>6</sub> vitamers are available. Of importance to researchers as well as to food producers and consumers is the relative stability of the forms of vitamin B<sub>6</sub>. Generally, as a group, B<sub>6</sub> vitamers are labile, but the degree to which each is degraded varies. In solution, the forms are light sensitive,<sup>[13,14]</sup> but this sensitivity is influenced by pH. Pyridoxine, pyridoxal, and pyridoxamine are relatively heat stable in an acid medium, but they are heat labile in an alkaline medium. The hydrochloride and base forms are readily soluble in water, but they are minimally soluble in organic solvents.

The coenzyme form of vitamin B<sub>6</sub>, PLP, is found covalently bound to enzymes via a Schiff base with an ε-amino group of lysine in the enzyme. While non-enzymatic reactions with PLP or PL and metal ions can occur,<sup>[14]</sup> in enzymatic reactions, the amino group of the substrate for the given enzyme forms a Schiff base via a transamination reaction. PLP has been reported to be a coenzyme for over 100 enzymatic reactions.<sup>[15,16]</sup> Of these, nearly half involve transamination-type reactions. Transamination reactions are but one type of reaction that occur as a result of Schiff base formation.

## BIOCHEMISTRY AND FUNCTIONS

Before describing the functions of B<sub>6</sub> in human health in greater detail, it is worth noting that the measurement of B<sub>6</sub> vitamers and metabolites is complicated. Not only are there numerous methods, but various matrices are used. Reviews of the methods commonly used are available.<sup>[17–19]</sup>

## ASSESSMENT OF STATUS

The assessment of vitamin B<sub>6</sub> status is central to an understanding of its nutrition in humans. A variety of methods have been utilized for this purpose. These are

---

*James E. Leklem, Ph.D.*, is Emeritus Professor of Nutrition at the Oregon State University, Corvallis, Oregon, U.S.A.

**Table 1** Historical highlights of vitamin B<sub>6</sub> research

1932	A compound with the formula of C <sub>3</sub> H <sub>11</sub> O <sub>3</sub> N is isolated from rice polishings
1934	Gyorgy shows that there is a difference between the rat pellagra preventive factor and vitamin B <sub>2</sub> . He calls this vitamin B <sub>6</sub>
1938	Lepkovsky reports isolation of pure crystalline vitamin B <sub>6</sub> . Keresztesky and Stevens, Gyorgy, Kuhn, and Wendt, and Ichibad and Michi also report isolation of vitamin B <sub>6</sub>
1939	Chemical structure is determined and vitamin B <sub>6</sub> synthesized by Kuhn and associates and by Harris and Folkers
1942	Snell and coworkers recognize existence of other forms of pyridoxine
1953	Snyderman and associates observe convulsions in an infant and anemia in an older child fed a vitamin B <sub>6</sub> -deficient diet

given in Table 3 and are divided into direct, indirect, and dietary methods.<sup>[20–22]</sup> Direct indices of vitamin B<sub>6</sub> status are those in which one or more of the B<sub>6</sub> vitamers or the metabolite 4-pyridoxic acid are measured. These are usually measured in plasma, erythrocytes, or urine samples because tissue samples are not normally available. Indirect measures are those in which metabolites of metabolic pathways in which PLP is required for specific enzymes are measured, or in which activities of PLP-dependent enzymes are determined. In this latter case, an activity coefficient is often determined by measuring the enzyme activity in the presence and absence of excess PLP.

Dietary intake of vitamin B<sub>6</sub> itself is not sufficient to assess vitamin B<sub>6</sub> status, especially if only a few days of data are obtained. In addition to the inherent problems in obtaining accurate dietary intake information, the nutrient databases used in determining the vitamin B<sub>6</sub> content of diets are often incomplete with respect to values for this vitamin. Thus, reports of vitamin B<sub>6</sub> status based only on nutrient intake must be viewed with caution. Some of the suggested values for the evaluation of status given in Table 3 are based on the relationship of vitamin B<sub>6</sub> and tryptophan metabolism.<sup>[23]</sup> Plasma pyridoxal-5'-phosphate concentration is considered one of the better indicators of vitamin B<sub>6</sub>

status.<sup>[24]</sup> Lumeng, Li, and Lui<sup>[25]</sup> have shown that plasma PLP concentration is a good indicator of tissue PLP levels in rats. In humans, plasma PLP concentration is significantly correlated with dietary vitamin B<sub>6</sub> intake.<sup>[26]</sup> The means reported range from 27 to 75 nmol/L for males and from 26 to 93 μmol/L for females (see Table 9 in Ref.<sup>[27]</sup>). These ranges should not necessarily be considered as normal, since the values reflect studies in which dietary intake was controlled and other studies in which dietary intake was not assessed. As discussed by Shultz and Leklem,<sup>[26]</sup> dietary intake of both vitamin B<sub>6</sub> and protein influences the fasting plasma PLP concentration. Miller, Leklem, and Shultz<sup>[28]</sup> have shown that plasma PLP and total vitamin B<sub>6</sub> concentrations in males are inversely related to protein intake in males whose protein intake ranges from 0.5 to 2 g/kg per day. Similar results from metabolic studies in women support these findings in men.<sup>[29]</sup>

Other factors that may influence plasma PLP and should be considered when using this index as a measure of vitamin B<sub>6</sub> status include the physiological variables of age,<sup>[30–32]</sup> exercise,<sup>[33]</sup> and pregnancy.<sup>[34]</sup> Rose et al. determined the plasma PLP concentration in men ranging in age from 18 to 90 yr.<sup>[30]</sup> They observed a decrease in plasma PLP with age, especially after 40 yr of age. However, one must keep in mind that the PLP concentration was determined 1–2 hr after a meal. The intake of vitamin B<sub>6</sub> may have influenced the data. Also, the carbohydrate intake could have resulted in a depressed plasma PLP concentration.<sup>[33]</sup> Hamfelt has reviewed the effect of age on plasma PLP and observed that investigators in several countries<sup>[32]</sup> have seen decreased vitamin B<sub>6</sub> status with increasing age. The mechanism of this decrease remains to be determined. There is one controlled metabolic study that has evaluated vitamin B<sub>6</sub> status in different age groups. Lee and Leklem<sup>[31]</sup> studied five women aged 20–27 yr and eight women aged 51–59 yr under conditions in which the women received a constant daily vitamin B<sub>6</sub> intake of 2.3 mg for 4 weeks, followed by 10.3 mg per day for 3 weeks. Compared

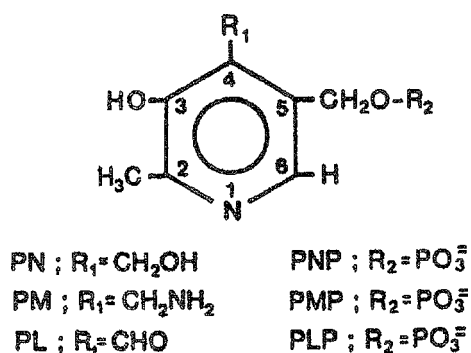
**Fig. 1** Structure of B<sub>6</sub> vitamers. (From Ref.<sup>[27]</sup>.)

Table 2 Physical properties of B<sub>6</sub> vitamers

Vitamin	Molecular weight	Stability to white light <sup>a</sup> (pH 4.5)		pK		Fluorescence maxima <sup>b</sup>		Ultraviolet absorption spectra <sup>c</sup>			
		8 hr	15 hr	pK <sub>1</sub>	pK <sub>2</sub>	Activation (λ)	Emission (λ)	0.1 N HCl		pH 7.0	
								λ <sub>max</sub>	ε <sub>max</sub>	λ <sub>max</sub>	ε <sub>max</sub>
Pyridoxine	169.1	97%	90%	5.0	8.9	325	400	291	8900	254	3760
Pyridoxamine	168.1	81%	57%	3.4	8.1	325	405	293	8500	324	7100
Pyridoxal	167.2	97%	68%	4.2	8.7	320	385	288	9100	317	8800
Pyridoxine-5'-phosphate	249.2	—	—	—	—	322	394	290	8700	253	3700
Pyridoxamine-5'-phosphate	248.2	—	—	2.5	3.5	330	400	293	900	325	7400
Pyridoxal-5'-phosphate	247.2	—	—	2.5	4.1	330	375	293	7200	388	5500
4-Pyridoxic acid	183.2	—	—	—	—	325 <sup>d</sup>	425 <sup>d</sup>	—	—	—	—
						355 <sup>e</sup>	445 <sup>e</sup>				

<sup>a</sup>Percentage stability compared to solution in dark.<sup>[9]</sup> 8 hr, 15 hr = length of time exposed to light.

<sup>b</sup>From Ref.<sup>[10]</sup>; pH 7.0.

<sup>c</sup>Data are for PN-HCl, PL-HCl, PM-2HCl, PLP monohydrate, PMP dihydrate.<sup>[10]</sup>

<sup>d</sup>pH 3.4, 0.01 N acetic acid.

<sup>e</sup>pH 10.5, 0.1 N NH<sub>4</sub>OH, lactone of 4-PA.

**Table 3** Methods for assessing vitamin B<sub>6</sub> status and suggested values for adequate status

Index	Suggested value for adequate status
<i>Direct</i>	
Blood	
Plasma pyridoxal-5'-phosphate <sup>a</sup>	>30 nmol/L <sup>a</sup>
Plasma pyridoxal	NV
Plasma total vitamin B <sub>6</sub>	>40 nmol/L
Erythrocyte pyridoxal-5'-phosphate	NV
Urine	
4-Pyridoxic acid	>3.0 μmol/day
Total vitamin B <sub>6</sub>	>0.5 μmol/day
<i>Indirect</i>	
Blood	
Erythrocyte alanine aminotransferase	>1.25 <sup>b</sup>
Erythrocyte aspartate aminotransferase	>1.80 <sup>b</sup>
Urine	
2 g Tryptophan load test; xanthurenic acid	<65 μmol/day
3 g Methionine load test; cystathionine	<351 μmol/day
Oxalate excretion	NV
<i>Dietary intake</i>	
Vitamin B <sub>6</sub> intake, weekly average	>1.2–1.5 mg/day
Vitamin B <sub>6</sub> : protein ratio	>0.02
Pyridoxine-β-glucoside	NV
<i>Other</i>	
EEG pattern	NV

NV, no value established; limited data available, each laboratory should establish its own reference with an appropriate healthy control population.

<sup>a</sup>Reference values in this table are dependent on sex, age, and protein intake and represent lower limits.<sup>[22]</sup>

<sup>b</sup>For each aminotransferase measure, the activity coefficient represents the ratio of the activity with added PLP to the activity without PLP added.

with the younger women, the older women had a lower mean plasma PLP and plasma and urinary total vitamin B<sub>6</sub> and slightly higher urinary 4-pyridoxic acid excretion with the 2.3-mg intake. Interestingly, there was no difference in urinary excretion of xanthurenic or kynurenic acid following a 2-g L-tryptophan load. Thus, while there may be age-related differences in vitamin B<sub>6</sub> metabolism, there is no significant age effect on functional activity of vitamin B<sub>6</sub> when intake is adequate. The metabolism of vitamin B<sub>6</sub> has been studied in elderly men and women older than 60 yr. While younger individuals were not examined in the same study, the researchers concluded that the elderly had an increased vitamin B<sub>6</sub> requirement, indicative of increased metabolism. Kant, Moser-Veillon, and Reynolds<sup>[35]</sup> observed no age-related impairment in the absorption or phosphorylation of vitamin B<sub>6</sub>. However, there was an increase in plasma alkaline phosphatase activity with age that would increase hydrolysis of PLP.

The use of plasma PLP as a status indicator has been questioned<sup>[36]</sup> and the determination of plasma PL recommended. Others have also suggested that plasma PL may be an important indicator of status. When Barnard et al.<sup>[37]</sup> studied the vitamin B<sub>6</sub> status in pregnant women and nonpregnant controls, they found that plasma PLP concentration was 50% lower in the pregnant women but that the concentration of the total of PLP and PL was only slightly lower. When concentrations of PLP and PL were expressed on a per-gram-albumin basis, there was no difference between groups. In contrast, in pregnant rats, both plasma PLP and PL decreased, as did liver PLP, in comparison with nonpregnant control rats.<sup>[38]</sup> These studies are in direct opposition to each other but do provide support for the need to determine several indices of vitamin B<sub>6</sub> status.<sup>[22,24,36]</sup>

Urinary 4-pyridoxic acid excretion is considered a short-term indicator of vitamin B<sub>6</sub> status. In deficiency studies in males<sup>[39]</sup> and females,<sup>[40]</sup> the decrease in

urinary 4-pyridoxic acid paralleled the decrease in plasma PLP concentration. As reflected in the studies in which dietary intake was assessed or known, 4-pyridoxic acid excretion accounts for about 40–60% of the intake (see Table 10 in Ref.<sup>[27]</sup>). Because of the design of most studies and the limited number of studies done with females compared with males, it is not possible to determine whether there is a significant difference between males and females. However, males consistently had higher plasma PLP and total vitamin B<sub>6</sub> concentrations as well as higher excretion of 4-pyridoxic acid and total vitamin B<sub>6</sub>. Urinary total vitamin (all forms, including phosphorylated and glycosylated) excretion is not a sensitive indicator of the vitamin, except in situations where intake is very low.<sup>[27,39]</sup>

Erythrocyte transaminase activity (alanine and aspartate) has been used to assess vitamin B<sub>6</sub> status in a variety of populations,<sup>[29,40,41,42,46,47]</sup> including oral-contraceptive users.<sup>[22,44,45]</sup> Transaminase activity is considered a long-term indicator of vitamin B<sub>6</sub> status. Most often, it has been measured in the presence and absence of excess PLP.<sup>[43]</sup> While this index is used to assess status, there is no unanimous agreement, and some consider it to be less reliable than other indicators.<sup>[22,47]</sup> The long life of the erythrocyte and tight binding of PLP to hemoglobin may explain the lack of a consistent significant correlation between plasma PLP and transaminase activity or activity coefficient. An additional consideration that complicates the use of aminotransferases is the finding of genetic polymorphism of erythrocyte alanine aminotransferase.<sup>[48]</sup>

Urinary excretion of tryptophan metabolites following a tryptophan load, especially excretion of xanthurenic acid, has been one of the most widely used tests for assessing vitamin B<sub>6</sub> status.<sup>[49,50]</sup> The use of this test has, however, been questioned,<sup>[51,52]</sup> especially in disease states or in situations in which hormones may alter tryptophan metabolism independent of a direct effect of vitamin B<sub>6</sub> metabolism.<sup>[53]</sup>

Other tests for status include the methionine load,<sup>[54]</sup> oxalate excretion, electroencephalographic tracings,<sup>[55]</sup> and lymphocyte proliferation.<sup>[56]</sup> These tests are used less often but under appropriate circumstances provide useful information. The review by Reynolds<sup>[36]</sup> provides an excellent critique of methods currently in use for assessment of vitamin B<sub>6</sub> status.

## FUNCTIONS

### Immune System Functions

The involvement of PLP in a multiplicity of enzymatic reactions<sup>[57]</sup> suggests that it serves many functions in the body. PLP acts as a coenzyme for serine transhydroxymethylase,<sup>[58]</sup> one of the key enzymes involved

in one-carbon metabolism. Alteration in one-carbon metabolism can then lead to changes in nucleic acid synthesis. Such changes may be one of the keys to the effect of vitamin B<sub>6</sub> on immune function.<sup>[59,60]</sup> Studies in animals have shown that vitamin B<sub>6</sub> deficiency adversely affects lymphocyte production<sup>[59]</sup> and antibody response to antigens.<sup>[60]</sup> Additional studies in animals support an effect of vitamin B<sub>6</sub> on cell-mediated immunity.<sup>[61]</sup> A review, though dated, of vitamin B<sub>6</sub> and immune competence is all that is currently available.<sup>[62]</sup>

### Gluconeogenesis

Gluconeogenesis is key to maintaining an adequate supply of glucose during caloric deficit. Pyridoxal-5'-phosphate is involved in gluconeogenesis via its role as a coenzyme for transamination reactions<sup>[57]</sup> and for glycogen phosphorylase.<sup>[63]</sup> In animals, a deficiency of vitamin B<sub>6</sub> results in decreased activities of liver alanine and aspartate aminotransferase.<sup>[64]</sup> However, in humans (females), a low intake of vitamin B<sub>6</sub> (0.2 mg/day), as compared with an adequate intake (1.8 mg/day), did not significantly influence fasting plasma glucose concentrations.<sup>[65]</sup> Interestingly, the low vitamin B<sub>6</sub> intake was associated with impaired glucose tolerance in this study.

Glycogen phosphorylase is also involved in maintaining adequate glucose supplies within liver and muscle and, in the case of liver, is a source of glucose for adequate blood glucose levels. In rats, a deficiency of vitamin B<sub>6</sub> has been shown to result in decreased activities of both liver<sup>[66]</sup> and muscle glycogen phosphorylase.<sup>[63,66,67]</sup> Muscle appears to serve as a reservoir for vitamin B<sub>6</sub>,<sup>[63,67,68]</sup> but a deficiency of the vitamin does not result in mobilization of these stores. However, Black, Guirard, and Snell<sup>[67]</sup> have shown that a caloric deficit does lead to decreased muscle phosphorylase content. These results suggest that the reservoir of vitamin B<sub>6</sub> (as PLP) is only utilized when there is a need for enhanced gluconeogenesis. In male mice, the half-life of muscle glycogen phosphorylase has been shown to be approximately 12 days.<sup>[69]</sup> In contrast to rats with a low intake of vitamin B<sub>6</sub>, those given an injection of a high dose of PN, PL, or PM (300 mg/kg) show a decrease in liver glycogen and an increase in serum glucose.<sup>[70]</sup> This effect is mediated via increased secretion of adrenal catecholamines. The extent to which lower intake of B<sub>6</sub> vitamins has this effect or whether this occurs in humans remains to be determined.

### Erythrocyte Function

Vitamin B<sub>6</sub> has an additional role in erythrocyte function and metabolism. The function of PLP as a



coenzyme for transaminases in erythrocytes has been mentioned. In addition, both PL and PLP bind to hemoglobin.<sup>[71,72]</sup> The binding of PL to the  $\alpha$  chain of hemoglobin<sup>[73]</sup> increases the O<sub>2</sub> binding affinity,<sup>[74]</sup> while binding to the  $\beta$  chain of hemoglobin S or A lowers it.<sup>[75]</sup> The effect of PLP and PL on O<sub>2</sub> binding may be important in sickle cell anemia.<sup>[76]</sup>

Pyridoxal-5'-phosphate serves as a cofactor for  $\delta$ -aminolevulinic acid synthetase,<sup>[77]</sup> the enzyme that catalyzes the condensation of glycine and succinyl-CoA to form  $\delta$ -aminolevulinic acid. This latter compound is the initial precursor in heme synthesis.<sup>[78]</sup> Therefore, vitamin B<sub>6</sub> plays a central role in erythropoiesis. A deficiency of the vitamin in animals can lead to hypochromic microcytic anemia. Furthermore, in humans, there are several reports of patients with pyridoxine-responsive anemia.<sup>[79]</sup> However, not all patients with sideroblastic anemia (in which there is a defect in 5-aminolevulinic acid synthetase) respond to pyridoxine therapy.<sup>[80]</sup>

### Niacin Formation

One of the more extensive functions of vitamin B<sub>6</sub> that has been researched is its involvement in the conversion of tryptophan to niacin.<sup>[50]</sup> This research is in part related to the use of the tryptophan load in evaluating vitamin B<sub>6</sub> status. While PLP functions in at least four enzymatic reactions in the complex tryptophan–niacin pathway, there is only one PLP-requiring reaction in the *direct* conversion of tryptophan to niacin. This step is the transformation of 3-hydroxykynurenine to 3-hydroxyanthranilic acid and is catalyzed by kynureninase. Leklem et al. have examined the effect of vitamin B<sub>6</sub> deficiency on the conversion of tryptophan to niacin.<sup>[81]</sup> In this study, the urinary excretion of *N*-methylnicotinamide and *N*'-methyl-2-pyridone-5-carboxamide, two metabolites of niacin, was evaluated in women. After 4 weeks of a low-vitamin B<sub>6</sub> diet, the total excretion of these two metabolites following a 2-g L-tryptophan load was approximately half that when subjects received 0.8–1.8 mg vitamin B<sub>6</sub> per day. This suggests that low vitamin B<sub>6</sub> has a moderate negative effect on niacin formation from tryptophan.

### Nervous System Functions

In addition to the effect of vitamin B<sub>6</sub> on tryptophan-to-niacin conversion, there is another tryptophan pathway that is vitamin B<sub>6</sub> dependent. The conversion of 5-hydroxytryptophan to 5-hydroxytryptamine is catalyzed by the PLP-dependent enzyme 5-hydroxytryptophan decarboxylase.<sup>[82]</sup> Other neurotransmitters, such as taurine, dopamine, norepinephrine, histamine, and  $\gamma$ -aminobutyric acid, are also synthesized by

PLP-dependent enzymes.<sup>[82]</sup> The involvement of PLP in neurotransmitter formation and the observation that there are neurological abnormalities in human infants<sup>[83,84]</sup> and animals<sup>[85]</sup> deficient in vitamin B<sub>6</sub> provide support for a role of vitamin B<sub>6</sub> in nervous system function. Recent reviews on the relationship between nervous system function and vitamin B<sub>6</sub> are available.<sup>[86,87]</sup>

In infants fed a formula in which the vitamin B<sub>6</sub> was lost during processing, convulsions and abnormal electroencephalograms (EEGs) were observed.<sup>[83]</sup> Treatment of the infants with 100 mg of pyridoxine produced a rapid improvement in the EEGs. In these studies reported by Coursin, the protein content of the diet appeared to be correlated with the vitamin B<sub>6</sub> deficiency and the severity of symptoms. Other evidence for a role of vitamin B<sub>6</sub> comes from studies of pyridoxine-dependent seizures, an autosomal recessive disorder. Vitamin B<sub>6</sub> dependency, though a rare cause of convulsions, has been reported by several investigators.<sup>[88,89]</sup> The convulsions occur during the neonatal period, and administration of 30–100 mg of pyridoxine is usually sufficient to prevent them and correct an abnormal EEG.<sup>[89,90]</sup> However, there are atypical patients who present a slightly different clinical picture and course but are responsive to pyridoxine.<sup>[91]</sup>

Vitamin B<sub>6</sub> deficiency in adults has also been reported to result in abnormal EEGs,<sup>[55,92]</sup> especially in individuals on a high-protein (100 g/day) intake. In one study,<sup>[93]</sup> subjects received a diet essentially devoid of vitamin B<sub>6</sub> (0.06 mg). Grabow and Linkswiler fed to 11 men a high-protein diet (150 g) and 0.16 mg of vitamin B<sub>6</sub> for 21 days.<sup>[93]</sup> No abnormalities in EEGs were observed; nor were there changes in motor nerve conduction times in five subjects who had this measurement. Kretsch, Sauberlich, and Newbrun<sup>[55]</sup> observed abnormal EEG patterns in two of eight women after 12 days of a low (0.05 mg/day) vitamin B<sub>6</sub> diet. Feeding 0.5 mg/day corrected the abnormal pattern. While there were differences in the length of the period of deficiency in these studies, which may explain the differences observed, it appears that long-term very low vitamin B<sub>6</sub> intakes are necessary before abnormal EEGs are observed in humans.

Another aspect of the relationship of vitamin B<sub>6</sub> (as PLP) to the nervous system is the development of the brain under conditions of varying intakes of the vitamin. Kirksey and coworkers have conducted numerous well-designed studies in this area. These have utilized the rat model to examine the development of the brain, especially during the critical period when cells undergo rapid mitosis. Early experiments showed that dietary restriction of vitamin B<sub>6</sub> in the dams was associated with a decrease in alanine aminotransferase and glutamic acid decarboxylase activity and low brain weights of progeny.<sup>[94]</sup>

Alterations in fatty acid levels, especially those involved in myelination,<sup>[95]</sup> decreases in cerebral sphingolipids and in the area of the neocortex and cerebellum, as well as reduced molecular and granular layers of the cerebellum have all been noted.<sup>[96]</sup>

One of the more intriguing and controversial aspects of vitamin B<sub>6</sub> is its role in lipid metabolism.<sup>[97]</sup> Studies conducted more than 60 years ago suggested a link between fat metabolism and vitamin B<sub>6</sub>.<sup>[98]</sup> Subsequent research showed that liver lipid levels were significantly lower in vitamin B<sub>6</sub>-deficient vs. pair-fed rats.<sup>[99]</sup> The changes were due mainly to lower triglyceride levels, whereas cholesterol levels were not different. In contrast, Abe and Kishino showed that rats fed a high-protein (70%), vitamin B<sub>6</sub>-deficient diet developed fatty livers and suggested that this was due to impaired lysosomal degradation of lipid.<sup>[100]</sup> The synthesis of fat in vitamin B<sub>6</sub>-deficient rats has been reported to be greater,<sup>[101]</sup> normal,<sup>[102]</sup> or depressed.<sup>[103]</sup> The observed differences may be related to the meal pattern of the animals.<sup>[104]</sup>

The effect of vitamin B<sub>6</sub> deprivation on fatty acid metabolism has also received attention. A pyridoxine deficiency may impair the conversion of linoleic acid to arachidonic acid.<sup>[83,105]</sup> Cunnane and coworkers<sup>[105]</sup> found that phospholipid levels of both linoleic and  $\gamma$ -linolenic acid were increased in vitamin B<sub>6</sub>-deficient rats, but the level of arachidonic acid was decreased as compared with that of control levels in plasma, liver, and skin. They suggested that both linoleic desaturation and  $\gamma$ -linoleic acid elongation may be impaired by a vitamin B<sub>6</sub> deficiency. She, Hayakawa, and Tsuge<sup>[106]</sup> have observed decreased activity of terminal  $\Delta^6$ -desaturase in the linoleic acid desaturation system in rats fed a vitamin B<sub>6</sub>-deficient diet and a positive correlation between phosphatidylcholine (PC) content and  $\Delta^6$ -desaturase activity in liver microsomes. Subsequent work by She et al. suggests that alteration of *S*-adenosylmethionine (SAM) to *S*-adenosylhomocysteine is involved in these changes.<sup>[107]</sup> In one of the few studies of vitamin B<sub>6</sub> and fatty acid metabolism in humans, desoxypyridoxine was utilized to induce a vitamin B<sub>6</sub> deficiency.<sup>[199]</sup> Xanthurenic acid excretion following a 10-g D,L-tryptophan load indicated a moderate vitamin B<sub>6</sub>-deficient state. Only minor changes in fatty acid levels in plasma and erythrocytes were observed as a result of the deficiency produced. The pattern of fatty acids observed was interpreted by the authors to support the findings of Witten and Holman.<sup>[104]</sup> The work of She, Hayakawa, and Tsuge<sup>[107]</sup> supports this. This provides a plausible mechanism, because the primary metabolic steps in fatty acid metabolism do not involve nitrogen-containing substrates, a feature common to most PLP-dependent enzymatic reactions.

The change observed in arachidonic acid levels and the role it plays in cholesterol metabolism may have

clinical implications. The effect, if any, of vitamin B<sub>6</sub> on cholesterol metabolism remains controversial. Studies by Lupien and coworkers have shown that the rate of incorporation of [<sup>14</sup>C]-acetate into cholesterol was increased in vitamin B<sub>6</sub>-deficient rats as compared to controls.<sup>[108]</sup> However, the amount of cholesterol in plasma and liver of rats and other species has been reported to be increased, not changed, or even decreased.<sup>[108]</sup> Significant positive correlation between plasma PLP and high-density-lipoprotein (HDL) cholesterol and negative correlations with total cholesterol and low-density-lipoprotein (LDL) cholesterol have been reported in monkeys fed atherogenic Western diets and a "prudent" Western diet.<sup>[109]</sup> However, the diets fed to the monkeys contained distinctly different amounts of vitamin B<sub>6</sub>. The use of supplemental vitamin B<sub>6</sub> in reduction of blood cholesterol has not been definitively tested. Serfontein and Ubbink reported decreased serum cholesterol (0.8 mmol/L) in 34 subjects given a multivitamin containing 10 mg of pyridoxine.<sup>[110]</sup> The reduction was mainly as LDL cholesterol. In another study, pyridoxine (50 mg/day) administration prevented the increase in serum cholesterol seen when disulfiram was administered.<sup>[111]</sup> Controlled trials of pyridoxine are needed to resolve the role of vitamin B<sub>6</sub> in modifying serum cholesterol levels.

The role of vitamin B<sub>6</sub> in lipid metabolism remains unclear. Evidence to date suggests a role in modifying methionine metabolism and thus an indirect effect on phospholipid and fatty acid metabolism. This effect and one on carnitine synthesis<sup>[112]</sup> appear to be the primary effects of vitamin B<sub>6</sub> on lipid/fatty acid metabolism.

### Hormone Modulation / Gene Expression

One of the more intriguing functions of PLP is as a modulator of steroid action.<sup>[113,114]</sup> Reviews of this interaction are available.<sup>[115,116]</sup> PLP can be used as an effective tool in extracting steroid receptors from the nuclei of tissues on which the steroid acts.<sup>[117]</sup> Under conditions of physiological concentration of PLP, reversible reactions occur with receptors for estrogen,<sup>[118]</sup> androgen,<sup>[119]</sup> progesterone,<sup>[120]</sup> and glucocorticoids.<sup>[121]</sup> PLP reacts with a lysine residue on the steroid receptor. As a result of the formation of a Schiff base, there is inhibition of the binding of the steroid-receptor complex to DNA.<sup>[113]</sup> Holley et al. found that when female rats were made vitamin B<sub>6</sub> deficient and injected with [<sup>3</sup>H]-estradiol, a greater amount of the isotope accumulated in the uterine tissues of the deficient animal than in the tissues of controls.<sup>[122]</sup> Bunce and Vessal studied the dual effect of zinc and vitamin B<sub>6</sub> deficiency on estrogen uptake by the uterus.<sup>[123]</sup> They found that there was an

increased uptake of the hormone in both the vitamin B<sub>6</sub>- and the zinc-deficient animals. A combined deficiency of the two nutrients resulted in even greater retention of estrogen. The number of estrogen receptors was not altered by the deficiency of vitamin B<sub>6</sub>. This study suggests that there might be increased sensitivity of the uterus (or other end-target tissues) to steroids when vitamin B<sub>6</sub> status is abnormal.

Sturman and Kremzner found enhanced activity of ornithine decarboxylase in testosterone-treated vitamin B<sub>6</sub>-deficient animals as compared to control animals.<sup>[124]</sup> DiSorbo and Litwack observed increased tyrosine aminotransferase activity in hepatoma cells raised on a pyridoxine-deficient medium and treated with triamcinolone acetonide as compared to pyridoxine-sufficient cells treated with the same steroid.<sup>[125]</sup> Allgood and Cidlowski<sup>[126]</sup> have used a variety of cell lines and a range of intracellular PLP concentrations to show that vitamin B<sub>6</sub> modulates transcriptional activation by several (androgen, progesterone, and estrogen) steroid hormone receptors. This supports the role of vitamin B<sub>6</sub> as a physiological modulator of steroid hormone action.

Oka et al.<sup>[127]</sup> have found that in vitamin B<sub>6</sub>-deficient rats, the level of albumin mRNA was sevenfold that of control rats. They suggest that PLP modulates albumin gene expression by inactivation of tissue-specific transcription factors. Oka and coworkers have also observed a sevenfold increase in the level of mRNA for cytosolic aminotransferase in vitamin B<sub>6</sub>-deficient rats as compared to that of vitamin B<sub>6</sub>-sufficient rats.<sup>[128]</sup> Subsequent work by Oka et al.<sup>[129]</sup> shows an inverse relationship between intracellular PLP concentration and albumin mRNA in rats given amino acid loads. Thus, PLP may be a modulator of gene expression in animals, especially under conditions of altered amino acid supply. Given the intimate relationship of vitamin B<sub>6</sub> and amino acid metabolism, these investigations open up for study a new area of metabolic regulation via altered intracellular nutrient (PLP) concentration.

## VITAMIN B<sub>6</sub> REQUIREMENTS

Considering the numerous functions in which vitamin B<sub>6</sub> is involved, assessment of the requirement for this vitamin becomes important. Reviews of vitamin B<sub>6</sub> requirements are available.<sup>[130–132]</sup>

Several relevant studies have been conducted. These have been carried out in both young and elderly adults and in males and females.<sup>[27,133–135]</sup> While some of them are similar to previous ones in that they employed depletion/repletion design<sup>[133–135]</sup> and diets with high B<sub>6</sub> bioavailability, others have used diets more representative of the usual U.S. diet.<sup>[27]</sup>

What is also different about some of these studies is that they have included additional measurements that may be indicative of intercellular function of PLP. Meydani et al.<sup>[136]</sup> examined the effect of different levels of vitamin B<sub>6</sub> (pyridoxine added to a low-B<sub>6</sub> food diet) on immune function. They observed that adequate immune function in elderly women was not achieved until 1.9 mg/day of vitamin B<sub>6</sub> was fed. Men required 2.88 mg/day to return function to baseline levels. In addition, several indices of vitamin B<sub>6</sub> status were measured. Based on when these values for these indices returned to predepletion levels, the requirement for vitamin B<sub>6</sub> was estimated to be 1.96 and 1.90 mg/day for men and women, respectively.

Kretsch et al.<sup>[135]</sup> fed four graded doses of vitamin B<sub>6</sub> to eight young women following a depletion diet (for 11–28 days). Based on this and other studies, less than 0.5 mg/day is needed to observe clinical signs of vitamin B<sub>6</sub> deficiency. Functional signs, such as abnormal EEGs, were only seen with an intake lower than 0.5 mg/day. Various biochemical measures, including the functional tests of tryptophan metabolite excretion (xanthurenic acid) and erythrocyte aspartate transaminase (EAST) stimulation, were normalized at the 1.5 and 2.0 mg/day level, respectively. The authors stated that if all currently used biochemical measures were to be normalized, then more than 0.020 mg of vitamin B<sub>6</sub> per gram of protein is required.

Hansen et al.<sup>[29]</sup> used a different approach in evaluating the effect of graded doses of vitamin B<sub>6</sub> on status. First, rather than feeding a diet deficient in vitamin B<sub>6</sub>, a diet containing a level that was low but within the realm of what individuals might normally consume was fed. Various levels of pyridoxine (as an oral solution) were then added to the basal diet (range 0.8–2.35 mg B<sub>6</sub>/day). Based on both direct and indirect measures (including tryptophan metabolite excretion), it was concluded that a B<sub>6</sub>/protein ratio greater than 0.20 was required to normalize all vitamin B<sub>6</sub> status indices. Ribaya-Mercado et al.<sup>[133]</sup> evaluated the vitamin B<sub>6</sub> requirements of elderly men and women in a depletion/repletion study. The authors concluded that the vitamin B<sub>6</sub> requirements of elderly men and women are about 1.96 and 1.90 mg/day, respectively. The vitamin B<sub>6</sub> (pyridoxine) fed to these subjects was in a highly bioavailable form.

A metabolic study in young women evaluated the requirement for vitamin B<sub>6</sub>.<sup>[134]</sup> Again, a depletion/repletion design was used and several indices of vitamin B<sub>6</sub> status were measured. These included urinary 4-PA excretion, plasma PLP, erythrocyte PLP, and erythrocyte alanine aminotransferase (EALT) and EAST activity coefficients. Using predepletion baseline levels (after 9 days of feeding 1.60 mg/day) of these indices as a basis for comparison in determining adequacy, the amount of vitamin B<sub>6</sub> required to normalize

these indices was 1.94 mg/day (B<sub>6</sub> to protein ratio of 0.019).

An important consideration relative to many of these metabolic studies that have been used in establishing the adult vitamin B<sub>6</sub> recommended dietary allowance (RDA) is the composition of the diets used. Most were ones in which the amount of vitamin B<sub>6</sub> from food was low and of relatively high bioavailability. Vitamin B<sub>6</sub> was added back to the diets in the form of pyridoxine hydrochloride and thus is considered 100% bioavailable. Therefore, the total vitamin B<sub>6</sub> in the diets is probably 95–100% bioavailable. Taken together, these four recent metabolic studies support a higher vitamin B<sub>6</sub> requirement for women and men than is currently employed. A value of 1.9 mg/day for women and 2.2 mg/day for men is recommended. Since the vitamin B<sub>6</sub> in these studies was highly available, the inclusion of a factor for bioavailability would further increase the RDA.<sup>[137]</sup>

The above discussion has focused on the vitamin B<sub>6</sub> requirement for adults aged 18–70. There has been little research to support a statement of recommendations for children (aged 1–10) or adolescents (aged 11–18).

### Food Sources

There are various forms of vitamin B<sub>6</sub> in foods. In general, these forms are a derivative of pyridoxal, pyridoxine, and pyridoxamine. Pyridoxine and pyridoxamine (or their respective phosphorylated forms) are the predominant forms in plant foods such as lima beans, spinach, broccoli, avocados, white beans, lentils, nuts, and brown rice. Although there are exceptions, pyridoxal, as the phosphorylated form, is the predominant form in foods. (Data on the amount of each of the three forms are listed in Table 4 of Ref.<sup>[27]</sup>.)

### DISEASE AND TOXICITY

Several books<sup>[2,3,6,7]</sup> and reviews<sup>[5]</sup> have examined the relationship between specific diseases and vitamin B<sub>6</sub> nutrition in detail. There are numerous diseases or pathological conditions in which vitamin B<sub>6</sub> metabolism is altered. The primary indicator of an alteration in vitamin B<sub>6</sub> metabolism has been an evaluation of tryptophan metabolism or the plasma PLP concentration. The first of these is an indirect measure of status and the second is a direct measure. Conditions in which tryptophan metabolism has been shown to be altered and in which vitamin B<sub>6</sub> (pyridoxine) administration was used include asthma,<sup>[138]</sup> diabetes,<sup>[139]</sup> certain cancers,<sup>[52]</sup> pellagra,<sup>[140]</sup> and rheumatoid arthritis.<sup>[141]</sup> Diseases and pathological conditions in which plasma PLP levels have been shown to be depressed include asthma,<sup>[142]</sup> diabetes,<sup>[143]</sup> renal

disorders,<sup>[144]</sup> alcoholism,<sup>[145]</sup> heart disease,<sup>[146]</sup> pregnancy,<sup>[35,147,200]</sup> breast cancer,<sup>[148]</sup> Hodgkin's disease,<sup>[149]</sup> and sickle cell anemia.<sup>[76]</sup> Hypophosphatasia is an example of a condition in which plasma PLP levels are markedly elevated in some individuals.<sup>[150a]</sup> Relatively few of these studies have exhaustively evaluated vitamin B<sub>6</sub> metabolism.

### Coronary Heart Disease

The relationship between vitamin B<sub>6</sub> and coronary heart disease can be viewed from both an etiological perspective and that of the effect of the disease state on vitamin B<sub>6</sub> metabolism. With respect to an etiological role, altered sulfur amino acid metabolism has been suggested to result in vascular damage. A poor vitamin B<sub>6</sub> status can result in an increased circulating concentration of homocysteine.<sup>[151]</sup> In the trans-sulfuration pathway, serine and homocysteine condense to produce cystathionine. This reaction is catalyzed by the PLP-dependent enzyme cystathionine β-synthase. In genetic disorders of this enzyme, homocysteine accumulates in the plasma.<sup>[152]</sup> An increased incidence of arteriosclerosis has been associated with this enzyme defect.<sup>[153]</sup> In addition, elevated levels of homocysteine in the plasma have been observed in people with ischemic heart disease.<sup>[154,155]</sup> There has been an explosion in the number of papers suggesting that elevated plasma homocysteine is a risk factor for heart disease and stroke. While folic acid is most effective in reducing the plasma concentration of homocysteine,<sup>[155,157]</sup> vitamin B<sub>6</sub> has been shown to be most effective in reducing plasma homocysteine when a methionine load is given. A European study of 750 patients with vascular disease and 800 control subjects found that increased fasting homocysteine (more than 12.1 μmol/L) was associated with elevated risk of vascular disease.<sup>[158]</sup> In this study, a plasma concentration of PLP below the 20th percentile (less than 23 μmol/L) for controls was associated with increased risk. This relationship between plasma PLP and atherosclerosis was independent of homocysteine levels. Other studies have also found an increase in coronary artery disease risk and low PLP levels in plasma.<sup>[156,159]</sup>

While some animal experiments have shown that rhesus monkeys made vitamin B<sub>6</sub> deficient develop atherosclerotic lesions,<sup>[160]</sup> other studies do not reveal any pathological lesions.<sup>[161]</sup> In humans at risk for coronary heart disease, a negative correlation between dietary vitamin B<sub>6</sub> and bound homocysteine has been observed.<sup>[162]</sup> For some people with homocysteinuria, treatment with high doses of vitamin B<sub>6</sub> reduces the plasma concentration of homocysteine in certain patients but does not totally correct methionine metabolism,<sup>[163]</sup> especially when there is an increased

methionine intake. Thus, if vitamin B<sub>6</sub> therapy is to be successful in reducing vascular lesions, diet modification with a lowered methionine intake may be necessary. The extent to which supplemental vitamin B<sub>6</sub> intake (beyond normal dietary intakes) may reduce the risk of coronary heart disease is not known.

A second aspect of coronary heart disease is the relationship between the presence of the disease and vitamin B<sub>6</sub> status. Several recent studies have found that the plasma PLP concentrations in people with coronary heart disease are significantly lower (21–41 nmol/L) than those in healthy controls (32–46 nmol/L).<sup>[110,146,164]</sup> However, Vermaak et al. have found that the decrease in plasma PLP concentration is only seen in the acute phase of myocardial infarction.<sup>[165]</sup> Unfortunately, other measures of vitamin B<sub>6</sub> status have not been evaluated in this disease. In one study,<sup>[164]</sup> giving cardiac patients vitamin B<sub>6</sub> supplements (amounts not given) resulted in plasma PLP levels well above normal. The effect of long-term vitamin B<sub>6</sub> therapy on recurrence of coronary artery disease has not been evaluated.

Elevated plasma cholesterol concentration has been strongly associated with an increased risk of coronary heart disease. As previously reviewed, vitamin B<sub>6</sub> may influence cholesterol metabolism. Serfontein and Ubbink<sup>[110]</sup> have found that use of a multivitamin supplement containing about 10 mg of pyridoxine for 22 weeks by hypercholesterolemic adult men resulted in a significant decrease in cholesterol levels, with most of the reduction due to a decreased level of LDL cholesterol. Smoking is an additional risk factor for coronary heart disease. Interestingly, smokers have decreased plasma levels of PLP.<sup>[110,166]</sup> Evidence to date suggests a link between several risk factors for coronary heart disease and altered vitamin B<sub>6</sub> status and a potential beneficial effect of increased vitamin B<sub>6</sub> intake on cholesterol levels. Furthermore, well-controlled studies are needed before the therapeutic effect of vitamin B<sub>6</sub> can be evaluated for this disease.

## HIV/AIDS

Vitamin B<sub>6</sub> status<sup>[167,168]</sup> and, to a limited extent, metabolism<sup>[169]</sup> have been examined in persons with human immunodeficiency virus (HIV). Because of the link between immune function and vitamin B<sub>6</sub>,<sup>[62]</sup> one would expect that maintaining an adequate vitamin B<sub>6</sub> status is critical for HIV patients. Several studies have evaluated vitamin B<sub>6</sub> intake,<sup>[168,170,171]</sup> and the progression of the disease as related to intake of nutrients, including vitamin B<sub>6</sub>.<sup>[170]</sup> These studies generally found low intakes of vitamin B<sub>6</sub>, and one study<sup>[172]</sup> reported an inverse relationship between vitamin B<sub>6</sub> intake and progression.

Biochemical assessment of vitamin B<sub>6</sub> status has been done in several studies<sup>[167,168,171]</sup> and has revealed it to be poor. In most of these studies,<sup>[167,168]</sup> α-EAST activity and stimulation was used as an index of status. In the studies, samples were frozen, which may have compromised the data and subsequent evaluation. Although other researchers have measured and reported low levels of “serum vitamin B<sub>6</sub>,” they failed to specify what form was being measured.<sup>[171,172]</sup> Therefore, given the complexities of nutritional well-being in HIV/AIDS patients and methodological problems in these studies, it is difficult to assess the role of vitamin B<sub>6</sub> in this syndrome.

In vitro studies suggest that PLP may play a role in HIV/AIDS. Salhany and Schopfer<sup>[173]</sup> found that PLP binds to the CD4 receptors at a site that is competitive with a known antiviral agent (4,4'-diisothiocyanato-2,2'-stilbenedisulfonate). Other investigators have found that PLP is a noncompetitive inhibitor of HIV-1 reverse transcriptase.<sup>[174,175]</sup> Based on these in vitro studies, clinical trials with vitamin B<sub>6</sub> appear warranted.

## Premenstrual Syndrome

Premenstrual syndrome (PMS) is another clinical situation for which vitamin B<sub>6</sub> supplementation has been suggested.<sup>[176]</sup> Estimates indicate that 40% of women are affected by this syndrome.<sup>[177]</sup> Using a wide variety of parameters, no difference in vitamin B<sub>6</sub> status was observed in women with PMS compared to those not reporting symptoms.<sup>[51,178]</sup> Nevertheless, beneficial effects of B<sub>6</sub> administration on at least some aspects of PMS have been reported.

Treatment of PMS with vitamin B<sub>6</sub> has been based in part on the studies of Adams et al.,<sup>[179]</sup> in which PN was used to manage the depression observed in some women taking oral contraceptives. Of the several studies in which PN was used to treat PMS, there have been open-type studies that were double-blind and placebo-controlled. Open studies are prone to a placebo effect error, often as high as 40%. Of the well-controlled type, one study showed no effect of pyridoxine therapy,<sup>[180]</sup> whereas three studies reported significant improvement of at least some of the symptoms associated with PMS. In one study, 21 of 25 patients improved.<sup>[181]</sup> Another study found that about 60% of 48 women showed improvement with pyridoxine (200 mg/day) and 20% showed improvement with placebo.<sup>[182]</sup> The fourth study<sup>[183]</sup> reported improvement in some symptoms in 55 women treated daily with 150 mg of pyridoxine. Brush<sup>[176]</sup> has reported results of studies he has conducted using vitamin B<sub>6</sub> alone and vitamin B<sub>6</sub> plus magnesium. His data suggest that doses of 150–200 mg of vitamin B<sub>6</sub> are necessary before a significant positive effect is observed. In addition, the

combination of vitamin B<sub>6</sub> plus magnesium appears to be beneficial. The complexity of PMS and the subjective nature of symptom reporting continue to result in contradictions and controversy in the lay and scientific literature. Kleijnen et al.<sup>[184]</sup> have reviewed 12 controlled trials in which vitamin B<sub>6</sub> was used to treat PMS. They concluded that there is only weak evidence of a positive effect of vitamin B<sub>6</sub>. There may be a decrease in the availability of vitamin B<sub>6</sub> during PMS, possibly due to cell transport competition, from fluctuating hormone concentrations. An increase in vitamin B<sub>6</sub> concentration could overcome competition and may explain the relief of symptoms seen in some women following high-dose vitamin B<sub>6</sub> supplementation.

### Sickle Cell Anemia

Low levels (18 μmol/L) of plasma PLP have been reported in 16 persons with sickle cell anemia.<sup>[76]</sup> Treatment of 5 of these patients with 100 mg of pyridoxine hydrochloride per day for 2 mo resulted in a reduction of severity, frequency, and duration of painful crises in these persons. The mechanism by which vitamin B<sub>6</sub> acts is not known, but it may be related to pyridoxal and PLP binding to hemoglobin.

### Asthma

Depressed levels of plasma and erythrocyte PLP have also been reported in persons with asthma.<sup>[142]</sup> Of significance was the fact that all persons were receiving bronchodilators. Treatment of seven asthmatics with 100 mg of pyridoxine hydrochloride per day resulted in a reduction in the duration, occurrence, and severity of their asthmatic attacks. Subsequent work by one of these authors has not fully supported the earlier findings.<sup>[185]</sup> Treatment of 15 asthmatics with vitamin B<sub>6</sub> did not result in a significant difference in symptom scores, medication usage, or pulmonary function tests as compared to placebo treatment. Ubbink et al.<sup>[186]</sup> have shown that theophylline lowers plasma and erythrocyte PLP. Pyridoxal kinase is inhibited by

theophylline and was responsible for the decreased PLP level in the plasma and presumably intracellularly.

### Carpal Tunnel Syndrome

At least five placebo-controlled trials from four different laboratories have shown that administration of PN relieved the symptoms of carpal tunnel syndrome (pain and/or numbness in hands).<sup>[187,188]</sup> In one study, no significant improvement was observed.<sup>[189]</sup> Since supplementation with vitamin B<sub>6</sub> well in excess of the RDA was required for improvement (generally 50–150 mg), it would seem that individuals with this disorder have a high metabolic demand or that the vitamin is active in some non-coenzyme role. Two recent studies examined the relationship between plasma PLP and carpal tunnel syndrome. One study<sup>[190]</sup> found no relationship between symptoms of carpal tunnel syndrome and plasma PLP, but a study by Keniston et al.<sup>[191]</sup> found a significant inverse univariate relationship between plasma PLP concentration and the prevalence of pain, the frequency of tingling, and nocturnal awakening.

### Drug–Vitamin B<sub>6</sub> Interaction

Treatment of persons with various drugs may also compromise vitamin B<sub>6</sub> status and hence result in an increased need for the vitamin. Table 4 lists several drugs and their effect on vitamin B<sub>6</sub> status. Bhagavan has reviewed these interactions in detail.<sup>[192]</sup> A common feature of these drug interactions is their adverse effect on central nervous system function. In addition, many of these drugs react with PLP via Schiff base formation. This reaction can result in decreased levels of PLP in tissues, such as the brain, leading to a functional deficiency. In most cases, supplemental vitamin B<sub>6</sub> reverses the adverse consequences of the drug. Oral contraceptives do not react directly with PLP but do induce enzyme synthesis. Some of these enzymes are PLP dependent, and as a result, PLP is metabolically trapped in tissues. This may then lead to a depressed plasma PLP concentration.<sup>[193]</sup> In addition, the

**Table 4** Drug–vitamin B<sub>6</sub> interactions

Drug	Examples	Mechanism of interaction
Hydrazines	Iproniazid, isoniazid, hydralazine	React with pyridoxal and PLP to form a hydrazone
Antibiotic	Cycloserine	Reacts with PLP to form an oxime
L-DOPA	L-3,4-Dihydroxyphenylalanine	Reacts with PLP to form tetrahydroquinoline derivatives
Chelator	Penicillamine	Reacts with PLP to form thiazolidine
Oral contraceptives		Ethinyl estradiol, mestranol, increased enzyme levels in liver and other tissues; retention of PLP
Alcohol	Ethanol	Increased catabolism of PLP; low plasma levels

**Table 5** Toxicity symptoms reported to be associated with chronic use of high-dose pyridoxine

Ref.	Symptoms
Coleman et al. <sup>[150b]</sup>	Motor and sensory neuropathy; vesicular dermatosis on regions of the skin exposed to sunshine
Schaumburg et al. <sup>[150C]</sup>	Peripheral neuropathy; loss of limb reflexes; impaired touch sensation in limbs; unsteady gait; impaired or absent tendon reflexes; sensation of tingling that proceeds down neck and legs
Brush <sup>[176]</sup>	Dizziness; nausea; breast discomfort or tenderness
Bernstein and Lobitz <sup>[153]</sup>	Photosensitivity on exposure to sun

synthetic estrogens specifically affect enzymes of the tryptophan–niacin pathway, resulting in abnormal tryptophan metabolism.<sup>[81]</sup> There may be a need for extra vitamin B<sub>6</sub> above the current EDA in a small proportion of women using oral contraceptives and consuming low levels of the vitamin. Any drug that interacts with the reactive molecule PLP in a Schiff base reaction should be considered an instigator of resultant adverse effects on vitamin B<sub>6</sub> status and a subsequent negative influence on central nervous system function.

### Hazards of High Doses

With the therapeutic use of pyridoxine for various disorders and self-medication has come the potential problem of toxicity. Schaumburg et al. have identified several individuals who developed a peripheral neuropathy associated with chronic high-dose use of pyridoxine.<sup>[194]</sup> Subsequent to this, other reports of toxicity related to pyridoxine ingestion have been published.<sup>[195]</sup> The minimal dose at which toxicity develops remains to be determined. Other toxicity symptoms have been identified. These symptoms and those reported by Schaumburg et al. are listed in Table 5. They are relatively rare, and the use of pyridoxine doses of 2–250 mg/day for extended periods of time appears to be safe.<sup>[196]</sup>

In rats given high doses of pyridoxine hydrochloride for 6 weeks, there was a decrease in testis, epididymis, and prostate gland weight at the 500- and 1000-mg/kg dose.<sup>[197]</sup> There was also a decrease in mature spermatid counts. This high intake would be equivalent to 1.5–2.0 g of vitamin B<sub>6</sub> for a human.<sup>[198]</sup> Thus, the application of these data to human nutrition is not clear. Additional safety evaluation is found in the DRI guidelines.<sup>[132]</sup>

### CONCLUSIONS

Since vitamin B<sub>6</sub> was first described, a great deal of information about its functional and metabolic characteristics has been gathered. The involvement of the

active form, PLP, in such a wide spectrum of enzymatic reactions is an indication of the importance of this vitamin. In addition to the involvement of PLP in amino acid metabolism and carbohydrate metabolism, its reactivity with proteins points to the diversity of action of this vitamin. Further research is needed on the factors controlling the metabolism of vitamin B<sub>6</sub> and determination of vitamin B<sub>6</sub> needs of specific populations. With knowledge of the functional properties of vitamin B<sub>6</sub> and quantitation of its metabolism under various physiological and nutritional conditions, the health and well-being of individuals can be improved.

### REFERENCES

1. *Methods in Vitamin B<sub>6</sub> Nutrition*; Leklem, J.E., Reynolds, R.D., Eds.; Plenum Press: New York, 1981.
2. *Vitamin B<sub>6</sub> Metabolism and Role in Growth*; Tryfiates, G.P., Ed.; Food and Nutrition Press: Westport, CN, 1980.
3. *Vitamin B<sub>6</sub>: Its Role in Health and Disease*; Reynolds, R.D., Leklem, J.E., Eds.; Alan R. Liss: New York, 1985.
4. *Vitamin B<sub>6</sub> Pyridoxal Phosphate; Coenzymes and Cofactors*; Dolphin, D., Poulson, R., Avramovic, O., Eds.; John Wiley and Sons: New York, 1986; Vol. 1.
5. Merrill, A.H., Jr.; Henderson, J.M. Diseases associated with defects in vitamin B<sub>6</sub> metabolism or utilization. *Annu. Rev. Nutr.* **1987**, *7*, 137–156.
6. *Clinical and Physiological Applications of Vitamin B<sub>6</sub>*; Leklem, J.E., Reynolds, R.D., Eds.; Alan R. Liss: New York, 1988.
7. *Vitamin B<sub>6</sub> Metabolism in Pregnancy, Lactation and Infancy*; Raiten, D.J., Ed.; CRC Press: Boca Raton, FL, 1995.
8. Gyorgy, P. Vitamin B<sub>2</sub> and the pellagra-like dermatitis of rats. *Nature* **1934**, *133*, 448–449.
9. IUPAC–IUB Commission on Biochemical Nomenclature. Nomenclature for vitamin B<sub>6</sub>

- and related compounds. *Eur. J. Biochem.* **1973**, *40*, 325–327.
10. Storvick, C.A.; Benson, E.M.; Edwards, M.A.; Woodring, M.J. Chemical and microbiological determination of vitamin B<sub>6</sub>. *Meth. Biochem. Anal.* **1964**, *12*, 183–276.
  11. Bridges, J.W.; Davies, D.S.; Williams, R.T. Fluorescence studies on some hydroxypyridines including compounds of the vitamin B<sub>6</sub> group. *Biochem. J.* **1966**, *98*, 451–468.
  12. Harris, S.A.; Harris, E.E.; Burke, R.W. Pyridoxine. In *Kirk-Othmer Encyclopedia of Chemical Technology*; 1968; Vol. 16, 806–824.
  13. Ang, C.Y.W. Stability of three forms of vitamin B<sub>6</sub> to laboratory light conditions. *J. Assoc. Off. Anal. Chem.* **1979**, *62*, 1170–1173.
  14. Schaltenbrand, W.E.; Kennedy, M.S.; Coburn, S.P. Low-ultraviolet “white” fluorescent lamps fail to protect pyridoxal phosphate from photolysis. *Clin. Chem.* **1987**, *33*, 631.
  15. Hughes, R.C.; Jenkins, W.T.; Fischer, E.H. The site of binding of pyridoxal-5'-phosphate to heart glutamic-aspartic transaminase. *Proc. Natl. Acad. Sci. U. S. A.* **1962**, *48*, 1615–1618.
  16. Sauberlich, H.E. Interaction of vitamin B<sub>6</sub> with other nutrients. In *Vitamin B<sub>6</sub>: Its Role in Health and Disease*; Reynolds, R.D., Leklem, J.E., Eds.; Alan R. Liss: New York, 1985; 193–217.
  17. Vanderslice, J.T.; Brownlec, S.G.; Cortisoz, M.E.; Maire, C.E. Vitamin B<sub>6</sub> analyses: sample preparation, extraction procedures, and chromatographic separations. In *Modern Chromatographic Analysis of the Vitamins*; Deleenheer, A.P., Lambert, W.E., DeRuyter, M.G.M., Eds.; Marcel Dekker: New York, 1985; Vol. 30, 436–475.
  18. Reynolds, R.D. Vitamin B<sub>6</sub>. In *Methods in Clinical Chemistry*; Pesce, A.J., Kaplan, L.A., Eds.; Mosby: Washington, DC, 1987; 558–568.
  19. Gregory, J.F. Methods for determination of vitamin B<sub>6</sub> in foods and other biological materials: a critical review. *J. Food. Comp. Anal.* **1988**, *1*, 105–123.
  20. Sauberlich, H.E. Vitamin B<sub>6</sub> status assessment: past and present. In *Methods in Vitamin B<sub>6</sub> Nutrition*; Leklem, J.E., Reynolds, R.D., Eds.; Plenum Press: New York, 1981; 203–240.
  21. Leklem, J.E.; Reynolds, R.D. Challenges and direction in the search for clinical applications of vitamin B<sub>6</sub>. In *Clinical and Physiological Applications of Vitamin B<sub>6</sub>*; Leklem, J.E., Reynolds, R.D., Eds.; Alan R. Liss: New York, 1988; 437–454.
  22. Leklem, J.E. Vitamin B<sub>6</sub>: a status report. *J. Nutr.* **1990**, *120*, 1503–1507.
  23. Brown, R.R.; Rose, D.P.; Leklem, J.E.; Linkswiler, H.; Arend, R. Urinary 4-pyridoxic acid, plasma pyridoxal phosphate and erythrocyte aminotransferase levels in oral contraceptive users receiving controlled intakes of vitamin B<sub>6</sub>. *Am. J. Clin. Nutr.* **1975**, *28*, 10–19.
  24. Leklem, J.E.; Reynolds, R.D. Recommendations for status assessment of vitamin B<sub>6</sub>. In *Methods in Vitamin B<sub>6</sub> Nutrition*; Leklem, J.E., Reynolds, R.D., Eds.; Plenum Press: New York, 1981; 389–392.
  25. Lumeng, L.; Li, T.-K.; Lui, A. The interorgan transport and metabolism of vitamin B<sub>6</sub>. In *Vitamin B<sub>6</sub>: Its Role in Health and Disease*; Reynolds, R.D., Leklem, J.E., Eds.; Alan R. Liss: New York, 1985; 35–54.
  26. Shultz, T.D.; Leklem, J.E. Urinary 4-pyridoxic acid, urinary vitamin B<sub>6</sub> and plasma pyridoxal phosphate as measures of vitamin B<sub>6</sub> status and dietary intake of adults. In *Methods in Vitamin B<sub>6</sub> Nutrition*; Leklem, J.E., Reynolds, R.D., Eds.; Plenum Press: New York, 1981; 297–320.
  27. Leklem, J.E. Vitamin B<sub>6</sub>. In *Handbook of Vitamins*, 3rd Ed.; Marcel Dekker Inc.: New York, 2001; 339–396.
  28. Miller, L.T.; Leklem, J.E.; Shultz, T.D. The effect of dietary protein on the metabolism of vitamin B<sub>6</sub> in humans. *J. Nutr.* **1985**, *115*, 1663–1672.
  29. Hansen, C.M.; Leklem, J.E.; Miller, L.T. Changes in vitamin B<sub>6</sub> status indicators of women fed a constant protein diet with varying levels of vitamin B<sub>6</sub>. *Am. J. Clin. Nutr.* **1997**, *66*, 1379–1387.
  30. Rose, C.S.; Gyorgy, P.; Butler, M.; Andres, R.; Norris, A.H.; Shock, N.W.; Tobin, J.; Brin, M.; Spiegel, H. Age differences in vitamin B<sub>6</sub> status of 617 men. *Am. J. Clin. Nutr.* **1976**, *29*, 847–853.
  31. Lee, C.M.; Leklem, J.E. Differences in vitamin B<sub>6</sub> status indicator responses between young and middle-aged women fed constant diets with two levels of vitamin B<sub>6</sub>. *Am. J. Clin. Nutr.* **1985**, *42*, 226–234.
  32. Hamfelt, A.; Soderhjelm, L. Vitamin B<sub>6</sub> and aging. In *Clinical and Physiological Applications of Vitamin B<sub>6</sub>*; Leklem, J.E., Reynolds, R.D., Eds.; Alan R. Liss: New York, 1988; 95–107.
  33. Leklem, J.E. Physical activity and vitamin B<sub>6</sub> metabolism in men and women: interrelationship with fuel needs. In *Vitamin B<sub>6</sub>: Its Role in Health and Disease*; Reynolds, R.D., Leklem, J.E., Eds.; Alan R. Liss: New York, 1985; 221–241.



34. Brophy, M.H.; Siiteri, P.K. Pyridoxal phosphate and hypertensive disorders of pregnancy. *Am. J. Obstet. Gynecol.* **1975**, *121*, 1075–1079.
35. Kant, A.K.; Moser-Veillon, P.B.; Reynolds, R.D. Effect of age on changes in plasma, erythrocyte and urinary B<sub>6</sub> vitamers after an oral vitamin B<sub>6</sub> load. *Am. J. Clin. Nutr.* **1988**, *48*, 1284–1290.
36. Reynolds, R.D. Biochemical methods for status assessment. In *Vitamin B<sub>6</sub> Metabolism in Pregnancy, Lactation and Infancy*; Raiten, D.J., Ed.; CRC Press: Boca Raton, FL, 1995; 41–59.
37. Barnard, H.C.; Dekock, J.J.; Vermaak, W.J.H.; Potgieter, G.M. A new perspective in the assessment of vitamin B<sub>6</sub> nutritional status during pregnancy in humans. *J. Nutr.* **1987**, *117*, 1303–1306.
38. van den Berg, H.; Bogaards, J.J.P. Vitamin B<sub>6</sub> metabolism in the pregnant rats: effect of progesterone on the (re)distribution in material vitamin B<sub>6</sub> stores. *J. Nutr.* **1987**, *117*, 1866–1874.
39. Kelsay, J.; Baysal, A.; Linkswiler, H. Effect of vitamin B<sub>6</sub> depletion on the pyridoxal, pyridoxamine and pyridoxine content of the blood and urine of men. *J. Nutr.* **1968**, *94*, 490–494.
40. Mikac-Devic, D.; Tomanic, C. Determination of 4-pyridoxic acid in urine by a fluorimetric method. *Clin. Chim. Acta* **1972**, *38*, 235–238.
41. Guillard, J.C.; Berekski-Regung, B.; Lequeu, B.; Moreau, D.; Klepping, J. Evaluation of pyridoxine intake and pyridoxine status among aged institutionalized people. *Int. J. Vitam. Nutr. Res.* **1984**, *54*, 185–193.
42. Vennaak, W.J.H.; Barnard, H.C.; van Dalen, E.M.S.P.; Potgieter, G.M. Correlation between pyridoxal 5'-phosphate levels and percentage activation of aspartate aminotransferase enzyme in haemolysate and plasma during in vitro incubation studies with different B<sub>6</sub> vitamers. *Enzyme* **1986**, *35*, 215–224.
43. Sauberlich, H.E.; Canhain, J.E.; Baker, E.M.; Raica, N.; Herman, Y.F. Biochemical assessment of the nutritional status of vitamin B<sub>6</sub> in the human. *Am. J. Clin. Nutr.* **1972**, *25*, 629–642.
44. Driskell, J.A.; Clark, A. J.; Moak, S.W. Longitudinal assessment of vitamin B<sub>6</sub> status in Southern adolescent girls. *J. Am. Diet. Assoc.* **1987**, *87*, 307–310.
45. Shane, V.; Contractor, S.F. Assessment of vitamin B<sub>6</sub> status. Studies on pregnant women and oral contraceptive users. *Am. J. Clin. Nutr.* **1975**, *28*, 739–747.
46. Cinnamon, A.D.; Beaton, J.R. Biochemical assessment of vitamin B<sub>6</sub> status in man. *Am. J. Clin. Nutr.* **1970**, *23*, 696–702.
47. Kirksey, A.; Keaton, K.; Abernathy, R.P.; Greger, J.L. Vitamin B<sub>6</sub> nutritional status of a group of female adolescents. *Am. J. Clin. Nutr.* **1978**, *31*, 946–954.
48. Ubbink, J.B.; Bisshart, S.; van den Berg, I.; deVilliers, L.S.; Becker, P.J. Genetic polymorphism of glutamate-pyruvate transaminase (alanine aminotransferase): influence on erythrocyte activity as a marker of vitamin B<sub>6</sub> nutritional status. *Am. J. Clin. Nutr.* **1989**, *50*, 1420–1428.
49. Leklem, J.E. Quantitative aspects of tryptophan metabolism in humans and other species: a review. *Am. J. Clin. Nutr.* **1971**, *24*, 659–671.
50. Brown, R.R. The tryptophan load test as an index of vitamin B<sub>6</sub> nutrition. In *Methods in Vitamin B<sub>6</sub> Nutrition*; Leklem, J.E., Reynolds, R.D., Eds.; Plenum Press: New York, 1985; 321–340.
51. van den Berg, H.; Louwense, E.S.; Bruinse, H.W.; Thissen, J.T.N.M.; Schrijver, J. Vitamin B<sub>6</sub> status of women suffering from premenstrual syndrome. *Hum. Nutr. Clin. Nutr.* **1986**, *40C*, 441–450.
52. Brown, R.R. Possible role of vitamin B<sub>6</sub> in cancer prevention and treatment. In *Clinical and Physiological Applications of Vitamin B<sub>6</sub>*; Leklem, J.E., Reynolds, R.D., Eds.; Alan R. Liss: New York, 1988; 279–301.
53. Bender, D.A. Oestrogens and vitamin B<sub>6</sub>—actions and interactions. *World Rev. Nutr. Diet* **1987**, *51*, 140–188.
54. Linkswiler, H.M. Methionine metabolite excretion as affected by a vitamin B<sub>6</sub> deficiency. In *Methods in Vitamin B<sub>6</sub> Nutrition*; Leklem, J.E., Reynolds, R.D., Eds.; Plenum Press: New York, 1981; 373–381.
55. Kretsch, M.J.; Sauberlich, H.E.; Newbrun, E. Electroencephalographic changes and periodontal status during short-term vitamin B<sub>6</sub> depletion of young nonpregnant women. *Am. J. Clin. Nutr.* **1991**, *53*, 1266–1274.
56. Kwak, H.K.; Hansen, C.M.; Leklem, J.E. Improved vitamin B<sub>6</sub> status is positively related to lymphocyte proliferation in young women consuming a controlled diet. *J. Nutr.* **2002**, *132*, 3308–3312.
57. Sauberlich, H.E. Section IX. Biochemical systems and biochemical detection of deficiency. In *The Vitamins: Chemistry, Physiology, Pathology, Assay*, 2nd Ed.; Sebrell, W.H., Harris, R.S., Eds.; Academic Press: New York, 1968; Vol. 2, 44–80.
58. Schirch, L.; Jenkins, W.T. Serine transhydroxymethylase. *J. Biol. Chem.* **1964**, *239*, 3797–3800.
59. Axelrod, A.E.; Trakatelles, A.C. Relationship of pyridoxine to immunological phenomena. *Vitam. Horm.* **1964**, *22*, 591–607.

60. Chandra, R.K.; Puri, S. Vitamin B<sub>6</sub> modulation of immune responses and infection. In *Vitamin B<sub>6</sub>: Its Role in Health and Disease*; Reynolds, R.D., Leklem, J.E., Eds.; Alan R. Liss: New York, 1985; 163–175.
61. Robson, L.C.; Schwarz, M.R. Vitamin B<sub>6</sub> deficiency and the lymphoid system I. Effect of cellular immunity and in vitro incorporation of <sup>3</sup>H-uridine by small lymphocytes. *Cell Immunol.* **1975**, *16*, 135–144.
62. Rall, L.C.; Meydani, S.N. Vitamin B<sub>6</sub> and immune competence. *Nutr. Rev.* **1993**, *51*, 217–225.
63. Krebs, E.G.; Fischer, E.H. Phosphorylase and related enzymes of glycogen metabolism. In *Vitamins and Hormones*; Harris, R.S., Wool, I.G., Lovaine, J.A., Eds.; Academic Press: New York, 1964; Vol. 22, 399–410.
64. Angel, J.F. Gluconeogenesis in meal-fed, vitamin B<sub>6</sub> deficient rats. *J. Nutr.* **1980**, *110*, 262–269.
65. Rose, D.P.; Leklem, J.E.; Brown, R.R.; Linkswiler, H.M. Effect of oral contraceptives and vitamin B<sub>6</sub> deficiency on carbohydrate metabolism. *Am. J. Clin. Nutr.* **1975**, *28*, 872–878.
66. Angel, J.F.; Mellor, R.M. Glycogenesis and gluconeogenesis in meal-fed pyridoxine-deprived rats. *Nutr. Rep. Int.* **1974**, *9*, 97–107.
67. Black, A.L.; Guirard, B.M.; Snell, E.E. The behavior of muscle phosphorylase as a reservoir for vitamin B<sub>6</sub> in the rat. *J. Nutr.* **1978**, *108*, 670–677.
68. Russell, L.E.; Bechtel, P.J.; Easter, R.A. Effect of deficient and excess dietary vitamin B<sub>6</sub> on amino and glycogen phosphorylase activity and pyridoxal phosphate content in two muscles from postpubertal gilts. *J. Nutr.* **1985**, *115*, 1124–1135.
69. Butler, P.E.; Cookson, E.J.; Beyon, R.J. The turnover and skeletal muscle glycogen phosphorylase studied using the cofactor, pyridoxal phosphate, as a specific label. *Biochem. Biophys.* **1985**, *A847*, 316–323.
70. Lau-Cam, C.A.; Thadikonda, K.P.; Kendall, B.F. Stimulation of rat liver glucogenolysis by vitamin B<sub>6</sub>: a role for adrenal catecholamines. *Res. Commun. Chem. Pathol. Pharmacol.* **1991**, *73*, 197–207.
71. Mehansho, H.; Henderson, L.M. Transport and accumulation of pyridoxine and pyridoxal by erythrocytes. *J. Biol. Chem.* **1980**, *255*, 11,901–11,907.
72. Fonda, M.L.; Harker, C.W. Metabolism of pyridoxine and protein binding of the metabolites in human erythrocytes. *Am. J. Clin. Nutr.* **1982**, *35*, 1391–1399.
73. Kark, J.A.; Bongiovanni, R.; Hicks, C.U.; Tarassof, G.; Hannah, J.S.; Yoshida, G.Y. Modification of intracellular hemoglobin with pyridoxal and pyridoxal 5'-phosphate. *Blood Cells* **1982**, *8*, 299–314.
74. Benesch, R.; Benesch, R.E.; Edalji, R.; Suzuki, T. 5'-Deoxy pyridoxal as a potential antisickling agent. *Proc. Natl. Acad. Sci. U.S.A.* **1977**, *74*, 1721–1723.
75. Maeda, N.; Takahashi, K.; Aono, K.; Shiga, T. Effect of pyridoxal 5'-phosphate on the oxygen affinity of human erythrocytes. *Br. J. Haematol.* **1976**, *34*, 501–509.
76. Reynolds, R.D.; Natta, C.L. Vitamin B<sub>6</sub> and sickle cell anemia. In *Vitamin B<sub>6</sub>: Its Role in Health and Disease*; Reynolds, R.D., Leklem, J.E., Eds.; Alan R. Liss: New York, 1985; 301–306.
77. Kikuchi, G.; Kumar, A.; Talmage, P. The enzymatic synthesis of  $\gamma$ -aminolevulinic acid. *J. Biol. Chem.* **1958**, *233*, 1214–1219.
78. Bottomley, S.S. Iron and vitamin B<sub>6</sub> metabolism in the sideroblastic anemias. In *Nutrition in Hematology*; Lindenbaum, J.L., Ed.; Churchill Livingstone: New York, 1983; 203–223.
79. Horrigan, D.L.; Harris, J.W. Pyridoxine responsive anemia in man. *Vitam. Horm.* **1968**, *26*, 549–568.
80. Pasanen, A.V.O.; Salmi, M.; Tenhunen, R.; Vuopio, P. Haem synthesis during pyridoxine therapy in two families with different types of hereditary sideroblastic anemia. *Ann. Clin. Res.* **1982**, *14*, 61–65.
81. Leklem, J.E.; Brown, R.R.; Rose, D.P.; Linkswiler, H.; Arend, R.A. Metabolism of tryptophan and niacin in oral contraceptive users receiving controlled intakes of vitamin B<sub>6</sub>. *Am. J. Clin. Nutr.* **1975**, *28*, 146–156.
82. Dakshinamurti, K. Neurobiology of pyridoxine. In *Advances in Nutritional Research*; Draper, H.H., Ed.; Plenum Press: New York, 1982; Vol. 4, 143–179.
83. Coursin, D.B. Convulsive seizures in infants with pyridoxine-deficient diet. *J. Am. Med. Assoc.* **1954**, *154*, 406–408.
84. Maloney, C.J.; Parmalee, A.H. Convulsions in young infants as a result of pyridoxine deficiency. *J. Am. Med. Assoc.* **1954**, *154*, 405–406.
85. Alton-Mackey, M.G.; Walker, B.L. Graded levels of pyridoxine in the rat during gestation and the physical and neuromotor development of offspring. *Am. J. Clin. Nutr.* **1973**, *26*, 420–428.
86. Malouf, R.; Grimley Evans, J. The effect of vitamin B<sub>6</sub> on cognition. *Cochrane Database Syst. Rev.* **2003**, *4*, CD0004393.
87. Guilarte, T.R. The role of vitamin B<sub>6</sub> in central nervous system development: neurochemistry

- and behavior. In *Vitamin B<sub>6</sub> Metabolism in Pregnancy, Lactation, and Infancy*; Raiten, D.J., Ed.; CRC Press: Boca Raton, FL, 1995; 77–92.
88. Garry, R.; Yonis, Z.; Brahain, J.; Steinitz, K. Pyridoxine-dependent convulsions in an infant. *Arch. Dis. Child.* **1962**, *37*, 21–24.
  89. Iinuma, K.; Narisawa, K.; Yamauchi, N.; Yoshida, T.; Mizuno, T. Pyridoxine dependent convulsion: effect of pyridoxine therapy on electroencephalograms. *Tohoku. J. Exp. Med.* **1971**, *105*, 19–26.
  90. Baniker, A.; Turner, M.; Hopkins, I.J. Pyridoxine dependent seizures—a wider clinical spectrum. *Arch. Dis. Child.* **1983**, *58*, 415–418.
  91. Goutieres, F.; Aicardi, J. Atypical presentations of pyridoxine-dependent seizures: a treatable cause of intractable epilepsy in infants. *Ann. Neurol.* **1985**, *17*, 117–120.
  92. Canhwn, J.E.; Baker, E.M.; Harding, R.S.; Sauberlich, H.E.; Plough, I.C. Dietary protein: its relationship to vitamin B<sub>6</sub> requirements and function. *Ann. N. Y. Acad. Sci.* **1969**, *166*, 16–29.
  93. Grabow, J.D.; Linkswiler, H. Electroencephalographic and nerve-conduction studies in experimental vitamin B<sub>6</sub> deficiency in adults. *Am. J. Clin. Nutr.* **1969**, *22*, 1429–1434.
  94. Aycock, J.E.; Kirksey, A. Influence of different levels of dietary pyridoxine on certain parameters of developing and mature brains in rats. *J. Nutr.* **1976**, *106*, 680–688.
  95. Thomas, M.R.; Kirksey, A. Postnatal patterns of fatty acids in brain of progeny for vitamin B<sub>6</sub> deficient rats before and after pyridoxine supplementation. *J. Nutr.* **1976**, *106*, 1415–1420.
  96. Morre, D.M.; Kirksey, A.; Das, G.D. Effects of vitamin B<sub>6</sub> deficiency on the developing central nervous system of the rat. Gross measurements and cytoarchitectural alterations. *J. Nutr.* **1978**, *108*, 1250–1259.
  97. Mueller, J.F. Vitamin B<sub>6</sub> in fat metabolism. *Vitam. Horm.* **1964**, *22*, 787–796.
  98. Birch, T.W. The relations between vitamin B<sub>6</sub> and the unsaturated fatty acid factor. *J. Biol. Chem.* **1938**, *124*, 775–793.
  99. Audet, A.; Lupien, P.J. Triglyceride metabolism in pyridoxine-deficient rats. *J. Nutr.* **1974**, *104*, 91–100.
  100. Abe, M.; Kishino, Y. Pathogenesis of fatty liver in rats fed a high protein diet without pyridoxine. *J. Nutr.* **1982**, *112*, 205–210.
  101. Sabo, D.J.; Francesconi, R.P.; Gershoff, S.N. Effect of vitamin B<sub>6</sub> deficiency on tissue dehydrogenases and fat synthesis in rats. *J. Nutr.* **1971**, *101*, 29–34.
  102. Angel, J.F. Lipogenesis by hepatic and adipose tissues from meal-fed pyridoxine-deprived rats. *Nutr. Rep. Int.* **1975**, *11*, 369–378.
  103. Angel, J.F.; Song, G.-W. Lipogenesis in pyridoxine-deficient nibbling and meal-fed rats. *Nutr. Rep. Int.* **1973**, *8*, 393–403.
  104. Witten, P.W.; Holman, R.T. Polyethenoid fatty acid metabolism, VI. Effect of pyridoxine on essential fatty acid conversions. *Arch. Biochem. Biophys.* **1952**, *41*, 266–273.
  105. Cunnane, S.C.; Manku, M.S.; Horrobin, D.F. Accumulation of linoleic and  $\gamma$ -linolenic acids in tissue lipids of pyridoxine-deficient rats. *J. Nutr.* **1984**, *114*, 1754–1761.
  106. She, Q.B.; Hayakawa, T.; Tsuge, H. Effect of vitamin B<sub>6</sub> deficiency on linoleic acid desaturation in arachidonic acid biosynthesis of rat liver microsomes. *Biosci. Biochem.* **1994**, *58*, 459–463.
  107. She, Q.B.; Hayakawa, T.; Tsuge, H. Alteration in the phosphatidylcholine biosynthesis of rat liver microsomes caused by vitamin B<sub>6</sub> deficiency. *Biosci. Biotechnol. Biochem.* **1995**, *59*, 163–167.
  108. Delmore, C.B.; Lupien, P.J. The effect of vitamin B-6 deficiency on the fatty acid composition of the major phospholipids in the rat. *J. Nutr.* **1976**, *106* (2), 169–180.
  109. Fincnam, J.E.; Faber, M.; Weight, M.J.; Labadarious, D.; Taljaard, J.J.F.; Steytler, J.G.; Jacobs, P.; Kritchevsky, D. Diets realistic for Westernized people significantly effect lipoproteins, calcium, zinc, vitamin-C, vitamin-E, vitamin B<sub>6</sub> and hematology in vervet monkeys. *Atherosclerosis* **1987**, *66*, 191–203.
  110. Serfontein, W.J.; Ubbink, J.B. Vitamin B<sub>6</sub> and myocardial infarction. In *Clinical and Physiological Applications of Vitamin B<sub>6</sub>*; Leklem, J.E., Reynolds, R.D., Eds.; Alan R. Liss: New York, 1988; 201–217.
  111. Major, L.F.; Goyer, P.F. Effects of disulfiram and pyridoxine on serum cholesterol. *Ann. Intern. Med.* **1978**, *88*, 53–56.
  112. Cho, Y.-O.; Leklem, J.E. In vivo evidence of vitamin B<sub>6</sub> requirement in carnitine synthesis. *J. Nutr.* **1990**, *120*, 258–265.
  113. Litwack, G.; Miller-Diener, A.; DiSorbo, D.M.; Schmidt, T.J. Vitamin B<sub>6</sub> and the glucocorticoid receptor. In *Vitamin B<sub>6</sub>: Its Role in Health and Disease*; Reynolds, R.D., Leklem, J.E., Eds.; Alan R. Liss: New York, 1985; 177–191.
  114. Cidlowski, J.A.; Thanassi, J.W. Pyridoxal phosphate: a possible cofactor in steroid hormone action. *J. Steroid Biochem.* **1981**, *15*, 11–16.
  115. Tully, D.B.; Allgood, V.E.; Cidlowski, J.A. Modulation of steroid receptor-mediated gene

- expression by vitamin B<sub>6</sub>. *FASEB J.* **1994**, *8*, 343–349.
116. Brandsch, R. Regulation of gene expression by cofactors derived from B vitamins. *J. Nutr. Sci. Vitaminol.* **1994**, *40*, 371–399.
117. Compton, M.M.; Cidlowski, J.A. Vitamin B<sub>6</sub> and glucocorticoid action. *Endocr. Rev.* **1986**, *7*, 140–148.
118. Muldoon, T.G.; Cidlowski, J.A. Specific modification of rat uterine estrogen receptor by pyridoxal 5'-phosphate. *J. Biol. Chem.* **1980**, *255*, 3100–3107.
119. Hiipakka, R.A.; Liao, S. Effect of pyridoxal phosphate on the androgen receptor from rat prostate: inhibition of receptor aggregation and receptor binding to nuclei and to DNA cellulose. *J. Steroid Biochem.* **1980**, *13*, 841–846.
120. Nishigori, H.; Moudgil, V.K.; Taft, D. Inactivation of avian progesterone receptor binding to ATP-sepharose by pyridoxal 5'-phosphate. *Biochem. Biophys. Res. Commun.* **1978**, *80*, 112–118.
121. Allgood, V.E.; Powell-Oliver, F.E.; Cidlowski, J.A. Vitamin B<sub>6</sub> influences glucocorticoid receptor-dependent gene expression. *J. Biol. Chem.* **1990**, *265*, 12,424–12,433.
122. Holley, J.; Bender, D.A.; Coulson, W.F.; Symes, E.K. Effects of vitamin B<sub>6</sub> nutritional status on the uptake of (<sup>3</sup>H) oestradiol into the uterus, liver and hypothalamus of the rat. *J. Steroid Biochem.* **1983**, *18*, 161–165.
123. Bunce, G.E.; Vessal, M. Effect of zinc and/or pyridoxine deficiency upon oestrogen retention and oestrogen receptor distribution in the rat uterus. *J. Steroid Biochem.* **1987**, *26*, 303–308.
124. Sturman, J.A.; Kremzner, L.T. Regulation of ornithine decarboxylase synthesis: effect of a nutritional deficiency of vitamin B<sub>6</sub>. *Life Sci.* **1974**, *14*, 977–983.
125. DiSorbo, D.M.; Litwack, G. Changes in the intracellular levels of pyridoxal 5'-phosphate affect the induction of tyrosine aminotransferase by glucocorticoids. *Biochem. Biophys. Res. Commun.* **1981**, *99*, 1203–1208.
126. Allgood, V.E.; Cidlowski, J.A. Vitamin B<sub>6</sub> modulates transcriptional activation by multiple members of the steroid hormone receptor superfamily. *J. Biol. Chem.* **1992**, *267*, 3819–3824.
127. Oka, T.; Komori, N.; Kuwahata, M.; Okada, M.; Natori, Y. Vitamin B<sub>6</sub> modulates expression of albumin gene by inactivating tissue-specific DNA-binding protein in rat liver. *Biochem. J.* **1995**, *309*, 243–248.
128. Oka, T.; Komori, N.; Kuwahata, M. et al. Pyridoxal 5'-phosphate modulates expression of cytosolic aspartate aminotransferase gene by inactivation of glucocorticoid receptor. *J. Nutr. Sci. Vitaminol.* **1995**, *41*, 363–375.
129. Oka, T.; Kuwahata, M.; Sugitatsu, H.; Tsuge, H.; Asagi, K.; Kohri, H.; Horiuchi, S.; Natori, Y. Modulation of albumin gene expression by amino acid supply in rat liver is mediated through intracellular concentration of pyridoxal 5'-phosphate. *J. Nutr. Biochem.* **1997**, *8*, 211–216.
130. Hansen, C.M.; Leklem, J.E. Vitamin B<sub>6</sub> status and requirements of women of childbearing age. In *Vitamin B<sub>6</sub> Metabolism in Pregnancy, Lactation, and Infancy*; Paiten, D.J., Ed.; CRC Press: Boca Raton, FL, 1995; 41–59.
131. Driskell, J.A. Vitamin B<sub>6</sub> requirements of humans. *Nutr. Res.* **1994**, *14*, 293–324.
132. Vitamin B<sub>6</sub>. In *Dietary Reference Intakes for Thiamin, Riboflavin, Niacin, Vitamin B<sub>6</sub>, Folate, Vitamin B<sub>12</sub>, Pantothenic acid, Biotin, and Choline*; Food and Nutrition Board, Institute of Medicine/National Academy Press: Washington, DC, 1998; 150–195.
133. Ribaya-Mercado, J.D.; Russell, R.M.; Sahyoun, N.; Morrow, F.D.; Gershoff, S.N. Vitamin B<sub>6</sub> requirements of elderly men and women. *J. Nutr.* **1991**, *121*, 1062–1074.
134. Huang, Y.C.; Chen, W.; Evans, M.A.; Mitchell, M.E.; Shultz, T.D. Vitamin B<sub>6</sub> requirement and status assessment of young women fed a high-protein diet with various levels of vitamin B<sub>6</sub>. *Am. J. Clin. Nutr.* **1998**, *67*, 208–220.
135. Kretsch, M.J.; Sauberlich, H.E.; Skala, J.H.; Johnson, H.L. Vitamin B<sub>6</sub> requirement and status assessment: young women fed a depletion diet followed by plant- or animal-protein diet with graded amounts of vitamin B<sub>6</sub>. *Am. J. Clin. Nutr.* **1995**, *61*, 1091–1101.
136. Meydani, S.N.; Ribaya-Mercado, J.D.; Russell, R.M. et al. Vitamin B<sub>6</sub> deficiency impairs interleukin-2 production and lymphocyte proliferation in elderly adults. *Am. J. Clin. Nutr.* **1991**, *53*, 1275–1280.
137. Hansen, C.M.; Leklem, J.E.; Miller, L.T. Vitamin B<sub>6</sub> status indicators decrease in women consuming a diet high in pyridoxine glucoside. *J. Nutr.* **1996**, *126*, 2512–2518.
138. Collip, P.J.; Goldzier, S.; Weiss, N.; Soleyman, Y.; Snyder, R. Pyridoxine treatment of childhood bronchial asthma. *Ann. Allergy* **1975**, *35*, 93–97.
139. Musajo, L.; Benassi, C.A. Aspects of disorders of the kynurenine pathway of tryptophan metabolism in man. In *Advances in Clinical Chemistry*; Sobotka, H., Steward, C.P., Eds.; Academic Press: New York, 1964; Vol. 7, 63–135.

140. Hankes, L.V.; Leklem, J.E.; Brown, R.R.; Mekel, R.C.P.M. Tryptophan metabolism of patients with pellagra: problem of vitamin B<sub>6</sub> enzyme activity and feedback control of tryptophan pyrrolase enzyme. *Am. J. Clin. Nutr.* **1971**, *24*, 730–739.
141. Flinn, J.H.; Price, J.M.; Yess, N.; Brown, R.R. Excretion of tryptophan metabolites by patients with rheumatoid arthritis. *Arthritis Rheum.* **1964**, *7*, 201–210.
142. Reynolds, R.D.; Natta, C.L. Depressed plasma pyridoxal phosphate concentrations in adult asthmatics. *Am. J. Clin. Nutr.* **1985**, *41*, 684–688.
143. Hollenbeck, C.B.; Leklem, J.E.; Riddle, M.C.; Connor, W.E. The composition and nutritional adequacy of subject-selected high carbohydrate, low fat diets in insulin-dependent diabetes mellitus. *Am. J. Clin. Nutr.* **1983**, *38*, 41–51.
144. Stone, W.J.; Warnock, L.G.; Wagner, C. Vitamin B<sub>6</sub> deficiency in uremia. *Am. J. Clin. Nutr.* **1975**, *28*, 950–957.
145. Lumeng, L.; Li, T.-K. Vitamin B<sub>6</sub> metabolism chronic alcohol abuse. Pyridoxal phosphate levels in plasma and the effects of acetaldehyde on pyridoxal phosphate synthesis and degradation in human erythrocytes. *J. Clin. Invest.* **1974**, *53*, 693–704.
146. Serfontein, W.J.; Ubbink, J.B.; DeVilliers, C.S.; Rapley, C.H.; Becker, P.J. Plasma pyridoxal-5'-phosphate level as risk index for coronary artery disease. *Atherosclerosis* **1985**, *55*, 357–361.
147. Wachstein, M.; Kellner, I.D.; Orez, J.M. Pyridoxal phosphate in plasma and leukocytes of normal and pregnant subjects following B<sub>6</sub> load tests. *Proc. Soc. Exp. Biol. Med.* **1960**, *103*, 350–353.
148. Potera, C.; Rose, D.P.; Brown, R.R. Vitamin B<sub>6</sub> deficiency in cancer patients. *Am. J. Clin. Nutr.* **1977**, *30*, 1677–1679.
149. Devita, V.T.; Chabner, B.A.; Livingston, D.M.; Oliverio, V.T. Anergy and tryptophan metabolism in Hodgkin's disease. *Am. J. Clin. Nutr.* **1971**, *24*, 835–840.
150. (a) Coburn, S.P.; Whyte, M.P. Role of phosphatases in the regulation of vitamin B<sub>6</sub> metabolism in hypophosphatasia and other disorders. In *Clinical and Physiological Applications of Vitamin B<sub>6</sub>*; Leklem, J.E., Reynolds, R.D., Eds.; Alan R. Liss: New York, 1988; 65–93; (b) Coleman, M. Studies of the administration of pyridoxine to children with Down's syndrome. In *Clinical and Physiological Applications of Vitamin B<sub>6</sub>*; Leklem, J.E., Reynolds, R.D., Eds.; Alan R. Liss: New York, 1988; 317–328; (c) Schaumberg, H., Kaplan, J., Windebank, A. et al. Sensory neuropathy from pyridoxine abuse. A new megavitamin syndrome. *N. Engl. J. Med.* **1983**, *309*, 445–448; (d) Bernstein, A.L., Lobitz, C.S. A clinical and electrophysiologic study of the treatment of painful diabetic neuropathies with pyridoxine. In *Clinical and Physiological Applications of Vitamin B<sub>6</sub>*; Leklem, J.E., Reynolds, R.D., Eds.; Alan R. Liss: New York, 1988; 415–423.
151. McCully, K.S. Homocysteine theory of arteriosclerosis: development and current status. *Atheroscler. Rev.* **1983**, *11*, 157–246.
152. Mudd, S.H.; Levy, H.L. Disorders of transsulfuration. In *The Metabolic Basis of Inherited Disease*; Stanbury, J.B. et al., Ed.; McGraw-Hill: New York, 1983; 522–559.
153. Wall, R.T.; Harlan, J.M.; Harker, L.A. et al. Homocysteine-induced endothelial cell injury in vitro: a model for the study of vascular injury. *Thromb. Res.* **1980**, *18*, 113–121.
154. Robinson, K.; Mayer, E.L.; Miller, D. et al. Hyperhomocysteinemia and low pyridoxal phosphate: common and independent reversible risk factors for coronary artery disease. *Circulation* **1995**, *92*, 2825–2830.
155. Morrison, H.I.; Schaubel, D.; Desmeules, M.; Wigle, D.T. Serum folate and risk of fatal coronary heart disease. *J. Am. Med. Assoc.* **1996**, *275*, 1893–1896.
156. Woodside, J.V.; Yarnell, J.; McMaster, D.; Young, I.S.; Harmon, D.L.; McCrum, E.E.; Patterson, C.C.; Gey, K.F.; Whitehead, A.S.; Evans, A. Effect of B-group vitamins and anti-oxidant vitamins on hyperhomocysteinemia: a double-blind, randomized, factorial-design, controlled trial. *Am. J. Clin. Nutr.* **1998**, *67*, 858–866.
157. Friso, S.; Girelli, D.; Martinelli, N. Low plasma vitamin B-6 concentrations and modulation of coronary artery disease risk. *Am. J. Clin. Nutr.* **2004**, *79*, 992–998.
158. Robinson, K.; Arheart, K.; Refsum, H.; Brattstrom, L.; Boers, G.; Ueland, P.; Rubba, P.; Palma-Reis, R.; Meleady, R.; Daly, L.; Witteman, J.; Graham, I. Low circulating folate and vitamin B<sub>6</sub> concentrations: risk factors for stroke, peripheral vascular disease and coronary artery disease. *Circulation* **1998**, *97*, 437–443.
159. Kelly, P.J.; Shih, V.E.; Kistler, J.P.; Barron, M.; Lee, H.; Mandell, R.; Furie, K.L. Low vitamin B<sub>6</sub> but not homocyst(e)ine is associated with increased risk of stroke and transient ischemic attack in the era of folic acid grain fortification. *Stroke* **2003**, *34*, e51–e54.

160. Rinehart, J.F.; Greenberg, L.D. Pathogenesis of experimental arteriosclerosis in pyridoxine deficiency with notes on similarities to human arteriosclerosis. *Arch. Pathol.* **1951**, *51*, 12–18.
161. Krishnaswamy, K.; Rao, S.B. Failure to produce atherosclerosis in *Macaca radiata* on a high-methionine, high-fat, pyridoxine-deficient diet. *Atherosclerosis* **1977**, *27*, 253–258.
162. Swift, M.E.; Shultz, T.D. Relationship of vitamins B<sub>6</sub> and B<sub>12</sub> to homocysteine levels: risk for coronary heart disease. *Nutr. Rep. Int.* **1986**, *34*, 1–14.
163. Boers, G.H.; Smals, A.G.H. et al. Pyridoxine treatment does not prevent homocystinemia after methionine loading in adult homocystinuria patients. *Metabolism* **1983**, *32*, 390–397.
164. Vermaak, W.J.H.; Barnard, H.C.; Potgieter, G.M.; Marx, J.D. Plasma pyridoxal-5'-phosphate levels in myocardial infarction. *S. Afr. Med. J.* **1986**, *70*, 195–196.
165. Vermaak, W.J.H.; Barnard, H.C.; Potgieter, G.M.; Theron, H. du T. Vitamin B<sub>6</sub> and coronary artery disease. Epidemiological observations and case studies. *Atherosclerosis* **1987**, *63*, 235–238.
166. Serfontein, W.J.; Ubbink, J.B.; De Villiers, L.S.; Becker, P.J. Depressed plasma pyridoxal-5'-phosphate levels in tobacco-smoking men. *Atherosclerosis* **1986**, *59*, 341–346.
167. Baum, M.K.; Shor-Posner, G.; Bonvchi, P. et al. Influence of HIV infection on vitamin status requirements. *Ann. N. Y. Acad. Sci.* **1992**, *669*, 165–173.
168. Baum, M.K.; Mantero-Atienza, E.; Shor-Posner, G. et al. Association of vitamin B<sub>6</sub> status with parameters of immune function in early HIV-1 infection. *J. AIDS* **1991**, *4*, 1122–1132.
169. Pease, J.; Niewinski, M.; Pietrak, D.; Leklem, J.E.; Reynolds, R.D. Vitamin B<sub>6</sub> metabolism and status in HIV positive and HIV negative high-risk patients. *FASEB J.* **1998**, *12*, A510.
170. Tang, A.M.; Graham, N.M.H.; Kirby, A.J. et al. Dietary micronutrient intake and risk of progression to acquired immunodeficiency syndrome (AIDS) in human immunodeficiency virus type 1 (HIV-1)-infected homosexual men. *Am. J. Epidemiol.* **1993**, *138*, 937–951.
171. Coodley, G.O.; Coodley, M.K.; Nilson, H.D.; Lovdell, M.D. Micronutrient concentrations in the HIV wasting syndrome. *J. AIDS* **1993**, *7*, 1595–1600.
172. Tang, A.M.; Graham, N.M.H.; Chandra, R.K.; Saah, A.J. Low serum vitamin B<sub>12</sub> concentrations are associated with faster human immunodeficiency virus type 1 (HIV-1) disease progression. *J. Nutr.* **1997**, *127*, 345–351.
173. Salhany, J.M.; Schopfer, L.M. Pyridoxal 5'-phosphate binds specifically to soluble CD4 protein, the HIV-1 receptor. *J. Biol. Chem.* **1993**, *268*, 7643–7645.
174. Mitchell, L.L.W.; Cooperman, B.S. Active site studies of human immunodeficiency virus reverse transcriptase. *Biochemistry* **1992**, *31*, 7707–7713.
175. Moen, L.K.; Bathurst, I.C.; Barr, P.J. Pyridoxal 5'-phosphate inhibits the polymerase activity of a recombinant RNase H-deficient mutant HIV-1 reverse transcriptase. *AIDS Res. Hum. Retroviruses* **1992**, *8*, 597–604.
176. Brush, M.G. Vitamin B<sub>6</sub> treatment of premenstrual syndrome. In *Clinical and Physiological Applications of Vitamin B<sub>6</sub>*; Leklem, J.E., Reynolds, R.D., Eds.; Alan R. Liss: New York, 1988; 363–379.
177. O'Brien, P.M.S. The premenstrual syndrome: a review of the present status of therapy. *Drugs* **1982**, *24*, 140–151.
178. Mira, M.; Stewart, P.M.; Abraham, S.F. Vitamin and trace element status in premenstrual syndrome. *Am. J. Clin. Nutr.* **1988**, *47*, 636–641.
179. Adams, P.W.; Rose, D.P. et al. Effects of pyridoxine hydrochloride (vitamin B<sub>6</sub>) upon depression associated with oral contraception. *Lancet* **1973**, *1*, 897.
180. Stokes, J.; Mendels, J. Pyridoxine and premenstrual tension. *Lancet* **1972**, *1*, 1177–1178.
181. Abraham, G.E.; Hargrove, J.T. Effect of vitamin B<sub>6</sub> on premenstrual symptomatology in women with premenstrual tension syndromes: a double blind crossover study. *Infertility* **1980**, *3*, 155–165.
182. Barr, W. Pyridoxine supplements in the premenstrual syndrome. *Practitioner* **1984**, *228*, 425–428.
183. Kendall, K.E.; Schurr, P.P. The effects of vitamin B<sub>6</sub> supplementation on premenstrual syndromes. *Obstet. Gynecol.* **1987**, *70*, 145–149.
184. Kleijnen, J.; Riet, G.T.; Knipschild, P. Vitamin B<sub>6</sub> in the treatment of the premenstrual syndrome—a review. *Br. J. Obstet. Gynecol.* **1990**, *97*, 847–852.
185. Simon, R.A.; Reynolds, R.D. Vitamin B<sub>6</sub> and asthma. In *Clinical and Physiological Applications of Vitamin B<sub>6</sub>*; Leklem, J.E., Reynolds, R.D., Eds.; Alan R. Liss: New York, 1988; 307–315.
186. Ubbink, J.B.; Delpont, R.; Bissbort, S.; Vermaak, W.J.; Becker, P.J. Relationship between vitamin B<sub>6</sub> status and elevated pyridoxal kinase levels induced by theophylline therapy in humans. *J. Nutr.* **1990**, *120*, 1352–1359.
187. Driskell, J.A.; Wesley, R.L.; Hess, I.E. Effectiveness of pyridoxine hydrochloride treatment on

- carpal tunnel syndrome patients. *Nutr. Rep. Int.* **1986**, *34*, 1031–1040.
188. Kasdan, M.L.; James, C. Carpal tunnel syndrome and vitamin B<sub>6</sub>. *Plast. Reconstr. Surg.* **1987**, *79*, 456–459.
189. Smith, G.P.; Rudge, P.J.; Peters, J.J. Biochemical studies of pyridoxal and pyridoxal phosphate status and therapeutic trial of pyridoxine in patients with carpal tunnel syndrome. *Ann. Neurol.* **1984**, *15*, 104–107.
190. Franzblau, A.; Rock, C.L.; Werner, R.A. et al. The relationship of vitamin B<sub>6</sub> status to median nerve function and carpal tunnel syndrome among active industrial workers. *J. Occup. Environ. Med.* **1996**, *38*, 485–491.
191. Keniston, R.C.; Nathan, P.A.; Leklem, J.E.; Lockwood, R.S. Vitamin B<sub>6</sub>, vitamin C, and carpal tunnel syndrome. *J. Occup. Environ. Med.* **1997**, *39*, 949–959.
192. Bhagavan, H.N. Interaction between vitamin B<sub>6</sub> and drugs. In *Vitamin B<sub>6</sub>: Its Role in Health and Disease*; Reynolds, R.D., Leklem, J.E., Eds.; Alan R. Liss: New York, 1985; 401–415.
193. Leklem, J.E. Vitamin B<sub>6</sub> requirement and oral contraceptive use—a concern? *J. Nutr.* **1986**, *116*, 475–477.
194. Schaumburg, H.; Kaplan, J.; Windebank, A.; Vick, N.; Rasmus, S.; Pleasure, D.; Brown, M.J. Sensory neuropathy from pyridoxine abuse: a new megavitamin syndrome. *N. Engl. J. Med.* **1983**, *309*, 445–448.
195. Dalton, K.; Dalton, M.J.T. Characteristics of pyridoxine overdose neuropathy syndrome. *Acta Neurol. Scand.* **1987**, *76*, 8–11.
196. Cohen, M.; Bendich, A. Safety of pyridoxine—a review of human and animal studies. *Toxicol. Lett.* **1986**, *34*, 129–139.
197. Mori, K.; Kaido, M.; Fujishiro, K.; Inoue, N.; Koide, O. Effects of megadoses of pyridoxine on spermatogenesis and male reproductive organs in rats. *Arch. Toxicol.* **1992**, *66*, 198–203.
198. Cohen, P.A.; Schneidman, K.; Ginsberg-Fellner, F. et al. High pyridoxine diet in the rat: possible implications for megavitamin therapy. *J. Nutr.* **1973**, *103*, 143–151.
199. Mueller, J.F.; Iacono, J.M. Effect of desoxy-pyridoxine-induced vitamin B<sub>6</sub> deficiency on polyunsaturated fatty acid metabolism in human beings. *Am. J. Clin. Nutr.* **1963**, *12*, 358–367.
200. Cleary, R.E.; Lumeng, L.; Li, T.-K. Maternal and fetal plasma levels of pyridoxal phosphate at term: adequacy of vitamin B-6 supplementation. *Am. J. Obstet. Gynecol.* **1975**, *121*, 25–28.

# Vitamin B<sub>12</sub>

Lindsay H. Allen  
Katharine M. Jones

United States Department of Agriculture—Western Human Nutrition Research Center,  
University of California, Davis, California, U.S.A.

## INTRODUCTION

Because vitamin B<sub>12</sub> is found only in animal source foods (ASF), strict vegetarianism has long been associated with a greater risk of deficiency of this vitamin. The elderly, many of whom lose their ability to absorb vitamin B<sub>12</sub>, and the small proportion of the population with pernicious anemia (PA) due to lack of intrinsic factor (IF) are also established high-risk groups for this vitamin deficiency. It is generally assumed that clinical symptoms of B<sub>12</sub> deficiency take many years to appear after intake or absorption becomes inadequate. However, in recent years, it has become apparent that this deficiency is much more prevalent than previously assumed, affecting a high proportion of people in developing countries and even many lacto-ovo-vegetarians. Considering the number and size of population groups at risk of deficiency, it is important that we develop the most sensitive and specific methods of assessing vitamin B<sub>12</sub> status and understand the potential adverse functional consequences of this deficiency across the life span.

## VITAMIN B<sub>12</sub> STRUCTURE AND FUNCTION

### Structure

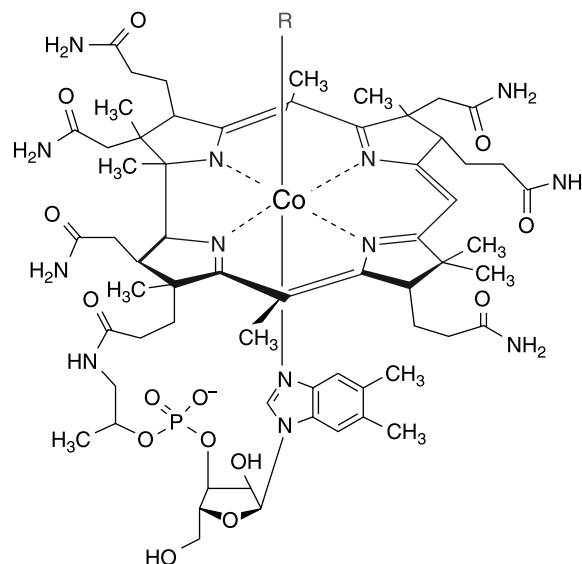
Vitamin B<sub>12</sub>, or cobalamin (Cbl), is a water-soluble vitamin with a molecular weight of 1355. Symptoms of Cbl deficiency were first described in the early 18th century, but the vitamin was not isolated until 1948. The molecule contains a corrinoid ring with a cobalt molecule at its center, beneath which is linked a nucleotide (Fig. 1). Analogs of Cbl have different structures of the nucleotide and do not retain the active properties of Cbl. However, the ligands linked to the

cobalt atom above the plane of the ring account for the various forms of active Cbl (Table 1).

The two forms of vitamin B<sub>12</sub> with metabolic activity are 5'-deoxyadenosylcobalamin (AdoCbl) and methylcobalamin (MeCbl). Hydroxycobalamin (OHCbl) and cyanocobalamin (CNCbl) are also biologically active after conversion to AdoCbl or MeCbl. Cyanocobalamin is rare in nature, but after isolation is used in the laboratory and is also the form used in vitamin B<sub>12</sub> supplements. AdoCbl and MeCbl are generally considered to be light sensitive, but CNCbl is relatively stable.

### Coenzyme Function

In humans, vitamin B<sub>12</sub> functions as a coenzyme for only two reactions in the body, catalyzed by methylmalonyl CoA mutase and methionine synthase. AdoCbl transfers a hydrogen atom in the methylmalonyl CoA mutase reaction, which is required for the conversion



**Fig. 1** The chemical structure of vitamin B<sub>12</sub>. (From <http://www.engr.psu.edu/wep/EngCompSp98/Aclausi/HodgkinD7.html>.) (View this art in color at [www.dekker.com](http://www.dekker.com).)

Lindsay H. Allen is at the USDA—Western Human Nutrition Research Center and Department of Nutrition, University of California, Davis, California, U.S.A.

Katharine M. Jones is at the USDA—Western Human Nutrition Research Center and Department of Nutrition, University of California, Davis, California, U.S.A.



**Table 1** Cobalamins with vitamin B<sub>12</sub> activity

R-group	Biological role of cobalamin
-5'-Deoxyadenosyl	Adenosylcobalamin—coenzyme for methylmalonyl CoA mutase
-CH <sub>3</sub>	Methylcobalamin—coenzyme for methionine synthase
-CN	Cyanocobalamin—biologically active upon conversion to AdoCbl or MeCbl
-OH	Hydroxycobalamin—biologically active upon conversion to AdoCbl or MeCbl

of propionyl CoA to succinyl CoA, an integral step in odd-chain fatty acid breakdown (Fig. 2). Propionyl CoA is first converted to methylmalonyl CoA via a carboxylase, after which AdoCbl-dependent methylmalonyl CoA mutase converts methylmalonyl CoA to succinyl CoA.

Methylcobalamin accepts and donates a methyl group in the second vitamin B<sub>12</sub>-dependent reaction, in which methionine synthase converts methyltetrahydrofolate (CH<sub>3</sub>-THF) and homocysteine (Hcy) to tetrahydrofolate (THF) and methionine (Fig. 3). Methionine is then metabolized to *S*-adenosylmethionine (SAM), a universal methyl donor. THF is further metabolized to methylenetetrahydrofolate (CH<sub>2</sub>-THF), which is a cofactor for thymidylate synthetase, the enzyme that converts uracil (dUMP) to thymidine (dTMP). As a cofactor for methionine synthase, vitamin B<sub>12</sub> plays an important role in the synthesis of purines, pyrimidines, and amino acids, and in the transfer of methyl groups.

## VITAMIN B<sub>12</sub> METABOLISM

### Digestion and Absorption

The digestion of vitamin B<sub>12</sub> is unique in its complexity (Fig. 4). When Cbl is released from the proteins to which it is attached in food, haptocorrin (Hc), a B<sub>12</sub>

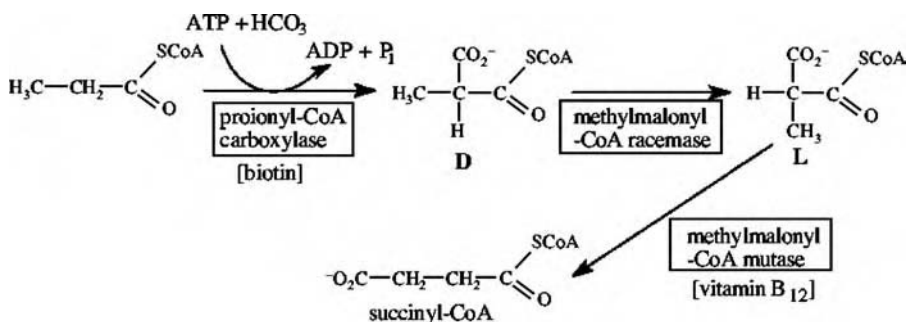
binder found in the salivary and esophageal glands, binds the vitamin. In the stomach, Cbl remains bound to Hc, while IF, a second B<sub>12</sub> binding protein, is secreted by the parietal cells. Haptocorrin has a higher affinity for Cbl than IF, and must be degraded by proteolytic enzymes from the small intestine before IF can bind the vitamin. In the ileum, Cbl-IF specific receptors bind the complex, and absorption occurs by endocytosis into endothelial cells, in a calcium-dependent but energy-independent process that takes about 3–4 hr. Percentage absorption decreases with the size of the dose.<sup>[1]</sup> The recommended dietary intake values for the United States/Canada assume that vitamin B<sub>12</sub> in food is 50% bioavailable. One percent of free vitamin B<sub>12</sub> is absorbed passively, which is important because sufficient amounts of the vitamin can be absorbed from large doses (i.e., 500 μg/day) to restore and maintain B<sub>12</sub> status even in individuals lacking IF.

The complexity of the digestive process means that abnormalities can occur at several points. An inability to effectively degrade proteins in food, such as that occurring in achlorhydria or atrophic gastritis, often prevents release of vitamin B<sub>12</sub> from food. Transfer of vitamin B<sub>12</sub> from food to Hc, which is dependent on pH and pepsin secretion, may also be compromised. Finally, lack of IF, due to the autoimmune condition PA, will prevent the uptake of Cbl by the ileal endothelial cells.

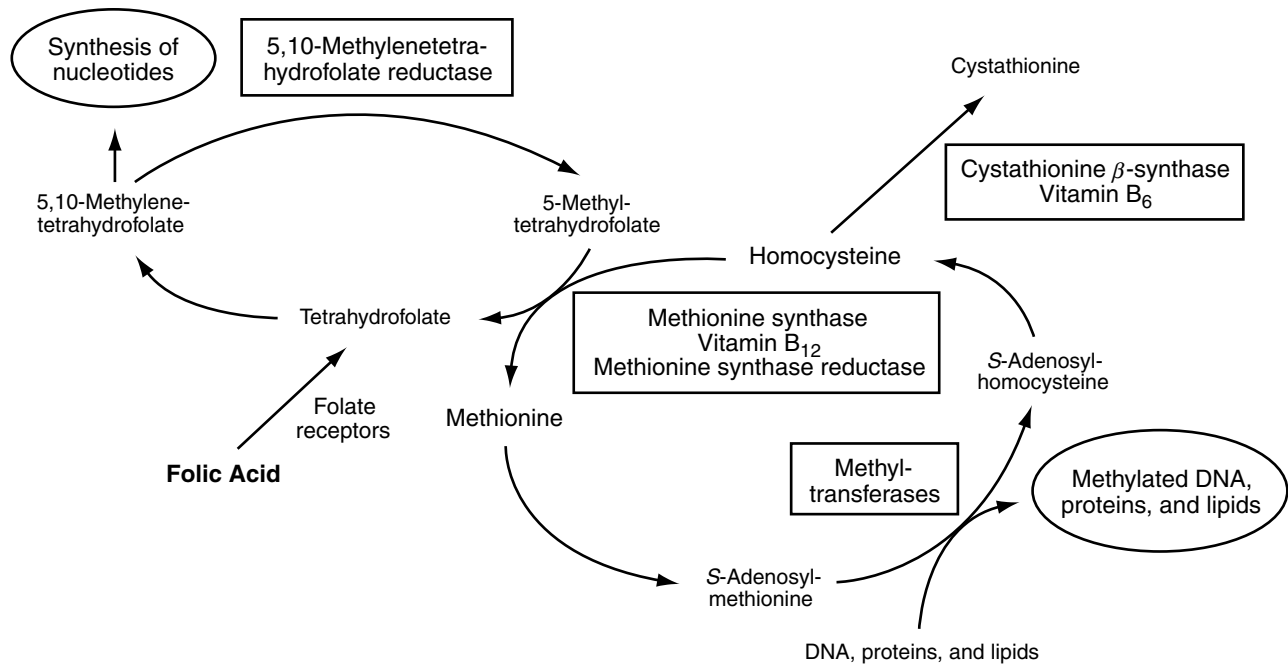
### Transport Proteins

#### Transcobalamin II (TC II)

After absorption into the endothelium, IF is degraded, and free vitamin B<sub>12</sub> is bound to transcobalamin II (TC II), which then transports B<sub>12</sub> through the plasma. TC II, which has a half-life of several minutes, is produced locally by many cells and is thought to play a role in cellular export of vitamin B<sub>12</sub>, as well as plasma transport. It is the only one of the three plasma B<sub>12</sub> binding proteins (transcobalamins I, II, and III) that is responsible for receptor-mediated uptake of B<sub>12</sub> into



**Fig. 2** 5'-Deoxyadenosylcobalamin is a coenzyme for methylmalonyl CoA mutase, which converts methylmalonyl CoA to succinyl CoA. (From: [http://heibeck.freeshell.org/NESA/Biochem\\_Fall\\_2001/Lipid\\_Metab.pdf](http://heibeck.freeshell.org/NESA/Biochem_Fall_2001/Lipid_Metab.pdf).)



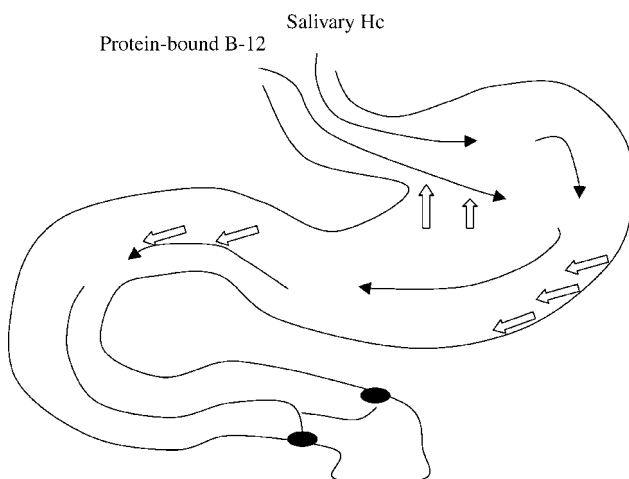
**Fig. 3** Methylcobalamin is a coenzyme for methionine synthase, which transfers methyl-tetrahydrofolate and homocysteine to tetrahydrofolate and methionine. (From Botto, L.D.; Moore, C.A.; Khoury, M.J.; Erickson, J.D. *Neural tube defects*. *N. Engl. J. Med.* 1999, 341, 1515.)

cells, and constitutes about 10–20% of the total plasma B<sub>12</sub>. Transcobalamin II is cleared from the plasma by the kidney, liver, heart, lung, spleen, and intestine.<sup>[2]</sup>

### Haptocorrin

Approximately 75% of plasma vitamin B<sub>12</sub> is bound to Hc (transcobalamins I + III), which has a half-life of 9–10 days, and can be thought of as a circulating store of the vitamin. Haptocorrin is produced in red blood

cell precursors, hepatoma cells, salivary glands, and granulocytes, and is largely unsaturated. An absence of Hc protein does not alter vitamin B<sub>12</sub> metabolism detrimentally, but an inability to produce TC II results in symptoms of vitamin B<sub>12</sub> deficiency, including megaloblastic anemia and neurological abnormalities.<sup>[3]</sup> Several genetic polymorphisms have been identified in proteins involved in the metabolism of vitamin B<sub>12</sub>, which may lead to reduced plasma concentrations of vitamin B<sub>12</sub>.



**Fig. 4** Vitamin B<sub>12</sub> digestion requires adequate stomach acidity, and secretion of haptocorrin and intrinsic factor before receptor-mediated absorption can occur in the ileum.

### Excretion and Storage

Vitamin B<sub>12</sub> is excreted through the urine, bile, and feces. Enterohepatic recirculation of vitamin B<sub>12</sub> is efficient, with 65–75% reabsorbed,<sup>[4]</sup> and therefore plays an important role in maintaining adequate Cbl status. Vitamin B<sub>12</sub> is stored in the liver, which in an adult human may contain 1–2 mg of a 2–5 mg total body pool.

## VITAMIN B<sub>12</sub>–NUTRIENT INTERACTIONS

### Vitamin B<sub>12</sub> and Folate

Both vitamin B<sub>12</sub> and folate are involved in the methionine synthase pathway (Fig. 3). According to the “folate trap” hypothesis, CH<sub>3</sub>-THF builds up in

excess when vitamin B<sub>12</sub> deficiency prevents methionine synthesis from proceeding. While it was originally thought that vitamin B<sub>12</sub> deficiency trapped CH<sub>3</sub>-THF intracellularly, it is possible that Cbl-deficient cells fail to retain intracellular CH<sub>3</sub>-THF. This theory is supported by data showing a rise in plasma folate concentration in vitamin B<sub>12</sub> deficient animals and humans.<sup>[5]</sup> Inadequate availability of folate coenzyme (CH<sub>2</sub>-folate) for DNA synthesis, due to folate or B<sub>12</sub> deficiency, can produce megaloblastic anemia. However, folate deficiency does not produce the neuropathy that accompanies strict vitamin B<sub>12</sub> deficiency.

## DIETARY REQUIREMENTS AND SOURCES

### Food Sources

Vitamin B<sub>12</sub> is synthesized by micro-organisms, but not plants and animals, and humans depend on ASF, fortified foods, and supplements for dietary Cbl. Organ meats, beef, pork, poultry, fish, shellfish, eggs, and dairy products are rich sources of vitamin B<sub>12</sub> (Table 2). Cobalamins from other sources including algae and yeast are probably not biologically active.<sup>[1]</sup> Although dietary requirements are minimal when compared to those of other micronutrients, the facts that vitamin B<sub>12</sub> is present in a limited number of food sources and that the digestive process is complex make deficiency a risk for certain populations. This certainly includes strict vegetarians, who lack sources of vitamin B<sub>12</sub> in their diet,<sup>[6]</sup> and the elderly, who may have an impaired ability to absorb the vitamin from food sources due to gastric atrophy. There are also multiple reports of lower plasma vitamin B<sub>12</sub> concentrations in lacto-ovo-vegetarians than in omnivores.<sup>[7,8]</sup> Populations in developing countries are also at risk for vitamin B<sub>12</sub> deficiency, due to the high cost and low availability of ASF, and a lack of fortified foods

**Table 2** Animal source foods (ASF) rich in vitamin B<sub>12</sub>

ASF	B <sub>12</sub> (µg per 100 g)
Beef liver, fried	83.0
Chicken liver, fried	21.0
Beef, cooked	1.3–4.0
Pork, cooked	0.7
Turkey, cooked	0.4
Chicken, cooked	0.3
Tuna, canned in oil	2.2
Egg, fried	1.4
Cheese	0.4–1.7
Milk, whole	0.5

(From USDA National Nutrient Database. <http://www.nal.usda.gov/finic/cgi-bin/nut-search.pl>.)

and supplements. (See the section on “Vitamin B<sub>12</sub> Deficiency.”)

### Dietary Reference Intakes

Daily loss of Cbl is estimated to be 0.1% of the total body pool.<sup>[1]</sup> Assuming a total body pool of 2–5 mg, the daily losses for adults would be 2–5 µg. Due to the low ratio of daily losses to the total body pool, vitamin B<sub>12</sub> deficiency may take several years to develop after the removal of ASF, vitamin B<sub>12</sub> fortified foods, and supplements from the diet. This time could be substantially shorter in people who reabsorb less of the vitamin by enterohepatic recirculation, due to lower output in bile as a result of depleted liver stores or malabsorptive disorders. It has been estimated that with a daily turnover rate of 0.1% per day, it can take from 1.5 to 11.6 yr to see signs of B<sub>12</sub> deficiency depending on initial liver B<sub>12</sub> stores.<sup>[1]</sup>

The adult recommended dietary allowance (RDA) of 2.4 µg is based on the intake levels required to maintain hematological status and normal vitamin B<sub>12</sub> plasma concentrations.<sup>[1]</sup> The RDA in pregnancy increases to 2.6 µg due to transfer of newly absorbed B<sub>12</sub> to the fetus, and to 2.8 µg during lactation to cover secretion of B<sub>12</sub> into breast milk. There is no tolerable upper level of intake as no negative consequences have been associated with excessive vitamin B<sub>12</sub> consumption.

The recommended intake of 0.4 µg for infants is based on the average intake (AI) of infants fed principally with breast milk.<sup>[1]</sup> The intake estimates assume that breast milk concentration averages 0.42 µg/L milk, based on a review of B<sub>12</sub> concentrations in the milk of well-nourished women. However, as vitamin B<sub>12</sub> is tightly bound to haptocorrin in human milk, and not all methods for vitamin B<sub>12</sub> analysis release the vitamin in milk, reported values vary widely and are uncertain. The AI of infants aged 7–12 mo is extrapolated from the requirement of 0–6-mo-old infants. The remaining RDAs for children and adolescents are extrapolated down from adult values, as sufficient data on intake within these groups are lacking. Table 3 summarizes the current daily recommended intakes for all age groups.

## VITAMIN B<sub>12</sub> STATUS THROUGHOUT THE LIFE CYCLE

### The Pregnant Woman

Intestinal absorption of Cbl is increased during pregnancy,<sup>[9]</sup> although an overall fall in maternal plasma vitamin B<sub>12</sub> is observed and accompanied by a fall in Cbl binders. As many as 15–30% of women may have

**Table 3** Dietary recommended intakes of vitamin B<sub>12</sub>

Age group	DRI B <sub>12</sub> (µg/day)	Data used to determine DRI
Infants, 0–6 mo	0.4	AI of breastfed infants
Infants, 7–12 mo	0.5	AI extrapolated from AI of infants, 0–6 mo
Children, 1–3 yr	0.9	RDA extrapolated from RDA for adults
Children, 4–8 yr	1.2	RDA extrapolated from RDA for adults
Children, 9–13 yr	1.8	RDA extrapolated from RDA for adults
Adolescents, 14–18 yr	2.4	RDA extrapolated from RDA for adults
Adults, 19–50 yr	2.4	RDA based on intake required to maintain hematological status and plasma B <sub>12</sub> concentration
Adults, over 50 yr	2.4	RDA based on intake required to maintain hematological status and plasma B <sub>12</sub> concentration
Pregnant women	2.6	RDA based on adult RDA plus the amount of B <sub>12</sub> deposited into the fetus daily
Lactating women	2.8	RDA based on adult RDA plus the amount of B <sub>12</sub> secreted into breast milk daily

DRI = dietary recommended intake; AI = adequate intake; RDA = recommended dietary allowance.

low plasma vitamin B<sub>12</sub> during the third trimester of pregnancy, but concentrations rise sharply postpartum; therefore, hemodilution, which increases plasma volume by approximately 50%, may account for some of this transient decrease. However, the fact that users of oral contraceptives also have lower plasma B<sub>12</sub> concentrations<sup>[10]</sup> suggests that hemodilution alone may not be entirely responsible. Low plasma B<sub>12</sub> during pregnancy is less likely to reflect a true deficiency in women with diets containing adequate ASF, and most pregnant women with low plasma B<sub>12</sub> concentrations do not exhibit other signs of deficiency.<sup>[11]</sup>

Insufficient research has been conducted on the relationship between maternal vitamin B<sub>12</sub> status and pregnancy outcome. Fetal malformations were not associated with maternal plasma Cbl concentration in the first trimester of pregnancy in a French population.<sup>[12]</sup> However, cord blood vitamin B<sub>12</sub> (but not maternal plasma vitamin B<sub>12</sub>) was correlated with birthweight in a study of 188 pregnant women.<sup>[13]</sup> Moreover, homocysteinemia is a risk factor for numerous adverse pregnancy outcomes including birth defects<sup>[14]</sup> and pre-eclampsia;<sup>[15]</sup> it is thus reasonable to assume, but not yet proven, that maternal vitamin B<sub>12</sub> deficiency could have adverse effects on pregnancy outcome. In rural Nepal, where 65% of a group of pregnant women had low plasma B<sub>12</sub> concentrations, homocysteinemia and low plasma B<sub>12</sub> were associated with a doubling of pre-eclampsia and preterm delivery.<sup>[16]</sup>

### The Neonate and Infant

Up to 60% of the Cbl absorbed in pregnancy is concentrated in the fetus, and the rate of transfer increases

throughout pregnancy.<sup>[17]</sup> At birth, the total body content of vitamin B<sub>12</sub> is approximately 50 µg, about half of which is stored in the liver. Plasma vitamin B<sub>12</sub> concentration is usually twice that of the mother, but may be more than fourfold higher. When mothers suffer from vitamin B<sub>12</sub> deficiency, which may be highly prevalent in developing countries, their infants are also likely to have low vitamin stores, a phenomenon that can be improved by maternal supplementation with the vitamin.

After the neonatal period, the plasma vitamin B<sub>12</sub> concentration of the infant begins to decline. Based on a requirement of 0.1 µg Cbl per day for tissue synthesis, the neonatal body stores can last approximately 8 mo even if vitamin B<sub>12</sub> is completely absent from the diet. However, this assumes that the infant is born with adequate stores, which may not be true of infants of malnourished and vitamin B<sub>12</sub> deficient mothers.

### Breast Milk as a Source of Vitamin B<sub>12</sub>

Human milk has an impressive unbound Cbl binding capacity, approximately 1000 times greater than that of plasma, due to its high concentration of Hc. The large amount of Hc in milk may suppress Cbl-dependent intestinal microorganisms, such as *E. coli*, because Hc-bound Cbl is unavailable to micro-organisms.

Colostrum contains vitamin B<sub>12</sub> in excess, after which breast milk Cbl content decreases. Breast milk may contain 100–2000 pmol B<sub>12</sub>/L, but on average, a well-nourished woman's milk contains 300–600 pmol B<sub>12</sub>/L throughout the lactational period. In women with a low B<sub>12</sub> intake, concentrations are lower and often correlated with maternal plasma B<sub>12</sub> values.

There are many case reports of neonates diagnosed with vitamin B<sub>12</sub> deficiency as a result of maternal veganism; both low infant stores at birth and low breast milk B<sub>12</sub> would contribute to this serious situation. Breast milk Cbl < 362 pmol/L may be insufficient to meet infant requirements, as infant urinary methylmalonic acid (MMA) is inversely related to milk B<sub>12</sub> at concentrations below this level.<sup>[18]</sup>

## VITAMIN B<sub>12</sub> DEFICIENCY

### Methods for Evaluating Vitamin B<sub>12</sub> Status

The accepted cutoff point for a plasma vitamin B<sub>12</sub> concentration that defines deficiency has been typically set as 148 pmol/L (200 pg/ml), and individuals with values below this point may show symptoms of deficiency. A plasma Cbl concentration between 148 and 220 pmol/L (200–300 pg/ml) is often used to designate marginal deficiency. In a study of infants, plasma MMA was markedly elevated (indicating vitamin B<sub>12</sub> deficiency) when plasma vitamin B<sub>12</sub> was less than 220 pmol/L,<sup>[19]</sup> and in groups ranging from elderly adults<sup>[20]</sup> to Guatemalan schoolers,<sup>[21]</sup> MMA increases when plasma B<sub>12</sub> falls below about 265 pmol/L (350 pg/ml). Using a cutoff of 300 pmol/L plasma Cbl to identify potential cases of B<sub>12</sub> deficiency, plasma Cbl had a diagnostic sensitivity of 0.40 and specificity of 0.98, based on elevated plasma MMA (>0.34 μmol/L) to confirm diagnosis.<sup>[22]</sup> Thus, plasma B<sub>12</sub> is a reasonable, but not perfect, indicator of risk of vitamin B<sub>12</sub> deficiency, and low concentrations should generate concern.

Diagnosis of B<sub>12</sub> status using plasma Cbl can be supplemented with additional assays for the metabolites MMA and Hcy, which become elevated in deficiency. MMA increases in plasma and urine due to an inability to convert methylmalonyl CoA to succinyl CoA via methylmalonyl CoA mutase. Normal plasma MMA concentrations are in the nanomole range, but in Cbl deficiency they may be in the micromole range. Homocysteine may also be elevated in B<sub>12</sub> deficiency due to the inability of methionine synthesis to proceed (Fig. 3). However, while elevated MMA is specific to vitamin B<sub>12</sub> deficiency, it is not analyzed routinely due to the need for specialized equipment and its high cost. Elevated Hcy may be a product of folate deficiency, or disease, and its use as a tool to specifically diagnose vitamin B<sub>12</sub> deficiency is limited.

### Causes of Deficiency

Poor absorption and inadequate ingestion are the chief causes of vitamin B<sub>12</sub> deficiency. For individuals in

affluent settings, inadequate ingestion is less likely than poor absorption when consumption of ASF is relatively frequent. When ASF intake is limited, however, the risk of deficiency derives from low intake of the vitamin, although in the elderly the main cause of deficiency is usually poor absorption.

### Inadequate absorption

Inadequate Cbl absorption is widely accepted to be the principal cause of vitamin B<sub>12</sub> deficiency in affluent countries and may occur for several reasons. First, in PA, the lack of IF leads to an inability to absorb Cbl through the IF–Cbl receptor process. However, only about 2–4% of the elderly, for example, have PA.<sup>[23]</sup> Second, conditions that alter intestinal function, such as achlorhydria and lack of enzymes such as pepsin, can lead to inefficient absorption of B<sub>12</sub> from food. Third, overgrowth of intestinal bacteria competing for the vitamin may lead to deficiency, a cause that is more important in conditions such as tropical sprue and after some types of intestinal resection. One study found that patients with bacterial overgrowth due to atrophic gastritis absorbed significantly less protein-bound B<sub>12</sub> than control subjects, but that antibiotic therapy rapidly normalized absorption.<sup>[24]</sup>

In the elderly, infection with *Helicobacter pylori*, in particular, may contribute to B<sub>12</sub> deficiency by causing atrophic gastritis, lack of gastric acid, and, in its final stages, a lack of IF. Subsequently, there is impaired absorption of food-bound B<sub>12</sub>.<sup>[25]</sup> Vitamin B<sub>12</sub> deficiency associated with malabsorption is common in elderly populations and prevalence is often high in this group. For example, in 548 surviving participants of the original Framingham Study, the prevalence of Cbl deficiency was estimated to be more than 12% in free-living elderly Americans (women and men aged 67–94 yr).<sup>[20]</sup>

### Inadequate ingestion

Dietary vitamin B<sub>12</sub> deficiency has been described in affluent populations, traditionally in exceptional communities that practice religious dietary restrictions, or adhere to strict dietary guidelines, such as macrobiotic or vegan diets. Hindus, for example, often restrict intake of meat, or meat and eggs, and may suffer the consequences of deficiency.

Some studies suggest that lacto-ovo- or lacto-vegetarians (who consume animal products, but not meat) are also at risk for developing deficiency. In a study of German vegetarians, 60% had evidence of elevated plasma Hcy and MMA.<sup>[26]</sup> Elevated MMA was found in 5% of the omnivores, 77% of the lacto-ovo-vegetarians, and 83% of the vegans. Mean plasma vitamin B<sub>12</sub> concentrations of lacto-vegetarians were

substantially lower than those of nonvegetarians in studies in India.<sup>[27]</sup> Case reports of dietary induced vitamin B<sub>12</sub> deficiency have been made in teenagers, and incidence of severe infant deficiency associated with maternal dietary restriction has also been reported. In a study of macrobiotic children (mean age 6.4 yr) who had followed a strict macrobiotic diet in early childhood but had been omnivorous since that time, MMA and Hcy were elevated and cognitive function was altered.<sup>[28]</sup>

In developing countries, dietary induced vitamin B<sub>12</sub> deficiency may be more common, especially in low socioeconomic status groups, where ASF are inaccessible due to high cost. Widespread vitamin B<sub>12</sub> deficiency has been observed in several countries in Latin America and Southeast Asia, where a predominantly plant-based diet is consumed. The reported prevalence of low plasma B<sub>12</sub> values in various countries in Latin America was about 40% across the life span, and in both sexes. More than one-half of pregnant Nepali women had elevated Hcy and MMA.<sup>[16]</sup> In a group of vegetarian and nonvegetarian adults living in Pune, India, B<sub>12</sub> deficiency was detected in 47% based on low plasma Cbl, and in 73% based on elevated MMA.<sup>[27]</sup>

### Consequences of Deficiency

Clinical symptoms of deficiency in adults are often nonspecific, and include fatigue, apathy, listlessness, diarrhea, and anorexia. Some patients experience oral discomfort, such as soreness of the tongue or ulceration. Although initial clinical symptoms may be vague, nevertheless, dramatic hematological, neurological, and immunological changes may occur (Table 4).

### Hematological changes

The hematological consequences of vitamin B<sub>12</sub> deficiency include megaloblastic anemia due to a reduced capacity to synthesize DNA rapidly, caused by alterations in the methionine synthase pathway.

Hemoglobin develops at a normal pace but mitosis lags behind. As a result, RBC production is deranged and an abnormally large nucleus is extruded, leaving behind a large cytoplasm filled cell. A mean corpuscular volume (MCV) > 115 fl defines megaloblastic cells, which may be as large as 130–150 fl. Total erythrocyte B<sub>12</sub> does not change as the blood cell matures because the nucleus of the red cell is extruded and B<sub>12</sub> is largely present in this organelle. Although megaloblastic anemia is recognized as a classic symptom of vitamin B<sub>12</sub> deficiency, many individuals may not experience measurable hematological change. In addition, megaloblastic anemia is a nonspecific outcome of B<sub>12</sub> deficiency, as folate deficiency induces the same hematological changes through the same pathway. While the presence of megaloblastic anemia may alert clinicians to the need to assess folate and B<sub>12</sub> status, it is important to recognize that the anemia occurs at a much later and more severe stage of B<sub>12</sub> depletion. Indicators of status, such as MMA and plasma Cbl, are more sensitive.

### Neuropathies

In the elderly, vitamin B<sub>12</sub> deficiency produces subacute combined degeneration (SCD), a syndrome of irregular spongiform demyelination of spinal cord (SC) white matter, and astrogliosis. Whereas deficiency in the elderly primarily affects change in the spinal cord, in infants the central nervous system (CNS) is damaged. In fact, Cbl deficiency in this age group can produce severe brain damage that may not be completely reversible upon Cbl therapy.

Common domains of neural symptoms in vitamin B<sub>12</sub> deficient elderly are: 1) sensory (paresthesias, diminished proprioception, diminished vibratory sensation); 2) motor (weakness); 3) reflex disorder-related; 4) autonomic (incontinence, impotence); 5) gait-related (ataxia); 6) mental (intellectual/behavioral impairment); and 7) visual (impaired visual acuity).<sup>[29]</sup> Deficiency is often resolved, and symptoms reversed, with Cbl therapy. Either megadoses of vitamin B<sub>12</sub>

**Table 4** Commonly used indicators of vitamin B<sub>12</sub> deficiency

Marker	Cut-off	Specificity
Plasma vitamin B <sub>12</sub>	Deficient: <148 pmol/L Marginal: <220 pmol/L	Specific to B <sub>12</sub> status
Plasma MMA	>0.28 μmol/L	Specific to B <sub>12</sub> status
Plasma Hcy	>12 μmol/L	Nonspecific, also elevated in folate deficiency and some disease states
MCV	>95 fL	Nonspecific, also elevated in folate deficiency
Neutrophil hypersegmentation	>5 five-lobed neutrophils	Nonspecific, also elevated in folate deficiency
dUST test	>10% suppression	Nonspecific, also elevated in folate deficiency

MMA = Methylmalonic acid; Hcy = homocysteine.

can be injected intramuscularly or large doses (500–1000 µg/day) of crystalline B<sub>12</sub> can be taken orally. Because 1% of the vitamin can be passively absorbed without the need for IF, oral treatment is effective for many patients with PA or deficiency caused by gastric atrophy, and consumption of foods fortified with B<sub>12</sub> predicts higher plasma B<sub>12</sub> in the elderly.<sup>[30]</sup> Demyelination of nerves associated with SCD is likely responsible for the majority of symptoms experienced by the elderly.

There are numerous case reports of severe B<sub>12</sub> deficiency in infants of mothers with PA or mothers practicing a vegan/lacto-vegetarian diet.<sup>[31]</sup> Symptoms include regression of mental development, abnormal pigmentation, hypotonia of muscles, enlarged liver and spleen, sparse hair, tremors, irritability, anorexia, failure to thrive, poor brain growth, refusal of solid foods, and diarrhea. Marked cerebral atrophy and ventricular enlargement may also be present.<sup>[32]</sup> Onset of deficiency in infants occurs within a few months of dietary absence and patients are often responsive to Cbl treatment. B<sub>12</sub> deficiency in infancy may have long-term consequences. A follow-up study of six children with severe B<sub>12</sub> deficiency in infancy showed mixed outcomes.<sup>[33]</sup> In the Netherlands, infants aged 4–18 mo who were born to macrobiotic mothers developed psychomotor skills later than omnivorous controls.<sup>[34]</sup>

### Immune function

In developing countries, both immunomodulation associated with malnutrition and repeated exposure to infection promote high rates of morbidity and mortality. Recently, an immunomodulating role specific to vitamin B<sub>12</sub> has been reported. Markers that may be influenced by vitamin B<sub>12</sub> status include: 1) complement component C3; 2) CD4 and CD8 T cell counts, and CD4/CD8 ratio; 3) natural killer (NK) cell activity; and 4) TNF-α concentration. Low lymphocyte counts, elevated CD4 cells, decreased CD8 cells, elevated CD4/CD8 ratio, and suppressed NK cell activity have been observed in B<sub>12</sub> deficiency. Therapy restored several of these abnormal values.<sup>[35]</sup> Vegans in the United States have signs of compromised immune function, including lower leukocyte counts and C3, even when micronutrient levels appear normal.<sup>[36]</sup> The extent to which vitamin B<sub>12</sub> deficiency is responsible for such changes in immune function requires further exploration.

### CONCLUSIONS

This review has highlighted several new aspects of our knowledge of vitamin B<sub>12</sub>. The more important issues

include the much higher global prevalence of this deficiency than is generally recognized and the fact that even those who avoid meat but eat other ASF are at higher risk of depletion. Deficiency also occurs more rapidly than was formerly believed, especially in people whose stores are relatively depleted or who malabsorb the vitamin. At the same time, our understanding of the mechanisms that cause the adverse functional consequences of deficiency is at a relatively primitive stage, and previously unknown adverse consequences are being identified. Because vitamin B<sub>12</sub> can be safely added as a fortificant to food, or taken orally in high doses, greater attention should be paid to ensuring that this nutrient deficiency is detected and treated in at-risk groups.

### ARTICLE OF FURTHER INTEREST

*Folate*, p. 219

### REFERENCES

1. Institute of Medicine. *Dietary Reference Intakes: Thiamin, Riboflavin, Niacin, Vitamin B6, Folate, Vitamin B12, Pantothenic Acid, Biotin, and Choline*; National Academy Press: Washington, DC, 2000.
2. Schneider, R.J.; Burger, R.L.; Mehlman, C.S.; Allen, R.H. The role and fate of rabbit and human transcobalamin II in the plasma transport of vitamin B12 in the rabbit. *J. Clin. Invest.* **1976**, *57*, 27–38.
3. Meyers, P.A.; Carmel, R. Hereditary transcobalamin II deficiency with subnormal serum cobalamin levels. *Pediatrics* **1984**, *74*, 866–871.
4. Grasbeck, R. Biochemistry and clinical chemistry of vitamin B12 transport and the related diseases. *Clin. Biochem.* **1984**, *17*, 99–107.
5. Compher, C.W.; Kinosian, B.P.; Stoner, N.E.; Lentine, D.C.; Buzby, G.P. Choline and vitamin B12 deficiencies are interrelated in folate-replete long-term total parenteral nutrition patients. *J. Parenter. Enteral Nutr.* **2002**, *26*, 57–62.
6. Alexander, D.; Ball, M.J.; Mann, J. Nutrient intake and haematological status of vegetarians and age–sex matched omnivores. *Eur. J. Clin. Nutr.* **1994**, *48*, 538–546.
7. Helman, A.D.; Darnton-Hill, I. Vitamin and iron status in new vegetarians. *Am. J. Clin. Nutr.* **1987**, *45*, 785–789.
8. Herrmann, W.; Schorr, H.; Obeid, R.; Geisel, J. Vitamin B-12 status, particularly holotranscobalamin II and methylmalonic acid concentrations,

- and hyperhomocysteinemia in vegetarians. *Am. J. Clin. Nutr.* **2003**, *78*, 131–136.
9. Hellegers, A.; Okuda, K.; Nesbitt, R.E., Jr.; Smith, D.W.; Chow, B.F. Vitamin B<sub>12</sub> absorption in pregnancy and in the newborn. *Am. J. Clin. Nutr.* **1957**, *5*, 327–331.
  10. Shojania, A.M. Oral contraceptives: effect of folate and vitamin B<sub>12</sub> metabolism. *Can. Med. Assoc. J.* **1983**, *126*, 244–247.
  11. Pardo, J.; Peled, Y.; Bar, J.; Hod, M.; Sela, B.A.; Rafael, Z.B.; Orvieto, R. Evaluation of low serum vitamin B(12) in the non-anaemic pregnant patient. *Hum. Reprod.* **2000**, *15*, 224–226.
  12. Stoll, C.; Dott, B.; Alembik, Y.; Koehl, C. Maternal trace elements, vitamin B<sub>12</sub>, vitamin A, folic acid, and fetal malformations. *Reprod. Toxicol.* **1999**, *13*, 53–57.
  13. Frery, N.; Huel, G.; Leroy, M.; Moreau, T.; Savard, R.; Blot, P.; Lellouch, J. Vitamin B<sub>12</sub> among parturients and their newborns and its relationship with birthweight. *Eur. J. Obstet. Gynecol. Reprod. Biol.* **1992**, *45*, 155–163.
  14. Vollset, S.E.; Refsum, H.; Irgens, L.M.; Emblem, B.M.; Tverdal, A.; Gjessing, H.K.; Mosen, A.L.; Ueland, P.M. Plasma total homocysteine, pregnancy complications, and adverse pregnancy outcomes: the Hordaland homocysteine study. *Am. J. Clin. Nutr.* **2000**, *71*, 962–968.
  15. Levine, R.J.; England, L.J.; Sibai, B.M. Elevated plasma homocysteine in early pregnancy: a risk factor for the development of severe preeclampsia. *Am. J. Obstet. Gynecol.* **2002**, *186*, 1107.
  16. Bondevik, G.T.; Schneede, J.; Refsum, H.; Lie, R.T.; Ulstein, M.; Kvale, G. Homocysteine and methylmalonic acid levels in pregnant Nepali women. Should cobalamin supplementation be considered? *Eur. J. Clin. Nutr.* **2001**, *55*, 856–864.
  17. Giugliani, E.R.; Jorge, S.M.; Goncalves, A.L. Serum vitamin B<sub>12</sub> levels in parturients, in the intervillous space of the placenta and in full-term newborns and their interrelationships with folate levels. *Am. J. Clin. Nutr.* **1985**, *41*, 330–335.
  18. Specker, B.L.; Miller, D.; Norman, E.J.; Greene, H.; Hayes, K.C. Increased urinary methylmalonic acid excretion in breast-fed infants of vegetarian mothers and identification of an acceptable dietary source of vitamin B-12. *Am. J. Clin. Nutr.* **1988**, *47*, 89–92.
  19. Schneede, J.; Dagnelie, P.C.; van Staveren, W.A.; Vollset, S.E.; Refsum, H.; Ueland, P.M. Methylmalonic acid and homocysteine in plasma as indicators of functional cobalamin deficiency in infants on macrobiotic diets. *Pediatr. Res.* **1994**, *36*, 194–201.
  20. Lindenbaum, J.; Rosenberg, I.H.; Wilson, P.W.; Stabler, S.P.; Allen, R.H. Prevalence of cobalamin deficiency in the Framingham elderly population. *Am. J. Clin. Nutr.* **1994**, *60*, 2–11.
  21. Rogers, L.M.; Boy, E.; Miller, J.W.; Green, R.J.; Allen, L.H. High prevalence of cobalamin deficiency in Guatemalan school children: associations with low plasma holotranscobalamin II, and elevated serum methylmalonic acid and plasma homocysteine concentrations. *Am. J. Clin. Nutr.* **2003**, *77* (2), 433–440.
  22. Holleland, G.; Schneede, J.; Ueland, P.M.; Lund, P.K.; Refsum, H.; Sandberg, S. Cobalamin deficiency in general practice. Assessment of the diagnostic utility and cost-benefit analysis of methylmalonic acid determination in relation to current diagnostic strategies. *Clin. Chem.* **1999**, *45*, 189–198.
  23. Carmel, R. Prevalence of undiagnosed pernicious anemia in the elderly. *Arch. Intern. Med.* **1996**, *156*, 1097–1100.
  24. Suter, P.M.; Golner, B.B.; Goldin, B.R.; Morrow, F.D.; Russell, R.M. Reversal of protein-bound vitamin B<sub>12</sub> malabsorption with antibiotics in atrophic gastritis. *Gastroenterology* **1991**, *101*, 1039–1045.
  25. Carmel, R.; Perez-Perez, G.I.; Blaser, M.J. *Helicobacter pylori* infection and food-cobalamin malabsorption. *Dig. Dis. Sci.* **1994**, *39*, 309–314.
  26. Herrmann, W.; Geisel, J. Vegetarian lifestyle and monitoring of vitamin B-12 status. *Clin. Chim. Acta* **2002**, *326*, 47–59.
  27. Refsum, H.; Yajnik, C.S.; Gadkari, M.; Schneede, J.; Vollset, S.E.; Orning, L.; Guttormsen, A.B.; Joglekar, A.; Sayyad, M.G.; Ulvik, A.; Ueland, P.M. Hyperhomocysteinemia and elevated methylmalonic acid indicate a high prevalence of cobalamin deficiency in Asian Indians. *Am. J. Clin. Nutr.* **2001**, *74*, 233–241.
  28. Louwman, M.W.; van Dusseldorp, M.; van de Vijver, F.J.; Thomas, C.M.; Schneede, J.; Ueland, P.M.; Refsum, H.; van Staveren, W.A. Signs of impaired cognitive function in adolescents with marginal cobalamin status. *Am. J. Clin. Nutr.* **2000**, *72*, 762–769.
  29. Heaton, E.B.; Savage, D.G.; Brust, J.C.; Garrett, T.J.; Lindenbaum, J. Neurologic aspects of cobalamin deficiency. *Medicine (Baltimore)* **1991**, *70*, 229–245.
  30. Campbell, A.K.; Miller, J.W.; Green, R.; Haan, M.N.; Allen, L.H. Serum gastrin and intake of crystalline vitamin B-12 are associated with plasma vitamin B-12 in an elderly Latino population. *J. Nutr.* *in press*.



31. Allen, L.H. Impact of vitamin B-12 deficiency during lactation on maternal and infant health. *Adv. Exp. Med. Biol.* **2002**, *503*, 57–67.
32. Wighton, M.C.; Manson, J.I.; Speed, I.; Robertson, E.; Chapman, E. Brain damage in infancy and dietary vitamin B12 deficiency. *Med. J. Aust.* **1979**, *2*, 1–3.
33. Graham, S.M.; Arvela, O.M.; Wise, G.A. Long-term neurologic consequences of nutritional vitamin B12 deficiency in infants. *J. Pediatr.* **1992**, *121*, 710–714.
34. Dagnelie, P.C.; van Staveren, W.A. Macrobiotic nutrition and child health: results of a population-based, mixed-longitudinal cohort study in The Netherlands. *Am. J. Clin. Nutr.* **1994**, *59*, 1187S–1196S.
35. Tamura, J.; Kubota, K.; Murakami, H.; Sawamura, M.; Matsushima, T.; Tamura, T.; Saitoh, T.; Kurabayshi, H.; Naruse, T. Immunomodulation by vitamin B12: augmentation of CD8+ T lymphocytes and natural killer (NK) cell activity in vitamin B12-deficient patients by methyl-B12 treatment. *Clin. Exp. Immunol.* **1999**, *116*, 28–32.
36. Haddad, E.H.; Berk, L.S.; Kettering, J.D.; Hubbard, R.W.; Peters, W.R. Dietary intake and biochemical, hematologic, and immune status of vegans compared with nonvegetarians. *Am. J. Clin. Nutr.* **1999**, *70*, 586S–593S.

#### FURTHER READINGS

- Stabler, S.P. Vitamin B-12. In *Present Knowledge in Nutrition*, 8th Ed.; ISLI Press: Washington, DC, 2001; 230–240.
- Weir, D.G.; Scott, J.M. Cobalamin. In *Modern Nutrition in Health and Disease*, 9th Ed.; Shils, M.E., Olson, J.M., Shike, M., Ross, C.A., Eds.; Lippincott, Williams & Wilkins: Baltimore, 1999; 447–458.

# Vitamin C

Mark Levine

Arie Katz

Sebastian J. Padayatty

Yaohui Wang

Peter Eck

Molecular and Clinical Nutrition Section, Digestive Diseases Branch, National Institute of Diabetes and Digestive and Kidney Diseases, National Institutes of Health, Bethesda, Maryland, U.S.A.

Oran Kwon

Korea Food and Drug Administration, Seoul, Korea

Shenglin Chen

Jee-Hyuk Lee

Molecular and Clinical Nutrition Section, Digestive Diseases Branch, National Institute of Diabetes and Digestive and Kidney Diseases, National Institutes of Health, Bethesda, Maryland, U.S.A.

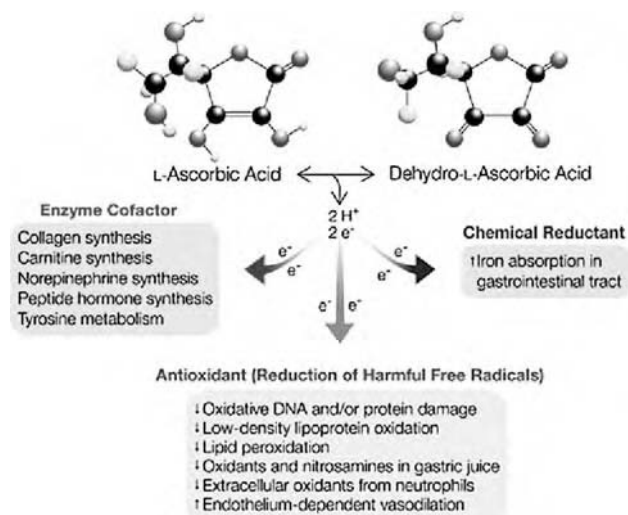
## INTRODUCTION

Vitamin C (L-ascorbic acid, ascorbate) is a water-soluble micronutrient essential for human health. It is a six-carbon lactone with a molecular weight of 176 (Fig. 1).<sup>[1]</sup> Humans and other primates cannot synthesize ascorbate because of multiple mutations in

the gene encoding gulonolactone oxidase, the terminal enzyme in the biosynthetic pathway of the vitamin. Thus, humans have to obtain vitamin C from food.

## BIOCHEMISTRY AND FUNCTIONS

Vitamin C is an electron donor, and this property accounts for its known and postulated functions. As an antioxidant, or reducing agent, the vitamin sequentially donates two electrons from the C2–C3 double bond. The first intermediate, formed by the loss of one electron, is the unstable free radical semi-dehydroascorbic acid. This intermediate is relatively



**Fig. 1** Actions of vitamin C. (From Ref.<sup>[1]</sup>) (View this art in color at [www.dekker.com](http://www.dekker.com).)

*Mark Levine, M.D.*, is at the Molecular and Clinical Nutrition Section, Digestive Diseases Branch, National Institute of Diabetes and Digestive and Kidney Diseases, National Institutes of Health, Bethesda, Maryland, U.S.A.

*Arie Katz, M.D.*, is at the Molecular and Clinical Nutrition Section, Digestive Diseases Branch, National Institute of Diabetes and Digestive and Kidney Diseases, National Institutes of Health, Bethesda, Maryland, U.S.A.

*Sebastian J. Padayatty, M.D., Ph.D.*, is at the Molecular and Clinical Nutrition Section, Digestive Diseases Branch, National Institute of Diabetes and Digestive and Kidney Diseases, National Institutes of Health, Bethesda, Maryland, U.S.A.

*Yaohui Wang, M.D.*, is at the Molecular and Clinical Nutrition Section, Digestive Diseases Branch, National Institute of Diabetes and Digestive and Kidney Diseases, National Institutes of Health, Bethesda, Maryland, U.S.A.

*Peter Eck, Ph.D.*, is at the Molecular and Clinical Nutrition Section, Digestive Diseases Branch, National Institute of Diabetes and Digestive and Kidney Diseases, National Institutes of Health, Bethesda, Maryland, U.S.A.

*Oran Kwon, Ph.D.*, is Senior Scientific Officer at the Division of Dietary Supplement Standards, Korea Food and Drug Administration, Seoul, Korea.

*Shenglin Chen, Ph.D.*, is at the Molecular and Clinical Nutrition Section, Digestive Diseases Branch, National Institute of Diabetes and Digestive and Kidney Diseases, National Institutes of Health, Bethesda, Maryland, U.S.A.

*Jee-Hyuk Lee, Ph.D.*, is at the Molecular and Clinical Nutrition Section, Digestive Diseases Branch, National Institute of Diabetes and Digestive and Kidney Diseases, National Institutes of Health, Bethesda, Maryland, U.S.A.

unreactive and does not interact with other compounds to form potentially harmful free radicals, and can be reversibly reduced to ascorbate. Semidehydroascorbic acid undergoes further oxidation to form the more stable product dehydroascorbic acid (DHA) (Fig. 1), which can be reduced back to ascorbate by glutathione or by three distinct enzymatic reduction reactions.<sup>[2,3]</sup> If not reduced, DHA undergoes ring rupture and is irreversibly hydrolyzed to 2,3-diketogulonic acid. The latter is metabolized to xylose, xylonate, lyxonate, and oxalate, which is a clinically significant end product of vitamin C metabolism.

### Enzymatic Functions

Vitamin C is a cofactor for eight different enzymes in mammals (Fig. 1).<sup>[1]</sup> Three enzymes participate in collagen hydroxylation and two in carnitine biosynthesis; one is necessary for norepinephrine biosynthesis, another is required for amidation of peptide hormones, and one participates in tyrosine metabolism. It is assumed that scurvy, the disease caused by vitamin C deficiency, is due to impaired functioning of these enzymes, although direct experimental proof is lacking.

### Reducing (Nonenzymatic) Functions

#### Vitamin C as an antioxidant in vitro

Vitamin C may have nonenzymatic functions due to its reduction–oxidation (redox) potential (Fig. 1). In vitro evidence suggests that it may have a role as a reducing agent both intra- and extracellularly. In the cell, ascorbate might protect intracellular proteins from oxidation. The vitamin and other antioxidants may regulate transcription or translation and may affect post-translational modification. Extracellular vitamin C might protect against oxidants and oxidant-mediated damage. In vitro studies suggest that it may be the primary antioxidant in plasma for quenching aqueous peroxy radicals as well as lipid peroxidation products. In vitro, vitamin C is preferentially oxidized before other plasma antioxidants such as uric acid, tocopherols, and bilirubin. However, these oxidation–reduction reactions may not specifically require the vitamin in vivo. Vitamin C may quench oxidants that leak from activated neutrophils or macrophages that, in turn, may damage supporting tissues such as collagen or surrounding fibroblasts. Many antioxidant effects demonstrated in vitro have uncertain importance in the intact organism.<sup>[4]</sup>

#### Effects on atherogenesis

Vitamin C can theoretically reduce atherogenesis by protecting low-density lipoprotein (LDL) from

metal-catalyzed oxidation and by affecting monocyte adhesion and platelet aggregation. In vitro, it inhibits metal-catalyzed oxidation of LDL at concentrations above 40–50  $\mu\text{M}$ .<sup>[5]</sup> However, metal-catalyzed oxidation may not be important in vivo because the high oxidant and metal concentrations and the relatively long periods of time needed to induce oxidation in vitro are unlikely to occur in humans, especially since the relevant cations (iron, copper) in vivo are tightly bound to proteins. In depletion–repletion studies, no significant relationship was found between vitamin C dose and plasma concentrations of  $\text{F}_2$ -isoprostanes, which are considered as biomarkers of endogenous lipid peroxidation.<sup>[6]</sup> Another potential protective mechanism is indirect, as vitamin C can regenerate oxidized  $\alpha$ -tocopherol (vitamin E) in LDL in vitro. Additional effects of extracellular vitamin C in atherosclerosis could be due to its action on adhesion of monocytes to endothelium or aggregation of platelets and leukocytes. Again, these effects have not been shown in vivo, and their clinical relevance is unclear. Although laboratory data show a possible protective role for vitamin C in atherosclerotic heart disease, epidemiologic data are inconsistent. Diets rich in fruits and vegetables, and therefore rich in vitamin C, protect against atherosclerosis and many other diseases.<sup>[7,8]</sup> However, it is not known whether this protection is due to the high vitamin C content of such diets or to other reasons.

#### Effects on blood flow and endothelial function

In some, but not all, patients with coronary artery disease, administration of large doses of oral vitamin C (2–4 g for acute administration and 500 mg/day for chronic treatment) resulted in improved endothelium-dependent vasodilation.<sup>[9]</sup> Such a vasodilatory effect may be compatible with enhanced bioactivity of endothelium-derived nitric oxide (EDNO). Vitamin C did not alter blood flow in healthy subjects and did not reverse endothelial dysfunction in hypertensive patients. Some studies have shown that the vitamin may ameliorate endothelial vasomotor dysfunction when administered intra-arterially in patients with chronic heart failure, type 2 diabetes, and coronary spastic angina, or when given intravenously to smokers. However, intra-arterial concentrations in these studies were far higher than can be achieved under physiological conditions. More data are needed to determine whether endothelium-dependent vasodilation mediated by vitamin C has clinical relevance.

#### Effect on nitrate tolerance

Due to its redox properties, ascorbic acid is a candidate to prevent nitrate tolerance.<sup>[10]</sup> Tolerance to nitrates, used to treat heart disease, develops within the first

day of continuous exposure and makes treatment less effective. Vitamin C given orally at doses of 3–6 g/day prevented the development of tolerance in some healthy subjects and in patients with ischemic heart disease or heart failure. Because these studies were short term and involved small numbers of patients, the clinical utility of vitamin C treatment in the prevention of nitrate tolerance is not yet clear.

#### Effects in stomach and duodenum

Vitamin C can quench reactive oxygen metabolites in the stomach and duodenum, and prevent the formation of mutagenic *N*-nitroso compounds. As its concentration in gastric juice is approximately three times higher than that in plasma, vitamin C appears to be an attractive candidate for the prevention of gastric cancer. Whether this suggested antioxidant action has significance in vivo is uncertain. Although high vitamin C dietary intake correlates with reduced risk of gastric cancer, it is unknown whether the vitamin itself or other components in plant-derived foods are responsible for the protective effect.

#### Iron absorption

Vitamin C promotes iron absorption in the small intestine by maintaining the element in the reduced ( $\text{Fe}^{2+}$ ) form. It can increase soluble nonorganic iron absorption 1.5–10-fold depending on iron status, the vitamin dose, and the type of test meal. Amounts necessary for enhancing iron absorption (20–60 mg)<sup>[11]</sup> are found in foods that are good sources of the vitamin. However, the effect of vitamin C on hemoglobin concentration is modest at best, at least in small, short-term studies.

## PHYSIOLOGY

### Tissue Distribution

Vitamin C is widely distributed in the human body, and many organs contain millimolar concentrations of the vitamin. The highest concentrations are found in adrenal and pituitary glands, at 30–50 mg/100 g of tissue. Liver, spleen, pancreas, kidney, brain, and lens contain 5–30 mg/100 g.<sup>[12]</sup> The choroid plexus actively secretes the vitamin into the cerebrospinal fluid. Ascorbate in the cerebrospinal fluid is then concentrated by many parts of the brain. It is unknown why many of these tissues concentrate vitamin C.

High ascorbate concentrations (10–50-fold higher than that in plasma) are also found in white blood cells such as neutrophils, lymphocytes, and monocytes. When activated by exposure to bacterial or fungal pathogens, human neutrophils rapidly accumulate

additional vitamin C, with intracellular concentrations increasing approximately 10-fold. This accumulation is mediated by a process termed ascorbate recycling, of unknown function.<sup>[13]</sup> Since ascorbate recycling does not occur in pathogens, and since neutrophils are the primary host-defense cells in human blood, the process may represent a eukaryotic defense mechanism against pathogens.

### Tissue Accumulation

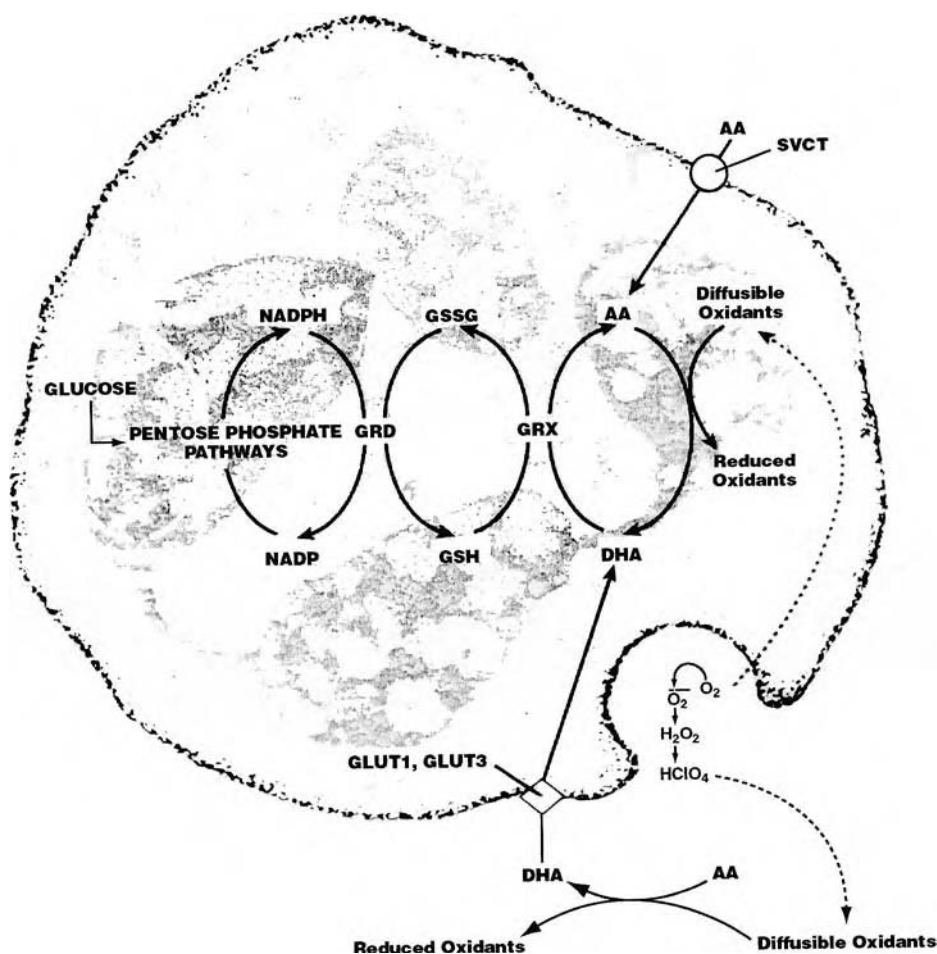
Vitamin C is accumulated in tissues by two distinct pathways. One pathway is sodium-dependent transport. The other is termed ascorbate recycling,<sup>[13]</sup> and dehydroascorbic acid (DHA, oxidized vitamin C) is transported independent of sodium and reduced intracellularly to ascorbate.

#### Sodium-dependent vitamin C transport

Two sodium-dependent vitamin C transporters, SVCT1 and SVCT2, have been identified.<sup>[14,15]</sup> Both of these carrier proteins couple the transport of 2  $\text{Na}^+$  : 1 vitamin C. SVCT1 is a low affinity, high velocity transporter.<sup>[15]</sup> SVCT2 has a 10-fold higher affinity for vitamin C but exhibits a lower rate of uptake. SVCT1 is found in kidney, liver, small intestine, thymus, and prostate. In the small intestine and kidney, SVCT1 is primarily localized in the epithelium, consistent with a role in intestinal absorption and renal reabsorption of vitamin C. SVCT2 has a more general distribution, with mRNA found in most tissues, including the brain, retina, placenta, spleen, small intestine, and gonads.<sup>[14]</sup> Neither of these transporters transports DHA.<sup>[15]</sup> Dehydroascorbic acid is transported by the facilitative glucose transporters GLUT1, GLUT3,<sup>[16]</sup> and GLUT4, which do not transport vitamin C. The gene for human SVCT1 (hSVCT1) has been mapped to chromosome 5q23, and that for human SVCT2 (hSVCT2) to chromosome 20p12.3.

#### Sodium-independent transport of DHA (ascorbate recycling)

Ascorbate recycling is a process in which extracellular ascorbate is oxidized to DHA, which, in turn, is transported into cells through glucose transporters and reduced back to ascorbate (Fig. 2).<sup>[13]</sup> Ascorbate recycling enables rapid accumulation of vitamin C in activated neutrophils and is induced by Gram-positive and Gram-negative bacteria, and *Candida albicans*. Neutrophils from patients with chronic granulomatous disease do not make oxidants due to defective superoxide generation, and these neutrophils cannot recycle vitamin C. The clinical importance of ascorbate recycling is not known. Possibilities include protection of



**Fig. 2** Mechanisms of vitamin C accumulation in human neutrophils. Vitamin C accumulation in neutrophils occurs by ascorbic acid transport and recycling. Ascorbic acid (AA) is transported by sodium-dependent vitamin C transporters (SVCTs) that maintain millimolar concentrations inside resting neutrophils. Recycling occurs when bacteria, yeast, or pharmacologic agents activate neutrophils. Activated neutrophils secrete reactive oxygen species that oxidize extracellular AA to dehydroascorbic acid (DHA). DHA is rapidly transported into neutrophils by glucose transporters (GLUT1, GLUT3) and is then immediately reduced to AA by the glutathione-dependent protein glutaredoxin (GRX). Glutathione (GSH) utilized during DHA reduction is regenerated from glutathione disulfide (GSSG) by glutathione reductase (GRD) and NADPH. NADPH is a product of glucose metabolism through the pentose phosphate pathway. (Reproduced with permission from Padayatty, S.J.; Levine, M. *Can. Med. Assoc. J.* 2001, 164 (3), 353–355.)

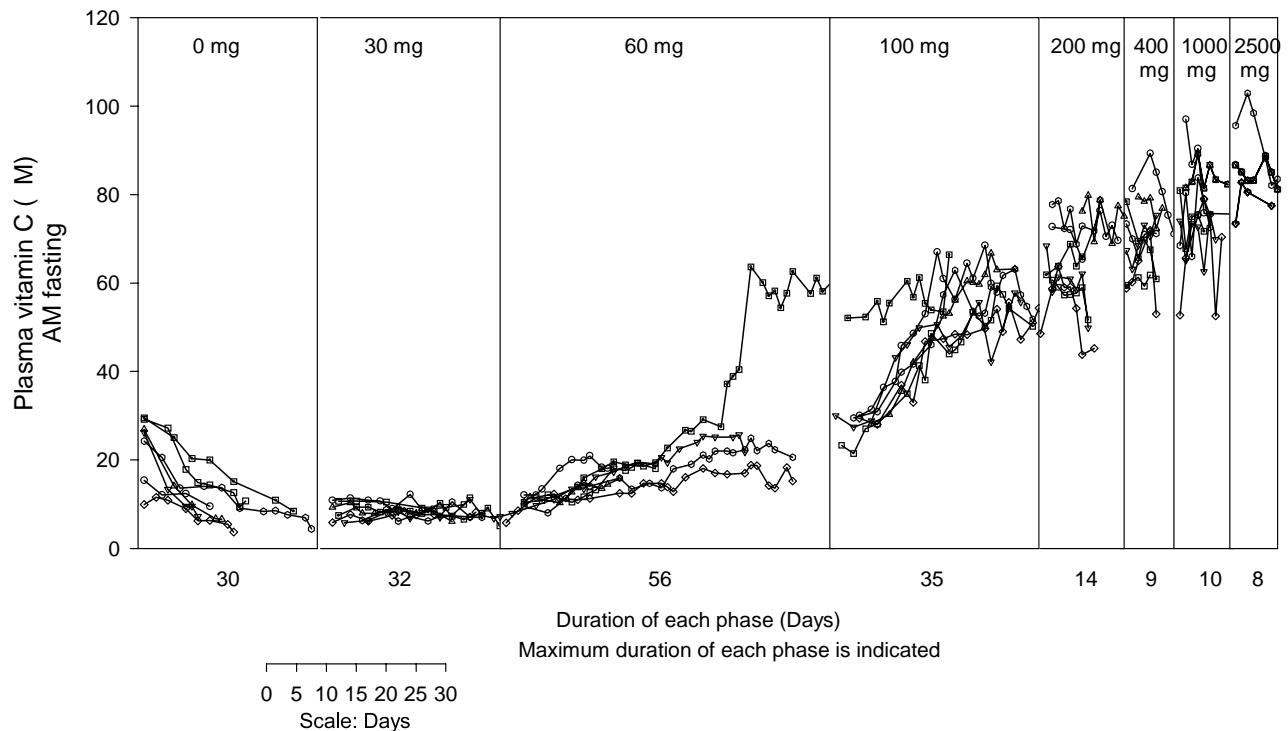
neutrophil and surrounding tissues from oxidative damage, enhanced phagocytosis or bacterial killing, and activation of programmed cell death. Recycling does not occur in bacteria or in other pathogens, suggesting that it may be a host-specific protective mechanism.

### Plasma and Cell Concentrations

Steady-state plasma concentrations in relation to dose

Steady-state plasma concentration data as a function of dose were obtained in 7 healthy men and 15 healthy women aged 19–26 yr, each of whom was hospitalized for approximately 5–6 mo.<sup>[6,17]</sup> A depletion–repletion design was used. Inpatient subjects consumed a diet containing less than 5 mg of vitamin C per day, and all other nutrients in adequate amounts. After depletion of the vitamin (plasma concentrations of  $6.9 \pm 2 \mu\text{M}$  for men and  $8 \pm 1 \mu\text{M}$  for women), steady-state plasma concentrations were obtained for daily

vitamin C doses of 30, 60, 100, 200, 400, 1000, and 2500 mg. The vitamin was measured using HPLC with coulometric electrochemical detection. The relationship between plasma steady-state concentration and dose was sigmoidal. At a dose of 30 mg, there was only a small increase in plasma vitamin C concentration compared to nadir. At the dose range of 30–100 mg, small changes in daily vitamin C intake resulted in large changes in steady-state plasma concentrations (Figs. 3 and 4). Although curves for men (Fig. 3)<sup>[17]</sup> and women (Fig. 4)<sup>[6]</sup> were sigmoidal, the steep portion of the curve for women was shifted to the left compared to men. Women had higher steady-state plasma vitamin C concentrations than men in the dose range of 30–100 mg daily. These differences disappeared at doses of 200 mg per day and higher. At a dose of 200 mg, the curves for both men and women were near plateau. At doses of 400 mg daily and higher, plasma was saturated with a vitamin C concentration of approximately  $70\text{--}80 \mu\text{M}$ . At these large doses, ingestion of the vitamin resulted in decreased absorption (i.e., decreased bioavailability) and increased urinary excretion as described later.



**Fig. 3** Vitamin C plasma concentration as a function of dose in men. Seven men were hospitalized for 4–6 mo as described in the text. The duration in days for each subject for the depletion phase (0 mg) and for receipt of 7 different vitamin C doses is shown on the X axis. The maximum duration of each phase is indicated numerically. Fasting vitamin C concentrations for all phases of the study are shown on the Y axis. Vitamin C doses for each phase are indicated at the top of the figure. Each subject is indicated by a different symbol. There was variation between subjects in the time taken to reach nadir and in the number of days required to reach steady state for each dose. Reproduced with permission from M Levine, Y Wang, A Katz, P Eck, O Kwon, S Chen, J Lee, SJ Padayatty Ideal Vitamin C Intake. *Biofactors* 2001; 15, 71–74.

### Steady-state circulating blood cell concentrations in relation to dose

Vitamin C was measured in circulating neutrophils, monocytes, and lymphocytes at steady state, at the same daily doses as for plasma. Utilizing active transport, these cells accumulated vitamin C 10–50-fold compared to plasma concentrations. Intracellular concentrations increased substantially between 30 and 100 mg daily doses.<sup>[6,17]</sup> Cells saturated before plasma, at daily doses of 100–200 mg. This is probably because the maximal transport velocity (apparent  $V_{max}$ ) of the tissue vitamin C active transporter SVCT2 is approximately 70  $\mu$ M.

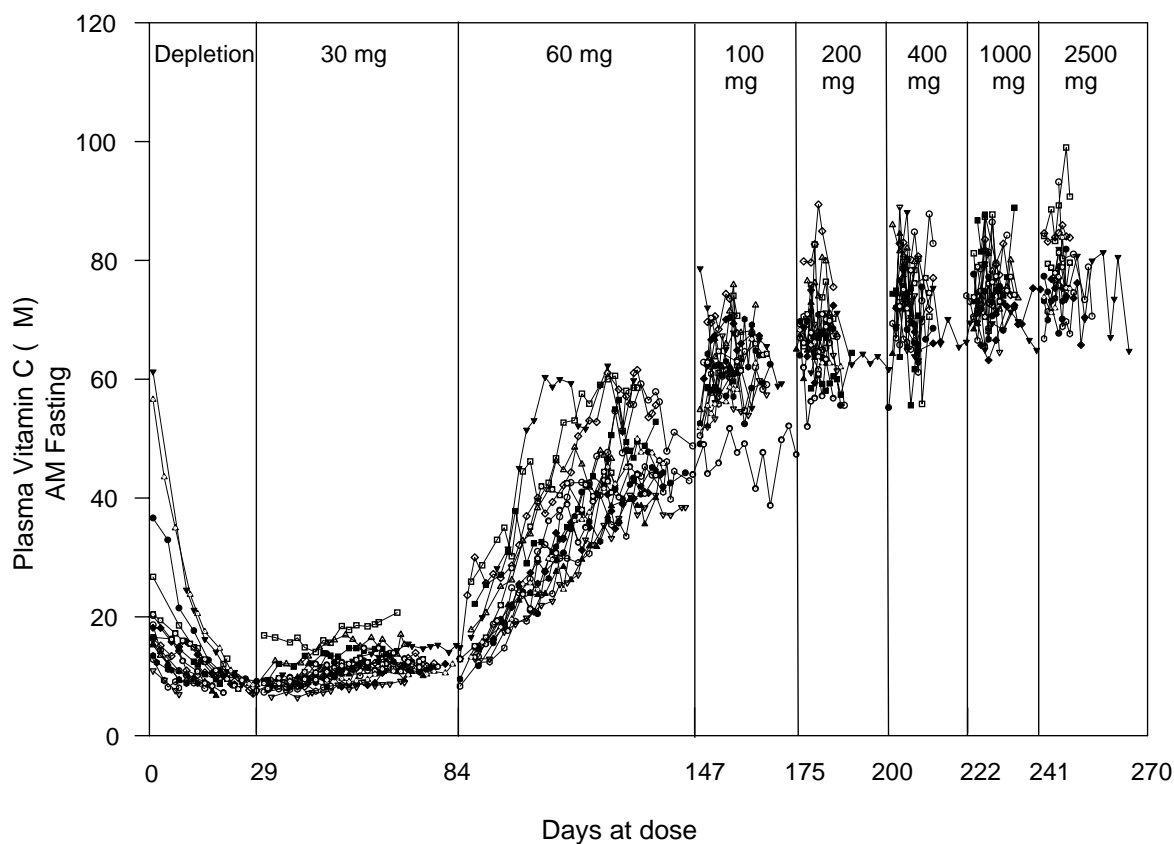
### Bioavailability

Bioavailability of oral vitamin C was determined in depletion–repletion studies by comparison of plasma concentrations of the vitamin after oral and after intravenous administration. The studies were done with doses of 15, 30, 50, 100, 200, 500, and 1250 mg.

The experiments were performed at steady state, since bioavailability is best studied at equilibrium for plasma and tissue.<sup>[6,17]</sup> At steady state for any given dose of vitamin C, its concentrations in plasma and in tissues are in equilibrium. When oral or intravenous doses of vitamin C are given acutely at this stage, plasma concentrations rise and then return to baseline for that steady state. This rise and return to baseline forms an area under the curve (AUC), which can be used to determine bioavailability of the vitamin.

To measure bioavailability, the same doses of vitamin C were given orally and intravenously at different times during steady state, usually a day apart. After administration of the vitamin, its plasma concentrations were measured at intervals of minutes to hours. Bioavailability was calculated as the area under the curve (AUC) for the oral dose ( $AUC_{po}$ ) divided by the area under the curve for the intravenous dose ( $AUC_{iv}$ ). For a single dose of vitamin C, it was calculated as (approximately) 100% for 200 mg, 73% for 500 mg, and 49% for 1250 mg.

The AUC method could not be used for vitamin C doses of 200 mg and lower. This method is only



**Fig. 4** Vitamin C plasma concentration as a function of dose in women. Fifteen women were hospitalized for 4–6 mo as described in the text. vitamin C concentrations are shown as a function of days at dose. Doses are indicated at the top of the figure. Each symbol represents a different subject. There is a 1 day gap between all doses for bioavailability sampling. Doses through 200 mg daily were received by 15 subjects, through 1000 mg daily by 13 subjects, and through 2500 mg by 10 subjects. (Reproduced with permission from Ref.<sup>[6]</sup>.)

accurate if volume of distribution and rate of clearance are constant. Vitamin C distribution differs between plasma, circulating blood cells, and other tissues. The differences in distribution are less pronounced at higher doses, when plasma and circulating cells are saturated with the vitamin. Moreover, renal excretion is not linear, as it only starts above the renal threshold, as described later. Therefore, a mathematical model was developed to account for these factors. Using this, bioavailability was found to be 80% for 100 mg and 46% for 1250 mg.

The values calculated by the two methods mentioned above are for vitamin C administered as a chemically pure substance in an aqueous solution. When given as a supplement, bioavailability depends on the preparation and may be reduced substantially by factors such as supplement binders and supplement dissolution time in the gastrointestinal tract. When administered as plant-derived food, the bioavailability of vitamin C is currently unknown and might be altered by other substances in the food.

### Renal Excretion

Urinary excretion of vitamin C was measured at steady state for doses of 30–1250 mg daily. At oral doses below 60 mg/day, no vitamin C appeared. At an oral dose of 100 mg/day, corresponding to a plasma concentration of approximately 60  $\mu$ M in both men and women, approximately 25 mg of vitamin C in men and 50 mg in women was excreted in the urine.<sup>[6,17]</sup> As oral doses increased, the vitamin appeared in the urine in increasing quantity. While a larger quantity of vitamin C was absorbed as doses increased, the percentage of the absorbed dose decreased. This percentage decrease in absorption is decreased bioavailability. For example, when 1250 mg of vitamin C was given orally, approximately 600 mg was absorbed and subsequently excreted in the urine. Upon intravenous administration, without the confounding effects of intestinal absorption, virtually the entire administered dose was excreted at 500 and 1250 mg. Since vitamin C is not protein bound, it is presumably filtered at

the glomeruli and reabsorbed in the renal tubules. When the ability of the kidney to reabsorb vitamin C is overwhelmed (the transport mechanism for reabsorption is saturated), the vitamin appears in the urine, analogous to glucosuria in patients with uncontrolled diabetes. In patients with end-stage renal disease, excess vitamin C cannot be excreted. In such patients, vitamin C doses above 200 mg can accumulate and produce hyperoxalemia. On the other hand, many patients with end-stage renal disease on dialysis lose vitamin C during dialysis and have chronically low plasma concentrations.

### Potential Variable Factors

Healthy subjects were studied for 5–6 mo to determine plasma and cell concentrations, bioavailability, and renal excretion of ascorbate in relation to dose (pharmacokinetics). It is possible that the pharmacokinetics findings will be different in subjects with acute and chronic diseases and in the elderly. Prolonged hospitalization for these subjects is not possible for the purpose of obtaining pharmacokinetics data, and to do so will require the development of new methods.

### VITAMIN C DEFICIENCY AND SCURVY

The earliest recorded descriptions of scurvy are in Egyptian hieroglyphics ca. 3000 B.C. James Lind published his *A Treatise of the Scurvy* in 1753, providing evidence that fruits could prevent the disease.<sup>[18]</sup> As noted by Lind and later confirmed by others, the early symptoms of scurvy are weakness, fatigue, listlessness, and lassitude. The physical signs that follow include petechial hemorrhage; perifollicular hyperkeratosis; erythema and purpura; bleeding into the skin, subcutaneous tissues, muscles, and joints; coiled hairs; breakdown of wounds; arthralgias and joint effusions; swollen and friable gums; hypochondriasis and depression; Sjögren syndrome; fever; shortness of breath; and confusion. In severe scurvy, irreversible changes may occur, including dental loss, bone damage, and sequelae of internal hemorrhage and infection. Untreated, the disease is uniformly fatal. The signs related to wound dehiscence and friable gums may reflect impaired collagen synthesis. As noted above, however, there is no experimental evidence that directly links these signs and low vitamin C concentrations to diminished enzyme actions. Frank scurvy is now rare and is seen in the United States primarily among malnourished populations, including patients with cancer cachexia and malabsorption, poor and elderly people, alcoholics, individuals with chemical dependency, and some individuals consuming idiosyncratic diets.

Subclinical vitamin C deficiency may be much more common than overt disease, and is difficult to recognize, since the early symptoms of deficiency are unremarkable and nonspecific.

### INDICATIONS AND USAGE

#### Food Sources

Vitamin C is widely distributed in fruits and vegetables. Fruits rich in vitamin C include strawberry, papaya, orange, kiwifruit, cantaloupe, grapefruit, mango, and honeydew melon. Vegetables with a high content of the vitamin are broccoli, Brussels sprout, cabbage, potato, sweet potato, cauliflower, red and green pepper, tomato, snow pea, and kale.<sup>[1]</sup> Fruit juices such as orange juice, tomato juice, grapefruit juice, and fortified juices are also sources of the vitamin. Vitamin C is labile, and its content in plant foods may vary to some extent depending on season, transportation, shelf time, storage, and cooking practices. Five servings of a variety of fruits and vegetables per day, as recommended by the U.S. Department of Agriculture (USDA) and the U.S. National Cancer Institute (NCI), provide 210–280 mg of vitamin C. Fruit and vegetable consumption restricted to a narrow selection could provide smaller amounts.

#### Functions in Relation to Concentration

Other than to prevent scurvy, there is no direct evidence that a particular vitamin C plasma or tissue concentration is more beneficial than others. It is uncertain whether the various biochemical roles of vitamin C, either known or postulated, are related to concentrations of the vitamin in vivo. There are, however, hints that the optimum plasma concentration is higher than the minimum required to prevent clinical scurvy (approximately 10 mg/day). For example, in his *Treatise*, James Lind mentions that the most prominent sign of impending scurvy is fatigue, or “lassitude.”<sup>[18]</sup> In vitamin C depletion–repletion studies fatigue was also noted, and in one study, it appeared at vitamin C plasma concentrations of approximately 20 μM. There are also indirect findings suggesting that a higher plasma vitamin C concentration may be beneficial: The  $V_{max}$  of the vitamin C transporter hSVCT2 is 70 μM; LDL oxidation in vitro is inhibited by vitamin C at 40–50 μM; plasma concentration is tightly controlled at 70–80 μM, and circulating blood cells saturate at approximately these concentrations. The optimal plasma concentration for vitamin C is yet to be determined by clinical studies.



## Possible Benefits of Vitamin C Consumption

Diets with 200 mg or more of vitamin C from fruits and vegetables are associated with lower risk of cancer (especially cancers of the oral cavity, esophagus, stomach, colon, and lung)<sup>[19]</sup> and stroke, and with reduced overall mortality. Higher fruit and vegetable consumption and plasma vitamin C concentrations are inversely related to risk of ischemic heart disease, diabetic complications, and blood pressure in hypertensive patients. The USDA and NCI recommendations of consuming five fruit and vegetable servings daily are based on this extensive evidence. These studies, however, are correlational. Whether vitamin C in fruits and vegetables confers these benefits is not known. It may be a surrogate marker for fruit and vegetable consumption and, perhaps, for other healthy lifestyle practices. In the United States, approximately 30% of adults consume less than 2.5 servings of fruits and vegetables per day, and the estimated vitamin C intake is even lower among some groups, including children.

Vitamin C as a food supplement was tested for primary prevention of cancer, cardiovascular disease, stroke, and age-related eye diseases. In epidemiological studies and in some large-scale interventional studies, vitamin C was consumed in combination with other food supplements such as vitamins and antioxidants, and was partially obtained from foods. Under these conditions, it did not provide the health benefits seen with consumption of fruits and vegetables: Vitamin C supplements did not prevent cancer, heart disease, stroke, or cataract. To date, no large-scale interventional studies have been reported where vitamin C was administered as a sole supplement.

Vitamin C as a food supplement has also been tested for its effects on disease outcome for hypertension, diabetes, infectious diseases, and age-related eye diseases. Some small, short-term studies suggest that consumption of vitamin C supplements might lower blood pressure in hypertensive and diabetic patients. No large-scale studies are available to confirm these findings. Some experiments show an improvement in lipid profile and insulin sensitivity in diabetic patients who consumed vitamin C supplements, but others fail to do so. Contrary to what has been suggested by some, daily vitamin C supplementation did not decrease common cold incidence in most studies. Similarly, data are insufficient to conclude that vitamin C supplements have an effect on reducing severity of illness due to common cold, except, perhaps, in some people who are vitamin C deficient. Although some small studies suggested that supplementation might prevent cataract, larger studies showed no effect of vitamin C supplementation on the development or progression of cataracts.

## Prevention of Deficiency

Steady-state plasma concentrations achieved by a vitamin C dose of 60 mg/day can prevent deficiency for 10–14 days, and those achieved by 100 mg/day can probably prevent deficiency for approximately 1 mo. The above only applies to healthy people who, under otherwise normal conditions, are depleted of vitamin C alone. There is currently little knowledge of vitamin C metabolism in disease states. Deficiency might occur more rapidly in various clinical circumstances where low concentrations were reported, such as in smokers, and in patients with diabetes, myocardial infarction, pancreatitis, end-stage renal disease, and in critical illness requiring intensive care unit support.

## Treatment of Scurvy

Upon diagnosis of scurvy, based primarily on clinical findings and confirmed by plasma concentrations of vitamin C, treatment can be initiated with doses of 100 mg given three times a day. An initial intravenous dose of 100 mg may be administered. If diagnosis and treatment are prompt, permanent damage can be prevented.

## Dietary Reference Intakes (DRIs)

Dietary reference intakes are a set of nutrient-based reference values that can be used for planning diets and that are meant to expand the concept of recommended daily allowances (RDAs) in the United States.<sup>[20]</sup> DRIs have several categories: estimated average requirement (EAR), RDA, adequate intake (AI), and upper limit (UL). The EAR is the median usual intake value that is estimated to meet the requirements of half the healthy individuals in a life stage and gender group. This value is used to calculate the RDA, which is the average daily dietary intake level that is sufficient to meet the nutrient requirements of nearly all healthy individuals in a life stage and gender group. The RDA is calculated as the EAR plus two standard deviations of the EAR measurement. AI, or adequate intake, is derived when data to establish EARs are insufficient and, therefore, an RDA cannot be set. It is based on experimentally derived intake levels or approximations of observed mean nutrient intake by groups of apparently healthy people. UL, or upper limit, is the highest level of continuing daily nutrient intake that is likely to pose no risk of adverse health effects in almost all individuals in a life stage and gender group.

## DRI Values for Vitamin C

Dietary reference intake values were published for ascorbic acid by the Food and Nutrition Board of the U.S. National Academy of Sciences in a report released in April 2000.<sup>[20]</sup> EARs were calculated based on data on neutrophil saturation and urinary excretion that were obtained in a depletion–repletion study in men as described earlier. The EAR for men 19 yr and older was established as 75 mg/day. The requirement for women in the same age group was extrapolated based on body weight differences, and the EAR was set at 60 mg/day. The RDAs for vitamin C in the United States were calculated from these EAR values. In this report from 2000, the RDAs were increased from 60 to 90 mg/day for men and to 75 mg/day for women (Table 1). Using Food and Nutrition Board criteria, data published after the DRI recommendations were released suggest that the RDA for healthy young women should be increased to 90 mg/day, and that the RDA for men may have been underestimated and should be increased to 105 mg/day. UL recommendations are discussed below under adverse effects.

### Use in Pregnancy

The RDA for vitamin C during pregnancy is 80 mg/day for women aged 14–18 yr and 85 mg/day

**Table 1** Recommended dietary allowances (RDAs)<sup>a</sup> for vitamin C consumption

Group	RDA (mg/day)	
<i>Infants</i> <sup>b</sup>	<i>Boys</i>	<i>Girls</i>
0–6 mo	40	40
7–12 mo	50	50
<i>Children</i>	<i>Boys</i>	<i>Girls</i>
1–3 yr	15	15
4–8 yr	25	25
9–13 yr	45	45
14–18 yr	75	65
<i>Adults</i>	<i>Men</i>	<i>Women</i>
19 yr and older	90	75
<i>Pregnancy</i>		
14–18 yr		80
19–50 yr		85
<i>Lactation</i>		
14–18 yr		115
19–50 yr		120

<sup>a</sup>U.S. Food and Nutrition Board of the Institute of Medicine, 2000.

<sup>b</sup>Values for infants are given as adequate intake (AI), since RDAs are unavailable. Note that AI values may be higher than RDAs due to the different methods of estimation. The data used for infant AIs are milk composition and amount of milk consumed. RDAs for children are based on assumed differences in body weight from adults, for whom data are available.

for women 19 yr and older (Table 1). This increase, compared to the recommendations in nonpregnancy, is based on the assumption that additional vitamin C is required to provide adequate transfer to the fetus. Plasma vitamin C concentrations decrease during pregnancy, perhaps secondary to hemodilution or active transfer to the fetus, but this decrease has not been shown to have clinical significance. Vitamin C deficiency during pregnancy is associated with increased risk of infection, premature rupture of membranes, premature delivery, and eclampsia. However, it is unknown whether vitamin C deficiency contributes to these conditions or is simply a marker of poor nutritional status. Precise data are lacking regarding fetal requirements and quantity of maternal vitamin C transferred to the fetus. Therefore, an increase of 10 mg/day for pregnancy was recommended based on data that intakes of 7 mg/day of vitamin C prevent young infants from developing scurvy.

### Use in Disease

Some studies, as discussed above, suggest that vitamin C administration may have health benefits in those with endothelial dysfunction, such as patients with ischemic heart disease, diabetes, or hypertension, and that it may reduce tolerance to nitrates. However, there are currently not enough data to support specific vitamin C intake recommendations in such patients other than the RDA and the general recommendation for fruit and vegetable intake.

### Optimum Vitamin C Intake

Recommendations for optimum intake should be based on its dietary availability, steady-state concentrations in plasma and in tissue in relation to dose, bioavailability, urinary excretion, adverse effects, biochemical and molecular function in relation to concentration, beneficial effects in relation to dose (direct effects and epidemiological observations), and prevention of deficiency. Although recent studies provided valuable data on some of these aspects, additional clinical reports are needed to provide definitive recommendations for optimal intake in health and disease. Some recommendations can still be made now using available data. Five or more varied servings of fruits and vegetables daily will provide approximately 200 mg of vitamin C and might offer protection against cardiovascular diseases and stroke. It is recommended that healthy people strive to meet this ingestion amount using fruits and vegetables, not supplements.

## ADVERSE EFFECTS

The toxic effects of vitamin C are few and are dose related. Ingestion of 3–5 g at once can cause diarrhea and bloating. The vitamin enhances iron absorption from the small intestine and may, in large doses, increase the risk of iron overload in patients who are prone to that condition (such as patients with hemochromatosis, thalassemia major, or sideroblastic anemia, or patients who require multiple, frequent red blood cell transfusions). In healthy individuals, vitamin C most probably does not induce iron overabsorption in doses as high as 2 g. In patients with glucose-6-phosphate dehydrogenase (G6PD) deficiency, hemolysis was induced by intravenous vitamin C administration as well as by oral administration of single doses of at least 6 g of the vitamin. Doses of 3 g may cause transient hyperuricosuria, but this does not occur at doses of less than 1 g. Likewise, oxalate excretion may be increased by ingestion of 1 g or more daily of the vitamin in some individuals, although the clinical importance of this is unknown. Large-scale studies in healthy individuals with no prior history of kidney stones did not show an increased risk of formation of renal calculi with increased vitamin C consumption from food and supplements. However, vitamin C at doses of 1 g daily and higher may precipitate this problem in some individuals with occult hyperoxaluria. In patients receiving dialysis treatment, hyperoxalemia has been induced by repeated intravenous administration of 1 g, and it may also be promoted by daily doses of 500 mg. Although adequate vitamin C intake for patients with end-stage renal disease on dialysis is not known, based on current evidence, it probably should not exceed 200 mg daily.<sup>[1]</sup>

In its latest published recommendations, the Food and Nutrition Board set the tolerable upper limit (UL) for vitamin C at 2 g daily, based on gastrointestinal adverse effects at higher doses.<sup>[20]</sup> Of note, there are no clinical indications at this time for such doses, although some patients ingest these amounts for possible benefit despite little or inconclusive evidence.

Vitamin C, at doses of 250 mg and above, may cause false-negative results for stool occult blood with guaiac-based tests. Intake of the vitamin should be reduced to less than 250 mg for several days prior to such testing. Several harmful effects have erroneously been attributed to the vitamin, including hypoglycemia, rebound scurvy, infertility, mutagenesis, and destruction of vitamin B<sub>12</sub>. None of these effects are caused by vitamin C.

## COMPENDIAL/REGULATORY STATUS

Not applicable.

## REFERENCES

1. Levine, M.; Rumsey, S.C.; Daruwala, R.; Park, J.B.; Wang, Y. Criteria and recommendations for vitamin C intake. *J. Am. Med. Assoc.* **1999**, *281*, 1415–1423.
2. Winkler, B.S.; Orselli, S.M.; Rex, T.S. The redox couple between glutathione and ascorbic acid: a chemical and physiological perspective. *Free Radic. Biol. Med.* **1994**, *17*, 333–349.
3. Rumsey, S.C.; Levine, M. Absorption, transport, and disposition of ascorbic acid in humans. *Nutr. Biochem.* **1998**, *9*, 116–130.
4. Padayatty, S.J.; Katz, A.; Wang, Y. et al. Vitamin C as an antioxidant: evaluation of its role in disease prevention. *J. Am. Coll. Nutr.* **2003**, *22*, 18–35.
5. Jialal, I.; Fuller, C.J. Effect of vitamin E, vitamin C and beta-carotene on LDL oxidation and atherosclerosis. *Can. J. Cardiol.* **1995**, *11*, 97G–103G.
6. Levine, M.; Wang, Y.; Padayatty, S.J.; Morrow, J. A new recommended dietary allowance of vitamin C for healthy young women. *Proc. Natl. Acad. Sci. U.S.A.* **2001**, *98*, 9842–9846.
7. Joshipura, K.J.; Hu, F.B.; Manson, J.E. et al. The effect of fruit and vegetable intake on risk for coronary heart disease. *Ann. Intern. Med.* **2001**, *134*, 1106–1114.
8. Khaw, K.T.; Bingham, S.; Welch, A. et al. Relation between plasma ascorbic acid and mortality in men and women in EPIC-Norfolk prospective study: a prospective population study. *European Prospective Investigation into Cancer and Nutrition. Lancet* **2001**, *357*, 657–663.
9. Gokce, N.; Keane, J.F. Jr.; Frei, B. et al. Long-term ascorbic acid administration reverses endothelial vasomotor dysfunction in patients with coronary artery disease. *Circulation* **1999**, *99*, 3234–3240.
10. McVeigh, G.E.; Hamilton, P.; Wilson, M. et al. Platelet nitric oxide and superoxide release during the development of nitrate tolerance: effect of supplemental ascorbate. *Circulation* **2002**, *106*, 208–213.
11. Hallberg, L.; Brune, M.; Rossander-Hulthen, L. Is there a physiological role of vitamin C in iron absorption? *Ann. N. Y. Acad. Sci.* **1987**, *498*, 324–332.
12. Hornig, D. Distribution of ascorbic acid, metabolites and analogues in man and animals. *Ann. N. Y. Acad. Sci.* **1975**, *258*, 103–118.

13. Wang, Y.; Russo, T.A.; Kwon, O.; Chanock, S.; Rumsey, S.C.; Levine, M. Ascorbate recycling in human neutrophils: induction by bacteria. *Proc. Natl. Acad. Sci. U.S.A.* **1997**, *94*, 13,816–13,819.
14. Tsukaguchi, H.; Tokui, T.; Mackenzie, B. et al. A family of mammalian Na<sup>+</sup>-dependent L-ascorbic acid transporters. *Nature* **1999**, *399*, 70–75.
15. Daruwala, R.; Song, J.; Koh, W.S.; Rumsey, S.C.; Levine, M. Cloning and functional characterization of the human sodium-dependent vitamin C transporters hSVCT1 and hSVCT2. *FEBS Lett.* **1999**, *460*, 480–484.
16. Rumsey, S.C.; Kwon, O.; Xu, G.W.; Burant, C.F.; Simpson, I.; Levine, M. Glucose transporter isoforms GLUT1 and GLUT3 transport dehydroascorbic acid. *J. Biol. Chem.* **1997**, *272*, 18,982–18,989.
17. Levine, M.; Conry-Cantilena, C.; Wang, Y. et al. Vitamin C pharmacokinetics in healthy volunteers: evidence for a recommended dietary allowance. *Proc. Natl. Acad. Sci. U.S.A.* **1996**, *93*, 3704–3709.
18. Lind, J. Lind's *Treatise on Scurvy*. Bicentenary Volume. Stewart, C.P., Guthrie, D., Eds.; Edinburgh University Press: Edinburgh, 1953.
19. Byers, T.; Guerrero, N. Epidemiologic evidence for vitamin C and vitamin E in cancer prevention. *Am. J. Clin. Nutr.* **1995**, *62*, 1385S–1392S.
20. Food and Nutrition Board, Panel on Dietary Antioxidants and Related Compounds. *Dietary Reference Intakes for Vitamin C, Vitamin E, Selenium, and Carotenoids*; National Academy Press: Washington, DC, 2000; 95–184.



# Vitamin E

Maret G. Traber

Linus Pauling Institute, Oregon State University, Corvallis, Oregon, U.S.A.

## INTRODUCTION

Vitamin E was discovered in 1922 by Evans and Bishop<sup>[2]</sup> and was described as a dietary factor required for reproduction in rodents. Since then, great advances have been made in our understanding of the antioxidant and nonantioxidant roles of vitamin E in human nutrition. Nonetheless, no specific biochemical function, other than that of an antioxidant, has been proven as the mechanism as to why humans require it. Indeed, the nonspecific nature of the vitamin's antioxidant role has led advocates to suggest that amounts far in excess of dietary requirements might be beneficial to promote health, delay aging, and decrease the risk of chronic diseases. This entry will address facts about vitamin E, the gaps in our knowledge, and our expectations for the future.

## NAME AND GENERAL DESCRIPTION

Vitamin E [ $\alpha$ -tocopherol is called *RRR*- $\alpha$ -tocopherol; or on labels, *D*- $\alpha$ -tocopherol; or more formally, 2,5,7,8-tetramethyl-2*R*-(4'*R*,8'*R*,12-trimethyltridecyl)-6-chromanol] is a fat-soluble vitamin.<sup>[1]</sup> Positions 2, 4', and 8' of tocopherols are chiral carbon centers that are in the *R*-conformation in naturally occurring tocopherols (Fig. 1), but theoretically can take on either the *R*- or *S*-conformations. The chemical synthesis of  $\alpha$ -tocopherol results in an equal mixture of eight different stereoisomers (*RRR*, *RSR*, *RRS*, *RSS*, *SRR*, *SSR*, *SRS*, and *SSS*). Therefore, synthetic  $\alpha$ -tocopherol is called *all rac*- $\alpha$ -tocopherol; or on labels, *DL*- $\alpha$ -tocopherol; or more formally, 2,5,7,8-tetramethyl-2*RS*-(4'*RS*,8'*RS*,12-trimethyltridecyl)-6-chromanol.

Dietary components with vitamin E antioxidant activity include  $\alpha$ -,  $\beta$ -,  $\gamma$ -, and  $\delta$ -tocopherols, and  $\alpha$ -,  $\beta$ -,  $\gamma$ -, and  $\delta$ -tocotrienols.<sup>[1]</sup> All these molecules have a chromanol ring and vary in the number of methyl groups on the chromanol ring. Tocopherols have a

phytyl tail, while tocotrienols have an unsaturated tail.  $\alpha$ -Tocopherol and  $\alpha$ -tocotrienol have three methyl groups,  $\beta$  and  $\gamma$  have two, and  $\delta$  has one. A new vitamin E form,  $\alpha$ -tocomononol, has been described to be present in cold water marine fishes,<sup>[3,4]</sup> and is unusual in that it has a single double bond in the tail.

Importantly, only  $\alpha$ -tocopherol meets human vitamin E requirements because only this form has been shown to reverse human vitamin E deficiency symptoms and is recognized preferentially by the hepatic  $\alpha$ -tocopherol transfer protein ( $\alpha$ -TTP).<sup>[1]</sup> Defects in the gene for  $\alpha$ -TTP result in vitamin E deficiency both in humans and in animal models, as will be discussed below. It is for this reason that this vitamin has been defined for human requirements as  $\alpha$ -tocopherol.<sup>[1]</sup>

## VITAMIN E SUPPLEMENTS

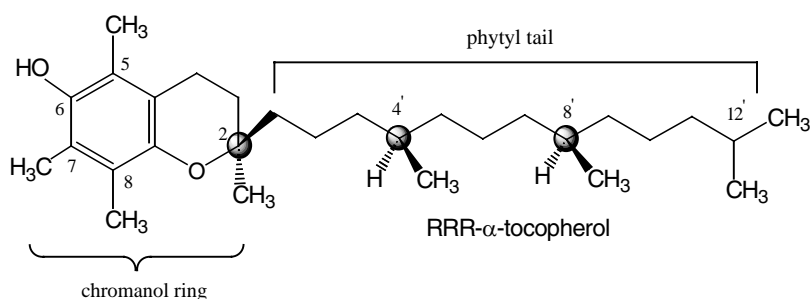
Most vitamin E supplements and food fortificants contain *all rac*- $\alpha$ -tocopherol, and can also have mixtures of tocopherols or tocotrienols. Often, supplements are sold as esters, which protect  $\alpha$ -tocopherol from oxidation. These can be acetates, succinates, or nicotinate of  $\alpha$ -tocopherol. Either the natural stereoisomer (*RRR*- $\alpha$ -tocopherol) or the synthetic (*all rac*- $\alpha$ -tocopherol) form can be sold as an ester, e.g., *D*- or *DL*- $\alpha$ -tocopheryl acetate, respectively. However, it is important to note that only half of the vitamin E in synthetic mixtures contains the 2*R*-stereochemistry. Thus, only 50% of *all rac*- $\alpha$ -tocopherol meets human requirements.<sup>[1]</sup>

## BIOCHEMISTRY AND FUNCTIONS

### Antioxidant Activity

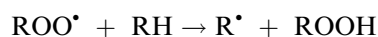
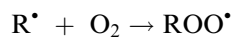
Vitamin E is the most potent lipid-soluble antioxidant in human plasma and tissues.<sup>[5]</sup> Hence, it protects polyunsaturated fatty acids within membranes and plasma lipoproteins from oxidation by reactive oxygen species. For example, a peroxy radical in a membrane is 1000 times more likely to attack a vitamin E molecule than a polyunsaturated fatty acid.<sup>[6]</sup>

Maret G. Traber, Ph.D., is at the Department of Nutrition and Exercise Sciences and at Linus Pauling Institute, Oregon State University, Corvallis, Oregon, U.S.A.

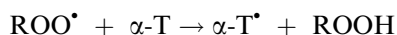


**Fig. 1** Structure of *RRR*- $\alpha$ -tocopherol showing three chiral centers with the 2 position important for biologic activity.

In the absence of vitamin E, a chain reaction occurs:



However, if vitamin E (e.g.,  $\alpha$ -T) is present, the hydroxyl group on the chromanol ring reacts with the peroxy radical to form a tocopheroxyl radical and a lipid hydroperoxide. Thus, vitamin E acts as a chain-breaking antioxidant, thereby preventing further autoxidation of lipids.<sup>[7]</sup>



The tocopheroxyl radical ( $\alpha\text{-T}^{\bullet}$ ) has a number of possible fates. It can react with another radical to form nonreactive products. Alternatively, it can be further oxidized to tocopheryl quinone, a two-electron oxidation product. Another possibility is “vitamin E recycling,” where the tocopheroxyl radical is restored to its unoxidized form by other antioxidants such as vitamin C, ubiquinol, or thiols, such as glutathione.<sup>[8]</sup> This “recycling” process depletes other antioxidants; hence, an adequate intake of other dietary antioxidants is important to maintain vitamin E concentrations. In addition, the tocopheroxyl radical, because it is relatively long lived and if there are no other coantioxidants with which it could react, can hypothetically re-initiate lipid peroxidation.<sup>[9]</sup> Upston, Terentis, and Stocker<sup>[9]</sup> have called this “TMP or tocopherol-mediated peroxidation” and claim it can occur in vivo based on the detection of both oxidized lipids and unoxidized vitamin E in atherosclerotic lesions.

In addition to its antioxidant activity,  $\gamma$ -tocopherol and other non- $\alpha$ -vitamin E forms can also trap reactive nitrogen oxides because they have an unsubstituted position on the chromanol ring.<sup>[10]</sup> Cooney et al.<sup>[11]</sup> reported that  $\gamma$ -T is more effective in detoxification of  $\text{NO}_2$  than  $\alpha$ -T. Furthermore, Hoglen et al.<sup>[12]</sup> demonstrated that 5-nitro- $\gamma$ -tocopherol (2,7,8-trimethyl-2-(4,8,12-trimethyldecyl)-5-nitro-6-chromanol; NGT) is the major reactive product between peroxy nitrite and  $\gamma$ -tocopherol. NGT has been reported in the plasma of zymosan-treated rats,<sup>[13]</sup> cigarette smokers,<sup>[14]</sup>

patients with coronary artery disease,<sup>[15]</sup> as well as in brains collected postmortem from patients with Alzheimer’s disease.<sup>[16]</sup>

It is vital to observe that all tocopherols and tocotrienols have antioxidant activity, and in some systems many of these have been reported to have higher antioxidant activity than  $\alpha$ -tocopherol.<sup>[17,18]</sup> Nonetheless, it must be emphasized that the relationship between biologic activity and antioxidant activity is not clear.  $\alpha$ -Tocopherol has the highest biologic activity, suggesting it shows some specific molecular function.

## Biologic Activity

Biologic activity is a historic term indicating a disconnection between molecules having vitamin E antioxidant activity and a relative *lack* of in vivo biologic function. Observations in rodent experiments carried out in the 1930s formed the basis for determining the “biologic activity” of this vitamin.<sup>[19]</sup> Although the various molecules with vitamin E activity had somewhat similar structures and antioxidant activities, they differed in their abilities to prevent or reverse specific vitamin E deficiency symptoms (e.g., fetal resorption, muscular dystrophy, and encephalomalacia).<sup>[20]</sup>  $\alpha$ -Tocopherol, with three methyl groups and a free hydroxyl group on the chromanol ring with the phytyl tail meeting the ring in the *R*-orientation (Fig. 1), has the highest biological activity. This specific structural requirement for biological, but not chemical, activity is now known to be dependent upon the hepatic  $\alpha$ -TTP.<sup>[21]</sup> As will be discussed below,  $\alpha$ -TTP maintains plasma, and indirectly tissue,  $\alpha$ -tocopherol concentrations.<sup>[22,23]</sup>

## Molecular Functions

In addition to antioxidant activity, there are specific  $\alpha$ -tocopherol-dependent functions that normalize cellular signaling and metabolism in a variety of cells.<sup>[24]</sup>  $\alpha$ -Tocopherol plays a critical role through its ability to inhibit the activity of protein kinase C,<sup>[25]</sup> a central player in many signal transduction pathways.

Specifically, it modulates pathways of platelet aggregation,<sup>[26,27]</sup> endothelial cell nitric oxide production,<sup>[28,29]</sup> monocyte/macrophage superoxide production,<sup>[30]</sup> and smooth muscle cell proliferation.<sup>[31]</sup> Regulation of adhesion molecule expression and inflammatory cell cytokine production by  $\alpha$ -tocopherol have also been reported.<sup>[32]</sup>

These have been reports regulation of the expression of lipoprotein receptors by  $\alpha$ -tocopherol. Both the scavenger receptor BI(SR-BI),<sup>[33]</sup> and its homolog, CD36,<sup>[34,35]</sup> are decreased by high cellular  $\alpha$ -tocopherol and increased by low concentrations.

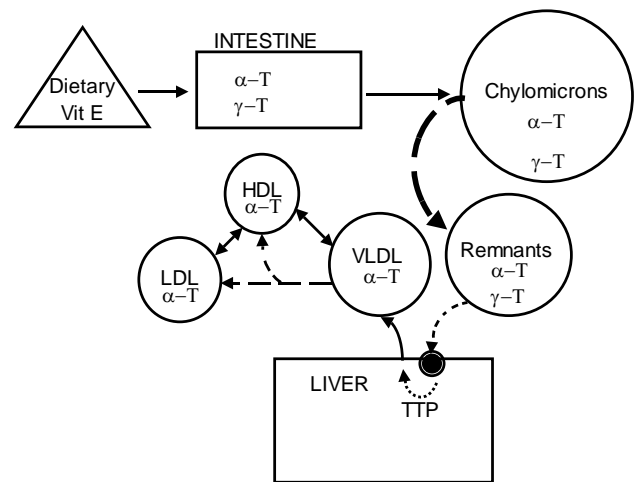
$\gamma$ -Tocopherol, as well as its metabolite ( $\gamma$ -CEHC;  $\gamma$ -carboxyethyl hydroxychroman), possesses anti-inflammatory properties, because stimulated macrophages and epithelial cells, treated with  $\gamma$ -tocopherol, have decreased cyclo-oxygenase-2 activity and lower levels of prostaglandin E<sub>2</sub> (PGE<sub>2</sub>) synthesis.<sup>[36]</sup> Moreover, in rats fed a high  $\gamma$ -T diet (33 mg/kg chow) and subjected to carrageenan-induced inflammation, PGE<sub>2</sub> and leukotriene B<sub>4</sub> synthesis were decreased by 46% and 70%, respectively.<sup>[37]</sup> Additionally,  $\gamma$ -CEHC has been shown to increase sodium excretion.<sup>[38]</sup>

The in vivo significance of many of these various effects and the role of vitamin E in signaling pathways remain controversial because most of the information in this area has been obtained from in vitro studies. Additionally, microarray technology has been used to show changes in gene expression in response to vitamin E,<sup>[39,40]</sup> but the physiologic relevance has not yet been clearly documented. More studies in humans are needed to relate  $\alpha$ -tocopherol intakes and tissue concentrations to optimal tissue responses and gene regulation.

## PHYSIOLOGY

### Absorption and Plasma Transport

Intestinal absorption of vitamin E is dependent upon normal processes of fat absorption. Specifically, both biliary and pancreatic secretions are necessary for solubilization of this vitamin in mixed micelles containing bile acids, fatty acids, and monoglycerides (Fig. 2).  $\alpha$ -Tocopheryl acetates (or other esters) from vitamin E supplements are hydrolyzed by pancreatic esterases to  $\alpha$ -tocopherol prior to absorption. Low fat diets limit vitamin E absorption, especially from supplements.<sup>[41]</sup> Following micellar uptake by enterocytes, it is incorporated into chylomicrons and secreted into the lymph. Once in the circulation, chylomicron triglycerides are hydrolyzed by lipoprotein lipase (LPL). During chylomicron catabolism in the circulation, vitamin E is nonspecifically transferred both to tissues and to other circulating lipoproteins.<sup>[42]</sup>



**Fig. 2** Intestinal vitamin E absorption and plasma lipoprotein transport. Vitamin E absorption requires both biliary and pancreatic secretions for solubilization of vitamin E in mixed micelles. Following micellar uptake by enterocytes, vitamin E (shown as  $\alpha$ - and  $\gamma$ -tocopherols,  $\alpha$ -T and  $\gamma$ -T) is incorporated into chylomicrons and is secreted into the lymph. During chylomicron catabolism in the circulation, it is nonspecifically transferred both to tissues and to other circulating lipoproteins (not shown). It is not until the vitamin E-containing chylomicrons reach the liver that discrimination between the various dietary vitamin E forms occurs. The hepatic  $\alpha$ -TTP preferentially facilitates secretion of  $\alpha$ -tocopherol from the liver into the plasma in very low density lipoproteins (VLDLs). In the circulation, VLDLs are catabolized to LDLs. During this lipolytic process, all of the circulating lipoproteins (e.g., LDL and HDL) become enriched with  $\alpha$ -tocopherol.

It is not until the vitamin E-containing chylomicrons reach the liver that discrimination between the various dietary vitamin E forms occurs. The hepatic  $\alpha$ -TTP preferentially facilitates secretion of  $\alpha$ -tocopherol, specifically 2R- $\alpha$ -tocopherols, but not other tocopherols or tocotrienols, from the liver into the plasma in very low-density lipoproteins (VLDLs).<sup>[43,44]</sup> In the circulation, VLDLs are catabolized to low-density lipoproteins (LDLs). During this lipolytic process, all of the circulating lipoproteins become enriched with  $\alpha$ -tocopherol.

There is no evidence that vitamin E is transported in the plasma by a specific carrier protein. Instead, the vitamin is nonspecifically transported in all of the lipoprotein fractions.<sup>[45]</sup> An advantage of this transport is that oxidation-susceptible lipids are protected by the simultaneous transport of a lipid-soluble antioxidant. Similarly, delivery of vitamin E to tissues is dependent upon lipid and lipoprotein metabolism. Thus, as peroxidizable lipids are taken up by tissue, the tissues simultaneously acquire a lipid-soluble antioxidant.

Plasma  $\alpha$ -tocopherol concentrations in humans range from 11 to 37  $\mu\text{mol/L}$ , while  $\gamma$ -tocopherol



concentrations are roughly 2–5  $\mu\text{mol/L}$  and tocotrienol concentrations are less than 1  $\mu\text{mol/L}$ , even in subjects supplemented with tocotrienols.<sup>[46]</sup> When plasma lipids are taken into account, the lower limits of normal level are 1.6  $\mu\text{mol } \alpha\text{-tocopherol/mmol lipid}$  (sum of cholesterol and triglycerides), or 2.5  $\mu\text{mol } \alpha\text{-tocopherol/mmol cholesterol}$ .<sup>[47]</sup>

The apparent half-life of *RRR*- $\alpha$ -tocopherol in plasma of normal subjects is approximately 48 hr,<sup>[48]</sup> while that of *SRR*- $\alpha$ -tocopherol is only 15 hr,<sup>[48]</sup> and that of  $\gamma$ -tocopherol is also similar to the *SRR*- $\alpha$ -tocopherol, about 15 hr.<sup>[49]</sup> This relatively fast turnover of 2*S*- $\alpha$ -tocopherol is also accompanied by increased metabolism.<sup>[50]</sup> The comparatively fast disappearance of the 2*S*- $\alpha$ -tocopherols indicates that by 48 hr, nearly 90% of the 2*S*-forms have been removed from the plasma, while 50% of the 2*R*-forms remain. It is then no wonder that the plasma disappearance curves of *RRR*- and *all rac*- $\alpha$ -tocopherols are parallel; they both trace the 2*R*-forms' disappearance.<sup>[51–53]</sup>

### Tissue Delivery

Vitamin E is delivered to tissues by three methods, none of which is specific for vitamin E. But rather its trafficking depends on mechanisms of lipid and lipoprotein metabolism. These include transfer from triglyceride-rich lipoproteins during lipolysis, delivery as a result of receptor-mediated lipoprotein uptake, and exchange between lipoproteins or tissues.

With respect to lipolysis, LPL facilitates the delivery of  $\alpha$ -tocopherol from triglyceride-rich lipoproteins to cells, as shown *in vitro*.<sup>[54]</sup> The importance of this pathway was demonstrated *in vivo* when LPL was overexpressed in muscle, resulting in increased vitamin E delivery to muscle.<sup>[55]</sup>

Both low- and high-density lipoproteins (LDL and HDL, respectively) have been shown to deliver vitamin E to tissues. The LDL receptor-mediated uptake of LDL delivers the lipoprotein particle via an endocytic pathway, and vitamin E is released during lipoprotein degradation.<sup>[56]</sup> In contrast, HDL binds to the SR-BI allowing selective delivery of the HDL lipids, including vitamin E, to the cells.<sup>[57]</sup> In SR-BI knockout mice, plasma  $\alpha$ -tocopherol concentrations are elevated. Some tissues (e.g., brain<sup>[58]</sup> and lung<sup>[33]</sup>) contain decreased  $\alpha$ -tocopherol contents, while hepatic tocopherol concentrations are unchanged. But biliary tocopherol excretion is decreased.<sup>[59]</sup> Apparently, SR-BI-mediated hepatic uptake of HDL-associated  $\alpha$ -tocopherol is coupled to biliary excretion of vitamin E.<sup>[59]</sup>

Although vitamin E spontaneously exchanges between lipoproteins,<sup>[60]</sup> the phospholipid transfer protein (PLTP) facilitates the exchange of phospholipids between lipoproteins, as well as the transfer of

vitamin E from VLDL to HDL and from lipoproteins into cells.<sup>[61]</sup> PLTP knockout mice compared with wild types have higher vitamin E in apolipoprotein B-containing lipoproteins (VLDL or LDL).<sup>[62]</sup> The involvement of the plasma cholesteryl ester transfer protein (CETP) in this transfer process was ruled out.<sup>[62]</sup>

The regulation of tissue vitamin E is not well understood, but it is seen that  $\alpha$ -tocopherol is the predominant form in tissues as a result of its plasma concentrations.<sup>[22]</sup> The ATP-binding cassette transporter (ABCAI) has been shown to participate in the efflux of  $\alpha$ -tocopherol from cells to HDL.<sup>[63]</sup> Apparently, excess vitamin E could be removed from cells via ABCAI facilitating its transfer to apolipoprotein AI, and transport via HDL to the liver where SR-BI could mediate vitamin E transfer into a liver pool destined for excretion in bile.

### Metabolism and Excretion

Vitamin E is excreted as intact tocopherols or tocotrienols, oxidized forms, and a metabolic product.<sup>[42]</sup>  $\alpha$ - and  $\gamma$ -Tocopherols as well as  $\alpha$ - and  $\gamma$ -tocotrienols are metabolized to  $\alpha$ - and  $\gamma$ -CEHCs [2,5,7,8-tetra-methyl- and 2,7,8-trimethyl-2-(2'-carboxyethyl)-6-hydroxy-chromans], respectively, by humans.<sup>[42]</sup> CEHCs were first described in rats fed high amounts of  $\delta$ -tocopherols.<sup>[64]</sup> About 1% of a dose of  $\alpha$ -tocopherol or tocotrienol and 5% of a dose of  $\gamma$ -tocopherol or tocotrienol are excreted in the urine as CEHCs.<sup>[65]</sup> Based on studies in hepatocytes,<sup>[66,67]</sup> it is likely that the liver synthesizes CEHCs. Studies in renal dialysis patients<sup>[68,69]</sup> suggest that in addition to urinary excretion,<sup>[42]</sup> bile may be a major route for CEHC excretion. Similarly, CEHCs have been found in both rat urine and bile.<sup>[70]</sup>

The importance of vitamin E metabolism in the regulation of vitamin E status is unknown. The various forms of vitamin E appear to be metabolized similar to xenobiotics in that they are initially oxidized by P450s, conjugated, and excreted in urine or bile. CEHCs have a shortened phytol tail, resulting from  $\omega$ -oxidation, a cytochrome P450 (CYP)-mediated process, followed by  $\beta$ -oxidation.<sup>[71–73]</sup> Hepatic CYP 4F2 is involved in  $\omega$ -oxidation of  $\alpha$ - and  $\gamma$ -tocopherols,<sup>[73]</sup> and so could CYP 3A.<sup>[66,71,72,74]</sup> It should be noted that a compound can stimulate CYPs other than those involved in its own metabolic pathway; thus, interactions with a variety of pathways are possible.

CEHCs can be sulfated or glucuronidated.<sup>[75–77]</sup> Both free and conjugated forms have been detected in plasma,<sup>[76]</sup> urine,<sup>[42]</sup> and bile.<sup>[78]</sup> All of the systems involved in vitamin E metabolism could be under PXR regulation.<sup>[79]</sup>

Dietary vitamin E forms, such as  $\gamma$ -tocopherol<sup>[80]</sup> or  $\gamma$ -tocotrienol,<sup>[81]</sup> are more actively metabolized to CEHCs than  $\alpha$ -tocopherol.<sup>[50,65,75]</sup> In fact, nearly all of the absorbed  $\gamma$ -tocopherol has been estimated to be metabolized to  $\gamma$ -CEHC.<sup>[75]</sup> High  $\alpha$ -tocopherol intakes, e.g., supplements, lead to both increased  $\alpha$ -CEHC<sup>[82]</sup> and  $\gamma$ -CEHC excretion.<sup>[65]</sup> Thus, vitamin E metabolism may be a key factor in hepatic disposal of excess vitamin E.

## HUMAN VITAMIN E DEFICIENCY

Vitamin E deficiency was first described in children with fat malabsorption syndromes, principally abetalipoproteinemia, cystic fibrosis, and cholestatic liver disease.<sup>[83]</sup> Subsequently, humans with severe deficit with no known defect in lipid or lipoprotein metabolism were described to have a defect in the  $\alpha$ -TTP gene.<sup>[84]</sup>

Erythrocyte fragility, hemolysis, and anemia were described as vitamin E deficiency symptoms in various animals fed diets devoid of this antioxidant.<sup>[85]</sup> However, in humans, the major symptom is a peripheral neuropathy characterized by the degeneration of large caliber axons in the sensory neurons.<sup>[86]</sup>

## INDICATIONS AND USAGE

### Food Sources

Vitamin E can be readily obtained from food, but relatively few foods have high  $\alpha$ -tocopherol concentrations.<sup>[87]</sup> Generally, the richest sources are vegetable oils. Wheat germ oil, safflower oil, and sunflower oil contain predominantly  $\alpha$ -tocopherol, while soy and corn oils have mainly  $\gamma$ -tocopherol. All of these oils are polyunsaturated. Good sources of monounsaturated oils, such as olive or canola oils, also have  $\alpha$ -tocopherol to a large extent. Whole grains and nuts, especially almonds, are also good  $\alpha$ -tocopherol sources. Fruits and vegetables, although rich in water-soluble antioxidants, are *not* good sources of vitamin E. Indeed, desserts are a major source of vitamin E in the American diet.<sup>[88]</sup>

In the past, it was assumed for the purpose of calculating dietary vitamin E intakes in  $\alpha$ -tocopherol equivalents ( $\alpha$ -TEs) that  $\gamma$ -tocopherol can substitute for  $\alpha$ -tocopherol with an efficiency of 10%.<sup>[89]</sup> However, functionally,  $\gamma$ -tocopherol is not equivalent to the latter. Caution should be exercised in applying  $\alpha$ -TEs to estimates of  $\alpha$ -tocopherol intakes when corn or soybean oils (hydrogenated vegetable oils) represent the major oils present in foods. These oils have high  $\gamma$ -tocopherol contents, and if food tables reporting

$\alpha$ -TEs are used to estimate dietary  $\alpha$ -tocopherol,  $\alpha$ -tocopherol intakes may be overestimated.

## Treatment of Vitamin E Deficiency

Overt vitamin E deficiency occurs only rarely in humans and almost never as a result of inadequate vitamin E intakes. It does occur as a result of genetic abnormalities in  $\alpha$ -TTP<sup>[90]</sup> and various fat malabsorption syndromes.<sup>[91]</sup> Vitamin E supplementation halts the progression of the neurologic abnormalities caused by inadequate nerve tissue  $\alpha$ -tocopherol, and in some cases, has reversed them.<sup>[92]</sup>

Patients with these disorders require daily pharmacologic vitamin E doses for life to overcome and prevent the deficiency symptoms. Generally, subjects with Ataxia with Vitamin E Deficiency (AVED) are advised to consume 1000 mg *RRR*- $\alpha$ -tocopherol per day in divided doses, those with abetalipoproteinemia 100 mg/kg body weight, and for cystic fibrosis 400 mg/day. However, patients with fat malabsorption due to impaired biliary secretion generally do not absorb orally administered vitamin E. They are treated with special forms of vitamin E, such as  $\alpha$ -tocopheryl polyethylene glycol succinate, which spontaneously form micelles, obviating the need for bile acids.<sup>[93]</sup>

## Chronic Disease Prevention

In individuals at risk for vitamin E deficiency, it is clear that supplements should be recommended to prevent it. What about vitamin E supplement in normal individuals? Dietary changes such as decreasing fat intakes,<sup>[94]</sup> substituting fat-free foods for fat-containing ones, and increasing reliance on meals away from the home have resulted in decreased consumption of  $\alpha$ -tocopherol-containing foods. Therefore, intakes of the vitamin E recommended dietary allowance (RDA)—15 mg  $\alpha$ -tocopherol—may be difficult. The most recent estimates of  $\alpha$ -tocopherol intakes by Americans suggest that less than 10% consume adequate amounts of the vitamin, and that women have lower intakes than men.<sup>[95]</sup> Increased consumption of nuts and seeds, as well as olive and canola oils, may be useful in increasing  $\alpha$ -tocopherol intakes.

The potential role of vitamin E in preventing or ameliorating chronic diseases has prompted many investigators to ask if supplements might be beneficial. When “excess” amounts of many vitamins are consumed, they are excreted and provide no added benefits. Antioxidant nutrients may, however, be different. Heart disease and stroke, cancer, chronic inflammation, impaired immune function, Alzheimer’s disease—a case can be made for the role of oxygen-free radicals in the etiology of all of these disorders, and

even in aging itself. Do antioxidant nutrients counteract the effects of free radicals and thereby ameliorate these disorders? And if so, do large quantities of antioxidant supplements have beneficial effects beyond “required” amounts? *The 2000 DRI Report on Vitamin C, Vitamin E, Selenium, and Carotenoids* stated that there was insufficient proof to warrant advocating supplementation with antioxidants.<sup>[1]</sup> But it also stated that the hypothesis that antioxidant supplements might have beneficial effects was promising. Despite the lack of positive findings from various intervention studies,<sup>[96,97]</sup> and some more positive findings from others,<sup>[98–101]</sup> the consequences of a long-term increased antioxidant intake in healthy people are not known. Moreover, a study examining the relationship between the genetic background of diabetic women and the benefits of antioxidant supplementation found a marked beneficial effect on the minimum luminal diameter in haptoglobin 1 allele homozygotes, but not in those with the haptoglobin 2 allele.<sup>[102]</sup> Thus, it would appear that subjects with high oxidative stress and the appropriate genetic background may benefit from antioxidant supplements, but not in those without these factors.

### Dietary Reference Intakes

In 2000, the Food and Nutrition Board of the Institute of Medicine, National Academy of Sciences published the *Dietary Reference Intakes for Vitamin C, Vitamin E, Selenium and the Carotenoids*.<sup>[1]</sup> Recommendations for vitamin E intakes are shown in Table 1.

The requirements for vitamin E intakes are based primarily on its long-term (5–7 yr) depletion and repletion studies in humans carried out by Horwitt et al.<sup>[103]</sup> Serum  $\alpha$ -tocopherol concentrations and the corre-

sponding hydrogen peroxide-induced erythrocyte hemolysis were determined at various intervals. Serum concentrations necessary to prevent in vitro erythrocyte hemolysis in response known levels of vitamin E intake in subjects who had undergone experimentally induced vitamin E deficiency were used to determine estimated average requirements (EARs) for vitamin E. The RDAs are levels that represent the daily  $\alpha$ -tocopherol intakes required to ensure adequate nutrition in 95–97.5% of the population and are an overestimation of the level needed for most people in any given group.

### Vitamin E Units

The Food and Nutrition Board defined vitamin E for human requirements to include only  $\alpha$ -tocopherol and specifically those forms with 2*R*- $\alpha$ -tocopherol stereochemistry.<sup>[1]</sup> According to the *U.S. Pharmacopoeia* (USP), 1 international unit (IU) of vitamin E equals 1 mg *all rac*- $\alpha$ -tocopheryl acetate, 0.67 mg *RRR*- $\alpha$ -tocopherol, or 0.74 mg *RRR*- $\alpha$ -tocopheryl acetate.<sup>[104]</sup> These conversions were estimated on the relative “biologic activities” of the various forms when tested in the rat assay for vitamin E deficiency, the fetal resorption assay. These USP IUs are currently used in labeling vitamin E supplements and food fortificants. It should be noted that the 2000 RDA does not use vitamin E USP units; rather the recommendation is set at 15 mg 2*R*- $\alpha$ -tocopherols. To convert IU to milligram of 2*R*- $\alpha$ -tocopherols, the IU *RRR*- $\alpha$ -tocopherol (or its esters) is multiplied by 0.65, while the IU *all rac*- $\alpha$ -tocopherol (or its esters) is multiplied by 0.45.

### ADVERSE EFFECTS

#### Upper Tolerable Limits

High vitamin E intakes are associated with an increased tendency to bleed. It is not known if this is a result of decreased platelet aggregation caused by an inhibition of protein kinase C by  $\alpha$ -tocopherol,<sup>[26]</sup> some other platelet-related mechanism,<sup>[105]</sup> or decreased clotting due to a vitamin E interaction with vitamin K.<sup>[106]</sup> It has also been suggested that extraordinarily high vitamin E intakes may interfere with activation of vitamin K.<sup>[107]</sup> Individuals who are deficient in vitamin K or who are on anticoagulant therapy are at increased risk of uncontrolled bleeding. Thus, patients on anticoagulant therapy should be monitored when taking vitamin E supplements to insure adequate vitamin K intakes.<sup>[108]</sup>

The 2000 Food and Nutrition Board of the Institute of Medicine, National Academy of Sciences,

**Table 1** Estimated average requirements (EARs), recommended dietary allowances (RDAs), and average intakes (AIs) (mg/day) for  $\alpha$ -tocopherol in adults and children

Lifestage	EAR	RDA	AI
0–6 mo			4
7–12 mo			6
1–3 yr	5	6	
4–8 yr	6	7	
9–13 yr	9	11	
14–18 yr	12	15	
Adult (male or female)	12	15	
Pregnancy	12	15	
Lactation	16	19	

(Adapted from Ref.<sup>[1]</sup>.)

recommended 1000 mg as an upper limit (UL) of all forms of  $\alpha$ -tocopherol in supplements taken by adults 19 yr and older, including pregnant and lactating women. The vitamin E UL was set for only supplements because it is impossible to consume enough  $\alpha$ -tocopherol-containing foods to achieve a daily 1000 mg intake for prolonged periods of time. The UL was defined for *all* forms of  $\alpha$ -tocopherol, not just the 2*R*-forms, because all eight of the stereoisomeric forms in *all rac*- $\alpha$ -tocopherol are absorbed and delivered to the liver and therefore potentially have adverse effects. The ULs for supplements containing either *RRR*- or *all rac*- $\alpha$ -tocopherol supplements are 1500 IU *RRR*- $\alpha$ -tocopherol or its esters, or 1100 IU of *all rac*- $\alpha$ -tocopherol or its esters. The UL for *RRR*- $\alpha$ -tocopherol is apparently higher because each capsule of *RRR*- $\alpha$ -tocopherol contains fewer milligram of  $\alpha$ -tocopherol than does one containing *all rac*- $\alpha$ -tocopherol.

ULs were set for children and adolescents by adjusting the adult limit on the basis of relative body weight. No UL was set for infants due to lack of adequate data. The 2000 Food and Nutrition Board did recommend that food be the only source of vitamin E for infants. However, a UL of 21 mg/day was suggested for premature infants with birth weight of 1.5 kg, based on the adult UL.

### Adverse Interactions of Drugs and Vitamin E

Drugs intended to promote weight loss by impairing fat absorption, such as Orlistat or olestra, can also impair vitamin E and other fat-soluble vitamin absorption. Therefore, multivitamin supplementation is recommended. Supplements should be taken with meals at times other than when these drugs are taken to allow adequate absorption of the fat-soluble vitamins.

Findings from two clinical trials have suggested adverse vitamin E effects. One study was a 3-yr, double-blind trial of antioxidants (vitamins E and C,  $\beta$ -carotene, and selenium) in 160 subjects on simvastatin–niacin or placebo therapy.<sup>[109,110]</sup> In subjects taking antioxidants, there was less benefit of the drugs in raising HDL cholesterol than was expected,<sup>[109]</sup> while there was an increase in clinical end points [arteriographic evidence of coronary stenosis, or the occurrence of a first cardiovascular event (death, myocardial infarction, stroke, or revascularization)].<sup>[110]</sup> The other study was the Women's Angiographic Vitamin and Estrogen (WAVE) Trial, a randomized, double-blind trial of 423 postmenopausal women with at least one coronary stenosis at baseline coronary angiography. In postmenopausal women on hormone replacement therapy, all-cause mortality was higher in women assigned to

antioxidant vitamins compared with placebo group (HR, 2.8; 95% CI, 1.1–7.2;  $P = 0.047$ ).<sup>[111]</sup> The reasons for these adverse effects, especially mortality, are unclear because a meta-analysis of more than 80,000 subjects taking part in vitamin E intervention trials did not find increased mortality in those taking vitamin E.<sup>[112]</sup> However, reports of adverse effects of vitamin E supplements in humans are so rare that the Food and Nutrition Board set the upper tolerance level for vitamin E using data from studies in rats.<sup>[11]</sup>

### CONCLUSIONS

One of the real difficulties in setting requirements or making recommendations for optimal vitamin E intakes is that the function of the antioxidant remains undefined. Certainly, its *in vitro* antioxidant function has been agreed upon for decades, but questions remain as to whether this is the only function of vitamin E, or if indeed antioxidant activity is its *in vivo* function.<sup>[113,114]</sup> In addition, if the vitamin functions solely as an antioxidant, then biomarkers of oxidative stress will never be useful for setting requirements because oxidative damage certainly can be modulated by antioxidants in addition to vitamin E. Thus, one of the major thrusts is to establish the function of vitamin E. One important area that is currently under investigation is its role in inflammation<sup>[115]</sup> and immune function.<sup>[116]</sup> But, here again, the role of oxidative stress confounds the findings because leukocytes release reactive oxygen species and this is attenuated by vitamin E.<sup>[30]</sup> Clearly, defining vitamin E function(s) is the goal of future studies.

### REFERENCES

1. Food and Nutrition Board; Institute of Medicine. *Dietary Reference Intakes for Vitamin C, Vitamin E, Selenium, and Carotenoids*; National Academy Press: Washington, 2000.
2. Evans, H.M.; Bishop, K.S. On the existence of a hitherto unrecognized dietary factor essential for reproduction. *Science* **1922**, *56*, 650–651.
3. Yamamoto, Y.; Maita, N.; Fujisawa, A.; Takashima, J.; Ishii, Y.; Dunlap, W.C. A new vitamin E (alpha-tocomonoenol) from eggs of the Pacific salmon *Oncorhynchus keta*. *J. Nat. Prod.* **1999**, *62*, 1685–1687.
4. Yamamoto, Y.; Fujisawa, A.; Hara, A.; Dunlap, W.C. An unusual vitamin E constituent (alpha-tocomonoenol) provides enhanced antioxidant protection in marine organisms adapted to

- cold-water environments. *Proc. Natl. Acad. Sci. U.S.A.* **2001**, *98*, 13,144–13,148.
5. Burton, G.W.; Joyce, A.; Ingold, K.U. First proof that vitamin E is major lipid-soluble, chain-breaking antioxidant in human blood plasma. *Lancet* **1982**, *8293*, 327.
  6. Burton, G.W.; Traber, M.G. Vitamin E: antioxidant activity, biokinetics and bioavailability. *Annu. Rev. Nutr.* **1990**, *10*, 357–382.
  7. Ingold, K.U.; Webb, A.C.; Witter, D.; Burton, G.W.; Metcalfe, T.A.; Muller, D.P. Vitamin E remains the major lipid-soluble, chain-breaking antioxidant in human plasma even in individuals suffering severe vitamin E deficiency. *Arch. Biochem. Biophys.* **1987**, *259*, 224–225.
  8. Packer, L. Vitamin E is nature's master antioxidant. *Sci. Am. Sci. Med.* **1994**, *1*, 54–63.
  9. Upston, J.M.; Terentis, A.C.; Stocker, R. Tocopherol-mediated peroxidation of lipoproteins: implications for vitamin E as a potential antiatherogenic supplement. *FASEB J.* **1999**, *13*, 977–994.
  10. Christen, S.; Woodall, A.A.; Shigenaga, M.K.; Southwell-Keely, P.T.; Duncan, M.W.; Ames, B.N.  $\gamma$ -Tocopherol traps mutagenic electrophiles such as  $\text{NO}_x$  and complements  $\alpha$ -tocopherol: physiological implications. *Proc. Natl. Acad. Sci. U.S.A.* **1997**, *94*, 3217–3222.
  11. Cooney, R.V.; Franke, A.A.; Harwood, P.J.; Hatch-Pigott, V.; Custer, L.J.; Mordan, L.J. Gamma-tocopherol detoxification of nitrogen dioxide: superiority to alpha-tocopherol. *Proc. Natl. Acad. Sci. U.S.A.* **1993**, *90*, 1771–1775.
  12. Hoglen, N.C.; Waller, S.C.; Sipes, I.G.; Liebler, D.C. Reactions of peroxynitrite with gamma-tocopherol. *Chem. Res. Toxicol.* **1997**, *10*, 401–407.
  13. Christen, S.; Jiang, Q.; Shigenaga, M.K.; Ames, B.N. Analysis of plasma tocopherols alpha, gamma, and 5-nitro-gamma in rats with inflammation by HPLC coulometric detection. *J. Lipid Res.* **2002**, *43*, 1978–1985.
  14. Leonard, S.W.; Bruno, R.S.; Paterson, E.; Schock, B.C.; Atkinson, J.; Bray, T.M.; Cross, C.E.; Traber, M.G. 5-Nitro- $\gamma$ -tocopherol increases in human plasma exposed to cigarette smoke in-vitro and in-vivo. *Free Radical Biol. Med.* **2003**, *38*, 813–819.
  15. Morton, L.W.; Ward, N.C.; Croft, K.D.; Puddey, I.B. Evidence for the nitration of gamma-tocopherol in vivo: 5-nitro-gamma-tocopherol is elevated in the plasma of subjects with coronary heart disease. *Biochem. J.* **2002**, *364*, 625–628.
  16. Williamson, K.S.; Gabbita, S.P.; Mou, S.; West, M.; Pye, Q.N.; Markesbery, W.R.; Cooney, R.V.; Grammas, P.; Reimann-Philipp, U.; Floyd, R.A.; Hensley, K. The nitration product 5-nitro-gamma-tocopherol is increased in the Alzheimer brain. *Nitric Oxide* **2002**, *6*, 221–227.
  17. Serbinova, E.; Kagan, V.; Han, D.; Packer, L. Free radical recycling and intramembrane mobility in the antioxidant properties of alpha-tocopherol and alpha-tocotrienol. *Free Radical Biol. Med.* **1991**, *10*, 263–275.
  18. Kamal-Eldin, A.; Appelqvist, L.A. The chemistry and antioxidant properties of tocopherols and tocotrienols. *Lipids* **1996**, *31*, 671–701.
  19. Emerson, O.H.; Emerson, G.A.; Mohammad, A.; Evans, H.M. The chemistry of vitamin E. Tocopherols from natural sources. *J. Biol. Chem.* **1937**, *22*, 99–107.
  20. Machlin, L.J. Vitamin E. In *Handbook of Vitamins*; Hoffman-La Roche, Inc.: Nutley, NJ, 1991; 99–144.
  21. Hosomi, A.; Arita, M.; Sato, Y.; Kiyose, C.; Ueda, T.; Igarashi, O.; Arai, H.; Inoue, K. Affinity for alpha-tocopherol transfer protein as a determinant of the biological activities of vitamin E analogs. *FEBS Lett.* **1997**, *409*, 105–108.
  22. Leonard, S.W.; Terasawa, Y.; Farese, R.V., Jr.; Traber, M.G. Incorporation of deuterated *RRR*- and *all rac*  $\alpha$ -tocopherols into plasma and tissues of  $\alpha$ -tocopherol transfer protein deficient mice. *Am. J. Clin. Nutr.* **2002**, *75*, 555–560.
  23. Terasawa, Y.; Ladha, Z.; Leonard, S.W.; Morrow, J.D.; Newland, D.; Sanan, D.; Packer, L.; Traber, M.G.; Farese R.V., Jr. Increased atherosclerosis in hyperlipidemic mice deficient in alpha-tocopherol transfer protein and vitamin E. *Proc. Natl. Acad. Sci. U.S.A.* **2000**, *97*, 13,830–13,834.
  24. Azzi, A.; Breyer, I.; Feher, M.; Pastori, M.; Ricciarelli, R.; Spycher, S.; Staffieri, M.; Stocker, A.; Zimmer, S.; Zingg, J.M. Specific cellular responses to alpha-tocopherol. *J. Nutr.* **2000**, *130*, 1649–1652.
  25. Boscoboinik, D.; Szweczyk, A.; Hensey, C.; Azzi, A. Inhibition of cell proliferation by alpha-tocopherol. Role of protein kinase C. *J. Biol. Chem.* **1991**, *266*, 6188–6194.
  26. Freedman, J.E.; Farhat, J.H.; Loscalzo, J.; Keaney, J.F.J. Alpha-tocopherol inhibits aggregation of human platelets by a protein kinase C-dependent mechanism. *Circulation* **1996**, *94*, 2434–2440.
  27. Freedman, J.E.; Li, L.; Sauter, R.; Keaney, J.F.J. Alpha-tocopherol and protein kinase C

- inhibition enhance platelet-derived nitric oxide release. *FASEB J.* **2000**, *14*, 2377–2379.
28. Keane, J.F., Jr.; Simon, D.I.; Freedman, J.E. Vitamin E and vascular homeostasis: implications for atherosclerosis. *FASEB J.* **1999**, *13*, 965–975.
  29. Ulker, S.; McKeown, P.P.; Bayraktutan, U. Vitamins reverse endothelial dysfunction through regulation of eNOS and NAD(P)H oxidase activities. *Hypertension* **2003**, *41*, 534–539.
  30. Cachia, O.; Benna, J.E.; Pedruzzi, E.; Descomps, B.; Gougerot-Pocidallo, M.A.; Leger, C.L. Alpha-tocopherol inhibits the respiratory burst in human monocytes. Attenuation of p47(phox) membrane translocation and phosphorylation. *J. Biol. Chem.* **1998**, *273*, 32,801–32,805.
  31. Azzi, A.; Ricciarelli, R.; Zingg, J.M. Non-antioxidant molecular functions of alpha-tocopherol (vitamin E). *FEBS Lett.* **2002**, *519*, 8–10.
  32. Devaraj, S.; Li, D.; Jialal, I. The effects of alpha tocopherol supplementation on monocyte function. Decreased lipid oxidation, interleukin 1 beta secretion, and monocyte adhesion to endothelium. *J. Clin. Invest.* **1996**, *98*, 756–763.
  33. Kolleck, I.; Witt, W.; Wissel, H.; Sinha, P.; Rustow, B. HDL and vitamin E in plasma and the expression of SR-BI on lung cells during rat perinatal development. *Lung* **2000**, *178*, 191–200.
  34. Devaraj, S.; Hugou, I.; Jialal, I. Alpha-tocopherol decreases CD36 expression in human monocyte-derived macrophages. *J. Lipid Res.* **2001**, *42*, 521–527.
  35. Ricciarelli, R.; Zingg, J.M.; Azzi, A. Vitamin E reduces the uptake of oxidized LDL by inhibiting CD36 scavenger receptor expression in cultured aortic smooth muscle cells. *Circulation* **2000**, *102*, 82–87.
  36. Jiang, Q.; Elson-Schwab, I.; Courtemanche, C.; Ames, B.N. Gamma-tocopherol and its major metabolite, in contrast to alpha-tocopherol, inhibit cyclooxygenase activity in macrophages and epithelial cells. *Proc. Natl. Acad. Sci. U.S.A.* **2000**, *97*, 11,494–11,499.
  37. Jiang, Q.; Ames, B.N. Gamma-tocopherol, but not alpha-tocopherol, decreases proinflammatory eicosanoids and inflammation damage in rats. *FASEB J.* **2003**, *17*, 816–822.
  38. Murray, E.D.J.; Wechter, W.J.; Kantoci, D.; Wang, W.H.; Pham, T.; Quiggle, D.D.; Gibson, K.M.; Leipold, D.; Anner, B.M. Endogenous natriuretic factors 7: biospecificity of a natriuretic gamma-tocopherol metabolite LLU-alpha. *J. Pharmacol. Exp. Ther.* **1997**, *282*, 657–662.
  39. Roy, S.; Lado, B.H.; Khanna, S.; Sen, C.K. Vitamin E sensitive genes in the developing rat fetal brain: a high-density oligonucleotide microarray analysis. *FEBS Lett.* **2002**, *530*, 17–23.
  40. Gohil, K.; Chakraborty, A.A. Applications of microarray and bioinformatics tools to dissect molecular responses of the central nervous system to antioxidant micronutrients. *Nutrition* **2004**, *20*, 50–55.
  41. Leonard, S.W.; Good, C.K.; Gugger, E.T.; Traber, M.G. Enhanced vitamin E bioavailability from fortified breakfast cereal compared with encapsulated supplements. *Am. J. Clin. Nutr.* **2004**, *79*, 86–92.
  42. Brigelius-Flohé, R.; Traber, M.G. Vitamin E: function and metabolism. *FASEB J.* **1999**, *13*, 1145–1155.
  43. Traber, M.G.; Burton, G.W.; Ingold, K.U.; Kayden, H.J. *RRR*- and *SRR*-alpha-tocopherols are secreted without discrimination in human chylomicrons, but *RRR*-alpha-tocopherol is preferentially secreted in very low density lipoproteins. *J. Lipid Res.* **1990**, *31*, 675–685.
  44. Traber, M.G.; Burton, G.W.; Hughes, L.; Ingold, K.U.; Hidaka, H.; Malloy, M.; Kane, J.; Hyams, J.; Kayden, H.J. Discrimination between forms of vitamin E by humans with and without genetic abnormalities of lipoprotein metabolism. *J. Lipid Res.* **1992**, *33*, 1171–1182.
  45. Traber, M.G. Vitamin E. In *Modern Nutrition in Health and Disease*; Shils, M.E., Olson, J.A., Shike, M., Ross, A.C., Eds.; Williams & Wilkins: Baltimore, 1999; Vol. 9, 347–362.
  46. O’Byrne, D.; Grundy, S.; Packer, L.; Devaraj, S.; Baldenius, K.; Hoppe, P.P.; Kraemer, K.; Jialal, I.; Traber, M.G. Studies of LDL oxidation following alpha-, gamma-, or delta-tocotrienyl acetate supplementation of hypercholesterolemic humans. *Free Radical Biol. Med.* **2000**, *29*, 834–845.
  47. Traber, M.G.; Jialal, I. Measurement of lipid-soluble vitamins—further adjustment needed? *Lancet* **2000**, *355*, 2013–2014.
  48. Traber, M.G.; Ramakrishnan, R.; Kayden, H.J. Human plasma vitamin E kinetics demonstrate rapid recycling of plasma *RRR*- $\alpha$ -tocopherol. *Proc. Natl. Acad. Sci. U.S.A.* **1994**, *91*, 10,005–10,008.
  49. Traber, M.G.; Paterson, E.; Atkinson, J.; Ramakrishnan, R.; Iacovoni, V.; Cross, C. Studies in humans using deuterium-labeled  $\alpha$ - and  $\gamma$ -tocopherols demonstrate rapid plasma

- $\gamma$ -tocopherol disappearance. *FASEB J.* **2003**, *17*, A279.
50. Traber, M.G.; Elsner, A.; Brigelius-Flohe, R. Synthetic as compared with natural vitamin E is preferentially excreted as alpha-CEHC in human urine: studies using deuterated alpha-tocopheryl acetates. *FEBS Lett.* **1998**, *437*, 145–148.
  51. Traber, M.G.; Rader, D.; Acuff, R.; Brewer, H.B.; Kayden, H.J. Discrimination between *RRR*- and *all rac*- $\alpha$ -tocopherols labeled with deuterium by patients with abetalipoproteinemia. *Atherosclerosis* **1994**, *108*, 27–37.
  52. Lauridsen, C.; Engel, H.; Jensen, S.K.; Craig, A.M.; Traber, M.G. Lactating sows and suckling piglets preferentially incorporate *RRR*- over *all rac*- $\alpha$ -tocopherol into milk, plasma and tissues. *J. Nutr.* **2002**, *132*, 1258–1264.
  53. Traber, M.G.; Winklhofer-Roob, B.M.; Roob, J.M.; Khoschsorur, G.; Aigner, R.; Cross, C.; Ramakrishnan, R.; Brigelius-Flohe, R. Vitamin E kinetics in smokers and non-smokers. *Free Radical Biol. Med.* **2001**, *31*, 1368–1374.
  54. Traber, M.G.; Olivecrona, T.; Kayden, H.J. Bovine milk lipoprotein lipase transfers tocopherol to human fibroblasts during triglyceride hydrolysis in vitro. *J. Clin. Invest.* **1985**, *75*, 1729–1734.
  55. Sattler, W.; Levak-Frank, S.; Radner, H.; Kostner, G.; Zechner, R. Muscle-specific overexpression of lipoprotein lipase in transgenic mice results in increased alpha-tocopherol levels in skeletal muscle. *Biochem. J.* **1996**, 15–19.
  56. Traber, M.G.; Kayden, H.J. Vitamin E is delivered to cells via the high affinity receptor for low-density lipoprotein. *Am. J. Clin. Nutr.* **1984**, *40*, 747–751.
  57. Goti, D.; Reicher, H.; Malle, E.; Kostner, G.; Panzenboeck, U.; Sattler, W. High-density lipoprotein (HDL3)-associated alpha-tocopherol is taken up by HepG2 cells via the selective uptake pathway and resecreted with endogenously synthesized apo-lipoprotein B-rich lipoprotein particles. *Biochem. J.* **1998**, *332*, 57–65.
  58. Goti, D.; Hrzenjak, A.; Levak-Frank, S.; Frank, S.; van der Westhuyzen, D.R.; Malle, E.; Sattler, W. Scavenger receptor class B, type I is expressed in porcine brain capillary endothelial cells and contributes to selective uptake of HDL-associated vitamin E. *J. Neurochem.* **2001**, *76*, 498–508.
  59. Mardones, P.; Strobel, P.; Miranda, S.; Leighton, F.; Quinones, V.; Amigo, L.; Rozowski, J.; Krieger, M.; Rigotti, A. Alpha-tocopherol metabolism is abnormal in scavenger receptor class B type I (SR-BI)-deficient mice. *J. Nutr.* **2002**, *132*, 443–449.
  60. Traber, M.G.; Lane, J.C.; Lagmay, N.; Kayden, H.J. Studies on the transfer of tocopherol between lipoproteins. *Lipids* **1992**, *27*, 657–663.
  61. Kostner, G.M.; Oettl, K.; Jauhainen, M.; Ehnholm, C.; Esterbauer, H.; Dieplinger, H. Human plasma phospholipid transfer protein accelerates exchange/transfer of alpha-tocopherol between lipoproteins and cells. *Biochem. J.* **1995**, *305*, 659–667.
  62. Jiang, X.C.; Tall, A.R.; Qin, S.; Lin, M.; Schneider, M.; Lalanne, F.; Deckert, V.; Desrumaux, C.; Athias, A.; Witztum, J.L.; Lagrost, L. Phospholipid transfer protein deficiency protects circulating lipoproteins from oxidation due to the enhanced accumulation of vitamin E. *J. Biol. Chem.* **2002**, *277*, 31,850–31,856.
  63. Oram, J.F.; Vaughan, A.M.; Stocker, R. ATP-binding cassette transporter A1 mediates cellular secretion of alpha-tocopherol. *J. Biol. Chem.* **2001**, *276*, 39,898–39,902.
  64. Chiku, S.; Hamamura, K.; Nakamura, T. Novel urinary metabolite of d-delta-tocopherol in rats. *J. Lipid Res.* **1984**, *25*, 40–48.
  65. Lodge, J.K.; Ridlington, J.; Vaule, H.; Leonard, S.W.; Traber, M.G.  $\alpha$ - and  $\gamma$ -Tocotrienols are metabolized to carboxyethyl-hydroxychroman (CEHC) derivatives and excreted in human urine. *Lipids* **2001**, *36*, 43–48.
  66. Birringer, M.; Pfluger, P.; Kluth, D.; Landes, N.; Brigelius-Flohe, R. Identities and differences in the metabolism of tocotrienols and tocopherols in HepG2 cells. *J. Nutr.* **2002**, *132*, 3113–3118.
  67. Parker, R.S.; Swanson, J.E. A novel 5'-carboxy-chroman metabolite of gamma-tocopherol secreted by HepG2 cells and excreted in human urine. *Biochem. Biophys. Res. Commun.* **2000**, *269*, 580–583.
  68. Smith, K.S.; Lee, C.-L.; Ridlington, J.W.; Leonard, S.W.; Devaraj, S.; Traber, M.G. Vitamin E supplementation increases circulating vitamin E metabolites tenfold in end-stage renal disease patients. *Lipids* **2003**, *38*, 813–819.
  69. Himmelfarb, J.; Kane, J.; McMonagle, E.; Zaltas, E.; Bobzin, S.; Boddupalli, S.; Phinney, S.; Miller, G. Alpha and gamma tocopherol metabolism in healthy subjects and patients with end-stage renal disease. *Kidney Int.* **2003**, *64*, 978–991.
  70. Hattori, A.; Fukushima, T.; Imai, K. Occurrence and determination of a natriuretic hormone,

- 2,7,8-trimethyl-2-(beta-carboxyethyl)-6-hydroxy chroman, in rat plasma, urine, and bile. *Anal. Biochem.* **2000**, *281*, 209–215.
71. Parker, R.S.; Sontag, T.J.; Swanson, J.E. Cytochrome P4503A-dependent metabolism of tocopherols and inhibition by sesamin. *Biochem. Biophys. Res. Commun.* **2000**, *277*, 531–534.
  72. Birringer, M.; Drozan, D.; Brigelius-Flohe, R. Tocopherols are metabolized in HepG2 cells by side chain omega-oxidation and consecutive beta-oxidation. *Free Radical Biol. Med.* **2001**, *31*, 226–232.
  73. Sontag, T.J.; Parker, R.S. Cytochrome P450 omega-hydroxylase pathway of tocopherol catabolism: novel mechanism of regulation of vitamin E status. *J. Biol. Chem.* **2002**, *277*, 25,290–25,296.
  74. Ikeda, S.; Tohyama, T.; Yamashita, K. Dietary sesame seed and its lignans inhibit 2,7,8-trimethyl-2-(2'-carboxyethyl)-6-hydroxychroman excretion into urine of rats fed gamma-tocopherol. *J. Nutr.* **2002**, *132*, 961–966.
  75. Swanson, J.E.; Ben, R.N.; Burton, G.W.; Parker, R.S. Urinary excretion of 2,7, 8-trimethyl-2-(beta-carboxyethyl)-6-hydroxychroman is a major route of elimination of gamma-tocopherol in humans. *J. Lipid Res.* **1999**, *40*, 665–671.
  76. Stahl, W.; Graf, P.; Brigelius-Flohe, R.; Wechter, W.; Sies, H. Quantification of the alpha- and gamma-tocopherol metabolites 2,5,7,8-tetramethyl-2-(2'-carboxyethyl)-6-hydroxychroman and 2,7,8-trimethyl-2-(2'-carboxyethyl)-6-hydroxychroman in human serum. *Anal. Biochem.* **1999**, *275*, 254–259.
  77. Pope, S.A.; Burtin, G.E.; Clayton, P.T.; Madge, D.J.; Muller, D.P. Synthesis and analysis of conjugates of the major vitamin E metabolite, alpha-CEHC. *Free Radical Biol. Med.* **2002**, *33*, 807–817.
  78. Kiyose, C.; Saito, H.; Kaneko, K.; Hamamura, K.; Tomioka, M.; Ueda, T.; Igarashi, O. Alpha-tocopherol affects the urinary and biliary excretion of 2,7,8-trimethyl-2 (2'-carboxyethyl)-6-hydroxychroman, gamma-tocopherol metabolite, in rats. *Lipids* **2001**, *36*, 467–472.
  79. Traber, M.G. Vitamin E, nuclear receptors and xenobiotic metabolism. *Arch. Biochem. Biophys.* **2004**, *423*, 6–11.
  80. Bieri, J.G.; Everts, R.P. Gamma tocopherol: metabolism, biological activity and significance in human vitamin E nutrition. *Am. J. Clin. Nutr.* **1974**, *27*, 980–986.
  81. Sen, C.K.; Khanna, S.; Roy, S.; Packer, L. Molecular basis of vitamin E action. Tocotrienol potently inhibits glutamate-induced pp60(c-Src) kinase activation and death of HT4 neuronal cells. *J. Biol. Chem.* **2000**, *275*, 13,049–13,055.
  82. Schultz, M.; Leist, M.; Elsner, A.; Brigelius-Flohe, R. Alpha-carboxyethyl-6-hydroxychroman as urinary metabolite of vitamin E. *Methods Enzymol.* **1997**, *282*, 297–310.
  83. Kayden, H.J.; Traber, M.G. Absorption, lipoprotein transport and regulation of plasma concentrations of vitamin E in humans. *J. Lipid Res.* **1993**, *34*, 343–358.
  84. Ouahchi, K.; Arita, M.; Kayden, H.; Hentati, F.; Ben Hamida, M.; Sokol, R.; Arai, H.; Inoue, K.; Mandel, J.-L.; Koenig, M. Ataxia with isolated vitamin E deficiency is caused by mutations in the  $\alpha$ -tocopherol transfer protein. *Nat. Genet.* **1995**, *9*, 141–145.
  85. Machlin, L.J. *Vitamin E: A Comprehensive Treatise*; Marcel Dekker, Inc.: New York, 1980.
  86. Cavalier, L.; Ouahchi, K.; Kayden, H.J.; DiDonato, S.; Reutenauer, L.; Mandel, J.-L.; Koenig, M. Ataxia with isolated vitamin E deficiency: heterogeneity of mutations and phenotypic variability in a large number of families. *Am. J. Hum. Genet.* **1998**, *62*, 301–310.
  87. Sheppard, A.J.; Pennington, J.A.T.; Weihrauch, J.L. Analysis and distribution of vitamin E in vegetable oils and foods. In *Vitamin E in Health and Disease*; Packer, L., Fuchs, J., Eds.; Marcel Dekker, Inc.: New York, 1993; 9–31.
  88. Ma, J.; Hampl, J.S.; Betts, N.M. Antioxidant intakes and smoking status: data from the continuing survey of food intakes by individuals 1994–1996. *Am. J. Clin. Nutr.* **2000**, *71*, 774–780.
  89. Food and Nutrition Board; National Research Council. In *Recommended Dietary Allowances*; National Academy of Sciences Press: Washington, DC, 1989.
  90. Cavalier, L.; Ouahchi, K.; Kayden, H.J.; Di Donato, S.; Reutenauer, L.; Mandel, J.L.; Koenig, M. Ataxia with isolated vitamin E deficiency: heterogeneity of mutations and phenotypic variability in a large number of families. *Am. J. Hum. Genet.* **1998**, *62*, 301–310.
  91. Sokol, R.J.; Guggenheim, M.A.; Iannaccone, S.T.; Barkhaus, P.E.; Miller, C.; Silverman, A.; Balistreri, W.F.; Heubi, J.E. Improved neurologic function after long-term correction of vitamin E deficiency in children with chronic



- cholestasis. *N. Engl. J. Med.* **1985**, *313*, 1580–1586.
92. Martinello, F.; Fardin, P.; Ottina, M.; Ricchieri, G.L.; Koenig, M.; Cavalier, L.; Trevisan, C.P. Supplemental therapy in isolated vitamin E deficiency improves the peripheral neuropathy and prevents the progression of ataxia. *J. Neurol. Sci.* **1998**, *156*, 177–179.
93. Sokol, R.J.; Butler-Simon, N.A.; Bettis, D.; Smith, D.J.; Silverman, A. Tocopheryl polyethylene glycol 1000 succinate therapy for vitamin E deficiency during chronic childhood cholestasis: neurologic outcome. *J. Pediatr.* **1987**, *111*, 830–836.
94. Mueller-Cunningham, W.M.; Quintana, R.; Kasim-Karakas, S.E. An ad libitum, very low-fat diet results in weight loss and changes in nutrient intakes in postmenopausal women. *J. Am. Diet. Assoc.* **2003**, *103*, 1600–1606.
95. Maras, J.E.; Bermudez, O.I.; Qiao, N.; Bakun, P.J.; Boody-Alter, E.L.; Tucker, K.L. Intake of alpha-tocopherol is limited among US adults. *J. Am. Diet. Assoc.* **2004**, *104*, 567–575.
96. Yusuf, S.; Dagenais, G.; Pogue, J.; Bosch, J.; Sleight, P. Vitamin E supplementation and cardiovascular events in high-risk patients. The Heart Outcomes Prevention Evaluation Study Investigators. *N. Engl. J. Med.* **2000**, *342*, 154–160.
97. Gruppo Italiano per lo Studio della Streptochinasi nell'Infarto Miocardico. Dietary supplementation with *n*-3 polyunsaturated fatty acids and vitamin E after myocardial infarction: results of the GISSI-Prevenzione trial. *Lancet* **1999**, *354*, 447–455.
98. Salonen, J.T.; Nyyssonen, K.; Salonen, R.; Lakka, H.M.; Kaikkonen, J.; Porkkala-Sarataho, E.; Voutilainen, S.; Lakka, T.A.; Rissanen, T.; Leskinen, L.; Tuomainen, T.P.; Valkonen, V.P.; Ristonmaa, U.; Poulsen, H.E. Antioxidant Supplementation in Atherosclerosis Prevention (ASAP) Study: a randomized trial of the effect of vitamins E and C on 3-year progression of carotid atherosclerosis. *J. Intern. Med.* **2000**, *248*, 377–386.
99. Salonen, R.M.; Nyyssonen, K.; Kaikkonen, J.; Porkkala-Sarataho, E.; Voutilainen, S.; Rissanen, T.H.; Tuomainen, T.P.; Valkonen, V.P.; Ristonmaa, U.; Lakka, H.M.; Vanharanta, M.; Salonen, J.T.; Poulsen, H.E. Six-year effect of combined vitamin C and E supplementation on atherosclerotic progression: the Antioxidant Supplementation in Atherosclerosis Prevention (ASAP) Study. *Circulation* **2003**, *107*, 947–953.
100. Boaz, M.; Smetana, S.; Weinstein, T.; Matas, Z.; Gafer, U.; Iaina, A.; Knecht, A.; Weissgarten, Y.; Brunner, D.; Fainaru, M.; Green, M.S. Secondary prevention with antioxidants of cardiovascular disease in endstage renal disease (SPACE): randomised placebo-controlled trial. *Lancet* **2000**, *356*, 1213–1218.
101. Fang, J.C.; Kinlay, S.; Beltrame, J.; Hikiti, H.; Wainstein, M.; Behrendt, D.; Suh, J.; Frei, B.; Mudge, G.H.; Selwyn, A.P.; Ganz, P. Effect of vitamins C and E on progression of transplant-associated arteriosclerosis: a randomised trial. *Lancet* **2002**, *359*, 1108–1113.
102. Levy, A.P.; Friedenber, P.; Lotan, R.; Ouyang, P.; Tripputi, M.; Higginson, L.; Cobb, F.R.; Tardif, J.C.; Bittner, V.; Howard, B.V. The effect of vitamin therapy on the progression of coronary artery atherosclerosis varies by haptoglobin type in postmenopausal women. *Diabetes Care* **2004**, *27*, 925–930.
103. Horwitt, M.K.; Harvey, C.C.; Duncan, G.D.; Wilson, W.C. Effects of limited tocopherol intake in man with relationships to erythrocyte hemolysis and lipid oxidations. *Am. J. Clin. Nutr.* **1956**, *4*, 408–419.
104. United States Pharmacopeia. Vitamin E. In *The United States Pharmacopeia*; United States Pharmacopeia Convention, Inc.: Rockville, 1980; 846–848.
105. Chan, A.C.; Wagner, M.; Kennedy, C.; Chen, E.; Lanuville, O.; Mezl, V.A.; Tran, K.; Choy, P.C. Vitamin E up-regulates arachidonic acid release and phospholipase A2 in megakaryocytes. *Mol. Cell. Biochem.* **1998**, *189*, 153–159.
106. Frank, J.; Weiser, H.; Biesalski, H.K. Interaction of vitamins E and K: effect of high dietary vitamin E on phylloquinone activity in chicks. *Int. J. Vitam. Nutr. Res.* **1997**, *67*, 242–247.
107. Landes, N.; Birringer, M.; Brigelius-Flohé, R. Homologous metabolic and gene activating routes for vitamins E and K. *Mol. Aspects Med.* **2003**, *24*, 337–344.
108. Kim, J.M.; White, R.H. Effect of vitamin E on the anticoagulant response to warfarin. *Am. J. Cardiol.* **1996**, *77*, 545–546.
109. Cheung, M.C.; Zhao, X.Q.; Chait, A.; Albers, J.J.; Brown, B.G. Antioxidant supplements block the response of HDL to simvastatin-niacin therapy in patients with coronary artery disease and low HDL. *Arterioscler. Thromb. Vasc. Biol.* **2001**, *21*, 1320–1326.

110. Brown, B.G.; Zhao, X.Q.; Chait, A.; Fisher, L.D.; Cheung, M.C.; Morse, J.S.; Dowdy, A.A.; Marino, E.K.; Bolson, E.L.; Alaupovic, P.; Frohlich, J.; Albers, J.J. Simvastatin and niacin, antioxidant vitamins, or the combination for the prevention of coronary disease. *N. Engl. J. Med.* **2001**, *345*, 1583–1592.
111. Waters, D.D.; Alderman, E.L.; Hsia, J.; Howard, B.V.; Cobb, F.R.; Rogers, W.J.; Ouyang, P.; Thompson, P.; Tardif, J.C.; Higginson, L.; Bittner, V.; Steffes, M.; Gordon, D.J.; Prochan, M.; Younes, N.; Verter, J.I. Effects of hormone replacement therapy and antioxidant vitamin supplements on coronary atherosclerosis in postmenopausal women: a randomized controlled trial. *J. Am. Med. Assoc.* **2002**, *288*, 2432–2440.
112. Vivekananthan, D.P.; Penn, M.S.; Sapp, S.K.; Hsu, A.; Topol, E.J. Use of antioxidant vitamins for the prevention of cardiovascular disease: meta-analysis of randomised trials. *Lancet* **2003**, *361*, 2017–2023.
113. Traber, M.G.; Packer, L. Vitamin E: beyond antioxidant function. *Am. J. Clin. Nutr.* **1995**, *62* (Suppl.), 1501S–1509S.
114. Zingg, J.M.; Azzi, A. Non-antioxidant activities of vitamin E. *Curr. Med. Chem.* **2004**, *11*, 1113–1133.
115. Jialal, I.; Devaraj, S. Antioxidants and atherosclerosis: don't throw out the baby with the bath water. *Circulation* **2003**, *107*, 926–928.
116. Meydani, S.N.; Meydani, M.; Blumberg, J.B.; Leka, L.S.; Siber, G.; Loszewski, R.; Thompson, C.; Pedrosa, M.C.; Diamond, R.D.; Stollar, B.D. Vitamin E supplementation and in vivo immune response in healthy elderly subjects. A randomized controlled trial. *J. Am. Med. Assoc.* **1997**, *277*, 1380–1386.



# Vitamin K

**J.W. Suttie**

*College of Agricultural and Life Sciences, University of Wisconsin-Madison,  
Madison, Wisconsin, U.S.A.*

## INTRODUCTION

Vitamin K activity is exhibited by phyloquinone, found in green plants, and by a series of menaquinones, which are synthesized by a limited number of anaerobic bacteria. The metabolic role of this vitamin is as a substrate for an enzyme, the vitamin K-dependent carboxylase, which mediates a posttranslational modification of a small number of proteins by converting specific glutamyl residues to  $\gamma$ -carboxyglutamyl (Gla) residues. These proteins include a number that regulate hemostasis: prothrombin, factor VII, factor IX, factor X, and proteins C, S, and Z. The bone protein, osteocalcin, and matrix Gla protein, several found in bone and other tissues, also require vitamin K for their synthesis as do a small number of less well-characterized proteins. The human requirement for vitamin K is low, and the adequate intake for adult men and women is currently set at 120 and 90  $\mu\text{g}/\text{day}$ , based on median intakes of the U.S. population. The classical symptom of a vitamin K deficiency, a hemorrhagic event, is essentially impossible to produce in adults without some underlying factor influencing absorption of the vitamin. However, newborn infants are routinely supplemented with vitamin K to prevent a condition called hemorrhagic disease of the newborn. A small amount of the protein osteocalcin circulates in plasma, and this protein is not maximally  $\gamma$ -carboxylated at normal levels of intake. There is currently a great deal of interest in a possible role of vitamin K in promoting skeletal health. Supplementation of the diet with 45 mg of menaquinone-4 is a widely used treatment for osteoporosis in Japan and other parts of Asia. The efficacy of this treatment in North America or Europe has not yet been established but remains a question of significant research interest.

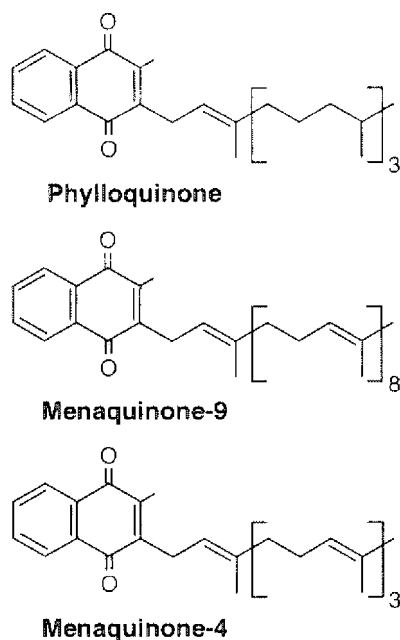
## BACKGROUND, CHEMISTRY, AND DIETARY SOURCES

In the early 1930's, Henrik Dam observed that chicks consuming very low lipid diets developed subdural or muscular hemorrhages and that blood taken from these animals clotted slowly. This hemorrhagic disease could not be cured by supplementation with any other known dietary factor, and Dam<sup>[1]</sup> proposed the existence of a new fat-soluble factor, vitamin K. Subsequent studies by Dam and others<sup>[2]</sup> established that the antihemorrhagic factor was present both in the lipid extracts of green plants and in preparations of fish meal that had been subjected to bacterial action. The vitamin could be isolated from alfalfa as a yellow oil, and it was characterized as 2-methyl-3-phytyl-1,4-naphthoquinone<sup>[3]</sup> and synthesized by Doisy's group at the St. Louis University. The Doisy group also isolated a crystalline form of the vitamin from putrefied fish meal and demonstrated that this compound contained an unsaturated polyprenyl side chain at the 3-position of the naphthoquinone ring.

The term vitamin K is now used as a generic descriptor of 2-methyl-1,4-naphthoquinone (menadiene) and all derivatives of this compound that exhibit an antihemorrhagic activity in animals fed a vitamin K-deficient diet (Fig. 1). The major dietary source of vitamin K, the form found in green plants, is commonly called vitamin K<sub>1</sub>, but is preferably called phyloquinone. The compound, 2-methyl-3-farnesylgeranylgeranyl-1,4-naphthoquinone, first isolated from putrefied fish meal, is one of a series of vitamin K compounds with unsaturated side chains called multiprenylmenaquinones, which are produced by a limited number of anaerobic bacteria and are present in large quantities in the lower bowel. This particular menaquinone has 7 isoprenoid units in the side chain and was once called vitamin K<sub>2</sub>. That term is currently used to describe any of the vitamers with an unsaturated side chain, and this compound is more correctly identified as menaquinone-7 (MK-7). The predominant menaquinones found in the gut are MK-7 through MK-9, but smaller amounts of others are also present. Menadiene is used as a source of vitamin K activity in poultry and swine rations, and a specific

---

*J.W. Suttie, Ph.D.*, is at the Department of Biochemistry, College of Agricultural and Life Sciences, University of Wisconsin-Madison, Madison, Wisconsin, U.S.A.



**Fig. 1** Structures of vitamin K active compounds. Phylloquinone (vitamin K<sub>1</sub>) synthesized in plants is the main dietary form of vitamin K. Menaquinone-9 is a prominent member of a series of menaquinones (vitamin K<sub>2</sub>) produced by intestinal bacteria and menaquinone-4, while a minor bacterial product can be synthesized by animal tissues from phylloquinone.

compound, menaquinone-4 (2-methyl-3-geranylgeranyl-1,4-naphthoquinone), is formed in animal tissues by its alkylation.<sup>[4]</sup> This is the biologically active form of the vitamin present in animal tissues when menadione is used as the dietary form of vitamin K.

Standardized procedures to assay the vitamin K content of foods, and sufficient values<sup>[5]</sup> to provide reasonable estimates of its daily intake are now available (Table 1). In general, foods with higher phylloquinone content are green leafy vegetables. Those providing substantial amounts of the vitamin to the majority of the population are spinach (380 µg/100 g), broccoli (180 µg/100 g), and iceberg lettuce (35 µg/100 g). Fats and oils are also a major contributor to the vitamin K content of the diet. Soybean oil (190 µg/100 g) and canola oil (130 µg/100 g) are quite high, while corn oil (3 µg/100 g) is a very poor source. The source of fat or oil will influence the vitamin K content of margarine and prepared foods with a high fat content. The process of hydrogenation to convert plant oils to solid margarines or shortening converts some of the phylloquinone to 2',3'-dihydrophylloquinone with a completely saturated side chain. The biological activity of this form of the vitamin is not accurately known, but it has been reported that the intake of this form of the vitamin by the American population may be 20–25% that of phylloquinone.<sup>[6]</sup>

**Table 1** Phylloquinone concentration of common foods<sup>a</sup>

Food item	µg/100 g
<i>Vegetables</i>	
Collards	440
Spinach	380
Salad greens	315
Broccoli	180
Brussels sprouts	177
Cabbage	145
Bib lettuce	122
Asparagus	60
Okra	40
Iceberg lettuce	35
Green beans	33
Green peas	24
Cucumbers	20
Cauliflower	20
Carrots	10
Tomatoes	6
Potatoes	1
<i>Protein sources</i>	
Dry soybeans	47
Dry lentils	22
Liver	5
Eggs	2
Fresh meats	<1
Fresh fish	<1
Whole milk	<1
<i>Fats and oils</i>	
Soybean oil	193
Canola oil	127
Cottonseed oil	60
Olive oil	55
Margarine	42
Butter	7
Corn oil	3
<i>Prepared foods</i>	
Salad dressings	100
Coleslaw	80
Mayonnaise	41
Beef chow mein	31
Muffins	25
Doughnuts	10
Potato chips	15
Apple pie	11
French fries	5
Macaroni/cheese	5
Lasagna	5
Pizza	4
Hamburger/bun	4
Hot dog/bun	3
Baked beans	3
Bread	3

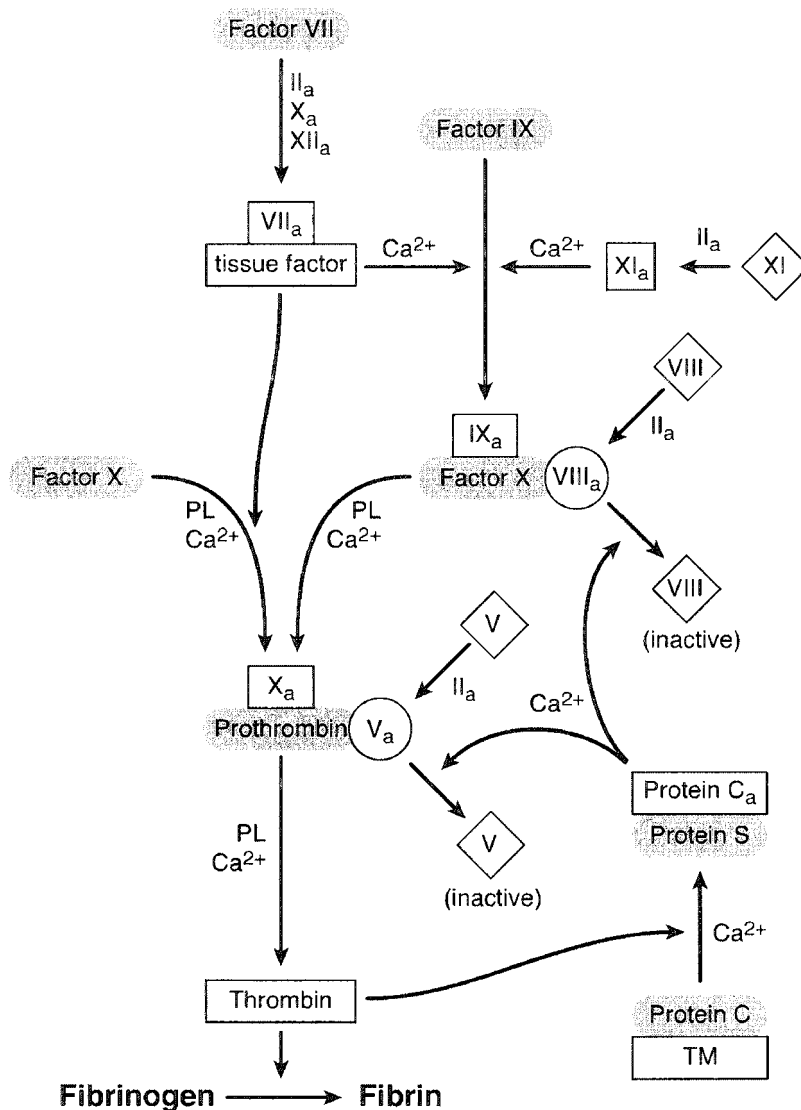
<sup>a</sup>Median values.  
(Modified from Ref.<sup>[5]</sup>.)

**VITAMIN K-DEPENDENT PROTEINS**

The classical sign of a vitamin K deficiency has been the development of a hemorrhagic syndrome, and the first proteins identified as requiring vitamin K for their synthesis were plasma clotting factors. Many of the proteins involved in regulating blood coagulation (Fig. 2) are protease zymogens, which are sequentially activated through a series of events, many involving membrane-associated complexes with each other and with accessory proteins.<sup>[7-9]</sup> Prothrombin (clotting factor II) is the circulating zymogen of the procoagulant thrombin, and was the first protein shown to be dependent on vitamin K for its synthesis. Clotting factors VII, IX, and X were all initially identified because their activity was decreased in the plasma of a patient with a hereditary bleeding disorder<sup>[10]</sup> and were subsequently shown to depend on vitamin K for their synthesis. These four “vitamin K-dependent clotting factors” were the

only proteins known to require this vitamin for their synthesis until the mid-1970s. Proteins C and S were discovered after it had been shown that prothrombin contained Gla residues. They were subsequently shown to have an anticoagulant, rather than a procoagulant, role in hemostasis. The seventh vitamin K-dependent plasma protein, protein Z, is not a protease zymogen and also exhibits an anticoagulant role under some conditions. The amino terminal, “Gla domain,” of the four vitamin K-dependent procoagulants is very homologous, and the 10–13 Gla residues in each are in essentially the same position as in prothrombin. These proteins play a critical role in hemostasis, and a large number of genetic variants of these proteins have been identified as risk factors in coagulation disorders.<sup>[11]</sup> The cDNA and genomic organization of each of these proteins is also well documented.<sup>[11]</sup>

The first vitamin K-dependent, Gla-containing protein discovered, which was not located in plasma,



**Fig. 2** Involvement of vitamin K-dependent clotting factors in blood coagulation. The vitamin K-dependent procoagulants shown as gray ovals (prothrombin, F-VII, F-IX, F-X) circulate as zymogens of serine proteases until converted to their active (subscript a) forms. This process is initiated by an “extrinsic” pathway when vascular injury exposes tissue factor to blood. The product of the activation of one factor can activate a second zymogen, and this cascade effect results in the rapid activation of prothrombin to thrombin and the subsequent conversion of soluble fibrinogen to the insoluble fibrin clot. A number of steps in this series of activations involve an active protease, a second vitamin K-dependent protein substrate, and an additional plasma protein cofactor (circles) to form a Ca<sup>2+</sup>-mediated association with a phospholipid surface. The formation of activated F-X can also take place through an “intrinsic” pathway involving thrombin activation of F-XI and subsequently F-IX. Two vitamin K-dependent proteins which participate in hemostatic control function as anticoagulants, not procoagulants. Protein C is activated by thrombin (II<sub>a</sub>) in the presence of an endothelial cell protein called thrombomodulin (TM). Activated protein C functions in a complex with protein S to inactivate V<sub>a</sub> and VIII<sub>a</sub> and to limit clot formation.



was the bone protein osteocalcin.<sup>[12,13]</sup> This 49 residue protein contains three Gla residues and has little structural homology to the vitamin K-dependent plasma proteins. Although it is the second most abundant protein in bone, its function is not clearly defined. It does appear to be involved in some manner in the control of tissue mineralization or skeletal turnover, but lack of functional osteocalcin has not been related to poor mineralization, and osteocalcin gene “knockout” mice have been shown to produce more dense bone rather than a defect in bone formation. A second low-molecular-weight (79 residue) protein with five Gla residues was also first isolated from bone<sup>[14]</sup> and called matrix Gla protein. This protein is also present in other tissues and is synthesized in cartilage and many other soft tissues. Like osteocalcin, details of its physiological role are unclear. But in studies with MGP “knockout” mice, death ensued from spontaneous calcification of arteries and cartilage.

A limited number of other mammalian proteins have been found to contain Gla residues and are therefore dependent on vitamin K for their synthesis. One is Gas 6, a ligand for the tyrosine kinase Ax1,<sup>[15]</sup> which appears to be a growth factor for mesangial and epithelial cells. Four members of a transmembrane Gla protein family (PRGP-1, PRGP-2, TMG-3, and TMG-4) have been cloned,<sup>[16]</sup> but the roles of these cell-surface receptors are not yet known. There have also been reports of other peptide-bound Gla residues in mammalian tissue, but no specific proteins have been identified. Vitamin K-dependent proteins are not confined to vertebrates, and a large number of toxic venom peptides secreted by marine *Conus* snails are rich in Gla residues.<sup>[17]</sup> Gla-containing proteins or peptides have also been identified in some snake venoms, and the carboxylase that is needed to form Gla residues has been cloned from *Drosophila*.<sup>[18,19]</sup> This indicates that  $\gamma$ -carboxyglutamic acid is of ancient evolutionary origin and suggests that numerous vitamin K-dependent proteins are yet to be discovered.

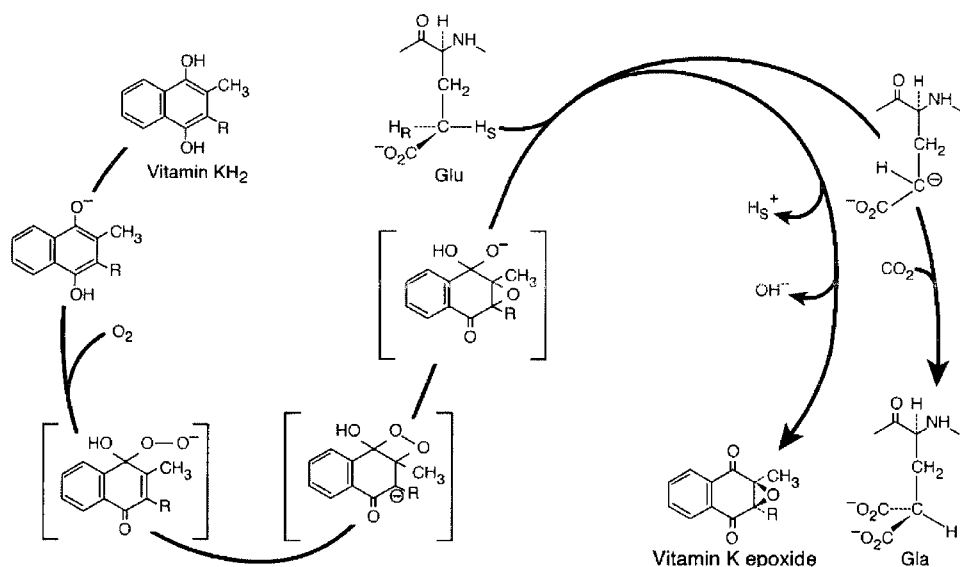
## BIOCHEMICAL ROLE OF VITAMIN K

The biochemical basis for the early observations that vitamin K was needed to maintain normal prothrombin concentrations was not established until the mid-1970s, and the observations leading to an understanding of the functional role of vitamin K have been reviewed.<sup>[20]</sup> A circulating inactive form of prothrombin was found in the plasma of patients treated with oral anticoagulants, and it was demonstrated that the prothrombin produced when hypoprothrombinemic rats were given vitamin K and a protein synthesis inhibitor was not radiolabeled if radioactive amino

acids were administered at the same time as the vitamin.<sup>[21]</sup> These data suggested the presence of a hepatic precursor protein pool in the hypoprothrombinemic rat, which could be converted to prothrombin by a posttranslational modification. The “abnormal prothrombin” isolated from the plasma of cows fed the anticoagulant dicoumarol was shown to lack the specific calcium-binding sites present in normal prothrombin. Acidic peptides obtained by proteolytic enzyme digestion of prothrombin, but not the “abnormal prothrombin,” were subsequently shown<sup>[22,23]</sup> to contain  $\gamma$ -carboxyglutamic acid (Gla), a previously unrecognized acidic amino acid that was responsible for the calcium-binding properties of prothrombin.

The discovery of Gla residues in prothrombin directly led to the demonstration<sup>[24]</sup> that crude rat liver microsomal preparations contained an enzymatic activity (the vitamin K-dependent carboxylase) that promoted a vitamin K-dependent incorporation of  $H^{14}CO_3^-$  into Gla residues of the endogenous precursors of vitamin K-dependent proteins present in these preparations. This carboxylation reaction does not require adenosine triphosphate (ATP), and the energy to drive this process is derived from the oxidation of the reduced, hydronaphthoquinone form of vitamin K (vitamin  $KH_2$ ) by  $O_2$  to form vitamin K-2,3-epoxide (Fig. 3). A general understanding of the properties of this unique enzyme was gained from studies utilizing this crude enzyme preparation, and these data have been adequately reviewed.<sup>[20,25]</sup>

The primary gene product of the vitamin K-dependent proteins contains a very homologous domain between the amino terminus of the mature protein and the signal sequence that targets the polypeptide for the secretory pathway. This “propeptide” region appears to be both a “docking” or “recognition” site for the enzyme,<sup>[11,26]</sup> and a modulator of the activity of the enzyme by decreasing the apparent  $K_m$  of the Glu site substrate.<sup>[27]</sup> This peptide is cleaved before secretion of the protein, and although the binding affinities of propeptides from different proteins for the carboxylase differ significantly,<sup>[28]</sup> propeptides are required for efficient carboxylation. Glutamate-containing peptides with no homology to vitamin K-dependent proteins have been shown to be good substrates for the carboxylase if a propeptide is attached.<sup>[29,30]</sup> The molecular role of the vitamin in this reaction is to abstract the hydrogen on the  $\gamma$ -carbon of the glutamyl residue to allow attack of  $CO_2$  at this position. The association between epoxide formation, Gla formation, and  $\gamma$ -C–H bond cleavage has been studied, and the reaction efficiency defined as the ratio of Gla residues formed to  $\gamma$ -C–H bonds cleaved has been shown to be independent of Glu substrate concentrations, and to approach unity at high  $CO_2$  concentrations. These studies have been adequately reviewed.<sup>[31]</sup>



**Fig. 3** The vitamin K-dependent  $\gamma$ -glutamyl carboxylase. An interaction of O<sub>2</sub> with vitamin KH<sub>2</sub>, the reduced (hydronaphthoquinone) form of vitamin K, to generate intermediates leading to an oxygenated metabolite, which is sufficiently basic to abstract the  $\gamma$ -hydrogen of the glutamyl residue. The products of this reaction are vitamin K-2,3-epoxide and a glutamyl carbanion. Attack of CO<sub>2</sub> on the carbanion leads to the formation of a  $\gamma$ -carboxyglutamyl residue (Gla). The bracketed peroxy, dioxetane, and alkoxide intermediates have not been identified in the enzyme catalyzed reaction but are postulated based on model organic reactions. The available data are consistent with their presence.

A key finding essential to a complete understanding of the detailed mechanism of action of this enzyme has been the identification of an intermediate chemical form of vitamin K, which could be sufficiently basic to abstract the  $\gamma$ -hydrogen of the glutamyl residue. It has been proposed<sup>[32–34]</sup> that the initial attack of O<sub>2</sub> at the naphthoquinone carbonyl carbon adjacent to the methyl group results in the formation of a dioxetane ring, which generates an alkoxide intermediate. The general scheme<sup>[35]</sup> shown in Fig. 3 is consistent with all the available data, but there is no direct chemical evidence for any of these intermediates, and the mechanism remains a hypothesis at this time. Progress in purifying the enzyme was slow,<sup>[36,37]</sup> but the enzyme was eventually purified to near homogeneity<sup>[38]</sup> and cloned.<sup>[39]</sup> It is a unique 758 amino acid residue protein with a sequence suggestive of an integral membrane protein. The multiple Glu sites on the substrate for this enzyme are carboxylated processively,<sup>[40]</sup> and they are bound to the enzyme via their propeptide, while the Gla domain undergoes intramolecular movement to reposition each Glu for catalysis. The release of the carboxylated substrate has been reported to be the rate limiting step in the reaction.<sup>[41]</sup> Further details of the morphology of the enzyme within the membrane and the location and identification of key active site residues are available in recent reviews.<sup>[28,42–44]</sup>

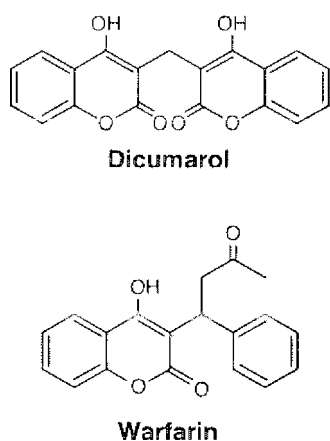
## VITAMIN K METABOLISM

The major route of phylloquinone metabolite excretion is via the feces, and very little unmetabolized vitamin is excreted.<sup>[45]</sup> Details of the metabolic transformation of vitamin K are currently lacking, but it has been shown<sup>[46]</sup> that the side chains of phylloquinone and

MK-4 are shortened by the rat to seven carbon atoms, yielding an  $\omega$ -carboxylic acid group that is cyclized to form a  $\gamma$ -lactone. This lactone was excreted in the urine as a glucuronic acid conjugate. Radioactive phylloquinone metabolism has also been studied in humans,<sup>[47]</sup> and it has been shown that about 20% of an injected dose of either 1 mg or 45  $\mu$ g of phylloquinone was excreted in the urine in 3 days, and that 40–50% was excreted in the feces via the bile. Two different aglycones of phylloquinone were tentatively identified as the 5- and 7-carbon side-chain carboxylic acid derivatives, and there is evidence that indicates that there are numerous unidentified metabolites.

A major pathway of vitamin K metabolism is that which is involved in the reduction and recycling of the epoxide formed by the carboxylase. Although the epoxide had been demonstrated before the carboxylase was identified,<sup>[48]</sup> the existence and importance of this pathway became clear when it was demonstrated that the hepatic ratio of the epoxide relative to that of the vitamin was increased in animals administered the 4-hydroxycoumarin anticoagulant warfarin.<sup>[49]</sup> This class of drugs was discovered in the early 1930s, following studies of a hemorrhagic disease of cattle consuming improperly cured sweet clover hay that was prevalent in the American upper midwest and western Canada. The cause of the prolonged clotting times was found to be a decrease in the prothrombin activity of blood, and the compound was isolated from spoiled sweet clover, characterized<sup>[50]</sup> as 3,3'-methylbis-4-(hydroxycoumarin), and called dicumarol (Fig. 4). A large number of analogs of dicumarol were synthesized and tested for their anticoagulant activity, and the compound first used as both a rodenticide and as therapy for thrombotic disease was warfarin [3- $\alpha$ -(acetylbenzyl)-4-hydroxycoumarin]. Several other coumarin





**Fig. 4** Structure of dicumarol and warfarin. Dicumarol was the compound isolated from sweet clover as a toxic hemorrhagic factor, and warfarin is the most commonly used of a number of 4-hydroxycoumarin anticoagulants.

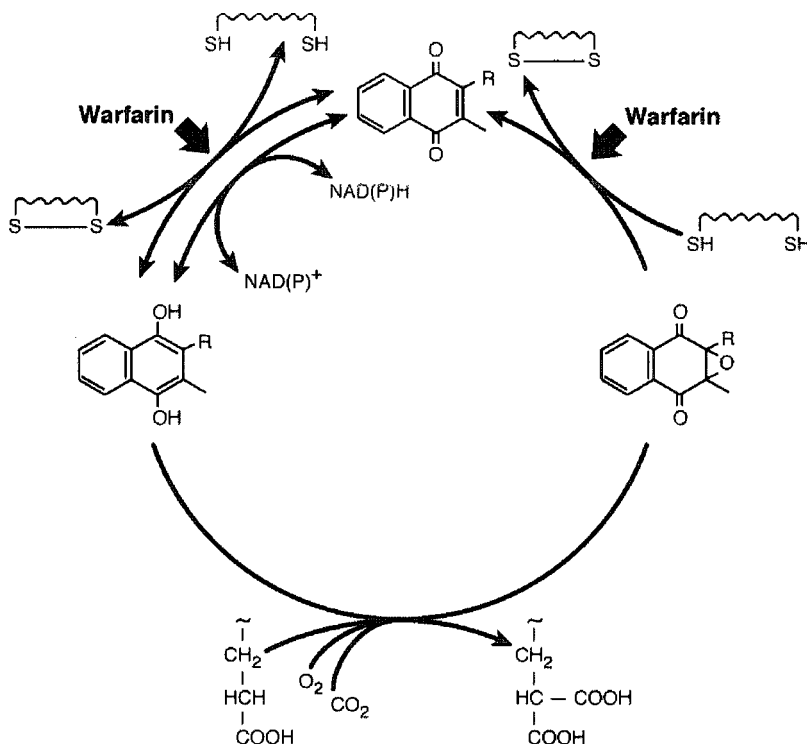
derivatives have been developed for clinical use as oral anticoagulants. Although warfarin has a very favorable pharmacologic profile and is essentially the only coumarin derivative prescribed in North America, others are widely used in Europe.

The observations that warfarin increased tissue epoxide levels led to an understanding that its inhibition of vitamin K action was indirect through an inhibition of the 2,3-epoxide reductase.<sup>[51]</sup> Blocking of this enzyme prevents the reduction of the epoxide to the quinone form of the vitamin and eventually to

the carboxylase substrate, vitamin  $\text{KH}_2$ . Widespread use of warfarin as an anticoagulant rodenticide led to the appearance of strains of warfarin-resistant-rats, and the study of the activity of the epoxide reductase in livers of these animals was a key to an understanding<sup>[52,53]</sup> of the details of the vitamin K cycle (Fig. 5). Three forms of vitamin K [the quinone (K), the hydro-naphthoquinone ( $\text{KH}_2$ ), and the 2,3-epoxide (KO)] can feed into this liver vitamin K cycle. In normal liver, the ratio of vitamin K-2,3-epoxide to the less oxidized forms of the vitamin is about 1:10 but can increase to a majority of epoxide in an anticoagulated animal. In addition to the epoxide reductase, the quinone and hydronaphthoquinone forms of the vitamin can also be interconverted by a number of NAD(P)H-linked reductases, including one that appears to be a microsomal-bound form of the extensively studied liver DT-diaphorase activity. The epoxide reductase utilizes a sulfhydryl compound as a reductant *in vitro*, but the physiological reductant has not been identified.<sup>[54]</sup> Efforts to purify this enzyme have proceeded slowly, but the recent identification of the gene for this protein<sup>[55,56]</sup> should lead to a rapid increase in an understanding of this important pathway of vitamin K metabolism.

## VITAMIN K DEFICIENCIES AND REQUIREMENTS

The classic example of a human vitamin K deficiency is that of hemorrhagic disease of the newborn or early



**Fig. 5** Metabolism of vitamin K tissues in animals. Vitamin K epoxide which is formed in the carboxylation reaction, is reduced to the quinone form of the vitamin by a warfarin-sensitive pathway, "vitamin K epoxide reductase," which is driven by a reduced dithiol. The naphthoquinone form of the vitamin can be reduced to the hydronaphthoquinone form either by the same warfarin-sensitive dithiol-driven reductase or by one or more of the hepatic NADH or NADPH-linked quinone reductases that are less sensitive to warfarin.

vitamin K deficiency bleeding (VKDB) occurring during the first week of life in healthy appearing neonates.<sup>[57]</sup> Contributing factors are: low placental transfer of phyloquinone, low clotting factor levels, a sterile gut, and the low vitamin K content of breast milk. The incidence of the disease is low, but the mortality rate from intracranial bleeding is high, and prevention by oral or parenteral administration of vitamin K immediately following birth is the standard cure. Late VKDB is a syndrome occurring between 2 and 12 weeks of age predominantly in exclusively breastfed infants<sup>[58,59]</sup> or infants with severe intestinal malabsorption problems. The current recommendations of the American Academy of Pediatrics advise that “vitamin K (phyloquinone) should be given to all newborns as a single, intramuscular dose of 0.5–1 mg,” and if this advice is followed, the disease is effectively prevented.

Uncomplicated adult deficiencies of vitamin K are extremely rare, and most diets contain an adequate amount. The historical indication of a vitamin K deficiency depended on a relatively insensitive measure, the “prothrombin time” (PT), to assess adequacy of the vitamin K-dependent clotting factors. Inadequacy has, however, been reported in patients subjected to long-term total parenteral nutrition, and supplementation of the vitamin is advised under these circumstances. Low lipid intake or the impaired lipid absorption resulting from the lack of bile salts will also adversely affect vitamin K absorption. Depression of the vitamin K-dependent coagulation factors has frequently been reported in malabsorption syndromes and in other gastrointestinal disorders (for example, cystic fibrosis, sprue, celiac disease, ulcerative colitis, regional ileitis, ascaris infection, and short-bowel syndrome). These reports and numerous cases of the most commonly reported cause of a vitamin K deficiency, a vitamin K-responsive hemorrhagic event in patients receiving antibiotics, have been extensively reviewed.<sup>[60]</sup> These episodes have usually been assumed to be due to decreased utilization of menaquinones produced in the lower bowel by these patients. However, it is possible that some cases may represent low dietary intake alone or an effect of the antibiotics on blood coagulation not related to a vitamin K-induced hypoprothrombinemia. Recently, a number of controlled studies utilizing diets containing approximately 10 µg/day or less of phyloquinone<sup>[61–63]</sup> have demonstrated alterations using more sensitive markers of vitamin K status, but a clinically significant decrease in PTs was not seen.

The Dietary Reference Intakes (DRI) project of the Food and Nutrition Board/Institute of Medicine has recently established recommended intakes of vitamin K for the U.S. and Canadian populations.<sup>[5]</sup> There are ample data to establish that essentially all

individuals do not consume sufficient vitamin K to maximally  $\gamma$ -carboxylate their circulating osteocalcin and that supplementation with about 1 mg/day of phyloquinone is needed to achieve this response. As the clinical significance of this apparent deficiency has not been established, these indices of adequacy were not used to set a reference value. The only indicator of vitamin K status with known clinical significance is the PT, and alterations in the PT by changes in dietary intake alone are uncommon to nonexistent. As circulating phyloquinone concentration is very dependent on previous day intake, it is also not a satisfactory indicator of an adequate intake. Intakes of vitamin K that are in the range of 10% of those consumed by the general population have been demonstrated to result in decreases in urinary Gla excretion and small increases in under- $\gamma$ -carboxylated prothrombin. However, no studies have utilized a range of intakes, which would allow the calculation of an estimated average requirement or a recommended dietary allowance. As insufficient data to determine these values are available, the dietary reference value used was the adequate intake (Table 2). This value is defined as: “the recommended average daily intake level based on observed or experimentally determined approximations or estimates of nutrient intake by a group (or groups) of apparently healthy people that are assumed to be adequate.” Adequate intakes of infants are based on the phyloquinone content of human milk and assume that infants also receive prophylactic vitamin K at birth. Those for children, adolescents, and adults are based on the highest median intake for each age group reported by the Third National Health and Nutrition Examination Survey (NHANES III). Based on those data, the intakes of pregnant or lactating women do not differ from those of the general population. At the present time, there are relatively few dietary supplements containing vitamin K, and only a few foods that are fortified with it.

**Table 2** Adequate intakes of vitamin K

Population	Vitamin K (µg/day)
0–6-mo-old infants	2.0
7–12-mo-old infants	2.5
1–3-yr-old children	30
4–8-yr-old children	55
9–13-yr-old boys and girls	60
14–18-yr-old boys and girls <sup>a</sup>	75
19–70+-yr-old men	120
19–70+-yr-old women <sup>a</sup>	90

<sup>a</sup>No alteration of intake for pregnancy or lactation.

(From Ref.<sup>[5]</sup>. Dietary Reference Intakes; National Academy Press.)

## VITAMIN K AND SKELETAL HEALTH

Three of the vitamin K-dependent proteins, osteocalcin, matrix Gla protein, and protein S, are synthesized in bone, and this has focused attention on the role of vitamin K-dependent proteins in bone. The “fetal warfarin syndrome,” characterized by chondrodysplasia punctata, a hypoplasia of the nasal bridge, and punctata calcification of the growth plate of rapidly growing bone, can result from oral anticoagulant treatment during the first trimester of pregnancy,<sup>[64]</sup> and this has also suggested a specific role for these proteins in bone development. Small amounts of osteocalcin circulate in plasma, and it is clear that a fraction of the protein in individuals within the normal population is not completely  $\gamma$ -carboxylated and can be influenced by vitamin K status.<sup>[62,63,65–67]</sup> Depending on assay conditions and the specific epitopes detected by the various assay kits utilized to measure total and under- $\gamma$ -carboxylated osteocalcin (ucOC), the fraction of ucOC reported in normal populations has ranged from 30–40 to <10%. Normal dietary intake of vitamin K is not sufficient to maximally  $\gamma$ -carboxylate osteocalcin, and a recent study<sup>[68]</sup> has established that supplementation with 1 mg of phylloquinone per day ( $\sim 10\times$  the current RDI) is required to achieve maximal  $\gamma$ -carboxylation. Attempts to link this apparent marker of vitamin K insufficiency with bone health have included epidemiologic observations that a low intake is associated with increased hip fracture risk<sup>[69,70]</sup> and reports that ucOC is correlated with low bone mass.<sup>[71,72]</sup> These associations do not necessarily imply causation, and they might simply be surrogate markers of general nutrient deficiencies. Patients on oral anticoagulant therapy have very high ucOC levels, and a number of attempts to correlate this treatment with alterations in bone mineral density have not yielded consistent outcomes.<sup>[73]</sup> Available data do not support a link between increased ucOC and decreased mineralization and tend to suggest that functional osteocalcin decreases or controls ectopic mineralization. Rats can be maintained on a protocol where a high intake of warfarin is accompanied by administration of large amounts of phylloquinone maintaining adequate levels of plasma clotting factors, but  $\gamma$ -carboxylation of osteocalcin is effectively blocked. A mineralization disorder characterized by complete fusion of proximal tibia growth plate and cessation of longitudinal growth has been observed utilizing this protocol.<sup>[74]</sup> These data strongly suggest that a skeletal vitamin K-dependent protein regulates the deposition of bone mineral but that the outcome is not decreased mineralization. Studies utilizing transgenic mice lacking the osteocalcin gene<sup>[75]</sup> have also demonstrated an increase in bone mineralization rather than a decrease.

Although near maximal carboxylation of osteocalcin does not appear to be needed for bone mineralization, vitamin K supplementation is a common therapy for osteoporosis in Japan and other Asian countries. The standard amount supplemented is 45 mg of menaquinone-4 per day, a pharmacological rather than nutritional approach. Positive responses in bone mineral density at specific sites or reduction in fracture rates of postmenopausal osteoporotic women have been reported,<sup>[76,77]</sup> and MK-4 has been reported<sup>[78,79]</sup> to increase markers of bone formation or bone mineral density in experimental animals or human subjects. It is of interest that menaquinone-4 can be synthesized in animal tissues from phylloquinone, and that many tissues have high concentrations of menaquinone-4 produced by this transformation.<sup>[80,81]</sup> Menaquinone-4 does have effects on cultured bone cells that are not seen with phylloquinone,<sup>[82]</sup> and it has been reported that other medium chain length menaquinones, but not phylloquinone, have apoptotic effects on malignant cell lines.<sup>[83]</sup> The positive responses in bone health reported to result from the supplementation of 45 mg per day of menaquinone have not been studied with a similar amount of phylloquinone. However, supplementation of 1 mg phylloquinone per day to postmenopausal women between 50 and 60 yr of age for 3 yr has been reported<sup>[84]</sup> to reduce ( $P < 0.05$ ) the decrease in bone mineral density of the femoral neck. In this study, the decrease in mineral loss from the lumbar spine was not altered. Calcium intake in the countries where menaquinone-4 supplementation has been widely used is relatively low, and studies of the efficacy of 45 mg of MK-4 in maintaining the skeletal health of women in North America or Western Europe have not yet been reported. Matrix Gla protein is also found in bone and other tissues with potential for calcification. Studies of the matrix Gla protein “knockout” mouse indicated that these animals died from massive calcifications of the large arteries within 8 weeks of birth,<sup>[85]</sup> and a rapid calcification of the elastic lamellae of arteries and heart valves has been seen in a rat model where matrix Gla protein carboxylation was blocked.<sup>[86]</sup> There are reports of an association between low vitamin K intake and aortic calcification<sup>[87]</sup> and an inverse correlation between menaquinone intake and aortic calcification, myocardial infarction, and sudden cardiovascular death.<sup>[88]</sup> These data are very preliminary, and whether or not individuals with low vitamin K status are at risk for cardiovascular disease is not yet clear. A great deal of additional data would be needed to classify low vitamin K intake as a risk factor for cardiovascular disease.

## REFERENCES

1. Dam, H. The antihaemorrhagic vitamin of the chick. Occurrence and chemical nature. *Nature* **1935**, *135*, 652–653.
2. Almquist, H.J.; Stokstad, E.L.R. Hemorrhagic chick disease of dietary origin. *J. Biol. Chem.* **1935**, *111*, 105–113.
3. MacCorquodale, D.W.; Cheney, L.C.; Binkley, S.B.; Holcomb, W.F.; McKee, R.W.; Thayer, S.A.; Doisy, E.A. The constitution and synthesis of vitamin K<sub>1</sub>. *J. Biol. Chem.* **1939**, *131*, 357–370.
4. Dialameh, G.H.; Yekundi, K.G.; Olson, R.E. Enzymatic alkylation of menaquinone-o to menaquinones by microsomes from chick liver. *Biochim. Biophys. Acta.* **1970**, *223*, 332–338.
5. Food and Nutrition Board, Institute of Medicine. *Dietary Reference Intakes*; National Academy Press: Washington, DC, 2001.
6. Booth, S.L.; Webb, D.R.; Peters, J.C. Assessment of phylloquinone and dihydrophyloquinone dietary intakes among a nationally representative sample of U.S. consumers using 14-day food diaries. *J. Am. Diet. Assoc.* **1999**, *99*, 1072–1076.
7. Dahlback, B. Blood coagulation. *Lancet* **2000**, *355*, 1627–1632.
8. Mann, K.G. Thrombin formation. *Chest* **2003**, *124*, 4S–10S.
9. Huang, M.; Rigby, A.C.; Morelli, X.; Grant, M.A.; Huang, G.; Furie, B.; Seaton, B.; Furie, B.C. Structural basis of membrane binding by Gla domains of vitamin K-dependent proteins. *Nat. Struct. Biol.* **2003**, *10*, 751–756.
10. Giangrande, P.L.F. Six characters in search of an author: the history of the nomenclature of coagulation factors. *Br. J. Haematol.* **2003**, *121*, 703–712.
11. Ichinose, A.; Davie, E.W. The blood coagulation factors: their cDNAs, genes, and expression. In *Hemostasis and Thrombosis*, 3rd Ed.; Colman, R.W., Hirsh, J., Marder, V.J., Salzman, E.W., Eds.; Lippincott: Philadelphia, 1994; 19–54.
12. Hauschka, P.V.; Lian, J.B.; Gallop, P.M. Direct identification of the calcium-binding amino acid  $\gamma$ -carboxyglutamate, in mineralized tissue. *Proc. Natl. Acad. Sci. U.S.A.* **1975**, *72*, 3925–3929.
13. Price, P.A.; Otsuka, A.S.; Poser, J.W.; Kristaponis, J.; Raman, N. Characterization of a  $\gamma$ -carboxyglutamic acid-containing protein from bone. *Proc. Natl. Acad. Sci. U.S.A.* **1976**, *73*, 1447–1451.
14. Price, P.A.; Williamson, M.K. Primary structure of bovine matrix Gla protein, a new vitamin K-dependent bone protein. *J. Biol. Chem.* **1985**, *260*, 14,971–14,975.
15. Manfioletti, G.; Brancolini, C.; Avanzi, G.; Schneider, C. The protein encoded by a growth arrest-specific gene (*gas6*) is a new member of the vitamin K-dependent proteins related to protein S, a negative coregulator in the blood coagulation cascade. *Mol. Cell. Biol.* **1993**, *13*, 4976–4985.
16. Kulman, J.D.; Harris, J.E.; Xie, L.; Davie, E.W. Identification of two novel transmembrane  $\gamma$ -carboxyglutamic acid proteins expressed broadly in fetal and adult tissues. *Proc. Natl. Acad. Sci. U.S.A.* **2001**, *98*, 1370–1375.
17. Bandyopadhyay, P.K.; Garret, J.E.; Shetty, R.P.; Keate, T.; Walker, C.S.; Olivera, B.M.  $\gamma$ -Glutamyl carboxylation: an extracellular posttranslational modification that antedates the divergence of molluscs, arthropods, and chordates. *Proc. Natl. Acad. Sci. U.S.A.* **2002**, *99*, 1264–1269.
18. Li, T.; Yang, C.T.; Jin, D.; Stafford, D.W. Identification of a drosophila vitamin K-dependent  $\gamma$ -glutamyl carboxylase. *J. Biol. Chem.* **2000**, *275*, 18,291–18,296.
19. Walker, C.S.; Shetty, R.P.; Clark, K.; Kazuko, S.G.; Letsou, A.; Olivera, B.M.; Bandyopadhyay, P.K. On a potential global role for vitamin K-dependent gamma-carboxylation in animal systems. Evidence for a gamma-glutamyl carboxylase in *Drosophila*. *J. Biol. Chem.* **2001**, *276*, 7769–7774.
20. Suttie, J.W. Vitamin K-dependent carboxylase. *Annu. Rev. Biochem.* **1985**, *54*, 459–477.
21. Shah, D.V.; Suttie, J.W. Mechanism of action of vitamin K: evidence for the conversion of a precursor protein to prothrombin in the rat. *Proc. Natl. Acad. Sci. U.S.A.* **1971**, *68*, 1653–1657.
22. Stenflo, J.; Fernlund, P.; Egan, W.; Roepstorff, P. Vitamin K dependent modifications of glutamic acid residues in prothrombin. *Proc. Natl. Acad. Sci. U.S.A.* **1974**, *71*, 2730–2733.
23. Nelsestuen, G.L.; Zytkevich, T.H.; Howard, J.B. The mode of action of vitamin K. Identification of  $\gamma$ -carboxyglutamic acid as a component of prothrombin. *J. Biol. Chem.* **1974**, *249*, 6347–6350.
24. Esmon, C.T.; Sadowski, J.A.; Suttie, J.W. A new carboxylation reaction. The vitamin K-dependent incorporation of H<sup>14</sup>CO<sub>3</sub><sup>-</sup> into prothrombin. *J. Biol. Chem.* **1975**, *250*, 4744–4748.
25. Olson, R.E. The function and metabolism of vitamin K. *Annu. Rev. Nutr.* **1984**, *4*, 281–337.
26. Furie, B.; Furie, B.C. Molecular and cellular biology of blood coagulation. *N. Engl. J. Med.* **1992**, *326*, 800–806.
27. Knobloch, J.E.; Suttie, J.W. Vitamin K-dependent carboxylase. Control of enzyme activity by the “propeptide” region of factor X. *J. Biol. Chem.* **1987**, *262*, 15,334–15,337.

28. Presnell, S.R.; Stafford, D.W. The vitamin K-dependent carboxylase. *Thromb. Haemostas.* **2002**, *87*, 937–946.
29. Furie, B.C.; Ratcliffe, J.V.; Tward, J.; Jorgensen, M.J.; Blaszkowsky, L.S.; DiMichele, D.; Furie, B. The  $\gamma$ -carboxylation recognition site is sufficient to direct vitamin K-dependent carboxylation on an adjacent glutamate-rich region of thrombin in a propeptide-thrombin chimera. *J. Biol. Chem.* **1997**, *272*, 28,258–28,262.
30. Stanley, T.B.; Wu, S.-M.; Houben, R.J.T.J.; Mutucumarana, V.P.; Stafford, D.W. Role of the propeptide and gamma glutamic acid domain of factor IX for in vitro carboxylation by the vitamin K-dependent carboxylase. *Biochemistry* **1998**, *37*, 13,262–13,268.
31. Suttie, J.W. Vitamin K. In *Handbook of Vitamins*; Rucker, R.B., Suttie, J.W., McCormick, D.B., Machlin, L.J., Eds.; Marcel Dekker: New York, 2001; 115–164.
32. Dowd, P.; Ham, S.W.; Geib, S.J. Mechanism of action of vitamin K. *J. Am. Chem. Soc.* **1991**, *113*, 7734–7743.
33. Dowd, P.; Ham, S.-W.; Hershline, R. Role of oxygen in the vitamin K-dependent carboxylation reaction. Incorporation of a second atom of  $^{18}\text{O}$  from molecular oxygen- $^{18}\text{O}_2$  into vitamin K oxide during carboxylase activity. *J. Am. Chem. Soc.* **1992**, *114*, 7613–7617.
34. Kuliopulos, A.; Hubbard, B.R.; Lam, Z.; Koski, E.J.; Furie, B.; Furie, B.C.; Walsh, C.T. Dioxygen transfer during vitamin K dependent carboxylase catalysis. *Biochemistry* **1992**, *31*, 7722–7728.
35. Dowd, P.; Ham, S.-W.; Naganathan, S.; Hershline, R. The mechanism of action of vitamin K. *Annu. Rev. Nutr.* **1995**, *15*, 419–440.
36. Harbeck, M.C.; Cheung, A.Y.; Suttie, J.W. Vitamin K-dependent carboxylase: partial purification of the enzyme by antibody affinity techniques. *Thromb. Res.* **1989**, *56*, 317–323.
37. Hubbard, B.R.; Ulrich, M.M.W.; Jacobs, M.; Vermeer, C.; Walsh, C.; Furie, B.; Furie, B.C. Vitamin K-dependent carboxylase: affinity purification from bovine liver by using a synthetic propeptide containing the  $\gamma$ -carboxylation recognition site. *Proc. Natl. Acad. Sci. U.S.A.* **1989**, *86*, 6893–6897.
38. Wu, S.-M.; Morris, D.P.; Stafford, D.W. Identification and purification to near homogeneity of the vitamin K-dependent carboxylase. *Proc. Natl. Acad. Sci. U.S.A.* **1991**, *88*, 2236–2240.
39. Wu, S.-M.; Cheung, W.-F.; Frazier, D.; Stafford, D. Cloning and expression of the cDNA for human  $\gamma$ -glutamyl carboxylase. *Science* **1991**, *254*, 1634–1636.
40. Stenina, O.; Pudota, B.N.; McNally, B.A.; Himmema, E.L.; Berkner, K.L. Tethered processivity of the vitamin K-dependent carboxylase: factor IX is efficiently modified in a mechanism which distinguishes Gla's from Glu's and which accounts for comprehensive carboxylation in vivo. *Biochemistry* **2001**, *40*, 10,301–10,309.
41. Hallgren, K.W.; Himmema, E.L.; McNally, B.A.; Berkner, K.L. Carboxylase overexpression effects full carboxylation but poor release and secretion of factor IX: implications for the release of vitamin K-dependent proteins. *Biochemistry* **2002**, *41*, 15,045–15,055.
42. Furie, B.C.; Furie, B. Structure and mechanism of action of the vitamin K-dependent  $\gamma$ -glutamyl carboxylase: recent advances from mutagenesis studies. *Thromb. Haemostas.* **1997**, *78*, 595–598.
43. Furie, B.; Bouchard, B.A.; Furie, B.C. Vitamin K-dependent biosynthesis of  $\gamma$ -carboxyglutamic acid. *Blood* **1999**, *93*, 1798–1808.
44. Berkner, K.L. The vitamin K-dependent carboxylase. *J. Nutr.* **2000**, *130*, 1877–1880.
45. Taylor, J.D.; Millar, G.J.; Jaques, L.B.; Spinks, J.W.T. The distribution of administered vitamin K $_1$ - $^{14}\text{C}$  in rats. *Can. J. Biochem. Physiol.* **1956**, *34*, 1143–1152.
46. Wiss, O.; Gloor, H. Absorption, distribution, storage and metabolites of vitamin K and related quinones. *Vitam. Horm.* **1966**, *24*, 575–586.
47. Shearer, M.J.; McBurney, A.; Barkhan, P. Studies on the absorption and metabolism of phylloquinone (vitamin K $_1$ ) in man. *Vitam. Horm.* **1974**, *32*, 513–542.
48. Matschiner, J.T.; Bell, R.G.; Amelotti, J.M.; Knauer, T.E. Isolation and characterization of a new metabolite of phylloquinone in the rat. *Biochim. Biophys. Acta.* **1970**, *201*, 309–315.
49. Bell, R.G.; Matschiner, J.T. Warfarin and the inhibition of vitamin K activity by an oxide metabolite. *Nature* **1972**, *237*, 32–33.
50. Link, K.P. The discovery of dicumarol and its sequels. *Circulation* **1959**, *19*, 97–107.
51. Sadowski, J.A.; Suttie, J.W. Mechanism of action of coumarins. Significance of vitamin K epoxide. *Biochemistry* **1974**, *13*, 3696–3699.
52. Zimmermann, A.; Matschiner, J.T. Biochemical basis of hereditary resistance to warfarin in the rat. *Biochem. Pharmacol.* **1974**, *23*, 1033–1040.
53. Hildebrandt, E.F.; Suttie, J.W. Mechanism of coumarin action: sensitivity of vitamin K metabolizing enzymes of normal and warfarin-resistant rat liver. *Biochemistry* **1982**, *21*, 2406–2411.
54. Wallin, R.; Sane, D.C.; Hutson, S.M. Vitamin K 2,3-epoxide reductase and the vitamin K-dependent  $\gamma$ -carboxylation system. *Thromb. Res.* **2003**, *108*, 221–226.

55. Rost, S.; Fregin, A.; Ivaskevicius, V.; Conzelmann, E.; Hortnagel, K.; Pelz, H.J.; Lappegard, K.; Seifried, E.; Scharrer, I.; Tuddenham, E.G.D.; Muller, C.R.; Strom, T.M.; Oldenburg, J. Mutations in VKORC1 cause warfarin resistance and multiple coagulation factor deficiency type 2. *Nature* **2004**, *427*, 537–541.
56. Li, T.; Chang, C.Y.; Jin, D.Y.; Lin, P.J.; Khvorova, A.; Stafford, D.W. Identification of the gene for vitamin K epoxide reductase. *Nature* **2004**, *427*, 541–544.
57. Lane, P.A.; Hathaway, W.E. Vitamin K in infancy. *J. Pediatr.* **1985**, *106*, 351–359.
58. Greer, F.R. The importance of vitamin K as a nutrient during the first year of life. *Nutr. Res.* **1995**, *15*, 289–310.
59. Von Kries, R.; Shearer, M.; McCarthy, P.T.; Haug, M.; Harzer, G.; Gobel, U. Vitamin K<sub>1</sub> content of maternal milk: influence of the stage of lactation, lipid composition, and vitamin K<sub>1</sub> supplements given to the mother. *Pediatr. Res.* **1987**, *22*, 513–517.
60. Savage, D.; Lindenbaum, J. Clinical and experimental human vitamin K deficiency. In *Nutrition in Hematology*; Lindenbaum, L., Ed.; Churchill Livingstone: New York, 1983; 271–320.
61. Allison, P.M.; Mummah-Schendel, L.L.; Kindberg, C.G.; Harms, C.S.; Bang, N.U.; Suttie, J.W. Effects of a vitamin K-deficient diet and antibiotics in normal human volunteers. *J. Lab. Clin. Med.* **1987**, *110*, 180–188.
62. Booth, S.L.; O'Brien-Morse, M.E.; Dallal, G.E.; Davidson, K.W.; Gundberg, C.M. Response of vitamin K status to different intakes and sources of phyloquinone-rich foods: comparison of younger and older adults. *Am. J. Clin. Nutr.* **1999**, *70*, 368–377.
63. Sokoll, J.J.; Booth, S.L.; O'Brien, M.E.; Davidson, K.W.; Tsaioun, K.I.; Sadowski, J.A. Changes in serum osteocalcin, plasma phyloquinone, and urinary  $\gamma$ -carboxyglutamic acid in response to altered intakes of dietary phyloquinone in human subjects. *Am. J. Clin. Nutr.* **1997**, *65*, 779–784.
64. Shaul, W.L.; Emery, H.; Hall, J.G. *Chondrodysplasia punctata* and maternal warfarin use during pregnancy. *Am. J. Dis. Child.* **1975**, *129*, 360–362.
65. Sokoll, J.J.; Sadowski, J.A. Comparison of biochemical indexes for assessing vitamin K nutritional status in a healthy adult population. *Am. J. Clin. Nutr.* **1996**, *63*, 566–573.
66. Binkley, N.C.; Krueger, D.C.; Engelke, J.A.; Foley, A.L.; Suttie, J.W. Vitamin K supplementation reduces serum concentrations of under- $\gamma$ -carboxylated osteocalcin in healthy young and elderly adults. *Am. J. Clin. Nutr.* **2000**, *72*, 1523–1528.
67. Knapen, M.H.J.; Hamulyak, K.; Vermeer, C. The effect of vitamin K supplementation on circulating osteocalcin (bone Gla protein) and urinary calcium excretion. *Ann. Intern. Med.* **1989**, *111*, 1001–1005.
68. Binkley, N.C.; Krueger, D.C.; Kawahara, T.N.; Engelke, J.A.; Chappell, R.J.; Suttie, J.W. A high phyloquinone intake is required to achieve maximal osteocalcin  $\gamma$ -carboxylation. *Am. J. Clin. Nutr.* **2002**, *76*, 1055–1060.
69. Feskanich, D.; Weber, P.; Willett, W.C.; Rockett, H.; Booth, S.L.; Colditz, G.A. Vitamin K intake and hip fractures in women: a prospective study. *Am. J. Clin. Nutr.* **1999**, *69*, 74–79.
70. Booth, S.L.; Tucker, K.I.; Chen, H. Dietary vitamin K intakes are associated with hip fracture but not with bone mineral density in elderly men and women. *Am. J. Clin. Nutr.* **2000**, *71*, 1201–1208.
71. Vergnaud, P.; Garnero, P.; Meunier, P.J.; Breart, G.; Kamilhagi, K.; Delmas, P.D. Undercarboxylated osteocalcin measured with a specific immunoassay predicts hip fracture in elderly women: the EPIDOS study. *J. Clin. Endocrinol. Metab.* **1997**, *82*, 719–724.
72. Szulc, P.; Arlot, M.; Chapuy, M.C.; Duboeuf, F.; Meunier, P.J.; Delmas, P.D. Serum undercarboxylated osteocalcin correlates with hip bone mineral density in elderly women. *J. Bone Miner. Res.* **1994**, *9*, 1591–1595.
73. Caraballo, P.J.; Gabriel, S.E.; Castro, M.R.; Atkinson, E.J.; Melton, L.J. III. Changes in bone density after exposure to oral anticoagulants: a meta-analysis. *Osteoporosis Int.* **1999**, *9*, 441–448.
74. Price, P.A.; Williamson, M.K.; Haba, T.; Dell, R.B.; Jee, W.S.S. Excessive mineralization with growth plate closure in rats on chronic warfarin treatment. *Proc. Natl. Acad. Sci. U.S.A.* **1982**, *79*, 7734–7738.
75. Ducy, P.; Desbois, C.; Boyce, B.; Pinero, G.; Story, B.; Dunstan, C.; Smith, E.; Bonadio, J.; Goldstein, S.; Gundberg, C.; Bradley, A.; Karsenty, G. Increased bone formation in osteocalcin-deficient mice. *Nature* **1996**, *382*, 448–452.
76. Orimo, H.; Shiraki, M.; Tomita, A.; Morii, H.; Fujita, T.; Ohata, M. Effects of menatetrenone on the bone and calcium metabolism in osteoporosis: a double-blind placebo-controlled study. *J. Bone Miner. Metab.* **1988**, *16*, 106–112.
77. Shiraki, M.; Shiraki, Y.; Aoki, C.; Miura, M. Vitamin K<sub>2</sub> (menatetrenone) effectively prevents fracture and sustains lumbar bone mineral density in osteoporosis. *J. Bone Miner. Res.* **2000**, *15*, 515–521.

78. Iwamoto, I.; Kosha, S.; Fujino, T.; Nagata, Y. Effects of vitamin K<sub>2</sub> on bone of ovariectomized rats and on a rat osteoblastic cell line. *Gynecol. Obstetr. Invest.* **2002**, *53*, 144–148.
79. Ozuru, R.; Sugimoto, T.; Yamaguchi, T.; Chihara, K. Time-dependent effects of vitamin K<sub>2</sub> (menatetrenone) on bone metabolism in postmenopausal women. *Endocr. J.* **2002**, *49*, 363–370.
80. Ronden, J.E.; Drittij-Reijnders, M.-J.; Vermeer, C.; Thijssen, H.H.W. Intestinal flora is not an intermediate in the phyloquinone–menaquinone-4 conversion in the rat. *Biochim. Biophys. Acta.* **1998**, *1379*, 69–75.
81. Davidson, R.T.; Foley, A.L.; Engelke, J.A.; Suttie, J.W. Conversion of dietary phyloquinone to tissue menaquinone-4 in rats is not dependent on gut bacteria. *J. Nutr.* **1998**, *128*, 220–223.
82. Binkley, N.C.; Suttie, J.W. Vitamin K nutrition and osteoporosis. *J. Nutr.* **1995**, *125*, 1812–1821.
83. Yoshida, T.; Miyazawa, K.; Kasuga, I.; Yokoyama, T.; Minemura, K.; Ustumi, K.; Aoshima, M.; Ohyashiki, K. Apoptosis induction of vitamin K<sub>2</sub> in lung carcinoma cell lines: the possibility of vitamin K<sub>2</sub> therapy for lung cancer. *Int. J. Oncol.* **2003**, *23*, 627–632.
84. Braam, L.A.; Knapen, M.H.; Geusens, P.; Brouns, F.; Hamulyak, K.; Gerichhausen, M.J.; Vermeer, C. Vitamin K<sub>1</sub> supplementation retards bone loss in postmenopausal women between 50 and 60 years of age. *Calcif. Tissue Int.* **2003**, *73*, 21–26.
85. Luo, G.; Ducy, P.; McKee, M.D. Spontaneous calcification of arteries and cartilage in mice lacking matrix Gla protein. *Nature* **1997**, *386*, 78–81.
86. Price, P.A.; Faus, S.A.; Williamson, M.K. Warfarin causes rapid calcification of the blastic lamellae in rat arteries and heart valves. *Arterioscler. Thromb. Vasc. Biol.* **1998**, *18*, 1400–1407.
87. Jie, K.S.; Bots, M.L.; Vermeer, C.; Witteman, J.C.; Grobbee, D.E. Vitamin K intake and osteocalcin levels in women with and without aortic atherosclerosis: a population-based study. *Atherosclerosis* **1995**, *116*, 117–123.
88. Geleijnse, J.M.; Vermeer, C.; Grobbee, D.E.; Schurgers, L.J.; Knapen, M.H.; van der Meer, I.H.; Hofman, A.; Witteman, J.C.M. Dietary intake of Menaquinone is associated with a reduced risk of coronary heart disease: The Rotterdam study. *J. Nutr.* **2004**, *134*, 3100–3105.

# Yohimbe (*Pausinystalia johimbe*)

Joseph M. Betz

National Institutes of Health, Bethesda, Maryland, U.S.A.

## INTRODUCTION

Yohimbe is made from the bark of a West African tree, *Pausinystalia johimbe* (K. Schum.) Pierre ex Beille, a member of the madder family (Rubiaceae). Teas made from the bark have been used in Africa as aphrodisiacs and for other purposes. The bark contains a series of closely related indole alkaloids, with the single compound yohimbine predominating. In the United States, products that contain yohimbe bark or yohimbe bark extract (alone or in combination with other ingredients) are available as dietary supplements. These products are sold as enhancing libido, for weight loss, and as aids for bodybuilding. There is virtually no published scientific research on yohimbe that supports these or any other claims. Instead, there is a very large literature on the single alkaloid, yohimbine. This literature is of variable quality and encompasses everything from in vitro studies of mechanism of action to animal research to human clinical trials, mostly on the utility of yohimbine in certain types of erectile dysfunction. The modern consensus appears to be that the pure compound yohimbine is effective for treating certain mild types of erectile dysfunction in some men, but does not act as an aphrodisiac. Yohimbine hydrochloride is available as a prescription drug for treatment of certain types of erectile dysfunction in the United States. There are a few older studies that examine yohimbine for weight loss, but these studies were largely inconclusive. There are concerns about the safety of yohimbine, and especially about the potential of this compound to cause drug/herb interactions.

## BACKGROUND

There are a number of other economically and medicinally important plants in the madder family Rubiaceae, including coffee (*Coffea arabica*), ipecac [*Psychotria ipecacuanha* (Brot.) Stokes], and *Cinchona calisaya* Wedd., the source of quinine. As mentioned

earlier, yohimbe refers to the bark of the species *P. johimbe*.

The raw material is collected from the wild and enters into commerce in the form of flattened or slightly curled (quilled) pieces 75 cm long and 4–8 mm thick. The bark is characterized by an external corky layer of a gray-brown color covered with isolated lichens. When examined in this form, the crude material shows numerous longitudinal and transverse fissures. When the bark is broken, the transverse fracture is of a uniform yellowish-brown to orange-brown color, and presents short, soft fibers like rough velvet.<sup>[1]</sup>

## CHEMISTRY AND PREPARATION

According to Tyler,<sup>[2]</sup> yohimbe “enjoys a considerable folkloric reputation as an aphrodisiac (a drug that enhances sexual performance and desire),” and several authors of herbal use guides intended for lay readers have provided information on traditional use of the bark.<sup>[3–5]</sup>

Tyler<sup>[2]</sup> provides a recipe that “recommends boiling 6–10 teaspoonfuls of inner bark shavings in a pint of water for a few minutes, straining, sweetening and drinking the beverage.” All of these popular authors place yohimbe in the unsafe category due to unpleasant side effects, while the German Commission E has published a negative monograph on the plant due to lack of efficacy data and safety concerns.<sup>[6]</sup> Western observations on the use of yohimbe for purposes of sexual enhancement extend back over a century.

In 1900, Oberwarth and Loewy<sup>[7]</sup> reported that yohimbe exerted a strong aphrodisiac effect in animals and humans. Authentic yohimbe bark has been reported to contain up to 6% total alkaloids. The major alkaloid in the plant and the one most thoroughly studied is yohimbine (17 $\alpha$ -hydroxy-yohimban-16 $\alpha$ -carboxylic acid methylester).<sup>[2]</sup> Minor alkaloids isolated from *P. johimbe* bark include ajmaline, alloyohimbine, pseudoyohimbine, corynanthine, corynantheine,  $\alpha$ -yohimbane, and  $\beta$ -yohimbane.<sup>[8]</sup> In addition to its presence in *Pausinystalia*, yohimbine and its derivatives have been isolated from a number of plant genera in the family Apocynaceae, including *Rauwolfia*, *Amsonia*, *Vallesia*, *Aspidosperma*, and *Vinca*, from *Gelsemium* and *Strychnos* (Loganiaceae),

Joseph M. Betz, Ph.D., is Director of the Dietary Supplement Methods and Reference Materials Program in the office of Dietary Supplements, National Institutes of Health (NIH), Bethesda, Maryland, U.S.A.



and from *Alchornea* (Euphorbiaceae). Very soon after the compounds responsible for the biological activity of yohimbe were identified and characterized, research shifted away from the effects of the plant to the effects of the isolated compounds. Probably as a result of this trend, no reports of human studies on the effect of crude yohimbe bark or its extracts on sexual performance can be found in the literature. *P. johimbe* bark remains the major source of commercial yohimbine, as synthetic processes are prohibitively expensive.

Unfortunately, the lack of published research on yohimbe, yohimbe extract, yohimbe products limits the following discussions to the major alkaloid, yohimbine. The contributions of the minor alkaloids and nonalkaloidal constituents to the biological activity of yohimbe cannot be addressed, and the aphrodisiac (vs. erectile dysfunction) activity of the plant is also impossible to evaluate. Any discussion of the use of the bark for sexual enhancement thus begins and ends with folklore. Proponents of botanical medicines will deem this to be sufficient evidence of efficacy and safety, while critics (or skeptics) will require modern scientific evidence. Some help is provided by the fairly rich literature on yohimbine, but even this must be tempered by the fact that it represents only about 15% of the total alkaloid of the tree bark and that virtually nothing is known about the nonalkaloidal constituents.

## PRECLINICAL STUDIES

Yohimbine (Fig. 1) is a potent  $\alpha_2$ -adrenoreceptor blocker of short duration and a weaker  $\alpha_1$ -adrenergic antagonist with some antidopaminergic properties.<sup>[9-12]</sup> Yohimbine HCl has been available as a prescription drug for the treatment of male impotence for decades, and is still registered for that use in many countries. The drug has been used both in oral dosage forms and as an injection. In addition to this application,

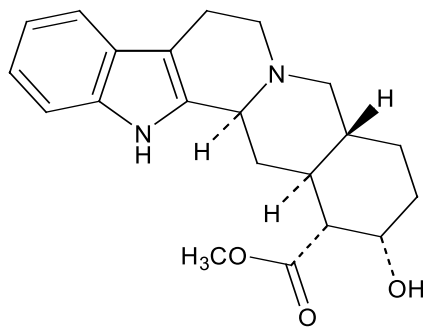


Fig. 1 Yohimbine.

the compound has more recently been used as a pharmacological probe to study the involvement of  $\alpha_2$ -adrenoreceptors in the regulation of autonomic function. Yohimbine has also been used to treat female sexual dysfunction, but the few published clinical trials have reported that yohimbine is no better than placebo for this indication.

Animal studies over the years confirm the effects of yohimbine on male sexual behavior. A review by Tam, Worcel, and Wyllie<sup>[13]</sup> notes that in male rats, the alkaloid decreases the latencies of intromission, mounting, and ejaculation; induces mating behavior and copulatory behavior during sexual exhaustion; and at low doses enhances the ejaculatory response. Similar results have been reported in dogs and golden hamsters. The 25th edition of the *United States Dispensatory*<sup>[7]</sup> noted that yohimbine "has been used by clinicians in neurasthenic impotence, with reports which are generally favorable." The text goes on to state that the compound is of no value when the impotence is caused by organic nerve damage and is harmful when impotence is caused by chronic inflammatory disease of the sexual organs or the prostate gland.

A number of proprietary yohimbine-containing drug products intended for the treatment of impotence were available on the U.S. market prior to the prescription drug review mandated by the 1960 amendment of the Federal Food, Drug, and Cosmetic Act. The most heavily studied of these products was Afrodex<sup>®</sup>, which contained a mixture of 5 mg of extract of *Strychnos nux vomica* L. (1-4% strychnine), 5 mg of methyl testosterone, and 5 mg of yohimbine hydrochloride.<sup>[14]</sup> There are numerous published clinical trials of this product, involving thousands of human subjects. The trials were largely positive, with few reported side effects, but following the prescription drug review, the product disappeared from the U.S. marketplace (although it was available in Africa as late as 1973).

Scientific understanding of yohimbine and its biological activity has evolved within the context of modern investigations into sexual dysfunction. While there has been a considerable amount of research on the effects of yohimbine on impotence and erectile dysfunction (E-D) no published studies on the use of this compound for its purported male aphrodisiac ("enhancement of sexual performance and desire") properties could be found. The distinction between therapeutic agents useful for treating a medical disorder (E-D) and relatively commonplace ingredients with aphrodisiac properties is significant. Powerful compounds such as sildenafil (Viagra<sup>®</sup>) (or yohimbine HCl), available only with a physician's prescription, fall into the former category, while "legendary love potions," like Spanish fly, glandular secretions from musk deer and civet cats, oats (*Avena sativa*), ginseng (*Panax* spp.), and oysters fall, into the latter.<sup>[15]</sup> Yohimbe-containing

dietary supplement products intended to “enhance sexual performance and desire” are widely available in health food stores, supermarkets, and pharmacies, and over the Internet. In addition to the scientific and medical implications of these diverging definitions, there may be regulatory significance as well. A material that affects a disease state like E-D is regulated as a drug in the United States, while a product intended to maintain or enhance libido may be legally marketed as a dietary supplement. As noted, there have been a number of E-D studies (including meta-analyses) on yohimbine HCl, the drug, but no published human clinical studies on yohimbe bark or any of its crude preparations could be located.

## EFFICACY

Yohimbine HCl has been used in the management of select cases of organic impotence. A number of randomized controlled clinical trials have been performed over the past several decades. The quality of the trials and diagnoses of the etiology of the E-D have been variable, and so results have been equivocal. A 1994 review notes that yohimbine has “enjoyed a reputation as an aphrodisiac although no effect on sexual drive in humans has been adequately demonstrated.”<sup>[16]</sup> The review also pointed out that yohimbine has been evaluated for effects on erectile disorder in a number of placebo-controlled but otherwise poorly designed clinical trials and been found to have a modest therapeutic benefit over placebo, particularly in psychogenic erectile disorder. More methodologically sound trials performed over the past decade have produced enough data to allow a meta-analysis to be performed.

The absorption and pharmacokinetics of yohimbine are fairly straightforward. The compound is absorbed rapidly from the gastrointestinal (GI) tract, and because the free base is highly lipophilic, it quickly crosses the blood-brain barrier into the CNS. Peak plasma levels have been found to be achieved 10–45 min after ingestion of 10 mg of yohimbine HCl, and it is eliminated rapidly (mean half-life 0.58 hr). Oral bioavailability ranges from 7 to 87%, and less than 1% of the orally administered drug is excreted unchanged in the urine. The biological activity of yohimbine lasts longer than the absorption and half-life would suggest, raising the possibility that it is converted into an active metabolite with a longer duration of action than the parent molecule. Major metabolites of yohimbine are 10-hydroxy-yohimbine and 11-hydroxy-yohimbine.<sup>[16]</sup>

The systematic review and meta-analysis of randomized clinical trials published by Ernst and Pittler in 1998<sup>[17]</sup> indicates that all authors had reported significant placebo effects, but still concludes that yohimbine

is more effective than placebo in treating erectile dysfunction. In their publication, Ernst and Pittler describe the best two trials in some detail. In one trial, 61 subjects who had been treated for secondary erectile dysfunction for at least 6 mo were given 5.4 mg of yohimbine HCl or matching placebo 3 times daily for 8 weeks and then crossed over for 8 more weeks. At 4 week intervals, patients self-reported quality and frequency of erections. After 8 weeks, 36.7% of the drug group and 12.9% of the placebo group ( $p < 0.05$ ) reported good stimulated erections. In the placebo group, 41.9% ( $p < 0.02$ ) of patients reported positive results after crossover to the drug. In the second trial, 82 patients, included regardless of the degree, duration, or etiology of their E-D, were divided into groups ranked as having mild, moderate, or severe E-D. The initial dose was one 5.4 mg yohimbine HCl tablet or matching placebo 4 times per day. The dose was raised to two 5.4 mg tablets 4 times daily on the second day, with dosage reduced by 1 tablet per day if adverse events occurred. Success was assessed by Derogatis Sexual Functioning Inventory, penile brachial index test, and daytime arousal test. After 4 weeks, 14% of the drug patients had experienced full restoration of erectile function and 20% had partial response. As a caveat to their meta-analysis, Ernst and Pittler did note that publication bias (the tendency to publish positive trials but not negative studies) could not be ruled out.

At least two clinical trials of yohimbine HCl (alone or in combination) in E-D have been published since the meta-analysis. Guay et al.<sup>[18]</sup> administered 5.4 mg of yohimbine HCl 3 times a day for 4 weeks to 18 men with organic erectile dysfunction. At 4 weeks, the dose was doubled and the trial continued for an additional 4 weeks. There was no placebo group. Fifty percent of the patients in the treatment group responded. Leuret et al.<sup>[19]</sup> performed a double-blind, placebo-controlled, three-way crossover study comparing the effects of L-arginine glutamate/yohimbine HCl, yohimbine HCl, and placebo. Forty-eight patients with at least a 3 mo history of mild to moderate E-D were randomized and treated. Doses of 6.0 g of arginine/6.0 mg yohimbine HCl, 6.0 mg yohimbine, or placebo were administered once daily for 2 weeks. The most recent clinical review by Tam, Worcel, and Wyllie,<sup>[13]</sup> reinforces the conclusions found in earlier trials: Yohimbine is an effective therapy to treat certain forms of mild organic erectile dysfunction in some men.

## MECHANISM OF ACTION

Several possible mechanisms for the utility of yohimbine in erectile dysfunction have been proposed. Early

work focused on the effects of the alkaloid on peripheral blood flow in the penis. Its action on peripheral blood vessels resembles (but is weaker than) that of reserpine, a structurally similar alkaloid found in Indian snakeroot, *Rauwolfia serpentina* (L.) Benth. ex Kurz (Apocynaceae). Penile erection is achieved when the smooth muscle of the corpus cavernosum (spongy erectile tissue) is relaxed and there is an increase in cavernosal blood flow and a decrease in outflow. Penile flaccidity (the usual state) is maintained when the cavernosal smooth muscle is contracted. Smooth muscle contraction is mediated by the  $\alpha$ -adrenergic neuroeffector system. As noted previously, yohimbine blocks  $\alpha_2$ -adrenoreceptors. Its peripheral effects on penile hemodynamics could thus be at least partly ascribed to increasing cholinergic and decreasing adrenergic activity, thus increasing inflow and decreasing outflow of blood (i.e., by interfering with the penile detumescence status quo).

Studies in rodents have focused on the central effects of yohimbine on sexual function. Most of the evidence for dominance of CNS-mediated activity is derived from experiments that show that the alkaloid increases sexual motivation even in sexually exhausted rats due to its action on central  $\alpha_2$ -adrenoreceptors found in the locus coeruleus of the brain. Blockage of these brain adrenoreceptors appears to reverse a central negative feedback mechanism that regulates penile erection and maintains detumescence. Some doubts remain about the importance of this proposed mechanism in the overall biological activity of yohimbine because the compound does not increase sexual desire or thoughts in human clinical trials. The combined evidence from human and animal studies indicates that yohimbine is far less potent in stimulating sexual behavior in humans than in rats. One possible explanation for this finding is the existence of powerful and multiple inhibitory controls on sexual behavior in humans that are not present in rats; i.e., the cognitive aspects of sex are far more important in humans than the basic instinctive functions observed in animals.<sup>[20]</sup>

Increased understanding of the role of nitric oxide (NO) in vascular smooth muscle function has led to a reinvestigation of the manner in which yohimbine works in E-D. Upon sexual stimulation, the terminal axons of the parasympathetic nerves release NO. This compound diffuses into the smooth muscles that line the arteries of the corpus cavernosum and activates guanylate cyclase. This enzyme catalyzes the conversion of guanosine triphosphate (GTP) to cyclic guanosine monophosphate (cGMP), which causes penile smooth muscle relaxation. The effects of cGMP are eventually reversed (and erection ceases) because cGMP is converted into its inactive form by phosphodiesterase 5 (PDE5), an enzyme found in penile tissue.

Sildenafil exerts its biological activity by inhibiting PDE5 and preventing breakdown of cGMP. Filippi et al.<sup>[21]</sup> found that yohimbine blocks smooth muscle contraction induced by adrenergic agonists and also those induced by nonadrenergic substances such as endothelin-1 (ET-1). They also reported that this effect is unrelated to antagonism at ET-1 receptors. These data suggest that yohimbine counteracts ET-1 induced contraction by altering NO release from endothelial tissue. This was tested in the in vitro model by mechanically removing endothelial cells (the source of NO) from the experimental preparation. This blocked the relaxant effect of yohimbine on the tissue. Conversely, yohimbine activity was strongly increased by inhibiting cGMP degradation.

A recent study by Ajayi et al.<sup>[22]</sup> measured the effects of an aqueous extract of the plant bark of *P. johimbe* on renal circulation in order to test the hypothesis that the extract has effects on NO production and/or ET-1-like actions. Results suggest a strong possibility of postreceptor crosstalk between  $\alpha_2$ -adrenoreceptors and endothelin as well as a direct effect of  $\alpha_2$ -adrenoreceptors on NO production. The study also demonstrates the importance of performing preclinical and clinical trials on plant materials and their extracts rather than on the presumed "actives" (in this case, yohimbine). The study used an aqueous extract of yohimbe bark and was therefore relatively devoid of yohimbine and other lipophilic alkaloids, suggesting the presence of as yet unidentified active principles in the bark.

Today, many botanical ingredients (including yohimbe) are being touted in the United States as legal "natural" substances that enhance endogenous androgenic steroid production<sup>[23]</sup> (and are hence marketed as bodybuilding aids). No published evidence that yohimbe (or yohimbine) has the effect of increasing lean muscle mass could be found in peer reviewed scientific literature. None of the studies cited previously support the use of yohimbine as an anabolic agent, and Gurguis and Uhde<sup>[24]</sup> report that its administration has no effect on plasma growth hormone levels.

There was a flurry of interest in yohimbine and several other compounds (including synephrine) during the late 1980s and early 1990s when it was found that a number of  $\alpha$ -adrenergic agents caused increased lipolysis in rodent brown adipocytes in vitro.<sup>[25-28]</sup> A number of small human trials of yohimbine (but not yohimbe) for weight loss have been published, but the results are contradictory and have not been repeated. Subsequent work on human adipocytes has demonstrated that the basic biochemistry of rodent and human adipocytes is substantially different, and these compounds do not increase lipolysis in human cells in vitro. Because of the small sizes of the trials

and their equivocal results, the evidence base for efficacy of yohimbine in weight loss does not currently support this claim. No published clinical trials (or studies of any sort) on yohimbe and weight loss could be found in the literature.

## ADVERSE SIDE EFFECTS

Clinical trial reports have indicated that the adverse effects of yohimbine in these settings are few and mild.<sup>[25,29–31]</sup> Ernst and Pittler warn that this relatively small number may reflect the strict inclusion criteria used for clinical trials rather than true incidence rates. The known pharmacological actions of yohimbine allow one to predict an increase in adrenergic tone that may cause an increase in blood pressure, but that result has not been observed in normotensive individuals in trials. It may, however, exacerbate elevated blood pressure in hypertensive individuals. Other expected adrenergic effects include anxiety and manic symptoms. Yohimbine-containing products have the potential to produce psychiatric symptoms, primarily anxiety and panic, especially in individuals with pre-existing panic disorder, and the compound has been used to provoke panic attacks and anxiety in studies of the pathophysiology, psychopharmacology, and treatment of anxiety disorders.<sup>[32]</sup>

Case reports indicate that yohimbine produces a number of reactions in certain individuals at doses below those required for peripheral  $\alpha$ -adrenergic blockade. Manifestations of these effects include anti-diuresis and central excitation (elevated blood pressure and heart rate, increased motor activity, nervousness, irritability, and tremors). Dizziness, headache, skin flushing, and orthostatic hypotension have also been reported. The recommended dose of yohimbine HCl for E-D is 5.4 mg 3 times daily. Doses of 20–30 mg produce increases in blood pressure and heart rate, piloerection, and rhinorrhea. Paresthesias, incoordination, tremulousness, and dissociative states have been reported in the most severe cases.<sup>[24,33–36]</sup> The apparent monoamine oxidase inhibitory effect of this compound is probably attributable to weak calcium channel blocking activity.<sup>[37]</sup> Therefore, yohimbine is contraindicated with tyramine-containing foods, antidepressants, and other mood modifying drugs.<sup>[33]</sup> In a likely idiosyncratic reaction, yohimbine was reported to have induced a generalized erythrodermic skin eruption, progressive renal failure, and a lupus-like syndrome in a patient being treated for impotence.<sup>[38]</sup> A single case report of a massive overdose of yohimbine has been reported.<sup>[39]</sup> The patient was a 62-year-old man who had ingested a hundred 2 mg tablets. His symptoms following ingestion (tachycardia, hypertension,

and anxiety of brief duration) were consistent with the predicted findings outlined above. He was treated with activated charcoal, observed for 19 hr, and released with normal blood pressure and heart rate. The short duration of the symptoms can be explained by the pharmacokinetics of yohimbine.

A topic of more recent concern is the likelihood that yohimbine can cause drug/drug interactions. Yohimbine has been reported to raise blood pressure in patients taking tricyclic antidepressants and to produce withdrawal symptoms and anxiety in opioid-dependent individuals (i.e., patients undergoing methadone therapy). As an  $\alpha_2$ -adrenergic antagonist, yohimbine opposes the effects of clonidine and may potentiate the  $\alpha_2$ -adrenoreceptor blocking properties of phenothiazines.<sup>[40]</sup> The negative German Commission E monograph for the use of yohimbe (as opposed to yohimbine) in E-D is based on lack of efficacy studies on the plant material as well as the potential adverse effects outlined.<sup>[6]</sup>

Unfortunately, while the literature on the safety and efficacy of yohimbine is instructive and may provide useful insight into the safety and efficacy of yohimbe, there are questions that cannot be answered without putting the plant material itself or products made from the plant into rigorous preclinical and clinical studies. The effects of the minor alkaloids or of the other chemical constituents (such as the water-soluble compounds) on the safety/efficacy of the plant cannot be known until such research is done. Tyler noted that the bark was used to make a tea.<sup>[2]</sup> The alkaloids of yohimbe are marginally water soluble (if at all), while the aqueous extract yohimbe bark used by Ajayi et al.<sup>[22]</sup> was found to be biologically active in its own right. Very little has been published on the identity or nature of the water-soluble constituents of the plant. If basic questions about the safety and efficacy of the botanical itself cannot be answered at this time, the picture for products that contain more than one botanical component are even more bleak. Yohimbine was an ingredient in a dietary supplement called LipoKinetix that was associated with severe hepatotoxicity in seven individuals. The yohimbine present is unlikely to have been the cause of the toxicity, but its contribution when combined with the other ingredients is unknown.

Finally, as products have proliferated in the marketplace, various investigators have performed surveys of yohimbine content in yohimbe products.<sup>[41,42]</sup> Yohimbe bark has been reported to contain about 0.7% yohimbine and about 3.9% total alkaloids. Marketed U.S. dietary supplement products were found to contain 0–0.05% yohimbine. Only those in the higher range of yohimbine content were observed to contain other alkaloidal components. Several of the products contained multiple botanical

ingredients, but none of these contained much yohimbine. Products purchased via the Internet from various countries were found to contain from 0 to 9.5 mg of yohimbine per unit. In the U.S. products, alkaloid levels in only 2 of 18 tested materials contained amounts of alkaloid that approach clinical relevance (many contained no alkaloid), while 4 of the 20 Internet products were found to contain amounts of yohimbine that approach levels that may be a cause of concern. As long as case reports for adverse reactions as well as efficacy (at least at the level of anecdote) rely on inconsistent products in an ever-changing marketplace, the utility and safety of yohimbe for any use will remain in dispute.

## REFERENCES

- Lewis, W.H.; Elvin-Lewis, M.P.F. *Medical Botany: Plants Affecting Man's Health*; John Wiley & Sons: New York, 1977; 326–327.
- Tyler, V.E. *The New Honest Herbal*; G.F. Stickley Co.: Philadelphia, 1987; 240–241.
- Duke, J.A. *CRC Handbook of Medicinal Herbs*; CRC Press Co., Inc.: Boca Raton, 1986; 351.
- Kowalchik, C.; Hylton, W.H. *Rodale's Illustrated Encyclopedia of Herbs*; Rodale Press: Emmaus, 1987; 520.
- Dispensary of the United States of America*, 20th Ed.; Remington, J.P., Wood, H.C., Eds.; J.B. Lippincott Co.: Philadelphia, 1918; 1670.
- The Complete German Commission E Monographs—Therapeutical Guide to Herbal Medicines*; Blumenthal, M., Busse, W.R., Goldberg, A., et al., Eds.; American Botanical Council/Integrative Medicine Communication: Austin, Tx/Boston, 1998 (Klein, S., Rister, R.S., Trans.).
- Dispensary of the United States of America*, 25th Ed.; Osol, A., Farrar, G.E., Eds.; J.B. Lippincott Co.: Philadelphia, 1955; 1932.
- Willaman, J.J.; Li, H.L. *Lloydia*. **1970**, 33s, 1.
- Hoffman, B.B.; Lefkowitz, R.J. Alpha-adrenergic receptor subtypes. *New Engl. J. Med.* **1980**, 302, 1390–1396.
- Goldberg, M.; Robertson, D. Yohimbine: a pharmacological probe for study of the alpha 2-adrenoreceptor. *Pharm. Rev.* **1983**, 35, 143–180.
- Sanghvi, I.; Gershon, J. Yohimbine: behavioral and biochemical effects in mice. *Arch. Int. Pharmacodyn. Ther.* **1974**, 210, 108–120.
- Scatton, B.; Zivkovic, B.; Jaroslav, D. Antidopaminergic properties of yohimbine. *J. Pharmacol. Exp. Ther.* **1980**, 215, 494–499.
- Tam, S.W.; Worcel, M.; Wyllie, M. Yohimbine: a clinical review. *Pharmacol. Ther.* **2001**, 91, 215–243.
- Margolis, R.; Sangree, H.; Prieto, P.; Stein, L.; Chinn, S. Clinical studies on the use of Afrodex in the treatment of impotence: statistical summary of 4000 cases. *Curr. Ther. Res.* **1967**, 9, 213–219.
- Drewes, S.E.; George, J.; Khan, F. Recent Findings on natural products with erectile-dysfunction activity. *Phytochemistry* **2003**, 62, 1019–1025.
- Riley, A.J. Yohimbine in the treatment of erectile disorder. *B. J. Clin. Pract.* **1994**, 48, 133–136.
- Ernst, E.; Pittler, M.H. Yohimbine for erectile dysfunction: a systematic review and meta-analysis of randomized clinical trials. *J. Urol.* **1998**, 159, 433–436.
- Guay, A.T.; Spark, R.F.; Jacobson, J.; Murray, F.T.; Geisser, M.E. Yohimbine treatment of organic erectile dysfunction in a dose-escalation trial. *Int. J. Impotence Res.* **2002**, 14, 25–31.
- Lebret, T.; Hervé, J.-M.; Gorny, P.; Worcel, M.; Botto, H. Efficacy and safety of a novel combination of L-arginine glutamate and yohimbine hydrochloride: a new oral therapy for erectile dysfunction. *Eur. Urol.* **2002**, 41, 608–613.
- Allard, J.; Giuliano, F. Central nervous system agents in the treatment of erectile dysfunction: how do they work? *Curr. Urol. Rep.* **2001**, 2, 488–494.
- Filippi, S.; Luconi, M.; Granchi, S.; Natali, A.; Tozzi, P.; Forti, G.; Ledda, F.; Maggi, M. Endothelium-dependency of yohimbine-induced corpus cavernosum relaxation. *Int. J. Impotence Res.* **2002**, 14, 295–307.
- Ajayi, A.A.; Newaz, M.; Hercule, H.; Salch, M.; Bode, C.O.; Oyekan, A.O. Endothelin-like action of *Pausinystalia yohimbe* aqueous extract on vascular and renal regional hemodynamics in Sprague Dawley rats. *Meth. Find. Exp. Clin. Pharmacol.* **2003**, 25, 817–822.
- Barron, R.L.; Vanscoy, G.J. Natural products and the athlete: facts and folklore. *Ann. Pharmacother.* **1993**, 27, 607–615.
- Gurguis, G.N.M.; Uhde, T.W. Plasma 3-methoxy-4-hydroxyphenylethylene glycol (MHPG) and growth hormone responses to yohimbine in panic disorder patients and normal controls. *Psychoneuroendocrinology* **1990**, 15, 217–224.
- Galitzky, J.; Rivière, D.; Tran, M.A.; Montastruc, J.L.; Berlan, M. Pharmacodynamic effects of chronic yohimbine treatment in healthy volunteers. *Eur. J. Clin. Pharmacol.* **1990**, 39, 447–451.
- Berlan, M.; Galitzky, J.; Riviere, D.; Foureau, M.; Tran, M.A.; Flores, R.; Louret, J.P.; Houin, G.; Lafontan, M. Plasma catecholamine levels and lipid mobilization induced by yohimbine in obese and non-obese women. *Int. J. Obesity* **1988**, 15, 305–315.
- McCarty, M.F. Pre-exercise administration of yohimbine may enhance the efficacy of exercise

- training as a fat loss strategy by boosting lipolysis. *Med. Hypoth.* **2002**, *58*, 491–495.
28. Galitzky, J.; Taouis, M.; Berlan, M.; Riviere, D.; Garrigues, M.; Lafontan, M. Alpha 2-antagonist compounds and lipid mobilization: evidence for a lipid mobilizing effect of oral yohimbine in healthy male volunteers. *Eur. J. Clin. Invest.* **1988**, *18*, 587–594.
  29. Sonda, L.P.; Mazo, R.; Chancellor, M.B. The role of yohimbine for the treatment of erectile impotence. *J. Sex Marital Ther.* **1990**, *16*, 15–21.
  30. Susset, J.G.; Tessier, C.D.; Wincze, J.; Bansal, S.; Malhotra, C.; Schwacha, M.G. Effect of yohimbine hydrochloride on erectile impotence: a double-blind study. *J. Urol.* **1989**, *141*, 1360–1363.
  31. Morales, A.; Condra, M.; Owen, J.A.; Surridge, D.H.; Fenemore, J.; Harris, C. Is yohimbine effective in the treatment of organic impotence? Results of a controlled trial. *J. Urol.* **1987**, *137*, 1168–1172.
  32. Wong, A.H.C.; Smith, M.; Boon, H.S. Herbal remedies in psychiatric practice. *Arch. Gen. Psychiatry* **1998**, *55*, 1033–1044.
  33. *Physicians' Desk Reference*, 46th Ed.; Medical Economics Data: Montvale, NJ, 1992; 650, 900, 1190, 1686, 2263.
  34. Grossman, E.; Rosenthal, T.; Pelag, E.; Holmes, C.; Goldstein, D.S. Oral yohimbine increases blood pressure and sympathetic nervous outflow in hypertensive patients. *J. Cardiovasc. Pharmacol.* **1993**, *22*, 22–26.
  35. Holmberg, G.; Gershon, S. Autonomic and psychic effects of yohimbine hydrochloride. *Psychopharmacologia* **1961**, *2*, 93–106.
  36. Holmberg, G.; Gershon, S.; Beck, L.H. Yohimbine as an autonomic test drug. *Nature* **1962**, *183*, 1313–1314.
  37. Watanabe, K.; Yano, S.; Horiuchi, H.; Yamanaka, E.; Aimi, N.; Sakai, S. Ca<sup>2+</sup> channel-blocking effect of the yohimbine derivatives, 14 beta-benzoyloxyyohimbine and 14 beta-pho-nitrobenzoyloxyyohimbine. *J. Pharm. Pharmacol.* **1987**, *39*, 439–443.
  38. Sandler, B.; Aronson, P. Yohimbine-induced cutaneous drug eruption, progressive renal failure, and lupus-like syndrome. *Urology* **1993**, *41*, 343–345.
  39. Friesen, K.; Palatnick, W.; Tenenbein, M. Benign course after massive ingestion of yohimbine. *J. Emergency Med.* **1993**, *11*, 287–288.
  40. Valli, G.; Giardina, E.-G.V. Benefits, adverse effects and drug interactions of herbal therapies with cardiovascular effects. *J. Am. Coll. Cardiol.* **2002**, *39*, 1083–1095.
  41. Betz, J.M.; White, K.D.; DerMarderosian, A.H. Gas chromatographic determination of yohimbine in commercial yohimbe products. *J. AOAC Int.* **1995**, *78*, 1189–1194.
  42. Zanolari, B.; Ndjoko, K.; Ioset, J.R.; Marston, A.; Hostettmann, K. Qualitative and quantitative determination of yohimbine in authentic yohimbe bark and in commercial aphrodisiacs by HPLC–UV–API/MS methods. *Phytochem. Anal.* **2003**, *14*, 193–201.



Carolyn S. Chung  
Janet C. King

Children's Hospital Oakland Research Institute, Oakland, California, U.S.A.

## INTRODUCTION

Zinc is the most abundant intracellular trace element. It is present in every living cell in the body and has many diverse biological functions. Because zinc is a component of many enzymes involved in the synthesis and degradation of carbohydrates, lipids, proteins, nucleic acids, and gene expression, as well as in the metabolism of other nutrients,<sup>[1]</sup> it has a multitude of physiological and biochemical functions, notably in embryogenesis, immunity, and growth. The element is abundant in the food supply; however, its absorption from foods depends on the presence or absence of substances in foods that can bind zinc and make it unavailable for absorption. In 1961, the human requirement for zinc was shown by reports of hypogonadism and dwarfism of rural Iranian boys who consumed food that contained zinc, but which was not readily absorbed.<sup>[2]</sup> The significance of the clinical and public health implications of zinc health is currently being addressed and deserves attention. In cases of inadequacy, primarily in developing countries, treatment with supplements (zinc sulfate, zinc gluconate, etc.) is effective.

## BIOCHEMISTRY AND PHYSIOLOGIC FUNCTIONS

Zinc has a 2+ charge ( $Zn^{2+}$ ). It has an atomic number of 30 and an atomic weight of 65.37 (isotopic mean). In the pure form, it is a bluish white metal. Zinc is a strong Lewis acid, meaning it is an electron acceptor. It has a particular affinity for thiol and hydroxy groups and for amine electron donors.<sup>[3]</sup> The metal readily forms complexes with amino acids, peptides, proteins, and nucleotides. It does not exhibit redox chemistry.

---

Carolyn S. Chung, Ph.D., is a Postdoctoral Fellow at Children's Hospital, Oakland Research Institute, Oakland, California, U.S.A.

Janet C. King, Ph.D., is a Senior Scientist at Children's Hospital Oakland Research Institute, Oakland and Professor at UC, Berkeley, Davis, California, U.S.A.

## Catalytic, Structural, and Regulatory Functions

Zinc functions as a catalytic, structural, and regulatory component of nearly 300 enzymes, in which it maintains structural integrity and plays a role in regulation of gene expression.<sup>[4]</sup> In humans, the element is critical for the proper function of about 60 enzymes. Enzymes that require zinc for their catalytic function are found in all six enzyme classes (ligases, isomerases, lyases, hydrolases, transferases, and oxidoreductases).<sup>[5]</sup> An enzyme is considered to be a zinc metalloenzyme if removal of zinc reduces enzyme activity without affecting the protein structure per se, and if reconstitution with zinc restores activity.<sup>[6]</sup> The metal may serve a catalytic function for these enzymes by serving as an electron acceptor. It is a catalyst for RNA polymerase, alkaline phosphatase, and carbonic anhydrase.

In its structural role, zinc helps proteins fold into their three-dimensional configurations; this folding is required for these proteins to have biological activity. "Zinc fingers," or loops formed by binding zinc to the amino acids, cysteine, and histidine, enable the folding to take place.<sup>[7]</sup> Examples of proteins requiring zinc for normal structure include DNA transcription factors (e.g., metal transcription factor 1), nuclear receptors (e.g., retinoic acid receptors), and enzymes (e.g., copper-zinc superoxide dismutase). Zinc finger proteins are widely distributed in the cell and also bind to RNA molecules and other proteins. This interaction with other molecules allows for transcriptional and translational control and signal transduction. This ability to regulate gene expression may explain the tight homeostatic control of zinc metabolism. Zinc fingers and their basic functions may also explain the nonspecific symptoms that characterize zinc deficiency.<sup>[8]</sup>

Zinc and sulfur join to form thiolate clusters in proteins such as metallothionein. These clusters allow metallothionein to exchange electrons and react with oxidants (nitric oxide, glutathione/glutathione reductase) in the body. When oxidized, thiolate clusters release zinc. The activity of nitric oxide synthase<sup>[9]</sup> may explain the increased oxidative stress in cells associated with zinc deficiency.<sup>[10]</sup>

As a regulatory agent, zinc controls the expression of various genes (e.g., the metallothionein gene),<sup>[11]</sup>



programmed cell death or apoptosis,<sup>[12]</sup> and synaptic signaling.<sup>[13]</sup> Zinc binds to zinc finger domains on a protein called metal response element transcription factor (MTF1). The zinc-MTF1 complex then binds to metal response elements (MREs) on the promoter area of the gene<sup>[14]</sup> and thereby regulates gene expression.<sup>[15]</sup> Individual human responses to dietary zinc intake are highly variable and may be explained by slight alterations in the regulation of the MTF1 gene.<sup>[16]</sup> Genes associated with apoptosis and immune function are also responsive to zinc regulation.<sup>[17]</sup>

Zinc regulates immune function by receptor-mediated signal transduction. Zinc bound to a T-cell receptor joins with the protein tyrosine kinase enzyme<sup>[18]</sup> to activate the T cell. The transfer of information between and within cells that activate or inhibit communication with other cells, or that initiate signal transduction, allows an ion channel or a second messenger system to further activate immune cell function, differentiation, and proliferation.<sup>[19]</sup> The metal also functions as a signal molecule when released in the synaptic vesicles of “zinc-containing” nerve cells found almost exclusively in the brain<sup>[20]</sup>. Zinc-containing neurons bind zinc and glutamate suggesting that zinc may regulate the function of glutamatergic synapses.<sup>[20]</sup>

### Protein and Nucleic Acid Metabolism

Zinc plays a fundamental role in protein and nucleic acid metabolism, and cell division and differentiation. Deficiency has a greater effect on cell division, a function of nucleoprotein synthesis, than on cell growth, which is a function of protein synthesis. The adverse effects of inadequacy on gene expression and DNA or RNA metabolism impair cell division and cause growth failure.<sup>[21]</sup> The effect of severe zinc shortage on protein synthesis may increase amino acid oxidation. The metal is required for the normal synthesis of collagen (essential for wound healing), metallothionein (a protein involved in zinc homeostasis), and immune proteins.

### Lipid and Carbohydrate Metabolism

Zinc-dependent enzymes are involved in the metabolism of carbohydrate and lipid, and release of energy. They also are involved in the synthesis of long-chain fatty acids from their dietary precursors and the formation of various prostaglandins. Zinc also appears to stabilize membranes by binding directly to protein and lipid components. Impaired glucose tolerance is associated with zinc deficiency, possibly because the metal is required for insulin to control glucose uptake by adipocytes.

## METABOLISM

### Zinc Distribution in Humans

Zinc is present in all tissues, organs, fluids, and secretions of the body. The total body content is 1.5 g in females and 2.5 g in males. The zinc concentration of various tissues of the body and proportion of total body Zn vary. Its concentration is highest in bone, muscle, prostate, and kidney tissue and is lowest in brain, skin, heart, and plasma.<sup>[22]</sup> Bone and skeletal muscle comprise 86% of total body zinc. Approximately, 95% is found within cells.<sup>[23]</sup>

### Zinc Absorption

Advances in knowledge regarding the molecular understanding of zinc absorption by the gastrointestinal tract contribute to and support previous studies of zinc metabolism, absorption kinetics, and homeostatic regulation. The discovery of zinc transporters suggests that zinc metabolism in human cells is strongly influenced by transporter genes regulated by diet and hormones/cytokines, by their tissue specificity of expression and interactions, as well as by mutations and polymorphisms in these genes and their phenotypic consequences.

Two families of zinc transporter proteins exist. The ZnT (ZnT1–ZnT9) and ZIP family (at least 15 mammalian ZIP transporters) each have numerous members.<sup>[24,25]</sup> ZnTs facilitate zinc efflux across the plasma membrane or into intracellular vesicles. In contrast, ZIPs enable zinc influx into cells or from vesicles. Localization and expression of ZnT and ZIP genes may be a function of physiologic conditions and body zinc status.<sup>[26,27]</sup> Specific transporters, more than bind multiple divalent ions, may explain some metal-metal interactions (e.g., zinc and iron).<sup>[28]</sup> Human ZnT and ZIP genes respond to zinc by up- or downregulation,<sup>[17]</sup> and may contribute to the tight homeostatic control of zinc.

Zinc is absorbed along the entire intestinal tract.<sup>[29]</sup> The human jejunum has the highest rate of absorption.<sup>[30]</sup> However, other studies with humans and animals suggest the duodenum is most important to the overall amount of zinc absorbed because the duodenal lumen has the highest initial zinc concentration after a meal.<sup>[31]</sup> Zinc resecreted into the digestive tract from sloughed-off intestinal and pancreatic cells or endogenous secretions contributes to the high concentration of zinc in the duodenal lumen. The estimated average requirement (EAR) and recommended dietary allowance (RDA) for zinc are now based on endogenous zinc excretion, to which intestinal secretion is the major contributor. Apparent absorption

averages 33% and is a factor used to compute the RDA.<sup>[32]</sup> Factors that influence endogenous intestinal zinc secretion, such as pancreatic insufficiency and inflammatory bowel disease, have an impact on intestinal zinc absorption/retention. The relationship between endogenous zinc loss and absorbed zinc is the basis around which the new RDA was constructed.

### Homeostatic Regulation

Total body zinc is primarily controlled by intestinal absorption. When dietary zinc intake decreases, absorption increases.<sup>[33,34]</sup> At the same time, endogenous losses decrease in response to low dietary intake.<sup>[32]</sup> During times of severe dietary zinc restriction, losses can be reduced to less than 1 mg/day.<sup>[35]</sup> Changes in physiologic state such as lactation increase absorption.<sup>[33,36]</sup> In contrast, states of stress and infectious disease may decrease zinc absorption.<sup>[6]</sup>

### Zinc Turnover and Transport

Plasma zinc comprises only 0.1% of total body zinc and is maintained within a narrow range (10–15  $\mu\text{mol/L}$ ). Reduction of zinc status in humans results in decreased plasma zinc levels, but results are not consistent.<sup>[37]</sup> Severe zinc depletion markedly reduces these levels.<sup>[38]</sup> Acute disease can decrease plasma zinc,<sup>[39]</sup> but acute starvation increases the levels to above normal.<sup>[40]</sup> After food is eaten, plasma zinc declines by about 15% over the next 2–3 hr, and may reflect hormonally regulated tissue zinc redistribution.<sup>[41]</sup> An increase in plasma zinc occurs when consumption is above the RDA.<sup>[42,43]</sup>

Zinc in plasma is bound to the proteins, albumin,<sup>[6]</sup> and  $\alpha_2$ -macroglobulin. Approximately, 70% of it in plasma is bound to albumin and exchanges easily ( $K_d = 7.5\text{M}$ ) with it.  $\alpha_2$ -Macroglobulin, a protease inhibitor and carrier of growth factors, binds the metal tightly and represents most of the remaining protein-bound zinc in plasma.<sup>[6,44]</sup> The flux of zinc through the plasma in the body is  $\sim 130$  times/day.<sup>[45]</sup>

Zinc in blood is found mainly in leukocytes (6 mg of Zn/ $10^6$  cells) compared to erythrocytes (1 mg of Zn/ $10^6$  cells).<sup>[46]</sup> Leukocytes actively make proteins, and cDNA array analyses have shown that leukocyte genes are very sensitive to zinc.<sup>[17]</sup> Genes expressed in circulating leukocytes may respond to plasma zinc levels.

Kinetic data, with both radioactive and stable isotopes, model how zinc pools turn over. Two metabolic pools have been identified in humans: a rapid pool that turns over in  $\approx 12.5$  days and a slow pool that turns over in 300 days.<sup>[47,48]</sup> Zinc rapidly turns over in liver, pancreas, kidney, and spleen, while slow turnover is

found in muscle and erythrocytes, followed by bone and the nervous system. Using a comparable metabolic model in rats identified the thymus, skin, spleen, intestine, and, especially, the bone marrow as important organs for zinc metabolism.<sup>[49]</sup> An exchangeable zinc pool (EZP) whose size is influenced by zinc intake has been defined in human subjects.<sup>[50]</sup> It is decreased after severe dietary zinc restriction. This may reflect the pool of zinc available to tissues and may therefore provide a measure of zinc status. The EZP encompasses all of the zinc in the plasma compartment, and some in the hepatic compartment.

### Zinc Reserves

Zinc has no specific storage site. Conservation mechanisms are such that tissue zinc levels are maintained during depletion. Supplemental zinc, above normal requirements, may provide some reserve in animals during a state of deficiency.<sup>[51]</sup> Occurrence of a comparable reserve in humans has not been investigated. Retention of body zinc is accomplished through powerful retention mechanisms and recycling. Red blood cells contain between 20 and 40  $\mu\text{g Zn/g}$  hemoglobin,<sup>[46,52]</sup> and the average circulating hemoglobin content is 750 g in adults. This represents a red blood cell zinc pool of 15–30 mg. The average life span of a red blood cell is 120 days. Therefore, turnover for this zinc pool is between 0.12 and 0.25 mg/day. This suggests that a meaningful amount of zinc needs to be supplied for erythropoiesis. A decline in erythropoiesis is known to occur with severe zinc deficiency in experimental animals.<sup>[53]</sup>

### Excretion

The major route of zinc excretion is secretion into the gastrointestinal tract. This is the combined contribution from the pancreatic secretions (enterohepatic circulation), sloughing of mucosal cells into the intestinal lumen, and transepithelial flux of intestinal zinc from the serosa to the mucosa.<sup>[6]</sup> The metal lost via pancreatic secretions comprises an ill-defined mixture, but certainly includes zinc metalloenzymes. It is not surprising, therefore, that pancreatic zinc secretion is stimulated by meals. Quantitatively, this may constitute the major route of fecal elimination. Gastrointestinal secretion is a function directly related to dietary zinc intake. Estimates are as low as  $<1$  mg/day in a severe dietary zinc restriction state (0.3 mg/day).<sup>[35]</sup> At realistic intakes of 7–15 mg/day, secretion is 3.0–4.6 mg/day,<sup>[32,54]</sup> and increases proportionately at higher intakes. Urinary zinc output is low ( $<1$  mg/day) and is refractory to change over a wide intake range (4–25 mg/day).<sup>[35,55]</sup> Starvation/trauma

and other conditions that increase muscle protein catabolism will increase urinary zinc as the load of amino acids filtered by the kidney increases. Some supplements that bind zinc tenaciously (e.g., zinc picolinate) may promote its loss in the urine.<sup>[56]</sup> Glucagon has been shown to regulate zinc reabsorption by the renal tubular system.<sup>[57]</sup> A number of zinc transporters are expressed in kidney. It has been proposed that ZnT1, an efflux transporter, is oriented such that it contributes to zinc reabsorption.<sup>[58]</sup> While not well explored, it is generally held that zinc transporter expression responding to dietary zinc intake regulates endogenous zinc secretion into the intestine and zinc conservation by the renal supply.

Other losses of zinc include those through integument (1 mg/day), semen (1 mg/ejaculate), menstruation (0.1–0.5 total), and pregnancy (100 mg total).<sup>[59]</sup> Lactation causes losses of 2.2 mg/day at 4 weeks and 0.9 mg/day at 35 weeks.<sup>[32]</sup> A few women produce milk with low amounts of the metal, although this reduction is not explained by altered expression of the transporter ZnT4 in mammary gland.<sup>[60]</sup>

## ZINC INADEQUACY

### Identification of Inadequacy

Diagnosis of zinc deficiency is difficult due to the lack of a specific diagnostic marker. Plasma or serum zinc concentrations are most widely used for assessment of zinc status. However, plasma concentrations do not fluctuate with modest changes in dietary zinc and are influenced by metabolic conditions unrelated to zinc status (e.g., stress, infection, and hormonal state). Until more definitive markers are available, the status can be estimated from the dietary zinc intake and plasma zinc concentration. An individual with a low nonfasting plasma zinc level, i.e., less than 65 µg/dl, and a usual zinc intake that is less than the EAR should be considered at risk of poor zinc status. Deficiency may be common in less developed countries.<sup>[61,62]</sup> The mainly cereal- and grain-based diets consumed in less developed countries contain zinc in a form (bound to phytate) that is made unavailable for absorption by the intestine. Groups in the United States that are vulnerable to zinc deficiency include growing children, pregnant and lactating women, and possibly the elderly.<sup>[61]</sup>

### Symptoms of Inadequacy

Symptoms of severe zinc deficiency include dermatitis, alopecia (loss of hair), delayed wound healing, and apathy.<sup>[22]</sup> Poor growth, loss of appetite, impaired

immune function, and cognitive changes may occur in children with modest inadequacy.<sup>[63]</sup> Factors predisposing an individual to zinc depletion include increased requirement (infantile and adolescent growth spurts, pregnancy and lactation, and chronic infection), inadequate dietary supply (poor food choices, lack of animal food sources, alcoholism, and low socioeconomic status), decreased absorption (diet high in zinc chelating agents such as phytate, gastrointestinal dysfunction or disease), or increased losses (diarrheal fluid loss, postinfection or trauma, burns, surgery, and uncontrolled diabetes).

## INDICATIONS AND USAGE

### Zinc Sources

Major dietary sources of zinc include shellfish, red meats, liver, poultry and dairy products, whole grains, legumes, and fortified cereals. Since zinc functions as a cofactor or component of enzymes and proteins, it is not surprising that it is found primarily in animal food sources. In the United States, approximately 25% of the dietary zinc intake comes from beef.<sup>[64,65]</sup> Cereal grains also contain zinc in the outer layers of the kernel and the germ. Thus, refined cereals have less zinc than do whole grains. Infant formulas, infant cereals, and ready-to-eat breakfast cereals are fortified with zinc in the United States. The average zinc intake of Americans from food is 13 mg of zinc per day for men and 9 mg of zinc per day for women.<sup>[32]</sup>

### Bioavailability

The proportion of dietary zinc that is available for absorption in the small intestine varies depending on the other components of the diet. Phytate, a storage molecule for phosphorus in grains and seeds, strongly binds zinc in the gut making it unavailable for absorption.<sup>[66]</sup> The presence of calcium in the diet may enhance the binding between phytate and zinc, and further reduce zinc absorption.<sup>[67,68]</sup> On the other hand, protein or amino acids also bind zinc in the gut and increase the amount absorbed.<sup>[69]</sup> Since phytate is the primary dietary factor influencing zinc absorption, the availability of zinc for absorption can be predicted from the phytate : zinc molar ratio of the diet, which is calculated as follows:<sup>[70]</sup>

$$(\text{mg phytate}/660)/(\text{mg zinc}/65.4)$$

Diets with a phytate : zinc molar ratio below 15 are considered to have relatively high zinc availability, whereas those with a molar ratio greater than 25 have

low availability.<sup>[71]</sup> Since animal food sources do not contain phytate, meat-based diets have phytate:zinc ratios below 15. Cereal-based diets lacking animal food sources tend to have ratios above 25.

### Supplement Use

About 15% of the Americans augment their dietary intake of zinc with zinc supplements.<sup>[72,73]</sup> The amount of zinc in multivitamin/multimineral supplements ranges from 10 to 25 mg/dose. Oral supplements may also be purchased that provide as much as 100 mg of zinc per tablet. When the average zinc intake from food and supplements is compared to the average intake from food alone, it is increased from 10 to 11 mg zinc per day. However, the 95th percentile of intake from food and supplements ranges from 33 to 45 mg/day due to the high amounts of zinc in some supplements.

### Recommended Intake Levels

In 2002, the U.S. Food and Nutrition Board of the National Academy of Sciences reviewed its recommendations for zinc intake.<sup>[32]</sup> A factorial approach was used to set the RDA meaning that the recommended intake is based on the amount of zinc required to replace zinc losses from the body each day. The RDA represents a daily intake that ensures adequate nutrition for 95–97.5% of the population and is an overestimation of the level needed in most individuals. The recommendations are summarized in Table 1.

### Treatment of Zinc Depletion

Supplementation with a modest amount of zinc readily corrects zinc depletion.<sup>[74,75]</sup> The amount used should not exceed the zinc upper levels (ULs) (Table 2).

### Prevention of Zinc Depletion In Children Worldwide

From the results of a series of randomized trials performed around the world, it is evident that modest zinc supplementation enhances linear growth,<sup>[74]</sup> and reduces the incidence of diarrheal disease,<sup>[76,77]</sup> pneumonia,<sup>[78]</sup> and malaria<sup>[75,79]</sup> in children living in developing countries. In populations with evidence of dietary zinc deficiency and with high rates of stunting and/or low plasma zinc concentrations, supplementation should be implemented to promote children's growth, particularly for children under 24 mo of age. Criteria for identifying populations at risk for zinc deficiency are summarized in Table 3. The suggested

**Table 1** Recommended dietary allowance (RDA)<sup>a</sup>

Age	RDA (mg/day)	
	Male	Female
0–6 mo <sup>b</sup>		
7–12 mo	3	3
1–3 yr	3	3
4–8 yr	5	5
9–13 yr	8	8
14–18 yr	11	9
19–50 yr	11	8
≤51 yr	11	8
<i>Pregnancy</i>		
≤18 yr		13
19–50 yr		11
<i>Lactation</i>		
≤18 yr		14
19–50 yr		12

<sup>a</sup>U.S. Food and Nutrition Board of the Institute of Medicine, 2002.

<sup>b</sup>Recommended intake is equivalent to average human milk zinc content.

dosage of supplemental zinc is 5 mg/day for children under 6 yr of age and 10 mg/day for those over 6 and adults.<sup>[1]</sup>

The World Health Organization (WHO) advocates providing 20 mg/day of zinc supplementation for 10–14 days (10 mg/day for infants under 6 mo old) for management of acute diarrhea.<sup>[80]</sup>

### Disease Treatment

#### Common cold

The use of zinc lozenges within 24 hr of the onset of cold symptoms and continued every 2–3 hr while awake has been advocated for reducing the duration of the common cold.<sup>[81]</sup> Ten randomized controlled trials have been conducted to evaluate the use of zinc lozenges on the duration of colds; five showed a positive effect and five reported no effect. A meta-analysis of the effectiveness of the lozenges in reducing the duration of the common cold failed to find a significant effect.<sup>[82]</sup> Taking these lozenges every 2–3 hr while awake results in a total zinc intake that exceeds the recommended upper zinc level (UL) of 40 mg/day (Table 2). Some individuals have reported gastrointestinal disturbances and mouth irritation while using them.<sup>[83]</sup>

#### Alzheimer's disease

Brains of patients with Alzheimer's disease are filled with numerous deposits of a substance called amyloid.

**Table 2** Tolerable upper intake levels (UL) for zinc

Age group	UL (mg/day)
0–6 mo	4
7–12 mo	5
1–3 yr	7
4–8 yr	12
9–13 yr	23
14–18 yr	34
19–50 yr	40
>50 yr	40
<i>Pregnancy</i>	
≤18 yr	34
>18 yr	40
<i>Lactation</i>	
≤18 yr	34
>18 yr	40

The primary component of amyloid is a protein called A-beta, which is normally found in many body fluids such as plasma and cerebrospinal fluid. A-beta binds to zinc very strongly at levels that are only slightly higher than those normally found in the human brain. Possibly, abnormal brain zinc metabolism in Alzheimer's patients causes A-beta to deposit as amyloid.<sup>[84,85]</sup> In a study of 12 nuns with Alzheimer's disease, plasma zinc levels were measured about 1 yr before their deaths. Those nuns with low blood zinc levels had more brain plaques at autopsy. This does not indicate that poor zinc nutrition is a cause of Alzheimer's disease, since it is possible that people with this disorder metabolize zinc differently.

### HIV/AIDS

Zinc is required for the synthesis of immune proteins and for maintaining normal immune function. In the late stages of acquired immunodeficiency syndrome (AIDS), excessive losses of zinc from diarrhea increase the requirement for zinc. Furthermore, plasma zinc concentrations may be low as a result of cytokine-directed redistribution of zinc in the liver and other

tissues. In a randomized controlled trial of zinc supplementation (45 mg zinc per day for 1 mo), opportunistic infections were reduced in AIDS patients in comparison to a placebo group. However, the human immunodeficiency virus (HIV) requires zinc; here, zinc supplementation may actually enhance disease progression. In one observational study, use of zinc supplements was associated with poorer survival among AIDS patients. Until further information is available on optimal zinc intakes for HIV-infected individuals, the amount of supplemental zinc taken by AIDS patients should not exceed the UL (Table 3).

### Other diseases

Prepubertal children with sickle cell disease (SCD) may have zinc deficiency and may benefit from zinc supplementation to improve linear growth and weight gain. SCD children supplemented with 10 mg zinc per day had significantly greater increases in height ( $0.66 \pm 0.29$  cm/yr), sitting height ( $0.97 \pm 0.40$  cm/yr), knee height ( $3.8 \pm 1.2$  mm/yr), and arm circumference Z scores ( $0.27 \pm 0.12$  cm/yr).<sup>[86]</sup>

Wilson's disease is an autosomal recessive inherited disorder in which excessive copper is stored in the liver and later in the brain and other organs that results in liver and/or neuropsychiatric disease. Treatment requires life long administration of copper chelators (D-penicillamine, and trientine). Oral zinc supplements are frequently used as an alternative treatment. However, prospective randomized controlled studies have not been conducted.<sup>[87,88]</sup>

### Contraindications

At present, the incidence of zinc toxicity is far less frequent than that of moderate or mild zinc deficiency. However, with increased use of zinc supplements and zinc-fortified foods, the tolerance for high intakes may be exceeded, and toxicity may occur. In 1998, about one-half of the toddlers in the United States reported zinc intakes that were greater than the UL recommended by the Institute of Medicine (IOM).<sup>[89]</sup>

**Table 3** Criteria for identifying populations at risk for zinc deficiency

Indicator	Criterion	Recommended cut-off
Rates of stunting among children under 5 years	Length-for-age or height-for-age Z-score < -2	≥20% of the population
Adequacy of dietary zinc intakes	Proportion of population with intakes below two-thirds of the RDA	≥20% of the population
Plasma or serum zinc	Proportion of population below nonfasting concentration of 65 μg/dl (70 μg/dl fasting)	≥20% of the population

(Adapted from Ref.<sup>[1]</sup>.)

Isolated outbreaks of acute toxicity have occurred as a result of consumption of food or beverages contaminated with zinc from galvanized containers or from accidental exposure to zinc oxide fumes. The overt toxicity symptoms include nausea, vomiting, epigastric pain, lethargy, and fatigue.

Chronic overdosage of zinc (i.e., 100–300 mg zinc per day) is of greater concern than acute toxicity because it is more common and is less easily detected. The major consequence of chronic excess zinc is its negative effect on copper absorption and status. Intakes as low as 60 mg zinc per day have been shown to reduce erythrocyte copper–zinc superoxide dismutase (ESOD) activity, a sensitive marker of copper status.<sup>[90]</sup> Doses between 50 and 100 mg zinc per day have lowered high-density lipoprotein (HDL) cholesterol in some,<sup>[91,92]</sup> but not all, studies.<sup>[93]</sup> ULs of zinc intake, based on studies using ESOD activity, have been established by the U.S. Food and Nutrition Board of the Institute of Medicine<sup>[32]</sup> to prevent the symptoms of zinc overdosage.

## ADVERSE INTERACTIONS

Zinc deficiency may also be related to a competitive interaction with iron. The findings are varied, however, possibly due to the form of iron, whether the additional iron is taken with a meal or not, and the amounts of iron and zinc fed. In general, large quantities of supplemental iron (i.e., greater than 50 mg) appear to reduce zinc absorption,<sup>[94]</sup> and the effect is greater when iron and zinc are given together under fasting conditions than when consumed with food or as part of a meal.<sup>[95,96]</sup> Since supplemental iron, but not supplemental zinc, is often prescribed for pregnant women, infants, and children, there is a concern that their zinc status could be impaired. It is unlikely, however, that high intake of iron in food interferes with zinc absorption.

## Alcohol and Drugs

Alcohol and other drugs may have an adverse effect on zinc status by reducing zinc absorption or by increasing zinc excretion. When alcohol is used on a regular basis, it appears to increase zinc losses and lower tissue zinc levels. This does not occur with occasional alcohol use. The effect of alcohol on zinc is dependent on the amount and frequency of alcohol consumption.

A number of drugs can affect zinc status. Some anticancer drugs and aspirin may chelate zinc and make it less available for absorption. Other drugs, such as penicillamine, chelate zinc within the tissues and increase zinc losses. Prophylactic coadministration of

25 mg of zinc may be indicated when these drugs are used.

## CONCLUSIONS

Groups at risk of zinc deficiency include those with high zinc needs such as preterm infants, growing children and adolescents, and pregnant and lactating women. Dietary zinc intakes in the United States are adequate for most groups, with the exception of vegans, who may not consume fortified cereals, and possibly the elderly. Supplemental zinc has been used to treat a variety of diseases; however, not all disease outcomes are improved. Individuals experiencing trauma and tissue breakdown lose zinc from tissues, and zinc supplements are used to treat wound healing. Supplements may also be indicated for those taking drugs that chelate zinc. The WHO advocates providing 20 mg/day of zinc supplementation for 10–14 days (10 mg/day for infants under 6 months old) for management of acute diarrhea.<sup>[80]</sup>

## REFERENCES

1. IZNC Group. IZiNCG Technical Document #1: assessment of the risk of zinc deficiency in populations and options for its control. *Food Nutr. Bull.* **2004**, *2* (1 Suppl. 2), S91–S204.
2. Prasad, A.S.; Halsted, J.A.; Nadami, M. Syndrome of iron deficiency anaemia hepatosplenomegaly, hypogonadism, dwarfism and geophagia. *Am. J. Med.* **1961**, *31*, 532–546.
3. da Silva, J.J.R.; RJP, W. *The Biological Chemistry of the Elements: The Inorganic Chemistry of Life*; Clarendon Press: Oxford, 1991; 1–561.
4. Cousins, R.J. Metal elements and gene expression. *Annu. Rev. Nutr.* **1994**, *14*, 449–469.
5. Vallee, B.L.; Falchuk, K.H. The biochemical basis of zinc physiology. *Physiol. Rev.* **1993**, *73*, 79–118.
6. Cousins, R.J. Zinc. In *Present Knowledge in Nutrition*; Ziegler, E.E., Filer, L.J., Jr., Eds.; ILSI Press: Washington, DC, 1996; 293–306.
7. Klug, A.; Rhodes, D. ‘Zinc fingers’: a novel protein motif for nucleic acid recognition. *Tr. Biochem. Sci.* **1987**, *12*, 464–469.
8. Cousins, R.J.; Lanningham-Foster, L. Regulation of cysteine-rich intestinal protein, a zinc finger protein, by mediators of the immune response. *J. Infect. Dis.* **2000**, *182* (Suppl. 1), S81–S84.
9. Cui, L.; Blanchard, R.K.; Cousins, R.J. Regulation of zinc metabolism and genomic outcomes. *J. Nutr.* **2003**, *133*, 51–56.
10. Powell, S.R. The antioxidant properties of zinc. *J. Nutr.* **2000**, *130* (5), 1447S–1454S.

11. Cousins, R.J. et al. Regulation of zinc metabolism and genomic outcomes. *J. Nutr.* **2003**, *133* (5 Suppl. 1), 1521S–1526S.
12. Thompson, C.B. Apoptosis in the pathogenesis and treatment of disease. *Science* **1995**, *267*, 1456–1462.
13. Thornalley, P.J.; Vasak, M. Possible role for metallothionein in protection against radiation-induced oxidative stress. *Biochim. Biophys. Acta* **1985**, *827*, 36–44.
14. Lichtlen, P. et al. Target gene search for the metalresponsive transcription factor MTF-1. *Nucleic Acids Res.* **2001**, *29* (7), 1514–1523.
15. Jiang, H.; Daniels, P.J.; Andrews, G.K. Putative zinc-sensing zinc fingers of metal-response element-binding transcription factor-1 stabilize a metal-dependent chromatin complex on the endogenous metallothionein-I promoter. *J. Biol. Chem.* **2003**, *278* (32), 30,394–30,402.
16. Otsuka, F. et al. Novel responses of ZRF, a variant of human MTF-1, to in vivo treatment with heavy metals 1. *Biochim. Biophys. Acta (BBA)—Gene Struct. Expr.* **2000**, *1492* (2–3), 330–340.
17. Cousins, R.J. et al. A global view of the selectivity of zinc deprivation and excess on genes expressed in human THP-1 mononuclear cells. *Proc. Natl. Acad. Sci. U.S.A.* **2003**, *100* (12), 6952–6957.
18. Huse, M.; Eck, M.J.; Harrison, S.C. A Zn<sup>2+</sup> ion links the cytoplasmic tail of CD4 and the N-terminal region of Lck. *J. Biol. Chem.* **1998**, *273* (30), 18,729–18,733.
19. Maret, W. Crosstalk of the group IIa and IIb metals calcium and zinc in cellular signaling. *Proc. Natl. Acad. Sci.* **2001**, *98* (22), 12,325–12,327.
20. Frederickson, C.J.; et al. Importance of zinc in the central nervous system: the zinc-containing neuron. *J. Nutr.* **2000**, *130* (5), 1471S–1483S.
21. Rivera, J.A. et al. Zinc supplementation improves the growth of stunted rural Guatemalan infants. *J. Nutr.* **1998**, *128*, 556–562.
22. King, J.C.; Keen, C.L. Zinc. In *Modern Nutrition in Health and Disease*; Shils, M.E., Ed.; Lea & Febiger: Philadelphia, 1999; 223–239.
23. Truong-Tran, A.Q. et al. Cellular zinc fluxes and the regulation of apoptosis/gene-directed cell death. *J. Nutr.* **2000**, *130* (5), 1459S–1466S.
24. Eide, D.J. The SLC39 family of metal ion transporters. *Pflügers Arch. Eur. J. Physiol.* **2004**, *447*, 796–800.
25. Palmiter, R.D.; Huang, L. Efflux and compartmentalization of zinc by members of the SLC30 family of solute carriers. *Pflügers Arch. Eur. J. Physiol.* **2004**, *447*, 744–751.
26. Liuzzi, J.P. et al. Zinc transporters 1, 2 and 4 are differentially expressed and localized in rats during pregnancy and lactation. *J. Nutr.* **2003**, *133* (2), 342–351.
27. Dufner-Beattie, J. et al. Structure, function, and regulation of a subfamily of mouse zinc transporter genes. *J. Biol. Chem.* **2003**, *278* (50), 50,142–50,150.
28. McMahon, R.J.; Cousins, R.J. Mammalian zinc transporters. *J. Nutr.* **1998**, *128*, 667–670.
29. Solomons, N.W.; Cousins, R.J. Zinc. In *Absorption and Malabsorption of Mineral Nutrients*; Solomons, N.W., Rosenberg, I.H., Eds.; Alan R. Liss, Inc.: New York, 1984; 125–197.
30. Lee, H.H. et al. Zinc absorption in human small intestine. *Am. J. Physiol.* **1989**, *256*, G87–G91.
31. Matseshe, J.W. et al. Recovery of dietary iron and zinc from the proximal intestine of healthy man: studies of different meals and supplements. *Am. J. Clin. Nutr.* **1980**, *33*, 1946–1953.
32. Institute of Medicine, P.o.M. In *Dietary Reference Intakes: Vitamin A, Vitamin K, Arsenic, Boron, Chromium, Copper, Iodine, Iron, Manganese, Molybdenum, Nickel, Silicon, Vanadium, and Zinc*; National Academy Press: Washington, DC, 2002.
33. Fung, E.B. et al. Zinc absorption in women during pregnancy and lactation: a longitudinal study. *Am. J. Clin. Nutr.* **1997**, *66*, 80–88.
34. Morgan, P.N. et al. The plasma zinc response to food consumption in elderly women. *FASEB J.* **1990**, *4*, A648.
35. Baer, M.T.; King, J.C. Tissue zinc levels and zinc excretion during experimental zinc depletion in young men. *Am. J. Clin. Nutr.* **1984**, *39*, 556–570.
36. Moser-Veillon, P.B. Zinc needs and homeostasis during lactation. *Analyst* **1995**, *120*, 895–897.
37. King, J.C. Assessment of zinc status. *J. Nutr.* **1990**, *120*, 1474–1479.
38. Gordon, P.R. et al. Effect of acute zinc deprivation on plasma zinc and platelet aggregation in adult males. *Am. J. Clin. Nutr.* **1982**, *35*, 113–119.
39. Falchuck, K. Effect of acute disease and ACTH on serum zinc proteins. *N. Engl. J. Med.* **1977**, *296*, 1129–1134.
40. Fell, G.S. et al. Urinary zinc levels as an indication of muscle catabolism. *Lancet* **1973**, *2*, 280–282.
41. King, J.C. et al. Daily variation in plasma zinc concentrations in women fed meals at six-hour intervals. *J. Nutr.* **1994**, *124*, 508–516.
42. Cao, J.; Cousins, R.J. Metallothionein mRNA in monocytes and peripheral blood mononuclear cells and in cells from dried blood spots increases after zinc supplementation of men. *J. Nutr.* **2000**, *130* (9), 2180–2187.

43. Jackson, M.J. Zinc and di-iodohydroxyquinoline therapy in acrodermatitis enteropathica. *J. Clin. Pathol.* **1977**, *30*, 284–287.
44. Cousins, R.J. Systemic transport of zinc. In *Zinc in Human Biology*; Mills, C.F., Ed.; Springer-Verlag: London, 1989; 79–93.
45. Lowe, N.M. et al. A compartmental model of zinc metabolism in healthy women using oral and intravenous stable isotope tracers. *Am. J. Clin. Nutr.* **1997**, *65*, 1810–1819.
46. Milne, D.B.; Ralston, N.V.; Wallwork, J.C. Zinc content of cellular components of blood: methods for cell separation and analysis evaluated. *Clin. Chem.* **1985**, *31*, 65–69.
47. Foster, D.M. et al. Zinc metabolism in humans: a kinetic model. *Am. J. Physiol.* **1979**, *237*, R340–R349.
48. Wastney, M.E. et al. Kinetic analysis of zinc metabolism and its regulation in normal humans. *Am. J. Physiol.* **1986**, *251*, R398–R408.
49. Dunn, M.A.; Cousins, R.J. Kinetics of zinc metabolism in the rat: effect of dibutyryl cAMP. *Am. J. Physiol.* **1989**, *256*, E420–E430.
50. Miller, L.V. et al. Size of the zinc pools that exchange rapidly with plasma zinc in humans: alternative techniques for measuring and relation to dietary zinc intake. *J. Nutr.* **1994**, *124*, 268–276.
51. Emmert, J.L.; Baker, D.H. Zinc stores in chickens delay the onset of zinc deficiency symptoms. *Poult. Sci.* **1995**, *74*, 1011–1021.
52. Diaz-Gomez, N.M. et al. The effect of zinc supplementation on linear growth, body composition, and growth factors in preterm infants. *Pediatrics* **2003**, *111* (5), 1002–1009.
53. Morgan, P.N.; Wehr, C.M.; King, J.C. Suppression of erythrocyte production in zinc deficient pregnant rats. *FASEB J.* **1993**, *5*, A930–A939.
54. Hambidge, M. Human zinc deficiency. *J. Nutr.* **2000**, *130*, 1344S–1349S.
55. Jackson, M.J.; Jones, D.A.; Edwards, R.H.T. Zinc homeostasis in man: studies using a new stable isotope-dilution technique. *Br. J. Nutr.* **1984**, *51*, 199–208.
56. Seal, C.J.; Heaton, F.W. Effect of dietary picolinic acid on the metabolism of exogenous and endogenous zinc in the rat. *J. Nutr.* **1985**, *115*, 986–993.
57. Victory, W.; Levenson, R.; Vander, A.J. Effect of glucagon on zinc excretion in anesthetized dogs. *Am. J. Physiol.* **1981**, *240*, F299–F305.
58. Cousins, R.J.; McMahon, R.J. Integrative aspects of zinc transporters. *J. Nutr.* **2000**, *130* (Suppl. 5S), 1384S–13847S.
59. Swanson, C.A.; King, J.C. Zinc and pregnancy outcome. *Am. J. Clin. Nutr.* **1987**, *46*, 763–771.
60. Michalczyk, A. et al. Analysis of zinc transporter, hZnT4 (Slc30A4), gene expression in a mammary gland disorder leading to reduced zinc secretion into milk. *Hum. Genet.* **2003**, *113*, 202–210.
61. Sandstead, H. Zinc deficiency. A public health problem? *Am. J. Dis. Child* **1991**, *145* (8), 853–859.
62. Gibson, R.S. Zinc nutrition in developing countries. *Nutr. Res. Rev.* **1994**, *7*, 151–173.
63. Black, M.M. Zinc deficiency and child development. *Am. J. Clin. Nutr.* **1998**, *68* (Suppl.), 464S–469S.
64. Subar, A.F. et al. Dietary sources of nutrients among US adults, 1989 to 1991. *J. Am. Diet. Assoc.* **1998**, *98* (5), 537–547.
65. Ma, J.; Betts, N.M. Zinc and copper intakes and their major food sources for older adults in the 1994–96 continuing survey of food intakes by individuals (CSFII). *J. Nutr.* **2000**, *130* (11), 2838–2843.
66. Sandstrom, B.; Lonnerdal, B. Promoters and antagonists of zinc absorption. In *Zinc in Human Biology*; Mills, C.F., Ed.; Springer-Verlag: Devon, U.K., 1989; 57–78.
67. Wood, R.J.; Zheng, J.J. High dietary calcium intakes reduce zinc absorption and balance in humans. *Am. J. Clin. Nutr.* **1997**, *65*, 1803–1809.
68. Hunt, J.R. et al. High- versus low-meat diets: effects on zinc absorption, iron status, and calcium copper, iron, magnesium, manganese, nitrogen, phosphorus, and zinc balance in postmenopausal women. *Am. J. Clin. Nutr.* **1995**, *62*, 621–632.
69. Sandstrom, B. *Proc. Nutr. Soc.* **1992**, *51*, 211–218.
70. World Health Organization. *Trace Elements in Human Nutrition and Health*; World Health Organization: Geneva, 1996.
71. Sandstrom, B. Dietary pattern and zinc supply. *Zinc in Human Biology*; Mills, C.F., Ed.; Springer-Verlag: Devon, U.K., 1989; 350–363.
72. Briefel, R.R. et al. Zinc intake of the U.S. population findings from the Third National Health and Nutrition Examination Survey 1988–1994. *J. Nutr.* **2000**, *130* (5), 1367S–1373S.
73. Ervin, R.B.; Kennedy-Stephenson, J. Mineral intakes of elderly adult supplement and non-supplement users in the third national health and nutrition examination survey. *J. Nutr.* **2002**, *132* (11), 3422–3427.
74. Brown, K.H. et al. Effect of supplemental zinc on the growth and serum zinc concentrations of prepubertal children: a meta-analysis of randomized controlled trials. *Am. J. Clin. Nutr.* **2002**, *75*, 1062–1071.
75. Bates, C.J. et al. A trial of zinc supplementation in young rural Gambian children. *Br. J. Nutr.* **1993**, *69*, 243–255.



76. Ruel, M.T. et al. Impact of zinc supplementation on morbidity from diarrhea and respiratory infections among rural Guatemalan children. *Pediatrics* **1997**, *99* (6), 808–813.
77. Sazawal, S. et al. Efficacy of zinc supplementation in reducing the incidence and prevalence of acute diarrhea—a community-based, double blind, controlled trial. *Am. J. Clin. Nutr.* **1997**, *66*, 413–418.
78. Sazawal, S. et al. Zinc supplementation reduces the incidence of acute lower respiratory infections in infants and preschool children: A double-blind, controlled trial. *Pediatrics* **1998**, *102*, 1–5.
79. Shankar, A.H. et al. The influence of zinc supplementation on morbidity due to *Plasmodium falciparum*: a randomized trial in preschool children in Papua New Guinea. *Am. J. Trop. Med. Hyg.* **2000**, *62* (6), 663–669.
80. World Health Organization and UNICEF *WHO/UNICEF Joint Statement: Clinical Management of Acute Diarrhoea*; United Nations Children's Fund/World Health Organization: Geneva, 2004; 1–7.
81. Zinc lozenges reduce the duration of common cold symptoms. *Nutr. Rev.* **1997**, *55*, 82–85.
82. Jackson, J.L.; Peterson, C.; Lesho, E. A meta-analysis of zinc salts lozenges and the common cold. *Arch. Int. Med.* **1997**, *157*, 2373–2376.
83. Garland, M.L.; Hagemeyer, K.O. The role of zinc lozenges in treatment of the common cold. *Ann. Pharmacother.* **1998**, *32*, 63–69.
84. Licastro, F. et al. Impaired peripheral zinc metabolism in patients with senile dementia of probable Alzheimer's type as shown by low plasma concentrations of thymulin. *Biol. Trace Elem. Res.* **1996**, *51*, 55–62.
85. Cuajungco, M.P.; Lees, G.J. Zinc and Alzheimer's disease: is there a direct link? *Brain Res. Rev.* **1997**, *23*, 219–236.
86. Zemel, B.S. et al. Effect of zinc supplementation on growth and body composition in children with sickle cell disease. *Am. J. Clin. Nutr.* **2002**, *75* (2), 300–307.
87. Ferenci, P. Review article: diagnosis and current therapy of Wilson's disease. *Aliment. Pharmacol. Ther.* **2004**, *19* (2), 157–165.
88. Turnlund, J. Copper. In *Modern Nutrition in Health and Disease*; Shils, M.E., Olsen, J., Shike, M., Eds.; Lea & Febiger: Philadelphia, 1994; 231–241.
89. Arsenault, J.E.; Brown, K.H. Zinc intake of US preschool children exceeds new dietary reference intakes. *Am. J. Clin. Nutr.* **2003**, *78* (5), 1011–1017.
90. Yadrick, M.K.; Kenney, M.A.; Winterfeldt, E.A. Iron, copper, and zinc status: response to supplementation with zinc or zinc and iron in adult females. *Am. J. Clin. Nutr.* **1989**, *49* (1), 145–150.
91. Black, M.R. et al. Zinc supplements and serum lipids in young adult white males. *Am. J. Clin. Nutr.* **1988**, *47* (6), 970–975.
92. Hooper, P.L. et al. Zinc lowers high-density lipoprotein-cholesterol levels. *J. Am. Med. Assoc.* **1980**, *244* (17), 1960–1961.
93. Samman, S.; Roberts, D.C. The effect of zinc supplements on lipoproteins and copper status. *Atherosclerosis* **1988**, *70* (3), 247–252.
94. Solomons, N.W.; Jacob, R.A. Studies on the bioavailability of zinc in humans: effects of heme and nonheme iron on the absorption of zinc. *Am. J. Clin. Nutr.* **1981**, *34*, 475–482.
95. Solomons, N.W. et al. Studies on the bioavailability of zinc in humans: mechanism of the intestinal interaction of nonheme iron and zinc. *J. Nutr.* **1983**, *113*, 337–349.
96. Solomons, N.W. et al. Studies on the bioavailability of zinc in man. II. Absorption of zinc from organic and inorganic sources. *J. Lab. Clin. Med.* **1979**, *94*, 335–343.

# Index

- Accutane<sup>®</sup> (vitamin A), 710  
Acetylcholine, 105, 107  
Acetyl-CoA carboxylase, biotin and, 32, 33  
Acetyl-L-carnitine. *See* Carnitine.  
Acitretin<sup>®</sup> (vitamin A), 710  
Acyl carrier protein (ACP), and pantothenic acid, 517, 518, 519, 520, 522, 523  
AdoMet. *See* SAME.  
Adrenarche and adrenopause, 169  
 $\alpha$ -Adrenoceptor blockers, and *Pygeum africanum* extract, 570, 573  
Afrodex<sup>®</sup> (yohimbe), 784  
Age-related macular degeneration. *See* AMD.  
Aglycone, and quercetin, 577, 578  
Alanine, and glutamine, 291  
*Allium sativum*. *See* Garlic.  
Alzheimer-type dementia, 107  
AMD, and lutein, 409, 417  
Anabolic steroids, 10, 11  
Androgens, 7, 169  
Androstenediol, 7, 10  
Androstenedione, 7–13, 172  
    adverse effects, 11  
    biochemistry and physiology, 7–8  
    contamination, 11  
    detection, 12  
    and feminization, 7, 10, 11  
    hormonal effects, 8–11  
        in men, 8–10  
        in women, 10–11  
    metabolism, 10  
    mislabeling, 11–12  
    muscle size and strength, effects on, 10  
    pharmacokinetics, 8–11  
        in men, 8–10  
        in women, 10–11  
    prohormones, 7, 10  
    precursor, 7  
    purity of, 11  
    regulatory status, 7, 12  
    site of production, 7  
    toxicity, 11  
    usage, 8. *See also* Doping.  
Anemia  
    iron and, 360, 361  
Aneurin. *See* Thiamin.  
*Angelica sinensis*. *See* Dang gui.  
Anticonvulsants, biotin and, 35, 36, 37  
Antiemetic, ginger, 241–248  
Antispasmodic effect, valerian and, 687  
Anxiolytic effect  
    kava and, 376, 377  
    valerian and, 687, 691, 697  
Arachidonic acid (AA), 494, 505, 506, 507, 509, 511, 512, 513  
Arginine paradox, 19  
Ascorbate, ascorbic acid. *See* Vitamin C.  
Astragalus, 25–30  
    biochemistry and function, 25–27  
    cardiovascular effects, 27  
    dosages, 28  
    driving, effect on, 28  
    hepatoprotective effects, 27  
    immunomodulatory effects, 25  
    indications, 28  
    interactions, 28  
    lactation, use in, 28  
    mutagenicity, 28  
    overdose, 28  
    pharmacodynamics, 25  
    pharmacokinetics, 25  
    precautions, 28  
    pregnancy, 28  
    regulatory status, 29  
    safety profile, 28  
    side effects, 28  
    toxicology, 28  
*Astragalus membranaceus*. *See* Astragalus.  
*Astragalus mongholicus*. *See* Astragalus.  
Avidin, 31, 35  
Awa. *See* Kava.  
Azidothymidine (AZT), and shiitake, 659, 661  
  
Bantu siderosis, 360  
Basic fibroblast growth factor (bFGF), and  
    *Pygeum africanum* extract, 571, 573  
B-complex vitamins  
    biotin, 31–40  
    folate, 219–228  
    niacin (vitamin B<sub>3</sub>), 483–491  
    pantothenic acid (vitamin B<sub>5</sub>), 517–525  
    thiamin (vitamin B<sub>1</sub>), 677–686  
    vitamin B<sub>6</sub>, 715–734  
    vitamin B<sub>12</sub>, 735–744  
Benign prostatic hyperplasia. *See* BPH.  
Berberine. *See* Goldenseal.  
Berzelius, discoverer of selenium, 645  
Betaine, and choline, 105, 106, 107, 109  
Bidrolar<sup>®</sup> (*Pygeum africanum* extract), 574  
Bifidobacteria. *See* Lactobacilli.  
Biotin, 31–40  
    absorption, intestinal, 31, 33, 34, 36  
    adequate intake (AI), 37  
    anticonvulsants and, 35, 36, 37  
    bioavailability, 33, 35  
    biochemistry, 31–33  
    blood, transport in, 34  
    carboxylases and, 31–33, 34, 35, 36, 37  
    as cofactor, 31  
    deficiency

- Biotin (*contd.*)  
 diagnosis, 35–37  
 marginal deficiency, 36  
 occurrence, 35–36  
 treatment of, 37  
 symptoms of, 36  
 digestion of protein bound, 33  
 estimated average requirement (EAR), 37  
 excretion, urinary, 35, 36  
 gene expression and, 37  
 hepatic uptake, 34  
 history of, 31  
 intake, 37  
 pharmacology, 35  
 physiology of, 33–35  
 renal handling, 34–35  
 structure, 31  
 synthesis  
   Goldberg/Sternbach method, 31  
   microbial, 31  
 toxicity, 37  
 transport, 33–35  
   in blood, 34  
   in CNS, 35  
   in human milk, 35  
   in placenta, 35  
 transporters, 33, 34, 35  
 usage, 37
- Biotinidase, 33, 34, 36
- Bisphosphonates, 69
- Black cohosh, 41–53  
 adverse effects, 50  
 biochemistry and functions, 48–49  
   cell proliferation, 49  
   CNS effects, 49  
   ER competitive binding, 48  
   estrus induction, 49  
   hormonal secretion, 49  
   neurotransmitter binding, 49  
   osteopenia inhibition, 49  
   plasma hormone levels, 48  
   receptor expression, 48  
   uterine weight, 49  
 chemistry, 41–42  
   aromatic acids, 41  
   triterpenes, 41  
 clinical studies, 42, 48  
 commercial products, 42  
 compendial/regulatory status, 50  
 description, botanical, 41  
 dosage, 42, 50  
 lactation, use in, 49  
 menopause, 42  
 pregnancy, use in, 49  
 regulatory status, 50  
 Remifemin<sup>®</sup>, 42, 48, 50  
 triterpene glycosides in, 41
- Bone mineral density (BMD). *See also* Osteoporosis.  
 DHEA and, 171  
 isoflavones and, 367  
 phosphorus and, 540  
 red clover and, 596
- Borate, 55, 57. *See also* Boron.
- Boric acid, 55, 56, 57. *See also* Boron.
- Boromycin, HIV and, 56. *See also* Boron.
- Boron, 55–63  
 animal and human tissues, 57  
 bioavailability and excretion, 58  
 biochemical forms, 55  
 boroster, 55  
 cartilage and bone structure, 60  
 dietary sources, 59  
 environmental forms, 55  
 immune function, 60  
 indications and usage, 59  
 insulin and glucose metabolism, 60  
 mineral metabolism, 59  
 nonfood personal care products, 59  
 overdose, 61  
 plant-based foods, 57  
 procaryotes, 56  
 sources and intakes, 58  
   dietary recommendations, 58  
   dietary supplements, 58  
 speciation, 55  
 steroid metabolism, 60
- BPH  
 and *Pygeum africanum* extract, 569, 570, 571  
 and saw palmetto, 638–639
- Calbindin, 67
- Calcitriol therapy, 70
- Calcium, 65–71  
 absorption of, 65, 67–68, 69, 70  
   magnesium in, 447  
 adverse reactions to, 70  
 contraindications in use of, 70  
 in cytosol, 18, 66, 124  
 excretion, 68  
 in extracellular fluid (ECF), 65, 66, 67  
 indications and usage, 68–70  
   ancillary therapy, 70  
   osteoporosis therapy, 69  
 internal economy of, 66–68  
   magnesium in, 451–452  
 magnesium, in Ca channel blocking, 445–456  
 metabolic functions, 65–66  
   bone remodeling/resorption, 65, 66, 67  
   intraluminal effects, 66  
   “off-loop” effects, 66  
 overdose, 70  
 pharmacology/physiology, 65–68  
 and phosphorus, 538, 539, 540, 541, 542  
 precautions, 70  
 preparations of, 69  
 protein tertiary structure and, 65  
 recommended intake levels, 68–69  
 regulatory status, 70  
 supplementation, 68, 70  
 thyroxin absorption, interference with, 70
- Calcium paradox disease, 66
- Camellia sinensis*. *See* Green tea polyphenols.
- Cantoni, G., discoverer of SAME, 1, 2
- Carbidopa, and 5-HTP, 350, 351, 353  
 and peripheral L-aromatic amino acid decarboxylase (AADC) inhibitors, 350, 353
- Carboxylases, biotin and, 31–33, 34, 35, 36, 37
- Careseng<sup>®</sup> (Asian ginseng), 261
- Carnitine, 73–80  
 adverse effects, 78  
 biochemistry and functions, 73–75  
   acyl-CoA/CoA ratio, modulation of, 74  
   ammonia intoxication prevention, 75

- fatty acids, transfer of, 73–74
  - glucocorticoid action, mimicking, 75
  - membrane phospholipid remodeling, 75
  - mitochondrial decay, reversal of, 75
  - thyroid hormone action, antagonism toward, 75
- CoA, interrelations with, 522
- compendial/regulatory status, 78
- deficiencies, 76
- dietary reference intake (DRI), 75
- indications and usage, 76–78
  - cardiovascular disease, 76, 77
  - chronic fatigue, 77
  - depression and cognitive function, 77, 78
  - diabetes, 78
  - end-stage renal disease, 76
  - exercise performance, 77
  - human immunodeficiency virus (HIV) infection, 78
  - liver dysfunction with hyperammonemia, 78
  - replacement therapy, 76–78
  - supplementation, 76–78
  - weight reduction, 77
- physiology, 75, 76
  - bioavailability, 75
  - biosynthesis, 75
  - dietary intake, 75
  - distribution, 75
  - homeostasis and renal handling, 76
  - tissue accumulation, 76
- recommended dietary allowance, 75
- Carnitine acetyltransferase (CAT), 74
- Carnitine–acylcarnitine translocase (CACT), 73, 74
- Carnitine palmitoyltransferase I (CPT I), 73
- β-Carotene, 81–87. *See also* Carotenoids.
  - absorption and metabolism, 81, 82–83
  - as antioxidant, 81, 84
  - bioavailability, 81–83
  - biochemistry and functions, 81
    - solar radiation, protection against, 81
    - vitamin A activity, 81, 83
  - contraindications, 84–85
  - indications and usage, 83–84
    - cancer prevention, 83
    - cardiovascular disease, 84
    - erythropoietic protoporphyria, 84, 85
    - and lung cancer risk, 81, 83, 84, 85
    - and lutein, 412, 416, 417
    - as provitamin A, 701, 702, 705, 706, 708
    - recommended intakes, 83
    - regulatory status, 85
    - safe upper level, 83
    - sources, 82, 83, 85
    - toxicity/adverse effects, 85
- Carotenodermia, 85, 418
- Carotenoids
  - β-carotene, 81–85
  - lutein, 409–420
  - lycopene, 421–434
  - and vitamin A, 702, 705, 706, 707, 708
- Cartilage
  - boron and, 60
  - chondroitin and, 113, 114
  - glucosamine and, 279, 280, 283, 284
- Cascara sagrada, 89–93
  - appearance, 89
  - chemistry, 89
    - glycosides, 89
  - commercial preparations, 89
  - laxative, use as, 90
  - pharmacology, 90
  - toxic activities, 90
  - use in humans, 91–92
    - adverse reactions, 91
    - contraindications, 91
    - dosage forms, 91
    - dose, 91
    - precautions, 91
    - regulatory status, 91
- Cataract, and lutein, 409, 417
- Chacon, and maca, 435
- Chasteberry, 95–103
  - adverse effects, 100
  - chemistry, 95
    - agnuside, 95
    - casticin, 95
    - diterpenes, 95
    - flavonoids, 95
    - iridoids, 95
  - clinical studies, 96–99
    - acne and, 99
    - corpus luteum insufficiency and, 96, 98
    - hyperprolactinemia and, 98
    - infertility and, 98–99
    - mastalgia and, 97–98
    - menstrual cycle irregularity and, 98–99
    - PMS and, 96–97
  - dosage, 100
  - mechanism of action, 99
    - dopaminergic, 99
    - estrogenic, 99, 100
    - prolactin, 98, 99
  - products, 100
  - therapeutic indications, 96
- Chitin, glucosamine precursor, 281, 282, 284
- Cholesterol synthesis, and coenzyme Q<sub>10</sub>, 121, 123, 127, 129
- Choline, 105–111
  - adequate intake (AI), 105, 109
  - biochemistry and nutrients, 105–106
    - synthesis, 105, 106, 107, 108, 109
  - and brain, 107–108
    - development, 108
    - function, 107
  - deficiency of, and organ function, 107
    - and cancer, 107
    - cardiovascular disease, 107
    - renal dysfunction, 107
  - dietary recommendations, 109
  - homocysteine, 105, 107, 110
  - physiology, 106–107
    - metabolism, 106–107
  - requirement, 108–109
    - adverse effects, 109
    - food sources, 109
    - gender and, 108
    - in milk, 108–109
    - in plasma, 109
    - pregnancy and, 108
- Chondroitin, 113–119
  - biochemistry, 113–114
    - and bovine spongiform encephalopathy (mad cow disease) risk, 117
  - clinical studies, 115–117
  - mechanisms of action, 115
  - and NSAIDs, 116, 117
  - pharmacology, 114

- Chondroitin (*contd.*)  
 bioavailability, 114  
 pharmacokinetics, 114  
 physiology, 113–114  
 preparations, 115  
 safety, 117  
 side effects, 117  
 structure, 113–114
- Chondroitin sulfate, 113, 114, 115, 116, 117
- Chrysanthemum parthenium*. *See* Feverfew.
- Cimicifuga racemosa*. *See* Black cohosh.
- Climacteric symptoms. *See also* Menopause.  
 black cohosh and, 41, 42  
 isoflavones and, 367
- Clonidine, 213
- Cobalamin. *See* Vitamin B<sub>12</sub>.
- Coenzyme A (CoA), and pantothenic acid.  
*See* Pantothenic acid.
- Coenzyme Q<sub>10</sub>, 121–131  
 analysis, 121  
 biochemistry, 121–123  
 biosynthesis, 121, 126, 127  
 enzymatic reduction, 123  
 mevalonate pathway, 121, 126  
 deficiency, 127, 128–129  
 aging, 128  
 cardiomyopathy, 127, 129  
 exercise, 129  
 genetic disorders, 127, 128  
 neurological disorders, 129  
 statin therapy, 129  
 dosage, 130  
 extraction, 121  
 functions, 123–125  
 antiatherogenic effects, 124  
 antioxidant activity, 123, 124  
 apoptosis, role in, 124  
 electron transport chain, role in, 123  
 enzymatic functions, 123  
 lipid peroxidation, role in, 124  
 mitochondrial pore opening, role in, 123–124  
 nonenzymatic functions, 123–125  
 protonmotive Q cycle, role in, 123  
 thermogenesis, role in, 124  
 uncoupling protein function, 124  
 vascular effects, 125  
 physiology, 125–128  
 bioavailability, 126–128  
 catabolism, 127  
 circulation, 126  
 endoplasmic reticulum (ER)–Golgi system and, 126  
 intracellular distribution, 125–126  
 regulation of tissue content, 127  
 tissue distribution, 125, 128. *See also* bioavailability.  
 transport, 126  
 uptake, 126, 127  
 semiquinone radical, 124  
 side effects, 130
- Commensal flora, 381, 382, 383, 384, 385
- Condensed tannins. *See* Proanthocyanidins.
- Contractile dysfunction, 572, 573
- Copper, 133–141  
 absorption, 134  
 actions, 133–134  
 in enzymes, 133, 136  
 adequate intake (AI), 135  
 biochemistry, 133–134  
 deficiency, 133, 135. *See also* indications and usage.  
 depletion experiments, 134, 135  
 estimated average requirement (EAR), 134, 135  
 glutathione metabolism and, 133  
 hypercholesterolemia and, 133  
 indications and usage, 134–137  
 anemia, 133, 135, 137  
 burn victims, use in, 136  
 cardiovascular abnormalities, 133, 135, 136  
 osteoporosis, 136  
 premature infants, use in, 136  
 iron and, 133  
 physiology, 133–134  
 phytates and, 134  
 recommended dietary allowance (RDA), 134, 135  
 sources, 134  
 supplements, 134  
 tolerable upper intake level (UL), 136, 137  
 toxicity, 136–137  
 vitamin C and, 137  
 in Western diet, 134  
 zinc and, 136, 137
- Copper gluconate, 134, 136
- CoQ, CoQH<sub>2</sub>. *See* Coenzyme Q<sub>10</sub>.
- Cortisol, and DHEA, 168
- Cranberry, 143–149  
 adverse effects, 146  
 chemistry, 143  
 flavonoids, 143, 145  
 phenolic acids, 143  
 proanthocyanidins, 144, 145  
 clinical studies, 146  
 efficacy, 146  
 contraindications, 147  
 drug interactions, 147  
 preclinical studies, 144  
 antiadhesion, 145  
 antioxidant, 145  
 atherosclerosis, 145  
 bioavailability, 144  
 cancer, 146  
 dental plaque, 145  
*Helicobacter pylori*, 145  
 urinary acidification, 144, 147  
 urinary tract infection, 145, 146  
 regulatory status, 147  
 safety studies, 146
- Crataegus*. *See* Hawthorn.
- Creatine, 151–158  
 adverse effects, 157  
 biochemistry and function, 151–153  
 biosynthesis, 151–153  
 chemical synthesis, 152  
 creatine kinase reaction, 152  
 structure, 151, 152  
 deficiency and supplementation, 151  
 deficiency syndromes, 153–156  
 AGAT deficiency, 155  
 GAMT deficiency, 153–155  
 significance of, 155, 156  
 SLC6A8 deficiency, 155  
 dosage, 151  
 physiology, 153  
 accumulation, 153  
 clearance, 153  
 tissue distribution, 153  
 sources, 156

- therapeutic use, 156, 157
  - in biosynthesis disorders, 156
  - ergogenic aid, 156
  - in neuromuscular disease, 156, 157
  - in sports, 156
- transporter, 151, 153, 155
- Creatine kinase (CK), 151–153
- Creatine phosphate, 541
  - as a phosphorus source, 537–538, 541
  
- DADS, and garlic, 230, 231, 233, 234, 235
- Daidzein, 363, 365, 366
- Dam, H., and vitamin K, 771
- Dang gui, 159–166
  - biochemistry and function, 159–162
    - pharmacodynamics, 159
    - pharmacokinetics, 159
  - dosages, 163
  - effects, 162
    - analgesic, 162
    - antioxidant, 161
    - on bone cells, 162
    - cardiovascular, 159
    - on driving, 164
    - gynecological, 161
    - hematopoietic, 161
    - hemorrhological, 159
    - hepatoprotective, 160
    - hormonal, 161
    - immunomodulatory, 161
    - menopausal, 161
    - on smooth muscle, 161
    - wound-healing, 162
  - medical indications, 162
  - regulatory status, 164
  - safety profile, 163
    - carcinogenicity, 164
    - contraindications, 163
    - interactions, 163
    - lactation, use in, 164
    - mutagenicity, 164
    - overdose, 164
    - precautions, 163
    - pregnancy, use in, 164
    - side effects of, 163
    - toxicology, 164
- DAS, and garlic, 231, 233, 234, 235
- DATS, and garlic, 234, 235
- Dehydroepiandrosterone, 167–176
  - biochemistry and physiology, 167–169
    - adrenarche and adrenopause, 169
    - biosynthesis and metabolism, 167–168
    - mechanisms of action, 169
    - production, regulation of, 168
  - compendial/regulatory status, 173
  - and cortisol, 168
  - history, 167
  - pharmacokinetics, 169–170
    - absorption and tissue distribution, 169
    - bioavailability, metabolism, and clearance, 169–170
    - supplementation, 170
  - pharmacology and toxicology, 172–173
    - adverse reactions, 173
    - contraindications, 173
    - dosage and administration, 173
    - drug interactions, 173
    - sources and preparations, 173
  - therapeutic applications, 170–172
    - adrenal insufficiency, 170
    - adrenopause and age-related disorders, 170–171
    - potential benefits, 171–172
- Depressant, valerian and, 691
- Depression, SAME and, 3, 4
- DHEA. *See* Dehydroepiandrosterone.
- Diallyl disulfide. *See* DADS.
- Diallyl sulfide. *See* DAS.
- Diallyl trisulfide. *See* DATS.
- Diatoms, and EFA, 505
- Dihomo- $\gamma$ -linolenic acid (DHHLA), 494
- Dihydrotestosterone (DHT), 571, 572
- Docosahexaenoic acid (DHA)
  - and omega-3 fatty acids, 493, 494, 495, 496, 497, 498, 499
  - and omega-6 fatty acids, 505, 507, 509, 512
- Docosapentaenoic acid (DPA)
  - and omega-3 fatty acids, 493, 497
- Dolichol synthesis, and coenzyme Q<sub>10</sub>, 121, 123, 129
- Doping, and anabolic steroids, 7, 11
- Du Vigneaud, V., experiments relating to SAME, 1
  
- Echinacea, 177–187
  - active principles, effects, and standardization, 178–183
    - adverse effects, 184–185
    - alkamides, 181–183
    - caffeic acid derivatives, 180–181
    - clinical efficacy, 183–184
    - clinical particulars, 184–185
    - contraindications, 184–185
    - dosage, 184
    - immunomodulatory activities, 183
    - polysaccharides and glycoproteins, 179–180
    - toxicological considerations, 185
  - historical use, 177
  - preparations, 177
  - regulatory status, 177
  - taxonomy
    - and upper respiratory tract infections, 177, 184
- Echinilin™ (echinacea), 184
- $\omega$ 3 EFA. *See* Omega-3 fatty acids.
- $\omega$ 6 EFA. *See* Omega-6 fatty acids.
- Efacal® (evening primrose), 203
- Efamast® (evening primrose), 197
- Efamol® (evening primrose), 204
- Eicosapentaenoic acid (EPA)
  - and omega-3 fatty acids, 493, 494, 495, 496, 497, 498, 499
  - and omega-6 fatty acids, 505, 507, 513
- End-stage renal disease. *See* ESRD.
- Endurance sports
  - androstenedione and, 7
  - creatine and, 156
- Energy storage, role of phosphorus, 539, 540, 541
- Ephedra, 189–195
  - action, 190
    - on asthma, 190
    - on heart, 190
  - adverse events, 192
  - clinical trials, 191
  - constituents, 190
    - alkaloids, 190, 191, 192
  - contraindications, 193
  - description, botanical, 189

- Ephedra (*contd.*)  
 drug interactions, 193  
 efficacy, 191  
   for athletic performance, 192  
   for weight loss, 191  
 historical use, 189–190  
 Nagai, N., and, 189  
 pharmacokinetics, 191  
 preclinical studies, 191  
 toxicology, 192  
   in vitro, 192  
   in vivo, 192  
*Ephedra* spp., 189  
 Epidermal growth factor (EGF), 571, 573  
 EPO. *See* Evening primrose.  
 Epogam<sup>®</sup> (evening primrose), 197, 199  
 Epogen<sup>®</sup> (iron), 361  
 Ergotamine, 213  
 Eritadenine, 658, 660  
 ESRD, and calcium, 66, 69, 70  
 Essential fatty acids (EFA), 505, 507, 509, 511  
 Estradiol, 7, 9, 10. *See also* Estrogens.  
 Estrogens, 7, 9, 10, 61, 169  
 Evening primrose, 197–210  
   and atopic dermatitis, 199–200  
   and cancer, 202–203  
   and cardiovascular disease, 201–202  
     antioxidant, 201  
   description, botanical, 197  
   and diabetes mellitus-induced neuropathy, 205–206  
   essential fatty acids, 197  
   and inflammatory diseases, 198–199  
   omega-3 fatty acids, 197  
   omega-6 fatty acids, 197  
     eicosanoids, 198, 201  
     metabolic functions, 197  
   and rheumatoid arthritis, 200–201  
   and women's health, 203–205  
     hot flashes, use in, 203  
     mastalgia, use in, 204  
     PMS, use in, 204  
     pregnancy, use in, 204  
 Evening primrose oil. *See* Evening primrose.
- $\omega$ 3 FA. *See* Omega-3 fatty acids.  
 FAD, 623, 624, 625, 626, 627, 629  
 Farnesyl pyrophosphate, coenzyme Q<sub>10</sub> precursor,  
   121, 122, 123, 127, 128, 129  
 FastOne<sup>®</sup> (proanthocyanidins), 563  
 Fatty acids (FA), 493, 495, 498, 499  
    $\beta$ -oxidation, CoA in, 521  
   synthesis, ACP and CoA in, 520  
   transesterification of, 73, 74, 77  
 Feminization, androstenedione and, 10, 11  
 Ferritin, 357, 358, 360  
 Feverfew, 211–217  
   ancient uses, 212  
   emmenagogue, use as, 212, 215  
   description, botanical, 211  
   modern uses  
     arthritis, use in, 212, 214–215  
     migraine, use in, 212, 214  
     psoriasis, use in, 212  
   chemical constituents, 213  
   essential oil, 213  
   flavonoids, 213  
   parthenolide, 211, 213, 215  
   sesquiterpene lactone (STL), 211, 213, 215  
   clinical studies, 214–215  
     mechanism of action, 215  
   safety, 215  
     adverse effects, 215  
     anti-platelet aggregation, 216  
     contraindications, 215  
     drug interactions, 215  
     toxicology, 215  
 Flavin adenine dinucleotide. *See* FAD.  
 Flavin mononucleotide. *See* FMN.  
 Flavonoids, 363. *See also* Isoflavones.  
   and quercetin, 577, 578, 579, 581  
   in saw palmetto, 638  
 Flavonol, and quercetin, 577  
 FloraGlo<sup>®</sup> (lutein), 418  
 FMN, 623, 624, 625, 626, 630  
 Folate, 219–228  
   active forms, 219, 220, 221  
   biochemistry and functions, 219–221  
     methionine synthesis, 221, 224  
     nucleotide synthesis, 220–221  
     serine–glycine interconversion, 220  
   and choline, 105, 107, 109, 110  
   coenzymes. *See* active forms.  
   compendial/regulatory status, 226  
   contraindications, 226  
   deficiency, 222–224  
     cancer, 223–224  
     megaloblastic anemia, 222–223  
     neural tube defects, 223  
     vascular disease, 223  
   genetic diseases involving, 223  
   homocysteine and, 221, 223, 224, 225  
   indications and usage, 224–226  
     alcoholism, 225  
     cancer prevention, 225–226  
     deficiency, treatment of, 224  
     drugs, adverse effects on folate status, 225  
     hyperhomocysteinemia, 223, 225  
     neural tube defects, prevention of, 224–225  
     pregnancy, 223, 224  
     renal conditions, 225  
     supplementation, 224  
   one-carbon metabolism, 219, 220, 222  
   physiology, 221–222  
     absorption, 221  
     bioavailability, 221–222  
     excretion, 222  
     tissue retention and turnover, 222  
     transport, 221–222  
   precautions and adverse reactions, 226  
     drug interactions, 226  
     overdosage, 226  
   recommended intake, 224  
   structure, 219  
   and vitamin B<sub>12</sub>, 221, 222, 223, 224, 225,  
     226, 737–738  
 Folic acid. *See* Folate.  
 Follicle-stimulating hormone (FSH) levels, 595  
 Foudaril<sup>®</sup> (*Pygeum africanum* extract), 574  
 Fragile histidine triad (FHIT) gene, 107  
 French maritime pine bark extract.  
   *See* Pycnogenol<sup>®</sup>.  
 Funk, C., thiamin and, 677

- GAGs**  
chondroitin sulfate, 113, 114, 115, 116, 117  
glucosamine and, 279, 283
- GAIT**, 115, 116
- Ganoderma lucidum*. *See* Reishi.
- Ganopoly<sup>®</sup>**, reishi and, 607, 609
- Garlic**, 229–240  
adverse effects of, 229  
chemistry, 229–230  
  allicin, 230, 231, 232, 235  
  alliin, 230, 231  
  allyl sulfur compounds, 230, 231, 232, 233, 234, 235, 236  
health promotion, 231–236  
  antimicrobial effects, 231  
  apoptosis, 235  
  bioactivation and response to carcinogens, 234  
  cancer prevention, 231, 233–235  
  cell differentiation, 235  
  cell proliferation, 235  
  cardiovascular effects, 231  
  detoxification and specificity, 234–235  
  dietary modifiers and efficacy of, 236  
  nitrosamine formation and metabolism, 233  
  usage, 229
- Genistein**, 363, 364, 365, 366, 367
- Gerard, J., and feverfew**, 212
- Ginger**, 241–248  
adverse effects, 245, 246  
antiemetic activity, 241–244  
  chemotherapy-induced nausea and vomiting, 243–244  
  hyperemesis gravidarum (morning sickness), 242–243  
  motion sickness, 242  
  postoperative nausea and vomiting, 244  
anti-inflammatory activity, 244–245  
  osteoarthritis, 244–245  
cardiovascular effects, 245  
constituents, 241  
  gingerols, 241, 242, 244, 245  
contraindications, 246  
description, 241  
dose, 245–246  
gastrointestinal effects, 245  
herb–drug interactions, 246  
pharmacodynamics, 241–245  
pharmacokinetics, 241  
pregnancy, use in, 242, 246  
toxicity, 246
- Ginkgo biloba*, 249–257  
chemistry, 250–252  
  bilobalide, 249, 251, 254  
  flavonoids, 249, 250, 251, 253  
  formulation and analysis, 252  
  ginkgolides, 249, 251, 253, 255  
  triterpene lactones, 250  
clinical studies, 254–256  
  on adverse effects, 255  
  on cerebral insufficiency, 254  
  on memory, 254, 255  
  on toxicity, 255  
cultivation and history of use, 250  
description, botanical, 249  
extract, 250  
preclinical studies, 252–254  
  antioxidant activity, 252  
  gene expression, 252  
  protein function, 252  
regulatory status, 256
- Ginseng, American**, 259–264. *See also* Ginseng, Asian.  
adaptogenic properties, and Asian ginseng, 259, 260  
chemistry, 259  
  dammarane saponins, 259  
  ginsenosides, 259, 260, 261  
  phytosterols, 260  
description, botanical, 259  
effects, 260–261  
  on cancer, 261  
  on immune system, 261  
  on memory, 260  
  on metabolism, 260  
  on stress and fatigue, 260–261  
interactions, 261–262  
  with diseases or conditions, 262  
  with drugs, 261  
  with food, 262  
nutritional and medicinal values, 260–261  
  antioxidant activity, 260  
preparation of products, 259  
quality control, 262  
regulatory status, 262  
safety, 261
- Ginseng, Asian**, 265–277. *See also* Ginseng, American.  
chemistry and preparation of products, 266–267  
  active constituents, 266  
  formulation and analysis, 266–267  
  ginsenosides, 265, 266, 268, 270, 272  
  source materials, 266  
clinical studies, 271–274  
  aqueous extract, 273  
  immunomodulation, 273  
  performance, 271–273  
  standardized extract, 273  
contraindications, 274  
indications, 274  
  from clinical data, 274  
  in folk medicine, 274  
  in pharmacopoeias and traditional medicine, 274  
interactions and side effects, 274–275  
  lactation, use in, 275  
  pregnancy, use in, 275  
overdose, 275  
preclinical studies, 267–271  
  CNS, action in, 268–269  
  embryo, fetal, and perinatal toxicity, 271  
  free radical scavenging effects, 267–268  
  genotoxicity, 271  
  immunological effects, 268  
  metabolic effects, 269–270  
  pharmacodynamic properties, 267  
  pharmacokinetics and metabolism, 270–271  
  preclinical safety data, 271  
  repeated dose toxicity, 271  
  reproduction toxicity, 271  
  single dose toxicity, 271
- Ginsenosides**  
  in American ginseng, 259, 260, 261  
  in Asian ginseng, 265, 266, 268, 270, 272
- Gitelman's syndrome**, 451
- Glucosamine**, 279–286  
chemistry and physiology, 279, 280  
  proteoglycans, 279  
  structure, 279  
  transporter, 280  
chitin (precursor), 281, 282, 284  
and chondroitin, 113, 114, 115, 116, 117



- Glucosamine (*contd.*)  
 clinical trials, 283–284  
 disease modification, 284  
 dose, 283, 284  
 glycosaminoglycans (GAGs), 279, 283  
 and osteoarthritis (OA), 279–284  
   cartilage, 279, 280, 283, 284  
   osteoarthritis therapy, use in, 280–281  
 pharmacology and pharmacokinetics, 280  
 preparations, 281  
   cocrystals and coprecipitates, 282  
   comparison, 283  
   glucosamine hydrochloride, 282  
   glucosamine sulfate, 281  
   glucosamine with sulfate, 281–282  
   physical mixtures, 282–283  
 safety, 284  
   adverse effects, 281, 283
- Glucosamine/chondroitin Arthritis Intervention Trial.  
*See* GAIT.
- Glutamine, 287–296  
 biochemistry and functions, 287–288  
   biological synthesis and utilization, 287–288  
   metabolic functions, 288  
 catabolic disease, 290–291  
   catabolic states, 290–291  
   interorgan transport, 291  
 description, general, 287  
 glutamate dehydrogenase (GDH), 288, 290  
 glutaminase (GA), 288, 290  
   hepatic glutaminase (hGA), 288  
   kidney glutaminase (kGA), 288  
 glutaminolysis, 288  
 nutritional supplementation, 291–293  
   athletic performance enhancement, 292  
   immune system enhancement, 293  
   intestinal renewal and function, 292  
   sickle cell disease, 292  
   total parenteral nutrition (TPN), 291–292  
   in very-low-birth-weight infants, 292  
 physiology, 288–289  
   cell proliferation, 288–289  
   cellular functions, 288  
 synthesis, 288, 290, 291  
 systemic metabolism, 289–290  
   acidosis, control of, 290  
   cycling in brain and liver, 289–290  
   production by muscle and lung, 290
- Glutamine synthetase (GS), 287, 289, 290  
*Glycyrrhiza glabra. See* Licorice.
- Glycones, and quercetin, 577, 578
- Glycosaminoglycans. *See* GAGs.
- Goldenseal, 297–308  
 berberine, 297, 298, 302, 303, 304, 305  
 chemistry, 299  
   alkaloids, 299  
   formulation and analysis, 299  
 clinical studies on berberine, 302  
   cardiovascular and circulatory disorders, 302–303  
   cirrhosis, 303  
   diarrhea, 303  
   digestive, hepatic, and gastrointestinal disorders, 303  
   parasitic disease, 303  
 contraindications, 303  
 description, 297  
   yellow root, 297  
 dosage and toxicity, 303  
 drug interactions, 304  
 history and traditional uses, 298–299  
   immunostimulatory effect, 298  
 $\beta$ -hydrastine, 297, 299, 300, 302  
 precautions, 304–305  
 preclinical studies on berberine, 300–302  
   adrenal functions, 301  
   antiarrhythmic effects, 301  
   antiproliferative activity, 300  
   cancer, 300  
   cardiotonicity and cardioprotection, 301  
   cardiovascular and circulatory functions,  
     and berberine, 301  
   chemopreventive activity, 300  
   chemotherapy adjunct activity, 300  
   congestive heart failure, 301  
   connective, tissue functions, 302  
   cytotoxicity, 300  
   diarrhea, 301  
   digestive, hepatic, and gastrointestinal functions, 301  
   endocrine and hormonal functions, 301  
   fungal infections, 301  
   hepatic functions, 301  
   hypertension, 301  
   immunology, 301  
   infectious diseases, 301–302  
   integumentary, muscular, and skeletal functions, 302  
   microbial infections, 301  
   osteoporosis, 302  
   parasitic infections, 302  
   receptor and neurotransmitter mediated functions, 302  
   respiratory and pulmonary functions, 302  
 preclinical studies on goldenseal and berberine, 299–300  
   antimicrobial and antifungal activity, 300  
   cardiovascular and circulatory functions, 299  
   immune functions, 299–300  
   respiratory and pulmonary functions, 300  
 pregnancy and lactation, use in, 304  
 toxicity, 304
- Grape seed extract, 309–325  
 angiotensin, 316  
 anthocyanidin, 309, 314  
 catechin, 309, 310, 311, 312, 314, 315, 317, 318, 319  
 chemical composition, 309–311  
 endothelial cells and, 313, 316, 317  
 endothelium-dependent vasorelaxation (EDR), 313  
 epicatechin, 310, 313, 314, 316, 318  
 mechanisms of action, 311–313  
   anti-inflammatory, 312–313  
   antioxidant, 311–312  
   immunostimulatory, antiviral, and anticancer, 313  
   vasodilation, 313  
 oligomeric proanthocyanidins (OPC), 310, 314, 318  
 pharmacokinetics, 314  
   animal and human studies, 314  
 pharmacology, 314–318  
   anticarcinogenic and anticancer effects, 314  
   energy metabolism, effects on, 318  
   hair growth effects, 316  
   hepatoprotective and tissue protective effects, 316  
   inflammation and allergy protective effects, 316  
   metabolic and nutritional effects, 315–316  
   obesity management, 318  
   postoperative edema effects, 317  
   premenstrual syndrome effects, 316  
   renal and cardioprotective effects, 315–316  
   skin and wound healing effects, 317

- vascular effects, 317
- visual effects, 317
- procyanidin, 309, 310, 311, 312, 313, 314, 315, 316, 317, 318, 319
- regulatory issues of, 318
- usage, 318
- Green tea polyphenols, 327–336
  - biotransformation and bioavailability, 331–333
    - enzymology, 332
    - pharmacokinetics, 332
  - cancer, effect on, 329
    - animal studies, 329
    - antioxidant/pro-oxidant activity, 320
    - epidemiological studies, 329
    - inhibitory activity, 330–331
    - mechanisms of prevention, 329–330
    - mechanisms, other, 331
  - cardiovascular diseases, effect on, 328
    - animal studies, 328
    - human studies, 328
  - catechins, 327, 330, 331, 332, 333
    - epigallocatechin-3-gallate (EGCG), 327, 329, 330, 331, 332, 333
  - diabetes, effect on, 329
  - neurodegenerative disorders, effect on, 328–329
  - prevention of diseases, 327, 329
- GSE. *See* Grape seed extract.
- Gyorgy, P., and vitamin B<sub>6</sub>, 715
  
- Haber–Weiss–Fenton reaction, 357
- Hallervorden–Spatz syndrome, 524
- Haptocorrin, 736, 737
- Hawthorn, 337–347
  - action and pharmacology, 338–341
    - antiarrhythmic effects, 339
    - cardioprotective effects, 340
    - coronary flow, increase of, 339
    - pharmacological activities, other, 340–341
    - pharmacokinetics, 341
    - positive inotropic action, 339
    - vasorelaxing effects, 339
  - adverse reactions, 342
    - drug interactions, 342
    - effects, 342
  - clinical studies, 339, 341, 343–344
  - compendial/regulatory status, 345
  - contraindications, 342
  - general description, 337–338
    - fruits (berries), 337, 338
    - leaves and flowers, 337, 338
    - plant, 337
    - preparations, 338
    - starting material, 337
  - indications and usage, 341–342
    - in heart failure, 341, 342
  - overdosage, 345
  - precautions, 342
  - toxicology, 341
- HDL. *See* Lipoproteins.
- Hereditary hemochromatosis, 359
- Highly unsaturated fatty acids (HUFAs)
  - and omega-3 fatty acids, 493, 494
  - and omega-6 fatty acids, 505, 507, 508, 509
- Hill, J., and feverfew, 212
- Hirase, S., and ginkgo, 249
- His, W., experiments relating to SAME, 1
- HMG-CoA reductase, and coenzyme Q<sub>10</sub>, 121, 122, 127, 129
- Hormone replacement therapy (HRT), and isoflavones, 366, 368
- Host defense potentiator (HDP), and shiitake, 657, 659
- Hova<sup>®</sup> (valerian), 693
- 5-HTP. *See* 5-Hydroxytryptophan.
- Hydrastis canadensis*. *See* Goldenseal.
- 5-Hydroxytryptophan, 349–355. *See also* Serotonin.
  - adverse side effects of, 353
  - clinical use of, 350–353
    - depression, 350–352
    - fibromyalgia, 352
    - headaches, 352
    - neurological disorders, 352–353
    - obesity, 350
    - sleep aid, 352
  - eosinophilia–myalgia syndrome, 349, 353
  - pharmacokinetics and metabolism, 349–350
  - regulatory issues of, 354
- Hypericum perforatum*. *See* St. John's wort.
- Hyperphosphatemia, 539
  
- IdB 1016<sup>®</sup> (milk thistle), 476
- Idebenone, coenzyme Q<sub>10</sub> analog, 129
- Insulin, 60
- Insulinlike growth factor (IGF), 571
- Intrinsic factor (IF), 736
- Iron, 357–362
  - acute effects of, 358–359
  - bioavailability, 358
  - compendial/regulatory status, 362
  - dietary forms, 358
    - heme, 358
    - iron response element (IRE), 358
    - nonheme, 358, 359
    - regulation of absorption, 358
    - transport proteins, 358
  - doses, 358, 359, 361
  - hemoglobin, and iron, 358, 360
  - indications and usage, 360–361
    - contraindications, 361
    - deficiency, treatment of, 360, 361
    - with drugs affecting iron status, 361
    - recommended intakes, 360
    - supplementation, 360, 362
  - myoglobin, and iron, 358
  - overload, 359–360
    - Bantu siderosis, 360
    - hereditary hemochromatosis, 359
    - transfusion, 360
  - precautions and adverse reactions, 361–362
    - and riboflavin, 626, 628
    - and vitamin A, 711
    - and vitamin C, 747, 754
- Isoflavones, 363–372
  - aglycones in, 363, 365
  - Asian intake, 365
  - chronic disease prevention and treatment, 366–368
    - cancer, 366–367
    - cognitive function, 367–368
    - coronary heart disease, 367
    - menopausal symptoms, 367
    - osteoporosis, 367

- Isoflavones (*contd.*)  
 content in soy, 363–365  
 controversies in use, 368–369  
   breast cancer patients, 368  
   infants, 368  
   reproduction, 368  
   thyroid function, 368  
 $\beta$ -glycosides in, 363, 364  
 and hormone replacement therapy (HRT), 366, 368  
 metabolism, 365  
 physiological properties, 365–366  
   antioxidant activity, 366  
   estrogenlike activity, 365, 367, 368  
   signal transduction, 366  
 recommended intakes, 369  
 and *Rhizobium*, 363  
 safety, 369  
 Isoprostanes, 511
- Jarsin<sup>®</sup> (St. John's wort), 666  
 Jet lag, and melatonin, 463
- Kava, 373–380  
   awa, 373  
   chemistry, 374–376  
     kavain, 374, 376, 379  
     methysticin, 374, 376  
   clinical studies, 377–379  
     on anxiolytic quality, 377  
     on metabolism, 376, 378  
   Cuzent, research on, 374  
   description, botanical, 373  
   Forester, J.G., description of, 374  
   Gobley, research on, 374  
   historical background, 373  
   preclinical studies, 376–377  
     on anxiolytic quality, 376  
     on metabolism, 376, 377  
   toxicity, 378  
 Keratinocyte growth factor (KGF), 571  
   testosterone, 572  
 Keratomalacia, and vitamin A, 703  
 Keshan disease, 645, 649  
 Kunzle<sup>®</sup> (*Pygeum africanum* extract), 574
- Lactobacilli, 381–389  
   action and pharmacology, 383  
     host defense, mechanisms of, 383–384  
     vaccine development, implications, 384  
   adverse effects, 386–387  
   bioavailability, 382–383  
     proprietary and probiotic strains, 382–383  
   description, general, 381  
   drug interactions/safety, 387  
     regulatory status, 387–388  
   indications and usage, 385–386  
     dose–range effects, 386  
     labeling, 385  
   oral vaccines, 384, 388  
   preparation, 385  
*Lactobacillus acidophilus*. *See* Lactobacilli.  
*Lactobacillus casei*. *See* Lactobacilli.  
 Lacto-lycopene<sup>™</sup> (lycopene), 421  
 LAP. *See* Shiitake.  
 Lapacho. *See* Pau d'arco.  
 L-Arginine, 15–24  
   absorption, 15  
   adverse effects, 20  
   and aging, 17  
   biochemistry, 15–17  
     arginine paradox, 19  
     endogenous production, 16  
   and carcinogenesis, 20  
   deficiency, 15–16  
   endocrine actions, 17–18  
     ACTH secretion, 18  
     growth hormone (GH) secretion, 17–18  
     insulin secretion, 18  
     prolactin (PRL) secretion, 18  
   metabolic pathways, 16–17, 19  
   and nitric oxide, 15, 17, 18, 19, 20  
   nonendocrine actions, 18–20  
     on cardiovascular system, 18–19  
     on immune system, 19–20  
   ornithine, active form, 17, 20  
   physiology, 17–20  
   and somatostatin release inhibition, 17  
   sources, 15  
   toxicity, 16  
 L-Carnitine. *See* Carnitine.  
 LDL. *See* Lipoproteins.  
 Lecithin, and choline, 106, 107, 108, 109  
 Legalon<sup>®</sup> (milk thistle), 470, 476  
 Lentinacin. *See* Eritadenine.  
 Lentinan, 656, 657, 658, 659, 660, 661, 662. *See also* Shiitake.  
*Lentinus edodes*. *See* Shiitake.  
*Lentinus edodes* mycelium (LEM). *See* Shiitake.  
 Lentysine. *See* Eritadenine.  
*Lepidium meyenii*. *See* Maca.  
 Lerner, A., discoverer of melatonin, 460  
 L-Glutamine. *See* Glutamine.  
 Licorice, 391–399  
   chemistry, 393  
     flavonoids, 391, 394  
     glycyrrhizin, 391, 393, 394  
     triterpene saponins, 391  
   description, botanical, 391  
   historical uses, 392  
   efficacy, 396  
   modern uses, 393  
     as flavoring agent, 393  
     in food industry, 393  
     in medicine, 393  
   pharmacokinetics, 396  
   preclinical and clinical studies, 394–396  
     activity on sex hormones, 394  
     anti-*Helicobacter pylori* activity, 395  
     anti-inflammatory activity, 395  
     antimicrobial activity, 395  
     antitumoral activity, 395  
     antiulcer activity, 395  
     antiviral effects, 396  
     effect on oxidative stress, 396  
     glucocorticoid and antiglucocorticoid activity, 394  
     mineralocorticoid activity, 394  
   preparation of products, 393  
     analysis, 394  
     formulations, 393

- side effects, 397
  - drug interactions, 397
- Ligustrum, 25
- Ligustrum lucidum*. *See* Ligustrum.
- Lind, J., and scurvy, 751
- Ling zhi. *See* Reishi.
- Linoleic acid (LA), 505, 506, 507, 509, 512, 513
- $\alpha$ -Linolenic acid (ALA), 493, 505, 506, 507, 513
- $\alpha$ -Lipoic acid, 401–407
  - antioxidant properties of, 401
  - chemistry, 401
  - lipoate, 401, 402, 403, 404
    - dihydrolipoate, 401, 402
  - metabolism and dynamics, 401–402
  - and reactive oxygen species (ROS), 402, 403, 404
  - supplement uses, 402
    - glutathione, 402
    - vitamin C, 402
    - vitamin E, 402
  - synthesis, 401, 403
  - therapeutic uses, 403
    - burning mouth syndrome, 404
    - cancer, 404
    - hepatitis C, 404
    - liver disease, 404
    - mitochondrial enzyme defects, 404
    - smell dysfunction, 404
- LipoKinetix<sup>®</sup> (yohimbe), 787
- Lipoproteins
  - and  $\beta$ -carotene, 81, 84
  - and coenzyme Q<sub>10</sub>, 124, 126
  - and garlic, 232, 233
  - and grape seed extract, 312, 313, 315, 319
  - and isoflavones, 367
  - and  $\alpha$ -lipoic acid, 403
  - and lutein, 412, 415, 416
  - and lycopene, 425
  - and niacin, 488
  - and proanthocyanidins, 558
  - and quercetin, 580
  - and red clover, 592, 598
  - and vitamin C, 746
  - and vitamin E, 759, 760
  - and zinc, 797
- Liu Wan-Tai, and ginkgo, 250
- Liver disease, SAME deficiency and, 3, 4
- Lower urinary tract symptoms (LUTS), and
  - Pygeum africanum* extract, 569, 570, 572
- Lutein, 409–420. *See also* Carotenoids.
  - adverse effects, 418
  - and age-related macular degeneration, 409, 417
  - biochemistry and functions, 409–412
    - cell membrane structure, 410
    - interactions with vitamins, 412
    - and oxygen partial pressure, 412
    - redox balance, 411
    - short wavelength light filtering, 410–411
    - signal transduction, 412
    - site of action, 411–412
  - biophysics, 409–412
  - and cataract, 409, 417
  - compensial/regulatory status, 418
  - indications and usage, 416–418
    - benefits, 417–418
    - concentration vs. action, 417
    - sources, 416–417
  - photosynthesis, 409
  - physiology, 412–416
    - bioavailability, 414–416
    - bioavailability, factors affecting, 416
    - macular response, 414
    - plasma concentration, 413–414
    - potential variable factors, 416
    - serum response, 414
    - tissue distribution, 412–413
  - reference intakes, 418
  - and retinal injury, 410
- Lyc-O-Mato<sup>®</sup> (lycopene), 421, 428
- Lycopene, 421–434
  - activity, whole food vs. supplements, 430
  - analysis and characterization, 423–424
  - bioavailability, 425–426
  - chemistry and biochemistry, 421–423
  - chronic disease, role in, 426–427
    - antioxidant activity, 426, 427
    - cancer, 427–429
    - cardiovascular disease, 429
  - distribution, in plasma and tissue, 426, 427
  - safety and adverse effects, 429
    - lycopenemia, 429
  - sources, dietary and supplement, 421, 422
  - stability and isomerization, 424–425
- Lycopenemia, 429
- Lycovit<sup>®</sup> (lycopene), 421
- Ma huang. *See* Ephedra.
- Maca, 435–443
  - biological studies, 439–441
    - aphrodisiac activity in, 439
    - cytotoxic and chemopreventive activities in, 440–441
    - fertility-enhancing activity in, 439
    - activities, other, 441
  - chemical studies, 436–439
    - alkaloids, 437
    - essential oils, 437
    - glucosinolates, 437
    - macamides, 438
    - nutritional constituents, 436
    - secondary metabolites, 436–439
  - classification, 435–436
  - commercial preparations, 441
  - cosmetics, use in, 441
  - cultivation, 436
  - standardization of products, 437, 441
  - traditional and medicinal uses, 435, 436
    - AIDS, 436
    - anticancer, 436
    - fertility, 436
- Macular pigment, 409, 703. *See also* Lutein, Vitamin A.
- Magnesium, 445–455
  - biochemistry and physiology, 445–446
    - enzyme interactions, 445
    - ion channels, 445–446
    - nucleic acids and membranes, structure of, 445
  - composition of, 446
  - deficiency, causes of, 450–451
    - diabetes mellitus, 451
    - gastrointestinal disorders, 450
    - renal disorders, 450–451
  - deficiency, manifestations of, 451–454
    - chronic latent, 453–454
    - moderate to severe, 451–453

- Magnesium (*contd.*)  
 deficiency, prevalence of, 450  
 depletion, management of, 454  
 homeostasis, cellular, 446  
 homeostasis, in body, 446–448  
   absorption, intestinal, 446–447  
   bioavailability, 447  
   renal regulation, 447–448  
   sources and intake, 446  
   tissue sources, 448  
 requirements, 448–449  
   assessment of, 448  
   recommended intake, 449  
 status, assessment of, 449–450  
   analytic procedures, 449  
   tests, 449–450
- Megaloblastic anemia  
 and folate, 222–223  
 and vitamin B<sub>12</sub>, 737, 741
- Melatonin, 457–466  
 adverse effects of, 464  
 circadian rhythms in production of, 458, 459  
 effects of, 461–464  
   antiaging action, 464  
   antihypertensive action, 464  
   as antioxidant, 463–464  
   circadian rhythms, phase-shifting of, 463  
   sleep promotion, 458, 459, 461–463  
 history, 457–458  
 Lerner, A., 460  
 metabolism, 458–459  
 pineal gland, in production of, 457, 460  
 plasma levels, 459–461  
 receptors, 458–459  
 regulatory status, 458, 464  
 response to light, 457, 458, 459, 460  
 and serotonin, 458  
 synthesis, 458  
 tryptophan (precursor), 458, 459  
 usage, 464
- Menopausal symptoms. *See* Climacteric symptoms.
- Menopause, black cohosh and, 42
- Metallochaperones, copper and, 133
- Methylcrotonyl-CoA carboxylase, biotin and, 32
- Milk alkali syndrome, 70
- Milk thistle, 467–482  
 absorption and transport, 468–470  
 action and pharmacology, 470–474  
   anticancer effects, 471  
   antilipidemic effects, 471  
   antioxidant activity, 470  
   liver cells, effect of, 470–471  
 chemistry, 468  
   flavonolignans, 467, 468, 476, 477  
   silibinin, 468, 469, 471, 476  
   silymarin, 467, 468, 470, 471, 474, 477  
 contraindications/adverse effects, 477  
 current use, 468  
 dosages/forms, 476  
 drug interactions, 477  
 historical uses, 467  
 indications and usage, 474–476  
   alcoholic or virus-induced hepatitis, 474  
   cancer, 474  
   cirrhosis, 474  
   lipidemia, 474  
   liver disorders, 474  
   primary biliary cirrhosis, 474  
   subacute or acute liver disease, 474  
   overdosage, 477  
   regulatory status, 477
- Minner, H., and pine bark, 546
- Muscle mass, androstenedione and, 7, 10
- Muscle protein breakdown, and glutamine, 291, 292, 293
- Nagai, N., and ephedra, 189
- Neo Urgenin<sup>®</sup> (*Pygeum africanum* extract), 574
- Niacin, 483–491  
 adverse reactions, 488  
   flushing, 488  
   liver toxicity, 489  
 contraindications, 488  
 deficiency, treatment of, 487  
   Hartnup's syndrome, effect in, 487  
 description, general, 483  
 dietary sources, 483  
 drugs, adverse effects of, 488  
 genomic stability, 486, 489  
 indications and usage, 486  
   recommended dietary allowance (RDA), 486  
 mono-ADP-ribosylation, 485  
 NAD-consuming enzymes, 486  
 and nicotinamide, 484, 486, 487  
 oxidant-induced cell injury, prevention of, 488  
 pharmacology, 483  
 precautions, 488  
 Sir2-like protein, 485, 486
- Night blindness, and vitamin A, 703, 707
- Non-insulin-dependent diabetes mellitus (NIDDM), 170
- Nonsteroidal anti-inflammatory drugs. *See* NSAIDs.
- Norandrostenedione, 7
- Normobrost<sup>®</sup> (*Pygeum africanum* extract), 574
- Normoprost<sup>®</sup> (*Pygeum africanum* extract), 574
- Novasoy<sup>®</sup> (isoflavones), 364
- NSAIDs  
 chondroitin and, 116, 117  
 feverfew and, 215
- Oenothera biennis*. *See* Evening primrose.
- Omega-3 fatty acids, 493–504.  
   *See also* Omega-6 fatty acids.  
 arachidonic acid (AA), 494  
 biochemistry and function, 493–495  
   efficiency of conversion, 493  
   functions, 493  
   membrane ion channels, 495  
   synthesis, 493  
   tissue distribution, 493  
 dihomo- $\gamma$ -linolenic acid (DHLA), 494  
 and evening primrose, 197  
 food sources, 495, 496  
 $\alpha$ -linolenic acid (ALA), 493  
 potential health benefits, 496–499  
   asthma, 498  
   cancer, 498–499  
   coronary heart disease (CHD), 496–498  
   diabetes, 498  
   diabetes, arthritis, and inflammatory diseases, 498  
   human development, 499  
   neurological and psychological conditions, 499

- recommended intakes, 499
- safety, 495–496
- Omega-6 fatty acids, 505–515. *See also* Omega-3 fatty acids.
- arachidonic acid (AA), 505, 506, 507, 509, 511, 512, 513
- biochemical selectivity, 512
- biological actions, 512
- dietary sources, 505–507
- and evening primrose, 197
- health consequences, 513
- linoleic acid (LA), 505, 506, 507, 509, 512, 513
- $\alpha$ -linolenic acid (ALA), 505, 506, 507, 513
  - biosynthesis of membrane phospholipids, 509
  - distribution of, 507
  - in membrane phospholipids, 507–509
- metabolism of, 507–509
- pathologies, 507
- production by plants, 512–513
- structures and biosynthesis of, 505
- transformation of, into eicosanoids, 509–512
  - biosynthesis and actions of prostaglandins, 509–511
  - biosynthesis of leukotrienes, 511–512
  - P450 hydroxylase pathways, 512
  - related hydroxy fatty acids, 511–512
- Osteoarthritis
  - chondroitin and, 113–117
  - ginger and, 244–245
  - glucosamine and, 279–284
  - SAMe and, 4
- Osteoporosis
  - calcium and, 66, 69, 70
  - copper and, 136
  - isoflavones and, 367
  - red clover and, 596, 597
  - vitamin K and, 771, 778
- Panax ginseng*. *See* Ginseng, Asian.
- Panax quinquefolium*. *See* Ginseng, American.
- Pantothenic acid (vitamin B<sub>5</sub>), 517–525
  - bioavailability, 523
  - cofactor degradation, 518–519
  - cofactor synthesis, 517–518
    - acyl carrier protein (ACP) synthesis, 518
    - coenzyme A, cellular location, 518
    - coenzyme A synthesis, 517, 518
  - deficiency, 523
  - food sources, 523
  - inherited disorder of, 524
  - metabolic role, 519–522
    - carnitine, interrelations with, 522
    - fatty acid  $\beta$ -oxidation, CoA in, 521
    - fatty acid synthesis, ACP and CoA in, 520
    - ketone body metabolism, CoA in, 521
    - organic acid metabolism, CoA in, 522
    - oxidative decarboxylation, CoA in, 520–521
  - microbial synthesis, 517
  - physiology, 522–523
    - absorption, 522
    - excretion, 522–523
    - transport, 522
  - recommended intakes, 523
  - structure, 517, 518
  - supplementation, 523–524
- Parathyroid hormone. *See* PTH.
- Pau d'arco, 527–535
  - antifungal use, 529
  - botanical products, 529
  - chemistry, 528–529
    - naphthaquinones, 527, 528, 530, 531, 532
  - clinical trials, 531–532
    - anticancer efficacy, 531
    - antivaginitis/antivaginitis, 532
  - description, botanical, 527
  - historical uses, 527
  - preclinical studies, in vitro, 530–531
    - antibacterial activity, 530
    - anticancer activity, 530
    - antifungal activity, 530
    - antimalarial activity, 530
    - antioxidant activity, 530
    - antipsoriatic activity, 530
    - antitrypanosomal activity, 531
    - antiviral activity, 530
    - neurodegenerative effects, 531
    - snakebites, 531
  - preclinical studies, in vivo, 531
    - anticancer activity, 531
    - antischistosomiasis activity, 531
    - cancer chemopreventive action, 531
    - toxicity, 531
    - regulatory status, 532
- Pausinystalia johimbe*. *See* Yohimbe.
- Pellagra, niacin and, 483, 487, 488
- Pernicious anemia. *See* Megaloblastic anemia.
- Phosphates. *See* Phosphorus.
- Phosphatidylcholine. *See* Lecithin.
- Phosphatidylethanolamine *N*-methyltransferase (PEMT), 106, 107
- Phosphocreatine (PCr), 151–153
- Phosphorus, 537–543
  - absorption, intestinal, 538
    - magnesium in, 447
  - additives, 537, 538
  - blood concentration, 538
  - and calcium, 538, 539, 540, 541, 542
  - compendial/regulatory status, 542
  - contraindications, 541
  - dietary reference intake (DRI), 538
  - dietary sources, 537
  - forms, 537
  - homeostasis, 538–539
    - parathyroid hormone (PTH) in, 538, 539
  - indications and usage, 540–541
    - deficiency, 540–541
  - overdosage, 542
  - upper limit (UL), 542
  - precautions and adverse reactions, 541
  - roles of, 539–540
    - bone mineralization, 540
    - phosphorylation reactions, 540
    - structural functions, 539, 540
  - supplements, 538
  - urinary excretion, 539
  - and vitamin D, 538, 540
- Phytates, copper and, 134
- Pinus pinaster*. *See* French maritime pine.
- Piper methysticum*. *See* Kava.
- PMS
  - calcium and, 66
  - Chasteberry and, 96–97
  - evening primrose and, 204
  - grape seed extract and, 316
  - vitamin B<sub>6</sub> and, 724–725

- Polyunsaturated fatty acids (PUFA), 505, 509, 511  
 Potenza<sup>®</sup> (*Pygeum africanum* extract), 574  
 Prasterone. *See* DHEA.  
 Pregnenolone, DHEA precursor, 167  
 Prestara<sup>™</sup> (DHEA), 167, 172  
 Premenstrual syndrome. *See* PMS.  
 Prenyltransferases, and coenzyme Q<sub>10</sub>, 123, 127, 128, 129  
 Proanthocyanidins, 555–568  
   adverse biological effects, 563–564  
   biochemistry, 555  
   biological markers, alteration of, 557–561  
     animal models and human studies, 559–560  
     antioxidants, 557  
     atherosclerosis, 558  
     bacterial antiadhesion, 561  
     cancer, 557  
     cytotoxicity, 557  
     diabetes, and glucose and insulin metabolism, 561  
     free radicals, 557  
     immune function, 561  
     inflammatory response, inhibition of, 558–559  
     liposome and LDL oxidation, inhibition of, 558  
     mechanisms of action, 558  
     NO-dependent vasodilation, 560  
     platelet aggregation, decreased in, 559  
     reperfusion, 561  
     vasoconstriction, 560  
   compendial/regulatory status, 563  
   description, general, 555  
   dietary sources and intake, 561–563  
     foods, 561, 563  
     supplements, 562, 563  
   and grape seed extract, 309, 314, 315  
   physiology, 555–557  
   and Pycnogenol<sup>®</sup>, 559, 562  
 Probiotics, 382, 383, 386. *See also* Lactobacilli.  
   action, 383  
   bifidobacteria, 382, 386  
   dietary supplement, 385  
   lactobacilli, 386  
   modulation, 384  
   strains, 382, 384, 385, 386  
   therapy, 384  
 Pro Flow<sup>®</sup> (*Pygeum africanum* extract), 574  
 Progesterone receptor (PR), 590, 591  
 Prolitrol<sup>®</sup> (*Pygeum africanum* extract), 574  
 Pronitol<sup>®</sup> (*Pygeum africanum* extract), 574  
 Propionyl-CoA carboxylase, biotin and, 32, 36  
 Proscar<sup>®</sup> (saw palmetto), 639  
 Prostaglandin endoperoxide H<sub>2</sub> (PGH<sub>2</sub>), 509, 510  
 Prostaglandin endoperoxide H synthase (PGHS), 509, 510, 512  
 Proteoglycans, and chondroitin, 113, 114  
 Provitamin A, 701, 702, 705, 706, 707  
 Provol<sup>®</sup> (*Pygeum africanum* extract), 574  
*Prunus africana*. *See* *Pygeum africanum* extract.  
 PTH  
   and calcium, 65, 66  
   and magnesium, 451–452  
 Pursh, F., and cascara sagrada, 89  
 Pycnogenol<sup>®</sup>, 545–553  
   chemistry and production, 546  
     analysis, 546  
     composition, 546  
     formulations, 546  
     phenolic compounds, 546  
     stability, 546  
   children, use in, 551  
   clinical studies, 549–551  
     antidiabetic effects, 551  
     antihypertensive effect, 549  
     asthma symptoms, reduction of, 550  
     cholesterol lowering, 550  
     circulation, effect on, 545, 551  
     deep vein thrombosis, prevention of, 550  
     edema formation, inhibition of, 550  
     erectile function improvement, 550  
     gingival bleeding, 550  
     immune modulation, 550  
     menstrual cramps and pain, reduction of, 551  
     microcirculation improvement, 549  
     platelet aggregation, inhibition of, 549  
     sperms, improvement of quality of, 551  
     UV-induced damage, inhibition of, 551  
     vascular retinopathy, effects in, 550  
   contraindications, 551  
   description, botanical, 545  
   preclinical studies, 546–549  
     absorption and metabolism, 549  
     adhesion molecules, inhibition of, 548  
     adrenaline-induced vasoconstriction, inhibition of, 547  
     animal toxicology, 549  
     antiaging effects, 548  
     antihypertensive effect, 547  
     antioxidative effects in biological systems, 548  
     antioxidative substances, stimulation of synthesis of, 548  
     blood glucose lowering, 549  
     capillary sealing, 547  
     cognitive function, enhancement of, 548  
     e-NOS, stimulation of, 546  
     immune system, stimulation of, 548  
     inflammatory mediators, inhibition of, 548  
     matrix metalloproteases, inhibition of, 548  
     NF- $\kappa$ B, interaction with, 548  
     protein binding, 547  
     radical-scavenging activity, 545, 547  
     spasmolytic activity, 549  
     UV-induced damage, inhibition of, 548  
   pregnancy, use in, 551  
   observed drug interactions, 551  
   optimum intake, 551  
   regulatory status, 551  
   side effects, 551  
*Pygeum africanum* extract, 569–575  
   adverse effects, 573  
   cell proliferation, 571, 573  
   clinical studies, 569–570  
     benign prostatic hyperplasia (BPH), 569–570  
   mechanism of function, 571–573  
     bladder function, effects on, 571–573  
     prostate growth, effects on, 571  
   pharmaceutical description, 569  
   products, 573  
 Pyridoxal, 715  
 Pyridoxamine, 715  
 Pyridoxine, 715  
 Pyruvate carboxylase, biotin and, 32, 36  
  
 Quercetin, 577–585  
   absorption of, 577–578  
   adverse effects, 581  
   bioavailability, 578–579

- biosynthesis and natural sources of, 577
  - cellular and molecular actions, 579–581
    - antioxidant properties of, 579
    - cancer, effects on, 579–580
    - cardiovascular diseases, effects on, 580
    - inflammation, effects on, 580–581
    - effects, other, 581
  - indications and usage, 581
  - metabolism, 578
  - regulatory status, 582
- Red clover, 587–602
- adverse effects, 598–600
    - botanical misidentification, 599
    - clinical trials, reported, 600
    - coumarins, presence of, 599
    - cytochrome P450, inhibition of, 599
    - heavy metal contamination, 598
    - pesticide residues, 598–599
    - thyroid function, 599
  - chemical constituents, 588–589
    - compounds used for standardization, 589
  - common names, 587
  - description, botanical, 587–588
  - dosage and preparation of, 598
  - isoflavones in, 363
  - pharmacokinetics and metabolism, 589
  - pharmacological activity, 589–591
    - cancer-related effects, antioxidant, 591–592
    - cancer-related effects, antiproliferative, 592
    - glucose and lipid metabolism, 592
    - hormonal effects, estrogen receptor dependent, 589–591
    - hormonal effects, other receptor dependent, 591
    - hormonal effects, receptor independent, 591
    - inflammation and immune function, 592
    - biological activities, other, 592–593
    - thyroid function, 592
  - regulatory status, 600
  - safety, 599–600
    - in cancer patients, 599
    - in pregnant women and children, 599–600
  - traditional and medicinal uses, 588
    - external, 588
    - internal, 588
  - usage, 593–598
    - breast cancer, 595
    - cardiovascular disease risk, 596–598
    - caveats, 593, 594
    - cyclical mastalgia, 595
    - endometrial effects, 595
    - menopause, 593–595
    - osteoporosis prevention and treatment, 596, 597
    - prostate cancer, 595–596
- 5- $\alpha$ -Reductase inhibitors
- and *Pygeum africanum* extract, 570, 573
- Reishi, 603–622
- antibacterial and antiviral effect, 615–618
    - anti-HIV activity, 616
    - on Epstein–Barr virus, 616
    - on Gram-positive and Gram-negative bacteria, 615
    - on HBV infection, 618
    - on *Helicobacter pylori*, 615
    - mechanism consideration, 617
    - on other viruses, 616
  - antidiabetic effect, 614–615
  - antitumor effect, 607–609, 612
    - chemo- and radiopreventive, 609
    - PC-SPES, 609
    - as single agent, 607
  - cardiovascular and circulatory functions, 615
    - cholesterol and lipid metabolism, 615
    - hypertension, 615
  - complement system, effect of, 613
  - cultivation, 603–604
  - description, general, 603
  - dosage forms, 618
  - edibility, 603
  - effect on immune effector cells, 611–613
    - macrophages, 612, 617
    - mast cells, 612
    - natural killer (NK) cells, 612, 617
    - splenocytes, 611
    - T cells, 611, 617
  - enzyme-inhibiting activity, 609
  - habitat, 603
  - hepatoprotective activity, 613
  - histamine release inhibition, 613
  - immunomodulatory effects, 610, 613, 617
  - mitogenic activity, 610
  - nutritional components, 604–607
    - bioactive constituents, 605
    - nucleotides and nucleosides, 607
    - polysaccharides, 605, 607, 609, 612, 616
    - proteins, 605
    - triterpenes, 605
    - triterpenoids, 607, 609, 615
  - related species, 603
  - safety profile, 618
    - drug interactions, 618
  - side effects, 618
  - therapeutic applications, 607
    - preclinical and clinical studies, 607
  - toxicity, 618
  - traditional uses, 604
- Remifemin<sup>®</sup> (black cohosh), 42, 48, 50
- Retinal injury, and lutein, 410
- Retinal pigment. *See* Macular pigment.
- Retinaldehyde, retinoic acid, retinol. *See* Vitamin A.
- Rhamnus purshiana*. *See* Cascara sagrada.
- Riboflavin, 623–624
- adverse effects, 640
  - antioxidant potential
  - assessment of status, 628–629
  - biochemistry and functions, 523–524
  - deficiency, 624
    - in alcoholism, 625
    - anemia, 628
    - carcinogenesis, 628
  - dietary recommendations, 628–629
    - recommended dietary allowance (RDA), 629
  - fat metabolism, 627–628
  - flavin coenzymes, 623, 624
  - in HIV infection, 628
  - homocysteine metabolism, 627
  - and iron, 626, 628
  - safety, 630
  - UV light, sensitivity to, 623–624
- Rökan<sup>™</sup> (ginkgo), 250
- Sabal serrulata*. *See* Saw palmetto.
- S-Adenosyl-L-methionine. *See* SAMe.
- S-Adenosylmethionine, 105, 108



- S-Allylcysteine (SAC), 231, 233, 234, 235, 236  
 S-Allyl mercaptocysteine. *See* SAMC.  
 SAMC, and garlic, 234,  
 SAmE  
   adverse effects of, 4  
   Cantoni, G., 1  
   deficiency, 3  
   and depression, 3, 4  
   discovery of, 1–2  
   drug/supplement interactions, 5  
   Du Vigneaud, V., 1  
   enzymes in synthesis of SAmE, 2–3  
   and gene expression, 3  
   hepatic metabolism of, 2  
   His, W., 1  
   indications and usage, 3–5  
   liver disease and, in animals, 3  
   osteoarthritis and, 4  
   pharmacokinetics, 4  
   side effects, 4  
   synthesis of, 2  
 Saw palmetto, 635–644  
   BPH, 638–639  
     current medical treatment, 638–639  
     efficacy in control of symptoms, 639  
     botanical treatments, other, 638  
   chemistry, 637–638  
     fatty acids, 637, 640, 642  
     flavonoids, 638  
   description, botanical, 635  
   ecological distribution, 635  
   historical use, 636–637  
   pharmacokinetics, 642  
   pharmacology, 640–642  
     antiandrogenic activity, 641  
     antispasmodic activity, 641  
     estrogenic properties, 641  
     urological symptoms, 640  
   primary use, 635–636  
   regulatory status, 642  
   safety, 639–640  
     lactation, use in, 639  
     pregnancy, use in, 639  
     side effects, 639  
 Scurvy, 746, 751  
 Sedative action, and valerian, 687, 691, 697  
 Sedonium<sup>®</sup> (valerian), 696, 697  
 Selective estrogen receptor modulators. *See* SERMs.  
 Selenium, 645–652  
   assessment of status, 649  
   Berzelius, 645  
   biochemistry and function, 646–648  
     antioxidant properties, 647  
     cancer chemoprevention, 647–648  
     selenoproteins, and thiol redox reactions, 647  
     selenoproteins, and thyroid hormone metabolism, 647  
     selenoproteins, synthesis of, 646  
     transport, 647  
   chemical forms of, 646  
   and coenzyme Q<sub>10</sub>, 127  
   deficiency, 645, 649  
     Keshan disease, 645, 649  
   dietary intake, 648–649  
   dietary reference intake (DRI), 649–650  
     recommended dietary allowance (RDA), 650  
   metabolism, 648  
     regional variations in, 645, 649  
     sources, 648–649  
     supplementation, 650  
     toxicity, 650  
 Selenomethionine, 649, 650  
*Serenoa repens*. *See* Saw palmetto.  
 SERMs  
   and calcium, 69  
   isoflavones, 365, 366  
 Serotonin  
   and 5-HTP, 349, 350, 351, 352, 353  
     5-hydroxyindoleacetic acid (5-HIAA),  
       metabolite of, 350, 351, 353  
   and melatonin, 458  
 Sex-hormone-binding globulin (SHBG)  
   and DHEA, 170  
   and red clover, 591, 595, 596  
 Shiitake, 653–664  
   artificial cultivation, 655  
   blood serum cholesterol and, 658  
   edibility, 653  
   habitat and distribution, 653  
   medicinal uses, 660–662  
     antifungal activity, 661  
     toxicity and side effects, 661–662  
   nutritional value, 653–654  
     carbohydrates, 653  
     minerals, 654  
     polysaccharides, 654, 656, 657, 660  
     protein, 653, 654, 656, 657, 658, 660, 661  
     vitamins, 653, 654, 662  
   preclinical studies, 655–660  
     AIDS, 657, 659, 661, 662  
     anticarcinogenic and antitumor effects, 656–657  
     antiparasitic effects, 659  
     antiviral and antibacterial effects, 659–660  
     cardiovascular effects, 658  
     hepatoprotective effects, 659  
     HIV, 659, 661  
     immune-modulating effects, 657  
     KS-2- $\alpha$ -Mannan peptide, 657  
     LEM and LAP extracts from, and  
       culture media, 657  
     therapeutic applications, 655  
   preparations of, 662  
     dosage, 662  
     drug interactions, 662  
   sarcoma, 180, 656, 657  
   taxonomic classifications, 655  
 Siliphos<sup>®</sup> (milk thistle), 476  
 Silipide<sup>®</sup> (milk thistle), 476  
*Silybum marianum*. *See* Milk thistle.  
 Single nucleotide polymorphisms, 106  
 Skin photosensitivity, and carotenoids, 84  
 Sleep promotion  
   melatonin and, 458, 459  
   valerian and, 688  
 Sleep-Qik<sup>®</sup> (valerian), 697  
 Soy, isoflavones in. *See* Isoflavones.  
 Squalene synthase, and coenzyme Q<sub>10</sub>, 123, 127, 128, 129  
 Statins, and coenzyme Q<sub>10</sub>, 121, 127, 129, 130  
 Steroid hormones. *See also* Anabolic steroids.  
   androstenedione, 7–13  
   DHEA, 167–176  
 St. John's wort, 665–676  
   chemistry and preparation of products, 665  
   hyperforin, 666, 667

- hypericin, 666, 671
- clinical studies, 667–673
  - adverse effects, 669–670
  - anxiety disorders, 669
  - depression, 667–669, 671
  - drug interactions, 671
  - herb–drug interactions, 665, 673
  - mutagenicity, 671
  - photosensitivity, 670
  - reproduction, 670
- current uses, 665
- Super Prostate Formula<sup>®</sup> (*Pygeum africanum* extract), 574
- Symptomatic slow-acting drugs in osteoarthritis (SYSADOA), 115, 280
  
- Tabebuia*. *See* Pau d'arco.
- Tadenan<sup>®</sup> (*Pygeum africanum* extract), 574
- Tanacetum parthenium*. *See* Feverfew.
- Tanakan<sup>™</sup> (ginkgo), 250
- Tardive dyskinesia, 108
- TCM, 25, 28, 159, 189, 250, 392, 604
- Tea. *See* Green tea polyphenols.
- Tebonin<sup>™</sup> (ginkgo), 250
- Tebonin forte<sup>™</sup> (ginkgo), 250
- Testosterone, 7, 9, 10, 169, 571, 572
- Tetrahydrofolates, 220, 221, 222
- Thiamin, 677–686
  - bioavailability, 681–682
    - antagonists, 682
    - lipid-soluble analogs, 682
  - biochemistry and functions, 677–678
    - phosphates, 677
  - coenzymatic function, 677
  - congenital disorders, 684
    - Leigh's disease, 684
    - maple syrup urine disease, 684
    - Roger's syndrome, 684
  - deficiency, 683
    - beriberi, 677, 683
  - Funk, C., 677
  - general description, 677
  - non-coenzymatic function, 677–678
  - pharmacokinetics, 681
  - physiology, 678–681
    - absorption and transport, 678–679
    - placental transport, 680–681
    - renal excretion, 680
  - potential variable factors, 683–684
  - requirements and allowances, 684
    - recommended dietary allowance (RDA), 684
  - sources, 684
  - status, 682–683
  - toxicity, 684
  - Williams, R.R., 677
- Thioctic acid. *See*  $\alpha$ -Lipoic acid.
- Thiouracil, and coenzyme Q<sub>10</sub>, 127
- Thisilyn<sup>®</sup> (milk thistle), 476
- Thisilyn Pro<sup>™</sup> (milk thistle), 476
- Thyroid stimulating hormone. *See* TSH.
- $\alpha$ -Tocopherol. *See* Vitamin E.
- Tocopherol-mediated peroxidation, 758
- Tomato, lycopene source, 421, 430
- Traditional Chinese medicine. *See* TCM.
- Transferrin, 358, 360
- Trifolium pratense*. *See* Red clover.
- Trinovin<sup>®</sup> (red clover), 595
- Triterpene glycosides, in black cohosh, 41
- Tryptophan, melatonin precursor, 458, 459
- TSH, 70
  
- Ubiquinol, ubiquinone. *See* Coenzyme Q<sub>10</sub>.
- UDP-glucuronosyltransferases (UGT), 578, 580
- UTI. *See* Urinary tract infection.
  
- Vaccinium macrocarpon*. *See* Cranberry.
- Valerian, 687–700
  - chemical constituents, 689
    - iridoids, 689, 693, 697
    - monoterpenes, 689
    - sesquiterpenes, 689, 693, 697
    - valepotriates, 689–690
    - volatile oil, 689
  - clinical studies, 693–697
    - sleep disorders, in, 693
  - description, botanical, 688
  - pharmacological activity, 691–693
    - alkaloids, 692
    - total extracts, 691
    - toxicology of valepotriates, 692
    - valepotriates, 692
    - volatile oil, 692
  - pharmacopeial status, 688–689
    - dosage, 688
    - dosage forms, 688
  - safety of, 697–698
    - contraindications and drug indications, 697
  - taxonomy, 687–688
  - traditional uses, 687
- Valeriana Natt<sup>®</sup> (valerian), 697
- Valeriana officinalis*. *See* Valerian.
- Valmane<sup>®</sup> (valerian), 689
- Viagra<sup>®</sup>, and yohimbe, 784
- Visual pigments. *See* Macular pigments.
- Vitamin A, 701–713
  - adverse effects, 710–711
  - and  $\beta$ -carotene, 81–85, 701, 702, 705, 706, 707, 708
  - biochemistry and function, 702–704
    - activation, 702
      - nuclear receptors, in cell differentiation and fetal development, 702–703
      - ocular functions, 703
    - and coenzyme Q<sub>10</sub>, 127, 128
  - contraindications, 711
  - deficiency, 704, 707
  - dietary reference intake (DRI), 708, 709
  - food sources, 707–708
  - interactions, 711
    - and iron, 711
  - metabolism, 705–707
    - intestinal absorption, 705
    - plasma transport, 706–707
    - renal loss, 707
    - storage, 706
  - physiology, 703–707
    - transport and binding proteins, 704–707
  - recommended dietary allowance (RDA), 709
  - status, 707
  - units of activity, 708–709
  - upper intake level, 710, 711
  - use of, in disease, 709–710

- Vitamin B<sub>1</sub>. *See* Thiamin.
- Vitamin B<sub>3</sub>. *See* Niacin.
- Vitamin B<sub>5</sub>. *See* Pantothenic acid.
- Vitamin B<sub>6</sub>, 715–734
- assessment of status, 715–719
    - dietary intake, 716
    - direct indices, 716–717
    - indirect indices, 718–719
  - biochemistry and functions, 715
  - in disease and toxicity, 723–726
    - asthma, 725
    - carpal tunnel syndrome, 725
    - coronary heart disease, 723–724
    - drug–vitamin B<sub>6</sub> interactions, 725–726
    - HIV/AIDS, 724
    - overdosage, 726
    - premenstrual syndrome, 724–725
    - sickle cell anemia, 725
  - food sources, 723
  - functions, 719–722
    - erythrocyte function, 719–720
    - gluconeogenesis, 719
    - hormone modulation/gene expression, 721–722
    - immune system functions, 719
    - lipid metabolism, 721
    - nervous system functions, 720–721
    - niacin formation, 720
- Gyorgy, P., 715
- history, 716
- and magnesium, 447
- names, 715
- physical and chemical properties, 715, 717
- requirements, 722–723
- recommended dietary allowance (RDA), 723
- Vitamin B<sub>12</sub>, 735–744
- coenzyme function, 735–736
  - deficiency, 738, 740–742
    - causes, 740–741
    - hematological changes due to, 741
    - and immune function, 742
    - indicators of, 740, 741
    - neuropathies due to, 741–742
  - dietary reference intake (DRI), 738, 739
  - and folate, 221, 222, 223, 224, 225, 226, 737–738
  - food sources, 738
  - metabolism, 736–737
    - digestion and absorption, 736
    - excretion and storage, 737
    - transport proteins, 736–737
  - status, 738–740
    - in breast milk, 739–740
    - in the neonate and infant, 739
    - in pregnancy, 738–739
  - structure, 735
  - and vegetarianism, 735, 740–741
- Vitamin C, 745–755
- biochemistry and functions, 745–747
    - as antioxidant, 746
    - atherogenesis, effects on, 746
    - blood flow and endothelial function, effects on, 746
    - enzymatic functions, 746
    - iron absorption, 747, 754
    - nitrate tolerance, prevention of, 746–747
    - stomach and duodenum, effects in, 747
  - and coenzyme Q<sub>10</sub>, 123, 124
  - and copper, 137
  - deficiency (scurvy), 751
  - food sources, 751
  - indications and usage, 751–753
    - adverse effects, 754
    - concentration vs. function, 751
    - deficiency, prevention of, 752
    - dietary reference intake (DRI), 752–753
    - disease, use in, 753
    - optimum intake, 753
    - possible benefits, 752
    - pregnancy, use in, 753
    - scurvy, treatment of, 752
  - and lutein, 412, 417
  - physiology, 747–751
    - bioavailability, 749–750
    - blood cell concentrations, 749
    - plasma concentrations, 748–749
    - potential variable factors
    - recycling, 747–748
    - renal excretion, 751–752
    - tissue accumulation, 747
    - tissue distribution, 747
    - transport, 747
- Vitamin D
- and calcium, 65, 66, 67
  - and magnesium, 447, 451–452, 454
  - and phosphorus, 538, 540
- Vitamin E, 757–769
- adverse effects, 762–763
    - drugs, interactions with, 763
    - upper tolerable limits, 762–763
  - biochemistry and functions, 757
    - antioxidant activity, 757–758
    - biologic activity, 758
    - molecular functions, 758–759
    - recycling, 758
  - and coenzyme Q<sub>10</sub>, 124, 129
  - deficiency, 761
  - excretion, 760–761
  - forms, 757
  - indications and usage, 761–762
    - chronic disease prevention, 761–762
    - deficiency, treatment of, 761
    - dietary reference intake (DRI), 762
    - food sources, 761
    - units, 762
  - and lutein, 412, 417
  - metabolism, 760–761
  - physiology, 759–761
    - absorption and transport, 759
    - tissue delivery, 760
  - supplements, 757
  - vitamin K, interaction with, 762
- Vitamin K, 771–782
- biochemical role of, 774–775
  - chemistry, 771
    - menaquinone, 771, 777, 778
    - phylloquinone, 771, 775, 777, 778
  - Dam, H., 771
  - deficiencies and requirements, 776–777
  - dietary sources, 772
  - metabolism, 775–776
  - osteoporosis, 771, 778
  - proteins, 773–774
    - blood coagulation, 773, 777
    - matrix Gla protein, 771, 774, 778
    - osteocalcin, 771, 774, 777

- and skeletal health, 778
  - vitamin E, interaction with, 762
  - Vitex agnus castus*. *See* Chasteberry.
- William, R.R., structure and synthesis of thiamin, 677
- Western clinical herbal medicine, 28
- Xangold<sup>®</sup> (lutein), 418
- Xanthophylls, 409. *See also* Carotenoids.
- Xerophthalmia, and vitamin A, 703
- Yohimbe, 783–789
  - adverse side effects, 787
    - anxiety and manic symptoms, 787
    - drug interactions, 787
  - chemistry, 783
    - yohimbine, 783, 784, 786, 787
    - yohimbine hydrochloride, 783, 784, 785
  - description, botanical, 783
  - efficacy, 785
    - as aphrodisiac, 783, 785
    - in erectile dysfunction, 783, 784, 785
  - mechanism of action, 785–787
    - nitric oxide, role of, 786
  - preclinical studies, 784–785
  - preparation, 783
- Zeaxanthins, 409. *See also* Carotenoids.
- Zinc, 791–800
  - adverse interactions, 797
    - alcohol and drugs, 797
  - biochemistry, 791
  - and copper, 136, 137
  - deficiency of, 794
    - identification, 794
    - symptoms, 794
  - exchangeable zinc pool (EZP), 793
  - functions of, 791–792
    - catalytic, 791
    - lipid and carbohydrate metabolism, 792
    - protein and nucleic acid metabolism, 792
    - regulatory, 791–792
    - structural, 791
  - indications and usage, 794–797
    - Alzheimer's disease, treatment of, 795–796
    - bioavailability, 794–795
    - cold, treatment of, 795
    - contraindications, 796
    - depletion, prevention of, 795, 796
    - depletion, treatment of, 795
    - HIV/AIDS, treatment of, 796
    - recommended intake levels, 795
    - sources, 794
    - supplement use, 795
  - and magnesium absorption, 447
  - metabolism, 792–794
    - absorption, 792–793
    - distribution, in humans, 792
    - excretion, 793–794
    - homeostatic regulation, 793
    - reserves, 793
    - turnover and transport, 793
  - metallothionein, 791, 792
  - recommended dietary allowance (RDA), 792, 793, 795
  - synthesis, 791, 792, 796

*Zingiber officinale*. *See* Ginger.

Zintona<sup>®</sup> (ginger), 242



*Encyclopedia of*

# Dietary Supplements



*Coates • Blackman • Cragg  
Levine • Moss • White*

## about the encyclopedia . . .

Situated as a scientific checkpoint for the many over-the-counter supplements carried in today's nutritional products marketplace, this definitive *Encyclopedia of Dietary Supplements* presents **peer-reviewed, objective entries** that rigorously review **the most significant scientific research**—funneling basic chemical, preclinical, and clinical data into a descriptive form universally useful to health care professionals, researchers, and educated, health-conscious consumers.

*Presents evidence-based information on all of the major vitamin and mineral micronutrients, single herbs and botanicals, phytochemicals, and other bioactive preparations.*

Containing nearly **100** entries contributed and peer-reviewed by renowned subject-specific experts, the *Encyclopedia* surveys vitamins, beta-carotene, niacin, and folate...omega-3 and omega-6 fatty acids, isoflavones, and quercetin...calcium, copper, iron, and phosphorus...5-hydroxytryptophan, glutamine, and L-arginine...St. John's wort, ginkgo biloba, green tea, kava, and noni...androstenedione, DHEA, and melatonin...coenzyme Q10 and S-adenosylmethionine...shiitake, maitake, reishi, and cordyceps...and numerous additional varieties of supplements.

## about the editors . . .

PAUL M. COATES is Director of the Office of Dietary Supplements, National Institutes of Health, Bethesda, Maryland. Formerly a Research Professor at the University of Pennsylvania School of Medicine, Philadelphia, Dr. Coates received the Ph.D. degree from Queen's University, Kingston, Ontario, Canada.

MARC R. BLACKMAN is Chief of the Endocrine Section in the Laboratory of Clinical Investigation at the National Center for Complementary and Alternative Medicine, National Institutes of Health, Bethesda, Maryland. He received the M.D. degree from the New York University School of Medicine, New York.

GORDON M. CRAGG is Chief of the Natural Products Branch of the National Cancer Institute, National Institutes of Health, Frederick, Maryland. Dr. Cragg received the Ph.D. degree from the University of Oxford, Oxford, United Kingdom.

MARK LEVINE is Section Chief of Molecular and Clinical Nutrition at the National Institute of Diabetes and Digestive and Kidney Diseases, National Institutes of Health, Bethesda, Maryland. Dr. Levine received the M.D. degree from Harvard Medical School, Boston, Massachusetts.

JOEL MOSS is Chief of the Pulmonary–Critical Care Medicine Branch of the National Heart, Lung, and Blood Institute, National Institutes of Health, Bethesda, Maryland. He received the Ph.D. and M.D. degrees from the New York University School of Medicine, New York.

JEFFREY D. WHITE is Director of the Office of Cancer Complementary and Alternative Medicine, National Cancer Institute, National Institutes of Health, Bethesda, Maryland. He received the M.D. degree from the Howard University College of Medicine, Washington, D.C.

*Printed in the United States of America*



MARCEL DEKKER  
NEW YORK

DK2209

ISBN 0-8247-5504-9



9 0000



9 780824 755041