

*Supplement F2: The Chemistry of Amino, Nitroso, Nitro and Related Groups.*

Edited by Saul Patai

Copyright © 1996 John Wiley & Sons, Ltd.

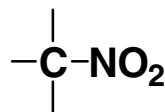
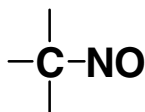
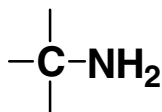
ISBN: 0-471-95171-4

Supplement F2  
The chemistry of  
**amino, nitroso, nitro  
and related groups**

## THE CHEMISTRY OF FUNCTIONAL GROUPS

*A series of advanced treatises under the general editorship of  
Professors Saul Patai and Zvi Rappoport*

- The chemistry of alkenes (2 volumes)
  - The chemistry of the carbonyl group (2 volumes)
    - The chemistry of the ether linkage
    - The chemistry of the amino group
  - The chemistry of the nitro and nitroso groups (2 parts)
    - The chemistry of carboxylic acids and esters
    - The chemistry of the carbon–nitrogen double bond
      - The chemistry of amides
      - The chemistry of the cyano group
    - The chemistry of the hydroxyl group (2 parts)
      - The chemistry of the azido group
      - The chemistry of acyl halides
    - The chemistry of the carbon–halogen bond (2 parts)
  - The chemistry of the quinonoid compounds (2 volumes, 4 parts)
    - The chemistry of the thiol group (2 parts)
  - The chemistry of the hydrazo, azo and azoxy groups (2 parts)
    - The chemistry of amidines and imidates (2 volumes)
  - The chemistry of cyanates and their thio derivatives (2 parts)
    - The chemistry of diazonium and diazo groups (2 parts)
    - The chemistry of the carbon–carbon triple bond (2 parts)
  - The chemistry of ketenes, allenes and related compounds (2 parts)
    - The chemistry of the sulphonium group (2 parts)
  - Supplement A: The chemistry of double-bonded functional groups (2 volumes, 4 parts)
  - Supplement B: The chemistry of acid derivatives (2 volumes, 4 parts)
  - Supplement C: The chemistry of triple-bonded functional groups (2 volumes, 3 parts)
  - Supplement D: The chemistry of halides, pseudo-halides and azides (2 volumes, 4 parts)
  - Supplement E: The chemistry of ethers, crown ethers, hydroxyl groups and their sulphur analogues (2 volumes, 3 parts)
  - Supplement F: The chemistry of amino, nitroso and nitro compounds and their derivatives (2 parts)
    - The chemistry of the metal–carbon bond (5 volumes)
      - The chemistry of peroxides
    - The chemistry of organic selenium and tellurium compounds (2 volumes)
      - The chemistry of the cyclopropyl group (2 parts)
      - The chemistry of sulphones and sulphoxides
    - The chemistry of organic silicon compounds (2 parts)
      - The chemistry of enones (2 parts)
    - The chemistry of sulphinic acids, esters and their derivatives
    - The chemistry of sulphenic acids and their derivatives
      - The chemistry of enols
    - The chemistry of organophosphorus compounds (4 volumes)
    - The chemistry of sulphonic acids, esters and their derivatives
      - The chemistry of alkanes and cycloalkanes
  - Supplement S: The chemistry of sulphur-containing functional groups
  - The chemistry of organic arsenic, antimony and bismuth compounds
    - The chemistry of enamines (2 parts)
  - The chemistry of organic germanium, tin and lead compounds
- UPDATES
- The chemistry of  $\alpha$ -haloketones,  $\alpha$ -haloaldehydes and  $\alpha$ -haloimines
  - Nitrones, nitronates and nitroxides
    - Crown ethers and analogs
    - Cyclopropane derived reactive intermediates
  - Synthesis of carboxylic acids, esters and their derivatives
    - The silicon–heteroatom bond
    - Syntheses of lactones and lactams
  - The syntheses of sulphones, sulphoxides and cyclic sulphides
- Patai's 1992 guide to the chemistry of functional groups—*Saul Patai*



---

---

Supplement F2

**The chemistry of  
amino, nitroso, nitro  
and related groups**

Part 1

*Edited by*  
SAUL PATAI  
*The Hebrew University, Jerusalem*

---

1996

JOHN WILEY & SONS  
CHICHESTER-NEW YORK-BRISBANE-TORONTO-SINGAPORE  
*An Interscience<sup>®</sup> Publication*

---

---

Copyright © 1996 John Wiley & Sons Ltd,  
Baffins Lane, Chichester,  
West Sussex PO19 1UD, England  
National 01243 779777  
International (+44) 1243 779777  
e-mail (for orders and customer service enquiries): cs-books@wiley.co.uk  
Visit our Home Page on <http://www.wiley.co.uk>  
or <http://www.wiley.com>

All Rights Reserved. No part of this publication may be reproduced, stored in a retrieval system, or transmitted, in any form or by any means, electronic, mechanical, photocopying, recording, scanning or otherwise, except under the terms of the Copyright Designs and Patents Act 1988 or under the terms of a licence issued by the Copyright Licensing Agency, 90 Tottenham Court Road, London W1P 9HE, UK, without the permission in writing of the publisher

*Other Wiley Editorial Offices*

John Wiley & Sons, Inc., 605 Third Avenue,  
New York, NY 10158-0012, USA

Jacaranda Wiley Ltd, 33 Park Road, Milton,  
Queensland 4064, Australia

John Wiley & Sons (Canada) Ltd, 22 Worcester Road,  
Rexdale, Ontario M9W 1L1, Canada

John Wiley & Sons (Asia) Pte Ltd, Clementi Loop #02-01,  
Jin Xing Distripark, Singapore 129809

***Library of Congress Cataloging-in-Publication Data***

***British Library Cataloguing in Publication Data***

A catalogue record for this book is available from the British Library

ISBN 0 471 95171 4

Typeset in 9/10pt Times by Laser Words, Madras, India  
Printed and bound in Great Britain by Biddles Ltd, Guildford, Surrey  
This book is printed on acid-free paper responsibly manufactured from sustainable forestation, for which at least two trees are planted for each one used for paper production.

# Contributing authors

Pinchas Aped	Department of Chemistry, Bar-Ilan University, Ramat-Gan 52900, Israel
Shmuel Bittner	Institutes for Applied Research and Department of Chemistry, Ben-Gurion University of the Negev, Beer-Sheva 84105, Israel
Richard D. Bowen	Chemistry and Chemical Technology, University of Bradford, Bradford, West Yorkshire BD7 1DP, UK
G. V. Boyd	Department of Organic Chemistry, The Hebrew University of Jerusalem, Jerusalem 91904, Israel
Silvia Bradamante	Università degli Studi di Milano, CNR, Centro di Studio sulla Sintesi e Stereochimica di Speciali Sistemi Organici, via Golgi 19, 20133 Milano, Italy
Mary Stinecipher Campbell	DX-2 Explosive Science Technology, MS C920, Los Alamos National Laboratory, Los Alamos, New Mexico 87545-0000, USA
Lars Carlsen	Department of Environmental Chemistry, National Environmental Research Institute, P.O.Box 358, Frederiksborgvej 399, DK-4000 Roskilde, Denmark
H. K. Chagger	Department of Fuel and Energy, University of Leeds, Leeds LS2 9JT, UK
Y. L. Chow	Department of Chemistry, Simon Fraser University, Burnaby, British Columbia V5A 1S6, Canada
Helge Egsgaard	Environmental Science and Technology Department, Risø National Laboratory, DK-4000 Roskilde, Denmark
Peter Eyer	Walther-Straub-Institut für Pharmakologie und Toxikologie der Ludwig-Maximilians-Universität München, Nussbaumstrasse 26, D-80336 München, Germany
Luciano Forlani	Università di Bologna, Dipartimento di Chimica Organica 'A. Mangini', viale Risorgimento 4, 40136 Bologna, Italy
Albert J. Fry	Department of Chemistry, Wesleyan University, Middletown, Connecticut 06459, USA
D. Galleman	Walther-Straub-Institut für Pharmakologie und Toxikologie der Ludwig-Maximilians-Universität München, Nussbaumstrasse 26, D-80336 München, Germany
T. I. Ho	National Taiwan University, Department of Chemistry, Roosevelt Road, Sec. 4, Taipei, Taiwan, Republic of China

William M. Horspool	Department of Chemistry, The University of Dundee, Dundee DD1 4HN, Scotland
Joel F. Liebman	Department of Chemistry and Biochemistry, University of Maryland, Baltimore County Campus, 1000 Hilltop Circle, Baltimore, Maryland 21250, USA
Alan H. Mehler	10401 Grosvenor Place, Apt. 404, Rockville, Maryland 20852, USA
Christiana A. Mitsopoulou	Department of Chemistry, University of Athens, 15771 Athens, Greece
Norma S. Nudelman	Universidad de Buenos Aires, Facultad de Ciencias Exactas y Naturales, Ciudad Universitaria, 1428 Buenos Aires, Argentina
Paul Rademacher	Institut für organische Chemie der Universität Essen, D-45117 Essen, Germany
Edward W. Randall	Department of Chemistry, Queen Mary and Westfield College, Mile End Road, London E1 4NS, UK
J. P. B. Sandall	University of Exeter, Department of Chemistry, Chemistry Building, Stocker Road, Exeter EX4 4QD, UK
Hanoch Senderowitz	Department of Chemistry, Columbia University, New York, NY 10027, USA
John Shorter	School of Chemistry, University, of Hull, Hull HU6 7RX, UK
Suzanne W. Slayden	Department of Chemistry, George Mason University, 4400 University Drive, Fairfax, Virginia 22030-4444, USA
Howard E. Smith	Department of Chemistry, Vanderbilt University, Nashville, Tennessee 37235, USA
Salvatore Sorriso	Dipartimento di Chimica, Università di Perugia, via Elce di sotto 10, 06100 Perugia, Italy
Kenneth C. Westaway	Department of Chemistry and Biochemistry, Laurentian University, Ramsey Lake Road, Sudbury, Ontario, Canada P3E 2C6
A. Williams	Department of Fuel and Energy, University of Leeds, Leeds LS2 9JT, UK
D. Lyn H. Williams	University of Durham, Department of Chemistry, Science Laboratories, South Road, Durham DH1 3LE, UK
Jacob Zabicky	Institutes for Applied Research and Department of Chemistry, Ben-Gurion University of the Negev, Beer-Sheva 84105, Israel
Heinrich Zollinger	Technisch-Chemisches Laboratorium, ETH-Zentrum, CH-8092 Zürich, Switzerland

# Foreword

The material reviewed in the present volume *Supplement F2: The chemistry of amino, nitroso, nitro and related groups* has been previously covered in the following books in the Chemistry of the Functional Groups series:

The chemistry of the amino group (1968);

The chemistry of the nitro and nitroso groups, Parts 1 and 2 (1969);

Supplement F: The chemistry of amino, nitroso and nitro compounds and their derivatives, Parts 1 and 2 (1982).

Nitrones, nitronates and nitroxides ('Update' volume, 1989).

The chapters in this Supplement F2 generally contain references up to the middle of 1995. Of the planned contents of this book, only three chapters failed to materialize. These were on NQR and ESR, on pyrolysis, and on photoinduced electron transfer reactions. I hope that these missing subjects will be dealt with in a later forthcoming supplementary volume of the series.

I would be very grateful to any reader who would communicate to me comments or criticisms regarding the contents or the presentation of this volume.

Jerusalem  
June 1996

SAUL PATAI

# The Chemistry of Functional Groups

## Preface to the series

The series 'The Chemistry of Functional Groups' was originally planned to cover in each volume all aspects of the chemistry of one of the important functional groups in organic chemistry. The emphasis is laid on the preparation, properties and reactions of the functional group treated and on the effects which it exerts both in the immediate vicinity of the group in question and in the whole molecule.

A voluntary restriction on the treatment of the various functional groups in these volumes is that material included in easily and generally available secondary or tertiary sources, such as Chemical Reviews, Quarterly Reviews, Organic Reactions, various 'Advances' and 'Progress' series and in textbooks (i.e. in books which are usually found in the chemical libraries of most universities and research institutes), should not, as a rule, be repeated in detail, unless it is necessary for the balanced treatment of the topic. Therefore each of the authors is asked not to give an encyclopaedic coverage of his subject, but to concentrate on the most important recent developments and mainly on material that has not been adequately covered by reviews or other secondary sources by the time of writing of the chapter, and to address himself to a reader who is assumed to be at a fairly advanced postgraduate level.

It is realized that no plan can be devised for a volume that would give a complete coverage of the field with no overlap between chapters, while at the same time preserving the readability of the text. The Editors set themselves the goal of attaining reasonable coverage with moderate overlap, with a minimum of cross-references between the chapters. In this manner, sufficient freedom is given to the authors to produce readable quasi-monographic chapters.

The general plan of each volume includes the following main sections:

(a) An introductory chapter deals with the general and theoretical aspects of the group.  
(b) Chapters discuss the characterization and characteristics of the functional groups, i.e. qualitative and quantitative methods of determination including chemical and physical methods, MS, UV, IR, NMR, ESR and PES — as well as activating and directive effects exerted by the group, and its basicity, acidity and complex-forming ability.

(c) One or more chapters deal with the formation of the functional group in question, either from other groups already present in the molecule or by introducing the new group directly or indirectly. This is usually followed by a description of the synthetic uses of the group, including its reactions, transformations and rearrangements.

(d) Additional chapters deal with special topics such as electrochemistry, photochemistry, radiation chemistry, thermochemistry, syntheses and uses of isotopically labelled compounds, as well as with biochemistry, pharmacology and toxicology. Whenever applicable, unique chapters relevant only to single functional groups are also included (e.g. 'Polyethers', 'Tetraaminoethylenes' or 'Siloxanes').



This plan entails that the breadth, depth and thought-provoking nature of each chapter will differ with the views and inclinations of the authors and the presentation will necessarily be somewhat uneven. Moreover, a serious problem is caused by authors who deliver their manuscript late or not at all. In order to overcome this problem at least to some extent, some volumes may be published without giving consideration to the originally planned logical order of the chapters.

Since the beginning of the Series in 1964, two main developments have occurred. The first of these is the publication of supplementary volumes which contain material relating to several kindred functional groups (Supplements A, B, C, D, E, F and S). The second ramification is the publication of a series of 'Updates', which contain in each volume selected and related chapters, reprinted in the original form in which they were published, together with an extensive updating of the subjects, if possible, by the authors of the original chapters. A complete list of all above mentioned volumes published to date will be found on the page opposite the inner title page of this book. Unfortunately, the publication of the 'Updates' has been discontinued for economic reasons.

Advice or criticism regarding the plan and execution of this series will be welcomed by the Editors.

The publication of this series would never have been started, let alone continued, without the support of many persons in Israel and overseas, including colleagues, friends and family. The efficient and patient co-operation of staff-members of the publisher also rendered us invaluable aid. Our sincere thanks are due to all of them.

The Hebrew University  
Jerusalem, Israel

SAUL PATAI  
ZVI RAPPOPORT

# Contents

1	Molecular mechanics calculations <b>Pinchas Aped and Hanoch Senderowitz</b>	1
2	Structural chemistry <b>Salvatore Sorriso</b>	85
3	Chiroptical properties of amino compounds <b>Howard E. Smith</b>	105
4	Photoelectron spectra of amines, nitroso and nitro compounds <b>Paul Rademacher</b>	159
5	The chemistry of ionized, protonated and cationated amines in the gas phase <b>Richard D. Bowen</b>	205
6	Mass spectrometry of nitro and nitroso compounds <b>Helge Egsgaard and Lars Carlsen</b>	249
7	NMR of compounds containing $-\text{NH}_2$ , $-\text{NO}_2$ and $-\text{NO}$ groups <b>Edward W. Randall and Christiana A. Mitsopoulou</b>	295
8	Thermochemistry of amines, nitroso compounds, nitro compounds and related species <b>Joel F. Liebman, Mary Stinecipher Campbell and Suzanne W. Slayden</b>	337
9	Acidity and basicity <b>Silvia Bradamante</b>	379
10	Hydrogen bonding and complex formation involving compounds with amino, nitroso and nitro groups <b>Luciano Forlani</b>	423
11	Electronic effects of nitro, nitroso, amino and related groups <b>John Shorter</b>	479
12	Advances in the chemistry of amino and nitro compounds <b>G. V. Boyd</b>	533
13	Diazotization of amines and dediazonation of diazonium ions <b>Heinrich Zollinger</b>	627

14	S-Nitroso compounds, formation, reactions and biological activity <b>D. Lyn H. Williams</b>	665
15	Photochemistry of amines and amino compounds <b>Tong Ing Ho and Yuan L. Chow</b>	683
16	Photochemistry of nitro and nitroso compounds <b>Tong-Ing Ho and Yuan L. Chow</b>	747
17	Radiation chemistry of amines, nitro and nitroso compounds <b>William M. Horspool</b>	823
18	The electrochemistry of nitro, nitroso, and related compounds <b>Albert J. Fry</b>	837
19	Rearrangement reactions involving the amino, nitro and nitroso groups <b>D. Lyn H. Williams</b>	857
20	The synthesis and uses of isotopically labelled amino and quaternary ammonium salts <b>Kenneth C. Westaway</b>	893
21	Displacement and <i>ipso</i> -substitution in nitration <b>J. P. B. Sandall</b>	949
22	Nitric oxide from arginine: a biological surprise <b>Alan H. Mehler</b>	973
23	Reactions of nitrosoarenes with SH groups <b>P. Eyer and D. Galleman</b>	999
24	Analytical aspects of amino, quaternary ammonium, nitro, nitroso and related functional groups <b>Jacob Zabicky and Shmuel Bittner</b>	1041
25	Environmental aspects of compounds containing nitro, nitroso and amino groups <b>H. K. Chagger and A. Williams</b>	1169
26	S <sub>N</sub> Ar reactions of amines in aprotic solvents <b>Norma S. Nudelman</b>	1215
	Author index	1301
	Subject index	1393

# List of abbreviations used

Ac	acetyl (MeCO)
acac	acetylacetone
Ad	adamantyl
AIBN	azoisobutyronitrile
Alk	alkyl
All	allyl
An	anisyl
Ar	aryl
Bz	benzoyl (C <sub>6</sub> H <sub>5</sub> CO)
Bu	butyl (also <i>t</i> -Bu or Bu <sup><i>t</i></sup> )
CD	circular dichroism
CI	chemical ionization
CIDNP	chemically induced dynamic nuclear polarization
CNDO	complete neglect of differential overlap
Cp	$\eta^5$ -cyclopentadienyl
Cp*	$\eta^5$ -pentamethylcyclopentadienyl
DABCO	1,4-diazabicyclo[2.2.2]octane
DBN	1,5-diazabicyclo[4.3.0]non-5-ene
DBU	1,8-diazabicyclo[5.4.0]undec-7-ene
DIBAH	diisobutylaluminium hydride
DME	1,2-dimethoxyethane
DMF	<i>N,N</i> -dimethylformamide
DMSO	dimethyl sulphoxide
ee	enantiomeric excess
EI	electron impact
ESCA	electron spectroscopy for chemical analysis
ESR	electron spin resonance
Et	ethyl
eV	electron volt

Fc	ferrocenyl
FD	field desorption
FI	field ionization
FT	Fourier transform
Fu	furyl(C <sub>4</sub> H <sub>3</sub> )
GLC	gas liquid chromatography
Hex	hexyl(C <sub>6</sub> H <sub>13</sub> )
c-Hex	cyclohexyl(C <sub>6</sub> H <sub>11</sub> )
HMPA	hexamethylphosphortriamide
HOMO	highest occupied molecular orbital
HPLC	high performance liquid chromatography
i-	iso
Ip	ionization potential
IR	infrared
ICR	ion cyclotron resonance
LAH	lithium aluminium hydride
LCAO	linear combination of atomic orbitals
LDA	lithium diisopropylamide
LUMO	lowest unoccupied molecular orbital
M	metal
<i>M</i>	parent molecule
MCPBA	<i>m</i> -chloroperbenzoic acid
Me	methyl
MNDO	modified neglect of diatomic overlap
MS	mass spectrum
n	normal
Naph	naphthyl
NBS	<i>N</i> -bromosuccinimide
NCS	<i>N</i> -chlorosuccinimide
NMR	nuclear magnetic resonance
Pc	phthalocyanine
Pen	pentyl(C <sub>5</sub> H <sub>11</sub> )
Pip	piperidyl(C <sub>5</sub> H <sub>10</sub> N)
Ph	phenyl
ppm	parts per million
Pr	propyl (also <i>i</i> -Pr or Pr <sup><i>i</i></sup> )
PTC	phase transfer catalysis or phase transfer conditions
Pyr	pyridyl (C <sub>5</sub> H <sub>4</sub> N)

R	any radical
RT	room temperature
<i>s</i> -	secondary
SET	single electron transfer
SOMO	singly occupied molecular orbital
<i>t</i> -	tertiary
TCNE	tetracyanoethylene
TFA	trifluoroacetic acid
THF	tetrahydrofuran
Thi	thienyl(SC <sub>4</sub> H <sub>3</sub> )
TLC	thin layer chromatography
TMEDA	tetramethylethylene diamine
TMS	trimethylsilyl or tetramethylsilane
Tol	tolyl(MeC <sub>6</sub> H <sub>4</sub> )
Tos or Ts	tosyl( <i>p</i> -toluenesulphonyl)
Trityl	triphenylmethyl(Ph <sub>3</sub> C)
Xyl	xylyl(Me <sub>2</sub> C <sub>6</sub> H <sub>3</sub> )

In addition, entries in the 'List of Radical Names' in *IUPAC Nomenclature of Organic Chemistry*, 1979 Edition. Pergamon Press, Oxford, 1979, p. 305–322, will also be used in their unabbreviated forms, both in the text and in formulae instead of explicitly drawn structures.

## CHAPTER 1

# Molecular mechanics calculations

PINCHAS APED

*Department of Chemistry, Bar-Ilan University, Ramat-Gan 52900, Israel*  
*Fax: (972-3)535-1250 e-mail: APED@GEFEN.CC.BIU.AC.IL*

and

HANOCH SENDEROWITZ

*Department of Chemistry, Columbia University, New York, NY 10027, USA*  
*Fax: (001-212)678-9039; e-mail: sender@still3.chem.columbia.edu*

---

I. INTRODUCTION	2
II. DEVELOPMENT OF THE COMPUTATIONAL MODEL	3
A. Molecular Mechanics	3
B. Specific Force Fields—MM2	5
1. MM2 potential functions	5
2. MM2 parameterization of amines	6
a. Acyclic amines	6
b. Cyclic amines	8
c. Heats of formation	10
d. Dipole moments	11
3. MM2' parameterization of nitro compounds and MM2 parameterization of nitrosamines, nitramines, nitrates and oximes	11
4. MM2 parameterization of nitro compounds, enamines and aniline derivatives	14
5. MM2 parameterization of the N—C—N anomeric moiety	14
C. MM3	20
1. MM3 potential functions	21
2. MM3 parameterization of amines	23
a. Bond length and bond angle parameters	23
b. Torsional angle parameters	24
c. Moments of inertia	24
d. Four-membered and five-membered rings	24
e. Hydrogen bonding	27
f. Heats of formation	29

3.	MM2 and MM3 parameterization of nitro compounds	29
a.	Structure	30
b.	Rotational barriers	31
c.	Vibrational spectra	32
d.	Heats of formation	32
4.	MM2 and MM3 parameterization of enamines and aniline derivatives	33
a.	Structure	33
b.	Conformational energies and rotational barriers	34
c.	Heats of formation	35
d.	Vibrational spectra	35
5.	Other force fields	35
a.	AMBER	35
b.	Tripos 5.2	36
c.	DREIDING	37
d.	Universal Force Field (UFF)	38
D.	Energetic comparison between MM2, MM3, AMBER, Tripos 5.2, DREIDING and UFF	40
III.	APPLICATION OF THE COMPUTATIONAL MODEL	42
A.	Conformational Analysis and Structural Investigation	43
1.	Tertiary amines	43
2.	Polyamines	55
a.	Diamines	55
b.	Tri- and tetraamines	57
c.	Cryptands and azacrown ethers	59
3.	Medium-size rings	60
4.	Biologically active compounds	62
B.	Spectroscopic Experiments and the Study of Chemical Effects	66
1.	Nitrogen proton affinities and amine basicity	66
2.	Magnetic anisotropy of cyclopropane and cyclobutane	68
3.	CD spectra of <i>N</i> -nitrosopyrrolidines	69
4.	<sup>17</sup> O and <sup>15</sup> N NMR spectra of <i>N</i> -nitrosamines	70
C.	Mechanisms of Chemical Reactions	72
D.	Heat of Formation and Density Calculations of Energetic Materials	76
IV.	ACKNOWLEDGMENT	81
V.	REFERENCES	81

## I. INTRODUCTION

Theory plays an invaluable role in our understanding of organic chemistry and is enhanced by the usage of rigorously built computational models. While *ab initio* calculations are certainly the most physically ‘correct’ way to treat chemical systems, they are limited, with current computer technology, to molecules with a relatively small number of heavy (nonhydrogen) atoms. Larger systems are best handled by molecular mechanics provided that high-quality force-field parameters are available. In such cases, the method can provide accurate molecular properties using only a fraction of the computational resources needed by quantum mechanical methods. The rapid increase in affordable computational power and the integration of many force fields into ‘user friendly’ molecular modeling packages has further contributed to the development and widespread usage of the method.

In Section II of this review we develop the molecular mechanics computational model by presenting the potential functions of several commonly used force fields and discussing, in some detail, the parameterization procedures for the type of compounds considered



in this work. In Section III, we describe the applications of the resulting force fields to a variety of problems in amino, nitro and nitroso chemistry. Typically, molecular mechanics calculations have been used, primarily, to obtain (minimum energy) molecular structures and conformational energies. However, the examples provided in this review span a much broader range of applications, from ‘traditional’ conformational analysis and structural investigation to spectroscopic experiments, heats of formation calculations of energetic materials and the study of chemical effects and reaction mechanisms. Of the molecular systems considered here, the vast majority of calculations has been performed for amines while fewer examples are found for nitro compounds and, still fewer, for nitroso ones. Calculations of other nitrogen-containing molecules, in particular, organometallic complexes and biological macromolecules, are also found in the literature but these fall beyond the scope of the current work.

Finally, we would like to point out that although we made a special effort to cover most of the seminal works, this review is not intended to provide an exhaustive coverage of the available literature, but rather, to serve as a guideline to the usage of molecular mechanics calculations in this field.

## II. DEVELOPMENT OF THE COMPUTATIONAL MODEL

### A. Molecular Mechanics

Molecular mechanics<sup>1</sup> is an empirical computational method which can provide accurate molecular properties with minimal computational cost. The method treats the molecule as a collection of atoms held together by forces. The forces are described by classical potential functions and the set of all these functions is the force field. The force field defines a multidimensional Born–Oppenheimer surface but, in contrast with quantum mechanics, only the motion of the nuclei is considered and the electrons are assumed to find the optimal distribution among them. Since there are no strict rules regarding the number or type of potential functions to be used, many different molecular mechanics force fields have been developed over the years. These can be classified according to the type of potential functions employed in their construction. In the following we concentrate on extended valence force fields which include both diagonal (stretching, bending, torsion and nonbonded interactions) and off-diagonal terms (cross terms). The latter are employed when two internal coordinates end on the same atom or on nearest-neighbor atoms. The potential energy of the molecule in the force field arises due to deviations from ‘ideal’ geometry defined by structural parameters and is given by a sum of energy contributions (equation 1).

$$E_{\text{total}} = E_{\text{stretch}} + E_{\text{bend}} + E_{\text{torsion}} + E_{\text{nonbonded}} + E_{\text{cross terms}} \quad (1)$$

The first three terms, stretch, bend and torsion, are common to most force fields although their explicit form may vary. The nonbonded terms may be further divided into contributions from Van der Waals (VdW), electrostatic and hydrogen-bond interactions. Most force fields include potential functions for the first two interaction types (Lennard-Jones type or Buckingham type functions for VdW interactions and charge–charge or dipole–dipole terms for the electrostatic interactions). Explicit hydrogen-bond functions are less common and such interactions are often modeled by the VdW expression with special parameters for the atoms which participate in the hydrogen bond (see below).

The number and type of cross terms vary among different force fields. Thus, AMBER<sup>2</sup> contains no cross terms, MM2<sup>3</sup> uses stretch–bend interactions only and MM3<sup>4</sup> uses stretch–bend, bend–bend and stretch–torsion interactions. Cross terms are essential for an accurate reproduction of vibrational spectra and for a good treatment of strained molecular systems, but have only a small effect on conformational energies.

Given a set of potential functions, the results of any molecular mechanics calculation depend critically on the parameters. These may be obtained from two main sources,

namely experimental data or high-level quantum mechanics (usually *ab initio*) calculations. Experimentally based parameters have two main advantages: (1) they describe the 'real world' rather than another computational model of it; (2) they reflect molecular free energies rather than enthalpies. However, such parameters are often hard to obtain, not available for all systems of interest, nonuniform (that is, obtained by different experimental techniques and often in diverse media) and usually do not provide a complete description of the molecular potential surface including all minima and transition states. In contrast, parameters from high-level quantum mechanical calculations are available for all molecular systems, up to a certain size, are uniform (that is, always describe an isolated molecule and, if desired, may be obtained at the same level of theory) and can provide a complete description of the molecular potential energy surface. The two main disadvantages of such parameters, namely their possibly high computational cost and dependence on the theoretical model, are gradually resolved with the rapid development of computational power (which by far exceeds similar developments in experimental techniques) and the consequent accumulation of experience in this field, and today, many parameters for use in molecular mechanics calculations are derived in such a manner. Regardless of the source of the parameters, an essential (although not necessarily correct) assumption for the applicability and usefulness of molecular mechanics is their transferability, i.e. once they are derived, usually from a small set of model compounds, they may be used for other larger (but similar) systems.

In order for a force field to be considered adequate for treatment of a particular molecular system (or a class of molecules) it must provide an accurate description of its properties such as geometry, dipole moment, conformational energies, barriers to rotation, heat of formation and vibrational spectra, while the reference data come either from experiment or from high-level *ab initio* calculations. Some care must be taken when evaluating the performance of molecular mechanics force fields through comparison with experimental or theoretical data<sup>1</sup>: Since different experimental techniques provide different structural and energetic parameters which also differ from those obtained by quantum mechanical calculations, a force field parameterized according to data from a specific source can reproduce data from other sources only qualitatively (a partial solution to this problem is provided in MM3-94, where it is possible to obtain  $r_e$  bond lengths which are supposed to provide the best fit to *ab initio* results<sup>4</sup>).

Several force fields have been used in molecular mechanics calculations of amino, nitro and nitroso compounds but for only two, MM2<sup>5,15-17,20,21,43,44</sup> and MM3<sup>6,43,44</sup>, has a specific parameterization been reported in the literature. Several features of these systems are of particular importance and a challenge to molecular mechanics calculations and must be included in any critical evaluation of the force-field performance. For amino compounds these are the treatments of nitrogen inversion, the reproduction of changes in C-H bond lengths when antiperiplanar to a nitrogen lone pair (lp) and the consequent calculation of the Bohlmann bands in the IR spectra, the reproduction of the shortening of C-N bonds in tertiary amines, the treatment of inter- and intramolecular hydrogen bonds and the reproduction of structural and energetic manifestations of stereoelectronic effects such as the anomeric effect characteristic of N-C-X moieties and the *gauche* effect characteristic of N-C-C-X moieties (X = electronegative atom/group). As for nitro compounds, the two most challenging aspects are the possible conjugation of the nitro group to other  $\pi$  systems and the consequent geometry of the molecule and the barriers for rotation around the C-N bond in aromatic and aliphatic nitro compounds.

In the following we will present the explicit form of the potential functions and the parameterization of most of the force fields used in molecular mechanics calculations of amino, nitro and nitroso compounds and evaluate their performance according to these criteria.

## B. Specific Force Fields—MM2

Several force fields have been used in molecular mechanics calculations of amino, nitro and nitroso compounds. The most intensive work has been done with MM2 and, in recent years, also with MM3, probably due to the generally recognized high performance of these force fields and since they are the only ones which have undergone extensive specific parameterization for these systems, however, several other calculations are also found in the literature (see below). We therefore start with the MM2 and MM3 force fields where we briefly outline the specific form of the potential functions and discuss, in some detail, the parameterization procedure for the type of compounds discussed in this chapter. We then turn to several other force fields which have not undergone specific parameterization but were nevertheless used in the calculations (AMBER, Tripos, DREIDING, UFF). We conclude with a brief comparison of the energetic performance of all force fields.

The MM2 force field<sup>3</sup> is probably the most extensively parameterized and intensively used force field to date. It reproduces a variety of molecular properties such as geometry, dipole moments, conformational energies, barriers to rotation and heats of formation. Of particular importance for calculations of amines is that MM2 treats lone pairs on  $sp^3$  nitrogens (and oxygens) as pseudo atoms with a special atom type and parameters. A closely related force field, MM2<sup>7</sup>, was derived from MM2 by Osawa and Jaime. MM2' uses the same potential functions as MM2, but employs a different set of parameters in an attempt to better reproduce barriers to rotation about single C–C bonds.

### 1. MM2 potential functions<sup>1,3</sup>

Within the MM2 force field, the molecular steric energy is given by

$$E_{\text{total}} = E_{\text{stretch}} + E_{\text{bend}} + E_{\text{stretch-bend}} + E_{\text{torsion}} + E_{\text{vdW}} + E_{\text{electrostatic}} \quad (2)$$

The stretching energy is given by a sum of quadratic (harmonic) and cubic terms:

$$E_{\text{stretch}}(i, j) = K(r_{ij} - r_{ij}^0)^2 + K1(r_{ij} - r_{ij}^0)^3 \quad (3)$$

where  $r_{ij}$  and  $r_{ij}^0$  are the actual and 'natural' bond lengths between atoms  $i$  and  $j$ , respectively, and  $K$  and  $K1$  are stretching force constants:  $r_{ij}^0$  is subjected to primary electronegativity effects<sup>8</sup> which allow for a better reproduction of experimental data such as, for example, the shortening of C–N bonds along the series  $\text{CH}_3\text{NH}_2 \rightarrow (\text{CH}_3)_2\text{NH} \rightarrow (\text{CH}_3)_3\text{N}$  (see Section II.C.2 for more details).

The bending energy is given by

$$E_{\text{bend}}(i, j, k) = K(\theta_{ijk} - \theta_{ijk}^0)^2 + K1(\theta_{ijk} - \theta_{ijk}^0)^6 \quad (4)$$

where  $\theta_{ijk}$  and  $\theta_{ijk}^0$  are the actual and 'natural'  $i$ – $j$ – $k$  bond angles and  $K$  and  $K1$  are bending force constants.

The stretch–bend energy allows for the  $i$ – $j$  and  $j$ – $k$  bonds to stretch when the angle between them ( $i$ – $j$ – $k$ ) closes and is given by

$$E_{\text{stretch-bend}} = K[(r_{ij} - r_{ij}^0) + (r_{jk} - r_{jk}^0)](\theta_{ijk} - \theta_{ijk}^0) \quad (5)$$

where  $K$  is the stretch–bend force constant and all other parameters have their usual meaning.

Torsional energy is given by

$$E_{\text{torsion}}(i, j, k, l) = 0.5V1(1 + \cos \omega_{ijkl}) + 0.5V2(1 - \cos 2\omega_{ijkl}) + 0.5V3(1 + \cos 3\omega_{ijkl}) \quad (6)$$

where  $V1$ ,  $V2$  and  $V3$  are adjustable parameters and  $\omega_{ijkl}$  is the torsional angle.

The VdW energy is given by a Buckingham type potential function<sup>9</sup>:

$$E_{\text{VdW}}(i, j) = \begin{cases} \varepsilon[2.9 \times 10^5 \exp(-12.5r_{ij}^*/r_{ij}) - 2.25(r_{ij}^*/r_{ij})^6] & r^*/r \leq 3.311 \\ \varepsilon \times 336.176(r_{ij}^*/r_{ij})^2 & r^*/r > 3.311 \end{cases} \quad (7)$$

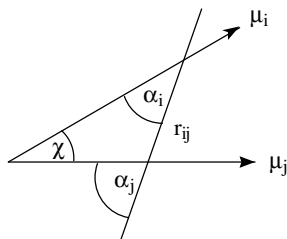
where  $r_{ij}^* = r_i + r_j$  = sum of VdW radii of atoms  $i$  and  $j$  and  $\varepsilon = (\varepsilon_i \varepsilon_j)^{0.5}$  is the well depth of the  $i$ - $j$  VdW potential curve.

The electrostatic energy is given by charge-charge or dipole-dipole interactions:

$$E_{\text{charge-charge}}(i, j) = q_i q_j / \varepsilon r_{ij} \quad (8)$$

$$E_{\text{dipole-dipole}}(ij) = (\mu_i \mu_j / \varepsilon r_{ij}^3)(\cos \chi - 3 \cos \alpha_i \cos \alpha_j) \quad (9)$$

where, in equation 8,  $q_i$  and  $q_j$  are partial atomic charges on atoms  $i$  and  $j$ ,  $\varepsilon$  is the dielectric constant and  $r_{ij}$  is the distance between atoms  $i$  and  $j$ . All the terms in equation 9 are defined in structure **1**.



(1)

## 2. MM2 parameterization of amines<sup>5</sup>

The parameterization of the MM2 force field for amines<sup>5</sup> was originally based on experimental data with occasional references to quantum mechanical calculations mainly to evaluate conformational energies. Missing parameters (bond lengths and angles) for several unique amino functionalities were later evaluated from *ab initio* calculations and incorporated into the force field<sup>10</sup>. As in the case of alcohols it was found necessary to include explicit lp on  $sp^3$  nitrogens. The main disadvantage of this treatment is that ammonia, for example, does not invert through a symmetrical transition state. However, apart from this shortcoming, the lp formalism seems to reproduce well the structural and energetic characteristics of amines. A complete list of amine parameters is provided in Reference 5.

*a. Acyclic amines.* An initial set of amine parameters was based on the microwave (MW) structures of ammonia and methylamines. A comparison of MM2, *ab initio*, MW and infrared (IR) structures for these model compounds is provided in Table 1. Four discrepancies between calculations and experiment are apparent: (1) MM2 calculations do not reproduce the decrease in C-N bond lengths on going from primary to secondary

TABLE 1. Calculated (MM2, MM3 and *ab initio*) and observed structural parameters for ammonia and methylamines (bond lengths in Å, bond angles and tilt angles in degrees, dipole moments in Debye)<sup>5,6</sup>. Reprinted with permission from Refs. 5 and 6. Copyright (1985, 1990) American Chemical Society

Parameter	MM2	MM3 <sup>a</sup>	<i>Ab initio</i> <sup>b</sup>	MW	ED
Ammonia					
N–H	1.013	1.015	1.003	1.0144 ± 0.002	
H–N–H	107.6	107.1	107.2	107.1 ± 0.9	
dipole moment	1.43	1.49	1.92	1.47	
Methylamine					
C–H	1.114	1.110	1.095 (a) 1.086 (s)	1.093 ± 0.006	
C–N	1.454	1.463	1.484	1.474 ± 0.005	1.467 ± 0.002
N–H	1.015	1.014	1.010	1.014	
H–C–H	109.0 (a) <sup>c</sup> 109.1 (s) <sup>c</sup>	108.71 107.79	108.4 (a) 107.5 (s)	109.47 ± 0.8	
C–N–H	111.3	112.29	110.0	112.1 ± 0.8	
H–N–H	105.4	106.42	105.9	105.85 ± 0.6	
N–C–H		111.01 110.27		110.3 <sup>d</sup>	
CH <sub>3</sub> tilt	0.19		3.9	3.5	
dipole moment	1.33	1.29		1.336	
Dimethylamine (2)					
N–H	1.017	1.018	0.999	1.019 ± 0.007	1.00 ± 0.2
C–N	1.460	1.462	1.461	1.463 ± 0.005	1.455 ± 0.002
C–H	1.115	1.110	1.080	1.084 ± 0.005	1.106 ± 0.002
C–H'	1.115	1.110	1.081	1.098 ± 0.004	1.106 ± 0.002
C–H''	1.115	1.110	1.090	1.098 ± 0.004	1.106 ± 0.002
C–N–H	109.5	109.83	112.3	108.9 ± 0.3	107 ± 2.0
C–N–C	112.1	112.42	115.1	112.2 ± 0.2	111.8 ± 0.6
N–C–H	109.4	110.28	109.4	109.7 ± 0.3	
N–C–H'	110.7	110.47	109.2	108.2 ± 0.3	112.0 ± 0.8
N–C–H''	110.7	110.22	114.0	113.8 ± 0.3	
H–C–H'	108.2	107.65	108.0	109.0 ± 0.2	106.8 ± 0.8
H–C–H''	108.3	108.48	108.5	109.2 ± 0.2	106.8 ± 0.8
H'–C–H''	109.4	109.64	107.6	107.2 ± 0.3	106.8 ± 0.8
CH <sub>3</sub> tilt	0.9			3.4	
dipole moment	1.10	1.07		1.03	
Trimethylamine					
C–N	1.465	1.460	1.445	1.454 ± 0.003	1.454 ± 0.002
C–N–C	110.9	111.20	111.9	110.9 ± 0.6	
N–C–H		111.37 110.54 110.30	113.0 109.8		110.2 <sup>e</sup> 110.2 110.2
dipole moment	0.64	0.62	0.75	0.63	

<sup>a</sup>MM3 data for ammonia were calculated for this work with MM3-94.

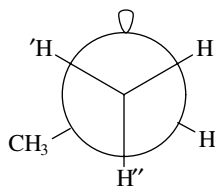
<sup>b</sup>*ab initio* data for ammonia (HF/6-31G\*) were taken from P. C. Hariharan and J. A. Pople, *Mol. Phys.*, **27**, 209 (1974). *Ab initio* data for trimethylamine (HF/6-31G\*) were calculated for this work.

<sup>c</sup>(a) = one hydrogen is *anti* to the nitrogen's lp and the other is *gauche* to the nitrogen's lp; (s) = both hydrogens are *gauche* to the nitrogen's lp.

<sup>d</sup>Taken from Reference 11.

<sup>e</sup>Taken from Reference 12.

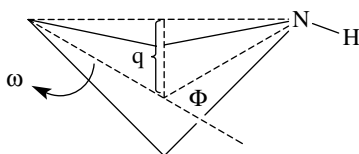
to tertiary amines. This problem has been dealt with in later versions of MM2 through the electronegativity effect (see Section II.B.1 and Section II.C.1). (2) Both IR spectra and *ab initio* calculations<sup>5</sup> have demonstrated the increase in C–H bond lengths when antiperiplanar to a nitrogen lp. This effect is not reproduced by MM2 (but is reproduced by later versions of MM3, see Section II.C.1). (3) The MM2 C–N–H and C–N–C angles are much closer to the MW values than the *ab initio* ones. (4) The H'–C–H'' angle (see structure **2**) is approximately tetrahedral in contrast with both MW and *ab initio* results, which show *ca* 2° shrinkage.



(2)

The torsional parameters for the methylamine fragment were chosen to reproduce the barriers to rotation in methylamine, dimethylamine and trimethylamine. The calculated values, 1.90, 3.04 and 4.22 kcal mol<sup>-1</sup> for the three methylamines, respectively, are in good agreement with the experimental ones (1.98, 3.22 and 4.35 kcal mol<sup>-1</sup>). The torsional parameters for the C–C–N–H and C–C–N–lp fragments were chosen to reproduce the axial/equatorial energy difference in piperidine (0.30 and 0.25–0.74 kcal mol<sup>-1</sup> in favour of the equatorial hydrogen conformation from MM2 calculations and NMR experiments, respectively) at the expense of ethylamine (0.13 and –0.6 kcal mol<sup>-1</sup> in favor of the C–C–N–lp *gauche* conformation from MM2 calculations and experiment, respectively), since it was not possible to fit both molecules with the same set of torsional parameters. Finally, the C–N–C–C fragment was chosen to reproduce the experimental free-energy difference between the *trans* and *gauche* conformations of methylethylamine (>1.3 and 1.14 kcal mol<sup>-1</sup> from MW and MM2, respectively).

*b. Cyclic amines.* The smallest cyclic amine considered during MM2 parameterization is the four-membered ring azetidine (**3**). As customary with MM2 treatments of 4-membered rings, unique bending and torsional parameters were applied to this molecule. A far-IR study has shown azetidine to be puckered with a planar barrier height of 1.26 kcal mol<sup>-1</sup> and an equatorial hydrogen preference of 0.27 kcal mol<sup>-1</sup>.<sup>13</sup> An electron diffraction (ED) study confirmed the nonplanarity of the system with an observed puckering angle (see structure **3**) of 33°.<sup>14</sup> The MM2 numbers are 1.09 and 0.05 kcal mol<sup>-1</sup> for the barrier height and equatorial hydrogen preference, respectively, and 36.2° for the puckering angle. While the calculated barrier and puckering angle are in good agreement with the experimental values, MM2 overestimates the stability of the H-axial conformer, probably due to



(3)

TABLE 2. Calculated (MM2 and MM3) and observed (ED and MW/ED) structure of azetidide (bond lengths in Å, bond angles,  $\Phi$ ,  $q$  and  $\omega$ , in degrees; see structure 3 for the definition of  $\Phi$ ,  $q$  and  $\omega$ )<sup>5,6</sup>. Reprinted with permission from Refs. 5 and 6. Copyright (1985, 1990) American Chemical Society

Structural feature	MM2 <sup>a</sup>	MM3 <sup>b</sup>	ED	MW/ED
C–N	1.471	1.475	1.482 ± 0.006	1.473
C–C	1.549	1.563	1.553 ± 0.009	1.563
C–H	1.116		1.107 ± 0.003	
N–H	1.014		1.002 ± 0.014	
C–N–C	92.5	91.26	92.2 ± 0.4	91.2
C–C–C	86.6	84.85	86.9 ± 0.4	84.6
C–C–N	86.4	88.24	85.8 ± 0.4	88.2
H–C–H	114.3		110.0 ± 0.7	
$\Phi$	36.2	29.0	33.1 ± 2.4	29.7
$q$	0.311			
$\omega$	10.7			

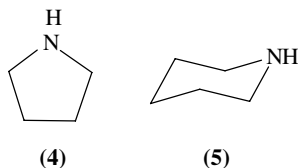
<sup>a</sup>The MM2 force field was parameterized to reproduce the ED values.

<sup>b</sup>The MM3 force field was parameterized to reproduce the MW/ED values.

a lp effect which prevents a realistic inversion of the nitrogen and thus stabilizes this form (in the ‘real world’ this minima may vanish due to repulsion between the axial hydrogen and the C3 methylene which leads to nitrogen inversion). A comparison of MW and MM2 structures for azetidide is provided in Table 2 and shows good agreement between theory and experiment.

Not much information is available for the five-membered ring pyrrolidine (4). MM2 calculations predicted that the 2-half-chair form is preferred over a host of other conformers by an average of 0.3 kcal mol<sup>-1</sup> with a 4.37 kcal mol<sup>-1</sup> barrier to planarity. The ‘equatorial’ hydrogen is calculated to be favored by  $\Delta E = 0.20$  kcal mol<sup>-1</sup> over the axial one.

Much controversy is found in the literature regarding the conformational preference of the six-membered ring piperidine (5)<sup>5</sup>. However, most experimental evidence is consistent with a predominance of the H-equatorial conformer by 0.25–0.74 kcal mol<sup>-1</sup>. As noted above, the C–C–N–H and C–C–N–lp torsional parameters were adjusted to reproduce an intermediate value of 0.30 kcal mol<sup>-1</sup>. MM2 calculations of this system have revealed, perhaps contrary to chemical intuition, that most of the energy difference between the H-axial and H-equatorial conformers results from torsional energy while the 1,3-diaxial interactions have only a negligible contribution<sup>5</sup>.



The conformational behavior of *N*-methyl-piperidine (6) had been extensively studied. Most researchers now agree that the Me-equatorial conformer is favored by about 2.7 kcal mol<sup>-1</sup>. The C–N–C–C torsional parameter was adjusted to produce an energy difference,  $\Delta E$ , of 2.50 kcal mol<sup>-1</sup>, most of which comes from torsional and bending contributions. A comparison of calculated and observed conformational energies in simple mono-cyclic amines is given in Table 3. In most cases the agreement between MM2 and experimental values is very good. One notable exception is *cis*-2,6-di-*t*-butylpiperidine,

TABLE 3. Calculated (MM2) and observed conformational energies (kcal mol<sup>-1</sup>) in monocyclic amines<sup>5</sup>. Reprinted with permission from Ref. 5. Copyright (1985) American Chemical Society

Compound	Stable conformer	$\Delta E_{\text{calculated}}$	$\Delta E_{\text{experimental}}$
Azetidene	puckered, N-H eq	0.05	0.27
Pyrrrolidine	2-env. or half-chair	0.24	0.20 ± 0.04
Cyclobutylamine	NH <sub>2</sub> eq (gg) <sup>a</sup>	0.15	0.16
Cyclohexylamine	NH <sub>2</sub> eq (gg) <sup>a</sup>	1.37	1.1–1.8
1-Amino-1-methylcyclohexane	Methyl eq	0.64	
eq-1-Amino-2-methylcyclohexane	Methyl eq	1.45	
1-Amino-eq-2-methylcyclohexane	NH <sub>2</sub> eq	1.28	
1-Amino-2,2-dimethylcyclohexane	NH <sub>2</sub> eq	1.12	
Piperidine	N-H eq	0.30	0.3–0.8
eq-2-Methylpiperidine	N-H eq	0.29	
ax-2-Methylpiperidine	N-H eq	0.23	
3-Methylpiperidine	CH <sub>3</sub> eq	1.62	1.6, 1.65
eq-3-Methylpiperidine	N-H eq	0.30	
ax-3-Methylpiperidine	N-H eq	0.49	
4-Methylpiperidine	CH <sub>3</sub> eq	1.75	1.9, 1.93
2,2,6,6-Tetramethylpiperidine	N-H eq	0.40	
<i>cis</i> -2,6-Di- <i>t</i> -butylpiperidine	N-H ax	-0.65	0.65
<i>N</i> -Methylpiperidine	CH <sub>3</sub> eq	2.50	0.4–3.15
2-Methylpiperidine (N-H eq)	CH <sub>3</sub> eq	2.11	2.5 <sup>b</sup>
eq-2-Methyl- <i>N</i> -methylpiperidine	N-CH <sub>3</sub> eq	1.68	2.5 <sup>b</sup>
eq-3-Methyl- <i>N</i> -methylpiperidine	N-CH <sub>3</sub> eq	2.57	2.5 <sup>b</sup>
eq-4-Methyl- <i>N</i> -methylpiperidine	N-CH <sub>3</sub> eq	2.47	2.5 <sup>b</sup>
eq-4- <i>t</i> -Butyl- <i>N</i> -methylpiperidine	N-CH <sub>3</sub> eq	2.52	2.5 <sup>b</sup>
1,2,2,6-Tetramethylpiperidine	N-CH <sub>3</sub> eq	1.70	1.95 ± 0.2
1-eq,2-Dimethylpiperidine	2-CH <sub>3</sub> eq	1.68	1.5, 1.9, 1.7
1-eq,3-Dimethylpiperidine	3-CH <sub>3</sub> eq	1.62	1.5, 1.77, 1.6
1-eq,4-Dimethylpiperidine	4-CH <sub>3</sub> eq	1.72	1.98, 1.8
2,3,3-Trimethylpiperidine	2-CH <sub>3</sub> eq	1.24	
2,2,3-Trimethylpiperidine	3-CH <sub>3</sub> eq	1.13	
1-eq,2,3,3-Tetramethylpiperidine	2-CH <sub>3</sub> eq	0.60	

<sup>a</sup>Each C-C-N-1p torsion is *gauche*.

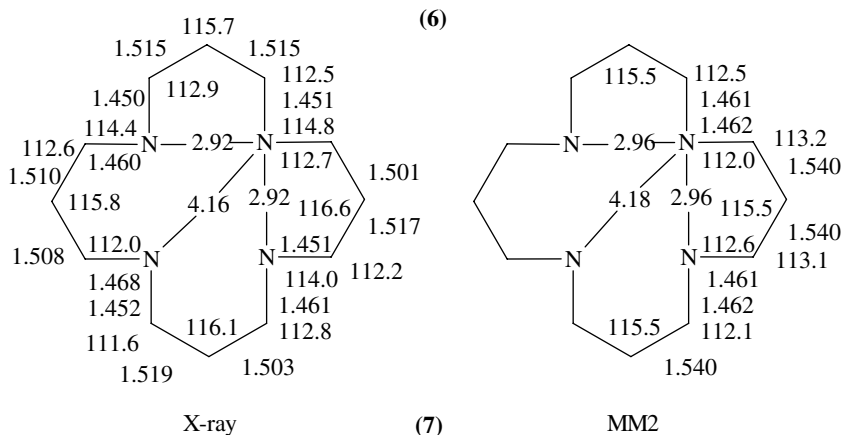
<sup>b</sup>This approximate value was taken as an average from analogous systems.

where MM2 calculations favor the H-axial conformation (axial:equatorial ratio of 3:1) in contrast with experiment (axial:equatorial ratio of 1:3). One possible explanation to this discrepancy is an inverted assignment of the IR bands to the two conformers.

The last molecule considered in this parameterization study was 1,5,9,13-tetraazacyclohexadecane (**7**). A comparison between MM2 and X-ray results (see structure **7**)<sup>5</sup> reveals good fit between theory and experiment (the X-ray C-C bond lengths are shorter than the MM2 corresponding ones, partly since the data were collected at room temperature with no corrections for thermal motion).

*c. Heats of formation.* The parameters used in the calculation of heats of formation for aliphatic amines are C-N, N-H, N-Me, N-CHR<sub>2</sub>, R<sub>2</sub>NH, R<sub>3</sub>N and N-CR<sub>3</sub>. These were obtained according to the following method: Using bond enthalpies from the hydrocarbon part of the force field, the sum of the hydrocarbon fragment contributions, torsional increments (necessary to account for the thermal excitation of the rotation about bonds with low rotational barriers), conformational population increments (necessary to account for any additional conformations), translation-rotation increments (4kT) and steric energy was





calculated and matched against the experimental heats of formation of 20 aliphatic amines in a least-squares manner to derive appropriate values for the aforementioned parameters. These were incorporated in the force field and used in all subsequent heat of formation calculations. A comparison between calculated and experimental results is provided in Table 4. As expected from a least-squares procedure, the agreement between experiment and calculation is generally very good with a standard deviation over 18 comparisons of  $0.46 \text{ kcal mol}^{-1}$  (two molecules, cyclobutylamine and 3-azabicyclo[3.2.2]nonane, were excluded from the above comparison since their experimental heats of formation are suspected to be erroneous<sup>5</sup>). However, the true test of these parameters, and indeed of all force field parameters developed in this and similar studies, should involve systems which were not included in the data set for the parameterization.

*d. Dipole moments.* Calculation of dipole moments for amines required the assignment of bond moments to the N–lp, N–H and N–C bonds. This was done by fitting the calculated dipole moments of several aliphatic amines to the calculated ones via a least-squares procedure. The results are presented in Table 5 and show good agreement between MM2 and experimental values. The only notable exception is quinuclidine, where the approximations inherent to the dipole moment calculation scheme employed in MM2 (neglect of induced dipole moments) have the largest effect.

### 3. MM2' parameterization of nitro compounds and MM2 parameterization of nitrosamines, nitramines, nitrates and oximes

Molecular mechanics calculations of the title compounds are much less common than those of amines, probably due to the lack of high quality parameters. In particular, none of these systems (save the nitro group, see Section II.C.3) has been parameterized during the original development of, and later additions to, the MM2 force fields by the Allinger group. Consequently, any serious attempt at modeling such systems must begin with the development of suitable parameters for their unique functionalities. In the following we list several examples where MM2 was parameterized for, and subsequently used in, the structural and energetic study of nitro compounds, nitrosamines, nitramines, nitrates and oximes.

TABLE 4. Heats of formation and standard deviations (SD) (kcal mol<sup>-1</sup>) for amino compounds as calculated by the MM2 and MM3 force fields and observed by experiment<sup>a,6</sup>. Reprinted with permission from Refs. 5 and 6. Copyright (1985, 1990) American Chemical Society

Compound	MM2	MM3	Experiment
Methylamine	-5.10	-5.04	-5.50
Dimethylamine	-4.06	-4.04	-4.43
Trimethylamine	-6.15	-6.09	-5.76
Ethylamine	-11.82	-11.92	-11.35
Diethylamine	-17.60	-17.41	-17.33
Triethylamine	-21.66	-21.49	-22.17
<i>n</i> -propylamine	-16.89	-16.95	-16.77
Isopropylamine	-20.38	-20.31	-20.02
<i>n</i> -Butylamine	-21.95	-21.85	-21.98
<i>sec</i> -Butylamine	-24.79	-24.31	-25.06
Isobutylamine	-23.77	-23.51	-23.57
<i>t</i> -Butylamine	-28.90	-28.90	-28.90
Piperidine	-11.73	-11.83	-11.76
2-Methylpiperidine	-20.39	-20.30	-20.19
Cyclobutylamine	11.10	9.90	9.90
Cyclopentylamine	-13.68	-13.70	-13.13
Quinuclidine	-0.98	-1.29	-1.03
Diisopropylamine		-31.67	-34.41
Cyclohexylamine		-24.86	-2.06
Pyrrolidine	-0.43	-0.94	-0.80
Azetidine		24.62	24.62
3-Azabicyclo[3.2.2]nonane	-7.21		-10.44
2,2,6,6-Tetramethyl-4-piperidone	-65.64		-65.43
SD <sup>b</sup>	0.46 (18)	0.35 (20)	

<sup>a</sup>When a discrepancy occurred between the experimental data reported in References 5 and 6, the later value was used.

<sup>b</sup>Number of comparisons are given in parentheses.

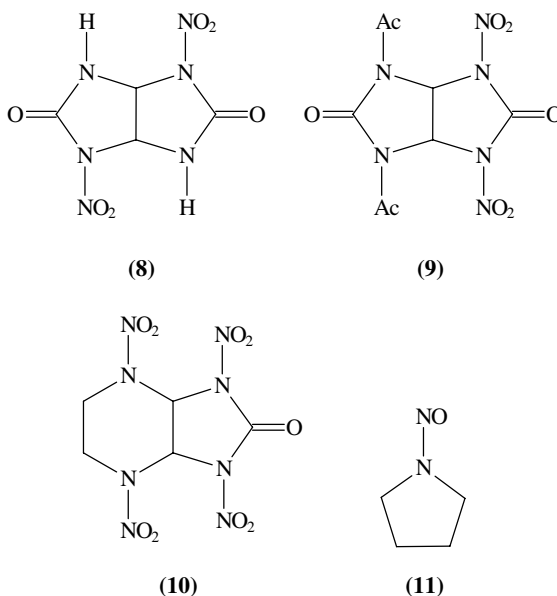
TABLE 5. Calculated (MM2) and observed dipole moments of amines (Debye)<sup>5</sup>. Reprinted with permission from Ref. 5. Copyright (1985) American Chemical Society

Compound	MM2	Experiment
Ammonia	1.43	1.47
Methylamine	1.33	1.30
Dimethylamine	1.10	1.03
Trimethylamine	0.64	0.63, 0.79-0.91
<i>n</i> -Propylamine	1.33	1.17, 1.25
Isopropylamine	1.33	1.20, 1.45
Ethylamine	1.33	1.23
Diethylamine	1.10	1.04-1.27
Triethylamine	0.64	0.67-1.02
<i>n</i> -Butylamine	1.33	1.33-1.45
Pyrrolidine	1.11	1.34, 1.44
<i>N</i> -Methylpiperidine	0.64	0.80-1.34
Piperidine	1.10	1.05-1.35
<i>N</i> -Methylpiperidine	0.64	0.65-0.95
2-Methylpiperidine	1.10	1.171 <sup>a</sup>
Quinuclidine	0.64	1.17, 1.22, 1.57

<sup>a</sup>6-31G *ab initio* calculations.

Parameters for the nitro group have been developed within the framework of the MM2' force field<sup>15</sup>. The nitro group was considered to be composed of a five-valent nitrogen connected to two oxygen atoms by two double bonds. Structural and energetic parameterization was based on the experimental structures of nitromethane, nitroethylene and nitrobenzene and on experimental heats of formation of nitromethane, nitroethane, nitropropane, nitrobutane, dinitromethane, trinitromethane and nitrobenzene, respectively. Parameters were determined by a least-squares fit procedure. The resulting force field faithfully reproduced the experimental data for all the molecules used in the parameterization data set with an average absolute error between experiment and calculation of 0.009 Å (8 comparisons) for bond lengths, 0.7° (8 comparisons) for bond angles, 0.015 D (2 comparisons) for dipole moments and 1.0 kcal mol<sup>-1</sup> (7 comparisons) for heats of formation. A complete list of parameters and force field results is given in Reference 15.

Delpeyroux and coworkers<sup>16</sup> have developed a set of molecular mechanics parameters for nitramines (R-N-NO<sub>2</sub>) for the EMO program and used it in conjunction with MM2-85 parameters to calculate the structures of 1,4-dinitro-glycoluril (**8**), 1,3-dinitro-4,6-diacetyl-glycoluril (**9**) and 2,5,7,9-tetra-nitro-tetraazabicyclo(4.3.0)nonanone (**10**). The complete parameter list for the nitramine functionality is provided in Reference 16 but the parameterization procedure is not discussed.



A set of MM2 (QCPE 395, 1980) parameters for nitrosamines (R-N-NO) was developed by Polonski and coworkers<sup>17</sup> in the course of their study on the conformational dependence of Circular Dichroism of *N*-nitrosopyrrolidines (**11**). Parameters for the N-N torsion were obtained by fitting the barrier to rotation of the nitroso group as determined from NMR measurements for similar systems (*ca* 23 kcal mol<sup>-1</sup>). Other parameters involving the Nsp<sup>2</sup> were taken from a set used for azoalkanes<sup>18</sup>. *N*-Nitrosodimethylamine ((CH<sub>3</sub>)<sub>2</sub>N-NO) was chosen as a model compound and its gas-phase electron diffraction structure was used to determine 'natural' bond lengths and angles. The remaining stretching and bending parameters were determined according to Pearlstein and Hopfinger<sup>19</sup> where the corresponding potential functions for *N*-nitrosodimethylamine were calculated

with MNDO. Bond dipole moments were estimated from partial atomic charges obtained by a Mulliken population analysis of an *ab initio* wavefunction. The complete nitrosamines parameters set is provided in Reference 17.

MM2-85 and MM2-87 parameters for a five-membered heterocyclic aromatic ring incorporating the N–O unit and for conjugated oximes ( $R = N-O-H$ ) were developed by Kooijman and colleagues as part of their work on muscarinic agonists<sup>20</sup>. Parameters were derived based on Cambridge Structural Database statistics and semiempirical calculations, but the derivation procedure is not discussed by these authors. The new parameters are claimed to reproduce bond lengths and angles in a set of appropriate test structures retrieved from the Cambridge Structural Database to within 0.02 Å and 3° of the experimental data and to reproduce the observed dipole moments for a set of five-membered heterocyclic rings to within 0.4 D, but no detailed comparison is provided in the paper. A complete list of the new parameter is available in Reference 20.

Parameters for nitrates ( $R-O-NO_2$ ) have been developed for the MM2-85 force field by Wang and coworkers<sup>21</sup>. Force constants and ‘natural’ values for bond lengths and angles involving the nitrate group were obtained from the microwave structure of methyl nitrate and ethyl nitrate. The force constant, ‘natural’ bond length and dipole moment for the C–O bond were modified from the MM2 original ones to account for the electron-withdrawing properties of the  $NO_2$  group. Torsional parameters for rotation around the  $HC-ONO_2$  and  $CC-ONO_2$  bonds were obtained by fitting the experimental barrier to rotation of methyl nitrate and ethyl nitrate, respectively. Those for rotation around the  $HCO-NO_2$  and  $C=C-CONO_2$  bonds were obtained by fitting the corresponding torsional profiles of methyl nitrate and propenyl nitrate as calculated by MINDO/3. Finally, heat of formation parameters for N–O and N=O were obtained by fitting the experimental values for methyl nitrate, ethyl nitrate and 1,2,3-propanetriol trinitrate. A comparison between force field results and experimental data reveals moderately reasonable reproduction of the latter for all systems used in the data set for the parameterization. In particular, bond lengths and angles (heavy atoms only) for methyl nitrate and ethyl nitrate are reproduced to within 0.01 Å and 7° from their respective microwave values, those for 1,2,3-propanetriol trinitrate to within 0.02 Å and 5° from their X-ray values and dipole moments and heats of formation for methyl nitrate, ethyl nitrate and 1,2,3-propanetriol trinitrate are reproduced to within 0.3 D and 0.4 kcal mol<sup>-1</sup>. The *trans-gauche* energy difference of ethyl nitrate is also in very good agreement with the experimental value (0.5 kcal mol<sup>-1</sup> from both experiment and calculations). However, the performance of these parameters for other nitrates could not be evaluated since the only other compounds calculated in this work, isopropyl nitrate, propenyl nitrate and benzyl nitrate, have not been experimentally reported at the time of its publication. A complete list of the new force field parameters is provided in Reference 21.

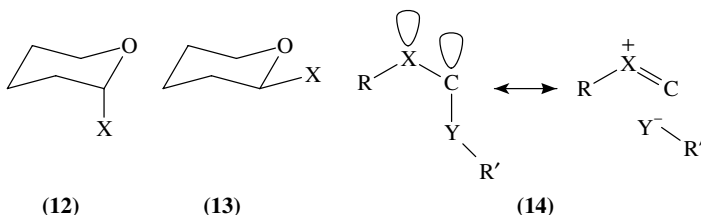
#### 4. MM2 parameterization of nitro compounds, enamines and aniline derivatives

Parameterization of MM2 for nitro compounds, enamines and aniline derivatives has been performed in conjunction with the parameterization of MM3 and will be discussed in Sections II.C.3 and II.C.4.

#### 5. MM2 parameterization of the N–C–N anomeric moiety

Although the treatment of stereoelectronic effects is somewhat beyond the traditional capabilities of molecular mechanics, force fields can be suitably parameterized to reproduce their energetic and structural manifestations. In the following, we discuss the parameterization of MM2-80 and MM2-87 for the anomeric effect characteristic of the N–C–N moiety<sup>22</sup>.

The anomeric effects<sup>23</sup> was first observed in carbohydrates and defined as the preference of an electronegative substituent at the anomeric center of a pyranose ring for the axial (**12**) rather than the equatorial (**13**) position, in contrast to what is expected from steric considerations. Extensive theoretical and experimental work<sup>23,24</sup> has subsequently revealed the generality of the phenomenon and the effect was redefined as the tendency of an R-X-C-Y moiety (X = O, N, S; Y = OR, NR<sub>2</sub>, halogen) to adopt *gauche* rather than *anti* conformation around the X-C and when present, C-Y bonds (the latter referred to as the *exo*-anomeric effect). The currently most accepted explanation of the anomeric effect is given in Molecular Orbitals terms<sup>25</sup> and invokes delocalization of a lone pair situated on X into the adjacent  $\sigma^*$  C-Y orbital (**14**). This is a two-electron two-orbital stabilizing interaction whose magnitude depends on the relative orientation of the participating orbitals and on the energy gap between them. Thus, attention is shifted from an R-X-C-Y *gauche* orientation to an X-C-Y-lp *anti* one. The manifestations of the anomeric effect, relevant to molecular mechanics calculations, are twofold: (1) energetic preference of conformers having a lp antiperiplanar to a  $\sigma^*$  orbital; (2) changes in bond lengths and angles as a results of such lp- $\sigma^*$  interaction.



Several studies have been devoted to the parameterization of molecular mechanics force fields for the anomeric effect<sup>22,26</sup>. Here we concentrate on the works of the Tel Aviv group relevant to amines, namely the modification and parameterization of MM2-80 and, later, MM2-87 to allow the treatment of stereoelectronic effects characteristic of the R-N-C-N-R (R = H, alkyl) moiety<sup>22</sup>. These include: (1) energetic preference of conformers with a nitrogen lp antiperiplanar to an adjacent C-N bond; (2) energetic preference of conformers with an intramolecular hydrogen bond; (3) structural changes in the R-N-C-N-R moiety where an N2-C3-N4-lp antiperiplanar arrangement results in shortening of the C3-N4 bond, elongation of the N2-C3 bond and opening of the C1-N2-C3 and N2-C3-N4 bond angles; (4) changes in C-N bond lengths to tertiary amines incorporated in anomeric moieties. It has long been recognized<sup>22-25</sup> that the anomeric effect in the N-C-N moiety is weaker than that in O-C-O due to the poorer  $\sigma$ -acceptor characteristics of the C-N bond and the consequent weaker lp<sub>N</sub>- $\sigma^*$ <sub>C-N</sub> overlap. As a result its energetic and structural manifestations are expected to be less pronounced than in the case of the oxygen analog.

Most of the data for these parameterization studies came from *ab initio* calculations although other sources were also used, in particular, to validate the resulting force field. Thus a set of small model molecules with different conformations of the R-N-C-N-R moiety was calculated at various levels of theory and the results used to derive torsional parameters, hydrogen bond parameters and conformationally dependent correction terms for 'natural' bond lengths and angles, as described below:

**Torsional parameters.** These (in conjunction with hydrogen bonding parameters, see below) were chosen to reproduce the *ab initio* conformational energies of the model compounds.

**Hydrogen bonds.** When an N-C-N moiety has hydrogen atoms on either nitrogens, several of its conformations may be stabilized by intramolecular hydrogen bonds. Since MM2 does not have a special potential function for hydrogen bonding, such interactions

were originally treated, in a nondirectional manner, by assigning special VdW parameters to the H...N atom pair. This treatment has been replaced by directional hydrogen bonding where the VdW  $\varepsilon$  parameter (equation 7) is correlated with the geometry of the hydrogen bond according to:

$$\varepsilon = \varepsilon' G \exp(-DR) \quad (10)$$

where  $\varepsilon$  is a new VdW energy parameter,  $DR = \text{abs}(r - r^0)$  and  $G$  is a geometrical fit term given by:

For the N-lp...H-N interaction:

$$G = \begin{cases} \cos(\omega) & 0 < \omega < 80 \\ 46.26240356 \exp(-4\omega) & 80 < \omega < 180 \end{cases} \quad (11)$$

where  $\omega$  is the lp-N...N-H torsion.

For the N-lp...H(C-N) interaction:

$$G = (1 - \cos \alpha)(1 - \cos \beta) \quad (12)$$

In equation 12,  $\alpha$  is the N-lp...H angle and  $\beta$  is the lp...H-C angle.

*Structural parameters.* Variations of bond lengths and bond angles in the C1-N2-C3-N4-C5 moiety as a result of the aforementioned lp<sub>N</sub>- $\sigma_{C-N}^*$  overlap were introduced into MM2 by deriving conformationally dependent correction terms for  $r^0$  and  $\theta^0$ . This treatment circumvented the electronegativity correction to bond lengths implemented in MM2-87 (Sections II.B.1 and II.C.1).

*Inner C-N bonds.*  $r^0$  was made a function of the geometry of the anomeric moiety according to:

$$r^0 = r^0 - \delta r \quad (13)$$

where, for the N2-C3 bond, for example,  $\delta r$  is given by:

$$\delta r = 0.5K1[1 + \cos(2\omega_{23})] - 0.5K2[1 + \cos(2\omega_{34})] + d \quad (14)$$

where  $\omega_{23}$  and  $\omega_{34}$  are the lp-N2-C3-N4 and N2-C3-N4-lp torsions. The first term in equation 14 causes  $r^0$  shortening while the second causes its elongation;  $d$  is used to correct for conformationally independent bond length variations such as bond shortening, known to appear when several heteroatoms are connected to the same carbon<sup>8</sup>. The values of  $K1$ ,  $K2$  and  $d$  were determined by fitting MM2 results to the *ab initio* values.

*Outer C-N bonds.* Outer C-N bonds in the R-N-C-N-R moiety are known<sup>22,26</sup> to inversely depend on the adjacent inner bond lengths probably due to a hybridization effect. 'Natural' bond lengths for those bonds were determined according to:

$$r^0 = r^0 + D \quad (15)$$

$$D = a\delta r + b \quad (16)$$

where  $\delta r$  is the change in the adjacent inner bond while  $a$  and  $b$  were determined as before, by fitting *ab initio* results.

*C-N bond lengths in tertiary amines.* Experimental and *ab initio* calculations have demonstrated the gradual decrease in C-N bond lengths when going from primary ( $\text{CH}_3\text{NH}_2$ ) to secondary ( $(\text{CH}_3)_2\text{NH}$ ) to tertiary ( $(\text{CH}_3)_3\text{N}$ ) amines<sup>5</sup>. However, when a tertiary amine is incorporated in an anomeric unit, the cumulative effect of anomeric interactions, steric interactions and conformationally independent C-X bond shortening<sup>8</sup> add up to level off this trend. Moreover, a statistical analysis of C-N bond lengths in

primary, secondary and tertiary amines retrieved from the Cambridge Structural Database revealed only negligible differences<sup>22b</sup>. Correction terms for tertiary C–N ‘natural’ bond lengths were derived for the N–C–N moiety based on a comparison with the results of *ab initio* calculations of suitable model systems.

*N–C–N bond angles.* The ‘natural’ value ( $\theta^0$ ) for the N–C–N bond angle was determined from *ab initio* calculations of suitable model compounds. Since this angle depends on the conformation of the anomeric moiety, conformationally dependent correction terms for  $\theta^0$  were derived according to:

$$\theta^{\prime} = \theta^0 + \delta\theta \quad (17)$$

$$\delta\theta = 0.5K1[\cos(2\omega_{23}) - 1] + 0.5K2[\cos(2\omega_{34}) - 1] \quad (18)$$

where  $\omega_{23}$  and  $\omega_{34}$  are defined as in equation 14 and  $K1$  and  $K2$  determined by fitting *ab initio* results.

*C–N–C bond angles.* Theory predicts<sup>22–25</sup> an opening of these angles as a result of an anomeric interaction. Thus conformationally dependent correction terms for  $\theta^0$  were derived according to:

$$\theta^{\prime} = \theta^0 + \delta\theta \quad (19)$$

$$\delta\theta = 0.5K1[1 + \cos(2\omega_{23})] + 0.5K2[1 + \cos(2\omega_{34})] \quad (20)$$

where  $\omega_{23}$  and  $\omega_{34}$  are defined as in equation 14 and  $K1$  and  $K2$  determined by fitting *ab initio* results.

Torsional parameters and VdW parameters for internal hydrogen bonds in the N–C–N moiety were obtained by fitting the *ab initio* rotational profiles of methylenediamine (MDA, **15**) and *N*-methylmethylenediamine (NMMDA, **16**). A comparison of relative conformational energies between *ab initio* and MM2 results for **15** and **16** is provided in Table 6. Bond length correction terms for inner and outer C–N bonds ( $K1$ ,  $K2$  and

TABLE 6. Relative energies (kcal mol<sup>-1</sup>) of all possible conformers of methylenediamine (MDA, **15**) and *N*-methylmethylenediamine (NMMDA, **16**) as calculated *ab initio* (HF/3-21G//HF/3-21G) and with the reparameterized force field (MM2-87 version)<sup>a</sup>. Reproduced from Ref. 22b by permission of Elsevier Science Ltd

	<i>ab initio</i>	MM2
<b>MDA (15)</b>		
aa	0.00	0.00
ag	1.62	1.21
g <sup>+</sup> g <sup>+</sup>	2.70	3.39
g <sup>+</sup> g <sup>-</sup>	8.23	5.56
<b>NMMDA (16)</b>		
aa	0.00	0.00
ag <sup>-</sup>	1.23	1.46
ag <sup>+</sup>	1.69	1.95
g <sup>+</sup> a	1.50	1.36
g <sup>-</sup> g <sup>-</sup>	2.27	4.10
g <sup>+</sup> g <sup>+</sup>	2.48	3.55

<sup>a</sup>Conformers of the lp–N2–C3–N4–lp moiety are defined via two torsional angles: D1 = lp–N2–C3–N4; D2 = N2–C3–N4–lp, a = *anti*, g = *gauche*<sup>22b</sup>.

TABLE 7. Selected structural parameters (bond lengths in Å, bond angles and torsional angles in degrees) of methylenediamine (MDA, **15**), *N*-methylmethylenediamine (NMMDA, **16**), *N,N*-dimethylmethylenediamine (NNDMMDA, **17**) and tetramethylmethylenediamine (TMMDA, **18**) as calculated *ab initio* (ai, HF/3-21G/HF/3-21G) and with the reparameterized force field (MM2-87 version)<sup>a</sup>. Reproduced from Ref. 22b by permission of Elsevier Science Ltd

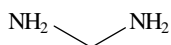
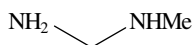
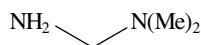
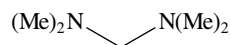
<b>MDA (15)</b>											
	ai	MM2	ag	ai	MM2	ai	MM2	g <sup>+</sup> g <sup>+</sup>	ai	MM2	g <sup>+</sup> g <sup>-</sup>
N1-C2	1.466	1.468	1.459	1.457	1.458	1.461	1.460	1.464	1.464	1.461	1.464
C2-N3	1.466	1.468	1.470	1.467	1.470	1.461	1.460	1.464	1.464	1.461	1.461
N1-C2-N3	118.3	117.8	113.4	113.8	113.6	106.9	107.9	110.4	110.4	108.7	108.7
<b>NMMDA (16)</b>											
	ai	MM2	aa	ai	MM2	ai	MM2	ag <sup>+</sup>	ai	MM2	g <sup>+</sup> a
N1-C2	1.464	1.469	1.457	1.457	1.458	1.455	1.458	1.458	1.468	1.472	1.461
C2-N3	1.464	1.466	1.467	1.465	1.469	1.471	1.469	1.469	1.457	1.456	1.464
N3-C4	1.467	1.467	1.465	1.468	1.468	1.467	1.468	1.468	1.470	1.469	1.468
N1-C2-N3	118.2	118.4	113.8	113.8	114.3	113.3	113.1	114.4	114.4	114.4	108.5
C2-N3-C4	115.9	112.3	115.7	112.6	112.6	114.9	112.4	114.4	114.4	114.0	115.0
N1-C2-N3-C4	-61.9	-61.2	70.9	66.9	66.9	172.3	175.8	-57.8	-57.8	-66.1	67.1
<b>NNDMMDA (17)</b>											
	ai	MM2	ag	ai	MM2	ai	MM2	g <sup>+</sup> g <sup>+</sup>	ai	MM2	g <sup>-</sup> g <sup>-</sup>
N1-C2	1.461	1.470	1.452	1.452	1.460	1.459	1.466	1.460	1.466	1.466	1.460
C2-N3	1.465	1.462	1.472	1.466	1.466	1.460	1.457	1.460	1.457	1.457	1.458
N3-C4	1.464	1.461	1.465	1.463	1.463	1.463	1.465	1.463	1.463	1.465	1.464
N3-C5	1.464	1.461	1.464	1.462	1.462	1.465	1.465	1.462	1.465	1.465	1.468
N1-C2-N3	118.0	119.2	114.5	114.3	109.2	110.1	109.2	110.1	109.2	110.1	108.7
C2-N3-C4	114.4	111.0	112.9	110.7	110.7	113.6	109.5	113.6	113.6	109.5	109.8
C2-N3-C5	114.4	111.0	113.8	111.2	111.2	113.5	112.8	111.2	113.5	112.8	112.1
N1-C2-N3-C4	66.8	61.9	166.3	172.5	172.5	167.1	171.7	167.1	171.7	167.1	115.6
N1-C2-N3-C5	-66.0	-62.1	-63.4	-64.4	-64.4	-61.7	-65.8	-61.7	-65.8	-61.7	67.1
<b>TMMDA (18)</b>											
	ai	MM2	g <sup>+</sup> g <sup>+</sup> <sup>b</sup>	ai	MM2	ai	MM2	g <sup>+</sup> g <sup>+</sup>	ai	MM2	g <sup>+</sup> g <sup>+</sup>
N1-C2	1.458	1.466	1.458	1.458	1.466	1.458	1.466	1.458	1.466	1.466	1.461
N1-C4	1.463	1.466	1.463	1.463	1.466	1.463	1.466	1.463	1.466	1.466	1.459
N1-C5	1.463	1.466	1.463	1.463	1.466	1.463	1.466	1.463	1.466	1.466	1.468
N1-C2-N3	110.4	114.0	110.4	110.4	114.0	110.4	114.0	110.4	114.0	114.0	107.5
C4-N1-C2	113.9	109.2	113.9	109.2	109.2	113.9	109.2	113.9	109.2	109.2	108.7
C5-N1-C2	113.6	113.6	113.6	113.6	113.6	113.6	113.6	113.6	113.6	113.6	112.1
C4-N1-C2-N3	165.9	177.2	165.9	177.2	177.2	165.9	177.2	165.9	177.2	177.2	112.1
C5-N1-C2-N3	-63.5	-60.4	-63.5	-60.4	-60.4	-63.5	-60.4	-63.5	-60.4	-60.4	112.1

<sup>a</sup>Conformers of the lp-N2-C3-N4-lp moiety are defined via two torsional angles: D1 = lp-N2-C3-N4-lp, a = anti, g = gauche<sup>22b</sup>.

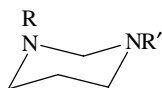
<sup>b</sup>The only conformer of this molecule observed experimentally.



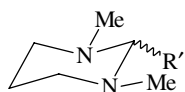
$d$  of equation 14 and  $a$  and  $b$  of equation 16) were derived through fitting MM2 results to *ab initio* geometries of **15**, **16**, *N,N*-dimethylmethylenediamine (NNDMMDA, **17**) and tetramethylmethylenediamine (TMMMDA, **18**). The latter two molecules were also used to derive correction terms for fitting tertiary C–N bonds. A ‘natural’ value for the N–C–N angle and correction terms for the N–C–N and C–N–C angles were derived in a similar manner. A comparison of selected structural parameters between *ab initio* and MM2 results for **15–18** is provided in Table 7 and a complete list of the parameters is given in References 22a and 22b.

**(15)****(16)****(17)****(18)**

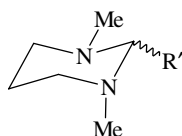
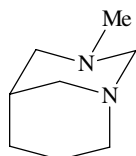
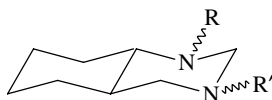
The performance of the modified force field was evaluated by comparing calculated and experimental relative stability of a series of 1,3-diaza cyclic compounds (**19–24**).

**(19)**

	a	b	c	d	e	f	g
R =	H	Me	<i>t</i> -Bu	Me	Et	<i>i</i> -Pr	<i>t</i> -Bu
R' =	H	H	H	Me	Et	<i>i</i> -Pr	Me



R' = Me

**(20)****(21)****(22)****(23)**

	a	b	c	d
R =	H	Me	H	Me
R' =	H	H	Me	Me

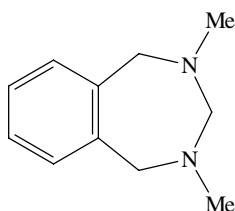
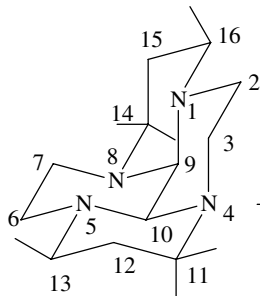
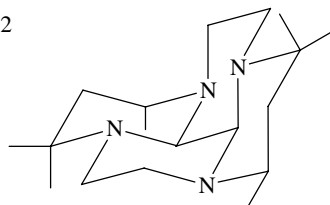
**(24)****(25)****(26)**

TABLE 8. Conformational energies (kcal mol<sup>-1</sup>) of 1,3-diazacyclic compounds (**19–24**) as calculated by the modified MM2 force field (MM2-80 version) and observed experimentally (eq.—equatorial; ax.—axial)<sup>22a</sup>. Reproduced by permission of John Wiley & Sons, Inc.

System	eq.eq.	eq.ax.	ax.eq.	ax.ax.
<b>19a</b> -Calc.	4.9	1.1		0.0
<b>19b</b> -Calc.	3.4	0.0	1.4	0.1
<b>19b</b> -Exp.		N-Hax predominant		
<b>19c</b> -Calc.	3.5	0.0	5.5	4.7
<b>19c</b> -Exp.		N-Hax ~ 66%		
<b>19d</b> -Calc.	1.76	0.0		4.03
<b>19d</b> -Exp.	favored			
<b>19e</b> -Calc.	1.9	0.0		4.0
<b>19e</b> -Exp.	favored			
<b>19f</b> -Calc.	2.5	0.0		5.8
<b>19f</b> -Exp.	favored			
<b>19g</b> -Calc.	1.9	0.0		
<b>19g</b> -Exp.	favored			
<b>20</b> (R' = eq)-Calc.	3.7	0.0		3.8
<b>20</b> (R' = eq)-Exp.		favored		
<b>20</b> (R' = ax)-Calc.	4.2	1.0		4.0
<b>21</b> -Calc.	0.0	1.8		
<b>21</b> -Exp.	100%			
<b>22</b> -Calc.	0.0			14.3
<b>22</b> -Exp.	100%			
<b>23a</b> -Calc.	4.9	1.1	1.2	0.0
<b>23a</b> -Exp.				favored
<b>23b</b> -Calc.	3.6	0.1	1.2	0.0
<b>23b</b> -Exp.	60%			
<b>23c</b> -Calc.	3.4	1.5	0.0	0.2
<b>23c</b> -Exp.	25%			
<b>23d</b> -Calc.	2.11	0.41	0.0	3.92
<b>23d</b> -Exp.	40%			
<b>24</b> -Calc.	4.3	0.0		1.4
<b>24</b> -Exp.		100%		

The results, presented in Table 8, show that in most cases the conformer with the lowest steric energy indeed corresponds to the experimentally most favored one. In addition, several molecules containing the N–C–N moiety were retrieved from the Cambridge Structural Database and calculated with the new parameter set. A comparison between MM2 and X-ray geometries (selected structural parameters only) for two conformers of 1,4,5,8-tetraazadecalin (**25**, **26**) is provided in Table 9 and shows good fit between the experimental and calculated data.

Other nitrogen-containing anomeric moieties, similarly treated within the MM2 framework, are N–C–O<sup>27,28</sup> and N–C–F<sup>29</sup>. These works, however, exceed the scope of this chapter and will not be discussed here.

### C. MM3

The MM3 force field<sup>4</sup> was developed in order to correct for some of the basic limitations and flaws in MM2 by providing a better description of the molecular potential surface in terms of the potential functions and the parameters. One major outcome of the improved force field is the omission of lone pairs on nitrogen and oxygen since the reason for their inclusion in MM2 was no longer pertinent. This allows for a realistic

TABLE 9. Selected structural parameters (bond lengths in Å, bond angles and torsional angles in degrees) of **25** and **26** as calculated by the modified MM2 force field (MM2-80 version) and observed experimentally (X-ray diffraction)<sup>22a</sup>. Reproduced by permission of John Wiley & Sons, Inc.

	<b>25</b>		<b>26</b>	
	X-ray	MM2	X-ray	MM2
Anomeric center C2–N1–C8–N8–C7				
N1–C2	1.467(1)	1.65	1.463(4)	1.465
N1–C9 ( <i>endo</i> )	1.474(1)	1.462	1.451(4)	1.448
C9–N8 ( <i>endo</i> )	1.456(1)	1.452	1.471(2)	1.465
N8–C7	1.468(1)	1.466	1.467(4)	1.467
N1–C16	1.482(1)	1.76	1.476(3)	1.466
N8–C14	1.494(1)	1.480	1.496(3)	1.486
C2–N1–C9	109.0(1)	109.6	109.9(2)	111.8
N1–C9–N8	112.6(1)	113.5	113.5(2)	113.7
C7–C8–C9	109.6(1)	110.8	110.4(2)	109.7
C2–N1–C9–N8	177.9(1)	–178.7	–66.8(2)	–70.5
C16–N1–C9–N8	–61.5(1)	–56.1	58.0(3)	56.8
N1–C9–N8–C7	–66.8(1)	–71.6	175.6(2)	179.4
N1–C9–N8–C14	60.8(1)	57.3	–57.6(3)	–54.9
Anomeric center C3–N4–C10–N5–C6				
N5–C6	1.463(1)	1.465	1.457(2)	1.464
N5–C10 ( <i>endo</i> )	1.470(1)	1.462	1.449(3)	1.449
C10–N4 ( <i>endo</i> )	1.457(1)	1.452	1.489(3)	1.466
N4–C3	1.468(1)	1.466	1.471(3)	1.466
N4–C11	1.496(1)	1.480	1.490(3)	1.487
N5–C13	1.479(1)	1.476	1.471(3)	1.468
C6–N5–C10	108.9(1)	109.6	110.9(2)	111.8
N5–C10–N4	112.5(1)	113.5	112.0(2)	113.4
C3–N4–C10	109.0(1)	110.8	109.6(2)	109.9
C6–N5–C10–N4	178.3(1)	178.7	–68.3(2)	–71.8
C13–N5–C10–N4	–60.8(1)	–56.2	60.3(2)	56.7
N5–C10–N4–C3	–66.2(1)	–71.6	175.8(2)	179.5
N5–C10–N4–C11	61.2(1)	57.3	–58.0(2)	–54.9

treatment of nitrogen inversion, a process which was not handled by MM2<sup>6</sup>. Of particular interest for amino compounds is the inclusion of a directional hydrogen bond potential function<sup>30b</sup> and an improved treatment of the electronegativity and Bohlmann effects for C–H bonds<sup>31</sup>.

A new feature in MM3 is the full Newton–Raphson minimization algorithm. This allows for the location and verification of transition states and for the calculation of vibrational spectra. Indeed, many of the new potential functions in MM3 were included to provide a better description of the potential energy surface which is required for an accurate calculation of vibrational spectra.

### 1. MM3 potential functions<sup>4</sup>

Within the latest published MM3 force field (MM3-94), the molecular energy is given by:

$$\begin{aligned}
 E_{\text{total}} = & E_{\text{stretch}} + E_{\text{bend}} + E_{\text{stretch-bend}} + E_{\text{bend-bend}} + E_{\text{torsion}} \\
 & + E_{\text{torsion-stretch}} + E_{\text{vdW}} + E_{\text{electrostatic}} + E_{\text{hydrogen bond}}
 \end{aligned}
 \quad (21)$$

The stretch–bend, torsional, electrostatic and VdW terms in MM3 are identical in form to the corresponding ones in MM2 (although the electrostatic treatment in MM3 also includes charge–dipole interactions and the VdW terms have slightly different numerical coefficients) and will not be further discussed here.

The stretching energy is an extension of the expression used in MM2:

$$E_{\text{stretch}}(i, j) = K(r_{ij} - r_{ij}^0)^2 + K1(r_{ij} - r_{ij}^0)^3 + K2(r_{ij} - r_{ij}^0)^4 \quad (22)$$

where  $K$ ,  $K1$  and  $K2$ ,  $r_{ij}$  and  $r_{ij}^0$  have their usual meanings. All ‘natural’ bond lengths ( $r^0$ ) are subjected to a primary electronegativity correction of the form<sup>8,31</sup>:

$$r^{\text{(new)}} = r^{\text{(old)}} + \Delta r_a + (0.62)\Delta r_b + (0.62)^2\Delta r_c + (0.62)^3\Delta r_d + \dots \quad (23)$$

Thus,  $r^0$  for an X–Y bond is shortened or elongated when electronegative or electropositive atoms (a, b, c, d, . . .) are connected to either X or Y, respectively. The amount of change in  $r^0$  decreases with the substituent number (i.e. the first substituent has the largest effect, the second a smaller one and so on; substituents are ordered according to their  $\Delta r$  values). A secondary electronegativity effect which changes  $r^0$  of X–Y in X–Y–Z based on the substituent on Z, and which amounts to 0.4 times the primary effect, is also used in MM3.

It has been known for a long time that amines which have a hydrogen on a carbon attached to the nitrogen so that the C–H bond is antiperiplanar to the lone pair, show abnormally low stretching frequencies for those C–H bonds. In order to reproduce this (Bohlmann) effect MM3 corrects the ‘natural’ bond lengths and force constants of such C–H bonds by<sup>31</sup>:

$$\Delta r^0 = V0 + 0.5V1(1 + \cos \omega) + 0.5V2(1 - \cos 2\omega) \quad (24)$$

$$\Delta K = [2\mu(2\pi c)^2 / (-0.0001023)^2](r^0 - 1.3982)\Delta r^0 \quad (25)$$

where, in equation 24,  $V0$ ,  $V1$  and  $V2$  are parameters and  $\omega$  is a torsional angle which describes the relationship between the hydrogen and the nitrogen’s lone pair and, in equation 25,  $\mu$  is the reduced mass,  $r^0$  is the ‘natural’ bond length and  $\Delta r^0$  is the cumulative correction to  $r^0$  (i.e. from the electronegativity and Bohlmann effects).

The bending energy in MM3 is given by:

$$E_{\text{bend}}(i, j, k) = K(\theta_{ijk} - \theta_{ijk}^0)^2 + K1(\theta_{ijk} - \theta_{ijk}^0)^3 + K2(\theta_{ijk} - \theta_{ijk}^0)^4 \\ + K3(\theta_{ijk} - \theta_{ijk}^0)^5 + K4(\theta_{ijk} - \theta_{ijk}^0)^6 \quad (26)$$

where all the variables have their usual meaning.

The bend–bend energy in MM3 is given by:

$$E_{\text{bend–bend}} = K(\theta_1 - \theta_1^0)(\theta_2 - \theta_2^0) \quad (27)$$

where  $\theta_1$  and  $\theta_2$  are bond angles centered on the same atom.

The torsion–stretch energy is given by:

$$E_{\text{torsion–stretch}}(i, j, k, l) = K(r_{jk} - r_{jk}^0)(1 + 3 \cos \omega_{ijkl}) \quad (28)$$

where  $r_{jk}$  and  $r_{jk}^0$  are the actual and ‘natural’ bond lengths of the central bond and  $\omega_{ijkl}$  is the torsional angle. This type of interaction allows for the  $j$ – $k$  bond to elongate upon eclipsing of atoms  $i$  and  $l$ .

In the original MM3 force field, hydrogen bonding energy was described as a sum of electrostatic (dipole-dipole) interactions and an explicit hydrogen bonding energy function of the VdW form. This type of approach lacked the directionality associated with hydrogen bonding and consequently did not perform satisfactorily in all cases. A directional term was therefore added on top of the hydrogen bonding function to MM3-92 and its parameters optimized in MM3-94. The explicit form of the function is<sup>30b</sup>:

$$E_{\text{hydrogen bond}} = \varepsilon_{\text{HB}}\{184000 \exp[-12.0r_{\text{YH}}/r] - F(\beta, r_{\text{XH}}) \times 2.25(r/r_{\text{YH}})^6\}/\varepsilon \quad (29)$$

$$F(\beta, r_{\text{XH}}) = \cos \beta(r_{\text{XH}}/r_{\text{XH}}^0) \quad (30)$$

Here,  $\varepsilon_{\text{HB}}$  is the hydrogen bonding energy parameter,  $r$  is the ‘natural’ hydrogen bond distance,  $r_{\text{YH}}$  is the actual hydrogen bond distance Y...H,  $\beta$  is the H-X...Y angle,  $r_{\text{XH}}$  and  $r_{\text{XH}}^0$  are the actual and ‘natural’ H-X bond lengths, respectively, and  $\varepsilon$  is the dielectric constant.

## 2. MM3 parameterization of amines<sup>6</sup>

As in the case of the MM2 force field, parameterization of MM3 for amines was based mainly on experimental data with occasional references to *ab initio* calculations, mainly to evaluate relative conformational energies and derive appropriate torsional parameters. As mentioned above, one notable difference between the two force fields is the removal of lp on sp<sup>3</sup> nitrogens from MM3. This simplifies the treatment of vibrational spectra and allows for a realistic treatment of nitrogen inversion which could not be handled by MM2. As usual with MM3, parameterization was aimed at reproducing a variety of molecular properties such as structure, steric energy, dipole moments, moments of inertia, heat of formation and vibrational spectra. A complete list of MM3 parameters for amines is provided in Reference 6.

*a. Bond length and bond angle parameters.* A comparison of selected structural parameters between MM3, ED and MW results for methylamine, dimethylamine and trimethylamine is provided in Table 1. ‘Natural’ bond lengths and force constants for C-N and N-H bonds were derived by fitting the experimentally observed structures and vibrational spectra of the three methylamines. By using an appropriate electronegativity correction for the ‘natural’ C-N bond length when a hydrogen is connected to the nitrogen, MM3 reproduces the decrease in C-N bond lengths along the primary → secondary → tertiary amine series<sup>5,6</sup>. The overall agreement between calculated and experimental bond lengths is very good. However, since the MM3 version used in this parameterization study did not include corrections for the Bohlmann effect, vibrational frequencies of C-H bonds *anti* to a nitrogen lp were consistently calculated to be too high. Appropriate corrections were introduced in subsequent versions of MM3 and the overall RMS error between calculation and experiment in C-H frequencies in a more extended set of amines (33 C-H comparisons) was reduced from 47 to 17 cm<sup>-1</sup>, close to the hydrocarbon limit of the force field<sup>31</sup>. N-H and C-N bond moments were chosen to reproduce the dipole moments of ammonia and trimethylamine, respectively, and were later slightly modified to evenly distribute the error among all methylamines. The results (Table 1) show good agreement between theory and experiment.

Parameters for bond angles were derived in a similar manner, first by considering the methylamines only, and later by modifying the resulting parameters to reproduce the observed structures of the bulkier amines, diisopropylamine and di-*t*-butylamine. The N-C angle was chosen to fit ethylamine. However, since in its current form the force field cannot reproduce the experimentally observed dependence of this angle on the

lp-N-C-C torsion<sup>32</sup>, compromise values were chosen that yield 113.1° (experiment: 115.0°) and 112.1° (experiment: 109.7°) for *trans* and *gauche* ethylamine, respectively. Fitting the bending force constants was complicated by the coupling of vibrational modes, in particular for the H-C-N and H-N-C angles. In principle, improvements in these frequencies require the usage of additional cross-terms, but these are not included in MM3.

The inversion barrier of ammonia is calculated by MM3 to be 5.5 kcal mol<sup>-1</sup>, in very good agreement with the experimental value of 5.8 kcal mol<sup>-1</sup><sup>33</sup>.

*b. Torsional angle parameters.* Deriving torsional parameters for the amino compounds presented several problems, the most notable of which are: (1) the lack of experimental data for some important torsions; (2) the different quantitative and qualitative conformational preferences around the lp-N-C-C torsion in different molecules (for example, ethylamine and piperidine, see Section II.B.2.a); (3) the need to simultaneously fit multiple conformational energies of different systems. The first difficulty was dealt with by utilizing *ab initio* data for a number of key rotational barriers (e.g. in propylamine<sup>34</sup> and methylethylamine<sup>35</sup>) and the two latter ones, by employing a procedure for a simultaneous minimization of the RMS error between the results of MM3 calculations and a set of reference data for up to 10 torsional parameters of as many as 10 compounds with up to 10 conformers per compound. Thus, based on the conformational preference of methylamine, ethylamine, isopropylamine, methylethylamine, piperidine and 2-methylpiperidine, the H-N-C-H, H-N-C-C and C-N-C-C torsional parameters were determined together to describe the rotation around the N-C bond. Similarly, ethylamine, propylamine and *N*-3-dimethylpiperidine were employed to describe the rotation around the C-C bond by simultaneously fitting the C-C-C-N and H-C-C-N torsions. A comparison between MM3 and experimental results for selected systems is provided in Table 10 and generally shows good agreement between theory and experiment. The N-C-C-N rotational profile was not determined in conjunction with the other parameters for rotation around the C-C bond, but rather was fit to a series of ethylenediamine conformers calculated *ab initio*<sup>36</sup>. The results (Table 11) are less satisfying than what is usual with MM3. Although the relative energies of the two most stable conformers are reasonably well reproduced, all conformers with a *gauche* N-C-C-N orientation are calculated to be too low in energy. It was suggested that the lack of a directional component in the hydrogen bonding function employed in this study is the route of this problem, causing MM3 to report similar H-bonding energies regardless of the orientation of the nitrogen lp with respect to the other amino hydrogens<sup>6</sup>. However, subsequent calculations of this system with a later version of the force field which included a directional hydrogen bond function<sup>30b</sup> did not lead to a significant improvement (Table 11).

*c. Moments of inertia.* The overall quality of structures obtained from MM3 calculations can be deduced by comparing the calculated and experimental (MW) moments of inertia. Such a comparison for several amino compounds is provided in Table 12 and shows good agreement between theory and experiment (MM3 moments of inertia are expected to be slightly larger than those obtained by MW, since the former method is parameterized to give  $r_g$  structures while the latter gives  $r_o$  structures).

*d. Four-membered and five-membered rings.* As customary with MM3, four- and five-membered rings were assigned unique parameters based on appropriate model compounds. Parameterization for four-membered rings was based on the structure of azetidine (3) which is available from electron diffraction<sup>14</sup>, combined MO/ED studies<sup>37</sup> and a combined

TABLE 10. Calculated (MM3) and observed conformational energies (kcal mol<sup>-1</sup>) in simple amines<sup>6</sup>. Reprinted with permission from Ref. 6. Copyright (1990) American Chemical Society

Compound	Conformer	$\Delta E_{\text{calculated}}$	$\Delta E_{\text{experimental}}$
Methylamine	staggered	0	0
	Methyl eclipsed	1.4493	1.44 <sup>a</sup>
Ethylamine	<i>trans</i>	0	0
	<i>gauche</i>	-0.1035	0.3
Ethylamine <i>gauche</i>	Methyl staggered	0	0
	Methyl eclipsed	2.9967	2.91
Ethylamine <i>anti</i>	Methyl staggered	0	0
	Methyl eclipsed	2.9976	3.09
Methylethylamine <sup>b</sup>	C-N-C-C = 180°	0	0
	C-N-C-C = 120°	3.2453	3.44
	C-N-C-C = 60°	1.1788	1.2
	C-N-C-C = 0°	5.9479	5.83
	C-N-C-C = 300°	1.1989	0.93
	C-N-C-C = 240°	3.0686	2.87
Propylamine (C-C-C-lp = <i>trans</i> ) <sup>c</sup>	Tt	0	0
	Gt	0.8259	0.42
Propylamine (C-C-C-lp = <i>gauche</i> ) <sup>c</sup>	Tg'	0	0
	Gg	0.8831	0.41
	GG'	0.4840	0.05
Isopropylamine <sup>d</sup>	GG	0	0
	GT	0.2181	0.446
Piperidine	equatorial	0	0
	axial	0.2894	0.4
2-Methylpiperidine	H-eq; Me-eq	0	0
	H-eq, Me-ax	2.3865	2.52
<i>N</i> -3-Dimethylpiperidine	diequatorial	0	0
	3-ax, N-eq	1.4516	1.6

<sup>a</sup>This is an arbitrary number picked to fit the torsional frequency.

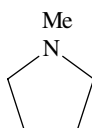
<sup>b</sup>6-31 G\* calculations.

<sup>c</sup>Conformers are defined by the C-C-C-N (upper case) and C-C-N-lp (lower case) torsions, respectively; t = *trans*, g = *gauche*, g' defines the structure in which the Nlp is closer to the methyl group.

<sup>d</sup>Conformers are defined by two lp-N-C-C torsions.

MW/ED study<sup>38</sup>. A comparison between the experimental results and MM3 calculations is provided in Table 2 and reveals good agreement between the two methods. The latest gas-phase NMR study of this system has clearly demonstrated the presence of two conformers [axial and equatorial with respect to the H(N)] in accord with early IR and Raman studies but in disagreement with a later IR work. MM3 results are consistent with the two-minima representation of the system, the equatorial one calculated to be more stable by 0.06 kcal mol<sup>-1</sup>.

Parameterization for five-membered rings was based on the combined *ab initio*/gas-phase ED studies of pyrrolidine (**4**)<sup>39</sup> and *N*-methylpyrrolidine (**27**)<sup>40</sup>. For pyrrolidine, an



(27)

TABLE 11. Conformational energies (kcal mol<sup>-1</sup>) of ethylenediamine as calculated *ab initio* (6-31G\*\*), by the original MM3 force field (MM3) and by MM3 augmented with a directional hydrogen bonding potential function (MM3-94)<sup>a30b</sup>. Reproduced by permission of John Wiley & Sons Ltd

Conformer	6-31 G**	MM3	MM3-94
gGg'	0.000	0.000	0.000
tGg'	0.018	-0.294	-0.268
tTt	1.095	1.642	1.058
gGg	0.560	0.123	-0.086
tGt	1.508	0.562	0.330
tTg	1.201	1.649	1.065
gTg'	1.053	1.348	0.742
tGg	1.293	0.546	0.329
gTg	1.177	1.587	0.984
g'Gg'	3.709	1.359	1.639
TS1 <sup>b</sup>	6.285	5.336	6.109
TS2 <sup>c</sup>	5.491	5.059	5.109

<sup>a</sup> Conformations are defined by the lp1-N1-C-C, N1-C-C-N2 and C-C-N2-lp2 torsional angles: t = *trans*, g = *gauche*<sup>+</sup>, g' = *gauche*<sup>-</sup>.

<sup>b</sup> TS1:N-C-C-N = 0°.

<sup>c</sup> TS1:N-C-C-N = 120°.

TABLE 12. Moments of inertia (amu × Å<sup>2</sup>) for several amino compounds as obtained experimentally (MW) and calculated by MM3<sup>6</sup>. Reprinted with permission from Ref. 6. Copyright (1990) American Chemical Society

Compound		<i>I</i> <sub>a</sub>	<i>I</i> <sub>b</sub>	<i>I</i> <sub>c</sub>
Methylamine	exp	4.9020	22.3450	23.2980
	MM3	4.9609	22.2853	23.2362
Ethylamine ( <i>trans</i> )	exp	15.9133	57.7631	64.8013
	MM3	16.5321	56.7842	64.2156
Ethylamine ( <i>gauche</i> )	exp	15.5868	56.5169	64.5809
	MM3	15.3518	58.1360	65.8644
Dimethylamine	exp	14.7589	54.1435	61.5115
	MM3	14.8499	54.5580	61.8268
Trimethylamine	exp	NA	57.9504	NA
	MM3	58.5473	58.5473	103.2886
Isopropylamine	exp	60.6562	63.3525	108.9900
	MM3	61.6128	63.8159	109.6782
Azetidine	exp	44.1429	44.5792	76.4683
	MM3	44.3840	44.5569	75.8386
Pyrrolidine	exp	73.9449	75.6710	129.9822
	MM3	74.1838	75.3309	129.0938

envelope conformation with the nitrogen out of plane and the H(N) in axial orientation was found to be the most stable conformer. In contrast, MM3 calculations favor the H-equatorial conformer although only to a small extent (0.34 kcal mol<sup>-1</sup>). Both experiment and MM3 calculations predict the global minimum of *N*-methylpiperidine as envelope shaped with the nitrogen out of plane and an equatorial *N*-methyl. MM3 calculates the Me-axial conformer to be 2.02 kcal mol<sup>-1</sup> higher in energy. A structural comparison for these two compounds is provided in Table 13 and reveals good fit between theory and experiment.



TABLE 13. Calculated (MM3) and observed (ED) structures of pyrrolidine (axial) and *N*-methylpyrrolidine (equatorial) (bond lengths in Å, bond angles and flap angles in degrees)<sup>6</sup>. Reprinted with permission from Ref. 6. Copyright (1990) American Chemical Society

	MM3	Experiment
Pyrrolidine		
C–N	1.470	1.469
C–N–C	105.1	105.2
flap angle	39.0	39.0
<i>N</i> -Methylpyrrolidine		
C–N	1.462	1.455
C–N–C	107.2	107.4
flap angle	40.8	41.7

*e. Hydrogen bonding*<sup>6,30b</sup>. In the original MM2 force field, hydrogen bonding was treated, similar to all other intramolecular forces, as a sum of VdW and dipole–dipole interactions between the appropriate atoms. In later versions of MM2, special VdW parameters were introduced for atom pairs participating in hydrogen bonding which allowed for a better estimate of the interaction energy<sup>3,30a</sup>. This (nondirectional) treatment was carried over to the original MM3 force field<sup>4</sup> and later replaced by a directional hydrogen bonding potential function<sup>30b</sup>.

The key model for determining the appropriate parameters for hydrogen bonding in amines is the ammonia dimer. Since the N...H hydrogen bond is very weak (*ca* 2 kcal mol<sup>-1</sup>) both *ab initio* calculations and experiment have predicted several structures and energies for this system. Most of the early work is consistent with the predominance of the cyclic (**28**) and linear (**29**) structures while later studies have supported the modified cyclic structure (**30**). The first parameterization attempts (nondirectional treatment) were aimed to create local minima for the cyclic and linear structures. By modifying the VdW radius parameter of the H(N) atom and choosing appropriate parameters for the N...H pair, dimerization energies of -2.28 and -2.27 kcal mol<sup>-1</sup> for **28** and **29**, respectively, were obtained, in good agreement with the *ab initio* results of Latajka and Scheiner which predicted almost identical energies for the two structures<sup>41</sup>. Less satisfying, however, are the calculated structures with N...N distances of 2.88 and 3.02 Å for **28** and **29**, in contrast with the expected values of 3.15 and 3.35 Å<sup>30b</sup>.

As noted above, more recent experimental studies of the ammonia dimer favor the modified cyclic structure **30**. In light of these latest findings, new parameters have been developed [specifically, the VdW radius of H(N) was increased to 1.6 Å, similar to that of H(O) and H(C)] resulting in interaction energies of -2.17 and -0.56 kcal mol<sup>-1</sup> and N...N distances of 3.07 and 2.50 Å for the linear and modified cyclic structures, respectively.

Following the introduction of a directional hydrogen bonding potential function into MM3, the parameterization of the force field for the ammonia dimer was undertaken anew<sup>30b</sup>. Three conformers were considered, namely **28**, **29** and a bifurcated structure **31**, and were calculated *ab initio* at the 6-31G\*\* level. The results (after corrections for Basis Set Superimposition Error; BSSE) favor the linear dimer over the cyclic one by 0.4 kcal mol<sup>-1</sup> and yield dimerization energies of -2.49, -2.09 and -0.62 kcal mol<sup>-1</sup> for **28**, **29** and **31**, respectively. A comparison of force field (original MM3 and MM3 with the directional hydrogen bonding function) and *ab initio* results for the three ammonia

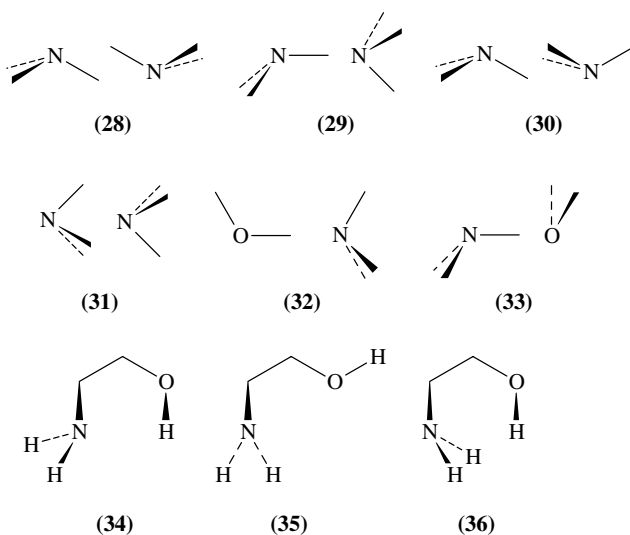


TABLE 14. Energetic and structural parameters for three ammonia dimers (**29**, **28** and **31**) as calculated *ab initio* (6-31G\*\* + BSSE correction), by the original MM3 force field (MM3) and by MM3 augmented with a directional hydrogen bonding potential function (MM3-94)<sup>a,30b</sup>. Reproduced by permission of John Wiley & Sons Ltd from Ref. 30b

	6-31G**	MM3	MM3-94
(NH <sub>3</sub> ) <sub>2</sub> linear ( <b>29</b> )			
<i>E</i> dimerization	-2.49	-2.18	-2.54
dipole moment	2.875	2.808	2.162
N...N	3.408	3.035	3.342
N...H	2.411	2.113	2.324
(NH <sub>3</sub> ) <sub>2</sub> cyclic ( <b>28</b> )			
<i>E</i> dimerization	-2.09	-1.79	-2.19
dipole moment	0.008	0.000	0.000
N...N	3.276	2.960	3.302
N...H	2.607	2.400	2.593
(NH <sub>3</sub> ) <sub>2</sub> bifurcated ( <b>31</b> )			
<i>E</i> dimerization	-0.62	-1.83	-1.35
dipole moment	3.915	3.099	3.091
N...N	3.750	2.845	3.174
N...H	3.481	2.614	2.925

<sup>a</sup>Dimerization energies in kcal mol<sup>-1</sup>, dipole moments in Debye, distances in Å.

dimers is provided in Table 14 and reveals only moderate agreement between the two methods, although the directional treatment of hydrogen bonding is clearly better than the nondirectional one.

Two additional systems in which hydrogen bonds are expected to play a dominant role, ammonia-water complex and 2-aminoethanol, were calculated *ab initio* and by the new MM3 force field. Two ammonia-water complexes were considered, one with an N...H-O bridge (**32**) and the other with an O...H-N bridge (**33**). As expected from the relative H-donor/H-acceptor properties of nitrogen and oxygen, **32** was calculated

TABLE 15. Energetic and structural parameters for two ammonia–water complexes (**32** and **33**) as calculated *ab initio* (6-31G\*\* + BSSE correction) and by the MM3 force field augmented with a directional hydrogen bonding potential function<sup>a30b</sup>. Reproduced by permission of John Wiley & Sons Ltd from Ref. 30b

	6-31G**	MM3
<b>NH<sub>3</sub>–H<sub>2</sub>O linear (32)</b>		
E dimerization	–5.75	–5.80
dipole moment	3.906	3.185
O...N	3.050	3.009
N...H	2.101	2.063
O–H	0.951	0.955
<b>NH<sub>3</sub>–H<sub>2</sub>O linear (33)</b>		
E dimerization	–1.94	–1.92
dipole moment	1.963	1.890
O...N	3.350	3.296
N...H	2.347	2.279
O–H	1.002	1.018

<sup>a</sup>Dimerization energies in kcal mol<sup>–1</sup>, dipole moments in Debye, distances and bond lengths in Å.

to be the more stable complex by 3.81 kcal mol<sup>–1</sup> (6-31G\*\* + BSSE correction) and 3.88 kcal mol<sup>–1</sup> (MM3). Selected structural parameters for **32** and **33**, as calculated *ab initio* and with MM3, are compared in Table 15 and show reasonable agreement between the two methods.

The relative energies of 11 minima and two transition state conformers of 2-aminoethanol have been determined by 6-31G\*\* calculations (including corrections for BSSE) and by MM3. Both methods predict the g'Gg' conformer (**34**, defined by the lp–N–C–C, N–C–C–O and C–C–O–H torsions, respectively) with an internal N...H–O hydrogen bond to be the global minimum. Other conformations with an O...H–N hydrogen bond (e.g. **35**) are calculated to be higher in energy by 1.5–2.2 kcal mol<sup>–1</sup>. The general agreement between *ab initio* and MM3 calculations is good except for the tGg' structure (**36**), where the lp on nitrogen points away from the hydroxy hydrogen. Due to the removal of lp from MM3, this force field overestimates the hydrogen bonding energy in this conformer. A comparison of conformational energies and the structure of the global minimum (**34**) between *ab initio* and MM3 calculations is provided in Reference 30b.

*f. Heats of formation.* Heats of formation for aliphatic amines were calculated in the usual way<sup>1</sup> by using the same 7 parameters already used in MM2 (see Section II.B.2.c) and adding two new ones (C–N bond energy when both atoms are in a four-membered ring and a structural parameter for nitrogen attached *exo* to a four-membered ring). The results are given in Table 4 and show excellent agreement between theory and experiment (standard deviation over 20 comparisons of 0.35 kcal mol<sup>–1</sup><sup>43</sup>) except for diisopropylamine, whose experimental value was suggested to be erroneous (as also confirmed by *ab initio* calculations<sup>42</sup>).

### 3. MM2 and MM3 parameterization of nitro compounds<sup>43</sup>

The parameterization of MM3-90 for the nitro group was based on experimental and *ab initio* results of several aliphatic and aromatic nitro compounds as described below.

For all aromatic systems, the nitro group was treated as if it was not conjugated to the rest of the system. As usual with MM3, the aim was to fit  $r_g$  bond lengths,  $r_\alpha$  bond angles, rotational barriers, vibrational spectra and heats of formation. Since MM2 had not been specifically parameterized for nitro compounds by the Allinger group in the past, the parameters developed for MM3 were modified and included in MM2-90. A complete list of the parameters for both force fields is provided in Reference 43.

*a. Structure.* A comparison of structural parameters for the nitro group (see Reference 43 for a complete comparison) between MM2, MM3 and experiment for the compounds studied in Reference 43 is provided in Table 16. The agreement between force field calculations and experimental results is generally very good. A closer scrutiny of the data reveals, however, that for all structural parameters the experimental data span a larger

TABLE 16. Selected structural parameters of the nitro group (bond lengths in Å, bond and torsional angles in degrees, dipole moments in Debye) for the set of nitro compounds used in the parameterization of MM2 and MM3 as obtained by the two force fields and from experiment<sup>a43</sup>. Reproduced by permission of Elsevier Science Ltd from Ref. 43

	MM2	MM3	Experiment
<b>Bond Lengths (Å)</b>			
<b>C–N</b>			
nitromethane	1.504	1.502	1.489 ( $r_s$ )
2-nitropropane	1.508	1.510	1.508 (MW)
2-methyl-2-nitropropane	1.512	1.516	1.533 (ED, $r_g$ )
nitrocyclopropane	1.494	1.495	1.488 (calc.)
nitroethylene	1.473	1.473	1.470
nitrobenzene	1.476	1.483	1.478 (ED)
range	0.039	0.043	0.063
<b>N–O</b>			
nitromethane	1.222	1.224	1.224 ( $r_s$ )
2-nitropropane	1.222	1.225	1.226 ( $r_g$ )
2-methyl-2-nitropropane	1.222, 1.223	1.225, 1.225	1.240 (ED, $r_g$ )
nitrocyclopropane	1.221, 1.220	1.224, 1.225	1.240 (ED, $r_g$ )
			1.213 (calc.)
nitroethylene	1.222, 1.221	1.223, 1.224	1.218, 1.218
nitrobenzene	1.222	1.224	1.218 (ED)
range	0.003	0.002	0.027
<b>Bond Angles (deg)</b>			
<b>C–N–O</b>			
nitromethane	116.5	116.5	117.3
2-nitropropane	117.1, 116.5	117.1, 116.3	116.8, 116.8
2-methyl-2-nitropropane	118.0, 116.6	117.5, 116.6	118.9, 118.9
nitrocyclopropane	114.7, 116.3	115.5, 117.1	115.0 (assumed)
			115.0 (calc.)
nitroethylene	115.2, 117.7	115.7, 117.7	116.2, 117.8
nitrobenzene	116.9	117.0	118.3
range	3.3	2.2	3.9
<b>O–N–O</b>			
nitromethane	127.0	127.1	125.3
2-nitropropane	126.5	126.6	126.4
2-methyl-2-nitropropane	125.3	126.0	122.2
nitrocyclopropane	129.0	127.4	130.0

TABLE 16. (continued)

	MM2	MM3	Experiment
nitroethylene	127.1	126.6	126.0
nitrobenzene	126.2	126.1	123.4
range	3.7	1.4	7.8
Dihedral Angles (deg)			
C–C–N–O			
2-nitropropane	61.6	60.7	42.1
	60.9	60.7	77.9
2-methyl-2-nitropropane	120.4	120.2	
	0.3	0.0	16.5
	119.9	120.2	
nitroethylene	0.0	0.0	0.0
nitrobenzene	0.0	0.0	0.0
Dipole Moments (D)			
nitromethane	3.61	3.49	3.46
2-nitropropane	3.63	3.60	3.75
2-methyl-2-nitropropane	3.67	3.63	3.74
nitrocyclopropane	3.68	3.94	3.95
nitroethylene	3.95	3.78	3.70
nitrobenzene	3.99	3.81	4.01
range	0.38	0.45	0.55

<sup>a</sup>For each structural parameter, the difference between the two extreme values is provided at the end of the list. (The 'range' columns were added by the present authors).

range than either force field results. Thus, for example, while the O–N–O bond angle is always calculated to be in the range of 125.3°–129.0° and 126.0°–127.4° for MM2 and MM3, respectively, the corresponding experimental numbers are 122.2°–130.0°. Similar trends are observed for all other structural parameters as well as for the dipole moments, and suggests that the force fields are perhaps not sensitive enough to the different chemical environments of the nitro groups in these systems.

*b. Rotational barriers.* A comparison of the rotational barriers of the nitro group in several aliphatic and aromatic nitro compounds between experimental data and MM2 and MM3 calculations is provided in Table 17. The data are clearly divided into two groups.

TABLE 17. Nitro group rotational barriers ( $\text{cm}^{-1}$ ) for the set of nitro compounds used in the parameterization of MM2 and MM3 as obtained by the two force fields and from experiment<sup>43</sup>. Reproduced by permission of Elsevier Science from Ref. 43

	MM2	MM3	Experiment
CH <sub>3</sub> –NO <sub>2</sub>	18	2	6
CH <sub>3</sub> CH <sub>2</sub> –NO <sub>2</sub>	130	19	<14
(CH <sub>3</sub> ) <sub>2</sub> CH–NO <sub>2</sub>	267	150	0
(CH <sub>3</sub> ) <sub>3</sub> –NO <sub>2</sub>	3	28	202
cyclo-C <sub>3</sub> H <sub>5</sub> –NO <sub>2</sub>	2945	3020	3300
CH <sub>2</sub> CH–NO <sub>2</sub>	3419	3800	6510 <sup>a</sup>
C <sub>6</sub> H <sub>5</sub> –NO <sub>2</sub>	2974	3243	3260

<sup>a</sup>Estimated from IR data and not from microwave data.

While aliphatic nitro compounds are essentially free rotors around the C–N bond with experimental and calculated barriers to rotation in the order of 0–0.3 kcal mol<sup>-1</sup>, the conjugated systems, namely nitrobenzene, nitroethylene and nitrocyclopropane (where the conjugation is between the p orbital of the nitro group and the  $\sigma$  system of the cyclopropane ring), have much higher barriers of several kcal mol<sup>-1</sup>. Both experimental and the molecular mechanics results suggest that while the geometry of nitrobenzene and nitroethylene is planar, the nitro group in nitrocyclopropane bisects the plane of the cyclopropyl ring. The overall agreement between experiment and calculation is very good.

*c. Vibrational spectra.* A complete list of the vibrational frequencies for the 8 molecules used in this parameterization work is given in Reference 43. The overall agreement between experiment and calculation is reasonable with a root-mean-square error over 8 compounds of 57 cm<sup>-1</sup>. The planar systems show more coupling between different vibrational modes and are therefore more dependent on cross-terms in the vibrational calculation. Since only few cross-terms are included in the MM3 version employed here (MM3-90), the vibrational frequencies of the planar systems are reproduced to a smaller degree of accuracy than the nonplanar ones. The fit between experiment and calculation for C–H frequencies in nitro compounds is greatly improved upon inclusion of electronegativity corrections for bond lengths and force constant as implemented in MM3-94. The RMS error for a set of 5 nitroalkanes (nitromethane, dinitromethane, trinitromethane, nitroethane, 2-nitropropane) is reduced from 69.7 cm<sup>-1</sup> to 33.0 cm<sup>-1</sup>, close to that obtained for the hydrocarbon part of the force field<sup>31</sup>. The nitro group is strongly electron-withdrawing and consequently exerts a strong shortening effect on C–H bonds, hence the dramatic improvement.

*d. Heats of formation.* Heats of formation for nitro compounds were calculated with the bond-energy scheme<sup>1</sup>. Values for five parameters (C–N and N–O bond energies and structural terms for primary, iso and tertiary groups connected to the nitrogen of the nitro group) were obtained through a least-squares fit to the experimental heats of formation of 7 nitroalkanes. Because of the paucity of the experimental data, the accuracy of the numbers is claimed to be somewhat limited<sup>43</sup>. A comparison between the observed and calculated heats of formation for the molecules in the data set is provided in Table 18 and reveals good fit between theory and experiment. The standard deviation over 7 comparisons is 0.28 and 0.26 kcal mol<sup>-1</sup> for MM2 and MM3, respectively.

TABLE 18. Heats of formation and standard deviations (SD) (kcal mol<sup>-1</sup>) for nitro compounds as calculated by the MM2 and MM3 force fields and observed by experiment<sup>43</sup>. Reproduced by permission of Elsevier Science Ltd from Ref. 43

	MM2	MM3	Experiment
Nitromethane	-17.76	-17.76	-17.76
Nitroethane	-24.47	-24.45	-24.45
1-Nitropropane	-29.86	-29.59	-29.59
2-Nitropropane	-33.66	-33.22	-33.22
2-Methyl-2-nitropropane	-42.33	-42.33	-42.33
1-Nitrobutane	-34.09	-34.39	-34.39
2-Nitrobutane	-38.66	-39.10	-39.10
SD <sup>a</sup>	0.28 (7)	0.26 (7)	

<sup>a</sup>Number of comparisons are given in parentheses.

4. MM2 and MM3 parameterization of enamines and aniline derivatives<sup>44</sup>

The parameterization of MM2 and MM3 for enamines and aniline derivatives was based on the experimental and *ab initio* results of vinylamine, *N*-methylvinylamine, aniline, *N*-methylaniline and *N,N*-dimethylaniline. A complete list of parameters for both force fields is provided in Reference 44.

*a. Structure.* Stretching parameters for the C–N bond and bending parameters for the C–C–N, C–N–C and C–N–H bond angles were derived from *ab initio* calculations of vinylamine, *N*-methylvinylamine and aniline. The bending parameters for H–C–N were set equal to those of H–C–O. For MM3 they were further modified to best reproduce the experimental data. The amino groups of all the compounds studied in this work were calculated to be pyramidal, as also supported by other theoretical and experimental works<sup>44</sup>. Selected structural parameters (see Reference 44 for a complete comparison) for the R<sub>2</sub>C=C–NR<sub>2</sub> moiety of vinylamine, *N*-methylvinylamine, 1-aminopropene, aniline, *N*-methylaniline and *N,N*-dimethylaniline are gathered in Table 19. The general agreement

TABLE 19. Selected structural parameters of the R<sub>2</sub>C=C–NR<sub>2</sub> moiety (bond lengths in Å, bond and torsional angles in degrees) for the set of enamines and aniline derivatives used in the parameterization of MM2 and MM3 as obtained by the two force fields, from *ab initio* calculations and from experiment<sup>44</sup>. Reproduced by permission of John Wiley & Sons, Inc. from Ref. 44

	MM2	MM3	<i>ab initio</i>	Experiment
Bond lengths (Å)				
C=C				
vinylamine <sup>a</sup>	1.340	1.341	1.343	1.335
<i>N</i> -methylvinylamine <sup>b</sup>	1.342	1.341	1.324	
1-aminopropene- <i>trans</i> <sup>c</sup>	1.341	1.342	1.341	
1-aminopropene- <i>cis</i>	1.342	1.344	1.344	
aniline <sup>d</sup>	1.399	1.403	1.401	1.397
<i>N</i> -methylaniline <sup>e</sup>	1.402/1.402	1.406/1.405	1.397	
<i>N,N</i> -dimethylaniline <sup>f</sup>	1.408	1.409		1.405
(C=C)–N				
vinylamine <sup>a</sup>	1.405	1.397	1.395	1.397
<i>N</i> -methylvinylamine <sup>b</sup>	1.402	1.393	1.389	
1-aminopropene- <i>trans</i> <sup>c</sup>	1.405	1.397	1.405	
1-aminopropene- <i>cis</i>	1.405	1.397	1.402	
aniline <sup>d</sup>	1.406	1.398	1.415	1.402
<i>N</i> -methylaniline <sup>e</sup>	1.450	1.396	1.44	
<i>N,N</i> -dimethylaniline <sup>f</sup>	1.406	1.399		1.43
(C=C)–N–C				
<i>N</i> -methylvinylamine <sup>b</sup>	1.457	1.462	1.449	
<i>N</i> -methylaniline <sup>e</sup>	1.457	1.462	1.48	
<i>N,N</i> -dimethylaniline <sup>f</sup>	1.454	1.463		1.46
N–H				
vinylamine <sup>a</sup>	1.020/1.020	1.016/1.015	1.003/1.006	1.010
<i>N</i> -methylvinylamine <sup>b</sup>	1.020	1.017	0.997	
1-aminopropene- <i>trans</i> <sup>c</sup>	1.020/1.020	1.016/1.015	1.015/1.016	
1-aminopropene- <i>cis</i>	1.020/1.019	1.016/1.015	1.014/1.015	
aniline <sup>d</sup>	1.020	1.015	1.007	1.001
<i>N</i> -methylaniline <sup>e</sup>	1.020	1.016	1.03	

(continued overleaf)

TABLE 19. (continued)

	MM2	MM3	<i>ab initio</i>	Experiment
Bond Angles (deg)				
C–C–N				
vinylamine <sup>a</sup>	124.0	125.8	126.1	125.2
<i>N</i> -methylvinylamine <sup>b</sup>	127.7	128.1	127.7	
1-aminopropene- <i>trans</i> <sup>c</sup>	123.3	125.8	126.1	
1-aminopropene- <i>cis</i>	125.0	127.5	126.3	
aniline <sup>d</sup>	120.7	120.7	120.6	
<i>N</i> -methylaniline <sup>e</sup>	118.0	119.0		
<i>N,N</i> -dimethylaniline <sup>f</sup>	122.8/122.7	121.5/121.4		
C–N–C				
<i>N</i> -methylvinylamine <sup>b</sup>	116.6	116.9	119.5	
<i>N</i> -methylaniline <sup>e</sup>	117.3	119.4		
<i>N,N</i> -dimethylaniline <sup>f</sup>	113.0/115.8	111.6/118.0		116
Torsional Angles (deg)				
C–C–N–H				
vinylamine <sup>a</sup>	154.8/23.3	154.2/26.5	148.9/22.5	
<i>N</i> -methylvinylamine <sup>b</sup>	155.4	161.8	151.0	
1-aminopropene- <i>trans</i> <sup>c</sup>	–154.5/–23.2	–154.2/–26.6	–141.9/–17.0	
1-aminopropene- <i>cis</i>	158.3/27.1	157.6/30.8	145.0/18.1	
aniline <sup>d</sup>	155.7/24.0	154.3/27.5		
<i>N</i> -methylaniline <sup>e</sup>	23.4	21.8		
C–C–N–C				
<i>N</i> -methylvinylamine <sup>b</sup>	20.8	24.4	14.2	
<i>N</i> -methylaniline <sup>e</sup>	158.5	162.5		
<i>N,N</i> -dimethylaniline <sup>f</sup>	21.2/156.5	20.0/158.8		

<sup>a</sup>Experiment: MW; *ab initio* calculations: 5-31G\*.

<sup>b</sup>*Ab initio* calculations: 4-31G(N\*).

<sup>c</sup>*Ab initio* calculations: MP2/6-31G\*.

<sup>d</sup>Experiment: MW; *ab initio* calculations: 4-31G(N\*).

<sup>e</sup>*Ab initio* calculations: STO-3G.

<sup>f</sup>Experiment: ED.

between molecular mechanics calculations and experimental/*ab initio* results is good, although a comprehensive comparison is hindered by the paucity of the experimental data and the different levels of *ab initio* calculations. The dipole moments of vinylamine and *N*-methylvinylamine were determined from *ab initio* calculations to be 1.548 D (6-31G\*)<sup>45</sup> and 1.51 D (4-31G(N\*))<sup>46</sup>, respectively. Both MM3 and, in particular, MM2 do a good job in reproducing the dipole moment for vinylamine (1.524 D and 1.546 D for MM2 and MM3, respectively) but underestimate that of *N*-methylvinylamine yielding values of 1.281 (MM2) and 1.258 (MM3) Debye. The experimental dipole moment of aniline (1.53 D)<sup>47</sup> is well reproduced by both force fields (MM2: 1.544 D; MM3: 1.542 D).

*b. Conformational energies and rotational barriers.* The energy difference between the *cis* and *trans* conformers of *N*-methylvinylamine was calculated *ab initio* (4-31G(N\*)) to be 1.26 kcal mol<sup>-1</sup> in favor of the former<sup>46</sup>. This number is well reproduced by both MM2 (1.18 kcal mol<sup>-1</sup>) and MM3 (1.19 kcal mol<sup>-1</sup>). MM2 also does a good job in reproducing the *ab initio* (MP2/6-31G\*) *cis*–*trans* energy difference in 1-aminopropene of 0.79 kcal mol<sup>-1</sup> in favor of the *trans* conformer<sup>48</sup>, but the MM3 value is slightly too high (0.76 and 0.97 kcal mol<sup>-1</sup> for MM2 and MM3, respectively). The rotational barriers



around the C(sp<sup>2</sup>)-N bond in aniline, *N*-methylaniline and vinylamine were found to be 3.54 (IR)<sup>49</sup>, 3.47 (IR)<sup>50</sup> and 4.95 (6-31G\*)<sup>45</sup> kcal mol<sup>-1</sup>, respectively. The corresponding MM2 estimates are 5.27, 5.38 and 4.95 kcal mol<sup>-1</sup> and those of MM3, 3.58, 3.91 and 5.01 kcal mol<sup>-1</sup>, in excellent agreement with the experimental/*ab initio* data. The torsional barrier around the N-CH<sub>3</sub> bond in *N*-methylvinylamine was found to be 3.09 kcal mol<sup>-1</sup> (IR)<sup>50</sup> and calculated as 3.09 and 3.32 kcal mol<sup>-1</sup> by MM2 and MM3, respectively. The experimental (IR) barrier to N-inversion in vinylamine of 1.08 kcal mol<sup>-1</sup><sup>51</sup> is also well reproduced by MM3 (1.03 kcal mol<sup>-1</sup>). The overall reproduction of the energetic data in these systems by both force fields is good, the MM3 values being in a slightly better agreement with the experimental/*ab initio* ones.

*c. Heats of formation.* A comparison of experimental and calculated heats of formation for aniline, *N*-ethylaniline, *N*-naphthylamine and 2-naphthylamine is provided in Table 20. Due to the large errors in the experimental values, the accuracy is less than usual with a standard deviation over 4 comparisons of 0.7 kcal mol<sup>-1</sup> for both MM2 and MM3.

*d. Vibrational spectra.* A comparison of experimental and calculated vibrational spectra for vinylamine, *N*-methylvinylamine and aniline is provided in Reference 44. The RMS error in the calculated frequencies is about 57 cm<sup>-1</sup>, close to that obtained for unsaturated hydrocarbons. The two main sources of error are N-H stretching frequencies which, due to the unaccounted electronegativity effect of the sp<sup>2</sup> carbon connected to the nitrogen, are systematically calculated too low by an average of 75 cm<sup>-1</sup>, and C-H bond frequencies which suffer from the lack of 2-center bend-bend cross-terms. Both problems could not be solved without major changes to the force field but, fortunately, do not lead to any discernible structural errors<sup>44</sup>.

## 5. Other force fields

In this section we briefly outline the explicit form of several general purpose force fields and present the results of calculations on amino and nitro compounds performed as part of their validation.

*a. AMBER*<sup>2</sup>. The molecular energy within the AMBER force field framework is given by:

$$E_{\text{total}} = E_{\text{stretch}} + E_{\text{bend}} + E_{\text{torsion}} + E_{\text{nonbonded}} + E_{\text{hydrogen bond}} \quad (31)$$

TABLE 20. Heats of formation and standard deviation (SD) (kcal mol<sup>-1</sup>) for enamines and aniline derivatives as calculated by the MM2 and MM3 force fields and observed by experiment<sup>44</sup>. Reproduced by permission of John Wiley & Sons, Inc. from Ref. 44

	MM2/MM3	Experiment
Aniline	20.50	20.81
<i>N</i> -Ethylaniline	14.71	13.5
1-Naphthylamine	37.79	37.7
2-Naphthylamine	36.11	35.5
SD <sup>a</sup>	0.70 (4)	

<sup>a</sup>Number of comparisons is given in parentheses.

In the following equations, all parameters have their usual meanings unless otherwise noted.

$$E_{\text{stretch}}(i, j) = K(r_{ij} - r_{ij}^0)^2 \quad (32)$$

$$E_{\text{bend}}(i, j, k) = K(\theta_{ijk} - \theta_{ijk}^0)^2 \quad (33)$$

$$E_{\text{torsion}}(i, j, k, l) = 0.5Vn[1 + \cos(n\omega_{ijkl} - \gamma)] \quad (34)$$

where, in equation 34,  $\gamma$  is a phase correction;

$$E_{\text{nonbonded}}(i, j) = A_{ij}/r_{ij}^{12} - B_{ij}/r_{ij}^6 - q_i q_j / \epsilon r_{ij} \quad (35)$$

$$E_{\text{hydrogen bond}} = C_{ij}/r_{ij}^{12} - D_{ij}/r_{ij}^{10} \quad (36)$$

where  $A_{ij}$ ,  $B_{ij}$ ,  $C_{ij}$  and  $D_{ij}$  are adjustable parameters.

No specific parameterization of AMBER for amino, nitro or nitroso compounds has been published. However, several calculations with this force field are found in the literature and are discussed in Section II.D and in Section III of this chapter.

*b. Tripos 5.2*<sup>52</sup>. The Tripos 5.2 force field<sup>52</sup> is implemented in the Sybyl molecular modeling package<sup>53</sup>. The molecular mechanics energy within the framework of this force field is given by:

$$E_{\text{total}} = E_{\text{stretch}} + E_{\text{bend}} + E_{\text{out-of-plane}} + E_{\text{torsion}} + E_{\text{nonbonded}} \quad (37)$$

In the following equations, all parameters have their usual meanings unless otherwise noted:

$$E_{\text{stretch}}(i, j) = K(r_{ij} - r_{ij}^0)^2 \quad (38)$$

$$E_{\text{bend}}(i, j, k) = K(\theta_{ijk} - \theta_{ijk}^0)^2 \quad (39)$$

$$E_{\text{out-of-plane}}(i, j, k, l) = Kd^2 \quad (40)$$

where  $d$  is the distance from atom  $i$  to the plane defined by atoms  $j$ ,  $k$  and  $l$ ;

$$E_{\text{torsion}}(i, j, k, l) = K[1 + s/|s| \cos(|s|\omega_{ijkl})] \quad (41)$$

where  $s$  is the rotation degeneracy;

$$E_{\text{nonbonded}}(i, j) = K(1.0/a_{ij}^{12} - 2.0/a_{ij}^6) \quad (42)$$

where  $a_{ij}$  is the distance between atoms  $i$  and  $j$  divided by the sum of their VdW radii, and  $K$  is the geometric mean of the VdW constants associated with the two atoms. An electrostatic term is also included in the force field, but was omitted from the calculations described below due to ambiguities in the calculation of atomic charges, the dielectric functions and the cutoffs, and will not be discussed here.

Several calculations on amino and nitro compounds were performed as part of the validation of Tripos 5.2<sup>52</sup>. Thus, the rotational barriers in methylamine and dimethylamine were calculated to be 2.8 and 4.9 kcal mol<sup>-1</sup>, respectively, in fair agreement with experiment (2.0<sup>54</sup> and 3.6<sup>54</sup> kcal mol<sup>-1</sup>, respectively), and the  $A$ -value of the nitro group was calculated to be 0.6 kcal mol<sup>-1</sup>, only about half of the experimental value

(1.1 kcal mol<sup>-1</sup><sup>55</sup>). In addition, several amino and nitro compounds were retrieved from the Cambridge Structural Database (CSD)<sup>56</sup>, all having  $R$  factors lower than 0.05, and analyzed for their heavy-atom RMS movement upon energy minimization. The results, an average RMS movement of 0.326 Å for 19 structures (CSD notation: ABBUMO10, ABZTCX, ACADOS, ACBUOL, ACHTAR10, ACIMDC, ACKYNU, ACMBPN, ACONTN10, ACNPEC, ACRAMS, ACXMPR, ADELOX10, ADENOS10, ADMINA, ADMOPM, ADRTAR, AFCYDP, AFMSCY; see Reference 52), suggest that the X-ray structures are indeed close to minima on the potential energy functions of the isolated molecules as described by this force field. However, the ability of the force field to identify the global minimum or a set of low-energy minima from among the multitude of conformations available to such molecular systems cannot be assessed in this manner. Additional results obtained with the Tripos 5.2 force field are discussed below in Section II.D.

*c. DREIDING*<sup>57</sup>. The DREIDING force field is an attempt to address the problem of the arithmetic explosion of parameters required in force field calculations by developing a set of combination rules which would allow for parameters to be developed from a small set of basic atomic properties. Within this framework, the molecular energy is given by:

$$E_{\text{total}} = E_{\text{stretch}} + E_{\text{bend}} + E_{\text{torsion}} + E_{\text{inversion}} + E_{\text{vdW}} + E_{\text{electrostatic}} + E_{\text{hydrogen bond}} \quad (43)$$

In the following equations, all parameters have their usual meanings, unless otherwise noted:

$$E_{\text{stretch}}(i, j) = 0.5K(r_{ij} - r_{ij}^0)^2 \quad (\text{harmonic function}) \quad (44)$$

or

$$E_{\text{stretch}}(i, j) = \text{De}\{\exp[-(\alpha n r_{ij} - r_{ij}^0)] - 1\}^2 \quad (\text{Morse function}) \quad (45)$$

where, in equation 45,  $n$  is the bond order, De is the dissociation energy ( $n \times 70$  kcal mol<sup>-1</sup>),  $K$  is the force constant ( $0.5n \times 700$  kcal mol<sup>-1</sup>/Å<sup>2</sup>) and  $\alpha$  is a scaling factor given by  $(K/2\text{De})^{0.5}$ ;

$$E_{\text{bend}}(i, j, k) = [0.5K_{ijk}(\sin \theta_{ijk}^0)^2](\cos \theta_{ijk} - \cos \theta_{ijk}^0)^2 \quad (\text{harmonic in } \cos \theta) \quad (46)$$

or

$$E_{\text{bend}}(i, j, k) = 0.5K_{ijk}(\theta_{ijk} - \theta_{ijk}^0)^2 \quad (\text{harmonic in } \theta) \quad (47)$$

where  $k = 100$  (kcal mol<sup>-1</sup>)/rad<sup>2</sup>;

$$E_{\text{torsion}}(i, j, k, l) = 0.5V_{jkl}\{1 - \cos[n_{jkl}(\omega_{jkl} - \omega_{jkl}^0)]\} \quad (48)$$

where  $n_{jkl}$  is the periodicity and  $\omega_{jkl}^0$  is the 'natural' torsional angle.

The inversion potential function is applied to all atoms  $i$  connected to exactly three other atoms,  $j$ ,  $k$  and  $l$ . For nonplanar systems it is given by:

$$E_{\text{inversion}}(i, j, k, l) = 0.5C_i(\cos \Psi_i - \cos \Psi_i^0)^2 \quad (49)$$

where  $C_i = K_i/(\sin \Psi_i^0)^2$ ,  $\Psi_i$  is the angle between the  $i-l$  bond and the  $j-i-k$  plane and  $K_i$  is the force constant. For planar systems the inversion energy is given by:

$$E_{\text{inversion}}(i, j, k, l) = K_i(1 - \cos \Psi_i) \quad (50)$$

where  $K_i$  and  $\Psi_i$  are defined as above.

The nonbonded interactions are given by a Lennard-Jones 12-6 type expression (LJ) or an exponential-6 form (X6):

$$E_{\text{vdW-LJ}}(i, j) = Ar_{ij}^{-12} - Br_{ij}^{-6} \quad (51)$$

$$E_{\text{vdW-X6}}(i, j) = A \exp(-Cr_{ij}) - Br_{ij}^{-6} \quad (52)$$

where  $r_{ij}$  is the distance between the two atoms and  $A$ ,  $B$  and  $C$  are obtained from atomic parameters by suitable combination rules.

Electrostatic and hydrogen bond energies are given by:

$$E_{\text{electrostatic}}(i, j) = 322.0637(q_i q_j / \epsilon r_{ij}) \quad (53)$$

$$E_{\text{hydrogen bond}}(D, H, A) = D_{\text{HB}}[5(r_{\text{HB}}/r_{\text{DA}})^{12} - 6(r_{\text{HB}}/r_{\text{DA}})^{10}] \cos^4(\theta_{\text{DHA}}) \quad (54)$$

where, in equation 54,  $\theta_{\text{DHA}}$  is the (donor)-(hydrogen)-(acceptor) angle, and  $r_{\text{DA}}$  is the distance between the donor and acceptor atoms.  $D_{\text{HB}}$  and  $r_{\text{HB}}$  were assigned values of 9.5 kcal mol<sup>-1</sup> and 2.75 Å, respectively, based on results for the water dimer.

In accord with the DREIDING underlying philosophy, no specific parameterization was performed for amino, nitro or nitroso compounds. Rather, a set of atomic parameters were assigned for sp<sup>1</sup>, sp<sup>2</sup> and sp<sup>3</sup> nitrogen as well as for nitrogen involved in resonance, and a set of combination rules was developed which allows for the determination of parameters for all combinations of atoms. Several calculations of amino and nitro compounds were performed as part of the validation of DREIDING<sup>57</sup>. The barrier to inversion of ammonia was calculated to be 7.4 and 8.1 kcal mol<sup>-1</sup> when using the harmonic cos  $\theta$  and harmonic  $\theta$  bending functions, respectively, both in reasonable agreement with the experimental value (5.8 kcal mol<sup>-1</sup><sup>38</sup>) but less satisfactory than the MM3 estimate of 5.5 kcal mol<sup>-1</sup><sup>6</sup>. The barriers to rotation in methylamine, dimethylamine and trimethylamine were calculated to be 2.09, 2.92 and 3.53 kcal mol<sup>-1</sup>, respectively. The first value is in excellent agreement with experiment (1.98 kcal mol<sup>-1</sup><sup>54</sup>) but the two latter ones underestimate the corresponding barriers by 0.7 and 0.9 kcal mol<sup>-1</sup>. The  $A$ -value of the nitro group was calculated to be 1.58 kcal mol<sup>-1</sup>, in reasonable agreement with the experimental value (1.1 kcal mol<sup>-1</sup><sup>55</sup>).

As in the case of Tripos 5.2<sup>52</sup>, several amino and nitro compounds were retrieved from the CSD and analyzed for their (all) atom movements upon energy minimization. Although the set of 19 amino and nitro compounds calculated with DREIDING is identical to that examined by Tripos 5.2, a direct comparison between the performance of the two force fields is not possible since the former reported RMS movements of all atoms while the latter, of heavy atoms only. The all atom average RMS movement reported by DREIDING for the set of 19 compounds is 0.298 Å and the conclusions we derived for the Tripos force field apply also here. Additional results obtained with the DREIDING force field are discussed in Section II.D.

*d. Universal Force Field (UFF)*<sup>58,59</sup>. The Universal Force Field (UFF) may be regarded as a conceptual extension of the DREIDING force field to cover the entire periodic table. Parameters are developed from a small set of atomic properties based only on the element, its hybridization and connectivity while appropriate combination rules are applied to allow for parameter derivation for any combination of atoms. Furthermore, the 'classic' bending potential function has been modified to allow for calculation of inorganic molecules and organo-metallic complexes. Within the UFF force field the molecular energy is given by:

$$E_{\text{total}} = E_{\text{stretch}} + E_{\text{bend}} + E_{\text{torsion}} + E_{\text{inversion}} + E_{\text{vdW}} + E_{\text{electrostatic}} \quad (55)$$

In the following equations, all parameters have their usual meanings, unless otherwise noted:

$$E_{\text{stretch}}(i, j) = 0.5K_{ij}(r_{ij} - r_{ij}^0)^2 \quad (\text{harmonic function}) \quad (56)$$

or

$$E_{\text{stretch}}(i, j) = D_{ij}\{\exp[-\alpha(r_{ij} - r_{ij}^0)] - 1\}^2 \quad (\text{Morse function}) \quad (57)$$

where, in equation 57,  $D_{ij}$  is the dissociation energy,  $\alpha$  is a scaling factor given by  $(K_{ij}/2D_{ij})^{0.5}$  and all other parameters have their usual meaning;

$$E_{\text{bend}}(i, j, k) = K_{ijk} \sum C_n \cos(n\theta_{ijk}) \quad (58)$$

where the number of terms in this Fourier expansion depends on the molecular geometry;

$$E_{\text{torsion}}(i, j, k, l) = K_{ijkl} \sum C_n \cos(n\omega_{ijkl}) \quad (59)$$

where the force constant and the expansion coefficients are determined by the rotational barrier, the periodicity of the potential and the ‘natural’ angle;

$$E_{\text{inversion}}(i, j, k, l) = K_{ijkl}(C_0 + C_1 \cos \omega_{ijkl} + C_2 \cos 2\omega_{ijkl}) \quad (60)$$

This expression is used in all cases where atom  $i$  is connected to exactly three other atoms,  $j$ ,  $k$  and  $l$ . Here,  $K_{ijkl}$  is the force constant,  $\omega_{ijkl}$  is the angle between the  $i-l$  axis and the  $i-j-k$  plane and the expansion coefficients depend on the central atom type;

$$E_{\text{vdw}}(i, j) = D_{ij}[-2(X_{ij}/r_{ij})^6 + (X_{ij}/r_{ij})^{12}] \quad (61)$$

where  $D_{ij}$  is the well depth,  $X_{ij}$  is the VdW bond length and  $r_{ij}$  is the distance between the two atoms;

$$E_{\text{electrostatic}}(i, j) = 332.0637(q_i q_j / \epsilon r_{ij}) \quad (62)$$

where  $q_i$  and  $q_j$  are partial atomic charges,  $\epsilon$  is the dielectric constant and  $r_{ij}$  is the distance between atoms  $i$  and  $j$ .

As in the case of DREIDING, the underlying philosophy of UFF does not allow for parameters to be developed for specific molecular systems (e.g. amino, nitro or nitroso). Rather, these are extracted from atomic parameters using a set of combination rules. Several calculations on amino and nitro compounds were performed as part of the validation of UFF<sup>58,59</sup>. In the following we refer to the structural results and save the discussion of the energetic ones to Section II.D.

A comparison of structural data as calculated by UFF with experimental and MM2 results for dimethylamine, trimethylamine, 1,5,9,13-tetraaza-cyclohexadecane (**7**), azetidene (**3**) and nitromethane is provided in Table 21<sup>59</sup>. Given the known inaccuracies inherent to any comparison of experimental and theoretical structural data, UFF appears to predict the general structure of unstrained saturated amines reasonably well (bond lengths and bond angles to within 0.026 Å and 2.5° of the experimental values) although it does not reproduce the experimentally observed shortening of C–N bonds when going from secondary to tertiary amines. The performance of UFF, however, is considerably reduced when going to the strained azetidene (**3**) or unsaturated nitromethane where differences of up to 0.076 Å in bond lengths (N–O bond in nitromethane) and 7.4° in bond angles (C–C–N bond in azetidene) are observed. In addition, UFF predicts azetidene to be planar, in contrast with the puckered geometry obtained from both experiment and MM2 and MM3 calculations. Clearly, special parameters are needed for an accurate description

TABLE 21. Selected structural parameters for dimethylamine, trimethylamine, 1,3,5,9-tetraazacyclohexadecane (**7**), azetidine (**3**) and nitromethane as calculated by UFF and MM2 and obtained from experiment<sup>58,59</sup>

	UFF	MM2 <sup>a</sup>	Experiment <sup>b</sup>
Dimethylamine			
C–N	1.464	1.461	1.464
C–H	1.110	1.113	1.090
N–H	1.047	1.020	1.022
C–N–C	110.2	112.3	112.0
Trimethylamine			
C–N	1.471	1.455	1.451
C–H	1.112	1.114	1.109
C–N–C	110.0	110.9	110.9
1,5,9,13-Tetraazacyclohexadecane ( <b>7</b> )			
C–N (av.)	1.470	1.462	1.457
C–C (av.)	1.537	1.540	1.511
N1...N5	3.24	2.96	2.92
N1...N9	4.50	4.18	4.14
C–C–C (av.)	113.5	115.5	116.0
C–C–N (av.)	111.8	113.2	112.4
Azetidine ( <b>3</b> )			
C–N	1.463	1.471	1.482
C–C	1.514	1.549	1.553
C–H	1.112	1.116	1.107
N–H	1.048	1.014	1.022
C–C–C	84.9	86.6	86.9
C–C–N	93.2	86.4	85.8
$\phi$	0.1	36.2	33.1 $\pm$ 2.4
Nitromethane			
C–N	1.455	1.503	1.489
N–O	1.300	1.222	1.224
N–C–H (av.)	110.0	110.2	107.2
C–N–O	120.2	116.5	117.3
O–N–O	119.7	127.0	125.3

<sup>a</sup>MM2 calculations for 1,3,5,9-tetraazacyclohexadecane (**7**) and azetidine (**3**) were taken from Reference 59, which refers to the original Allinger parameterization of amines<sup>5</sup>. However, to the best of our knowledge this force field did not include the primary electronegativity corrections. Those for dimethylamine and trimethylamine were calculated for this work with MM2-91 and those for nitromethane were taken from Reference 43.

<sup>b</sup>See References 58 and 59 for the sources of the experimental data.

of strained and unsaturated systems, as demonstrated by the success of MM2 and MM3 in this field.

#### D. Energetic Comparison Between MM2, MM3, AMBER, Tripos 5.2, DREIDING and UFF

In this section we provide a short comparison of conformational energies for a set of nitrogen-containing molecules as obtained by several commonly used molecular mechanics force fields and by experiment. The data, collected in Table 22, were mostly taken from Reference 60 but several were calculated for this work.

Any attempt to evaluate the performance of empirical force fields by comparing calculated and experimental conformational energies is influenced by choices of the molecules to be included in the data set and of the source of the experimental data. Clearly, there

is no point to include in the data set classes of molecules for which the force field has not been parameterized or, in the interest of generality, such with unusual functionalities. With respect to the second issue, the experimental results should preferably reflect gas-phase conformational enthalpies. In the absence of such data, free energies measured in solution may be used but, in this case, comparison with calculations is strictly valid only when there is a good reason to believe that solvent and entropy effects are negligible.

Table 22 provides a comparison of conformational energies for several simple amino compounds and a single nitro compound between some of the commonly used force fields and experiment. The force fields compared here are MM2-91 (MacMinim/MM2 implementation which is computationally identical to the original MM2-91<sup>61</sup>), MM3-92 (Macintosh implementation which is computationally identical to the original MM3-92<sup>62</sup>), AMBER as implemented in MacroModel 4.0<sup>63</sup>, DREIDING 2.2 and UFF 1.01 as implemented in Cerius2<sup>64</sup> (the latter force field was used as originally developed,

TABLE 22. A comparison of rotational barriers and conformational energies (kcal mol<sup>-1</sup>) for several amino compounds and a single nitro compound between several commonly used force fields and experiment (all experimental and calculated data are taken from Reference 60 unless otherwise noted); the last entry provides the Average Absolute Error (kcal mol<sup>-1</sup>) between theory and experiment<sup>60</sup>. Reproduced by permission of John Wiley & Sons, Inc. from Ref. 60

	MM2-91	MM3-92	AMBER	UFF 1.01	DREID -ING 2.2	Tripos 5.2	Experi -ment
Rotational barriers							
methylamine	1.9 <sup>a</sup>	1.4 <sup>b</sup>	2.1 <sup>c</sup>	<i>d</i>	2.1 <sup>e</sup>	2.8 <sup>f</sup>	2.0 <sup>g</sup>
dimethylamine	3.0 <sup>a</sup>	2.8 <sup>b</sup>	2.3 <sup>c</sup>	<i>d</i>	2.9 <sup>e</sup>	4.9 <sup>f</sup>	3.6 <sup>g</sup>
Ethylamine							
<i>gauche-anti</i>	-0.1	-0.1	-0.1	-0.7	-0.1	0.1	0.7 <sup>h</sup>
A values							
NO <sub>2</sub>	0.8 <sup>i</sup>	1.0 <sup>b</sup>	1.8 <sup>c</sup>	<i>d</i>	1.6 <sup>e</sup>	0.6 <sup>f</sup>	1.1 <sup>j</sup>
NH <sub>2</sub>	1.4	1.2	-0.3	0.8	0.5	0.0	1.5 <sup>k</sup>
(CH <sub>3</sub> ) <sub>2</sub> NH	1.0	1.1	1.2	2.0	0.6	1.5	1.3 <sup>k</sup>
Piperidine derivatives (axial-equatorial)							
<i>N</i> -methyl	2.5	2.4	1.3	3.7	1.8	0.5	3.2 <sup>k</sup>
2-methyl	2.1	2.4	1.2	3.1	1.6	1.1	2.5 <sup>l</sup>
3-methyl	1.6	1.5	0.5	1.3	1.0	0.8	1.6 <sup>k</sup>
4-methyl	1.7	1.8	1.1	1.8	1.3	1.4	1.9 <sup>k</sup>
Ave. Abs. Error	0.34	0.39	0.99	0.61 <sup>m</sup>	0.73	1.03	

<sup>a</sup>Reference 5.

<sup>b</sup>MM3-94 calculations for this work (including parameters for the NO<sub>2</sub> group).

<sup>c</sup>Calculated for this work with MacroModel 5.0 implementation of AMBER.

<sup>d</sup>Not available.

<sup>e</sup>Reference 57.

<sup>f</sup>Reference 52.

<sup>g</sup>Microwave measurements in the gas phase<sup>54</sup>. For dimethylamine, MM2 was originally parameterized to reproduce a later value of 3.22 kcal mol<sup>-1</sup> as obtained by MW measurements. See J. E. Wallrab and V. W. Laurie, *J. Chem. Phys.*, **54**, 532 (1971).

<sup>h</sup> $\Delta E$  measurement in the gas phase.

<sup>i</sup>MM2-91 calculations for this work (including parameters for the NO<sub>2</sub> group).

<sup>j</sup> $\Delta G$  measurement in solution at room temperature<sup>55</sup>.

<sup>k</sup> $\Delta G$  measurement in solution, low temperature.

<sup>l</sup> $\Delta G$  measurement in the gas phase.

<sup>m</sup>Over 7 comparisons.

namely without the charge model) and Tripos 5.2<sup>52</sup> as implemented in Alchemy III<sup>65</sup> (see Reference 60 for more computational details).

*Rotational barriers.* All the force fields examined here reproduce the experimentally observed increase in the rotational barrier on going from methylamine to dimethylamine and, in particular, MM2 and DREIDING do a good job in matching the experimental data.

*Ethylamine.* All force fields (save Tripos 5.2) predict the wrong (*gauche*) global minimum for this molecule. However, both the experimental and calculated energy differences between the *anti* and *gauche* conformers are small.

*A-value.* Both MM2 and MM3 do a good job in reproducing the *A*-value of the amino and dimethylamino groups. MM3 also faithfully reproduces the experimental *A*-value for the nitro group while MM2 slightly underestimates this number. None of the other force fields is consistent in reproducing the experimental results along the nitro, amino and *N,N*-dimethylamino series.

*Piperidine derivatives.* Again, both MM2 and MM3 do a good job in reproducing the experimental axial-equatorial energy differences of piperidine derivatives. All other force fields rather seriously overestimate the stability of axial conformations and consequently underestimate the energy difference. The only exception is UFF, which overestimates the aforementioned energy difference for *N*-methylpiperidine and 2-methylpiperidine.

The overall performance of the different force fields in reproducing the experimental data can be estimated from the average absolute error. The results of this analysis are provided at the bottom of Table 22 and are divided into three groups. MM2 and MM3 have the smallest average absolute errors, 0.34 and 0.39 kcal mol<sup>-1</sup>, respectively, followed by UFF (0.61 kcal mol<sup>-1</sup>) and DREIDING (0.73 kcal mol<sup>-1</sup>) and finally by AMBER (0.99 kcal mol<sup>-1</sup>) and Tripos 5.2 (1.03 kcal mol<sup>-1</sup>). The good performance of MM2 and MM3 are not surprising as both force fields have undergone extensive parameterization for the amino and nitro groups, as discussed above. Perhaps more surprising is the relatively good performance of UFF (although they are greatly reduced when incorporating the recommended charge model) especially since this force field has been shown to perform rather poorly on a more extensive set of organic compounds<sup>60</sup>. The results obtained with DREIDING are encouraging and suggest that the problem of the huge number of parameters needed in force field calculations may be ultimately overcome by the development of atomic-based parameters and the derivation of appropriate combination rules. Based on these results, both AMBER and Tripos 5.2 can be employed in energetic calculations of amino compounds only in a qualitative manner. Finally, we would like to re-emphasize that the overall picture and conclusions presented here are subject to changes upon replacement or inclusion of additional molecules in the data set.

### III. APPLICATION OF THE COMPUTATIONAL MODEL

The use of molecular mechanics calculations has become common practice in chemical research since the early 80s, when general-purpose force fields, incorporated into user-oriented computer programs, started to appear (Figure 1). As noted above, the most popular and extensively used force fields are undoubtedly those developed by Allinger's group, namely MMI (early 70s), MM2 (1977-) and, more recently, MM3 (1988-).

From among the different classes of compounds considered in this work, most of the computational work was done on amines, while less examples are found for nitro compounds and very few for nitroso ones. The different studies may be classified into several major areas: (1) conformational analysis and structural investigation; (2) spectroscopic experiments and study of chemical effects; (3) investigation of chemical reactions mechanism; (4) heats of formation and density calculations, especially of high energetic materials. In the following sections we will concentrate on molecular mechanics based research studies, or on such where molecular mechanics calculations played a



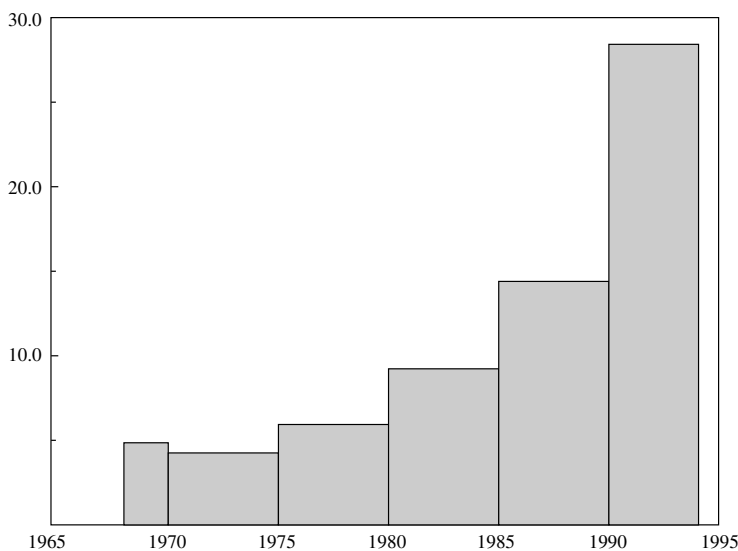


FIGURE 1. Number of publications (per year) relating to force fields and dealing with amines, nitro or nitroso compounds, during the years 1968–1994. Most of the works, prior to 1975, are connected with vibrational force fields

dominant role, and provide examples from all four areas presented above. Clearly, more examples of occasional use of the method may be found in the literature.

## A. Conformational Analysis and Structural Investigation

### 1. Tertiary amines

Among molecular mechanics calculations of nitrogen-containing compounds, the conformational analysis of tertiary amines is the single most studied subject. Based on steric crowding in the vicinity of the nitrogen, aliphatic tertiary amines may be classified into three groups and characterized by the relative energies of barriers to nitrogen inversion and rotation around single C–N bonds where, in general, bulkier substituents around the nitrogen lead to lower barriers for inversion but higher barriers to rotation<sup>66,67a</sup>. (i) relatively unhindered amines, for which inversion barriers are significantly higher than rotational ones; (ii) moderately crowded amines, where inversion and rotational processes have comparable barriers; (iii) highly crowded amines, for which barriers associated with isolated rotation are expected to be much higher than inversion ones. (In a recent study<sup>67b</sup> it was claimed that in such compounds, all the possible conformers may interconvert via one, or several successive, steps of an inversion-rotation process. Thus, isolated rotation processes are not detectable by NMR based techniques. See also ref. 67c). In the two extreme cases, (i) and (iii), the two types of process may in principal be studied separately, both experimentally and by calculations. Such studies usually start with the construction of a conformational map, including all possible conformational interconversion pathways followed by molecular mechanics calculations of thermodynamically stable and transition state forms and by dynamic NMR experiment (DNMR), the latter analyzed in conjunction with the theoretical results.

Tertiary amines of class (i) were studied by Bushweller and coworkers, starting with simple examples such as diethylmethylamine (DEMA) and triethylamine (TEA)<sup>68</sup>. The

TABLE 23. Letter designation for naming tertiary amine conformations

Letter	Compound	Orientation
<i>First letter</i>		
G	DEMA	CCH <sub>3</sub> group <i>gauche</i> to the lp and to the NCH <sub>3</sub> group
	TEA	Methyl group <i>gauche</i> to the lp and to an A group
	EMAB	Methyl (CH <sub>2</sub> N) group <i>gauche</i> to the lp and to the NCH <sub>3</sub> group
	IDMA	An isopropyl methyl group <i>gauche</i> to the lp
	EMAP	CCH <sub>3</sub> group <i>gauche</i> to the lp and to the NCH <sub>3</sub> group
G'	DEMA	CCH <sub>3</sub> group <i>gauche</i> to the lp and to the other N-ethyl group
	TEA	Methyl group <i>gauche</i> to the lp and to an A group
	EMAB	Methyl (CH <sub>2</sub> N) group <i>gauche</i> to the lp and to the 2-butyl group
	EMAP	CCH <sub>3</sub> group <i>gauche</i> to the lp and to the isopropyl group
A	DEMA	CCH <sub>3</sub> group <i>anti</i> to the lp
	TEA	Methyl group <i>anti</i> to the lp
	EMAB	Methyl (CH <sub>2</sub> N) group <i>anti</i> to the lp
	IDMA	An isopropyl methyl group <i>anti</i> to the lp
	EMAP	CCH <sub>3</sub> group <i>anti</i> to the lp
<i>Second letter</i>		
G	DEMA	Same as first letter
	TEA	Same as first letter
	EMAB	C1 methyl of 2-butyl <i>gauche</i> to the lp and to the N-methyl
	IDMA	An isopropyl methyl group <i>gauche</i> to the lp
	EMAP	The isopropyl methine H <i>gauche</i> to the lp and to the N-methyl
G'	DEMA	Same as first letter
	TEA	Same as first letter
	EMAB	C1 methyl of 2-butyl <i>gauche</i> to the lp and to the N-ethyl
	EMAP	The isopropyl methine H <i>gauche</i> to the lp and to the N-ethyl
A	DEMA	Same as first letter
	TEA	Same as first letter
	EMAB	C1 methyl of 2-butyl <i>anti</i> to the lp
	IDMA	An isopropyl methyl group <i>gauche</i> to the lp
	EMAP	The isopropyl methine H <i>anti</i> to the lp
<i>Third letter</i>		
G	TEA	Same as first letter
	EMAB	C4 methyl of 2-butyl <i>gauche</i> to methine H and to the C1 methyl
G'	TEA	Same as first letter
	EMAB	C4 methyl of 2-butyl <i>gauche</i> to methine H and to the nitrogen
A	TEA	Same as first letter
	EMAB	C4 methyl of 2-butyl <i>anti</i> to methine H

DNMR spectra of DEMA suggest that the GG conformer is the global minimum (see Table 23 for naming conventions), but that it rapidly (on the NMR time scale at 102 K) interconverts with rotamers of different symmetry, such as GG' and G'G. The assignment of the spectra largely depends on the availability of accurate chemical shifts values ( $\Delta\delta$ ) for the NCH<sub>2</sub> protons in *gauche* and *anti* orientations to the nitrogen lone pair (lp). These were obtained from the NMR spectra of a similar system, *t*-butylmethylethylamine and its deuterated derivatives which, based on MM2 calculations (1980 version with preliminary parameters for amines), were assigned to a single conformer where the diastereotopic proton assumed both orientations (all other rotamers of the systems were calculated to be at least 3 kcal mol<sup>-1</sup> above the global minimum and thus should not be detectable in

the NMR experiment). The MM2 force field employed in this work was further tested for its ability to reproduce rotational barriers around C–N bonds. The calculated value for trimethylamine ( $4.7 \text{ kcal mol}^{-1}$ ) is in very good agreement with the experimental one ( $4.4 \text{ kcal mol}^{-1}$ <sup>69</sup>). Having satisfied this requirement, MM2 calculations were next used to map the potential surface of DEMA using the ‘double driver’ option to get a 5000-point potential energy grid as a function of the two LP–N–C–C dihedral angles. The results are presented as a contour map in Figure 2 where in addition to the energy minima (i.e. conformers) indicated by their symbols, the energy peaks and saddle points (i.e. rotational barriers) are also marked. The MM2 calculations point out the GG' (or G'G) as the most stable conformer, however only slightly ( $0.05 \text{ kcal mol}^{-1}$ ) below the GG one. The AG' and AG are two additional low-energy conformers ( $0.47$  and  $0.66 \text{ kcal mol}^{-1}$ , respectively), while other stable forms (G'G', AA) are at least  $2.96 \text{ kcal mol}^{-1}$  higher in energy, as could be expected noting their severe 1,5 pentane-like interactions. Thus MM2 predicts DEMA to exist as a mixture of four NMR detectable conformers. The apparent contradiction with the NMR spectra, which revealed only two sets of peaks, was readily solved by examining the potential energy surface: Rotational barriers for the GG'  $\leftrightarrow$  GG  $\leftrightarrow$  G'G and AG  $\leftrightarrow$  AG' interconversions, which involve alkyl...lp eclipsing only, were calculated to be  $\leq 4.5 \text{ kcal mol}^{-1}$  and thus could not be separated on the NMR time scale which, at the experimental temperature (100 K), requires a minimum conformational interconversion barrier of *ca*  $5 \text{ kcal mol}^{-1}$ . In contrast, the GG'  $\leftrightarrow$  AG interconversion which proceeds

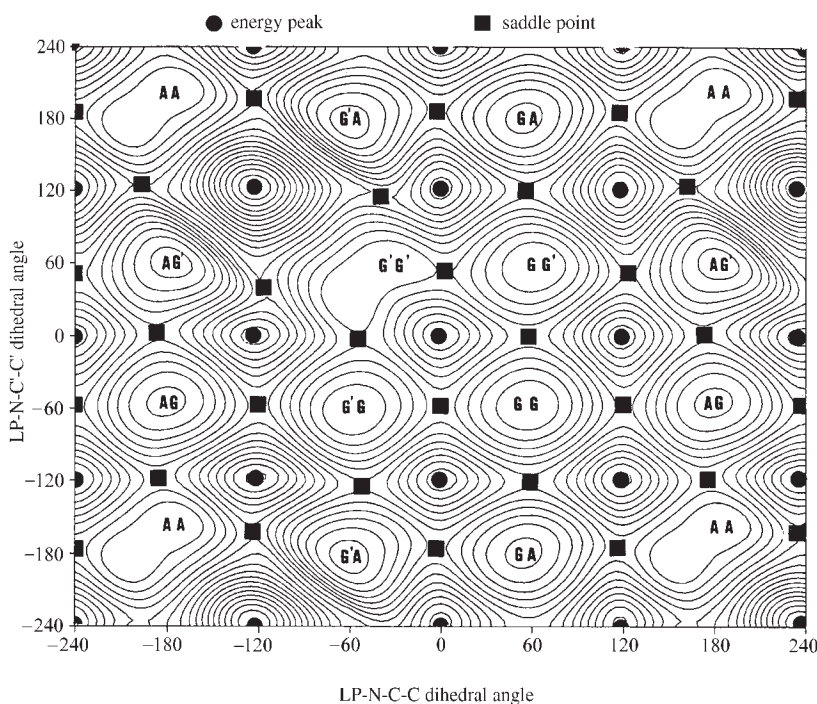
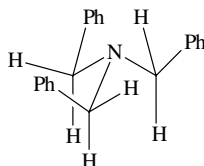


FIGURE 2. An energy contour map for diethylmethylamine recomputed using the MM2-91 force field. The separation between contour lines is  $1.0 \text{ kcal mol}^{-1}$

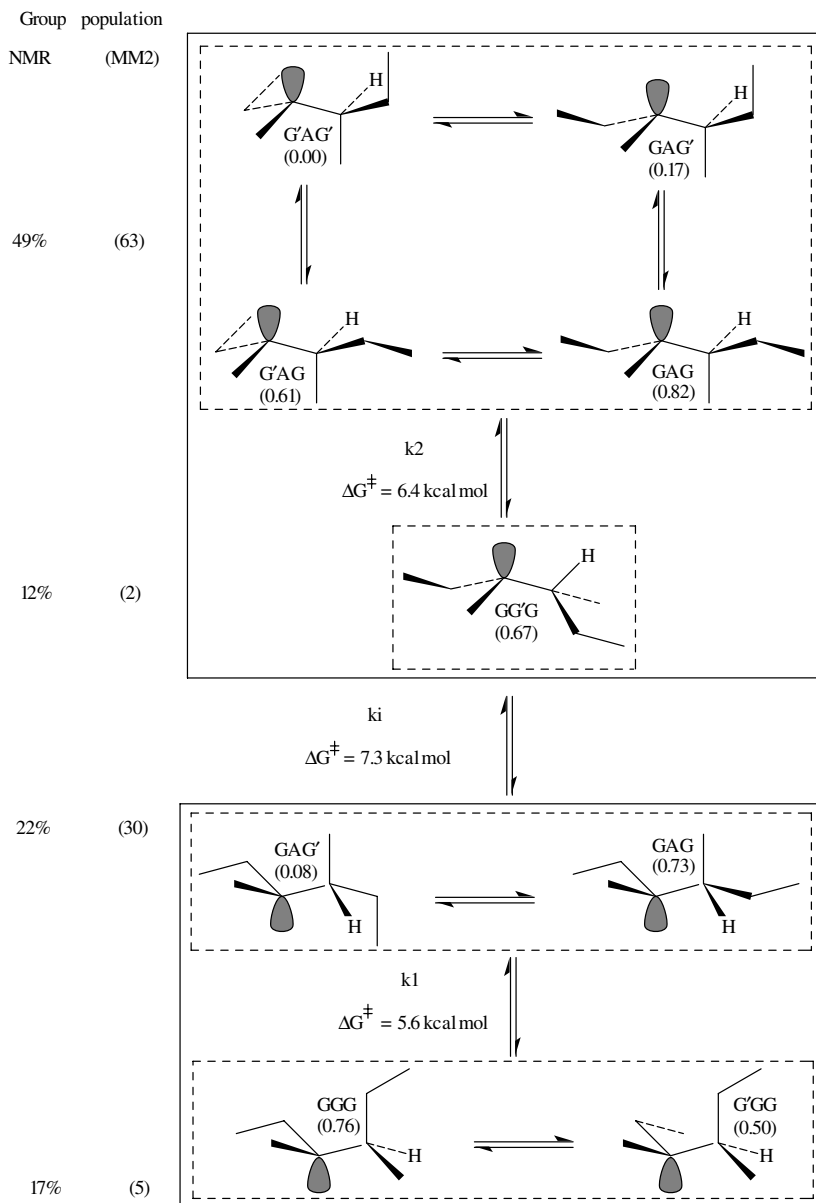
through an alkyl...alkyl eclipsing conformation was calculated to have a rotational barrier of 6.0 kcal mol<sup>-1</sup> resulting in separation into two conformational families.

Triethylamine (TEA) can be regarded as an extension of DEMA to a rotameric space defined by three lp-N-C-C dihedral angles. The conformers are grouped into three low-energy rotameric families: G'G'G', GAG (AGG, GAG, GGA) and GAG' (AGG', G'AG, GG'A etc.), all within a 0.2 kcal mol<sup>-1</sup> range (MM2). Other groups, G'G'G' (C1), G'AG', AAG and AAA, are all at least 2.9 kcal mol<sup>-1</sup> above the global minimum and could therefore be excluded from the discussion. A symmetrically related system, tribenzylamine (TBA)<sup>70</sup> shows a different picture: The lowest-energy conformer according to MM2 is of C3 symmetry (**37**), the two next ones are a C1 (1.17 kcal mol<sup>-1</sup>) and Cs (1.98) forms. A comparison of the areas below the NMR peaks assigned to the two lowest-energy forms, C3 and C1, indicated a free-energy difference of 0.18 kcal mol<sup>-1</sup> in favor of the former. While this trend is reproduced by MM2, the calculated energy difference (1.17 kcal mol<sup>-1</sup> in favor of the C3 form) is too large and is only slightly reduced (0.95 kcal mol<sup>-1</sup>) upon the introduction of an entropy correction term due to the 12:4 statistical preference of C1 over C3. This discrepancy between theory and experiment may well be attributed to the absence of suitable parameters in the force field version used in this study to adequately describe the Ar-C-N moiety. The rotational barriers in this system involve Ar...lp eclipsing and, in contrast with both DEMA and TEA, are high enough ( $\Delta G^\ddagger = 5.5$  kcal mol<sup>-1</sup>) to allow for conformational separation by DNMR. No attempt was made to calculate these barriers with MM2.



(37)

An example of a class (ii) tertiary amine is provided by *N*-ethyl-*N*-methyl-2-aminobutane (EMAB<sup>71</sup>), a moderately crowded amine in which some of the rotational barriers are energetically comparable to the N-inversion ones. In this compound a chiral carbon adjacent to a chiral nitrogen gives rise to four families of stereoisomers (defined by the chirality at the carbon and nitrogen atoms, respectively): *RR*, *SS*, *RS* and *SR*, each having 27 possible conformers. The *RR/SS* and *RS/SR* relate as enantiomeric couples, while the *RR/RS* and *SS/SR* families are diastereomers, and may interconvert via N-inversion. This leads to a total of 54 forms which, in principle, can be distinguished by NMR in achiral solvents. A combined DNMR-molecular mechanics study of EMAB and some of its selectively deuterated derivatives found 18 of the latter populated enough to be NMR detectable. Four subspectra could be identified and were assigned to the diastereomeric couple *RR* (or *SS*; two subspectra with relative populations of 49% and 12%) and *RS* (or *SR*; two subspectra with relative populations of 22% and 17%). The interconversions among the rotamers within a group (same subspectra) are fast on the NMR time scale even at 104 K, while those among the groups (different subspectra) are detectable and their rate constant and  $\Delta G^\ddagger$  values could be measured. These are rotational processes when the groups involved belong to the same diastereomer (*k*<sub>1</sub>, *k*<sub>2</sub> in Scheme 1), and inversion (*k*<sub>i</sub>) between the diastereomeric couples. 50 of the possible 54 forms converged during MM2 calculations, of which the G'AG' of the *RR* family (see Table 23 for naming conventions), assigned to the most populated NMR subspectra, was indeed found to be the global minimum. All the 9 lowest-energy conformers ( $E_{\text{rel}} \leq 0.76$  kcal mol<sup>-1</sup> according



SCHEME 1. Conformational map of the  $R_cR_N$  and  $R_cS_N$  diastereomers of *N*-ethyl-*N*-methyl-2-aminobutane (EMAB). Interconversions among conformers within dashed boxes are fast on the NMR time scale at 104 K. Those between dashed boxes occur via rotations about the methine carbon–nitrogen bond with barriers which are DNMR-visible. The interconversion between the solid boxes occurs via nitrogen inversion (disstereomeric interconversion). The values in parentheses are MM2-80 results. Reprinted with permission from Reference 71. Copyright (1988) American Chemical Society

to MM2) could be assigned to the four subspectra, and the relative populations of these groups at 104 K (assuming equal entropy) were calculated as 63%, 2%, 30% and 5%, giving the same order as, and good agreement with, the experimental results. All conformers having a methine proton *anti* to the nitrogen lp (e.g. *RR*: GGA; *RS*: AG'A) were found to be at least  $1.09 \text{ kcal mol}^{-1}$  above the global minimum, resulting in an expected relative population of less than 0.5% at 104 K. Indeed, no such structures were identified in NMR spectra. The rotational barriers for the interconversions within the groups were calculated by the dihedral driver option as  $4.4 \text{ (G'AG' } \leftrightarrow \text{ GAG')}$  and  $4.0 \text{ kcal mol}^{-1} \text{ (G'AG' } \leftrightarrow \text{ G'AG; GAG' } \leftrightarrow \text{ GAG)}$ , i.e. predicted to be too fast on the NMR time scale even at 104 K, which confirms the conclusions drawn from the DNMR. The complete picture of the stereodynamics of EMAB is presented in Scheme 1.

More recent studies of class (ii) tertiary amines, namely isopropylamines, were performed by Bushweller's group and employed a combination of  $^1\text{H}$ - and  $^{13}\text{C}$ -DNMR experiments and molecular mechanics calculations using a latter version of the MM2 force field (MM2-87) with specific parameters for amines. Isopropylidimethylamine (IDMA)<sup>72</sup> was found to exist as an equilibrium mixture of three conformers: 2 enantiomers with C1 symmetry (AG, GA) and a Cs form (GG), interconverting via rotation around the nitrogen-methine carbon bond. The two NMR subspectra of approximately 3:1 ratio were assigned to the AG/GA and GG rotamers, respectively. The rotational barriers obtained by DNMR,  $4.4\text{--}4.5 \text{ kcal mol}^{-1}$  for the AG/GA  $\leftrightarrow$  GG interconversion, and a lower limit of  $5.2 \text{ kcal mol}^{-1}$  for the direct (i.e. not via the Cs form) AG  $\leftrightarrow$  GA one, seem reasonable: The latter process involves simultaneous eclipsing of 2 couples of methyl groups, while in the former, one of the eclipsed couples is H...Me. The 'driver' option was again used to calculate the rotational potential around the N-CH(CH<sub>3</sub>)<sub>2</sub> bond (see Figure 3) and the three rotamers were separately minimized. The calculations confirm the NMR picture of three, almost energetically equal conformers (NMR:  $\Delta_g(\text{GG-AG/GA}) = 0.07 \pm 0.02 \text{ kcal mol}^{-1}$ ; MM2:  $\Delta H(\text{AG/GA-GG}) = 0.19 \text{ kcal mol}^{-1}$ ). The calculated  $5.37 \text{ kcal mol}^{-1}$  barrier for the AG/GA  $\leftrightarrow$  GG transition, and  $7.84 \text{ kcal mol}^{-1}$  for the enantiomeric interconversion, though probably a little overestimated, suggest that the actual exchange between the two enantiomers occurs via the Cs conformer. To further confirm that no isolated diastereotopic methyl rotations are involved in the NMR visible dynamic processes, all the barriers for such rotations in the AG and GG conformers were calculated by MM2-87 (such rotations may also average hydrogen signals and lead to

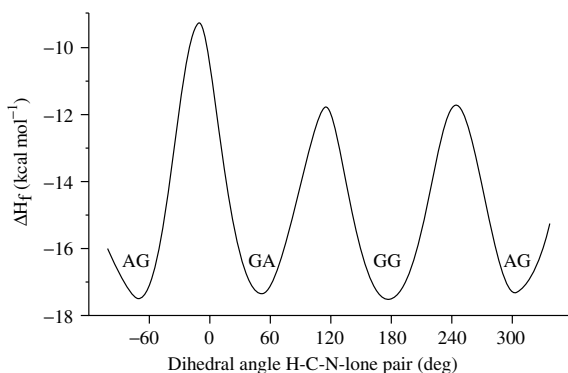
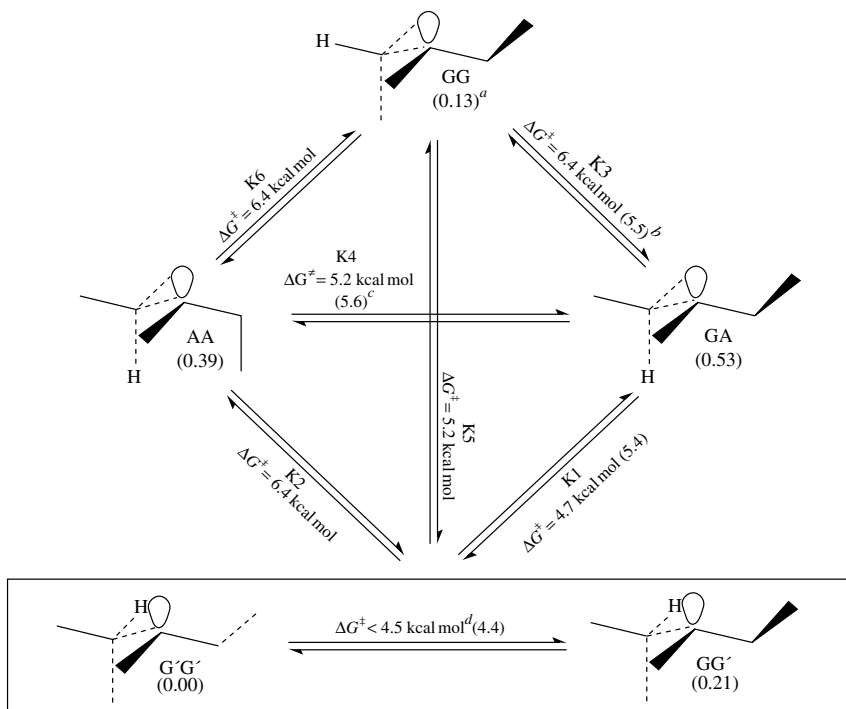


FIGURE 3. Rotational energy profile around the methine carbon-nitrogen bond of isopropylidimethylamine (IDMA) as calculated by MM2-87. Reprinted with permission from Reference 72. Copyright (1992) American Chemical Society

temperature-dependent spectra). As a preliminary test, the appropriate barrier in trimethylamine was calculated to be  $4.37 \text{ kcal mol}^{-1}$  (an improvement over the MM2-80 value of  $4.7 \text{ kcal mol}^{-1}$ ; see above) and is now in excellent agreement with the experimental value ( $4.4 \text{ kcal mol}^{-1}$ ; see above). All such rotations in IDMA were found to be in the  $2.96\text{--}4.24 \text{ kcal mol}^{-1}$  range, i.e. below the detectable threshold by NMR at 95 K.

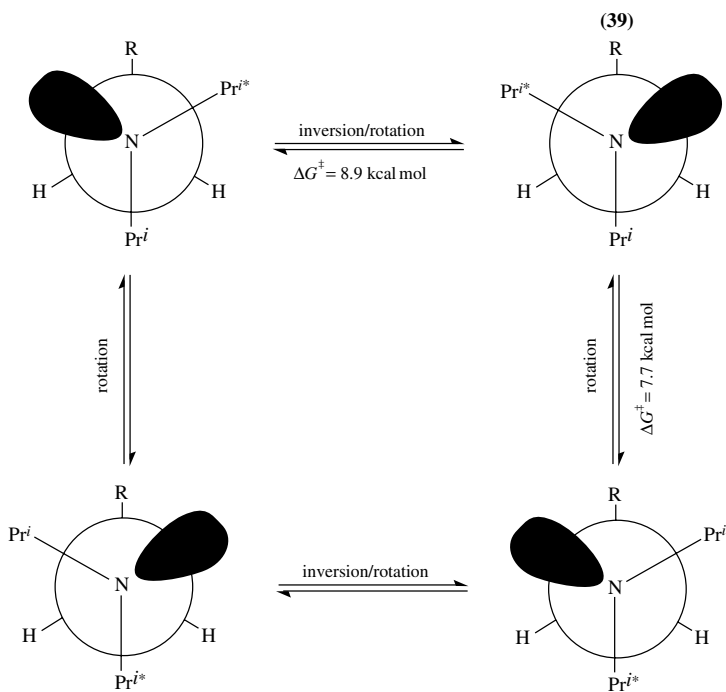
A closely related system to both IDMA and EMAB is the chiral tertiary amine *N*-ethyl-*N*-methyl-2-aminopropane (EMAP)<sup>73</sup>. As in the case of EMAB, its DNMR spectra could be accurately simulated assuming four subspectra. These were assigned to the  $G'G' \leftrightarrow GG'$  (59%),  $GG$  (34%),  $GA$  (2%) and  $AA$  (5%) conformational families. The DNMR simulation of EMAP and its d7 deuterated derivative, in the range of 95–130 K, also provided the rotational barriers for the appropriate conformational interconversions. As in the case of DEMA, MM2-87 calculations were used to map the conformational space of EMAP as defined by the two dihedral angles  $\text{lp-N-CH-CH}_3$  and  $\text{lp-N-CH}_2\text{-CH}_3$ , providing results in excellent agreement with the DNMR ones. The calculated potential surface reveals twelve stable conformers separated by energy barriers. The five rotamers assigned to the four NMR subspectra were all calculated to be in the range of  $0.53 \text{ kcal mol}^{-1}$  above the global minimum ( $G'G'$ ), while all other forms are at least  $2.7 \text{ kcal mol}^{-1}$  higher in energy, i.e. predicted to be NMR invisible. The MM2 calculated rotational barriers (see Scheme 2), though they seem to be consistently a little



SCHEME 2. Conformational map of *N*-ethyl-*N*-methyl-2-aminopropane (EMAP). Reproduced with permission from reference 73. <sup>a</sup>MMP2-87 relative energies in parenthesis. <sup>b</sup>MMP2-87  $\Delta H^\ddagger$  values in parenthesis. <sup>c</sup>The rotational barrier for the direct  $GG \leftrightarrow GG'$  exchange was calculated as  $8.5 \text{ kcal mol}^{-1}$ . <sup>d</sup>lower limit for DNMR detection in this study

overestimated, have a standard deviation of only  $0.5 \text{ kcal mol}^{-1}$  from the experimental values.

Even more sterically hindered tertiary amines were studied by Lunazzi and coworkers<sup>75,76</sup>. In a series of *N,N*-diisopropyl<sup>66</sup>, *N-t*-butyl-neopentyl and *N-t*-butyladamantyl amines<sup>74</sup> some of the NMR detectable dynamic processes are of inversion-rotation type. Scheme 3 summarizes the possible interconversions in the diisopropyl series: For the neopentyl derivative **38** for example, the DNMR (<sup>1</sup>H and <sup>13</sup>C) shows two successive processes during the cooling procedure, with barriers of 8.9 and 7.7 kcal mol<sup>-1</sup>. MM2-82 calculations of **39** define 3 possible rotamers around the R-C-N- $\text{lp}$  dihedral angle (Figure 4). Since the G<sup>+</sup> and G<sup>-</sup> (*gauche*<sup>+</sup> and *gauche*<sup>-</sup>) are enantiomeric forms, and the A (*anti*) conformer, with isopropyl groups on both sides of the *t*-butyl one, is much higher in energy (about 7 kcal mol<sup>-1</sup>), only one rotamer, the G<sup>+</sup> (or G<sup>-</sup>), should be considered. A further analysis of this structure called for a check of the various combinations of the isopropyl methine proton with respect to the  $\text{lp}$ , i.e. the two  $\text{lp-N-C(CH}_3)_2\text{-H}$  dihedral angles: 11 distinct conformers could thus be minimized by MM2, half of which lie within  $1.5 \text{ kcal mol}^{-1}$  of the lowest form, and should be considered when determining significantly populated conformations.



SCHEME 3. Reproduced with permission from Reference 74

For *N*-ethyl-*N-tert*-butylneopentylamine (ETNA, **40**)<sup>74</sup>, three successive processes are sequentially revealed during the cooling procedure in the DNMR spectra, with barriers of 8.1, 7.3 and 6.0 kcal mol<sup>-1</sup>. As in the diisopropylamine series, the highest barrier is attributed to an inversion/rotation process (**40a** ↔ **40b**), and the lower ones to rotations



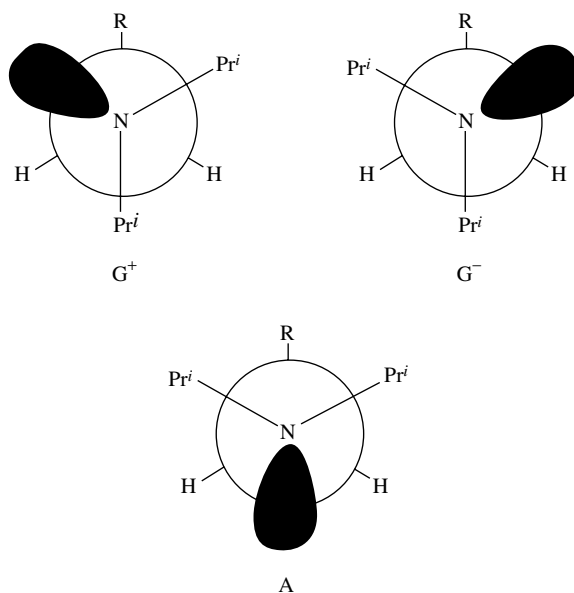
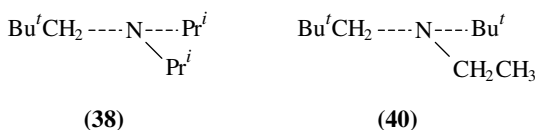
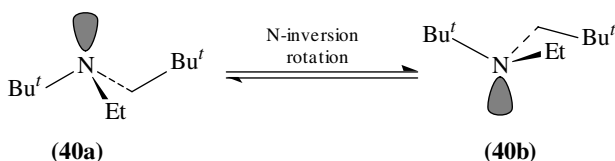


FIGURE 4. Newman projections (along the N-CH<sub>2</sub> bond) for the three rotamers of RCH<sub>2</sub>-N-(*i*-Pr)<sub>2</sub>



around single bonds. Further cooling to 108 K slows down the low-energy barrier process and gives rise to 2 signals of 9:1 ratio in the <sup>13</sup>C-NMR spectra. Assuming that the only relevant structures of **40b** are those with *anti* *t*-butyl groups, MM2-85 was used to calculate the three possible rotamers around the N-ethyl bond (**40c-e**). On the basis of the relative MM2 steric energies (**40c**: 0.00; **40d**: 1.20; **40e**: 0.67 kcal mol<sup>-1</sup>), and assuming identical entropies, the relative populations of the three rotamers were calculated to be 64.9%:8.6%:26.5% at 298 K and 95.2%:0.4%:4.4% at 108 K. The good agreement with the above NMR results at 108 K (peak ratio of 9:1) suggests that the low barrier process indeed relates to N-ethyl rotation. In addition to the energy minima, the complete rotational potential around this C-N bond was calculated and is presented in Figure 5. The barrier to the **40c** → {**40d**} → **40e** interconversion is 5.7 kcal mol<sup>-1</sup>, in very good agreement with the experimental result (6 kcal mol<sup>-1</sup>).



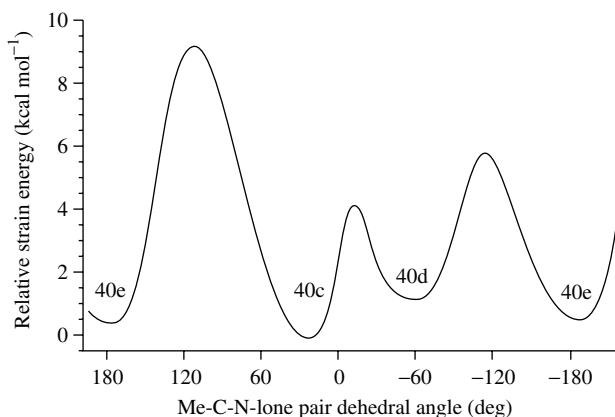
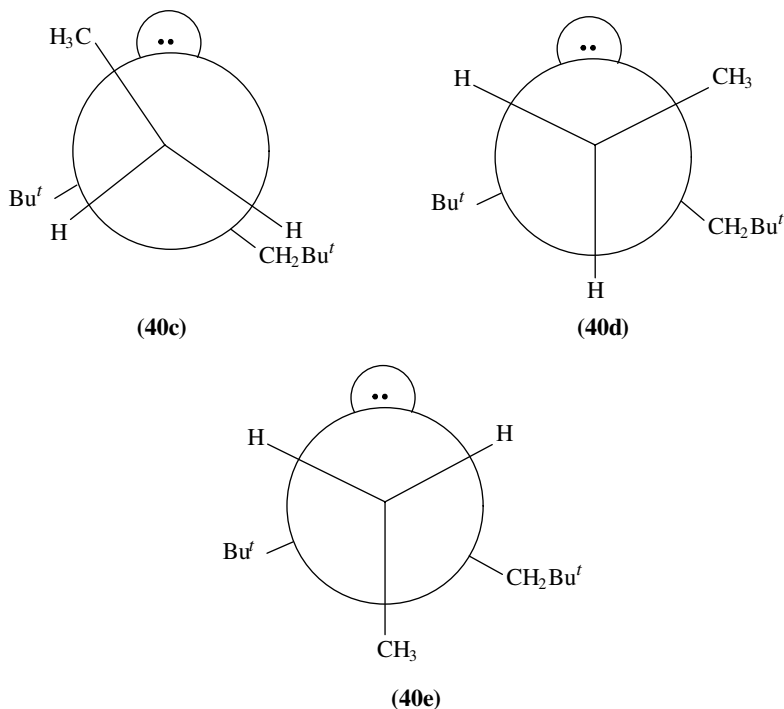
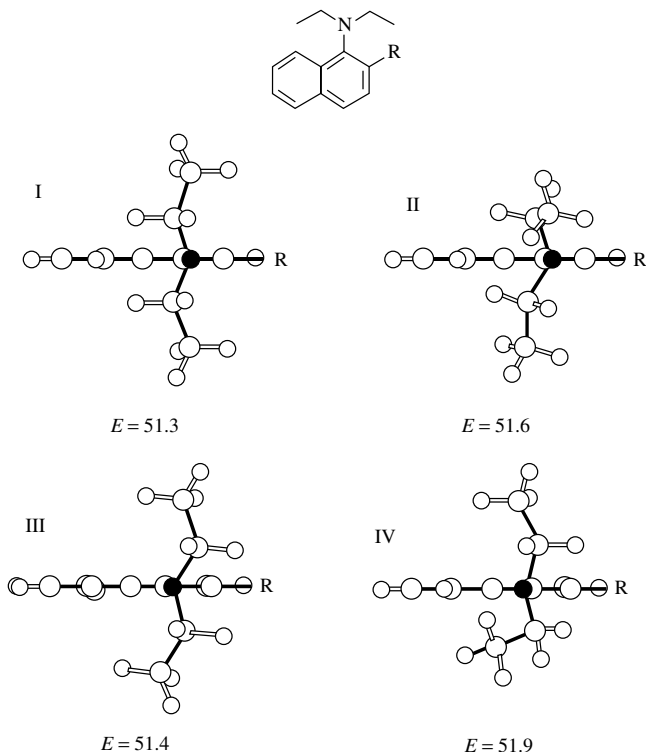


FIGURE 5. Rotational energy profile about the N-ethyl bond for *N*-ethyl-*N*-*t*-butylneopentylamine (ETNA, **40**) as calculated by MM2-85. Reproduced with permission from Reference 74

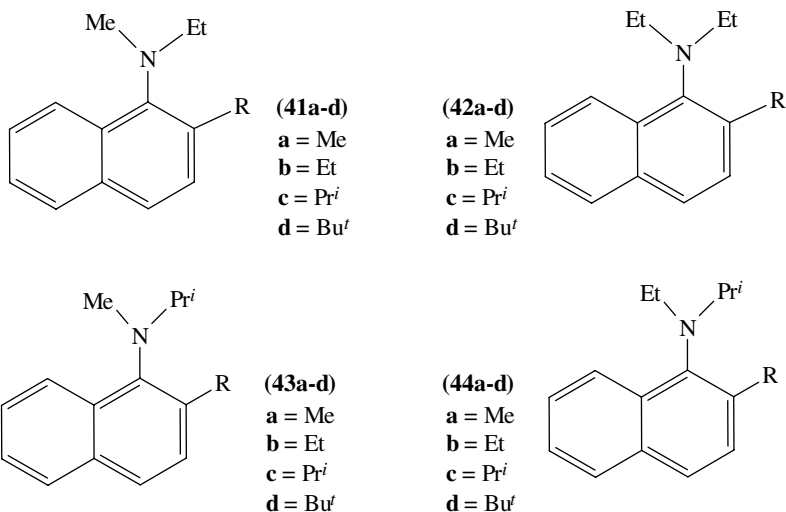


Tertiary amines of class (iii) were also studied by Lunazzi and coworkers<sup>75</sup>. A series of beta-substituted-alpha-amino naphthalenes **41a-d-44a-d** were investigated using DNMR and NOE experiments and molecular mechanics. Such systems allow for separation between rotational processes, whose barriers around Ar-N bonds are quite high (15–23 kcal mol<sup>-1</sup>), and inversion, known to have particularly low barriers

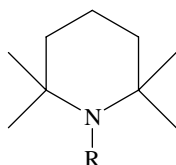
in aromatic amines ( $\Delta G^\ddagger = 7.24 \text{ kcal mol}^{-1}$  for aniline<sup>76</sup>). The systematic increase in measured  $\Delta G^\ddagger$  values with the bulkiness of R (on going from a to d) supports the exclusion of N-inversion from this dynamic process. (As stated before, this conclusion is rather questionable, and the DNMR detected process may better be characterized as an inversion-rotation type). Detailed MM2-82 calculations for the *N,N*-diethyl structures **42a** and **42d** show 4 energy minima, all having the inversion plane approximately perpendicular to the naphthalene plane, in agreement with the NMR conclusions (Scheme 4). (A recent structural investigation of crowded tertiary amines<sup>77</sup> supports this finding: While dimethylaniline was found to adopt a (minimum energy) conformation in which the lp is approximately perpendicular to the plane of the phenyl ring, the more hindered *N*-(2,6-diisopropylphenyl)-piperidine adopts a  $90^\circ$  twisted conformation (NMR, X-ray performed on the *meta*-nitro derivative). An intermediate situation was calculated (MM2) for the parent *N*-phenylpiperidine system.) The analysis of the conformational space was performed by a combination of NOE and molecular mechanics, the latter used to establish the various interproton distances. The quasi-planar structures of **42a-d** were also calculated, to estimate the transition state energies. The observed trend is well reproduced by the calculations giving (MM2 results in parentheses) 17.5 (12.0), 18.6 (16.0), 19.3 (17.1) and 21.2 (22.3) kcal mol<sup>-1</sup> for **42a-d**, respectively, with an average deviation of about 15%.



SCHEME 4. Top view of the conformers (I-IV) corresponding to the four energy minima ( $E$ , kcal mol<sup>-1</sup>) as obtained by MM2 calculations for **42a** (R = Me) and **42d**. Reproduced with permission from Reference 75



Cyclic tertiary amines are characterized by a smaller number of dynamical processes, in comparison with the acyclic analogs, due to ring constrains. Thus, sterically hindered 2,2,6,6-tetramethyl piperidines (**45–51**) were subjected to DNMR analysis combined with MM3-92 calculations<sup>67a</sup>. The calculations included all possible rotamers based on the chair conformation of the piperidine ring, except for the N-isobutyl derivative **48**, where the twist-boat forms were also considered. The computed structures of the energy minima are in accord with experimentally observed phenomena. For example, the presence of intramolecular hydrogen bond, indicated by both NMR and IR spectra of **50** and **51**, is accounted for by the calculated structures of the corresponding minima with an OH...N distance of *ca* 2.1 Å. Similarly, the flattening of the crowded amino group, detected in the X-ray structure of 1,2,2,6,6-pentamethyl-4-*tert*-butyl-4-hydroxypiperidine (C2–N–C6 angle of 118.2°<sup>78</sup>), is also well reproduced (C2–N–C6 = 117°–118.5° for compounds **45–51**). The ‘double driver’ option was used to map the potential energy surface of compounds **46–50** in terms of the N–C<sub>α</sub> and C<sub>α</sub>–C<sub>β</sub> torsions and to locate minimum-energy conformers and lowest-energy pathways among them. The calculated results for the rotational barriers are in good agreement with the experimental ones [DNMR (MM3): 10.6 (9.0), 10.9 (9.6), 12.4 (11.9), 16.7 (13.8), 18.5 (17.9)], where MM3 underestimates the barriers by an average of 1.3 kcal mol<sup>-1</sup>, a standard deviation of less than 12%.

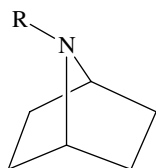


(45-51)

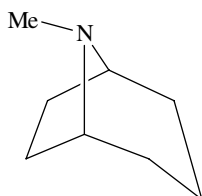
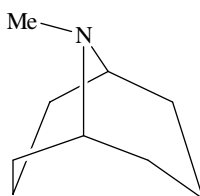
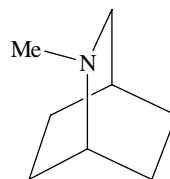
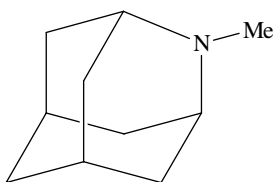
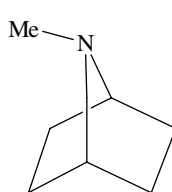
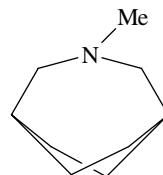
	<b>45</b>	<b>46</b>	<b>47</b>	<b>48</b>	<b>49</b>	<b>50</b>	<b>51</b>
R =	Me	Et	Bu	Bu <sup>t</sup>	–CH <sub>2</sub> –C(R1)	(R2) CH <sub>3</sub>	
R1 =					Me	Me	Ph
R2 =					OAc	OH	OH

Unlike the MM2 force field, there is no explicit treatment of the nitrogen (or oxygen) lone pair in MM3. This allows one to calculate planar amine structures, as a model to

transition structures for nitrogen inversion. This procedure, however, should be practiced with caution since the force field has been parameterized for pyramidal  $sp^3$  N type amines. Belostotskii and coworkers<sup>79</sup> have recently taken advantage of this feature and estimated the inversion barriers in a series of rigid, hindered cyclic amines (**52a-f**, **53-58**). The calculated results (Table 24), generally show the correct trend, and reproduce about 85% (standard deviation) of the experimental  $\Delta G^\ddagger$  values.

**(52a-f)**

	a	b	c	d	e	f
R =	Me	Et	Pri	Bu	Bu <sup>i</sup>	Bu <sup>t</sup>

**(53)****(54)****(55)****(56)****(57)****(58)**

## 2. Polyamines

*a. Diamines.* The simplest diamine, methylenediamine, belongs to a more general type of compound with an X-C-Y moiety, which is characterized by the anomeric effect. The molecular mechanics treatment of such structures has been described in Section II.B.5 of this review. Other diamines, in which the amino groups are separated by more than one carbon atom, were studied by the CFF<sup>81</sup>, MM2-87<sup>82</sup> and MM3 force fields (see Section II.C.2 for the latter case). The conformational space of 1,2-ethanediamine (EDA) can be defined by the two peripheral lp-N-C-C, and the central N-C-C-N dihedral angles. Selected energetic and geometrical results for the lowest-energy conformers of

TABLE 24. Experimental (DNMR) and calculated (MM3) inversion barriers of several azabicyclo and azatricyclo compounds

Compound	$\Delta G^\ddagger$ [Reference]	MM3 estimated barrier to inversion (kcal mol <sup>-1</sup> )
<b>52a</b>	13.8 [80a]	10.6
<b>52b</b>	6.1 [79]	4.9
<b>53</b>	8.2 [80b]	8.3
<b>54</b>	7.1 [80c]	6.6
<b>55</b>	5.7 [80d]	4.3
<b>56</b>	7.8 [80c]	6.6
<b>57</b>	8.8 [80e]	8.0
<b>58</b>	14.4 [80a]	10.0

TABLE 25. Selected energetic and geometrical results for 1,2-ethanediamine (EDA) as calculated *ab initio* and by the CFF and MM2 force fields and obtained experimentally (relative energy in kcal mol<sup>-1</sup>, bond lengths in Å, bond angles and torsional angles in degrees)

Conformer <sup>a</sup>	Method	Erel	C-C	C-N	N-C-C	lp-N-C-C	N-C-C-N	C-C-N-lp
AGG'	MM2 <sup>82</sup>	0.00	1.536	1.456	111.5	178.6	62.9	-62.0
	CFF <sup>81</sup>	0.01 (0.00) <sup>b</sup>	1.548	1.475	110.6	180.0	60.8	-61.9
	<i>ab initio</i> <sup>c</sup>	0.04 (0.00)	1.539	1.475	111.0		57.8	
	MW <sup>83</sup>		1.546	1.469	111.5		63.0	
GGG'	MM2	0.39	1.536	1.457	111.3	66.3	66.2	-59.1
	CFF	0.03 (0.02)	1.547	1.475	110.4	63.1	61.9	-61.9
	<i>ab initio</i>	0.00 (0.50)	1.532	1.474	108.6		61.9	
	MW ED <sup>84</sup>		1.546 1.545	1.469 1.469	109.0 110.2		63.0 64.0	

<sup>a</sup>A = 180°, G = 60°, G' = -60°.

<sup>b</sup>In parentheses, relative free enthalpies corrected for statistical weights. CFF calculates another conformer, AAG, as the global minimum; see text.

<sup>c</sup>3-21G calculations from Reference 85. In parentheses, 6-31G relative energies from Reference 81.

EDA, as obtained by molecular mechanics and *ab initio* calculations, together with gas-phase experimental data, are presented in Table 25. Electron diffraction suggests that the most stable form of EDA has a *gauche* central torsional angle, while the microwave results were interpreted in terms of two stable conformers, AGG' and GGG'. While both MM2 and *ab initio* calculations confirm these findings, CFF locates another low-energy conformer, AAG, and calculates all three to be within 0.02 kcal mol<sup>-1</sup> (enthalpies corrected for statistical weights) of the global minimum. The CFF force field seems to overestimate the stability of conformations with an *anti* N-C-C-N torsion (all are calculated to be at least 1.3 and 1.1 kcal mol<sup>-1</sup> above the lowest-energy form by MM2 and *ab initio*, respectively). This is attributed to the lack of hydrogen-bond interactions in this version of the force field. The geometrical features, though, are reproduced somewhat better than by MM2.

The next linear diamine, 1,3-propanediamine (PDA), was also studied by the same force fields. Four conformational families were considered and defined by the two

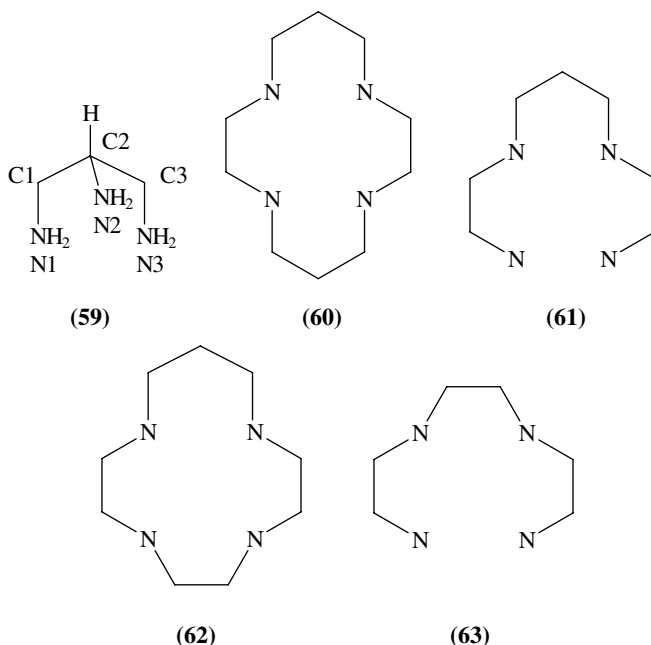
central N–C–C torsions, while the two peripheral lp–N–C–C angles determined the conformations within each group. In the lack of experimental data for PDA, the only reference for comparison came from partial 6-31G *ab initio* results of one representative form of each group<sup>81</sup>, which indicated that the two most stable conformers belong to the G'A and AA conformational families. CFF calculations of the entire conformational space indeed found the lowest conformers of each of these groups to be among the four most stable forms, within only 0.01 kcal mol<sup>-1</sup> (corrected enthalpies, see above) of the global minimum. All conformers belonging to the other two groups, namely G'G' and G'G, were calculated to be at least 0.4 and 0.6 kcal mol<sup>-1</sup> higher in energy. MM2 reversed the order of the two lowest groups, but only by 0.7 kcal mol<sup>-1</sup>, and calculated the other two to be at least 1.24 and 1.42 kcal mol<sup>-1</sup> above the global minimum.

A series of alkyl substituted 1,4-diazacyclohexanes (piperazines) was also studied by MM2<sup>82</sup>. These were divided into three categories according to the degree of substitution on the nitrogen atom (0, 1 and 2 alkyl substitutions) and their conformers were defined by the substituent orientation at the carbon and nitrogen centers (axial or equatorial). The few experimental data, relevant to piperazine conformational analysis, consist of dipole moment measurements<sup>86</sup>, ultrasonic relaxation spectra<sup>87</sup> and Raman spectroscopy<sup>88</sup>, all measured in solution. A comparison between the MM2 calculated conformational ratios and those obtained experimentally does not lead to a decisive conclusion. The discrepancies were attributed<sup>89</sup> to the questionable reliability of the dipole moment measurement technique on the one hand, and to the possible role of intermolecular hydrogen bonds which were not accounted for in the calculations, on the other. Similarly, barriers to ring inversion, in the range of 9.6–20.6 kcal mol<sup>-1</sup>, are only qualitatively reconstructed. Again, the experimental data fail to provide a definite reference point. For example, values in the range of 12.2–16.2 kcal mol<sup>-1</sup> were published for the lowest barrier of *N,N'*-dimethylpiperazine<sup>90</sup>. MM2 calculations faithfully reproduce the ED deduced geometries of the unsubstituted piperazine and its *N,N'*-dimethyl derivative. Most bond lengths and angles are within the experimental error, except for the ring C–N–C angle in the latter compound, for which the difference exceeds 4°.

MM2 calculations (a PC version of MM2-89) were used in a theoretical conformational analysis of substituted ethanes with vicinal phenyl groups of the general form R1PhCH–CHPhR2 where R1 and R2 are amino and/or hydroxy moieties<sup>91</sup>. Conformational stability in these systems results from the interplay between three major effects: (1) steric interactions between the neighboring phenyl groups and the R1 and R2 substituents; (2) electrostatic interaction between the phenyl groups; (3) intramolecular O–H...O, O–H...N, N–H...O and N–H...N hydrogen bonds. The inclusion of hydrogen bonding parameters in MM2<sup>30a</sup> allowed for the treatment of the latter interaction type, while the unique electrostatic effect was accounted for through the V1 parameter of the C(sp<sup>2</sup>)–C(sp<sup>3</sup>)–C(sp<sup>3</sup>)–C(sp<sup>2</sup>) torsional potential. The conformational space for these compounds was defined by the three possible relative orientations of the phenyl groups about the Ph–C–C–Ph torsion, i.e. ap (antiperiplanar), (+)-sc (+synclinal) and (–)-sc (–synclinal). Comparison with experiment was performed for the vicinal coupling constants between the two benzylic hydrogens. <sup>3</sup>J<sub>gauche</sub> and <sup>3</sup>J<sub>anti</sub> were calculated for the lowest-energy minima of the main three conformational families (using a Karplus-type equation<sup>92</sup>), averaged over the corresponding MM2 calculated populations and compared with the NMR results. A fairly good correlation was obtained between the computed and experimental values, with an average deviation of 1.0 Hz for a total of 20 comparisons.

*b. Tri- and tetraamines.* The smallest aliphatic triamine, propane-1,2,3-triamine (PTA, **59**), was calculated with a reparameterized MM2 force field<sup>93</sup>. The only source of

experimental data for comparison came from an X-ray structure of the trihydrochloride monohydrate salt, and the parameterization was aimed at fitting this structure by changing the values of the appropriate stretching and bending parameters for the amino and ammonium nitrogen. The resulting new parameter set resembled that used for cobalt complexes of triamines<sup>94</sup>. (Ammonium compounds, as well as amino-metal complexes, are generally beyond the scope of this chapter, and are only briefly mentioned in connection with their neutral, or metal-free, forms.) Atomic charges for this system came from MNDO calculations (the authors used a MacroModel implementation of MM2, with atomic charges rather than bond dipoles), and the neutral form of PTA as well as its mono-, di- and tri-protonated derivatives were conformationally analyzed. The conformational map of PTA may be defined via the two C–C–C–N dihedral angles, giving rise, in principle, to six basic forms (regardless of the nitrogen lone-pair orientations), namely AA, AG<sup>+</sup> (G<sup>-</sup>A), AG<sup>-</sup> (G<sup>+</sup>A), G<sup>+</sup>G<sup>+</sup> (G<sup>-</sup>G<sup>-</sup>), G<sup>+</sup>G<sup>-</sup> and G<sup>-</sup>G<sup>+</sup>. The most stable conformation was calculated to be the AA one, though this could not be confirmed experimentally. For the tri-protonated derivative, however, the AA form was found to be only the third best, 3.13 kcal mol<sup>-1</sup> above the global minimum. The two most stable calculated conformers, separated by only 0.27 kcal mol<sup>-1</sup>, were of the AG<sup>+</sup> and AG<sup>-</sup> types, and closely resembled the structures of two PTA.H<sub>3</sub><sup>3+</sup> cations found in the asymmetric unit.



Small and medium-size macrocycles bearing four nitrogen atoms were calculated<sup>95</sup> with an early force field used in the EFF program<sup>96,97</sup> as part of a study dealing with the extra stability of metal complexes formed by the cyclic ligands over their open-chain analogs. Thus, the structures of 1,4,8,11-tetraazacyclotetradecane (cyclam **60**) and 2,3,2-tet(1,4,8,11-tetraazaundecane), **61**, as well as their Ni(II) complexes, were optimized. The observed differences in enthalpy upon complex formation, between the cyclic (**62** and **60**) and open chain (**63** and **61**, respectively) ligands, could only be reproduced when a N–Ni bond involving a secondary nitrogen was made 1.7 kcal mol<sup>-1</sup> more stable than a similar



bond to a primary nitrogen. Hence the authors concluded that the above extra stability, known as 'the macrocyclic effect' and observed also for smaller rings, could be attributed to the presence of more secondary nitrogens in the cyclic analog. A potential problem lies in the values of the bond dipoles used in these calculations which, although considered unreliable in EFF<sup>98</sup>, still had a significant influence on the calculated  $\Delta H$ : For the open-chain compounds, where the dipoles were free to rotate to the most favorable orientation, the total energy was relatively independent of their values. In the cyclic compounds, however, the dipoles were 'forced' into close proximity in the central 'hole', giving rise to considerable electrostatic repulsion, which would be relieved on complex formation. Since this effect is much more pronounced in the gas phase than in aqueous solutions, where the dipoles are solvated by water molecules, the authors chose to use much smaller bond-dipole values.

*c. Cryptands and azacrown ethers.* Several examples are found in the literature where molecular mechanics calculations have been used to explore the structure and conformational space of host molecules of the cryptand<sup>99,100</sup> and azacrown<sup>101</sup> families. The two known crystal structures of the hexaimino cryptand **64**<sup>100</sup> were used to derive four starting conformations. These were denoted as SSS, SSO, SOO and OOO, where S and O stand for *syn* and *anti* arrangements of the iminic nitrogen atoms around each phenyl group (see Figure 6). A molecular dynamics based conformational search was used to locate all possible arrangements of the four basic conformers, and these were later minimized using the MM2MX program<sup>102</sup>. Several parameters had to be added to the force field, for example the N=C–C(Ar)–C(Ar) and N=C–C(Ar)–H torsional V2 parameter (fitted by the authors) and several bond dipoles which were taken from MM2-87 or derived from MOPAC calculated atomic charges. The specific semiempirical method used to derive the bond dipoles was not given in References 100 and 101. The latter parameters seem to have a significant influence on the relative stability of the above four conformers.

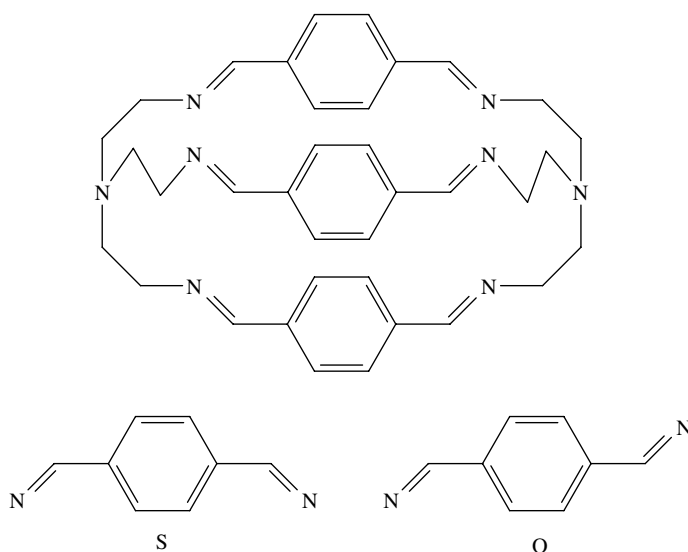
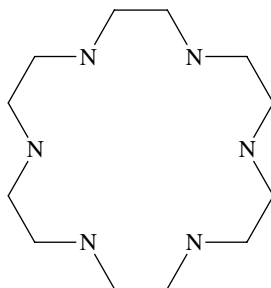


FIGURE 6. Schematic representation of the hexaimino cryptand (**64**)

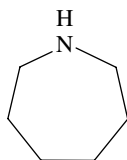
MOPAC derived bond dipoles were also used by Santos and Drew<sup>101</sup> to reparameterize MM2-87 for a conformational analysis study of 18-azacrown-6, **65**. Seven starting conformations were taken from previous calculations of the oxygen analog 18-crown-6, together with one observed in two crystal structures containing the  $[H_6(18\text{-aza-crown})]^{6+}$  cation. Several series of calculations were performed to test the effect of various bond-dipole values, and the inclusion/exclusion of lone pairs on the nitrogen atoms. As long as lone pairs were included, the highest symmetry,  $D_{3d}$ , conformer was found to be the global minimum, regardless of the bond-dipole values. The energetic preference of this form over the next best conformations varied though, between  $1.7 \text{ kcal mol}^{-1}$  for structures minimized using half the MOPAC values, to  $4.0 \text{ kcal mol}^{-1}$  when using the full bond dipoles. When no nitrogen lone pairs were included, the  $C_i$ ,  $C'_i$  and  $C_2$  forms became more favorable. These results significantly differ from those of the oxygen analog, for which the  $C_i$  form was found to be the most stable one, both by molecular mechanics calculations (AMBER<sup>103a,b</sup>, VBFF<sup>103c</sup> and MM2<sup>103d</sup>) and also as the conformation adopted in the crystalline state<sup>104</sup>. Only when no bond dipoles or atomic charges were assigned to 18-crown-6 (which seems highly unrealistic) did the  $D_{3d}$  form come out as the most stable one. MOPAC calculations of 18-azacrown-6 largely agree with the MM2 results. The molecular mechanics minimized structures were later used as starting geometries for calculations of the  $H_3^{3+}$  protonated macrocycle, as well as for its host-guest complexes with small organic anions.



(65)

### 3. Medium-size rings

An extensive study of the conformational behavior of perhydroazepine **66** was carried out by Espinosa and coworkers<sup>105</sup>. This pure force field based analysis, with no reference to experiment or other theoretical methods, was part of a series of studies on cycloheptane, cycloheptene and some of their oxygen, sulfur and nitrogen heterocyclic analogs. MM2



(66)

and MM3-92 (with the 1985<sup>5</sup> and 1990<sup>6</sup> amine parameters, respectively) were used to locate the stable conformers, as well as the transition structures connecting them. Energetic minima could be classified into two main families, chair/twist-chair (C/TC) and boat/twist-boat (B/TB), while in each case the axial, equatorial or isoclinal orientation of the N–H was also considered. Both force fields located the same collection of conformers, with similar geometries and general energetic picture, the most stable ones belonging to the TC family while the highest-energy ones belonged to the B family. The two force fields differ, however, in the relative stability of several conformers within each family. Four, energetically different, chair, four twist-chair, one boat and one twist-boat conformers were located, most having several isoenergetic counterparts leading to a total of 34 conformers (disregarding the N–H orientation). MM3 calculations predict the TC1 conformation, with an axial N–H to be the most stable one, closely followed by TC5 with an equatorial N–H (relative energy < 0.02 kcal mol<sup>-1</sup>). The latter is calculated to be the most stable conformer according to MM2. The lowest-energy forms of each family, as found by both force fields, are shown in Figure 7 along with their calculated relative energies. Six transition states of boat type, divided into 2 energetically equal subgroups of 4 and 2, were found to separate the stable boat forms, completing a pseudorotational cycle of the B/TB family. The two main conformational families are connected by 14 TC ↔ B type transition states (divided into 4, energetically different, subgroups with 4, 4, 4 and 2 members) with energies (i.e. barriers) higher than 7 kcal mol<sup>-1</sup>. These structures are formed when 2 atoms interchange their relative positions with regard to a hypothetical equatorial ring plane, leading in the process to near-coplanarity of 5 of the 7 ring atoms. The main contribution to the transition state energies come from opening of the ring bond angles during this flattening process. The complete pseudorotational equilibrium, as a function of the two N–C–C–C dihedral angles, is presented in Scheme 5. As previously discussed, the MM3 force field can treat nitrogen inversion. Barriers to such processes, leading to interconversion between the axial and equatorial forms of several conformers,

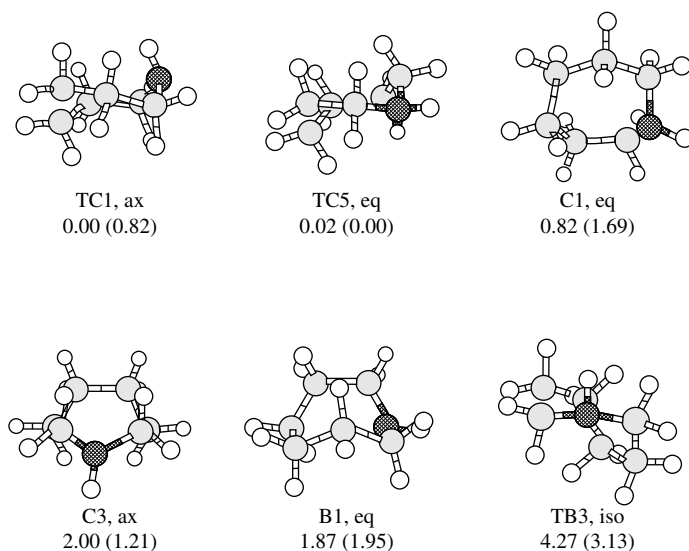
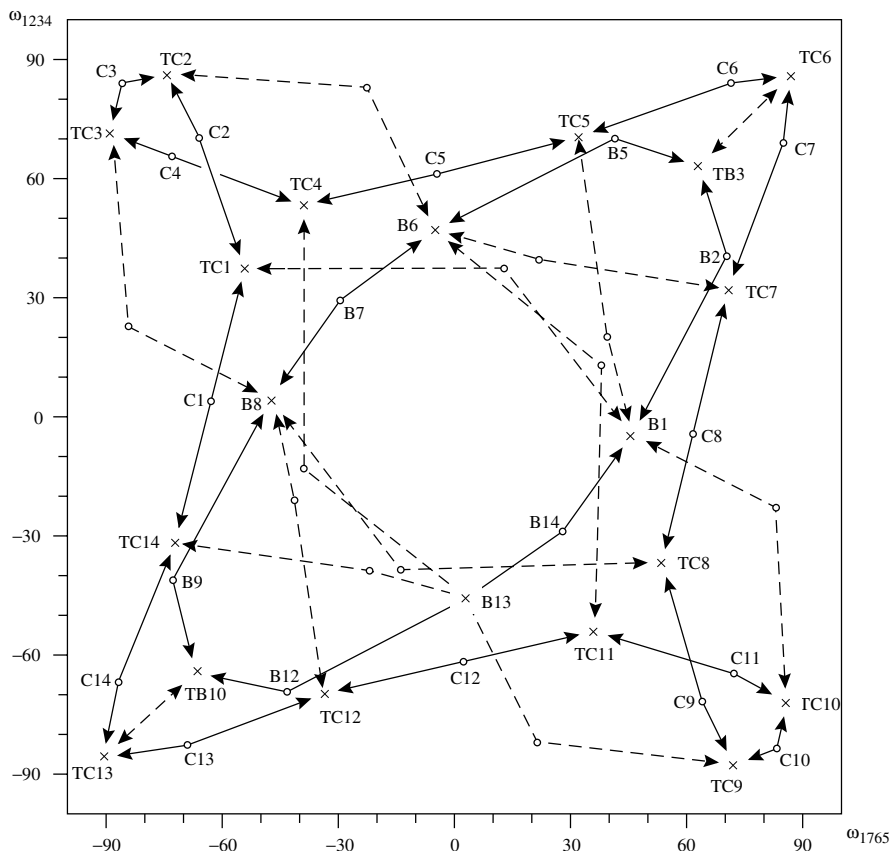


FIGURE 7. The lowest-energy form of each of the conformational families of perhydroazepine **66** as calculated by MM2 and MM3 (MM2 relative energies in parentheses)



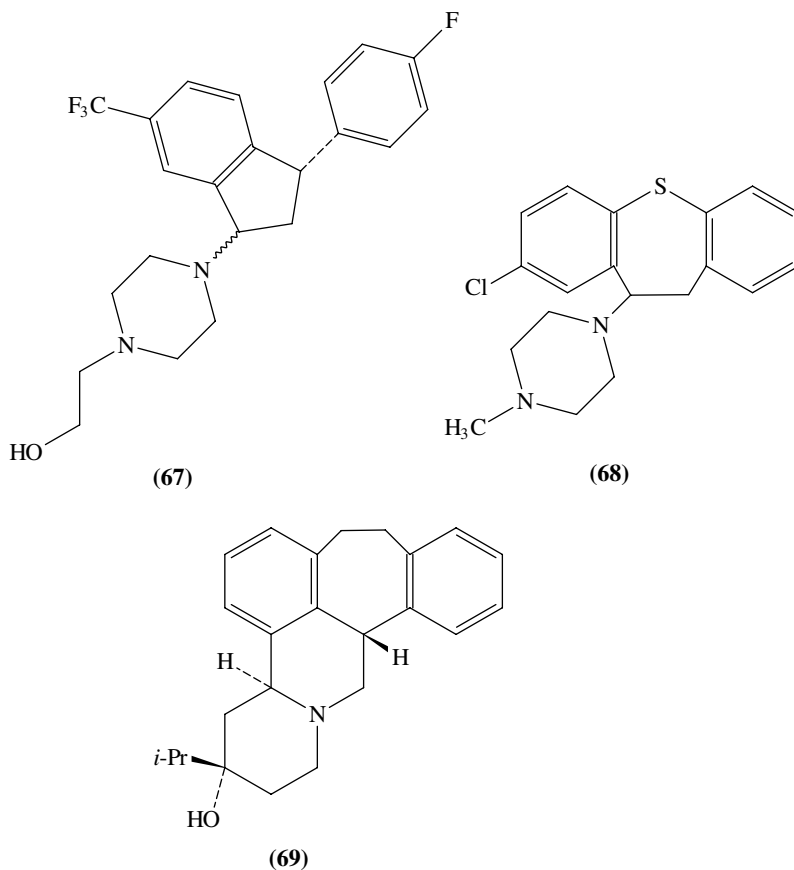
SCHEME 5. Schematic representation of the conformational equilibrium of perhydroazepine **66** as a function of the two dihedral angles  $\omega_{1234}$  and  $\omega_{1765}$ . Continuous lines represent C/TC and B/TB families. TC  $\leftrightarrow$  B transitions are represented by broken lines. (x) and (o) represent minimum and maximum energies, respectively. Reproduced with permission from Reference 105

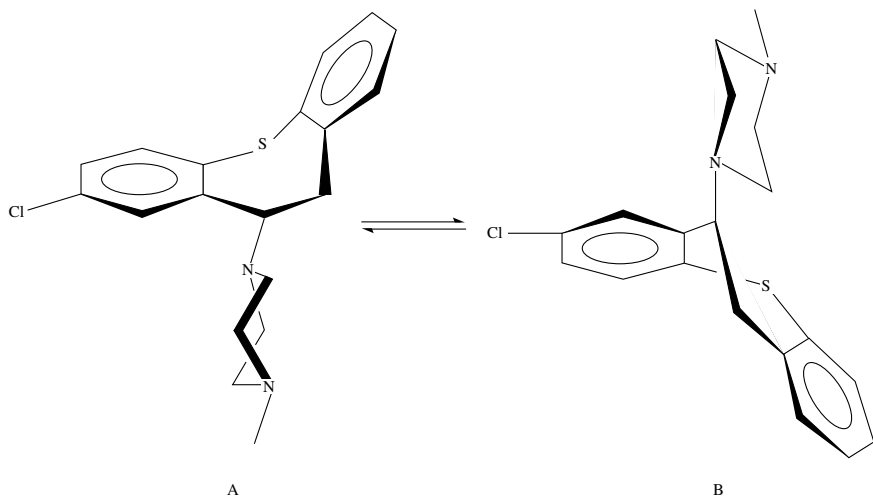
were calculated by a full matrix Newton–Raphson optimization of structures in which the N–H bond and the C2 and C7 atoms lie in the same plane. The inversion transition states were characterized by one imaginary vibrational frequency in the range of  $-420$  to  $-500$   $\text{cm}^{-1}$ , demonstrating first-order saddle points. The calculated barrier values, in the  $1.9$ – $3.2$   $\text{kcal mol}^{-1}$  range, are quite low in comparison with that of ammonia ( $5.5$  and  $5.8$   $\text{kcal mol}^{-1}$  from MM3 calculations and experiment, respectively; see Section II.c.2), partly due to the energy height of the ground state considered as the process origin (the barrier was calculated as the difference between the flat transition state and the minimum with the highest-energy orientation of the N–H bond).

#### 4. Biologically active compounds

QCFF/PI and PCILO calculations<sup>106</sup>, as well as a combined MM3, NMR X-ray crystallography and structure comparison study<sup>107–109</sup>, were used to identify biologically active

compounds with respect to dopamine receptor agonism. In a typical work, Liljefors and Boegesoe<sup>109</sup> have carried out conformational analysis of molecules containing piperidine and piperazine rings (**67–69**). Three degrees of freedom were considered, for example, in analyzing compound **68**: (1) the rotation about the bond connecting the piperazine ring and the tricyclic ring system; (2) flip of the seven-membered ring via the C–S–C bridge; (3) pseudoaxial–pseudoequatorial interconversion of the piperazine ring via rotation about the C–C bond of the ethylene bridge. The global minimum was found to have a pseudoaxial piperazine ring and a tricyclic ring system in conformation A (Scheme 6). The complete lp–N–C–H rotational curve, shown in Figure 8 for both the A and B groups, presents forms with a pseudoequatorial piperazine ring, and includes all other low-lying energy minima. It appears from Figure 8 that in addition to the global minimum (not shown in the graph) and to the conformer observed in the crystalline state<sup>110a,b</sup> (conformer **a** in Figure 8; MM2 relative energy of 0.4 kcal mol<sup>-1</sup>), only the conformer designated **e** (1.2 kcal mol<sup>-1</sup>) should be considered as a candidate for biological activity. All other stable forms were calculated to be 2.4–7.5 kcal mol<sup>-1</sup> above the global minimum. Next, the lowest-energy calculated structures of compounds **67–69** were compared using a least-squares molecular superimposition technique. The energetic cost of small variations in dihedral angles, needed to improve the overlap, was monitored by MM2. This comparison





SCHEME 6. Reproduced with permission from J. H. Brown and C. H. Bushweller, *J. Med. Chem.*, **31**, 306 (1988)

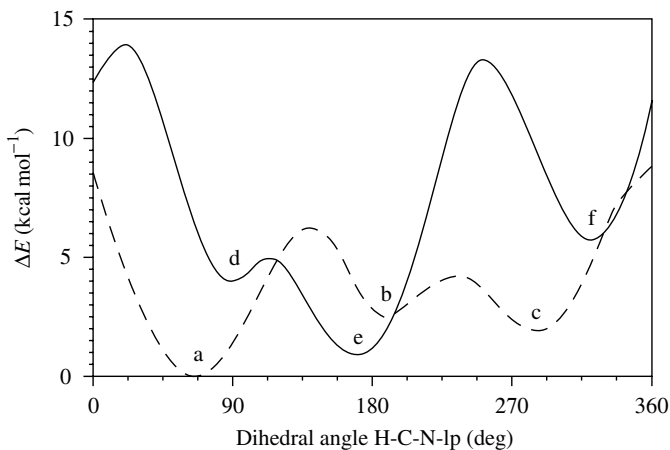


FIGURE 8. MM2-85 calculated lp-N-C-H rotational potential curve (C in the tricyclic ring system) for **68**, with a pseudoequatorial piperazine ring. The conformations A (dashed line) and B (solid line) are defined in Scheme 6. Reproduced with permission from Reference 108

strongly suggested that the most probable candidate for the dopamine receptor active conformation is the **e** conformer.

In another work, a series of substituted 2-aminoindans was analyzed using MM2-85<sup>108</sup>. The calculated potential energy surface for rotation around the CH-CH-CH<sub>2</sub>-N and CH-CH<sub>2</sub>-N-lp in model compound **70** is presented in Figure 9 and shows 9 minima. These were scrutinized as potential candidates for dopamine receptor agonists, according to several criteria: The highest-energy conformation **f** ( $E_{\text{rel}} = 7.3 \text{ kcal mol}^{-1}$ )

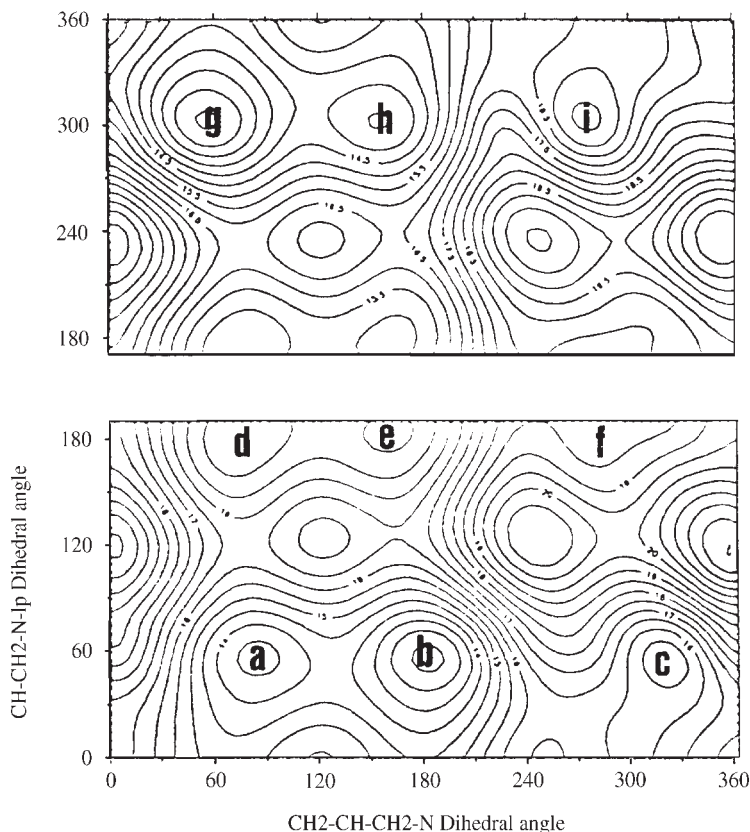
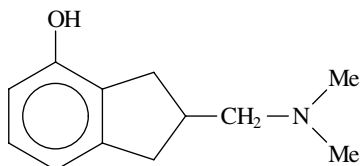


FIGURE 9. MM2-85 calculated torsional potential surface for the two-angle driver of the side chain of (*S*)-4-hydroxy-2-[(dimethylamino)methyl]indan **70**. Reproduced with permission from Reference 108



(**70**)

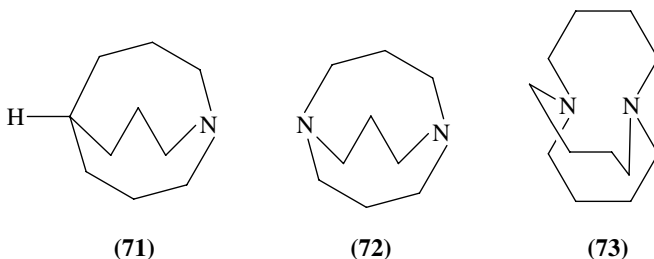
as well as conformers **c** and **i**, in which the nitrogen atom sticks out too far above the aromatic ring plane, were ruled out. Among the remaining conformers, only two, **a** and **h** ( $E_{\text{rel}} = 2.1$  and  $0.0$  kcal mol<sup>-1</sup>, respectively), satisfy the requirement of an N-lone pair directing downward and roughly perpendicular to the aromatic ring. These two conformers were fully minimized by MM2, and then fitted, by a least-squares method, to a known compound, used as a dopamine agonist template. Both gave reasonably good fits, and

another parameter, namely the distance between the nitrogen and hydrogen bond donor group (the aromatic OH), could not assist in the distinction between them.

## B. Spectroscopic Experiments and the Study of Chemical Effects

### 1. Nitrogen proton affinities and amine basicity

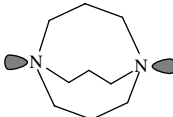
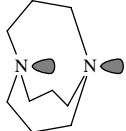


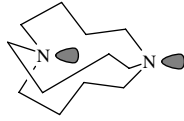

Alder and coworkers have used an early version of Allinger's molecular mechanics program series, MM1, in their study of bicyclic amines and diamines with bridgehead nitrogens<sup>111</sup>. The work was aimed at rationalizing the measured proton affinities and ionization energies of such compounds, using a combination of computational (semiempirical, *ab initio* and force field calculations) and experimental (photoelectron spectra, proton affinities measurements and <sup>1</sup>H and <sup>13</sup>C NMR) data. Because of the inclusion of specific lone pairs on sp<sup>3</sup> nitrogens in MM1 and MM2 and the consequent inability of these force fields to treat planar nitrogen atoms (see Section II.B.3), the molecular mechanics results for these systems are only qualitative. Experimental evidence, for example, supports nearly planar bridgehead nitrogens in the mono- and diazabicyclo[3.3.3]undecane (**71** and **72**) while for **71**, MM1 finds two conformers with inside and outside pyramidal nitrogens, the latter favored by only 3.75 kcal mol<sup>-1</sup>. The calculated relative energies, N...N distances and C-N-C bond angles for the three possible basic structures of the symmetrical diamines **72** and **73** are shown in Table 26. In diamines, the nitrogen lone pairs can interact in two ways: directly through-space, or through-bond, by mixing with other  $\sigma$  or  $\pi$  bonds in the molecule. The calculated N-C-C-C and C-C-C-C dihedral angles, along the hydrocarbon bridges (near-*gauche* in **72** and **66** and 80° in **73**), are far from the optimal values for through-bond coupling (0° and 180°), thus supporting the through-space mechanism. This is in contrast with the situation in the smaller bicyclic diamines ([2.2.2] and [2.3.3]), in which the shorter bridges are in favorable conformations for through-bond interactions. The strained structures of **72**, **73** and their unsymmetrical analogs, [4.3.3] and [4.4.3], force the nitrogen atoms to be more flattened compared with the smaller systems, leading to generally lower lone-pair ionization energies. At the same time the nitrogens are pushed into close proximity, increasing the overlap between the lone pairs.



In a later work<sup>112</sup>, Alder has used molecular-mechanics-like arguments to analyze and rationalize trends in amine basicity resulting from strain effects. The suggested model assumes that changes in (Brønsted) basicity or proton affinity (PA) result from differences in steric energy between the amine and its protonated ion. The steric energy may be divided, as is done in molecular mechanics, to contributions of bond stretching, bond-angle bending, torsional strain and nonbonded interactions. In series of analog compounds, it is sometimes possible to isolate one such term as the main source of strain effecting the basicity. The quantitative application of this model requires the calculation of steric

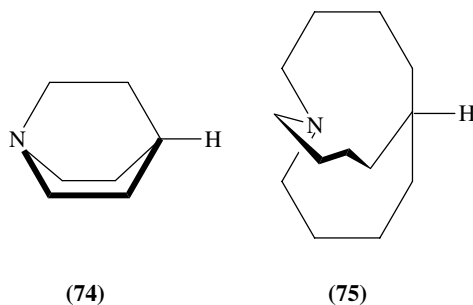


TABLE 26. Force field (MM1) calculations of 1,5-diazabicyclo[3.3.3]undecane **72** and 1,6-diazabicyclo[4.4.4]tetradecan **73** (distances in Å, bond angles in degrees, relative energies in kcal mol<sup>-1</sup>)<sup>111</sup>

Structure	Symmetry	C–N–C angle	N–N distance	$E_{rel}$
	$C_{3h}$	114.8	3.34	0.00
	$C_3$	116.2 (out) 116.9 (in)	2.61	5.56
	$C_{3h}$	119.6	2.44	23.01
	$D_3$	117.2	4.27	40.37
	$C_3$	118.2 (out) 111.8 (in)	3.34	26.97
	$D_3$	113.8	2.61	0.00

energies of amines and their protonated analogs. Since at that time, reliable force field parameters for ammonium ions were not available, only a qualitative discussion could be held. The steric energy term which is most likely to affect amine basicity is the bending one. It is reasonable to assume that the bending potential of protonated amines resembles that of the corresponding hydrocarbons, and is much more rigid than the potential of the neutral amines, which readily inverts via a planar geometry with a relatively low energy (i.e. barrier). Thus, deviations of the C–N–C angle from its ideal geometry (close to tetrahedral) increases the strain difference between the amine and its protonated form, leading to a reduced basicity. Indeed, in the small-ring cyclic amine series, azetidene, aziridine and 1-azabicyclo[1.1.0]butane, the measured PA values, 222.7, 215.7 and 212 kcal mol<sup>-1</sup>, decrease in reverse proportionality to the strain of the system (an alternative explanation involves the change in hybridization around the nitrogen atom,

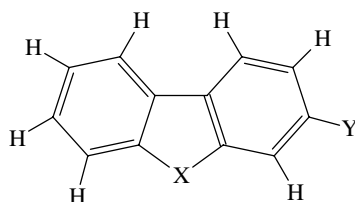
leading to a greater s-character of the lone pair as the size of the ring is reduced). Relatively small increases in N–C–N bond angles are observed in the bicyclic amines series, discussed in the previous work. The measured PA values for 1-azabicyclo[2.2.2]octane (**74**), which has a normal pyramidal nitrogen, and for 1-azabicyclo[3.3.3]undecane (**71**), with an almost flat nitrogen, are almost identical (*ca* 233 kcal mol<sup>-1</sup>). On the other hand, in 1-azabicyclo[4.4.4]tetradecane (**75**), where the bridgehead nitrogen is pyramidalized inward (according to MM1 and MM2 calculations), there is a 16.5 kcal mol<sup>-1</sup> decrease in the PA (relative to **71** and **74**). This difference matches almost exactly the surplus steric energy of 18.5 kcal mol<sup>-1</sup> calculated by MM2 for the conformer with an outward-directed lone pair, suggesting that the decreased basicity of **75** comes almost entirely from the increase in steric energy as the nitrogen inverts outward to accept the proton.



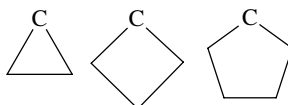
While all strain effects in monoamines are basicity weakening, it is possible to find cases in di- and polyamines where strain is relieved upon protonation, leading to increased basicity. This phenomenon is observed in 1,4-diaminobutane derivatives where an almost linear N...H–(N<sup>+</sup>) hydrogen bond in the mono-protonated derivatives leads to a stable, seven-membered ring structure. Thus, for example, the measured PA of 1,6-diazabicyclo[4.4.4]tetradecane (**73**) is 228.3 kcal mol<sup>-1</sup>, about 11 kcal mol<sup>-1</sup> higher than its monoamine analog **75**, despite the similar, inwardly pyramidalized, nitrogen conformation of both neutral amines.

## 2. Magnetic anisotropy of cyclopropane and cyclobutane

Aromatic amino and nitro compounds were calculated using the MM2 force field in a study of the magnetic anisotropy of the cyclopropane and cyclobutane ring systems<sup>113</sup>. A series of fluorenes in which position 9 was unsubstituted, or part of a three-, four- or five-membered ring leading to a spiro system, and position 2 was substituted by H, NO<sub>2</sub> or NH<sub>2</sub> groups (**76a–c** to **79a–c**) was synthesized and analyzed by NMR. The chemical shift of the peri hydrogens, H-1 and H-8, was used as a probe and assumed to depend on the sum of contributions from the substituted fluorene (where the contribution of the aromatic system was assumed to be constant) and the spirocycloalkanes. The two extreme cases, **76a–c** and **79a–c**, served as unperturbed, reference models. In order to isolate the special contributions from the small rings, a method developed by Allinger<sup>114</sup> was used, which correlates proton chemical shifts with the sum of the VdW interaction energies related to these protons. For this purpose, structures **76a–c** to **79a–c** were calculated using a PCModel implementation of MM2 (MMX<sup>115</sup>), and all possible conformers and their relative populations were determined. A significant deviation from the VdW energies/chemical shift correlation in the case of the three-membered ring clearly confirmed the assumption of an upfield chemical shift induced by cyclopropane on protons located over the face of the ring.



(76) (77) (78) (79)

X = CH<sub>2</sub>(a) Y = H; (b) Y = NO<sub>2</sub>; (c) Y = NH<sub>2</sub>

### 3. CD spectra of *N*-nitrosopyrrolidines

Polonski and coworkers have used the MM2 force field in their study of the conformational dependence of Circular Dichroism (CD) of *N*-nitrosopyrrolidines<sup>17,116</sup>. Since no parameters were available for the *N*-nitroso system, preliminary parameterization work had to be done (see Section II.B.3). The bicyclic and tricyclic *N*-nitrosopyrrolidine derivatives, **82–86**, were synthesized and their CD spectra recorded and compared with that of the related, more flexible, monocyclic systems, **80** and **81**. The MM2 calculated geometries and conformational energies of **80–86** compare favorably with the available experimental data. Thus the energy difference between the *Z* and *E* stereoisomers for the 3-substituted pyrrolidines (**80–84**) was calculated, as expected, to be very low (<0.05 kcal mol<sup>-1</sup>). The lowest-energy conformation of **81** was calculated by MM2 to be the *E* isomer with an equatorial phenyl substituent, a half-chair conformation of the five-membered ring and a close-to-planar NNO group, all in good agreement with the crystal structure (Table 27). The vicinal coupling constants, <sup>3</sup>*J*<sub>HCCH</sub>, between the C-alpha and C-beta protons of **82–86** were calculated for each minimum energy conformation using an improved Karplus equation

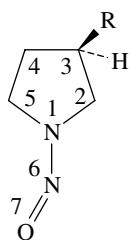
TABLE 27. A comparison of selected torsional angles (degrees) of 3-phenyl-*N*-nitrosopyrrolidine, **81**, as calculated by MM2 and measured by X-ray crystallography<sup>a</sup>

Torsional angle <sup>b</sup>	X-ray	MM2	
		E-eq <sup>c</sup>	E-ax
2-3-4-5	-38.4	41.5	-40.2
1-2-3-4	31.1	-36.0	33.7
3-4-5-1	30.0	-29.9	30.0
1-2-3-Ph	155.3	-162.1	-85.9
2-1-6-7	-179.4	179.1	-178.5
<i>E</i> <sub>rel</sub> (kcal mol <sup>-1</sup> )		0.00	1.28

<sup>a</sup>The enantiomeric form was calculated by MM2.

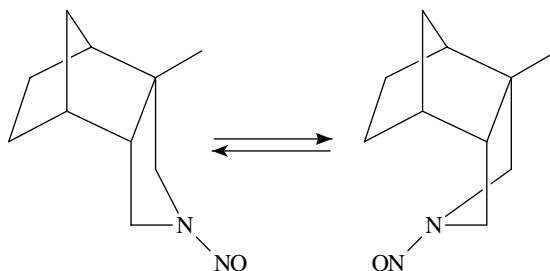
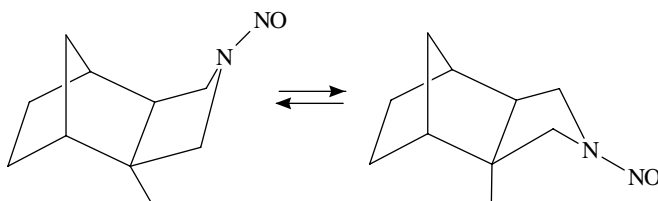
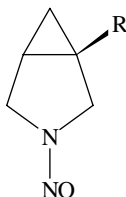
<sup>b</sup>For numbering, see structure **81**.

<sup>c</sup>Equatorial and axial phenyl groups.



(80) R = Me

(81) R = Ph

*exo*-(82)*endo*-(82)*exo*-(83)*endo*-(83)

(84) R = Me

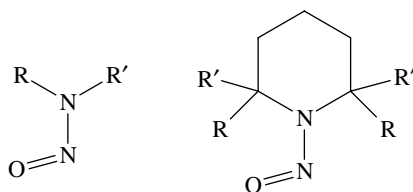
(85) R = Ph

(86) R = Pr<sup>i</sup>

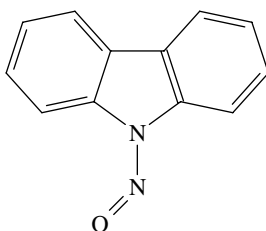
(Gandour and coworkers<sup>117</sup>) and the appropriate dihedral angles obtained by MM2, and were compared with the values measured by NMR in solution. For the bicyclic derivatives, **84–86**, which in solution exist in a single conformation, the calculated and experimental values agree to within 5% (standard deviation). For **82** and **83**, the observed coupling constants result from the *exo-endo* equilibrium, and the comparison with the calculated values for each conformer demonstrated the predominance of the latter form in each case. The geometry of the five-membered ring and the conformational composition in solution, established by the combined NMR–MM2 study, were later used to rationalize the CD spectra of these systems. It was shown that the skeleton (five-membered ring) geometry is indeed the major factor in determining the sign of the  $n-\pi^*$  Cotton effect, and that the CD curve can be correctly explained using the ‘lower symmetry’ sector rule earlier proposed by these authors<sup>118</sup>.

#### 4. <sup>17</sup>O and <sup>15</sup>N NMR spectra of *N*-nitrosamines

Cerioni has used MM2 calculations in a comparative analysis of <sup>17</sup>O and <sup>15</sup>N NMR spectra of a series of aliphatic and aromatic *N*-nitrosamines<sup>119</sup> (no computational details were given in this work). In particular, two groups of aliphatic (**87–89** and **90–92**) and



	R	R'		R	R'
(87)	Me	Me	(90)	H	H
(88)	Et	Et	(91)	Me	H
(89)	Pr <sup>i</sup>	Pr <sup>i</sup>	(92)	Me	Me
(93)	Ph	Ph			
(95)	Ph	Me			



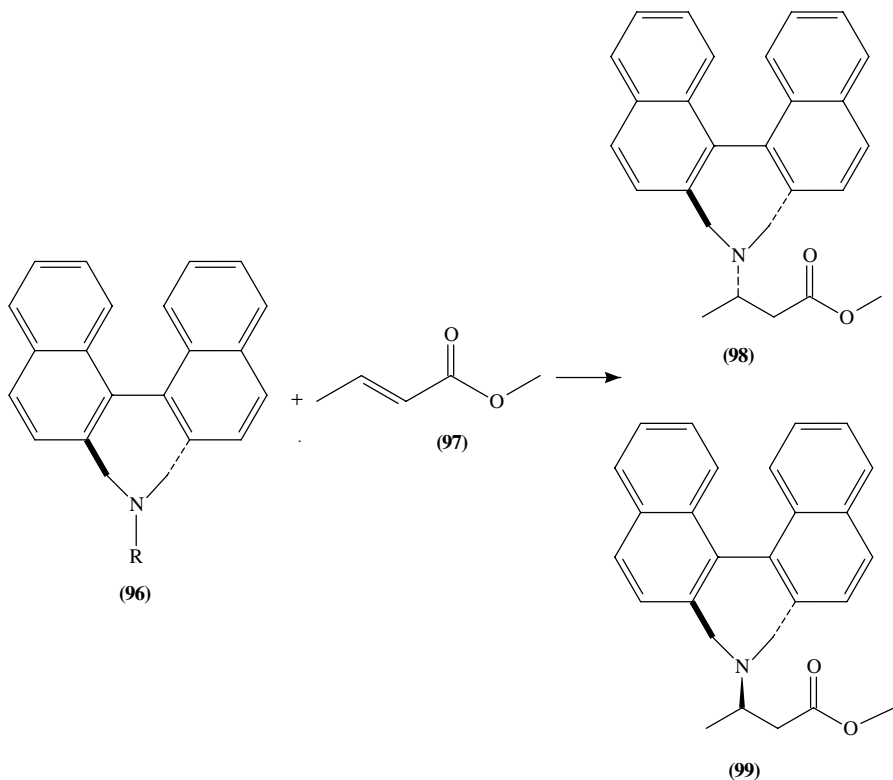
(94)

one group of aromatic (**93–95**) *N*-nitrosamine derivatives were studied. The downfield shift observed in the  $^{17}\text{O}$  spectrum when going from the aliphatic to the aromatic compounds was larger than for the corresponding amides (+55 ppm difference between **87** and **95**, compared with only +26 ppm between *N,N*-dimethylformamide and *N*-methyl-*N*-phenylacetamide). This is in accord with the MM2 calculated torsional angle between the phenyl plane and the functional group (nitroso or carbonyl) for the two systems, namely  $62^\circ$  for the amide<sup>120</sup> but only  $23^\circ$  for compound **95**, allowing for a much better conjugation. The latter value is also in good agreement with the microwave result for this system ( $28^\circ$ <sup>121</sup>). MM2 calculates two different torsional angles,  $30^\circ$  and  $47^\circ$ , for the diphenyl derivative **93**, and a value near  $0^\circ$  for the rigid carbazole system of **94**. These values are in accord with the NMR results, which show a +93 ppm downfield shift when going from **95** to **94**, but only about a third of this value between **95** and **93**. A smaller diversity exists among the aliphatic compounds with 5 and 9 ppm ranges for **87–89** and **90–91**, respectively (an exception to the above is found for compound **92** which is further shifted by +67 ppm, relative to **91**). In contrast, the  $^{15}\text{N}$  chemical shifts seem to be determined mostly by steric factors both for N-1 and N-2 ( $-39.5/+9.7$  ppm shifts for N-1/N-2, on going from **87** to **89**, but only  $-36.9/+9.6$  when comparing **87** with **93**). The steric dependence of the  $^{17}\text{O}$  chemical shift may be well explained by the MM2 optimized structures of **87–92**: In all cases save **92**, the nitroso oxygen lies near a C- $\alpha$  hydrogen, thus experiencing similar environments, and the nitroso group is calculated to be coplanar with the average plane of the ring (C–N–N–O torsional angle ranging from  $22^\circ$  to  $27^\circ$ ). Only in **92** is the nitroso group forced into close proximity with the methyl group. Indeed, a linear relationship is found between the differences in MM2-estimated VdW energies

and the changes in chemical shifts for **90–92** (though a definite conclusion should not be drawn, of course, from three points only).

### C. Mechanisms of Chemical Reactions

Following their molecular-mechanics-based study on intramolecular radical additions in hydrocarbons<sup>122</sup> Houk's group have used a slightly modified MM2 force field to model the stereoselective Michael addition of an optically active amine to methylacrylate<sup>123</sup>. When the reaction employs the neutral amine **96**, a ratio of 4.1:1 for the diastereomers **98** and **99** is obtained as the kinetic product, followed by a slow equilibration of the reaction mixture to a 1:1 ratio (Scheme 7). The corresponding lithium amide, however, gave isomer **99** almost exclusively. The model developed for the addition to the neutral amine assumes a tetrahedral N...C(sp<sup>2</sup>)-C(sp<sup>2</sup>) attack angle, and a 2.0 Å N...C transition state bond length. This latter parameter has been introduced into the MM2 force field as a special 'natural' bond length between the nitrogen and the olefinic carbon, beta to the ester carbonyl. The torsional potential around this bond was calculated using various values for the H-N...C(sp<sup>2</sup>)-C(sp<sup>2</sup>) dihedral angle, and the resulting curves, for both **98**- and **99**-like transition states, denoted as **98a** and **99a**, are presented in Figure 10. These torsional potentials show two clear local minima for each case: near 150° and 330° for **98a**, and at about 60° and 250° for **99a**. A Boltzmann distribution, calculated from



SCHEME 7

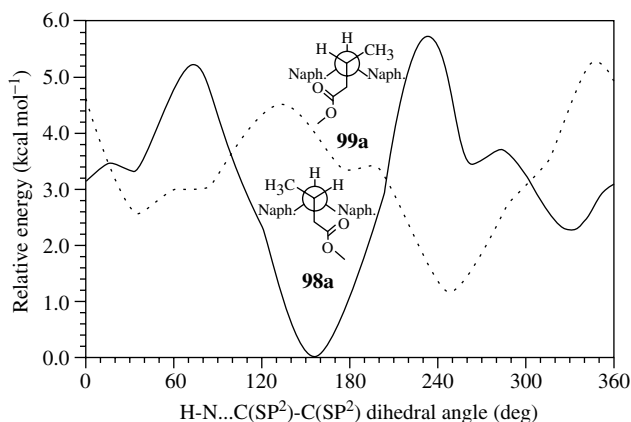
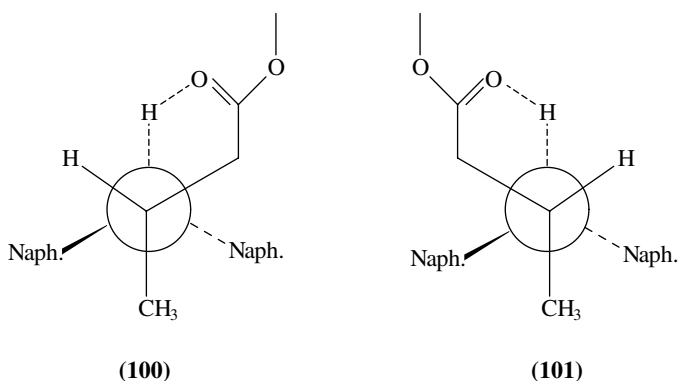
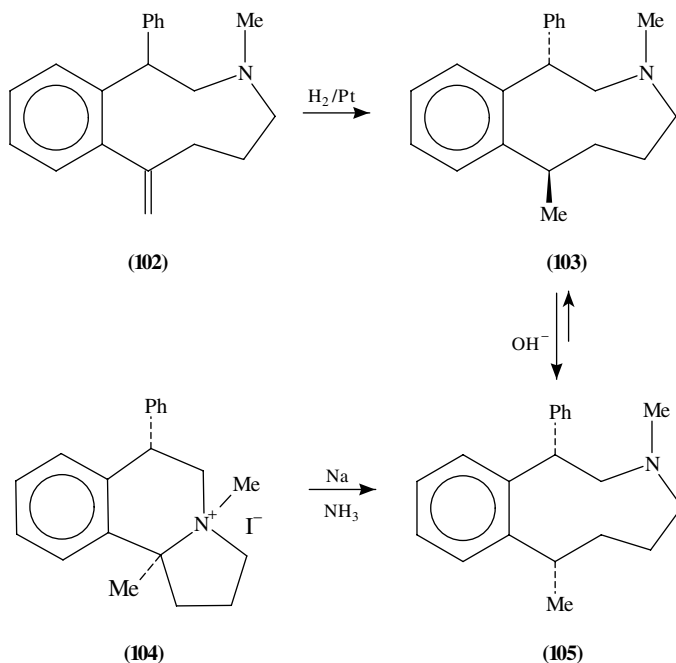


FIGURE 10. The torsional potential (relative energies) around the N...C bond in the two model transition state structures, **98a** and **99a**, for the neutral Micheal addition

the molecular mechanics energies of these minima, predicts a 4:1 product ratio, in very good agreement with the observed kinetic product mixture. Since the two diastereomeric products are calculated to have nearly identical steric energies, the final thermodynamic ratio of 1:1 can also be rationalized. For the ionic reaction, a simple model of a six-center transition state involving a H(N)...O=C interaction was assumed (structures **100** and **101**), where the H(N) simulates the Li cation. This cyclic structure fixes the transition state to H-N...C(sp<sup>2</sup>)-C(sp<sup>2</sup>) values close to 300° and 60°, for the **98a**- and **99a**-like species, respectively, making **101** more stable, and leading to the kinetic predominance of product **99**.



In another work, Maryanoff and Almond have used a combined molecular mechanics-experimental approach to rationalize the high 1,4-diastereoselectivity in the hydrogenation/reduction of hexahydro-1-phenyl-3-benzazone derivatives and the NMR spectra and relative stability of the resulting diastereomers<sup>124</sup>. Two diastereomers with a nitrogen containing a nine-membered ring, **103** and **105**, were synthesized by hydrogenation and reduction of the appropriate precursors, **102** and **104**, respectively (Scheme 8). Upon treatment with a basic solution, amine **103** was completely converted



SCHEME 8

into a 3:7 ratio mixture of its diastereomeric counterpart, **105**, and an elimination product (not shown in Scheme 8). Molecular mechanics calculations were performed with three main objectives: (1) assigning the stereochemistry of the two hydrogenation/reduction products (**103** and **105**), which could not be done based on the NMR spectra only; (2) rationalizing the differences in the thermodynamic stability of diastereomers **103** and **105**, as suggested by the disappearance of the former and the persistence of the latter under basic conditions (see above); (3) suggesting a model to account for the diastereofacial selectivity in the catalytic hydrogenation  $\text{102} \rightarrow \text{103}$ . The conformational space of the nine-membered ring was explored as follows: Initial geometries were obtained from the four stable conformations of cyclononane found by Anet and Krane<sup>125</sup>. These were searched for reasonably flat dihedral angles and, wherever such an angle was found, a benzo ring was fused onto the cyclononane. The initial set of starting geometries (18) was doubled by adding the appropriate substituents at both axial and equatorial positions. MM2 minimization of the 36 conformations obtained for each diastereomer gave, after elimination of all nonunique or enantiomeric forms, 9 and 7 stable conformers for **103** and **105**, respectively. The three lowest-energy forms for each diastereomer, representing a combined population of >95% (Boltzmann distribution), are listed in Table 28, together with their MM2 calculated energies. Coupling constants between the vicinal protons at C-1 and C-2 in these structures were calculated from the appropriate dihedral angles and compared with the NMR spectra of the two products. The assigned stereochemistry was further supported by additional structural parameters, such as the relative orientation of the C-methyl group with respect to the benzene ring, leading to a different degree of deshielding and consequently different chemical shifts. Based on the MM2 calculated energies (Table 28), a **105:103** ratio of 3.3:1 was calculated, in accord with the experimental findings which suggest higher thermodynamical stability for **105**

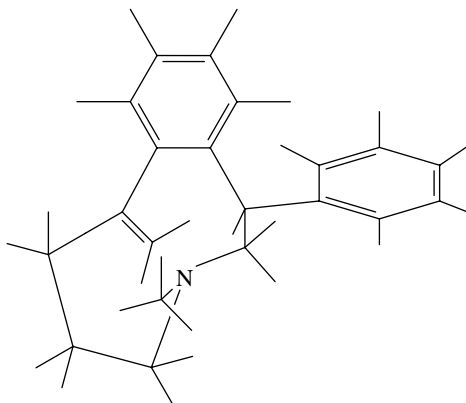


TABLE 28. The most stable conformations of *trans*- and *cis*-2,3,4,5,6,7-hexahydro-3,7-dimethyl-1-phenyl-1*H*-3-benzazonine (**103** and **105**) as calculated by MM2-80

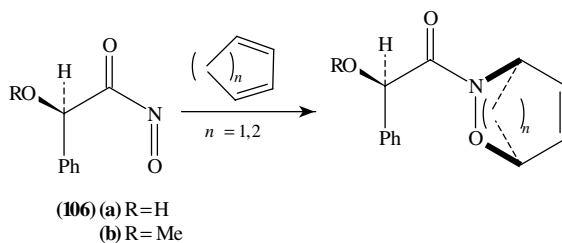
Conformer	$\Delta G^a$	% Composition	Conformer	$-\Delta G^a$	% Composition
<b>103a</b>	24.71	67.87	<b>105a</b>	24.08	59.76
<b>103b</b>	25.42	20.48	<b>105b</b>	24.54	27.49
<b>103c</b>	25.99	7.82	<b>105c</b>	25.35	7.82

<sup>a</sup>In kcal mol<sup>-1</sup>. A zero change in  $\Delta S$  was assumed.

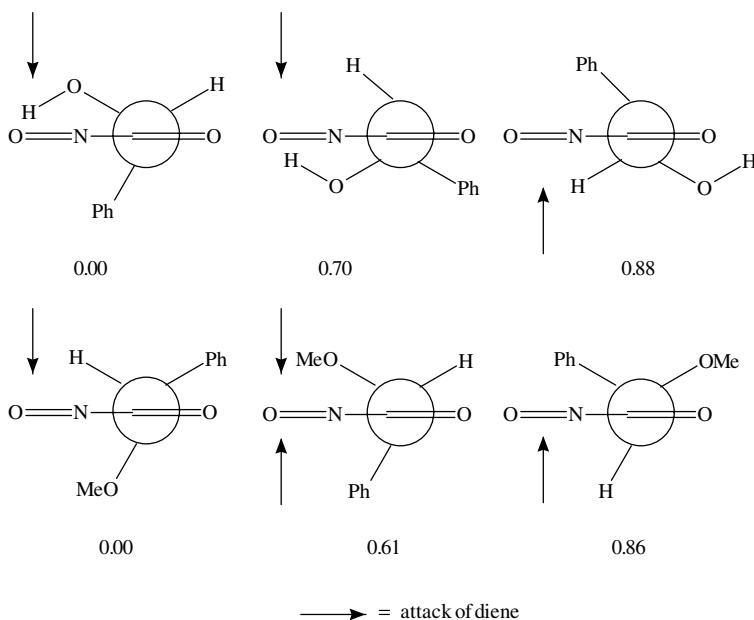
(although the 'real' thermodynamic ratio could not have been determined experimentally because of the irreversible transformation into the elimination product; see above). A similar analysis was carried out for the **103** precursor, **102**. Here an MMP1-based conformational search (The MMP1 program includes the MM1 force field with conjugated  $\pi$ -system calculations; at that time, the MM2-80 program did not include this option) located 8 conformers with an overwhelming preference for the most stable one (a Boltzmann population of 83% at 25 °C). In this conformer (**102a**), the exocyclic methylene is not coplanar with the fused benzene ring (in accord with the UV spectrum), and its top face is thus more exposed to reactants. This simple model, which neglects solvation and complexation effects, still predicts a substantial preference for one diastereomeric product, in partial agreement with the experimental data which suggest complete diastereoselectivity (i.e. only one diastereomer, **103**, is formed in the hydrogenation of **102**).

**(102a)**

The MM2 force field as implemented in MacroModel 2.0 was used by Miller and Procter in an attempt to rationalize the different diastereoselectivity observed in the cycloaddition of the chiral acyl-nitroso compounds **106a** and **106b** with cyclopenta- and cyclohexadienes (Scheme 9)<sup>126</sup>. Since the *anti* arrangement of the acyl-nitroso group was calculated, both by *ab initio* and molecular mechanics, to be 2.8 kcal mol<sup>-1</sup> more stable than the *syn* one, only the former needed to be considered. The calculated, three lowest rotamers of **106a** and **106b** about the N(=O)–C(=O)–C–O torsion are shown in Scheme 10, together with their MM2 relative energies and the preferred directions for a diene attack, based on the relative steric hindrance at the two faces of the nitroso bond. For the hydroxy derivative (**106a**) both the lowest and second-lowest energy conformers exhibit a preference for the same direction of a diene attack. A similar preference is also deduced for the global



SCHEME 9

SCHEME 10. The three lowest-energy rotamers of the acyl-nitroso compounds, **106a** (upper row) and **106b** (lower row), as calculated by MM2. Relative energies are in kcal mol<sup>-1</sup>

minimum of the methoxy derivative (**106b**). However, for the second lowest energy form of this system, the diene approach is almost equally hindered from both sides of the N=O bond. Indeed, cycloadditions involving the methoxy derivative are experimentally known to be less selective than those involving the hydroxy one.

#### D. Heat of Formation and Density Calculations of Energetic Materials

Among the most important characteristics of energetic materials are their heat of formation and density. The former is a measure of the energy capacity that is released during explosion, while the latter is directly related to performance parameters such as detonation velocity and pressure. The experimental difficulties and hazards in treating such compounds further incite the development of theoretical methods for predicting their needed properties. Organic nitro and N-nitro derivatives are an important class of energetic materials.

Akutsu and coworkers<sup>127-129</sup> have tried to establish the capability of low-cost computational methods, such as semiempirical molecular orbitals and molecular mechanics calculations, to provide accurate heats of formation for nitro compounds. The recent parameterization of the most popular force fields, MM2 and MM3, as well as Osawa's version of MM2, MM2', for nitro compounds, has been described in Section II of this chapter. The excellent performance of the first two in calculating heats of formation of such systems is demonstrated in Table 18, showing standard deviations of less than 0.3 kcal mol<sup>-1</sup> for both force fields. The main problem is still the very small and limited series of compounds used for parameterization. Thus, the parameter set does not cover cases of poly nitro compounds, where the nitro groups substitute the same, or neighboring, carbons. Similarly, aromatic nitro compounds were not included in the experimental data set and N-nitro derivatives were completely ignored. The parameters used by Akutsu were those determined by Tanabe and collaborators<sup>15</sup> for nitro compounds and by Lauderdale and Rodgers<sup>130</sup> for nitramines. The results (i.e. gas-phase heats of formation), as calculated by the MM2 and MM2' force fields for a series of aliphatic and aromatic nitro compounds, are presented in Table 29 with their deviations from the experimentally observed values. As evident from the data, the largest errors occur when more

TABLE 29. MM2 and MM2' calculated gas-phase heats of formation for aliphatic and aromatic nitro compounds

Compound	Experiment	Reference <sup>a</sup>	MM2-Exp. <sup>b</sup>	MM2'-Exp. <sup>c</sup>
Nitromethane	-17.8	P		-0.5
Nitroethane	-24.4	P,C	+1.3	-0.1
1-Nitropropane	-29.6	P	+0.8	+0.7
2-Nitropropane	-33.2	P,C	+2.2	+3.4
1-Nitrobutane	-34.4	P,C	-0.2	-1.8
2-Nitrobutane	-39.1	P,C	+2.5	+3.6
Dinitromethane	-14.1	P	+3.0	+1.7
1,1-Dinitroethane	-24.1	I		+6.3
1,2-Dinitroethane	-22.9	I		-2.7
1,1-Dinitropropane	-24.1	P	+1.6	+1.6
1,3-Dinitropropane	-31.6	I		-1.1
2,2-Dinitropropane	-27.0	I		-5.4
1,1-Dinitrobutane	-34.1	I		+5.8
1,4-Dinitrobutane	-38.9	I		-1.9
Trinitromethane	-0.05	P	+8.8	+1.5
1,1,1-Trinitroethane	-12.4	I		+11.6
1,1,1-Trinitropropane	-18.4	I		+14.3
Tetranitromethane	19.2	C	+80.1	+11.2
Nitrobenzene	16.1	P	-1.2	
<i>o</i> -Nitrotoluene	9.3	K	-0.6	
<i>m</i> -Nitrotoluene	4.1	K	+2.8	
<i>p</i> -Nitrotoluene	7.4	P	-0.5	
<i>o</i> -Dinitrobenzene	20.2	K	+2.6	
<i>m</i> -Dinitrobenzene	12.9	P	-0.9	
<i>p</i> -Dinitrobenzene	13.3	K	-2.0	
1,3,5-trinitrobenzene	14.9	P	-4.7	
2,4,6-Trinitrotoluene	10.4	P	-0.4	

<sup>a</sup>Values in kcal mol<sup>-1</sup>. When several sources used for the theoretical works gave different experimental values as reference, the latest was quoted; C = J. D. Cox and G. Piltcher, *Thermochemistry of Organic and Organometallic Compounds*, Academic Press, London, 1969; P = J. B. Pedley, R. D. Naylor and S. P. Kirby, *Thermochemical Data of Organic Compounds*, 2nd ed., Chapman and Hall, London, 1986; I = B. I. Istomin and V. Palm, *Reakt. Sposobnosti Org. Soedin.*, **10**, 583 (1973); K = Kagakukai, Nippon, Kagakubinran, Maruzen, Tokyo, 1984.

<sup>b</sup>Reference 127.

<sup>c</sup>Reference 128.

than one nitro group reside on the same carbon. When such cases are excluded, the fit between theory and experiment seems quite reasonable with standard deviations of 1.6 and 2.1 kcal mol<sup>-1</sup> for the aliphatic series, as calculated by MM2 and MM2', respectively, and 2.2 kcal mol<sup>-1</sup> for the aromatic compounds, as calculated by MM2'. Next, condensed-phase heats of formation, which are more relevant for energetic compounds, were estimated by combining  $\Delta H_V$  and  $\Delta H_s$  obtained from additivity rules (the authors used Laidler's values for  $\Delta H_V$ <sup>131</sup> and Bondi's values for  $\Delta H_s$ <sup>132</sup>) with the MM2' calculated gas-phase  $\Delta H_f^0$ . Several results are given in Table 30 and are less satisfactory than the gas-phase numbers, with standard deviations of 3.0 and 5.6 kcal mol<sup>-1</sup> for the liquid and solid phases, respectively (these rather large standard deviations were obtained even when excluding the worst discrepancies, such as 2-methyl-2,3,3-trinitrobutane and -propane, which are claimed to have large errors in the experimental values<sup>133</sup>, and 1,1,1-trinitroethane which already had a very large error in the gas-phase calculated  $\Delta H_f^0$ ; see Table 29). These authors have also calculated the heats of formation of N-nitro compounds (nitramines)<sup>129</sup>, using a value of 11.1 kcal mol<sup>-1</sup> for the missing N-NO<sub>2</sub> bond enthalpy increment. The results (Table 31) are of a comparable quality: 3.9 kcal mol<sup>-1</sup> (standard deviation) for the gas-phase heats of formation, and 6.0 kcal mol<sup>-1</sup> (after exclusion of the very nitro-crowded 1,1,1,3,5,5,5-heptanitro-3-azapentane) for the solid phase.

Traditional methods to estimate solid-phase density from molecular structure are primarily based on a simple summation of appropriate atomic or group volumes. The basic disadvantage of these 'group or volume additivity' procedures<sup>134</sup> is that they disregard crystal-packing efficiency and molecular conformation. Thus, conformational isomers, or even different compounds with the same functional group composition, will all be calculated to have the same density. To solve this problem, Ammon and coworkers have developed a scheme to estimate molecular densities by predicting possible crystal

TABLE 30. MM2' calculated condensed-phase heats of formation for aliphatic nitro compounds

Compound	Liquid phase			Solid phase		
	Experiment	reference <sup>a</sup>	MM2'-Exp. <sup>b</sup>	Experiment	reference	MM2'-Exp.
1-Nitrobutane	-46.0	C	-2.0			
2-Nitrobutane	-49.6	C	+2.4			
Dinitromethane	-25.1	C	-2.4			
1,1-Dinitroethane	-34.7	S	+0.8			
1,2-Dinitroethane				-42.0	C	-5.8
1,1-Dinitropropane	-40.1	C	+0.4			
1,3-Dinitropropane	-53.5	C	+3.6			
2,2-Dinitropropane				-44.9	C	-0.4
2,2-Dimethyl- 1,3-Dinitropropane				-66.4	S	-9.0
1,1,1-Trinitroethane				-27.5	S	+14.7
1,1,1-Trinitropropane	-28.1	S	+0.2			
2-Methyl- 2,3,3-trinitrobutane				-79.2	C	+21.6
2-Methyl- 2,3,3-trinitropentane				-69.4	C	+6.3
1,1,1,4-Tetranitrobutane	-42.8	P	-3.1	-45.3	P	+6.0
2,2,3,3-Tetranitrobutane	-40.1	P	+6.6	-43.5	P	-1.8

<sup>a</sup>Values in kcal mol<sup>-1</sup>. For references, see Tables 29; S = D. R. Stull, E. F. Westrum Jr. and G. E. Sinke, *The Chemical Thermodynamics of Organic Compounds*, Wiley, New York, 1969.

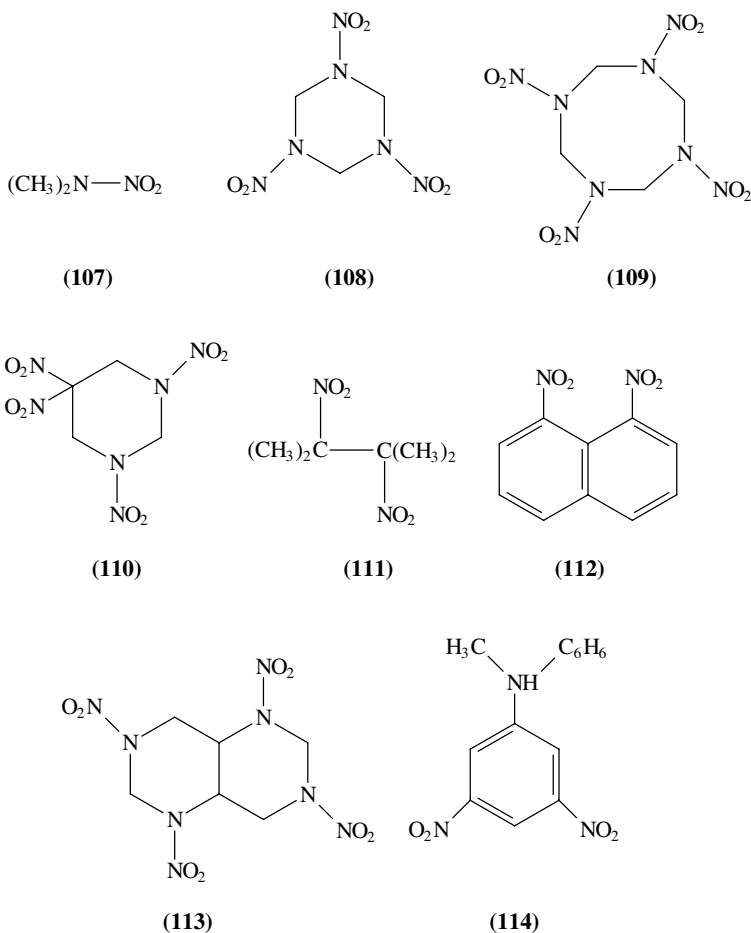
<sup>b</sup>Reference 128.

TABLE 31. MM2' calculated gas- and solid-phase heats of formation for several nitramines

Compound	Gas phase			Solid phase		
	experiment	reference <sup>a</sup>	MM2'-Exp. <sup>b</sup>	experiment	reference	MM2'-Exp.
DMN ( <b>107</b> )	-0.2	C	+1.1	-16.9	C	+4.1
DEN	-12.7	P	+2.0			
1,4-Dinitropiperazine	13.9	P	+7.2	-12.7	P	+7.3
RDX ( <b>108</b> )	46.8	U	-4.0	14.7	S	-4.0
HMX ( <b>109</b> )	56.4	U	+1.4	17.9	S	-2.9
DNNC ( <b>110</b> )				2.0	B	-6.3
2,2,4,6,6-Pentanitro-4-azaheptane				-55.4	P	-6.9
1,3,3,5,7,7-Hexanitro-1,5-diazaoctane				-5.0	B	+8.4
1,1,1,3,5,5,5-Heptanitro-3-azapentane				-6.7	P	+14.3

<sup>a</sup>Values in kcal mol<sup>-1</sup>. For references, see Tables 29 and 30; B = Reference 133.

<sup>b</sup>Reference 129.



structures, and incorporated it into their MOLPAK computer program<sup>135</sup>. The procedure operates according to the following steps: (1) Obtaining the geometry of the desired molecule in isolation (usually, but not always, of the most stable conformer) either by calculation, or by taking a known structure from a data base. The preferred source in MOLPAK is a semiempirical AM1 calculated geometry. (2) Obtaining the crystallographic symmetry, i.e. the definition of the unit cell and the crystallographic space group. This, in principle, can be obtained from an external source, such as the Cambridge Structural Database (CSD). In MOLPAK, a set of group symmetries is calculated, using rules stored in subgroups or 'patterns' relating to the various space groups (the January 92 version of MOLPAK covers crystal types belonging to *ca* 83% of the structures found in the CSD). (3) Defining the size of the 3D model of the crystal lattice and building it by applying the appropriate symmetry rules. The size of the model is taken as the 'coordination sphere' of the molecule which includes all neighboring molecules in a close VdW contact with it. An analysis of experimentally determined structures gave an average number of fourteen molecules in the 'coordination sphere'. (4) Each initial lattice model is then refined, without changing the internal molecular geometry (rigid-body approximation), using a central force field (WMIN) of the general form given in equation 63:

$$W_c = (1/2Z) \sum_i^n \sum_{i \neq j}^N (q_i q_j / r_{ij} - A_i A_j / r_{ij}^6 + B_i B_j \exp[(C_i + C_j) r_{ij}]) \quad (63)$$

where  $Z$  is the number of molecules per unit cell,  $W_c$  is the lattice energy (in kcal mol<sup>-1</sup>),  $A$ ,  $B$  and  $C$  are energy coefficients,  $q_i$  are atomic charges,  $r_{ij}$  are interatomic distances, and  $n$  and  $N$  are the number of atoms in one, and all, unit cells, respectively.

To overcome the problem of obtaining accurate values for the atomic charges, the Coulombic term in equation 63 was eliminated and replaced by an appropriate parameterization of  $A$ ,  $B$  and  $C$  to fit a set of known structures. Other schemes, such as the PCK/ME procedure of Ritchie<sup>136</sup> which uses a model of atom-centered multipoles (ACME), may also be used at this stage. (5) The dimensions of the unit cell are calculated from the refined lattice, and used to determine its volume and density. The entire process is iterative, and provides a set of possible crystal structures for the studied molecule. The energy coefficients,  $A$ ,  $B$  and  $C$ , of the WMIN force field have been determined for the first-row elements C, H, N, O and F, and their values are given in Reference 135. A series of nitro and nitramine compounds were studied by the MOLPAK program. Selected results, presented as molecular volumes, are given in Table 32, and show a very good fit (SD = 1.08%) with the experimental data.

TABLE 32. Unit cell volume per molecule (Å<sup>3</sup>) as calculated by MOLPAK and observed experimentally, for several nitro compounds and nitramines

Compound	V/Z	
	calculated	observed <sup>a</sup>
<b>111</b>	411.15	409.20
<b>112</b>	233.31	229.43
<b>113</b>	590.99	597.43
<b>114</b>	346.50	344.32

<sup>a</sup>Taken from the Cambridge Structural Database (CSD).

## IV. ACKNOWLEDGMENT

We are grateful to Prof. Norman L. Allinger for his most valuable discussion and comments.

## V. REFERENCES

- (a) U. Burkert and N. L. Allinger, *Molecular Mechanics*, ACS Monograph 177, American Chemical Society, Washington D.C., 1982.  
(b) D. B. Boyd and K. B. Lipkowitz, *J. Chem. Educ.*, **59**, 269 (1982).  
(c) E. M. Engler, J. D. Andose and P. v. R. Schleyer, *J. Am. Chem. Soc.*, **95**, 8005 (1973).  
(d) C. Altona and D. H. Faber, *Top. Curr. Chem.*, **45**, 1 (1974).  
(e) L. S. Bartell, *J. Am. Chem. Soc.*, **99**, 3279 (1977).  
(f) S. R. Niketic and K. Rasmussen, *The Consistent Force Field*, Springer-Verlag, Berlin, 1977.  
(g) E. Osawa and H. Musso, *Top. Stereochem.*, **13**, 117 (1982).
- (a) S. J. Weiner, P. A. Kollman, D. A. Case, U. C. Singh, C. Chio, G. Alagona, S. Profeta and P. Weiner, *J. Am. Chem. Soc.*, **106**, 765 (1984).  
(b) S. J. Weiner, P. A. Kollman, D. T. Nguyen and D. A. Case, *J. Comput. Chem.*, **7**, 230 (1986).
- (a) N. L. Allinger, *J. Am. Chem. Soc.*, **99**, 8127 (1977).  
(b) N. L. Allinger and Y. Yuh, *QCPE*, **12**, 395 (1980).  
(c) MM2: N. L. Allinger, Y. H. Yuh and S. Profeta, Program No. 406 Quantum Chemistry Program Exchange, Indiana University, Bloomington, Ind.  
(d) MM2: N. L. Allinger, Y. H. Yuh and S. Profeta, MM2-87, Quantum Chemistry Program Exchange, Indiana University, Bloomington, Ind.
- (a) N. L. Allinger, Y. Yuh and J. -H. Lii, *J. Am. Chem. Soc.*, **111**, 8551 (1989).  
(b) MM3: Available from the Quantum Chemistry Program Exchange, Indiana University, Bloomington, IN and Tripos Associates, 1699 Hanley Road, St. Louis, MI 63144.
- S. Profeta Jr. and N. L. Allinger, *J. Am. Chem. Soc.*, **107**, 1907 (1985).
- L. R. Schmitz, and N. L. Allinger, *J. Am. Chem. Soc.*, **112**, 8307 (1990).
- C. Jaime and E. Osawa, *Tetrahedron*, **39**, 2769 (1983).
- N. L. Allinger, M. R. Imam, M. R. Frierson, Y. H. Yuh and L. Schafer, in *Mathematics and Computational Concepts in Chemistry*, (Ed. N. Trinajstić), Eis Horwood, London, 1986.
- A. D. Buckingham and B. D. Utting, *Annu. Rev. Phys. Chem.*, **21**, 287 (1970).
- J. M. Leonard and W. P. Ashman, *J. Comput. Chem.*, **11**, 230 (1990).
- K. Takagi and T. Kojima, *J. Phys. Soc. Jpn.*, **30**, 1145 (1971).
- B. Beagley and A. R. Medwid, *J. Mol. Struct.*, **38**, 229 (1977).
- L. A. Carreira and R. C. Lord, *J. Chem. Phys.*, **51**, 2735 (1969).
- (a) V. S. Mastryukov, O. V. Dorofeeva, L. V. Vilkov and I. Hargittai, *J. Mol. Struct.*, **34**, 99 (1976).  
(b) O. V. Dorofeeva, V. S. Mastryukov and L. V. Vilkov, *J. Chem. Soc. Chem. Commun.*, 772 (1973).
- K. Tanabe, S. Tsuzuki, T. Uchimaru and E. Osawa, *Chemistry Express*, **3**, 367 (1988).
- D. Delpeyroux, B. Blaive and R. Gallo, *Propellants, Explosives, Pyrotechnics*, **19**, 70 (1994).
- T. Polonski, M. J. Milewska and A. Katrusiak, *J. Am. Chem. Soc.*, **115**, 11410 (1993).
- J. Kao and D. Leister, *J. Am. Chem. Soc.*, **110**, 7286 (1988).
- A. J. Hopfinger and R. A. Pearlstein, *J. Comput. Chem.*, **5**, 486 (1984).
- H. Kooijman, J. A. Kanters and J. Kroon, *Acta Crystallogr.*, **B49**, 356 (1993).
- D. -A. Wang, S. -S. Li and H. -M. Xiao, *Acta Chimica Sinica*, **50**, 335 (1992).
- (a) P. Aped, B. Fuchs, L. Schleifer and S. Wolfe, *J. Comput. Chem.*, **10**, 265 (1989).  
(b) H. Senderowitz, P. Aped and B. Fuchs, *Tetrahedron*, **48**, 1131 (1992).
- (a) A. J. Kirby, *The Anomeric Effect and Related Stereoelectronic Effects on Oxygen*, Springer-Verlag, Berlin, 1983.  
(b) W. A. Szarek and D. Horton (Eds.), *Anomeric Effect. Origins and Consequences*, ACS Symposium Series 87, Washington D.C., 1979.  
(c) P. Deslongchamps, *Stereoelectronic Effects in Organic Chemistry*, Wiley, New York, 1983.  
(d) G. R. J. Thatcher (Ed.) *The Anomeric Effect and Associated Stereoelectronic Effects*, ACS Symposium Series 539, Washington D.C., 1992.  
(e) E. Juaristi and G. Cuevas, *The Anomeric Effect*, CRC Press, Boca Laton. Fl., Inc. 1995.

24. (a) T. A. Crabb and A. R. Katritzky, *Adv. Heterocycl. Chem.*, **36**, 1 (1983).  
(b) S. Wolfe, M. H. Wangbo and D. J. Mitchell, *Carbohydr. Res.*, **69**, 1 (1979).
25. (a) C. Altona, Ph.D. Thesis, University of Leiden, 1964.  
(b) C. Romers, C. Altona, H. R. Buys and E. Havinga, *Top. Stereochem.*, **4**, 39 (1969).
26. (a) L. Norskov-Lauritsen and N. L. Allinger, *J. Comput. Chem.*, **5**, 326 (1984).  
(b) P. Aped, Y. Apeloig, A. Elleneweig, B. Fuchs, I. Goldberg, M. Karni and E. Tartakovsky, *J. Am. Chem. Soc.*, **109**, 1486 (1987).  
(c) P. Aped, B. Fuchs, I. Goldberg, H. Senderowitz, E. Tartakovsky and S. Weinman, *J. Am. Chem. Soc.*, **114**, 5585 (1992).  
(d) H. Senderowitz and B. Fuchs, *J. Mol. Struct. THEOCHEM*, invited article, in press.  
(e) B. Fernández, M. A. Rios and L. Carballeira, *J. Comput. Chem.*, **12**, 78 (1991).
27. H. Senderowitz, P. Aped, and B. Fuchs, *Helv. Chim. Acta*, **73**, 2113 (1990).
28. H. Senderowitz, P. Aped and B. Fuchs, *J. Comput. Chem.*, **14**, 944 (1993).
29. H. Senderowitz, P. Aped and B. Fuchs, *Tetrahedron*, **49**, 3879 (1992).
30. (a) N. L. Allinger, R. A. Kok and M. R. Iman, *J. Comput. Chem.*, **9**, 591 (1988).  
(b) J. -H. Lii and N. L. Allinger, *J. Phys. Org. Chem.*, **7**, 591 (1994).
31. H. D. Thomas, K. Chen and N. L. Allinger, *J. Am. Chem. Soc.*, **116**, 5887 (1994).
32. Y. Hamada, M. Tsuboi, K. Yamanouchi and K. Kuchitsu, *J. Mol. Struct.*, **146**, 253 (1986).
33. J. D. Swalen and J. Ibers, *J. Chem. Phys.*, **36**, 1914 (1962).
34. L. R. Schmitz, N. L. Allinger and S. Profeta Jr., *J. Comput. Chem.*, **9**, 460 (1988).
35. N. L. Allinger, U. Burkert and S. Profeta Jr., *J. Comput. Chem.*, **1**, 281 (1980).
36. C. Van Alsenoy, K. Siam, J. D. Ewbank and L. Schafer, *J. Mol. Struct. THEOCHEM*, **136**, 77 (1986).
37. D. Cremer, O. V. Dorofeeva and V. S. Mastryukov, *J. Mol. Struct.*, **75**, 225 (1981).
38. H. Gunther, G. Schrem and H. Oberhammer, *J. Mol. Spectrosc.*, **104**, 152 (1984).
39. G. Pfafferoth, H. Oberhammer, J. E. Boggs and W. Caminati, *J. Am. Chem. Soc.*, **107**, 2305 (1985).
40. G. Pfafferoth, H. Oberhammer and J. E. Boggs, *J. Am. Chem. Soc.*, **107**, 2309 (1985).
41. Z. Latajka and S. Scheiner, *J. Comput. Chem.*, **8**, 674 (1987).
42. N. L. Allinger, L. R. Schmitz, I. Motoc, C. Bender and J. K. Labanowski, *J. Phys. Org. Chem.*, **3**, 732 (1990).
43. N. L. Allinger, J. Kuang and H. D. Thomas, *J. Mol. Struct. THEOCHEM*, **209**, 125 (1990).
44. N. L. Allinger, L. Yan and K. Chen, *J. Comput. Chem.*, **15**, 1321 (1994).
45. Y. Koga and S. Kondo, *J. Mol. Spectrosc.*, **105**, 93, (1984).
46. Y. Amatatsu, K. Hamada and M. Tsuboi, *J. Mol. Spectrosc.*, **111**, 29 (1985).
47. Selected values of electric dipole moments for molecules in the gas phase, National Standard Reference Data—National Bureau of Standards, **10** (1967).
48. MP2 methods at the 6-31G\* level using the GAUSSIAN90 program, See W. J. Hehre, L. Radom, P. v. R. Schleyer and J. A. Pople, *Ab initio Molecular Orbital Theory*, Wiley, New York, 1986.
49. J. C. Evans, *Spectrochim. Acta*, **16**, 428 (1960).
50. R. A. Kydd and A. R. C. Dunham, *J. Mol. Struct.*, **98**, 39 (1983).
51. R. Meyer, *Helv. Chim. Acta*, **61**, 1418 (1978).
52. M. Clark, R. D. Cramer III and N. Van Opdenbosch, *J. Comput. Chem.*, **10**, 982 (1989).
53. Tripos Associates, 1699 S. Hanley Road, Suite 303, St. Louis, MO, 63144, SYBYL 5.2 (1988).
54. J. P. Lowe, *Prog. Phys. Org. Chem.*, **6**, 1 (1968).
55. N. C. Franklin and H. Feltkamp, *Tetrahedron*, **22**, 2801 (1966).
56. F. H. Allen, S. Bellard, M. D. Brice, B. A. Cartwright, A. Doubleday, H. Higgs, T. Hummelink, B. G. Hummelink-Peters, O. Kennard, W. D. S. Motherwell, J. R. Rodgers and D. G. Watson, *Acta Crystallogr.*, **35**, 2331 (1979).
57. S. L. Mayo, B. D. Olafson and W. A. Goddard III, *J. Phys. Chem.*, **94**, 8897 (1990).
58. A. K. Rappe, C. J. Casewit, K. S. Colwell, W. A. Goddard III and W. M. Skiff, *J. Am. Chem. Soc.*, **114**, 10024 (1992).
59. C. J. Casewit, K. S. Colwell and A. K. Rappe, *J. Am. Chem. Soc.*, **114**, 10035 (1992).
60. K. Gundertofte, T. Liljersors, P. -O. Norrby, and I. Pettersson, *J. Comput. Chem.*, **17**, 429 (1996).
61. MacMimic/MM2(91), InStar Software AB, IDEON Research Park, S-223 70 Lund, Sweden.
62. InStar Software AB, IDEON Research Park, S-223 70 Lund Sweden.
63. F. Mohamadi, N. G. J. Richards, W. C. Guida, R. Liskamp, M. Lipton, C. Caufield, G. Chang, T. Hendrickson and W. C. Still, *J. Comput. Chem.*, **11**, 440 (1990).



64. Cerius2 is available from Molecular Simulations Inc., 16 New England Executive Park, Burlington, MA 01803.
65. Alchemy III, Tripos Associates Inc., 1699 South Hanley Road, Suite 303, St. Louis, Missouri 63144.
66. J. E. Anderson, D. Casarini and L. Lunazzi, *J. Chem. Soc., Perkin Trans. 2*, **11**, 1791 (1990).
67. (a) A. M. Belostotskii, H. E. Gottlieb, P. Aped and A. Hassner, submitted for publication.  
(b) A. M. Belostotskii, P. Aped and A. Hassner, *THEOCHEM*, submitted.  
(c) C. H. Bushweller, W. G. Anderson, P. E. Stevenson, D. L. Burkey and I. W. O'Neil, *J. Am. Chem. Soc.*, **96**, 3892 (1974).
68. M. R. Whalon, J. G. Brennan, R. P. Marcantonio and R. P. Domingue, *J. Am. Chem. Soc.*, **104**, 6224 (1982).
69. D. R. Lide Jr. and D. E. Mann, *J. Chem. Phys.*, **28**, 572 (1958).
70. S. H. Fleischman, M. R. Whalon, C. D. Rithner, G. L. Grady and C. H. Bushweller, *Tetrahedron Lett.*, **23**, 4233 (1982).
71. C. T. Danehey Jr., G. L. Grady, P. R. Bonneau and C. H. Bushweller, *J. Am. Chem. Soc.*, **110**, 7269 (1988).
72. J. H. Brown and C. H. Bushweller, *J. Am. Chem. Soc.*, **114**, 8153 (1992).
73. J. H. Brown and C. H. Bushweller, *J. Phys. Chem.*, **98**, 11411 (1994).
74. J. E. Anderson, D. Casarini and L. Lunazzi, *J. Chem. Soc. Perkin Trans. 2*, 1431 (1991).
75. S. Davalli, L. Lunazzi and D. Macciantelli, *J. Org. Chem.*, **56**, 1739 (1991).
76. L. Lunazzi, C. Magagnoli, M. Guerra and D. Macciantelli, *Tetrahedron Lett.*, 3031 (1979).
77. A. G. Giumanini, G. Verardo, S. Bruckner, L. Malpezzi and G. Cerioni, *J. Mol. Struct.*, **323**, 139 (1994).
78. M. Cygler, T. Markowicz, J. Skolimowski and R. Skowronski, *J. Mol. Struct.*, **68**, 161 (1980).
79. A. M. Belostotskii, H. E. Gottlieb and A. Hassner, *J. Am. Chem. Soc.*, in press.
80. (a) S. F. Nelsen, J. T. Ippoliti, T. B. Frigo and P. A. Petillo, *J. Am. Chem. Soc.*, **111**, 1776 (1989).  
(b) S. F. Nelsen, D. J. Steffek, G. T. Cunkle and P. M. Gannett, *J. Am. Chem. Soc.*, **104**, 6641 (1982).  
(c) S. F. Nelsen, G. R. Weisman, E. L. Clennan and V. E. Peacock, *J. Am. Chem. Soc.*, **98**, 6893 (1976).  
(d) S. F. Nelsen and G. R. Weisman, *J. Am. Chem. Soc.*, **98**, 1842 (1976).
- (e) J. W. Davies, J. R. Malpass and R. E. Moss, *Tetrahedron Lett.*, **26**, 4533 (1985).
81. K. Rasmussen and C. Tosi, *Acta Chem. Scand. Ser. A*, **A37**, 79 (1983).
82. L. Carballeira, R. A. Mosquera, M. A. Rios and C. A. Tovar, *J. Mol. Struct.*, **193**, 263 (1989).
83. K. M. Marstokk and H. Mollendal, *J. Mol. Struct.*, **49**, 221 (1978).
84. (a) A. Yokozeki and K. Kuchitsu, *Bull. Chem. Soc. Jpn.*, **44**, 2926 (1971).  
(b) A. Yokozeki and K. Kuchitsu, *Bull. Chem. Soc. Jpn.*, **43**, 2664 (1970).
85. C. Van Alsenoy, K. Siam, J. D. Ewbank and L. Schafer, *J. Mol. Struct. THEOCHEM*, **136**, 77 (1986).
86. N. L. Allinger, J. G. D. Carpenter and F. M. Karkowski, *J. Am. Chem. Soc.*, **87**, 1232 (1965).
87. V. M. Gittins, P. J. Heywood and E. Wyn-Jones, *J. Chem. Soc. Perkin Trans. 2*, 1642 (1976).
88. K. Fukushima, *Bull. Chem. Soc. Jpn.*, **52**, 2871 (1979).
89. A. R. Katritzky, V. J. Baker, F. M. S. Brito-Palma, I. J. Ferguson and L. Anghoni, *J. Chem. Soc. Perkin Trans. 2*, 1746 (1980).
90. (a) R. G. Lett, L. Petrakis, A. F. Ellis and R. K. Jensen, *J. Phys. Chem.*, **74**, 2816 (1970).  
(b) R. K. Harris and R. A. Spragg, *J. Chem. Soc., Chem. Commun.*, 314 (1966).  
(c) J. L. Sdmeier and G. Occupati, *J. Am. Chem. Soc.*, **90**, 154 (1968).
91. T. G. Momchilova and P. M. Ivanov, *J. Mol. Struct. THEOCHEM*, **107**, 133 (1993).
92. C. A. G. Hassnoot, F. A. M. De Leeuw and C. Altona, *Tetrahedron*, **36**, 2783 (1980).
93. R. Cini, G. Giorgi, D. Masi, A. Sabatini and A. Vacca, *J. Chem. Soc. Perkin Trans. 2*, 765 (1991).
94. T. W. Hambley, C. J. Hawkins, J. A. Palmer and M. R. Snow, *Aust. J. Chem.*, **34**, 45 (1981).
95. R. D. Hancock and G. J. McDougall, *Adv. Mol. Relaxation Interact. Processes*, **18**, 99 (1980).
96. G. J. McDougall, R. D. Hancock and J. C. A. Boeyens, *J. Chem. Soc. Dalton, Trans.*, 1438 (1978).
97. J. C. A. Boeyens, G. J. McDougall and R. D. Hancock, *S. Afr. J. Chem.*, **32**, 23 (1979).
98. N. L. Allinger, *Adv. Phys. Org. Chem.*, **13**, 1 (1976).
99. P. G. Potvin and M. H. Wong, *Can. J. Chem.*, **66**, 2914 (1988).

100. M. G. B. Drew, D. Marrs, J. Hunter and J. Nelson, *J. Chem. Soc., Dalton Trans.*, 11 (1992).
101. M. A. Santos and M. G. B. Drew, *J. Chem. Soc., Faraday Trans.*, **87**, 1321 (1991).
102. MM2MX program contained with the RIPS program QCPE No. 588: D. M. Ferguson and D. J. Raber, Quantum Chemistry Program Exchange, Chemistry Department, Indiana University, IN, QCPE 395, and based on N. L. Allinger and Y. H. Yuh, MM2-77, 1989.
103. (a) G. Wipff, P. Weiner and P. A. Kollman, *J. Am. Chem. Soc.*, **104**, 3249 (1982).  
(b) A. E. Howard, U. C. Singh, M. Billeter and P. A. Kollman, *J. Am. Chem. Soc.*, **110**, 6984 (1988).  
(c) M. J. Bovill, D. J. Chadwick, I. O. Sutherland and D. Watkin, *J. Chem. Soc., Perkin Trans. 2*, 1529 (1980).  
(d) J. R. Damewood, W. D. Anderson and J. J. Urban, *J. Comput. Chem.*, **9**, 111 (1988).
104. D. Maveerick, P. Seiler, W. B. Schweizer and J. D. Dunitz, *Acta Crystallogr., Sect. B*, **36**, 615 (1980).
105. A. Espinosa, M. A. Gallo, A. Entrena and J. A. Gomez, *J. Mol. Struct.*, **326**, 249 (1994).
106. D. Kocjan and D. D. Hadzi, *J. Pharm. Pharmacol.*, **35**, 780 (1983).
107. A. M. Johansson, J. L. G. Nilsson, A. Karlen, U. Hacksell, K. Svensson, A. Carlsson, L. Kenne and S. Sundell, *J. Med. Chem.*, **30**, 1135 (1987).
108. H. Wikstrom, J-H. Lii and N. L. Allinger, *J. Med. Chem.*, **30**, 1115 (1987).
109. T. Liljefors and K. P. Boegesoe, *J. Med. Chem.*, **31**, 306 (1988).
110. (a) T. J. Petcher, J. Schmutz, H. P. Weber and T. G. White, *Experientia*, **31**, 1390 (1975).  
(b) A. Jaunin, T. J. Petcher and H. P. Weber, *J. Chem. Soc. Perkin Trans. 2*, 186 (1977).
111. R. W. Alder, R. J. Arrowsmith, A. Casson, R. B. Sessions, E. Heilbronner, B. Kovac, H. Huber and M. Taagepera, *J. Am. Chem. Soc.*, **103**, 6137 (1981).
112. R. W. Alder, *Chem. Rev.*, **89**, 1215 (1989).
113. M. E. Jason and P. R. Kurzwil, *J. Org. Chem.*, **56**, 3664 (1991).
114. S. Li and N. L. Allinger, *Tetrahedron*, **44**, 1335 (1988).
115. Serena Software, Box 3076, Bloomington, IN, 47402-3076.
116. T. Polonski and M. J. Milewska, *Tetrahedron Lett.*, **32**, 3255 (1991).
117. (a) W. J. Colucci, S. J. Jungk and R. D. Gandour, *Magn. Reson. Chem.*, **23**, 335 (1985).  
(b) W. J. Colucci, R. D. Gandour and E. A. Mooberry, *J. Am. Chem. Soc.*, **108**, 7141 (1986).
118. T. Polonski and K. Prajer, *Tetrahedron*, **32**, 847 (1976).
119. G. Cerioni, *J. Phys. Org. Chem.*, **4**, 260 (1991).
120. D. W. Boykin, G. H. Deadwyler and A. L. Baumstark, *Magn. Reson. Chem.*, **26**, 19 (1988).
121. W. Caminati and A. G. Giumanini, *J. Mol. Struct.*, **162**, 255 (1987).
122. (a) Y. -D. Wu and K. N. Houk, *J. Am. Chem. Soc.*, **109**, 908 (1987).  
(b) D. C. Spellmeyer and K. N. Houk, *J. Org. Chem.*, **52**, 959 (1987).
123. K. Rudolf, J. M. Hawkins, R. J. Loncharich and K. N. Houk, *J. Org. Chem.*, **53**, 3879 (1988).
124. B. E. Maryanoff and H. R. Almond Jr., *J. Org. Chem.*, **51**, 3295 (1986).
125. F. A. L. Anet and J. Krane, *Isr. J. Chem.*, **20**, 72 (1980).
126. A. Miller and G. Procter, *Tetrahedron Lett.*, **31**, 1041 (1990).
127. Y. Akutsu, S. Tahara, M. Tamura and T. Yoshida, *J. Energ. Mater.*, **9**, 161 (1991).
128. Y. Akutsu and M. Tamura, *J. Energ. Mater.*, **11**, 39 (1993).
129. Y. Akutsu, R. Che and M. Tamura, *J. Energ. Mater.*, **11**, 195 (1993).
130. W. J. Lauderdale and S. L. Rodgers, *Prediction of Molecular Properties*, AFAL-TR-87-063 (1987).
131. K. J. Laidler, *Can. J. Chem.*, **34**, 626 (1956).
132. A. Bondi, *J. Chem. Eng. Data*, **8**, 371 (1963).
133. S. Bourasseau, *J. Energ. Mater.*, **8**, 266 (1990).
134. See Reference 5 of Reference 135.
135. J. R. Holden, Z. Du and H. L. Ammon, *J. Comput. Chem.*, **14**, 422-437 (1993).
136. (a) J. P. Ritchie, *J. Am. Chem. Soc.*, **107**, 1829 (1985).  
(b) J. P. Ritchie and S. M. Bachrach, *J. Comput. Chem.*, **8**, 499 (1987).

## CHAPTER 2

# Structural chemistry

SALVATORE SORRISO

*Dipartimento di Chimica, Laboratorio di Chimica Fisica, Università di Perugia,  
06100 Perugia, Italy*

*Fax: 00 39 75 500 8851; e-mail: SORRISO@UNIPG.IT*

---

I. LIST OF ABBREVIATIONS	85
II. INTRODUCTION	85
III. THE AMINO GROUP	86
A. Aliphatic Amines	86
B. Alicyclic Amines	88
C. Aromatic Amines	90
D. Heterocyclic Amines and Related Molecules	95
IV. THE NITROSO GROUP	95
V. THE NITRO GROUP	97
VI. CONCLUSIONS	101
VII. ACKNOWLEDGEMENTS	101
VIII. REFERENCES	102

---

### I. LIST OF ABBREVIATIONS

ED	Electron diffraction
e.s.d.	Estimated standard deviation; it is shown in parentheses and refers to the last digits
G	Gas phase
ND	Neutron diffraction
<i>R</i>	Reliability index. The lower <i>R</i> , the more reliable are the results. <i>R</i> values ranging from 0.08 to 0.03 (8 and 3%, respectively) are usually obtained and it is possible to go down to 0.02
S	Solid phase
XD	X-ray diffraction

### II. INTRODUCTION

*Period covered by the review:* The present review constitutes an update and a continuation of the preceding one relating to the same functional groups<sup>1</sup>.

Most papers published refer to quite complicated molecular frameworks and have as their only purpose determining the structure of the molecule itself as a whole; in fact, they do not pay particular attention to functional groups, which are the object of our work.

Since structural aspects of the present groups have been treated previously<sup>1</sup>, they will not be further examined unless they are new and interesting.

*Techniques used in the research examined:* In the period examined the most widely used technique was X-ray diffraction, even though neutron diffractometry has recently become popular.

The basic information indispensable to both these techniques may be found in the introduction to the previous reviews<sup>1,2</sup>. Further details may be found in Reference 3.

*Units:* Bond distances will be given in angstroms (Å) and bond angles in degrees (°).

### III. THE AMINO GROUP

The compounds considered in this section have been subdivided, according to the molecular skeleton to which the amino group is attached, into four basic types: aliphatic, alicyclic, aromatic and heterocyclic.

#### A. Aliphatic Amines

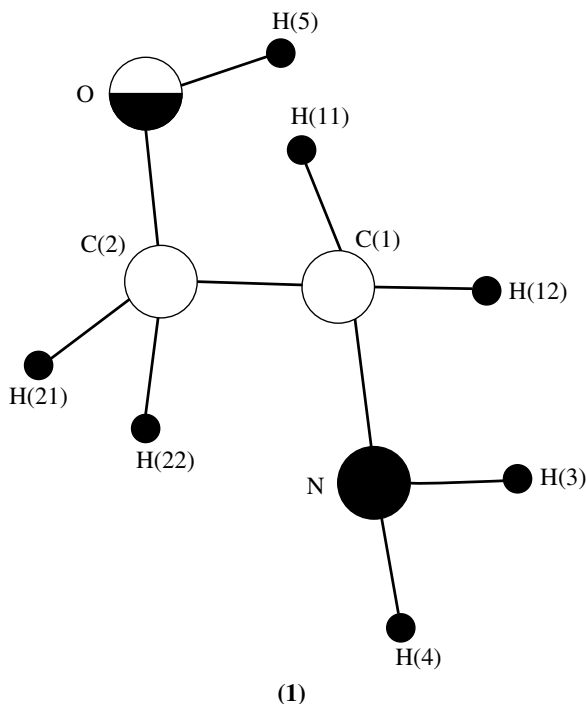
The previous review<sup>1</sup> has treated in detail only the following amines: methylamine, dimethylamine, trimethylamine, 2-aminoethanol, ethylenediamine, nitroguanidine and similar ones. In the period of the present review, some simple molecules of interest have been treated such as the aminoethanol series, including mono-, di- and tri-substituted derivatives, as well as a number of derivatives of guanidine. These will be dealt with for purposes of internal comparison.

*a. Aminoethanols.* The structure of the monoethanolamine molecule (C<sub>2</sub>H<sub>7</sub>NO, MEAM) was previously studied using microwaves<sup>1</sup>. More recently, it has been determined once more using low-temperature single-crystal X-ray diffractometry (I)<sup>4</sup> ( $R = 0.044$ ), together with the related diethanolamine molecule (C<sub>4</sub>H<sub>11</sub>NO<sub>2</sub>, DEAM) ( $R = 0.030$ ) and triethanolamine (C<sub>6</sub>H<sub>15</sub>NO<sub>3</sub>, TEAM) ( $R = 0.033$ ).

The molecules of monoethanolamine (MEAM) are arranged in a three-dimensional grid. Rings of two N—H...O bridged DEAM molecules are linked via strong O—H...N bonds into one-dimensional tube-like stacks; weak N—H...O bonds across the rings are also present. In the cases of DEAM and TEAM characteristic dimeric units are shown<sup>4</sup>. 'All H atoms of the donor groups (i.e. the hydroxy, amino and imino groups) are involved in the hydrogen bonding system. Each molecule donates and accepts a total of six hydrogen bonds with mean strength increasing in the sequence MEAM, DEAM, TEAM. The length of the C—O bonds is influenced by the number of strong hydrogen bonds (one or two) in which the respective O atom participates'<sup>4</sup>.

*b. Guanidines.* Studies have been made of the following molecules: 2-nitroguanidine (CH<sub>4</sub>N<sub>4</sub>O<sub>2</sub>), 2-cyanoguanidine (C<sub>2</sub>H<sub>4</sub>N<sub>4</sub>) and 1,2,3-triaminoguanidine (CH<sub>9</sub>N<sub>6</sub>).

The crystalline structure of 2-nitroguanidine had already been previously studied by Bryden and coworkers<sup>1</sup> (Ref. 29 therein). They there report the existence, but not the position, of hydrogen bonds, which was instead rendered possible through the use of the neutron powder diffraction method<sup>5</sup>. The skeleton backbone of this molecule consisting of a central C atom and four N atoms is almost coplanar. Both nitramine groups are essentially on the plane of the molecular skeleton.



Uncorrected values			
N—C(1)	1.449 (3)	C(1)—C(2)	1.518 (4)
C(2)—O	1.418 (3)	N···O <sup>i</sup>	2.785 (3)
N···O <sup>ii</sup>	3.138 (3)	O···N <sup>iii</sup>	3.282 (3)
N—H(3)	0.82 (5)	N—H(4)	0.91 (2)
O—H(5)	1.04 (4)	H(3)···O <sup>i</sup>	2.05 (5)
H(4)···O <sup>ii</sup>	2.23 (2)	H(5)···N <sup>iii</sup>	2.36 (4)
N—C(1)—C(2)	114.2 (2)	C(1)—C(2)—O	109.2 (2)
N—H(3)···O <sup>i</sup>	149 (3)	N—H(4)···O <sup>ii</sup>	175 (3)
O—H(5)···N <sup>iii</sup>	147 (3)		

For the 2-cyanoguanidine molecule<sup>6</sup> the static deformation density has been mapped by least-square refinement against low-temperature X-ray data in order to explain the fact that the C—N bonds around the C atom are almost identical and the fact that a large negative charge ( $-0.2 e$ ) is on the N(3) atom. Hence one must take all the resonance forms (2) into consideration.

In the 1,2,3-triaminoguanidine ( $\text{CH}_8\text{N}_6$ )<sup>7</sup> one C—N bond is particularly short (1.292 Å) while all other bond distances are comparable to the typical lengths of the C—N and N—N single bond distances. The structure consists of sheets of TAG oriented in the direction along the  $b$  axis and held together by molecular forces and hydrogen bonds.

In Table 1 we report structural parameters for some aliphatic amines.

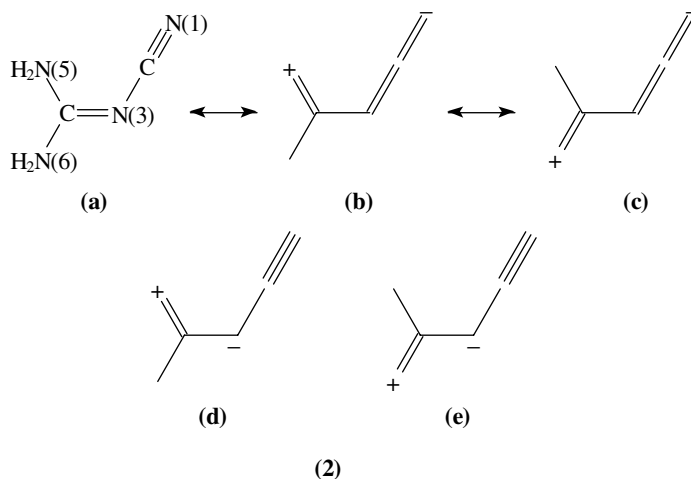


TABLE 1. Dimensions of the amino group in some aliphatic amines

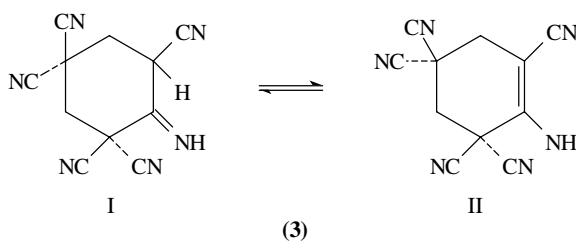
Compound	C–N	N–H	<C–N–H	<H–N–H	State	Method	Reference
Monoethanolamine	1.449(3)	0.82(5) 0.91(2)			<i>S</i>	XD	4
Diethanolamine	1.471(1)	0.88(1)			<i>S</i>	XD	4
Triethanolamine	1.467(1)				<i>S</i>	XD	4
2-Nitroguanidine	1.309(7)	0.96(2) 0.98(2)	119.0(1) 115.0(1)	125.0(1)	<i>S</i>	ND	5
	1.330(8)	1.00(2) 0.96(2)	121.0(1) 121.0(1)	119.0(1)			
2-Cyanoguanidine	1.334(8) <sup>a</sup>	1.00 <sup>a</sup> 1.00 <sup>a</sup>	120.0(11) 120.9(11)	119(2)	<i>S</i>	XD	6
	1.343(8) <sup>a</sup>	0.98 <sup>a</sup> 0.99 <sup>a</sup>	122.6(11) 120.6(11)	116(2)			
1,2,3-Triaminoguanidine	1.292(1) 1.373(1) 1.381(1)				<i>S</i>	XD	7

<sup>a</sup>Vibration corrected bond lengths based on the riding model for C(2)–N(1), rigid body libration for other C–N bonds, libration plus riding motion for N–H bonds.

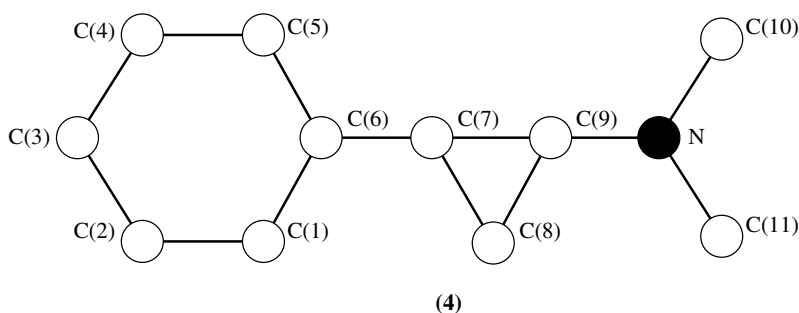
## B. Alicyclic Amines

In the previous review<sup>1</sup> this group of molecules was not taken into consideration.

*a.* 2,2,4,4,6-Pentacyanocyclohexenamine (C<sub>11</sub>H<sub>6</sub>N<sub>6</sub>)<sup>8</sup>. In this structure the presence of an olefinic bond constrains the molecule to assume a ‘half-chair’ conformation with the C(4) atom in the furthest position from the best plane. There is a conjugation involving the NH<sub>2</sub> group and the olefin. So C–NH<sub>2</sub> [1.354(3)] bond distance is shorter than 1.475, which is typical in aliphatic C–N bond length and, at the same time, is at the upper end of the range [1.30(1)–1.33(1)] usually observed for olefine-amine derivatives. It is surprising that the group NH<sub>2</sub> is twisted with respect to the molecular plane. For this molecule, in theory, two tautomers (3) may exist; X-ray measurements indicate the presence of only one tautomer (II) in the solid state.



*b. N,N-Dimethyl-2-phenylcyclopropylamine hydrochloride* ( $C_{11}H_{16}N$ )(4)<sup>9</sup>. This molecule is an inhibitor for an important class of enzymes, viz. the monoamino oxidases (MAO). Compounds of the type of *trans*-phenylcyclopropylamine 'are drugs of steric interest as they contain the phenethylamine skeleton common to many neurotropic compounds, but with a rigid ethylamine side chain locked by cyclopropane ring'<sup>9</sup>.



Uncorrected values					
C(1)–C(2)	1.43 <sup>a</sup>	C(2)–C(3)	1.32	C(3)–C(4)	1.37
	1.39		1.36		1.43
C(4)–C(5)	1.36	C(5)–C(6)	1.36	C(6)–C(7)	1.51
	1.40		1.35		1.49
C(7)–C(8)	1.51	C(8)–C(9)	1.461	C(9)–N	1.48
	1.50		1.51		1.40
C(10)–N	1.49	C(11)–N	1.49		
	1.50		1.46		
C(1)–C(2)–C(3)	120	C(2)–C(3)–C(4)	120	C(3)–C(4)–C(5)	119
	124		118		118
C(4)–C(5)–C(6)	125	C(5)–C(6)–C(1)	115	C(5)–C(6)–C(7)	123
	123		119		121
C(6)–C(7)–C(8)	125	C(7)–C(8)–C(9)	59	C(8)–C(9)–N	115
	124		62		119
C(9)–N–C(10)	110	C(10)–N–C(11)	111		
	111		110		

<sup>a</sup>The upper and lower figures refer to the A and B molecules respectively.

Two independent molecules, A and B, are contained in each asymmetric unit, one being the mirror image of the other. The conformation of the two is not very different from that observed for molecules with a similar biological activity.

TABLE 2. Structural parameters of the amino group in some alicyclic amines

Compound	C–N	N–H	<C–N–H	<H–N–H	State	Method	Reference
2,2,4,4,6-Pentacyano-cyclohexenamine	1.354(3)	0.94(3) 0.95(3)	122(2) 127(2)	110(2)	S	XD	8
<i>N,N</i> -Dimethyl-2-phenylcyclopropylamine hydrochloride <sup>a</sup>	1.48 1.40				S	XD	9
1,2- <i>trans</i> -Diaminocyclohexanehydrobromide	1.482(6) 1.509(6) 1.487(6) 1.510(6)	0.94(12) <sup>b</sup>			S	XD	10
1,4- <i>trans</i> -Diaminocyclohexanedihydrochloride	1.494				S	XD	11

<sup>a</sup>There are two molecules in the asymmetric unit.

<sup>b</sup>Average.

In Table 2 structural parameters of the amino group in some alicyclic compounds are reported in order to make a comparison. From this table one can see a clear difference in the C–N bond distance between 2,2,4,4-pentacyanocyclohexenamine and some salts.

### C. Aromatic Amines

*a. 1,2-Diaminobenzene* (C<sub>6</sub>H<sub>8</sub>N<sub>2</sub>) (**5**)<sup>12</sup> ( $R = 0.053$ ). The N(1) atom shows considerable deviation from the plane of the aromatic ring. In each NH<sub>2</sub> group one of the two N–H bonds is approximately coplanar with the ring. The lone pair of the nitrogen atom is situated on the opposite side as compared with the ring plane, such an orientation avoiding any repulsion between the lone pairs and overlap with the aromatic electron system is possible. There is evidence that both N atoms are almost totally sp<sup>3</sup>-hybridized.

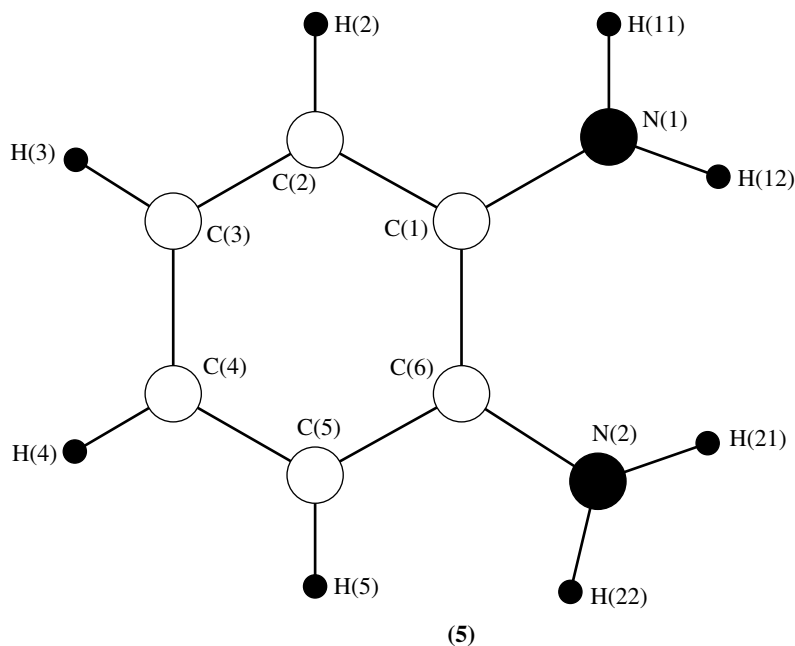
*b. Hexaaminobenzene* (C<sub>6</sub>H<sub>12</sub>N<sub>6</sub>) (**6**)<sup>13</sup>. The molecule has six identical CNH<sub>2</sub> groups. The crystal packing is dominated by weak intermolecular NH⋯N interaction such that the nitrogen lone pair is positioned between adjacent hydrogens of nearby molecules. This results in an arrangement in which each molecule is surrounded by twelve other molecules in three different orientations.

*Ab initio* molecular orbital calculations have been carried out with the program GRAD-SCF. The results obtained for the *D*<sub>3d</sub> and *S*<sub>6</sub> structures are compared with experimental data. Calculated C–C and C–N bond distances are in good agreement, unlike the N–H lengths. The calculated geometry for NH<sub>2</sub> groups is little different than that found experimentally.

In Table 3 structural parameters are presented for some characteristic aromatic amines.

*c. o-Aminobenzoic acid* (C<sub>7</sub>H<sub>7</sub>NO<sub>2</sub>). Two types of orthorhombic crystal of *o*-aminobenzoic acid exist under different conditions, that studied by Brown and Erhrensberg (anthranilic acid I, low-temperature form)<sup>18</sup> and the other studied by Boone and coworkers (anthranilic acid II, higher-temperature form)<sup>19</sup>.





Uncorrected values					
C(1)–C(2)	1.385(2)	C(2)–C(3)	1.388(2)	C(3)–C(4)	1.381(2)
C(4)–C(5)	1.381(2)	C(5)–C(6)	1.390(2)	C(6)–C(1)	1.407(2)
C(1)–N(1)	1.406(2)	N–H(11)	0.93(2)	N–H(12)	0.93(2)
C(2)–N(2)		C–H	1.04–0.96(2)	N–H(22)	0.97(2)
N(1)–C(1)–C(2)	122.3(2)	N(1)–C(1)–C(6)	118.6(2)	C(1)–C(2)–C(3)	121(2)
C(2)–C(3)–C(4)	119.8(2)	C(3)–C(4)–C(5)	119.8(2)	C(4)–C(5)–C(6)	121.1(2)
C(5)–C(6)–C(1)	1119.2(2)	C(6)–C(1)–C(2)	119.0(2)	N(2)–C(6)–C(5)	122.4(2)
C(6)–N(2)–H(22)	112.4(12)	C(1)–N(1)–H(11)	119.(12)	C(1)–N(1)–H(2)	115.9(12)
C(6)–N(2)–H(21)	110.3(12)				

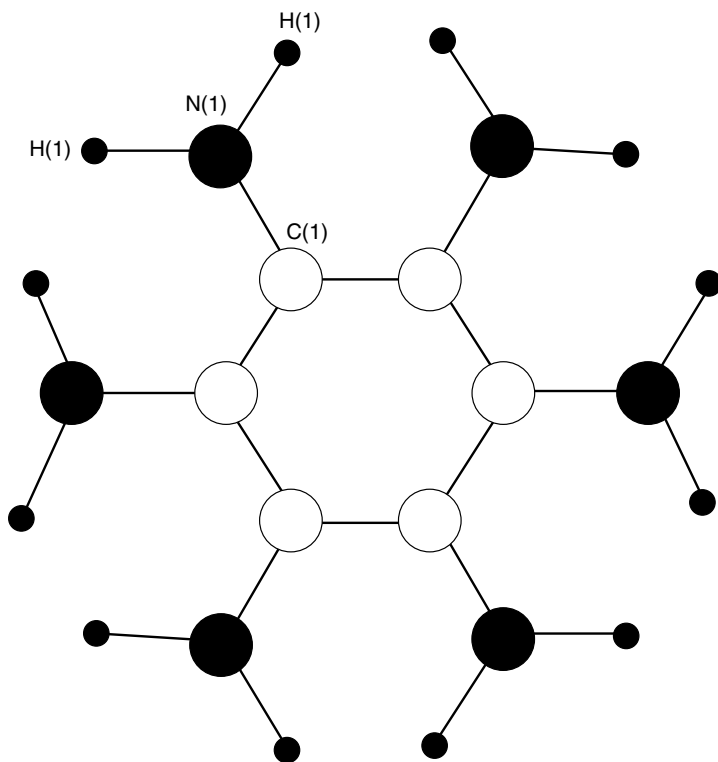
The low-temperature form I is stable up to 81 °C, above which temperature the structure changes to form II. Anthranilic acid I has 2 independent molecules for each asymmetric unit, one being neutral while the other has a zwitterionic form ( $C_6H_4NH_3^+COO^-$ ).

Anthranilic acid II possesses only non-zwitterionic molecules which form dimers of the A–A type.

*d. m-Aminobenzoic acid* ( $C_7H_7NO_3$ )<sup>20</sup>. has two independent molecules, A and B, both of them non-zwitterionic, forming dimers of the A–B type.

*e. p-Aminosalicylic acid* ( $C_7H_5N_5O$ )<sup>21</sup>. The data for *p*-aminosalicylic acid are in agreement with the idea that the resonance structures are determinant in explaining the structure of this molecule.

*f. 3,5-Diamino-2,4,6-trinitrobenzoic acid* and related molecules<sup>24</sup>. Four similarly-structured molecules [containing the groups COOH (I), OH (II), F (III), C(=O)NH<sub>2</sub> (IV),



(6)

Uncorrected values				
	experimental	calculated		
		$D_{3d}^a$	$S_6^a$	$S_6^b$
N(1)–C(1)	1.432 (8)	1.457	1.459	1.426
N(1)–H(1)	0.879 (56)	1.03	1.031	1.001
N(1)–H(1)′	0.841 (67)	1.03	1.032	1.004
C(1)–C(1)′ <sup>c</sup>	1.383 (6)	1.396	1.395	1.392
				$S_6^b$
C(1)–N(1)–H(1)	112 (4)	108.6	108.1	110.1
C(1)–N(1)–H(1)′	116 (5)	108.6	107.9	110.1
H(1)–N(1)–H(1)′	110 (5)	104.8	104.7	106.0
N(1)–C(1)–C(1)′ <sup>d</sup>	120 (1)	120.0	119.5	119.2
N(1)–C(1)–C(1)′ <sup>c</sup>	120 (1)	120.0	120.5	120.8
C(1)′ <sup>c</sup> –C(1)–C(1)′ <sup>d</sup>	120.00 (2)	120.0	119.9	119.9
CC–NH <sup>e</sup>		35.3	22.1, 48.2	10.9, 52.5

<sup>a</sup>STO-3G.<sup>b</sup>6-31G\*(N).<sup>c</sup>1/2-z, -1/2+x, y.<sup>d</sup>1/2+y, z, 1/2-x.<sup>e</sup>Torsion angle.

TABLE 3. Dimensions of the amino group in some aromatic compounds

Compound	C–N	N–H	<C–N–H	<H–N–H	State	Method	Reference
1,2-Diaminobenzene	1.406(2)	0.93(2)	111.9(12)	113.0(17)	S	XD	12
	1.408(2)	0.93(2)	115.9(12)				
Hexaaminobenzene		0.93(2)	110.3(1.2)	112.8(1.6)	S	XD	13
	1.432(8)	0.879(56)	112.4(1.1)				
		0.841(67)	116(5)				
2-Aminophenol	1.429(7) <sup>a</sup>				S	XD	14
2-Amino-4-methylphenol	1.417(3)				S	XD	15
2-Amino-4-chlorophenol	1.433(9) <sup>a</sup>				S	XD	14
2-Amino-5-nitrophenol	1.404(3)	0.85(4)	111(3)	108(4)	S	XD	16
		0.97(5)	123(3)				
<i>o</i> -Aminobenzoic acid <sup>b</sup>	1.364(5)				S	XD	17
<i>o</i> -Aminobenzoic acid (anthranilic acid I) <sup>c</sup>	1.386(3) <sup>d</sup>	1.059(9)	111.6(6)	110.9(8)	S	ND	18
		1.022(9)	110.4(5)				
	1.455(4)	1.039(8)	106.7(5)	113.8(7)			
		1.049(10)	113.0(6)				
<i>o</i> -Aminobenzoic acid (anthranilic acid II)	1.349(9)	0.84(4)	123.6(2.6)		S	XD	19
		0.74(5)	117.1(3.7)				
<i>m</i> -Aminobenzoic acid <sup>f</sup>	1.379(5) <sup>d</sup>	0.86(3)	119.9(2.1)		S	XD	20
		0.91(3)	115.0(1.7)				
	1.395(5) <sup>e</sup>	0.92(3)	117.0(1.8)				
		0.91(3)	114.9(1.6)				
<i>p</i> -Aminosalicylic acid	1.364(2)	0.91(3)	120(2)	125(2)	S	XD	21
		0.83(3)	115(2)				
5-Fluoro-2,4,6-trinitro-1,3-benzenediamine	1.315(8)	1.06(9)	119(5)	120(9)	S	XD	22
		1.0(2)	121(7)				
	1.320(9)	1.1(1)	117(8)	121(10)			
		1.0(1)	121(6)				
3,5-Diamino-2,4,6-trinitrophenol	1.320(7)	0.87(6)	120(4)	113(5)	S	XD	23
		1.11(7)	119(4)				
	1.314(7)	0.88(7)	129(5)	109(7)			
	1.463(6)	0.78(7)	121(5)				
3,5-Diamino-2,4,6-trinitrobenzoic acid	1.321(3)				S	XD	24
	1.327(3)						
<i>o</i> -Nitroaniline <sup>f</sup> ( $\gamma$ -form)	1.371(18) <sup>d</sup>	0.94(11)	113(7)	146(10)	S	XD	25
		0.78(11)	101(8)				
	1.350(19) <sup>e</sup>	1.04(11)	126(6)	124(9)			
		0.89(11)	109(7)				
2,4-Dinitroaniline	1.352		107.0	127.5	S	XD	26
			125.2				
2,6-Dinitroaniline	1.339(2)				S	XD	27
<i>m</i> -Cyanoaniline	1.408(7)				S	XD	28
<i>p</i> -Cyanoaniline	1.360(5)				S	XD	28
<i>p</i> -Chloroaniline	1.464(2)				S	XD	29

(continued overleaf)

TABLE 3. (continued)

Compound	C–N	N–H	<C–N–H	<H–N–H	State	Method	Reference
2-Methyl-4-nitroaniline	1.353(3)	0.78(4) 0.86(6)	126(2) 121(4)	113(5)	<i>S</i>	XD	30
3-Chloro-4-fluoroaniline	1.398(2)				<i>S</i>	XD	31

<sup>a</sup>Corrected for molecular libration.<sup>b</sup>Monoclinic form.<sup>c</sup>Low-temperature form; there are two molecules per asymmetric unit: one is neutral and the other a zwitterion.<sup>d</sup>Molecule A.<sup>e</sup>Molecule B.<sup>f</sup>There are two molecules per asymmetric unit.

TABLE 4. Relevant bond distances and angles in some heterocyclic amines

Compound	C–N	N–H	<C–N–H	<H–N–H	State	Method	Reference
5-Amino-1- <i>H</i> - 1,2,4-triazole	1.342	0.92 0.89	123 126	107	<i>S</i> <i>S</i>	XD XD	32
3-Amino-5-nitro- 1,2,4-triazole	1.342(2)				<i>S</i>	XD	33
1-Methyl-5-amino- 3-methylthio- 1,2,4-triazole	1.359(3)				<i>S</i>	XD	34
1-Phenyl-5-amino- 3-methylthio- 1,2,4-triazole	1.356(2)				<i>S</i>	XD	34
3,5-Diamino-1- <i>H</i> - 1,2,4-triazole	1.353(3)	0.89(2) 0.86(2)	115(2) 119(2)	115(2)	<i>S</i>	XD	32
	1.376(3)	0.93(2) 0.83(2)	114(1) 115(2)	114(2)			
5-Aminotetrazole monohydrate	1.330(2)	0.87(2) 0.88(2)	119(1) 121(1)	119(2)	<i>S</i>	XD	35
2-Amino-1,3-oxazole	1.343(4)	0.91(5)	122(1)		<i>S</i>	XD	36
2-Amino-1,3-thiazole	1.330(7)	0.83(4) 0.76(4)	125(3) 122(3)	113(5)	<i>S</i>	XD	37
2,5-Diamino- 1,3,4-thiadiazole	1.347(2) 1.346(2)				<i>S</i>	XD	38
2,6-Diaminopyridine <sup>a</sup>	1.377(4)	1.018(9) 1.010(8)	116.3(5) 115.9(5)	113.2(7)	<i>S</i>	ND	39
2,4,6-Triamino- pyrimidine <sup>b</sup>	1.364(10) 1.374(9) 1.371(9) 1.381(10) 1.376(9) 1.369(9)				<i>S</i>	XD	40
2-Amino-6- methoxypyrazine	1.344	0.89 0.87	120 118	122	<i>S</i>	XD	41

TABLE 4. (continued)

Compound	C–N	N–H	<C–N–H	<H–N–H	State	Method	Reference
2,4,6-Triamino-1,3,5-triazine	1.343(2)	0.914(21)	117.2(12)	120.6(18)	S	XD	42
	0.877(27)		119.5(9)				
	1.337(1)	0.813(12)	118.2(15)	123.1(21)			
	1.362(4)	0.881(21)	117.2(18)				
		0.926(28)	110.0(12)	119.0(9)			
	1.338(2)	0.926(15)	114.7(15)				
		1.034(5)	119.1(2)	118.9(4)	S	ND	42
	1.346(2)	1.002(5)	120.1(2)				
		1.362(1)	1.009(4)	117.4(4)	120.9(4)		
			1.027(2)	118.5(3)			
	1.000(6)	115.3(2)					
	1.021(4)	115.9(3)					
3,6-Diamino-1,2,4,5-tetrazine	1.332(1)	0.94(2)	121	115	S	XD	43
		0.87(1)	124				

<sup>a</sup>At 20 K.<sup>b</sup>The asymmetric unit in the structure consists of two crystallographically independent molecules.

respectively] reflect the clear effect of the amino and nitro substituents. For example, the four benzene C–C bonds per molecule directly associated with the amino group fragments are substantially longer than the usual 1.40 Å value observed in ordinary aromatic rings; the four C–C bond length averages in molecules (I)–(IV) are 1.431(3), 1.434(9), 1.433(7) and 1.434(3) Å, respectively. The averages of the internal C–C–C angles at the benzene ring atoms linked to the amino and the nitro substituents are 116.0(2) and 122.2(2)°, 116.5(6) and 121.4(6)°, 116.4(4) and 122.1(4)° and 116.2(2) and 122.2(2) in molecules (I)–(IV).

The eight C–NH<sub>2</sub> distances in the four compounds are remarkably similar, ranging from 1.314(7) to 1.332(3) with an average of 1.321(8) Å. The twelve C–NO<sub>2</sub> distances cover the wider range of 1.409(6) to 1.463(6), although the four C(4)–N bonds span the more limited range of 1.420(3) to 1.439(2) Å.

## D. Heterocyclic Amines and Related Molecules

Table 4 gives structural parameters for amino groups in some heterocyclic compounds.

## IV. THE NITROSO GROUP

As already outlined in the previous review<sup>1</sup>, the nitroso group is of great interest from the theoretical point of view but also because of the facility with which these molecules dimerize; only a few monomeric structures have been noted in the literature in the period under examination.

In Table 5 structural parameters for nitroso groups are presented.

A comparison of structures of *N*-methyl-*N*-nitroso-*p*-nitrobenzamide, *N,N'*-dimethyl-*N*-nitroso-urea, *N*-methyl-*N*-nitroso-urea, 2-nitroso-2-azabicyclo[2.2.2]octan-3-one to those of *N*-methyl-*N'*-nitro-*N*-nitrosoguanidine and *N,N'*-dimethyl-*N''*-cyano-*N*-nitrosoguanidine shows that the N–N and C–NNO bond lengths in the nitroguanidines<sup>44</sup> are similar to those found in the nitrosoamides, but that the corresponding bonds in

TABLE 5. Bond lengths and angles in some nitroso compounds

Compound	X/Y–N	N–O	X/Y–N–O	State	Method	Reference
<i>N</i> -Methyl- <i>N</i> '-nitroso- <i>N</i> '-nitroguanidine <sup>a</sup>	1.3415(13) <sup>y</sup>	1.2276(14)	114.11(9) <sup>y</sup>	<i>S</i>	XD	44
	1.3596(14)	1.2187(16)	114.01(10)			
	1.3521(10)	1.2195(10)	114.12(7)	<i>S</i>	XD	45
<i>N</i> -Methyl- <i>N</i> -nitroso- <i>N</i> '-nitroguanidine	1.326(2) <sup>y</sup>	1.231(29)	114.4(2) <sup>y</sup>	<i>S</i>	XD	46
<i>N,N'</i> -Dimethyl- <i>N</i> -nitroso- <i>N</i> '-nitroguanidine	1.332(2) <sup>y</sup>	1.227(2)	113.9(2) <sup>y</sup>	<i>S</i>	XD	46
3,3-Di- <i>isopropyl</i> -1( <i>Z</i> )-nitroso-1-( <i>p</i> -tolyl)urea	1.327(2) <sup>y</sup>	1.240(2)	114.0(1) <sup>y</sup>	<i>S</i>	XD	47
3,3-Di- <i>benzyl</i> -1( <i>E</i> )-nitroso-1-(2-tolyl)urea	1.345(5) <sup>y</sup>	1.227(5)	114.5(3) <sup>y</sup>	<i>S</i>	XD	47
1-(4-Methoxyphenyl)-3-methyl-1( <i>E</i> )-nitroso- <i>N</i> '-nitroguanidine	1.357(6) <sup>y</sup>	1.219(5)	114.3(3) <sup>y</sup>	<i>S</i>	XD	47
1-(2-Chloroethyl)-3-( <i>trans</i> -4-methylcyclohexyl)-1-nitroso- <i>N</i> '-nitroguanidine	1.333(4) <sup>y</sup>	1.218(4) <sup>y</sup>	114.6 <sup>y</sup>	<i>S</i>	XD	48
1-Nitro-1'-nitroso-bicyclopropyl	1.573 <sup>x</sup>	1.246	106.8 <sup>x</sup>	<i>S</i>	XD	49
<i>trans</i> -1,4-Dichloro-1,4-dinitroso-cyclohexane	1.505(7) <sup>x</sup>	1.139(5)	116.5(6) <sup>x</sup>	<i>S</i>	XD	50
5,5-Dimethyl-2-nitroso-3-phenylamino-2-cyclohexen-1-one	1.337(2) <sup>x</sup>	1.301(2)	118.3(1) <sup>x</sup>	<i>S</i>	XD	51
1,5-Dinitro-3-nitroso-1,3,5-triazacycloheptane	1.316(4) <sup>y</sup>	1.237(4)	113.4(3) <sup>y</sup>	<i>S</i>	XD	52
	1.315(4) <sup>y</sup>	1.228(4)	114.6(3) <sup>y</sup>			
2-Nitroso-2-azabicyclo-(2.2.2)octan-3-one	1.353(4) <sup>y</sup>	1.227(5)	113.4(4) <sup>y</sup>	<i>S</i>	XD	46
<i>trans</i> -1,8-Dinitroso-1,8-diazadecaline	1.322(6) <sup>y</sup>	1.222(6)	113.8(5) <sup>y</sup>	<i>S</i>	XD	53
	1.306(5) <sup>y</sup>	1.242(5)	114.9(4) <sup>y</sup>			
<i>N</i> -Nitroso- <i>N</i> -benzyl- <i>p</i> -chloroaniline	1.339(5) <sup>y</sup>	1.237(5)	114.4(4) <sup>y</sup>	<i>S</i>	XD	54
<i>p</i> -Nitrosoanisole	1.467(10) <sup>x</sup>	1.228(8)	113.6(6) <sup>x</sup>	<i>S</i>	XD	55
<i>p</i> -Nitrosodiphenylamine	1.403(5) <sup>x</sup>	1.256(5)	112.8(3) <sup>x</sup>	<i>S</i>	XD	56
<i>N</i> -Nitrosodiphenylamine	1.344(5) <sup>y</sup>	1.206(7)	114.9(4) <sup>y</sup>	<i>S</i>	XD	57
Tetramethylammonium benzonitrosolate	1.357 <sup>x</sup>	1.261	116.8 <sup>x</sup>	<i>S</i>	XD	58
	1.351 <sup>x</sup>	1.268	117.2 <sup>x</sup>			
1-4-Dinitrosopiperazine	1.336(4) <sup>y</sup>	1.202(4)	113.4(3) <sup>y</sup>	<i>S</i>	XD	59

<sup>a</sup>Three values are reported: two for molecules in the monoclinic form, and one for the orthorhombic one; x indicates C–N bond; y indicates N–N bond.

the nitroso-*N*'-nitroguanidines are significantly shorter and longer, respectively. Thus it appears<sup>45</sup> that nitrosation of *N*-methyl-*N*'-nitroguanidine and *N*-methyl-*N*'-cyanoguanidine modifies the electronic character of the guanidine system so that the C–N–N bonding system resembles that of nitrosamides.

*a*. 4-Nitrosodiphenylamine (C<sub>12</sub>H<sub>10</sub>N<sub>2</sub>O)<sup>56</sup>. The aromatic rings are planar, the dihedral angle between the two planes being 56.6°. An H bond is present between N(1) and O(1), of length 2.923(5) Å.

*b. N-Nitrosodiphenylamine* ( $C_{12}H_{12}N_2O$ )<sup>57</sup>. The N=O bond length is 1.206 Å. Pauling in 1944 had predicted a value of 1.18 Å for this length but most of the values measured are greater, probably because of ionization or hybridization.

*c. 1,4-Dinitrosopiperazine* ( $C_4H_8N_4O_2$ )<sup>59</sup>. The piperazine ring has a chair conformation and the two nitroso groups are in the *anti* form.

## V. THE NITRO GROUP

Examination of the literature has brought to light the existence of about 4000 articles that make use of diffractometry.

Table 6 collects structural parameters for nitro groups.

TABLE 6. Structural parameters for some nitro compounds

Compound	C-N	N-O	<C-N-O	<O-N-O	State	Method	Reference
1,2-Difluorodinitroethylene	1.476(5)	1.206(5)	119.8(3)	126.0(3)	<i>S</i>	XD	60
	1.476(5)	1.208(5)	114.2(3)	127.0(3)			
1,1-Diododinitroethylene <sup>a</sup>	1.454(10)	1.208(5)	114.6(3)	118.4(3)	<i>S</i>	XD	61
	1.494(10)	1.208(5)	118.4(3)				
2-Methyl-2-nitro-1,3-propanediol	1.506(4)	1.210(4)	117.4(3)	122.3(3)	<i>S</i>	XD	62
		1.200(4)	120.3(3)				
2-Bromo-2-nitro-1,3-propanediol	1.540(8)	1.540(8)	1.197(10)	1.184(10)	<i>S</i>	XD	63
			1.184(10)				
2-Methyl-2,3,3-trinitrobutane	1.554(5)	1.530(5)	1.530(5)	1.530(5)	<i>S</i>	XD	64
	1.549(4)						
	1.530(5)						
1,4-Difluoro-1,1,4,4-tetranitro-2,3-butanediol	1.535	1.205	116	128	<i>S</i>	XD	65
	1.540	1.209	116				
		1.203	117				
	1.542(8)	1.206	116				
1,12-Dinitrodecane	1.486(3)	1.208(3)	119.2(3)	122.1(3)	<i>S</i>	XD	66
		1.208(3)	118.6(3)				
1,1'-Dinitrobicyclopentyl	1.641(4)	1.306(4)	116.8(3)	126.5(3)	<i>S</i>	XD	67
	1.665(4)	1.209(4)	116.7(3)				
		1.329(4)	1.215(5)				
1,1'-Dinitrobicyclohexyl	1.551(2)	1.214(2)	118.2(1)	123.2(81)	<i>S</i>	XD	67

(continued overleaf)

TABLE 6. (continued)

Compound	C—N	N—O	<C—N—O	<O—N—O	State	Method	Reference
1,1'-Dinitrobi- cycloheptyl		1.212(2)	118.6(1)				
	1.551(9)	1.224(7)	117.8(7)	123.5(7)	S	XD	67
		1.204(7)	118.7(7)				
	1.543(9)	1.214(7)	119.2(8)	123.5(8)			
		1.216(8)	117.3(7)				
<i>N</i> -Methyl- <i>p</i> - nitroaniline	1.434(4)	1.243(3)	118.0(3)	122.0(3)	S	XD	68
		1.226(3)	120.0(3)				
<i>N,N</i> -Diethyl- <i>p</i> - nitroaniline <sup>a</sup>	1.437(4)	1.234(5)	118.7(3)	121.9(3)	S	XD	69
		1.223(5)	119.4(3)				
	1.429(5)	1.221(5)	119.7(3)	121.7(4)			
		1.231(5)	118.6(4)				
<i>o</i> -Nitroaniline <sup>a</sup> ( $\gamma$ -modification)	1.490(20)	1.223(18)	114.2(12)	125.7(14)	S	XD	25
		1.216(18)	120.0(13)				
	1.429(19)	1.248(169)		120.6(12)			
		1.223(16)	121(12)				
<i>m</i> -Nitroaniline	1.467(4)	1.222(3)	119.7(2)	122.2(39)	S	XD	70
		1.223(3)	118.1(3)				
2-Methyl-4- nitroaniline	1.422(3)	1.229(3)	119.9(2)	121.6(2)	S	XD	27
		1.230(3)	118.6(2)				
2-Methoxy-4- nitroaniline	1.429(4)	1.221(3)			S	XD	71
		1.234(4)					
3,4-Dichloro- nitrobenzene	1.486(8)	1.197(8)	118.4(6)	125.2(6)	S	XD	72
		1.227(8)	116.4(5)				
2,6-Dimethoxy-3- nitrobenzoic acid	1.461(3)	1.187(3)	120.6(3)	121.4(3)	S	XD	73
		1.199(3)	118.0(3)				
Benzyl-4-nitro- benzoate	1.470(2)	1.216(2)	118.2(1)	123.4(2)	S	XD	74
		1.218(2)	118.4(1)				
2-Pyridyl-4- nitrobenzoate	1.470(4)	1.206(3)	118.6(2)	123.0(3)	S	XD	75
		1.207(3)	118.4(2)				
2-Amino-5- nitrophenol	1.462(3)	1.228(3)	118.2(2)	122.6(3)	S	XD	16
		1.221(3)	119.2(2)				
<i>o</i> -Dinitrobenzene	1.472(3)	1.222(3)			S	XD	76
		1.221(3)					
<i>p</i> -Dinitrobenzene	1.478	1.218	117.9	124.5	S	XD	77
		1.220	117.6				
$\gamma$ -4-Chloro-1,2- dinitrobenzene	1.470(4)	1.220(3)	117.2(3)	125.5(3)	S	XD	78
		1.230(3)	117.2(2)				
	1.481(4)	1.210(4)	118.0(3)	124.6(3)			
		1.225(4)	117.3(3)				
$\beta$ -4-Chloro-1,2- dinitrobenzene	1.478(11)	1.200(9)	116.8(8)	127.4(8)	S	XD	78
		1.231(9)	115.8(8)				



TABLE 6. (continued)

Compound	C—N	N—O	<C—N—O	<O—N—O	State	Method	Reference
	1.486(8)	1.208(88)	117.6(8)	125.7(7)			
<i>o</i> -Dinitrotetra- methylbenzene	1.469	1.2073 1.2234	116.6(7)		<i>S</i>	XD	79
Methoxy-methoxy- 2,4-dinitro- benzene	1.467(2)	1.223(2)	117.0(1)	124.5(1)	<i>S</i>	XD	80
	1.460(2)	1.211(2)	118.5(1)				
		1.219(2)	117.9(1)	123.4(1)			
1-Chloro-2,4- dinitrobenzene <sup>b</sup>	1.470(2)	1.219(2)	118.8(1)		<i>S</i>	XD	81
	1.477(2)	1.218(2)	118.0(2)	125.1(2)			
		1.220(2)	116.8(1)				
		1.213(2)	116.9(2)	125.0(2)			
		1.224(2)	118.08(2)				
1-Fluoro-2,4- dinitrobenzene	1.481(8)	1.213(88)	117.5(7)	124.2(7)	<i>S</i>	XD	82
		1.158(7)	118.3(7)				
	1.490(7)	1.220(2)	116.8(1)				
		1.212(6)	118.4(6)	123.5(6)			
		1.237(6)	118.2(6)				
1,5-Difluoro-2,4- dinitrobenzene	1.460(2)	1.226(2)	117.7(2)	123.6(2)	<i>S</i>	XD	83
		1.227(3)	118.8(2)				
	1.464(2)	1.216(3)	118.7(2)	125.1(2)			
		1.234(4)	116.2(2)				
1-Methoxy- methoxy-3,5- dinitrobenzene	1.474(4)	1.225(4)	117.7(3)	124.2(3)	<i>S</i>	XD	84
		1.214(4)	118.1(3)				
	1.472(3)	1.212(4)	118.5(83)	123.6(3)			
		1.209(4)	117.9(3)				
2,5-Dinitro- benzoic acid	1.477	1.218			<i>S</i>	XD	85
		1.223					
	1.471	1.212					
		1.215					
3,5-Dinitro- benzoic acid	1.472(3)	1.219(3)	117.6(2)	124.5(2)	<i>S</i>	XD	86
		1.216(3)	117.9(2)				
	1.472(3)	1.214(3)	117.3(2)	123.7(2)			
		1.211(3)	119.0(2)				
3,5-Diamino- 2,4,6-trinitro benzoic acid	1.447(3)	1.223(2)	118.0(2)	121.5(2)	<i>S</i>	XD	24
		1.234(2)	120.5(2)				
	1.439(2)	1.226(2)	119.9(2)	119.8(2)			
		1.239(3)	120.3(2)				
	1.451(3)	1.231(3)	120.5(2)	121.8(2)			
		1.225(3)	117.7(2)				
3,5-Diamino- 2,4,6-trinitro phenol	1.409(6)	1.240(6)	119.1(4)	117.9(4)	<i>S</i>	XD	23

(continued overleaf)

TABLE 6. (continued)

Compound	C–N	N–O	<C–N–O	<O–N–O	State	Method	Reference
2,4-Dinitroaniline	1.463(6)	1.277(6)	123.0(4)	124.1(4)	<i>S</i>	XD	26
		1.208(5)	117.6(4)				
	1.424(6)	1.237(6)	118.2(4)				
		1.247(6)	120.1(4)				
		1.248(5)	120.0(4)				
1.442	1.250	119.7	121.4				
	1.225	118.9					
	1.480	1.213	116.0	126.3			
2,6-Dinitroaniline	1.451(2)	1.219	117.7	121.4(3)	<i>S</i>	XD	27
		1.227(2)	119.8(3)				
	1.459(2)	1.220(2)	118.8(3)				
		1.222(2)	120.1(3)	121.4(3)			
		1.209(2)	118.5(3)				
2-Nitroimidazole <sup>c</sup>	1.432(2)	1.235(2)	117.2(2)	125.1(2)	<i>S</i>	XD	87
		1.226(2)	117.8(2)				
4-Nitroimidazole	1.420(3)	1.229(2)	118.5(2)	123.0(2)	<i>S</i>	XD	88
		1.227(3)	118.4(2)				
2-Methyl-4-nitroimidazole	1.419(2)	1.224(3)	118.1(3)	123.3(3)	<i>S</i>	XD	89
		1.220(2)	118.6(3)				
3-Nitro-1,2,4-triazole	1.449	1.216	117.7	124.7	<i>S</i>	XD	90
		1.218	117.6				
3-Amino-5-nitro-1,2,4-triazole	1.447(2)	1.226(2)	118.8(2)	124.1(1)	<i>S</i>	XD	32
		1.221(2)	118.2(1)				
2,3-Dimethyl-5-nitroindole	1.449(2)	1.215(2)	119.4(2)	121.5(2)	<i>S</i>	XD	91
		1.241(2)	119.1(2)				
2-Chloro-3,5-dinitrothiophene	1.44(1)	1.23(1)	117.7(7)	124.8(9)	<i>S</i>	XD	92
		1.21(1)	117.5(8)				
	1.43(1)	1.21(1)	117.4(7)	126.4(8)			
2,5-Dimethyl-3,4-dinitrothiophene	1.455(2)	1.24(1)	116.3(7)	123.9(2)	<i>S</i>	XD	93
		1.211(3)	118.4(2)				
	1.445(2)	1.212(3)	117.6(2)				
		1.218(2)	117.9(2)	124.0(2)			
		1.221(2)	118.1(2)				
1,4-Dinitroimidazole	1.441(3)	1.223(3)	117.0(2)	125.2(2)	<i>S</i>	XD	94
		1.234(3)	117.8(2)				
	1.420(3)	1.214(3)	115.4(2)	129.3(2)			
1,3-Dinitro-naphthalene	1.462(4)	1.207(3)	115.4(2)	123.0(3)	<i>S</i>	XD	95
		1.219(5)	117.8(3)				
	1.474(4)	1.195(4)	118.9(3)				
		1.205(3)	118.1(3)	124.1(3)			
		1.207(4)	117.7(3)				

<sup>a</sup>There two molecules in the asymmetric unit.<sup>b</sup>Phase I.<sup>c</sup>At 105 K.

*a. trans-1,2-Difluorodinitroethylene*<sup>61</sup>. One of the two nitro groups shows significant deviation from coplanarity with the rest of the molecule with the average value of the four torsion angles involving the C(1)–N(1) bond being 14.3°. Similar averaging gives 0.6° for the other nitro group and 0.8° for the C(1)–C(2) twist. The C–N bond distances for both nitro groups are nearly identical (1.476 Å). The C–C double-bond distance is unusually short at 1.284 Å.

*b. 1,1'-Dinitrobicyclopentyl, 1,1'-dinitrobicyclohexyl and 1,1'-dinitrobicycloheptyl*<sup>67</sup>. The five-membered rings adopt skew conformations and the molecule, a *gauche* conformation with an apparent N–C–C–N torsion angle of –73.4°. Both NO<sub>2</sub> groups are nearly coplanar with the central C–C bond. In this conformation, the oxygen atoms, O(2) and O(2a), make close contacts with the methylene groups adjacent to the central carbons. The conformation with both NO<sub>2</sub> groups coplanar with the central C–C bond is inherently more stable than a conformation where the NO<sub>2</sub> groups are perpendicular to the central atoms, despite the expectation that the NO<sub>2</sub> groups would tend to avoid each other to the maximum extent.

The cyclohexyl ring adopts a chair conformation characterized by the near-coplanarity of the atoms C(2), C(3), C(4) and C(6). Neither of the nitro groups deviate significantly from planarity.

The cycloheptyl rings adopt chair-like conformations characterized by the near-coplanarity of atoms C(3), C(4), C(5) and C(6), which form the 'back' of the chair, and atoms C(2), C(3), C(6) and C(7), which form the 'seat' of the chair. Both nitro groups show small but only marginally significant tetrahedral distortions.

*c. o-Dinitrobenzene*<sup>76</sup>. The two nitro groups are twisted out of the mean plane of the benzene ring by angles of 41°. The overall conformation is clearly determined by the disposition of the two *ortho* nitro groups, which are rotated about the C–N bonds in the same sense and to about the same amount. These rotations bring atoms O(2) and O(3) into contact, the distance between them being about 2.77 Å, which is close to the standard van der Waals diameter of oxygen (2.8 Å); there are also close contacts between N(1) and N(2) (2.94 Å). The two N atoms in *o*-DNB are displaced out of the ring plane by nearly equal opposite amounts. The angles N(1)–C(1)–C(2) and N(2)–C(2)–C(1) are larger than 120° by 1.4° and 1.8°, respectively, and so the two N atoms are slightly splayed apart to 2.94 Å, whereas the distance in a hypothetical planar molecule with 120° bond angles would be 2.85°.

## VI. CONCLUSIONS

From the results published in the period reviewed in the present work there is no relevant novelty as regards the structure of amino, nitroso and nitro groups.

All evidence and comments reported previously<sup>1</sup> remain altogether valid.

## VII. ACKNOWLEDGEMENTS

We are indebted to Consiglio Nazionale delle Ricerche, Rome, and the Italian Minister for Universities for financial support.

We also acknowledge the valuable collaboration of Mrs Maria Gabriella Fabrizi and Mr Marco Pelliccia in preparing the manuscript and the drawings.

## VIII. REFERENCES

1. S. Sorriso, in *The Chemistry of Amino, Nitroso and Nitro Compounds and Their Derivatives*, Part 1 (Ed. S. Patai), Chap. 1, Wiley-Interscience, Chichester, 1982.
2. S. Sorriso, in *The Chemistry of Diazonium and Diazo Groups*, Part 1 (Ed. S. Patai), Chap. 3, Wiley-Interscience, Chichester, 1978.
3. A. K. Cheetham, in *Solid State Chemistry: Techniques* (Eds. A. K. Cheetham and P. Day), Chap. 2, Oxford Science Publications, 1987.
4. D. Mootz, D. Brodalla and M. Wiebcke, *Acta Crystallogr.*, **C45**, 754 (1989).
5. C. S. Choi, *Acta Crystallogr.*, **B37**, 1955 (1981).
6. F. L. Hirshfeld and H. Hope, *Acta Crystallogr.*, **B36**, 406 (1980).
7. A. J. Bracuti, *Acta Crystallogr.*, **C42**, 1887 (1986).
8. R. A. Bell, B. E. Brown, M. Duarte, H. E. Howard-Lock and C. J. Lock, *Can. J. Chem.*, **65**, 261 (1987).
9. D. Carlstrom, *Acta Crystallogr.*, **B31**, 2185 (1975).
10. M. D. Morse and J. P. Chesick, *Acta Crystallogr.*, **B32**, 954 (1976).
11. J. D. Dunitz and P. Strickler, *Helv. Chim. Acta*, **49**, 2502 (1966).
12. C. Stålhandske, *Cryst. Struct. Commun.*, **10**, 1081 (1981).
13. D. A. Dixon, J. C. Calabrese and J. S. Miller, *Angew. Chem., Int. Ed. Engl.*, **28**, 90 (1989).
14. S. Ashfaquzzaman and A. K. Pant, *Acta Crystallogr.*, **B35**, 1394 (1979).
15. S. Kashino, M. Tomita and M. Haisa, *Acta Crystallogr.*, **C44**, 730 (1988).
16. M. Haisa, S. Kashino and T. Kawashima, *Acta Crystallogr.*, **B36**, 1598 (1980).
17. H. Takazawa, S. Ohba and Y. Saito, *Acta Crystallogr.*, **C42**, 1880 (1986).
18. C. J. Brown and M. Ehrenberg, *Acta Crystallogr.*, **C41**, 441 (1985).
19. C. D. G. Boone, J. L. Derissen and J. C. Schoone, *Acta Crystallogr.*, **B33**, 3205 (1977).
20. J. Voogd, B. H. M. Verzijl and A. J. M. Duisenberg, *Acta Crystallogr.*, **B36**, 2805 (1980).
21. C. -T. Lin, P. -Y. Siew and S. R. Byrn, *J. Chem. Soc., Perkin Trans. 2*, 957 (1978).
22. H. L. Ammon, S. K. Bhattacharjee and J. R. Holden, *Acta Crystallogr.*, **B38**, 1851 (1982).
23. S. K. Bhattacharjee and H. L. Ammon, *Acta Crystallogr.*, **B37**, 2082 (1981).
24. H. L. Ammon and S. M. Prasad, *Acta Crystallogr.*, **C41**, 921 (1985).
25. N. N. Dhaneshwar, S. S. Tavale and L. M. Pant, *Acta Crystallogr.*, **B34**, 2507 (1978).
26. L. Prasad, E. J. Gabe and Y. Le Page, *Acta Crystallogr.*, **B38**, 674 (1982).
27. L. Párkányi and A. Kálmán, *J. Mol. Struct.*, **125**, 315 (1984).
28. S. Merlino and F. Sartori, *Acta Crystallogr.*, **B38**, 1476 (1982).
29. G. Ploug-Sorensen and E. Krogh Andersen, *Acta Crystallogr.*, **C41**, 613 (1985).
30. G. F. Lipscomb, A. F. Garito and R. S. Narang, *J. Chem. Phys.*, **75**, 1509 (1981).
31. M. Kubota and S. Ohba, *Acta Crystallogr.*, **B48**, 849 (1992).
32. G. L. Starova, O. V. Frank-Kamenetskaya and V.V. Makarski, *Acta Crystallogr.*, **A34**, S113 (1978).
33. E. Garcia and K. -Y. Lee, *Acta Crystallogr.*, **C48**, 1682 (1992).
34. A. Kálmán and G. Y. Argay, *J. Mol. Struct.*, **102**, 391 (1983).
35. D. D. Bray and J. G. White, *Acta Crystallogr.*, **B35**, 3089 (1979).
36. A. Albinati, M. G. Marcon, P. Traldi and P. Cavoli, *Acta Crystallogr.*, **B37**, 2090 (1981).
37. C. Caranoni and J. P. Reboul, *Acta Crystallogr.*, **B38**, 1255 (1982).
38. H. Senda and J. Maruha, *Acta Crystallogr.*, **C43**, 347 (1987).
39. C. H. Schwalbe, G. J. B. Williams and T. F. Koetzle, *Acta Crystallogr.*, **C43**, 2191 (1987).
40. C. H. Schwalbe and G. J. B. Williams, *Acta Crystallogr.*, **B38**, 1840 (1982).
41. S. K. Vohra, G. W. Harrington, D. E. Zacharias and D. Swern, *J. Org. Chem.*, **44**, 1128 (1979).
42. J. N. Varghese, A. M. O'Connell and E. N. Maslen, *Acta Crystallogr.*, **B33**, 2102 (1977).
43. C. Krieger, H. Fischer and F. A. Neugebauer, *Acta Crystallogr.*, **C43**, 1320 (1987).
44. S. Nordenson and J. Hvosllef, *Acta Crystallogr.*, **B37**, 373 (1981).
45. S. Rice, M. Y. Cheng, R. E. Cramer, M. Mandel, H. F. Mower and K. Seff, *J. Am. Chem. Soc.*, **106**, 239 (1984).
46. K. Prout, J. Fail, S. Hernandez-Cassou and F. Ming Miao, *Acta Crystallogr.*, **B38**, 2176 (1982).
47. K. Yamaguchi, G. Matsumura, M. Tanno, S. Sueyoshi and N. Miyata, *Acta Crystallogr.*, **C48**, 1051 (1992).
48. H. W. Smith, A. Camerman and N. Camerman, *J. Med. Chem.*, **21**, 468 (1978).
49. Y. Kai, P. Knochel, S. Kwiatkowski, J. D. Dunitz, J. F. M. Oth, D. Seebach and H. O. Kalinowski, *Helv. Chim. Acta*, **65**, 137 (1982).

50. F. Ming Miao, D. Chantry, T. Harper and D. Crowfoot Hodgkin, *Acta Crystallogr.*, **B38**, 3152 (1982).
51. G. Gilli, V. Bertolasi and A. C. Veronese, *Acta Crystallogr.*, **B39**, 450 (1983).
52. M. Pickering, J. Rylance, R. W. Small and D. Stubley, *Acta Crystallogr.*, **B47**, 782 (1991).
53. R. L. Willer, C. K. Lowe-Ma, D. W. Moore and L. F. Johnson, *J. Org. Chem.*, **49**, 1481 (1984).
54. K. Prout, P. Lowe and F. Ming Miao, *Cryst. Struct. Commun.*, **11**, 147 (1982).
55. H. J. Talberg, *Acta Chem. Scand.*, **33**, 289 (1979).
56. N. N. Dhaneshwar, S. N. Naik and S. S. Tavale, *Acta Crystallogr.*, **C47**, 217 (1991).
57. A. Banerjee, C. J. Brown and J. F. Lewis, *Acta Crystallogr.*, **B38**, 2744 (1982).
58. J. Kopf and G. Klar, *Cryst. Struct. Commun.*, **8**, 591 (1979).
59. K. Sekido, K. Okamoto and S. Hirokawa, *Acta Crystallogr.*, **C41**, 741 (1985).
60. K. Baum, T. G. Archibald, D. Tzeng, R. Gilardi, J.L. Flippen-Anderson and C. George, *J. Org. Chem.*, **56**, 537 (1991).
61. K. Baum, S. S. Bigelow, N. V. Nguyen, T. G. Archibald, R. Gilardi, J. L. Flippen-Anderson and C. George, *J. Org. Chem.*, **57**, 235 (1992).
62. H. E. Marr III, G. J. Kruger and J. M. Stewart, *Acta Crystallogr.*, **B33**, 2886 (1977).
63. D. S. Sake Gowda and R. Rudman, *J. Chem. Phys.*, **77**, 4666 (1982).
64. S. Y. Lee, L. L. Koh, Y. L. Lam and H. H. Huang, *Bull. Chem. Soc. Jpn.*, **65**, 489 (1992).
65. C. Dickinson and J. R. Holden, *Acta Crystallogr.*, **B35**, 487 (1979).
66. M. B. Hursthouse, R. L. Short, T. A. Ainscow, J. L. Henshall, R. M. Hooper and M. R. Belmont, *Acta Crystallogr.*, **C44**, 689 (1988).
67. Y. L. Lam, H. H. Huang and T. W. Hambley, *J. Chem. Soc., Perkin Trans. 2*, 2039 (1990).
68. T. W. Panunto, Z. Urbanczyk-Lipkowska, R. Johnson and M. C. Etter, *J. Am. Chem. Soc.*, **109**, 7786 (1987).
69. J. Maurin and T. M. Krygowski, *J. Mol. Struct.*, **172**, 413 (1988).
70. G. Ploug-Sørensen and E. Krogh Andersen, *Acta Crystallogr.*, **C42**, 1813 (1986).
71. S. Mehdi, *Acta Crystallogr.*, **C48**, 749 (1992).
72. S. Kumakura and Y. Kuroishi, *Bull. Chem. Soc. Jpn.*, **56**, 1541 (1983).
73. G. M. Frankenbach, D. Britton and M. C. Etter, *Acta Crystallogr.*, **C47**, 553 (1991).
74. P. G. Jones, A. Dolle, A. J. Kirby and J. K. Parker, *Acta Crystallogr.*, **C45**, 234 (1989).
75. M. L. Glowka and I. Iwanicka, *Acta Crystallogr.*, **C46**, 1342 (1990).
76. F. H. Herbstein and M. Kapon, *Acta Crystallogr.*, **B46**, 567 (1990).
77. F. Di Renzo, A. Domenicano and L. Riva di Sanseverino, *Acta Crystallogr.*, **B36**, 586 (1980).
78. A. Wilkins and R. W. H. Small, *Acta Crystallogr.*, **C41**, 1509 (1985).
79. P. Sgarabotto, M. Braghetti, R. S. Cataliotti, G. Paliani, S. Sorriso, V. Caia and S. Santini, *Can. J. Chem.*, **65**, 2122 (1987).
80. P. G. Jones, G. M. Sheldrick, R. Glenn and A. J. Kirby, *Z. Kristallogr.*, **163**, 85 (1983).
81. S. Sharma, N. Weiden and A. Weiss, *J. Chem. Phys.*, **90**, 483 (1989).
82. A. Wilkins and R. W. H. Small, *Acta Crystallogr.*, **C47**, 220 (1991).
83. M. Kubota and S. Ohba, *Acta Crystallogr.*, **B48**, 849 (1992).
84. P. G. Jones, G. M. Sheldrick, A. J. Kirby and A. J. Briggs, *Acta Crystallogr.*, **C41**, 1377 (1985).
85. S. J. Grabowski and T. M. Krygowski, *Acta Crystallogr.*, **C41**, 1224 (1985).
86. J. A. Kanters, J. Kroon, R. Hoofit, A. Schouten, J. A. M. van Schijndel and J. Brandsen, *Croat. Chem. Acta*, **64**, 353 (1991).
87. I. K. Larsen, *Acta Crystallogr.*, **C40**, 285 (1984).
88. I. Ségalas, J. Poitras and A. L. Beauchamp, *Acta Crystallogr.*, **C48**, 295 (1992).
89. A. Kálmán, F. van Meurs and J. Tóth, *Cryst. Struct. Commun.*, **9**, 709 (1980).
90. G. Evrard, F. Durant, A. Michel, J. C. Fripiat, J. L. Closset and A. Copin, *Bull. Soc. Chim. Belg.*, **93**, 233 (1984).
91. G. Bocelli and C. Rizzoli, *Acta Crystallogr.*, **C45**, 1180 (1989).
92. A. Mugnoli, D. Spinelli, G. Consiglio and R. Noto, *J. Heterocycl. Chem.*, **25**, 177 (1988).
93. A. Mugnoli, M. Novi, G. Guanti and C. Dell'Erba, *Cryst. Struct. Commun.*, **7**, 703 (1978).
94. M. R. Grimmett, S. -T. Hua, K. -C. Chang, S. A. Foley and J. Simpson, *Aust. J. Chem.*, **42**, 1281 (1989).
95. H. L. Ammon, *Acta Crystallogr.*, **C47**, 2252 (1991).

## CHAPTER 3

# Chiroptical properties of amino compounds

HOWARD E. SMITH

*Department of Chemistry, Vanderbilt University, Nashville, Tennessee 37235, USA*  
*Fax: 00 615 322 4936*

---

I. INTRODUCTION	106
II. ASYMMETRIC SYNTHESIS	107
A. Synthesis Using Enzymes	107
B. Reduction of Ketoximes and Ketoxime Ethers with Chiral Metal Hydride Reagents	109
C. Reduction of Imines with Chiral Metal Hydride Reagents	112
D. Reduction of Imines with Hydrogen in the Presence of a Chiral Titanium Hydride Complex	114
E. Amination of Alkenes with Chiral Borohydride Reagents	117
F. Aziridination of Alkenes with Chiral Diimine-based Catalysts	119
G. Kinetic Resolution Using a Modified Sharpless Reagent	120
III. ESTIMATION OF ENANTIOMERIC EXCESS	121
A. Quantitative Aspects	121
B. Chromatography Using Chiral Stationary Phases	121
C. Nuclear Magnetic Resonance Methods	124
IV. ELECTRONIC CIRCULAR DICHROISM (ECD)	130
A. Amino Chromophore	130
B. Effect of the Amino Group on the Benzene Chromophore	133
1. Benzene sector rule	133
2. Benzene chirality rule	135
C. Chromophoric Derivatives	137
1. <i>N</i> -Salicylidene derivatives and the salicylidenamino chirality rule	137
2. Exciton coupled circular dichroism (ECCD) spectra	139
a. <i>N</i> -Benzylidene derivatives	139
b. <i>N</i> -Benzoyl derivatives	142
D. <i>N</i> -Nitrosamines	143

V. VIBRATIONAL OPTICAL ACTIVITY (VOA) .....	146
A. Vibrational Circular Dichroism (VCD) .....	146
B. Raman Optical Activity (ROA) .....	150
VI. REFERENCES .....	153

---

## I. INTRODUCTION

In the introduction to the earlier review in 1982, 'Chiroptical Properties of Amino, Nitroso and Nitro Compounds'<sup>1</sup>, for which this chapter is a supplement, a brief sketch was given of the historical developments which caused the rotation for sodium D light (589 nm) to be the chiroptical property most frequently reported for chiral substances. Useful compilations of this chiroptical property for natural products, including  $\alpha$ -amino acids<sup>2</sup>, alkaloids<sup>3</sup> and amino sugars<sup>4</sup>, are available, and the absolute configurations of a host of chiral substances, including chiral amino, nitroso and nitro compounds, are presented in two collections<sup>5,6</sup>. In the one which has been recently updated<sup>5</sup>, the absolute configurations of approximately 9000 compounds, the method by which each configurational assignment was made, the sign of the rotatory power for a particular enantiomer and the appropriate literature reference are given. In the other<sup>6</sup>, the absolute configurations, the sign of the rotatory power for a given state (liquids or as solutions in various solvents) and literature references are tabulated for 6000 compounds, each compound having only one chiral center (asymmetric carbon atom). Even using these large compilations of rotatory powers, rotatory power comparisons for the establishment of absolute configuration are not as reliable a tool as optical rotatory dispersion<sup>7</sup> (ORD) and circular dichroism<sup>8</sup> (CD) measurements. Using rotatory power data, however, Brewster<sup>9</sup> developed a set of rules which can be used to relate the rotatory power of chiral substances to their absolute configurations, and these rules are sometimes used when other methods of configurational assignment cannot be easily utilized.

The focus of the earlier chapter was a brief outline of the sources of chiral amino compounds, application of Brewster's rules for the assignment of the absolute configurations to a few chiral amines, a discussion of the ORD and CD in the visible (380–780 nm) and near-ultraviolet (200–380 nm) spectral regions of chiral amino compounds and some of their derivatives, and how the observed Cotton effects (CEs) in their ORD curves and CD spectra relate to their conformational preferences and absolute configurations.

At that time, as now, the enantiomers of many chiral amines were obtained as natural products or by synthesis from naturally occurring amines,  $\alpha$ -amino acids and alkaloids, while others were only prepared by introduction of an amino group by appropriate reactions into substances from the chiral pool: carbohydrates, hydroxy acids, terpenes and alkaloids. In this connection, a recent review<sup>10</sup> outlines the preparation of chiral aziridines from enantiomerically pure starting materials from natural or synthetic sources and the use of these aziridines in stereoselective transformations. Another report<sup>11</sup> gives the use of the enantiomers of the  $\alpha$ -amino acid esters for the asymmetric synthesis of nitrogen heterocyclic compounds.

In synthetic operations, when a symmetrical (achiral) substrate is used, the product is racemic. Diastereomers are separated by physical methods, and the enantiomers of racemic amines are frequently obtained by fractional crystallization of diastereomeric salts formed with chiral acids. Although resolution of racemic amines by fractional crystallization of enantiomeric salts is still an important technique<sup>12</sup> and the laboratory scale resolutions of many racemic amines have been reported<sup>13</sup>, the separation of the enantiomers of chiral amines by chromatography<sup>14–16</sup> and their preparation by asymmetric synthesis using enzymes<sup>17</sup> and other asymmetric catalysts<sup>18</sup> have had extensive development during the

last decade. These methods are now discussed as important sources of the enantiomers of chiral amines together with recently developed methods for the establishment of enantiomeric excess (ee).

These developments are to be viewed in the light of a trend for the pharmaceutical industry to develop single enantiomeric drugs in the quest for safer, more potent and selective products<sup>19-21</sup>. However, a more significant factor contributing to the movement toward single enantiomeric drugs is the stance taken by the US FDA (Food and Drug Administration) which in 1992 announced<sup>22</sup> the availability of a policy statement, 'FDA's Policy Statement for the Development of New Stereoisomeric Drugs', in connection with the introduction of new drugs. Although the FDA will continue to approve racemates on a case by case basis, companies will be required to demonstrate in their submission documents that the racemic mixture is safe by conducting studies on the individual enantiomers.

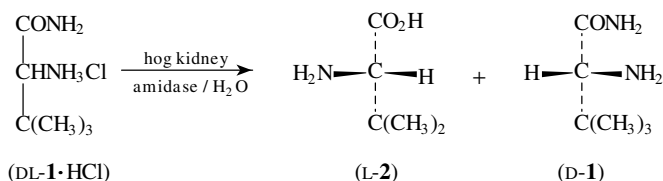
In addition to a review of the recent developments in the preparation of chiral amino compounds, developments concerning the interpretation of their ORD and CD in the visible and ultraviolet spectral regions will be reviewed, together with the emerging impact of vibrational (infrared) optical activity (VOA) observations, including vibrational circular dichroism (VCD) and Raman optical activity (ROA) measurements<sup>23</sup>, on important stereochemical problems concerning chiral amino compounds.

Extensive developments in the preparation of the enantiomers of chiral nitroso and nitro compounds have not appeared since the earlier review<sup>1</sup>, and thus no additional discussion of the sources of nitroso and nitro compounds is made in this supplement. However, because of the continuing interest in carcinogenic properties of *N*-nitrosamines and related compounds<sup>24</sup>, there has been a number of reports concerning the ECD and VCD of such compounds, and the ECD and VCD of nitrosamines are discussed as derivatives of chiral amines.

## II. ASYMMETRIC SYNTHESIS

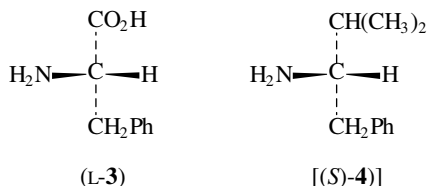
### A. Synthesis Using Enzymes

The oldest form of asymmetric synthesis utilized enzymes as catalysts, and very early, enzyme catalysts were applied to the solution of problems associated with the optical resolution of  $\alpha$ -amino acids and their derivatives, to the subsequent estimation of the optical purity of the isomers so obtained and to the determination of the absolute configurations of specific amino acids<sup>25</sup>. An example of the usefulness of enzymes for the preparation of pure enantiomers of  $\alpha$ -amino acids is the stereoselective hydrolysis of synthetic racemic *tert*-leucinamide hydrochloride (DL-1·HCl) in water using hog kidney amidase giving *L*-*tert*-leucine (L-2) and leaving D-1 unchanged<sup>26</sup>. Although this particular enzymic reaction was done to correlate the absolute configurations of the respective enantiomers of **2** with their rotatory powers, the synthesis gave pure samples of D-1 and L-2 in gram quantities. Similar reactions using a commercially available amidase yielding the *L*- $\alpha$ -amino acids and the *D*- $\alpha$ -amino amides of a number of  $\alpha$ -amino acids can be followed by synthetic operations which convert the respective enantiomers to the chiral primary amines. Such a sequence of reactions has been reported by which *L*-phenylalanine (L-3) was converted to

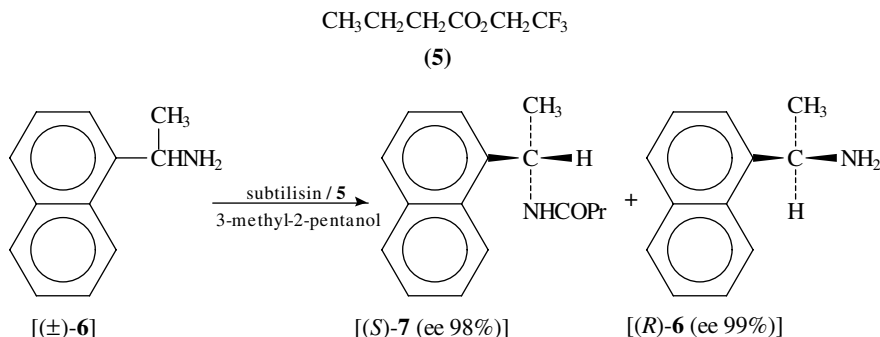




(*S*)-2-amino-3-methyl-1-phenylbutane [(*S*)-**4**], the carboxyl group becoming an isopropyl group<sup>27</sup>. The use of  $\alpha$ -amino acids and other reagents can afford either enantiomer of a variety of chiral primary amines.

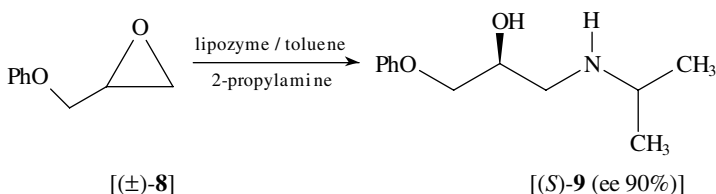


It is to be noted that in recent years, reviews have extolled the virtues of biocatalysts<sup>28</sup>, but only a few examples have appeared of the utilization of enzymes as catalysts for the direct formation of the enantiomers of chiral amines in which the amino group is not vicinal to a carboxyl group. One report outlines the resolution of a number of chiral amines by the enzymatic acylation of the amine with trifluoroethyl *n*-butyrate (**5**) in 3-methyl-3-pentanol, catalyzed by the commercially available enzyme, subtilisin Carlsberg, a protease from *Bacillus licheniformis*<sup>29</sup>. For reaction with racemic  $\alpha$ -(1-naphthyl)ethylamine [( $\pm$ )-**6**] with **5** in the presence of subtilisin as the biocatalyst, *N*-[(*S*)]- $\alpha$ -(1-naphthyl)ethyl]butyramide [(*S*)-**7**] was obtained with an ee of 98%. In another experiment with a different set of isolation conditions, the unreacted amine, (*R*)- $\alpha$ -(1-naphthyl)ethylamine [(*R*)-**6**], was isolated with an ee of 99%. For the other nine different racemic amines used, the acylation had the same degree of enantioselectivity, and the amide formed had the same generic configuration as (*S*)-**7**. It should be noted that the degree of stereoselectivity for the reaction is extremely sensitive to the solvent used, and no enantioselectivity was observed when toluene, octane or cyclohexane was the solvent<sup>29</sup>.

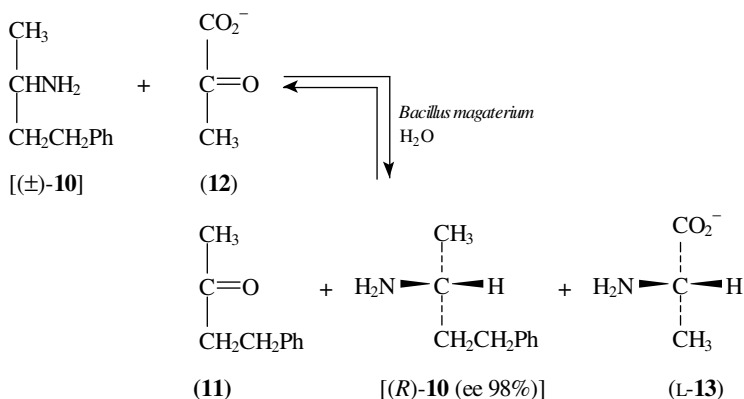


A similar enzyme-catalyzed stereoselective synthesis of enantiomers of propanolamines has been recently reported<sup>30</sup>. Addition of a lipozyme from the fungus *Mucor miehei* to the epoxide ( $\pm$ )-**8** in toluene and then a slightly more than one half molar equivalent of 2-propylamine gave a 29% conversion of ( $\pm$ )-**8** to (*S*)-**9** with an ee of 90%. For some benzene ring-substituted epoxides, both the percent conversion of the epoxide and the ee of product are slightly higher<sup>30</sup>.

Another general method for the preparation of chiral primary amines, which may be less convenient than that using subtilisin Carlsberg, utilizes a microorganism, *Bacillus megaterium*, *Pseudomonas aeruginosa* or *Pseudomonas putida*, grown in such a way that it produces an  $\omega$ -amino acid transaminase<sup>31</sup>. An  $\omega$ -amino acid transaminase is one

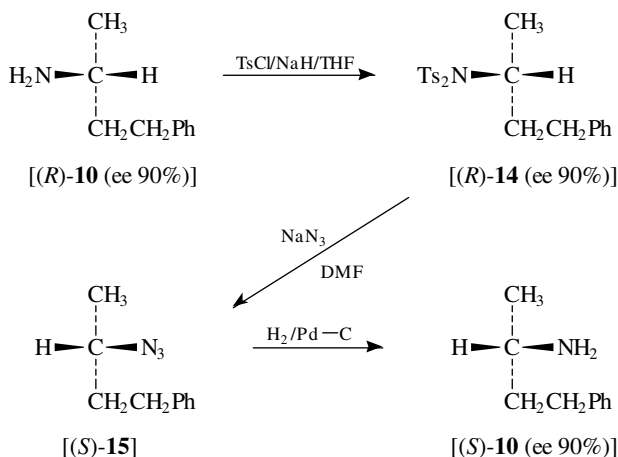


which exhibits the property of converting the terminal  $-\text{CH}_2-\text{NH}_2$  group of an  $\omega$ -amino acid to a  $-\text{CH}=\text{O}$  group. Thus (*S*)-1-phenyl-3-aminobutane [(*S*)-**10**] was deaminated in a racemic mixture ( $\pm$ )-**10** in water in the presence of an  $\omega$ -amino acid transaminase preparation from *Bacillus megaterium*, leaving a 60% yield of (*R*)-**10** with an ee 98% and 4-phenyl-2-butanone (**11**). Pyruvate anion (**12**) was the amino group acceptor and was converted to L-alaninate anion (L-**13**). As shown, the reaction is completely reversible and, using different reaction conditions and product isolation procedures, a ketone such as **11** can be converted to (*S*)-**10** with the same enzyme and an amino group donor such as L-alanine (L-**13**). As an alternate to the formation of the enantiomer of (*R*)-**10**, its chiral center may be inverted by conversion to the *N,N*-di-(*p*-toluenesulfonyl)imide [(*R*)-**14**], displacement in dimethylformamide (DMF) of the di(toluenesulfonyl)imide group with azide ion in an  $\text{S}_{\text{N}}2$  reaction and then reduction of the resulting azide [(*S*)-**15**] with hydrogen over palladium on carbon<sup>32</sup>. In the reaction shown, the ee of (*S*)-**10** was found to be the same as that of (*R*)-**14**, since the reaction of (*R*)-**14** with azide ion goes by way of complete inversion of the configuration at the chiral center in (*R*)-**14**<sup>32</sup>. The enzymic reaction utilizing an  $\omega$ -amino acid transaminase is also very general, and an extremely large number of different groups may be attached to the secondary carbon atom to which the amino group is attached. Among these may be alkyl and aryl groups and phenyl groups with a halo, hydroxyl or alkoxy substituent<sup>31</sup>.

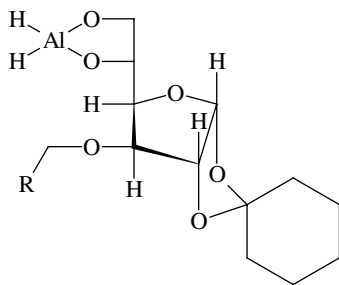


## B. Reduction of Ketoximes and Ketoxime Ethers with Chiral Metal Hydride Reagents

An early approach to the formation of chiral amines by nonenzymatic asymmetric synthesis was the reduction of prochiral ketoximes and their *O*-tetrahydropyranyl and *O*-methyl derivatives with lithium aluminum hydride-3-*O*-benzyl-1,2-*O,O*-cyclohexylidene- $\alpha$ -D-glucofuranose complex (**16**)<sup>33</sup> in ether and prochiral ketoximes

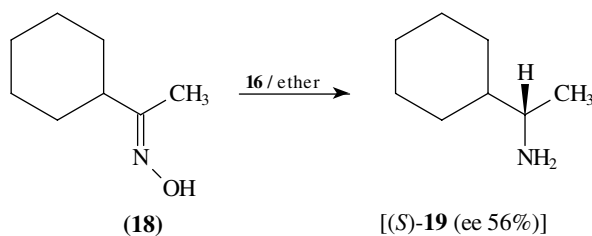


with lithium aluminum hydride-3-*O*-cyclohexylmethyl-1,2-*O*,*O*-cyclohexylidene- $\alpha$ -*D*-glucofuranose complex (**17**)<sup>34</sup> in ether. Both aryl alkyl and dialkyl ketoximes and their *O*-tetrahydropyranyl and *O*-methyl derivatives were reduced, and afforded amines with the *S* configuration. Thus, reduction of cyclohexyl methyl ketoxime (**18**) with **16** gave (*S*)-1-cyclohexylethylamine [(*S*)-**19**] with an ee of 56%, the highest ee obtained using either **16** or **17**<sup>33,34</sup> but considered too low to be synthetically useful. The asymmetric reductions with **16** of ten prochiral ketoximes and their *O*-methyl and *O*-tetrahydropyranyl derivatives gave amines with the known *S* configuration. Three additional amines for which the absolute configurations had not been established earlier were, on the basis of a similar enantioselectivity for the reduction, assigned the *S* configuration<sup>33</sup>. For reduction with the lithium aluminum hydride glucofuranose complex **17**, the degree of asymmetric synthesis was improved as compared to the reduction with **16**, but the enantioselectivity was the same<sup>34</sup>. When the reduction was done with either **16** or **17** in the presence of a small amount of ethanol, the complex was modified by the addition of ethanol, and the reductions gave the amines with the *R* configuration<sup>33,34</sup>, a stereochemical outcome consistent with the proposed transition state for the reaction of methyl phenyl ketone with **16** to yield (*S*)- $\alpha$ -phenylethyl alcohol<sup>35</sup>.

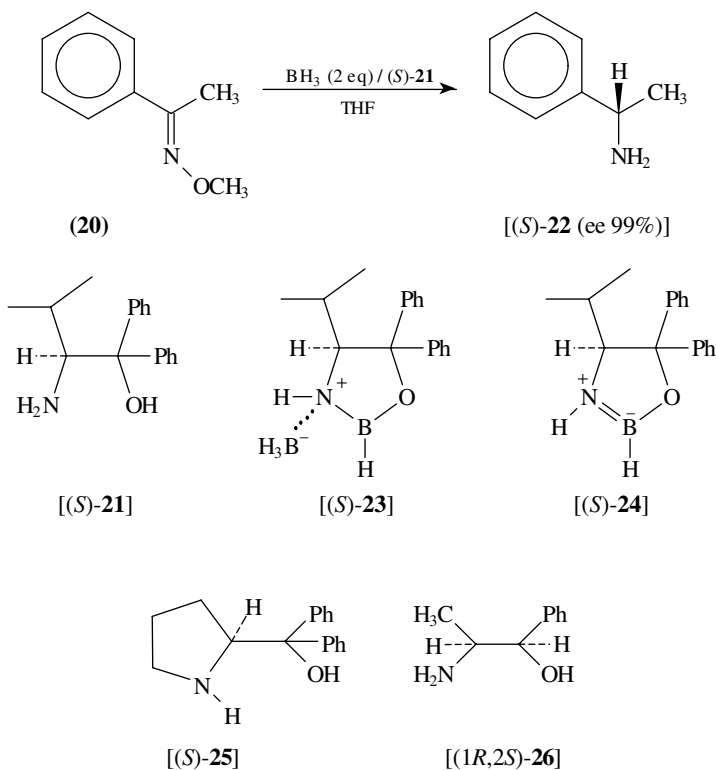


(**16**) R = C<sub>6</sub>H<sub>5</sub>  
 (**17**) R = *c*-C<sub>6</sub>H<sub>11</sub>

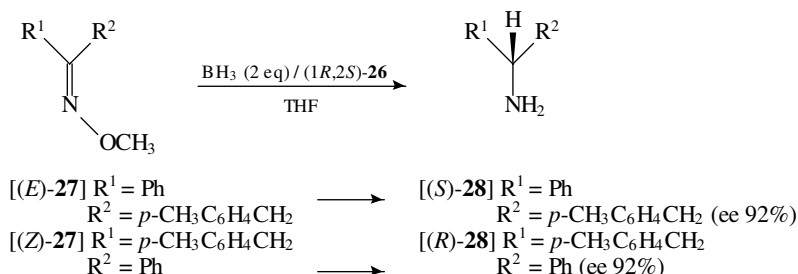
Substantially higher enantioselectivities were achieved by reduction of the *O*-alkyl derivatives of prochiral ketoximes with borane (BH<sub>3</sub>) and chiral auxiliaries prepared



from  $\alpha$ -amino acids<sup>36</sup>. Thus, treatment of the acetophenone *O*-methyloxime (**20**) with a twofold excess of borane (BH<sub>3</sub>) in tetrahydrofuran (THF) and an equivalent amount of the chiral auxiliary (*S*)-2-amino-3-methyl-1,1-diphenylbutanol [(*S*)-**21**] gave (*S*)- $\alpha$ -phenylethylamine [(*S*)-**22**] after isolation with an ee of 99%, the chiral auxiliary (*S*)-**21** prepared from L-valine<sup>36</sup>. Reduction of the corresponding ketoxime of **20** with borane in the presence of chiral auxiliary (*S*)-**21** gave (*S*)-**22** with an ee of only 0.6%<sup>36</sup>. In reactions using (*S*)-**21** and borane in THF for the reduction of prochiral ketones, the active reducing agent was shown to have the structure and configuration (*S*)-**23**<sup>37</sup>, formed by the addition of borane to the oxazaborolidine (*S*)-**24**. For the reduction of prochiral ketones to carbinols, however, a better chiral auxiliary is (*S*)-2-(diphenylhydroxymethyl)-pyrrolidine [(*S*)-**25**], synthesized directly by reaction of *N*-(benzyloxycarbonyl)-L-proline methyl ester with phenylmagnesium chloride in THF<sup>37</sup>. The chiral auxiliary (*S*)-**25** has not been used for the reduction of ketoximes or ketoxime ethers.



Ring-substituted acetophenone *O*-methyloximes were reduced to the corresponding ring-substituted analogues of (*S*)- $\alpha$ -phenylethylamines [(*S*)-**22**] with ee values of 71–87%<sup>38</sup> using the chiral auxiliary (*S*)-**21** and borane in THF. This configuration is the same generic configuration as that found on reduction of the *E* (*anti*) isomer of ketoxime ethers with borane in the presence of the chiral auxiliary (–)-norephedrine [(1*R*,2*S*)-2-amino-1-phenyl-1-propanol; (1*R*,2*S*)-**26**]<sup>39</sup>. Thus, reduction of the *O*-methyl derivative of (*E*)-phenyl *p*-tolylmethyl ketoxime [(*E*)-**27**] with borane in THF and the chiral auxiliary (1*R*,2*S*)-**26** gave a 64% yield of (*S*)-1-phenyl-2-(*p*-tolyl)ethylamine [(*S*)-**28**] with an ee of 92%. Reduction of the *Z* (*syn*) isomer [(*Z*)-**27**] gave a similar yield of (*R*)-**28** also with an ee of 92%. This inverse enantioselectivity between the *anti* and *syn* isomers was also observed with other aryl and alkyl ketoxime ethers. The orientation and extent of the asymmetric induction was found to be independent of the bulkiness of the ether group on the nitrogen atom and, as shown in the reaction below, attack of the B–H moiety took place from the *Re*(C)–*si*(N) face of (*E*)-**27** and the *Si*(C)–*si*(N) face of (*Z*)-**27**. The *si*(N) face selection in each case shows that the stereochemistry of the oxime moiety is responsible for the stereoselectivity. Presumably, the stereochemical outcome in the reduction of acetophenone *O*-methyloxime (**20**) to (*S*)- $\alpha$ -phenylethylamine [(*S*)-**22**] is the result of **20** existing predominantly in the *E* configuration.

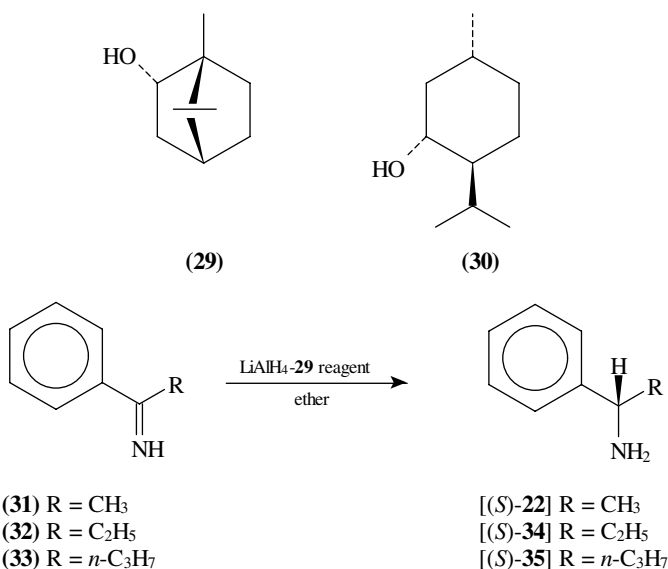


In the asymmetric reduction of ketones, stereodifferentiation has been explained in terms of the steric recognition of two substituents on the prochiral carbon by chirally modified reducing agents<sup>40</sup>. Enantiomeric excesses for the reduction of dialkyl ketones, therefore, are low because of the little differences in the bulkiness of the two alkyl groups<sup>40</sup>. In the reduction of ketoxime ethers, however, the prochiral carbon atom does not play a central role for the stereoselectivity, and dialkyl ketoxime ethers are reduced in the same enantiomeric excess as are aryl alkyl ketoxime ethers. Reduction of the oxime benzyl ethers of (*E*)- and (*Z*)-2-octanone with borane in THF and the chiral auxiliary (1*R*,2*S*)-**26** gave (*S*)- and (*R*)-2-aminooctane in 80 and 79% ee, respectively<sup>39</sup>.

### C. Reduction of Imines with Chiral Metal Hydride Reagents

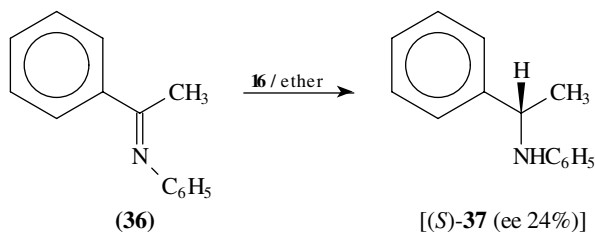
Another early attempt to prepare enantiomers of chiral amines by a nonenzymatic asymmetric synthesis was the reduction of alkyl aryl ketimines and diaryl ketimines using chiral alkoxy aluminum hydrides, these reducing agents prepared *in situ* by partial decomposition in ether of lithium aluminum hydride with (+)-borneol (**29**), (–)-menthol (**30**) or (–)-quinine<sup>41</sup>. Thus reduction of the aryl alkyl ketimines **31–33** with the lithium aluminum hydride-(+)-borneol (LiAlH<sub>4</sub>-**29**) reagent gave the levorotatory enantiomers of the  $\alpha$ -phenylalkylamines (**22**, **34** and **35**) in very low enantiomeric excess. The absolute configuration of (–)-**22** had been previously established as *S* and, in analogy, the levorotatory isomers of **34** and **35** were also assigned the *S* absolute configuration. These

configurational assignments have subsequently been confirmed<sup>5</sup>. When the lithium aluminum hydride-(*-*)-menthol ( $\text{LiAlH}_4$ -**30**) reagent was used, the dextrorotatory amines were obtained, also in low enantiomeric excess, the opposite stereoselectivity for the reducing agents being the result of the opposite configurations, *S* and *R*, respectively, for the stereogenic center to which the hydroxyl group is attached in the two alcohols, **29** and **30**, from which the reducing reagents were prepared<sup>41</sup>. When  $\alpha$ -naphthyl phenyl and phenyl *o*-tolyl ketimines were reduced with the  $\text{LiAlH}_4$ -**29** and  $\text{LiAlH}_4$ -**30** reagents, the levorotatory and dextrorotatory isomers, respectively, of the corresponding chiral amines were obtained in low enantiomeric excess, but any conclusions as to the absolute configurations of those amines formed in enantiomeric excess could not be drawn. Reduction of 2,4,6-trimethylphenyl phenyl ketimine with either reagent gave the corresponding racemic amine<sup>41</sup>.

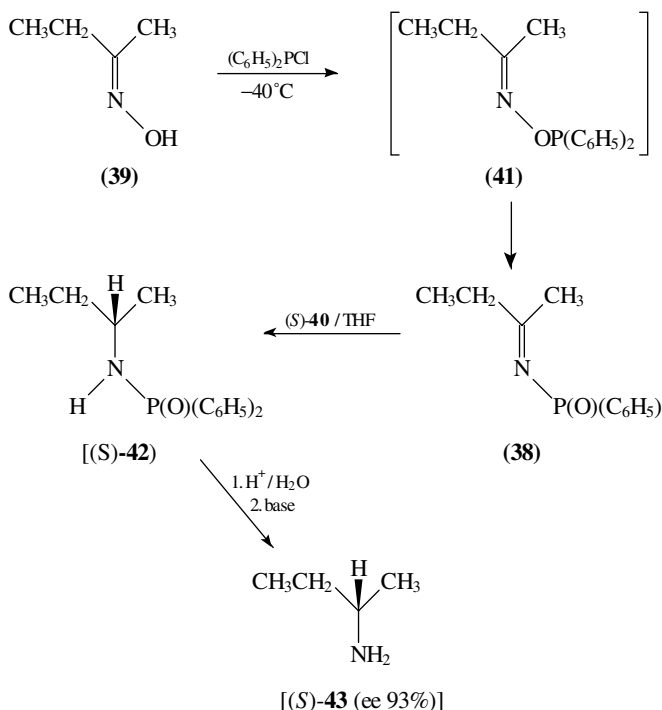


Similar to the reduction of prochiral ketoximes and their *O*-substituted derivatives<sup>33</sup>, the reduction of *N*-(1-phenylethylidene)aniline (**36**) with a lithium aluminum hydride-3-*O*-benzyl-1,2-*O*,*O*-cyclohexylidene- $\alpha$ -D-glucofuranose complex (**16**) gave (*S*)-*N*-phenyl- $\alpha$ -phenylethylamine [(*S*)-**37**] in a rather low enantiomeric excess (24%)<sup>42</sup>. As in the reduction of ketoximes and ketoxime ethers with this same chiral reagent, the reduction of other *N*-(1-phenylalkylidene)anilines gave the corresponding chiral amines with enantiomeric excesses too low for practical utility. The reaction, however, was used as a means for the assignment of the *S* absolute configuration to the levorotatory enantiomers of the *N*-phenyl- $\alpha$ -phenyl-*n*-propylamine and *N*-phenyl- $\alpha$ -phenylisopropylamine analogues of (*S*)-**37**<sup>42</sup>. There is no report of the reduction of prochiral ketimines or *N*-alkyl or *N*-phenyl ketimines with borane in THF in the presence of chiral auxiliaries (*S*)-**21**, (*S*)-**25** or (1*R*,2*S*)-**26**.

In an attempt to prepare alkylamines by asymmetric reduction of imines with chiral hydride reagents, diphenylphosphinyl imines (**38**), prepared by reaction of ketoximes (**39**) with chlorodiphenylphosphine [ $(\text{C}_6\text{H}_5)_2\text{PCl}$ ], were reduced in the presence of a variety of chiral aluminum and boron hydride reagents<sup>43</sup>. Among the most promising reagents was BINAHL-H<sup>44</sup> (**40**), a chiral hydride compound prepared by the modification of lithium

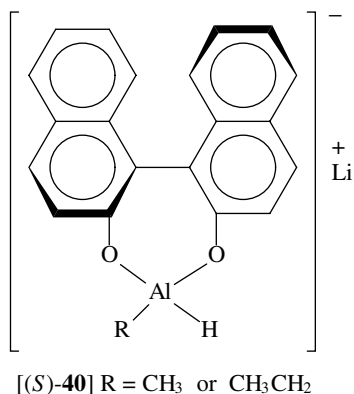


aluminum hydride with equimolar amounts of (*R*)- or (*S*)-1,1'-binaphth-2,2'-diol and a simple alcohol, usually methanol or ethanol. Also promising were the chiral hydride reagents (*2S,3R*)-4-dimethylamino-3-methyl-1,2-diphenyl-2-butanol/ $\text{LiAlH}_4$ <sup>45</sup> and 9-*O*-(1,2:5,6-di-*O*-isopropylidene- $\alpha$ -D-glucopyranosyl)-9-boratabicyclo[3.3.1]nonane<sup>46</sup>. Using (*S*)-**40**, the *N*-diphenylphosphinyl imine **38**, prepared from the corresponding ketoxime **39** via the intermediate **41**, was reduced to the (*S*)-*N*-(diphenylphosphinyl)amine **[(S)-42]** which on hydrolysis afforded (*S*)-2-aminobutane **[(S)-43]** in rather low yield (38%) but with an enantiomeric excess of 93%<sup>43</sup>.

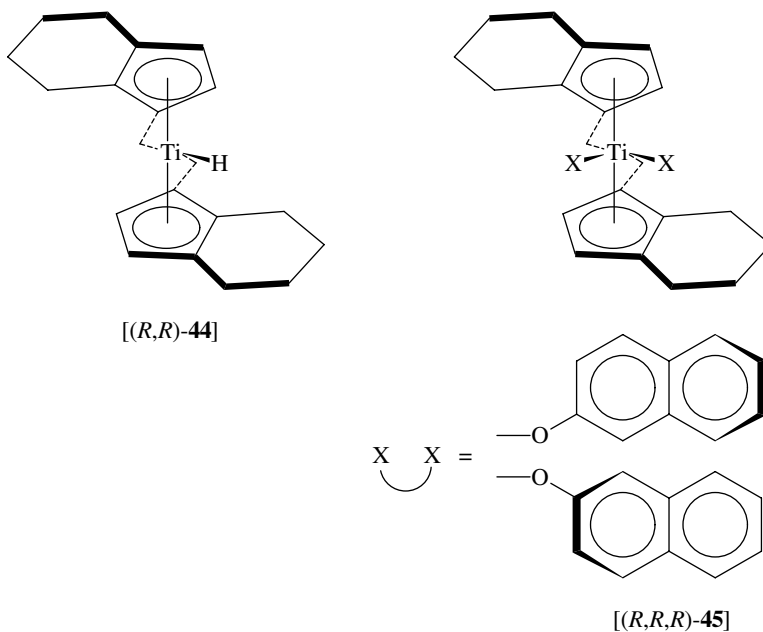


#### D. Reduction of Imines with Hydrogen in the Presence of a Chiral Titanium Hydride Complex

More recently, an important chiral titanium catalyst for the asymmetric reduction with hydrogen of *N*-substituted dialkyl ketimines to enantioenriched amines has been



developed which gives synthetic results comparable or superior to those reported using other metal catalysts<sup>47,48</sup>. The hydrogenation catalyst (*R,R*)-ethylene-1,2-bis( $\eta^5$ -4,5,6,7-tetrahydro-1-indenyl)titanium hydride [(*R,R*)-**44**] is generated *in situ* from the air-stable titanocene complex (*R,R*)-ethylene-1,2-bis( $\eta^5$ -4,5,6,7-tetrahydro-1-indenyl)titanium (*R*)-1,1'-binaphth-2,2'-diolate [(*R,R,R*)-**45**], prepared as described earlier<sup>49,50</sup> with a modification of workup<sup>51</sup>. The 1,1'-binaphth-2,2'-diolate derivative [(*R,R,R*)-**45**] serves as a precatalyst, and sequential treatment of (*R,R,R*)-**45** in THF with 2 equivalents of *n*-butyllithium and 2.5–3 equivalents of phenylsilane provide the active catalyst (*R,R*)-**44**. When the catalyst (*R,R*)-**44** is generated under a hydrogen atmosphere, no silane is required<sup>48</sup>. Thus the silane serves to stabilize the active catalyst during manipulation. The proposed catalytic cycle for reduction is given in Figure 1, (*R,R*)-(EBTHI)Ti–H





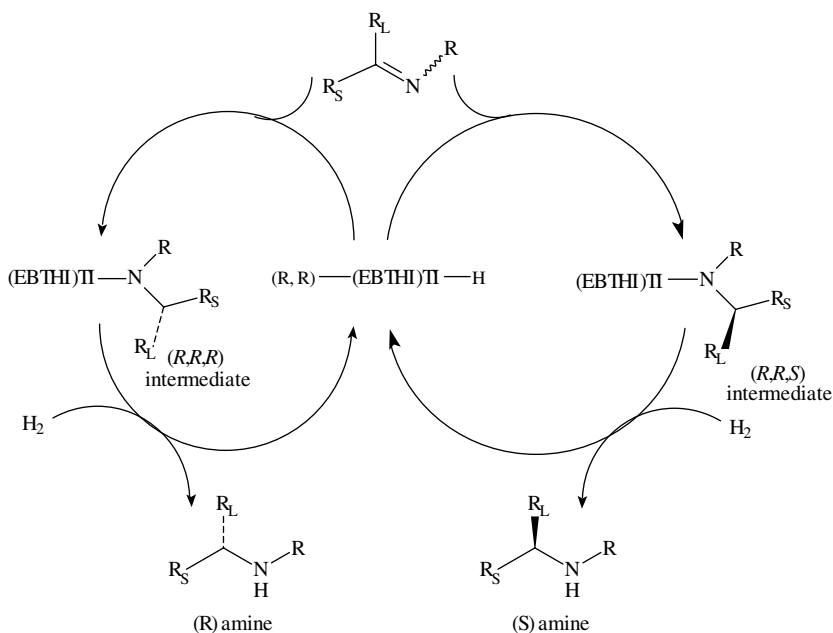
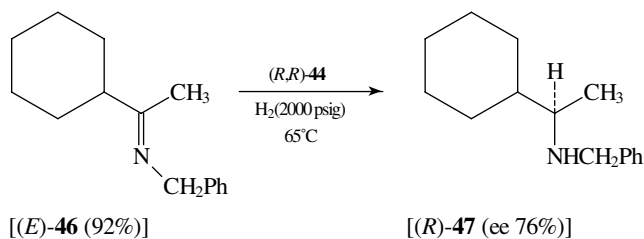


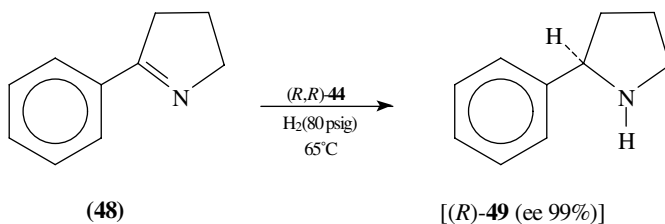
FIGURE 1. Scheme showing the reduction of the imine  $\text{R}_S\text{R}_L\text{C}=\text{N}-\text{R}$  with hydrogen using the chiral catalyst  $(R,R)$ -ethylene-1,2-bis( $\eta^5$ -4,5,6,7-tetrahydro-1-indenyl)titanium hydride [ $(R,R)$ -(EBTHI)Ti-H,  $(R,R)$ -**44**], prepared from the precatalyst  $(R,R)$ -ethylene-1,2-bis( $\eta^5$ -4,5,6,7-tetrahydro-1-indenyl)titanium  $(R)$ -1,1'-binaphthyl-2,2'-diolate [ $(R,R,R)$ -**45**]. Reprinted with permission from Reference 52. Copyright (1994) American Chemical Society

representing the active catalyst  $(R,R)$ -**44**<sup>52</sup>. The first step of the cycle is reaction of the titanium hydride with an imine to form two diastereomeric titanium amide complexes. The second step is hydrogenolysis of the intermediate amide complexes to regenerate the titanium hydride and to form the two amine enantiomers, the *syn* and *anti* imines reacting to give the amines with opposite absolute configurations. For the twelve acyclic ketimines studied<sup>51</sup>, the enantiomeric excesses of the products correlate roughly with the *anti/syn* ratio. For example, reduction with hydrogen at 2000 psig and 65 °C of *N*-(1-cyclohexylethylidene)benzylamine (**46**), with an *anti/syn* ratio of 11:1 (*E* 92%), gave  $(R)$ -*N*-benzyl-1-cyclohexylethylamine [ $(R)$ -**47**] with an enantiomeric excess of 76%<sup>51</sup>. High pressures of hydrogen are required to achieve a high degree of asymmetric synthesis. When the hydrogen pressure was reduced to 500 psig for the reduction of imine **46** at 65 °C, the ee of  $(R)$ -**41** was reduced to 43%<sup>51</sup>. The dependence of the ee values on



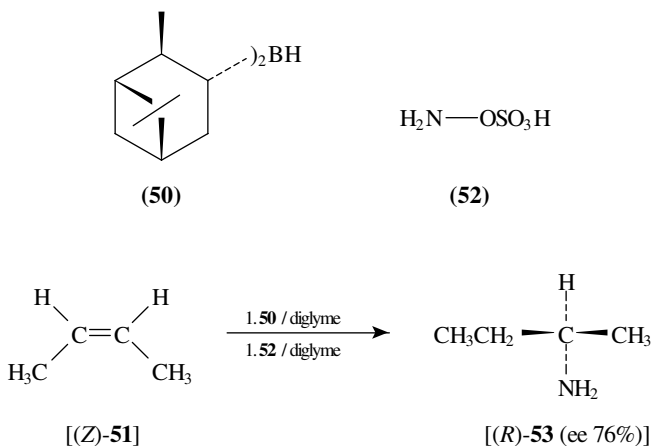
hydrogen pressure is explained on the basis of the interconversion of the *syn* and *anti* isomers of **46** during hydrogenation<sup>52</sup>. Since in general it is the *anti* isomer of acyclic ketimine which is the more stable, ketimines are generally converted to the amine with an excess of the *R* enantiomer, but even at 2000 psig of hydrogen with acyclic ketimines, the enantiomer excesses of the amines, except for *N*-methylamines, are below the level of practical utility.

The hydrogenation of eleven cyclic imines to corresponding cyclic amines, such as 2-phenyl-1-pyrroline (**48**) to (*R*)-2-phenylpyrrolidine [(*R*)-**49**] using (*R,R*)-**44** as catalyst, however, was found to occur with excellent degrees of asymmetric synthesis, and the enantiomeric excesses obtained with cyclic imines are virtually insensitive to changes in hydrogen pressure<sup>48</sup>. The reaction can be carried out at low pressure (80 psig) and higher temperature (65 °C) or at medium pressure (500 psig) and lower temperature (21–45 °C) with little or no change in the ee of the product, and five-, six- and seven-membered cyclic imines are reduced with excellent enantioselectivity<sup>48</sup>. Reduction of **48** at 500 psig and 21 °C and at 80 psig and 65 °C each gave (*R*)-**49** with the same enantiomeric excess<sup>48</sup>.

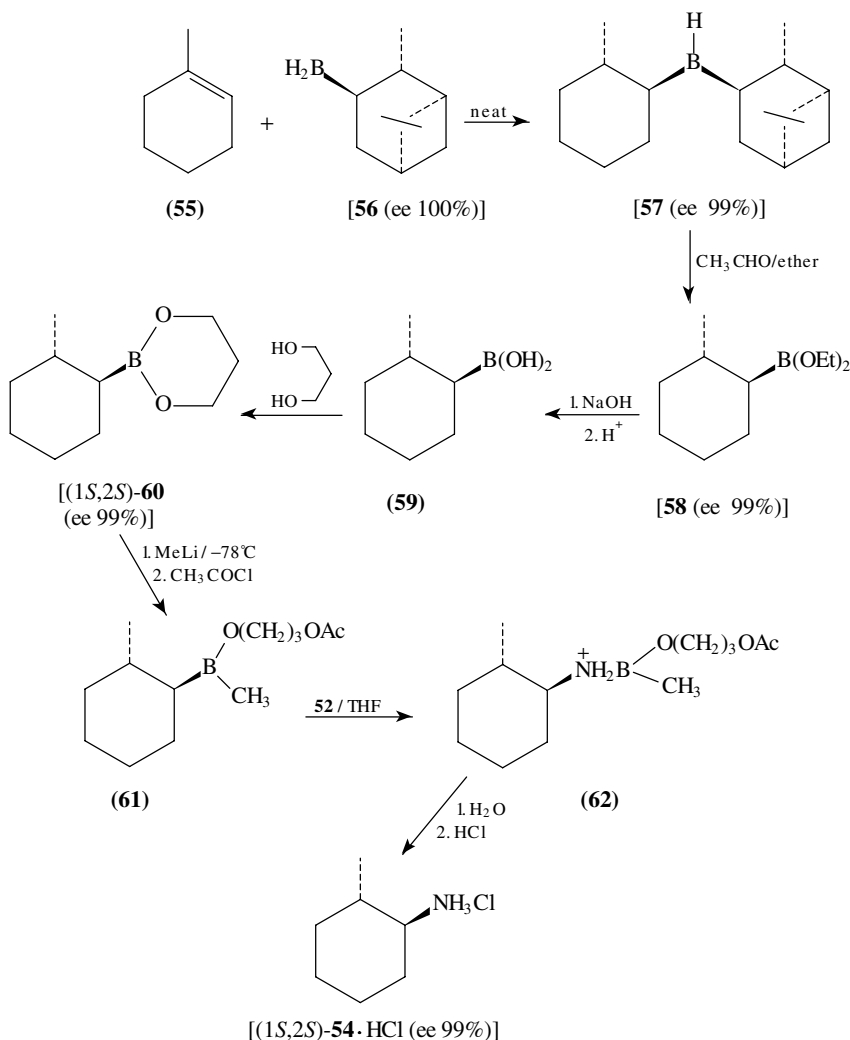


### E. Amination of Alkenes with Chiral Borohydride Reagents

The earliest use of a borohydride reagent for the enantioselective preparation of a chiral amine by amination of the corresponding alkene<sup>53</sup> employed diisopinocampheylborane (**50**) prepared from (+)- $\alpha$ -pinene<sup>54</sup>. Thus *cis*-2-butene [(*Z*)-**51**] was treated with **50** in diglyme to form an organoborane intermediate which, on treatment with hydroxylamine-*O*-sulphonic acid (**52**) in diglyme, gave (*R*)-2-aminobutane [(*R*)-**53**], which after correction for the low enantiomeric excess of the (+)- $\alpha$ -pinene (68%) used to form **50**, had an ee of 76%, but in rather low chemical yield (13%)<sup>53</sup>.



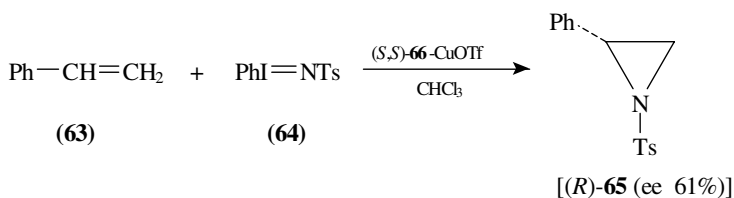
A similar reaction sequence was used to prepare a number of chiral primary amines utilizing the preferential migrating tendency of secondary alkyl groups as compared to primary groups in the reaction of organoboranes with hydroxylamine-*O*-sulphonic acid (**52**)<sup>55</sup>. An example of this rather long sequence is the preparation of (1*S*,2*S*)-*trans*-2-methylcyclohexylamine hydrochloride [(1*S*,2*S*)-**54**·HCl] from 1-methylcyclohexene (**55**) using isopinocampheylborane (**56**), prepared from (+)- $\alpha$ -pinene<sup>55</sup>. Reaction of **55** with the borane **56**, in a one-pot synthesis by way of the intermediates **57**, **58** and **59**, gave 2-[(1*S*,2*S*)-*trans*-2-methylcyclohexyl]-1,3,2-dioxaborbinane [(1*S*,2*S*)-**60**] in 85% yield. Treatment of (1*S*,2*S*)-**60** in ether at  $-78^\circ\text{C}$  with methyllithium in ether and then acetyl chloride gave the crude boronic ester **61** in quantitative yield. The latter was dissolved in THF, and solid **52** was added. Treatment of the reaction product with water and then hydrochloric acid gave (1*S*,2*S*)-**54**·HCl in 76% yield with an ee of 99%<sup>55</sup>.



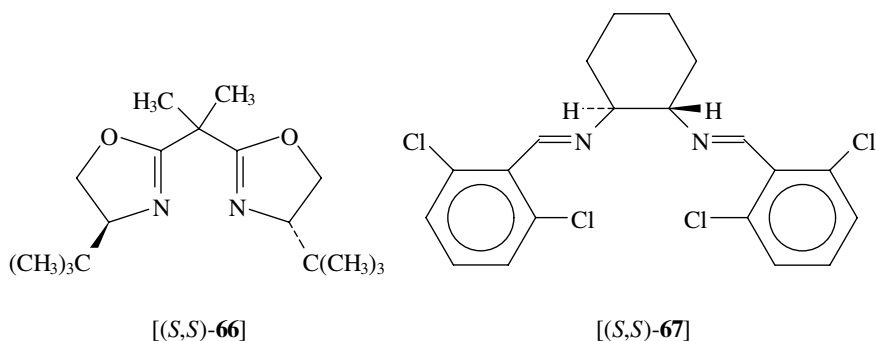
Other chiral acyclic and cyclic amine hydrochlorides with ee values of at least 99% were prepared in a similar way<sup>55</sup>, and since both (+)- and (-)- $\alpha$ -pinene are available with ee values of 100%, both enantiomers of *trans*-2-methylcyclohexylamine hydrochloride (**54**-HCl) and other hydrochlorides thus prepared are available by the same synthetic route.

### F. Aziridination of Alkenes with Chiral Diimine-based Catalysts

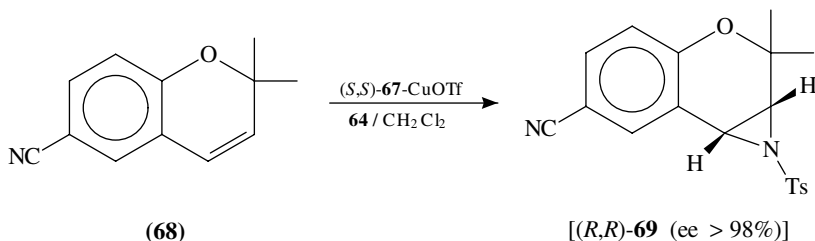
The first catalytic, asymmetric aziridination of an alkene in good yield and high enantioselectivity was recently reported<sup>56</sup>. Thus styrene (**63**) was treated with [*N*-(*p*-toluenesulphonyl)imino]phenyliodinane (**64**) and an asymmetric copper catalyst to yield (*R*)-*N*-(*p*-toluenesulphonyl)-2-phenylaziridine [(*R*)-**65**] in 97% yield with an ee of 61%, the catalyst being the complex formed *in situ* in chloroform from the chiral bis[(*S,S*)-4-*tert*-butyloxazoline] [(*S,S*)-**66**] and copper(I) triflate (CuOTf)<sup>56</sup>, the reaction proceeding by way of a nitrene transfer<sup>57</sup>.



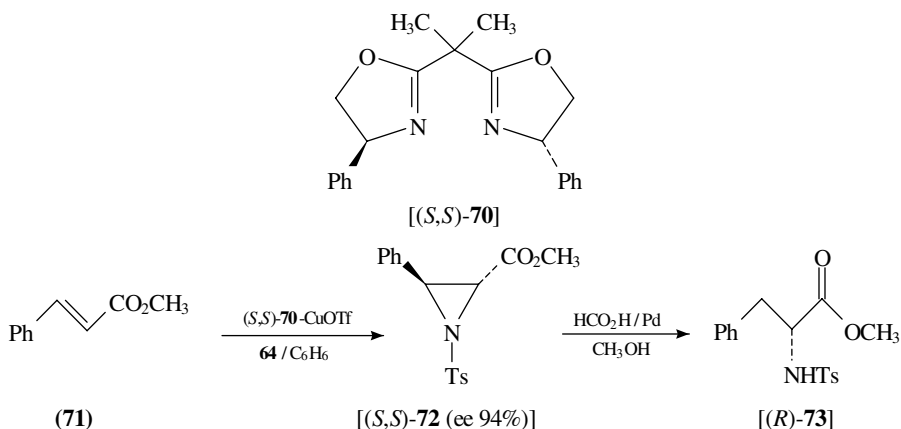
Benzylidene derivatives of the enantiomers of 1,2-diaminocyclohexane are also excellent ligands for the Cu(I)-catalyzed asymmetric aziridination of olefins with **64**, but the enantioselectivities using acyclic alkenes were about the same as those using ligand (*S,S*)-**66**<sup>58</sup>. When (*S,S*)-bis-(2,4-dichlorobenzylidenediamino)cyclohexane [(*S,S*)-**67**] was employed with Cu(I) triflate, 6-cyano-2,2-dimethylchromene (**68**) was converted to (*R,R*)-**69** in a 75% yield with an ee greater than 98%<sup>58</sup>.



When the ligand (*S,S*)-**70** was used, methyl cinnamate (**71**) was converted to the corresponding aziridine (*S,S*)-**72** in 63% yield with an ee of 94%<sup>59</sup>, but the optimal conditions for the aziridination of the cinnamate esters cannot be reliably extrapolated to other acyclic olefins<sup>59</sup>. Reductive ring opening of (*S,S*)-**72** by transfer hydrogenation<sup>60</sup> afforded the corresponding (*R*)-methyl *N*-(*p*-toluenesulphonyl)phenylalaninate [(*R*)-**73**] and established the absolute configuration of (*S,S*)-**72**<sup>59</sup>. This latter reaction and other reactions of the

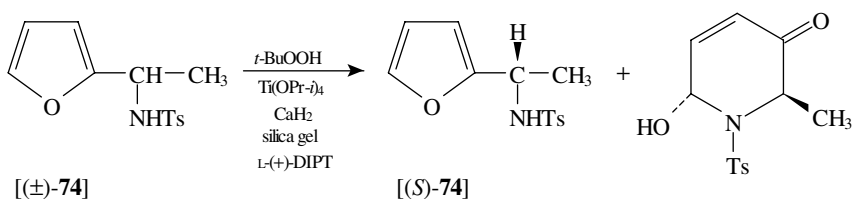


enantiomers of chiral aziridines in stereoselective transformations<sup>10,59,61</sup> demonstrates the general usefulness of such compounds in asymmetric synthesis.



### G. Kinetic Resolution Using a Modified Sharpless Reagent

Kinetic resolution of secondary allylic alcohols by Sharpless asymmetric epoxidation using *tert*-butylhydroperoxide in the presence of a chiral titanium–tartrate catalyst has been widely used in the synthesis of chiral natural products. As an extension of this synthetic procedure, the kinetic resolution of  $\alpha$ -(2-furfuryl)alkylamides with a modified Sharpless reagent has been used<sup>62</sup>. Thus treatment of racemic *N*-*p*-toluenesulphonyl- $\alpha$ -(2-furfuryl)ethylamine **[( $\pm$ )-74]** with *tert*-butylhydroperoxide, titanium isopropoxide  $[\text{Ti}(\text{OPr-}i)_4]$ , calcium hydride ( $\text{CaH}_2$ ), silica gel and L-(+)-diisopropyl tartrate [L-(+)-DIPT] gave (*S*)-*N*-*p*-toluenesulphonyl- $\alpha$ -(2-furfuryl)ethylamine **[(*S*)-74]** in high chemical yield and enantiomeric excess<sup>62</sup>. Similarly prepared were the (*S*)-*N*-*p*-toluenesulphonyl- $\alpha$ -(2-furfuryl)-*n*-propylamine and other homologues of (*S*)-**74** using L-(+)-DIPT. When D-(–)-DIPT was used, the enantiomers were formed<sup>62</sup>.



### III. ESTIMATION OF ENANTIOMERIC EXCESS

#### A. Quantitative Aspects

For a nonracemic mixture of enantiomers prepared by resolution or asymmetric synthesis, the composition of the mixture was given earlier as percent optical purity (equation 1), an operational term, which is determined by dividing the observed specific rotation ( $[\alpha]_{\text{obs}}$ ) of a particular sample of enantiomer with that of the pure enantiomer ( $[\alpha]_{\text{max}}$ ), both of which were measured under identical conditions. Since at the present, the amount of enantiomers in a mixture is often measured by nonpolarimetric methods, use of the term percent optical purity is obsolete, and in general has been replaced by the term percent enantiomeric excess (ee) (equation 2) introduced in 1971<sup>63</sup>, usually equal to the percent optical purity,  $[R]$  and  $[S]$  representing the relative amounts of the respective enantiomers in the sample.

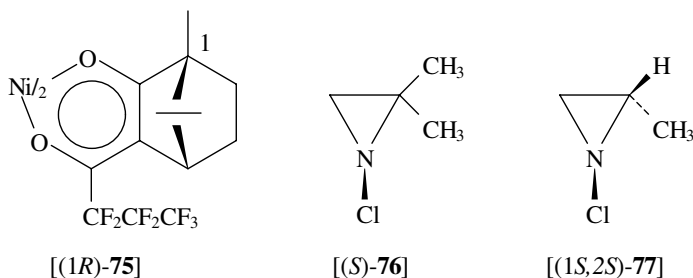
$$\text{Percent optical purity} = ([\alpha]_{\text{obs}}/[\alpha]_{\text{max}})(100) \quad (1)$$

$$\text{Percent enantiomeric excess} = ([R] - [S]/[R] + [S])(100) \quad (2)$$

Various methods, including polarimetry, competitive reaction methods and isotope-dilution techniques, are available to determine the specific rotation of a pure enantiomer<sup>64</sup>. More precise and convenient estimation of ee values is made by measurement of the relative amounts of the enantiomers in a sample by gas chromatography (GC) and high performance liquid chromatography (HPLC) methods, and NMR techniques<sup>64</sup>. The relative amount of enantiomers can be determined by chromatography on an achiral support if they are derivatized using an enantiomerically pure reagent (chiral derivatizing agent, CDA) so as to prepare two diastereomers which are separated by the chromatography. Outlined below are direct chromatographic methods employing chiral stationary phases (CSPs) on which the enantiomers of chiral amines are separated by both GC<sup>65,66</sup> and HPLC methods<sup>67</sup>.

#### B. Chromatography Using Chiral Stationary Phases

In the gas chromatographic (GC) separation of enantiomers, solutions of chiral metal  $\beta$ -diketonates such as nickel(II) bis[(1*R*)-3-(heptafluorobutyryl)camphorate] [(1*R*)-**75**] in squalene are used as highly selective chiral stationary phases (CSP) coating the inside of a capillary column and using nitrogen as the carrier gas<sup>68</sup>. Thus resolution of ( $\pm$ )-1-chloro-2,2-dimethylaziridine [( $\pm$ )-**76**] was reported by gas chromatographic separation on (1*R*)-**75**<sup>68</sup>. The nitrogen atom in **76** constitutes the sole chiral center in the molecule which, in the constrained *N*-chloroaziridine structure, is stable to inversion on GC using a CSP prepared from (1*R*)-**75**<sup>68</sup>. Using a different but related chiral



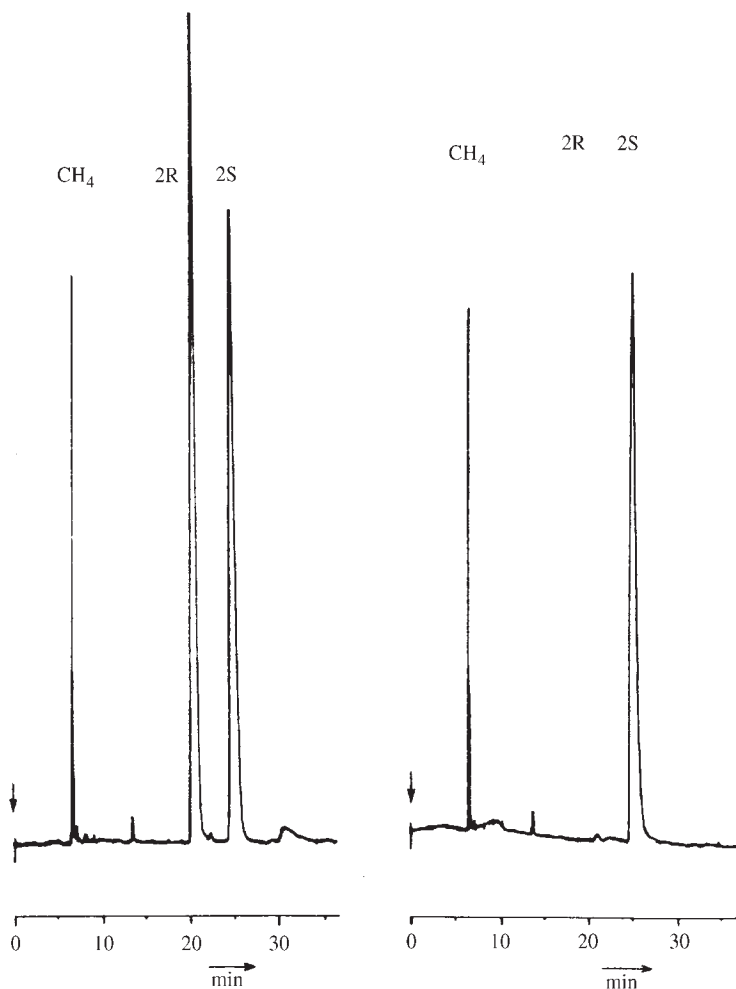
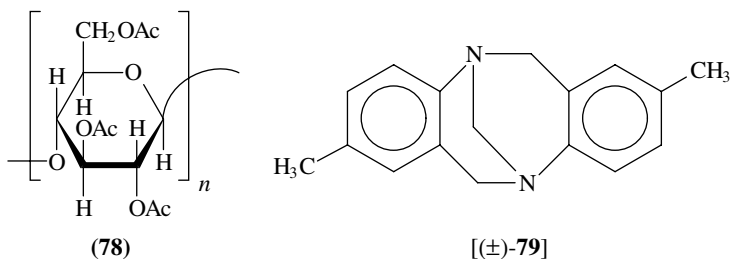


FIGURE 2. Record of the gas chromatographic resolution of ( $\pm$ )-*trans*-1-chloro-2-methylaziridine [( $\pm$ )-**77**] on nickel(II) bis[(1*R*)-3-(heptafluorobutyl)camphorate] [(1*R*)-**75**] (0.156 M in squalene) at 63 °C. Column, 100 m  $\times$  0.5 mm nickel capillary; carrier gas 2.9 mL/min N<sub>2</sub>; split ratio 1:50. (Left chromatograph) ( $\pm$ )-**77**; (right chromatograph) (1*S*,2*S*)-**77** (ee 99%). Reprinted with permission from Reference 69. Copyright (1982) American Chemical Society

stationary phase, slow racemization of **76** was detected<sup>69</sup>, indicating that the metal chelate may participate in decreasing the activation barrier of nitrogen inversion in **76**. In related experiments, chlorination of 2-methylaziridine gave a mixture of *cis*- and *trans*-1-chloro-2-methylaziridine (**77**) which were identified by GCMS<sup>69</sup>. On standing at elevated temperature the *cis* diastereomer disappeared, and GC of the remaining more thermodynamically stable *trans* racemate on (1*R*)-**75** dispersed in squalene as the stationary phase showed complete resolution of the two enantiomers (Figure 2). When an enantiomer of **77** was synthesized from *L*-alanine, (1*S*,2*S*)-**77** was obtained with an ee

of 99% (Figure 2), showing that the separation shown in the left panel of Figure 2 is a true enantiomeric separation and allowing, on the basis of the synthesis, the assignment of the absolute configuration to the respective peaks in Figure 2<sup>69</sup>. It is to be noted that this column, the stationary phase prepared from (1*R*)-**75** dispersed in squalene, has low sample capacity, but may be suitable for isolation of the pure enantiomers in mg quantities, sufficient for the determination of chiroptical data on the analytes<sup>70</sup>. When only one chromatographic peak is detected, care must be exercised to be sure it represents one enantiomer by use of another sample known to be the racemate or partially racemic mixture of the analyte under investigation.

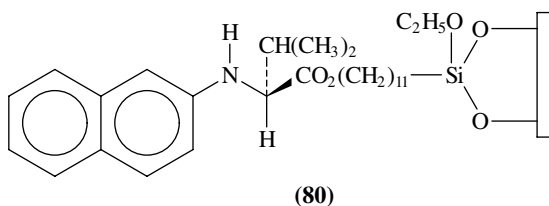
The observation that some racemic amino acids gave two spots on paper chromatography<sup>71</sup> was the first indication that chiral recognition by cellulose in high performance liquid chromatography (HPLC) might be feasible. Since then, various derivatives of cellulose have been examined as chiral absorbants<sup>72</sup>. One such chiral stationary phase (CSP) is microcrystalline cellulose triacetate (MCCTA or CTA-I) (**78**) which is the product of the heterogeneous acetylation of microcrystalline cellulose<sup>72</sup>. Although CSP **78** has been used for the resolution of Troger's base [(±)-**79**], **78** and other derivatives of cellulose and of other polysaccharides are not generally useful for the resolution of simple chiral amines<sup>72</sup>. The application of these HPLC columns to the separation of enantiomers of chiral substances incorporating multiple functional groups has been studied extensively, but it is difficult to determine exactly what structural features are required for enantioseparation. On an empirical basis, however, various CSP of this type have been found useful for the resolution of many substances including many materials useful as pharmaceuticals and agrochemicals. The packing materials are commercially available (Daicel Chemical Industries, Ltd), but currently the loading capacity of these columns is limited, and the technology for preparative separation of enantiomers remains to be developed.



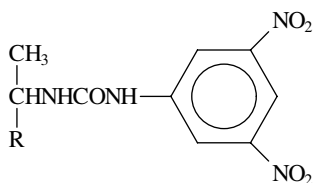
Other types of CSP have been investigated for enantiomeric separation, both for the estimation of enantiomer ratios in partially racemic samples and for preparative separation of enantiomers<sup>73</sup>, and those that act by attractive interactions between nonionic functionalities are termed donor-acceptor CSPs (DA CSPs). By optimization of hydrogen bonding,  $\pi$  donor-acceptor, dipole stacking and steric interactions between the CSP and the analyte, a number of highly selective CSPs suitable for a broad range of analytes and showing high chromatographic efficiencies have been prepared<sup>73</sup>. These CSP are prepared by covalently linking a monolayer of chiral precursor to a support, usually silica (**80**), with good mechanical properties. Typically, unfunctionalized molecules will show little or no separability on most DA CSPs, and quite often derivatization is required for separation. Nevertheless, DA CSPs are generally the most practical wide-spectrum CSPs available for HPLC<sup>73</sup>.

An easily accessible DA CSP derived from L-*N*-(2-naphthyl)valine (**80**) was used to separate appropriately derivatized amines, amino alcohols and thiols, derivatization consisting of *N*-, *O*- and *S*-acylation with 3,5-dinitrobenzoyl chloride or 3,5-dinitrophenyl





isocyanate<sup>74</sup>. Using a  $4.6 \times 250$ -mm column packed with **80**, the 3,5-dinitrophenyl isocyanate derivatives of 2-aminobutane [(±)-**81**],  $\alpha$ -phenylethylamine [(±)-**82**] and other amines were completely separated on elution with 10% 2-propanol in hexane, (*R*)-**81** and (*S*)-**82** being the more strongly retained<sup>74</sup>. This particular DA CSP is commercially available (Regis Chemical Co.), and it and similar DA CSP will be of utility in the preparation of the pure enantiomers of chiral amines.



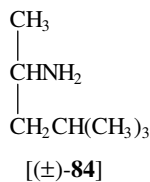
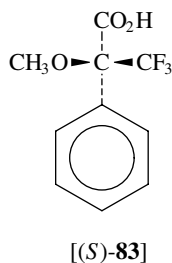
[(±)-**81**] R = CH<sub>3</sub>CH<sub>2</sub>

[(±)-**82**] R = C<sub>6</sub>H<sub>5</sub>

### C. Nuclear Magnetic Resonance Methods

Since nuclear magnetic resonance instruments are ubiquitous in organic chemistry laboratories, NMR methods for the estimation of enantiomer ratios are easily and rapidly done<sup>75</sup>. Since enantiomers give identical NMR signals in an achiral medium, the ratio of enantiomers requires the use of a chiral auxiliary or an achiral reagent that converts the mixture of enantiomers into a diastereomeric mixture. As long as there is a large enough chemical shift nonequivalence for the respective diastereomers to give baseline resolution of the appropriate signals, integration gives a direct measure of the diastereomeric composition which can be related directly to the enantiomeric composition of the original mixture.

There are three types of chiral auxiliary that are used: chiral derivatizing agents (CDAs), chiral lanthanide shift reagents (CLSRs) and chiral solvating agents (CSAs)<sup>75</sup>. Chiral derivatizing agents (CDAs), such as the enantiomers of  $\alpha$ -methoxy- $\alpha$ -(trifluoromethyl)phenylacetic acid (MPA, **83**)<sup>76</sup>, require the separate formation of discrete



diastereomers prior to NMR analysis and care has to be taken to insure that neither kinetic resolution nor racemization of the derivatizing agent occurs during derivatization.

Of the CDAs, the most widely used are the enantiomers of MTPA (**83**) which have been used successfully for the estimation of enantiomeric excess of chiral alcohols and amines<sup>77</sup>. Thus, Figure 3 shows both the proton and fluorine-19 NMR spectra of the two diastereomers of *N*-(4-methyl-2-pentyl)- $\alpha$ -methoxy- $\alpha$ -trifluoromethylphenylacetamide, prepared from ( $\pm$ )-**83** and 4-methyl-2-pentylamine [( $\pm$ )-**84**]. Figure 3 illustrates the advantage of using the signals from the trifluoromethyl group over those from the protons of the MTPA amide for determination of the enantiomeric composition. The signals for the protons of the isopropyl group, as well as those for the  $\alpha$ -methoxyl group, occur as two sets of overlapping doublets, one for the *R,S/S,R* enantiomeric pair and another for the *R,R/S,S* enantiomeric pair. Any attempt at obtaining the relative proportions of the diastereomers by integration of the overlapping proton signal would lead to very inaccurate results. The <sup>19</sup>F NMR spectrum taken at 94.1 MHz is uncomplicated and shows a separation of 10 Hz for the signals for the two diastereomeric pairs, so that the relative areas of these signals easily can be obtained by integration. For use with a chiral amine, the enantiomers of **83** are easily prepared by asymmetric synthesis<sup>77</sup> or are available commercially in enantiomerically pure form either as the acid or acid chloride. Because there is no hydrogen atom  $\alpha$  to the carboxyl group, racemization during derivatization using an enantiomer of **83** or the respective acid chloride is impossible. Finally, useful NMR configurational correlation schemes have been devised that permit the assignment of the absolute configuration of amines in MPTA derivatives<sup>78</sup>.

More recently, the chiral phosphonate **85** has been used as a CDA with chiral amines to form diastereomeric phosphonic amides (**86**)<sup>79</sup> which are analyzed by <sup>31</sup>P-NMR spectroscopy for the determination of enantiomeric ratios. The reagent is readily prepared from (*S*)-2-butanol and phosphorous trichloride, and all  $\alpha$ -amino acids and amines thus far examined react quantitatively in a few hours at room temperature in aqueous ethanol<sup>79</sup>.

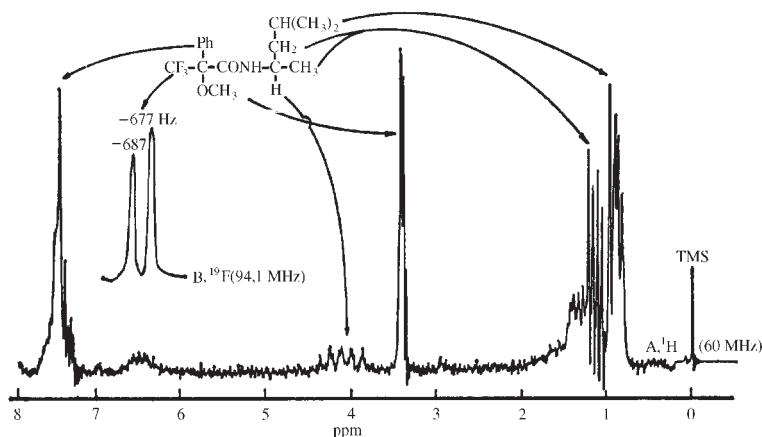
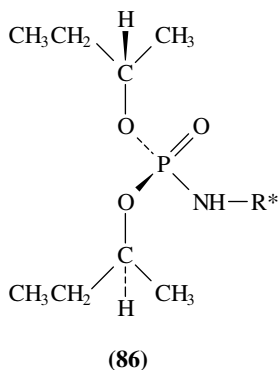
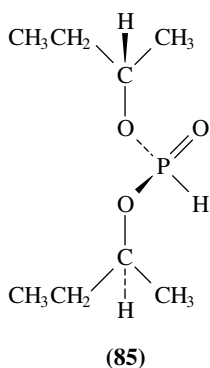
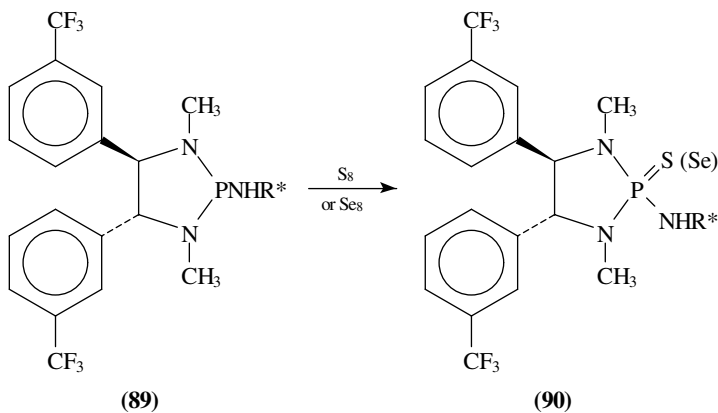
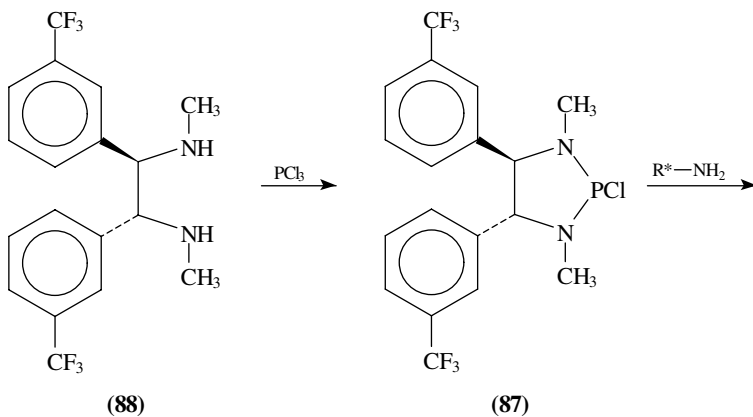


FIGURE 3. The NMR spectra of the two racemic diastereomers of *N*-(4-methyl-2-pentyl)- $\alpha$ -methoxy- $\alpha$ -trifluoromethylphenylacetamide prepared from racemic  $\alpha$ -methoxy- $\alpha$ -(trifluoromethyl)phenylacetic acid [MTPA, ( $\pm$ )-**83**] and racemic 4-methyl-2-pentylamine [( $\pm$ )-**84**]: (A) 60-MHz proton spectrum in chloroform-*d* with tetramethylsilane (TMS) as the internal standard; (B) 94.1-MHz fluorine-19 spectrum in chloroform-*d* with trifluoroacetic acid as the internal standard. Reprinted with permission from Reference 76. Copyright (1969) American Chemical Society



Another phosphorus containing CDA (**87**) has also been described for the estimation of the enantiomeric excess of chiral amines<sup>80</sup>. The phosphorus CDA **87** is formed quantitatively and instantaneously *in situ* in an NMR tube by reaction of phosphorus trichloride ( $\text{PCl}_3$ ) with the chiral diamine **88**. Addition to the NMR tube of the chiral amine ( $\text{R}^*\text{-NH}_2$ ) for which the ee is to be determined gives the diastereomeric phosphorous derivatives



(**89**), again formed instantaneously and quantitatively<sup>80</sup>. A first <sup>31</sup>P NMR spectrum of the trivalent phosphorus derivative **89** may be recorded and the enantiomeric composition the chiral amine determined, and then the <sup>13</sup>C NMR spectrum may also be recorded. In a second step, it is possible to form new derivatives **90** by direct addition to the NMR tube of excess molecular sulphur (S<sub>8</sub>) or selenium (Se<sub>8</sub>), the diastereomer derivatives **90** perhaps giving a larger separation of the diastereomeric <sup>31</sup>P or <sup>13</sup>C NMR signals<sup>80</sup>.

The enantiomeric excess of a partially racemic chiral amine may also be estimated using an achiral phosphorus coupling reagent, methylphosphonothioic dichloride (**91**)<sup>81</sup>. The latter reacts in the presence of triethylamine in deuteriochloroform to afford diastereomeric methylphosphonothioic diamides. When racemic allylglycine methyl ester [(±)-**92**] was used with **91**, the <sup>31</sup>P NMR spectrum of the reaction product showed three well-separated singlets: one for the racemate (±)-**93** [(*R,R*)-**93** + (*S,S*)-**93**] and one for each of the two *meso* diastereomers [(*R,S*)-**94** and (*R,S*)-**95**], with a *meso*/racemic ratio of 49.51 (Figure 4)<sup>81</sup>. The ratio of these singlets is directly related to the ee of the α-amino acid ester **92**. For enantiomerically enriched **92** (ee 96.6%) the two *meso* signals could just be observed, and integration of the signal gave an ee of 97% for the α-amino acid ester **92**<sup>81</sup>. Equally satisfactory results were observed using other α-amino acid esters and chiral alkyl- and α- and β-arylalkylamines<sup>81</sup>.

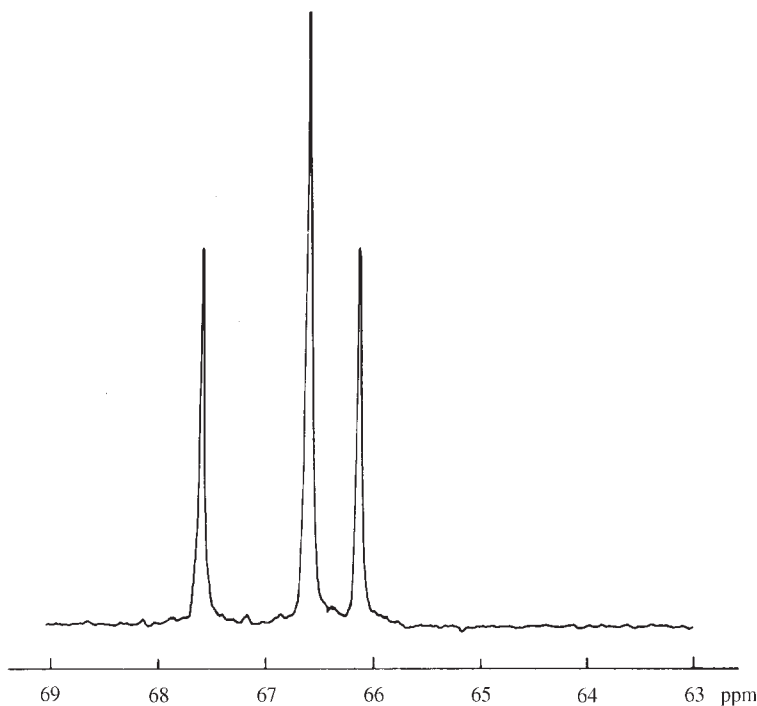
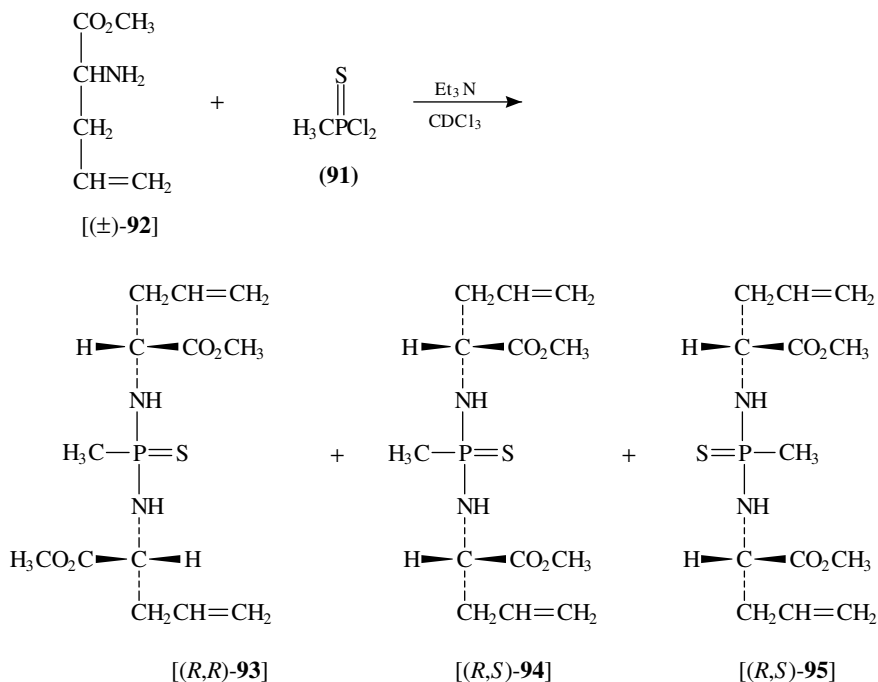
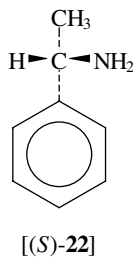
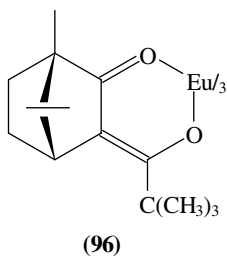


FIGURE 4. Phosphorus-31 NMR spectrum of a mixture prepared by reaction of racemic allylglycine methyl ester [(±)-**92**] and methylphosphonothioic dichloride (**91**) in deuteriochloroform, showing from left to right, a singlet for a *meso* compound [(*R,S*)-**94** or (*R,S*)-**95**], a singlet for the racemate (±)-**93** and a singlet for the other *meso* compound [(*R,S*)-**94** or (*R,S*)-**95**]. Reprinted with permission from Reference 81. Copyright (1986) American Chemical Society



The first nuclear magnetic resonance chiral lanthanide shift reagent (CLSR) reported was tris[3-(*tert*-butylhydroxymethylene)-*d*-camphorato]europium(III) (**96**), prepared from *d*-camphor<sup>82</sup>. Figure 5 illustrates the influence of this reagent on the <sup>1</sup>H NMR spectra of the enantiomers of  $\alpha$ -phenylethylamine (**22**). The large downfield shift of the resonances of **22** in the presence of **96** from their positions in the absence of **96** in carbon tetrachloride is the result of pseudocontact interaction between the europium(III) atom and a rapidly exchanging mixture of coordinated and free amine. Noteworthy in the spectra in Figure 5 are the frequency differences in the resonance of the corresponding protons of (*R*)-**22** and (*S*)-**22**, which provide a useful method for determining the enantiomeric excess of chiral compounds including amines<sup>82</sup>.



Other CLSRs have been developed<sup>83</sup> and have been widely used for the determination of enantiomer ratios and the assignments of absolute configurations<sup>84</sup>. After complexation with europium(III) chloride (EuCl<sub>3</sub>), *N,N'*-1,2-ethylenebis(L-aspartic acid) (L,L-**97**) and related *N,N'*-1,2-ethylenebis(aspartic acid) ligands were recently reported<sup>85</sup> as highly

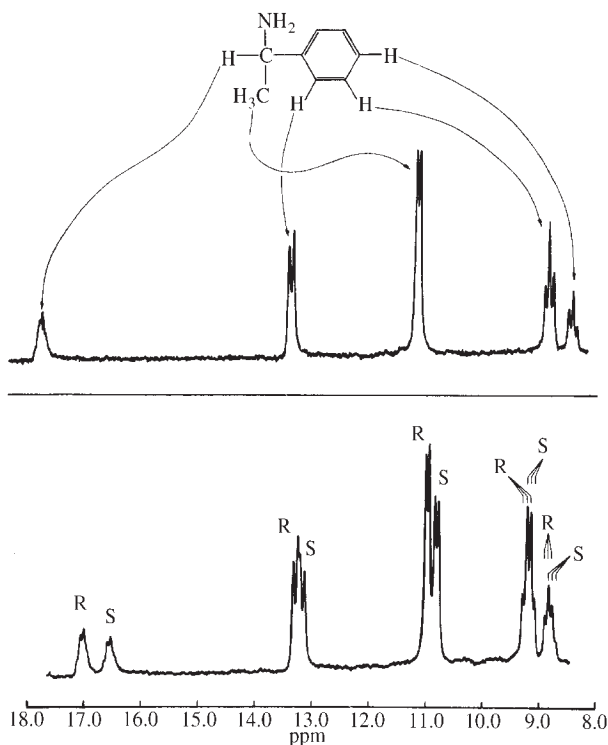
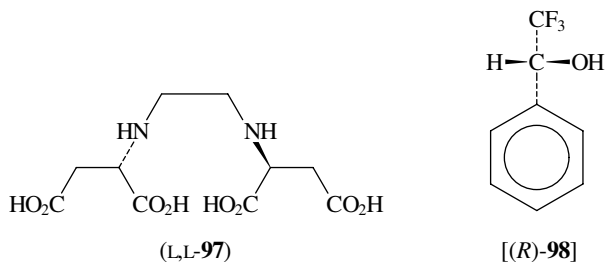


FIGURE 5. Proton NMR spectra of solutions prepared from (*S*)- $\alpha$ -phenylethylamine [(*S*)-**22**] (10  $\mu$ L) (upper spectrum) and a mixture of (*R*)- and (*S*)- $\alpha$ -phenylethylamine [(*R*)- and (*S*)-**22**] (7 and 5  $\mu$ L, respectively) (lower spectrum) in 0.3 mL of a carbon tetrachloride solution of tris[3-(*tert*-butylhydroxymethylene)-*d*-camphorato]europium(III) (**96**). The chemical shift scale applies only to the lower spectrum. Reprinted with permission from Reference 82. Copyright (1970) American Chemical Society

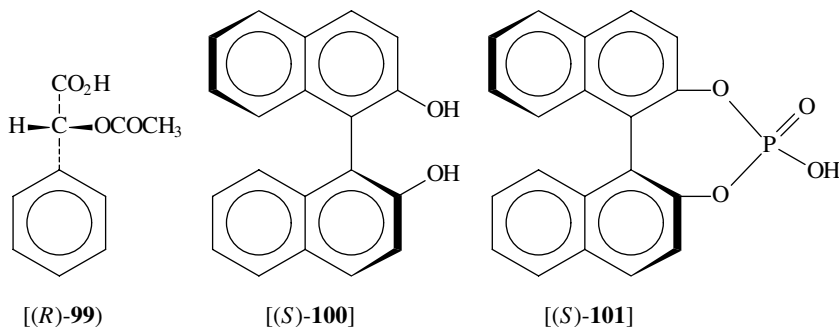
suitable shift reagents for the determination of enantiomeric ratios of partially racemic  $\alpha$ -amino acids and  $\alpha$ -alkyl-substituted  $\alpha$ -amino acid in aqueous solution.



Related to the NMR use of CLSRs is the application of chiral solvating agents (CSAs), so-called because the first report of the determination of enantiomeric excess by NMR was that of a partially racemic sample of 2,2,2-trifluoro-1-phenylethanol (**98**),

using (*R*)- $\alpha$ -phenylethylamine [(*R*)-**22**] as the NMR solvent<sup>86</sup>. Since this first report, a wide variety of combinations of solute and CSA functional group types have been reported<sup>87</sup>. Aryltrifluoromethylcarbinols such as **98** and  $\alpha$ -arylethylamines such as **22** have been among the most extensively employed. This derives in part from their general applicability and in part from their commercial availability in enantiomerically pure forms. Chiral solvating agents of this type rely on hydrogen bonding as the primary solute-binding force. If the solute is a hydrogen bond acceptor such as a tertiary amine, the CSA of choice is an efficient hydrogen bond donor such as **98**; and if the solute is a hydrogen bond donor such as an alcohol, the CSA is a hydrogen bond acceptor such as **22**. The CSA concentration is usually chosen to be three or four times that of the chiral solute with an achiral cosolvent, aprotic and relatively nonpolar if possible, so chosen that competition with either the solute or CSA is avoided.

More recently (*R*)-*O*-acetylmandelic acid<sup>88</sup> [(*R*)-**99**], (*S*)- $\alpha$ -methoxy- $\alpha$ -(trifluoromethyl)phenylacetic acid<sup>89</sup> (MTPA) [(*S*)-**83**] and other chiral acids<sup>89</sup> have been used as CSAs. These acids form diastereomeric salts soluble in benzene-*d*<sub>6</sub> or chloroform-*d* with a wide range of amines and amino alcohols, permitting a direct measure of their enantiomeric composition. Enantiomers of 1,1'-binaphth-2,2'-diol<sup>90</sup> (**100**) and 1,1'-binaphth-2,2'-diylphosphoric acid (**101**) and other derivatives of **100** and **101** have also been successfully used as CSAs in chloroform-*d* and benzene-*d*<sub>6</sub> for the estimation of enantiomeric excesses of a number of  $\beta$ -amino alcohols<sup>90</sup>, and enantiomers of **101** have been used for cyclic secondary and tertiary amines<sup>91</sup>.



#### IV. ELECTRONIC CIRCULAR DICHROISM (ECD)

##### A. Amino Chromophore

As discussed in the earlier review of the chiroptical properties of the amino chromophore<sup>1</sup>, it was recognized very early on the basis of optical rotatory dispersion (ORD) measurements that for some chiral amines, Cotton effects are associated with the electronic transitions below 250 nm, and the ECD spectra are characterized by two oppositely signed dichroic absorption bands in the region 190–240 nm (Figure 6) corresponding to the electronic absorption maxima of trimethylamine in the gas phase at 199 and 227 nm<sup>1</sup>. The disappearance of the ECD bands on protonation of the nitrogen lone pair of electrons supports the conclusion that this dichroic absorption is associated with electronic transitions of the lone-pair electrons on the nitrogen atom<sup>1</sup>.

On the basis of a comprehensive ECD study of chiral 2-alkyl-substituted piperidines<sup>92</sup>, such as (*S*)- $\alpha$ -pipercoline [(*S*)-2-methylpiperazine, (*S*)-**102**] and their *N*-methyl derivatives [(*S*)-**103**] in ethanol, the sign of the strong, long-wavelength CE near 200 nm, shifted to

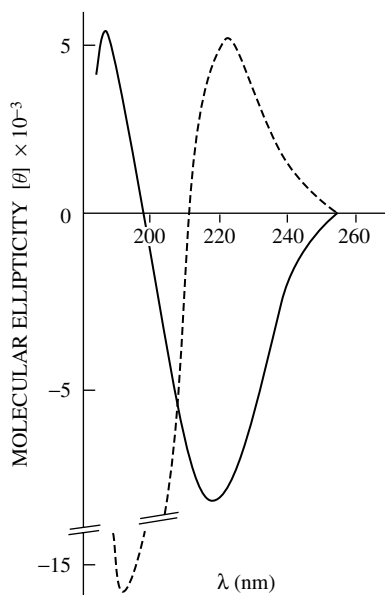
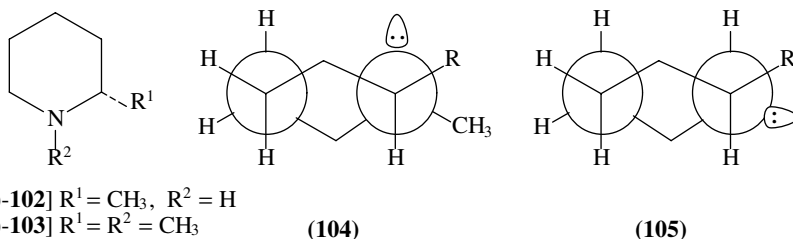


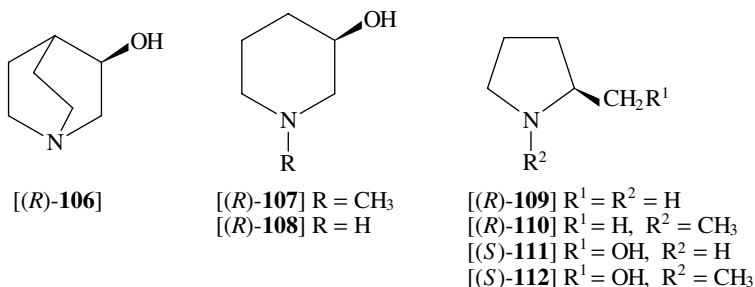
FIGURE 6. Circular dichroism spectra of (*R*)-2-methylpyrrolidine [(*R*)-**109**] (solid line) and (*R*)-1,2-dimethylpyrrolidine [(*R*)-**110**] (dashed line) in hexane. Reproduced from Reference 94 by permission of Pergamon Press



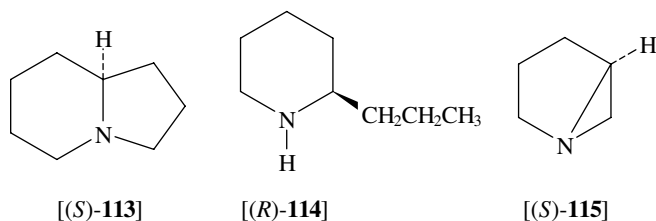
220 nm in cyclohexane and assigned to the  $n \rightarrow \sigma^*$  transition of the amino group, is empirically correlated with the absolute configuration at C-2<sup>92</sup>. For an *N*-methyl-2-alkylpiperidine in cyclohexane, the *N*-methyl group has an equatorial conformation (**104**), and the CE near 200 nm for the configuration shown in **104** is positive, and (*S*)-**102** and (*S*)-**103** show a positive CE near 200 nm. For other six-membered cyclic secondary amines in which the 2-alkyl group is larger than a methyl group, the lone pair of electrons on nitrogen is equatorial (**105**), and the CE is negative. Thus a counterclockwise (negative) direction (**104**) from the C-2 alkyl group to the lone pair of electrons results in a positive CE; a clockwise (positive) direction (**105**) gives a negative CE<sup>93</sup>. Similar ECD measurements show that this simple piperidine helicity rule predicts the sign of the observed positive CE near 200 nm for conformationally rigid (*R*)-quinuclidin-3-ol [(*R*)-**106**] and also supports the predicted conformation and assigned absolute configuration for (*R*)-1-methylpiperidin-3-ol [(*R*)-**107**] and (*R*)-piperidin-3-ol [(*R*)-**108**], (*R*)-**107** showing a positive CE near 200 nm while that of (*R*)-**108** is negative<sup>93</sup>. When the ECD spectra of 2-substituted pyrrolidines (*R*)-**109**, (*R*)-**110**, (*S*)-**111** and (*S*)-**112** were studied<sup>94</sup>,



it was observed that as with the 2-substituted piperidines, *N*-methylation usually results in an inversion of the sign of the observed CEs (Figure 6). However, the sign of the long-wavelength CE at about 220 nm does not conform to the simple helicity rule found for the 2-substituted piperidines, since the pyrrolidine ring is itself chiral and makes its own contribution to the observed CEs. The rotational contribution due to the pyrrolidine ring chirality appears to be opposite in sign and larger in magnitude than that due to the 2-substituent in both the secondary and tertiary amines<sup>94</sup>.



As a continuation of the studies with chiral piperidines and pyrrolidines, the ECD spectrum of the indolizidine (*S*)-1-azabicyclo[4.3.0]nonane [(*S*)-**113**] was compared with that of (*R*)-coniine [(*R*)-2-propylpiperidine, (*R*)-**114**] from which (*S*)-**113** was prepared<sup>95</sup>. The optical rotatory dispersion (ORD) of (*S*)-**114** showed a plain negative curve, descending steeply below 230 nm with a barely visible positive CE centered at 205 nm. For the hydrochloride of (*S*)-**114**, the CE at 205 nm was not present and an almost flat plain negative ORD curve to nearly 200 nm was seen. The free base (*S*)-**113**, which on the basis of its <sup>1</sup>H NMR spectrum has its free pair of electrons *trans* to the hydrogen atom at C-6, and its hydrochloride both showed plain positive ORD curves, similar to that of (*R*)-**114**, and for (*S*)-**113**, also a positive CE at 206 nm. Since the configurationally related (*S*)-**113** and (*R*)-**114** each gives a CD maximum of the same sign and similar wavelength and magnitude for the  $n \rightarrow \sigma^*$  transition of the nitrogen chromophore, the oppositely signed ORD curves for the two compounds must reflect a change in the net rotational contribution from transitions below 200 nm. From this and previous studies<sup>93,94</sup>, it appears that the indolizidine system as in **113** has its own chiroptical identity and cannot be treated as a simple pyrrolidine or piperidine chromophore. Since the *trans* indolizidine system with the *S* configuration gives a positive CE for the longest wavelength transition at 205 nm of the nitrogen chromophore, the sign of this CE may be useful in assigning the absolute configuration of substituted *trans*-fused indolizidines<sup>95</sup>.

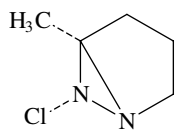
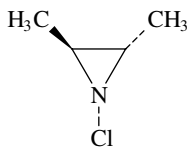


The ORD curves and ECD spectra of a number of chiral methyl-substituted cyclic amines, aziridine, azetidine, pyrrolidine and piperidine, and their *N*-methyl, *N*-halo and *N*-cyano derivatives, and of (*S*)-1-azabicyclo[3.1.0]hexane [(*S*)-**115**] were measured<sup>96</sup>.

The possibility of application of the quadrant rule for the *N*-chloramine derivatives was discussed, and a similar rule was also proposed for the *N*-cyano derivatives<sup>96</sup>.

In contrast to the study of conformationally rigid cyclic secondary and tertiary amines, the ECD of the enantiomers of 2-aminobutane (**53**) were studied in solution and in the gas phase over the wavelength region 150–260 nm<sup>97</sup>, and in addition to the CD maxima at shorter wavelength for the amino chromophore, a CD maximum was also detected at about 250 nm. This maximum is at a lower energy than that of the first excited state at 212 nm in the gas phase and 206 nm in hexane solution and is assigned to the forbidden singlet–triplet transition of the amino chromophore, negative in the ECD spectrum of (*R*)-**53** and positive in that of (*S*)-**53**<sup>97</sup>.

In line with the current interest in the chemical and physical properties of chiral aziridines<sup>10</sup>, an experimental and theoretical investigation of the chiroptical properties of a series of *N*-haloaziridines and *N*-halodiaziridines, such as (*S*)-1-chloro-2,2-dimethylaziridine [(*S*)-**76**], (1*S*,2*S*)-1-chloro-2-methylaziridine [(1*S*,2*S*)-**77**] and (1*R*,5*S*,6*R*)-6-chloro-5-methyl-1,6-diazobicyclo[3.1.0]hexane [(1*R*,5*S*,6*R*)-**116**], were described<sup>98</sup>, followed by a similar investigation of *N*-acetylaziridines<sup>99</sup>. A study of the ECD of C<sub>2</sub>-symmetric *N*-haloaziridines, such as (2*S*,3*S*)-1-chloro-2,3-dimethylaziridine [(2*S*,3*S*)-**117**], suggested that a quadrant sector rule for the *N*-haloaziridine chromophore connects the longest-wavelength CE sign in the 260–300 nm region with the stereochemical environment of the chromophore<sup>100</sup>. *N*-Haloaziridinecarboxylic esters are a specific case for the *N*-haloaziridine chromophore, and the sign of this CE cannot be correlated with their respective configurations. For these compounds, the second CE sign at 220–230 nm in the ECD spectra obeys a reverse quadrant sector rule<sup>100</sup>. Finally, the chiroptical properties of the bridgehead aziridine (*S*)-1-azabicyclo[3.1.0]hexane [(*S*)-**115**] have been investigated experimentally and theoretically in the ultraviolet and infrared absorption regions<sup>101</sup>. The ECD spectrum of (*S*)-**115** was also measured in the gas phase in the vacuum ultraviolet region (150–200 nm)<sup>101</sup>, and the three ECD maxima detected below 200 nm were assigned to the transitions of the lone pair on the nitrogen atom<sup>101</sup>, but no simple chirality rule emerged from this UV-ECD study<sup>101</sup>.

[(1*R*,5*S*,6*R*)-**116**][(2*S*,3*S*)-**117**]

## B. Effect of the Amino Group on the Benzene Chromophore

### 1. Benzene sector rule

The influence of the amino group on the carbonyl, the carboxyl and the benzene chromophores was reviewed earlier<sup>1</sup>. Since then significant work only with regard to the influence of various groups, including the amino, substituted amino and ammonium groups, on the benzene chromophore has been published, including far-ultraviolet ECD observations on chiral  $\alpha$ -phenylalkylamines and  $\alpha$ -phenylalkylamine hydrochlorides<sup>102</sup>, and reviewed<sup>103,104</sup>, and has resulted in the formulation of the benzene sector rule<sup>105</sup> and the benzene chirality rule<sup>38</sup>.

The benzene sector rule<sup>105</sup> may be used to correlate the absolute configuration of a contiguous chiral center of a monosubstituted benzene compound with the sign of the CE

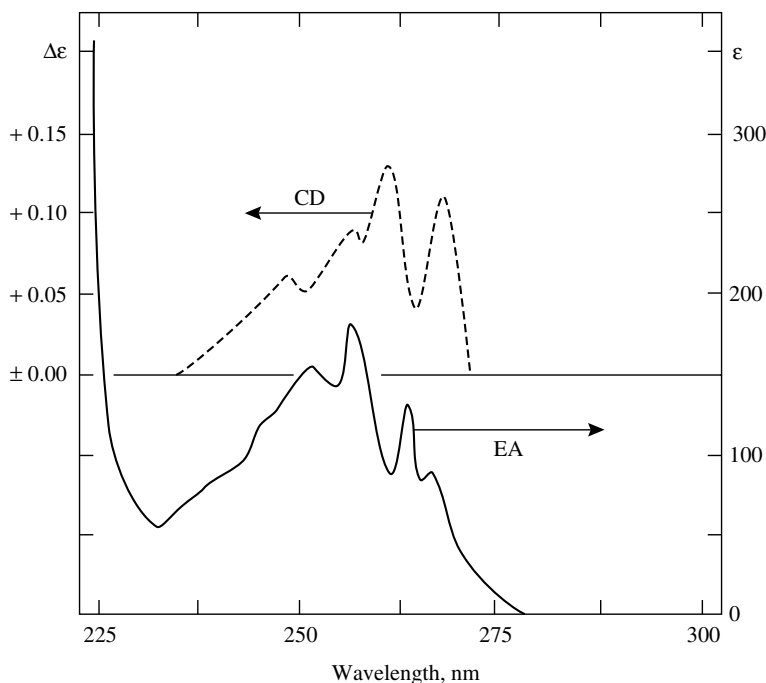
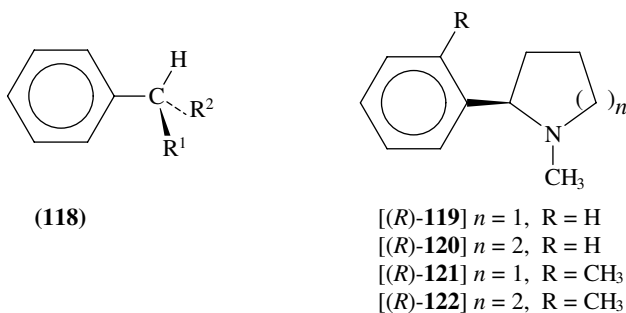


FIGURE 7. Electronic absorption (EA) and circular dichroism (CD) spectra of (*S*)- $\alpha$ -phenylethylamine [(*S*)-**22**] in methanol. Reproduced from Reference 103 by permission of the Croatian Chemical Society



associated with  ${}^1L_b$  electronic transitions from about 250 to 270 nm (Figure 7). These CEs are associated with transitions to totally symmetric vibrational modes in the lowest-energy electronically excited state and are the result of vibronic borrowing from benzene transitions at shorter wavelength. The sign of these CEs depends only on the chirality of the center immediately attached to the benzene ring, and for such benzene compounds with a hydrogen atom at this chiral center, molecular orbital calculations and spectroscopic measurements indicate that the preferred conformation is such that the hydrogen atom at the chiral center eclipses or nearly eclipses the phenyl ring plane<sup>105</sup>. Thus the preferred conformation of (*S*)- $\alpha$ -phenylethylamine [(*S*)-**22**] is shown as **118** (R<sup>1</sup> = NH<sub>2</sub>, R<sup>2</sup> = CH<sub>3</sub>). This conformational preference and ECD data for a whole host of chiral

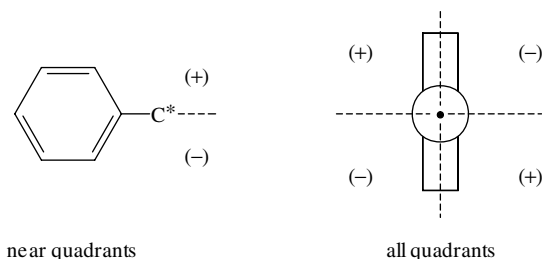


FIGURE 8. Quadrant projections for application of the benzene sector rule to chiral monosubstituted benzene compounds

phenylcarbinamines, phenylcarbinols and related compounds<sup>105</sup> suggest the quadrant projection shown in Figure 8 to predict the sign of the  ${}^1L_b$  CEs of a monosubstituted benzene compound. The signs shown on the projection in Figure 8 give the CD contribution to the  ${}^1L_b$  CEs for groups lying in the four quadrants. For groups lying on sector boundaries, there is no contribution to the CEs. The sum of these contributions gives the sign to the CEs of the  ${}^1L_b$  band, the signs for the particular quadrants following from the observed negative CEs for (*R*)-1-phenylethanol (**118**,  $R^1 = \text{CH}_3$ ,  $R^3 = \text{OH}$ ). Again using ECD data, sequences for the summation of rotatory contributions to the  ${}^1L_b$  CEs are  $\text{SH}$ ,  $\text{CO}_2^-$ ,  $\text{C}(\text{CH}_3)_3 > \text{CH}_3 > \text{NH}_2$ ,  ${}^+\text{NH}_3$ ,  ${}^+\text{N}(\text{CH}_3)_3$ ,  $\text{OH}$ ,  $\text{OCH}_3$ ,  $\text{Cl}$ ; and  $\text{CH}_3 > \text{CO}_2\text{H} > {}^+\text{NH}_3$ ,  $\text{OH}$ ,  $\text{OCH}_3$ . These sequences may be used in connection with the sector signs in Figure 8 and will have a general usefulness for the establishment of the absolute configuration of related benzene compounds in which one substituent at the chiral center is a hydrogen atom. Since a methyl group makes a larger contribution to the  ${}^1L_b$  CEs than does an amino group or ammonium group, any phenylalkylcarbinamine, phenylalkylcarbinamine salt or their *N*-alkyl derivatives with the same generic absolute configuration as (*S*)-**22** is predicted to show positive  ${}^1L_b$  CEs (Figure 7). With the opposite generic configuration, (*R*)-1-methyl-2-phenylpyrrolidine [(*R*)-**119**] and (*R*)-1-methyl-2-phenylpiperidine [(*R*)-**120**] show negative  ${}^1L_b$  CEs<sup>105</sup> as is predicted by the benzene sector rule.

## 2. Benzene chirality rule

The sign of the  ${}^1L_b$  CEs from about 250 to 270 nm in the CD spectra of chiral phenylcarbinamines such as (*S*)-**22** is determined by vibronic borrowing from allowed transitions at shorter wavelength. On ring substitution, transition moments are induced in the ring bonds adjacent to the attachment bond of the chiral group, resulting in enhanced coupling of the  ${}^1L_b$  transition with the chiral group. As given by the benzene chirality rule<sup>104</sup> and as summarized in Table 1 for the rotatory contributions to the  ${}^1L_b$  CEs for a chiral benzene compound such as (*R*)- $\alpha$ -phenylethylamine [(*R*)-**22**] with a chiral substituent giving a negative vibronic contribution to the  ${}^1L_b$  CEs, a sign reversal for the  ${}^1L_b$  CEs on *para* substitution with an atom or group with a positive spectroscopic moment<sup>106</sup> ( $\text{CH}_3$ ) can be viewed as the overshadowing of the vibronic rotational strength by a positive induced contribution of opposite sign. Thus (*R*)- $\alpha$ -phenylethylamine [(*R*)-**22**] gives negative  ${}^1L_b$  CE<sup>38</sup> while that for CEs of (*R*)- $\alpha$ -(*p*-methylphenyl)ethylamine [(*R*)-**123**] is positive<sup>38</sup>. On *para* substitution with a group with a negative spectroscopic moment<sup>106</sup> ( $\text{CF}_3$ ), the sign of the  ${}^1L_b$  CEs is unchanged since the vibronic and induced contributions have the same sign, and (*R*)- $\alpha$ -(*p*-trifluoromethylphenyl)ethylamine [(*R*)-**124**] shows negative  ${}^1L_b$  CEs,

TABLE 1. Rotational contributions to the  ${}^1L_b$  Cotton effects for a chiral benzene compound with a single chiral substituent giving a negative vibronic contribution to the  ${}^1L_b$  Cotton effects

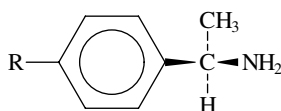
Contribution <sup>a</sup>	Substituent		
	<i>para</i>	<i>meta</i> <sup>b</sup>	<i>ortho</i>
	No additional ring substituent		
vibronic induced	negative $\pm 0$	negative $\pm 0$	negative $\pm 0$
	Substitution by a group with a positive spectroscopic moment <sup>c</sup>		
vibronic induced	negative positive	negative negative	negative positive
	Substitution by a group with a negative spectroscopic moment <sup>c</sup>		
vibronic induced	negative negative	negative positive	negative negative

<sup>a</sup>For the enantiomers the respective signs for the contributions are reversed.

<sup>b</sup>The signs are the same for the 3,5-disubstituted compounds.

<sup>c</sup>See Reference 106 for spectroscopic moments.

an unchanged sign from that of the unsubstituted parent<sup>38</sup>. *Meta* substitution by an atom or group will result in bond moments in an opposite sense from that caused by the same atom or group in the *para* position. Thus on *meta* substitution by a group with a positive spectroscopic moment, both the vibronic and induced contribution have the same sign, and the sign of the  ${}^1L_b$  CEs is the same as the unsubstituted parent. For *meta* substitution by a group with a negative spectroscopic moment, the sign of the induced contribution is opposite to that of the vibronic contribution. *Ortho* substitution again reverses the sense of the induced bond transition moments from those induced by the same *meta* substituents.



[(*R*)-**123**] CH<sub>3</sub>

[(*R*)-**124**] CF<sub>3</sub>

If the vibronic and induced contributions to the  ${}^1L_b$  CEs have the same sign (Table 1), the sign of the CEs for an enantiomer for a particular ring-substituted phenylalkylcarbinamine or carbinol can be predicted with certainty. When the vibronic and induced contributions are of opposite sign (Table 1), a prediction as to the sign of the  ${}^1L_b$  CEs shown by a particular enantiomer is ambiguous. However, all of the phenylcarbinamines and carbinols so far reported that are *para*- or *ortho*-substituted with an atom or group with a positive spectroscopic moment<sup>106</sup> (CH<sub>3</sub>, F, Cl, Br, OH and OCH<sub>3</sub>) show  ${}^1L_b$  CEs of opposite sign to that of the unsubstituted parent. Thus while (*R*)-1-methyl-2-phenylpyrrolidine [(*R*)-**119**] and (*R*)-1-methyl-2-phenylpiperidine [(*R*)-**120**] show negative  ${}^1L_b$  CEs<sup>105</sup>, their *ortho* methyl-substituted derivatives, (*R*)-1-methyl-2-(*o*-methylphenyl)pyrrolidine [(*R*)-**121**] and (*R*)-1-methyl-2-(*o*-methylphenyl)piperidine [(*R*)-**122**], each with a preferred conformation such that the hydrogen atom at the chiral center eclipses the benzene ring plane, show positive  ${}^1L_b$  CEs<sup>104</sup>. For the few phenylcarbinamines and carbinols with a group having a negative spectroscopic moment (CN, CF<sub>3</sub>) in the *meta* position, the sign of the  ${}^1L_b$  CEs did not change from that of the

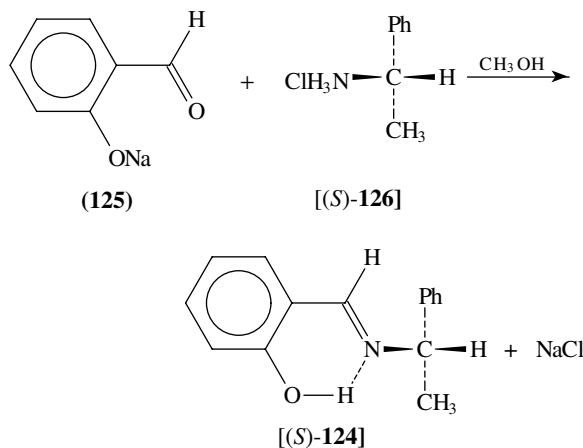
unsubstituted parent<sup>38</sup>. The benzene chirality rule has been successfully used to correlate the signs of the  $^1L_b$  CEs for enantiomers of a substantial number of ring-substituted benzene compounds<sup>38,104,107</sup>, including chiral perhydrobenzocycloalkanes, some with amino groups at chiral centers<sup>108</sup>.

## C. Chromophoric Derivatives

### 1. *N*-Salicylidene derivatives and the salicylidenamino chirality rule

Of the number of chromophoric derivatives of chiral amines for potential use in the establishment of their absolute configuration by ECD measurement<sup>1</sup>, only a few have proven to be generally useful. Of these, intensive investigation of the *N*-salicylidene (Schiff base) derivatives of chiral primary amines, including unsubstituted and ring-substituted  $\alpha$ - and  $\beta$ -arylalkylamines,  $\alpha$ -amino acids, unsaturated and saturated aliphatic and alicyclic amines, and amino sugars, has resulted in the formulation of the salicylidenamino chirality rule<sup>109,110</sup>. The application of this rule has recently been reviewed<sup>110</sup> and has been successfully used for the establishment of absolute configuration of chiral primary amines in connection with other stereochemical studies<sup>38</sup>. In related studies, the conformations of a series of pyridoxyl-*L*- $\alpha$ -amino acid Schiff bases were deduced from their CD spectra<sup>111</sup>.

*N*-Salicylidene Schiff bases derivatives, such as (*S*)-*N*-salicylidene- $\alpha$ -phenylethylamine<sup>112</sup> [(*S*)-**124**], can be formed *in situ* by reaction of sodium salicylaldehyde (**125**) with (*S*)- $\alpha$ -phenylethylamine hydrochloride<sup>112</sup> [(*S*)-**126**] in methanol, and show a number of CEs from about 210 to 400 nm (Figure 9), the sign of the CEs associated with the electronic transitions near 315 nm and 255 nm being correlated with the absolute configuration of the chiral center to which the nitrogen atom is attached<sup>110</sup>. The derivatives can also be formed by reaction of salicylaldehyde with the corresponding amine, and when the Schiff base is formed on a macro scale it can be isolated in the usual way. The formation *in situ*, however, is a substantial asset associated with salicylidenamino (SA) chromophoric derivatives. Since **125** and an amine salt are usually solids at room temperature, semimicro amounts (1 or 2 mg) of **125** and the amine salt can easily be weighed before mixing.



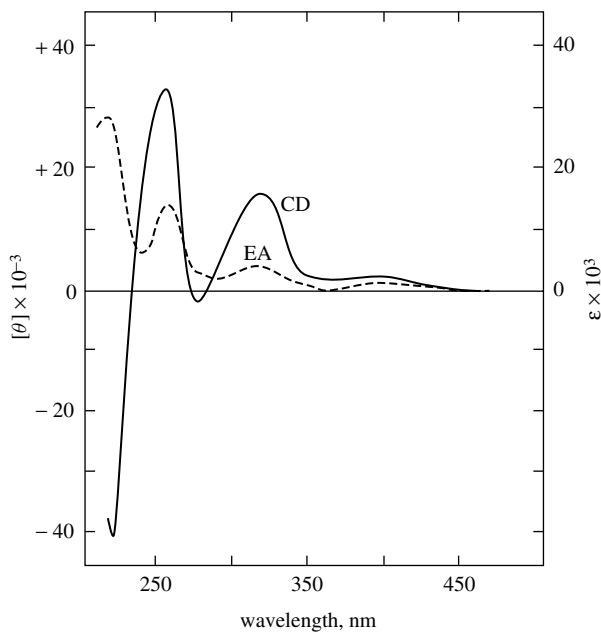


FIGURE 9. Electronic absorption (EA) and circular dichroism (CD) spectra of (*S*)-*N*-salicylidene- $\alpha$ -phenylethylamine [(*S*)-124] in methanol. Reprinted with permission from Reference 109. Copyright (1974) American Chemical Society

In the ECD spectrum of the *N*-salicylidene derivatives, such as (*S*)-*N*-salicylidene- $\alpha$ -phenylethylamine [(*S*)-124], the CEs associated with the electronic transition near 315 (band I) and 255 nm (band II) are the result of exciton coupling of the respective electronic transition moments of the salicylidenamino (SA) chromophore with electronic transition moments in the amine moiety and lead to the statement of the salicylidenamino chirality rule: when the coupled electronic transition moments are arbitrarily viewed as being directed away from each other (Figure 10), positive chirality (right-handed screw) results in a positive contribution of bands I and II and negative chirality (left-handed) screw results in a negative contribution to the CEs. The sign of the observed CEs is then the algebraic sum of the positive and negative contributions to the CEs of bands I and II, the sum being related to the distribution of groups in the amine moiety with respect to

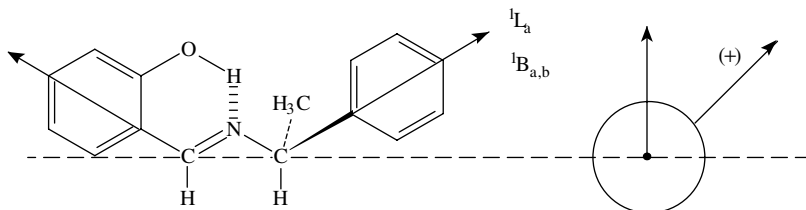
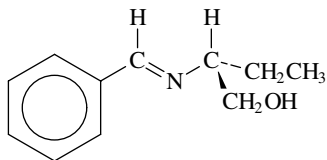


FIGURE 10. Chirality of the coupled electronic transition moments in the preferred conformation of the (*S*)-*N*-salicylidene- $\alpha$ -phenylethylamine [(*S*)-124]. Reproduced with permission from Reference 110. Copyright (1983) American Chemical Society

the salicylidenamino chromophore. Simple conformational analysis can be used to predict the sign of the observed CEs for a particular enantiomer<sup>110</sup>. A recent X-ray study and force field calculation on the (*R*)-*N*-benzylidene-2-amino-1-butanol<sup>113</sup> [(*R*)-**127**] support the preferred conformation for (*S*)-**124** and, as shown in Figure 10, the benzene ring and the conjugated C=N bond in both (*S*)-**124** and (*R*)-**127** form an almost planar  $\pi$  system with the hydrogen atom at the chiral center eclipsing the azomethine hydrogen atom.

[(*R*)-**127**]

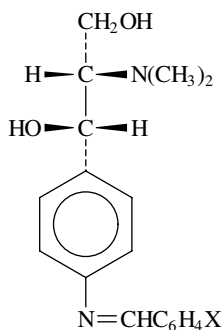
In the cases of the *N*-salicylidene derivatives of amines with one or more unsaturated groups,  $\alpha$ - and  $\beta$ -arylalkylamines,  $\alpha$ -amino acid salts and esters, and unsaturated aliphatic amines, coupling of the transition moments of the *N*-salicylidene moiety with the  $\pi$  electron transition moments of the unsaturated group is extremely strong, and the chirality of this coupling gives the sign to the observed CEs at 315 nm (band I) and 255 nm (band II). For the *N*-salicylidene derivatives of amines without unsaturated groups, including aliphatic and cyclic amines and amino sugars, the CEs are less intense, but application of the salicylidenamino chirality rule is also based on the coupled oscillator mechanism. The CEs associated with bands I and II originate from coupling of the SA chromophore with transition moments in the rest of the molecule. The effect due to the polarizability of the C–H bond is assumed to be negligible, and C–C and C–O bond transition moments vicinal and homovicinal to the SA chromophore are the dominant contributors to the CEs. Since the polarizability of a C–O bond is smaller than that of a C–C bond, the contribution of a vicinal or homovicinal C–O bond is less than that of a corresponding C–C bond. Conformational analysis then gives the algebraic sum of this coupling and relates the sign of the CEs of bands I and II in the CD spectrum with a particular absolute configuration of the *N*-salicylidene derivative<sup>110</sup>.

## 2. Exciton coupled circular dichroism (ECCD) spectra

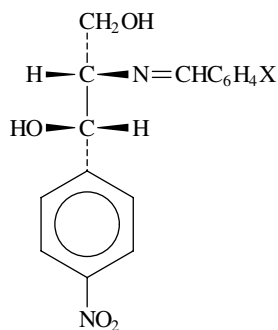
*a. N-Benzylidene derivatives.* A series of Schiff base derivatives was prepared by reaction of an enantiomer of (1*S*)-(+)-*threo*-1-(4-aminophenyl)-2-dimethylamino-1,3-propanediol<sup>114</sup> and of (1*S*)-(+)-*threo*-1-(4-nitrophenyl)-2-amino-1,3-propanediol<sup>115</sup> with benzaldehyde and a number of ring-substituted benzaldehydes, including salicylaldehyde, [(1*S*,2*S*)-**128**] and [(1*S*,2*S*)-**129**] as chromophoric derivatives for the establishment of the preferred conformations and absolute configurations of amines by CD measurements. The CD spectra of the Schiff bases of both of these chiral amines, even those of (1*S*,2*S*)-**128** in which the chromophore is not attached to a chiral center but to the benzene ring of the amine moiety, show strong CD maxima associated with the *N*-benzylidene chromophore similar to those shown by the *N*-salicylidene derivatives. The correlation of the CEs shown by ring-substituted derivatives such as (1*S*,2*S*)-**128** with their absolute configurations has not been studied extensively, and in the case of the (1*S*,2*S*)-**129** derivatives, none appears to be superior to the *N*-salicylidene derivative for the establishment of absolute configurations<sup>115</sup>.

Three other substituted benzaldehydes, *p*-dimethylaminobenzaldehyde (**130**), julolidinecarboxaldehyde (**131**) and *p*-dimethylaminocinnamaldehyde (**132**), have been reported for use in the preparation of chromophoric derivatives of chiral amines<sup>116,117</sup>.

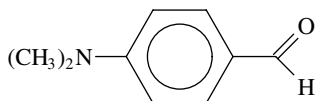




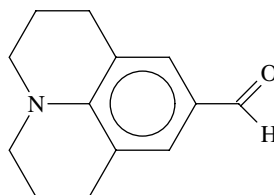
[(1S,2S)-128]



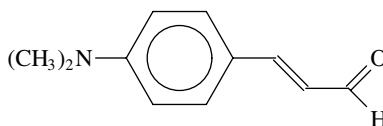
[(1S,2S)-129]



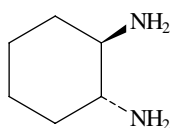
(130)



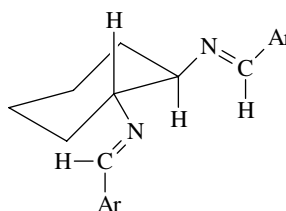
(131)



(132)



[(R,R)-133]



[(R,R)-134]

The three aldehydes react readily under very mild conditions with (*R*)-*trans*-1,2-cyclohexanediamine [(*R,R*)-133] to afford the respective bis(Schiff) bases (*R,R*)-134 which show exciton coupled circular dichroism (ECCD) spectra<sup>118</sup> (Figure 11). Figure 11 shows the CD spectrum of the derivative formed by condensation of 131 with (*R,R*)-133. The chromophore using 131 has a long-wavelength absorption maximum at 331 nm, and thus the bis(Schiff) base shows a negative bisignate CD curve centered near this same wavelength, the negative sign of the long-wavelength CD maximum at 351 nm correlating with the negative torsion angle of the nitrogen atom attachment bonds in the diamine moiety. Upon protonation of the tertiary amino groups in the aldehyde moiety of the Schiff bases, the absorption spectra undergo drastic bathochromic shifts, and the intensities of the

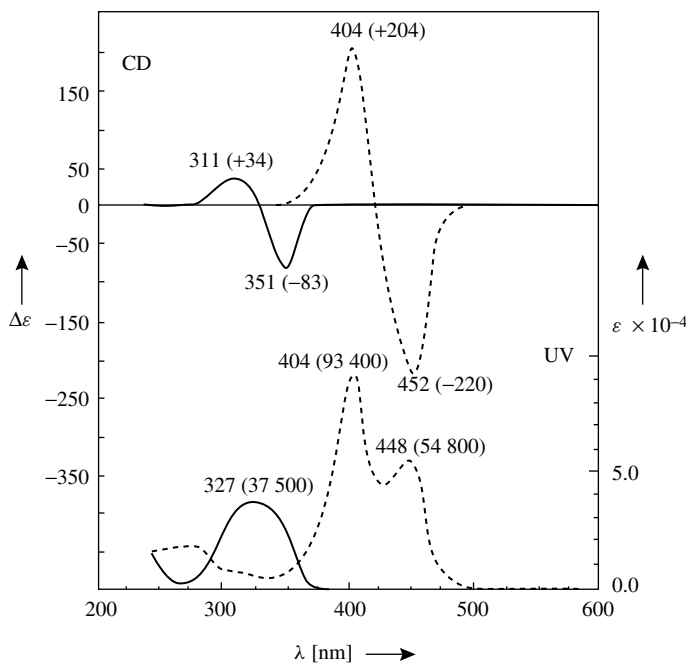


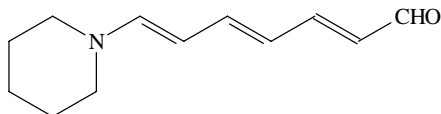
FIGURE 11. Electronic absorption (UV) and circular dichroism (CD) spectra in acetonitrile: neutral (solid line) and protonated (dashed line) bis(Schiff) base (*R,R*)-**134** prepared by condensation of julolidinecarboxaldehyde (**131**) with (*R*)-*trans*-1,2-diaminocyclohexane [(*R,R*)-**133**]. Reproduced from Reference 116 by permission of VCH Publishers

respective CEs are enhanced 2–3-fold (Figure 11). This increase in the sensitivity of the method and the bathochromic shift may be important when samples themselves contain chromophoric groups or impurities whose absorption bands may overlap with those of the chromophores and interfere with analysis.

The ECD spectra of the bis(Schiff) base derivatives prepared from **130–132** were successfully correlated with the absolute configurations of chiral 1,2- and 1,3-diamines<sup>116,117</sup> and chiral 1-amino-2-hydroxyl compounds in which the amino group was converted to the imine group and the hydroxyl group was converted to 5-(*p*-methoxyphenyl)pentadienoate group, the latter with an absorption minimum at about 330 nm and thus also strongly coupling with the imine chromophore<sup>116,117</sup>.

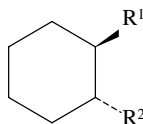
In work related to the bisimine derivatives discussed above, the ultraviolet-visible and circular dichroism behaviour due to exciton coupling in a biscyanine dye, prepared by condensation of two equivalents of 7-piperidinohepta-2,4,6-trienal (merocyanine, **135**) with (*S,S*)-*trans*-1,2-diaminocyclohexane [(*S,S*)-**133**], was reported<sup>119</sup>. The CD spectrum of the resulting protonated bisimino compound is unusual in that it shows two CD maxima at 547 and 476 nm, negative and positive, respectively, of similar intensity<sup>119</sup>, termed a negative bisignate CD curve or a negative exciton coupled Cotton effect (ECCE). These maxima were shown to be the result of exciton coupling of the protonated chromophores, but the negative sign is opposite to that predicted on the basis of CD observations with the dibenzamide derivative of (*S,S*)-**133**, also the result of exciton coupling<sup>118–120</sup>. In the chiral biscyanine dyes, such a large CE separation arising from exciton coupling has

not been encountered before, but calculations by molecular mechanics and the  $\pi$ -electron SCF-CI-DV MO method yield typical exciton split CD curves. The calculations also indicate that the sign reversal in the bisignate CD of the bicyanine dye in comparison with that of the corresponding dibenzoate derivative is due to the unique conformation of the two cyanine dye side chains<sup>121</sup>.



(135)

*b. N-Benzoyl derivatives.* The dibenzoate chirality rule<sup>122</sup>, which correlates the sign of exciton coupled CD spectra of the dibenzoate derivatives of vicinal diols [(*R,R*)-**136**] with their absolute configurations, has been extended to the benzoyl derivatives of vicinal amino alcohols [(*R,R*)-**137**] and vicinal diamines (*R,R*)-**138**<sup>123</sup>. The dibenzoate chirality rule is based on the fact that the transition dipole responsible for the 230 nm band of each benzoate group in (*R*)-*trans*-*O,O'*-dibenzoyl-1,2-cyclohexanediol [(*R,R*)-**136**] is nearly parallel to the C–O bond in the alcohol moiety. The coupling of these moments results in two strong CEs of the same amplitude but of opposite signs around 233 (first CE) and 219 nm (second CE). A negative torsion angle as in (*R,R*)-**136** between the interacting moments results in a negative first CE and a positive second CE, the couplet termed a negative exciton coupled Cotton effect (ECCE); a positive torsion angle results in a positive ECCE. Since in a *N*-alkylbenzamide the transition moment analogous to that of the 230 nm band in the benzoate group is also nearly parallel to the C–N bond of the amine moiety, it was anticipated and in fact found that the dibenzoate chirality rule could be applied to vicinal amino alcohols and vicinal diamines, and both (*R,R*)-*N,O*-dibenzoyl-2-aminocyclohexanol [(*R,R*)-**137**] and (*R*)-*trans*-*N,N'*-dibenzoyl-1,2-cyclohexanediamine [(*R,R*)-**138**] show negative ECCE, similar to that shown by (*R,R*)-**136**<sup>123</sup>.



[(*R,R*)-**136**]  $R^1 = R^2 = \text{OBz}$

[(*R,R*)-**137**]  $R^1 = \text{OBz}, R^2 = \text{NHBz}$

[(*R,R*)-**138**]  $R^1 = R^2 = \text{NHBz}$

Exciton coupling can also occur between the benzamide chromophore and other  $\pi$ -electron systems, and (*S*)-*N*-benzoyl- $\alpha$ -(2-furfuryl)alkylamines [(*S*)-**139**] show positive ECCE spectra<sup>62</sup> with a bisignate CE couplet centered at about 228 nm. For the enantiomers the ECCE spectra are negative<sup>62</sup>. Similarly the *p*-bromobenzoyl group linked to the *N*-terminus of a helical peptide chain is useful as a CD probe in the determination of the relationship between the *C*( $\alpha$ )-configuration of coded and noncoded  $\alpha$ -amino acids and peptide helix screw sense in solution, the bisignate CE center around 238 nm the result of the interaction between the *p*-bromobenzamido chromophore and the peptide chromophores<sup>124</sup>.

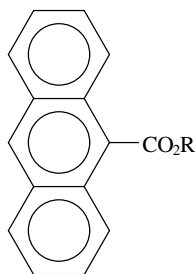
(1*R*,2*R*)-2-*p*-Chlorobenzamido-1-phenyl-1-cyclohexanol [(1*R*,2*R*)-**140**] also shows an ECCD spectrum, but with only a single negative CE above 205 nm. The latter is



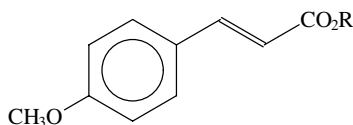
[(*S*)-**139**] R = CH<sub>3</sub>, CH<sub>2</sub>CH<sub>2</sub>CH<sub>3</sub> or CH<sub>2</sub>CH(CH<sub>3</sub>)<sub>2</sub>    [(*1R,2R*)-**140**]

associated with a transition of the *p*-chlorobenzamido chromophore and its sign is the result of chirality of the exciton coupling of the transition moment of the chromophore with the  $\pi \rightarrow \pi^*$  transition moment below 200 nm of the phenyl group at C-1 in the cyclohexane ring<sup>125</sup>.

The principle of exciton coupling between vicinal benzoate chromophores has been extended to other aromatic carboxylic acid derivatives<sup>126</sup>, including those of ring-substituted benzoic acids, 9-anthranic acid (**141**) and *p*-methoxycinnamic acid (**142**). These derivatives have been widely used for the determination of the absolute stereochemistry in polyol natural products<sup>127</sup>. The circular dichroism of the *N*-*p*-bromobenzoyl group combined with various *O*-, *O,O'*-di- and *O,O',O''*-tri-(*p*-bromobenzoyl) derivatives of 2-amino-2-deoxygalactopyranoside<sup>128</sup> and an *N*-anthranoyl group combined with tri-, tetra- and penta-*p*-methoxycinnamoyl derivatives of acyclic 1-amino polyols<sup>129</sup> were studied to improve and develop microscale CD methods for the structural study of amino sugars.



(**141**)

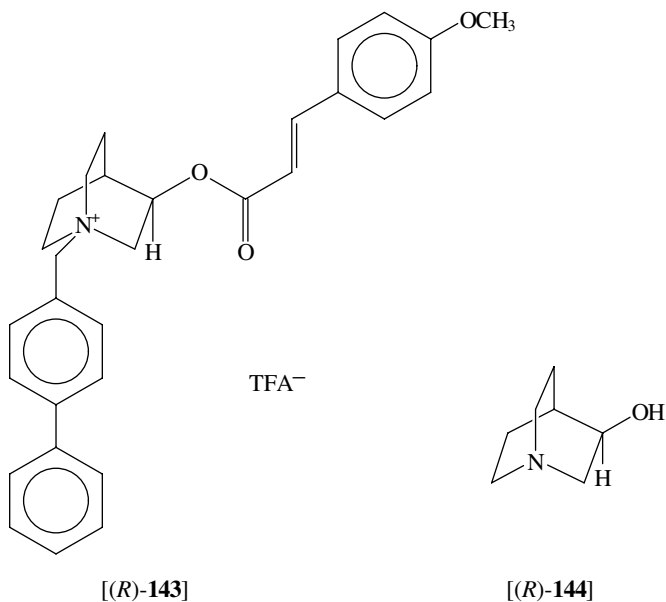


(**142**)

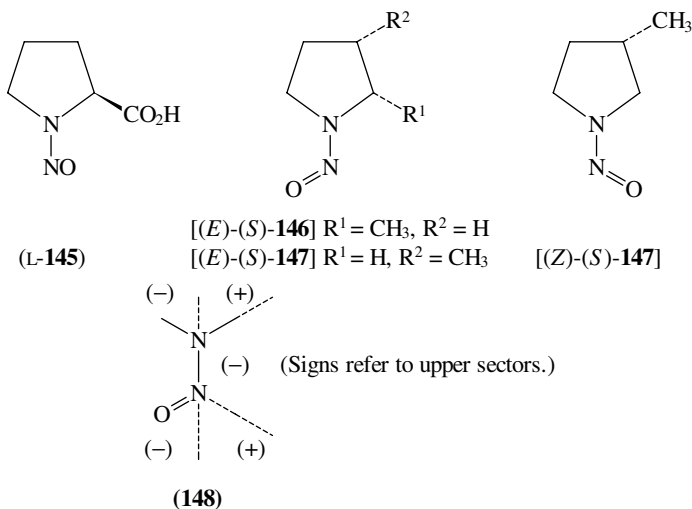
The ECCD method was extended to determination of the absolute configurations and conformations of chiral organic molecules containing chromophores which are either pre-existent in the molecule or introduced through derivatization by *O*- or *N*-acylation and also incorporating a tertiary amino group<sup>130</sup>. This latter group was derivatized through quaternary ammonium salt formation using *p*-phenylbenzyl chloride<sup>130</sup>. Thus the trifluoroacetate (TFA) salt of the *O*-*p*-methoxycinnamoyl-*N*-*p*-phenylbenzyl derivative (*R*)-**143** of (*R*)-3-quinuclidinol [(*R*)-**144**] gives an ECCD spectrum with a negatively split exciton couplet in agreement with the *R* configuration for **143**, the same configuration previously established by X-ray diffraction for **144**<sup>131</sup>. The use of a chromophoric derivative for tertiary amino groups should find substantial application in the establishment of the absolute configurations of other natural products incorporating a tertiary amino group.

#### D. *N*-Nitrosamines

As a continuation of the interest in the electronic circular dichroism (ECD) of the chiral nitrosamines, the ECD of the *N*-nitroso derivatives of chiral 4-, 5- and 6-membered cyclic



amines, including *N*-nitroso-*L*-proline (**L-145**) and a number of ring-substituted *N*-nitroso-*L*-prolines, were measured<sup>132</sup>. The effect of the nitrosamine group conformation, pyrrolidine geometry, different perturbing substituents and hydrogen bonding on the sign and magnitude of the  $n \rightarrow \pi^*$  CD band centered around 350 nm were discussed<sup>132</sup>. A negative CD band due to the  $\pi \rightarrow \pi^*$  transition was observed for all *N*-nitrosamines having the *L*-proline configuration at C-2 regardless of the nitroso group conformation. As an extension of this work, the ECD spectra of several 2- and 3-substituted *N*-nitrosopyrrolidines were studied in solvents of varying polarity<sup>133</sup>. 2-Substituted nitrosopyrrolidines such as (*S*)-2-methyl-*N*-nitrosopyrrolidine [(*S*)-**146**], as shown by their <sup>1</sup>H NMR spectrum, prefer the



*E* conformation [(*E*)-(*S*)-**146**] whereas 3-substituted nitrosopyrrolidines [(*S*)-**147**] exist roughly as an equimolar mixture of the *E* and *Z* conformers [(*E*)- and (*Z*)-(*S*)-**147**]. Thus the CD spectrum of (*S*)-3-methyl-*N*-nitrosopyrrolidine shows pronounced fine structure and crosses the zero line within the  $n \rightarrow \pi^*$  transition spectral region (Figure 12). The bisignate CD curves for the  $n \rightarrow \pi^*$  transition of the nitrosamine chromophore is ascribed to the *E*-*Z* equilibrium of the chromophore or to vibrational–electronic coupling, and on either of these bases, the general validity of the symmetry sector rule (**148**) proposed<sup>134</sup> some years ago for the planar nitrosamine chromophore was questioned. More recently the chiroptical properties of the enantiomers of a substantial number of *N*-nitrosopyrrolidines, including (*S*)-**145** and (*S*)-**146**, were studied in some detail<sup>135</sup>, and it was shown that the CD of monocyclic compounds such as (*S*)-**145** and (*S*)-**146** depends on substituent, solvent and temperature effects and, as a result, some of the *N*-nitrosamines exhibit bisignate CD curves in the region of the  $n \rightarrow \pi^*$  transition. Conformationally rigid bi- and tricyclic *N*-nitrosamines, such as (1*S*,5*R*)-*N*-nitroso-1-methyl-3-azabicyclo[3.1.0]hexane [(1*S*,5*R*)-**149**], show monosignate CEs, the rotational strengths of which are almost solvent-independent. Thus bisignate curves result from the presence of two half-chair conformers of the pyrrolidine ring in equilibrium and contributing opposite CD signs. On the basis of the molecular geometries as calculated by the molecular mechanic (MM2) method for a particular ring-substituted *N*-nitrosopyrrolidine and taking into consideration the amounts of and the rotational contributions of the *E*-*Z* and half-chair conformations, the CE signs were predicted using the sector rule for the planar nitrosamine chromophore shown in **148**.

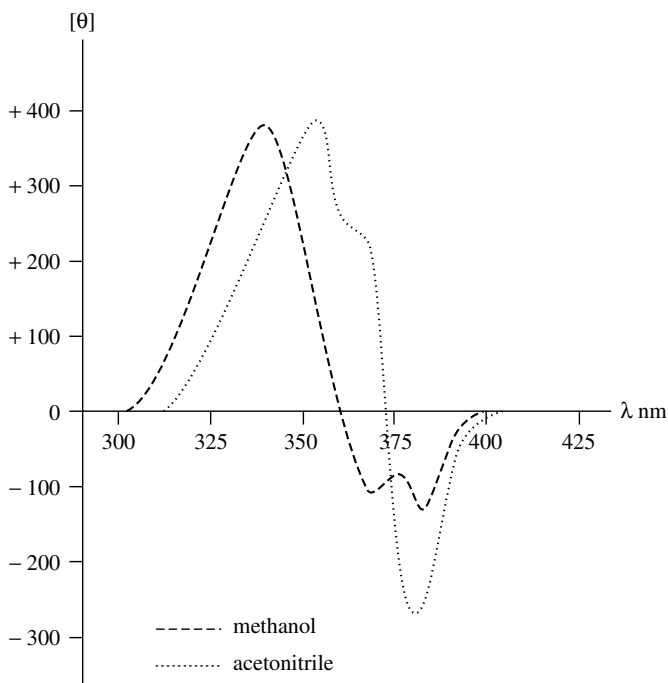
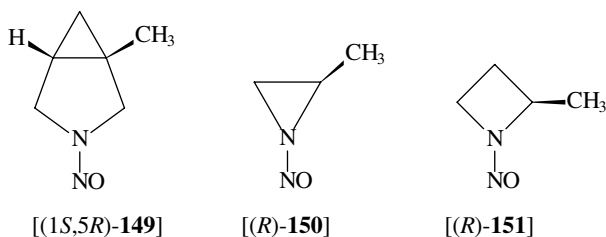
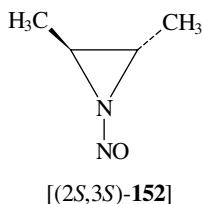


FIGURE 12. Electronic circular dichroism spectra of (*S*)-3-methyl-*N*-nitrosopyrrolidine [(*S*)-**147**]. Reproduced from Reference 133 by permission of Acta Chemica Scandinavica



The stereochemistry and chiroptical properties of the nonplanar nitrosamine group in chiral ring-substituted *N*-nitrosaziridines<sup>136</sup> and *N*-nitrosazetidines<sup>137</sup>, such as (*R*)-2-methyl-1-nitrosaziridine [(*R*)-150] and (*R*)-2-methyl-1-nitrosazetidene [(*R*)-151], were investigated by means of nonempirical quantum chemical calculations and by measurement of their CD spectra. For (*R*)-150, four conformational diastereomers can contribute to the observed CEs, and on the basis of the calculated equilibrium of these diastereomers and the rotational contribution of each as given by a spiral sector rule, the same as that for chiral *N*-acylaziridine, the known absolute configuration of (*R*)-150 is correlated with the sign of its  $n \rightarrow \pi^*$  CE in the 350–500 nm region. Similar considerations allow the correlation of the sign of this same CE with the absolute configuration of (*2S*)-*trans*-2,3-dimethyl-1-nitrosaziridine [(*2S,3S*)-152]. A second transition at shorter wavelength near 240 nm which has an oppositely signed and stronger CE is assigned as a  $\pi \rightarrow \pi^*$  transition of the inherently chiral nitroso chromophore<sup>136</sup>. The presence of the ester functionality, however, in an *N*-nitrosaziridine results in a reversal of the CE sign of both the  $n \rightarrow \pi^*$  and  $\pi \rightarrow \pi^*$  transitions.



For alkyl-substituted *N*-nitrosazetidines, it was shown that the CD spectra can be interpreted on the basis of conformational diastereoisomerism, taking into account the nonplanarity of the nitrosazetidene chromophore<sup>137</sup>. For a particular configuration, the CE sign of the  $n \rightarrow \pi^*$  transition in the 350–400 nm region is determined by the intrinsic chirality of the chromophore and obeys a spiral rule, the same as that for nonplanar nitrosaziridines where the absence of the local plane of symmetry in the nitrosamine chromophore does not permit the use of the planar sector rule 148.

## V. VIBRATIONAL OPTICAL ACTIVITY (VOA)

### A. Vibrational Circular Dichroism (VCD)

Although Lowry in his classical treatise in 1935 discussed the possibility of detection of circular dichroism arising from molecular vibration transitions<sup>138</sup>, only in the past two decades has it been possible to measure optical activity associated with infrared absorption transitions, CD maxima first being detected in the VCD spectrum for the C–H stretching modes of the enantiomers of 2,2,2-trifluoro-1-phenylethanol as the neat liquid<sup>139</sup>. This work was initiated with the view that such measurements would eventually yield information concerning absolute configurations and molecular conformations of

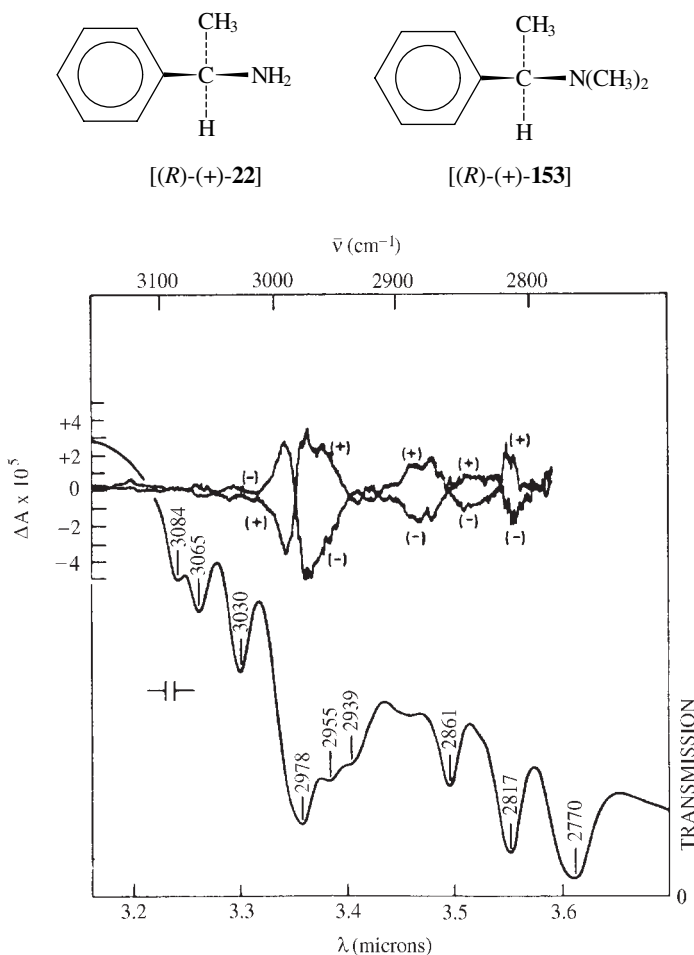


FIGURE 13. Vibrational circular dichroism and transmission spectra of (*R*)-(+)- and (*S*)-(-)-*N,N*-dimethyl- $\alpha$ -phenylethylamine [*(R)*-(+)- and (*S*)-(-)-**153**] in carbon tetrachloride. Reprinted with permission from Reference 140. Copyright (1976) American Chemical Society

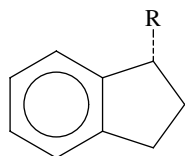
such molecules<sup>139</sup>. A more extensive study of the VCD in the C–H, O–H and N–H stretching bands of a number of chiral compounds as the neat liquid and in carbon tetrachloride, including the enantiomers of  $\alpha$ -phenylethylamine [*(R)*-(+)- and (*S*)-(-)-**22**] and their *N,N*-dimethyl derivatives [*(R)*-(+)- and (*S*)-(-)-**153**] (Figure 13), was reported<sup>140</sup>. This work was also undertaken for the development of the formal theory of VCD to explore the accuracy of calculations on simple well-defined systems for which unambiguous calculations and experiments can both be performed. To assess the possible role of the methyl group as a probe for the assignment of absolute configuration, the VCD spectra of several chiral  $\alpha$ -substituted phenylethanes, including (*R*)- $\alpha$ -phenylethylamine [*(R)*-**22**] and its *p*-bromo derivative, were examined in the 1400–1480 cm<sup>-1</sup> region both as the neat liquid and in carbon tetrachloride<sup>141</sup>. In these compounds, all with the same



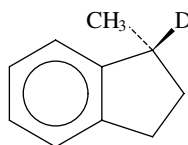
generic configuration, the negative VCD maximum at about  $1450\text{ cm}^{-1}$  was interpreted as being due to interaction of the methyl group deformation with a near-degenerate phenyl mode<sup>141</sup>.

The VCD spectra of (*R*)- and (*S*)-**22** were also examined in the mid-infrared region ( $900\text{--}1625\text{ cm}^{-1}$ )<sup>142</sup>. These spectra, with unusual VCD features, showed that the VCD associated with the C- $\alpha$  hydrogen atom and the phenyl ring vibrational modes appears to be significant in understanding the relationship of VCD features to stereochemistry and that the mid-infrared VCD of (*R*)- and (*S*)-**22** as the neat liquid differ from those of a dilute solution in carbon tetrachloride<sup>140</sup>. In connection with this work, the infrared and Raman spectra of several  $\alpha$ -substituted phenylethanes were measured so as to identify the stretching vibrations of the methine and methyl groups<sup>143</sup>. These identifications were facilitated by the deuteration of the methine group in all of the molecules examined, including  $\alpha$ -phenylethylamine (**22**), and of the methyl group and phenyl group in  $\alpha$ -phenylethyl alcohol, and it was found that the methine stretching vibrational frequency and its intensity are significantly affected by substitution at the carbon atom to which the methine hydrogen atom and methyl group are directly attached<sup>143</sup>.

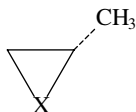
The VCD of (*R*)- and (*S*)-1-aminoindan [(*R*)- and (*S*)-**154**], (*R*)- and (*S*)-1-methylindan [(*R*)- and (*S*)-**155**], and (*R*)-1-methylindan-1-*d*[(*R*)-**156**] were measured in the  $800\text{--}1600\text{ cm}^{-1}$  region, and in each spectrum, the sign of the VCD maximum at about  $1350\text{ cm}^{-1}$ , positive for the *R* configuration and negative for the *S* configuration, was found to correlate with the absolute configuration<sup>144</sup>. This correlation is in agreement with one found for (*S*)-methyloxirane<sup>145</sup> [(*S*)-**157**] and (*R*)-methylthiirane<sup>144,146</sup> [(*R*)-**158**] and reflects the importance of VCD measurements in stereochemical analysis of chiral ring systems. General correlation rules, however, have not been established to relate the absolute configuration at a particular chiral center in a chiral molecule of substantial size with CD maxima in its VCD spectrum.



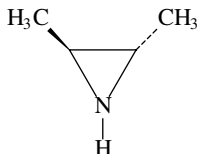
[(*R*)-**154**] R = NH<sub>2</sub>  
[(*R*)-**155**] R = CH<sub>3</sub>



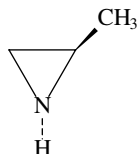
[(*R*)-**156**]



[(*S*)-**157**] X = O  
[(*S*)-**158**] X = S



[(2*S*,3*S*)-**159**]



[(1*R*,2*R*)-**160**]

Small, rigid chiral molecules, such as methyl-substituted oxiranes<sup>147</sup>, thiiranes<sup>148</sup> and aziridines<sup>149,150</sup>, have attracted much attention for VOA studies since they have a potential for serving as a bench mark for rigorous theoretical investigations. Thus the

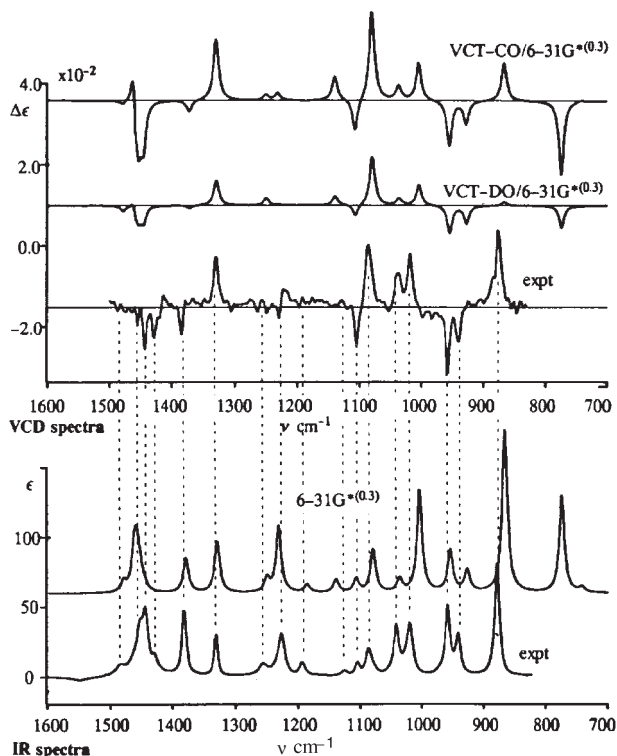


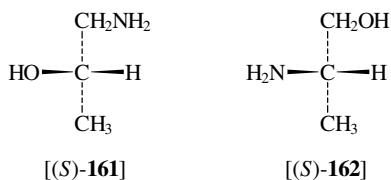
FIGURE 14. Theoretically simulated and experimental vibrational circular dichroism (VCD) and infrared (IR) spectra of (2*S*,3*S*)-2,3-dimethylaziridine [(2*S*,3*S*)-**159**] carbon tetrachloride in the region 700–1600  $\text{cm}^{-1}$ . Reproduced from Reference 149 by permission of the National Research Council of Canada

experimental VCD spectra of (2*S*,3*S*)-2,3-dimethylaziridine<sup>149</sup> [(2*S*,3*S*)-**159**] and (2*R*)-2-methylaziridine<sup>150</sup> [(2*R*)-**160**] were measured in the 800–1500  $\text{cm}^{-1}$  region. The VCD spectrum of (2*S*,3*S*)-**159** (Figure 14) was interpreted with the help of *ab initio* vibronic coupling theory (VCT) both in the common origin (CO) and distributed origin (DO) gauge. Both VCT-CO and VCT-DO methods predict VCD and IR spectra that are in good agreement with the experimental spectra (Figure 14). The VCT method together with the 6-31G\*(0.3) basis set can be employed with confidence in determining the absolute configuration for rigid chiral molecules such as (2*S*,3*S*)-**159**. Using the VCT method with the 6-31G\*(0.3) basis set, the VCD spectrum was computed for each of the *cis* and *trans* conformational diastereomers of (2*R*)-2-methylaziridine [(2*R*)-**160**], the rotatory strengths of many absorptions being oppositely signed and of similar magnitude in the two conformational enantiomers which differ in configuration at the nitrogen atom<sup>150</sup>. The experimental VCD spectrum of (2*R*)-**160** was found to be dominated by the contribution of the *trans* conformational diastereomer [(1*R*,2*R*)-**160**] present in greater abundance.

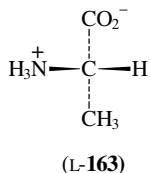
A similar *ab initio* computational and VCD study in the 800–1500  $\text{cm}^{-1}$  range using (5*S*)-1-azabicyclo[3.1.0]hexane [(5*S*)-**115**] gave VCD spectra calculated at three different computational levels which are well reproduced in the experimental VCD spectrum<sup>151</sup>.

The success of these *ab initio* calculations in predicting the signs of many of the VCD features of molecules of particular absolute configurations suggests that it should eventually be possible to interpret VCD spectra at a fundamental level, rather than simply relying on empirical correlations.

In connection with this suggestion, VCD measurements and calculations were also investigated with (*S*)-1-amino-2-propanol [(*S*)-**161**] and (*S*)-2-amino-1-propanol [(*S*)-**162**]<sup>152</sup>, two similar molecules which can assume a number of intramolecularly hydrogen-bonded conformations. The goal of this work was the assessment of the relative influence on VCD intensity of hydroxyl and amino groups at a chiral center and the applicability of *a priori* VCD calculations to the interpretation of the spectra for molecules with several conformers of similar energy. The vibrational frequencies, infrared intensities and VCD intensities, the latter using the vibronic coupling theory (VCT), were calculated for all hydrogen-bonded conformers with *ab initio* wave functions at a 6-31G<sup>(0,3)</sup> basis set. Comparison of the experimental and calculated spectra allowed correlation of the major VCD features with only a few predominant conformers<sup>152</sup>.



The VOA of  $\alpha$ -amino acids has also been examined in some detail as an aid to the use of VCD measurements in the understanding of peptide conformation<sup>153,154</sup>. The VCD spectra of L-alanine (L-**163**)<sup>153,154</sup>, several other L- $\alpha$ -amino acids and dipeptides were measured in water and deuterium oxide between 900 and 1700  $\text{cm}^{-1}$ . In both solvents, a characteristic (-,+) VCD pattern near 1325  $\text{cm}^{-1}$  (negative at higher frequency) was observed for the two orthogonal methine bending modes in L- $\alpha$ -amino acids and in L-dipeptides only for a methine bond adjacent to a carboxylate group. For the L- $\alpha$ -amino acids at the low pH or for the N-terminus of a dipeptide, no VCD intensity, which was interpreted in terms of a ring current mechanism, was observed for these methine bending modes<sup>155</sup>. The CH-stretching VCD spectra of several amino acids were examined as a function of pH<sup>156</sup>. At neutral and high pH, the VCD spectra exhibited a large positive VCD intensity bias which is associated with the  $\text{C}_\alpha\text{-H}$  methine stretching mode. At low pH, the bias is absent and only weak VCD spectra are observed, and the VCD spectra were interpreted within the framework of the ring current mechanism<sup>155</sup>. It was proposed, however, that closed pathways due to a variety of intramolecular interactions in the amino acids can support vibrationally generated ring currents which give rise to VCD intensity enhancement<sup>156</sup>.



## B. Raman Optical Activity (ROA)

In the last two decades, interest has also turned to the possible use of Raman optical activity (ROA) as an additional probe into the stereochemistry of chiral molecules<sup>157</sup>. The

term Raman circular dichroism is not used since the word dichroism refers to differential absorption. The process responsible for Raman scattering is different from that producing infrared absorption, and the effect cannot be regarded as a manifestation of infrared circular dichroism although both are forms of vibrational optical activity<sup>158</sup>. For the phenomena, the term Raman circular intensity differential (CID) is used with the symbol  $\Delta$  expressed as in equation 3,

$$\Delta = (I^R - I^L)/(I^R + I^L) \quad (3)$$

where  $I^R$  and  $I^L$  are intensities of the scattered light in right and left circularly polarized incident light. The CID ( $\Delta$ ) can be defined for light scattered at  $90^\circ$  which is linearly polarized perpendicular ( $\Delta_x$ ) and parallel ( $\Delta_z$ ) to the scattering plane<sup>158</sup>.

The first report for observation of the differential Raman scattering, using the enantiomers of  $\alpha$ -phenylethylamine (**22**)<sup>159</sup>, could not be verified and in fact was based on artifacts<sup>158,160</sup>. Using improved instrumentation, the sum and difference spectra for (*R*)- $\alpha$ -phenylethylamine [(*R*)-**22**] were successfully measured with parallel scattering (Figure 15), the signal intensities measured in photon counts<sup>160</sup> from which its CIDs were calculated. With these data and those using the spectra of (*-*)- $\alpha$ -pinene (**164**),

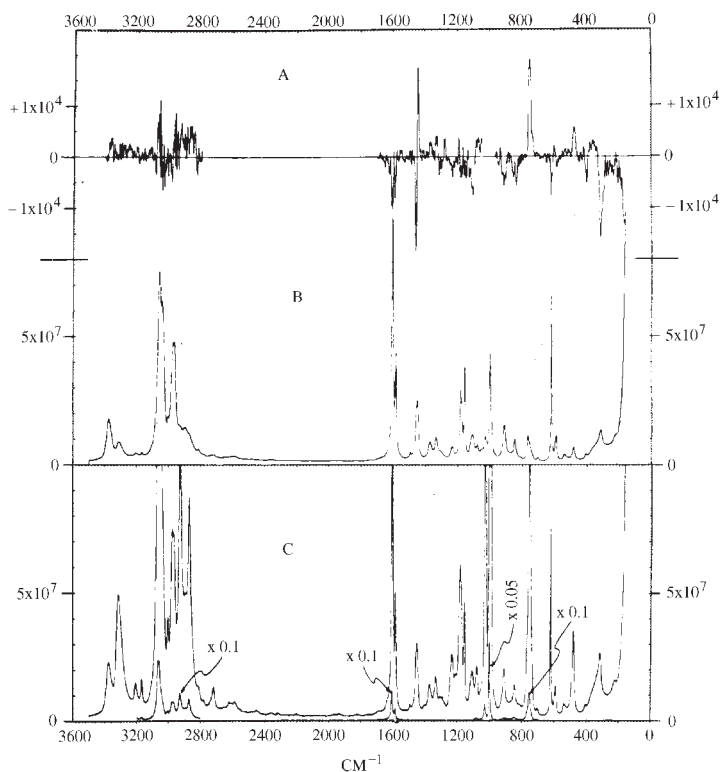
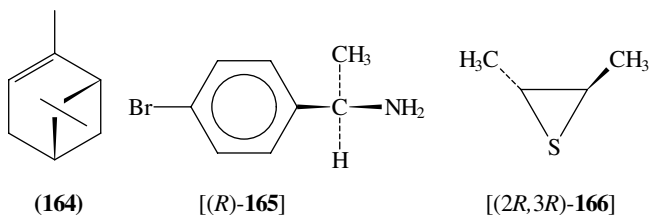


FIGURE 15. Raman circular intensity spectra for (*R*)- $\alpha$ -phenylethylamine [(*R*)-**22**] in photon counts: (A) difference spectrum,  $(I_z^R - I_z^L)$ ; (B) sum spectrum,  $(I_z^R + I_z^L)$ ; (C) difference spectrum,  $(I_x^R - I_x^L)$ . Reprinted with permission from Reference 160. Copyright (1975) American Chemical Society



it was suggested that the degenerate antisymmetric CH<sub>3</sub> deformation mode centered at 1450 cm<sup>-1</sup> has important potential for probing the local environment of methyl groups<sup>160</sup>. In (*R*)-**22** the local degeneracy of the methyl group is removed by the asymmetric environment and a sizable CID couplet (negative at higher wave number) was found, and no change in sign of this couplet at 1450 cm<sup>-1</sup> was expected by replacing the phenyl group with a substituted phenyl group<sup>160</sup>. Other work also suggested that for Raman CIDs in methyl asymmetric deformations and methyl torsions, the methyl group could function as a powerful new probe of chirality<sup>161</sup>, and the *R* absolute configuration of (+)-1-methylindane [(+)-**155**] was confirmed on a comparison of its ROA spectrum, especially using the antisymmetric deformation mode of the methyl group at 1450 cm<sup>-1</sup>, with that of (*R*)- $\alpha$ -phenylethylamine [(*R*)-**22**]<sup>162</sup>. When the Raman CID spectrum between 80 and 2000 cm<sup>-1</sup> of (*R*)- $\alpha$ -(*p*-bromophenyl)ethylamine [(*R*)-**165**] was examined<sup>163</sup>, however, no corresponding CID couplet at 1450 cm<sup>-1</sup> was found, but instead a new Raman band associated with a large positive CID appeared at 1410 cm<sup>-1</sup> and is almost certainly a stretching mode of the substituted aromatic ring<sup>163</sup>. On this basis then the methyl asymmetric deformation at 1450 cm<sup>-1</sup> should be used with caution<sup>163</sup>. In line with this conclusion and as discussed above in connection with the interpretation of vibration circular dichroism, the infrared and Raman spectra of several  $\alpha$ -substituted phenylethanes were measured to identify the stretching vibrations of the methine and methyl groups<sup>143</sup>, and it was found that the methine stretching vibrational frequency and its intensity are significantly affected by substitution at the carbon atom to which the methine hydrogen atom and methyl group are directly attached<sup>143</sup>.

As discussed above, the VCD studies of small, rigid chiral molecules, such as methyl-substituted oxiranes<sup>147</sup>, thiiranes<sup>148</sup> and aziridines<sup>149,150</sup>, have attracted much attention since they have a potential for serving as benchmarks for theoretical investigations. The same is true for ROA studies, and the experimental ROA spectrum in the 200–1500 cm<sup>-1</sup> region of (+)-*trans*-2,3-dimethylthiirane, known to have the 2*R*,3*R* absolute configuration, was compared with that calculated by *ab initio* quantum calculations for (2*R*,3*R*)-2,3-dimethylthiirane [(2*R*,3*R*)-**166**]<sup>164</sup>. The excellent level of agreement obtained for the observed and calculated ROA signs suggests that the absolute configuration of such chiral molecules can be determined confidently using a comparison of ROA observations and *ab initio* quantum mechanical calculations of the ROA of a particular enantiomer<sup>164</sup>.

Recently there has also developed an interest in the ROA of biologically significant molecules such as  $\alpha$ -amino acids in aqueous solution due to a substantial increase in instrument sensitivity based on backscattering of the scattered light instead of the usual perpendicular (90°) scattering arrangement<sup>165</sup>. Using this new instrumentation, the experimentally observed ROA of L-alanine<sup>165,166</sup> (L-**163**) in water, 1 N sodium hydroxide and 1 N hydrochloric acid between 720 and 1700 cm<sup>-1</sup> and the *ab initio* calculated Raman and ROA intensities for the zwitterionic form of L-alanine (L-**163**) using the 6-31G and 6-31G\* basis sets were found to agree remarkably well with experimental parameters in the lower frequency region<sup>165</sup>. With a small revision for the experimental observation for L-**163** in aqueous sodium hydroxide and hydrochloric acid, refinement of Raman and ROA

band assignments were made<sup>166</sup>. Also, comparison of the backscattered ROA spectra of L-alanine (L-**163**), L-alanine-2-*d*<sub>1</sub>, and L-alanine-3,3,3-*d*<sub>3</sub> in water and deuterium oxide in the 800–1700 cm<sup>-1</sup> frequency region and the *ab initio* calculations of Raman and ROA intensities with a 6-31G\* basis set for the zwitterionic forms (L-**163**) gave excellent agreement between experiment and calculation for both Raman and ROA spectra<sup>167</sup>. The success of these *ab initio* calculations in correctly predicting the signs of many of the observed ROA features of a molecule as large as L-alanine suggests that it should eventually be possible to interpret ROA spectra at a fundamental level, rather than relying on empirical correlations to extract stereochemical information. Unfortunately,  $\alpha$ -amino acids larger than L-alanine are too large at this time for similar *ab initio* calculations, but the L-alanine results reported earlier<sup>165</sup> were used to interpret the backscattered ROA spectra between 600 and 1600 cm<sup>-1</sup> of a number of simple  $\alpha$ -amino acids larger than L-alanine, L-serine, L-cysteine, L-valine, L-threonine and L-isoleucine, in water<sup>168</sup>. It was shown that similarities between the  $\alpha$ -amino acid ROA spectra will enable ROA to make important contributions to solution conformation studies. It appears that the C(2)–H deformations and symmetric CO<sub>2</sub><sup>-</sup> stretch offer the most reliable ROA signature for stereochemical correlations, including the determination of absolute configurations.

## VI. REFERENCES

1. H. E. Smith, in *Supplement F: The Chemistry of Amino, Nitroso and Nitro Compounds and Their Derivatives*, Part 2 (Ed. S. Patai), Chap. 23, Wiley, Chichester, 1982, pp. 999–1034.
2. J. S. Davies (Ed.), *Amino Acids and Peptides*, Chapman and Hall, New York, 1985.
3. J. S. Glasby, *Encyclopedia of the Alkaloids*, Plenum Press, New York, Vols. 1 and 2, 1975; Vol. 3, 1977; Vol. 4, 1983.
4. D. Horton, in *The Amino Sugars*, Vol. 1A (Ed. R. W. Jeanloz), Chap. 1, Academic Press, New York, 1969, pp. 190–211.
5. W. Klyne and J. Buckingham, *Atlas of Stereochemistry, Absolute Configurations of Organic Molecules*, 2nd ed., Vol. 1, Oxford University, New York, 1978; Vol. 2, Chapman and Hall, London, 1978; J. Buckingham and R. A. Hill, *Atlas of Stereochemistry, Absolute Configurations of Organic Molecules, Supplement to the Second Edition*, Chapman and Hall, New York, 1986.
6. J. Jacques, C. Gros and S. Broucier, in *Stereochemistry*, Vol. 4, *Absolute Configurations of 6000 Selected Compounds with One Asymmetric Carbon Atom* (Ed. H. B. Kagen), Georg Thieme, Stuttgart, 1977.
7. C. Djerassi, *Optical Rotatory Dispersion, Applications to Organic Chemistry*, McGraw-Hill, New York, 1960.
8. L. Velluz, M. Legrand and M. Grosjean, *Optical Circular Dichroism, Principles, Measurements, and Applications*, Academic Press, New York, 1965.
9. J. H. Brewster, *J. Am. Chem. Soc.*, **81**, 5475 (1959).
10. D. Tanner, *Angew. Chem., Int. Ed. Engl.*, **33**, 599 (1994).
11. H. Waldmann, *Synlett*, 133 (1995).
12. J. Jacques, A. Collet and S. H. Wilen, *Enantiomers, Racemates, and Resolutions*, Wiley, New York, 1981.
13. P. Newman, *Optical Resolution Procedures for Chemical Compounds*, Vol. 1: *Amines and Related Compounds*, Optical Resolution Information Center, Manhattan College, Riverdale, NY, 1978.
14. S. Ahuja (Ed.), *Chiral Separations by Liquid Chromatography*, ACS Symposium Series 471, American Chemical Society, Washington, D.C., 1991.
15. E. Francotte, *J. Chromatogr. A*, **666**, 565 (1994).
16. G. Subramanian (Ed.), *A Practical Approach to Chiral Separations by Liquid Chromatography*, VCH, Weinheim, 1994.
17. D. I. Stirling, in *Drug Stereochemistry, Analytical Methods and Pharmacology*, 2nd ed. (Ed. I. W. Wainer), Chap. 8, Marcel Dekker, New York, 1993, pp. 213–243.
18. R. Noyori, *Asymmetric Catalysis in Organic Synthesis*, Wiley, New York, 1994.
19. S. C. Stinson, *Chem. Eng. News*, **71**, No. 39, 38 (1993).
20. J. Carey, *Chem. Br.*, **29**, 1053 (1993).

21. S. C. Stinson, *Chem. Eng. News*, **72**, No. 38, 38 (1994).
22. *Fed. Reg.*, **57**, 22249 (1992).
23. M. Freemantle, *Chem. Eng. News*, **73**, No. 3, 27 (1995).
24. R. N. Loepky and C. J. Michejda (Eds.), *Nitrosamines and Related N-Nitroso Compounds, Chemistry and Biochemistry*, ACS Symposium Series 553, American Chemical Society, Washington, D.C., 1992.
25. J. P. Greenstein and M. Winitz, *Chemistry of the Amino Acids*, Vol. 2, Chap. 20, Wiley, New York, 1961, pp. 1753–1816.
26. N. Izumiya, S.-C. J. Fu, S. M. Birnbaum and J. P. Greenstein, *J. Biol. Chem.*, **205**, 221 (1953).
27. Y. Son, C. Park, J. S. Koh, N. Choy, C. S. Lee, H. Choi, S. C. Kim and H. Yoon, *Tetrahedron Lett.*, **35**, 3745 (1994).
28. G. M. Whitesides and C.-H. Wong, *Angew. Chem., Int. Ed. Engl.*, **24**, 617 (1985).
29. H. Kitaguchi, P. A. Fitzpatrick, J. E. Huber and A. M. Klibanov, *J. Am. Chem. Soc.*, **111**, 3094 (1989).
30. A. Kamal and M. V. Roa, *Tetrahedron: Asymmetry*, **5**, 1881 (1994).
31. D. I. Stirling, A. L. Zeitlin and G. W. Matcham, U.S. Patent 4950 606 (1990).
32. C. Johansen and A. Fiksdahl, *Chirality*, **6**, 161 (1994).
33. S. R. Landor, O. O. Sonola and A. R. Tatchell, *J. Chem. Soc., Perkin Trans. 1*, 1902 (1974).
34. S. R. Landor, Y. M. Chan, O. O. Sonola and A. R. Tatchell, *J. Chem. Soc., Perkin Trans. 1*, 493 (1984).
35. S. R. Landor, B. J. Miller and A. R. Tatchell, *J. Chem. Soc. (C)*, 2280 (1966).
36. S. Itsuno, M. Nakano, K. Miyazaki, H. Masuda, K. Ito, A. Hirao and S. Nakahama, *J. Chem. Soc., Perkin Trans. 1*, 2039 (1985).
37. E. J. Corey, R. K. Bakshi and S. Shibata, *J. Am. Chem. Soc.*, **109**, 5551 (1987).
38. S. T. Pickard and H. E. Smith, *J. Am. Chem. Soc.*, **112**, 5741 (1990).
39. Y. Sakito, Y. Yoneyoshi and G. Suzukamo, *Tetrahedron Lett.*, **29**, 223 (1988).
40. T. Imai, T. Tamura, A. Yamamuro, T. Sato, T. A. Wollmann, R. M. Kennedy and S. Masamune, *J. Am. Chem. Soc.*, **108**, 7402 (1986).
41. O. Cervinka, V. Suchan, O. Kotynek and V. Dudek, *Collect. Czech. Chem. Commun.*, **30**, 2484 (1965).
42. S. R. Landor, O. O. Sonola and A. R. Tatchell, *J. Chem. Soc., Perkin Trans. 1*, 605 (1978).
43. R. O. Hutchins, A. Abdel-Magid, Y. P. Stercho and A. Wambsgans, *J. Org. Chem.*, **52**, 702 (1987).
44. R. Noyori, I. Tomino, Y. Tanimoto and M. Nishizawa, *J. Am. Chem. Soc.*, **106**, 6709 (1984).
45. S. Yamaguchi and H. S. Mosher, *J. Org. Chem.*, **38**, 1870 (1973).
46. H. C. Brown, W. S. Park and B. T. Cho, *J. Org. Chem.*, **51**, 3278 (1986).
47. C. A. Willoughby and S. L. Buchwald, *J. Am. Chem. Soc.*, **114**, 7562 (1992).
48. C. A. Willoughby and S. L. Buchwald, *J. Org. Chem.*, **58**, 7627 (1993).
49. F. R. W. P. Wild, L. Zsolnai, G. Huttner and H. H. Brintzinger, *J. Organomet. Chem.*, **232**, 233 (1982).
50. S. Collins, B. A. Kuntz and Y. Hong, *J. Org. Chem.*, **54**, 4154 (1989).
51. C. A. Willoughby and S. L. Buchwald, *J. Am. Chem. Soc.*, **116**, 8952 (1994).
52. C. A. Willoughby and S. L. Buchwald, *J. Am. Chem. Soc.*, **116**, 11703 (1994).
53. L. Verbit and P. J. Heffron, *J. Org. Chem.*, **32**, 3199 (1967).
54. G. Zweifel and H. C. Brown, *J. Am. Chem. Soc.*, **86**, 393 (1964).
55. H. C. Brown, K.-W. Kim, T. E. Cole and B. Singaram, *J. Am. Chem. Soc.*, **108**, 6761 (1986).
56. D. A. Evans, K. A. Woerpel, M. M. Hinman and M. M. Faul, *J. Am. Chem. Soc.*, **113**, 726 (1991).
57. Z. Li, R. W. Quan and E. N. Jacobsen, *J. Am. Chem. Soc.*, **117**, 5889 (1995).
58. Z. Li, K. R. Conser and E. N. Jacobsen, *J. Am. Chem. Soc.*, **115**, 5326 (1993).
59. D. A. Evans, M. M. Faul, M. T. Bilodeau, B. A. Anderson and D. M. Barnes, *J. Am. Chem. Soc.*, **115**, 5328 (1993).
60. B. ELAmin, G. M. Anantharamaiah, G. P. Royer and G. E. Means, *J. Org. Chem.*, **44**, 3442 (1979).
61. D. Tanner, P. G. Andersson, A. Harden and P. Somfai, *Tetrahedron Lett.*, **35**, 4631 (1994).
62. W.-S. Zhou, X.-Y. Zhu and J.-F. Cheng, *Tetrahedron: Asymmetry*, **4**, 1501 (1993).
63. J. D. Morrison and H. S. Mosher, *Asymmetric Organic Reactions*, Chap. 1, Prentice-Hall, Englewood Cliffs, N.J., 1971, pp. 10–11.

64. J. D. Morrison (Ed.), *Asymmetric Synthesis*, Vol. 1, *Analytical Methods*, Academic Press, New York, 1983.
65. V. Schurig, in Reference 64, Chap. 5, pp. 59–86.
66. V. Schurig and M. Jung, in *Recent Advances in Chiral Separations* (Eds. D. Stevenson and I. D. Wilson), Plenum, New York, 1990, pp. 117–133.
67. W. H. Pirkle and T. C. Pochapsky, in *Advances in Chromatography*, Vol. 27 (Eds. J. C. Giddings, E. Grushka and P. R. Brown), Chap. 3, Marcel Dekker, New York, 1987, pp. 73–127.
68. V. Schurig, W. Burkle, A. Zlatkis and C. F. Poole, *Naturwissenschaften*, **66**, 423 (1979).
69. V. Schurig and W. Burkle, *J. Am. Chem. Soc.*, **104**, 7573 (1982).
70. V. Schurig and U. Leyrer, *Tetrahedron: Asymmetry*, **1**, 865 (1990).
71. M. Kotake, T. Sakan, N. Nakamura and S. Senoh, *J. Am. Chem. Soc.*, **73**, 2973 (1951).
72. T. Shibata, I. Okamoto and K. Ishii, *J. Liq. Chromatogr.*, **9**, 313 (1986).
73. W. H. Pirkle and T. C. Pochapsky, *Chem. Rev.*, **89**, 347 (1989).
74. W. H. Pirkle, T. C. Pochapsky, G. S. Mahler, D. E. Corey, D. S. Reno and D. M. Alessi, *J. Org. Chem.*, **51**, 4991 (1986).
75. D. Parker, *Chem. Rev.*, **91**, 1441 (1991).
76. J. A. Dale, D. L. Dull and H. S. Mosher, *J. Org. Chem.*, **34**, 2543 (1969).
77. Y. L. Bennani, K. P. M. Vanhessche and K. B. Sharpless, *Tetrahedron: Asymmetry*, **5**, 1473 (1994).
78. J. A. Dale and H. S. Mosher, *J. Am. Chem. Soc.*, **95**, 512 (1973).
79. R. Hulst, N. Koen de Vries and B. L. Feringa, *Angew. Chem., Int. Ed. Engl.*, **31**, 1092 (1992).
80. A. Alexakis, J. C. Frutos, S. Mutti and P. Mangeney, *J. Org. Chem.*, **59**, 3326 (1994).
81. B. L. Feringa, B. Srijtveen and R. M. Kellogg, *J. Org. Chem.*, **51**, 5484 (1986).
82. G. M. Whitesides and D. W. Lewis, *J. Am. Chem. Soc.*, **92**, 6979 (1970).
83. M. D. McCreary, D. W. Lewis, D. L. Wernick and G. M. Whitesides, *J. Am. Chem. Soc.*, **96**, 1038 (1974).
84. R. R. Fraser, in Reference 64, Chap. 9, pp. 173–196.
85. R. Hulst, N. Koen de Vries and B. L. Feringa, *J. Org. Chem.*, **59**, 7453 (1994).
86. W. H. Pirkle, *J. Am. Chem. Soc.*, **88**, 1837 (1966).
87. G. R. Weisman, in Reference 64, Chap. 8, pp. 153–171.
88. D. Parker and R. J. Taylor, *Tetrahedron*, **43**, 5451 (1987).
89. S. C. Benson, P. Cai, M. Colon, M. A. Haiza, M. Tokles and J. K. Snyder, *J. Org. Chem.*, **53**, 5335 (1988).
90. M. Michalik and C. Dobler, *Tetrahedron*, **46**, 7739 (1990).
91. M. J. Shapiro, A. E. Archinal and M. A. Jarema, *J. Org. Chem.*, **54**, 5826 (1989).
92. J. C. Craig, S.-Y. C. Lee, W. E. Pereira, Jr., H. C. Beyerman and L. Maat, *Tetrahedron*, **34**, 501 (1978).
93. B. Ringdahl, U. F. W. Ohnsorge and J. C. Craig, *J. Chem. Soc., Perkin Trans. 2*, 697 (1981).
94. B. Ringdahl, W. E. Pereira, Jr. and J. C. Craig, *Tetrahedron*, **37**, 1659 (1981).
95. B. Ringdahl, A. R. Pinder, W. E. Pereira, Jr., N. J. Oppenheimer and J. C. Craig, *J. Chem. Soc., Perkin Trans. 1*, 1 (1984).
96. R. G. Kostyanovsky, I. M. Gella, V. I. Markov and Z. E. Samojlova, *Tetrahedron*, **30**, 39 (1974).
97. A. Basil and A. Gedanken, *J. Am. Chem. Soc.*, **111**, 9237 (1989).
98. G. V. Shustov, G. K. Kadorkina, R. G. Kostyanovsky and A. Rauk, *J. Am. Chem. Soc.*, **110**, 1719 (1988).
99. G. V. Shustov, G. K. Kadorkina, S. V. Varlamov, A. V. Kachanov, R. G. Kostyanovsky and A. Rauk, *J. Am. Chem. Soc.*, **114**, 1616 (1992).
100. G. V. Shustov, A. V. Kachanov, V. A. Korneev, R. G. Kostyanovsky and A. Rauk, *J. Am. Chem. Soc.*, **115**, 10267 (1993).
101. A. Rauk, D. Yang, D. Tsankov, H. Wieser, Y. Koltypin, A. Gedanken and G. V. Shustov, *J. Am. Chem. Soc.*, **117**, 4160 (1995).
102. W. C. Johnson, Jr., L. P. Fontana and H. E. Smith, *J. Am. Chem. Soc.*, **109**, 3361 (1987).
103. H. E. Smith, *Croat. Chem. Acta*, **62**, 201 (1989).
104. H. E. Smith, in *Circular Dichroism Principles and Applications* (Eds. K. Nakanishi, N. Berova and R. W. Woody), Chap. 15, VCH, New York, 1994, pp. 413–442.
105. H. E. Smith and L. P. Fontana, *J. Org. Chem.*, **56**, 432 (1991).
106. J. R. Platt, *J. Chem. Phys.*, **19**, 263 (1951).
107. D. F. Colon, S. T. Pickard and H. E. Smith, *J. Org. Chem.*, **56**, 2322 (1991).



108. R. J. Lorentzen, J. H. Brewster and H. E. Smith, *J. Am. Chem. Soc.*, **114**, 2181 (1992).
109. H. E. Smith, J. R. Neergaard, E. P. Burrows and F.-M. Chen, *J. Am. Chem. Soc.*, **96**, 2908 (1974).
110. H. E. Smith, *Chem. Rev.*, **83**, 359 (1983).
111. L. Casella and M. Gullotti, *J. Am. Chem. Soc.*, **105**, 803 (1983).
112. H. E. Smith, E. P. Burrows, M. J. Marks, R. D. Lynch and F.-M. Chen, *J. Am. Chem. Soc.*, **99**, 707 (1977).
113. N. Heuser, M. Klein, J. Messinger, V. Buss, E. Raabe and C. Kruger, *J. Chem. Soc., Chem. Commun.*, 945 (1987).
114. V. M. Potapov, V. M. Dem'yanovich, V. P. Zaitsev and S. Kh. Sharipova, *Zh. Org. Khim.*, **23**, 510 (1987).
115. V. M. Potapov, V. M. Dem'yanovich, V. P. Zaitsev and S. Kh. Sharipova, *Zh. Org. Khim.*, **26**, 2574 (1990).
116. D. Gargiulo, G. Cai, N. Ikemoto, N. Bozhkova, J. Odingo, N. Berova and K. Nakanishi, *Angew. Chem., Int. Ed. Engl.*, **32**, 888 (1993).
117. D. Gargiulo, N. Ikemoto, J. Odingo, N. Bozhkova, T. Iwashita, N. Berova and K. Nakanishi, *J. Am. Chem. Soc.*, **116**, 3760 (1994).
118. N. Harada and K. Nakanishi, *Circular Dichroic Spectroscopy, Exciton Coupling in Organic Stereochemistry*, University Science Books, Mill Valley, CA, 1983.
119. D. Gargiulo, F. Derguini, N. Berova, K. Nakanishi and N. Harada, *J. Am. Chem. Soc.*, **113**, 7046 (1991).
120. V. Buss, K. Kolster and B. Gors, *Tetrahedron: Asymmetry*, **4**, 1 (1993).
121. N. Berova, D. Gargiulo, F. Derguini, K. Nakanishi and N. Harada, *J. Am. Chem. Soc.*, **115**, 4769 (1993).
122. N. Harada and K. Nakanishi, *J. Am. Chem. Soc.*, **91**, 3989 (1969).
123. M. Kawai, U. Nagai and M. Katsumi, *Tetrahedron Lett.*, **36**, 3165 (1975).
124. C. Toniolo, F. Formaggio, M. Crisma, H. E. Schoemaker and J. Kamphuis, *Tetrahedron: Asymmetry*, **5**, 507 (1994).
125. D. Pini, A. Petri, C. Rosini, P. Salvadori, R. Giorgi, C. Di Bugno, L. Turbanti and F. Marchetti, *Tetrahedron*, **50**, 205 (1994).
126. G. Cai, N. Bozhkova, J. Odingo, N. Berova and K. Nakanishi, *J. Am. Chem. Soc.*, **115**, 7192 (1993).
127. K. Nakanishi and N. Berova, in *Circular Dichroism Principles and Applications* (Eds. K. Nakanishi, N. Berova and R. W. Woody), Chap. 13, VCH, New York, 1994, pp. 361–398.
128. L.-C. Lo, N. Berova, K. Nakanishi, E. Q. Morales and J. T. Vazques, *Tetrahedron: Asymmetry*, **4**, 321 (1993).
129. P. Zhou, N. Berova, W. T. Wiesler and K. Nakanishi, *Tetrahedron*, **49**, 9343 (1993).
130. N. Zhao, N. Kumar, K. Neuenschwander, K. Nakanishi and N. Berova, *J. Am. Chem. Soc.*, **117**, 7844 (1995).
131. R. W. Baker and P. J. Pauling, *J. Chem. Soc., Perkin Trans. 2*, 2340 (1972).
132. W. Gaffield, R. E. Lundin and L. K. Keffer, *Tetrahedron*, **37**, 1861 (1981).
133. B. Ringdahl, *Acta Chem. Scand.*, **44**, 42 (1990).
134. T. Polonski and K. Prajer, *Tetrahedron*, **32**, 847 (1976).
135. T. Polonski, M. J. Milewska and A. Katrusiak, *J. Am. Chem. Soc.*, **115**, 11410 (1993).
136. G. V. Shustov, A. V. Kachanov, G. K. Kadorkina, R. G. Kostyanovsky and A. Rauk, *J. Am. Chem. Soc.*, **114**, 8257 (1992).
137. G. V. Shustov and A. Rauk, *J. Am. Chem. Soc.*, **117**, 928 (1995).
138. T. M. Lowry, *Optical Rotatory Power*, Longmans Green, London, 1935; republished by Dover, New York, 1964, Chap. 18, pp. 229–236.
139. G. Holzwarth, E. C. Hsu, H. S. Mosher, T. R. Faulkner and A. Moscovitz, *J. Am. Chem. Soc.*, **96**, 251 (1974).
140. L. A. Nafie, T. A. Keiderling and P. J. Stephens, *J. Am. Chem. Soc.*, **98**, 2715 (1976).
141. C. N. Su and T. A. Keiderling, *Chem. Phys. Lett.*, **77**, 494 (1981).
142. P. L. Polavarapu, D. F. Michalska, J. R. Neergaard and H. E. Smith, *J. Am. Chem. Soc.*, **106**, 3376 (1984).
143. P. L. Polavarapu and H. E. Smith, *J. Phys. Chem.*, **92**, 1774 (1988).
144. L. P. Fontana, T. Chandramouly, H. E. Smith and P. L. Polavarapu, *J. Org. Chem.*, **53**, 3379 (1988).

145. P. L. Polavarapu, B. A. Hess, Jr. and L. J. Schaad, *J. Chem. Phys.*, **82**, 1705 (1985).
146. P. L. Polavarapu, B. A. Hess, Jr., L. J. Schaad, D. O. Henderson, L. P. Fontana, H. E. Smith, L. A. Nafie, T. B. Freedman and W. M. Zuk, *J. Chem. Phys.*, **86**, 1140 (1987).
147. S. T. Pickard, H. E. Smith, P. L. Polavarapu, T. M. Black, A. Rauk and D. Yang, *J. Am. Chem. Soc.*, **114**, 6850 (1992); *J. Am. Chem. Soc.*, **116**, 4529 (1994).
148. P. L. Polavarapu, S. T. Pickard, H. E. Smith and R. S. Pandurangi, *Talanta*, **40**, 687 (1993).
149. D. Yang, T. Eggimann, H. Wieser, A. Rauk and G. V. Shustov, *Can. J. Chem.*, **71**, 2028 (1993).
150. A. Rauk, T. Eggimann, H. Wieser, G. V. Shustov and D. Yang, *Can. J. Chem.*, **72**, 506 (1994).
151. A. Rauk, D. Yang, D. Tsankov, H. Wieser, Yu. Kolytyn, A. Gedanken and G. V. Shustov, *J. Am. Chem. Soc.*, **117**, 4140 (1995).
152. X. Qu, M. Citra, R. Ragunathan, T. B. Freedman and L. A. Nafie, *Proc. SPIE-Int. Soc. Opt. Eng.*, **2089**, 142 (1993).
153. M. Diem, *J. Am. Chem. Soc.*, **110**, 6967 (1988).
154. T. B. Freedman, A. C. Chernovitz, W. M. Zuk, M. G. Paterlini and L. A. Nafie, *J. Am. Chem. Soc.*, **110**, 6970 (1988).
155. T. B. Freeman and L. A. Nafie, *Top. Stereochem.*, **17**, 113 (1987).
156. W. M. Zuk, T. B. Freedman and L. A. Nafie, *J. Phys. Chem.*, **93**, 1771 (1989).
157. L. D. Barron and A. D. Buckingham, *Mol. Phys.*, **20**, 1111 (1971).
158. L. D. Barron, M. P. Bogaard and A. D. Buckingham, *J. Am. Chem. Soc.*, **95**, 603 (1973).
159. B. Bosnich, M. Moskovits and G. A. Ozin, *J. Am. Chem. Soc.*, **94**, 4750 (1972).
160. W. Hug, S. Kint, G. F. Bailey and J. R. Scherer, *J. Am. Chem. Soc.*, **97**, 5589 (1975).
161. D. Barron, *Nature*, **255**, 458 (1975).
162. H.-J. Hansen, H.-R. Sliwka and W. Hug, *Helv. Chim. Acta*, **62**, 1120 (1979).
163. L. D. Barron, *J. Chem. Soc., Perkin Trans. 2*, 1790 (1977).
164. P. L. Polavarapu, S. T. Pickard, H. E. Smith, T. M. Black, L. D. Barron and L. Hecht, *Talanta*, **40**, 545 (1993).
165. L. D. Barron, A. R. Gargaro, L. Hecht and P. L. Polavarapu, *Spectrochim. Acta*, **47A**, 1001 (1991).
166. L. D. Barron, A. R. Gargaro, L. Hecht and P. L. Polavarapu, *Spectrochim. Acta*, **48A**, 261 (1992).
167. G.-S. Yu, T. B. Freedman, L. A. Nafie, Z. Deng and P. L. Polavarapu, *J. Phys. Chem.*, **99**, 835 (1995).
168. A. R. Gargaro, L. D. Barron and L. Hecht, *J. Raman Spectrosc.*, **24**, 91 (1993).

## CHAPTER 4

# Photoelectron spectra of amines, nitroso and nitro compounds

PAUL RADEMACHER

*Institut für Organische Chemie der Universität Essen, D-45117 Essen, Germany*  
Fax: (0201)-183-3082; e-mail: RADEM@OC1.ORGCHEM.UNI-ESSEN.DE

---

I. INTRODUCTION . . . . .	160
II. AMINES . . . . .	161
A. Ammonia . . . . .	161
B. Aliphatic Amines . . . . .	163
C. Aromatic Amines . . . . .	171
1. Anilines . . . . .	171
2. Aminonaphthalenes . . . . .	176
D. IP Values and Proton Affinities . . . . .	178
E. IP Values and Biological Activity . . . . .	179
F. Transannular Interaction of Amino Groups with Other Functional Groups . . . . .	181
G. Diamines . . . . .	183
H. Polyamines . . . . .	186
I. Miscellaneous Amino Compounds . . . . .	188
III. NITROSO COMPOUNDS . . . . .	188
A. Nitrosomethane and Other Nitrosoalkanes . . . . .	188
B. Nitrosobenzene and Related Compounds . . . . .	191
C. Miscellaneous Nitroso Compounds . . . . .	192
IV. NITRO COMPOUNDS . . . . .	192
A. Nitromethane and Other Nitroalkanes . . . . .	193
B. Nitrobenzene and Related Compounds . . . . .	197
C. Miscellaneous Nitro Compounds . . . . .	200
V. ACKNOWLEDGEMENTS . . . . .	201
VI. REFERENCES . . . . .	201

---

## I. INTRODUCTION

Molecular photoelectron spectroscopy (PES) is widely used to study the electronic structure of molecules, and compounds can be characterized by their PE spectra. In this chapter the results of ultraviolet PE spectroscopic (UPS) studies of molecules which incorporate amino, nitroso or nitro groups will be summarized.

The basic principles of PES, the experimental methods, the interpretation procedures and the applications have been described in several books<sup>1-10</sup>. There are also some more recent review articles<sup>11-13</sup>. Extensive data collections are available, e.g. by Robinson<sup>14</sup>. Also 'the early days' of PES have been highlighted<sup>15,16</sup>. Only a few words are hence necessary to provide a basis for the following statements.

The fundamental principle of PES is the photo-electric effect. A molecule M in the gas phase is irradiated with monochromatic UV light which is usually generated by a helium discharge source (HeI 21.22 eV, 58.43 nm; HeII 40.81 eV, 30.38 nm). Electrons can be ejected when their binding energy is lower than the photon energy leaving behind a radical cation M<sup>+•</sup> in a certain electronic and vibrational state.



The kinetic energy of the ejected electrons  $E_{\text{kin}}(e)$  is measured and the ionization energy or ionization potential IP is obtained from the energy conservation condition.

$$IP = h\nu - E_{\text{kin}}(e) \quad (2)$$

Measuring a PE spectrum, the number of photo-electrons per time unit ('count rate') is recorded as a function of the kinetic energy or IP. Since the radical cation may be excited to different vibrational states, the ionization band exhibits in general vibrational fine structure and the *adiabatic* IP, i.e. transition to the vibrational ground state of M<sup>+•</sup>, can be distinguished from the *vertical* IP, i.e. transition with the greatest Franck-Condon factor. The latter property (IP<sub>v</sub>) is of higher relevance when studying the electronic structure of a molecule because it is linked with the energy  $\varepsilon$  of the molecular orbital (MO), from which it was ejected, by Koopmans' theorem<sup>17</sup>

$$IP_i = -\varepsilon_i^{\text{SCF}} \quad (3)$$

stating that the vertical ionization energies are equal to the negative values of the SCF orbital energies which are obtained by quantum chemical calculations. Actually, this is an approximation, which can fail and lead to wrong interpretation of spectral data. Quantitative characteristics of a PE spectrum, such as position and intensity of the ionization bands, vibrational structure, Jahn-Teller and spin-orbital effects, are in general sufficient for reliable assignments of the IPs of simple molecules. The spectra of polyatomic molecules are usually analysed with the aid of quantum chemical calculations making use of Koopmans' approximation.

Compounds with a certain functional group have a certain number of atoms in common and thus their PE spectra should resemble each other. In particular, this holds for the members of a homologous series of compounds. And for large molecules seldom will a total assignment of all IPs be intended but the IPs related to the characteristic MOs of the functional groups. These are, e.g., the  $\pi$  orbitals of double or triple bonds and the  $n$  (lone-pair) orbitals on heteroatoms like nitrogen, phosphorus, oxygen, sulphur and the halogens. Of particular value are PE spectroscopic studies of structural effects on functional groups. These can be electronic perturbations by substituents, steric strain, conjugation etc.

Many of the investigations on compounds to be included in this chapter were performed in the 1970s. Because instrumentation has made little progress in UPS in more recent

years, there can be no reservation to including these spectra. However, some of the computational methods used at that time are no longer adequate today and therefore are generally given lower priority. In a few cases, semi-empirical AM1<sup>18</sup> or outer valence Green's function (OVGF)<sup>19</sup> calculations were added. Experience has shown that for organic compounds with heteroatoms of the second period of the PSE, in particular nitrogen and oxygen, these methods can give even better results than high-level *ab initio* calculations.

Some unpublished PE spectra or spectral data from the author's laboratory are included. These have been measured using a Leybold-Heraeus UPG 200 spectrometer with a HeI radiation source. Orbitals were plotted with the program PERGRA<sup>20</sup>.

In the following sections ionization energies are given as vertical IP values unless stated otherwise.

## II. AMINES

The structure, reactivity and biological properties of amines are largely determined by the electron lone-pair at the nitrogen atom. Most amines have a pyramidal structure similar to that of ammonia. Typical bond angles at the nitrogen atom are little different from 109.5° and the  $n_N$  orbital can be described as an  $sp^3$  hybrid. However, the classification of the electron lone-pair as 'non-bonding' should not lead to the false conception that removal of an electron has no effect on the structure. The ionization bands of electrons from  $n_N$  orbitals are usually rather broad indicating substantial structural differences between molecule and radical cation. This can be explained by delocalization of the electron lone-pair or interaction of the  $n_N$  orbital with orbitals of the substituents. On the other hand, removal of an electron is accompanied by a flattening of the N pyramid as the most important structural change.

### A. Ammonia

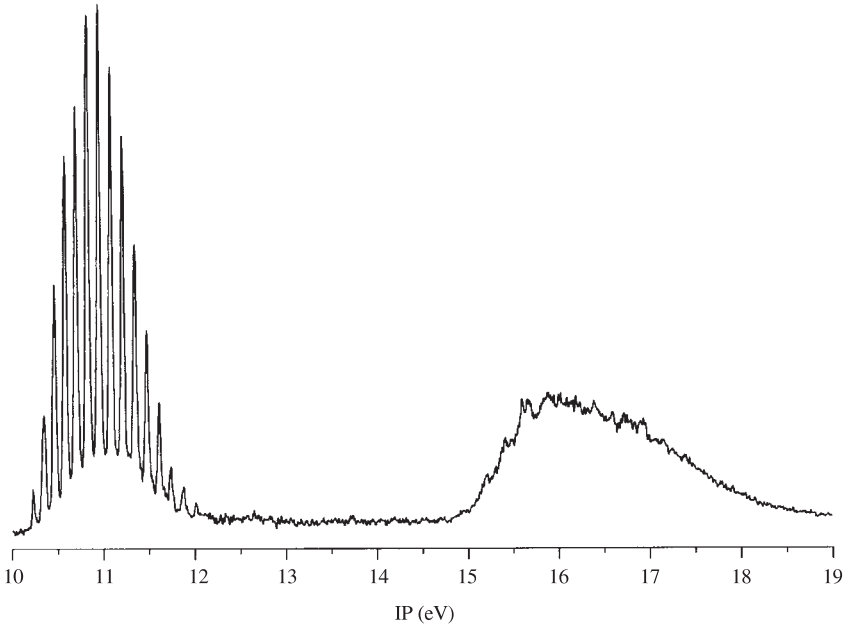
The parent compound of all amines, ammonia, has a pyramidal structure with N–H bond lengths of 101.5 pm and H–N–H bond angles of 106.6°. The electronic structure of the ground state may be represented as

$$(1a_1)^2(2a_1)^2(1e)^4(3a_1)^2.$$

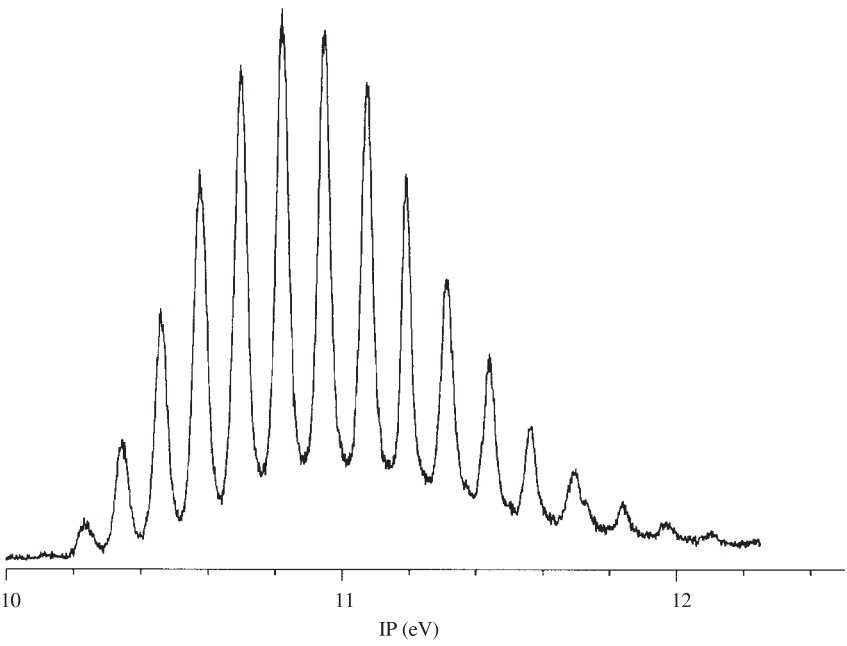
The  $3a_1 = n_N$  orbital (HOMO) is largely made up by the  $2p_z$  orbital of the nitrogen atom and houses the electron lone-pair. The doubly degenerate orbital  $1e$  is strongly N–H bonding and can be termed  $\sigma_{NH}$ . The orbital  $2a_1$  can be described as the symmetric combination of the nitrogen  $2s$  and the hydrogen  $1s$  atomic orbitals. It is strongly N–H bonding. The  $1a_1$  orbital is essentially the nitrogen  $1s$  AO. Only electrons from the two highest occupied MOs of ammonia are accessible by HeI radiation usually employed in UPS.

The PE spectrum of  $NH_3$  (Figure 1) has been analysed frequently and is described even in textbooks<sup>1,4,21</sup>. The first band ( $IP_a = 10.073$ ,  $IP_v = 10.90$  eV<sup>4,22</sup>) consists of a long single series in the out-of-plane bending vibration mode ( $\nu_2$ ) having at least 18 member peaks. The progression shows negative anharmonicity with spacings ranging from about 111 to 140 meV (895–1130  $cm^{-1}$ ). The structure of this band, which at first sight would not have been expected for the removal of a non-bonding electron, is a consequence of the large geometrical change associated with the ionization, since the ground state of  $NH_3^{+\bullet}$  is planar.

The second band ( $IP_a = 14.725$ ,  $IP_v \approx 15.8$  and  $16.5$  or  $16.8$  eV<sup>4,21</sup>) has a completely different shape. As a result of Jahn-Teller splitting there are two maxima. Vibrational structure is found in the regions 14.7–15.9 eV and 16.3–17.8 eV. The mean separation is *ca* 165 meV = 1330  $cm^{-1}$ . In the middle region (15.9–16.3 eV) there are only weak



(a)



(b)

FIGURE 1. PE spectrum of ammonia: (a) full spectrum, (b) first band expanded

indications of vibrational bands, which is caused by predissociation of the radical cation. The third band has its maximum at 21.22 eV<sup>1</sup>.

It is well known that a change in the H–N–H valence angle of NH<sub>3</sub> is important for the energy of the  $n_N$  orbital. In the transition from the pyramidal to planar conformation, this orbital destabilizes appreciably with decreasing contribution of the nitrogen 2s orbital. This is also reflected in the very low ionization potentials of planar amines (see below).

## B. Aliphatic Amines

In Tables 1–8 the first IP values of various amines are summarized. These values refer to the removal of an electron from the  $n_N$  orbital of the amines. The other ionizations of simple saturated aliphatic amines are of no particular interest. They are associated with the orbitals of the  $\sigma$  framework of the molecules. More interesting are the effects of substituents and other structural factors on the energy of the  $n_N$  ionization or—in the limits of Koopmans' theorem<sup>17</sup>,  $IP_i = -\varepsilon_i^{\text{SCF}}$ —on the energy of the  $n_N$  orbital.

TABLE 1.  $n_N$  ionization potentials (eV) of primary amines RNH<sub>2</sub>

R	IP	References
Me	9.64	22
Et	9.46	22
Pr	9.34	22
<i>i</i> -Pr	9.36	22
<i>c</i> -Pr	9.41	21
All	9.43	25
Bu	9.29	22
<i>i</i> -Bu	9.28	22
<i>s</i> -Bu	9.27	22
<i>t</i> -Bu	9.25	22
Pen	9.30	22
Hex	9.31	26
<i>c</i> -Hex	9.15	26
Oct	9.25	26
<i>c</i> -Oct	9.13	26
Me <sub>3</sub> SiCH <sub>2</sub>	9.07	27
PhCH <sub>2</sub> CH <sub>2</sub>	8.99	28
Ph	10.80	21

TABLE 2.  $n_N$  ionization potentials (eV) of acyclic secondary amines R<sub>2</sub>NH

R	IP	References
Me	8.94	22
Et	8.74	26
Pr	8.55	22
<i>i</i> -Pr	8.42	22
All	8.79	25
Bu	8.49	22
<i>i</i> -Bu	8.47	22
Pen	8.45	22
<i>c</i> -Hex	8.14	26
Me <sub>3</sub> SiCH <sub>2</sub>	8.36	27
Ph	10.64	29

TABLE 3.  $n_N$  ionization potentials (eV) of acyclic secondary amines  $R^1R^2NH$ 

$R^1$	$R^2$	IP	References
Me	PhCH <sub>2</sub> CH <sub>2</sub>	8.66	28
Me	Me <sub>3</sub> SiCH <sub>2</sub>	8.55	27
Me	Cyclodecyl	8.46	26
Me	PhCH <sub>2</sub>	8.78	30
Et	Me <sub>3</sub> SiCH <sub>2</sub>	8.46	27
Ph	C <sub>6</sub> F <sub>5</sub>	11.16	31

TABLE 4.  $n_N$  ionization potentials (eV) of acyclic tertiary amines  $R_3N$ 

R	IP	References
H	10.92	32
Me	8.53	33, 34
Et	8.08	33, 34
Pr	7.92	33, 34
<i>i</i> -Pr	7.18	35
<i>c</i> -Pr	8.44	36
All	8.30	25
Bu	7.90	33, 34
Pen	7.85	22
Me <sub>3</sub> SiCH <sub>2</sub>	7.66	27
Ph	7.00	37
CHF <sub>2</sub>	11.65	38
F <sub>3</sub> C	12.52	38
H <sub>3</sub> Si	9.7	39
Me <sub>3</sub> Si	8.58	40
H <sub>3</sub> Ge	9.2	39

TABLE 5.  $n_N$  ionization potentials (eV) of tertiary amines  $R^1R^2R^3N$ 

$R^1$	$R^2$	$R^3$	IP	References
Me	Me	Et	8.22	34
Me	Me	<i>i</i> -Pr	8.20	41
Me	Me	Bu	8.35	41
Me	Me	<i>i</i> -Bu	8.31	41
Me	Me	<i>t</i> -Bu	8.08	41
Me	Me	Pen	8.33	26
Me	Me	Me <sub>3</sub> SiCH <sub>2</sub>	8.20	27
Me	Me	PhCH <sub>2</sub> CH <sub>2</sub>	8.35	28
Me	Me	Ph	9.85	42
Me	Me	H <sub>2</sub> B	9.51	43
Me	Me	Me <sub>2</sub> B	8.92	43
Me	Me	F <sub>2</sub> B	9.71	43
Me	Me	Cl <sub>2</sub> B	9.56	43
Me	Me	Br <sub>2</sub> B	9.60	43
Me	Me	H <sub>3</sub> Si	8.5	39
Me	Me	Me <sub>3</sub> Si	8.03	40
Me	Et	Et	8.44	34
Me	H <sub>3</sub> Si	H <sub>3</sub> Si	9.2	39

(continued)



TABLE 5. (continued)

R <sup>1</sup>	R <sup>2</sup>	R <sup>3</sup>	IP	References
Me	Me <sub>3</sub> Si	Me <sub>3</sub> Si	8.21	40
Et	Et	Me <sub>3</sub> SiCH <sub>2</sub>	7.93	27
Et	Et	Ph	9.70	42
Et	<i>i</i> -Pr	<i>i</i> -Pr	7.66	26
Et	Me <sub>3</sub> SiCH <sub>2</sub>	Me <sub>3</sub> SiCH <sub>2</sub>	7.82	27
Pr	Pr	Ph	9.63	26
Pr	Pr	Me <sub>3</sub> Si	7.83	40
Pr	Me <sub>3</sub> Si	Me <sub>3</sub> Si	8.18	40
<i>i</i> -Pr	<i>i</i> -Pr	<i>c</i> -Pr	7.79	36
<i>i</i> -Pr	<i>i</i> -Pr	Ph	8.93	26
<i>i</i> -Pr	<i>c</i> -Pr	<i>c</i> -Pr	8.14	36
<i>c</i> -Pr	<i>t</i> -Bu	<i>t</i> -Bu	7.76	36
Bu	Bu	Ph	9.52	26
Ph	Ph	Me <sub>3</sub> Si	8.05	31
Ph	Ph	SiMe <sub>2</sub> C <sub>6</sub> F <sub>5</sub>	7.69	31
Ph	Ph	Ph <sub>3</sub> Si	7.32	31
Ph	Ph	(C <sub>6</sub> F <sub>5</sub> ) <sub>3</sub> Si	8.07	31
Ph	Me <sub>3</sub> Si	Me <sub>3</sub> Si	10.43	26
CF <sub>3</sub>	CHF <sub>2</sub>	CHF <sub>2</sub>	12.08	38

TABLE 6. *n*<sub>N</sub> ionization potentials (eV) of cyclic secondary amines

	IP	References
(CH <sub>2</sub> ) <sub>2</sub> NH	9.84	44, 45
(CH <sub>2</sub> ) <sub>3</sub> NH	9.04	23
(CH <sub>2</sub> ) <sub>4</sub> NH	8.77	23, 46
2,5-Dihydropyrrole	8.51	23
(CH <sub>2</sub> ) <sub>5</sub> NH	8.64	23, 46
1,2,5,6-Tetrahydropyridine	8.64	23
(CH <sub>2</sub> ) <sub>6</sub> NH	8.41	23
O(CH <sub>2</sub> CH <sub>2</sub> ) <sub>2</sub> NH	8.91	46
(CH <sub>2</sub> ) <sub>7</sub> NH	8.41	26
7-Azanorbornane	9.00	47

TABLE 7. *n*<sub>N</sub> ionization potentials (eV) of cyclic tertiary amines

	IP	References
(CH <sub>2</sub> ) <sub>2</sub> NMe	9.23	24, 45
(CH <sub>2</sub> ) <sub>3</sub> NMe	8.93	24
(CH <sub>2</sub> ) <sub>4</sub> NMe	8.41	23, 24
(CH <sub>2</sub> ) <sub>4</sub> NHex- <i>c</i>	7.96	46
1-Methyl-2,5-dihydropyrrole	8.61	23
(CH <sub>2</sub> ) <sub>5</sub> NMe	8.35	23, 24, 48
(CH <sub>2</sub> ) <sub>5</sub> NHex- <i>c</i>	7.93	46
(CH <sub>2</sub> ) <sub>5</sub> NCH <sub>2</sub> SiMe <sub>3</sub>	8.18	27
1-Methyl-1,2,5,6-tetrahydropyridine	8.29	23
(CH <sub>2</sub> ) <sub>6</sub> NMe	8.29	23, 24
(CH <sub>2</sub> ) <sub>7</sub> NMe	8.02	24, 48, 49
(CH <sub>2</sub> ) <sub>7</sub> NEt	7.93	49

(continued overleaf)

TABLE 7. (continued)

	IP	References
(CH <sub>2</sub> ) <sub>7</sub> NPr- <i>i</i>	7.69	49
(CH <sub>2</sub> ) <sub>7</sub> NBu- <i>t</i>	7.64	49
(CH <sub>2</sub> ) <sub>8</sub> NMe	7.93	24
(CH <sub>2</sub> ) <sub>9</sub> NMe	7.99	24, 48
(CH <sub>2</sub> ) <sub>10</sub> NMe	8.00	24
(CH <sub>2</sub> ) <sub>11</sub> NMe	8.12	26
(CH <sub>2</sub> ) <sub>12</sub> NMe	8.11	24
(CH <sub>2</sub> ) <sub>15</sub> NMe	8.16	24
O(CH <sub>2</sub> CH <sub>2</sub> ) <sub>2</sub> NMe	8.64	26
O(CH <sub>2</sub> CH <sub>2</sub> ) <sub>2</sub> NHex- <i>c</i>	8.18	46
CH <sub>2</sub> (SiMe <sub>2</sub> CH <sub>2</sub> ) <sub>2</sub> NMe	7.90	27
1-Azabicyclo[1.1.0]butane	≈9.75	50
1-Azabicyclo[2.2.2]octane (quinclidine)	8.06	51
1-Aza-5-borabicyclo[3.3.0]octane	8.06	43
1-Azabicyclo[3.3.3]undecane (manxine)	7.13	52
1-Azabicyclo[4.4.4]tetradecane	7.84	52
9-Methyl-9-azabicyclo[3.3.1]nonane	7.84	53
1-Azadamantane	7.94	54
1-Azatwistane	7.98	51

TABLE 8.  $n_N$  ionization potentials (eV) of simple halogenoamines

	IP	References
H <sub>2</sub> NF	11.62	32
(F <sub>3</sub> C) <sub>2</sub> NF	12.45	38
HNF <sub>2</sub>	12.38	32
F <sub>2</sub> CHNF <sub>2</sub>	12.33	38
F <sub>3</sub> CNF <sub>2</sub>	12.62	38
H <sub>2</sub> NCl	10.60	55
HNCl <sub>2</sub>	10.52	55
NF <sub>3</sub>	13.83	32
H <sub>2</sub> NBr	10.18	56, 57
HNBr <sub>2</sub>	10.1	58
NBr <sub>3</sub>	10.10	56
MeNHCl	9.70	59
MeNCl <sub>2</sub>	10.06	59
Me <sub>2</sub> NCl	9.25	60
MeNHBr	9.60	56
MeNBr <sub>2</sub>	9.62	56
Me <sub>2</sub> NBr	9.15	56, 60

Morishima and coworkers<sup>23</sup> observed that the first IPs of cyclic secondary amines and their N-methyl derivatives (Tables 6 and 7) fall in the order of increasing ring size, i.e. aziridine > azetidine > pyrrolidine > piperidine > hexahydroazepine (hexamethyleneimine). The authors suggested that this is because of changes in the overall hybridization of the nitrogen atom as the ring size is increased, i.e. change of the lone-pair orbital  $n_N$  from an sp<sup>2</sup> hybrid (in aziridine) towards an sp<sup>3</sup> orbital. Similar as in cycloalkanes the s character of the carbon-hydrogen bond increases with decreasing ring size, in cyclic amines the s character of the lone-pair electrons increases. This is confirmed by a linear correlation of the first IPs of cyclic amines and the <sup>13</sup>C-<sup>1</sup>H nuclear spin coupling constants of the corresponding cycloalkanes.

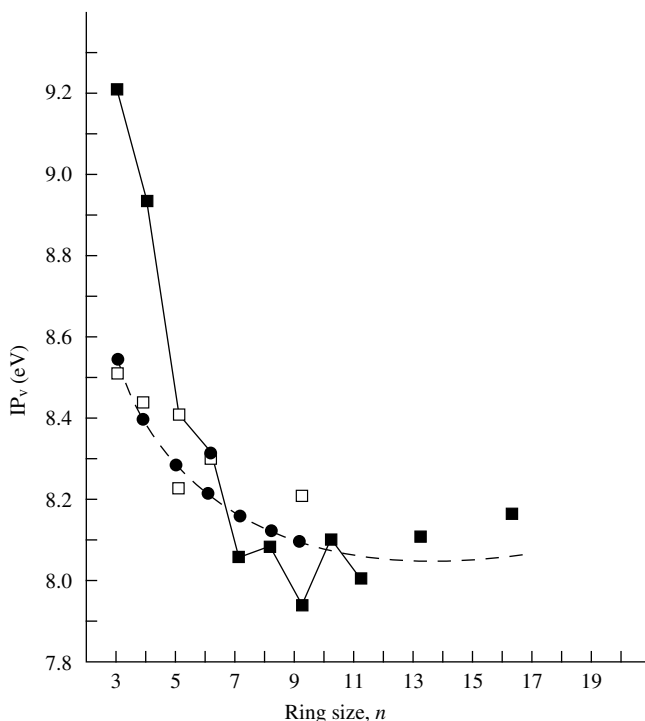


FIGURE 2. Plot of experimental  $n_N$  IPs for cyclic *N*-methyl amines (■). Experimental (□) and calculated (●) IPs for open-chain methyl dialkylamines having the same number of carbon atoms are also shown. Reproduced with permission from Reference 24

The higher members in the series of *N*-methyl derivatives (ring size  $\geq 8$ ) exhibit rather constant  $IP(n_N)$  values with minor variations probably owing to conformational effects<sup>24</sup> (Figure 2). The cyclic *N*-methylamines with an even number of ring atoms seem to exhibit a somewhat larger IP than those with an odd ring size.

The energy of the  $n_N$  orbital of amines varies appreciably with the substitution of the nitrogen atom. Accordingly, the lone-pair ionization is a sensitive indicator of the electron donating or withdrawing power of substituents. The main effect of alkyl groups can be attributed to inductive destabilization of the nitrogen valence orbitals. But also steric and conformational effects are of importance. The contribution of hyperconjugative effects or—in other words—interaction of the  $n_N$  orbital with  $\sigma$  or pseudo  $\pi$  orbitals of the substituents can best be studied in compounds with a rigid or at least minor flexible conformation.

From the IP values of primary, secondary and tertiary amines,  $R-NH_2$ ,  $R_2NH$ ,  $R_2NH$  and  $R_3N$  with  $R$  being simple alkyl groups like Me, Et, Pr... (Tables 1–5), it is obvious that the effects of the substituents on lowering the ionization energy of the lone-pair electrons are not additive but that groups already present ‘dilute’ the action of the next one. The second and the third substituent have roughly only half the effect of the first one. However, a striking exception is triisopropylamine which has an abnormally low  $IP(n_N)$  of only 7.18 eV<sup>35</sup>. As has been shown by Bock and coworkers<sup>35</sup>, this tertiary amine has a planar configuration of the nitrogen atom. The ‘extra’ destabilization of the  $n_N$  orbital

of this compound caused by the planarization can be estimated by comparison with other amines to about 0.5 eV.

Comparison of  $IP(n_N)$  values of cyclic secondary amines (Table 6) with those of the respective 1-methyl derivatives (Table 7) reveals that the effect of the additional methyl group decreases from 0.6 eV in aziridine to 0.1 eV in hexahydroazepine (hexamethyleneimine).

An interesting interplay of steric and electronic effects is presented by tertiary cyclopropylisopropylamines  $c\text{-Pr}_n i\text{-Pr}_{3-n}\text{N}$  ( $n = 1-3$ )<sup>36</sup> (Tables 4 and 5):

	$c\text{-Pr}_3\text{N}$	$c\text{-Pr}_2(i\text{-Pr})\text{N}$	$c\text{-Pr}(i\text{-Pr}_2)\text{N}$	$i\text{-Pr}_3\text{N}^{35}$
$IP(n_N)$ :	8.44	8.14	7.79	7.18 eV

The surprisingly large difference of the  $IP(n_N)$  values [ $\Delta IP(n_N) = 1.26$  eV] of the first and the last member of this series indicates that tricyclopropylamine behaves more like a simple tertiary amine with linear alkyl groups [ $IP(n_N) = 8.5 - 7.9$  eV, Table 4] than like its acyclic analogue  $i\text{-Pr}_3\text{N}$ . This is confirmed by an X-ray structure analysis of  $c\text{-Pr}_3\text{N}$  which revealed C–N–C angles of  $110.1^\circ$  with approximate  $C_{3v}$  symmetry indicating normal pyramidality of the nitrogen atom<sup>61</sup>. In the series  $c\text{-Pr}_3\text{N} \rightarrow c\text{-Pr}_2(i\text{-Pr})\text{N} \rightarrow c\text{-Pr}(i\text{-Pr}_2)\text{N} \rightarrow i\text{-Pr}_3\text{N}$ , the shift  $\Delta IP(n_N)$  for replacing a cyclopropyl by an isopropyl group increases from 0.30 eV for the first pair to 0.61 eV for the last pair, which is in accord with increasing planarization of the nitrogen atom.

Another very interesting system is the series of fluoroamines  $\text{NH}_{3-n}\text{F}_n$  ( $n = 0-3$ ) (Table 8) which has been investigated by Bock and coworkers<sup>32</sup>. As expected from the difference in electronegativity between H and F, all ionizations energies increase with F substitution. For  $\text{NH}_3 \rightarrow \text{H}_2\text{NF}$  and for  $\text{H}_2\text{NF}_2 \rightarrow \text{NHF}_2$  both increments  $\Delta IP(n_N)$  are about 0.7 eV. For  $\text{NHF}_2 \rightarrow \text{NF}_3$  a considerably larger shift of 1.45 eV is observed. This is rationalized by MNDO results indicating that for  $\text{NF}_3$ ,  $n_N$  is bonding, while for the other members of this series it is anti-bonding<sup>32</sup>. In addition, also an increase of the s character in the hybrid orbital of the lone-pair may contribute to this effect. The F–N–F bond angle of  $\text{NF}_3$  is about  $106^\circ$ .  $\text{NF}_3$  has the highest nitrogen lone-pair ionization energy known so far, even exceeding the value 12.52 eV for the nearly planar  $\text{N}(\text{CF}_3)_3$ <sup>38</sup> (Table 4). Relative to the planar amines  $i\text{-Pr}_3\text{N}^{35}$  and 1-azabicyclo[3.3.3]undecane<sup>52</sup> (see Section II.D) with their rather low lone-pair ionization of only *ca* 7.1 eV, the span of  $n_N$  ionizations  $\Delta IP(n_N) = 13.8 - 7.1 = 6.7$  eV results, indicating that the  $\text{NH}_3^{+*}$  radical cation ground state is extremely substituent-sensitive. Compared to ammonia [ $IP(n_N) = 10.9$  eV], the fluorine ligands cause a stabilization of 2.9 eV, while —on the other side—destabilization up to 3.8 eV has been found. An exceptionally low  $IP(n_N) = 7.66$  eV was also found for tris(trimethylsilylmethyl)amine,  $\text{N}(\text{CH}_2\text{SiMe}_3)_3$ <sup>27</sup>, indicating that trimethylsilylmethyl substituents are powerful electron donors.

The reduced energy difference between the ground state of the neutral molecules and the resulting radical cation states are best rationalized in terms of stabilizing delocalization of the positive charge. Applying Koopmans' theorem<sup>17</sup>,  $IP_i = -\varepsilon_i^{\text{SCF}}$ , and using perturbation arguments, the replacement of substituents, e.g. Me by  $\text{CH}_2\text{SiMe}_3$ , destabilizes the  $n_N$  orbital both inductively and due to increased hyperconjugation ( $n_N/\sigma_{\text{CSi}}$ ).

By comparison with IP data from silylamines, the vertical IP corresponding to a nitrogen 2p orbital in planar trimethylamine was estimated to be 7.7–7.9 eV<sup>40</sup>.

Larger alkyl groups are well-known to decrease the IPs of heteroatomic compounds relative to smaller ones. Danby and coworkers<sup>62</sup> have shown that vertical ionization potentials can be described empirically by using substituent parameters  $\mu_R$  ( $\mu_{\text{Me}} = 0$ ,  $\mu_R$  is negative for larger alkyl groups) with equation 4.

$$IP(\text{RX}) = IP(\text{MeX}) + \chi_{\text{RX}} \cdot \mu_{\text{R}} \quad (4)$$

$\chi_{RX}$  is a parameter characterizing the homologous series RX. The values of  $\mu_R$  are direct measures of the polar inductive effects of alkyl groups relative to that of methyl and correlate well with Taft's  $\sigma^*$  values. Substituent-induced IP shifts can thus be handled by linear free energy relationships (LFER) of the Hammett  $\rho\sigma$ -type.

Nelsen<sup>41</sup> extended such correlations to cyclic compounds for which  $\mu_R$  is not defined, by introducing a parameter  $n_{\text{eff}}$  representing the 'effective number of carbon atoms' in the alkyl groups (equation 5).

$$n_{\text{eff}} = 1 + \frac{\mu_R}{\mu_{\text{Et}}} \quad (5)$$

With these parameters the first IP of tertiary amines can be calculated (equation 6).

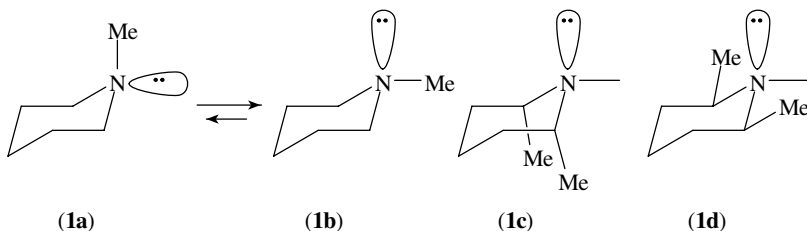
$$\text{IP}_{\text{calc}} = 8.92 - 0.13 \Sigma n_{\text{eff}} \quad (6)$$

The deviation  $\Delta$  of the experimental IP values from that predicted by equation 6 for ordinary amines is only  $\pm 0.03$  eV, which is about the size of the experimental error in measuring IP. Larger deviations indicate significant changes of the bond angles at the nitrogen atom, and equation 7 has been proposed to estimate the average C–N–C bond angle  $\alpha$  of a tertiary amine from its ionization potential<sup>41</sup>.

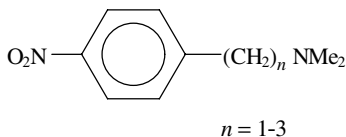
$$\alpha = 110.8 - 10.5\Delta \quad (7)$$

Obviously the  $n_N$  ionization energy is a function of the type, number and position of the substituents. The  $\text{IP}(n_N)$  values of 4-substituted quinuclidines correlate linearly with Taft's  $\sigma^*$  values<sup>51</sup> (Figure 3).

In piperidine the electron lone-pair can occupy either an axial or an equatorial position; in 1-methylpiperidine the axial orientation (**1b**) is favoured by 99:1 over the equatorial (**1a**). PE spectra and *ab initio* calculations on methylpiperidines indicate that axial 2-methyl substituents lower the amine lone-pair ionization potential by about 0.26 eV, while equatorial 2-methyl substituents as well as methyl groups on carbon atoms 3 and 4 lower the lone-pair IP by less than 0.1 eV<sup>63</sup>. This establishes the mechanism of stabilization of the amine radical cation as hyperconjugative electron release, which is larger for CC bonds than for CH bonds. The anti-periplanar orientation of the nitrogen lone-pair and the vicinal C–Me bond (**1c**) is much more favourable for this type of interaction than the synclinal orientation (**1d**).



The  $n_N$  ionizations of tertiary aliphatic amines (Table 5) are mostly lower than 9 eV and thus small enough for an electron donor in charge-transfer (CT) interactions. Mutai and collaborators<sup>64</sup> have studied intramolecular CT interaction in a series of 1-( $\omega$ -dimethylaminoalkyl)-4-nitrobenzenes.



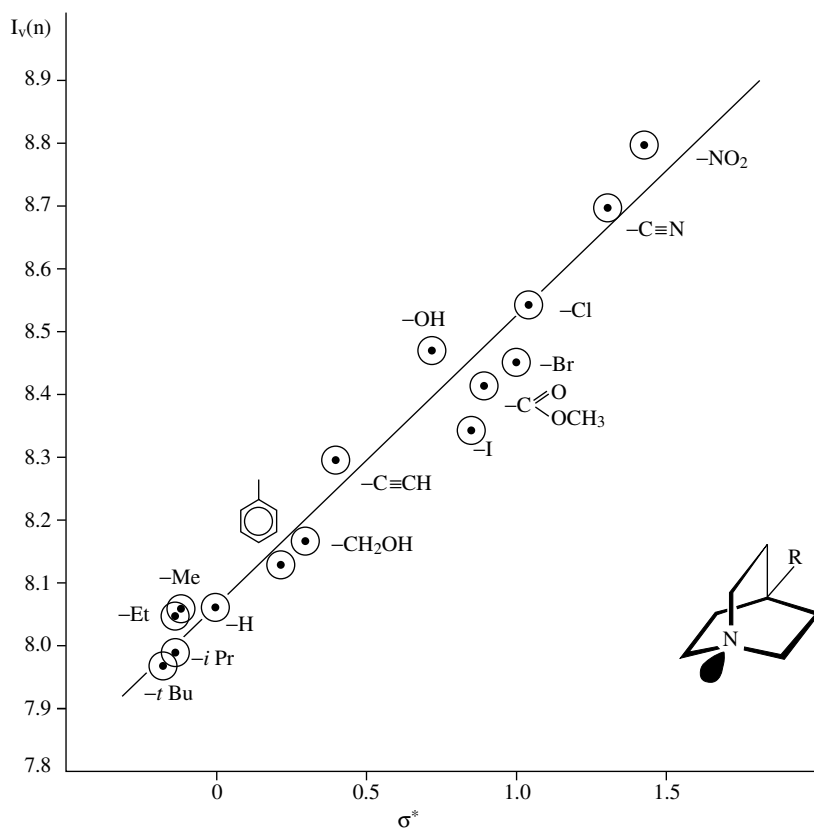


FIGURE 3. Regression of lone-pair ionization energies of 4-substituted quinuclidines vs Taft's  $\sigma^*$  values of the substituents. Reproduced with permission from Reference 12

However, the first ionization bands in the PE spectra of these compounds (vertical IPs are  $n = 1$ : 8.67 eV,  $n = 2$ : 8.61 eV,  $n = 3$ : 8.50 eV) show no apparent anomaly which might be ascribed to intramolecular  $n/\pi$  type CT interaction. This fact suggests that the CT interaction found by UV spectroscopy is weak and that the molecules are present in their open-chain forms under the experimental conditions employed for recording the PE spectra.

Morishima and coworkers<sup>30</sup> have studied the CT complexes of iodine with various cyclic and bicyclic amines containing non-adjacent double bonds or aromatic rings. They could show that the iodine-amine CT absorption is a useful means of assigning the  $n_N$  ionizations in the PE spectra of amines.

For some amines it can be very difficult if not impossible to measure the  $IP(n_N)$  value because of overlap by other strong ionization bands. Benzylamine,  $\text{PhCH}_2\text{NH}_2$ , is an example. Its PE spectrum<sup>26,65</sup> exhibits two strong overlapping bands in the lower energy region (<12 eV) with maxima at 9.03 and 9.39 eV. The corresponding ionizations are most probably related to the aromatic  $\pi$  MOs ( $\pi_2$  and  $\pi_3$ ). The second band has a hardly noticeable shoulder at about 9.7 eV which might originate from the  $n_N$  ionization.

### C. Aromatic Amines

Large changes of the electronic structure and, in particular, of the  $n_N$  orbital occur when the amino group is directly attached to another functional group with  $n$  or  $\pi$  orbitals. Such systems have typical electronic, structural and chemical properties and will not be dealt with here in detail. Examples are hydrazines, hydroxylamines, enamines and amides. The most interesting feature of these systems which has been studied by PES are conformation-dependent orbital interactions<sup>66,67</sup>. A special case are the aromatic amines which are not considered as a unique class of compounds although, owing to  $n/\pi$  conjugation, their properties deviate considerably from those of aliphatic amines.

#### 1. Anilines

The simplest aromatic amine, aniline, is a much weaker base than aliphatic primary amines. Also, its structure deviates from that of the latter amines: The sum of the bond angles at the nitrogen atom of aniline is  $345^\circ$ , while in primary aliphatic amines it is about  $330^\circ$ , and the  $\text{NH}_2$  group is tilted by  $37.5 \pm 2^\circ$  against the plane of the ring<sup>68,69</sup>. This partial planarization of the nitrogen atom is caused by delocalization of the nitrogen lone-pair by  $n_N/\pi_{\text{Ph}}$  orbital interaction. As a sole symmetry element the molecule has a symmetry plane bisecting the amino group and the benzene ring and it belongs to the point group  $C_s$ . Since there is only minor deviation from  $C_{2v}$  symmetry (only the atoms of the amino group do not lie in the ring plane<sup>69</sup>) sometimes this point group is used to approximately describe properties of aniline.

Aniline has 50 electrons, thus there are 25 doubly occupied MOs. Seven of these belong to the 1s electrons of the C and N atoms and the remaining 18 are valence-shell MOs. Some of these are depicted in Figure 4. Aniline is one of the most important basic organic compounds, and its PE spectrum (Figure 5) has been investigated by several authors, e.g., (see, References 21,42,70–76). A HeII spectrum was published by Palmer and coworkers<sup>75</sup>. The relevant data are summarized in Table 9. Because of the interaction of the nitrogen lone-pair with the  $\pi$  electrons of the benzene ring the MOs  $\pi_2$  and  $\pi_3$ , which are degenerate in benzene, are split. The first and the third ionization band of aniline correspond to the out-of-phase and the in-phase combination of  $n_N$  and  $\pi_3$ , while

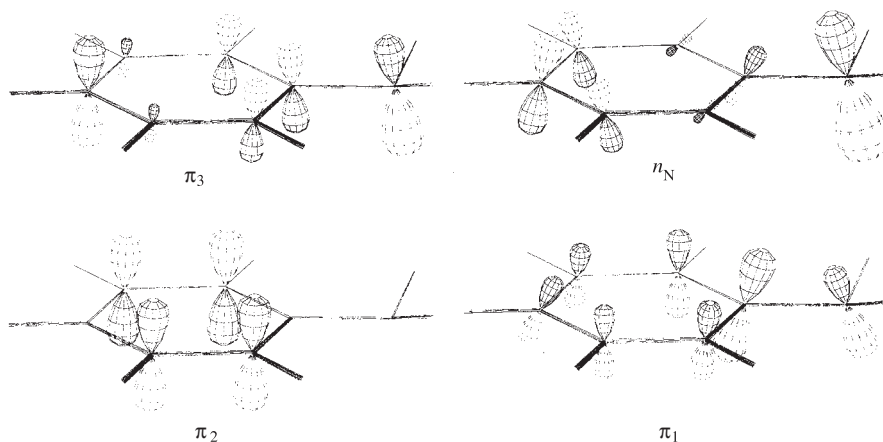


FIGURE 4. MOs of aniline (AM1 results)

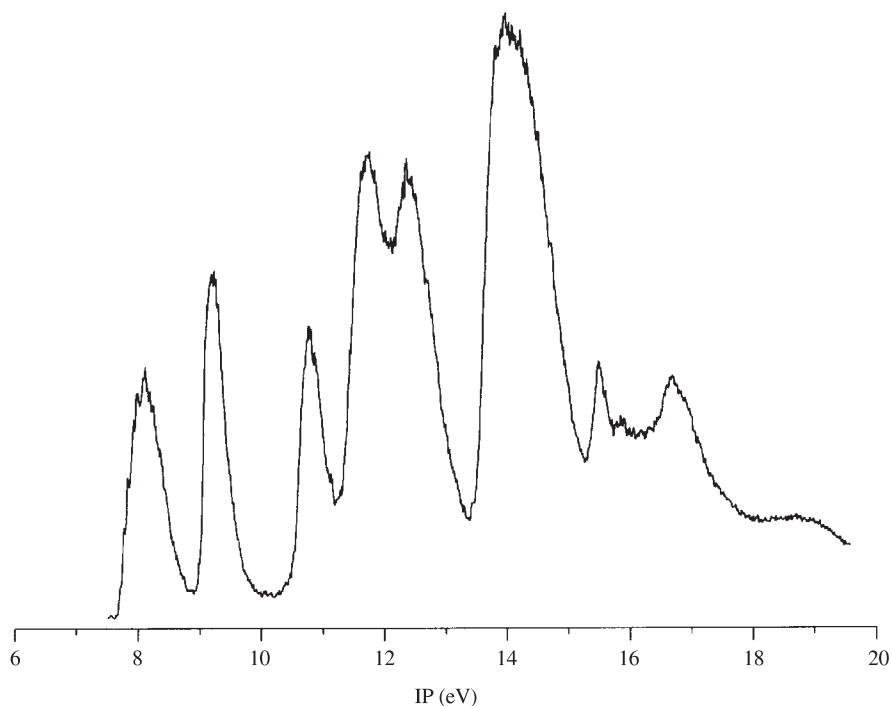


FIGURE 5. PE spectrum of aniline

TABLE 9. Ionization potentials IP (eV) and orbital energies  $\varepsilon$  (eV) of aniline

IP <sup>26</sup>	$-\varepsilon^a$	$-\varepsilon^b$	$-\varepsilon^c$	Ionic state <sup>d</sup>	MO
8.07	7.95	8.52	8.14	17a' (3b <sub>1</sub> )	$\pi_3$ ( $\pi_3-n_N$ )
9.20	9.10	9.65	9.32	8a'' (1a <sub>2</sub> )	$\pi_2$
10.80	11.91	11.54	10.71	16a' (2b <sub>1</sub> )	$n_N$ ( $\pi_3 + n_N$ )
11.74	13.23	11.77	11.07	7a'' (8b <sub>2</sub> )	$\sigma$
12.39	13.54	12.31	11.56	15a' (13a <sub>1</sub> )	$\sigma$
	14.35	13.81	12.83	14a' (1b <sub>1</sub> )	$\pi_1$
14.05	15.82	14.10	13.27	13a' (7b <sub>2</sub> )	$\sigma$
	16.15	14.70	13.82	12a' (12a <sub>1</sub> )	$\sigma$
	16.21	14.60	13.71	6a'' (6b <sub>2</sub> )	$\sigma$
15.52	17.53	16.64	15.58	11a' (11a <sub>1</sub> )	$\sigma$
15.9	18.57	17.29		5a'' (5b <sub>2</sub> )	$\sigma$
16.75	19.14	17.89		10a' (10a <sub>1</sub> )	$\sigma$
19.0 <sup>e</sup>		22.53		9a' (9a <sub>1</sub> )	$\sigma$
22.5 <sup>e</sup>		23.26		4a'' (4b <sub>2</sub> )	$\sigma$

<sup>a</sup>*Ab initio* [4-31G]<sup>21</sup>.<sup>b</sup>AM1<sup>26</sup>.<sup>c</sup>OVGF(AM1)<sup>26</sup>.<sup>d</sup> $C_s(C_{2v})$  symmetry.<sup>e</sup>From Reference 75.



the second band corresponds to  $\pi_2$ . For simplicity reasons, the HOMO and HOMO-2 are termed  $\pi_3$  and  $n_N$ , respectively. Somewhat more difficult is the identification of the ionization related to  $\pi_1$  since it is superposed by a strong  $\sigma$  ionization. Relative to benzene<sup>21</sup>,  $\pi_1$  and  $\pi_2$  are unshifted, while  $\pi_3$  is destabilized by 1.2 eV, which reflects the electron-donating effect of the amino group. Similar relations are also found for the unoccupied  $\pi$  MOs of aniline which were studied by Jordan's group<sup>77</sup> and by Distefano and coworkers<sup>78</sup> by electron transmission spectroscopy (ETS). The results are reproduced graphically in Figure 6.

In Table 9, the IP values of aniline are compared with orbital energies obtained by quantum chemical calculations. The agreement is sufficient for the assignments even for most of the higher IPs, although the sequence of  $6a''$  and  $12a'$  is inverted by the semi-empirical methods relative to the *ab initio* results. The smallest deviations—at least for the lower IPs—is found for the outer valence Green's function (OVGF)<sup>19</sup> technique, coupled with semi-empirical AM1<sup>18</sup> calculations.

By zero kinetic energy (ZEKE) PE spectroscopy a value of  $7.7206 \pm 0.0002$  eV has been determined for the first adiabatic IP of aniline<sup>79</sup>. This technique makes it possible to obtain accurate and detailed information about molecular ions.

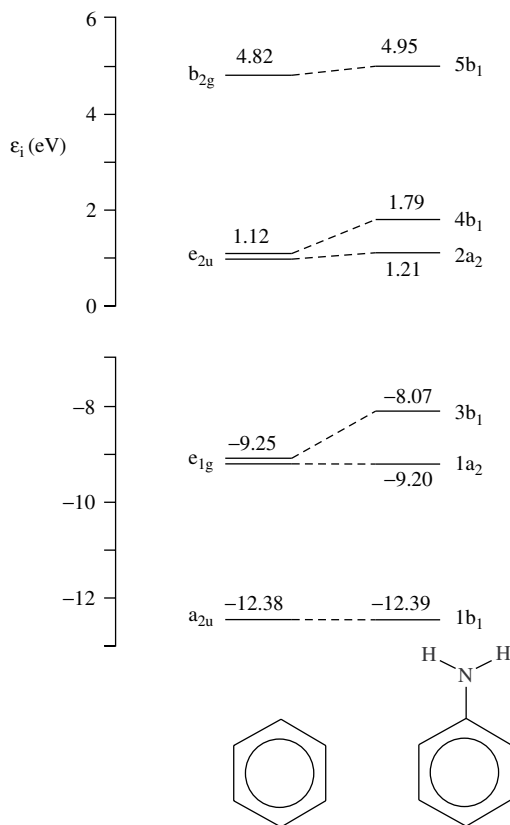


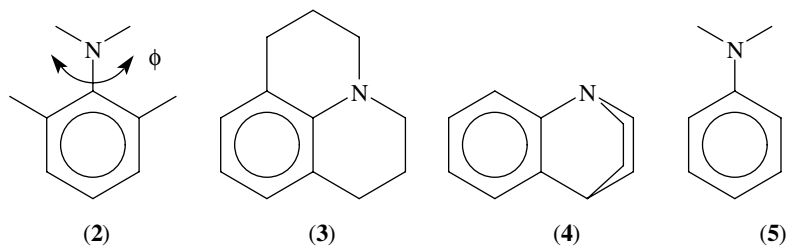
FIGURE 6. Correlation diagram for the occupied and vacant  $\pi$  MOs of benzene and aniline. Values from References 21 and 78

In Table 10 the first three IPs of some substituted anilines are summarized. Aniline and other aromatic amines are systems well suited for studies of substituent effects on the electronic structure and the effects of steric inhibition to resonance<sup>42,71,72,74,75,80,81</sup>. Since such effects mainly affect the electronic structure of the benzene ring it would lead too far covering these compounds here in detail. However, a few remarks seem to be adequate. Because of the electron delocalization there are several MOs with substantial  $n_N$  contributions. However, in most cases the third highest occupied MO (HOMO-2), or the third IP, is mainly related to the electron lone-pair. Therefore, the assignment of the IPs is generally the same as for the parent molecules: IP<sub>1</sub> and IP<sub>2</sub> are assigned to  $\pi_3$  and  $\pi_2$ , respectively, and IP<sub>3</sub> is assigned to  $n_N$ .

In the toluidines (methylanilines) the  $n_N$  MO is destabilized by 0.2–0.3 eV, while in the corresponding monofluoroanilines it is stabilized by about 0.1 eV<sup>75</sup>. The effect of several fluorine atoms seems to be additive, as indicated by the IP( $n_N$ ) value of pentafluoroaniline<sup>42,71</sup> which is 0.7 eV greater than that of aniline.

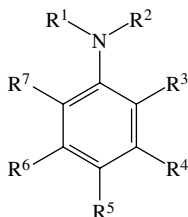
If only N-substituted aniline derivatives are considered, the IP( $\pi_2$ ) value is observed close to that of the parent compound and to vary in a rather narrow range (8.8–9.1 eV). On the other hand, for IP( $\pi_3$ ) (7.0–7.7 eV) and IP( $n_N$ ) (9.5–10.3 eV) larger deviations relative to unsubstituted aniline and greater variation with substitution are found. This can be explained by perturbations of the corresponding benzene MOs by the substituents which is minimal for  $\pi_2$ , because it has no coefficients on C-1 and N ( $C_s$  symmetry). In asymmetric aniline derivatives also  $\pi_2$  is expected to interact to a substantial extent with  $n_N$ .

Steric resonance inhibition has been ascertained for *N*-methyl- and *N,N*-dimethylanilines with further substituents in the *ortho* positions<sup>42,72</sup>. By considering the changes in the first three orbital levels as observed by PE spectroscopy, the amount by which the nitrogen lone-pair electrons are twisted about the N-phenyl bond can be estimated. For example, the dihedral angle of *N,N*-dimethyl-2,6-dimethylaniline (**2**) was estimated at 30–46° from the lone-pair ionization energy as well as from the split of  $\pi_2$  and  $\pi_3$ . These ‘classical’ investigations by Maier and Turner<sup>42</sup> in the field of conformational analysis by PE spectroscopy have been reviewed previously<sup>66,67</sup>.



Julolidine (**3**) and benzoquinuclidine (**4**) can be considered as aniline derivatives with parallel and perpendicular electron lone-pairs, respectively. Relative to *N,N*-dimethylaniline (**5**), the simplest tertiary aromatic amine, the  $n_N$  orbital of julolidine is destabilized by 0.20 eV, while that of benzoquinuclidine is destabilized by 0.80 eV<sup>42</sup>. In the latter compound there is no  $n/\pi$  conjugation while in the former it has a maximum value and, accordingly, the splitting of the first and the third IP is much smaller (0.70 eV) than in the former (2.55 eV) compound.

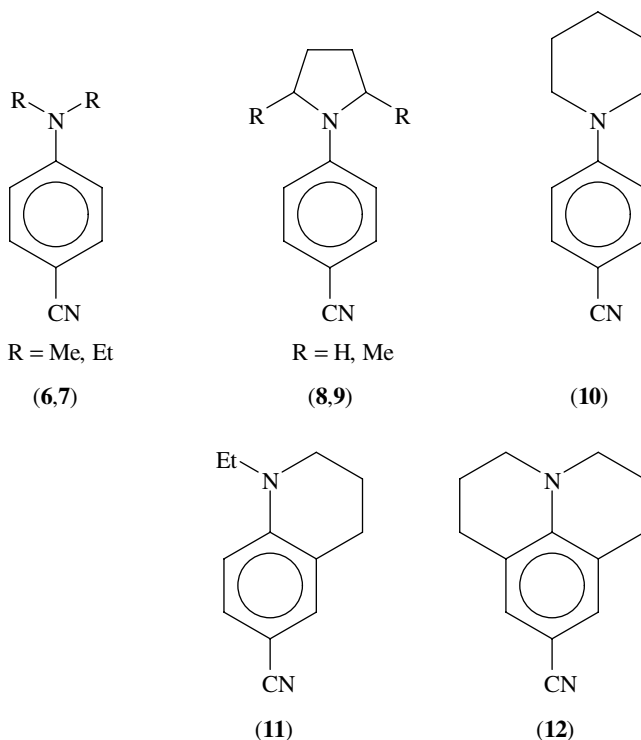
Rettig and Gleiter<sup>81</sup> have studied the dependence of intramolecular rotation in 4-cyano-*N,N*-dialkylanilines **6–12** on the twist angle by fluorescence, UV absorption and PE spectroscopic measurements. The twist angles were determined from the split of the first and the third IP. While in molecules **6**, **8** and **9**, **11** and **12** the twist of the amino group

TABLE 10. Ionization potentials (eV) of substituted anilines<sup>a</sup>

R <sup>1</sup>	R <sup>2</sup>	R <sup>3</sup>	R <sup>4</sup>	R <sup>5</sup>	R <sup>6</sup>	R <sup>7</sup>	$\pi_3$	$\pi_2$	$n_N$	References
							8.07	9.20	10.80	26
Me							7.68	9.10	10.28	26, 82
Et							7.61	9.06	10.22	26
Pr							7.53	9.00	10.11	26, 82
<i>i</i> -Pr							7.51	8.98	10.09	26, 82
Bu							7.55	9.03	10.10	26
<i>t</i> -Bu							7.62	9.04	9.99	26
CH <sub>2</sub> Ph							7.57, 7.74	9.10	10.14	26, 82
Me	Me						7.45	9.00	9.85	42
Me	Me	Me				Me	7.85	8.60	8.85	42
Me	Me			Me			7.48	9.06	9.65	70
Me	Me			CN			7.86	9.56	10.19	81
Me	Me			COMe			7.69	9.15	9.97	83
Me	Me			COCH <sub>2</sub> Cl			7.69	9.24	10.06	83
Me	Me			COCH <sub>2</sub> Br			7.7	9.2	10.1	83
		Me					7.84	8.84	10.63	75
		Me				Me	7.75	8.50	10.55	42
			Me				7.82	8.89	10.55	75
				Me			7.81	9.06	10.50	75
Et	Et						7.20	8.90	9.70	42
Et	Et			CN			7.65	9.45	10.08	81
Pr	Pr						7.12	8.90	9.63	26
<i>i</i> -Pr	<i>i</i> -Pr						7.17	7.81	8.93	26
Bu	Bu						7.00	8.76	9.52	26
-(CH <sub>2</sub> ) <sub>4</sub> -				CN			7.56	9.41	10.05	81
-(CH <sub>2</sub> ) <sub>5</sub> -				CN			7.89	9.64	10.10	81
		NH <sub>2</sub>					7.69	8.59	10.55	84
			NH <sub>2</sub>						11.01	
				NH <sub>2</sub>			7.60	8.26	10.05	84
									11.44	
									9.71	84
									11.54	
		F					8.18	9.58	10.95	75
			F				8.32	9.30	10.96	75
				F			8.18	9.57	10.91	75
				Cl			8.18	9.51	10.64	70
						Cl	8.20	9.10	11.10	42
		F	F	F	F	F	8.95	9.75	11.50	42, 71
Ph		F	F	F	F	F	8.17	9.54, 9.66	11.16	31
Ph	Me <sub>3</sub> Si	F	F	F	F	F	8.05	9.29, 9.46	10.08	31
		Ph					7.70, 8.70	9.15, 9.50	10.60	85
SiMe <sub>3</sub>							7.70	9.01	10.09	31
SiMe <sub>3</sub>	SiMe <sub>3</sub>						8.25	9.03	10.43	26

<sup>a</sup>R<sup>1</sup>...R<sup>7</sup> is H if not indicated otherwise

relative to the benzene ring is rather small ( $\phi < ca 10^\circ$ ), in **7** and **10** it is about  $20\text{--}30^\circ$ . In accordance with a scheme involving an excited state crossing it was found that the rate constant for formation of the twisted intramolecular charge transfer excited state increases considerably with the ground state twist angle  $\phi$ .



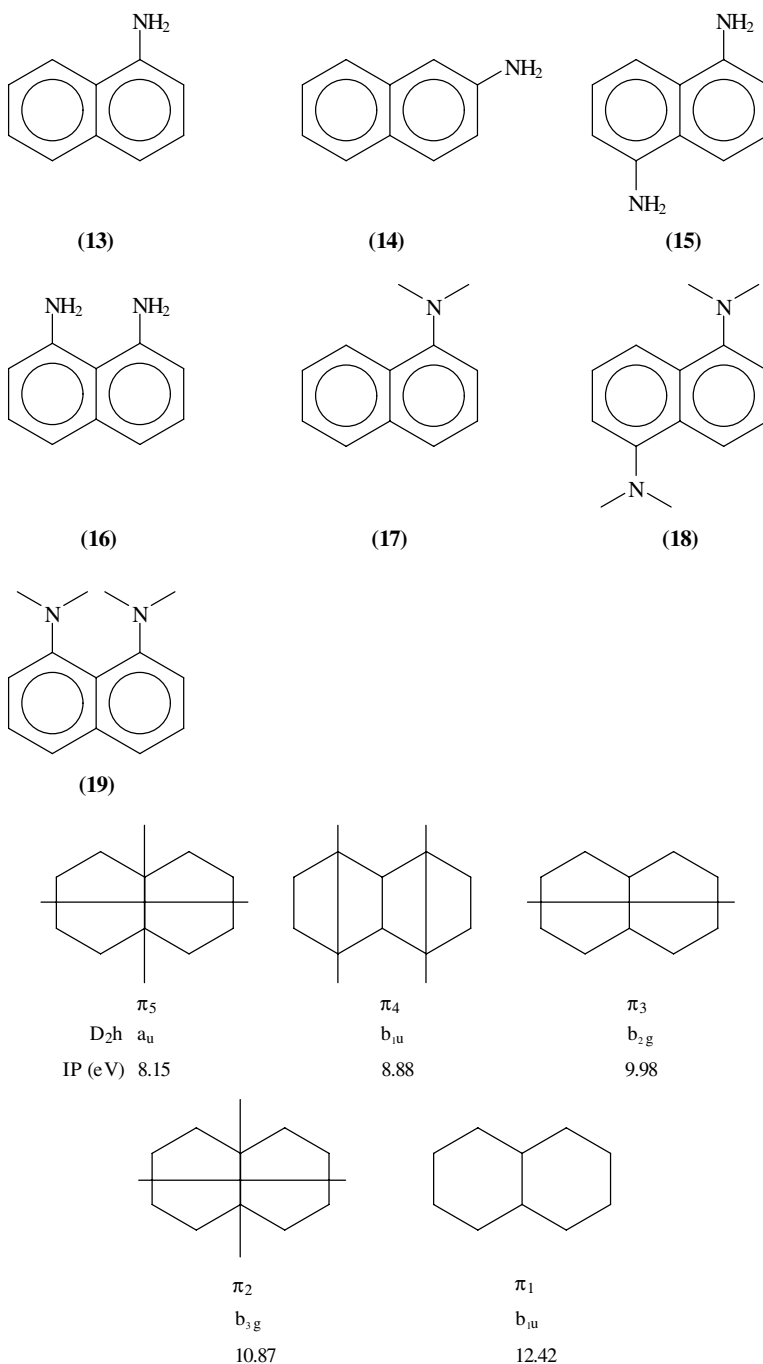
## 2. Aminonaphthalenes

The PE spectra of  $\alpha$ - and  $\beta$ -naphthylamine (**13,14**) were studied by Maier<sup>86</sup> and by Klasinc and coworkers<sup>87</sup>. Maier<sup>86</sup> has also analysed the spectra of peri-amino and dimethylamino naphthalenes (**15–19**).

From the nodal properties of the naphthalene  $\pi$  MOs (Figure 7) it is obvious that attachment of substituents in positions 1,4,5 and 8 will have only little effect on  $\pi_5$  whereas the other  $\pi$  MOs will be affected. Substituents in the other positions will interact with all  $\pi$  MOs of naphthalene in amounts proportional to the size of the coefficients in the respective positions.

The expectations regarding  $\pi_4$  are excellently confirmed in  $\alpha$ -naphthylamine (**13**) (Figure 8). The  $\text{IP}(\pi_4)$  value of this compound is practically the same as that of naphthalene while, for  $\pi_3$  and  $\pi_5$ ,  $\Delta\text{IP}$  values of *ca* 0.3 eV are found. However, also  $\Delta\text{IP}(\pi_2)$  is very small. For  $\beta$ -naphthylamine (**14**)  $\pi_2\text{--}\pi_5$  are destabilized in a much more uniform manner relative to naphthalene by 0.4–0.7 eV.

Similar statements for  $\text{IP}(\pi_4)$  can be made for the two diamionaphthalenes (**15,16**). Peri-substituted naphthalenes are examples of molecules with strong intramolecular crowding which can result in unique physicochemical properties. 1,8-Bis(dimethylamino)naphthalene (**19**) ('proton sponge'<sup>88,89</sup>) has been found to have an

FIGURE 7. Nodal characteristics of the five occupied  $\pi$  MOs of naphthalene

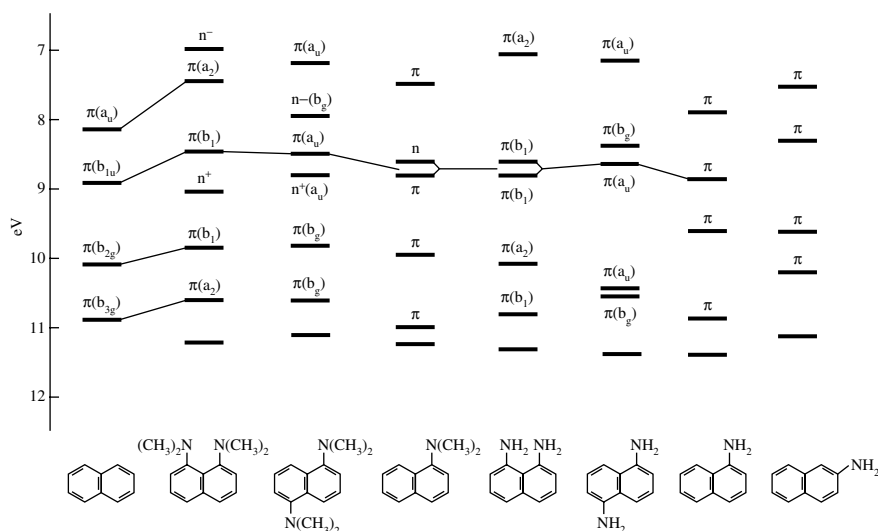


FIGURE 8. Correlation diagram of the ionization potentials of aminonaphthalenes. Reproduced with permission from Reference 86

abnormally high basicity,  $pK_a = 12.34$ , which has been associated with relief of steric strain and of nitrogen lone-pair interactions on protonation.

In **19** the first and the fourth IP are assigned to the two  $n_N$  ionizations ( $n^+$  and  $n^-$ ) while in 1,5-bis(dimethylamino)naphthalene (**18**) the corresponding ionizations are IP<sub>2</sub> and IP<sub>4</sub>. The split  $\Delta IP = IP(n^-) - IP(n^+)$  is 2.0 eV in **19** and 0.82 eV in **18**. It is remarkable that the larger split in **19** is not only caused by direct through-space interaction of the lone-pairs but also by through-bond interactions with naphthalene  $\sigma$  orbitals<sup>86,90</sup>. The analysis of the PE spectra of **18** and **19** suggests that the dimethylamino groups are rotated by about 60°<sup>86</sup>.

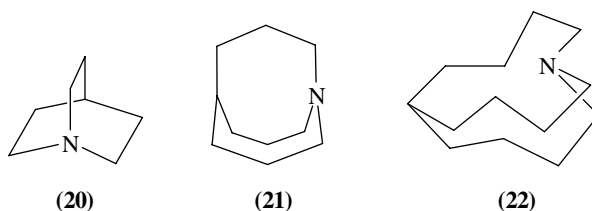
#### D. IP Values and Proton Affinities

It is well known that alkyl substitution changes the basicity of amines. However, solvation effects lead to an anomalous order of basicities in solution ( $NH_3 \approx$  tertiary amine < primary amine < secondary amine). From gas-phase proton affinity data the intrinsic effects of alkyl substituents can be evaluated and a quite regular order ( $NH_3 <$  primary amine < secondary amine < tertiary amine) is obtained<sup>91</sup>.

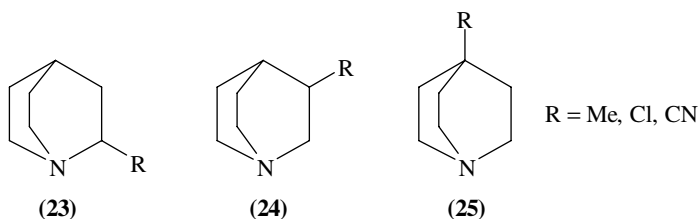
For simple aliphatic amines, like the methylamines, there is a linear inverse correlation between proton affinities and vertical IPs<sup>34</sup>. A low IP value should therefore indicate high proton affinity and vice versa. The proton affinity PA(B) of a molecule B is related to the homolytic bond energy  $D(B^+ - H)$  in the conjugate acid, as indicated by equation 8. If the homolytic bond dissociation energy is assumed to be constant for a particular functional group, e.g. N-H, the proton affinity will exhibit a linear correlation with the quantity  $IP(H) - IP(B)$ , and such correlations have been reported for the proton affinities and the nitrogen lone-pair ionizations<sup>46,92</sup>.

$$PA(B) = IP(H) - IP(B) + D(B^+ - H) \quad (8)$$

However, in more complicated amines, this straight correlation is violated. The bicyclic tertiary amine 1-azabicyclo[4.4.4]tetradecane (**22**) and the acyclic tertiary amine *n*-Bu<sub>3</sub>N have nearly the same first IP (7.84 and 7.90 eV, respectively), but the proton affinity of the bicyclic amine is 20 kcal mol<sup>-1</sup> lower than that of the acyclic<sup>52</sup>. On the other hand, for other bridge-head tertiary amines like 1-azabicyclo[2.2.2]octane (quinuclidine, **20**) and 1-azabicyclo[3.3.3]undecane (manxine, **21**) the expected relation between proton affinities and IP values is observed. The extraordinary properties of 1-azabicyclo[4.4.4]tetradecane (**22**) are caused by its unusual conformation: the nitrogen lone-pair is directed inward into the bicycle where protonation is not possible. In the protonated form, the strained out-conformation is adopted. This makes it the least basic known tertiary amine with purely saturated alkyl substituents. Its p*K*<sub>a</sub>, measured in ethanol/water, is only +0.6<sup>93</sup>. Strain effects on amine basicities have been reviewed by Alder<sup>88</sup>.



Heilbronner and coworkers<sup>94</sup> have studied several 2-, 3- and 4-substituted quinuclidines (**23**–**25**) by PES and ICR spectroscopy. A linear correlation of the gas-phase basicities and the *n*<sub>N</sub> ionization energies—relative to the unsubstituted parent molecule—was established. Comparison of the solution p*K*<sub>a</sub> values with gas-phase basicities revealed that 2-substituted quinuclidines (**23**) exhibit sizeable solvent-induced proximity effects, i.e. that the corresponding quinuclidinium ions are more acidic in solution than expected on the basis of proton affinities.



## E. IP Values and Biological Activity

Houk and coworkers<sup>28</sup> have investigated the PE spectra of psychotropic drugs like phenethylamines, tryptamines and LSD and found a correlation between hallucinogenic activity and IP values. Drugs with low IPs are recognized hallucinogens. However, not only first but also second IPs must be taken into account. As examples, human dosage data and average IP values of the first two ionizations (IP<sub>av</sub>) are given for some drugs in Table 11.

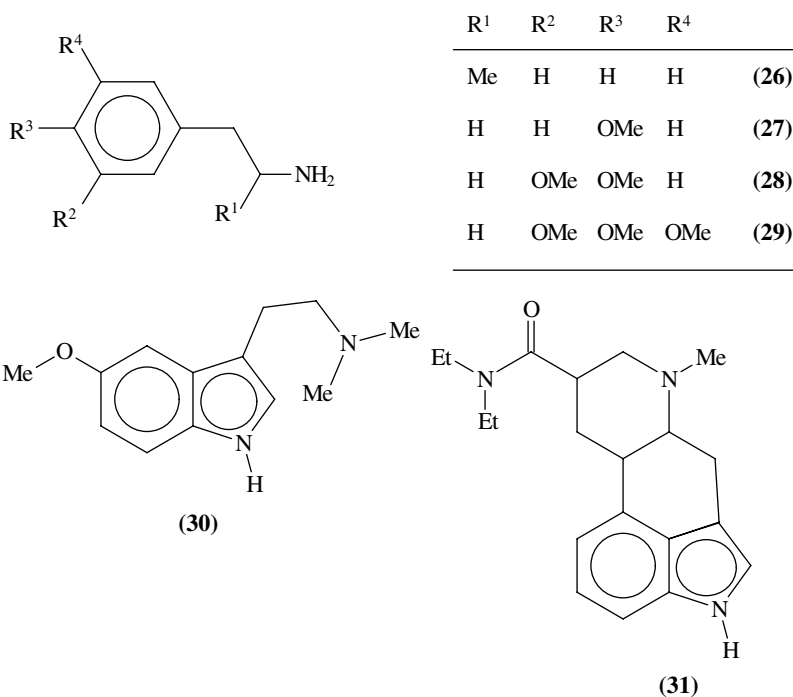
Similarly, the minimal effective brain level, MEBL (nmol/g), required for the drug to interfere with the conditioned avoidance response of rats correlates linearly with IP<sub>av</sub>. The least-squares correlation is

$$\text{MEBL} = 17.2 \times \text{IP}_{\text{av}} - 132 \quad (9)$$

with a correlation coefficient (*r*) of 0.95.

TABLE 11. Human dosage data MU and average values of the first two ionizations  $IP_{av}$  (eV) of some drugs<sup>a</sup>

	$IP_{av}$	MU <sup>b</sup>
Amphetamine ( <b>26</b> )	9.09	0
4-Methoxyphenethylamine ( <b>27</b> )	8.68	<1
3,4-Dimethoxyphenethylamine ( <b>28</b> )	8.44	<0.2
Mescaline ( <b>29</b> )	8.18	1
5-Methoxydimethyltryptamine ( <b>30</b> )	7.70	>31
LSD ( <b>31</b> )	7.64	3700

<sup>a</sup>From Reference 28.<sup>b</sup>Mescaline units. Activity in humans relative to that of mescaline.

The effect of a biologically active compound is based on its ability to form a complex with a receptor. The intensity of the biological effect is proportional to the stability of this complex, which is dependent on the strength of the interaction of the effector molecule with the active centre of the receptor. The electron structure of the molecule can be decisive for this interaction and this may explain the correlation of ionization potentials and pharmacological properties of certain compounds.

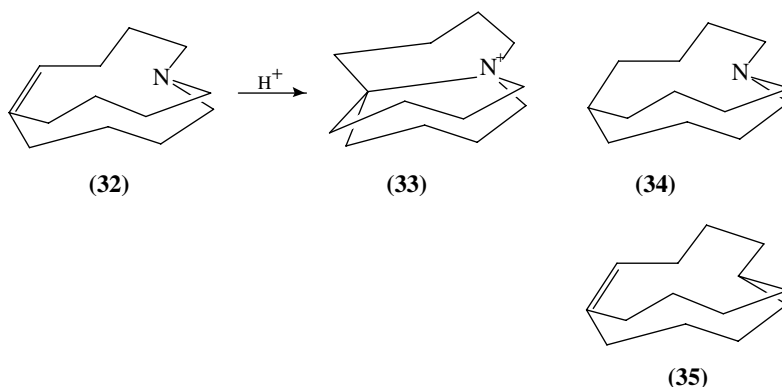
The PE spectra of some other alkaloids like methadone and the opiate narcotics morphine, codeine and heroin have been investigated by Klasinc and coworkers<sup>95</sup>. Also in this study structure-activity relationships based on IPs were sought but not found. Since the interaction of the drug molecule with the receptor is highly specific, it is not unreasonable that the molecular rather than the electronic structure is more important for the physiological activity.



### F. Transannular Interaction of amino Groups with Other Functional Groups

Strong through-space interactions are possible in medium rings. Such interactions have been discovered in certain alkaloids like cryptopine and protopine, which are characterized by atypical properties of their functional groups like low basicity of amino groups and low carbonyl reactivity of carbonyl groups.

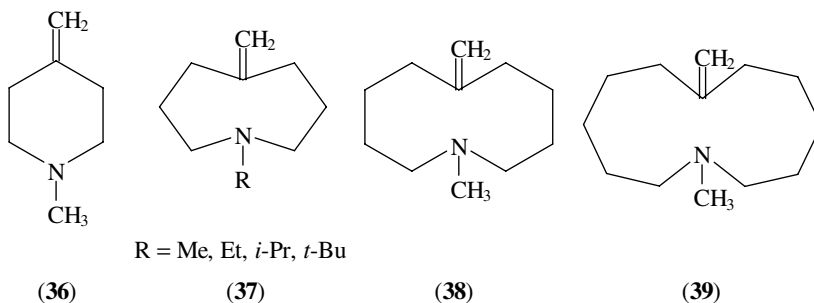
The bicyclic aminoalkene 1-azabicyclo[4.4.4]tetradec-5-ene (**32**) behaves actually like an enamine<sup>96</sup>. It is oxidized more readily than its saturated analogues. Protonation does not occur on the nitrogen atom but at the double bond accompanied by transannular cyclization (**32** → **33**).



In order to determine the electronic interaction between the amino and the alkene functionalities, the  $n$  and  $\pi$  orbital energies of **32** and the two analogous monofunctional compounds 1-azabicyclo[4.4.4]tetradecane (**34**) and bicyclo[4.4.4]tetradec-1-ene (**35**) should be known.  $n_N$  and  $\pi_{C=C}$  of **32** and **34** have been determined by PES, while  $\pi_{C=C}$  of the unknown alkene **35** has been estimated. The data are depicted in Figure 9.

In the difunctional aminoalkene **32** the  $\pi_{C=C}$  MO is destabilized relative to that of alkene **35** by *ca* 0.5 eV while the  $n_N$  orbital is stabilized relative to that of amine **35** by the same amount. This is the largest  $n_N/\pi_{C=C}$  interaction known so far.

In the monocyclic aminoalkenes **36**–**39** with an exocyclic CC double bond, only for the eight-membered ring compounds **37** has sizeable  $n_N/\pi_{C=C}$  interaction been detected by PES<sup>48,97</sup>. The through-space interaction of these orbitals in aminoalkenes was found to increase exponentially as their distance decreases<sup>97</sup>.



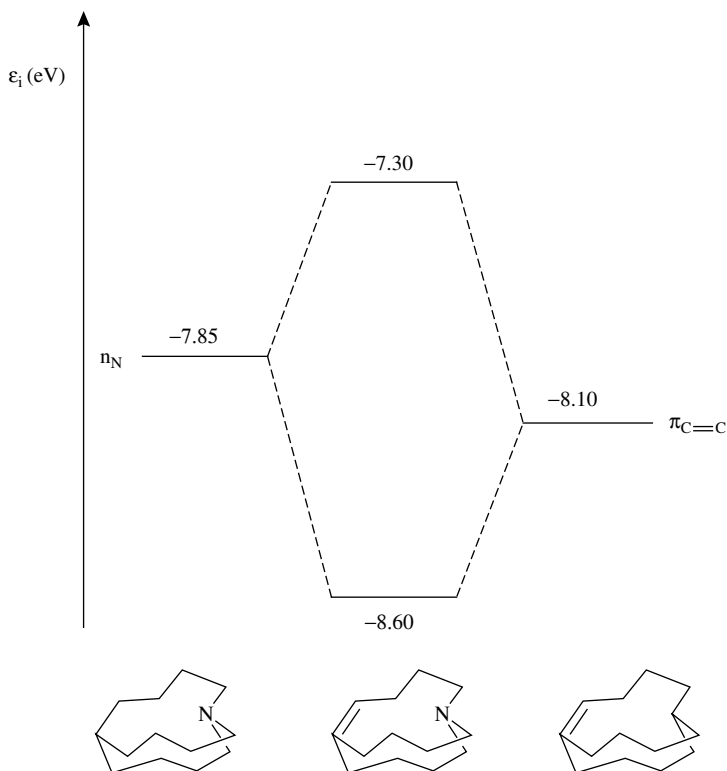
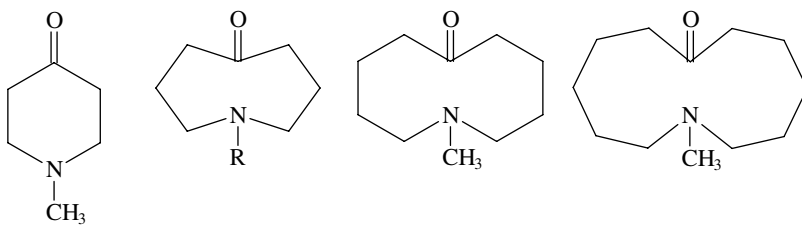


FIGURE 9. Orbital correlation diagram for 1-azabicyclo[4.4.4]tetradece-5-ene (**32**), 1-azabicyclo[4.4.4]tetradeceane (**34**) and bicyclo[4.4.4]tetradece-1-ene (**35**)

Also, the transannular interactions between amino and carbonyl groups in aminoketones, like **40–44**, were studied by PES<sup>48</sup>. Pronounced stabilization of the  $n_N$  orbital and destabilization of the  $n_O$  orbital was established by comparison of the relevant ionization potentials with those of the corresponding monofunctional compounds. The shift of the  $n_O$  orbital was noticed as the best indicator of transannular  $n_N/\pi_{C=O}$  interaction and the maximum value was again found for the system with an eight-membered ring (**41**).

These investigations, which can be considered as relevant for the modelling of analogous bimolecular reactions, have been reviewed recently<sup>97</sup>.

Martin and coworkers<sup>47</sup> have recorded and analysed the PE spectra of 7-azanorbornane (**45**), 7-azanorbornene (**46**) and 7-azanorbornadiene (**47**) as well as of related urethanes. Of prominent interest are the orientation of the lone-pair in **46** (*syn* or *anti*), the through-space interaction with  $\pi$  bonds in **46** and **47**, and the participation of  $\sigma$  bond orbitals. For **45** an IP ( $n_N$ ) value of 9.00 eV has been measured. The  $n_N$  orbital in this molecule has high contributions of the C–N bonds and of the *anti*-oriented C<sup>1</sup>–C<sup>2</sup> and C<sup>3</sup>–C<sup>4</sup>  $\sigma$  bonds. These orbitals mix into the lone-pair of nitrogen in an antibonding way, which causes the comparatively low ionization energy. The *syn* form is the prevailing conformer of **46**. There is direct interaction (homoconjugation) between  $n_N$  and  $\pi_{C=C}$  leading to the splitting of the two highest occupied levels (8.75 and 9.73 eV), which is enforced by interactions with  $\sigma$  bond orbitals. In **47** (8.60, 9.40 and 10.50 eV) there is strong



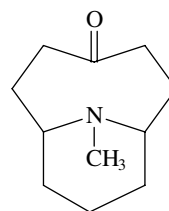
R = Me, Et, *i*-Pr, *t*-Bu,  
4-CH<sub>3</sub>-C<sub>6</sub>H<sub>4</sub>

(40)

(41)

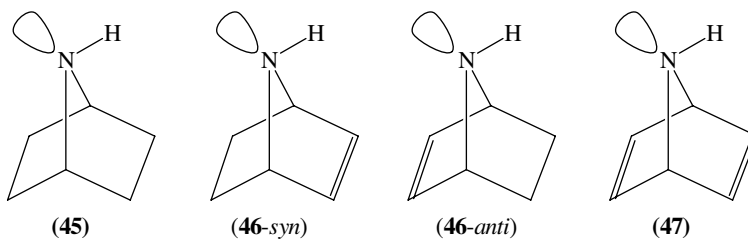
(42)

(43)



(44)

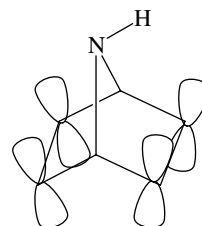
interaction between the lone-pair and two  $\pi$  bonds. The  $n$  character increases from the highest to the third highest level. This is consistent with the relative band intensities in the HeI and HeII PE spectra of **47**.



(45)

(46-*syn*)(46-*anti*)

(47)



## G. Diamines

In diamines there are two ionizations associated with the electron lone-pairs. Even when the nitrogen atoms have equal substituents or are related by symmetry, the two IPs are different in energy. The two eigenvalues are not degenerate because the point group of a diamine does not allow this.

Linear combination of the two lone-pair orbitals ( $n_1$  and  $n_2$ ) with reference to the relevant symmetry operation leads to a symmetric ( $n^+$ ) and an antisymmetric combination ( $n^-$ ).

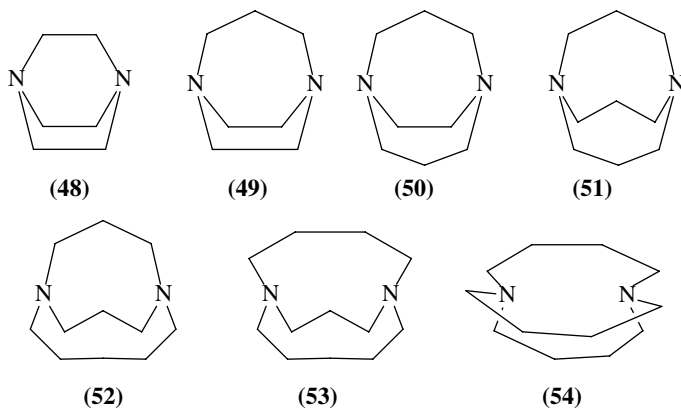
$$n^+ = 1/\sqrt{2} (n_1 + n_2) \quad (10)$$

$$n^- = 1/\sqrt{2} (n_1 - n_2) \quad (11)$$

The energy difference  $\Delta n$  of  $n^+$  and  $n^-$  is attributed to the interaction of  $n_1$  and  $n_2$ .  $\Delta n$  is dependent on the separation of the two nitrogen atoms by the number of  $\sigma$  bonds and also on their mutual geometrical orientation.

PE spectra of diamines have been reviewed briefly by Alder and Sessions<sup>98</sup>.

The nitrogen lone-pairs can interact both directly through-space and by mixing with other  $\sigma$  or  $\pi$  bonds in the molecule (through-bond interactions)<sup>99</sup> which may lead to  $\Delta n$  values of more than 2 eV. For bicyclic diamines with both nitrogen atoms in bridgehead positions, the relative contributions of the two modes of interaction as a function of bridge-size have been studied<sup>52,100</sup>. 1,4-Diazabicyclo[2.2.2]octane (DABCO, **48**) forms an unusually persistent radical cation in solution ( $t_{1/2} \approx 1$  a in  $\text{CH}_3\text{CN}$  at  $20^\circ\text{C}$ )<sup>101</sup> and shows two bands at 7.52 and 9.65 eV in its PE spectrum<sup>102,103</sup>. This large split of the two  $n_{\text{N}}$  ionizations is caused by effective through-bond interaction of the two lone-pairs via the three C–C bonds, placing  $n_{\text{N}}^+$  above  $n_{\text{N}}^-$ . Homologous diamines (**49–54**) show much smaller energy differences in their first two IPs, and in most cases the first IP relates to  $n_{\text{N}}^-$  (see Figure 10).



The first IPs of these diamines are exceptionally low. In solution too these compounds are easily oxidized giving long-lived radical cations, which are presumed to contain 3-electron  $\sigma$  bonds. This is in accordance with  $\text{IP}(n_{\text{N}}^+) > \text{IP}(n_{\text{N}}^-)$ , i.e. through-space interaction dominates any through-bond effects.

Lone-pair ( $n/n$ ) interactions have been studied exhaustively on various diamines<sup>98,104–106</sup> including 1,3-diamines and imidazolidines. Since  $n/n$  interactions usually are conformation-dependent<sup>66,67</sup>, from the PE spectra some information about the conformational properties of such compounds may be obtained. A thorough data compilation has been published by Mayer and Martin<sup>107</sup>.

As another example, in Figure 11 the PE spectrum of 1,3-diazaadamantane (**55**)<sup>108</sup> is depicted. There are two well separated  $n_{\text{N}}$  ionization bands at 7.75 ( $n_{\text{N}}^-$ ) and 8.78 eV

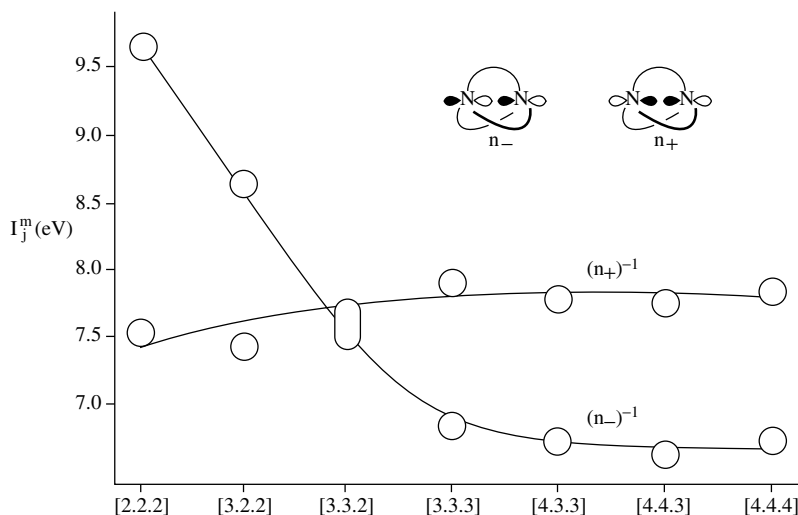


FIGURE 10. Vertical ionization energies for the first two bands in the PE spectra of bicyclic bridgehead diamines: [2.2.2] = 1,4-diazabicyclo[2.2.2]octane (**48**), etc. Reprinted with permission from Reference 52. Copyright (1981) American Chemical Society

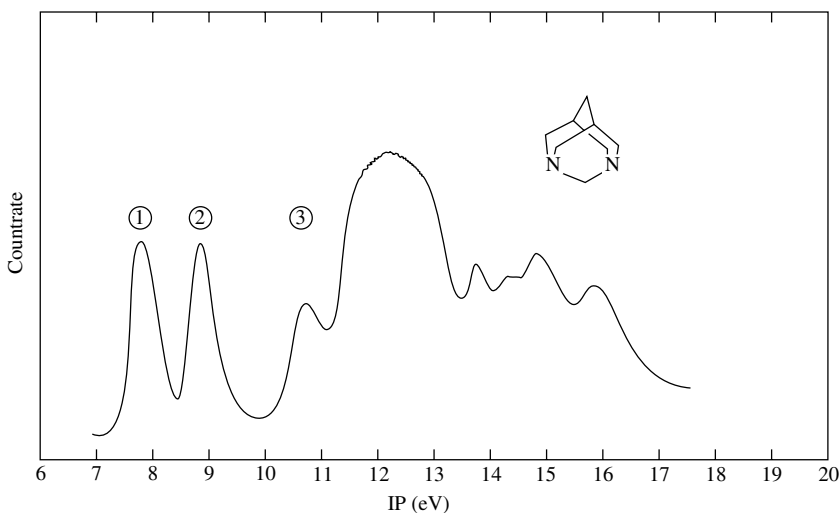
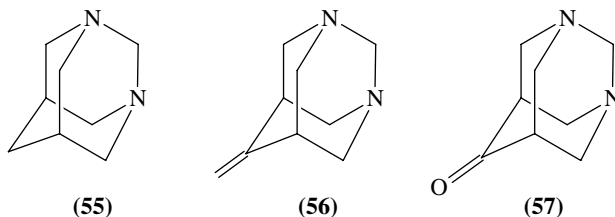


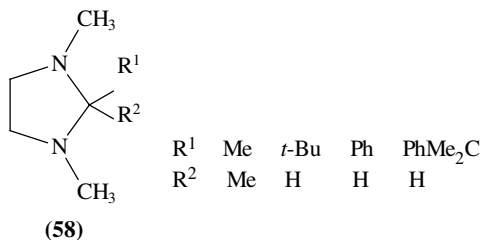
FIGURE 11. PE spectrum of 1,3-diazaadamantane (**55**). Reprinted from Reference 108 with kind permission from Elsevier Science Ltd

( $n_N^+$ ). The splitting is dominated by through-space interaction. In 6-methylene-1,3-diazaadamantane (**56**) and 1,3-diazaadamantan-6-one (**57**) Gleiter and coworkers<sup>108</sup> have also investigated the participation of another functional group in the  $n/n$  interaction. In **56** the two  $n_N$  orbitals are a little destabilized (*ca* 0.1 eV) relative to **55**, whereas in **57** the inductive effect of the CO group leads to a stabilization of *ca* 0.5 eV. The ionization

potentials of azaadamantanes have recently been calculated by Galasso<sup>109</sup> in a Green's function *ab initio* study.

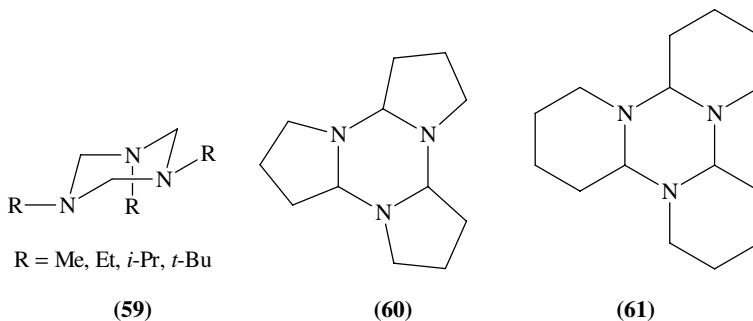


The PE spectra of four 2-substituted 1,3-dimethylimidazolidines (**58**) have been recorded and analysed using AM1 and PM3 quantum chemical calculations<sup>106</sup>. A single broad band is found for the two  $n_N$  ionizations and the energies of the two  $n_N$  orbitals are split by only 0.0–0.3 eV indicating little  $n/n$  interaction. This is consistent with envelope conformations of the five-membered ring of **58** and an axial-equatorial orientation of the two N-methyl groups.



## H. Polyamines

The PE spectra of some cyclic triamines with the nitrogen atoms in 1,3-positions like hexahydro-1,3,5-triazines (**59**) and tetracyclic derivatives such as **60** and **61** have been studied and interpreted with regard to their conformational properties<sup>110</sup>. The  $n_N$  ionizations lead to two strongly overlapping bands between 7.5 and 9.5 eV which are consistent with diequatorial-monoaxial nitrogen substituent orientations at the hexahydro-1,3,5-triazine rings.



The azaadamantanes with nitrogen atoms in bridgehead positions present an interesting series of compounds with 1,3- $n/n$  interactions in a rigid cage. The PE spectrum of

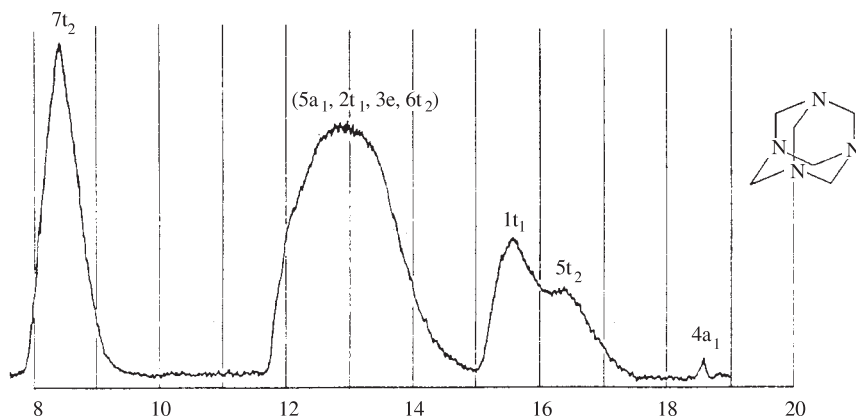
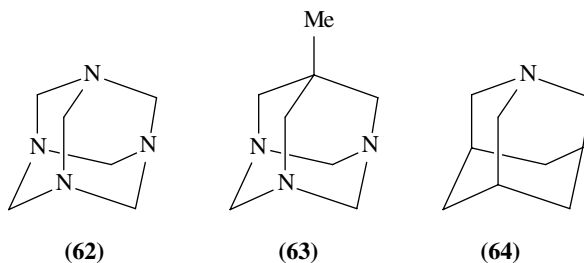


FIGURE 12. PE spectrum of urotropine (**62**), with assignments. Reprinted from Reference 111 with kind permission from Elsevier Science Ltd

urotropine (1,3,5,7-tetraazaadamantane, **62**) is depicted in Figure 12. The unique feature of this molecule is, of course, the presence of four tetrahedrally arranged nitrogen lone-pairs (point group  $T_d$ ). These occupy the orbitals  $7t_2$  and  $5a_1$  of which the former is threefold degenerate and is occupied by six electrons. The first ionization band (8.4 eV) is readily identified as the  $7t_2$  lone-pair combination. The band exhibits no significant indication of a Jahn-Teller distortion. There is then a large gap between this band and the broad unresolved composite band commencing at 11.8 eV with a maximum at *ca* 12.7 eV, indicating that the  $7t_2/5a_1$  lone-pair splitting amounts to *ca* 4.3 eV. This suggests that the through-space interaction is enhanced by coupling with the C–N bonds<sup>109,111</sup>.



1,3-Diazaadamantane (**55**) was mentioned in the preceding chapter. In 1,3,5-triazaadamantane the three lone-pairs occupy a doubly degenerate orbital of  $e$  symmetry and an  $a_1$  MO. Accordingly, two bands for the  $n$  ionizations are expected in the PE spectrum, which has not yet been measured. However, the experimental data for its 7-methyl derivative (**63**) are 8.08 and 9.90 eV<sup>104</sup>, which can be expected to be quite close to those of the parent molecule. The average  $IP(n_N)$  values of the azaadamantanes exhibit the variation 7.94 eV (1-azaadamantane<sup>54</sup>, **64**, Table 7), 8.27 eV (**55**), 8.69 eV (**63**) and 9.49 eV (**62**). This sequence reflects the increasing stabilization of the lone-pair orbitals as a consequence of more effective interaction within the cage. The electrochemical oxidation potentials<sup>112</sup> of these compounds parallel their first IPs: 0.86 V and 7.75 eV (**55**), 1.02 V and 8.08 eV (**63**), 1.37 V and 8.4 eV (**62**).

## I. Miscellaneous Amino Compounds

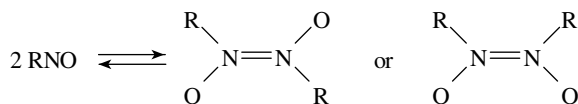
Compounds in which the amino group is directly connected with another functional group like hydrazines, hydroxylamines, enamines and amides were already briefly mentioned in Section II.C. In several cases it has been shown that orbital interactions of these systems can be used for conformational analysis by PES<sup>66,67</sup>.

Alkaloids have been mentioned in Section II.E.

PES has been applied to study biologically active molecules with amino groups and their constituents like nucleic bases and related compounds (e.g. adenine, guanine, thymine, cytosine, hypoxanthine and their methyl derivatives)<sup>113–120</sup> and amino acids<sup>92,121,122</sup> or their methyl esters<sup>123</sup>.

## III. NITROSO COMPOUNDS

Solutions of many organic nitroso compounds, R–NO, display blue or blue-green colours owing to a weak absorption in the visible region ( $\lambda \approx 700$  nm,  $\epsilon < 50$ ). In the crystalline state, however, most of these compounds are colourless or at most pale yellow. The reason for this phenomenon is the dimerization reaction<sup>124</sup>. The dimers have an NN distance of about 131 pm, which indicates a certain degree of double-bond character, and show *E/Z* isomerism. They may thus be termed diazene-1,2-dioxides.



PE spectroscopic studies of C-nitroso compounds have sometimes been hampered by these properties, but also the dimer–monomer transformation has been studied by this technique<sup>125,126</sup> (*vide infra*).

## A. Nitrosomethane and Other Nitrosoalkanes

The HeI PE spectrum of nitrosomethane (Figure 13) was first studied by Bergmann and Bock<sup>125,127</sup>. This compound as well as several other aliphatic and aromatic C-nitroso compounds were investigated by Pfab and coworkers<sup>126,128</sup>, however several of them were dimers.

Nitrosomethane, CH<sub>3</sub>NO, has twelve occupied molecular orbitals, of which ten are of *a'* and two of *a''* symmetry. Of these the outer six valence MOs appear in the HeI range. Some of these orbitals are depicted in Figure 14. The energetic order of the three highest occupied MOs was predicted as  $n^+(9a') < \pi(2a'') < n^-(10a')$ <sup>125–127</sup>. The  $\pi$ -type orbital is the  $\pi_{\text{N}=\text{O}}$ , and  $n^+$  and  $n^-$  are the in-phase and the out-of-phase combination, respectively, of oxygen and nitrogen lone-pairs. These orbitals can be considered as the characteristic MOs of C-nitroso compounds and the corresponding IPs should be identified in the PE spectra. In Table 12 the observed ionization potentials are summarized together with the relevant results of quantum chemical calculations.

The PE spectrum of nitrosomethane shows three distinct ionization regions: a separate band at low energy ( $\text{IP}_a = 9.15$ ,  $\text{IP}_v = 9.76$  eV<sup>126</sup>) followed by two intense and broad composite bands with maxima at 13.9 and 16.3 eV. The assignment of the first band as arising from  $n^-(10a')$  is unambiguous, whereas to the second band  $\pi(2a'')$  and  $n^+(9a')$  contribute, and the third band originates from  $\pi(1a'')$  and perhaps a  $\sigma$  ionization. The two  $\pi$  MOs of MeNO are the in-phase and the out-of-phase combinations of  $\pi_{\text{N}=\text{O}}$  and a pseudo  $\pi$  orbital of the methyl group ( $\pi_{\text{Me}}$ ).



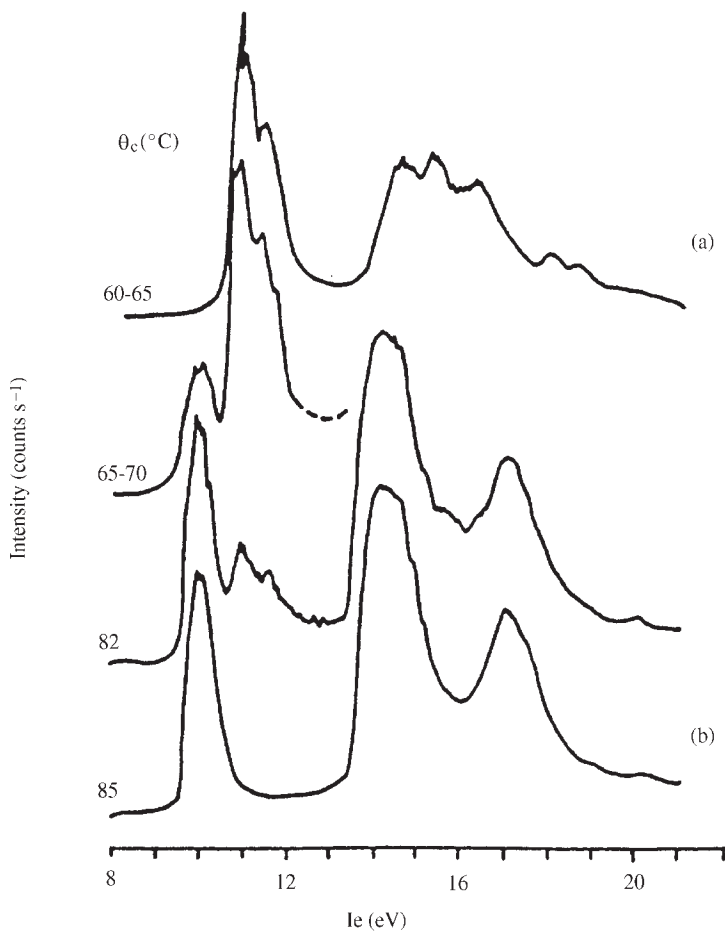


FIGURE 13. PE spectra of nitrosomethane (b) and its *cis*-dimer (a) displaying the temperature-dependent decomposition of *cis*-(MeNO)<sub>2</sub> into MeNO. Reproduced (modified) with permission from Reference 125

TABLE 12. Ionization potentials IP (eV) and orbital energies  $\varepsilon$  (eV) of nitrosomethane

IP <sup>126</sup>	$-\varepsilon^a$	$-\varepsilon^b$	$-\varepsilon^c$	$-\varepsilon^d$	Ionic state	MO
9.76	11.7	11.14	10.34	9.86	10a'	$n^-$
13.7	16.1	15.28	13.48	13.06	9a'	$n^+$
14.1	14.9	14.71	13.57	13.28	2a''	$\pi_2$ ( $\pi_{N=O}$ )
16.3	19.6	17.54	17.08	16.66	1a''	$\pi_1$ ( $\pi_{Me}$ )

<sup>a</sup>CNDO<sup>127</sup>.

<sup>b</sup>*Ab initio*<sup>126</sup>.

<sup>c</sup>AM1<sup>26</sup>.

<sup>d</sup>OVGF(AM1)<sup>26</sup>.

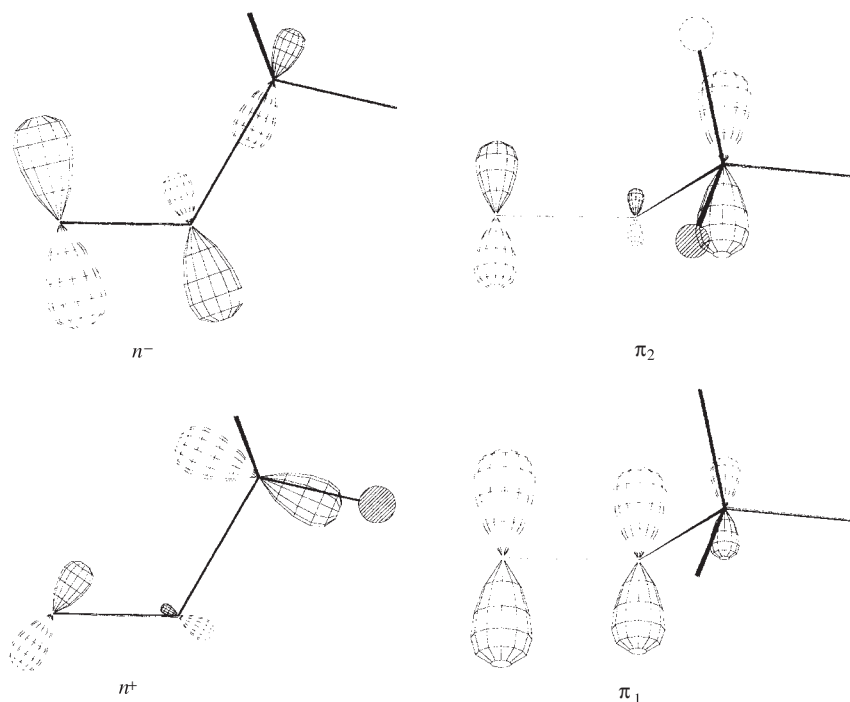


FIGURE 14. MOs of nitrosomethane (AM1 results)

In the second band of monomeric nitrosomethane two vertical IPs (13.7 and 14.1 eV, Table 12) can be determined, and according to Koopmans' theorem<sup>17</sup> they should be assigned to  $\pi$  ( $2a''$ ) and  $n^-$  ( $10a'$ ), respectively<sup>126</sup>. However, the inverse assignment, implying a breakdown of Koopmans' theorem, has been established by comparison with the spectra of isoelectronic molecules and with *ab initio* calculations for MeNO and the corresponding radical cations<sup>126</sup>. The incipient vibrational structure on the high-energy side of this composite band supports this conclusion. As is indicated by the data displayed in Table 12, this assignment is also supported by AM1 and OVGf(AM1) calculations.

In Table 13 the ionization potentials of some more C-nitroso compounds are collected. The spectrum of monomeric *t*-nitrosobutane<sup>126</sup> exhibits a well separated band at 9.05 eV. The following ionizations show maxima at 11.85 and 12.46 eV. The spectrum is dominated by a strong composite band from 12.9–14.5 eV. The spectrum can be assigned by comparison with nitrosomethane. The substitution of Me by *t*-Bu lowers the  $n^-$  ionization energy of the nitroso group by 0.7 eV, whereas the  $n^+$  and  $\pi$  ionization energies are lowered by 1.8 and 1.7 eV, respectively.

In the perhalogenonitrosomethanes<sup>126</sup>, which do not form dimers, the first IP is again assigned to  $n^-$ , which is stabilized relative to that of MeNO proportional to the electronegativity of the halogen substituent and, as expected, the largest shift is observed for the trifluoro derivative. The next bands following at higher energies can all be assigned to halogen lone-pair ionizations<sup>126</sup>. Higher ionizations at 14.5–17.1 and 16.1–18.4 eV are assigned to  $IP(n^+)$  and  $IP(\pi)$ , respectively.

TABLE 13. Ionization potentials (eV) of C-nitroso compounds RN=O

R	$n^-$	$n^+$	$\pi$	$n_{\text{Hal}}/\pi_{\text{Ar}}$	References
Me	9.76	13.7	14.1		125, 126
<i>t</i> -Bu	9.05	11.85	12.46		126
CF <sub>3</sub>	11.06	17.1	18.4	15.9, 16.2	126
CF <sub>2</sub> Cl	10.81	16.4		13.04, 15.28	126
CFCl <sub>2</sub>	10.58	16.0		12.32, 12.68	126
CCl <sub>3</sub>	10.30	15.3–15.7	17.0	11.84, 12.30, 13.11	126
CCl <sub>2</sub> Br	10.22	15.1	16.5	11.26, 11.61, 12.10	126
CClBr <sub>2</sub>	10.02	14.9	16.3	10.94, 11.34, 11.62	126
CBr <sub>3</sub>	9.96	14.5	16.1	10.68, 11.05, 11.29	126
Ph	8.51			9.49, 9.90	129

The electronic structure of aliphatic C-nitroso compounds is thus characterized by unusually strong lone-pair interactions in the nitroso group giving rise to  $n^-/n^+$  splittings up to 6 eV, a high-lying antibonding MO ( $n^-$ ) followed by strongly bonding and closely adjacent  $\pi_{\text{N=O}}$  and  $n^+$  MOs.

PE spectroscopic studies on nitrosoalkanes at variable temperatures were performed by Bergmann and coworkers<sup>125</sup> and by Pfab and coworkers<sup>126</sup>. Below about 65 °C spectra of the two isomeric dimers of MeNO are recorded, from 70 °C upwards the *cis* dimer is accompanied by rearrangement to the *trans* isomer supporting direct *cis-trans* isomerization (Figure 13). Above 85 °C only the monomer is observed in the spectrum<sup>125</sup>. The PE spectrum of monomeric *t*-BuNO was scanned at temperatures above 150 °C. At lower temperatures the spectrum of the *trans* dimer could be recorded and began to change above 120 °C<sup>126</sup>. To our knowledge, the spectra of C-nitroso dimers were not analysed in detail.

## B. Nitrosobenzene and Related Compounds

The PE spectrum of nitrosobenzene has been investigated by Rabalais and Colton<sup>129</sup> and by Green and coworkers<sup>128</sup>. Unfortunately, the published IP values are considerably at variance. From the characteristic IPs of C-nitroso compounds only  $\text{IP}(n^-) = 8.51$  eV could be assigned as the first IP.  $\text{IP}_2$  and  $\text{IP}_3$  were identified as ionizations of electrons from the benzene MOs  $\pi_2$  and  $\pi_3$  (Table 13).

Some IP data have been published for *p*-substituted nitrosobenzenes with substituents like Me, Cl, NMe<sub>2</sub> and OMe<sup>128</sup>. Four  $\text{IP}(n^-)$  values between 7.78 (4-nitroso-*N,N*-dimethylaniline, **65**) and 9.02 eV (4-chloronitrosobenzene, **66**) were observed. The corresponding value of 1-methyl-3-nitroso-2-phenylindole (**67**) was found to be 7.50 eV<sup>130</sup>.

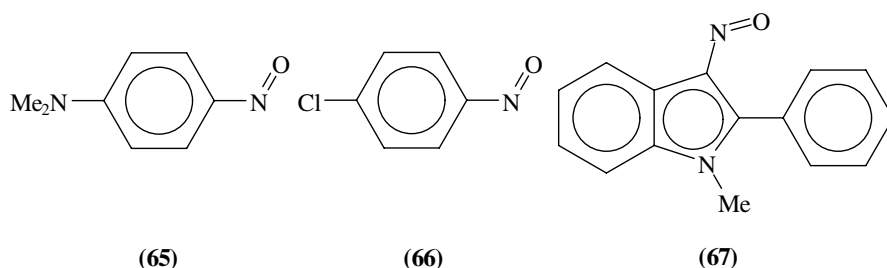








TABLE 14. Ionization potentials (eV) of nitrosamines  $R_2N-NO$ 

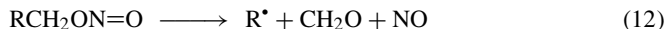
$R_2N$	$\pi_2$	$n_{NO}$	References
R = Me	9.09	9.69	133
R = Et	8.76	9.39	133
R = <i>i</i> -Pr	8.58	9.18	133
 N	9.71	10.70	45
 N	9.00	9.47	26
 N	8.84	9.47	26
 N	8.76	9.30	26
 N	9.16	9.54, 10.74 <sup>a</sup>	26
 N	8.74	9.33	26

<sup>a</sup> $n_{NO}$  of morpholine oxygen atom.

### C. Miscellaneous Nitroso Compounds

Several other nitroso compounds have been investigated by PES. The nitrosyl halides<sup>125</sup>, Hal-NO, are basic inorganic compounds. Of particular interest for organic chemists are nitrosamines,  $R_2N-NO$ , and nitrites, RO-NO. The NO group occurs as a ligand in transition metal complexes and PE spectra of complexes of chromium, manganese, iron, cobalt and nickel have been measured<sup>131</sup>.

The PE spectrum of methyl nitrite has been investigated by Bergmann and Bock<sup>127</sup>. Some alkyl nitrites have been studied as precursors of radicals which are generated by thermolysis from the former compounds<sup>132</sup>.



The main feature in the PE spectra of aliphatic nitrosamines<sup>45,133-138</sup> are two very distinctive bands in the region 8.5-10.0 eV which are assigned to a  $\pi$ -type orbital  $\pi_2$  mainly localized on the amino nitrogen atom and an  $n_{NO}$  orbital. IPs of some nitrosamines are summarized in Table 14.

### IV. NITRO COMPOUNDS

The nitro group is of high importance in organic chemistry, in particular in aromatic compounds because of its strong electron acceptor capacity. In accordance with this property, the nitro group has low-lying occupied and unoccupied orbitals, and the characteristic IPs of nitro compounds are usually found higher than 10 eV, which may lead to problems in the analysis of PE spectra.

The PE spectra of the two basic organic nitro compounds, nitromethane and nitrobenzene, were first analysed by Rabalais<sup>139</sup>. These and other nitro compounds have been the

subject of intensive investigations<sup>21,136,137,140-144</sup>. Nitrobenzene derivatives have also been studied with regard to the variation of the electronic structure of the benzene ring caused by substituents<sup>80,141</sup>.

The assignment of the characteristic ionization bands of organic nitro compounds remained ambiguous for many years. In particular, there have been conflicting interpretations regarding the order and energy of the lone-pair orbitals of the nitro group. On the basis of band shape and intensity analysis of HeI and HeII spectra of simple aliphatic nitro compounds, Huang and coworkers<sup>143</sup> assigned the first IP to the two  $n_{\text{O}}$  orbitals ( $n_{\text{O}^-}$  and  $n_{\text{O}^+}$ ) and the second to the non-bonding  $\pi$  orbital ( $\pi_2$ ). This assignment was confirmed by Penning ionization spectra<sup>144</sup>.

### A. Nitromethane and Other Nitroalkanes

The simplest organic nitro compound, nitromethane,  $\text{CH}_3\text{NO}_2$ , has 32 electrons of which 6 are core electrons of the carbon, nitrogen and oxygen atoms. According to  $C_s$  symmetry of the molecule, there are 10 occupied MOs of  $a'$  and 6 of  $a''$  symmetry. However, a better classification of the orbitals is possible in the point group  $C_{2v}$  which can be assumed in good approximation. Then the occupied MOs factorize as  $8a_1$ ,  $1a_2$ ,  $2b_1$  and  $5b_2$ . The most characteristic MOs are depicted in Figure 15.

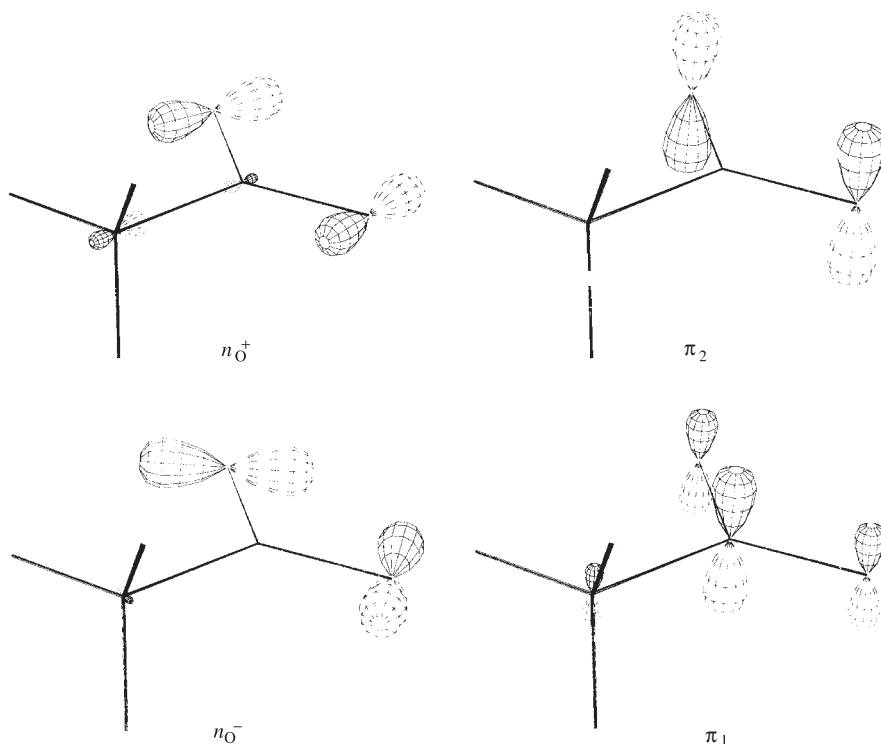


FIGURE 15. MOs of nitromethane (AM1 results)

The orbitals  $2b_1$  ( $\pi_1$ ) and  $1a_2$  ( $\pi_2$ ) are the totally bonding and the non-bonding  $\pi$  orbital, respectively, of the nitro group. The orbitals  $8a_1$  ( $n_{O^+}$ ) and  $5b_2$  ( $n_{O^-}$ ) are essentially the in-phase and the out-of-phase combination, respectively, of oxygen lone-pair orbitals;  $n_{O^-}$  has some bonding character,  $n_{O^+}$  is slightly antibonding and  $\pi_2$  is nonbonding.

In Figure 16 the PE spectrum of nitromethane is depicted. The relevant data are summarized in Table 15.

The PE spectra of nitromethane and other nitroalkanes (Figure 17) present a severe problem, which has been investigated most thoroughly both experimentally and theoretically: There are two overlapping bands between 10 and 13 eV which have to be assigned to three ionizations, namely to the three non-bonding orbitals of the nitro group ( $\pi_2$ ,  $n_{O^+}$ ,  $n_{O^-}$ ). A breakdown of Koopmans' theorem has to be considered as even more probable than in the case of nitrosomethane (Section III.A). Most likely is the assignment given recently by Huang and coworkers<sup>143,144</sup>, who included HeII and Penning ionization electron spectra.

The first band shows a vibrational spacing of  $480 \pm 70 \text{ cm}^{-1}$  while the second exhibits a progression of  $540 \pm 40 \text{ cm}^{-1}$ , both relating to the symmetric bending of the nitro group<sup>139,143</sup>. For the first band the adiabatic IP is lower than the vertical IP, but for the second they are the same, indicating appreciable geometrical reorientation in the former case, and little in the latter, upon ionization. The first band is more intense than the second; the intensity ratio was found to be 1.41. These features of band structure and intensities are consistent with the first band being due to the overlap of two components attributable

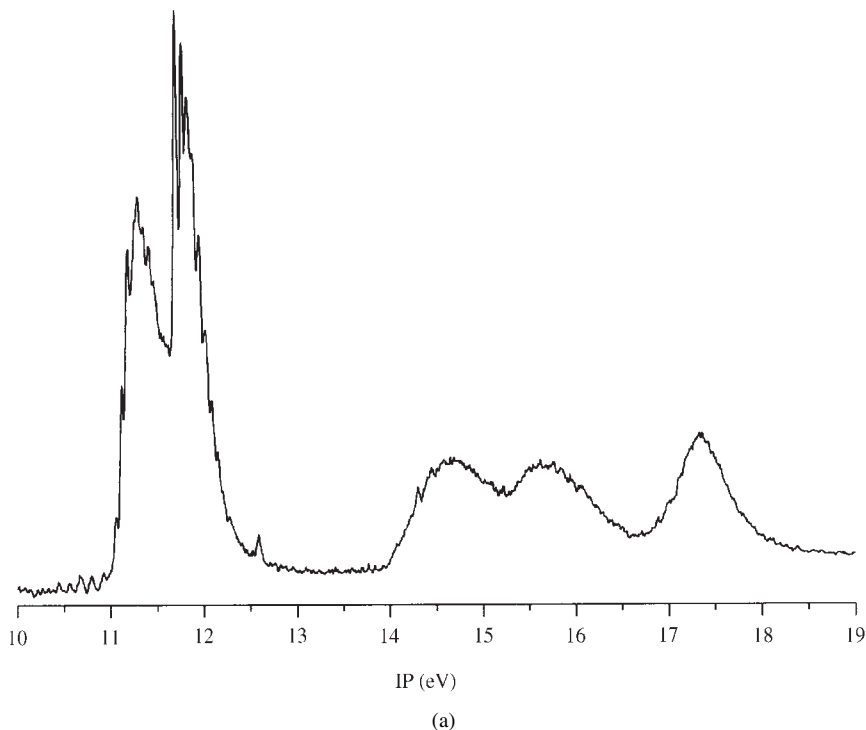


FIGURE 16. PE spectrum of nitromethane: (a) full spectrum, (b) left part expanded

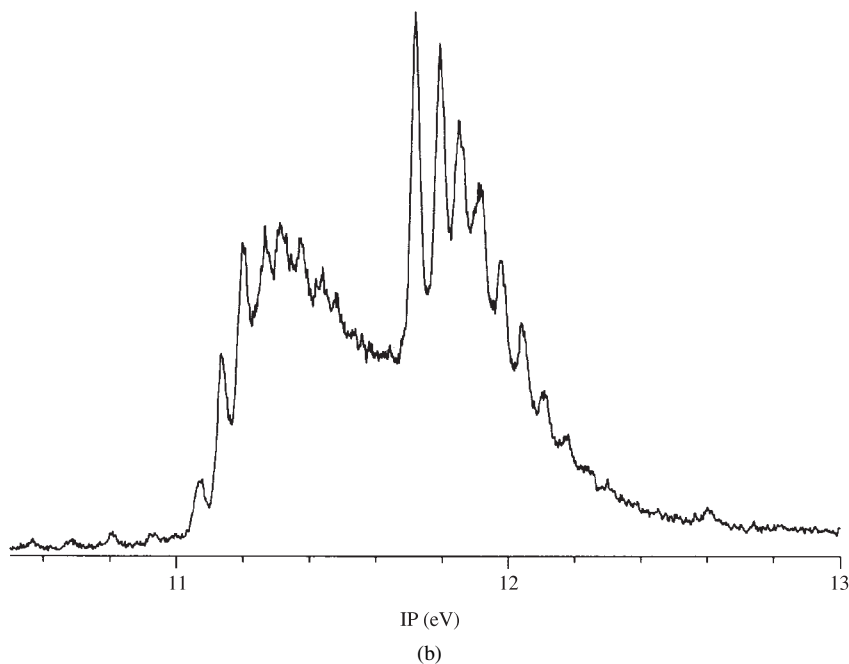


FIGURE 16. (continued)

TABLE 15. Ionization potentials IP (eV) and orbital energies  $\varepsilon$  (eV) of nitromethane

IP <sup>143</sup>	$-\varepsilon^a$	$-\varepsilon^b$	$-\varepsilon^c$	Ionic state <sup>d</sup>	MO
11.31	13.46	11.99	11.07	8a <sub>1</sub> (10a')	n <sub>O</sub> <sup>+</sup>
	13.60	12.44	11.36	5b <sub>2</sub> (6a'')	n <sub>O</sub> <sup>-</sup>
11.72	12.14	11.97	11.46	1a <sub>2</sub> (5a'')	$\pi_2$
14.70	16.70	14.62	14.18	4b <sub>2</sub> (9a')	$\pi_{\text{CH}_3}$
15.70	17.17	14.90	14.53	2b <sub>1</sub> (4a'')	$\pi_{\text{CH}_3}$
17.38	19.92	19.44	18.35	3b <sub>2</sub> (8a')	$\sigma_{\text{NO}^-}$
	20.53	18.96	17.89	1b <sub>1</sub> (3a'')	$\pi_1$
19.21	20.80	19.75	18.60	7a <sub>1</sub> (7a')	$\sigma_{\text{CN}}, \sigma_{\text{NO}^+}$
20.39	23.73	24.90	23.18	6a <sub>1</sub> (6a')	2s <sub>N}, 2s<sub>O</sub></sub>

<sup>a</sup>*Ab initio* [6-31G]<sup>143</sup>.<sup>b</sup>AM1<sup>26</sup>.<sup>c</sup>OVGF (AM1)<sup>26</sup>.<sup>d</sup>C<sub>2v</sub>(C<sub>s</sub>) symmetry.

to the removal of electrons from two orbitals with some bonding or anti-bonding character (n<sub>O</sub><sup>+</sup> and n<sub>O</sub><sup>-</sup>), while the second band is associated with ejection of an electron from an essentially non-bonding orbital ( $\pi_2$ ).

As indicated by the *ab initio* results<sup>143</sup> (Table 15), the orbitals n<sub>O</sub><sup>+</sup> and n<sub>O</sub><sup>-</sup> are almost degenerate. However, the AM1 results show  $\pi_2$  and n<sub>O</sub><sup>+</sup> to be very close in energy, while

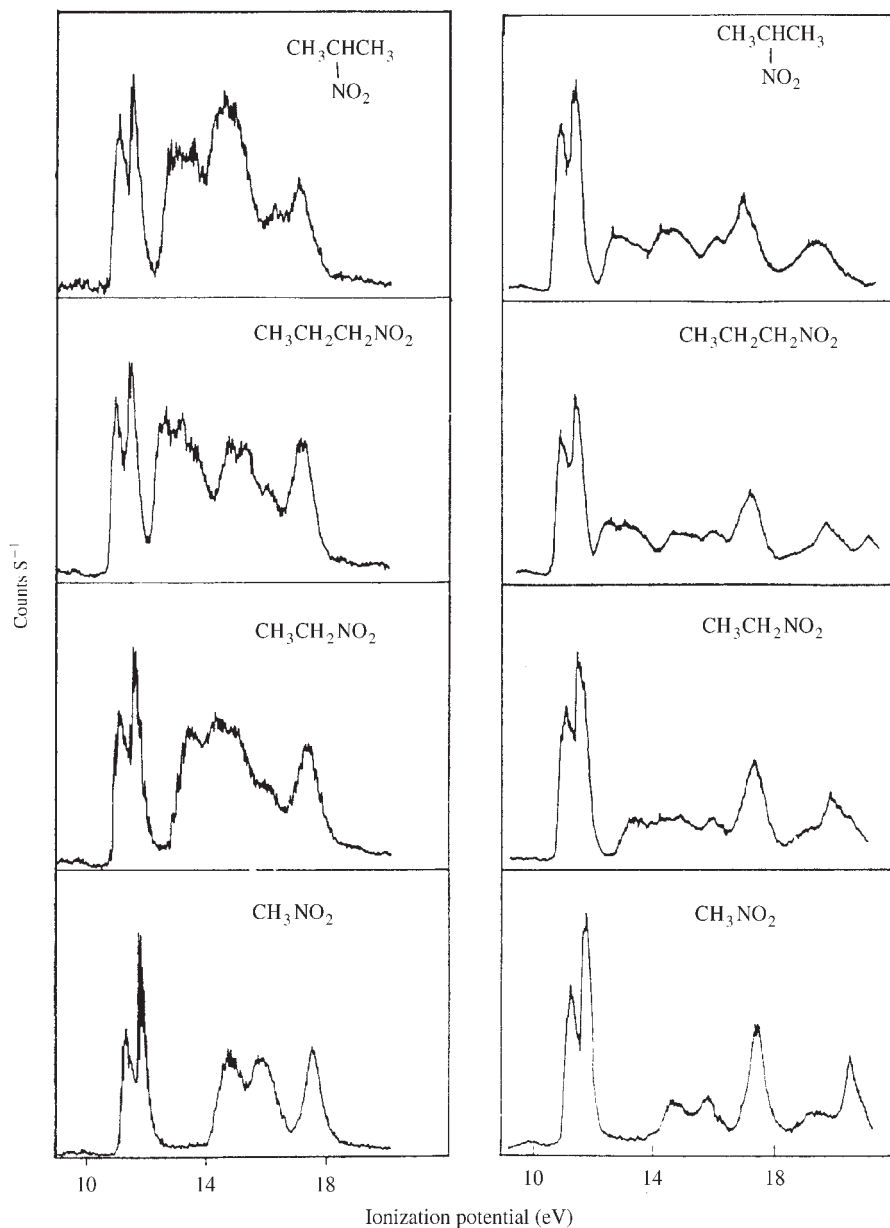


FIGURE 17. HeI (left) and HeII (right) spectra of nitromethane, nitroethane, 1- and 2-nitropropane. Reproduced with permission from Reference 143



TABLE 16. Ionization potentials (eV) of nitro compounds R-NO<sub>2</sub>

R	$n_{O^+}/n_{O^-}$	$\pi_2$	References
Me	11.31	11.72	143
Et	11.08	11.51	143
Pr	10.96	11.40	143
<i>i</i> -Pr	10.88	11.30	143

for the OVGF(AM1) results this holds for  $\pi_2$  and  $n_{O^-}$ , which is not consistent with the assignments given by Huang and coworkers<sup>143</sup>. But these results cannot be considered as very significant because of the shortcomings of semi-empirical methods in dealing with lone-pairs on neighbouring atoms.

The HeI and HeII spectra of some simple nitroalkanes are depicted in Figure 17. IP values are collected in Table 16. The assignment of the characteristic IPs is analogous to those of nitromethane (Table 15). Comparison of the data reveals that the orbitals are destabilized in a manner parallel to the electron-donating power of the alkyl groups<sup>143</sup>. The gap between the first two ionizations remains essentially constant, between 0.41 and 0.44 eV, in the series.

## B. Nitrobenzene and Related Compounds

Nitrobenzene has 64 electrons of which 18 are 1s core electrons of the non-hydrogen atoms. In the point group  $C_{2v}$  the occupied MOs factorize as  $16a_1$ ,  $2a_2$ ,  $3b_1$  and  $11b_2$ . A schematic diagram of some MOs is shown in Figure 18.

The orbitals associated mainly with the nitro group are:  $1b_1(\pi_1)$ ,  $1a_2(\pi_2)$ ,  $11b_2(n_{O^-})$  and  $16a_1(n_{O^+})$ .

The PE spectrum of nitrobenzene (Figure 19) has been investigated repeatedly<sup>21,139-142,144</sup>.

In Table 17 the relevant data from the most recent investigation<sup>144</sup>, which is also based on Penning ionization electron spectra, are summarized. The characteristic ionizations of

TABLE 17. Ionization potentials IP (eV) and orbital energies  $\varepsilon$  (eV) of nitrobenzene

IP <sup>144</sup>	$-\varepsilon^a$	Ionic state	MO
9.93	9.91	$2a_2$	$\pi_2$ (Ar)
10.35	10.65	$3b_1$	$\pi_3$ (Ar)
11.1	13.18	$16a_1$	$n_{O^+}$ (NO <sub>2</sub> )
	13.39	$11b_2$	$n_{O^-}$ (NO <sub>2</sub> )
11.23	12.06	$1a_2$	$\pi_2$ (NO <sub>2</sub> )
12.73	14.67	$10b_2$	$\sigma$ (Ar)
13.0	14.80	$2b_1$	$\pi_1$ (Ar)
13.48	14.85	$15a_1$	$\sigma$ (Ar)
14.88	16.84	$9b_2$	$\sigma$ (Ar)
15.47	17.77	$14a_1$	$\sigma$ (Ar)
	18.10	$8b_2$	$\sigma$ (Ar, NO <sub>2</sub> )
15.8	19.16	$13a_1$	$\sigma$ (Ar, NO <sub>2</sub> )
16.71	19.67	$7b_2$	$\sigma$ (NO <sub>2</sub> )
	20.09	$1b_1$	$\pi_1$ (NO <sub>2</sub> )

<sup>a</sup>Ab initio [6-31G]<sup>144</sup>.

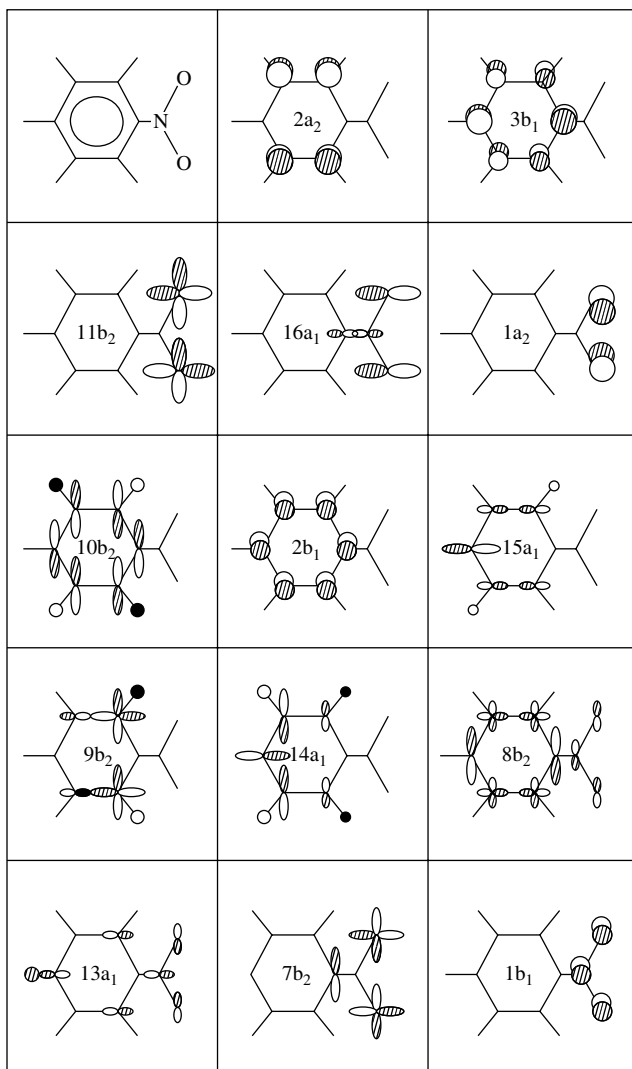


FIGURE 18. Schematic diagram for MOs of nitrobenzene. Reproduced with permission from Reference 144

the nitro group are assigned to the composite band in the region 10.5–12 eV with maxima at 11.1 eV ( $n_{\text{O}^+}$ ,  $n_{\text{O}^-}$ ) and at 11.23 eV ( $\pi_2$ ). As expected, the ionizations of the aromatic  $\pi$  orbitals are shifted by 0.6–1.1 eV to higher energies compared to benzene.

The PE spectra of several substituted nitrobenzenes like the nitrotoluenes, fluoro-nitrobenzenes and dinitrobenzenes have been investigated<sup>141</sup>. Some data are summarized in Table 18. For the characteristic IPs of the nitro group ( $n_{\text{O}^+}$ ,  $n_{\text{O}^-}$ ,  $\pi_2$ ) one or two ionizations, which are close to those found for unsubstituted nitrobenzene, have been assigned.

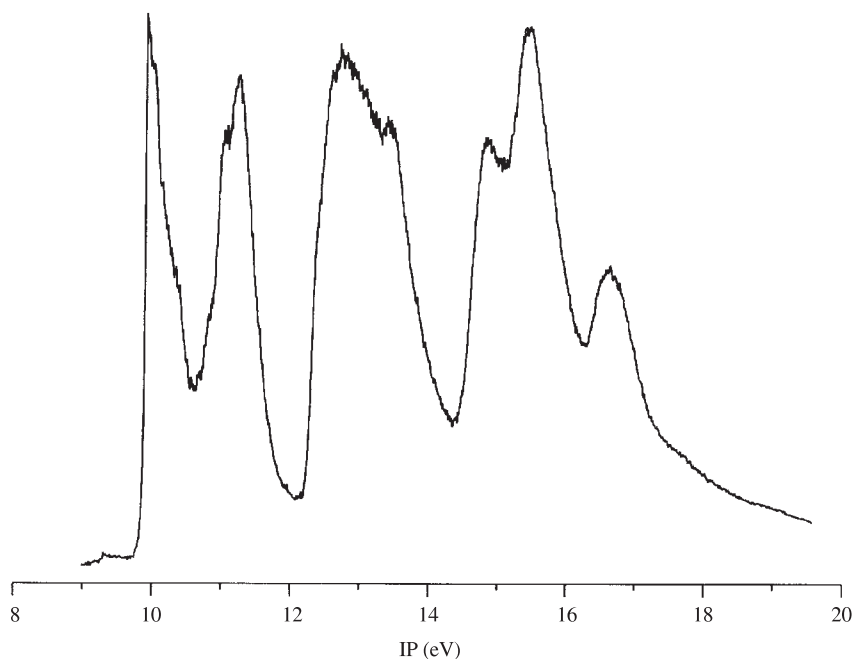
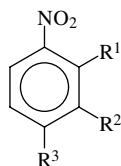


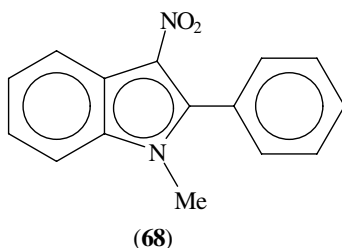
FIGURE 19. PE spectrum of nitrobenzene

TABLE 18. Ionization potentials IP (eV) of substituted nitrobenzenes<sup>a</sup>

R <sup>1</sup>	R <sup>2</sup>	R <sup>3</sup>	$n_{O^+}/n_{O^-}/\pi_2$	$\pi_{Ar}$	References
Me	Me	Me	11.1, 11.23	9.93, 10.35	144
			11.05	9.66	141
			10.73, 11.06	9.69, 10.04	141
F	F	F	10.88, 11.12	9.5, 10.03	141
			11.29	9.86, 10.37	141
			11.35	10.08, 10.47	141
			11.12, 11.34	10.06, 10.45	141

<sup>a</sup>R<sup>1</sup>... R<sup>3</sup> is H if not indicated otherwise

Other compounds containing a nitrobenzene unit like substituted benzamides<sup>145</sup>, azobenzenes<sup>146</sup>, *N*-benzylideneanilines<sup>147</sup> and donor-acceptor cyclophanes<sup>148</sup> have been investigated by PES. The PE spectrum of 1-methyl-3-nitro-2-phenylindole (**68**) has been measured<sup>130</sup>.



### C. Miscellaneous Nitro Compounds

The PE spectra and electronic structures of some nitroalkenes like nitroethene<sup>149</sup> and the isomeric nitropropenes<sup>150</sup>, including their thermolysis<sup>151</sup>, have been studied recently. A correlation diagram for the experimentally determined ionization potentials for the nitropropenes is reproduced in Figure 20.

As expected for the electron-withdrawing effect of the nitro group, the  $\pi_{C=C}$  orbital is stabilized appreciably in the nitropropenes relative to propene. When compared with nitromethane, the orbitals localized on the nitro group are in general destabilized owing to the larger electron-donating ability of the propenyl group compared to the methyl group. Among the nitropropenes there are only minor shifts in the relative energies of the  $n_O$  orbitals, but there are appreciable variations in the position of  $\pi_2$ . Thus in 3-nitropropene  $\pi_2$  lies more than 0.3 eV below that of 1-nitropropene.

*N,N*-Dimethylnitramine has been studied by Rabalais and coworkers<sup>136</sup> by UV and X-ray PES and by Rao<sup>137</sup>. Besides the characteristic orbitals of the nitro group there is another high-lying  $\pi$ -type orbital which is largely localized on the amine nitrogen atom and can be termed  $n_N$ . The corresponding ionizations are generally found between 9 and 12.5 eV. IPs of some nitramines are given in Table 19.

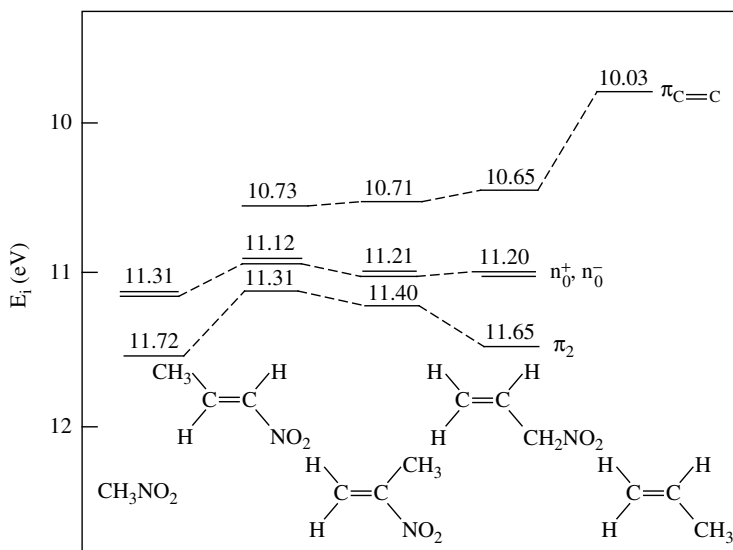






FIGURE 20. Ionization potentials of nitropropenes, nitromethane and propene. Reproduced with permission from Reference 150

TABLE 19. Ionization potentials (eV) of nitramines  $R_2N-NO_2$ 

$R_2N$	$n_{O^-}$	$n_{O^+}$	$\pi_2$	$n_N$	References
R = Me	9.91	10.45	10.93	11.63	136
R = Et	9.62	10.36	10.64	11.39	26
	9.73	10.40	10.69	11.37	26
	9.66	10.46	10.85	11.52	26
	9.95	10.56, 10.84 <sup>a</sup>	11.10	11.63	26
	9.42	10.31	10.51, 10.67	11.26	26

<sup>a</sup> $n_O$  of morpholine oxygen atom.

## V. ACKNOWLEDGEMENTS

The author wishes to express his gratitude to Mr Klaus Kowski for recording PE spectra and his technical assistance in the preparation of the manuscript. He is grateful to Dr Hubert Kuhn for assistance with OVGf calculations and to Mr W. Sicking for his help with MO plots. Financial support by the Fonds der Chemischen Industrie is gratefully acknowledged.

## VI. REFERENCES

1. D. W. Turner, C. Baker, A. D. Baker and C. R. Brundle, *Molecular Photoelectron Spectroscopy*, Wiley-Interscience, London, 1970.
2. A. D. Baker and D. Betteridge, *Photoelectron Spectroscopy. Chemical and Analytical Aspects*, Pergamon Press, Oxford, 1972.
3. T. A. Carlson, *Photoelectron and Auger Spectroscopy*, Plenum Press, New York and London, 1975.
4. J. W. Rabalais, *Principles of Ultraviolet Photoelectron Spectroscopy*, Wiley, New York, 1977.
5. A. D. Baker and C. R. Brundle (Eds.), *Electron Spectroscopy: Theory, Techniques and Applications*, Vols. 1–5, Academic Press, London, 1977–1984.
6. R. E. Ballard, *Photoelectron Spectroscopy and Molecular Orbital Theory*, A. Hilger, Bristol, 1978.
7. J. Berkowitz, *Photoabsorption, Photoionization and Photoelectron Spectroscopy*, Academic Press, New York, 1979.
8. P. K. Ghosh, *Introduction to Photoelectron Spectroscopy*, Wiley, New York, 1983.
9. J. H. D. Eland, *Photoelectron Spectroscopy*, 2nd ed., Butterworths, London, 1984.
10. V. I. Nefedov and V. I. Vovna, *Electron Structure of Chemical Compounds*, Nauka, Moscow, 1987 (in Russian).
11. H. Bock, *Angew. Chem.*, **89**, 631 (1977); *Angew. Chem., Int. Ed. Engl.*, **16**, 613 (1977).
12. E. Heilbronner, in *Molecular Spectroscopy* (Ed. A. R. West), Heyden and Son Ltd., London, 1977, pp. 422–451.
13. N. Knöpfel, T. Olbricht and A. Schweig, in *Physikalische Methoden in der Chemie* (Eds. B. Schröder and J. Rudolph), VCH Verlagsgesellschaft, Weinheim, 1985, pp. 205–227.
14. J. W. Robinson, *Handbook of Spectroscopy*, CRC Press, Boca Raton, 1974; S. G. Lias, J. E. Bartmess, J. F. Liebman, J. L. Holmes, R. D. Levin and W. G. Mallard, *J. Phys. Chem. Ref. Data*, **17**, Suppl. 1, 1 (1988); *NIST Standard Reference Database 25, Structures and Properties*, National Institute of Standards and Technology, Gaithersburg, MD, USA.
15. A. D. Baker, *J. Electron Spectrosc. Relat. Phenom.*, **66**, 11 (1993).
16. D. W. Turner, *J. Electron Spectrosc. Relat. Phenom.*, **73**, R11 (1995).
17. T. Koopmans, *Physica*, **1**, 104 (1934).

18. M. J. S. Dewar, E. G. Zoebisch, H. F. Healy and J. J. P. Stewart, *J. Am. Chem. Soc.*, **107**, 3902 (1985).
19. D. Danovich, Y. Apeloig and S. Shaik, *J. Chem. Soc., Perkin Trans. 2*, 321 (1993).
20. R. Sustmann and W. Sicking, *Chem. Ber.*, **120**, 1323 (1987).
21. K. Kimura, S. Katsumata, Y. Achiba, T. Yamazaki and S. Iwata, *Handbook of HeI Photoelectron Spectra of Fundamental Organic Molecules*, Japan Scientific Societies Press, Tokyo, 1981.
22. M. Takahashi, I. Watanabe and S. Ikeda, *J. Electron Spectrosc. Relat. Phenom.*, **37**, 275 (1985).
23. I. Morishima, K. Yoshikawa, M. Hashimoto and K. Bekki, *J. Am. Chem. Soc.*, **97**, 4283 (1975).
24. C. Caletti, M. L. D. Vona, P. Gargano, F. Grandinetti, C. Galli and C. Lillocci, *J. Chem. Soc., Perkin Trans. 2*, 667 (1986).
25. J. B. Peel and G. D. Willett, *Aust. J. Chem.*, **30**, 2571 (1977).
26. P. Rademacher, K. Kowski and R. Poppek, unpublished results.
27. H. Bock, W. Kaim, M. Kira, H. Osawa and H. Sakurai, *J. Organomet. Chem.*, **164**, 295 (1979).
28. L. N. Domelsmith, L. L. Munchausen and K. N. Houk, *J. Am. Chem. Soc.*, **99**, 4311 (1977).
29. H. J. Haink, J. E. Adams and J. R. Huber, *Ber. Bunsenges. Phys. Chem.*, **78**, 436 (1974).
30. K. Yoshikawa, A. Matsui and I. Morishima, *J. Chem. Soc., Perkin Trans. 2*, 1057 (1977).
31. A. Nagy, J. C. Green, L. Szepes and L. Zanathy, *J. Organomet. Chem.*, **419**, 27 (1991).
32. H. Baumgaertel, H. W. Jochims, E. Ruehl, H. Bock, R. Dammel, J. Minkwitz and R. Nass, *Inorg. Chem.*, **28**, 943 (1989).
33. D. H. Aue, H. M. Webb and M. T. Bowers, *J. Am. Chem. Soc.*, **97**, 4136 (1975).
34. D. H. Aue, H. M. Webb and M. T. Bowers, *J. Am. Chem. Soc.*, **98**, 311 (1976).
35. H. Bock, I. Göbel, Z. Havlas, S. Liedle and H. Oberhammer, *Angew. Chem.*, **103**, 193 (1991); *Angew. Chem., Int. Ed. Engl.*, **30**, 187 (1991).
36. V. Chaplinski, K. Kowski, P. Rademacher and A. de Meijere, to be published.
37. G. Distefano, S. Pignataro, L. Szepes and J. Borossay, *J. Organomet. Chem.*, **102**, 313 (1975).
38. H. Bürger, G. Pawelke, R. Dammel and H. Bock, *J. Fluorine Chem.*, **19**, 565 (1982).
39. S. Cradock, E. A. V. Ebsworth, W. J. Savage and R. A. Whiteford, *J. Chem. Soc., Faraday Trans. 2*, **68**, 934 (1972).
40. P. Livant, M. L. McKee and S. D. Worley, *Inorg. Chem.*, **22**, 895 (1983).
41. S. F. Nelsen, *J. Org. Chem.*, **49**, 1891 (1984).
42. J. P. Maier and D. W. Turner, *J. Chem. Soc., Faraday Trans. 2*, **69**, 521 (1973).
43. H. Bock and W. Fuß, *Chem. Ber.*, **104**, 1687 (1971).
44. D. H. Aue, H. M. Webb, W. R. Davidson, M. Vidal, M. T. Bowers, H. Goldwhite, L. E. Vertal, J. E. Douglas, P. A. Kollman and G. L. Kenyon, *J. Am. Chem. Soc.*, **102**, 5151 (1980).
45. P. Rademacher, G. Irsch, W. Sicking and E. -U. Würthwein, *J. Mol. Struct.*, **197**, 291 (1989).
46. F. P. Colonna, G. Distefano, S. Pignato, G. Pitacco and E. Valentin, *J. Chem. Soc., Faraday Trans. 2*, **71**, 1572 (1975).
47. H. -J. Altenbach, D. Constant, H. -D. Martin, B. Mayer, M. Müller and E. Vogel, *Chem. Ber.*, **124**, 791 (1991).
48. G. Spanka and P. Rademacher, *J. Org. Chem.*, **51**, 592 (1986).
49. G. Spanka, R. Boese and P. Rademacher, *J. Org. Chem.*, **52**, 3362 (1987).
50. D. H. Aue, H. M. Webb and M. T. Bowers, *J. Am. Chem. Soc.*, **97**, 4137 (1975).
51. G. Bieri and E. Heilbronner, *Helv. Chim. Acta*, **57**, 546 (1974).
52. R. W. Alder, R. J. Arrowsmith, A. Casson, R. B. Sessions, E. Heilbronner, B. Kovac, H. Huber and M. Taagepera, *J. Am. Chem. Soc.*, **103**, 6137 (1981).
53. S. F. Nelsen, C. R. Kessel and D. J. Brien, *J. Am. Chem. Soc.*, **101**, 702 (1980).
54. C. Worrell, J. W. Verhoeven and W. N. Speckamp, *Tetrahedron*, **30**, 3525 (1974).
55. M. K. Livett, E. Nagy-Felsobuki, J. B. Peel and G. D. Willett, *Inorg. Chem.*, **17**, 1608 (1978).
56. D. Colbourne, D. C. Frost, C. A. McDowell and N. P. C. Westwood, *Can. J. Chem.*, **57**, 1279 (1979).
57. E. Nagy-Felsobuki, J. B. Peel and G. D. Willett, *J. Electron Spectrosc. Relat. Phenom.*, **13**, 17 (1978).
58. E. Nagy-Felsobuki and J. B. Peel, *J. Electron Spectrosc. Relat. Phenom.*, **15**, 61 (1979).
59. E. Nagy-Felsobuki and J. B. Peel, *J. Chem. Soc., Faraday Trans. 2*, **74**, 1927 (1978).
60. F. Carnovale, T. -H. Gan and J. B. Peel, *Aust. J. Chem.*, **32**, 719 (1979).
61. V. Chaplinski, A. de Meijere, T. Haumann and R. Boese, to be published. An X-ray structure analysis of the hydrochloride salt has recently been published: M. L. Gillaspay, B. A. Lefker, W. A. Hada and D. J. Hoover, *Tetrahedron Lett.*, **41**, 7399 (1995).
62. B. J. Cocksey, J. H. D. Eland and C. J. Danby, *J. Chem. Soc. (B)*, 790 (1971).
63. M. D. Rozeboom and K. N. Houk, *J. Am. Chem. Soc.*, **104**, 1189 (1982).

64. K. Mutai, K. Kobayashi and T. Kobayashi, *Chem. Lett.*, 1047 (1977).
65. N. Bodor, M. J. S. Dewar, W. B. Jennings and S. D. Worley, *Tetrahedron*, **26**, 4109 (1970).
66. M. Klessinger and P. Rademacher, *Angew. Chem.*, **91**, 885 (1979); *Angew. Chem., Int. Ed. Engl.*, **18**, 826 (1979).
67. R. S. Brown and F. S. Jorgensen, *Electron Spectroscopy: Theory, Techniques and Applications* (Eds. C. R. Brundle and A. D. Baker), Vol. 5., Academic Press, London, 1984, pp. 1–122.
68. D. G. Lister, J. K. Tyler, J. H. Hog and N. W. Larsen, *J. Mol. Struct.*, **23**, 253 (1974).
69. Y. Wang, S. Saebo and C. U. Pittman, *J. Mol. Struct. (Theochem)*, **281**, 91 (1993).
70. A. D. Baker, D. P. May and D. W. Turner, *J. Chem. Soc. (B)*, 22 (1968).
71. T. Debies and J. W. Rabalais, *J. Electron Spectrosc. Relat. Phenom.*, **1**, 355 (1973).
72. S. A. Cowling and R. A. W. Johnstone, *J. Electron Spectrosc. Relat. Phenom.*, **2**, 161 (1973).
73. T. Kobayashi and S. Nagakura, *Bull. Chem. Soc. Jpn.*, **47**, 2563 (1974).
74. F. Marschner, *Tetrahedron*, **31**, 2303 (1975).
75. M. H. Palmer, W. Moyes, M. Spiers and J. N. A. Ridyard, *J. Mol. Struct.*, **53**, 235 (1979).
76. J. Nordgren, L. Selander, L. Petterson, R. Brammer, M. Bäckström, C. Nordling and H. Agren, *Chem. Phys.*, **84**, 333 (1984).
77. K. D. Jordan, J. A. Michejda and P. D. Burrow, *J. Am. Chem. Soc.*, **98**, 7189 (1976).
78. G. Distefano, A. G. Giumanini, A. Modelli and G. Poggi, *J. Chem. Soc., Perkin Trans. 2*, 1623 (1985).
79. X. Song, M. Yang, E. R. Davidson and J. P. Reilly, *J. Chem. Phys.*, **99**, 3224 (1993).
80. C. N. R. Rao, *Tetrahedron*, **32**, 1561 (1976).
81. W. Rettig and R. Gleiter, *J. Phys. Chem.*, **89**, 4676 (1985).
82. P. Rademacher, V. -M. Bass, M. Wildemann and H. Weger, *Chem. Ber.*, **110**, 1939 (1977).
83. G. Distefano, G. Granozzi, R. Bertoniello, P. R. Olivato and S. A. Guerro, *J. Chem. Soc., Perkin Trans. 2*, 1459 (1987).
84. D. G. Streets, W. E. Hall and G. P. Ceasar, *Chem. Phys. Lett.*, **17**, 90 (1972).
85. J. P. Maier and D. W. Turner, *Discuss. Faraday Soc.*, **54**, 149 (1972).
86. J. P. Maier, *Helv. Chim. Acta*, **57**, 994 (1974).
87. L. Klasinc, B. Kovac and H. Güsten, *Pure Appl. Chem.*, **55**, 289 (1983).
88. R. W. Alder, *Chem. Rev.*, **89**, 1215 (1989).
89. H. A. Staab and T. Saupe, *Angew. Chem.*, **100**, 895 (1988); *Angew. Chem., Int. Ed. Engl.*, **27**, 865 (1988).
90. H. -D. Martin and B. Mayer, *Angew. Chem.*, **95**, 281 (1983); *Angew. Chem., Ed. Int. Engl.*, **22**, 283 (1983).
91. D. K. Bohme in *The Chemistry of Functional Groups. Supplement F: The Chemistry of Amino, Nitroso and Nitro Compounds and their Derivatives*, Vol. 2 (Ed. S. Patai), Wiley, Chichester, 1982, pp. 731–762.
92. S. Campbell, E. M. Marzluff, M. T. Rodgers, J. L. Beauchamp, M. E. Rempe, K. F. Schwinck and D. L. Lichtenberger, *J. Am. Chem. Soc.*, **116**, 5257 (1994).
93. R. W. Alder and R. J. Arrowsmith, *J. Chem. Res.*, (S), 163; (M), 2301 (1980).
94. E. Heilbronner, E. Honegger, J. Lecoultré, C. A. Grob, R. Houriet and E. Rolli, *Helv. Chim. Acta*, **69**, 2114 (1986).
95. L. Klasinc, B. Rusic, A. Sabljic and N. Trinajstic, *J. Am. Chem. Soc.*, **101**, 7477 (1979).
96. R. W. Alder, R. J. Arrowsmith, C. St. J. Boothby, E. Heilbronner and Y. Zhong-zhi, *J. Chem. Soc., Chem. Commun.*, 940 (1982).
97. P. Rademacher, *Chem. Soc. Rev.*, **24**, 143 (1995).
98. R. W. Alder and R. B. Sessions, in *The Chemistry of Functional Groups. Supplement F: The Chemistry of Amino, Nitroso and Nitro Compounds and their Derivatives*, Vol. 2 (Ed. S. Patai), Wiley, Chichester, 1982, pp. 763–803.
99. R. Hoffmann, *Acc. Chem. Res.*, **4**, 1 (1971).
100. M. Braga and S. Larsson, *J. Phys. Chem.*, **96**, 9218 (1992).
101. T. M. McKinney and D. H. Geseke, *J. Am. Chem. Soc.*, **87**, 3013 (1965).
102. P. Bischof, J. A. Hashmall, E. Heilbronner and V. Hornung, *Tetrahedron Lett.*, 4025 (1969).
103. E. Heilbronner and K. A. Muszkat, *J. Am. Chem. Soc.*, **92**, 3818 (1970).
104. S. F. Nelsen and J. M. Buschek, *J. Am. Chem. Soc.*, **96**, 7930 (1974).
105. R. W. Alder, E. Heilbronner, E. Honegger, A. B. McEwen, R. E. Moss, E. Olefirowicz, P. A. Petillo, R. B. Sessions, G. R. Weisman, J. M. White and Z. -Z. Yang, *J. Am. Chem. Soc.*, **115**, 6580 (1993).

106. P. Rademacher, U. Schüle, H. -D. Beckhaus and C. Rüchardt, *J. Chem. Res.*, (S), 20; (M), 274 (1995).
107. H. -D. Martin and B. Mayer, *Angew. Chem.*, **95**, 281 (1983); *Angew. Chem., Int. Ed. Engl.*, **22**, 283 (1983).
108. R. Gleiter, M. Kobayashi and J. Kuthan, *Tetrahedron*, **32**, 2775 (1976).
109. V. Galasso, *J. Mol. Struct. (Theochem)*, **336**, 47 (1995).
110. K. Beck, S. Hünig, R. Poppek, F. Prokschy and P. Rademacher, *Chem. Ber.*, **119**, 554 (1986).
111. W. Schmidt, *Tetrahedron*, **29**, 2129 (1973).
112. S. F. Nelsen and P. J. Hintz, *J. Am. Chem. Soc.*, **94**, 7114 (1972).
113. S. Peng, A. Padva and P. R. LeBreton, *Proc. Natl. Acad. Sci. U.S.A.*, **73**, 2966 (1976).
114. D. Dougherty, K. Wittel, J. Meeks and S. P. McGlynn, *J. Am. Chem. Soc.*, **98**, 3815 (1976).
115. C. Yu, S. Peng, I. Akiyama, J. Lin and P. R. LeBreton, *J. Am. Chem. Soc.*, **100**, 2303 (1978).
116. J. Lin, C. Yu, S. Peng, I. Akiyama, K. Li, L. K. Lee and P. R. LeBreton, *J. Am. Chem. Soc.*, **102**, 4627 (1980).
117. J. Lin, C. Yu, S. Peng, I. Akiyama, K. Li, L. K. Lee and P. R. LeBreton, *J. Phys. Chem.*, **84**, 1006 (1980).
118. S. Urano, X. Yang and P. R. LeBreton, *J. Mol. Struct.*, **214**, 315 (1989).
119. K. Tasaki, X. Yang, S. Fetzter and P. R. LeBreton, *J. Am. Chem. Soc.*, **112**, 538 (1990).
120. R. E. Ballard, J. Jones and D. Read, *Chem. Phys. Lett.*, **121**, 45 (1985).
121. T. P. Debies and J. W. Rabalais, *J. Electron Spectrosc. Relat. Phenom.*, **3**, 315 (1974).
122. L. Klasinc, *J. Electron Spectrosc. Relat. Phenom.*, **8**, 161 (1976).
123. L. Klasinc, *Int. J. Quantum Chem., Quantum Biol. Symp.*, **5**, 373 (1978).
124. W. Lüttke, P. N. Skancke and M. Traetteberg, *Theor. Chim. Acta*, **87**, 321 (1994) and references cited therein.
125. H. Bergmann, S. Elbel and R. Demuth, *J. Chem. Soc., Dalton Trans.*, 401 (1977).
126. N. P. Ernsting, J. Pfab, J. C. Green and J. Römel, *J. Chem. Soc., Faraday Trans. 2*, **76**, 844 (1980).
127. H. Bergmann and H. Bock, *Z. Naturforsch.*, **30B**, 629 (1975).
128. R. Egdell, J. C. Green, C. N. R. Rao, B. G. Gowenlock and J. Pfab, *J. Chem. Soc., Faraday Trans. 2*, **72**, 988 (1976).
129. J. W. Rabalais and R. J. Colton, *J. Electron Spectrosc. Relat. Phenom.*, **1**, 83 (1972/73).
130. M. Colonna, L. Greci, M. Poloni, G. Marrosu, A. Trazza, F. P. Colonna and G. Distefano, *J. Chem. Soc., Perkin Trans. 2*, 1229 (1986).
131. P. Dedeва, G. Fronzoni, G. de Alti and A. Lisini, *J. Mol. Struct.*, **226**, 265 (1991) and references cited therein.
132. F. A. Houle and J. L. Beauchamp, *J. Am. Chem. Soc.*, **100**, 3290 (1978).
133. D. R. Battiste, L. P. Davis and R. V. Nauman, *J. Am. Chem. Soc.*, **97**, 5071 (1975).
134. D. Betteridge, S. K. Hasanuddin and D. I. Rees, *Anal. Chem.*, **48**, 1078 (1976).
135. T. Kobayashi, *Z. Physik. Chem.*, **97**, 269 (1975).
136. M. G. White, R. J. Colton, T. H. Lee and J. W. Rabalais, *Chem. Phys.*, **8**, 391 (1975).
137. C. N. R. Rao, *Ind. J. Chem.*, **14A**, 147 (1976).
138. R. Ellerbrock and P. Rademacher, *J. Mol. Struct.*, **265**, 93 (1992).
139. J. W. Rabalais, *J. Chem. Phys.*, **57**, 960 (1972).
140. T. Kobayashi and S. Nagakura, *Chem. Lett.*, 903 (1972).
141. M. H. Palmer, W. Moyes, M. Spiers and J. N. A. Ridyard, *J. Mol. Struct.*, **55**, 243 (1979).
142. S. Katsumata, H. Shiromaru, K. Mitani, S. Iwata and K. Kimura, *Chem. Phys.*, **69**, 423 (1982).
143. C. Y. Mok, W. S. Chin and H. H. Huang, *J. Electron Spectrosc. Relat. Phenom.*, **57**, 213 (1991).
144. W. S. Chin, C. Y. Mok, H. H. Huang, S. Masuda, S. Kato and Y. Harada, *J. Electron Spectrosc. Relat. Phenom.*, **60**, 101 (1992).
145. E. J. McAlduff, B. M. Lynch and K. N. Houk, *Can. J. Chem.*, **56**, 495 (1978).
146. S. Millefiori and A. Millefiori, *Can. J. Chem.*, **59**, 821 (1981).
147. L. Klasinc, B. Ruscic, G. Heinrich and H. Güsten, *Z. Naturforsch., Part B*, **32**, 1291 (1977).
148. R. Gleiter, W. Schäfer and H. A. Staab, *Chem. Ber.*, **121**, 1257 (1988).
149. L. Pasa-Tolic, L. Klasinc and S. P. McGlynn, *Chem. Phys. Lett.*, **170**, 113 (1990).
150. W. S. Chin, C. Y. Mok and H. H. Huang, *J. Chem. Soc., Faraday Trans.*, **87**, 1685 (1991).
151. W. S. Chin, C. Y. Mok and H. H. Huang, *J. Am. Chem. Soc.*, **112**, 2053 (1990).



## CHAPTER 5

# The chemistry of ionized, protonated and cationated amines in the gas phase

RICHARD D. BOWEN

*Chemistry and Chemical Technology, University of Bradford, Bradford,  
West Yorkshire BD7 1DP, England, UK  
Fax: 44 (0)1274 385350*

---

I. ABBREVIATIONS .....	205
II. INTRODUCTION .....	206
III. IONIZED AMINES AND ISOMERIC STRUCTURES .....	207
A. Alkylamines .....	207
1. Conventional ionized amine structures .....	207
2. Distonic ions (DIs) .....	208
B. Reactions of Ionized Alkylamines .....	217
1. Overview and comparison with ionized alcohols and ethers .....	217
2. Fragmentation of unrearranged ionized alkylamines .....	218
a. $\alpha$ -Cleavage .....	219
b. Alkane elimination .....	221
3. Fragmentation of rearranged ionized alkylamines .....	221
a. Pseudo- $\alpha$ -cleavage .....	221
b. Alkene or alkenyl radical elimination .....	223
c. Other reactions .....	225
4. Reactions of immonium ions derived from ionized alkylamines .....	226
C. Reactions of Ionized Unsaturated and Cyclic Amines .....	231
D. Reactions of Ionized Arylamines .....	233
IV. PROTONATED AND ALKYL CATIONATED AMINES .....	234
A. Formation and Properties of Protonated and Alkyl Cationated Amines .....	234
B. Reactions of Protonated Amines .....	236
C. Reactions of Tetraalkylammonium Ions .....	240
D. Comparison of the Reactions of Protonated Amines and Tetraalkylammonium Ions .....	241

V. CONCLUSIONS .....	243
VI. ACKNOWLEDGEMENTS .....	243
VII. REFERENCES .....	243

---

## I. ABBREVIATIONS

CA	collisional activation
CI	chemical ionization
CID	collision-induced dissociation
CIDI	collision-induced dissociative ionization
CS	charge-stripping
DHT	double hydrogen transfer
DI	distonic ion
EI	electron ionization
ERMS	energy-resolved mass spectrometry
ESR	electron spin resonance
FA	flowing afterglow
FAB	fast atom bombardment
ICR	ion-cyclotron resonance
INC	ion-neutral complex
KE	kinetic energy
LELT	low-energy low-temperature
MIKE	mass-analysed ion kinetic energy
MO	molecular orbital
NR	neutralization-reionization
PA	proton affinity
PBC	proton-bridged complex
PEP	potential energy profile
RI	relative intensity
RRKM	Rice-Ramsperger-Kassel-Marcus
SHT	single hydrogen transfer
SIFT	selected ion flow tube

## II. INTRODUCTION

As was pointed out in Supplement F some fifteen years ago<sup>1</sup>, the principal dissociation routes of radical-cations derived from simple amines have been extensively studied and documented for several decades<sup>2</sup>. It is no accident that many basic texts on organic mass spectrometry treat the fragmentation of ionized alkylamines at an early stage. The electron ionization (EI) spectra tend to be clean, typically being dominated by abundant primary fragment ions formed by  $\alpha$ -cleavage, together with secondary (and sometimes higher order) fragment ions derived by well-defined routes. Such spectra are readily interpreted and of obvious analytical value; consequently, they form an excellent illustration of structure elucidation by mass spectrometry<sup>3</sup>.

As might have been expected in a relatively established subdiscipline of chemistry of this kind, there has been a gradual but remorseless accumulation of further information in new systems of increasing complexity. However, most of this additional analytical knowledge in essence amounts to an extension and development of established ideas to cover larger or more functionalized molecules and ions. Under these circumstances, the

exhaustive cataloguing of the fragmentation patterns of ionized amines and related species would be of relatively little didactic value. Consequently, it has not been attempted in this chapter.

In contrast, the discovery of novel ion structures and the characterization of their reactivity by experimental and theoretical means has revolutionized what might be described as the physical organic chemistry of ionic species in the gas phase. These advances are relevant in many fields, including the mechanism of dissociation of gaseous ions and the influence of solvation on the stability of ions in solution. Therefore, the main objective of this chapter is to summarize recent progress in understanding the chemistry of ionic species derived from amines by mass spectrometry and the implications of this insight in classical solution chemistry. Even a restricted account of this nature must necessarily be selective, but it is hoped it will convey an idea of the versatility of mass spectrometry and related techniques for investigating old and new problems in chemistry. This chapter is primarily intended to give the non-specialist reader an overview of the insight which has been obtained from recent mass spectrometric studies of amines, but ample references are made to relevant comprehensive reviews aimed at a more specialized audience. Attention is focussed on alkylamines,  $C_nH_{2n+3}N$ , partly on account of their simplicity, but also because many of the most interesting developments have occurred in this field.

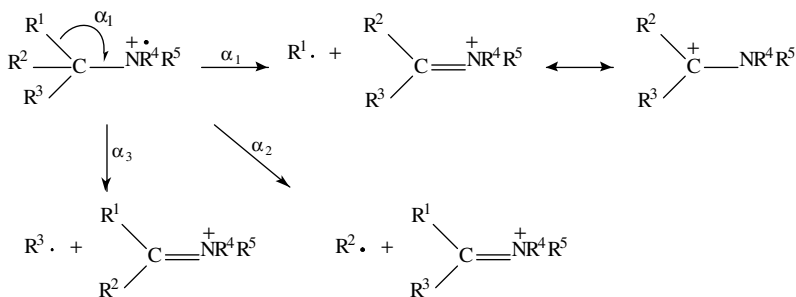
### III. IONIZED AMINES AND ISOMERIC STRUCTURES

#### A. Alkylamines

##### 1. Conventional ionized amine structures

Despite the invention during the past decade or two of numerous alternative ionization methods designed to permit formation of gaseous ions from all manner of substrates, EI remains a particularly suitable means of obtaining the mass spectra of simple alkylamines. There are two reasons: first, the low ionization energy of amines and, secondly, the powerful fragmentation directing properties of the ionized amino function<sup>2,3</sup>. Consequently, ionized amines are readily formed by EI of the parent compound and the derived molecular ions dissociate readily, especially in fast reactions occurring in the source of the instrument. The main fragmentation route is almost always  $\alpha$ -cleavage, particularly at high internal energies<sup>2,3</sup>.

Traditionally, this dissociation has often been considered to be 'triggered' by the lone electron situated in the singly occupied non-bonding orbital on nitrogen (Scheme 1). In other words, ionization is regarded as occurring by removal of one of the lone pair electrons on the nitrogen atom, thus rendering the derived radical-cation vulnerable to



simple C–C bond fission with expulsion of an alkyl radical to give a resonance stabilized ‘immonium’ (occasionally called ‘imminium’ or ‘iminium’) ion. This view is sufficiently accurate to retain clear analytical and interpretive value. However, it is an oversimplification for at least two reasons. First, ionization with high energy (70 eV) electrons permits the production of molecular ions in excited electronic states that may decompose before collapsing to the ground state. Secondly, at low internal energies (in low voltage spectra or for long-lived metastable ions), it is possible for the initial radical-cation to undergo hydrogen transfer or even skeletal rearrangement before dissociation occurs from a structure other than the ionized molecule. The first possibility was recognized many years ago, but the importance of considering isomerization of ionized amines prior to fragmentation has been critically addressed only relatively recently. It is now known that many ionized alkylamines do rearrange to other structures before fragmenting, so it is important to review the nature and significance of these isomerizations.

## 2. Distonic ions (DIs)

It had long been suspected by many organic mass spectroscopists that alternative ion structures would have comparable or lower energies than the parent ionized amine. Thus,  $\bullet\text{CH}_2\text{NH}_3^+$ , in which the formal radical site is located on carbon and the positive charge resides on the nitrogen atom, appears to possess many favourable structural features compared to ionized methylamine,  $\text{CH}_3\text{NH}_2^+$ . These isomeric species may be derived from protonated methylamine,  $\text{CH}_3\text{NH}_3^+$ , by hydrogen atom abstraction from the isoelectronic  $\text{NH}_3^+$  or  $\text{CH}_3$  entities, respectively. Early molecular orbital (MO) calculations<sup>4</sup> supported this idea and also indicated that the homologous unconventional radical-cations,  $\bullet\text{CH}_2\text{CH}_2\text{NH}_3^+$  and  $\bullet\text{CH}_2\text{CH}_2\text{OH}_2^+$ , should be stable species<sup>5</sup>. Subsequent experimental work established that each member of pairs of isomeric radical-cations such as  $\text{CH}_3\text{NH}_2^+$  and  $\bullet\text{CH}_2\text{NH}_3^+$  exist in energy wells with a sizeable barrier towards their interconversion<sup>6,7</sup>. In other words, these species are kinetically and thermodynamically stable. Moreover, both experimental<sup>6–11</sup> and theoretical<sup>12,13</sup> studies indicated that  $\bullet\text{CH}_2\text{ZH}^+$  structures (Z = OH, OR,  $\text{NH}_2$ , SH, Cl, etc.) not only occupy discrete potential energy wells but also have enthalpies of formation which are comparable to, or even lower than, those of the isomeric  $\text{CH}_3\text{Z}^+$  radical-cations. Higher homologues of these unconventional ion structures also were generated and shown to be stable. Important examples include  $\bullet\text{CH}_2\text{CH}_2\text{NH}_3^+$ <sup>11</sup>,  $\text{CH}_3\text{CH}\bullet\text{NH}_3^+$ <sup>14</sup>,  $\bullet\text{CH}_2\text{NH}_2^+\text{CH}_3$ <sup>15</sup> and  $\bullet\text{CH}_2\text{CH}_2\text{CH}_2\text{NH}_3^+$ <sup>16,17</sup>. Selected pertinent energetics are summarized in Table 1.

TABLE 1. Energetic data for ionized amines and their distonic isomers<sup>a</sup>

Ionized amine ( $\text{A}^+$ )	$\Delta H_f(\text{A}^+)$	Distonic ion (DI)	$\Delta H_f(\text{DI})$	$E_c(\text{A}^+ \rightarrow \text{DI})$
$\text{CH}_3\text{NH}_2^+$	858 <sup>b</sup>	$\bullet\text{CH}_2\text{NH}_3^+$	850 <sup>c</sup>	167 <sup>c</sup>
$\text{CH}_3\text{CH}_2\text{NH}_2^+$	828 <sup>b</sup>	$\bullet\text{CH}_2\text{CH}_2\text{NH}_3^+$	795 <sup>d</sup>	138 <sup>d</sup>
		$\text{CH}_3\text{CH}\bullet\text{NH}_3^+$	799 <sup>d</sup>	142 <sup>d</sup>
$(\text{CH}_3)_2\text{NH}^+$	795 <sup>b</sup>	$\bullet\text{CH}_2\text{NH}_2^+\text{CH}_3$	820 <sup>d</sup>	192 <sup>d</sup>
$\text{CH}_3\text{CH}_2\text{CH}_2\text{NH}_2^+$	795 <sup>b</sup>	$\bullet\text{CH}_2\text{CH}_2\text{CH}_2\text{NH}_3^+$	753 <sup>e</sup>	63 <sup>e</sup> ; 38 <sup>f</sup>
$\text{CH}_3\text{CH}_2\text{CH}_2\text{CH}_2\text{NH}_2^+$	770 <sup>g</sup>	$\bullet\text{CH}_2\text{CH}_2\text{CH}_2\text{CH}_2\text{NH}_3^+$	720 <sup>e</sup>	13 <sup>e</sup> ; 13 <sup>f</sup>

<sup>a</sup>Values in  $\text{kJ mol}^{-1}$ .

<sup>b</sup>Reference 18 (see also References 19, 20 and 21).

<sup>c</sup>Calculated (Reference 19).

<sup>d</sup>Calculated (Reference 20).

<sup>e</sup>Calculated (Reference 21).

<sup>f</sup>Experimental estimate (Reference 17).

<sup>g</sup>Estimated from data in Reference 21.

## 5. The chemistry of ionized, protonated and cationated amines in the gas phase 209

A new generic term, distonic ion (DI)<sup>22</sup>, was coined to describe these unconventional radical-cations. The word 'distonic' is derived from the Greek 'διεστος' and Latin 'distant', meaning 'separate'. This name stresses that the formal charge and spin sites are located on different 'heavy' atoms. This emphasis is chemically valuable, because many distonic ions show reactivities which are strongly influenced by the separate ionic and radical centres. Indeed, it has been suggested that distonic ions behave as charged radicals, i.e., their chemistry is dominated by the influence of the radical site<sup>23</sup>.

The term DI was initially devised to describe species in which the charge and spin sites were located on adjacent atoms (e.g.  $\bullet\text{CH}_2\text{NH}_3^+$ ). These radical-cations are occasionally referred to as ionized ylids, on account of their structural relationship with the ylids (e.g.  $^-\text{CH}_2\text{NH}_3^+$ ). Another name used in the early 1980s was radical-ion dipole complex<sup>11,24</sup>, but this expression has fallen into disuse, not least because the presence of a normal C–Z bond<sup>25</sup> is inconsistent with the idea that such species consist of a complex of ionized carbene and  $\text{ZH}_2$  (e.g.  $\text{NH}_3$ ). Nowadays, almost all radical-cations with separate charge and spin sites are referred to as DIs; exceptions include cases such as ionized alkenes, in which the ionic and radical positions located on adjacent atoms may be considered to arise by ionization of a  $\pi$ -system<sup>26</sup>. A Greek prefix is used to indicate the separation between the radical and ionic centres; thus,  $\bullet\text{CH}_2\text{NH}_3^+$  is an  $\alpha$ -DI,  $\bullet\text{CH}_2\text{CH}_2\text{NH}_3^+$  is a  $\beta$ -DI and  $\bullet\text{CH}_2\text{CH}_2\text{CH}_2\text{NH}_3^+$  is a  $\gamma$ -DI.

Early research in this area often relied upon collision-induced dissociation (CID), alias collisional activation (CA), spectra to distinguish between the isomeric conventional and unconventional radical-cations. In these CID or CA experiments<sup>27–30</sup>, undissociated ions of relatively low internal energy are energized by collision with a neutral target gas (typically oxygen, helium, argon or xenon); the energized ions then fragment relatively rapidly in ways that are frequently structure-specific. In most systems, the CID spectrum consists almost entirely of singly-charged fragment ions; however, some CID spectra also contain valuable signals corresponding to the formation of doubly (and, occasionally, triply) charged ions arising by charge-stripping (CS). Both the CID/CA and CS spectra serve as valuable 'fingerprints' of the parent ion. In particular, the observation of distinct CID or CA spectra for isomeric species establishes that each has an independent existence and occupies its own potential energy well. CS spectra are actually extremely useful for distinguishing conventional  $\text{CH}_3\text{Z}^{++}$  species from their unconventional  $\bullet\text{CH}_2\text{ZH}^+$  isomers.

Thus the CID spectra of  $\text{CH}_3\text{NH}_2^{++}$  and  $\bullet\text{CH}_2\text{NH}_3^+$  are diagnostically different (Figure 1)<sup>11</sup>. The former shows a stronger signal at  $m/z$  15 ( $\text{CH}_3^+$ ), as would be expected since this ion is accessible via C–N cleavage of  $\text{CH}_3\text{NH}_2^{++}$  but not  $\bullet\text{CH}_2\text{NH}_3^+$ . Moreover, the spectrum of  $\bullet\text{CH}_2\text{NH}_3^+$  is dominated by a very narrow 'spike' at  $m/z$  15.5 (i.e.  $31^{++}$ ) which is of very minor significance in the spectrum of  $\text{CH}_3\text{NH}_2^{++}$ . This contrast in the CS portion of the spectrum reflects the stability of the dications derived from  $\text{CH}_3\text{NH}_2^{++}$  and  $\bullet\text{CH}_2\text{NH}_3^+$ :  $^+\text{CH}_2\text{NH}_3^+$  is a stable species, existing in a distinct energy well, but  $\text{CH}_3\text{NH}_2^{++}$  dissociates spontaneously or isomerizes to  $^+\text{CH}_2\text{NH}_3^+$ <sup>31</sup>.

In contrast to the conventional isomers, which obviously correspond to ionized neutral molecules, none of the unconventional species has a stable neutral counterpart. This fact is very useful in characterizing the unconventional species, because the application of modern neutralization–reionization (NR) techniques readily differentiates them from their conventional isomers. In the NR experiment<sup>32,33</sup>, the ions are neutralized (typically by being caused to collide with a target gas consisting of alkali metal atoms or *N,N*-dimethylaniline, from which an electron is readily captured) and the resultant neutral species are then reionized by collision with another gas (typically oxygen). The essence of this technique involves the formation of neutral species having the same connectivity of atoms as the ions under investigation. If this neutral species is stable, the ions should survive NR and a 'survivor' signal, corresponding to regeneration of the original ion, should appear in the

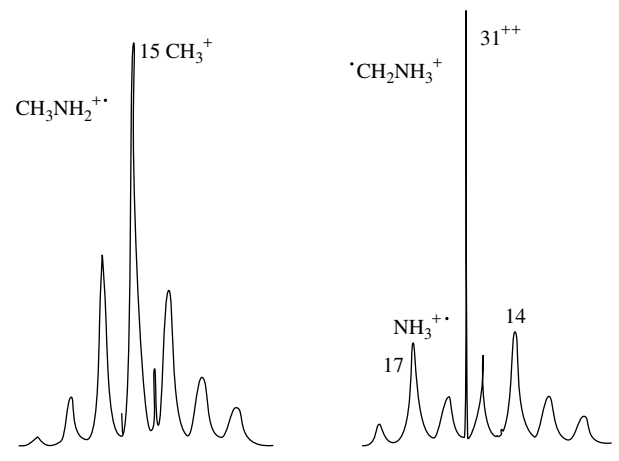


FIGURE 1. Partial CID and CS Spectra of (a)  $\text{CH}_3\text{NH}_2^{\bullet+}$  and (b)  $\bullet\text{CH}_2\text{NH}_3^+$ . Reproduced by permission of the Canadian Chemical Society from J. L. Holmes, F. P. Lossing, J. K. Terlouw and P. C. Burgers, *Can. J. Chem.*, **61**, 2305 (1983)

NR spectrum. On the other hand, if the neutral species is not stable, no survivor signal is expected. In the present context, conventional ionized amines show survivor signals, but their unconventional isomers do not because the corresponding neutrals are unstable (thus, neutralization of  $\bullet\text{CH}_2\text{NH}_3^+$ ,  $\bullet\text{CH}_2\text{CH}_2\text{NH}_3^+$  and  $\bullet\text{CH}_2\text{CH}_2\text{CH}_2\text{NH}_3^+$  would give either the hypervalent biradicals  $\bullet\text{CH}_2\text{NH}_3^{\bullet}$ ,  $\bullet\text{CH}_2\text{CH}_2\text{NH}_3^{\bullet}$  and  $\bullet\text{CH}_2\text{CH}_2\text{CH}_2\text{NH}_3^{\bullet}$  or the zwitterionic species  $^-\text{CH}_2\text{NH}_3^+$ ,  $^-\text{CH}_2\text{CH}_2\text{NH}_3^+$  and  $^-\text{CH}_2\text{CH}_2\text{CH}_2\text{NH}_3^+$ , respectively, all of which dissociate spontaneously).

The value of NRMS is illustrated by the differentiation of  $\text{CH}_3\text{CH}_2\text{CH}_2\text{NH}_2^{\bullet+}$  from  $\bullet\text{CH}_2\text{CH}_2\text{CH}_2\text{NH}_3^+$ . A survivor signal at  $m/z$  59 is present only in the former case, for which it is strong<sup>17</sup>. In contrast, the CID spectra of  $\text{CH}_3\text{CH}_2\text{CH}_2\text{NH}_2^{\bullet+}$  and  $\bullet\text{CH}_2\text{CH}_2\text{CH}_2\text{NH}_3^+$  are quite similar and dominated by formation of  $\text{CH}_2=\text{NH}_2^{\bullet+}$  at  $m/z$  30<sup>17</sup>.

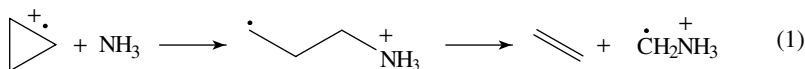
Other means for distinguishing DIs from their conventional isomers include thermochemical data and bimolecular reactions. The first method relies on differences in enthalpies of formation, which may be insufficient for forming firm conclusions, especially if the isomeric species have similar enthalpies or are generated by processes which have appreciable reverse critical<sup>34</sup> energies. Thus,  $\text{CH}_3\text{NH}_2^{\bullet+}$  and  $\bullet\text{CH}_2\text{NH}_3^+$  have quite similar enthalpies and cannot be identified on this basis. Note that this similarity in enthalpy does not always occur for  $\text{CH}_3\text{ZH}^{\bullet+}$  and  $\bullet\text{CH}_2\text{ZH}_2^+$  pairs: the  $\alpha$ -DI is 35 and 65  $\text{kJ mol}^{-1}$  more stable than its conventional isomer when  $Z = \text{OH}$  and  $\text{F}$ , respectively<sup>18,19</sup>.

Characterization of ion structures by bimolecular reactions, in which an ion is allowed to react with a neutral gas of known structure and the ionic products are analysed by mass spectrometry, depends on isomeric species having distinctive reactivities which reflect the functional group(s) that are present. This method is conceptually analogous to the use of structure-specific test reagents in classical solution chemistry. Sometimes a group may be transferred to a particular ion from the gas (methylene transfer is commonly encountered); on other occasions, hydrogen transfer is monitored. The latter is conveniently combined with isotopic labelling.

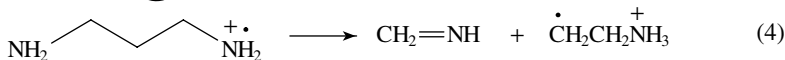
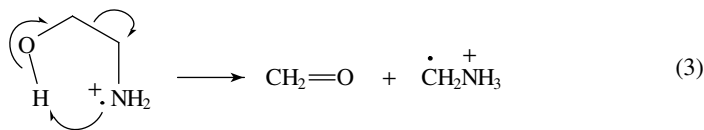
## 5. The chemistry of ionized, protonated and cationated amines in the gas phase 211

It is clear that DIs of general formula  $C_nH_{2n+3}N^{+\bullet}$  cannot be made by direct ionization of their neutral counterparts because these species are not stable. However, these DIs have been generated by a variety of indirect means.

The first route involves a suitable bimolecular reaction. An early seminal example was the production of  $\bullet CH_2NH_3^+$  by reaction of  $NH_3$  with ionized cyclopropane<sup>35</sup>; this process involves ring opening to give the  $\gamma$ -DI,  $\bullet CH_2CH_2CH_2NH_3^+$ , which then eliminates ethylene (equation 1). Subsequent investigations<sup>36</sup> confirmed the involvement of  $\bullet CH_2CH_2CH_2NH_3^+$  and also showed that this reaction is associated with ionized cyclopropane because ionized propene undergoes mainly proton transfer<sup>35,37,38</sup>. Moreover, formation of  $\bullet CH_2NH_3^+$  involves very little hydrogen exchange, as is shown by the production of  $\bullet CH_2ND_3^+$  by reaction of ionized cyclopropane with  $ND_3$  and similar labelling experiments<sup>38,39</sup>. Similarly,  $\bullet CH_2NH_3^+$  is formed by methylene transfer from ionized ketene to  $NH_3$  (equation 2)<sup>40</sup>.

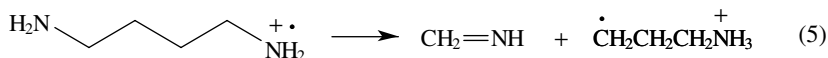


The second general route to these DIs is fragmentation of a suitable precursor, typically via a process involving hydrogen transfer to the nitrogen atom. Thus,  $\bullet CH_2NH_3^+$  is produced by elimination of formaldehyde from ionized ethanolaniline and similar species (equation 3)<sup>13</sup>. A related route (expulsion of methylene imine from ionized 1,3-diaminopropane, equation 4) gives access to  $\bullet CH_2CH_2NH_3^+$ <sup>13</sup>. This procedure suffers from the drawback that the fragmentation may entail a reverse critical energy and so produce a DI containing an appreciable internal energy, even at the threshold for its formation. Nevertheless, it is convenient in practice, especially for generating  $\bullet CH_2NH_3^+$  and related  $\alpha$ -DIs; moreover, it has the advantage of being compatible with conventional EI methodology in ordinary instruments, provided an unambiguous fragmentation can be designed.

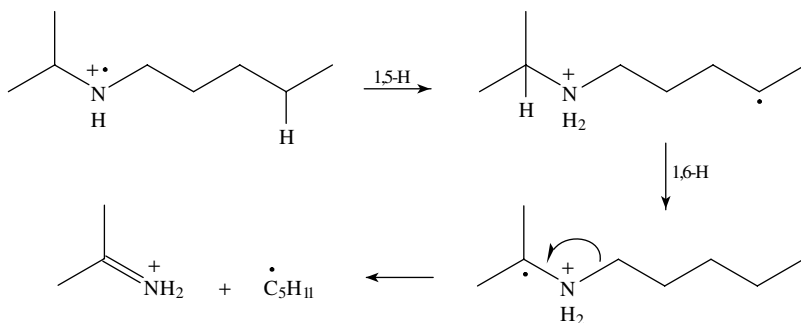


The third method by which DIs are formed is isomerization of the corresponding ionized amines. In the present context, this route is the most important because it reflects the chemistry of ionized amines. However, it is not always viable, particularly for smaller DIs. Thus,  $\bullet CH_2NH_3^+$  is not accessible by isomerization of  $CH_3NH_2^{+\bullet}$  because of the substantial energy barrier (*ca* 165<sup>19</sup> kJ mol<sup>-1</sup>) towards the required 1,2-H shift. Similar remarks apply to  $\beta$ -DIs, which cannot be readily formed from the corresponding ionized amines by a 1,3-H shift. Thus, there is a barrier of *ca* 140<sup>20</sup> kJ mol<sup>-1</sup> towards rearrangement of  $CH_3CH_2NH_2^{+\bullet}$  to  $\bullet CH_2CH_2NH_3^+$ . On progressing to the homologous  $\gamma$ -DIs, 1,4-H shifts in the corresponding ionized amines become easier. Thus, an early upper limit of *ca* 38 kJ mol<sup>-1</sup> was inferred for the barrier to isomerization of  $CH_3CH_2CH_2NH_2^{+\bullet}$  to  $\bullet CH_2CH_2CH_2NH_3^+$ <sup>17</sup>. This rearrangement of  $CH_3CH_2CH_2NH_2^{+\bullet}$  certainly has a lower critical energy than that (*ca* 80 kJ mol<sup>-1</sup>) for ethyl radical loss

because exchange of the hydrogen atoms of the amino function with those attached to carbon precedes  $\alpha$ -cleavage at low internal energies<sup>17</sup>. Despite the increased facility of these 1,4-H transfers,  $\cdot\text{CH}_2\text{CH}_2\text{CH}_2\text{NH}_3^+$  is more conveniently generated by fragmentation of ionized bifunctional precursors (e.g. by loss of methylene imine from ionized 1,4-diaminobutane, equation 5).



Even smaller barriers exist towards hydrogen transfers through larger transition states<sup>17,26</sup>. Consequently, DIs are formed from the corresponding ionized amines with increasing facility as the length of the alkyl chain increases. Similarly, rearrangement to DIs sometimes occurs readily for ionized amines containing two N-alkyl substituents because hydrogen transfers between the hydrocarbon chains becomes possible. Thus, an  $\alpha$ -DI derived from an isopropyl group is formed by a route involving such reciprocal hydrogen transfer, (Scheme 2)<sup>41,42</sup>.



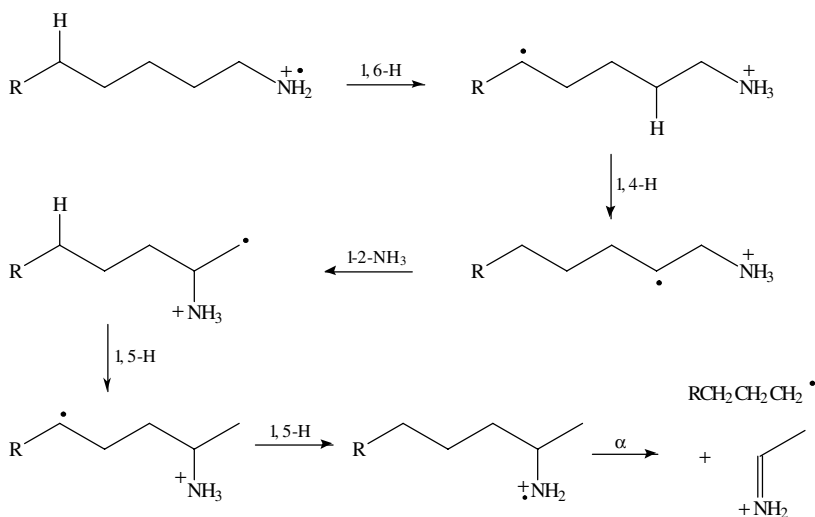
SCHEME 2

Three main factors influence the ease of formation of DIs from ionized amines. The hydrogen transfer(s) necessary to effect this transformation occur more readily at low energies and long lifetimes because they then compete more effectively with dissociations involving bond cleavages. Moreover, hydrogen transfers through six-, seven- and eight-membered ring transition states are especially favourable<sup>43</sup>. Finally, isomerization to DIs occurs most readily for ionized primary and secondary amines; indeed, there is little or no evidence for the formation of DIs from ionized tertiary alkylamines. This trend reflects the reduction in the hydrogen abstraction capacity of the nitrogen atom on progressing from ionized primary to tertiary amines<sup>44</sup>.

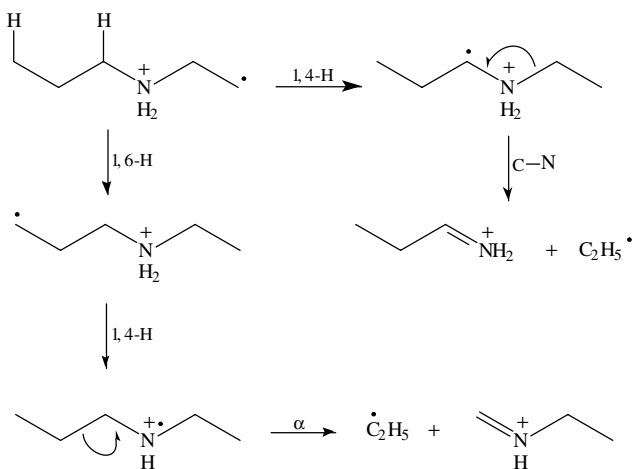
The existence of stable DIs in  $\text{C}_n\text{H}_{2n+3}\text{N}^{+\bullet}$  systems has significant implications. It is no longer necessarily correct to assume that the ionized amine retains this structure until it fragments. Furthermore, new dissociation pathways which are not open to unrearranged ionized amines become accessible via DIs. The most general of these novel pathways is probably pseudo- $\alpha$ -cleavage, in which a radical apparently accessible only by unfavourable  $\beta$ -cleavage of an ionized linear 1-alkylamine or similar substrate is lost<sup>43-50</sup>. This process involves isomerization of the ionized 1-alkylamine to the corresponding ionized 2-alkylamine, which then fragments to give  $\text{CH}_3\text{CH}=\text{NH}_2^+$ , (Scheme 3). Other fragmentations intelligible in terms of reciprocal hydrogen transfers involving DIs include an unusual C-N cleavage starting from ionized isopropyl-*n*-pentylamine (Scheme 2)<sup>41,42</sup>. In order to understand these processes, it is necessary to summarize the basic types fragmentation and isomerization of simple DIs.



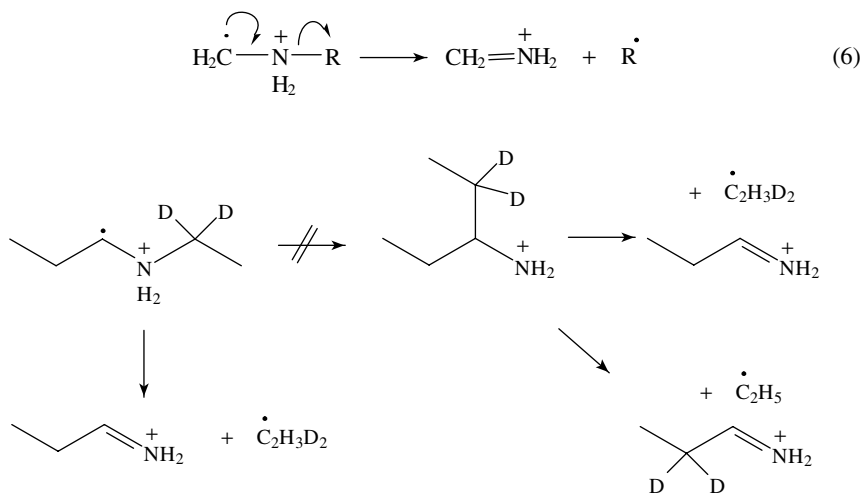
5. The chemistry of ionized, protonated and cationated amines in the gas phase 213



DIs usually fragment via quite different routes to those of the corresponding ionized amines. Thus, unlike ionized amines,  $\alpha$ -DIs rarely, if ever, undergo  $\alpha$ -cleavage. Instead, C–N fission occurs, especially for  $\alpha$ -DIs containing more than one N-alkyl substituent<sup>26</sup>. Thus,  $\bullet\text{CH}_2\text{NH}_2^+\text{CH}_3$  expels  $\text{CH}_3^\bullet$ , with production of  $\text{CH}_2=\text{NH}_2^{+15}$ . Similarly,  $\text{CH}_3\text{CH}_2\text{CH}^\bullet\text{NH}_2^+\text{CH}_2\text{CH}_3$  (generated from  $\text{CH}_3\text{CH}_2\text{CH}_2\text{NH}_2^+\text{CH}_2\text{CH}_2^\bullet$ ) loses  $\text{C}_2\text{H}_5^\bullet$ , (Scheme 4)<sup>42</sup>. This distinction between  $\alpha$ -DIs and ionized amines may, however, be blurred by the possibility of interconversion of these conventional and unconventional isomers of  $\text{C}_n\text{H}_{2n+3}\text{N}^{+\bullet}$ , particularly at low internal energies and in systems containing long alkyl chains.



Although this process appears to be a simple cleavage, which intuitively might have been expected to occur with little or no reverse critical energy, there is evidence from thermochemical measurements<sup>51</sup> and MO calculations<sup>12,21,52</sup> for a barrier towards the reverse reaction, particularly when small radicals are lost. The metastable peak for loss of  $\text{CH}_3^\bullet$  from  $\bullet\text{CH}_2\text{NH}_2^+\text{CH}_3$  is broad and dish-topped<sup>15</sup>, so confirming the presence of a sizeable reverse critical energy. This behaviour is fairly general for loss of an N-alkyl group from  $\alpha$ -DIs (equation 6)<sup>41,42</sup>. One possible explanation is that N-alkyl elimination is preceded by a 1,2-shift from nitrogen to carbon, to give an energetic (or 'hot') form of the corresponding ionized amine (here  $\text{CH}_3\text{CH}_2\text{NH}_2^{+\bullet}$ ). Such a rationalization is not consistent with labelling experiments, which reveal that the alkyl groups in potentially symmetric systems do not become equivalent prior to fragmentation. Thus,  $\text{CH}_3\text{CH}_2\text{CH}^\bullet\text{NH}_2^+\text{CD}_2\text{CH}_3$  is not able to reach  $\text{CH}_3\text{CH}_2(\text{CH}_3\text{CD}_2)\text{CHNH}_2^{+\bullet}$  before an ethyl radical is expelled (Scheme 5), because the metastable peaks for loss of  $\text{CH}_3\text{CH}_2^\bullet$  and  $\text{CH}_3\text{CD}_2^\bullet$  have different shapes<sup>41,42</sup>.

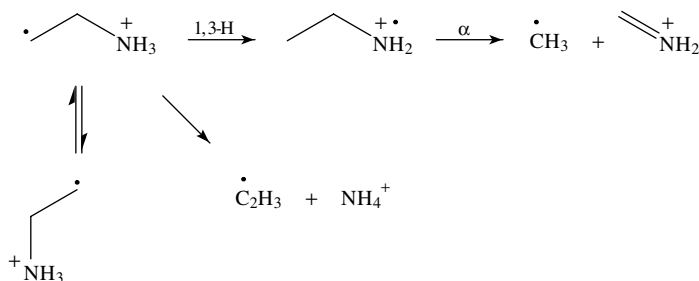


SCHEME 5

$\beta$ -DIs also fragment by C–N cleavage, usually accompanied by hydrogen transfer to nitrogen. These processes result in loss of an alkene or an alkenyl radical, respectively. Thus,  $\bullet\text{CH}_2\text{CH}_2\text{NH}_3^+$  loses  $\text{C}_2\text{H}_3^\bullet$ , with formation of  $\text{NH}_4^+$ , though the dominant reaction at low internal energies is actually  $\text{CH}_3^\bullet$  loss<sup>14</sup>. The hydrogen transfer associated with  $\text{C}_n\text{H}_{2n-1}^\bullet$  elimination in these systems is favoured by the relatively high proton affinity (PA) of the ammonia (or alkylamine) molecule accessible by C–N cleavage. This hydrogen transfer tends to show a strong 1,4-regioselectivity. Thus,  $(\text{CH}_3)_2\text{C}^\bullet\text{CD}_2\text{NH}_3^+$  yields only  $\text{NH}_4^+$  in butenyl radical loss<sup>42</sup>.

Loss of  $\text{CH}_3^\bullet$  requires hydrogen transfer from nitrogen to carbon, presumably to give  $\text{CH}_3\text{CH}_2\text{NH}_2^{+\bullet}$ , which then fragments by  $\alpha$ -cleavage (Scheme 6). Both these hydrogen transfer processes are subject to substantial isotope effects discriminating against D-migration<sup>14</sup>, so indicating that these steps are probably rate-limiting in each case. Fragmentations corresponding to loss of an alkenyl radical (or production of an alkenyl cation or related ionized alkene) from  $\beta$ -DIs often persist at high internal energies (e.g. the CID spectrum<sup>11</sup> of  $\bullet\text{CH}_2\text{CH}_2\text{NH}_3^+$  is dominated by  $\text{C}_2\text{H}_3^\bullet$  loss, which also occurs for metastable ions, and production of  $\text{C}_2\text{H}_3^+$  or  $\text{C}_2\text{H}_4^{+\bullet}$ ).

5. The chemistry of ionized, protonated and cationated amines in the gas phase 215



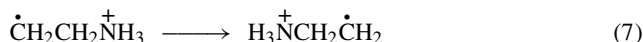
SCHEME 6

$\gamma$ -DIs might be expected to eliminate an alkene with production of an  $\alpha$ -DI, as was illustrated previously by the generation of  $\bullet\text{CH}_2\text{NH}_3^+$  from  $\bullet\text{CH}_2\text{CH}_2\text{CH}_2\text{NH}_3^+$  (equation 1). However, this view is complicated by the possibility of isomerization to the corresponding ionized amine by a 1,4-H shift. This conventional isomer may then fragment by  $\alpha$ -cleavage. Thus, the CID spectrum of ions generated as  $\bullet\text{CH}_2\text{CH}_2\text{CH}_2\text{NH}_3^+$  is dominated by  $\text{CH}_3\text{CH}_2\bullet$  loss via rearrangement to  $\text{CH}_3\text{CH}_2\text{CH}_2\text{NH}_2^{\bullet+}$ <sup>17</sup>. Parallel isomerizations to form isomeric DIs or ionized amines occur readily for  $\delta$ - and other DIs in which the charge and radical sites are sufficiently far apart to permit facile hydrogen shifts.

An interesting contrast with the analogous  $\gamma$ -DIs corresponding to ionized alcohols emerges at this point: a 1,4-H shift is not observed for  $\bullet\text{CH}_2\text{CH}_2\text{CH}_2\text{OH}_2^{+7,17}$ , which fragments by loss of water in preference to isomerizing to ionized *n*-propanol. Thus, the 1,4-H shifts occur more readily in nitrogenous systems; this contrast is intelligible in terms of the lower critical energies for hydrogen abstraction by ionized amino groups, which in turn may reflect the less stringent geometrical restraints compared to the corresponding H-shifts in the analogous ionized alcohols<sup>7</sup>, as uncovered by MO calculations<sup>53,54</sup>. However,  $\bullet\text{CH}_2\text{CH}_2\text{CH}_2\text{CH}_2\text{OH}_2^+$  and related  $\delta$ -DIs containing oxygen do undergo facile 1,5-H shifts<sup>17</sup>.

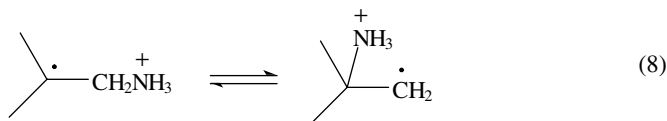
As might have been anticipated, the principal isomerization pathway for many DIs is hydrogen transfer. This process usually involves at least a five-membered ring transition state. However, isolated exceptions are known. Thus, as noted previously,  $\bullet\text{CH}_2\text{CH}_2\text{NH}_3^+$  undergoes an irreversible 1,3-H shift to form  $\text{CH}_3\text{CH}_2\text{NH}_2^{\bullet+}$ , which then expels  $\text{CH}_3\bullet$ . The unidirectional nature of this hydrogen transfer is established by the loss of  $\text{CH}_2\text{D}\bullet$  with high specificity from  $\bullet\text{CH}_2\text{CH}_2\text{ND}_3^+$  via rearrangement to  $\text{CH}_2\text{DCH}_2\text{NH}_2^{\bullet+}$ <sup>14</sup>.

Skeletal isomerizations are also important for  $\beta$ -DIs, which undergo a facile rearrangement corresponding to a 1,2-NH<sub>3</sub> shift. Thus,  $\bullet\text{CH}_2\text{CH}_2\text{NH}_3^+$  interconverts rapidly with  $\text{H}_3\text{N}^+\text{CH}_2\text{CH}_2\bullet$  (equation 7). The ease of this degenerate rearrangement was predicted by early MO calculations<sup>5</sup>, supported by later theoretical studies<sup>20,55-57</sup> and confirmed by labelling experiments<sup>14</sup>. Thus, metastable  $\bullet\text{CD}_2\text{CH}_2\text{NH}_3^+$  and  $\bullet\text{CH}_2\text{CD}_2\text{NH}_3^+$  behave identically in expelling  $\text{CH}_3\bullet$  and  $\text{CHD}_2\bullet$  in a common ratio (4:3).

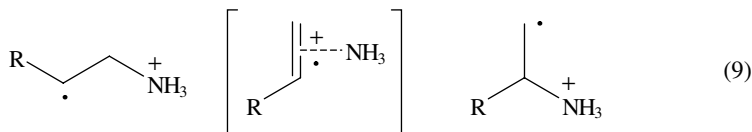


The calculated barrier (*ca* 120 kJ mol<sup>-1</sup>)<sup>20</sup> towards the 1,2-NH<sub>3</sub> migration in  $\bullet\text{CH}_2\text{CH}_2\text{NH}_3^+$  is large compared to the extremely small barrier (*ca* 10 kJ mol<sup>-1</sup>) for the corresponding 1,2-OH<sub>2</sub> shift in the oxygen analogue,  $\bullet\text{CH}_2\text{CH}_2\text{OH}_2^+$ <sup>55-57</sup>. Nevertheless, it remains sufficiently facile that 1,2-NH<sub>3</sub> migration in  $\beta$ -DIs occurs more rapidly than fragmentation. Thus, the CID spectra of related pairs of isomeric DIs such as

$(\text{CH}_3)_2\text{C}\cdot\text{CH}_2\text{NH}_3^+$  and  $\cdot\text{CH}_2(\text{CH}_3)_2\text{C}\cdot\text{NH}_3^+$  often are indistinguishable<sup>41,42</sup>, as would be expected if the 1,2-NH<sub>3</sub> shift occurred readily (equation 8).



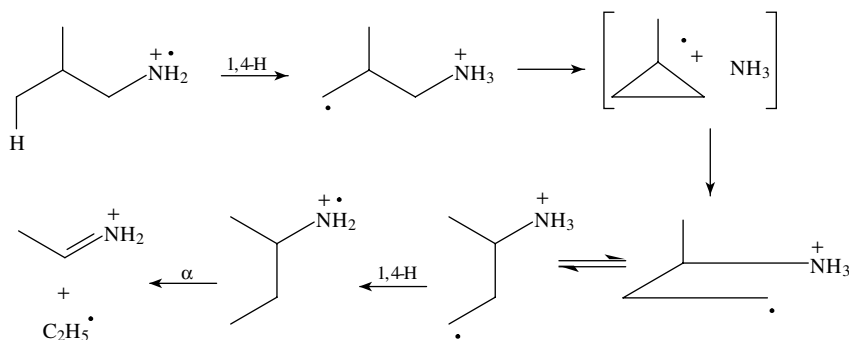
This 1,2-NH<sub>3</sub> migration is the key step in the reorganization of the heavy atom skeleton which precedes pseudo- $\alpha$ -cleavage of ionized long-chain alkylamines (Scheme 3). The transition state for this process may be considered to resemble a tight complex of an ionized alkene (ethylene in the case of the archetypal  $\beta$ -DI,  $\cdot\text{CH}_2\text{CH}_2\text{NH}_3^+$ ) and NH<sub>3</sub> (equation 9). This idea is consistent with the behaviour of adduct ions  $[\text{C}_n\text{H}_{2n}\text{NH}_3]^+\cdot$  generated by direct combination of the appropriate ionized alkene and NH<sub>3</sub><sup>58,59</sup>.



At least some  $\gamma$ -DIs, including those derived from ionized branched primary amines, have appreciable bonding between the  $\alpha$ - and  $\gamma$ -carbon atoms<sup>48–50,60–62</sup>. In the case of homologues of  $\cdot\text{CH}_2\text{CH}_2\text{CH}_2\text{NH}_3^+$ , formation of a full C–C bond would lead to an ionized cyclopropane and ammonia (or an alkylamine, if the initial DI has more than one substituent on nitrogen). However, the ionic and neutral components in such systems may remain bound by virtue of ionic forces. Species of this kind are called ion-neutral complexes (INCs)<sup>63</sup>. The ionic and neutral partners may be attracted together so strongly by ion–dipole and related forces that the INC is substantially stabilized (by 50–100 kJ mol<sup>–1</sup>, in favourable cases) relative to the sum of the enthalpies of the isolated components. These INCs provide a means of interpreting many previously baffling fragmentations in a unified and mechanistically satisfying manner. The essence of INC-mediated explanations is that the ionic and neutral components become sufficiently ‘free’ to display their inherent properties. Thus, an incipient cation may isomerize and hydrogen transfers between the partners may take place; more complex processes, in which the components recombine in new ways, are also possible. The defining characteristic of INCs is the ability of the partners to rotate around one another. It is this geometric freedom which permits hydrogen transfers between initially remote sites and novel recombinations of the components. True INCs are often considered to occupy discrete potential energy wells; however, it is possible that some INCs correspond to entropic bottlenecks rather than to stable intermediates.

The possibility of forming species resembling an ionized cyclopropane coordinated to ammonia or an alkylamine offers an attractive route for isomerizing the skeleton of the original  $\gamma$ -DI via a process which corresponds to a 1,3-NH<sub>3</sub> shift<sup>48–50</sup>. Thus,  $\text{CH}_3(\cdot\text{CH}_2)\text{CHCH}_2\text{NH}_3^+$  may rearrange to  $\text{CH}_3(\text{NH}_3^+)\text{CHCH}_2\text{CH}_2\cdot$  via this means (Scheme 7). The equivalent 1,3-rearrangement for  $\gamma$ -DIs formed from the analogous ionized ethers is extremely facile and of greater general importance<sup>61,64–67</sup>. Nevertheless, this 1,3-NH<sub>3</sub> migration provides an explanation for several unexpected alkyl radical eliminations from ionized *n*-alkylamines which cannot be formulated either as  $\alpha$ -cleavage of the initial structure or as pseudo- $\alpha$ -cleavage occurring after a 1,2-NH<sub>3</sub> shift in a  $\beta$ -DI.

5. The chemistry of ionized, protonated and cationated amines in the gas phase 217



SCHEME 7

## B. Reactions of Ionized Alkylamines

### 1. Overview and comparison with ionized alcohols and ethers

In general, the behaviour of ionized amines shows many similarities to those of the analogous ionized alcohols or ethers. Both classes of radical-cation tend to dissociate at high internal energies via  $\alpha$ -cleavage without prior rearrangement and the ease of fragmentation increases dramatically with branching at the carbon atom carrying the heteroatom<sup>68</sup>. However, there are important differences which reflect the disparate influences of the two heteroatoms. The corresponding chapter on the chemistry of ionized alcohols and ethers<sup>69</sup> should be consulted for a more detailed analysis of the structure and reactivity of  $\text{C}_n\text{H}_{2n+2}\text{O}^+$  radical-cations.

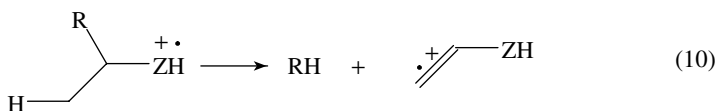
In fast reactions, ionized amines show an even greater propensity to undergo the ubiquitous  $\alpha$ -cleavage than do ionized alcohols and ethers. This distinction may reflect the superior stability of the immonium ions compared to their oxonium ion counterparts<sup>18,70,71</sup>. Thus, the hydride anion affinities [ $D(\text{R}^+ - \text{H}^-)$ , corresponding to the heterolytic bond dissociation energy of the conjugate compound] of immonium ions are *ca*  $100 \text{ kJ mol}^{-1}$  lower than those of the analogous oxonium ions [e.g.  $D(\text{R}^+ - \text{H}^-)$  of  $\text{CH}_2=\text{OH}^+$  are 912 and  $1054 \text{ kJ mol}^{-1}$ , respectively]<sup>72</sup>.

Another difference is the reduced importance of fragmentations entailing C–N fission compared to the analogous routes involving C–O cleavage. Even ionized amines containing a tertiary alkyl substituent rarely decompose directly to give a simple carbonium ion,  $\text{C}_n\text{H}_{2n+1}^+$ . The analogous tertiary alcohols and ethers do show appreciable signals corresponding to  $\text{C}_n\text{H}_{2n+1}^+$  in their spectra. Thus, the relative intensities (RIs) of the peak at  $m/z$  57 in the 70 eV spectra of *t*-butylamine, *t*-butanol and *t*-butyl methyl ether are 2–7, 9–18 and 25–27%, respectively<sup>73</sup>. Moreover, this trend persists in the low-energy, low-temperature (LELT) spectra, obtained by ionization with 12 eV electrons at a source temperature of 350 K. However, analysis of the LELT spectra of larger ethers shows that the  $\text{C}_n\text{H}_{2n+1}^+$  ions may be secondary fragment ions, formed by dissociation of oxonium ions produced by  $\alpha$ -cleavage, rather than primary fragments of ionized ethers<sup>74,75</sup>.

Similarly, ionized alcohols and ethers containing a chain of at least three contiguous carbon atoms attached at one end to the oxygen atom frequently expel water or the alcohol derived from the smaller alkyl group<sup>76–80</sup>. However, the corresponding ionized amines rarely eliminate ammonia or small alkylamines in great abundance. This contrast reflects energetic factors. Water and small alcohols are extremely stable molecules ( $\Delta H_f = -240$  and  $-190 \text{ kJ mol}^{-1}$ , respectively, for water and methanol), but ammonia and methylamine are not particularly stable ( $\Delta H_f = -20$  and  $-25 \text{ kJ mol}^{-1}$ , respectively)<sup>82,83</sup>. Moreover,

a nitrogen atom is even better than an oxygen atom at stabilizing a positive charge on an adjacent carbon atom<sup>81</sup>. Consequently, the combination of products corresponding to  $C_nH_{2n}^{+•}$  and RZH is energetically much less favourable when  $Z = N$  than when  $Z = O$ , particularly when compared to the energy of the alternative products obtained by  $\alpha$ -cleavage.

Several of these differences, including the enhanced tendency of species generated as  $C_nH_{2n+1}OR^{+•}$  to lose ROH, remain in slow reactions, particularly those of metastable ions with moderately long alkyl chains (i.e. containing  $\delta$ -hydrogen atoms). Nevertheless, some similarities also become apparent. Thus, many metastable  $C_mH_{2m+1}(CH_3)CHZH^{+•}$  ( $Z = O, NH$ ) and  $C_mH_{2m+1}(CH_3)CHOCH_3^{+•}$  species eliminate an alkane,  $C_mH_{2m+2}$ , derived from the principal alkyl substituent at the branch point and a hydrogen atom from the adjacent methyl group<sup>65,84,85</sup>. These reactions, which may be interpreted in generic terms as a 1,2-elimination with a low degree of concert perhaps involving INCs (equation 10), give rise to ionized enols, enol ethers and enamines, respectively.



Despite this superficial similarity, however, subtle differences between the behaviour of ionized amines and the analogous ionized alcohols and ethers remain. Thus, metastable ionized 2-butylamine loses 80% ethane; in contrast, ionized 2-butanol eliminates both ethane (35%) and methane (40%)<sup>85</sup>. The latter reaction corresponds to loss of the smaller methyl group and an  $\alpha$ -hydrogen atom from the larger ethyl substituent at the branch point. Methane loss does not occur from ionized amines with a methyl substituent on the  $\alpha$ -carbon, with the solitary exception of ionized isopropylamine which does expel methane (10%). However, ionized 3-hexylamine eliminates both ethane (35%) and propane (20%)<sup>85</sup>.

Other similarities and contrasts include the occasional importance of fragmentations corresponding to single and double hydrogen transfer which result in alkene ( $C_mH_{2m}$ ) and alkenyl radical ( $C_mH_{2m-1}^{\cdot}$ ) loss, respectively. Thus, the major fragmentation of metastable ionized isobutyl alcohol is expulsion of an allyl ( $C_3H_5^{\cdot}$ ) radical, but the analogous amine does not undergo this process to an appreciable extent<sup>86,87</sup>. However, this trend is reversed for the neopentyl homologues: metastable ionized neopentanol loses  $CH_3OH$  but not  $C_4H_7^{\cdot}$ , whereas metastable ionized neopentylamine does undergo double hydrogen transfer with elimination of a methallyl radical<sup>45,88</sup>. Many of these rearrangements involve DIs and pertinent examples are discussed in Section III.B.3.

## 2. Fragmentation of unrearranged ionized alkylamines

Definite trends are observed in the intensities of the signals due to the molecular ion and the primary fragment ions in the EI spectra of alkylamines. These trends are more clearly apparent in the LEIT spectra, because the relative intensities of the molecular ions are enhanced relative to those in the conventional 70-eV 500-K spectra. A survey of the LEIT spectra of about 30 small alkylamines containing up to six carbon atoms revealed three important trends in the EI spectra of amines<sup>75</sup>. The relative abundance of the molecular ion is markedly reduced by branching at the  $\alpha$ -carbon atom and significantly diminished by increasing the length of the principal alkyl substituent, but it is usually enhanced by progressive methylation of the nitrogen atom.

As noted previously, ionized primary and secondary alkylamines isomerize to DIs provided they have sufficiently long alkyl chains and are allowed enough time. These

## 5. The chemistry of ionized, protonated and cationated amines in the gas phase 219

isomerizations are usually reversible. Consequently, provided that the DI reverts only to the original ionized amine, fragmentation of the regenerated radical-cation will appear to occur from the initial structure. Indeed, such a specific interconversion with DIs might be undetectable, even by isotopic labelling. However, this situation rarely obtains in practice. Further hydrogen transfers and/or skeletal rearrangements are possible, as illustrated previously. Thus, once an ionized long-chain primary alkylamine has isomerized to a DI by a 1,4- or 1,5- or 1,6-H shift from carbon to nitrogen, additional 1,4- or 1,5- or 1,6-H transfers between carbon atoms often become feasible. The end result is extensive exchange of the hydrogen atoms on the various sites within the original alkyl group, if it is long enough, or between alkyl chains if the nitrogen atom carries more than one substituent. Moreover, if the relay of hydrogen shifts may transfer the radical site to the  $\beta$ -carbon atom, facile  $\text{NH}_3$  migration and skeletal rearrangement occurs to give an isomeric  $\beta$ -DI, which may undergo subsequent hydrogen transfer(s) leading to pseudo- $\alpha$ -cleavage (Section III.B.3.a).

*a.  $\alpha$ -Cleavage.* In view of the complications arising from the possibility of intramolecular hydrogen transfers, detailed mechanistic studies on  $\alpha$ -cleavage generally should be conducted on ionized tertiary alkylamines, which do not rearrange to DIs. Another approach is to study ionized amines which have alkyl chains that are too short to permit the hydrogen transfer process. The importance of these caveats has been appreciated only relatively recently and must be borne in mind in assessing early mechanistic work on  $\alpha$ -cleavages.

$\alpha$ -Cleavage has traditionally been regarded as an extremely simple process, in which a C—C bond is broken essentially without reverse critical energy other than that which might arise if the products happen to have a total enthalpy of formation lower than that of the fragmenting ion. This view was undermined by the discovery that several ionized *t*-butylamines,  $(\text{CH}_3)_3\text{CNHR}^{+\bullet}[\text{R} = \text{H}, \text{CH}_3 \text{ or } (\text{CH}_3)_3\text{C}]$ , expel a methyl radical with the production of a broad dished metastable peak, even though the resultant products lie 30–50  $\text{kJ mol}^{-1}$  higher in energy than the reactant<sup>89</sup>. The observation of this kinetic energy (KE) release (11–21  $\text{kJ mol}^{-1}$ ) indicates that there is a definite energy barrier towards the reverse reaction; moreover, a relatively specific part of this reverse critical energy is partitioned as translation. Methyl radical loss from ionized isopropylamines also is accompanied by a significant KE release (*ca* 5  $\text{kJ mol}^{-1}$ ), but the corresponding metastable peaks have a Gaussian profile, rather than a flat or dished top. In contrast, the loss of larger alkyl groups is characterized by narrow Gaussian metastable peaks corresponding to small KE releases (<2  $\text{kJ mol}^{-1}$ ).

The distinctive behaviour encountered for methyl loss by  $\alpha$ -cleavage may indicate that there is something unusual about reactions involving this particular radical. A simple treatment of energy partitioning in terms of the direction of the transition state co-ordinate (dynamical theory) predicts that a significant portion of any reverse critical energy will be released as translation (i.e. kinetic energy) only if the expelled neutral species does not contain more than four or five atoms<sup>90–92</sup>. This criterion would include methyl, but not ethyl or higher alkyl radicals.

A related point concerns the relative ease of alkyl radical elimination from ionized amines. It has been known for many years that the relative rates for competing  $\alpha$ -cleavages of ionized amines increase with the size of the expelled radical in the conventional 70-eV El spectra of alkylamines and similar substrates<sup>3,68</sup>. In particular,  $\text{H}^\bullet$  is expelled much more slowly than  $\text{CH}_3^\bullet$ , which in turn is lost much more slowly than  $\text{C}_2\text{H}_5^\bullet$  and larger radicals, which are eliminated slightly more readily as their size increases. This trend, which does not always reflect the energetics of the competing fragmentations, is occasionally referred to as a ‘degrees of freedom’ effect, because it appears to follow probability factors. However, more recent work on alkyl radical loss from ionized tertiary

amines of various lifetimes has revealed that the kinetics of this fundamental process are not as simple as was hitherto thought<sup>93-95</sup>.

The order of ease of alkyl radical loss at low internal energy (i.e. in the dissociation of metastable ions) differs from that at high internal energies. The strong initial trend ( $H^{\bullet} \ll CH_3^{\bullet} \ll C_2H_5^{\bullet}$ ) still holds good, but  $C_3H_7^{\bullet}$ ,  $C_4H_9^{\bullet}$  and larger groups are lost progressively less readily than  $C_2H_5^{\bullet}$ , which is lost at a faster rate than any other simple alkyl group. An identical order in the relative rates was observed for alkyl radical elimination from  $R^1R^2CHCH=C(OH)_2^{+\bullet}$  radical-cations<sup>96-98</sup>; moreover, the corresponding  $R^1R^2CHCH=CHOCH_3^{+\bullet}$  species appear to behave similarly<sup>99</sup>. In the former case, an explanation<sup>98</sup> for the maximization of the rate for expulsion of  $C_2H_5^{\bullet}$  was offered in terms of frontier orbital<sup>100,101</sup> effects. Although these conclusions cannot necessarily be extrapolated to  $\alpha$ -cleavage of ionized amines, it is likely that the occurrence of a common trend reflects a generic influence of the various alkyl groups on the rate of bond fission at a branch point which applies both to formal  $\alpha$ - and  $\gamma$ -cleavages.

$\alpha$ -Cleavage is also subject to interesting isotope effects. Most isotope effects observed in the fragmentation of gaseous ions are normal: the unlabelled species is lost more rapidly than its labelled analogue at both high and low internal energies, with the magnitude of the isotope effect increasing as the internal energy of the dissociating ions decreases<sup>90,102-105</sup>. Normal isotope effects of this kind are observed in the  $\alpha$ -cleavage of tertiary alkylamines labelled in the near vicinity of the bond which is broken. Thus,  $CH_3N(C_5H_{11})CH_2CD_2CH_2CH_2CH_3^{+\bullet}$ , in which the C-D bonds are immediately adjacent to the C-C bond which is broken in  $\alpha$ -cleavage, showed a normal isotope effect of 1.034 (per deuterium atom) increasing to 1.30 for loss of a butyl radical in fast reactions at 70 eV in the ion source and in the slow dissociation of metastable ions in the second field-free region, respectively<sup>93</sup>. These isotope effects per deuterium atom are obtained by taking the square root of the overall isotope effect induced by substitution to give a  $CD_2$  group (or cube route, in the case of substitution to produce a  $CD_3$  group, etc).

In contrast, unusual trends in the isotope effects were found when the C-D bonds were located three bonds away from the C-C bond that is broken in  $\alpha$ -cleavage of  $CH_3N(C_5H_{11})CH_2CH_2CH_2CD_2CH_3^{+\bullet}$ . In fast reactions at 70 eV, a small inverse isotope effect of 0.98<sub>6</sub> was observed; but, at the longer lifetimes and lower average internal energies appropriate to fragmentation of metastable ions in the second field-free region, a normal isotope effect of 1.08 was found<sup>93</sup>.

Subsequent work confirmed this apparently abnormal behaviour. Deuteriation at remote sites (the  $\delta$ - or  $\epsilon$ -position) induces small inverse secondary isotope effects in  $\alpha$ -cleavages occurring in the ion source, but normal isotope effects in the decomposition of metastable ions in the field-free regions<sup>94,95</sup>. The time dependence of the isotope effect was also studied by field ionization kinetics, which permit the analysis of fragmentations occurring after lifetimes as short as  $10^{-12} s^{-1}$ . It was found that the inverse isotope effect favouring loss of the deuteriated radical operates at times shorter than  $10^{-9} s^{95}$ .

An explanation for the isotope effects was given in terms of differences in the zero-point energies of the transition states and the influence of slight reductions of isotope-dependent frequencies on the state sums.

The first factor is responsible for normal isotope effects, which arise because the bonds being affected by deuteriation are weakened in the transition state, but the absolute effect is greater on the bonds to deuterium rather than protium because the former have higher vibrational frequencies (typically by a factor of *ca* 1.37). This factor essentially reflects zero-point energy effects, so it becomes progressively more important at lower internal energies.

The second factor is the absolute magnitude of the molecular vibrational frequencies which change as the transition state is being formed. This factor reflects the influence



## 5. The chemistry of ionized, protonated and cationated amines in the gas phase 221

of the term allowing for the density of states in the Rice–Ramsperger–Kassel–Marcus (RRKM)<sup>106</sup> theory for the rates of the competing fragmentations. Lower frequency vibrations contribute more than higher frequency vibrations to the total number of states because the spacing between adjacent states is smaller and the number of states within a given energy interval is increased. Consequently, the term reflecting the density of states is more sensitive to changes in lower frequency vibrations than to variations in higher frequency vibrations. As a result, when the reduction in frequencies associated with the weakening of the relevant bonds is considered, the influence of reducing the C–D frequencies is greater than that of reducing the C–H frequencies, even though the latter are reduced by a greater amount than the former. This statistical weighting effect should become more important relative to the zero-point energy effect at higher internal energies, thus explaining the inverse isotope effect in  $\alpha$ -cleavage of ionized tertiary alkylamines labelled in the  $\delta$ - or  $\varepsilon$ -position.

The observation of relatively small secondary isotope effects on these  $\alpha$ -cleavages indicates that the developing radical does not isomerize to a more stable structure. Thus, the loss of labelled and unlabelled butyl radicals in the ratio 1.10:1 from metastable ionized diisopentylmethylamine containing a C–D methine group in one pentyl chain is inconsistent with the occurrence of a 1,2 shift in the developing isobutyl radical<sup>107</sup>. Such a rearrangement would lead to a *t*-butyl radical, which is *ca* 20 kJ mol<sup>-1</sup> more stable than its isobutyl isomer<sup>108</sup>. However, any shift of this kind would be expected to be quite strongly suppressed by a much larger primary deuterium isotope, as is observed in alkyl radical loss from suitable ionized alkanes<sup>109</sup>. Parallel effects also operate in the analogous system in which a 2-phenethyl radical, C<sub>6</sub>H<sub>5</sub>CH<sub>2</sub>CH<sub>2</sub><sup>\*</sup>, rather than the more stable methylbenzyl radical, C<sub>6</sub>H<sub>5</sub>CH<sup>\*</sup>CH<sub>3</sub>, is lost<sup>107</sup>. These experiments show that simple radicals are stable with respect to 1,2-H shifts, even when these shifts produce more stable isomeric radicals. The barriers to 1,2-H shifts in radicals is in stark contrast to the behaviour of the corresponding cations, which readily isomerize in this manner<sup>110</sup>. The slow rate of such 1,2-H shifts to spin centres is also a major feature of the chemistry of DIs<sup>26,97–99,111</sup>.

*b. Alkane elimination.* This process does not compete effectively with  $\alpha$ -cleavage at high internal energies, but becomes more noticeable as the energy of the dissociating ions is reduced. Thus, the LELT spectrum of 2-butylamine shows a significant [M – CH<sub>4</sub>]<sup>+\*</sup> at *m/z* 57, though the base peak at *m/z* 44 corresponds to loss of the larger alkyl group (C<sub>2</sub>H<sub>5</sub><sup>\*</sup>) by  $\alpha$ -cleavage<sup>75</sup>. As noted previously, CH<sub>4</sub> loss accounts for 10% of the metastable ion current for dissociation of ionized 2-butylamine<sup>84</sup>.

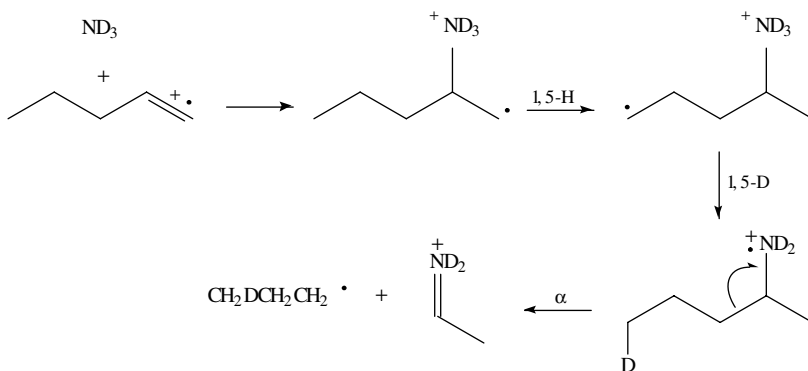
Alkane loss without prior rearrangement typically shows a distinct regioselectivity corresponding to a formal 1,2-elimination. Consequently, it is related to  $\alpha$ -cleavage in that the departing alkyl group picks up a hydrogen atom from the other substituent at the branch point, e.g. equation 10. However, the 1,2-selectivity in alkane elimination may be undermined if the alkyl chains are sufficiently long to permit hydrogen transfers to precede fragmentation. Thus, metastable (CH<sub>3</sub>CH<sub>2</sub>)<sub>2</sub>CHND<sub>2</sub><sup>+\*</sup> loses C<sub>2</sub>H<sub>6</sub> with high selectivity (*ca* 95%), but propane and butane loss from (CH<sub>3</sub>CH<sub>2</sub>CH<sub>2</sub>)<sub>2</sub>CHND<sub>2</sub><sup>+\*</sup> and (CH<sub>3</sub>CH<sub>2</sub>CH<sub>2</sub>CH<sub>2</sub>)<sub>2</sub>CHND<sub>2</sub><sup>+\*</sup>, respectively, occur after extensive hydrogen exchange<sup>84</sup>.

### 3. Fragmentation of rearranged ionized alkylamines

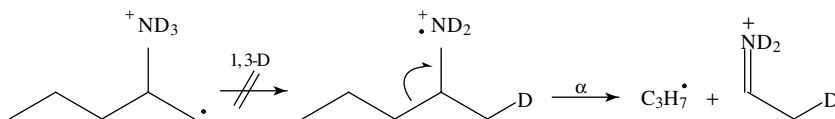
*a. Pseudo- $\alpha$ -cleavage.* This reaction is probably the most important general fragmentation which involves rearrangement. A sequence of hydrogen transfers leads to a  $\beta$ -DI, which undergoes a 1,2-NH<sub>2</sub> shift, followed by further hydrogen transfer to form an isomeric ionized amine (Scheme 3). This isomerized ionized amine then fragments by

$\alpha$ -cleavage to give an immonium ion which would be inaccessible by bond fission of the original structure. Thus,  $m/z$  44 ( $\text{CH}_3\text{CH}=\text{NH}_2^+$ ) is formed by pseudo- $\alpha$ -cleavage of ionized 1-octylamine, via rearrangement to ionized 2-octylamine.

Crucial evidence in favour of this mechanism was accumulated through CID experiments, which established that the structure of the fragment ion is  $\text{CH}_3\text{CH}=\text{NH}_2^+$ , and labelling studies, which revealed the occurrence of extensive exchange of hydrogen atoms attached to many sites within the initial hydrocarbon chain, thus leading to the conclusion that hydrogen transfers played an important part in the rearrangement<sup>43-50</sup>. Related work on the bimolecular reactions of ionized alkenes with ammonia within ion-cyclotron resonance (ICR) instruments confirmed the importance of intermediates derived from these precursors and allowed the mechanism for pseudo- $\alpha$ -cleavage to be refined<sup>58,59,112</sup>. Thus, interaction of ionized 1-pentene with ammonia resulted in the formation of a  $\text{C}_2\text{H}_6\text{N}^+$  product ion<sup>112</sup>. Various  $\text{C}_5\text{H}_{10}^{+\bullet}$ ,  $\text{C}_6\text{H}_{12}^{+\bullet}$  and  $\text{C}_7\text{H}_{14}^{+\bullet}$  species generated from alkenes reacted with ammonia to give a  $[\text{C}_n\text{H}_{2n}^{+\bullet} \text{NH}_3]$  adduct, but  $\text{C}_2\text{H}_6\text{N}^+$  ions were formed only from adducts derived from ionized 1-alkenes<sup>58,59</sup>. Non-terminal ionized alkenes reacted instead by proton transfer to form  $\text{NH}_4^+$  ions. When  $\text{ND}_3$  was used in place of  $\text{NH}_3$ ,  $\text{C}_2\text{H}_6\text{D}_2\text{N}^+$  was the major fragment (95% selectivity) in reactions involving ionized pentene, but an increasing amount (22 and 25%, respectively) of  $\text{C}_2\text{H}_5\text{DN}^+$  was formed from ionized hexene and heptene<sup>58</sup>. The preference for forming  $\text{C}_2\text{H}_6\text{D}_2\text{N}^+$  is consistent with a mechanism in which the immonium ion is formed by transfer of a protium (H) atom to the isolated methylene group from a remote part of the alkyl chain to leave a new radical site to which one deuterium atom is transferred from nitrogen. This route yields an ionized 2-alkylamine containing an  $\alpha$ - $\text{CH}_3$  substituent which is retained in the fragment ion (Scheme 8)<sup>58,59</sup>. There is rarely sufficient time for a deuterium atom initially situated on nitrogen to be incorporated into the  $\alpha$ -methyl group by this route. Moreover, the absence of a  $\text{C}_2\text{H}_3\text{D}_3\text{N}^+$  signal shows that a route in which a 1,3-H shift transfers a deuterium atom directly to the isolated methylene group does not compete with the route involving reciprocal hydrogen transfers, (Scheme 9).



SCHEME 8



SCHEME 9

## 5. The chemistry of ionized, protonated and cationated amines in the gas phase 223

The reduction in the selectivity of forming  $C_2H_6N^+$  as the alkyl chain length is increased reflects the enhanced rate of hydrogen exchange processes which allow a deuterium atom to be transferred to a position in which it is incorporated in the immonium ion.

Pseudo- $\alpha$ -cleavage competes relatively poorly with  $\alpha$ -cleavage in fast dissociations in conventional 70-eV EI spectra. However, it becomes more important at lower internal energies and often dominates the fragmentation of metastable ionized amines.

Pseudo- $\alpha$ -cleavage is most important for ionized primary amines, though the corresponding radical-cations derived from secondary amines show the reaction to a reduced extent; but ionized tertiary amines fragment by  $\alpha$ -cleavage without rearrangement<sup>93</sup>. This effect is clearly seen in the relative intensities of the appropriate peaks in the LETS spectra of *n*-octylamine [ $m/z$  44 (pseudo- $\alpha$ -cleavage), 100%;  $m/z$  30 ( $\alpha$ -cleavage), 45%], methyl-*n*-octylamine [ $m/z$  58 (pseudo- $\alpha$ -cleavage), 8%;  $m/z$  44 ( $\alpha$ -cleavage), 100%] and dimethyl-*n*-octylamine [ $m/z$  72 (pseudo- $\alpha$ -cleavage), *ca* 1%;  $m/z$  58 ( $\alpha$ -cleavage), 100%] (Figure 2)<sup>112</sup>. The suppression of pseudo- $\alpha$ -cleavage by *N*-alkylation is consistent with the efficacy of hydrogen atom abstraction, which decreases markedly on progressing from  $NH_2^{+\bullet}$ , through  $NHCH_3^{+\bullet}$  to  $N(CH_3)_2^{+\bullet}$ <sup>44</sup>.

*b. Alkene or alkenyl radical elimination.* Other processes involving rearrangement also occur for ionized amines, especially at low internal energies, including elimination of an alkene or an alkenyl radical. The first of these reactions corresponds to bond cleavage accompanied by a single hydrogen transfer (SHT). In contrast, two hydrogen atoms must be transferred when  $C_nH_{2n-1}^\bullet$  is lost via double hydrogen transfer (DHT). These two processes may well be related, at least in some cases, since the second hydrogen transfer needed to permit  $C_nH_{2n-1}^\bullet$  loss could occur in an intermediate in which SHT has already taken place en route to  $C_nH_{2n}$  expulsion.

The most important example of alkene elimination is found for ionized 1-pentylamine, for which propene loss is the dominant fragmentation of metastable ions. However, this channel is not of general importance: metastable ionized 1-butylamine eliminates a much smaller proportion (15%) of ethylene and higher homologues of metastable ionized *n*-pentylamine rarely expel alkenes to any appreciable extent<sup>44</sup>. Nevertheless,  $[M - C_nH_{2n}]^{+\bullet}$  ions do appear in LETS spectra of long-chain primary alkylamines (e.g. at  $m/z$  31, 45, 59, 73, 87 and 101 for 1-octylamine, Figure 2)<sup>113</sup>.

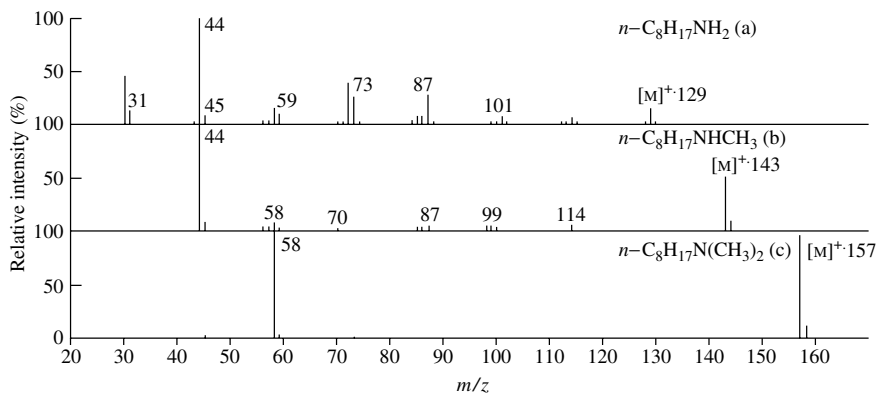
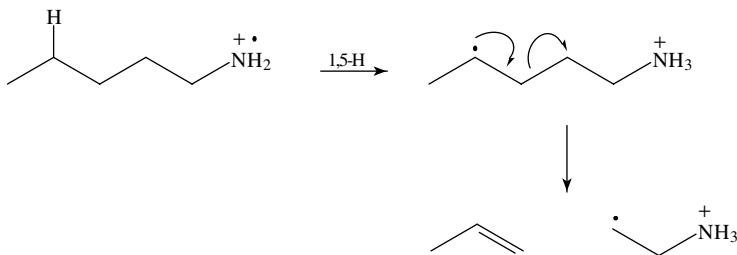


FIGURE 2. LETS spectra of (a) 1-octylamine, (b) *N*-methyl-1-octylamine and (c) *N*-dimethyl-1-octylamine. Reproduced by permission of J. Wiley & Sons from R. D. Bowen and A. Maccoll, *Org. Mass Spectrom.*, **20**, 331 (1985)

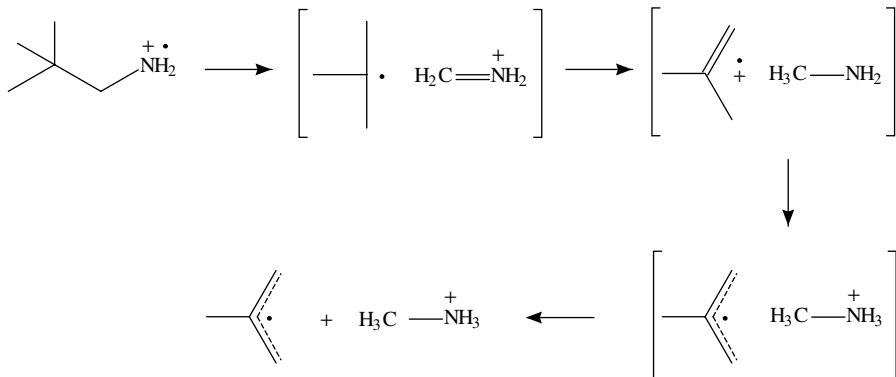
Although it may superficially appear logical to assume that the structure of the  $[M - C_nH_{2n}]^+$  ions correspond to smaller ionized amines (e.g.  $CH_3CH_2NH_2^{+\bullet}$  from  $CH_3CH_2CH_2CH_2CH_2NH_2^{+\bullet}$ ), this possibility seems unlikely from mechanistic and energetic considerations<sup>44</sup>. Production of a DI, which might be of comparable or lower energy (e.g.  $\bullet CH_2CH_2NH_3^+$  or  $CH_3CH^+NH_3$ ), appears a more attractive option (e.g. Scheme 10). This channel for alkene loss by  $\sigma$ -cleavage of a  $\gamma$ - or  $\delta$ -DI is a vindication of the suggestion that the fragmentation of ionized amines might proceed via intramolecular hydrogen abstraction from the hydrocarbon chain by the amino function<sup>114</sup>.



SCHEME 10

DHT reactions often are preferentially associated with branched alkyl chains. Thus, the base peak in the LEIT spectrum of neopentylamine is  $[M - C_4H_9]^+$  arising by  $\alpha$ -cleavage, but a sizeable  $[M - C_4H_7]^+$  signal (25% RI) corresponding to formation of  $[CH_3NH_3^+]$  is also present<sup>88</sup>. Furthermore, metastable ionized neopentylamine expels more  $C_4H_7^{\bullet}$  (75%) than  $C_4H_9^{\bullet}$  (25%)<sup>44,88,115</sup>. However, DHT is suppressed by N-methylation: the ions at  $m/z$  46 and 60 [ $(CH_3)_2NH_2^+$  and  $(CH_3)_3NH^+$ , respectively] in the spectra of *N*-methylneopentylamine and *N*-dimethylneopentylamine are of negligible importance<sup>88</sup>. Moreover, even at extremely long lifetimes, metastable  $(CH_3)_3CCH_2NHCH_3^{+\bullet}$  eliminates only a very minor proportion (8%) of  $C_4H_7^{\bullet}$ <sup>44,115</sup>.

The precise mechanism of these interesting DHT processes proved controversial, but DIs and, perhaps, INCs are probably involved. An early explanation of DHT in ionized neopentylamine suggested that it proceeded via INCs comprising  $[C_4H_9^{\bullet}$  and  $CH_2=NH_2^+]$ ,  $[C_4H_8^{+\bullet}$  and  $CH_3NH_2]$  and  $[C_4H_7^{\bullet}$  and  $CH_3NH_3^+]$  (Scheme 11)<sup>44</sup>. This suggestion was consistent with labelling experiments, which showed that the hydrogen

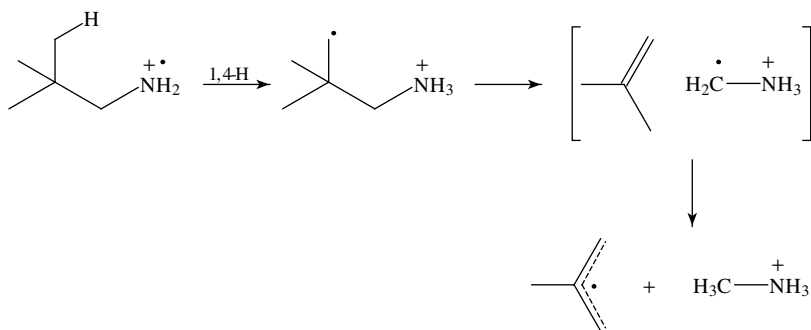


SCHEME 11

5. The chemistry of ionized, protonated and cationated amines in the gas phase 225

atoms of the  $\alpha$ -methylene group were always retained in the ionic product. Thus,  $(\text{CH}_3)_3\text{CCD}_2\text{NH}_2^{+\bullet}$  loses  $\text{C}_4\text{H}_7^\bullet$  [presumably the 2-methylallyl radical], with formation of  $\text{CHD}_2\text{NH}_3^+$ . Support for this mechanism was adduced from the effects of progressive methylation on nitrogen on the relative abundance of ions formed by DHT and  $\alpha$ -cleavage of ionized neopentylamines, the former process being sufficiently favoured energetically to dominate the latter only in the case of  $(\text{CH}_3)_3\text{CCH}_2\text{NH}_2^{+\bullet}$ . Moreover, a similar energetic analysis of ionized isobutyl alcohol, the derived methyl ether and the analogous amine had previously concluded that DHT is circumvented for  $(\text{CH}_3)_2\text{CHNH}_2^{+\bullet}$  as the corresponding INC,  $[(\text{CH}_3)_2\text{CH}^\bullet\text{CH}_2=\text{NH}_2^+]$  is inaccessible at low internal energies because it was insufficiently stabilized relative to the separated products<sup>116</sup>.

However, a later analysis<sup>115</sup> disputed this conclusion and proposed instead that DHT in ionized neopentylamine proceeds via the DI,  $(\text{CH}_3)_2(\text{CH}_2^\bullet)\text{CCH}_2\text{NH}_3^+$ , which then undergoes bond fission to the INC,  $[(\text{CH}_3)_2\text{C}=\text{CH}_2^\bullet\text{CH}_2\text{NH}_3^+]$ , containing an  $\alpha$ -DI. Subsequent hydrogen transfer then leads to  $\text{CH}_2=(\text{CH}_3)\text{C}-\text{CH}_2^\bullet$  and  $\text{CH}_3\text{NH}_3^+$ , possibly via the INC,  $[\text{CH}_2=(\text{CH}_3)\text{C}-\text{CH}_2^\bullet\text{CH}_3\text{NH}_3^+]$  (Scheme 12). This mechanism also accounts for the occurrence of  $\text{C}_2\text{H}_5^\bullet$  loss from metastable  $(\text{CH}_3)_2\text{CHCH}_2\text{NH}_2^{+\bullet}$ , which occurs after skeletal rearrangement of the  $\gamma$ -DI  $\text{CH}_3(\text{CH}_2^\bullet)\text{CHCH}_2\text{NH}_3^+$  (Scheme 13).



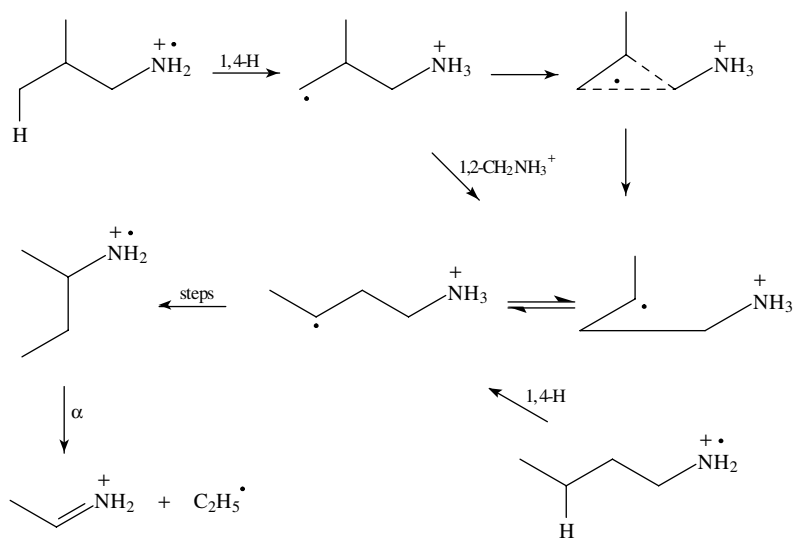
SCHEME 12

This second alternative is more consistent with the general behaviour of ionized alkylamines, many of which isomerize rapidly to DIs. Thus, extensive exchange of the hydrogen atoms attached to nitrogen with those of the methyl groups precedes butenyl radical loss from ionized labelled neopentylamines<sup>116</sup>.

Most hydrogen transfers and other isomerizations of ionized alkylamines generally occur via DIs rather than INCs<sup>82</sup>. However, the participation of an INC in DHT remains an attractive proposition, even if it occurs after the first hydrogen transfer has taken place to give a DI. DHT involving an intact N-alkyl chain and eventual C–N cleavage may also occur via isomerization to a  $\beta$ -DI, with production of an ammonium (or alkylammonium) cation<sup>42</sup>.

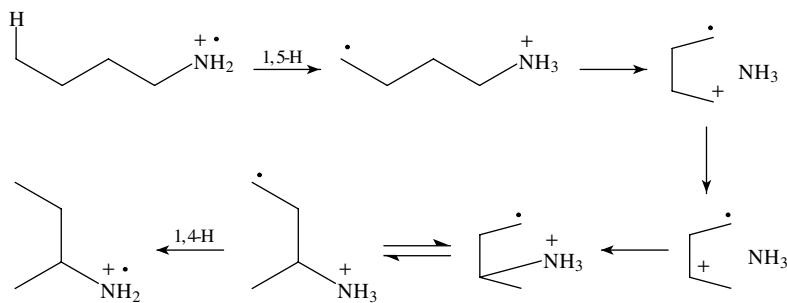
As with pseudo- $\alpha$ -cleavage, the suppression of SHT and DHT by N-alkylation reflects the reduced tendency of ionized secondary and especially tertiary amines to undergo the initial hydrogen transfer steps to form DIs<sup>44</sup>. This common trend also supports the contention that ionized amines generally isomerize via DIs.

*c. Other reactions.* Certain routes for alkyl radical expulsion which are not  $\alpha$ -cleavages cannot readily be interpreted as pseudo- $\alpha$ -cleavages. Thus, ionized 1-butylamine loses



SCHEME 13

$\text{C}_2\text{H}_5^\bullet$ . The chain length is insufficient to permit the hydrogen transfers needed for pseudo- $\alpha$ -cleavage. Low-energy multiphoton dissociation-ionization studies<sup>117</sup> show that ionized 1-butylamine has predominantly isomerized via a  $\delta$ -DI to ionized 2-butylamine, which may then fragment via  $\alpha$ -cleavage. One route for this rearrangement involves complexes containing  $\text{C}_4\text{H}_8^+\bullet$  species (Scheme 14). A mechanistically attractive alternative is isomerization of the appropriate  $\gamma$ -DI via 1,2- $\text{CH}_2\text{-NH}_3^+$  shifts (see Schemes 7 and 13).



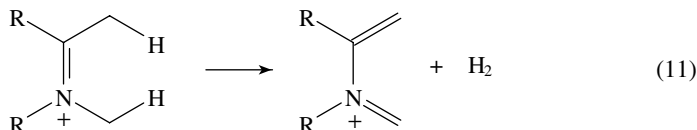
SCHEME 14

#### 4. Reactions of immonium ions derived from ionized alkylamines

The reactions of  $\text{C}_n\text{H}_{2n+2}\text{N}^+$  immonium ions generated by dissociative ionization of alkylamines have been reviewed recently<sup>118</sup>, so only a brief summary is presented. The principal reaction is loss of an alkene,  $\text{C}_m\text{H}_{2m}$ , with formation of a smaller immonium ion<sup>3,68</sup>. Some lower members of the homologous series ( $n = 2-5$ ) lose an alkyne,  $\text{C}_m\text{H}_{2m-2}$ , to give a protonated alkylamine<sup>119-121</sup>, but this fragmentation is rapidly superseded by alkene elimination for larger  $\text{C}_n\text{H}_{2n+2}\text{N}^+$  species.

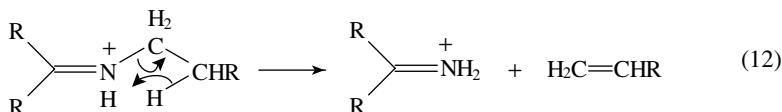
5. The chemistry of ionized, protonated and cationated amines in the gas phase 227

Loss of molecular hydrogen is also important for certain immonium ions with at least one N-methyl group and a hydrocarbon chain containing one hydrogen atom less than a complete alkyl group attached to the nitrogen atom. The archetypal example is  $\text{CH}_3\text{CH}=\text{NH}^+\text{CH}_3$ . This reaction, which occurs both in fast fragmentations in the ion source and in the dissociation of metastable ions, is found by  $^2\text{H}$ -labelling to occur with a 1,4-regioselectivity. Thus,  $\text{CH}_3\text{CH}=\text{ND}^+\text{CH}_3$  loses  $\text{H}_2$ , but  $\text{CH}_3\text{CH}=\text{NH}^+\text{CD}_3$  eliminates HD;  $\text{CD}_3\text{CH}=\text{NH}^+\text{CH}_3$  loses both  $\text{H}_2$  and HD, after exchange of the protium and deuterium atoms in the  $\text{C}_2\text{HD}_3$  entity has taken place<sup>122</sup>. This unusual fragmentation, which is rationalized by equation 11, occurs with a large and relatively specific kinetic energy release. Furthermore, the overall isotope effects on the rate of  $\text{H}_2$  and HD loss from labelled analogues in which either N- $\text{CD}_2$ -D or C- $\text{CD}_2$ -D bonds must be broken are similar (*ca* 1.7:1)<sup>122</sup>, thus suggesting that these two C-H bonds are broken in concert in the transition state<sup>118</sup>. Both the regioselectivity and the association of a large KE release with a 1,4-elimination are extremely unusual, if not unique, for loss of molecular hydrogen from isolated organic ions. Part of the reason for this behaviour may lie in the stability of the resultant unsaturated immonium ion (e.g.  $\text{CH}_2=\text{CHN}^+\text{H}=\text{CH}_2$ , formed by 1,4- $\text{H}_2$  loss from  $\text{CH}_3\text{CH}=\text{NH}^+\text{CH}_3$ ). In contrast, the smallest immonium ion,  $\text{CH}_2=\text{NH}_2^+$ , is distinct among immonium ions in losing molecular hydrogen with a large KE release via a route involving 1,2-elimination<sup>123</sup>. It is this route, rather than 1,4-elimination, which is usual for most small organic ions. In any event, the observation of significant  $\text{C}_n\text{H}_{2n}\text{N}^+$  ions is often analytically useful because  $\text{H}_2$  elimination is associated with the  $\text{RCH}_2\text{CH}=\text{NH}^+\text{CH}_3$ ,  $\text{CH}_3\text{C}(\text{R})=\text{NH}^+\text{CH}_3$ ,  $\text{RCH}_2\text{CH}=\text{N}^+(\text{CH}_3)_2$ ,  $\text{CH}_3\text{C}(\text{R})=\text{NH}^+(\text{CH}_3)_2$  and similar structures.



There are at least six different routes for alkene elimination from  $\text{C}_n\text{H}_{2n+2}\text{N}^+$  species. However, the two most important involve loss of an alkene derived from an intact N-alkyl substituent.

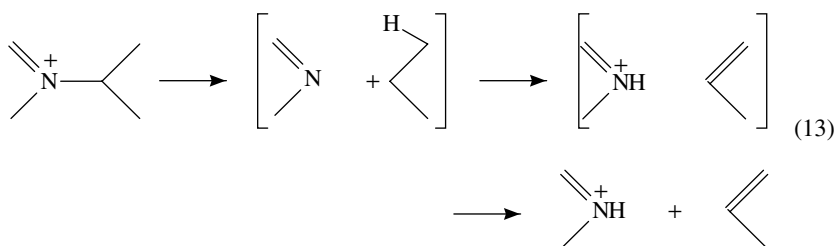
The first route results in expulsion of  $\text{C}_m\text{H}_{2m}$  with associated hydrogen transfer from the N-R group ( $\text{R} = \text{C}_n\text{H}_{2m+1}$ ) to nitrogen. Typically, the alkene is derived from the largest alkyl substituent. Thus, for example,  $\text{CH}_2=\text{N}^+(\text{C}_m\text{H}_{2m+1})_2$  eliminates  $\text{C}_m\text{H}_{2m}$  with formation of  $\text{CH}_2=\text{NH}^+\text{C}_m\text{H}_{2m+1}$ ; similarly,  $\text{CH}_2=\text{NH}^+\text{C}_m\text{H}_{2m+1}$  loses  $\text{C}_m\text{H}_{2m}$  to produce  $\text{CH}_2=\text{NH}_2^+$ . This fragmentation has traditionally been rationalized as a four-centre reaction (equation 12) despite the fact that it has been known for many years that specific  $\beta$ -hydrogen transfer does not always occur, in either fast<sup>124</sup> or slow<sup>125</sup> dissociations of this general class<sup>126</sup>.



More recent work<sup>93,127-129</sup> has shown that  $\beta$ -hydrogen transfer takes place only if the cation corresponding to the N-R substituent is stable. Thus,  $\text{CH}_2=\text{N}^+(\text{CH}_3)\text{CH}(\text{CD}_3)_2$  and related species expel  $\text{C}_3\text{HD}_5$ , via specific D-transfer<sup>128,129</sup>, because isopropyl cation is stable with respect to a 1,2-H shift. In contrast, if the associated cation readily rearranges to a more stable isomer, there is actually a discrimination against

$\beta$ -hydrogen transfer, as is shown by the loss of predominantly (79%)  $C_3H_4D_2$  from  $CH_2=N^+(CH_3)CH_2CD_2CH_3$ <sup>93,128,129</sup>, which would be expected to expel only  $C_3H_5D$  via the traditional mechanism. This contrasting regioselectivity is intelligible if the fragmentation is INC-mediated<sup>118,127-129</sup>. Furthermore, this mechanism also explains why the dissociation of immonium ions by this route is accompanied by only a moderate KE release ( $T_{1/2}$ , the KE release estimated from the width at half-height of the corresponding Gaussian metastable peak, is typically *ca* 2–3  $\text{kJ mol}^{-1}$ ).

When stretching, the N–C bond leads to a stable carbocation, a unidirectional hydrogen transfer to nitrogen occurs from one of the original  $\beta$ -carbon atoms, without rearrangement of the developing cation. Consequently, the loss of  $C_3HD_5$  from  $CH_2=N^+(CH_3)CH(CD_3)_2$  and homologous immonium ions is explained (equation 13)<sup>128,129</sup>.

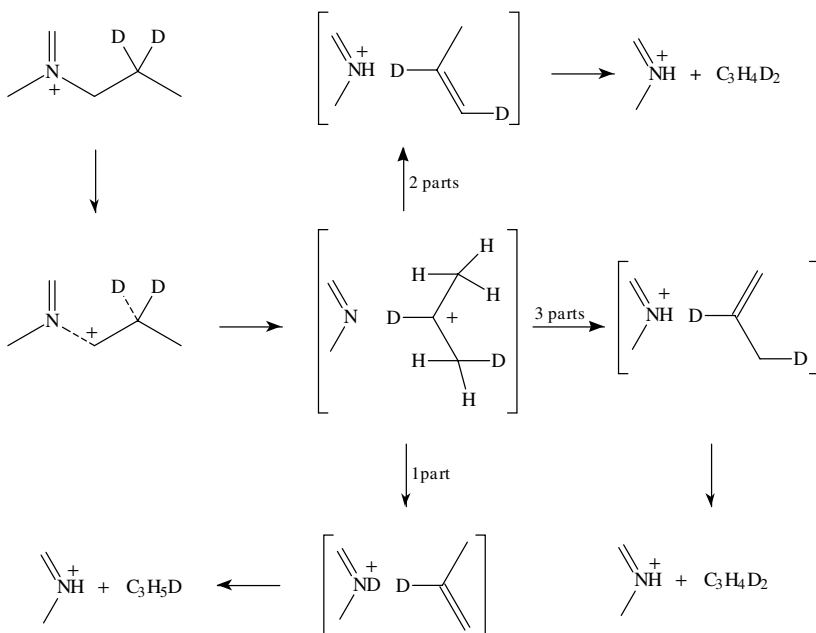


On the other hand, when the initial bond elongation would lead to an unstable carbocation such as a primary carbonium ion, isomerization of the developing cation occurs, via a 1,2-H shift, with formation of an INC containing a rearranged carbocation. The positive charge in this isomerized cation generally is located on the carbon atom that was in the  $\beta$ -position in the initial N–R group. The subsequent hydrogen transfer to nitrogen occurs from a carbon atom next to that carrying the formal cationic site. These carbon atoms are those which were in the  $\alpha$ - and  $\gamma$ -position in the original N–R substituent. Therefore, the strong preference for apparent  $\alpha$ - and  $\gamma$ -hydrogen transfer in  $CH_2=N^+(CH_3)CD_2CH_2CH_3$ ,  $CH_2=N^+(CH_3)CH_2CD_2CH_3$  and  $CH_2=N^+(CH_3)CH_2CH_2CD_3$  is explained<sup>128,129</sup>. The minor residual contribution from apparent  $\beta$ -hydrogen transfer reflects the migration of one hydrogen atom from the  $\beta$ - to the  $\alpha$ -carbon during the isomerization step. Thus,  $CH_2=N^+(CH_3)CH_2CD_2CH_3$  rearranges to  $CH_2=N^+(CH_3)CH(CH_2D)CH_3$ , which undergoes H- and D-transfer in the ratio 5:1, to a first approximation (Scheme 15).

Further important aspects of this mechanism include the occurrence of a small isotope effect (*ca* 1.08:1, overall) favouring H-migration in the developing  $CH_2CH_2CH_3$  entity of  $CH_2=N^+(CH_2CH_2CH_3)CH_2CD_2CH_3$  over the corresponding D-migration in the putative  $CH_2CD_2CH_3$  entity<sup>128,129</sup>. This finding indicates that the 1,2-H/D shift is beginning to occur as the appropriate N–C bond is stretched on the way to the transition state for the reaction, thus circumventing formation of an unstable *n*-propyl cation. Exactly parallel effects were found in alkene loss from protonated *n*-propylamines, thus underlining the generic nature of this type of INC-mediated process<sup>130</sup>. Moreover, the minor deviation of the ratios of  $\alpha$ -,  $\beta$ - and  $\gamma$ -hydrogen transfer from those (2:1:3) expected from the first-order approximation was explained by invoking a small preference factor (*ca* 1.13:1) favouring transfer from the original  $\alpha$ -carbon<sup>128</sup>. This preference factor arises because the isopropyl cation formed by isomerization of the *n*-propyl entity does not enjoy full rotational freedom; consequently, hydrogen transfer from the methyl group derived from

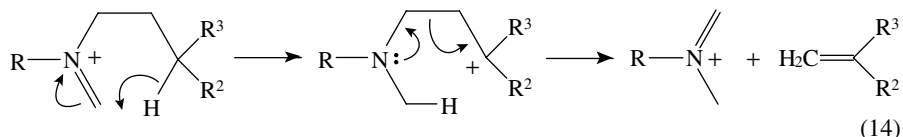


5. The chemistry of ionized, protonated and cationated amines in the gas phase 229



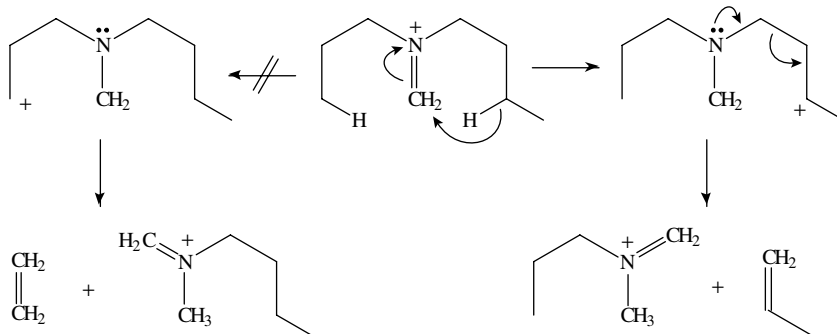
the  $\alpha$ -methylene group is slightly favoured because the nitrogen atom is initially closer to this methyl group than the more distant  $\gamma$ -methyl group.

The second general fragmentation of immonium ions results in loss of an alkene containing fewer carbon atoms than the N-R substituent. Usually,  $C_{m-1}H_{2m-2}$  is lost from  $CH_2=N^+(C_mH_{2m+1})_2$  or  $CH_2=NH^+C_mH_{2m+1}$ . This route occurs less frequently than the alternative involving  $C_mH_{2m}$  elimination, but it remains a common reaction<sup>3,118</sup>. This second fragmentation differs substantially from the first in showing a pronounced regioselectivity (>99%) involving 1,5-hydrogen transfer<sup>93,128,129</sup>. Thus,  $CH_2=N^+(CH_3)CH_2CH_2CD_2CH_2CH_3$  is unique among  $^2H$ -labelled analogues of  $CH_2=N^+(CH_3)CH_2CH_2CH_2CH_2CH_3$  in undergoing  $C_4H_7D$  loss via 1,5-D transfer<sup>118</sup>. These data are consistent with fragmentation via a pericyclic process isoelectronic with the retro 'ene' reaction<sup>131</sup>.



Several sources of information indicate that this fragmentation is better described as a two-step process (equation 14), in which the 1,5-H shift is largely or wholly completed before C-C cleavage occurs. Thus, both the KE release accompanying this dissociation and the extent to which it competes with the alternative fragmentation in which  $C_mH_{2m}$  is lost are strongly influenced by the degree of substitution at the  $\gamma$ -carbon atom. As this carbon atom becomes more heavily substituted, the KE release decreases sharply and  $C_{m-1}H_{2m-2}$  elimination competes more effectively with  $C_mH_{2m}$  loss<sup>127</sup>. These trends are

sensible if the mechanism involves a substantial build-up of positive charge on the  $\gamma$ -carbon atom during the course of the reaction. Furthermore, competition experiments in alkene elimination from  $\text{CH}_2=\text{N}^+\text{R}^1\text{R}^2$  ions, in which the 1,5-H shift may occur from a  $\gamma$ -carbon atom in either of the two N-alkyl substituents, show that the hydrogen is transferred essentially exclusively (>99% selectivity) from the more heavily substituted site<sup>132</sup>. Thus,  $\text{CH}_2=\text{N}^+(\text{CH}_2\text{CH}_2\text{CH}_3)\text{CH}_2\text{CH}_2\text{CH}_2\text{CH}_3$  expels  $\text{C}_3\text{H}_6$  with a large KE release ( $T_{1/2} = 48 \text{ kJ mol}^{-1}$ ) from the *n*-butyl group, rather than  $\text{C}_2\text{H}_4$  (which would be expected to have a very large KE release) from the *n*-propyl substituent (Scheme 16).



SCHEME 16

The large KE releases that typically accompany alkene loss via this channel are further evidence that the reaction involves an intermediate or transition state of substantially higher energy than the combined enthalpy of the products. Loss of  $\text{C}_2\text{H}_4$  usually gives rise to a very broad dish-shaped metastable peak ( $T_{1/2}$  ca  $70 \text{ kJ mol}^{-1}$ ); elimination of  $\text{C}_3\text{H}_6$  normally produces a similar peak when it may be formulated to proceed via a primary cation, but a rather less broad, flat-topped peak ( $T_{1/2}$  ca  $50 \text{ kJ mol}^{-1}$ ) when it can occur via a secondary cation. The peak for expulsion of  $\text{C}_4\text{H}_8$  via a tertiary cation remains broad, but generally it is not flat-topped, and the KE release is reduced still further ( $T_{1/2}$  ca  $25 \text{ kJ mol}^{-1}$ )<sup>127,132</sup>. Typical examples of the various peak shapes for alkene loss from immonium ions are shown in Figure 3.

In addition to the influence of the level of substitution at the  $\gamma$ -carbon atom, progressive homologation also diminishes the KE release. Thus, the  $T_{1/2}$  values for  $\text{C}_{m-1}\text{H}_{2m-2}$  loss from  $\text{CH}_2=\text{N}^+(\text{CH}_3)\text{CH}_2(\text{CH}_2)_{m-2}\text{CH}_3$  ions decrease sharply from  $70 \text{ kJ mol}^{-1}$  for  $\text{CH}_2=\text{N}^+(\text{CH}_3)\text{CH}_2\text{CH}_2\text{CH}_3$  ( $m = 3$ , primary cation at the  $\gamma$ -carbon atom in the intermediate or transition state), to  $45 \text{ kJ mol}^{-1}$  for  $\text{CH}_2=\text{N}^+(\text{CH}_3)\text{CH}_2\text{CH}_2\text{CH}_2\text{CH}_3$  ( $m = 4$ , secondary cation at the  $\gamma$ -carbon atom)<sup>127</sup>. However, further homologation results in a more gradual reduction ( $T_{1/2} = 33, 19, 11, 9.6, 8.9$  and  $7.0 \text{ kJ mol}^{-1}$  for  $m = 5, 6, 8, 10, 14$  and  $18$ , respectively) because the substitution level at the  $\gamma$ -carbon atom remains constant<sup>133</sup>. This progressive decline, which is accompanied by a gradual change in peak shape from flat-topped to approximately Gaussian profile, has been interpreted in terms of a 'degrees of freedom' effect<sup>133</sup>. As the eliminated alkene increases in size, there are more ways of distributing energy in the vibrational and rotational modes, so the partitioning of reverse critical energy as translational (i.e. KE release) is diminished. Moreover, the estimated reverse critical energy for the reaction declines from  $173$  ( $m = 3$ ) to  $70 \text{ kJ mol}^{-1}$  ( $m = 18$ ) as the homologous series of ions is ascended; consequently, the total amount of energy, some of which may be partitioned as translation, also decreases.

## 5. The chemistry of ionized, protonated and cationated amines in the gas phase 231

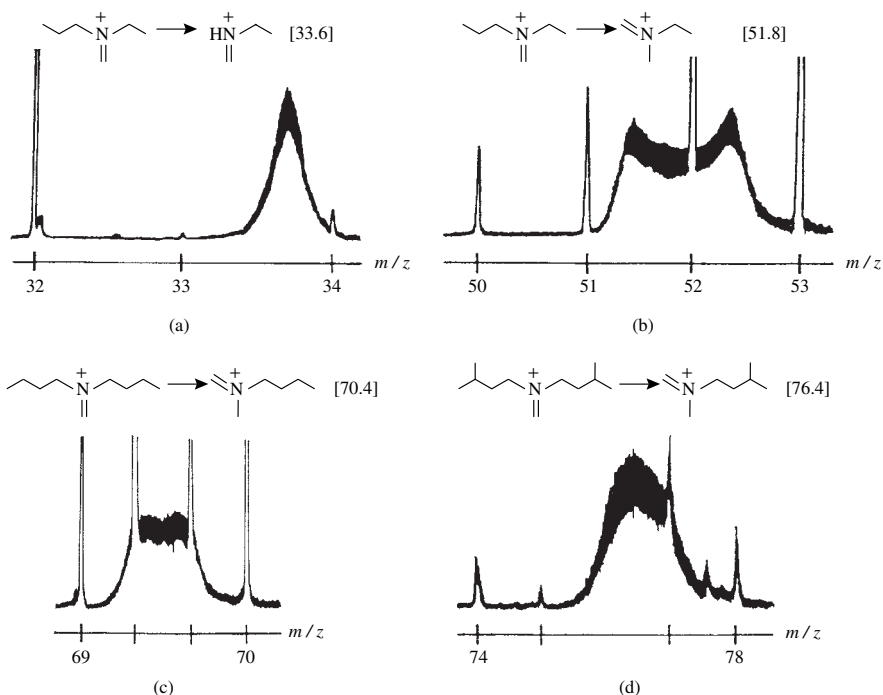


FIGURE 3. Metastable peaks for loss of (a)  $C_3H_6$  from  $CH_2=N^+(CH_2CH_3)CH_2CH_2CH_3$ , (b)  $C_2H_4$  from  $CH_2=N^+(CH_2CH_3)CH_2CH_2CH_3$ , (c)  $C_3H_6$  from  $CH_2=N^+(CH_2CH_2CH_2CH_3)_2$  and (d)  $C_4H_8$  from  $CH_2=N^+[CH_2CH_2CH(CH_3)_2]_2$ . Reproduced by permission of The Royal Society of Chemistry from R. D. Bowen, *J. Chem. Soc., Perkin Trans. 2*, 409 (1982)

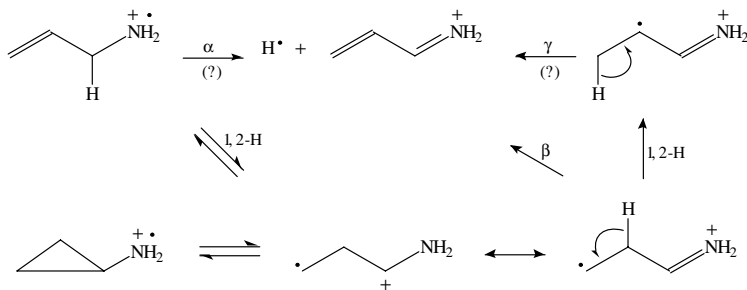
### C. Reactions of Ionized Unsaturated and Cyclic Amines

In contrast to ionized alkenols, which have been extensively investigated<sup>133</sup>, radical-cations derived from alkenylamines have received much less detailed attention. This omission, which partly reflects the relative difficulty in synthesizing unsaturated amines, particularly if incorporation of  $^2H$ - or  $^{13}C$ -labels is required, is unfortunate because the chemistry of ionized alkenols<sup>134</sup> and the derived ionized ethers, which have been studied more recently<sup>135-138</sup>, is rich and interesting.

The limited data which are available suggest that  $\alpha$ -cleavage of the saturated N-alkyl substituent(s) continues to dominate the fragmentations of ionized alkenylamines. Thus,  $CH_2=CHCH_2NHCH_2CH_3$  and  $CH_2=CHCH_2NHCH_2CH_2CH_3$  serve as precursors for the unsaturated immonium ion  $CH_2=CHCH_2NH^+=CH_2$ , via ionization and elimination of  $CH_3^\bullet$  and  $C_2H_5^\bullet$ , respectively<sup>139</sup>. At low internal energies, this immonium ion eliminates HCN, via DHT, and a minor amount of  $C_3H_6$ , via SHT, in sharp contrast to its saturated analogue,  $CH_3CH_2CH_2NH^+=CH_2$ , which loses  $C_2H_4$  and  $C_3H_6$ . Thus, the presence of the double bond appears to modify the chemistry in the ionized amine ( $\alpha$ -cleavage of the double bond is obviously difficult) and the derived immonium ion (the usual channels for alkene elimination are disrupted because the allyl group has quite different properties from the *n*-propyl substituent). The loss of  $C_3H_6$  from both  $CH_3CH_2CH_2NH^+=CH_2$  and  $CH_2=CHCH_2NH^+=CH_2$  is deceptive: these fragmentations are not analogous to one

other. The former entails hydrogen transfer from the largest N-alkyl substituent to the nitrogen atom; the latter involves hydrogen transfer in a different direction, from the isolated methylene group of  $\text{CH}_2=\text{CHCH}_2\text{NH}^+=\text{CH}_2$  to the terminal methylene group of the allyl substituent. This process presumably proceeds via a 1,5-H shift, but this deduction has not yet been confirmed by labelling experiments. The analogous process to  $\text{C}_3\text{H}_6$  expulsion from  $\text{CH}_3\text{CH}_2\text{CH}_2\text{NH}^+=\text{CH}_2$  would be  $\text{C}_3\text{H}_4$  loss from  $\text{CH}_2=\text{CHCH}_2\text{NH}^+=\text{CH}_2$ ; however, this reaction requires formal proton abstraction from an incipient allyl cation, which would give rise to an unfavourable geometry of allene in which the  $p$ -orbitals of the developing new  $\pi$ -bond are orthogonal<sup>140,141</sup>.

Many intriguing possibilities exist for isomerization of ionized alkenylamines to DIs. A detailed study of the chemistry of metastable ionized allylamine and cyclopropylamine showed that both these species rearrange readily to the DI  $\cdot\text{CH}_2\text{CH}_2\text{CH}=\text{NH}_2^+$ , which is accessible via a 1,2-H shift or ring opening by C–C cleavage, respectively (Scheme 17)<sup>142</sup>. Previous electron spin resonance (ESR) studies at 77 K reveal that this DI is formed in condensed phases from both ionized allylamine and cyclopropylamine<sup>143</sup>. In the gas phase, loss of a hydrogen atom is the major fragmentation; this process was shown by CID experiments to give the conjugated immonium ion,  $\text{CH}_2=\text{CHCH}=\text{NH}_2^+$ . Thermochemical data were used to construct a potential energy profile (PEP<sup>144</sup>) for the system, which showed that ionized allylamine and cyclopropylamine had comparable energies, that were estimated to be some  $80 \text{ kJ mol}^{-1}$  above that of  $\cdot\text{CH}_2\text{CH}_2\text{CH}=\text{NH}_2^+$ . Loss of a hydrogen atom was interpreted as  $\beta$ -cleavage of this DI.



SCHEME 17

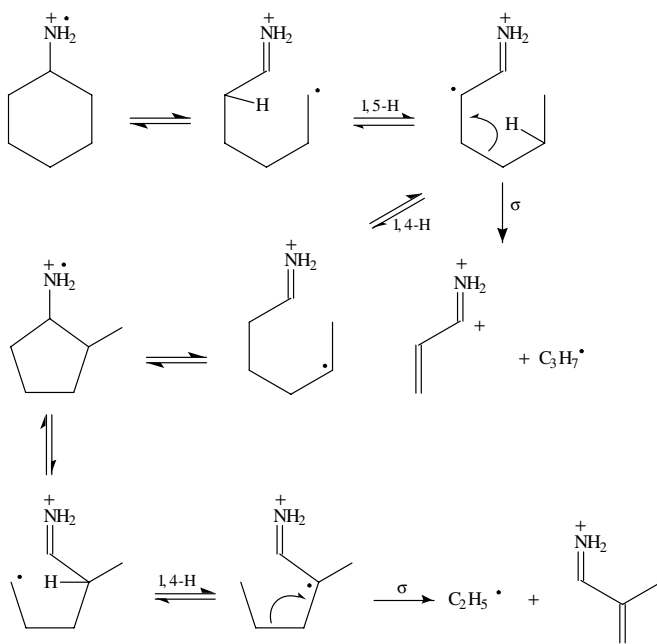
However, this explanation contrasts with conclusions drawn from the general mechanism of alkyl radical loss from the analogous ionized alkenyl methyl ethers, in which  $\beta$ -cleavage was found to involve an appreciable additional reverse critical energy<sup>138</sup>. Thus, CID studies show that  $\text{CH}_3\text{CH}=(\text{CH}_3)\text{CCH}_2\text{OCH}_3^+$  eliminates the terminal methyl group via two consecutive 1,2-H shifts and  $\gamma$ -cleavage of the resultant ionized enol ether,  $\text{CH}_3\text{CH}(\text{CH}_3)\text{CH}=\text{CHOCH}_3^+$ , instead of undergoing  $\beta$ -cleavage of the initial DI,  $\text{CH}_3\text{CH}^*(\text{CH}_3)\text{CH}_2\text{CH}^+\text{OCH}_3$  ( $\leftrightarrow \text{CH}_3\text{CH}^*(\text{CH}_3)\text{CH}_2\text{CH}=\text{O}^+\text{CH}_3$ ). Parallel effects were previously reported for alkyl radical losses from DIs isomeric with ionized carboxylic acids [e.g.  $\text{CH}_3\text{CH}^*(\text{CH}_3)\text{CH}_2\text{C}^+(\text{OH})_2$ ]<sup>97,98</sup>. The barrier towards the apparently favourable  $\beta$ -cleavage is intelligible in terms of frontier orbital considerations and reflects the preference for radicals to add to the  $\alpha$ - or  $\gamma$ -position of conjugated cationic systems<sup>100,101</sup>.

In the case of the  $\text{C}_3\text{H}_5\text{NH}_2^+$  species,  $\beta$ -cleavage of  $\cdot\text{CH}_2\text{CH}_2\text{CH}=\text{NH}_2^+$  gives the same product ion as  $\alpha$ -fission of  $\text{CH}_2=\text{CHCH}_2\text{NH}_2^+$  or  $\gamma$ -cleavage of  $\text{CH}_3\text{CH}=\text{CHNH}_2^+$ , so these possibilities cannot be distinguished by CID experiments. Nevertheless, depending on size of the barrier towards  $\beta$ -fission, it may be more consistent

## 5. The chemistry of ionized, protonated and cationated amines in the gas phase 233

to regard hydrogen atom elimination from  $C_3H_5NH_2^{+\bullet}$  as an  $\alpha$ - or  $\gamma$ -cleavage, even if the dissociating species have higher energies than  $\bullet CH_2CH_2CH=NH_2^+$ .

Larger ionized cycloalkylamines show reactions involving DIs which represent extension of the chemistry of their acyclic counterparts. Thus, metastable ionized cyclohexylamine and ionized 2-methylcyclopentylamine undergo the same fragmentations, as is shown by the identical<sup>145</sup> mass-analysed ion kinetic energy (MIKE<sup>146,147</sup>) spectra of these species. This common behaviour was interpreted in terms of reciprocal hydrogen transfers involving DIs (Scheme 18)<sup>145</sup>. Note how the loss of both  $C_2H_5\bullet$  and  $C_3H_7\bullet$  (in the ratio 100:5) is again attributed to  $\gamma$ -cleavage of species (ionized enamines, in this system) accessible by reciprocal hydrogen transfers. In contrast, the isomeric ionized cyclopentylmethylamine displays a distinct MIKE spectrum because ring opening to give similar stabilized DIs is no longer possible.



SCHEME 18

## D. Reactions of Ionized Arylamines

It has long been known that the characteristic fragmentation associated with the  $ArNH_2^{+\bullet}$  entity is elimination of a neutral species having a mass of 27 a.m.u.<sup>2,3</sup>. Early results had also led mass spectroscopists to surmise that HNC, rather than the more stable tautomer, HCN, was eliminated. This conjecture was subsequently shown to be true by collision-induced dissociative ionization (CIDI) experiments, during which  $HNC^{+\bullet}$  is distinguished from  $HCN^{+\bullet}$ <sup>148</sup>. In this CIDI technique, the ionic fragment from dissociation of the parent ion in the field-free region of a mass spectrometer is removed by being retarded by an additional applied voltage<sup>148,149</sup>. The neutral fragment, which is not affected by this voltage, is then subjected to ionization and dissociation by collision with a target gas. The success of the CIDI experiments depends on the stability of HNC and

HNC (and the corresponding ionized species) in the gas phase which arises because the facile intermolecular hydrogen transfers that would allow HNC to tautomerize to HCN in condensed phases are not possible. Thus, HNC is distinguishable from HCN because they may be specifically transformed to  $\text{HNC}^{+\bullet}$  and  $\text{HCN}^{+\bullet}$ , respectively, and these  $[\text{H,C,N}]^{+\bullet}$  species dissociate in diagnostically different ways. Subsequent work, including high level MO calculations, indicates that both pairs of neutral and ionized isomers occupy energy wells; HCN is more stable than HNC (by *ca* 80  $\text{kJ mol}^{-1}$ ), but the order of stability is reversed for the corresponding radical-cations ( $\text{HNC}^{+\bullet}$  is *ca* 75  $\text{kJ mol}^{-1}$  more stable than  $\text{HCN}^{+\bullet}$ ). Large barriers (125–275  $\text{kJ mol}^{-1}$ ) exist towards interconversion of both neutral and ionized pairs by a 1,2-H shift<sup>150</sup>.

Similar experiments reveal that ionized N-heterocycles such as pyridines eliminate HCN, rather than HNC<sup>148</sup>. This distinction offers a potentially useful means of distinguishing between isomeric anilines and pyridines.

When ionized aminopyridines are considered, it is found that they resemble ionized anilines. Thus, all three isomers of  $\text{C}_5\text{NH}_4\text{NH}_2^{+\bullet}$  eliminate HNC; moreover, their distinct CID and CS spectra indicate that these three isomers of  $\text{C}_5\text{NH}_4\text{NH}_2^{+\bullet}$  do not interconvert before fragmenting<sup>151</sup>.

Some attention has been given to the structure of the  $\text{C}_5\text{H}_6^{+\bullet}$  radical-cation formed by HNC loss from  $\text{C}_6\text{H}_5\text{NH}_2^{+\bullet}$ . It had long been tacitly assumed that this species was ionized cyclopentadiene. The energetics and kinetics of this reaction have been investigated by photoionization, which indicates that the transition state lies *ca* 80  $\text{kJ mol}^{-1}$  above the threshold for production of  $\text{C}_5\text{H}_6^{+\bullet}$  and HCN<sup>152</sup>. Related studies on the pronounced dependence of the ionization energy for formation of  $\text{C}_5\text{H}_6^{+\bullet}$  with the source residence times gave a similar transition state energy, which was interpreted to reflect formation of the less favourable combination of products,  $\text{C}_5\text{H}_6^{+\bullet}$  and HNC, with little or no excess energy<sup>153</sup>. This view is consistent with the CIDI experiments<sup>148</sup>.

#### IV. PROTONATED AND ALKYL CATIONATED AMINES

##### A. Formation and Properties of Protonated and Alkyl Cationated Amines

Since most amines are basic, production of the conjugate acids by chemical ionization (CI)<sup>154,155</sup> under proton transfer conditions is normally facile. Conversely, ammonia, methylamine and other small amines are often used as CI reagent gases ( $\text{NH}_4^+$ ,  $\text{CH}_3\text{NH}_3^+$  and related alkylammonium ions are formed as reagent ions). Variation of the reagent ion allows the exothermicity of protonation to be altered, thus permitting control and selectivity in the ionization process. However, many substrates react by capturing the ammonium ion, instead of abstracting a proton from it. The  $[\text{M}+\text{NH}_4]^+$  and related adducts which result from this reagent ion capture are useful in analysing numerous classes of compounds.

In contrast to protonated primary, secondary and tertiary amines, tetraalkyl ammonium ions,  $\text{R}_4\text{N}^+$ , obviously cannot be produced by protonation of the parent amine. In principle, however, these species may be made by alkyl cationation of the amine. In practice, other ionization methods are usually employed to form the gaseous ions from the appropriate salts. Thus, fast atom bombardment (FAB)<sup>156,157</sup> of a solution of tetraalkylammonium bromides in a glycerol matrix is a convenient means of generating the free tetraalkylammonium ion in the gas phase. A modified procedure, in which an amine is dissolved in thioglycerol/2,2'-dithioethanol matrix saturated with oxalic acid, allows  $\text{RNH}_3^+$ ,  $\text{R}_2\text{NH}_2^+$  and  $\text{R}_3\text{NH}^+$  ions to be produced under closely similar conditions<sup>158</sup>.

The advent of methods for determining proton affinities by studying bimolecular reactions in the gas phase has provided a wide range of interesting thermochemical data.

## 5. The chemistry of ionized, protonated and cationated amines in the gas phase 235

Three main techniques have been developed. First, the pressure in the source of the mass spectrometer may be increased sufficiently to permit collisions between ions and neutral species to occur. Typically, a pulsed high-pressure source is used<sup>159</sup>. Secondly, ions may be prepared and allowed to react with neutral species in a stream of gas (the flowing afterglow, FA, method); since the ion(s) may be selected in such an apparatus, this method is known as the selected ion flow tube (SIFT) technique<sup>160</sup>. Thirdly, ions may be allowed to interact with neutrals in an ICR instrument; in this case, the pressure remains relatively low, but the ions are restrained in their cycloidal trajectories for a sufficiently long period to permit collisions to occur<sup>161</sup>. The first two methods permit true thermal equilibria to be established for proton transfer reactions. Consequently, by determining the temperature variation of the equilibrium constant for a bimolecular process<sup>162</sup>, it is possible to measure the enthalpy change ( $\Delta H$ ) for the reaction. A similar procedure is in principle possible for experiments in ICR instruments, but the pressure may be too low to allow either collisional thermalization of the reactants to precede reaction or a genuine equilibrium to be reached. However, the scope of ICR has been greatly increased by the introduction of Fourier Transform (FTICR) methods<sup>163,164</sup>.

These bimolecular reactions have provided accurate proton affinities (PAs) for many amines<sup>165,166</sup>. In addition, cation affinities are accessible, usually by combining the enthalpy of formation ( $\Delta H_f$ ) of cationic species derived from PA measurements with similar data for the bare cation. Thus, the knowledge that the PA of  $\text{CH}_3\text{NH}_2$  is  $896^{166} \text{ kJ mol}^{-1}$  sets  $\Delta H_f(\text{CH}_3\text{NH}_3^+) = 611 \text{ kJ mol}^{-1}$ . Since  $\Delta H_f(\text{CH}_3^+) = 1092 \text{ kJ mol}^{-1}$  and  $\Delta H_f(\text{NH}_3) = -46 \text{ kJ mol}^{-19}$ , the methyl cation affinity of  $\text{NH}_3$  may be deduced to be  $1092 - 46 - 611 = 435 \text{ kJ mol}^{-1}$ .

These PA data are of obvious interest in physical-organic chemistry. Not only do they define the inherent properties of the parent bases, thus permitting a more refined understanding of the correlation between molecular structure and basicity, but they also show how solvents affect the reactivity of amines.

Thus, the order of increasing basicity of the series of amines  $(\text{CH}_3)_n\text{NH}_{3-n}$  ( $n = 0-3$ ) was for many years considered anomalous: in solution,  $(\text{CH}_3)_2\text{NH}$  is slightly more basic than  $\text{CH}_3\text{NH}_2$ , which is more basic than  $(\text{CH}_3)_3\text{N}$ , which in turn is more basic than  $\text{NH}_3$  ( $\text{p}K_a = 10.77, 10.62, 9.80$  and  $9.27$ , respectively). Various explanations for this anomalous order were advanced, including variations in the degree of hybridization of the nitrogen atom with its level of substitution. However, the order in the gas phase is  $[(\text{CH}_3)_3\text{N} > (\text{CH}_3)_2\text{NH} > \text{CH}_3\text{NH}_2 > \text{NH}_3; \text{PAs} = 942, 923, 896$  and  $854 \text{ kJ mol}^{-1}$ , respectively], which would be expected on an intuitive basis if addition of each electron-rich methyl group enhanced the basicity of the amine by progressively stabilizing the protonated species. This true order of basicity is modified in solution because replacement of each N-H bond by an N-CH<sub>3</sub> group reduces the efficiency of solvation of the  $(\text{CH}_3)_n\text{NH}_{3-n}^+$  cation by hydrogen bonding of the solvent (typically  $\text{H}_2\text{O}$ ) to the polarized  $^+\text{N}-\text{H}$  entity. Another view of the same effect is that solvation of the  $(\text{CH}_3)_n\text{NH}_{3-n}^+$  cations is least effective for  $(\text{CH}_3)_3\text{NH}^+$  because this species causes the greatest disruption to the hydrogen bonding in solution. As a result, the apparent basicity of  $(\text{CH}_3)_n\text{NH}_{3-n}$  is systematically and progressively diminished below the true value as  $n$  increases because the resultant  $(\text{CH}_3)_n\text{NH}_{3-n}^+$  ions are less efficiently stabilized by solvation. Therefore, conflicting trends arising from inherent properties and solvent effects are responsible for the apparently anomalous order of basicity in solution.

Another fallacy to be refuted by PA data was the widespread belief that the low basicity of arylamines compared to alkylamines simply reflects delocalization of the lone pair of electrons on the nitrogen atom within the aromatic ring. Thus, the low basicity of aniline ( $\text{p}K_a = 4.58$ ) compared to ammonia ( $\text{p}K_a = 9.27$ ) is often attributed to such a conjugative

effect. However, in the gas phase, aniline is a stronger base than ammonia (PA = 876 and 854 kJ mol<sup>-1</sup>, respectively)<sup>166</sup>. Indeed, almost all monoalkylamines are inherently more basic than ammonia. The apparent weak basicity of aniline in solution at least partly reflects the difficulty in solvating the conjugate acid, PhNH<sub>3</sub><sup>+</sup>, caused by the bulky phenyl group. In contrast, the smaller NH<sub>4</sub><sup>+</sup> ammonium cation is readily and effectively solvated. Nevertheless, the basicity of amines is affected by delocalization of the nitrogen lone pair: aniline is a weaker base than cyclohexylamine both in solution and in the gas phase (PAs = 876 and 926 kJ mol<sup>-1</sup><sup>166</sup>, respectively).

Correlations between the basicity of an amine and the hybridization of the nitrogen atom have been developed. Early work revealed that the basicity is diminished by increasing the s-character in the nitrogen lone pair<sup>167</sup>. Thus, the PA of piperidine (sp<sup>3</sup> nitrogen) is 23 kJ mol<sup>-1</sup> greater than that of pyridine (sp<sup>2</sup> nitrogen). Similarly, the PA of aziridine is lower than that of dimethylamine by 21 kJ mol<sup>-1</sup>, because of ring strain, which tends to increase the proportion of s-character in the exocyclic bonds. However, care must be taken to allow for polarizability effects in such comparisons<sup>168</sup>.

As might have been anticipated, diamines are still more basic than amines, particularly if the added proton may occupy a site in which it is effectively bound to both amino groups. Thus, 1,4- and 1,5-diaminoalkanes have exceptionally high PAs (*ca* 1000 kJ mol<sup>-1</sup>)<sup>165</sup>.

## B. Reactions of Protonated Amines

This section focuses on protonated alkylamines, since it is in these systems that interesting novel reactions have been uncovered.

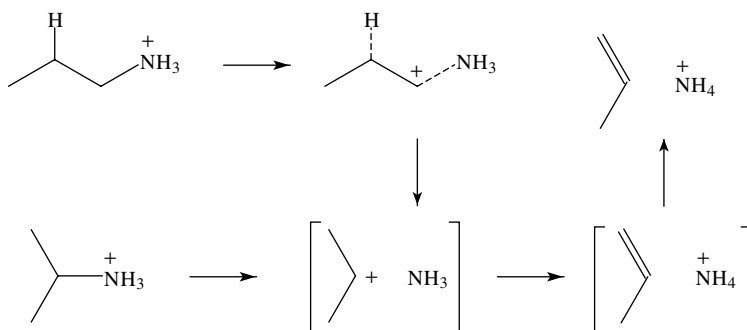
The simplest protonated amine to be studied in detail was metastable CH<sub>3</sub>NH<sub>3</sub><sup>+</sup>, which loses H<sub>2</sub> with a large and relatively specific KE release (*T* = 78 kJ mol<sup>-1</sup>)<sup>123</sup>. This reaction has a high regioselectivity (≥99%) and it was originally classified, together with similar fragmentations of CH<sub>3</sub>CH<sub>3</sub><sup>+</sup>, CH<sub>2</sub>=NH<sub>2</sub><sup>+</sup>, CH<sub>2</sub>=OH<sup>+</sup> and CH<sub>2</sub>=SH<sup>+</sup>, as a symmetry-forbidden 1,2-elimination<sup>123,169</sup>. Subsequent detailed studies<sup>170,171</sup> including high level molecular orbital (MO) calculations of the fragmentation of CH<sub>2</sub>=NH<sub>2</sub><sup>+</sup>, CH<sub>2</sub>=OH<sup>+</sup> and, most recently, CH<sub>3</sub>NH<sub>3</sub><sup>+</sup><sup>172</sup>, have led to descriptions of H<sub>2</sub> loss in terms of molecular reaction dynamics as a 1,2-elimination in which the transition state is skewed towards the carbon atom of the system. Consequently, the initial interpretation of H<sub>2</sub> loss from CH<sub>3</sub>NH<sub>3</sub><sup>+</sup> as a symmetry-forbidden 1,2-elimination is an oversimplification, even though it does provide a rationalization of the regiochemistry and KE release associated with this process.

Higher homologues of CH<sub>3</sub>NH<sub>3</sub><sup>+</sup> do not lose H<sub>2</sub> in slow reactions. Instead, alkene elimination, which is impossible for CH<sub>3</sub>NH<sub>3</sub><sup>+</sup>, generally dominates<sup>173</sup>. Loss of ammonia or a small alkylamine derived by C–N cleavage occasionally competes with alkene elimination. Thus, metastable C<sub>*n*</sub>H<sub>2*n*+1</sub>NH<sub>3</sub><sup>+</sup> fragments to give either C<sub>*n*</sub>H<sub>2*n*+1</sub><sup>+</sup> and NH<sub>3</sub> or C<sub>*n*</sub>H<sub>2*n*</sub> and NH<sub>4</sub><sup>+</sup> depending on the nature of the alkyl substituent. The trends in the competition between ammonia (or alkylamine, in the case of the analogous protonated secondary and tertiary amines) and alkene elimination are highly significant. Contrary to a naive expectation, alkene loss is favoured in systems in which the principal alkyl substituent is secondary or tertiary. Thus, metastable CH<sub>3</sub>CH<sub>2</sub>CH<sub>2</sub>NH<sub>3</sub><sup>+</sup> loses C<sub>3</sub>H<sub>6</sub> and NH<sub>3</sub> in the ratio 81:19, whereas the corresponding ratio for the isomeric species, (CH<sub>3</sub>)<sub>2</sub>CHNH<sub>3</sub><sup>+</sup>, is 99:1. Similarly, (CH<sub>3</sub>)<sub>3</sub>CNH<sub>3</sub><sup>+</sup>, from which facile NH<sub>3</sub> expulsion with formation of the stable (CH<sub>3</sub>)<sub>3</sub>C<sup>+</sup> cation might have been anticipated, loses mainly (95%) C<sub>4</sub>H<sub>8</sub>, whereas CH<sub>3</sub>CH<sub>2</sub>CH<sub>2</sub>CH<sub>2</sub>NH<sub>3</sub><sup>+</sup> and (CH<sub>3</sub>)<sub>2</sub>CHCH<sub>2</sub>NH<sub>3</sub><sup>+</sup> eliminate predominantly NH<sub>3</sub> (73 and 86%, respectively), even though C–N cleavage in these cases would lead to unstable primary cations<sup>174</sup>.



## 5. The chemistry of ionized, protonated and cationated amines in the gas phase 237

This curious trend is explicable if dissociation occurs via an INC-mediated mechanism. If the cation derived by elongation of the bond joining the principal alkyl substituent to the nitrogen atom is stable, proton transfer from a  $\beta$ -carbon atom to the developing amine occurs, thus resulting in alkene loss. This fragmentation is always favoured over amine expulsion because the PAs of amines are substantially greater than those of simple alkenes. However, if the C–N bond stretching in the initial stages of the reaction leads towards an unstable cation, rearrangement occurs with the release of a substantial amount of potential energy, thus increasing the average internal energy of the system. This energizing of the species comprising an incipient stable cation and a coordinated amine allows expulsion of the amine to compete with proton transfer leading to alkene loss. An illustrative example is shown for isomeric  $C_3H_7NH_3^+$  species in Scheme 19.



SCHEME 19

Starting from  $(CH_3)_2CHNH_3^+$ , C–N stretching leads to  $[(CH_3)_2CH^+ NH_3]$ , which generally undergoes proton transfer to  $[CH_3CH=CH_2 NH_4^+]$ , with eventual elimination of  $C_3H_6$ . Relatively few ions (*ca* 1%) generated as  $(CH_3)_2CHNH_3^+$  dissociate directly to  $(CH_3)_2CH^+$  and  $NH_3$  because these products have a higher total enthalpy of formation ( $\Sigma\Delta H_f = 824 \text{ kJ mol}^{-1}$ ) than  $CH_3CH=CH_2$  and  $NH_4^+$  ( $\Sigma\Delta H_f = 653 \text{ kJ mol}^{-1}$ ). In contrast, the analogous process leading to  $[CH_3CH_2CH_2^+ NH_3]$  from  $CH_3CH_2CH_2NH_3^+$  is preempted by isomerization of the developing  $CH_3CH_2CH_2^+$  cation to give an energized form of  $[(CH_3)_2CH^+ NH_3]$ <sup>174</sup>. The rearrangement of an incipient primary ( $CH_3CH_2CH_2^+$ ) to a secondary cation  $[(CH_3)_2CH^+]$  releases approximately  $70^{18,175} \text{ kJ mol}^{-1}$  energy, which profoundly affects the reactivity of the resultant  $[(CH_3)_2CH^+ NH_3]$  ions. These more energized ions show an enhanced tendency (*ca* 19%) to expel  $NH_3$ , since this process does not entail the additional proton transfer required for  $C_3H_6$  elimination. In cases where primary structures can rearrange to tertiary isomers, an even greater quantity of potential energy (*ca*  $140^{18,175} \text{ kJ mol}^{-1}$ ) is released, which energizes the rearranged species more strongly, thereby explaining why  $NH_3$  loss is so strongly favoured for  $(CH_3)_2CHCH_2NH_3^+$ . This explanation is consistent with the increased KE release which accompanies fragmentation of protonated amines in which rearrangement of the alkyl cation is postulated<sup>174</sup>. Thus, the  $T_{1/2}$  values for  $C_4H_8$  loss from  $(CH_3)_2CHCH_2NH_3^+$  and  $(CH_3)_3CNH_3^+$  are 2.4 and 1.0  $\text{kJ mol}^{-1}$ , respectively.

In addition to this trend in which  $NH_3$  elimination competes more effectively with alkene loss from protonated amines containing primary alkyl substituents, a second weaker effect is observed progressively favouring alkene expulsion as the nitrogen atom is methylated. Thus, the percentage (86, 47 and 28, respectively) of  $C_4H_8$  loss from

$(\text{CH}_3)_2\text{CHCH}_2\text{NH}_3^+$ ,  $(\text{CH}_3)_2\text{CHCH}_2\text{NH}_2\text{CH}_3^+$  and  $(\text{CH}_3)_2\text{CHCH}_2\text{NH}(\text{CH}_3)_2^+$  declines steadily<sup>174</sup>. This subsidiary trend chiefly reflects the effects of *N*-methylation on the energetics of the products (the higher PAs of methylamine and dimethylamine, relative to ammonia, enhance the preference for the proton transfer leading to alkene elimination).

Early MO calculations on the mechanism of  $\text{C}_3\text{H}_6$  elimination from  $(\text{CH}_3)_2\text{CHNH}_3^+$  suggested that this reaction proceeds via an intermediate proton-bridged complex (PBC), in which propene and ammonia are coordinated to a common proton<sup>173</sup>. Later research featuring MO calculations and <sup>2</sup>H-labelling led to a refinement of the mechanism for  $\text{C}_3\text{H}_6$  elimination from  $\text{CH}_3\text{CH}_2\text{CH}_2\text{NH}_3^+$ <sup>130</sup>. The labelling experiments showed that the hydrogen transfer to nitrogen was unidirectional and that the ratio of hydrogen transfer from the original  $\alpha$ -,  $\beta$ - and  $\gamma$ -carbon atoms was 2:1:3. This ratio is what would be anticipated on the basis of irreversible isomerization of  $\text{CH}_3\text{CH}_2\text{CH}_2\text{NH}_3^+$  to  $[(\text{CH}_3)_2\text{CH}^+\text{NH}_3]$ , followed by  $\beta$ -H transfer in this rearranged species to give  $\text{CH}_3\text{CH}=\text{CH}_2$  and  $\text{NH}_4^+$ . The MO calculations indicated that the transition state for dissociation of  $\text{CH}_3\text{CH}_2\text{CH}_2\text{NH}_3^+$  was a species in which the C–N bond was stretched and a 1,2-H shift from the  $\alpha$ - to the  $\beta$ -carbon atom was beginning to occur. Strong evidence was presented that the reactions of  $\text{CH}_3\text{CH}_2\text{CH}_2\text{NH}_3^+$  were INC-mediated, but it was concluded that the INC may correspond to an ‘entropic bottleneck’, rather than to a species in a true potential energy well<sup>130</sup>.

Thus, the chemistry of protonated alkylamines,  $\text{RNH}_3^+$ , shows many parallels to that of the related immonium ions,  $\text{RNH}^+=\text{CH}_2$  and  $\text{RN}^+(\text{CH}_3)=\text{CH}_2$ <sup>118</sup>. Loss of an alkene derived by hydrogen abstraction from R appears to be INC-mediated; unidirectional rearrangement of the primary alkyl group occurs in cases where  $\text{R}^+$  would be an unstable cation, thus resulting in a discrimination against the expected  $\beta$ -H transfer for *n*-propyl and related primary alkyl substituents; this isomerization releases internal energy, which activates the ion to undergo an increased proportion of fragmentations with higher critical energies (ammonia or imine expulsion) and leads to an increase in the KE release for dissociation; and the transition state is a structure in which the C–N is being broken and a concomitant 1,2-H shift is occurring. These common features reflect the underlying generic nature of the reaction.

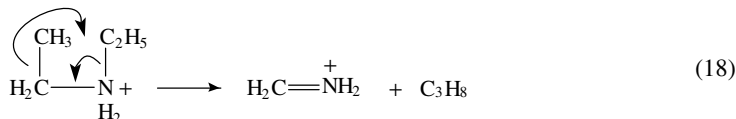
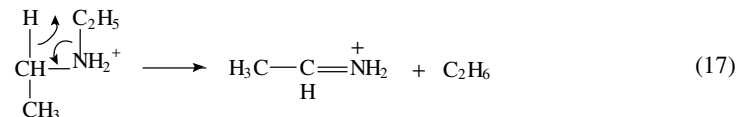
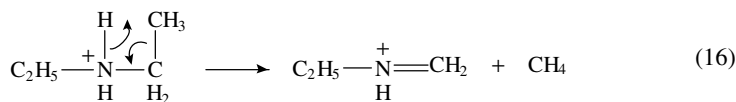
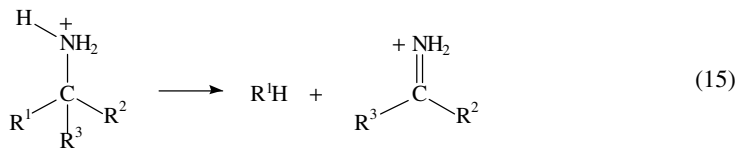
CID experiments show that isomeric  $(\text{C}_m\text{H}_{2m+1})_n\text{NH}_{4-n}^+$  ions ( $n = 1, 2$  or  $3$ ) generally have distinct CID spectra; thus,  $\text{CH}_3\text{CH}_2\text{CH}_2\text{CH}_2\text{NH}_3^+$ ,  $\text{CH}_3\text{CH}_2(\text{CH}_3)\text{CHNH}_3^+$ ,  $(\text{CH}_3)_2\text{CHCH}_2\text{NH}_3^+$  and  $(\text{CH}_3)_3\text{CNH}_3^+$  are distinguishable on this basis, but the spectra of  $\text{CH}_3\text{CH}_2\text{CH}_2\text{CH}_2\text{NH}_3^+$  and  $(\text{CH}_3)_2\text{CHCH}_2\text{NH}_3^+$  are similar<sup>176–178</sup>. These results confirm that these  $(\text{C}_m\text{H}_{2m+1})_n\text{NH}_{4-n}^+$  ions occupy discrete potential energy wells, as would be expected intuitively.

Whereas metastable  $\text{C}_n\text{H}_{2n+1}\text{NH}_3^+$  ions do not undergo loss of molecular hydrogen and only rarely lose an alkane in comparatively low abundance for  $n \geq 3$ <sup>158</sup>, these fragmentations are observed to a greater extent at higher internal energies (CID spectra)<sup>176–178</sup>. Therefore, the low abundance or absence of alkane and hydrogen loss from metastable ions must reflect the nature of the reactions, because both processes give rise to exceptionally favourable combinations of products in which the cationic component is an immonium ion. Early MO calculations<sup>176</sup> indicated that 1,2-elimination of  $\text{CH}_4$  from  $(\text{CH}_3)_2\text{CHNH}_3^+$  entails a critical energy of *ca* 340 kJ mol<sup>-1</sup>. Consequently, this apparently favourable dissociation route competes relatively poorly with alkene and ammonia (or alkylamine) loss even when the ions have been strongly energized by high-energy (8 keV) collision.

Nevertheless, alkane losses are analytically useful in distinguishing between isomeric  $\text{C}_n\text{H}_{2n+1}\text{NH}_3^+$  species. Thus,  $\text{CH}_3\text{CH}_2(\text{CH}_3)\text{CHNH}_3^+$  loses mainly  $\text{C}_2\text{H}_6$  and only a little  $\text{CH}_4$  (19 and 4%, respectively, of the base peak for  $\text{NH}_3$  loss), whereas

5. The chemistry of ionized, protonated and cationated amines in the gas phase 239

$(\text{CH}_3)_3\text{CNH}_3^+$  expels  $\text{CH}_4$  (11% of the base peak for  $\text{NH}_3$  loss) and no  $\text{C}_2\text{H}_6$ , as would be expected if the reaction predominantly involves simple 1,2-elimination across the C–N bond (equation 15). In more substituted systems, three distinct channels for the 1,2-elimination may operate. Thus, protonated dimethylamine loses  $\text{CH}_4$  (equation 16),  $\text{C}_2\text{H}_6$  (equation 17) and  $\text{C}_3\text{H}_8$  (equation 18) to give signals 22, 49 and 55% of the intensity of the base peak for loss of  $\text{C}_2\text{H}_4$ <sup>178</sup>.



The CID spectra of  $(\text{C}_m\text{H}_{2m+1})_n\text{NH}_{4-n}^+$  species have been studied over a range of collision energies. Thus, breakdown graphs, in which the relative abundances of the various fragment ions formed in these energy-resolved mass spectrometry (ERMS)<sup>179–181</sup> experiments are plotted as a function of the (relatively low) collision energy, reveal that  $\text{C}_m\text{H}_{2m}$  loss usually dominates the fragmentation at low energies. However, as the collision energy is increased,  $\text{C}_m\text{H}_{2m}$  elimination declines in importance from *ca* 70% at 0–1 eV to *ca* 10% at 9–12 eV. In contrast, the ion,  $\text{C}_m\text{H}_{2m+1}^+$ , formally arising by amine expulsion, increases in significance until it accounts for 30–50% of the product ions at 9–12 eV<sup>178</sup>.

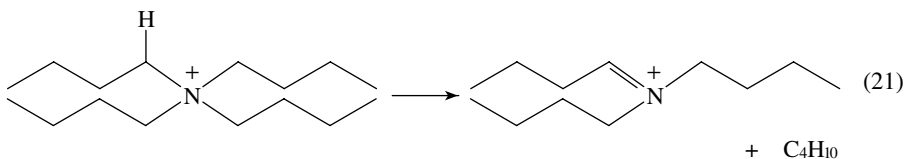
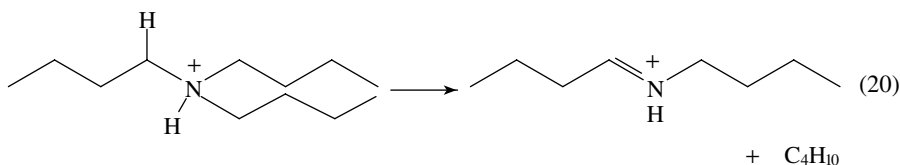
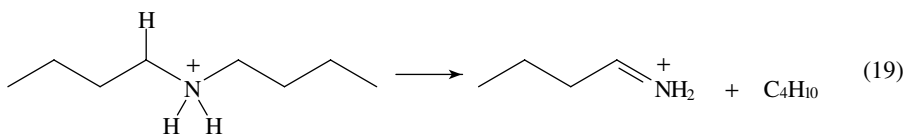
Although this behaviour is logical and correlates well with the interpretation of the fragmentation of metastable  $(\text{C}_m\text{H}_{2m+1})_n\text{NH}_{4-n}^+$  species via a mechanism involving INCs (the product arising by C–N bond cleavage is favoured at higher internal energies), the  $\text{C}_m\text{H}_{2m+1}^+$  ion is not necessarily formed from the parent in one step. Moreover, isomerization of the alkyl substituent will almost certainly occur to give a secondary or tertiary isomer of  $\text{C}_m\text{H}_{2m+1}^+$ . This caveat is underlined by the observation at high collision energies of fragment ions which correspond to elimination of two  $\text{C}_m\text{H}_{2m}$  molecules from both  $(\text{C}_m\text{H}_{2m+1})_2\text{NH}_2^+$  and  $(\text{C}_m\text{H}_{2m+1})_3\text{NH}^+$  ions; furthermore, other carbocations become noticeable at relatively high collision energies. Thus, the breakdown graphs of  $(\text{C}_3\text{H}_7)_3\text{NH}^+$  and  $(\text{C}_4\text{H}_9)_3\text{NH}^+$  show ions corresponding to loss of two molecules of  $\text{C}_3\text{H}_6$  and  $\text{C}_4\text{H}_8$ , respectively, which reach a maximum relative abundance of 20 and 15% at about 4 and 7 eV, respectively. Moreover, the high energy regions of these graphs also show appreciable signals for  $\text{C}_3\text{H}_5^+$ , which is known to be the principal fragment ion formed by dissociation of  $\text{C}_3\text{H}_7^+$  and  $\text{C}_4\text{H}_9^+$ <sup>182,183</sup>.

### C. Reactions of Tetraalkylammonium Ions

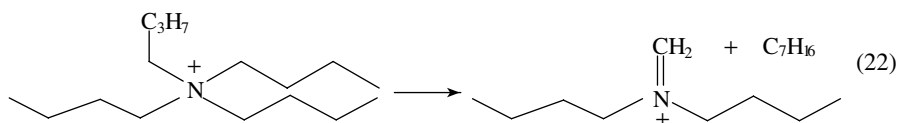
The reactions of  $R_nNH_{4-n}^+$  species show many common features, including significant trends as  $n$  is increased from 1 to 4. However, the behaviour of tetraalkyl ammonium ions ( $n = 4$ ) possesses some characteristics which set them aside from the homologous protonated amines.

The principal difference is the greatly increased competition of alkane loss, which sometimes occurs by more than one channel, even from metastable  $R_4N^+$  ions<sup>158,184-189</sup>. Thus,  $(C_mH_{2m+1})_4N^+$  species eliminate  $C_mH_{2m+2}$  to a far greater extent than their  $(C_mH_{2m+1})_nNH_{4-n}^+$  homologues do when  $n = 1, 2$  or  $3$ . Moreover, expulsion of an alkane,  $C_{2m-1}H_{4m}$ , derived from one intact N-alkyl substituent and part of another (compare equation 18), generally dominates the fragmentation of  $(C_mH_{2m+1})_4N^+$  species. In contrast, the homologous metastable  $(C_mH_{2m+1})_nNH_{4-n}^+$  ions never react in this fashion. Thus, metastable  $(n-C_4H_9)_2NH_2^+$  ions lose mainly  $C_4H_8$ ,  $C_4H_9NH_2$  and  $C_4H_{10}$  in the ratio 100:32:2;  $(n-C_4H_9)_3NH^+$  reacts similarly, with a strong preference for alkene loss, a moderate side reaction involving  $(n-C_4H_9)_2NH$  expulsion and only a slightly increased contribution from alkane elimination. However, metastable  $(n-C_4H_9)_4N^+$  loses  $C_4H_8$ ,  $C_4H_9NH_2$  and  $C_4H_{10}$  in the ratio 100:8:37; consequently, alkane loss is enhanced at the expense of amine expulsion for the tetraalkylammonium species. Moreover,  $(n-C_4H_9)_4N^+$  is unique among the  $(C_mH_{2m+1})_{4-n}NH_n^+$  ions in expelling  $C_7H_{16}$  (87% of the relative abundance of  $C_4H_8$  loss). Similarly, the major reaction of metastable  $(n-C_3H_7)_4N^+$  is elimination of  $C_5H_{12}$ ; in contrast, the corresponding  $(n-C_3H_7)_2NH_2^+$  and  $(n-C_3H_7)_3NH^+$  species lose mainly  $C_3H_6$ , together with minor amounts of  $C_3H_7NH_2$  or  $(n-C_3H_7)_2NH$  and an even smaller quantity of  $C_3H_8$ , but no  $C_5H_{12}$ <sup>158</sup>.

Elimination of  $C_{2m-1}H_{4m}$  from metastable  $(C_mH_{2m+1})_4N^+$  species may be explained as a 1,2-elimination, resulting in formation of the immonium ion,  $(C_mH_{2m+1})_2^+N=CH_2$ . This process is analogous to the loss of  $C_mH_{2m+2}$  from  $(C_mH_{2m+1})_nNH_{4-n}^+$  ions ( $n = 1, 2$  or  $3$ ). Loss of  $C_mH_{2m+2}$  entails C-N cleavage and abstraction of a hydrogen atom from the  $\alpha$ -carbon atom of another N-alkyl substituent; elimination of  $C_{2m-1}H_{4m}$  requires C-N cleavage and abstraction of an alkyl group from the same position of an N-alkyl substituent. Thus,  $(C_4H_9)_2NH_2^+$  and  $(C_4H_9)_3NH^+$  lose  $C_4H_{10}$  (equations 19 and 20, respectively), but  $(C_4H_9)_4N^+$  eliminates either  $C_4H_{10}$  or  $C_7H_{16}$  (equations 21 and 22, respectively)<sup>158</sup>.



## 5. The chemistry of ionized, protonated and cationated amines in the gas phase 241



It is interesting that abstraction of a hydrogen atom, rather than an alkyl radical, from the  $\alpha$ -carbon is strongly favoured as long as an N–H entity is present in the ion. The loss of  $C_{2m-1}H_{4m}$  from  $(C_mH_{2m+1})_4N^+$  ions could be considered to correspond to sequential elimination of two neutral species, rather than expulsion of an alkane in which a new C–C bond is formed. Very few other examples of such C–C bond formation in the fragmentation of low energy ions have been reported.

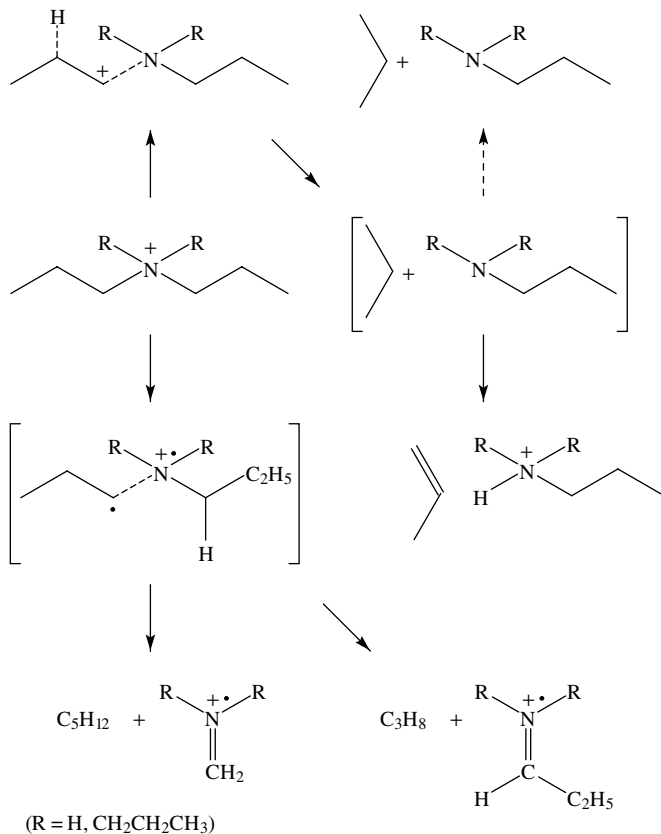
However, there are sound thermochemical arguments for rejecting the possibility of consecutive loss of  $C_mH_{2m+1}^{\bullet}$  and  $C_{m-1}H_{2m-1}^{\bullet}$  radicals, which would lead to products at least  $300 \text{ kJ mol}^{-1}$  higher in energy than those formed by  $C_{2m-1}H_{4m}$  elimination<sup>158</sup>. Another possibility is successive loss of  $C_mH_{2m+2}$  and  $C_{m-1}H_{2m-2}$ . This explanation is at first sight consistent with the known reactions of many of the immonium ions,  $(C_mH_{2m+1})_2^+N=CH_2$ , which often expel  $C_{m-1}H_{2m-2}$  over a wide range of internal energies<sup>118</sup>. However, a weakness of this suggestion is the absence of  $C_{2m}H_{2m+2}$  loss from  $(C_mH_{2m+1})_4N^+$  ions. Thus, several  $(n-C_3H_7)_2^+N=CHR$  ions eliminate  $C_2H_4$  and  $C_3H_6$  at similar rates<sup>118,132</sup>. Therefore, if ' $C_5H_{12}$ ' loss from  $(C_3H_7)_4N^+$  actually occurred by elimination of  $C_3H_8$  to give  $(C_3H_7)_2^+N=CHC_2H_5$ , which subsequently expelled  $C_2H_4$ , a contribution from  $C_3H_8$  loss from the latter would also be expected, giving the impression that  $(C_3H_7)_4N^+$  eliminated  $C_6H_{14}$ . However, no such reaction is observed<sup>158</sup>. Consequently, the interpretation of  $C_{2m-1}H_{4m}$  elimination as sequential loss of  $C_mH_{2m+2}$  and  $C_{m-1}H_{2m-2}$ , although thermochemically plausible, is unsatisfactory.

The CID spectra of the tetraalkylammonium ions are dominated by alkane elimination. Thus, breakdown graphs reveal that loss of  $C_3H_{12}$  is the most abundant ion in the spectrum of  $(n-C_3H_7)_4N^+$  over a wide range of collision energies, reaching a maximum of *ca* 70% of the total at about 3 eV. Elimination of  $C_3H_6$  and, to a lesser degree,  $C_3H_8$  are also important at lower collision energies; however, the abundance of the corresponding fragment ions declines quite sharply as the collision energy is increased and a new signal appears for formation of  $C_3H_7^+$ . Although this signal corresponds to elimination of  $(n-C_3H_7)_3N$  from  $(n-C_3H_7)_4N^+$ , it need not necessarily arise in one step because both the ions formed by  $C_3H_6$  and  $C_3H_8$  loss from  $(n-C_3H_7)_4N^+$  are likely to give  $C_3H_7^+$  when activated by high energy collisions. A qualitatively similar breakdown graph is found for the higher homologue,  $(n-C_4H_9)_4N^+$ <sup>158</sup>.

### D. Comparison of the Reactions of Protonated Amines and Tetraalkylammonium Ions

The trends that are observed in the reactions of  $(C_mH_{2m+1})_{4-n}NH_n^+$  ions have been interpreted in terms of changes in the underlying energetics of the species arising by heterolytic and homolytic cleavage of the C–N bond<sup>189</sup>. Elimination of  $C_mH_{2m}$  [and, occasionally,  $(C_mH_{2m+1})_{3-n}NH_n$ ] occurs after heterolytic cleavage to form  $[C_mH_{2m+1}^+ (C_mH_{2m+1})_{3-n}NH_n]$ , which undergoes proton transfer to give  $[C_mH_{2m} (C_mH_{2m+1})_{3-n}NH_{n+1}^+]$ . Rearrangement of the cation to a stable isomer accompanies heterolytic cleavage, whenever possible. Separation of the components results in alkene expulsion. The occasional occurrence of amine loss to give  $C_mH_{2m+1}^+$  is explained by dissociation of  $[C_mH_{2m+1}^+ (C_mH_{2m+1})_{3-n}NH_n]$  without proton transfer. In contrast, homolytic cleavage yields  $[C_mH_{2m+1}^{\bullet} (C_mH_{2m+1})_{3-n}NH_n^{\bullet+}]$ . Hydrogen atom abstraction

from the  $\alpha$ -carbon atom then leads to elimination of  $C_mH_{2m+2}$ ; alternatively, alkyl radical abstraction from this position results in  $C_{2m-1}H_{4m}$  loss. This mechanism is illustrated for  $(C_3H_7)_{4-n}NH_n^+$  in Scheme 20.



SCHEME 20

When only one or two alkyl groups are present, the energy of the species produced by heterolytic cleavage is substantially lower (by 60–100 kJ mol<sup>-1</sup>, depending on the stabilization of the species by ion–dipole and related forces) than that arising from homolytic cleavage. Addition of a further alkyl group favours the homolytic cleavage somewhat more strongly than the heterolytic alternative, but the former remains significantly lower in energy. However, continuation of this process to the tetraalkylammonium ion results in a differential stabilization of the homolytic cleavage which is so great that the alternative cleavages have very similar critical energies<sup>158,189</sup>.

The changes in the relative energies of the species formed by heterolytic and homolytic cleavages chiefly reflect the strong influence of progressive N-alkylation in lowering the ionization energy of the  $(C_mH_{2m+1})_{3-n}NH_n$  amine which outstrips the corresponding trend in the PA of these amines. Thus,  $\Delta H_f(C_3H_7)_nNH_{3-n}^{+\bullet}$  declines markedly from 778 kJ mol<sup>-1</sup> for  $C_3H_7NH_2^{+\bullet}$  to 552 kJ mol<sup>-1</sup> for  $(C_3H_7)_3NH^{+\bullet}$ . In contrast, the corresponding decrease in  $\Delta H_f(C_3H_7)_nNH_{4-n}^+$  from 548 kJ mol<sup>-1</sup> for  $C_3H_7NH_3^+$  to

## 5. The chemistry of ionized, protonated and cationated amines in the gas phase 243

389 kJ mol<sup>-1</sup> for (C<sub>3</sub>H<sub>7</sub>)<sub>3</sub>NH<sup>+</sup> is less pronounced<sup>158</sup>. Therefore, alkane loss via homolytic cleavage competes much more effectively with alkene elimination via heterolytic cleavage for the tetraalkylammonium ions.

## V. CONCLUSIONS

Much insight has been gained during the last 15–20 years into the structure and reactivity of ions derived from amines. Advances in instrumentation, the invention of new methods for generating ions and characterizing the structure of both the charged and neutral products of their reactions, together with the complementary information accessible by MO calculations, have permitted detailed descriptions of many of these ionic fragmentations. Novel ion structures, especially distonic species and ion-neutral complexes, play a vital role in the chemistry of many ions generated from amines. Some fragmentations reflect the influence of a radical site; for instance, the hydrogen abstractions through 5-, 6-, 7- and 8-membered ring transition states which initiate the rearrangement of ionized *n*-alkylamines prior to pseudo- $\alpha$ -cleavage. Others reflect features of classical cation chemistry; for example, the rearrangement of primary *N*-alkyl substituents which precedes alkene elimination from immonium ions and protonated alkylamines. These mechanistic studies have brought the behaviour of ionized, protonated and cationated amines in the gas phase firmly within the compass of physical-organic chemistry. The resultant knowledge of the inherent properties of ions derived from amines has further enhanced the analytical value of mass spectrometry and shed light on the influence of solvent effects on the properties of amines.

## VI. ACKNOWLEDGEMENTS

This review would not have been possible without the pioneering work of numerous scientists, many of whom (including Dr S. Hammerum, Professors H. E. Audier, G. Bouchoux, P. J. Derrick, A. G. Harrison, J. L. Holmes, P. Longevialle, F. P. Lossing, A. Maccoll, T. H. Morton, N. M. M. Nibberring, H. Schwarz, J. K. Terlouw and H. -J. Veith) provided reprints and/or engaged in valuable discussions. I am grateful to all of them, particularly Steen Hammerum, with whom I have enjoyed a long and informative debate on the reactions of ionized amines and immonium ions.

## VII. REFERENCES

1. H. Schwarz and K. Levsen, Chapter 3 in *Supplement F, The Chemistry of Amines, Nitroso and Nitro Compounds* (Ed. S. Patai), Wiley, Chichester, 1982.
2. For representative texts, see:
  - (a) J. H. Beynon, *Mass Spectrometry and Its Applications to Organic Chemistry*, Elsevier, Amsterdam, 1960.
  - (b) K. Biemann, *Mass Spectrometry*, McGraw-Hill, New York, 1962.
  - (c) H. Budzikiewicz, C. Djerassi and D. H. Williams, *Interpretation of Mass Spectra of Organic Compounds*, Holden-Day, San Francisco, 1964.
  - (d) G. Spittler, *Massenspektrometrische Strukturanalyse organischer Verbindungen*, Verlag-Chemie, Weinheim, 1966.
  - (e) H. Budzikiewicz, C. Djerassi and D. H. Williams, *Mass Spectra of Organic Compounds*, Holden-Day, San Francisco, 1967.
  - (f) J. H. Beynon, R. A. Saunders and A. E. Williams, *The Mass Spectra of Organic Molecules*, Elsevier, Amsterdam, 1968.
  - (g) R. A. W. Johnstone, *Mass Spectrometry for Organic Chemists*, Cambridge University Press, 1972.
3. For a systematic treatment, see: F. W. McLafferty and F. Turecek, *Interpretation of Mass Spectra*, 4th ed., University Science Books, Mill Valley, California, 1993.

4. W. A. Lathan, L. A. Curtiss, W. J. Hehre, J. B. Lilse and J. A. Pople, *Prog. Phys. Org. Chem.*, **11**, 175 (1974).
5. B. T. Goulding and L. Radom, *J. Am. Chem. Soc.*, **98**, 6331 (1976).
6. J. K. Terlouw, W. Heerma and G. Dijkstra, *Org. Mass Spectrom.*, **16**, 326 (1981).
7. J. L. Holmes, F. P. Lossing, J. K. Terlouw and P. C. Burgers, *J. Am. Chem. Soc.*, **104**, 2931 (1982).
8. J. K. McLeod, W. Bouma and L. Radom, *J. Am. Chem. Soc.*, **104**, 2930 (1982).
9. H. Halim, B. Ciommer and H. Schwarz, *Angew. Chem., Int. Ed. Engl.*, **21**, 528 (1982).
10. Y. Apeloig, B. Ciommer, G. Frenking, M. Karni, A. Mandelbaum, H. Schwarz and A. Weisz, *J. Am. Chem. Soc.*, **105**, 2186 (1983).
11. J. L. Holmes, F. P. Lossing, J. K. Terlouw and P. C. Burgers, *Can. J. Chem.*, **61**, 2305 (1983).
12. W. J. Bouma, R. H. Nobes and L. Radom, *J. Am. Chem. Soc.*, **104**, 2929 (1984).
13. W. J. Bouma, R. H. Nobes and L. Radom, *Org. Mass Spectrom.*, **20**, 12 (1983).
14. S. Hammerum, D. Kuck and P. J. Derrick, *Tetrahedron Lett.*, **25**, 893 (1984).
15. S. Hammerum, *Acta Chem. Scand.*, **22**, 430 (1987).
16. T. M. Sack, R. L. Cerny and M. L. Gross, *J. Am. Chem. Soc.*, **107**, 4562 (1985).
17. C. Wesdemiotis, P. O. Danis, R. Feng, J. Tso and F. W. McLafferty, *J. Am. Chem. Soc.*, **107**, 8059 (1985).
18. J. L. Franklin, J. G. Dillard, H. M. Rosenstock, J. T. Herron, K. Draxl and F. H. Field, *Ionization Potentials, Appearance Potentials and Heats of Formation of Gaseous Positive Ions*, National Bureau of Standards, Washington, D.C., 1969; H. M. Rosenstock, K. Draxl, B. W. Steiner and J. T. Herron, *J. Phys. Chem. Ref. Data, Suppl. 1*, **6** (1977).
19. B. F. Yates, W. J. Bouma and L. Radom, *J. Am. Chem. Soc.*, **109**, 2250 (1987).
20. B. F. Yates and L. Radom, *Org. Mass Spectrom.*, **22**, 430 (1987).
21. B. F. Yates and L. Radom, *J. Am. Chem. Soc.*, **109**, 2910 (1987).
22. B. F. Yates, W. J. Bouma and L. Radom, *J. Am. Chem. Soc.*, **106**, 5805 (1984).
23. M. M. Green, *Tetrahedron*, **36**, 2687 (1980).
24. For an early review, see: H. Schwarz, *Nachr. Chem. Tech. Lab.*, **31**, 451 (1983).
25. W. J. Bouma, J. M. Dawes and L. Radom, *Org. Mass Spectrom.*, **18**, 12 (1983).
26. For a comprehensive review of the chemistry of distonic ions, see: S. Hammerum, *Mass Spectrom. Rev.*, **7**, 123 (1988).
27. F. W. McLafferty, P. F. Bente, III, R. Kornfield, S. -C. Tsai, and I. Howe, *J. Am. Chem. Soc.*, **95**, 2120 (1973).
28. K. Levsen and H. Schwarz, *Angew. Chem., Int. Ed. Engl.*, **15**, 509 (1976).
29. R. G. Cooks, *Collision Spectroscopy*, Plenum Press, New York, 1978.
30. F. W. McLafferty, in *High Performance Mass Spectrometry* (Ed. M. L. Gross), A.C.S. Symposium Ser. 70, American Chemical Soc., Washington, D.C., 1978.
31. For a review, see: W. Koch, F. Maquin, D. Stahl and H. Schwarz, *Chimia*, **39**, 376 (1985).
32. J. K. Terlouw and H. Schwarz, *Angew. Chem., Int. Ed. Engl.*, **26**, 805 (1987).
33. J. L. Holmes, *Mass Spectrom. Rev.*, **8**, 513 (1989).
34. The expression 'critical energy' corresponds conceptually to the term 'activation energy': A. Maccoll, *Org. Mass Spectrom.*, **15**, 225 (1980).
35. M. L. Gross and F. W. McLafferty, *J. Am. Chem. Soc.*, **93**, 1267 (1971).
36. T. M. Sack, R. L. Cerny and M. L. Gross, *J. Am. Chem. Soc.*, **107**, 4562 (1985).
37. L. W. Sieck, R. Gorden and P. Ausloos, *J. Am. Chem. Soc.*, **94**, 7157 (1972).
38. S. G. Lias and T. J. Buckley, *Int. J. Mass Spectrom. Ion Processes*, **56**, 123 (1984).
39. M. L. Gross, *J. Am. Chem. Soc.*, **94**, 3744 (1972).
40. T. Drewello, N. Heinrich, W. P. Maas, N. M. M. Nibbering, T. Weiske and H. Schwarz, *J. Am. Chem. Soc.*, **109**, 4810 (1987).
41. T. Bjornholm, S. Hammerum and D. Kuck, *Adv. Mass Spectrom.*, 787 (1985).
42. T. Bjornholm, S. Hammerum and D. Kuck, *J. Am. Chem. Soc.*, **111**, 3862 (1988).
43. H. E. Audier, G. Sozzi and J. P. Denhez, *Tetrahedron*, **42**, 1179 (1986).
44. S. Hammerum, J. B. Christensen, H. Egsgaard, E. Larsen, P. J. Derrick and K. F. Donchi, *Int. J. Mass Spectrom. Ion Processes*, **47**, 351 (1983).
45. S. Hammerum, *Tetrahedron Lett.*, **22**, 157 (1981).
46. H. E. Audier, A. Milliet and J. P. Denhez, *Org. Mass Spectrom.*, **18**, 131 (1983).
47. H. E. Audier and A. Milliet, *Int. J. Mass Spectrom. Ion Processes*, **47**, 475 (1983).
48. G. Sozzi, H. E. Audier, J. -P. Denhez and A. Milliet, *Nouv. J. Chem.*, **7**, 735 (1983).



## 5. The chemistry of ionized, protonated and cationated amines in the gas phase 245

49. H. E. Audier, J. -P. Denhez, A. Milliet and G. Sozzi, *Org. Mass Spectrom.*, **19**, 79 (1984).
50. H. E. Audier, J. -P. Denhez, A. Milliet and G. Sozzi, *Can. J. Chem.*, **62**, 931 (1984).
51. P. C. Burgers, J. L. Holmes and J. K. Terlouw, *J. Chem. Soc., Chem. Commun.*, 642 (1984).
52. W. J. Bouma, R. H. Nobes and L. Radom, *Org. Mass Spectrom.*, **17**, 315 (1982).
53. M. Yamamoto, T. Takeuchi and K. Nishimoto, *Org. Mass Spectrom.*, **20**, 541 (1985).
54. T. Takeuchi, S. Veno, M. Yamamoto, T. Matsushita and K. Nishimoto, *Int. J. Mass Spectrom. Ion Phys.*, **64**, 33 (1985).
55. W. J. Bouma, R. H. Nobes and L. Radom, *J. Am. Chem. Soc.*, **105**, 1743 (1983).
56. R. Postma, P. J. A. Ruttink, B. L. M. van Baar, J. L. Holmes, J. K. Terlouw and P. C. Burgers, *Chem. Phys. Lett.*, **123**, 409 (1986).
57. J. J. Russell, H. S. Rzepa and D. A. Widdowson, *J. Chem. Soc., Chem. Commun.*, 623 (1983).
58. H. E. Audier and J. C. Tabet, *Org. Mass Spectrom.*, **20**, 313 (1985).
59. S. Hammerum, S. Ingemann and N. M. M. Nibbering, *Org. Mass Spectrom.*, **20**, 314 (1985).
60. H. E. Audier and G. Sozzi, *Org. Mass Spectrom.*, **19**, 150 (1984).
61. H. E. Audier, G. Bouchoux, Y. Hoppilliard and A. Milliet, *Org. Mass Spectrom.*, **17**, 382 (1982).
62. K. Laderoute and A. G. Harrison, *Org. Mass Spectrom.*, **20**, 624 (1985).
63. For reviews, see:
  - (a) T. H. Morton, *Tetrahedron*, **38**, 3195 (1982).
  - (b) D. J. McAdoo, *Mass Spectrom. Rev.*, **7**, 363 (1988).
  - (c) B. L. M. van Baar, J. K. Terlouw, S. Akkok, W. Zummack and H. Schwarz, *Int. J. Mass Spectrom. Ion Processes*, **81**, 217 (1987); N. Heinrich and H. Schwarz, in *Ion and Cluster Ion Spectroscopy* (Ed. J. P. Maier), Elsevier, Amsterdam, 1988, p. 329.
  - (d) S. Hammerum, in *Fundamentals of Gas-Phase Ion Chemistry* (Ed. K. R. Jennings), Kluwer, Dordrecht, 1990, p. 379.
  - (e) R. D. Bowen, *Acc. Chem. Res.*, **24**, 364 (1991).
  - (f) H. -F. Grutzmacher, *Int. J. Mass Spectrom. Ion Processes*, **118/119**, 825 (1992).
  - (g) P. Longevialle, *Mass Spectrom. Rev.*, **11**, 157 (1992).
  - (h) D. J. McAdoo and T. H. Morton, *Acc. Chem. Res.*, **26**, 295 (1993).
64. C. E. Hudson and D. J. McAdoo, *Org. Mass Spectrom.*, **14**, 109 (1979).
65. C. E. Hudson, R. D. Lerner, R. Aleman and D. J. McAdoo, *J. Phys. Chem.*, **84**, 155 (1980).
66. R. D. Bowen and A. Maccoll, *J. Chem. Soc., Perkin Trans. 2*, 147 (1990).
67. R. D. Bowen, D. Suh and J. K. Terlouw, *Org. Mass Spectrom.*, **29**, 791 (1994).
68. F. W. McLafferty, *Anal. Chem.*, **29**, 1782 (1957).
69. F. Turecek, 'Mass spectrometry of alcohols and ethers', in *The Chemistry of Hydroxyl, Ether and Peroxide Groups* (Ed. S. Patai), Wiley, Chichester, 1993, p. 373.
70. F. P. Lossing, Y. -T. Lam and A. Maccoll, *Can. J. Chem.*, **59**, 2228 (1981).
71. F. P. Lossing, *J. Am. Chem. Soc.*, **99**, 7526 (1977).
72. F. P. Lossing and J. L. Holmes, *J. Am. Chem. Soc.*, **106**, 6917 (1984).
73. *The Eight Peak Index of Mass Spectra*, 2nd edn., Mass Spectrometry Data Centre, AWRE, Reading, 1974.
74. R. D. Bowen and A. Maccoll, *Org. Mass Spectrom.*, **19**, 379 (1984).
75. R. D. Bowen and A. Maccoll, *Org. Mass Spectrom.*, **20**, 331 (1985).
76. W. A. Chupka, *J. Chem. Phys.*, **30**, 191, 1959.
77. R. G. Cooks, L. Hendricks and J. H. Beynon, *Org. Mass Spectrom.*, **10**, 625 (1975).
78. M. L. Gross, F. L. De Roos and M. K. Hoffman, *Org. Mass Spectrom.*, **12**, 258 (1977).
79. P. J. Derrick, T. M. Gardiner and A. G. Loudon, *Adv. Mass Spectrom.*, **7**, 77 (1978).
80. D. J. McAdoo and C. E. Hudson, *Int. J. Mass Spectrom. Ion Phys.*, **22**, 615 (1987).
81. K. Osapay, J. Delhalle, K. M. Nsunda, E. Rolli, R. Houriet and L. Hevesi, *J. Am. Chem. Soc.*, **111**, 5028 (1989).
82. J. D. Cox and G. Pilcher, *Thermochemistry of Organic and Organometallic Compounds*, Academic Press, New York, 1970.
83. J. B. Pedley, R. D. Naylor and S. P. Kirby, *Thermochemical Data of Organic Compounds*, 2nd edn., Chapman and Hall, London, 1986.
84. S. Hammerum, K. F. Donchi and P. J. Derrick, *Int. J. Mass Spectrom. Ion Processes*, **47**, 347 (1983).
85. S. Hammerum, *J. Chem. Soc., Chem Commun.*, 858 (1988); S. Hammerum and H. E. Audier, *J. Chem. Soc., Chem Commun.*, 860 (1988).
86. S. Tajima, J. van der Greef and N. M. M. Nibbering, *Org. Mass Spectrom.*, **13**, 551 (1978).

87. R. D. Bowen and D. H. Williams, *J. Chem. Soc., Chem Commun.*, 836 (1981).
88. R. D. Bowen and A. Maccoll, *J. Chem. Soc., Perkin Trans. 2*, 1005 (1984).
89. S. Hammerum and P. J. Derrick, *J. Chem. Soc., Chem Commun.*, 996 (1985).
90. P. J. Derrick and K. F. Donchi, in *Comprehensive Chemical Kinetics* (Eds. C. H. Bamford and C. F. H. Tipper), **24**, Elsevier, Amsterdam, 1981, p. 53.
91. J. R. Christie, P. J. Derrick and G. J. Rickard, *J. Chem. Soc., Faraday Trans. 2*, 304, 1978; G. J. Rickard, N. W. Cole and P. J. Derrick, *J. Am. Chem. Soc.* **100**, 2904 (1978).
92. S. Ingemann and S. Hammerum, *Adv. Mass Spectrom.*, **8**, 647 (1980).
93. S. Ingemann, S. Hammerum and P. J. Derrick, *J. Am. Chem. Soc.*, **110**, 3869 (1988).
94. S. Ingemann, S. Hammerum, P. J. Derrick, R. H. Fokkens and N. M. M. Nibbering, *Org. Mass Spectrom.*, **24**, 885 (1989).
95. S. Ingemann, E. Klufft, N. M. M. Nibbering, C. E. Alison, P. J. Derrick and S. Hammerum, *Org. Mass Spectrom.*, **26**, 875 (1991).
96. T. Weiske and H. Schwarz, *Chem. Ber.*, **116**, 323 (1983).
97. T. Weiske, H. Halim and H. Schwarz, *Chem. Ber.*, **118**, 495 (1985).
98. T. Weiske and H. Schwarz, *Tetrahedron*, **42**, 6245 (1986).
99. R. D. Bowen, P. Clifford, J. T. Francis and J. K. Terlouw, unpublished results.
100. K. Fukui, *Acc. Chem. Res.*, **4**, 57 (1971).
101. I. Fleming, *Frontier Orbitals and Organic Chemical Reactions*, Wiley, London, 1976.
102. R. Neeter and N. M. M. Nibbering, *Org. Mass Spectrom.*, **7**, 1091 (1973).
103. R. D. Smith and J. H. Futrell, *Org. Mass Spectrom.*, **11**, 309 (1976).
104. P. T. Mead, K. F. Donchi, J. C. Traeger, J. R. Christie and P. J. Derrick, *J. Am. Chem. Soc.*, **102**, 3364 (1980).
105. W. Tumas, R. F. Foster, M. J. Pellerite and J. I. Brauman, *J. Am. Chem. Soc.*, **105**, 7464 (1983); **109**, 961 (1987).
106. W. Forst, *Theory of Unimolecular Reactions*, Academic Press, New York, 1973.
107. S. Hammerum, *Acta Chem. Scand.*, **28B**, 707 (1984).
108. S. W. Benson, *Thermochemical Kinetics*, 2nd edn., Wiley, New York, 1976.
109. I. Howe, *Org. Mass Spectrom.*, **10**, 767 (1975).
110. L. Kaplan, in *Reactive Intermediates* (Eds. M. Jones and R. A. Moss), Vol. 1, Wiley, New York, 1978, p. 163.
111. J. S. Splitter, in *Applications of Mass Spectrometry to Organic Stereochemistry* (Eds. J. S. Splitter and F. Turecek), VCH, Weinheim 1994, p. 39.
112. D. L. Miller and M. L. Gross, *Org. Mass Spectrom.*, **18**, 239 (1983).
113. R. D. Bowen and A. Maccoll, *Org. Mass Spectrom.*, **18**, 576 (1983).
114. H. O. Krabbenhoft, *J. Org. Chem.*, **41**, 1774 (1976).
115. S. Hammerum and P. J. Derrick, *J. Chem. Soc., Perkin Trans. 2*, 1577 (1986).
116. R. D. Bowen and D. H. Williams, *J. Chem. Soc., Chem. Commun.*, 836 (1981).
117. G. Siuzdak and J. J. BelBruno, *J. Phys. Chem.*, **94**, 4559 (1990).
118. R. D. Bowen, *Mass Spectrom. Rev.*, **10**, 225 (1991).
119. K. Levsen and F. W. McLafferty, *J. Am. Chem. Soc.*, **96**, 139 (1974).
120. G. Cum, G. Sindona and N. A. Uccella, *Ann. Chim. (Rome)*, **64**, 169 (1974).
121. R. D. Bowen, D. H. Williams and G. Hvistendahl, *J. Am. Chem. Soc.*, **99**, 7509 (1977); R. D. Bowen and A. G. Harrison, *Org. Mass Spectrom.*, **16**, 180 (1981); R. D. Bowen, *J. Chem. Soc., Perkin Trans. 2*, 403 (1982).
122. N. A. Uccella, I. Howe and D. H. Williams, *J. Chem. Soc. (B)*, 1933 (1971).
123. D. H. Williams and G. Hvistendahl, *J. Am. Chem. Soc.*, **96**, 6753 (1974).
124. C. Djerassi and C. Fenselau, *J. Am. Chem. Soc.*, **87**, 5747, 5752 (1965); S. Sample and C. Djerassi, *J. Am. Chem. Soc.*, **88**, 1937 (1966).
125. G. A. Smith and D. H. Williams, *J. Am. Chem. Soc.*, **91**, 5254 (1969).
126. R. D. Bowen and D. H. Williams, *J. Am. Chem. Soc.*, **102**, 2752 (1980).
127. R. D. Bowen, *J. Chem. Soc., Perkin Trans. 2*, 1219 (1980).
128. H. J. Veith and J. H. Gross, *Org. Mass Spectrom.*, **26**, 1097 (1991).
129. R. D. Bowen, A. W. Colburn and P. J. Derrick, *J. Chem. Soc., Perkin Trans. 2*, 285 (1991); 2363 (1992).
130. T. H. Morton and H. E. Audier, *Org. Mass Spectrom.*, **28**, 1218 (1993).
131. For a review of the 'ene' reaction, see: H. M. R. Hoffmann, *Angew. Chem., Int. Ed. Engl.*, **8**, 556 (1969).

## 5. The chemistry of ionized, protonated and cationated amines in the gas phase 247

132. R. D. Bowen, *J. Chem. Soc., Perkin Trans. 2*, 409 (1982).
133. H. J. Veith and J. H. Gross, *Org. Mass Spectrom.*, **28**, 867 (1993).
134. G. Bouchoux, *Mass Spectrom. Rev.*, **7**, 1, 203 (1988).
135. T. A. Molenaar-Langeveld, R. H. Fokkens and N. M. M. Nibbering, *Org. Mass Spectrom.*, **23**, 364 (1988).
136. R. D. Bowen, A. D. Wright and P. J. Derrick, *Org. Mass Spectrom.*, **27**, 905 (1992); R. D. Bowen, A. D. Wright, A. W. Colburn and P. J. Derrick, *Int. J. Mass Spectrom. Ion Processes*, **116**, 193 (1992).
137. J. A. Cao, M. George and J. L. Holmes, *J. Am. Soc. Mass Spectrom.*, **3**, 1044 (1992).
138. R. D. Bowen and A. D. Wright, *J. Chem. Soc., Chem. Commun.*, 1005 (1981); 96 (1992); A. D. Wright and R. D. Bowen, *Can. J. Chem.*, **71**, 1073 (1993).
139. R. D. Bowen, *J. Chem. Soc., Chem. Commun.*, 807 (1985).
140. D. H. Aue, W. R. Davidson and M. T. Bowers, *J. Am. Chem. Soc.*, **98**, 6700 (1976).
141. S. Fornarini, M. Speranza, M. Attina, F. Cacace and P. Giacomellio, *J. Am. Chem. Soc.*, **106**, 2498 (1984).
142. G. Bouchoux, J. P. Flament, Y. Hoppilliard, J. Tortajada, R. Flammang and A. Maquestiau, *J. Am. Chem. Soc.*, **111**, 5560 (1989).
143. S. Dai, Q. Guo, J. T. Wang and F. Williams, *J. Chem. Soc., Chem. Commun.*, 1069 (1988).
144. For reviews of the PEP approach, see: D. H. Williams, *Acc. Chem. Res.*, **10**, 280 (1977); D. H. Williams, *Philos. Trans. R. Soc. London, Ser. A*, **293**, 117 (1977); R. D. Bowen, D. H. Williams and H. Schwarz, *Angew. Chem., Int. Ed. Engl.*, **18**, 451 (1979); R. D. Bowen and D. H. Williams, in *Rearrangements in Ground and Excited States* (Ed. P. DeMayo), Vol. 1, Chap. 2, Academic Press, New York, 1980.
145. H. E. Audier, J. -P. Denhez, A. Milliet and G. Sozzi, *Org. Mass Spectrom.*, **19**, 79 (1984).
146. R. G. Cooks, J. H. Beynon, R. M. Caprioli and G. R. Lester, *Metastable Ions*, Elsevier, Amsterdam, 1973.
147. K. Levsen, *Fundamental Aspects of Organic Mass Spectrometry*, Verlag-Chemie, Weinheim, 1978.
148. P. C. Burgers, J. L. Holmes, A. A. Mommers and J. K. Terlouw, *Chem. Phys. Lett.*, **102**, 1 (1983).
149. P. C. Burgers, J. L. Holmes, A. A. Mommers, J. E. Szulejko and J. K. Terlouw, *Org. Mass Spectrom.*, **19**, 442 (1984); J. L. Holmes and A. A. Mommers, *Org. Mass Spectrom.*, **19**, 460 (1984).
150. G. Frenking and H. Schwarz, *Naturwissenschaften*, **69**, 446 (1982); W. Koch, G. Frenking and H. Schwarz, *Naturwissenschaften*, **77**, 473 (1984).
151. C. E. C. A. Hop, M. Dakabu and J. L. Holmes, *Org. Mass Spectrom.*, **23**, 609 (1988).
152. T. Baer and T. E. Carney, *J. Chem. Phys.*, **76**, 1304 (1982).
153. C. Lifshitz, P. Gotchiguian and R. Roller, *Chem. Phys. Lett.*, **95**, 106 (1983).
154. M. S. B. Munson and F. H. Field, *J. Am. Chem. Soc.*, **88**, 2621 (1966).
155. For a monograph, see: A. G. Harrison, *Chemical Ionization Mass Spectrometry*, CRC Press, Florida, 1983.
156. M. Barber, R. S. Bardoli, R. D. Sedgwick and A. N. Tyler, *Nature*, **293**, 270 (1981).
157. For a review, see: L. D. Letter, O. W. Hand, R. G. Cooks and R. A. Walton, *Mass Spectrom. Rev.*, **7**, 465 (1988). See also: M. P. Lacey and T. Keough, *Rapid Commun. Mass Spectrom.*, **3**, 46 (1989).
158. N. L. Bosma and A. G. Harrison, *Can. J. Chem.*, **72**, 2205 (1994).
159. A. J. Cunningham, J. D. Payzant and P. Kebarle, *J. Am. Chem. Soc.*, **94**, 7627 (1972).
160. D. K. Bohme, R. S. Hemsworth, H. W. Rundle and H. I. Schiff, *J. Chem. Phys.*, **58**, 5304 (1973).
161. D. B. Dunkin, F. C. Fehsenfeld, A. L. Schmeltekopf and E. E. Ferguson, *J. Chem. Phys.*, **49**, 1365 (1968).
162. J. D. Baldeschwieler, *Science*, **159**, 263 (1968).
163. K. P. Wanczek, *Int. J. Mass Spectrom. Ion Processes*, **60**, 11 (1984).
164. A. G. Marshall, *Acc. Chem. Res.*, **18**, 316 (1985).
165. For an early compilation of PAs, see: J. L. Wolf, R. H. Staley, I. Koppel, M. Taagepera, R. T. McIver, Jr, J. L. Beauchamp and R. W. Taft, *J. Am. Chem. Soc.*, **99**, 5417 (1977).
166. S. G. Lias, J. F. Liebman and R. D. Levin, *J. Phys. Chem. Ref. Data*, **13**, 695 (1984); S. G. Lias, J. E. Bartmess, J. F. Liebman, J. L. Holmes, R. D. Levin and W. G. Mallard, *J. Phys. Chem. Ref. Data*, **17**, Suppl. 1 (1988).
167. D. H. Aue, H. M. Webb and M. T. Bowers, *J. Am. Chem. Soc.*, **97**, 4136, 4137 (1975).
168. D. H. Aue, H. M. Webb and M. T. Bowers, *J. Am. Chem. Soc.*, **94**, 4726 (1972).

169. D. H. Williams and G. Hvistendahl, *J. Chem. Soc., Perkin Trans. 2*, 881 (1975).
170. G. Hvistendahl and E. Uggerud, *Org. Mass Spectrom.*, **20**, 541 (1985); G. Hvistendahl and E. Uggerud, *Acta Chem. Scand.*, **42A**, 328 (1988).
171. K. F. Donchi, B. A. Rumpf, G. D. Willett, J. R. Christie and P. J. Derrick, *J. Am. Chem. Soc.*, **110**, 347 (1988).
172. E. L. Diestad, A. M. L. Diestad, H. Skaune, K. Rudd, T. Helgaker, E. Uggerud and T. Vulpus, *Eur. Mass Spectrom.*, **1**, 121 (1995).
173. E. J. Reiner, R. A. Poirer, M. R. Peterson, I. G. Csizmadia and A. G. Harrison, *Can. J. Chem.*, **64**, 1652 (1986).
174. R. D. Bowen, E. J. Reiner and A. G. Harrison, *J. Chem. Soc., Perkin Trans 2*, 1009 (1988).
175. F. P. Lossing and J. L. Holmes, *J. Am. Chem. Soc.*, **106**, 6917 (1984).
176. M. L. Sigsby, R. J. Day and R. G. Cooks, *Org. Mass Spectrom.*, **14**, 556 (1979).
177. W. Wagner, H. Heimbach and K. Levsen, *Int. J. Mass Spectrom. Ion Phys.*, **36**, 125 (1980).
178. E. J. Reiner, A. G. Harrison and R. D. Bowen, *Can. J. Chem.*, **67**, 2081 (1989).
179. S. A. McLuckley, G. L. Glish and R. G. Cooks, *Int. J. Mass Spectrom. Ion Phys.*, **39**, 219 (1981).
180. D. D. Fetterolf and R. A. Yost, *Int. J. Mass Spectrom. Ion Phys.*, **44**, 37 (1982).
181. S. A. McLuckley and R. G. Cooks, in *Tandem Mass Spectrometry* (Ed. F. W. McLafferty), Wiley, New York, 1983.
182. D. H. Williams and G. Hvistendahl, *J. Am. Chem. Soc.*, **96**, 6755 (1974).
183. B. Davis, D. H. Williams and A. N. H. Yeo, *J. Chem. Soc. (B)*, 81 (1970).
184. H. H. Gierlich, F. W. Rollgen, F. Borchers and K. Levsen, *Org. Mass Spectrom.*, **12**, 367 (1977).
185. M. Fischer and H. -J. Veith, *Helv. Chim. Acta*, **61**, 3038 (1978).
186. M. Ohashi, R. P. Barrow and W. R. Benson, *J. Am. Chem. Soc.*, **103**, 3943 (1981).
187. H. -J. Veith, *Org. Mass Spectrom.*, **18**, 154 (1983).
188. H. Mestdagh, N. Morin and C. Rolando, *Org. Mass Spectrom.*, **23**, 246 (1988).
189. S. Beranova and C. Wesdemiotis, *Int. J. Mass Spectrom. Ion Processes*, **134**, 83 (1994).

## CHAPTER 6

# Mass spectrometry of nitro and nitroso compounds

HELGE EGSGAARD

*Environmental Science and Technology Department, Risø National Laboratory, DK-4000 Roskilde, Denmark*

*Fax: +45-42-37-04-03; e-mail: Helge.Egsgaard@Risoe.dk*

and

LARS CARLSEN

*National Environmental Research Institute, Department of Environmental Chemistry, DK-4000 Roskilde, Denmark*

*Fax: 45-46-30-11-14; e-mail: mklc@hami1.dmu.dk*

---

I. INTRODUCTION . . . . .	250
II. MASS SPECTROMETRY . . . . .	250
A. Unimolecular Dissociations . . . . .	251
B. Collision Experiments . . . . .	253
C. Neutralization/Reionization . . . . .	254
III. IONIZATION . . . . .	255
A. Radical Cations—Ionization Energy . . . . .	255
B. Radical Anions—Electron Affinity . . . . .	256
C. Chemical Ionization—Proton Affinity . . . . .	258
IV. NITRO COMPOUNDS . . . . .	258
A. Generalized Fragmentation Processes . . . . .	258
B. Simple Cleavages . . . . .	259
C. Rearrangements . . . . .	259
1. Tautomerism: Nitro/ <i>aci</i> -nitro radical cations . . . . .	259
2. N—O isomerization: Nitro/nitrite radical cations . . . . .	262
3. Aliphatic nitro compounds: Cyclization reactions . . . . .	262
D. Hydrogen Transfer Reactions: The <i>ortho</i> -Effect . . . . .	264
1. Rearrangements due to <i>ortho</i> -effects . . . . .	267
2. <i>ortho</i> -Effects in anions . . . . .	269

E. Remote Oxidation	270
1. Remote oxidation of multiple carbon bonds	270
2. Remote oxidation of imine and ketenimine functionalities	273
3. Competing oxidation of sulphur and carbon	276
F. Polynitro Aromatics	281
1. Nitroadamantanes	281
2. Di- and tri-nitroaromatics	281
G. Nitro-heteroaromatics	281
1. Nitroazoles	281
2. 3-Nitro-2 <i>H</i> -chromenes and 3-nitrochromanes	284
H. Annelation Processes	286
I. Protonated Nitro Compounds	287
V. NITROSO COMPOUNDS	290
VI. REFERENCES	291

---

## I. INTRODUCTION

During the last decade knowledge of the ion chemistry of nitro compounds in the gas phase has increased significantly, partly due to the more widespread use of specialized techniques. Thus various ionization methods, in particular electron impact ionization and chemical ionization, have been used extensively. In addition, structure investigations as well as studies on fragmentation pathways have involved metastable ion dissociations, collision activation and neutralization/reionization studies, supplementary to studies carried out in order to disclose the associated reaction energetics and reaction dynamics. In general, the application of stable isotopes plays a crucial role in the in-depth elucidation of the reaction mechanisms.

The rationalization of mass spectrometric investigations of nitro compounds has benefited significantly from numerous studies applying techniques adopted from photochemistry, such as photodissociation, photoionization and photoelectron photoion coincidence spectroscopy.

The extensive research on nitro compounds confirms a rich gas-phase ion chemistry. It is, however, noteworthy that Porter, Beynon and Ast in the classical review, *The Modern Mass Spectrometer—A Complete Chemical Laboratory*, were able to demonstrate the capabilities of mass spectrometry with no less than thirty different experiments involving a single compound, i.e. nitrobenzene<sup>1</sup>.

A brief introductory section on advanced mass spectrometry is given with special emphasis on nitro and nitroso compounds, followed by a discussion addressing the reaction mechanisms characteristic for these classes of compound.

This report primarily covers the literature from the period 1980–1994 and is therefore a follow-up of the report by Schwarz and Levsen<sup>2</sup>.

## II. MASS SPECTROMETRY (MS)

The development of tandem MS techniques has undisputedly contributed significantly to the basic understanding of fundamental aspects of nitro compounds. Further possible analytical applications have benefited from an advanced use of ion chemistry. In particular, the MS studies on nitroarenes (nitro-PAHs), which are known to be highly mutagenic, should be emphasized as fast and reliable analytical strategies.

MS has proven to be a unique technique, since ionic reactions can be studied under strictly controlled conditions—even collision-free conditions can be achieved. Thus, MS may provide fundamental information on highly reactive systems.

### A. Unimolecular Dissociations

The ions observed as a result of unimolecular dissociations (metastable ions) in the mass spectrometer correspond to reactions in the low- $\mu\text{s}$  time frame<sup>3-5</sup>. Due to the duality of the reaction rate and the available energy, only processes with rather low-energy requirements are observed<sup>3-5</sup>, which is nicely reflected in the metastable ion spectrum of nitromethane (Figure 1)<sup>6</sup>. Two dominant processes, i.e. the loss of  $\text{OH}^\bullet$  ( $m/z$  44) and  $\text{CH}_3\text{O}^\bullet$  ( $m/z$  30), respectively, are observed leading directly to the conclusion that these reactions have critical energies within a few hundredths of  $\text{meV}$ <sup>7</sup>. Recent literature reviews<sup>8,9</sup> offer excellent discussions on the metastable ion dissociations. Nevertheless, it appears reasonable to summarize the more important aspects.

It is generally assumed that similar product ion abundances indicate that the metastable ions exhibit identical structures. It should, however, be emphasized that the abundance ratios can be highly sensitive to variations in internal energies. Hence, based on variation in the product ion abundance ratios only, it cannot unambiguously be concluded that the parent ion structures are different<sup>3-5</sup>.

Closely related to the metastable ion structure is the determination of kinetic energy release, which appears as a rather sensitive probe to reaction dynamics<sup>3-5</sup>. However, a comprehensive analysis of the kinetic energy release is in general a complicated process and requires detailed information regarding the ion-optic system<sup>3-5</sup>.

Nevertheless, even used as a qualitative probe, kinetic energy release determinations are rather useful. Thus, two isomeric metastable ions showing identical fragmentation as well as the same peak shape, i.e. identical kinetic energy release, most likely originate from the same precursor<sup>3-5</sup>. On the other hand, if significant differences are observed in the kinetic energy release (visualized in the peak shape), it has to be concluded that the

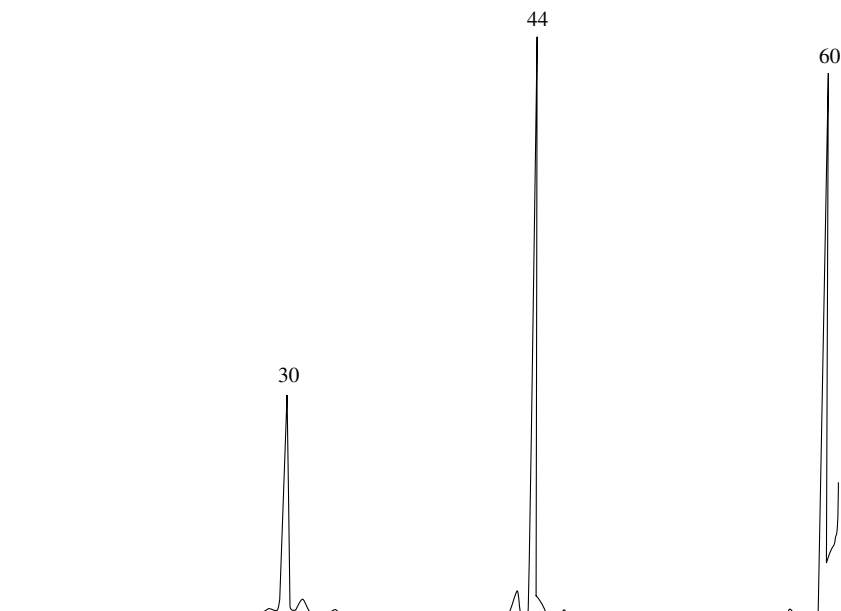


FIGURE 1. Metastable ion spectrum of the molecular ion of nitromethane<sup>6</sup>

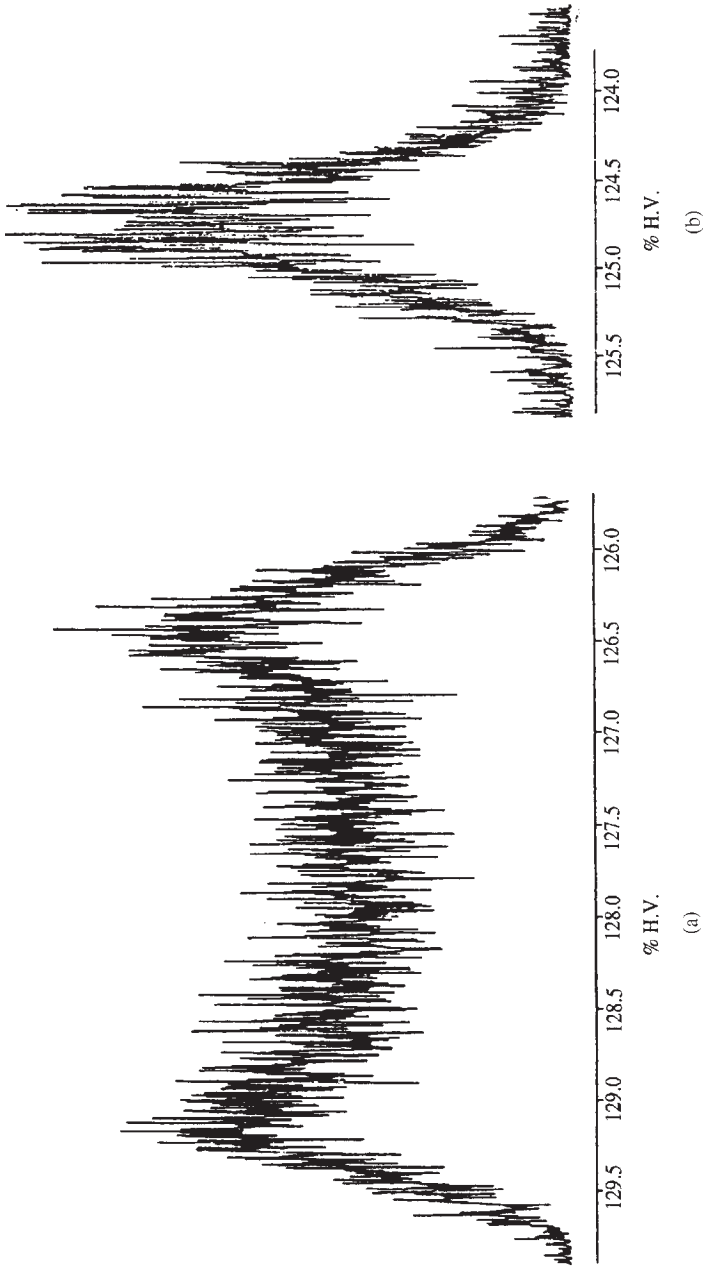


FIGURE 2. Peak shapes of the  $[M - NO]^+$  ions of (a) *p*-nitro-aniline (kinetic energy release 1240 meV) and (b) *p*-nitrobenzaldehyd (kinetic energy release 70 meV) Adapted from Reference 11



fragmentation apparently takes place via different structures/transition states<sup>10,11</sup>. Finally, it should be noted that the kinetic energy release reflects qualitatively the strain of the TS involved in the fragmentation process, i.e. tight systems show the highest release displayed by broad peaks. This may be illustrated by two closely related reactions, namely the NO loss from *p*-nitro-aniline and *p*-nitrobenzaldehyd, respectively (Figure 2)<sup>11</sup>. The peak shape for the fragmentation of *p*-nitro-aniline ion shows a very high kinetic energy release pointing to a very tight TS<sup>11</sup>. In addition, analysis of the energy partitioning of the system has revealed that a large fraction of the reverse activation energy appears as kinetic energy<sup>11</sup>.

## B. Collision Experiments

The above-mentioned sensitivity of metastable ion spectra to variations in internal energy can be surmounted by excitation of the ion of interest with a target gas at low pressure (*ca*  $10^{-6}$  mbar)<sup>3,5,12-14</sup>. Collision activation has been used extensively in ion structure analyses<sup>3,5</sup>. Differences observed in collision activation MS can be related directly to structural differences in the parent ions. However, the ions giving rise to metastable ion spectra can make up quite a large fraction of the decomposing ions following collision activation<sup>5</sup>. The effect may be of particular importance when using instruments operating with moderate translational energies<sup>5</sup>. However, focussing on the endothermic processes, i.e. the processes observed in the collision activation mass spectra only, the effect of initial energy may be reduced. In Figure 3, the collision activation mass spectrum of nitromethane is shown. The difference compared to the metastable spectrum shown in Figure 1 is striking. The feature in the collision-induced spectrum is the simple cleavage of a C–N bond giving rise to  $\text{NO}_2^+$  ( $m/z$  46) and, to a minor extent,  $\text{CH}_3^+$  ( $m/z$  15). This direct reaction is virtually absent in the metastable spectrum as dominated by rearrangement processes (Figure 1).

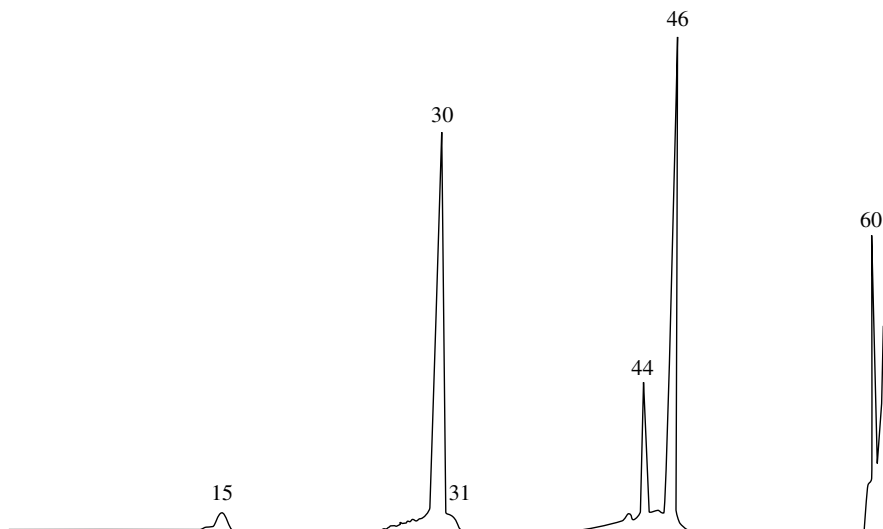


FIGURE 3. Collision activation mass spectrum of the molecular ion of nitromethane<sup>15</sup>

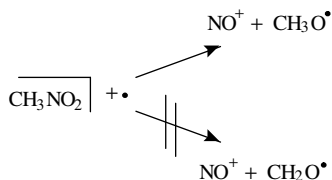
### C. Neutralization/Reionization

The technique of neutralization/reionization mass spectrometry (NRMS), originally introduced by McLafferty, invokes the formation of fast neutrals from a preselected ion beam, any residual ions being deflected, followed by collision-induced reionization of the neutrals and a subsequent mass spectrometric analysis<sup>16-21</sup>.

The NRMS technique has been used to distinguish between ion structures, which by other means are not distinguishable, i.e. in situations where fast isomerization takes place after collision activation, but prior to fragmentation<sup>5</sup>. Thus, NRMS experiments have been used to disclose, e.g., the site of protonation of nitroarenes<sup>22</sup>.

The fast neutrals may well originate from ordinary fragmentations, i.e. metastable ions. Thus, NRMS experiments enable studies on the 'neutral-half' of the MS. In the case of nitromethane, the dominant generation of  $\text{NO}^+$  is associated with a simultaneous formation of a ' $\text{CH}_3\text{O}^\bullet$ ' species. Using the NRMS technique it is possible unambiguously to distinguish between the possible  $\text{CH}_2\text{OH}^\bullet$  and  $\text{CH}_3\text{O}^\bullet$  structures<sup>23</sup>; See Scheme 1. The fragmentation of nitromethane apparently gives rise to the latter<sup>7</sup>.

In addition, the NRMS technique is an excellent tool to generate and characterize otherwise non-achievable compounds. Thus, the elusive *aci*-nitromethane was successfully



SCHEME 1

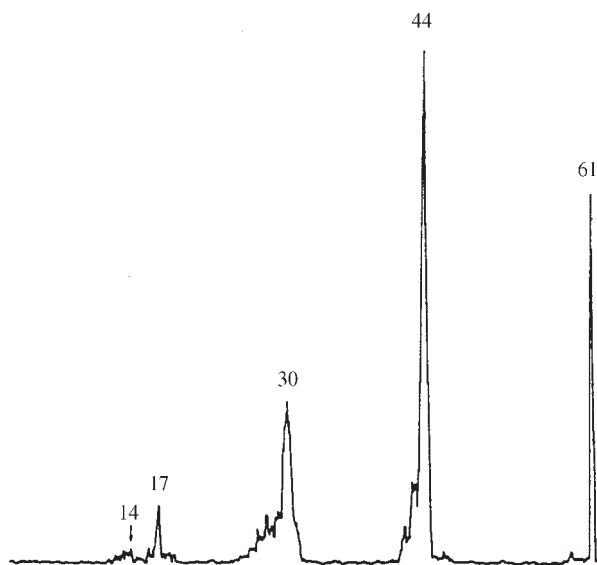


FIGURE 4. Neutralization/reionization mass spectrum of  $[\text{M} - \text{C}_2\text{H}_4]^+$  ion of 1-nitropropane<sup>15</sup>

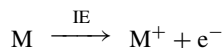
generated by neutralization of the  $[M - C_2H_4]^+$  ion of 1-nitropropane as demonstrated by the dominant recovery signal at  $m/z$  61. The identity of the survivor is given by the fragments in comparison with that of nitromethane; cf Figure 3<sup>15</sup>. The NRMS spectrum is shown in Figure 4. It appears that the loss of  $OH^*$  ( $m/z$  44) is the characteristic feature. In the case of nitromethane, this process is apparently only significant for long-lived ions with an appropriate internal energy; cf Figure 1.

### III. IONIZATION

Ionization may take place by the interaction with a particle sufficiently high in energy, e.g. an electron or a photon, or by the addition of charged species, e.g. an electron or a proton. The thermochemistry associated with the ionization process provides information on ion structures, since a structure may be assigned based on heat of formation when compared to data of reference ions. Thus, the determination of ionization energy, electron affinity and proton affinity plays a central role in mass spectrometry.

#### A. Radical Cations—Ionization Energy

The heat of formation of a positive ion in the gas phase is obtained by taking the heat of formation of the corresponding neutral species and adding the energy required to remove an electron from the molecule, i.e. the ionization energy<sup>24</sup>:



Protocols for the estimation of heat of formation of cations have been developed<sup>25–28</sup>. It appears that heat of formation of positive ions in homologous series is well represented by the equation:

$$\Delta_f H(M^+) = A - Bn + \frac{C}{n}$$

where  $A$ ,  $B$  and  $C$  are constants for a given homologous series and  $n$  is the total number of atoms in the molecule. The success of this approximation is due to the fact that the ionization energy within homologous series varies linearly with  $n^{-1}$ . The terms  $A$  and  $Bn$  reflect the additive nature of heats of formation for the corresponding neutrals.

Nitro compounds were not included in the comprehensive list given elsewhere<sup>24</sup>. However, taking the data available for the  $C_1$  to  $C_4$  species<sup>24</sup> the constants  $A = 237$ ,  $B = 1.8$  and  $C = 84$  can be derived for 1-nitroalkanes<sup>29</sup>. It is apparent that the ionization energies of nitroalkanes are significantly lower than those for the corresponding alkanes. Thus, the ionization energy of nitromethane is 11.02 eV<sup>30</sup> compared to 12.51 eV for methane<sup>24</sup>. The prototypical organic nitro compounds, nitromethane and nitrobenzene, have been studied by high resolution photoelectron spectroscopy; cf Figure 5<sup>31</sup>. The weakest bound molecular orbital in nitromethane has been identified as the  $a_1$  bonding orbital<sup>31,32</sup>. The first and second ionization bands of nitromethane show extensive vibrational structure. The vibrational progression was assigned to the symmetric  $NO_2$  bending mode<sup>31</sup>. However, the spacing was approximately 565  $cm^{-1}$ , which is significantly lower than in the molecular ground state (647  $cm^{-1}$ ) and implies that the  $ONO$  angle of the ionized state is considerably different from the molecular ground state<sup>31</sup>. *Ab initio* calculations are in complete agreement, as the  $ONO$  angle is calculated to be 137.8° and 125.8° for ionized and neutral forms, respectively<sup>32,33</sup>.

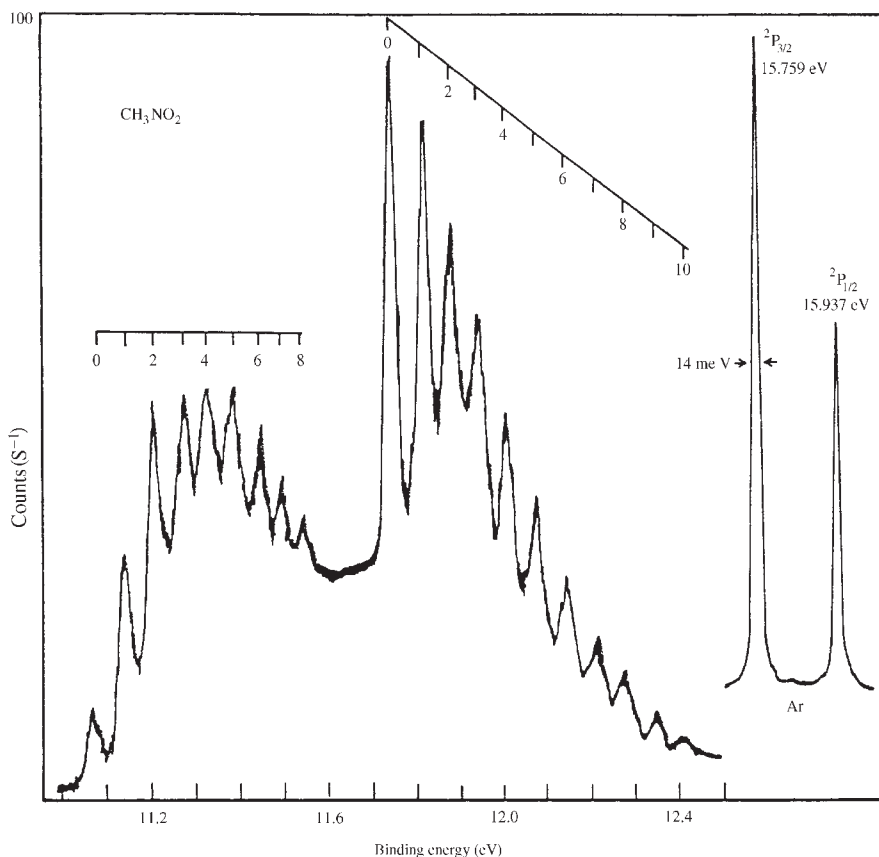
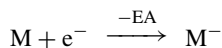


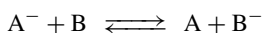
FIGURE 5. The lowest energy ionization bands of nitromethane. The vibrational progressions are labelled. The argon lines are shown to the right. Reproduced by permission of the American Institute of Physics from Ref. 31

### B. Radical Anions—Electron Affinity

The electron affinity (EA) for a molecule is a quantity which is analogous to the ionization energy for cations. Thus, the electron affinity is defined as the negative of the enthalpy change for the electron attachment reaction:



Electron affinities of molecules are of interest not only in gas-phase reactions, e.g. in negative chemical ionization mass spectrometry, but also in the field of condensed-phase chemistry. It is characteristic that negative ions are by far not studied to the same level of detail as the corresponding positive ions. However, during the last decade a large number of EA determinations based on measurements of electron transfer equilibria utilizing pulsed high-pressure mass spectrometry have been reported<sup>34,35</sup>.



The equilibrium concentration of the ions  $A^-$  and  $B^-$  participating in the equilibrium can be directly observed by mass spectrometry. Thus, the free-energy change can be derived from the equilibrium constant, since the concentrations of the neutral species are known in advance. Similarly, by measuring the temperature dependence of the equilibrium constants, the associated enthalpy and entropy can be obtained from van't Hoff plots. By measuring a series of interconnecting equilibria, an appropriate scale can be established. The primary standard in such work has frequently been  $SO_2$  whose electron affinity is well established by electron photodetachment<sup>36</sup>.

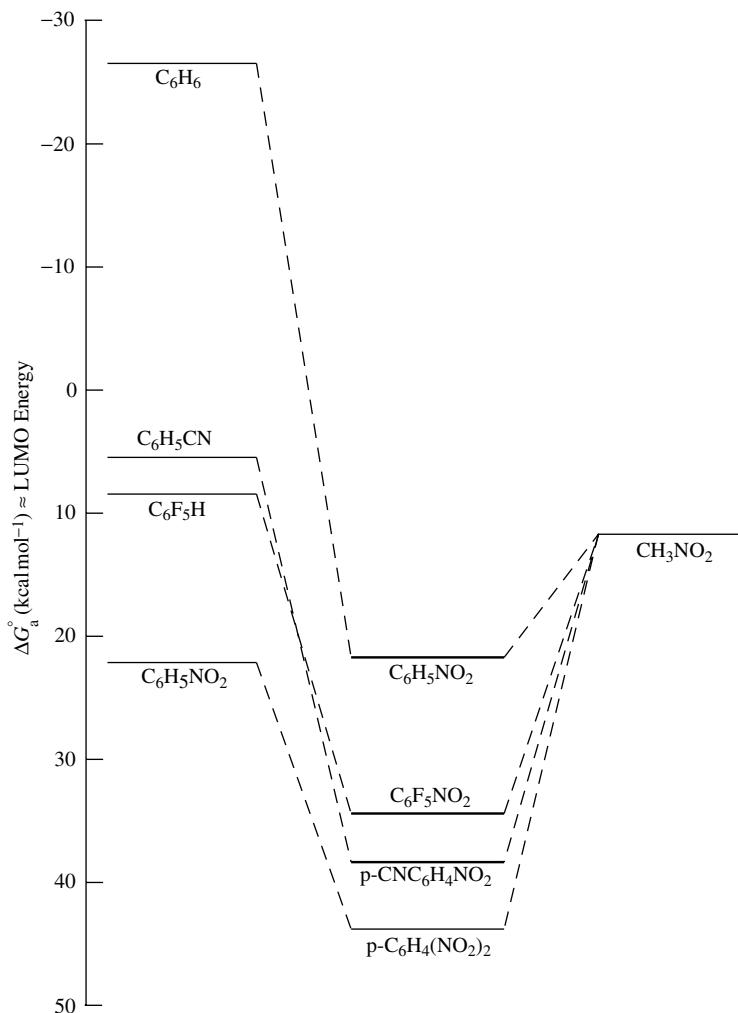


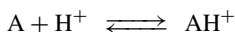
FIGURE 6. Schematic plot of LUMO energies of aromatic compounds and the resulting LUMO from the interaction of the aromatic LUMO and the substituent LUMO<sup>37</sup>. Energy for the  $NO_2$  substituent LUMO is approximated by the EA of nitromethane<sup>37</sup>. Reprinted with permission from Reference 37. Copyright (1989) American Chemical Society

Aromatic compounds have a lowest unoccupied molecular orbital (LUMO), sufficiently low in energy to lead to stable radical anions upon electron capture. The presence of electron-withdrawing substituents such as  $\text{NO}_2$  lowers the energy of the LUMO and, hence, increases the EA leading to rather stable anions. This is illustrated in Figure 6, where the  $-\Delta G^\circ$  is used as an approximate value for the energy levels of the various orbitals<sup>37</sup>. This figure shows that the LUMO of the nitro group is much lower than the LUMO of benzene. Thus, when benzene is substituted with a nitro group, the LUMO of the nitro group will make a dominant contribution to nitrobenzene LUMO causing much of the LUMO to be located on the nitro group<sup>37</sup>. Thus, the extra electron apparently enters a  $\pi^*$ -orbital<sup>37</sup>.

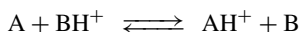
Electron affinities for 35 substituted nitrobenzenes have been reported and provided a comprehensive data set for the examination of substituent effects<sup>38</sup>. The data were used to derive Taft gas-phase substituent parameters and discussed qualitatively based on frontier orbital molecular theory<sup>38</sup>. The rate constants for the *exo*-energetic electron-transfer reactions were found to be close to those predicted by the ADO (average dipole orientation) theory<sup>38</sup>.

### C. Chemical Ionization—Proton Affinity

The proton affinity is defined in terms of the hypothetical reaction



as the negative of the enthalpy change. Since entropy associated with transfer reactions of atomic particles in general is low, the proton affinity can be used directly to predict the equilibrium between a protonated species and neutral molecule



since

$$-RT \ln K_{\text{eq}} = \Delta_r G = \Delta_r H - T \Delta_r S \approx \Delta_r H$$

It appears that gas-phase basicity of nitro compounds has been studied only scarcely. Thus, only the values of the parent compounds, nitromethane ( $179.2 \text{ kcal mol}^{-1}$ ) and nitrobenzene ( $193.4 \text{ kcal mol}^{-1}$ ), are found in the comprehensive listing given in Reference 39. The rather high PA values for nitro compounds suggest protonation by common chemical ionization reagent systems, such as hydrogen ( $\text{H}_3^+$ ) and methane ( $\text{CH}_5^+$ ).

## IV. NITRO COMPOUNDS

### A. Generalized Fragmentation Processes

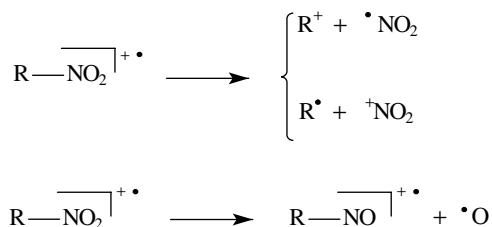
The fragmentation of the radical cations of nitro compounds may be initiated by a surprisingly high number of different mechanisms. The following reaction mechanisms appear as particularly important and will be discussed comprehensively:

- Simple cleavages, e.g. the rupture of the C–N bond.
- Tautomerism, i.e. the nitro/*aci*-nitro radical cations.
- Isomerization of the nitro functionality, i.e. the nitro/nitrite radical cations.
- Hydrogen transfer prior to fragmentation, e.g. the *ortho* effect.
- Extensive rearrangement, e.g. electro-cyclic ring-closure.
- Remote oxidation.

In addition, the ion chemistry of nitro compounds following protonation as well as that of negative ions will be discussed.

## B. Simple Cleavages

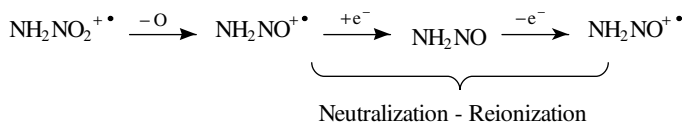
Nitro compounds may show two different simple cleavages with respect to the nitro functionality, i.e. cleavage of the C–N and N–O bond, respectively.



Stevenson's rule<sup>3,40</sup> predicts comparable ion intensities near the thermodynamic onset for  $\text{CH}_3^+$  and  $\text{NO}_2^+$  produced by a C–N bond rupture of the nitromethane radical cation since  $\text{CH}_3^+$  and  $\text{NO}_2^+$  are close in ionization energies. However, the difference between the dissociation limit and the observed appearance energy amounts to 1.2 eV<sup>41</sup>. The energy release with photon energy of 14.73 eV was 0.37 eV and 0.24 eV for  $\text{NO}_2^+$  and  $\text{CH}_3^+$ , respectively<sup>41</sup>. Thus, it was concluded that either  $\text{CH}_3^+$  or  $\text{NO}_2^+$  was formed in an electronically excited state rather than in an electronic ground state<sup>41</sup>. This suggests that the  $\text{CH}_3^+$  may arise from a specific excited molecular ion<sup>41</sup>.

The cleavage of the C–N bond in the nitrobenzene radical cation, on the other hand, gives rise to the  $\text{C}_6\text{H}_5^+$  ion. This reaction has been studied by PEPICO and, based on fragmentation rates, it was concluded that the  $\text{NO}_2$  loss most likely takes place from an electronically excited state<sup>42</sup>. However, a later PEPICO study revealed that the dependence of the fragmentation rate constants on internal energy is in good agreement with the RRKM/QET calculations assuming a slightly tight transition state<sup>43</sup>. In addition, the average kinetic energy release was in good quantitative agreement with that calculated by statistical phase space theory<sup>43</sup>.

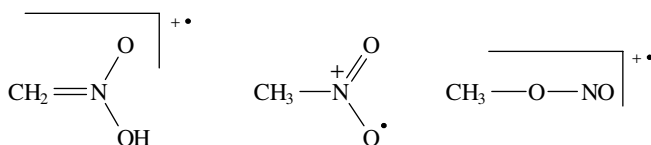
Electron impact mass spectra of nitro compounds show generally  $[\text{M} - \text{O}]^{\bullet+}$  ions, however, in low intensity. Several  $[\text{M} - \text{O}]^{\bullet+}$  ions, e.g. the  $[\text{M} - 16]^{\bullet+}$  of nitromethane<sup>44</sup> and nitroethene<sup>45</sup>, has by tandem mass spectrometry unambiguously been demonstrated to be of the nitroso form. Particularly interesting is the use of the parent nitramide in NRMS study of the elusive nitrosamide<sup>46</sup>.



## C. Rearrangements

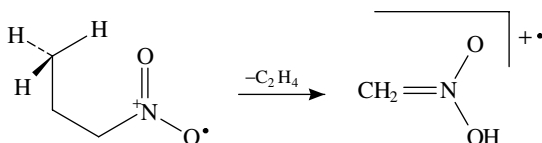
### 1. Tautomerism: Nitro/aci-nitro radical cations

The fragmentation characteristics of the  $\text{CH}_3\text{NO}_2$  isomers have been studied by a number of investigators and the system constitutes one of the most well-decribed within the field of mass spectrometry. Apparently intricate inter-relations between the isomers do exist.



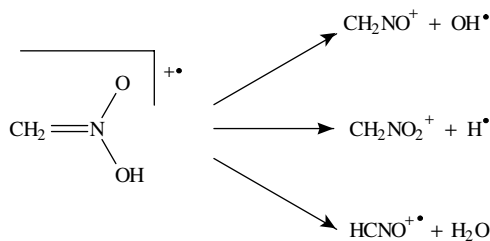
The *aci*-form of the nitro group is frequently claimed in pure chemistry. However, only *aci*-nitromethane appears to have been comprehensively studied as an isolated species<sup>15</sup>. Ionized keto-enol systems are characterized by reversal of the relative stabilities of the single species compared to their neutral counterparts. Thus, the ionized enols are generally the thermodynamically more favoured tautomers by approximately 15–20 kcal mol<sup>-1</sup>, the two tautomers being separated by a significant barrier of *ca* 50 kcal mol<sup>-1</sup><sup>47-49</sup>.

The *aci*-nitromethane radical ion may be generated by a facile loss of ethylene from the radical cation of 1-nitropropane via a 1,5-hydrogen shift<sup>15,50,51</sup>.



The complete potential energy surface of nitromethane, *aci*-nitromethane and methyl nitrite is accurately known by experiment (Figure 7)<sup>52</sup>. Thus, the *aci*-nitromethane radical cation, based on appearance energy measurements, has been found as the more stable by 6 kcal mol<sup>-1</sup><sup>52</sup>.

The *aci*-nitromethane ions decompose by the loss of  $\text{H}^{\bullet}$ ,  $\text{OH}^{\bullet}$  and  $\text{H}_2\text{O}$ <sup>15,50,52</sup>; see Scheme 2.



SCHEME 2

It has been shown that isomerization of the nitromethane radical cation to the *aci*-form is the rate-determining step for the loss of  $\text{OH}^{\bullet}$ <sup>15,50,52</sup>; cf Figure 7. This is in contrast to the elimination of  $\text{H}_2\text{O}$ , where the final step becomes rate determining<sup>52</sup>; cf Figure 7. A very large isotope effect apparently operates in the nitro-to-*aci* isomerization<sup>50,53</sup>. Thus,  $k_{\text{H}}/k_{\text{D}}$  has been determined to be in excess of 50<sup>50</sup>. Such a high value points to quantum mechanical tunneling, which consequently has been used as a basis for disclosing the reaction<sup>53</sup>. As a result of the significant isotope effect, the isomerization cannot be traced in the case of  $\text{D}_3$ -nitromethane<sup>50,53</sup>. However, the process is immediately observed for the  $\text{D}_0$ ,  $\text{D}_1$ ,  $\text{D}_2$  isotopomers<sup>50</sup>. The loss of the hydrogen atom has the highest energy requirement and occurs apparently directly from the *aci*-form<sup>52</sup>.



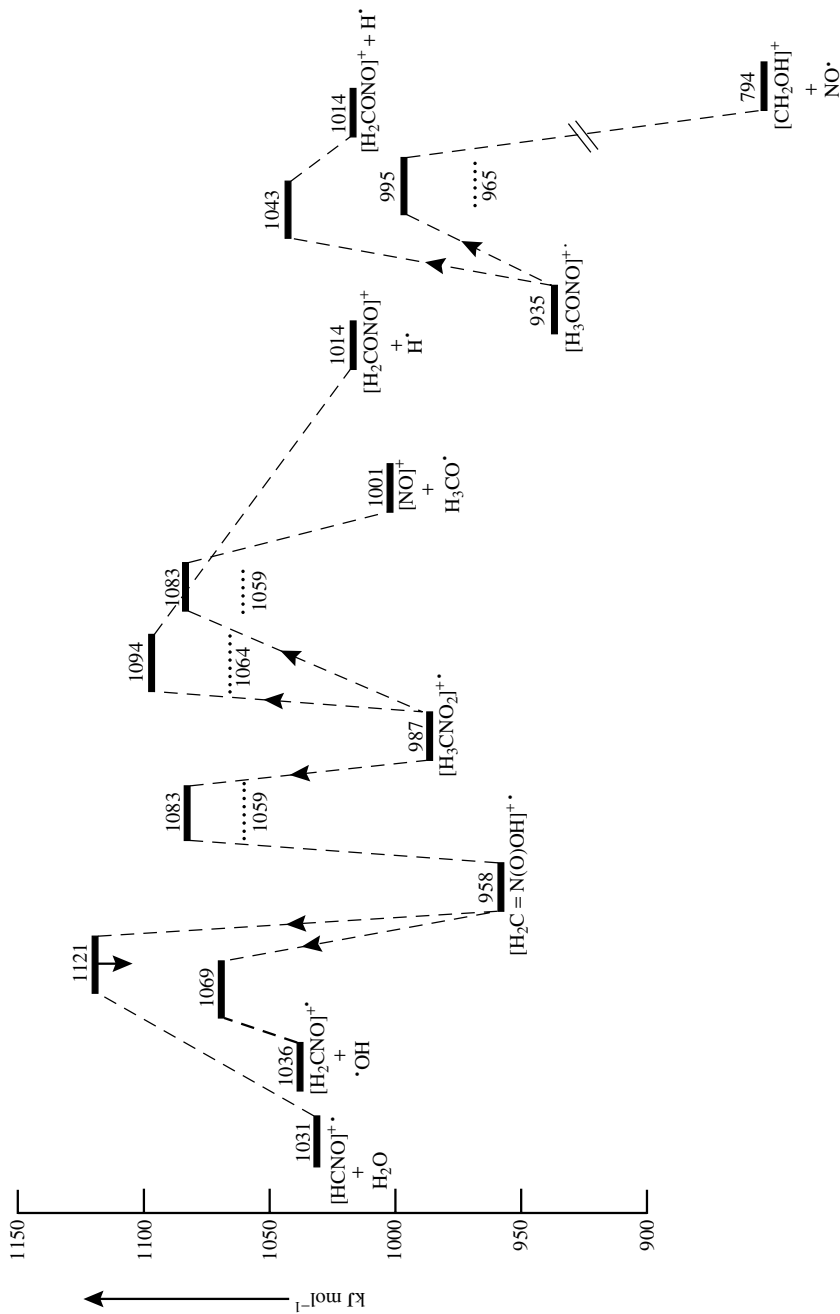
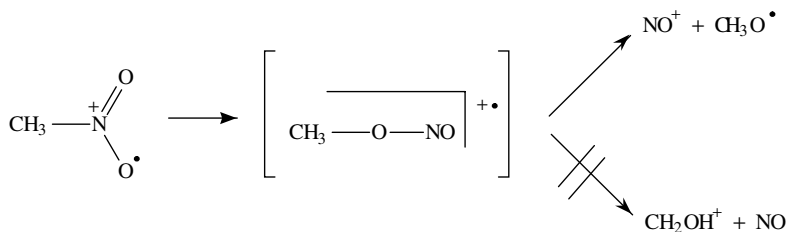


FIGURE 7. The potential energy surface of nitromethane, *anti*-nitromethane and methyl nitrite<sup>52</sup>. The dots indicate transitions determined from daughter ion appearance energies<sup>52</sup>. Such values may possess a significant kinetic shift<sup>3</sup>

## 2. N–O isomerization: Nitro/nitrite radical cations

The N–O isomerization may be visualized by the generation of  $\text{NO}^+$  vs the loss of NO from the molecular ion. In the case of nitromethane, the formation of  $\text{NO}^+$  may be unexpected because methyl nitrite ions decompose unimolecularly to  $\text{CH}_2\text{OH}^+$  and  $\text{NO}$ <sup>30,52,54–56</sup>; see Scheme 3. However, the isomerization gives rise to highly excited methyl nitrite ions, which will favour a fragmentation with a high frequency factor, i.e. a simple cleavage instead of the formal 1,2-hydrogen shift to an  $\alpha$ -dinitronic ion. The latter has recently been suggested to be a common intermediate in the surprisingly complex unimolecular fragmentation of the methyl nitrite radical cation<sup>57</sup>.



SCHEME 3

Finally, it should be recalled that the neutral  $\text{CH}_3\text{O}$  species associated with the formation of  $\text{NO}^+$  from the nitromethane radical cation is purely the methoxy radical<sup>7</sup>.

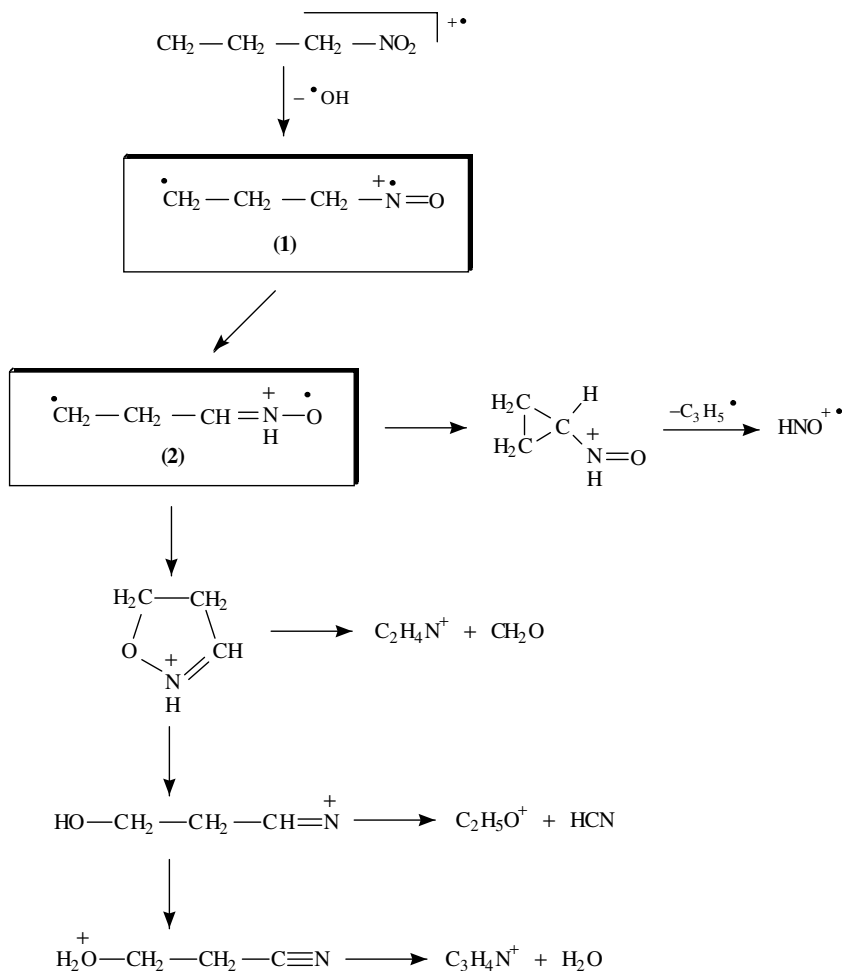
In the case of nitroaromatics, the NO loss may in addition take place by a rearrangement involving the *ortho* position<sup>11</sup>. The determination of the associated kinetic energy release has played a central role in the elucidation of the mechanisms. Thus, the amount of kinetic energy released from a series of substituted nitrobenzenes is *para* > *ortho* > *meta* if the substituents are electron-donating, whereas the reverse order is noted in the case of electron-withdrawing substituents<sup>58</sup>. The observations were rationalized in terms of the stability of the product ion and the ring sizes of transition states of the reactions, i.e. three- or four-membered ring size<sup>58</sup>.

Studies applying the PEPICO technique have, on the other hand, lead to a much more refined picture of those reactions, because PEPICO makes possible the measurement of dissociation rates and kinetic energy release of ions with selected internal energies<sup>43</sup>. Thus, the formation of  $\text{C}_6\text{H}_5\text{O}^+$  and  $\text{NO}^+$  from nitrobenzene ions proceeds via rate-determining transition states. Near the threshold the formation of  $\text{NO}^+$  is most probably preceded by a nitro–nitrite isomerization, since no model seems able to account for the observed *small* kinetic energy release by a direct fragmentation through a tight TS with a large reverse activation energy<sup>43</sup>. Increasing the internal energy gives rise to increase in the average kinetic energy release beyond that predicted by a loose TS model, e.g. nitro–nitrite isomerization. This implies that the nitrobenzene ion at higher internal energies no longer completely isomerizes and  $\text{NO}^+$  is produced directly through a rate-determining TS relatively high in energy<sup>43</sup>.

## 3. Aliphatic nitro compounds: Cyclization reactions

More than three decades ago 1-nitropropane was studied by deuterium labelling<sup>59</sup>. It was shown that the molecular ions of 1-nitropropane can decompose via two channels following the 1,5-hydrogen shift, i.e. a  $\gamma$ -hydrogen shift from the terminal methyl group to

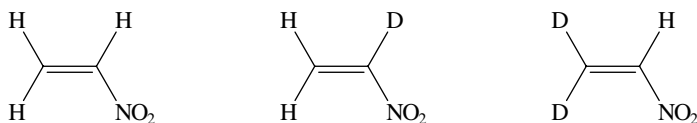
oxygen in the nitro group<sup>59</sup>. One channel corresponds to an elimination of ethylene giving rise to the *aci*-nitromethane ions, as discussed above. The alternative route involves the loss of a hydroxyl radical. The resulting ions undergo a series of very specific rearrangements leading to loss of  $C_3H_5^+$ ,  $H_2O$ ,  $HCN$  and  $CH_2O$ , respectively<sup>51,59</sup>; see Scheme 4. Those processes have been studied by tandem mass spectrometry<sup>51</sup>.



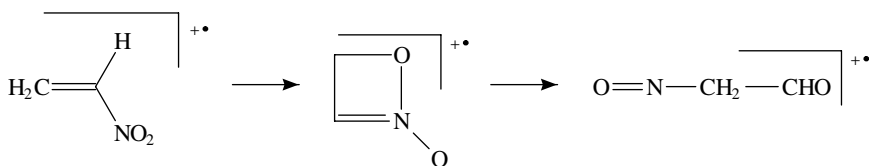
SCHEME 4

The proposal that ions of type **2** undergo ring closure to three- and five-membered rings whereas ions of type **1** do not cyclize to four-membered ring, fits nicely with the concept of  $\sigma$ -assisted/ $\sigma$ -resisted cyclization reactions<sup>60</sup>.

Fragmentation of the nitroethylene radical cation has been studied by deuterium labelling and tandem mass spectrometry and compared to the fragmentation of the corresponding nitrosoethylene<sup>61</sup>.

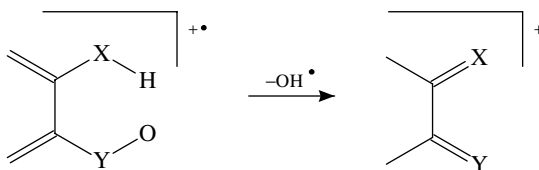


It appears that the radical cation of nitroethylene in the  $\mu\text{sec}$  time frame rearranges to ionized nitrosoacetaldehyde via the 4*H*-oxazet N-oxide<sup>61</sup>. The informative part of the spectra corresponds to the ions originating from  $\text{CHO}^\bullet$  and  $\text{H}_2\text{CO}$  losses from the molecular ion<sup>61</sup>.



#### D. Hydrogen Transfer Reactions: The *ortho*-Effect

One of the best known *ortho*-effects is the loss of a hydroxyl radical resulting from the interaction between a nitro group and a hydrogen atom in an adjacent substituent through a cyclic TS<sup>62</sup>.



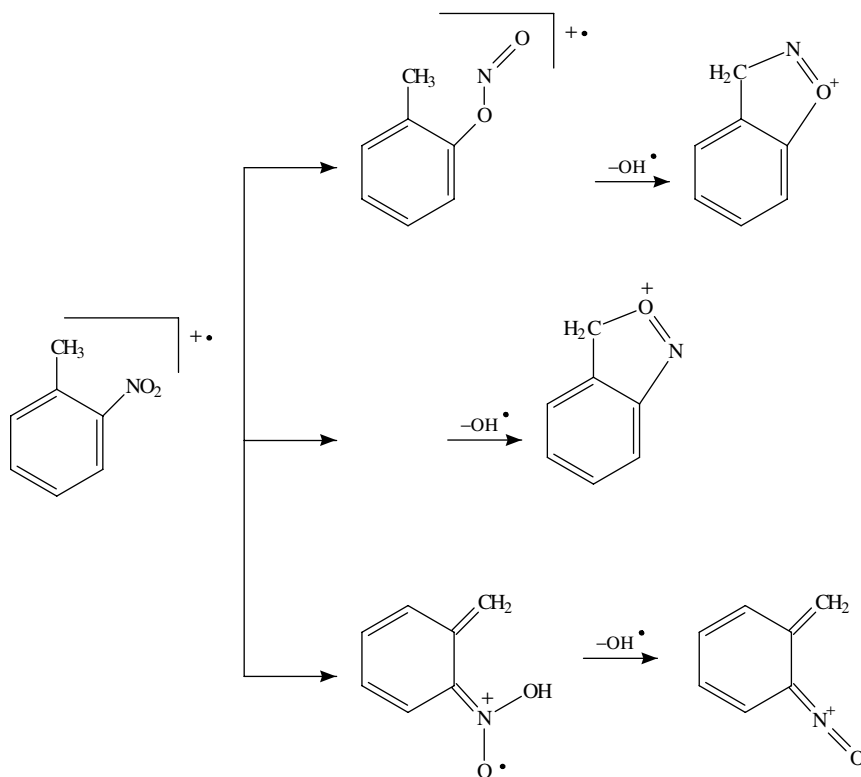
However, it should be emphasized that the  $\text{OH}^\bullet$  loss also occurs from *meta*- and *para*-substituted nitrobenzenes provided a side-chain of more than one carbon atom and at least one  $\alpha$ -hydrogen atom is present. This loss of  $\text{OH}^\bullet$  shows up to a minor, but nevertheless significant, extent.

Mass spectrometry of 2-nitrotoluene, which may be regarded as a prototype in this context, was studied as early as 1959<sup>63</sup> and has since been studied intensively. By deuterium labelling it has been demonstrated that the hydrogen lost through a  $\text{OH}^\bullet$  comes exclusively from the methyl group<sup>64</sup>. The dissociation dynamics of energy-selected 2-nitrotoluene radical cations has been studied by photoelectron photoion coincidence spectroscopy (PEPICO)<sup>65</sup>. The breakdown diagram and the  $\text{OH}^\bullet$  loss rates were determined. The measured rates were consistent with a mechanism in which the parent 2-nitrotoluene radical cation rearranges to an energetically more favourable structure prior to the loss of  $\text{OH}^\bullet$ . The rearranged ion was calculated to be 1.62 eV more stable than the 2-nitrotoluene radical cation and to dissociate with a critical energy of 1.5 eV<sup>65</sup>.

The kinetic energy release for the loss of  $\text{OH}^\bullet$  from the 2-nitrotoluene ion has been reported<sup>66</sup>. The relatively small value, 20–50 meV<sup>66</sup>, is characteristic of reactions involving a simple bond cleavage with neglectable reverse activation energy<sup>3</sup>. This implies that the final step, in a by-necessity complex reaction, is likely to be a simple bond cleavage.

The actual nature of the  $[\text{M} - \text{OH}^\bullet]^+$  product ion has been approached by several research groups. Beynon and coworkers have discussed possible mechanisms for the

loss of  $\text{OH}^\bullet$  radical<sup>67</sup>. Thus, it has been suggested that the molecular ion undergoes rearrangement to the nitrite form prior to the  $\text{OH}^\bullet$  loss (Scheme 5). Such a rearrangement is frequently invoked in the fragmentation of both aliphatic as well as aromatic compounds. In the second mechanism, no specific intermediate was claimed. Meyerson and coworkers, on the other hand, suggested that the fragmentation takes place straightforwardly via an intermediate formed by an initial simple hydrogen transfer, this product ion, hence, not containing a second ring system<sup>68</sup>.



SCHEME 5

A subsequent study of the unimolecular dissociations of a number of precursor molecules leads to the conclusion that the  $[\text{M} - \text{OH}^\bullet]^+$  product ion possesses the 1,2-benzisoxazolenium structure, although the coexistence of other structures could not be ruled out<sup>67</sup>. This assignment is, however, partly in conflict with previous results demonstrating that the subsequent facile loss of CO from the  $[\text{M} - \text{OH}^\bullet]^+$  product ion involves exclusively the carbon from the methyl group<sup>67,69</sup>. This inconsistency may be sought for in the uncertainty of the structures of some of the applied reference ions. Thus, the exact mechanism for the loss of  $\text{OH}^\bullet$  remains uncertain as does the actual identity of the product ion. The heat of formation,  $900 \pm 15 \text{ kJ mol}^{-1}$ , predicted for  $[\text{M} - \text{OH}^\bullet]^+$ , may turn out as highly diagnostic in establishing the structure in future experiments<sup>65</sup>.

The possibility that the loss of  $\text{OH}^\bullet$  from the molecular ion of ethylnitrobenzenes takes place from a common structure has been comprehensively studied<sup>64,70-73</sup>. It appears that the efficiency of the process is *ortho* > *meta* > *para*. By deuterium labelling, a high specificity for the involvement of the  $\alpha$ -hydrogens in the loss of  $\text{OH}^\bullet$  from the *ortho* isomer has been demonstrated<sup>64,71</sup>. In contrast to this, the losses of  $\text{OH}^\bullet$  from the *meta* and *para* isomers appear much less favoured. In the latter cases the loss of  $\text{OH}^\bullet$  is preceded by an extensive hydrogen scrambling, leading to a virtual 'loss of identity'<sup>71</sup>. The critical energy for the loss of  $\text{OH}^\bullet$  for the *ortho* isomer is remarkably low (0.05 eV) whereas the critical energies from the *meta* and *para* isomers are substantially higher, by approximately 1 eV<sup>71</sup>. In addition, the structures of  $[\text{M} - \text{OH}]^+$  ions have been studied by measurements of metastable ion spectra, collisional activation MS, kinetic energy release, photodissociation and critical energies for the formation of these ions and their subsequent decomposition<sup>70-73</sup>. It has been shown that for the *ortho* isomer the loss of  $\text{OH}^\bullet$  is a unique reaction and totally different from that of *meta* and *para* isomers; cf Figure 8<sup>72</sup>. In addition, the rates of unimolecular decomposition of the metastable  $\text{M}^{+\bullet}$  and  $[\text{M} - \text{OH}]^+$  are different for *meta* and *para* isomers<sup>72</sup>. The collision-induced MS of  $[\text{M} - \text{OH}]^+$  show significant differences as well. On this basis, a common structure, e.g. a

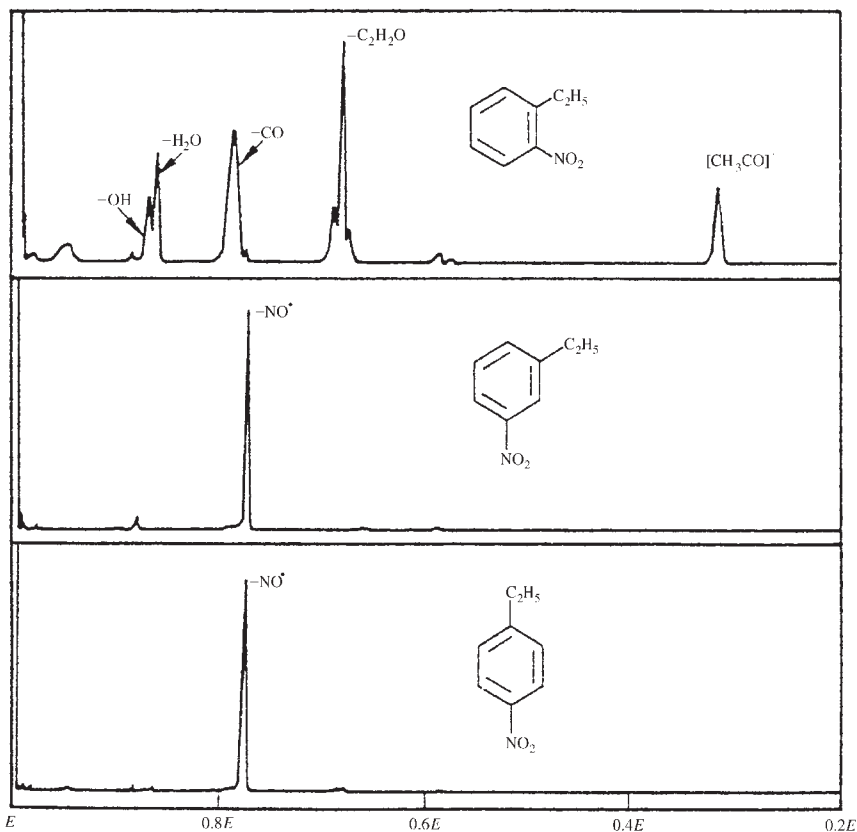


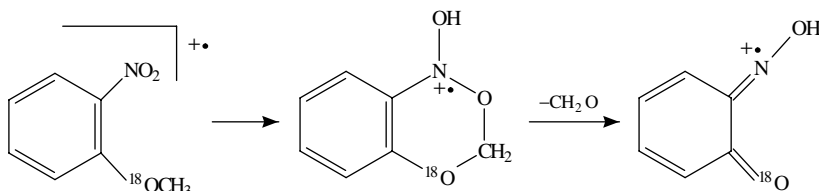
FIGURE 8. Metastable ion spectra of  $[\text{M} - \text{OH}]^+$  ions of isomeric ethylnitrobenzenes<sup>71</sup>

methylnitrocycloheptatriene ion to be involved in the loss of  $\text{OH}^\bullet$  from ethylnitrobenzenes, was unambiguously rejected<sup>71</sup>.

### 1. Rearrangements due to ortho-effects

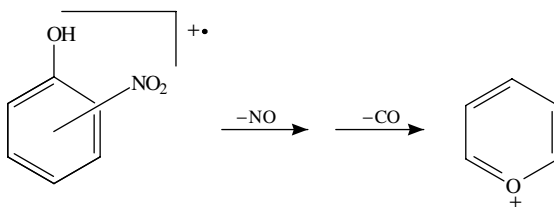
The loss of isobaric neutral species from the molecular ions of isomeric nitroanisoles has been studied using deuterium labelling<sup>74</sup>. The mass analysis indicated that specific loss of  $\text{CH}_2\text{O}$  occurs from the molecular ions of 2-nitroanisole, while a specific loss of  $\text{NO}$  takes place from 3-nitroanisole<sup>74</sup>. Although the peak due to  $[\text{M} - \text{NO}]^+$  is neglectable in the MS of 2-nitroanisole, it is apparently an important transient intermediate in the consecutive fragmentation of the molecular ions.

The mechanism for loss of  $\text{CH}_2\text{O}$  from 2-nitroanisole is highly unusual, as evidenced by the study of 2-nitro- $^{18}\text{O}$ -anisole and 4-nitro- $^{18}\text{O}$ -anisole<sup>75</sup>. The label of 4-nitro- $^{18}\text{O}$ -anisole is completely retained in the consecutive loss of  $\text{NO}$  and  $\text{CO}$ , as expected from an isolated nitro group. The fragmentation of 2-nitro- $^{18}\text{O}$ -anisole shows a loss of  $\text{CH}_2\text{O}$  maintaining the  $^{18}\text{O}$ -label in the fragment ion  $[\text{M} - \text{CH}_2\text{O}]^+$ , demonstrating that the oxygen atom of  $\text{CH}_2\text{O}$  comes from the nitro group rather than from the methoxy group<sup>75</sup>. By contrast, the  $\text{CO}$  lost from the low-intensity  $[\text{M} - \text{NO}]^{+\bullet}$  ion contains the label, hence demonstrating that the methoxy oxygen is involved in the  $\text{CO}$  elimination in this case<sup>75</sup>. A rationalization of this complex mechanism has been presented<sup>75</sup>; see Scheme 6.



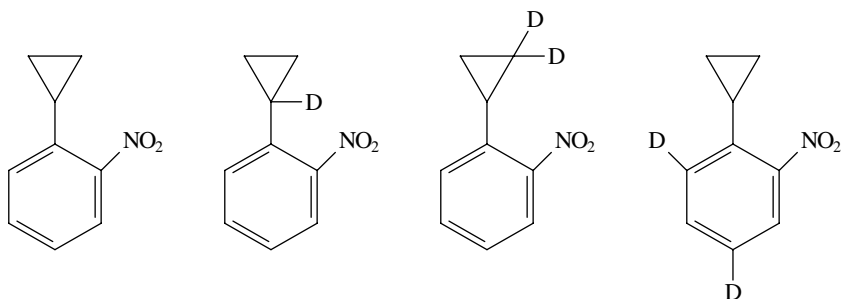
SCHEME 6

The characterization of the  $[\text{M} - \text{NO} - \text{CO}]^+$  ions, i.e.  $\text{C}_5\text{H}_5\text{O}^+$  of *o*-, *m*- and *p*-nitrophenol, has been attempted based on translational energy release measurements on metastable ions<sup>76</sup>. It appeared that in all cases the pyrylium structures closely resemble that observed for the high-energy ions, i.e. when fragmentation of the  $\text{C}_5\text{H}_5\text{O}^+$  ions takes place in ion source. However, when the slower reactions occurred in a field-free region the values for kinetic release did not coincide with any of the structures investigated. Thus, it seems clear that at least one additional structure has to be included to account for the fragmentation of the long-lived ions<sup>76</sup>; see Scheme 7.

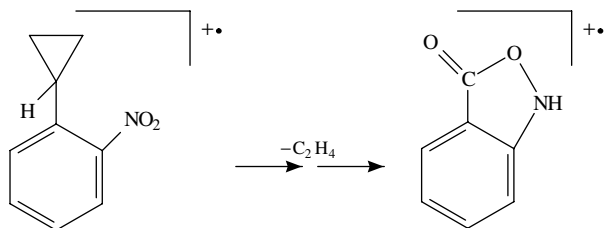


SCHEME 7

The alkene loss from ionized cycloalkyl-substituted nitrobenzenes has been studied by isotopic labelling and collision activation mass spectrometry<sup>77</sup>. The reaction path was found to depend highly on the placement of the nitro group. The *ortho* nitro-substituted phenylcyclopropane and its isotopomers were studied.



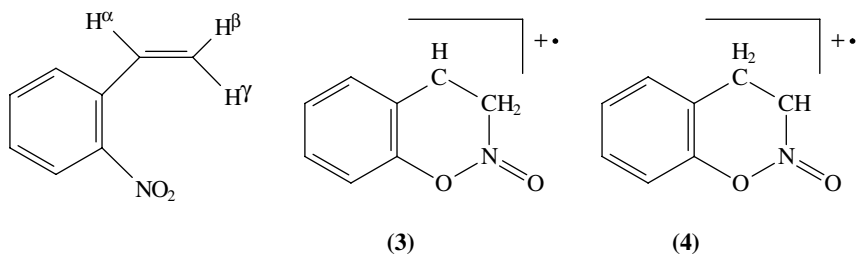
It appeared that, exclusively, the methylene hydrogens of the cyclopropane are involved in the ethylene formation<sup>77</sup>. The product ion,  $[M - C_2H_4]^{+\bullet}$ , was by collision activation MS found to be perfectly identical with that of the molecular ion of [2,1]-benzisoxazoline-3-one<sup>77</sup>; see Scheme 8.



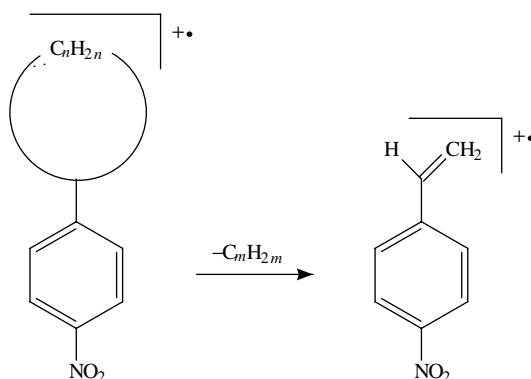
SCHEME 8

The corresponding *para* nitro-substituted cyclopropane does not eliminate ethylene. However, alkene elimination is observed for the higher homologues, i.e.  $n = 3-5$ . The product ion has in this case been proved to be 4-nitrostyrene<sup>77</sup>; see Scheme 9.

Another classical case with respect to *ortho*-effects is found for 2-nitrostyrene<sup>78</sup>. The conceivable regio- and stereo-specifically labelled 2-nitrostyrenes have, in addition to the ring-labelled isotopomer, been studied by collision activation mass spectrometry<sup>79</sup>. Undoubtedly, the most striking result was the nearly equal contribution of both (in the neutral molecule diastereotopic) hydrogens of the  $\beta$ -carbon.



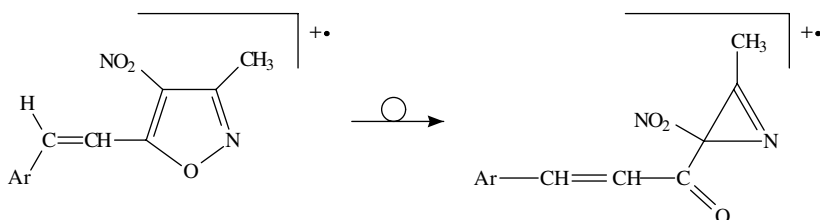




SCHEME 9

The collision-induced spectra of the  $[M - OD]^+$  ions generated from the regio- and stereo-specifically labelled compounds revealed identical MS, suggesting the formation of a common ion structure for this long-lived daughter ion<sup>79</sup>. A tentative rationalization was based on an initial isomerization, leading to the radical cation of the corresponding nitrite followed by an electrocyclic ring closure to yield the nitronic ester **3**<sup>79</sup>. Hydrogen exchanges may take place consecutively by facile 1,2-hydrogen shifts within the structures **3** and **4**. The eventual loss of  $OH^\bullet$  was assumed to take place following ring-opening of the nitronic ester functionality and a subsequent rearrangement of the C-nitroso compound to the corresponding oxime<sup>79</sup>.

The electron impact mass spectra of 3-methyl-4-nitro-5-styryl-isoxazoles exhibit, on the contrary, only negligible loss of  $OH^\bullet$ <sup>80</sup>. This has been interpreted in terms of an isoxazole-to-azirine rearrangement<sup>80</sup>. The latter fragments directly to an abundant cinnamoyl ion as well as rearranges to oxazole and an epoxide through an intramolecular oxidation of the ethylenic bond by the nitro group<sup>80</sup>; see Scheme 10.

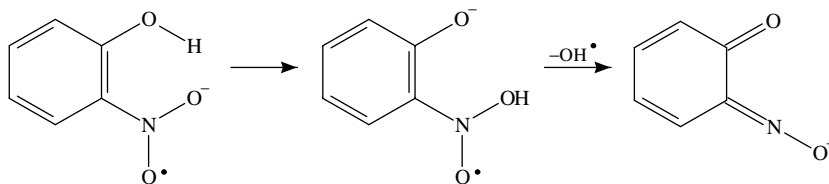


SCHEME 10

## 2. *ortho*-Effects in anions

It is interesting to note the effect of charge on hydroxyl loss from *ortho*-substituted nitrobenzene ions. The loss of  $OH^\bullet$  is observed from many *ortho*-substituted nitrobenzene molecular anions<sup>66</sup>. This *ortho*-effect is often operative in apparent analogy with the corresponding cations. The results can be rationalized if an intramolecular proton transfer is

assumed as a first step as opposed to an intramolecular hydrogen transfer in the corresponding cations<sup>66</sup>. This assumption is further supported by the low, less than 50 meV, kinetic energy release, which obviously is consistent with a simple cleavage with a low reverse critical energy as second step; see Scheme 11.



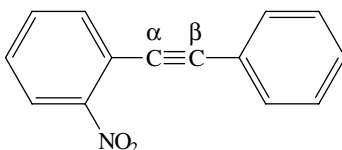
SCHEME 11

As a consequence, a higher degree of charge localized at the substituents in the transition state for proton transfer in the anions is developed. Thus, the relative importance of the  $\text{OH}^\bullet$  loss is directly related to the capability of the substituent to accept a negative charge, and hence as reflected in the gas-phase acidity of the parent compound<sup>66</sup>. In contrast, very little charge is localized at the reaction site in the transition state for hydrogen transfer within the cations. Thus, in this case, the relative importance of the  $\text{OH}^\bullet$  loss seems to correlate to the homolytic bond strength which has to be overcome<sup>66</sup>.

## E. Remote Oxidation

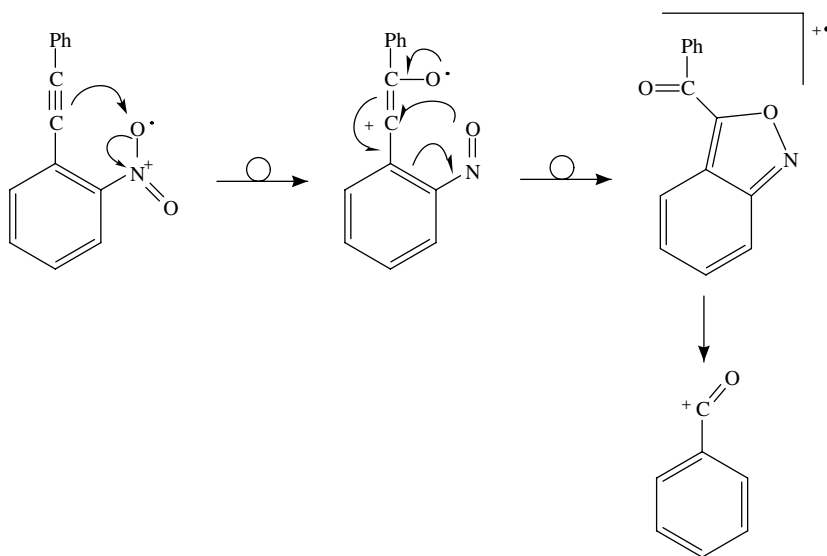
### 1. Remote oxidation of multiple carbon bonds

The oxygen transfer from an *ortho* nitro group to a carbon-carbon triple bond has been studied by high-resolution mass spectrometry, linked scan techniques and chemical substitution<sup>81</sup>. Oxygen transfers to both acetylenic carbons were detected as parallel fragmentation pathways<sup>81</sup>.

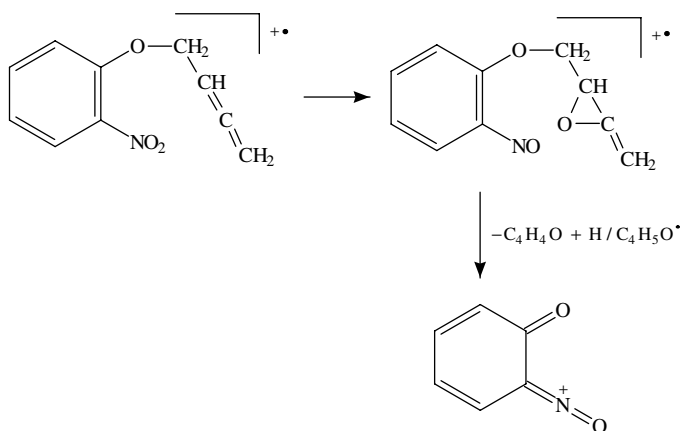


The oxygen transfer to the  $\beta$ -acetylenic carbon results in the very intense benzoyl cation, whereas the transfer to the  $\alpha$ -carbon, via a series of fragments corresponding to the loss of  $\text{OH}^\bullet$ , CO and  $\text{CO}_2$ , respectively, leads to annelated heterocycles such as the radical cation of carbazole, as a result of elimination of CO<sup>81</sup>. The generation of the benzoyl cation was rationalized as shown in Scheme 12<sup>81</sup>.

Oxygen transfers from the nitro group to allenic double bonds have been studied in 2-nitrophenyl allenylmethyl ether<sup>82</sup>. The *ortho* interaction is obviously in agreement with the observed elimination of both the  $\text{C}_4\text{H}_5\text{O}^\bullet$  radical and  $\text{C}_4\text{H}_4\text{O}$  from the molecular ion<sup>82</sup>; see Scheme 13. The loss of  $\text{C}_4\text{H}_4\text{O}$  is followed by elimination of a hydrogen atom. Thus, the two routes apparently result in a common fragment ion<sup>82</sup>. The  $[\text{M} - \text{C}_4\text{H}_4\text{O}]^{+\bullet}$  ion is also observed in the study of the *para* isomer. However, in the latter case the fragment ion is formed by a completely different pathway, i.e. by the subsequent losses of  $\text{C}_4\text{H}_4$  and atomic oxygen, respectively<sup>82</sup>.

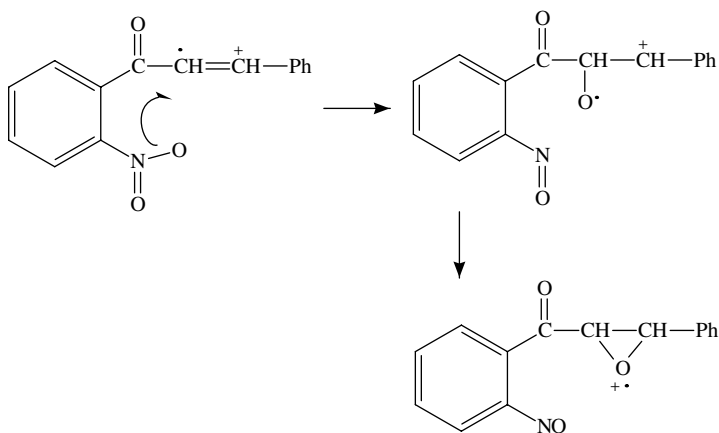


SCHEME 12

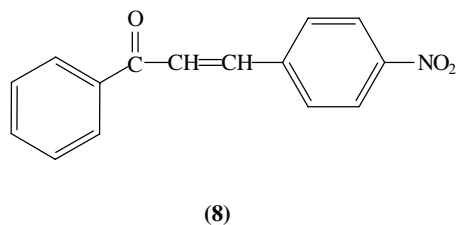
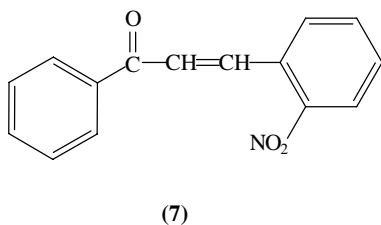
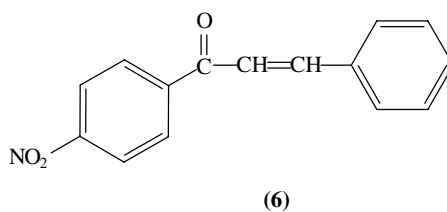
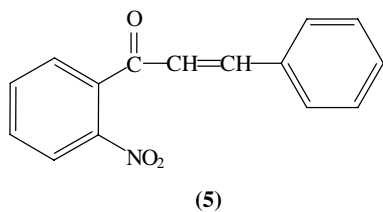


SCHEME 13

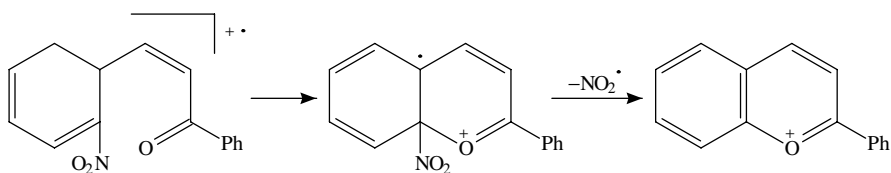
The electron impact and chemical ionization mass spectra of selected nitro-substituted isomeric benzalacetophenones, benzyl ketones and aromatic epoxides have been examined<sup>83</sup>. The isomeric pairs display rather significant differences following ionization. Thus, the *ortho* nitrobenzalacetophenone **5** shows an abundant series of ions due to fragmentation of the epoxide intermediate originating from an oxygen transfer from the nitro group. The first step is an abstraction of the oxygen by the radical site located on the  $\beta$ -carbon. These processes are virtually absent in the *para* isomers **6** and **8**<sup>83</sup>. The fragmentation of the *para* isomers presumably leads to a series of cyclized product ions<sup>83</sup>; see Scheme 14.



SCHEME 14

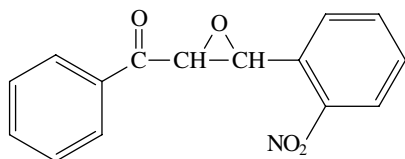


A comparison of the spectra of the *ortho* isomers, **5** with **7**, reveals that fragmentation due to oxidation of the styryl double bond apparently is absent in **7**. Instead, the MS of the latter exhibits ions corresponding to the formation of a benzopyrylium ion; see Scheme 15.

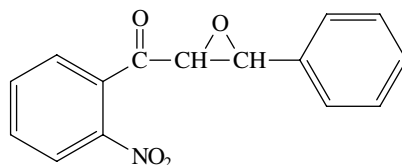


SCHEME 15

The MS of the epoxides **9** and **10** appear as rather interesting, since they may be regarded as the nitro analogues of the nitroso-epoxide intermediates discussed above.

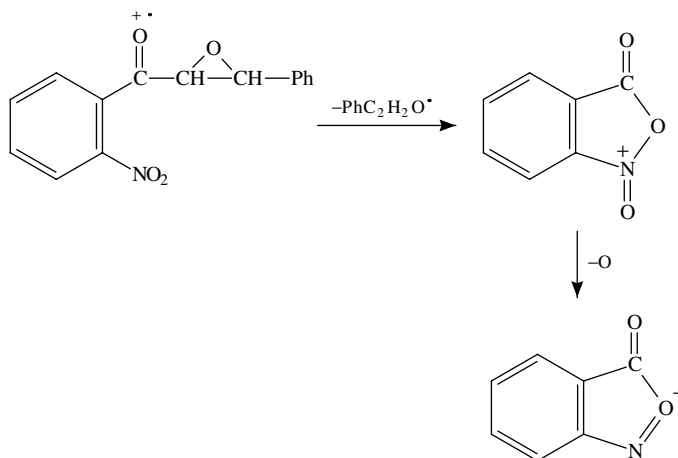


(9)



(10)

The cleavage  $\alpha$  to the carbonyl (and the epoxide) functionality generates the acylium ions in high yield. Thus, the benzoyl cation is the base peak in the mass spectrum of **9**<sup>83</sup>. However, the nitro group *ortho* to the carbonyl group in the isomer **10** significantly influences the fragmentation due to the interaction with the acylium group, the latter formally being a result of the  $\alpha$ -cleavage. A subsequent loss of atomic oxygen accounts for the most abundant ion in this spectrum<sup>83</sup>; see Scheme 16.



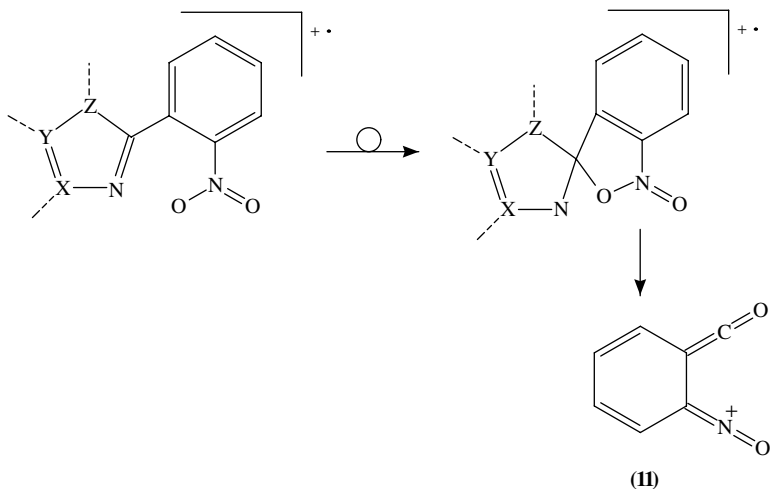
SCHEME 16

The observed differences in the fragmentation pathways of the isomeric pairs were further enhanced under chemical ionization conditions. Thus, elimination reactions became even more pronounced in the *ortho*-nitro-substituted compounds than in the *para* isomers<sup>83</sup>.

## 2. Remote oxidation of imine and ketenimine functionalities

The mass spectra of heterocycles containing an integrated 2-nitrobenzaldehyde-imine moiety exhibit a  $m/z$  134 ion of significant abundance<sup>84</sup>. The study of  $m/z$  134 was based on MIKE spectra supplementary to measurements of kinetic energy release<sup>84</sup>. Accordingly, the  $m/z$  134 was assigned to the *o*-quinoid structure **11**, the latter being proposed to be generated by isomerization of the precursor ion to give a spiro intermediate from

which the  $m/z$  134 arises synchronously. The mechanism represents an oxygen transfer from the *ortho* nitro group to the imino carbon via a five-membered transition state<sup>84</sup>; see Scheme 17.



SCHEME 17

Illustrative examples of intramolecular oxidations of remote groups in nitroaromatic ions are the redox reactions occurring in ionized benzotriazoles and triazolopyridines bearing *o*-nitroaryl substituents on nitrogen<sup>85</sup>. Dissociative ionization apparently causes

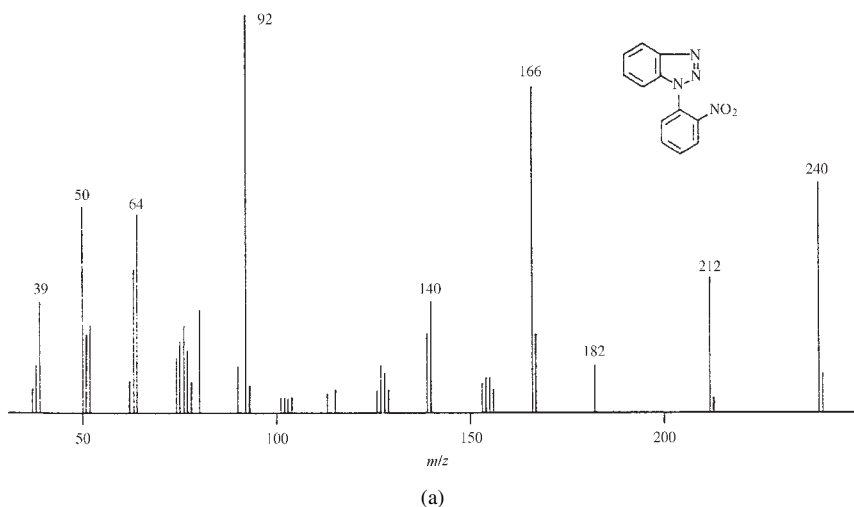


FIGURE 9. Electron impact mass spectra of (a) 1-(2-nitrophenyl)benzotriazole, **12**, and (b) 1-(4-nitrophenyl)benzotriazole, **13**, respectively<sup>85</sup>. Reprinted from Reference 85 with kind permission of Elsevier Science-NL, Sara Burgerhartstraat 25, 1055 KV Amsterdam, The Netherlands

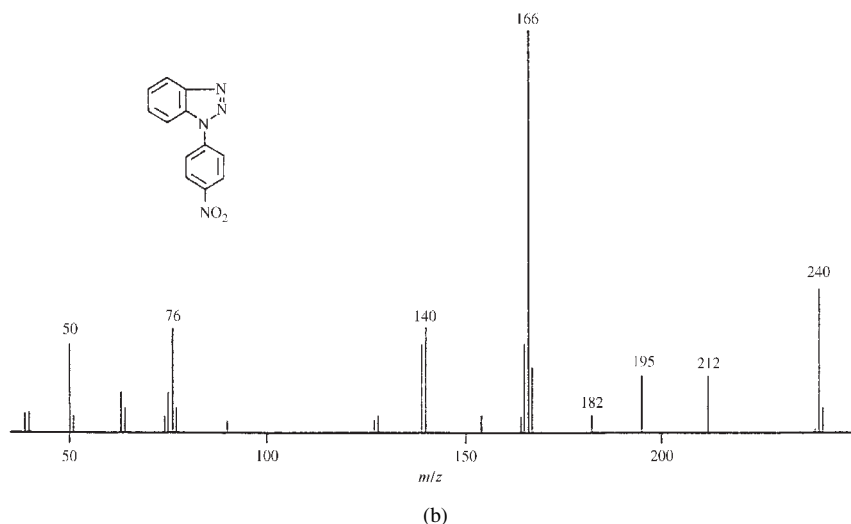
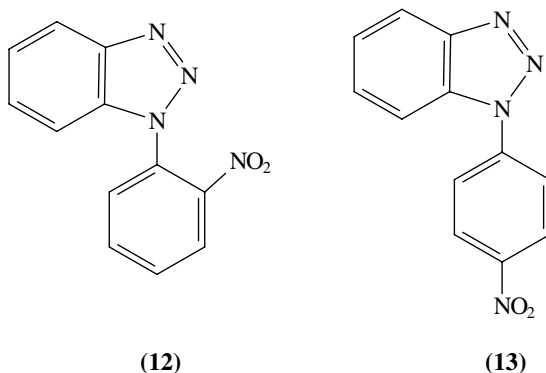
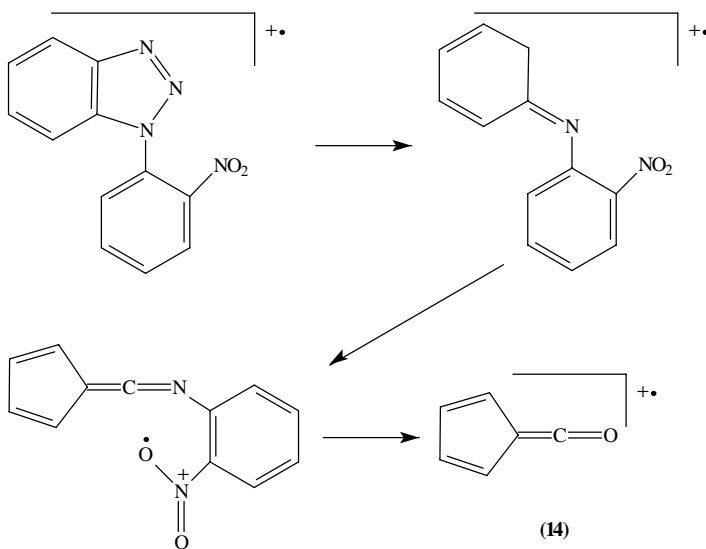


FIGURE 9. (continued)

an intramolecular process involving the *o*-nitro group and the benzene ring of the annelated triazole. The importance of the *ortho* position of the nitro group is unambiguously demonstrated by the MS of 1-(2-nitrophenyl)benzotriazole **12** and 1-(4-nitrophenyl)benzotriazole **13** given in Figure 9<sup>85</sup>. The mass spectrum of **12** is very similar in the high-mass region to that of **13**, but, on the other hand, very different in the low-mass region due to the base-peak ( $m/z$  92) and its daughter ions.



The significant behaviour of the compound **12** on electron impact ionization, i.e. the formation of a dominating ionic species,  $m/z$  92, **14**, has been rationalized as shown in scheme 18<sup>85</sup>. It should be noted that the intermediacy of the ionized iminocarbene was proposed along with the possibility that an oxygen transfer takes place directly from the nitro group to the annelated benzene ring. Similarly, ionized 2- and 3-azafulven-6-ones were demonstrated to be formed from the appropriate heterocycles<sup>85</sup>.



SCHEME 18

### 3. Competing oxidation of sulphur and carbon

Competing oxygen transfers from *ortho* nitro groups to sulphur and carbon, respectively, have been studied for allyl sulphide, styryl sulphides, allenyl sulphides and ethynyl sulphides<sup>86-89</sup>.

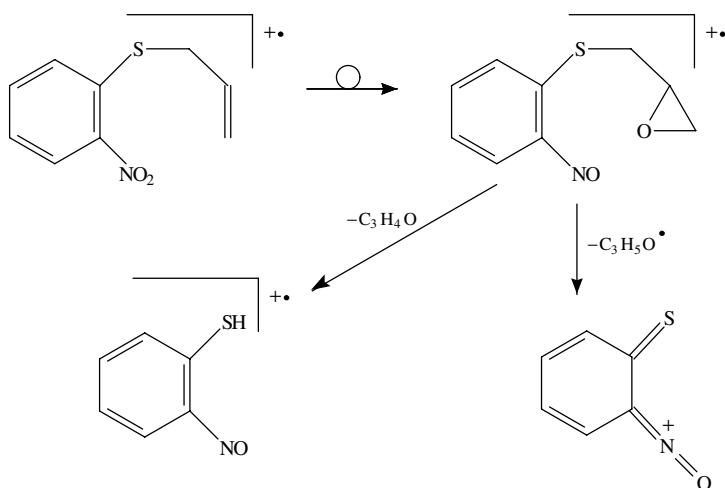
Oxygen transfer from the nitro group to the C=C group in allyl 2-nitrophenyl sulphide followed by a simple cleavage resulted in intense fragment ions corresponding to ionized 2-nitrosothiophenol and the related thioquinoid structure, respectively<sup>86</sup>; see Scheme 19. Further, a double oxygen transfer from the nitro group to the sulphur atom has been suggested in order to account for the extrusion of  $\text{HSO}_2^\bullet$  from the molecular ion<sup>86</sup>; see Scheme 20. By collision activation the product ion was disclosed as protonated quinoline<sup>86</sup>.

The allyl 2-nitrophenyl sulphoxide is apparently not an intermediate in this reaction as the MS of the latter compound is dominated by a cleavage reaction giving rise to  $\text{C}_3\text{H}_5^+$ , whereas the ions corresponding to a loss of the  $\text{HSO}_2^\bullet$  radical apparently are of low intensity<sup>86</sup>. Thus, it was concluded that the double oxygen transfer to sulphur most probably should be formulated as a concerted reaction<sup>86</sup>.

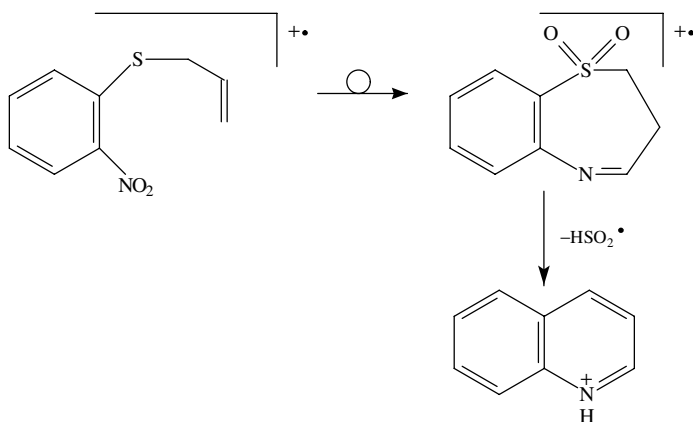
The double oxygen transfer to sulphur is also a characteristic feature of 2-nitrophenyl styryl sulphides<sup>87</sup>. The rearranged molecular ion undergoes fragmentation in two parallel pathways. Elimination of  $\text{SO}_2$  affords the radical cation of 2-phenylbenzopyrrole and is followed by a loss of  $\text{H}^\bullet$ ; see Scheme 21. In addition, this ion is formed by a direct loss of  $\text{HSO}_2^\bullet$  from the rearranged molecular ion<sup>87</sup>.

The additional double bond in the corresponding allenyl 2-nitrophenyl sulphides causes a significant preference of the oxygen transfer to carbon<sup>88</sup>. The dominant ions correspond to the radical cations of 2[3*H*]-benzothiazolone and protonated benzothiazole, respectively<sup>88</sup>. Both ions require the transfer of two oxygens to carbon in the side-chain as well as extensive rearrangements of the molecules; see Scheme 22. The transfer of





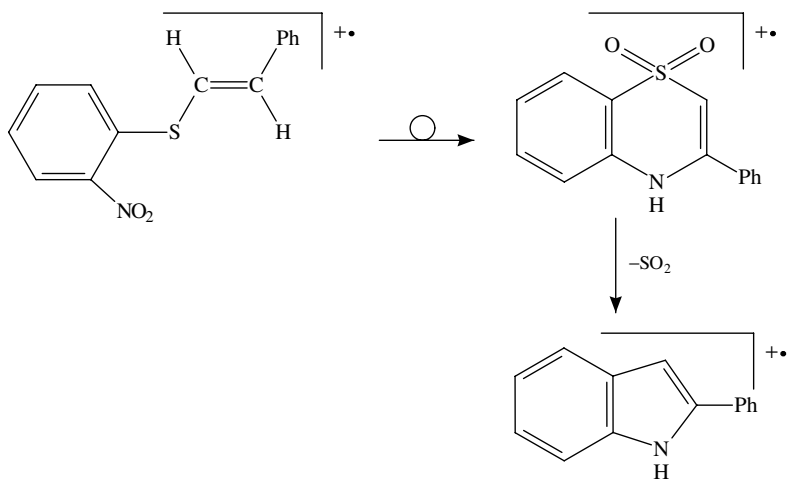
SCHEME 19



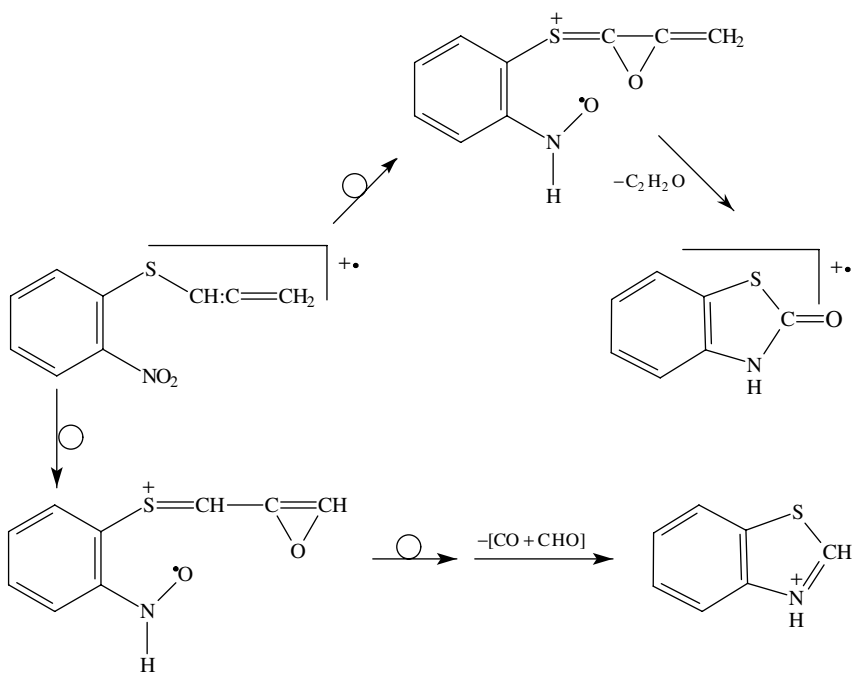
SCHEME 20

oxygen to sulphur is, on the other hand, visualized through a minor loss of SO from the molecular ion<sup>88</sup>. It should be noted that the proposed *ortho* interactions in the allenyl 2-nitrophenyl sulphide are virtually absent in the spectrum of the corresponding *para* isomer<sup>88</sup>.

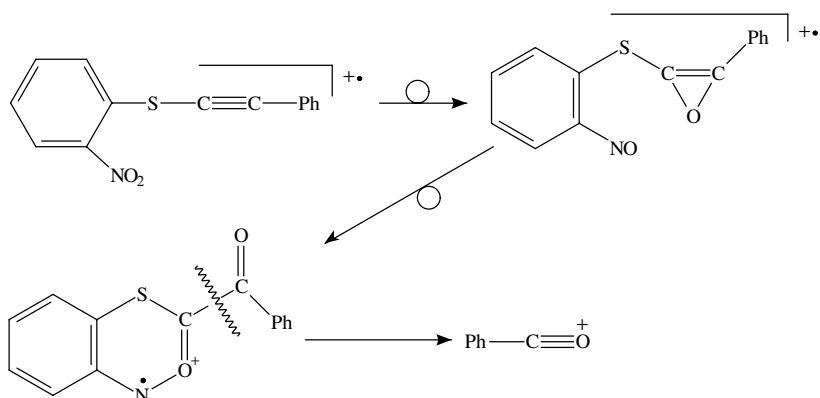
It seems interesting to compare the mass spectrometric features of 2-nitrophenyl-phenylethynyl sulphides with the fragmentation of the nitrodiphenylacetylenes discussed above. Apparently, oxygen transfers to both the acetylenic carbons and sulphur take place<sup>89</sup>. The transfer of a single oxygen to the  $\beta$ -carbon leads, via a mechanism closely resembling the fragmentation of nitrodiphenylacetylenes, to the benzoyl cation<sup>89</sup>. The latter ion apparently is the base peak in the MS of the major part of the compounds studied<sup>89</sup>; see Scheme 23.



SCHEME 21

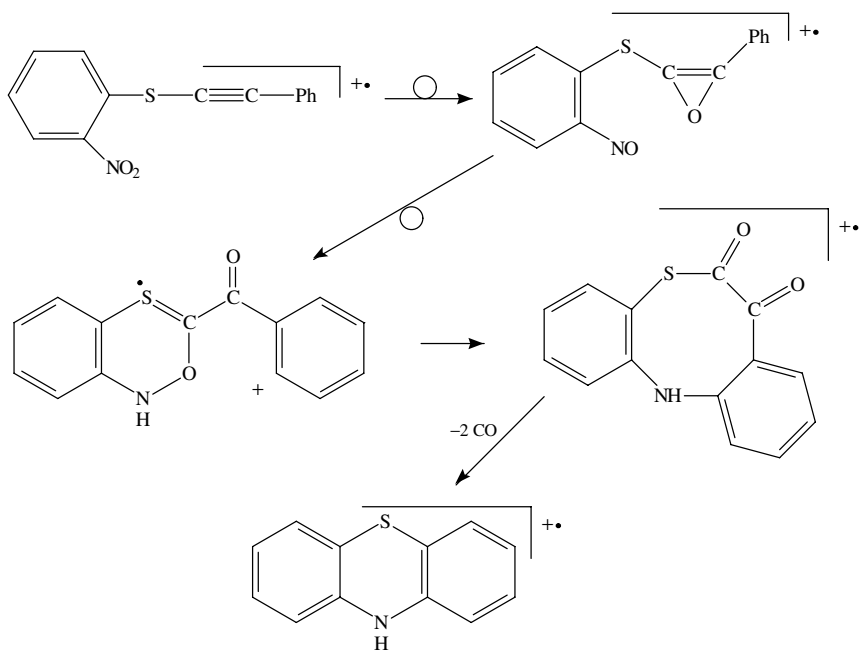


SCHEME 22



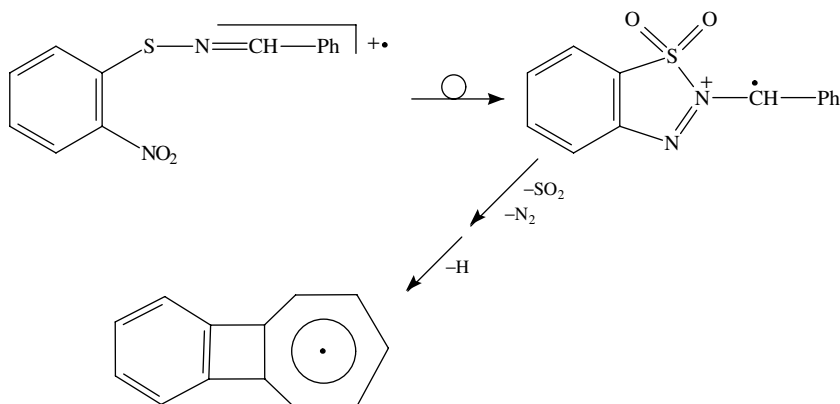
SCHEME 23

The transfer of two oxygens to the acetylenic carbons involving a series of rearrangements, followed by the loss of two CO molecules, leads to the phenothiazine radical cation, with the proposed fragmentation pathway being supported by collision activation MS<sup>89</sup>; see Scheme 24. Although the transfer of oxygen to sulphur apparently is of minor importance, the loss of a  $\text{HSO}_2^*$  radical from a rearranged molecular ion seems to resemble the mechanism proposed for the equivalent fragmentation of allyl 2-nitrophenyl sulphide and 2-nitrophenyl styryl sulphides<sup>86,87,89</sup>.



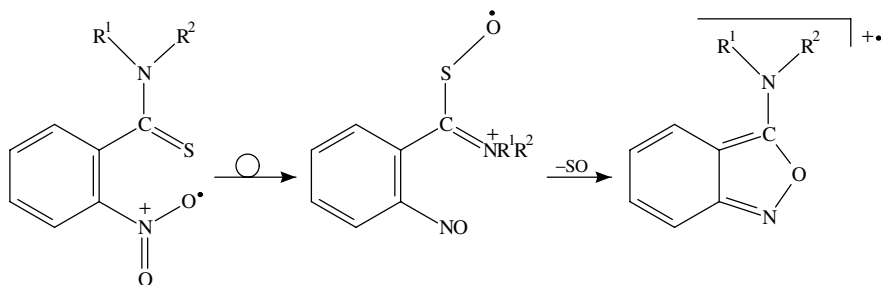
SCHEME 24

Since the nitro group apparently is able to transfer oxygen atoms to substituents in the *ortho* position containing multiple bonds or heteroatoms, the *N*-arylidene-2-nitrobenzenesulphenamides constitute an interesting class of compounds<sup>90</sup>. Thus, unexpected *ortho* interactions of the nitro groups apparently operate as the molecular ions expel SO<sub>2</sub> and N<sub>2</sub>, leading to a rather abundant hydrocarbonic ion assigned as 1,2-phenylenetropylium<sup>90</sup>; see Scheme 25. The loss of HSO<sub>2</sub><sup>•</sup> is of minor significance<sup>90</sup>.



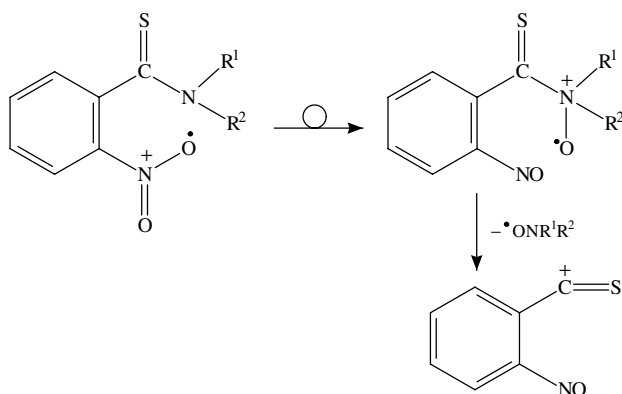
SCHEME 25

A competing oxygen migration in *ortho* nitroaryl thioamides on electron impact has been reported<sup>91</sup>. The loss of SO from the molecular ions is a highly significant process<sup>91</sup>. A mechanism involving an initial oxygen migration to the sulphur atom through a favourable six-membered TS followed by cyclization with concomitant expulsion of SO has been proposed<sup>91</sup>; see Scheme 26.



SCHEME 26

The migration of an oxygen atom from the nitrogen of the nitro group to the nitrogen moiety of the thioamide results in the formation of a stable *o*-nitrosothiobenzoyl cation<sup>91</sup>. It is assumed that the actual mechanism to be initiated by the migration of oxygen through a six-membered transition state is followed by an  $\alpha$ -fission<sup>91</sup>; see Scheme 27.

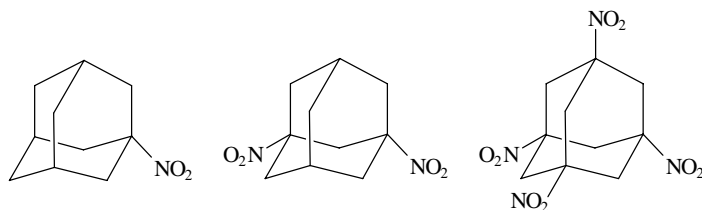


SCHEME 27

## F. Polynitro Aromatics

### 1. Nitroadamantanes

The fragmentation pathways of adamantane, 1-nitroadamantane, 1,3-dinitroadamantane and 1,3,5,7-tetranitroadamantane have been studied by tandem high-resolution MS<sup>92</sup>. It was found that the fragmentation of the nitroadamantanes was initiated by consecutive losses of the nitro groups and followed by fragmentation of the hydrocarbon back-bone<sup>92</sup>.



### 2. Di- and tri-nitroaromatics

The fragmentations of 2,4,6-trinitrotoluene have been studied using isotope labelling and MS/MS techniques<sup>93,94</sup>. The major pathways include the loss of OH<sup>•</sup> and H<sub>2</sub>O, followed by the subsequent loss of NO or NO<sub>2</sub>. The facile transfer of a methyl hydrogen to oxygen gives rise to the key fragment (*m/z* 210) initiating a number of important fragmentation sequences<sup>93</sup>. There is virtually no ring disintegration until the majority of the attached groups are lost<sup>94</sup>.

In addition, a series of dinitroaromatic compounds has been studied by collision activation MS<sup>95</sup>. Strong effects due to competitive processes were noted<sup>95</sup>.

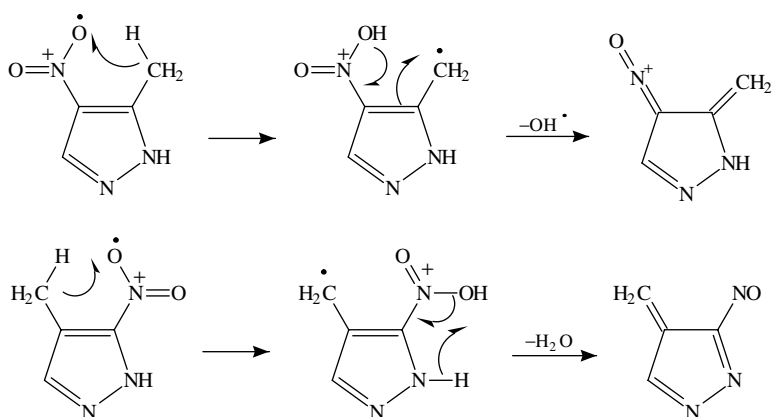
## G. Nitro-heteroaromatics

### 1. Nitroazoles

The substituted heteroaromatic compounds provide excellent opportunities for mechanistic studies of the interaction between the nitro group and other substituents. This is due

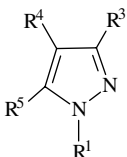
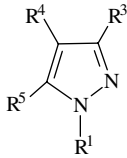
to the unique synthetic possibilities as well as a more straightforward evaluation of the role of the aromatic back-bone. Thus, MS of nitroazoles, i.e. nitropyrazoles and nitroimidazoles, has been investigated in detail by the effect of substitution and isotope labelling by Luijten and Thuij<sup>96-99</sup>.

Various nitropyrazoles and nitroimidazoles have been studied<sup>96-99</sup>; see Table 1. The loss of OH<sup>•</sup> from methyl-substituted nitropyrazoles and nitroimidazoles appears as a useful probe in determining the actual location of the substituents. Thus, it could be established that in the case of adjacent methyl and nitro groups, the loss of OH<sup>•</sup> originates exclusively from these substituents<sup>96-98</sup>. In addition to the loss of OH<sup>•</sup> the presence of a mobile N-bonded hydrogen atom leads to the elimination of H<sub>2</sub>O, as is visualized by the mechanisms for loss of OH<sup>•</sup> and H<sub>2</sub>O from 3(5)-methyl-4-nitropyrazole and 4-methyl-3(5)-nitropyrazole, respectively<sup>98</sup>; see Scheme 28.



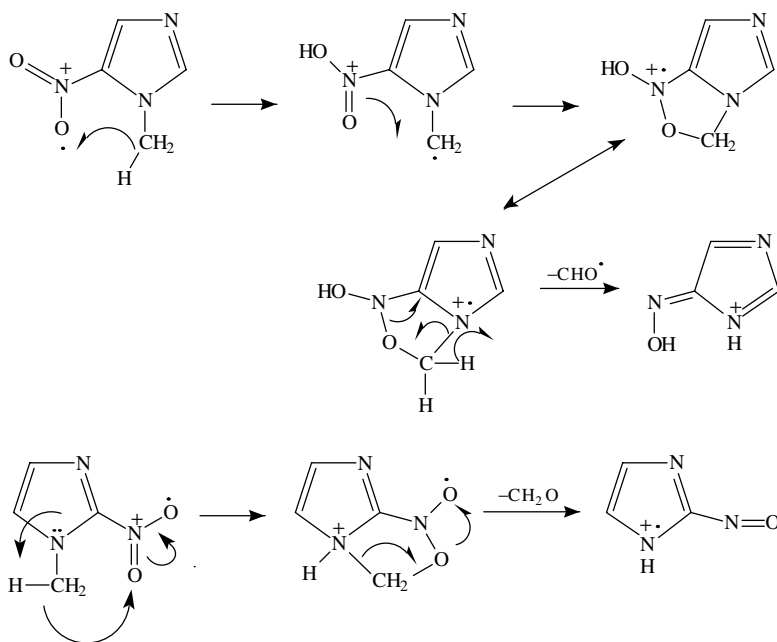
SCHEME 28

TABLE 1

 Pyrazoles				 Imidazoles			
R <sup>1</sup>	R <sup>3</sup>	R <sup>4</sup>	R <sup>5</sup>	R <sup>1</sup>	R <sup>2</sup>	R <sup>4</sup>	R <sup>5</sup>
H	Me	NO <sub>2</sub>	H	H	H	Me	NO <sub>2</sub>
H	Me	H	NO <sub>2</sub>	H	Me	NO <sub>2</sub>	H
H	NO <sub>2</sub>	H	H	H	NO <sub>2</sub>	Me	H
H	NO <sub>2</sub>	Me	H	H	NO <sub>2</sub>	H	H
Me	H	H	NO <sub>2</sub>	Me	H	H	NO <sub>2</sub>
Me	H	NO <sub>2</sub>	H	Me	H	NO <sub>2</sub>	H
Me	H	H	NO <sub>2</sub>	Me	NO <sub>2</sub>	H	H
Me	NO <sub>2</sub>	H	H				

The presence of a significant kinetic isotope effect for the losses of  $\text{OH}^\bullet$  from the nitroazoles ( $k_{\text{H}}/k_{\text{D}} = 4.6$ ) supports the suggestion that the fragmentations are adequately described by a stepwise hydrogen transfer, followed by cleavage of the  $\text{OH}$  moiety or, alternatively, rearrangement to structures which can eliminate  $\text{OH}^\bullet$  and  $\text{H}_2\text{O}^{98}$ .

Loss of small O-containing molecules, such as  $\text{CHO}^\bullet$  and  $\text{CH}_2\text{O}$ , can also take place. Three structural requirements for these reactions have been identified: (1) The methyl and nitro group must be in a mutual *ortho* position. Further, the reaction is strongly favoured if (2) the methyl group is bonded to a ring nitrogen and (3) a second heterocyclic moiety or a second heteroatom is close to the methyl group<sup>99</sup>. This is reflected in the relative intensities of the fragment ions. The reaction mechanisms for loss of the formyl radical and the elimination of formaldehyde are illustrated by the fragmentations of 1-methyl-5-nitroimidazole and 1-methyl-2-nitroimidazole, respectively<sup>99</sup>; see Scheme 29.

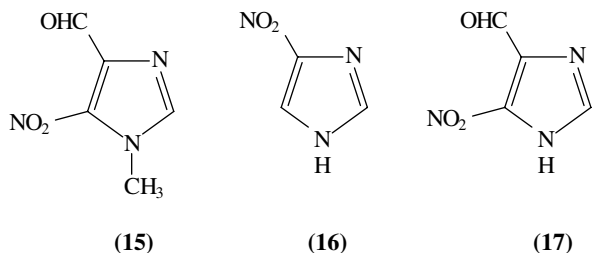


SCHEME 29

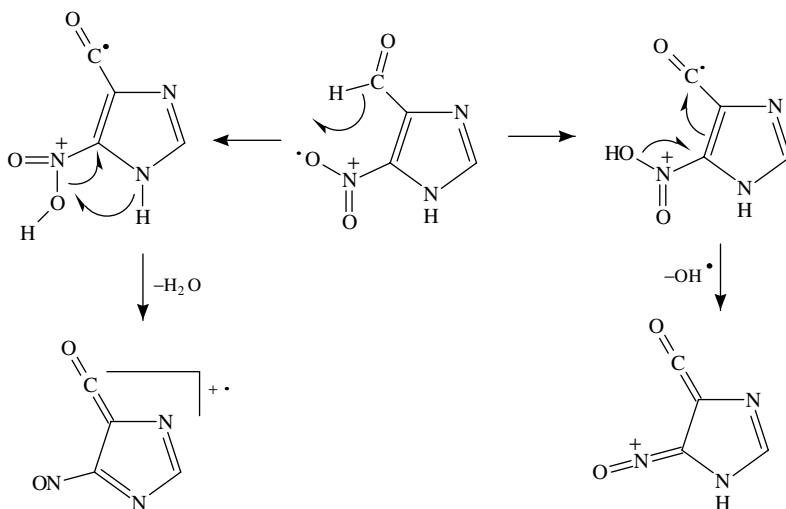
It should be noted that the operation of these effects is attributed to the interaction of substituents only. Thus, in no cases has involvement of ring atoms of the diazole in the losses of  $\text{CHO}^\bullet$  and  $\text{CH}_2\text{O}$  been detected<sup>99</sup>. The use of the labelled compounds unambiguously demonstrated that the diazole ring of the molecular ion structures is retained in the fragment ion discussed above<sup>99</sup>.

The MS of some nitro derivatives of imidazole-4(5)-carboxaldehyde have been studied<sup>100</sup>. Based on the compounds **15**–**17**, several new features caused by the interaction between the nitro group and adjacent substituents were disclosed. It should be noted that for the compounds **16** and **17**, there is a rapid equilibrium between the two possible tautomers resulting in equivalence of the 4 and 5 positions.

Surprisingly, the  $[\text{M} - \text{H}_2\text{O}]^{+\bullet}$  and  $[\text{M} - \text{CH}_2\text{O}]^{+\bullet}$  ions are observed, whereas there is virtually no loss of  $\text{CHO}^\bullet$ <sup>100</sup>. The fragmentation pattern of 5(4)-nitro-imidazole-4(5)



carboaldehyde, **17**, corroborates the presence of the formyl group. Thus, the primary losses of  $\text{OH}^\bullet$  and  $\text{H}_2\text{O}$  are consistent with the H-shift from the formyl group to the nitro group followed by the loss of  $\text{OH}^\bullet$  or by elimination of  $\text{H}_2\text{O}$  via mechanisms similar to that reported for methylnitroimidazoles; see Scheme 30. The ion corresponding to loss of  $\text{H}_2\text{O}$  is the base peak in the MS of **17**<sup>100</sup>.



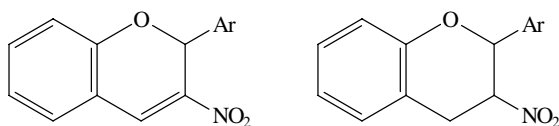
SCHEME 30

The elimination of  $\text{OH}^\bullet$  and  $\text{H}_2\text{O}$  has been explained by assuming an initial H-transfer from the formyl group to the nitro group, followed by a migration of a hydrogen atom from the methyl group to the methyl-carrying nitrogen atom in line with the fragmentation of '*o*-methylnitroimidazoles'<sup>100</sup>.

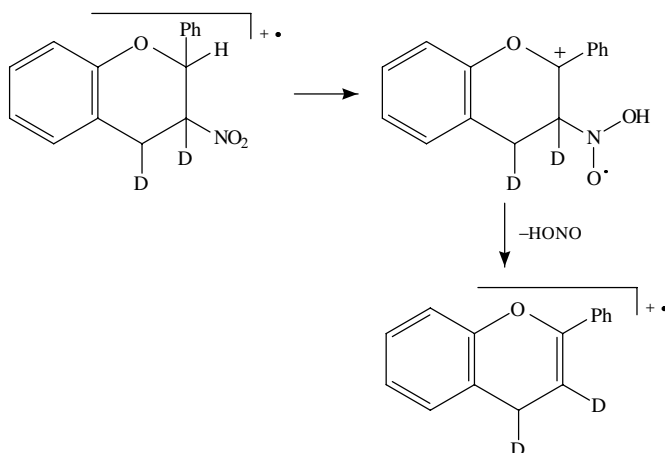
## 2. 3-Nitro-2*H*-chromenes and 3-nitrochromanes

The electron impact mass spectra of series of 2-aryl-3-nitro-2*H*-chromenes and 2-aryl-3-nitrochromanes with varying functionalities have been reported<sup>101</sup>. The molecular ion is always of considerable intensity. Loss of  $\text{NO}_2$  from  $\text{M}^{+\bullet}$  is responsible for the base peak in the nitrochromenes<sup>101</sup>. In contrast, the  $[\text{M} - \text{HONO}]^{+\bullet}$  is apparently the more abundant ion in the nitrochromanes. This unusual loss of HONO is always observed in the metastable time-frame<sup>101</sup>.





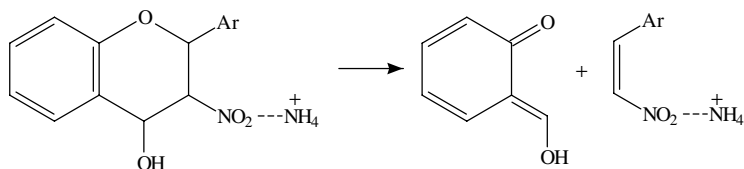
The formation of  $[M - \text{HONO}]^{+\bullet}$  has been demonstrated by deuterium labelling to be associated with hydrogen transfer from the 2-position to the nitro group<sup>101</sup>. This leads to a stabilized radical cation which, following the expulsion of HONO, produces a very stable daughter ion; see Scheme 31.



SCHEME 31

All the compounds studied exhibited  $M^{\bullet-}$  accompanied by intense  $[M - \text{NO}_2]^{-\bullet}$  fragment ions in their electron capture negative ion chemical ionization spectra. Additional ions were of low intensity<sup>101</sup>.

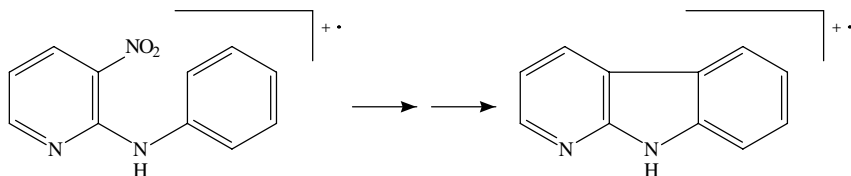
Chemical ionization MS of 2-aryl-3-nitro-2*H*-chromenes and 4-hydroxy-3-nitroflavans have been studied using methane and ammonia as reagent gases<sup>102</sup>. The behaviour of 2-aryl-3-nitro-2*H*-chromenes was found to resemble that of aromatic nitro compounds. Thus, the methane spectra are characterized by the  $\text{MH}^+$  ions, whereas the ammonia spectra reveal dominant cluster ions, e.g.  $[\text{M} + \text{NH}_4]^+$ <sup>102</sup>. Chemical ionization of the 4-hydroxy-3-nitroflavans leads, on the other hand, to a significantly increased fragmentation. Thus, the base peaks in the methane spectra are due to loss of  $\text{H}_2\text{O} + \text{NO}_2$ . In the ammonia spectra a rather complicated picture developed. Apparently, the dominant fragmentation is a retro Diels-Alder reaction of the ammonium adduct<sup>102</sup>; see Scheme 32.



SCHEME 32

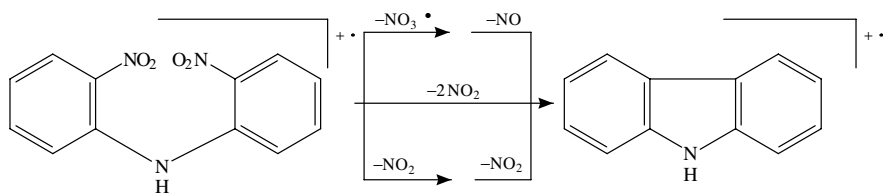
## H. Annulation Processes

Electron impact induced fragmentation of 2-nitrodiaryl amines has been studied. An important path is the annulation to carbazoles, as illustrated by the fragmentation of 2-phenylamino-3-nitropyridine<sup>103</sup>; see Scheme 33. The identity of the product ions was confirmed by collision activation MS upon comparison with authentic samples<sup>103</sup>.



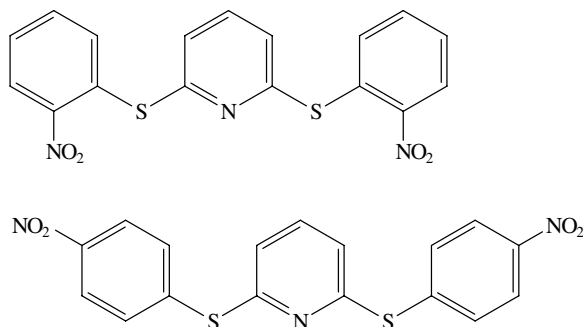
SCHEME 33

Proximity effects and *ortho* interactions in 2,2'-disubstituted diaryl amines have been reported<sup>104</sup>. Thus, phenazine, phenazine-N-oxide and carbazole were formed by loss of small neutral fragments, such as NO, NO<sub>2</sub> and NO<sub>3</sub><sup>•</sup>, from the molecular ions, as illustrated by the formation of carbazole from 2,2'-dinitrodiphenylamine; see Scheme 34. Of particular interest is the loss of NO<sub>3</sub><sup>•</sup>, as demonstrated by high-resolution MS data and metastable ion spectra<sup>104</sup>.



SCHEME 34

The electron impact induced *ortho* effects in 2-nitro-substituted aromatic sulphides containing e.g. 2-pyridyl, 2-(5-methylthio-1,3,4-thiadiazolyl) moieties have been studied<sup>105</sup>, the 2,6-bis(nitrophenylthio)pyridines being typical representatives for the compounds studied<sup>105</sup>.

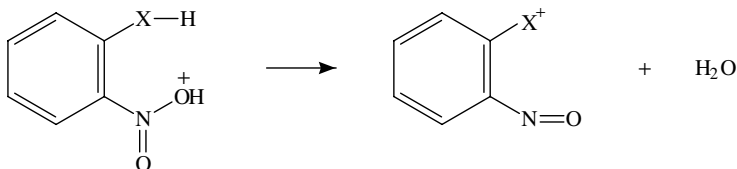


The decomposition of these compounds is strongly affected by several competing *ortho*-effects, due to the interaction of the nitro group(s) with neighbouring electron-deficient N-heterocycles. These *ortho*-effects can be grouped into three classes: (I) primary cyclization reactions by loss of small radicals, e.g.  $\text{NO}_2$  and  $\text{OH}^\bullet$ , (II) intra-molecular oxygen transfers from the nitro group to the heterocyclic ring systems and (III) primary skeletal rearrangements by intramolecular oxygen transfers followed by the extrusion of, e.g.,  $\text{SO}$  and  $\text{SO}_2$ <sup>105</sup>.

### I. Protonated Nitro Compounds

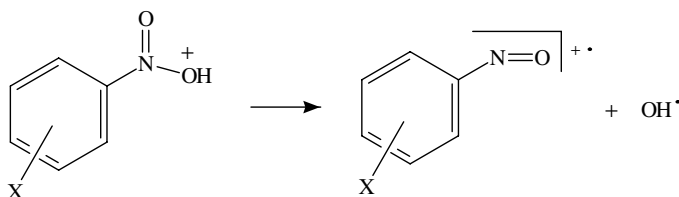
The chemical ionization MS of a selection of substituted nitrobenzenes have been studied<sup>106</sup>. The  $\text{H}_2$  chemical ionization MS appeared significantly more useful for characterization of, e.g., isomeric compounds than the corresponding methane spectra, apparently due to the higher internal energy deposited in the protonated molecule by the reaction with  $\text{H}_3^+$ , and consequently in the more extensive fragmentation<sup>106</sup>.

The nitroarenes with an *ortho* substituent bearing a hydrogen show loss of  $\text{H}_2\text{O}$  from the protonated molecule. This fragment frequently turns out as the predominant ion in the MS. It should be noted that this fragmentation is absent in the corresponding *meta* and *para* isomers<sup>106</sup>. The  $\text{H}_2\text{O}$  elimination resembles the characteristic loss of  $\text{OH}^\bullet$  from the molecular ions in the electron impact mass spectra (cf Section IV.D.1) and is as such indicative of protonation of a nitro group followed by [1,4] elimination of  $\text{H}_2\text{O}$ <sup>106</sup>; see Scheme 35.



SCHEME 35

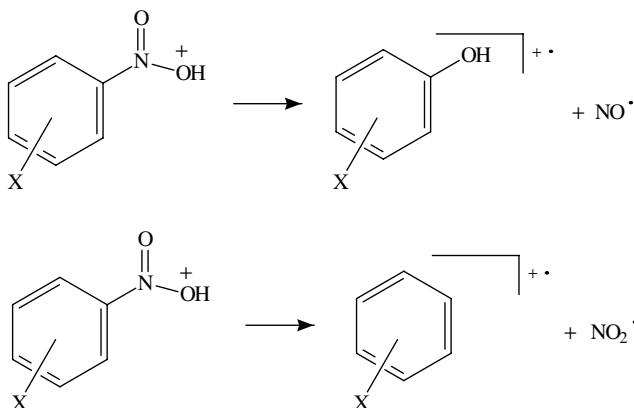
The loss of  $\text{OH}^\bullet$  from the protonated molecule appears to be a general feature of nitroarenes; see Scheme 36. However, this process is particularly dominant for compounds with electron-donating substituents *ortho* or *para* to the nitro function. Thus, this fragmentation reaction can be rationalized in terms of protonation of the nitro group, the  $[\text{MH}-\text{OH}]^+$  fragment being stabilized by electron donation through the mesomeric effect of the substituent<sup>106</sup>.



SCHEME 36

The loss of  $\text{NO}$ ,  $\text{HNO}$ ,  $\text{NO}_2$  and  $\text{HNO}_2$  moieties is all a result of fragmentations common for nitroarenes. The importance of these fragmentation paths appears to be more

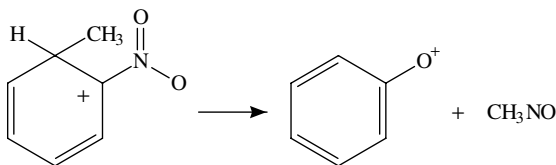
pronounced for nitroarenes containing electron-donating substituents in the *meta* position than for those being substituted in the *ortho* or *para* positions. It should be noted that the observed loss of, e.g.,  $\text{NO}_2$  may still occur from the nitro-protonated species. This is supported by the collision-induced fragmentations at 10 and 50 eV, where the loss of  $\text{NO}_2$  is replaced by loss of  $\text{HNO}_2$  as the internal energy of the fragmenting ion increases, in complete accordance with the expected increase of simple bond fissions at the expense of rearrangement reactions with increasing internal energy<sup>106</sup>. Thus, the MS/MS results are consistent with protonation predominantly of the nitro group. The thermodynamically favoured site of protonation of nitrobenzene was previously demonstrated to be the nitro function rather than the aromatic ring<sup>107</sup>; see Scheme 37.



SCHEME 37

The sites of protonation of aromatic compounds, including the possible three monofluoronitrobenzenes, have been studied by neutralization-reionization mass spectrometry (NRMS)<sup>22</sup>. The NRMS experiments on the  $\text{MD}^+$  species generated by  $\text{D}_2$  chemical ionization clearly indicated that the  $\text{D}^+$  attachment takes place to the nitro group rather than to the aromatic ring, as evidenced by the abundant losses of  $\text{OD}^\bullet$  and  $\text{DNO}_2$  ( $\text{NO} + \text{OD}^\bullet$ )<sup>22</sup>.

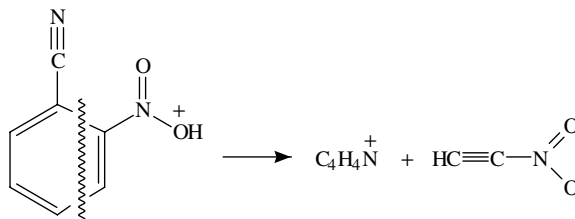
In addition, a number of unusual fragmentation reactions, specific for certain substituents, have been observed for the nitroarenes. Thus, the protonated 2-nitrotoluene apparently eliminates nitrosomethane<sup>108</sup>. This reaction is not observed for either the *meta* or the *para* isomers and, hence, clearly involves the interaction of the two adjacent groups; see Scheme 38.



SCHEME 38

The dominant formation of  $m/z$  78 in the fragmentation of the metastable ion of 2-cyanonitrobenzene has been rationalized by analogy to the  $\text{HCN}$  elimination from

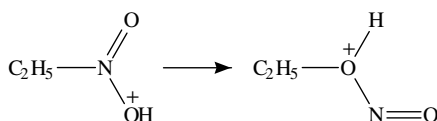
ionized benzonitrile<sup>108</sup>. Thus, a mechanism involving the elimination of nitroacetylene was proposed<sup>108</sup>; see Scheme 39.



SCHEME 39

Direct analysis of complex samples have revealed neutral losses as most useful<sup>5</sup>. Thus, nitroarenes have been identified based on the losses of OH<sup>•</sup> from the [M + H]<sup>+</sup> ions<sup>109</sup>. However, the fact that some isomers will be detected with a very low sensitivity, if at all, puts a strong limitation to this strategy.

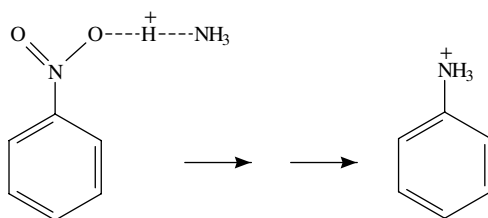
Protonated aliphatic/alicyclic nitro compounds have not been studied to the same extent as the nitroarenes. However, the isomeric [C<sub>2</sub>H<sub>6</sub>NO<sub>2</sub>]<sup>+</sup> ions and their rearrangement in the gas phase have been subject to studies<sup>110</sup>. The protonated ethyl nitrite and nitroethane were generated by proton transfer from different Brønsted acids. In addition, protonated ethyl nitrite was obtained as a result of addition of NO<sup>+</sup> to ethanol<sup>110</sup>. The existence of two different [C<sub>2</sub>H<sub>6</sub>NO<sub>2</sub>]<sup>+</sup> structures, i.e. protonated ethyl nitrite and protonated nitroethane, was demonstrated. Slow isomerization of protonated nitroethane to protonated ethyl nitrite has been elucidated<sup>110</sup>; see Scheme 40.



SCHEME 40

The chemical ionization of nitro compounds has been reported to cause chemical transformation of the analyte. Thus, reduction of the nitro group to the corresponding amine appears as a common process. The extent of reduction depends on the ion source temperature and the possible presence of water in the system. It should be noted that the protonated amine and the [MH - NO]<sup>+</sup> ion are isobaric and the possible differentiation can be achieved applying either high resolution or isotopical shift techniques. With the use of H<sub>2</sub>O, respectively D<sub>2</sub>O, as reagent gases, it was demonstrated that [MH - 30]<sup>+</sup> ions mainly were due to the reduction of the compounds to the corresponding amines<sup>111</sup>.

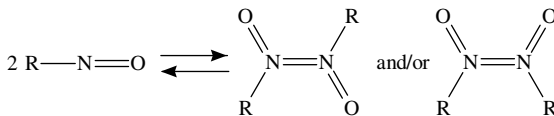
The use of ammonia for the protonation of nitroarenes leads frequently to formation of adduct ions, e.g. [M + NH<sub>4</sub>]<sup>+</sup>, but *not* to the protonated species (MH<sup>+</sup>)<sup>112,113</sup>. The ammonia chemical ionization spectrum of nitrobenzene shows, in addition to a series of adduct ions, a dominant signal corresponding to the anilinium ion (*m/z* 94)<sup>112,114,115</sup>. Evidence for the isomerization of the [M + NH<sub>4</sub>]<sup>+</sup> adduct followed by successive loss of NO and OH<sup>•</sup> or NH<sub>3</sub> to give ions corresponding to the substitution products, e.g. the anilinium ion, has been given<sup>115</sup>; see Scheme 41.



SCHEME 41

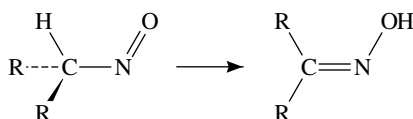
## V. NITROSO COMPOUNDS

Mass spectrometric investigations of C-nitroso compounds are rarely encountered in the literature<sup>2</sup>. C-nitroso compounds are difficult to handle due to dimerization and isomerization. Dimerization is a common feature leading to a dimer exhibiting *cis/trans* isomeric forms; see Scheme 42.



SCHEME 42

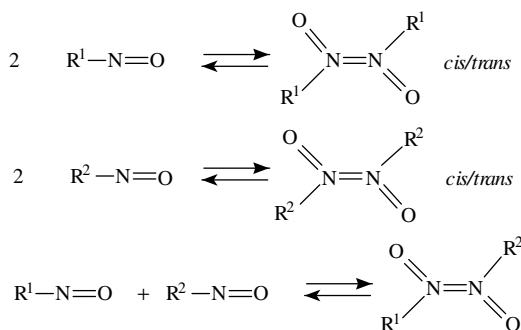
C-nitroso compounds exhibiting an  $\alpha$ -H, such as nitrosomethane and nitrosoethane, may isomerize to the corresponding oxime, as evidenced by mass spectrometry<sup>116,117</sup>. Unsaturated C-nitroso compounds may undergo electrocyclic ring closure as discussed below.



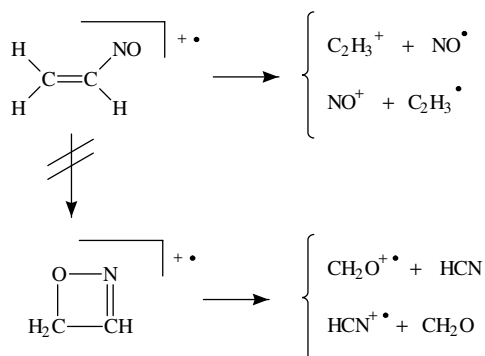
Consequently, the MS investigations of C-nitroso compounds are frequently hampered by superimposed spectra due to dimerization/rearrangement of the initial compound. Further, electron impact spectra of larger non-aromatic C-nitroso compounds in general carry little information due to extensive fragmentation<sup>118</sup>.

A study of a series of C-nitroso compounds, including monomers as well as dimers, by field desorption has demonstrated the superiority of this technique to this class of compounds<sup>118</sup>. All the compounds display intense molecular ions<sup>118</sup>. The method has a significant potential for studies of the equilibrium between mixed and pure C-nitroso compounds, since the amount of pure and mixed dimers present in a solution apparently can be visualized by the relative abundances of the respective molecular ions; see Scheme 43. Determination of the concentrations versus time may resolve the kinetics of the dimer formation<sup>118</sup>.

The parent nitrosoethene has been characterized by MS strategies<sup>45</sup>. The compound was generated by low-pressure pyrolysis using surface-promoted reactions of nitroethene<sup>45</sup>. The MS reveal that nitrosoethene undergoes a simple cleavage. The charge predominantly remaining on the  $C_2H_3$  fragment was unambiguously demonstrated by application of deuterium labelling<sup>45</sup>. Thus, the isotope shifts observed in the collision-induced MS of



SCHEME 43



SCHEME 44

the pyrolytically generated compound apparently exclude the operation of  $[2\pi + 2\pi]$  intramolecular cycloaddition, since it may be expected that the ionized isomeric 4-*H*-1,2-oxazete fragments to  $\text{HCN}^+ \cdot$  and  $\text{CH}_2\text{O}^+ \cdot$ <sup>119</sup>; see Scheme 44.

## VI. REFERENCES

1. C. J. Porter, J. H. Beynon and T. Ast, *Org. Mass Spectrom.*, **16**, 101 (1981).
2. H. Schwarz and K. Levsen, in *Chemistry of the Functional Groups, Suppl. F: The Chemistry of Amino, Nitroso and Nitro Compounds and Their Derivatives*, Part 1, (Ed. S. Patai), Chap. 3, Wiley, Chichester 1982, p. 85.
3. K. Levsen, *Fundamental Aspects of Organic Mass Spectrometry*, Verlag Chemie, Weinheim, 1978.
4. R. G. Cooks, J. H. Beynon, R. M. Caprioli and G. R. Lester, *Metastable Ions*, Elsevier, Amsterdam, 1973.
5. K. L. Busch, G. L. Glish and S. McLuckey, *Mass Spectrometry/Mass Spectrometry: Techniques and Applications of Tandem Mass Spectrometry*, VCH Verlagsgesellschaft, Weinheim, 1988.
6. H. Egsgaard, L. Carlsen, H. Flôrencio, T. Drewello and H. Schwarz, unpublished.
7. C. Lifshitz, M. Rejwan, I. Levin and T. Peres, *Int. J. Mass Spectrom. Ion Processes*, **84**, 271 (1988).
8. J. L. Holmes and J. K. Terlouw, *Org. Mass Spectrom.*, **15**, 383 (1980).
9. A. Fraefel and L. Seibl, *Mass Spectrom. Rev.*, **4**, 151 (1985).
10. R. K. Boyd and J. H. Beynon, *Int. J. Mass Spectrom. Ion Phys.*, **23**, 163 (1977).
11. J. H. Beynon, M. Bertrand and R. G. Cooks, *J. Am. Chem. Soc.*, **95**, 1739 (1973).

12. K. Levsen and H. Schwarz, *Mass Spectrom. Rev.*, **2**, 77 (1983).
13. F. W. McLafferty (Ed.), *Tandem Mass Spectrometry*, Wiley-Interscience, New York, 1983.
14. F. W. McLafferty, *Acc. Chem. Res.*, **13**, 33 (1980).
15. H. Egsgaard, L. Carlsen, H. Flórencio, T. Drewello and H. Schwarz, *Ber. Bunsenges. Phys. Chem.*, **93**, 76 (1989).
16. C. Wesdemiotis and F. W. McLafferty, *Chem. Rev.*, **87**, 485 (1987).
17. J. K. Terlouw and H. Schwarz, *Angew. Chem.*, **99**, 829 (1987).
18. J. K. Terlouw, *Adv. Mass Spectrom.*, **11B**, 984 (1989).
19. J. L. Holmes, *Mass Spectrom. Rev.*, **8**, 513 (1989).
20. F. W. McLafferty, *Science*, **247**, 925 (1990).
21. F. Turecek, *Org. Mass Spectrom.*, **27**, 1087 (1992).
22. A. W. McMahon, F. Chadikun, A. G. Harrison and R. E. March, *Int. J. Mass Spectrom. Ion Processes.*, **87**, 275 (1989).
23. P. C. Burgers and J. K. Terlouw, *Structures and Reactions of Gas-phase Organic Ions*, Special Periodic Report, Vol. 10, Royal Society of Chemistry, 1989, p. 35.
24. S. G. Lias, J. E. Bartmess, J. F. Liebman, J. L. Holmes, R. D. Levin and W. G. Mallard, *J. Phys. Chem. Ref. Data*, **17**, suppl 1 (1988).
25. J. L. Holmes, M. Fingas and F. P. Lossing, *Can. J. Chem.*, **59**, 80 (1981).
26. J. L. Holmes and F. P. Lossing, *Can. J. Chem.*, **60**, 2365 (1982).
27. J. L. Holmes, F. P. Lossing and P. C. Burgers, *Int. J. Mass Spectrom. Ion Phys.*, **47**, 133 (1983).
28. F. P. Lossing and J. L. Holmes, *J. Am. Chem. Soc.*, **106**, 6917 (1984).
29. H. Egsgaard and L. Carlsen, unpublished.
30. J. P. Gilman, T. Hsieh and G. G. Meisels, *J. Chem. Phys.*, **78**, 1174 (1983).
31. J. W. Rabalias, *J. Chem. Phys.*, **57**, 960 (1972).
32. M. L. McKee, *J. Phys. Chem.*, **90**, 2335 (1986).
33. M. L. McKee, *J. Am. Chem. Soc.*, **108**, 5784 (1986).
34. P. Kebarle and S. Chowdhury, *Chem. Rev.*, **87**, 513 (1987).
35. T. Heinis, S. Chowdhury and P. Kebarle, *Org. Mass Spectrom.*, **28**, 358 (1993).
36. R. J. Cellota, R. A. Bennet and J. L. Hall, *J. Chem. Phys.*, **60**, 1740 (1974).
37. G. W. Dillow and P. Kebarle, *J. Am. Chem. Soc.*, **111**, 5592 (1989).
38. S. Chowdhury, H. Kishi, G. W. Dillow and P. Kebarle, *Can. J. Chem.*, **67**, 603 (1989).
39. S. G. Lias, J. F. Liebman and R. D. Levin, *J. Phys. Chem. Ref. Data*, **13**, 695 (1984).
40. D. P. Stevenson, *Discuss. Faraday Soc.*, **10**, 35 (1951).
41. Y. Niwa, S. Tajima and T. Tsuchiya, *Int. J. Mass Spectrom. Ion Phys.*, **40**, 287 (1981).
42. M. Panczel and T. Baer, *Int. J. Mass Spectrom. Ion Processes*, **58**, 43 (1984).
43. T. Nishimura, P. R. Das and G. G. Meisels, *J. Chem. Phys.*, **84**, 6190 (1986).
44. H. Egsgaard and L. Carlsen, Proc. 41st ASMS Conf. Mass Spectrom. Allied Topics, San Francisco, May 1993, p. 993a.
45. H. Egsgaard and L. Carlsen, *J. Chem. Res. (S)*, 18 (1987).
46. H. Egsgaard, L. Carlsen, T. Weiske, D. Sülzle and H. Schwarz, *Chem. Phys. Lett.*, **199**, 643 (1992).
47. G. Bouchoux, *Mass Spectrom. Rev.*, **7**, 1 (1988).
48. G. Bouchoux, *Mass Spectrom. Rev.*, **7**, 203 (1988).
49. H. Schwarz, *Adv. Mass Spectrom. 1985*, Part A (Ed. J. F. Todd), p 13 (1986).
50. H. Egsgaard, L. Carlsen and S. Elbel, *Ber. Bunsenges. Phys. Chem.*, **90**, 369 (1986).
51. S. K. Hindawi, R. H. Fokkens, F. A. Pinkse and N. M. M. Nibbering, *Org. Mass Spectrom.*, **21**, 243 (1986).
52. M. Sirois, J. L. Holmes and C. E. C. A. Hop, *Org. Mass Spectrom.*, **25**, 167 (1990).
53. R. Arakawa, *J. Bull. Chem. Soc. Jpn.*, **62**, 2064 (1989).
54. M. P. Irion, A. Selinger, A. W. Castleman Jr., E. E. Ferguson and K. G. Weil, *Chem. Phys. Lett.*, **147**, 33 (1988).
55. H. Egsgaard and L. Carlsen, *Chem. Phys. Lett.*, **147**, 30 (1988).
56. J. P. Gilman, T. Hsieh and G. G. Meisels, *J. Chem. Phys.*, **78**, 3767 (1983).
57. D. Schröder, D. Sülzle, O. Dutuit, T. Baer and H. Schwarz, *J. Am. Chem. Soc.*, **116**, 6395 (1994).
58. S. Tajima, T. Azami, T. Tsuchiya and N. M. M. Nibbering, *Sh. Bunseki*, **31**, 51 (1983).
59. N. M. M. Nibbering Th. J. de Boer and H. J. Hofman, *Recl. Trav. Chim. Pays-Bas*, **84**, 481 (1965).
60. J. W. Verhoeven, *Recl. Trav. Chim. Pays-Bas*, **99**, 369 (1980).



61. H. Egsgaard and L. Carlsen, *Org. Mass Spectrom.*, **24**, 1031 (1989).
62. H. Schwarz, *Top. Curr. Chem.*, **73**, 231 (1978).
63. J. H. Beynon, G. R. Lester and A. E. Williams, *J. Phys. Chem.*, **63**, 1861 (1959).
64. A. R. Butcher and C. B. Thomas, *Org. Mass Spectrom.*, **14**, 448 (1979).
65. J-D Shao and Tomas Baer, *Int J. Mass Spectrom and Ion Processes.*, **86**, 357 (1988).
66. S. A. McLuckey and G. L. Glush, *Org. Mass Spectrom.*, **22**, 224 (1987).
67. C. G. Herbert, E. A. Larka and J. H. Beynon, *Org. Mass Spectrom.*, **19**, 306 (1984).
68. S. Meyerson, I. Puskas and E. K. Fields, *J. Am. Chem. Soc.*, **88**, 4974 (1966).
69. J. H. Beynon, R. A. Saunders, A. Topham and A. E. Williams, *J. Chem. Soc.*, 6403 (1965).
70. M. A. Baldwin, *Org. Mass Spectrom.*, **15**, 109 (1980).
71. M. A. Baldwin, D. M. Carter and J. Gilmore, *Org. Mass Spectrom.*, **17**, 45 (1982).
72. M. A. Baldwin and H. J. Bowley, *Org. Mass Spectrom.*, **17**, 580 (1982).
73. T. G. Morgan, E. E. Kingston, F. M. Harris and J. H. Beynon, *Org. Mass Spectrom.*, **17**, 594 (1982).
74. C. G. Macdonald and M. J. Lacey, *Org. Mass Spectrom.*, **17**, 91 (1982).
75. K. B. Tomer, T. Gebreyesus and C. Djerassi, *Org. Mass Spectrom.*, **7**, 383 (1973).
76. C. J. Porter, C. J. Proctor, E. A. Larka and J. H. Beynon, *Org. Mass Spectrom.*, **17**, 331 (1982).
77. G. Depke, W. Klose and H. Schwarz, *Org. Mass Spectrom.*, **18**, 495 (1983).
78. S. Middleton, M. Butcher and R. F. Mathews, *Aust. J. Chem.*, **27**, 2583 (1974).
79. G. Depke, W. Klose, H. Schwarz, W. Blum and W. J. Richter, *Org. Mass Spectrom.*, **18**, 568 (1983).
80. R. K. M. R. Kallury and J. Hemalatha, *Org. Mass Spectrom.*, **15**, 659 (1980).
81. D. V. Ramana and N. V. S. Rama Krishna, *Org. Mass Spectrom.*, **24**, 66 (1989).
82. D. V. Ramana, K. K. Balasubramanian, M. S. Sudha and T. Balasubramanian, *J. Am. Soc. Mass Spectrom.*, **6**, 195 (1995).
83. P. S. Kulkarni, H. V. Kamath and S. N. Kulkarni, *Org. Mass Spectrom.*, **19**, 334 (1984).
84. A. Könnecke, P. Lepom, R. Dörre, E. Liepmann, R. Herzshuh, B. Kralj, B. Stanovnik and M. Tisler, *Org. Mass Spectrom.*, **15**, 75 (1980).
85. A. Maquestiau, R. Flammang, M. Flammang-Barbieux, Lin-Zhi Chen and C. Wentrup, *Int. J. Mass Spectrom and Ion Processes.*, **86**, 235 (1988).
86. D. V. Ramana, N. Sundaram and M. George, *Org. Mass Spectrom.*, **24**, 63 (1989).
87. D. V. Ramana, N. Sundaram and M. George, *Org. Mass Spectrom.*, **25**, 161 (1990).
88. D. V. Ramana and N. V. S. Rama Krishna, *Org. Mass Spectrom.*, **27**, 515 (1992).
89. D. V. Ramana and N. V. S. Rama Krishna, *Org. Mass Spectrom.*, **24**, 485 (1989).
90. D. V. Ramana, N. Sundaram and M. George, *Org. Mass Spectrom.*, **22**, 140 (1987).
91. D. V. Ramana and S. K. Viswanadham, *Org. Mass Spectrom.*, **18**, 162 (1983).
92. J. Yinon and S. Bulusu, *Org. Mass Spectrom.*, **21**, 529 (1986).
93. S. Bulusu and T. Axenrod, *Org. Mass Spectrom.*, **14**, 585 (1979).
94. W. R. Carper, R. C. Dorey, K. B. Tomer and F. W. Crow, *Org. Mass Spectrom.*, **19**, 623 (1984).
95. J. Yinon, *Org. Mass Spectrom.*, **27**, 689 (1992).
96. W. C. M. M. Luijten and J. van Thuijl, *Org. Mass Spectrom.*, **14**, 577 (1979).
97. W. C. M. M. Luijten and J. van Thuijl, *Org. Mass Spectrom.*, **16**, 199 (1981).
98. W. C. M. M. Luijten and J. van Thuijl, *Org. Mass Spectrom.*, **17**, 299 (1982).
99. W. C. M. M. Luijten and J. van Thuijl, *Org. Mass Spectrom.*, **17**, 304 (1982).
100. A. Cert, P. Delgado-Cobos and M. T. Pérez-Lanzac, *Org. Mass Spectrom.*, **21**, 499 (1986).
101. D. Mitchell, R. D. Bowen, K. R. Jennings, R. S. Varma and G. W. Kalbalka, *J. Chem. Soc., Perkin Trans. 2*, 1495 (1987).
102. S. R. Deshpande, H. M. Mathur and G. K. Trivedi, *Ind. J. Chem.*, **24B**, 1142 (1985).
103. R. Gawinecky, D. Rasala and T. Bak, *Org. Mass Spectrom.*, **27**, 39 (1992).
104. D. V. Ramana and P. Mahalakshmi, *Org. Mass Spectrom.*, **28**, 107 (1993).
105. S. Pappalardo and M. Di Grazia, *Org. Mass Spectrom.*, **20**, 392 (1985).
106. A. G. Harrison and R. K. M. R. Kallury, *Org. Mass Spectrom.*, **15**, 284 (1980).
107. Y. H. Lau and P. Kebarle, *J. Am. Chem. Soc.*, **98**, 7452 (1976).
108. R. A. Crombie and A. G. Harrison, *Org. Mass Spectrom.*, **23**, 327 (1988).
109. D. Schuetzle, T. L. Riley, T. J. Prater, T. M. Harvey and D. F. Hunt, *Anal. Chem.*, **54**, 265 (1982).
110. G. de Petris, *Org. Mass Spectrom.*, **25**, 557 (1990).
111. J. Yinon and M. Laschever, *Org. Mass Spectrom.*, **16**, 264 (1981).

112. R. G. Gillis, *Org. Mass Spectrom.*, **21**, 415 (1986).
113. A. G. Harrison, *Chemical Ionization Mass Spectrometry*, 2nd ed., CRC Press, Boca Raton, 1992.
114. W. J. van der Hart, W. C. M. M. Luijten and J. van Thuijl, *Org. Mass Spectrom.*, **15**, 463 (1980).
115. K. G. Das, R. A. Swamy, J. van Thuijl, W. Onkenhout, D. Fraisse and J. C. Tabet, *Org. Mass Spectrom.*, **18**, 34 (1983).
116. D. C. Frost, W. M. Lau, C. A. McDowell and N. P. C. Westwood, *J. Phys. Chem.*, **86**, 3577 (1982).
117. G. B. M. Eastwood and G. L. Pratt, *J. Chem. Soc. (A)*, 2337 (1970).
118. R. L. Johnson, O. W. Lever Jr. and D. A. Brent, *Org. Mass Spectrom.*, **118**, 36 (1983).
119. K. Wieser and A. Berndt, *Angew. Chem.*, **87**, 72 (1975).

## CHAPTER 7

# NMR of compounds containing –NH<sub>2</sub>, –NO<sub>2</sub> and –NO groups

EDWARD W. RANDALL

*Department of Chemistry, Queen Mary and Westfield College, London, UK*  
Fax: +44 181 981 8745; e-mail: E.W.Randall@qmw.ac.uk

and

CHRISTIANA A. MITSOPOULOU

*Department of Chemistry, University of Athens, 15771 Athens, Greece*  
Fax: +30 1 7232 094; e-mail: cmitsop@atlas.uoa.ariadne.t.gr

---

I. INTRODUCTION	296
A. Previous Volume	297
B. Chemical Shifts	297
C. Indirect Spin–Spin Couplings	298
D. Effects of Exchange, Hydrogen Bonding and Protonation	299
E. Relaxation Effects	299
F. Shift Standards	300
II. EFFECT OF ALKYL GROUPS ON THE FUNCTIONAL GROUPS NH <sub>2</sub> AND NO <sub>2</sub> AND NO	300
III. EFFECT OF AMINO, NITRO AND NITROSO GROUPS ON THE NMR SPECTRA OF THE AROMATIC RING	301
A. <sup>1</sup> H Chemical Shifts	301
B. <sup>13</sup> C Chemical Shifts	302
IV. EFFECT OF ARYL GROUPS ON THE FUNCTIONAL GROUPS NH <sub>2</sub> , NO <sub>2</sub> AND NO	303
A. Anilines and their Derivatives	303
1. Substituent effects on <sup>15</sup> N chemical shifts	303
2. Substituent solvation effect on <sup>15</sup> N anilines	308
B. Nitrobenzenes	310
1. Substituent effects on <sup>15</sup> N chemical shifts	310
2. Substituent effects on <sup>17</sup> O chemical shifts	312

C. Nitroso Compounds	315
1. Substituent effects on $^{14}\text{N}$ , $^{15}\text{N}$ and $^{17}\text{O}$ chemical shifts	315
V. NMR DETERMINATIONS OF STRUCTURE IN SOLUTION	317
A. Substituent Effects on One-bond ( $^{15}\text{N}$ - $^{13}\text{C}$ ) Couplings	317
B. One-bond $^{15}\text{N}$ - $^1\text{H}$ Couplings	318
C. Liquid Crystal Solvents	320
D. Solid State NMR	321
E. Relationship of Aromatic Nitro Group Torsion Angles with $^{17}\text{O}$ Chemical Shifts	325
VI. IMAGING	330
VII. REFERENCES	332

## I. INTRODUCTION

The functional groups  $-\text{NH}_2$ ,  $-\text{NO}$  and  $-\text{NO}_2$  contain atoms which have the following naturally occurring NMR active nucleides:  $^1\text{H}$ ,  $^2\text{H}$ ,  $^{14}\text{N}$ ,  $^{15}\text{N}$  and  $^{17}\text{O}$ . Table 1 lists some of their basic NMR characteristics as well as those of the  $^{13}\text{C}$  isotope of the carbon atom, which is invariably one of the atoms normally attached to nitrogen in the compounds discussed in this book.

The main NMR interactions in solution of interest to chemists are the chemical shift relative to some stated standard ( $\delta$ ), the indirect coupling constant ( $J$ ) and the relaxation times:  $T_1$  (spin-lattice);  $T_2$  (spin-spin: related to the line width); and  $T_{1\rho}$ , the relaxation time in the rotating frame. In the case of solids and oriented samples both the direct dipole-dipole and the electric quadrupole interactions assume greater importance. We shall confine our attention in this chapter to diamagnetic compounds so that we may neglect nuclear interactions with electron spins.

The spin half nuclei  $^1\text{H}$ ,  $^{13}\text{C}$  and  $^{15}\text{N}$ , in the absence of chemical exchange and in diamagnetic molecules, give spectra with very narrow lines which are easy to resolve especially at high magnetic fields at least for small molecules, but the low abundances of  $^{13}\text{C}$  and especially  $^{15}\text{N}$  lead to weak signals. This inherent low sensitivity can be overcome by pulse FT techniques and accumulation, or in some cases by indirect detection (the inverse mode) most commonly with  $^1\text{H}$  as the observed nucleide. In solution this requires the presence of a  $J$  ( $^1\text{H}$ - $^{15}\text{N}$ ) coupling.

Of the nuclei with  $I > 1/2$ , namely  $^2\text{H}$  ( $I = 1$ ),  $^{14}\text{N}$  ( $I = 1$ ) and  $^{17}\text{O}$  ( $I = 5/2$ ), the latter two give very large line widths, which can be hundreds or thousands of Hz, except in

TABLE 1. Magnetic properties of some nuclei

Magnetogyric ratio $\gamma/10^7$ rad $\text{T}^{-1} \text{s}^{-1}$	Nucleide	Spin	Magnetic moment <sup>a</sup> $\mu/\mu_{\text{N}}$	Electric quadrupole moment <sup>b</sup>	Resonance frequency in a field of 2.35 T	Percent natural abundance	Receptivity at natural abundance
26.7510	$^1\text{H}$	1/2	4.8371		100.000	99.985	1.000
4.1064	$^2\text{H}$	1	1.2126	$2.73 \times 10^{-3}$	15.351	0.015	$1.45 \times 10^{-6}$
6.7263	$^{13}\text{C}$	1/2	1.2162		25.145	1.108	$1.76 \times 10^{-2}$
1.9324	$^{14}\text{N}$	1	0.5709	$7.1 \times 10^{-2}$	7.224	99.63	$1.00 \times 10^{-3}$
-2.7107	$^{15}\text{N}$	1/2	-0.4903		10.137	0.37	$3.85 \times 10^{-6}$
-3.6266	$^{17}\text{O}$	5/2	-2.2407	$-2.6 \times 10^{-2}$	13.557	$3.7 \times 10^{-3}$	$1.08 \times 10^{-5}$

<sup>a</sup>Multiples of the nuclear magneton.

<sup>b</sup>Multiples of barns ( $10^{-24} \text{cm}^2$ ).

cases of very high symmetry such as  $^{14}\text{NH}_4^+$  and  $^{14}\text{NO}_3^-$ , and  $\text{C}^{17}\text{O}$  in metalocarbonyls (which are of no concern here). The exception is  $^2\text{H}$ , which because it has a relatively small quadrupole moment normally gives very narrow lines even though the local symmetry at the deuterium atom is invariably low.

There have been numerous books and reviews<sup>1-10</sup> of the NMR behaviour for each of the nucleides of interest in his chapter. The work of Witanowski and coworkers<sup>1a</sup> is particularly useful since it has a relatively up-to-date compilation of data for the nitrogen isotopes, which are of prime concern here.

Also referenced are several books<sup>11-14</sup> which deal with the phenomenon of NMR in general at a variety of levels.

## A. Previous Volume

There was no special chapter devoted to NMR in the last edition in 1982, but such is the utility of the technique that many references were made to NMR studies in other chapters. Our main concern here will be work published after that date. Although commercial FT pulse spectrometers had been available for ten or more years, the techniques of spectroscopy in two frequency dimensions, 2D-NMR, were in their infancy<sup>11</sup>, whereas now they are almost commonplace.

Similarly, instruments operating at 11.7 T (500 MHz for protons) were then only just being introduced whereas now 14.1 T spectrometers (600 MHz) are widespread, those at 17.6 T (750 MHz) are available and the development of spectrometers operating at even higher frequencies is underway.

All these advances have resulted not only in increases in resolution but have also alleviated the detection problems to a considerable extent. As a result, the last decade has seen a dramatic growth in  $^{15}\text{N}$ - and  $^{17}\text{O}$ -NMR spectroscopy as a versatile method for studying molecular structure, both in isotropic (liquid) and anisotropic (solid) phases. Studies at a natural abundance level of the nucleides are now commonplace. The scope of chemical applications extends from inorganic, organometallic and organic chemistry to biochemistry and molecular biology, and includes the study of reactive intermediates, biopolymers and enzyme-inhibitor complexes.

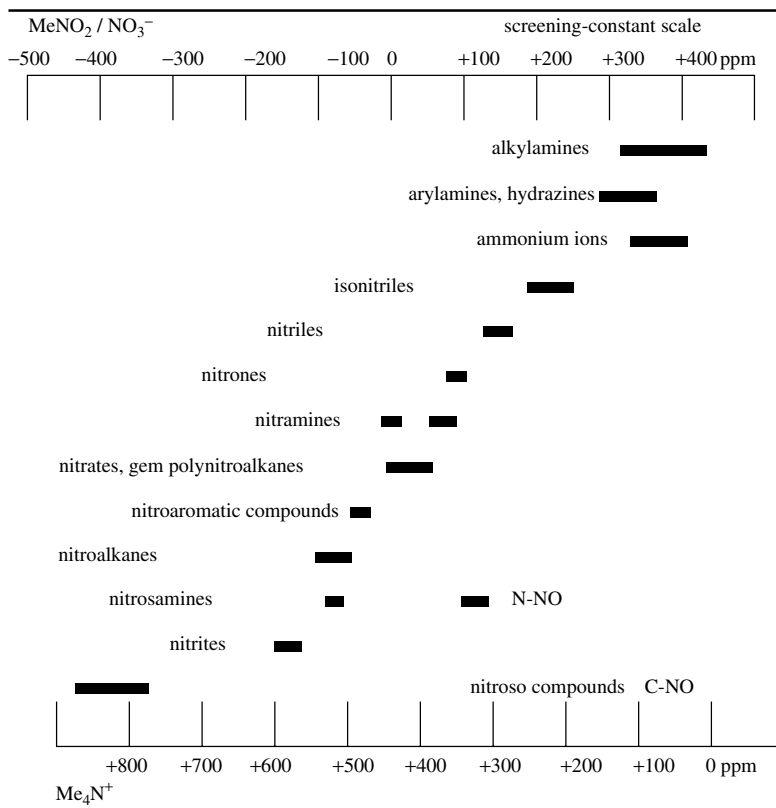
## B. Chemical Shifts

It is not our concern here to delve into the theory of chemical shifts, since most studies mentioned are essentially empirical in their approach and have aimed to correlate the measured shifts with electronic factors. The main fact, however, is that unlike proton shifts, the shifts for other nuclei are governed by the Van Vleck second-order paramagnetic term, which is not easy to handle since its magnitude depends not only on the ground electronic state but also on the manifold of excited states.

It is worth noting in passing that isotope effects on the shielding constants are negligible. The importance of this is that for each of the isotope pairs  $^1\text{H}$ ,  $^2\text{H}$  and  $^{14}\text{N}$ ,  $^{15}\text{N}$  the chemical shifts are the same. On the other hand, isotopic replacement of the atom bound to the centre being investigated, such as  $^{15}\text{N}$  in the isotopomeric pairs,  $\text{R}^{15}\text{N}^1\text{H}_2$  and  $\text{R}^{15}\text{N}^2\text{H}_2$ , leads to small shifts in the  $^{15}\text{N}$  resonance. Normally the shift is linearly dependent on the number  $n$  of groups replaced, such as in the series  $[\text{R}^{15}\text{N}(\text{H})_n(\text{H})_{4-n}]^+$  for which the incremental shift is  $0.30 \pm 0.01$  ppm. A summary of shift ranges for the nitrogen shifts in the compounds of interest here is given in Table 2.

In the normal 'average ( $\Delta E$ ) approximation'  $\Delta E$  is equated with the lowest energy (highest wavelength,  $\lambda_{\text{max}}$ ) transition in the UV region. If  $\Delta E$  is small, the effect is large and a shift to low field results. This is frequently referred to as a paramagnetic shift (even

TABLE 2. Approximate range of nitrogen chemical shifts in organic molecules with amino, nitro and nitroso groups



though the overall susceptibility is diamagnetic). The nucleus is said to be deshielded. Related terms are 'diamagnetic shift' and 'more shielded nucleus' and these signify a shift to higher field (lower frequency).

The bond order is also important and reference is frequently made accordingly to the 'bond order term'. Shifts to low field occur as the bond order increases. The terms are not independent.

There are many instances of correlation between  $1/\lambda_{\max}$  and the chemical shift for both the nitrogen nucleides and  $^{17}\text{O}$  as well as for  $^{13}\text{C}$ . It has been used as an aid for assignments.

Authors frequently resort to Valence Bond Theory and its picturesque canonical forms in discussions of results. Readers must make their own judgements on the utility of such approaches. In this chapter we merely report the views of the original authors.

### C. Indirect Spin-Spin Couplings

The couplings of main interest here are those between protons,  $^{15}\text{N}$  and  $^{13}\text{C}$ , since the remaining nucleides rarely give resolved couplings because they are quadrupolar.

Normally there is fast relaxation of the quadrupolar nucleus, and this leads to the decoupling of it from other spins.

The one-bond couplings, which are determined almost exclusively by the Fermi contact term, have been treated in some detail, and they have been used to good effect to reveal details of the structural situation particularly at the  $^{15}\text{N}$  centre, as discussed in Section V.

#### D. Effects of Exchange, Hydrogen Bonding and Protonation

The possibility of proton exchange involving the  $-\text{NH}_2$  group is always present. It causes an averaging of both the  $^1\text{H}$  and  $^{15}\text{N}$  shifts, if the exchange is fast enough; otherwise there is line broadening in the slow exchange limit, and possibly a loss of signal, because of such broadening, at intermediate rates. Exchange effects on coupling constants depend upon whether the spins remain correlated during the exchange. If they do then the  $J$  values, like the shifts, are averaged over the values for the different sites. Otherwise, the spins become decoupled.

Hydrogen bonding presents a common complication for all the groups under consideration in this chapter. For each of the groups the presence of lone-pairs allows it to function as the donor group, but in addition the hydrogens of the  $\text{NH}_2$  group can function as acceptors. Consequently the NMR signals of each of the groups depend frequently on such details as the nature of the solvent and the concentration. The solvent pH is also critical. Firstly there is the question of exchange of the hydrogens of the  $\text{NH}_2$  group, which may be base catalysed. Secondly there is the possibility of protonation. Hydrogen bonding to a solvent may be regarded as incipient protonation as regards its effect on the chemical shift.

In the case of ionic species, which may be represented by the ammonium ion, the nitrogen chemical shift depends upon the nature of the counter ion as well as the concentration. Shifts as large as 6 ppm have been noted.

#### E. Relaxation Effects

Chemists pay much less attention to the NMR relaxation rates than to the coupling constants and chemical shifts. From the point of view of the NMR spectroscopist, however, the relaxation characteristics are far more basic, and may mean the difference between the observation or not of a signal. For the quadrupolar nucleides such as  $^{14}\text{N}$  the relaxation characteristics are dominated by the quadrupole relaxation. This is shown by the absence of any nuclear Overhauser effect for the  $^{14}\text{N}$  ammonium ion despite its high symmetry, which ensures that the quadrupole relaxation is minimized. Relaxation properties are governed by motional characteristics normally represented by a correlation time, or several: translational, overall rotational and internal rotational, and thus are very different for solids, liquids and solutions.

Because spectral accumulation is almost invariably used, the choice of the relaxation delay becomes critical. In the case of the quadrupolar nuclei the small relaxation times allow extremely rapid accumulations. This is vital for  $^{17}\text{O}$  studies at natural abundance since the receptivity is so small. The  $^{15}\text{N}$  nucleus, on the other hand, is frequently characterized by very large values for  $T_1$ , and since the recommended delay is five times  $T_1$ , this leads to long accumulation times.

In imaging, faster accumulation by means of the steady-state free precession (SSFP) has been used successfully for  $^{15}\text{N}$ , but the method has so far not been reported for spectroscopy, although it should prove useful there also, provided proper attention is paid to phasing problems.

## F. Shift Standards

The preferred standard for both the hydrogen nucleides and  $^{13}\text{C}$  is tetramethylsilane (TMS). Indeed it is quite feasible to refer all shifts to the proton resonance of TMS, but most spectroscopists prefer a homonuclear reference.

For the nitrogen nucleides there are several reference substances in use. The latest large compilation of nitrogen shifts uses nitromethane (or tetramethyl ammonium ion) as the standard<sup>1a</sup>. This compound has the advantage that it is easily employed as an internal standard for organic samples, and the  $^{14}\text{N}$  line width is not excessive, so that its use is not confined to the  $^{15}\text{N}$  isotope. An alternative, which is restricted to use as an external standard, is ammonium nitrate, which has the advantage of containing *two* nitrogens only one of which gives an Overhauser effect. It thus may be employed not only for shift referencing, but also for checking of the double resonance parameters and for phasing of the spectra. The pH and concentration should be controlled: the conditions which we use are 5M ammonium nitrate [ $^{15}\text{N}_2$ ] in 2N  $\text{HNO}_3$ . In the case of some of the compounds under consideration here, an external standard has the utility that the solution conditions are not modified by the addition of an internal standard however inert it may be. If very accurate shifts are required, then corrections should be made for solution susceptibilities, although it may be said here that these corrections are normally so small that only rarely is the procedure necessary. If it is, then investigators may care to bless Witanowski and his collaborators for listing the relevant details<sup>1a</sup>.

In the case of  $^{17}\text{O}$ , a common reference compound is water. For multinuclear studies involving both  $^{17}\text{O}$  and either of the nitrogen nucleides, nitromethane would appear to offer an attractive candidate.

## II. EFFECT OF ALKYL GROUPS ON THE FUNCTIONAL GROUPS $\text{NH}_2$ AND $\text{NO}_2$ AND $\text{NO}$

Table 2 gives the approximate range of nitrogen chemical shifts in the organic compounds with which this book deals. The  $^{14}\text{N}$  and  $^{15}\text{N}$  NMR spectra of amino- and nitro-aliphatic compounds have been reviewed<sup>1,2,15</sup> and the effects of the alkyl group on the  $^{15}\text{N}$  chemical shifts have been investigated.

Aliphatic amines are characterized by nitrogen NMR signals at the high-field (low-frequency) limit of the normal range of shifts ( $-50$  to  $+15$  ppm referred to  $\text{Me}_4\text{N}^+$ ). The increasing alkyl substitution of the nitrogen atom in the series



results in a downfield (high-frequency) shift of the nitrogen resonance signal (Table 3).

The  $^{15}\text{N}/^{13}\text{C}$  correlations for aliphatic amines in cyclohexane, with slopes of the correlation lines of 2.06, 1.96 and 1.39 ppm N/ppm C for primary, secondary and tertiary amines respectively, show that substituent parameters may be derived and applied in a manner that has been successful for  $^{13}\text{C}$  NMR<sup>2</sup>.

Similarly a nitro group is shielded by the increasing alkyl substitution of the nitrogen-bound carbon atom (in a narrow range of  $+275$  to  $+365$  ppm, Table 3) in the series



and for mono-nitroalkanes a linear relationship exists with Taft constants.

A nitro group is also shielded by conjugation with an adjacent  $\pi$  system or by bonding to an electronegative group<sup>1c</sup>. This may be simply explained in terms of  $\pi$ -bond order and charge density changes and the average excitation energy approximation of the theory of chemical shifts.



TABLE 3.  $^{15}\text{N}$  chemical shifts of some aliphatic amines and nitroalkanes<sup>2</sup>

Compound	Solvent	$\delta^{15}\text{N}$ (ppm) <sup>a</sup>
$\text{MeNH}_2$	liquid	-43.0
	benzene (0.2M)	-41.5
	DMSO (0.2M)	-39.3
$\text{EtNH}_2$	MeOH	+24.8
$n\text{-PrNH}_2$	liquid	-24.0
$i\text{-PrNH}_2$	liquid	+1.0
$\text{Me}_2\text{NH}$	liquid	-36.2
$\text{Et}_2\text{NH}$	liquid	+3.0
$(n\text{-Pr})_2\text{NH}$	liquid	+40.3
$\text{Me}_3\text{N}$	liquid	-32.0
	benzene	-30.9
	chloroform	-27.4
$\text{Et}_3\text{N}$	liquid	+8.0
$\text{MeNO}_2$	liquid	+332.5
$\text{EtNO}_2$	liquid	+344.5
$n\text{-PrNO}_2$	liquid	+342.0
$\text{R}_2\text{CHNO}_2$	liquid	+353
$\text{R}_3\text{CNO}_2$	liquid	+362

<sup>a</sup>Referred to  $\text{Me}_4\text{N}^+$ , temperature 30 °C.

Conformational effects on  $^{15}\text{N}$  shifts in substituted cyclohexanes make an axial  $\text{NH}_2$  more shielded than an equatorial one. Also,  $^{15}\text{N}$  resonances are deshielded by  $\beta$  substitution more extensively than are  $^{13}\text{C}$  resonances of cyclic hydrocarbons, but the magnitude of the effect depends on the degree of nitrogen substitution. Carbons in the  $\gamma$  position shield the nitrogen in a manner analogous to  $^{13}\text{C}$ , but to a smaller extent in methanol than in cyclohexane solutions, and less for tertiary amines than for primary and secondary amines. These differences have been attributed in part to possible conformational influences on the stereoelectronic relationships between the lone pair and the C-C bonds.

The nitrogen nuclei in C-nitroso moieties are strongly deshielded and the smallest algebraical shieldings are observed for nitrosoalkanes. They are shielded from -603 to -590 referred to neat nitromethane. If there is a fluoro substituent (F or  $\text{CF}_3$ ) at the  $\alpha$ -C atom of a nitrosoalkane, the nitrogen shielding increases appreciably (-485 to -425 ppm referred to neat nitromethane). This is attributed to an increased excitation energy of the  $n \rightarrow \pi^*$  transition<sup>1b</sup>, in accord with some correlations of the nitrogen shieldings in  $\text{X}-\text{N}=\text{O}$  structures with the corresponding low-wavelength absorption bands in their electronic spectra.

### III. EFFECT OF AMINO, NITRO AND NITROSO GROUPS ON THE NMR SPECTRA OF THE AROMATIC RING

#### A. $^1\text{H}$ Chemical Shifts

The  $^1\text{H}$ -NMR spectra of amino, nitro and nitroso compounds have been reviewed<sup>16,17</sup>, and the effects of these substituents on the proton chemical shifts have been investigated<sup>16</sup>. Table 4 gives these substituent effects for mono-substituted benzenes.

There have been many attempts to relate the substituent shifts in benzenes to the electron densities of the molecule, either total or only  $\pi$ -densities. It can be seen that

TABLE 4. Substituent effects on  $^1\text{H}$  shifts in mono-substituted benzenes<sup>a</sup>

Substituent	$\Delta\delta_{\text{H}}$		
	<i>ortho</i>	<i>meta</i>	<i>para</i>
$\text{NO}_2$	0.95	0.26	0.38
$\text{NH}_2$	-0.75	-0.25	-0.65
$\text{NMe}_2$	-0.66	-0.18	-0.67
$\text{NHMe}$	-0.80	-0.22	-0.68

<sup>a</sup>Solvent  $\text{CCl}_4$ , ppm relative to benzene.

$\text{NO}_2$ , which is a strongly electron-withdrawing group, deshields all the protons but the effect is largest at the *ortho* and *para* positions. The converse is true for  $-\text{NH}_2$ , a strongly electron-donating group. In fact the effect of amino, nitro and nitroso groups on the  $^1\text{H}$  chemical shifts of benzene is a combination of inductive, resonance and magnetic anisotropy effects, and there is a very approximate rule that there is an upfield shift of about 10 ppm at the CH proton for a unit increase in the  $\pi$ -electron density at the attached carbon atom. Also in the case of the  $\text{NH}_2$  group (in  $\text{RNH}_2$ ), which is capable of forming intermolecular hydrogen bonds with solvent molecules, the observed proton chemical shift depends critically on solute concentration, the nature of the solvent, temperature and other effects.

## B. $^{13}\text{C}$ Chemical Shifts

The  $^{13}\text{C}$ -NMR spectra of amino, nitro and nitroso compounds have been investigated extensively<sup>16,18-21</sup>. Table 5 gives these substituent effects for mono-substituted benzenes for each of these groups.

TABLE 5. Substituent effects on  $^{13}\text{C}$  shifts in mono-substituted benzenes<sup>19,21-23</sup>

Substituent <sup>a</sup>	C-1	Position		
		<i>ortho</i>	<i>meta</i>	<i>para</i>
H	0	0	0	0
$\text{NH}_2$	+20.2	-14.1	+0.6	-9.6
$\text{NH}_3^+$	+0.1	-5.8	+2.2	+2.2
NO	+19.8	-5.5	+1.0	+6.4
$\text{NO}_2$	+20.0	-4.8	+0.9	+5.8
$\text{SO}_2\text{NH}_2$	+15.3	-2.9	+0.4	+3.3
$\text{NHMe}$	+21.9	-16.4	+0.6	-12.6
$\text{NMe}_2$	+22.6	-15.8	+0.5	-11.8
$\text{NEt}_2$	+19.9	-15.3	+1.4	-12.2
$\text{NPh}_2$	+19.0	-4.6	+0.9	-5.8
$\text{NHPh}$	+14.7	-10.6	+0.8	-7.6
$\text{NHCOMe}$	+11.1	-9.9	+0.2	-5.6
$\text{CH}_2\text{NH}_2$	+15.5	-1.1	0.0	-1.9
$\text{CH}_2\text{NHCH}_2\text{Ph}$	+11.9	-0.5	-0.3	-1.7
$\text{CONH}_2$	+5.8	-1.1	-0.3	+2.7

<sup>a</sup>Parts per million relative to benzene. Data obtained relative to internal TMS and converted using  $\delta_{\text{C}} = 128.5$  for benzene. Solute concentration ca 10% in  $\text{CDCl}_3$ .

Shifts for *meta* carbon atoms remain almost unaffected by all kinds of substituents, unlike shifts for *ortho* and *para* carbons. Electron-releasing substituents (electron donors) increase  $\pi$  electron densities in *ortho* and *para* positions and thereby induce a shielding relative to benzene ( $\delta_{\text{C}(o,p)} < 128.5$  ppm)<sup>22</sup>. Electron-withdrawing groups (electron acceptors), on the other hand, decrease the *ortho* and *para*  $\pi$  electron densities and lead to a deshielding relative to benzene ( $\delta_{\text{C}(o,p)} > 128.5$  ppm).

In the *ortho* positions, the substituent chemical shifts are between those for a double and a single bond, as would be expected on the basis of an aromatic bond. For these positions proximate interactions such as electric field effects assume an increased importance.

In nitrobenzene, for example, the intramolecular electric field of the nitro group increases the  $\sigma$  electron densities at the *ortho* carbon nuclei, so reducing the electron density at the attached protons. This effect, in fact, overcompensates the effect of electron withdrawal by the nitro group, and a net shielding is observed (Table 5).

*Para* carbon shieldings, however, clearly follow the pattern described by the canonical formulae. They may be correlated well with the total charge densities<sup>22</sup> and with the Hammett constants.

#### IV. EFFECT OF ARYL GROUPS ON THE FUNCTIONAL GROUPS $\text{NH}_2$ , $\text{NO}_2$ AND $\text{NO}$

Over the last two decades, NMR chemical shifts have been used extensively as probes of electronic substituent effects<sup>24,25</sup>. Although  $^1\text{H}$  chemical shifts show small but systematic changes with molecular substitution, the larger chemical shift ranges of  $^{13}\text{C}$  and  $^{19}\text{F}$  nuclei make them more useful probes, as has been demonstrated in studies of substituent effects in substituted aromatic derivatives<sup>23,25-28</sup>. The utility of NMR chemical shifts as probes of substituent electronic effects relies on there being a linear relationship between measured substituent chemical shifts (SCS) and calculated electron densities. Although there is a good theoretical basis for these terms, complicating influences from a number of other factors contribute to chemical shifts, so that precise correlations are not usually obtained, except in compounds with closely related structures. The utilization of chemical shifts as electronic probes therefore depends mainly on empirical SCS correlations with electron density in substituted aromatics or similar systems.

##### A. Anilines and their Derivatives

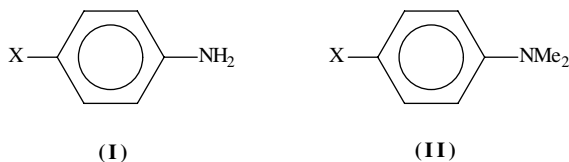
###### 1. Substituent effects on $^{15}\text{N}$ chemical shifts

The problem of substituent effects in aromatic systems, particularly in benzene derivatives, has long been a subject of interest<sup>29</sup>. Nitrogen resonance positions of *para*-substituted anilines are known to be influenced by the extent of nitrogen lone-pair delocalization<sup>30</sup>. As shown in Table 6, the resonance position of aniline is shifted to higher shielding when an electron-donating substituent is present in the *para* position<sup>31</sup>. Conversely, electron-withdrawing *para* substituents shift the resonance position to lower shielding.

N-methylation of aniline results in shifts of the aniline nitrogen resonance to higher shielding (Table 6), and this has been discussed in terms of perturbation of the lone-pair  $\pi$ -delocalization by the methyl group<sup>37</sup>.

The effect of *para* substituents in *N,N*-dimethylanilines is similar to that observed for N-unsubstituted anilines, but the range is slightly larger.

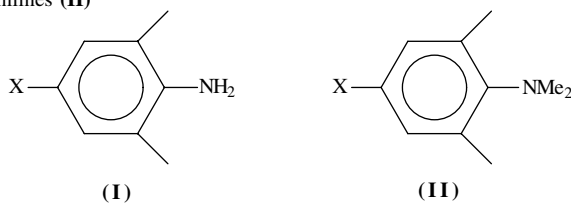
In the case of 2,6-dimethylanilines (Table 7), although the chemical shifts for corresponding *para* substituents are at somewhat higher shielding than those of *para* substituents of aniline, owing to the shielding effect of the *ortho* methyl groups, the

TABLE 6.  $^{15}\text{N}$  chemical shifts for *para*-substituted anilines (**I**) and *para*-substituted *N,N*-dimethylanilines (**II**)

X	$\delta_{\text{N}}$ (ppm) <sup>a</sup> ( <b>I</b> )	$\Delta\delta_{\text{N}}$ (ppm) <sup>b</sup> ( <b>I</b> )	$\delta_{\text{N}}$ (ppm) <sup>a</sup> ( <b>II</b> )	$\Delta\delta_{\text{N}}$ (ppm) <sup>b</sup> ( <b>II</b> )
H	59.76	0.0	44.88	0.0
NMe <sub>2</sub>	53.47	-6.29	42.60	-2.28
OMe	54.55	-5.21	40.77	-4.11
Me	57.82	-1.94	42.76	-2.12
F	55.66	-4.10	42.73	-2.15
Cl	60.36	0.60	49.11	4.23
Br	61.21	1.45	50.08	5.20
I	62.43	2.67	48.26	3.38
CN	73.18	13.42	59.64	14.76
NO <sub>2</sub>	79.48	19.72	68.60	23.72
NH <sub>2</sub>	56.01	-3.75	38.44	-6.44
OH	36.09	-3.27		
COOH	72.34	12.58	59.04	14.16

<sup>a</sup>Resonance positions to lower shielding relative to anhydrous ammonia. Samples were run as *ca* 2M solutions in DMSO

<sup>b</sup> $\Delta\delta_{\text{N}} = \delta_{\text{NX}} - \delta_{\text{NH}}$ . Positive values denote shifts to lower shielding.

TABLE 7.  $^{15}\text{N}$  chemical shifts for *para*-substituted 2,6-dimethylanilines (**I**) and *para*-substituted 2,6-*N,N*-tetramethylanilines (**II**)

X	$\delta_{\text{N}}$ (ppm) <sup>a</sup> ( <b>I</b> )	$\Delta\delta_{\text{N}}$ (ppm) <sup>b</sup> ( <b>I</b> )	$\delta_{\text{N}}$ (ppm) <sup>a</sup> ( <b>II</b> )	$\Delta\delta_{\text{N}}$ (ppm) <sup>b</sup> ( <b>II</b> )
H	55.77	0.0	16.80	0.0
NMe <sub>2</sub>	53.11	-2.46	13.56	-3.24
OMe	51.20	-4.57		
Me	52.75	-3.02	15.97	-0.83
F	53.10	-2.67	13.90	-2.90
Cl	57.46	1.69		
Br	58.68	2.91	17.57	0.77
I				
CN	72.05	16.28	18.23	1.43
NO <sub>2</sub>	81.04	25.27	27.71	10.91
NH <sub>2</sub>	52.26	-3.57	13.67	-3.13
OH				
COOH	67.80	12.03	21.53	4.73

<sup>a</sup>Resonance positions to lower shielding relative to anhydrous ammonia. Samples were run as *ca* 2M solutions in DMSO

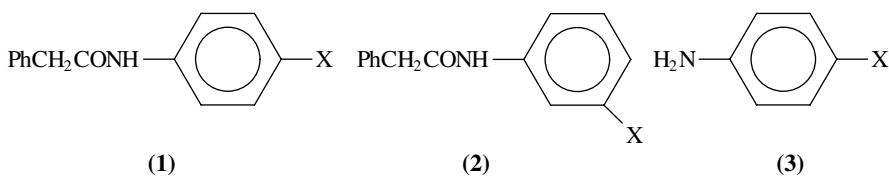
<sup>b</sup> $\Delta\delta_{\text{N}} = \delta_{\text{NX}} - \delta_{\text{NH}}$ . Positive values denote shifts to lower shielding.

*para* substituent exerts an effect on the resonance position that is similar to that observed for the anilines<sup>31,32</sup>.

A substantial divergence from the behaviour described up to now occurs with the 2,6-*N,N*-tetramethyl anilines (Table 7). The effect of the *para* substituent is no longer systematic, and no good correlation with substituent electronic properties is displayed. Evidently, the extent of nitrogen lone-pair delocalization in these compounds reflects a balance between electronic demand for, and steric inhibition of, delocalization that varies with the individual compounds. Nitrogen chemical shifts are a sensitive probe for these effects.

<sup>15</sup>N substituent chemical shifts (SCS) of a variety of anticonvulsant phenylacetanilides **1** and **2**, with a substituent at the *para* or *meta* position of the aniline moiety, were analysed by means of DSP (dual substituent parameter) equations<sup>33</sup>.

The two parameters are  $\sigma$  and  $\rho$  and appear in equation 1 or 2:



$$^{15}\text{N SCS} = \rho_I\sigma_I + \rho_R\sigma_R \quad (1)$$

or

$$^{15}\text{N SCS} = \rho_I\sigma_I + \rho_R\sigma_R + C \quad (2)$$

where *I* indicates inductive, *R* represents resonance, and *C* is a constant term specified for each correlation.

The <sup>15</sup>N chemical shifts of **1** and **2** together with the data for the relevant *para*-substituted anilines (**3**) are summarized in Table 8. At first glance it is clear that the

TABLE 8. <sup>15</sup>N chemical shifts<sup>b</sup> ( $\delta_N$ ) and substituent chemical shifts (SCS, in parentheses) of phenylacetanilides **1** and **2**<sup>33</sup>

Substituent	Series (1)	Series (2)
NH <sub>2</sub>		136.1 (+0.5)
NHMe		62.2 <sup>a</sup>
NMe <sub>2</sub>		136.4 (+0.8)
		56.0 <sup>a</sup>
OH	133.3 (-2.3)	136.0 (+0.4)
OMe	133.5 (-2.1)	42.3 <sup>a</sup>
Et	134.7 (-0.9)	135.9 (-0.3)
Me	134.9 (-0.7)	135.5 (-0.3)
H	135.6	135.3 (-0.3)
F	134.5 (-1.1)	135.6
Cl	134.5 (-1.1)	135.5 (-0.5)
Br	134.7 (-0.9)	135.1 (-0.5)
CN	137.6 (+2.0)	134.9 (-0.6)
Ac	137.5 (+1.9)	134.8 (-0.8)
NO <sub>2</sub>	138.2 (+2.6)	135.2 (-0.4)

<sup>a</sup>Nitrogen of the substituent

<sup>b</sup>Solvent (CD<sub>3</sub>)<sub>2</sub>SO, referred to NH<sub>3</sub>.

range of  $^{15}\text{N}$  SCN for **1** is small, and the chemical shift difference between the *p*-OH derivative (with a representative electron donor substituent) and the *p*-NO<sub>2</sub> derivative (a representative electron acceptor) is only about 5 ppm, compared with a difference of some 25 ppm between the same two substituents reported for  $^{15}\text{N}$  (SCS) of *para*-substituted anilines (**3**).

It seems that  $^{15}\text{N}$  chemical shifts of amide nitrogen are much less sensitive to electron withdrawal and donation than  $^{15}\text{N}$  shifts of amines because of the strong conjugation of the amide nitrogen lone-pair electrons with the carbonyl groups, which compete for conjugation with the  $\pi$ -systems of the benzene rings.

A plot of  $^{13}\text{C}$  SCS for C<sub>1</sub> (i.e. carbon nuclei *para* to the substituent) of **3** against  $^{15}\text{N}$  SCS of **3** (Figure 1a) indicates that the slope changes as the substituents change from a donor to an acceptor to show the bilinear dependency. This is evidence for the presence of an interaction between the substituent and the NH<sub>2</sub> group, a well-known phenomenon. For compounds (**1**) which carry such mild substituents as the -NH(C=O)- group rather than -NH<sub>2</sub>, a rough linear correlation is expected between  $^{15}\text{N}$  shifts and  $^{13}\text{C}$  shifts of C<sub>1</sub>. The plot is shown in Figure 1b. The linearity is good, to indicate further a sharp contrast between a strong substituent -NH<sub>2</sub> and a mild substituent -NH(C=O)-.

The differences between **1** and **3** are revealed also in the DSP-NCR analyses of C<sub>1</sub> shifts on these compounds<sup>34</sup>. The analyses were based on equation 3, namely

$$^{13}\text{C SCN} = \rho_I\sigma_I + \rho_R\sigma_R/(1 - \varepsilon\sigma_R) \quad (3)$$

where  $\varepsilon$  is a constant for each fixed substituent and characterizes the electron demand exerted by the fixed substituent on the resonance effects of the variable substituents.

The similarity observed for the correlation of the carbon shifts *para* to the substituent for **1** and **2** indicates that the nitrogen shift is a better probe of the transmission of the substituent effect to nitrogen. This conclusion can also be reached from a study of the polyfluorinated anilines.

According to the data of Table 9, the  $^{15}\text{N}$  signals of nitrogen in polyfluorinated anilines are shifted *ca* 29 ppm upfield with respect to their hydrocarbon analogues. As in the case of hydrocarbon compounds, the introduction of electron-accepting substituents in the fluorinated benzene ring leads to a downfield shift of the  $^{15}\text{N}$  signal of the amino group, the effect of *ortho* substituents being stronger than that of substituents in *para* position. Electron-donating substituents show an analogous effect which has the same sign, but the value of the shift is smaller (Table 9).

TABLE 9.  $^{15}\text{N}$  chemical shifts of nitrogen-containing polyfluoroaromatic compounds<sup>38,1</sup> (ppm vs NH<sub>3</sub>)

Compound	$\delta_{\text{N}}$ (ppm)	Compound	$\delta_{\text{N}}$ (ppm)
4-NEt <sub>2</sub> C <sub>6</sub> F <sub>4</sub> NH <sub>2</sub>	30.0	2,6-F <sub>2</sub> C <sub>6</sub> F <sub>3</sub> NH <sub>2</sub>	26.6
4-NH <sub>2</sub> C <sub>6</sub> F <sub>4</sub> NH <sub>2</sub>	25.5	C <sub>6</sub> F <sub>5</sub> NMe <sub>2</sub>	16.7
4-MeOC <sub>6</sub> F <sub>4</sub> NH <sub>2</sub>	28.8	C <sub>6</sub> F <sub>4</sub> NCl <sub>2</sub>	104.2
4-MeC <sub>6</sub> F <sub>4</sub> NH <sub>2</sub>	43.2	4-CF <sub>3</sub> C <sub>6</sub> F <sub>4</sub> NCl <sub>2</sub>	95.1
4-HC <sub>6</sub> F <sub>4</sub> NH <sub>2</sub>	29.9	4-H-C <sub>6</sub> F <sub>4</sub> NO <sub>2</sub>	350.4
C <sub>6</sub> F <sub>5</sub> NH <sub>2</sub>	24.4	C <sub>6</sub> F <sub>5</sub> NO <sub>2</sub>	350.4
4-CF <sub>3</sub> C <sub>6</sub> F <sub>4</sub> NH <sub>2</sub>	44.4	4-CF <sub>3</sub> C <sub>6</sub> F <sub>4</sub> NO <sub>2</sub>	350.2
4-CNC <sub>6</sub> F <sub>4</sub> NH <sub>2</sub>	59.7	4-CH <sub>3</sub> OC <sub>6</sub> F <sub>4</sub> NO <sub>2</sub>	354.8
4-NO <sub>2</sub> C <sub>6</sub> F <sub>4</sub> NH <sub>2</sub>	51	4-NO <sub>2</sub> C <sub>6</sub> F <sub>4</sub> NO <sub>2</sub>	349.2
2-NO <sub>2</sub> C <sub>6</sub> F <sub>4</sub> NH <sub>2</sub>	54	2,6-F <sub>2</sub> C <sub>6</sub> F <sub>4</sub> NO <sub>2</sub>	354.3
2-NH <sub>2</sub> C <sub>6</sub> F <sub>4</sub> NH <sub>2</sub>	31.6	C <sub>6</sub> F <sub>5</sub> NO	893.3
2-NO <sub>2</sub> -5-CF <sub>3</sub> C <sub>6</sub> F <sub>4</sub> NH <sub>2</sub>	52	C <sub>6</sub> F <sub>5</sub> CONH <sub>2</sub>	113.2

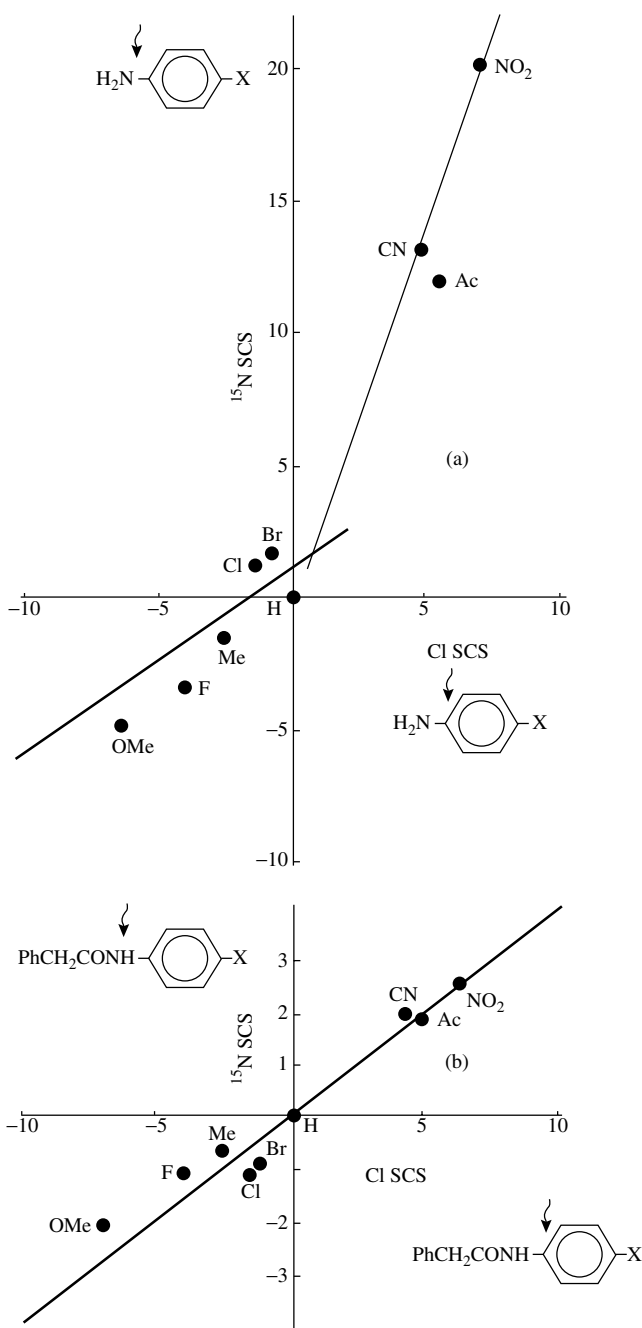


FIGURE 1. Plots of  $^{15}\text{N}$  SCS against  $^{13}\text{C}$  Cl SCS for *p*-substituted: (a) anilines, (b) phenylacetanilides<sup>33</sup>

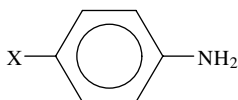
In the  $^{15}\text{N}$  NMR spectrum of pentafluorodimethylaniline, the  $^{15}\text{N}$  signal is shifted upfield with respect to the same signal in the  $^{15}\text{N}$  NMR spectrum of pentafluoroaniline. The analogous shift has been observed also earlier for hydrocarbon analogues<sup>35</sup>, and was attributed to the increased electron density on nitrogen in dimethylaniline due to weakening of the  $\pi$ -character of the C–N bond, reducing the paramagnetic contribution to the chemical shift value. In the case of substituents at nitrogen capable of strong  $p_{\pi}-p_{\pi}$  interaction with it, the latter may be expected to be considerably deshielded and the corresponding signal in  $^{15}\text{N}$  NMR spectrum of *N,N*-dichloropolyfluoroanilines will be observed in a lower field with respect to that of pentafluoroaniline<sup>36</sup>.

Summarizing, changes in screening of nitrogen induced by introduction of fluorine into nitrogen-containing aromatic compounds are said to be controlled mainly by the radial factor  $\langle r^{-3} \rangle_{2p(\text{N})}$ , which depends on the electron density on nitrogen<sup>37</sup>. When the pentafluorophenyl group and nitrogen, both strong electron acceptors, are directly bonded with each other, they act jointly, leading to increase of electron density on the RN fragment with respect to the hydrocarbon analogue, decreasing it on other fragments of the molecule. Increased electron density on nitrogen of polyfluorinated derivatives in comparison with their hydrocarbon analogues shows itself in the  $^{15}\text{N}$  NMR spectra as an upfield shift of the signal.

## 2. Substituent solvation effect on $^{15}\text{N}$ anilines

A study<sup>39</sup> of substituent effects on the  $^{15}\text{N}$  chemical shift ( $\delta^{15}\text{N}$ ) (Table 10) for 4-substituted anilines in DMSO was interpreted in terms of substituent solvation-assisted resonance (SSAR) effects. Solvation of certain conjugated  $\pi$ -electron-acceptor (+R) substituents has been found to give significant enhancements in the acidities of anilines, phenols and other acids<sup>40,41</sup>, and the magnitudes of these enhancements increase with

TABLE 10.  $^{15}\text{N}$  NMR chemical shifts of 4-substituted anilines<sup>39,42</sup>



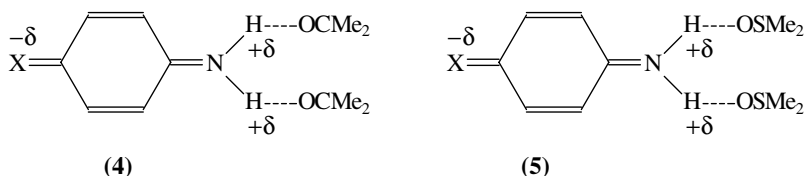
X	$-\delta^{15}\text{N}^a$	$-\delta^{15}\text{N}^a$
OMe	62.9	58.4
Me	59.9	55.2
F	60.7	55.8
Cl	57.5	52.9
CF <sub>3</sub>	52.1	45.7
SCF <sub>3</sub>	51.3	45.2
H	57.8	53.0
CO <sub>2</sub> Me	49.1	41.9
CO <sub>2</sub> Ph	49.4	42.3
COMe	48.3	41.0
CN	48.0	39.8
SO <sub>2</sub> Me	42.4	41.2
NO <sub>2</sub>	42.4	33.5
SO <sub>2</sub> CF <sub>3</sub>		31.4

<sup>a</sup>Chemical shift values upfield (from HCONH<sub>2</sub> as external reference) in 1.7 M Me<sub>2</sub>CO-d<sub>6</sub> solutions.



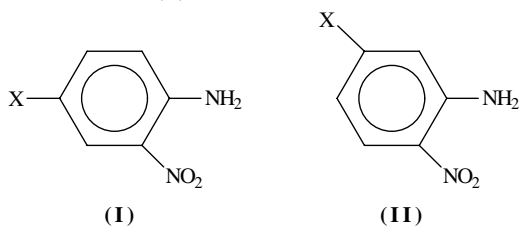
increasing  $\pi$ -electron donation to the conjugated substituent from the deprotonation centre of the anionic forms. In the case of anilines in DMSO, hydrogen-bond solvation by DMSO of the NH groups increases the donation of  $\pi$ -electrons to the conjugated +R substituent and this electron donation has been found to permit SSAR enhancement effects on the  $\delta(^{15}\text{N})$  of the appropriate neutral aniline solutes<sup>39</sup>.

When  $\delta(^{15}\text{N})$  values for the previously used series of 13 *para*-substituted anilines were measured in acetone<sup>42</sup>, a significantly weaker hydrogen-bond acceptor solvent than DMSO, a smaller shift dependence on *para*  $\pi$ -electron-acceptor substituent solvation (SSAR) effects in acetone was observed (Table 10). This reduction<sup>42</sup> was expressed by the (rather unsatisfactory) forms, **4** and **5**.



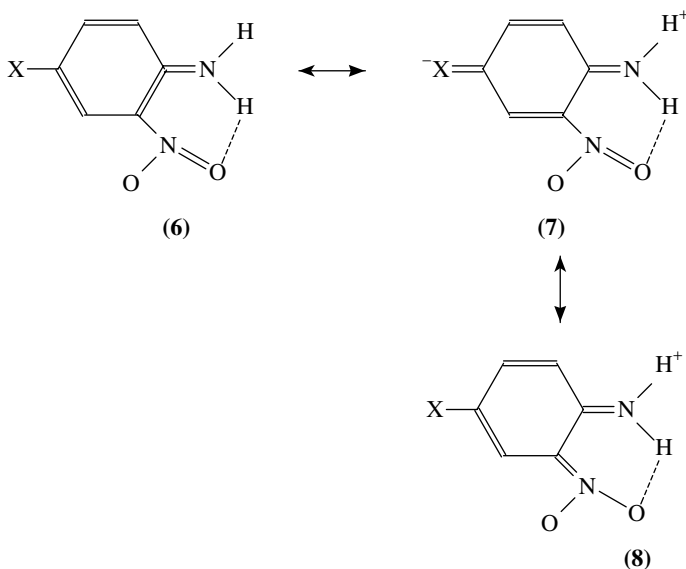
In the case of 5-substituted 2-nitroanilines (Table 11) it was observed<sup>42</sup> that there are no significant SSAR effects for the *meta*-substituted compounds, in contrast to the relatively large SSAR  $\text{N}^{15}$  shifts observed<sup>39</sup> for 4-substituted 2-nitroanilines in DMSO, which could be expressed by the resonance forms **6**–**8**<sup>43</sup>.

TABLE 11.  $^{15}\text{N}$  NMR chemical shifts of 4-substituted (**I**) and 5-substituted (**II**) nitroanilines<sup>39,42</sup>



X	$-\delta^{15}\text{N}$ ( <b>I</b> ) <sup>a</sup>	$-\delta^{15}\text{N}$ ( <b>II</b> ) <sup>a</sup>
OMe	37.4	32.0
Me	36.7	34.6
F	35.8	31.4
Cl	32.7	
CF <sub>3</sub>	27.7	31.5
SCF <sub>3</sub>	27.0	
H	34.6	34.6
CO <sub>2</sub> Me	25.4	
CO <sub>2</sub> Et	25.9	33.2
COMe	24.7	33.0
CN	23.4	
SO <sub>2</sub> Me	24.2	30.6
NO <sub>2</sub>	18.8	29.8

<sup>a</sup>Chemical shift values upfield (from  $\text{HCONH}_2$ ) as external reference in 1.7 M  $\text{Me}_2\text{SO}-d_6$  solutions.



## B. Nitrobenzenes

### 1. Substituent effects on $^{15}\text{N}$ chemical shifts

Substituent effects on  $^{13}\text{C}$  and  $^1\text{H}$  chemical shifts in the benzene ring of nitrobenzene derivatives are easily measurable and have been previously reported<sup>44,45</sup>. However, studies of substituent effects on nitro chemical shifts are more difficult because of the low inherent sensitivity of both the  $^{15}\text{N}$  and  $^{17}\text{O}$  nuclei<sup>46</sup>. Despite the growing literature on natural abundance  $^{15}\text{N}$  NMR spectroscopy<sup>46</sup>, until 1983 there had been relatively few reports<sup>47-49</sup> pertaining to nitro groups. This was the result of several factors: the low natural abundance of  $^{15}\text{N}$ ; the long spin relaxation times and small negative nuclear Overhauser effects. Optimization of pulse-flip angles and recycle times in the FT NMR experiment is required to overcome the first difficulty. The second difficulty, i.e. potential signal nulling arising from partial (negative) NOEs, can be overcome by gating the proton decoupler on only during data acquisition to remove long-range N–H couplings without contributing to a buildup of NOE.

The nitrogen chemical shifts of aromatic nitro groups seem potentially to be a measure of the field-inductive effects of substituents.

Data for some nitrobenzene derivatives in DMSO and cyclohexane are collected<sup>50</sup> in Table 12.

Because the difference in the shieldings between the two solvents for one nitrobenzene derivative is constant at almost 4.5 ppm, there is no evidence of any serious influence of substituents on the range and direction of solvent-induced variation in the shielding of the aromatic nitro group.

Some clear and important observations can be made from Table 12, if one excludes the 2-substituted nitrobenzenes from consideration, for which short-range effects can take place. If one compares only solutions in a given solvent, all of the substituents examined in position 3 as well as in position 4 seem invariably to induce an increase in the magnetic shielding of the nitrogen nucleus, with respect to that in nitrobenzene. Moreover, there is only a small difference, for a given substituent and solvent, between the *meta* and *para* effects on the shielding. The largest effects of this kind are exerted by an additional nitro

TABLE 12. Nitrogen NMR shieldings of a nitro group in substituted nitrobenzenes<sup>50</sup> (0.25 M solutions)

Substituent	Nitrogen shielding (ppm) <sup>a</sup>	
	in cyclohexane	in DMSO
none	12.62	8.32
2-Me	7.34	3.26
3-Me	12.27	8.23
4-Me	12.63	8.46
2-OMe	12.32	7.74
3-OMe	12.71	9.17
4-OMe	13.74	9.52
4-NMe <sub>2</sub>		10.11
2-F	18.04	14.30
3-F	15.87	11.46
4-F	15.43	11.21
2-Cl	13.63	9.21
3-Cl	15.86	11.56
4-Cl	15.30	10.74
2-Br	12.34	7.23
3-Br	15.95	11.76
4-Br	15.23	10.75
2-I	10.70	4.23
3-I	15.93	11.35
4-I	14.67	9.76
2-NO <sub>2</sub>	18.49	13.24
3-NO <sub>2</sub>	18.25	13.34
4-NO <sub>2</sub>	17.65	12.57
3,5-di-NO <sub>2</sub>	22.67	17.63

<sup>a</sup>Nitrogen shielding in ppm referenced to external neat nitromethane.

group, about +5 ppm, which is comparable to the range of solvent-induced variations in the shielding for a given substituent. Thus, solvent and substituent effects on the nitrogen shieldings in nitrobenzenes are comparable in magnitude, and an important conclusion follows that there is practically no sense in considering the latter for anything else than dilute solutions in a given solvent.

Comparison of substituent effects on the nitrogen shielding in substituted nitrobenzenes with substituent parameters<sup>44</sup> showed that, whereas shifts for *meta*-substituted nitrobenzenes have a reasonable linear correlation with the  $\sigma_m$  parameters, the *para*-substituted nitrobenzenes not only fail to give an analogous correlation with the parameter set, but also show evident discrepancies in the signs of substituent-induced changes in the nitrogen shielding with respect to the signs of the  $\sigma_p$  parameters involved. Since the parameters considered are collective in the sense that they try to integrate all possible effects exerted by a given substituent in a given position in the aromatic ring, it can be concluded that the nitrogen shieldings of the nitro groups do not respond to the resonance or conjugative effects, and that they are sensitive primarily to the so-called field/inductive effects of substituents.

In the case of polyfluorinated<sup>38</sup> nitrobenzenes, the signals of nitrogen are shifted *ca* 20 ppm upfield with respect to their hydrocarbon analogues (Table 9). The explanation is the same as in the case of the polyfluorinated anilines. The smaller upfield shift of <sup>15</sup>N signals in 2,6-difluoronitrobenzene and *N*-sulphonyl-2,6-difluoroaniline compared to those of pentafluoro-substituted derivatives, especially in the case of 2,6-difluoronitrobenzene [ $\Delta\delta(^{15}\text{N})$  14 ppm], can be interpreted in terms of a reduced conjugation of NO<sub>2</sub> and NSO

groups with the  $\pi$ -systems of 2,6-difluorobenzene rings, but that effect is weaker in the case of pentafluorophenyl ones.

## 2. Substituent effects on $^{17}\text{O}$ chemical shifts

Although Christ<sup>51</sup> examined  $^{17}\text{O}$  shifts of some substituted nitrobenzenes 35 years ago, only at the beginning of the following decade did systematic studies of the substituent effects on  $^{17}\text{O}$  chemical shifts appear in the literature with the first reports<sup>52,53</sup> of substituted anisoles, acetophenones and benzaldehydes. The potential of this probe as a measure of substituent electronic effects was demonstrated.

Lipkowitz<sup>54</sup> studied the  $^{17}\text{O}$  shifts of some *meta*- and *para*-substituted nitrobenzenes. However, the high concentrations and small range of substituents investigated make these data of limited use.

Some time later the feasibility of obtaining  $^{17}\text{O}$  spectra for natural abundance samples at relatively low concentration was demonstrated<sup>55,56</sup>. This was an important step because intermolecular interactions can markedly affect chemical shifts and, if only electronic substituent effects are to be examined, then all extraneous influences must be minimized.

The study<sup>55</sup> of the  $^{17}\text{O}$  spectra of nine *para*-substituted nitrobenzenes, whose electron-donating or -attracting groups cover a 3-fold larger range of  $\sigma$  values than those which had been studied by Lipkowitz<sup>54</sup>, revealed that the  $^{17}\text{O}$  shieldings are strongly influenced by the nature of the *para* substituent and in a manner completely consistent with the existing valence bond theory.

Substituent effects on the  $^{17}\text{O}$  chemical shifts in *meta*- and *para*-substituted nitrobenzenes are presented in Table 13, showing that these shifts are quite sensitive to the nature of the substituent, and range over nearly 40 ppm. Examination of Table 13 shows that the direction of substituent effects is different for  $^{15}\text{N}$  and  $^{17}\text{O}$  shifts, with electron-withdrawing substituents (such as  $\text{NO}_2$ ,  $\text{CN}$  or  $\text{CF}_3$ ) causing upfield  $^{15}\text{N}$  and

TABLE 13.  $^{17}\text{O}$  shielding<sup>a</sup> data for some *meta*- and *para*-substituted nitrobenzenes<sup>56</sup> (3- or 4-X-C<sub>6</sub>H<sub>4</sub>NO<sub>2</sub>)

X	$\delta^{17}\text{O}$ (ppm)	
	<i>para</i>	<i>meta</i>
NEt <sub>2</sub>	-33.4	
NH <sub>2</sub>	-25.6	0.8
OMe	-9.8	
OH	-6.7	
F	-1.3	2.9
Cl	0.6	
Br		4.0
Me	-3.3	-0.4
H	0.0 <sup>b</sup>	0.0
CHO	8.1	1.9
CF <sub>3</sub>	7.7	2.7
CN	7.5	3.5
NO <sub>2</sub>	11.5	5.0
COMe	3.3	
COOMe	7.2	

<sup>a</sup>Positive shifts are downfield relative to H<sub>2</sub>O. Error  $\pm 0.1$  ppm.

<sup>b</sup>Nitrobenzene has an  $^{17}\text{O}$  chemical shift *ca* 569 ppm downfield from H<sub>2</sub>O.

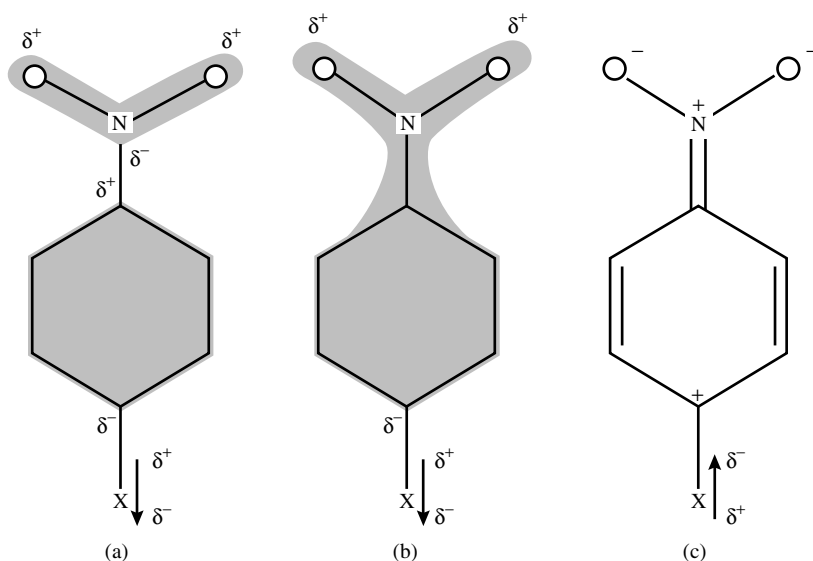


FIGURE 2.  $\pi$ -Polarization effects: (a) separate localized polarization of the side-chain and ring  $\pi$  systems: (b) extended polarization of the ring and the side-chain conjugated  $\pi$  system: (c) possible representation of extended polarization in terms of field-induced resonance. The dipolar substituent X stabilizes particular resonance forms, thus bringing about enhanced electron density changes at conjugated sites such as the terminal oxygen atoms. Note that the substituent shown has an electron-donating polar effect (e.g. a methyl group). Electron-withdrawing substituents, which have a dipole opposite to that shown, would destabilize this resonance form. Reprinted with permission from P. Balakrishnan and D. W. Boykin, *J. Org. Chem.*, **50**, 3663 (1985). Copyright (1985) American Chemical Society

downfield  $^{17}\text{O}$  shifts<sup>56</sup>. This multinuclear approach to the study of substituents effects proves the generality of the  $\pi$ -polarization concept by showing that distant substituents can readily polarize the  $\pi$  electrons of an NO bond (see Figure 2).

The  $^{17}\text{O}$  spectral data of polyfluoronitrobenzene and its derivatives are given in Table 14.

It can be seen that there is a deshielding of oxygen for each case, compared with the hydrocarbon analogue, which confirms a reduced conjugation of the  $\text{NO}_2$  (and NSO) group with the  $\pi$ -systems of polyfluorobenzene rings<sup>58</sup>.

The values for the  $^{17}\text{O}$  chemical shifts for  $\beta$ -nitrostyrenes (**9**) in acetonitrile at  $70^\circ\text{C}$  are given in Table 14; the chemical shifts of these compounds are in the region reported for nitrobenzenes<sup>57</sup>. Electron-attracting substituents cause deshielding of the nitro signal whereas electron-donating groups produced shielding<sup>58</sup>.

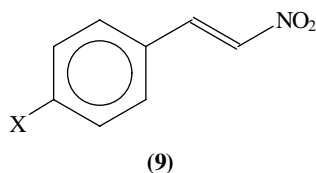
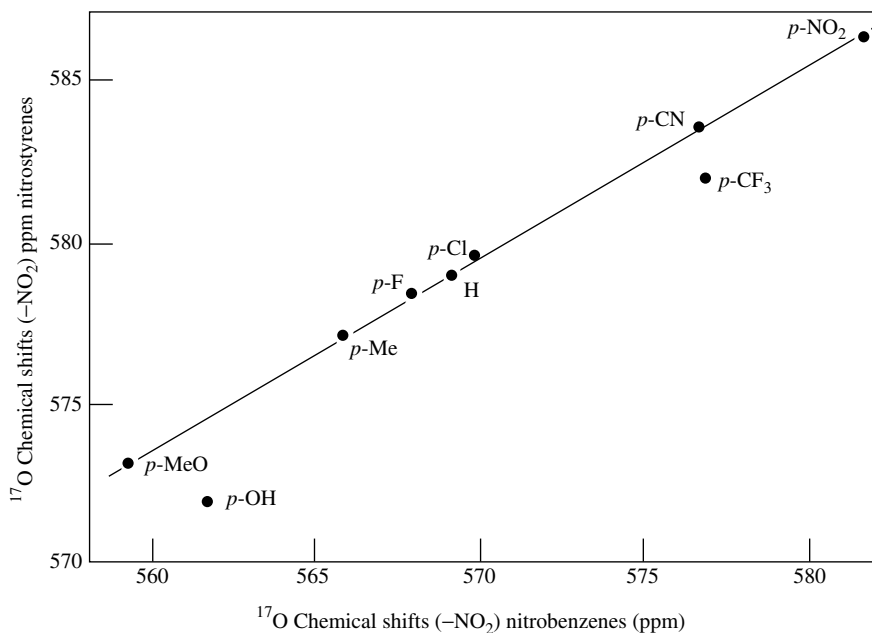


TABLE 14.  $^{17}\text{O}$  chemical shift of some nitro compounds containing aromatic derivatives (ppm vs  $\text{H}_2\text{O}$ )

Compound	$\delta^{17}\text{O}$	Compound	$\delta^{17}\text{O}$
$\text{C}_6\text{F}_5\text{NO}_2$	$627 \pm 4$	$\text{Py}_\text{F}\text{NO}_2$	$632 \pm 3$
$\text{C}_6\text{F}_5\text{NSO}$	$437 \pm 3$	$4\text{-CF}_3\text{C}_6\text{F}_4\text{NSO}$	$441 \pm 6$
$2\text{-NH}_2\text{C}_6\text{H}_4\text{NO}_2$	558	$4\text{-NMe}_2\text{C}_6\text{H}_4\text{CH}=\text{CHNO}_2$	562.4
$3\text{-NH}_2\text{C}_6\text{H}_4\text{NO}_2$	575	$4\text{-OHC}_6\text{H}_4\text{CH}=\text{CHNO}_2$	572.0
$4\text{-NH}_2\text{C}_6\text{H}_4\text{NO}_2$	585	$4\text{-OMeC}_6\text{H}_4\text{CH}=\text{CHNO}_2$	573.0
$2\text{-NO}_2\text{C}_6\text{H}_4\text{NO}_2$	608	$4\text{-MeC}_6\text{H}_4\text{CH}=\text{CHNO}_2$	577.1
$3\text{-NO}_2\text{C}_6\text{H}_4\text{NO}_2$	570	$4\text{-FC}_6\text{H}_4\text{CH}=\text{CHNO}_2$	578.4
$4\text{-NO}_2\text{C}_6\text{H}_4\text{NO}_2$	585	$\text{C}_6\text{H}_5\text{CH}=\text{CHNO}_2$	578.8
$2\text{-ClC}_6\text{H}_4\text{NO}_2$	610	$4\text{-ClC}_6\text{H}_4\text{CH}=\text{CHNO}_2$	579.5
$3\text{-ClC}_6\text{H}_4\text{NO}_2$	567	$4\text{-BrC}_6\text{H}_4\text{CH}=\text{CHNO}_2$	579.6
$\text{C}_6\text{F}_5\text{NO}$	$699 \pm 2$	$4\text{-CF}_3\text{C}_6\text{H}_4\text{CH}=\text{CHNO}_2$	582.1
$4\text{-NEtC}_6\text{F}_4\text{NO}_2$	$644 \pm 4$	$4\text{-CNC}_6\text{H}_4\text{CH}=\text{CHNO}_2$	583.5
$4\text{-MeOC}_6\text{F}_4\text{NO}_2$	$633 \pm 4$	$4\text{-NO}_2\text{C}_6\text{H}_4\text{CH}=\text{CHNO}_2$	586.2
$4\text{-HC}_6\text{F}_4\text{NO}_2$	$631 \pm 3$		

FIGURE 3. Plot of  $^{17}\text{O}$  chemical shift ( $\text{NO}_2$ ) nitrobenzenes vs  $^{17}\text{O}$  chemical shift ( $\text{NO}_2$ )  $\beta$ -nitrostyrenes in  $\text{CH}_3\text{CN}$ . Reproduced from Reference 58 by permission of Elsevier Science B.V.

The range of SCS values ( $p\text{-CH}_3\text{O}$  to  $p\text{-NO}_2$ ) for nitrostyrenes is about 13 ppm. The correlation of the  $^{17}\text{O}$  chemical shift data for nitrostyrenes with that for nitrobenzenes<sup>57</sup> gives a slope of 0.58 (Figure 3), which indicates that a comparable reduction in substituent effects results when the nitro function is separated from a  $p$ -substituted phenyl group by a carbon-carbon double bond.

Since the correlation of  $^{17}\text{O}$  chemical shifts of nitrobenzenes and nitrostyrenes is very good and nitrobenzene chemical shifts have been related to the  $\pi$ -electron density on oxygen<sup>57</sup>, it appears that the chemical shift of the nitrostyrenes is dependent upon the  $\pi$ -electron density on the nitro oxygen also.

### C. Nitroso Compounds

#### 1. Substituent effects on $^{14,15}\text{N}$ and $^{17}\text{O}$ chemical shifts

*C-nitroso.* Following disagreements between earlier studies for nitrosobenzene<sup>59,60</sup>, Dahn and coworkers<sup>61</sup> measured the  $\delta(^{17}\text{O})$  of several C-nitroso compounds (see Table 15) and confirmed very low field values in the region of 1530–1550 ppm, among the most shielded values reported so far<sup>59,62,63</sup>. Association to give azodioxy dimers led to shifts at much higher field ( $440 \pm 20$  ppm).

Tautomerism exists in the case of *o*- and *p*-nitrosophenols and naphthols which exist mainly as the quinone oximes, and which also give high field shifts. The values for the oxime groups in the 1,2-naphthoquinones, for example, were 229 and 265 ppm for the 1-oxime and the 2-oxime respectively.

These high field values occur also in nitrones such as  $\text{Ph}-\text{N}(\text{O})=\text{CH}-\text{Ph}$  (at 377 ppm) and pyridine *N*-oxide (349 ppm).

Nitrogen shifts in these compounds behave similarly (Table 16).

*S-nitroso, N-nitroso and O-nitroso.* Some nitrogen and  $^{17}\text{O}$  shift ranges for these compounds are listed below for comparison with the C-nitroso.

		$^{15}\text{N}$	$^{17}\text{O}$
Nitrosamines	$\text{R}_2\text{N}-\text{N}=\text{O}$	200–155	670
Nitrites	$\text{RO}-\text{N}=\text{O}$	207–180	800
Thionitrites	$\text{RS}-\text{N}=\text{O}$	400–450	1300
Nitroso	$\text{RC}-\text{N}=\text{O}$	500–590	1540

This concordance between the nitrogen and  $^{17}\text{O}$  shifts arises because of the importance of the  $\Delta E$  term, a rough measure of which is given by UV spectra and CD maxima. Some comparisons are given in Table 17.

The high shift values for  $\text{NO}^+$  (474 ppm for  $^{17}\text{O}$  and  $-3$  ppm for nitrogen) relative to lower values for  $\text{X}-\text{N}=\text{O}$  compounds is good evidence for differences in chemical shift anisotropy as pertain in  $^{13}\text{C}$  NMR for the alkynes relative to alkanes and alkenes<sup>64</sup>. The higher symmetry of acetylene leads to a high field shift.

TABLE 15.  $^{17}\text{O}$  chemical shifts of C- and S-nitroso compounds<sup>61a</sup>

Compound	$\delta(^{17}\text{O})$ (N=O) (ppm)
$\text{Me}_3\text{C}-\text{N}=\text{O}$	1538.2 <sup>b</sup> 1542.4
$\text{Ph}-\text{N}=\text{O}$	1533.4
$2\text{-Me}-\text{C}_6\text{H}_4-\text{N}=\text{O}$	1543.1 1550.8
$\text{Ph}_3\text{CS}-\text{N}=\text{O}$	1293.0
$\text{AcNHCH}(\text{COOH})-\text{CMe}_2\text{S}-\text{N}=\text{O}$	1312.4

<sup>a</sup>Solvent:  $\text{CH}_3\text{CN}$ , relative to  $\text{H}_2\text{O}$ .

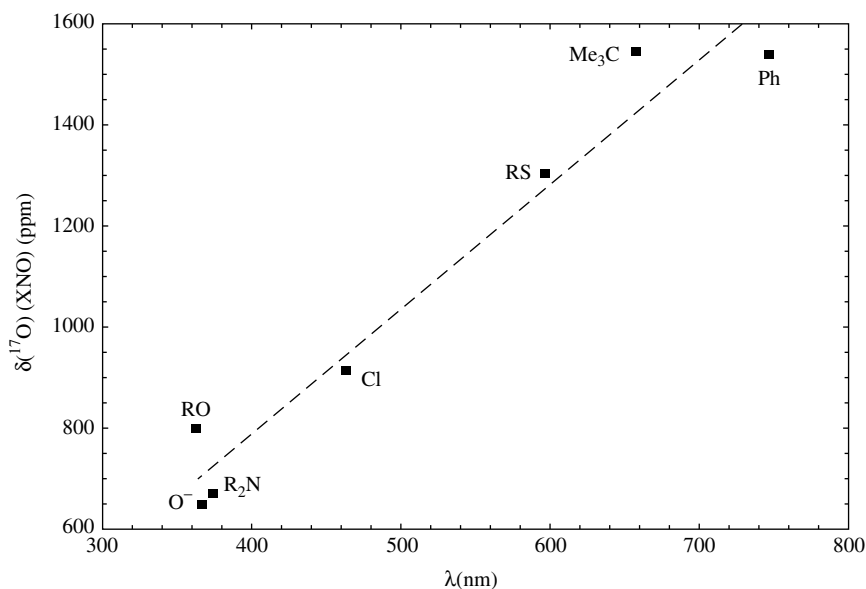
<sup>b</sup>A high field peak at 390 ppm corresponds to the azodioxy dimer.

TABLE 16.  $^{15}\text{N}$  chemical shifts of nitroso compounds in  $\text{CDCl}_3$  measured with respect to  $4.5\text{M}$   $\text{NH}_4\text{NO}_3$ 

Compound	Solvent	$\delta^{15}\text{N}$ (ppm)
Ph-NO	none	913
$\text{Me}_2\text{N}-\text{C}_6\text{H}_4-\text{NO}$	$\text{CDCl}_3$	804.3
$\text{Ph}_3\text{C}-\text{S}-\text{NO}$	$\text{CDCl}_3$	806.5
$\text{Ph}_2\text{N}-\text{NO}$	none	268.7 (N-1) 554.4 (N-2)
PhMeN-NO	none	250.7 (N-1) 543.8 (N-2)

TABLE 17.  $^{14,15}\text{N}$  and  $^{17}\text{O}$  chemical shifts, CD maxima and longest wavelength UV/v is absorptions, and rotational barriers of nitrosyl compounds<sup>66</sup>

Compound	$\delta^{14,15}\text{N}$	$\delta^{17}\text{O}$	$\lambda(n \rightarrow \pi^*)$ (nm)	Rotational barrier (kcal mol <sup>-1</sup> )
RR'R''CNO	590	1538	680	
PhNO	530	1533	755	7.7
RSNO	452	1300	600	
RONO	190	800	355	10.5
$\text{R}_2\text{NNO}$	155	670	365	23
$\text{O}^-\text{NO}$	229	650	357	
$\text{NO}^+$	-3	474	<210	

FIGURE 4. Plot of  $\delta(^{17}\text{O})$  vs CD maxima and  $\lambda(n \rightarrow \pi^*)$  of nitroso compounds X-NO. Reproduced from Reference 61 by permission of Verlag Helvetica Chimica Acta AF



Donor groups X conjugated with NO in XNO ( $X = \text{Me} < \text{Ph} < \text{RS} < \text{RO} < \text{R}_2\text{N} < \text{O}^-$ ) increase the shieldings at the nitroso O-atom via resonance  $\text{X}-\text{N}=\text{O} \leftrightarrow \text{X}^+=\text{N}-\text{O}^-$ . The resonance-donating power of the group X can be represented by Taft's substituent constant  $\sigma_{\text{R}}$ . Figure 4 shows that the plot of  $\delta(^{17}\text{O})$  vs  $\sigma_{\text{R}}$  is reasonably linear ( $r = 0.95$ ).

The large difference between the nitrogen shieldings in nitroso groups and those molecules that are isomeric, tautomeric or related in any way to nitroso structures facilitates their spectral distinction<sup>1b</sup>.

The amino nitrogens of N-nitroso compounds are deshielded substantially more than those of electronically analogous amides, and well separated resonances frequently can be detected<sup>65</sup>, where geometrical isomerism is possible.

Substituent effects have been discussed in terms of electronic and geometrical influences on the extent of nitrogen lone-pair delocalization<sup>66</sup>.

## V. NMR DETERMINATIONS OF STRUCTURE IN SOLUTION

### A. Substituent Effects on One-bond $^{15}\text{N}-^{13}\text{C}$ Couplings

In aniline derivatives, ring substituents are known to have to profound influence on the directly bonded  $^{15}\text{N}-^1\text{H}$  and  $^{15}\text{N}-^{13}\text{C}$  spin coupling interactions<sup>67-69</sup>. Binsch and coworkers<sup>70</sup> have successfully related the one-bond  $^{15}\text{N}-^{13}\text{C}$  coupling constant to the atomic hybridizations by the empirical equation 4

$$^1J(^{15}\text{N}^{13}\text{C}) = S_{\text{N}}S_{\text{C}}/80 \quad (4)$$

where  $S_{\text{N}}$  and  $S_{\text{C}}$  represent the percentage s character of the N and C contributions to the N-C bond. This relationship works reasonably well provided that the coupling interaction is dominated by the contact mechanism<sup>71-73</sup> and the s electron character of the lone pairs remains unchanged<sup>74</sup>. Thus, in going from aniline to *p*-nitroaniline, the observed increases in  $^1J(^{15}\text{NH})$  and  $^1J(^{15}\text{N}^{13}\text{C})$  are readily explained in terms of a substituent-induced delocalization of the lone pair corresponding to a change in hybridization to give a more flattened amino-nitrogen pyramid.

The effect on  $^{15}\text{N}$  and  $^{13}\text{C}$  chemical shifts in anilines<sup>75-77</sup> and nitrobenzenes<sup>74</sup> of a reduced resonance interaction caused by *ortho* substituents which sterically twist the amino and nitro groups from coplanarity with the aryl ring has been extensively investigated and is fairly well documented.

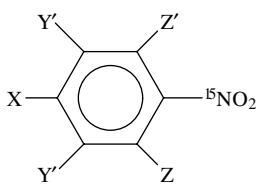
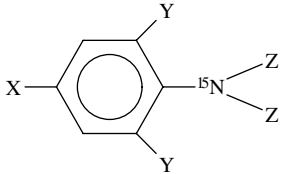
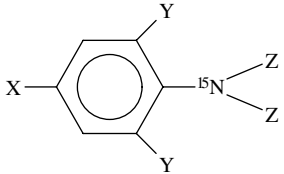
The effect on  $^1J(^{15}\text{N}^{13}\text{C})$  of steric inhibition of conjugation has been studied<sup>90</sup> in the case of a series of  $^{15}\text{N}$ -labelled nitrobenzenes and a series of *N,N*-dimethylanilines (Table 18).

In the case of nitrobenzenes, the narrow range of the observed  $^1J(^{15}\text{N}^{13}\text{C})$  values reported in Table 18, approximately 2 Hz, despite the substantial changes in the electronic character of the substituents involved, suggests that the N-C *p*-bond order is probably very small and is not of primary importance in determining the coupling in these systems. Also, it seems that the nominally  $\text{sp}^2$  hybridization of the nitro-group nitrogen, and the aryl carbon to which it is coupled, remain essentially unchanged.

In the case of anilines several points are noteworthy of consideration in Table 18.

It may be seen that enhanced coupling results from both methylation at nitrogen (1.1 Hz) and the introduction of amino group at the *para* position (2.6 Hz), whereas methylation at the *ortho* positions causes a small decrease (0.2 Hz). The decrease in  $^1J(^{15}\text{N}^{13}\text{C})$  of *N,N*-dimethylaniline and its *N,N*-dimethyl derivatives is explained by inhibition of the resonance interaction resulting from sterically induced twisting of the substituent group from coplanarity with the aryl ring.

TABLE 18. Some experimental  $^1J(^{15}\text{N}^{13}\text{C})$  values in nitrobenzene and aniline derivatives<sup>78</sup>

Compound	X	Y	Y'	Z	Z'	$J_{\text{exp}}^a$ (Hz)
	H	H	H	H	NH <sub>2</sub>	14.8
	Me	NO <sub>2</sub>	H	Me	NH <sub>2</sub>	15.8
	NH <sub>2</sub>	H	H	H	H	16.2
	NH <sub>2</sub>	Me	Me	H	H	15.8
	Me	H	NO <sub>2</sub>	Me	NH <sub>2</sub>	15.6
	MeO	H	Me	H	H	15.9
	NH <sub>2</sub>	H	H	Me	Me	16.6
	Me <sub>2</sub> N	Me	NO <sub>2</sub>	H	H	14.7
	<i>t</i> -Bu	H	H	H	H	15.0
	Me	NO <sub>2</sub>	H	H	H	18.0
	Me	H	H	H	H	14.9
	<i>t</i> -Bu	H	H	<i>t</i> -Bu	<i>t</i> -Bu	13.7
	Cl	H	H	H	H	15.4
	H	H	H	H	H	14.7
	H	NO <sub>2</sub>	H	H	H	15.9
	Me	H	H	Me	Me	14.7
	NO <sub>2</sub>	H	H	H	H	15.3
	H	H	H	H	H	12.1
	NO <sub>2</sub>	H	H	H	H	14.7
	H	H	H	Me	H	13.2
NO <sub>2</sub>	H	H	Me	H	15.6	
	H	Me		Me		12.9
	NO <sub>2</sub>	Me		Me		14.2
	H	Me		H		11.9
	NO <sub>2</sub>	Me		H		14.8
	Br	Br		H		17.6
Br	Br		Me		16.3	

<sup>a</sup> $^1J(^{15}\text{N}^{13}\text{C})$  values and <sup>13</sup>C chemical shifts were measured at 5000 Hz/16 K real points.

## B. One-bond <sup>15</sup>N–<sup>1</sup>H Couplings

It is well known that one can obtain valuable structural and stereochemical information from  $^1J(^{15}\text{N}-^1\text{H})$  and study the distribution of bonding electrons. The theory of spin–spin coupling is covered satisfactorily in many books<sup>79,80</sup>.

Values of one-bond coupling  $^1J(^{15}\text{N}-^1\text{H})$  are the largest in magnitude of all <sup>15</sup>N couplings to the proton and are generally regarded as being dominated by the Fermi contact term.

The possibility of obtaining spin–spin coupling information from measurements involving the <sup>14</sup>N nucleus is generally impossible, because rapid quadrupolar relaxation of <sup>14</sup>N

causes decoupling of the spins. In the symmetrical cases for which results are available,  $^{14}\text{N}$  spin couplings to a nucleus X may be converted to  $^{15}\text{N}$  couplings by equation 5, simply by use of the ratio of the  $\gamma$ s, since there are no other isotope effects arising from electronic changes.

$$J(^{15}\text{N}-\text{X}) = -1.4027J(^{14}\text{N}-\text{X}) \quad (5)$$

One-bond  $^{15}\text{N}$  couplings to  $^1\text{H}$  are negative (because of the negative sign for the magnetogyric ratio) (Table 19) and can vary from about 50 to around 135 Hz in magnitude for different compounds (Table 20).

There is a correlation between the amount of s character in the N-H bond and the magnitude of the corresponding spin-spin coupling<sup>81</sup>:

$$\%s = 0.34^1 J(^{15}\text{N}-^1\text{H}) \quad (6)$$

so that the magnitude grows with increasing s-character of the bond concerned, with the main exception of the ketimines. Susskind and coworkers<sup>82</sup> carried out Partially Restricted Molecular Orbital (PRMO) calculations at the INDO level of approximation in order to study s- and p-transmitted components for  $^{15}\text{N}-^1\text{H}$  couplings in a set of molecules. As expected the values of one-bond couplings are transmitted almost exclusively through the s-framework. The only contribution to the  $^{15}\text{N}-^1\text{H}$  coupling is the Fermi contact term. Table 21 contains some data for the coupling between  $^{15}\text{N}$  and  $^1\text{H}$ .

TABLE 19. Some  $^{15}\text{N}-^1\text{H}$  couplings across one bond

Compound	Solvent	$(-)^1J(^{15}\text{N}-^1\text{H})$ (Hz)	Reference
$\text{PhN}=\text{NC}_6\text{H}_4\text{NH}_2$ - <i>p</i>	DMSO	87.0	85
$4\text{-NH}_2\text{C}_6\text{F}_4\text{NH}_2$	$\text{CH}_2\text{Cl}_2$	80.3	86
$4\text{-MeOC}_6\text{F}_4\text{NH}_2$	$\text{CH}_2\text{Cl}_2$	85.0	86
$4\text{-MeC}_6\text{F}_4\text{NH}_2$	$\text{CH}_2\text{Cl}_2$	80.3	86
$4\text{-CF}_3\text{F}_4\text{NH}_2$	$\text{CH}_2\text{Cl}_2$	90.6	86
$4\text{-CNC}_6\text{F}_4\text{NH}_2$	$\text{CH}_2\text{Cl}_2$	87.9	86
$4\text{-NO}_2\text{C}_6\text{F}_4\text{NH}_2$	$\text{CH}_2\text{Cl}_2$	90.4	86
$2\text{-NO}_2\text{C}_6\text{F}_4\text{NH}_2$	$\text{CH}_2\text{Cl}_2$	90.4	86
$3\text{-NO}_2\text{C}_6\text{F}_4\text{NH}_2$	acetone- $\text{d}_6$	85.4	87
$4\text{-NO}_2\text{C}_6\text{F}_4\text{NH}_2$	acetone- $\text{d}_6$	91.0	87
$\text{PhNH}^- \text{Li}^+$	acetone- $\text{d}_6$	54.7	88
4-Aminoazobenzene	$\text{Me}_2\text{SO}-\text{d}_6$	88.2	84

TABLE 20. Values of one-bond  $^{15}\text{N}$  couplings to  $^1\text{H}$

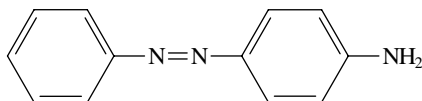
Compounds	Range of $(-)^1J(^{15}\text{N}-^1\text{H})$ (Hz)
Ketimines, $\text{R}_2\text{C}=\text{NH}$	50
NH in three-membered rings	50 to 65
Alkylamines, ammonium ions, hydroxylamines, hydrazines	60 to 80
Arylamines and enamines	80 to 95
$\text{NH}^+$ in cations derived from aromatic azine systems and from imines	90
Amides and related structure	90 to 100
NH moieties in aromatic azole systems	95 to 110
Protonated nitriles, $\text{R}-\text{C}\equiv\text{NH}$	135

TABLE 21. Transmission mechanisms of one-bond  $^{15}\text{N}-^1\text{H}$  couplings<sup>82</sup>

Molecule	Fermi contact			Experimental (Hz)
	INDO	s	p	
Cyanamide	-85.81	-85.57	-0.24	89.4
Methylenimine	-3.75	-0.94	-2.81	
Pyrrrole	-88.41	-86.86	-1.54	96.48
Aniline	-90.56	-89.56	-1.00	92.0
Formamide	-78.68	-77.69	-0.99	88.0

The determination of the structures of anilines from the one-bond  $^{15}\text{N}-\text{H}$  couplings is a typical example. The lone pair of nitrogen has more p character than in  $\text{NH}_3$  or the ammonium ion<sup>83</sup> because it is partially delocalized into the p system. This leads to an increase of the s character in the N-H bond and thus an increase in the comparison to the values for  $\text{NH}_3$  ( $J = -61.2$  Hz, liquid), aniline ( $J = -82.3$  Hz, DMSO) and *p*-nitroaniline ( $J = -89.4$  Hz, DMSO). The major structural factor is the increase in the HNH bond angle on going from  $\text{NH}_3$  to aniline and nitroaniline. The one-bond  $^{15}\text{N}-^1\text{H}$  coupling constants in anilines have been found to be intermediate between those expected for tetrahedral nitrogen (ammonium ion,  $\text{sp}^3$ ) and trigonal nitrogen (pyrrrole,  $\text{sp}^2$ ) which are 73.5 and 96.5 Hz, respectively.

Other structural studies<sup>84</sup> involving the use of  $^1J(^{15}\text{N}-^1\text{H})$  data include evidence for the site of protonation of 4-aminoazobenzene (**10**).



(10)

4-aminoazobenzene has three different kinds of nitrogen atoms within one molecule. One is an amino nitrogen ( $\text{N}\gamma$ ) (with an approximately p-hybridized lone pair), and the others are azo nitrogens ( $\text{N}\alpha$ ,  $\text{N}\beta$ ) with s-hybridized lone pairs. Upon protonation, the hybridization state of the lone pairs and the electronic environment around the nitrogen atom are greatly affected, resulting in marked changes in sign and magnitude of spin-spin coupling constants and chemical shifts of  $^{15}\text{N}$  nuclei together with changes in the nuclear Overhauser effect (NOE) of the  $^{15}\text{N}$  nucleus. It has been confirmed<sup>84</sup> that in weak acid solutions there are two monocationic species, in one of which the proton is attached to the  $\beta$ -azo nitrogen and in the other to the amino nitrogen, and that in fairly strongly acidic solutions the 4-aminoazobenzene molecule exists as a dicationic species protonated at the amino and  $\alpha$ -azo nitrogens but not at the  $\beta$ -azo nitrogen.

### C. Liquid Crystal Solvents

The advantages of the study of the NMR spectroscopy of solutes dissolved in liquid crystal solvents for structural studies have been exploited extensively despite the well-known limitations of the technique, and many compounds have been studied<sup>89,90</sup>.

The  $^1\text{H}$  magnetic resonance spectra of pyrrole- $^{15}\text{N}$  in two nematic solvents have been reported<sup>91</sup>. The dipolar coupling constants were used to derive relative internuclear distances, and it was found that the N-H bond distance relative to the distance

between the  $\beta$ -protons varied by almost 2% for the five solutions examined. Two liquid crystals were used as solvents: *N*(-*p*-ethoxybenzylidene)-*p'*-*n*-butylaniline (EBBA) which forms a nematic mesophase in the temperature range 35–79 °C, and *p*-*n*-butyl-*p'*-methoxyazoxybenzene (Phase IV), which has a nematic range of 16–76 °C.

It was shown that the solute molecules orient with the two-fold axis perpendicular to the liquid-crystal optic axis. This effect may be caused by the orienting influence of hydrogen bonding between the NH proton of pyrrole- $^{15}\text{N}$  and the solvent—the calculated NH bond length is indeed slightly different from the value determined by microwave spectroscopy and differs in different nematic solvents (on the assumption that the anisotropy in the one-bond  $J$ -coupling is negligible). The dipolar couplings were re-analysed<sup>92</sup> by inclusion of the effect of harmonic vibrational motion. The apparent NH bond length is then reduced by up to 3%, and the total spread in value is reduced from 2 to 1%. This leads to the conclusion that there is a real difference of about 3% between the N–H bond lengths for pyrrole in Phase IV and in the gas.

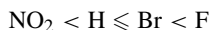
The NMR spectra of *p*-nitroaniline[1- $^{14}\text{N}$ ], *p*-nitroaniline[1- $^{15}\text{N}$ ] in Merck's nematic Phase VIIa and *p*-bromoaniline[1- $^{15}\text{N}$ ] in nematic Phase IV, each partially oriented in the solvent, have been studied<sup>93</sup>. At first the difficulties experienced with aniline and its derivatives<sup>90</sup>, namely broad  $^1\text{H}$  lines, were attributed to the quadrupole effect of the  $^{14}\text{N}$  nucleus<sup>94</sup>. But it was shown<sup>93</sup> that although the quadrupole effect of the  $^{14}\text{N}$  nucleus is not negligible, the main reason for line broadening is the effect of water-catalysed exchange of the  $\text{NH}_2$  hydrogens, since suppression of exchange allows reasonably narrow-lined spectra of *p*-nitroaniline[1- $^{14}\text{N}$ ] to be obtained. The use of  $^{15}\text{N}$ -enriched samples, besides producing narrower lines, provides a sufficient number of dipolar couplings for the detailed determination of the molecular shape.

The molecular reorientation is found to be correlated with  $\text{NH}_2$  internal motions. The non-planar nature of the molecules is shown by both the uncorrected and the vibrationally corrected data.

Considerable changes are produced by the substituents in all the parameters involving the  $\text{NH}_2$  group: the N–H distances increase markedly; the H–N–H angles decrease toward the values for ammonium ion (109.5°) and for ammonia (106.7°), and the dihedral out-of-plane angles increase slightly (by 5° for *p*-nitroaniline[1- $^{15}\text{N}$ ], but by very little for *p*-bromoaniline[1- $^{15}\text{N}$ ]).

Diagonalization of the ordering matrix<sup>93</sup> leads to the determination of the angle between its principal axis and the molecular fixed axis. The result is  $6.5 \pm 0.3^\circ$  for *p*-nitroaniline and  $3.2 \pm 0.5^\circ$  for *p*-bromoaniline.

The effect of the substituents at the  $\text{NH}_2$  pyramid is confirmed to be a flattening by electron-withdrawing substituents, and an accentuation by electron donors since the order observed for the out-of-plane angle,  $\varphi$ , with respect to the substituent R is



## D. Solid State NMR

The last ten years have seen increasing development in the field of high-resolution solid state NMR. This is due to the exploitation of relatively new methodologies, such as those which enable better resolved spectra to be obtained from quadrupolar nuclei and those which facilitate the measurement of internuclear distances.

There are also reports of interesting  $J$  coupling effects in some magic angle spinning (MAS) spectra as well as new experiments for purposes such as spectral editing.

So far, there have been rather few applications of  $^{15}\text{N}$  CPMAS NMR at the natural abundance of the isotope<sup>95</sup> and, in most cases,  $^{15}\text{N}$ -labelling has been employed.

As a typical example we give the results of  $^{13}\text{C}$  and  $^{15}\text{N}$  NMR studies on 1,8-bis(dimethylamino)naphthalene and its monohydrated salt with tetrazole<sup>96</sup> (Table 22).

On the basis of the solution and solid state  $^{15}\text{N}$  results, an equilibrium involving the half protonated form of the base in the solution of the complex salt has been identified. The  $^{13}\text{C}$  results for the solutions, on the other hand, are very similar to those found for the solid state, and are rather insensitive to salt formation. So it seems that the  $^{15}\text{N}$  NMR data provide the most suitable means of investigating the structure of the compounds studied in both solution and the solid state.

In 1989 Gullion and Schaefer<sup>97</sup> described the rotational-echo, double-resonance (REDOR) technique. Distances measured by this method may be used in the determination of bound-ligand conformations without the limitations imposed by crystallization, molecular weight or solubility. They have performed<sup>98</sup> REDOR  $^{15}\text{N}$ - $^{13}\text{C}$  NMR experiments, on an alanine cocrystallized from five-component alanines, isotopically enriched in  $^{13}\text{C}$ ,  $^{15}\text{N}$  or  $^{12}\text{C}$ . REDOR  $^{15}\text{N}$ - $^{13}\text{C}$  NMR involves the dephasing of  $^{13}\text{C}$  magnetization by  $^{15}\text{N}$   $180^\circ$  pulses synchronized with magic angle spinning. The C-N dipolar coupling determines the extent of dephasing. The results of these experiments on alanine show that it is practical to use REDOR to measure the C-N dipolar coupling in 5 mmol of a  $^{13}\text{C}$ - $^{15}\text{N}$  labelled pair having an internuclear separation of the order of 4.5 Å.

Garbow and McWherter<sup>99</sup> have defined the methods and requirements for constructing structural models from REDOR data, using the tripeptide melanostatin [Pro-Leu-Gly-NH<sub>2</sub>] as a model system. REDOR experiments were performed on a series of selectively  $^{13}\text{C}$ - and  $^{15}\text{N}$ -labelled melanostatins allowing the distances between the labelled carbon and nitrogen atom in each case to be determined. A comparison with the X-ray structure showed excellent agreement. The REDOR distances provided effective constraints on the values of the backbone dihedral angles of melanostatin, therefore providing a direct determination of the solid state conformation. The determination of distances in a large molecule like a protein, by using DANTE-selected Rotational-Echo Double-Resonance NMR<sup>100</sup>, has been proposed.

An interesting 'three-dimensional separated-local-field/dilute-spin-exchange solid state NMR experiment' has been reported<sup>101</sup> where homonuclear spin-exchange cross-peaks provide correlation in the  $\omega_2/\omega_3$  plane. Resonances are resolved along the  $\omega_1$  axis by their heteronuclear dipolar couplings. The experiment was demonstrated experimentally with the  $^1\text{H}$ - $^{15}\text{N}$  heteronuclear and  $^{15}\text{N}$ - $^{15}\text{N}$  homonuclear dipole-dipole interactions in a single crystal sample of uniformly  $^{15}\text{N}$ -labelled glycylglycine at an arbitrary orientation. Although glycylglycine has two magnetically inequivalent molecules per unit cell giving rise to four nitrogen resonances, the resonances from the two amino acid groups in the unit overlapped accidentally at this orientation of the crystal. In the three-dimensional experiment, however, the resonances were nevertheless resolved by their heteronuclear dipole-dipole couplings. This type of experiment is expected to be particularly important for studying proteins in the solid state, because it directly addresses the severe overlap and assignment problems for both chemical shifts and dipolar interaction and, as a bonus, provides a clear way to measure the magnitudes of the splittings from heteronuclear dipole-dipole interactions.

The conformational properties of mono-substituted cyclohexanes,  $\text{C}_6\text{H}_{11}\text{X}$ , in their thiourea inclusion compounds have been studied<sup>102</sup>. Variable-temperature MAS spectra demonstrate that a 'chair-chair' ring inversion process occurs in the thiourea tunnel, in which the axial and equatorial conformers are interconverted. Predominance of the equatorial conformer is found when  $\text{X} = \text{NH}_2$ .

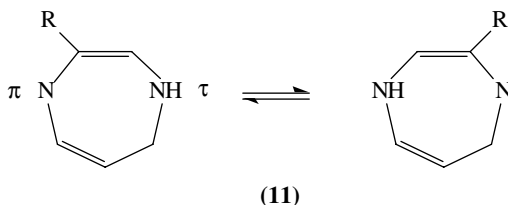
Solid state  $^{15}\text{N}$  NMR has also been used<sup>103</sup> to study lyophilized powders of  $^{15}\text{N}$ -enriched histidine and imidazole, prepared from aqueous solutions with pH ranging

TABLE 22.  $^{13}\text{C}$  and  $^{15}\text{N}$  solution and solid state NMR data for 1,8-bis(dimethylamino)naphthalene and its monohydrated salt with tetrazole<sup>96</sup>

Compounds		Chemical shifts <sup>a</sup> for a solution in $\text{CD}_3\text{CN}$	CPMAS chemical shifts <sup>a</sup>
	N-Me	44.7 (134.4) <sup>b</sup>	42.0 45.4
	$\text{C}_2$	113.8 (156.9)	113.4
	$\text{C}_{1a}$	121.3	122.1
	$\text{C}_4$	122.5	122.1
	$\text{C}_3$	126.5 (159.1)	125.3
	$\text{C}_{4a}$	138.8 (160.8)	138.2
	$\text{C}_1$	151.7	150.6
	N	-338.1	-329.7
	N-Me	46.0 (138.4) <sup>b</sup>	44.7
	$\text{C}_2$	119.3 (161.7)	117.8
	$\text{C}_{1a}$	120.5	124.3
	$\text{C}_4$	127.3 (162.5)	128.7
	$\text{C}_3$	127.5 (162.7)	131.2
	$\text{C}_{4a}$	137.2	136.2
	$\text{C}_1$	147.6	151.0
	N	-343.7	-340.0
	$\text{C}'_5$	147.7 (204.0)	145.2
	$\text{N}'_1$	-78.8	-56.4
	$\text{N}'_2$	-1.6	11.4

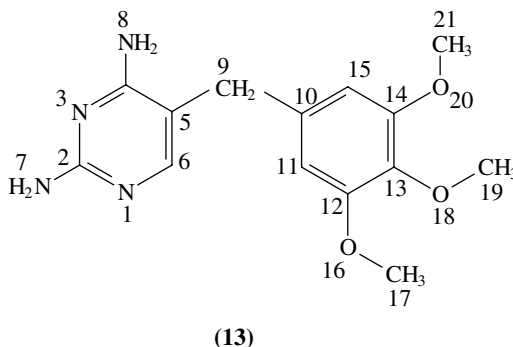
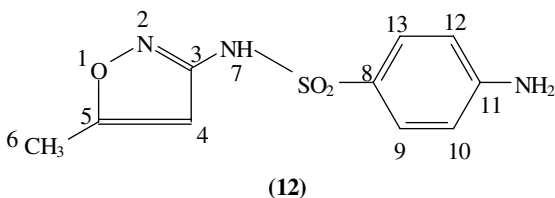
<sup>a</sup> $^{13}\text{C}$  chemical shifts are given with respect to TMS and  $^{15}\text{N}$  chemical shifts with respect to external neat nitromethane.<sup>b</sup> $^1J$  coupling data are given in parentheses

between 2 and 12.5. The  $^{15}\text{N}$  shift anisotropy is found to double on deprotonation of the  $\pi$ -nitrogen atom and is dependent on the protonation state of nitrogen. The tautomeric exchange (**11**) is slow or non-existent in the solid as shown by the observation of two  $^{15}\text{N}$  resonances for the free base imidazole ( $\text{R} = \text{H}$ ).



Solid samples of histidine, prepared from solutions of different pH, show slow exchange between cationic and neutral forms. Furthermore, only a single tautomer (the  $\text{N}^{\tau}\text{-H}$ ) is observed for the neutral and anionic species.

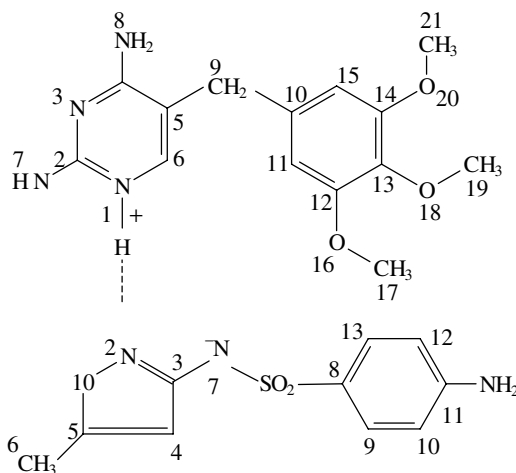
The combined use of natural-abundance solid state  $^{13}\text{C}$  and  $^{15}\text{N}$  NMR has shown<sup>104</sup> that the structure of the trimethoprim:sulphamethoxazole complex (TMP:SMZ) is best described by transfer of the proton N(7) of SMZ (**12**) to N(1) of TMP (**13**).



A solution-state and solid-state nuclear magnetic resonance study of the complex and its separate components in both their neutral and ionized (TMP hydrochloride and SMZ sodium salt) forms was undertaken in order to elucidate the TMP-SMZ interactions. Inspection of the data for the complex in the solid state shows that the  $^{13}\text{C}$  chemical shifts are consistent with the ionic structure proposed by Nakai and coworkers<sup>105</sup> (**14**). Stabilization of the complex is achieved by the resulting ionic interaction and by the formation of two intermolecular hydrogen bonds.

The results of a comprehensive  $^{13}\text{C}$  CP/MAS NMR study of the structure of solid polypeptides, prepared by polymerization of amino acid N-carboxyanhydrides under various conditions, have been reported<sup>105,107</sup>. In the case of poly(L-alanine) it was found that





(14)

the signals of all three carbons were clearly split into two peaks, one being assigned to the  $\alpha$ -helix structure and the other to the antiparallel pleated-sheet structure<sup>106</sup>.

High-resolution dipolar/chemical shift NMR experiments for solids have been used to measure the N–H bond distances in a series of compounds<sup>108</sup>, many of which have also been studied by neutron diffraction, such as <sup>15</sup>N glycine. The results demonstrate that, when recorded carefully, with attention paid to the experimental procedures described, two-dimensional/chemical shift spectra can yield bond distances accurate to within 0.005 Å, and the mutual orientation of dipolar and chemical shift tensors accurate to within 3°. A comparison of N–H bond distances obtained by solid state NMR techniques with distances obtained by single-crystal neutron-diffraction techniques is shown in Figure 5. The bond lengths obtained by NMR are consistently 0.0035 Å longer than those measured by neutron-diffraction techniques, owing mainly to differences in the time scales of the measurements (NMR events are observed over intervals usually no shorter than tens of microseconds whereas neutron-diffraction events require only picoseconds), and in the distance function sampled (NMR measures the dipole–dipole interactions, which are proportional to  $1/r^3$ , but diffraction experiments measure scattering amplitudes, which are proportional to  $1/r$ ).

In systems from which only a polycrystalline or an amorphous sample can be obtained, NMR becomes the method of choice since the diffraction technique requires single crystal samples.

Double-cross-polarization <sup>15</sup>N MAS NMR has been employed<sup>109</sup> to study the transport and metabolism of D- and L-alanine by aerococcus viridans.

### E. Relationship of Aromatic Nitro Group Torsion Angles with <sup>17</sup>O Chemical Shifts

In 1985 Boykin and Balakrishnan<sup>110</sup> showed for the first time that the <sup>17</sup>O chemical shifts of the nitro group vary with the torsion angle that describes the orientation of the group relative to the atoms of the aromatic ring. The very large chemical shift range for this nucleus makes it particularly attractive for examining the influences of subtle changes in molecular structure despite its poor receptivity. The large quadrupole moment normally results in very short relaxation times: on the one hand these broaden the lines, but on the

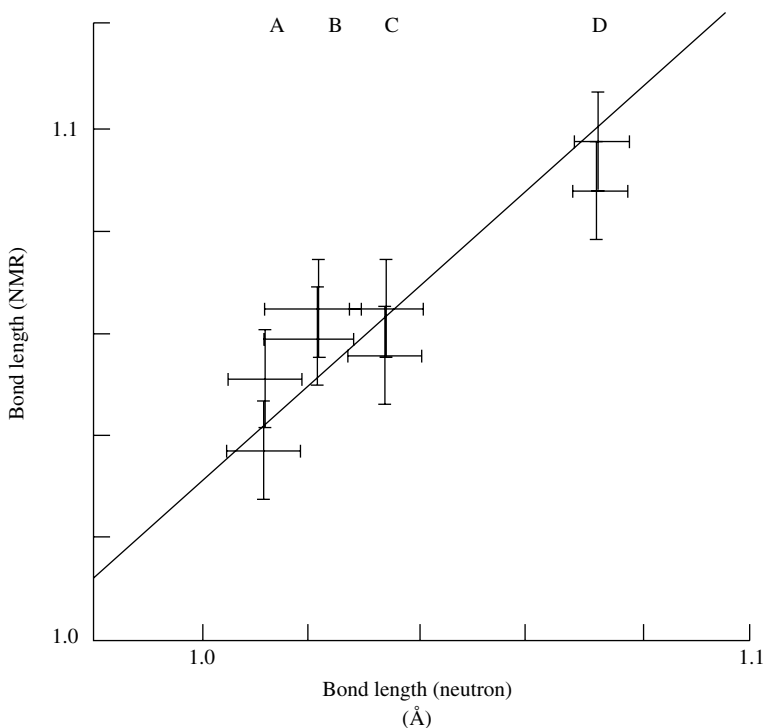


FIGURE 5. Comparison of  $^{15}\text{N}$ - $^1\text{H}$  bond distances obtained by solid state NMR techniques with distances obtained by single-crystal neutron-diffraction techniques. Reprinted with permission from Reference 108. Copyright (1987) American Chemical Society

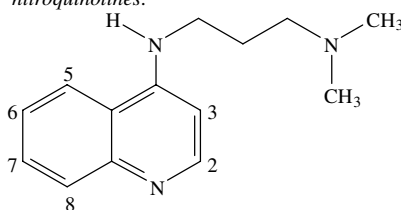
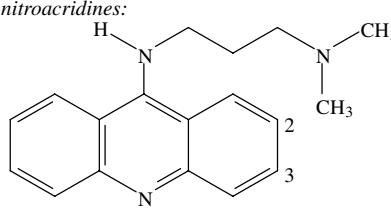
other they also permit very rapid accumulation of spectra, which offsets the sensitivity problem.

The  $^{17}\text{O}$  chemical shifts of a series of *sterically crowded* aromatic nitro compounds and their torsion angles between the aromatic rings and the nitro groups are given in Table 23. A comparison of the chemical shifts of nitrobenzene, 1-nitronaphthalene and 9-nitroanthracene reveals a substantial deshielding trend. Although an increase in overlap between the nitro group and the aromatic ring with increasing ring size would be expected to result in increasing single bond character of the nitro function and should be reflected by a shielding trend, the opposite is observed. This corresponds to increasing nitrogen-oxygen double bond character of the respective nitro groups, which can be explained in terms of a rotation of the nitro group relative to the plane of the aromatic ring.

The apparent relationship between torsion angle and  $^{17}\text{O}$  chemical shift has been explored further by examination of the data for several *ortho* alkyl-substituted nitrobenzenes and dinitrobenzenes (Table 23). The deshielding values of the shifts reflect increasing nitrogen-oxygen double bond character, which is expected as the nitro group is rotated from the plane of the aromatic ring.

Figure 6 shows a good correlation between torsional angle and  $^{17}\text{O}$  chemical shift. The empirical equation 7 has been established by Boykin and Balakrishnan<sup>110</sup>, between nitro group torsion angles ( $q$  in degrees) and the chemical shifts of the  $^{17}\text{O}$  resonance of the

TABLE 23.  $^{17}\text{O}$  chemical shifts for aromatic nitro compounds

$\delta^{17}\text{O}$ (ppm)	Compound	Torsion angle (deg)
575	nitrobenzene	0
605	1-nitronaphthalene	
637	9-nitroanthracene	85
575	2-nitronaphthalene	
612	1,5-dinitronaphthalene	48.7
609,578	1,3-dinitronaphthalene	
599	1,8-dinitronaphthalene	43
602	<i>o</i> -nitrotoluene	
572	<i>p</i> -nitrotoluene	
597	2,4-dimethylnitrobenzene	
612	2,3-dimethylnitrobenzene	
629	2,6-dimethylnitrobenzene	
628	2,4,6-trimethylnitrobenzene	65
657	2,4,6-tri- <i>t</i> -butylnitrobenzene	
584	<i>p</i> -dinitrobenzene	8
579	<i>m</i> -dinitrobenzene	11
609	<i>o</i> -dinitrobenzene	
627	<i>N</i> -[2-(dimethylamino)ethyl]-3-methyl-2-nitrobenzamide hydrochloride	69
629	<i>N</i> -[2-(dimethylamino)ethyl]-3-ethyl-2-nitrobenzamide hydrochloride	72
632	<i>N</i> -[2-(dimethylamino)ethyl]-3-isopropyl-2-nitrobenzamide hydrochloride	76
644	<i>N</i> -[2-(dimethylamino)ethyl]-3- <i>t</i> -butyl-2-nitrobenzamide hydrochloride	92
	<i>nitroquinolines:</i>	
		
561	3-nitro	0
646	2-methyl-3-nitro	100
628	5-nitro	79
646	6-methyl-5-nitro	100
569	6-nitro	10
596	7-methyl-6-nitro	42
579	7-nitro	22
612	8-methyl-7-nitro	60
627	8-nitro	78
633	7-methyl-8-nitro	85
	<i>nitroacridines:</i>	
		

(continued overleaf)

TABLE 23. (continued)

$\delta^{17}\text{O}$ (ppm)	Compound	Torsion angle (deg)
605	1-nitro	52
567	2-nitro	7
582	3-nitro	25
623	4-nitro	73

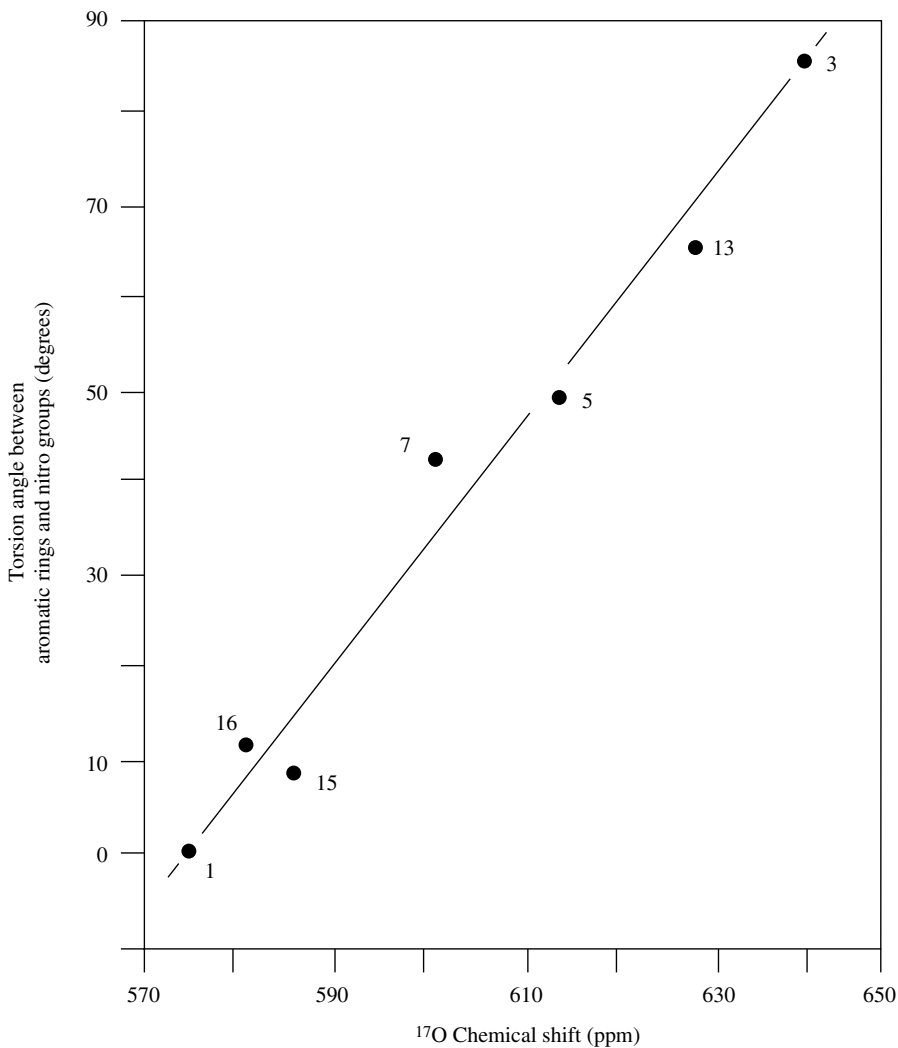
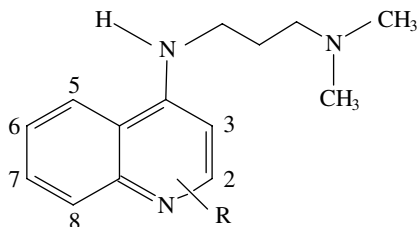


FIGURE 6. Plot of torsional angle between aromatic rings and nitro groups vs the  $^{17}\text{O}$  chemical shift (ppm) data. Reprinted with permission from D. J. Craik, G. C. Levy and R. T. C. Brownlee, *J. Org. Chem.*, **48**, 1601 (1983). Copyright (1983) American Chemical Society

nitro group ( $d$ ):

$$\theta = (1.29\delta \pm 0.24) - 739 \quad (7)$$

Boyd and coworkers<sup>111</sup> used equation 7 to determine the nitro-group torsion angles by  $^{17}\text{O}$  NMR spectroscopy for a series of 4-(alkylamino)-nitroquinolines (**15**) and their *ortho* methyl-substituted analogues, but they noticed that the range of  $^{17}\text{O}$  NMR chemical shifts seen with these N-heterocyclic compounds is larger (561–646 ppm) than the range for the nitroaromatics<sup>110</sup> (Table 23).



(15)

Whereas most of the NMR-determined changes in torsion angle on addition of an *ortho* methyl group were in the expected range, two were not. In 2-methyl-3-nitroquinoline, addition of a 2-methyl group to a 3-nitro derivative led to a change in chemical shift of 85 ppm, indicating (by equation 7) a change in nitro-group torsion angle of  $> 90^\circ$ . In 7-methyl-8-nitroquinoline, addition of a 7-methyl group to 8-nitroquinoline gave very little apparent change. So the crystallographic torsion angles were used to calculate a modified version (equation 8) of the equation<sup>111</sup>:

$$\theta = 1.18(\pm 0.13)\delta - 661 \quad (8)$$

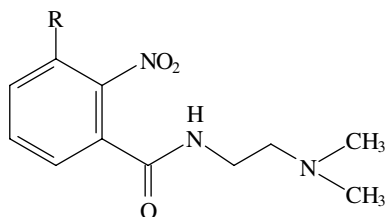
Equation 8 was then used to compute torsional angles for the nitroquinolines. Unhindered nitro groups gave values close to coplanar for the aromatic ring as expected, whereas addition of one *ortho* methyl group increased the torsion angle to *ca*  $30^\circ$ . The 5-nitro derivative had a nitro-group torsion angle of *ca*  $80^\circ$ , due to *peri* interactions with the 4-aminoalkyl side-chain.

It is known<sup>112</sup> that nitro groups *ortho* to primary or secondary amines are usually planar owing to hydrogen bonding. However, when the *ortho* group has a tertiary  $\text{sp}^3$  nitrogen<sup>113–115</sup> the torsion angle can increase by more than  $40^\circ$ , and changing the *ortho* group to an  $\text{sp}$  nitrogen<sup>116</sup> can further increase the nitro-group torsion angle by *ca*  $50^\circ$ .

The 8-nitroquinoline derivative is the first example of a nitroarene with a *peri* aromatic nitrogen substituent, and the torsion angle of  $70^\circ$ – $78^\circ$  (measured by both NMR spectroscopy and X-ray crystallography) indicates the substantial steric effect of the nitrogen lone pair. Addition of a 7-methyl group at the other *ortho* position of the nitro group of this compound results in the nitro group being virtually at right angles to the ring (torsion angle  $86^\circ$ ).

Using the same equation (8) Boyd and coworkers<sup>117</sup> calculated the torsion angles in a series of 3-nitro-4-alkylbenzamides (**16**).  $^{17}\text{O}$  chemical shifts indicated similar amide torsion angles (from  $35^\circ$  to  $45^\circ$ ) as the alkyl group varied from hydrogen to *t*-butyl, but widely differing nitro-group torsion angles; from  $36^\circ$  (hydrogen) to  $92^\circ$  (*t*-butyl) (Table 23). Crystal structures of the isopropyl and *t*-butyl derivatives indicate amide-group torsion angles ( $50^\circ$  and  $64^\circ$ ) somewhat larger than those predicted by  $^{17}\text{O}$  NMR, and nitro-group torsion angles ( $59^\circ$  and  $65^\circ$ , respectively) considerably smaller than those

predicted by  $^{17}\text{O}$  NMR ( $75^\circ$  and  $92^\circ$ , respectively). These results support earlier data<sup>111</sup> that  $^{17}\text{O}$  chemical shifts predict erroneously large nitro-group torsion angles in non-rigid but sterically crowded molecules, because of additional contributions to the shift resulting from van der Waals repulsions.



(16)

## VI. IMAGING

In 1982 Hall and Sukumar<sup>118</sup> demonstrated the ability to select species processing distinct chemical shifts in images, where the chemical shifts do not overlap, using capillaries of water, acetone, benzene and methylene chloride. Since then, volume-localized spectroscopy and chemical-shift imaging have been applied to a number of medical and non-medical problems. Most of these studies, however, are focused on the  $^1\text{H}$  and  $^{31}\text{P}$  nucleides, especially those investigations which are clinically oriented<sup>119,120</sup>.

With respect to non-clinical studies, however, such as those which are biological or chemical, other nuclei like  $^{13}\text{C}$ ,  $^{14}\text{N}$  or  $^{15}\text{N}$  come more easily into consideration. And although it is true that there were then some papers with  $^{13}\text{C}$  images reported in the literature<sup>121</sup> before 1988 and one  $^{14}\text{N}$  image (liquid nitrogen)<sup>122</sup> was published in that year, it was not until 1992 that chemically shifted  $^{14}\text{N}$  images were reported<sup>123</sup>, and  $^{15}\text{N}$  images from samples at either natural abundance or enriched concentration were obtained, at least in the liquid phase<sup>124</sup>. The separated images were for the ammonium and nitrate ions, which each give a narrow line, and for the different types of nitrogen in the azide ion, namely at the central and terminal positions. These give slightly broader resonances than do the other ions, and with conventional imaging spectrometers which employ small switchable gradient sets that are unshielded some (or all!) of the image intensity may be lost.

The latest imaging work in high field gradients, however, has shown that broad lines may be imaged easily even for solids, so that imaging of  $^{14}\text{N}$  should no longer be a problem despite the short values for  $T_2$ .

The steady-state free-precession (SSFP) technique was used with no NOE, and in the case of aniline the  $T_1$  of the  $^{15}\text{N}$  was reduced by addition of chromium acetylacacate as a relaxation reagent to the sample. The  $^{15}\text{N}$  spectrum of aniline showed a single broad line ( $\Delta\nu_{1/2} = 42$  Hz) in which, because of proton exchange<sup>125,126</sup>, there is no evidence of  $^{15}\text{N}$ - $^1\text{H}$  coupling ( $J = 80$  Hz).

As in spectroscopy, there are two ways of imaging  $^{15}\text{N}$  (and  $^{14}\text{N}$ ), the direct and the indirect method. In the direct mode the simplest enhancement is available with  $^{15}\text{N}\{^1\text{H}\}$ d.r. experiments in which the Overhauser effect is used to advantage. The maximum value of the effect is  $-3.93$  for  $^1\text{H}\{^{15}\text{N}\}$ . The NOE is negligible for  $^{14}\text{N}$ , as we have seen already.

The first NOE-enhanced  $^{15}\text{N}$  image which was reported<sup>127</sup> was for aniline- $^{15}\text{N}$ . It is interesting, because in this sample the exchange processes cause partial collapse of the  $^1\text{H}$

and the  $^{15}\text{N}$  multiplets to broad lines<sup>127</sup>. These multiplets are observed only under very dry conditions<sup>125</sup>. A single but still broadened  $^{15}\text{N}$  line ( $\Delta\nu = 20$  Hz) was obtained for this sample (a 99.5% enriched sealed aniline- $^{15}\text{N}$  sample). Irradiation at the  $^1\text{H}$  resonance frequency of the nearly collapsed  $\text{NH}_2$  proton doublet ( $\Delta\nu_{1/2} = 42$  Hz) at sufficient power caused sharpening of the  $^{15}\text{N}$  resonance to 18 Hz, but more importantly results in its enhancement by a factor of  $-3.7$ . 1D profiles and 2D images were obtained in the magnitude mode (see Figure 7). The total acquisition time was 16 min, which resulted in an S/N ratio for the profile of approximately 10:1.

Phenylhydrazine was used for  $^{15}\text{N}$  images enhanced by the NOE *at natural abundance*. As in the case of aniline, proton exchange leads to nearly complete collapse of the  $^{15}\text{N}$ -H couplings for both the NH and  $\text{NH}_2$  groups. The two groups are different, however, in that the process is more rapid for the  $\text{NH}_2$  than for the NH group and so leads to a narrower  $^{15}\text{N}$  line (16 Hz at  $20^\circ\text{C}$ ) compared with the  $\text{NH}_2$  value of 80 Hz in the single-resonance experiment. The NOE values are nearly equal<sup>128</sup> at a value of about  $-2.9$ , and the  $T_1$  values for  $^{15}\text{N}$  were measured as  $8.40 \pm 0.1$  s (for NH) and  $3.91 \pm 0.01$  s (for  $\text{NH}_2$ ).

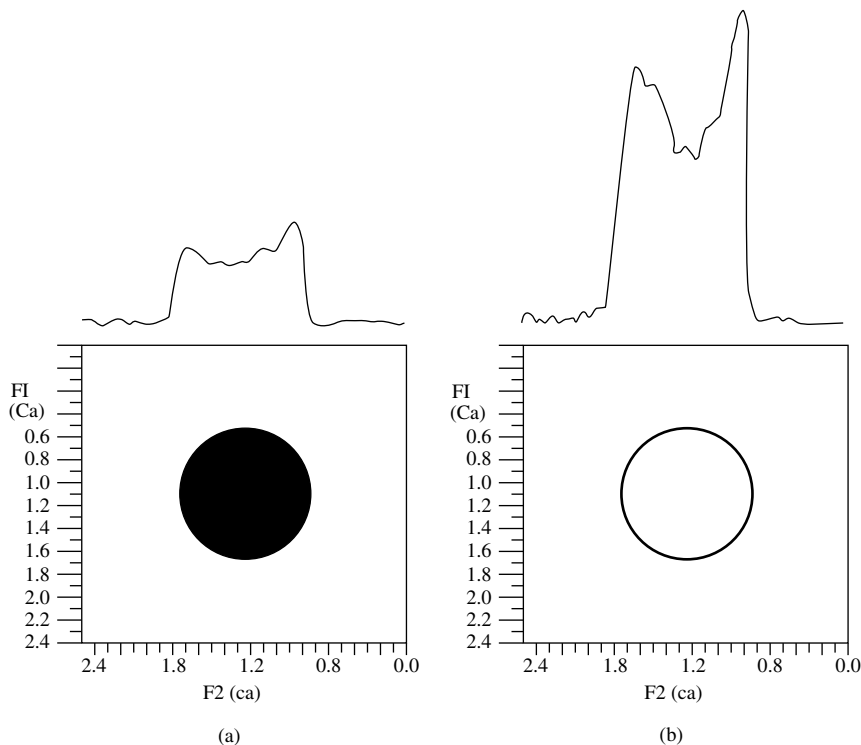


FIGURE 7. Fourier 2D spin-echo  $^{15}\text{N}$  images of aniline- $^{15}\text{N}$  without slice selection. A trace through the centre of each image is also shown. Echo time (TE) = 35 ms; pulse width = 55 ms, pulse angle ( $\alpha$ ) =  $90^\circ$ , number of transients per phase-encoding step (NT) = 16, number of phase-encoding steps (NPE) = 64, number of data points collected in  $F_2(\text{NP}) = 256$ , repetition time (TR) = 10.05 s, in-plane spatial resolution =  $0.39 \times 0.39$  mm. (a) Single resonance; total imaging time = 2 h 52 min. (b) Double resonance ( $^{15}\text{N}\{^1\text{H}\}$ ) on during relaxation delay of 10 s only; total imaging time = 2 h 52 min<sup>127</sup>

It is established therefore that imaging of  $^{15}\text{N}$  by direct methods is feasible and can be improved by  $^{15}\text{N}\{^1\text{H}\}$  experiments even when the  $^{15}\text{N}$  resonance is broadened by rapid exchange of attached protons. But if the compound of interest has resolved  $J(^{15}\text{N}-^1\text{H})$  interactions, then indirect detection by a SEDOR  $J^1\text{H}\{^{15}\text{N}\}$  experiment for liquids offers much greater sensitivity<sup>129-131</sup>.

## VII. REFERENCES

- (a) M. Witanowski, L. Stefaniac and G. A. Webb, *Nitrogen NMR Spectroscopy*, in *Annual Reports on NMR Spectroscopy*, **25**, 2 (1993).  
(b) M. Witanowski, L. Stefaniac and G. A. Webb, *Nitrogen NMR Spectroscopy*, in *Annual Reports on NMR Spectroscopy*, **18**, 2 (1986).  
(c) M. Witanowski and G. A. Webb (Eds), *Nitrogen NMR*, Plenum Press, London and New York, 1973.
- G. C. Levy and R. L. Lichter, *Nitrogen-15 Nuclear Magnetic Resonance Spectroscopy*, Wiley-Interscience, New York, 1979.
- J. Mason, in *Multinuclear NMR* (Ed. J. Mason), Plenum Press, New York, 1987, p. 355.
- D. G. Gillies and E. W. Randall, *Nitrogen NMR*, in *Progress in NMR*, **6**, 119 (1970).
- W. von Philipsborn and R. Mueller, *Angew. Chem. Int. Ed. Engl.*, **25**, 383 (1986).
- G. J. Martin, M. L. Martin and J. P. Gouesnard, in *NMR Basic Principles and Progress* **18**, *15-N NMR Spectroscopy*, Springer-Verlag, Heidelberg, 1981.
- W. McFarlane and H. C. E. McFarlane, in *Multinuclear NMR* (Ed. J. Mason), Plenum Press, New York, 1987, p. 403.
- D. W. Boykin,  *$^{17}\text{O}$ -NMR Spectroscopy in Organic Chemistry* (Ed. D. W. Boykin), CRC Press, Boca Raton, 1990.
- E. Curzon, B. T. Golding, C. Pierpoint and B. W. Waters, *J. Organomet. Chem.*, **262**, 263 (1984).
- B. Gordillo and E. L. Eliet, *J. Am. Chem. Soc.*, **113**, 2172 (1991).
- R. R. Ernst, G. Bodenhausen and A. Wokaum, *Principles of Nuclear Magnetic Resonance in One and Two Frequency Dimensions*, Clarendon Press, Oxford, 1987.
- D. Shaw, *Fourier Transform NMR Spectroscopy*, Studies in Physical and Theoretical Chemistry, Vol. 30, 2nd ed., Elsevier, Amsterdam, 1984.
- R. Freeman *A Handbook of Nuclear Magnetic Resonance*, Longman, Harlow, 1988.
- R. K. Harris and B. E. Mann, *NMR and the Periodic Table*, Academic Press, London, 1978.
- J. P. Gouesnard and J. Dorie, *Nouv. J. Chim.*, **6**, 143 (1982); J. Dorie and J. P. Gouesnard, *J. Chim. Phys. Phys.-Chim. Biol.*, **82**, 369 (1985).
- R. J. Abraham and P. Loftus in *Proton and Carbon-13 NMR Spectroscopy*, Heyden, London, 1978.
- C. N. R. Rao in *The Chemistry of the Nitro and Nitroso Groups*, Part 1 (Ed. H. Feuer), Wiley-Interscience, New York, 1969, p. 79, p. 137 and references cited therein.
- J. D. Memory and N. K. Wilson, *NMR of Aromatic Compounds*, Wiley, New York, 1982.
- G. C. Levy, R. L. Lichter and G. L. Nelson, *Carbon-13 Nuclear Magnetic Resonance Spectroscopy*, 2nd ed., Wiley-Interscience, New York, 1980, pp. 111-112.
- E. D. Becker, *High Resolution NMR—Theory and Chemical Applications*, 2nd ed., Academic Press, New York, 1980.
- D. E. Leyden and R. H. Cox, in *Analytical Applications of NMR*, Chemical Analysis Series, Vol 48 (Eds. P. J. Elving and J. D. Winefordner), Wiley-Interscience, New York, 1977.
- E. Breitmaier and W. Voelter, *Carbon-13 NMR Spectroscopy*, 3rd completely rev. ed., VCH, Weinheim, New York, 1987, pp. 319, 320.
- D. F. Ewig, *Org. Magn. Reson.*, **12**, 499 (1979).
- D. F. Ewing, in *Correlation Analysis in Chemistry: Recent Advances* (Eds. J. Shorter and N. B. Chapman), Chap. 8, Plenum Press, New York, 1978.
- W. J. Hehre, R. W. Taft and R. D. Topsom, *Prog. Phys. Org. Chem.*, **12**, 159 (1976).
- J. Bromilow, R. T. C. Brownlee, V. O. Lopez and R. W. Taft, *J. Org. Chem.*, **44**, 4766 (1979).
- H. M. Hugel, D. P. Kelly, R. J. Spear, J. Bromilow, R. T. C. Brownlee and D. J. Craik, *Aust. J. Chem.*, **32**, 1511 (1979).
- G. J. Martin, M. L. Martin and S. Odier, *Org. Magn. Reson.*, **7**, 2 (1975).
- C. Hansch, A. Leo and R. W. Taft, *Chem. Rev.*, **91**, 165 (1991).



30. Reference 2, pp. 53–57.
31. M. P. Sibi, E. C. Prince, J. LeMelle and R. L. Lichter, *Spectrosc. Int. J.*, **2**, 198 (1983).
32. M. P. Sibi and R. L. Lichter, *J. Org. Chem.*, **42**, 2999 (1977).
33. C. Yamagami, N. Takao and Y. Takeuchi, *Aust. J. Chem.*, **41**, 1 (1988).
34. C. Yamagami, N. Takao, T. Nishioka, T. Fujita and Y. Takeuchi, *Org. Magn. Reson.*, **22**, 439 (1984).
35. Reference 2, p. 220.
36. M. P. Sibi and R. L. Lichter, *J. Org. Chem.*, **42**, 2999 (1977).
37. D. M. Kanjia, J. Mason, I. A. Stenhouse, R. E. Banks and N. D. Venayak, *J. Chem. Soc., Perkin Trans. 2*, 975 (1981).
38. G. G. Furin, A. I. Rezvukhin, M. A. Fedotov and G. G. Yakobson, *J. Fluorine Chem.*, **22**, 231 (1983); G. G. Furin, M. A. Fedotov, G. G. Yakobson and A. V. Zibarev, *J. Fluorine Chem.*, **28**, 273 (1985).
39. T. Yokoyama, I. Hamazone, M. Mishima, M. J. Kamlet and R. W. Taft, *J. Org. Chem.*, **52**, 163 (1987).
40. R. W. Taft and R. D. Tompson, *Prog. Phys. Org. Chem.*, **16**, 1 (1987).
41. M. Mishima, R. T. McIver, R. W. Taft, F. G. Bordwell and W. N. Olmstead, *J. Am. Chem. Soc.*, **106**, 2717 (1984).
42. T. Yokoyama, T. Komaki, H. Sato, R. W. Taft and F. Anvia, *J. Org. Chem.*, **54**, 3983 (1989).
43. M. J. Kamlet and R. W. Taft, *J. Org. Chem.*, **47**, 1734 (1982).
44. J. Bromilow, R. T. C. Brownlee, D. J. Craik, M. Sadek and R. W. Taft, *J. Org. Chem.*, **45**, 2429 (1980).
45. R. D. Batts and G. Pallos, *Org. Magn. Reson.*, **13**, 349 (1980).
46. Reference 2, pp. 53–57.
47. W. Bremser, J. I. Kroschwitz and J. D. Roberts, *J. Am. Chem. Soc.*, **91**, 6189 (1969).
48. D. T. Clark and J. D. Roberts, *J. Am. Chem. Soc.*, **88**, 745 (1966).
49. M. Witanowski, L. Stefaniak and G. A. Webb, *J. Chem. Soc. (B)*, 1065 (1967).
50. M. Witanowski, W. Sicinska, Z. Biedrzycka and G. A. Webb, *Magn. Reson. Chem.*, **31**, 916 (1993).
51. H. A. Christ and P. Diehl, *Helv. Phys. Acta*, **36**, 170 (1963); H. A. Christ, *Helv. Phys. Acta*, **33**, 572 (1960).
52. M. Katoh, T. Sugawara, Y. Kawada and H. Iwamura, *Bull. Chem. Soc. Jpn.*, **52**, 3475 (1979).
53. T. E. St. Amour, M. I. Burgar, B. Valentine and D. Fiat, *J. Am. Chem. Soc.*, **103**, 1128 (1981).
54. K. B. Lipkowitz, *J. Am. Chem. Soc.*, **104**, 2647 (1982).
55. R. R. Fraser, A. J. Ragauskas and J. B. Stothers, *J. Am. Chem. Soc.*, **104**, 6475, (1982).
56. D. J. Craik, G. C. Levy and R. T. C. Brownlee, *J. Org. Chem.*, **48**, 1601 (1983).
57. D. J. Craik, G. C. Wenz and R. T. C. Brownlee, *J. Org. Chem.*, **48**, 1601 (1983).
58. D. W. Boykin, A. L. Baumstark, P. Balakrishnan, A. Perjessy and P. Hrniciar, *Spectrochim. Acta*, **40A**, 887 (1984).
59. G. G. Furin, A. I. Rezvukhin, M. A. Fedotov and G. G. Yakobson, *J. Fluorine Chem.*, **22**, 231 (1983).
60. K. G. Orrell, V. Sik and D. Stephenson, *Magn. Reson. Chem.*, **25**, 1007 (1987).
61. H. Dahn, P. Pechy and R. Floegel, *Helv. Chim. Acta*, **77**, 306 (1994).
62. G. Cerioni, *J. Phys. Org. Chem.*, **4**, 260 (1991).
63. L. O. Anderson and J. Mason, *J. Chem. Soc., Dalton Trans.*, 202 (1974).
64. D. W. Boykin, *Spectrosc. Lett.*, **23**, 1133 (1990).
65. R. Bonnett, R. Holleyhead, B. L. Johnson and E. W. Randall, *J. Chem. Soc., Perkin Trans. 1*, 2261 (1975).
66. H. A. Christ, P. Diehl, H. R. Schneider and H. Dahn, *Helv. Chim. Acta*, **44**, 865 (1961).
67. T. Axenrod, P. S. Pregosin, M. J. Wieder, R. B. Bradley, E. D. Becker and G. A. Milne, *J. Am. Chem. Soc.*, **93**, 6536 (1971).
68. R. E. Wasylishen, *Can. J. Chem.*, **54**, 833 (1976).
69. T. Axenrod, M. J. Wieder, Tun Khin, G. A. Webb, H. J. C. Yeh and S. Bulusu, *Org. Magn. Reson.*, **12**, 1 (1979).
70. G. Binsch, J. B. Lambert, B. N. Roberts and D. J. Roberts, *J. Am. Chem. Soc.*, **86**, 5564 (1964).
71. J. M. Schulman and T. Venanzi, *J. Am. Chem. Soc.*, **98**, 4701 (1976).
72. J. M. Schulman and T. Venanzi, *J. Am. Chem. Soc.*, **98**, 6739 (1976).
73. Tun Khin and G. A. Webb, *Org. Magn. Reson.*, **10**, 175 (1977).

74. G. A. Webb, in *NMR and the Periodic Table* (Eds. R. K. Harris and B. E. Mann), Academic Press, London, 1978, p. 49.
75. P. C. Lauterbur, *J. Chem. Phys.*, **38**, 1415 (1963).
76. M. S. Sibi and R. L. Lichter, *J. Org. Chem.*, **42**, 2999 (1977).
77. J. Dorie, B. Mechin and G. Martin, *Org. Magn. Reson.*, **12**, 229 (1979).
78. T. Axenrod, C. M. Watnick, M. J. Wieder, S. Dughthai, G. A. Webb, H. J. C. Yeh, S. Bulusu and M. M. King, *Org. Magn. Reson.* **20**, 11 (1982).
79. Reference 1c, Chap. 1, p. 31.
80. Reference 2, Chap. 2, p. 108.
81. A. J. R. Bourn and E. W. Randall, *Mol. Phys.*, **8**, 567 (1964).
82. S. M. Susskind, G. E. Scuseria and R. H. Contreras, *Z. Phys. Chem. (Leipzig)*, **266**, 395 (1985).
83. V. M. S. Gil and W. von Philipsborn, *Magn. Reson. Chem.*, **27**, 409 (1989).
84. Yoshihiro Kuroda, Hohi Lee and Akio Kuwae, *J. Phys. Chem.*, **84**, 3417 (1980).
85. I. Yavari and J. D. Roberts, *Org. Magn. Reson.*, **20**, 325 (1982).
86. A. I. Resvukhin, G. G. Furin and G. G. Jakobson, *Izv. Akad. Nauk SSSR, Ser. Khim.*, 2512 (1981).
87. V. Mlynarik, *Collect. Czech. Chem. Commun.*, **48**, 948 (1983).
88. Shoichi Ide, Kazuhisa Iwasawa, Akihiro Yoshino, Tadayoshi Yoshida and Kensuke Takashi, *Magn. Reson. Chem.*, **25**, 675 (1987).
89. J. W. Emsley and J. C. Lindon, *NMR Spectroscopy Using Liquid Crystal Solvents*, Pergamon, Oxford, 1975.
90. C. L. Khetrpal and A. C. Kumar, in *Advances in Magnetic Resonance* (Ed. J. J. Waugh), Academic Press, New York, 1977.
91. J. M. Briggs, E. J. Rakhama and E. W. Randall, *J. Magn. Reson.*, **17**, 55 (1975).
92. J. W. Emsley and E. W. Randall, *J. Magn. Reson.*, **23**, 481 (1976).
93. G. Fronza, R. Mondelli, F. Lelj, E. W. Randall and C. A. Veracine, *J. Magn. Reson.*, **37**, 275 (1980).
94. P. Diehl, *Pure Appl. Chem.*, **32**, 111 (1972).
95. H. Knicker, R. Frund and H. D. Ludemann, *Naturwissenschaften*, **80**, 219 (1993).
96. E. Grech, L. Stefaniak, I. Ando, H. Yoshimizu, G. A. Webb and L. Sobczyk, *Bull. Chem. Soc. Jpn.*, **63**, 2716 (1990).
97. T. Gullion and J. Schaefer, *J. Magn. Reson.*, **81**, 196 (1989).
98. Y. Pan, T. Gullion and J. Schaefer, *J. Magn. Reson.*, **90**, 330 (1990).
99. J. R. Garbow and C. A. McWhorter, *J. Am. Chem. Soc.*, **115**, 238 (1993).
100. Y. Pan and J. Schaefer, *J. Magn. Reson.*, **90**, 341 (1990).
101. B. S. A. Kumar and S. J. Opella, *J. Magn. Reson., Series A*, **101**, 333 (1993).
102. A. E. Aliev and K. D. M. Harris, *J. Am. Chem. Soc.*, **115**, 6369 (1993).
103. M. Munowitz, W. W. Bachovchin, J. Herzfeld, C. M. Dobson and R. G. Griffin, *J. Am. Chem. Soc.*, **104**, 1192 (1982).
104. R. Fruttero, G. E. Hawkes, E. W. Randall, A. Gasco and C. J. Groombridge, *J. Chem. Soc., Perkin Trans. 2*, 1863 (1988).
105. H. Nakai, M. Takasuka and M. Shiro, *J. Chem. Soc., Perkin Trans. 2*, 1459 (1984).
106. D. Muller and H. R. Kricheldorf, *Polym. Bull. (Berlin)*, **6**, 101 (1981).
107. H. R. Kricheldorf and D. Muller, *Macromolecules*, **16**, 615 (1983).
108. J. E. Roberts, G. S. Harbison, M. G. Munowitz, J. Herzfeld and R. G. Griffin, *J. Am. Chem. Soc.*, **109**, 4163 (1987).
109. G. S. Jacob, J. Schaefer and G. E. Wilson, Jr., *J. Biol. Chem.*, **260**, 2777 (1985).
110. P. Balakrishnan and D. W. Boykin, *J. Org. Chem.*, **50**, 3663 (1985).
111. M. Boyd, P. D. W. Boyd, G. J. Atwell, W. R. Wilson and W. A. Denny, *J. Chem. Soc. Perkin Trans. 2*, 579 (1992).
112. H. H. Cady, *Acta Crystallogr.*, **23**, 601 (1967).
113. A. F. Hegarty, M. T. McCormack, B. J. Hathaway and L. Hulett, *J. Chem. Soc., Perkin Trans. 2*, 1136 (1977).
114. J. R. Holden and C. Dickinson, *J. Phys. Chem.*, **73**, 1199 (1969).
115. C. P. Huber, *Acta Crystallogr., Sect. C*, **41**, 1076 (1985).
116. R. E. Cobbleddick, F. W. B. Einstein, N. Farrell, A. B. Gilchrist and D. Sutton, *J. Chem. Soc., Dalton Trans.*, 373 (1977).
117. M. Boyd, H. H. Lee, R. F. Anderson and W. A. Denny, *J. Chem. Soc., Perkin Trans. 2*, 291 (1994).

118. L. D. Hall and S. Sukumar, *J. Magn. Reson.*, **50**, 161 (1982).
119. P. T. Callaghan, *Principles of Nuclear Magnetic Resonance Microscopy*, Oxford University Press, Oxford, 1991.
120. P. Mansfield and P. G. Morris, *Advances in Magnetic Resonance*, Supplement 2, Academic Press, San Diego, 1982, p. 65.
121. N. M. Szeverenyi and G. E. Maciel, *J. Magn. Reson.*, **80**, 389 (1988).
122. A. Haase and D. Hopfel, *Chem. Commun.*, 580 (1988).
123. P. Kinches, D. S. Powlson, E. W. Randall and S. C. R. Williams, *J. Magn. Reson.*, **97**, 208 (1992).
124. P. Kinches, E. W. Randall and S. C. R. Williams, *J. Magn. Reson.*, **98**, 458 (1992).
125. E. W. Randall and J. J. Zuckerman, *J. Am. Chem. Soc.*, **90**, 3167 (1968).
126. M. R. Bramwell and E. W. Randall, *Chem. Commun.*, 251 (1969).
127. P. Kinches, E. W. Randall and S. C. R. Williams, *J. Magn. Reson., Series A*, **103**, 234 (1993).
128. J. M. Briggs, L. F. Farnell and E. W. Randall, *J. Magn. Reson.*, **60**, 460 (1984).
129. E. W. Randall, in *Some Double Resonance Methods in Imaging Experiments*, Proceedings of International School of Physics (Enrico Fermi), 'Nuclear Magnetic Double Resonance', (Ed. B. Maraviglia), North-Holland, Amsterdam, 1993, pp. 423–448.
130. P. Kinches, E. W. Randall and S. C. R. Williams, *J. Magn. Reson.*, **100**, 625 (1992).
131. P. Kinches, E. W. Randall and S. C. R. Williams, *J. Magn. Reson., Series B*, **105**, 253 (1994).

## CHAPTER 8

# Thermochemistry of amines, nitroso compounds, nitro compounds and related species\*

JOEL F. LIEBMAN

*Department of Chemistry and Biochemistry, University of Maryland Baltimore  
County, 5401 Wilkens Avenue, Baltimore, Maryland 21228-5398, USA  
Fax: 410-455-2608; e-mail: JLIEBMAN@UMBC2.UMBC.EDU*

MARY STINECIPHER CAMPBELL

*DX-2 Explosive Science Technology, MS C920, Los Alamos National Laboratory,  
Los Alamos, New Mexico 87545-0000, USA  
Fax: 505-667-0500; e-mail: MSCAMPBELL@LANL.GOV*

and

SUZANNE W. SLAYDEN

*Department of Chemistry, George Mason University, 4400 University Drive, Fairfax,  
Virginia 22030-4444, USA  
Fax: 703-993-1055; e-mail: SSLAYDEN@GMU.EDU*

---

I. INTRODUCTION	338
A. Definition of Thermochemistry	338
B. Classes of Compounds to be Discussed	339
II. CORRELATIONS OF ENTHALPIES OF FORMATION OF ALKYL NITROGEN-CONTAINING COMPOUNDS	339
III. ALIPHATIC AND ALICYCLIC MONOAMINES	343
A. Acyclic Amines	343
B. Alicyclic Amines	345

---

\* Contribution from the US government. Not subject to copyright.

IV. ANILINES AND OTHER AROMATIC AMINES	348
A. Aniline and <i>N</i> -Alkylated Anilines	348
B. Primary Aromatic Amines Containing more than One Benzenoid Ring	349
C. Secondary and Tertiary Aromatic Amines	350
V. POLYAMINES	350
A. Aliphatic Diamines	351
B. Alicyclic Diamines	352
C. Aromatic Diamines	353
D. Alicyclic Triamines	354
E. Tetramines	355
VI. NITROSO COMPOUNDS	357
A. Nitrosobenzene and Its Methylated Derivatives	357
B. Nitrosobenzene and Amino Substitution	358
C. Nitrosoarecols	358
D. Aliphatic Nitroso Compounds	360
VII. AROMATIC NITRO COMPOUNDS	361
A. The Roles of Resonance and Steric Effects: Molecular Families and Reference States	361
B. Nitrobenzenes	362
C. Nitroanilines	364
D. Nitrotoluenes	366
VIII. NITRO COMPOUNDS AS EXPLOSIVES	368
A. Definitions	368
B. Experimental Determination of the Enthalpy of Formation of Explosives	369
C. Sensitivity of Explosives	370
IX. REFERENCES	371

## I. INTRODUCTION

### A. Definition of Thermochemistry

As has been our practice in other thermochemistry chapters in the ‘Patai series’<sup>1</sup>, we commence our discussion by defining key concepts. The word ‘Thermochemistry’ is taken here to mean ‘Enthalpy of Formation’<sup>2</sup> (or, more colloquially, ‘Heat of Formation’), and will be written  $\Delta_f H_f$  in lieu of the more proper but much less widely used  $\Delta_f H_m^\circ$ . Enthalpy and energy will dominate our discussion; heat capacity, entropy and gibbs energy<sup>3</sup> will be all but ignored. To maximize understanding of fundamental molecular phenomena requires us to minimize complications from intermolecular interactions and so we wish to present data for gas-phase species under the ‘standard’ conditions of 25 °C (298 K) and 1 atmosphere. However, most of the species in this chapter—like the vast majority of organic compounds—are ‘naturally’ liquid or solid under conventional laboratory and thermochemically idealized conditions alike. We will make use of ancillary quantities such as experimentally measured phase-change enthalpies to ‘correct’ the state of the species. When these phase-change enthalpies are unavailable from experiment, enthalpies of vaporization will often be estimated<sup>4</sup>, and enthalpies of fusion<sup>5</sup> measured at the melting point will be accepted without correction to 298 K. Enthalpies of sublimation are likewise taken from Reference 6 without any correction. We will also often find it necessary to use enthalpies of formation without any correction to the gaseous state because both measurements and reliable estimated phase-change enthalpies are absent.

## B. Classes of Compounds to be Discussed

The two primary classes of species to be discussed in this chapter are amines, namely those compounds of the generic formula  $RR^1R^2N$ , where  $R^i$  is either hydrogen or hydrocarbyl and nitro compounds,  $RNO_2$ . Not all types of amines, nitro compounds and their derivatives will be discussed here. No mention will be made of the thermochemistry of imines, N-amino and N-acyl derivatives; discussion of multiply bonded nitrogen, hydrazines and amides belongs elsewhere. The thermochemistry of enamines will also be omitted, having been the subject of a recent review<sup>7</sup>, and derivatives of pyrrole and indole will be ignored because of their aromaticity. Discussions of nitro compounds are limited to nitro aromatic compounds. Following the precedent of the earlier relevant chapter in the Patai series<sup>8</sup> we also include a brief treatment of nitrites,  $RONO$ , and nitrates,  $RONO_2$  to accompany our discussion of nitro compounds. Nitroso compounds will also be discussed.

### II. CORRELATIONS OF ENTHALPIES OF FORMATION OF ALKYL NITROGEN-CONTAINING COMPOUNDS

It has been firmly established that thermochemical properties of a homologous series of compounds show a linear dependence on the number of carbon atoms in the alkyl group<sup>1,9-11</sup>. Especially useful is equation 1 which expresses the standard molar enthalpies of formation of a homologous series as a function of the total number of carbon atoms in the compound,  $n_c$ .

$$\Delta H_f^\circ(l) = \alpha_l \cdot n_c + \beta_l \quad (1a)$$

$$\Delta H_f^\circ(g) = \alpha_g \cdot n_c + \beta_g \quad (1b)$$

$$\Delta H_f^\circ(l,g) = \alpha \cdot n_c + \beta \quad (1c)$$

In general, the function is unreliable<sup>12</sup> for  $n_c = 1$ . Ideally, the constants in equation 1 are derived from several members of the homologous series for which  $n_c \geq 4$ . Only occasionally, however, have enough experimental data been available to fulfill this condition. In the present case, few nitrogen-containing compounds for which there are gaseous enthalpy-of-formation data possess more than four carbon atoms in a hydrocarbyl substituent. Nonetheless, even restricted data sets may yield useful information. The numerical values in Table 1 were produced by applying the method of weighted least squares to the measured enthalpy of formation data for alkyl amines, nitrites, nitrates and nitro compounds.

The slopes,  $\alpha_g$ , for various  $n$ -alkyl substituted homologous series are commonly compared to the 'universal' slope (methylene increment) of  $-20.6 \text{ kJ mol}^{-1}$  calculated for the  $n$ -alkanes<sup>9</sup>. An unanswered question is whether for 'large enough'  $n_c$  the methylene increment should be identical for all functionalized alkanes. In previous studies it is shown that the slopes vary, although not too widely ( $ca \pm 2 \text{ kJ mol}^{-1}$ ), and there is no discernible relationship between the functional group and  $\alpha$ . With three exceptions, the slopes reported in Table 1 are in line with those calculated for other functional group series.

The slope for the gaseous 2-nitroalkanes is unusually steep, rivaled only by an identical slope for di- $n$ -alkylsulphoxides<sup>1</sup>. There are two other indications that at least one of the two data points may be incorrect. Generally, isomerization of an  $n$ -alkyl to a *sec*-alkyl or *tert*-alkyl substituent results in a slightly less negative slope, but for the nitroalkanes the opposite trend is seen in Table 1. Also, the slopes for liquid and gaseous phases must be different for any homologous series of compounds (a manifestation of the increasing enthalpy of vaporization), but for the 2-nitroalkanes, they are essentially identical.

TABLE 1. Constants from the least-squares analysis of equation 1 for nitrogen-containing alkanes<sup>a</sup> (kJ mol<sup>-1</sup>)

Homologous series	$\Delta H_f^\circ(\text{l})$		$\Delta H_f^\circ(\text{g})$	
	$\alpha_1$	$\beta_1$	$\alpha_g$	$\beta_g$
Primary amines				
<i>n</i> -RNH <sub>2</sub> [C <sub>2</sub> -C <sub>4</sub> ]	-27.1	-20.0	-22.4	-2.8
<i>sec</i> -RNH <sub>2</sub> [C <sub>3</sub> , C <sub>4</sub> ]	-25.2	-36.7	-21.1	-20.5
Secondary amines				
<i>n</i> -R <sub>2</sub> NH [C <sub>2</sub> -C <sub>4</sub> ]	-25.4	-3.4	-20.8	9.14
Tertiary amines				
<i>n</i> -R <sub>3</sub> N [C <sub>2</sub> -C <sub>4</sub> , C <sub>6</sub> , C <sub>8</sub> -C <sub>10</sub> (l); C <sub>2</sub> -C <sub>3</sub> (g)]	-25.4	23.8	-22.7	43.6
Diamines				
1,2-(NH <sub>2</sub> ) <sub>2</sub> R [C <sub>3</sub> -C <sub>4</sub> ]	-22.5	-30.3	-20.4	7.6
Nitrites				
<i>n</i> -RONO [C <sub>3</sub> , C <sub>4</sub> (l); C <sub>2</sub> -C <sub>4</sub> (g)]	-31.8	-55.2	-22.2	-55.5
<i>sec</i> -RONO [C <sub>3</sub> -C <sub>4</sub> ]	-23.9	-92.7	-19.2	-75.9
<i>tert</i> -RONO [C <sub>4</sub> -C <sub>5</sub> ]	-19.2	-129.1	-20.1	-91.1
Nitro compounds				
<i>n</i> -RNO <sub>2</sub> [C <sub>2</sub> -C <sub>5</sub> (l); C <sub>2</sub> -C <sub>4</sub> (g)]	-23.8	-96.1	-21.1	-60.2
<i>sec</i> -RNO <sub>2</sub> [C <sub>3</sub> , C <sub>4</sub> , C <sub>10</sub> (l); C <sub>3</sub> , C <sub>4</sub> (g)]	-24.4	-107.6	-24.7	-64.8
Dinitro compounds				
1,1-(NO <sub>2</sub> ) <sub>2</sub> R [C <sub>2</sub> , C <sub>3</sub> , C <sub>5</sub> ]	-22.9	-100.5		
1,ω-(NO <sub>2</sub> ) <sub>2</sub> R [C <sub>3</sub> -C <sub>4</sub> ]	-36.2	-96.2		
Nitrates				
<i>n</i> -RONO <sub>2</sub> [C <sub>2</sub> , C <sub>3</sub> ]	-24.1	-142.2	-19.8	-114.5

<sup>a</sup>In the least-squares analyses of equation 1, the individual enthalpies were weighted inversely as the squares of the experimental uncertainty intervals, except for the nitrites for which some errors were not reported.

Omitting the liquid-phase enthalpy of formation for 2-nitrodecane gives a slope of  $-27.2$ , which is somewhat larger. This third enthalpy of formation for the liquid phase probably mitigates the effect of the incorrect value in the regression analysis.

There are problems with the enthalpy of formation data for the *n*-alkyl and *tert*-alkyl nitrite families. The values used in this work were taken from the review by Batt and Robinson<sup>8</sup>, but only the value for methyl nitrite appears in Pedley. Batt and coworkers determined all (except ethyl and *t*-pentyl nitrite) the other liquid-phase enthalpies of formation and of vaporization, except the enthalpy of vaporization for isopropyl nitrite was calculated. Although the gaseous enthalpy-of-formation data for the other series in Table 1 form reasonably straight lines, it is evident from inspection of a graphical plot that at least one of the data points for the *n*-alkyl nitrites is incorrect. The  $\alpha_g$  of equation 1, calculated using only the more recent *n*-propyl and *n*-butyl nitrite data, is  $-26.8$  which is much too steep to be credible, while  $\alpha_g$  calculated from ethyl and *n*-propyl nitrites is  $-17.5$ , also an incredible value. The liquid-phase slope in Table 1, determined from only the *n*-propyl and *n*-butyl nitrites, is also much steeper than any other known slope. The slope calculated from only the gaseous ethyl and *n*-butyl nitrites is  $-22.2$ , essentially identical to  $\alpha_g$ , the slope of the best straight line in Table 1. Interpolating a value for the enthalpy of formation of *n*-propyl nitrite gives  $-123.5$  kJ mol<sup>-1</sup> which is slightly outside the reported error for the experimental value of  $-118.8 \pm 4.2$  kJ mol<sup>-1</sup>. Finally, a comparison of the gaseous enthalpies of formation for the 1-nitroalkanes with the corresponding nitrites shows that the values for the ethyl and *n*-butyl derivatives are virtually identical while those of the

*n*-propyl compounds differ by 5 kJ mol<sup>-1</sup>. The value derived above for *n*-propyl nitrite now compares with the experimental value of -123.8 kJ mol<sup>-1</sup> for 1-nitropropane. Thus, the enthalpy of formation for *n*-propyl nitrite is most likely the incorrect value.

One of the two enthalpies of formation for the tertiary alkyl nitrites is most probably incorrect. As seen in Table 1, not only is the slope for the liquid-phase data less negative than that for the gas-phase data, but it is much less steep than all other liquid-phase data of which we know. Part of the discrepancy is due to the inverted order of the archival enthalpies of vaporization: *t*-butyl nitrite = 34.4 kJ mol<sup>-1</sup> and *t*-pentyl nitrite = 33.5 kJ mol<sup>-1</sup>.

We would like to extrapolate equation 1 to generate enthalpy-of-formation values for the higher homologs in each of the nitrogen-containing families. The constancy of  $\alpha$  and  $\beta$  values for restricted or expanded data sets can be explored using homologous series for which there are extensive data, such as *n*-alkanes, *n*-alkanols, *n*-alkanethiols and *n*-alkyl chlorides and bromides. For each series, constants were calculated from all experimental enthalpies of formation for  $n_c \geq 4$  and from experimental enthalpies of formation for  $n_c = 2-4$  only, the most commonly encountered restricted data set. When the slopes for both sets in a series are compared, the change is variable, ranging from almost no change for the *n*-alkanols (0.2 kJ mol<sup>-1</sup>) to a quite large change for the *n*-alkyl bromides (2.3 kJ mol<sup>-1</sup>)<sup>12</sup>. In all cases the smaller data set produces a slope which is more negative and an intercept which is less negative. Whatever the uncertainty about the accuracy of the enthalpy of formation derived from an extrapolation using the smaller data set, it is probable the result is at least a lower limit.

Examination of plots of the enthalpies of formation of the various nitrogen-containing homologous series in the gaseous or liquid phase reveals several features. Selected data are shown in Figure 1. The enthalpies of formation become more negative as the oxygen content of the functional group increases (the nitrite and nitro families are nearly co-linear). Compared to the corresponding hydrocarbons, the enthalpies of formation of amines are less negative and the enthalpies of formation of the vicinal diamino alkanes are yet less negative. The enthalpies of formation of all the oxygen-nitrogen functionalized alkanes are more negative than the corresponding alkanes and the enthalpies of formation of the 1, $\omega$ -dinitro alkanes are more negative than either (there are seemingly no gas-phase

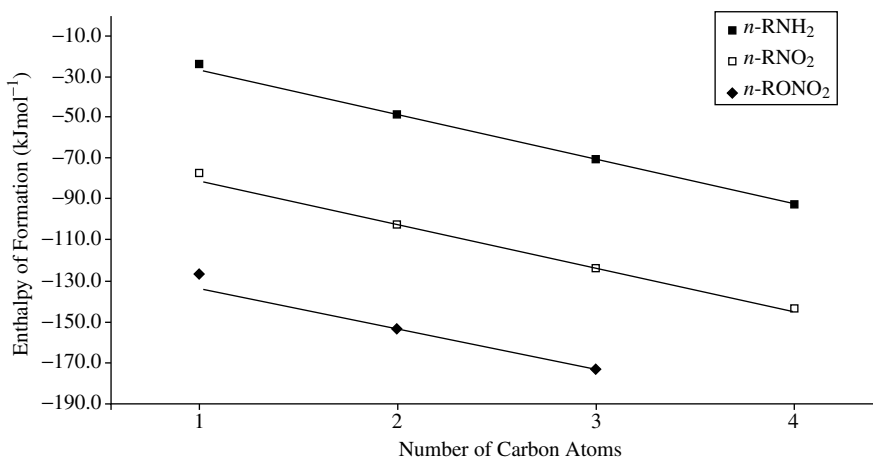


FIGURE 1. Enthalpies of formation of nitrogen-containing compounds (g)



data). Among primary, secondary and tertiary amines containing the same total number of carbons as *n*-alkyl groups, primary amines have the most negative and tertiary amines the least negative enthalpy of formation. Amines thus behave similarly to alcohols and ethers in that alcohols have more negative heats of formation than the isomeric ethers.

It is readily apparent that the enthalpy of formation of the methyl derivative in each of the *n*-alkyl series in Table 1 deviates from the otherwise apparently linear relationship established by the higher members of the series<sup>12</sup>. This 'methyl effect' is well-known, if little understood. In every case here, the experimental methyl compound enthalpy is less negative than that derived from the appropriate regression constants. It has been shown that the magnitude of the methyl deviation generally increases as the electronegativity of the attached heteroatom increases in both the gaseous and liquid phases<sup>13,14</sup>. In the present case, the primary, secondary and tertiary methyl amines deviate less than nitromethane, which deviates less than methyl nitrate and methyl nitrite. (If the gaseous enthalpies of formation of only *n*-propyl and *n*-butyl nitrite are considered, the methyl nitrite deviation from the extrapolated line is 1.2 kJ mol<sup>-1</sup> in the 'wrong' direction, a further indication of the incorrectness of one of these values.) The increase in deviation with oxygen content and with proximity of oxygen to methyl accords with both our understanding of an electronegativity effect on the methyl deviation as well as our prior experience with sulphur and sulphur-oxygen containing compounds<sup>1</sup>.

Because the enthalpies of formation of a homologous series correlate with the number of carbon atoms according to equation 1, the enthalpies of formation of any one series must correlate with the enthalpies of formation of any other series with like *n<sub>c</sub>*, as in equation 2.

$$\Delta H_f^\circ(\text{RZ}) = \alpha_{z,z'} \Delta H_f^\circ(\text{RZ}') + \beta_{z,z'} \quad (2)$$

An informative comparison for the nitrogen-containing compounds is with the corresponding hydrocarbons, either R-H or R-CH<sub>3</sub>.

A typical plot of equation 2 is shown for RNH<sub>2</sub> versus R-CH<sub>3</sub> in Figure 2. As also observed from plots of equation 1, the methyl group is destabilizing relative to the *n*-alkyl group and the *sec*-alkyl groups are stabilizing. We know from our data compendia that *t*-butyl amine and neopentane are more stable than their respective isomers and we can now observe that fact graphically. Only for the case where Z is a relatively electropositive

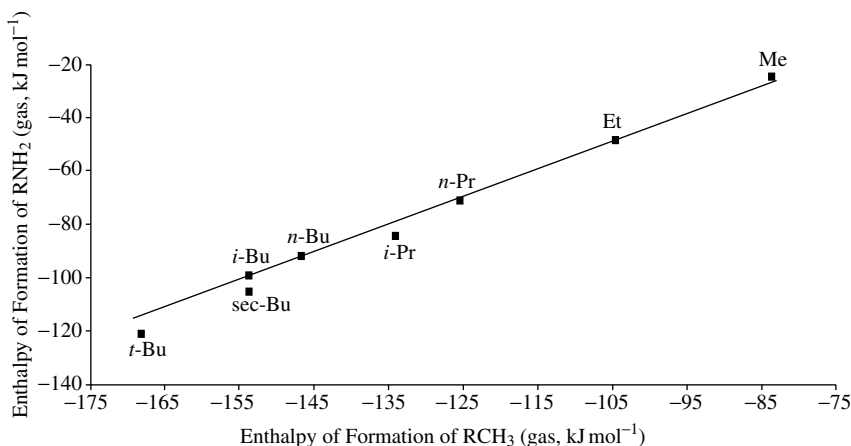


FIGURE 2. Enthalpies of formation of alkyl amines vs alkyl methanes

atom such as Li is the effect of branching in R on enthalpies of formation reversed<sup>15</sup>, in keeping with the differences in bond polarity  $R^{\delta-}Z^{\delta+}$  and  $R^{\delta+}Z^{\delta-}$ . The data point for R = isobutyl lies on the line for R = *n*-alkyl. Plotting equation 2 for alcohols or other larger data sets shows that this is a general result. This provides a method for deriving the enthalpies of formation of primary isoalkyl compounds for which experimental data are lacking. For example, the gaseous enthalpies of formation for isobutyl nitrate and 2-methyl-1-nitropropane are calculated to be  $-201$  and  $-151$  kJ mol<sup>-1</sup>, respectively. In a plot of equation 2 for primary R-ONO versus RCH<sub>3</sub> (R = Et, *n*-Pr, *n*-Bu, *i*-Bu), the best straight line does not include the *n*-propyl nitrite. Again it appears that this is a discrepant enthalpy of formation. Calculating an enthalpy of formation for *n*-propyl nitrite (g) from the constants derived from equation 2 (obviously excluding R = *n*-Pr) gives a value of *ca*  $-123$  kJ mol<sup>-1</sup>. This compares favorably with the value derived above from equation 1.

A plot of secondary amines, RR'NH, versus the corresponding hydrocarbon, RR'CH<sub>2</sub>, is instructive. Compared to the straight line established by the symmetrical di-*n*-alkyl species (R, R' = Et, *n*-Pr, *n*-Bu), the data point for the dimethyl species is above the line and hence the amine appears destabilized. The di-isopropyl, isopropyl *tert*-butyl, and di-*tert*-butyl species appear stabilized, as expected. However, among the latter three, the di-*tert*-butyl species is not stabilized nearly as much as either the di-isopropyl or the mixed isopropyl *tert*-butyl species, and the mixed secondary/tertiary species is slightly less stabilized than the di-secondary, suggesting that the steric effect of the tertiary group is important. The overall effect when R = Me and R' = *tert*-Bu is destabilizing compared to the *n*-alkyl line. Evidently the destabilizing effect of methyl (combined perhaps with a destabilizing steric effect) dominates over a stabilizing tertiary group.

### III. ALIPHATIC AND ALICYCLIC MONOAMINES

As part of recent reviews of the thermochemistry of oxygen- and sulphur-containing functional groups<sup>1</sup>, we found investigation of the energies associated with 'exchange' particularly useful<sup>16</sup>. For example, recall the 'ether/methylene exchange' energy quantity  $\delta_3$  defined by

$$\delta_3(R, R^1) \equiv \delta_3(g, RCH_2R^1, ROR^1) = \Delta H_f(g, RCH_2R^1) - \Delta H_f(g, ROR^1) \quad (3)$$

and also the analogously defined 'thioether/methylene', 'alcohol/methyl' and 'thiol/methyl exchange' quantities. The rationale for this procedure is readily apparent from equation 1. The exchange quantity  $\delta\Delta H_f$  for two compounds from homologous series with identical slopes and with the same  $n_c$  equals the difference of the intercepts ( $\delta\beta$ ), that is, a constant. For the oxygen- and sulphur-containing compounds and the corresponding alkanes, the slopes differ only slightly and the approach is justified. Inspection of Table 1 shows that some of the nitrogen-containing families have values considerably different from the alkanes and thus the individual exchange quantities are expected to differ accordingly. However, because there are limited data available for nitrogen-containing compounds belonging to homologous series and because we need to establish a basis for comparing more structurally complex compounds in later sections, the exchange analysis will be performed and the limitations noted.

#### A. Acyclic Amines

We distinguished between alcohols and ethers and between thiols and thioethers, and so we will consider the three relevant exchange quantities for amines, one apiece for primary, secondary and tertiary species. For each exchange reaction, all species are in the

same physical state.

$$\delta_4(\text{prim}/\text{R}) \equiv \delta_4(\text{RMe}, \text{RNH}_2) = \Delta H_f(\text{RMe}) - \Delta H_f(\text{RNH}_2) \quad (4)$$

$$\delta_5(\text{sec}/\text{R}, \text{R}^1) \equiv \delta_5(\text{RCH}_2\text{R}^1, \text{RNHR}^1) = \Delta H_f(\text{RCH}_2\text{R}^1) - \Delta H_f(\text{RNHR}^1) \quad (5)$$

$$\delta_6(\text{tert}/\text{R}, \text{R}^1, \text{R}^2) \equiv \delta_6(\text{RR}^1\text{R}^2\text{CH}, \text{RR}^1\text{R}^2\text{N}) = \Delta H_f(\text{RR}^1\text{R}^2\text{CH}) - \Delta H_f(\text{RR}^1\text{R}^2\text{N}) \quad (6)$$

For the exchange increments involving oxygen and sulphur, the individual hydrocarbon or  $R^i$  groups were divided into four classes: methyl, primary, secondary and tertiary. Although perhaps desirable for conceptual understanding or numerical accuracy, we lack the data to differentiate amines into all of the obvious classes. For example, we have no enthalpy-of-formation value for a secondary amine with affixed primary and secondary alkyl groups such as ethyl isopropyl amine. Likewise, we lack data for most tertiary amines except for trimethyl and tri-*n*-alkyl amines. While there are plentiful data for the liquid tri-*n*-alkyl amines, there are no data for most of the corresponding hydrocarbons. The presence of aromatic rings interacting with the amino functionality introduces new complexities and discussion of these species is deferred to another section of this chapter.

Numerical values for the various amine/hydrocarbon difference quantities,  $\delta_4(\text{prim}/\text{R})$ ,  $\delta_5(\text{sec}/\text{R}, \text{R}^1)$  and  $\delta_6(\text{tert}/\text{R}, \text{R}^1, \text{R}^2)$  calculated using all available gas-phase data, and some estimated data, are shown in Table 2.  $\delta_4(\text{prim}/\text{prim})$  is derived from the  $\Delta H_f$  data for ethylamine, 1-propylamine and 1-butylamine; from isopropyl and *sec*-butylamine, we find  $\delta_4(\text{prim}/\text{sec})$ ; and finally, for  $\delta_4(\text{prim}/\text{tert})$ , *tert*-butylamine is the sole representative species. The monotonic increase of the four  $\delta_4$  values is smaller than the regular *ca* 10 kJ mol<sup>-1</sup> increase for the corresponding alcohol/methyl exchanges, but is certainly greater than the essentially unvarying thiol/methyl exchanges<sup>1</sup>.

Consider now  $\delta_5(\text{sec}/\text{R}, \text{R}^1)$ . All four exchange energies in which  $\text{R} = \text{R}^1$  can be calculated. There are three values for which the substituent groups are primary: Et, *n*-Pr and *n*-Bu. The data available for secondary R groups are limited to *i*-Pr while those for tertiary R groups are limited to *t*-Bu. Increased branching in the alkyl group attached to nitrogen makes the exchange energy more positive in the order dimethyl < di-primary < di-secondary just as it does for oxygen and sulphur ethers. Unlike those ethers though, for which the exchange value further increases with di-tertiary substitution, the exchange energy for the di-tertiary amine decreases considerably. The strain energy of di-*t*-butyl species has confused and bemused us before<sup>1</sup>. We know of no relevant amine data for several of the remaining possible combinations of  $\delta_5(\text{sec}/\text{R}, \text{R}^1)$ . Interestingly, all of the  $\delta_5(\text{sec}/\text{R}, \text{R}^1)$ —except  $\text{R} = \text{R}^1 = t\text{-Bu}$ —are roughly consistent with a constant second

TABLE 2. Enthalpy-of-formation differences between gaseous primary, secondary and tertiary amines and the corresponding hydrocarbons (kJ mol<sup>-1</sup>)

R	Methyl	Primary	Secondary	Tertiary
$\delta_4(\text{prim}/\text{R})$	-60	-56	-50	-47
$\delta_5(\text{sec}/\text{R}, \text{R}^1)$				
Methyl	-86	?	?	-78
Primary		-73	?	?
Secondary			-58	-59
Tertiary				-70
$\delta_6(\text{tert}/\text{R}, \text{R}^1, \text{R}^2)$				
Methyl, methyl	-111			
Primary, primary		-93		

difference,  $\delta\delta_7(\text{R}, \text{R}^1)$ , of  $ca\ 38 \pm 4\ \text{kJ mol}^{-1}$ .

$$\delta\delta_7(\text{R}, \text{R}^1) = \delta_4(\text{prim}/\text{R}) + \delta_4(\text{prim}/\text{R}^1) - \delta_5(\text{sec}/\text{R}, \text{R}^1) \quad (7)$$

There remain two acyclic secondary amines for which there are no experimental enthalpies of formation for the corresponding hydrocarbons: butyl isobutyl amine and diisobutyl amine. These missing enthalpies of formation are easily estimated using an accurate group additivity scheme<sup>17</sup>. A complete listing of individual  $\delta_5(\text{sec}/\text{prim}, \text{prim})$  values, including the newly estimated ones, is: Et, Et ( $-74.7$ ); Pr, Pr ( $-71.6$ ); *n*-Bu, *n*-Bu ( $-71.6$ ); Bu, *i*-Bu ( $-65.8$ ); and *i*-Bu, *i*-Bu ( $-64.3$ ). Hoping that the exchange quantities for the *n*-alkyl species are constant, we might think that  $\delta_5(\text{sec}/\text{Et}, \text{Et})$  is discrepant. However, after examining the exchange quantities and the enthalpies of formation of the isomeric dibutyl species we are led to conclude that the measured enthalpy of formation of di-*n*-butyl amine is probably incorrect. The isomerization of *n*-BuNH<sub>2</sub> to *i*-BuNH<sub>2</sub> is  $-6.9\ \text{kJ mol}^{-1}$  and isomerization of *n*-butyl isobutyl amine to di-isobutyl amine is  $-8.2\ \text{kJ mol}^{-1}$ . These values are typical for isomerization of butyl groups attached to Cl,  $-\text{OH}$ ,  $-\text{O}-$ ,  $-\text{SH}$ ,  $-\text{S}-$  and  $-\text{SS}-$ , the largest of which is  $-9.2\ \text{kJ mol}^{-1}$  for isomerization of thiols<sup>1</sup>. Thus, the isomerization value for dibutyl amine to butyl isobutyl amine of  $-14.4\ \text{kJ mol}^{-1}$  is highly discrepant while one-half the isomerization value for di-*n*-butyl amine to di-isobutyl amine of  $-11.3\ \text{kJ mol}^{-1}$  is only slightly less so. The exchange quantities for di-*n*-alkyl amines are probably not constant, but because most of the derivations in later sections are based on ethyl or propyl substructures, we choose  $\delta(\text{sec}/\text{prim}, \text{prim})$  as the average of  $\text{R} = \text{R}^1 = \text{Et}$  and *n*-Pr.

For the tertiary amines, the desired exchange values are available from experiment only for  $\text{R} = \text{R}^1 = \text{R}^2 = \text{Me}$  and  $\text{R} = \text{R}^1 = \text{R}^2 = \text{Et}$ . The gaseous enthalpy of formation for the hydrocarbon corresponding to tri-*n*-propyl amine has not been measured, but it may be reliably estimated<sup>17</sup> as  $-251.0\ \text{kJ mol}^{-1}$ . A derived  $\delta_6(\text{tert}/\text{n-Pr}, \text{n-Pr}, \text{n-Pr})$  is  $ca\ -90\ \text{kJ mol}^{-1}$ . Because  $\delta_6(\text{tert}/\text{Et}, \text{Et}, \text{Et}) = -97\ \text{kJ mol}^{-1}$ , it is apparent that the exchange quantities for tertiary amines are not constant, as was surmised from the slopes reported in Table 1. Most of the derivations involving tertiary amines in later sections are based on an ethyl or propyl substructure and so an intermediate value of  $-93\ \text{kJ mol}^{-1}$  is recommended.

Finally, because equation 8 is expected to be nearly thermoneutral for both  $\text{X} = \text{N}, \text{CH}$  in the absence of any special electronic or steric effects,  $\delta_5(\text{sec}/\text{R}, \text{R}^1)$  is approximately the average of  $\delta_4(\text{prim}/\text{R})$  and  $\delta_6(\text{tert}/\text{R}, \text{R}^1, \text{R}^2)$  as can be verified for the relevant values in Table 2.



## B. Alicyclic Amines

Let us now consider amines associated with saturated rings. We find that there are five distinct types of amines relevant to our discussion. The first type comprise primary amines with nitrogen affixed to a secondary carbon in a saturated ring. These are the cycloalkylamines with the generic formula  $(\text{CH}_2)_{n-1}\text{CHNH}_2$  (**1**). The acyclic  $\delta_4(\text{prim}/\text{sec})$  equals  $-50\ \text{kJ mol}^{-1}$  for acyclic secondary amines. For primary amines with secondary cycloalkyl groups and for  $n = 5$  and 6,  $\delta_4(\text{cyclic pri}/\text{sec})$  values of  $-51$  and  $-50\ \text{kJ mol}^{-1}$  are found. For  $n = 3$ , using experimentally determined enthalpies save an estimated  $\Delta H_v(\text{CypyrMe})$ , a plausible difference of  $-53\ \text{kJ mol}^{-1}$  is found. However, using the aforementioned protocol for the  $n = 4$  case results in a difference of  $-59\ \text{kJ mol}^{-1}$ . Substituted cyclobutane derivatives are usually anomalously stabilized<sup>18</sup>.

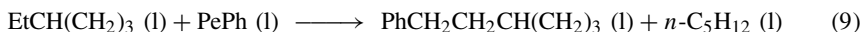
The second type of amine replaces a  $\text{CH}_2$  in the ring by a  $\text{NH}$  thereby transforming cycloalkanes  $(\text{CH}_2)_n$  (**2**) into their monoaza derivatives  $(\text{CH}_2)_{n-1}\text{NH}$  (**3**). This change would appear to be related to the acyclic  $\delta_5(\text{sec}/\text{prim}, \text{prim})$  of  $-73 \text{ kJ mol}^{-1}$ . For  $n = 3, 5, 6$  and  $7^{19}$ , the  $\delta_5(\text{cyclic sec}/\text{prim}, \text{prim})$  equals  $-73, -73, -76$  and  $-73$ . We lack the  $n = 4$  exchange energy. None of our analysis precludes polycyclic species and so we consider 3-azabicyclo[3.2.2]nonane (**4**) for which the enthalpy of formation is known to be  $-43.6 \pm 0.9 \text{ kJ mol}^{-1}$ . While we know of no thermochemical data for the parent hydrocarbon, **5**, we need not be thwarted if we are willing to use estimates to guide us in other estimates. Let us use the enthalpy of formation of the 3-oxa derivative and the appropriate ether/methylene exchange energy from Reference 1.  $\Delta H_f(\text{g}, \text{5})$  is thus predicted to be  $-118 \text{ kJ mol}^{-1}$ . The resulting exchange energy of  $-74 \text{ kJ mol}^{-1}$  for the polycyclic  $n = 7$  species is consistent with both the monocyclic and acyclic analogs.

The third type of amines are the C-alkylated derivatives of the preceding type of species. Their thermochemical data are surprisingly sparse. One example is that of 2-methylpiperidine, a ring-containing analog of the unrepresented acyclic  $\delta_5(\text{sec}/\text{prim}, \text{sec})$  class of amines. From its literature value of  $-84.4 \pm 1.0 \text{ kJ mol}^{-1}$  and that of methylcyclohexane, we derive the desired exchange energy increment cyclic  $\delta_5(\text{sec}/\text{prim}, \text{sec}) = -68 \text{ kJ mol}^{-1}$ . The second example of this class of compounds is the highly toxic alkaloid 2-propylpiperidine (a.k.a. coniine). From Kharasch and Domalski, we find the nearly century-old enthalpy of formation for the liquid of  $-241 \text{ kJ mol}^{-1}$ . Combining this with an estimated  $\Delta H_v$  results in a value of  $-192 \text{ kJ mol}^{-1}$  for the enthalpy of formation of the gas. This value is incompatible with the *ca*  $-121 \text{ kJ mol}^{-1}$  value obtained by summing the enthalpy of formation of gaseous propylcyclohexane and  $\delta_5(\text{cyclic sec}/\text{prim}, \text{sec})$ . Is the century-old measurement wrong or is the fault in our estimation approach? We also consider as an example of the third type of compound, *trans*-decahydroquinoline, with its year-old reported enthalpy of formation<sup>20</sup> of  $-112.9 \pm 0.7 \text{ kJ mol}^{-1}$ . With this value and cyclic  $\delta_5(\text{sec}/\text{prim}, \text{sec})$  we would predict an enthalpy of formation of decalin, its hydrocarbon analog, of  $-181 \text{ kJ mol}^{-1}$  in splendid agreement with its archival experimental value of  $-182.1 \pm 2.3 \text{ kJ mol}^{-1}$ . We hesitate to argue that new data are more accurate than old data, although that is a good general guideline for the selection of  $\Delta H_f$  values.

The fourth type of amine is the *N*-alkylated derivatives of monoazacycloalkanes. Our archives include the enthalpies of formation of four conceptually simple liquid species: the *N*-alkylated piperidines where  $\text{R} = \text{Pr}, \text{Bu}, \text{Cyp}, \text{and Cyhx}$ . To assess the accuracy of the experimental enthalpies, we can employ a multi-step procedure involving estimation of the enthalpies of vaporization of the piperidines and of the monosubstituted cyclohexanes (where necessary) using the same procedure as before<sup>21</sup>, then using the value of  $\delta_6(\text{tert}/\text{R}, \text{R}^1, \text{R}^2)$  to 'derive' the enthalpy of formation of the monosubstituted cyclohexane and comparing the derived values for gaseous alkylcycloalkanes with experimental or semi-experimental values. Alternatively, we can confirm consistency of the piperidines by ascertaining how constant is the difference of the enthalpies of formation of liquid *N*-alkylated piperidine and alkylated cyclohexane<sup>22</sup>. Choosing the latter approach, we find the differences of the substituted piperidine and cyclohexane liquid enthalpies of formation to be 90, 91, 80 and 89  $\text{kJ mol}^{-1}$ . Three of the results are mutually consistent. Which, if any, is correct? Recall that our earlier logic suggested a 'constant' difference of enthalpies of formation of the gaseous species ( $\delta_6(\text{tert}/\text{R}, \text{R}^1, \text{R}^2)$ ) and a 'constant' difference of enthalpies of vaporization for arbitrary cases<sup>23</sup>. From these we can derive  $\delta_6(\text{liquid}, \text{tert}/\text{R}, \text{R}^1, \text{R}^2)$  as *ca* 89  $\text{kJ mol}^{-1}$ . It is the cyclopentylpiperidine that is the outlier while the other three amines are in excellent agreement.

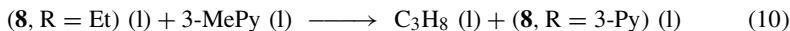
This success encourages us to consider the other monocyclic tertiary amines for which there are enthalpies of formation. In particular, consider *N*-(2-phenylethyl)azetidine (**6**),

the sole azetidines for which enthalpy of formation data seemingly are available. The natural comparison is with phenethylcyclobutane, for which we estimate an enthalpy of formation of the liquid of  $25 \text{ kJ mol}^{-1}$  by assuming thermoneutrality of the liquid-phase transalkylation reaction 9.



From this and  $\delta_6(\text{lq})$ ,  $\Delta H_f(\mathbf{6}, \text{lq})$  is predicted to be  $114 \text{ kJ mol}^{-1}$  compared to the experimental value of  $122 \text{ kJ mol}^{-1}$ . The comparatively large discrepancy is suggestive that azetidines, like cyclobutanes, enjoy unusual substituent effects.

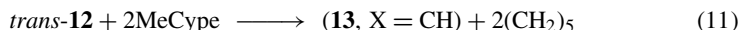
We now consider *N*-methyl-2-(3-pyridyl)pyrrolidine (**7**), also known as the alkaloid nicotine. Paralleling our discussion of coniine, we find in Kharasch and Domalski the nearly century-old enthalpy of formation for the liquid of  $39 \text{ kJ mol}^{-1}$ . Is this value plausible? With  $\delta_6(\text{liquid}, \text{tert/R}, \text{R}^1, \text{R}^2)$  necessary to transform a tertiary amine into the corresponding hydrocarbon<sup>24</sup>, we would conclude that the enthalpy of formation of liquid 1-methyl-2-(3-pyridyl)cyclopentane (**8**, R = 3-Py) is *ca*  $-50 \text{ kJ mol}^{-1}$ . To estimate the last datum in another way, we assume that equation 10 is essentially thermoneutral.



We derive the desired enthalpy of formation to be *ca*  $-12 \text{ kJ mol}^{-1}$ . The origin of the nearly  $40 \text{ kJ mol}^{-1}$  discrepancy eludes us. Again the age of the data is suggestive of problems.

The fifth and final type of amine are bicyclic tertiary amines, e.g. the isomeric quinuclidine (**9**) and pyrrolizidine (**10**). Do the earlier-derived gaseous and liquid  $\delta_6(\text{tert/R}, \text{R}^1, \text{R}^2)$  values remain valid? From the enthalpy of formation of gaseous bicyclo[2.2.2]octane (**11**) of  $-99 \pm 1.1 \text{ kJ mol}^{-1}$  we calculate an enthalpy of formation of  $-6 \pm 3 \text{ kJ mol}^{-1}$  for **9**. From the archival enthalpy of formation of gaseous *cis*-bicyclo[3.3.0]octane (**12**) of  $-92.9 \pm 1.5 \text{ kJ mol}^{-1}$ , we deduce an enthalpy of formation of pyrrolizidine of  $0 \pm 3 \text{ kJ mol}^{-1}$ . The literature values for these species are  $-4.2 \pm 1.3 \text{ kJ mol}^{-1}$  and  $-3.9 \text{ kJ mol}^{-1}$ , respectively<sup>25</sup>. That the hydrocarbons have a 6 kJ difference while the nitrogen compounds are identical is a surprise—this may reflect the uncertainty or error in the analysis, or the estimations of enthalpy of vaporization, both ours or from the literature. What about the liquid? Using temperature-uncorrected fusion enthalpies for solid **11** and **9**, we derive enthalpies for the corresponding liquids of  $-138$  and  $-49 \text{ kJ mol}^{-1}$ . The literature enthalpies of formation of liquid **10** and **12** are  $-136.0 \pm 1.3$  and  $-48.3 \pm 3.1 \text{ kJ mol}^{-1}$  resulting in a  $\delta_6$  of  $-87.7 \pm 3.4 \text{ kJ mol}^{-1}$ , in agreement with our previously suggested difference.

Consider now the *cis*-2,8-dimethyl-*trans*-pyrrolizidine (**13**, X = N), with its *trans*-ring fusion and its gas-phase enthalpy of formation of  $-66.7 \pm 2.6 \text{ kJ mol}^{-1}$ . The enthalpy of formation of the corresponding hydrocarbon, 2,8-dimethyl-*trans*-bicyclo[3.3.0]octane (**13**, X = CH) is estimated to be  $-126 \text{ kJ mol}^{-1}$  by assuming thermoneutrality of reaction 11.



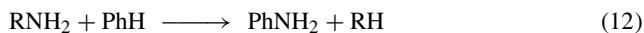
An exchange quantity,  $\delta_6(\text{tert/sec}, \text{sec}, \text{sec})$ , not previously calculated, is found to be *ca*  $-59 \text{ kJ mol}^{-1}$  from this example. By comparison with other exchange quantities in Table 2 this value seems inaccurate<sup>26</sup>. However, we note that the *cis/trans* enthalpy difference of pyrrolizidine (*ca*  $14 \text{ kJ mol}^{-1}$  from Reference 25) is significantly less than the *ca*  $26 \text{ kJ mol}^{-1}$  we deduce for bicyclooctane. This should not surprise us because trivalent nitrogen has been known to accommodate strain by partial or total planarization<sup>27</sup>.

#### IV. ANILINES AND OTHER AROMATIC AMINES

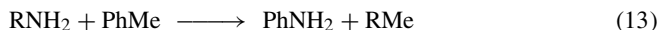
We now turn to the subject of aromatic amines. The number of classes of aromatic species vastly exceeds the number of classes of aliphatic and alicyclic amines. We somewhat arbitrarily consider mixed aromatic/ 'ali-' species such as *N,N*-dimethylaniline and *N*-methyldiphenylamine as aromatic and so they accompany the totally 'aromatic' triphenylamine instead of joining the totally 'ali-' species trimethylamine. However more numerous the compounds of potential interest, the number of relevant aromatic species for which there are appropriate thermochemical data is also few.

##### A. Aniline and *N*-Alkylated Anilines

The first compound of interest is aniline (**14**) itself. While drawings of its resonance structures permeate textbooks, the research literature acknowledges ambiguities as to its quantitation<sup>28</sup>. For example, there is a *ca* 38 kJ mol<sup>-1</sup> spread of plausible resonance energies for aniline as defined by the exothermicity of reaction 12



as R varies from Me to *t*-Bu. The authors of Reference 28 recommend R = *i*-Pr or *t*-Bu<sup>29</sup> for which the resonance energy of aniline (beyond that of benzene) is *ca* 17 and 9 kJ mol<sup>-1</sup> respectively. A related reaction



generates a resonance stabilization energy of *ca* -14 and -11 kJ mol<sup>-1</sup> for these two R groups. Further problems in defining resonance energies in aromatic amines arise as we consider *N*-alkylated anilines because we lack the enthalpy of formation of the reference aliphatic amines. For example, consider *N,N*-dimethylaniline (**15**). Equation 13 suggests the use of *i*-PrNMe<sub>2</sub> or *t*-BuNMe<sub>2</sub> but, regretfully, no enthalpies of formation have been reported for either species. We note that even the simpler question of the accuracy of the enthalpies of formation of *N*-alkylated anilines is problematic since these compounds are expected to oxidize and polymerize on standing, thus compromising the thermochemical measurement.

Since we recognize the enthalpy of reaction 13 as the difference of the exchange reactions  $\delta_4(\text{prim}/\text{Ph})$  and  $\delta_4(\text{prim}/\text{R})$ , let us calculate the exchange quantities  $\delta_4 - \delta_6$  using aromatic substituents and compare them to the values in Table 2. The data are sparse. From the enthalpies of formation of aniline (**14**) and *N,N*-dimethylaniline (**15**) and the corresponding alkyl benzenes, we can immediately calculate  $\delta_4(\text{prim}/\text{Ph}) = -36.7 \pm 1.2$  kJ mol<sup>-1</sup> and  $\delta_6(\text{tert}/\text{Ph}, \text{Me}, \text{Me}) = -96.5 \pm 4.8$  kJ mol<sup>-1</sup>. These quantities are less negative than their all-aliphatic counterparts. There are two experimental enthalpy-of-formation values in the literature<sup>30,31</sup> for *N*-methylaniline (**16**) and calculating  $\delta_5(\text{sec}/\text{Ph}, \text{Me})$  from either of them results in values which are compatible with the trend noted in Table 2. Remembering from a previous section that  $\delta_5$  is roughly the average of  $\delta_4$  and  $\delta_6$ , we directly calculate  $\delta_5(\text{sec}/\text{Ph}, \text{Me})$  as *ca* -67 kJ mol<sup>-1</sup> and thus the enthalpy of formation of *N*-methylaniline as *ca* 97 kJ mol<sup>-1</sup>. This result is compatible with the  $\Delta H_f$  derived from the enthalpy of reaction measurements<sup>31</sup> which is not so surprising. The near thermoneutrality of that measurement provides an experimental rationalization for our previous estimate of  $\delta_5$  from equation 8. In contrast, the value from the enthalpy of combustion measurements is quite different<sup>30</sup>.

A second assessment of the enthalpy of formation of **16** is made by extending equation 13 and its reaction enthalpy to include the *N*-methylated anilines **16** and **15**.

Difference quantity  $\delta_{14}(\text{Ph, Me})$  is defined independent of whether the amine be primary, secondary or tertiary.

$$\delta_{14}(\text{Ph, Me}) = [\Delta H_f(\text{PhNRR}^1) + \Delta H_f(\text{MeCHRR}^1)] - [\Delta H_f(\text{MeNRR}^1) + \Delta H_f(\text{PhCHRR}^1)] \quad (14)$$

We find the results  $-24 \pm 2$  and  $-14 \pm 5$   $\text{kJ mol}^{-1}$  for **14** and **15**, respectively. If equation 14 is accepted as a quantitative measure of resonance stability of anilines, then *N,N*-dimethylaniline has a lower resonance energy than the parent aniline. We would have expected the alkyl groups on nitrogen to stabilize the positive charge in the dipolar resonance structure and so, if anything, we would have expected *N,N*-dimethylaniline to have the higher resonance or stabilization energy. If  $\delta_{14}(\text{Ph, Me})$  for **16** is the average of the other two, the resonance energy of **16** interpolates that of **14** and **15**. The enthalpy of formation of the monomethylated species is thus calculated to be  $96 \pm 5$   $\text{kJ mol}^{-1}$ .

Consider *N*-ethylaniline (**17**) in concert with **16**. The literature enthalpy of formation of **17** is  $56.3 \pm 5.9$   $\text{kJ mol}^{-1}$ . The calculated  $\delta_5(\text{sec}/\text{Ph, Et})$  of *ca*  $-48$   $\text{kJ mol}^{-1}$  is not incompatible with the values in Table 2 and their aromatic extensions calculated above. One can estimate the enthalpy of formation **17** by assuming methyl/ethyl difference quantities are reasonably constant. Two such are equations 15 and 16.

$$\delta_{15}(\text{Me, Et}) \equiv [\Delta H_f(\text{g, MeNRR}^1) - \Delta H_f(\text{g, EtNRR}^1)] \quad (15)$$

$$\delta_{16}(\text{Me, Et}) \equiv \frac{1}{2}[\Delta H_f(\text{g, Me}_2\text{NR}) - \Delta H_f(\text{g, Et}_2\text{NR})] \quad (16)$$

There are data only for  $\text{R} = \text{H}$  and  $\text{R}^1 = \text{H}$ , resulting in difference quantities of 24.4 and 27.0  $\text{kJ mol}^{-1}$ . The enthalpy of formation of *N*-ethylaniline calculated using the average of  $\delta_{15}$  and  $\delta_{16}$  and each of the two literature values for *N*-methylaniline would be *ca* 59 and 70  $\text{kJ mol}^{-1}$ . The former value is closer to the literature value. Perhaps we should not be surprised because the same problems that may beset combustion measurements of the enthalpy of formation of *N*-methylaniline are likely to be applicable to *N*-ethylaniline, especially since measurements of both species appear in the same literature source.

## B. Primary Aromatic Amines Containing more than One Benzenoid Ring

Let us now turn to compounds with more than one benzenoid ring. The first species are the isomeric  $\alpha$ - and  $\beta$ -naphthylamines, **18a** and **18b**. The archival enthalpies of formation are found to be  $157.6 \pm 6.9$  and  $133.8 \pm 5.1$   $\text{kJ mol}^{-1}$ . The  $24 \pm 9$   $\text{kJ mol}^{-1}$  difference of these two numbers is incompatible with the near-zero difference of the enthalpies of formation for the isomeric naphthols, methyl- and bromonaphthalenes<sup>32</sup>. Which or either naphthylamine has the 'correct' enthalpy of formation? The gas-phase enthalpies of formation of the naphthols differ from their single benzene ring analog, phenol, by 66  $\text{kJ mol}^{-1}$  in close agreement with the difference between the methyl-naphthalenes and toluene, 63, and between the brominated and parent hydrocarbons,  $69 \pm 6$  and  $68 \pm 2$   $\text{kJ mol}^{-1}$  respectively. That is, it is plausibly asserted<sup>33</sup> that the difference quantities  $\delta_{17}$  are nearly constant and equal.

$$\delta_{17} = \Delta H_f(1\text{-NpX, g}) - \Delta H_f(\text{PhX, g}) = \Delta H_f(2\text{-NpX, g}) - \Delta H_f(\text{PhX, g}) \quad (17)$$

Taking an average phenyl/naphthyl enthalpy difference of  $66 \pm 3$   $\text{kJ mol}^{-1}$  results in a predicted enthalpy of formation of either naphthylamine of *ca* 153  $\text{kJ mol}^{-1}$ . Both naphthylamine values are problematic. The  $\alpha$ -isomer just fits this estimate by invoking allowances from large error bars. Interestingly, using the older enthalpies of (solid)



formation and of sublimation of **18b** (the same and sole references as for its isomer **18a**), we find an enthalpy of formation of the gaseous species to be  $150.9 \pm 6.8 \text{ kJ mol}^{-1}$ . Now, agreement between the enthalpy of formation of both **18a** and **18b** and with our expectation is confirmed<sup>34</sup>.

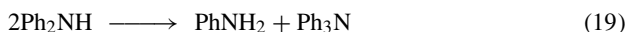
We now turn to derivatives of biphenyl. Our archives show a  $12.8 \pm 6.3 \text{ kJ mol}^{-1}$  difference in the enthalpies of formation of the 2- and 4-amine as solids<sup>35</sup>. Is this difference due to strain in the former species? One probe of the strain energy is to consider the enthalpies of reaction 12 for R = 2- and 4-PhC<sub>6</sub>H<sub>4</sub>.  $\delta_{12}$  for the 2-isomer equals  $1.5 \pm 2.6 \text{ kJ mol}^{-1}$ . We do not know what it is for the 4-isomer because we lack all phase-change enthalpy data for this species. Intuitively, this difference quantity should be 0 because no stabilizing or destabilizing effects are expected for this isomer. We thus conclude that 2-aminobiphenyl is essentially strain-free.

### C. Secondary and Tertiary Aromatic Amines

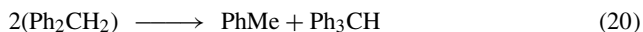
In this section we discuss the phenylamines. The first comparison involves the series NH<sub>3</sub>, PhNH<sub>2</sub> (**14**), Ph<sub>2</sub>NH (**19**) and Ph<sub>3</sub>N (**20**) and their corresponding enthalpies of formation of  $-45.94 \pm 0.35$ ,  $87.1 \pm 1.0$ ,  $219.3 \pm 3.0$  and  $326.8 \pm 4.1 \text{ kJ mol}^{-1}$ . It is interesting to note that the effects of sequential phenylation as manifested by the difference of  $\Delta H_f(\text{NH}_3)$  and  $\Delta H_f(\mathbf{14})$  and of  $\Delta H_f(\mathbf{14})$  and  $\Delta H_f(\mathbf{19})$ , are essentially equal,  $133.0 \pm 1.1$  and  $132.2 \pm 3.2 \text{ kJ mol}^{-1}$  respectively. This means that equation 18 is thermoneutral.



However, the difference of  $\Delta H_f(\mathbf{19})$  and  $\Delta H_f(\mathbf{20})$  is much less positive,  $107.5 \pm 5.1 \text{ kJ mol}^{-1}$ , suggesting that triphenylamine is more stable than we would have thought and/or diphenylamine is correspondingly less stable<sup>36</sup>. Equivalently, disproportionation reaction 19 is found to be  $25 \text{ kJ mol}^{-1}$  exothermic.



By comparison, the related reaction of the phenylmethanes



is more sensibly endothermic<sup>37</sup> by  $8.1 \pm 2.1 \text{ kJ mol}^{-1}$ . We assert 'sensibly' because steric repulsion between the phenyls destabilizes the phenylmethanes and we would have thought also the phenylamines as well. Furthermore, the general 'saturation' of conjugative effects would have suggested decreasing amounts of additional stabilization as the number of phenyls in the phenylamine increase. Finally, we note that the corresponding methyl reactions



are exothermic by *ca*  $9 \text{ kJ mol}^{-1}$  for both reactions.

### V. POLYAMINES

Earlier in this chapter we discussed the enthalpies of formation of both aliphatic and aromatic monoamines. We now turn to polyamines where an obvious question is whether the effect of multiple amino groups on enthalpies of formation is simply the additive effects

of the individual amino groups or whether there is any stabilization or destabilization in the molecule that results from the concurrent presence of more than one amino group.

### A. Aliphatic Diamines

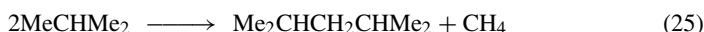
Let us start with aliphatic species and sequentially move the amino groups apart. We are seemingly thwarted immediately. There is no enthalpy of formation reported for methylenediamine (diaminomethane)  $\text{CH}_2(\text{NH}_2)_2$  (**21**), a species we recognize as the simplest polyaminoalkane. As such the exothermicity of reaction 22



cannot be directly determined so as to allow its use as a probe of intersubstituent effects. We are not surprised by the absence of the desired data. After all, this species has never been synthesized. However, in that the gas-phase enthalpies of formation of mono-, di- and trimethylamine have the same enthalpy of formation to within  $5 \text{ kJ mol}^{-1}$ , we are confident that we can learn about the enthalpy of formation of **21** by studying that of its *N,N,N',N'*-tetramethyl derivative, **22**, with its experimentally measured gas-phase value of  $-17.7 \pm 1.8 \text{ kJ mol}^{-1}$ . In the absence of any steric or electronic effects, the following reaction clearly would be thermoneutral:

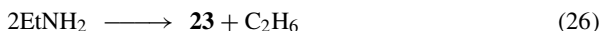


In fact, this reaction is exothermic by almost  $45 \text{ kJ mol}^{-1}$ . This exothermicity is consistent with anomeric effect reasoning<sup>38</sup>. Steric effects on the enthalpy of reactions 22 and 23 are expected to be small. After all, reactions 24 and 25—the all-hydrocarbon counterparts of reactions 22 and 23—are exothermic by  $-11.5 \pm 0.9$  and  $-7.7 \pm 1.5 \text{ kJ mol}^{-1}$  and so differ in their exothermicities by but 4 kJ.

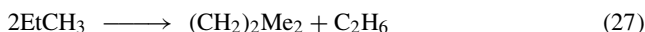


Let us assume that the difference in exothermicities between reactions 24 and 25 is the same as between 22 and 23. We thus conclude that reaction 22 will be exothermic by the exothermicity of reaction 23 and the difference of reactions 24 and 25. The net result is some  $45 + 4 = 49 \text{ kJ mol}^{-1}$ . The enthalpy of formation of **21** is predicted<sup>39</sup> to be *ca*  $-21 \text{ kJ mol}^{-1}$ .

If two amino groups *geminal*- to each other provide stabilization, what about *vicinal*- to each other? The archetype here is 1,2-diaminoethane or ethylenediamine,  $(\text{CH}_2)_2(\text{NH}_2)_2$  (**23**) with a gas-phase enthalpy of formation of  $-17.6 \pm 0.6 \text{ kJ mol}^{-1}$ . Reaction 26



is exothermic by *ca*  $5 \text{ kJ mol}^{-1}$  while its hydrocarbon counterpart, reaction 27

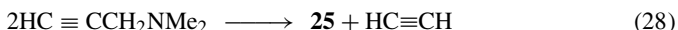


is thermoneutral to better than  $1 \text{ kJ mol}^{-1}$ . It appears that *vic*-diamino substitution is stabilizing<sup>40</sup> but not to as great an extent as *gem*-substitution. The enthalpy of formation of three C-alkylated ethylenediamines are known: the 1-Me, 1-Et and 1,1-Me<sub>2</sub> derivatives with corresponding gas-phase values of  $-53.6 \pm 0.5$ ,  $-74.0 \pm 0.8$  and  $-90.2 \pm 0.7 \text{ kJ mol}^{-1}$ . Another natural comparison for ethylenediamines is with the correspondingly alkylated ethylamines wherein a  $\text{CH}_2\text{NH}_2$  group is deaminated to form  $\text{CH}_3$ . Thus the three compounds above are deaminated to isopropylamine, 2-butylamine and *t*-butylamine,

respectively. The enthalpy of formation changes are  $-30$ ,  $-31$  and  $-31$   $\text{kJ mol}^{-1}$ , nearly the same as the  $-29.8$  found for the non-alkylated ethylenediamine  $\rightarrow$  ethylamine transformation.

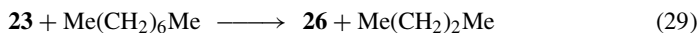
What about species where the two amino groups are further apart? Here the data are sparse. Consider now 1,4-diaminobutane (**24**) with a suggested<sup>41</sup> gas-phase enthalpy of formation of  $-65$   $\text{kJ mol}^{-1}$ . The amino groups are far apart in terms of the number of carbons that separate them, while the possibility of intramolecular interactions makes them potentially near. From summing  $\Delta H_f(n\text{-hexane})$  and twice the exchange increment  $\delta_5(\textit{prim/prim})$  we would have a value of only  $-57$   $\text{kJ mol}^{-1}$ . The difference of  $8$   $\text{kJ mol}^{-1}$  is suggestive of intramolecular hydrogen bonding.

Another interesting comparison involves *N,N,N',N'*-tetramethyl-2-butyne-1,4-diamine (**25**) for no hydrogen bonding is expected in any phase. The experimentally measured enthalpy of formation data are for the liquid. The following formal reaction can be written:



which we expect to be essentially thermoneutral. We accede to the fact that both amines are liquids and have decided against estimating the enthalpy of vaporization of both aminoalkynes. Instead, we estimate the enthalpy of condensation for acetylene to obtain the enthalpy of formation of the liquid. So doing, we find reaction 28 is endothermic by *ca*  $9$   $\text{kJ mol}^{-1}$ . This is a large discrepancy from our prediction, but there is reason to suspect enthalpy of formation values for acetylenic amines<sup>42</sup>.

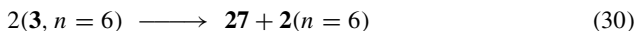
The last acyclic diamine we will discuss is 1,6-diaminohexane or hexamethylenediamine (**26**). How much interaction is there between the two amino groups? The desired enthalpy of formation is available in both condensed phases<sup>43</sup>,  $-205(\text{s})$  and  $-164(\text{lq})$ . If all hydrogen bonding and any other intersubstituent interaction were negligible, then reaction 29 would be thermoneutral.



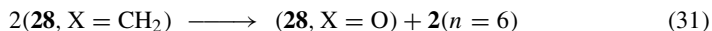
For both phases, thermoneutrality is found to within  $2$   $\text{kJ mol}^{-1}$ . Intramolecular hydrogen bonding in gaseous **26** is thus unlikely.

## B. Alicyclic Diamines

The simplest isolable species that fits this description is piperazine (**27**) with an enthalpy of formation<sup>44</sup> of  $29.4$   $\text{kJ mol}^{-1}$ . Can we reliably estimate this value in terms of the conceptually simpler acyclic amines, acyclic polyamines, alicyclic amines or other heterocycles? One may estimate it simply as the sum of the enthalpy of formation of cyclohexane (**2**,  $n = 6$ ) and twice the exchange energy,  $\delta_5$ . The predicted value is  $21$   $\text{kJ mol}^{-1}$ , suggestive of at least  $7$   $\text{kJ mol}^{-1}$  of strain. Do not forget that **27** should enjoy stabilization as befits its being a *vic*-diamine. This destabilization is twice that of piperidine (**3**,  $n = 6$ ) as relatedly defined by its measured enthalpy of formation and that estimated by summing the enthalpy of formation of cyclohexane and  $1 \cdot \delta_5$ . Equivalently, disproportionation reaction 30 is found to be thermoneutral.

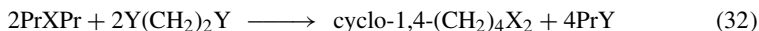


This should not be taken for granted. After all, the related oxygen disproportionation reaction involving tetrahydropyran and 1,4-dioxane (**28**, cyclo-1,4-X(CH<sub>2</sub>)<sub>4</sub> with X = CH<sub>2</sub> and O respectively)



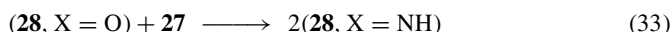
is endothermic by *ca*  $7$   $\text{kJ mol}^{-1}$ .

To compensate for the ignored vicinal interactions, consider now the formal reactions involving six-membered ring species (equations 32a, X = NH, Y = NH<sub>2</sub>; 32b, X = O, Y = OH; 32c, X = CH<sub>2</sub>, Y = Me):



Individually preserved are the numbers of CH<sub>2</sub> and Me; NH and NH<sub>2</sub> (primary and secondary amines); O and OH (ether and alcohol) groups. The 'C', 'N' and 'O' cases are *ca* thermoneutral, endo by 14 and endothermic by 23 kJ mol<sup>-1</sup> respectively. We conclude piperazine is strained and that piperazine interpolates its carbon and oxygen analogs, **2**(*n* = 6) and **28**(X = O).

The last comparison for piperazine involves a 1,4-diheterocyclohexane that has two different types of heteroatoms, morpholine (**28**, X = NH). We find the following disproportionation reaction:



is endothermic<sup>45</sup> by *ca* 2 kJ mol<sup>-1</sup>. The species with one nitrogen and oxygen apiece is the average of those with two.

We now turn to 1,4-diazabicyclo[2.2.2]octane (**29**). While the two nitrogens have long been thought to interact considerably from the vantage point of ionization energies and proton affinities<sup>46</sup>, it is not obvious that would also be deduced from examination of enthalpies of formation. The simplest probe of this interaction is the enthalpy of the following nitrogen transfer disproportionation reaction involving the bisaza **29** and the carbocyclic **11**:



This reaction is essentially thermoneutral in the gas phase as would have been expected in the absence of *vic*- and transannular interactions<sup>47</sup>. It would thus appear that conclusions drawn from neutral and ion thermochemistry need not be compatible<sup>48</sup>.

Consider now the monocyclic/acyclic + bicyclic exchange reaction



This reaction is endothermic by *ca* 18 kJ mol<sup>-1</sup>. It is tempting to identify the source of the destabilization as the three boat cyclohexanes (or, more properly, piperazines **29**) on the right<sup>49</sup>.

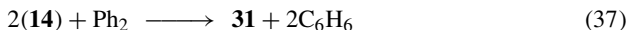
### C. Aromatic Diamines

We should naturally start with the three isomeric phenylene or benzene-diamines, **30o**, **30m** and **30p**. The literature is littered with confusing results. Our prejudice is to choose the enthalpies of formation  $-0.3 \pm 4.2$ ,  $-7.8 \pm 4.2$  and  $6.4 \pm 4.2$  kJ mol<sup>-1</sup> because they all come from the same source: Pedley recommends the same values for the *o*- and *m*-isomer but surprisingly chooses an earlier value of  $3.1 \pm 0.7$  kJ mol<sup>-1</sup> for the *p*-compound. We note more recent values for the *o*- and *m*-species that differ by *ca* 30 kJ mol<sup>-1</sup> from the archival ones—and in opposite directions<sup>50</sup>. Other than recommending new measurements, we abstain from attempting to evaluate these numbers. Hoping not to prejudice the experimentalist, we may nonetheless predict the enthalpies of formation for all three phenylenediamines as solids, liquids and gases free of any complicating intramolecular interactions. Assuming thermoneutrality for reaction 36

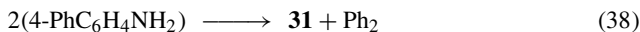


values of 2.6, 13.6 and 91.6 kJ mol<sup>-1</sup>, respectively, are found.

There are many possible diaminobiphenyls, but only for the 4,4'-species [a.k.a. benzidine (**31**)] are there enthalpy-of-formation data from this century<sup>51</sup>. Consider now the formal all-solid transamination reaction



This reaction is endothermic by 12 kJ mol<sup>-1</sup>. The formal monoamine 'conproportionation' reaction 38

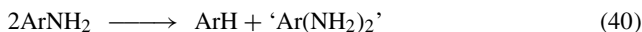


is endothermic by 8 kJ mol<sup>-1</sup>. What is the instability of solid **31** due to: physical state, structural or experimental effects? Both of these reaction enthalpies seem quite insignificant compared to that involving acetanilide and the corresponding diacetyl derivative of benzidine (**32**) in reaction 39.



Using literature values for all four substances results in an endothermicity of *ca* 80 kJ mol<sup>-1</sup>. This last value is suspect<sup>52</sup>.

We now consider heteroaromatic diamines with the condition that an amino group is not  $\alpha$  to a heterocyclic nitrogen. The only thermochemical data we can find are for 2,8-diaminoacridine for which the solid-phase enthalpy is 127  $\pm$  7 kJ mol<sup>-1</sup>. In the absence of significant substituent and solid state effects, thermoneutrality is expected for the conproportionation reaction 40 that produces diaminoarenes from monoamine derivatives.



From data in our archives, we derive an exothermicity for the diaminoacridine synthesis by *ca* 4  $\pm$  21 kJ mol<sup>-1</sup>. The large uncertainty obscures and thus compromises any thermochemical conclusion we should wish to make.

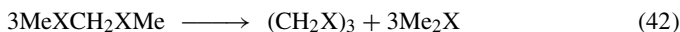
#### D. Alicyclic Triamines

The first species we will discuss is 1,3,5-trimethylhexahydro-1,3,5-triazine (**33**, X = NMe). The gas-phase trimerization enthalpy of *N*-methylmethylenimine (**34**), reaction 41, has been evaluated<sup>53</sup> to be -178 kJ mol<sup>-1</sup>.



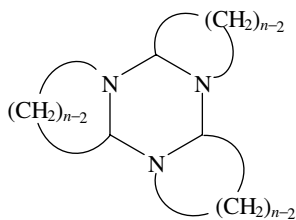
From gas-phase ion-molecule reactions we obtain<sup>54</sup> the necessary enthalpy of formation of **34**, 44  $\pm$  8 kJ mol<sup>-1</sup>, and so derive  $\Delta H_f(\mathbf{33}, \text{g})$  as equal to *ca* -46 kJ mol<sup>-1</sup>. Is this number plausible? We start with the trimerization enthalpy. Intuitively, this number for C=N bonded species should interpolate the trimerization enthalpy of species with C=C and C=O bonds. More precisely, since it is N and not C that is methylated, the trimerization enthalpy of **34** should be close to that of CH<sub>2</sub>NH. As such, this reaction enthalpy should interpolate that of CH<sub>2</sub>O and CH<sub>2</sub>CH<sub>2</sub>. Our thermochemical archive includes the enthalpies of formation of these latter two substances and of their trimers, 1,3,5-trioxane (**33**, X = O), and cyclohexane (alternatively identified as **33**, X = CH<sub>2</sub> and **2**, *n* = 6), from which derive the desired reaction enthalpies -140.1 and -276.0 kJ mol<sup>-1</sup> respectively. The reaction enthalpy for the X = NMe case interpolates that of X = CH<sub>2</sub> and X = O as expected from size and electronegativity reasoning.

We can also consider the formal reactions 42



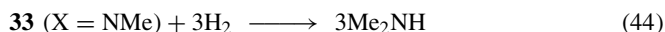
for  $X = O, CH_2$  and  $NMe$ . We find these reactions are *ca*  $27 \text{ kJ mol}^{-1}$  endothermic, 3 endothermic and 64 exothermic, respectively. The nitrogen value is out of line. We acknowledge that the enthalpy of formation of  $CH_2NH$  is a subject of major dispute<sup>55</sup> and so, by inference, is that of its  $N$ -methylated derivative.

From liquid-phase hydrogenation studies<sup>56</sup>, we can derive the enthalpy of formation of the perhydro-tris[1,2-*a*: 3,4-*c*: 5,6-*e*]pyrrolo-1,3,5-triazine and of perhydro-tris[1,2-*a*: 3,4-*c*: 5,6-*e*]pyrido-1,3,5-triazine (**35** with  $n = 5$  and 6, respectively). Correcting for medium effects in directly measured enthalpies of solution, hydrogenolysis reaction 43



(35)

is found to be exothermic by 105 and  $127 \text{ kJ mol}^{-1}$  respectively for  $n = 5$  and  $n = 6$ . This results in liquid-phase enthalpies of formation of **35** for  $n = 5$  and 6 respectively of  $-18$  and  $-132 \text{ kJ mol}^{-1}$  respectively. These values are not particularly consistent with each other. The 5,6 ring fusion in **35** ( $n = 5$ ) and the 6,6 ring fusion in **35** ( $n = 6$ ) should not result in any significant strain effects. Furthermore, the  $H-H$  repulsion arising from inter-5-membered ring interactions should be comparable to the corresponding 6-membered ring interactions. What about that of the monocyclic **33** ( $X = NR$ )? Let us make the comparison of liquid-phase thermochemical studies of either **35** with that of its gas-phase monocyclic analog **33** ( $X = NMe$ ) by use of formal reaction 44



The results are not particularly consistent here either. This last reaction, exothermic by *ca*  $-206 \text{ kJ mol}^{-1}$ , is not consistent with either result in equation 43. We strongly doubt the principal source of error is the difference of choice of phases employed<sup>57</sup>. The difference of the hexahydrotriazine enthalpies of formation,  $-18 - (-132) = 114 \text{ kJ mol}^{-1}$ , is comparable to three times the difference of liquid pyrrolidine and piperidine,  $132 \text{ kJ mol}^{-1}$ . (The difference for other pairs of corresponding 5- and 6-membered ring species includes  $166 \text{ kJ mol}^{-1}$  for cyclopentane and cyclohexane, and 162 for perhydroindene and decalin.) The origin of the *ca* 20 and  $50 \text{ kJ mol}^{-1}$  discrepancies remains enigmatic.

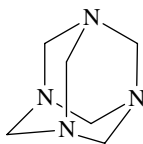
## E. Tetramines

The first tetramine we will discuss is the acyclic  $N,N'$ -bis-(2-aminoethyl)propane-1,3-diamine (**36**) with an accompanying gas-phase enthalpy of formation<sup>58</sup> of  $0.0 \pm 3.3 \text{ kJ mol}^{-1}$ . In the absence of intramolecular hydrogen bonding and any *vic*- and more distant diamine effects, this value could be estimated by summing the enthalpy of formation of  $n$ -undecane,  $2\cdot\delta_4$  and  $2\cdot\delta_5$ . The calculated value is  $-17 \text{ kJ mol}^{-1}$ . Because the calculated enthalpy of formation is more negative than the experimentally measured

quantity, it suggests that the gaseous tetramine **36** is destabilized. It is unclear in what way **36** could be destabilized.

The next tetramine we will discuss is the monocyclic 1,4,8,11-tetraazacyclotetradecane (**37**) with an accompanying gas-phase enthalpy of formation<sup>58</sup> of  $18.0 \pm 3.3 \text{ kJ mol}^{-1}$ . Summing the most recent value for the enthalpy of formation of its carbocyclic analog, cyclotetradecane<sup>59</sup> ( $278 \text{ kJ mol}^{-1}$ ), and  $4\cdot\delta_5$  results in a predicted value of  $22 \text{ kJ mol}^{-1}$ . Ignoring any consequence of intramolecular hydrogen bonding and *vic*- and other diamine effects, we find agreement is satisfactory.

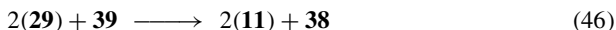
We now turn to one of the longest known, simplest and most symmetric polyamines—1,3,5,7-tetraazaadamantane (a.k.a. hexamethylene tetramine) (**38**). Is this species strained? A related but simpler question asks whether the ‘parent carbocycle’ adamantane (**39**) is strained. The answer to this latter question depends on the author. Some argue that its structural rigidity results in unavoidable geometric distortions and thus strain<sup>60</sup> while others have used adamantane as a strainless reference state for deriving strain of other hydrocarbons<sup>61</sup>. Perhaps a fairer question<sup>62</sup> to ask is whether **38** is more or less strained than **39**. In the absence of any additional interactions, the enthalpy of formation of **38** may be estimated as the sum of that of **39** and  $4\cdot\delta_6$ . We find that the tetramine is stabilized relative to the hydrocarbon by  $38 \text{ kJ mol}^{-1}$ . The degree of stabilization is surprisingly large. However, we observe that the tetramine has an extensive collection of stabilizing *gem*-diamine units; there are six N–C–N units found in it. As with other stabilizing interactions, optimal stabilization by two geminal amino groups requires a specific orientation of the substituents. The acyclic diamine has considerably more flexibility than the tetramine to approximate this orientation while the tetramine lacks this flexibility. Additionally, stabilizing effects tend to saturate. As such, parallelling equation 23, we consider the formal reaction



(38)

We do not expect an exothermicity of  $ca\ 6\cdot45 = 270 \text{ kJ mol}^{-1}$  as would be found for six independent *gem*-diamino groups: it is exothermic by *only*  $153 \text{ kJ mol}^{-1}$ , a large and impressive number.

The final comparison we will make in this section considers the formal reaction



This reaction conserves the number of  $>\text{CH}-$ ,  $-\text{CH}_2-$  and tertiary amine groups, as well as both boat and chair six-membered rings. What are not conserved are the number of vicinal and geminal diamino groups. The left-hand side has 6 of the former and the right-hand side has 6 of the latter. We find the reaction is exothermic by  $ca\ 45 \text{ kJ mol}^{-1}$  for gas-phase species and  $32 \text{ kJ mol}^{-1}$  for solids. Our prejudice for geminal stabilization being more significant than vicinal is validated, although the degree of stabilization is less than we would have anticipated from the acyclic species discussed earlier in this section<sup>63</sup>.

## VI. NITROSO COMPOUNDS

Despite the plethora of amines and nitro compounds for which enthalpies of formation are available, there are few nitroso compounds for which we have the desired data. This difference, in part, reflects the comparative interest in the three classes of compounds. Amines are precursors of numerous bioactive compounds, chelating agents and dyes; nitro compounds are precursors of amines and many are components of explosives. By contrast, nitroso compounds are seemingly less important and therefore less likely to be available in the purity, quantities and structural diversity wished for by the thermochemically inclined scientist. In addition, we acknowledge the difficulty of synthesizing nitroso compounds by either reduction of the corresponding nitro compounds or by oxidation of the corresponding primary amines. Most importantly, perhaps, is that many putative nitroso compounds normally exist as the isomeric oximes<sup>64</sup>, while others are normally found as their azo-dioxy dimers<sup>65</sup>. As such, the energetics of tautomer and monomer/dimer interconversion are additional, nontrivial measurements that need to be made in order to acquire the desired nitroso 'number'<sup>66</sup>. We note that few direct measurements have been reported since Batt's chapter in this series<sup>8</sup>.

### A. Nitrosobenzene and Its Methylated Derivatives

Through a collection of indirect measurements, the enthalpy of formation of gaseous nitrosobenzene (**40**) has recently been reevaluated<sup>67</sup> to be  $210 \pm 8 \text{ kJ mol}^{-1}$ , in interesting comparison to those values reported earlier<sup>68</sup>. The need for indirect, i.e. not 'simple', combustion and phase-change measurements is unavoidable for this species because nitrosobenzene is normally dimeric.

Although likewise unequivocally dimeric as solids, 2,6-dimethyl- and 2,4,6-trimethylnitrosobenzene (**41** and **42**) allow for relatively unequivocal thermochemical analysis of both the monomeric and dimeric gases. The desired enthalpies of formation<sup>67</sup> of monomeric **41** and **42** are  $207.3 \pm 12.3$  and  $140.6 \pm 12.5 \text{ kJ mol}^{-1}$  respectively. Are these values for the enthalpies of formation of nitrosobenzene derivatives consistent with each other? The first comparison considers the difference of the enthalpies of formation of nitroso and nitro compounds,  $\text{ArNO}$  and  $\text{ArNO}_2$ ,  $\delta_{47}(\text{Ar}; \text{NO}, \text{NO}_2)$ :

$$\delta_{47}(\text{Ar}; \text{NO}, \text{NO}_2) \equiv \Delta H_f(\text{ArNO}, \text{g}) - \Delta H_f(\text{ArNO}_2, \text{g}) \quad (47)$$

For  $\text{Ar} = \text{Ph}$ , 2,6- $\text{Me}_2\text{C}_6\text{H}_3^-$  and 2,4,6- $\text{Me}_3\text{C}_6\text{H}_2^-$ , the three difference quantities equal  $143 \pm 8$ ,  $131.2 \pm 2.3$  and  $134.2 \pm 2.9 \text{ kJ mol}^{-1}$ . Although within experimental error these three numbers are essentially equal, the spread between the methylated and non-methylated compounds may be significant.

The next comparison entails the difference of the enthalpies of formation of the nitroso and correspondingly methylated benzene,  $\delta_{48}(\text{Ar}; \text{NO}, \text{Me})$ :

$$\delta_{48}(\text{Ar}; \text{NO}, \text{Me}) \equiv \Delta H_f(\text{ArNO}, \text{g}) - \Delta H_f(\text{ArMe}, \text{g}) \quad (48)$$

For  $\text{Ar} = \text{Ph}$ , 2,6- $\text{Me}_2\text{C}_6\text{H}_3^-$  and 2,4,6- $\text{Me}_3\text{C}_6\text{H}_2^-$ , the three difference quantities equal<sup>69</sup>  $160 \pm 8$ ,  $149.3 \pm 2.0$  and  $151.8 \pm 2.3 \text{ kJ mol}^{-1}$ . Again, within experimental error, these three numbers are essentially equal, exhibiting the same pattern in the spread of values. We recall the near constancy<sup>70</sup> of the related difference  $\delta(\text{Ar}; \text{COOH}, \text{Me})$ .

What about the difference  $\delta_{49}(\text{Ar}; \text{NO}, \text{H})$ .

$$\delta_{49}(\text{Ar}; \text{NO}, \text{H}) \equiv \Delta H_f(\text{ArNO}, \text{g}) - \Delta H_f(\text{ArH}, \text{g}) \quad (49)$$

For  $\text{Ar} = \text{Ph}$ , 2,6- $\text{Me}_2\text{C}_6\text{H}_3^-$  and 2,4,6- $\text{Me}_3\text{C}_6\text{H}_2^-$ , the three difference quantities equal<sup>69</sup>  $127 \pm 8$ ,  $122.5 \pm 1.9$  and  $123.3 \pm 2.3 \text{ kJ mol}^{-1}$ . Within experimental error, these three



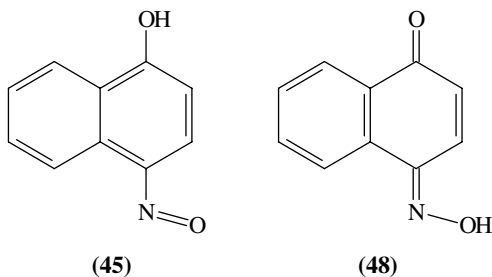
numbers are essentially equal and the spread between methylated and non-methylated species has decreased. That these difference quantities are essentially independent of methylation suggests weak interaction between the nitroso group and the rest of the molecule.

## B. Nitrosobenzene and Amino Substitution

Direct calorimetric measurements on a monomeric nitroso compound with a strong interaction between the nitroso group and the rest of the molecule are possible for the 4-(*N,N*-dimethylamino)nitrosobenzene (**43**). We adopt here the recently measured values<sup>71</sup> for the enthalpy of formation of  $103.0 \pm 1.6$  and  $185.0 \pm 2.3$  kJ mol<sup>-1</sup> for the solid and gaseous species respectively<sup>72</sup> and now examine the values for aforementioned  $\delta_{47}$ ,  $\delta_{48}$  and  $\delta_{49}$ . Using the enthalpy of formation of 4-(*N,N*-dimethylamino)nitrosobenzene (**44**) from Reference 71 as well<sup>73</sup>,  $\delta_{47}$  is found to be  $122.2 \pm 3.5$  kJ mol<sup>-1</sup>. This value is significantly less than that found for the other nitroso compounds and suggests that there is more nitroso/amino conjugative stabilization in **43** than nitro/amino conjugative stabilization in **44**. We welcome the corresponding comparison with the 3-isomers of **43** and **44** where no such conjugative stabilization is customarily proposed. We cannot make use of  $\delta_{48}$  because we lack enthalpy-of-formation data for the desired 4-*N,N*-trimethylaniline<sup>74</sup>.  $\delta_{49}$  equals  $84.0 \pm 3.2$  kJ mol<sup>-1</sup>, suggestive of *ca* 40 kJ mol<sup>-1</sup> of stabilization in **43**.

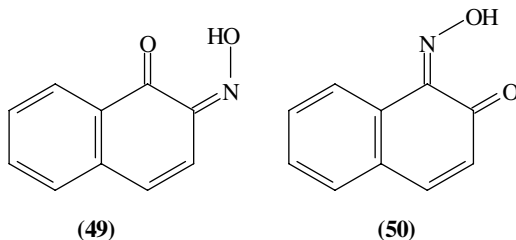
## C. Nitrosoarenoles

What about  $\pi$ -electron donor substituents on nitrosoarenes other than dimethylamino? Pedley gives us the enthalpies of formation for three hydroxy derivatives: the isomeric 4-nitroso-1-naphthol, 2-nitroso-1-naphthol and 1-nitroso-2-naphthol, species **45–47** respectively. Of the three species, only the first cannot have an intramolecular hydrogen bond. By analogy to nitrophenols<sup>75</sup>—there being no thermochemical data for the more related and hence relevant nitronaphthols—we expect that species **46** would be less stable than **45**. After all, gaseous 2-nitrophenol is *ca* 20 kJ mol<sup>-1</sup> less stable than its 4-isomer. We recall from the discussion of the isomeric naphthylamines that 1- and 2-naphthol are of almost identical stability. This suggests that species **46** and **47** should be of comparable stability. Both expectations are sorely violated by the literature results: the enthalpies of formation of species **45**, **46** and **47** increase in the order  $-20.3 \pm 4.9$ ,  $-5.4 \pm 6.2$  and  $36.1 \pm 4.7$  kJ mol<sup>-1</sup> respectively. If there is experimental error, where does the error lie?

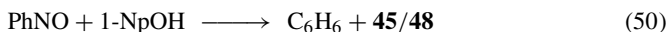


One possibility is that these species should be described as naphthoquinone oximes<sup>76</sup> in which case species **45**, now redrawn as **48**, is recognized as a 1,4-naphthoquinone

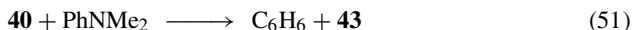
derivative and so more stable than the 1,2-naphthoquinone derivatives, **49** and **50** respectively. Another possibility is an error in the measurement of the enthalpy of sublimation. Regardless of the resolution of the nitroso/oxime dichotomy, we cannot explain why the phase-change enthalpies of species **46/49** and **47/50** should differ by some  $30 \text{ kJ mol}^{-1}$ . The seeming discrepancy in the sublimation enthalpies of species **46/47** and **47/50** is about the same as the discrepancy in the enthalpies of formation of these species as gases. The difference for the solids is much smaller and much more reasonable,  $11.3 \pm 5.0 \text{ kJ mol}^{-1}$ .



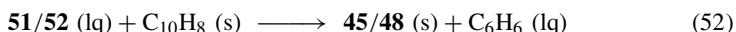
There is also the possibility that the enthalpy of combustion is in error. Because there is no possibility of intramolecular hydrogen bonding, the 1,4-disubstituted species, **45/48**, is expected to be the most 'normal'. Consider the formal reaction



Accepting the above enthalpy of formation of nitrosobenzene and the archival values for the other species, this reaction is deduced to be *ca*  $60 \text{ kJ mol}^{-1}$  exothermic. This nitroso/hydroxy induced stabilization value is perhaps not unreasonably large—for comparison, the corresponding nitroso/dimethylamino stabilization value in equation 51 is  $43 \pm 10 \text{ kJ mol}^{-1}$ .



Pedley cites as his primary source for **43** a reference from 1968 and ignores the early 20th century sources given by Kharasch<sup>2a</sup>. For the three solid-phase nitrosonaphthols/naphthoquinone oximes, we find the enthalpies of combustion from the former archive are  $-4827.2$ ,  $-4873.6$  and  $-4884.9 \text{ kJ mol}^{-1}$  and from the latter archive are  $-4868.3$ ,  $-4885.6$  and  $-4882.6 \text{ kJ mol}^{-1}$ . If we assume the enthalpy of sublimation of species **45/48** is correct and we use the earlier enthalpy of formation, then reaction 50 is exothermic by only *ca*  $20 \text{ kJ mol}^{-1}$ . Interestingly, Kharasch gives us the enthalpy of combustion of 4-nitrosophenol (**51**) (or is it benzoquinone oxime, **52**?) which comes from the same primary source as its naphthalene siblings **45–50**. Using these data, but benzene and naphthalene from Pedley, we find the mixed phase reaction



to be some  $7 \text{ kJ mol}^{-1}$  exothermic. This result is preeminently plausible as is the near-thermoneutrality of the mixed-phase quinone reaction



using the enthalpy of formation of the quinones from Pedley, and the requisite fusion enthalpy of *p*-benzoquinone from Pedley and Domalski respectively. A reinvestigation of the various enthalpies of formation and of sublimation presented in this section is in order<sup>77</sup>.

### D. Aliphatic Nitroso Compounds

Despite the above enunciated difficulties in obtaining pure nitroso compounds for conventional calorimetric measurements, gas-phase chemists have been active in devising methods for obtaining the C–NO bond enthalpy of monomeric nitroso species. In principle—and in practice—the desired enthalpy of formation of RNO may be obtained if we know the enthalpy of formation of both NO and the organic radical<sup>78</sup>. One such method consists of directly determining the rates of gas-phase reaction 54



in both directions<sup>79</sup> and deconvoluting the desired enthalpy and entropy of reaction from the observed gibbs energy. Another method involves the direct photochemical cleavage of RNO with monochromatic photons and making assorted corrections from the threshold measurement to the thermochemical quantity of interest at 298 K.

The authors of primary Reference 80 present their own and selected literature values for the R–NO bond enthalpies for the hydrocarbyl cases of Me, Et, *t*-Bu, allyl and benzyl, as well as mixed fluorinated, chlorinated methyl radicals. We now wish to compare nitroso species with the corresponding amino and nitro compounds. Choosing what we consider the most reliable and relevant nitroso compound data, and accompanying them with the corresponding radical data, we derive enthalpies of formation of gaseous nitrosomethane, 2-methyl-2-nitrosopropane and  $\alpha$ -nitrosotoluene<sup>81</sup> to be  $65 \pm 2$ ,  $-29 \pm 4$  and  $174 \pm 7$  kJ mol<sup>-1</sup>. (By comparison, the earlier values recommended<sup>8</sup> for nitrosomethane and 2-methyl-2-nitrosopropane were 70 and  $-42$  kJ mol<sup>-1</sup> respectively.)

In order to estimate the enthalpies of formation of nitroso compounds from the corresponding amine or nitro compounds, we derive difference quantities  $\delta_{55}$  and  $\delta_{56}$ . The nitroso/amino difference quantity  $\delta_{55}(\text{NO}, \text{NH}_2; \text{R})$  is defined by

$$\delta_{55}(\text{NO}, \text{NH}_2; \text{R}) \equiv \Delta H_f(\text{RNO}, \text{g}) - \Delta H_f(\text{RNH}_2, \text{g}) \quad (55)$$

and the nitroso/nitro difference quantity is defined by

$$\delta_{56}(\text{NO}, \text{NO}_2; \text{R}) \equiv \Delta H_f(\text{RNO}, \text{g}) - \Delta H_f(\text{RNO}_2, \text{g}) \quad (56)$$

For R = Me, *t*-Bu and PhCH<sub>2</sub>,  $\delta_{55}(\text{NO}, \text{NH}_2; \text{R})$  equals  $88 \pm 2$ ,  $90 \pm 4$  and  $86 \pm 7$  kJ mol<sup>-1</sup>. For R = Me, *t*-Bu and PhCH<sub>2</sub>,  $\delta_{56}(\text{NO}, \text{NO}_2; \text{R})$  equals  $139 \pm 2$ ,  $146 \pm 5$  and  $143 \pm 7$  kJ mol<sup>-1</sup>. Ignoring all error bars, the range of values is smaller for the  $\delta_{55}$  and thus we conclude that estimation from the corresponding amine is more reliable. Nonetheless, in that both sets of values of  $\delta_{55}$  and  $\delta_{56}$  are so comparably independent of R makes us conclude that the NH<sub>2</sub>, NO and NO<sub>2</sub> groups are surprisingly similar.

We conclude this section with discussion of the question of whether these enthalpies of formation for MeNO, *t*-BuNO and PhCH<sub>2</sub>NO are 'plausible'? Should we wish to use solely experimentally measured quantities, the thermochemically instructive comparison of hydrogen and alkyl derivatives<sup>14</sup> is complicated in the current case by the fragility of HNO and the seeming nonexistence of H–NO<sub>2</sub>. Comparison with aryl derivatives seems precarious because we are convinced of conjugation with the aromatic ring. As is recalled from organic chemistry classes, amino is strongly  $\pi$ -electron donating and nitro is strongly  $\pi$ -electron withdrawing. There is thus no way that nitroso can mimic both groups<sup>82</sup>. Indeed, the difference of the enthalpies of formation of aniline and nitrosobenzene is  $123 \pm 8$  kJ mol<sup>-1</sup>, some 30 kJ mol<sup>-1</sup> higher than found for the above saturated nitroso and amino compounds. By contrast, the  $142 \pm 8$  kJ mol<sup>-1</sup> difference for nitrosobenzene and nitrobenzene is nearly the same as for the above aliphatic species. This is compatible

with the conclusion<sup>83</sup> that nitrobenzene lacks net resonance stabilization by its conjugation of the nitro group and aromatic ring, while aniline is stabilized with its amino group. Acknowledging seeming consistency, we close with the admission that lacking a trustworthy calorimetric bench mark for any RNO species where R is a saturated (tetracoordinate) carbon allows for the possibility that the current values may be replaced by still newer values, to be prominently featured in the next amino/nitroso/nitro Patai supplement 'F3').

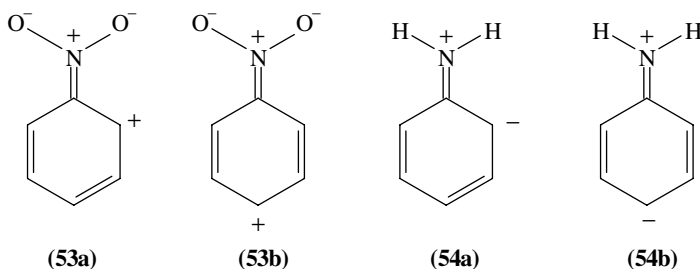
## VII. AROMATIC NITRO COMPOUNDS

### A. The Roles of Resonance and Steric Effects: Molecular Families and Reference States

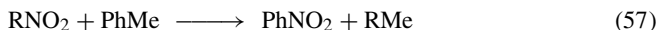
Numerous aromatic nitro compounds have explosive properties, and thus it is important to understand the role that enthalpy of formation has on the sensitivity and long-term stability of these compounds. We will examine three nitro-substituted aromatic families for which thermochemical data can be found in the literature<sup>2,84</sup>: derivatives of nitrobenzene, aniline and toluene. The choice of these three families allows us to compare the various electronic effects exerted by the parent functional group. The parent compounds differ electronically with respect to the aromatic ring in that:

- the nitro group of nitrobenzene is both  $\sigma$ - and  $\pi$ -electron withdrawing,
- the amino group of aniline is  $\pi$ -electron donating but  $\sigma$ -electron withdrawing,
- the methyl group of toluene has only a slightly inductive  $\sigma$ -electron donating effect into the aromatic ring.

Ionic or dipolar valence-bond resonance structures of nitrobenzene (**53a,b**) and aniline (**54a,b**) illustrate the difference of  $\pi$ -electron density in the ring of these two compounds<sup>85</sup>.

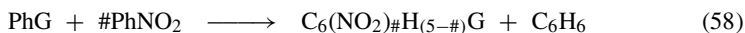


Because of the opposite nature of the  $\pi$  interactions between the ring and either the nitro or the amino substituent, let us assess the stabilization energies of nitrobenzene and aniline. In equation 13, the resonance stabilizing energy of aniline was defined as the exothermicity of a reaction involving arbitrary reference states. By analogy to equation 13, we may write equation 57 for nitrobenzene and the same arbitrary reference states, R = *i*-Pr or *t*-Bu.



For these two R groups the reaction is endothermic by 22 and 26 kJ mol<sup>-1</sup> and so nitrobenzene is seriously destabilized relative to our chosen reference states. Resonance energy most generally arises from stabilizing  $\pi$  interactions. That nitrobenzene is planar and has hindered rotation around the C–N bond attests to  $\pi$  interactions between the ring and the nitro group. However, there are also powerful inductive  $\sigma$  interactions between the ring and the electron-withdrawing NO<sub>2</sub> group. These are destabilizing<sup>86</sup>—far more so than those between the ring and the less  $\sigma$ -withdrawing NH<sub>2</sub> group. Accordingly, the  $\pi$  stabilization and the ‘true’ resonance energy of aniline is less ameliorated than that of nitrobenzene.

The comparisons we will make within each family involve experimental enthalpies of formation and the derived enthalpy of destabilization (DSE). If there are no intramolecular interactions in the nitrosubstituted parent compound, equation 58 would be thermo-neutral.



A numerical value for the net destabilization (or stabilization) for a species is the DSE, which is expressed in equation 59.

$$\text{DSE} = \{ \Delta H_f(\text{PhG}) + \# \cdot \Delta H_f(\text{PhNO}_2) - \# \cdot \Delta H_f(\text{C}_6\text{H}_6) \} - \Delta H_f(\text{C}_6(\text{NO}_2)\#\text{H}_{(5-\#)}\text{G}) \quad (59)$$

where G = NO<sub>2</sub>, NH<sub>2</sub> or CH<sub>3</sub>; # is the number of nitro substituent groups; and where all species are in the same physical state. The resultant value inside the brackets { } is the additivity-calculated value for the compound of interest. If the experimentally measured enthalpy of formation, the last term in equation 59, is more positive than the additivity result, the totality of the intramolecular interactions has produced a destabilization of the molecule, denoted by a negative sign. Stabilization of the molecule is occurring if the calculated DSE is a positive value. From the definition it is seen that the greater the negative value found for DSE, the greater the destabilization while the more positive the value found for DSE, the greater the stabilization.

## B. Nitrobenzenes

Table 3 presents the experimental enthalpies of formation of polynitrobenzenes and Table 4 presents the calculated additivity values and DSEs for these same compounds. Enthalpy-of-formation values have been determined experimentally for all three dinitrobenzene isomers in the gaseous state. The enthalpy-of-formation difference between the *meta* and *para* isomers is indistinguishable from 0. Conventional wisdom suggests that the *para* isomer should be destabilized relative to the *meta* because of adjacent positive charges in key ionic or polar resonance structures. Thus it seems that electronic effects due to *meta/para* dinitro substituent position are small. This small enthalpy-of-formation difference is similar to that for the *meta* and *para* dicyano, difluoro and dichloro benzenes, but does not mimic the *ca* 22 kJ mol<sup>-1</sup> difference for the phthalic acids with which the

TABLE 3. Enthalpies of formation of polynitrobenzenes (including benzene and nitrobenzene)<sup>a</sup>

#	Solid	Liquid	Gaseous	Reference
0	39.0	49.0 ± 0.6	82.6 ± 0.7	
1	0.9	12.5 ± 0.5	67.5 ± 0.5	
2 ( <i>o</i> -)	-1.8 ± 0.7	21.2 ± 0.8	86.0 ± 2.3	
( <i>m</i> -)	-27.4 ± 0.5	-6.9 ± 0.6	59.6 ± 0.9	
( <i>p</i> -)	-38.7 ± 0.5	-5.2 ± 1.3	59.9 ± 2.6	
3 (1,3,5-)	-37.2 ± 0.5	-20.4 ± 0.6	62.4 ± 2.1	
(1,3,5-)	-14.1			84
(1,2,4-)	-19.7			2b
(1,2,4-)	29.0			84
6	126			90
	199.2			90

<sup>a</sup>In kJ mol<sup>-1</sup>.

TABLE 4. Calculated destabilization enthalpies of the polynitrobenzenes (kJ mol<sup>-1</sup>)

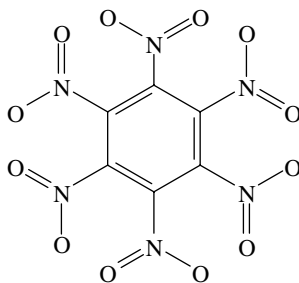
#	Additivity enthalpy			Calculated destabilization		
	solid	liquid	gaseous	solid	liquid	gaseous
2	-37.2	-24.0	52.4			
( <i>o</i> -)				-35.4	-45.2	-33.6
( <i>m</i> -)				-9.8	-17.1	-7.2
( <i>p</i> -)				1.5	-18.8	-6.9
3	-75.3	-60.5	37.3			
(1,3,5-)				-38.1	-40.1	-25.1
(1,2,4-)				-55.6		
6	-190			-316 <sup>a</sup>		
				-389 <sup>a</sup>		

<sup>a</sup>We have insufficient information to decide between the two enthalpies of formation of hexanitrobenzene (from Reference 90) and so give destabilization enthalpies corresponding to each source.

dinitrobenzenes are isoelectronic. The difference between the *ortho* and *meta/para* isomers is *ca* 26 kJ mol<sup>-1</sup> and may be attributed to steric interaction. One reason that the *ortho* steric interaction is so great is because the strain is partially relieved by rotation of a nitro group from planarity with the ring, thereby losing conjugation and raising the energy of the  $\pi$  system<sup>87</sup>. However, in the solid state the *para* isomer is more stable than the *meta*, paralleling the difference found for the phthalic acids. To result in such a difference, the lattice energy of the *para* isomer must be greater than that of the *meta* isomer<sup>88</sup>.

The solid-phase enthalpy-of-formation data for the 1,2,4- and 1,3,5-trinitrobenzenes are wildly discrepant. Whichever of them are compared, the 1,2,4-trinitrobenzene isomer is less stable than the 1,3,5-isomer. The dominant destabilization of the 1,2,4-isomer is probably due to the *ortho* dinitro interaction. We would welcome enthalpy-of-formation data on the 1,2,3-trinitrobenzene isomer.

The compound with the maximum steric interactions is hexanitrobenzene (HNB) (55) with nitro groups at every ring position. The X-ray crystal structure<sup>89</sup> showed the nitro groups were rotated by 53° around their C–N bond axes. This gives a distance between the oxygens of 2.88 Å instead of 1.55 Å as would be found in a completely planar model. The calculated<sup>90</sup> DSE is over 300 kJ mol<sup>-1</sup>. The alternate nitro groups around the ring are easily hydrolyzed by atmospheric moisture to form 1,3,5-trinitro-2,4,6-trihydroxybenzene, also known as trinitrophenol. In addition, in the presence of light one of the nitro groups rearranges to form pentanitrophenyl nitrite, the otherwise unprecedented solid-phase aryl nitrite<sup>91</sup>.



(55)

### C. Nitroanilines

The enthalpies of formation for nitrated anilines are listed in Table 5 and their destabilization energies are given in Table 6. Also included are the related compounds with additional amino groups, diaminotrinitrobenzene (DATB, **56**) and triaminotrinitrobenzene (TATB, **57**). Their destabilization energies are calculated from equations 59 and 60:

$$\text{DSE} = \{2 \cdot \Delta H_f(\text{PhNH}_2) + 3 \cdot \Delta H_f(\text{PhNO}_2) - 4 \cdot \Delta H_f(\text{C}_6\text{H}_6)\} - \Delta H_f(\text{DATB}) \quad (60)$$

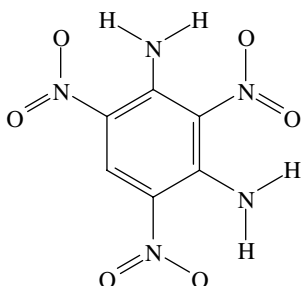
$$\text{DSE} = \{3 \cdot \Delta H_f(\text{PhNH}_2) + 3 \cdot \Delta H_f(\text{PhNO}_2) - 5 \cdot \Delta H_f(\text{C}_6\text{H}_6)\} - \Delta H_f(\text{TATB}) \quad (61)$$

TABLE 5. Enthalpy of formation of nitroanilines (kJ mol<sup>-1</sup>)

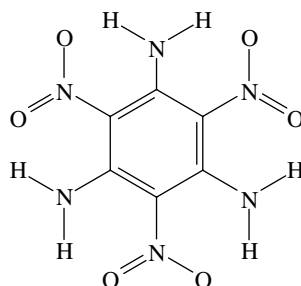
#	Solid	Liquid	Gaseous	Reference
0	20.8	31.3 ± 1.0	87.1 ± 1.0	
1 ( <i>o</i> -)	-26.1 ± 0.5	-9.4 ± 1.0	63.8 ± 4.2	
( <i>m</i> -)	-38.3 ± 0.5	-14.4 ± 1.0	58.4 ± 1.3	
( <i>p</i> -)	-42.0 ± 0.8	-20.7 ± 1.1	58.8 ± 1.5	
2 (2,3-)	-11.7 ± 2.9			
(2,4-)	-67.8 ± 2.9			
(2,5-)	-44.3 ± 2.9			
(2,6-)	-50.6 ± 2.9			
(3,4-)	-32.6 ± 2.9			
(3,5-)	-38.9 ± 2.9			
3 (2,4,6-)	-116			2b
4 (2,3,4,6-)	-49.3			2b
5	208			2b
		3-Aminoaniline		
3 (2,4,6-)	-97.9 ± 2.5	3,5-Diaminoaniline		
3 (2,4,6-)	-139.5 ± 4.1			

TABLE 6. Calculated destabilization enthalpies of polynitroanilines (kJ mol<sup>-1</sup>)

#	Additivity enthalpy			Calculated destabilization		
	solid	liquid	gaseous	solid	liquid	gaseous
1	-17.3	-4.2	72.0			
( <i>o</i> -)				8.8	5.2	8.2
( <i>m</i> -)				21.0	10.2	13.6
( <i>p</i> -)				24.7	16.5	13.2
2	-55.4					
(2,3-)				-43.7		
(2,4-)				12.4		
(2,5-)				-11.0		
(2,6-)				-4.8		
(3,4-)				-22.8		
(3,5-)				-16.5		
3 (2,4,6-)	-93.5			22.5		
4 (2,3,4,6-)	-92.6			-43.3		
5	-130.7			-339		
			3-Aminoaniline			
3 (2,4,6-)	-111.7			-13.8		
			3,5-Diaminoaniline			
3 (2,4,6-)	-129.9			9.6		

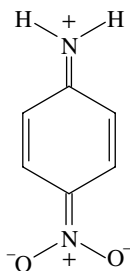


(56)

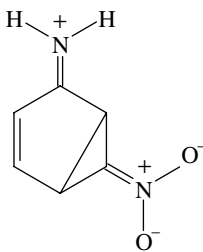


(57)

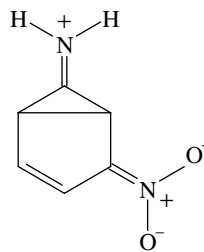
As was the case for dinitrobenzene, the *meta* and *para* nitroaniline isomers have essentially the same gaseous enthalpy of formation. In the gaseous phase, it is surprising to find that despite the more 'attractive' quinonoid resonance structures<sup>92</sup> for the *para* isomer (58) than for the *meta* (59) the *meta* and *para* nitroaniline have essentially the same gas-phase enthalpy of formation. In the solid and liquid states the intermolecular stabilization lowers the enthalpy of formation of the *para* isomer relative to the *meta*. Interestingly, the gas-phase intramolecularly hydrogen-bonded *ortho* isomer is of comparable stability to its isomers. In contrast, it is considerably less stable than its isomers in the solid state because it can form fewer intermolecular hydrogen bonds. All isomers of nitroaniline are more stable than calculated by additivity.



(58)



(59a)



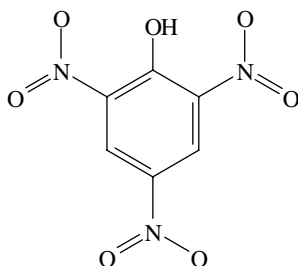
(59b)

All the solid dinitroaniline isomers have been thermochemically studied. The most stable isomer is 2,4-dinitroaniline, which results in the only positive DSE in the isomeric set. Progressively less stable are the 2,6-, 2,5-, 3,5-, 3,4- and 2,3-dinitroanilines. The two least stable isomers experience dinitro steric interactions. The large stability difference between these two is surprising because it appears there is a possibility in the 2,3-isomer for nitro/amino hydrogen bonding. Perhaps the steric effect between the nitro groups requires the 2-nitro group to rotate out of the plane of the ring and thus presents a poorer position for hydrogen bonding. That the species are in the solid phase complicates our understanding. The exact ordering of the 2,4-, 2,6- and 2,5-isomers, all of which have intramolecular hydrogen bonding between the amino and the nitro groups, depends on the relative stabilizing contributions from the 'competing' *meta* and *para* orientations of the amino and nitro groups. The 3,5-isomer has no steric destabilizing effect but it also lacks intramolecular hydrogen-bonding derived stabilization.

Trinitroaniline (TNA) has but one isomer (the long known 2,4,6-species) with a reported enthalpy of formation. Its positive DSE, and hence relative stabilization, is due to hydrogen



bonding and the favorable positioning of the three nitro groups. TNA has also been called picramide because it is a derivative of picric acid<sup>93</sup> (**60**), and has found use as a heat-resistant explosive<sup>94</sup>.

**(60)**

The tetranitroaniline is destabilized by steric interaction between three neighboring nitro groups. It has been used as an explosive booster (a moderately sensitive explosive between the detonator and the main charge that magnifies the shock from the detonator to start the detonation in the more insensitive main charge)<sup>94</sup>.

Pentanitroaniline (PNA) has five neighboring nitro groups and is destabilized even more than the tetranitro compound by repulsive steric interactions. The 3- and 5-nitro groups are easily hydrolyzed as observed earlier for HNB. PNA was studied as an initiating explosive (a sensitive explosive that will decompose to hot gaseous products explosively by a hot wire or weak shock)<sup>98</sup>.

Formal sequential addition of amino groups to 2,4,6-trinitroaniline gives 1,3-diamino-2,4,6-trinitrobenzene (DATB, **56**) and 1,3,5-triamino-2,4,6-trinitrobenzene (TATB, **57**). TATB is more stable than expected from the additivity calculation. The ability to have hydrogen bonding with three amino groups both intra- and inter-molecularly in the crystal stabilizes the molecule. The molecule that results is thermally stable and used as an explosive in situations where a very insensitive explosive is needed.

#### D. Nitrotoluenes

The enthalpies of formation for nitrated toluenes are listed in Table 7 and their calculated destabilization energies are given in Table 8. One polynitrotoluene, 2,4,6-trinitrotoluene, is the well-known explosive TNT (**61**).

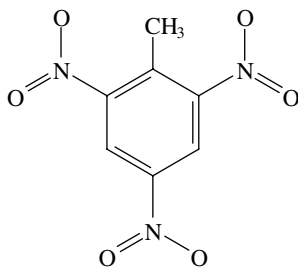
**(61)**

TABLE 7. Enthalpy of formation of nitrotoluenes ( $\text{kJ mol}^{-1}$ )

#	Solid	Liquid	Gaseous	Reference
0	5.8	$12.4 \pm 0.6$	$50.4 \pm 0.6$	
1				
	( <i>o</i> -)	$-9.7 \pm 3.7$		
	( <i>m</i> -)	$-31.5 \pm 3.2$		
	( <i>p</i> -)	$-48.1 \pm 2.9$	$-31.2$	$31.0 \pm 3.8$
2				
	(2,3-)	$-15.9$		84
	(2,4-)	$-66.4 \pm 3.0$	$33.2 \pm 3.2$	
	(2,4-)	$-44.0$		84
	(2,5-)	$-34.3$		84
	(2,6-)	$-55.2 \pm 2.2$		
	(2,6-)	$-37.7$		84
	(3,4-)	$-14.6$		84
	(3,5-)	$-43.5$		84
3				
	(2,4,6-)	$-65.5 \pm 3.0$	$-43.6 \pm 3.2$	$43.4 \pm 6.4$
	(2,4,6-)	$-35$		84
	(2,3,4-)	$15.1$		84
	(2,3,5-)	$-23.0$		84
	(2,3,6-)	$-16.7$		84
	(2,4,5-)	$-15.5$		84
	(3,4,5-)	$-5.0$		84

TABLE 8. Calculated destabilization enthalpies of polynitrotoluenes ( $\text{kJ mol}^{-1}$ )

#	Additivity enthalpy			Calculated destabilization		
	solid	liquid	gaseous	solid	liquid	gaseous
1						
	$-32.3$	$-24.1$	$35.3$		$-14.4$	
					$7.4$	
				$15.8$	$7.1$	$4.3$
2						
	$-70.4$		$20.2$	$-54.5$		
				$-4.0$		$-13.0$
				$-26.4$		
				$-36.1$		
				$-19.3$		
				$-32.7$		
				$-55.8$		
				$-26.9$		
3						
	$-108.5$	$-97.1$	$5.1$	$-43$	$-53.5$	$-38.3$
				$-73.5$		
				$-123.6$		
				$-85.5$		
				$-91.8$		
				$-93.0$		
				$-103.5$		

There are no measured enthalpy-of-formation data for all three mononitrated toluenes in the same phase. However, combining the enthalpy of formation of solid 4-nitrotoluene with its fusion enthalpy results in an enthalpy of formation of the liquid of  $-31.3 \text{ kJ mol}^{-1}$ , a result within experimental error of the liquid 3-isomer. These species are stabilized by  $7 \text{ kJ mol}^{-1}$  by the DSE definition. In addition, liquid 2-nitrotoluene is *ca*  $21 \text{ kJ mol}^{-1}$  less stable than its isomers. Destabilization of the *ortho* isomer could be due to steric effects. Inductive electron-donation may stabilize the *meta* and *para* isomers. The solid 2,4- and 2,6-dinitrotoluenes each have two reported enthalpies of formation. The order of stability of the two isomers are contradictory, depending upon the source. The other isomers exhibit decreasing stability in the order: 3,5- > 2,5- > 2,3-  $\cong$  3,4-. Again, depending on the source of data, the 2,4- and 2,6-isomers are either more stable than the other isomers or they are of comparable stability to the 3,5- and 2,5-isomers. If the former, the overall stability order is very similar to the corresponding dinitroanilines. Relative to their calculated additivity values, the dinitrotoluenes are more destabilized than their dinitroaniline counterparts. No intramolecular hydrogen bonding can occur to explain the stabilities of the species. Thus, the comparable instability of the 2,3- and 3,4-isomers suggests that any important steric interaction is between the nitro groups. The reversal of stability order for the 2,5- and 3,5-dinitro substituted isomers in changing from the aniline parent to the toluene parent may be due to the lack of intramolecular hydrogen bonding in the 2,5-dinitrotoluene and the presumed greater lattice energy of the symmetrical 3,5-dinitrotoluene.

The trinitrotoluene isomers follow the same trends, invoking dinitro steric interactions and favorable solid lattice energies, as the dinitrotoluenes.

## VIII. NITRO COMPOUNDS AS EXPLOSIVES

### A. Definitions

An explosive is a chemical compound which has both fuel (H and/or C) and oxidizer (here O on a nitro group) that reacts producing a sudden large change in volume accompanied by rapid release of energy. The high  $\text{N}_2$  bond strength and the fact that elemental nitrogen is a gas both contribute to the near-ubiquity of nitrogen in explosives. If enough of the explosive compound is compressed such that a chemical reaction can occur before it physically fragments, and a shock wave is formed inside the sample, the resulting reaction is called a detonation. If there is no shock wave, the reaction is called a deflagration. The major difference in the two reactions is the velocity of propagation of the reaction front. The deflagration has a velocity of the order of  $\text{cm-s}^{-1}$  instead of  $\text{km-s}^{-1}$ —a difference of five orders of magnitude.

The maximum reaction enthalpy that can be produced by either process is the same because no additional oxygen is added, but experimentally the products are different because the temperature at which the products are formed is different. In detonation, this temperature is known as the freeze-out temperature and is between 1500 and 1700 K. In deflagration the temperature can be much higher and depends on the enthalpy produced. In detonation or deflagration, the maximum enthalpy of the reaction of the explosive is found from the difference between the enthalpies of formation of its most stable products and that of the compound itself, without the addition of oxygen or other elements. The determination of enthalpy of formation of the explosive is important for determining if there is enough enthalpy to drive the detonation. Explosives with higher enthalpy of detonation are more powerful and usually need less confinement to sustain a detonation. The most stable products of an explosive and their energetic priority for formation from a compound with elemental composition of C,H,N and O (most explosives contain only

TABLE 9. Experimental and calculated major detonation products formed at 1500 K (moles of product formed per mole TNT)

Product	Maximum enthalpy mole product	Experimental mole product <sup>a</sup>	Calculated mole product <sup>a</sup>
H <sub>2</sub> O	2.5	1.60	1.06
CO <sub>2</sub>	1.75	1.25	2.19
CO	0	1.98	0.56
C(s)	5.25	3.65	3.57
N <sub>2</sub>	1.5	1.32	1.49

<sup>a</sup>See Reference 95.

these elements) are H<sub>2</sub>O, CO<sub>2</sub>, C(s) and N<sub>2</sub>. For example, the detonation equation producing the products with maximum enthalpy of detonation from the well-known explosive TNT (**61**) is:



This reaction has a calculated  $\Delta H_{\text{det}}$  of  $-5.90 \text{ kJ g}^{-1}$  ( $-1340 \text{ kJ mol}^{-1}$ ). The measured experimental value<sup>99</sup> was  $-4.56 \text{ kJ g}^{-1}$  ( $-1036 \text{ kJ mol}^{-1}$ ). Experimental values are always less negative than the calculated maximum enthalpy because the products formed are not necessarily the most stable ones at standard temperature and pressure. The analyzed products and a composition that was calculated<sup>95</sup> at a freeze-out temperature of 1500 K using the Tiger (thermodynamic equilibrium and explosive performance, detonation velocity and pressure) computer code<sup>96</sup> are compared in Table 9. The most significant difference between yield of experimental and calculated products is in the carbon-containing products. The actual products include considerable carbon monoxide, the formation of which does not release as much enthalpy as does the formation of carbon dioxide<sup>97</sup>. The amount of water formed, with its relatively large negative enthalpy of formation, is also less experimentally than calculated. In the idealized detonation equation, 5.75 moles of gas are formed from a mole of solid TNT: the real detonation process produces 6.15 moles of gas. Other explosives that have less excess carbon (that is, more oxygen) produce relatively more moles of gas.

## B. Experimental Determination of the Enthalpy of Formation of Explosives

The enthalpy of formation of an explosive compound is found in the same manner as any other compound except sensitive explosives are first tested with a very small sample or combined with standard benzoic acid for burning. Reviewing the protocol, a special Parr bomb<sup>98</sup> is used that is built to withstand the high pressures possible on burning. The bomb is pressurized with 30 atm of oxygen and the explosive pellet is ignited with a hot wire to give the standard combustion products H<sub>2</sub>O, CO<sub>2</sub>, N<sub>2</sub> and HNO<sub>3</sub>. The amount of nitric acid is found by titration and the enthalpy is corrected to the standard combustion products. The enthalpy at constant volume is corrected to enthalpy of combustion at constant pressure. From this latter enthalpy of combustion, the enthalpy of formation is found from the combustion reaction for the compound. Some high nitrogen content explosives leave carbon- and nitrogen-containing residues which are not standard combustion products with well-defined stoichiometry and enthalpy. Such explosives are burned with a known amount of standard benzoic acid to complete combustion to the standard products. Table 10 shows the enthalpy of formation of some high-nitrogen heterocycles that have required this additional benzoic acid. The high nitrogen content compounds and salts

TABLE 10. Enthalpy of formation of some heterocyclic nitro compounds ( $\text{kJ mol}^{-1}$ )

Compound	$\Delta H_f(s)$	Reference
3-Nitro-1,2,4-triazol-5-one (NTO)	$-129.4 \pm 1.1$	98
Ethylenediammonium salt of NTO (ENTO)	$-467.8 \pm 5.9$	99
3-Amino-5-nitro-1,2,4-triazole (ANTA)	$91.2 \pm 7.5$	100
3,6-Bis(ANTA)tetrazine <sup>a</sup>	$731.8 \pm 4.6$	101
Ammonium salt of 5-nitrotetrazole (ANT)	$19.7 \pm 0.8$	102
Ethylenediammonium salt of 5-nitrotetrazole	$233 \pm 12$	102

<sup>a</sup>This compound is more properly named 3,6-bis[3-amino-5-nitro-1*H*-1,2,4-triazol-1-yl]-1,2,4,5-tetrazine.

with positive enthalpies of formation result in more nitrogen gas (with its definitionally zero enthalpy of formation) formed in their combustion products than is formed from compounds richer in carbon that burn to form carbon dioxide (with its large negative enthalpy of formation). What must be remembered for explosive performance is there must be enough enthalpy of detonation to drive the detonation, but not so much that the compound is sensitive to shock and other accidental stimuli.

### C. Sensitivity of Explosives

The desirable sensitivity of an explosive is dependent on its use. Of course, it should not be so sensitive that it cannot be handled or stored for a few years without decomposition. Small amounts of a sensitive explosive are used to start the reaction in the detonator. With the modern initiation systems<sup>94</sup> of flying plates or exploding bridge wires, even these detonator explosives can be less sensitive than those used in the past. Another use is as the booster explosive which requires moderate sensitivity. The largest use of explosives is in the main charge, which does the 'work'. The least sensitive explosive that will do the work is used to prevent accidents during handling.

The sensitivity of an explosive is tested by its reaction to heat and shock. In the three families of nitrated aromatics discussed earlier (cf Sections VII.A–D), the more highly nitrated compounds are explosives which have been tested for their sensitivity to impact. Many methods for testing sensitivity have been used. The figure of insensitiveness (FI, commonly used in numerous older studies) measured<sup>103</sup> the proportion of total gas a compound produced on various levels of impact and compared this number with that of picric acid, which was arbitrarily given a value of 100. Table 11 shows the enthalpy of formation and FI for the isomers of trinitrotoluene, polynitroanilines and trinitrobenzene. The thermal and shock stabilities of the aromatic polynitro compounds are very good as long as the nitro groups are not in adjacent positions on the ring. Table 11 seems to show a relation between the destabilization enthalpy and one method of characterizing sensitivity.

More recently, explosives have been tested for impact sensitivity by an impact machine in which 40 mg of explosive on sandpaper are placed between an anvil and a steel cylinder. A 2.5 kg weight is dropped from different heights and the sound produced serves to indicate a 'go' or 'no go'. The result from 25 'drops' is calculated to give a height at which the probability of explosion is 50%. Results from a compilation<sup>104</sup> are presented in Table 12 and show that the relative values of TNT and picric acid are reversed from the previous table. TNT is relatively more sensitive on the 'Type 12 impact machine' than in the FI impact test. TATB is so insensitive that it fails to explode at the maximum drop height of the machine.

TABLE 11. Figure of insensitiveness (FI) compared to enthalpy of destabilization (DSE, kJ mol<sup>-1</sup>)

Compound	DSE	FI <sup>a</sup>	Reference
1,2,4-Trinitrobenzene	-56	103	84
1,3,5-Trinitrobenzene	-38	109	94
2,4,6-Trinitroaniline	+22	111	94
2,3,4,6-Tetranitroaniline	-43	86	94
Pentanitroaniline	-339	36	94
2,3,4-Trinitrotoluene	-124	92	84
2,3,5-Trinitrotoluene	-86	101	84
2,4,6-Trinitrotoluene (TNT)	-74	114	84
3,4,5-Trinitrotoluene	-104	95	84
3,4,6-Trinitrotoluene	-93	102	84

<sup>a</sup>FI (picric acid) = 100 by definition.

TABLE 12. Impact and thermal sensitivity of explosives

Compound	Impact sensitivity Type 12 machine Drop height (cm)	Temperature of onset of exotherm (°C)
HNB ( <b>55</b> )	15	165
TNT ( <b>61</b> )	148	250
Picric acid ( <b>60</b> )	191	260
DATB ( <b>56</b> )	320	300
TATB ( <b>57</b> )	>320	340

When heated, an explosive will begin to decompose exothermically. If a large enough sample is heated above its critical temperature, it will explode. The critical temperature is dependent on the shape and size of the explosive sample, its thermal conductivity and its kinetics of decomposition<sup>105</sup>. A small-scale test for comparison of the thermal stability of explosives is differential thermal analysis (DTA). A few milligrams of sample are placed in a capillary tube and separate thermocouples are placed in the sample and in an accompanying inert sample. The temperature is raised by 10 deg min<sup>-1</sup> as the differential temperature of the thermocouples is monitored. As the explosive begins to exotherm, it is monitored on a plot of temperature vs differential temperature. Table 12 shows the thermal stability of some nitroaromatics<sup>103</sup>.

## IX. REFERENCES

- See, for example, S. W. Slayden and J. F. Liebman, in *Supplement E2: Chemistry of Hydroxyl, Ether and Peroxide Groups* (Ed. S. Patai), Wiley, Chichester, 1993; J. F. Liebman, K. S. K. Crawford and S. W. Slayden, in *Supplement S: The Chemistry of Sulphur-containing Functional Groups* (Eds. S. Patai and Z. Rappoport), Wiley, Chichester, 1993; S. W. Slayden, J. F. Liebman and G. W. Mallard, in *Supplement D: The Chemistry of Halides, Pseudo-halides and Azides, Vol. 2* (Eds. S. Patai and Z. Rappoport), Wiley, Chichester, 1995.
- The primary source of information for enthalpies of formation is J. B. Pedley, R. D. Naylor and S. P. Kirby, *Thermochemical Data of Organic Compounds* (2nd Ed.), Chapman & Hall, New York, 1986. The successor to this volume, J. B. Pedley, *Thermochemical Data and Structures of Organic Compounds*, Vol. I, Thermodynamics Research Center, College Station, Texas, USA, 1994, has recently been published. We have used values from this latter source when the compounds were not included in the earlier edition. In any case, no reference citation is given except for occasionally referring to either volume as 'Pedley' or merely 'archival'. Where data were

obtained from some other source, that reference is explicitly given. Some of our other preferred secondary sources include:

- (a) M. S. Kharasch, *Bur. Stand. J. Res.*, **2**, 359 (1929).
- (b) G. R. Handrick, *Ind. Eng. Chem.*, **48**, 1366 (1956) and the earlier *Report on Study of Pure Explosive Compounds* by G. R. Handrick and W. C. Lothrop, a document from Arthur D. Little Inc. for the Office of the Chief of Ordnance, Contract No. DA-19-020-ORD-47 C-58247, dated May 1, 1952. We heartily thank Dr. Handrick for making this study available to the authors.
- (c) D. R. Stull, E. F. Westrum, Jr. and G. C. Sinke, *The Chemical Thermodynamics of Organic Compounds*, Wiley, New York, 1969.
- (d) E. S. Domalski, *J. Phys. Chem. Ref. Data*, **1**, 221 (1972).
- (e) E. S. Domalski and E. D. Hearing, *J. Phys. Chem. Ref. Data*, **22**, 805 (1993).  
These sources will usually be referred to as 'Kharasch', 'Handrick', 'Stull, Westrum and Sinke'; 'Domalski' and 'Domalski and Hearing'.
3. For the reader interested in these data, we cite the compendia, E. S. Domalski, W. H. Evans and E. D. Hearing, 'Heat Capacities and Entropies of Organic Compounds in the Condensed Phase', *J. Phys. Chem. Ref. Data*, **13**, Suppl. 1 (1984), and its supplement E. S. Domalski and E. D. Hearing, *J. Phys. Chem. Ref. Data*, **19**, 881 (1990).
4. Unless indicated to the contrary, all estimated enthalpies of vaporization use the approach in J. S. Chickos, D. G. Hesse, J. F. Liebman and S. Y. Panshin, *J. Org. Chem.*, **53**, 3435 (1988).
5. Unless indicated to the contrary, all measured enthalpies of fusion are taken from the compendia by Domalski and coworkers<sup>3</sup> and by W. E. Acree, Jr., *Thermochim. Acta*, **189**, 37 (1991); **219**, 97 (1993) and a still unpublished supplement (personal communication). We thank Dr William Acree for providing us with his unpublished data.
6. J. S. Chickos, in *Molecular Structure and Energetics: Physical Measurements* (Eds. J. F. Liebman and A. Greenberg), VCH, New York, 1987 and unpublished supplement (personal communication). We thank Dr James Chickos for providing us with his unpublished study.
7. J. F. Liebman and H. M. Perks, in *The Chemistry of Enamines* (Ed. Z. Rappoport), Wiley, Chichester, 1994.
8. L. Batt and G. N. Robinson, in *Supplement F. Chemistry of Amino, Nitroso and Nitro Compounds and their Derivatives* (Ed. S. Patai), Wiley, Chichester, 1982.
9. E. J. Prosen, W. H. Johnson and F. D. Rossini, *J. Res. Natl. Bur. Stand.*, **37**, 51 (1946).
10. J. D. Cox and G. Pilcher, *Thermochemistry of Organic and Organometallic Compounds*, Academic Press, New York, 1970.
11. P. Sellers, G. Stridh and S. Sunner, *J. Chem. Eng. Data*, **23**, 250 (1978).
12. The original statement for the relationship in equation 1 was given in Reference 9 as

$$\Delta H_f^\circ[\text{Y}-(\text{CH}_2)_m-\text{H}(\text{g})] = A' + Bm + \Delta$$

where ' $\Delta$ ' is a term which has a small finite value for the lower members, being largest for  $m = 0$ , and becomes zero for the higher members beginning near  $m = 4$ '. In that study, Y was  $\text{CH}_3$  as well as other carbon-containing substituent groups. Subsequent analysis in Reference 10 showed that only the first part of the quoted phrase is true. The  $\Delta$  values do not necessarily decrease and the enthalpy-of-formation deviation for an ethyl-substituted compound may sometimes be smaller than that for butyl.

13. R. L. Montgomery and F. D. Rossini, *J. Chem. Thermodyn.*, **10**, 471 (1978).
14. J. F. Liebman, J. A. Martinho Simões and S. W. Slayden, *Struct. Chem.*, **6**, 65 (1995).
15. J. F. Liebman, J. A. Martinho Simões and S. W. Slayden, in *Lithium Chemistry: A Theoretical and Experimental Overview* (Eds. A. -M. Sapse and P. von R. Schleyer), Wiley, New York, 1995.
16. By contrast, we do not use 'Benson group increments', a generally powerful thermochemical technique summarized in the volume by S. W. Benson himself, *Thermochemical Kinetics*, 2nd edition, Wiley, New York, 1976, and used in many thermochemical chapters throughout the Patai series. For the classes of compounds discussed in the current chapter, we believe the necessary number of parameters (included to reflect electrostatic interactions, proximity effects, steric repulsions and ring corrections) is excessive.
17. The group additivity values were taken from 'Revised Group Additivity Values of Enthalpies of Formation (at 298 K) of Carbon-Hydrogen Compounds', by N. Cohen, prepared for National Institute of Standards and Technology, 1994 as Aerospace Report No. ATR-94(7263)-1. The

revision of group additivity values to predict thermochemical properties by means of Benson's group additivity method (Reference 16) is based on the experimental enthalpies of formation found in the compendium by Pedley. We thank Dr Norman Cohen for giving us a copy of his report.

18. For example, see A. Greenberg and T. A. Stevenson, in *Molecular Structure and Energetics: Studies of Organic Molecules* (Vol. 3) (Ed. J. F. Liebman and A. Greenberg), VCH, Deerfield Beach, 1986.
19. This was derived from the difference of the gas-phase enthalpies of formation of the archival cycloheptane and hexahydroazepine, the latter quantity of  $-45.2 \pm 1.9 \text{ kJ mol}^{-1}$  reported in X. -W. An, Z. -L. Zhang, S. Wang, J. Yan, R. Hu and J. Hu, *Huaxue Xuebao*, **39**, 485 (1980).
20. W. V. Steele, R. D. Chirico, A. Nguyen and S. E. Knipmeyer, *J. Chem. Thermodyn.*, **26**, 515 (1994).
21. James S. Chickos, personal communication to the authors.
22. If the semiempirical equations proposed in Reference 4 are correct, then the exothermicity of the reaction  $\text{RX} + \text{R}^1\text{Y} \rightarrow \text{RY} + \text{R}^1\text{X}$  would be identical in the gaseous and liquid phases. Experience shows the assumption generally results in much poorer agreement for all-solid reactions. No such semiempirical equations for enthalpy of sublimation and its estimation appear to be available, although some cancellation is expected.
23. From Reference 4, we derive that  $4.7 \text{ kJ mol}^{-1}$  is the estimated, and assumed, universal contribution of one carbon to enthalpies of vaporization for all monosubstituted hydrocarbons and  $8.9$  is the parameter for tertiary amines.
24. Strictly speaking, we should consider nicotine a bifunctional species and so use the analysis in J. S. Chickos, D. G. Hesse and J. F. Liebman, *J. Org. Chem.*, **54**, 5250 (1989) to estimate enthalpy of vaporization. However, in that the enthalpy of combustion data are old and the two substituents (tertiary amine and pyridine) are rather far apart and not involved in hydrogen bonding, we continue with our simplified analysis.
25. M. P. Kozina, L. P. Timofeeva, G. L. Gal'chenko, I. M. Skvortsov and I. V. Antipova, *J. Gen. Chem. USSR*, **51**, 367 (1981).
26.  $\delta_4(\text{prim}/\text{R})$  differs by 6 for R that is *prim* and *sec* and  $\delta_{5\text{sec}}(\text{R}, \text{R}^1)$  differs by 15 for R and  $\text{R}^1$  both *prim* and both *sec*. Extrapolating to  $\delta_6(\text{tert}/\text{R}, \text{R}^1, \text{R}^2)$  where the Rs are all primary vs all secondary, the new difference quantity should be *ca*  $-70 \text{ kJ mol}^{-1}$ . Using the assumed thermoneutrality of equation 8 as a guide, the difference quantity should be *ca*  $-66 \text{ kJ mol}^{-1}$ .
27. For example, consider the near-planar nitrogen in 1-azabicyclo[3.3.3]undecane (manxine), N. J. Leonard, J. C. Coll, A. H. -J. Wang, R. J. Missavage and I. C. Paul, *J. Amer. Chem. Soc.*, **93**, 4639 (1971). Regrettably, we know of no enthalpy of formation measurements on either this heterocycle or the corresponding hydrocarbon, manxane.
28. See, for example, S. Böhm, M. Decouzon, O. Exner, J. -F. Gal and P. -C. Maria, *J. Org. Chem.*, **59**, 8127 (1994).
29. This appears plausible to us having earlier done so for understanding the energetics of aryl halides, cf S. W. Slayden, J. F. Liebman and W. G. Mallard, in *Supplement D2: The Chemistry of Organic Halides, Pseudohalides and Azides* (Eds. S. Patai and Z. Rappoport), Wiley, Chichester, 1995: *i*-Pr and Ph have the substituent-bearing carbon bonded to two other carbons and *t*-Bu and Ph have the substituent-bearing carbon bonded just to carbon and not bonded to hydrogen or any additional univalent group.
30. (a) Both W. E. Garner and C. L. Abernathy, *Proc. Roy. Soc. London*, **99A**, 213 (1921) and G. N. Vriens and A. C. Hill, *Ind. Eng. Chem.*, **44**, 2732 (1952) report nearly identical enthalpies of combustion of **16** of *ca*  $-974 \text{ kJ mol}^{-1}$  from which an enthalpy of formation of the liquid of *ca*  $32 \text{ kJ mol}^{-1}$  is found. The latter authors also give  $\Delta H_{\text{v}}(\mathbf{16}) = 53 \text{ kJ mol}^{-1}$  and so the desired gas-phase enthalpy of formation is *ca*  $85 \text{ kJ mol}^{-1}$ .  
(b) J. P. Guthrie, J. Barker, P. A. Cullimore, J. Lu and D. C. Pike, *Can. J. Chem.*, **71**, 2109 (1993) consider the above data as part of a reaction calorimetry study and suggest  $\Delta H_{\text{f}}(\text{g}, \mathbf{38}) = 84 \text{ kJ mol}^{-1}$ .
31. O. I. Kachurin, N. M. Matvienko and V. G. Chekhuta, *Ukr. Khim. Zh.*, **45**, 139 (1979) and N. M. Matvienko, O. I. Kachurin and V. G. Chekhuta, *Ukr. Khim. Zh.*, **48**, 1046 (1982) report a high-temperature acid-catalyzed transmethylation  $2(\mathbf{16}) \rightleftharpoons \mathbf{14} + \mathbf{15}$  with an accompanying reaction enthalpy of *ca*  $-4 \text{ kJ mol}^{-1}$ . From these data, we derive  $\Delta H_{\text{f}}(\text{g}, \mathbf{16}) = 96 \text{ kJ mol}^{-1}$ .



32. The enthalpies of formation for the naphthols are from Pedley; for the methylnaphthalenes, from R. Sabbah, R. Chastel and M. Laffitte, *Thermochim. Acta*, **10**, 353 (1974); and for the bromonaphthalenes, from M. A. V. Ribeiro da Silva, M. L. C. C. H. Ferrao and A. J. M. Lopes, *J. Chem. Thermodyn.*, **25**, 229 (1993).
33. See Ribeiro da Silva and coworkers in Reference 32.
34. Our success is at a price. After all, we have three occasionally conflicting prejudices with regard to choice of data. The first is to use recommended archival values. The second is to use the most recent piece of data. The third is to use an alternative but selected source, e.g. the same reference for two isomers. We have acted according to our last, but weakest, prejudice here. We admit that given the well-established carcinogenicity of  $\beta$ -naphthylamine, there is no way in clear conscience to recommend remeasurement of the quantities of interest.
35. There is a 30 kJ mol<sup>-1</sup> difference in the recommended enthalpies of formation of solid 2-aminobiphenyl in the two volumes by Pedley, cf the new measurements reported in W. F. Steele, R. D. Chirico, S. E. Knipmeyer and A. Nguyen, *J. Chem. Thermodyn.*, **23**, 957 (1991). This difference attests to the difficulty of making enthalpy-of-formation measurements on amines, a conclusion already intimated in the discussion of the naphthylamines.
36. The three methylamines have comparable enthalpies of formation (to within 5 kJ mol<sup>-1</sup>) and the enthalpy of formation of the parent NH<sub>3</sub> is some 20 kJ mol<sup>-1</sup> more negative than that of any of the amines.
37. The necessary enthalpy of formation of gaseous diphenylmethane is from W. V. Steele, R. D. Chirico and N. K. Smith, *J. Chem. Thermodyn.*, **17**, 671 (1995).
38. A. J. Kirby, *The Anomeric Effect and Related Stereoelectronic Effects at Oxygen*, Springer-Verlag, Berlin, 1983; P. Delongchamps, *Stereoelectronic Effects in Organic Chemistry*, Wiley, New York, 1983.
39. We neglect here any effect of intramolecular hydrogen bonding because we doubt its presence. The necessary N··H··N angle would be *ca* 90° instead of the proper 180° found in the geometry that would allow for optimum hydrogen bonding.
40. The corresponding reactions 2EtX → XCH<sub>2</sub>CH<sub>2</sub>X + CH<sub>3</sub>CH<sub>3</sub> of ethyl halides to form the ethylene dihalide are endothermic by 14 kJ mol<sup>-1</sup>, *endo* by 2 and *exo* by 2 for Cl, Br and I, respectively. This suggests some hydrogen bonding stabilization exists for the diamino case, even if the N··H··N angle is manifestly non-optimum.
41. The enthalpy of formation of the solid amine is  $-141.0 \pm 1.7$  kJ mol<sup>-1</sup> and is from D. R. Stull, *Bull. Chem. Thermodyn.*, **2**, 5 (1958) accompanied by an enthalpy of sublimation of 75.7 kJ mol<sup>-1</sup> from Drs Sarah Hosseini and James Chickos, unpublished results.
42. The thermochemical consequences of interactions of acetylenes with amines is unexplored save the studies of the enthalpies of formation of species **25**, HC≡CCH<sub>2</sub>NMe<sub>2</sub> and the unsubstituted HC≡CCH<sub>2</sub>NH<sub>2</sub>, and (HC≡CCH<sub>2</sub>)<sub>3-n</sub>Pr<sub>n</sub>N, with *n* = 0, 1 and 2. A probe for the accuracy of their enthalpies of formation is the formal enthalpy of hydrogenation of HC≡CCH<sub>2</sub>NH<sub>2</sub>. The enthalpy of vaporization of this amine is predicted to be essentially the same as its saturated analog. Equivalently, the enthalpy of hydrogenation of the pure liquid should equal that of the gas, and both equal the phase appropriate difference of the enthalpy of formation of the unsaturated and saturated amines. In the absence of any substituent effects, this propargylamine hydrogenation enthalpy would be the same as that of propyne. Should steric demands of NH<sub>2</sub> and Me be equated, then the propargylamine hydrogenation enthalpy will equal that of 1-butyne. For the amine, the enthalpy of hydrogenation equals  $-307.2 \pm 1.0$  kJ mol<sup>-1</sup>. By contrast, for propyne, 1-butyne(g) and 1-butyne(lq), the hydrogenation enthalpies equal  $-289.6 \pm 1.0$ ,  $-290.8 \pm 1.2$  and  $-288.5 \pm 1.2$  kJ mol<sup>-1</sup>, respectively. It is hard to imagine how propargylamine differs so much from the parent, all-hydrocarbon, alkynes. This apparent incongruity makes us suspect the enthalpy-of-formation results for all of the acetylenic amines. But disregarding them is a pyrrhic victory because the thermochemical data base on polyamines has been meaningfully decreased.
43. O. P. Kuznetsova, E. A. Miroshnichenko, A. N. Zelenetskii, G. V. Rakova, Y. A. Lebedev and N. S. Enikolopyan, *Proc. Natl. Acad. Sci. U.S.S.R.*, **226**, 147 (1976), citing A. G. Tomilov and K. S. Smirnov, *Adiponitrile and Hexamethylenediamine* (in Russian), Khimya, Moscow, 1974.
44. This value illustrates the virtue of not being thermochemical purists. It was obtained by averaging the enthalpy of formation of solid piperazine from Pedley and from An and coworkers (Reference 19) and summing the result with the enthalpy of sublimation from Chickos. In that the last quantity was measured at a mean temperature of 294 K instead of the idealized 298 K, errors are in fact minimal.

45. The enthalpy of formation of liquid and gaseous morpholine are  $-185.7 \pm 2.7$  and  $-142.8 \pm 3.3$   $\text{kJ mol}^{-1}$ , respectively: K. Pihlaja and P. Vainiotalo, unpublished results, cited by K. Pihlaja in *Molecular Structure and Energetics: Physical Measurements* (Eds. J. F. Liebman and A. Greenberg), VCH, New York, 1987. From the same source we find *N*-methylmorpholine is *ca* 21  $\text{kJ mol}^{-1}$  less stable than its 1,3-counterpart paralleling the earlier conclusion that *vic*-diamines are less stable than the related *gem*-diamines.
46. R. H. Staley and J. L. Beauchamp, *J. Am. Chem. Soc.*, **96**, 1604 (1974).
47. On the other hand, this reaction is endothermic by almost 10  $\text{kJ mol}^{-1}$  in the solid state. This is surprising because the monoamine has a nonzero dipole moment and a molecular structure that allows for formation of linear arrays of intermolecularly  $\text{N} \cdots \text{H}-\text{C}$  hydrogen-bonded molecules in the crystal, while the other species have zero dipoles and lack the possibility of such stabilization mechanisms in the solid.
48. We are being somewhat disingenuous here. If performed and interpreted correctly and with the appropriate ancillary phase-change enthalpy information, the enthalpy of formation of an arbitrary species by ion–molecule reaction chemistry and by combustion calorimetry must be the same. That the ionization potential of quinuclidine is higher than 1,4-diazabicyclo[2.2.2]octane simply says that there is a stabilizing effect in the radical cation of the latter not found in the former. This information does not say that there is a stabilizing effect in the neutral molecular form of the latter not found in the former. After all, we trust the reader is not bothered by the fact that the ionization potential order of the cyclohexenes increases in the order: 1,3-diene < 1,4-diene < 1-ene < ‘1,3,5-triene’ (benzene).
49. This boat-chair difference is not immediately obtainable from experiment, e.g. the high-temperature conformational isomerization — and then quenching — of cyclohexane does not result in a chair  $\rightarrow$  boat interconversion, but rather chair  $\rightarrow$  twist-boat; M. Squillacote, R. S. Sheridan, O. L. Chapman and F. A. L. Anet, *J. Am. Chem. Soc.*, **97**, 3244 (1975).
50. For the *o*-isomer, there is a new value of  $39.1 \pm 5.7$   $\text{kJ mol}^{-1}$  [I. Contineanu, L. Wagner, L. Stanescu and D. I. Marchidan, *Rev. Roum. Chim.*, **27**, 205 (1982)] and for the *m*-isomer, there is a new value of  $-33.3 \pm 7.3$   $\text{kJ mol}^{-1}$  [I. B. Rabinovich, N. V. Karyakin, E. S. Dzhirimova, S. A. Siling, I. L. Ponomarev and S. V. Vinogradova, *Bull. Acad. Sci. USSR, Div. Chem. Sci.*, 716 (1984)].
51. In Kharasch we find the enthalpies of formation of solid 2,4'- and 4,4'-diaminobiphenyl from an 1889 paper. The two values differ by *ca* 4  $\text{kJ mol}^{-1}$  with the latter isomer more stable. Do we accept this *ca* 4  $\text{kJ mol}^{-1}$  to be the difference of the enthalpies of formation of the two isomers? We now admit that there are two more recent, but still archival, measurements for the 4,4'-isomer which differ from the earlier one by *ca* 20 and 24  $\text{kJ mol}^{-1}$ . (The new ones were reported in 1908 and 1944.)
52. It is frustrating that this result, and accordingly the enthalpy of formation of **54**, is probably in error. After all, it is often assumed that acetylated amines are easier to purify than the parent amine — for example, we recall that samples of acetanilide are generally clean white solids while those of aniline are discolored liquids.
53. The original study is B. G. Gowenlock and K. E. Thomas, *J. Chem. Soc. (B)*, 409 (1966). The value we have taken makes use of the ‘corrections’ suggested by S. W. Benson, F. R. Cruickshank, D. M. Golden, G. R. Haugen, H. E. O’Neal, A. S. Rodgers, R. Shaw and R. Walsh, *Chem. Rev.*, **69**, 279 (1969).
54. R. A. L. Peerboom, S. Ingemann, N. M. M. Nibbering and J. F. Liebman, *J. Chem. Soc., Perkin Trans. 2*, **2**, 1825 (1990).
55. There is a *ca* 70  $\text{kJ mol}^{-1}$  uncertainty accompanying  $\Delta H_f(\text{CH}_2\text{NH})$ , cf. B. J. Smith, J. A. Pople, L. A. Curtiss and L. Radom, *Aust. J. Chem.*, **45**, 285 (1992). We will not attempt to resolve this issue in the current chapter.
56. K. B. Wiberg, D. Y. Nakaji and K. M. Morgan, *J. Am. Chem. Soc.*, **115**, 3527 (1993).
57. From the approach suggested in J. S. Chickos, D. G. Hesse and J. F. Liebman, *J. Org. Chem.*, **55**, 3833 (1990), we conclude that the errors of ignoring multiple substitution and a small multiple of RT will not ameliorate the seemingly disparate enthalpies of formation of the three triamines of interest.
58. R. M. Clay, S. Lorr, G. Keenan and W. V. Steele, *J. Am. Chem. Soc.*, **105**, 2070 (1983).
59. J. S. Chickos, D. G. Hesse, S. Y. Panshin, D. W. Rogers, M. Saunders, P. M. Uffer and J. F. Liebman, *J. Org. Chem.*, **57**, 2897 (1992).
60. E. M. Engler, J. D. Andose and P. v. R. Schleyer, *J. Am. Chem. Soc.*, **95**, 8005 (1973).

61. D. Van Vechten and J. F. Liebman, *Isr. J. Chem.*, **21**, 105 (1981).
62. It has been asserted that the choice of thermochemical reference states, including those for strain energy considerations, is inherently subjective and so this question cannot be objectively answered: see, J. F. Liebman and D. Van Vechten, in *Molecular Structure and Energetics: Physical Measurements* (Eds. J. F. Liebman and A. Greenberg), VCH, New York, 1987.
63. To calibrate our thinking, the resonance or extra stabilization found in benzene as opposed to a species with three isolated double bonds is *ca* 151 kJ mol<sup>-1</sup>, which we note is fortuitously nearly the identical value as found in the comparison of these nitrogenous heterocycles.
64. As such, a more thorough description of the energetics of nitroso compounds may well logically appear in a future Patai volume on functional groups devoted to carbon-containing double bonds such as monoalkenes, imines and ketones and aldehydes, since oximes would seem to belong with these functionalities.
65. As such, a more thorough description of the energetics of nitroso compounds may well logically appear in a future Patai volume on functional groups devoted to nitrogen–nitrogen bonds such as hydrazo, azo and azoxy compounds, since azodioxy species would seem to belong with these functionalities. We additionally note that these azodioxy species can occur in both *cis*- and *trans*-form, and the relative stability seems dependent on the affixed hydrocarbyl moiety.
66. We refer to this as a thermochemical measurement when, in fact, the necessary equilibrium measurement techniques are usually found among the arsenal of the kineticist. A minor distinction to the reader perhaps, but it appears to the authors that except for Benson and his descendants, thermochemists and kineticists generally inadequately communicate.
67. W. E. Acree, Jr., S. A. Tucker, G. Pilcher, A. Chowdary. M. D. M. C. Ribeiro da Silva and M. J. S. Monte, *J. Chem. Thermodyn.*, **25**, 1252 (1993).
68. From Batt (Reference 8), we find values of 215 ± 8, 249 ± 13 and 203 ± 4 kJ mol<sup>-1</sup>.
69. The enthalpy of formation of the gaseous tetramethylbenzene was obtained by summing Pedley's value for the liquid and the enthalpy of vaporization from R. Sabbah, D. Tabet and S. Bélaadi, *Thermochim. Acta*, **247**, 193 (1994).
70. M. Colomina, C. Turrión, P. Jiménez, M. V. Roux and J. F. Liebman, *Struct. Chem.*, **5**, 141 (1994).
71. W. E. Acree, Jr., S. A. Tucker, G. Pilcher and G. Toole, *J. Chem. Thermodyn.*, **26**, 85 (1994).
72. We note now that Handrick cites some studies from the end of the last century and early in this. Admitting that our prejudices suggest using the values from Reference 71 and hence from this decade, it is nonetheless interesting that the most recent and the early values 'merely' differ by *ca* 30 kJ mol<sup>-1</sup>. This difference is non-negligible, but is not particularly worse than the spread of values for the parent nitrosobenzene using much more contemporary techniques and analyses.
73. To be most consistent with the selection of the enthalpy of formation of 4-dimethylaminonitrosobenzene, we have decided to use in this section the enthalpy of formation of 4-dimethylaminonitrobenzene from Acree and coworkers in Reference 71; as well, we acknowledge the merely 3 kJ mol<sup>-1</sup> discrepant value found in J. Furukawa, S. Murata, M. Sakiyami and S. Seki, *Bull. Chem. Soc. Jpn.*, **57**, 3058 (1984).
74. Kharasch gives us a nearly 90-year-old enthalpy of formation of the solid amine. However, no enthalpy of sublimation is seemingly available.
75. See R. Sabbah and M. Gouali, *Aust. J. Chem.*, **47**, 1651 (1994) and references cited therein.
76. This appears quite likely; cf. K. T. Finley and L. K. J. Tong, in *The Chemistry of the Carbon–Nitrogen Double Bond* (Ed. S. Patai), Wiley, London, 1970. Nonetheless, in that the question of species 'identification' persists is suggestive that the two tautomers are relatively close in energy and so our analysis continues quite unfazed by this seeming ambiguity.
77. We welcome a study of the tautomerically frozen species, some synthetically and calorimetrically suitable alkoxy nitrosobenzenes, their *p*-benzoquinone *O*-alkyloxime isomers and the corresponding naphthalene analogs.
78. Two recent reviews of hydrocarbon radical enthalpies of formation are J. Berkowitz, G. B. Ellison and D. Gutman, *J. Phys. Chem.*, **98**, 1744 (1994) and W. Tsang, in *Energetics of Organic Free Radicals* [Vol. 4 in the SEARCH Series (Eds. J. A. Martinho Simões, A. Greenberg and J. F. Liebman), Blackie Academic & Professional, an imprint of Chapman & Hall, London, in press]. The enthalpies of formation of hydrocarbyl radicals is still a subject of some dispute. Admitting our prejudices, the values chosen in the current study are those recommended by the latter reference.

8. Thermochemistry of amines, nitroso, nitro compounds and related species 377

79. Strictly speaking, the reaction should read  $R + NO + M \rightleftharpoons RNO + M$ , but the third body  $M$  does not affect our analysis. We note  $R/NO$  reactions in either direction are not expected to have an enthalpy of activation save that of the reaction enthalpy. This situation is thus unlike the reaction  $(RNO)_2 \rightleftharpoons 2RNO$  whether or not the third body  $M$  is present.
80. A. A. Boyd, B. Nozière and R. Desclaux, *J. Phys. Chem.*, **99**, 10815 (1995).
81. We are surprised that there are no enthalpies of formation available for either allylamine or 3-nitropropene. As such, we ignore the datum for 3-nitrosopropene. We also ignore the datum for nitrosoethane because we prefer the more recent one for  $\alpha$ -nitrosotoluene as the archetype of an NO affixed to a primary carbon.
82. 'Thermochemically' is the operative word here. After all, NO can formally delocalize and thus stabilize both negative and positive charges as illustrated by the acidity of oximes; cf. the well-established existence of  $(R_2CNO)^-$  and the Nef reaction, cf. the putative existence of  $(R_2CNO)^+$ .
83. Recall the following 'thermochemical mimicry' analysis from S. W. Slayden, J. F. Liebman and W. G. Mallard, in *Supplement D2, The Chemistry of Organic Halides, Pseudohalides and Azides* (Eds. S. Patai and Z. Rappoport), Wiley, Chichester, 1995. The difference of the enthalpies of formation of  $RBr$  and  $RNH_2$  is largely independent of the alkyl group  $R$  but the difference for bromobenzene and aniline shows the latter species enjoys *ca* 30 kJ mol<sup>-1</sup> of stabilization relative to the former. By contrast, the difference of the enthalpies of formation of  $RCl$  and  $RNO_2$  is largely independent of the alkyl group  $R$  and the difference for chlorobenzene and nitrobenzene shows no particular stabilization or destabilization of the latter species relative to the former. Accordingly, aniline is more stabilized than nitrobenzene by *ca* 30 kJ mol<sup>-1</sup>.
84. The data for some of the more unusual isomers are from W. E. Garner and C. L. Abernethy, *Proc. Royal Soc. London*, **99A**, 213 (1921). While these numbers have less reliability than those determined later, nonetheless these values are useful for comparison with each other and within sets of isomers.
85. We avoid here the comparison of the electronegativities of nitrogens as found in nitrobenzene and aniline. Questions of group electronegativities, hybridization and partial charges are usually interesting, but they are usually subtle and seemingly largely unresolved.
86. A. Greenberg and T. A. Stevenson, *Molecular Structure and Energetics: Studies of Organic Molecules* (Eds. J. F. Liebman and A. Greenberg), VCH, Deerfield Beach, 1986. See also the discussion in J. F. Liebman and R. M. Pollack, in *The Chemistry of Enones, Part 1* (Eds. S. Patai and Z. Rappoport), Wiley, New York, 1989 wherein the resonance energy of crotonaldehyde was shown to be less than that of piperylene while the rotational barriers are in the reverse order.
87. From Stull, Westrum and Sinke we find the barrier to rotation of the nitro group in nitrobenzene is 25.1 kJ mol<sup>-1</sup>, to be compared with the rotational barrier of the amino group in aniline of 14.2 kJ mol<sup>-1</sup>.
88. The ordering of the two values is hard to rationalize because there are two opposing influences. Because of its shape, *p*-dinitrobenzene may be expected to 'pack' better than the *m*-isomer, thereby increasing its relative enthalpy of fusion. However, the latter has a nonzero dipole moment while the former does not. Intermolecular, electrostatic attraction is expected to be stronger for the crystalline *meta* compound.
89. Z. A. Akopyan, Yu. T. Struchkov and V. G. Dashevskii, *Zh. Strukt. Khim.*, **7**, 408 (1966).
90. Two enthalpy-of-formation values were found for HNB (**55**) [C. L. Coon (Lawrence Livermore National Laboratory), personal communication to M. S. C. (1985); Y. N. Matiushin, V. V. Odintsov and V. I. Pepekin, *High Explosive Database—Part C*, Semenov Institute of Chemical Physics, Moscow (1994)] but neither reference is readily useful for learning the details on procedures used to keep the compound from decomposing during analysis. The kinetic instability of HNB has prevented its use as a production explosive although it is very powerful. The synthesis of HNB was challenging, and had the stability properties been calculated before it was made, the resources could have been used to make a more useful compound. The results from the study of HNB did help improve understanding of stability calculations. These methods include deriving densities<sup>96</sup> and enthalpies of formation, two properties of explosives that determine their performance, and hence are useful as guides to the synthesis of new compounds.
91. This observation was made by Coon, in Reference 90. To the best of our knowledge, there are no experimental data for the enthalpy-of-formation difference of simple nitroarenes and aryl nitrites such as  $PhNO_2$  and  $PhONO$ . Given earlier enunciated complications regarding measurements of alkyl nitrites, we are not surprised by this gap in our knowledge.

92. J. F. Liebman, in *Molecular Structure and Energetics: Studies of Organic Molecules* (Eds. J. F. Liebman and A. Greenberg), VCH, Deerfield Beach, 1986.
93. Picric acid was one of the first explosives to have been prepared (in 1758, by nitrating wool). It was also used as a dye because of its bright yellow color.
94. Encyclopedia of Explosives and Related Items, PATR 2700 [Picatinny Arsenal, Dover, NJ (1960–1978)].
95. D. Ornellas, *J. Phys. Chem.*, **72**, 2390 (1968). Strictly speaking, the code used in this paper was the RUBY code, H. B. Levine and R. E. Sharples, Report UCRL-6185, Lawrence Radiation Laboratory, Livermore, CA, 1962 using the BKW equation of state from C. L. Mader, Report LA-2900, Los Alamos Scientific Laboratory (1963). (See also C. L. Mader, *Numerical Modeling of Detonation*, University of California Press, 1979)
96. Tiger code reference: M. Cowperthwaite and W. H. Zwisler, *TIGER Computer Documentation*, SRI Publication No. Z106 (January 1973).
97. The enthalpies of formation of CO and CO<sub>2</sub> are  $-110.53$  and  $-393.51$  kJ mol<sup>-1</sup>, respectively, corresponding to an endothermicity of  $ca$  85 kJ(mol CO)<sup>-1</sup> produced in the formal reaction CO<sub>2</sub>(g) + C(s) → 2CO.
98. A. Finch, P. J. Gardner, A. J. Head and H. S. Majdi, *J. Chem. Thermodyn.*, **23**, 1169 (1991).
99. K. -Y. Lee and M. M. Stinecipher, *Propellants, Explosives, and Pyrotechnics*, **14**, 241 (1989). Handrick (Reference 2b) spoke of a 'salt link' or correction of  $ca$  67 kJ mol<sup>-1</sup> associated with the formation of a salt from the reaction of an acid and base. From the enthalpy of formation of ethylenediamine from Pedley and of the ethylenediammonium salt of 3-nitro-1,2,4-triazol-5-one from the current reference, and the suggested 'salt link' ( $\times 2$ ), the enthalpy of formation of 3-nitro-1,2,4-triazol-5-one is predicted to be  $-135$  kJ mol<sup>-1</sup>. This is in wonderful agreement with that reported in Reference 103.
100. K. -Y. Lee, C. B. Storm, M. A. Hiskey and M. D. Coburn, *J. Energ. Mater.*, **9**, 415 (1991).
101. K. -Y. Lee, M. D. Coburn and M. A. Hiskey, Los Alamos National Laboratory Technical Report, LA-12582-MS (June 1993).
102. K. -Y. Lee and M. D. Coburn, *J. Energ. Mater.*, **1**, 109 (1983).
103. R. Robertson, *J. Chem. Soc.*, **119**, 1 (1921).
104. P. M. Dobratz and P. C. Crawford, LLNL Explosives Handbook, UCRL-52997 Change 2 (January 1985).
105. R. N. Rogers, *Thermochim. Acta*, **11**, 131 (1975).

## CHAPTER 9

# Acidity and basicity

SILVIA BRADAMANTE

*CNR, Centro di studio sulla Sintesi e Stereochimica di Speciali Sistemi Organici, c/o Dipartimento di Chimica Organica e Industriale, Università di Milano, via Golgi 19, 20133 Milano, Italia*

*Fax: 39 2 236.43.69; e-mail: BRADA@ICIL64.CILEA.IT*

---

I. ABBREVIATIONS	380
II. INTRODUCTION	380
III. GAS-PHASE SOLUTION CORRELATION	381
A. Acidity and Basicity Scales in Solution	381
1. Proton transfer in water and DMSO	381
2. Complex formation with Lewis acids	381
3. Hydrogen bonding	381
B. Acidity and Basicity Scales in the Gas Phase	382
1. Scales relative to proton	382
2. Metal cation binding	384
3. Organometallic and organic cation binding	385
4. Anion binding and electron affinities	385
5. Cationic hydrogen bonds	385
C. Gas Phase–Solution Relationships	385
IV. NITROGEN BASES	388
A. Amine Derivatives	388
B. Amidines and Guanidines	392
C. Amidates and Amides	395
V. NITROGEN ACIDS	395
A. Structural Characterization of Metal Amides in the Solid State and in Solution	396
B. Amine Derivatives	398
C. NH Bond Dissociation Energy	400
D. Carboxamides and Related Compounds	403
VI. HYDROXAMIC ACID AS AMPHOTERIC SYSTEMS	405
VII. HETEROCYCLES	407
VIII. NITRO DERIVATIVES	409

A. Nitromethane Derivatives . . . . .	409
B. Structure of Nitroalkanes and their Conjugated Bases . . . . .	411
C. Nitroaryl-substituted Methanes . . . . .	414
IX. REFERENCES . . . . .	416

---

## I. ABBREVIATIONS

AN	acetonitrile
BDE	bond dissociation energy
CHA	cyclohexylamine
$D(A-H)$	bond dissociation energy
DME	dimethoxyethane
DN	donor number
DSP	dual substituent parameter
$-EA(A^-)$	electron affinity
EG	ethylene glycol
EPA	electron pair acceptor
EW	electron withdrawing
EWG	electron-withdrawing group
FT-ICR	Fourier transform ion cyclotron resonance
GAPT	generalized atomic polar tensors
$GB$	gas-phase basicity
HBA	hydrogen-bond acceptor
HBD	hydrogen-bond donor
HPMS	high-pressure mass spectrometry
IBE	intrinsic bond energy
ICR	ion cyclotron resonance
$IE(H)$	ionization energy
ISM	intersecting state model
MCA	methyl cation affinity
NB	nitrobenzene
NMP	<i>N</i> -methylpyrrolidine-2-one
$PA$	proton affinity
PNS	principle of nonperfect synchronization
RSE	radical stabilization energy
TEP	triethylphosphate

## II. INTRODUCTION

This review is an update of the contribution on analogous topics that appeared in previous volumes of this series<sup>1,2</sup>. It is not intended to be comprehensive, but rather a critical survey of the emerging research lines, views and re-interpretation of old facts under the stimulus of new experimental results. The last decade has seen an explosion of gas-phase chemistry with wide spread investigations of proton transfer reactions of various acids and bases. We felt it to be logical and convenient to treat simultaneously, in each specific sub-chapter, gas-phase and solution data to offer a wide aspect of the topic and facilitate connections between the two approaches. Therefore, the content of the review is organized in such a way that specific data on nitrogen bases and acids is preceded by preliminaries on the acidity and basicity scales, both in solution and in the gas phase. On the same grounds, we postponed the treatment of nitrogen acids to a discussion on structural aspects of

nitranions, both in the solid and in solution. Amphoteric and heterocyclic systems are treated on their own because they present both basic and acidic properties. The final sub-chapter is dedicated to recent advances in nitroalkanes.

### III. GAS-PHASE SOLUTION CORRELATION

#### A. Acidity and Basicity Scales in Solution

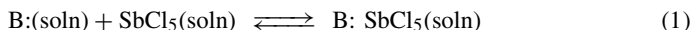
##### 1. Proton transfer in water and DMSO

Precise  $pK_a$  values in water and mixed aqueous solutions, based on well-known experimental methods of measurement<sup>3</sup>, are available in the literature<sup>4</sup>. The problem of measuring  $pK_a$  values for weak bases and acids has also been overcome<sup>5</sup>. Acting alternatively as a hydrogen-bond acceptor (HBA) or a hydrogen-bond donor (HBD), water strongly solvates both cations and anions.

In the case of non-HBD solvents, such as DMSO, the measured  $pK_a$  values are absolute (that is, free from ion pairing) and can be directly compared with gas-phase acidities<sup>6</sup>; in addition, knowledge of the heats of ionization in DMSO<sup>7</sup> allows the evaluation of a possible entropy effect when the two phases are compared. The mechanism of proton transfer between oxygen and nitrogen acids and bases in aqueous solution has been reviewed<sup>8</sup>.

##### 2. Complex formation with Lewis acids

The Lewis acid–base reaction leading to complex formation<sup>9,10</sup> has been recently<sup>11</sup> considered in relation to the role of solvation effects. Many scales of thermodynamic parameters have been suggested. The concept of donor number (DN) was proposed by Gutmann<sup>12</sup>, and defined as the  $\Delta H$  (kcal mol<sup>-1</sup>) for the interaction of a basic solvent with SbCl<sub>5</sub> in 1,2-dichloromethane at room temperature:



Subsequently, DN has been defined according to the reaction



as the enthalpy change at 25 °C under 1 atm pressure in dichloromethane<sup>13</sup>. The two approaches are complementary. These scales, which cover a wide range of reactivity (*ca* 150 kJ mol<sup>-1</sup>), can be considered ‘hard basicity’ scales. Conversely, those using I<sub>2</sub>, I–X (X = electron withdrawing group, EWG) or HgBr<sub>2</sub> as reference acids are called ‘soft basicity’ scales.

##### 3. Hydrogen bonding

Few attempts<sup>14</sup> have yet been made to establish general scales for hydrogen-bond acidity and basicity. In his book<sup>11</sup>, Reichardt reviewed the hydrogen-bond subject when he analysed solvent effects. Kamlet and Taft defined a  $\beta$  scale of solvent HBD basicities, as well as an  $\alpha$  scale of solvent HBA acidities<sup>15</sup>. Although a large number of properties have been interpreted in terms of hydrogen-bond acidity ( $\alpha$ ) and/or hydrogen-bond basicity ( $\beta$ )<sup>16</sup>, it is only recently that an effort has been made for building general HBD and HBA scales based on thermodynamic measures<sup>17–20</sup>.

A scale was developed of relative hydrogen-bond basicity for a wide variety of compounds by means of their retention in gas chromatography<sup>21</sup>. Results indicate that the



use of hydrogen-bond basicity scales based on the free energy of formation of hydrogen-bond complexes to the rationalization of solvation-related phenomena must be used with discretion.

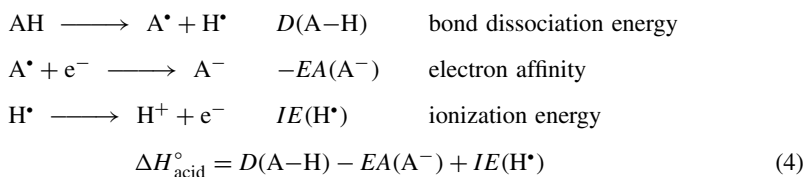
## B. Acidity and Basicity Scales in the Gas Phase

### 1. Scales relative to proton

The acidity of a substrate AH in the gas phase is measured using the standard enthalpy change  $\Delta H_{\text{acid}}^{\circ}$  for the heterolytic bond dissociation:



As the process cannot be directly studied,  $\Delta H_{\text{acid}}^{\circ}$  can be calculated as follows<sup>22</sup> with good approximation ( $\pm 2 \text{ kJ mol}^{-1}$ ):



The proton affinity  $PA$  of a substrate B, defined as  $\Delta_f H^{\circ}(\text{B})$ , can be similarly calculated<sup>22</sup>:



Inspection of equations 3 and 5 leads to the following:  $\Delta H_{\text{acid}}^{\circ}$  of substrate AH is equal to  $PA$  of its anion  $\text{A}^{-}$ , and  $PA$  of substrate B is equal to  $\Delta H_{\text{acid}}^{\circ}$  of its cation  $\text{BH}^{+}$ . Nevertheless, in accordance with common scientific use, the acidity scale of AH is presented separately from the basicity scale of B. Analogously, gas-phase acidity ( $\Delta G_{\text{acid}}^{\circ}$ ) and gas-phase basicity ( $GB$ ) are used for the Gibbs free-energy scales. The values have been obtained using various experimental methods. A critical review of three different experimental approaches for measuring bond energies has recently been published and considered radical kinetics, gas-phase acidity cycles and photoionization mass spectroscopy<sup>23</sup>. None of these methods appears to be completely satisfactory, but all of the measurements made using one method lead to bond energies within the error bars of the others (with the exception of the ethylene case). The gas-phase basicity of most organic compounds is within the 700–1000  $\text{kJ mol}^{-1}$  range, whereas the gas-phase acidities are within the 450  $\text{kJ mol}^{-1}$  range. Tables 1 and 2 show some significant values of

TABLE 1. Gas-phase basicities: thermodynamic data in  $\text{kJ mol}^{-1}$  for  $\text{BH}^{+} \rightarrow \text{B} + \text{H}^{+}$

	$PA$	$GB$	$T\Delta S^{\circ}$
$\text{CH}_3\text{NO}_2$	750	718	32
$\text{NH}_3$	853.5	818	35.5
$(\text{CH}_3)_2\text{NCHO}$	884	852	32
$\text{CH}_3\text{NH}_2$	896	861	35
$\text{C}_5\text{H}_5\text{N}$	924	892	32
$(\text{CH}_3)_3\text{N}$	942	909	33
$(\text{CH}_3)_2\text{N}(\text{CH}_2)_3\text{N}(\text{CH}_3)_2$	1021	969	52

TABLE 2. Gas-phase acidities: thermodynamic data in  $\text{kJ mol}^{-1}$  for  $\text{AH} \rightarrow \text{A}^- + \text{H}^+$ 

	$\Delta H_{\text{acid}}^{\circ}$	$\Delta G_{\text{acid}}^{\circ}$	$T\Delta S^{\circ}$
$\text{HNO}_2$	358	1330	28
$\text{CH}_3\text{NO}_2$	1491	1463	28
$\text{HCONH}_2$	1506	1476	30
$(\text{CH}_3)_2\text{NH}$	1658	1628	30
$\text{CH}_3\text{NH}_2$	1687	1656	31
$\text{NH}_3$	1689	1657	32

TABLE 3. Effect of hybridization on  $PA$  in  $\text{kJ mol}^{-1}$ 

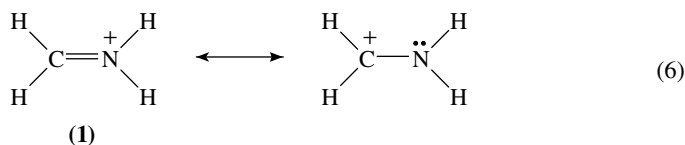
Compound	$PA^a$
$\text{H}_3\text{C}-\text{NH}_2$	896
$\text{H}_2\text{C}=\text{NH}$	845
$\text{HC}\equiv\text{N}$	717

<sup>a</sup>Reference 24.

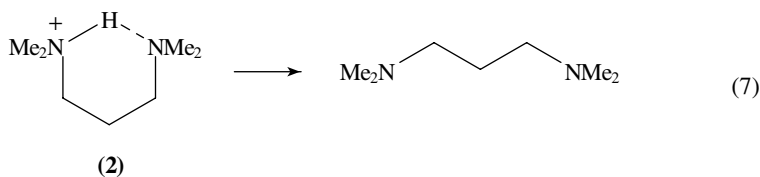
nitrogen-containing compounds. Acidity decreases with an increase in  $\Delta H_{\text{acid}}^{\circ}$  while the basicity increases with an increase in  $PA$ .

Deprotonation processes are exclusively governed by intrinsic structural effects, without any external stabilization. Therefore, the thermodynamic data are affected by the nature of the atom bound to the proton, its hybridization, the adjacent functionality and the transmitted substituent effects.

The physico-chemical aspects of proton transfer reactions involving amines have been interpreted in terms of various intrinsic effects arising from their molecular structures. Although acidities increase by increasing the  $s$  character of the reacting atom, no quantitative relation has been found between the  $s$  character and the variation in basicity in the case of oxygen and nitrogen bases. In particular the  $sp^2$ -hybridized nitrogen bases are very close in  $PA$  to the corresponding  $sp^3$  bases (as shown in Table 3). This has been ascribed to the extra-stabilizing effect of the resonance structures (equation 6).



The loss of symmetry which occurs after deprotonation leads to bigger  $T\Delta S^{\circ}$  values and the gain in degrees of freedom in internal rotation leads to bigger entropy values, as shown in reaction 7.



The gas-phase basicity and acidity of amines were in a chapter of the first updated volume of this series<sup>2</sup>, which provides extensive tables of values of aliphatic and aromatic

amines. However, some of these values have subsequently been revised and reported by Lias and coworkers<sup>24</sup>, and these are the values which will be used in this review.

The value of the *PA* of ammonia has been extensively discussed, and values ranging from 202 to 208 kcal mol<sup>-1</sup> have been proposed. In particular, since the originally accepted value of 204 kcal mol<sup>-1</sup>, a different value of 208.3 kcal mol<sup>-1</sup> has been suggested on the basis of high-pressure mass spectrometry (HPMS) experiments<sup>25</sup>. The same authors<sup>25b</sup> subsequently reversed their arguments, returning to the accepted value of *PA*(NH<sub>3</sub>) = 204 kcal mol<sup>-1</sup>.

In most papers the experimental proton affinity difference between water and ammonia is taken as being equal to 37.5 kcal mol<sup>-1</sup>. Various calculated values of this gap have appeared. The *PA* values of ammonia and water were 205.6 and 168 or 168.6 kcal mol<sup>-1</sup> respectively ( $\Delta PA = 37$  or 37.6 kcal mol<sup>-1</sup>) according to Dixon and Lias<sup>26</sup>; the work of Defrees and McLean<sup>27</sup> led to similar calculations of *PA*(NH<sub>3</sub>) = 204.0 and *PA*(H<sub>2</sub>O) = 165.1, with  $\Delta PA = 38.9$  kcal mol<sup>-1</sup>, although Pople and coworkers<sup>28</sup> predicted a  $\Delta PA = 39.4$  kcal mol<sup>-1</sup>.

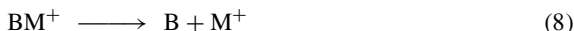
Notwithstanding the large body of *PA* data, the significant uncertainties of the experimental *PA* values of water and ammonia (up to 3–4 kcal mol<sup>-1</sup>) have meant that no absolute affinity scale is yet available.

Using Fourier transform ion cyclotron resonance spectrometry (FT-ICR), Taft<sup>29</sup> rechecked the proton transfer equilibria of a large number of compounds with a basicity that is lower than that of H<sub>2</sub>O. These new data have been compared with those obtained by McMahon's group using the ICR method<sup>30</sup> and found to be very close despite the differences in instrumentation, temperature and experimental techniques. On the contrary, discrepancies have been found with the values determined using HPMS, and when comparing the experimental and calculated basicities of fluorinated ammonia derivatives. The basicity of difluoroammonia F<sub>2</sub>NH is approximately 43 kcal mol<sup>-1</sup> weaker than that of ammonia. *Ab initio* calculations [Gaussian 92, HF/6-311G\*\* basis set, fully optimized geometry, zero-point vibrational energy (ZPV) differences included] predict  $PA_{\text{calc}}(\text{NH}_3) = 208.3$  kcal mol<sup>-1</sup><sup>25,26</sup> and  $PA_{\text{calc}}(\text{F}_2\text{NH}) = 159.4$  kcal mol<sup>-1</sup> with  $\Delta PA = 49$  kcal mol<sup>-1</sup>, to be compared with the experimental value  $\Delta PA(\text{NH}_3) = 43$  kcal mol<sup>-1</sup>. The same discrepancy has been found for FNH<sub>2</sub>.

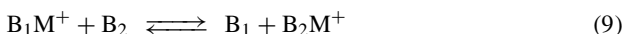
*Ab initio* molecular orbital calculations at the G2 level of theory is found<sup>31</sup> consistently to reproduce experimental proton affinities to an accuracy of 10 kJ mol<sup>-1</sup> for a range of bases with *PA* spanning *ca* 500 kJ mol<sup>-1</sup>.

## 2. Metal cation binding

By analogy with the basicity towards protons (equation 5) the basicity towards monocharged metal ions (Table 4) is defined by means of the thermodynamics of the reaction:



In practice, thermodynamic data are obtained from the metal-ion transfer reactions:



Kebarle and coworkers<sup>32</sup> proposed a basicity scale towards K<sup>+</sup>, in which the potassium affinities are always smaller than the corresponding *PA* values.

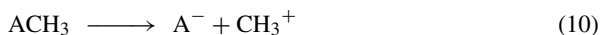
More precise relative Gibbs free-energy scales were established using equation 9. Other metal cations have also been considered, such as Li, Al and Mn: in general, the order of basicity found in the K<sup>+</sup> scale was not altered<sup>33</sup>.

TABLE 4. Gas-phase basicities towards  $K^+$ ; thermodynamic data in  $\text{kJ mol}^{-1}$  for  $BK^+ \rightarrow B + K^+$ 

	$K^+(A)$	$K^+(GB)$	$K^+(T\Delta S^\circ)$
$\text{NH}_3$	75	50	25
$(\text{CH}_3)_3\text{N}$	84	54	30
$\text{C}_5\text{H}_5\text{N}$	88	63	25
$(\text{CH}_3)_2\text{NCHO}$	130	96	34

### 3. Organometallic and organic cation binding

Knowledge of the gas-phase interactions between cations involving elements of group 14 and electron donor molecules has been used to create various basicity scales. In addition, the absolute methyl cation affinities (MCA) scale has been built by calculating the enthalpies of reactions 10 and 11 by means of  $PA$  and  $\Delta H^\circ$ <sup>34</sup>.



### 4. Anion binding and electron affinities

ICR and HPMS have been used to determine the thermochemical data of reactions:



where EPA = electron pair acceptor.

Many gas-phase acidity scales have been proposed, according to the nature of the interacting systems<sup>35-39</sup>.

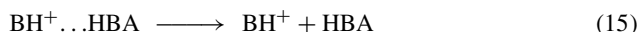
The electron affinity  $EA$  is related to the energy of the lowest unoccupied molecular orbital and is defined as the enthalpy at 0 K for<sup>22</sup>:



Since reaction 14 can be considered similar to reaction 13, approximations between  $EA$  and Gibbs free-energy are possible; this subject has been reviewed by Kebarle and Chowdhury<sup>40</sup>.

### 5. Cationic hydrogen bonds

In general, the interaction of a protonated base  $\text{BH}^+$  with a neutral HBA is described by the following relationship:

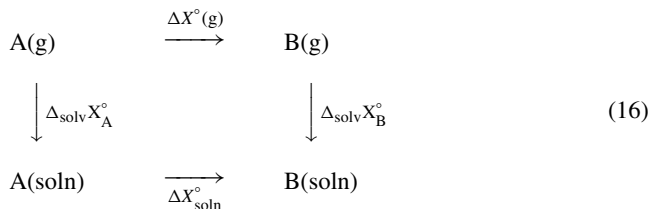


By keeping either  $\text{BH}^+$  or HBA constant, hydrogen-bond basicity or acidity scales can be built<sup>41-43</sup>.

## C. Gas Phase-Solution Relationships

Over the last decade, many approaches have been proposed for relating acidity-basidity dependent properties in gas phase and solution. To evaluate the solvation effect, the

following thermodynamic cycle is adopted:



where A and B are neutral or ionic reactants and products,  $\Delta X^\circ$  is the change in thermodynamic function  $H^\circ$ ,  $G^\circ$  or  $S^\circ$ , and solv (= solvation) represents the transfer from the gas phase to the solution.

$$\Delta X^\circ_{\text{soln}} = \Delta X^\circ(\text{g}) + [\Delta_{\text{solv}} X^\circ_{\text{B}} - \Delta_{\text{solv}} X^\circ_{\text{A}}] \quad (17)$$

where  $\Delta X^\circ_{\text{soln}}$  is defined as the sum of an intrinsic gas-phase component and a differential solvation term that quantitatively accounts for the variation in basicity or acidity order between the two phases.

The effects of hydration on the basicity of many classes of organic compounds (mainly oxygen and nitrogen bases) have been studied experimentally and/or by using useful approximations for evaluating the change in the thermodynamic functions. In this context, protonated and deprotonated forms of  $\alpha$ -amino acids have been considered<sup>44</sup>. However, this approach has generally been found to be accurate only in the case of simple mono-functional molecules.

Within the general framework of relating solution and gas-phase behaviour, many theoretical approaches have been developed to evaluate ion hydration:

- (1) the continuum methods<sup>45</sup>;
- (2) the Monte Carlo and molecular dynamic simulations<sup>46</sup>;
- (3) the supermolecule approach<sup>47</sup>.

Alternatively, a great number of correlations have been made in order to establish empirical relationships between gas-phase and solution acidity and basicity.

In general, there is always an attenuation in effects from gas phase to solution (slope < 1), but this has been found to be particularly large for substituent effects of the basicity of alkylamines<sup>48</sup> and pyridines<sup>49</sup> in water.

Evaluation of the relative differential solvation term was made possible when a linear relationship with a slope close to 1 was found. The reference plot was obtained correlating  $\Delta G^\circ(\text{aq})$  versus the  $GB$  of large aromatic hydrocarbons (slope *ca* 1): in fact, these hydrocarbons are not specifically solvated, give highly charge-delocalized cations and have negligible specific interactions. Under these circumstances, the polarizability and resonance effects are similar in the gas phase and in water with the differential solvation of B and  $\text{BH}^+$  remaining almost constant. Thus, any deviation from the reference line is a measure of the relative differential solvation<sup>50</sup>.

Much work has been conducted to find a similar relationship for acidity. The limitation of measuring weak acidities in water has been overcome by the use of acidities in DMSO<sup>6</sup>, with  $\Delta G^\circ(\text{DMSO})$  versus  $\Delta G^\circ_{\text{acid}}$  of large unsaturated hydrocarbons being the reference relationship. In this correlation  $\text{NH}_3$  is a deviant point. This result was attributed to specific differential solvation: on deprotonation, ammonia generates the small and highly charge-localized  $\text{NH}_2^-$  anion. Comparison of the  $\Delta G^\circ(\text{DMSO})$  and the  $\Delta G^\circ_{\text{acid}}$  of many classes of compounds showed that electron-withdrawing substituted anilines were less acidic in DMSO, which can be explained by the stronger HBD (greater solvation of the neutral)

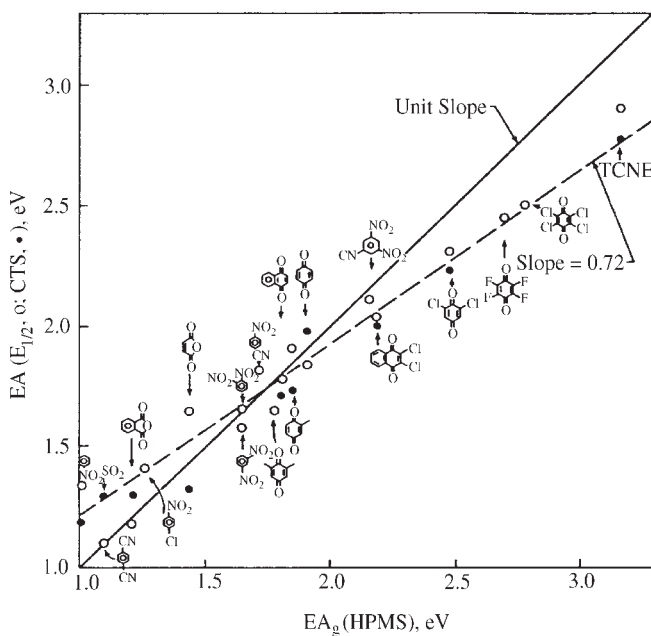


FIGURE 1. Plot of gas-phase electron affinities from electron-transfer equilibria measurements vs electron affinities deduced from polarographic half-wave potentials and charge-transfer spectra. The observed slope is not equal to 1 but is *ca* 0.72. This reveals the effect of decreasing solvation exothermicity with increasing charge delocalization of negative ions since high *EA* molecules lead to ions with more extensive charge delocalization ( $1 \text{ eV} = 96.48456 \text{ kJ mol}^{-1}$ ). Reprinted with permission from Reference 40. Copyright (1987) American Chemical Society

and weaker ion solvation due to considerable charge delocalization in the anions. This effect was also found by plotting the basicities in water against the gas-phase basicities of some enamino ketones<sup>51</sup>. The greater acidities measured in DMSO and water than in the gas-phase of *p*-NO<sub>2</sub>- and *p*-NO-phenol were attributed to charge localization on the substituent<sup>52</sup>.

As with proton transfer reactions, the thermodynamic data determined in the two phases can also be compared in the case of electron transfer reactions, as shown in Figure 1<sup>40</sup>.

By correlating the gas-phase and solution data derived from proton transfer reaction, the deviations were accounted for by solvation effects on the reactive centre and/or the substituent.

In the case of solvents with a low solvating power, in which protonated or deprotonated species are not free from counterion effects, spectroscopic and thermodynamic parameters associated with hydrogen bonding or Lewis acid–base interactions can be usefully related to *PA* or *GB*. Kamlet and coworkers<sup>53</sup> reported linear relationships for five series of bases with sp<sup>2</sup>- and sp<sup>3</sup>-hybridized oxygen and sp-, sp<sup>2</sup>- and sp<sup>3</sup>-hybridized nitrogen. At the same time, Zeegers-Huyskens presented the relationships<sup>54</sup> reported in Figure 2.

More details on the possibility of correlating the acidity and basicity values derived in solution and in the gas-phase can be found in the chapter written by Gal and Maria<sup>55</sup>, where the authors concentrated on the possibility of relating acid/base interactions in various media.

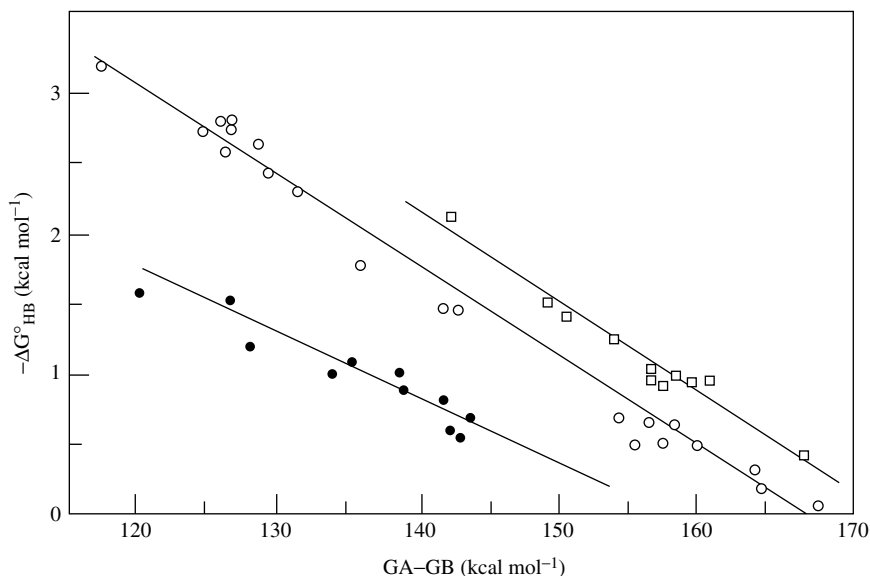


FIGURE 2. Gibbs free-energy of hydrogen bonding, in tetrachloromethane, between OH HBD and N HBA (□ nitriles, ○ pyridines, ● anilines). Reproduced with permission from Reference 54

#### IV. NITROGEN BASES

##### A. Amine Derivatives

The constants of ion pair formation of 33 amines with 2,4-dinitrophenol in benzene ( $K_B$ ) have been compared with the  $pK_a$  in water<sup>56</sup>. The effects of structural variations on basicity are larger in water than in benzene for primary and secondary cyclic amines, but similar for tertiary amines. The Taft and Hancock equation [where  $\sigma^*$  has the usual meaning and  $E_s^C(R^i)$  is the steric effect of a component substituent]

$$\log K_B = \rho^* \sigma^* + \sum_i a_i E_s^C(R^i) + c \quad (18)$$

allows the unified treatment of the determined  $K_B$  values and indicates that the overall effects of the three substituents at nitrogen can be well accounted for by electronic and steric effects.

In the absence of any chelation effect, the relative base strength of substituted unconjugated amines [ $\text{Me}_2\text{NR}$  with  $R = \text{H}, \text{CH}_3, \text{C}_2\text{H}_5, i\text{-C}_3\text{H}_7, i\text{-C}_4\text{H}_9, \text{sec-C}_4\text{H}_9, t\text{-C}_4\text{H}_9, c\text{-C}_6\text{H}_{11}, t\text{-C}_5\text{H}_{11}, \text{neo-C}_5\text{H}_{11}, \text{C}_6\text{H}_5\text{CH}_2, \text{H}_2\text{C}=\text{CHCH}_2, \text{HC}\equiv\text{CCH}_2, \text{CF}_3\text{CH}_2, \text{NCCH}_2, (\text{CH}_3)_2\text{NCH}_2$ ] is governed by the substituent and the solvent. Investigation of their relative basicity in water and in the gas phase indicates that the importance of polarizability effects over field/inductive effects is greater in the gas phase than in solution<sup>57</sup>. The hydrogen substituent does not correlate with the other substituents: in fact, in addition to having different hyperconjugation forms, it also offers an additional site for hydrogen-bond formation (Figure 3).

The gas-phase basicity order of alkylamines can be reproduced in terms of softness of the alkyl groups (using the Fukui function  $f_k^-$  and local softness parameter  $s_k^-$ ), this being far more important than group electronegativity<sup>58</sup>.

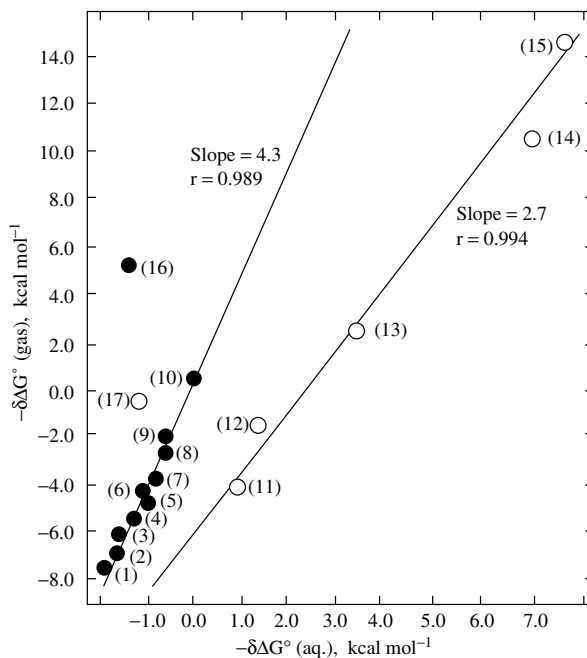
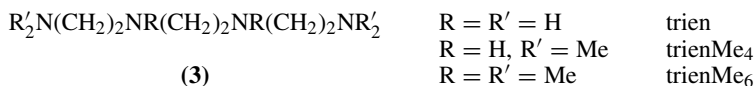


FIGURE 3. Gas-phase vs aqueous basicities of substituted dimethylamines: (1) *tert*-amyl; (2) *c*-C<sub>6</sub>H<sub>11</sub>; (3) *tert*-butyl; (4) *sec*-butyl; (5) neoamyl; (6) isopropyl; (7) isobutyl; (8) *n*-propyl; (9) ethyl; (10) methyl; (11) benzyl; (12) allyl; (13) propargyl; (14) CF<sub>3</sub>CH<sub>2</sub>; (15) NCCH<sub>2</sub>; (16) H; (17) (CH<sub>3</sub>)<sub>2</sub>NCH<sub>2</sub>. Reprinted with permission from Reference 57. Copyright (1987) American Chemical Society

The gas-phase and solution basicities of various amines XCH<sub>2</sub>N(CH<sub>3</sub>)<sub>2</sub> containing polar groups (X = CN, CCl<sub>3</sub>, C<sub>6</sub>F<sub>5</sub>, HC≡C, H<sub>2</sub>C=CH, C<sub>6</sub>H<sub>5</sub>) in different solvents have been compared<sup>59</sup> in order to discover the factors that affect the ionization of difunctional molecules and to interpret structure-acidity relationships correctly. The considered solvents were: H<sub>2</sub>O, MeOH, EtOH, 2-PrOH, EG (ethylene glycol), DMSO, TEP (triethylphosphate), AN (acetonitrile) and NB (nitrobenzene). As analysed using solvatochromic parameters ( $\pi^*$  = the solvent's dipolarity-polarizability constant,  $\alpha$  and  $\beta$  = the solvent's hydrogen-bond acidity and basicity constants, respectively), the solvation effects on basicities are not adequately accounted for by the solvent's dipolarity-polarizability constant  $\pi^*$ . A better representation of the non-specific interactions between solvents and trimethylammonium ion is obtained using the product of  $\pi^*$  and the solvent dipole moment  $\mu$ .

The basicity constants (Table 5) of the stepwise protonation of methylated tetramines (trienMe<sub>4</sub> and trienMe<sub>6</sub>) have been considered and compared with those of the unsubstituted parent triethylenetetramine (trien).



The log *K* values were found to decrease as the degree of methylation increased. Analysis of the data led to the conclusion that the first two protonations were on the terminal tertiary nitrogen, followed by the others on the inner nitrogens<sup>60</sup>.



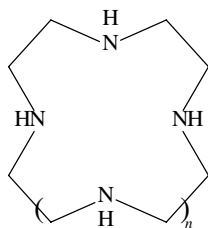
TABLE 5. Basicity constants in water (ionic strength 0.1, at 25 °C) of the stepwise protonation of methylated tetramines

Amine	Protonation	log <i>K</i>
trien Me <sub>6</sub>	I	9.11
	II	8.35
	III	5.26
	IV	2.24
trienMe <sub>4</sub>	I	9.19
	II	8.43
	III	5.62
	IV	2.73
trien <sup>a</sup>	I	9.95
	II	9.31
	III	6.86
	IV	3.66

<sup>a</sup>Reference 62.

The protonation sequence of linear aliphatic polyamines H<sub>2</sub>N[CH<sub>2</sub>]<sub>k</sub>NH[CH<sub>2</sub>]<sub>l</sub>-(NH[CH<sub>2</sub>]<sub>m</sub>)<sub>n</sub>NH<sub>2</sub> with *k*-*m* = 2-4, *n* = 0-3 can be determined using <sup>13</sup>C NMR spectroscopy<sup>61</sup>.

The basicity constants (Table 6) of the stepwise protonation of polyazacycloalkanes have been determined.



(4)

$$\begin{aligned}
 n = 4 \quad N = 7 \\
 n = 5 \quad N = 8 \\
 n = 6 \quad N = 9 \\
 n = 7 \quad N = 10 \\
 n = 8 \quad N = 11
 \end{aligned}$$

*N* = number of nitrogen atoms

TABLE 6. Basicity constants in water (in 0.5 M NaClO<sub>4</sub>, at 25 °C) of the stepwise protonation of polyazacycloalkanes

Protonation	<i>N</i> = 7 <sup>a</sup>	<i>N</i> = 8 <sup>a</sup>	<i>N</i> = 9 <sup>b,c</sup>	<i>N</i> = 10 <sup>b,d</sup>	<i>N</i> = 11 <sup>b,e</sup>	<i>N</i> = 12 <sup>b,e</sup>
I	9.83	10.01	9.59	9.85	9.79	9.75
II	9.53	9.5	9.40	9.44	9.48	9.65
III	8.84	9.1	8.77	8.95	9.02	8.88
IV	6.72	8.29	8.27	8.56	8.64	8.96
V	4.04	5.01	6.37	7.79	8.06	8.12
VI	2.43	3.71	4.22	5.24	6.44	7.82
VII	2.3	2.98	3.24	3.84	4.49	5.66
VIII		1.97	2.31	3.02	3.58	4.27
IX			1.8	1.97	2.76	3.58
X				1.8	2.26	2.62
XI					1.7	2.3
XII						1.0 (estimated)

<sup>a</sup>Reference 63.

<sup>b</sup>0.15 M NaClO<sub>4</sub>.

<sup>c</sup>Reference 64.

<sup>d</sup>Reference 65.

<sup>e</sup>Reference 66.

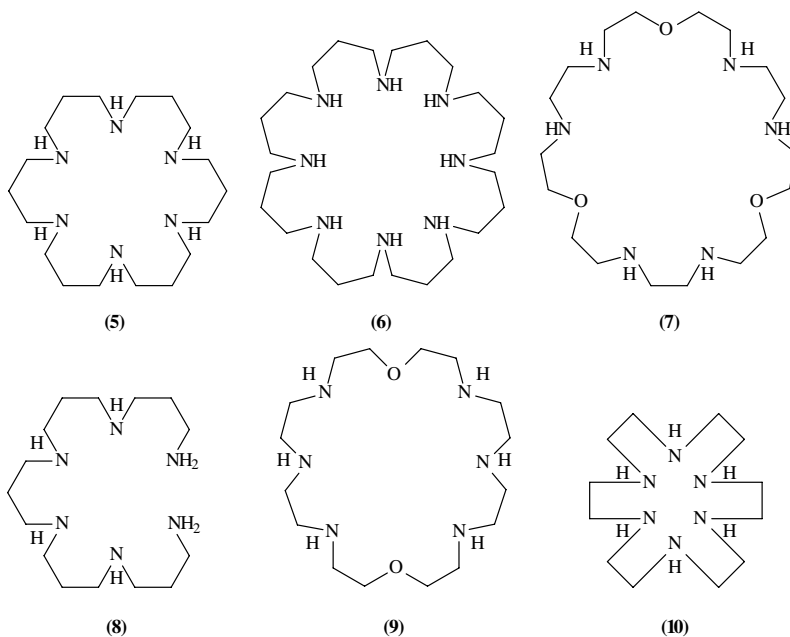


TABLE 7. Basicity constants in water (ionic strength = 0.1 M TsNa at 25 °C) of the stepwise protonation of compounds **5–10**

Protonation	<b>5</b>	<b>6</b>	<b>7</b>	<b>8</b>	<b>9</b>	<b>10<sup>a</sup></b>
I	10.50	10.65	9.35	10.10	9.15	10.20
II	10.20	10.55	9.25	10.10	9.00	9.25
III	9.25	9.70	8.35	9.30	8.20	8.75
IV	8.00	9.20	6.80	8.70	7.20	4.10
V	7.05	8.20	5.65	7.70	3.70	≈2
VI	6.40	7.75	5.55	7.00	3.40	≈1
VII		6.85				
VIII		6.50				

<sup>a</sup>Reference 68.

Macrocyclic polyamines have been extensively studied by Lehn's group<sup>67</sup> and the protonation constants of polyamines [24]ane-N<sub>6</sub> (**5**), [32]ane-N<sub>8</sub> (**6**) and [27]ane-N<sub>6</sub>O<sub>3</sub> (**7**) have been evaluated and compared with those of the acyclic analog (**8**) and of the macrocycles [24]-N<sub>6</sub>O<sub>2</sub> (**9**) and [18]-N<sub>6</sub> (**10**)<sup>68</sup> (Table 7).

Proton affinities of some  $\alpha$ -amino acids have been presented by Bojensen<sup>69</sup> who used the kinetic approach developed by Cooks and coworkers<sup>70</sup>. Alternatively, Gorman *et al.*<sup>71</sup> used FT ion cyclotron resonance spectrometry to determine gas-phase basicities of 20 common  $\alpha$ -amino acids, from which proton affinities have been derived. The relative ordering of *PA* of the two research groups presents noticeable differences relative to histidine, glutamine, glutamic acid, alanine, methionine and threonine. According to Gorman, discrepancies could arise from Cook's method tested for monofunctional compounds, although this argument has been challenged by the Danish group<sup>72</sup>.

The solution basicities in water at 25 °C of *ortho*-, *meta*- and *para*-substituted primary, secondary and tertiary anilines have been widely discussed by Smith<sup>1</sup>. Preliminary gas-phase data were reported by Bohme<sup>2</sup>. Subsequently, the gas-phase basicities (proton

affinities) of 15 substituted anilines were determined by measuring proton transfer equilibria by means of a pulsed electron beam high pressure mass spectrometer<sup>73</sup>. Nitrogen protonation occurs when  $\sigma$ - and  $\pi$ -donating substituents are present at the *para* position and electron-donating substituents are on nitrogen. Conversely,  $\pi$ -donating substituents at the *meta* position favour ring protonation: these anilines show higher basicities than expected. However, when a strong electron-withdrawing substituent, such as CN and CF<sub>3</sub>, is at the *meta* position, nitrogen protonation occurs again because ring protonation is not favoured. A linear relationship between the gas-phase basicities and the basicities in water of nitrogen-protonated anilines was obtained with an attenuation factor of *ca* 4.

## B. Amidines and Guanidines

The general topic of the basicity of amidines has been recently covered in a chapter<sup>74</sup> in the book *The Chemistry of Amidines and Related Compounds*. Here, the general scheme rationalizing the dependence of basicity on the nature of the substituents is outlined.

The basicity of compounds containing the amidino group N=C–N depends on the substituents at the three sites (both nitrogens and the amidino carbon atom) and the protonation site is the imino nitrogen atom<sup>75</sup>. It has been shown<sup>76</sup> that, at any of the three sites, in the series of monosubstituted amidines, their p*K*<sub>a</sub> values obey Hammett's equation.

$$\text{p}K_{\text{a}} = \text{p}K_{\text{a}}^0 - \rho\sigma \quad (19)$$

In addition, the p*K*<sub>a</sub> values of amidines substituted at the imino nitrogen atom correlate with the p*K*<sub>a</sub> values of the corresponding primary amines and, in turn, this correlation can be used to predict the p*K*<sub>a</sub> values of trisubstituted amidines. The p*K*<sub>a</sub> values of a series of trisubstituted formamidines (C<sub>6</sub>H<sub>5</sub>–N=CH–NR<sup>1</sup>R<sup>2</sup>), with variable substituents at the amino nitrogen atom, correlate with the p*K*<sub>a</sub> values of corresponding secondary amines R<sup>1</sup>R<sup>2</sup>NH; the correlations are in the following form:

$$\text{p}K_{\text{a}}(\text{amidine}) = \text{p}K_{\text{a}}^0 + \alpha[\text{p}K_{\text{a}}(\text{amine}) - \text{p}K_{\text{a}}(\text{aniline})] \quad (20)$$

The p*K*<sub>a</sub> values of amidines containing two substituted phenyl rings (one at the imino nitrogen and the other at the amidino carbon atom) do not obey a simple dual parameter equation, but fit the following equation:

$$\text{p}K_{\text{a}} = \text{p}K_{\text{a}}^0 - \rho_{\text{im}}\sigma_{\text{im}} - \rho_{\text{F}}\sigma_{\text{F}} - \mu\sigma_{\text{im}}\sigma_{\text{F}} \quad (21)$$

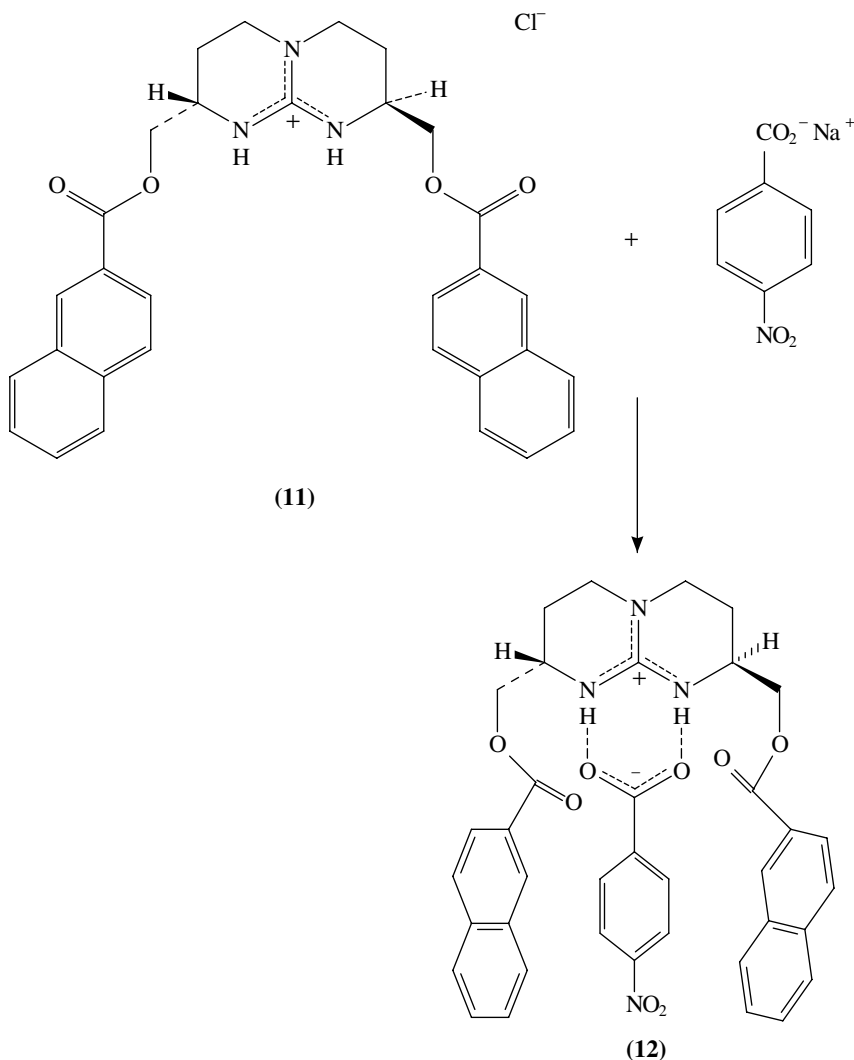
where  $\sigma_{\text{im}}$  and  $\sigma_{\text{F}}$  are the Hammett-type constants at the imino nitrogen and the functional carbon, respectively, and  $\mu$  represents the mutual interaction of the substituents.

Following the same reasoning, a general equation has been proposed to predict p*K*<sub>a</sub> values of amidines containing various substituents at the three sites of the amidino group:

$$\text{p}K_{\text{a}} = \text{p}K_{\text{a}}^0 - \rho_1\sigma_1 - \rho_2\sigma_2 - \rho_3\sigma_3 - \mu_{12}\sigma_1\sigma_2 - \mu_{13}\sigma_1\sigma_3 - \mu_{23}\sigma_2\sigma_3 \quad (22)$$

where  $\sigma_k$  and  $\sigma_l$  are the  $\sigma$  constants of the substituents at each pair of the site (*k* and *l*) of the amidino group, and  $\mu_{k,l}$  represents the mutual interaction between the substituents.

Molecular recognition by abiotic synthetic receptors has been considered an important goal in biorganic chemistry. The guanidinium group (p*K*<sub>a</sub> *ca* 13.5), which remains protonated over a wide range of pH, is able to form (strongly zwitterionic) hydrogen bonds with carboxylates and phosphates. This behaviour has been exploited to build optically active abiotic receptors<sup>77</sup>. Lehn's group has shown that a bis-naphthoyl ester of the rigid bicyclic guanidine (**11**) can complex sodium *p*-nitrobenzoate, sodium *p*-methoxybenzoate



and sodium phenylacetate. The chirality of **11** forces any substrate to bind in a dissymmetric environment, allowing the enantioselective recognition of chiral carboxylic acids. When *N*-acetyl and *N*-*tert*-butoxycarbonyl derivatives of sodium tryptophan were examined, two diastereomeric complexes were detected.

The X-ray crystal structure of the nitrate salt of the chiral bicyclic guanidine<sup>78</sup> (Figure 4) indicates that the counter ion is bound by two virtually parallel hydrogen bonds to both of the protonated guanidinium nitrogen atoms. The nitrate ion is not coplanar with the guanidinium system, but tilted by 20.8° with respect to the plane through the atoms N(1), N(2), N(3) and C(1). The extraordinary basicities<sup>79</sup> of these bicyclic guanidines is well illustrated by the fact that, if an equimolar amount of the free base of **13** is added to an acetonitrile solution of the salt of acetyl-D,L-alanine and of 1,8-bis-(dimethylamino)naphthalene

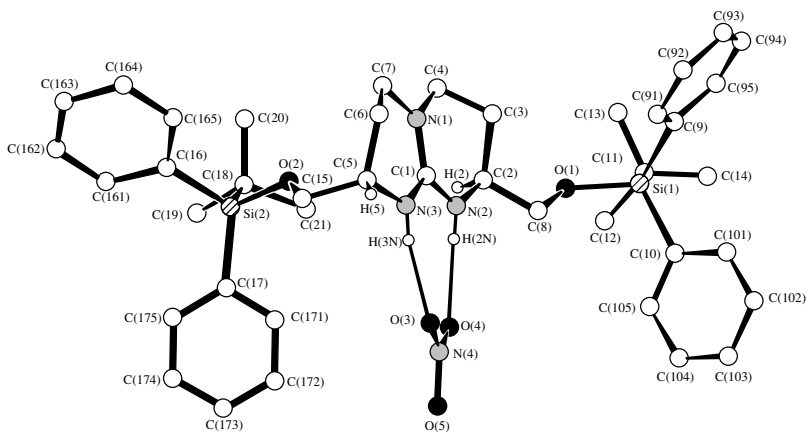
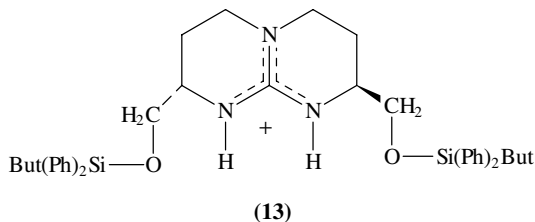
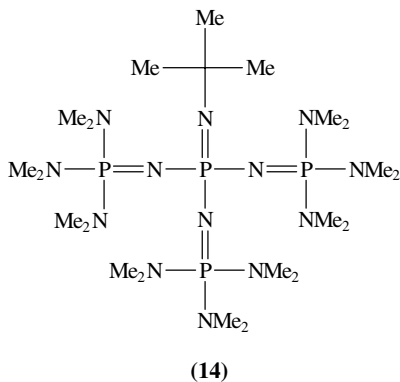


FIGURE 4. Molecular structure of nitric salt of chiral bicyclic guanidine (**13**)<sup>78</sup>. Reproduced by permission of the Royal Society of Chemistry

(proton sponge), <sup>1</sup>H NMR shows evidence of the complete deprotonation of the proton sponge cation and the formation of diastereoisomeric host-guest complex.

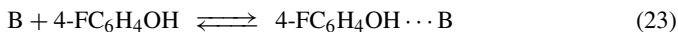


Multiply aminated phosphinimines behave as exceptionally strong bases and this property has been recently exploited by Schwesinger in a variety of organic reactions<sup>80</sup>. In particular, among the group of kinetically highly active uncharged peralkylated polyamino-phosphazenes, P4-*t*-Bu (**14**) is one of the most hindered and basic, more than 24 pK units stronger than 1,8-bis-(dimethylamino)naphthalene or triethylamine and *ca* 18 pK units stronger than DBU.



### C. Amidates and Amides

The scale of hydrogen-bond basicity  $pK_{\text{HB}}$ , initially developed by Taft and coworkers<sup>14</sup>, has been extended by Abraham and coworkers<sup>81</sup>, and is based on the formation of hydrogen-bond complexes of a base B with a hydrogen-bond reference donor as 4-fluorophenol in  $\text{CCl}_4$  at 25 °C:



$$K_{\text{HB}} = [4\text{-FC}_6\text{H}_4\text{OH} \cdots \text{B}] / [\text{B}][4\text{-FC}_6\text{H}_4\text{OH}] \text{ and } pK_{\text{HB}} = \log K_{\text{HB}}$$

The  $pK_{\text{HB}}$  values can be transformed to give the parameter  $\beta_2^{\text{H}} = (pK_{\text{HB}} + 1.1)/4.636$ , which ranges from 0 (no basicity) to 1 (basicity of HMPA). This scale has been extended to many organic functionalities including amidines<sup>82</sup> and amides<sup>83</sup>.

On the basis of IR evidence it has been proposed<sup>84</sup> that alkylamidates are the strongest known hydrogen-bonding carbonyl bases and that the order of hydrogen-bond basicity may be alkylamidates  $\approx$  HMPA > vinylogous amides  $\approx$  benzamidates > amides (Table 8).

TABLE 8. Hydrogen-bond basicity of amidates  $\text{RCON}^-\text{N}^+\text{Me}_3$  and, for comparison, some carboxyamides in  $\text{CCl}_4$

Amidates	$pK_{\text{HB}}$	$\beta_2^{\text{H}}$
R = Pr <sup>i</sup>	3.32	0.95
Bu <sup>t</sup>	3.25	0.94
1-Adamantyl	3.56	1.01
<i>N,N</i> -Dimethylformamide	2.10 <sup>a</sup>	0.69
<i>N,N</i> -Diethylacetamide	2.47 <sup>a</sup>	0.77
1-Methyl-2-piperidone	2.60 <sup>a</sup>	0.80
<i>N,N'</i> -Dimethyl- <i>N,N'</i> -trimethyleneurea	2.79 <sup>a</sup>	0.84
3-Dimethylamino-5,5-dimethylcyclohexenone	2.92	0.87
HMPA	3.56 <sup>b</sup>	1.00

<sup>a</sup>Reference 83.

<sup>b</sup>Reference 14.

### V. NITROGEN ACIDS

When substituted with identical groups, NH hydrogen acids are more acidic than CH carbon acids, and thus ammonia is more acidic than methane, and aniline more acidic than toluene, etc. Notwithstanding the great importance of metal amides as bases, systematic study of the acidity of NH nitrogen acids has received attention only since the development of acidity scales in organic solvents for investigating the acidity of CH carbon acids. This delay may be due to the fact that, with the exception of the sulphonamides, cyanamides and imides, the majority of nitrogen acids are weak. Moreover, carbanions are ubiquitous intermediates in organic chemistry and nitranions (the conjugate bases of nitrogen acids), which are usually harder species than carbanions, give rise to a complex landscape of interactions with the cation and solvent. Structural investigations of nitranion salts have appeared more recently than analogous studies of carbanionic and organometallic species. It will therefore be useful to describe some recent important results concerning the characterization of nitranions in terms of their bonding, structure and interactions with the cation and solvent.

### A. Structural Characterization of Metal Amides in the Solid State and in Solution

X-ray crystal studies have contributed much towards clarifying the molecular arrangements of metal amides in the solid state, while  $^{13}\text{C}$ ,  $^{15}\text{N}$  and lithium countercation NMR have revealed the structural and dynamic aspects of various interactions in solution. Collum<sup>85</sup> pioneered NMR spectroscopic, crystal structure and theoretical approaches to the awareness of this class of compounds. Structural studies in the solid state involved metal dialkylamides<sup>86</sup>, isopropylamides<sup>87</sup>, allylamides<sup>88</sup>, piperides<sup>86a,89</sup>, amidomagnesiates<sup>90</sup>, various silylamides<sup>91</sup>, cyanamide<sup>92</sup> and chiral amides<sup>93</sup>. Dimers<sup>94</sup>, tetramers, and up to decameric and dodecameric<sup>95</sup> oligomers, as well as adamantanoid<sup>96</sup> arrangements, have been found. Computations<sup>97</sup> have very often closely mimicked experimental results, and the role of structure upon reactivity has also been investigated (e.g. in carbonylation reactions<sup>98</sup>).

Boche and coworkers drew attention to the solid state structure of mixed amine–metal amide<sup>99</sup> and silylamide–nitrile complexes<sup>100</sup> as models of reaction intermediates.

Polyazacycloalkanes of the series  $[3k]\text{ane-N}_k$  ( $7 \leq k \leq 12$ ) are known to form polynuclear complexes with metal ions such as  $\text{Mn}^{2+}$ ,  $\text{Co}^{2+}$ ,  $\text{Ni}^{2+}$ ,  $\text{Zn}^{2+}$  and  $\text{Cd}^{2+}$ , and can generally include more than one ion, thus forming dinuclear complexes; trinuclear complexes have been found with  $k = 12, 13$ . When  $\text{Pd}^{2+}$  was used, di- and trinuclear complexes with azamacrocycles  $[18]\text{ane-N}_6$  and  $[21]\text{ane-N}_7$  were found and their structures have been ascertained by means of X-ray analyses. In the case of the trinuclear complex, deprotonation of a secondary amino group occurs both in solution and the solid state<sup>101</sup> (Figure 5).

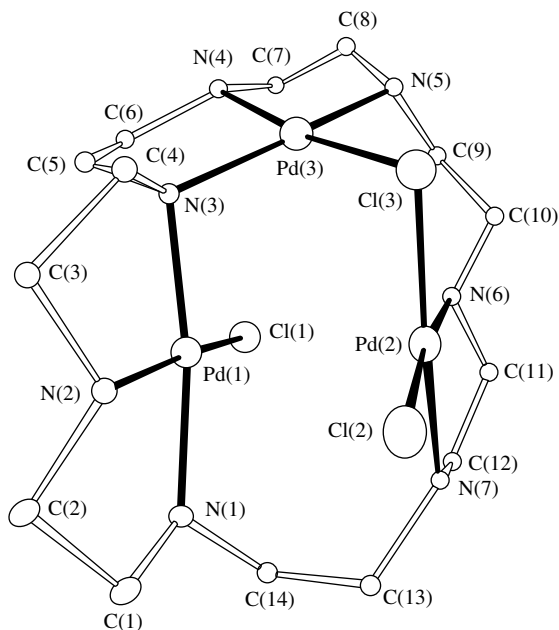


FIGURE 5. ORTEP view of the complex cation  $[\text{Pd}_3([\text{21}]\text{aneN}_7)\text{Cl}_3]^{2+}$ . The deprotonated nitrogen is  $\text{N}3^{101}$ . Reprinted by permission of the Royal Society of Chemistry

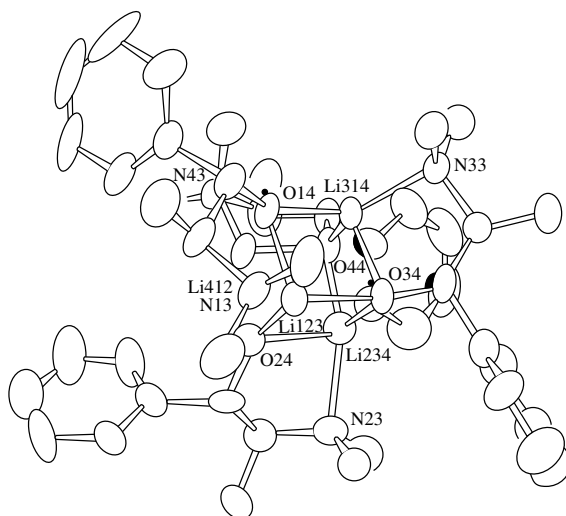


FIGURE 6. ORTEP diagram of the lithium *N*-methylpseudoephedrate (I) solid state tetramer. Hydrogen atoms have been omitted for clarity. Reprinted with permission from Reference 102. Copyright (1990) American Chemical Society

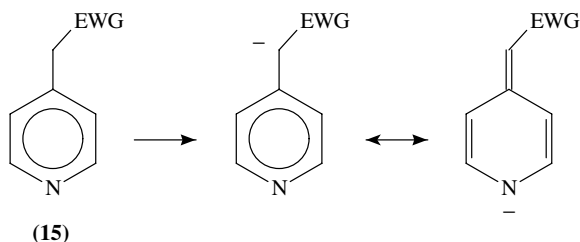
Solid state investigations have been generally corroborated by solution studies. The X-ray structure of lithium *N*-methylpseudoephedrates<sup>102</sup> indicates the tetrameric aggregation in which the lithium atoms are chelated between oxygen and nitrogen (Figure 6). The structure in solution has been demonstrated to be tetrameric in benzene by means of vapour pressure osmometry (VPO, 37 °C) and cryoscopy (5.5 °C).

Nitranion salts of heterocyclic NH-azoles have been investigated in the solid state<sup>103</sup> and solutions of different solvents, and with various counterions<sup>104</sup>. The initial explorative <sup>1</sup>H NMR study has been more recently extended to the <sup>13</sup>C NMR investigation of nitranions PhN<sup>-</sup>X, in which the nature of X allows the inclusion of amine, nitramide, sulphonamide, phosphonamide, cyanamide and carboxamide functionalities<sup>105</sup>. The results show the considerable structural reorganization undergone by the precursor nitrogen acid PhNHX upon deprotonation: the effect on <sup>13</sup>C shifts exerted by the [2.2.1] cryptand indicates the few cases in which ion pairing and/or aggregation occurs. Correlative analysis of the NMR data shows the effect of the substituent in PhN<sup>-</sup>X, revealing that charge transfer from the nitrogen atom to the phenyl ring is dominated by the resonance component of the effects exerted by the substituent X. Unlike the analogous acid–base pair of toluene carbon acids PhCH<sub>2</sub>X and benzyl carbanions PhCH<sup>-</sup>X, there is no correlation whatsoever between C<sub>para</sub> of PhN<sup>-</sup>X and Bordwell's acidities of PhNHX in DMSO. The energetics of the deprotonation process are dominated by the polar-inductive component of the effect exerted by the substituent X. The different sensitivities of charge release from nitrogen in nitranions, as well as of the acidities of nitrogen acids, are accounted for by structural arrangements in these species. The results indicate that the lone pair developing on the nitrogen atom upon deprotonation has a limited chance of providing an extra resonance stabilization to the anion in comparison with the neutral. The nitrogen atom adopts a planar sp<sup>2</sup> configuration (the two electron pairs occupying a p and an sp<sup>2</sup> orbital, respectively) when X is a group containing a π system. If nitranions similarly adopt such a configuration at the nitrogen atom, with colinearity of the p orbitals of the phenyl ring,



the nitrogen atom and the substituent X, the electron pair residing in the nitrogen  $sp^2$  orbital can enhance electron release from the nitrogen atom to both the phenyl and the substituent. The absence of any direct overlap of the nitrogen  $sp^2$  orbital with the p orbital of X explains why the acidity of nitrogen acids is only marginally affected by substituents characterized by strong resonance electron-withdrawing (EW) power.

These considerations have been confirmed<sup>106</sup> by the finding that nitranion  $^{15}\text{N}$  resonances can undergo displacements of opposite sign in relation to the shift of the precursor nitrogen acid. Low-field and high-field displacements respectively occur when a  $\sigma(sp^2)$  or a  $\pi(p-\pi)$  charge is generated. Thus, in the anion of 2- and 4-picoline, there is a substantial increase in the  $\pi$ -negative charge on the pyridyl nitrogen: in these anions a high-field displacement of the  $^{15}\text{N}$  resonance is observed in relation to the neutral precursor. Deprotonation of pyrrole, as well as of aromatic amines and carboxamides, generates and locates the negative charge in an  $sp^2$  orbital of the nitrogen atom: the  $^{15}\text{N}$  shift of pyrrole nitranion is low-field displaced in relation to that of the neutral pyrrole. A more subtle interpretation of the low-field shift of the  $^{15}\text{N}$  nitranion resonance of aromatic or heteroaromatic amines comes from a detailed RHF/6-31G\* study<sup>107</sup> of pyridyl amine nitranions. The isotropic low-field shift of  $^{15}\text{N}$  aromatic amine nitranions is associated with a decrease in the  $\pi$  charge density on nitrogen: in a simplified picture, the  $sp^2$  electron pair generated by the deprotonation of the NH- acid 'pushes away' the  $p-\pi$  electron pair on nitrogen. Anionic species generated by the CH-deprotonation of 2- and 4-alkylpyridines should be considered real nitranions. In fact, it has been shown that metalation of 4-alkylpyridines originates in the solid state *N*-metalated-4-alkylidene-1,4-dihydropyridines<sup>108</sup>. Similar results have also been found in solutions of dipolar aprotic, metal-coordinating solvents (DMSO)<sup>109</sup> and the results have been used to probe the EW capacities of substituents at the methyldene group in position 4.



$^{13}\text{C}$  and  $^{15}\text{N}$  NMR studies of nitranions of the pyridyl type have been extended to a large variety of azine<sup>110</sup> and azole<sup>109a,111</sup> systems. The charge densities on the nitrogen atoms of these nitranions have been empirically computed using  $^{15}\text{N}$  shift/ $\pi$ -charge relationships: the resulting  $^{13}\text{C}$  and  $^{15}\text{N}$  charge maps are consistent and congruent.

Nitranions originated by the deprotonation of aldehyde phenylhydrazones can be seen as diazaallylic anions:  $\pi$ -charge delocalization has also been investigated using the NMR approach in these systems<sup>112</sup>.

## B. Amine Derivatives

Quantitative and semiquantitative equilibrium acidity scales have been established for weak carbon acids in cyclohexylamine (CHA)<sup>113</sup>, dimethoxyethane (DME)<sup>114</sup>, dimethylsulphoxide (DMSO)<sup>115</sup> and THF<sup>116</sup>.

Fraser and coworkers<sup>116</sup> measured the relative acidities of 15 weakly acidic hydrocarbons in THF using  $^{13}\text{C}$  NMR spectroscopy. However, as the experiments were

performed using 0.1–0.5 M solutions, the results may have been perturbed by aggregation effects, as pointed out by the authors and by Streitwieser<sup>117</sup>. Streitwieser proposed an indicator scale of caesium ion pairs in THF. A table of  $pK_a$  values of organic indicator acids measured in THF, CHA, DMSO and DME has been also reported<sup>118</sup>. In THF and CHA acidities have been placed on an absolute basis by assigning a  $pK_a$  of 18.49 to 9-PhFl (9-phenyl fluorene), while  $pK_a$  values of 17.9 and 17.55 have been determined in DMSO and DME respectively. (In DME the values were referred to 1,1,3,3,-tetraphenylpropene with an assumed  $pK_a$  value of 25.25, statistically corrected.)

For a number of carbon acids, an excellent correlation exists between the relative  $pK_a$  values in these four solvents:

$$pK_a(\text{solvent}) = \text{slope} \times pK_a \text{ THF} + \text{intercept} \quad (24)$$

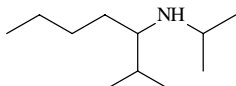
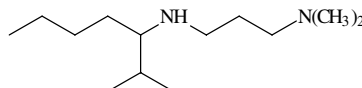
Solvent	=	Slope	Intercept	$r^2$
CHA	=	1.02	-0.307	0.999
DMSO	=	0.934	+1.52	0.995
DME	=	0.999	-0.402	0.997

The independence of CH-carbon acidities from the solvent can be attributed to the fact that only highly delocalized carbanions have been considered. When aggregation or specific solvent ion-pairing effects are operative, deviations from this behaviour are expected.

Due to the high interest in metalation reactions with lithium amide or alkyllithiums, an indicator scale of lithium ion pairs in THF has been developed<sup>119</sup>. Aggregation studies have indicated that organolithium species exist predominantly, if not exclusively, as monomers in the  $10^{-3}$ – $10^{-4}$  M concentration range. Particular attention has been devoted to the lithium and caesium ion-pair acidities of diphenylamine in THF<sup>120</sup> that, at 25 °C, have been found to be 19.05 and 24.20, respectively.

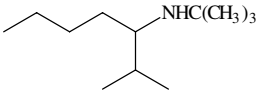
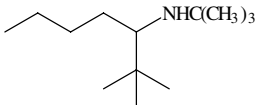
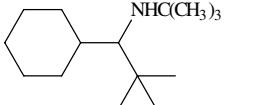
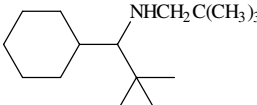
A range of more than 10  $pK_a$  units is presented by the THF<sup>121</sup> acidities of 15 secondary amines having either two alkyl or an alkyl and a silyl, or two silyl substituents of different bulk, as shown in Table 9.

TABLE 9.  $pK_a$  values for secondary amines in THF<sup>121</sup>

Amine	$pK_a$
$(\text{CH}_3)_3\text{SiNHSi}(\text{CH}_3)_3$	29.5
$(\text{CH}_3)_2\text{CHNHSi}(\text{CH}_3)_3$	31.4
$(\text{CH}_3)_3\text{CCH}_2\text{NHSi}(\text{CH}_3)_3$	33.2
$(\text{CH}_3)_3\text{CNHSi}(\text{CH}_3)_3$	33.6
$\text{C}_2\text{H}_5\text{CH}(\text{CH}_3)\text{NHCH}_2\text{CH}_2\text{CH}_3$	35
<i>cis</i> -2,6-Dimethylpiperidine	35.2
$(\text{CH}_3)_2\text{CHNHCH}(\text{CH}_3)_2$	35.7
Dicyclohexylamine	35.7
2,2,6,6-Tetramethylpiperidine	37.3
	37.6
	37.9

(continued overleaf)

TABLE 9. (continued)

Amine	$pK_a$
	38.3
	39.1
	39.5
	40.0

The first acidity measurement of aniline was reported by McEwen<sup>122</sup>. He assigned an ion-pair  $pK_a$  of 27 to aniline in benzene in relation to MeOH in benzene, which was assumed to have an ion-pair  $pK_a$  of 16. Acidities of a number of substituted anilines were measured by means of the  $H_-$  method in  $H_2O$ -DMSO mixture<sup>123</sup>, and by NMR<sup>124</sup>, calorimetric<sup>125</sup> and electrochemical<sup>126</sup> methods in liquid ammonia at  $-31^\circ C$ .

The equilibrium acidities of aniline and 26 of its derivatives have recently been measured<sup>127</sup> in DMSO solution and they cover a range of 15  $pK_a$  units. The  $pK_a$  values of anilines in DMSO are 10 units higher than the ion-pair  $pK_a$  values obtained in liquid ammonia. This effect has been attributed to the greater capacity of ammonia to solvate the proton. When the  $pK_a$  values determined in DMSO were compared with those derived in  $H_2O$ -DMSO or EtOH-DMSO, it was evident that the latter were appreciably lower. This behaviour is different from that found for the carbon acids. The  $H_2O$ -DMSO mixture can solvate nitranions better than pure DMSO, in line with the fact that nitranions are better HBA than carbanions<sup>128</sup> (see Table 10).

A plot of the  $pK_a$  values of anilines in DMSO versus the  $pK_a$  values of anilinium ions in water is linear with a slope of 1.8. This allows the extrapolation of  $41 \pm 1$  for the  $pK_a$  of ammonia in DMSO from that of  $NH_4^+$  in water (9.27)<sup>127</sup>. Alternatively, the  $pK_a$  of ammonia in DMSO has been extrapolated<sup>105</sup> from the intersystem correlation between the DMSO acidities of  $NH_2X$  and  $PhNHX$  as a value of 35.8. Extrapolation of the  $pK_a$  value of ammonia from the Taft-like dual substituent parameter (DSP) of  $NH_2X$  DMSO acidities gave a similar value of 36.6.

### C. NH Bond Dissociation Energy

Bordwell<sup>129</sup> developed a method of estimating relative bond dissociation energies (BDE) for families of acids, HA, by combining equilibrium acidity constants,  $pK_{HA}$ , with the oxidation potential of their conjugated bases,  $A^-$ , both measured in DMSO:

$$\Delta BDE(\text{kcal mol}^{-1}) = 1.37\Delta pK_{HA} + 23.06\Delta E_{ox}(A^-) \quad (25)$$

TABLE 10. Equilibrium acidities of aromatic amines determined by the H<sub>+</sub> method in H<sub>2</sub>O/DMSO and pure DMSO

	pK <sub>a</sub> (DMSO)	pK <sub>a</sub> (H <sup>+</sup> )
Anilines		
3-Me	31.0	
H	30.7	
3-MeO	30.5	
3-Cl	28.5	25.6
3-CF <sub>3</sub>	28.2	25.4
3-Br	28.4	
3-CN	27.5	24.6
4-MeSO <sub>2</sub>	25.6	
4-CN	25.3	22.7
4-PhSO <sub>2</sub>	24.9	
4-PhCO	24.4	
4-NO <sub>2</sub>	20.9	
2-F	28.7	
4-F	30.7	
2,4-(F) <sub>2</sub>	28.6	
2-Cl	27.6	
4-PhS	28.2	
4-MeCO	25.3	
4-CF <sub>3</sub> SO <sub>2</sub>	21.8	
4-Cl	29.4	
4-CF <sub>3</sub>	27	
4-Br	29.1	
2,4-(NO <sub>2</sub> ) <sub>2</sub>	15.9	15
4-NO <sub>2</sub> -2,5(Cl <sub>2</sub> ) <sub>2</sub>	17.4	
2,6-(Cl) <sub>2</sub>	24.8	
2,4(Cl) <sub>2</sub>	26.3	
Pyridines		
4-NH <sub>2</sub> -pyridine	26.5	22.3
2-NH <sub>2</sub> -pyridine	27.7	23.5
Diphenylamines		
4-NO <sub>2</sub> C <sub>6</sub> H <sub>4</sub> NHPh	16.85	15.7
3-ClC <sub>6</sub> H <sub>4</sub> NHPh	23.4	20.7
Ph <sub>2</sub> NH	24.95	22.4

TABLE 11. Homolytic bond dissociation energies (BDEs) of some H–N bonds<sup>133</sup>

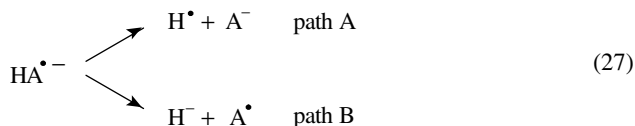
	pK <sub>HA</sub> <sup>a</sup>	E <sub>ox</sub> (A <sup>-</sup> ) <sup>b</sup>	BDE (kcal mol <sup>-1</sup> ) <sup>c</sup>	BDE (kcal mol <sup>-1</sup> ) <sup>d</sup>
PhNH <sub>2</sub>	30.6	-0.992	92 ± 1	88 ± 2 <sup>e</sup>
PhNHMe	29.5	-1.054	89.0	87.5 ± 2 <sup>e</sup>
Ph <sub>2</sub> NH	24.95	-0.856	87.5 ± 1	87.3 <sup>f</sup>
Pyrrole	23.05	-0.355	97.0	99 ± 6 <sup>g</sup>

<sup>a</sup>Measured in DMSO.<sup>b</sup>Measured by cyclic voltammetry in DMSO.<sup>c</sup>Calculated.<sup>d</sup>Literature data.<sup>e</sup>Reference 134.<sup>f</sup>Reference 135.<sup>g</sup>Reference 136.

Subsequently, he used the equation proposed by Friedrich<sup>130</sup> to estimate BDEs:

$$\text{BDE}(\text{kcal mol}^{-1}) = 1.37 \text{ p}K_{\text{HA}} + 23.06 E_{\text{ox}}(\text{A}^-) + C \quad (26)$$

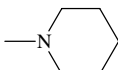
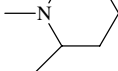
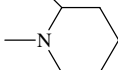
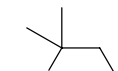
with  $C = 55.4\text{--}55.9 \text{ kcal mol}^{-1}$  (a value of 56 has also been used, and more recently one of 73<sup>131,132</sup>). The BDEs estimated in this way agree remarkably well with the values obtained in the gas phase ( $\pm 2 \text{ kcal}$ ) (Table 11), although the relationship must be considered empirical<sup>133</sup>. The cleavage modes of radical anions have also been considered<sup>131</sup>:



In the case of anilines, path A will be favoured on the basis of the values of oxidation potentials, in analogy with the gas-phase results.

An extensive study<sup>132</sup> has been presented on the polarizability effects of alkyl groups in RX moieties (R = Me, Et, *i*-Pr and *t*-Bu; X = CH<sub>2</sub>, S, SO<sub>2</sub>, O and N) in families of weak acids and on the stabilities of adjacent anions and radicals in DMSO solution. Some of the results related to the 9-(dialkylamino)fluorenes are given in Table 12. The increases in acidity are believed to be caused by the progressive increases in anion stabilizing

TABLE 12. Acidities and homolytic bond dissociation energies of the acidic C–H bonds in 9-(dialkylamino)fluorenes (9-R<sup>1</sup>R<sup>2</sup>NFIH)

Substituted amino (R <sup>1</sup> R <sup>2</sup> N)	pK <sub>HA</sub> <sup>a</sup>	E <sub>ox</sub> (A <sup>-</sup> ) <sup>b</sup>	BDE
R <sup>1</sup> = R <sup>2</sup> = Me	22.5	-1.418	71.5
R <sup>1</sup> = R <sup>2</sup> = Et	21.4	-1.388	70.5
R <sup>1</sup> = R <sup>2</sup> = <i>i</i> -Pr	20.8	-1.242	73
	22.5	-1.382	72
	21.4	-1.348	71.5
	19.4	-1.198	72
	18.2	-1.166	71

<sup>a</sup>Equilibrium acidities measured in DMSO: Reference 139.

<sup>b</sup>Oxidation potentials of the conjugated anions measured in DMSO solution and referenced to the ferrocene/ferrocenium couple.

polarizability effects of the R group that parallel increases in alkyl size. Polarizability effects stabilize anions but not the analogous radicals.

Taking advantage<sup>137</sup> of the outlined method and considering that RSE (radical stabilization energy) is equivalent to the variation in BDE, Bordwell estimated the RSEs of radicals of the type A-C•H-D, where A is an electron acceptor and D an electron donor. Comparison of the oxidation potential of  $\alpha$ -H<sub>2</sub>N and  $\alpha$ -R<sub>2</sub>N carbanions derived from fluorene, acetophenones and malononitrile indicates that *N*-alkylation has little or no effect on the stability of the corresponding  $\alpha$ -amino radicals (no captodative effect). Nevertheless, when saturation effects are taken into account there is evidence of a synergistic (captodative) effect. This indicates that the presence of strong donor and acceptor groups attached to a radical centre stabilizes the radicals with synergistic effects, in accord with the previous literature data<sup>138</sup>.

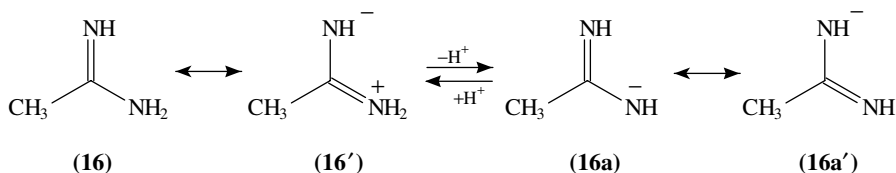
$$\text{RSE} = \Delta\text{BDE} \quad (28)$$

#### D. Carboxamides and Related Compounds

A comparison of acidities of six series of analogous oxygen, nitrogen and carbon acids in DMSO solution and in the gas phase has shown that the nitrogen acids are more acidic than their carbon acid counterparts by  $17 \pm 5 \text{ kcal mol}^{-1}$  ( $\text{kcal mol}^{-1} = 1.37 \text{ p}K_{\text{a}}$  unit), and that the oxygen acids are more acidic than the nitrogen acids by a similar amount. Differently, carboxamides have been found only slightly more acidic than their carbon acid analogues, the ketones ( $1\text{--}2 \text{ kcal mol}^{-1}$  in DMSO and  $7\text{--}8 \text{ kcal mol}^{-1}$  in the gas phase<sup>140</sup>). This behaviour has been rationalized in terms of destabilization of carboxamide conjugate bases by lone pair–lone pair repulsions, together with some resonance stabilization of the carboxamide.

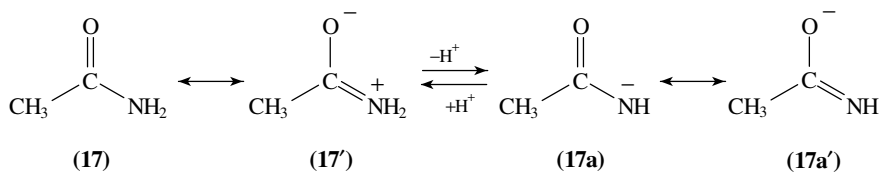
The replacement of the C=O bond in carboxamides by the C=S bond, as in thioamides<sup>141</sup>, causes increases in acidity of the N–H bond by  $8\text{--}10 \text{ kcal mol}^{-1}$  and weakening of the N–H bond by  $14\text{--}17 \text{ kcal mol}^{-1}$ , evaluated by using relation 26. This effect has been considered a consequence of large increases in ground state energies and the superior ability of sulphur than oxygen in stabilizing a negative charge or odd electron.

In the gas phase, the acidity of H–C bond increases as the *s* character of carbon increases and the homolytic bond dissociation energy decreases as shown by considering the following compounds: H<sub>3</sub>CCH<sub>3</sub>, H<sub>2</sub>C=CH<sub>2</sub> and HC≡CH with  $\Delta G_{\text{acid}}(\text{kcal mol}^{-1}) = 413, 401$  and  $370$  and BDE ( $\text{kcal mol}^{-1}$ ) =  $98, 110$  and  $132$ , respectively. A similar trend with the changes in hybridization of nitrogen was not demonstrated, due to the paucity of available data. The problem could be more complicated in the case of substrates containing more acidifying centres as acetamidine, for which the following scheme can be considered:



Although an analogous scheme can be written for acetamide, recent *ab initio* calculations<sup>142</sup> have questioned the importance of resonance in amides, i.e.  $\mathbf{17} \leftrightarrow \mathbf{17}'$ , indicating that the nitrogen in  $\mathbf{17}$  has a slight negative charge rather than the positive

charge imposed by the resonance contributor **17'**.



The equilibrium acidities in DMSO have been measured for acetamidine, benzamidine, *N,N'*-diphenylbenzamidine, *N,N*-diethylbenzamidine, diphenylmethanimine, guanidine, *N,N'*-diphenylguanidine, *N,N'*-diphenylurea, and *N,N'*-diphenylthiourea<sup>143</sup>. Combination of the resulting  $\text{pK}_a$  values with the oxidation potentials of their conjugated bases gave estimates of their BDEs. These values have been compared with those of the corresponding carboxamides and thiocarboxamides. The changes in hybridization of nitrogen between  $\text{NH}_3$  and  $\text{Ph}_2\text{C}=\text{NH}$  produce a changes in acidities and BDEs similar to the increases observed for the increase in the *s* character of carbon. Nevertheless, the BDE of  $\text{H}-\text{N}$  in  $\text{HN}_3$  is 25  $\text{kcal mol}^{-1}$  lower than that in  $\text{Ph}_2\text{C}=\text{NH}$ , despite the apparent similarities in hybridization.

Thioacetamide is more acidic than acetamide and acetamidine by 9.6 and 11.8  $\text{kcal mol}^{-1}$  (Table 13). Replacement of the methyl group by an amino group causes a decrease in acidity. The effects of substituting one phenyl group at the acidic sites produce an increase in acidity, not different from the increase obtained by introducing a phenyl group at each of the nitrogen atoms. This is due to the strong steric interaction between the two phenyl groups that allow only one phenyl group to overlap with the negative charge or odd electron.

The equilibrium acidities of aldoximes, amidoximes and ketoximes<sup>144</sup> have also been measured in DMSO solution. It has been found that *syn*- and *anti*-benzaldoximes have nearly the same acidities, contrary to the finding in aqueous solution where the *anti* isomers are less acidic. The lower acidity of the *anti* isomers in aqueous solution is attributable to steric inhibition of solvation of the strongly hydrogen-bonded oxide ion by the phenyl group, a factor that is absent in DMSO. The 8.3  $\text{pK}_a$  unit difference between the acidity of acetaldoxime (28.5) and benzaldoxime (*syn*- 20.2, *anti*- 20.3) in DMSO points to appreciable delocalization of the negative charge in the benzaldoximide ion into the benzene ring.

Ionization equilibria of sulphamide, phenylsulphamide, mono-, di- and tri-substituted sulphamides have been considered and  $\text{pK}_a$  values have been determined<sup>145</sup> for

TABLE 13. Acidities of amidines and related compounds in DMSO

	$\text{pK}_a$
$\text{CH}_3\text{C}(=\text{NH})\text{NH}_2$	27.1
$\text{CH}_3\text{C}(=\text{O})\text{NH}_2$	25.5
$\text{CH}_3\text{C}(=\text{S})\text{NH}_2$	18.5
$\text{PhC}(=\text{NH})\text{NH}_2$	26.7
$\text{PhC}(=\text{O})\text{NH}_2$	23.3
$\text{CH}_3\text{C}(=\text{S})\text{NH}_2$	16.9
$\text{Ph}_2\text{C}=\text{NH}$	31.0
$(\text{H}_2\text{N})_2\text{C}=\text{NH}$	28.5
$(\text{H}_2\text{N})_2\text{C}=\text{O}$	26.9
$(\text{H}_2\text{N})_2\text{C}=\text{S}$	21.0

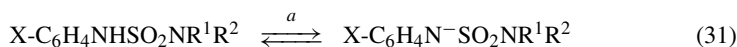
equilibrium *a* in 60% v/v EtOH–H<sub>2</sub>O:



R = H, X-aryl, alkyl

It has been found that in the case of equilibrium 30 the corresponding aliphatic series exhibit decreased  $\text{p}K_a$  values by about 5  $\text{p}K_a$  units<sup>146</sup>.

Under the same experimental conditions<sup>147</sup> the following equilibria have also been considered and  $\text{p}K_a$  values have been determined to be in the range 9–12.

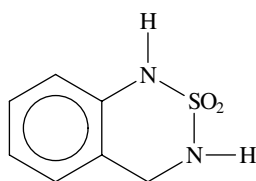


X = Me, H, Br, Cl, OMe, OEt, NO<sub>2</sub>

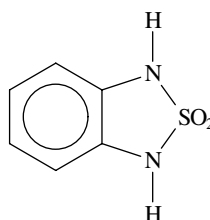
R<sup>1</sup> = H, Ac, Me

R<sup>2</sup> = cyclo-C<sub>6</sub>H<sub>11</sub>, Bu, CH<sub>2</sub>C<sub>6</sub>H<sub>5</sub>

When cyclic sulphamides (**18** and **19**) were studied<sup>148</sup>, it was found that the six-membered rings are more acidic than their acyclic analogues by *ca* 2.5  $\text{p}K_a$  units and that the five-membered cyclic sulphamides are *ca* 4  $\text{p}K_a$  units more acidic than the model open-chain counterparts.



(18)



(19)

## VI. HYDROXAMIC ACIDS AS AMPHOTERIC SYSTEMS

Notwithstanding their name, hydroxamic acids (**20**) are amphoteric systems with behaviours that are both basic and acidic. The chemistry of hydroxamic acids and *N*-hydroxyimides was reviewed by Bauer and Exner<sup>149</sup> in 1974. Since then, the basic properties of hydroxamic acid derivatives have received little attention. Given the similarity of the activity coefficient behaviour of hydroxamic acids and other carbonyl bases (amides), it was originally assumed that the carbonyl oxygen rather than the nitrogen atom was the site of protonation<sup>150,151</sup>, but some recent IR studies have revealed signs of *N*-protonation<sup>152</sup>. This question has been recently addressed by Bagno and colleagues<sup>153</sup>, who concluded from NMR measurements made in aqueous solution that acetohydroxamic acid undergoes carbonyl protonation as the dominant process. The protonation equilibrium of this compound was determined in aqueous sulphuric acid and the use of the excess acidity method led to  $m^* = 0.25$  and  $\text{p}K_{\text{BH}} = -1.15$ . The gas-phase basicity of some



hydroxamic acid derivatives (Table 14) has been determined<sup>154</sup>, the values indicating that they are  $7 \text{ kcal mol}^{-1}$  weaker bases than amides. The protonation site cannot be determined from gas-phase results, but a pH-metric study of the dissociation constants of L- $\alpha$ -alaninehydroxamic and  $\beta$ -alaninehydroxamic acids has shown that the  $\text{NH}_3^+$  group is more acidic than the NHOH group for the  $\alpha$ -derivative, while the reverse is true for the  $\beta$ -isomer<sup>155</sup>.

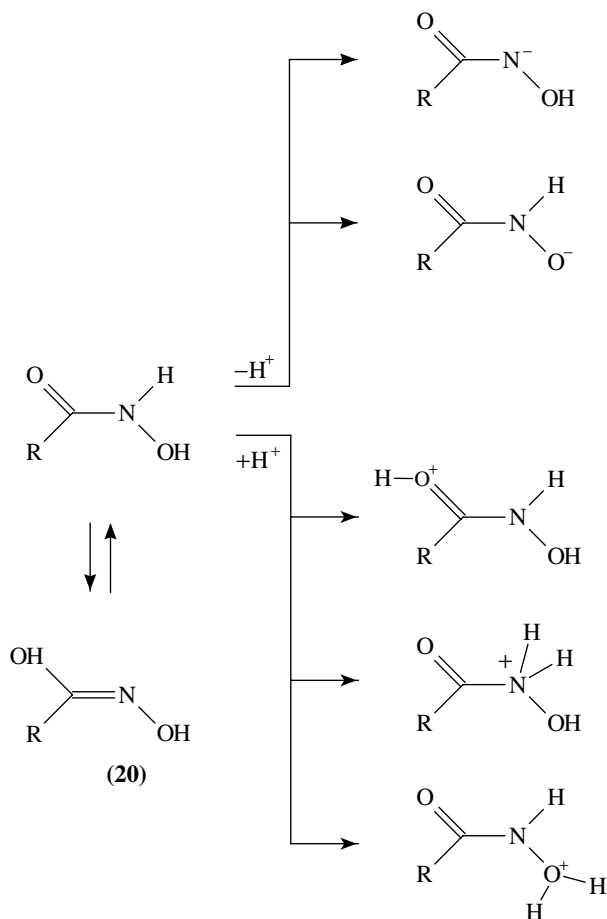


TABLE 14. Gas-phase basicities of some hydroxamic acid derivatives ( $\text{kcal mol}^{-1}$ )

Compound	<i>GB</i>
MeCONHOH	197.3
MeCONMeOH	200.9
MeCONHOMe	201.3

TABLE 15. Gas-phase acidities of acetohydroxamic acid, acetamides and their methyl derivatives

<i>N</i>	Compounds	$\Delta G_{\text{acid}}^{\circ}$ (kcal mol <sup>-1</sup> )
1	MeCONHOH	339.1
2	MeCONHOMe	343.7
3	MeCONMeOH	346.9
4	MeCONH <sub>2</sub>	355.0
5	MeCONHMe	354.5

There has been a longstanding controversy as to whether hydroxamic acids are NH or OH acids. The IR and UV evidence presented by Exner and coworkers<sup>149</sup> indicated that they are NH acids in dioxane and aqueous alcohol solvents, and this conclusion has also been supported by a <sup>17</sup>O NMR study<sup>156</sup>. However, other studies<sup>157</sup> on *meta*- and *para*-substituted benzohydroxamic acids led to the conclusion that, in aqueous solution, RCONHO<sup>-</sup> ions were at least as present as RCON(OH)<sup>-</sup> ions. More recently, Crumbliss and coworkers<sup>158</sup> have concluded that, in an aqueous 2M NaNO<sub>3</sub> solution, aceto- and benzohydroxamic acids act as OH rather than NH acids. Bordwell's group<sup>159</sup> measured the equilibrium acidities in DMSO of aceto- and benzohydroxamic acids, as well as their *N*- and *O*-alkyl derivatives, and concluded that hydroxamic acids act as NH acids in non-HBD solvents, such as DMSO, DMF, CH<sub>3</sub>CN etc., but they may act primarily as OH acids in hydroxylic solvents.

The gas-phase acidities of hydroxamic acid and its *N*- and *O*-methyl derivatives have been measured using FT ion cyclotron resonance (Table 15)<sup>160</sup>. The acidity order is the same as that found in DMSO although, in this solvent, the *O*-methylation of acetohydroxamic acid decreases the acidity by 1 pK unit and the *N*-methylation by 3.6 pK units, respectively.

## VII. HETEROCYCLES

Imidazole is a five-membered heterocycle with both basic and acidic properties. As part of histidine, it plays an important role in proton transfer processes at the active site of certain enzymes, and is thus considered a good model for studying enzymatic modes of action by means of computational approaches. Much work has been done to characterize this molecule and its derivatives. The proton affinity<sup>161</sup> of imidazole has been determined experimentally by Taft and coworkers, who also determined the gas-phase basicities of pyrazole, all possible isomeric methylpyrazoles (13 derivatives), and a selected set of methylimidazoles (8 derivatives), using STO-3G fully-optimized geometries of neutral molecules and their corresponding cations. The protonation energies of imidazole, calculated subsequently by Meyer<sup>162</sup> using the HF/6-311G\*\* basis set with additional polarization functions on hydrogen atoms<sup>163</sup>, are lower than those previously calculated without polarization functions. The substitution of hydrogen with a methyl group causes a small increase in the deprotonation/protonation energies of 1 kcal mol<sup>-1</sup>. The overall picture indicates that imidazole and 4-methyl imidazole seem to be interchangeable in model studies of the protonation of histidine.

Knowing the equilibrium constants for the protonation of the amino and imidazole nitrogens, and the kinetics of deprotonation of the C(2) carbon of imidazole, it was possible to investigate nitrogen-protonation microequilibria and the C(2)-deprotonation microkinetics of histidine, histamine and other related compounds<sup>164</sup>.

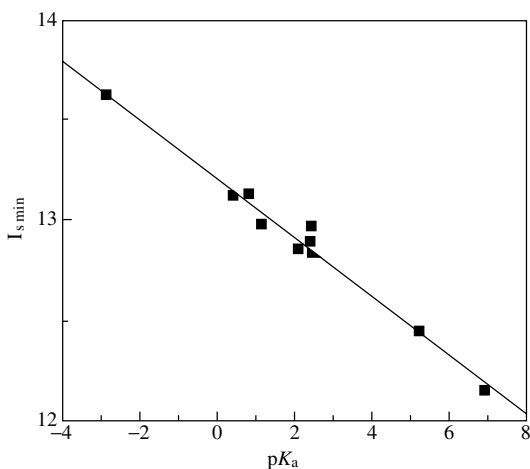


FIGURE 7. Correlation between experimentally determined aqueous  $pK_a$  values and ring nitrogens  $I_{s,\min}$  of ten azines and azoles. The least-squares equation of the line is  $y = 13.2004 - 0.1468x$ , with a correlation coefficient of 0.99. Reprinted with permission from Reference 170. Copyright (1991) American Chemical Society

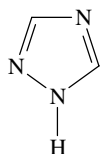
Elguero's group reported<sup>165</sup> an empirical relationship between  $pK_a$  values (acid and basic) for a large number of azoles in water at 25 °C.

$$pK_a(\text{NH}) = 0.985pK_a(\text{NH}^+) + 6.95 \quad (32)$$

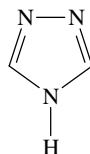
All of the azoles showed a linear variation of these values except the pyrazoles, which belong to a parallel line 4.5  $pK_a$  units apart. Fully optimized INDO geometries have been calculated for 12 azoles, as well as their cations and anions, both isolated and specifically solvated by five water molecules<sup>166</sup>. Evaluation of the protonation and deprotonation energies of the solvated molecules indicates a behaviour similar to that found experimentally in solution. In particular, the difference between pyrazoles (and indazoles) and all the other azoles is a consequence of the protonation of the nitrogen contiguous to NH, that is due to a difference in basicity.

Among the semiempirical methods used to evaluate protonation and deprotonation energies in azoles, only INDO seems to estimate the electrostatic proximity effects<sup>167</sup> correctly.

The thermodynamic properties of 3,5-bis(trifluoromethyl)-1,2,4-triazole have been measured and discussed in the light of the conclusions provided by *ab initio* calculations (MP2/6-31G\*//6-31G\* level of accuracy) applied to trifluoromethyl-substituted triazoles, the parent triazole and pyrazole. It is worth noticing that **21** is more stable than **21a** by 6.7 kcal mol<sup>-1</sup><sup>168</sup>.



(21)



(21a)

Experimental and theoretical studies of the basicity and acidity of benzene-substituted indoles were performed<sup>169</sup>. In aqueous solution, the  $\text{p}K_{\text{a}}$  values are above  $-4$  for the bases and above  $15$  for the acids. Gas-phase ionization enthalpies have been calculated using the AM1 semiempirical method.

Politzer and coworkers<sup>170</sup> have recently presented a linear relationship ( $r = 0.99$ ) between the measured aqueous  $\text{p}K_{\text{a}}$  values<sup>171</sup> of a series of azines and azoles ( $9 \text{ p}K_{\text{a}}$  units) and the magnitude of the lowest value ( $I_{\text{s,min,eV}}$ ) of the average local ionization energy,  $I(\mathbf{r})$ , on the molecular surface;  $I(\mathbf{r})$  is defined within the framework of SCF-MO theory as

$$I(\mathbf{r}) = \sum [\rho_i(\mathbf{r})|\varepsilon_i|/\rho(\mathbf{r})] \quad (33)$$

where  $\rho_i(\mathbf{r})$  is the electron density of the  $i$ th molecular orbital at the point  $\mathbf{r}$ ,  $\varepsilon_i$  is the orbital energy and  $\rho(\mathbf{r})$  is the total electron density. The correlation is reported in Figure 7.

### VIII. NITRO DERIVATIVES

Kinetic and equilibrium acidities of several families of nitroalkanes have been discussed extensively in the chapter by Lewis<sup>172</sup>, where the effects of changing substituents and the nature of the base, together with the role of the solvent on rates of ionization and equilibria, have been considered.

Nonetheless, in the last decade nitroalkanes have been studied extensively because they are regarded as a good model for testing the applicability of new approaches to interpret proton transfer reactions. In fact, although nitroalkanes are strong carbon acids, their proton transfer behaviour is anomalous: for example, they are 'slow' acids (deprotonation of nitroalkanes and reprotonation of nitronate anions are slower than for other carbon acid families) and substituent effects within the series  $\text{XC}_6\text{H}_4\text{CH}_2\text{NO}_2$  are greater on the rates of deprotonation than on the equilibrium acidities. Among the many approaches<sup>173-177</sup>, Bernasconi has formulated the Principle of Nonperfect Synchronization (PNS)<sup>178</sup>, according to which a product stabilizing factor (resonance or solvation) lowers the intrinsic reaction rate ( $k_0$ ) if it develops late, relative to the transfer of the negative charge from the base to the carbon acid, but enhances  $k_0$  if it develops early. The late development of solvation relative to the development of the nitronate anion at the transition state has been believed to be the main reason for the increase in the intrinsic rate constants ( $k_0$ ) with the increase in the DMSO content of the solvent. Essentially the same reason has been invoked to explain the variation of the disparity of Bronsted coefficients ('imbalance') in nitroalkanes with the solvent. Such imbalances are understood as the difference between the variation of the deprotonation rates with the  $\text{p}K_{\text{a}}$  of the carbon acid (measured by  $\alpha\text{CH}$ ) and with the  $\text{p}K_{\text{a}}$  of the base (measured by  $\beta\text{B}$ ),  $\alpha\text{CH} - \beta\text{B}$ , assuming that  $\beta$  is a rough measure of bond formation or charge transfer at the transition state.

On the same subject, Arnaut<sup>179</sup> has recently published a paper in which the Intersecting State Model (ISM) proposed by Formosinho<sup>180,181</sup> is used to provide a general approach to the deprotonation of carbon acids, including nitroalkanes. This model assumes that the activation energy of a reaction can be adequately calculated from the energetic variation occurring in the bonds of the reactants and products that suffer major geometry and/or frequency changes in the course of the reaction.

#### A. Nitromethane Derivatives

Since the equilibrium acidities of nitro-activated carbon acids have been considered<sup>172</sup> in the preceding volume of this series, we show in Table 16 some significant values determined in DMSO from the enlarged compilation of DMSO equilibrium acidities proposed by Bordwell<sup>6b</sup>.

TABLE 16.  $pK_a$  values of some nitro-activated carbon acids in DMSO at 25 °C

5-Nitrobarbituric acid	0.8
PhSO <sub>2</sub> CH <sub>2</sub> NO <sub>2</sub>	7.1
CH <sub>2</sub> =CHCH <sub>2</sub> NO <sub>2</sub>	7.7
PhCH <sub>2</sub> NO <sub>2</sub>	12.3
Nitrocycloheptane	15.8
Nitrocyclopentane	16.0
CH <sub>3</sub> CH <sub>2</sub> NO <sub>2</sub> <sup>a</sup>	16.7
Me <sub>2</sub> CHNO <sub>2</sub>	16.9
CH <sub>3</sub> NO <sub>2</sub> <sup>b</sup>	17.2
Nitrocyclobutane	17.8
Nitrocyclohexane	17.9
<i>p</i> -NO <sub>2</sub> C <sub>6</sub> H <sub>4</sub> CH <sub>3</sub>	20.4

<sup>a</sup>Reference 182;<sup>b</sup> $pK_a$  of nitromethane has been determined also in NMP (*N*-methylpyrrolidine-2-one) and found to be 19.8<sup>183</sup>.TABLE 17.  $pK_a$  values for some nitro-activated carbon acids in water and DMSO

	H <sub>2</sub> O	DMSO
CH <sub>3</sub> NO <sub>2</sub>	10.2	17.2
PhCH <sub>2</sub> NO <sub>2</sub>	6.88	12.3
CH <sub>3</sub> CH(NO <sub>2</sub> ) <sub>2</sub>	5.2	6.6
4-NO <sub>2</sub> C <sub>6</sub> H <sub>4</sub> CH <sub>2</sub> CN	13.4	12.3

The differences in  $pK_a$  values determined in water and DMSO, as shown in Table 17, might be interpreted as indicating differences in the solvation of the respective carbanions: the increase in  $pK_a$  going from water to DMSO may be seen as the consequence of the loss of hydrogen-bonding solvation of the nitronate. The carbanion containing an aromatic ring seems to be better solvated in dipolar aprotic solvent, therefore its  $pK_a$  decreases. A detailed study by Bernasconi<sup>184</sup> and Bunnell indicates that  $pK_a$  changes can be better rationalized by considering the solvent effect on the stability of the carbanion, the carbon acid and the hydronium ion. Although the  $pK_a$  values of nitromethane and phenylnitromethane increase similarly, in nitromethane there is a strong destabilization of the carbanion, while in phenylnitromethane the destabilization of the carbanion is weaker but compensated by a greater stabilization of the carbon acid.

It has been found that a good correlation exists between Bordwell's  $pK_a$  values and heats of deprotonation ( $\Delta H_D$ ) determined in DMSO<sup>7</sup>. In particular, when nitro compounds were considered together with ketones, they generated the following good ( $r = 0.993$ ) linear correlation:

$$\Delta H_i^\circ = 1.015 \Delta G_i^\circ - 4.43 \quad (34)$$

Table 18 shows the free energies and enthalpies of ionization of some nitroalkanes.

The BDEs in the series NO<sub>2</sub>CXH<sub>2</sub> (X = H, F, OH, NH<sub>2</sub>, CH<sub>3</sub>, CH=O and CH=CH<sub>2</sub>) have been calculated<sup>186</sup> (MP4/6-31G\*\*//HF/3-21G), and compared with those previously calculated<sup>187</sup> and the experimental values<sup>188</sup>. The BDE were analyzed in terms of IBE (Intrinsic Bond Energies) and radical stabilization energies by comparing the BDE of C–H and C–NO<sub>2</sub> in a series of related compounds. They are almost constant (59–62 kcal mol<sup>-1</sup>) due to a near cancellation of the increase in IBE (more positive)

TABLE 18. Thermodynamic properties for ionization of nitroalkanes in DMSO at 25 °C

	$\Delta H_i^{\circ a}$ (kcal mol <sup>-1</sup> )	$\Delta G_i^{\circ b}$ (kcal mol <sup>-1</sup> )	$\Delta S_i^{\circ}$ (cal mol <sup>-1</sup> deg <sup>-1</sup> )
Nitromethane	20.1 ± 0.9	25.1	-16.8
Nitroethane	18.3 ± 0.9	24.4	-20.5
Nitropropane	19.1 ± 0.9	24.8	-19.1
2-Nitropropane	19.3 ± 0.9	24.7	-18.1
Nitrobutane	18.8 ± 0.8	24.5	-19.1
Nitrocyclobutane	19.6 ± 0.9	26.0	-21.5

<sup>a</sup> $\Delta H_i^{\circ}$  have been calculated using the formula  $\Delta H_i^{\circ} = \Delta H_D^{\text{KDMSYL}} + 48.0(\pm 0.8)$  where the value of 48.0 (±0.8) kcal mol<sup>-1</sup> is the heat of autoprotolysis of DMSO<sup>185</sup>.

<sup>b</sup> $\Delta G_i^{\circ}$  values have been calculated from the formula  $\Delta G_i^{\circ} = 2.303 RT(\text{p}K_a + \log 14)$  with SD = 0.1 kcal mol<sup>-1</sup>.

due to the substituent and an increase in radical stabilization energy (more negative) with the exception of NO<sub>2</sub>CH=O (52 kcal mol<sup>-1</sup>) and NO<sub>2</sub>CH=CH<sub>2</sub> (71 kcal mol<sup>-1</sup>) where differences in radical stabilization have been invoked.

## B. Structure of Nitroalkanes and their Conjugated Bases

Various studies<sup>189</sup> at the semiempirical and *ab initio* levels have indicated that the nitromethyl anion adopts a planar C<sub>2v</sub> conformation, and the di- and trinitromethyl anions have been predicted to be non-planar, the latter having a propeller-like geometry<sup>190,191</sup>. None of the basis sets used so far included both polarization and diffuse functions. Recently, an *ab initio* calculation (HF/6-31++G\*\* basis set, fully optimized geometry, ZPV (Zero Point Vibrational) energy differences included) has been performed<sup>192</sup>, indicating that the barrier to rotation around the C–N bond is 128 kJ mol<sup>-1</sup>. The calculated *EA* of CH<sub>2</sub>NO<sub>2</sub><sup>•</sup> was 168 kJ mol<sup>-1</sup>, considerably different from the experimental 50 kJ mol<sup>-1</sup>. There was better agreement between the calculated proton affinity at C[PA(C) = 1579 kJ mol<sup>-1</sup>] and the experimental<sup>193</sup> one (1500 kJ mol<sup>-1</sup>).

The electronic structures of CH(NO<sub>2</sub>)<sub>3</sub> and its conjugated base have been recently studied at the HF/6-31G\* and HF/6-31++G\*\* levels of theory by Cioslowski and coworkers<sup>194</sup>. The observed changes in geometry, the electron densities at the critical points and the GAPT (Generalized Atomic Polar Tensors)<sup>195</sup> charges have revealed the presence of Y-aromaticity in C(NO<sub>2</sub>)<sub>3</sub><sup>-</sup> anion. The computed geometry of the anion has indicated that the carbon atoms are coplanar with the nitrogens, while the oxygens are rotated out of plane leading to a structure with a D<sub>3</sub> symmetry, as reported in Figure 8. This is in contrast to previous calculations (STO-3G level) by Edgecombe and Boyd<sup>190,191</sup> in favour of the propeller structure with C<sub>3</sub> symmetry. Absolute gas-phase acidities calculated with the different basis sets are shown in Table 19.

TABLE 19. Calculated absolute gas-phase acidities of CH(NO<sub>2</sub>)<sub>3</sub>

HF/6-31G*	321 (kcal mol <sup>-1</sup> )
HF/6-31++G**	317.2 <sup>a</sup>
HF/6-31++G** + ZPE	307.8 <sup>b</sup>
exp	n/a

<sup>a</sup>At the HF/6-31G\* geometries.

<sup>b</sup>Zero-point energies calculated from unscaled vibrational frequencies at the HF/6-31G\* level.

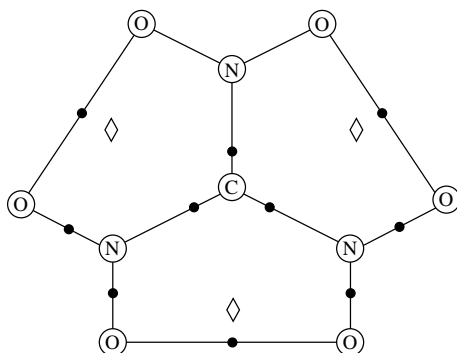
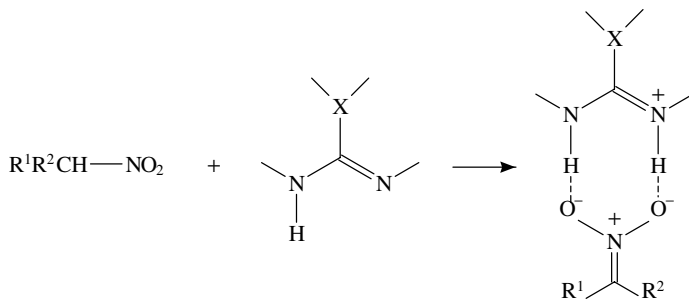
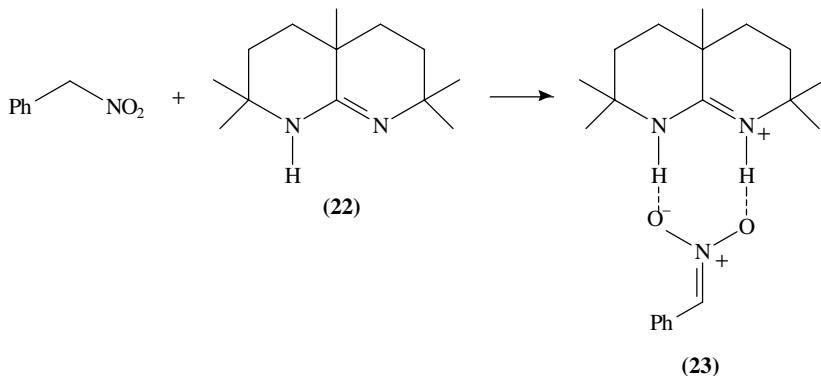


FIGURE 8. Molecular graph of the  $\text{C}(\text{NO}_2)_3^-$  anion. Heavy dots denote bond points and diamonds denote ring points. Reprinted with permission from Reference 194. Copyright (1991) American Chemical Society

Nitroalkanes are remarkably acidic in water ( $\text{p}K_a$  of  $\text{MeNO}_2$  is  $10.2^{172}$ ), but less in non-hydroxylic solvents ( $\text{p}K_a$  of nitroalkanes are 28.6–30.4 in acetonitrile<sup>196</sup>). Evidence of their capacity to give tightly-bound ion pairs with bicyclic cations, as reported in the scheme, is provided on the basis of  $^1\text{H}$  NMR spectroscopy by Boyle and coworkers<sup>196</sup>.



In addition, it has been possible to isolate the complex **23** derived from the reaction of phenylnitromethane with the amidine **22**.



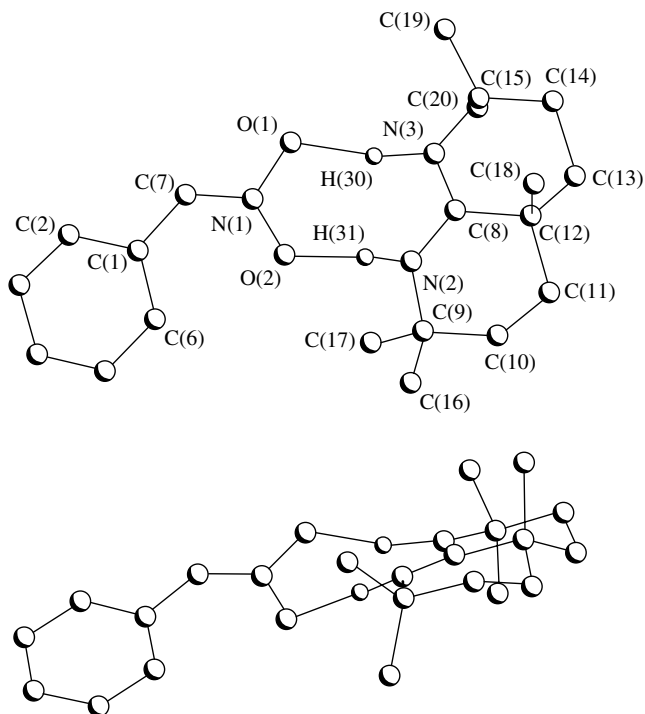


FIGURE 9. The X-ray crystal structure of complex **23**, viewed from two different perspectives<sup>196</sup>. Reproduced by permission of the Royal Society of Chemistry

The X-ray structure of **23**, shown in Figure 9, confirms that the hydrogen-bonding pattern and the internal geometry of the anion is similar to that reported for lithium phenylnitronate by Boche and coworkers<sup>197</sup>. The lithium phenylnitronate, prepared from phenylnitromethane and lithium ethoxide in ethanol, exhibits the presence of hydrogen bonds with ethanol incorporated into the crystal. In turn, this agrees with the conclusions derived for nitronates from acidity measurements on nitro compounds in protic solvents<sup>198</sup> (Figure 10).

By using an *ab initio* MO approach at the HF/6-31G\* level, Avakyan and Fateyev have determined structures and energies of the tautomeric forms of C- and N-nitro compounds MeCH<sub>2</sub>NO<sub>2</sub> and MeNHNO<sub>2</sub>, and of their corresponding anions<sup>199</sup>. By comparing energy values ( $E_{\text{total}}$ ) of molecule pairs **24a–26a** and **24b–26b**, the true nitro compounds are found to be thermodynamically more stable than their *aci*-forms by 18.5 kcal mol<sup>-1</sup> and 14 kcal mol<sup>-1</sup>, respectively. Among the *aci*-form conformers **26a** and **26b**, the *Z,Z* appeared to be the most stable using the AM1 approximation.

Although the equilibrium constant for the formation of *aci*-nitromethane (**27**) is very small, strongly basic solutions drive the equilibrium by formation of the *aci*-anion (**28**)<sup>200</sup>. When nitromethane was adsorbed on basic oxides (MgO and CaO) and zeolites (CsX), evidence for the formation of the *aci*-form was given by means of solid state NMR. The results indicate that nitromethane could be a much more discriminating probe than CO<sub>2</sub> for studying basic sites in zeolites<sup>201</sup>.



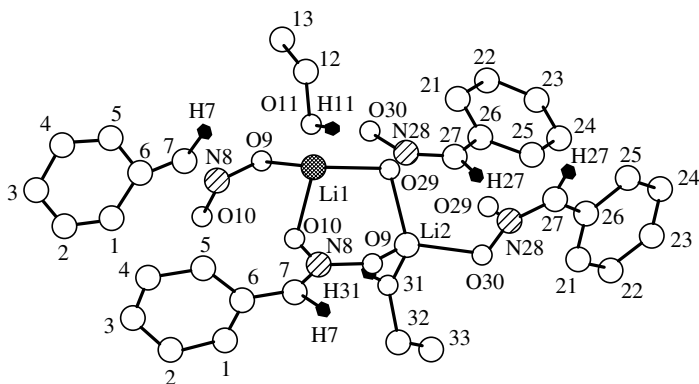
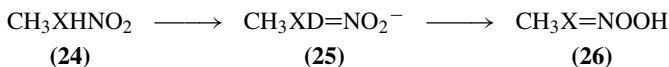
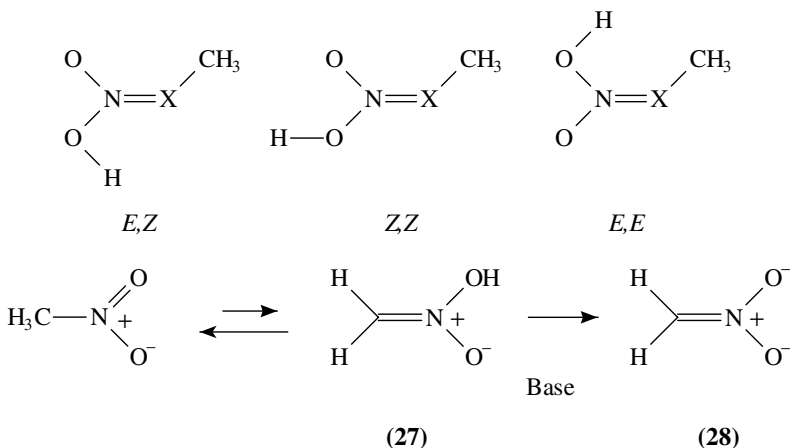


FIGURE 10. Crystal structure of  $[\text{PhCH}^-\text{NO}_2\text{Li}^+\cdot\text{C}_2\text{H}_5\text{OH}]_n$ . The H atoms of the phenyl ring and the ethyl moiety have been omitted; the C atoms are only labeled by numbers<sup>197</sup>. Reproduced by permission of VCH, Weinheim



(a) X = CH

(b) X = N



### C. Nitroaryl-substituted Methanes

The various derivatives of *o*- and *p*-nitrotoluene are the most familiar class of compounds which can be considered vinylogous nitromethanes. Due to the low solubility in water of most of the compounds belonging to this class,  $pK$  values have been determined in aqueous-organic solvents. The availability of many  $pK$  scales in these solvent mixtures and the possibility of relating the relative acidities to the  $pK_a$  scale has been discussed<sup>202</sup>. Some equilibrium constants are shown in Table 20.

While nitroalkanes are weaker acids in DMSO than in water, nitroarylmethanes show a decrease in their  $pK_a$  values on increasing DMSO concentration.

TABLE 20. Equilibrium constants for nitroarylmethanes

Compound	Solvent	pK	
<i>Toluene derivatives</i>			
4-Nitro	5% water-95% DMSO	22.1	<i>a</i>
	5% MeOH-95% DMSO	21.6	<i>a</i>
	3% MeOH-98% DMSO	25.7	<i>a</i>
	DMSO	20.4	<i>b</i>
2-Nitro	water (estimate)	≥25	<i>a</i>
2,4-Dinitro	40% water-60% DMSO	15	<i>a</i>
	30% water-70% DMSO	15.2	<i>a</i>
	30% MeOH-70% DMSO	16.2	<i>a</i>
	40% MeOH-60% DMSO	16.6	<i>a</i>
2,4,6-Trinitro	MeOH	15.6	<i>a,a'</i>
	aqueous ethylenediamine	14.45	<i>c</i>
	water	13.61	<i>d</i>
	50% water-50% DMSO	10.5	<i>e</i>
<i>Diphenyl methane derivatives</i>			
4-Nitro	50% water-50% DMSO	<i>ca</i> 20	<i>f</i>
4, 4'-Dinitro	50% water-50% DMSO	14.94	<i>e,g</i>
2, 4, 4'-Trinitro	50% water-50% DMSO	12.19	<i>d</i>
2, 2', 4, 4'-Tetranitro	water	13.16	<i>d</i>
	50% water-50% DMSO	10.90	<i>d,e</i>
2, 2', 4, 4', 6-Pentanitro	50% water-50% DMSO	7.68	<i>e</i>
2, 2', 4, 4', 6, 6'-Hexanitro	50% water-50% DMSO	5.01	<i>e</i>

<sup>a</sup>Reference 203.<sup>a'</sup>Reference 204.<sup>b</sup>Reference 205.<sup>c</sup>Reference 206.<sup>d</sup>Reference 207.<sup>e</sup>Reference 208.<sup>f</sup>Reference 209.<sup>g</sup>Reference 210.TABLE 21. Equilibrium acidity of nitro-substituted diphenylmethanes in 30% H<sub>2</sub>O-70% DMSO at 25 °C

	<i>n</i> = number of NO <sub>2</sub>	pK <sub>a</sub>	ΔpK <sub>a</sub>
	0	30.6 (DMSO)	
		27.2 (H <sub>2</sub> O-DMSO)	
		28.9 (mean)	
4-Nitro	1	16.90	12.4
4, 4'-Nitro	2	15.54	1.36
4, 4', 4''-Nitro	3	12.89	2.65
4, 4', 4'', 2-Nitro	4	9.93	2.96
4, 4', 4'', 2, 2'-Nitro	5	7.68	2.25
4, 4', 4'', 2, 2', 2''-Nitro	6	7.20	0.48

4-Nitrotoluene is characterized by low acidity, while 2,4-dinitro- and 2,4,6-trinitrotoluene show higher acidities. Moreover, it is known that a *p*-nitro group has a higher resonance stabilizing effect in comparison with a *o*-nitro group, but the effect of additional substitution on the phenyl ring does not produce a proportional effect on the acidity because of the resonance saturation effect. Concerning the equilibrium acidity of diphenylmethane derivatives, the values shown in Table 21 indicate that it increases by increasing the number of nitro groups, but the resonance saturation effect appears to be

overcome by the effects produced by the absence of coplanarity of the two phenyl rings in the highly substituted nitroarylmethanes ( $n = 5$  or  $6$ ). Those effects are mainly due to the conjugation of the  $sp^2$ -hybridized carbanionic carbon with only one phenyl ring (the pycryl one in the case of  $n = 5$ ). Accordingly, the penta- and hexasubstituted nitroarylmethanes behave as  $\alpha$ -substituted 2,4,6-trinitrotoluenes. These compounds seem to be among the strongest benzylic-type carbon acids: they are more acidic than phenylnitromethane ( $pK_a = 7.93$  in 50%  $H_2O$ -50% DMSO) and 2,4-dinitrophenylacetonitrile ( $pK_a = 8.06$  in 50%  $H_2O$ -50% DMSO)<sup>211</sup>.

In the case of some nitrotriphenylmethanes, thermodynamic data determined in the  $H_2O$ -DMSO mixture<sup>212</sup> indicate that (a) the increase in *o*-nitro groups in the three phenyl rings produces an important steric effect, (b) while the first *p*-nitro group produces an increase in acidity analogous to that found in diphenylmethane, the other *p*-nitro groups are less efficient: this can be ascribed to the propeller arrangement of the three phenyl ring in these anions. While the first *p*-nitro group could exert an additional stabilization of the negative charge, the other groups are less effective.

In the study of the reaction of 2,4,6-trinitrotoluene with base (NaOMe, under first-order conditions), kinetic and equilibrium data for reaction in methanol-DMSO have been obtained. Since it has been found that plots of logarithms of rate and equilibrium constants versus the mole fraction of DMSO are linear, the value in pure methanol have been extrapolated ( $K_p = 12.4 \text{ l mol}^{-1}$ )<sup>213</sup>.

## IX. REFERENCES

1. J. W. Smith, in *The Chemistry of the Amino Group* (Ed. S. Patai), Wiley, London, 1968, pp. 161-200.
2. D. K. Bohme, in *Supplement F: The Chemistry of Amino, Nitroso and Nitro Compounds* (Ed. S. Patai), Wiley, Chichester, 1982, pp. 731-762.
3. A. Albert and E. P. Serjeant, in *The Determination of Ionization Constants. A Laboratory Manual*, 3rd ed., Chapman and Hall, London, 1984.
4. (a) D. D. Perrin, *Dissociation Constants of Organic Bases in Aqueous Solution*, Butterworth, London, 1965.  
(b) E. P. Serjeant and B. Dempsey, *Ionization Constants of Organic Acids in Aqueous Solution*, Pergamon, Oxford, 1979.
5. (a) R. A. Cox and K. Yates, *Can. J. Chem.*, **61**, 2225 (1983),  
(b) A. Bagnò, G. Scorrano, and R. A. More O'Ferrall, *Rev. Chem. Intermed.*, **7**, 313 (1987).
6. (a) F. G. Bordwell, *Acc. Chem. Res.*, **21**, 456 (1988).  
(b) R. W. Taft and F. G. Bordwell, *Acc. Chem. Res.*, **21**, 463 (1988).
7. E. M. Arnett and K. G. Venkatasubramaniam, *J. Org. Chem.*, **48**, 1569 (1983).
8. F. Hibbert, *Adv. Phys. Org. Chem.*, **22**, 113 (1986).
9. E. N. Gur'yanova, I. P. Gol'dshtein and I. P. Romm, *Donor-Acceptor Bond*, Wiley, New York, 1975.
10. W. B. Jensen, *The Lewis Acid-Base Concept. An Overview*, Wiley, New York, 1980.
11. C. Reichardt, *Solvents and Solvent Effects in Organic Chemistry*, 2nd ed., VCH, Weinheim, 1988.
12. (a) V. Gutmann, *Coordination Chemistry in Non-Aqueous Solutions*, Springer-Verlag, Vienna, 1968.  
(b) V. Gutmann, *Coord. Chem. Rev.*, **15**, 207 (1975).  
(c) V. Gutmann, *The Donor-Acceptor Approach to Molecular Interactions*, Plenum, Press, New York, 1978.
13. P. -C. Maria, J. -F. Gal, L. Elégant and M. Azzaro, *Thermochim. Acta*, **115**, 67 (1987).
14. (a) D. Gurka and R. W. Taft, *J. Am. Chem. Soc.*, **91**, 4794 (1969).  
(b) R. W. Taft, D. Gurka, L. Joris, P. v. R. Schleyer and J. W. Rakshys, *J. Am. Chem. Soc.*, **91**, 4801 (1969).
15. (a) M. J. Kamlet and R. W. Taft, *J. Am. Chem. Soc.*, **98**, 377 (1976).  
(b) R. W. Taft and M. J. Kamlet, *J. Am. Chem. Soc.*, **98**, 2886 (1976).

16. (a) R. W. Taft, J. -L. M. Abboud, M. J. Kamlet and M. H. Abraham, *J. Solution Chem.*, **14**, 153 (1985).  
(b) M. H. Abraham, R. M. Doherty, M. J. Kamlet and R. W. Taft, *Chem. Br.*, **22**, 551 (1986).  
(c) M. J. Kamlet, R. M. Doherty, J. -L. M. Abboud, M. H. Abraham and R. W. Taft, *Chemtech*, 566 (1986).  
(d) M. J. Kamlet and R. W. Taft, *Acta Chem. Scand., Ser. B*, **39**, 611 (1985).
17. (a) M. H. Abraham, P. P. Duce, J. J. Morris and P. J. Taylor, *J. Chem. Soc., Faraday Trans. 1*, **83**, 2867 (1987).  
(b) M. H. Abraham, P. P. Duce, P. L. Grellier, D. V. Prior, J. J. Morris and P. J. Taylor, *Tetrahedron Lett.*, **29**, 1587 (1988).  
(c) M. H. Abraham, P. L. Grellier, D. V. Prior, P. P. Duce, J. J. Morris and P. J. Taylor, *J. Chem. Soc., Perkin Trans. 2*, 699 (1989).  
(d) M. H. Abraham, P. L. Grellier, D. V. Prior, R. W. Taft, J. J. Morris, P. J. Taylor, C. Laurence, M. Berthelot, R. M. Doherty, M. J. Kamlet, J. -L. M. Abboud, K. Sraidi and G. Guihéneuf, *J. Am. Chem. Soc.*, **110**, 8534 (1988).  
(e) M. H. Abraham, P. L. Grellier, D. V. Prior, J. J. Morris, P. J. Taylor, C. Laurence and M. Berthelot, *Tetrahedron Lett.*, **30**, 2571 (1989).
18. J. -L. M. Abboud, C. Roussel, E. Gentric, K. Sraidi, J. Lauransan, G. Guihéneuf, M. J. Kamlet and R. W. Taft, *J. Org. Chem.*, **53**, 1545 (1988) and preceding papers in the series.
19. M. H. Abraham, P. L. Grellier, D. V. Prior, J. J. Morris, P. Taylor, P. -C. Maria and J. -F. Gal, *J. Phys. Org. Chem.*, **2**, 243 (1989).
20. (a) M. H. Abraham, *Final Report, Scales of Hydrogen-Bonding Workshop*, London, July 1–3, 1987.  
(b) M. H. Abraham, G. J. Buist, P. L. Grellier, R. A. McGill, D. V. Prior, S. Olliver, E. Turner, J. J. Morris, P. J. Taylor, P. Nicolet, P. -C. Maria, J. -F. Gal, J. -L. M. Abboud, R. M. Doherty, M. J. Kamlet, W. J. Shuely and R. W. Taft, *J. Phys. Org. Chem.*, **2**, 540 (1989).  
(c) M. H. Abraham, P. L. Grellier, D. V. Prior, J. J. Morris and P. J. Taylor, *J. Chem. Soc., Perkin Trans. 2*, 521 (1990).
21. J. Li, Y. Zhang, H. Ouyang and P. W. Carr, *J. Am. Chem. Soc.*, **114**, 9813 (1992).
22. J. E. Bartmess and R. T. McIver, Jr., in *Gas-Phase Ion Chemistry*, Vol. 2 (Ed. M. T. Bowers), Chap. 11, Academic Press, New York, 1979.
23. J. Berkowitz, G. B. Ellison and D. Gutman, *J. Phys. Chem.*, **98**, 2744 (1994).
24. (a) S. G. Lias, J. F. Liebman and R. D. Levin, *J. Phys. Chem. Ref. Data*, **13**, 695, (1984).  
(b) S. G. Lias, *Gas Phase Basicities and Proton Affinities. Additions and Corrections*, 1987.
25. (a) M. Meot-Ner (Mautner) and L. W. Sieck, *J. Am. Chem. Soc.*, **113**, 4448 (1991).  
(b) J. E. Szukijko and T. B. McMahon, *Int. J. Mass Spectrom. Ion Processes*, **109**, 279 (1991).  
(c) J. E. Szukijko and T. B. McMahon, *J. Am. Chem. Soc.*, **115**, 783 (1993).
26. D. A. Dixon and S. G. Lias, in *Molecular Structure and Energetics*, Vol. 2 (Eds. J. F. Liebman and A. Greenberg), VCH, New York, 1987, pp. 269–314.
27. D. D. Defrees and A. D. McLean, *J. Comput. Chem.*, **7**, 321 (1986).
28. (a) J. A. Pople, M. Head-Gordon, D. Fox, K. Raghavachari and L. A. Curtiss, *J. Chem. Phys.*, **90**, 5622 (1989).  
(b) L. A. Curtiss, C. Jones, G. Trucks, K. Raghavachari and J. A. Pople, *J. Chem. Phys.*, **93**, 511 (1990).  
(c) B. J. Smith and L. Radom, *J. Am. Chem. Soc.*, **115**, 4885 (1993).
29. A. Koppel, F. Anvia and R. W. Taft, *J. Phys. Org. Chem.*, **7**, 717 (1994).
30. (a) C. E. Doiron and T. B. McMahon, *Can. J. Chem.*, **59**, 2689 (1981).  
(b) D. F. Drummond and T. B. McMahon, *J. Phys. Chem.*, **85**, 3746 (1981).  
(c) S. M. Collyer and T. B. McMahon, *J. Phys. Chem.*, **87**, 909 (1983).
31. B. J. Smith and L. Radom, *J. Am. Chem. Soc.*, **115**, 4885 (1993).
32. J. Sunner and P. Kebarle, *J. Am. Chem. Soc.*, **106**, 6135 (1984).
33. (a) J. S. Uppal and R. H. Staley, *J. Am. Chem. Soc.*, **104**, 1238 (1982).  
(b) J.-F. Gal, R. W. Taft and R. T. McIver, Jr., *Spectros. Int. J.*, **3**, 96 (1984).
34. (a) J. I. Brauman, J. A. Dodd and C. -C. Han, in *Nucleophilicity* (Eds. J. -M. Harris and S. P. McManus), Chap. 2, Advances in Chemistry Series, No. 215, ACS, Washington, D.C. 1987.  
(b) J. I. Brauman and C. -C. Han, *J. Am. Chem. Soc.*, **110**, 5611 (1988).  
(c) T. B. McMahon and P. Kebarle, *Can. J. Chem.*, **63**, 3160 (1985).  
(d) T. B. McMahon, T. Heinis, G. Nicol, J. K. Hovey and P. Kebarle, *J. Am. Chem. Soc.*, **110**, 7591 (1988).

35. (a) J. W. Larson and T. B. McMahon, *J. Am. Chem. Soc.*, **104**, 5848 (1982).  
(b) J. W. Larson and T. B. McMahon, *J. Am. Chem. Soc.*, **105**, 2944 (1983).  
(c) J. W. Larson and T. B. McMahon, *Inorg. Chem.*, **23**, 2029 (1984).  
(d) J. W. Larson and T. B. McMahon, *J. Am. Chem. Soc.*, **106**, 517 (1984).  
(e) J. W. Larson and T. B. McMahon, *J. Am. Chem. Soc.*, **109**, 6230 (1987).
36. M. Meot-Ner (Mautner) and L. W. Sieck, *J. Am. Chem. Soc.*, **108**, 7525 (1986).
37. (a) E. P. Grimsrud, S. Chowdhury and P. Kebarle, *Int. J. Mass Spectrom. Ion Processes*, **68**, 57 (1986).  
(b) G. W. Dillow and P. Kebarle, *J. Am. Chem. Soc.*, **110**, 4877 (1988).
38. (a) J. W. Larson and T. B. McMahon, *J. Am. Chem. Soc.*, **107**, 766 (1985).  
(b) J. W. Larson and T. B. McMahon, *Inorg. Chem.*, **26**, 4018 (1987).  
(c) J. W. Larson, J. E. Szulejko and T. B. McMahon, *J. Am. Chem. Soc.*, **110**, 7604 (1988).
39. (a) J. W. Larson and T. B. McMahon, *J. Phys. Chem.*, **88**, 1083 (1984).  
(b) J. W. Larson and T. B. McMahon, *Can. J. Chem.*, **62**, 675 (1984).
40. P. Kebarle and S. Chowdhury, *Chem. Rev.*, **87**, 513 (1987).
41. R. G. Keese and A. W. Castleman, Jr., *J. Phys. Chem. Ref. Data*, **15**, 1011 (1986).
42. M. Meot-Ner (Mautner), *J. Am. Chem. Soc.*, **106**, 1257 (1984).
43. (a) M. Meot-Ner (Mautner), *J. Am. Chem. Soc.*, **105**, 4912 (1983).  
(b) M. Meot-Ner (Mautner) and C. A. Deakyne, *J. Am. Chem. Soc.*, **107**, 469 (1985).  
(c) C. A. Deakyne and M. Meot-Ner (Mautner), *J. Am. Chem. Soc.*, **107**, 474 (1985).
44. M. J. Locke and R. T. McIver, Jr., *J. Am. Chem. Soc.*, **105**, 4226 (1983).
45. (a) M. H. Abraham, J. Liszi and E. Kristóf, *Aust. J. Chem.*, **35**, 1273 (1982): *Calculations on Ionic Solvation*, VII, and previous papers in this series.  
(b) M. H. Abraham, E. Matteoli and J. Liszi, *J. Chem. Soc., Faraday Trans. 1*, **79**, 2781 (1983).
46. J. Chandrasekhar, D. C. Spellmeyer and W. L. Jorgensen, *J. Am. Chem. Soc.*, **106**, 903 (1984).
47. (a) A. Pullman, in *The World of Quantum Chemistry* (Eds. B. Pullman and R. Parr), Reidel, Dordrecht, 1976, pp. 149–187.  
(b) A. Pullman, in *Quantum Theory of Chemical Reactions*, Vol. 2 (Eds. R. Daudel, A. Pullman, L. Salem and A. Veillard), Reidel, Dordrecht, 1980, pp. 1–24.  
(c) A. Pullman, *Study Week on Chemical Events in the Atmosphere and Their Impact on Environment*, November 7–11, 1983 (Ed. G. B. Marino-Bettolo), *Pontif. Acad. Sci. Scripta Varia*, **56**, 1985 pp. 25–50.
48. (a) D. H. Aue, H. M. Webb and M. T. Bowers, *J. Am. Chem. Soc.*, **94**, 4726 (1972).  
(b) D. H. Aue, H. M. Webb and M. T. Bowers, *J. Am. Chem. Soc.*, **98**, 318 (1976).
49. R. W. Taft, in *Proton-Transfer Reactions* (Eds. E. F. Caldin and V. Gold), Chap. 2, Chapman and Hall, London, 1975.
50. R. W. Taft, in *Kinetics of Ion-Molecule Reactions* (Ed. P. Ausloos), Plenum Press, New York, 1979, pp. 271–293.
51. R. W. Taft, J. -F. Gal, S. Gèribaldi and P. -C. Maria, *J. Am. Chem. Soc.*, **108**, 861 (1986).
52. (a) M. Fujio, R. T. McIver, Jr. and R. W. Taft, *J. Am. Chem. Soc.*, **103**, 4017 (1981).  
(b) M. Mishima, R. T. McIver, Jr., R. W. Taft, F. G. Bordwell and W. N. Olmstead, *J. Am. Chem. Soc.*, **106**, 2717 (1984).
53. M. J. Kamlet, R. M. Doherty, J. -L. M. Abboud, M. H. Abraham and R. W. Taft, *Chemtech*, **566** (1986).
54. T. Zeegers-Huyskens, *J. Mol. Liq.*, **32**, 191 (1986).
55. J. F. Gal and P. C. Maria, in *Progress in Organic Chemistry*, Vol. 17 (Ed. R. W. Taft), Wiley, New York, 1990, pp. 159–238.
56. V. Frenna, N. Vivona, G. Consiglio and D. Spinelli, *J. Chem. Soc., Perkin Trans. 2*, 1865 (1985).
57. A. D. Headley, *J. Am. Chem. Soc.*, **109**, 2347 (1987).
58. A. Beaten, W. De Profit, W. Langenaeker and P. Geerlings, *J. Mol. Struct. Theochem*, **306**, 203 (1994).
59. A. D. Headley and M. E. McMurry, *J. Phys. Org. Chem.*, **7**, 63 (1994).
60. R. Barbucci, V. Barone, M. Micheloni and L. Rusconi, *J. Phys. Chem.*, **85**, 64 (1981).
61. D. N. Hague and A. D. Moreton, *J. Chem. Soc., Perkin Trans. 2*, 265 (1994).
62. M. Delfini, A. L. Segre, F. Conti, R. Barbucci, V. Barone and R. Ferruti, *J. Chem. Soc., Perkin Trans.*, 900 (1980).
63. M. Micheloni, P. Paoletti and A. Bianchi, *Inorg. Chem.*, **24**, 3702 (1985).
64. A. Bencini, A. Bianchi, E. Garcia-España, M. Giusti, M. Micheloni and P. Paoletti, *Inorg. Chem.*, **26**, 681 (1987).

65. A. Bencini, A. Bianchi, E. Garcia-España, M. Giusti, S. Mangani, M. Micheloni, P. Orioli and P. Paoletti, *Inorg. Chem.*, **26**, 1243 (1987).
66. A. Bencini, A. Bianchi, E. Garcia-España, M. Micheloni and P. Paoletti, *Inorg. Chem.*, **27**, 176 (1988).
67. B. Dietrich, M. W. Hosseini, J. -M. Lehn and R. B. Sessions, *Helv. Chim. Acta*, **66**, 1262 (1983).
68. M. Kodama, E. Kimura and S. Yamaguchi, *J. Chem. Soc. Dalton Trans.*, 2536 (1980).
69. G. Bojensen, *J. Am. Chem. Soc.*, **109**, 5557 (1987).
70. S. A. McLuckey, D. Cameron and R. G. Cooks, *J. Am. Chem. Soc.*, **103**, 1313 (1981).
71. G. S. Gorman, J. P. Speir, C. A. Turner and I. J. Amster, *J. Am. Chem. Soc.*, **114**, 3986 (1992).
72. G. Bojensen and T. Breindhal, *J. Chem. Soc. Perkin Trans. 2*, 1029 (1994).
73. Y. K. Lau, K. Nishizawa, R. Tse, A. S. Brown and P. Kebarle, *J. Am. Chem. Soc.*, **103**, 6291 (1981).
74. J. Oszczapowicz, in *The Chemistry of Amidines and Related Compounds* (Eds. S. Patai and Z. Rappoport), Wiley, Chichester, 1991, pp. 623–688.
75. J. Ševčík and F. Grambal, in *The Chemistry of Amidines and Imidates* (Ed. S. Patai), Wiley, London, 1975.
76. J. Oszczapowicz and M. Kumińska, *J. Chem. Soc., Perkin Trans. 2*, 103 (1994).
77. A. Echavarren, A. Galán, J. -M. Lehn and J. de Mendoza, *J. Am. Chem. Soc.*, **111**, 4994 (1989).
78. A. Gleich, F. P. Schmidtchen, P. Mikulcik and G. Müller, *J. Chem. Soc., Chem. Commun.*, 55 (1990).
79. R. Schwesinger, *Chimia*, **39**, 269 (1985).
80. (a) R. Schwesinger and H. Schlemper, *Angew. Chem., Int. Ed. Engl.*, **26**, 1167 (1987).  
(b) R. Schwesinger, *Nachr. Chem. Tec. Lab.*, **38**, 1214 (1990).
81. M. H. Abraham, P. L. Grellier, D. V. Prior, J. J. Morris and P. J. Taylor, *J. Chem. Soc., Perkin Trans. 2*, 521 (1990).
82. E. D. Raczyńska, C. Laurence and M. Berthelot, *Can. J. Chem.*, **70**, 2203 (1992).
83. J. -Y. Le Questel, C. Laurence, A. Lachkar, M. Helbert and M. Berthelot, *J. Chem. Soc. Perkin Trans. 2*, 2091 (1992).
84. A. Chardin, M. Berthelot, C. Laurence and D. G. Morris, *J. Phys. Org. Chem.*, **7**, 705 (1994).
85. D. B. Collum, *Acc. Chem. Res.*, **26**, 227 (1993).
86. (a) B. L. Lucht and D. B. Collum, *J. Am. Chem. Soc.*, **116**, 7949 (1994).  
(b) A. S. Galianoroth, Y. J. Kim, J. H. Gilchrist, A. T. Harrison, D. J. Fuller and D. B. Collum, *J. Am. Chem. Soc.*, **113**, 5053 (1991).
87. K. Bergander, R. X. He, N. Chandrakumar, O. Eppers and H. Gunther, *Tetrahedron*, **50**, 5861 (1994).
88. J. Barluenga, R. Gonzalez, F. J. Fananas, M. Yus and F. Foubelo, *J. Chem. Soc., Perkin Trans. 1*, 1069 (1994).
89. F. E. Romesberg, J. H. Gilchrist, A. T. Harrison, D. J. Fuller and D. B. Collum, *J. Am. Chem. Soc.*, **113**, 5751 (1991).
90. W. Clegg, K. W. Henderson, R. E. Mulvey and P. A. Oneil, *J. Chem. Soc., Chem. Commun.*, 769 (1994).
91. (a) B. L. Lucht and D. B. Collum, *J. Am. Chem. Soc.*, **116**, 6009 (1994),  
(b) G. Becker, K. Hubler and J. Weidlein, *Z. Anorg. Allgem. Chem.*, **620**, 16 (1994),  
(c) M. A. Nichols, D. Waldmuller and P. G. Williard, *J. Am. Chem. Soc.*, **116**, 1153 (1994),  
(d) P. Kosse, E. Popowski, M. Veith and V. Huch, *Chem. Ber.*, **127**, 2103 (1994),  
(e) F. E. Romesberg, M. P. Bernstein, J. H. Gilchrist, A. T. Harrison, D. J. Fuller and D. B. Collum, *J. Am. Chem. Soc.*, **115**, 3475 (1993),  
(f) B. Tecklenburg, U. Klingebiel and D. Schmidtbase, *J. Organomet. Chem.*, **426**, 287 (1992).
92. D. R. Armstrong, F. A. Banbury, I. Cragghine, M. G. Davidson, F. S. Mair, E. Pohl, P. R. Raithby and R. Snaith, *Angew. Chem., Int. Ed. Engl.*, **32**, 1769 (1993).
93. D. Sato, H. Kawasaki, I. Shimada, Y. Arata, K. Okamura, T. Date and K. Koga, *J. Am. Chem. Soc.*, **114**, 761 (1992).
94. M. P. Bernstein and D. B. Collum, *J. Am. Chem. Soc.*, **115**, 789 (1993).
95. N. P. Lorenzen, J. Kopf, F. Olbrich, U. Schumann and E. Weiss, *Angew. Chem., Int. Ed. Engl.*, **29**, 1441 (1990).
96. I. Cragghine, M. G. Davidson, O. Kocian, F. S. Mair, E. Pohl, P. R. Raithby, R. Snaith, N. Spencer and J. F. Stoddart, *Angew. Chem., Int. Ed. Engl.*, **32**, 1182 (1993).
97. F. E. Romesberg and D. B. Collum, *J. Am. Chem. Soc.*, **116**, 9187 (1994).

98. N. S. Nudelman, E. Lewkowicz and J. J. P. Furlong, *J. Org. Chem.*, **58**, 1847 (1993).
99. G. Boche, I. Langlotz, M. Marsch, K. Harms and N. E. S. Nudelman, *Angew. Chem., Int. Ed. Engl.*, **31**, 1205 (1992).
100. G. Boche, I. Langlotz, M. Marsch, K. Harms and G. Frenking, *Angew. Chem., Int. Ed. Engl.*, **32**, 1171 (1993).
101. A. Bencini, A. Bianchi, P. Dapporto, E. Garcia-Espana, M. Micheloni, P. Paoletti and P. Paoli, *J. Chem. Soc., Chem. Commun.*, **19**, 1382 (1990).
102. E. M. Arnett, M. A. Nichols and A. T. McPhail, *J. Am. Chem. Soc.*, **112**, 7059 (1990).
103. C. Lambert, F. Hampel and P. Von R. Schleyer, *Angew. Chem., Int. Ed. Engl.*, **31**, 1209 (1992).
104. S. Bradamante, A. Marchesini and G. Pagani, *J. Chem. Soc., Perkin Trans. 2*, 568 (1973).
105. S. Bradamante and G. A. Pagani, *J. Chem. Soc., Perkin Trans. 2*, 1055 (1986).
106. E. Barchiesi and S. Bradamante, *J. Phys. Org. Chem.*, **3**, 139 (1990).
107. C. Gatti, A. Ponti, A. Gamba and G. Pagani, *J. Am. Chem. Soc.*, **114**, 8634 (1992).
108. E. Anders, A. Opitz and R. Boese, *Chem. Ber.*, **125**, 1267 (1992).
109. (a) A. Abbotto, S. Bradamante and G. A. Pagani, *J. Org. Chem.*, **58**, 444 (1993),  
(b) S. Bradamante and G. A. Pagani, *Pure Appl. Chem.*, **61**, 709 (1989).
110. A. Abbotto, V. Alanzo, S. Bradamante and G. A. Pagani, *J. Chem. Soc., Perkin Trans. 2*, 481 (1991).
111. A. Abbotto, S. Bradamante and G. A. Pagani, *J. Org. Chem.*
112. E. Barchiesi, S. Bradamante, C. Carfagna and R. Ferraccioli, *J. Chem. Soc., Perkin Trans. 2*, 1565 (1988).
113. (a) A. J. Streitwieser, J. H. Hammons, E. Ciuffarin and J. I. Brauman, *J. Am. Chem. Soc.*, **89**, 59 (1967),  
(b) A. J. Streitwieser, E. Ciuffarin and J. H. Hammons, *J. Am. Chem. Soc.*, **89**, 63 (1967),  
(c) A. J. Streitwieser, E. Juaristi and L. L. Nebenzhal, in *Comprehensive Carbanion Chemistry* (Eds E. Buncl and T. Durst), Elsevier, Amsterdam, 1980.
114. E. S. Petrov, M. I. Terekhova and A. I. Shatenshtein, *Zh. Obshch. Khim.*, **44**, 1118 (1974).
115. W. S. Matthews, J. E. Bares, J. E. Bartmess, F. G. Bordwell, F. J. Cornforth, G. E. Drucker, Z. Margolin, R. J. McCallum, G. J. McCollum and N. R. Vanier, *J. Am. Chem. Soc.*, **97**, 7006 (1975).
116. R. R. Fraser, M. Bresse and T. S. Mansour, *J. Chem. Soc., Chem. Commun.*, 620 (1983).
117. A. Streitwieser Jr, D. A. Bors and M. J. Kaufman, *J. Chem. Soc. Chem. Commun.*, 1394 (1983).
118. D. A. Bors, M. J. Kaufman and A. J. Streitwieser, *J. Am. Chem. Soc.*, **107**, 6975 (1985).
119. S. Gronert and A. J. Streitwieser, *J. Am. Chem. Soc.*, **108**, 7016 (1986).
120. J. A. Krom, J. T. Petty and A. J. Streitwieser, *J. Am. Chem. Soc.*, **115**, 8024 (1993).
121. R. R. Fraser and T. S. Mansour, *J. Org. Chem.*, **49**, 3442 (1984).
122. W. K. McEwen *J. Am. Chem. Soc.*, **58**, 1124 (1936).
123. R. A. Cox, R. J. Stewart, *J. Am. Chem. Soc.*, **98**, 488 (1976).
124. (a) T. Birkall, W. L. Jolly, *J. Am. Chem. Soc.*, **88**, 5439 (1966),  
(b) L. L. Lagowski, *Pure Appl. Chem.*, **25**, 429 (1971).
125. E. M. Arnett, T. C. Moriarty, L. E. Small, J. P. Rudolph and R. P. Quirk, *J. Am. Chem. Soc.*, **95**, 1492 (1973).
126. J. Courtot-Coupez and M. LeDemenez, *Bull. Soc. Chim. Fr.*, 1033 (1969).
127. F. G. Bordwell and D. J. Algrim, *J. Am. Chem. Soc.*, **110**, 2964 (1988).
128. L. Grefenstein and G. Pagani, *J. Org. Chem.*, **46**, 3336 (1981).
129. F. G. Bordwell and M. J. Bausch, *J. Am. Chem. Soc.*, **108**, 2473 (1986).
130. I. E. Friedrich, *J. Org. Chem.*, **48**, 3851 (1983).
131. X. -M. Zhang and F. G. Bordwell, *J. Am. Chem. Soc.*, **116**, 904 (1994).
132. F. G. Bordwell and X. -M. Zhang, *J. Am. Chem. Soc.*, **116**, 973 (1994).
133. F. G. Bordwell, J. -P. Cheng, G. -Z. J. Ji, A. V. Satish and X. Zhang, *J. Am. Chem. Soc.*, **113**, 9790 (1991).
134. D. F. McMillen and D. M. Golden, *Ann. Rev. Phys. Chem.* **33**, 493 (1982).
135. V. T. Varlamov and E. T. Denisov, *Dokl. Akad. Nauk USSR*, **293**, 126 (1987).
136. J. H. Richardson, L. M. Stephenson and J. I. Brauman, *J. Am. Chem. Soc.*, **97**, 1160 (1975).
137. F. G. Bordwell, and T. -Y. Lynch, *J. Am. Chem. Soc.*, **111**, 7558 (1989).
138. (a) H. G. Viehe, Z. Janousek, R. Merenyi and L. Stella, *Angew. Chem., Int. Ed. Engl.*, **18**, 917 (1979),  
(b) H. G. Viehe, Z. Janousek, R. Merenyi and L. Stella, *Acc. Chem. Res.*, **18**, 148 (1985).

139. F. G. Bordwell, J. P. Cheng, S. E. Seyedrezai and C. A. Wilson, *J. Am. Chem. Soc.*, **110**, 8178 (1988).
140. F. G. Bordwell, H. E. Fried, D. L. Hughes, T. -Y. Lynch, A. V. Satish and Y. E. Whang, *J. Am. Chem. Soc.*, **55**, 3330 (1990).
141. F. G. Bordwell, J. A. Harrelson and T. -Y. Lynch, *J. Org. Chem.*, **55**, 3337 (1990).
142. K. B. Wiberg and K. E. Laidig, *J. Am. Chem. Soc.*, **109**, 5935 (1987).
143. F. G. Bordwell and G. -Z. Ji, *J. Am. Chem. Soc.*, **113**, 8398 (1991).
144. F. G. Bordwell and G. -Z. Ji, *J. Org. Chem.*, **57**, 3019 (1992).
145. T. J. Hannigan and W. J. Spillane, *J. Chem. Soc., Perkin Trans. 2*, 851 (1982).
146. B. Unterhalt and E. Seebach, *Arch. Pharm.*, **314**, 51 (1981).
147. S. D. McDermott, P. O. Burke and W. J. Spillane, *J. Chem. Soc., Perkin Trans. 2*, 499 (1984).
148. P. O. Burke, S. D. McDermott, T. J. Hannigan and W. J. Spillane, *J. Chem. Soc., Perkin Trans. 2*, 1851 (1984).
149. L. Bauer and O. Exner, *Angew. Chem., Int. Ed. Engl.*, **13**, 376 (1974).
150. (a) J. Buglass, K. Hudson and J. G. Tillett, *J. Chem. Soc. (B)*, 123 (1971),  
(b) F. Di Furia, G. Modena and P. Scrimin, *Nouv. J. Chim.*, **8**, 45 (1984).
151. (a) M. Novak, G. A. Bonham, L. K. Molher and K. M. Peet, *J. Org. Chem.*, **53**, 3903 (1988),  
(b) K. K. Ghosh, S. K. Rajput and K. K. Krishnani, *J. Phys. Org. Chem.*, **5**, 39 (1992).
152. (a) R. Pande and S. G. Tandom, *Talanta*, **38**, 1015 (1991).  
(b) M. Paul and R. Pande, *Fresenius Z. Anal. Chem.*, **342**, 193 (1992).
153. A. Bagno, C. Comuzzi and G. Scorrano, *J. Am. Chem. Soc.*, **116**, 916 (1994).
154. M. Decouzon, O. Exner, J. -F. Gal and P. -C. Maria, *J. Org. Chem.*, **57**, 1621 (1992).
155. E. Farkas and T. Kiss, *J. Chem. Soc., Perkin Trans. 2*, 1255 (1990).
156. E. Lipczynska-Kochany and H. Iwamura, *J. Org. Chem.*, **47**, 5277 (1982).
157. (a) R. E. Plapinger, *J. Org. Chem.*, **24**, 802 (1959).  
(b) J. Gernstein and W. P. Jenks, *J. Am. Chem. Soc.*, **86**, 4655 (1964),  
(c) G. M. Steinberg and R. Swidler, *J. Org. Chem.*, **30**, 2362 (1965).
158. (a) B. Monzyk and A. L. Crumbliss, *J. Org. Chem.*, **45**, 4670 (1980),  
(b) C. P. Brink and A. L. Crumbliss, *J. Org. Chem.*, **47**, 1171 (1982),  
(c) C. P. Brink, L. L. Fish and A. L. Crumbliss, *J. Org. Chem.*, **50**, 2277 (1985).
159. F. G. Bordwell, H. E. Fried, D. L. Hughes, T. -Y. Lynch, A. V. Satish and Y. E. Whang, *J. Org. Chem.*, **55**, 3330 (1990).
160. M. Decouzon, O. Exner, J. -F. Gal and P. C. Maria, *J. Org. Chem.*, **55**, 3980 (1990).
161. (a) S. G. Lias, J. F. Libman and R. D. Levin, *Chem Phys. Ref. Data*, **13**, 695 (1984),  
(b) J. Catalan, J. L. G. De Paz, M. Yanez, R. M. Claramunt, C. Lopez, J. Elguero, F. Anvia, J. H. Quian, M. Taagepera and R. W. Taft, *J. Am. Chem. Soc.*, **112**, 1303 (1990).
162. M. Meyer, *J. Mol. Struct.*, **304**, 45 (1994).
163. R. Krishnan, J. S. Binkley, R. Seeger and J. A. Pople, *J. Chem. Phys.*, **72**, 650 (1980).
164. B. Noszal and D. L. Rabenstein, *J. Phys. Chem.*, **95**, 4761 (1991).
165. (a) J. Catalan, M. Menendez and J. Elguero, *Bull. Soc. Chim. Fr.*, **1**, 30 (1985),  
(b) J. Catalan, J. L. M. Abboud and J. Elguero, *Adv. Heterocycl. Chem.*, **41**, 187 (1987).
166. J. Catalan, M. Sanchez-Cabezudo, J. L. G. De Paz and J. Elguero, *Theochem J. Mol. Struct.*, **166**, 415 (1988).
167. (a) C. H. DePuy, S. R. Kass and G. P. Bean, *J. Org. Chem.*, **53**, 4427 (1988),  
(b) J. Catalan, J. L. G. De Paz, J. Elguero, A. Martinez, R. W. Taft and F. Anvia, *Theochem J. Mol. Struct.*, **205**, 367 (1990).
168. A. E. Tipping, P. Jiminez, E. Ballesteros, J. -L. M. Abboud, M. Yanez, M. Essefar and J. Elguero, *J. Org. Chem.*, **59**, 1039 (1994).
169. (a) M. Balon, C. Carmona, J. Hidalgo, M. A. Munoz and P. Guardado, *Heterocycles*, **32**, 1123 (1991),  
(b) M. A. Munoz, P. Guardado, J. Hidalgo, C. Carmona and M. Balon, *Tetrahedron*, **48**, 5901 (1992).
170. T. Brinck, J. S. Murray, P. Politzer and R. E. Carter, *J. Org. Chem.*, **56**, 2934 (1991).
171. A. R. Katritzky, *Handbook of Heterocyclic Chemistry*, Pergamon Press, New York, 1985, p. 302.
172. E. S. Lewis, in *Supplement F: The Chemistry of Amino, Nitroso and Nitro Compounds* (Ed. S. Patai), Wiley, Chichester, 1982, pp. 715-729.
173. A. Pross and S. S. Shaik, *J. Am. Chem. Soc.*, **104**, 1129 (1982).
174. H. Yamataka and S. Nagase, *J. Org. Chem.*, **53**, 3232 (1988).



175. E. Grunwald, *J. Am. Chem. Soc.*, **107**, 125 (1985).
176. W. J. Albery, C. F. Bernasconi and A. J. Kresge, *J. Phys. Org. Chem.*, **1**, 29 (1988).
177. W. P. Jenks, *Chem. Rev.*, **85**, 511 (1985).
178. C. F. Bernasconi, *Advances in Physical Organic Chemistry*, Vol. 27, Academic Press, New York, 1992, pp. 1–238.
179. L. G. Arnaut, *J. Phys. Org. Chem.*, **4**, 726 (1991).
180. A. J. C. Varandas and S. J. Formosinho, *J. Chem. Soc., Chem. Commun.*, 163 (1986).
181. S. J. Formosinho, in *Theoretical and Computational Models for Organic Reactions* (Eds. S. J. Formosinho, I. G. Csizmadia and L. G. Arnaut), Kluwer, Amsterdam, 1991, p. 159.
182. W. S. Mathews, J. E. Bares, J. E. Bartmess, F. G. Bordwell, F. J. Cornforth, G. E. Drucker, A. Margolin, R. J. McCallum, G. J. McCallum and N. R. Vernier, *J. Am. Chem. Soc.*, **97**, 7006 (1975).
183. F. G. Bordwell, J. C. Branca, D. L. Hughes and W. N. Olmstead, *J. Org. Chem.*, **45**, 3305 (1980).
184. C. F. Bernasconi and R. D. Bunnell, *J. Am. Chem. Soc.*, **110**, 2900 (1988).
185. E. M. Arnett, L. E. Small, D. Oancea and D. Johnston, *J. Am. Chem. Soc.*, **98**, 7346 (1976).
186. M. L. McKee, *Chem. Phys. Lett.*, **164**, 520 (1989).
187. (a) M. Sana, G. Leroy, D. Peeters and G. Wilante, *J. Mol. Struct. Theochem*, **164**, 249 (1988),  
(b) G. Leroy, M. Sana, G. Wilante and D. Peeters, *J. Mol. Struct. Theochem*, **187**, 251 (1989).
188. J. B. Pedley, R. D. Naylor and S. P. Kirby, *Thermochemical Data of Organic Compounds*, 2nd ed., Chapman, New York, 1986.
189. E. Buncl and T. Durst, *Comprehensive Carbanion Chemistry. Part A, Structure and Reactivity*, Elsevier, Amsterdam, 1980, p.29.
190. K. E. Edgecombe and R. J. Boyd, *Can. J. Chem.*, **62**, 2887 (1984).
191. K. E. Edgecombe and R. J. Boyd, *Can. J. Chem.*, **61**, 45 (1983).
192. W. -K. Li, *Croat. Chem. Acta*, **63**, 127 (1990).
193. J. E. Bartmess, J. A. Scott and R. T. Mclver, Jr., *J. Am. Chem. Soc.*, **101**, 6046 (1979).
194. J. Cioslowski, T. M. Stacey and E. D. Fleischmann, *J. Am. Chem. Soc.*, **113**, 4751 (1991).
195. J. Cioslowski, *J. Phys. Rev. Lett.*, **62**, 1469 (1969).
196. P. H. Boyle, M. A. Convery, A. P. Davis, G. D. Hosken and B. A. Murray, *J. Chem. Soc., Chem. Commun.*, **3**, 239 (1992).
197. G. Klebe, K. H. Böhn, M. Marsch and G. Boche, *Angew. Chem., Int. Ed. Engl.*, **26**, 78 (1987).
198. F. G. Bordwell, J. C. Branca, D. L. Hughes and W. N. Olmstead, *J. Org. Chem.*, **45**, 3305 (1980).
199. V. G. Avakyan and O. V. Fateyev, *Theochem J. Mol. Struct.*, **262**, 39 (1992).
200. D. Barton and W. D. Ollis, in *Comprehensive Organic Chemistry* (Ed. I. O. Sutherland, ed.), Vol. 2, Pergamon Press, Oxford, 1979, pp. 335–336.
201. A. A. Kheir and J. F. Haw, *J. Am. Chem. Soc.*, **116**, 817 (1994).
202. E. Buncl and T. Durst, *Comprehensive Carbanion Chemistry. Part A, Structure and Reactivity*, Elsevier, Amsterdam, 1980, p. 323.
203. J. Lelievre, P. G. Farrell and F. Terrier, *J. Chem. Soc., Perkin Trans. 2*, 333 (1986).
204. C. F. Bernasconi, *J. Org. Chem.*, **36**, 1671 (1971).
205. F. G. Bordwel, D. Algrim and N. R. Vernier, *J. Org. Chem.*, **42**, 1817 (1977).
206. R. Schaal, *J. Chim. Phys.*, **52**, 796 (1955).
207. Terrier, J. Lelievre A. P. Chatrousse and P. G. Farrell, *J. Chem. Soc., Perkin Trans. 2*, 1479 (1985).
208. F. Terrier, H. -Q. Xie and P. G. Farrell, *J. Org. Chem.*, **55**, 2610 (1990).
209. P. G. Farrel, P. Fogel, A. P. Chatrousse, J. Lelievre and F. Terrier, *J. Chem. Soc., Perkin Trans. 2*, 51 (1985).
210. A. P. Chatrousse, F. Terrier, F. M. Fouad and P. G. Farrell, *J. Chem. Soc., Perkin Trans. 2*, 1243 (1979).
211. C. F. Bernasconi, D. A. V. Kliner, A. S. Mullin and J. X. Ni, *J. Org. Chem.*, **53**, 3342 (1988).
212. Terrier, H. Q. Xie, J. Lelievre, T. Boubaker and P. G. Farrel, *J. Chem. Soc., Perkin Trans. 2*, 1899 (1990).
213. D. N. Brooke and M. R. Crampton, *J. Chem. Res.*, **10**, 340 (1980).

## CHAPTER 10

# Hydrogen bonding and complex formation involving compounds with amino, nitroso and nitro groups

LUCIANO FORLANI

*Dipartimento di Chimica Organica 'A. Mangini', viale Risorgimento 4,  
40136-Bologna, Italy*

---

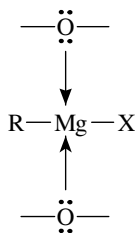
I. INTRODUCTION	424
II. AMINO GROUP	428
A. Hydrogen Bonding Interactions. Introduction	428
B. Intermolecular Hydrogen Bonding	430
C. Self-association of Amines	434
D. Intramolecular Hydrogen Bonding	435
E. Electron Donor-Acceptor Complexes	439
1. Introduction	439
2. Intermolecular electron donor-acceptor complexes	440
3. Complexes between amines and halogens	442
4. Intramolecular electron donor-acceptor complexes	443
III. NITROSO GROUP	447
IV. NITRO GROUP	450
A. Hydrogen Bonding	451
1. Intermolecular hydrogen bonding	451
2. Intramolecular hydrogen bonding	452
B. Electron Donor-Acceptor Complexes	455
V. COVALENT COMPLEXES BETWEEN AMINES AND NITRO ACTIVATED AROMATIC DERIVATIVES	457

VI. NON-COVALENT INTERACTIONS BETWEEN AMINES AND NITRO AROMATIC DERIVATIVES .....	460
A. Nature of the Complexes .....	461
B. Some Kinetic Features of Aromatic Nucleophilic Substitution Reactions .....	465
VII. REFERENCES .....	470

## I. INTRODUCTION

Although the 'conventional' way of describing reactions uses the chemical formula for 'naked molecules', this situation doesn't really exist: every time a solute is dissolved in a solvent, solute/solvent and/or solute/solute interactions (of a greater or lesser degree) take place<sup>1</sup>. Consequently, the energy level of starting compounds interacting with solvents or solute (or self-associating) is different from that of the 'free' molecules.

In most text-books this point of view is scarcely considered, and few cases are reported. A frequent example is the stabilization of Grignard reagents by electron donor solvents (usually by lone pairs of the oxygen atoms of ethers), as shown in **1**. This lack of attention is a simplification which generates little interest about the real nature of the starting materials and their energy levels, when reactions take place.



(1)

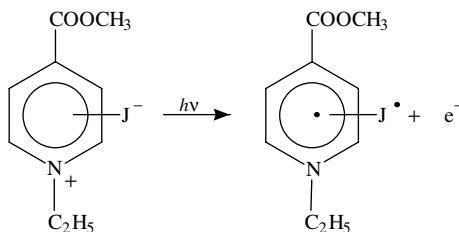
The first consequence is the problem of qualitatively or quantitatively rationalizing the effects of solvents and also of focusing on the physical and chemical properties of solvents, e.g. their polarity.

Thus, paying more attention to non-covalent solute-solute or solute-solvent interactions in reacting systems (which may be investigated immediately after the mixing of the reagents) is a reasonable way to obtain useful analyses (*ἀνάλλυσις*) of single and particular systems, as a starting point for a general view and rationalization (a synthesis, *συντάξις*) of this problem.

Some empirical parameters describing interactions between solvents and solutes, or the dependence of the reactivities on changes of the solvent, are important for a general explanation of molecular interactions<sup>1-3</sup> (in particular non-covalent interactions) because they introduce the idea that the immediate neighbours of the solute (or of the reaction centres) are a micro-region of great interest. Classical parameters which consider the medium as a homogeneous system may be hardly used to explain physical and chemical properties of solutes in solutions.

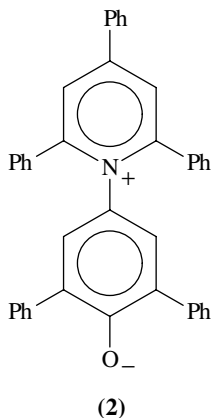
In 1948, Grunwald and Winstein<sup>2,4</sup> attempted to define the ionizing power of a solvent by the **Y** parameter, based on the comparison of the rate for the solvolysis of *t*-butyl chloride. In 1956, Kosower<sup>5</sup> made an attempt to define the polarity of a medium (solvent) by introducing the **Z** parameter based on the spectroscopic properties (in various solvents)

of the charge-transfer complex of 1-ethyl-4-carbomethoxy pyridinium iodide, involving the transformation reported in Scheme 1.



SCHEME 1

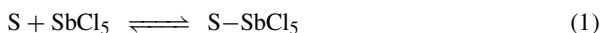
In 1963, Dimroth<sup>6</sup> introduced the  $E_T$  parameter based on the spectroscopic properties of an intramolecular charge transfer of the pyridinium phenoxide betaine dyes **2**, to define the solvent polarity for interpreting solvent effects on the reactivities.



In a recent review<sup>7</sup> Reichardt listed the solvatochromic dyes used as indicators of the polarity of solvents.

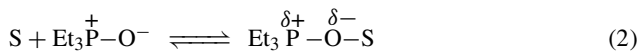
Gutmann introduced<sup>3</sup> the concepts of 'donor number' (donicity) and 'acceptor number' (acceptivity), as dimensionless numbers, for the characterization of donor properties of bases independently of the solvent.

The donor number has been defined as the negative  $\Delta H$  values for the formation of 1:1 adduct between solvents and antimony pentachloride, in 1,2-dichloroethane, at 25 °C<sup>8</sup>. In equilibrium 1, S is the solvent (with an unshared electron pair).



In this way, the concept of donicity explains some properties of substances usually defined 'apolar' from their usual parameters of polarity (dielectric constant, dipolar moment,  $E_T$  parameter value) but which presents high possibilities of interaction (and of solvation) with positively charged centres. This is the case of tertiary amines such as triethylamine (or of ethers such as THF, dioxane) which shows usual polarity parameters near that of apolar solvents (benzene, chloroform, chlorobenzene, 1,2-dichloroethane, etc.) but high ability to coordinate positive charges.

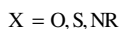
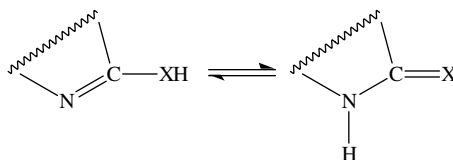
The electrophilic properties of molecules were derived from  $^{31}\text{P}$  NMR chemical shifts<sup>9</sup> produced by electrophilic solvents on triethylphosphine oxide as equilibrium 2 illustrates.



In this case the solvent (S) is an electron acceptor molecule.

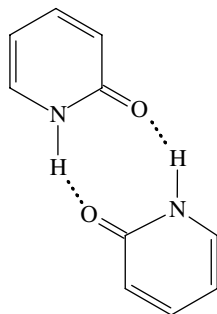
In numerous systems, a fundamental role is played by the van der Waals forces<sup>10,11</sup>. Conformations of single molecules and intermolecular aggregations are strongly affected by van der Waals interactions which may be evaluated by quantum chemical methods. 'True van der Waals' interactions are those when the dominant attractive contribution is the dispersion energy<sup>12</sup>; the term 'van der Waals complex' may be considered better than 'charge-transfer complex' when no charge is transferred during the complex formation.

The solute/solvent interaction may be very important in determining the reactivity of solutes. An example arises from the tautomeric equilibria (in particular in heterocyclic series<sup>13</sup>, involving potential amino, hydroxy, mercapto groups; see Scheme 1) which may be shifted toward the left or right by simple changes of solvent or of polar solutes with consequent changes in spectroscopic properties and chemical behaviour<sup>14</sup>. Hydrogen bonds too are of fundamental importance in determining the position of the equilibrium of Scheme 2.



SCHEME 2

The synergism of hydrogen bond strength and  $\pi$ -delocalization, as expressed by the idea of *resonance assisted hydrogen bonding* (RAHB)<sup>15</sup>, is an interesting tool in explaining some strong hydrogen bonds, and in particular the high availability to dimerization of linear<sup>16</sup> or cyclic amides<sup>17</sup>, as well as 2-hydroxypyridine and all related substances including proteins and some bases of DNA. Tautomerism and geometrical properties of nitrogen containing heterocyclic bases bearing potential amino, hydroxy and mercapto groups are strictly related to the presence of dimers like 3.

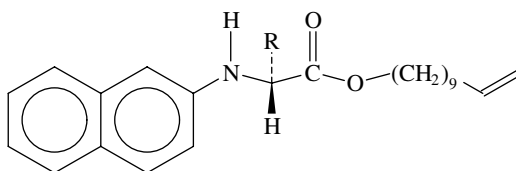


(3)

Non-covalent complexes (and hydrogen bonding complexes) are considered to be a relevant starting point in a conceptual revolution and in modern organic synthesis<sup>18</sup>; in general, hydrogen bonding is a fundamental force in a molecular recognition of biological macromolecules<sup>19,20</sup>.

Some practical applications of non-covalent interactions are also very interesting. The basis of the separation of enantiomers by the chromatographic method<sup>21</sup> is the preferential interaction of one enantiomer of a substance with one enantiomer of another substance, which is usually part of the chiral stationary phase. Non-covalent interactions are more frequent: hydrogen bonding, host–guest and donor–acceptor interactions.

For example<sup>22</sup>, separation of enantiomers of chiral molecules (amines, alcohols, amino acids) is possible by using a chiral stationary phase obtained from 10-undecenyl esters of *N*-(2-naphthyl)- $\alpha$ -amino acids (**4**). Amino groups are of fundamental importance in this practical application of the chiral recognition.



(4)

Following essential early work on hydrogen bonding interactions<sup>23,24</sup>, the investigation of the interactions with protons have generated much interest and had a great deal of success. The proton (and, in general, the proton carriers) is a very particular acid species, because it is in an extreme position among the series of positive centres (for example, it is the least polarizable among the acids). Nevertheless, hydrogen bonding interactions are the most important (and the most investigated) non-covalent interactions, because of the diffusion of the problem of hydrogen bonding in both chemical and biochemical systems.

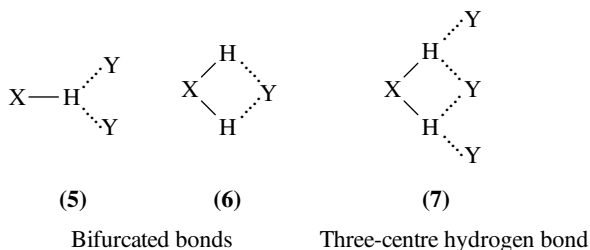
Comparing and making a distinction between hydrogen bonding and proton transfer can provide an important starting point in defining the field of hydrogen bonding interactions. In particular, in non-aqueous solvents, hydrogen bonding interactions may be related to aqueous acidities of both hydrogen donors and acceptors<sup>25</sup>. Attempts to rationalize the hydrogen-bond basicity (and hydrogen-bond acidity) using the equilibrium constant values of complexation, in tetrachloromethane, between a series of bases and some reference acids (or between a series of acids and a given base) afford scales of solute hydrogen-bond basicity (or acidity)<sup>26</sup>.

A simple (but essential) starting idea is that the conclusions arising from studies in different physical states (gas, liquid and solid) produce very important additional information, but it is dangerous to apply '*sic et simpliciter*' the conclusions obtained in one state (in particular in solid) to the other states (in particular in solutions).

The relatively recent development<sup>27</sup> of the direct methods of crystal structure analysis has produced a great increase in the number of crystal structures reported in the literature, particularly with regard to the possible hydrogen bonds (also for biological molecules). Hence, the classical spectroscopic data on hydrogen bonding in solution are backed up by X-ray diffraction analysis data.

As observed above, the solid state differs from the liquid state of solutions, under the usual experimental conditions, but some new ideas for an approach to hydrogen bonding originate from crystal analysis<sup>28</sup>. An example of this is offered by the fact that the hydrogen bonds observed in crystal structures are rarely linear. Bifurcated bonds (**5**,

**6**) and three-centre **(7)** (and four-centre) hydrogen bonds are frequently observed in the solid state (X is the hydrogen donor and Y is the hydrogen acceptor).



The recognition of hydrogen bonds is an indispensable tool for designing molecular aggregates, in the field of crystal engineering<sup>29</sup> as well as in the fields of supramolecular chemistry.

It is generally accepted that non-covalent interactions are the driving force of some biochemical transformations and interactions<sup>30,31</sup>. The molecular recognition, to form supramolecular species<sup>32</sup>, is possible if intermolecular interactions, non-covalent in character, originate in a well defined pattern<sup>33</sup>; consequently, the investigation of simple models of non-covalent interactions is the first step to understanding more complicated processes and situations. Defined structures involving self-assembled sub-units are formed by non-covalent interactions<sup>34</sup> and, in particular, by hydrogen bonding interactions<sup>35</sup>.

## II. AMINO GROUP

### A. Hydrogen Bonding Interactions. Introduction

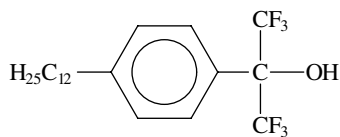
Attempts to organize the hydrogen bonding interactions are reported in numerous papers which provide classifications and tables for many substances, including amines. In principle, the energetic classification in two main groups<sup>36</sup> provides a simple tool (together with some other parameters such as bond length, geometry etc.) with which to recognize various hydrogen bonding interactions between solutes and solvents, and between solutes and solutes:

- (a) weak hydrogen bonding: bond energy  $< 50 \text{ kJ mol}^{-1}$  and mostly  $< 30 \text{ kJ mol}^{-1}$ ;
- (b) strong hydrogen bonding: bond energy  $> 50 \text{ kJ mol}^{-1}$  and in some cases  $> 100 \text{ kJ mol}^{-1}$ .

Hydrogen bonding versus proton transfer<sup>37</sup> and the nature of the hydrogen bond<sup>38</sup>, both in the liquid and in the gas phase, are subjects of extensive investigations and useful empirical rules to draw hydrogen bond patterns are well codified for organic compounds<sup>39</sup>.

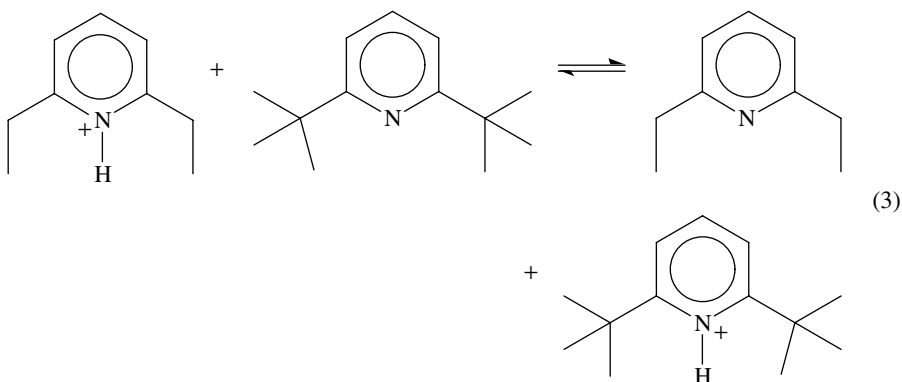
Attempts to evaluate the effective solute hydrogen bond acidity and basicity<sup>40</sup> produce quantitative scales of solute hydrogen-bonding, which may be of interest for application also to biochemical processes<sup>41</sup>. The indicator pair 4-nitroaniline/4-nitro-*N,N*-dimethylaminoaniline are used to state the equivalence<sup>42</sup> of solute and solvent scales of hydrogen bond basicity.

A scale of relative hydrogen bond basicity for a wide variety of solutes by means of their retention in gas chromatography was developed<sup>43</sup> by using 4-dodecylphenyl- $\alpha$ - $\alpha$ -bis-(trifluoromethyl) methanol **8** as hydrogen bond donor. The comparison of results with those obtained by hydrogen bond basicity measures employing FT-IR methods indicates good agreement when the formation of hydrogen bond complexes is 1:1. In other cases discrepancies may be observed.



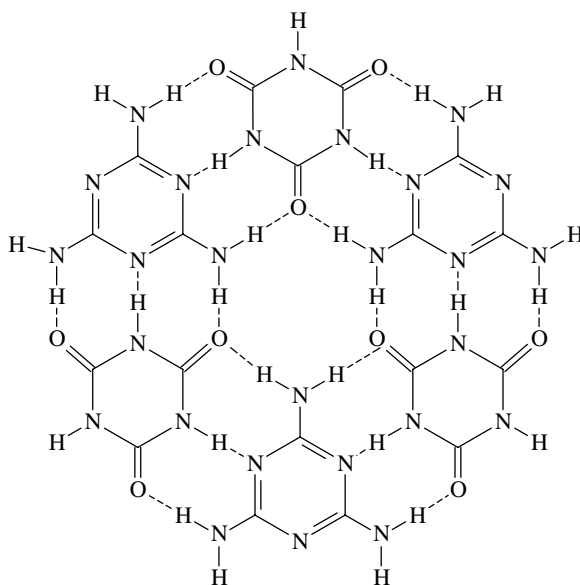
(8)

Usually, proton transfer in acid–base equilibria is a fast process, but very hindered systems show slow kinetics. The equilibrium (equation 3) regarding 2,4-dialkylpyridines proceeds through locked-rotor and with intermediates of low entropy<sup>44</sup>.



(3)

Many papers concerning the structural determination of hydrogen bonds in crystals were recently reviewed<sup>26</sup>. Hydrogen bonds are responsible for the self-assembling of



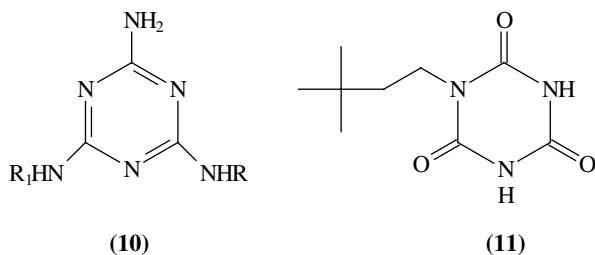
(9)



supramolecular aggregates<sup>45</sup> and, together with other non-covalent interactions which control molecular recognition, also for other self-assembly phenomena<sup>46</sup> and for the formation of hydrogen-bonded helices<sup>35</sup> as well as for the non-covalent synthesis of aggregates<sup>47</sup>.

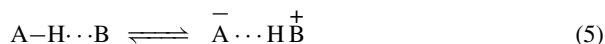
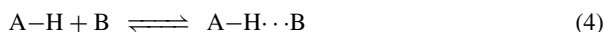
The cyclic hexamer **9** (named 'rosette') presents 18 hydrogen bonds<sup>48,49</sup>; **9** is the first step in the formation of the cyanuric acid/melamine lattice formed by a sheet of non-covalent aggregates<sup>50</sup>.

The hydrogen bond is the driving force in forming a supramolecular aggregate (with 54 hydrogen bonds<sup>51</sup>) between a compound containing nine melamine rings **10** and nine neohexylisocyanurate derivatives **11**. These supramolecular aggregates are well defined compounds, as tested by <sup>1</sup>H, <sup>13</sup>C NMR spectroscopic data, by gel permeation chromatography and vapor pressure osmometry<sup>52</sup>. The size of the substituents on the melamine ring (and on the cyanuric ring) influences the preorganization of precursors and the stability of aggregates: the stability of rosettes decreases as the size of substituents is reduced<sup>53</sup>.



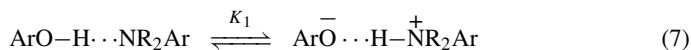
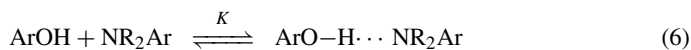
## B. Intermolecular Hydrogen Bonding

In principle, for a given acid (AH)–base (B) pair (such as nitrogen bases and the O–H group), interactions between AH and B are controlled by the equilibrium (equation 5) between the molecular complex arising from a first equilibrium (equation 4) and the ion pair, including the solvation of the ion pair and the effect of the delocalization charge<sup>54</sup>.



Interactions between tertiary aliphatic amines or *N,N*-dialkylanilines and substituted phenols are generally reported as models of O–H ⋯ N hydrogen bonds affording molecular complexes (equilibrium 4). A number of complexes between primary, secondary and tertiary aliphatic amines and dihydroxybenzenes (or dihydroxynaphthalenes) were isolated<sup>55</sup> to investigate the stoichiometry of these complexes. The phenol/amine ratios observed included values of 1:1, 2:1, 3:1 and 3:2.

Complexes between amines and phenols in apolar solvents<sup>56</sup> were extensively investigated by several techniques. The equilibrium between molecular complexes and ions was recently investigated<sup>57</sup> by <sup>1</sup>H NMR techniques for the complexes between phenols and *N,N*-dimethylaniline. The constant of the proton transfer equilibrium ( $K_1$  of equilibrium 7) increases on increasing  $\Delta pK_a$  (=  $pK_a$  of protonated base  $-pK_a$  of phenol) in water, and when the solutions are cooled.



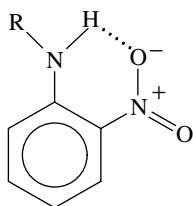
Triethylamine is a popular substance (because it is an aprotic base) to investigate interactions with OH groups, both aliphatic and aromatic, including diols: when the two OH groups are separated by a long chain they complex triethylamine independently<sup>58</sup>. Mixtures of triethylamine and phenols (investigated by vapour pressure osmometry) show non-ideal behaviour arising from the formation of complexes involving the presence of multimers<sup>12</sup>. Usually the formation constants of hydrogen-bridged complexes between phenols and bases are related to the protonation constant<sup>59</sup> of bases<sup>60</sup> but some deviations are observed (for example in the case of heterocyclic bases<sup>61</sup>), and they are explained by the particular nature of the considered bases.

The stability constant of complexes between  $\beta$ -cyclodextrine and *p*-nitroaniline is higher than that of aniline because the resonance charge delocalization (and London dispersion interactions) is an important factor influencing the stability of these complexes<sup>62</sup>. This behaviour parallels that of corresponding phenols.

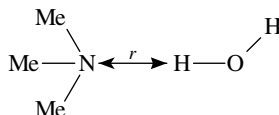
The dipole moments were related to hydrogen bond strength and to the ability of the proton acceptors (compounds with phosphoryl<sup>63</sup> and carbonyl<sup>64</sup> groups) to associate with phenol. Hydrogen bonded complexes of pyridines, quinolines and acridine with phenol are studied, in carbon tetrachloride, by dipole moment measures<sup>65</sup>. Dipole moments of the complexes were related to the ability of the acceptors to associate with phenol and with their basicity. Hydrogen bonds may either reinforce the dipole moments of the resultant of the group moments or may oppose the dipole moment direction, depending on the nature of the acceptor.

Amino groups may act not only as proton acceptor, but also as proton donor. Acidic N—H protons interact with basic solvents. In these cases an *ortho*-nitro group in an aniline system competes with the solvent by an internal hydrogen bond<sup>66</sup>, as depicted in **12**. The stretching frequencies (by IR spectra in carbon tetrachloride) of  $\nu_{\text{NH}}$  of complexes between *N*-methylaniline or diphenylamine (and some nitro-anilines<sup>66</sup>) and solvents depend on the proton accepting ability of the solvent (which is a moderate base)<sup>67</sup>. The frequency shifts are linearly related to the solvent's donor number (DN)<sup>3</sup>.

The biological interest of hydrogen bonding in aqueous solutions is well known; protonated amines and phenolate ions in water are associated by hydrogen bonds. The association constant ( $K = 0.81 \text{ mol}^{-1} \text{ dm}^3$ , measured in buffered aqueous solution) for the complex of the dication of ethylenediamine with the phenolate ion agrees with a weak hydrogen bonding  $\text{N}-\text{H} \cdots \text{O}$ <sup>68</sup>.



(12)



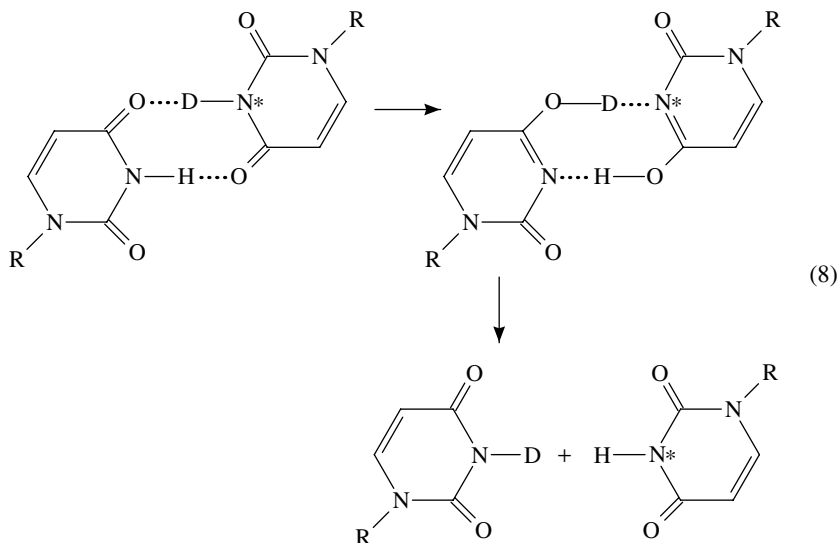
(13)

The trimethylamine/water system (for 10 isotopomers) was investigated by microwave spectroscopy<sup>69</sup>. The analysis of the rotational constants indicate a structure with an essentially linear single hydrogen bond ( $r = 1.818 \text{ \AA}$  in **13**).

The <sup>13</sup>C resonances in derivatives of aniline reveal that the carbon bearing a partially deuterated NH<sub>2</sub> group appears as a multiplet because of the deuterium isotope effect on the <sup>13</sup>C chemical shift, when the hydrogen exchange is low. This effect is larger for

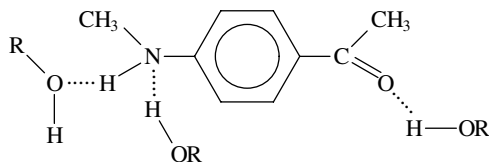
systems with intramolecular hydrogen bonds and allows an evaluation of the energies of the hydrogen bonds<sup>70</sup>. These observations are extended to intermolecular hydrogen bonds in partially deuterated nucleoside systems and indicate base-pairing of the nucleosides through intermolecular hydrogen bonds.

The H/D isotopic exchange in the uridine system (from starved nitrogen) may be explained by the mechanism (equation 8) involving dimerization of the hydroxy heterocycle<sup>70</sup>. Dimerization of hydroxy derivatives of aza-containing heterocycles plays an important role in assembling molecules, and in their tautomeric equilibria.



The dynamic <sup>1</sup>H NMR technique allows investigations on the rate of exchange between 3-substituted quinuclidinium ions and water. The rate of dissociation of amine/water (or amine/alcohol) complexes is determined<sup>71</sup> by the free energy contribution from the pK<sub>a</sub>-dependent hydrogen bond breaking, and from dispersion forces between acceptor and donor which may be at the most 40% of the activation energy of the dissociation of the complex. Similar importance may be attributed to a term for the formation of a cavity prior to the dissociation of the complexes.

Some *para*-substituted anilines in strongly hydrogen bonding solvents show two non-equivalently hydrogen bonded species with differently hybridized aniline nitrogens<sup>72</sup>; rehybridization of aromatic amino nitrogens depends on the OH acidity of the solvent molecule and the basicity of the substituted anilines. **14** shows three possible modes of interaction of *p*-aminoacetophenone and alcohol, where the amino group is simultaneously both a proton donor and an acceptor.



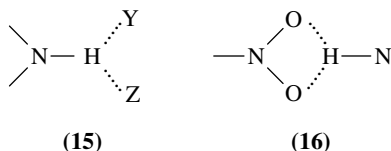
(14)

Many crystal structures are determined in order to study the hydrogen bond geometry. In the literature there are attempts to rationalize the classification of the geometrical properties of  $X-H \cdots Y$  ( $X, Y = N, O$ ) of hydrogen bonds (involving amide groups<sup>73</sup> too) by using statistical analyses of intermolecular hydrogen bonds in organic crystals (employing crystal data from the Cambridge Structural Data base).

The dependence of hydrogen bond distances (in linear hydrogen bonds) on the nature of the donor and acceptor atoms was investigated for  $N-H \cdots O=C$  interactions (ammonium salts, amines/carbonyl, carboxylate groups etc.); statistical investigation of the linearity of the  $N-H \cdots O=C$  bond shows<sup>74</sup> that the mean of the distribution of the angles is  $161^\circ$ . (mean on 1352 examples) for intermolecular hydrogen bonds, while intramolecular hydrogen bonds may be less linear (the mean on 152 considered examples is  $132^\circ$ ).

$N-H \cdots O=C$  hydrogen bonds show a tendency to occur in the directions of the oxygen  $sp^2$  lone pairs, probably because of an inherent preference for hydrogen bonding in a lone-pair direction and involving also steric factors<sup>75,76</sup>.

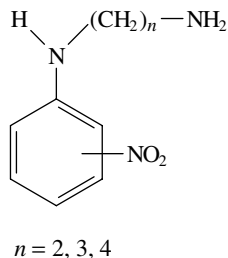
About 300 (of the 1500  $N-H \cdots O=C$  bonds considered) are three-centre bonds<sup>77</sup>. 'Three-centre bond' (as shown in **15**) is considered a better definition than 'bifurcated bond'. The three-centre bond is a situation where the proton interacts with two hydrogen bond acceptor atoms; both bonds are shorter than the sum of the van der Waals radii of the atoms involved. The two hydrogen bond acceptors may be different ( $Y \neq Z$  in **15**).



For *p*-nitroanilines, the intermolecular hydrogen bond between the amino group and the nitro group is an effective tool for organizing molecules in solid state. Even if several other hydrogen bonding interactions between nitro and amino groups are well codified, the three-centre hydrogen bond interaction between hydrogens of the amino groups and the two inside lone pairs of electrons of a single nitro group<sup>78</sup> is the more frequent picture of this interaction in the solid state as shown in **16**.

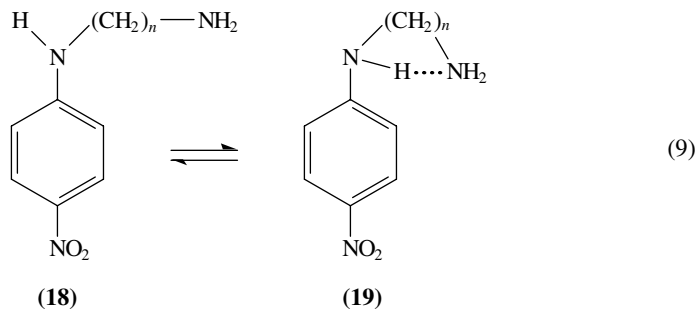
The crystal and molecular structure<sup>79</sup> of a carbazole/tetracyano ethylene 1:2 complex reveals the presence of a hydrogen bond between the amino group of the carbazole and a nitrile nitrogen of tetracyano ethylene in the solid state, which resembles the stronger hydrogen bond observed between amines and the cyano group.

Application of the solvatochromic comparison method (Kamlet and coworkers<sup>80</sup>) reveals a competition between intermolecular and intramolecular hydrogen bonding in molecules bearing both donor and acceptor groups<sup>81</sup> such as **17**.



(17)

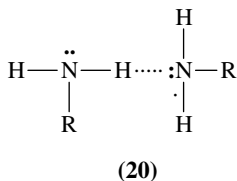
*N*-(*p*-Nitrophenyl)alkylenediamines **18** form intramolecular hydrogen bonds between the two N–H groups (aromatic and aliphatic) as reported in equilibrium 9. When hydrogen bond acceptor solvents are used, intramolecular hydrogen bonds are formed between **18** and solvents, but when the nitro group is in the *ortho* position, the hydrogen bond is formed between the aromatic amino and nitro groups.



### C. Self-association of Amines

Self-association of substances with acidic hydrogens<sup>82</sup>, including amines (to form, in a first approximate model, dimers mainly by hydrogen bonding interactions), is a long known problem. There are numerous reports in the literature on the thermodynamic, spectroscopic and structural aspects of self-association and dimer formation of water, alcohols, ammonia, amines and hydrogen sulphide<sup>83</sup>.

The dimerization energies in the vapor phase are of 2–3 kcal mol<sup>-1</sup><sup>84</sup>. Dimerization of aromatic or aliphatic amines<sup>85</sup> is the first step of the formation of aggregates and it is the usual model in investigating the properties of compounds containing the NH<sub>2</sub> group, when it is at the same time both a hydrogen donor and acceptor (**20**). Nevertheless, the formation of non-cyclic trimers is reported to be the best stoichiometry for the self-association of butylamines in cyclohexane<sup>86</sup>.



Dimer presence in apolar solvents is indicated as being responsible for some particular kinetic features when protic amines are nucleophilic reagents<sup>87,88</sup>. Aliphatic amines are slightly more associated than aromatic amines<sup>89–91</sup>.

Aniline may complex (as a proton donor) not only with tertiary amines (proton acceptors) such as *N,N*-dimethylaniline, pyridine or *N,N*-diethylcyclohexylamine, but also with apparently neutral molecules such as CCl<sub>4</sub><sup>92</sup>, benzene<sup>93</sup> or chloroform, which acts as proton donor toward amines<sup>94</sup>.

Usually, the influence of the solvent on the proton donor and acceptor interactions is relevant<sup>95</sup>. The importance of the amine/solvent hydrogen bonding interaction depends on the strength of the amine/amine hydrogen bonding interaction<sup>96</sup>.

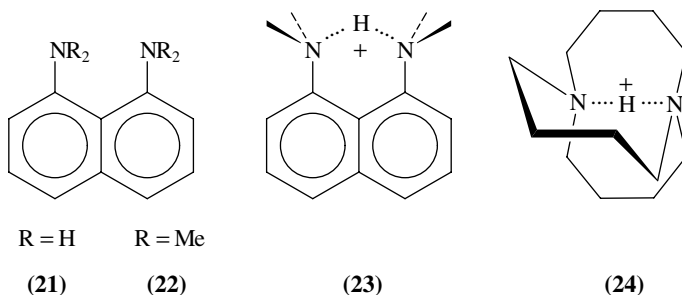
AM1 calculations on dimers of nitroanilines are of interest in investigating the intermolecular forces which orientate the individual molecules in crystal chains. Dimerization in solid crystal may be considered responsible for the differences in molecular geometry between solid and gas phases<sup>97</sup>.

Self-association of heterocycles containing NH groups (such as imidazoles<sup>98</sup>, triazoles<sup>99</sup> etc.) produces chains of planar molecules connected by N—H···N hydrogen bonds. The effects of intermolecular hydrogen bonding on the molecular structures are confirmed also by *ab initio* molecular orbital calculations<sup>100</sup>.

#### D. Intramolecular Hydrogen Bonding

Intramolecular hydrogen bonding is important in the explanation of both the physical and chemical properties of molecules, with particular attention to their spectroscopic properties.

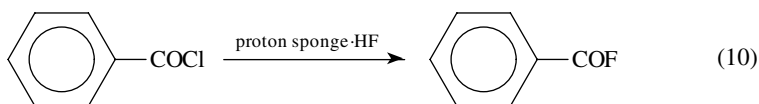
When two amino groups are in a rigid geometry as in the case of 1,8-diaminonaphthalene (**21**), some interesting properties (e.g. the anomalous strong basicity) of the amino groups can be understood by intramolecular hydrogen bonds<sup>101</sup>. Usually, if heteronuclear hydrogen bonds are formed, hydrogen bonds are weaker than homonuclear hydrogen bonds owing to lack of symmetry. This is the case of the ‘proton sponge’.



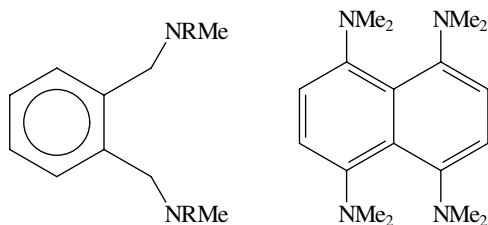
In **21**, the hydrogen bond is strong due to the short N—N distance in **23** (2.54–2.65 Å)<sup>101</sup> or in the 1,6-diaza[4,4,4]tetradecane cation **24** (2.53–2.60 Å)<sup>102</sup>. In addition, in cation **23** the  $\pi$ -delocalization reinforces the strength of the hydrogen bond<sup>103</sup>. At same time **23** presents a very low rate of proton transfer<sup>101,104</sup> to hydroxide ion in water [ $2 \times 10^5$  (s<sup>-1</sup> mol<sup>-1</sup> dm<sup>3</sup>)], while deprotonation of the usual ammonium ions is a diffusion controlled process [ $10^{10}$  (s<sup>-1</sup> mol<sup>-1</sup> dm<sup>3</sup>)]<sup>105</sup>.

The term ‘proton sponges’ indicates a series of compounds with unusually high basicity, compared to the basicity of isomers. A recent review<sup>106</sup> collects and discusses crystallographic results of the literature on this subject.

The hydrofluoride of a ‘proton sponge’ is used in MeCN as fluoride ion donor: benzoyl chloride is transformed into benzoyl fluoride<sup>107</sup> (reaction 10).



A number of deprotonation equilibria between 1,8-bis(dimethylamino)naphthalene and several acids, including phenols<sup>108</sup>, thiols<sup>109</sup>, N—H acids<sup>110</sup> and carboxylic acids<sup>111</sup>, have been investigated. 1,2-Bis(dialkylaminomethyl)benzenes **25** are also strong proton acceptors<sup>112</sup>.



R = Me, Et, Pr, Bu

(25)

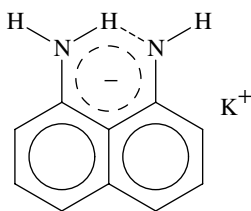
(26)

1,4,5,8-Tetra(dimethylamino)naphthalene **26** is a 'double proton sponge'<sup>113</sup> which may be diprotonated by strong acids (HBr). The  $pK_a$  values are 9.8 and 4.9 for the first and second protonation, respectively, on the dimethylsulphoxide  $pK_a$  scale while the  $pK_a$  of **22** is 7.5. **26** is a stronger base than **22** not only because of the electron donating effects of the amino groups in the *para* positions, but also because of the indirect steric effect in the other *peri* positions 4 and 5 of the naphthalene.

The complex between **20** and maleic acid reveals<sup>114</sup> (by X-ray diffraction analyses of single crystals) the presence of two intermolecular hydrogen bonds between the  $-NH_3^+$  group and the anion.

The protonated form of **22** shows the proton located in a cavity formed by four methyl groups. This proton exchanges slowly on the NMR time scale. The presence of proton in this cavity explains the dramatic high basicity of **22** ( $pK_a = 12.1$ ) with respect to **21** ( $pK_a = 4.61$ )<sup>115</sup>.

Nitrogen anions, such as amide anions, may be stabilized by hydrogen bonding in a similar way to that of oxyanions<sup>116</sup>. In fact, 1,8-diaminonaphthalene is more acid ( $K^+$  DMSYL/DMSO) than 1,5-diaminonaphthalene because of the stabilization of the anion by an intramolecular hydrogen bond as shown in **27**<sup>117</sup>.

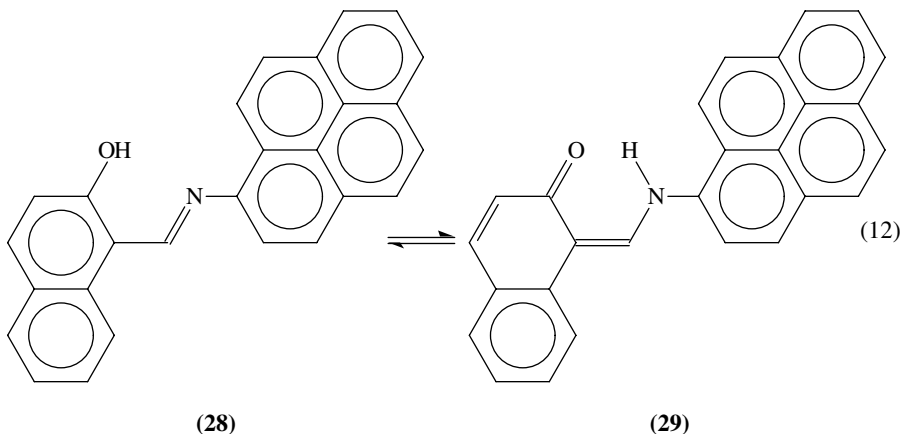
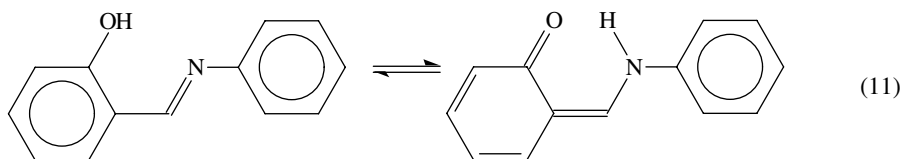


(27)

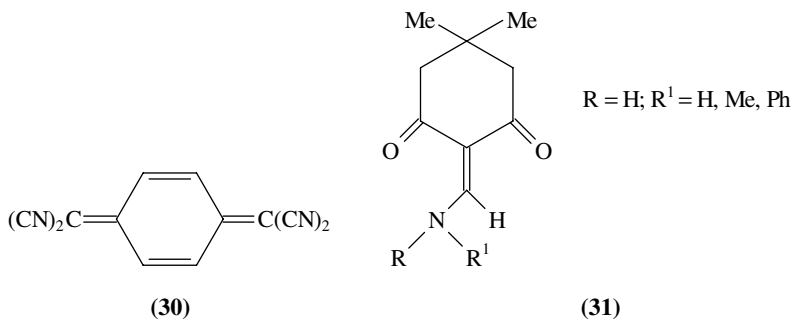
Generally, relative populations of conformers are strongly affected by the presence of internal hydrogen bonding interactions. *Gauche* forms are more populated forms than *anti* forms of conformational conformers of substituted ethanes when internal hydrogen bonding (between vicinal groups) intervenes to stabilize the *gauche* form with respect to the *anti* form. Electron-diffraction and *ab initio* investigations of the conformational composition of ethylenediamine show that the two *gauche* conformations are the more populated<sup>118</sup>. This geometrical situation implies an internal hydrogen bond which is a relevant parameter to rotamer stability in the vapour phase.

A particular effect of an intramolecular hydrogen bond occurs in *N*-salicylideneaniline derivatives<sup>119</sup> and anils of hydroxynaphthaldehydes<sup>120</sup>, and their tautomerism (shown

in equilibrium 11) is clearly affected by the intramolecular hydrogen bonding. The position of the hydrogen (the  $N \cdots H-O$  hydrogen bond is short) is sensitive to the substituent variation<sup>121</sup> on both rings, but substituent changes in the salicylidene moiety affect hydrogen bonding more than variations in the amine moiety. The differences in the proton transfer behaviour of derivatives of the system indicated by equilibrium 11 may be ascribed to intermolecular charge transfer interactions<sup>122</sup>. The intramolecular hydrogen bond  $O-H \cdots N$  (and the tautomeric equilibrium **28**  $\rightleftharpoons$  **29** in equation 12) is sensitive to the presence of charge transfer complexes<sup>123</sup> as observed in the case of some (solid) complexes between *N*-(2-hydroxy-1-naphthylmethylene)-1-pyreneamine and 7,7,8,8-tetracyanoquinodimethane derivatives **30**.

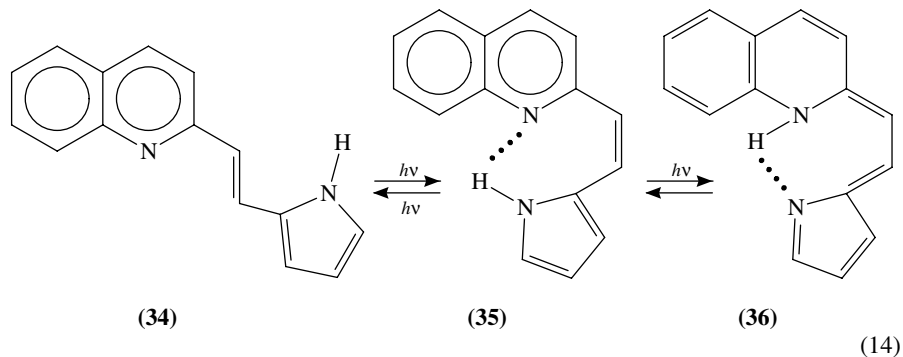
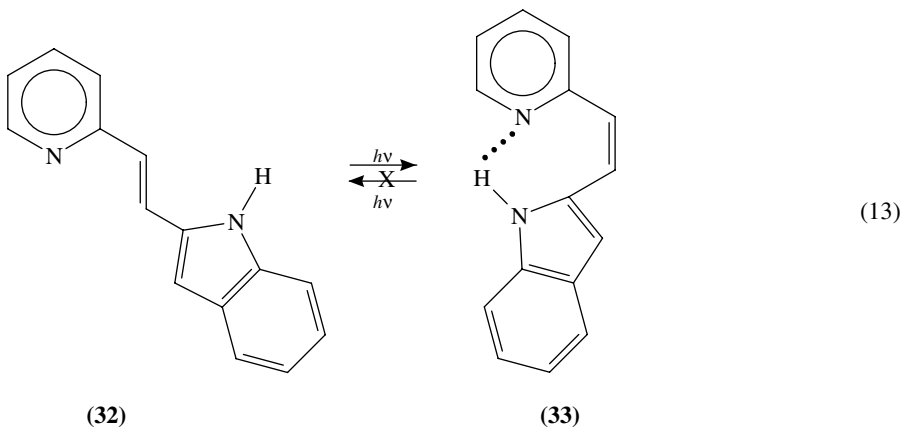


The process of rotation around the exocyclic  $C=C$  double bond in 2-aminomethylenedimedone **31** (investigated by the dynamic  $^1H$  NMR method) is affected by intramolecular hydrogen bonds and by the electronic effects of substituents on the nitrogen atom<sup>124</sup>. When  $R = H$ , the  $O-H \cdots N$  hydrogen bond prevents the rotation around the  $C=C$  double bond.

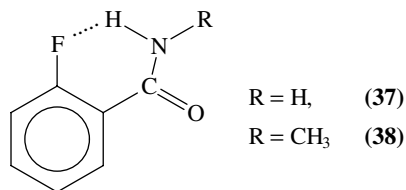




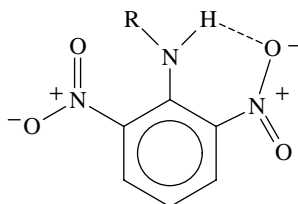
The internal hydrogen bond (N–H–N) is responsible for suppression of *cis*–*trans* isomerization in the singlet excited state of *cis*-1-(2-indolyl)-2-(2-pyridyl)ethene (**32**) of reaction 13. Clearly, the reverse isomerization is possible<sup>125</sup>. On the contrary, irradiation of *cis*-1-(2-pyrrolyl)-2-(2-quinolyl)ethene<sup>126</sup> (**35**) induces the isomerization to **34**. The isomerization (*cis*–*trans*) is possible because the excitation allows the tautomerization of **35** to **36** (equation 14).



Strong intramolecular hydrogen bonds are observed in 2-fluorobenzamide<sup>127</sup> (**37**). <sup>15</sup>N, <sup>19</sup>F, <sup>1</sup>H spin–spin couplings between fluorine (bonded to aromatic ring) and the nitrogen and the carbon of the amide group of 2-fluorobenzamide (**37**) and 2-fluoro-*N*-methylbenzamide (**38**) indicate that the spin information (F–N) is transmitted mainly through the hydrogen bond. A typical internal hydrogen bond occurs between an *ortho* nitro group and an amino (or hydroxy) group as shown<sup>128</sup> in **39**.



The geometry of the nitro group gives a simple and generally accepted explanation of the supposed loss of electron-withdrawing effects by resonance in the nitro group when it is twisted from the plane of the phenyl ring: steric hindrance<sup>129</sup> of groups in *ortho* positions to the nitro groups exerts steric hindrance to the resonance. In fact, in situations like **39**, the presence of internal hydrogen bonding may also play a role in hindrance to mesomeric interactions between the nitro group and the phenyl ring.



(39)

The idea of 'steric hindrance to resonance' starts from the principle that the mesomeric electron-withdrawing effect is larger when the involved orbitals present parallel directions than when they are twisted. Section II.E.4 reports a different point of view on the mechanism of the mesomeric electron-withdrawing effect of substituents.

Nitroanilines were extensively investigated by infrared, Raman, UV/VIS and <sup>1</sup>H NMR spectroscopic methods. In some cases the comparison with similar spectroscopic data of the corresponding *N,N*-dimethylanilines provides simple and consistent conclusions involving geometrical properties of molecules caused by intramolecular hydrogen bonding.

Similar conclusions are obtained from AM1 calculations on dimers of nitroanilines, which are of interest in investigating the intermolecular forces to orientate the individual molecules in crystal chains. Dimerization in solid crystals may be considered responsible for the differences in molecular geometry between solid and gas phases<sup>130</sup>.

## E. Electron Donor–Acceptor Complexes

### 1. Introduction

According to the valence bond theory, if a total charge-transfer occurs between neutral starting partners, all acceptor molecules will have a negative charge and all donor molecules a positive charge<sup>131</sup>.

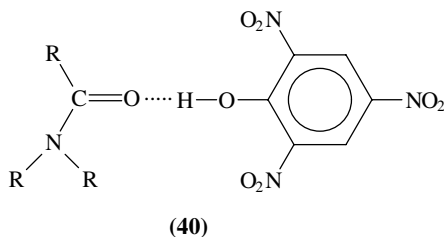
Aliphatic amines are simple lone-pair n-donors, similarly to other n-donors like phosphines, ethers, alcohols, iodides etc. Aromatic amines may be both n- and  $\pi$ -donors<sup>132</sup>. Typical  $\pi$ -donors are polycyclic aromatic derivatives;  $\pi$ -acceptors are polynitro aromatic derivatives, quinones etc.

Weak nucleophile–electrophile interactions (and the donor–acceptor complexes) are considered precursors in aromatic electrophilic substitutions<sup>133</sup> and in additions of electrophiles to C=C double bond of olefins: the first step (the addition of the electrophile to an electron-rich substrate) is probably the same for both reactions.

Some complications arise from the presence of proton donor–acceptor interactions<sup>134</sup> when the donor is a protic amine. The separate evaluation of the two kinds of interactions may be a difficult problem. Similarly, if the electron acceptor is also a proton donor, the overlapping of salification and complexation processes makes the separate investigation of the interactions very difficult. This is the case in the complexes between amines and picric acid or other related phenols. For complexes of 2,4,6-trinitro-3-hydroxypyridine<sup>135</sup> and

of some dinitro-2-hydroxypyridines<sup>136</sup> the main interaction is an intermolecular hydrogen bond, with some possibility of ion pair formation.

Complexes between amines and simple phenols (in variable stoichiometric ratios) were also isolated<sup>55</sup>. Solid stable complexes between picric acid and *N*-alkyl-*N,N*-dialkylamides show variable amide-picric acid ratios<sup>137</sup>. Probably in the solid state these complexes originate from hydrogen bonding interactions, while in solutions charge transfer (and proton transfer) complexes are involved. The major hydrogen bonding interaction between the C=O group of amides and the OH group of phenols is shown in **40**.

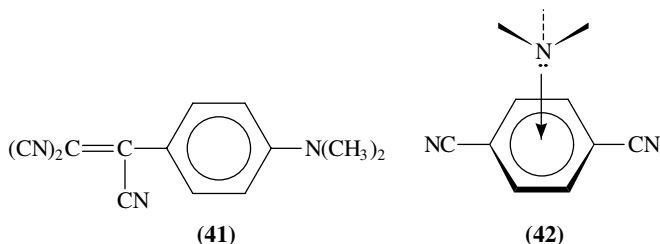


## 2. Intermolecular electron donor-acceptor complexes

In principle, the behaviour of any molecular species in forming donor-acceptor complexes depends on its ionization potential, electron affinity and polarizability. However, the donor (or acceptor) ability of a substance depends strongly on the requirements and properties of its partners. The same compound may act as a donor towards strong acceptor compounds or as an acceptor towards donor compounds. This is the case of the  $\pi$ -amphoteric *p*-tricyanovinyl-*N,N*-dimethylaniline (**41**) which is a donor towards 2,4,7-trinitrofluorenone and an acceptor towards *N,N*-dimethylaniline<sup>138</sup>.

Charge transfer complexes between amines and discharged substances were investigated extensively (mainly by spectroscopic methods). The choice of more simple models excludes the presence of proton donor-acceptor interactions which complicate the investigations of other interactions by overlapping different interactions.

Interactions between aliphatic amines (n-donors) and benzonitrile<sup>139</sup> or dicyanobenzenes<sup>140,141</sup> ( $\pi$ -acceptors), in *n*-hexane, are mainly electron donor-acceptor interactions. It is reasonable to assume that the lone-pair of the donor is perpendicular to the plane of the acceptor as reported in **42** for 1,4-dicyanobenzene.



The long known<sup>132</sup> electron donor-acceptor complexes between tertiary amines and carbon tetrahalides are simple systems. Thus, 1,4-diaza[2,2,2]bicyclooctane (DABCO) or quinuclidine afford solid complexes with carbon tetrabromide<sup>142</sup>.

UV/VIS spectroscopic analysis, as well as IR and <sup>1</sup>H and <sup>13</sup>C NMR in apolar solvents (iso-octane, chloroform) agrees with a stoichiometric ratio DABCO/CBr<sub>4</sub> 1:1 (*K* =

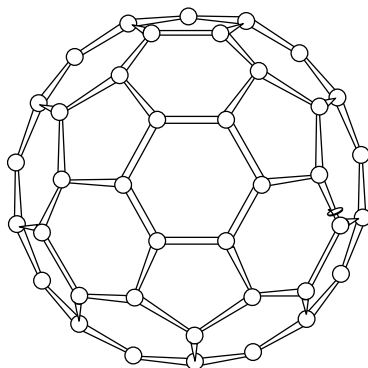
3.2 mol<sup>-1</sup> dm<sup>3</sup>) for the equilibrium in equation 15:



X-ray crystal analysis indicates that the DABCO/CBr<sub>4</sub> complex consists of alternating planes of the diamine and carbon tetrabromide in which each acceptor is bound to two donor units. The quinuclidine/CBr<sub>4</sub> complex consists of pairs of donor-acceptor systems in which every quinuclidine molecule is bound to only a single molecule of carbon tetrabromide.

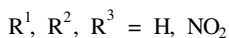
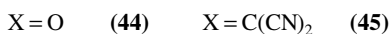
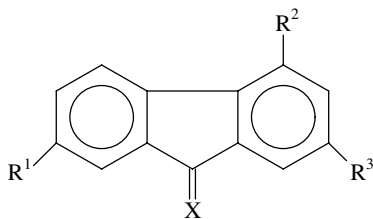
*N,N*-Dimethylaniline too is a useful electron-donor partner which interacts with electron-accepting substrates<sup>132</sup> such as acyl halides and sulphonyl halides<sup>143</sup>.

The formation of charge transfer complexes between *N,N*-dimethylaniline or *N,N*-diethylaniline and C<sub>60</sub> (**43**) or C<sub>70</sub><sup>144</sup> are recent subjects of spectroscopic studies, also in view of their potential optical and electronic applications. Even if the spectroscopic properties of C<sub>60</sub>, C<sub>70</sub> are complicated by the presence of aggregates in room temperature solutions, the emissions from the excited state charge transfer complexes between fullerenes and *N,N*-dialkylanilines are strongly solvent-dependent: exciplet emissions are observed in hexane, but in toluene they are absent<sup>145</sup>.



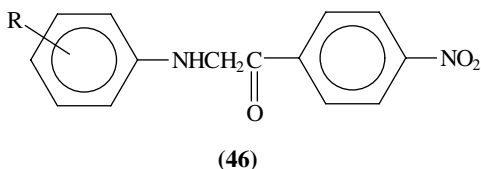
(43)

Polynitro-fluorenones **44** and 9-dicyanomethylenenitrofluorenes **45** (as acceptors) form molecular complexes with substituted anilines in various solvents<sup>146</sup>. The constant of



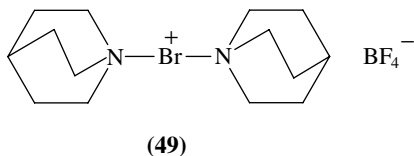
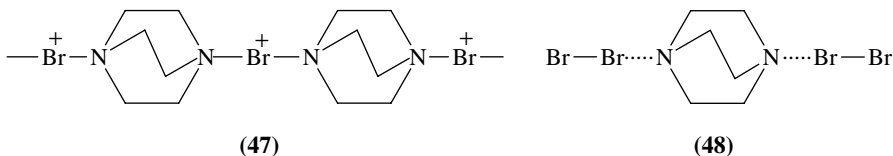
stability of the complex between **45** (when  $R^1 = R^2 = R^3 = \text{NO}_2$ ) and *N,N*-dimethyl aniline is increased on increasing the polarity of solvents. This fact may be explained by the polar character of the ground state of the considered complexes.

On the basis of X-ray crystallographic data (and of MNDO, MINDO/3 calculations), an interesting charge-transfer interaction is shown to be responsible for colour in solid (4-nitrophenacyl) anilines **46** and related compounds. Crystal packing of this compound reveals an alternating 'head-to-tail' arrangement: the aniline moiety is the electron donor part and the nitrophenacyl moiety is the acceptor<sup>147</sup>. The possible other tautomeric form of **46** cannot be responsible for the observed colours.



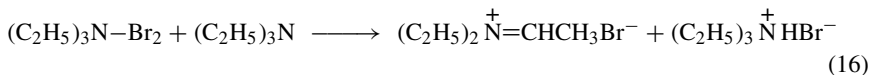
### 3. Complexes between amines and halogens

Complexes between halogen molecules and nitrogen atoms of amines have been investigated by several methods because of their importance as stable sources of active halogen. Charge-transfer complexes with 1:1 amine/halogen ratio have been found to possess a linear arrangement such as that shown in **47** for the cationic polymer of 1,4-diaza[2,2,2]bicyclooctane (DABCO)-bromine complex<sup>148</sup>, where  $\text{Br}_3^-$  is the counter ion. Also **48** is a reasonable structure of DABCO/ $2\text{Br}_2$  complex<sup>149</sup>. The complex between quinuclidine and bromine<sup>150</sup> has the structure **49** as determined by single-crystal X ray diffraction, in agreement with structure **47**.

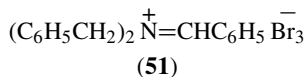
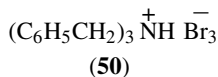


The electron donor-acceptor complex trimethylamine/dibromine shows a structure<sup>151</sup> (by electron diffraction in the gas phase) with an  $\text{N}-\text{Br}-\text{Br}$  angle of  $112^\circ$ . On the contrary, the structures of solid<sup>152</sup>  $(\text{CH}_3\text{N})_3/\text{I}_2$  [or  $(\text{CH}_3\text{N})_3/\text{ICl}$ <sup>153</sup>] show linear  $\text{N}-\text{I}-\text{I}$  (or  $\text{N}-\text{I}-\text{Cl}$ ) axes.

Complexes between tertiary aliphatic amines (triethylamine, tribenzylamine) and bromine are of interest also for their high reactivity. The  $\text{Et}_3\text{N}/\text{Br}_2$  complex cannot be isolated because of the very fast oxidation-reduction process of equation 16.

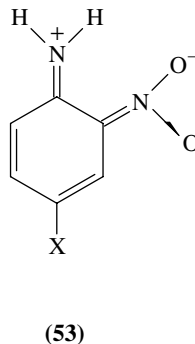
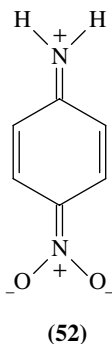


The product of tribenzylamine with bromine was reported<sup>154</sup> to be  $(\text{C}_6\text{H}_5\text{CH}_2)_3\text{NBr}^+\text{Br}^-$ , but it is actually a mixture of tribenzylammonium and *N,N*-dibenzylbenzylideneaminium tribromides **50** and **51**, respectively<sup>155</sup>.



#### 4. Intramolecular electron donor-acceptor complexes

The interactions between the nitro and the amino groups in *p*-nitroanilines have been described in classical terms as intramolecular charge-transfer from an electron-donating substituent to an electron-accepting substituent. Usually this kind of internal interaction is named 'through-conjugation'. This is described in structure **52** with strong separation of the charges in a quinonoid resonance structure which possesses a high degree of charge transfer character<sup>156</sup>.



On the other hand, all the substituents in *para* position to the amino group may be shown to interact with the amino group by classical mesomeric and inductive electronic processes. This is the case of 4-substituted-2-nitroanilines: their absorption (UV/VIS) spectra<sup>157</sup> are correlated with substituent constant  $\sigma_p^+$  in a Hammett plot.

Contributions by canonical structures like **53** are considered important. The absorption band of substituted anilines (with electron-withdrawing groups) contains an intramolecular charge-transfer transition which is strongly affected by the hydrogen bonding with protic solvents. The geometry of the amino nitrogen depends on the electron affinity of the electron-withdrawing substituent and on its position in relation to the amino group<sup>72</sup>.

In several examples including nitroanilines, the effect of twisting the chromophore from planarity decreases the absorption intensities. The reasons for the bathochromic effect as the angles of twist in the 4-aniline series increase is subject to discussion. When considering this (as well as in all attempts to obtain definitions of polarity of solvents by quantitative parameters) it is important to exclude or minimize the presence of hydrogen bonding overlapping<sup>158</sup> other interactions.

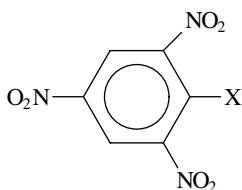
The classical idea of through-conjugation is revised: the importance of structures **52** and **53** was criticized in particular by Hiberty and Ohanessian<sup>159</sup>. There is a tendency to explain physical and chemical properties of derivatives of *p*-nitroaniline without considering quinonoid structures like **52** to be the most important ones.

Crystal data (by X-ray diffraction analysis) and calculation of net  $\pi$ -electron population for *N,N*-dialkyl-*p*-nitroaniline and for 3,5- and 2,6-dimethyl-4-nitroaniline indicate that

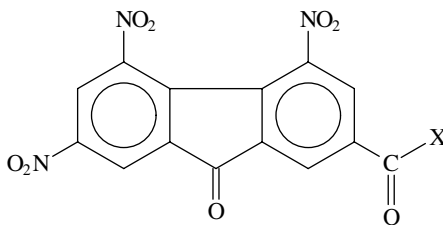
the classical through-conjugation with full charge transfer from the amino to the nitro group may be considered to make a relatively small contribution to the structure of *p*-nitroanilines<sup>160</sup>.

It is possible to evaluate the strength of several acceptor parts (including some nitroaromatic derivatives) in intramolecular charge transfer complexes in substrates such as **54** and **55** which also contain electron-donor fragments (X = PhNH-, PhO-, Ph-) from the oxidation potential of the complex and of the donor species<sup>161</sup>.

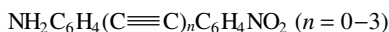
Crystallographic structural analysis<sup>162</sup> of compounds **56** bearing donor and acceptor moieties indicates the intramolecular origin for the charge-transfer (donor-acceptor) complex. The acetylene bridges, which must participate in the migration of the charge, are not themselves structurally changed. System **56** possesses a single bond/triple bond alternation pattern with none of the quinonoid structure usually expected and the charges are highly localized. The strong interaction between the donor and the acceptor groups is evident, but, even when the triple bond bridges have to participate in the migration of the charge, they are not structurally altered.



(54)

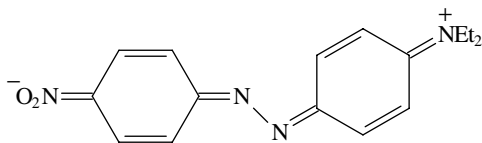


(55)

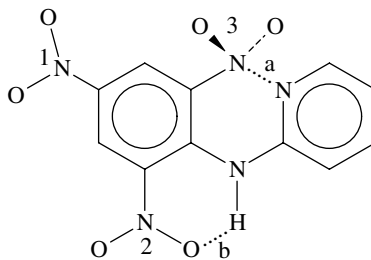


(56)

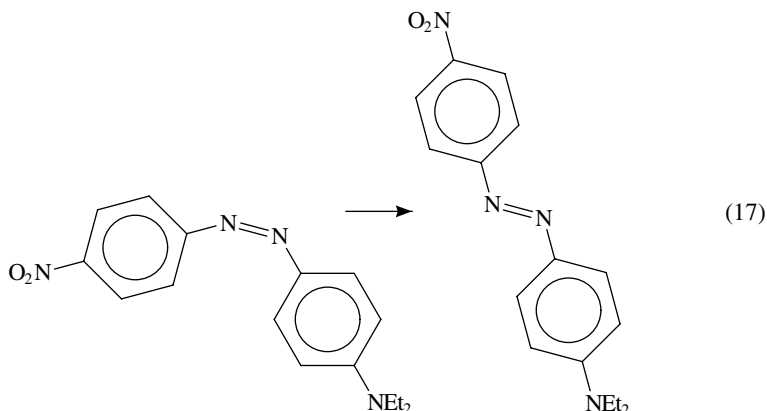
Thermal *cis-trans* isomerization of 4-(diethylamino)-4'-nitroazobenzene<sup>163</sup> (equation 17) is sensitive to changes in the solvent, both protic and aprotic. The mechanism of the isomerization in equation 17 has been postulated to proceed via a rotation around the N-N bond, facilitated by an intramolecular charge transfer interaction **57**. Increased solvent polarity increases the rate of the isomerization (equation 17) by stabilizing **57**. The isomerization is faster in hydrogen bonding solvents than in aprotic solvents of similar polarity. This fact is explained<sup>163</sup> by a hydrogen bonding interaction between the solvent and the nitro group of the dye: this interaction stabilizes the transition state of the isomerization in equation 17.



(57)



(58)



Crystallographic properties of the 2-*N*-(2,4,6-trinitrophenyl)pyridineamine (**58**) and of other related heterocycles<sup>164</sup> indicate inter- and intra-molecular interactions between the amino group and nitro groups. In **58** the two nitro groups N(1) and N(2) are coplanar with the phenyl ring, while the nitro group N(3) is twisted by about 40° from the phenyl ring plane. The relative geometry of the nitro groups, in particular of N(3), and of the 2-aminoheterocyclic moiety indicates that the classical conjugation theory can hardly explain the UV/VIS spectroscopic data.

The red shift observed on substituting hydrogen by a methyl group on the 2-amino group (also for nitroanilines) may be explained by the presence of an internal charge transfer which does not require coplanarity of the involved groups. An internal hydrogen bond (**b**) is observed between the amino and the *ortho*-nitro groups.

Conjugation between the phenyl ring and the nitro group should be greater when the nitro group is coplanar with the phenyl ring. Consequently, the bond between the N of the nitro group and the phenyl carbon should be shorter than when only the inductive effect is operating. In **58** the length of all the N–C(ring) bonds is the same, indicating that the electron-withdrawing power of the nitro group derives from an inductive rather than from a mesomeric effect. This conclusion agrees well with the quantitative evaluation of mesomeric effects by  $\sigma_R$  values of a Hammett-like correlation, which for all the electron-withdrawing groups are near to a zero value<sup>165</sup>.

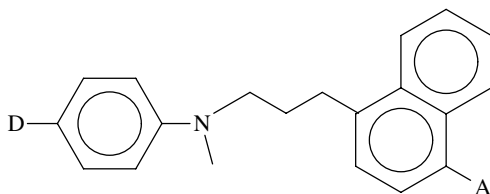
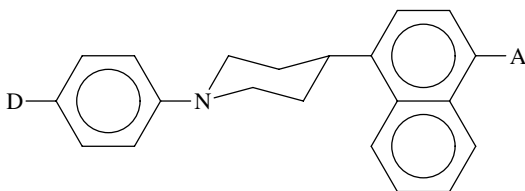
When the pyridine ring is replaced by a thiazole ring and a pyrimidine ring respectively (both bearing a trinitroaniline group in position 2), the intramolecular distance in **58** (**a**) changes to 2.821 Å and 2.692 and 2.765. On the other hand, the distance in the homocyclic series (2,4,6-trinitrodiphenylamine), **a** is 3.235 Å. This suggests the presence of an attractive interaction between the aza and nitro nitrogens and a consequent greater torsion angle of the nitro group compared to the benzene ring. This kind of interaction is an indication of the nature of molecular complexes between nitro derivatives and amines (see Section VI) which may be considered as responsible for catalytic behaviours in aromatic nucleophilic substitution reactions in apolar solvents.

Recent attempts to unify the polarity scales of solvents (for non-specific interactions) are of great interest in rationalizing the medium effects<sup>166</sup>. Generally, the spectroscopic properties of appropriate substances are used to check the solvating ability of solvents. 4-Nitroaniline is a useful indicator for estimating solvent polarity because it is an electron acceptor molecule which presents incomplete complexation with weak donor solvents<sup>167</sup>.

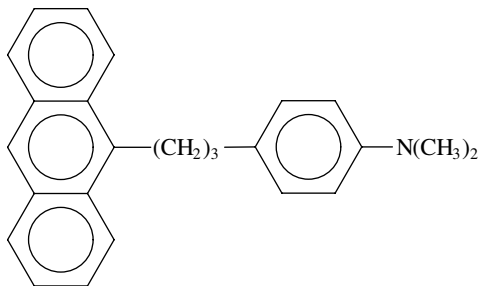
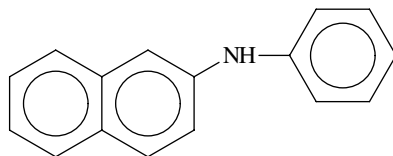
The problem of conformational dynamics on semi-rigid systems<sup>168</sup> in which donor and acceptor moieties are separated by saturated hydrocarbon spacers<sup>169</sup> is investigated by the



time-tested fluorescence spectroscopy<sup>170</sup>. Intramolecular charge transfer is used to investigate ultrafast dynamics involving motions of molecules or solvent organization<sup>171,172</sup>. Systems like **59** (where A is an electron acceptor group and D is an electron donor group) show an intramolecular charge transfer interaction. In moderately polar solvents (ethers) the only fluorescence observed is from a dipolar species, while in strongly associating solvents (alkanes) a folded dipolar species with a contact charge transfer interaction is produced<sup>173</sup>.

**(59)****(60)**

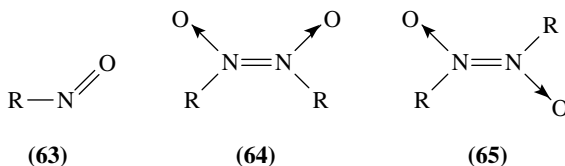
Intramolecular charge transfer in *p*-anthracene-(CH<sub>2</sub>)<sub>3</sub>-*p*-*N,N*-dimethylaniline (**61**) has been observed<sup>174</sup> in non-polar solvents. Measurements of fluorescence-decay (by the picosecond laser method) allow some conclusions about charge-transfer dynamics in solution: internal rotation is required to reach a favourable geometry for the formation of intramolecular charge-transfer between the donor (aniline) and the acceptor (anthracene).

**(61)****(62)**

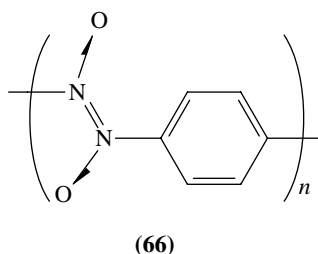
Spontaneous ionization from the charge-transfer state of 2-anilinonaphthalene (**62**) in water/methanol mixtures<sup>175</sup> shows (using picosecond spectroscopy) that the hydration of the electron limits the rate in the overall kinetics. For 8-(phenylamino)-1-naphthalenesulphonate, a water cluster (of 4 members) is the charge acceptor in the same way as observed for proton hydration<sup>175</sup>.

### III. NITROSO GROUP

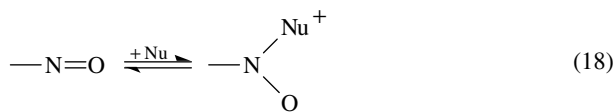
Nitroso derivatives (with the nitroso group bound to a carbon atom) can exist in three molecular forms<sup>176,177</sup>: the monomer **63** and the dimers **64** and **65**, *Z* and *E*, respectively. Aliphatic C-nitroso compounds are mainly dimers<sup>178</sup>. Aromatic nitroso derivatives, in solution, may be monomers or dimers, depending on the concentration and temperature, and on the substituent on the aromatic ring. Nitrosobenzene itself is in the *E* dimer form in the solid state<sup>179</sup>.



1,4- and 1,3-Dinitrosobenzenes are long-chain polymers<sup>180</sup>, probably in a cyclic form, based upon the *E*  $\text{N}_2\text{O}_2$  group **66**. Depolymerization to monomer occurs on heating and on vaporization of **66**.



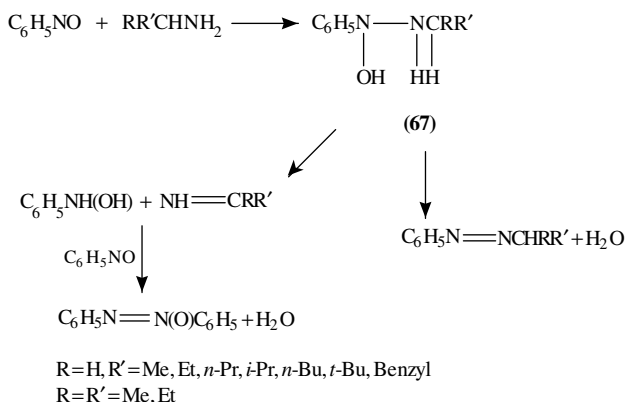
In principle, the addition of nucleophiles to the nitroso group produces adducts by the equilibrium equation 18 which may evolve to more stable reaction products<sup>181</sup>. The usual explanation is that the nitroso group is isoelectronic with the carbonyl group. The hydrated form of nitrosobenzene,  $\text{C}_6\text{H}_5\text{N}(\text{OH})_2$ , is considered unstable by electrochemical investigations<sup>182,183</sup> and its life-time is very short<sup>184</sup>.



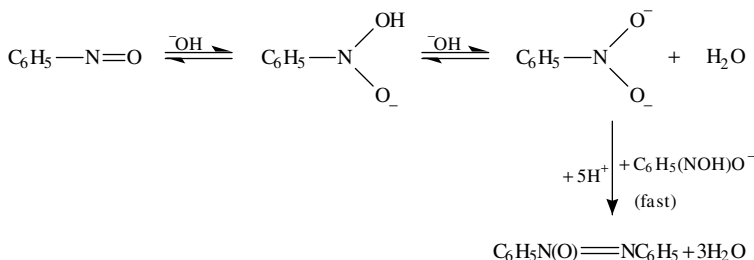
Reactions of nitrosobenzene with aliphatic amines<sup>185</sup> yield (phenylazo)alkanes and azoxybenzene as the main products. The adduct **67** is assumed to be an intermediate in obtaining both products, as seen in Scheme 3.

The addition of hydroxide ion to nitrosobenzene produces azoxybenzene<sup>186</sup>. Three techniques (electronic absorption spectroscopy, linear sweep voltammetry and d.c. polarography) have been used to study the equilibrium between nitrosobenzene and hydroxide ions. The probable reaction pathway to obtain azoxybenzene is indicated by Scheme 4. The importance of the nitroso group in the reduction of nitro derivatives by alkoxide ions, when the electron-transfer mechanism is operating, has been explained<sup>187</sup>.

A kinetic study of reactions between 4-substituted nitrosobenzene and methoxide ions (in methanol), to yield 4-substituted azoxybenzenes in the presence of oxygen, indicated

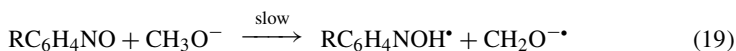


SCHEME 3



SCHEME 4

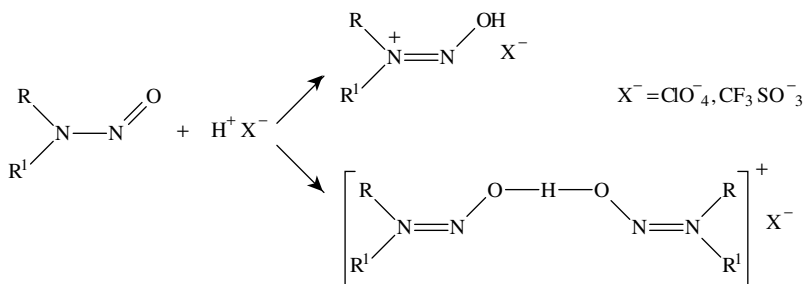
(mainly by a substituent electronic effect yielding a Hammett plot) the formation of  $\text{RC}_6\text{H}_4\text{NOH}$  as the rate-determining step of reaction 19<sup>188</sup>.



Usually, protic acids decompose *N*-nitrosoamines<sup>189</sup>, but recently several salts of *N*-nitroso compounds with acids have been prepared. Thus, nitrosoamines produce stable salts (1:1) with perchloric and trifluoromethanesulphonic acids which can be isolated, recrystallized and characterized as pure salts.

Nitrosoamines and hexafluorophosphonic acid afford 2:1 salts. Scheme 5 shows some examples of such salts. The unusual stability of these salts may be attributed to the use of non-nucleophilic counter ions and solvents. When a nucleophilic counter ion is present, the *N*-nitrosoamine decomposes to amine and  $\text{NOX}$  ( $\text{X} = \text{Cl}^-, \text{Br}^-, \text{SCN}^-, \text{I}^-$ ). In denitrosation reactions in acid solutions, *N*-nitroso compounds are also found<sup>190</sup> to yield hydrogen bonded complexes with a general acid  $\text{HX}$  as reported in **68** of Scheme 6. **68** may yield two different protonated species, since in nitrosoamines both oxygen and nitrogen are possible centres of protonation. Probably the more basic site is the oxygen atom<sup>191</sup>.

Reactions between nitroso compound and salts of nitro compounds afford nitrones, as illustrated by Scheme 7 involving the intermediate **69** which is the first step in the addition of the nitro carbanion to the  $\text{N}=\text{O}$  double bond<sup>192</sup>. In this case the leaving group is on the nucleophile.

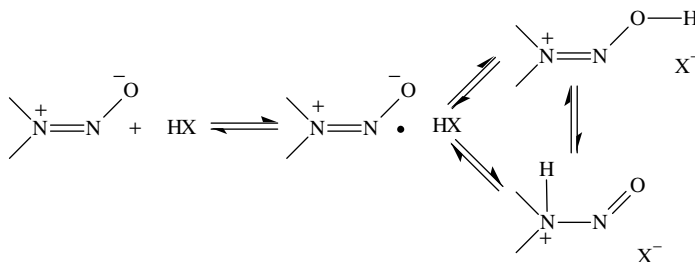


R=Me, R<sup>1</sup>=*t*-Bu;

R=R<sup>1</sup>=Me, Et;

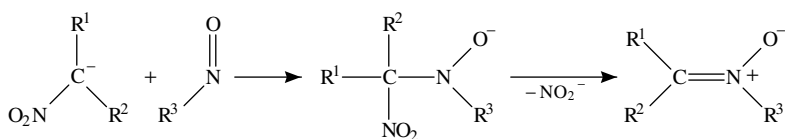
$\begin{array}{c} \text{R} \\ \diagup \\ \text{N} \\ \diagdown \\ \text{R}^1 \end{array}$  = piperidine, pyrrolidine, cyclohexylamine, morpholine

SCHEME 5



(68)

SCHEME 6



(69)

R <sup>1</sup> = H,	H	H	H	H	H	H
R <sup>2</sup> = Me	Me	C(O)NMe <sub>2</sub>	C(O)NHMe	CO <sub>2</sub> Me	C(O)NMe <sub>2</sub>	C(O)NHMe
R <sup>3</sup> = Ph	Ph	Ph	Ph	<i>t</i> -Bu	<i>t</i> -Bu	<i>t</i> -Bu

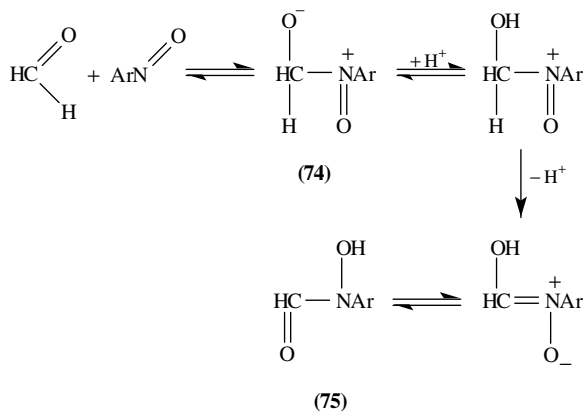
SCHEME 7

Addition of carbanions (which may be electrochemically generated), derived from active methylene compounds (such as fluorene or indene<sup>193</sup>), to nitrosobenzene produces the intermediate<sup>181</sup> **70**, which is dehydrated to the azomethine **71** or may be oxidized to the nitron derivative **72**, as illustrated by Scheme 8.



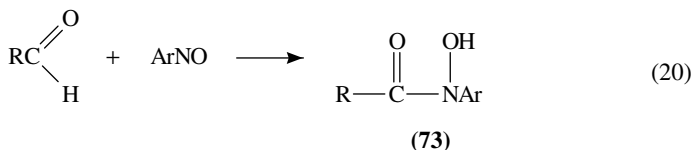
SCHEME 8

Nitrosobenzenes react with the carbonyl group of aldehydes to yield hydroxamic acids **73**, according to reaction 20. Recently, the reactions between some X-substituted nitrosobenzenes ( $X = \text{H}$ , *p*-Me, *p*-Cl, *m*-Cl, *p*-Br) and formaldehyde were reported<sup>194</sup> in order to investigate the mechanism of the hydroxamic acid formation. The mechanism reported in Scheme 9 involves a first equilibrium yielding the zwitterionic intermediate **74** which rearranges (by acid catalysis) into hydroxamic acid **75**. The presence of a general acid catalysis, the substituent effect ( $\rho$  values of the Hammett equation equal  $-1.74$ ),



SCHEME 9

deuterium/hydrogen isotope effects and the presence of a general base catalysis are the main points which support the mechanism depicted by Scheme 9.

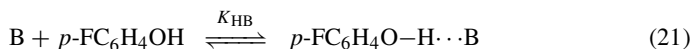


#### IV. NITRO GROUP

##### A. Hydrogen Bonding

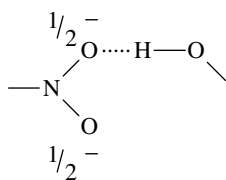
###### 1. Intermolecular hydrogen bonding

Recently<sup>195</sup>, the hydrogen bond basicity scale ( $pK_{\text{HB}}$  as logarithm of the formation constant of 4-fluorophenol/base complexes in carbon tetrachloride, equilibrium 21) has been measured for several nitro derivatives (nitromethane, nitrobenzene, *N*-nitrocamphorimine, 2-nitropropane, 4-nitro-*o*-xylene, 4-nitroanisole, *N,N*-diethyl-4-nitroaniline, 1-dimethylamino-2-nitroethylene, 1-piperidino-2-nitroethylene):

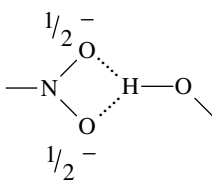


The electronic effect of the substituents on nitro-aromatics is rationalized by the Yukawa-Tsuno equation.

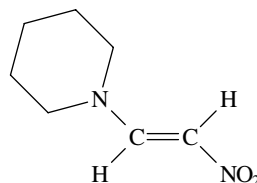
Complex 1:1 is considered the only complex present, but the hydrogen bond may be either two (76) or three center (77). Nitroenamines are more prone to complex with 4-fluorophenol than the nitroanilines and they form the strongest hydrogen bond presently known for nitro-bases. In particular, 1-piperidino-2-nitroethylene (78) and 1-dimethylamino-2-nitroethylene (79) (both in *E* form) present a hydrogen bond basicity comparable to that of tributylamine.



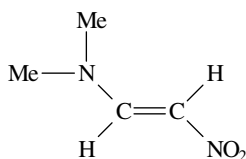
(76)



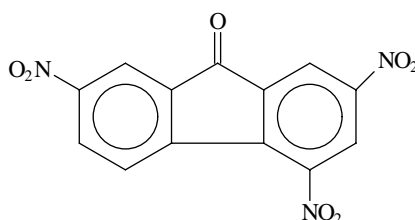
(77)



(78)



(79)

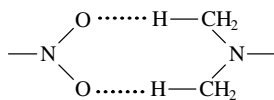


(80)

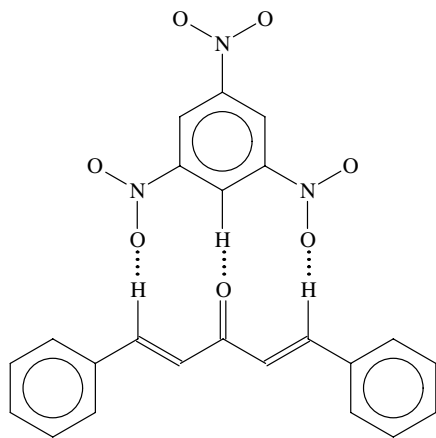
X-ray structural analysis of the charge-transfer complex between 2,4,7-trinitrofluorenone (**80**) and 2,6-dimethylnaphthalene shows the presence of C–H···O hydrogen bonding<sup>196</sup> involving both nitro and carbonyl groups of **80**. These hydrogen bonds importantly influence the molecular arrangement in a nearly coplanar ribbon-like structure also for other aromatic and aliphatic nitro derivatives.

Crystal structures of donor–acceptor complexes (1:1) between 4-nitrobenzoic acid and 4-*N,N*-(dimethylamino)benzoic acid<sup>197</sup>, 4-*N,N*-(dimethylamino)cinnamic acid and other related complexes containing nitro and dimethylamino groups are used to investigate<sup>198</sup> (by X-ray diffraction analysis) feeble C–H···O hydrogen bonds between nitro and dimethylamino groups, as depicted in **81** which is a frequent pattern in these cases. These feeble interactions may be of help in explaining the additional stabilization (to overcome entropic barriers) of organic and bioorganic molecular aggregates. Probably, they are effective for supramolecular architecture.

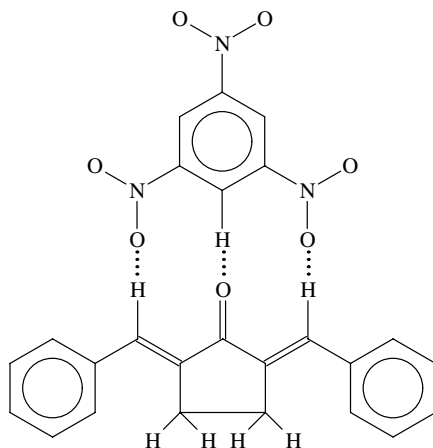
Another instance of C–H···O hydrogen bond yielding a supramolecular assembly (at least in the solid state) is from complexes **82** and **83** between 1,3,5-trinitrobenzene and dibenzylideneacetone or 2,5-dibenzylidenecyclopentanone, respectively, which were investigated by X-ray diffraction<sup>199</sup>. C–H···O hydrogen bonds (such as those of **82** and **83**) are three to five times weaker than N–H···O (and O–H···O) bonds<sup>200</sup>.



(81)



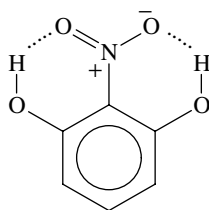
(82)



(83)

## 2. Intramolecular hydrogen bonding

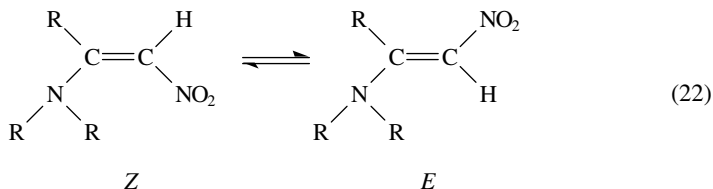
The molecular geometry of 2-nitrophenol<sup>201</sup> and of 2-nitroresorcinol<sup>202</sup> has been determined by a joint investigation of gas-phase electron diffraction and *ab initio* molecular orbital calculations. The molecule is planar and there is a strong, resonance-assisted intramolecular hydrogen bond between the nitro group oxygen and the hydroxy hydrogen as shown in **84** and in other resonance structures.



(84)

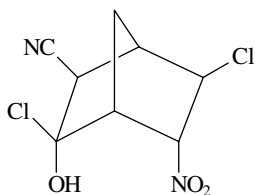
Intramolecular hydrogen bonding interactions may compete with hydrogen bonding with solvents. The electronic absorption spectra of 2-nitro-*p*-toluidine and 2-nitrophenol reveal<sup>203</sup> (by the solvatochromic comparison method) that the intramolecular hydrogen bond of amines is retained even in strongly basic solvents, while the intramolecular hydrogen bond between the hydroxy and nitro groups in 2-nitrophenol is broken to form an intramolecular hydrogen bond even in poorly basic solvents.

Nitroenamines are affected by the isomerism<sup>204</sup> shown in equilibrium 22. Compounds with primary ( $R^1 = R^2 = H$ ) or secondary amino ( $R^1 = H, R^2 = \text{alkyl}$ ) groups exist as mixtures of the intramolecularly hydrogen bonded *Z* and *E* forms, in an equilibrium (equation 22) depending on the solvent properties. The *E* form of a nitroenamine with a tertiary amino group is the more populated form.

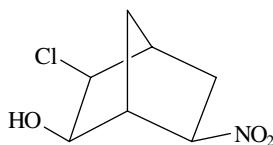


In the solid state, intermolecular and intramolecular C—H...O hydrogen bonds between nitro groups (or other oxygen-containing groups) and phenyl ring hydrogens are reported<sup>205</sup>. Intermolecular forces such as hydrogen bonds may cause twisting of the nitro group with respect to the phenyl ring plane of nitroaromatic derivatives<sup>206</sup>.

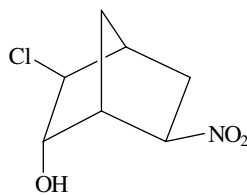
The crystallographic and spectroscopic investigations of 3-*exo*-6-*exo*-dichloro-5-*endo*-hydroxy-3-*endo*-nitrobicyclo[2.2.1]heptane-2-*exo*-carbonitrile (**85**), of 3-*exo*-chloro-6-*exo*-nitrobicyclo[2.2.1]heptan-2-*exo*-ol (**86**) and of 3-*exo*-chloro-6-*exo*-nitrobicyclo[2.2.1]heptan-2-*endo*-ol (**87**) reveal that in **85** there is an intramolecular hydrogen bond between the hydroxy and nitro groups<sup>207</sup>, while in **86** linear hydrogen bonding occurs intermolecularly between the hydroxy and nitro groups, and in **87** the intermolecular hydrogen bonds are unsymmetrically bifurcated<sup>208</sup>. A bifurcated intramolecular hydrogen bond is also observed in the (2-nitrophenyl)hydrazone of benzophenone<sup>209</sup> (**88**).



(85)

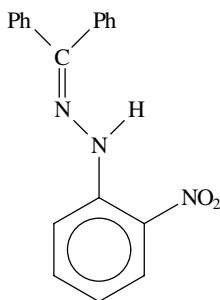


(86)



(87)

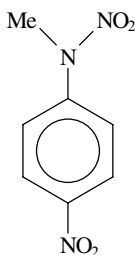




(88)

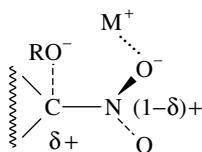
Crystal structures (by X-ray diffraction) indicate that the hydrogen of the N–H group is involved in an intramolecular hydrogen bond with the *ortho* nitro group and there is also an interaction between the same hydrogen atom and the C–C double bond of the phenyl ring (*H/π* interaction). When the nitro group is in the *para* position, the hydrogen bond is only with the C=C bond. This hydrogen bonding interaction is observed only in the solid phase and does not survive in solution.

The electronic effect of the nitro group bonded to the *N*-methyl group in anilines (89) is evaluated by canonical structure weights of *p*-nitro derivatives of benzene. The Hammett equation gives a  $\sigma$  value of +0.36 for the  $-\text{N}(\text{NO}_2)\text{Me}$  group in the *para* position: the usual strong electron-donating effect of the amino group is reverted by the electron-withdrawing ability of the nitro group<sup>210</sup>.

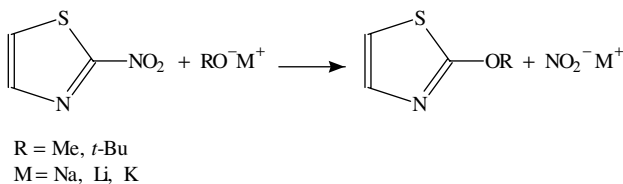


(89)

Some remarks about interactions between the nitro group and counter ions of anionic nucleophiles arise from the kinetic investigation of reactions of some 2-nitro-(1,3)-thiazoles and benzothiazoles toward nucleophiles<sup>211</sup>, where the nitro group is the leaving group, as shown in Scheme 10. The change of the counter ion in reactions with methoxide ( $\text{Li}^+$ ,  $\text{Na}^+$ ,  $\text{K}^+$ ) indicates that the presence of ion pairs enhances the reaction rate, probably by interaction between the cation and the nitro group as illustrated by 90.



(90)



SCHEME 10

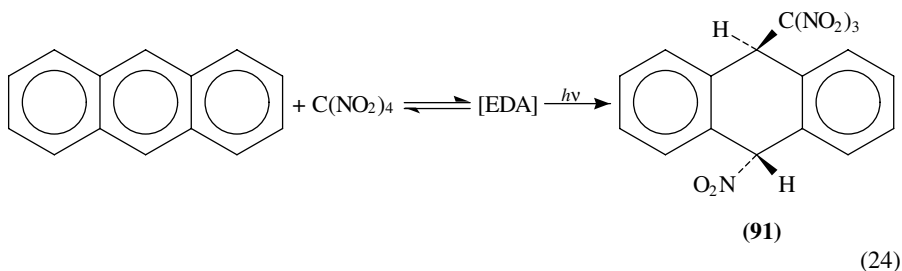
Comparison of the nucleofugality of nitro and chloro groups (as leaving groups) indicates that the presence of hydrogen bonding between the leaving group and the solvent produces variations in the observed reactivities. Hydrogen bonds increase the rate of departure of the nitro group more than the rate of departure of halogens. With neutral nucleophiles (amines) both 2-nitrothiazole<sup>211</sup> and 2-nitrobenzothiazole present autocatalytic kinetic behaviours<sup>212</sup> which may be explained by the presence of an interaction between the heterocyclic substrate and the amine, in an equilibrium preceding the substitution reactions (equilibrium 23).



Here,  $\text{HNC}_5\text{H}_{10}$  = piperidine;  $\text{ArNO}_2$  = 2-nitrothiazole, 2-nitrobenzothiazole;  $K_c$  = 0.19 and 0.29 ( $\text{mol}^{-1} \text{dm}^3$ ), respectively, at 25 °C in benzene.

### B. Electron Donor–Acceptor Complexes

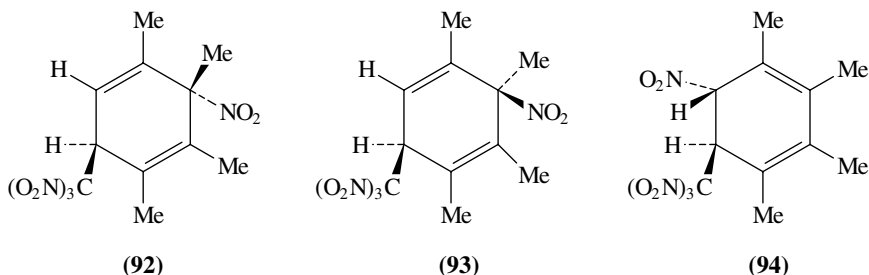
Tetranitromethane produces strongly coloured electron donor–acceptor (EDA) complexes with derivatives of the anthracene<sup>213</sup>, in dichloromethane. Specific irradiation of the charge transfer absorption band at  $\lambda > 500 \text{ nm}$  produces a rapid fading of the colour of the solutions. From these solutions, adduct **91** is obtained (reaction 24); its structure is ascertained by X-ray crystallographic diffraction. **91** is derived from an anti-addition of fragments of tetranitromethane by a multistep pathway<sup>214</sup>.



The excitation of these complexes generates intimate ion pairs which are well suited for the quantitative study of ion-pair and radical-pair dynamics. The behaviour of the ion pairs generated by this method parallels the behaviour of ion pairs generated by usual solvolytic reactions<sup>215</sup>.

Nitration of naphthalene<sup>216</sup>, phenol derivatives<sup>217</sup>, dibenzofuran<sup>218</sup> and 1,2,3,4-tetramethylbenzene<sup>219</sup> occurs in a similar way, by charge-transfer excitation of complexes of naphthalene derivatives with *N*-nitropyridinium or tetranitromethane acceptors. The

main products of reactions between 1,2,3,4-tetramethylbenzene and tetranitromethane are **92**, **93** and **94**. Transient cation radicals  $\text{ArCH}_3^{+\bullet}$  are spontaneously generated by excitation of the charge transfer complexes between methylbenzenes and tetranitromethane to afford side-chain nitration products<sup>220</sup>.

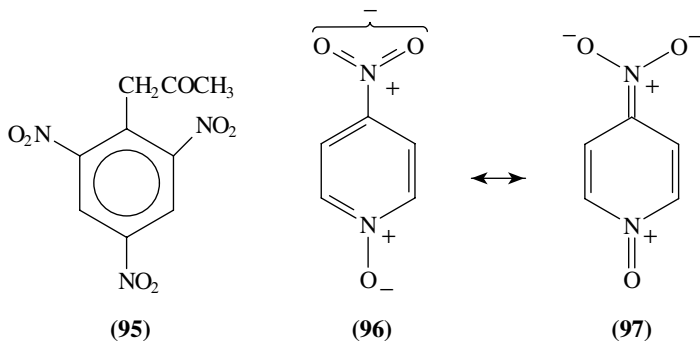


Aromatic nitro derivatives may act as electron acceptor molecules affording complexes with electron donor partners. This is the case of 1,3-dinitrobenzene which forms a 1:1 donor-acceptor complex with tetrathiafulvalene<sup>221</sup>. These complexes are of interest in the field of electrical conductivity.

The reduction potential of nitroanilines decreases on increasing the solvent electron acceptivity for aprotic solvents. The first step of the electrochemical reduction of nitroanilines is the radical  $\text{ArNO}_2^{\bullet-}$  (the electron is mainly on the nitro group). When the amino group interacts with the solvent by forming a hydrogen bond, the sensitivity of the nitro group to solvent acceptivity is enhanced<sup>222</sup>.

1-(2,4,6-trinitrophenyl) propan 2-one **95** produces<sup>223</sup> donor-acceptor complexes with aromatic hydrocarbons (benzene, naphthalene, phenanthrene, pyrene) in carbon tetrachloride and in chloroform. These complexes have a donor:acceptor ratio of 1:1 and 2:1 when the donor is in excess; their practical utility (together with complexes with other electron acceptor partners)<sup>224</sup> is for the separation (and the characterization) of polynuclear aromatic hydrocarbons from atmospheric pollutants or from hydrocarbon mixtures.

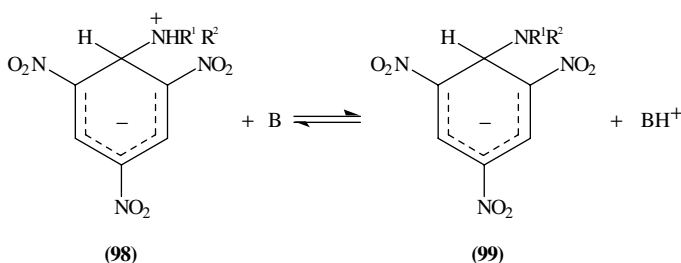
Intramolecular charge transfer in 4-nitropyridine N-oxide has been investigated by spectroscopic methods and by comparison with AM1 and MNDO semi-empirical methods to obtain the vibrational force field<sup>225</sup>. The results obtained indicate that protic solvents (water, methanol) favour the mesomeric form **97** which is also favoured in the crystal, by an internal interaction between the nitro and N-oxide groups<sup>226</sup>.



### V. COVALENT COMPLEXES BETWEEN AMINES AND NITRO ACTIVATED AROMATIC DERIVATIVES

$\sigma$ -Anionic complexes (Meisenheimer complexes) between activated homocyclic and heterocyclic aromatic substrates and nucleophiles have been extensively investigated by different methods and detailed reviews and books are available<sup>227-231</sup>. The nitro group is frequently used to activate aromatic nucleophilic substitutions in both the homocyclic and heterocyclic aromatic series<sup>231</sup>, and consequently to stabilize the  $\sigma$ -complexes.

Among the reported  $\sigma$ -complexes, there are several involving amines in both zwitterionic (**98**) or anionic (**99**) forms<sup>230,232</sup>. The equilibrium between **98** and **99** is considered to shift towards the right owing to the presence of a base which acts as a catalyst, as shown in Scheme 11<sup>231-233</sup>, where B may be the same reacting amine, or another (non-nucleophilic) added base, such as a tertiary amine.

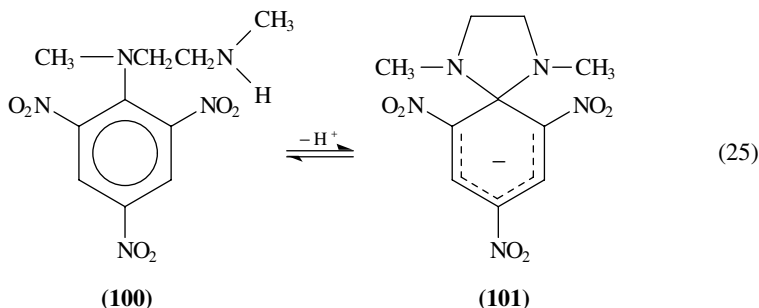


$R^1 = \text{H}, R^2 = \text{alkyl, aryl}$

$R^1, R^2 = \text{alkyl}$

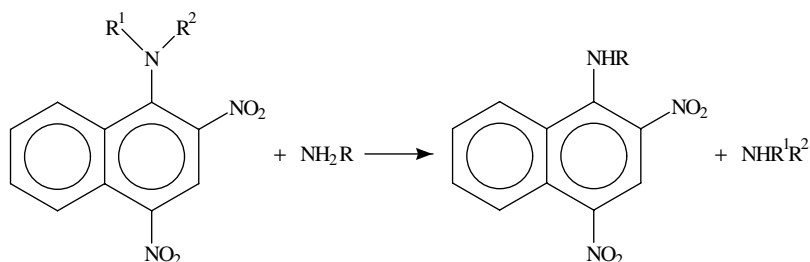
SCHEME 11

When the nucleophilic centre is in the starting substrate, as in the case of *N,N'*-dimethyl-*N*-picrylethylendiamine (**100**), equilibrium 25 affords protonated or unprotonated spiro-zwitterionic adduct **101** containing a diazolidine ring<sup>234</sup>.



Compound **102** is formed from **100** by a slow (but irreversible) process which competes with the formation of **101**. **102** arises from the usual displacement of the nitro group by the second amino group.

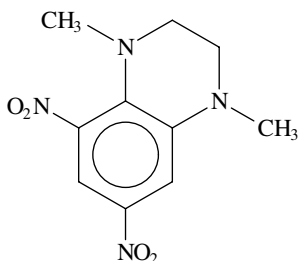
In some unusual cases, the amino group bonded to activated substrates may be replaced by primary amines, as in the case of the reaction of 2,4-dinitronaphthalene derivatives<sup>235</sup>, illustrated by Scheme 12.



$\text{R}^1 = \text{R}^2 = \text{methyl, ethyl}; \text{R}^1 = n\text{-butyl}, \text{R}^2 = \text{methyl};$

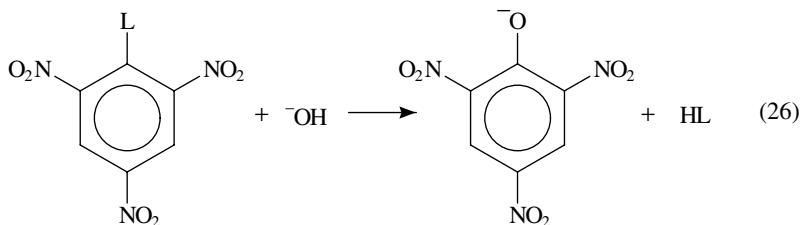
$\text{NR}^1\text{R}^2 = \text{piperidino}, \text{R} = \text{methyl, ethyl, } i\text{-propyl}$

SCHEME 12

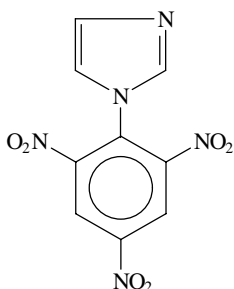


(102)

In the case of *N*-(2,4-dinitrophenyl)piperidine, *N*-(2,4-dinitrophenyl)morpholine<sup>236</sup>, *N*-(2,4,6-trinitrophenyl)piperidine and *N*-(2,4,6-trinitrophenyl)morpholine<sup>237</sup> the amino group is the leaving group with hydroxide ions, as shown by reaction 26. L (the leaving group) may be an *N*-piperidino or an *N*-morpholino group. These reactions are complicated by the formation of  $\sigma$  adducts in the unsubstituted positions of the phenyl ring.

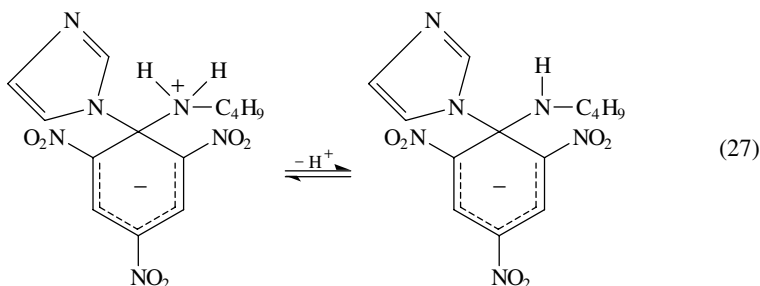


The same displacement occurs in the hydrolysis of picrylimidazole<sup>238</sup> (103). 103 reacts with *n*-butylamine in water<sup>239</sup> to yield picric acid (from the reaction with water) and *N*-*n*-butyl-2,4,6-trinitroaniline. The dependence of  $k_{\text{obs}}$  values ( $\text{s}^{-1} \text{mol}^{-1} \text{dm}^3$ ) on pH values indicates the presence (and importance) of equilibrium 27 on the reaction pathway of the



(103)

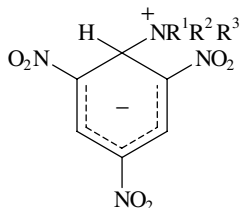
substitution reaction of the imidazole ring, which is the leaving group.



(27)

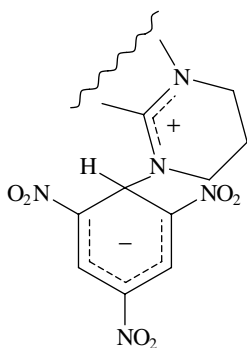
Tertiary amines too are found to produce  $\sigma$ -complexes **104** with 1,3,5-trinitrobenzene and related compounds. Complexes **104** are studied by spectroscopic and kinetic methods. In the case of 1,8-diazabicyclo-[5,4,0]-undec-7-ene (DBU) and 1,5-diazabicyclo[4,3,0]non-5-ene (DBN), the delocalization of the positive charge of the nucleophile moiety in the unsaturated system of DBN and DBU enhances the stability of the zwitterionic complex **105** and, of course, the nucleophilic power of these bases, as well as their basicity<sup>244</sup>.

For the system 1,3,5-trinitrobenzene/DBU, in toluene<sup>245</sup>, the formation of a molecular complex (probably donor-acceptor-like) precedes the formation of **105** and produces a



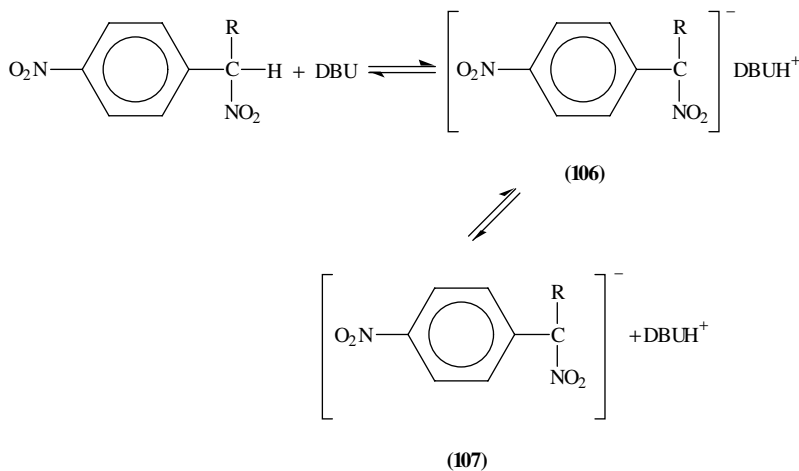
(104)

$\text{NR}^1\text{R}^2\text{R}^3 = 1,8\text{-diazabicyclo}[2,2,2]\text{octane}^{240}$ , quinuclidine<sup>240</sup>, 1,5-diazabicyclo[4,3,0]non-5-ene<sup>240</sup>, 1,8-diazabicyclo[5,4,0]undec-7-ene<sup>240-242</sup>, pentaisopropylguanidine<sup>243</sup>



(105)

particular kinetic feature (see Section VI.B). When 2,4,6-trinitrotoluene or other 1-alkyl-2,4,6-trinitrobenzenes react with DBU or *N,N,N',N'*-tetramethylguanidine<sup>246</sup>, the proton abstraction from the side chain<sup>247</sup> competes with zwitterionic complex formation<sup>248</sup>. In the case of the equilibrium between 1-nitro-1-(4-nitrophenyl)alkanes and DBU in acetonitrile<sup>249</sup>, the equilibrium of Scheme 13 of ion-pair formation **106** is followed by dissociation to free ions **107**, as indicated by kinetic investigations.



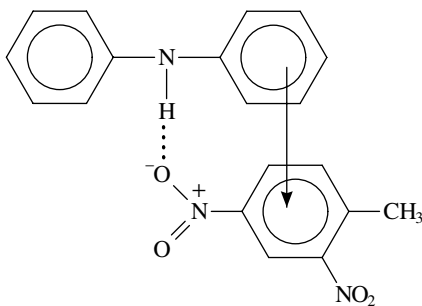
SCHEME 13

## VI. NON-COVALENT INTERACTIONS BETWEEN AMINES AND NITRO AROMATIC DERIVATIVES

In the literature, there are numerous reports regarding the interactions between amines and both electron and proton acceptors<sup>132</sup>, but less attention has been devoted to interactions between amines and aromatic electron acceptors, in particular when the substrate/amine system is a reacting system, as in the case of nucleophilic aromatic substitution ( $S_NAr$ ) reactions between amines and substrates activated by nitro or by other electron-withdrawing groups.

### A. Nature of the Complexes

The complexes involving molecules bearing the  $\text{NH}_2$ ,  $\text{NHR}$  groups are complicated by the possibility of the contemporaneous presence of different kinds of interactions, in particular electron donor–acceptor and proton donor–acceptor interactions. The complex **108** between diphenylamine and 2,4-dinitrotoluene<sup>250</sup> is considered a charge transfer complex with a probable relevant hydrogen bonding interaction, as indicated by  $^1\text{H}$  NMR spectroscopic data<sup>251</sup>.



(108)

In principle, aliphatic amines may interact as  $n$  electron donor molecules towards electron acceptor centres such as aromatic substrates, both homocyclic and heterocyclic, containing electron-withdrawing groups, usually nitro groups. These interactions are mainly electron donor–acceptor (EDA) interactions, in which aromatic amines are considered  $n$  or/and  $\pi$  electron donors.

In addition, there are two main kinds of hydrogen bonding interactions involving amines.

(i) Amines may interact with proton donors. Proton is a particular electron acceptor centre: the unshared electron pair of the nitrogen atom is responsible both for the strength of the hydrogen bond as well as for the basicity of the  $\text{NR}_2$  group (see Section II.B).

(ii) Protic amines, such as primary and secondary amines, are proton donor molecules in hydrogen bonding towards proton acceptor centres, as illustrated in **108**.

A general method to investigate the presence of solute/solute interactions is based on the spectroscopic differences of the mixtures (i.e. of amines and of potential acceptors) from the solutions of the separate substances. When appropriate solutions of amines are mixed with solutions of electron acceptor substrates, an instantaneous colour development may be observed even if no reaction products are formed.

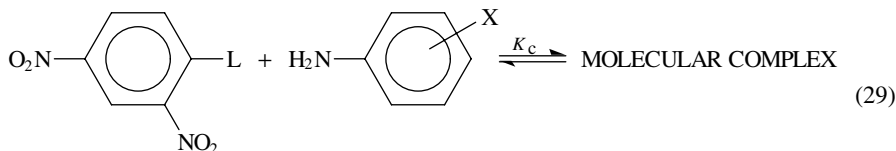
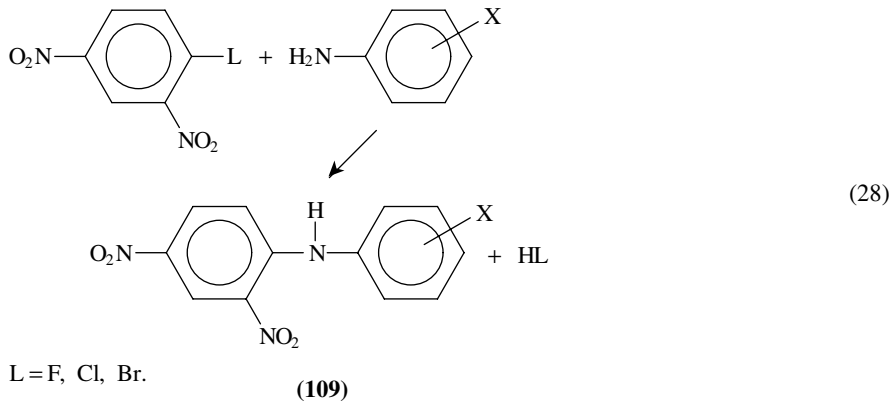
The extra absorbances observed by UV/VIS spectroscopy are due to equilibria which are quickly established after mixing, with the formation of non-covalent bonds and without (or before) reactions with covalent bond formations between the partners. The acidification of donor–acceptor mixtures, return the absorbance values of the spectrum to the values of the separate compounds.

Electron donor–acceptor complexes between amines and nitroarenes or other arenes bearing electron-withdrawing groups have been known for a long time. A crystalline solid complex between *p*-iodoaniline and 1,3,5-trinitrobenzene was investigated in 1943 by X-ray diffraction<sup>252</sup>. One of the interactions between these substances is between the amino group and the oxygen atoms of nitro groups, probably by weak hydrogen bonds.

The reactions between 2,4-dinitrohalobenzenes and *X*-substituted anilines in benzene produce the usual diphenylamines **109** by nucleophilic aromatic substitution reaction 28. The inspection of reaction mixtures by UV/VIS spectroscopy at ‘zero reaction



time' (i.e. before the formation of product of the substitution reactions **109**) reveals<sup>253</sup> the presence of an interaction between the substrate and the amine which is probably an electron donor-acceptor complex with an absorption band in the visible region of the spectrum, as required by charge-transfer complexes. These interactions are indicated by equilibrium 29 and were studied quantitatively by Benesi-Hildebrand treatment of UV/VIS spectroscopic data<sup>132</sup> and confirmed by <sup>1</sup>H NMR spectral data<sup>253</sup>.



L = F, Cl, Br.

The equilibrium 29 may refer to a single EDA complex; however, this is a simplification because several kinds of interaction may be operating; therefore the term 'molecular complex' may be more appropriate than the term 'EDA complex'.

Some  $K_c$  values are reported in Table 1. In some cases, the  $K_c$  values reported agree with  $K_c$  values calculated from kinetic data obtained for reactions like 28, shown in Table 1. From these data, it is hard to distinguish whether the electronic interactions are  $n \rightarrow \pi$  or  $\pi \rightarrow \pi$ .

A linear correlation between  $\log K_c$  of equilibrium 29 and the  $\sigma_x$  values of the Hammett equation gives a negative  $\rho$  value ( $-2.8 \pm 0.3$ ), which agrees with the electron donor ability of the amino group of substituted anilines<sup>253</sup>.

Complexation of electron acceptor substrates with aromatic solvents by electron donor-acceptor complexes is an important way of understanding solvation and reactivity behaviours.

1-Fluoro-2,4-dinitrobenzene (FDNB) interacts with benzene<sup>253</sup> (or other electron donor solvents) by equilibrium 30 ( $K_c = 0.018 \text{ mol}^{-1} \text{ dm}^3$  in  $\text{CDCl}_3$ ).



Apparent stability constants for interactions between 1-chloro-2,4-dinitrobenzene and benzene or mesitylene were found to be 0.76 and 0.96 ( $\text{mol}^{-1} \text{ dm}^3$ ) respectively, and between 4-chloro-3-nitrotrifluoromethylbenzene and benzene or mesitylene the values were 0.96

TABLE 1. Apparent stability constant ( $K_c$ ) of complexes between aromatic amines and 1-fluoro-2,4-dinitrobenzene (unless otherwise indicated) at 40 °C

Amine	Solvent	$K_c$ (mol <sup>-1</sup> dm <sup>3</sup> ) <sup>b</sup>	Reference
Aniline	benzene	0.068	253
Aniline	chloroform	0.70	253
Aniline <sup>a</sup>	benzene	0.068 <sup>a</sup>	253
Aniline <sup>a</sup>	chloroform	0.068 <sup>a</sup>	253
Aniline <sup>a,c</sup>	ethanol	0.34 <sup>a,c</sup> (0.49)	256
Aniline <sup>a,c</sup>	ethanol/ethyl acetate <sup>d</sup>	0.12 <sup>a,c</sup> (0.17)	256
Aniline <sup>a,c</sup>	ethyl acetate	0.05 <sup>a,c</sup>	256
Aniline	tetrahydrofuran	0.20 (0.31)	257
<sup>2</sup> H-Aniline-d7 <sup>e</sup>	chloroform	0.62 <sup>e</sup>	253
<i>N</i> -Methylaniline	benzene	0.66	253
<i>N</i> -Methylaniline	tetrahydrofuran	1.06 (0.65)	257
<i>N,N</i> -Dimethylaniline	benzene	0.44	253
<i>p</i> -Methoxyaniline	benzene	0.67	253
<i>p</i> -Methoxyaniline	tetrahydrofuran	1.17 (1.58)	257
<i>p</i> -Methoxyaniline	chloroform	0.37	258
<i>p</i> -Methoxyaniline	carbon tetrachloride	1.5	258
<i>p</i> -Methoxyaniline	chlorobenzene	0.29	258
<i>p</i> -Methoxyaniline	1,2-dichloroethane	0.95	258
<i>p</i> -Methoxyaniline	1,4-dioxane	0.81	258
<i>m</i> -Methoxyaniline	benzene	0.055	253
<i>m</i> -Methoxyaniline	tetrahydrofuran	0.20 (0.43)	257
<i>p</i> -Methylaniline	benzene	0.24	253
<i>p</i> -Methylaniline	tetrahydrofuran	0.41 (0.31)	257
<i>m</i> -Methylaniline	benzene	0.11	253
<i>m</i> -Methylaniline	tetrahydrofuran	0.43 (0.16)	257
<i>p</i> -Chloroaniline	benzene	0.022	253
<i>p</i> -Chloroaniline	tetrahydrofuran	0.46 (0.29)	257

<sup>a</sup> 1-Chloro-2,4-dinitrobenzene.

<sup>b</sup> Calculated from UV/VIS spectrophotometric analyses by Benesi-Hildebrand treatment. Range of  $\lambda$  values used in the determination: from 410 to 450 nm. In parentheses: values calculated from kinetic data.

<sup>c</sup> At 23.8 °C.

<sup>d</sup> 50:50, by volume.

<sup>e</sup> Calculated from <sup>1</sup>H NMR data in CDCl<sub>3</sub>.

and 0.48 (mol<sup>-1</sup> dm<sup>3</sup>) respectively, at 26 °C, with the electron donor partner being the solvent in all cases<sup>254</sup>.

The main consequence of EDA interactions between solvents of high donicity and nitroarenes is that amines in benzene (or in other similar solvents) compete with the solvents in complexing the nitroarenes<sup>253,254</sup>. This fact explains the ratio  $K_c^{\text{chloroform}}/K_c^{\text{benzene}} = 10$  for the molecular complex between aniline and FDNB (see Table 1).

Table 2 shows some  $K_c$  values of equilibria like 29 between nitroarenes and aliphatic amines. Even if differences in the mechanism of interactions (as well as differences in experimental conditions, in particular solvents and temperature) make a full comparison difficult, some main points from data of Table 2 are worthy of consideration.

(i) The introduction of a fluorine atom on the nitro-containing substrate stabilizes the complex:  $K_c^{\text{FDNB}} > K_c^{1,3\text{-DNB}}$  as required if the fluoro derivative interacts with amines by hydrogen bonding.

TABLE 2. Apparent constant of stability of molecular complexes between nitroaromatic derivatives and aliphatic amines in various solvents

Substrate <sup>a</sup>	Amine	Solvent	T(°C)	K <sub>c</sub> (mol <sup>-1</sup> dm <sup>3</sup> ) <sup>b</sup>	Reference
1,2-DNB	dibutylamine	<i>n</i> -hexane	27	0.25	255
1,2-DNB	tributylamine	<i>n</i> -hexane	27	0.098	255
1,3-DNB	<i>n</i> -butylamine	<i>n</i> -hexane	27	0.39	255
1,3-DNB	diethylamine	<i>n</i> -hexane	27	0.24	255
1,3-DNB	di- <i>n</i> -butylamine	<i>n</i> -hexane	27	0.20	255
1,3-DNB	triethylamine	<i>n</i> -hexane	27	0.089	255
1,3-DNB	tributylamine	<i>n</i> -hexane	27	0.043	255
1,4-DNB	<i>n</i> -butylamine	<i>n</i> -hexane	27	0.36	255
1,4-DNB	dibutylamine	<i>n</i> -hexane	27	0.17	255
1,4-DNB	tributylamine	<i>n</i> -hexane	27	0.032	255
FDNB	<i>n</i> -butylamine	toluene	21	14 <sup>c</sup>	259
FDNB	<i>n</i> -butylamine	cyclohexane	21	27	260
FDNB	piperidine	cyclohexane	21	79	260
CDNB	piperidine	cyclohexane	21	3.4	260
CDNB	<i>n</i> -butylamine	cyclohexane	21	0.08	260
FDNB	DABCO <sup>d</sup>	benzene	25	0.31; (0.31) <sup>c</sup>	261
FDNB	TE <sup>e</sup>	benzene	40	0.47 <sup>c</sup>	258
TNB	DBU <sup>f</sup>	toluene	18	12	245

<sup>a</sup>1,2-DNB = 1,2-dinitrobenzene; 1,3-DNB = 1,3-dinitrobenzene; 1,4-DNB = 1,4-dinitrobenzene; FDNB = 1-fluoro-2,4-dinitrobenzene; CDNB = 1-chloro-2,4-dinitrobenzene; TNB = 1,3,5-trinitrobenzene.

<sup>b</sup>Calculated from UV/VIS spectrophotometric data, unless otherwise indicated.

<sup>c</sup>Calculated from kinetic data.

<sup>d</sup>DABCO = 1,4-diaza[2.2.2]bicyclo-octane.

<sup>e</sup>TE = triethylamine.

<sup>f</sup>DBU = 1,8-diazabicyclo[5,4,0]undec-7-ene, K<sub>c</sub> = 7.3 at 25 °C, 5.7 at 33 °C; ΔH\* = -39 kJ mol<sup>-1</sup>, ΔS = -357 J mol<sup>-1</sup> K<sup>-1</sup>.

(ii) The stability order K<sub>c</sub><sup>FDNB</sup> > K<sub>c</sub><sup>CDNB</sup> for *n*-butylamine and piperidine indicates that a hydrogen bond is operating.

(iii) The presence of steric requirements for the formation of complexes is an important point to explain relative stabilities of complexes. The system aliphatic amines/dinitrobenzenes in hexane reveals the presence of an interaction, which is defined as an electron donor–acceptor (EDA) interaction<sup>255</sup>. The donor ability decreases by passing from primary amines (*n*-butylamine) to secondary amines (di-*n*-butylamine, diethylamine) and to tertiary amines (tri-*n*-butylamine and triethylamine) as indicated by the differences in stability of the complexes. The order K<sub>c</sub><sup>primary</sup> > K<sub>c</sub><sup>secondary</sup> > K<sub>c</sub><sup>tertiary</sup> is explained by the steric requirements of the electron donor for the formation of the complexes which are usual when donor–acceptor interaction is operating.

(iv) Piperidine is more prone to interacting with both FDNB and CDNB than *n*-butylamine (K<sub>c</sub><sup>piperidine</sup> > K<sub>c</sub><sup>*n*-butylamine</sup>). Generally, cyclic secondary amines have less steric requirements than non-cyclic secondary amines.

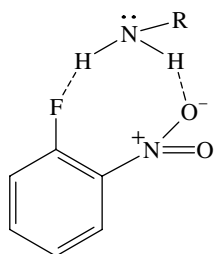
The change in the relative positions of the nitro groups affords the trends 1,2- > 1,3- > 1,4-dinitrobenzene, for the stability of the complexes, but the observed differences are moderate.

Recently<sup>262</sup>, the apparent stability constants of the complexes between aromatic fluoro derivatives and amines (shown in equilibrium 31, K<sub>c</sub> in mol<sup>-1</sup> dm<sup>3</sup>) in toluene-*d*<sub>8</sub> were evaluated by <sup>19</sup>F chemical shift measurements.

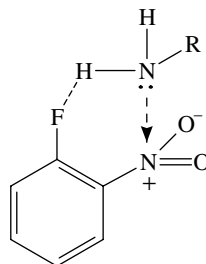


The main interaction of the complex of equilibrium 31 is probably a hydrogen bonding interaction between nitrofluorobenzenes and some amines. These complexes are more stable when the nitro groups are in position 2 of fluorobenzene than when they are in position 4. A reasonable explanation of this trend is the interaction of the *ortho* nitro group with the amine shown in **110**, in which a second hydrogen bond (between the amino and the nitro groups) enhances the interaction.

For *n*-butylamine, the  $K_c^{2\text{-nitrofluorobenzene}}/K_c^{4\text{-nitrofluorobenzene}}$  ratio equals 4, while for the secondary amine piperidine the ratio is higher ( $K_c^{2\text{-nitrofluorobenzene}}/K_c^{4\text{-nitrofluorobenzene}} = 9$ ). This supports an interaction between the two nitrogen atoms as shown in **111**, where the nitrogen of the amine is the electron donor and the nitrogen of the nitro group is the electron acceptor.



(110)



(111)

The self-association of amines (see Section II.C) is a complication which is almost impossible to evaluate, in all the quantitatively studied systems involving protic amines, in associating solvents, including the data and observations reported here.

## B. Some Kinetic Features of Aromatic Nucleophilic Substitution Reactions

The usual kinetic law for  $S_NAr$  reactions is the second-order kinetic law, as required for a bimolecular process. This is generally the case where anionic or neutral nucleophiles react in usual polar solvents (methanol, DMSO, formamide and so on). When nucleophilic aromatic substitutions between nitrohalobenzenes (mainly 2,4-dinitrohalobenzenes) and neutral nucleophiles (amines) are carried out in poorly polar solvents (benzene, hexane, carbon tetrachloride etc.) 'anomalous' kinetic behaviour may be observed<sup>263</sup>. Under pseudo-monomolecular experimental conditions (in the presence of large excess of nucleophile with respect to the substrate) each run follows a first-order kinetic law, but the rate constants ( $k_{\text{obs}}$  in  $\text{s}^{-1} \text{mol}^{-1} \text{dm}^3$ ) were not independent of the initial concentration value of the used amine. In apolar solvents the most usual kinetic feature is the increase of the  $k_{\text{obs}}$  value on increasing the  $[\text{amine}]_0$  values;  $[\text{amine}]_0$  indicates the initial concentration value of the amine.

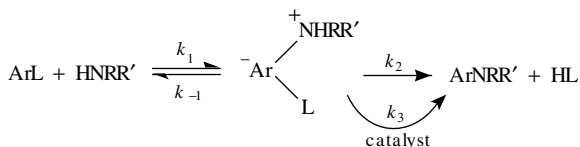
This kinetic feature is observed by using primary and secondary amines, both aromatic and aliphatic. Tertiary amines<sup>263</sup> (and other substances unable to produce substitution products such as 2-hydroxypyridine<sup>264</sup>) may act as a catalyst: in apolar solvents, in a series of runs carried out without changing the initial concentration value of substrate and of amines, it was found that the addition of tertiary amines enhances  $k_{\text{obs}}$  values.

In more polar solvents, as reported in 1954 by Ross and Kuntz<sup>256</sup>, for reactions between 2,4-dinitrochlorobenzene and aniline,  $k_{\text{obs}}$  values decrease with increasing  $[\text{amine}]_0$  values. A possible interpretation of this kinetic feature is the formation of a molecular compound between aniline and 2,4-dinitrochlorobenzene by a quickly established equilibrium, which

precedes the substitution process. In principle, such complex kinetic features are usually attributed to the presence of some equilibria preceding the reactions and involving the reactants and the solvent<sup>265,266</sup>.

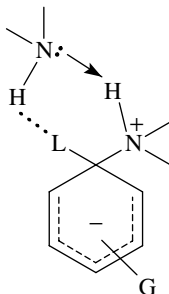
It is known that when the kinetic behaviour cannot be studied in the absence of the molecular complex (and the reactivity of the free reagent is unknown), the kinetic law by itself cannot indicate whether the complex observed is on the reaction pathway or is a non-productive equilibrium<sup>267</sup>. In  $S_NAr$  reactions discussed here, the usual experimental conditions  $[ArF]_0 < [RNH_2]_0$  are used. In some cases, the  $k_{obs}$  values obtained under experimental conditions  $[ArF]_0 > [RNH_2]_0$  may be assumed to involve only the uncatalysed process. As a consequence, it is possible to say that the presence of complexes (in apolar solvent) clearly produces an enhancement of the reactivity and a positive catalysis, while in polar solvents<sup>256</sup> the presence of complexes depresses the rate of substitution.

Scheme 14 has long been considered<sup>263,268</sup> the explanation of this kinetic behaviour with the intervention of a second molecule of catalyst (or of the same reacting amine) on the zwitterionic intermediate to promote the departure of the proton and of the leaving group.



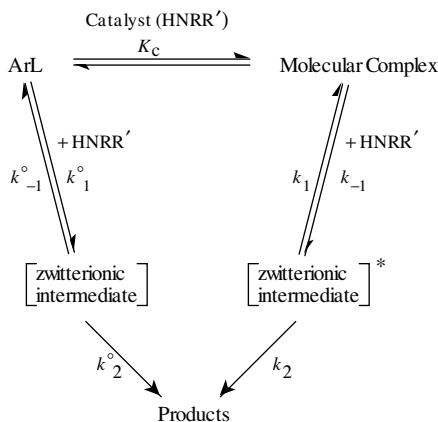
SCHEME 14

The more popular mechanism of HL elimination<sup>263</sup> (where L is the leaving group) is the SBGA mechanism (Specific Base General Acid) which involves a base-catalysed abstraction of the proton and the acid catalysed departure of the leaving group from the zwitterionic intermediate **112** (where G are electron-withdrawing groups) of the usual two-step mechanism of  $S_NAr$  reactions. In some cases, a concerted mechanism of departure of the proton and the leaving group is operating.



(112)

On the basis of the presence of the molecular complexes discussed in the previous section and of other observations<sup>253,260</sup>, Scheme 15 was proposed as an alternative to the more usually accepted mechanism shown by Scheme 14. The left part of Scheme 15 is the uncatalysed reaction pathway, while the part on the right is the catalysed one.



SCHEME 15

Equation 32 is derived from Scheme 15 and allows the evaluation of  $K_c$  values reported (in parentheses) in Tables 1 and 2.

$$k_{\text{obs}}(1 + K_c[\text{RNH}_2]_0) = k_0 + K_c k [\text{RNH}_2]_0 \quad (32)$$

By considering  $k = (k_1/k_{-1})k_2$  and  $k_0 = (k_1^0/k_{-1}^0)k_2^0$ , the first condition to observe catalytic behaviour is that  $k > k_0$ . Obviously when  $k_0 = k$ , no effect of the variation in the initial amount of amine may be detected and  $k_{\text{obs}}$  is an actual second-order rate constant; when  $k_0 < k$ , a decrease in  $k_{\text{obs}}$  values on increasing  $[\text{RNH}_2]_0$  values may be observed.

When  $K_c[\text{RNH}_2]_0 \ll 1$ ,  $k_0$  (for low values of initial amine concentration when fluoro derivatives are used, or when  $K_c$  is a low value as in cases of chloro derivatives),  $k_{\text{obs}}$  is  $k_0$  (the uncatalysed process). When  $K_c[\text{RNH}_2]$  becomes a high value (because  $[\text{RNH}_2]$  is increased), there is a leveling-off of the rate as shown in Figure 1.

The general overall kinetic behaviour of Figure 1 may be observed (under the experimental conditions  $[\text{ArF}]_0 < [\text{RNH}_2]_0$ ) if a large range of concentration values of amine is used, as in the case of the reactions between 2,4-dinitro-fluorobenzene and *n*-butylamine in benzene<sup>269</sup> or toluene<sup>259</sup>. The major part of cases reported in the literature concerns a more restricted range of  $[\text{amine}]_0$  values.

The first horizontal part of the plot of Figure 1 (A) corresponds to the substitution process in the absence of catalysis,  $k_{\text{obs}} = k_0$ . Consequently, it allows the evaluation of the reactivity of the 'free' substrate. This value is confirmed by runs carried out under experimental conditions  $[\text{ArF}]_0 > [\text{RNH}_2]_0$  (which are unusual in these investigations): the same  $k_{\text{obs}}$  value is obtained, in agreement with a second-order kinetic law, for reaction of 'free' substrate.

The second part (B) of the plot is referred to the presence of both processes: the substitution reaction of the 'free' substrate and the reaction of the complexed substrate. The plateau (C) is a leveling-off of the rate and corresponds to the saturation of the catalytic process: in this range of  $[\text{RNH}_2]_0$  values the main reaction is that of the complexed substrate.

A very interesting (and important) detail of the  $S_N\text{Ar}$  reaction showing positive catalysis is the dependence of catalysed and uncatalysed processes on the temperature and was investigated in several instances<sup>270-274</sup>. There are systems<sup>271,272</sup> in which the experimental reaction rate constant (in  $\text{s}^{-1} \text{mol}^{-1} \text{dm}^3$ ) is decreased on increasing the temperature. In other instances the increase in the temperature doesn't have an effect on  $k_{\text{obs}}$ <sup>273</sup>.

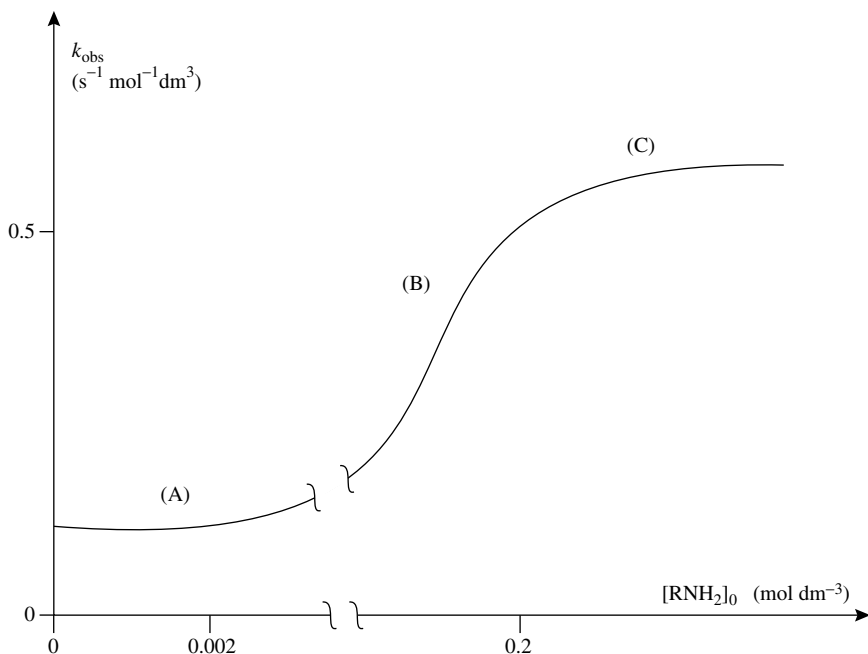


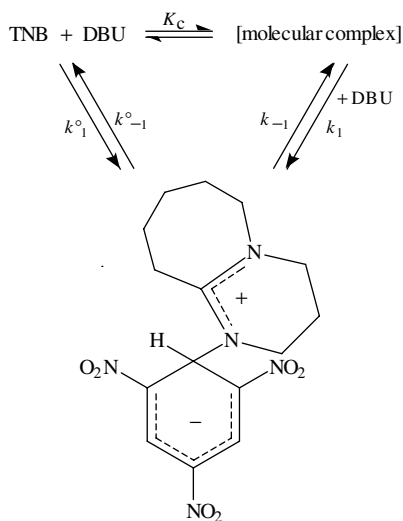
FIGURE 1. Diagram to show the effect of the increase in the initial concentration value of amine on the rate of substitution expressed as a second-order rate coefficient. Indicative  $[RNH_2]_0$  values and  $k_{obs}$  values are from reactions between 2,4-dinitrofluorobenzene and *n*-butylamine in toluene<sup>259</sup>

In the case of the reactions between 1,3,5-trinitrobenzene (TNB) and 1,8-diazabicyclo[5,4,0]undec-7-ene (DBU)<sup>245</sup>, in toluene, shown in Scheme 16, regarding the formation of a zwitterionic  $\sigma$ -complex,  $k_{obs}$  values are increased on increasing the  $[DBU]_0$  values: there is a catalytic effect of the base in a system without leaving group and proton. The increase in  $k_{obs}$  values is related to the presence of the molecular complex between TNB and DBU indicated by Scheme 16.

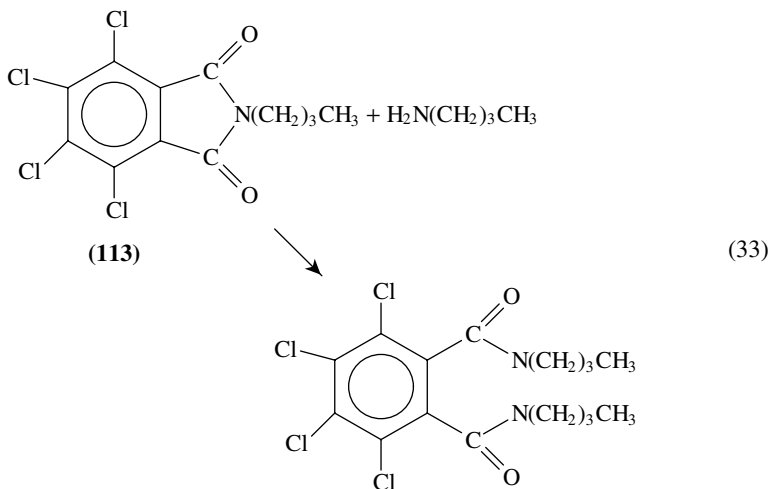
Analysis of the data allows the observation that the substrate/nucleophile association ( $K_c$  values, see Table 2) is clearly decreased on increasing the temperature, while the  $k_1$  and  $k_1^0$  of Scheme 16 (the attack of the DBU on the 'free' TNB and on the complexed TNB, respectively) are increased on increasing the temperature, showing activation parameters usual in  $S_NAr$  reactions.

The reaction of 1-fluoro-2,4,6-trinitrobenzene and 2,4-dimethoxyaniline, in cyclohexane, shows a negative activation enthalpy<sup>274</sup> ( $-30 \text{ kJ mol}^{-1}$ ), in agreement with a 'desolvative association mechanism' in which the nucleophile competes with the solvent in associating with the substrate in an equilibrium preceding the substitution process.

The reactions 33 between tetrachloro-*N-n*-butylphthalimide (**113**) and *n*-butylamine<sup>275</sup> in aprotic and apolar media (cyclohexane, benzene, toluene, xylenes) show a third experimental reaction order in the amines explained by the formation of a complex ( $n-\pi$ -like) between the electron acceptor substrate (the derivative of the phthalimide) and the electron donor nucleophile (the amine). In mixed solvents (such as the mixtures cyclohexane/aromatic solvents) the kinetic investigation reveals the presence of a competition between the electron donor solvent and the amine in complexing the substrate.



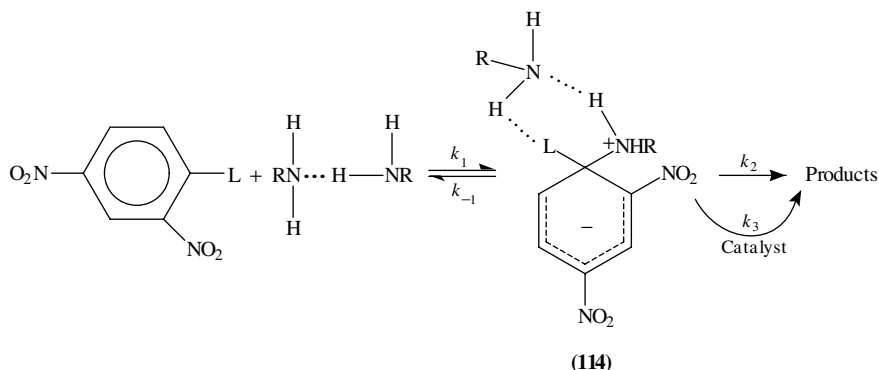
SCHEME 16



Another reaction mechanism explaining the observed enhancement of  $k_{\text{obs}}$  values with increasing  $[\text{amine}]_0$  values in  $S_N\text{Ar}$  reactions is the 'dimer mechanism'<sup>276</sup>, which involves the self-association of the amines<sup>277-279</sup> and which (in some cases) may be considered overlapped with mechanism of Scheme 14. A reaction pathway for 'dimer mechanism' is shown in Scheme 17. Considering the zwitterionic intermediate **114** it is possible to have a catalysis in removing the proton and the leaving group (reaction pathway indicated by  $k_3$ ).

On the other hand, it is reasonable to admit that several different mechanisms may be in competition to afford the products of the reaction. Under particular experimental conditions, a mechanism may predominate over another with a specific reaction pathway;





SCHEME 17

in other cases, depending on the experimental conditions, another reaction pathway may be the one leading to the final product.

Anyway, it is important to remember that a mechanism may hardly be *demonstrated*: a mechanism is a scientific theory which may be proved false by further observations<sup>280</sup>. In principle, our data are only able to give us some indications to the possible pathways of the reactions.

## VII. REFERENCES

1. C. Reichardt, *Solvent Effects in Organic Chemistry*, Verlag Chemie, New York, 1979.
2. J. E. Leffler and E. Grunwald, *Rates and Equilibria of Organic Reactions*, Wiley, New York, 1963.
3. V. Gutmann, *The Donor-Acceptor Approach to Molecular Interaction*, Plenum Press, New York, 1978.
4. E. Grunwald and S. Winstein, *J. Am. Chem. Soc.*, **70**, 846 (1948).
5. E. N. Kosower, *J. Am. Chem. Soc.*, **78**, 5700 (1956).  
E. N. Kosower, *J. Am. Chem. Soc.*, **80**, 3253 (1958).  
E. N. Kosower, *J. Am. Chem. Soc.*, **80**, 3261 (1958).
6. K. Dimroth, C. Reichardt, T. Siepmann and F. Bohlmann, *Ann. Chem.*, **661**, 1 (1963).
7. C. Reichardt, *Chem. Rev.*, **94**, 2319 (1994).
8. V. Gutmann, *Coordination Chemistry in Non-Aqueous Solvents*, Springer, Wien, 1968.
9. U. Maier, V. Gutmann and W. Gerger, *Monatsh. Chem.*, **106**, 1235 (1975).
10. R. Zahradnik and P. Hobza, *Pure Appl. Chem.*, **80**, 245 (1988).
11. S. Leutwyler, U. Even and J. Jortner, *J. Chem. Phys.*, **79**, 5769 (1983); S. Leutwyler, *J. Chem. Phys.*, **81**, 5480 (1984).
12. P. Hobza and R. Zahradnik, *Intermolecular Complexes*, Chap. I, Elsevier, Amsterdam, 1988, p. 25.
13. J. Elquero, C. Marzin, A. R. Katritzky and P. Linda, *The Tautomerism of Heterocycles*, Academic Press, London, 1976.
14. L. Forlani, *J. Heterocycl. Chem.*, **29**, 1461 (1992); M. Annese, L. Forlani, A. C. Bonamartini, C. Rizzoli and P. Sgarabotto, *J. Chem. Soc., Perkin Trans. 2*, 615 (1994).
15. P. Gilli, V. Ferretti, V. Bertolasi and G. Gilli, in *Advances in Molecular Structure Research* (Eds. M. Hargittai and I. Hargittai), Vol. 2, JAI Press Inc., Greenwich, 1995.
16. R. Huisgen and H. Waltz, *Chem. Ber.*, **89**, 2616 (1956); M. Davies and D. K. Thomas, *J. Org. Chem.*, **60**, 767 (1956); M. E. Hobbs and W. W. Bates, *J. Am. Chem. Soc.*, **74**, 746 (1952).
17. M. H. Kracov, C. M. Lee and H. G. Mautner, *J. Am. Chem. Soc.*, **87**, 892 (1965).
18. M. Mascali, *Contrib. Org. Synthesis*, **1**, 31 (1994).
19. J. S. Nowick and J. S. Chen, *J. Am. Chem. Soc.*, **114**, 1107 (1992).
20. A. Eschenmoser and E. Loewenthal, *Chem. Soc. Rev.*, **21**, 1 (1992).

21. W. H. Pirkle and T. C. Pochapsky, *Chem. Rev.*, **89**, 347 (1989).
22. W. H. Pirkle, T. C. Pochapsky, G. S. Mahler, D. E. Corey, D. S. Reno and D. M. Alessi, *J. Org. Chem.*, **51**, 4991 (1986).
23. L. Pauling, *The Nature of the Chemical Bond*, Cornell Press, New York, 1959.
24. G. C. Pimentel and A. L. McClellan, *The Hydrogen Bond*, W. H. Freeman Co., San Francisco, 1960.
25. S. E. Schullery and R. M. Scott, *J. Chem. Soc., Perkin Trans. 2*, 1559 (1984).
26. M. H. Abraham, *Chem. Soc. Rev.*, **22**, 73 (1993).
27. G. A. Jeffrey and W. Soenger, *Hydrogen Bonding in Biological Molecules*, Springer-Verlag, Berlin, 1991.
28. G. R. Desiraju, *Crystal Engineering: The Design of Organic Solids*, Elsevier, Amsterdam, 1989.
29. C. B. Aakeröy and K. R. Seddon, *Chem. Soc. Rev.*, **22**, 397 (1993).
30. P. Hobza and R. Zahradnik, *Intermolecular Complexes*, Chap. V, Elsevier, Amsterdam, 1988.
31. F. Vögtle, *Supramolecular Chemistry*, Wiley, New York, 1991.
32. J. M. Lehn, *Angew. Chem., Int. Ed. Engl.*, **27**, 90 (1988).
33. J. M. Lehn, *Angew. Chem., Int. Ed. Engl.*, **29**, 1304 (1990).
34. J. S. Lindsey, *New J. Chem.*, **15**, 153 (1991).
35. S. J. Geib, C. Vincent, E. Fan and A. D. Hamilton, *Angew. Chem., Int. Ed. Engl.*, **32**, 119 (1993).
36. J. Emsley, *Chem. Soc. Rev.*, **9**, 91 (1968).
37. A. C. Legon, *Chem. Soc. Rev.*, **22**, 153 (1993).
38. A. C. Legon and D. J. Millen, *Chem. Soc. Rev.*, **21**, 71 (1992).
39. M. C. Etter, *Acc. Chem. Res.*, **23**, 120 (1990).
40. M. H. Abraham, *J. Phys. Org. Chem.*, **6**, 660 (1993).
41. M. H. Abraham, P. L. Grellier, D. V. Prior, J. J. Morris and P. J. Taylor, *J. Chem. Soc., Perkin Trans. 2*, 521 (1990); M. H. Abraham, P. L. Grellier, D. V. Prior, P. P. Duce, J. J. Morris and P. J. Taylor, *J. Chem. Soc., Perkin Trans. 2*, 699 (1989).
42. M. H. Abraham, G. J. Buist, P. L. Grellier, R. A. McGill, D. V. Prior, S. Oliver, E. Turner, J. J. Morris, P. T. Taylor, P. Nicolet, P. C. Maria, J. F. Gal, J. L. M. Abboud, R. M. Doherty, M. J. Kamlet, W. J. Shuely and R. W. Taft, *J. Phys. Org. Chem.*, **2**, 540 (1989).
43. J. Li, Y. Zhang, H. Ouyang and P. W. Carr, *J. Am. Chem. Soc.*, **114**, 9813 (1992).
44. M. Meot-Ner (Mautner) and S. C. Smith, *J. Am. Chem. Soc.*, **113**, 862 (1991).
45. C. T. Seto and G. M. Whitesides, *J. Am. Chem. Soc.*, **113**, 712 (1991).
46. C. A. Hunter, *Chem. Soc. Rev.*, **23**, 101 (1994).
47. G. M. Whitesides, E. E. Simanek, J. P. Mathias, C. T. Seto, D. N. Chin, M. Mammen and D. M. Gordon, *Acc. Chem. Res.*, **28**, 37 (1995).
48. J. A. Zerkowski and G. M. Whitesides, *J. Am. Chem. Soc.*, **114**, 5473 (1992).
49. J. P. Mathias, E. E. Simanek, J. A. Zerkowski, C. T. Seto, and G. M. Whitesides, *J. Am. Chem. Soc.*, **116**, 4316 (1994).
50. E. E. Simanek, M. Mammen, D. M. Gordon, D. Chin, J. P. Mathias, C. T. Seto and G. M. Whitesides, *Tetrahedron*, **51**, 607 (1995).
51. J. P. Mathias, E. E. Simanek, C. T. Seto and G. M. Whitesides, *Angew. Chem., Int. Ed. Engl.*, **32**, 1766 (1993).
52. J. P. Mathias, C. T. Seto, E. E. Simanek and G. M. Whitesides, *J. Am. Chem. Soc.*, **116**, 1725 (1994).
53. J. P. Mathias, E. E. Simanek and G. M. Whitesides, *J. Am. Chem. Soc.*, **116**, 4326 (1994).
54. P. Barczynski, Z. Dega-Szafran and M. Szafran, *J. Chem. Soc., Perkin Trans. 2*, 765 (1985).
55. J. E. Barry, M. Finkelstein and S. D. Ross, *J. Org. Chem.*, **49**, 1669 (1984).
56. M. M. Davies in *The Chemistry of Nonaqueous Solvents* (Ed. J. J. Lagowski), Vol 3, Academic Press, London, 1970.
57. M. Ilczyszyn, *J. Chem. Soc., Faraday Trans.*, **90**, 1411 (1994).
58. S. Rózycka-Roszak and E. Turska, *J. Chem. Soc., Perkin Trans. 2*, 227 (1985).
59. Z. Dega-Szafran and M. Szafran, *J. Chem. Soc., Perkin Trans. 2*, 897 (1987).
60. D. D. Perrin, *Dissociation Constants of Organic Bases in Aqueous Solution*, Butterworths, London, 1965.
61. M. Orbán, A. Kiss and L. Barcza, *J. Chem. Soc., Perkin Trans. 2*, 1815 (1987).
62. A. Buvári and L. Barcza, *J. Chem. Soc., Perkin Trans. 2*, 543 (1988).
63. T. Gramstad and L. J. Stangeland, *Acta Chem. Scand.*, **47**, 605 (1993).
64. T. Gramstad, *Acta Chem. Scand.*, **46**, 1087 (1992).

65. T. Gramstad, *Acta Chem. Scand.*, **47**, 985 (1993).
66. G. González and E. Clavijo, *J. Chem. Soc. Perkin Trans. 2*, 1751 (1985).
67. Y. Wang, H. Li, J. Chao, F. Zhang and M. Dai, *Wuli Huaxue Xuebao*, 217 (1994); *Chem. Abstr.*, **121**, 82412q (1994).
68. N. Stahl and W. P. Jencks, *J. Am. Chem. Soc.*, **108**, 4196 (1986).
69. M. J. Tubergen and R. L. Kuczkowski, *J. Am. Chem. Soc.*, **115**, 9263 (1993).
70. J. Reuben, *J. Am. Chem. Soc.*, **109**, 316 (1987).
71. U. Berg and W. P. Jencks, *J. Am. Chem. Soc.*, **113**, 6997 (1991).
72. R. Nakagaki, I. Aoyama, K. Shimizu and M. Akagi, *J. Phys. Org. Chem.*, **6**, 261 (1993).
73. A. Gavezzotti and G. Filippini, *J. Phys. Chem.*, **98**, 4831 (1994).
74. R. Taylor and O. Kennard, *Acc. Chem. Res.*, **17**, 320 (1984).
75. R. Taylor, O. Kennard and W. Versichel, *J. Am. Chem. Soc.*, **105**, 5761 (1983).
76. R. Taylor, O. Kennard and W. Versichel, *Acta Crystallogr., Sect. B*, **B40**, 280 (1984).
77. R. Taylor, O. Kennard and W. Versichel, *J. Am. Chem. Soc.*, **106**, 244 (1984).
78. T. W. Panunto, Z. Urbánczyk-Lipkowska, R. Johnson and M. C. Etter, *J. Am. Chem. Soc.*, **109**, 7786 (1987).
79. J. Masnovi, R. J. Baker, R. L. Towns and Z. Chen, *J. Org. Chem.*, **56**, 176 (1991).
80. M. J. Kamlet, J. L. Abboud, M. H. Abraham and R. W. Taft, *J. Org. Chem.*, **48**, 2877, (1983).
81. L. Giacomelli, R. Cattana, J. Anunziata, J. J. Silber, M. Hedrera, A. Salerno and I. Perillo, *J. Phys. Org. Chem.*, **7**, 162 (1994).
82. C. N. R. Rao and T. Pradeep, *Chem. Soc. Rev.*, **20**, 477 (1991).
83. P. Hobza and R. Zahradnik, *Chem. Rev.*, **88**, 871 (1988).
84. H. Landeck, H. Wolff and R. Gotz, *J. Phys. Chem.*, **81**, 718 (1977).
85. D. M. Brewis, N. B. Chapman, J. S. Paine, J. Shorter, and D. J. Wright, *J. Chem. Soc., Perkin Trans. 2*, 1787 (1974).
- G. Pannetier, L. Abello, *Bull. Soc. Chim. France*, 1645 (1966).
86. J. C. Schug and W. M. Chang, *J. Phys. Chem.*, **75**, 938 (1971).
87. N. S. Nudelman, *J. Phys. Org. Chem.*, **2**, 1 (1991).
88. A. Arcoria, E. Maccarone, G. Musumarra and G. A. Tomaselli, *Tetrahedron*, **31**, 2523 (1975).
89. J. H. Lady and K. B. Whetsel, *J. Phys. Chem.*, **68**, 1001 (1964).
- H. Landeck, H. Wolff and R. Götz, *J. Phys. Chem.*, **81**, 718 (1977).
- H. Wolff and R. Wurtz, *J. Phys. Chem.*, **74**, 1600 (1970).
90. J. L. Mateos, R. Cetina and O. Chao, *J. Chem. Soc., Chem. Commun.*, 519 (1965).
91. M. Kern, B. Servais, L. Abello and G. Pannetier, *Bull. Soc. Chim. France*, 2763 (1968).
92. H. Wolff and G. Gamer, *J. Phys. Chem.*, **76**, 871, (1972).
93. J. H. Lady and K. B. Whetsel, *J. Phys. Chem.*, **69**, 1596 (1965).
94. K. B. Whetsel and J. H. Lady, *J. Phys. Chem.*, **68**, 1010 (1964).
95. R. L. Werner, J. M. Quinn and J. K. Haken, *Spectrochim. Acta*, **38A**, 887 (1982).
96. J. E. Sinsheimer and A. M. Keuhnelian, *Anal. Chem.*, **46**, 89 (1974).
97. L. K. Vinson and J. J. Dannenberg, *J. Am. Chem. Soc.*, **111**, 2777 (1989).
98. S. Martinez-Carrera, *Acta Crystallogr.*, **20**, 783 (1966).
99. P. Goldstein, J. Ladell and G. Abowitz, *Acta Crystallogr. Sect. B*, **25**, 135 (1969).
100. F. Ramondo, L. Bencivenni, G. Portalone and A. Domenicano, *Struct. Chem.*, **5**, 1 (1994).
101. H. A. Staab and T. Saupe, *Angew. Chem., Int. Ed. Engl.*, **27**, 865 (1988).
102. R. W. Alder, *Tetrahedron*, **46**, 683, (1990).
103. P. Gilli, V. Bertolasi, V. Ferretti and G. Gilli, *J. Am. Chem. Soc.*, **116**, 909 (1994); G. Gilli, V. Bertolasi, V. Ferretti and P. Gilli, *Acta Crystallogr.*, **B49**, 564 (1993).
104. F. Hibbert, *Acc. Chem. Res.*, **17**, 115 (1984).
105. M. Eigen, *Angew. Chem., Int. Ed. Engl.*, **3**, 1 (1964).
106. A. L. Llamas-Saiz, C. Foces-Foces and J. Elguero, *J. Mol. Struct.*, **328**, 297 (1994).
107. R. D. Chambers, S. R. Korn and G. Sandford, *J. Fluorine Chem.*, **69**, 103 (1994).
108. B. Brzezinski, G. Schroeder, E. Grech, Z. Malaraski and L. Sobczyk, *J. Mol. Struct.*, **274**, 75, (1992).
109. B. Brzezinski, E. Grech, Z. Malaraski and L. Sobczyk, *Polish J. Chem.*, **68**, 261 (1994).
110. B. Brzezinski, E. Grech, Z. Malaraski and L. Sobczyk, *J. Chem. Soc., Perkin Trans. 2*, 1267 (1991).
111. B. Brzezinski, E. Grech, Z. Malaraski and L. Sobczyk, *J. Chem. Soc., Perkin Trans. 2*, 857 (1991).

112. G. Schroeder, B. Brzezinski, A. Jarczewski, E. Grech and J. Nowicka-Scheibe, *J. Mol. Struct.*, **344**, 89 (1995).
113. T. Barth, C. Krieger, F. A. Neugebauer and H. A. Staab, *Angew. Chem., Int. Ed. Engl.*, **30**, 1028 (1991).
114. E. Bartoszak, Z. Dega-Szafran, M. Jaskólski and M. Szafran, *J. Chem. Soc. Faraday Trans.*, **91**, 87 (1995).
115. S. G. Lias, J. F. Liebman and R. O. Lewin, *J. Phys. Chem. Ref. Data*, **13**, 695 (1984).
116. W. N. Olmstead, Z. Margolin and F. G. Bordwell, *J. Org. Chem.*, **45**, 3295 (1980); E. M. Arnett and L. E. Small, *J. Am. Chem. Soc.*, **99**, 808 (1977).
117. E. M. Arnett, K. G. Venkatasubramaniam, R. T. McIver Jr, E. K. Fukuda, F. G. Bordwell and R. D. Press, *J. Am. Chem. Soc.*, **104**, 325 (1982).
118. M. R. Kazerouni, L. Hedberg and K. Hedberg, *J. Am. Chem. Soc.*, **116**, 5279 (1994).
119. M. D. Cohen, G. M. Schmidt and S. Flavian, *J. Chem. Soc.*, 2041 (1964).
120. M. D. Cohen, Y. Hirshberg and G. M. Schmidt, *J. Chem. Soc.*, 2060 (1964).
121. K. Wozniak, H. He, J. Klinowski, W. Jones, T. Dziembowska and E. Grech, *J. Chem. Soc., Faraday Trans.*, **91**, 77 (1995).
122. T. Inabe, I. Gautier-Luneau, N. Hoshino, K. Okaniwa, H. Okamoto, T. Mitani, U. Nagashima and Y. Maruyama, *Bull. Chem. Soc. Jpn.*, **64**, 801 (1991).
123. T. Inabe, I. Luneau, T. Mitani, Y. Maruyama and S. Takeda, *Bull. Chem. Soc. Jpn.*, **67**, 612 (1994).  
T. Inabe, N. Hoshino-Miyajima, I. Luneau, T. Mitani and Y. Maruyama, *Bull. Chem. Soc. Jpn.*, **67**, 622 (1994).
124. M. Petrova, V. Negrebetsky, A. Rekis, A. Strakovs, J. Paulins and E. Gudriniece, *Latv. Khim. Z.*, **4**, 474 (1993); *Chem. Abstr.*, **121**, 82172m (1994).
125. T. Arai, T. Iwasaki and K. Tokumaru, *Chem. Lett.*, 691 (1993).
126. T. Arai, M. Moriyama and K. Tokumaru, *J. Am. Chem. Soc.*, **116**, 3171 (1994).
127. I. D. Rae, J. A. Weigold, R. H. Contreras and R. R. Biekofsky, *Magn. Reson. Chem.*, **31**, 836 (1993).
128. J. Majer and V. Kadeřábek, *Collect. Czech. Chem. Commun.*, **47**, 1100 (1982).
129. T. Yokoyama, R. W. Taft and M. J. Kamlet, *Spectrochim. Acta*, **40A**, 669 (1984); M. J. Kamlet, J. L. Abboud and R. W. Taft, *J. Am. Chem. Soc.*, **99**, 6027 (1977).
130. L. K. Vinson and J. J. Dannenberg, *J. Am. Chem. Soc.*, **111**, 2777 (1989).
131. F. Vögtle, *Supramolecular Chemistry. An Introduction*, Wiley, New York, 1991, p. 293.
132. R. F. Foster, *Organic Charge Transfer Complexes*, Academic Press, New York, 1969.
133. J. K. Kochi, *Angew. Chem., Int. Ed. Engl.*, **27**, 1227 (1988).
134. Y. M. Yssa, A. M. Hindaway, A. E. El-Kholy and R. M. Issa, *Gazz. Chim. Ital.*, **111**, 27 (1981).
135. J. Koziol, *Gazz. Chim. Ital.*, **122**, 143 (1992).
136. J. Koziol, A. Nowek and P. Tomasik, *Gazz. Chim. Ital.*, **120**, 403 (1990).
137. J. E. Barry, M. Finkelstein and S. D. Ross, *Tetrahedron*, **32**, 223 (1976).
138. D. J. Sandman and A. F. Richter, *J. Am. Chem. Soc.*, **101**, 7079 (1979).
139. J. D. Anunziata, J. O. Singh and J. J. Silber, *Can. J. Chem.*, **59**, 1291 (1981).
140. J. D. Anunziata, N. S. Galaverna, J. O. Singh and J. J. Silber, *Can. J. Chem.*, **64**, 1491 (1986).
141. M. A. Biasutti, J. D. Anunziata and J. J. Silber, *Spectrochim. Acta*, **48A**, 169 (1992).
142. S. C. Blackstock, J. P. Lorand and J. K. Kochi, *J. Org. Chem.*, **52**, 1451 (1987).
143. H. Kothandaraman and N. Arumugasamy, *J. Chem. Soc., Perkin Trans. 2*, 1115 (1986).
144. R. J. Sension, A. Z. Szarka, G. R. Smith and R. M. Hochstrasser, *Chem. Phys. Lett.*, **185**, 179 (1991); Y. Wang, *J. Phys. Chem.*, **96**, 764 (1992); J. V. Caspar and Y. Wang, *Chem. Phys. Lett.*, **218**, 179 (1991); R. Seshadri, C. N. R. Rao, H. Pal, T. Mukherjee and J. P. Mittal, *Chem. Phys. Lett.*, **205**, 395 (1993).
145. Ya -P. Sun, C. E. Bunker and B. Ma, *J. Am. Chem. Soc.*, **116**, 9692 (1994).
146. P. Bruni, C. Conti, E. Giorgini, and G. Tosi, *Gazz. Chim. Ital.*, **122**, 35 (1992).
147. R. F. Abdulla, D. B. Boyd, N. D. Jones and J. K. Swartzendruber, *J. Org. Chem.*, **50**, 3502 (1985).
148. L. K. Blair, J. Baldwin and W. C. Smith, *J. Org. Chem.*, **42**, 1816 (1977).
149. O. Hassel and C. Roemming, *Q. Rev. Chem. Soc.*, **16**, 1 (1962).
150. L. K. Blair, K. D. Parris, P. Sen Hii and C. P. Brock, *J. Am. Chem. Soc.*, **105**, 3649 (1983).
151. S. Shibata and J. Iwata, *J. Chem. Soc., Perkin Trans. 2*, **9**, (1985).
152. O. Hassel and H. Hope, *Acta Chem. Scand.*, **14**, 391 (1960).

153. J. Yarwood, *Spectroscopy and Structure of Molecular Complexes*, Plenum Press, London, 1973, p. 217.
154. H. Bohme and W. Krause, *Chem. Ber.*, **84**, 170 (1951).
155. G. Bellucci, R. Bianchini and R. Ambrosetti, *J. Chem. Soc., Perkin Trans. 2*, 39, (1987).
156. G. W. Wheland, *Resonance Theory in Organic Chemistry*, Wiley, New York, 1955.
157. T. Yokoyama, R. W. Taft and M. J. Kamlet, *Spectrochim. Acta*, **40A**, 669 (1984).
158. M. J. Kamlet, J. L. Abboud and R. W. Taft, *J. Am. Chem. Soc.*, **99**, 6027 (1977).
159. C. Hiberty and G. Ohanessian, *J. Am. Chem. Soc.*, **106**, 6963 (1984).
160. T. M. Krygowski and J. Maurin, *J. Chem. Soc., Perkin Trans. 2*, 695 (1989).
161. K. P. Butin, A. A. Moiseeva, I. G. Il'ina and E. V. Ivanova, *Vestn. Mosk. Univ., Ser.2: Khim.*, **82**, (1994); *Chem. Abstr.*, **120**, 322519e (1994).
162. M. Graham, V. M. Miskowski, J. W. Perry, D. R. Coulter, A. E. Stiegman, W. P. Schaefer and R. E. Marsh, *J. Am. Chem. Soc.*, **111**, 8771 (1989).
163. K. S. Schanze, T. Fleming Mattox and D. G. Whitten, *J. Org. Chem.*, **48**, 2808 (1983).
164. L. Forlani, L. P. Battaglia, A. B. Corradi and P. Sgarabotto, *J. Cryst. Spectrosc. Res.*, **22**, 705 (1992).
165. J. Shorter, in *Correlation Analysis in Chemistry. Recent Advances*, (Eds. N. B. Chapman and J. Shorter), Plenum Press, New York, 1978.
166. R. S. Drago, M. S. Hirsch, D. C. Ferris and C. W. Chronister, *J. Chem. Soc., Perkin Trans. 2*, 219 (1994).
167. R. S. Drago, *J. Org. Chem.*, **57**, 6547 (1992).
168. M. R. Wasielewski, D. W. Minsek, M. P. Niemczyk, W. A. Svec and N. C. Yang, *J. Am. Chem. Soc.*, **112**, 2823 (1990).
169. H. Overing, M. N. Paddon-Row, M. Heppener, A. M. Oliver, E. Cotsaris, J. W. Verhoeven and N. S. Hush, *J. Am. Chem. Soc.*, **109**, 3258 (1987).
170. G. J. Kavarnos and N. J. Turro, *Chem. Rev.*, **86**, 401 (1986).
171. I. H. M. van Stokkum, A. M. Brouwer, H. J. van Ramesdonk and T. Scherer, *Proc. Kon. Ned. Akad. Wetensch.*, **96**, 43 (1993).
172. J. -F. Létard, R. Lapouyade and W. Retting, *J. Am. Chem. Soc.*, **115**, 2441 (1993).
173. I. H. M. van Stokkum, T. Scherer, A. M. Brouwer and J. W. Verhoeven, *J. Phys. Chem.*, **98**, 852 (1994).
174. Y. Wang, M. C. Crawford and K. B. Eisenthal, *J. Am. Chem. Soc.*, **104**, 5874 (1982).
175. J. Lee and G. W. Robinson, *J. Am. Chem. Soc.*, **107**, 6153 (1985).
176. B. G. Gowenlock and K. McCullough, *J. Chem. Soc., Perkin Trans. 2*, 551 (1989).
177. K. G. Orrel, D. Stephenson and J. H. Verlaque, *J. Chem. Soc., Perkin Trans. 2*, 1297 (1990).
178. M. Azoulay and E. Fischer, *J. Chem. Soc., Perkin Trans. 2*, 637 (1982).
179. D. A. Dieterich, I. C. Pauland and D. Y. Curtis, *J. Am. Chem. Soc.*, **96**, 6372 (1974).
180. L. Anderson, M. Cameron, B. G. Gowenlock and I. J. McEwen, *J. Chem. Soc., Perkin Trans. 2*, 243 (1992).
181. P. Zuman and B. Shah, *Chem. Rev.*, **94**, 1621 (1994).
182. A. Darchen and C. Moinet, *J. Electroanal. Chem.*, **61**, 373 (1975).
183. P. Zuman, Z. Fijalek, D. Dumanovic and D. Suznjevic, *Electroanalysis*, **4**, 783 (1992).
184. A. Darchen and C. Moinet, *J. Electroanal. Chem.*, **78**, 81 (1977).
185. Y. M. Wu, L. Y. Ho and C. H. Cheng, *J. Org. Chem.*, **50**, 392 (1985).
186. P. Zuman and Z. Fijalek, *J. Org. Chem.*, **56**, 5486 (1991).
187. I. R. Bellobono, P. Govoni and F. Zavattarelli, *J. Chem. Soc., Perkin Trans. 2*, 981 (1974).
188. F. Zavattarelli, I. R. Bellobono and P. L. Beltrame, *J. Chem. Soc., Perkin Trans. 2*, 983 (1974).
189. L. K. Keefer, L. Ohannessian and J. A. Hrabie, *J. Org. Chem.*, **54**, 2432 (1989).
190. S. S. Al-Kaabi, G. Hallett, T. A. Meyer and D. Lyn H. William, *J. Chem. Soc., Perkin Trans. 2*, 1803 (1984).
191. G. Kohnstam, W. A. Petch and D. L. H. Williams, *J. Chem. Soc., Perkin Trans. 2*, 423 (1984); S. J. Kuhn and J. S. McIntyre, *Can. J. Chem.*, **44**, 105 (1966); T. Sone, Y. Tokuda, T. Sakai, S. Shinkai and O. Manabe, *J. Chem. Soc., Perkin Trans. 2*, 298 (1981).
192. I. M. Lyapkaio, S. L. Ioffe, Y. A. Strelenko and V. A. Tartakovskii, *Mendeleev Commun.*, **51** (1994).
193. Y. Mugnier, J. -C. Gard, Y. Huang, Y. Couture, A. Lasia and J. Lessard, *J. Org. Chem.*, **58**, 5329 (1993).
194. S. Uršić, *Helv. Chim. Acta*, **76**, 131 (1993).

195. C. Laurence, M. Berthelot, M. Lucon and D. G. Morris, *J. Chem. Soc., Perkin Trans. 2*, 491 (1994.)
196. T. Suzuki, H. Fujii, T. Miyashi and Y. Yamashita, *J. Org. Chem.*, **57**, 6744 (1992).
197. C. V. Krishnamohan Sharma, K. Panneerselvam, T. Pilati and G. R. Desiraju, *J. Chem. Soc., Chem. Commun.*, 832 (1992).
198. C. V. Krishnamohan Sharma and G. R. Desiraju, *J. Chem. Soc., Perkin Trans. 2*, 2345 (1994).
199. K. Biradha, C. V. K. Sharma, K. Panneerselvam, L. Shimoni, H. L. Carrell, D. E. Zacharias and G. R. Desiraju, *J. Chem. Soc., Chem. Commun.*, 1473 (1993).
200. G. R. Desiraju, *Acc. Chem. Res.*, **24**, 290 (1991).
201. K. B. Borisenko, C. W. Bock and I. Hargittai, *J. Phys. Chem.*, **98**, 1442 (1994).
202. K. Borisenko and K. B. Hargittai, *J. Phys. Chem.*, **97**, 4080 (1993).
203. M. J. Kamlett and R. W. Taft, *J. Org. Chem.*, **47**, 1734 (1982).
204. J. L. Chiara, A. Gómez-Sánchez and J. Bellanato, *J. Chem. Soc., Perkin Trans. 2*, 787 (1992).
205. R. Taylor and O. Kennard, *J. Am. Chem. Soc.*, **104**, 5063 (1982); G. I. Birnbaum, J. Giziewicz, E. J. Gabe, T. S. Lin and W. H. Prusoff, *Can. J. Chem.*, **65**, 2135 (1987).
206. O. N. Ventura, E. L. Coitino, K. Irving, A. Iglesias and A. Lledos, *J. Mol. Struct. (Theochem)*, **210**, 427 (1990).  
J. M. Cense, V. Agafonov, R. Ceolin, P. Ladure and N. Rodier, *Struct. Chem.*, **5**, 79 (1994).
207. J. C. A. Boeyens, L. Denner and J. P. Michael, *J. Chem. Soc., Perkin Trans. 2*, 767 (1984).
208. J. C. A. Boeyens, L. Denner and J. P. Michael, *J. Chem. Soc., Perkin Trans. 2*, 1569 (1984).
209. M. G. B. Drew and G. R. Willey, *J. Chem. Soc., Perkin Trans. 2*, 215 (1986).
210. R. Anulewicz, T. M. Krygowski, R. Gawinecki and D. Rasala, *J. Phys. Org. Chem.*, **6**, 257 (1993).
211. L. Forlani, *J. Chem. Soc., Perkin Trans. 2*, 1699 (1991).
212. S. Di Pietro, L. Forlani and P. E. Todesco, *Gazz. Chim. Ital.*, **107**, 135 (1977).
213. J. M. Masnovi, J. K. Kochi, E. F. Hilinski and P. M. Rentzepis, *J. Am. Chem. Soc.*, **108**, 1126 (1986).
214. J. M. Masnovi and J. K. Kochi, *J. Org. Chem.*, **50**, 5245 (1985).
215. J. M. Masnovi and J. K. Kochi, *J. Am. Chem. Soc.*, **107**, 7880 (1985); S. Sankararaman, W. A. Haney and J. Kochi, *J. Am. Chem. Soc.*, **109**, 7824 (1986).
216. S. Sankararaman and J. Kochi, *J. Chem. Soc., Perkin Trans. 2*, 1 (1991); S. Sankararaman and J. Kochi, *J. Chem. Soc., Perkin Trans. 2*, 165 (1991); E. K. Kim, T. M. Bockman and J. K. Kochi, *J. Chem. Soc., Perkin Trans. 2*, 1879 (1992).
217. N. Tanaka, *Fukuoka Kyoiku Daigaku Kiyō, Dai-3-bunsatsu: Sugaku, Rika, Gijutsuka Hen*, **43**, 35 (1994); *Chem. Abstr.*, **122**, 20193f (1995).
218. L. Ebersson, M. P. Hartshorn, F. Radner, M. Merchan and B. O. Roos, *Acta Chem. Scand.*, **47**, 176 (1993).
220. C. P. Butts, L. Ebersson, G. J. Foulds, K. L. Fulton, M. P. Hartshorn and W. T. Robinson, *Acta Chem. Scand.*, **49**, 76 (1995).
221. J. M. Masnovi, S. Sankararaman and J. K. Kochi, *J. Am. Chem. Soc.*, **111**, 2263 (1989).
222. M. R. Bryce, S. R. Davies, M. B. Hursthouse and M. Motevalli, *J. Chem. Soc., Perkin Trans. 2*, 1713 (1988).
223. M. A. Santa Ana, I. Chadwick and G. González, *J. Chem. Soc., Perkin Trans. 2*, 1755 (1985).
224. J. A. Chudek, R. Foster and D. R. Twisleton, *J. Chem. Soc., Perkin Trans. 2*, 1385 (1983).
225. F. Casellato, C. Vecchi, A. Girelli and P. G. Farrel, *Thermochim. Acta*, **13**, 37 (1975); F. Pelizza, F. Casellato and A. Girelli, *Thermochim. Acta*, **4**, 135 (1972); F. Casellato, C. Vecchi and A. Girelli, *Gazz. Chim. Ital.*, **108**, 21 (1978).
226. M. Joyeux, M. T. C. Martins Costa, D. Rinaldi and Nguyen Quy Dao, *Spectrochim. Acta*, **45A**, 967 (1989).
227. D. Bougeard, J. R. Bourie, Nguyen Quy Dao and B. Hennion, *Spectrochim. Acta*, **51A**, 21 (1995).
228. M. J. Strauss, *Chem. Rev.*, **70**, 667 (1970).
229. F. Terrier, *Chem. Rev.*, **82**, 78 (1982).
230. G. A. Artamkina, M. P. Egorov and I. P. Beletskaya, *Chem. Rev.*, **82**, 427 (1982).
231. E. Buncel, in *The Chemistry of Functional Groups, Supplement F* (Ed. S. Patai), Chap. 27, Wiley, Chichester 1982; E. Buncel, M. R. Crampton, M. J. Strauss and F. Terrier, *Electron-Deficient Aromatic- and Heteroaromatic-Base Interactions*, Elsevier, Amsterdam, 1984.
232. F. Terrier, *Nucleophilic Aromatic Displacement*, VCH Publ. New York, 1991.

233. J. F. Bunnett and V. Cartano, *J. Am. Chem. Soc.*, **103**, 4861 (1981); J. F. Bunnett, S. Sekiguchi and L. A. Smith, *J. Am. Chem. Soc.*, **103**, 4865 (1981); S. Sekiguchi and J. F. Bunnett, *J. Am. Chem. Soc.*, **103**, 4871 (1981).
234. M. R. Crampton and B. Gibson, *J. Chem. Soc., Perkin Trans. 2*, 533 (1981); M. R. Crampton and C. Greenhalgh, *J. Chem. Soc., Perkin Trans. 2*, 1175 (1983); M. R. Crampton and P. J. Routledge, *J. Chem. Soc. Perkin Trans. 2*, 573 (1984); R. A. Chamberlin and M. R. Crampton, *J. Chem. Soc., Perkin Trans. 2*, 425 (1994).
235. E. Bunzel and W. Eggmann, *J. Am. Chem. Soc.*, **99**, 5958 (1977); E. Bunzel, M. Hamaguchi and A. R. Norris, *J. Chem. Soc. Perkin Trans. 2*, 2205 (1980); E. Bunzel, M. Hamaguchi and A. R. Norris, *Can. J. Chem.*, **59**, 795 (1981).
236. S. Sekiguchi, T. Horie, T. Suzuki and M. Hosokawa, *J. Chem. Soc., Perkin Trans. 2*, 1783 (1989).
237. E. B. de Vargas, R. H. de Rossi and A. V. Veglia, *J. Org. Chem.*, **51**, 1976 (1986).
238. E. B. de Vargas and R. H. de Rossi, *J. Phys. Org. Chem.*, **2**, 507 (1989); S. Sekiguchi, H. Hishikura, Y. Hirokawa and N. Ono, *Tetrahedron*, **46**, 5567 (1990).
239. R. H. de Rossi and E. B. Vargas, *J. Am. Chem. Soc.*, **103**, 1533 (1981); E. B. de Vargas and R. H. de Rossi, *Tetrahedron Lett.*, **23**, 4423 (1982).
240. L. Forlani, M. Sintoni and P. E. Todesco, *J. Chem. Res. (S)*, 344 (1986).
241. G. Collina and L. Forlani, *J. Phys. Org. Chem.*, **1**, 351 (1988).
242. G. Schroeder, M. Želazna and B. Koziol, *J. Prakt. Chem.*, **334**, 183 (1992).
243. G. Schroeder, J. Przybyl and B. Leska, *Polish J. Chem.*, **67**, 273 (1993).
244. Y. Yamamoto and S. Kojima, in *The Chemistry of Amidines and Imidates* (Eds. S. Patai and Z. Rappoport), Vol. 2, Wiley, Chichester, 1991.
245. E. D. Raczynska, P. C. Maria, J. F. Gal and M. Decouzon, *J. Phys. Org. Chem.*, **1**, 725 (1994).
246. C. Cimorelli and L. Forlani, *J. Phys. Org. Chem.*, **2**, 653 (1989).
247. N. Sugimoto, M. Sasaki and J. Osugi, *Bull. Chem. Soc. Jpn.*, **57**, 366 (1984).
248. N. Sugimoto, M. Sasaki and J. Osugi, *Bull. Chem. Soc. Jpn.*, **54**, 2598 (1981).
249. G. Schroeder, B. Leska, J. Przybyl and A. Jarczewski, *Polish J. Chem.*, **67**, 1131 (1993).
250. W. Galezowski and A. Jarczewski, *J. Chem. Soc., Perkin Trans. 2*, 1647 (1989).
251. M. Qureshi, S. A. Nabi, A. Mohammad and P. M. Qureshi, *J. Solid State Chem.*, **44**, 186 (1982).
252. P. M. Qureshi, R. K. Varshney and S. I. M. Kamoopuri, *Spectrochim. Acta*, **54A**, 963 (1989).
253. H. M. Powell, G. Huse and P. W. Cooke, *J. Chem. Soc.*, 153 (1943).
254. L. Forlani, *Gazz. Chim. Ital.*, **112**, 205 (1982).
255. E. Durantini, L. Zingaretti, J. D. Anunziata and J. J. Silber, *J. Phys. Org. Chem.*, **5**, 557 (1992).
256. J. O. Singh, J. D. Anunziata and J. J. Silber, *Can. J. Chem.*, **63**, 903 (1985).
257. S. D. Ross and I. Kuntz, *J. Am. Chem. Soc.*, **76**, 3000 (1954).
258. L. Forlani and V. Tortelli, *J. Chem. Res. (S)*, 62 (1982).
259. L. Forlani, *J. Chem. Res. (S)*, 260; (M), 2379 (1984).
260. L. Forlani and M. Bosi, *J. Phys. Org. Chem.*, **5**, 429 (1992).
261. L. Forlani, *J. Chem. Soc., Perkin Trans. 2*, 1525 (1993).
262. L. Forlani and V. Tortelli, *J. Chem. Res. (S)*, 258 (1982).
263. L. Forlani and E. Mezzina, *J. Chem. Soc., Perkin Trans. 2*, 2019 (1995).
264. C. F. Bernasconi, *Mechanism and Reactivity in Aromatic Nucleophilic Substitution Reactions*, M.T.P. Int. Rev.; Org. Chem., Ser. One, **3**, 33 (1973).
265. L. Forlani, E. Marianucci and P. E. Todesco, *Gazz. Chim. Ital.*, **122**, 349 (1992).
266. J. O. Edwards, E. F. Greene and J. Ross, *J. Chem. Educ.*, **45**, 381 (1968).
267. J. F. Bunnett, in *Investigation of Rates and Mechanisms of Reactions* (Eds. E. S. Lewis and A. Weissberger), Vol. VI, Chap. 8, Wiley, New York, 1974.
268. W. P. Jencks, *Catalysis in Chemistry and Enzymology*, Chap. 9, McGraw-Hill, New York, 1969.
269. J. F. Bunnett and J. J. Randall, *J. Am. Chem. Soc.*, **80**, 6020 (1958).
270. F. Pietra and D. Vitali, *J. Chem. Soc. (B)*, 1200 (1968).
271. L. Forlani and P. E. Todesco, *J. Chem. Soc., Perkin Trans. 2*, 313 (1980).
272. S. M. Chiacchera, J. O. Singh, J. D. Anunziata and J. J. Silber, *J. Chem. Soc., Perkin Trans. 2*, 987 (1987).
273. O. Banjoko and C. Ezeani, *J. Chem. Soc., Perkin Trans. 2*, 1357 (1982).
274. O. Banjoko and C. Ezeani, *J. Chem. Soc., Perkin Trans. 2*, 531 (1986).
275. J. Hayami, S. Otani, F. Yamaguchi and Y. Nishikawa, *Chem. Lett.*, 739 (1987); J. Hayami, N. Sugiyama and H. Suezaki, *XII<sup>o</sup> Conf. Phys. Org. Chem.*, Padova-I, P 91 (1994).

275. O. B. Nagy, M. wa Muanda and J. B. Nagy, *J. Phys. Chem.*, **83**, 1961 (1979).
276. N. S. Nudelman and D. Palleros, *J. Chem. Soc., Perkin Trans. 2*, 1277 (1984).
277. D. Palleros and N. S. Nudelman, *J. Chem. Soc., Perkin Trans. 2*, 479 (1985).
278. N. S. Nudelman and D. Palleros, *J. Org. Chem.*, **48**, 1607 (1983).
279. N. S. Nudelman and J. M. Montserrat, *J. Chem. Soc., Perkin Trans. 2*, 1073 (1990).
280. K. R. Popper, *Conjectures and Refutations*, Routledge and Kegan, London, 1965.



## CHAPTER 11

# Electronic effects of nitro, nitroso, amino and related groups

JOHN SHORTER

School of Chemistry, University of Hull, Hull HU6 7RX, UK

Fax: (home)+44-01947-603348

---

I. INTRODUCTION	480
A. The Scope of this Chapter	480
B. Historical Introduction	481
II. THE HAMMETT EQUATION	487
A. Introduction	487
B. Multiparameter Extensions	489
III. ELECTRONIC EFFECTS OF THE NITRO GROUP ON THE STRENGTHS OF CARBOXYLIC AND OTHER ACIDS	491
A. Alicyclic, Aliphatic and Related Systems	491
B. Aromatic Systems	493
C. Acids of the Type Ph-G-COOH	494
D. Phenol and Anilinium Ion	496
IV. THE <i>ORTHO</i> -EFFECT OF NO <sub>2</sub>	498
A. Introduction	498
B. Ionization of Carboxylic and Other Acids	498
C. The Reactions of <i>ortho</i> -Substituted Benzoic Acids with Diazodiphenylmethane (DDM)	501
V. SUBSTITUENT CONSTANTS OF THE NITRO GROUP FROM THE APPLICATION OF MODERN EXPERIMENTAL AND THEORETICAL TECHNIQUES	503
A. Experimental Techniques	503
B. Theoretical Techniques	506
VI. ELECTRONIC EFFECTS OF NO <sub>2</sub> ON VARIOUS SYSTEMS AND PROCESSES	507
A. Formation and Stabilization of Carbanions	507
1. Introduction	507
2. Equilibrium acidities of nitrocarbon acids	508

3. Kinetic acidities of nitrocarbon acids . . . . .	508
4. Correlation analysis of C—H acidity . . . . .	509
B. Nucleophilic Substitution . . . . .	510
C. Electrophilic Aromatic Substitution . . . . .	512
VII. SUBSTITUENT CONSTANTS OF NO <sub>2</sub> AND OF GROUPS CONTAINING IT: RECAPITULATION AND SOME EXTENSION . . . . .	513
A. Introduction . . . . .	513
B. Recapitulation . . . . .	514
C. The Effects of Substituents Containing NO <sub>2</sub> . . . . .	514
VIII. ELECTRONIC EFFECTS OF THE NITROSO GROUP . . . . .	515
IX. ELECTRONIC EFFECTS OF THE AMINO GROUP AND RELATED GROUPS . . . . .	516
A. Introduction . . . . .	516
B. Inductive Effect of the Amino Group and Related Groups . . . . .	517
C. Resonance Effect of the Amino Group and Related Groups . . . . .	518
D. Electronic Effects of the Amino Group and Related Groups on the Strengths of Benzoic and Other Acids . . . . .	518
E. The <i>Ortho</i> -Effect of the Amino Group and Related Groups . . . . .	520
F. Substituent Effects in Highly Electron-Demanding Reactions . . . . .	520
X. SOME FURTHER MULTIPARAMETER TREATMENTS OF SUBSTITUENT EFFECTS . . . . .	521
A. Introduction . . . . .	521
B. Exner's Analysis . . . . .	521
C. C. G. Swain's Treatments . . . . .	522
D. The Poly Substituent-Parameter (PSP) Equation . . . . .	522
E. Charton's LDR Equation . . . . .	524
XI. REFERENCES AND NOTES . . . . .	525

## I. INTRODUCTION

### A. The Scope of this Chapter

Previous articles by the present contributor in *The Chemistry of Functional Groups* series have dealt with the electronic effects of the sulphonio group<sup>1</sup>, of the sulphinyl and sulphonyl groups<sup>2</sup>, of SOOH and related groups<sup>3</sup>, of amidino, guanidino and related groups<sup>4</sup>, of ether and hydroxyl groups<sup>5</sup>, and of cyano, isocyano, acetylenic and diazono groups<sup>6</sup>. In the first two cases<sup>1,2</sup> there was copious information from which to draw, but fairly comprehensive surveys were practicable. In the third and fourth contributions<sup>3,4</sup> the amount of information available was very restricted. In the fifth and sixth cases<sup>5,6</sup> the amount of available material was enormous and the treatment was highly selective both in the topics covered and in the illustrative examples provided. This will be the situation *a fortiori* for the present chapter, because the nitro group and the amino group and closely related groups are extremely popular substituents. In the space available it is not possible to give detailed accounts of all the substituents of interest. The contributor has therefore decided to give a fairly thorough account of the nitro group and to deal with the other relevant substituents much more concisely.

It is appropriate that the present Introduction should contain a specifically historical section, particularly in relation to the nitro group, whose electronic effect played a distinctive role in organic chemistry long before it was recognized as such. In this section and in later sections references are often given to classical papers and texts, whose importance has been overlaid by more recent work.

The quantitative study of the electronic effects of these groups is naturally much concerned with the Hammett equation and its extensions. The next main section therefore contains a summary of the salient features of the Hammett equation and cognate linear free-energy relationships, along the general lines of corresponding sections in certain of the contributor's previous articles in the series<sup>1,2,5,6</sup>. This prepares the ground for a discussion of the electronic effects of the nitro group on the strengths of carboxylic and other acids: alicyclic, aliphatic and aromatic systems are covered. The discussion of aromatic systems leads to a further main section on the *ortho*-effect of NO<sub>2</sub>, in which electronic effects are moderated by steric and other influences. The emphasis of much of the chapter is deliberately 'chemical', but in the next section the application of modern spectroscopic and theoretical techniques to the nitro group is explored. The following section deals with several important areas for the manifestation of the electronic effects of NO<sub>2</sub>: the formation and stabilization of carbanions, nucleophilic substitution (both aliphatic and aromatic) and electrophilic aromatic substitution. Most of the treatment thus far has concerned NO<sub>2</sub> as a substituent directly attached to the molecular skeleton of interest. A further section now deals with various substituents containing one or more nitro groups.

In a short section the electronic effect of the nitroso group is discussed. In the following section the electronic effects of the amino group and related groups are examined. The topics include the inductive effect and the resonance effect of these groups, their influence on the strength of benzoic and other acids, the *ortho*-effect and substituent effects in highly electron-demanding reactions. One topic which is only mentioned briefly in passing is the electronic effects of unipolar substituents such as NMe<sub>3</sub><sup>+</sup>. The corresponding topic was dealt with in considerable detail in some of the earlier contributions to the series<sup>3,5,6</sup>, and this was, of course, effectively the sole main topic in the article on the sulphonio group<sup>1</sup>. Because of the highly variable nature of the electronic effects of any given unipolar substituent and the difficulty of incorporating data for such substituents in Hammett and other linear free-energy relationships, appropriate treatment of the topic must inevitably be highly detailed. It was therefore decided to omit this topic in the present chapter.

Multiparameter treatments such as the Yukawa-Tsuno equation and the dual substituent-parameter equation have long been important and further treatments have been devised in recent years. A final section is devoted to some of these, with an indication of the place of NO<sub>2</sub>, NH<sub>2</sub> and some other groups in these treatments.

## B. Historical Introduction

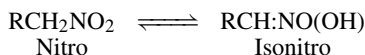
Nitrobenzene was first prepared in 1834 by Mitscherlich<sup>7</sup>. Aniline was first obtained from the destructive distillation of indigo in 1826 by Unverdorben<sup>8</sup>, who named it *krySTALLIN*. It was rediscovered in coal tar by Runge in 1834<sup>9</sup>, and called by him *cyanol*. In 1842 it was obtained by Fritzsche<sup>10</sup> through the distillation of indigo (from *Indigofera anil*) with potash and was then first called *aniline*. At about the same time, Zinin<sup>11</sup> obtained a base by reducing nitrobenzene and this was named by him *benzidam*. Hofmann investigated these variously prepared substances during the early 1840s and showed them to be identical<sup>12</sup>. After a short time the compound became known generally as aniline or phenylamine (initially it was *phenamide*). The study of nitrobenzene and aniline and their derivatives was pursued energetically throughout the 19th century from the 1830s onwards. A great deal of information was accumulated<sup>13</sup>, much of which was difficult to understand before the theory of valency and the structural theory of organic chemistry were developed in the third quarter of the century.

Aliphatic analogues of aniline and nitrobenzene were discovered somewhat later. Methylamine and ethylamine were first prepared by Wurtz in 1849<sup>14</sup>, and thereafter many aliphatic amines were made and their properties studied<sup>13</sup>, particularly by Hofmann<sup>15</sup>.

Nitrite esters of aliphatic alcohols were discovered long before aliphatic nitro compounds were made. Indeed ethyl nitrite was obtained by the alchemist-chemist Johann Kunckel von Löwenstern (Kunkel) in 1681<sup>16</sup>. It was prepared and characterized more definitely by Liebig around 1840<sup>17</sup>. Certainly by the middle of the century it was appreciated that the alkyl nitrites are esters, which may be hydrolysed by alkalis or acids into alcohols and nitrous acid and converted by reducing agents into alcohols and nitrogen. About 1872 it was realized by Victor Meyer that there should be another series of 'alkyl nitrites' with properties more analogous to those of nitrobenzene. By the action of silver nitrite on amyl iodide he obtained a compound of the same molecular formula as amyl nitrite, but quite different properties, to which he gave the name nitropentane<sup>18,19</sup>. His choice of silver nitrite as a reagent may well have been influenced by his knowledge of the peculiar behaviour of silver cyanide in its reactions with alkyl halides to give alkyl isocyanides rather than alkyl cyanides<sup>6</sup>. Also in 1872 Kolbe prepared nitromethane by the reaction of alkali metal nitrite with alkali metal chloroacetate<sup>20</sup>. During the next twenty years Meyer and his students carried out extensive investigations of aliphatic nitro compounds<sup>21</sup>.

It will be convenient to develop separately the relevant historical background for the nitro group and the amino group in aliphatic and in aromatic systems. We shall deal first with the nitro group in aliphatic systems. It would be appropriate to mention here that the activating and directing effects of the nitro group in aliphatic systems were surveyed in great detail in an earlier volume of this Series, including over five hundred references<sup>22</sup>. A review article of 1947 contains many early references to aliphatic nitro compounds<sup>23</sup>.

At an early stage it was found that the nitro group had the power of activating the hydrogen atom(s) on the carbon to which the NO<sub>2</sub> is attached. Victor Meyer found that primary and secondary (but not tertiary) nitro compounds dissolve slowly in alkali and if alcohol is added an alkali metal salt of the nitro compound is precipitated. Thus the activation of CH by NO<sub>2</sub> was associated with incipient acidity and the behaviour of the group in this way was similar to that of certain other groups such as CN, COMe and COOEt<sup>6</sup>. It was more than twenty years, however, before the incipient acidity of CH adjacent to NO<sub>2</sub> was correctly formulated in terms of the tautomerism of nitro and isonitro or *aci* forms.



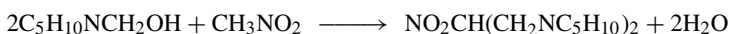
In 1896 Hantzsch and Schultze obtained the separate nitro and isonitro forms of phenylnitromethane and studied their properties and their interconversion<sup>24</sup>. Hantzsch introduced the term *pseudo-acid* to describe neutral compounds which form alkali metal salts corresponding to their *aci* forms.

Victor Meyer also discovered the reactions of aliphatic nitro compounds with nitrous acid, which likewise depend on the activation of CH by NO<sub>2</sub><sup>21</sup>. Primary nitro compounds give nitrolic acids RC(NO<sub>2</sub>):NOH, secondary nitro compounds give pseudo-nitroles R<sub>2</sub>C(NO)NO<sub>2</sub> and tertiary nitro compounds, having no activated CH, do not react.

As in the case of other groups which activate adjacent CH<sup>6</sup>, the nitro group in aliphatic nitro compounds soon acquired importance in preparative organic chemistry, particularly for condensation reactions. The condensing agents are normally bases. Thus nitromethane will react with benzaldehyde to give first a nitro-alcohol and then a nitro-olefin (Priebis, 1884<sup>25</sup>):

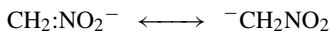


In 1896 Henry<sup>26</sup> found that nitromethane reacted with *N*-hydroxymethylpiperidine to form 2-nitro-1,3-di-*N*-piperidinopropane:



In the 20th century many further reactions of aliphatic nitro compounds were discovered, as detailed in the review articles cited above<sup>22,23</sup>.

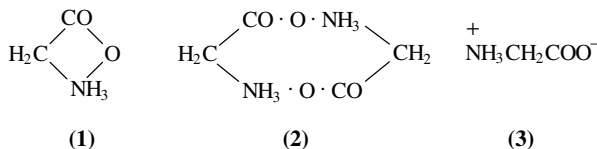
The mechanisms of the condensation and many other reactions of nitroalkanes are formulated nowadays in terms of carbanions, as in the case of reactions involving CH activated by other groups<sup>6</sup>. The ion generated from a nitroalkane by the action of base is regarded as a resonance hybrid; e.g. for nitromethane:



with the negative charge residing mainly on the nitro group. In entering into reaction as a nucleophile, the ion is considered to be polarized to concentrate the negative charge on the  $\alpha$ -carbon atom. The essential features of the mechanisms of reactions involving molecules with activated CH were put forward by Lapworth early in the 20th century<sup>27</sup>. For a long time authors seem to have been reluctant to accept mechanisms involving carbanions. However, in the early nineteen-thirties formulations involving carbanions became more widely used, although the actual term carbanion was not rapidly adopted. Hammett's book (1940)<sup>28</sup> appears to have been one of the first texts to use the term freely. By the nineteen-thirties a fair number of 'stable' carbanions, as opposed to highly reactive intermediates, were recognized, and this no doubt helped to make the idea of carbanionic intermediates more acceptable. Thus it was known that dinitromethane in water was a slightly stronger acid than acetic acid, while nitroform  $\text{HC}(\text{NO}_2)_3$  was a moderately strong acid.

There is not much historical background which it is necessary to explore for the amino group in aliphatic systems. The amino group, and substituted amino groups, are of interest as reaction centres rather than as substituents influencing reactivity elsewhere in the molecule; cf the situation in aromatic systems, dealt with below. However, one matter which should be mentioned, since it has been known for a long time, is the peculiar behaviour of amino acids.

It has been known for well over a century that amino acids, such as glycine (aminoacetic acid) and alanine ( $\alpha$ -aminopropionic acid), give neutral solutions in water and are somewhat reluctant to form metallic salts<sup>13</sup>. It was recognized that these peculiarities were due to the presence of both an acidic centre and a basic centre in the same molecule, and their neutrality was attributed to *self-saturation*. The interaction between the amino and carboxyl groups was expressed by writing ring structures for amino acids, either as monomers or dimers, e.g. **1** or **2**, respectively. The correct formulation in terms of *zwitter-ions*, e.g. **3**, was not possible until the theory of electrolytic dissociation was well established. The concept of *zwitter-ions* appears to have been originated as early as 1894 by Bredig<sup>29</sup> and was well applied to the amino acids by Bjerrum in 1923<sup>30,31</sup>. In connection with the effect of substituents on the acidity of aliphatic carboxylic acids, it is important to remember that potentiometric titration of amino acids indicates the effect of the pole  $\text{NH}_3^+$ , and not of  $\text{NH}_2$ , on the dissociation constant of the carboxyl group.



We turn now to the historical background to the effects of nitro and amino groups in aromatic systems. It would be appropriate to mention here that there have been several articles pertinent to these topics in earlier volumes of the Series. In 1968 Chuchani contributed a chapter on the directing and activating effects of the amino group and related groups<sup>32</sup>, with over 340 references. In 1970 Urbański reviewed the directing effects of

the nitro group in electrophilic and radical aromatic substitutions<sup>33</sup>, with over ninety references. In Part 1 of the same volume published a year earlier, de Boer and Dirx had contributed a chapter on the activating effects of the nitro group in aromatic (nucleophilic) substitutions<sup>34</sup>, with almost six hundred references.

Soon after the structural relationships between the *ortho*-, *meta*- and *para*-disubstituted derivatives of benzene had been established, attempts to formulate orientation rules began. It was recognized early on that the substituent already present tended to direct further substitution either to the *ortho*- and *para*-positions or to the *meta*-position. The problem of formulating orientation rules was thus essentially to classify substituents as *ortho/para* or *meta* directing and then to correlate the two classes with chemical character. The earliest attempts at this were by Hübner<sup>35</sup> in 1875 and Noelling<sup>36</sup> in 1876. The latter actually suggested that *meta* directing groups were of a 'strongly acid character', which showed remarkable insight in view of the rudimentary ideas as to the nature of acidity that were prevalent at that time. Empirical orientation rules were gradually refined, notably by Armstrong (1887)<sup>37</sup>, Crum Brown and Gibson (1892)<sup>38</sup>, Vorländer (1902)<sup>39</sup> and Hammick and Illingworth (1930)<sup>40</sup>. By the time of the last-mentioned it was well recognized that the factor underlying the mode of action of a substituent was its electronic structure, as we shall see below. However, it should be mentioned in passing that prior to the development of the electronic theory of organic chemistry, Flürscheim had treated the 'alternation' characteristic of directing effects in terms of an electrical (but not 'electronic') concept of 'alternating chemical affinity' (1902 and later<sup>41</sup>).

In 1910 Holleman published a remarkable book about the direct introduction of substituents into benzene, which brought together the then known information about aromatic substitution<sup>42</sup>. In this book there was for the first time an emphasis on the importance of quantitative measurements of the percentage yields of isomers in aromatic substitution and on the value of measurements of relative velocities of substitution under standard conditions. The latter led to the recognition that *ortho/para* orienting substituents tended to increase the rate of substitution compared with benzene, whereas *meta* orienting substituents decreased the reaction rate. Holleman was able to rank substituents in order of 'relative directing power', thus:

*ortho/para* directing groups:



strongly directing

weakly directing

*meta* directing groups (all more weakly directing than the *ortho/para* directing groups):

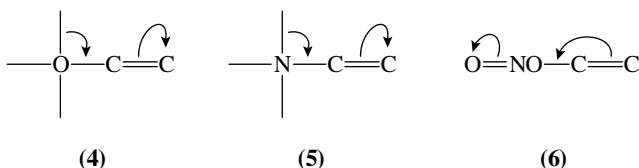


least directive power

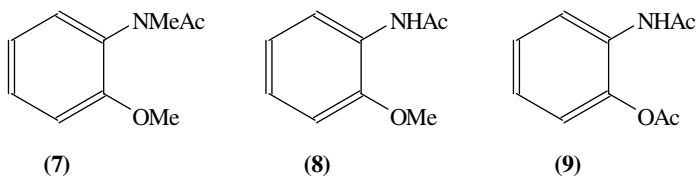
By World War I it was certainly well recognized that both  $\text{NH}_2$  and  $\text{NR}_2$  were strongly *ortho/para* directing and activating; indeed so activating that with some reagents and under some conditions, the reaction did not stop with the introduction of one further group but polysubstitution was prone to occur, e.g. aniline reacts with bromine water to give tribromoaniline.  $\text{NHAcyl}$  was known to be somewhat less activating. It was also well recognized that  $\text{NO}_2$  was *meta* directing and was strongly deactivating<sup>43</sup>.

In the nineteen-twenties the examination of the directing effects of nitro, amino and related groups was prominent in the work of various research groups, particularly those involved in the controversies regarding electronic theories of organic chemistry which raged from 1924 for several years<sup>44-46</sup>. Thus in 1926-27 Robert Robinson and his

associates published a series of papers on 'The Relative Directing Powers of Groups of the Forms RO and RR'N in Aromatic Substitution'. Part IV of the series by Allan, Oxford, Robinson and Smith<sup>47</sup> in 1926 contains the earliest fairly comprehensive statement of the main features of the electronic theory which Robinson was developing, this being given as necessary background to a 'A Discussion of the Observations Recorded in Parts I, II, and III'. (There were in all eight Parts in the series.) The 'observations' were the percentages of isomers formed in the nitration of appropriate substrates, which were made the basis of a numerical scale of 'relative directing power'. This was mainly for alkoxy groups<sup>5</sup>. The results were shown by Robinson to be accommodated by his electronic theory of organic chemistry, in which alkoxy-, amino- and dialkylamino-benzenes were classified as 'hetero-enoid' or 'crotenoid' systems, favouring the 'anionoid' reactivity of benzene through conjugative polarization represented as **4** or **5**. Robinson's interest in hetero-enoid systems was originally aroused by Collie's observation in 1883<sup>48</sup> that when ethyl  $\beta$ -aminocrotonate reacted with alkyl iodide some of the alkylation occurred on the  $\alpha$ -carbon atom. Nitro-substituted benzenes were classified by Robinson as 'katio-enoid' or 'crotonoid' systems, favouring the 'kationoid' reactivity of benzene through conjugative polarization represented as **6**. This accounted for the activating effect of a *p*-nitro group on the displacement of a chloro group by a basic reagent<sup>49</sup>.



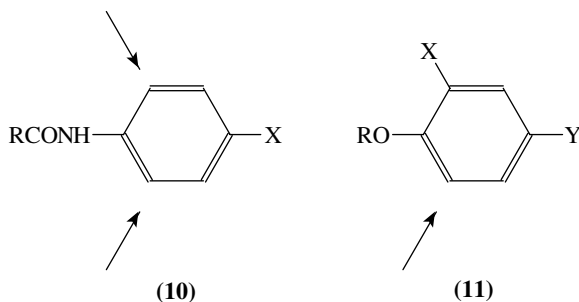
At around the same time Ingold and his collaborators began a series of publications on 'The Nature of the Alternating Effect in Carbon Chains'. Part I of the series appeared in 1925<sup>50</sup>; the series ended with Part XXXII in 1930<sup>51</sup>. Several of the earlier Parts were concerned with aspects of the controversy about electronic theories of organic chemistry which arose between Ingold and Robinson<sup>44-46</sup>. Ingold initially favoured the approach of Flürscheim<sup>41</sup>, but by Part V<sup>52</sup> of the series was formulating reactivity in terms of electrons<sup>46</sup>. Part I<sup>50</sup> of the series concerned the directing influence of the nitroso group in aromatic substitution. The *ortho/para* directing nature found for this group was considered by Ingold to constitute a test case in favour of Flürscheim's treatment, but Robinson was able to show that it could easily be accommodated by his electronic theory<sup>46,53</sup>. Parts III<sup>54</sup>, V<sup>52</sup> and VI<sup>55</sup> of Ingold's series were much concerned with the 'relative directive efficiencies' of oxygen, nitrogen and fluorine, and the studies involved determining the percentages of the various isomers formed in the nitration of such substrates as **7** to **9**. Part III reported a study of the mononitration of tertiary benzylamines and their salts. On the basis of Flürscheim's theory Ingold had predicted that the free amine would be nitrated in the *meta*-position and the salt in the *ortho*- and/or *para*-position. The experimental results in Part III appeared to confirm this prediction. Robinson admitted that he would have expected the opposite orientation and undertook a re-examination of the systems. He found that the free amine was nitrated at *ortho*- and *para*-positions and the



salt at a *meta*-position, in accordance with his electronic theory<sup>56</sup>. Ingold later carried out much useful work on the directing effects of  $\text{NMe}_3^+$  and of other positive poles, as well as on the damping influence of interposing methylene groups on the directing effect of the nitro group<sup>57,58</sup>.

As Ingold's version of the electronic theory developed,  $\text{NH}_2$ ,  $\text{NR}_2$  and  $\text{NHAcyl}$  groups were classified as  $-I$  and  $+T$  in their electronic effects, signifying electron attraction through the *Inductive Effect* and electron release by the *Tautomeric Effect*<sup>59</sup>. Later the latter was subdivided into the *Mesomeric Effect M* (polarization) and *Electromeric Effect E* (polarizability)<sup>60</sup>. The  $\text{NO}$  group was also classified as  $-I$  and  $+T$  in its electronic effect, while  $\text{NO}_2$  was classified as  $-I$  and  $-T$ .

Work of a rather different nature involving the directive effects of  $\text{NHAcyl}$  groups was pursued in the nineteen-twenties by Orton and colleagues, and after Orton's death in 1930 was continued by Brynmor Jones in a long series of papers on 'Halogenation of Phenolic Ethers and Anilides'<sup>61</sup>. The emphasis of the work was rather on the phenolic ethers, i.e. on the directive effects of alkoxy groups, and this aspect was discussed by the present author in an earlier contribution to the *Chemistry of Functional Groups* series<sup>5</sup>. This work concerned the measurement of the velocities of halogenation (usually chlorination) of many series of phenolic ethers and a few series of anilides in 99% acetic acid. In these studies the complication of isomer formation in electrophilic aromatic substitution was eliminated by using substrates in which either the *para* or the *para* and one *ortho* position was already occupied by a group such as  $\text{CH}_3$ ,  $\text{Cl}$ ,  $\text{NO}_2$  etc. In this way the velocity of substitution was brought within range of convenient measurement and only one product was obtained, as in **10** or **11**.



Of general interest for chemical kinetics in this extensive work was the demonstration of the additive effects of the various substituents involved and the finding that the effects of substituents on reaction velocity were exerted largely through the energy of activation rather than the non-exponential factor of the Arrhenius equation<sup>62</sup>. Much information was obtained on the activating influences of the various alkoxy groups<sup>5,62</sup> and some on the activating influences of various acylamino groups. For example<sup>63</sup>, the series *p*- $\text{AcNHC}_6\text{H}_4\text{X}$ , where  $\text{X} = \text{Cl}$ ,  $\text{Br}$  or  $\text{COOH}$ , gave the following order of diminishing activating power:

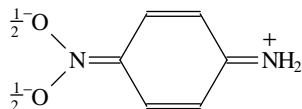


(See also earlier related work by Orton and Bradfield<sup>64</sup>.)

Nitro and amino groups also played an important role in the elucidation of structural effects through dipole moment measurements in the nineteen-thirties<sup>65</sup>. There was great interest in comparing the dipole moments of corresponding aliphatic and aromatic compounds, e.g.  $\text{MeNO}_2$  and  $\text{PhNO}_2$ . It was found that these frequently differed somewhat, in



a direction which appeared to confirm the occurrence in the aromatic compound of a movement of electrons corresponding to the mesomeric effect that had been postulated in the electronic theory of organic chemistry. This led to the concept of 'mesomeric moment' and various ways of estimating this from observed dipole moments were devised. The actual values depended on the method of estimation employed, but various methods applied to a series of substituents gave similar trends. Thus Sutton<sup>66</sup> suggested a value of  $-0.68$  for the mesomeric moment of  $\text{PhNO}_2$ , the minus sign indicating mesomeric electron withdrawal by the nitro group in the aromatic system. Marsden and Sutton<sup>67</sup> found  $1.12D$  and  $1.55D$  for the mesomeric moments of  $\text{PhNH}_2$  and  $\text{PhNMe}_2$  respectively. (Observed dipole moments are usually between  $1D$  and  $4D$ .) It was found, however, that the mesomeric moment associated with a given group may vary when other substituents are present in the molecule. Bennett and Glasstone<sup>68</sup> measured the dipole moments of several *para*-substituted anilines (among various series of compounds) and compared the experimental values with those calculated from the corresponding monosubstituted compounds. In the case of *p*-nitroaniline, the observed dipole moment was  $6.20D$ , compared with a calculated value of  $4.66D$ , corresponding to enhanced mesomeric effects through participation of the canonical structure **12** in the resonance hybrid. However, much of the way in which dipole moment measurements were interpreted in the nineteen-thirties is now regarded as over-simplified<sup>69</sup>, but there was great interest at the time in the relationship of the signs of the mesomeric moments to the *ortho/para* or *meta* orientating influence of the groups, i.e. whether electrons were moving from the substituent into the ring or *vice versa*<sup>65</sup>.



(12)

## II. THE HAMMETT EQUATION<sup>70</sup>

### A. Introduction

The Hammett equation is the best-known example of a linear free-energy relationship (LFER), that is an equation which implies a linear relationship between free energies (Gibbs energies) of reaction or activation for two related processes<sup>71</sup>. It describes the influence of polar *meta*- or *para*-substituents on reactivity for side-chain reactions of benzene derivatives.

The Hammett equation (1937)<sup>72-77</sup> takes the form of equation 1 or 2:

$$\log k = \log k^0 + \rho\sigma \quad (1)$$

$$\log K = \log K^0 + \rho\sigma \quad (2)$$

The symbol  $k$  or  $K$  is the rate or equilibrium constant, respectively, for a side-chain reaction of a *meta*- or *para*-substituted benzene derivative, and  $k^0$  or  $K^0$  denotes the statistical quantity (intercept term) approximating to  $k$  or  $K$  for the 'parent' or 'unsubstituted' compound. The *substituent constant*  $\sigma$  measures the polar (electronic) effect of replacing H by a given substituent (in the *meta*- or *para*-position) and is, in principle, independent of the nature of the reaction. The *reaction constant*  $\rho$  depends on the nature of the reaction (including conditions such as solvent and temperature) and measures the susceptibility of the reaction to polar effects. Hammett chose the ionization of benzoic

TABLE 1. Selected values<sup>a</sup> of  $\sigma$ ,  $\sigma^+$  and  $\sigma^-$  constants

Substituent	$\sigma_m$	$\sigma_p$	$\sigma_p^+$	$\sigma_p^-$
Me	-0.07	-0.17	-0.31	—
OMe	0.12	-0.27	-0.78	—
SMe	0.15	0.00	-0.60	0.21
OH	0.12	-0.37	-0.92	—
SH	0.25	0.15	—	—
NMe <sub>2</sub>	-0.15	-0.63	-1.7	—
F	0.34	0.06	-0.07	—
Cl	0.37	0.23	0.11	—
CF <sub>3</sub>	0.43	0.54	—	0.65
CN	0.61	0.65	—	0.88
NO <sub>2</sub>	0.71	0.78	—	1.24
CO <sub>2</sub> H	0.37	0.45	—	0.73

<sup>a</sup>These values, drawn from various sources, are presented solely for illustration. The table should not itself be used uncritically as a source of  $\sigma$  values for correlations. See rather References 74, 78 and 79. The values for NMe<sub>2</sub> and NO<sub>2</sub> will be discussed later in this chapter.

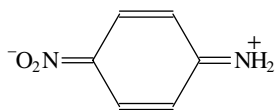
acids in water at 25 °C as a standard process. For this,  $\rho$  is defined as 1.000, and the value of  $\sigma$  for a given substituent is then  $\log(K_a/K_a^0)$ , where  $K_a$  is the ionization constant of the substituted benzoic acid and  $K_a^0$  that of benzoic acid itself. Selected values of  $\sigma$  for well-known substituents are given in Table 1. They are readily interpreted qualitatively in simple electronic terms, i.e. through the inductive (*I*) effect and the resonance or conjugative (*R*) effect.

Jaffé (1953)<sup>80</sup> showed that while many rate or equilibrium data conform well to the Hammett equation (as indicated by correlation coefficient), many such data are outside the scope of the equation in its original form and mode of application. Deviations are commonly shown by *para*-substituents with considerable +*R* or -*R* effect<sup>81</sup>. Hammett himself found that *p*-NO<sub>2</sub> (+*R*) showed deviations in the correlation of reactions of anilines or phenols. The deviations were systematic in that a  $\sigma$  value of *ca* 1.27 seemed to apply, compared with 0.78 based on the ionization of *p*-nitrobenzoic acid. Other examples were soon discovered and it became conventional to treat them similarly in terms of a 'duality of substituent constants'.

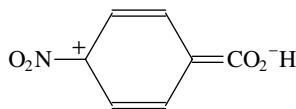
When  $\sigma$  values based on the ionization of benzoic acids are used, deviations may occur with +*R* *para*-substituents for reactions involving -*R* electron-rich reaction centres, and with -*R* *para*-substituents for reactions involving +*R* electron-poor reaction centres. The explanation of these deviations is in terms of 'cross-conjugation', i.e. conjugation involving substituent and reaction centre.

In the ionization of the *p*-nitroanilinium ion, the free base is stabilized by delocalization of electrons involving the canonical structure **13**. An analogous structure is not possible for the *p*-nitroanilinium ion. In the ionization of *p*-nitrophenol, analogous delocalization is possible in both phenol and phenate species, but is more marked in the ion. Thus, in both the aniline and the phenol system *p*-NO<sub>2</sub> is effectively more electron-attracting than in the ionization of benzoic acid, where the reaction centre is incapable of a -*R* effect, and indeed shows a small +*R* effect (**14**).

An example of a reaction series in which large deviations are shown by -*R* *para*-substituents is provided by the rate constants for the solvolysis of substituted *t*-cumyl chlorides. ArCMe<sub>2</sub>Cl<sup>82</sup>. This reaction follows an S<sub>N</sub>1 mechanism, with intermediate formation of the cation ArCMe<sub>2</sub><sup>+</sup>. A -*R* *para*-substituent such as OMe may stabilize the

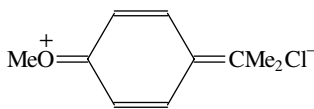


(13)

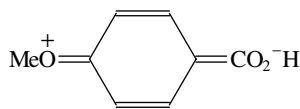


(14)

activated complex, which resembles the carbocation–chloride ion pair, through delocalization involving structure **15**. Such delocalization will clearly be more pronounced than in the species involved in the ionization of *p*-methoxybenzoic acid, which has a reaction centre of feeble  $+R$  type (**16**). The effective  $\sigma$  value for *p*-OMe in the solvolysis of *t*-cumyl chloride is thus  $-0.78$ , compared with the value of  $-0.27$  based on the ionization of benzoic acids.



(15)



(16)

The special substituent constants for  $+R$  *para*-substituents are denoted by  $\sigma^-$ , and those for  $-R$  *para*-substituents are denoted by  $\sigma^{+82}$ . They are based respectively on the reaction series discussed above. Selected values are given in Table 1. Characteristic  $\sigma^-$  or  $\sigma^+$  values are sometimes distinguished for *meta*-substituents also, but only for a minority of substituents which show very marked  $+R$  or  $-R$  effects do these differ significantly from ordinary  $\sigma$  values. The range of applicability of the Hammett equation is greatly extended by means of  $\sigma^-$  and  $\sigma^+$ , notably to nucleophilic (by  $\sigma^-$ ) and to electrophilic (by  $\sigma^+$ ) aromatic substitution.

However, the 'duality of substituent constants' and the attempt to deal with cross-conjugation by selecting  $\sigma^+$ ,  $\sigma$  or  $\sigma^-$  in any given case is somewhat artificial. The contribution of the resonance effect of a substituent relative to its inductive effect must in principle vary continuously as the electron-demanding quality of the reaction centre is varied, i.e. the extent to which it is electron-rich or electron-poor. A 'sliding scale' of substituent constants would be expected for each substituent having a resonance effect and not just a pair of discrete values:  $\sigma^+$  and  $\sigma$  for  $-R$ , or  $\sigma^-$  and  $\sigma$  for  $+R$  substituents<sup>83</sup>.

## B. Multiparameter Extensions<sup>75.76.84</sup>

There are two main types of treatment, both involving multiparameter extensions of the Hammett equation, which essentially express the 'sliding scale' idea.

In the Yukawa–Tsuno equation (1959)<sup>85</sup> (equation 3), the sliding scale is provided by multiple regression on  $\sigma$  and  $(\sigma^+ - \sigma)$  or  $(\sigma^- - \sigma)$ , depending on whether the reaction is more or is less electron-demanding than the ionization of benzoic acid. (There is a corresponding equation for equilibria.) The quantity  $r^\pm$  gives the contribution of the enhanced  $\pm R$  effect in a given reaction. (The equation was modified in 1966<sup>86</sup> to use  $\sigma^0$  instead of  $\sigma$  values, see below, but the essential principles are unaltered.)

$$\log k = \log k^0 + \rho[\sigma + r^\pm(\sigma^\pm - \sigma)] \quad (3)$$

In the form of treatment developed by Taft and his colleagues since 1956<sup>87–89</sup>, the Hammett constants are analyzed into inductive and resonance parameters, and the sliding scale is then provided by multiple regression on these. Equations 4 and 5 show the basic

relationships, the suffix BA signifying benzoic acid. The  $\sigma_I$  scale is based on alicyclic and aliphatic reactivities (see below), and the factor 0.33 in equation 4 is the value of a 'relay coefficient',  $\alpha$ , giving the indirect contribution of the resonance effect to  $\sigma_m$ . However, the ionization of benzoic acids is not regarded as an entirely satisfactory standard process, since it is subject to some slight effect of cross-conjugation (see structure **16** above). Consideration of 'insulated series', not subject to this effect, e.g. the ionization of phenylacetic acids, is used as the basis of a  $\sigma^0$  scale, which can be analyzed by equations 6 and 7<sup>90</sup>. (Note the different value of  $\alpha$ .) By a different procedure Wepster and colleagues<sup>83</sup> devised an analogous  $\sigma^n$  ( $n$  = normal, i.e. free from the effects of cross-conjugation). Analysis of  $\sigma^+$  and  $\sigma^-$  constants correspondingly involves  $\sigma_R^+$  and  $\sigma_R^-$ .

$$\sigma_m = \sigma_I + 0.33\sigma_R(\text{BA}) \quad (4)$$

$$\sigma_p = \sigma_I + \sigma_R(\text{BA}) \quad (5)$$

$$\sigma_m^0 = \sigma_I + 0.5\sigma_R^0 \quad (6)$$

$$\sigma_p^0 = \sigma_I + \sigma_R^0 \quad (7)$$

Multiple regression on  $\sigma_I$  and  $\sigma_R$ -type parameters employs the 'dual substituent-parameter' equation, which may be written as in equation 8<sup>91</sup>. (The combining of the  $k$  and  $k^0$  terms implies that there is no intercept term allowed, and  $k^0$  is now the actual value for the parent system, cf below.) For any given reaction series the equation is applied to *meta*- and *para*-substituents separately, and so values of  $\rho_I$  and  $\rho_R$  characteristic both of reaction and of substituent position are obtained. The various  $\sigma_R$ -type scales are linearly related to each other only approximately. In any given application the scale which gives the best correlation must be found<sup>92</sup>.

$$\log(k/k^0) = \rho_I\sigma_I + \rho_R\sigma_R \quad (8)$$

Values of  $\sigma^0$ ,  $\sigma_I$  and  $\sigma_R$ -type parameters for certain substituents are given in Table 2. It should be mentioned that Exner has developed a slightly different procedure for analysing sigma values<sup>93</sup> into inductive and resonance components<sup>76,77,94</sup>.

A slightly different procedure for carrying out multiple regression on  $\sigma_I$  and  $\sigma_R$ -type parameters employs the 'extended Hammett equation' of Charton<sup>95</sup>, which may be written as in equation 9. For the substituent X,  $Q$  is the absolute value of the property to be correlated ( $\log k$  or  $\log K$  in the case of reactivity), i.e. not expressed relative to X = H,  $h$  is introduced as the appropriate intercept term, and the regression coefficients are  $\alpha$  and  $\beta$ . (Charton has used various symbols at various times.)

$$Q = \alpha\sigma_{I,X} + \beta\sigma_{R,X} + h \quad (9)$$

TABLE 2. Selected values<sup>a</sup> of  $\sigma^0$ ,  $\sigma_I$  and  $\sigma_R$ -type constants

Substituent	$\sigma_m^0$	$\sigma_p^0$	$\sigma_I$	$\sigma_R(\text{BA})$	$\sigma_R^0$	$\sigma_R^+$	$\sigma_R^-$
Me	-0.07	-0.15	-0.05	-0.12	-0.10	-0.25	—
OMe	0.06	-0.16	0.26	-0.53	-0.41	-1.02	—
NO <sub>2</sub>	0.70	0.82	0.63	0.15	0.19	—	0.61
F	0.35	0.17	0.52	-0.46	-0.35	-0.57	—
Cl	0.37	0.27	0.47	-0.24	-0.20	-0.36	—

<sup>a</sup>See footnote to Table 1. The values for NO<sub>2</sub> will be discussed later in this chapter.

The correlation analysis of spectroscopic properties in terms of  $\sigma_I$  and  $\sigma_R$ -type parameters has been very important. Substituent effects on  $^{19}\text{F}$  NMR shielding in fluorobenzenes have been studied in great detail by Taft and colleagues<sup>90,96,97</sup>. For  $\delta_m^{\text{F}}$  linear regression on  $\sigma_I$  is on the whole satisfactory, but a term in  $\sigma_R^0$  with a small coefficient is sometimes introduced. The correlation analysis of  $\delta_p^{\text{F}}$ , however, requires terms in both  $\sigma_I$  and  $\sigma_R$ -type parameters, with  $\sigma_R^0$  being widely applicable. Many new values of these parameters have been assigned from fluorine chemical shifts. In recent years there has also been extensive use of correlation analysis of  $^{13}\text{C}$  NMR data<sup>98,99</sup>.

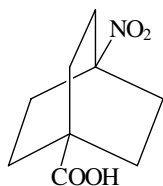
The correlation analysis of infrared data has been much examined by Katritzky, Topsom and colleagues<sup>100,101</sup>. Thus the intensities of the  $\nu_{16}$  ring-stretching bands of mono- and di-substituted benzenes may be correlated with the  $\sigma_R^0$  values of the substituents and these correlations may be used to find new  $\sigma_R^0$  values.

Finally, in this account of multiparameter extensions of the Hammett equation, we comment briefly on the origins of the  $\sigma_I$  scale. This had its beginnings around 1956<sup>89</sup> in the  $\sigma'$  scale of Roberts and Moreland<sup>102</sup> for substituents X in the reactions of 4-X-bicyclo[2.2.2]octane-1 derivatives. However, at that time few values of  $\sigma'$  were available. A more practical basis for a scale of inductive substituent constants lay in the  $\sigma^*$  values for  $\text{XCH}_2$  groups derived from Taft's analysis of the reactivities of aliphatic esters into polar, steric and resonance effects<sup>89,103-105</sup>. For the few  $\sigma'$  values available it was shown that  $\sigma'$  for X was related to  $\sigma^*$  for  $\text{XCH}_2$  by the equation  $\sigma' = 0.45\sigma^*$ . Thereafter the factor 0.45 was used to calculate  $\sigma_I$  values of X from  $\sigma^*$  values of  $\text{XCH}_2$ <sup>106</sup>. These matters will be referred to again later in this chapter, and other methods of determining  $\sigma_I$  values will also be mentioned. Taft's analysis of ester reactivities was also important because it led to the definition of the  $E_s$  scale of substituent steric parameters, thereby permitting the development of multiparameter extensions of the Hammett equation involving steric as well as electronic terms.

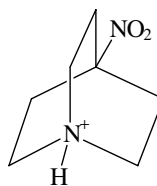
### III. ELECTRONIC EFFECTS OF THE NITRO GROUP ON THE STRENGTHS OF CARBOXYLIC AND OTHER ACIDS<sup>107</sup>

#### A. Alicyclic, Aliphatic and Related Systems

The simplest indicator of the electronic effect of a substituent X is its influence on the ionization constant of an organic acid into which it is substituted. For the least complicated behaviour, the group should not be conjugated with the molecular skeleton and should not be too close to the acidic centre. The change in acid strength produced by X is conveniently expressed as  $\Delta\text{p}K_a$ , defined as  $(\text{p}K_a)_\text{H} - (\text{p}K_a)_\text{X}$ , so that an increase in acid strength is associated with a positive value of  $\Delta\text{p}K_a$ . In Table 3 the  $\Delta\text{p}K_a$  value of 1.05 for 4-nitrobicyclo[2.2.2]octane-1-carboxylic acid (**17**) (in 50% w/w EtOH-H<sub>2</sub>O at 25 °C) and of 3.48 for the 4-nitroquinuclidinium ion (**18**) (in water at 25 °C) are clear indications



(17)



(18)

TABLE 3. The influence of the nitro group on the strengths of alicyclic and related acids<sup>107</sup>

Acid	Solvent	Temp. (°C)	pK <sub>a</sub> X = H	pK <sub>a</sub> X = NO <sub>2</sub>	ΔpK <sub>a</sub> <sup>a</sup>	σ <sub>I</sub> <sup>b</sup> (calc)
1. 4-X-Bicyclo[2.2.2]octane-1-carboxylic acid	50% w/w EtOH-H <sub>2</sub> O	25	6.87	5.82	1.05	0.673 <sup>c</sup>
2. 4-X-Quinuclidinium ion	H <sub>2</sub> O	25	11.12	7.64	3.48	0.642
3. 9-X-10-Triptoic acid	50% w/w EtOH-H <sub>2</sub> O	25	5.20	4.40	0.80	0.681
4. 9-X-10-Triptoic acid	80% w/w MCS-H <sub>2</sub> O	25	6.23	5.43	0.80	0.683
5. 3-X-Adamantane-1-carboxylic acid	50% v/v <sup>d</sup> EtOH-H <sub>2</sub> O	25	6.90	6.00	0.90	0.655

<sup>a</sup> ΔpK<sub>a</sub> = (pK<sub>a</sub>)<sub>H</sub> - (pK<sub>a</sub>)<sub>NO<sub>2</sub></sub>.

<sup>b</sup> From the appropriate regression equations in Charton's review<sup>109</sup>.

<sup>c</sup> By definition, see text.

<sup>d</sup> i.e. a solvent made up from equal volumes of ethanol and water. See further in Section III.C, Reference 126.

of the electronegative or electron-attracting nature of NO<sub>2</sub>. The influence of this reaches the acidic centre by induction through the bonds of the molecular skeleton or through the electric field of the substituent as moderated by the dielectric behaviour of the molecular cavity and the solvent. The respective roles of these two modes of transmission have long been a matter of controversy<sup>108</sup>. Both are 'inductive' in the most general meaning of the term in physics and we shall continue the traditional practice of describing them collectively as the 'inductive effect'.

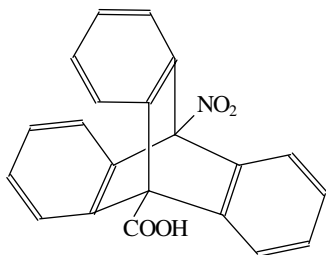
Data for the bicyclooctane system in 50% w/w EtOH-H<sub>2</sub>O are the basis for primary σ<sub>I</sub> values according to Charton<sup>109</sup>, calculated through equation 10<sup>110</sup>.

$$\sigma_I = \Delta pK_a / 1.56 \quad (10)$$

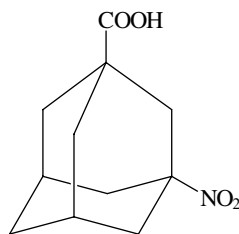
This procedure gave a value 0.673 for σ<sub>I</sub> of the nitro group, which was rounded to 0.67. The available values of σ<sub>I</sub> (including that for NO<sub>2</sub> as 0.67 and 'secondary' values for certain substituents<sup>109</sup>) were used by Charton to establish regression equations of the general form of equation 11:

$$pK_a = L\sigma_I + h \quad (11)$$

for systems 2 to 5 in Table 3<sup>111</sup>. The back-calculated values of σ<sub>I</sub> for NO<sub>2</sub> are shown in the last column of the Table. The range of values from about 0.64 to 0.68 indicates that the value of 0.67 is reasonably applicable throughout these rather varied systems (**18** to **20**). It should be noted, however, that the data points for NO<sub>2</sub> exert a strong influence on the regressions, since at σ<sub>I</sub> = 0.67, NO<sub>2</sub> is at one extreme of the scale for the substituents involved. For comparison we mention σ<sub>I</sub> values as follows: CF<sub>3</sub>, 0.40; Cl, 0.47; CN, 0.57.



(19)



(20)

In his work *ca* 1956 based on the analysis of substituent effects in aliphatic ester reactions, Taft<sup>87,89</sup> derived  $\sigma^* = 1.40$  for  $\text{CH}_2\text{NO}_2$ , which gave  $\sigma_I = 0.63$  by application of the equation  $\sigma_I = 0.45\sigma^*$  (see Section II.B). In 1964, however, Charton<sup>112</sup> derived the considerably higher value of 0.76 for  $\sigma_I$  of  $\text{NO}_2$ . This was based on a regression of the  $\text{p}K_a$  values of substituted acetic acids in water at 25 °C against the  $\sigma_I$  values of the substituents. There is a similar regression in his 1981 review<sup>109,113</sup>. If the  $\text{p}K_a$  value of nitroacetic acid is taken as 1.655 (the mean of two reasonably concordant values in the literature<sup>107c</sup>) and inserted into this regression<sup>113</sup>, a  $\sigma_I$  value of 0.77 for  $\text{NO}_2$  is obtained, close to Charton's earlier value<sup>112</sup>. In Charton's 1981 review<sup>109</sup> the  $\text{p}K_a$  values of substituted acetic acids are used as a secondary source of  $\sigma_I$  values, but this has to be done circumspectly, because of the possibility of additional effects arising from the mutual proximity of substituent and carboxyl groups. Such effects may notably be steric in nature or may involve internal hydrogen bonding. In the case of the nitro group it appears that the nett influence of such effects is slightly to increase the acidity of the carboxyl group. The  $\text{p}K_a$  value of  $\beta$ -nitropropanoic acid is 3.79 at 25 °C in water. If this value be inserted into the regression for substituted acetic acids, a  $\sigma_I$  value of 0.247 for  $\text{CH}_2\text{NO}_2$  is obtained. This shows the 'damping' effect of the  $\text{CH}_2$  group, for which a decremental factor of about 2.7 has been suggested<sup>89</sup>. On this basis the  $\sigma_I$  value of  $\text{NO}_2$  may be calculated from the above value for  $\text{CH}_2\text{NO}_2$  as  $0.247 \times 2.7 = 0.667$ , in good agreement with the value based on the bicyclooctane system, as discussed above.

## B. Aromatic Systems

Measurements of the dissociation constants of *m*-nitrobenzoic acid and *p*-nitrobenzoic acid began with Ostwald in 1889<sup>114</sup>. However, the first reasonably precise values were obtained by Dippy and coworkers in the nineteen-thirties, as part of an extensive study of the ionization of carboxylic acids by conductimetric methods<sup>115</sup>. The  $\text{p}K_a$  values in water at 25 °C of *m*-nitrobenzoic acid and *p*-nitrobenzoic acid were found to be 3.493 and 3.425, respectively, compared with 4.203 for benzoic acid itself. On the basis of these values Hammett<sup>28,116</sup> proposed  $\sigma$  values of 0.710 for *m*- $\text{NO}_2$  and 0.778 for *p*- $\text{NO}_2$  (see Section II.A). These  $\sigma$  values have commonly been used thereafter, often rounded to 0.71 and 0.78, respectively.

The marked acid-strengthening effect of *p*- $\text{NO}_2$  is usually attributed to the influence of the electron-attracting inductive effect (+*I*), augmented by a small electron-attracting mesomeric or resonance effect (+*R*). The smaller acid-strengthening effect of *m*- $\text{NO}_2$  is explained as the resultant of the inductive effect and a small 'relayed' influence of the resonance effect. If  $\sigma_p$  is regarded simply as a sum of  $\sigma_I$  and  $\sigma_R$  (Section II.B) and  $\sigma_I$  is taken as 0.67 (Section III.A), a value of  $0.78 - 0.67 = 0.11$  is indicated for  $\sigma_R$ . The relay factor of 0.33 for the resonance effect accounts reasonably well for the value of  $\sigma_m$  as  $\sigma_I + 0.33\sigma_R = 0.67 + 0.04 = 0.71$ ; cf 0.71 above.

During the past half-century the  $\text{p}K_a$  values of *m*- and *p*-nitrobenzoic acids have been redetermined by several research groups, employing various experimental methods, including conductimetric, electrometric and spectrophotometric methods. The results have recently been considered by a Working Party on the Compilation and Critical Evaluation of Structure-Reactivity Parameters under the auspices of the Commission on Physical Organic Chemistry of the International Union of Pure and Applied Chemistry<sup>79</sup>. The  $\sigma$  values derived from the individual redeterminations all agree fairly closely with those proposed by Hammett<sup>28,116</sup>. Detailed consideration leads to weighted mean values of 0.734 for *m*- $\text{NO}_2$  and 0.777 for *p*- $\text{NO}_2$ , to be rounded to 0.73 and 0.78, respectively, for most purposes in correlation analysis, i.e. the new value for *p*- $\text{NO}_2$  is effectively identical to the old value, but the new value for *m*- $\text{NO}_2$  is 0.02 units higher than the old. Such  $\sigma$

values for *m*- and *p*-NO<sub>2</sub> appear to be reasonably well applicable to reactions of benzoic acid and its derivatives in aqueous organic solvents. However, the application of the simple classical Hammett equation should always be approached with circumspection. The possibility of solvent effects on  $\sigma$  values should be borne in mind, and also the possible intervention of hydrophobic effects of substituents, which may mimic electronic effects. The importance of hydrophobic effects in influencing reactivity has only been realized in recent years. Such effects have been discussed in detail by Hoefnagel and Wepster<sup>117</sup> and have been expressed in terms of Hansch's hydrophobic substituent constant  $\pi$ <sup>118</sup>. The  $\pi$  value of NO<sub>2</sub> is modest at  $-0.28$ , cf CN,  $-0.57$ ; Cl,  $0.71$ ; CF<sub>3</sub>,  $0.88$ ; Bu<sup>t</sup>,  $1.98$ ; and under most circumstances substituent hydrophobic effects will be of minor significance in the case of NO<sub>2</sub>. (For a brief introduction to substituent hydrophobic effects on reactivity, see the account of OPh in a previous article in this series<sup>119</sup>.)

In recent years Pytela and coworkers<sup>120</sup> have obtained indications of a solvent effect on  $\sigma_m$  and/or  $\sigma_p$  for NO<sub>2</sub>. This research group determined the apparent  $pK_a$  values for a large number of substituted benzoic acids in one-component organic solvents<sup>121</sup>. Their results for *m*- and *p*-nitrobenzoic acids are most easily discussed in terms of the relative order of the  $pK_a$  values. In MeOH or EtOH the  $pK_a$  values are in the order *m*-NO<sub>2</sub> > *p*-NO<sub>2</sub>, as in water, but in DMF or sulpholane the order is *m*-NO<sub>2</sub> < *p*-NO<sub>2</sub>. These relationships suggest that there may be a reversal of the order of the  $\sigma$  values in aprotic solvents, which would probably be connected with the absence of hydrogen bonding of the solvent to the O of NO<sub>2</sub>. This could be seen as diminishing the +*R* effect. Unfortunately, however, the  $pK_a$  values determined in DMF or sulpholane are not very reproducible, and the mean errors quoted are of such a size as to cast doubt on the reality of the reversal of the  $pK_a$  values. Further, the reversal does not occur with acetonitrile or acetone as solvent, but again the mean errors quoted are rather large. It is interesting, however, that a tendency to reversal is also found for certain solvents when the substituent is CN or SO<sub>2</sub>Me.

The electron-attracting effect of a *p*-nitro group is somewhat reduced by the presence of bulky groups in the adjacent positions. This is shown most simply by the effect of inserting flanking 3- and 5-methyl groups into 4-nitrobenzoic acid. The  $\Delta pK_a$  values of 4-nitro-, 3-methyl- and 3,5-dimethyl-benzoic acids in 44.1% w/w EtOH-H<sub>2</sub>O, 25 °C, are respectively as follows: 1.25,  $-0.17$  and 0.80. If the effect of the groups in the 4-nitro-3,5-dimethyl acid is strictly additive, its  $\Delta pK_a$  value should be  $1.25 - 2 \times 0.17 = 0.91$ . The observed effect is 0.80 and this indicates that the acid-strengthening effect of 4-NO<sub>2</sub> is appreciably reduced by the flanking methyl groups. This is usually attributed to an inhibition of the resonance effect of the NO<sub>2</sub> group by the methyl groups twisting it out of the plane of the benzene ring, thus making the  $p\pi$  orbital overlap of NO<sub>2</sub> and ring less effective. However, the interpretation of the above results for NO<sub>2</sub> in terms of steric inhibition of resonance is not everywhere accepted<sup>122,123</sup>.

### C. Acids of the Type Ph-G-COOH

It was mentioned in Section II.B that the ionization of benzoic acids is not regarded as an entirely satisfactory standard process, since in the case of  $-R$  substituents, such as OMe, it is subject to some slight effect of cross-conjugation (see structure 16). Consideration of 'insulated series', not subject to this effect, e.g. the ionization of phenylacetic acids, is used as the basis of the  $\sigma^0$  scale. For the sake of uniformity  $\sigma^0$  values for +*R* substituents have also been based on such systems. Wepster and colleagues<sup>124,125</sup>, however, have criticized the use of systems in which the substituent is 'insulated' by methylene groups from the reaction centre for its tendency to lead to slightly exalted values of  $\sigma^0$  for +*R* substituents, i.e. the supposed insulation is not 100% effective. They see an analogy to the very pronounced exaltations that occur in the effects of +*R* substituents on the



TABLE 4. The influence of the nitro group on the strengths of acids of the type Ph-G-COOH in 50% v/v EtOH-H<sub>2</sub>O, 25 °C<sup>124-126</sup>

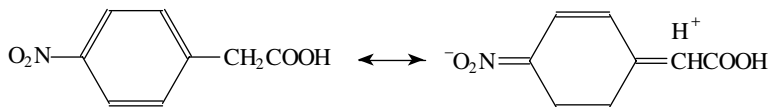
G	$\Delta pK_a^a$ <i>m</i> -NO <sub>2</sub>	$\Delta pK_a^a$ <i>p</i> -NO <sub>2</sub>	$\rho$	$\sigma_m$ (calc)	$\sigma_p$ (calc)
CH <sub>2</sub>	0.49	0.61	0.71	0.69	0.86
CH <sub>2</sub> CH <sub>2</sub>	0.24	0.31	0.36	0.67	0.86
CMe <sub>2</sub> CH <sub>2</sub>	0.27	0.36	0.38	0.71	0.95
NHCH <sub>2</sub>	0.24	0.50	0.38	0.63	1.32
NHCH <sub>2</sub> CH <sub>2</sub>	0.17	0.29	0.23	0.74	1.26
OCH <sub>2</sub>	0.38	0.51	0.52	0.73	0.98
SCH <sub>2</sub>	0.36	0.56	0.51	0.71	1.10

$$^a \Delta pK_a = (pK_a)_H - (pK_a)_{NO_2}$$

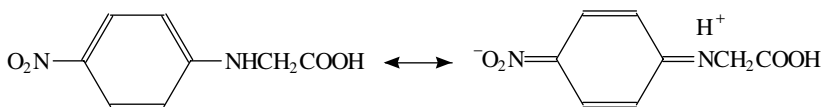
ionization of Ph-G-COOH with G = NHCH<sub>2</sub>, OCH<sub>2</sub> or SCH<sub>2</sub>. It is suggested that CH<sub>2</sub> is capable of a slight -R interaction with the benzene ring through its hyperconjugation and this can lead to cross-conjugation with a +R substituent. If this view be accepted, for +R substituents it is better simply to assume that  $\sigma$  values based on benzoic acid ionization are effectively values of  $\sigma^0$ , since COOH shows a +R effect and there can be no cross-conjugation. This has been done explicitly in a recent compilation by Exner<sup>77</sup>.

The above points will now be illustrated with respect to the nitro group. The most convenient data for this purpose are for ionization in 50% v/v EtOH-H<sub>2</sub>O<sup>124-126</sup>. (Data for other solvent compositions are also in the References<sup>124,125</sup>.)  $\Delta pK_a$  values for the effects of *m*- and *p*-NO<sub>2</sub> on the various acids Ph-G-COOH, along with the corresponding Hammett  $\rho$  values (Section II.A), are shown in Table 4. The values of  $\sigma_m$  (calc) and  $\sigma_p$  (calc) are obtained as  $\sigma(\text{calc}) = \Delta pK_a/\rho$ .

The data for most of the systems give values of  $\sigma_m(\text{calc})$  reasonably close to the value of  $\sigma_m$  for NO<sub>2</sub> on the benzoic acid-based scale, as discussed in Section III.B. In fact, excluding the *N*-phenylglycine system, which may be complicated by zwitter-ion formation, the mean value for  $\sigma_m(\text{calc})$  is 0.71. However, the values of  $\sigma_p(\text{calc})$  for the effects of NO<sub>2</sub> in the phenylacetic and 3-phenylpropanoic acid systems are appreciably greater than the benzoic acid-based value of 0.78 (Section III.B). This supports the views of Wepster and colleagues<sup>124,125</sup> that cross-conjugation between a +R substituent and methylene, as in structure **21**, may enhance the electron-attracting effect of the substituent. While it is possible that such enhancement might be due to a specific influence of solvent, no enhancement is apparent in the corresponding data for *p*-nitrobenzoic acid:  $\Delta pK_a = 1.19$ ,  $\rho = 1.50$ ; therefore  $\sigma_p(\text{calc}) = 0.79$ <sup>117</sup>. The behaviour of *p*-NO<sub>2</sub> in 3-methyl-3-phenylbutanoic acid indicates enhancement of the electronic effect, presumably through C-C hyperconjugation involving the methyl groups. The enhancement is even more marked in the acids involving NH, O or S as part of G, conjugation of the lone pair electrons of N, O or S doubtless being involved, e.g. structure **22**. The  $\sigma_p(\text{calc})$  values for NO<sub>2</sub> in cross-conjugation with NH, O or S appear to be comparable overall with the  $\sigma_p^-$  value of about 1.25 (Section III.D).



(21)



(22)

#### D. Phenol and Anilinium Ion

The ionization of phenol and anilinium ion are both processes which are greatly facilitated by +*R* *para*-substituents such as NO<sub>2</sub>, SO<sub>2</sub>Me, CN, etc. (Section II.A). The  $\rho$  values are most reliably determined by linear regression of  $-\text{p}K_{\text{a}}$  on  $\sigma$  for the *meta*-substituted substrates only, and the following equations 12 and 13 are typical<sup>127</sup>. ( $\text{p}K_{\text{a}}$  values are for solutions in water at 25 °C.)

Phenols

$$-\text{p}K_{\text{a}} = -9.936 + 2.205\sigma \quad (12)$$

(±0.078)

$$n = 9, r = 0.9957, s = 0.0579, \psi = 0.105$$

Anilinium ions

$$-\text{p}K_{\text{a}} = -4.567 + 2.847\sigma \quad (13)$$

(±0.079)

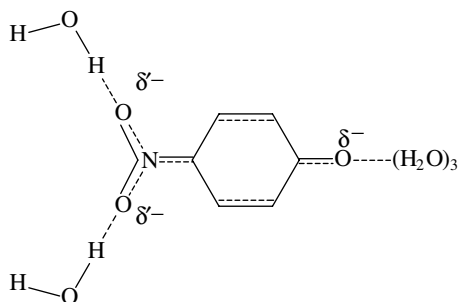
$$n = 11, r = 0.9965, s = 0.0603, \psi = 0.092$$

(In these regressions  $n$  = number of data points,  $r$  = correlation coefficient,  $s$  = standard deviation of estimate,  $\psi$  = Exner's statistic of goodness of fit<sup>128,129</sup>.) The insertion of observed  $\text{p}K_{\text{a}}$  values for the *meta*-nitro-substituted compounds (8.39 and 2.47, respectively) into the above expressions gives apparent values of  $\sigma_m$  for NO<sub>2</sub> as 0.70 and 0.74, respectively. These values are close to the benzoic acid-based value of  $\sigma_m$  for NO<sub>2</sub> (Section III.B). However, the corresponding insertion of  $\text{p}K_{\text{a}}$  values (7.15 and 1.00, respectively) for the *para*-nitro-substituted compounds gives apparent values of  $\sigma_p$  for NO<sub>2</sub> as 1.26 and 1.25, respectively. These values are considerably enhanced from the benzoic-acid-based value of 0.78. The explanation for this enhancement is in terms of cross-conjugation, as given in Section II.A.

Such enhanced sigma values for +*R* groups are commonly designated as  $\sigma^-$  values. In the case of NO<sub>2</sub>, Exner<sup>78</sup> tabulates two values of  $\sigma_p^-$  from phenol ionization (1.28 and 1.24) and two values from anilinium ionization (1.23 and 1.25). The good agreement between these several determinations suggests that 1.25 should be a fairly reliable value for  $\sigma^-$  of NO<sub>2</sub>. Such good agreement between the phenol- and anilinium-based values is rather unusual and an inspection of Exner's compilation<sup>78</sup> reveals a number of groups for which discrepancies of about 0.1 unit or more exist as between the two scales<sup>130</sup>. This provides a warning that the values based on the two systems should not be mixed in correlations. Ideally only one of these systems should be chosen as the basis for the  $\sigma^-$  scale. The other should be regarded as a system for treatment by the Yukawa-Tsuno equation<sup>85,86</sup> or other multiparameter extensions<sup>84</sup> of the Hammett equation (Section II.B).

Further light is shed on the behaviour of +*R* substituents in phenol by studies of gas-phase acidity. Fujio, McIver and Taft<sup>131</sup> measured the gas-phase acidities, relative to

phenol, of 38 *meta*- or *para*-substituted phenols by the ion cyclotron resonance (ICR) equilibrium constant method. The results were treated by linear free-energy relationships and comparisons were made with the behaviour in aqueous solution. The present author has summarized elsewhere the salient features of this work<sup>132</sup>. We will restrict the present discussion to +R substituents. For NO<sub>2</sub> the apparent value of  $\sigma_m$  in the gas phase is 0.72, which the authors regard as essentially the same as the value in aqueous solution. However,  $\sigma_p^-(g)$  is 1.04, compared with 1.23 quoted as the value of  $\sigma_p^-(aq)$ . For several other +R substituents, e.g. CN and SO<sub>2</sub>Me,  $\sigma_p^-(g)$  is also lower than  $\sigma_p^-(aq)$ . The most important inference from this situation is that<sup>131</sup> 'the previously generally held view that  $\sigma_p^-(aq)$  values represent the inherent internal  $\pi$ -electron-acceptor ability of +R substituents must be incorrect. Instead,  $\sigma_p^-(aq)$  values are shown to involve a complex composite of field/inductive, internally enhanced  $\pi$ -electron delocalization, and specific substituent HBA solvation assisted resonance effects'. Thus, while the enhancement of the electron-attracting effect of NO<sub>2</sub> by hydrogen bonding to water is practically nil in the *meta* position, it is substantial in the *para* position because of the delocalization of charge from -O<sup>-</sup> into the substituent in the anion. The situation may be represented schematically as in structure **23**.



(23)

The influence of flanking methyl groups which was noted above (Section III.B) for the benzoic acid system is more marked in phenol ionization. The  $\Delta pK_a$  values of 4-nitro- and 3,5-dimethyl-phenol (compared with phenol itself) are 2.78 and -0.19, respectively (water, 25 °C)<sup>133</sup>. Thus the  $\Delta pK_a(\text{calc})$  value for 4-nitro-3,5-dimethylphenol, assuming strict additivity, is 2.59, compared with  $\Delta pK_a(\text{obs}) = 1.75$ , indicating marked steric inhibition of resonance through twisting the NO<sub>2</sub> out of the plane of the ring by the methyl groups.

The effect of 4-NO<sub>2</sub> on the acidity of phenol is somewhat enhanced by the introduction of methyl groups in the 2,6 positions<sup>134</sup>. Thus,  $\Delta pK_a$  values for 4-nitro- and 2,6-dimethylphenol are 2.78 and -0.59, respectively<sup>133</sup>, giving  $\Delta pK_a(\text{calc})$  for 4-nitro-2,6-dimethylphenol as 2.19.  $\Delta pK_a(\text{obs})$  is in fact 2.77. This enhancement is no doubt due to steric inhibition of the solvation of the O<sup>-</sup> in the phenate ion, which increases sensitivity to the electronic effects of the substituents, i.e. the  $\rho$  value. This effect is even more marked in 2,6-di-*tert*-butylphenol, for which the  $\Delta pK_a$  value (relative to phenol) is -3.06 (1:1 v/v EtOH-H<sub>2</sub>O, 25 °C)<sup>134</sup>. In this system  $\Delta pK_a$  for the 4-NO<sub>2</sub> compound is 6.73, relative to 2,6-di-*tert*-butylphenol, corresponding to a  $\rho$  value of about 5, compared with 2.9 for the ionization of phenol itself in the same solvent.

## IV. THE *ORTHO*-EFFECT OF NO<sub>2</sub>

### A. Introduction

The term *ortho*-effect has long been used to cover the peculiar influence of a substituent in the position *ortho* to a reaction centre, which often differs markedly from that of the same substituent in the *meta*- or *para*-position<sup>104,135,136</sup>. Steric phenomena have long been recognized as playing a major part in the *ortho*-effect. Primary steric effects of various kinds, including steric hindrance to the approach of the reagent or to solvation, and secondary steric effects have been invoked. In certain systems hydrogen-bonding and other intramolecular interactions have been postulated.

One of the main difficulties in understanding the *ortho*-effect, however, lies in adequately specifying the electronic effects of *ortho*-substituents. The relative contributions of *I* and *R* effects to the influence of *ortho*-substituents are liable to be very different from those operating at the *meta*- or *para*-position. There have been many attempts to develop scales of 'sigma-*ortho*' constants analogous to  $\sigma$ ,  $\sigma^0$ ,  $\sigma^+$ ,  $\sigma^-$ , etc. (Section II) for the *meta*- and *para*-positions, but such scales are never found to be of very general application<sup>104,136</sup>. The composition of the electronic influence of *ortho*-substituents with respect to *I* and *R* effects seems greatly subject to variation with the nature of the reaction, the side-chain, the solvent, etc. The inductive effect of an *ortho*-substituent operates at much shorter range than that of a *meta*- or *para*-substituent, but the orientations of substituent dipoles with respect to the reaction centre are very different from those of *meta*- or *para*-substituents. It is sometimes supposed that the resonance effect of an *ortho*-substituent tends to be inherently weaker than that of the same substituent in the *para*-position, because *ortho*-quinonoid instead of *para*-quinonoid structures may be involved in its operation. However, the resonance effect also is being delivered at rather short-range from the *ortho*-position.

The most fruitful treatment of the electronic effects of *ortho*-substituents involves the use of the same  $\sigma_I$  and  $\sigma_R$ -type constants as may be employed in correlation analysis for *meta*- and *para*-substituents by means of the 'dual substituent-parameter equation'<sup>91</sup> or the 'extended Hammett equation'<sup>95</sup> (Section II.B). Obviously it is a considerable assumption that these are valid for *ortho*-substituents and the implication is that in the correlation analysis any peculiarities may be adequately expressed through the coefficients of the inductive and resonance terms. Really satisfactory correlation analysis for any given reaction system requires a large amount of data and can only rarely be accomplished.

In Section IV.B we will discuss the *ortho*-effect of NO<sub>2</sub> as manifested in the ionization of carboxylic and other acids and (in Section IV.C) in the reactions of substituted benzoic acids with diazodiphenylmethane (DDM). Only in the case of the latter system can really satisfactory correlation analysis be taken as the basis for discussion. For most of the other systems discussion will have to be qualitative or, at best, semi-quantitative.

### B. Ionization of Carboxylic and Other Acids

*Ortho*-substituted benzoic acids involving electron-attracting substituents tend to be considerably stronger than their *para* isomers. The pK<sub>a</sub> values (water, 25 °C) for some *p*-X, *o*-X pairs are respectively as follows: NO<sub>2</sub>, 3.44, 2.17; Cl, 3.98, 2.92; F, 4.14, 3.27; SO<sub>2</sub>Me, 3.53, 2.53<sup>137</sup>; COOMe, 3.75<sup>125</sup>, 3.32 (30 °C). Thus a decrease in pK<sub>a</sub> of about one unit is typical for the effect of moving such a substituent from a *para*- to *ortho*-position. Doubtless this is considerably due to the increased inductive effect from the *ortho*-position. However, some contribution may also be made by the substituent twisting the carboxyl group out of the plane of the benzene ring, thereby reducing the extent of conjugation of the ring with the side-chain. This has the result of destabilizing

the undissociated form of the acid relative to the carboxylate ion, thereby enhancing acid strength. The deconjugation effect is shown most clearly in *o*-*t*-butylbenzoic acid, whose  $pK_a$  value is 3.54: cf the acid-weakening effect of the group in the *para*-position,  $pK_a = 4.40$ . The deconjugation effect must play some part in the case of the more bulky polar groups, for example  $SO_2Me$ , but not much in the case of F. In the case of  $NO_2$  much will depend on whether the group is essentially co-planar with the ring or twisted at right angles to the ring (see below). (According to a recent paper by Exner and coworkers, the importance of the deconjugation of the carboxyl group by twisting has sometimes been exaggerated<sup>138</sup>.) Another factor in the case of some substituents is hydrogen-bonding. Thus the very large increase in acidity as between *p*-hydroxy- and *o*-hydroxy-benzoic acid.  $pK_a$  values 4.58 and 3.03 respectively, is attributed to the stabilization of the anion of salicylic acid by internal hydrogen-bonding<sup>139</sup>.

Some further light on the behaviour of the nitro group as an *ortho*-substituent in affecting the strength of benzoic acid can be obtained by correlation analysis employing the extended Hammett equation (Section II.B) in the form of equation 14:

$$-pK_a = \alpha\sigma_I + \beta\sigma_R + \phi\nu + h \quad (14)$$

where  $\sigma_I$  and  $\sigma_R$  are, respectively, the inductive and resonance constants of Taft's analysis of ordinary Hammett  $\sigma$  constants (see Section II.B) and  $\nu$  is the steric substituent constant developed by Charton<sup>140-142</sup>. There are plenty of data for the ionization of *ortho*-substituted benzoic acids in water at 25 °C, but unfortunately correlation analysis proves not to be altogether straightforward. The establishment of the regression equation cannot be done unambiguously through the use of 'well-behaved' substituents (cf Section IV.C), and in the various equations that may be derived by taking various selections of substituents, the regression coefficients and the intercept term vary quite a lot. It would not be appropriate in this chapter to go into great detail. Suffice it to say that a fairly satisfactory equation may be based on 16 substituents: H, Me, Et,  $Pr^i$ ,  $Bu^t$ , F, Cl, Br, I, OMe, OPh, SMe,  $NH_2$ , SH,  $NO_2$ , Ph. Charton's values of  $\sigma_I$  and  $\sigma_R$  have been used (these were derived originally in connection with the correlation analyses outlined in Section IV.C) and  $NO_2$  and Ph are assumed to lie orthogonal to the benzene ring (see below). Regression equation 15 was obtained:

$$-pK_a = 2.478\sigma_I + 1.803\sigma_R + 0.763\nu - 4.093 \quad (15)$$

(±0.132)      (±0.130)      (±0.109)

$$n = 16, R = 0.988, s = 0.111, \psi = 0.178$$

( $R$  = multiple correlation coefficient; the other symbols have the same meanings as in connection with equations 12 and 13 in Section III.D.)

A rather striking feature of this equation is that the intercept 4.093 does not correspond closely to the observed  $pK_a$  value of 4.205 for benzoic acid itself, i.e. this acid is not acting as the true parent of the series of *ortho*-substituted benzoic acids. Examination of the data and the results of the correlation analysis suggests that all the *ortho*-substituted acids receive an initial increment in acidity caused in some way by the replacement of *o*-H by any other substituent. The regression was therefore repeated without the benzoic acid point and equation 16 was the result:

$$-pK_a = 2.360\sigma_I + 1.910\sigma_R + 0.588\nu - 3.920 \quad (16)$$

(±0.140)      (±0.135)      (±0.142)

$$n = 15, R = 0.990, s = 0.103, \psi = 0.166$$

From this equation it appears that the effective parent acid is at a  $pK_a$  value of 3.92. The regression coefficients of both the inductive effect and resonance effect terms indicate

a considerable increase in the transmission of these effects as compared with the *para*-position (in the corresponding regression the coefficients would be about unity), with a marginal increase in the importance of the inductive effect compared with the resonance effect. The  $\nu$  term indicates a significant contribution from the steric effect of the substituent deconjugating the carboxyl group by twisting. For the nitro group in an orthogonal conformation with respect to the benzene ring the substituent constants have the values  $\sigma_I = 0.67$ ,  $\sigma_R = 0.00$  and  $\nu = 0.35$ . The insertion of these values into equation 16 gives a  $\text{p}K_a(\text{calc})$  value of 2.133, in very good agreement with the observed value 2.173. If the nitro group is coplanar with the benzene ring, the values of the substituent constants are  $\sigma_I = 0.67$ ,  $\sigma_R = 0.10$  and  $\nu = 1.39$ . It is not possible to obtain an acceptable regression equation incorporating these values for the nitro group. Thus it appears that in an aqueous solution of *o*-nitrobenzoic acid the nitro group is essentially orthogonal to the benzene ring.

Before we leave the *ortho*-effect of  $\text{NO}_2$  as manifested in the ionization of *o*-nitrobenzoic acid, we will examine briefly the cumulative effect of two nitro groups on the ionization of benzoic acid. The necessary data are in Table 5. The effect of the two groups in the 3,5- and 2,4-dinitrobenzoic acids is almost strictly additive. The 3,4 acid shows a slight departure from additivity, probably due to mutual twisting of the nitro groups diminishing the resonance effect, particularly of the *p*- $\text{NO}_2$ . In 2,5-dinitrobenzoic acid there is a greater departure from strict additivity, probably the 'saturation' effect of having two strongly electron-attracting groups in the *para* disposition to each other. The most marked departure from additivity is shown by the 2,6 acid, which is considerably weaker than required by a strictly additive effect. The most likely explanation lies in steric inhibition of solvation of the carboxylate ion. The smaller departure from additivity shown by 2,3-dinitrobenzoic acid may be an indication of some steric inhibition of solvation, produced by the 3-nitro group increasing the steric interaction of the 2-nitro group with the carboxylate group—the 'buttressing' effect.

There are data for the effect of *o*- $\text{NO}_2$  in several acids of the general type  $\text{Ph-G-COOH}$ . The  $\text{p}K_a$  values (water, 25°C) of the parent acids and *p*- $\text{NO}_2$ , *o*- $\text{NO}_2$  pairs for various G are, respectively, as follows:  $\text{CH}_2$ , 4.31, 3.85, 4.00;  $\text{CH}_2\text{CH}_2$ , 4.66, 4.47, 4.50;  $\text{OCH}_2$ , 3.17, 2.89, 2.90;  $\text{SCH}_2$ , 3.38, 3.09, 3.10. (The data for the acids with  $\text{G} = \text{SCH}_2$  are at 20°C and are 'mixed' constants at an ionic strength of 0.10.) Thus the rather small effects of  $\text{NO}_2$  on the acidities of these acids differ little as between the *para*- and the *ortho*-position. This is typical of the effects of polar substituents in these systems, in which no steric inhibition by the *ortho*-substituent of conjugation involving the carboxyl group can occur. Presumably any increase in the transmission of the inductive effect of the substituent in moving from the *para*- to the *ortho*-position is more or less cancelled out by changes in the orientation of substituent dipoles relative to the reaction centre and possibly steric inhibition of the resonance effect of the nitro group.

TABLE 5. Cumulative effect of two nitro groups on the strength of benzoic acid in water at 25°C<sup>107</sup>

Isomer( $\text{NO}_2$ ) <sub>2</sub>	$\text{p}K_a$	$\Delta\text{p}K_a$ (obs) <sup>a</sup>	$\Delta\text{p}K_a$ (calc) <sup>a</sup>
2,3	1.85	2.35	2.74
2,4	1.42	2.78	2.81
2,5	1.62	2.58	2.74
2,6	1.14	3.06	4.06
3,4	2.82	1.38	1.49
3,5	2.82	1.38	1.42

<sup>a</sup> $\text{p}K_a$  benzoic acid, 4.20;  $\Delta\text{p}K_a$  values: *o*- $\text{NO}_2$ , 2.03; *m*- $\text{NO}_2$ , 0.71; *p*- $\text{NO}_2$ , 0.78.

In phenol ionization,  $pK_a$  values (water, 25 °C) for some *p*-X, *o*-X pairs are as follows: F, 9.91, 8.71; Cl, 9.42, 8.53; Br, 9.36, 8.44; CN, 7.95, 6.90; NO<sub>2</sub>, 7.15, 7.23; compared with 10.00 for phenol itself. (Various different values may be found in the literature<sup>107c</sup> for some of these substituted phenols. As far as possible the individual values quoted for each pair have been determined by the same authors.) The patterns for Hal and CN are similar, but that for NO<sub>2</sub> is different, the isomeric phenols differing little in acidity. The increase in acidity when an electron-attracting group is moved from the *para*- to *ortho*-position in phenol is doubtless due to an increased transmission of the inductive effect to the reaction centre, which more than outweighs any unfavourable effect of change in orientation. The anomalously low acidity of *o*-nitrophenol is usually attributed to stabilization of the undissociated form by hydrogen-bonding between OH and ONO.

For the ionization of the anilinium ion,  $pK_a$  values (water, 25 °C) for some *p*-X, *o*-X pairs are as follows: F, 4.65, 3.20; Cl, 4.05, 2.71; Br, 3.95, 2.55; CN, 1.75, 0.95; NO<sub>2</sub>, 1.13, -0.05; compared with 4.60 for the anilinium ion itself. Thus in every case a marked increase in acidity occurs when the substituent is moved from the *para*- to the *ortho*-position, although the changes for CN and for NO<sub>2</sub> are somewhat smaller than for the Hal. It might have been expected that at least with *o*-NO<sub>2</sub> hydrogen-bonding would play a part in stabilizing the protonated form relative to the neutral form, but there is no clear indication of this. Such an effect is apparent for the *N,N*-dimethylaniline system: *p*-NO<sub>2</sub>, 0.61; *o*-NO<sub>2</sub>, 2.92, compared with 5.15 for the *N,N*-dimethylanilinium ion itself. Here no internal hydrogen-bonding is possible in the unprotonated form and the stabilization of the protonated form by hydrogen-bonding between NH<sup>+</sup> and ONO leads to a very marked decrease in acidity.

### C. The Reactions of *ortho*-Substituted Benzoic Acids with Diazodiphenylmethane (DDM)

The point has already been made (Section IV.A) that discussion of the *ortho*-effect is frequently hampered by a lack of data for the wide range of *ortho*-substituted compounds necessary for satisfactory correlation analysis by means of the appropriate form of extended Hammett equation<sup>95</sup>. This situation was remedied some years ago by the present author and his colleagues<sup>143,144</sup> for the reactions of *ortho*-substituted benzoic acids with DDM. Rate coefficients (1 mol<sup>-1</sup> min<sup>-1</sup>) at 30 °C were measured for the reactions of benzoic and 32 *ortho*-substituted benzoic acids in 11 alcohols (including 2-methoxyethanol) as solvents<sup>143</sup>. The reaction involves a rate-determining proton transfer from the carboxylic acid to the DDM to form a diphenylmethanediazonium carboxylate ion-pair. Subsequent fast product-governing stages have been variously formulated<sup>143</sup>. A more restricted study was carried out for reaction at 30 °C of the substituted benzoic acids in 7 aprotic solvents<sup>144</sup>, in which the proton transfer is believed to be rate-limiting rather than rate-determining.

The correlation analysis employed the extended Hammett equation in the form of equation 17:

$$\log k = \alpha\sigma_I + \beta\sigma_R + \varphi\nu + h \quad (17)$$

(The symbols were defined in Section IV.B.) A full discussion of the *ortho*-effect as revealed in this work would be inappropriate here. We must restrict ourselves to the more limited task of indicating the role of *o*-NO<sub>2</sub>. We discuss first the work involving alcohols as solvents. To apply the extended Hammett equation, i.e. to determine the regression coefficients  $\alpha$ ,  $\beta$  and  $\varphi$  and the intercept term  $h$ , it is first necessary to select a set of substituents which can be expected to be 'well-behaved'. Particular problems for  $\sigma_R$  and  $\nu$  may be caused by conformational effects, and internal hydrogen-bonding may occur

as a further factor governing reactivity, for which parametrization is not included in equation 17.

Nine substituents (Set A: H, Me, Bu<sup>t</sup>, F, Cl, Br, I, CF<sub>3</sub> and CN) were selected as a basic set for the following qualities<sup>143</sup>: (i) symmetry and simplicity, (ii) freedom from conformational effects, (iii) lack of a large resonance effect, (iv) lack of any marked tendency to form hydrogen-bonds with the reaction centre. It proved possible to expand the list from 9 to 18 by making reasonable assumptions about the conformations of certain substituents, thus enabling them to be placed on the  $\sigma_R$  and  $\nu$  scales [Set B: Set A + Et, Pr<sup>i</sup>, OMe, OEt, OPh, SMe, SO<sub>2</sub>Me, CH<sub>2</sub>Ph, (CH<sub>2</sub>)<sub>2</sub>Ph]. Correlations based on Set B turned out to be superior to those based on Set A.

The regression equations were established for data in 11 alcohols as solvents and were used to assess the peculiar behaviour of another 15 *ortho*-substituents in respect of conformational effect and intramolecular hydrogen-bonding<sup>143,145</sup>. Here we are concerned with assessing the situation for *o*-NO<sub>2</sub>. We first give as an example the regression for 2-methoxyethanol as solvent:

$$\log k = 1.624\sigma_I + 0.964\sigma_R + 0.346\nu - 0.305 \quad (18)$$

$$(\pm 0.074) \quad (\pm 0.082) \quad (\pm 0.060)$$

$$n = 18, R = 0.990, s = 0.070$$

The regression coefficients are positive for the  $\sigma_I$  and  $\sigma_R$  terms because electron-attracting groups accelerate the reaction and electron-releasing groups retard it. The positive regression coefficient for the  $\nu$  term corresponds to the reaction being subject to steric acceleration by *ortho*-substituents through deconjugation of COOH with the benzene ring; cf Section IV.B.

For the nitro group there are two sets of substituent parameters:  $\sigma_I = 0.67$ ,  $\sigma_R = 0.10$  and  $\nu = 1.39$  for the group when coplanar with the benzene ring, and  $\sigma_I = 0.67$ ,  $\sigma_R = 0.0$  and  $\nu = 0.35$  for the group when orthogonal to the benzene ring. Thus the inductive effect is considered to be unaffected by twisting the nitro group, the resonance effect is eliminated by twisting to the orthogonal conformation and the steric effect is much greater for the coplanar conformation than for the orthogonal. We may now substitute these parameters in equation 18 and analogous equations for the reactions in the other solvents to obtain values of  $\log k(\text{calc, coplanar})$  and  $\log k(\text{calc, orthogonal})$ , which may be compared with  $\log k(\text{obs})$ . For equation 18,  $\log k(\text{calc, coplanar}) = 1.360$  and  $\log k(\text{calc, orthogonal}) = 0.904$ .  $\log k(\text{obs}) = 0.994$ , i.e. between the values calculated for the two conformations and somewhat closer to the value for the orthogonal conformation. Without quoting the regression equations<sup>143,146</sup>, we give the results of similar calculations for the reactions in various alcohols [solvent,  $\log k(\text{calc, coplanar})$ ,  $\log k(\text{calc, orthogonal})$ ,  $\log k(\text{obs})$ ]: methanol, 1.887, 1.321, 1.578; ethanol, 1.570, 1.006, 1.230; 2-methylbutan-2-ol, 1.056, 0.499, 0.734; benzyl alcohol, 2.410, 1.935, 2.170. In every case the observed value lies between the two extremes, indicating that an intermediate conformation of the nitro group is preferred. Thus both COOH and NO<sub>2</sub> groups are somewhat twisted out of the plane of the benzene ring, as has been found for the configuration of this acid in the solid state<sup>147</sup>. The correlation analyses for the reactions in aprotic solvents also indicate an intermediate conformation for the nitro group<sup>144,146</sup>. All these results contrast with indications of an essentially orthogonal nitro group for the ionization of *o*-nitrobenzoic acid in aqueous solution (Section IV.B).

It may be mentioned in passing that Chapman and coworkers<sup>148</sup> determined rate coefficients for the reactions at 30 °C of phenylacetic acid and various *meta*- or *para*-substituted phenylacetic acids with DDM in 10 alcohols as solvents. The nitro acids were included. There were some interesting indications of solvent dependence for the apparent  $\sigma$  values of *para*-substituents, including NO<sub>2</sub>, for which values ranging from 0.69 to 0.77 were



obtained. In further work the reactions of *ortho*-substituted phenylacetic acids with DDM were studied<sup>149</sup>, although not so great a variety of substituents was used as in the later work with benzoic acids<sup>143,144</sup>. The results for the *o*-alkyl groups formed the basis of a separation of polar and steric effects for *o*-hal and *o*-NO<sub>2</sub>. The essence of the treatment lay in considering the differential action of the solvent on the positive and the negative poles of the substituents in the various positions of the ring. The treatment was claimed to be reasonably successful in accounting for the substituent effects in alcohols of a wide range of polarity. However, the form of treatment has never been pursued further by the authors or apparently by anyone else.

## V. SUBSTITUENT CONSTANTS OF THE NITRO GROUP FROM THE APPLICATION OF MODERN EXPERIMENTAL AND THEORETICAL TECHNIQUES

### A. Experimental Techniques

The emphasis in the foregoing parts of this chapter has been deliberately 'chemical'. We have tried to explore the role of substituent constants in relation to understanding the effect of structure on reaction rates and equilibria, with particular reference to the NO<sub>2</sub> group as a substituent. This chemical emphasis will continue in the later parts of the chapter, for NO<sub>2</sub> and for the other substituents with which we are concerned, but in the present section there will be a change. In Section II.B brief reference was made to the use of substituent constants in the correlation analysis of spectroscopic data, particularly <sup>19</sup>F and <sup>13</sup>C substituent chemical shifts and infrared frequencies and intensities. These matters must now be explored in greater detail.

Attempts were made to apply Hammett benzoic acid-based  $\sigma_m$  and  $\sigma_p$  constants to the correlation analysis of spectroscopic data. Some significant correlations were obtained, but many of the correlations were rather poor, trends rather than precise relationships. Success in this area was found to involve the separation of inductive and resonance effects and the application of the dual substituent-parameter (DSP) equation (Section II.B). Indeed the development of the DSP equation became closely connected with the correlation analysis of <sup>19</sup>F NMR shielding of substituted fluorobenzenes at an early stage, around 1957<sup>106</sup>.  $\sigma_I$  and  $\sigma_R^0$  were applied extensively to <sup>19</sup>F NMR data<sup>90</sup>, and within a few years the correlations were being used to investigate 'the effect of solvent on the inductive order'<sup>96</sup>, and 'the effect of structure and solvent on resonance effects'<sup>97</sup>. New  $\sigma_I$  and  $\sigma_R^0$  values were based on the correlations. What happened with <sup>19</sup>F NMR set a pattern which was followed by later work. Established  $\sigma_I$  and  $\sigma_R^0$  values for substituents which were expected to be 'well-behaved' were used to set up regression equations. In the very early days the established substituent constants were all based on chemical reactivity (rate constants or equilibrium constants). <sup>19</sup>F NMR data for groups for which no appropriate substituent constants were available were then substituted into the regression equations to obtain '<sup>19</sup>F NMR-based values' of the substituent constants. Further, for the substituents which had been used to establish the regression equations, back-calculation from the NMR data led to '<sup>19</sup>F NMR-based values' for those substituents as well. Thus for many substituents both 'reactivity-based' and '<sup>19</sup>F NMR-based' values of  $\sigma_I$  and  $\sigma_R^0$  became available. For certain substituents there was a proliferation of values based on reactivity under various conditions or on <sup>19</sup>F NMR in different solvents. Slightly later, correlation analysis of infrared data led in particular to new  $\sigma_R^0$  values and, to a lesser extent, new  $\sigma_I$  values, which were described as 'IR-based'<sup>100,101</sup>. Somewhat later the same development occurred in connection with <sup>13</sup>C NMR, leading to '<sup>13</sup>C NMR-based' values<sup>98,99</sup>.

The  $\text{NO}_2$  group played a part in these developments. Thus  $\text{NO}_2$  was characterized by Taft<sup>87,89</sup> with a  $\sigma_I$  value of 0.63, based on the appropriate  $\sigma^*$  value in his analysis of reactivities in ester reactions. The application of  $^{19}\text{F}$  NMR found a  $\sigma_I$  value for  $\text{NO}_2$  of 0.56 in 'normal solvents', 0.49 in dioxane, 0.60 in 'weakly protonic solvents' and 0.80 in trifluoroacetic acid<sup>96</sup>. The last-mentioned high value was attributed to the effect of hydrogen-bonding of  $\text{NO}_2$  to  $\text{CF}_3\text{COOH}$ , but with this exception all the  $^{19}\text{F}$  NMR-based values lie considerably below the reactivity value of 0.63, which agrees moderately well with Charton's reactivity value of 0.67 (Section III.A)<sup>109</sup>. 'Normal solvents' included cyclohexane, benzene, carbon tetrachloride and other more polar solvents, while the principal 'weakly protonic solvents' were methanol and formic acid. The above figures appear to give some indication of slight enhancement of the  $+I$  of  $\text{NO}_2$  by hydrogen-bonding to 'weakly protonic solvents'. The very low value for  $\sigma_I$  in dioxane finds a parallel in the behaviour of  $\sigma_I$  for other electron-attracting groups (e.g. CN and COMe) and was attributed to Lewis acid-bonding of dioxane to the substituent<sup>98</sup>. A recent compilation of substituent constants gives a  $^{19}\text{F}$  NMR-based value for  $\text{NO}_2$  of 0.64 from a chemical shift determined in dilute solution in hydrocarbon solvent<sup>150</sup>; cf 0.56 above. The increase of 0.08 may be due to using a slightly different regression equation. (The application of this equation to the chemical shift data for 'weakly protonic solvents' would give a  $\sigma_I$  value of 0.65, in good agreement with the reactivity-based values above.) The  $\sigma_I$  value recommended in 1973 for  $\text{NO}_2$  by Ehrenson, Brownlee and Taft<sup>92</sup> was 0.65, while a recent tabulation<sup>151</sup> gives the equivalent  $\sigma_F$  value (see below) also as 0.65.

A  $\sigma_R^0$  value of 0.15 was given by Ehrenson, Brownlee and Taft<sup>92</sup>. Simple subtraction of the recommended  $\sigma_I$  value of 0.65 from the  $\sigma_p^0$  value of 0.82 given by Taft<sup>152</sup> would have yielded 0.17. A slightly lower value of  $\sigma_p^0$  was favoured by Yukawa, Tsuno and Sawada<sup>153</sup>, 0.80 to 0.81. We may take 0.15 as a fair estimate of  $\sigma_R^0$  based on the reactivity data available in the early 1970s. It is slightly higher than any value based on the assumption that for  $\text{NO}_2$  there is no valid distinction between  $\sigma_p$  and  $\sigma_p^0$  (see Section III.C), e.g. Charton's value 0.10 for  $\sigma_R$ , which was calculated by subtracting  $\sigma_I = 0.67$  from  $\sigma_p = 0.77$ <sup>109</sup>,  $^{19}\text{F}$  NMR studies shed no direct light on  $\sigma_R^0$  for  $\text{NO}_2$ , because cross-conjugation between F and  $\text{NO}_2$  in *p*-fluoronitrobenzene leads to enhancement of the  $+R$  effect of  $\text{NO}_2$  (Section II.A). It is only for  $-R$  substituents that  $^{19}\text{F}$  NMR studies yield  $\sigma_R^0$  values. The application of the  $^{19}\text{F}$  NMR method to  $+R$  substituents yields 'apparent' values, which may be designated  $\bar{\sigma}_R^0$ . For  $\text{NO}_2$  the value of  $\bar{\sigma}_R$  is about 0.2 from measurements in a wide range of supposedly indifferent solvents<sup>97</sup>. As in the case of  $\sigma_I$ ,  $\bar{\sigma}_R$  is increased by certain solvents. Thus in trifluoroacetic acid  $\bar{\sigma}_R \approx 0.30$ . Presumably hydrogen-bonding enhances both  $+I$  and  $+R$  effects. Measurements of infrared intensities do, however, give information about  $\sigma_R^0$  constants for  $+R$  substituents. Katritzky and colleagues<sup>154</sup> give a  $\sigma_R^0$  value of 0.174 for  $\text{NO}_2$  based on measurements with a solution of nitrobenzene in carbon tetrachloride. (Note: the sign of  $\sigma_R^0$  is not actually given by the correlation of infrared intensities, because the square of  $\sigma_R^0$  is involved. The sign can usually be inferred from other knowledge about the substituent.) The infrared value is thus somewhat higher than Charton's reactivity-based value of 0.10<sup>109</sup>.

There is a continual tendency for the values of  $\sigma_I$  and  $\sigma_R^0$  (and other  $\sigma_R$ -type constants) to be adjusted in the light of new measurements. Thus measurements in 1979<sup>155</sup> of *para*- $^{13}\text{C}$  substituent chemical shifts for a series of mono-substituted benzenes in very dilute solution in cyclohexane, carbon tetrachloride or deuteriochloroform were the basis for a redefinition of the  $\sigma_R^0$  scale and some amendment of  $\sigma_R^0$  values. However, the value for the nitro group was confirmed as 0.15.

Reynolds and coworkers<sup>156</sup> based a similar operation on <sup>13</sup>C substituent chemical shifts of *meta*- and *para*-substituted styrenes. Iterative multiple regression was used for the redefinition of the  $\sigma_I$  and  $\sigma_R^0$  scales. The authors also took the opportunity to replace the symbol  $\sigma_I$  by  $\sigma_F$ , having become convinced that the so-called inductive effect was entirely a field effect (see the present author's discussion of this matter<sup>76</sup>). The authors presented an extensive table in which their values of the substituent parameters are compared with those obtained by other authors. Their  $\sigma_R^0$  value of 0.144 for NO<sub>2</sub> essentially confirmed the various values of about 0.15 already mentioned and their  $\sigma_I$  value of 0.651 essentially confirmed the various values of about 0.65.

Happer<sup>157</sup> determined <sup>13</sup>C substituent chemical shifts for *meta*- and *para*-substituted styrenes in seven different solvents. Data for the side-chain carbons, and in the *meta* series for the ring carbon *para* to the substituent, were analyzed as a basis for assessing solvent effects on  $\sigma_I$ ,  $\sigma_R^0$ ,  $\sigma_R$  (BA) and  $\sigma_R^-$ . The  $\sigma_I$  values for NO<sub>2</sub> varied from 0.60 in DMSO to 0.71 in CDCl<sub>3</sub>; in EtOH the value was 0.64. The  $\sigma_R^0$  values for NO<sub>2</sub> varied from 0.08 in CCl<sub>4</sub> to 0.10 in benzene and in EtOH. Some doubts were, however, expressed regarding the reliability of the  $\sigma_R^0$  values for CN, NO<sub>2</sub> and CF<sub>3</sub>.

The influence of solvent on the inductive order of substituents was studied by Laurence and collaborators through infrared measurements on 4-substituted camphors<sup>158</sup>. From these Laurence<sup>159</sup> has tabulated new  $\sigma_F$  values applicable to solutions in carbon tetrachloride or other solvents of low dielectric constant, NO<sub>2</sub> came out at 0.68.

Mention must also be made of the use of studies of chemical reactions in the gas phase as a means of determining substituent constants. The investigation of substituent effects and linear free-energy relationships in the gas phase has become an enormous subject with which we can deal only briefly. Part of this subject was established a long time ago and consists in the study of such reactions as the pyrolysis of esters by the techniques of gas kinetics (see the review by Smith and Kelly<sup>160</sup>). One purpose of such work is to see how far substituent constants based on processes in solution may be applied successfully in the gas phase. This leads to the possibility of determining substituent constants in the complete absence of solvent. Work of this nature continues today; see the recent review by Holbrook in this Series<sup>161</sup>, which updates the earlier review by Taylor<sup>162</sup>. However, the use of NO<sub>2</sub> as a substituent in such gas-phase studies is fairly rare, presumably because the group often tends to get involved chemically in the reactions. CN is to be preferred as a strongly electron-attracting substituent.

The major activity in gas-phase studies now depends on the use of modern techniques such as ion cyclotron resonance (ICR). Thus, as already mentioned (Section III.D), Fujio, McIver and Taft<sup>131</sup> measured the gas-phase acidities, relative to phenol, of 38 *meta*- or *para*-substituted phenols by the ICR equilibrium constant method, and their results for +R substituents led them to suggest that such substituents in aqueous solution exerted solvation-assisted resonance effects. It was later<sup>163</sup> shown by comparison of gas-phase acidities of phenols with acidities of phenols in solution in DMSO that solvation-assisted resonance effects could also occur even when the solvent did not have hydrogen-bond donor properties. Indeed for *p*-NO<sub>2</sub> and certain other substituents these effects appeared to be larger than in aqueous solution.

Taft and Topsom<sup>151</sup> have fairly recently written an extensive review of the electronic effects of substituents in the gas phase. This article includes a tabulation of substituent inductive and resonance parameters. The inductive parameters (designated  $\sigma_F$ ) are based on measured spectroscopic properties in either the gas phase or in hydrocarbon or similar solvents. The resonance parameters were arrived at through the treatment of 38 gas-phase reactivity series by iterative multiple regression, using the  $\sigma_R^0$  values of Bromilow and coworkers<sup>155</sup> as the starting point. The  $\sigma_F$  value for NO<sub>2</sub> was found to be 0.65 (quoted

above), while the resonance parameter is given as 0.18. The column heading in Taft and Topsom's table is simply  $\sigma_R$ , but inspection shows that the values must be regarded as being those of  $\sigma_R^0$ , when the distinction matters, i.e. with  $-R$  substituents. The value of 0.18 for the resonance parameter of  $\text{NO}_2$  is slightly higher than any value previously suggested.

## B. Theoretical Techniques

The application of *ab initio* molecular orbital theory to suitable model systems has led to theoretical scales of substituent parameters, which may be compared with the experimental scales. Calculations (3-21G or 4-31G level) of energies or electron populations were made by Marriott and Topsom in 1984<sup>164</sup>. The results are well correlated with  $\sigma_F$  (i.e.  $\sigma_I$ ) for a small number of substituents whose  $\sigma_F$  values on the various experimental scales (gas phase, non-polar solvents, polar solvents) are concordant. The nitro group is considered to be one of these, with values 0.65 in the gas phase, 0.65 in non-polar solvents and 0.67 in polar solvents. The regression equations are the basis of theoretical  $\sigma_F$  values for about fifty substituents. The nitro group is well behaved and the derived theoretical value of  $\sigma_F$  is 0.66.

A theoretical scale of substituent resonance effects was based on calculations of electron populations in substituted ethylenes<sup>165</sup>. A suitable regression equation was again set up by using standard substituents, but in this case the quantum-mechanical quantity was correlated with infrared-based  $\sigma_R^0$  values. The equation was the basis of theoretical  $\sigma_R^0$  values for more than forty substituents. Here again it was possible to include the data for  $\text{NO}_2$  in the setting up of the regression equation. The theoretical value of  $\sigma_R^0$  came out as 0.19, just slightly larger than the experimental value which had been used, namely 0.17. A further redefinition of the theoretical scale was made fairly recently<sup>166</sup> as a result of a change of views as to the most suitable level of MO approximation. In the latest version  $\sigma_R^0$  comes out at 0.12, the literature value of 0.17 having again been used in setting up the regression equation. Thus the new theoretical value is rather closer to Happer's values from  $^{13}\text{C}$  NMR and to Charton's reactivity-based value (see Section V.A). Other recent theoretical papers by Topsom in which  $\text{NO}_2$  is featured are on a scale of variable  $\pi$ -electron transfer<sup>167</sup>, the influence of water on substituent field effects<sup>168</sup> (the theoretical  $\sigma_F$  value for  $\text{NO}_2$  rises to 0.74), the influence of water on substituent resonance effects<sup>169</sup> (the value of  $\sigma_R^0$  for  $\text{NO}_2$  rises from 0.12 to 0.14), the acidities of *ortho*-substituted phenols<sup>170</sup> and theoretical studies of the effects of hydration on organic equilibria<sup>171</sup>. There is also an extensive review of theoretical studies of electronic substituent effects<sup>172</sup>. It seems rash, however, to regard theoretical substituent parameters as in any way replacing those founded on experimental results.

Fairly recently there have been various other theoretical treatments of substituent effects, e.g. the correlation analysis of substituent effects on the acidity of benzoic acid by the AM1 method<sup>173</sup> and direct prediction of linear free-energy substituent effects from 3D structures using comparative molecular field analysis, the relevant data set being 49 substituted benzoic acids<sup>174</sup>. Very recently Russian workers have presented a new model for the inductive effect, in an extremely detailed communication in three parts<sup>175</sup>. The approach appears to be very successful in rationalizing a large amount of relevant experimental data.

Although the term 'theoretical techniques' in relation to electronic effects may commonly be taken to refer to quantum-mechanical methods, it is appropriate also to mention the application of chemometric procedures to the analysis of large data matrices. This is in a way complementary to analysis through substituent constants based on taking certain systems as standards and applying simple or multiple linear regression. Chemometrics involves the analysis of suitable data matrices through elaborate statistical procedures,

such as principal component analysis and factor analysis. The parameters characterizing substituents and processes emerge from the data analysis. As an example of this kind of work, the recent contributions of the group of Ludwig and Pytela will be mentioned briefly. Reference has already been made to the earlier work of these authors in determining the dissociation constants of a large number of substituted benzoic acids in different solvents (Section III.B)<sup>120,121</sup>. The results were treated as a data matrix by the chemometric methods referred to above, and various sets of Hammett  $\sigma$  values were derived for the 35 substituents involved. For the nitro group and other electron-attracting substituents, the  $\sigma$  values derived by principal component analysis were lower than those derived by factor analysis by several units in the second place of decimals. More recently these authors have augmented their own experimental results with other information from the literature to construct a data matrix of 46 sets of measurements on substituted benzoic acids in various solvents; a total of 51 *m*- or *p*-substituents was involved<sup>176,177</sup>. 'Optimized'  $\sigma$  values were tabulated<sup>177</sup>, those for the nitro group being 0.717 for  $\sigma_m$  and 0.780 for  $\sigma_p$ .

Other papers in the series 'Chemometrical Analysis of Substituent Effects' are on additivity of substituent effects in dissociation of 3,4-<sup>178</sup> or 3,5-<sup>179</sup>disubstituted benzoic acids in organic solvents and on the *ortho*-effect<sup>180</sup>. In the last-mentioned, data for the dissociation of *ortho*-substituted benzoic acids in 23 solvents are combined with data on the reactions with DDM (Section IV.C) and with other rate and equilibrium data bearing on the behaviour of *ortho*-substituents to form a matrix involving data for 69 processes and 29 substituents.

## VI. ELECTRONIC EFFECTS OF NO<sub>2</sub> ON VARIOUS SYSTEMS AND PROCESSES

### A. Formation and Stabilization of Carbanions

#### 1. Introduction

The Historical Introduction (Section I.B) showed how the activation of the hydrogen atom(s) on the carbon atom to which NO<sub>2</sub> is attached was recognized at an early stage to be associated with incipient acidity. Reaction mechanisms essentially involving carbanions were proposed by Lapworth<sup>27</sup> early in the 20th century and were gradually accepted by organic chemists over the next 30 to 40 years. By the 1930s some 'stable' carbanions, as opposed to highly reactive intermediates, were recognized, e.g. the behaviour of dinitromethane and nitroform as acids was known.

In the last half-century the  $pK_a$  values of thousands of carbon acids have been measured in a variety of solvents. In many such acids the ionization is stimulated by the NO<sub>2</sub> group, sometimes in association with other +I, +R groups, such as CN, COR or COOR. There have also been many studies of the kinetic acidities of carbon acids and of the mechanisms of reactions involving carbanion intermediates; again, in many cases NO<sub>2</sub> has played an important role. Clearly a comprehensive survey of NO<sub>2</sub>-promoted C-H acidity is not feasible here, and it will be necessary to concentrate on outlining a few main topics. The role of NO<sub>2</sub> in increasing C-H equilibrium acidity will be illustrated with a few structural series, some studies of kinetic acidity will be outlined, and developments in the correlation analysis of C-H acidity and in the understanding of the stabilization of carbanions by NO<sub>2</sub> and related groups will be discussed. Reactions of aliphatic systems depending on the activation of C-H bonds by NO<sub>2</sub> were surveyed in great detail in a volume of this Series in 1970, including over five hundred references<sup>22</sup>. Later developments may be followed by means of the annual Series *Organic Reaction Mechanisms*<sup>181</sup>.

## 2. Equilibrium acidities of nitrocarbon acids

Many  $pK_a$  values for nitrocarbon acids are in the compilations of Palm and colleagues<sup>182</sup>. A comprehensive study of the ionization of many carbon acids in DMSO has been made by Bordwell and colleagues and many of them are nitro compounds<sup>183</sup>.

The  $pK_a$  value of methane in water has been estimated as about 40 and that of  $\text{CH}_3\text{NO}_2$  has been determined as 10.2. Further substitution of H by  $\text{NO}_2$  leads to  $pK_a$  values of 3.6 for  $\text{CH}_2(\text{NO}_2)_2$  and 0.2 for  $\text{CH}(\text{NO}_2)_3$ . The values for the corresponding cyanocarbon acids are about 25, and 11.2 and  $-5.1$  respectively. In the cyanocarbon series the effect of successive substitution shows an extraordinary degree of additivity, in spite of the mutual proximity of the cyano groups. This is probably connected with the small size of CN and the linearity of  $\text{C}-\text{C}\equiv\text{N}$ . The larger and triangular nitro groups clearly interfere with each other, so that there is no additivity in the effect of successive substitution. In the result, whereas one nitro group is more acid-strengthening than one cyano group, three nitro groups are considerably less effective than three cyano groups.

The series  $\text{RCH}_2\text{NO}_2$  presents some interesting results for the effect of different groups R on  $pK_a$ : H, 10.2; Me, 8.6; Cl, 7.2; COOMe, 5.65; CN, 4.9;  $\text{NO}_2$ , 3.6; Ph, 6.9. The position of the Me point with respect to the 'parent' H point seems anomalous, since the normal inductive effect of the methyl group would be expected to diminish rather than enhance acidity. This anomalous effect of  $\alpha$ -methyl substitution continues with a further methyl group, for the  $pK_a$  value of  $\text{Me}_2\text{CHNO}_2$  is 7.75. The effects of lengthening and branching of an alkyl chain R in  $\text{RCH}_2\text{NO}_2$  also show some irregularities: Et, 8.98; Pr, 8.86;  $\text{Pr}^i$ , 9.21;  $\text{Bu}^i$ , 8.56.

$\text{NO}_2$  may also feature as a substituent influencing C-H acidity from a more remote site. Thus for ring substitution in the series  $\text{PhCH}(\text{NO}_2)_2$ , the  $pK_a$  values for the *m*- and *p*-nitro compounds are 2.82 and 2.63, respectively, compared with 3.89 for the unsubstituted compound (values in water, 20 °C). The  $\rho$  value for this reaction series is about 1.7, and these results for *m*- and *p*- $\text{NO}_2$  appear to indicate that ordinary Hammett  $\sigma$  values are applicable, whereas  $\sigma^-$  values might have been expected to be more relevant. Presumably this means that the delocalization of the negative charge in the carbanion is dominated by the  $(\text{NO}_2)_2$  groups, so that delocalization into the ring plays a minor role.

There are many  $pK_a$  data for the series  $\text{RCH}(\text{NO}_2)_2$ , which may be correlated with  $\sigma_I$  or  $\sigma^*$ <sup>184</sup> (Section II.B.). Certain R systems show deviations which may be discussed in terms of the occurrence of steric and other effects. Jones<sup>184</sup> presents various other interesting structural series of nitrocarbons.

## 3. Kinetic acidities of nitrocarbon acids

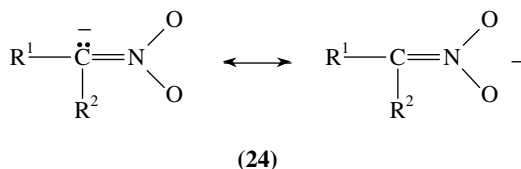
Various types of reaction of carbon acids are believed to proceed via dehydration (commonly referred to as deprotonation)<sup>185</sup>, notably halogenation in the presence of bases, and the rates of such processes are a measure of the kinetic acidities of the carbon acids. Extensive data of this nature exist, including some for nitrocarbon acids<sup>182</sup>. In recent years kinetic acidity has also been studied through the detritiation of appropriately tritiated compounds. The existence also of equilibrium acidity data under the same conditions permits rate-equilibrium correlations of the Brønsted type<sup>186</sup>, as well as Hammett treatments in appropriate cases. Studies of the rates of reaction of a given substrate with a series of bases also generate Brønsted correlations, and in appropriate cases also Hammett correlations.

Recent studies of kinetic acidity involving nitrocarbon acids have included the following: benzoate ion-promoted deprotonation of (3- or 4-nitrophenyl)nitromethane and (3,5-dinitrophenyl)nitromethane<sup>187</sup>; the deprotonation by various bases of a series of

(polynitrotriphenyl)methanes<sup>188,189</sup>; the deprotonation of bis(2,4-dinitrophenyl)methane promoted by 1,1,3,3-tetramethylguanidine<sup>190</sup>; and the deprotonation of 1-phenyl-1-nitroethane and of 1-phenyl-2-nitropropane promoted by hydroxide ion in water or alkoxide ion in alkanol<sup>191</sup>.

#### 4. Correlation analysis of C–H acidity

It is commonly supposed that the stabilization of carbanions by +R groups is due to delocalization of negative charge from the carbanionic carbon. In the case of NO<sub>2</sub>, resonance structures as in **24** are written<sup>184</sup>:



with the additional possibility that some groups R<sup>1</sup> and/or R<sup>2</sup> may also participate in the delocalization. It might therefore be expected that correlation analysis of the effects on C–H acidity of the substituent X in X–C–H would require electron delocalization parameters, perhaps related in some way to  $\sigma^-$  constants. In fact the problem of dealing with proximate substituents is much more difficult than treating the effect of a remote *p*-X on the acidities of phenols or anilinium ions (Sections II.A and III.D). It is much more analogous to dealing with the *ortho*-effect (Section IV).

Attempts at correlation analysis for X–C–H acidity have been made for a long time. Bowden and colleagues<sup>192</sup> examined the problem in 1970 for the p*K*<sub>a</sub> values of 9-X-fluorenes and related series. For a limited selection of substituents X in 9-X-fluorenes, a correlation with Taft's  $\sigma^*$  values for X was found<sup>89</sup>. A more general correlation, albeit with considerable scatter, was found with  $\Delta M$ , a parameter based on LCAO–MO calculations. Several dinitro-substituted diphenylmethanes fitted the line quite well and 2-nitrofluorene fitted passably; 9-cyanofluorene also fitted quite well, but malononitrile deviated strongly.

In recent years Pagani and coworkers have made detailed studies of the problem. In the space available we can only outline their work and interested readers should consult the very detailed papers. The authors have developed special scales of substituent constants for dealing with 'contiguous functionalities'<sup>193</sup>. These new substituent constants are  $\sigma_c^-$  (which seems to be related fairly closely to the ordinary  $\sigma^-$ ),  $\sigma_{IB}$  (which bears some relationship to  $\sigma_I$ , but not that close), and  $\sigma_{R-}$ , a special delocalization parameter. It is claimed<sup>194</sup> that 'these scales are appropriate for describing interactions between contiguous functionalities, as opposed to literature values which account for remote interactions'. Various C–H acidities in gas phase and in solution were successfully correlated by means of multiple regressions on  $\sigma_{IB}$  and  $\sigma_{R-}$ . The same parameters were used in the correlation of <sup>13</sup>C chemical shifts for the central carbon in the carbanions.

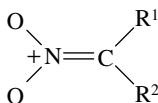
A recent paper (1993)<sup>195</sup> is devoted largely to the behaviour of cyano carbanions. It is concluded that the stabilization of carbanions by CN does not actually involve considerable transfer of  $\pi$  charge from the carbanionic carbon to CN. This does not, however, appear to have any implications for the explanation of stabilization of carbanions by the nitro group in terms of delocalization.

## B. Nucleophilic Substitution

$\text{NO}_2$  can exert important effects on reactivity both as a substituent in the substrate and in the nucleophile, and both in aliphatic<sup>196</sup> and in aromatic<sup>197</sup> substitution. We shall illustrate all the relevant features of the effects of  $\text{NO}_2$  in this respect.

The normal effect of  $\text{NO}_2$  on  $\text{S}_{\text{N}}1$  solvolysis of substrates such as benzhydryl chloride is to retard reaction. Thus in the ethanolysis of  $\text{XC}_6\text{H}_4\text{CHPhCl}$ ,  $\log k$  values (first-order rate coefficients,  $\text{s}^{-1}$ ) are as follows ( $50^\circ\text{C}$ ): H,  $-3.05$ ;  $m\text{-NO}_2$ ,  $-5.64$ ;  $p\text{-NO}_2$ ,  $-5.99$ <sup>198</sup>. The  $\rho$  value for this reaction is about  $-3.7$ , so the  $\log k$  values for the  $m\text{-NO}_2$  and  $p\text{-NO}_2$  derivatives correspond fairly closely to the  $\sigma$  values of  $0.71$  (or  $0.73$ ) and  $0.78$ , respectively (Section III.B). This reaction is, of course, strongly accelerated by  $-R$  *para*-substituents through cross-conjugation in the carbocationic transition state (Section II.A).

Although the effect of  $\text{NO}_2$  as a remote substituent on  $\text{S}_{\text{N}}1$  reactions is exerted through  $+I$  and  $+R$  electronic effects, there is evidence that groups which are normally  $\pi$ -electron acceptors may function as  $\pi$ -electron donors under extreme electron demand. Molecular orbital calculations support this idea<sup>167,172,199</sup> and there is some experimental evidence. Much of this concerns CN rather than  $\text{NO}_2$ <sup>200-203</sup>. It is mainly of the nature that when CN is actually attached to the reaction centre for  $\text{S}_{\text{N}}1$  solvolysis, it is not quite so retarding as might be expected from the operation of its inductive effect. However,  $\alpha$ -nitrodiarylmethyl cations have been obtained and characterized by NMR<sup>204</sup>;  $\pi$ -electron donation by  $\text{NO}_2$ , as in **25**, may contribute to their stabilization. There are also said to be signs of a cancelling of the normal  $+R$  effects of substituents such as  $\text{NO}_2$  and CN in the acidities of *para*-substituted pyridinium ions, which may indicate the onset of  $\pi$ -electron donor behaviour<sup>172,205-207</sup>.

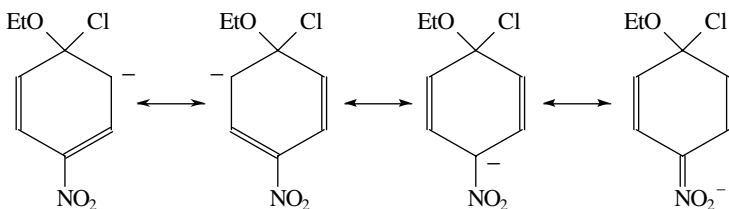


(25)

In contrast to the usual behaviour of the nitro group as a remote substituent in systems undergoing  $\text{S}_{\text{N}}1$  reactions, *o*- $\text{NO}_2$  and *p*- $\text{NO}_2$  are strongly activating in a substrate undergoing aromatic nucleophilic substitution. The attack of chlorobenzene by  $\text{EtO}^-$  in ethanol provides a suitable example. Chlorobenzene itself is not appreciably attacked below  $150^\circ\text{C}$ , but the reactions of *o*-nitrochlorobenzene and *p*-nitrochlorobenzene with this reagent can be conveniently studied around  $60^\circ\text{C}$ . Values of  $\log k$  (second-order rate coefficients,  $\text{dm}^3 \text{mol}^{-1} \text{s}^{-1}$ ) extrapolated to  $25^\circ\text{C}$  are  $-6.45$  and  $-6.05$ , respectively. The reaction of 2,4-dinitrochlorobenzene with  $\text{EtO}^-$  in EtOH can be studied at room temperature and  $\log k$  at  $25^\circ\text{C}$  is  $-1.31$ . Nucleophilic aromatic substitution is also activated by CN in the substrate, but not so strongly as by  $\text{NO}_2$ . Thus it does not appear possible to study the effect of CN by itself on the reaction of chlorobenzene with  $\text{EtO}^-$ , but for 2-cyano-4-nitrochlorobenzene and 2-nitro-4-cyanochlorobenzene  $\log k$  at  $25^\circ\text{C}$  has the values  $-3.15$  and  $-3.11$ , respectively, i.e. replacing  $\text{NO}_2$  by CN decreases  $\log k$  by  $1.84$  and  $1.80$ , respectively. Thus the reactivity decreases by a factor of about 70.

The activating effect of  $\text{NO}_2$  or CN is due to the electron-attracting effect of these groups, and in particular the  $+R$  component, assisting the delocalization of negative charge away from the reaction centre. This may be represented for the intermediate complex in terms of resonance involving structures such as **26**. The relevant transition states are similarly affected<sup>197</sup>. A heterocyclic N atom is also able to assist the delocalization of negative charge away from the reaction centre. The reaction of 2-chloro- or 4-chloropyridine with  $\text{EtO}^-$  in EtOH can be studied at around  $100^\circ\text{C}$ .  $\log k$  values extrapolated





(26)

to 25 °C are  $-8.4$  and  $-6.8$ , respectively<sup>208</sup>, rather lower than those for the corresponding chloronitrobenzenes. However, the presence of two heterocyclic N atoms exerts a powerful influence, e.g.  $\log k$  for 2-chloropyrimidine at 25 °C is  $-2.60$ <sup>208</sup>.

The reaction of  $\text{EtO}^-$  with chloro compounds in ethanol is actually not an entirely satisfactory system for studying the activating effect of CN on aromatic nucleophilic substitution, because there is a tendency for CN itself to react, forming the conjugate base of iminoether,  $-\text{C}(\text{OEt})=\text{NH}$ <sup>209</sup>.

The activating effects of  $\text{NO}_2$ , CN and heterocyclic N have been much studied in the reactions of 2-chloro-3-cyano-5-nitropyridine (and related compounds) with aniline and substituted anilines and other amine nucleophiles in various solvents<sup>210-212</sup>. 2-Chloro-3-cyano-pyridine is too unreactive for study, but the reaction of 2-chloro-5-nitropyridine with aniline in methanol gives a  $\log k$  value of  $-5.31$  at 40 °C<sup>210</sup>. For the corresponding reaction of 2-chloro-3-cyano-5-nitropyridine  $\log k$  is  $-1.68$ , i.e. the activation by CN is by a factor of over 4000<sup>211</sup>. The influence of inserting methyl groups adjacent to the nitro group of 2-chloro-3-cyano-5-nitropyridine was also studied. For 2-chloro-3-cyano-6-methyl-5-nitropyridine reacting with aniline in methanol at 30 °C,  $\log k = -2.50$ , and for 2-chloro-3-cyano-4,6-dimethyl-5-nitropyridine  $\log k = -4.38$ , compared with  $-1.93$  for the substrate without methyl groups. Thus 6-Me decreases the rate by a factor of about 3.7, while methyl groups in both positions adjacent to the nitro group together decrease the rate by a factor of about 282. The latter is certainly due to the methyl groups twisting the nitro group out of the plane of the ring and thereby inhibiting the  $+R$  effect (Section III.B,D). The small retarding influence of 6-Me by itself may be partly due to the  $-I$  effect of the methyl group, which is in the *meta* position with respect to the reaction centre, but will largely be due to the onset of the effect of twisting the nitro group.

The kinetics of the reactions of 2-fluoro-3-cyano-5-nitropyridine with various amine nucleophiles have also been studied<sup>211</sup>. These are complicated by the occurrence of base catalysis.

It might be expected that the activating effect of  $p\text{-NO}_2$  on nucleophilic aromatic substitution would be related to the  $\sigma^-$  value of the substituent. From various studies of nucleophilic aromatic substitution, Miller and Parker<sup>213</sup> obtained a  $\sigma^-$  value for  $p\text{-NO}_2$  of 1.27, very close to the values based on the ionization of substituted phenols or anilinium ions (Section III.D).

Numerous observations have been made of the relative activating effects of  $o\text{-NO}_2$  and  $p\text{-NO}_2$  in a substrate undergoing nucleophilic aromatic substitution<sup>214</sup>. In some systems  $o\text{-NO}_2 < p\text{-NO}_2$ ; this may be ascribed to differences in the orientation of dipoles and to a change in the  $+R$  effect of the group as between the ring positions (see Section IV). In other systems, however, the activating effects are in the order  $o\text{-NO}_2 > p\text{-NO}_2$ , sometimes markedly so. In such cases a favourable influence of hydrogen-bonding involving the  $o\text{-NO}_2$  group and the nucleophile has been invoked.

It should also be mentioned that NO<sub>2</sub> is the electron-attracting substituent which is most commonly used to stabilize Meisenheimer-type complexes. See, for example, recent studies of the reaction of 1,3,5-trinitrobenzene and phenoxide ions<sup>215</sup>, and the reactions of 4,6-dinitrobenzofuroxan with 5-substituted indoles<sup>216</sup>. See also the appropriate chapter in each year of the Series *Organic Reaction Mechanisms*<sup>181</sup>.

The introduction of NO<sub>2</sub> into the aniline molecule would be expected to reduce the nucleophilicity of NH<sub>2</sub> and for *p*-NO<sub>2</sub> this should be more or less according to  $\sigma^-$ . Examples of this are not easy to find, but there are the necessary data for the reactions of picryl chloride with substituted anilines in methanol. Log *k* for the reaction of aniline itself is about -0.2 at 25 °C (extrapolated from measurements at much lower temperatures). For the reaction of *p*-nitroaniline log *k* is -4.06;  $\rho$  is about -3.4. These values give an apparent sigma value of 1.13 for *p*-NO<sub>2</sub> in this system, a little below the value for  $\sigma^-$  of about 1.25 (Section III.D).

An example of the reduction of amine nucleophilicity by the +*I* effect of NO<sub>2</sub> is provided by the results of Grob and Schlageter<sup>217</sup> on the quaternization of 4-*X*-substituted quinuclidines (cf structure **18**) with methyl iodide in methanol at 10.0 °C. According to Charton<sup>109</sup>, the  $\rho_I$  value for this reaction is -1.12, and log *k* values for X = H and NO<sub>2</sub> are -2.35 and -3.18, respectively<sup>217</sup>. These give an apparent  $\sigma_I$  value of 0.74 for NO<sub>2</sub>, a little higher than Charton's value of 0.67 (Section III.A). Grob and Schlageter<sup>217</sup> carried out an analogous correlation in terms of  $\sigma_I^q$ , an inductive parameter based directly on the p*K*<sub>a</sub> values of 4-*X*-substituted quinuclidinium ions (cf structure **18**) as a standard system<sup>218</sup>, for which  $\rho_I$  is defined as 1.000. The  $\sigma_I^q$  value for NO<sub>2</sub> is 3.48. Grob has made extensive use of the  $\sigma_I^q$  scale in correlating the effects of substituents on log *k* for various reactions, including the solvolyses of 1-substituted 3-bromoadamantanes<sup>219</sup>, 4-substituted 2-chloro-2-methylbutanes<sup>220</sup> and 4-substituted bicyclo[2.2.2]octyl *p*-nitrobenzenesulphonates<sup>221</sup>. NO<sub>2</sub> features as a substituent in all of these, except the last-mentioned<sup>221</sup>, and they thus present examples of the retarding effect of remote NO<sub>2</sub> in the S<sub>N</sub>1 reactions of saturated aliphatic and carbocyclic systems<sup>222</sup>.

### C. Electrophilic Aromatic Substitution

The nitro group is deactivating in electrophilic aromatic substitution. There is much less literature to deal with than there was for the article on ether and hydroxyl groups<sup>5</sup>. As in the case of the previous articles<sup>5,6</sup>. Roger Taylor's excellent monograph<sup>223</sup> is a good guide to the literature up to about 1990 and references to particular parts of this book will be appropriate.

Table 6 displays data for the isomer proportions formed in the nitration and halogenation of nitrobenzene<sup>224</sup>. As with all +*I*, +*R* substituents, the formation of the *meta* isomer predominates. The reactions are far slower than those of benzene itself. Partial rate factors for the reaction of nitrobenzene with HNO<sub>3</sub>-H<sub>2</sub>SO<sub>4</sub> are as follows: *f*<sub>o</sub>, 1.08 × 10<sup>-8</sup>; *f*<sub>m</sub>,

TABLE 6. Isomer distributions (%) for nitration or chlorination of PhNO<sub>2</sub><sup>224</sup>

Reaction	Reagent	Temp. (°C)	<i>o</i>	<i>m</i>	<i>p</i>	1/2 <i>o</i> : <i>p</i>	1/2 <i>m</i> : <i>p</i>
Nitration	HNO <sub>3</sub>	0	6.4	93.2	0.3	10.7	155
	HNO <sub>3</sub> -H <sub>2</sub> SO <sub>4</sub>	25	6.1	91.8	2.1	1.5	21.9
	HNO <sub>3</sub> -CF <sub>3</sub> COOH	75	10.5	84.7	4.8	1.1	8.8
Chlorination	HOCl-H <sup>+</sup>	?	17.6	80.9	1.5	5.9	27.0

$16.2 \times 10^{-8}$ ;  $f_p$ ,  $7.26 \times 10^{-9}$  ( $25^\circ\text{C}$ )<sup>224</sup>. In the formation of the minor products, *ortho* substitution tends to be favoured relative to *para*, as shown by the ratios  $1/2o:p$ . At one time special interactions between the reagent and the substituent were often invoked to account for the *ortho* preference, which is now known to be widespread for other  $+R$  substituents and other electrophilic reagents. It is more likely that a general greater deactivation of the *para* position is responsible. The pattern of  $1/2m:p$  ratios (Table 6) is also in accord with this. It has been suggested that the greater deactivation of the *para* position is due to it carrying a slightly greater share of the positive charge than either *ortho* position in the Wheland intermediate<sup>224</sup>, and there is quantum-mechanical support for this idea.

In highly acidic media the actual state of substituents such as  $\text{NO}_2$  with regard to protonation or hydrogen-bonding is somewhat problematical. The slightly reduced *meta* preference for reactions in  $\text{HNO}_3\text{-CF}_3\text{COOH}$  (Table 6) suggests some difference in the state of the substituent in this medium, but it should be noted that these reactions were at a rather higher temperature.

There are extensive data for the acid-catalyzed protidesilylation of  $\text{XC}_6\text{H}_4\text{SiMe}_3$  in methanol-aqueous perchloric acid or acetic acid-aqueous sulphuric acid at  $50^\circ\text{C}$ <sup>225</sup>. Correlation analysis of the partial rate factors (relative rate constants) by means of the Yukawa-Tsuno equation (Section II.B) finds  $\rho = -5.3$  and  $r^+ = 0.65$ . These values are consistent with a relatively low demand for stabilization of the transition state by electron delocalization, i.e. the transition state is 'early' along the reaction coordinate. *p*- $\text{NO}_2$  is highly deactivating with  $f = 14 \times 10^{-5}$ , but *o*- $\text{NO}_2$  is even more deactivating, with  $f = 6.8 \times 10^{-5}$ . This contrasts with the deactivation order discussed above for nitration and chlorination (Table 6), and may be explained in terms of the 'early' transition state, well removed from the Wheland intermediate.

Data also exist for the base-catalyzed protidesilylation of  $\text{XC}_6\text{H}_4\text{SiMe}_3$  in aqueous DMSO<sup>226</sup>. This reaction involves the base-catalyzed cleavage of the silicon compound to give an aromatic anion  $\text{Ar}^-$ , and the usual substituent effects in electrophilic substitution are reversed: electron-attracting groups increase the reaction rate and electron-withdrawing groups decrease it. Thus the *m*- and *p*-nitro compounds are about  $10^5$  times more reactive than the parent ( $\text{X} = \text{H}$ ) compound.

Partial rate factors for the sulphonation of compounds  $\text{Ph}(\text{CH}_2)_n\text{NO}_2$  have been measured<sup>227</sup>,  $n$  being 0, 2 or 3. This is another system in which the *ortho* position is deactivated more than the *para*. Under the highly acidic conditions used it seems likely that the effective substituent is the hydrogen-bonded or even protonated group.

In Taylor's tabulation of sigma values<sup>228</sup>,  $\sigma^+$  and  $\sigma$  for *p*- $\text{NO}_2$  are given identical values of 0.79<sup>228</sup>. No distinction between these two types of substituent constant is to be expected for *p*- $\text{NO}_2$  in connection with electrophilic aromatic substitution. Some slight distinction between them is drawn for *m*- $\text{NO}_2$ :  $\sigma = 0.72$ ,  $\sigma^+ = 0.73$ .

## VII. SUBSTITUENT CONSTANTS OF $\text{NO}_2$ AND OF GROUPS CONTAINING IT: RECAPITULATION AND SOME EXTENSION

### A. Introduction

At the end of this long account of the electronic effects of  $\text{NO}_2$ , it seems useful to bring together and summarize some of the material which is scattered throughout it. Also, there are some relevant substituents which have not so far been mentioned, including polynitro groups and various other substituents in which  $\text{NO}_2$  is attached to some atom or group, which is in turn bonded to the molecular skeleton.

## B. Recapitulation

For  $\text{NO}_2$  the recommended values of  $\sigma_m$  and  $\sigma_p$  (benzoic acid scale) in the IUPAC document<sup>79</sup> are 0.73 and 0.78, respectively, compared with the 'traditional' values of 0.71 and 0.78, respectively (Section III.B). When these values are used for correlations of processes taking place in other than highly aqueous media, the possibility of specific solvent effects should be borne in mind. The fact that the  $\sigma$  values of  $\text{NO}_2$  are very much at the upper end of the scale for commonly used substituents means that they exert a strong influence in regression analysis and there is danger of their biasing a correlation unduly.

For correlations in which  $\sigma^0$  values are considered relevant, the ordinary  $\sigma_m$  and  $\sigma_p$  should be used (Section III.C). Similarly for correlations of electron-demanding processes in which the use of  $\sigma^+$  values is appropriate for  $-R$  substituents, the ordinary  $\sigma_m$  and  $\sigma_p$  values of  $\text{NO}_2$  should be used (Section VI.C). When the use of  $\sigma^-$  values is appropriate for  $+R$  substituents, the value 1.25 may often be used for  $\text{NO}_2$  (Section III.D, but see also Section V.A).

As to  $\sigma_I$ , the value of 0.67 for  $\text{NO}_2$  seems to be of wide application (Section III.C), but a slightly lower value, 0.65, may also be considered (Section V.A). Here also the possibility of solvent effects and the dangers of bias in correlations must be borne in mind. With  $\sigma_R$  or  $\sigma_R^0$  the range of values obtained by different methods presents a problem. A generally useful value for both these parameters appears to be 0.10, but it must be borne in mind that there is a school of thought which favours an appreciably higher value, at least 0.15 (Section V.A).

The  $\sigma_I$  value for  $\text{CH}_2\text{NO}_2$  may be taken as 0.25 (Section III.A).

## C. The Effects of Substituents Containing $\text{NO}_2$

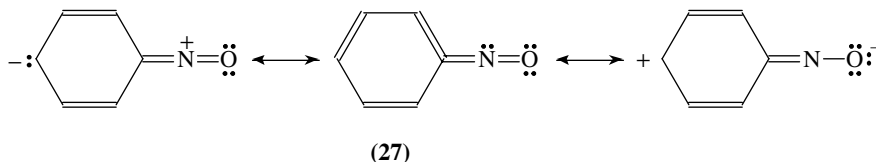
The various compilations of sigma values provide rather patchy information on this topic<sup>78,109,118,150</sup>. It would be very interesting to have full information on the series  $\text{CH}_n(\text{NO}_2)_{3-n}$ , but what is available is rather incomplete. As mentioned above, there is a  $\sigma_I$  value for  $\text{CH}_2\text{NO}_2$  of 0.25, but there are no values for  $\sigma_m$  and  $\sigma_p$  in the literature. There are a few values for nitro-substituted alkyl groups which can be arranged in a sensible series as follows (substituent,  $\sigma_m$ ,  $\sigma_p$ ):  $\text{CMe}_2\text{NO}_2$ , 0.18, 0.20;  $\text{CMe}(\text{NO}_2)_2$ , 0.54, 0.61;  $\text{CEt}(\text{NO}_2)_2$ , 0.56, 0.64;  $\text{C}(\text{NO}_2)_3$ , 0.72, 0.82. The  $\sigma_p$  values were experimentally determined, but not directly based on the ionization of substituted benzoic acids, while the  $\sigma_m$  values were calculated from the  $\sigma_p$  values by applying a factor, and Exner regards them as rather uncertain<sup>78</sup>. Presumably the inductive effect is easily the more important component of the electronic effect of these groups and the value of  $\sigma_p$  for  $\text{CMe}_2\text{NO}_2$  seems quite reasonable for the influence of a nitro group damped by an interposing carbon atom. Successive nitro groups become less effective: the cumulative effect of nitro groups attached to the same carbon atom would not be expected to be strictly additive.

This would be an appropriate point to deal with what is known about that little used substituent  $\text{ONO}_2$ . From the  $\text{pK}_a$  value of 2.26 for the appropriately substituted acetic acid in water, Charton<sup>112</sup> calculated  $\sigma_I$  for  $\text{ONO}_2$  to be 0.62, which he later revised to 0.66<sup>109</sup>. Thus the inductive effect of the group appears to be very similar to that of  $\text{NO}_2$ . Presumably the damping effect of the interposed O on the inductive effect of  $\text{NO}_2$  is just about counterbalanced by the contribution of the electron-attracting O atom. Various sources give values for  $\sigma_m$  and  $\sigma_p$  of 0.55 and 0.70, respectively<sup>78,150</sup>. Exner<sup>78</sup> considers these to be estimated rather than experimental values and regards them as rather uncertain. The resonance effect of this group would be expected to be small; the normal  $-R$  effect of an O attached to a benzene ring<sup>5</sup> will be opposed by the electron-attracting effect of

the  $\text{NO}_2$  moiety. The above values of  $\sigma_m$  and  $\sigma_p$  do not seem to harmonize very well with the value of  $\sigma_I$ .

### VIII. ELECTRONIC EFFECTS OF THE NITROSO GROUP

The NO group is a strongly electron-attracting group. The dipole moment of nitrosobenzene is  $3.14D$ , compared with  $3.97$  for nitrobenzene. The typical dipole moments of aliphatic compounds involving these groups are smaller:  $2.51D$  and  $3.14$  respectively<sup>229</sup>. These values indicate that NO, like  $\text{NO}_2$ , may exert  $+I$  and  $+R$  electronic effects (Section II.B). There is, however, one important difference between these two groups: the N atom in NO has a lone pair of electrons, and in consequence the group is also capable of exerting a  $-R$  effect. This dual nature of NO is indicated in the structures 27. A consequence of the possibility of a  $-R$  effect is that the NO group is *ortho/para* directing for aromatic electrophilic substitution. This matter does not seem to have been much investigated, but played a part in the dispute between Robinson and Ingold regarding electronic theories of organic chemistry (Section I.B<sup>46,50,53</sup>).



The main quantitative indication of the  $+I$  effect which is available is from  $^{19}\text{F}$  NMR shielding (Section V.A). This originally yielded a  $\sigma_I$  value of  $0.33$ <sup>96,230</sup>, but this has now been revised to  $0.41$ <sup>150</sup>. (A different regression equation was used.) At all events, the inductive effect of NO is clearly somewhat less than that of  $\text{NO}_2$ , which seems reasonable in relation to nitroso having one electronegative O atom and nitro having two. The  $^{19}\text{F}$  NMR method yielded a  $\sigma_R$  value of  $0.32$ <sup>97,230</sup>, but this has now been revised to  $0.25$ <sup>150</sup>. Thus the  $+R$  effect of NO appears to be rather stronger than that of  $\text{NO}_2$ . This point is referred to again below. It must be remembered that for a  $+R$  substituent the resonance parameter derived from  $^{19}\text{F}$  NMR is not to be identified with a  $\sigma_R^0$  constant, because the resonance effect is slightly enhanced by cross-conjugation between the substituent and F.

On the basis of the older values of  $\sigma_I$  and  $\sigma_R$ , Exner<sup>78</sup> calculated  $\sigma_m^0$  and  $\sigma_p^0$  values of  $0.49$  and  $0.65$ , respectively, by employing equations 6 and 7 (Section II.B). From the newer values of  $\sigma_I$  and  $\sigma_R$ , Hansch and colleagues<sup>150</sup> used a slightly more complicated procedure to calculate substituent constants  $c\sigma_m$  and  $c\sigma_p$  ( $c$  = calculated) as  $0.48$  and  $0.62$ , respectively. The two estimated sets of sigma values for NO agree fairly well with each other. Unfortunately the experimental values of  $\sigma_m$  and  $\sigma_p$  for NO, based on the dissociation constants of the substituted benzoic acids, are considerably higher:  $0.62$  and  $0.91$ , respectively<sup>150,231</sup>. When interpreted in terms of equations 4 and 5 (Section II.B), these  $\sigma$  values yield  $\sigma_I = 0.48$  and  $\sigma_R = 0.43$ . The latter value seems highly improbable; no dipolar  $+R$  substituent is recorded as having such a large value.

There is a further problem regarding a value for the resonance parameter of NO. The infrared method (Section V.A) yields a  $\sigma_R^0$  value of  $\pm 0.07$ <sup>154</sup>, cf  $0.31$  or  $0.25$  above.

The area of chemical reactivity for which there is most information regarding the electronic effects of NO is that involving processes to which a  $\sigma_p^-$  constant might be applicable, but even here the experimental evidence is not entirely straightforward. From studies of aromatic nucleophilic substitution (Section VII.B), Miller and Parker<sup>213</sup> obtained a  $\sigma^-$

value for *p*-NO of 1.46. i.e. appreciably higher than that of *p*-NO<sub>2</sub> in aromatic nucleophilic substitution, 1.27. (Table 9 of Reference 197 gives 1.486 for *p*-NO. Presumably this is a value that was recalculated from Reference 213 for some reason.) Miller<sup>232</sup> supposed that the inductive effect of NO would be rather smaller than that of NO<sub>2</sub>, so that the higher  $\sigma^-$  value of NO must indicate a greatly superior conjugative power of NO for activating nucleophilic aromatic substitution. This he attributed to the *internal* conjugation of the group being greater for NO<sub>2</sub> than for NO.

There are several other putative estimates of an exalted +*R* effect of NO. A value of 1.63 for  $\sigma^-$  of *p*-NO was based on the dissociation constants of substituted phenols in water<sup>233</sup>, and of 1.60 on the dissociation constants of phenols in 1:1 EtOH-H<sub>2</sub>O<sup>134</sup>. These values are in reasonable agreement with the above value based on aromatic nucleophilic substitution. However, the measurement of the dissociation constants of substituted *N,N*-dimethylanilinium ions in water at 25 °C<sup>233</sup> led to the extraordinary value of 0.15 for  $\sigma^-$ . It must be emphasized that the experimental work in this paper<sup>233</sup> appears to be very reliable. Further, there are indications of a similar anomaly in limited data for *N,N*-dipropylanilinium ion and its 4-NO derivative, whose p*K*<sub>a</sub> values in water are about 5.7 and 4.2, respectively. Since the  $\rho$  value for this ionization will be around 3, the apparent  $\sigma$  value indicated for *p*-NO is about 0.5, certainly very much lower than the values of about 1.4 to 1.6 discussed above. There is no doubt that these anomalies arise from tautomerism of the substrate. The authors<sup>233</sup> argue that the protonated form of 4-nitroso-*N,N*-dimethylaniline exists as a tautomeric equilibrium of a 'nitroso' form and a 'quinonoid' form, with the latter greatly predominating, i.e. the protonation is of NO rather than NMe<sub>2</sub>. This would account for the greatly reduced apparent  $\sigma$  value of NO. The same type of tautomerism might occur with 4-nitrosophenol, but the reasonable agreement of the apparent  $\sigma$  value for NO with that based on nucleophilic aromatic substitution shows that the 'nitroso' form greatly predominates.

One final anomaly: we have already commented on the enhanced value for the effect of *para*-substituents on the ionization of 2,6-di-*tert*-butylphenol in 1:1 v/v EtOH-H<sub>2</sub>O at 25 °C (Section III.D). In this solvent phenol itself has a p*K*<sub>a</sub> value of 11.16, and the values for the 4-NO and 4-NO<sub>2</sub> derivatives are 6.9 and 7.49, respectively<sup>134</sup>, i.e. NO has a greater acid-strengthening effect on phenol than NO<sub>2</sub> does, as we have already seen above for solutions in water. However, the p*K*<sub>a</sub> values of 2,6-di-*tert*-butylphenol and its 4-NO and 4-NO<sub>2</sub> derivatives in 1:1 v/v EtOH-H<sub>2</sub>O are 14.22, 9.41 and 7.49, respectively<sup>134</sup>, i.e. the acid-strengthening effects of NO and NO<sub>2</sub> are reversed. The apparent  $\sigma$  value of *p*-NO is now about 0.9. Presumably there is a considerable amount of 'quinonoid' form in this system.

## IX. ELECTRONIC EFFECTS OF THE AMINO GROUP AND RELATED GROUPS

### A. Introduction

In the space available this account will have to be rather concise. However, the much more detailed account of the nitro group contains much background material which will not need to be repeated.

The electronic effects of groups of the general formula NX<sup>1</sup>X<sup>2</sup> are governed primarily by the electronegative character of N relative to C and by the lone pair of electrons on the N atom. They therefore exert +*I* and -*R* effects, moderated by the electronic effects of X<sup>1</sup> and X<sup>2</sup>. As these moieties become more electron-attracting in character, the +*I* effect of the substituent as a whole is increased and the -*R* effect is decreased, and in the limit may become effectively zero.

These substituents present certain problems for the study of their electronic effects. These arise from the behaviour of the substituents as basic centres. Thus they are liable

to be protonated in acidic media and the study may then be of the electronic effects of  $\text{NX}^1\text{X}^2\text{H}^+$  rather than of  $\text{NX}^1\text{X}^2$ , or the electronic effect may be composite because of partial protonation. This type of complication may also arise in the absence of any acidic medium if the compound under study contains an acidic grouping, such as COOH. Thus aliphatic amino acids tend to exist in solution as zwitter-ions, and measurements of the  $\text{pK}_a$  values yield information about the effect of the pole  $\text{NH}_3^+$  and not the dipole  $\text{NH}_2$ . In aromatic amino-acids, however, the  $\text{NH}_2$  is less basic and the problem is then the need to apply corrections for a small content of zwitter-ion. The general problem becomes less serious when any acidic group in the molecule becomes very weak and also for  $\text{NX}^1\text{X}^2$  when basicity is reduced by the electron-attracting nature of  $\text{X}^1$  and/or  $\text{X}^2$ .

The amino group is both a hydrogen-bond donor and a hydrogen-bond acceptor. Solvents may therefore modify the electronic effects of the amino group by engaging with it in hydrogen-bond acceptor or hydrogen-bond donor interaction, respectively. For the general amino substituent  $\text{NX}^1\text{X}^2$  the possibility of the group acting as a hydrogen-bond donor will clearly depend on  $\text{X}^1$  or  $\text{X}^2$  being H. Electron-attracting groups  $\text{X}^1$  and/or  $\text{X}^2$  will decrease the tendency of N to act as a hydrogen-bond acceptor, but there may be the possibility of  $\text{X}^1$  and/or  $\text{X}^2$  acting as hydrogen-bond acceptor.

## B. Inductive Effect of the Amino Group and Related Groups

For  $\text{NH}_2$  and certain related groups the most convenient study of chemical reactivity which gives information about the inductive effects of the groups is the measurement of the  $\text{pK}_a$  values of 4-substituted quinuclidinium ions (cf Section III.A). In this way Charton<sup>109</sup> finds values for  $\sigma_I$  as follows:  $\text{NH}_2$ , 0.17;  $\text{MeNH}$ , 0.13;  $\text{Me}_2\text{N}$ , 0.17;  $\text{EtO}_2\text{CNH}$ , 0.28. (The experimental work was by Grob and Schlageter<sup>218</sup>.) When the substituent  $\text{NX}^1\text{X}^2$  contains more electron-attracting groups, Charton considers that values of  $\sigma_I$  may be safely based on the ionization of substituted acetic acids, because zwitter-ion formation will be negligible. In this way he finds the following values<sup>109</sup>:  $\text{PhNMe}$ , 0.15;  $\text{AcNH}$ , 0.28;  $\text{BzNH}$ , 0.28;  $\text{PhNH}$ , 0.30;  $\text{HCONH}$ , 0.33;  $\text{PhSO}_2\text{NH}$ , 0.33;  $\text{ClCH}_2\text{CONH}$ , 0.35;  $\text{Me}(\text{NO}_2)\text{N}$ , 0.39.

In his work on the analysis of substituent effects in aliphatic ester reactions, Taft<sup>87,89</sup> derived  $\sigma^*$  values, from which  $\sigma_I$  values may be calculated as follows:  $\text{NH}_2$ , 0.10;  $\text{Me}_2\text{N}$ , 0.10;  $\text{AcNH}$ , 0.28. Thus there are some discrepancies as between the results of Charton<sup>109</sup> and of Taft<sup>87,89</sup>.

The largest number of  $\sigma_I$  values has been obtained from  $^{19}\text{F}$  NMR substituent chemical shifts (Section V.A). Taft has been involved in measurements of this kind for around 40 years<sup>96,97</sup>. Fairly recently these data have been compiled and reanalyzed, with an emphasis on data for dilute solutions of substrates in hydrocarbon solvents. Some values for the amino group and related groups are as follows<sup>150</sup>:  $\text{NH}_2$ , 0.09;  $\text{NHNH}_2$ , 0.17;  $\text{PhNH}$ , 0.31;  $\text{AcNH}$ , 0.34;  $\text{NHCN}$ , 0.44;  $\text{N}(\text{CF}_3)_2$ , 0.55;  $\text{N}(\text{COF})\text{CF}_3$ , 0.62. A value for  $\text{NMe}_2$  is given as 0.17, but this is considered to be unreliable 'because of magnetic or other complications'<sup>150</sup>.

It will be seen that the  $\sigma_I$  values for  $\text{NX}^1\text{X}^2$  increase as the electron-attracting character of  $\text{X}^1$  and  $\text{X}^2$  increases. To set these values in context in the  $\sigma_I$  scale, we quote a few values for other kinds of substituents<sup>150</sup>:  $\text{OMe}$ , 0.30;  $\text{Cl}$ , 0.43;  $\text{COF}$ , 0.45;  $\text{CF}_3$ , 0.46;  $\text{CN}$ , 0.57;  $\text{SO}_2\text{Me}$ , 0.61;  $\text{NO}_2$ , 0.64. The largest  $\sigma_I$  values are provided by positive poles, e.g.  $\text{NMe}_3^+$ , 0.99. The significance of such values in relation to the wider field of linear free energy relationships is, however, a matter of debate<sup>234</sup>.

Exner tabulates  $\sigma_I$  values for many  $\text{NX}^1\text{X}^2$  substituents, mainly measured by the  $^{19}\text{F}$  NMR method<sup>78</sup>.

### C. Resonance Effect of the Amino Group and Related Groups

The resonance effects of these groups are greatly enhanced when they are exerting an influence on highly electron-demanding processes. This topic will be discussed later. Here we shall be concerned with the resonance effects as shown under milder conditions and measured either by  $\sigma_R^0$  or by  $\sigma_R(\text{BA})$  (Section II.B). For brevity we shall refer to the latter simply as  $\sigma_R$ . The distinction between the two types of resonance parameter is important with  $-I$  groups, cf the nitro group (Sections III.C and V.D).

Charton derives  $\sigma_R$  values simply by subtracting  $\sigma_I$  values from  $\sigma_p$  values, i.e. classical Hammett benzoic acid-based substituent constants<sup>109</sup>. In the next section the derivation of refined  $\sigma$  values for  $\text{NH}_2$  etc. will be discussed, i.e. the matter of applying a correction to allow for the zwitter-ion content of the substituted benzoic acid. Here we shall simply accept that Charton<sup>109</sup> uses what he believes to be the most reliable values of  $\sigma_p$  available to him. In this way Charton finds values for  $\sigma_R$  as follows:  $\text{NH}_2$ ,  $-0.80$ ;  $\text{Me}_2\text{N}$ ,  $-0.88$ ;  $\text{PhNH}$ ,  $-0.86$ ;  $\text{EtO}_2\text{CNH}$ ,  $-0.48$ ;  $\text{BzNH}$ ,  $-0.47$ ;  $\text{ClCH}_2\text{CONH}$ ,  $-0.42$ ;  $\text{HCONH}$ ,  $-0.40$ ;  $\text{AcNH}$ ,  $-0.35$ ;  $\text{PhSO}_2\text{NH}$ ,  $-0.36$ .

We set these in context in the  $\sigma_R$  scale by quoting values for a few substituents of other types;  $\text{Me}$ ,  $-0.16$ ;  $\text{ClCH}_2$ ,  $-0.08$ ;  $\text{Cl}$ ,  $-0.25$ ;  $\text{F}$ ,  $-0.48$ ;  $\text{MeO}$ ,  $-0.58$ . The  $\text{NH}_2$  group and its simplest derivatives in fact define the negative end of this resonance scale. The effect of introducing electron-attracting groups into  $\text{NH}_2$  and making the lone pair of electrons less available for delocalization is clearly seen.

A large number of  $\sigma_R^0$  values has been obtained from  $^{19}\text{F}$  NMR substituent chemical shifts (Section V.A.). A selection may be drawn from the compilation of data to which reference has already been made<sup>150</sup>:  $\text{NH}_2$ ,  $-0.48$ ;  $\text{NMe}_2$ ,  $-0.56$ ;  $\text{NHNH}_2$ ,  $-0.42$ ;  $\text{PhNH}$ ,  $-0.35$ ;  $\text{NHCN}$ ,  $-0.30$ ;  $\text{AcNH}$ ,  $-0.21$ ;  $\text{N}(\text{CN})_2$ ,  $-0.21$ ;  $\text{N}(\text{COF})\text{CF}_3$ ,  $0.01$ ;  $\text{N}(\text{COF})_2$ ,  $0.01$ ;  $\text{N}(\text{CF}_3)_2$ ,  $0.02$ .

The  $\sigma_R^0$  value for a given group is much less negative than the  $\sigma_R$  value. The effect of introducing electron-attracting moieties is clearly seen; in the limit the  $-R$  effect is completely inhibited; the very small positive values may be taken as zero within experimental error. We set these values in context by quoting a few values of  $\sigma_R^0$  for other types of substituents:  $\text{Me}$ ,  $-0.13$ ;  $\text{CH}_2\text{Cl}$ ,  $-0.02$ ;  $\text{OMe}$ ,  $-0.43$ ;  $\text{Cl}$ ,  $-0.16$ . It is also of interest to show a few of Charton's  $\sigma_R^0$  values, reactivity-based and determined as described in his review<sup>109</sup>:  $\text{NH}_2$ ,  $-0.42$ ;  $\text{NMe}_2$ ,  $-0.44$ ;  $\text{AcNH}$ ,  $-0.25$ ;  $\text{HCONH}$ ,  $-0.24$ . Agreement with the  $^{19}\text{F}$  NMR based values seems only fair, but those are for rather non-polar conditions, while Charton's values are for aqueous or aqueous organic solvents.

Values of  $\sigma_R^0$  for a large number of  $\text{NX}^1\text{X}^2$  groups have been determined by infrared intensity measurements<sup>154</sup> (Section V.A). A few values are as follows:  $\text{NH}_2$ ,  $-0.47$ ;  $\text{Me}_2\text{N}$ ,  $-0.53$ ;  $\text{NHNH}_2$ ,  $-0.49$ ;  $\text{PhNH}$ ,  $-0.50$ ;  $\text{AcNH}$ ,  $-0.41$ ;  $\text{Ph}_2\text{NH}$ ,  $-0.44$ ;  $\text{N}(\text{CF}_3)_2$ ,  $-0.13$ . It should be recalled that the sign of the resonance effect is not actually given by this method, but must be inferred from other knowledge. Agreement with the  $^{19}\text{F}$  NMR values is quite good in several cases, but there are particularly marked discrepancies for  $\text{AcNH}$  and  $\text{PhNH}$ .

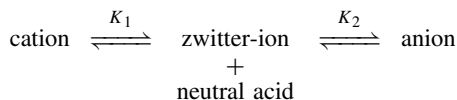
Exner tabulates  $\sigma_R^0$  values for many  $\text{NX}^1\text{X}^2$  substituents, measured by the  $^{19}\text{F}$  NMR method and/or the infrared intensity method<sup>78</sup>.

### D. Electronic Effects of the Amino Group and Related Groups on the Strengths of Benzoic and Other Acids

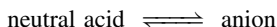
The ionization of *m*- or *p*-aminobenzoic acid is characterized by two  $\text{p}K_a$  values, for which we shall use the symbols  $\text{p}K_1$  and  $\text{p}K_2$ . The former is essentially concerned with the ionization of  $\text{NH}_3^+$  under the influence of  $\text{COOH}$ , the latter with the ionization of the



COOH group of the neutral acid. The situation is complicated, however, by the coexistence of the zwitter-ion with the neutral acid, so that the observed macroscopic constants  $K_1$  and  $K_2$  relate to equilibria as follows:



For the calculation of  $\sigma$  constants a  $\text{p}K_a$  value corresponding to



is required; the analysis of the macroscopic constants to this end is quite complicated: a simplifying assumption is required and the results depend on the particular assumption made. The matter has been considered by certain authors and the original papers should be consulted for details. We give a brief outline here<sup>79</sup>.

Serjeant<sup>235</sup> used values of 3.08 and 4.77 respectively for the  $\text{p}K_1$  and  $\text{p}K_2$  values of *m*-aminobenzoic acid in water at 25 °C and derived a  $\text{p}K_a$  value for the neutral acid of 4.20. He concluded that the value of  $\sigma_m$  for  $\text{NH}_2$  is effectively 0.00. Serjeant also considered *p*-aminobenzoic acid and derived a value for  $\sigma_p$  of  $\text{NH}_2$  equal to  $-0.57$ .

However, the situation for the latter acid was reconsidered in detail by van de Graaf, Hoefnagel and Wepster<sup>236</sup>. They obtained values of  $\text{p}K_1$  and  $\text{p}K_2$  (water, 25 °C) of 2.419 and 4.877 respectively by spectrophotometric measurements and calculated a value of  $\text{p}K_a$  of 4.83 for the ionization of the neutral acid. (The ratio of zwitter-ion to neutral acid present is 10.5:89.5.) From this  $\text{p}K_a$  value and 4.21 for the  $\text{p}K_a$  value of benzoic acid,  $\sigma_p$  of  $\text{NH}_2$  is  $-0.62$ . This is the recommended value in the IUPAC report<sup>79</sup>.

The need to consider the effect of zwitter-ion formation applied also to  $\text{Me}_2\text{N}$ . For aqueous solutions there appear to be no data relevant to obtaining a precise value of  $\sigma_m$ , but van de Graaf and colleagues have examined *p*-dimethylaminobenzoic acid<sup>236</sup>. They obtained values of  $\text{p}K_1$  and  $\text{p}K_2$  (water, 25 °C) of 2.568 and 4.996, respectively, and calculated a value of  $\text{p}K_a$  of 4.90 for the ionization of the neutral acid. (The ratio of zwitter-ion to neutral acid is 19.4:80.6.) From this  $\text{p}K_a$  value and 4.21 for the  $\text{p}K_a$  value of benzoic acid,  $\sigma_p$  for  $\text{Me}_2\text{N}$  is  $-0.69$ .

For many groups  $\text{NX}^1\text{X}^2$  there are values of  $\sigma_m$  and/or  $\sigma_p$  based on the ionization of substituted benzoic acids in 1:1 EtOH–H<sub>2</sub>O or other aqueous organic solvents<sup>230,237,238</sup>. The significance of some of these values is doubtful, because corrections for tautomerism should have been applied.

Very high  $\sigma$  values have been recorded for *m*- and *p*- $\text{NMe}_3^+$ , about 1.0 and 0.9 respectively. However, as already remarked, the significance of the substituent constants of unipolar groups is a matter of debate<sup>234</sup>.

Few data exist for the effect of the amino group and related groups on the strengths of acids of the type Ph–G–COOH. There is some information about the effect of *p*- $\text{NH}_2$  as a substituent in phenylacetic or phenylpropionic acid. From  $\text{p}K_a$  values in aqueous ethanolic solutions the apparent sigma value of *p*- $\text{NH}_2$  is in the range of about  $-0.20$  to  $-0.25$ <sup>124,125</sup>. (Corrections for zwitter-ion content have been applied by the authors concerned.) This range is much less negative than the  $\sigma_p$  value of  $-0.62$  derived above and corresponds fairly well to the  $\sigma^0$  value which would be expected from the values of  $\sigma_I$  and  $\sigma_R^0$  values discussed in Sections IX.A and IX.B. Exner<sup>78</sup> tabulates values of  $\sigma^0$  for numerous groups  $\text{NX}^1\text{X}^2$ , but many of them are calculated by means of theoretical relations between various types of sigma constant and are not independently determined experimental quantities. Also, there are not infrequent discrepancies.

The  $pK_a$  value of *m*-aminophenol is about 10.0 (water, 25 °C), i.e. very close to that of phenol itself, in accord with the very small electronic effect of *m*-NH<sub>2</sub>, as discussed above. For *p*-aminophenol the  $pK_a$  value is about 10.4, corresponding to an apparent  $\sigma$  value of about  $-0.2$ . This is very close to the  $\sigma^0$  value indicated above, as might be expected.

In the ionization of the *p*-aminoanilinium ion in 50% EtOH–H<sub>2</sub>O, the apparent  $\sigma$  value of the substituent is  $-0.42$ <sup>239</sup>. This is rather more negative than the  $\sigma^0$  value, which would have been expected to be applicable. This is an example of *resonance saturation* of two opposing powerful  $-R$  groups. A careful analysis of the effect of resonance saturation on the species involved on both sides of the equilibrium is required in order to explain the apparent enhancement of the  $-R$  effect of NH<sub>2</sub><sup>239</sup>.

### E. The *Ortho*-Effect of the Amino Group and Related Groups

In Section IV.B the effects of *ortho*-substituents on the strength of benzoic acid were analyzed in terms of Charton's substituent parameters<sup>109,143</sup> through equation 16. The  $pK_a$  value of *o*-aminobenzoic acid (water, 25 °C) is about 4.90. This may be compared with a value of 4.84 calculated by inserting  $\sigma_I = 0.17$ ,  $\sigma_R = -0.80$  and  $\nu = 0.35$  into equation 16. This seems to be fairly satisfactory agreement. It might have been expected that internal hydrogen-bonding would be a factor influencing the strength of this acid. On the one hand, the zwitter-ion might be stabilized by internal hydrogen-bonding; on the other hand, the carboxylate ion might be stabilized by internal hydrogen-bonding of the N–H...O<sup>1/2-</sup> type, cf the stabilization of the carboxylate ion of *o*-hydroxybenzoic acid by O–H...O<sup>1/2-</sup> hydrogen-bonding<sup>139</sup>. It may be that the opposed effects of internal hydrogen-bonding more or less cancel out.

*o*-Aminophenol differs from its *meta* and *para* isomers in being a slightly stronger acid than phenol, with a  $pK_a$  value of 9.7, compared with 10.0 for phenol. It seems probable that the *o*-aminophenoxide anion is stabilized by internal hydrogen-bonding.

We come now to the effects of *ortho*-substituents on the rate of reaction of benzoic acid with DDM (Section IV.C)<sup>143,144</sup>. Four NX<sup>1</sup>X<sup>2</sup> groups were examined in this work, but none of them were used in the basic set for establishing the regression equations from equation 17, because of the likelihood of interference by internal hydrogen-bonding. In fact, when the data for *o*-NH<sub>2</sub> were tested for conformity to the regression equations describing the rates of reaction in the 11 alcohols, no systematic discrepancies were found. This substituent might well have been included in the basic set. There was also no indication of any hydrogen-bonding effect in the case of *o*-NHMe. For NHPH there was an indication of a contribution from a favourable hydrogen-bonding effect and such an effect was more definite for *o*-NHAc. By 'favourable hydrogen-bonding effect' we mean the stabilization of the nascent carboxylate ion, leading to an increase in the reaction rate. Presumably such an effect is encouraged by the electron-attracting nature of Ph and particularly of Ac when these are components of NX<sup>1</sup>X<sup>2</sup>. The data obtained for the reaction in aprotic solvents were more limited, but for all four groups there was very clear evidence of favourable internal hydrogen-bonding. This was in accord with the general findings from the work involving aprotic solvents. For example, *o*-OH produced accelerations of about one thousand-fold. Clearly internal hydrogen-bonding is much increased when the solvent cannot act as a hydrogen-bond donor, or only feebly so.

### F. Substituent Effects in Highly Electron-Demanding Reactions

The amino group and its simple relatives, e.g. Me<sub>2</sub>N and PhNH, strongly accelerate the solvolysis of substrates such as benzhydryl chloride or tertiary cumyl chloride in solvents

such as ethanol or aqueous acetone. This facilitation of solvolysis has, however, rarely been characterized quantitatively, because the rates of reaction are inconveniently high. These substituents in the *para* position to a reaction centre exerting a strong electron-demand have the most negative  $\sigma^+$  values of any substituents commonly encountered, but such values are not based directly on the standard system, i.e. tertiary cumyl chloride solvolysis in 90% v/v aqueous acetone (Section II.A). They are based on a more amenable secondary reaction, such as acid-catalyzed protodesilylation or another process of electrophilic aromatic substitution (Section VI.C)<sup>223</sup>.

For  $\text{NH}_2$  Exner<sup>78</sup> gives several values of  $\sigma_p^+$  from various sources:  $-1.3$ ,  $-1.31$  and  $-1.47$ , so that a value of  $-1.36$  may be taken as an average value. Similarly for  $\text{Me}_2\text{N}$  the values given are:  $-1.7$ ,  $-1.5$  and  $-1.67$ , averaging  $-1.62$ . Values for  $\text{PhNH}$ ,  $\text{AcNH}$  and  $\text{BzNH}$  may be taken as  $-1.4$ ,  $-0.65$  and  $-0.6$ , respectively. The value for  $\text{Me}_2\text{N}$  being more negative than that for  $\text{NH}_2$  is usually attributed to the  $-I$  effect of the methyl groups. The less negative values for the acetyl- and benzoyl-substituted groups indicate that the lone pair of electrons of the N is delocalized into Ac or Bz and so is less available for the  $-R$  effect of  $\text{NX}^1\text{X}^2$ .

In considering quantitatively the response of these groups to high electron-demand there are certain *caveats*. In the first place it must be remembered that amino and related groups are liable to be protonated in the kind of media often used for studying electrophilic aromatic substitution. The observed substituent effect will then be that of the positive pole. Secondly, the straightforward application of the  $\sigma^+$  scale to electron-demanding reactions is not necessarily appropriate. It may well be that some form of multiparameter treatment is needed, perhaps the Yukawa-Tsuno equation (Section II.B).

## X. SOME FURTHER MULTIPARAMETER TREATMENTS OF SUBSTITUENT EFFECTS

### A. Introduction

Earlier sections of this chapter contain accounts of the Yukawa-Tsuno equation<sup>85,86</sup>, the Dual Substituent-Parameter (DSP) equation<sup>91,92</sup> and Extended Hammett (EH) equation<sup>95</sup> (see Section II.B), with the particular intention of showing how these may be applied to data sets involving the substituents of particular interest for this chapter. These equations are not now the only possibilities for multiparameter treatment. In this section we shall give accounts of some of the other approaches. The accounts will necessarily be brief, but key references will be given, with indications as to how the substituents of interest for this chapter fit into the various treatments.

### B. Exner's Analysis

This is essentially a method of providing an alternative set of  $\sigma_I$  and  $\sigma_R$  parameters for use in the DSP equation or EH equation. In the mid-1960's Exner<sup>94</sup> found evidence that the inductive effect from the *para* position of benzoic acid was stronger than that from the *meta* position by a factor of 1.14. He also suggested that  $\sigma_I$  values current at that time and based on alicyclic and aliphatic reactivities were out of scale with  $\sigma_m$  and  $\sigma_p$  by a factor of 1.10, and should be multiplied by this to introduce the  $\pi$ -inductive component. This led Exner to a revised analysis of  $\sigma_m$  and  $\sigma_p$  in terms of inductive and resonance components. He calculated revised  $\sigma_I$  values by multiplying the alicyclic/aliphatic values by 1.10, and then multiplying these further by 1.14 before subtracting from  $\sigma_p$  values to obtain revised values of  $\sigma_R$ .

The most dramatic changes were for some  $+R$  substituents, such as  $\text{NO}_2$  and  $\text{CN}$ , whose  $\sigma_R$  values dropped to zero. The implication of this is that such substituents are

normally not conjugated with the benzene ring and only become so in the presence of a  $-R$  *para*-substituent with which cross-conjugation is possible (Section II.A). Exner's recalculation of  $\sigma_R$  values imposes less dramatic changes on  $-R$  substituents, although these are still appreciable.

The status of Exner's revised  $\sigma_I$  and  $\sigma_R$  values has been debated for almost thirty years. A number of prominent workers in the field are rather critical of Exner's approach. For a fairly recent appraisal of the situation, see an article by the present author<sup>76</sup>. Exner has continued to propagate his view on this matter in his book published in 1988<sup>77</sup>. Some of his papers in the past few years indicate that he is developing further criticisms of aspects of the 'traditional' separation of inductive and resonance effects and of the ways in which correlation analysis of substituent effects is generally carried out<sup>138,240-243</sup>.

### C. C. G. Swain's Treatments

These began with a paper by Swain and Lupton<sup>244</sup> in 1968. The approach was slightly modified and greatly extended by Hansch's group in 1973<sup>245</sup>. During the first 15 years or so of its life, the Swain-Lupton treatment was applied extensively, but was also severely criticized. A revised version appeared in 1983 in a paper by Swain and coworkers<sup>246</sup>. This version was in its turn severely criticized, but also applied. The Swain-Lupton treatment was reviewed by the present author in 1978<sup>84</sup> and again more briefly in 1982<sup>75</sup>. A more recent review<sup>76</sup> covers also the revised version and an account of a mini-symposium in print in which several of Swain's critics set forth their views, and Swain replied<sup>247-250</sup>.

The Swain-Lupton treatment<sup>244</sup> was a reaction against the proliferation of scales of polar substituent constants. The authors maintained that the polar effect of any given substituent could be adequately expressed in terms of just two basic characteristics: a field constant  $\mathcal{F}$  and a fixed resonance constant  $\mathcal{R}$ . Swain and Lupton maintained that the correlation analysis of chemical reactivity data and spectroscopic data of aromatic systems could be carried out satisfactorily in terms of  $\mathcal{F}$  and  $\mathcal{R}$  (cf the four  $\sigma_R$ -type parameters introduced for the DSP equation), *meta* and *para* series being dealt with separately, as in the case of the DSP equation. The assumptions involved in establishing the  $\mathcal{F}$  and  $\mathcal{R}$  scales provoked much criticism. Nevertheless, the treatment achieved fair success when applied to chemical reactivity data and some spectroscopic data, particularly NMR<sup>75,84</sup>. The most notable success, however, was in the correlation analysis of biological activity data<sup>251</sup>.

The revised version<sup>246</sup> developed new scales of field and resonance parameters, the awkward symbols  $\mathcal{F}$  and  $\mathcal{R}$  being replaced by the more straightforward  $F$  and  $R$ . Some of the criticism made of the earlier form of the treatment had been met by the modifications, but the critics were still not satisfied<sup>247-249</sup>.

A compilation of  $F$  and  $R$  constants as revised by Hansch appeared in a book by Hansch and Leo<sup>118</sup>. A more recent compilation of substituent constants includes  $F$  and  $R$  values, revised again by Hansch<sup>150</sup>. Values are provided for numerous substituents of interest in this chapter.

### D. The Poly Substituent-Parameter (PSP) Equation

This equation is an elaboration of the dual substituent-parameter (DSP) equation. Its development has been relatively recent, but Taft and Topsom, who have been closely associated with it, have already written a long review article<sup>151</sup> involving the equation, and this article will probably acquire the status in respect of the PSP equation that the article of Ehrenson, Brownlee and Taft<sup>92</sup> has in connection with the DSP equation. The name Poly Substituent-Parameter Equation was devised by the present author in a short

account thereof<sup>76</sup>. Hopefully, that account and the present briefer one will encourage study of Taft and Topsom's article<sup>151</sup>.

The new treatment had its origins partly in *ab initio* molecular orbital calculations of substituent effects and partly in extensive studies of gas-phase proton transfer reactions from about 1980 (Section V.A). Various aspects of this work essentially drew attention to the importance of substituent polarizability. In 1986 Taft, Topsom and their colleagues<sup>252</sup> developed a scale of 'directional substituent polarizability parameters',  $\sigma_\alpha$ , by *ab initio* calculations of directional electrostatic polarization potentials at the 3-21G//3-31G level for a large set of CH<sub>3</sub>X molecules. The  $\sigma_\alpha$  values were shown to be useful in the correlation analysis of gas-phase acidities of several series of substrates<sup>252</sup>, and such work has subsequently been extended by Taft and Topsom<sup>151</sup>.

Values of  $\sigma_\alpha$  are available for over thirty substituents. H is the standard at 0.00 and the values range from +0.13 for F to -0.81 for Ph. The values for NO<sub>2</sub>, NH<sub>2</sub> and Me<sub>2</sub>N are -0.26, -0.16 and -0.44, respectively. To set these values in context we mention that the  $\sigma_\alpha$  values for Me, Cl, CN and SO<sub>2</sub>Me are -0.35, -0.43, -0.46 and -0.62, respectively.

The PSP equation is written by Taft and Topsom<sup>151</sup> in various forms. Equation 19 is a convenient form with which to begin this discussion:

$$-\delta\Delta G^\circ = \rho_F\sigma_F + \rho_R\sigma_R + \rho_\alpha\sigma_\alpha + \rho_\chi\sigma_\chi \quad (19)$$

The equation is written in terms of Gibbs energy changes, rather than  $\log K$  or  $\log k$ , because much of its application initially was to gas-phase reactions for which the use of Gibbs energies is conventional. Corresponding equations in terms of  $-\delta\Delta E^\circ$  or  $-\delta\Delta H^\circ$  have also been used. The negative sign is introduced to make the signs of  $\rho$  values correspond to the conventions of the Hammett equation.  $\sigma_F$  is Taft and Topsom's preferred symbol for the inductive constant  $\sigma_I$  (see Section V.A),  $\sigma_R$  is a resonance constant closely related to  $\sigma_R^0$ ,  $\sigma_\alpha$  the substituent polarizability parameter as above and  $\sigma_\chi$  is the substituent electronegativity parameter.

The inclusion of  $\sigma_\chi$  is to deal with the possibility that consideration of electronegativity may be helpful in understanding substituent effects. Values of  $\sigma_\chi$  come from *ab initio* calculations. On this scale H is taken as a standard at  $\sigma_\chi = 0.00$ , and the values range from -0.15 for SMe to +0.70 for F. NO<sub>2</sub>, NO, NH<sub>2</sub> and NMe<sub>2</sub> are at 0.46, 0.39, 0.33 and 0.34, respectively. To set these values in context we mention that the  $\sigma_\chi$  for Me, Cl, CF<sub>3</sub> and CN are 0.00, 0.16, 0.02 and 0.30, respectively. However, except at very short range, electronegativity effects of substituents are found not to be important, and the PSP equation may be simplified to equation 20:

$$-\delta\Delta G^\circ = \rho_F\sigma_F + \rho_R\sigma_R + \rho_\alpha\sigma_\alpha \quad (20)$$

Taft and Topsom's article<sup>151</sup> and also Topsom's<sup>171</sup> should be consulted for details of the setting up of the scales of substituent parameters. The equation has been applied to a wide range of gas-phase reactivities. (In the multiple regressions an intercept term is often permitted, but usually this turns out to be indistinguishable from zero, as it should be if equation 20 is valid.) For aliphatic and alicyclic saturated systems the resonance term is duly negligible. The roles of field, resonance and polarizability effects are discussed and the interpretation of the various  $\rho$  values is attempted.

When the equation is applied to reactions in solution, it is found that polarizability effects tend to be much smaller than in the gas phase, but the PSP equation has to be adapted to include Substituent Solvation Assisted Resonance (SSAR). (See Section III.D.) The PSP equation then assumes the form of equation 21:

$$-\delta\Delta G^\circ(\text{soln.}) = \rho_F\sigma_F + \rho_R\sigma_R + \rho_S\Delta\sigma_R \quad (21)$$

where  $\Delta\sigma_R$  is the SSAR parameter. A scale of  $\Delta\sigma_R$  values has been established. It is also necessary to use special  $\sigma_F(\text{aq.})$  values for some hydrogen-bond acceptor substituents in aqueous solution.

The SSAR phenomenon affects only +R substituents. The  $\Delta\sigma_R$  value of H is 0.00. Values for several +R substituents are as follows<sup>151</sup>: SO<sub>2</sub>Me, 0.02; CN, 0.07; COMe, 0.10; NO<sub>2</sub>, 0.18; NO, 0.32. Several of the substituents for which enhanced  $\sigma_F(\text{aq.})$  values are tabulated are +R substituents, but they do not include NO<sub>2</sub> or NO.  $\sigma_F(\text{aq.})$  values are given for NH<sub>2</sub> and NMe<sub>2</sub> as 0.19, cf the normal values at about 0.10.

A fairly recent study applied the PSP equation to good effect in discussing the gas-phase and aqueous solution basicities of about fifty 2-, 3- or 4-substituted pyridines and some 2,6-disubstituted compounds<sup>253</sup>. The substituents studied included 3- and 4-NO<sub>2</sub>, and 2-, 3- and 4-NH<sub>2</sub> and -NMe<sub>2</sub>, and these conformed fairly well to various relations and graphical plots. These groups also feature extensively in another study on the inherent dependence of resonance effects of strongly conjugated substituents on electron demand<sup>254</sup>.

### E. Charton's LDR Equation

This has been developed since 1986. The title letters stand for *Localized Delocalized Response*. The localized effect is Charton's preferred name for the inductive effect and delocalized effect is his preferred name for the resonance effect. Indeed, he would like to change the usual symbols from  $\sigma_I$  to  $\sigma_L$  and  $\sigma_R$  to  $\sigma_D$  for the purposes of the Extended Hammett (EH or LD) equation<sup>109</sup>. The response referred to is that of the substituent to the electronic demand of the site (i.e. reaction site in the correlation analysis of reactivity). Thus this equation, like the PSP equation, is concerned with the parametrization of substituent polarizability.

We shall describe the treatment only rather briefly, because a detailed article<sup>255</sup> and a useful introductory account<sup>256</sup> have already appeared. (The latter includes a table of substituent constants for about thirty common substituents.)

The LDR equation may be written as in equation 22:

$$Q_x = L\sigma_I + D\sigma_d + R\sigma_e + h \quad (22)$$

where  $Q_x$  is the property influenced by the substituent X,  $\sigma_I$  is the localized effect parameter, identical to  $\sigma_I$ ,  $\sigma_d$  is the intrinsic delocalized effect parameter for minimal electronic demand of the active site and  $\sigma_e$  gives the sensitivity of X to changes in electronic demand of the active site;  $h$  is the intercept term. Quantities  $\sigma_d$  and  $\sigma_e$  are defined by equation 23:

$$\sigma_D = \sigma_e\eta + \sigma_d \quad (23)$$

where  $\eta$  expresses the electronic demand of the active site and  $\sigma_D$  (i.e.  $\sigma_R$ ) is the relevant delocalized electronic parameter which would be used in the EH treatment of the system, i.e. a  $\sigma_R$ -type quantity. The main article mentioned above<sup>255</sup> should be consulted for the methods whereby the substituent parameter scales were established. Several hundred data sets have been treated by means of the LDR equation, and the various sigma parameters have been tabulated for more than 120 substituents.

As already mentioned, the  $\sigma_I$  values correspond to those of  $\sigma_I$  as derived by Charton<sup>109</sup>, while the values of  $\sigma_d$  are broadly similar to Charton's values of  $\sigma_R$ <sup>109</sup>. However, individual values may sometimes differ by a few units in the second place of decimals, consequent upon  $\sigma_d$  being derived from  $\sigma_D$  (i.e.  $\sigma_R$ ) in equation 23 by subtracting an electronic response term. Thus for NO<sub>2</sub> and NH<sub>2</sub>,  $\sigma_I$  values are 0.18 and -0.68, respectively; cf 0.10 and -0.80, respectively, for Charton's  $\sigma_R$  values<sup>109</sup>. H is the standard for  $\sigma_e$  at 0.00, and the scale runs from +0.041 for F to -0.29 for PPh<sub>2</sub>. The values for NO<sub>2</sub>

and  $\text{NH}_2$  are  $-0.077$  and  $-0.13$ , respectively. To set these values in context we mention the values for a few selected substituents: Me,  $-0.030$ ; Cl,  $-0.011$ ; OMe,  $-0.064$ .

The electronic demand parameter  $\eta$ , characteristic of a given process, is equal to the ratio of the coefficients  $R/D$  and has been shown to depend on the nature of the active site, skeletal group and medium. Contrary to the general view, electronic demand is roughly the same in magnitude for  $\sigma_R$  (based on benzoic acid ionization) and  $\sigma_R^0$  scales, but is positive for the former and negative for the latter.

It is claimed that, 'The LDR equation is the first successful model for electronic effects of substituents bonded to carbon in all substrates'<sup>257</sup>.

## XI. REFERENCES AND NOTES

1. J. Shorter, in *The Chemistry of the Sulphonium Group* (Eds. C. J. M. Stirling and S. Patai), Chap. 9, Wiley, Chichester, 1981.
2. J. Shorter, in *The Chemistry of Sulphones and Sulphoxides* (Eds. S. Patai, Z. Rappoport and C. J. M. Stirling), Chap. 10, Wiley, Chichester, 1988.
3. J. Shorter, in *The Chemistry of Sulphinic Acids, Esters and their Derivatives* (Ed. S. Patai), Chap. 17, Wiley, Chichester, 1990.
4. J. Shorter, in *The Chemistry of Amidines and Imidates*, Vol. 2 (Eds. S. Patai and Z. Rappoport), Chap. 13, Wiley, Chichester, 1991.
5. J. Shorter, in *The Chemistry of Hydroxyl, Ether and Peroxide Groups*, Supplement E2 (Ed. S. Patai), Chap. 9, Wiley, Chichester, 1993. [Corrigenda: Ref. 27 in this article should read C. K. Ingold and E. L. Holmes, *J. Chem. Soc.*, 1800 (1925); Ref. 25 should have year 1926.]
6. J. Shorter, in *The Chemistry of Triple-Bonded Functional Groups*, Supplement C2 (Ed. S. Patai), Chap. 5, Wiley, Chichester, 1994. [Corrigenda for this reference: p. 243, line 15, for  $0^*$  read  $\sigma^*$ ; p. 245, line 35, for II.A read III.A; p. 248, in (13) for 0.9965 read 0.9957; p. 249, lines 18 and 20, subscript  $\sigma$  should be  $\rho$ ; p. 263, Table 5,  $o:p$  and  $m:p$  should be preceded by 0.5; p. 274, line 13 up, for Series 1 read Series 2; p. 275, Table 13, for Series 3 read Series 4, and for Series 4 read Series 3; p. 277, line 19, the second  $\mathcal{F}$  and  $\mathcal{R}$  should be  $F$  and  $R$ .]
7. E. Mitscherlich, *Pogg. Ann. Phys. Chem.*, **31**, 625 (1834).
8. O. Unverdorben, *Pogg. Ann. Phys. Chem.*, **8**, 397 (1826).
9. F. Runge, *Pogg. Ann. Phys. Chem.*, **31**, 65, 513 (1834); **32**, 331 (1834).
10. C. J. Fritzsche, *J. Prakt. Chem.*, **20**[1], 453 (1840); **27**[1], 153 (1842); **28**[1], 202 (1843).
11. N. N. Zinin, *J. Prakt. Chem.*, **27**[1], 149 (1842).
12. This rather involved matter is summarized by H. E. Armstrong, in *Memorial Lectures Delivered before the Chemical Society 1893–1900*, Gurney and Jackson, London, 1901, pp. 640–643.
13. See, for example, *Watts' Dictionary of Chemistry*, 2nd ed. (Eds. M. M. Pattison Muir and H. Forster Morley), Longmans, Green and Co., London, in four vols., 1890–94.
14. C. A. Wurtz, *Compt. Rend.*, **28**, 223 (1849).
15. Reference 12, pp. 656–671, deals at some length with Hofmann's contributions to the chemistry of 'the volatile organic bases'.
16. Reference 13, Vol. II, p. 502.
17. J. Liebig, *Liebigs Ann.*, **30**, 142 (1839).
18. V. Meyer and O. Stuber, *Chem. Ber.*, **5**, 203 (1872).
19. V. Meyer, *Liebigs Ann.*, **171**, 1 (1874).
20. H. Kolbe, *J. Prakt. Chem.*, **5**[2], 427 (1872).
21. T. E. Thorpe, in *Memorial Lectures Delivered before the Chemical Society 1893–1900*, Gurney and Jackson, London, 1901, pp. 177–180.
22. H. H. Baer and L. Urbas, in *The Chemistry of the Nitro and Nitroso Groups*, Part 2 (Ed. H. Feuer), Chap. 3, Wiley, New York 1970.
23. N. Levy and J. D. Rose, *Quart. Rev.*, **1**, 358 (1947). According to these authors, dinitromethane was first prepared in 1864, but they give no reference.
24. A. R. Hantzsch and O. W. Schultze, *Chem. Ber.*, **29**, 699, 2251 (1896).
25. B. Priebs, *Liebigs Ann.*, **225**, 319 (1884).
26. L. Henry, *Bull. Acad. Roy. Belg.*, **32**, 33 (1896).
27. A. Lapworth, *Trans. Chem. Soc.*, **79**, 1269 (1901).
28. L. P. Hammett, *Physical Organic Chemistry*, McGraw-Hill, New York, 1940.

29. G. Bredig, *Z. Physik. Chem.*, **13**, 323 (1894).
30. N. Bjerrum, *Z. Physik. Chem.*, **104**, 147 (1923).
31. The absorption of the zwitter-ion concept into the corpus of organic chemistry may have been a little slow. For instance, the 3rd English edition of Paul Karrer's *Organic Chemistry* (Elsevier, New York, 1947) formulates the interaction between the amino and carboxyl groups in a rather vague way (p. 279). The 13th German edition (Georg Thieme, Stuttgart, 1959) has an excellent account in terms of zwitter-ions (p. 308).
32. G. Chuchani, in *The Chemistry of the Amino Group* (Ed. S. Patai), Chap. 5, Wiley, London, 1968.
33. T. Urbański, in *The Chemistry of the Nitro and Nitroso Groups*, Part 2 (Ed. H. Feuer), Chap. 2, Wiley, New York, 1970.
34. Th. J. de Boer and I. P. Dirckx, in *The Chemistry of the Nitro and Nitroso Groups*, Part 1 (Ed. H. Feuer), Chap. 8, Wiley, New York, 1969.
35. H. Hübner, *Chem. Ber.*, **8**, 873 (1875).
36. E. Noelting, *Chem. Ber.*, **9**, 1797 (1876).
37. H. E. Armstrong, *Trans. Chem. Soc.*, **51**, 258 (1887).
38. A. Crum Brown and J. Gibson, *Trans. Chem. Soc.*, **61**, 367 (1892).
39. D. Vorländer, *Liebigs Ann.*, **320**, 122 (1902).
40. D. Ll. Hammick and W. S. Illingworth, *J. Chem. Soc.*, 2358 (1930).
41. B. Flürscheim, *Trans. Chem. Soc.*, **95**, 718 (1909) and earlier papers.
42. A. F. Holleman, *Die direkte Einführung von Substituenten in den Benzolkern*, Veit, Leipzig, 1910.
43. In presenting this summary of the early part of the development of theories of aromatic substitution, the author is greatly indebted to the more extended account in W. A. Waters, *Physical Aspects of Organic Chemistry*, 4th ed., Chap. XVIII, Routledge and Kegan Paul, London, 1950.
44. M. D. Saltzman, *J. Chem. Educ.*, **57**, 484 (1980).
45. M. D. Saltzman, *Nat. Product Rep.*, **4**, 53 (1987).
46. J. Shorter, *Nat. Product Rep.*, **4**, 61 (1987).
47. J. Allan, A. E. Oxford, R. Robinson and J. C. Smith, *J. Chem. Soc.*, 401 (1926).
48. J. N. Collie, *Liebigs Ann.*, **226**, 316 (1883).
49. References 44–46 give references to the various accounts in which Robinson described the features of his electronic theory of organic reactions. The most comprehensive account was in R. Robinson, *Outline of an Electrochemical (Electronic) Theory of the Course of Organic Reactions*, Institute of Chemistry, London, 1932, 52pp.
50. C. K. Ingold, *J. Chem. Soc.*, 513 (1925).
51. J. W. Baker and C. K. Ingold, *J. Chem. Soc.*, 431 (1930).
52. C. K. Ingold and E. H. Ingold, *J. Chem. Soc.*, 1310 (1926).
53. See report of discussion at a meeting of the Chemical Society, *Chem. Ind. (London)*, 227 (1925).
54. C. K. Ingold and E. L. Holmes, *J. Chem. Soc.*, 1800 (1925).
55. E. L. Holmes and C. K. Ingold, *J. Chem. Soc.*, 1328 (1926).
56. H. R. Ing and R. Robinson, *J. Chem. Soc.*, 1655, (1926).
57. F. R. Goss, C. K. Ingold and I. S. Wilson, *J. Chem. Soc.*, 2440 (1926).
58. C. K. Ingold, F. R. Shaw and I. S. Wilson, *J. Chem. Soc.*, 1280 (1928).
59. C. K. Ingold, *Annu. Rep. Prog. Chem.*, **24**, 129 (1926).
60. C. K. Ingold, *Chem. Rev.*, **15**, 225 (1934).
61. Part I, A. E. Bradfield, Brynmor Jones and K. J. P. Orton, *J. Chem. Soc.*, 2810 (1929); Part XVIII, Brynmor Jones and E. N. Richardson, *J. Chem. Soc.*, 3939 (1956).
62. The earlier parts of the work on the kinetics of halogenation were summarized by A. E. Bradfield and Brynmor Jones, *Trans. Faraday Soc.*, **37**, 726 (1941).
63. Brynmor Jones, *J. Chem. Soc.*, 210 (1934).
64. K. J. P. Orton and A. E. Bradfield, *J. Chem. Soc.*, 986 (1927).
65. H. B. Watson, *Modern Theories of Organic Chemistry*, 2nd ed., Chap. 4, Oxford University Press, Oxford, 1941.
66. L. E. Sutton, *Proc. R. Soc. (London)*, **133A**, 668 (1931).
67. R. J. B. Marsden and L. E. Sutton, *J. Chem. Soc.*, 599 (1936).
68. G. M. Bennett and S. Glasstone, *Proc. R. Soc. (London)*, **145A**, 71 (1934).
69. O. Exner, *Dipole Moments in Organic Chemistry*, Chap. 6, Georg Thieme, Stuttgart, 1975.
70. This section is largely based on previous accounts in References 1, 2, 5 and 6, in which certain material was adapted (by kind permission of Oxford University Press) from J. Shorter, *Correlation Analysis in Organic Chemistry; An Introduction to Linear Free-Energy Relationships*, Chap. 2, Oxford Chemistry Series, 1973.



71. J. Shorter, *Correlation Analysis of Organic Reactivity*, Chap. 1, Research Studies Press, Wiley, Chichester, 1982.
72. Reference 28, Chap. 7.
73. L. P. Hammett, *Physical Organic Chemistry*, 2nd edn., Chap. 11, McGraw-Hill, New York, 1970.
74. O. Exner, in *Advances in Linear Free Energy Relationships* (Eds. N. B. Chapman and J. Shorter), Chap. 1, Plenum Press, London, 1972.
75. Reference 71, Chap. 3.
76. J. Shorter, in *Similarity Models in Organic Chemistry, Biochemistry, and Related Fields* (Eds. R. I. Zalewski, T. M. Krygowski and J. Shorter), Chap. 2, Elsevier, Amsterdam, 1991.
77. O. Exner, *Correlation Analysis of Chemical Data*, Plenum, New York and SNTL, Prague, 1988.
78. O. Exner, in *Correlation Analysis in Chemistry: Recent Advances* (Eds. N. B. Chapman and J. Shorter), Chap. 10, Plenum Press, New York, 1978.
79. J. Shorter, *Pure Appl. Chem.*, **66**, 2451 (1994).
80. H. H. Jaffé, *Chem. Rev.*, **53**, 191 (1953).
81. The symbol and sign conventions used for substituent effects in this chapter are those most frequently used by writers on correlation analysis in organic chemistry. *I* or *R* effects which withdraw electrons from the ring are regarded as positive. The sign convention is the opposite of that used by Ingold<sup>60</sup>, and which was observed in Section I.B. See Reference 71, pp. 229–230 for a more detailed discussion of symbol and sign conventions.
82. H. C. Brown and Y. Okamoto, *J. Am. Chem. Soc.*, **80**, 4979 (1958).
83. H. van Bekkum, P. E. Verkade and B. M. Wepster, *Recl. Trav. Chim. Pays-Bas*, **78**, 815 (1959).
84. J. Shorter, in Reference 78, Chap. 4.
85. Y. Yukawa and Y. Tsuno, *Bull. Chem. Soc. Jpn.*, **32**, 971 (1959).
86. Y. Yukawa, Y. Tsuno and M. Sawada, *Bull. Chem. Soc. Jpn.*, **39**, 2274 (1966).
87. R. W. Taft and I. C. Lewis, *J. Am. Chem. Soc.*, **80**, 2436 (1958).
88. R. W. Taft and I. C. Lewis, *J. Am. Chem. Soc.*, **81**, 5343 (1959).
89. R. W. Taft, in *Steric Effects in Organic Chemistry* (Ed. M. S. Newman), Chap. 13, Wiley, New York, 1956.
90. R. W. Taft, S. Ehrenson, I. C. Lewis and R. E. Glick, *J. Am. Chem. Soc.*, **81**, 5352 (1959).
91. S. Ehrenson, *Prog. Phys. Org. Chem.*, **2**, 195 (1964).
92. S. Ehrenson, R. T. C. Brownlee and R. W. Taft, *Prog. Phys. Org. Chem.*, **10**, 1 (1973).
93. It should be mentioned that the expression 'σ value' or 'σ constant' has acquired both a specialized and a more general meaning. The former denotes substituent constants based on the ionization of benzoic acids; the latter signifies polar (electronic) substituent constants in general. Thus the meaning of σ often has to be understood in context, but expressions such as 'sigma value' or 'σ-type constant' are preferable when the more general meaning is intended.
94. O. Exner, *Collect. Czech. Chem. Commun.*, **31**, 65 (1966).
95. See, for example, M. Charton, *J. Am. Chem. Soc.*, **91**, 6649 (1969).
96. R. W. Taft, E. Price, I. R. Fox, I. C. Lewis, K. K. Andersen and G. T. Davis, *J. Am. Chem. Soc.*, **85**, 709 (1963).
97. R. W. Taft, E. Price, I. R. Fox, I. C. Lewis, K. K. Andersen and G. T. Davis, *J. Am. Chem. Soc.*, **85**, 3146 (1963).
98. D. F. Ewing, in Reference 78, Chap. 8.
99. D. J. Craik and R. T. C. Brownlee, *Prog. Phys. Org. Chem.*, **14**, 1 (1983).
100. A. R. Katritzky and R. D. Topsom, in Reference 74, Chap. 3.
101. G. P. Ford, A. R. Katritzky and R. D. Topsom, in Reference 78, Chap. 3.
102. J. D. Roberts and W. T. Moreland, *J. Am. Chem. Soc.*, **75**, 2167 (1953).
103. Reference 71, Chap. 4.
104. J. Shorter, in Reference 74, Chap. 2.
105. Reference 70, Chap. 3.
106. R. W. Taft, *J. Am. Chem. Soc.*, **79**, 1045 (1957).
107. Except where a more specific reference is given, pK<sub>a</sub> values quoted explicitly, or quoted implicitly through correlations, in this chapter have been taken from the following compilations:
  - (a) G. Kortüm, W. Vogel and K. Andrussov, *Dissociation Constants of Organic Acids in Aqueous Solution*, Butterworths, London, 1961 (for I.U.P.A.C.). This is a reprint from *Pure and Applied Chemistry*, Vol. 1, Nos. 2 and 3.
  - (b) E. P. Serjeant and B. Dempsey, *Ionisation Constants of Organic Acids in Aqueous Solution*, Pergamon Press, Oxford, 1979 (I.U.P.A.C. Chemical Data Series, No. 23).

- (c) V. A. Palm (Ed.), and several compilers (from the Laboratory of Chemical Kinetics and Catalysis, Tartu State University, Estonia), *Tables of Rate and Equilibrium Constants of Heterolytic Organic Reactions*, Moscow, 1975–79, in 5 volumes, each being in two parts (10 books in all). Six supplementary volumes were published in 1984–90. Information about  $pK_a$  values may be found in particular in the first volume of each series. These volumes are especially useful for  $pK_a$  values determined in aqueous organic or purely organic solvents. Detailed references may be found in the above sources. Some use has also been made of Tables in Charton's review<sup>109</sup>, where detailed references are also given. Reference 107c has also been used as a source of rate constants in the present chapter, where no more specific reference is given.
108. For a recent review of the 'through-bonds' versus 'through-space' controversy, see J. Shorter, in Reference 76, especially pp. 117–120. See also K. Bowden and E. J. Grubbs, *Prog. Phys. Org. Chem.*, **19**, 183 (1993); O. Exner and Z. Friedl, *Prog. Phys. Org. Chem.*, **19**, 259 (1993).
  109. M. Charton, *Prog. Phys. Org. Chem.*, **13**, 119 (1981).
  110. Equation 58 on p. 137 of Reference 109.
  111. Equation 36 on p. 131 of Reference 109, with slightly different symbols. The correlation equations which are relevant to Table 3 are nos. 36, 27, 28 and 32 in Charton's Table 9, for our entries 2 to 5, respectively.
  112. M. Charton, *J. Org. Chem.*, **29**, 1222 (1964).
  113. Entry 6 in Table 9 of Reference 109.
  114. W. Ostwald, *Z. Phys. Chem.*, **3**, 170, 241, 369 (1889).
  115. J. F. J. Dippy, *Chem. Rev.*, **25**, 151 (1939) and references cited therein.
  116. L. P. Hammett, *J. Am. Chem. Soc.*, **59**, 96 (1937).
  117. A. J. Hoefnagel and B. M. Wepster, *J. Chem. Soc., Perkin Trans. 2*, 977 (1989).
  118. C. Hansch and A. J. Leo, *Substituent Constants for Correlation Analysis in Chemistry and Biology*, Wiley, New York, 1979.
  119. Reference 5, p. 423.
  120. O. Pytela, M. Ludwig and M. Večeřa, *Collect. Czech. Chem. Commun.*, **51**, 2143 (1986).
  121. M. Ludwig, V. Baron, K. Kalfus, O. Pytela and M. Večeřa, *Collect. Czech. Chem. Commun.*, **51**, 2135 (1986).
  122. V. Vsetecka and O. Exner, *Collect. Czech. Chem. Commun.*, **39**, 1140 (1974).
  123. This matter is very much tied in with Exner's approach to the analysis of  $\sigma$  values into inductive and resonance components. See References 75 and 94, and an appraisal of the situation by the present author in Reference 76. See Section X.B.
  124. A. J. Hoefnagel, J. C. Monshouwer, E. C. G. Snorn and B. M. Wepster, *J. Am. Chem. Soc.*, **95**, 5350 (1973).
  125. A. J. Hoefnagel and B. M. Wepster, *J. Am. Chem. Soc.*, **95**, 5357 (1973).
  126. The 50% v/v EtOH–H<sub>2</sub>O in Wepster's work is made by taking  $V \text{ cm}^3$  of ethanol and making up to  $2V \text{ cm}^3$  with water. It is thus different from the 50% EtOH–H<sub>2</sub>O mentioned in Table 3, which is made by mixing equal volumes of ethanol and water.
  127. Reference 5, p. 427.
  128. O. Exner, *Collect. Czech. Chem. Commun.*, **31**, 3222 (1966).
  129. Reference 71, Chapter 7.
  130. Reference 6, pp. 248–249.
  131. M. Fujio, R. T. McIver and R. W. Taft, *J. Am. Chem. Soc.*, **103**, 4017 (1981).
  132. Reference 76, pp. 102–104.
  133. G. W. Wheland, R. M. Brownell and E. C. Mayo, *J. Am. Chem. Soc.*, **70**, 2492 (1948).
  134. L. A. Cohen and W. M. Jones, *J. Am. Chem. Soc.*, **85**, 3397 (1963).
  135. Reference 65, p. 241.
  136. Reference 71, Chapter 4.
  137. M. Hojo, M. Utaka and Z. Yoshida, *Tetrahedron*, **27**, 4031 (1971).
  138. M. Decouzon, P. Ertl, O. Exner, J. -F. Gal and P. -C. Maria, *J. Am. Chem. Soc.*, **115**, 12071 (1993).
  139. G. E. K. Branch and D. L. Yabroff, *J. Am. Chem. Soc.*, **56**, 2568 (1934).
  140. M. Charton and B. I. Charton, *J. Org. Chem.*, **43**, 1161 (1978), and earlier papers referred to therein.
  141. M. Charton, in *Topics in Current Chemistry 114: Steric Effects in Drug Design* (Eds. M. Charton and I. Motoc), Springer-Verlag, Berlin, 1983, pp. 57–91.

142. M. Charton, in Reference 76, Chap. 11.
143. M. H. Aslam, A. G. Burden, N. B. Chapman, J. Shorter and M. Charton, *J. Chem. Soc., Perkin Trans. 2*, 500 (1981).
144. M. H. Aslam, N. B. Chapman, J. Shorter and M. Charton, *J. Chem. Soc., Perkin Trans. 2*, 720 (1981).
145. Reference 5, pp. 433–436.
146. M. H. Aslam, Ph.D. thesis, University of Hull, 1978. Also deposited material associated with References 143 and 144.
147. M. Kurahashi, M. Fukuyo and A. Shimada, *Bull. Chem. Soc. Jpn.*, **40**, 1296 (1967).
148. N. B. Chapman, J. R. Lee and J. Shorter, *J. Chem. Soc. (B)*, 769 (1969).
149. N. B. Chapman, J. R. Lee and J. Shorter, *J. Chem. Soc. (B)*, 755 (1970).
150. C. Hansch, A. Leo and R. W. Taft, *Chem. Rev.*, **91**, 165 (1991).
151. R. W. Taft and R. D. Topsom, *Prog. Phys. Org. Chem.*, **16**, 1 (1987).
152. R. W. Taft, *J. Phys. Chem.*, **64**, 1805 (1960).
153. Y. Yukawa, Y. Tsuno and M. Sawada, *Bull. Chem. Soc. Jpn.*, **45**, 1198 (1972).
154. R. T. C. Brownlee, R. E. J. Hutchison, A. R. Katritzky, T. T. Tidwell and R. D. Topsom, *J. Am. Chem. Soc.*, **90**, 1757 (1968).
155. J. Bromilow, R. T. C. Brownlee, V. O. Lopez and R. W. Taft, *J. Org. Chem.*, **44**, 4766 (1979).
156. W. F. Reynolds, A. Gomes, A. Maron, D. W. MacIntyre, A. Tanin, G. K. Hamer and I. R. Peat, *Can. J. Chem.*, **61**, 2376 (1983).
157. D. A. R. Happer, *J. Chem. Soc., Perkin Trans. 2*, 1673 (1984).
158. C. Laurence, M. Berthelot, M. Luçon, M. Helbert, D. G. Morris and J. -F. Gal, *J. Chem. Soc., Perkin Trans. 2*, 705 (1984).
159. C. Laurence, in Reference 76, Chap. 5.
160. G. G. Smith and F. W. Kelly, *Prog. Phys. Org. Chem.*, **8**, 75 (1971).
161. K. A. Holbrook, in *Supplement B2: The Chemistry of Acid Derivatives*, Vol. 2 (Ed. S. Patai), Chap. 12, Wiley, Chichester, 1992.
162. R. Taylor, in *Supplement B: The Chemistry of Acid Derivatives* (Ed. S. Patai), Wiley, Chichester, 1979, p. 860.
163. M. Mashima, R. T. McIver, R. W. Taft, F. G. Bordwell and W. N. Olmstead, *J. Am. Chem. Soc.*, **106**, 2717 (1984).
164. S. Marriott and R. D. Topsom, *J. Am. Chem. Soc.*, **106**, 7 (1984).
165. S. Marriott and R. D. Topsom, *J. Chem. Soc., Perkin Trans. 2*, 1045 (1985).
166. S. Marriott, A. Silvestro and R. D. Topsom, *J. Chem. Soc., Perkin Trans. 2*, 457 (1988).
167. S. Marriott, A. Silvestro and R. D. Topsom, *J. Mol. Struct. (Theochem)*, **184**, 23 (1989).
168. Cai Jinfeng and R. D. Topsom, *J. Mol. Struct. (Theochem)*, **204**, 353 (1990).
169. Jinfeng Cai and R. D. Topsom, *J. Mol. Struct. (Theochem)*, **228**, 181 (1991).
170. Tony Silvestro and R. D. Topsom, *J. Mol. Struct. (Theochem)*, **206**, 309 (1990).
171. R. D. Topsom, *Prog. Phys. Org. Chem.*, **17**, 107 (1990).
172. R. D. Topsom, *Prog. Phys. Org. Chem.*, **16**, 125 (1987).
173. T. Sotomatsu, Y. Murata and T. Fujita, *J. Comput. Chem.*, **10**, 94 (1989).
174. K. H. Kim and Y. C. Martin, *J. Org. Chem.*, **56**, 2723 (1991).
175. V. I. Galkin, A. R. Cherkasov, R. D. Sayakhov and R. A. Cherkasov, *Zh. Obshch. Khim.*, **65**, 458, 469, 474 (1995).
176. O. Pytela, *Collect. Czech. Chem. Commun.*, **59**, 159 (1994).
177. O. Pytela, *Collect. Czech. Chem. Commun.*, **59**, 381 (1994).
178. O. Pytela, J. Kulhánek, M. Ludwig and V. Říha, *Collect. Czech. Chem. Commun.*, **59**, 627 (1994).
179. O. Pytela, J. Kulhánek and M. Ludwig, *Collect. Czech. Chem. Commun.*, **59**, 1637 (1994).
180. O. Pytela and J. Liška, *Collect. Czech. Chem. Commun.*, **59**, 2005 (1994).
181. Published since 1965 by Wiley. The latest volume is *Organic Reaction Mechanisms 1993* (Eds. A. C. Knipe and W. E. Watts), Wiley, Chichester, 1995.
182. Reference 107c, Volume II, Part 1 and Supplementary Volume I, Issue 5.
183. F. G. Bordwell, *Acc. Chem. Res.*, **21**, 456 (1988) and references cited therein.
184. J. R. Jones, *The Ionization of Carbon Acids*, Chap. 5, Academic Press, London, 1973.
185. D. J. Cram, *Fundamentals of Carbanion Chemistry*, Academic Press, New York, 1965.
186. R. P. Bell, *The Proton in Chemistry*, 2nd edn., Chapman and Hall, London, 1973.
187. J. R. Gandler and C. F. Bernasconi, *J. Am. Chem. Soc.*, **114**, 631 (1992).
188. F. Terrier, T. Boubaker, L. Xiao and P. G. Farrell, *J. Org. Chem.*, **57**, 3924 (1992).

189. F. Terrier, L. Xiao, P. G. Farrell and D. Moskowitz, *J. Chem. Soc., Perkin Trans. 2*, 1259 (1992).
190. A. Jarczewski, G. Schroeder and K. T. Leffek, *Can. J. Chem.*, **69**, 468 (1991).
191. M. Amin and W. H. Saunders, *J. Phys. Org. Chem.*, **6**, 393 (1993).
192. K. Bowden, A. F. Cockerill and J. R. Gilbert, *J. Chem. Soc. (B)*, 179 (1970).
193. S. Bradamante and G. A. Pagani, *J. Org. Chem.*, **45**, 105, 114 (1980).
194. S. Bradamante and G. A. Pagani, *J. Chem. Soc., Perkin Trans. 2*, 1047 (1986).
195. A. Abbotto, S. Bradamante and G. A. Pagani, *J. Org. Chem.*, **58**, 449 (1993).
196. C. A. Bunton, *Nucleophilic Substitution at a Saturated Carbon Atom*, Elsevier, Amsterdam, 1963.
197. J. Miller, *Aromatic Nucleophilic Substitution*, Elsevier, Amsterdam, 1968.
198. Unless a more specific reference is given, rate coefficients in Section VI.B have been taken from the volumes of Reference 107c: Volume 3, Part 1 (first order nucleophilic substitution); Volume 4, Part 2 (aromatic nucleophilic substitution).
199. W. F. Reynolds, P. Dais, D. W. Macintyre, R. D. Topsom, S. Marriott, E. von Nagy-Felsobuki and R. W. Taft, *J. Am. Chem. Soc.*, **105**, 378 (1983).
200. P. G. Gassman and J. J. Talley, *J. Am. Chem. Soc.*, **102**, 1214 (1980).
201. P. G. Gassman and T. T. Tidwell, *Acc. Chem. Res.*, **16**, 279 (1983).
202. T. T. Tidwell, *Angew. Chem., Int. Ed. Engl.*, **23**, 20 (1984).
203. A. D. Allen, V. M. Kanagasabapathy and T. T. Tidwell, *J. Am. Chem. Soc.*, **108**, 3470 (1986).
204. G. A. Olah, G. K. S. Prakash, M. Arvanaghi, V. V. Krishnamurthy and S. C. Narang, *J. Am. Chem. Soc.*, **106**, 2378 (1984).
205. A. Fischer, W. J. Galloway and J. Vaughan, *J. Chem. Soc.*, 3591, 3596 (1964).
206. C. D. Johnson, I. Roberts and P. G. Taylor, *J. Chem. Soc., Chem. Commun.*, 897 (1977).
207. M. Taagapera, K. D. Summerhays, W. J. Hehre, R. D. Topsom, A. Pross, L. Radom and R. W. Taft, *J. Org. Chem.*, **46**, 891 (1981).
208. N. B. Chapman and D. A. Russell-Hill, *J. Chem. Soc.*, 1563 (1956).
209. Reference 197, p. 23.
210. N. B. Chapman, D. K. Chaudhury and J. Shorter, *J. Chem. Soc.*, 1975 (1962).
211. D. M. Brewis, N. B. Chapman, J. S. Paine, J. Shorter and D. J. Wright, *J. Chem. Soc., Perkin Trans. 2*, 1787 (1974).
212. D. M. Brewis, N. B. Chapman, J. S. Paine and J. Shorter, *J. Chem. Soc., Perkin Trans. 2*, 1802 (1974).
213. J. Miller and A. J. Parker, *Aust. J. Chem.*, **11**, 302 (1958).
214. Reference 197, p. 100.
215. E. Buncl and R. A. Manderville, *J. Phys. Org. Chem.*, **6**, 71 (1993).
216. F. Terrier, M. -J. Pouet, J. -C. Halle, S. Hunt, J. R. Jones and E. Buncl, *J. Chem. Soc., Perkin Trans. 2*, 1665 (1993).
217. C. A. Grob and M. G. Schlageter, *Helv. Chim. Acta*, **60**, 1884 (1977).
218. C. A. Grob and M. G. Schlageter, *Helv. Chim. Acta*, **59**, 264 (1976).
219. W. Fischer and C. A. Grob, *Helv. Chim. Acta*, **61**, 1588 (1978).
220. C. A. Grob and A. Waldner, *Helv. Chim. Acta*, **62**, 1736 (1979).
221. C. A. Grob and R. Rich, *Helv. Chim. Acta*, **62**, 2793 (1979).
222. C. A. Grob, *Angew. Chem., Int. Ed. Engl.*, **15**, 569 (1979).
223. R. Taylor, *Electrophilic Aromatic Substitution*, Wiley, Chichester, 1990.
224. Reference 223, pp. 308, 395 and 485–487.
225. Reference 223, pp. 143–154.
226. Reference 223, pp. 154–156.
227. Reference 223, pp. 346–347.
228. Reference 223, pp. 458–463.
229. From Table 16 in G. E. K. Branch and M. Calvin, *The Theory of Organic Chemistry*, Prentice-Hall, New York, 1946, p. 146.
230. F. S. Fawcett and W. A. Sheppard, *J. Am. Chem. Soc.*, **87**, 4341 (1965).
231. E. Yu. Belyaev, M. S. Tovbis and G. A. Suboch, *Zh. Org. Khim.*, **12**, 1826 (1976); English edition, **12**, 1790 (1976).
232. Reference 197, pp. 79–81.
233. M. M. Fickling, A. Fischer, B. R. Mann, J. Packer and J. Vaughan, *J. Am. Chem. Soc.*, **81**, 4226 (1959).
234. Reference 6, pp. 269–272.
235. E. P. Serjeant, *Aust. J. Chem.*, **22**, 1189 (1969).

236. B. van de Graaf, A. J. Hoefnagel and B. M. Wepster, *J. Org. Chem.*, **46**, 653 (1981).
237. O. Exner and J. Lakomý, *Collect. Czech. Chem. Commun.*, **35**, 1371 (1970).
238. E. N. Tsvetkov, D. I. Lobanov, M. M. Makhamatkhanov and M. I. Kabachnik, *Tetrahedron*, **25**, 5623 (1969).
239. A. J. Hoefnagel, M. A. Hoefnagel and B. M. Wepster, *J. Am. Chem. Soc.*, **98**, 6194 (1976).
240. O. Exner and M. Buděšínský, *Magn. Reson. Chem.*, **27**, 27 (1989).
241. M. Buděšínský and O. Exner, *Magn. Reson. Chem.*, **27**, 585 (1989).
242. M. Ludwig, S. Wold and O. Exner, *Acta Chem. Scand.*, **46**, 549 (1992).
243. O. Exner and T. M. Krygowski are in the course of publishing an article on the nitro group as a substituent, in which various issues about its electronic effect are addressed.
244. C. G. Swain and E. C. Lupton, *J. Am. Chem. Soc.*, **90**, 4328 (1968).
245. C. Hansch, A. Leo, S. H. Unger, K. H. Kim, D. Nakaitani and E. J. Lien, *J. Med. Chem.*, **16**, 1207 (1973).
246. C. G. Swain, S. H. Unger, N. R. Rosenquist and M. S. Swain, *J. Am. Chem. Soc.*, **105**, 492 (1983).
247. W. F. Reynolds and R. D. Topsom, *J. Org. Chem.*, **49**, 1989 (1984).
248. A. J. Hoefnagel, W. Oosterbeek and B. M. Wepster, *J. Org. Chem.*, **49**, 1993 (1984).
249. M. Charton, *J. Org. Chem.*, **49**, 1997 (1984).
250. C. G. Swain, *J. Org. Chem.*, **49**, 2005 (1984).
251. C. Hansch, in Reference 78, Chap. 9.
252. W. J. Hehre, C. -F. Pau, A. D. Headley, R. W. Taft and R. D. Topsom, *J. Am. Chem. Soc.*, **108**, 1711 (1986).
253. J. -L. M. Abboud, J. Catalán, J. Elguero and R. W. Taft, *J. Org. Chem.*, **53**, 1137 (1988).
254. R. W. Taft, J. L. M. Abboud, F. Anvia, M. Berthelot, M. Fujio, J. -F. Gal, A. D. Headley, W. G. Henderson, I. Koppel, J. H. Qian, M. Mishima, M. Taagepera and S. Ueji, *J. Am. Chem. Soc.*, **110**, 1797 (1988).
255. M. Charton, *Prog. Phys. Org. Chem.*, **16**, 287 (1987).
256. M. Charton and B. Charton, *Bull. Soc. Chim. France*, 199 (1988).
257. Reference 255, p. 238.

## CHAPTER 12

# Advances in the chemistry of amino and nitro compounds

G. V. BOYD

*Department of Organic Chemistry, The Hebrew University of Jerusalem, Jerusalem 91904, Israel*

*Fax: 972-2-658-5345; e-mail: EVA@BATATA.HUJI.AC.IL*

---

I. INTRODUCTION . . . . .	534
II. AMINO COMPOUNDS . . . . .	534
A. Synthesis of Amino Compounds . . . . .	534
1. By reduction . . . . .	534
a. Reduction of nitro compounds . . . . .	534
b. Reduction of hydroxylamines, oximes, nitrones, etc. . . . .	534
c. Reduction of amides and cyanides . . . . .	536
d. Reduction of azides . . . . .	537
2. By alkylation and arylation of amines and azides . . . . .	538
3. By modifications of the Gabriel synthesis . . . . .	540
4. From alcohols . . . . .	542
5. From epoxides, aziridines and oxetanes . . . . .	543
6. From imines . . . . .	545
7. By electrophilic amination . . . . .	550
8. Via $>\text{N}-\overset{\oplus}{\text{C}}<$ synthons . . . . .	553
9. By oxidative amination . . . . .	560
10. By photoamination . . . . .	561
11. By reductive alkylation . . . . .	562
12. By means of organoboron compounds . . . . .	564
13. Synthesis of olefinic and acetylenic amines . . . . .	567
14. By miscellaneous methods . . . . .	577
B. Reactions of Amino Compounds . . . . .	578
1. Oxidation and dehydrogenation . . . . .	578
2. Dealkylation . . . . .	581
3. Alkylation, arylation, etc. . . . .	583

4. Amination of olefins	587
5. Formation of enamines	588
6. Formation of amides etc.	590
7. Protection of amines	594
8. Formation of carbamates, ureas, isocyanates, etc.	595
9. Cyclization reactions	597
10. Formation of aminyl radicals	599
11. Miscellaneous reactions	601
III. NITRO COMPOUNDS	604
A. Synthesis	604
B. Reactions	607
1. Formation of oximes, nitrones, hydroxylamines, amines, etc.	607
2. Reactions of aliphatic nitro compounds with nucleophiles	610
3. Reactions of nitroalkenes	613
IV. REFERENCES	616

## I. INTRODUCTION

This chapter presents a selective account of advances in the chemistry of amino and nitro compounds since the appearance of previous volumes in this series<sup>1a-d</sup>. The emphasis in the section on nitro compounds is on aliphatic members of this class. The original plan to include a review of nitroso compounds was abandoned when it was found that there had not been sufficiently important developments in this area in the last 26 years. However, specific aspects of nitroso compounds are treated in this volume in the chapters by D. L. H. Williams, by A. H. Mehles and by P. Eyer and D. Galleman.

## II. AMINO COMPOUNDS

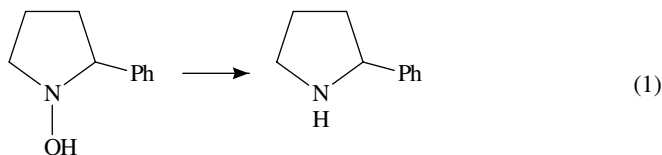
### A. Synthesis of Amino Compounds

#### 1. By reduction

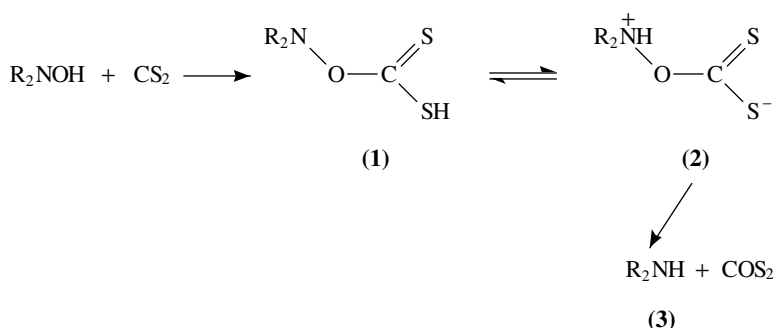
*a. Reduction of nitro compounds.* Nitroarenes are selectively hydrogenated to amines at room temperature and pressure with a borohydride exchange-resin/palladium catalyst. Keto, ester, cyano and chloro substituents are not affected and, moreover, aromatic nitro compounds are selectively reduced in the presence of aliphatic nitro compounds<sup>2</sup>. The reaction of nitroarenes with anhydrous hydrazine in refluxing ethanol in the presence of sodium nitrate and activated carbon gives aromatic amines. 1-Nitronaphthalene, for example, yields 96% of 1-aminonaphthalene<sup>3</sup>. The selective reduction of aromatic nitro groups to amino groups in the presence of olefinic, ester or halogen functions is accomplished by Rh<sub>6</sub>(CO)<sub>16</sub> in conjunction with aminated polystyrene<sup>4</sup>. Another chemoselective reduction of aromatic nitro compounds in the presence of carbonyl or halogen groups is by baker's yeast in basic solution<sup>5</sup>. The reaction of nitroarenes with sodium trimethylsilanethiolate (Me<sub>3</sub>SiSNa) in 1,3-dimethyl-2-imidazolidinone in a sealed tube at 185 °C for 24 h yields 83–99% of the corresponding amines<sup>6</sup>. Treatment of nitroarenes with diisobutyl telluride in the presence of titanium(IV) chloride and subsequent alkaline hydrolysis affords the corresponding arylamines in yields of 42–98%<sup>7</sup>.

*b. Reduction of hydroxylamines, oximes, nitrones, etc.* Titanium(III) chloride in aqueous methanol reduces hydroxylamines to amines; 1-hydroxy-2-phenylpyrrolidine, for instance,

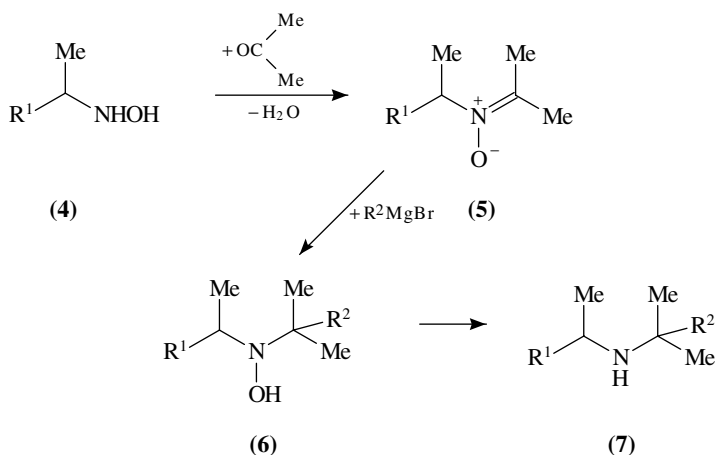
yields 2-phenylpyrrolidine (equation 1)<sup>8</sup>.



The formation of secondary amines **3** from hindered *N,N*-disubstituted hydroxylamines by the action of carbon disulphide is thought to proceed by way of the adducts **1**, which are in equilibrium with the betaines **2**. These break down into the amines **3** and 'COS<sub>2</sub>', which decomposes into the observed by-products carbon oxysulphide and sulphur<sup>9</sup>.



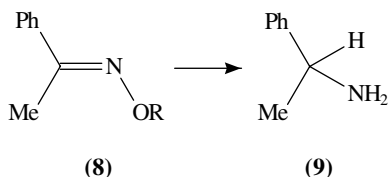
Treatment of hydroxylamines **4** ( $\text{R}^1 = \text{cyclohexyl, Ph or } 3,4\text{-(MeO)}_2\text{C}_6\text{H}_3$ ) with acetone gives nitrones **5**, which are transformed by Grignard reagents  $\text{R}^2\text{MgBr}$  ( $\text{R}^2 = \text{Me, Et, Bu, Ph}$  or allyl) into the hydroxylamines **6**; the latter are converted into the hindered secondary amines **7** by means of carbon disulphide<sup>10</sup>.



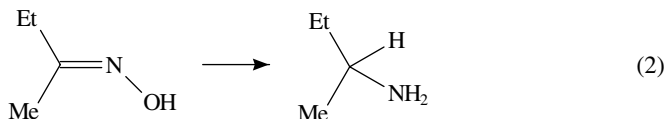
Tertiary amine *N*-oxides are rapidly deoxygenated by carbon disulphide<sup>11,12</sup>. Oximes are reduced to primary amines by titanium(III) chloride in the presence of sodium cyanoborohydride,  $\text{NaBH}_3\text{CN}$ <sup>13</sup>. The combined action of sodium borohydride and a chiral



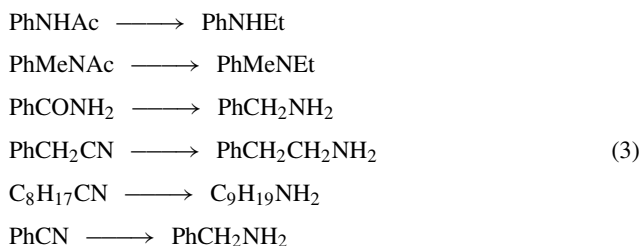
amino acid on ketoxime *O*-alkyl ethers yields optically active primary amines in up to 95% enantiomeric excess<sup>14</sup>. The chiral reducing agent  $\text{BH}_3/(-)$ -norephedrine converted the *anti*-oxime ethers **8** ( $\text{R} = \text{Me}, \text{C}_8\text{H}_{17}, \text{Me}_3\text{Si}$  or  $\text{PhCH}_2$ ) into the (*S*)-amine **9** in 92% enantiomeric excess, while the *syn*-oxime ethers gave the (*R*)-amine<sup>15</sup>.



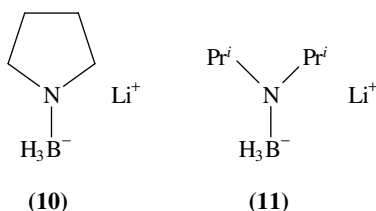
Fermenting baker's yeast transformed 2-butanone oxime containing 44% excess of the (*E*)-isomer into optically active (*R*)-2-aminobutane in 58% enantiomeric excess. The chiral amine was also obtained in 24% e.e. from the oxime acetate but the oxime methyl ether gave a racemic product (equation 2)<sup>16</sup>.



*c. Reduction of amides and cyanides.* Amides and cyanides are reduced to amines by the combined action of sodium borohydride and iodine in THF; some examples are shown below (equation 3)<sup>17</sup>:

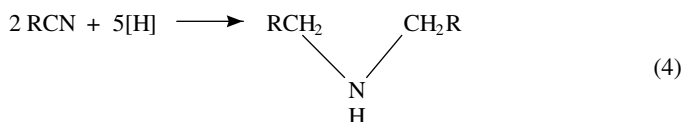


The lithium aminoborohydrides **10** and **11**, prepared from the complex  $\text{BH}_3 \cdot \text{THF}$  by treatment with, respectively, pyrrolidine and diisopropylamine, followed by butyllithium, are safe, powerful reducing agents. Tertiary amides are converted into amines, e.g. *N,N*-diethyldodecanoamide gives dodecyl-diethylamine and *N,N*-diethylsalicylamide gives diethyl (*o*-hydroxybenzyl)amine<sup>18</sup>. A similar reduction of tertiary amides  $\text{R}^1\text{CONR}^2\text{R}^3$  ( $\text{R}^1, \text{R}^2 = \text{Me}, \text{Et}, i\text{-Pr}$  or  $\text{Ph}$ ;  $\text{R}^3 = \text{H}, \text{Et}, i\text{-Pr}$  or  $\text{PhCH}_2$ ) to the amines  $\text{R}^1\text{CH}_2\text{NR}^2\text{R}^3$  by means of borane/dimethylsulphide has been reported<sup>19</sup>. Diborane, generated from sodium borohydride and boron trifluoride diethyl etherate, converts primary, secondary and tertiary amides into amines in moderate to high yields; lactams give the corresponding cyclic amines<sup>20</sup>. Sodium borohydride/bis(2-bromoethyl) selenium dibromide ( $\text{BrCH}_2\text{CH}_2$ )<sub>2</sub>SeBr<sub>2</sub> in THF is a selective reagent for the reduction of secondary amides to secondary amines; primary and tertiary amides are not affected<sup>21</sup>. Similarly, the combination sodium borohydride/ $\text{Et}_2\text{SeX}_2$  reduces amides to amines; for secondary amides the reactivity decreases in the sequence ( $\text{X} = \text{I}$ ) > ( $\text{X} = \text{Br}$ ) > ( $\text{X} = \text{Cl}$ ).



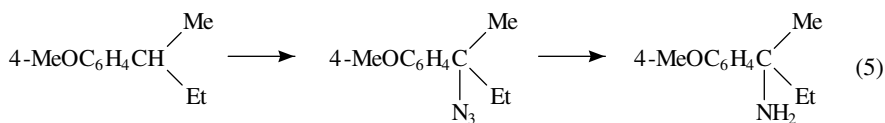
Only the iodine-containing reagent is capable of reducing primary and tertiary amides<sup>22</sup>.

High yields of secondary amines are obtained when solutions of nitriles in acetic acid are hydrogenated at room temperature and pressure over a 5% rhodium-on-alumina catalyst (equation 4); hydroxy, ethoxycarbonyl and tosylamino substituents are not affected<sup>23</sup>.

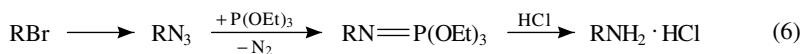


*d. Reduction of azides.* Synthetic uses of azides have been reviewed<sup>24</sup>. Primary amines are produced in good yields when aliphatic or aromatic azides are heated with hydrazine in ethanol in the presence of palladium<sup>25</sup>; the reduction is also accomplished by methanolic tin(II) chloride<sup>26</sup>, by sodium borohydride/copper sulphate in ice-cold methanol<sup>27</sup>, by magnesium and calcium in methanol<sup>28</sup>, by nickel boride generated *in situ* from sodium borohydride and nickel chloride in methanol<sup>29</sup> and by a borohydride exchange-resin/nickel acetate system<sup>30</sup>.

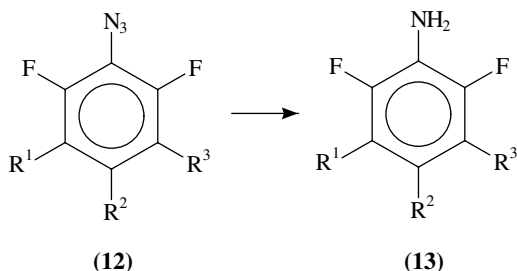
The benzylic hydrogen atom of alkylarenes is replaced by the azido group on treatment with trimethylsilyl azide in the presence of 2,3-dichloro-5,6-dicyano-1,4-benzoquinone; subsequent hydrogenation yields amines (e.g. equation 5)<sup>31</sup>.



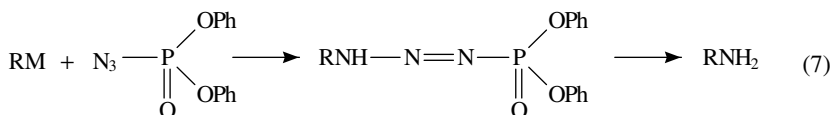
The following sequence (equation 6) constitutes a convenient alternative to the conversion of alkyl halides into alkylamines by the Gabriel reaction with potassium phthalimide. In this one-pot procedure, an alkyl bromide RBr (R = Bu, *i*-Bu, 2-pentyl, 2-octyl, PhCH<sub>2</sub>CH<sub>2</sub>, HC≡C, PhCH=CHCH<sub>2</sub>, cyclopentyl, cyclohexyl etc.) is treated with sodium azide in benzene in the presence of tetrabutylammonium bromide under phase-transfer conditions. Triethyl phosphite is then added and the resulting iminophosphorane is decomposed to the alkyl amine hydrochloride by adding benzene and hydrogen chloride<sup>32</sup>.



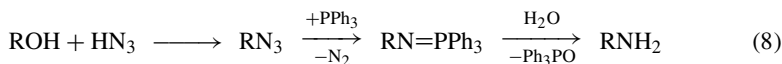
The action of tin(II) chloride in ethanol/ethyl acetate on the aryl azides **12** (R<sup>1</sup> = R<sup>3</sup> = F, R<sup>2</sup> = NO<sub>2</sub>, CHO or CO<sub>2</sub>Me; R<sup>1</sup> = NH<sub>2</sub>, R<sup>2</sup> = NO<sub>2</sub>, R<sup>3</sup> = H) leads to the corresponding anilines **13**<sup>33</sup>.



Organolithium or Grignard compounds derived from aryl or heteroaryl halides react with diphenyl phosphorazidate to give labile phosphinoyltriazenes, which on reductive work-up with aluminium hydride afford good yields of aryl or heteroaryl amines (equation 7)<sup>34</sup>.

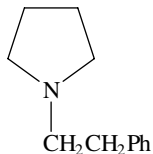


A one-pot procedure for the conversion of alcohols into alkylamines is by treatment of the former with hydrazoic acid in the presence of triphenylphosphine and diisopropyl azodicarboxylate; addition of triphenylphosphine to the resulting azide gives an iminophosphorane, which is hydrolysed to the alkylamine by water (equation 8)<sup>35</sup>.



## 2. By alkylation and arylation of amines and azides

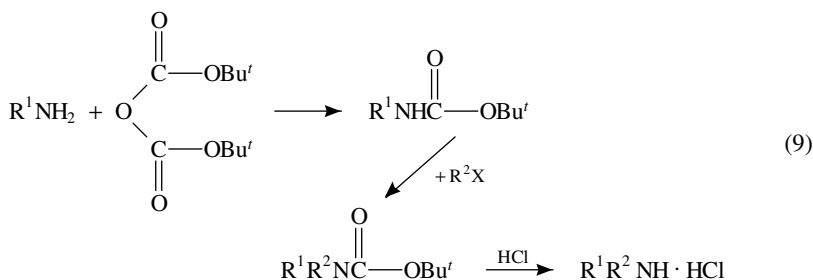
Aromatic amines  $\text{RNH}_2$  ( $\text{R} = \text{Ph}$ ,  $2\text{-MeC}_6\text{H}_4$  or  $4\text{-MeOC}_6\text{H}_4$ ) are phenylated by triphenylbismuth in the presence of 0.5 equivalent of copper(II) acetate to yield diarylamines  $\text{RNHPh}$ . Butylamine yields a mixture of *N*-butylaniline and *N*-butyldiphenylamine in this reaction and piperidine gives *N*-phenylpiperidine<sup>36</sup>. A similar alkylation of the secondary amines pyrrolidine, piperidine and morpholine with trimethylbismuth or tris(2-phenylethyl)bismuth in the presence of copper(II) acetate affords tertiary amines, e.g. **14**. The reaction proceeds by way of transient pentavalent bismuth compounds<sup>37</sup>.



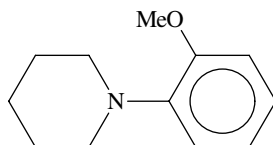
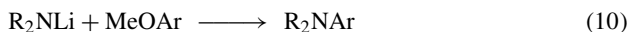
**(14)**

The direct high-pressure amination of ethylene with ammonia to give ethylamine occurs in the presence of acidic zeolite catalysts such as H-elinoptilolite, H-erionite or H-offretite<sup>38</sup>. Primary amines  $\text{R}^1\text{NH}_2$  ( $\text{R}^1 = \text{Bu}$ , cyclohexyl,  $\text{PhCH}_2$ , Ph or Ar) have been monoalkylated by reaction with di-*t*-butyl dicarbonate, followed by successive treatment of

the product with sodium hydride, an alkyl halide  $R^2 X$  ( $R^2 = \text{Me, Et, Pr, Bu, CH}_2=\text{CHCH}_2$  or  $\text{PhCH}_2$ ) and dilute hydrochloric acid (equation 9)<sup>39</sup>.

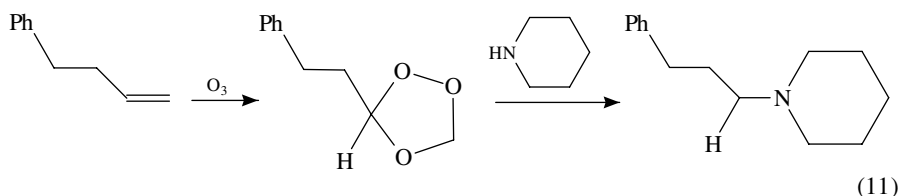


Lithium derivatives of dialkylamines react with aryl methyl ethers in refluxing THF by substitution to afford *N*-aryldialkylamines (equation 10). Similarly, lithium piperidine and veratrole give *N*-(2-methoxyphenyl)piperidine (15)<sup>40</sup>.

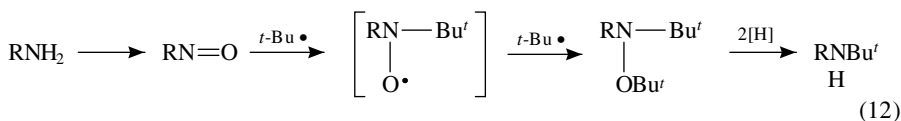


(15)

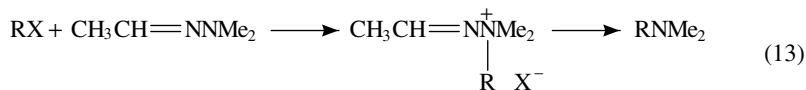
A method for the conversion of alkenes into tertiary amines is exemplified by the formation of *N*-(3-phenylpropyl)piperidine when the ozonide of 4-phenylbut-1-ene is heated with piperidine in the presence of 4 Å molecular sieves (equation 11). The carbon atom which is eliminated appears as piperidinium formate<sup>41</sup>.



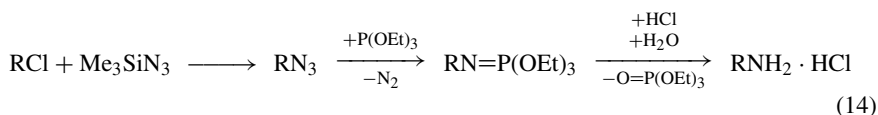
Hindered di-*t*-alkylamines  $\text{RNHBu}'$  ( $\text{R} = t\text{-Bu, } t\text{-octyl or 1-adamantyl}$ ) have been synthesized from *t*-alkylamines as follows. Reaction with peracetic acid gave the nitrosoalkanes  $\text{RNO}$ , which were treated with *t*-butyl radicals, generated from *t*-butylhydrazine and lead(IV) oxide, to yield *t*-butyloxyhydroxylamines. Reduction with sodium naphthalide in THF gave the products (equation 12). The di-*t*-alkyl-amines are inert to methyl iodide and dimethyl sulphate but can be alkylated by methyl fluorosulphonate<sup>42</sup>.



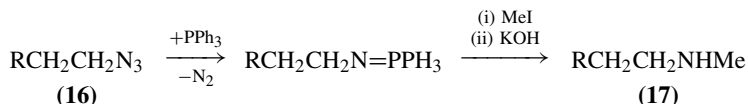
Alkyl halides are converted into the tertiary amines  $\text{RNMe}_2$  ( $\text{R} = \text{Me}, \text{Et}, \text{Bu}, \text{PhCH}_2, \text{CH}\equiv\text{CCH}_2$  etc.) by the action of acetaldehyde *N,N*-dimethylhydrazone, followed by hydrolysis of the product with methanolic potassium hydroxide (equation 13)<sup>43</sup>.



Tertiary alkyl chlorides, which cannot be aminated directly, react with trimethylsilyl azide under tin(IV) chloride catalysis to yield the corresponding alkyl azides. The crude products are directly converted into *t*-alkylamine hydrochlorides by consecutive treatment with triethyl phosphite and gaseous hydrogen chloride (equation 14)<sup>44</sup>.

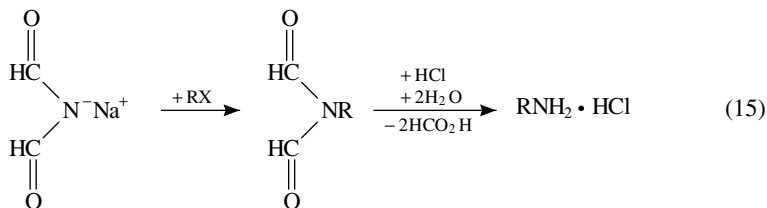


*N*-Methyl-*N*-(2-perfluoroalkyl)ethylamines **17** ( $\text{R} = \text{C}_4\text{F}_9, \text{C}_6\text{F}_{13}$  or  $\text{C}_8\text{F}_{17}$ ) were prepared from the azides **16** by sequential reaction with triphenylphosphine, methyl iodide and aqueous potassium hydroxide<sup>45</sup>.

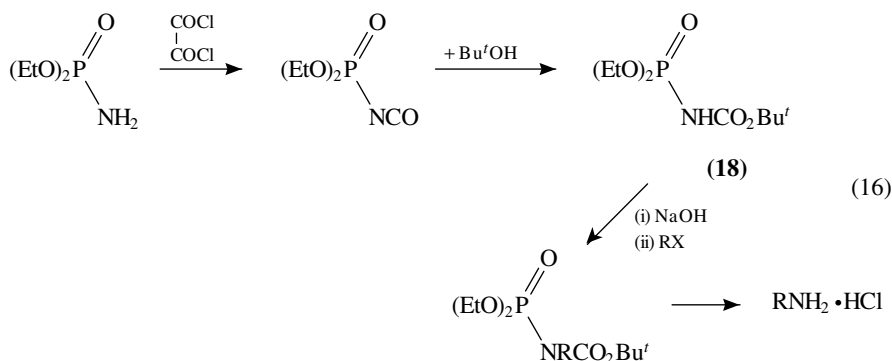


### 3. By modifications of the Gabriel synthesis

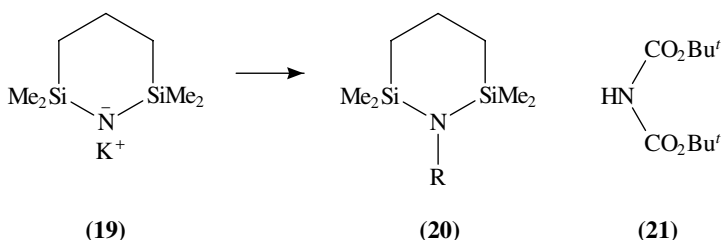
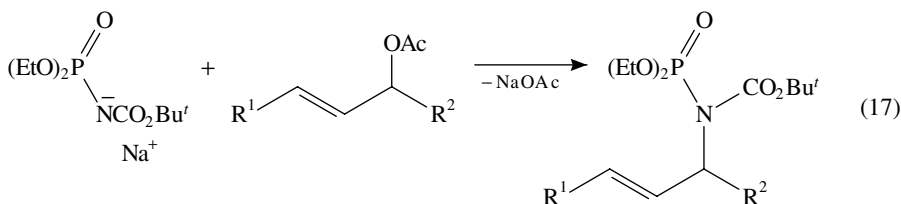
A number of syntheses of primary amines from reagents other than potassium phthalimide has been described (Review: Reference 46). Sodium diformylamide is a convenient substitute. It is alkylated in DMF or acetonitrile by adding an alkyl halide or tosylate and the products are decomposed by adding dilute hydrochloric acid to give alkylamine hydrochlorides in excellent yields (equation 15)<sup>47</sup>.



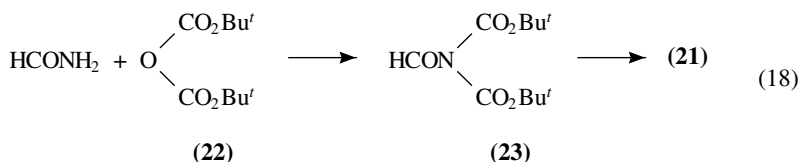
Diethyl *N*-(*t*-butoxycarbonyl)phosphoramidate **18** is obtained from diethyl phosphoramidate by successive treatment with oxalyl chloride and *t*-butyl alcohol. It forms a stable non-hygroscopic sodium salt, which reacts with a variety of alkyl halides in benzene in the presence of tetrabutylammonium bromide under phase-transfer conditions to give the corresponding *N*-alkyl derivatives. The latter are cleaved by hydrogen chloride in benzene to yield amine hydrochlorides (equation 16)<sup>48</sup>.



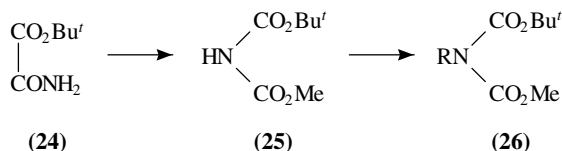
The sodium salt of **18** condenses with allylic acetates ( $E$ )- $\text{R}^1\text{CH}=\text{CH}-\text{CHR}^2\text{OAc}$  ( $\text{R}^1 = \text{Ph}$  or  $\text{C}_7\text{H}_{15}$ ;  $\text{R}^2 = \text{Me}$  or  $\text{C}_7\text{H}_{15}$ ) in THF in the presence of a catalytic amount of tetrakis(triphenylphosphine)palladium(0) to give doubly protected allylic amines (equation 17)<sup>49</sup>.



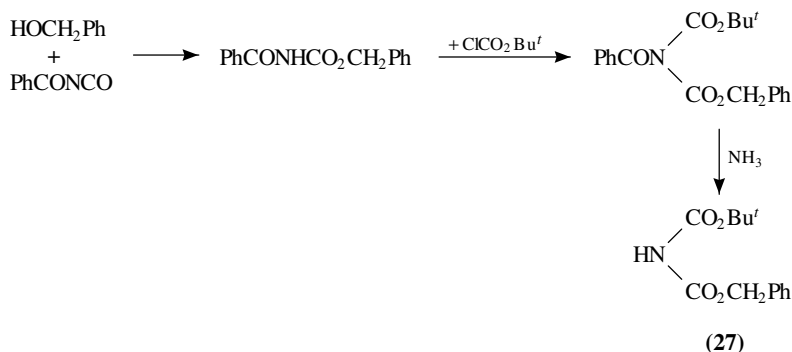
The potassium compound **19** is readily transformed into **20** ( $\text{R} = \text{alkyl}$ ) by the action of alkyl halides. The products are converted into salts of alkylamines  $\text{RNH}_2$  by acidic hydrolysis<sup>50</sup>. Uses of di-*t*-butyl imidodicarboxylate (**21**) have been reviewed<sup>46</sup>. Treatment of formamide with 'di-*t*-butyl dicarbonate' **22** gives the unstable formyl compound **23**, which yields **21** by the action of 2-diethylaminoethylamine (equation 18)<sup>51</sup>.



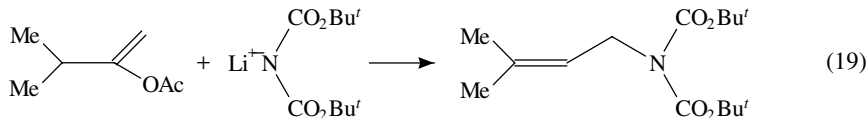
The analogue, *t*-butyl methyl iminodicarboxylate **25**, is obtained by the reaction of methanol with *t*-butyl oxamate (**24**) in the presence of lead tetraacetate. Its stable non-hygroscopic potassium salt is converted into alkyl derivatives **26** by the action of alkyl halides such as butyl bromide, allyl bromide, propargyl bromide and ethyl bromoacetate. The products are hydrolysed by trifluoroacetic acid to salts of primary amines, whereas molar sodium hydroxide gives the protected amines  $\text{RNHCO}_2 \text{Bu}^t$ .



A very similar reagent is benzyl *t*-butyliminodicarboxylate **27**, which is prepared from benzyl alcohol and benzoyl isocyanate, followed by 'exhaustive acylation' with *t*-butoxycarbonyl chloride. Aminolysis of the resulting triacylamine yields **27**. Treatment of the sodium salt of compound **27** with alkyl halides, followed by hydrolysis, gives primary amines<sup>53</sup>.



The synthesis of various allyl derivatives of di-*t*-butyl iminodicarboxylate **21** from its lithium salt and allyl acetates under Pd(0) catalysis has been described. Rearrangements have been observed in some reactions, e.g. equation 19. The products are cleaved to *t*-butoxycarbonylamines by trifluoroacetic acid at room temperature; dilute hydrochloric acid removes the second protecting group<sup>54</sup>.

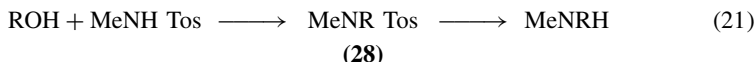


#### 4. From alcohols

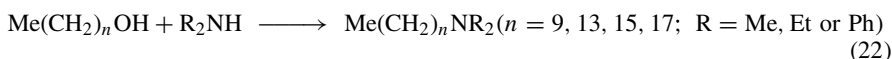
A convenient one-pot procedure for the conversion of alcohols into primary amines has been reported. The alcohol is converted into the corresponding alkyl halide by the action of bromotrichloromethane/triphenylphosphine and the product is treated successively with sodium azide, triethyl phosphite, hydrochloric acid and sodium hydroxide (equation 20)<sup>55</sup>, cf. equation 14.



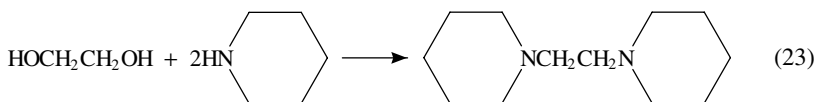
Secondary amines are obtained from alcohols when the alcohol is treated with *N*-methyltosylamine in the presence of triphenylphosphine and diethyl azodicarboxylate<sup>56,57</sup> and the tosyl group is then removed from the product **28** by treatment with sodium in liquid ammonia at  $-70^\circ\text{C}$  (equation 21)<sup>58</sup>.



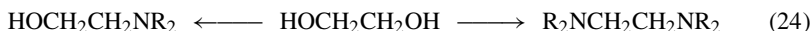
Transition-metal- and enzyme-catalyzed alkylations of ammonia and amines with alcohols and diols have been reviewed<sup>59</sup>.  $\text{RuCl}_2(\text{PPh}_3)_3$  is a homogeneous catalyst for the reaction of long-chain terminal alcohols with secondary amines to give tertiary amines (equation 22)<sup>60</sup>.



$\alpha,\omega$ -Diols react with secondary amines under ruthenium catalysis to yield diamines in high yields, e.g. equation 23<sup>61</sup>.

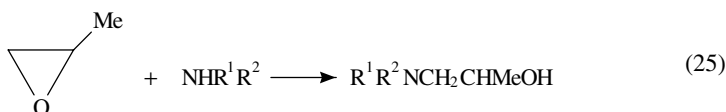
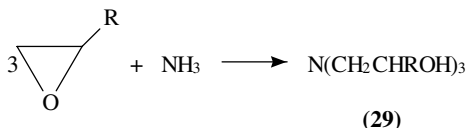


The course of the condensation of ethylene glycol with secondary amines ( $\text{Me}_2\text{NH}$ ,  $\text{Et}_2\text{NH}$ , pyrrolidine or morpholine) depends on the catalyst used. Triphenylphosphine complexes of ruthenium, e.g.  $\text{RuCl}_2(\text{PPh}_3)_3$ , give hydroxyalkylamines while hydrated ruthenium(III) chloride yields diamines (equation 24)<sup>62</sup>.



### 5. From epoxides, aziridines and oxetanes

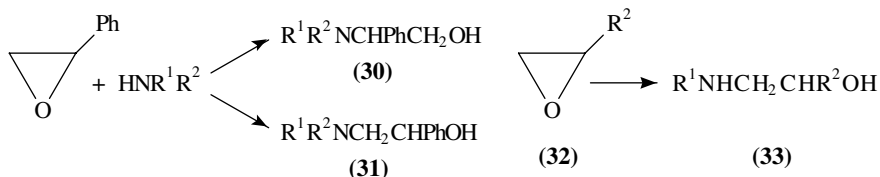
Optically pure tri(hydroxyalkyl)amines **29** ( $\text{R} = \text{Me, } t\text{-Bu, cyclohexyl or Ph}$ ) have been obtained from enantiomerically pure epoxides and methanolic ammonia<sup>63</sup>. Tetraphenylstibonium trifluoromethanesulphonate,  $\text{SbPh}_4^+\text{CF}_3\text{SO}_3^-$ , catalyses the reaction of epoxides with amines, e.g. diethylamine or aniline, to yield 2-hydroxyalkylamines in quantitative yields (equation 25)<sup>64</sup>.



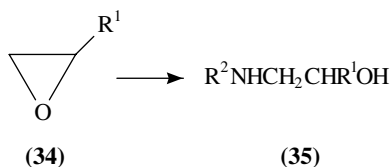
The lithium perchlorate-catalysed aminolysis of styrene oxide has been investigated. Amines of low nucleophilicity, such as aromatic amines, give almost exclusively products of type **30**, sterically hindered amines (diisopropylamine, dicyclohexylamine etc.) give



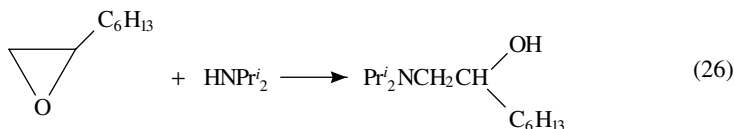
compounds **31** and unhindered aliphatic amines give mixtures. The first type of product is favoured when the reactions are conducted in acetone or ether, the second kind in protic solvents such as ethanol<sup>65</sup>. Alkanolamines **33** [ $R^1 = (S)\text{-CHMePh}$ , cyclohexyl,  $\text{PhCH}_2$ ,  $(S)\text{-CHMeCH}_2\text{OSiPh}_2\text{Bu}$  etc;  $R^2 = \text{Ph}$ , 2- $\text{ClC}_6\text{H}_4$ , 4- $\text{MeC}_6\text{H}_4$  or 4- $\text{O}_2\text{NC}_6\text{H}_4$ ] result from the reactions of aryethylene oxides **32** with the silylated amines  $R^1\text{NHSiMe}_3$ <sup>66</sup>.



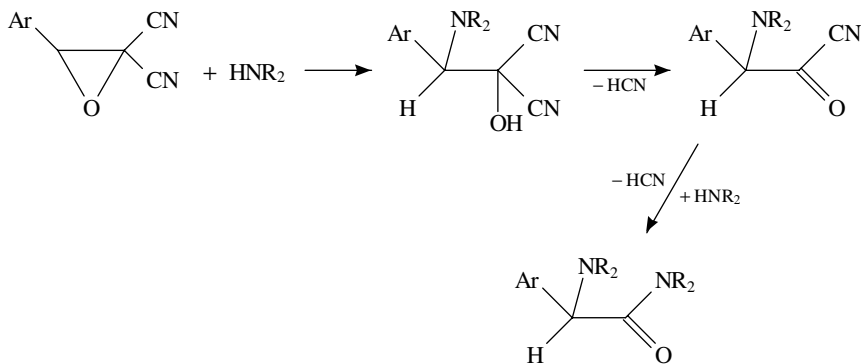
The regioselective ring-opening of epoxides **34** ( $R^1 = \text{Me}$ , vinyl, Ph etc.) with aminolead compounds  $R^2_3\text{PbNEt}_2$ , prepared from lithium diethylamide and  $R^2_3\text{PbBr}$ , gives good yields of the amino alcohols **35**<sup>67</sup>.

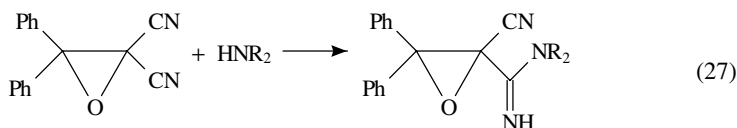


Catalysis of the aminolysis of epoxides by lanthanide triflates (ytterbium, neodymium and gadolinium trifluoromethanesulphonate) has been reported (e.g. equation 26)<sup>68</sup>.

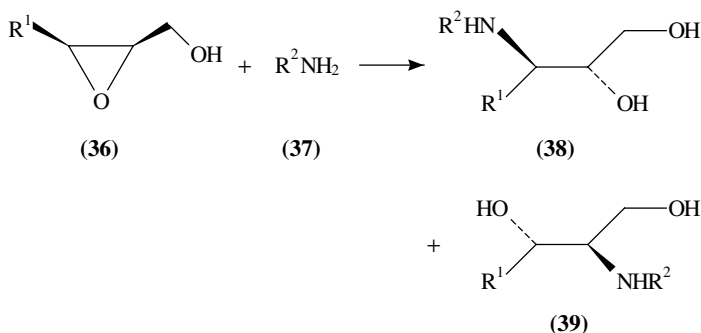


$\alpha,\alpha$ -Dicyanoepoxides react with amines (isopropylamine, isobutylamine, piperidine or morpholine) to yield either open-chain ketones or amidinoepoxides, depending on the structure of the starting epoxide. The former type is formed from monoaryldicyanoepoxides, while the amidines result from  $\beta,\beta$ -disubstituted  $\alpha,\alpha$ -dicyanoepoxides (equation 27)<sup>69</sup>.

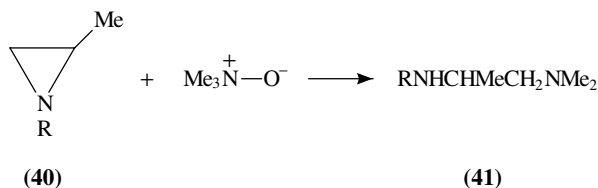




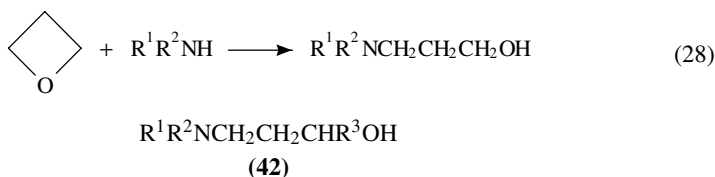
The regioselective ring-opening of the chiral epoxides **36** ( $R^1 = \text{Me, Pr or Ph}$ ) with aliphatic amines **37** ( $R^2 = t\text{-Bu, PhCH}_2 \text{ or C}_6\text{H}_{13}$ ) in the presence of titanium tetraisopropoxide leads to mixtures of the amino alcohols **38** and **39**, in which the former predominate<sup>70</sup>.



The 1,2-diamines **41** ( $R = \text{C}_6\text{H}_{13, PhCH}_2 \text{ or 4-MeOC}_6\text{H}_4\text{CH}_2$ ) result from the action of trimethylamine *N*-oxide on the aziridine **40** in the presence of lithium iodide and  $\text{Fe}_3(\text{CO})_{12}$ <sup>71</sup>.

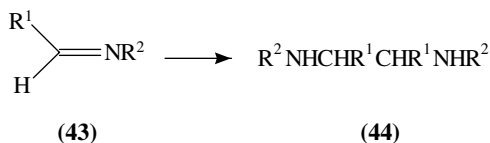


$\gamma$ -Amino alcohols are produced by the reaction of primary or secondary amines ( $\text{BuNH}_2, t\text{-BuNH}_2, \text{PhNH}_2, \text{Et}_2\text{NH}$  or  $\text{PhNHMe}$ ) with oxetane under the influence of ytterbium(III) trifluoromethanesulphonate (equation 28); 2-*n*-octyl- or 2-phenyloxetane afford only the isomers **42** ( $R^3 = \text{C}_8\text{H}_{17}$  or  $\text{Ph}$ )<sup>72</sup>.



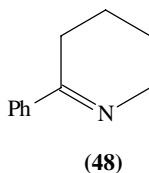
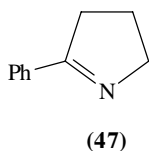
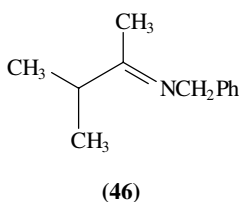
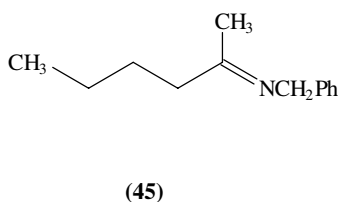
### 6. From imines

Reductive coupling of imines **43** ( $R^1 = \text{Me, Ph or 2-pyridyl}$ ;  $R^2 = \text{Me, Pr, } t\text{-Bu or PhCH}_2$ ) in THF under the influence of a low-valent titanium species, produced by the action of magnesium amalgam on titanium(IV) chloride, gave the DL-diamines

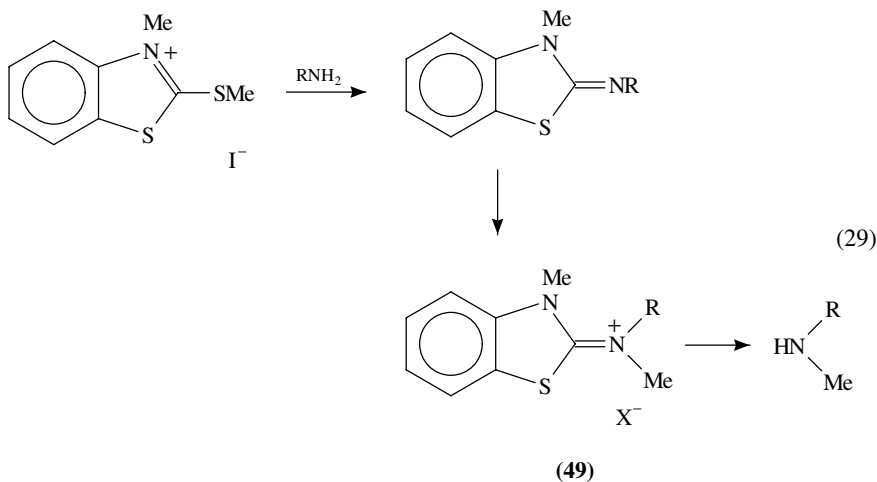


**44**, accompanied by minor amounts of the corresponding *meso*-isomers and the amines  $\text{R}^1\text{CH}_2\text{NHR}^2$ <sup>73</sup>.

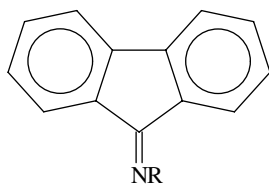
Hydrogenation of imines, e.g. **45–48**, with a chiral titanocene catalyst at 2000 psig gave the corresponding optically active secondary amines in high enantiomeric excess<sup>74</sup>. Imines are reduced to amines by trichlorosilane/boron trifluoride etherate in benzene<sup>75</sup>.



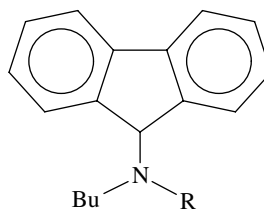
The *N*-monomethylation of primary amines  $\text{RNH}_2$  ( $\text{R} = \text{C}_8\text{H}_{17}$ ,  $\text{C}_{12}\text{H}_{25}$ ,  $\text{Ph}$ ,  $\text{PhCH}_2\text{CH}_2$  etc.) has been accomplished in high yield by condensation with 3-methyl-2-(methylthio)benzothiazolium iodide, followed by treatment of the resulting imine with methyl iodide or methyl tosylate to give the salts **49**. The latter yield the products  $\text{RNHMe}$  by the action of butylamine (equation 29)<sup>76</sup>.



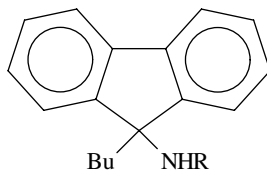
The iminofluorenes **50** are attacked by butyllithium at the nitrogen atom ('azophilic attack') to give the fluorenylamines **51**, accompanied by products **52** of 'carbophilic' addition. The proportion of the two types depends on the nature of the group R: for R = Me or Bu there is almost exclusive azophilic reaction, for R = *i*-Pr 64% azophilic and 16% carbophilic attack and for R = Ph or 4-MeC<sub>6</sub>H<sub>4</sub> 23% azophilic and 70% carbophilic reaction<sup>77</sup>.



(50)

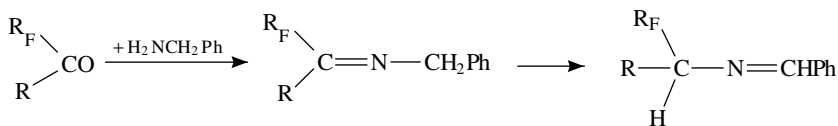


(51)



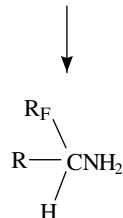
(52)

A synthesis of fluorinated primary aliphatic amines based on a [1,3]-proton shift has been described. The carbonyl compounds R<sub>F</sub>COR [R<sub>F</sub> = CF<sub>3</sub>, C<sub>2</sub>F<sub>6</sub>, C<sub>4</sub>F<sub>9</sub>, H(CF<sub>2</sub>)<sub>4</sub>, C<sub>6</sub>F<sub>5</sub> etc.; R = H, Ph etc.] are condensed with benzylamine and the resulting imines **53** are treated with triethylamine or DBU to give rearranged imines **54**. Acidic hydrolysis then gives the products<sup>78</sup>.



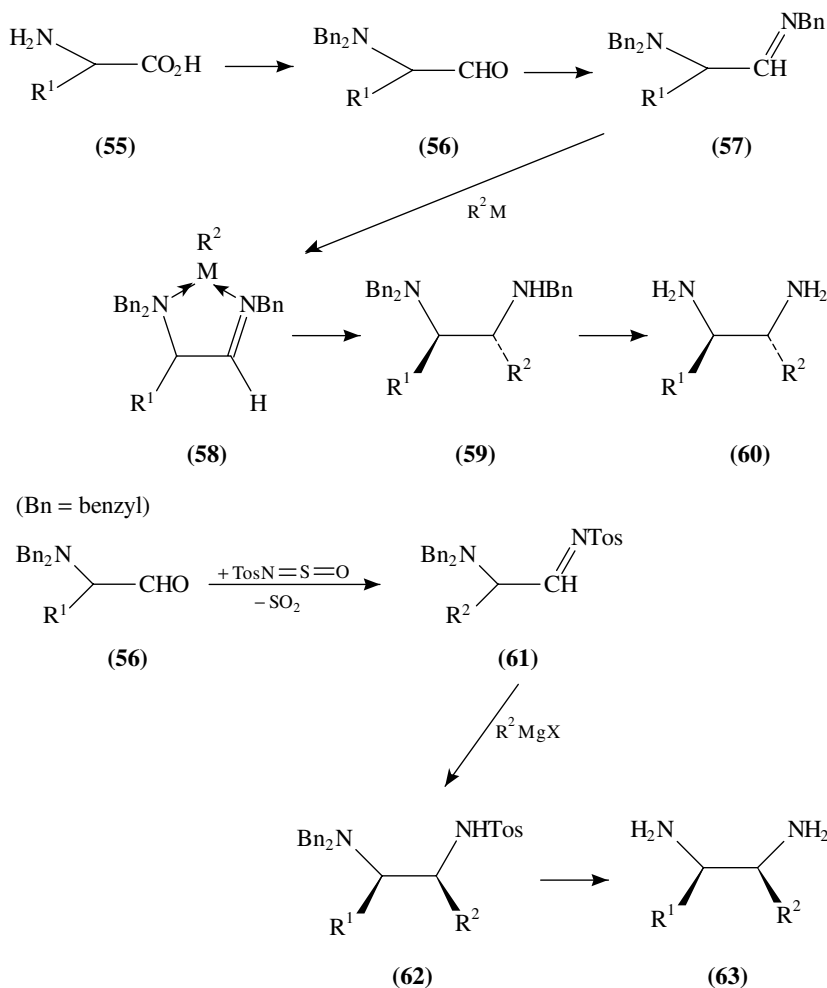
(53)

(54)

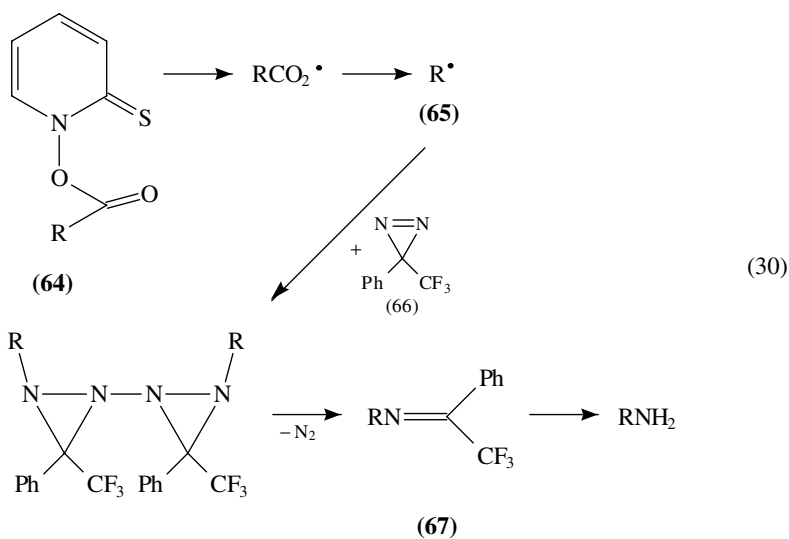


A diastereoselective synthesis of vicinal diamines has been described<sup>79</sup>. The aldehydes **56** derived from chiral amino acids **55** were converted into the *N*-benzylimines **57** and the latter were treated with organometallic reagents R<sup>2</sup>M in the presence of cerium(III)

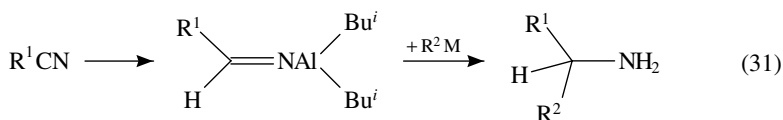
chloride to give the adducts **59** selectively. It is proposed that the intermediate chelates **58** are attacked preferentially at the less shielded side. Complete debenzoylation by hydrogenation in the presence of palladium dihydroxide gave the products **60**. To reverse the direction of diastereoselectivity, the donor strength of the aldimine nitrogen atom was weakened by preparing the *N*-tosyl derivatives **61**. Treatment of the latter with Grignard reagents  $R^2MgX$  ( $R^2 = \text{Me, Et, Bu, Ph etc.}$ ) gave 90–94% of the non-chelation controlled adducts **62**, which yielded the diamines **63**.



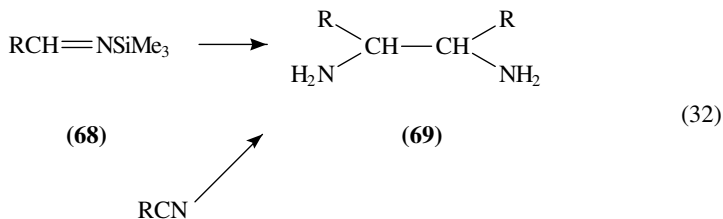
The sequence carbon radical  $\rightarrow$  imine  $\rightarrow$  amine is illustrated in equation 30. Irradiation of the pyridinethione **64** ( $R = \text{cyclohexyl}$ ) with the light of a tungsten lamp generates the cyclohexyl radical **65**, which was trapped as the imine **67** in the presence of the diazine **66**. The imine was finally hydrolysed to cyclohexylamine<sup>80</sup>.



An efficient primary amine synthesis via *N*-diisobutylaluminium imines has been described. A cyanide  $R^1CN$  ( $R^1 = \text{Bu}, \text{C}_8\text{H}_{17}, \text{Ph}, 2\text{-furyl}$  or  $2\text{-thienyl}$ ) is treated with diisobutylaluminium hydride and the product is converted into the amine by reaction with an organomagnesium or organolithium compound  $R^2M$  ( $R^2 = \text{Bu}, t\text{-Bu}, \text{allyl}$  or  $\text{benzyl}$ ) (equation 31)<sup>81</sup>.



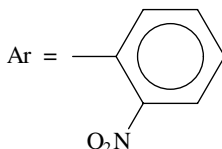
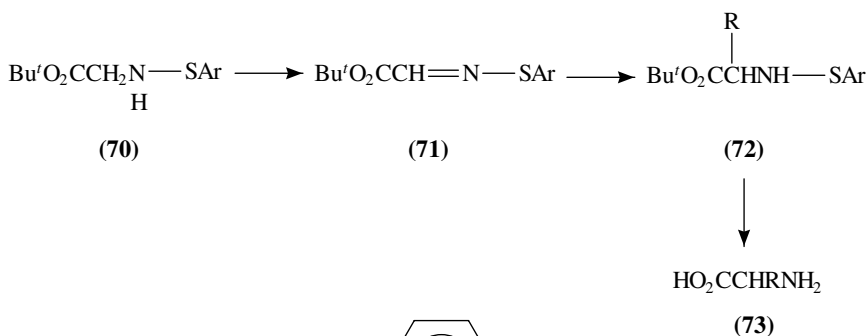
The *N*-trimethylsilylimines **68** ( $R = t\text{-Bu}, \text{Ph}, 2\text{-MeC}_6\text{H}_4$  or  $2\text{-BrC}_6\text{H}_4$ ), which are prepared by the reaction of non-enolizable aldehydes with lithium bis(trimethylsilyl)amide, followed by trimethylsilyl chloride, undergo pinacolic coupling induced by  $\text{NbCl}_4 \cdot 2\text{THF}$  to yield the vicinal diamines **69** as mixtures of *DL*- and *meso*-isomers, in which the former predominate. Another method for the preparation of 1,2-diamines is by the combined action of the niobium tetrachloride/tetrahydrofuran complex and tributyltin hydride on cyanides  $\text{RCN}$  ( $R = t\text{-Bu}, \text{Ph}, \text{cyclopentyl}$  or  $\text{pent-4-en-1-yl}$ ) (equation 32)<sup>82</sup>.



Aldimines are converted into diamines in up to 94% yields by heating with samarium(II) iodide in THF, followed by treatment with silica gel in methanol, e.g. equation 33<sup>83</sup>.



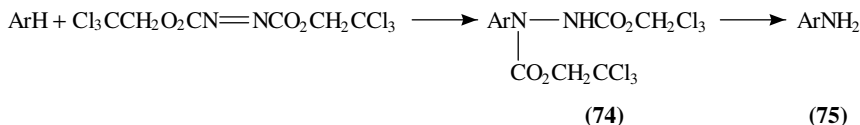
The nitrophenylsulphenimine **71** is formed from the sulphenamide **70** and *N*-chlorosuccinimide in the presence of triethylamine. The imine reacts with Grignard compounds RMgBr to yield sulphenamides **72**, which are cleaved by trifluoroacetic acid to the amino acids **73**. Hence **71** functions as an electrophilic glycine equivalent<sup>84</sup>.



### 7. By electrophilic amination

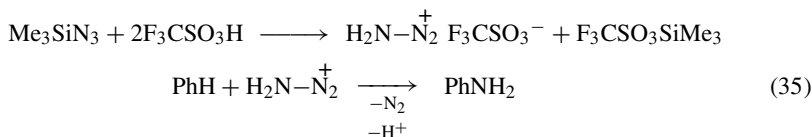
The *N*-amination of pyrazoles with hydroxylamine *O*-sulphonic acid in aqueous media at controlled pH allows the preparation of compounds with electron-withdrawing substituents<sup>85</sup>.

Electron-rich aromatic compounds, such as phenol, anisole and *N,N*-dimethylaniline, add to bis(2-trichloroethyl) azodicarboxylate under the influence of lithium perchlorate, boron trifluoride etherate or zinc chloride to yield *para*-substituted products **74**, which are transformed into the anilines **75** by means of zinc and acetic acid<sup>86</sup>. Triflic acid (trifluoromethanesulphonic acid) catalyses the reactions of phenyl azide with benzene, toluene, chlorobenzene and naphthalene, to give *N*-arylanilines (equation 34)<sup>87</sup>.

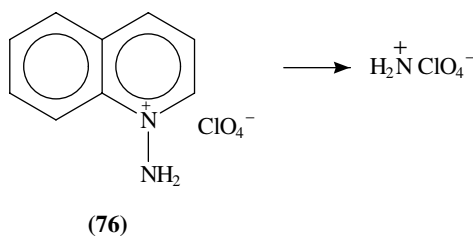


Treatment of benzene with trifluoromethanesulphonic acid, followed by trimethylsilyl azide, gives aniline in 94% yield. Toluene, *o*-xylene, mesitylene, chlorobenzene and

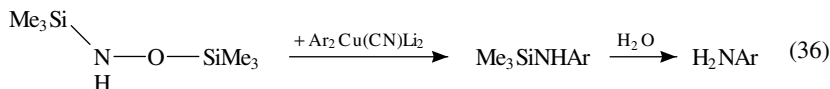
bromobenzene react analogously. The intermediate aminodiazonium triflate is a synthon for the nitrenium cation,  $\text{NH}_2^+$  (equation 35)<sup>88</sup>.



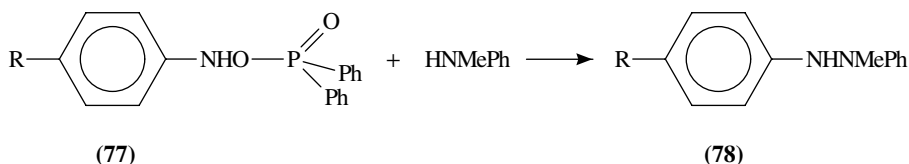
Similarly, benzene and hydrazoic acid in the presence of a mixture of fluorosulphonic and trifluoromethanesulphonic acid give aniline quantitatively. From toluene 100% of a mixture of *o*-, *m*- and *p*-toluidines is obtained and bromobenzene yields 42% *o*-bromoaniline and 47% *p*-bromoaniline, Butyl azide gives *N*-butylarylamines under these conditions<sup>89</sup>. Photolysis of 1-aminoquinolinium perchlorate (**76**) in aromatic hydrocarbons (benzene, toluene, ethylbenzene or mesitylene) in the presence of 18-crown-6 affords arylamines, e.g. aniline and *p*-toluidine, by way of the nitrenium ion<sup>90</sup>; cf Reference 91.



Lithium *t*-butyl *N*-tosyloxycarbamate,  $\text{Bu}^t\text{O}_2\text{CNTos Li}^+$ , is an electrophilic aminating agent for organometallic compounds  $\text{RM}$  ( $\text{MeLi}$ ,  $\text{BuLi}$ , *s*- $\text{BuLi}$  and  $\text{PhCu}$ ) to give, after hydrolysis, the protected amines  $\text{RNHCO}_2\text{Bu}^t$ <sup>92</sup>. Amines  $\text{ArNH}_2$  are produced in high yields in the reactions of organocopper compounds  $\text{Ar}_2\text{Cu}(\text{CN})\text{Li}_2$  derived from benzene, anisole, thiophen and pyridine with *N,O*-bis(trimethylsilyl)hydroxylamine  $\text{Me}_3\text{SiNHOSiMe}_3$  (equation 36)<sup>93</sup>.



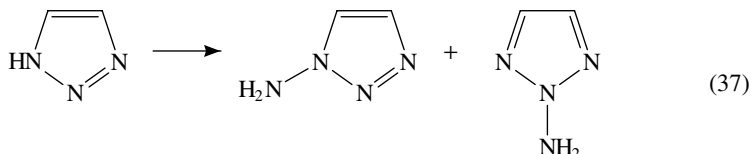
Acylhydrazines  $\text{R}^1\text{CONHNHR}^2$  ( $\text{R}^1 = \text{Ph}$  or  $\text{PhCH}_2$ ;  $\text{R}^2 = \text{Bu}$ ,  $\text{PhCH}_2$  or  $\text{Ph}$ ) are produced by the action of hydroxamic acids  $\text{R}^1\text{CONHOH}$  on the primary amines  $\text{R}^2\text{NH}_2$  in the presence of tosyl chloride or 2-chloro-1-methylpyridinium chloride<sup>94</sup>. *O*-(Diphenylphosphinoyl)-*N*-arylhydroxylamines **77** ( $\text{R} = \text{NO}_2$ ,  $\text{Ac}$ ,  $\text{Tos}$  or  $\text{CN}$ ) react with *N*-methylaniline to afford the hydrazine derivatives **78**<sup>95</sup>.



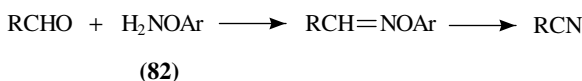
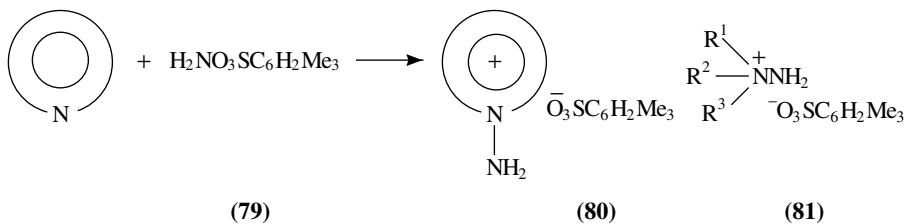
The efficiencies of *O*-(diphenylphosphinoyl)hydroxylamine and hydroxylamine-*O*-sulphonic acid as electrophilic aminating agents have been compared<sup>96</sup>. The conversion of



Grignard reagents  $\text{RMgX}$  into the amines  $\text{RNH}_2$  succeeds with the former but fails with the latter. The two reagents gave comparable yields in the *N*-amination of pyridine and quinoline but for indole and carbazole the first was more effective. It was concluded that, in general, hydroxylamine-*O*-sulphonic acid was more versatile<sup>96</sup>. 1,2,3-Triazole reacts with hydroxylamine *O*-sulphonic acid in aqueous potassium hydroxide to yield a mixture of 53% 1-amino-1,2,3-triazole and 14% of the 2-amino isomer (equation 37)<sup>97</sup>.

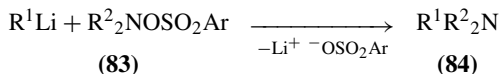


Electrophilic aminations with *O*-substituted hydroxylamines  $\text{H}_2\text{NOAr}$  and  $\text{H}_2\text{NOCOAr}$  (Ar = mesityl or dinitromesityl) have been reviewed<sup>98</sup>. Numerous heterocycles have been transformed by the mesityl derivative **79** into the salts **80** and tertiary amines into **81**. The action of *O*-(2,4-dinitrophenyl)hydroxylamine **82** [Ar = 2,4-( $\text{O}_2\text{N}$ ) $_2\text{C}_6\text{H}_3$ ] on aldehydes  $\text{RCHO}$  (R =  $\text{C}_6\text{H}_{13}$ , Ph, 4-MeOC $_6\text{H}_4$  and 4-O $_2\text{NC}_6\text{H}_4$ ) results in oximes, which form nitriles under basic conditions<sup>99</sup>.



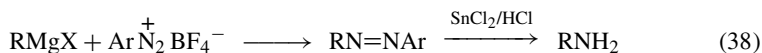
Organoboranes  $\text{R}_2\text{BH}$  or  $\text{R}_3\text{B}$  (R =  $\text{C}_{10}\text{H}_{21}$ , cyclohexyl or cyclooctyl etc.) react with hydroxylamine *O*-sulphonic acid or its mesityl derivative or with chloramine to form primary amines  $\text{RNH}_2$ <sup>100,101</sup>.

The action of chloroamine and bromoamine on organometallic reagents has been reviewed<sup>102</sup> and a comprehensive review of electrophilic aminations of carbanions has appeared<sup>103</sup>. Alkyl, alkenyl and aryllithium compounds are converted into tertiary amines **84** by reaction with the mesityl compounds **83** ( $\text{R}^2 = \text{Me}$  or Et; Ar = 2,4,6-Me $_3\text{C}_6\text{H}_2$ )<sup>104</sup>.

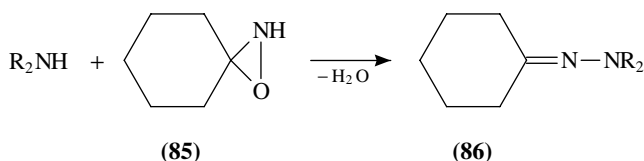


*O*-(Diphenylphosphinoyl)hydroxylamine  $\text{H}_2\text{NOP(O)Ph}_2$  and its *N,N*-dialkyl derivatives have been used for the amination of carbanions as well as of amines and sulphur and phosphorus nucleophiles<sup>103</sup>. Organic azides  $\text{R}^1\text{N}_3$  ( $\text{R}^1 = \text{Tos}$ ,  $\text{Ph}_3\text{Si}$ ,  $\text{PhSCH}_2$ ,  $\text{PhOCH}_2$  and  $\text{Me}_3\text{SiCH}_2$ ) and Grignard reagents  $\text{R}^2\text{MgX}$  form triazene derivatives  $\text{R}^1\text{N}=\text{N}-\text{NR}^2\text{MgX}$ ,

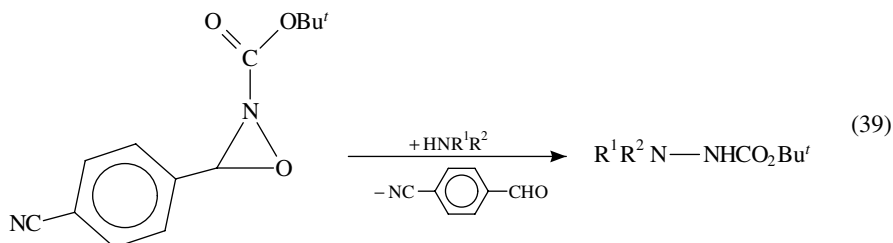
which afford primary amines  $R^1NH_2$  on hydrolysis or reduction<sup>24</sup>. Primary amines are produced from Grignard reagents and arenediazonium tetrafluoroborates, followed by reduction of the resulting azo compounds (equation 38)<sup>103</sup>.



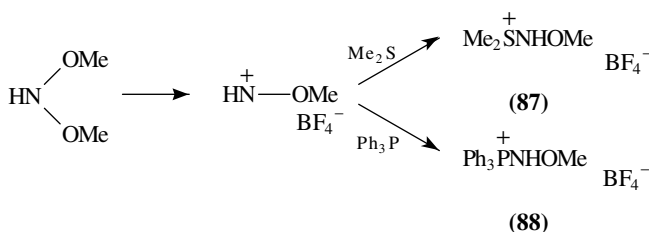
Electrophilic amination reactions by means of oxaziridines have been reviewed<sup>105</sup>. Cyclohexylidenehydrazines **86** are formed from secondary amines such as diethylamine, dibutylamine and morpholine and the spirooxaziridine **85**<sup>105</sup>.



2-Acyloxaziridines are unrivalled as acylamino transfer reagents, see e.g. equation 39<sup>106</sup>.

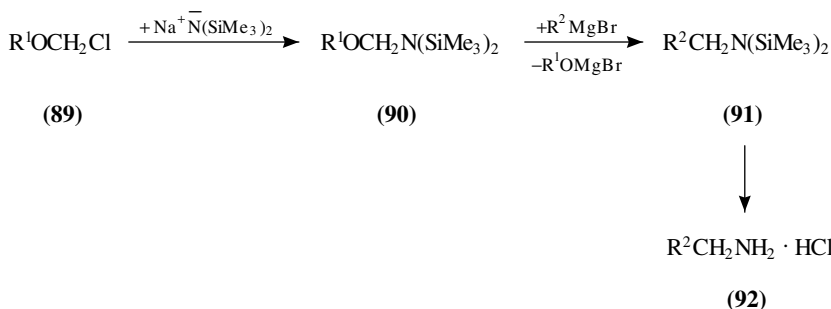


*N,N*-Dimethoxyamine is a source of the *N*-methoxynitrenium ion, which is generated by the action of boron trifluoride etherate. In the presence of dimethylsulphide the salt **87** is obtained; triphenylphosphine yields the analogue **88**<sup>107</sup>.

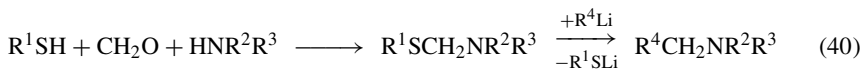


### 8. Via $>N-\overset{+}{C}<$ synthons

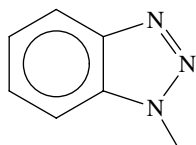
The disilylamines **90**, prepared from the chloro ethers **89** ( $R^1 = Me$  or  $C_6H_{13}$ ) and sodium bis(trisilylmethyl)amide function as synthetic equivalents of the  $(Me_3Si)_2NCH_2^+$  cation. They react with Grignard reagents  $R^2MgBr$  ( $R^2 = Me$ , *i*-Pr, cyclohexyl, Ph,  $PhCH_2$ ,  $CH_2=CHCH_2$  or  $C_3H_7C\equiv C$ ) to give the silylated amines **91**, which are hydrolysed to the corresponding amine hydrochlorides **92** by dilute hydrochloric acid<sup>108,109</sup>.



Similarly, aminomethyl sulphides (from amines, formaldehyde and mercaptans) react with organolithium compounds to afford amines (equation 40)<sup>110,111</sup>.



The synthetic utility of benzotriazole derivatives as  $>\text{N}-\overset{+}{\text{C}}< \leftrightarrow >\overset{+}{\text{N}}=\text{C}<$  synthons has been explored by Katritzky and his coworkers. The Mannich reaction of benzotriazole with primary aliphatic amines  $\text{RNH}_2$  and formaldehyde in an aqueous medium results in the formation of one or more of three types of product:  $\text{BtCH}_2\text{NHR}$ ,  $(\text{BtCH}_2)_2\text{NR}$  and  $(\text{BtCH}_2\text{NR})_2\text{CH}_2$  [Bt = benzotriazol-1-yl (**93**)]<sup>112</sup>. Benzotriazole and aliphatic or aromatic aldehydes yield compounds **94**<sup>113</sup>. The parent compound 1-hydroxymethylbenzotriazole reacts with aromatic amines to give secondary amines **95**, primary aliphatic amines give the tertiary amines **96** and aqueous ammonium acetate at room temperature yields **97**. The 1-benzotriazoles **98** are obtained from benzotriazole, aldehydes and aromatic amines<sup>114</sup>.



(93)



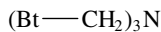
(94)



(95)



(96)



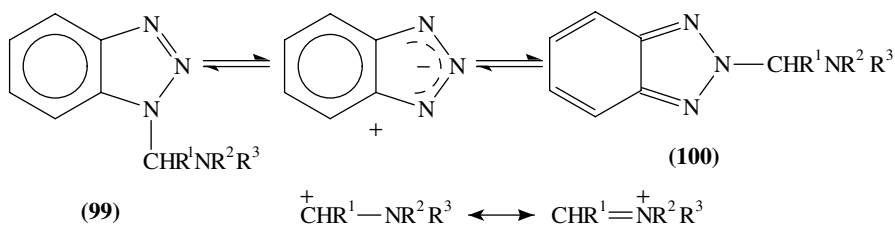
(97)



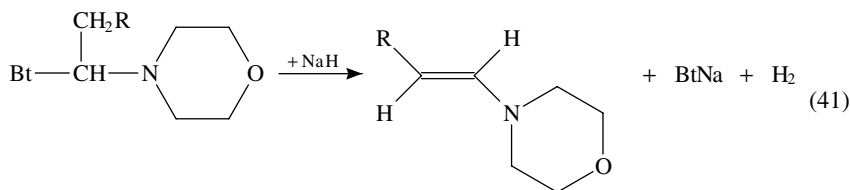
(98)

The products from benzotriazole, aldehydes and primary or secondary amines exist in the melt or in solution as equilibrium mixtures of 1- and 2-benzotriazolyl compounds, **99** and **100**, whereas the solids are 1-benzotriazoles **99**<sup>115</sup>. The equilibrium involves the resonance-stabilized aminomethyl cation and the delocalized benzotriazolide anion; it accounts for the ease with which the bond attached to the benzotriazole moiety is cleaved.

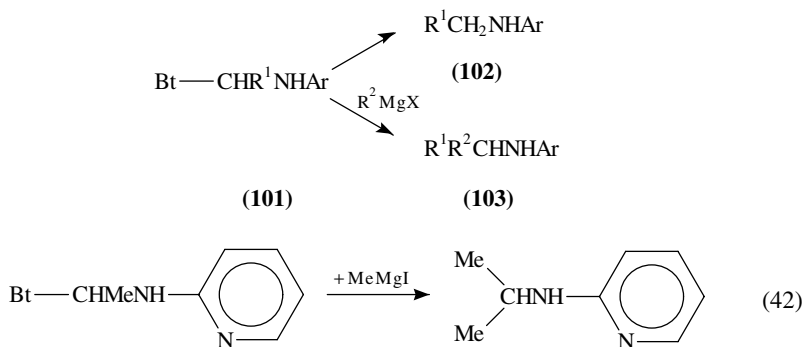
Heating the equilibrium mixture obtained from benzotriazole, an aldehyde  $\text{RCH}_2\text{CHO}$  ( $\text{R} = \text{Me}, \text{Et}, \text{Pr}$  or  $\text{Bu}$ ) and morpholine with sodium hydride in THF results in the



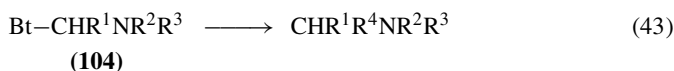
formation of an enamine with the elimination of sodium benzotriazolidine and hydrogen (equation 41)<sup>115c</sup>.



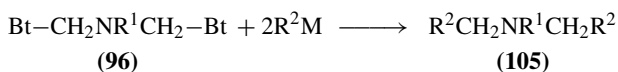
The benzotriazole derivatives **101** ( $R^1 = \text{alkyl}$ ) formed from aliphatic aldehydes, benzotriazole and primary aromatic amines are reduced by lithium aluminium hydride or sodium borohydride to secondary amines **102**, while Grignard reagents yield compounds of type **103**<sup>116</sup>. The reaction has been used for the side-chain alkylation of 2-aminopyridine (equation 42) (direct alkylation occurs predominantly at the ring nitrogen atom).



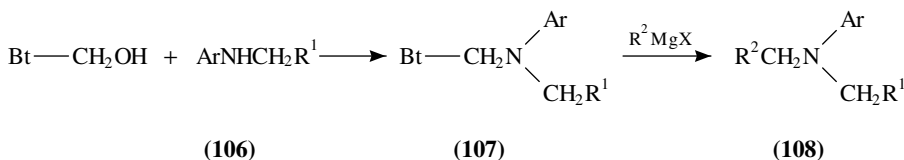
Numerous tertiary amines have been obtained from **104** ( $R^1 = \text{alkyl or aryl}$ ;  $R^2, R^3 = \text{alkyl}$ ) and sodium hydride or Grignard reagents (equation 43)<sup>116</sup>.



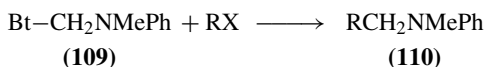
The tertiary amines **96** react with organometallic compounds to afford disubstituted products **105**<sup>117</sup>.



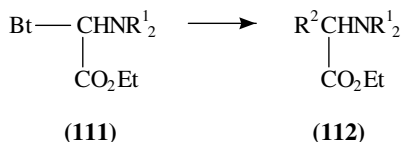
Treatment of secondary amines **106** with hydroxymethylbenzotriazole yields **107**, which forms tertiary amines **108** ( $\text{Ar} = \text{Ph}$  or  $4\text{-MeC}_6\text{H}_4$ ;  $\text{R}^1, \text{R}^2 = i\text{-Pr}, \text{PhCH}_2$  etc)<sup>118</sup>.



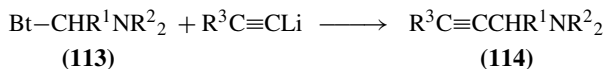
The benzotriazole **109** reacts with alkyl or allyl halides in the presence of bismuth(III) chloride and metallic aluminium to give the homoalkylated amines **110** in high yields<sup>119</sup>.



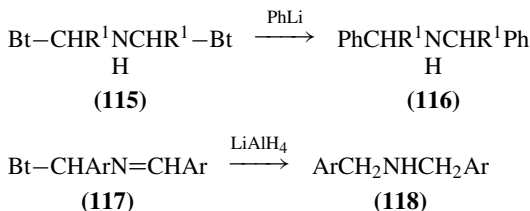
The benzotriazole derivatives **111**, obtained from benzotriazole, ethyl glyoxylate and secondary amines (diethylamine, pyrrolidine, piperidine or morpholine), furnish the amino esters **112** by the action of organozinc reagents  $\text{R}^2\text{ZnX}$  ( $\text{R}^2 = \text{Me}, \text{Bu}, \text{PhCH}_2$  or  $\text{Ph}$ )<sup>120</sup>.



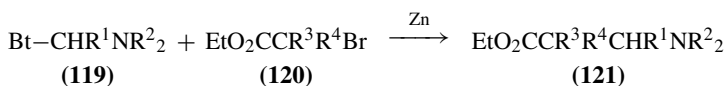
Tertiary propargylamines **114** ( $\text{R}^1 = \text{H}, \text{Pr}, i\text{-Pr}, \text{C}_7\text{H}_{15}$  or  $\text{Ph}$ ;  $\text{NR}^2_2 = \text{NMe}_2, \text{NEt}_2$ , pyrrolidin-1-yl, piperidin-1-yl etc;  $\text{R}^3 = \text{C}_6\text{H}_{13}, \text{C}_8\text{H}_{17}$  or  $\text{Ph}$ ) are formed from the benzotriazoles **113** and lithium acetylides<sup>121</sup>.



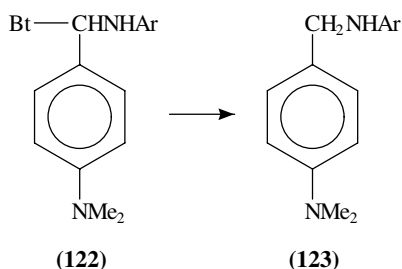
Hindered aliphatic aldehydes  $\text{R}^1\text{CHO}$  ( $\text{R}^1 = i\text{-Pr}$  or  $t\text{-Bu}$ ) react with benzotriazole and anhydrous methanolic ammonia to yield the secondary amines **115**, which are transformed into the phenylated amines **116** by the action of phenyllithium. Benzotriazole, aromatic aldehydes and ammonia give the imines **117**, which react with lithium aluminium hydride to form dibenzylamines **118**<sup>122</sup>.



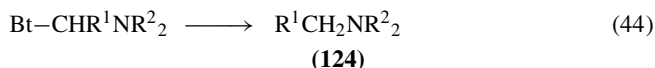
The 'Reformatsky reaction' of the benzotriazoles **119** ( $\text{R}^1 = \text{H}, \text{Pr}, i\text{-Pr}$  or  $\text{Ph}$ ;  $\text{NR}^2_2 =$  pyrrolidin-1-yl, piperidin-1-yl or morpholin-4-yl) with the bromo esters **120** ( $\text{R}^3, \text{R}^4 = \text{H}$  or  $\text{Me}$ ) in the presence of zinc affords the  $\beta$ -amino esters **121**<sup>123</sup>.



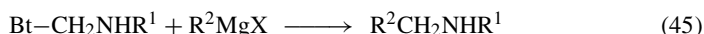
Compounds **122**, prepared from benzotriazole, *p*-dimethylaminobenzaldehyde and primary aromatic amines, are decomposed to the secondary amines **123** by sodium tetrafluoroborate<sup>124</sup>.



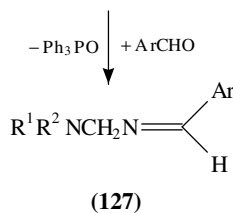
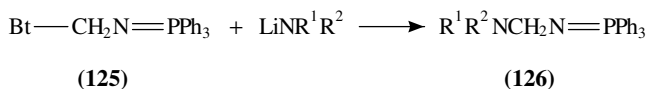
A variety of benzylamines **124** ( $\text{R}^1 = \text{Ph}, \text{Ar}, 2\text{-naphthyl}, \text{or } 3\text{- or } 4\text{-pyridyl}$  etc;  $\text{NR}^2_2 = \text{piperidin-1-yl}$  or  $\text{morpholin-4-yl}$ ) was obtained from benzotriazole, an aldehyde  $\text{R}^1\text{CHO}$  and an amine  $\text{HNR}^2_2$  and subsequent reduction of the products with sodium borohydride (equation 44)<sup>125</sup>.



*N*-Substitution of primary aliphatic amines  $\text{R}^1\text{NH}_2$  ( $\text{R}^1 = t\text{-Bu}, \text{C}_8\text{H}_{17}, \text{cyclopentyl}, \text{cyclohexyl}, \text{PhMeCH}$  etc.) to yield  $\text{R}^2\text{CH}_2\text{NHR}^1$  ( $\text{R}^2 = \text{Et}, \text{Ph}$  or  $\text{PhCH}_2$ ) is accomplished by condensation of the amine with benzotriazole and formaldehyde, followed by reaction of the products with Grignard reagents (equation 45)<sup>126</sup>.

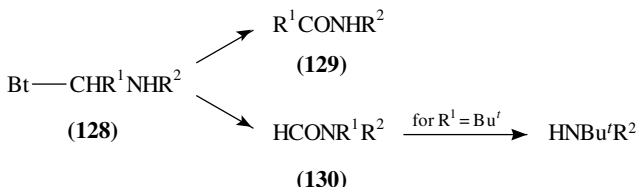


1-(Benzotriazol-1-yl)-*N*-triphenylphosphorylideneamine **125** and lithium amides  $\text{LiNR}^1\text{R}^2$  ( $\text{R}^1 = \text{Ph}, \text{R}^2 = \text{Me}; \text{NR}^1\text{R}^2 = \text{pyrrolidin-1-yl}$  or  $\text{morpholin-4-yl}$ ) afford the phosphoranes **126**, which are converted into  $\alpha$ -(arylideneamino)alkylamines **127** on treatment with aromatic aldehydes<sup>127</sup>.

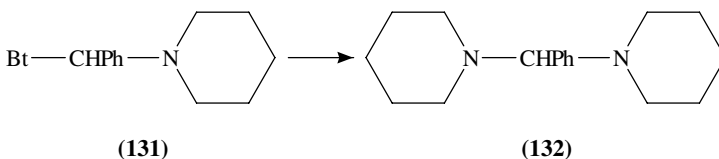


The *N*-*t*-butylation of aromatic amines has been described. The benzotriazoles **128** ( $\text{R}^1 = \text{Pr}, i\text{-Pr}$  or  $t\text{-Bu}; \text{R}^2 = \text{Ph}, \text{Ar}$  or 2- or 3-pyridyl) react with hydrogen peroxide under

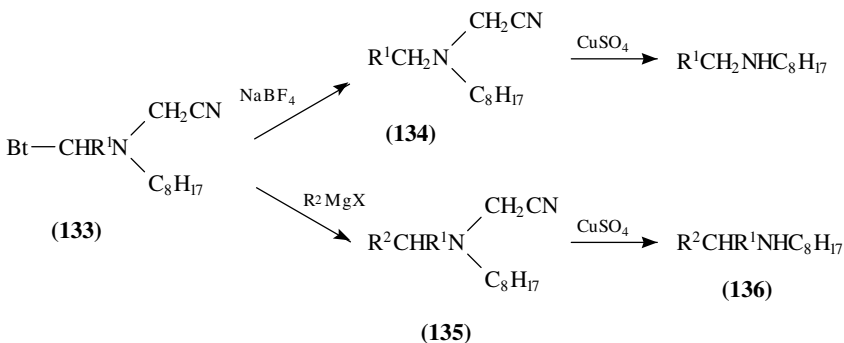
selenium dioxide catalysis to yield mixtures of amides **129** and rearranged formamides **130**. The latter are formed almost exclusively from **128** ( $R^1 = t\text{-Bu}$ ). Hydrolysis yields *N-t*-butylarylamines<sup>128</sup>.



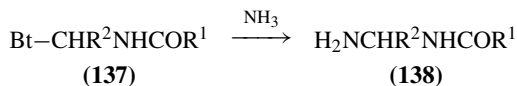
Symmetrical aminals, e.g. **132**, are obtained from benzotriazoles such as **131** on treatment with piperidine<sup>129</sup>.



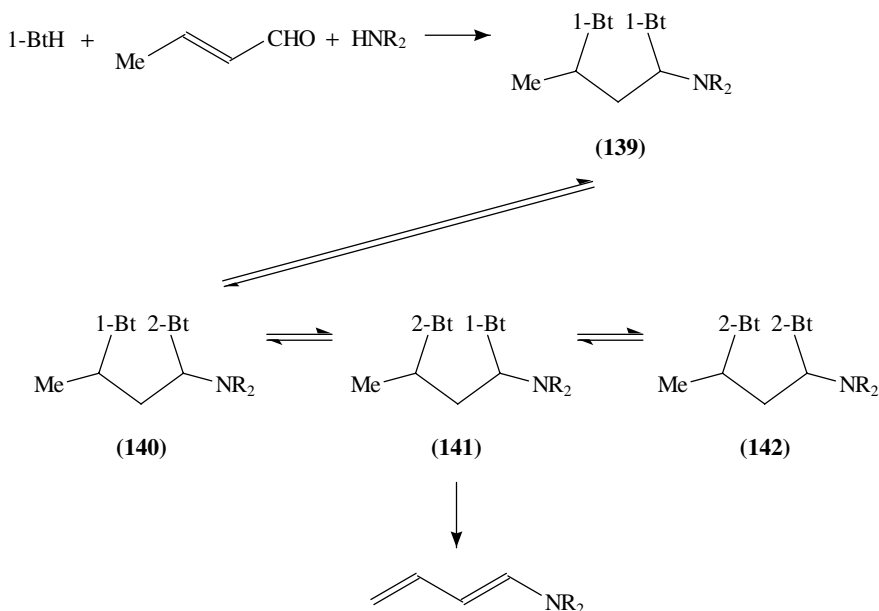
Compounds **133**, prepared by the condensation of benzotriazole with aldehydes  $R^1\text{CHO}$  ( $R^1 = \text{H}$ , Pr or Ph) and *N*-octylaminoacetonitrile, react with sodium tetrafluoroborate to give the cyanomethyl derivatives **134**. The latter are de-cyanomethylated by the action of copper(II) sulphate. Treatment of **133** with Grignard reagents affords the analogues **135** ( $R^2 = \text{Ph}$  or  $\text{PhCH}_2$ ) and thence the secondary amines **136**<sup>130</sup>.



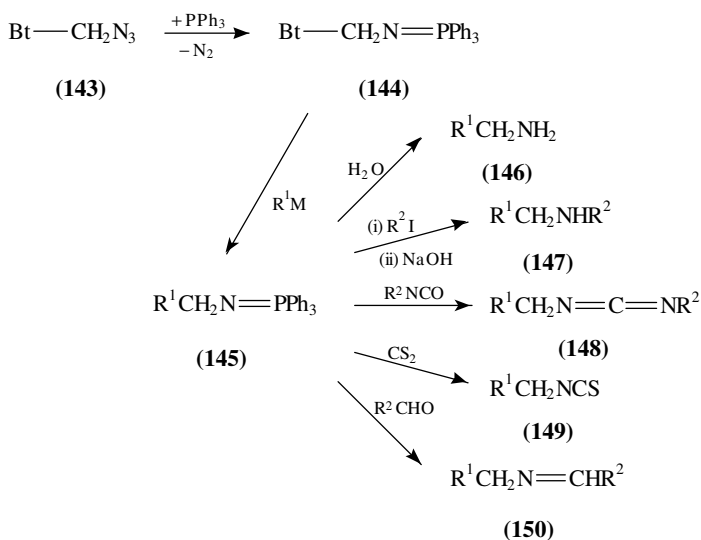
Primary amides  $R^1\text{CONH}_2$  ( $R^1 = \text{Me}$ , Ph etc.), benzotriazole and aldehydes  $R^2\text{CHO}$  ( $R^2 = \text{H}$ , Pr, *i*-Pr,  $\text{EtO}_2\text{C}$  etc.) give the benzotriazol-1-yl derivatives **137**, which with ammonia furnish monoacylated aminals **138**<sup>131</sup>.



Benzotriazole, secondary amines and  $\alpha,\beta$ -unsaturated aldehydes or ketones yield products which exist in solution as equilibrium mixtures of four possible isomers **139-142**. Heating this mixture with sodium hydride produces dianamines<sup>132</sup>.

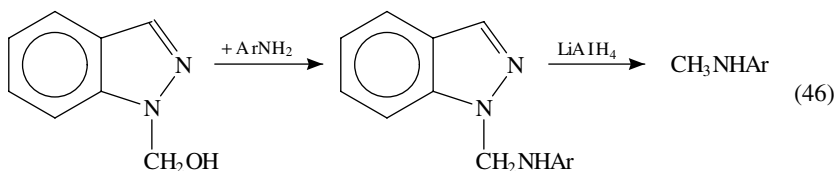


1-(Azidomethyl)benzotriazole **143** and triphenylphosphine form the phosphorane **144**, which can be converted into diverse primary amines **146** ( $R^1 = \text{C}_{12}\text{H}_{25}$ , Ph,  $\text{PhCH}_2$ ,  $\text{PhC}\equiv\text{C}$  etc.) by treatment with organometallic reagents and hydrolysis of the products **145**<sup>133</sup>. Alkylation of the intermediates **145** with  $R^2\text{I}$  yields secondary amines **147**. Other useful transformations of **145** are the formation of carbodiimides **148** by the action of isocyanates and of isothiocyanates **149** with carbon disulphide. Aldehydes give imines **150**<sup>134</sup>.





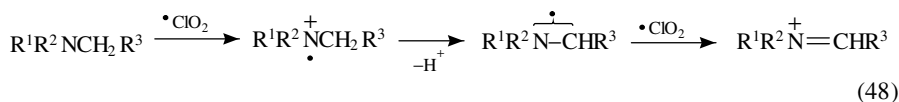
The *N*-methylation of primary aromatic amines by means of 1-(hydroxymethyl)-1*H*-indazole has been described (equation 46)<sup>135</sup>.



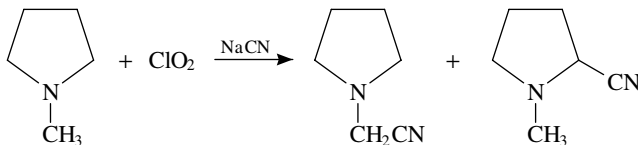
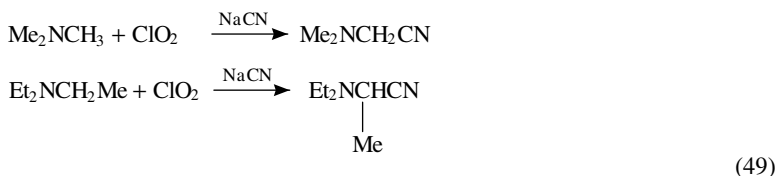
The Mannich reaction of secondary amines  $\text{R}^1_2\text{NH}$  (dibenzylamine, piperidine, morpholine, etc.), aldehydes  $\text{R}^2\text{CHO}$  ( $\text{R}^2 = \text{alkyl, Ph or 2-furyl}$ ) and thiols  $\text{R}^3\text{SH}$  ( $\text{R}^3 = \text{alkyl, Ph or benzyl}$ ) results in  $\alpha$ -amino sulphides, which react with Grignard compounds to give tertiary amines in good yields (equation 47)<sup>136</sup>.



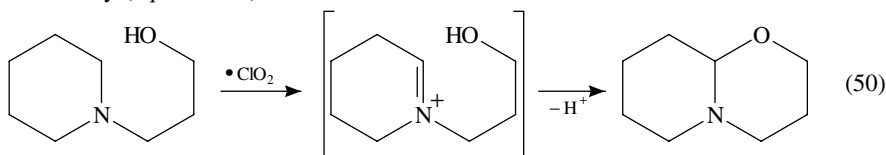
Iminium ions can be generated from tertiary amines and the free radical chlorine dioxide, a gas, which can be stored in aqueous solvents (equation 48)<sup>137</sup>.



The products can be trapped as  $\alpha$ -(cyanoalkyl)amines in the presence of sodium cyanide (equation 49)<sup>137</sup>



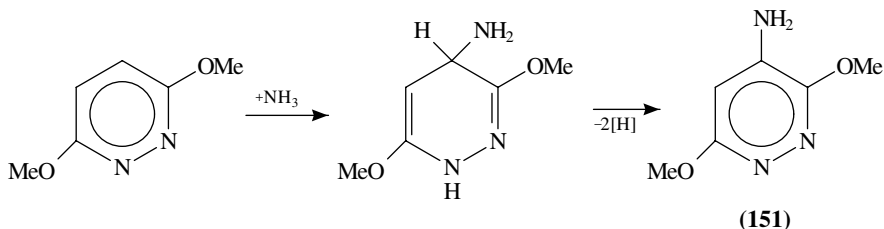
or internally (equation 50)<sup>137</sup>.



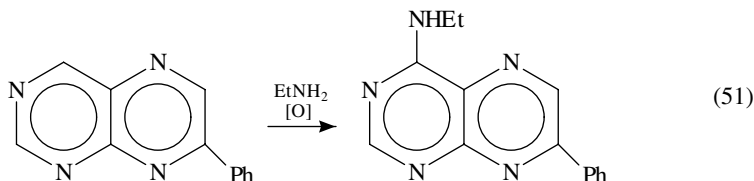
### 9. By oxidative amination

The Chichibabin reaction<sup>138</sup> and other aminations of nitrogen heterocycles<sup>139</sup> have been reviewed. Accounts of the introduction of an amino group into azines and nitroaromatic

compounds by means of potassium permanganate in liquid ammonia solution have appeared<sup>140</sup>. These reactions proceed by dehydrogenation of intermediate  $\sigma$ -adducts; see, for example, the formation of 4-amino-3,6-dimethoxypyridazine (**151**)<sup>141</sup>.

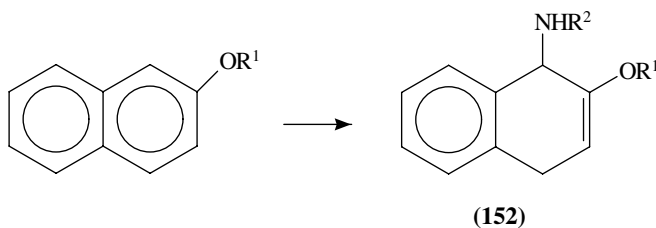


3-Nitropyridine yields a mixture of 2-, 4- and 6-amino-3-nitropyridines by this method<sup>142</sup>. An amino group is introduced into the 2-position of 1,*n*-dinitronaphthalenes ( $n = 3-8$ )<sup>143</sup> and various 5- and 8-nitroquinolines, such as 8-methyl-5-nitroquinoline and 6-chloro-8-nitroquinoline, have been aminated adjacent to the nitro group<sup>144</sup>. Pteridines are converted into alkylamino derivatives by the action of a solution of potassium permanganate in an alkylamine, e.g. equation 51<sup>145</sup>.



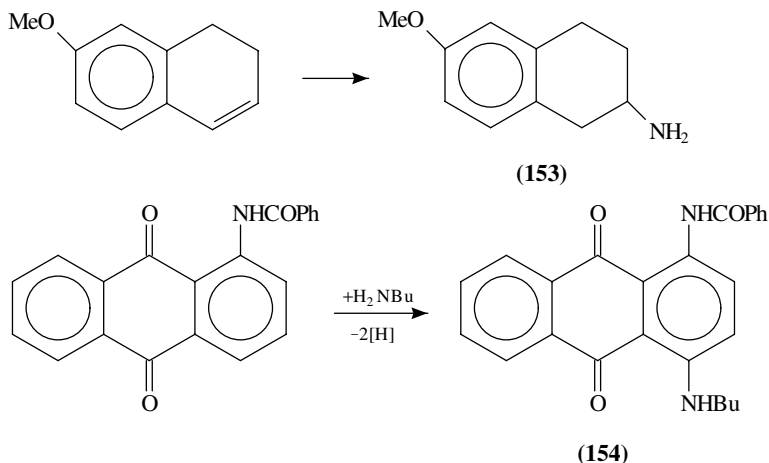
### 10. By photoamination

Irradiation of mixtures of 2-alkoxynaphthalenes ( $R^1 = \text{Me, Et or } i\text{-Bu}$ ) and ammonia or primary amines  $R^2\text{NH}_2$  ( $R = \text{Me, Et, Pr, } i\text{-Pr or } \text{CH}_2=\text{CHCH}_2$ ) in aqueous acetonitrile containing *m*-dicyanobenzene gives adducts **152**<sup>146</sup>.

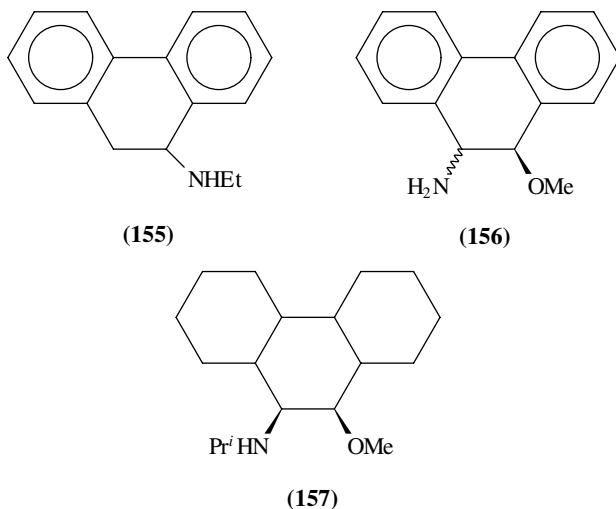


Photoamination of 7-methoxy-1,2-dihydronaphthalene in the presence of *p*-dicyanobenzene similarly affords the amine **153**<sup>147</sup> and 1-benzamido-9,10-anthraquinone reacts with butylamine under UV irradiation in air to yield **154**<sup>148</sup>.

The photoamination of naphthalene, several substituted naphthalenes, anthracene and phenanthrene with ammonia, methylamine or benzylamine in aqueous acetonitrile in the presence of *m*-dicyanobenzene gave aminated dihydroarenes, e.g. **155**. Secondary amines (dimethylamine and diethylamine) react less efficiently<sup>149</sup>. 9-Methoxyphenanthrene and

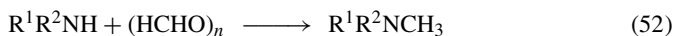


ammonia afforded **156** as a 75:25 mixture of *cis*- and *trans*-isomers, whereas with isopropylamine only the *cis*-adduct **157** was obtained<sup>150</sup>.



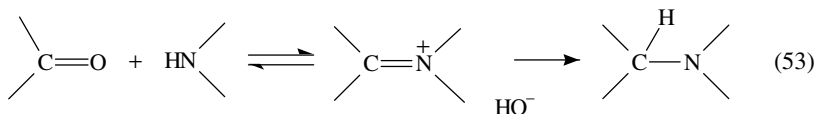
### 11. By reductive alkylation

The high-yield reductive methylation of numerous alkyl and arylamines and of dialkyl- and alkyl-arylamines with paraformaldehyde in the presence of zinc chloride and zinc borohydride has been reported (equation 52)<sup>151</sup>.



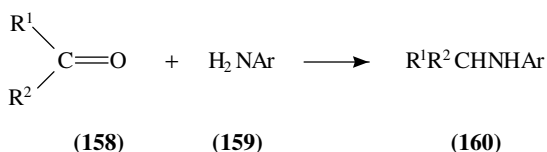
Refluxing a mixture of an aromatic amine  $\text{ArNH}_2$  and an aldehyde  $\text{RCHO}$  ( $\text{R} = \text{Pr}$ ,  $\text{PhCH}_2$ ,  $\text{Ph}$  or  $4\text{-ClC}_6\text{H}_4$ ) in ethanol in the presence of sodium hydrogen telluride gives the alkylated amine  $\text{ArNHCH}_2\text{R}$  in 22–95% yields<sup>152</sup>; secondary aliphatic amines react analogously<sup>153</sup>.

Sodium cyanoborohydride  $\text{NaBH}_3\text{CN}$  in methanol is the reagent of choice for the reductive alkylation of ammonia, primary aliphatic and aromatic amines and secondary aliphatic amines with aldehydes and relatively unhindered ketones (equation 53).

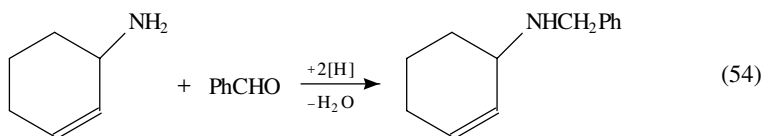


Carbonyl compounds include isobutyraldehyde, phenyl isopropyl ketone, glyoxylic acid and pyruvic acid. Diaryl ketones do not react<sup>154</sup>. Modifications of the method consist in the use of a borohydride exchange-resin<sup>155</sup>, of sodium triacetoxyborohydride  $\text{NaBH}(\text{OAc})_3$ <sup>156</sup> or in treating a mixture of a ketone and an amine with an equivalent of titanium(IV) chloride and Hünig's base (ethyl-diisopropylamine) in dichloromethane, followed by a methanolic solution of sodium cyanoborohydride<sup>157</sup>. The borane-pyridine complex<sup>158</sup> and hydrogen telluride<sup>159</sup> are excellent replacements for sodium cyanoborohydride.

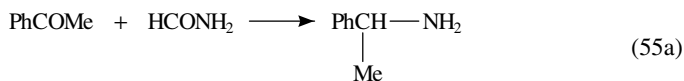
*N*-Alkylarylamines are produced from primary aromatic amines, ketones (acetone, butan-2-one, pentan-3-one, cyclohexanone, cycloheptanone etc.) and zinc dust in warm aqueous acetic acid. Methyl acetoacetate and aniline yield methyl 3-anilinoacetate,  $\text{MeO}_2\text{CCH}_2\text{CH}(\text{NHPH})\text{Me}$ <sup>160</sup>. The methylation of numerous primary and secondary aliphatic amines by means of paraformaldehyde in the presence of titanium(IV) isopropoxide and sodium borohydride has been reported<sup>161</sup>. When a suspension of an aromatic primary amine  $\text{ArNH}_2$  ( $\text{Ar} = \text{Ph}, 4\text{-MeC}_6\text{H}_4, 4\text{-FC}_6\text{H}_4, 3\text{-O}_2\text{NC}_6\text{H}_4$  etc) and sodium borohydride in THF is added to 3M sulphuric acid and 40% aqueous formaldehyde in THF, the *N,N*-dimethylated compound  $\text{ArNMe}_2$  is formed readily<sup>162</sup>. Very good yields of *N*-alkylarylamines **160** are obtained by treating a mixture of an aldehyde or ketone **158** ( $\text{R}^1 = \text{Me}, \text{Ph}$  etc.;  $\text{R}^2 = \text{H}$  or  $\text{Me}$ ), dilute sulphuric acid and THF with a solution of an aromatic amine **159** ( $\text{Ar} = \text{Ph}, 2\text{-MeC}_6\text{H}_4, 2\text{-}, 3\text{-}$  or  $4\text{-O}_2\text{NC}_6\text{H}_4$  etc.) in THF and then adding sodium borohydride<sup>163</sup>.



Phenyl hydrogen selenide, generated from diphenyl diselenide and sodium borohydride in ethanol, promotes the *N*-benzylation of cyclohex-2-enylamine (equation 54)<sup>164</sup>.



Conditions for the optimization of the Leuckart reaction have been established. Thus heating a mixture of acetophenone, formamide and water for 6 h at 205 °C, followed by the addition of 6M hydrochloric acid, gave a 86% yield of 1-phenylethylamine (equation 55a)<sup>165</sup>.



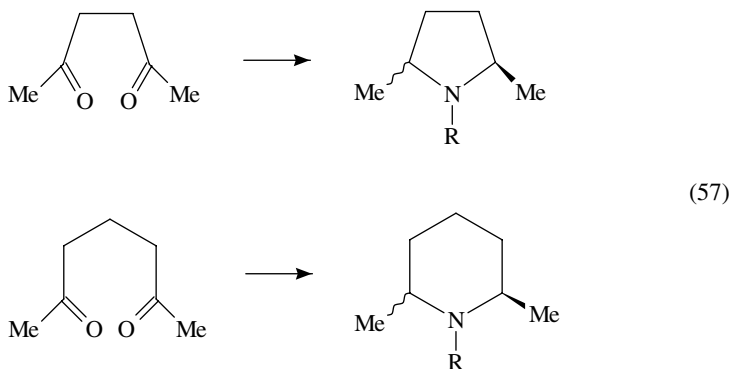
Phenylphosphinic acid and dialkyl sulphoxides are alternatives for, respectively, the reducing agent (formic acid) and the alkylating agent (an aldehyde) used for the *N*-alkylation of secondary aliphatic amines (the Eschweiler–Clarke procedure) (equation 55b)<sup>166</sup>.



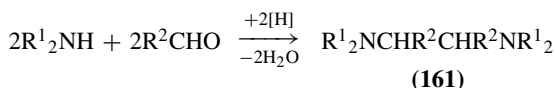
Reductive amination of aromatic aldehydes to give benzylamines is accomplished by heating the aldehyde and tritylamine with molecular sieves, followed by the addition of sodium cyanoborohydride. Catalytic hydrogenolysis of the products with palladium on charcoal yields the benzylamines (equation 56)<sup>167</sup>.



The reductive amination of hexane-2,5-dione and heptane-2,6-dione with ammonia and primary amines  $RNH_2$  ( $R = PhCH_2, Ph_2CH, PhMeCH, Ph, 4-MeOC_6H_4, 2-ClC_6H_4$  and  $2,6-Me_2C_6H_3$ ) under the influence of sodium cyanoborohydride or sodium triacetoxyborohydride has been studied. The reactions yield respectively pyrrolidines and piperidines as mixtures of *cis*- and *trans*-isomers; no cyclic products were obtained when 2-chloroaniline of 2,6-dimethylaniline were employed (equation 57)<sup>168</sup>.



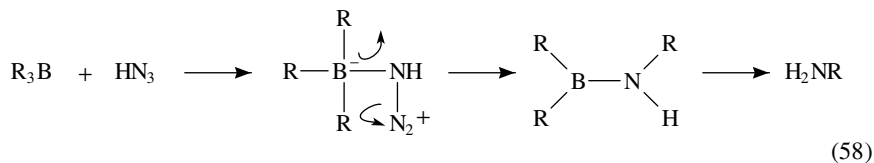
A one-pot procedure for the preparation of 1,2-diamines **161** ( $NR^1_2 = NMe_2, NEt_2$  or piperidin-1-yl;  $R^2 = Ph, Ar$  or 2-furyl) has been described: the lithium amide  $LiNR^1_2$  is added to an aldehyde  $R^2CHO$  and the mixture is treated successively with an equivalent of titanium(IV) chloride and a low-valent titanium reagent prepared by reducing titanium(IV) chloride with magnesium. The products are obtained in 23–81% yields as mixtures of DL- and *meso*-isomers<sup>169</sup>.



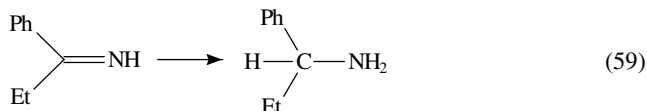
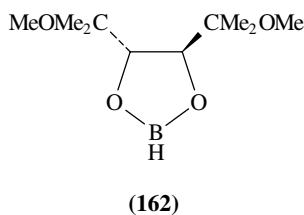
## 12. By means of organoboron compounds

Hydroboration of alkenes generates organoboranes, which react with sodium azide in the presence of an aqueous acid to give primary amines (equation 58). Thus 1-nonene

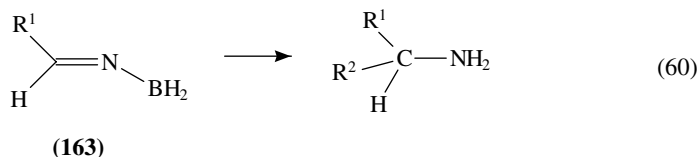
yields nonylamine and cyclohexene cyclohexylamine<sup>170</sup>.



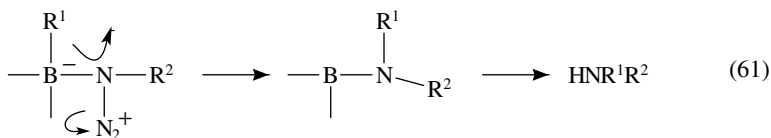
An analogous reaction is the conversion of olefins into primary amines by the consecutive action of  $BH_3$ , THF and trimethylsilyl azide<sup>171</sup>. The observation<sup>172</sup> that organoboranes and chloramine give primary amines is the basis of an amine synthesis in which olefins are treated with the complex  $BH_3 \cdot THF$ , followed by aqueous ammonia and aqueous sodium hypochlorite<sup>173</sup>. Imines are reduced by the chiral dioxaborolidine **162** to yield optically active amines. 1-Imino-1-phenylpropane, for instance, affords 1-phenylpropylamine in 73% enantiomeric excess (equation 59)<sup>174</sup>.

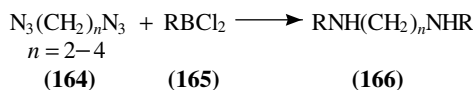


*N*-Borylimines **163** ( $R^1 = \text{Et, Pr, Ph, 2-MeC}_6\text{H}_4$  etc), formed from cyanides  $R^1\text{CN}$  and the  $BH_3 \cdot THF$  complex, react with organometallic compounds  $R^2M$  ( $R = \text{Bu, Pr, Ph}$  etc.) to yield primary amines (equation 60)<sup>175</sup>.

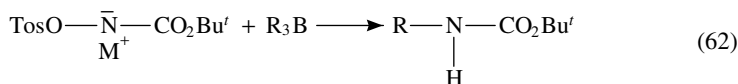


Secondary amines have been prepared from organoboron compounds  $R^1_3B$ ,  $R^1_2 BCl$  or  $R^1 BCl_2$  ( $R^1 = \text{Et, Bu, } i\text{-Bu, } s\text{-Bu, 3-hexyl, cyclopentyl}$  etc.) by treatment with azides  $R^2N_3$  ( $R^2 = \text{Bu, } i\text{-Bu, } s\text{-Bu, cyclohexyl, Ph}$  etc.) and aqueous work-up. It is suggested that the reactions proceed by way of anionotropic rearrangements (equation 61)<sup>176</sup>.



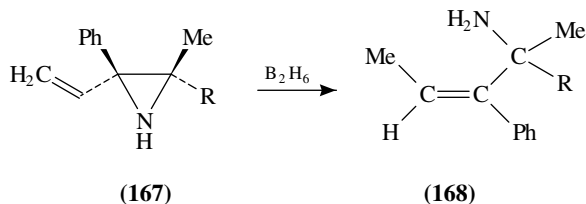


The procedure has been extended to the synthesis of *N,N'*-substituted diamines **166** from the diazides **164** and dichloroboranes **165**<sup>177</sup>. Primary amines protected by the *t*-butoxycarbonyl group are obtained by the action of trialkylboranes  $\text{R}_3\text{B}$  ( $\text{R} = \text{Bu}$ , *s*-Bu,  $\text{C}_8\text{H}_{17}$  or cyclohexyl) on the lithium or potassium salt of *t*-butyl *N*-(tosyloxy)carbamate (equation 62)<sup>178</sup>.

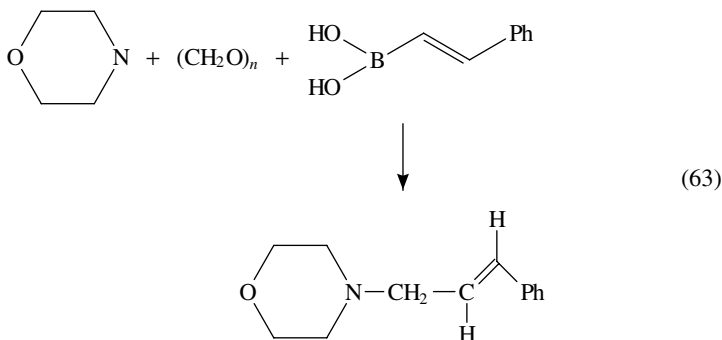


*N*-Chloroalkylamines  $\text{R}^1\text{NHCl}$  ( $\text{R}^1 = \text{Me}$ , Bu,  $\text{C}_7\text{H}_{15}$ , etc.), generated from primary amines and sodium hypochlorite, react with the alkyldimethylboranes  $\text{R}^2\text{BMe}_2$  ( $\text{R}^2 = \text{C}_6\text{H}_{13}$ , cyclopentyl or cyclohexyl) to give the secondary amines  $\text{R}^1\text{R}^2\text{NH}$  in 50–68% yields<sup>179</sup>.

The action of diborane on the 2-vinylaziridines **167** ( $\text{R} = \text{H}$  or Me) results exclusively in the (*Z*)-olefins **168**<sup>180</sup>.

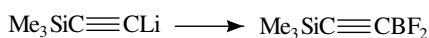
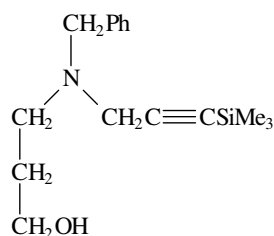
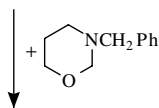


The Mannich reaction of secondary amines with paraformaldehyde and vinylboronic acids gives excellent yields of pure (*E*)-allylamines, e.g. equation 63<sup>181</sup>.



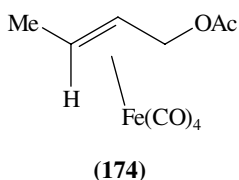
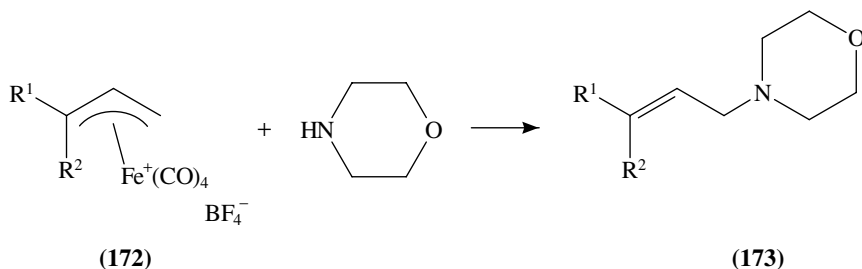
A synthesis of  $\beta$ -aminoacetylenes is exemplified by equation 64. The alkynylborane **170**, generated by the action of boron trifluoride diethyl etherate on the lithium compound

**169**, reacts with 3-benzyltetrahydro-1,3-oxazine to yield **171**<sup>182</sup>.

**(169)****(170)****(64)****(171)**

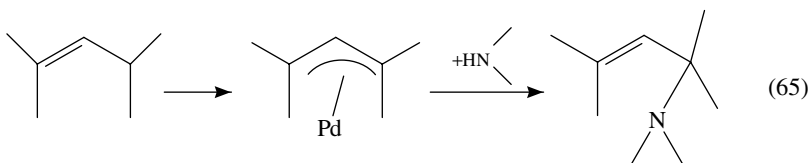
### 13. Synthesis of olefinic and acetylenic amines

Syntheses of primary allylic amines have been reviewed<sup>183</sup>. The regiochemistry of the reaction of iron carbonyl complexes with nucleophiles such as morpholine has been investigated. The ( $\eta^3$ -crotyl)  $\text{Fe}^+(\text{CO})_4 \text{BF}_4^-$  complexes **172** ( $\text{R}^1 = \text{H}$ ;  $\text{R}^2 = \text{Me}$  or  $\text{R}^1 = \text{Me}$ ;  $\text{R}^2 = \text{H}$ ) undergo preferential attack at the less substituted allyl terminus to yield allylic amines **173**. The ( $\eta^2$ -crotyl acetate)  $\text{Fe}(\text{CO})_4$  complex **174**, on the other hand, does not react with morpholine<sup>184</sup>.

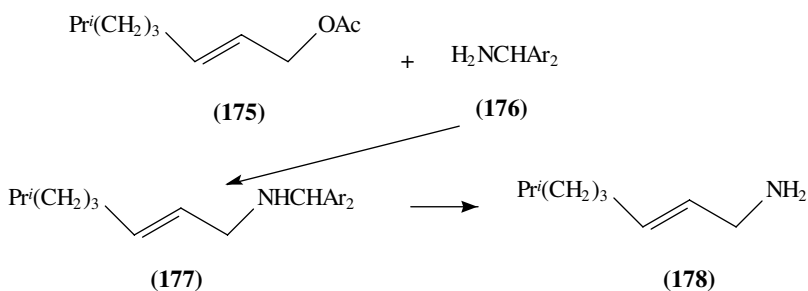




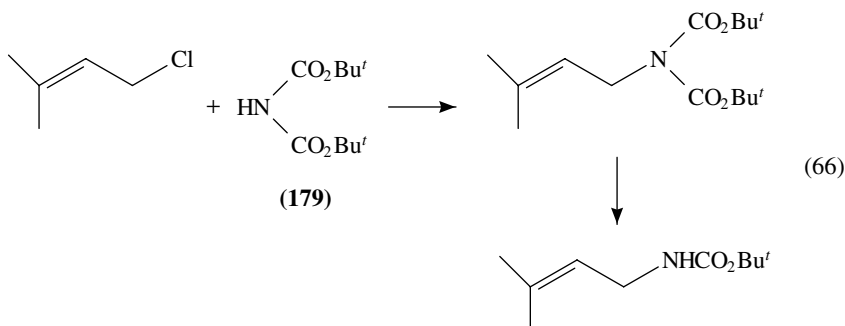
$\pi$ -Allylpalladium complexes react with primary or secondary amines to give allylamines (equation 65)<sup>185</sup>, but ammonia is inert<sup>186</sup>.



For the synthesis of primary allylic amines, an allyl acetate, e.g. **175**, is treated with the benzhydrylamine **176** (Ar = 4-MeOC<sub>6</sub>H<sub>4</sub>) in the presence of a catalytic amount of (Ph<sub>3</sub>P)<sub>4</sub>Pd and the product **177** is cleaved to the amine **178** with 88% formic acid<sup>186</sup>.

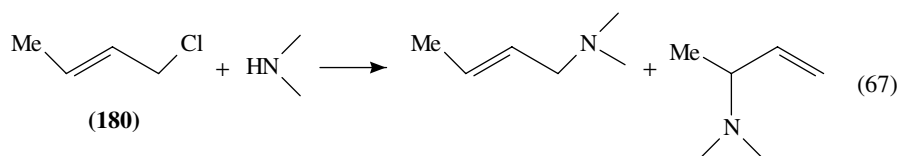


Protected primary allylic amines are prepared from allyl halides and di-*t*-butyl imidodicarbonate **179** in the presence of lithium iodide, followed by the selective removal of one of the protecting groups by means of trifluoroacetic acid, e.g. equation 66<sup>187</sup>.

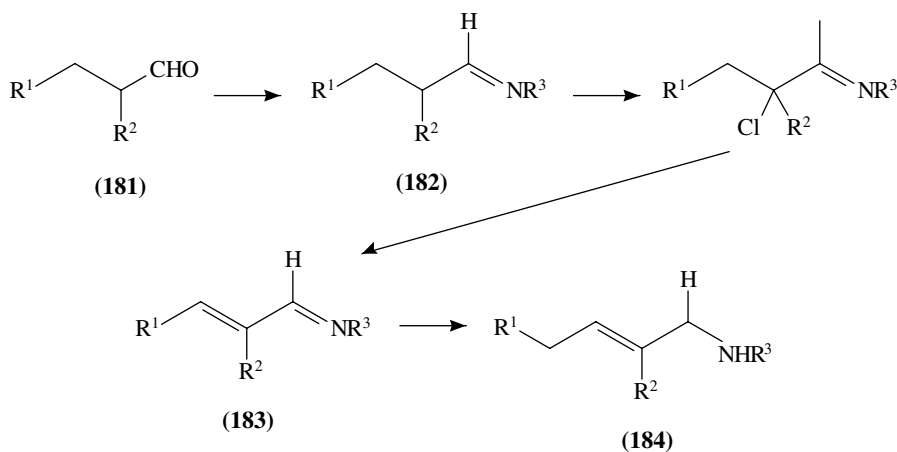


Protected allylic amines R<sup>1</sup>R<sup>2</sup>C=CHCH<sub>2</sub>N(CO<sub>2</sub>Bu<sup>t</sup>)<sub>2</sub> (R<sup>1</sup> = H or Me; R<sup>2</sup> = H, Me, Pr or Ph) are also obtained from the corresponding allylic acetates and the reagent **179** under Pd(0) catalysis<sup>188</sup>. Allylic alcohols (CH<sub>2</sub>=CHCH<sub>2</sub>OH, MeCH=CHCH<sub>2</sub>OH and CH<sub>2</sub>=CHCHMeOH) react with aromatic amines ArNH<sub>2</sub> (Ar = Ph, 4-MeC<sub>6</sub>H<sub>4</sub> or 2-BrC<sub>6</sub>H<sub>4</sub>) in the presence of catalytic amounts of mercury(II) tetrafluoroborate to yield the corresponding *N*-allylarylamines<sup>189</sup>. The reaction of but-2-enyl chloride (**180**) with amines (aniline, diethylamine and diphenylamine), catalysed by copper(II) perchlorate

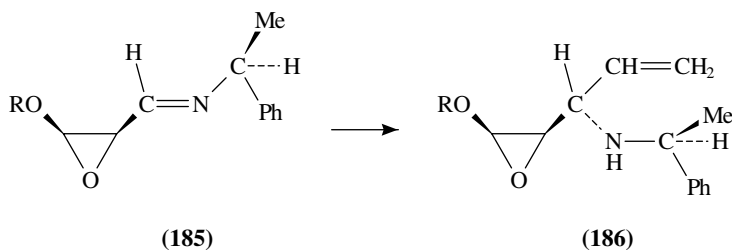
and metallic copper, leads to a mixture of unrearranged and rearranged allylic amines (equation 67)<sup>190</sup>.



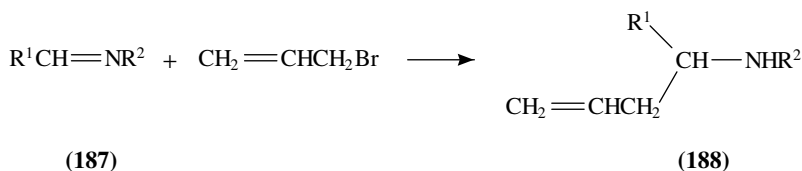
Secondary allylic amines **184** have been prepared from aldehydes **181** ( $R^1 = \text{H, Me}$  or  $\text{Ph}$ ;  $R^2 = \text{Me, Et}$  or  $\text{H}$ ) by the following sequence: treatment with an amine  $R^3\text{NH}_2$  ( $R^3 = i\text{-Pr, } t\text{-Bu, cyclohexyl}$  or  $\text{PhCH}_2$ ) yields an imine **182**, which is chlorinated by *N*-chlorosuccinimide. Dehydrochlorination of the resulting chloro compound with potassium *t*-butoxide gives an allylic imine **183**, which is reduced to the product by means of methanolic sodium borohydride<sup>191</sup>.



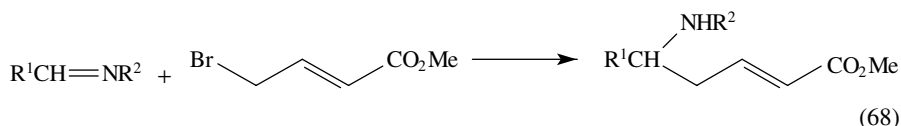
The chiral oxirane derivative **185** ( $R = 4\text{-BrC}_6\text{H}_4\text{CH}_2$ ) and vinylmagnesium bromide yield the allylic amine **186**; allylmagnesium bromide reacts in an analogous fashion<sup>192</sup>.



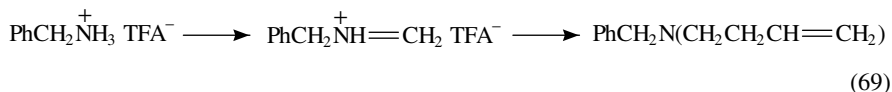
The bismuth- or tantalum-promoted allylation of aldimines **187** ( $R^1 = \text{Ph}$  or  $\text{PhCH=CHCH}_2$ ;  $R^2 = \text{Me, Ph}$  or  $\text{PhCH}_2$ ) with allyl bromide in the systems  $\text{Bi/Bu}_4\text{N}^+ \text{Br}^-/\text{MeCN}$  or  $\text{Ta/Bu}_4\text{N}^+ \text{Br}^-/\text{MeCN}$  yields the amines **188**<sup>193</sup>.



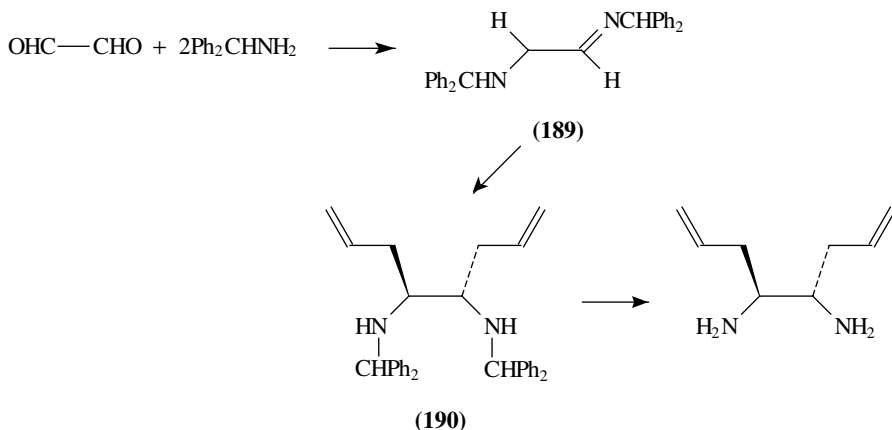
Homoallylic amines result from the reaction of aldimines, previously activated by boron trifluoride etherate, with allylic bromides in the presence of chromium(II) chloride, e.g. equation 68<sup>194</sup>.



Another general synthesis of homoallylamines is the conversion of the trifluoroacetate of a primary or secondary amine into the corresponding immonium salt by the action of aqueous formaldehyde, followed by successive treatment with allyltributylstannane and dilute hydrochloric acid; e.g. equations 69 and 70 (TFA = CF<sub>3</sub>CO<sub>2</sub>)<sup>195</sup>.

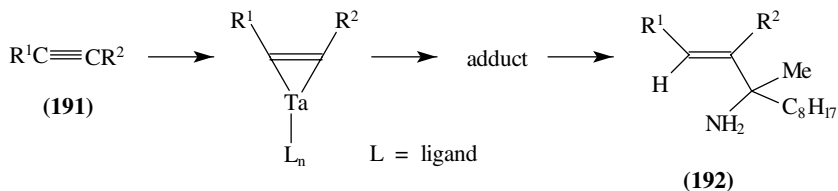


The preparation of vicinal diallyldiamines is illustrated by the following sequence: condensation of glyoxal with benzhydrylamine yields the diimine **189**, which is converted into **190** by the action of allylmagnesium chloride. The diphenylmethyl groups are then removed reductively by treatment with triethylsilane<sup>196</sup>.

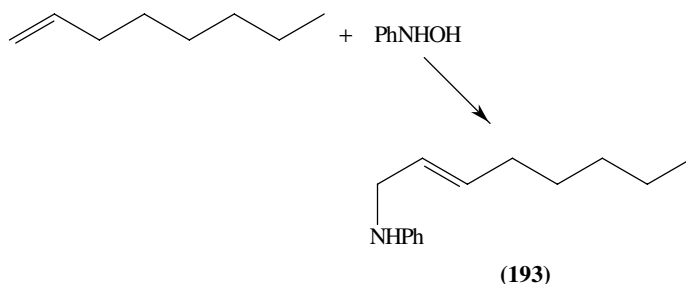
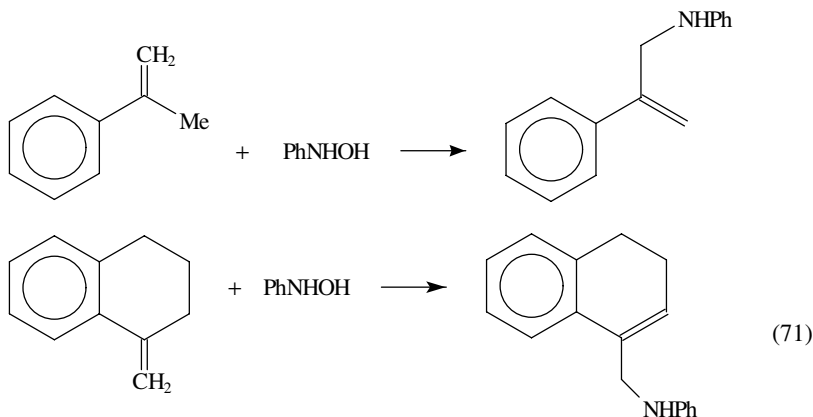
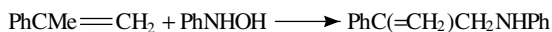


Acetylenes **191** (R<sup>1</sup> = C<sub>5</sub>H<sub>11</sub>, Me<sub>3</sub>Si or MeS; R<sup>2</sup> = C<sub>5</sub>H<sub>11</sub> or C<sub>10</sub>H<sub>21</sub>) react with tantalum(V) chloride and zinc to form tantalum complexes. Addition of the imine

$C_8H_{17}CMe=NMgI$ , produced from octyl cyanide and methylmagnesium iodide, affords adducts of unspecified structure, which are decomposed to the amines **192** by aqueous sodium hydroxide<sup>197</sup>.

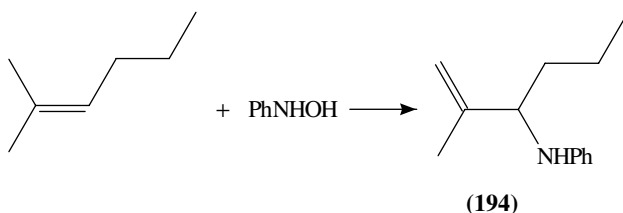


Conjugated arylalkenes undergo allylic amination on treatment with *N*-phenylhydroxylamine under the influence of iron phthalocyanin, e.g. equation 71. The yields from aliphatic olefins are very poor: 1-octene gives only 3% of the amine **193**<sup>198</sup>.

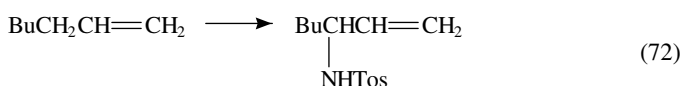


In the presence of the dioxomolybdenum complex  $MoO_2$  (dipic) (HMPA) (dipic = pyridine-2,6-dicarboxylate, HMPA = hexamethylphosphoramide), 2-methylhex-2-ene and phenylhydroxylamine produce the amine **194** in 52% yield; other alkenes react analogously<sup>199</sup>.

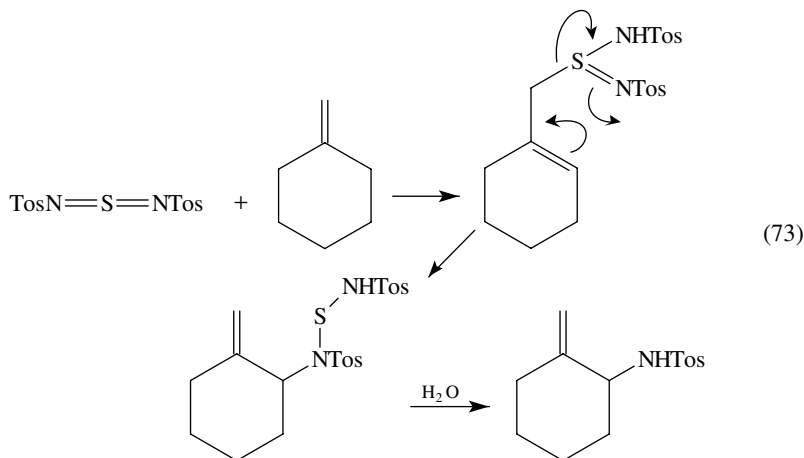
Bis(4-toluenesulfonyl)selenodiimide ( $TosN=Se=NTos$ ), prepared from Chloramine T and metallic selenium, reacts with olefins by insertion at the more substituted allylic



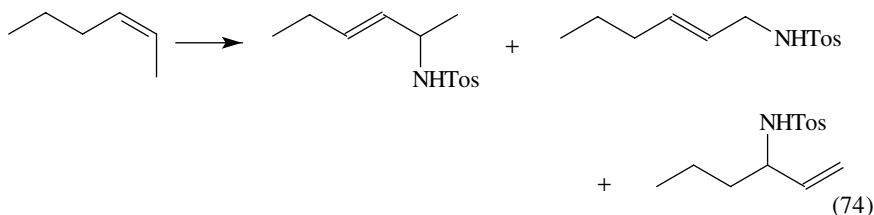
carbon atom to yield *N*-tosyl-allylamines, e.g. equation 72<sup>200</sup>.



*N*-Sulphinyl-4-toluenesulphonamide (TosN=S=O) and pyridine yield bis(4-toluenesulphonyl)sulphodiimide, which reacts analogously with olefins, e.g. equation 73<sup>201</sup>.

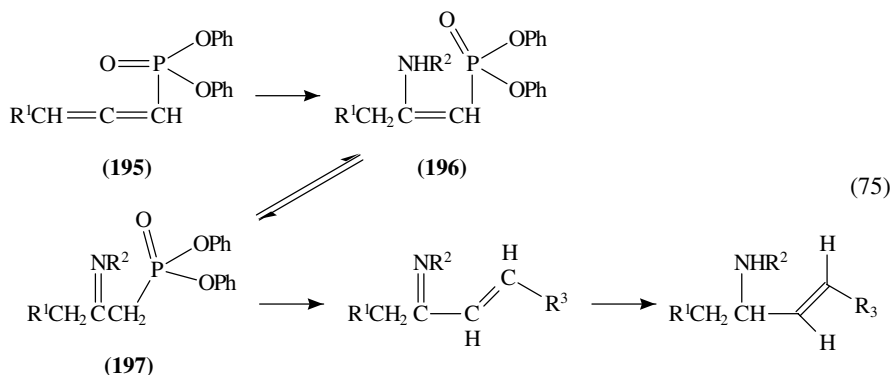


Mixtures of allylic tosylamines are produced from alkenes and tosyliminoiodobenzene (PhI=NTos), generated *in situ* from iodobenzene and 4-toluenesulphonamide under the influence of manganese tetraphenylporphyrin, e.g. equation 74<sup>202</sup>.

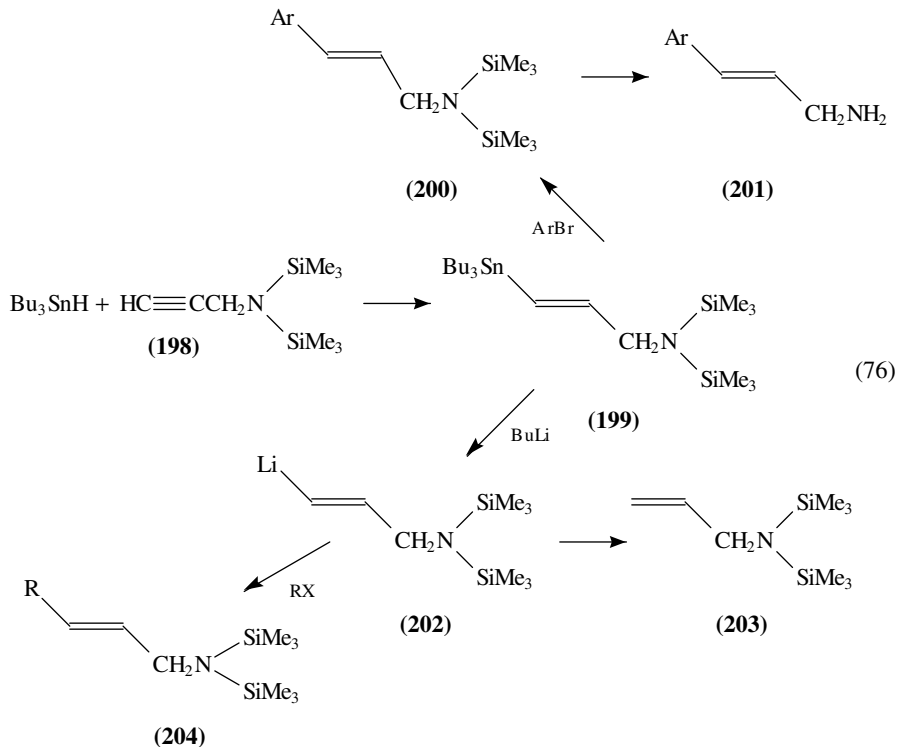


Phosphorylated allenes **195** ( $R^1 = \text{H}$  or  $\text{Me}$ ) are a source of secondary (*E*)-allylamines. The allenes are treated with an amine  $R^2\text{NH}_2$  ( $R^2 = t\text{-Bu}$  or  $4\text{-MeC}_6\text{H}_4$ ) and the products, which exist as equilibrium mixtures of enamines **196** and imines **197**, are olefinated by successive reaction with methyl lithium and an aldehyde  $R^3\text{CHO}$  ( $R = i\text{-Bu}$ ,  $4\text{-MeC}_6\text{H}_4$ ,  $\text{PhCH}_2\text{CH}_2$  etc). Reduction with sodium borohydride finally yields the

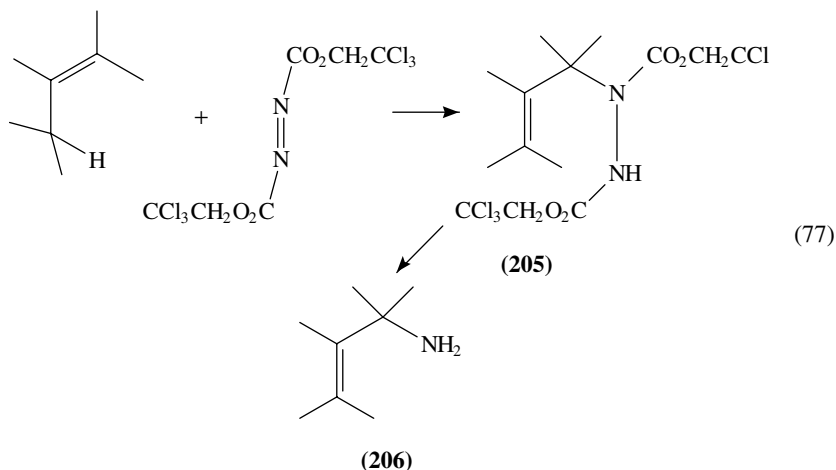
allylamines (equation 75)<sup>203</sup>.



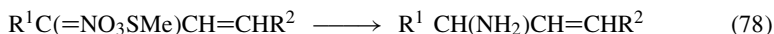
The silylated tin compound **199**, obtained from tributyltin hydride and *N*-bis(trimethylsilyl)propargylamine (**198**) in the presence of a trace of AIBN (2,2'-azobisisobutyronitrile), is a versatile reagent for the preparation of allylic amines. Treatment with aryl bromides ArBr (Ar = Ph, 4-MeOC<sub>6</sub>H<sub>4</sub>, 4-O<sub>2</sub>NC<sub>6</sub>H<sub>4</sub> etc.) under Pd(PPh<sub>3</sub>)<sub>4</sub> catalysis yields the silylated amines **200**, which are hydrolysed by acids to the free amines **201**. **199** is converted into the lithium compound **202**, which is transformed into **203** by aqueous ammonium chloride and into **204** by the action of alkyl halides RX (R = Me, Et or allyl) (equation 76)<sup>204</sup>.



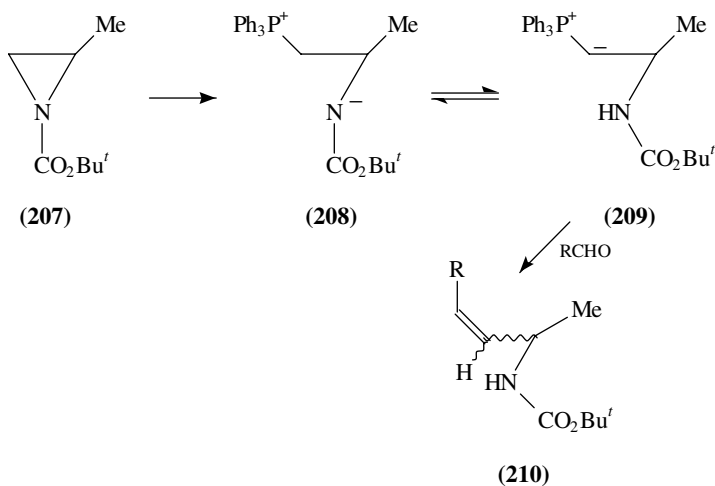
Silylated primary allylic amines, e.g.  $\text{CH}_2=\text{CHCH}_2\text{N}(\text{SiMe}_3)_2$ , are produced from allylic chlorides and the mixed reagent  $\text{AgI}/\text{LiN}(\text{SiMe}_3)_2$ <sup>205</sup>. The formation of allylic amines from olefins by the ene reaction is shown in equation 77. The ene adducts **205** from bis(2,2,2-trichloroethyl) azodicarboxylate are converted into **206** by zinc dust in acetone/acetic acid<sup>206</sup>.



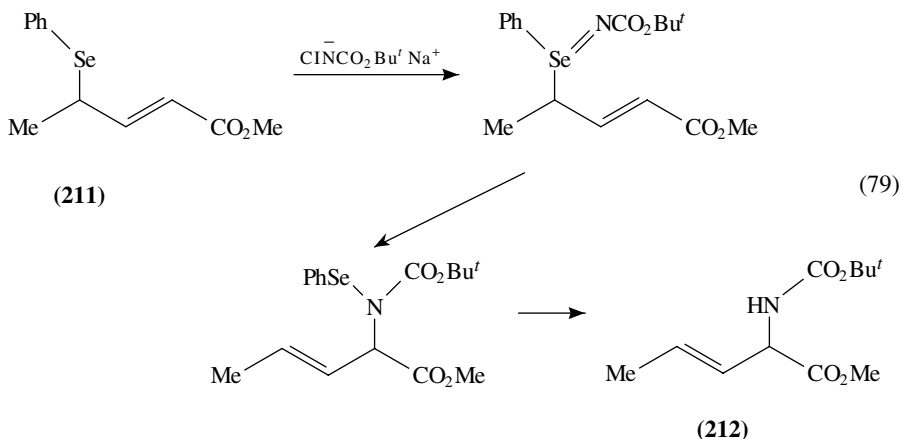
*O*-Methanesulphonyloximes of  $\alpha,\beta$ -unsaturated ketones yield allylic amines on reduction with lithium aluminium hydride (equation 78)<sup>207</sup>.



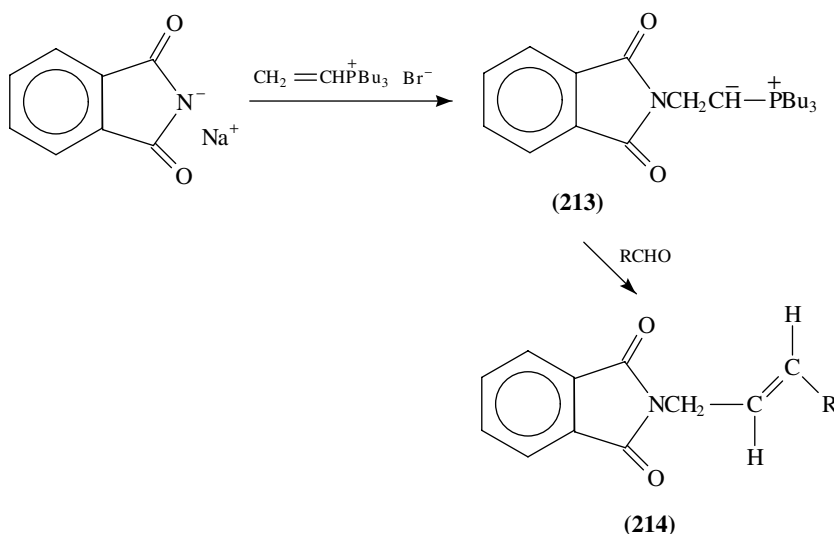
Protected primary allylic amines **210** are obtained<sup>208</sup> as mixtures of (*E*)- and (*Z*)-isomers by the combined action of an aldehyde  $\text{RCHO}$  ( $\text{R} = \text{C}_6\text{H}_{11}$ ,  $\text{Ph}$ ,  $4\text{-MeOC}_6\text{H}_4$ ,  $4\text{-CNC}_6\text{H}_4$ ,  $\text{PhCH}=\text{CH}$  etc.) and triphenylphosphine on the aziridine **207** by way of an equilibrium mixture of the betaines **208** and **209**.



The conversion of allylic selenides into allylic amines is illustrated for the ester **211**, which forms the protected amine **212** by reaction with sodium *t*-butyl *N*-chlorocarbamate. The reaction involves a [2,3] sigmatropic rearrangement (equation 79)<sup>209</sup>.



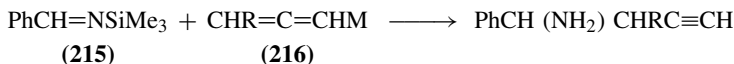
Tributylvinylphosphonium bromide forms the betaine **213** with sodium phthalimide. Addition of aldehydes RCHO (ketones are inert) gives almost exclusively the (*E*)-allylphthalimides **214**, which form the corresponding allylamines by cleavage with hydrazine<sup>210</sup>.



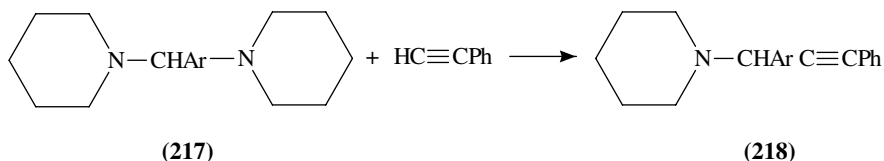
Copper(I) bromide catalyses the reaction of primary and secondary amines  $R^1R^2NH$  ( $R^1 = H, R^2 = i\text{-Pr, Bu, } t\text{-Bu, Ph, Ar, PhCH}_2$ ;  $NR^1R^2 = NEt_2$  or piperidin-1-yl) with the allenes  $R^3R^4C=C=CHBr$  ( $R^3 = H$  or Me;  $R^4 = Me, Et$  or *t*-Bu) to give propargylamines  $R^3R^4C(NR^1R^2)-C\equiv CH$ <sup>211</sup>. Propargyl acetates and phosphates are aminated by primary



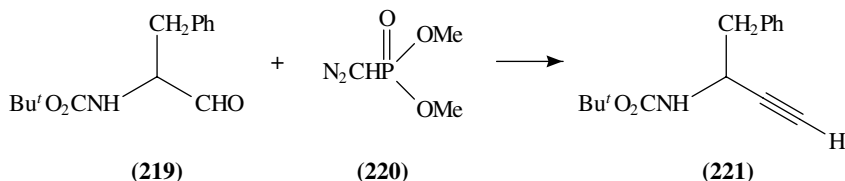
and secondary amines under the influence of copper(I) chloride to yield the corresponding propargylamines<sup>212</sup>. A one-pot synthesis of *N*-propargylarylamines  $\text{RC}\equiv\text{CCH}_2\text{NHAr}$  ( $\text{R} = \text{H}, \text{C}_6\text{H}_{13}, \text{Ph}, \text{Et}_2\text{NCH}_2, \text{CH}_2=\text{CMe}$ ) is by the addition of butyllithium to a mixture of the acetylene  $\text{RC}\equiv\text{CH}$  and a methoxymethylarylamine  $\text{ArNHCH}_2\text{OMe}$ . The imine  $\text{ArN}=\text{CH}_2$  is generated and reacts with the lithium compound  $\text{RC}\equiv\text{CLi}$  to form the product<sup>213</sup>. Primary *N*-alkynylamines are obtained from the silylated imine **215** and allenic organomagnesium, zinc or aluminium compounds **216**<sup>214</sup>.



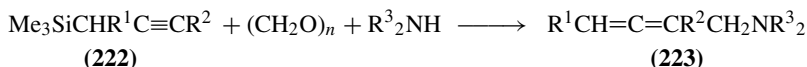
*N*-Propargylpiperidines **218** ( $\text{Ar} = \text{Ph}, 4\text{-MeOC}_6\text{H}_4$  or 2-thienyl) are produced from the animals **217** and phenylacetylene under the influence of copper(I) chloride<sup>215</sup>.



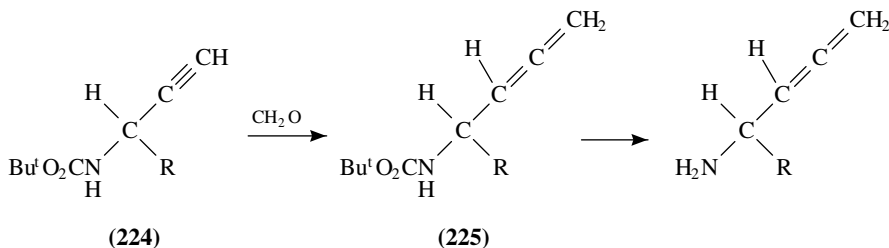
The chiral aldehyde **219** reacts with dimethyl diazophosphonate (**220**) to yield the protected propargylamine **221** of high optical purity<sup>216</sup>.



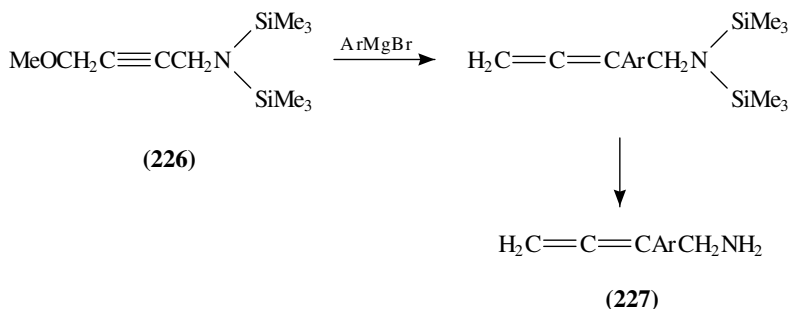
$\alpha$ -Allenic amines **223** are produced from the propargylsilanes **222** ( $\text{R}^1 = \text{H}$  or  $\text{Me}$ ;  $\text{R}^2 = \text{H}, \text{Me}$  or  $\text{SiMe}_3$ ), paraformaldehyde and secondary amines ( $\text{Et}_2\text{NH}, \text{Bu}_2\text{NH}$ , piperidine or morpholine) in the presence of trifluoroacetic acid<sup>217</sup>.



The protected propargylamines **224** ( $\text{R} = \text{H}, \text{CH}_2\text{CO}_2\text{Me}$  or  $\text{CH}_2\text{CH}_2\text{CO}_2\text{Me}$ ) react with aqueous formaldehyde under copper(I) bromide catalysis to yield the allene derivatives **225**. Deprotection with ethereal hydrogen chloride affords the free amines<sup>218</sup>.

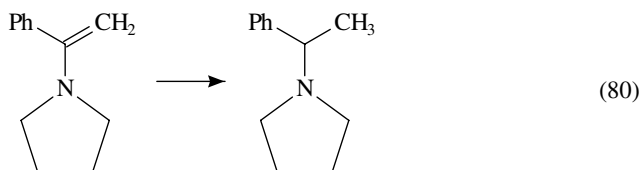


High yields of  $\beta$ -substituted allenic primary amines **227** are obtained by the CuBr·Me<sub>2</sub>S- or NiCl<sub>2</sub>·Ph<sub>2</sub>PCH<sub>2</sub>CH<sub>2</sub>CH<sub>2</sub>PPh<sub>2</sub>-catalysed reaction of the acetylene derivative **226** with aryl Grignard compounds and subsequent deprotection by flash chromatography<sup>219</sup>.

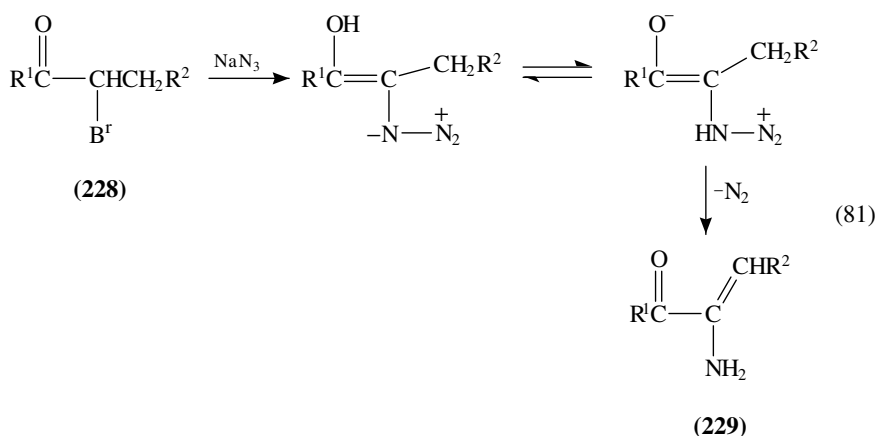


#### 14. By miscellaneous methods

Hydrogenation of enamines in the presence of a chiral titanocene catalyst yields optically active amines in more than 90% enantiomeric excess, e.g. equation 80<sup>220</sup>.

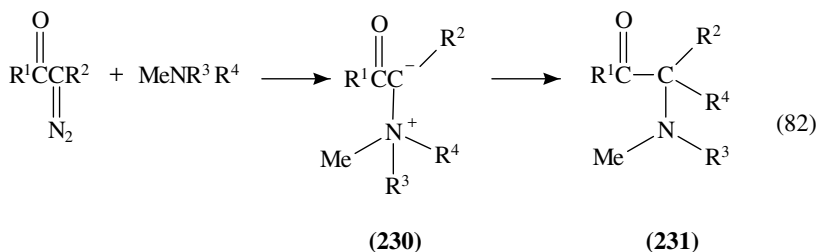


$\alpha$ -Enamino ketones **229** are produced by the action of sodium azide on  $\alpha$ -bromo ketones **228** (R<sup>1</sup> = Me or Ph; R<sup>2</sup> = CF<sub>3</sub> or CO<sub>2</sub> Et) as shown in equation 81<sup>221</sup>.

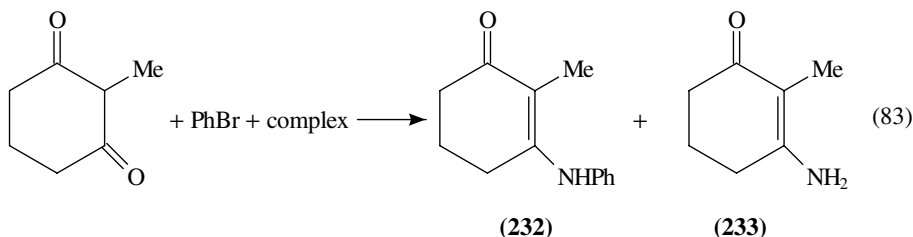


A simple synthesis of  $\alpha$ -amino ketones and esters **231** (R<sup>1</sup> = EtO or Ph; R<sup>2</sup> = H or CO<sub>2</sub>Et; R<sup>3</sup> = Me or CH<sub>2</sub>CO<sub>2</sub>Et; R<sup>4</sup> = PhCH<sub>2</sub> or CH<sub>2</sub>CO<sub>2</sub>Et) proceeds from diazo ketones and esters, respectively, tertiary amines and copper powder. The intermediate

ylides **230**, formed by carbenoid insertion reactions, undergo a [1,2] sigmatropic shift to give the products (equation 82)<sup>222</sup>.



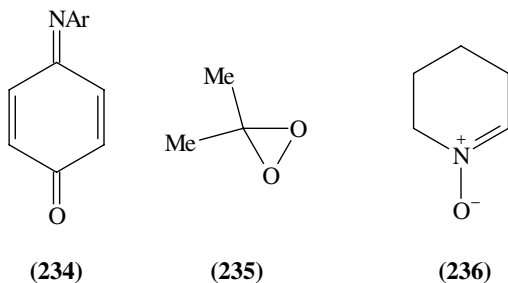
A new carbon–nitrogen bond formation reaction involves the fixation of molecular nitrogen. A mixture of titanium(III) or titanium(IV) chloride and magnesium in THF under nitrogen is treated with carbon dioxide to give the complex  $[\text{3THF} \cdot \text{Mg}_2 \text{Cl}_2 \text{O} \cdot \text{TiNCO}]$ . Addition of 2-methylcyclohexane-1,3-dione and bromobenzene and a catalytic amount of  $\text{Pd}(\text{PPh}_3)_4$  affords a mixture of the vinylamines **232** and **233** (equation 83)<sup>223</sup>.



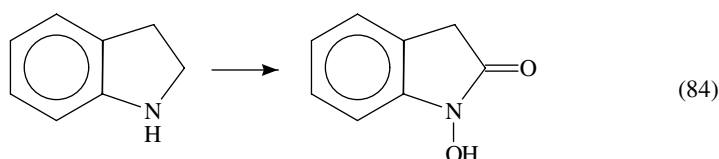
## B. Reactions of Amino Compounds

### 1. Oxidation and dehydrogenation

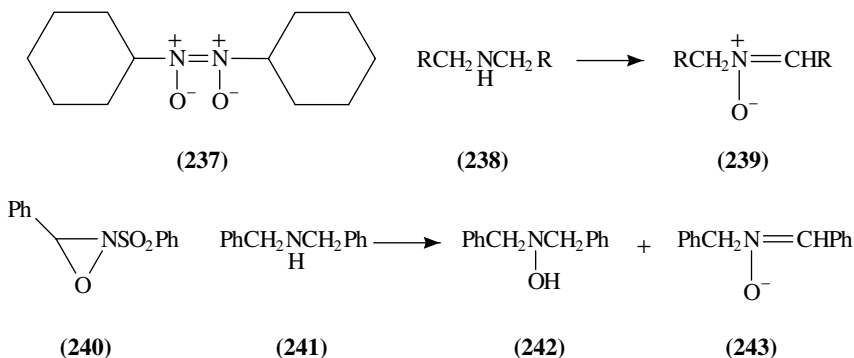
Anilines are converted into nitrosoarenes  $\text{ArNO}$  by the action of hydrogen peroxide in the presence of  $[\text{Mo}(\text{O})(\text{O}_2)_2(\text{H}_2\text{O}) (\text{HMPA})]^{224}$ , whereas catalysis of the reaction by titanium silicate and zeolites results in the formation of azoxybenzenes  $\text{ArN}(\text{O})=\text{NAr}^{225}$ . Azo compounds  $\text{ArN}=\text{NAr}$  are formed in 42–99% yields by the phase-transfer assisted potassium permanganate oxidation of primary aromatic amines in aqueous benzene containing a little tetrabutylammonium bromide<sup>226</sup>. The reaction of arylamines with chromyl chloride gives solid adducts which, on hydrolysis, yield mixtures of azo compounds, *p*-benzoquinone and *p*-benzoquinone anils **234**<sup>227</sup>.



Oxidation of primary amines  $\text{RNH}_2$  with dimethyldioxirane (**235**), generated from acetone and 'oxone',  $2\text{KHSO}_5 \cdot \text{KHSO}_4 \cdot \text{K}_2\text{SO}_2$ , affords the corresponding nitro compounds  $\text{RNO}_2$ <sup>228,229</sup>. Fluorine reacts with wet acetonitrile to produce an oxidizing agent which converts all types of primary aromatic amines into nitro compounds. Thus *p*-nitroaniline yields *p*-dinitrobenzene and *m*-hydroxyaniline gives *m*-nitrophenol<sup>230</sup>. Primary aliphatic amines, e.g.  $\text{C}_{12}\text{H}_{21}\text{NH}_2$ , cyclohexylamine and  $\text{PhCH}_2\text{NH}_2$ , react analogously<sup>231</sup>. Nitrones, e.g. **236** from piperidine, are obtained by the sodium tungstate-catalysed oxidation of secondary amines with hydrogen peroxide<sup>232</sup>. Oxidation of secondary amines with dimethyldioxirane gives hydroxylamines or nitrones in up to 99% yields<sup>233</sup>. Cyclic secondary amines such as pyrrolidine, piperidine, morpholine and indoline afford hydroxamic acids by the action of dimethyldioxirane in acetone, e.g. equation 84<sup>234</sup>.

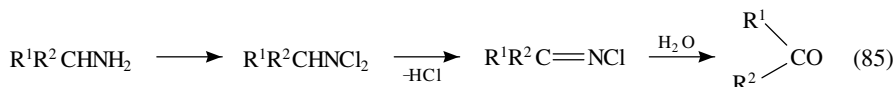


The reaction of cyclohexylamine with dimethyldioxirane has been examined in detail. The main products are cyclohexanone oxime and dimeric nitrosocyclohexane **237**; these are accompanied by a little nitrocyclohexane<sup>235</sup>. Nitrones **239** ( $\text{R} = \text{Et}$ ,  $\text{Bu}$  or  $\text{C}_6\text{H}_{13}$ ) are formed in 74–85% yields in the oxidation of secondary amines **238** with hydrogen peroxide under selenium dioxide catalysis<sup>236</sup>. Piperidine yields the nitrone **236** in this reaction<sup>236</sup>. A biphasic system of ethyl acetate and water containing sodium perborate ( $\text{NaBO}_3$ ), sodium hydrogen carbonate and *N,N'*-diacetylenediamine oxidizes primary aliphatic amines  $\text{RNH}_2$  to dimeric nitrosoalkanes  $(\text{RNO})_2$ <sup>237</sup>. The reaction of 3-phenyl-2-phenylsulphonyloxaziridine (**240**) with various amines more basic than pyridine has been investigated. Primary amines  $\text{RNH}_2$  ( $\text{R} = t\text{-Bu}$ , cyclohexyl,  $\text{PhCH}_2$  and 1-adamantyl) yield nitroso compounds  $\text{RNO}$  as mixtures of monomers and dimers, secondary amines yield mixtures of hydroxylamines and nitrones, e.g. **242** and **243** from dibenzylamine (**241**), and tertiary amines (triethylamine, *N*-methylpiperidine and quinuclidine) yield the corresponding *N*-oxides<sup>238</sup>.



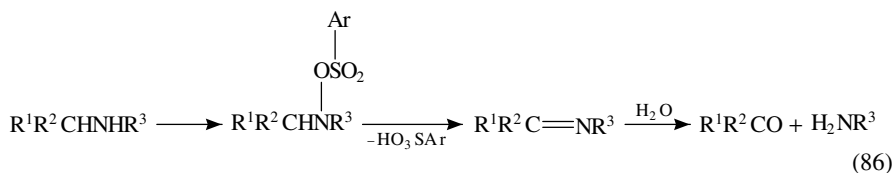
Primary amines  $\text{RNH}_2$ , where  $\text{R}$  is a primary alkyl group such as  $\text{Pr}$ , benzyl or allyl, are oxidized to *O*-benzoylhydroxamic acids  $\text{RNHOBz}$  by benzoyl peroxide<sup>239</sup>.

Oximes result from the reactions of primary aliphatic amines possessing  $\alpha$ -hydrogen atoms with hydrogen peroxide in the presence of the ten-membered ring zeolites TS-1 or TS-2. Thus isopropylamine yields acetone oxime and benzylamine gives benzaldehyde oxime<sup>240</sup>. Addition of hydrogen peroxide to a solution of a copper(II) salt in slightly acidic water gives an insoluble copper derivative  $\text{CuO}_2\text{H}$ , which oxidizes benzylamine to benzaldehyde<sup>241</sup>. High yields of ketones result when primary amines possessing  $\alpha$ -hydrogen atoms are treated with sodium hypochlorite in ethyl acetate/water under phase-transfer catalysis with tetrabutylammonium bromide. Cyclohexylamine gives cyclohexanone, benzhydrylamine benzophenone and 1-phenylethylamine acetophenone. The reactions proceed by way of *N*-chloroimines (equation 85)<sup>242</sup>.

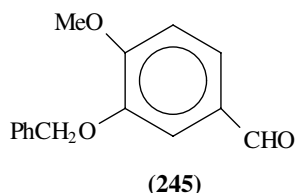
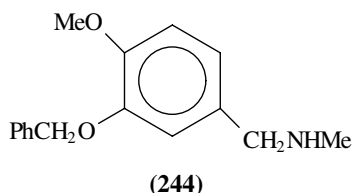


Similarly, tetrakis(pyridino)cobalt(II) dichromate [ $\text{pyridine}_4 \text{Co}(\text{HCrO}_4)_2$ ] smoothly oxidizes amines to carbonyl compounds<sup>243</sup>. The lithium or zinc salts of *N*-trimethylsilylamines  $\text{R}^1\text{R}^2\text{CHNHSiMe}_3$  are converted into carbonyl compounds  $\text{R}^1\text{R}^2\text{C}=\text{O}$  in good yields by reaction with air for 5–45 min at low temperatures. Other oxygen-sensitive functions, such as thioether or tertiary amino groups, are not affected<sup>244</sup>. Primary amines are oxidized to carbonyl compounds by iodossylbenzene (PhIO) in the presence of  $\text{Ru}(\text{PPh}_3)_2\text{Cl}_2$  and molecular sieves, e.g.  $\text{PhCH}_2\text{NH}_2 \rightarrow \text{PhCHO}$  and  $\text{Ph}_2\text{CHNH}_2 \rightarrow \text{Ph}_2\text{CO}$ . Secondary amines give imines, e.g.  $\text{PhCH}_2\text{NHPh} \rightarrow \text{PhCH}=\text{NPh}$  and  $\text{PhCH}=\text{CHCH}_2\text{NHPh} \rightarrow \text{PhCH}=\text{CHCH}=\text{NPh}$ <sup>245</sup>. Other methods for the conversion of secondary amines  $\text{R}^1\text{R}^2\text{CHNHR}^3$  into imines  $\text{R}^1\text{R}^2\text{C}=\text{NR}^3$  are by oxidation with *t*-butyl hydroperoxide in the presence of  $\text{Ru}(\text{PPh}_3)_3\text{Cl}_2$ <sup>246</sup>, with Ni(II) sulphate–potassium persulphate<sup>247</sup>, with a reagent prepared from copper(II) bromide and lithium *t*-butoxide<sup>248</sup> and with 4-methylmorpholine *N*-oxide in acetonitrile in the presence of tetrapropylammonium perchlorate and 4 Å molecular sieves<sup>249</sup>.

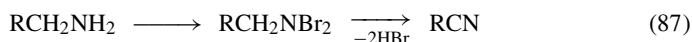
The oxidative deamination of primary and secondary amines is accomplished efficiently by treatment with 3-trifluoromethylbenzenesulphonyl peroxide  $(\text{ArSO}_2)_2\text{O}_2$  ( $\text{Ar} = 3\text{-F}_3\text{CC}_6\text{H}_4$ ) in ethyl acetate, followed by powered potassium hydroxide at  $-78^\circ\text{C}$  and finally water (equation 86).



Benzylamine gave benzaldehyde, hexylamine hexanal, octylamine octanal, 2-octylamine octan-2-one, cyclohexylamine cyclohexanone and dibenzylamine gave benzophenone<sup>250</sup>. Copper(I) chloride in pyridine in an atmosphere of oxygen converts primary amines into cyanides, e.g. benzylamine gave benzonitrile and 2-(3,4-dimethoxyphenyl)ethylamine gave 3,4-dimethoxyphenylacetonitrile. The secondary amine **244** gave the aldehyde **245** in this reaction<sup>251</sup>. An improvement of the procedure resulting in yields of better than 95% is to conduct the oxidation in the presence of 4 Å molecular sieves<sup>252</sup>. Other methods for carrying out

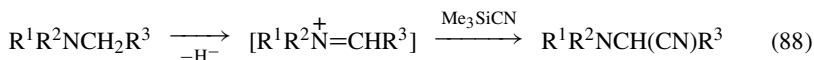


the oxidation of primary amines to cyanides are by using 4% aqueous sodium hypochlorite in the presence of hexadecyltrimethylammonium bromide<sup>253</sup>, potassium persulphate in the presence of nickel(II) sulphate<sup>254</sup>, silver(II) picolinate<sup>255</sup> or with *N*-bromosuccinimide to give an *N,N*-dibromide, which is decomposed by adding trimethylamine (equation 87).

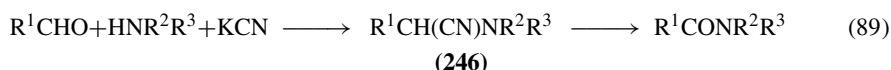


1,6-Diaminohexane gives 60% of adiponitrile in this reaction<sup>256</sup>.

The photooxidation of tertiary methylamines sensitized by electron acceptors such as 9,10-dicyanoanthracene in the presence of lithium perchlorate results in demethylation; thus tropinone yields nortropinone<sup>257</sup>. Photoinduced cyanation of tertiary amines with oxygen, a sensitizer and trimethylsilyl cyanide results in  $\alpha$ -cyano nitriles (equation 88)<sup>258</sup>.

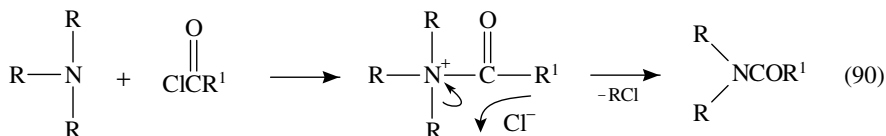


The cyanides **246**, obtained from aldehydes  $\text{R}^1\text{CHO}$  ( $\text{R}^1 = \text{alkyl, Ph or PhCH=CH}$ ), amines  $\text{HNR}^2\text{R}^3$  (aniline or morpholine etc.) and potassium cyanide undergo autoxidation in the presence of potassium *t*-butoxide to give amides (equation 89)<sup>259</sup>.



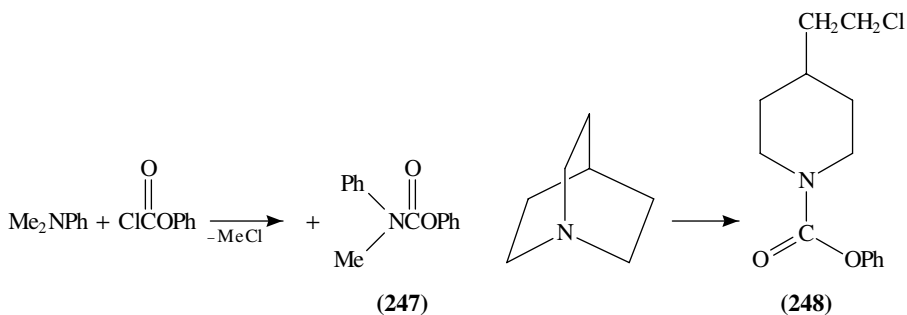
## 2. Dealkylation

Dealkylations of amines by means of acyl chlorides have been reviewed (equation 90)<sup>260</sup>.

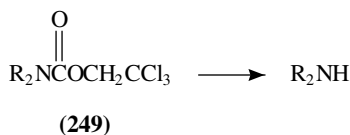


Phenyl carbonochloridate (phenyl chloroformate) effects the dealkylation of tertiary amines: *N,N*-dimethylaniline yields methyl chloride and the amide **247**, and quinuclidine yields the piperidine derivative **248**<sup>261</sup>.

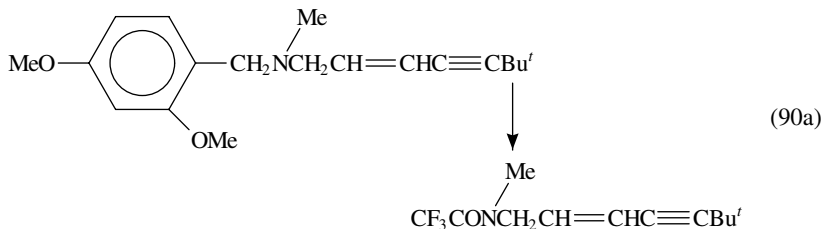
However, the resulting amides are difficult to hydrolyse. A more efficient dealkylating agent is 2,2,2-trichloroethyl carbonochloridate  $\text{ClC}(\text{O})\text{OCH}_2\text{CCl}_3$ . It readily decomposes



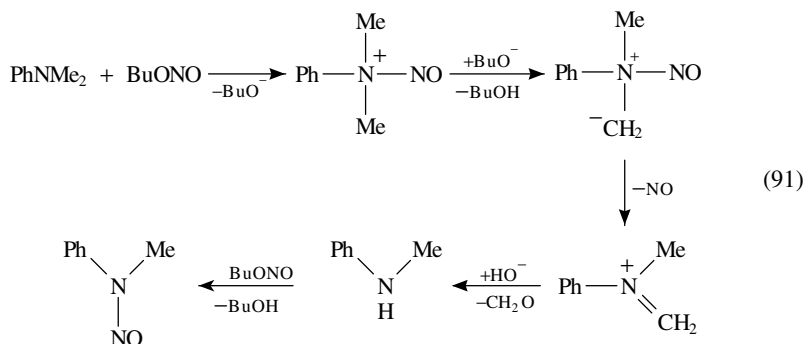
tertiary amines to give carbamates **249** which are easily cleaved to secondary amines by zinc in methanol or in acetic acid<sup>262</sup>.



Other useful reagents are vinyl carbonochloridate  $\text{ClC(O)OCH=CH}_2$ <sup>263</sup> and  $\alpha$ -chloroethyl carbonochloridate  $\text{ClC(O)OCHClCH}_3$ , which is unsurpassed in effectiveness. The resulting carbamates  $\text{R}_2\text{NCO}_2\text{CHClCH}_3$  are decomposed to secondary amines in hot methanol<sup>264</sup>. Tertiary *N*-methylamines  $\text{RArNMe}$  ( $\text{R} = \text{Me, Et, MeO}_2\text{CCH}_2\text{CH}_2$  or  $\text{CH}_2=\text{CHCH}_2\text{CH}_2$ ) are demethylated by the ruthenium-catalysed reaction with *t*-butyl hydroperoxide to give  $\text{RArNCH}_2\text{OObu}^t$ , which are hydrolysed to  $\text{RArNH} \cdot \text{HCl}$  by dilute hydrochloric acid. The procedure is chemoselective, *N*-alkyl groups other than methyl not being affected<sup>265</sup>. The debenylation of *N*-benzyl tertiary amines  $\text{PhCH}_2\text{NR}^1\text{R}^2$  with ethyl carbonochloridate gives carbamates  $\text{R}^1\text{R}^2\text{NCO}_2\text{Et}$ , which are converted into the secondary amines  $\text{R}^1\text{R}^2\text{NH}$  by the action of the boron complex  $\text{BI}_3 \cdot \text{Et}_2\text{NPh}$ <sup>266</sup>. A method for the selective *N*-demethylation of tertiary methylamines  $\text{R}^1\text{R}^2\text{NMe}$  is ruthenium(III)-catalysed oxidation with methanolic hydrogen peroxide to yield  $\text{R}^1\text{R}^2\text{NCH}_2\text{OMe}$ , followed by removal of the methoxymethyl group with dilute hydrochloric acid<sup>267</sup>. *para*-Substituted *N,N*-dimethylanilines  $4\text{-RC}_6\text{H}_4\text{NMe}_2$  ( $\text{R} = \text{Me, MeO or Cl}$ ) react with oxygen and acetic anhydride in the presence of copper(I) chloride or cobalt(II) chloride to give the demethylated products  $4\text{-RC}_6\text{H}_4\text{NMeAc}$ <sup>268</sup>. The combined action of trifluoroacetic anhydride and triethylamine on some unsaturated tertiary *N*-(2,4-dimethoxybenzyl)amines leads to the selective cleavage of the benzyl-nitrogen bond (equation 90a)<sup>269</sup>.



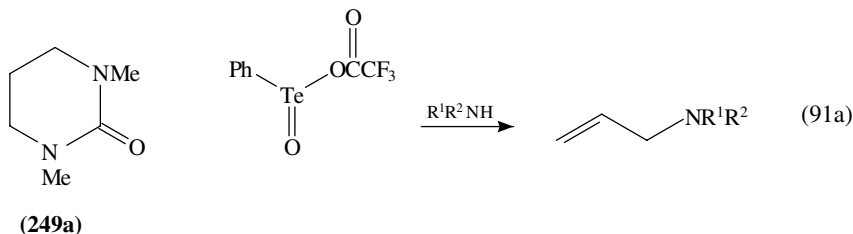
The reaction of tertiary aromatic amines with butyl nitrite has been investigated in detail. The main products arise from *N*-dealkylation/*N*-nitrosation, e.g. equation 91<sup>270</sup>.



### 3. Alkylation, arylation, etc.

Primary amines  $\text{RNH}_2$  ( $\text{R} = i\text{-Pr}, i\text{-Bu}, t\text{-Bu}$  or cyclohexyl) react with the carbamate  $\text{EtO}_2\text{CN}=\text{CCl}_2$  to yield the carbodiimides  $\text{EtO}_2\text{CN}=\text{C}=\text{NR}$ <sup>271</sup>. A new method of preparing imines is to add a carbonyl compound (2,6-dimethylcyclohexanone, 2-tetralone, 2-decalone etc.) to a preformed complex of a primary amine (*t*-butylamine, cyclohexylamine, benzylamine or 1-phenylethylamine) and titanium(IV) chloride suspended in hexane or octane<sup>272</sup>. Primary amines  $\text{R}^1\text{NH}_2$  ( $\text{R}^1 = t\text{-Bu}, \text{N}\equiv\text{C}, \text{Tos}$  or phthalimido) react with nitroso compounds  $\text{R}^2\text{NO}$  ( $\text{R}^2 = t\text{-Bu}, \text{pyrrolidin-1-yl}, \text{Ph}$  or 2-MeCC<sub>6</sub>H<sub>4</sub>) in the presence of the hypervalent iodine compound  $\text{PhI}(\text{OAc})_2$  to give unsymmetrical azoxy compounds  $\text{R}^1\text{N}=\overset{+}{\text{N}}(\text{O}^-)\text{R}^2$ <sup>273</sup>. Lithium salts of hindered secondary amines [diisopropylamine, bis(trimethylsilyl)amine and 2,2,6,6-tetramethylpiperidine] are obtained by ultrasonic irradiation of lithium metal and the amine in THF in the presence of isoprene as an electron carrier<sup>274</sup>.

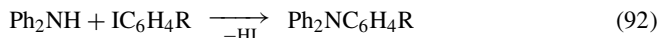
Monoalkylation of optically active 1-phenylethylamine with benzyl bromide in *N,N*-dimethylpropyleneurea (**249a**) at 100 °C in the presence of sodium carbonate gives the enantiomerically pure *N*-benzyl derivative. Isopropyl iodide and neopentyl iodide behave analogously<sup>275</sup>.



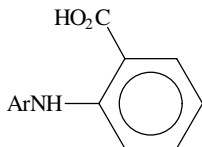
The reaction of allyltrimethylsilane with benzenetelluranyl trifluoroacetate, followed by a primary or secondary amine (octylamine, aniline, piperidine, etc.) and boron trifluoride etherate, yields the corresponding allylamine (equation 91a)<sup>276</sup>. *N*-Allylarylamines are formed in excellent yields from allyldialkyltelluronium bromides  $\text{CH}_2=\text{CHCH}_2\overset{+}{\text{Te}}\text{R}_2\text{Br}^-$  and arylamines<sup>277</sup>. *N*-Phenylation of primary amines (aniline, *p*-nitroaniline etc.) and of secondary amines (diethylamine, *N*-butylethylamine etc.) is achieved by treatment



with triphenylbismuth diacylates  $\text{Ph}_3\text{Bi}(\text{OR})_2$  ( $\text{R} = \text{Ac}, \text{OCCF}_3$  or  $\text{Tos}$ ) in the presence of copper powder<sup>278</sup>. Similarly, aryllead triacetates  $\text{ArPb}(\text{OAc})_3$  monoarylate aliphatic, aromatic and heteroaromatic amines under copper(II) acetate catalysis<sup>279</sup>. The Ullmann synthesis of triarylamines (equation 92) from diphenylamine and aryl iodides  $\text{IC}_6\text{H}_4\text{R}$  ( $\text{R} = 2-, 3-$  or  $4\text{-Me}, 2-, 3-$  or  $4\text{-Cl}, 3-$  or  $4\text{-OMe}$ ) proceeds efficiently in refluxing *o*-dichlorobenzene in the presence of copper, potassium carbonate and 18-crown-6 under phase-transfer conditions<sup>280</sup>.

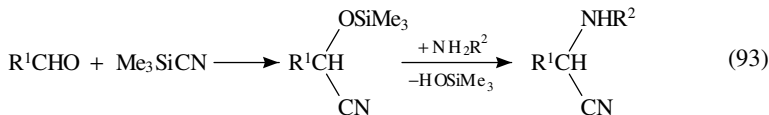


Primary and secondary amines (aniline, *t*-butylamine, diethylamine, diisopropylamine, pyrrolidine, piperidine and morpholine) are *N*-phenylated in good yields by adding the amine to a suspension of lithium in THF, followed by bromobenzene<sup>281</sup>. Aminostannanes, generated *in situ* by transamination of tributyl(diethylamino)tin with primary or secondary amines, undergo palladium-catalysed reactions with aryl bromides to yield arylated amines. Thus successive reaction of benzylmethylamine with the tin compound and ethyl 4-bromobenzoate in the presence of  $\text{PdCl}_2[\text{P}(2\text{-MeC}_6\text{H}_4)_3]$  gave 88% of 4-EtO<sub>2</sub>CC<sub>6</sub>H<sub>4</sub>NMeCH<sub>2</sub>Ph<sup>282</sup>. Diphenylamine-2-carboxylic acids **250** are obtained when arylamines  $\text{ArNH}_2$  ( $\text{Ar} = \text{Ph}, 4\text{-MeC}_6\text{H}_4, 4\text{-MeOC}_6\text{H}_4, 4\text{-H}_2\text{NC}_6\text{H}_4, 3\text{-ClC}_6\text{H}_4, 3\text{-O}_2\text{NC}_6\text{H}_4$  or  $4\text{-HO}_3\text{SC}_6\text{H}_4$ ) are heated with 2-chlorobenzoic acid in water in the presence of copper powder<sup>283</sup>.

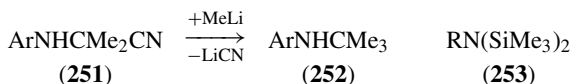


(250)

Trimethylsilyl trichloroacetate is a useful reagent for the *N*-trimethylsilylation of amines<sup>284</sup>. The combined action of primary aliphatic or aromatic amines and trimethylsilyl cyanide on aliphatic or aromatic aldehydes yields  $\alpha$ -amino nitriles (equation 93)<sup>285,286</sup>.

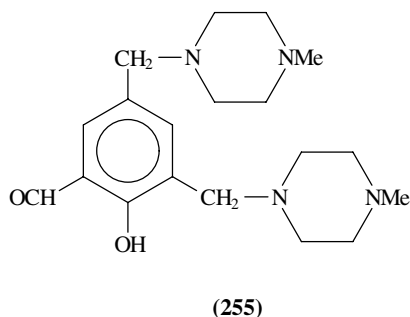
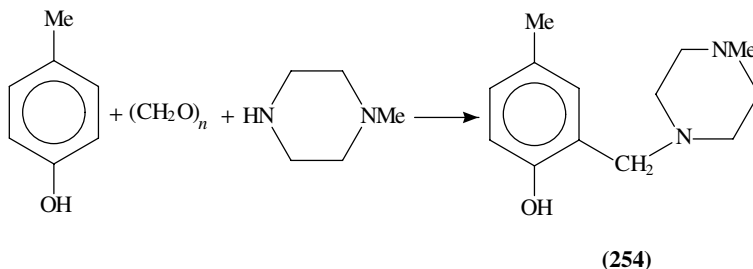


The  $\alpha$ -arylamino nitriles **251**, obtained from primary aromatic amines, trimethylsilyl cyanide and acetone in the presence of zinc chloride, react with methylolithium to give *N*-*t*-butylarylamines **252**<sup>287</sup>. *N,N*-Bis(trimethylsilyl)amines **253** ( $\text{R} = \text{allyl}, \text{benzyl}, 3\text{-phenylpropyl}$  etc.) are formed in 50–88% yields by the action of chlorotrimethylsilane on primary amines in the presence of a catalytic amount of titanium(IV) chloride<sup>288</sup>.

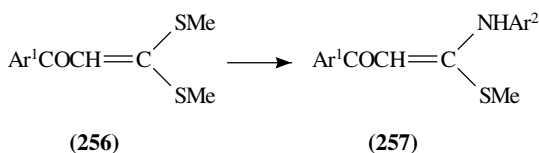


Trichlorosilane reacts with secondary amines (diethylamine, pyrrolidine, piperidine, morpholine and 1-methylpiperazine) to give the corresponding tris(dialkylamino)silanes  $\text{HSi}(\text{NR}_2)_3$ <sup>289</sup>.

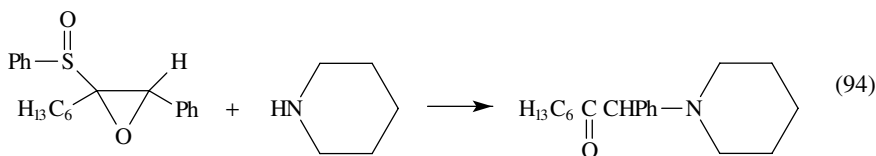
Aromatic Mannich reactions have been reviewed<sup>290</sup>. Recent examples are the formation of **254** from *p*-cresol, paraformaldehyde and 1-methylpiperazine and of **255** from salicylaldehyde, aqueous formalin and 1-methylpiperazine<sup>291</sup>.



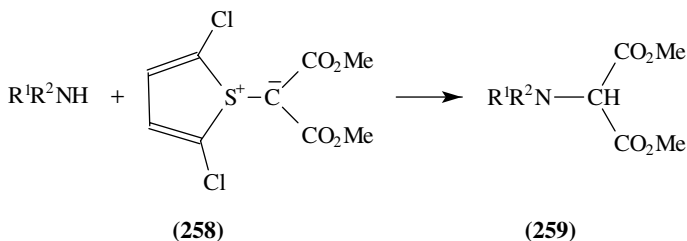
$\alpha$ -Oxoketene dithiacetals **256** ( $\text{Ar}^1 = \text{Ph}$ , 4-MeC<sub>6</sub>H<sub>4</sub>, 4-MeOC<sub>6</sub>H<sub>4</sub> or 4-ClC<sub>6</sub>H<sub>4</sub>) condense with primary aromatic amines Ar<sup>2</sup>NH<sub>2</sub> (Ar<sup>2</sup> = Ph, 2- or 4-ClC<sub>6</sub>H<sub>4</sub> or 4-MeC<sub>6</sub>H<sub>4</sub>) under the influence of boron trifluoride etherate to give *S,N*-acetals **257** in yields of up to 98%<sup>292</sup>.



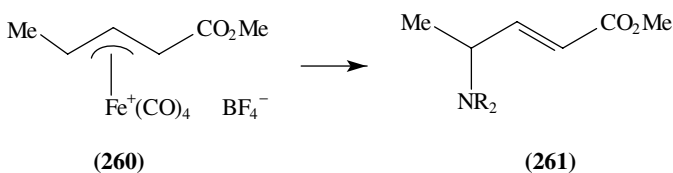
The reaction of  $\alpha,\beta$ -epoxy sulphoxides with aliphatic or aromatic amines affords  $\alpha$ -amino ketones, e.g. equation 94<sup>293</sup>.



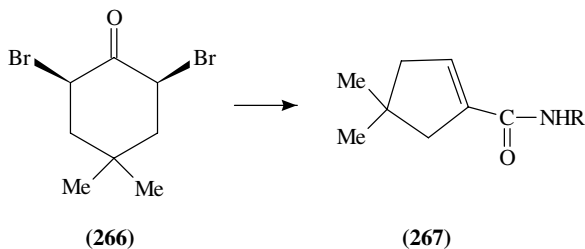
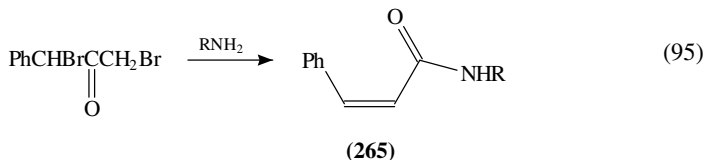
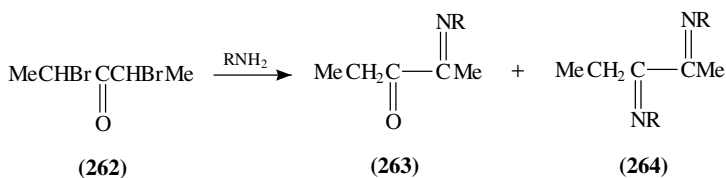
The joint action of primary or secondary amines (aniline, allylamine, benzylamine, butylmethylamine, *N*-methylglycine methyl ester etc.) and copper bis(acetylacetonate) on the thiophen ylide **258** leads to dimethyl aminomalonates **259** by a carbene insertion reaction<sup>294</sup>.

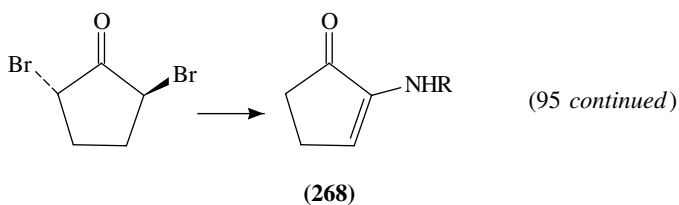


Treatment of secondary amines, e.g. dibenzylamine, with the complex **260**, followed by oxidative removal of the iron carbonyl group, yields methyl 4-dialkylamino enoates **261**<sup>295</sup>.

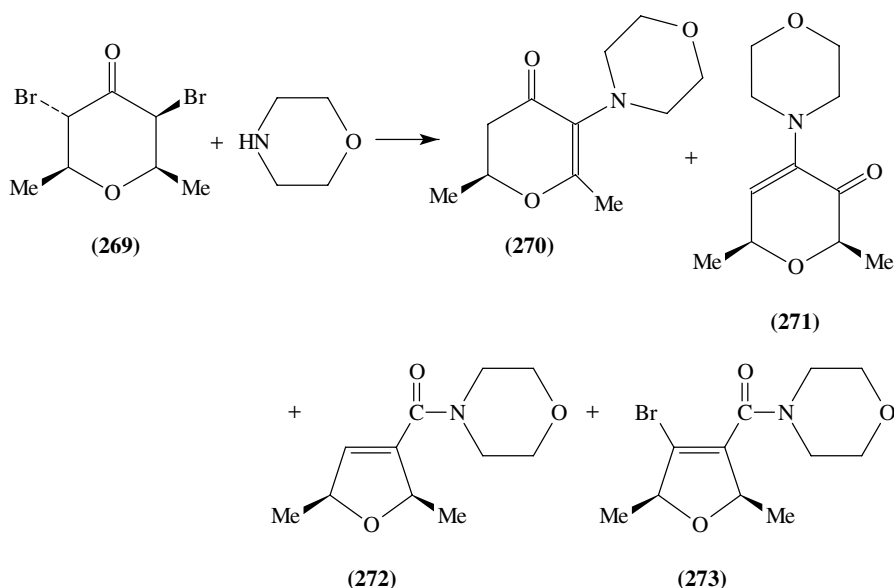


Aliphatic  $\alpha,\alpha'$ -dibromo ketones, such as 2,4-dibromopentan-3-one (**262**), react with primary amines  $\text{RNH}_2$  ( $\text{R} = \text{Me}, \text{Et}, \text{Pr}, i\text{-Pr}$  or  $t\text{-Bu}$ ) to give mixtures of imines **263** and lesser amounts of diimines **264**. 1,3-Dibromo-1-phenylpropan-2-one yields only the amide **265**, the product of a Favorskii rearrangement. The nature of the products from aliphatic amines and cyclic  $\alpha,\alpha'$ -dibromo ketones depends on ring size: the cyclohexanone derivative **266** gave Favorskii amides **267** ( $\text{R} = \text{Pr}, i\text{-Pr}$  or  $t\text{-Bu}$ ), while *trans*-2,5-dibromocyclopentanone afforded the enamines **268** ( $\text{R} = i\text{-Pr}$  or  $t\text{-Bu}$ ) (equation 95)<sup>296</sup>.



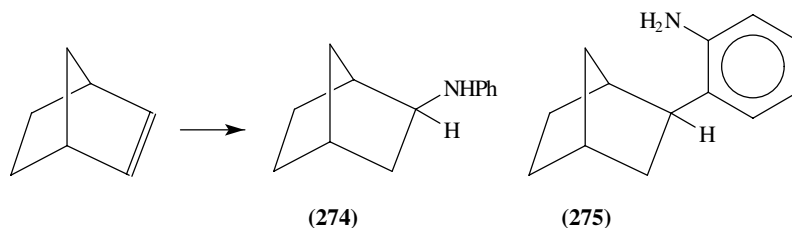


A mixture of enamines **270** and **271** and Favorskii products **272** and **273** is produced by the action of morpholine on the dibromotetrahydropyran-4-one **269**<sup>297</sup>.



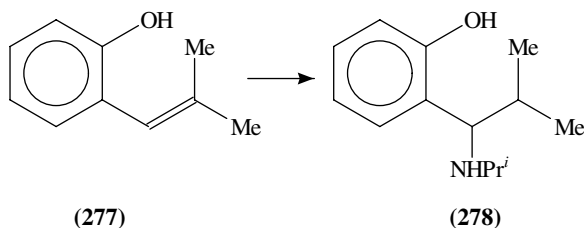
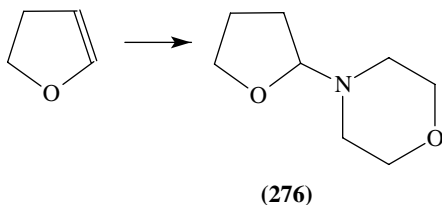
#### 4. Amination of olefins

Reactions of amines with alkenes have been reviewed<sup>298,299</sup>. Alkali metal amides are active homogeneous catalysts for the amination of olefins. Thus diethylamine and ethylene yield triethylamine when heated at 70–90 °C at 6–10 atm in the presence of lithium diethylamide and *N,N,N',N'*-tetramethylethylenediamine. Solutions of caesium amide promote the addition of ammonia to ethylene at 100 °C and 110 atm to give mixtures of mono-, di- and triethylamines<sup>300</sup>. The iridium(I)-catalysed addition of aniline to norbornene affords the anilinonorbornane **274**<sup>301</sup>. Treatment of norbornene with aniline

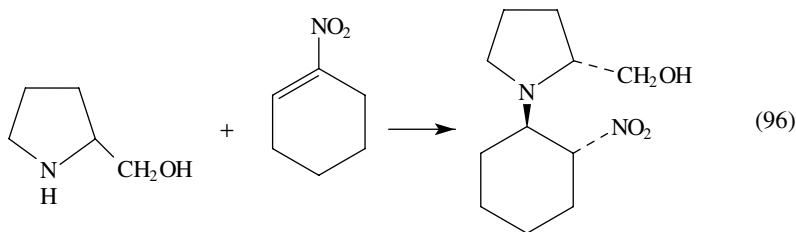


and a catalyst generated from  $\text{PhNHLi}$  and  $[\text{Rh}(\text{PET}_3)_2\text{Cl}]_2$  produces a mixture of the product **275** of 'hydroarylation' and minor amounts of **274**<sup>302</sup>.

The addition of morpholine to 2,3-dihydrofuran in the presence of palladium(II) thiocyanate·bis(triphenylphosphine) yields 2-(morpholin-4-yl)tetrahydrofuran (**276**)<sup>303</sup>. Irradiation of mixtures of 2-(2-methylpropenyl)phenol (**277**) and alkylamines yields adducts, e.g. **278** with isopropylamine<sup>304</sup>.



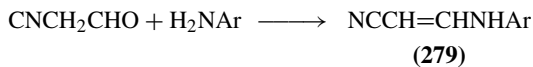
Chiral amino alcohols react with achiral nitroalkenes such as 1-nitrocyclohexene almost stereospecifically to give optically active products, e.g. equation 96<sup>305</sup>.



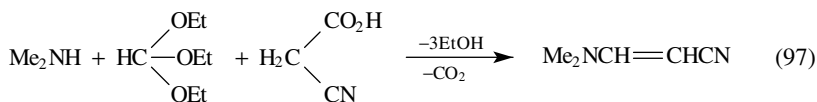
The action of piperazine on dilute solutions of fullerene  $\text{C}_{60}$  in toluene leads to a 'monoadduct', together with a mixture of regioisomeric 'diadducts'. The reactions take place at bonds joining six-membered rings and are accompanied by loss of hydrogen<sup>306</sup>.

### 5. Formation of enamines

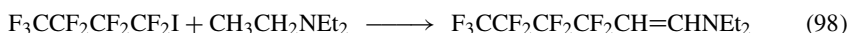
Cyanoacetaldehyde, freshly prepared by the ozonization of allyl cyanide or (*E*)-1,4-dicyanobut-2-ene, reacts with primary aromatic amines to give the  $\beta$ -cyanoenamines **279**<sup>307</sup>.



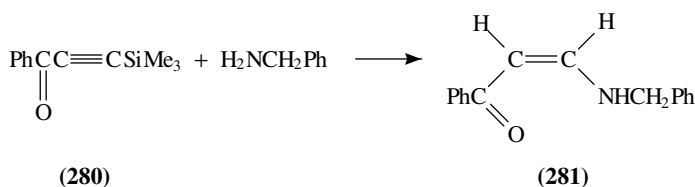
$\beta$ -Cyanoenamines are also obtained when mixtures of *ortho* esters, secondary amines and cyanoacetic acid are heated in a pressure bottle, e.g. equation 97<sup>308</sup>.



The Pd(PPh<sub>3</sub>)<sub>4</sub>-catalysed reaction of perfluoroalkyl iodides with tertiary aliphatic amines gives enamines in 40–50% yields, e.g. equation 98<sup>309</sup>.



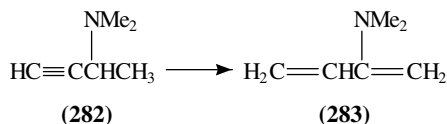
The *cis*-enamino ketone **281** is formed stereoselectively by the reaction of benzylamine with the (trimethylsilyl)ethynyl ketone **280**<sup>310</sup>.



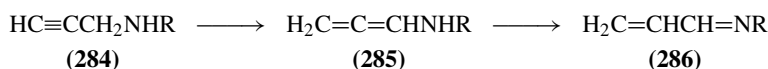
Irradiation of mixtures of 1,3-diketones and aliphatic or aromatic primary or secondary amines absorbed over montmorillonite clay or silica in a microwave oven affords enamino ketones, e.g. equation 99<sup>311</sup>.



3-Dimethylamino-1-butyne (**282**) undergoes a base-catalysed isomerization to 2-dimethylamino-1,3-butadiene (**283**)<sup>312</sup>.

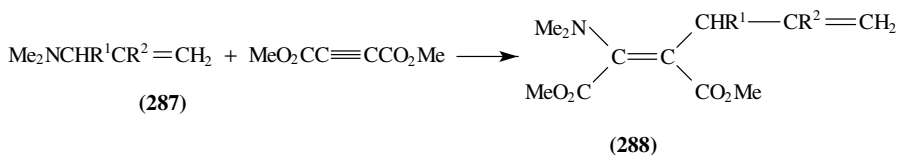


Secondary propargylic amines **284** (R = Pr, *t*-Bu, C<sub>5</sub>H<sub>11</sub>, C<sub>6</sub>H<sub>13</sub> or C<sub>7</sub>H<sub>15</sub>) rearrange to the enamines **285** and thence to the imines **286** in the presence of potassium *t*-butoxide<sup>313</sup>.

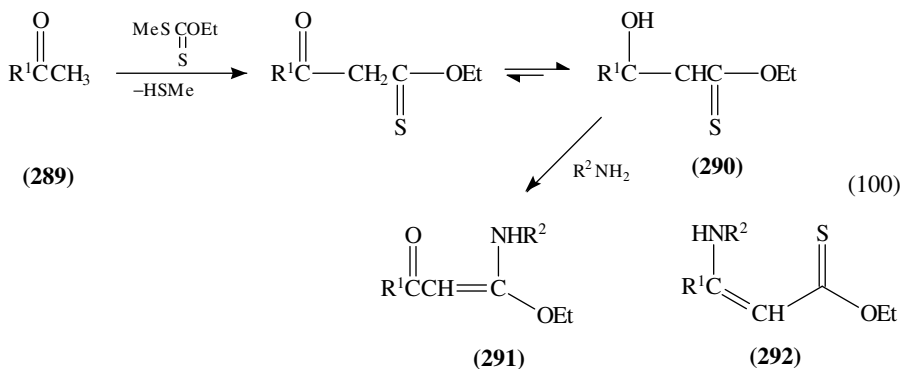


Allylamines **287** (R<sup>1</sup> = H or Me; R<sup>2</sup> = H, Me or Ph) form the rearranged adducts **288** with dimethyl acetylenedicarboxylate<sup>314</sup>.

The reaction of *S*-methyl *O*-ethyl dithiocarbonate with methyl ketones **289** (R<sup>1</sup> = Me, *i*-Pr or Ph) in toluene in the presence of sodamide gives thioxo esters, which exist in the



enol form **290**. Addition of primary amines  $\text{R}^2\text{NH}_2$  ( $\text{R}^2 = \text{Et}, \text{Pr}$  or cyclohexyl) and formic acid yields the  $\alpha$ -oxoketene *O,N*-acetals **291**. In the absence of formic acid the acetals are accompanied by about equal amounts of the enamino esters **292** (equation 100)<sup>315</sup>.



### 6. Formation of amides etc.

The absolute configuration of primary amines containing the chiral centre at the  $\alpha$ -position has been correlated with the relative  $^1\text{H}$  shifts (upfield or downfield) observed in the NMR spectra of the amides formed with (*S*)-*O*-methylmandelic acid,  $\text{PhCH}(\text{OMe})\text{CO}_2\text{H}$ <sup>316</sup>.

The reaction of tertiary amines such as trimethylamine or triethylamine, with acetyl or benzoyl chloride, followed by anion exchange with sodium tetraphenylborate gives stable crystalline non-hydroscopic acylammonium salts, e.g.  $\text{PhCONMe}_3 \text{BPh}_4^+$ <sup>-317</sup>.

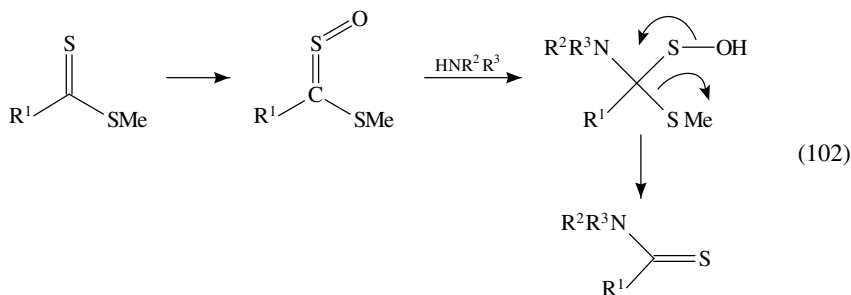
Heating carboxylic acids and primary amines and activated 4 Å molecular sieves under argon affords high yields of amides<sup>318</sup>. The conversion of primary aliphatic or aromatic amines into amides by reaction with carboxylic acids in lukewarm benzene under triphenylstibine oxide/tetraphosphorus decasulphide catalysis has been reported<sup>319</sup>. Benzoic acid reacts with aniline in hot pyridine in the presence of polyphosphoric acid trimethylsilyl ester to give benzanilide. In the absence of pyridine, *N,N'*-diphenylbenzamidine,  $\text{PhC}(\text{NPh})=\text{NPh}$ , is formed. A number of analogous amidines were prepared from carboxylic acids, primary amines and polyphosphoric acid trimethylsilyl ester<sup>320</sup>. Copper(I) chloride promotes the reaction of cyanides  $\text{RCN}$  with dimethylamine to yield the amidines  $\text{RC}(\text{=NH})\text{NMe}_2$ <sup>321</sup>. The formation of *N,N'*-disubstituted amidines  $\text{R}^1\text{C}(\text{=NR}^2)\text{NHR}^2$  from  $\text{R}^1\text{CN}$  and primary aliphatic or aromatic amines is catalysed by lanthanide(III) ions<sup>322</sup>.

*N,N*-Disubstituted thioformamides,  $\text{R}^1\text{R}^2\text{NCH}=\text{S}$ , are obtained from primary or secondary amines and dimethylthioformamide at 110 °C. Aromatic amines do not react for electronic reasons nor does *N*-methylcyclohexylamine because of steric hindrance<sup>323</sup>. Decomposition of carbon disulphide in a high-voltage discharge gives CS, which reacts

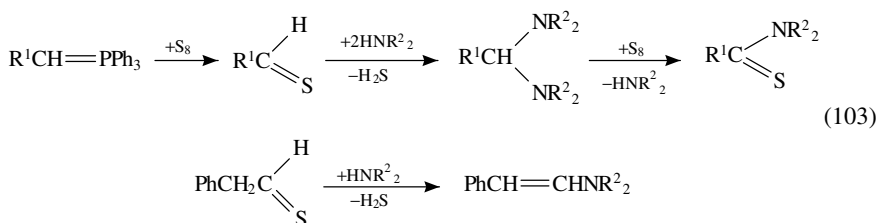
with amines [*t*-BuNH<sub>2</sub>, PhNH<sub>2</sub>, PhCH<sub>2</sub>NH<sub>2</sub>, Bu<sub>2</sub>NH, (*i*-Pr)<sub>2</sub>NH, MePhNH and Ph<sub>2</sub>NH] to yield thioformamides (equation 101)<sup>324</sup>.



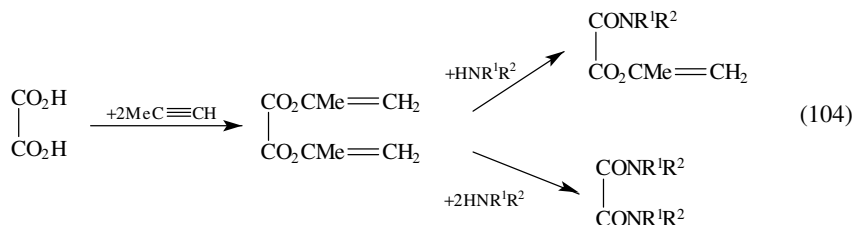
The formation of thioamides from amines (methylamine, dimethylamine and morpholine) and dithioester sulphines, prepared from dithio esters and peracids, is thought to proceed via the intermediates shown in equation 102<sup>325</sup>.



The reaction of thioaldehydes, generated from phosphonium ylides and sulphur with secondary amines such as dimethylamine, leads to thioamides. If the thioaldehydes possess a  $\alpha$ -hydrogen atom enamines are produced (equation 103)<sup>326</sup>.



Diisopropenyl oxalate results from the addition of oxalic acid to propyne. The ester condenses with all types of amines under ruthenium catalysis to yield the corresponding ester amides or oxamides, depending on the amounts of amines used (equation 104)<sup>327</sup>.

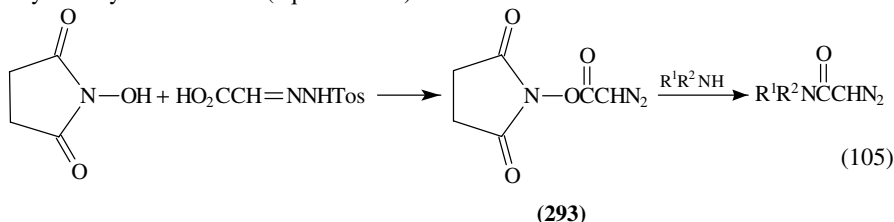


The reaction of  $\beta$ -keto esters with primary or secondary amines in the presence of a trace of 4-(dimethylamino)pyridine affords keto amides in good yields. Thus methyl acetoacetate and *p*-toluidine gave MeCOCH<sub>2</sub>CONHC<sub>6</sub>H<sub>4</sub>Me<sup>328</sup>. Several selective acylation reactions of amines have been described. Amines are converted into formamides

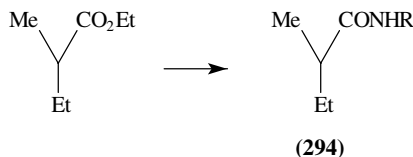


by cyanomethyl formate,  $\text{HCO}_2\text{CH}_2\text{CN}$ , under mild neutral conditions. Ethanolamine undergoes solely *N*-formylation<sup>329</sup>. All types of amines are acylated by vinyl esters  $\text{RCO}_2\text{CH}=\text{CH}_2$  ( $\text{R} = \text{Me}$ ,  $\text{C}_{15}\text{H}_{31}$  or  $\text{Ph}$ ) to form amides; hydroxyl groups are not affected<sup>330</sup>. *N*-Methoxydiacetamide,  $\text{MeONAc}_2$ , effects the chemoselective acetylation of primary amines in the presence of alcohols or secondary amines<sup>331</sup>. Similarly, *N*-(diethylcarbamoyl)-*N*-methoxyformamide,  $\text{Et}_2\text{NCON}(\text{OMe})\text{CHO}$ , is a selective formylating agent for primary amines; hydroxyl and secondary amino groups are inert. Thus  $\text{PhCH}(\text{OH})\text{CH}_2\text{NH}_2$  gave 93% of  $\text{PhCH}(\text{OH})\text{CH}_2\text{NHCHO}$  and  $\text{PhCH}_2\text{NHCH}_2\text{CH}_2\text{NH}_2$  gave 94% of  $\text{PhCH}_2\text{NHCH}_2\text{CH}_2\text{NHCHO}$ <sup>332</sup>. Acetone oxime esters  $\text{Me}_2\text{C}=\text{NOCOR}^1$  ( $\text{R}^1 = \text{Me}$ ,  $\text{Pr}$  or  $\text{CH}=\text{CHMe}$ ) and primary or secondary amines afford good yields of acylated amines  $\text{R}^1\text{CONR}^2\text{R}^3$  even in the presence of hydroxyl functions<sup>333</sup>.

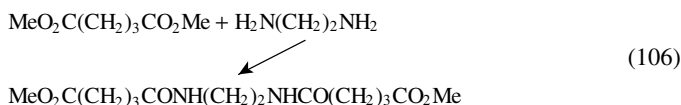
Transamidation reactions of unactivated amides are exemplified by the formation of *N*-acetylbenzylamine from acetamide and benzylamine in the presence of aluminium trichloride. Primary amines gave higher yields than secondary amines in these reactions. Activated amides, e.g.  $\text{MeCONMeCOBu}^t$  and  $\text{PhCONMeTos}$ , give good yields of, respectively, *N*-acetyl and *N*-benzoyl derivatives with both primary and secondary amines under mild conditions<sup>334</sup>. Diazoacetylations of all types of amines with succinimidyl diazoacetate **293** have been reported. The reagent, a stable crystalline solid, is prepared by the action of *N*-hydroxysuccinimide on glyoxylic acid tosylhydrazone in the presence of dicyclohexylcarbodiimide (equation 105)<sup>335</sup>.



*Candida antarctica* lipase in hexane catalyses the conversion of primary amines  $\text{RNH}_2$  ( $\text{R} = \text{Bu}$ ,  $\text{C}_8\text{H}_{17}$ ,  $\text{C}_{10}\text{H}_{21}$ ,  $\text{C}_{12}\text{H}_{25}$  and  $\text{PhCH}_2$ ) into the (*R*)-amines **294** by ethyl (*S*)-2-methylbutanoate<sup>336</sup>.

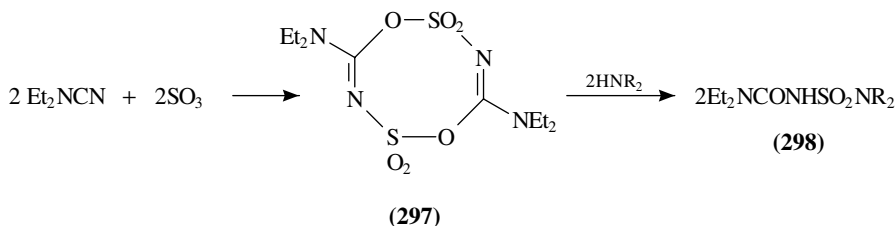
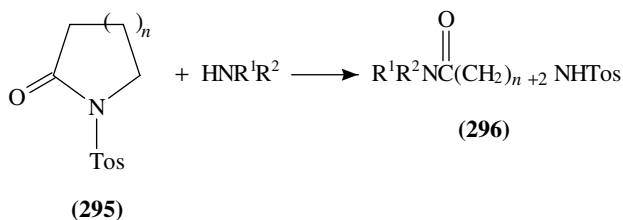


The enzyme also effects the aminolysis of non-activated diesters with diamines, e.g. equation 106<sup>337</sup>.

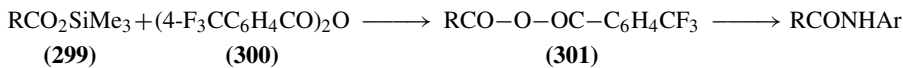


The lactams **295** ( $n = 1, 2, 3$  or  $4$ ) are cleaved to the amides **296** on treatment with secondary amines in the presence of aluminium trichloride<sup>338</sup>.

*N*-Cyanodiethylamine and sulphur trioxide yield the 1,5,2,6,3,7-dioxadithiadiazocine 2,2,6,6-tetroxide **297**, which reacts with aliphatic secondary amines to furnish the sulphonamides **298**<sup>339</sup>.

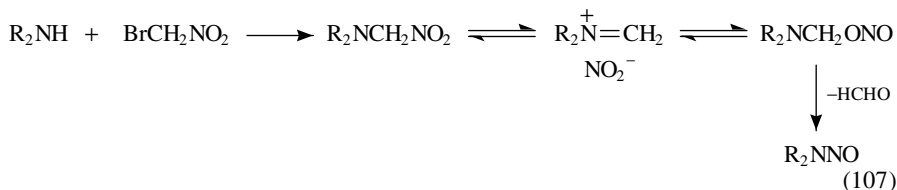


Weakly nucleophilic amines such as 2,4-dinitroaniline are acylated in excellent yields by the mixed anhydride **301**, prepared from the trimethylsilyl esters **299** ( $\text{R} = \text{Me}$ , *i*-Pr, *t*-Bu,  $\text{PhCH}_2\text{CH}_2$ , 2-MeC<sub>6</sub>H<sub>4</sub> etc.) and 4-trifluoromethylbenzoic anhydride (**300**) under titanium(IV) catalysis:<sup>340</sup>



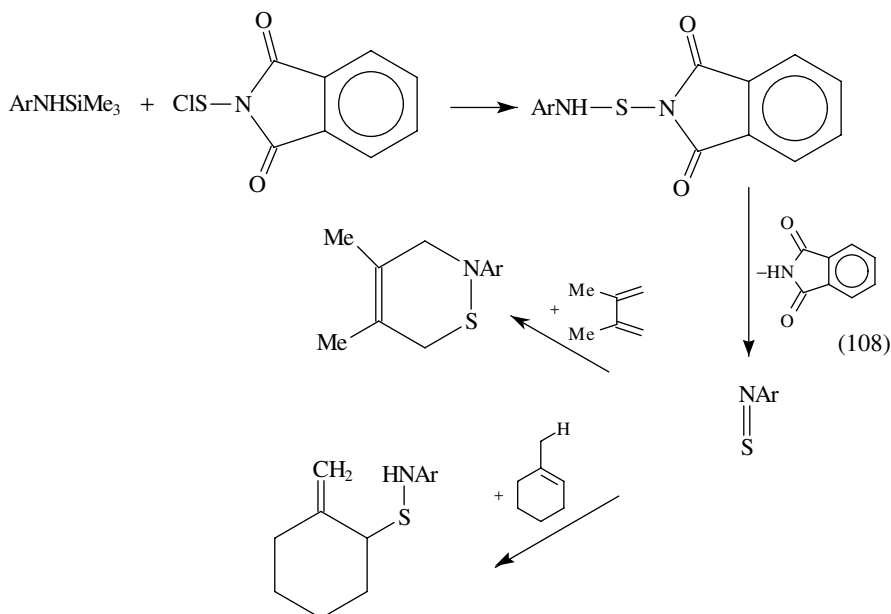
Allylamines  $\text{R}^1\text{CH}=\text{CHCH}_2\text{NR}^2\text{R}^3$  ( $\text{R}^1 = \text{Me}$ , Pr or Ph;  $\text{R}^2 = \text{Me}$ , Et or Bu;  $\text{R}^3 = \text{Et}$ ,  $\text{PhCH}_2$  or Ph) are carbonylated by carbon monoxide in the presence of  $\text{Pd}(\text{OAc})_2/\text{Ph}_2\text{PCH}_2\text{CH}_2\text{CH}_2\text{PPh}_2$  to give good yields of the amides  $\text{R}^1\text{CH}=\text{CHCH}_2\text{CONR}^2\text{R}^3$ .<sup>341</sup>

Heating mixtures of trifluoroacetic acid, a primary amine  $\text{RNH}_2$  ( $\text{R} = \text{C}_6\text{H}_{13}$ ,  $\text{PhCH}_2$ ,  $\text{PhCH}_2\text{CH}_2$ , Ph, Ar or 1-C<sub>10</sub>H<sub>7</sub>), triphenylphosphine and triethylamine in carbon tetrachloride affords trifluoroacetimidoyl chlorides  $\text{CF}_3\text{CCl}=\text{NR}$  in yields of 80–90%. The corresponding bromides are produced in carbon tetrabromide.<sup>342</sup> 1-Cyanobenzotriazole is a safe and convenient synthon for the cyanide cation. It converts secondary amines (diocetylamine, dibenzylamine, pyrrolidine etc.) into *N*-cyano derivatives.<sup>343</sup> Secondary amines, e.g. dibutylamine and morpholine, yield *N*-nitrosoamines by the action of bromonitromethane. A proposed mechanism is shown in equation 107.<sup>344</sup>



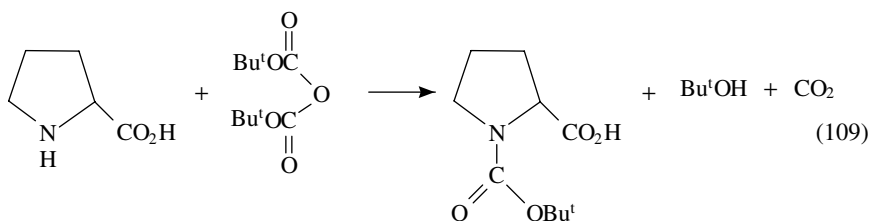
Trifluoroamine oxide  $\text{F}_3\text{N}^+\text{O}^-$  reacts with dialkylamines  $\text{R}_2\text{NH}$  at or below 0°C to give mixtures of *N*-fluorodialkylamines  $\text{R}_2\text{NF}$  and *N*-nitroso compounds  $\text{R}_2\text{N}-\text{NO}$ .<sup>345</sup> All types of secondary amines are converted into nitroamines  $\text{R}^1\text{R}^2\text{NNO}_2$  by treatment with ethylmagnesium bromide, followed by butyl nitrate.<sup>346</sup> *N*-(Arylamino-sulphonyl)phthalimides, prepared from trimethylsilylamines as shown in

equation 108, undergo a base-induced fragmentation at room temperature to yield transient thionitrosoarenes, which are trapped by 2,3-dimethylbuta-1,3-diene as Diels-Alder adducts and by 1-methylcyclohexene as ene products<sup>347,348</sup>.



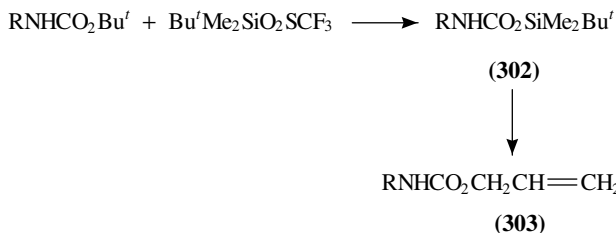
### 7. Protection of amines

Very high yields of *N-t*-butyloxycarbonylamines are obtained when solutions of hydrochlorides of primary or secondary aliphatic amines in methanol or ethanol are treated with di-*t*-butyl dicarbonate and ultrasound is applied until carbon dioxide is no longer evolved, e.g. equation 109. PhCH(OH)CHMeNHMe is acylated only at the nitrogen atom under these conditions<sup>349</sup>.

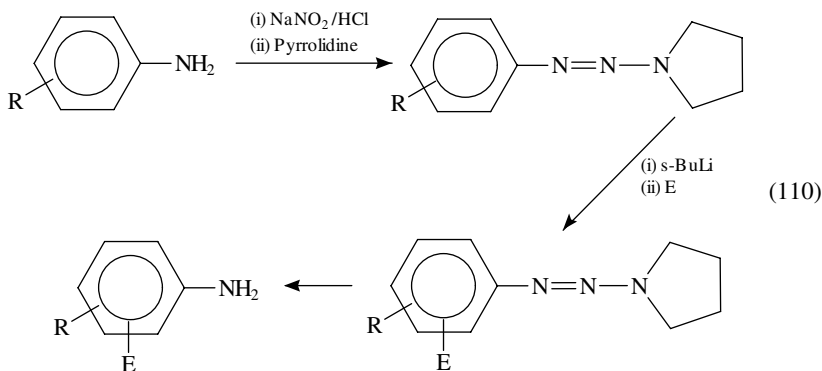


The *t*-butyldiphenylsilyl group has been recommended for the protection of primary amines. The derivatives *t*-BuPh<sub>2</sub>SiNHR are stable under basic conditions and to chromatography and are unreactive towards alkylating and acylating agents. They are smoothly cleaved by the action of 80% acetic acid or 0.5 M hydrochloric acid at room temperature<sup>350</sup>. *t*-Butoxycarbonylamines react with the *t*-butyldimethylsilyl ester of trifluoromethanesulphonic acid to give silyl carbamates **302**, which are decomposed to the free amines RNH<sub>2</sub> by the action of tetrabutylammonium fluoride. Treatment of the carbamates with alkyl halides in the presence of tetrabutylammonium fluoride gives alkyl

carbamates, e.g. **303** with allyl bromide<sup>351,352</sup>.

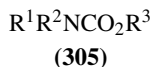
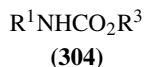


2-(Trimethylsilyl)ethanesulphonyl chloride,  $\text{Me}_3\text{SiCH}_2\text{CH}_2\text{SO}_2\text{Cl}$ , is useful for the protection of primary and secondary amines as sulphonamides, which are smoothly cleaved by fluoride ion<sup>353</sup>. Use of the triazene moiety as a protecting group for aromatic amines is illustrated in equation 110. The protected compounds react with *s*-butyllithium, followed by an electrophile E (carbon dioxide, acetophenone or trimethylsilyl chloride), to give, respectively, the corresponding carboxylic acid, alcohol or trimethylsilyl derivative, which are converted into the free amines by the action of nickel–aluminium alloy in aqueous–methanolic potassium hydroxide<sup>354</sup>.



### 8. Formation of carbamates, ureas, isocyanates, etc.

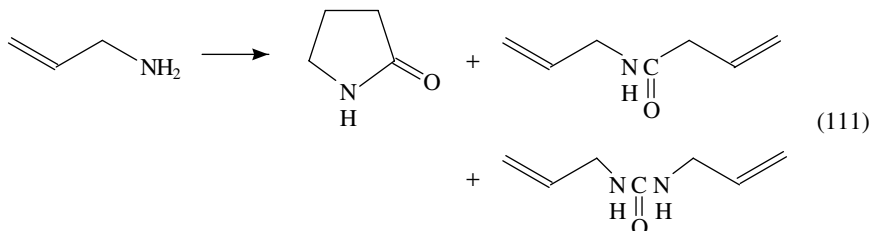
The combined action of alkyl halides and carbon dioxide on aliphatic primary or secondary amines affords alkyl carbamates **304** or **305**, respectively. The reactions are carried out in DMF<sup>355</sup> or in the presence of a pentaalkylguanidine<sup>356</sup>.



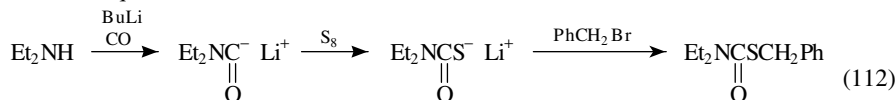
Primary aliphatic or aromatic amines  $\text{RNH}_2$  are converted into carbamates  $\text{RNHCO}_2\text{Et}$  on treatment with carbon monoxide and di-*t*-butyl peroxide in the presence of palladium(II) chloride and copper(II) chloride<sup>357</sup>. Carbamic esters **304** and **305** are also obtained from aliphatic amines and ortho carbonates  $(\text{R}^3\text{O})_4\text{C}$ <sup>358</sup>. Vinyl carbamates  $\text{R}^1_2\text{NCO}_2\text{CH}=\text{CHR}^2$  are produced from secondary aliphatic amines, acetylenes  $\text{R}^2\text{C}\equiv\text{CH}$  ( $\text{R}^2 = \text{Bu}$  or  $\text{Ph}$ ) and carbon dioxide in the presence of ruthenium(III) chloride<sup>359</sup>.

Primary amines  $\text{RNH}_2$  (e.g.  $\text{R} = \text{Bu}$ ) are converted into symmetrical ureas  $\text{RNHCONHR}$  at room temperature and atmospheric pressure by the action of

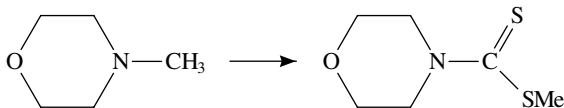
carbon monoxide in the presence of a catalyst prepared from montmorillonite, di(pyridine)palladium(II) acetate and copper(II) chloride<sup>360</sup>. Ureas RNHCONHR are also produced when primary aliphatic or aromatic amines are heated under pressure with carbon dioxide and a trace of  $\text{Ph}_3\text{SbO/P}_4\text{S}_{10}$ <sup>361</sup>. The photochemical carbonylation of allylamine at 20 atm mediated by dicobaltoctacarbonyl gave a mixture of pyrrolidin-2-one, *N*-allyl-3-butenamide and *N,N'*-diallylurea (equation 111)<sup>362</sup>.



Heating *N,N'*-diphenylurea with amines (butylamine, cyclohexylamine, benzylamine, 2,6-diethylaniline or morpholine) in DMF in the presence of triethylamine yields unsymmetrical ureas, e.g.  $\text{PhNHCONHBu}$  from butylamine<sup>363</sup>. High yields of isocyanates  $\text{RNCO}$  are obtained in the reactions of primary aliphatic amines, carbon dioxide and triethylamine with phosphorus oxychloride<sup>364</sup>. Treatment of secondary amines with butyllithium, followed by carbon monoxide at  $-78^\circ\text{C}$  under atmospheric pressure, sulphur and an alkyl halide affords *S*-alkyl thiocarbamates, e.g.  $\text{Et}_2\text{NC(O)SCH}_2\text{Ph}$  from diethylamine and benzyl bromide. The key step in the sequence is the generation of the lithium thiocarbamate shown in equation 112<sup>365</sup>.



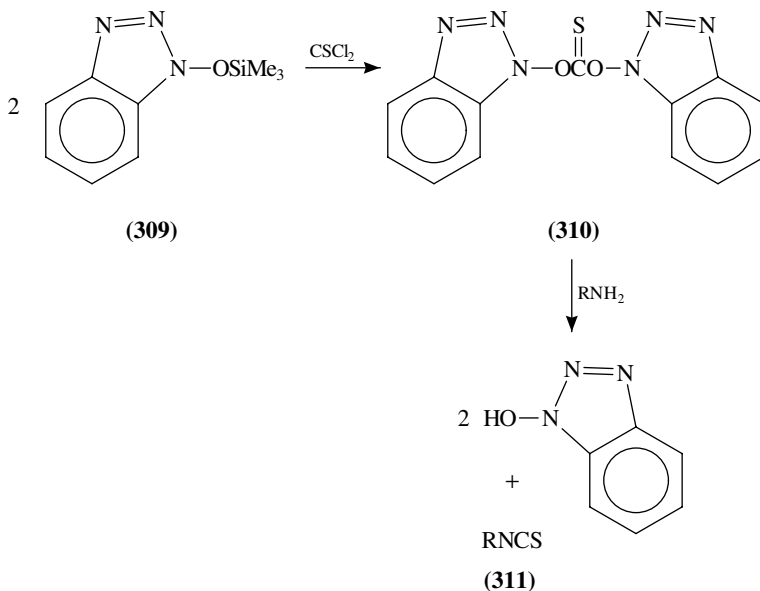
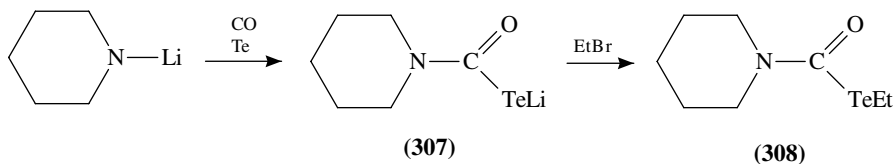
Sequential treatment of tertiary amines containing *N*-methyl or *N*-benzyl groups with carbon disulphide and alkyl halides gives alkyl dithiocarbamates in good to excellent yields. Thus *N*-methylmorpholine, carbon disulphide and methyl iodide in THF gave 91% of compound **306**<sup>366</sup>.



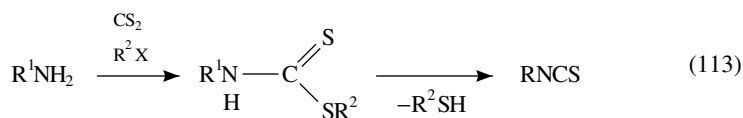
(306)

The conversion of symmetrical into unsymmetrical thioureas is exemplified by the formation of *N*-cyclohexyl-*N'*-phenylthiourea when *N,N*-diphenylthiourea is heated with cyclohexylamine and triethylamine in acetonitrile<sup>367</sup>. Carbonylation of lithium piperidine in the presence of tellurium generates the lithium carbamotellurate **307**, which is trapped as the *Te*-ethyl carbamotellurate **308** by ethyl bromide<sup>368</sup>.

1,1'-(Thiocarbonyldioxy)di(benzotriazole) **310**, prepared by the action of thiophosgene on 1-(trimethylsilyloxy)benzotriazole **309**, reacts with all types of primary amines at room temperature in the presence of triethylamine to give isothiocyanates **311** in 84–95% yields<sup>369</sup>.

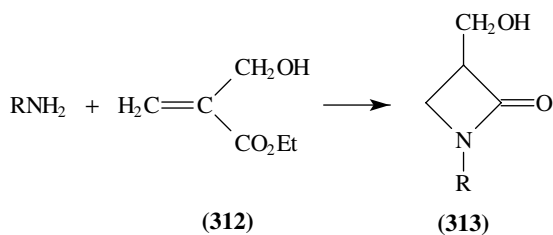


Primary amines  $\text{R}^1\text{NH}_2$  are converted into isothiocyanates by the action of carbon disulphide and alkyl halides  $\text{R}^2\text{X}$  in the presence of DBU (equation 113)<sup>370</sup>.

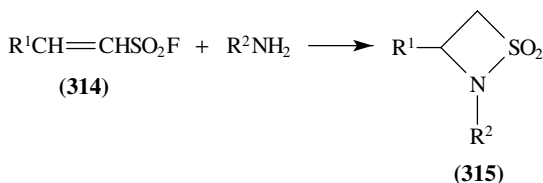


### 9. Cyclization reactions

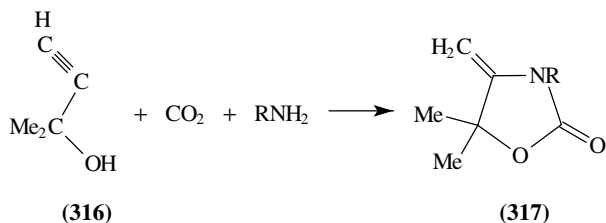
Heating amines  $\text{RNH}_2$  ( $\text{R} = \text{Pr}$ ,  $i\text{-Pr}$ ,  $\text{Bu}$ ,  $i\text{-Bu}$ ,  $t\text{-Bu}$ ,  $t\text{-Bu}$  or  $\text{PhCH}_2$ ) with ethyl 2-(hydroxymethyl)propenoate (312) in methanol affords the  $\beta$ -lactams 313<sup>371,372</sup>.



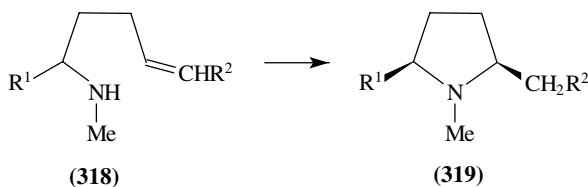
Unstable 2,3-dialkyl-1,2-thiazetidines 1,1-dioxides **315** ( $R^1 = \text{Bu}$  or  $\text{C}_6\text{H}_{13}$ ;  $R^2 = \text{Et}$ , *i*-Pr, *t*-Bu or  $\text{PhCH}_2$ ) are produced from the ethenesulphonyl fluorides **314** and primary amines<sup>373</sup>.



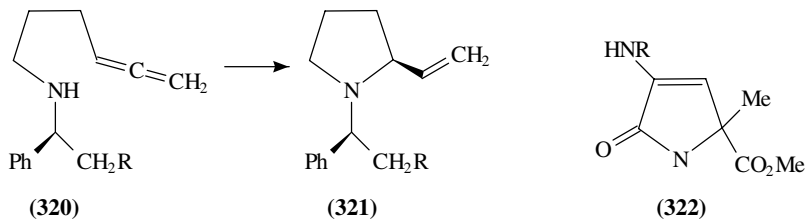
The propargyl alcohol **316** reacts with carbon dioxide and aliphatic or aromatic primary amines  $\text{RNH}_2$  under tributylphosphine catalysis to yield 5,5-dimethyl-4-methylene-oxazolidin-2-ones **317**<sup>374</sup>.



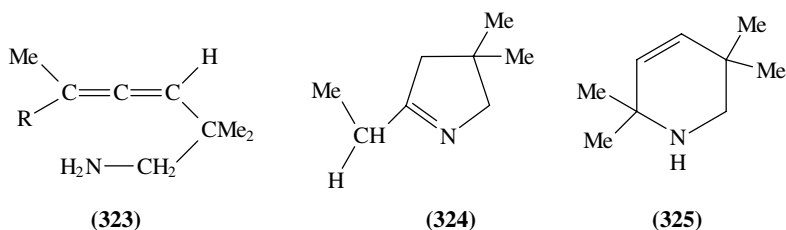
Cyclization of the *N*-(4-alkenyl)methylamines **318** ( $R^1 = \text{Me}$  or  $\text{Ph}$ ;  $R^2 = \text{H}$  or  $\text{Ph}$ ) under the influence of butyllithium gives the *cis*-pyrrolidines **319** stereoselectively<sup>375</sup>.



The 2-vinylpyrrolidines **321** are formed in up to 99% diastereomeric excess by the ring closure of the allenic sulphides or sulfoxides **320** ( $R = \text{PhS}$  or  $\text{PhSO}$ ), induced by silver(I) ions<sup>376</sup>.



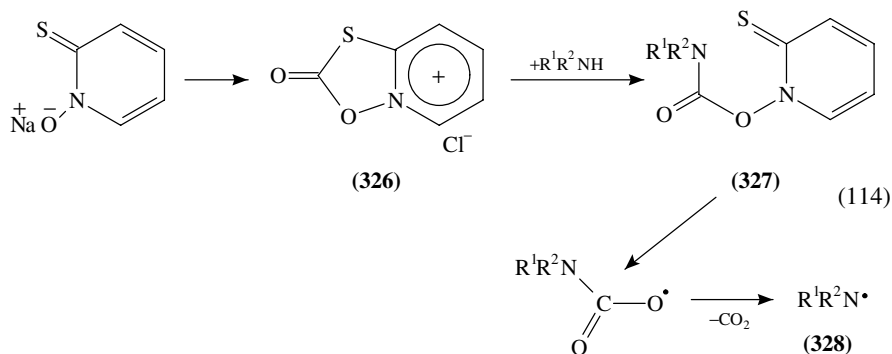
Ultrasound irradiation of mixtures of amines  $\text{RNH}_2$  ( $R = \text{PhCH}_2$ ,  $\text{Ph}$  or  $\text{Ar}$ ) and methyl pyruvate results in the 3-pyrrolin-2-ones **322**<sup>377</sup>. The silver tetrafluoroborate-catalysed cyclization of the allenic amines **323** leads either to a pyrroline **324** or tetrahydropyridine **325**, depending on the structure of the amine. The former is formed from **323** ( $R = \text{H}$ ), the latter from **323** ( $R = \text{Me}$ )<sup>378</sup>.



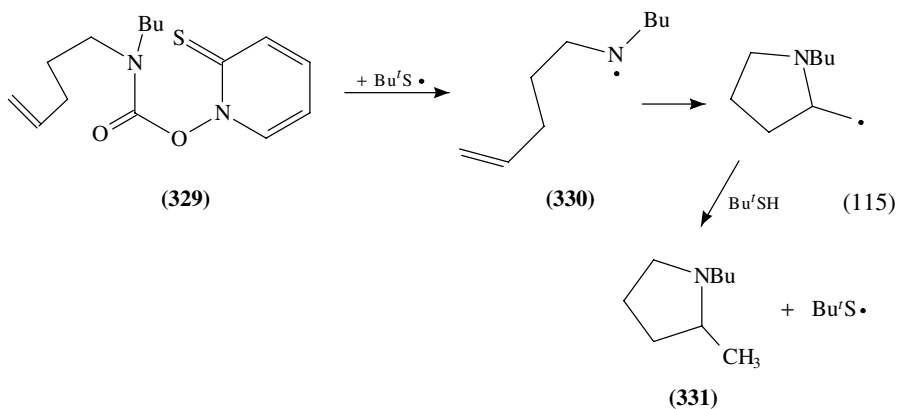
### 10. Formation of aminyl radicals

A review of the generation of aminyl radicals by photolysis and by metal-induced one-electron reductions of *N*-chloroamines has appeared<sup>379</sup>.

Aminyl radicals are produced by the sequence outlined in equation 114. The action of phosgene on the sodium salt of *N*-hydroxypyridine-2-thione yields the salt **326**, which reacts with amines to give **327**. The latter decompose to the radicals **328** on heating or irradiation<sup>380</sup>.

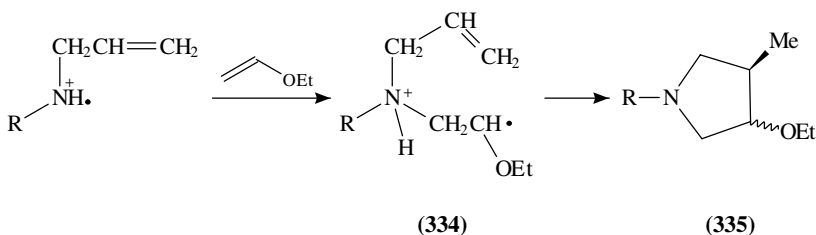
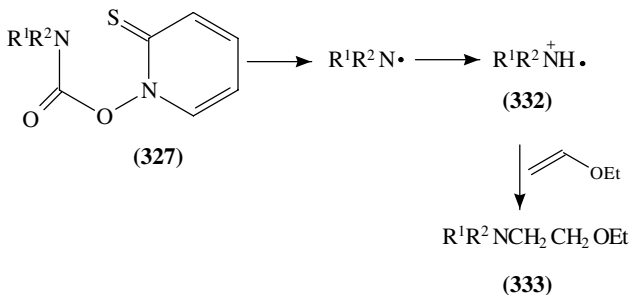


Treatment of **329**, the *N*-butyl-*N*-4-pentenyl analogue of **327**, with trifluoroacetic acid and *t*-butylthiolate radicals (from *t*-butylthiol) under irradiation with visible light gives the aminyl radical **330**, which cyclizes to the pyrrolidine **331** and a *t*-butylthiolate radical is regenerated (equation 115). It is believed that the process involves, at least partially, the aminium cation radical  $R^1R^2\overset{+}{N}H$ .<sup>381</sup>

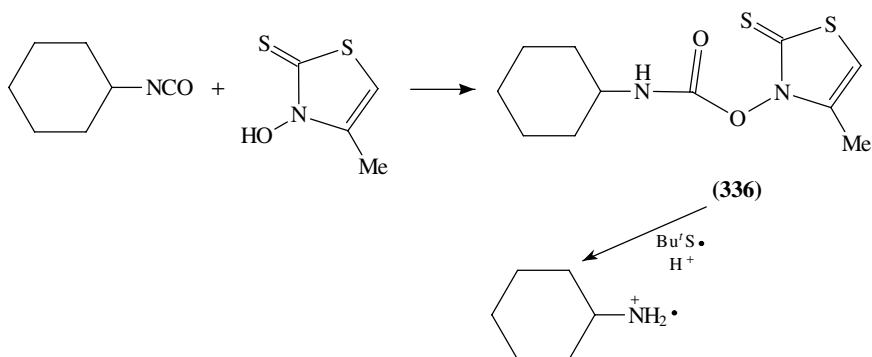




The carbamates **327** ( $R^1 = R^2 = \text{Pr}$  or  $\text{Bu}$ ) react with *t*-butylthiol, malonic acid and ethoxyethylene under irradiation to yield the (ethoxyethyl)amines **333** via the radical cations **332**. The *N*-allyl analogues **334** ( $R = \text{Pr}$  or  $\text{PhCH}_2$ ) cyclize to pyrrolidines **335**<sup>382</sup>.

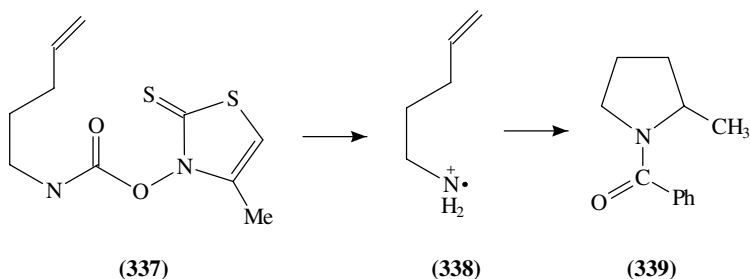


3-Hydroxy-4-methylthiazole-2(3*H*)thione carbamates, e.g. the cyclohexyl derivative **336**, are precursors for monoalkylammonium cation radicals, which cannot be prepared from 2-thioxopyridinyloxycarbamates. The carbamate is obtained from 3-hydroxy-4-methylthiazole-2(3*H*)-thione and cyclohexyl isocyanate. When irradiated in the presence of malonic acid and *t*-butyl hydrogen sulphide it yields the cyclohexylammonium cation  $\text{RNH}_2^+\cdot$  and thence cyclohexylamine<sup>383</sup>.

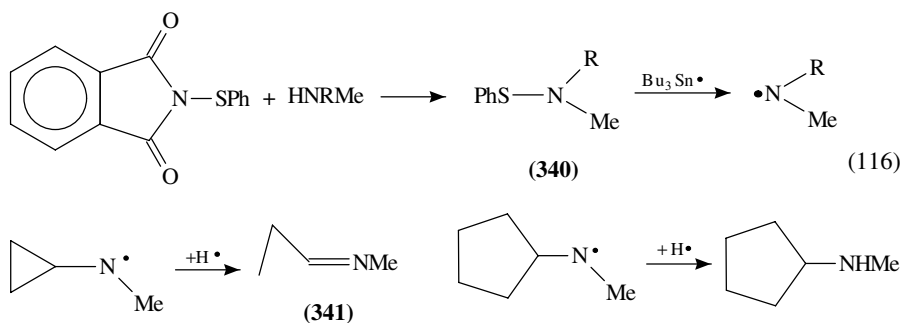


The *N*-4-pentenyl analogue **337** affords the radical cation **338**, which cyclizes to 2-methylpyrrolidine, isolated as the *N*-benzoyl derivative **339** in high yield<sup>383</sup>.

A general method for the generation of aminyl radicals is by treatment of sulphenamides **340**, prepared from secondary amines and *N*-benzenesulphenylphthalimide, with tributyltin hydride in the presence of AIBN (2,2'-azobisisobutyronitrile). The cyclopropyl derivative

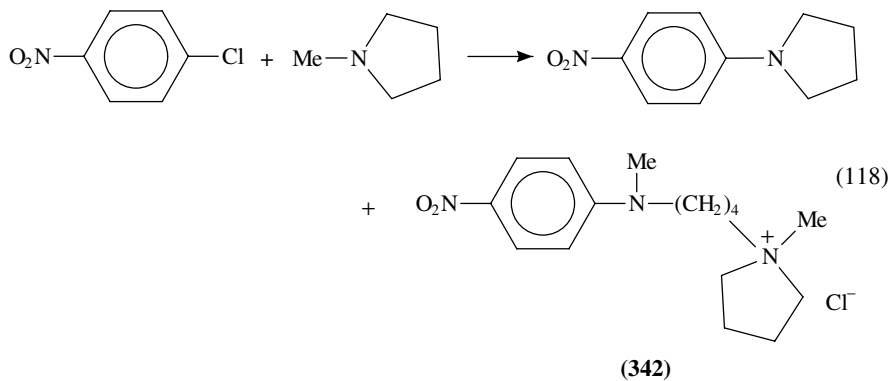
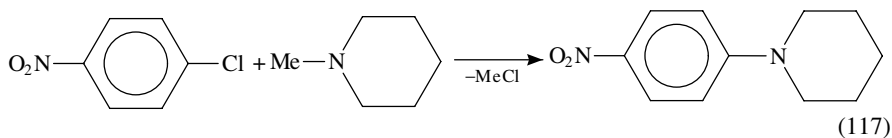


undergoes ring opening to the imine **341**, whereas *N*-methylcyclopentylamine is formed from the cyclopentyl analogue (equation 116)<sup>384</sup>.

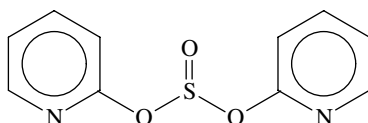


### 11. Miscellaneous reactions

The high-pressure reaction of *N*-methylpiperidine with 4-chloronitrobenzene yields *N*-(4-nitrophenyl)piperidine (equation 117); 2-chloronitrobenzene and chloro-2,4-dinitrobenzene behave analogously. *N*-Methylpyrrolidine and 4-chloronitrobenzene afford a mixture of *N*-(4-nitrophenyl)pyrrolidine and the product **342** of ring scission (equation 118)<sup>385</sup>.

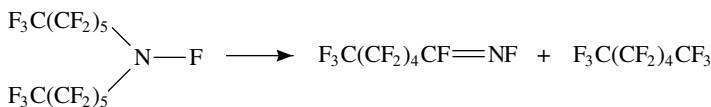


Di-2-pyridyl sulphite (**343**) (from 2-pyridone and thionyl chloride in the presence of triethylamine) transforms primary aliphatic and aromatic amines  $\text{RNH}_2$  into *N*-sulphinylamines  $\text{RN}=\text{S}=\text{O}$  and it dehydrates amides  $\text{ArCONH}_2$  to aryl cyanides, aldehyde oximes  $\text{RCH}=\text{NOH}$  ( $\text{R} = \text{C}_8\text{H}_{17}$ , 4-MeOC<sub>6</sub>H<sub>4</sub> or PhCH=CH) to the cyanides  $\text{RCN}$  and *N*-alkyl- and *N*-arylformamides  $\text{RNHCHO}$  to isocyanides  $\text{RNC}$ . Aliphatic and aromatic thioureas  $\text{R}^1\text{NHCSNHR}^2$  yield carbodiimides  $\text{R}^1\text{N}=\text{C}=\text{NR}^2$ . The chemistry of di-2-pyridyl sulphite thus closely resembles that of 2-halogenopyridinium salts (Mukaiyama's reagents)<sup>387</sup> and triphenylphosphine/diethyl azodicarboxylate (Mitsunobu reagent)<sup>388</sup>.



(343)

The perfluorinated amine **344** is cleaved by antimony pentafluoride to the imine **345** and the fluorocarbon **346**.

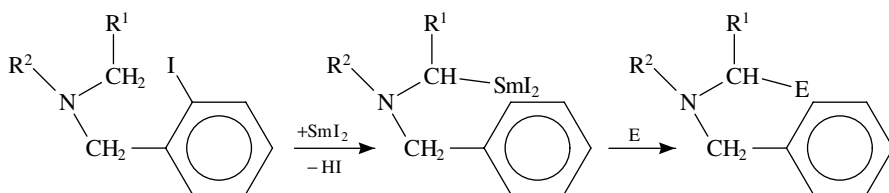


(344)

(345)

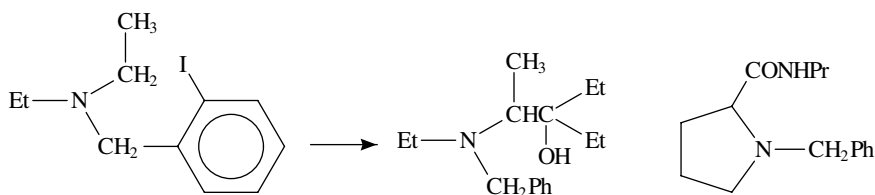
(346)

In the presence of samarium(II) iodide, *N*-(2-iodobenzyl)dialkylamines **347** react with electrophiles at an  $\alpha$ -carbon atom to yield deiodinated products by way of intermediate samarium compounds **348**. Thus *N*-(2-iodobenzyl)diethylamine and pentan-3-one afford the hydroxy amine **349** and *N*-(2-iodobenzyl)pyrrolidine and propyl isocyanate give the amide **350**.



(347)

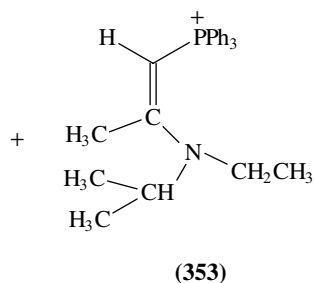
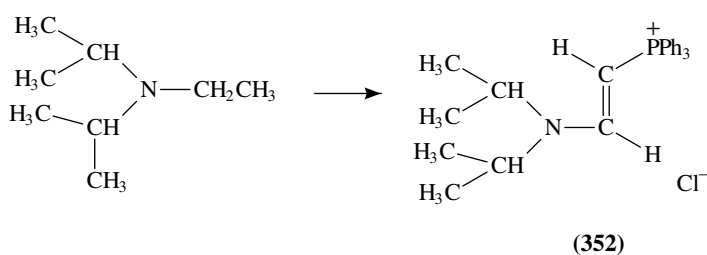
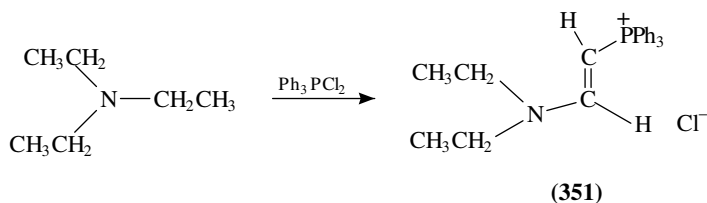
(348)



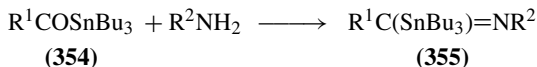
(349)

(350)

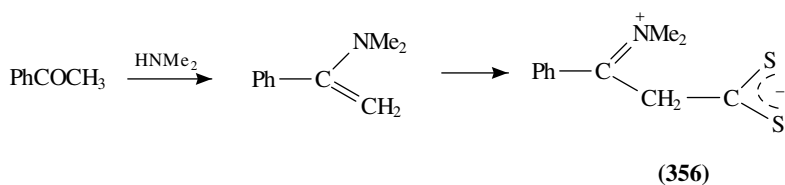
The action of triphenylphosphine dichloride, generated from triphenylphosphine and hexachloroethane, on tertiary amines leads to phosphonium salts. Triethylamine is converted into **351** and ethyldiisopropylamine gives a mixture of the salts **352** and **353**<sup>391</sup>.



Imidoystannanes **355** are produced by the action of acylstannanes **354** on primary aliphatic and aromatic amines in the presence of 3 Å molecular sieves<sup>392</sup>.

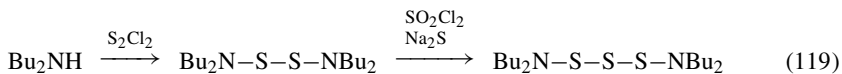


Acetophenone reacts with the adduct of sulphur dioxide to dimethylamine to yield the red betaine **356** by way of an intermediate enamine<sup>393</sup>.

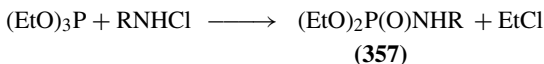


Bis(*N,N*-dialkylamino)trisulphides are formed by treatment of secondary amines with disulphur dichloride, followed by sulphuryl chloride and sodium sulphide, e.g.

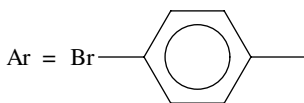
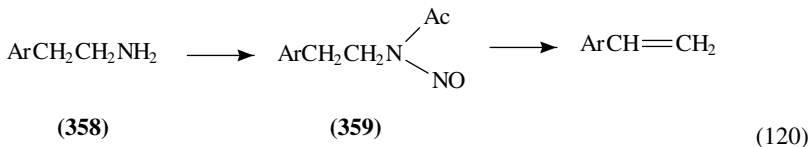
equation 119<sup>394</sup>.



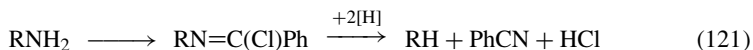
An Arbuzov reaction of triethyl phosphite with *N*-chloroamines RNHCl (R = *i*-Pr, cyclohexyl or PhCH<sub>2</sub>), prepared from the corresponding amines and aqueous sodium hypochlorite, leads to the phosphoramides **357** with the elimination of ethyl chloride<sup>395</sup>.



A method for the preparation of olefins from primary amines is shown in equation 120. Treatment of 2-(4-bromophenyl)ethylamine (**358**) with acetic acid, acetic anhydride and sodium nitrite generates the nitroso amide **359**, which decomposes to 4-bromostyrene in the presence of rhodium(II) acetate. The procedure is thus a mild, non-basic alternative to the classical Hofmann elimination of amines<sup>396,397</sup>.



The deamination of primary amines RNH<sub>2</sub> (R = C<sub>8</sub>H<sub>17</sub>, PhCH<sub>2</sub>, PhCHMe or PhCH=CHCH<sub>2</sub>) to the corresponding hydrocarbons is accomplished by conversion into the benzimidoyl chlorides, followed by reduction with tributyltin hydride in the presence of AIBN (equation 121)<sup>398</sup>.

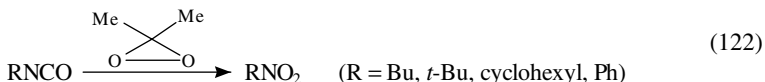


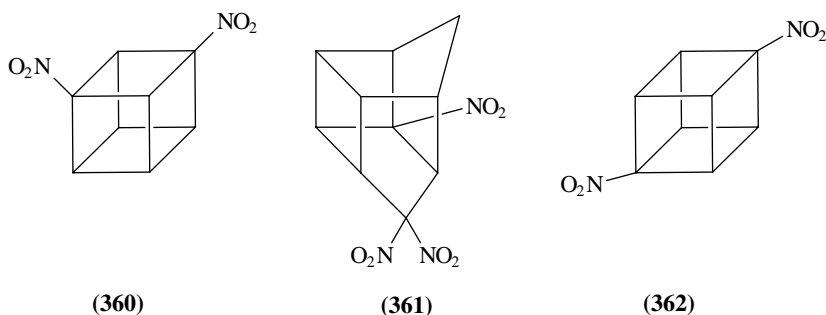
### III. NITRO COMPOUNDS

The chemistry of nitroalkenes has been reviewed<sup>399-401</sup> and an account of polynitro cage compounds, such as 1,3-dinitrocubane (**360**) and the trinitrobishomocubane **361**, has appeared<sup>402</sup>.

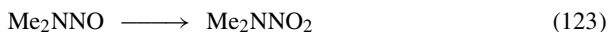
#### A. Synthesis

Sodium perborate in acetic acid converts oximes into nitro compounds; thus acetophenone oxime yields 52% of PhCHMeNO<sub>2</sub><sup>403</sup>. Nitroalkanes and nitroarenes are obtained from isocyanates and dimethyldioxirane (equation 122)<sup>404</sup>.

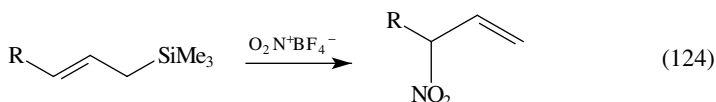




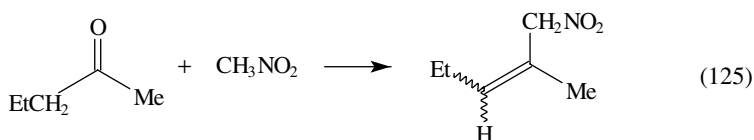
The dinitrocubane **362** was prepared from the corresponding diisocyanate in this way<sup>404</sup>. In contrast, treatment of isocyanates with nitronium tetrafluoroborate and nitric acid yields *N,N*-dinitroalkylamines, e.g. BuN(NO<sub>2</sub>)<sub>2</sub> from butyl isocyanate<sup>405</sup>. *N*-Nitrosodialkylamines are oxidized to the corresponding nitro amines by hydrogen peroxide in aqueous acetic acid, e.g. equation 123<sup>406</sup>.



3-Nitroalkenes are formed in the reaction of allyltrimethylsilanes with nitronium tetrafluoroborate in dichloromethane (equation 124)<sup>407</sup>.

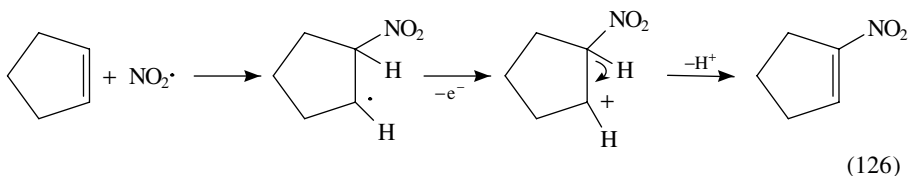


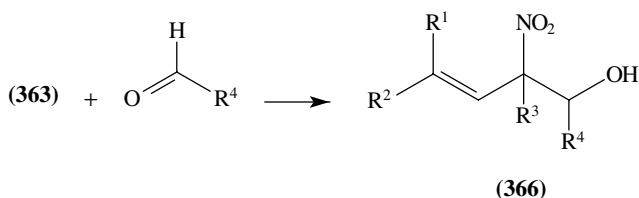
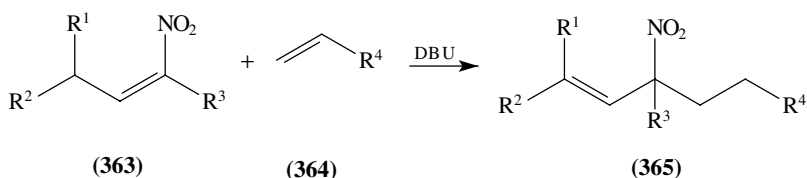
Aliphatic and alicyclic ketones condense with primary nitroalkanes under the influence of *N,N*-dimethylethylenediamine to yield allylic nitro compounds as mixtures of geometrical isomers, e.g. equation 125<sup>408</sup>.



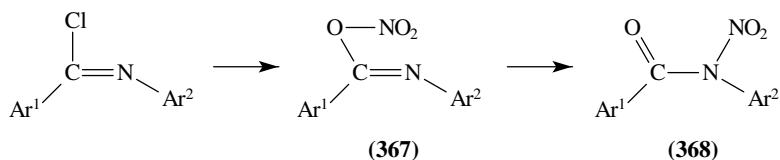
The base-catalysed Michael addition of  $\alpha,\beta$ -unsaturated nitro compounds **363** to electron-deficient olefins **364** ( $\text{R}^4 = \text{Ac}, \text{CO}_2\text{Me}$  or  $\text{CN}$ ) results in the formation of allylic nitro compounds **365**; aldehydes give alcohols **366** in this reaction<sup>409</sup>.

Exposure of mixtures of alkenes, ceric ammonium nitrate, acetic acid and chloroform to ultrasound leads to  $\alpha,\beta$ -unsaturated nitroalkenes. A free-radical mechanism was proposed for this reaction (equation 126)<sup>410</sup>.

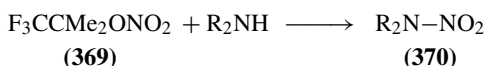




*N*-Nitroamides **368** are produced by the rapid rearrangement of the imidoyl nitrates **367** formed in the reactions of imidoyl chlorides with silver nitrate. The transient nitrate esters were detected by NMR spectroscopy<sup>411</sup>.

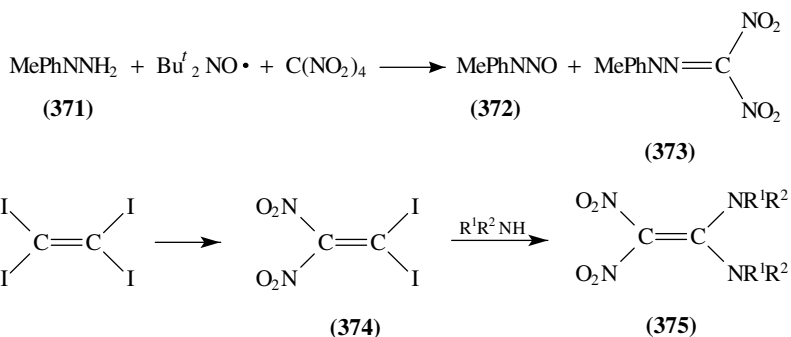


Secondary aliphatic amines, such as diethylamine, pyrrolidine or piperidine, react with the electron-poor nitrate ester 2-(trifluoromethyl)-2-propyl nitrate (**369**) under neutral conditions to afford the corresponding *N*-nitro derivatives **370**<sup>412</sup>.



The joint action of di-*t*-butyl nitroxide radicals and tetranitromethane on the hydrazine **371** in ether at room temperature yielded 75% of the *N*-nitroso compound **372**, together with 10% of the dinitrohydrazone **373**<sup>413</sup>.

1,1-Diiodo-2,2-dinitroethene (**374**), prepared by nitrating tetraiodoethene, condenses with all types of amines, e.g. propylamine, aniline and dimethylamine, to give the corresponding vicinal diamines **375**<sup>414</sup>.

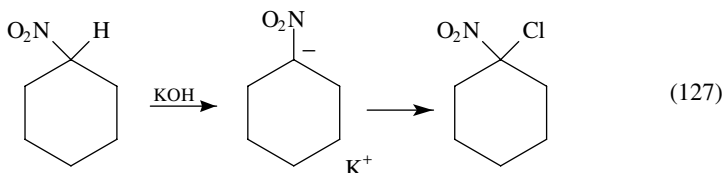


## B. Reactions

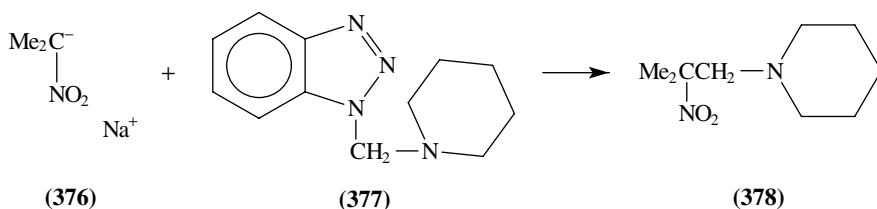
An extensive review on the use of nitroalkanes as alkyl anion synthons has appeared<sup>415</sup>.

### 1. Formation of oximes, nitrones, hydroxylamines, amines, etc.

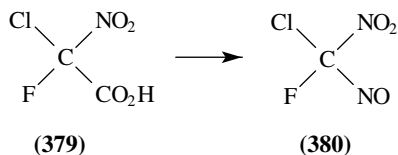
The potassium salts of nitro compounds, such as 2-nitropropane, nitrocyclohexane and ethyl  $\alpha$ -nitroacetate, are halogenated at the  $\alpha$ -position by *N*-chloro- or *N*-bromosuccinimide, e.g. equation 127<sup>416</sup>.



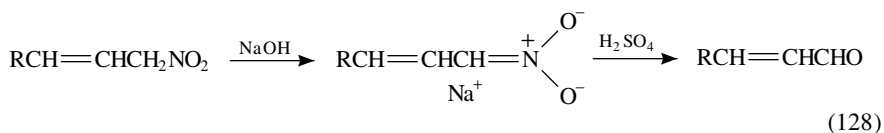
The fluorination of nitroalkanes has been described. A solution of acetyl hypofluorite, AcOF, is prepared by passing fluorine, diluted with nitrogen, into a cold suspension of hydrated sodium acetate in acetonitrile containing acetic acid. Adding a mixture of a nitroalkane and methanolic sodium methoxide yields the fluorinated nitroalkane, e.g. 1-fluoro-1-nitrocyclopentane from nitrocyclopentane<sup>417</sup>. A general method for alkylating nitroalkanes is exemplified by the reaction of the sodium nitronate **376** with the benzotriazole derivative **377** to yield **378**<sup>418</sup>.



Chlorofluoronitrosomethane (**380**) was obtained by the decarboxylative nitrosation of chlorofluoronitroacetic acid (**379**)<sup>419</sup>.

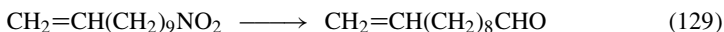


$\alpha,\beta$ -Unsaturated aldehydes are formed by acidic hydrolysis of the sodium salts of allylic nitro compounds (equation 128)<sup>420</sup>.

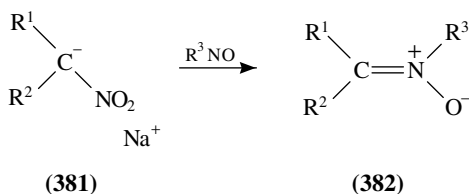




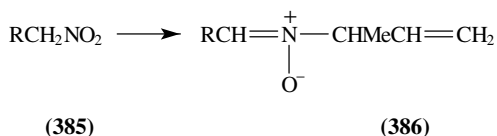
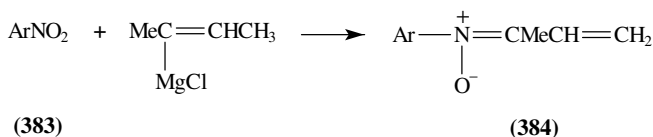
Successive treatment of primary or secondary nitroalkanes with triethylamine and hexadecyltrimethylammonium permanganate affords aldehydes or ketones, respectively (e.g. equation 129). Hydroxyl groups and olefinic double bonds are not affected<sup>421</sup>.



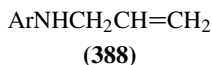
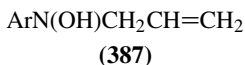
Secondary nitroalkanes are oxidized to ketones by 3-chloro- or 4-nitrobenzoyl peroxide by way of their anions; thus MePhCHNO<sub>2</sub> gives acetophenone in 92% yield<sup>422</sup>. The same reaction can be carried out with sodium chlorite in methylene chloride/aqueous sodium hydroxide/tetrabutylammonium hydrogen sulphate under phase-transfer conditions<sup>423</sup>. Nitrones **382** (R<sup>1</sup> = H or Me; R<sup>2</sup> = Me, CO<sub>2</sub>Me, CONHMe or CONMe<sub>2</sub>; R<sup>3</sup> = *t*-Bu or Ph) are formed when the sodium salts **381** of nitroalkanes are treated with the appropriate nitroso compounds<sup>424</sup>.



2-Butenylmagnesium chloride converts aromatic nitro compounds **383** (Ar = 2-MeC<sub>6</sub>H<sub>4</sub>, 2- or 4-ClC<sub>6</sub>H<sub>4</sub> or 2,6-Me<sub>2</sub>C<sub>6</sub>H<sub>3</sub>) into the nitrones **384**; aliphatic nitro compounds **385** (R = Pr or C<sub>5</sub>H<sub>11</sub>) yield allyl nitrones **386** in this reaction<sup>425</sup>.

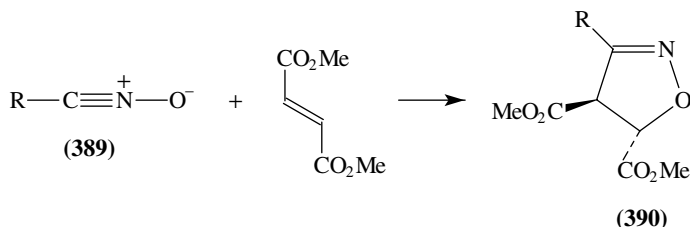


Treatment of aromatic nitro compounds with allylmagnesium chloride, followed by 1.4 equiv. of LiAlH<sub>4</sub>(LAH) and a trace of palladium on charcoal affords hydroxylamines **387** (Ar = Ph, 4-ClC<sub>6</sub>H<sub>4</sub>, 2-FC<sub>6</sub>H<sub>4</sub> or 3-MeOC<sub>6</sub>H<sub>4</sub>). If the amount of LAH is increased to 2.5 equiv. *N*-allylarylamines **388** result. 1-Nitrohexane and nitrocyclohexane react analogously<sup>426</sup>.

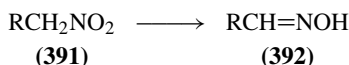


The reduction of nitroarenes to azoxy compounds ArN=N(O)Ar is promoted by bis-muth trichloride/powdered zinc<sup>427</sup>. Aromatic amines are formed in excellent yields in the reduction of nitroarenes with BH<sub>3</sub>/NiCl<sub>2</sub><sup>428</sup> or nickel boride<sup>429</sup>. Acyl, ester, amide and cyano groups are not affected. Reaction of the nitro compounds RCH<sub>2</sub>NO<sub>2</sub> (R = Ph, Bz

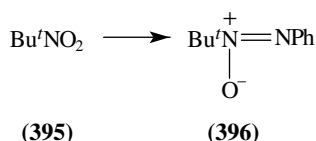
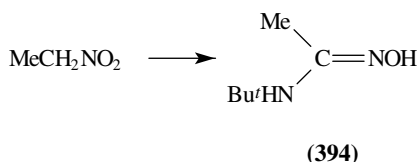
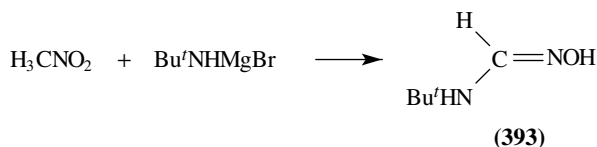
or MeO<sub>2</sub>C) with thionyl chloride and triethylamine generates nitrile oxides **389**, which have been trapped *in situ* by various dipolarophiles. Dimethyl fumarate, for instance, yields the isoxazolines **390**<sup>430</sup>.



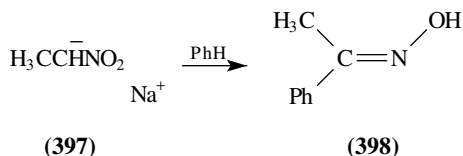
Oximes **392** are produced when acetone solutions of nitroalkanes **391** (R = PhCH<sub>2</sub>, EtO<sub>2</sub>CCH<sub>2</sub>CH<sub>2</sub>, 1-cyclohexenyl etc.) are irradiated in the presence of triethylamine<sup>431</sup>.



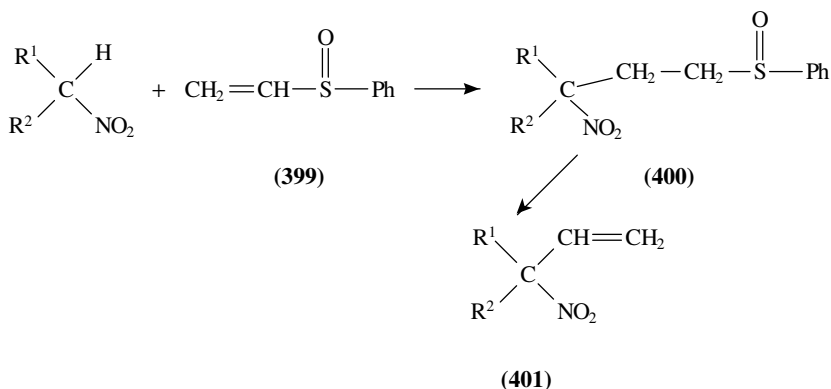
Nitromethane reacts with *t*-BuNHMgBr (prepared from ethylmagnesium bromide and *t*-butylamine in boiling THF) to give the oxime **393**; nitroethane yields the analogue **394**. The action of PhN(MgBr)<sub>2</sub> on 2-methyl-2-nitropropane (**395**) results in the azoxy compound **396**<sup>432</sup>.



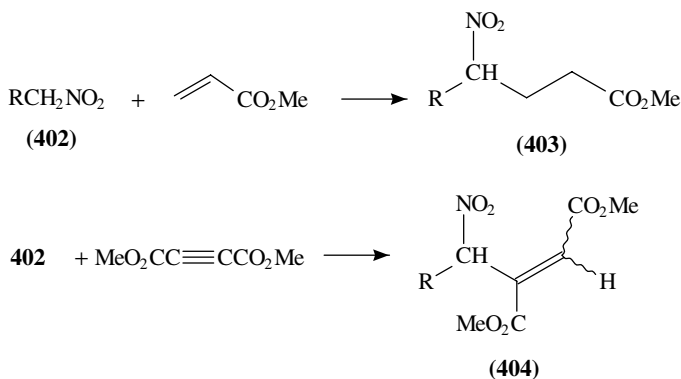
Treatment of the nitronate salt **397** (from nitroethane and methanolic sodium methoxide) with benzene in the presence of trifluoromethanesulphonic acid gives acetophenone oxime, which is obtained mainly as the (*E*)-isomer **398**<sup>433</sup>.



Reduction of nitroalkanes RNO<sub>2</sub> with samarium(II) iodide, obtained from samarium and 1,2-diiodoethane, yields either alkyhydroxylamines RNHOH or alkylamines RNH<sub>2</sub>, depending on the amount of the reagent<sup>434</sup>. The base-catalysed reaction of nitroalkanes with phenyl(vinyl) sulphoxide (**399**) yields the conjugate adducts **400**, which fragment to allylic nitro compounds **401** on thermolysis<sup>435</sup>.

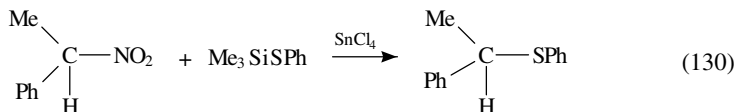


Addition of nitroalkanes **402** ( $\text{R} = \text{Me}, \text{Bu}, \text{Ph}$  etc.) to methyl acrylate without a solvent in the presence of Amberlyst-21 gives good yields of the esters **403**<sup>436</sup>. An analogous reaction with electrophilic acetylenes, e.g. dimethyl acetylenedicarboxylate, in the presence of potassium fluoride and tetrabutylammonium chloride yields adducts **404** as mixtures of geometrical isomers<sup>437</sup>.

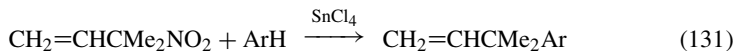


## 2. Reactions of aliphatic nitro compounds with nucleophiles

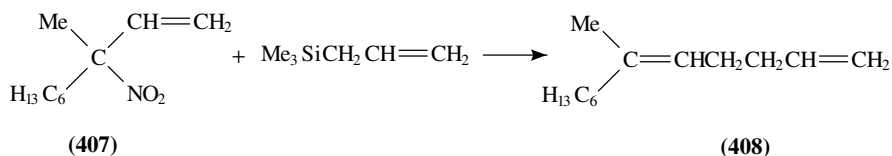
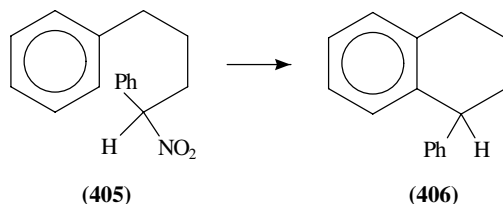
A review of the reaction of nitroalkanes  $\text{RNO}_2$  with carbon and heteroatom nucleophiles  $\text{X}$  to yield  $\text{RX}$  has appeared<sup>438</sup>. The nucleophilic displacement of a nitro group in benzylic and tertiary nitroalkanes by a thiophenyl group is exemplified in equation 130<sup>439</sup>.



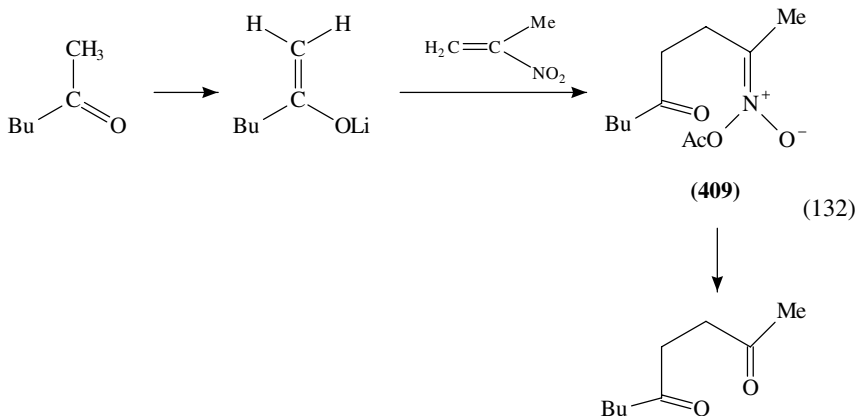
A similar reaction occurs with electron-rich aromatic compounds, such as toluene or anisole, under tin(IV) chloride catalysis, e.g. equation 131:



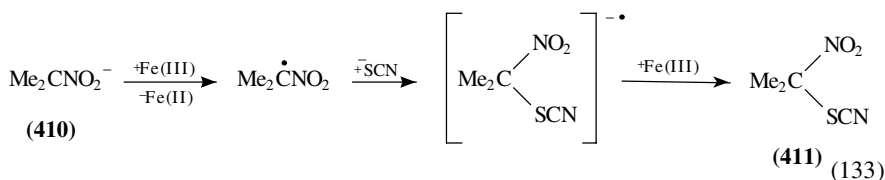
An intramolecular version of the process, **405**  $\rightarrow$  **406**, and a novel replacement reaction using allyltrimethylsilane, **407**  $\rightarrow$  **408**, were also reported<sup>440</sup>.



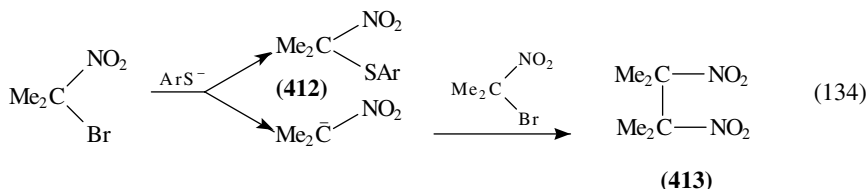
1,4-Diketones are produced from nitroalkenes and the lithium enolates of ketones. Equation 132 shows the reaction of the enolate of 2-hexanone with 2-nitropropene in the presence of acetic anhydride. The resulting betaine **409**, a greenish-blue liquid, is hydrolysed to the diketone by successive treatment with boron trifluoride and water<sup>441</sup>.



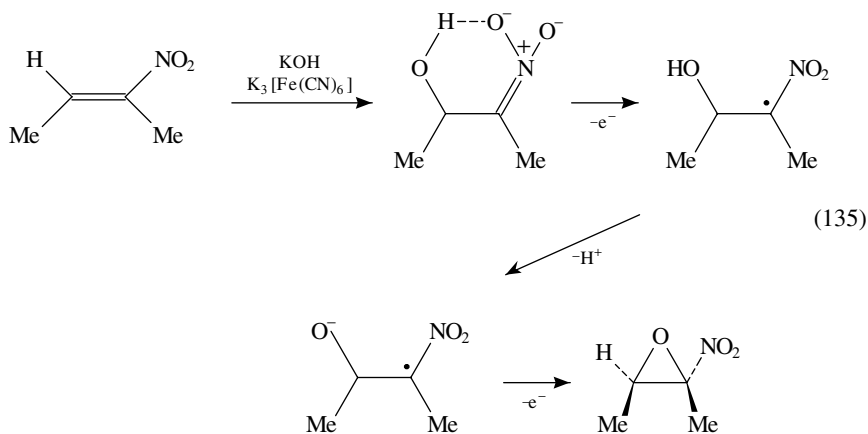
Reactions of aliphatic nitro compounds with nucleophiles have been reviewed<sup>442-444</sup>. The oxidative reaction of nitronate anions, e.g. **410**, with thiocyanate anions to yield thiocyanates **411** proceeds by a 'radical radical-anion chain mechanism'  $S_{RN}1$  (equation 133). Analogous replacements by azide, benzenesulphinate and 4-chlorobenzenethiolate have been reported<sup>445</sup>.



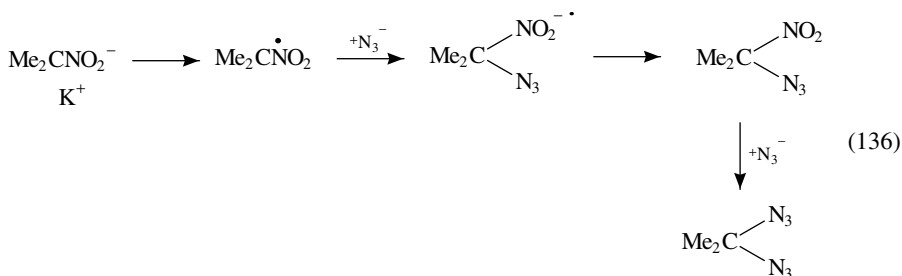
2-Bromo-2-nitropropane reacts with nitrobenzenethiolate anions  $\text{ArS}^-$  ( $\text{Ar} = 2\text{-}$  or  $4\text{-O}_2\text{NC}_6\text{H}_4$ ) in diffuse daylight to give substitution products **412** and 'dimers' **413** (equation 134)<sup>446,447</sup>



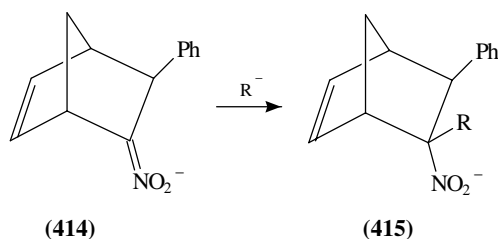
The oxidative addition of hydroxide anion to nitroalkenes, e.g. (*E*)-2-nitro-2-butene, which leads to epoxides, proceeds by way of radical anions (equation 135)<sup>448</sup>.



$\alpha$ -Nitroazides result from successive treatment of potassium salts of nitroalkanes with potassium hexacyanoferrate and sodium azide. The products react further with sodium azide/potassium hexacyanoferrate to yield *gem*-diazides (equation 136)<sup>449</sup>.

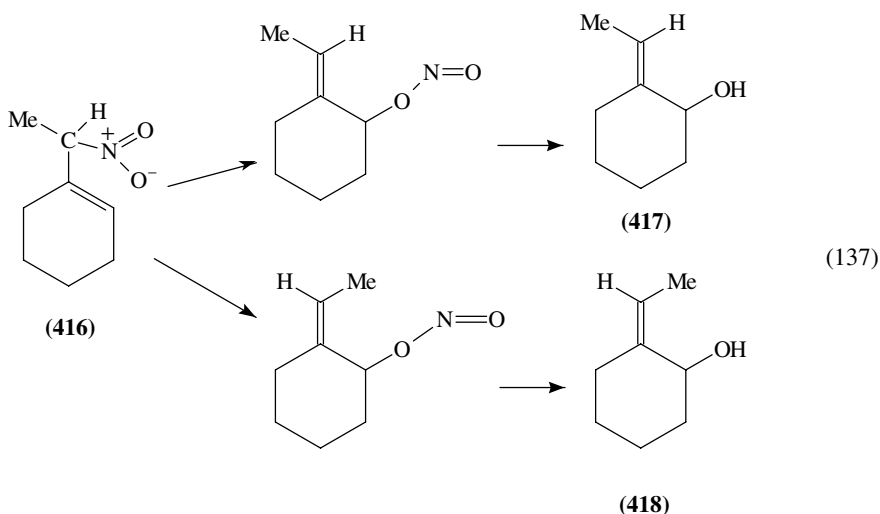


The nitronate anion **414** derived from phenylnorbornene reacts with benzenesulphinate, thiocyanate, nitrite or 4-chlorobenzenethiolate anions in the presence of Fe(III) by the  $\text{S}_{\text{RN}}1$  mechanism to give the norbornenes **415** ( $\text{R} = \text{O}_2\text{SPh}$ ,  $\text{SCN}$ ,  $\text{O}_2\text{N}$ , or  $\text{SC}_6\text{H}_4\text{Cl-4}$ , respectively). No cyclization occurred<sup>450</sup>.

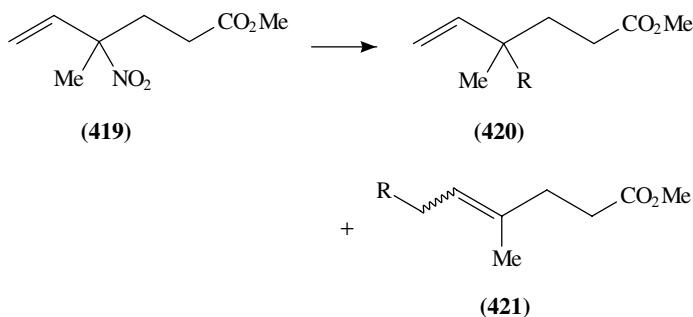


### 3. Reactions of nitroalkenes

Thermolysis of allylic nitro compounds results in the formation of rearranged allyl alcohols; the cyclohexene **416**, for instance, affords a 4:1 mixture of the cyclohexanol derivatives **417** and **418**. It is proposed that the process involves a [2,3] sigmatropic shift of a nitro group (equation 137)<sup>451</sup>.

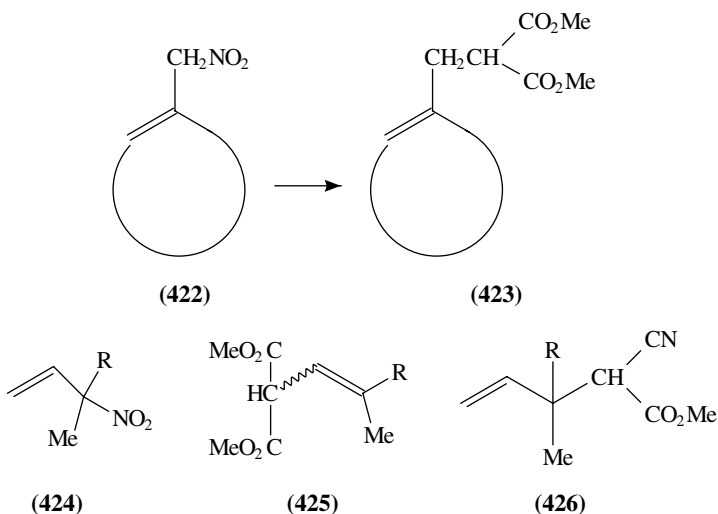


Substitution reactions of allylic nitro compounds often lead to rearranged products, as in palladium(0)-catalysed aminations and alkylations. Thus treatment of the nitro ester **419** with piperidine in the presence of tetrakis(triphenylphosphine)palladium yields a mixture of the unrearranged and rearranged amines **420** (R = piperidin-1-yl) and **421**

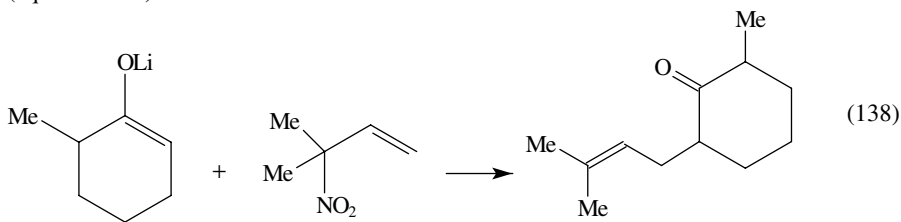


(R = piperidin-1-yl), respectively. Under similar conditions, the same ester reacts with sodium benzenesulphinate to give a 95:5 mixture of the kinetic product **420** (R = O<sub>2</sub>SPh) and the thermodynamic product **421** (R = O<sub>2</sub>SPh)<sup>452</sup>.

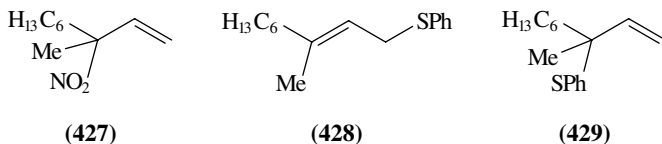
The carbanion derived from dimethyl malonate reacts with the cyclic nitro compounds **422** of ring size 5, 6, 7, 8 and 12 to afford the corresponding esters **423**. Acyclic allylic nitro compounds **424** (R = Me, CH<sub>2</sub>OAc or CO<sub>2</sub>Et) are attacked by bulky nucleophiles, such as dimethyl malonate anion, mainly at the terminal primary carbon atom to give rearranged products **425**, whereas smaller nucleophiles, e.g. the anion derived from methyl cyanoacetate, react at the tertiary carbon atom to yield **426**<sup>409a,453–455</sup>.



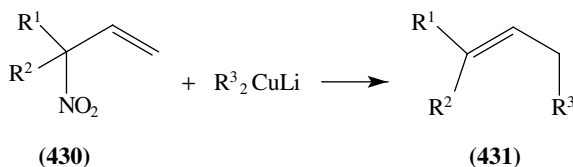
Another example of the formation of a rearranged product is the palladium(0)-catalysed reaction of the enolate ion of 2-methylcyclohexanone with 3-methyl-3-nitro-1-butene (equation 138)<sup>456</sup>.



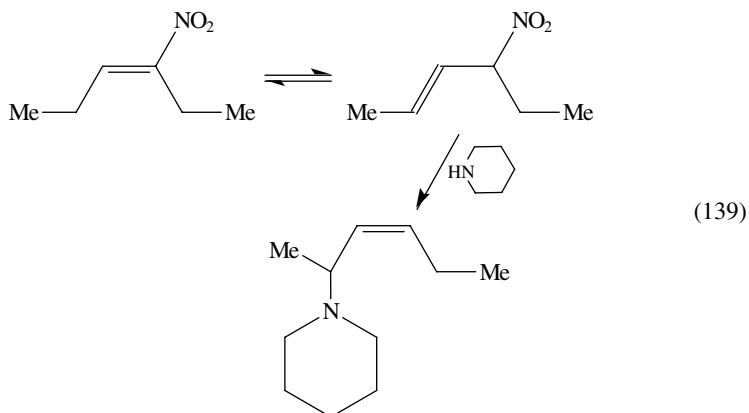
3-Methyl-3-nitro-1-nonene (**427**) and sodium phenylthiolate show different modes of behaviour under different conditions: in HMPA the product **428** of attack at the less hindered carbon atom is obtained, whereas in the presence of Pd(PPh<sub>3</sub>)<sub>4</sub> the isomer **429** is produced<sup>457</sup>.



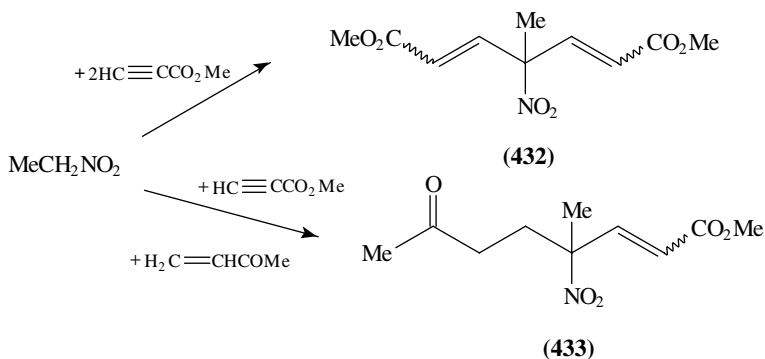
The allylic nitroalkenes **430** [ $R^1 = R^2 = \text{Me}$ ;  $R^1 = \text{Me}$ ,  $R^2 = \text{CO}_2\text{Et}$ ;  $R^1R^2 = (\text{CH}_2)_4$ ] react with lithium dialkylcuprates  $R^3_2\text{CuLi}$  ( $R^3 = \text{Bu}$  or  $\text{Ph}$ ), obtained from organolithium compounds and copper(I) iodide, to yield the rearranged olefins **431**<sup>458</sup>.



Under basic conditions,  $\alpha$ -nitroalkenes function as synthetic equivalents of allylic nitro compounds; 3-nitro-3-hexene, for instance, reacts with piperidine in the presence of  $\text{Pd}(\text{PPh}_3)_4$ , to give 2-piperidinyl-3-hexene (equation 139)<sup>459</sup>.



The two-fold Michael addition of nitroethane to methyl propiolate in the presence of potassium fluoride and the phase-transfer catalyst tetrabutylammonium chloride leads to the diester **432**. Treatment of nitroethane with methyl propiolate under these conditions, followed by methyl vinyl ketone, leads to the 'mixed' adduct **433**<sup>460</sup>.

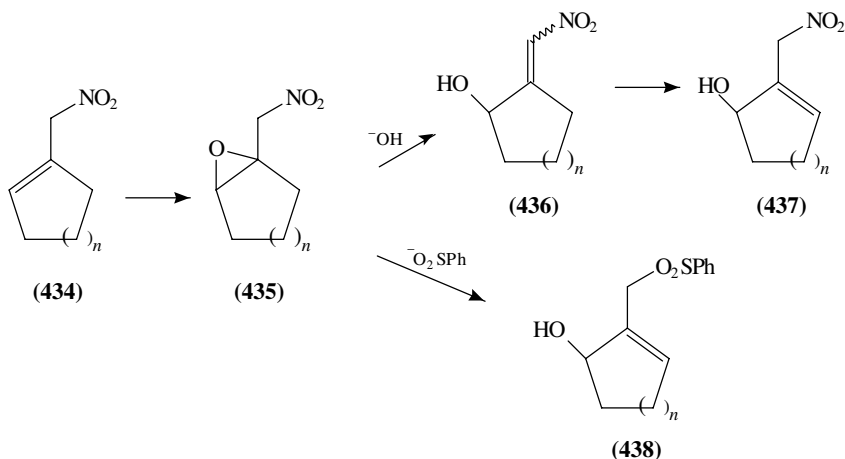


Oximes  $\text{RCH=NOH}$  are produced in the reduction of nitroalkanes  $\text{RCH}_2\text{NO}_2$  by carbon disulphide in the presence of triethylamine<sup>461</sup> or wet potassium carbonate and



a phase-transfer agent<sup>462</sup>. Best yields are obtained from allylic nitro compounds and aryl-nitromethanes. When further carbon disulphide and aqueous sodium hydroxide are added, nitriles RCN result<sup>463</sup>. Conjugated nitroalkenes are reduced by sodium borohydride in methanol/THF to saturated nitro compounds, e.g.  $\text{PhCH}=\text{CHNO}_2 \rightarrow \text{PhCH}_2\text{CH}_2\text{NO}_2$ , while  $\text{BH}_3 \cdot \text{THF}$ , generated from sodium borohydride and boron trifluoride etherate in THF, affords the hydroxylamine  $\text{PhCH}_2\text{CH}_2\text{NHOH}$ <sup>464</sup>.

The  $\beta,\gamma$ -epoxy nitro derivatives **435**, prepared by oxidation of allylic nitro compounds, e.g. **434**, with 3-chloroperbenzoic acid, undergo ring-opening on treatment with triethylamine in wet acetonitrile to yield the nitrovinyl alcohols **436**, which arrange to the allylic nitro alcohols **437** on heating. In contrast, reaction of the epoxides with the soft nucleophiles piperidine or sodium benzenesulphonate in the presence of palladium tetrakis(triphenylphosphine) results in ring-scission and replacement of the nitro group to give compounds **438**<sup>465</sup>.



#### IV. REFERENCES

- (a) S. Patai (Ed.), *The Chemistry of the Amino Group*, Wiley, London, 1968.  
 (b) H. Feuer (Ed.), *The Chemistry of the Nitro and Nitroso Groups. Part 1*, Wiley, New York, 1969.  
 (c) H. Feuer (Ed.), *The Chemistry of the Nitro and Nitroso Groups. Part 2*, Wiley, New York, 1970.  
 (d) S. Patai (Ed.), *Supplement F: The Chemistry of Amino, Nitroso and Nitro Compounds and Their Derivatives*, Wiley, Chichester, 1982.
- N. M. Yoon, H. W. Lee, J. Choi and H. J. Lee, *Bull. Korean Chem. Soc.*, **14**, 281 (1993).
- M. K. Park, D. G. Jang and B. H. Han, *Bull. Korean Chem. Soc.*, **12**, 709 (1991).
- K. Kaneda, H. Kuwahara and T. Imanaka, *J. Mol. Catal.*, **88**, L267 (1994).
- W. Baik, J. L. Han, K. C. Lee, N. H. Lee, B. H. Kim and J.-T. Hahn, *Tetrahedron Lett.*, **35**, 3965 (1994).
- J. R. Hwu, F. F. Wong and M. J. Shiao, *J. Org. Chem.*, **57**, 5254 (1992).
- I. Suzuki and Y. Hanazaki, *Chem. Lett.*, 549 (1986).
- Y. Kodaera, S. Watanabe, Y. Imada and S.-I. Murahashi, *Bull. Chem. Soc. Jpn.*, **67**, 2542 (1994).
- M. A. Schwartz, J. Gu and X. Hu, *Tetrahedron Lett.*, **33**, 1687 (1992).
- M. A. Schwartz and X. Hu, *Tetrahedron Lett.*, **33**, 1689 (1992).
- A. Yoshimura, K. Asada and S. Oae, *Bull. Chem. Soc. Jpn.*, **55**, 3000 (1982).
- M. F. Zippies, M.-J. De Vos and T. C. Bruice, *J. Org. Chem.*, **50**, 3228 (1985).
- J. P. Leeds and H. A. Kirst, *Synth. Commun.*, **18**, 777 (1988).

14. S. Itsuno, Y. Sakurai, K. Shimizu and K. Ito, *J. Chem. Soc., Perkin Trans. 1*, 1548 (1989).
15. Y. Sakito, Y. Yoneyoshi and G. Suzukamo, *Tetrahedron Lett.*, **29**, 223 (1988).
16. D. E. Gibbs and D. Barnes, *Tetrahedron Lett.*, **31**, 5555 (1990).
17. A. S. B. Prasad, J. V. B. Kanth and M. Periasamy, *Tetrahedron*, **48**, 4623 (1992).
18. G. B. Fisher, J. C. Fuller, J. Harrison, C. T. Goralski and B. Singaram, *Tetrahedron Lett.*, **34**, 1091 (1993).
19. M. Bonnat, A. Hercouet and M. LeCorré, *Synth. Commun.*, **21**, 1579 (1991).
20. S. Sengupta, D. P. Sahu and S. K. Chatterjee, *Indian J. Chem., Sect. B*, **33B**, 285.
21. S. Akabori and Y. Takanohashi, *Chem. Lett.*, 251 (1990).
22. S. Akabori, Y. Takanohashi, S. Aoki and S. Sato, *J. Chem. Soc., Perkin Trans. 1*, 3121 (1991).
23. A. Galan, J. De Mendoza, P. Prados, J. Rojo and A. M. Echavaren, *J. Org. Chem.*, **56**, 452 (1991).
24. E. F. V. Scriven and K. Turnbull, *Chem. Rev.*, **88**, 298 (1988).
25. A. A. Malik, S. B. Preston, T. G. Archibald, M. P. Cohen and K. Baum, *Synthesis*, 450 (1989).
26. S. N. Maiti, M. P. Singh and R. G. Micetich, *Tetrahedron Lett.*, **27**, 1423 (1986).
27. H. S. P. Rao and P. Siva, *Synth. Commun.*, **24**, 549 (1994).
28. S. N. Maiti, P. Spevak and A. V. N. Reddy, *Synth. Commun.*, **18**, 1201 (1988).
29. J. C. Sarma and R. P. Sharma, *Chem. Ind. (London)*, 764 (1987).
30. N. M. Yoon, J. Choi and Y. S. Shon, *Synth. Commun.*, **23**, 3047 (1993).
31. A. Guy, A. Lemor, J. Doussot and M. Lemaire, *Synthesis*, 900 (1988).
32. A. Koziara, K. Osowska-Pacewicka, S. Zawadzki and A. Zwierzak, *Synthesis*, 202 (1985).
33. K. R. Gee and J. F. W. Keana, *Synth. Commun.*, **23**, 357 (1993).
34. S. Mori, T. Aoyama and T. Shioiri, *Chem. Pharm. Bull.*, **34**, 1524 (1986).
35. E. Fabiano, B. T. Golding and M. M. Sadeghi, *Synthesis*, 190 (1987).
36. D. H. R. Barton, J. P. Finet and J. Khamsi, *Tetrahedron Lett.*, **28**, 887 (1987).
37. D. H. R. Barton, N. Ozbalik and M. Ramesh, *Tetrahedron Lett.*, **29**, 857 (1988).
38. M. Deeba, M. E. Ford and T. A. Johnson, *J. Chem. Soc., Chem. Commun.*, 562 (1987).
39. P. Dalla Croce, C. La Rosa and A. Ritieni, *J. Chem. Res., Synop.*, 346 (1988).
40. W. ten Hoeve, C. G. Kruse, J. M. Luteyn, J. R. G. Thiecke and H. Wynberg, *J. Org. Chem.*, **58**, 5101 (1993).
41. Y.-S. Hon and L. Lu, *Tetrahedron Lett.*, **34**, 5309 (1993).
42. E. J. Corey and A. W. Gross, *Tetrahedron Lett.*, **25**, 491 (1984).
43. R. F. Smith, J. L. Marcucci and P. S. Tingue, *Synth. Commun.*, **22**, 381 (1992).
44. A. Koziara, K. Osowska-Pacewicka, S. Zawadzki and A. Zwierzak, *Synthesis*, 487 (1987).
45. F. Guennouni, F. Szoenyi and A. Cambon, *Synth. Commun.*, **24**, 2653 (1994).
46. U. Ragnarsson and L. Grehn, *Acc. Chem. Res.*, **24**, 285 (1991).
47. Y. Han and H. Hu, *Synthesis*, 122 (1990).
48. A. Zwierzak and S. Pilichowska, *Synthesis*, 922 (1982).
49. R. O. Hutchins, J. Wei and S. J. Rao, *J. Org. Chem.*, **59**, 4007 (1994).
50. A. Hosomi, S. Kohra, Y. Tominaga and M. Inaba, *Chem. Pharm. Bull.*, **36**, 2342 (1988).
51. L. Grehn and U. Ragnarsson, *Synthesis*, 275 (1987).
52. C. T. Clarke, J. D. Elliott and J. H. Jones, *J. Chem. Soc., Perkin Trans. 1*, 1088 (1978).
53. L. Grehn and U. Ragnarsson, *Collect. Czech. Chem. Commun.*, **53**, 2778 (1988).
54. R. D. Connell, T. Rein, B. Akermark and P. Helquist, *J. Org. Chem.*, **53**, 3845 (1988).
55. A. Koziara, *J. Chem. Res., Synop.*, 296 (1989).
56. O. Mitsunobu and M. Yamada, *Bull. Chem. Soc. Jpn.*, **40**, 2380 (1967).
57. O. Mitsunobu and M. Eguchi, *Bull. Chem. Soc. Jpn.*, **44**, 3427 (1971).
58. M. L. Edwards, D. M. Stemerick and J. R. McCarthy, *Tetrahedron Lett.*, **31**, 3417 (1990).
59. D. M. Roundhill, *Chem. Rev.*, **92**, 1 (1992).
60. S. Ganguly and D. M. Roundhill, *Polyhedron*, **9**, 2517 (1990).
61. K. T. Huh, S. C. Shim and C. H. Doh, *Bull. Korean Chem. Soc.*, **11**, 45 (1990).
62. J. A. Marsella, *J. Org. Chem.*, **52**, 467 (1987).
63. W. A. Nugent and R. L. Harlow, *J. Am. Chem. Soc.*, **116**, 6142 (1994).
64. M. Fujiwara, M. Imada, A. Baba and H. Matsuda, *Tetrahedron Lett.*, **30**, 739 (1989).
65. M. Chini, P. Crotti and F. Macchia, *J. Org. Chem.*, **56**, 5939 (1991).
66. R. K. Atkins, J. Frazier, L. L. Moore and L. O. Weigel, *Tetrahedron Lett.*, **27**, 2451 (1986).
67. J. Yamada, M. Yumoto and Y. Yamamoto, *Tetrahedron Lett.*, **30**, 4255 (1989).
68. M. Chini, P. Crotti, L. Favero, F. Macchia and M. Pineschi, *Tetrahedron Lett.*, **35**, 433 (1994).

69. D. Hurtaud, M. Baudy-Floc'h, A. Robert and P. LeGrel, *J. Org. Chem.*, **59**, 4701 (1994).
70. M. Canas, M. Poch, X. Verdaguer, A. Moyano, M. A. Pericas and A. Riera, *Tetrahedron Lett.*, **32**, 6931 (1991).
71. W. Chamchaang and A. R. Pinhas, *J. Org. Chem.*, **55**, 2531 (1990).
72. P. Crotti, L. Favero, F. Macchia and M. Pineschi, *Tetrahedron Lett.*, **35**, 7089 (1994).
73. P. Mangeney, A. Tejero, A. Alexakis, F. Grosjean and J. Normant, *Synthesis*, 255 (1988).
74. (a) C. A. Willoughby and S. L. Buchwald, *J. Am. Chem. Soc.*, **114**, 7562 (1992).  
(b) C. A. Willoughby and S. L. Buchwald, *J. Org. Chem.*, **58**, 7627 (1993).
75. H. Okamoto and S. Kato, *Bull. Chem. Soc. Jpn.*, **64**, 3466 (1991).
76. A. R. Katritzky, M. Drewniak and J. M. Aurocochea, *J. Chem. Soc., Perkin Trans. 1*, 2359 (1987).
77. W. Dai, R. Srinivasan and J. A. Katzenellenbogen, *J. Org. Chem.*, **54**, 2204 (1989).
78. V. A. Soloshonok, A. G. Kirilenko, V. P. Kukhar and G. Resnati, *Tetrahedron Lett.*, **35**, 3119 (1994).
79. M. T. Reetz, R. Jaeger, R. Drewlies and M. Hübel, *Angew. Chem., Int. Ed. Engl.*, **30**, 103 (1991).
80. D. H. R. Barton, J. C. Jaszberenyi and E. A. Theodorakis, *J. Am. Chem. Soc.*, **114**, 5904 (1992).
81. P. Andreoli, L. Billii, G. Cainelli, M. Panunzio, G. Martelli and G. Spunta, *J. Org. Chem.*, **55**, 4199 (1990).
82. E. J. Roskamp and S. F. Pedersen, *J. Am. Chem. Soc.*, **109**, 3152 (1987).
83. E. J. Enholm, D. C. Forbes and D. P. Holub, *Synth. Commun.*, **20**, 981 (1990).
84. R. G. Lovey and A. B. Cooper, *Synlett*, 167 (1994).
85. V. M. Vinogradov, I. L. Dalinger and S. A. Shevedlev, *Mendeleev Commun.*, 111 (1993).
86. (a) I. Zaltsgendler, Y. Leblanc and M. A. Bernstein, *Tetrahedron Lett.*, **34**, 2441 (1993).  
(b) H. Mitchell and Y. Leblanc, *J. Org. Chem.*, **59**, 682 (1994).
87. G. A. Olah, P. Ramaiah, Q. Wang and G. K. S. Prakash, *J. Org. Chem.*, **58**, 6900 (1993).
88. G. A. Olah and T. D. Ernst, *J. Org. Chem.*, **54**, 1203 (1989).
89. (a) H. Takeuchi, T. Adachi and H. Nishiguchi, *J. Chem. Soc., Chem. Commun.*, 1524 (1991).  
(b) H. Takeuchi, T. Adachi, H. Nishiguchi, K. Itou and K. Koyama, *J. Chem. Soc., Perkin Trans. 1*, 867 (1993).
90. H. Takeuchi, D. Higuchi and T. Adachi, *J. Chem. Soc., Perkin Trans. 1*, 1525 (1991).
91. H. Takeuchi, S. Hayakawa, T. Tanahashi, A. Kobayashi, T. Adachi and D. Higuchi, *J. Chem. Soc., Perkin Trans. 2*, 847 (1991).
92. J. P. Genet, S. Mallart, C. Greck and E. Piveteau, *Tetrahedron Lett.*, **32**, 2359 (1991).
93. A. Casarini, P. Dembech, D. Lazzari, E. Marini, G. Reginato, A. Ricci and G. Seconi, *J. Org. Chem.*, **58**, 5620 (1993).
94. T. Okawara, Y. Kanazawa, T. Yamasaki and M. Furukawa, *Synthesis*, 183 (1987).
95. G. Boche, C. Meier and W. Kleemiss, *Tetrahedron Lett.*, **29**, 1777 (1988).
96. G. Sosnovsky and K. Purgstaller, *Z. Naturforsch., B: Chem. Sci.*, **44**, 582 (1989).
97. V. V. Kuzmenko and A. F. Pozharskii, *Zh. Org. Khim.*, **28**, 1320 (1992); *Chem. Abstr.*, **118**, 169 046k (1993).
98. Y. Tamura, J. Minamikawa and M. Ikeda, *Synthesis*, 1 (1977).
99. M. J. Miller and G. M. Loudon, *J. Org. Chem.*, **40**, 126 (1975).
100. (a) H. C. Brown, W. R. Heydkamp, E. Breuer and W. S. Murphy, *J. Am. Chem. Soc.*, **86**, 3565 (1964).  
(b) M. W. Rathke, N. Inoue, K. R. Warma and H. C. Bown, *J. Am. Chem. Soc.*, **88**, 2870 (1966).
101. Y. Tamura, J. Minamikawa, S. Fujii and M. Ikeda, *Synthesis*, 196 (1974).
102. P. Kovacic, M. K. Lowry and K. W. Field, *Chem. Rev.*, **70**, 639 (1970).
103. E. Erdik and M. Ay, *Chem. Rev.*, **89**, 1947 (1989).
104. G. Boche, N. Mayer, M. Bernheim and K. Wagner, *Angew. Chem., Int. Ed. Engl.*, **17**, 687 (1978).
105. S. Andreae and E. Schmitz, *Synthesis*, 327 (1991).
106. J. Vidal, L. Guy, S. Sterin and A. Collet, *J. Org. Chem.*, **58**, 4791 (1993).
107. V. F. Rudchenko, S. M. Ignatov and R. G. Kostyanovskii, *J. Chem. Soc., Chem. Commun.*, 261 (1990).
108. (a) H. J. Bestmann and G. Wölfel, *Angew. Chem., Int. Ed. Engl.*, **23**, 53 (1984).  
(b) H. J. Bestmann, G. Wölfel and K. Mederer, *Synthesis*, 848 (1987).
109. T. Morimoto, T. Takahashi and M. Sekiya, *J. Chem. Soc., Chem. Commun.*, 794 (1984).
110. G. F. Grillot and R. E. Schaffrath, *J. Org. Chem.*, **24**, 1035 (1959).
111. J. J. Eisch, J. F. McNulty and X. Shi, *J. Org. Chem.*, **59**, 7 (1994).

112. A. R. Katritzky, B. Pilarski and L. Urogdj, *J. Chem. Soc., Perkin Trans. 1*, 541 (1990).
113. A. R. Katritzky, S. Rachwal and B. Rachwal, *J. Chem. Soc., Perkin Trans. 1*, 791 (1987).
114. A. R. Katritzky, S. Rachwal and B. Rachwal, *J. Chem. Soc., Perkin Trans. 1*, 799 (1987).
115. (a) A. R. Katritzky, K. Yannakopoulou, W. Kuzmierkiewicz, J. M. Aurrocochea, G. J. Palenik, A. E. Kozioł, M. Szczesniak and R. Skarjune, *J. Chem. Soc., Perkin Trans. 1*, 2673 (1987).  
(b) A. R. Katritzky, Q.-H. Long, P. Lue and A. Joswiak, *Tetrahedron*, **46**, 8153 (1990).  
(c) A. R. Katritzky and K. Yannakopoulou, *Heterocycles*, **28**, 1121 (1989).
116. A. R. Katritzky, S. Rachwal and B. Rachwal, *J. Chem. Soc., Perkin Trans. 1*, 805 (1987).
117. A. R. Katritzky, K. Yannakopoulou, P. Lue, D. Rasala and L. Urogdj, *J. Chem. Soc., Perkin Trans. 1*, 225 (1989).
118. A. R. Katritzky, S. Rachwal and J. Wu, *Can. J. Chem.*, **68**, 456 (1990).
119. A. R. Katritzky, N. Shobana and P. A. Harris, *Tetrahedron Lett.*, **32**, 4247 (1991).
120. A. R. Katritzky, L. Urogdj and A. Mayence, *Synthesis*, 323 (1989).
121. A. R. Katritzky, J. K. Gallas and K. Yannakopoulou, *Synthesis*, 31 (1989).
122. A. R. Katritzky, X. Zhao and G. J. Hutchings, *Synthesis*, 703 (1991).
123. A. R. Katritzky and K. Yannakopoulou, *Synthesis*, 747 (1989).
124. J. Wang, H. Xu, X. Zhou, and S. Du, *Youji Huaxue*, **12**, 198 (1992); *Chem. Abstr.*, **116**, 255 247s (1992).
125. J. Wang, S. Du, W. Bao and X. Zhou, *Huaxue Shiji*, **15**, 19, 30 (1993); *Chem. Abstr.*, **119**, 72 290t (1993).
126. A. R. Katritzky, G. Noble, B. Pilarski and P. A. Harris, *Chem. Ber.*, **123**, 1443 (1990).
127. A. R. Katritzky, J. Jiang and P. A. Harris, *Can. J. Chem.*, **69**, 1153 (1991).
128. A. R. Katritzky and J.-J. Vanden Eynde, *J. Chem. Soc., Perkin Trans. 1*, 639 (1989).
129. A. R. Katritzky, K. Yannakopoulou and H. Lang, *J. Chem. Soc., Perkin Trans. 2*, 1867 (1994).
130. A. R. Katritzky, M. Latif and L. Urogdj, *J. Chem. Soc., Perkin Trans. 1*, 667 (1990).
131. A. R. Katritzky, L. Urogdj and A. Mayence, *J. Org. Chem.*, **55**, 2206 (1990).
132. A. R. Katritzky, Q.-H. Long and P. Lue, *Tetrahedron Lett.*, **32**, 3597 (1991).
133. A. R. Katritzky, J. Jiang and L. Urogdj, *Tetrahedron Lett.*, **30**, 3303 (1989).
134. A. R. Katritzky, J. Jiang and L. Urogdj, *Synthesis*, 565 (1990).
135. R. Saladino, C. Crestini and R. Nicoletti, *Heterocycles*, **38**, 567 (1994).
136. A. R. Katritzky, A. Bieniek and B. E. Brycki, *Chem. Scr.*, **29**, 33 (1989).
137. C.-K. Chen, A. G. Hortmann and M. R. Marzabadi, *J. Am. Chem. Soc.*, **110**, 4829 (1988).
138. C. K. McGill and A. Rappa, *Adv. Heterocycl. Chem.*, **44**, 1 (1988).
139. H. Vorbrüggen, *Adv. Heterocycl. Chem.*, **49**, 117 (1990).
140. (a) H. C. Van der Plas, *Janssen Chem. Acta*, **3**, 23 (1985).  
(b) H. C. Van der Plas, *Khim. Geterotsikl. Soedin.*, 1011 (1987); *Chem. Abstr.*, **108**, 150 331w (1988).  
(c) M. Wozniak and H. C. Van der Plas, *Acta Chem. Scand.*, **47**, 95 (1993).
141. H. Tondys and H. C. Van der Plas, *J. Heterocycl. Chem.*, **23**, 621 (1986).
142. M. Wozniak, A. Baranski and B. Szpakiewicz, *Justus Liebigs Ann. Chem.*, 875 (1991).
143. M. Wozniak and B. Szpakiewicz, *Pol. J. Chem.*, **65**, 1303 (1991).
144. M. Wozniak, K. Nowak and H. Poradowska, *Pol. J. Chem.*, **65**, 1077 (1991).
145. H. Sładowska, A. Van Veldhuizen and H. C. Van der Plas, *J. Heterocycl. Chem.*, **23**, 843 (1986).
146. T. Yamashita, K. Yamano, M. Yasuda and K. Shima, *Chem. Lett.*, 627 (1993).
147. T. Yamashita, M. Yasuda, T. Isami, S. Nakano, K. Tanabe and K. Shima, *Tetrahedron Lett.*, **34**, 5131 (1993).
148. K. Yoshida, M. Hikasa, K. Ishii, H. Kadota and Y. Yamashita, *J. Chem. Soc., Chem. Commun.*, 758 (1986).
149. M. Yasuda, T. Yamashita, K. Shima and C. Pac, *J. Org. Chem.*, **52**, 753 (1987).
150. M. Yasuda, K. Shiomori, S. Hamasuna, K. Shima and T. Yamashita, *J. Chem. Soc., Perkin Trans. 2*, 305 (1992).
151. S. Bhattacharyya, A. Chatterjee and S. K. Duttachowdhury, *J. Chem. Soc., Perkin Trans. 1*, 1 (1994).
152. P. Lue, J. Li, G. Li and X. Zhou, *Youji Huaxue*, **6**, 447 (1986); *Chem. Abstr.*, **107**, 133 591t (1987).
153. R. Wang and Y. Guan, *Gaodeng Xuexiao Huaxue Xuebao*, **11**, 894 (1990); *Chem. Abstr.*, **114**, 101 879w (1991).
154. R. F. Borch, M. D. Bernstein and H. D. Durst, *J. Am. Chem. Soc.*, **93**, 2897 (1971).

155. N. M. Yoon, E. G. Kim, H. S. Son and J. Choi, *Synth. Commun.*, **23**, 1595 (1993).
156. A. F. Abdel-Magid, C. A. Maryanoff and K. G. Carson, *Tetrahedron Lett.*, **31**, 5595 (1990).
157. C. L. Barney, E. W. Huber and J. R. McCarthy, *Tetrahedron Lett.*, **31**, 5547 (1990).
158. A. E. Moormann, *Synth. Commun.*, **23**, 789 (1993).
159. N. Kambe, T. Inagaki, N. Miyoshi, A. Ogawa and N. Sonoda, *Chem. Lett.*, 1275 (1987).
160. I. V. Mićović, M. D. Ivanović, D. M. Piatak and V. D. Bojić, *Synthesis*, 1043 (1991).
161. S. Bhattacharyya, *Tetrahedron Lett.*, **35**, 2401 (1994).
162. A. G. Giumanini, G. Chiavari, M. Musiani and P. Rossi, *Synthesis*, 743 (1980).
163. G. Verardo, A. G. Giumanini, P. Strazzolini and M. Poiana, *Synthesis*, 121 (1993).
164. A. Guy and J. F. Barbetti, *Synth. Commun.*, **22**, 853 (1992).
165. R. Carlson, T. Lejon, T. Lundstedt and E. LeClouerec, *Acta Chem. Scand.*, **47**, 1046 (1993).
166. R. Chauvin, *Synth. Commun.*, **21**, 1425 (1991).
167. S. K. Sharma, M. F. Songster, T. L. Colpitts, P. Hegyes, G. Barany and F. J. Castellino, *J. Org. Chem.*, **58**, 4993 (1993).
168. C. Boga, F. Manescalchi and D. Savoia, *Tetrahedron*, **50**, 4709 (1994).
169. C. Betschart and D. Seebach, *Helv. Chim. Acta*, **70**, 2215 (1987).
170. G. W. Kabalka, D. A. Henderson and R. S. Varma, *Organometallics*, **6**, 1369 (1987).
171. G. W. Kabalka, N. M. Goudgaon and Y. Liang, *Synth. Commun.*, **18**, 1363 (1988).
172. H. C. Brown, W. R. Heydkamp, E. Breuer and W. S. Murphy, *J. Am. Chem. Soc.*, **86**, 3565 (1964).
173. G. W. Kabalka, K. A. R. Sastry, G. W. McCollum and H. Yoshioka, *J. Org. Chem.*, **46**, 4296 (1981).
174. M. Nakagawa, T. Kawate, T. Kakikawa, H. Yamada, T. Matsui and T. Hino, *Tetrahedron*, **49**, 1739 (1993).
175. S. Itsuno, C. Hachisuka and K. Ito, *J. Chem. Soc., Perkin Trans. I*, 1767 (1991).
176. H. C. Brown, M. M. Midland, A. B. Levy, A. Suzuki, S. Sono and M. Itoh, *Tetrahedron*, **43**, 4079 (1987).
177. M. Vaultier, B. Carboni and P. Martinez-Fresneda, *Synth. Commun.*, **22**, 665 (1992).
178. J. P. Genet, J. Hajicek, L. Bischoff and C. Greck, *Tetrahedron Lett.*, **33**, 2677 (1992).
179. (a) G. W. Kabalka and Z. Wang, *Organometallics*, **8**, 1093 (1989).  
(b) G. W. Kabalka and Z. Wang, *Synth. Commun.*, **20**, 231 (1990).
180. R. Chaabouni, A. Laurent and B. Marquet, *Tetrahedron*, **36**, 877 (1980).
181. N. A. Petasis and I. Akritopoulou, *Tetrahedron Lett.*, **34**, 583 (1993).
182. M.-J. Wu, D.-S. Yan, H.-W. Tsai and S.-H. Chen, *Tetrahedron Lett.*, **35**, 5003 (1994).
183. R. B. Cheikh, R. Chaabouni, A. Laurent, P. Mison and A. Nafii, *Synthesis*, 685 (1983).
184. G. S. Silverman, S. Strickland and K. M. Nicholas, *Organometallics*, **5**, 2117 (1986).
185. Review: B. M. Trost, *Tetrahedron*, **33**, 2615 (1977).
186. B. M. Trost and E. Keinan, *J. Org. Chem.*, **44**, 3451 (1979).
187. R. A. T. M. van Benthem, J. J. Michels, H. Hiemstra and W. N. Speckamp, *Synlett*, 368 (1994).
188. R. D. Connell, T. Rein, B. Aakermark and P. Helquist, *J. Org. Chem.*, **53**, 3845 (1988).
189. J. Barluenga, J. Perez-Prieto and G. Asensio, *Tetrahedron*, **46**, 2453 (1990).
190. J. B. Baruah and A. G. Samuelson, *Tetrahedron*, **47**, 9449 (1991).
191. N. DeKimpe, E. Stanoeva, R. Verhé and N. Schamp, *Synthesis*, 587 (1988).
192. K. J. M. Beresford, G. P. Howe and G. Procter, *Tetrahedron Lett.*, **33**, 3355 (1992).
193. P. J. Bhuyan, D. Prajapati and J. S. Sandhu, *Tetrahedron Lett.*, **34**, 7975 (1993).
194. M. Giammaruco, M. Taddai and P. Ulivi, *Tetrahedron Lett.*, **34**, 3635 (1993).
195. P. A. Grieco and A. Bahsas, *J. Org. Chem.*, **52**, 1378 (1987).
196. W. L. Neumann, M. M. Rogic and T. J. Dunn, *Tetrahedron Lett.*, **32**, 5865 (1991).
197. K. Takai, H. Odaka, Y. Kataoka and K. Utimoto, *Tetrahedron Lett.*, **35**, 1893 (1994).
198. M. Johannsen and K. A. Jørgensen, *J. Org. Chem.*, **59**, 214 (1994).
199. A. Srivastava, Y. Ma, R. Pankayatselvan, W. Dinges and K. M. Nicholas, *J. Chem. Soc., Chem. Commun.*, 853 (1992).
200. K. B. Sharpless, T. Hori, L. K. Truesdale and C. O. Dietrich, *J. Am. Chem. Soc.*, **98**, 269 (1976).
201. K. B. Sharpless and T. Hori, *J. Org. Chem.*, **41**, 176 (1976).
202. J. P. Mahy, G. Bedi, P. Battioni and D. Mansuy, *Tetrahedron Lett.*, **29**, 1927 (1988).
203. F. Palacios, D. Aparicio and J. Garcia, *Synlett*, 260 (1994).
204. R. J. P. Corriou, G. Bolin and J. J. E. Moreau, *Bull. Soc. Chim. Fr.*, **130**, 273 (1993).
205. T. Murai, M. Yamamoto and S. Kato, *J. Chem. Soc., Chem. Commun.*, 789 (1990).

206. Y. Leblanc, R. Zamboni and M. A. Bernstein, *J. Org. Chem.*, **56**, 1971 (1991).
207. P. Kocovsky, *Synlett*, 677 (1990).
208. J. F. Dellaria, Jr. and K. J. Sallin, *Tetrahedron Lett.*, **31**, 2661 (1990).
209. R. G. Shea, J. N. Fitzner, J. E. Frankhauser, A. Spaltenstein, P. A. Carpino, R. M. Peevey, D. V. Pratt, B. J. Tenge and P. B. Hopkins, *J. Org. Chem.*, **51**, 5243 (1986).
210. A. I. Meyers, J. P. Lawson and D. R. Carver, *J. Org. Chem.*, **46**, 3119 (1981).
211. A. M. Caporusso, R. Geri, C. Polizzi and L. Lardicci, *Tetrahedron Lett.* **32**, 7471 (1991).
212. Y. Imada, M. Yuasa, I. Nakamura and S.-I. Murahashi, *J. Org. Chem.*, **59**, 2282 (1994).
213. J. Barluenga, P. J. Campos and G. Canal, *Synthesis*, 33 (1989).
214. L. Leboutet, G. Courtois and L. Miginiac, *J. Organomet. Chem.*, **420**, 155 (1991).
215. V. N. Komissarov, L.Yu. Ukhin, Zh. I. Orlova and O. A. Tokarskaya, *Zh. Org. Khim.*, **23**, 1325 (1987); *Chem. Abstr.* **108**, 204 183v (1988).
216. J. R. Hauske, P. Dorff, S. Julin, G. Martinelli and J. Bussolari, *Tetrahedron Lett.*, **33**, 3715 (1992).
217. D. Damour, J. Pernet, B. Randrianoelina and L. Miginiac, *J. Organomet. Chem.*, **396**, 289 (1990).
218. P. Masara, K. Jund and P. Bey, *Tetrahedron Lett.*, **25**, 1891 (1984).
219. J. R. McCarthy, C. L. Barney, D. P. Matthews and T. M. Bargar, *Tetrahedron Lett.*, **28**, 2207 (1987).
220. N. E. Lee and S. L. Buchwald, *J. Am. Chem. Soc.*, **116**, 5985 (1994).
221. K. Van Sant and M. S. South, *Tetrahedron Lett.*, **28**, 6019 (1987).
222. F. G. West, K. W. Glaeske and B. N. Naidu, *Synthesis*, 997 (1993).
223. Y. Uozumi, M. Mori and M. Shibasaki, *J. Chem. Soc., Chem. Commun.*, 81 (1991).
224. S. Tollari, M. Cuscela and F. Porta, *J. Chem. Soc., Chem. Commun.*, 1510 (1993).
225. H. R. Sonawane, A. V. Pol, P. P. Moghe, S. S. Biswas and A. Sudalai, *J. Chem. Soc., Chem. Commun.*, 1215 (1994).
226. M. Hadayatullah and A. Roger, *Bull. Soc. Chim. Belg.*, **102**, 59 (1993).
227. (a) C. Nallaiah and J. A. Strickson, *Tetrahedron*, **42**, 4083 (1986).  
(b) C. Nallaiah and J. A. Strickson, *Tetrahedron*, **42**, 4089 (1986).
228. (a) R. W. Murray, R. Jeyaraman and L. Mohan, *Tetrahedron Lett.*, **27**, 2335 (1986).  
(b) R. W. Murray, S. N. Rajadhyaksha and L. Mohan, *J. Org. Chem.*, **54**, 5783 (1989).
229. D. L. Zabrowski, A. E. Moormann and K. R. Beckwith, Jr., *Tetrahedron Lett.*, **29**, 4501 (1988).
230. M. Kol and S. Rozen, *J. Chem. Soc., Chem. Commun.*, 567 (1991).
231. S. Rozen and M. Kol, *J. Org. Chem.*, **57**, 7342 (1992).
232. S. Murahashi, H. Mitsui, T. Shiota, T. Tsuda and S. Watanabe, *J. Org. Chem.*, **55**, 1736 (1990).
233. (a) R. W. Murray and M. Singh, *Synth. Commun.*, **19**, 3509 (1989).  
(b) R. W. Murray and M. Singh, *J. Org. Chem.*, **55**, 2954 (1990).
234. S. M. Neset, T. Benneche and K. Undheim, *Acta. Chem. Scand.*, **47**, 1141 (1993).
235. J. K. Crandall and T. Reix, *J. Org. Chem.*, **57**, 6759 (1992).
236. S. Murahashi and T. Shiota, *Tetrahedron Lett.*, **28**, 2383 (1987).
237. W. W. Zajac, Jr., M. G. Darcy, A. P. Subong and J. H. Buzby, *Tetrahedron Lett.*, **30**, 6495 (1989).
238. W. W. Zajac, Jr., T. R. Walters and M. G. Darcy, *J. Org. Chem.*, **53**, 5856 (1988).
239. L. Grierson and M. J. Perkins, *Tetrahedron Lett.*, **34**, 7463 (1993).
240. J. S. Reddy and P. A. Jacobs, *J. Chem. Soc., Perkin Trans. 1*, 2665 (1993).
241. P. Capdevielle and M. Maumy, *Tetrahedron Lett.*, **31**, 3891 (1990).
242. G. A. Lee and H. H. Freedman, *Isr. J. Chem.*, **26**, 229 (1985).
243. Y. Hu and H. Hu, *Synth. Commun.*, **22**, 1491 (1992).
244. H. G. Chen and P. Knochel, *Tetrahedron Lett.*, **29**, 6701 (1988).
245. P. Müller and D. M. Gilabert, *Tetrahedron*, **44**, 7171 (1988).
246. S.-I. Murahashi, T. Naota and H. Taki, *J. Chem. Soc., Chem. Commun.*, 613 (1985).
247. S. Yamazaki, *Chem. Lett.*, 823 (1992).
248. J. Yamaguchi and T. Takeda, *Chem. Lett.*, 1933 (1992).
249. A. Goti and M. Romani, *Tetrahedron Lett.*, **35**, 6567 (1994).
250. R. V. Hoffman and A. Kumar, *J. Org. Chem.*, **49**, 4011 (1984).
251. T. Kametani, K. Takahashi, T. Ohsawa and M. Ihara, *Synthesis*, 245 (1977).
252. (a) P. Capdevielle, A. Lavigne and M. Maumy, *Synthesis*, 453 (1989).  
(b) P. Capdevielle, A. Lavigne, D. Sparfel, J. Baranne-Lafont, K. C. Nguyen and M. Maumy, *Tetrahedron Lett.*, **31**, 3305 (1990).

253. B. Juršič, *J. Chem. Res., Synop.*, 168 (1988).
254. S. Yamazaki and Y. Yamazaki, *Bull. Chem. Soc. Jpn.*, **63**, 301 (1990).
255. J. B. Lee, C. Parkin, M. J. Shaw, N. A. Hampson and K. I. MacDonald, *Tetrahedron*, **29**, 751 (1973).
256. W. Gottardi, *Monatsh. Chem.*, **104**, 1690 (1973).
257. J. Santamaria, R. Ouchabane and J. Rigaudy, *Tetrahedron Lett.*, **30**, 3977 (1989).
258. J. Santamaria, M. T. Kaddachi and J. Rigaudy, *Tetrahedron Lett.*, **31**, 4735 (1990).
259. T. H. Chuang, C. C. Yang, C. J. Chang and J. M. Fang, *Synlett*, 733 (1990).
260. J. H. Cooley and E. J. Evain, *Synthesis*, 1 (1989).
261. J. D. Hobson and J. G. McCluskey, *J. Chem. Soc. (C)*, 2015 (1967).
262. T. A. Montzka, J. D. Matiskeella and R. A. Partyka, *Tetrahedron Lett.*, 1325 (1974).
263. R. A. Olofson, R. C. Schnur, L. Bunes and J. P. Pepe, *Tetrahedron Lett.*, 1567 (1977).
264. R. A. Olofson, J. T. Martz, J.-P. Senet, M. Piteau and T. Malfroot, *J. Org. Chem.*, **49**, 2081 (1984).
265. S. Murahashi, T. Naota and K. Yonemura, *J. Am. Chem. Soc.*, **110**, 8256 (1988).
266. J. V. B. Kanth, K. R. Reddy and M. Periasamy, *Synth. Commun.*, **24**, 313 (1994).
267. S. Murahashi, T. Naota, N. Miyaguchi and T. Nakato, *Tetrahedron Lett.*, **33**, 6991 (1992).
268. S. Murata, K. Suzuki, A. Tamatani, M. Miura and M. Nomura, *J. Chem. Soc., Perkin Trans. 1*, 1387 (1992).
269. P. Nussbaum, K. Baumann, T. Dechat and M. Harasek, *Tetrahedron*, **47**, 4591 (1991).
270. (a) G. Verardo, A. G. Giumanini and P. Strazzolini, *Tetrahedron*, **46**, 4303 (1990).  
(b) G. Verardo, A. G. Giumanini and P. Strazzolini, *Tetrahedron*, **47**, 7845 (1991).
271. M. V. Vouk, *Zh. Org. Khim.*, **23**, 2023 (1987); *Chem. Abstr.*, **109**, 37 501j (1988).
272. R. Carlsson, U. Larsson and L. Hansson, *Acta Chem. Scand.*, **46**, 1211 (1992).
273. R. M. Moriarty, T. E. Hopkins, I. Prakash, B. K. Vaid and R. K. Vaid, *Synth. Commun.*, **20**, 2353 (1990).
274. A. De Nicola, J. Einhorn and J.-L. Luche, *J. Chem. Res., Synop.*, 278 (1991).
275. E. Juaristi, P. Murer and D. Seebach, *Synthesis*, 1243 (1993).
276. N. X. Hu, Y. Aso, T. Otsubo and F. Ogura, *Tetrahedron Lett.*, **29**, 4949 (1988).
277. C. D. Xu, S. M. Lu and X. Huang, *Chin. Chem. Lett.*, **4**, 869 (1993).
278. D. H. R. Barton, J. P. Finet and J. Khamsi, *Tetrahedron Lett.*, **27**, 3615 (1986).
279. D. H. R. Barton, D. M. X. Donnelly, J. P. Finet and P. J. Guiry, *Tetrahedron Lett.*, **30**, 1377 (1989).
280. S. Gauthier and J. M. J. Frechet, *Synthesis*, 383 (1987).
281. J. V. B. Kanth and M. Periasamy, *J. Org. Chem.*, **58**, 3156 (1993).
282. A. S. Guram and S. L. Buchwald, *J. Am. Chem. Soc.*, **116**, 7901 (1994).
283. R. F. Pellon, R. Carrasco and L. Roder, *Synth. Commun.*, **23**, 1447 (1993).
284. A. A. Galan, T. V. Lee and C. B. Chapleo, *Tetrahedron Lett.*, **27**, 4995 (1986).
285. (a) K. Mai and G. Patil, *Synth. Commun.*, **15**, 157 (1985).  
(b) K. Mai and G. Patil, *Org. Prep. Proced. Int.*, **17**, 183 (1985).
286. J.-P. Leblanc and H. W. Gibson, *Tetrahedron Lett.*, **33**, 6295 (1992).
287. M. J. Genin, C. Biles and D. L. Romero, *Tetrahedron Lett.*, **34**, 4301 (1993).
288. M. Schorr and W. Schmitt, *Phosphorus, Sulfur Silicon Relat. Elem.*, **68**, 25 (1992).
289. K. N. Radhamani, A. J. Elias and D. K. Padma, *Phosphorus, Sulfur Silicon Relat. Elem.*, **66**, 297 (1992).
290. H. Heany, in *Comprehensive Organic Synthesis* (Ed. B. M. Trost), Vol. 2, Pergamon, Oxford, 1991, p. 953.
291. M. Lubben and B. L. Feringa, *J. Org. Chem.*, **59**, 2227 (1994).
292. S. Kohra, S. Tutuya, M. Kimura, K. Ogata and Y. Tominaga, *Chem. Pharm. Bull.*, **41**, 1293 (1993).
293. T. Satoh, Y. Kaneko, K. Sakata and K. Yamakawa, *Bull. Chem. Soc. Jpn.*, **59**, 457 (1986).
294. S. Husinec, I. Juranic, A. Llobera and A. E. A. Porter, *Synthesis*, 721 (1988).
295. D. Enders and M. Finkam, *Synlett*, 401 (1993).
296. N. DeKimpe, L. D'Hondt and L. Moens, *Tetrahedron*, **48**, 3183 (1992).
297. K. Sato, M. Ohashi, E. Aoki and Y. Murai, *J. Org. Chem.*, **42**, 3713 (1977).
298. M. B. Gase, A. Lattes and J. J. Perie, *Tetrahedron*, **39**, 703 (1983).
299. J.-J. Brunet, D. Neibecker and F. Niedercorn, *J. Mol. Catal.*, **49**, 235 (1989).
300. G. P. Pez and J. E. Galle, *Pure Appl. Chem.*, **57**, 1917 (1985).

301. H. L. Casalnuovo, J. C. Calabrese and D. Milstein, *J. Am. Chem. Soc.*, **110**, 6738 (1988).
302. (a) J.-J. Brunet, D. Neibecker and K. Philipot, *J. Chem. Soc., Chem. Commun.*, 1215 (1992).  
(b) J.-J. Brunet, G. Commenges, D. Neibecker and K. Philipot, *J. Organomet. Chem.*, **469**, 221 (1994).
303. T. Baig, J. Jenck and P. Kalck, *J. Chem. Soc., Chem. Commun.*, 1552 (1992).
304. M. Yasuda, T. Sone, K. Tanabe and K. Shima, *Chem. Lett.*, 453 (1994).
305. M. L. Morris and M. A. Sturgess, *Tetrahedron Lett.*, **34**, 43 (1993).
306. K.-D. Kampe, N. Egger and M. Vogel, *Angew. Chem., Int. Ed. Engl.*, **32**, 1174 (1993).
307. M. Jachak, U. Kriessmann, M. Mittelbach and H. Junek, *Monatsh. Chem.*, **124**, 199 (1993).
308. L. René, J. Poncet and G. Auzou, *Synthesis*, 419 (1986).
309. Y. Huang and O. Zhou, *Tetrahedron Lett.*, **27**, 2397 (1986).
310. S. M. Bromidge, D. A. Entwistle, J. Goldstein and B. S. Orlek, *Synth. Commun.*, **23**, 487 (1993).
311. B. Rechsteiner, F. Texier-Boullet and J. Hamelin, *Tetrahedron Lett.*, **34**, 5071 (1993).
312. M. L. Farmer, W. E. Billups, R. B. Greenlee and A. N. Kurtz, *J. Org. Chem.*, **31**, 2885 (1966).
313. D. A. Ben-Efraim, *Tetrahedron*, **29**, 4111 (1973).
314. A. L. Schwan and J. Warkentin, *Can. J. Chem.*, **66**, 1686 (1988).
315. J. Moussounga, J. Bouquant and J. Chuche, *Synthesis*, 483 (1994).
316. B. M. Trost, R. C. Bunt and S. R. Pulley, *J. Org. Chem.*, **59**, 4202 (1994).
317. J. A. King, Jr. and G. L. Bryant, Jr., *J. Org. Chem.*, **57**, 5136 (1992).
318. J. Cossy and C. Pale-Grosdemange, *Tetrahedron Lett.*, **30**, 2771 (1989).
319. R. Nomura, T. Nakano, Y. Yamada and H. Matsuda, *J. Org. Chem.*, **56**, 4076 (1991).
320. S. Ogata, A. Mochizuki, M. Kakimoto and Y. Imai, *Bull. Chem. Soc. Jpn.*, **59**, 2171 (1986).
321. G. Rousselet, P. Capdevielle and M. Maumy, *Tetrahedron Lett.*, **34**, 6395 (1993).
322. J. H. Forsberg, V. T. Spaziano, T. M. Balasubramanian, G. K. Liu, S. A. Kinsley, C. A. Duckworth, J. J. Poteruca, P. S. Brown and J. L. Miller, *J. Org. Chem.*, **52**, 1017 (1987).
323. J. E. Mills, *Synthesis*, 482 (1986).
324. E. K. Moltzen, M. P. Kramer, A. Senning and K. J. Klabunde, *J. Org. Chem.*, **52**, 1156 (1987).
325. F. Cerreta, C. Lervierend and P. Metzner, *Tetrahedron Lett.*, **34**, 6741 (1993).
326. K. Okuma, Y. Komiya and H. Ohta, *Bull. Chem. Soc. Jpn.*, **64**, 2402 (1991).
327. M. Neveux, C. Bruneau, S. Lécolier and P. H. Dixneuf, *Tetrahedron*, **49**, 2629 (1993).
328. J. Cossy and A. Thellend, *Synthesis*, 753 (1989).
329. J. Deutsch and H. J. Niclas, *Synth. Commun.*, **23**, 1561 (1993).
330. S.-T. Chen, S.-Y. Chen, S.-J. Chen and K.-T. Wang, *Tetrahedron Lett.*, **35**, 3583 (1994).
331. Y. Kikugawa, K. Mitsui, T. Sakamoto, M. Kawase and H. Tamiya, *Tetrahedron Lett.*, **31**, 243 (1990).
332. N. Akikusa, K. Mitsui, T. Sakamoto and Y. Kikugawa, *Synthesis*, 1058 (1992).
333. S. Fernandez, E. Menendez and V. Gotor, *Synthesis*, 713 (1991).
334. E. Bon, D. C. H. Bigg and G. Bertrand, *J. Org. Chem.*, **59**, 4035 (1994).
335. A. Ouhia, L. Rene, J. Guilhem, C. Pascard and B. Badet, *J. Org. Chem.* **58**, 1641 (1993).
336. M. Quirós, V. M. Sánchez, R. Brieva, F. Rebolledo and V. Gotor, *Tetrahedron: Asymmetry*, **4**, 1105 (1993).
337. C. Astorga, F. Rebolledo and V. Gotor, *J. Chem. Soc., Perkin Trans. 1*, 829 (1994).
338. E. Bon, D. C. H. Bigg and G. Bertrand, *J. Org. Chem.*, **59**, 1904 (1994).
339. A. A. Michurin, A. V. Shishulina, A. N. Chernov and I. A. Verin, *Zh. Org. Khim.*, **28**, 1756 (1992); *Chem. Abstr.*, **119**, 28 118u (1993).
340. M. Miyashita, I. Shiina and T. Mukaiyama, *Bull. Chem. Soc. Jpn.*, **67**, 210 (1994).
341. S. Murahashi, Y. Imada and K. Nishimura, *J. Chem. Soc., Chem. Commun.*, 1578 (1988).
342. K. Tamura, H. Mizukami, K. Maeda, H. Watanabe and K. Uneyama, *J. Org. Chem.*, **58**, 32 (1993).
343. A. R. Katritzky, J. Brzezinski and J. N. Lam, *Rev. Roum. Chim.*, **36**, 573 (1991).
344. B. C. Challis and T. I. Yousaf, *J. Chem. Soc., Chem. Commun.*, 1598 (1990).
345. O. D. Gupta, R. L. Kirchmeier and J. M. Shreeve, *J. Am. Chem. Soc.*, **112**, 2383 (1990).
346. Z. Daszkiewicz, A. Domanski and J. B. Kyziol, *Org. Prep. Proced. Int.*, **26**, 337 (1994).
347. M. R. Bryce, A. Chesney, J. N. Heaton, G. N. McKelvey and M. Anderson, *Tetrahedron Lett.*, **35**, 5275 (1994).
348. M. R. Bryce, J. N. Heaton, P. C. Taylor and M. Anderson, *J. Chem. Soc., Perkin Trans. 1*, 1935 (1994).



349. J. Einhorn, C. Einhorn and J.-L. Luche, *Synlett*, 37 (1991).
350. L. E. Overman, M. E. Okazaki and P. Mishra, *Tetrahedron Lett.*, **27**, 4391 (1986).
351. R. S. Coleman and A. J. Carpenter, *Chemtracts: Org. Chem.*, **4**, 213 (1991).
352. M. Sakaitani and Y. Ohfune, *J. Org. Chem.*, **55**, 870 (1990).
353. S. M. Weinreb, D. M. Demko, T. A. Lessen and J. P. Demers, *Tetrahedron Lett.*, **27**, 2099 (1986).
354. M. L. Gross, D. H. Blank and W. M. Welch, *J. Org. Chem.*, **58**, 2104 (1993).
355. Y. Yoshida, S. Ishii, M. Watanabe and T. Yamashita, *Bull. Chem. Soc. Jpn.*, **62**, 1534 (1989).
356. W. D. McGhee, Y. Pan and D. P. Riley, *J. Chem. Soc., Chem. Commun.*, 699 (1994).
357. H. Alper, G. Vasapollo, F. W. Hartstock, M. Mlekuz, D. J. H. Smith and G. E. Morris, *Organometallics*, **6**, 2391 (1987).
358. S. Ishii, H. Nakayama, Y. Yoshida and T. Yamashita, *Bull. Chem. Soc. Jpn.*, **62**, 455 (1989).
359. (a) R. Mahe, P. H. Dixneuf and S. Lecolier, *Tetrahedron Lett.*, **27**, 6333 (1986).  
(b) Y. Sasaki and P. H. Dixneuf, *J. Org. Chem.*, **52**, 314 (1987).
360. B. M. Choudary, K. K. Rao, S. D. Pirozhkov and A. L. Lapidus, *Synth. Commun.*, **21**, 1923 (1991).
361. (a) R. Nomura, Y. Hasegawa, T. Toyosaki and H. Matsuda, *Chem. Express*, **7**, 569 (1992).  
(b) R. Nomura, Y. Hasegawa, M. Ishimoto, T. Toyosaki and H. Matsuda, *J. Org. Chem.*, **57**, 7339 (1992).
362. S. Mori, H. Matsuyoshi, K. Kudo and N. Sugita, *Chem. Lett.*, 1397 (1991).
363. K. Ramadas and N. Srinivasan, *Org. Prep. Proced. Int.*, **25**, 600 (1993).
364. T. E. Waldman and W. D. McGhee, *J. Chem. Soc., Chem. Commun.*, 957 (1994).
365. T. Mizuno, I. Nishiguchi, T. Okushi and T. Hirashima, *Tetrahedron Lett.*, **32**, 6867 (1991).
366. M. D. Pujol and G. Guillaumet, *Synth. Commun.*, **22**, 1231 (1992).
367. S. K. Ramada, N. Srinivasan and N. Janarthanan, *Tetrahedron Lett.*, **34**, 6447 (1993).
368. T. Inoue, T. Mogami, N. Kambe, A. Ogawa and N. Sonoda, *Heteroat. Chem.* **4**, 471 (1993).
369. H. Chang and S. Kim, *Bull. Korean Chem. Soc.*, **7**, 407 (1986).
370. Y. Hori, R. Maruyama, H. Motokawa and H. Taniguchi, *Chem. Express*, **3**, 411 (1988).
371. H. Amri, M. M. El Gaied, T. Ben Ayed and J. Villieras, *Tetrahedron Lett.*, **33**, 6159 (1992).
372. S. Matsubara, M. Yoshioka and K. Utimoto, *Chem. Lett.*, 827 (1994).
373. J. Chanet-Ray, N. Lahbabi and R. Vessiere, *C.R. l'Academie Sci., Ser. II Univers.*, **312**, 455 (1991).
374. J. Fournier, C. Bruneau and P. H. Dixneuf, *Tetrahedron Lett.*, **31**, 1721 (1990).
375. H. Fujita, M. Tokuda, M. Nitta and H. Suginome, *Tetrahedron Lett.*, **33**, 6359 (1992).
376. I. W. Davies, T. Gallagher, R. B. Lamont and D. I. C. Scopes, *J. Chem. Soc., Chem. Commun.*, 335 (1992).
377. S. B. Mandal and B. Achari, *Indian J. Chem., Sect. B*, **31B**, 357 (1992).
378. J. Grimaldi, J. Hatem, C. Henriet-Bernard and R. Maurin, *J. Chem. Res., Synop.*, 36 (1994).
379. L. Stella, *Angew. Chem., Int. Ed. Engl.*, **22**, 337 (1983).
380. M. Newcomb, S.-U. Park, J. Kaplan and D. J. Marquardt, *Tetrahedron Lett.*, **26**, 5651 (1985).
381. M. Newcomb and T. M. Deeb, *J. Am. Chem. Soc.*, **109**, 3163 (1987).
382. M. Newcomb and M. U. Kumar, *Tetrahedron Lett.*, **31**, 1675 (1990).
383. M. Newcomb and K. A. Weber, *J. Org. Chem.*, **56**, 1309 (1991).
384. (a) W. R. Bowman, D. N. Clark and R. J. Marmon, *Tetrahedron Lett.*, **32**, 6441 (1991).  
(b) W. R. Bowman, D. N. Clark and R. J. Marmon, *Tetrahedron*, **50**, 1275 (1994).
385. T. Ibata, M. Shang and T. Demura, *Chem. Lett.*, 359 (1994).
386. S. Kim and K. Y. Yi, *Tetrahedron Lett.*, **27**, 1925 (1986).
387. T. Mukaiyama, *Angew. Chem., Int. Ed. Engl.*, **18**, 707 (1979).
388. O. Mitsunobu, *Synthesis*, 1 (1981).
389. V. A. Petrov and D. D. DesMarteau, *Inorg. Chem.*, **31**, 3776 (1992).
390. M. Murakami, M. Hayashi and Y. Ito, *J. Org. Chem.*, **57**, 793 (1992).
391. H. Vorbrueggen and K. Krolkiewicz, *Helv. Chim. Acta*, **76**, 819 (1993).
392. H. Ahlbrecht and V. Baumann, *Synthesis*, 981 (1993).
393. H. Matschiner, C. P. Maschmeier, N. Maier and I. Hansen, *Phosphorus, Sulfur Silicon Relat. Elem.*, **84**, 223 (1993).
394. A. R. Katritzky, X. Zhao and G. J. Hitchings, *Synlett*, 473 (1990).
395. T. Suyama and Y. Fujiyama, *Nippon Kagaku Kaishi*, 1344 (1992); *Chem. Abstr.*, **118**, 124 637n (1993).

396. M. E. Jung, *Chemtracts: Org. Chem.*, **3**, 392 (1990).
397. A. G. Godfrey and B. Ganem, *J. Am. Chem. Soc.*, **112**, 3717 (1990).
398. T. Wirth and C. Rüchardt, *Chimia*, **42**, 230 (1988).
399. A. G. M. Barrett and G. G. Graboski, *Chem. Rev.*, **86**, 751 (1986).
400. H. Feuer and A. T. Nielsen, *Nitro Compounds. Recent Advances in Synthesis and Chemistry*, VCH, Weinheim, 1990.
401. V. V. Perekalin, E. S. Lipina, V. M. Berestovitskaya and D. A. Efremov, *Nitroalkenes: Conjugated Nitro Compounds*, Wiley, Chichester, 1994.
402. A. P. Marchand, *Tetrahedron*, **44**, 2377 (1988).
403. G. A. Olah, P. Ramaiah, C. S. Lee and G. K. S. Prakash, *Synlett*, 337 (1992).
404. P. E. Eaton and G. E. Wicks, *J. Org. Chem.*, **53**, 5353 (1988).
405. J. C. Bottaro, R. E. Penwell and R. J. Schmitt, *Synth. Commun.*, **21**, 945 (1991).
406. K. Yoshida, T. Nabeshima and Y. Yano, *J. Chem. Res., Synop.*, 192 (1991).
407. G. A. Olah and G. Rochin, *J. Org. Chem.*, **52**, 701 (1987).
408. R. Tamura, M. Sato and D. Oda, *J. Org. Chem.*, **51**, 4368 (1986).
409. (a) R. Tamura and L. S. Hegedus, *J. Am. Chem. Soc.*, **104**, 3727 (1982).  
(b) N. Ono, I. Hamamoto, A. Kamimura, A. Kaji and R. Tamura, *Synthesis*, 258 (1987).
410. J. R. Hwu, K.-L. Chen and S. Ananthan, *J. Chem. Soc., Chem. Commun.*, 1425 (1994).
411. E. Carvalho, J. Iley and E. Rosa, *J. Chem. Soc., Chem. Commun.*, 1429 (1988).
412. J. C. Bottaro, R. J. Schmitt and C. D. Bedford, *J. Org. Chem.*, **52**, 2291 (1987).
413. A. M. Krishnan, L. T. Wolford and J. H. Boyer, *Chem. Lett.*, 569 (1991).
414. K. Baum, S. S. Bigelow, N. V. Nguyen, T. G. Archibald, R. Gilardi, J. L. Flippen-Anderson and C. George, *J. Org. Chem.*, **57**, 235 (1992).
415. G. Rosini and R. Ballini, *Synthesis*, 833 (1988).
416. A. Amrollah-Madjdabadi, R. Beugelmans and A. Lechevallier, *Synthesis*, 828 (1986).
417. S. Rozen, A. Bar-Haim and E. Mishani, *J. Org. Chem.*, **59**, 6800 (1994).
418. A. R. Katritzky and F. Saczewski, *Gazz. Chim. Ital.*, **120**, 375 (1990).
419. I. V. Martynov, V. K. Brel and L. V. Uvarova, *Izv. Akad. Nauk SSSR, Ser. Khim.*, 952 (1986); *Chem. Abstr.*, **106**, 101 707y (1987).
420. J. Lou and W. Lou, *Synthesis*, 179 (1987).
421. P. S. Vankar, R. Rathore and S. Chandrasekaran, *Synth. Commun.*, **17**, 195 (1987).
422. C. Zhao, Y. Qu and X. Jiang, *Youji Huaxue*, **8**, 514 (1988); *Chem. Abstr.*, **110**, 172 672b (1989).
423. R. Ballini and M. Petrini, *Tetrahedron Lett.*, **30**, 5329 (1989).
424. I. M. Lyapkalo, S. L. Ioffe and V. A. Tartakovskii, *Mendeleev Commun.*, 51 (1994).
425. G. Bartoli, E. Marcantoni, M. Petrini and R. Dalpozzo, *J. Org. Chem.*, **55**, 4456 (1990).
426. (a) G. Bartoli, E. Marcantoni, M. Bosco and R. Dalpozzo, *Tetrahedron Lett.*, **29**, 2251 (1988).  
(b) L. Barboni, G. Bartoli, E. Marcantoni, M. Petrini and R. Dalpozzo, *J. Chem. Soc., Perkin Trans. 1*, 2133 (1990).
427. H. N. Borah, D. Prajapati, J. S. Sandhu and A. C. Ghosh, *Tetrahedron Lett.*, **35**, 3167 (1994).
428. A. Nose and T. Kudo, *Chem. Pharm. Bull.*, **34**, 3905 (1986).
429. A. Nose and T. Kudo, *Chem. Pharm. Bull.*, **37**, 816 (1989).
430. Y. J. Chen and C. N. Li, *J. Chin. Chem. Soc. (Taipei)*, **40**, 203 (1993).
431. H. Yakechi and M. Machida, *Synthesis*, 206 (1989).
432. E. T. Apasov, A. V. Kalinin, Yu. A. Strelenko and V. A. Tartakovskii, *Izv. Akad. Nauk SSSR, Ser. Khim.*, 2873 (1988); *Chem. Abstr.*, **110**, 231 091m (1989).
433. C. Berrier, R. Brahmī, H. Carreyre, J. M. Coustard, J. C. Jacquesy and B. Violeau, *Bull. Soc. Chim. Fr.*, 1730 (1991).
434. A. S. Kende and J. S. Mendoza, *Tetrahedron Lett.*, **32**, 1699 (1991).
435. R. Tanikaga, H. Sugihara, K. Tanaka and A. Kaji, *Synthesis*, 299 (1977).
436. R. Ballini, M. Petrini and G. Rosini, *Synthesis*, 711 (1987).
437. D. A. Anderson and J. R. Hwu, *J. Org. Chem.*, **55**, 511 (1990).
438. R. Tamura, A. Kamimura and N. Ono, *Synthesis*, 423 (1991).
439. N. Ono, T. Yanai and A. Kaji, *J. Chem. Soc., Chem. Commun.*, 1040 (1986).
440. N. Ono, T. Yanai, A. Kamimura and A. Kaji, *J. Chem. Soc., Chem. Commun.*, 1285 (1986).
441. M. Miyashita, B. Z. E. Awen and A. Yoshikoshi, *Tetrahedron*, **46**, 7569 (1990).
442. N. Kornblum, *Angew. Chem., Int. Ed. Engl.*, **14**, 734 (1975).
443. J. F. Bunnett, *Acc. Chem. Res.*, **11**, 413 (1978).
444. W. R. Bowman, *Chem. Soc. Rev.*, **17**, 283 (1988).

445. S. I. Al-Khalil and W. R. Bowman, *Tetrahedron Lett.*, **24**, 2517 (1983).
446. W. R. Bowman and G. D. Richardson, *J. Chem. Soc., Perkin Trans. 1*, 1407 (1980).
447. W. R. Bowman and G. D. Richardson, *Tetrahedron Lett.*, **22**, 1551 (1981).
448. W. R. Bowman, D. S. Brown, J. D. E. Chaffin, M. C. R. Symons, S. W. Jackson and N. A. Willcocks, *Tetrahedron Lett.*, **32**, 2285 (1991).
449. S. I. Al-Khalil, W. R. Bowman and M. C. R. Symons, *J. Chem. Soc., Perkin Trans. 1*, 555 (1986).
450. W. R. Bowman, D. S. Brown, C. A. Burns and D. Crosby, *J. Chem. Soc., Perkin Trans. 1*, 2099 (1993).
451. J. Boivin, L. El Kaim, J. Kervagoret and S. Z. Zard, *J. Chem. Soc., Chem. Commun.*, 1006 (1989).
452. N. Ono, I. Hamamoto, T. Kawai, A. Kaji, R. Tamura and M. Kakihana, *Bull. Chem. Soc. Jpn.*, **59**, 405 (1986).
453. N. Ono, I. Hamamoto and A. Kaji, *J. Chem. Soc., Chem. Commun.*, 821 (1982).
454. N. Ono, I. Hamamoto and A. Kaji, *J. Chem. Soc., Perkin Trans. 1*, 1439 (1986).
455. R. Tamura, Y. Kai, M. Kakihana, K. Hayashi, M. Tsuji, T. Nakamura and D. Oda, *J. Org. Chem.*, **51**, 4375 (1986).
456. N. Ono, I. Hamamoto and A. Kaji, *Bull. Chem. Soc. Jpn.*, **58**, 1863 (1985).
457. N. Ono, I. Hamamoto, T. Yanai and A. Kaji, *J. Chem. Soc., Chem. Commun.*, 523 (1985).
458. N. Ono, I. Hamamoto and A. Kaji, *J. Chem. Soc., Chem. Commun.*, 274 (1984).
459. R. Tamura, K. Hayashi, Y. Kai and D. Oda, *Tetrahedron Lett.*, **25**, 4437 (1984).
460. D. A. Anderson and J. R. Hwu, *J. Chem. Soc., Perkin Trans. 1*, 1694 (1989).
461. D. H. R. Barton, I. Fernandez, C. S. Richard and S. Z. Zard, *Tetrahedron*, **43**, 551 (1987).
462. D. Albanese, D. Landini and M. Penso, *Synthesis*, 333 (1990).
463. D. Albanese, D. Landini, M. Penso and G. Pozzi, *Synth. Commun.*, **20**, 965 (1990).
464. G. W. Kabalka, L. H. M. Guindi and R. S. Varma, *Tetrahedron*, **46**, 7443 (1990).
465. R. Tamura, M. Kato, K. Saegusa, D. Oda, T. Egawa and T. Yamamoto, *J. Org. Chem.*, **52**, 1640 (1987).

## CHAPTER 13

# Diazotization of amines and dediazonation of diazonium ions

HEINRICH ZOLLINGER

*Technisch-Chemisches Laboratorium, Eidgenössische Technische Hochschule  
(ETH), Zürich, Switzerland*

*Fax: +41 01 632 1072*

---

I. INTRODUCTION	628
II. DIAZOTIZATIONS	628
A. Diazotization with Alkali Nitrite in Aqueous and Concentrated Mineral Acids	628
B. Isolation of Diazonium Salts	636
C. Diazotization of 2- and 4-Aminophenols	637
D. Formation of Diazonium Salts under Anhydrous Conditions	639
E. Mechanism and Kinetics of Rate-limiting Nitrosation Steps	640
F. Nucleophilic Catalysis and the Transformation Mechanism of <i>N</i> -Nitrosoamines into Diazonium Ions	644
III. DEDIAZONIATIONS	646
A. Mechanisms of Dediazoniations	646
B. Hydro-de-diazoniations	650
C. Halo-de-diazoniations and Related Reactions	651
D. Substitutions of the Diazonio Group by Reagents with Reacting C-Atoms	653
E. Hydroxy- and Mercapto-de-diazoniations	656
F. Substitutions of the Diazonio Group by Carbonyl and Sulfonyl Groups	657
G. Metallo-de-diazoniations and Related Reactions	657
H. Photolytic Dediazoniations	657
IV. REFERENCES	658

---

## I. INTRODUCTION

In this chapter diazotization of primary aromatic and heteroaromatic amines and dediazonation of corresponding diazonium ions are reviewed. In principle, only investigations are included which were not yet mentioned in earlier volumes of *The Chemistry of Functional Groups* series, i.e. for diazotization the volume on amines<sup>1</sup> (1968) and for dediazonation that on triple-bonded functional groups<sup>2</sup> (1983). Exceptions are, of course, earlier investigations which have to be mentioned in the context of papers which were published more recently. Although primary aliphatic amines can be diazotized by the same methods as aromatic amines, the alkanediazonium ions formed are not stable. They lose dinitrogen rapidly and lead to solvolytic and rearranged products. These reactions of alkanediazonium ions were recently reviewed by Zollinger<sup>3a</sup>.

## II. DIAZOTIZATIONS

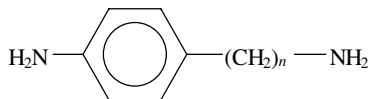
### A. Diazotization with Alkali Nitrite in Aqueous and Concentrated Mineral Acids

This classical method for diazotizations has been in use since the 1860s, in particular for the large-scale production of azo dyes, and was optimized many decades ago. Preparative aspects can be found most conveniently in the books of Fierz-David and Blangey<sup>4</sup> and Saunders and Allen<sup>5</sup>, or in the diazotization chapter of a recent supplementary volume of Houben-Weyl<sup>6</sup>. There is also a recent review of preparative aspects integrated in physical organic chemistry<sup>7a</sup>. Godovikova, Rakitin and Khmel'nitzki<sup>8</sup> and Zollinger<sup>7b</sup> reviewed diazotizations of weakly basic amines in strongly acid media. Many diazotizations of specific amines are described in *Organic Syntheses*. In the indexes of the various volumes of that series they cannot be found, however, under the names of the diazonium salts formed, but in the reaction methods part under 'Diazotization' with the name of the final product.

There are some general characteristics of diazotizations which should be mentioned at the beginning of this section. They are related to the amounts of acid and of nitrosating reagents to be used, and to the reaction temperature.

A considerably greater amount of mineral acid than the two equivalents necessary on the basis of the stoichiometry of diazotization should be used even if strongly basic amines are used as reagents. With weakly basic amines the acid concentration has to be even higher in order to dissolve the amine practically completely as ammonium ion.

Compounds bearing both an aliphatic and an aromatic amino group can be selectively diazotized at the aromatic amino group without hydroxy-de-amination at the aliphatic group, as shown by Kornblum and Iffland<sup>9</sup> for compounds of type 1. At pH < 3 only the aromatic amino group reacts with the nitrosating reagent; the aliphatic group is much more basic (*ca* 5 pK units) and so its equilibrium lies much further over in favor of the ammonium form.



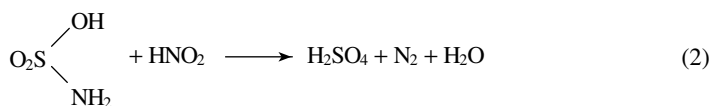
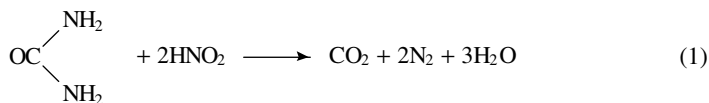
(1)

In contrast to the acid, *sodium nitrite* should not in general be added in excess. Firstly, as far as the ratio of amine to nitrite is concerned, diazotization is practically a quantitative reaction. In consequence, it provides the most important method for determining aromatic amines by titration. Secondly, an excess of nitrous acid exerts a very unfavorable influence on the stability of diazo solutions, as was shown by Gies and Pfeil<sup>10</sup>. Mechanistically the

reactions between aromatic diazonium and nitrite ions were investigated more recently by Opgenorth and R uchardt<sup>11</sup>. They showed that the primary and major reaction is the formation of aryl radicals from the intermediate 1-aryl-2-nitrodiazene (former name: arenediazonitrite  $\text{Ar}-\text{N}_2-\text{NO}_2$ ).

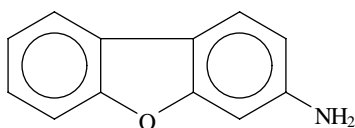
It is therefore important to measure the amount of nitrite required for a reaction as exactly as possible. Hence the azo chemist takes the following precautions:

- (1) Determination of the content of diazotizable amine by titration with nitrite.
- (2) Use of standard solutions of sodium nitrite.
- (3) Testing for excess of nitrous acid at the end of the reaction. For this purpose starch-potassium iodide papers are best used, and these indicate nitrite in acid solution by turning blue *instantaneously*. With some practice, the nitrite reaction can be clearly distinguished from the coloration caused by certain diazo compounds, such as those bearing nitro substituents. The latter react only after 0.5 to 2 seconds. Often the difference becomes more marked after dilution of the diazo solution with concentrated hydrochloric acid. A properly conducted diazotization should exhibit on completion a very weak nitrite reaction, corresponding to an excess of about  $10^{-4}$  M.
- (4) Nitrite in significant excess has to be destroyed. Traditionally urea has been employed as a nitrous acid scavenger yielding gaseous products, as shown in equation 1, but the reaction is slow. Therefore it was recommended to replace urea by sulfamic acid (equation 2). More recently, Williams and coworkers<sup>12</sup> quantitatively compared the reactivity of nine nitrous acid scavengers at various acidities. Their choice of scavengers also included some aromatic amines which, obviously, cannot be used as scavengers for diazotizations, but are suitable for trapping nitrous acid in other systems, e.g. for removing traces of  $\text{HNO}_2$  from nitric acid. Their results show that, among the scavengers suitable for use in removing excess nitrous acid from diazotization solutions, sulfamic acid has the highest rate at low acidity (0.05 M). Hydrazine and hydrazoic acid are faster at high acidities (0.5 and 1.3 M).



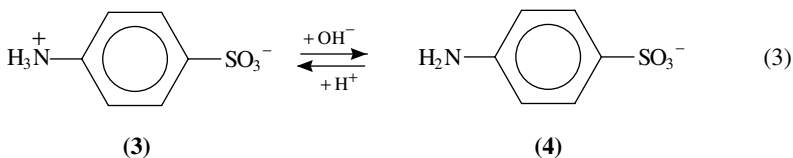
A low temperature of diazotization, normally close to  $0^\circ\text{C}$ , is advantageous for two reasons. Firstly, the solubility of free nitrous acid is greater, which means that there is less danger of the nitrous gases escaping from the acid medium. Secondly, the moderate stability of most diazonium salts demands it. These two factors usually outweigh the lower rate of reaction and the poorer solubility of the starting material, which are in themselves undesirable. In cases where the diazo compound is relatively stable, higher temperatures of diazotization may be used, such as  $10-15^\circ\text{C}$  for sulfanilic acid. On a large scale, certain diazotizations are carried out at  $30^\circ\text{C}$ ,  $40^\circ\text{C}$  and even higher; for example, 2-amino-5-benzamido-1,1'-diphenyl sulfone and its derivatives, or 3-aminodibenzofuran (2), are diazotized at  $50^\circ\text{C}$  (see Saunders and Allen<sup>5a</sup>). Diazotizations should be carried out above room temperature only in cases where a relatively dilute aqueous system ( $<2$  M amine,  $<1$  M mineral acid) is used and the diazonium salt formed does not precipitate.

In general, the temperature is kept at  $0^\circ\text{C}$  most easily by adding ice to the reaction mixture. In this way the considerable heat of reaction evolved during diazotization is dealt with more safely and effectively than by external cooling.



(2)

The 'indirect' method of diazotization is often used for aminoarenesulfonic acids which are relatively insoluble in acid solution where they are present as zwitterions (**3** in the case of sulfanilic acid; see equation 3). The easily soluble anion **4** is obtained by introducing the required amount of sodium carbonate or hydroxide, and nitrite is added to the approximately neutral solution, which is then run into mineral acid. Indirect diazotization is particularly recommended for the aminosulfonic acids of greater molecular mass but, contrary to some statements in the literature, the three anilinesulfonic acids themselves can be diazotized directly in suspension, the reaction proceeding quite smoothly after some practice.

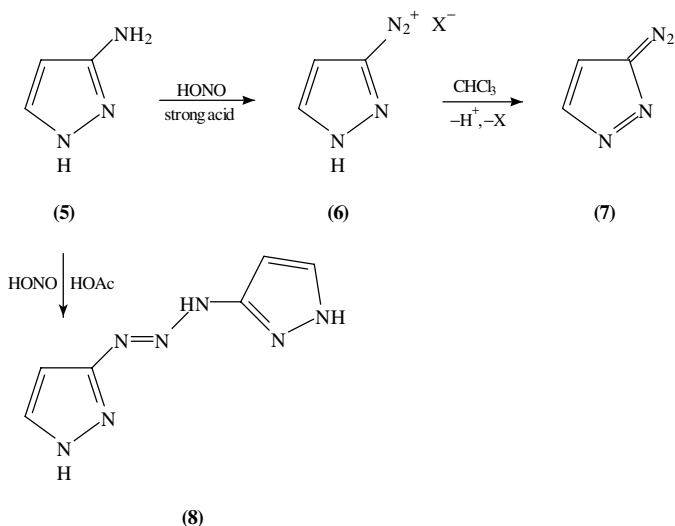


The diazotization of heteroaromatic amines is a ticklish procedure. In spite of the great increase in interest for disperse dyes based on heterocyclic diazo components, little systematic knowledge is available. In a review of such diazo components<sup>13</sup> practically nothing is mentioned on suitable methods of diazotization and on yields (which are in part low). The somewhat older review of Butler<sup>14</sup> is, in this respect, more informative. So too is the section on synthesis in the general review on diazoazoles by Cirincione and coworkers<sup>15</sup>.

The diazotization of heteroaromatic amines is basically analogous to that of aromatic amines. Among the five-membered systems the amino-azoles (pyrroles, diazoles, triazoles, tetrazoles, oxazoles, isooxazoles, thia-, seleno- and dithiazoles) have all been diazotized. In general, diazotization in dilute mineral acid is possible, but diazotization in concentrated sulfuric acid (nitrosylsulfuric acid, see below) or in organic solvents using an ester of nitrous acid (ethyl or 2-pentyl nitrite) is often preferable. Amino derivatives of aromatic heterocycles without ring nitrogen (furan and thiophene) can also be diazotized.

A characteristic property of most diazotizations of aminoazoles is the occurrence of a relatively stable transient intermediate (probably the *N*-nitrosoamine), in contrast with the diazotization of carbocyclic aromatic amines, where *N*-nitrosoamines have been considered to be unstable intermediates.

For the diazotization of heteroaromatic amines of the azole type, it is important to be aware of the fact that the heterocyclic nitrogen (or one of them in di-, tri- and tetrazoles) is more basic than the amino nitrogen. As a consequence the first diazonium ions formed may react with the starting material still present, forming a triazene. This secondary reaction can be avoided by working in a more acidic medium. For example, as shown in Scheme 1, diazotization of 3-amino-1*H*-pyrazole (**5**) yields pyrazole-3-diazonium salts (**6**) only in strong acids, e.g. 75% phosphoric acid; in aqueous acetic acid the product is the 1,3-di[3',3''-pyrazolo]-triazene (**8**) as found by Reimlinger and coworkers<sup>16</sup>. The diazonium chloride (**6**, X = Cl) can be isolated by precipitation with ether if the diazotization is carried out with 2-pentyl nitrite in methanol saturated with HCl gas. Dissolving the salt in chloroform leads to deprotonation, giving the (mesomeric) diazoalkane **7**. This compound



SCHEME 1

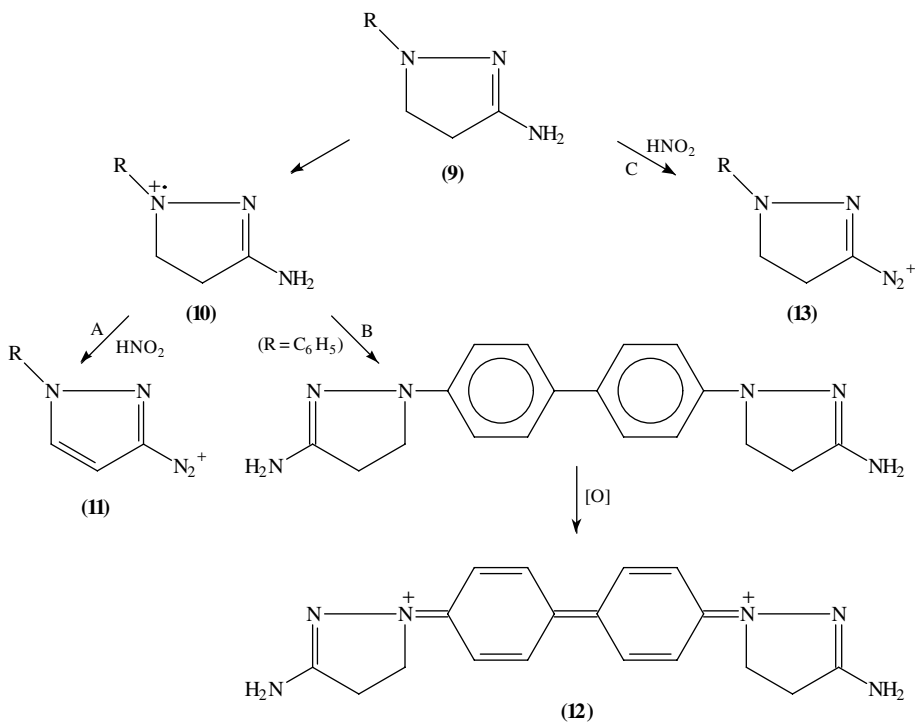
shows an infrared NN band ( $2130\text{ cm}^{-1}$ ) comparable to those of diazoalkanes, in contrast to the diazonium band of the cation ( $2205\text{ cm}^{-1}$ ).

The diazonium ions formed from aminoazoles are relatively strong acids. The  $\text{p}K_{\text{a}}$  values of five di-, tri- and tetrazalediazonium ions are reported to be between 3 and 4, i.e. about 10 units lower (more acidic) than those of the respective unsubstituted heterocycles (Vilarrasa and coworkers<sup>17</sup>). Therefore, deprotonation of the diazonium ion is easy and, depending on reaction conditions, yields either the diazonium salt or its conjugate base, i.e. the diazo compound. The electrophilic reactivity of the  $\beta$  nitrogen atom in the diazo group of the base is lower than the reactivity of the diazonio group of the cation<sup>18</sup>.

Reactions between 3-amino-2-pyrazolines (**9**) and nitrous acid were studied by Gorelik's group. The unsubstituted 3-amino-2-pyrazoline (**9**,  $\text{R} = \text{H}$ ) forms the pyrazole-3-diazonium ion (**11**,  $\text{R} = \text{H}$ ) in a combined hydrogenation and diazotization by the direct action of the diazotizing agent (2 equivalents) on the dihydroaromatic amine (Scheme 2, pathway A, Gorelik and Lomzakova<sup>19</sup>). For 1-phenyl-3-amino-2-pyrazoline (**9**,  $\text{R} = \text{C}_6\text{H}_5$ ) a completely different reaction was found (equation 5, pathway B). When aqueous  $\text{NaNO}_2$  is added to a solution of **9** ( $\text{R} = \text{C}_6\text{H}_5$ ) in dilute HCl, the red color characteristic of the cation radical **10** is observed. After 1–2 min it changes into a blue color. The blue compound when isolated corresponds to the dichloride of the dication of **12**. If the order in which these reagents are mixed is changed, the reaction leads to a different result. A solution of **9** ( $\text{R} = \text{C}_6\text{H}_5$ ) and two equivalents of  $\text{NaNO}_2$  in aqueous acetone is added to 17% HCl/ $\text{H}_2\text{O}$  over 1.5 hours. The product is 1-phenylpyrazole-3-diazonium chloride (**11**,  $\text{R} = \text{C}_6\text{H}_5$ ; Gorelik and coworkers<sup>20</sup>). This reaction therefore corresponds to pathway A obtained with 3-amino-2-pyrazoline.

However, Gorelik's group<sup>20</sup> found even a fourth alternative reaction! If the phenyl group in 1-phenyl-3-amino-2-pyrazoline contains electron-withdrawing substituents (2,4-dinitro or 4-phenylsulfonyl), diazotization is faster than dehydrogenation and consequently the 1-aryl-2-pyrazoline-3-diazonium ions **13** are formed (pathway C). Evidently the higher oxidation–reduction potential is increased by these substituents and prevents their oxidation to cation-radicals of the type **10** [ $\text{R} = 2,4\text{-(NO}_2)_2\text{C}_6\text{H}_3$ ,  $4\text{-CH}_3\text{COC}_6\text{H}_4$  or  $4\text{-C}_6\text{H}_5\text{SO}_2\text{C}_6\text{H}_4$ ].



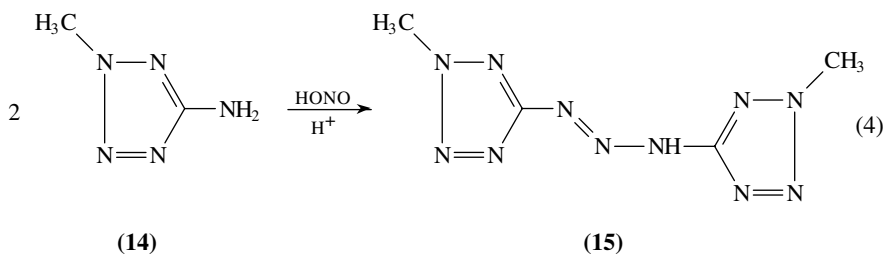


R=H or aryl (see text)

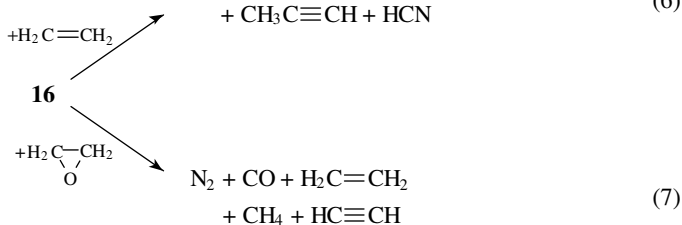
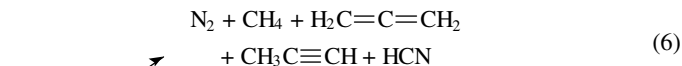
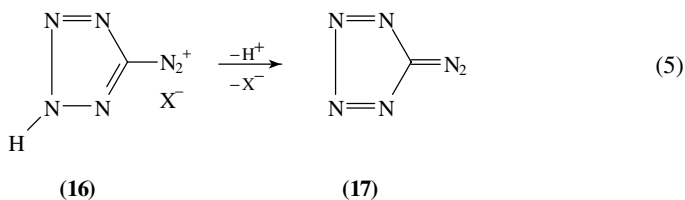
SCHEME 2

The diazonium ions **13** with electron-withdrawing substituents are *not* heteroaromatic compounds and therefore do not strictly come within the scope of this chapter. They are formally related to the alkenediazonium ions. Nevertheless, they are discussed here because in their properties they bear a close resemblance to heteroaromatic and arenediazonium ions rather than to alkenediazonium ions. In particular they can be obtained by direct diazotization of the amines, they are stable in an aqueous medium and they are capable of undergoing an azo coupling reaction.

In some cases the primary diazotization products cannot be isolated. For example, diazotization of 2-methyl-5-aminotetrazole (**14**) directly yields the triazene **15**, i.e. the *N*-coupling product, since the intermediate diazonium ion is reactive enough to give the *N*-coupling product with the parent amine even under strongly acidic conditions (equation 4; Butler and Scott<sup>21</sup>).



5-Diazotetrazole (**16**) was obtained by dropwise addition of 2-pentyl nitrite to a solution of 5-amino-1*H*-tetrazole in a 4:1 mixture of tetrahydrofuran and aqueous hydrochloric acid. The diazonium chloride can be extracted into ether. Shevlin<sup>22</sup> obtained the extremely explosive solid diazonium salt (**16**) by evaporation of that solution. He has recommended that not more than 0.75 mmol of diazonium salt be isolated at one time. An explosion during the diazotization of 5-aminotetrazole on a laboratory scale was described by Gray and coworkers<sup>23</sup>. The structure **17** (equation 5) indicates clearly that this diazo compound may have the tendency to decompose into ‘atomic carbon’ and three equivalents of dinitrogen—a reaction which is clearly highly exothermic. The decomposition of the tetrazole-5-diazonium chloride (**16**) has been studied by Shevlin<sup>22</sup> by coating the salt on the walls of a 500 ml flask in the presence of two substrates, ethene and ethylene oxide. With ethene the products found after heating the flask to 80 °C are shown in equation 6, and with ethylene oxide in equation 7. The products correspond to those found with atomic carbon formed by completely different methods (see references cited by Shevlin).



Diazotization of the aminopyridines and aminopyridine oxides was studied in detail by Kalatzis and coworkers. Diazotization of 3-aminopyridine and its derivatives is similar to that of aromatic amines because of the formation of rather stable diazonium ions. 2- and 4-aminopyridines were considered to resist diazotization or to form mainly the corresponding hydroxy compounds. However, Kalatzis<sup>24</sup> showed that true diazotization of these compounds proceeds in a similar way to that of the aromatic amines in 0.5–4.0 M hydrochloric, sulfuric or perchloric acid, by mixing the solutions with aqueous sodium nitrite at 0 °C. However, the rapidly formed diazonium ion is hydrolyzed very easily within a few minutes (hydroxy-de-diazonation). The diazonium ion must be used immediately after formation, e.g. for a diazo coupling reaction, or must be stabilized as the diazoate by prompt neutralization (after 45 s) to pH 10–11 with sodium hydroxide–borax buffer. All isomeric aminopyridine-1-oxides can be diazotized in the usual way (Kalatzis and Mastrokalos<sup>25</sup>). The diazotization of 5-aminopyrimidines results in a complex ring opening and conversion into other heterocyclic systems (see Nemeryuk and coworkers<sup>26</sup>).

When the heteroaromatic amine is insufficiently soluble in aqueous acid, it can be dissolved in the minimum volume of an organic solvent miscible with water. Dilute mineral acid and a solution of sodium nitrite are then added. An example is the diazotization of 2-phenyl-3,4-acetyl-5-methyl-pyrrole (Dattolo and coworkers<sup>27</sup>). As the amines become

more weakly basic, the normal method of diazotization becomes progressively more difficult. The equilibrium between amine and ammonium salt increasingly favors the former which, usually because of its poor solubility in water, is prevented from taking part in the reaction. Research into the mechanism of diazotization has demonstrated that the important step is the addition of the nitrosating agent to the *base* of the amine. Thus, the acidity for each diazotization should be so chosen that the equilibrium concentration of base corresponds to that of its saturated solution. This rule leads to the use of higher concentrations of aqueous mineral acid for weakly basic amines.

Yet in more concentrated aqueous mineral acids additional complications have to be considered. In hydrochloric acid containing more than 20% HCl, nitrous acid begins to exert an unfavorable oxidizing effect according to equation 8. As Hoffman<sup>28</sup> showed in a contribution to *Organic Syntheses*, diazotizations can be performed in mixtures of concentrated aqueous hydrochloric acid and glacial acetic acid (10:3). When nitrite solution is added dropwise to sulfuric or nitric acid of concentration greater than 25%, the rate of evolution of nitrous gases is greater than that of nitrosation.



Diazotization can be carried out without difficulty in 90–96% sulfuric acid, however. Nitrous fumes are given off as soon as aqueous solutions of nitrite salts are added to sulfuric acid of lower concentration, but *solid* sodium nitrite can be dissolved in 90–96% sulfuric acid at 0–10 °C smoothly and without evolution of gas. Nitrosylsulfuric acid,  $\text{NO}^+\text{HSO}_4^-$ , is formed. Directions for the preparation of 2 M nitrosylsulfuric acid are given by Fierz-David and Blangey<sup>4a</sup>, but sodium hydrogen sulfate crystallizes after some time from acid of this strength so that it is best to prepare a stock solution of 1 M sodium nitrite in 96% sulfuric acid, which is quite stable at room temperature.

More concentrated solutions of nitrosylsulfuric acid containing no sodium ions can be obtained by reducing a solution of nitric acid in concentrated sulfuric acid with gaseous  $\text{SO}_2$ .

We shall discuss the acid–base equilibria of nitrous acid in aqueous mineral acids of increasing concentration in Section II.E.

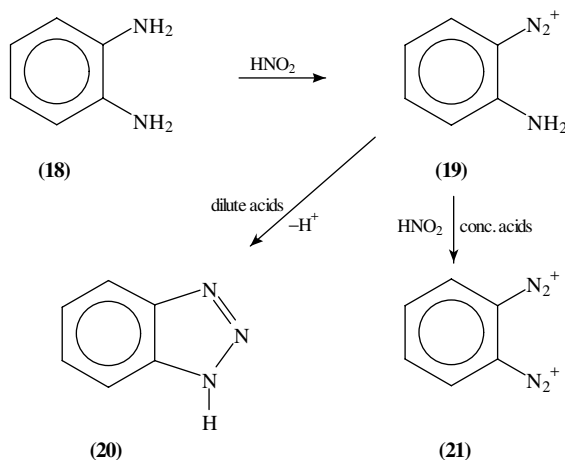
The nitrosylsulfuric acid method is particularly suitable for the diazotization of di- and trinitroanilines and aminoanthraquinones. Such amines may be added directly to the nitrosylsulfuric acid, but it is preferable to run the appropriate amount of nitrosylsulfuric acid into a solution of the amine in 96% sulfuric acid. In general, these diazotizations can be carried out at room temperature. The end-point is determined in the usual manner with iodide paper, but only after first diluting a few drops with ice. On completion, the whole is diluted with ice. The test with iodide paper fails in the case of polynitrodiazonium salts.

In 1969 a serious explosion took place in Basle when 287 kg (1.3 kmol) of 2-chloro-4,6-dinitroaniline was diazotized in 384 kg 40% nitrosylsulfuric acid. The temperature was increased from 30 °C to 50 °C and kept at that level. Shortly afterwards the explosion occurred; three workers were killed and 31 injured, some seriously. The reaction had been carried out twice before in the same way without difficulty. Detailed investigations (Bersier, Valpiana and Zubler<sup>29</sup>) with the help of differential scanning calorimetry showed that, at the high concentration of that batch, a strongly exothermic reaction (1500 kJ/kg) starts at about 77 °C. In contrast, when the reactants were diluted with 96% sulfuric acid to twice the volume, the reaction was found to begin at 146 °C, generating only 200 kJ/kg.

Bersier and coworkers<sup>29</sup> published a list of 20 aromatic and heteroaromatic amines whose stabilities in diazotization systems have been investigated. Aqueous systems are harmless, even with amines containing one or two nitro groups (provided that they can be diazotized at all in water). In 96% sulfuric acid, diazotizations of aminoanthraquinones are not dangerous; this is also the case for heteroaromatic amines in mixtures of sulfuric acid

and acetic acid. Diazotization of dinitro- and halogenodinitroanilines in 96% sulfuric acid, particularly with amine concentrations above 1 mol/kg, is dangerous. Aqueous systems are less hazardous because of the higher specific heat of water relative to that of sulfuric acid. If diazonium salts precipitate during the reaction one has to be careful in all cases, as solid diazonium salts can detonate (see Section II.B).

If an aromatic *o*-diamine such as 1,2-diaminobenzene (**18**) is diazotized in dilute aqueous acid, the 2-aminobenzene-1-diazonium ion formed first (**19**) undergoes a rapid intramolecular *N*-azo coupling reaction to give 1,2,3-benzotriazole (**20**). Both amino groups of **18** can, however, be diazotized in concentrated acid (Scheme 3), forming the bisdiazonium ion **21**. 1,3- and 1,4-diamines must also be bisdiazotized in concentrated acids in order to avoid intermolecular *N*- or *C*-coupling.



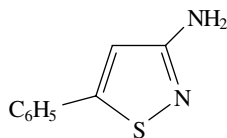
SCHEME 3

If the water content of the diazotization system is too high, the halogen atom in halogen-substituted mono- and dinitroanilines may be replaced by a hydroxy group in a bimolecular aromatic substitution. Analogous behavior was observed by Stacey's group<sup>30</sup> in the diazotization of pentafluoroaniline, where the 4-fluoro substituent became hydrolyzed. Later, Sonoda and Kobayashi's group<sup>31</sup> found that this side reaction does not take place if the diazotization is conducted in the dichloromethane–aqueous sulfuric acid two-phase system in the presence of tetrakis[3,5-bis(trifluoromethyl)-phenyl]borate.

In some cases the use of nitrosylsulfuric acid may be avoided if 1-naphthalenesulfonic acid is added to moderately concentrated sulfuric acid (20–60%). This greatly reduces the evolution of nitrous fumes compared with a solution of pure sulfuric acid of the same hydrogen ion concentration. It has not yet been investigated whether the phenomenon is due to the formation of an ion pair,  $[\text{C}_{10}\text{H}_7\text{SO}_3^-\text{NO}^+]$ , or whether it is simply a solubility effect. In any case, the total acidity range of 4–12 M has thereby become available for diazotization; technically crude sulfonation mixtures are used after dilution with water, for example, a solution of total acidity 4 M of which 2.7 M is due to sulfuric acid. A further advantage of the method lies in the stabilizing effect of the naphthalenesulfonic acid on the diazonium compounds formed (see Section II.B).

The rates of diazotizations in nitrosylsulfuric acid can be increased favorably by the addition of acetic or propionic acid. A mixture of the two acids is frequently used as an additive in diazotizations of heteroaromatic amines, as it has a lower melting point than acetic acid (0 °C or lower), but little is mentioned about it in the scientific literature

(review: Butler<sup>14</sup>). A good example of a diazotization in an acetic/propionic acid mixture at  $-40^{\circ}\text{C}$  was described by Goerdeler and Roegler<sup>32</sup> for 3-amino-5-phenylisothiazole (**22**). In phosphoric acid, in contrast, a diazotization of this compound gave a very low yield in the azo coupling reaction. The diazonium salts of the isomeric 5-aminoisothiazoles can be obtained by diazotization in 2 M  $\text{H}_2\text{SO}_4$ , but they are not very stable, except when they contain electron-attracting substituents (CN,  $\text{COCH}_3$  or  $\text{COOEt}$ ) in the 4-position. Other examples of diazotizations in acetic/propionic acid mixtures have been described in detail by Ginsberg and Goerdeler and by Alty and coworkers<sup>33,34</sup>.



(22)

Belyaev and coworkers<sup>35</sup> demonstrated that weakly basic aromatic amines which have a low solubility in diazotizing systems can be diazotized smoothly and with excellent yields ( $>97\%$ ) in mixtures of acetic acid and polyphosphoric acid.

## B. Isolation of Diazonium Salts

In most cases diazonium salts are not isolated, but are converted into products by reactions that can be carried out in situ. Moreover, it is actually recommended not to isolate these salts, not even for purification purposes, as many of them have a tendency to explode. In addition, the high solubility of most diazonium salts in water makes precipitation from this medium difficult. Therefore, to obtain solid diazonium salts the recommended method for many decades was to carry out diazotizations in ethanol followed by precipitation with ether. As inorganic salts of nitrous acid are scarcely soluble in ethanol, Knoevenagel recommended alkyl nitrites (ethyl or 2-pentyl nitrite) as diazotization reagents as long ago as 1890. Various other solvents have subsequently been used for diazotizations with alkyl nitrites (see Saunders and Allen<sup>5b</sup>), but as a method for obtaining solid diazonium salts this has been superseded by the isolation of diazonium tetrafluoroborates and, to a lesser degree, of hexafluorophosphates.

These salts can be made easily since tetrafluoroboric acid ( $\text{HBF}_4$ ) and hexafluorophosphoric acid ( $\text{HPF}_6$ ) are commercially available. However, the main advantage of the diazonium salts with the anions of these acids is their stability, which is significantly higher than that of probably all other diazonium salts. 4-Nitrobenzenediazonium tetrafluoroborate is nowadays even a commercial product. Preparative diazotization methods with these two acids can be found in *Organic Syntheses* (tetrafluoroborate: Starkey<sup>36</sup>; hexafluorophosphate: Rutherford and Redmont<sup>37</sup>).

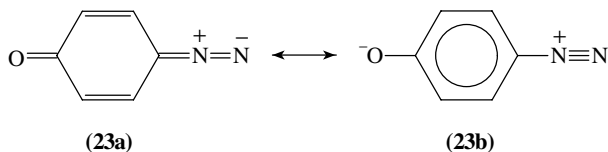
Another group of stable diazonium salts are the so-called diazonium metal double salts: the zinc double chlorides are particularly important. The term is misleading, as they are not associations between two salts but, in the case of Zn, are formed from two arenediazonium ions with the complex anion  $\text{ZnCl}_4^{2-}$ . This fact became obvious from crystal structure studies<sup>38-41</sup>. The reason for their increased stability relative to  $\text{ArN}_2^+\text{Cl}^-$  salts is that  $\text{ZnCl}_4^{2-}$  complex ions are less nucleophilic than free chloride ions.

Salts of diazonium ions with certain arenesulfonate ions also have a relatively high stability in the solid state. They are also used for inhibiting the decomposition of diazonium ions in solution. Experimental data<sup>42,43</sup> point to the formation of molecular

complexes of the diazonium ions with the arenesulfonates rather than to diazosulfonates ( $\text{ArN}_2\text{—OSO}_2\text{Ar}'$ ) as previously thought. For a diazonium ion in acetic acid/water (4:1), the complex equilibrium constants are found to increase in the order naphthalene < 1-methylnaphthalene < naphthalene-1-sulfonic acid < 1-naphthylmethanesulfonic acid. The sequence reflects the combined effects of the electron-donor properties of these compounds and the Coulomb attraction between the diazonium cation and the sulfonate anions (where present). Arenediazonium salt solutions are also stabilized by crown ethers.

### C. Diazotization of 2- and 4-Aminophenols

Diazotized 2- and 4-aminophenols as well as corresponding diazotized aminonaphthols and hydroxy derivatives of higher condensed aminoaromatic systems exist in neutral aqueous solutions as zwitterions (**23b**) which are mesomeric with the corresponding quinone diazides (**23a**). They can therefore be classified either as diazonium ions or as diazoketones. Indeed, preparative methods for these compounds include those typical for diazonium ions *and* those used for diazoketones.

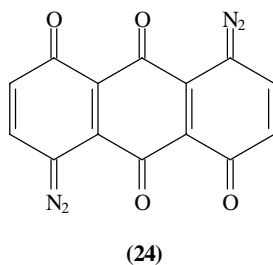


As the preparative methods related to the syntheses used for diazoketones are no diazotizations and, in part, do not start from amines, they are not within the scope of this book. They are reviewed in Zollinger's books on diazo chemistry<sup>3b,7c</sup>.

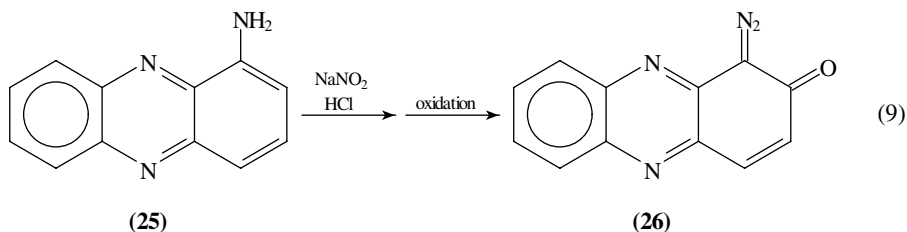
A compilation of some 240 examples in the book by Ershov, Nikiforov and de Jonge<sup>44a</sup> demonstrates, however, that the most frequently used method is diazotization, applied to 2- or 4-aminophenols in the same or a similar way as described in Section II.A. It may be recalled that the very first diazotization (Griess, 1858) was carried out with an aminophenol derivative.

The major problem of these diazotizations is oxidation of the initial aminophenols by nitrous acid to the corresponding quinones. Easily oxidized amines, in particular aminonaphthols, are therefore commonly diazotized in a weakly acidic medium ( $\text{pH} \approx 3$ ) so-called neutral diazotization or in the presence of zinc or copper salts. This process, which is due to Sandmeyer, is important in the manufacture of diazo components for metal complex dyes, in particular those derived from 1-amino-2-naphthol-4-sulfonic acid.

Sometimes decomposition reactions can be avoided by carrying out diazotizations in concentrated sulfuric acid. By this method Law and coworkers<sup>45</sup> obtained the 1,5-bisdiazonium salt (incorrectly called tetrazonium salt) of 1,5-diamino-4,8-dihydroxyanthraquinone, which is deprotonated to **24**. The structure was verified by cross-polarization magic angle spinning (CPMAS) <sup>13</sup>C NMR spectroscopy.



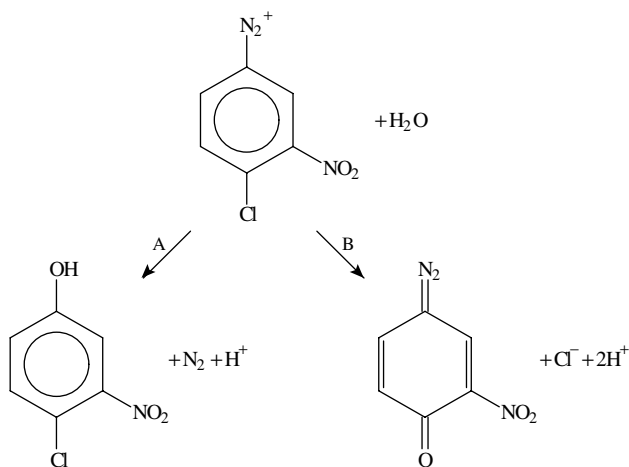
On the other hand, there is at least one case of an aromatic amine *without* a hydroxy group in the 2-position, namely 1-aminophenazine (**25**) which, after the initial diazotization, is oxidized within minutes by air or additional nitrous acid to the quinone diazide **26** (equation 9)<sup>46</sup>. In the corresponding diazotization of 2-aminophenazine the proportion of the quinone diazide (isomer of **26**) amounted to only 16%, but 30% unsubstituted phenazine was also found. The phenazine may have resulted from the overall redox reaction.



The diazonio group is characterized by extremely strong -M and -I effects. Therefore aromatic diazonium ions with a strongly nucleofugic leaving group in the 2- or 4-position readily undergo nucleophilic aromatic substitution of that leaving group by a hydroxy group, forming a quinone diazide. Primarily suitable for this type of substitution are compounds with halogens as leaving groups, but there are also cases in which a nitro group has been replaced by a hydroxy group, for example 4,2-chloronitrobenzene-diazonium ion hydrolyzes by denitration, forming 4-chloro-2-quinone-1-diazide<sup>47,48</sup>. On the other hand, in 2,3,5,6-tetrafluoro-4-nitroaniline the fluorine rather than the nitro group is displaced<sup>49</sup>.

Similar nucleophilic substitutions of other groups during diazotizations (chloro-denitrations) were found by Oku and Matsui<sup>50</sup> and Trimmer<sup>51</sup>.

The general applicability of this type of synthesis of quinone diazides is nevertheless limited since, depending on the type and number of substituents in the 2-, 4- and 6-positions of benzenediazonium ions, either hydroxy-de-diazotiation (reaction A in Scheme 4) or nucleophilic substitution of one of the groups in the 2-, 4- or 6-position (reaction B) will predominate<sup>52</sup>.



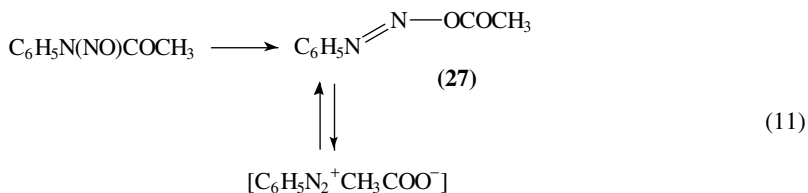
SCHEME 4

Recently, the substituent effect on the diazotization of substituted 2-aminophenols was studied<sup>53</sup> in aqueous hydrochloric acid solution. When the substituent is strongly electron-withdrawing, such as a nitro group, the diazotized product deprotonates and forms a substituted 1,2-benzoquinone-1-diazide which usually precipitates.

Syntheses of complex heterocyclic quinone diazides have been tabulated by Ershov, Nikiforov and de Jonge<sup>44b</sup> and more recently by Tišler's group<sup>54</sup>.

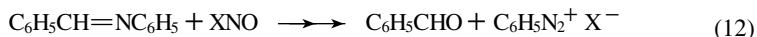
#### D. Formation of Diazonium Salts under Anhydrous Conditions

In the classical methods of diazotization an equimolar amount of water is formed as by-product. In certain cases this is not desirable. One method for obtaining diazonium salts without formation of water is the rearrangement of *N*-nitroso-*N*-arylacetyl amides. Bamberger<sup>55</sup> discovered in 1897 that *N*-nitrosoacetanilide decomposes easily in benzene to give biphenyl, acetic acid and dinitrogen (equation 10). Huisgen and Horeld<sup>56</sup> showed that the key step of Bamberger's reaction is the isomerization of *N*-nitrosoacetanilide to the diazo acetate (27) and Suschitzky<sup>57</sup> found that 27 dissociates into the diazonium-acetate ion pair 28 (equation 11).



The consecutive dediazonation is fast relative to the rate-determining steps in equation 11. The influence of the presence or absence of water on these dediazoniations of ion pairs like 28 will be discussed briefly in Section III.A of this review.

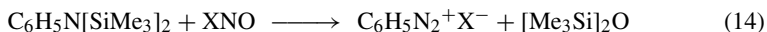
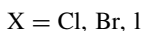
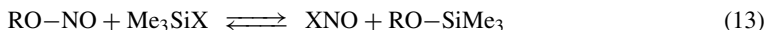
A second method for forming diazonium ions was initiated by Turcan<sup>58</sup> in 1935. He reported that nitrosyl chloride and dinitrogen tetroxide react with *N*-benzylideneaniline under mild conditions in anhydrous ether or benzene to produce benzaldehyde and the corresponding benzenediazonium salt (equation 12). After nitrosonium salts became readily available (Olah and coworkers<sup>59</sup>) Doyle's group<sup>60</sup> demonstrated that with  $\text{NO}^+\text{BF}_4^-$  or  $\text{NO}^+\text{SbF}_6^-$  in anhydrous acetonitrile or nitromethane yields are usually higher than 90%. Bachman and Michalowicz<sup>61</sup>, Zimmer and Singh<sup>62</sup> and Bott<sup>63</sup> found analogous ways of nitrosating other compounds of the type  $\text{Ar}-\text{N}=\text{Y}$ , where Y is CO (phenylisocyanate),  $\text{P}(\text{C}_6\text{H}_5)_3$  (triphenylphosphinephenylimine) or SO (sulfinylphenylimine).



Nitrosyl halides, particularly NOCl and NOBr, can also be used as diazotization reagents under anhydrous conditions, as these gases (NOCl: mp  $-59.6^\circ\text{C}$ , bp  $-6.4^\circ\text{C}$ ; NOBr: bp  $\approx 0^\circ\text{C}$ ) are readily soluble in many organic solvents. They can also be generated in situ in chlorinated hydrocarbons by reaction of trimethylsilyl halides with alkyl nitrites (equation 13) as shown by Weiss and Wagner<sup>64</sup>. The group of Weiss<sup>65</sup> found also that *N,N*-bissilylated anilines react in aprotic dichloromethane with generation of diazonium salts and formation of the nonnucleophilic hexamethyldisiloxane (equation 14).



The authors indicate that the monosilylated aniline  $C_6H_5NHSiMe_3$  reacts in many cases in an analogous way. This seems surprising, since the hydroxytrimethylsilane  $HOSiMe_3$  that is formed is a potential proton donor, as it will rapidly condense to give  $Me_3SiOSiMe_3 + H_2O$ .



Furthermore, Weiss and coworkers<sup>66</sup> developed also a method of diazotizing aminocyclopropenium salts with nitrosyl salts in the presence of two equivalents of trimethylchlorosilane to trap the water produced. In a modification of this method the authors showed that the use of the *tert*-butylated amine was an advantage, as the risk of oxidation of the alkylated amino group by the nitrosyl ion is less than in the case of the primary amine. This method would also appear to be suitable for the diazotization of other sensitive amines.

2-Amino- and 4-amino-1,2,4-triazole undergo a reductive dediazonation to 1,2,4-triazole when treated with nitrosonium tetrafluoroborate in the presence of mesitylene<sup>67</sup>.

Doyle and Bryker<sup>68</sup> reported high yields of arenediazonium tetrafluoroborates when aromatic amines were reacted with *tert*-butyl nitrite and trifluoroboro etherate in  $CH_2Cl_2$ . It is likely that nitrosyl fluoride is formed as nitrosating reagent by fluoride-alkoxy exchange.

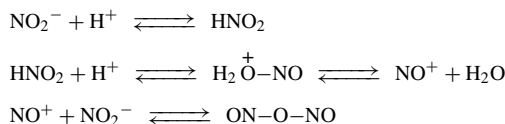
## E. Mechanism and Kinetics of Rate-limiting Nitrosation Steps

Challis and Butler's review on diazotizations in the volume on amines in *The Chemistry of Functional Groups* series<sup>1</sup> was published at a time (1968) when the principal mechanistic aspects of these reactions and the pioneering kinetic investigations allow a consistent description and evaluation of the characteristics of diazotizations to be given. In particular, there was convincing evidence for nitroso-de-protonation as the essential part of the diazotization. Kinetic results were consistent with three types of reacting nitrosation reagents, namely—depending on reaction conditions—with dinitrogen trioxide (nitrous anhydride,  $ON-ONO$ ), nitrosyl halides and a cationic nitrosating reagent which was either the nitrosonium ion ( $ON^+$ ) or the nitrosoacidium ion ( $ON-OH_2^+$ ). Corresponding to Ingold's general concepts of electrophilic substitutions it was assumed that, as a substrate, only arylamines, but, under strongly acidic conditions, arylammonium ions were considered—with some reservation—to be also capable of being reactive partners in diazotizations.

We are gratified to realize, almost thirty years later, that these results are essentially still valid. We owe this pleasant development first of all to Ridd. He started to investigate the mechanism of diazotization under Ingold and Hughes in 1950 and continued it independently until the early 1990s. Some of his former coworkers and other chemists became active in the same field.

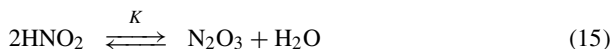
The classical discoveries of the reacting nitrosation reagents mentioned above were mainly the result of kinetic investigations. There were some surprising results, e.g. the dependence of the diazotization rate on the square of the nitrous acid concentration in sulfuric or perchloric acid up to 0.3 M. Nitrous acid is a fairly weak acid ( $pK_a = 3.15^{69}$ ). Therefore, the low concentration of nitrite ions in the last step of the nitrous acid equilibria system of Scheme 5 does not appear to favor the formation of dinitrogen trioxide.  $N_2O_3$  is, however, strongly indicated by the second order of rate on the (analytical) nitrous acid concentration.

Yet at fairly high nitrous acid concentrations (0.1 M) and at moderate acidities (4 M) the blue color of  $N_2O_3$  ( $\lambda_{max} = 625 \text{ nm}$ ) is easily detected by eye. A relatively recent

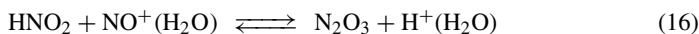


SCHEME 5

determination of the overall equilibrium constant of the system (equation 15) gave the value  $K = 3.0 \times 10^{-3} \text{ M}^{70}$ . Accurate determination of this constant is difficult, since  $\text{N}_2\text{O}_3$  decomposes easily into  $\text{NO}$  and  $\text{NO}_2$ . Pure  $\text{N}_2\text{O}_3$  is stable only as a pale blue solid or as an intensely blue liquid just above its freezing point ( $-100^\circ\text{C}$ ). The liquid starts to boil with decomposition above  $-40^\circ\text{C}$ . In spite of these qualitative properties, the value of  $K$  tells us clearly that the nucleophilicity of nitrite ion is sufficiently high for the last equilibrium of Scheme 5 to be effective.

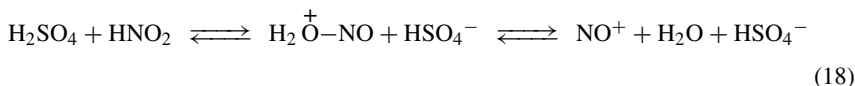


The decomposition of nitrous acid solutions was investigated by Bayliss and Watts<sup>71</sup> in 10–65% sulfuric acid. The rate constant for decomposition at  $19.5^\circ\text{C}$  increases from  $2.5 \times 10^{-4} \text{ s}^{-1}$  in 10%  $\text{H}_2\text{SO}_4$  to  $14 \times 10^{-4} \text{ s}^{-1}$  in 50%  $\text{H}_2\text{SO}_4$ , but decreases to almost zero in 65%  $\text{H}_2\text{SO}_4$ . As the maximum rate of decomposition occurs in those solutions in which both the nitrosyl ion (or the nitrosoacidium ion) and the nitrous acid molecule are present in appreciable concentrations, it is likely that the main pathway is that shown in equations 16 and 17. A more detailed inspection of Bayliss's and Watt's data (unfortunately given only in a figure, and not numerically) indicates, however, that there are other parallel reactions leading to decomposition.



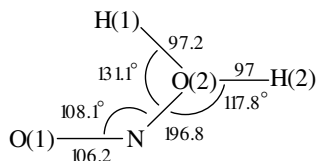
At higher concentration of sulfuric acid ( $>0.3 \text{ M}$ ), diazotization rates are no longer second order with respect to nitrous acid, but first order. Therefore,  $\text{N}_2\text{O}_3$  cannot be the nitrosating reagent. The marked acid catalysis indicates that the new agent is some species whose equilibrium concentration increases rapidly with increasing acidity. It may be the nitrosoacidium ion, but could also be the nitrosyl ion. Arguments for either  $\text{NO}^+$  or  $\text{H}_2\overset{+}{\text{O}}\text{-NO}$  or both as nitrosating reagent were discussed in the literature for many years. The arguments have been reviewed by Ridd<sup>72a</sup> and by Williams<sup>73a</sup>. In the opinion of the present author, there is no *experimental* evidence that clearly falsifies either  $\text{NO}^+$  or  $\text{H}_2\overset{+}{\text{O}}\text{-NO}$  as reagent in water.

More than thirty years ago Seel and Winkler<sup>74</sup> as well as Bayliss and coworkers<sup>75</sup> investigated the UV absorption spectra of sodium nitrite in aqueous solutions of sulfuric and perchloric acids (equation 18, for  $\text{H}_2\text{SO}_4$ ). The absorption band found at 250 nm is due either to the nitrosoacidium ion or to the nitrosyl ion. From the absorbency of this band the equilibrium concentrations of  $\text{HNO}_2$  and  $\text{NO}^+$  or  $\text{H}_2\overset{+}{\text{O}}\text{-NO}$  were calculated over the acid concentration ranges 0–100%  $\text{H}_2\text{SO}_4$  (by weight) and 0–72%  $\text{HClO}_4$  (by weight). For both solvent systems the concentrations determined for the two (or three) equilibrium species correlate with the acidity function  $H_R$ . This acidity function is defined for protonation–dehydration processes, and it is usually measured using triarylcarbinol indicators in the equilibrium shown in equation 19 (for a relatively recent review see Cox and Yates<sup>76</sup>).



The carbinol equilibrium (equation 19) is comparable to the nitrous acid equilibrium (equation 18), but this correlation does not exclude the nitrosoacidium intermediate because the corresponding protonated carbinol was not positively excluded in equation 19.

A speculative proposal was made thirty years ago by Schmid and Krenmayr<sup>77</sup>, namely that a nitrosyl ion solvated, but not covalently bonded, by a water molecule may be involved in these systems. This hypothesis was investigated theoretically in 1984 by Nguyen and Hegarty<sup>78</sup> who carried out *ab initio* SCF calculations of structure and properties employing the minimal STO-3G basis set, a split-valence basis set plus polarization functions. Optimized geometries of six planar and two nonplanar forms were studied for the nitrosoacidium ion. The lowest minimum of molecular electrostatic potential resulted for the structure **29**. Among the bond lengths it is indeed the N—O(2) bond (196.8 pm) that turns out to be significantly longer than expected for an N—O single bond (120–140 pm). Species **29** is therefore indeed a complex which, in classical terms, may be called a nitrosyl ion solvated with one molecule of water. The complex is calculated to be more stable than its fragments by 75 kJ mol<sup>-1</sup>.



(29)

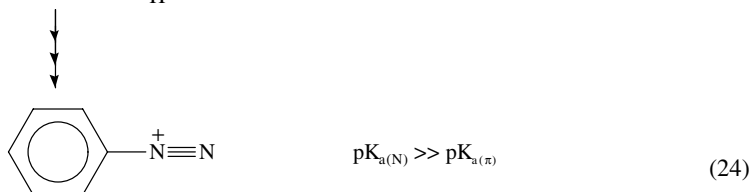
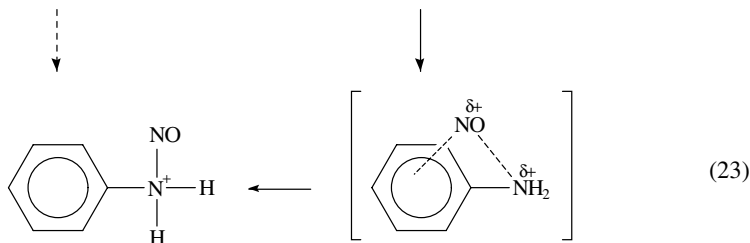
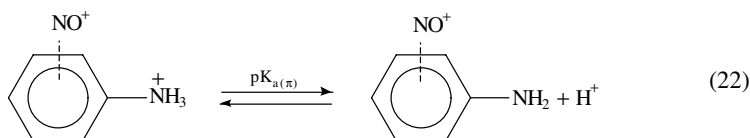
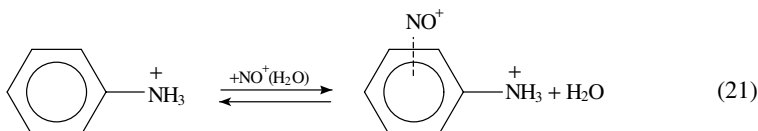
Shortly afterwards Jørgensen and Lawesson<sup>79</sup> investigated the same problem based on the concept of reactions controlled by charge and frontier orbitals<sup>80,81</sup>. Geometrical optimization has been performed using a 4-31G basis set. The calculated N—O(2) bond length is even a little longer than in Nguyen and Hegarty's work, namely 212.8 pm. The energy of the lowest unoccupied molecular orbital of the free nitrosyl ion is 123 kJ mol<sup>-1</sup> lower than the LUMO energy for the hydrated complex. This difference might account for the difference in reactivity. Jørgensen and Lawesson interpret these results on the basis of Coulomb interactions rather than orbital interaction.

On the basis of theory it is therefore now more likely that the solvated nitrosyl ion, but not the nitrosoacidium ion nor the 'free' nitrosyl ion, is the nitrosating agent in diazotization in moderately to strongly acidic solutions.

Is the anilinium ion able to react with a nitrosating reagent in strongly acidic solutions? Originally it was assumed that unsubstituted and alkylated ammonio groups like  $-\overset{+}{\text{N}}\text{H}_3$  and  $-\overset{+}{\text{N}}(\text{CH}_3)_3$  are prototypes of substituents without electron-donating power. Since quite some time, however, a large mass of data obtained with several completely different probes<sup>82</sup> indicates that these ammonio groups are modest  $\pi$ -donors with resonance effects similar to that of the isoelectronic *tert*-butyl group  $\text{CMe}_3$ . This is best seen in Taft's dual substituent parameter  $\sigma_{\text{R}}^+$ <sup>83,84</sup>:  $\text{NMe}_3$  has the value  $\sigma_{\text{R}}^+ = -0.11$ , similar to the value  $-0.18$  for  $\text{CMe}_3$ <sup>85</sup>. These negative values are clear evidence for electron donation. The

donor activity of the ammonio substituent is, however, much smaller than that of the amino group, for which  $\sigma_R^+ = -1.75^{83}$ .

Ridd and coworkers<sup>86</sup> found that the logarithm of the diazotization rate constant of aniline increased in the acidity function range  $H_0 + 0.5$  to  $-2.9$  linearly with a slope of 1. This result was interpreted with a slow step involving first the formation of a charge-transfer complex of the nitrosyl ion with the  $\pi$ -electrons of the anilinium ion, followed by the migration of the nitroso group to the nitrogen atom of the ammonio group. This rearrangement is postulated to be concerted with the transfer of an ammonio proton to a base of the system ( $H_2O$ ). The formation of a charge-transfer complex as intermediate is consistent with the fact that rates of diazotization are greater for naphthylamines than for anilines and aminopyridines of similar  $pK_a^{87,88}$ . Zollinger<sup>89</sup> proposed a slight change in that part of the mechanism involving the migration of the nitroso group. The  $pK_a$  of the dicationic charge-transfer complex must be significantly lower than that of the anilinium ion: electrophilic complexation of any benzene derivative bearing a Brønsted acid group such as  $-NH_3^+$  will increase the acidity constant of that group. Incorporating this consideration into the reaction mechanism of diazotization, the modified Ridd mechanism is shown in equations 20–24. In the original Ridd mechanism the steps 22 and 23 were combined in one step (here indicated by the dashed arrow). The inclusion of the solvated nitrosyl ion and the release of a water molecule in 21 is tentative. The original papers of Ridd<sup>86</sup> and Zollinger<sup>89</sup> contain only the (free) nitrosyl ion.



At very high acidities ( $H_0 < -3.5$ ) the logarithmic rate constant of diazotization decreases again. The dependency of  $\log k$  is linear in  $h_0^{-2.1}$ . At these high acidities the nitrous acid equilibrium (equation 18) is almost completely on the side of the (solvated) nitrosyl cation and that of the amine on the side of anilinium ion. Together with additional experimental data Ridd concluded already in 1960 that the deprotonations of the  $\pi$ -nitrosoanilinium dication (equation 22) and of the *N*-nitrosoanilinium ion (equation 24) belong to the rate-determining part of the reaction. We do not discuss these conditions because they were reviewed already by Challis and Butler in the original volume on amines in this series<sup>1</sup>.

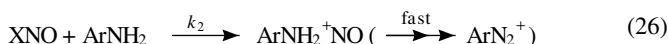
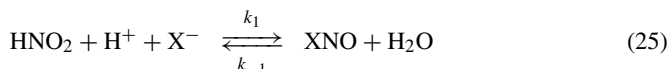
Aminopyridines<sup>90,91</sup>, aminopyridine-1-oxides<sup>25</sup>, 3-aminoquinoline<sup>92</sup> and 2-aminothiazole<sup>93</sup> are obviously diazotized by analogous processes. For 4-aminopyridine, 3-aminoquinoline and 2-aminothiazole it was shown that the monocation, protonated at the heterocyclic nitrogen, is nitrosated preferentially.

## F. Nucleophilic Catalysis and the Transformation Mechanism of *N*-Nitrosoamines into Diazonium Ions

In the preceding section we concentrated on the rate-limiting steps of diazotizations in aqueous sulfuric and perchloric acid. The results were the identification of dinitrogen trioxide and (solvated) nitrosyl ions as electrophilic reagents, aniline and anilinium ion as nucleophilic reagents and an interpretation of the influence of acidity.

More complex diazotizations in other mineral acids and the pathways of the transformations of the primarily formed *N*-nitrosoamines are the subject of this section.

As found by Schmid in the 1930s<sup>94</sup> diazotizations in aqueous hydrochloric or hydrobromic acid are more complex because they are catalyzed by halide ions. Hammett<sup>95a</sup> postulated an equilibrium (equation 25) which is shifted to the right on increasing the concentration or the nucleophilicity of the nucleophile  $X^-$ . Hydrogen sulfate and perchlorate ions are very weak nucleophiles; they are not measurably effective. In the absence of other nucleophiles the nitrite ion will be the only candidate in aqueous  $H_2SO_4$  solutions (except  $H_2O$  and  $OH^-$ , of course) and  $N_2O_3$  is formed (see Section II.E). Although  $NO_2^-$  is more strongly nucleophilic than  $Cl^-$  or  $Br^-$ , the halide ions will be more effective in dilute hydrochloric or hydrobromic acid, since their concentrations are much higher. Nitrosyl chloride and nitrosyl bromide are formed, which act as nitrosating agents in such systems. Later it was shown by various authors that other nucleophiles have an analogous effect, namely thiocyanate ion ( $SCN^-$ ), thiosulfate ion ( $HS_2O_3^-$ ), dimethyl sulfide and thiourea ( $H_2NCSNH_2$ ) or its alkyl derivatives. Equilibrium constants  $K$  for the formation of nitrosyl compounds  $XNO$  in equation 27 as well as diazotization rates with aniline, 2- and 4-chloroaniline, 1-naphthylamine and other aromatic amines were measured (see summary by Williams<sup>73b</sup> and by Zollinger<sup>7d</sup>).



$$K_{XNO} = \frac{k_1}{k_{-1}} = \frac{(HNO_2)[H^+][X^-]}{[XNO]} \quad (27)$$

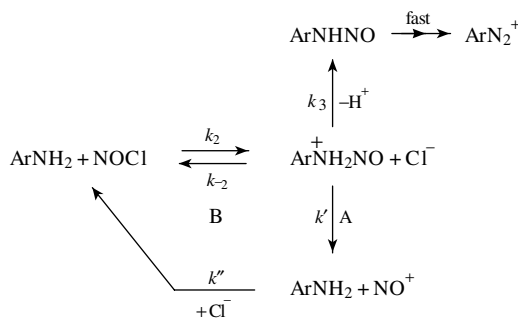
$$\text{rate} = \frac{k_2(HNO_2)[H^+][X^-](ArNH_2)K_a}{K_{XNO}([H^+] + K_a)} \quad (28)$$

( $K_a$  = acidity constant of  $ArNH_3^+$ )

The constants  $K_a$  increase with increasing nucleophilicity of  $X^-$  ( $Cl^- < Br^- < SCN^- < (H_2N)_2CS$ ). The rate constants for the nitrosation step ( $k_2$  in equation 26) are close to diffusion control in the case of  $X = Cl$  or  $Br$  but lower for reactions with nitrosation reagents  $XNO$  with stronger nucleophiles  $X^-$  (as expected). As in the case of diazotization by  $N_2O_3$  (Section II.E), either the formation of  $XNO$  or the nitrosation may be rate-limiting. The rate equation 28 is applicable only for reactions with a steady-state of  $XNO$ .

For a representative and relatively recent example of a comparative kinetic investigation of diazotization of aniline and 1-naphthylamine with various catalysts  $X^-$ , reference is made to the work of Castro and coworkers<sup>98</sup>. These authors found that the (overall) rates decrease under comparable conditions in the order  $X = Cl^- > Br^- > NO_2^- > SCN^- > (H_2N)_2CS > HS_2O_3^-$ . This sequence is not caused by higher nitrosation reactivity  $k_2$  of the nitrosating reagent  $XNO$ , but by higher values for  $K_{XNO}$  in the equilibrium (equation 25).

The nitrosation step (equation 26) was studied in the last ten years in more detail with respect to diffusion-controlled preassociation phenomena and the steps following the formation of the *N*-nitrosoanilinium ion in the step in equation 26. Besides the case of the diazotization of very reactive aniline derivatives where the formation of the nitrosyl halide (equation 25) is rate-limiting<sup>97</sup>, deprotonation of the *N*-nitrosoanilinium ion may be rate-limiting, namely if the denitrosation of  $Ar-NH_2NO^+$ , reforming  $Ar-NH_2$ , is faster than deprotonation<sup>88,98</sup>. For this denitrosation two mechanisms seem to be plausible, as shown in Scheme 6, namely either a monomolecular N–N bond dissociation into the amine and a nitrite ion which ultimately give  $NOCl$  again (A), or a bimolecular reaction of the *N*-nitrosoanilinium ion with a chloride ion (B).

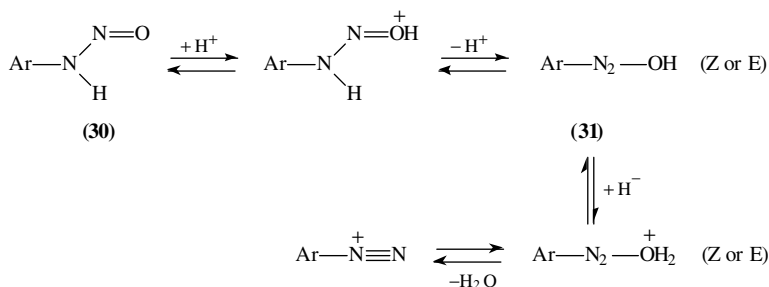


SCHEME 6

The work of the groups of Casado<sup>88</sup> and Castro<sup>98</sup>, as summarized in Scheme 6, brings us to the subsequent steps which are faster and therefore not easily accessible to mechanistic studies. Scheme 7 summarizes the most reasonable, but still tentative, mechanism.

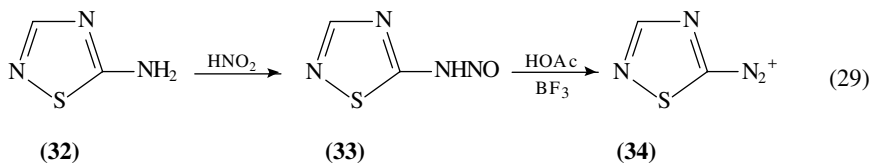
It is worth noting, however, that the prototropic equilibrium between the *N*-nitrosoamine (30) and the diazenol (31)<sup>†</sup> has been determined semiquantitatively for the analogous diazotization of an aliphatic amine. Fishbein and coworkers<sup>100</sup> determined an upper limit for the nitrosoamine equilibrium concentration (<1.5%).

<sup>†</sup> The new Guide to Nomenclature of IUPAC<sup>99</sup> includes a major change for naming diazo compounds of the general type  $R-N_2-X$ . These compounds are considered as derivatives of diazene ( $HN=NH$ ). Therefore diazohydroxides (or diazotic acids) and diazoates acquired the names diazenols and diazenolates, respectively.



SCHEME 7

Nevertheless, it is interesting that in the diazotization of a series (probably the majority) of five-membered heteroaromatic amines, at least one of the intermediates can be observed as a relatively long-lived transient species in appreciable concentration. Our understanding of the reaction conditions under which such intermediates are formed in detectable amounts is due mainly to Goerdeler and coworkers around 1960. Ginsberg and Goerdeler<sup>101</sup> nitrosated 5-amino-1,2,4-thiadiazole (**32**) in apolar solvents (e.g. ether) and isolated a compound, which was shown to be the corresponding nitrosoamine (**33**) on the basis of its IR spectrum. Addition of acetic acid and  $\text{BF}_3$  transformed this intermediate into the diazonium ion (**34**). The reaction in equation 29 is consistent with the general pattern of Scheme 7. Even under aqueous conditions the nitrosoamine **33** can be obtained if a relatively low concentration of  $\text{H}_2\text{SO}_4$  (1 M) is used.



More recently, other *N*-nitrosoamines of heteroaromatic compounds were obtained and characterized by the groups of Butler and of Stepanov<sup>102</sup>. Therefore, at least the nitrosoamine **33** does appear to be reasonably well documented as an intermediate on the pathway to the diazonium ion. A more extended review on the intermediates of Scheme 7 was published recently<sup>7e</sup>.

### III. DEDIAZONIATIONS

As mentioned in the introductory section of this chapter, dediazonation was reviewed in a volume of *The Chemistry of Functional Groups* series relatively recently (1983)<sup>2</sup> and again in more detail in a monograph in 1994<sup>7f</sup>. Therefore, we will concentrate here on a selection of major results published since the early 1980s on mechanisms of dediazoniations and on applications of dediazoniations in organic synthesis.

#### A. Mechanisms of Dediazoniations

Basically, diazonium ions can lose dinitrogen by three mechanisms:

(1) By heterolytic dissociation into carbocations and dinitrogen followed by the addition of a nucleophile (called  $\text{D}_\text{N} + \text{A}_\text{N}$  mechanism in the new IUPAC nomenclature<sup>103</sup>,  $\text{S}_\text{N}1$  in the former Ingold nomenclature).

(2) Via aryne intermediates: The aryne is formed in two steps, the first being a heterolytic dediazonation, followed by a heterolytic dissociation of a substituent (H, COO<sup>-</sup> etc.) in one of the *o*-positions relative to the diazonio group (D<sub>N</sub> + D<sub>N'</sub>). The (metastable) aryne reacts rapidly by addition of a Brønsted acid (H<sub>2</sub>O, HCl etc.).

(3) By single electron transfer from an electron donor, e.g. a transition metal ion, a trivalent phosphorous derivative or a base, followed by dissociation of the intermediate diazenyl radical in an aryl radical and dinitrogen. The aryl radical reacts with the solvent or with added reagents in various ways, as shown by the relatively large number of classical named reactions (Sandmeyer, Pschorr, Gomberg–Bachmann, Meerwein reactions).

In contrast to dediazoniations which follow mechanisms (1) and (3), the dediazonation via aryne intermediates has little importance in organic synthesis. The widely used trapping technique for aryne intermediates was shown recently to be applicable also to Buckminsterfullerene (C<sub>60</sub>)<sup>104</sup>, if 2-aminobenzoic acid is added to a refluxing benzene solution of C<sub>60</sub> and pentyl nitrite. A general caveat with respect of conclusions to negative results of trapping experiments as 'clear' evidence against aryne intermediates should be repeated here: Cadogan<sup>105</sup> reported a long time ago that (solid) benzenediazonium fluoroborate gave trapping products with tetracyclone or anthracene only if water was carefully excluded.

The dediazonation mechanism via aryl cation (1) was originally postulated by Hammett<sup>95b</sup>. Some apparent contradictions became clear by investigations of Swain and Zollinger in the 1970s (reviews<sup>2,2a,7f</sup>). The substituent effects, which were originally not understandable on the basis of a classical Hammett treatment, became clear by using dual substituent parameters (DSP), i.e. a treatment in which mesomeric (resonance) and field (inductive) effects are handled independently of each other. These two effects have opposite signs.

This property is relatively rare in the very large number of reactions for which substituent effects were evaluated quantitatively<sup>106</sup>. It seems to be common, however, for all dediazoniations of arenediazonium ions and of related compounds, e.g. of substituted phenyl azides forming nitrenes, as well as for additions of carbenes to alkenes.

These opposite signs can be explained by considering a twofold orbital interaction between the two parts of an arenediazonium ion, namely between the  $\pi$ -HOMO of the diazonio group and the  $\sigma$ -LUMO of the aryl residue, and between the  $\pi$ -HOMO of the aryl residue and the  $\pi$ -LUMO of the diazonio group. These two overlaps stabilize the C–N bond and reduce the rate of dediazonation into a phenyl cation and a nitrogen molecule. The two opposing HOMO–LUMO interactions are shown in Figure 1. Thus

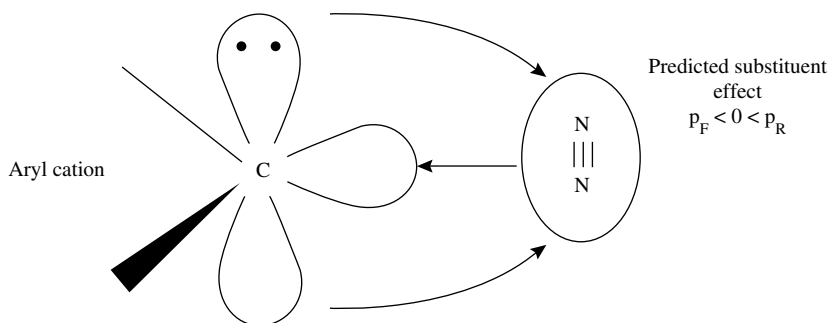
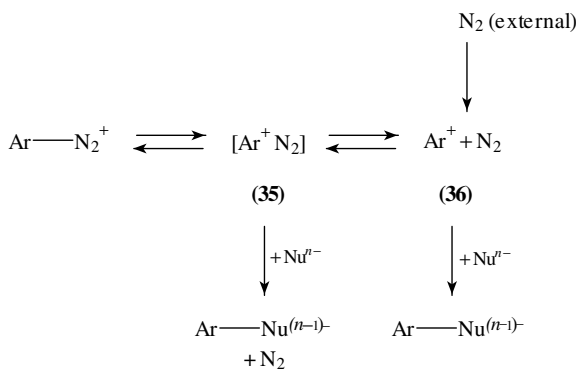


FIGURE 1. HOMO–LUMO interactions between N<sub>2</sub> and an aryl cation<sup>106</sup>. Reprinted with permission from H. Zollinger, *J. Org. Chem.*, **55**, 3846 (1990). Copyright (1990) American Chemical Society



the DSP treatment provides a reasonable interpretation of substituent effects on the basis of the  $D_N + A_N$  mechanism, i.e. rate-limiting formation of an aryl cation in aromatic dediazoniations.

Extended kinetic measurements of dediazoniations in trifluoroethanol, water and other solvents<sup>107,108</sup>, and a statistical treatment<sup>109</sup>, demonstrated that a mechanism with *two* steady-state intermediates, namely initial formation of a tight ion–molecule pair **(35)** followed by the ‘free’ (solvated) aryl cation **(36)**, fits the experimental results significantly better than a mechanism with **36** only (Scheme 8).

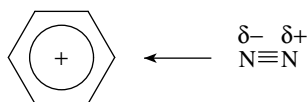


SCHEME 8

The very detailed kinetic investigation of the diazotization mechanism was, in part, necessary because the existence of a phenyl cation as its major hypothesis was doubted by theoreticians in the 1970s. Their calculated energy difference between the benzenediazonium ion and the phenyl cation was, depending on the calculation method used, 180–360 kJ mol<sup>-1</sup>, i.e. much higher than the experimental values of activation energies (114–117 kJ mol<sup>-1</sup><sup>110</sup>). As shown later, these experimental energies are very little influenced by the solvent<sup>111</sup>. For the sake of the theoreticians, the statement of Castenmiller and Buck made in their paper using MINDO/3 calculations in 1977<sup>112</sup> should be mentioned: ‘Calculations of this kind of model appear to be beyond the scope of the present possibilities’.

A quarter of a century later the situation is different. A very remarkable advance in the theoretical understanding of the dediazonation reaction is Glaser’s work<sup>113,114</sup>. Glaser and coworkers used for the calculation of changes in the stabilities of fragments of a molecule a new method, which is based on Bader’s theory of atoms in molecules<sup>115</sup>, and used *ab initio* methods on high levels (MP3 in the later calculations). The result for the activation energy of dissociation of the C–N bond in the benzenediazonium was calculated to be 105.9 kJ mol<sup>-1</sup> and, if electron correlation and the vibrational zero-point energy are included, 115 kJ mol<sup>-1</sup> — clearly an excellent result in comparison to the experimental values!

In addition to this very important result for the understanding of the dediazonation reaction, Glaser’s work revealed a completely new finding on the structure of arenediazonium ions: The calculations did not give a total charge of +1.0e for the diazonio group as we write it in the Blomstrand–Kekulé formula, but only +0.018e, namely –0.540e for N<sub>α</sub> and +0.558e for N<sub>β</sub>! The diazonio group in the benzenediazonium ion is therefore highly polarized. Glaser<sup>113</sup> proposed the formula **37** to represent its properties.



This dative bond description is therefore appropriate for the benzenediazonium ion. Glaser and coworkers found, however, that other diazonium ions ( $X-N_2^+$ ), e.g. fluorodiazonium ion ( $X = F$ ), have practically uncharged residues  $X$ , but highly charged diazonio groups, and that there are intermediate cases with a roughly even distribution of the positive charge on  $X$  and on  $N_2$ . In analogy to other problems, e.g. mesomeric structures or enol-keto equilibria, we think<sup>3c</sup> that it is appropriate to keep for naming the expression 'diazonium ion' for all compounds ( $X-N_2^+$ ), irrespective as to whether the positive charge is dominantly on  $X$  or  $N_2$ .

Fundamental knowledge on dediazoniations following mechanism (3), i.e. those initiated by an electron transfer, increased also significantly in the 1980s, but was based more on experimental than on theoretical work. Galli's experimental investigations<sup>116</sup> and his masterly review of 1988<sup>117</sup> demonstrated clearly that all homolytic dediazoniations, irrespective of whether they are catalyzed by metal ions or by light, whether they are carried out in the presence of stoichiometric or excess amounts of nonmetallic, inorganic or organic compounds, or whether electrochemical or radiolytic electron sources are used, are characterized by an initiation by electron transfer.

In these electron transfers a phenyldiazenyl radical is formed. At ambient temperature its lifetime was estimated to be  $10^{-7}$  s<sup>118</sup>; it is consistent with estimates of its decay rate constants<sup>119</sup>. Some accurate information on the lifetime of this radical was obtained by Suehiro's group, in part together with Rieker, at lower temperatures ( $-48$  to  $-117$  °C<sup>120</sup>, review<sup>121</sup>). Results indicate that the diazo group rotates about the  $C-N_\alpha$  axis and that the  $C-N_\alpha-N_\beta$  angle is about  $40^\circ$ .

Redox potentials of the halide ions explain<sup>117</sup> that direct electron release to the benzenediazonium ion takes place only with iodide (and astatide,  $^{211}\text{At}^{-122}$ ). This corresponds well with experience in organic synthesis: iodo-de-diazoniations are possible without catalysts, light or other special procedures. For bromo- and chloro-de-diazoniations, catalysis by cuprous salts (Sandmeyer reaction) is necessary. For fluorination, the Balz-Schiemann reaction of arenediazonium tetrafluoroborates in the solid state (thermolysis) or in special solvents must be chosen, i.e. a heterolytic dediazonation without electron transfer. Galli<sup>116,117</sup> demonstrated that in chloro-de-diazoniations the yield is strongly dependent on the redox potential of electron transfer catalysts (highest yields with  $\text{Cu}^+$  and  $\text{Sn}^{2+}$ ), but that the rate of electron transfer influences the yield also. Electron transfer is likely to be the rate-limiting step of aryl radical formation in dediazoniations catalyzed by transition metal salts.

An informative result for the competition between homolytic and heterolytic dediazoniations was found by Kuokkanen<sup>123</sup>: in DMSO the dediazonation of 4-nitrobenzenediazonium ion is homolytic, as shown by product analyses, and has an activation volume  $\Delta V^\ddagger = +(6.4 \pm 0.4) \times 10^{-3} \text{ M}^{-1}$ , whereas for the heterolytic reaction of benzenediazonium ion in DMSO  $\Delta V^\ddagger = +(10.4 \pm 0.4) \times 10^{-3} \text{ M}^{-1}$ .

The homolytic dediazoniations in alkaline aqueous solutions, in methanol and in highly nucleophilic solvents are extremely complex. CIDNP spectra were considered for many years as a useful source for the understanding of these processes, as shown by the relatively large number of such investigations before 1981 (16, see Zollinger<sup>7g</sup>), but the potential of this method for these problems seems to be exhausted (5 publications 1982–1992).

For the dyestuff and pigment industry, a better knowledge of dediazonation under such conditions would be useful because we estimate the loss in yields of industrially produced azo compounds due to competitive (unwanted) dediazonations to be at least 10% of the production. These 10% are mainly diazo tars which have been investigated systematically in only three papers since the 1950s<sup>124</sup>.

The stability of arenediazonium ions in solution and of their salts in the solid state against dediazonation is increased by complexation with crown ethers<sup>2b</sup>. Harada and Sugita<sup>124a</sup> showed recently that the shelf life of photosensitive diazonium salts for diazo imaging processes can be improved by this complexation.

## B. Hydro-de-diazoniations

As indicated by Kornblum in 1944<sup>125</sup> the classical method of hydro-de-diazonation by treating a diazonium salt in boiling acidic ethanol often leads to ethoxy-de-diazonation. Kornblum replaced that method by dediazonation in an aqueous solution of hypophosphorous acid ( $\text{H}_3\text{PO}_2$ ), in some cases in the presence of a catalyst, e.g. 0.05–0.10 mol% Cu. Experimental evidence indicates that aryl radicals are involved.

Another method using trivalent phosphorous compounds as single electron donors was developed recently by joint work of Yasui and Ohno with coworkers<sup>126</sup>. It is known that trivalent phosphorous compounds, which are easily converted into compounds of a higher oxidation state, readily form a fourth covalent bond when treated with an electrophile. Examples are the Arbuzov and the Wittig reactions. These authors demonstrated that arenediazonium salts react with triphenylphosphine or with trialkylphosphites (alkyl = methyl or ethyl) in methanol, ethanol, propanol and cyclohexanol at room temperature in the dark under  $\text{N}_2$  to give the corresponding arenes, i.e. the products of hydro-de-diazonation, together with triphenylphosphine oxide or with trialkyl phosphates. The yields of the arenes are dependent on the ratio of the reagents (optimum at diazonium salt: phosphorous compound = ca 2). In the presence of  $\text{O}_2$  yields are much lower. This and other evidence indicate a radical mechanism. The authors propose a radical-chain mechanism initiated by electron transfer from the phosphorous compound to the diazonium ion and formation of the aryl radical and the cation radical of the phosphorous reagent, e.g.  $(\text{C}_6\text{H}_5)_3\text{P}^{+\cdot}$ .

Earlier already 'one-pot' methods for the diazotization and hydro-de-diazonation of aromatic amines were developed<sup>127–129</sup>. Doyle<sup>128</sup> showed that diazotization of 17 representative aromatic amines with one to three electron-withdrawing and-releasing substituents using *tert*-butyl nitrite in *N,N*-dimethylformamide yields the corresponding deamination products in yields of 41–85%. Threadgill and Gledhill<sup>129</sup> used formamide as solvent. It is obvious that these two relatively good oxidizing solvents react in a similar way as the trivalent phosphorous compounds used by the Japanese groups<sup>126</sup>. In a mixture of equal volumes of acrylonitrile and acetonitrile, however, Doyle obtained only traces of the expected arene. Polyacrylonitrile was formed, indicating that acrylonitrile traps a radical intermediate.

Threadgill and Gledhill reported yields in the range 60–80% if the aniline derivative contains a nitro group. With weaker electron-withdrawing groups (COR, COOR, CN, Br) the yields are lower. The method does not work if the aniline contains only electron donor groups ( $\text{CH}_3$ ,  $\text{OCH}_3$ ). With regard to general applicability it is therefore inferior to Doyle's procedure, although it has the advantage that  $\text{NaNO}_2$  can be used as nitrosation reagent.

Keumi and coworkers<sup>130</sup> describe hydro-de-diazoniations of arenediazonium tetrafluoroborates using chlorotrimethylsilane,  $\text{Me}_3\text{SiCl}$ , in tetrahydrofuran or tetrahydrofuran/*N,N*-dimethylformamide mixtures. Excellent yields were obtained with polycyclic arene derivatives such as 2-fluorene-, 2-fluorenone- and 1-pyrenediazonium tetrafluoroborate and

other similar diazonium salts. In a modification of this method 2-halogenofluorenes can be synthesized. In the presence of azidotrimethylsilane in DMF solution the corresponding aryl azides are obtained.

### C. Halo-de-diazoniations and Related Reactions

Halo-de-diazoniations are a series of reactions in which the replacement of the diazonio group changes from a heterolytic de-diazonation in the case of the fluorination (Balz–Schiemann reaction) to transition metal-catalyzed chlorination and bromination (Sandmeyer reaction) and finally to iodination and astatination where no catalyst is necessary due to the favorable redox potentials of  $I^-$  and  $At^-$  ( $I^-: E^\circ = 1.3 \text{ V}$ ).

The reactions of  $CN^-$  and  $N_3^-$ , i.e. cyano- and azido-de-diazoniations, are closely related to the Sandmeyer type of halo-de-diazonation, as similar reaction conditions are applied.

For the classical Balz–Schiemann reaction, i.e. heating solid arenediazonium tetrafluoroborates without solvent, success with respect to yield is still rather difficult to predict.

In recent years, however, two fluoro-de-diazonation procedures were published which seem to be better, at least for the specific cases investigated.

In Milner's method<sup>132</sup> the amine is diazotized with solid nitrosonium tetrafluoroborate in  $CH_2Cl_2$  and, without isolation, the diazonium salt is heated and yields the fluoroarene in good yield. The method is also applicable to aniline derivatives bearing carboxy and hydroxy substituents, compounds which give poor yields in the classical procedure.

The new method of Yoneda's group<sup>132</sup> is also a 'one-pot' diazotization–fluoro-de-diazonation in a liquid–liquid two-phase mixture of pyridine and hydrogen fluoride. Yields for 25 aromatic amines and diamines are 50–100%, except for 2- and 3-fluorobenzoic acid, the three nitroanilines, 3- and 4-diaminobenzene and 4,4'-diaminodiphenyl-oxide (10–50%). In their 1994 paper the authors demonstrate that, in the same system, the photochemical decomposition gives in many cases significantly higher yields than the thermal reaction. The most spectacular increase in yield was found for the fluorination of 2-fluoroaniline where *o*-difluorobenzene was obtained photochemically in 80.2% yield, but thermally only in 0.6%!

Yoneda's method was applied to the synthesis of 4-fluoro-3-(trifluoromethyl)phenol, a useful herbicide. It was prepared in 84% yield<sup>133</sup>.

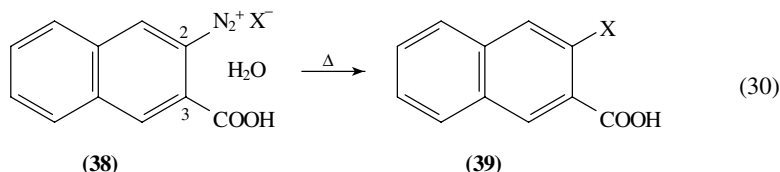
Fluoro-de-diazonation was reviewed by Olah, Chgambers and Prakash in their monograph on fluorinations<sup>134</sup>.

The most important finding for the synthetic applications of the Sandmeyer reaction is the clear experimental evidence of Galli<sup>116a</sup> that both oxidation states of copper ion are necessary for high yields. This claim is understandable on the basis of the reaction mechanism; cupric ions are a ligand transfer reagent (see reviews<sup>7h,117</sup>). The fact that the presence of  $Cu^{II}$  ions was not realized much earlier is understandable, because cuprous salts are rarely completely free of cupric impurities. In aqueous systems they form cupric ions by equilibration<sup>135</sup> as well as by air oxidation. The following comparative experiments of Galli<sup>116a</sup> in the chloro-de-diazonation of benzenediazonium sulfate in water at room temperature are instructive. Yields of chlorobenzene are: with 0.25 M  $CuCl$  45%; with 0.25 M  $CuCl + 0.25 \text{ M } Cu(NO_3)_2$  63%; with 0.25 M  $Cu(NO_3)_2 < 0.1\%$ .

Recently Dassbjerg and Lund<sup>136</sup> found a new modification of catalyzed chloro-de-diazonation. The treatment of arenediazonium or 3-pyridinediazonium fluoroborates with ferrous chloride in a 3:1 mixture of tetrachloromethane and acetonitrile (but not acetonitrile alone) yields the corresponding aryl chlorides or 3-chloropyridine respectively, in nearly quantitative yield.

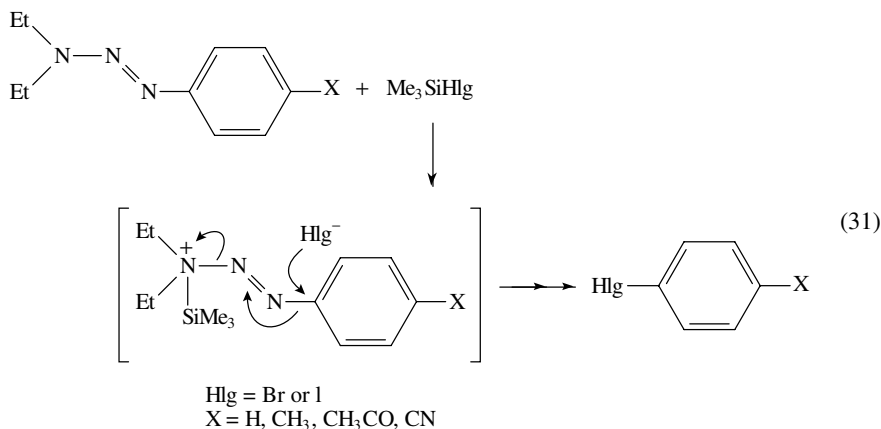
The bromo-de-diazonation of 3-carboxy-2-naphthalenediazonium bromide hydrate (**38**,  $X = Br$ ) is an interesting exception to the rule that bromo-de-diazoniations are successful

only in the presence of catalysts. Gougoutas<sup>137</sup> found that this diazonium salt forms 3-bromo-2-naphthoic acid (**39**, X = Br) in the solid state by thermolysis at 100 °C (70% yield). The analogous iodo-de-diazonium (X = I in equation 30) gives an 83% yield already by reaction at 30–60 °C<sup>138</sup>. Gougoutas determined also the X-ray structure of the two diazonium salts **38** (X = Br and Cl, respectively) and used that information for explaining their dediazoniations in comparison to Balz–Schiemann fluorinations. His conclusions were, however, in part criticized<sup>71</sup>.



Cyano-, azido- and iodo-de-diazoniations proceed in general in good yields by classical methods. Some modified procedures were reported, however, in the 1980s and 1990s. Keumi and coworkers<sup>130</sup> varied their method of treating diazonium salts with chlorotrimethylsilane (see Section III.B) for the formation of aryl azide by using azidotrimethylsilane as reagent with diazonium tetrafluoroborates in DMF solution.

1-Aryl-3,3-dialkyltriazenes are precursors for diazonium ions because they form diazonium ions in acid-catalyzed hydrolyses. Treatment of such triazenes with trimethylsilyl halides in acetonitrile at 60 °C resulted in the rapid evolution of nitrogen and in the formation of aryl halides<sup>139</sup> without an electron transfer reagent or another catalyst. Yields with silyl bromide and with silyl iodide were 60–95%. The authors explain the reaction as shown in equation 31. The formation of the intermediate is indicated by higher yields if electron-withdrawing substituents (X = CN, COCH<sub>3</sub>) are present. In the opinion of the present author, it is likely that the dissociation of this intermediate is not a concerted reaction, but that the dissociation of the *N*-aryl bond to form an aryl cation is followed by the addition of the halide. The reaction is therefore mechanistically not related to the homolytic halo-de-diazoniations.



1-Aryl-3,3-dialkyltriazenes were used for other types of halo-de-diazoniations<sup>140</sup>, namely triazenes in the presence of methanesulfonic acid, trifluoroacetic acid or a cation exchange resin (BioRad AG 50W-X12) in dry acetonitrile with NaI, LiBr, *n*-butylammonium fluoride or CsF at 75 °C. Brominations and iodinations yielded 75–99%

aryl halides, but fluorinations were not successful (4–10%; 20–24% in chlorinated solvents such as  $\text{CCl}_4$  or  $\text{CCl}_3\text{CN}$ ).

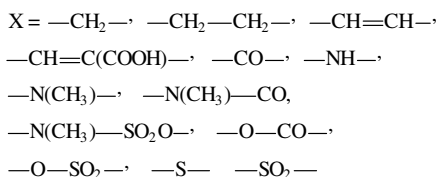
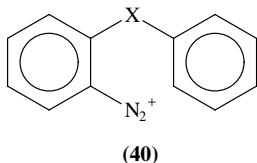
Triazenes can also be used to investigate the Sandmeyer mechanism proper, as shown in these and other papers from the same group<sup>140</sup>. However, the investigations demonstrate that their modifications allow bromo-de-diazoniations to be performed without an electron-transfer catalyst.

#### D. Substitutions of the Diazonio Group by Reagents with Reacting C-Atoms

In this section we include the intramolecular arylation of the Pschorr type, the intermolecular arylation (Gomberg–Bachmann reaction), the arylation of alkenes and alkynes (Meerwein reaction) and related processes.

Pschorr's synthesis of phenanthrene (1893) in five steps with the essential dediazonation and ring closure of 2-diazonio- $\alpha$ -phenylcinnamic acid giving, on addition of copper powder, phenanthrene-9-carboxylic acid, is today still the highest yielding one of all the reactions discussed in this section. Pschorr was able to get 93% yield, and today electrochemically induced Pschorr and related reactions<sup>141</sup> give almost quantitative yields in several cases.

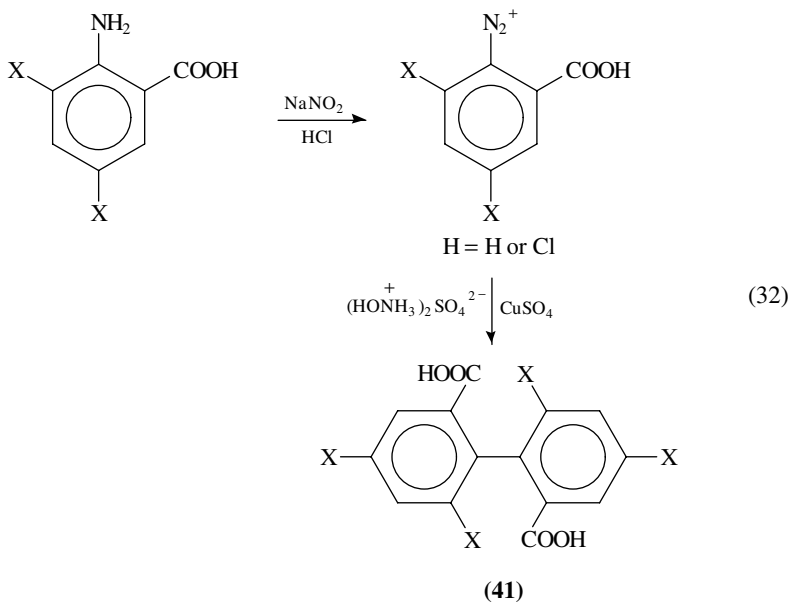
Instead of the ethene bridge between the two phenyl rings in the phenanthrene synthesis, a large number of other one- or two-atom bridges were tested after Pschorr in 1893. Thus, Graebe and Ullmann found, only one year later, that 2-diazoniobenzophenone (**40**,  $\text{X} = -\text{CO}-$ ) can be converted into fluorenone in an analogous manner, and also in excellent yield. With more than a dozen other bridging groups X the yield is, however, much lower (see compilation<sup>7j</sup>).



It is therefore not astonishing that in the Gomberg–Bachmann reaction, the intermolecular counterpart of the Pschorr synthesis, yields are generally low. The homolytic part of the Gomberg–Bachmann reaction is, in the opinion of March<sup>142</sup> and of the present author, not sufficiently well understood on the basis of the experimental data. Galli<sup>17a</sup> does not discuss this problem in his review.

An interesting reaction in the context of Gomberg–Bachmann arylation is the aryl dimerization and dediazonation of arenediazonium salts (equation 32). Both aryl groups in the diaryl product originate from the arenediazonium ion. As two procedures in *Organic Syntheses*<sup>143,144</sup> describe, diphenic acid (**41**,  $\text{X} = \text{H}$ ) and its *dl*-4,4',6,6'-tetrachloro derivative (**41**,  $\text{X} = \text{Cl}$ ) can be obtained by diazotization of 2-aminobenzoic acid and 3,5-dichloro-2-aminobenzoic acid respectively, followed by treatment of the diazonium salt solution with a mixture of copper(II) sulfate and bishydroxylammonium sulfate. Yields are fairly good (72–84% with  $\text{X} = \text{H}$ , 63–84% with  $\text{X} = \text{Cl}$ ). The mixture of  $\text{CuSO}_4$  and  $(\text{HONH}_3)_2\text{SO}_4^{2-}$  yields a redox equilibrium between  $\text{Cu}^+$  and  $\text{Cu}^{2+}$  ions. This mixture may be useful for other homolytic arylations, but we are not aware of a corresponding investigation<sup>†</sup>.

<sup>†</sup> In 1974 Cohen and coworkers<sup>145</sup> studied the influence of the two oxidation states of copper on aryl dimerization, but not with the mixture mentioned above.



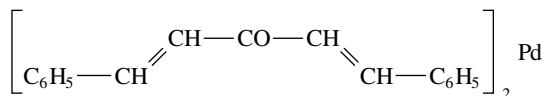
The arylation of alkenes was discovered by Meerwein<sup>146</sup> in 1939 using  $\alpha,\beta$ -unsaturated carbonyl compounds, namely coumarin and cinnamic derivatives. Diazotizations for Meerwein reactions are made in aqueous HCl. The substitution proper may be combined with addition of HCl to the double bond. As catalyst,  $\text{CuCl}_2$  is used. Various observations (see elsewhere<sup>7k</sup>) demonstrate that in typical Meerwein systems, part of  $\text{Cu}^{\text{II}}$  is reduced to  $\text{Cu}^{\text{I}}$ .

In the period 1955–1974 the Meerwein reaction was investigated intensively in the Soviet Union (review<sup>147</sup>). Various modifications were published in the 1970s, 1980s and early 1990s. They demonstrated in several cases that yields which, with few exceptions, were low in earlier publications can be surprisingly high. This is an astonishing difference to the Gomberg–Bachmann reactions.

The groups of Doyle and of Oae<sup>148</sup> showed that the yields can be improved by the use of arylamines and alkyl nitrites in place of arenediazonium ion, i.e. by a ‘one-pot’ diazotization–Meerwein procedure. A condition for good yields is, however, that the alkenes be activated by electron-withdrawing groups.

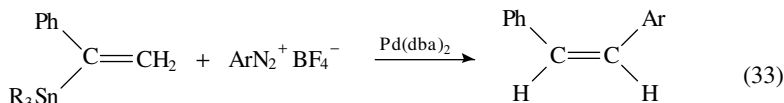
An interesting modification to the classical Meerwein reaction are palladium-catalyzed arylations, because they can be applied to alkenes bearing either electron-releasing or -withdrawing substituents (but not both). The key intermediate is an ‘arylpalladium’ species that can be generated in situ by several methods, e.g. from an aryl bromide or iodide with a palladiumtriarylphosphine or  $\text{Pd}^{\text{II}}$  acetate and base, respectively. The originally used preparation via arylmercury compounds is outdated, but the reaction can also be carried out using zero-valent Pd complexes prepared in situ from  $\text{Pd}^{\text{II}}\text{Cl}_2$  and sodium formate, or with bis(dibenzylideneacetone)palladium(0) [**42**,  $\text{Pd}(\text{dba})_2$ ]<sup>149</sup> and arenediazonium salts, in a method developed by Matsuda’s group<sup>150</sup>. In contrast to the use of bivalent Pd compounds<sup>151</sup>, the arylation with arenediazonium salts using  $\text{Pd}(0)$  compounds has the advantage that only catalytic amounts are necessary. Yields are highly dependent on substitution of the benzenediazonium salts. In most cases 51–75% was obtained, but very small yields with the 2,4,6-trimethyl and the 2- and 4-nitro derivatives<sup>152</sup>. The reaction can be performed at temperatures up to 50 °C as a ‘one-pot’ process by using a mixture

of an arylamine and *t*-butyl nitrite in chloroacetic acid or in a mixture of chloroacetic and acetic acid<sup>153</sup>. Styrene reacted with fourteen arylamines in the presence of 5 mol% Pd(dba)<sub>2</sub> to give the corresponding substituted stilbenes in yields of 46–97%. It is important for good yields to carry out these reactions in an acidic system. Without acid the yield was low (11%), and diazo tars were also formed.



(42)

Matsuda<sup>154</sup> also investigated the arylation of styrene derivatives containing leaving groups other than hydrogen. Both (*E*)- and (*Z*)-alkenylsilanes (Ar'CH=CHSiMe<sub>3</sub>) were easily aryldesilylated in the presence of Pd(dba)<sub>2</sub> in acetonitrile using arenediazonium tetrafluoroborates (ArN<sub>2</sub><sup>+</sup>BF<sub>4</sub><sup>-</sup>). The reactions gave mixtures of (*E*)-arylation products containing the aryl group at the  $\alpha$ - and  $\beta$ -carbon atoms, (*E*)-Ar'CH=CHAr and (*E*)-Ar'C(Ar)=CH<sub>2</sub>, as main products. This loss of regioselectivity disqualifies this reaction for synthetic purposes. Surprisingly, however,  $\alpha$ -styrylstannanes (**43**, R = CH<sub>3</sub>, C<sub>2</sub>H<sub>5</sub>, *n*-C<sub>4</sub>H<sub>9</sub>) selectively gave the (*Z*)- rather than the (*E*)-stilbene derivatives (equation 33<sup>155</sup>).



(43)

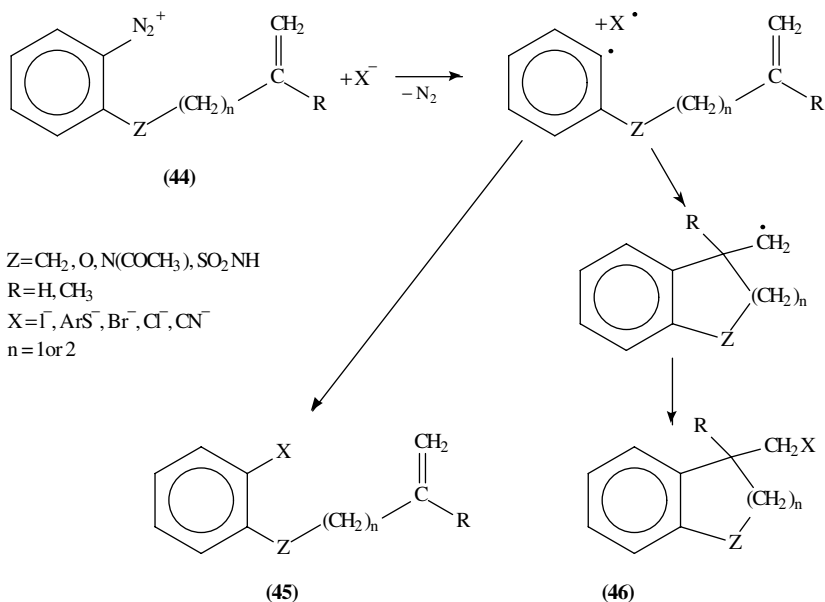
Besides two older examples of classical Meerwein reactions<sup>156</sup>, there is a more recent description of the reaction of 4-chlorobenzenediazonium chloride with but-3-en-2-one, catalyzed by Ti<sup>III</sup><sup>157</sup> in stoichiometric proportions. This method was developed by Citterio and gives 4-(4'-chlorophenyl)but-3-en-2-one in 65–75% yield.

Another new catalyst was described by Leardini and coworkers<sup>158</sup>, namely FeSO<sub>4</sub> in DMSO. It was applied to a Meerwein reaction of phenylethyne and substituted phenylethyne with arenediazonium salts containing a thioether group in the 2-position. 2-Phenylbenzothiophens are obtained in 55–95% yield.

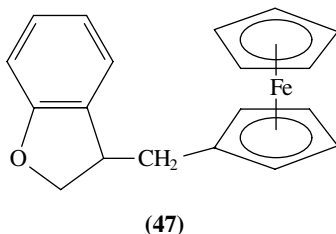
There are two recent summaries of Meerwein reactions<sup>71,159a</sup>. Intramolecular Meerwein reactions were studied in the late 1980s, first of all by Beckwith and coworkers<sup>160</sup>. The majority of their investigations (Scheme 9) were made with 2-(2'-propenyloxy)- and 2[(2'-methyl-2'-propenyl)oxy]benzenediazonium tetrafluoroborate (**44**, Z = -O-, *n* = 1, R = H and CH<sub>3</sub>, respectively). Other reagents were 2-(3'-butenyl)benzenediazonium tetrafluoroborate (**44**, Z = -CH<sub>2</sub>-, *n* = 1, R = H), and the compounds with an acetylamido [Z = N(COCH<sub>3</sub>)] and a sulfamoyl group (Z = -SO<sub>2</sub>NH-). The intramolecular Meerwein product **45** was obtained in DMSO, pyridine or acetone as solvents and with CuX<sub>2</sub> (X = Cl, Br), CuCN, NaI, NaI + I<sub>2</sub> and C<sub>6</sub>H<sub>5</sub>Sn as co-reagents. Most reactions gave good yields (60–89%). Lower yields of the cyclization product **46**, but significant amounts of the not cyclized product **45**, were found for compounds with longer side chains (e.g. **44**, Z = -O-, *n* = 2 or 3).

The homolytic character of these cyclizations was corroborated in the late 1980s in theoretical investigations<sup>161</sup>; and in the early 1990s by additional experimental work<sup>162</sup>. Beckwith<sup>163</sup> found also that the diazonium salt **44**, Z = -O-, *n* = 1, R = H) forms 3-ferrocenylmethyl-2,3-dihydrobenzofuran (**47**) in the presence of ferrocene.





SCHEME 9



### E. Hydroxy- and Mercapto-de-diazoniations

Hydroxy-de-diazoniations are well-known standard reactions for the replacement of aromatic amino groups by hydroxy groups. An aqueous solution of the diazonium salt is added slowly to boiling 5–35% (v/v) aqueous sulfuric acid. The hydroxy-de-diazonation may fail in the presence of reactive substituents in the *o*-position to the diazonio group (24 references mentioned by Cohen<sup>164</sup> in 1977!). Cohen's method of adding large amounts of Cu(NO<sub>3</sub>)<sub>2</sub> (15–100-fold excess) and Cu<sub>2</sub>O in equimolar amounts, relative to diazonium ions, is today hardly recommendable anymore due to environmental reasons.

Better yields are claimed by Satyamurthy and coworkers<sup>165</sup> for a process which consists of the hydrolysis of 1-aryl-3,3-diethyltriazenes in acetonitrile using a boiling mixture of the sulfonic acid resin BioRad AG 50W-X12 and water. For nine monosubstituted diethylaryltriazenes, phenols were obtained in yields of 65–95%.

A reaction which is related to hydroxy-de-diazoniations is the formation of aryl trifluoromethylsulfonic esters (aryl triflates, ArOSO<sub>2</sub>CF<sub>3</sub>) which became widely used reagents because of their leaving-group properties. The classical method of synthesis by esterification of phenols with trifluoromethane-sulfonic anhydride or -sulfonyl halide is, however, not applicable for the preparation of aryltriflates bearing a (free)

hydroxy group. Yoneda<sup>166</sup> found a highly effective preparation of aryltriflates by the thermal or photochemical de-diazonation of arenediazonium tetrafluoroborates in trifluoromethanesulfonic acid. The yields with 19 substituted benzenediazonium salts are, with two exceptions, in the range of 73–93% at the appropriate temperature (60–160 °C) or by using a high-pressure mercury vapor lamp at 12 °C.

Activity on new mercapto-de-diazoniations was small in the last two decades, except for a recent investigation of the use of thioglycolic acid forming arylthioglycolic acids<sup>167</sup>.

### F. Substitutions of the Diazonio Group by Carbonyl and Sulfonyl Groups

It has been known for a long time that CO and SO<sub>2</sub> react with aryl radicals and that the adducts formed are converted, in the presence of cupric halides as ligand transfer reagents, to arenecarboxylic halides and arenesulfonyl halides. The importance of a ligand transfer reagent was realized rather late, in 1977, by Doyle<sup>168</sup>. Even in a recent paper<sup>169</sup>, using highly pressurized CO as reagent and CuCl<sub>2</sub>, the yields are rather low (36–54% with seven diazonium salts). Higher yields (82–85%) are reported for the reaction of benzenediazonium tetrafluoroborate with CO (9 atm) in acetonitrile with 2 mol% Pd(II) acetate<sup>170</sup>.

The chlorosulfo-de-diazonation was discovered by Meerwein<sup>171</sup> in 1957, but little used, although in the experience of the present author it may give reasonably good yields.

Aldehydes and ketones are formed in reactions with carbonyl compounds, e.g. oximes, diacetyl and CO + tetraalkyltin<sup>172</sup> (see also Zollinger<sup>7m</sup>).

### G. Metallo-de-diazoniations and Related Reactions

The replacement of the diazonio group by metals and related transition elements was investigated intensively until the mid-20th century, particularly by Nesmeyanov and coworkers (reviews<sup>173</sup>). Most intensively studied were mercury-de-diazoniations. Since about 1970 there has been very little activity in the whole field of aryl-element chemistry as far as arenediazonium salts are involved. This decrease is probably due to the lack of interest for technological purposes, and to the environmental problem, which the synthesis and the use of the compounds cause.

### H. Photolytic Dediazoniations

Although it has been known since the early days of diazo chemistry that arenediazonium salt solutions are sensitive to light, photolytic dediazoniations have only marginal importance in organic synthesis. The recent successful photolytic fluoro-de-diazoniations of Yoneda and coworkers<sup>132</sup> were discussed in Section III.C.

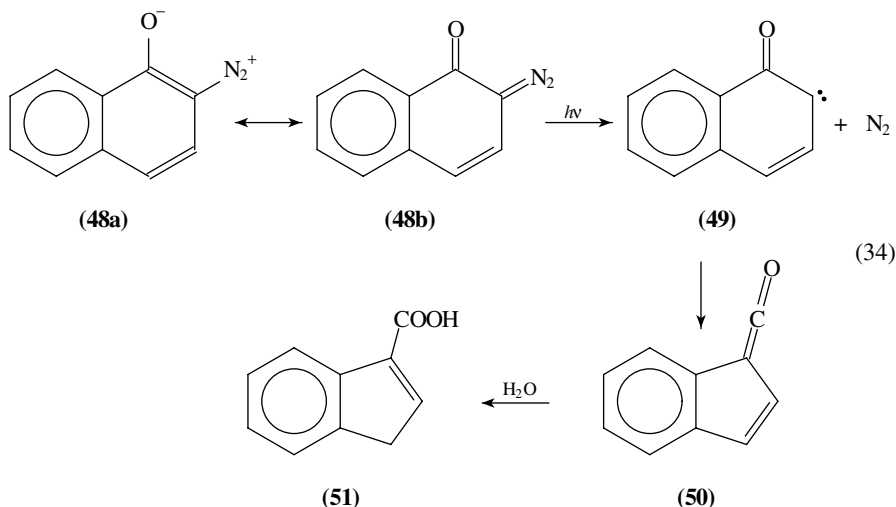
Photolytic dediazoniations are, however, important in image technology. These applications can be divided into four groups, namely (1) the use of products of heterolytic photo-de-diazonation as Lewis acid catalysts in cationic polymerization, (2) the use of the nitrogen gas for the formation of light-scattering vesicles in a polymer layer, (3) the use of the dediazonation process for rendering an irradiated polymer layer more or less soluble than the unexposed material and (4) the use of unexposed and, therefore, nondecomposed diazo compounds for dye formation by azo coupling reactions.

Chemical aspects of all four technologies were recently reviewed<sup>7n</sup>; here we review only briefly group (4) technology because it has some interest for general organic chemistry.

In 1924 the German company Kalle & Co. in Wiesbaden began production of 'blueprint' paper, i.e. a diazo reprographic paper. In that process a sheet coated with a diazonium compound was exposed to an optical image and developed by diazo coupling using a mono-

or di-hydroxynaphthalene derivative at high pH under wet (later also dry) conditions. In the exposure step before development the diazonium compound was destroyed by photolytic dediazonation; therefore the azo dye was formed only on those parts of the sheet which were not irradiated with visible light. Originally, 2-diazophenols were used as diazo components, later 1,2-naphthoquinone diazide (**48**). Nowadays, the most important compound is 2,5-diethoxy-4-morpholinobenzenediazonium tetrafluoroborate. Typical coupling components are acetoacetic anilide, 1-phenyl-3-carbamidopyrazolone-(5) and 2-hydroxy-6-methoxy-3-naphthoic acid-2'-toluidide for yellow, red and blue colors, respectively.

In the context of this technology Süs investigated already in 1944<sup>174</sup> the photolysis of *o*-quinone diazides. Equation 34 shows the photolysis sequence for 1,2-naphthoquinone diazide (**48**) formed in the diazotization of 2-amino-1-naphthol. The product of the photolytic step is a ketocarbene (**49**), which undergoes a Wolff rearrangement to a ketene (**50**). In the presence of water indene-3-carboxylic acid (**51**) is formed; this compound is highly soluble in water and can be removed in the development step. The reaction steps of equation 34 were investigated in recent years intensively, mainly by Canadian chemists<sup>175</sup> (see also the monograph of Tidwell on ketenes<sup>176</sup>).



The Wolff rearrangement is well known as a reaction of diazo ketones, i.e. of diazoalkanes with a carbonyl group in  $\alpha$ -position. Reaction 34 demonstrates that diazotized aminonaphthols are mesomeric with naphthoquinone diazides (**48b**) and that they have therefore also the character of quinonoid diazo ketones (see also Section II.C of this chapter). Wolff rearrangements take place also thermally and catalyzed by silver ions.

#### IV. REFERENCES

1. B. C. Challis and A. R. Butler, in *The Chemistry of the Amino Group* (Ed. S.Patai), Wiley, London, 1968, pp. 305–320.
2. H. Zollinger, in *The Chemistry of Functional Groups, Supplement C* (Eds. S. Patai and Z. Rappoport), Wiley, Chichester, 1983, pp. 603–669; (a) Sect. II.B; (b) pp. 644–646.
3. H. Zollinger, *Diazo Chemistry II. Aliphatic, Inorganic and Organometallic Compounds*, VCH Publ., Weinheim, 1995; (a) Chap. 2 and 4; (b) Sect. 2.6; (c) Chap. 11.
4. H. E. Fierz-David and L. Blangey, *Grundlegende Operationen der Farbenchemie*, 8th ed., Springer, Vienna, 1952 (English edition: *Fundamental Processes of Dye Chemistry*, Interscience, New York, 1959); (a) p. 244.

5. K. H. Saunders and R. L. M. Allen, *Aromatic Diazo Compounds*, 3rd ed., Arnold, London, 1985: (a) p. 7; (b) p. 23.
6. A. Engel, in *Houben-Weyl. Methoden der organischen Chemie* (Ed. D. Klamann), 4th ed., Vol.E 16a, Part II, Georg Thieme, Stuttgart, 1990, pp. 1053–1089.
7. H. Zollinger, *Diazo Chemistry I. Aromatic and Heteroaromatic Compounds*, VCH Publ., Weinheim, 1994: (a) Chap. 2 and 3; (b) Sect. 2.2; (c) Sect. 2.6; (d) pp. 54–55; (e) Sect. 3.4; (f) Chap. 8–10; (g) p. 202; (h) pp. 231–233; (i) pp. 237–238; (j) Table 10–6; (k) p. 247; (l) Sect. 10.9; (m) pp. 242–243; (n) Sect. 10.13.
8. T. I. Godovikova, O. A. Rakitin and L. I. Khmel'nitzki, *Uspekhi Khim.*, **52**, 777–786, (English edition) 440–445 (1983).
9. N. Kornblum and D. C. Iffland, *J. Am. Chem. Soc.*, **71**, 2137 (1949).
10. H. Gies and E. Pfeil, *Justus Liebigs Ann. Chem.*, **578**, 11 (1952).
11. H. -J. Opgenorth and C. Rüdhardt, *Justus Liebigs Ann. Chem.*, 1333 (1974).
12. J. Fitzpatrick, T. A. Meyer, M. E. O'Neill and D. L. H. Williams, *J. Chem. Soc., Perkin Trans. 2*, 927 (1984).
13. M. A. Weaver and L. Shuttleworth, *Dyes and Pigments*, **3**, 81 (1982).
14. R. N. Butler, *Chem. Rev.*, **75**, 241 (1975).
15. G. Cirrincione, A. M. Almerico, E. Aiello and G. Dattolo, *Adv. Heterocycl. Chem.*, **48**, 65 (1990).
16. H. Reimlinger, A. van Overstraeten and H. G. Viehe, *Chem. Ber.*, **94**, 1036 (1961).
17. J. Vilarrasa, E. Maléndez and J. Elguero, *Tetrahedron Lett.*, **1609** (1974).
18. H. Diener and H. Zollinger, *Can. J. Chem.*, **64**, 1102 (1986).
19. M. V. Gorelik and V. I. Lomzakova, *Zh. Org. Khim.*, **14**, 1051, 981EE (1978).
20. M. V. Gorelik, S. P. Titova, V. I. Rybinov, *Zh. Org. Khim.*, **16**, 1322, 1143EE (1980).
21. R. N. Butler and F. L. Scott, *J. Org. Chem.*, **32**, 1224 (1967).
22. P. B. Shevlin, *J. Am. Chem. Soc.*, **94**, 1379 (1972).
23. E. J. Gray, M. F. G. Stevens, G. Tennant and R. J. S. Vevers, *J. Chem. Soc., Perkin Trans. 1*, 1496 (1976).
24. E. Kalatzis, *J. Chem. Soc. (B)*, 273 (1967).
25. E. Kalatzis and C. Mastrolalos, *J. Chem. Soc., Perkin Trans. 2*, 1830, 1835 (1977).
26. M. P. Nemeryuk, A. L. Sedov, T. S. Safenova, A. Cerny and J. Krepelka, *Collect. Czech. Chem. Commun.*, **51**, 215 (1986).
27. G. Dattolo, G. Cirrincione, A. M. Almerico and E. Aiello, *Heterocycles*, **20**, 255 (1983).
28. R. V. Hoffman, in *Organic Syntheses*, Coll. Vol. VII (Ed. J. P. Freeman), Wiley, New York, 1990, pp. 508–511.
29. P. Bersier, L. Valpiana and H. Zubler, *Chemie-Ingenieur-Technik*, **43**, 1311 (1971).
30. G. M. Brooke, E. J. Forbes, R. D. Richardson, M. Stacey and J. C. Tatlow, *J. Chem. Soc.*, 2088 (1965).
31. H. Iwamoto, T. Sonoda and H. Kobayashi, *Tetrahedron Lett.*, **24**, 4703 (1983); H. Iwamoto, T. Sonoda and H. Kobayashi, *J. Fluorine Chem.*, **24**, 535 (1984).
32. J. Goerdeler and M. Roegler, *Chem. Ber.*, **103**, 112 (1970).
33. A. Ginsberg und J. Goerdeler, *Chem. Ber.*, **94**, 2043 (1961).
34. A. C. Alty, R. E. Banks, A. R. Thompson and B. R. Fishwick, *J. Fluorine Chem.*, **26**, 263 (1984).
35. E. Y. Belyaev, S. V. Tverdokhlebov, Y. I. Shpinell and E. B. Mel'nikov, *Zh. Org. Khim.*, **25**, 445, (English edition) 402 (1989).
36. E. B. Starkey, in *Organic Syntheses*, Coll. Vol. II (Ed. A. H. Blatt), Wiley, New York, 1943, pp. 225–227.
37. K. G. Rutherford and W. Redmont, in *Organic Syntheses*, Coll. Vol. V (Ed. H. E. Baumgarten), Wiley, New York, 1973, pp. 133–136.
38. B. Morosin and E. C. Lingafelter, *Acta Crystallogr.*, **12**, 611 (1959).
39. T. N. Polynova, N. G. Bokii and B. A. Porai-Koshits, *Zh. Struct. Khim.*, **6**, 878 (1965); *Chem. Abstr.*, **64**, 11978e (1966).
40. Y. M. Nesterova, B. A. Porai-Koshits, A. V. Upadiheva and L. A. Kazitsyna, *Zh. Struct. Khim.*, **7**, 129 (1966); *Chem. Abstr.*, **64**, 18555c (1966).
41. A. Mostad and C. Rømming, *Acta Chem. Scand.*, **22**, 1259 (1968).
42. S. Koller and H. Zollinger, *Helv. Chim. Acta*, **53**, 78 (1970).
43. V. E. Kampar, V. R. Kokars and O. Y. Neiland, *Zh. Obshch. Khim.*, **47**, 858, (English edition) 784 (1977).

44. V. V. Ershov, G. A. Nikiforov and C. R. H. I. de Jonge, *Quinone Diazides*, Elsevier, Amsterdam, 1951; (a) pp. 95–104; (b) pp. 105–106.
45. K. Y. Law, S. Kaplan and I. W. Tarnawsky, *Dyes and Pigments*, **17**, 41 (1991).
46. E. S. Olson, *J. Heterocycl. Chem.*, **14**, 1255 (1977).
47. I. Pikulik, R. U. Weber and H. Zollinger, *Helv. Chim. Acta*, **64**, 1777 (1981).
48. N. B. Kupletskaia and L. A. Kazitsyna, *Zh. Org. Khim.*, **22**, 1237, (English edition) 1114 (1986).
49. M. Hudlicky and H. M. Bell, *J. Fluorine Chem.*, **4**, 149 (1974).
50. A. Oku and A. Matsui, *J. Org. Chem.*, **44**, 3342 (1979).
51. R. W. Trimmer, L. R. Stover and A. C. Skjold, *J. Org. Chem.*, **50**, 3612 (1985).
52. O. Macháčková and V. Štěrba, *Collect. Czech. Chem. Commun.*, **36**, 3197 (1971).
53. K. Y. Law, I. W. Tarnawsky and P. T. Lubberts, *Dyes and Pigments*, **23**, 243 (1993).
54. W. Klötzer, G. Dörlner, B. Stanovnik and M. Tišler, *Heterocycles*, **22**, 1763 (1984).
55. E. Bamberger, *Ber. Dtsch. Chem. Ges.*, **30**, 366 (1897).
56. R. Huisgen and G. Horeld, *Justus Liebigs Ann. Chem.*, **562**, 137 (1949).
57. H. Suschitzky, *Angew. Chem.*, **79**, 636; *Angew. Chem., Int. Ed. (Engl.)*, **6**, 596 (1967).
58. J. Turcan, *Bull. Soc. Chim. France*, 627 (1935).
59. G. A. Olah, N. A. Overchuk and J. C. Lapierre, *J. Am. Chem. Soc.*, **87**, 5786 (1965).
60. M. P. Doyle, W. Wierenga and M. A. Zaleta, *J. Org. Chem.*, **37**, 1597 (1972); M. P. Doyle, M. A. Zaleta, J. E. DeBoer and W. Wierenga, *J. Org. Chem.*, **38**, 1663 (1973).
61. G. B. Bachman and W. Michalowicz, *J. Org. Chem.*, **23**, 1800 (1958).
62. H. Zimmer and G. Singh, *Angew. Chem.*, **75**, 574; *Angew. Chem., Int. Ed. (Engl.)*, **2**, 395EE (1963).
63. K. Bott, *Angew. Chem.*, **77**, 132; *Angew. Chem., Int. Ed. (Engl.)*, **4**, 148EE (1965).
64. R. Weiss and K. -G. Wagner, *Chem. Ber.*, **117**, 1973 (1984).
65. R. Weiss, K. -G. Wagner and M. Hertel, *Chem. Ber.*, **117**, 1965 (1984).
66. R. Weiss, K. -G. Wagner, C. Priesner and J. Macheleid, *J. Am. Chem. Soc.*, **107**, 4491 (1985).
67. R. A. Abramovitch, H. H. Gibson, T. Nguyen, S. Olivella and A. Sole, *Tetrahedron Lett.*, **35**, 2321 (1994).
68. M. P. Doyle and W. J. Bryker, *J. Org. Chem.*, **44**, 1572 (1979).
69. J. Tummavuori and P. Lumme *Acta Chem. Scand.*, **22**, 2003 (1968).
70. G. Y. Markovits, S. E. Schwartz and L. Newman, *Inorg. Chem.*, **20** 445 (1981).
71. N. S. Bayliss and D. W. Watts, *Aust. J. Chem.*, **16**, 927 (1963).
72. J. H. Ridd, *Adv. Phys. Org. Chem.*, **16**, 1 (1978); (a) p.19.
73. D. L. H. Williams, *Nitrosation*, Cambridge University Press, Cambridge, 1988; (a) p.8; (b) pp. 89–93.
74. F. Seel and R. Winkler, *Z. Phys. Chem.*, **25**, 217 (1960).
75. N. S. Bayliss, R. Dingle, D. W. Watts and R. J. Wilkie, *Aust. J. Chem.*, **16**, 933 (1963).
76. R. A. Cox and K. Yates, *Can. J. Chem.*, **61**, 2225 (1983).
77. H. Schmid and P. Krenmayr, *Monatsh. Chem.*, **98**, 417 (1967).
78. M. T. Nguyen and A. F. Hegarty, *J. Chem. Soc., Perkin Trans. 2*, 2037 (1984).
79. K. A. Jørgensen and S. O. Lawesson, *J. Chem. Soc., Perkin Trans. 2*, 231 (1985).
80. G. Klopman, *Chemical Reactivity and Reaction Paths*, Wiley, New York, 1974.
81. I. Fleming, *Frontier Orbitals and Organic Chemical Reactions*, Wiley, Chichester, 1976.
82. W. F. Reynolds and R. D. Topsom, *J. Org. Chem.*, **49**, 1989 (1984).
83. S. Ehrenson, R. T. C. Brownlee and R. W. Taft, *Prog. Phys. Org. Chem.*, **10**, 1 (1973).
84. R. W. Taft and R. D. Topsom, *Prog. Phys. Org. Chem.*, **16**, 1 (1987).
85. M. Charton, *Prog. Phys. Org. Chem.*, **13**, 119 (1981).
86. E. C. R. de Fabrizio, E. Kalatzis and J. H. Ridd, *J. Chem. Soc. (B)*, 533 (1966).
87. E. Kalatzis and J. H. Ridd, *J. Chem. Soc. (B)*, 529 (1966).
88. J. Casado, A. Castro, E. Iglesias, M. E. Peña and J. V. Tato, *Can. J. Chem.*, **64**, 133 (1986).
89. H. Zollinger, *Helv. Chim. Acta*, **71**, 1661 (1988).
90. E. Kalatzis, *J. Chem. Soc. (B)*, 277 (1967).
91. E. Kalatzis and P. Papadopoulos, *J. Chem. Soc., Perkin Trans. 2*, 248 (1981).
92. C. Bravo, A. Castro, E. Iglesias, J. Ramón Leis and M. E. Peña, *Bull. Soc. Chim. Fr.*, 573 (1987).
93. H. Diener, B. Gülec, P. Skrabal and H. Zollinger, *Helv. Chim. Acta*, **72**, 800 (1989).
94. H. Schmid, *Z. Elektrochem.*, **42**, 580 (1936); **43**, 626 (1937).
95. L. P. Hammett, *Physical Organic Chemistry*, McGraw-Hill, New York, 1940 (second edition 1970); (a) p.294 (1940); (b) p.295 (1940).

96. L. Abia, A. Castro, E. Iglesias, J. R. Leis and M. E. Peña, *J. Chem. Res. (S)*, 106 (1989).
97. E. D. Hughes and J. H. Ridd, *J. Chem. Soc.*, **70**, 82 (1958).
98. A. Castro, E. Iglesias, J. Ramón Leis and M. E. Peña, *Ber. Bunsenges. Phys. Chem.*, **90**, 891 (1986).
99. IUPAC: *A Guide to IUPAC Nomenclature of Organic Compounds. Recommendations 1993* (Eds. R. Panico, W. H. Powell and J. -C. Richer), Blackwell, London, 1994, Rule R-5.3.3.4.
100. J. Hovinen, J. Fishbein, S. N. Satapathy, J. Ho and J. Fishbein, *J. Am. Chem. Soc.*, **114**, 10321 (1992).
101. J. Goerdeler and K. Deselaers, *Chem. Ber.*, **91**, 1025 (1958); A. Ginsberg and J. Goerdeler, *Chem. Ber.*, **94**, 2043 (1961).
102. R. N. Butler, T. M. Lambe, J. C. Tobin and F. L. Scott, *J. Chem. Soc., Perkin Trans. 1*, 1357 (1973); N. D. Stepanov, M. S. Pevzner, Y. V. Serov and T. P. Temchenko, *Zh. Org. Khim.*, **25**, 2013, (English edition) 1819 (1989).
103. IUPAC: *Linear Representation of Reaction Mechanisms*, (Ed. J. S. Littler), *Pure Appl. Chem.*, **55**, 3846 (1990).
104. M. Tsuda, T. Ishida, T. Nogami, S. Kurono and M. Ohashi, *Chem. Lett.*, 2333 (1992).
105. J. I. G. Cadogan, *Acc. Chem. Res.*, **4**, 186 (1971).
106. H. Zollinger, *J. Org. Chem.*, **55**, 3846 (1990).
107. Y. Hashida, R. G. M. Landells, G. E. Lewis, I. Szele and H. Zollinger, *J. Am. Chem. Soc.*, **100**, 2816 (1978); M. D. Ravenscroft and H. Zollinger, *Helv. Chim. Acta*, **71**, 507 (1988).
108. M. D. Ravenscroft, K. Takagi, B. Weiss and H. Zollinger, *Gazz. Chim. Ital.*, **117**, 353 (1987).
109. J. Maurer, I. Szele and H. Zollinger, *Helv. Chim. Acta*, **62**, 1079 (1979).
110. M. L. Crossley, R. H. Kienle and C. H. Benbrook, *J. Am. Chem. Soc.*, **62**, 1400 (1940); P. Burri, G. H. Wahl and H. Zollinger, *Helv. Chim. Acta*, **57**, 2099 (1974).
111. T. Kuokkanen, *Finn. Chem. Lett.*, 81 (1981); H. Maskill and K. McCrudden, *Croat. Chim. Acta*, **65**, 567 (1992).
112. W. A. M. Castenmiller and H. M. Buck, *Recl. Trav. Chim. Pays-Bas*, **96**, 207 (1977).
113. R. Glaser, G. S.-C. Choy and C. J. Horan, *J. Org. Chem.*, **57**, 995 (1992).
114. R. Glaser and C. J. Horan, *J. Am. Chem. Soc.*, accepted (1996).
115. R. F. W. Bader, *Chem. Rev.*, **91**, 893 (1991) and earlier references cited there.
116. C. Galli, *J. Chem. Soc., Perkin Trans. 2*, 1459 (1981), 1139 (1982), 897 (1984): (a) p.1459 (1981).
117. C. Galli, *Chem. Rev.*, **88**, 765 (1988); (a) p.781.
118. L. F. Kasukhin, M. P. Ponomarchuk and A. L. Buchachenko, *Chem. Phys.*, **3**, 136 (1974).
119. O. Brede, R. Mehnert, W. Naumann and H. G. O. Becker, *Ber. Bunsenges. Phys. Chem.*, **84**, 666 (1980); P. S. Engel and D. B. Gerth, *J. Am. Chem. Soc.*, **105**, 6849 (1983).
120. T. Suehiro, T. Tashiro and R. Nakausa, *Chem. Lett.*, 1339 (1980); T. Suehiro, S. Masuda, T. Tashiro, R. Nakausa, M. Taguchi, A. Koike and A. Rieker, *Bull. Chem. Soc. Jpn.*, **59**, 1877 (1986); T. Suehiro, S. Masuda, R. Nakausa, M. Taguchi, A. Mori, A. Koike and M. Date, *Bull. Chem. Soc. Jpn.*, **60**, 3321 (1987); T. Suehiro, T. Sato, T. Sano, A. Koike and A. Rieker, *Chem. Lett.*, 1935 (1989).
121. T. Suehiro, *Rev. Chem. Intermediates*, **10**, 101 (1988).
122. G.-J. Meyer, K. Rössler and G. Stöcklin, *J. Am. Chem. Soc.*, **101**, 3121 (1979).
123. T. Kuokkanen, *Finn. Chem. Lett.*, **16**, 19 (1989).
124. J. Besse, W. Schwarz and H. Zollinger, *Helv. Chim. Acta*, **64**, 504, 513, 529 (1981).  
(a) K. Harada and K. Sugita, *J. Imaging Sci. Technol.*, **38**, 131 (1994).
125. N. Kornblum, *Org. React.*, **2**, 262 (1944).
126. S. Yasui, M. Fujii, C. Kawano, Y. Nishimura and A. Ohno, *Tetrahedron Lett.*, **32**, 5601 (1991); S. Yasui, K. Shioji and A. Ohno, *Tetrahedron Lett.*, **35**, 2695 (1994); S. Yasui, M. Fujii, C. Kawano, Y. Nishimura, K. Shioji and A. Ohno, *J. Chem. Soc., Perkin Trans. 2*, 177 (1994).
127. J. I. G. Cadogan and G. A. Molina, *J. Chem. Soc., Perkin Trans. 1*, 541 (1973).
128. M. P. Doyle, J. F. Dellaria, B. Siegfried and S. W. Bishop, *J. Org. Chem.*, **42**, 3494 (1977).
129. M. D. Threadgill and A. P. Giedhill, *J. Chem. Soc., Trans. Perkin 1*, 873 (1986).
130. T. Keumi, T. Umeda, Y. Inoue and H. Kitajima, *Bull. Chem. Soc. Jpn.*, **62**, 89 (1989).
131. D. J. Milner, *Synth. Commun.*, **22**, 73 (1992).
132. T. Fukuhara, T. Sawada and N. Yoneda, *Synth. Commun.*, **17**, 686 (1987); N. Yoneda, T. Fukuhara, T. Kikuchi and A. Suzuki, *Synth. Commun.*, **19**, 865 (1989); T. Fukuhara, S. Sasaki, N. Yoneda and A. Suzuki, *Bull. Chem. Soc. Jpn.*, **63**, 2958 (1990); T. Fukuhara, M. Sekiguchi and N. Yoneda, *Chem. Lett.*, 1011 (1994).

133. N. Yoneda, T. Fukuhara, K. Harada and A. Matsushita, Jpn. Kokai Tokkyo Koho, Jpn. P. 01 316 336 (1989); *Chem. Abstr.*, **113**, 223358p (1990).
134. G. A. Olah, R. D. Chgambers and G. K. Prakash, *Synthetic Fluorine Chemistry*, Wiley, New York, 1992, p. 178.
135. R. W. Ramette, *Inorg. Chem.*, **25**, 2481 (1986).
136. K. Dassbjerg and H. Lund, *Acta Chem. Scand.*, **46**, 157 (1992).
137. J. Z. Gougoutas and J. Johnson, *J. Am. Chem. Soc.*, **101**, 5672 (1979).
138. J. Z. Gougoutas, *J. Am. Chem. Soc.*, **101**, 5672 (1979).
139. H. Ku and J. R. Barrio, *J. Org. Chem.*, **46**, 5239 (1981).
140. J. R. Barrio, N. Satyamurthy, H. Ku and M. E. Phelps, *J. Chem. Soc., Chem. Commun.*, 443 (1983); N. Satyamurthy, J. R. Barrio, D. G. Schmidt, C. Kammerer, G. T. Bida and M. E. Phelps, *J. Org. Chem.*, **55**, 4560 (1990).
141. R. M. Elofson and F. F. Gadallah, *J. Org. Chem.*, **36**, 1769 (1971).
142. J. March, *Advanced Organic Chemistry*, 4th ed., Wiley, New York, 1992, p.719.
143. E. R. Atkinson and D. M. Murphy, in *Organic Syntheses*, Coll. Vol. IV (Ed. N. Rabjohn), Wiley, New York, 1963, pp. 872–876.
144. E. R. Atkinson and H. J. Lawler, in *Organic Syntheses*, Coll. Vol. I, second ed. (Ed. H. Gilman), Wiley, New York, 1964, pp. 222–224.
145. T. Cohen, R. J. Lewarchik and J. Z. Torino, *J. Am. Chem. Soc.*, **96**, 7753 (1974).
146. H. Meerwein, E. Buchner and K. van Ernster, *J. Prakt. Chem.*, **152**, 237 (1939).
147. A. V. Dombrovskii, *Uspehi Khim.*, **53**, 1625, (English edition) 943 (1984).
148. M. P. Doyle, B. Siegfried, R. C. Elliott and J. F. Dellaria, *J. Org. Chem.*, **42**, 2431 (1977); S. Oae, K. Shinhama and Y. H. Kim, *Bull. Chem. Soc. Jpn.*, **53**, 1065 (1980).
149. Y. Takahashi, T. Ito, S. Sakai and Y. Ishii, *J. Chem. Soc., Chem. Commun.*, 1065 (1970); T. Ukai, H. Kawazura, Y. Ishii, J. J. Bonnet and J. A. Ibers, *J. Organomet. Chem.*, **65**, 253 (1974).
150. K. Kikukawa and T. Matsuda, *Chem. Lett.*, 159 (1977).
151. F. Akiyama, H. Miyazaki, K. Kaneda, S. Teranishi, Y. Fujiwara, M. Abe and H. Taniguchi, *J. Org. Chem.*, **45**, 2359 (1980).
152. K. Kikukawa, K. Nagira, N. Terao, F. Wada and T. Matsuda, *Bull. Chem. Soc. Jpn.*, **52**, 5209 (1977).
153. K. Kikukawa, K. Maemura, Y. Kiseki, F. Wada and T. Matsuda, *J. Org. Chem.*, **46**, 4885 (1981).
154. K. Ikenaga, K. Kikukawa and T. Matsuda, *J. Chem. Soc., Perkin Trans. 1*, 1959 (1986).
155. K. Kikukawa, H. Umekawa and T. Matsuda, *J. Organomet. Chem.*, **311**, C44 (1986).
156. G. A. Reynolds and J. A. VanAllen, in *Organic Syntheses*, Coll. Vol. IV (Ed. N. Rabjohn), Wiley, New York, 1963, pp. 15–18; G. A. Ropp and E. C. Coynev, in *Organic Syntheses*, Coll. Vol. IV (Ed. N. Rabjohn), Wiley, New York, 1963, pp. 727–729.
157. A. Citterio, in *Organic Syntheses*, Coll. Vol. VII (Ed. J. P. Freeman), Wiley, New York, 1990, pp. 105–108.
158. R. Leardini, D. Nanni, A. Tundo and G. Zanardi, *Synthesis*, 335 (1988).
159. P. S. Engel, in *Houben-Weyl. Methoden der organischen Chemie*, 4th Ed., Vol. E 16a, Part II (Ed. D. Klamann), Georg Thieme, Stuttgart, 1990, pp. 1052–1136; (a) Table 107.
160. G. F. Meijs and A. L. J. Beckwith, *J. Am. Chem. Soc.*, **108**, 5890 (1986); A. N. Abeywickereema and A. L. J. Beckwith, *J. Am. Chem. Soc.*, **108**, 8227 (1986) and *J. Org. Chem.*, **52**, 2568 (1987); A. L. J. Beckwith and G. F. Meijs, *J. Org. Chem.*, **52**, 1922 (1987).
161. A. L. J. Beckwith and C. H. Schiesser, *Tetrahedron*, **41**, 3925 (1985); D. C. Spellmeyer and K. N. Houk, *J. Org. Chem.*, **52**, 959 (1987).
162. A. L. J. Beckwith and J. Zimmermann (1991), *J. Org. Chem.*, **56**, 5791 (1991); A. L. J. Beckwith and S. M. Palacios, *J. Phys. Org. Chem.*, **4**, 404 (1991); A. L. J. Beckwith and S. Gerba, *Aust. J. Chem.*, **45**, 289 (1992).
163. A. L. J. Beckwith, R. A. Jackson and R. W. Longmore, *Aust. J. Chem.*, **45**, 857 (1992).
164. T. Cohen, A. G. Dietz and J. R. Miser, *J. Org. Chem.*, **42**, 2053 (1977).
165. N. Satyamurthy, J. R. Barrio, G. T. Bida and M. E. Phelps, *Tetrahedron Lett.*, **31**, 4409 (1990).
166. N. Yoneda, T. Fukuhara, T. Mizokami and A. Suzuki, *Chem. Lett.*, 459 (1991).
167. Y. Yildirim and G. Okay, *Org. Prep. Proced. Int.*, **23**, 198 (1991).
168. M. P. Doyle, B. Siegfried and J. F. Dellaria, *J. Org. Chem.*, **42**, 2426 (1977).
169. G. A. Olah, A. -H. Wu, A. Bagno and G. K. S. Prakash, *Synlett.*, 596 (1990).
170. K. Nagira, K. Kikukawa, F. Wada and T. Matsuda, *J. Org. Chem.*, **45**, 2365 (1980).
171. H. Meerwein, G. Dittmar, G. Kaufmann and R. Raue, *Chem. Ber.*, **90**, 853 (1957).

172. K. Kikukawa, T. Ideomoto, A. Katayama, K. Kono, F. Wade and T. Matsuda, *J. Chem. Soc., Perkin Trans. I*, 1511 (1987).
173. A. N. Nesmeyanov, *Adv. Organomet. Chem.*, **10**, 1 (1972); O. A. Reutov and D. A. Ptitsyna, *Organomet. React.*, **4**, 73 (1972); R. C. Larock, *Organomercury Compounds in Organic Synthesis*, Springer, Berlin, 1985; J. L. Wardell, in *Inorganic Reactions and Methods*, Vol. 11 (Ed. J. J. Zuckerman), VCH Publ., Weinheim, 1988.
174. O. Süss, *Justus Liebigs Ann. Chem.*, **556**, 65, 85 (1944).
175. M. Barra, T. A. Fisher, G. J. Cernigliaro, R. Sinta and J. C. Scaiano, *J. Am. Chem. Soc.*, **114**, 2630 (1992); J. Andraos, Y. Chiang, C. -G. Huang, A. J. Kresge and J. C. Scaiano, *J. Am. Chem. Soc.*, **115**, 10605 (1993); J. Andraos, A. J. Kresge and V. V. Popik, *J. Am. Chem. Soc.*, **116**, 961 (1994).
176. T. T. Tidwell, *Ketenes*, Wiley, New York 1995.



## CHAPTER 14

# S- Nitroso compounds, formation, reactions and biological activity

D. LYN H. WILLIAMS

*Chemistry Department, University of Durham, Durham, UK*

*Fax: +44 191 384 4737; e-mail: D.L.H.WILLIAMS@durham.ac.uk*

---

I. INTRODUCTION .....	665
II. S-NITROSOTHIOLS .....	666
A. Formation .....	666
B. Properties and Chemical Reactions .....	669
C. Biological Activity .....	673
III. S-NITROSOTHIOCARBONYL COMPOUNDS .....	674
A. Formation .....	674
B. Reactions .....	675
IV. FORMATION AND REACTIONS OF OTHER S-NITROSO COMPOUNDS .....	676
A. S-Nitrososulphides .....	676
B. S-Nitrososulphinates (Sulphonyl Nitrites) .....	677
C. S-Nitroso Compounds with Inorganic Anions .....	678
1. Nitrosyl thiocyanate .....	678
2. Nitrosyl thiosulphate .....	678
3. Nitrosyl bisulphite .....	679
V. REFERENCES .....	680

---

### I. INTRODUCTION

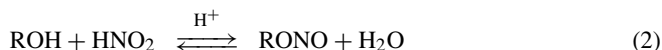
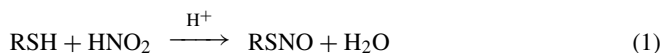
Nitroso compounds in general are quite well-known compounds, readily synthesized and their reactions have been studied. Some are important as intermediates in a number of important industrial processes, e.g. in diazotisation and azo dye formation, in caprolactam synthesis and in paracetamol manufacture. Compounds are very well-known in which the nitroso group is bound to carbon, nitrogen and oxygen sites within molecules. Much less well-known are those in which the nitroso group is bound to sulphur. These include principally *S*-nitrosothiols (sometimes called thionitrites), RSNO, generally henceforth referred to in this chapter as nitrosothiols. Other species including *S*-nitrosothiocarbonyl

compounds are less familiar. Nitrosothiols have not been as widely studied as their oxygen counterparts alkyl nitrites, generally because of their more reduced stability. However, in recent years there has been much interest generated in the chemistry of nitrosothiols following the major discoveries made in the late 1980s and early 1990s concerning the part played by nitric oxide in a number of physiological processes in human metabolism. Nitric oxide is believed to be formed naturally *in vivo* by an enzymatic reaction of L-arginine (leading to L-citrulline production) and also brought about *in vivo* by the administration of drugs such as glyceryl trinitrate (GTN), which has been used for over a century to treat problems in the blood circulatory system. Nitrosothiols (which have been detected *in vivo*) are believed to be involved in the nitric oxide saga in two ways: (a) as possible alternative (to GTN) NO-releasing drugs to make up for the deficiencies of spontaneous NO production in some clinical conditions, and (b) as a possible 'storage' area for nitric oxide *in vivo* in the mechanism of NO transfer within the body.

## II. S-NITROSO THIOLS

### A. Formation

Nitrosothiols are very easily generated by simple electrophilic nitrosation of thiols<sup>1</sup> (equation 1), just as alkyl nitrites are made from alcohols (equation 2), and *N*-nitrosamines from secondary amines (equation 3). The most convenient reagent is nitrous acid, generated from sodium nitrite and mineral acid in water or in mixed alcohol water solvents. In water the *S*-nitrosation of thiols is effectively irreversible, contrasting with the corresponding reaction of alcohols. This makes the product separation somewhat easier. The reason for the different behaviour is believed to arise from the differences in basicity (important in the reverse reaction) and nucleophilicity (important in the forward reaction) between the *O*- and *S*-sites. The reaction has been studied mechanistically<sup>2</sup> and it shows all the characteristics of electrophilic nitrosation (including catalysis by non-basic nucleophiles such as halide ions, thiocyanate ion and thiourea) which are very familiar in *N*-nitrosation. However, since thiols are not significantly protonated in acid solution *S*-nitrosation is generally a faster process overall than in *N*-nitrosation. Some kinetic data (values of  $k$  in rate =  $k[\text{HNO}_2][\text{H}^+][\text{RSH}]$ ) are given in Table 1 for the acid catalysed nitrosation of some thiols with nitrous acid. These rate constants tend to approach  $7000 \text{ dm}^6 \text{ mol}^{-2} \text{ s}^{-1}$  which is believed to be the diffusion controlled limit for the reaction of  $\text{NO}^+$  with the thiols. Similarly, second-order rate constants for the reactions of  $\text{ClNO}$ ,  $\text{BrNO}$  and  $\text{ONSCN}$  have been determined for some thiols and are given in Table 2. The by now well-established reactivity trend  $\text{ClNO} > \text{BrNO} > \text{ONSCN}$  is evident but the more reactive species are strangely well below the diffusion limit.



Other nitrosating agents have been used successfully to synthesize nitrosothiols, notably alkyl nitrites<sup>3</sup>, nitrosyl chloride<sup>4</sup>, dinitrogen trioxide<sup>5</sup> and dinitrogen tetroxide<sup>6</sup>. In principle any carrier of  $\text{NO}^+$  would suffice. One of the simplest nitrosothiols,  $\text{CF}_3\text{SNO}$  (a red unstable gas), has been made from both nitrosyl chloride and alkyl nitrites in reaction with  $\text{CF}_3\text{SH}$ <sup>7</sup>. Use of these reagents in organic solvents has some advantage over the

TABLE 1. Values of the third-order rate constant for the acid catalysed nitrosation of thiols with nitrous acid in water at 25 °C

RSH	$k/(\text{dm}^6 \text{mol}^{-2} \text{s}^{-1})$
Cysteine methyl ester	213
Cysteine	443
Glutathione	1080
Mercaptosuccinic acid	1334
Thioglycolic acid	2630
Mercaptopropanoic acid	4764

TABLE 2. Second-order rate constants for the reactions of ClNO, BrNO and ONSCN with thiols in water at 25 °C

	$k(\text{dm}^3 \text{mol}^{-1} \text{s}^{-1})$		
	ClNO	BrNO	ONSCN
Cysteine methyl ester	$1.0 \times 10^6$	$4.9 \times 10^4$	$7.0 \times 10^2$
Cysteine	$1.2 \times 10^6$	$5.8 \times 10^4$	$7.0 \times 10^2$
Glutathione	$5.7 \times 10^6$	$2.9 \times 10^5$	$1.9 \times 10^3$
Mercaptosuccinic acid	—	$2.6 \times 10^4$	—
Thioglycolic acid	$1.4 \times 10^7$	$1.1 \times 10^6$	$2.5 \times 10^4$
Mercaptopropanoic acid	—	$4.5 \times 10^5$	—

nitrous acid method when there are solubility difficulties in water. A well-tried successful procedure<sup>6</sup> is to use  $\text{N}_2\text{O}_4$  in carbon tetrachloride, hexane, ether or acetonitrile at  $-10^\circ\text{C}$ , when reaction is quantitative. Another excellent and more convenient procedure involves the use of *t*-butyl nitrite in organic solvents such as chloroform or acetonitrile<sup>8</sup> where again excellent yields have been reported (equation 4). In mechanistic studies in water it has been shown that nitrosothiols are formed in solution by attack of the thiolate anion (in mildly alkaline solution) with a large range of alkyl nitrites<sup>9</sup> (equation 5) and also with *N*-methyl-*N*-nitrosotoluene-*p*-sulphonamide<sup>10</sup>. In both cases reaction appears to involve simple nucleophilic attack by the thiolate ion at the nitrogen atom of the nitroso group and, as expected, reactions are much facilitated by the presence of electron-withdrawing substituents in the alkyl nitrite. Neither reaction appears to have been much used synthetically. Some rate data are given in Table 3 which give the second-order rate constants  $k$  for the reactions of nine alkyl nitrites with three thiolate anions. The rate enhancement by electron-withdrawing groups within the alkyl nitrites is clearly seen. Nitrosothiols can also be formed from disulphides RSSR by photolysis and reaction with nitric oxide, but this does not seem to have much synthetic potential<sup>11</sup>.

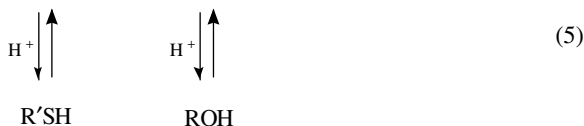
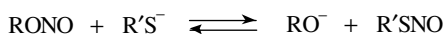
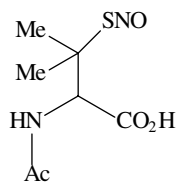


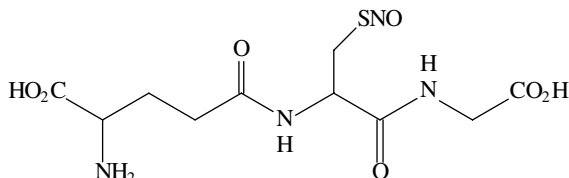
TABLE 3. Second-order rate constants for the reaction of alkyl nitrites with the thiolate ions derived from three thiols in water at 25 °C

RONO	$k(\text{dm}^3 \text{mol}^{-1} \text{s}^{-1})$		
	Cysteine	<i>N</i> -Acetylcysteine	Thioglycolic acid
Me <sub>3</sub> CONO	1.7	1.8	4.9
Me <sub>2</sub> CHONO	11	12	30
EtONO	28	31	75
(Me) <sub>2</sub> CH(CH <sub>2</sub> ) <sub>2</sub> ONO	27	30	75
EtO(CH <sub>2</sub> ) <sub>2</sub> ONO	169	169	417
Cl(CH <sub>2</sub> ) <sub>2</sub> ONO	1045	1010	2260
Br(CH <sub>2</sub> ) <sub>2</sub> ONO	1055	1030	2240
I(CH <sub>2</sub> ) <sub>2</sub> ONO	1060	1020	2260
Cl <sub>2</sub> CHCH <sub>2</sub> ONO	$1.2 \times 10^4$	—	—
Cl <sub>3</sub> CCH <sub>2</sub> ONO	Too fast to measure	—	—

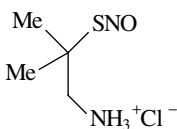
Early workers isolated nitrosothiols of varying degrees of stability, including EtSNO<sup>4</sup>, Ph<sub>3</sub>CSNO<sup>12</sup> and Me<sub>3</sub>CSNO<sup>13</sup>. However, in 1978 Field and coworkers<sup>14</sup> prepared the nitrosothiol derived from *N*-acetyl-*D,L*-penicillamine (SNAP) which is indefinitely stable in the solid form as deep green crystals with red reflections. SNAP (**1**), because of its solid state stability, has been much used as the typical nitrosothiol in a large number of biological experiments. Similarly, the derivative from glutathione (**2**) is now widely available as a stable solid<sup>15</sup>. The mounting interest in the biological activity of nitrosothiols



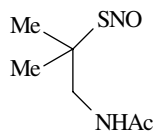
(1)



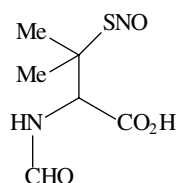
(2)



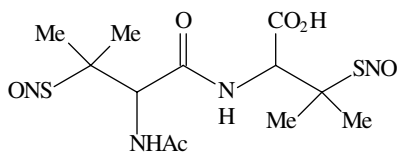
(3)



(4)



(5)



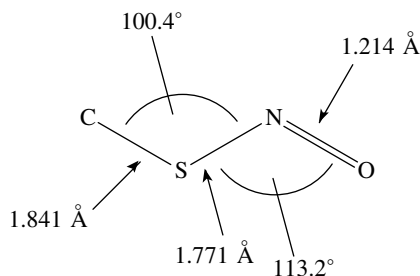
(6)

has resulted in the isolation of a large number of stable nitrosothiols including **3**<sup>16</sup>, **4**<sup>16</sup>, **5**<sup>17</sup> and the *S,S'*-dinitrosothiol **6**<sup>17</sup>.

## B. Properties and Chemical Reactions

The stable nitrosothiols are coloured either green or red. In general the tertiary structures (e.g. SNAP) are green. There is a general UV absorption band in the range 330–350 nm with extinction coefficients about  $10^3 \text{ mol}^{-1} \text{ dm}^3 \text{ cm}^{-1}$ , which has been used to monitor reactions of nitrosothiols by spectrophotometry in kinetic studies. The UV-visible spectra have been analysed and the electronic transitions assigned<sup>18</sup>. The infrared spectra of some nitrosothiols have also been analysed<sup>7</sup> and the stretching ( $1480\text{--}1530 \text{ cm}^{-1}$ ) and bending frequencies of the NO group identified, as has the C–S vibration in the  $600\text{--}730 \text{ cm}^{-1}$  region. Both <sup>1</sup>H and <sup>13</sup>C NMR spectra of nitrosothiols have also been examined<sup>16</sup>. There is a significant downfield shift of the  $\alpha$ -protons upon nitrosation of thiols and there is a similar shift of the  $\alpha$ -carbon resonances, which makes the techniques useful in showing whether *S*-nitrosation has occurred.

The molecular structure of SNAP has been obtained by X-ray crystallography<sup>14</sup>, and is shown in **7**. The C–S bond is rather long, but other features are as expected.



(7)

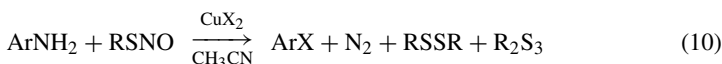
Since the discovery that nitric oxide is crucially involved in a range of physiological processes and indeed that it is synthesized *in vivo* from L-arginine (for review articles see References 19–22), there has been intense interest in a range of compounds which might act as NO donors. Consequently, the most studied reaction of nitrosothiols is that where decomposition to nitric oxide occurs.

Nitrosothiols decompose photochemically and thermally to give the corresponding disulphides and nitric oxide<sup>18,23,14,24</sup> (equation 6). In most cases the nitric oxide has not been identified as the primary product but rather as its oxidized form, nitrogen dioxide.



The reaction in water at pH 7.4 has been much studied since the discovery of the importance of nitric oxide. The products are as for the thermal and photochemical reactions, except that the final product is nitrite ion. This is to be expected since nitric oxide in aerated water at pH 7.4 also yields quantitatively nitrite ion<sup>25</sup>, by it is believed the series of equations 7–9, which involves oxidation to nitrogen dioxide, further reaction to give dinitrogen trioxide which, in mildly alkaline solution, is hydrolysed to nitrite ion. Under anaerobic conditions it is possible to detect nitric oxide directly from the decomposition of nitrosothiols using a NO-probe electrode system<sup>26</sup>. Solutions of nitrosothiols both in

water<sup>26</sup> and in organic solvents<sup>6,14</sup> will nitrosate, e.g. amines, probably via NO loss, oxidation and N<sub>2</sub>O<sub>3</sub> formation. In the absence of oxygen no nitrosation product is detected. Aryl halides are generated in excellent yields from nitrosothiols and arylamines at ambient temperatures in the presence of anhydrous Cu(II) halides in acetonitrile (equation 10)<sup>11</sup>. This probably involves an initial NO group transfer, probably indirectly via NO formation, although no mechanistic studies have been carried out.



Kinetic studies of the reaction of nitrosothiols in water at pH 7.4 have been reported and reveal a large range of different rate forms and half-lives. However, in 1993 it was realized<sup>27</sup> that reaction is brought about by catalytic quantities of Cu<sup>2+</sup>. There is a sufficient concentration of Cu<sup>2+</sup> in many samples of distilled water, and particularly buffer components, to allow reaction to occur. This accounts for the wildly erratic behaviour reported in the literature. When the concentration of Cu<sup>2+</sup> is carefully controlled sensible results emerge. There is a range of [Cu<sup>2+</sup>] for most of the nitrosothiols studied for which the second-order rate equation (equation 11) applies. Values of the second-order rate constant *k* vary with the structure of the nitrosothiol in such a way which suggests that the copper needs to be bidentately linked (a) with the N of the NO group (or the S of the SNO group) and (b) with another electron-donating system such as a nitrogen atom or negatively charged oxygen atom at positions within the molecule which allow a six-membered ring to be formed<sup>26</sup>. Both *N*-acetylation and the addition of a methylene group (which would give a 7-membered ring) resulted in sharp rate reductions. Very little reaction was discernible in the absence of function (b), e.g. for *t*-BuSNO. When Cu<sup>2+</sup> was rigorously excluded by complexation with EDTA, then again the reaction rate was reduced to a negligible value, even for reaction of the 'normally very reactive' nitrosothiols such as nitrosocysteine.

$$\text{Rate} = k[\text{RSNO}][\text{Cu}^{2+}] \quad (11)$$

Outside a given [Cu<sup>2+</sup>], zero-order behaviour (at high [Cu<sup>2+</sup>]) and the presence of an induction period (at low [Cu<sup>2+</sup>]) raised the possibility that the actual catalyst is Cu<sup>+</sup> and not Cu<sup>2+</sup>, formed by reduction of the latter by thiolate ion, a well-known reaction<sup>28</sup> (equation 12). This was confirmed by the use of a specific Cu<sup>+</sup>-chelating agent neocuproine (**8**) which resulted in a sharp rate reduction, leading eventually to a complete suppression of the reaction. The spectrum of the Cu<sup>+</sup>-**8** complex was observed from the reaction mixture. Further, the increased reactivity brought about by the addition of a thiol species supported this suggestion. At low concentrations of added thiol there was a sharp increase in the rate constant for the reaction of SNAP, whereas at higher concentrations there was a gentle reduction leading eventually to a stabilization effect (see Figure 1). The initial catalysis represents an increase in rate of Cu<sup>+</sup> formation (equation 12) whereas the subsequent rate reduction is believed to arise by complexation of Cu<sup>2+</sup> by thiolate (a well-known reaction<sup>29</sup>). This accounts for the contrasting literature reports, which state that in some cases added thiol increases the rate of decomposition whereas in other cases a stabilization effect is claimed. The outline reaction scheme is given in equations 13–15. Intermediate X<sub>1</sub> is probably RSCu<sup>+</sup> and X<sub>2</sub> is probably a structure similar to those given

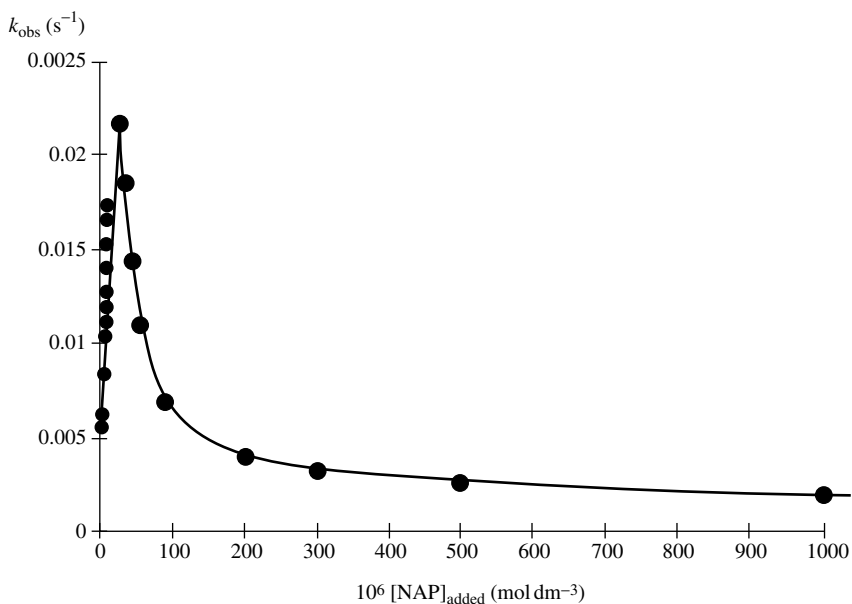
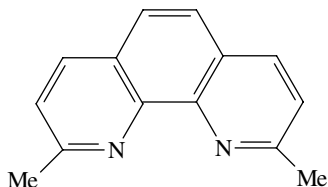
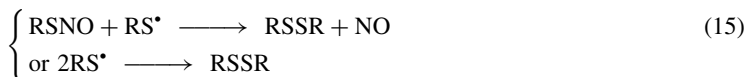
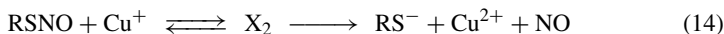
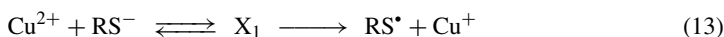
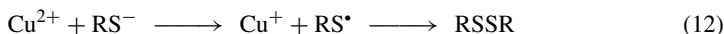
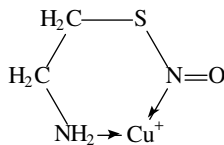


FIGURE 1. Rate constant for decomposition of *S*-nitroso-*N*-acetylpenicillamine in the presence of added *N*-acetylpenicillamine (NAP)

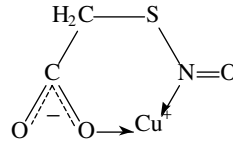
in **9** and **10** for two different nitrosothiols. It is likely that here  $\text{Cu}^+$  is also coordinated to two water molecules. Details of how NO is released from **9** and **10** are not yet clear, and it is possible that coordination is at the sulphur atom rather than the nitroso nitrogen atom.



(8)



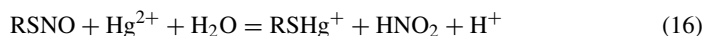
(9)



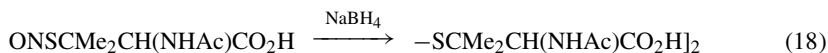
(10)

Nitrosothiols are also readily decomposed by mercuric ion to the corresponding coordinated thiols and nitrous acid (in acid solution) as in equation 16. This reaction has been used as the basis of an analytical procedure for thiol determination<sup>30</sup>. Mechanistic

studies have shown<sup>31</sup> that this is quite a different reaction to the  $\text{Cu}^{2+}$  catalysed reaction since (a) the  $\text{Hg}^{2+}$  reactions are generally much faster, (b) the reactions with  $\text{Hg}^{2+}$  are stoichiometric rather than catalytic, (c) no trace of  $\text{NO}$  was detected when the reaction was carried out anaerobically and (d) there is very little structure–reactivity dependence which is so evident for the  $\text{Cu}^{2+}$  reaction. All the evidence suggests that  $[\text{RS}(\text{Hg})\text{NO}]^{2+}$  is first formed and then undergoes nucleophilic attack by water at the nitroso nitrogen atom to release nitrous acid. A similar reaction can be achieved with an acid catalyst (equation 17) but only at fairly high acid concentration ( $\sim 2\text{M H}_2\text{SO}_4$ ) and only in the presence of a nitrous acid trap (such as sulphamic acid) which ensures the irreversibility of the process<sup>32</sup>.



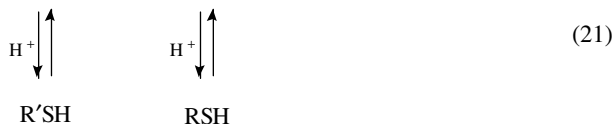
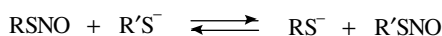
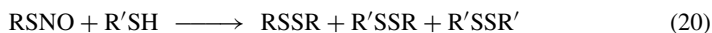
Nitrosothiols can also be reduced with sodium borohydride, leading (with SNAP<sup>14</sup>) to the disulphide formation (equation 18).



Oxidation is also a known reaction; examples are known where the reagents are fuming nitric acid<sup>33</sup> or  $\text{N}_2\text{O}_4$ <sup>34</sup>, the product being in each case the corresponding thionitrate (equation 19).



An important reaction of nitrosothiols is the exchange reaction of the nitroso group with another thiol, i.e. a transnitrosation. This has been demonstrated on a number of occasions<sup>6,35</sup>. Often, the final product is not the new nitrosothiol but its decomposition product, the disulphide. All three possible disulphides, for example, have been identified in the product mixture of the reaction of nitrosogluthathione (GSNO) with cysteine (equation 20). It is, however, possible to identify spectrophotometrically the primary products of transnitrosation<sup>36,37</sup>. Kinetic studies<sup>37</sup> have shown quite clearly that the reaction involves attack by the thiolate anion, probably in a direct reaction, and is an example of nucleophilic substitution at the nitroso nitrogen atom. The process (equation 21) is thus very similar to that reported in Section II.A for the corresponding reaction of the thiolate anions with alkyl nitrites (equation 5). It seems likely that other powerful nucleophiles will react in a similar fashion, but there appear to be no reports in the literature.





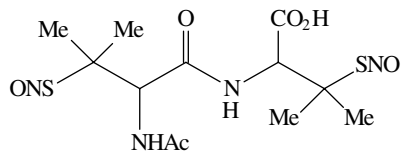
### C. Biological Activity

Since 1986, a remarkable number of discoveries have been made concerning the physiological actions of nitric oxide. A large number of review articles have appeared (typically References 19–21) and a vast amount of research is being undertaken in this area. It is now known that nitric oxide is synthesized *in vivo* from L-arginine and controls, among other functions vasodilation in the blood circulatory system. Administered drugs such as glyceryl trinitrate (GTN, by far the most widely used) and other organic nitrates also generate nitric oxide *in vivo* and are effective as a treatment for angina and other circulatory problems. There is a problem with glyceryl trinitrate in that it quickly induces a tolerance in some patients, so that there is a need for other NO-releasing compounds which can be used medically. Nitrosothiols present an obvious alternative solution.

There is no doubt that many nitrosothiols effect vasodilation<sup>38</sup> and also have a powerful inhibition effect on platelet aggregation<sup>39</sup>. Among those tested and shown to have significant activity are nitrosocysteine, SNAP, GSNO and nitrosocaptopril. Use is now made of these properties clinically by way of the administration of nitrosoglutathione (GSNO) (a) during coronary angioplasty<sup>40</sup> to inhibit platelet aggregation and (b) to treat a form of pre-eclampsia in pregnant women<sup>41</sup>. Details of the mode of action are not known, but a major factor is believed to be the ability to inhibit platelet aggregation at concentration levels which do not lower blood pressure, in contrast to some other NO-donors.

It has been argued that the so-called Endothelium Derived Relaxing Factor is in fact a nitrosothiol<sup>42</sup> and not nitric oxide itself. This, however, is not the generally held view at the present time. Nonetheless, it is quite likely that nitrosothiols are involved at some stage and the bulk of the nitric oxide in the blood<sup>43</sup> and in other tissues such as the lung<sup>44</sup> is found primarily in the form of nitrosothiol derivatives of proteins and peptides, notably GSNO. The anti-platelet aggregation effects of nitrosothiols may involve lower molecular weight nitrosothiols following the known (equation 21) transnitrosation between nitrosothiols and thiols<sup>45</sup>.

New nitrosothiols are being synthesized and tested for activity. These include structures **1–6** in Section II.A as well as those derived from cysteine residues within proteins. One example of a *S*-nitrosocysteine within a polypeptide<sup>46</sup> is remarkably stable in the solid form, contrasting with the marked instability of *S*-nitrosocysteine itself. The *S,S'*-dinitrosodithiol **11** has been shown to have platelet aggregation inhibition properties of the same order of magnitude as GTN and vasodilation properties somewhat less than those possessed by GTN<sup>17</sup>.



(11)

Nitrosothiols thus appear to have the necessary properties for clinical use as an alternative for GTN. There does not appear to be the same problem regarding tolerance<sup>47</sup>. Much testing experiments *in vivo* remain to be undertaken.

Little is known about the mode of action of nitrosothiols regarding their biological properties. There appears to be no direct connection between their reactivities towards nitric oxide loss and biological activity<sup>38,48</sup>. However, the experiments which have been carried out in these studies relating to rates of nitric oxide formation do not recognize

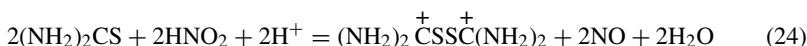
the vital part played by  $\text{Cu}^{2+}$  in these reactions and the quoted results may not represent a true reactivity sequence. It has been suggested<sup>49</sup> that some of the biological activities result from  $\text{NO}^+$  loss from  $\text{RSNO}$ , not in a unimolecular process (which would not make good chemical sense) but in the transnitrosation process discussed earlier in Section II.B (equation 21).

One important result, however, does point to the fact that nitric oxide release from nitrosothiols is a necessary reaction for there to be biological activity<sup>50</sup>. In a study using nitrosocysteine and GSNO it was shown that the specific copper(I) chelators neocuproine (**8**) and the structurally related bathocuproine sulphonate reduce the biological activity of both nitrosothiols. This indicates that copper(I) is required for biological activity, which ties in with the *in vitro* experiments described in Section II.B. The realization that copper plays such an important part in nitrosothiol decomposition accounts for the widely differing decomposition rates quoted in the literature, e.g. the half-life of nitrosocysteine has been reported as 15 min and also variously between 4 and 83 seconds. One of the factors important here, apart from the level of the  $[\text{Cu}^{2+}]$  present adventitiously, is the nature and concentration of the buffers used, since many of these, particularly those containing carboxylic acid groups, will themselves bind  $\text{Cu}^{2+}$  and hence reduce the catalytic activity. It is clear that there is a long way to go before the biological activities of nitrosothiols (and of nitric oxide) are fully understood at the molecular level.

### III. S-NITROSOETHIOCARBONYL COMPOUNDS

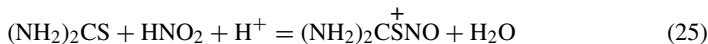
#### A. Formation

The sulphur atom of a thiocarbonyl compound is a powerful nucleophilic centre. Examples are to be found in the *S*-alkylation of thioamides and in the reaction of thiourea to give isothiuronium salts from alkyl halides. In a conventional  $\text{S}_{\text{N}}2$  reaction thiourea is approximately as powerful a nucleophile as is iodide ion in polar solvents as measured by the Pearson nucleophilicity parameter<sup>51</sup>. It is no surprise therefore that thiourea reacts with nitrous acid to give initially the *S*-nitrososulphonium ion (equation 22). This generates a red or yellow colour in solution, which is fairly characteristic of *S*-nitroso species. No salts have been isolated and the ion decomposes fairly readily in solution. In fact Werner<sup>52</sup> showed that thiourea can undergo two reactions with nitrous acid, one leading to thiocyanate ion and nitrogen products (equation 23) and the other to the disulphide cation (equation 24). These findings can be rationalized in terms of *N*-nitrosation (at low acidities) leading to nitrogen formation, and *S*-nitrosation (at higher acidities) leading to the disulphide cation.



The equilibrium constant for *S*-nitrososulphonium ion formation (equation 25) has been measured spectrophotometrically as  $5000 \text{ dm}^6 \text{ mol}^{-2}$  at  $25^\circ\text{C}$  in water<sup>53</sup>. This is a much larger figure than for the corresponding reactions leading to nitrosyl chloride, bromide and thiocyanate formation, reflecting the greater nucleophilicity of thiourea. The same effect is evident in the analysis of the rate constant for the nitrosation of thiourea by nitrous acid (equation 26). The value of the third-order rate constant  $k$  is  $6900 \text{ dm}^6 \text{ mol}^{-2} \text{ s}^{-1}$  at  $25^\circ\text{C}$ , which is very close to that found for a large number of reactive aromatic amines

and is believed to be at the diffusion-controlled limit for reaction of  $\text{NO}^+$  (or  $\text{H}_2\text{NO}_2^+$ ) with thiourea<sup>54</sup>. Alkyl thioureas react with much the same rate constant.



$$\text{Rate} = k[(\text{NH}_2)_2\text{CS}][\text{HNO}_2][\text{H}^+] \quad (26)$$

As expected, other carriers of  $\text{NO}^+$  such as nitrosamines<sup>55</sup>, alkyl nitrites<sup>56</sup> and a nitrososulphonamide<sup>57</sup> will also generate the *S*-nitrososulphonium ion from thiourea.

There appears to be little reported work on *S*-nitrosation reactions of simple thioketones. Thiocamphor when treated with *iso*-amyl nitrite in fact gives the oxime<sup>58</sup> (formerly called  $\alpha$  isonitroso compounds), presumably via the tautomeric form of the thione, i.e. the enethiol. In this respect the reaction is very similar to the reactions of ketones<sup>59</sup> which give oximes or *C*-nitroso compounds via the enol intermediates<sup>60</sup>.

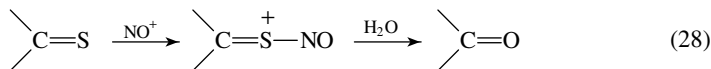
## B. Reactions

The *S*-nitrososulphonium ions derived from thiourea and its derivatives are not stable in solution but decompose to give the disulphide cation (*C,C*-dithiodiformamidinium) which has been isolated as its salts, e.g. the perchlorate and characterized by X-ray crystal analysis<sup>61</sup> (equation 27). This is an example of the more general reaction whereby, eventually, thioureas and also thioketones and thiocarbonates can be converted to the stable *-S-S-*dication by a range of oxidizing agents both chemical and electrochemical<sup>62</sup>.



The decomposition reaction has been studied mechanistically<sup>63</sup> and the kinetics have been interpreted in terms of the parallel pathways, one involving a bimolecular reaction between two  $(\text{NH}_2)_2\overset{+}{\text{C}}\text{SNO}$  species (leading to a second-order kinetic term) and the other a reversible formation of a radical intermediate  $[(\text{NH}_2)_2\text{CSSC}(\text{NH}_2)_2]^{\cdot+}$ .

At higher acidities the *S*-nitrosation reaction of thiourea leads to the formation of urea<sup>64</sup> (equation 28) via, it is believed, the intermediate formation of the *S*-nitroso species. The reaction can also be brought about by nitrosamines or alkyl nitrites as the carriers of  $\text{NO}^+$ . Reaction is thought to involve nucleophilic attack of the intermediate by water or the elimination of  $\text{HSNO}$  giving a carbodiimide, which is then hydrated.



An important property of the *S*-nitroso thiourea derivatives is the ability to effect electrophilic nitrosation of any of the conventional nucleophilic centres. This is manifest kinetically by the catalysis of nitrous acid nitrosation effected by added thiourea (equation 29). The situation is completely analogous to the catalysis of the same reactions by added halide ion or thiocyanate ion. The catalytic efficiency of thiourea depends on both the equilibrium constant  $K_{\text{XNO}}$  for the formation of the intermediate and also its rate constant  $k$  with typically a secondary amine<sup>65</sup>. Since  $K_{\text{XNO}}$  is known ( $5000 \text{ dm}^6 \text{ mol}^{-2}$ ), it is easy to obtain values of  $k$ . Values of  $k$  follow the trend  $(\text{NH}_2)_2\overset{+}{\text{C}}\text{SNO} < \text{ONSCN} < \text{BrNO} < \text{ClNO}$  whereas  $K_{\text{XNO}}$  values follow the opposite trend. Since the range of  $K_{\text{XNO}}$  values is very much larger than that of  $K$  values, the most efficient catalyst by far is thiourea. This is illustrated graphically in Figure 2 where the catalytic efficiencies of thiourea, thiocyanate

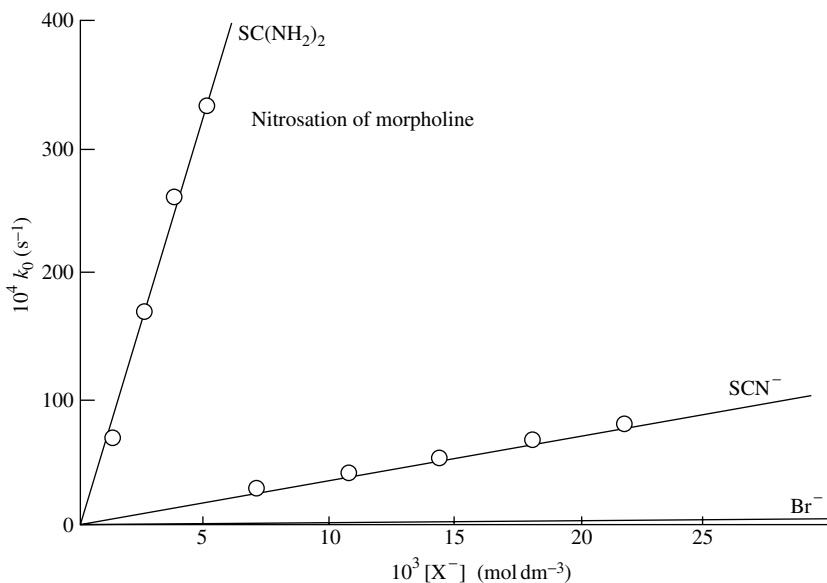
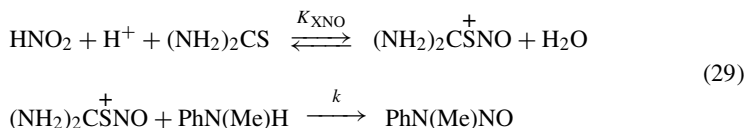


FIGURE 2. Catalysis by  $\text{Br}^-$ ,  $\text{SCN}^-$  and  $(\text{NH}_2)_2\text{CS}$  in the nitrosation of morpholine

ion and bromide ion are compared in the nitrosation of morpholine by nitrous acid<sup>66</sup>. A similar analysis has been carried out for the diazotisation of aniline<sup>67</sup> and earlier for aliphatic amines<sup>68</sup>. It appears that thiourea is the most efficient catalyst of nitrosation using aqueous nitrous acid.



#### IV. FORMATION AND REACTIONS OF OTHER S-NITROSO COMPOUNDS

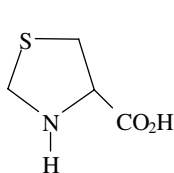
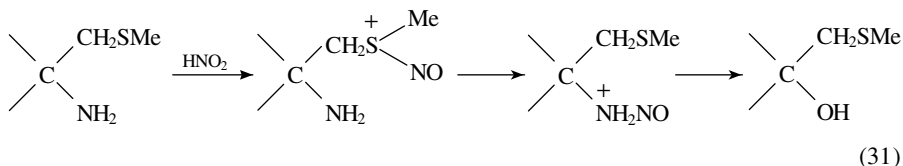
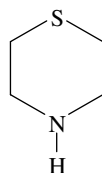
##### A. S-Nitrososulphides

It has been known for a long time that simple alkyl sulphides yield coloured (yellow or red) solutions when treated with alkyl nitrites or nitrous acid<sup>69</sup>. The colours fade on standing and products have not been identified. It does, however, seem likely that the coloured products are in fact *S*-nitroso ions (equation 30) by analogy with the corresponding reaction of thiols, although in this case there is no suitable leaving group which would lead to a stable product.



There is indirect kinetic evidence that *S*-nitrosation of a sulphide occurs<sup>70</sup>, followed by a *S* to *N* rearrangement of the nitroso group, leading finally to deamination (equation 31). The evidence is based on the much higher reaction rate when the sulphur atom is present.

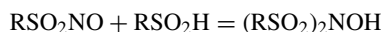
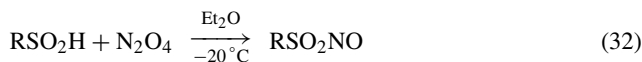
*S* to *N* transfer of the nitroso group has also been postulated on a number of other occasions<sup>53,71</sup> to explain enhanced reaction rates. Detailed kinetic studies on the nitrosation of thioproline<sup>72</sup> (**12**) and thiomorpholine<sup>73</sup> (**13**) reveal that two pathways can exist, which depend on the reaction conditions, (a) a direct reaction at nitrogen and (b) a direct reaction at sulphur followed by *S* to *N* migration of the nitroso group.

**(12)****(13)**

Sulphides should be capable of bringing about catalysis of nitrosation if the  $\begin{array}{c} \diagup \\ \text{S}^+ \\ \diagdown \end{array} \text{NO}$  ion is formed and if it is itself an electrophilic nitrosating agent. This has been shown to be the case<sup>74</sup> for the nitrosation of *N*-methylaniline in the presence of added dimethyl sulphide. The overall catalytic effect is approximately the same as that shown by bromide ion, but no data are available for the value of the equilibrium constant for  $\begin{array}{c} \diagup \\ \text{S}^+ \\ \diagdown \end{array} \text{NO}$  formation or for the rate constant for its reaction with the amine. Diazotisation of aniline is also catalysed by *S*-methylcysteine<sup>66</sup>. Evidence that *S*-nitroso sulphides can be generated from nitrosamines and sulphides comes from the substantial nucleophilic reactivity of methionine (approximately the same level as bromide ion) in the denitrosation of an aromatic nitrosamine in acid solution in the presence of a 'nitrite trap' such as hydrazine<sup>75</sup>.

## B. *S*-Nitrososulphinates (Sulphonyl Nitrites)

*S*-Nitrososulphinates can be made by treating sulphinic acids with  $\text{N}_2\text{O}_4$  at about  $-20^\circ\text{C}$  in ether (equation 32)<sup>76</sup>. Use of nitrous acid on alkyl nitrites leads to the formation of the corresponding hydroxylamines (equation 33) in a reaction where it is believed that the first formed nitrososulphinates nitrosates another molecule of the reactant sulphinic acid<sup>77</sup>.



The isolated nitrososulphinates are unstable brown crystals with the  $\text{N}=\text{O}$  IR absorption band near  $1840\text{ cm}^{-1}$ , i.e. at shorter wavelengths than in nitroso thiols ( $1490\text{--}1700\text{ cm}^{-1}$ ) due to the powerful electron-withdrawing effect of the sulphonyl group. They decompose

upon warming, giving off nitric oxide and forming the hydroxylamine derivative. They are claimed to be the most powerful nitrosating agents known, although there are no quantitative data available. They react with alcohols giving alkyl nitrites, thiols to give *S*-nitrosothiols and provide excellent reagents for deamination of aryl amines in acetonitrile containing anhydrous Cu(II) halides at room temperature<sup>78</sup>. Nitrosamines are formed from secondary amines in high yield at room temperature<sup>11</sup>. The most used reagent to date is 4-MeC<sub>6</sub>H<sub>4</sub>SO<sub>2</sub>NO.

The kinetics of the nitrosation of benzenesulphonic acid have been determined<sup>79</sup>. The reaction is very rapid and requires stopped-flow techniques. This makes benzenesulphonic acid an excellent trap for free nitrous acid, on par with the more well-known hydrazoic acid and hydrazinium ion<sup>80</sup>. In mildly acid solution reaction occurs via the sulphonic acid molecule and also the sulphinate ion. As expected, the latter is the more reactive and reaction takes place at the diffusion limit. All evidence points to the fact that the first nitrosation by NO<sup>+</sup> is the rate-limiting step.

## C. *S*-Nitroso Compounds with Inorganic Anions

### 1. Nitrosyl thiocyanate

When thiocyanate ions are added to nitrous acid in water, a pink colouration develops which is believed to be due to the formation of nitrosyl thiocyanate (equation 34), which is too unstable to be isolated but which can be used as a nitrosating agent in aqueous solution. Because the equilibrium constant for ONSCN formation<sup>81</sup> is quite large (30 dm<sup>6</sup> mol<sup>-2</sup>) at 25 °C, thiocyanate ion is an excellent catalyst for aqueous electrophilic nitrosation. The well established<sup>82</sup> series is Cl<sup>-</sup> < Br<sup>-</sup> < SCN<sup>-</sup> < (NH<sub>2</sub>)<sub>2</sub>CS. Thiocyanate ion is also a sufficiently powerful nucleophile to react in acid solution with nitrosamines in a denitrosation process (equation 35), which can only be driven to the right if the nitrosyl thiocyanate is removed by, e.g., reaction with a 'nitrite trap' such as hydrazoic acid.



↓  
Removed

There are numerous examples of the demonstration of the catalytic activity of thiocyanate ion for a wide variety of substrates. In general the *reaction* of ONSCN is rate-limiting, but in some cases (just as for the nitrosyl halides) with very reactive substrates the *formation* of ONSCN can be rate-limiting.

Although ONSCN has not been isolated, *ab initio* calculations<sup>83</sup> and application of HASB theory suggest that the nitroso group is bonded to the sulphur atom.

### 2. Nitrosyl thiosulphate

A yellow solution is formed when nitrous acid is added to thiosulphate ion in water<sup>84</sup>. This is believed to be due to the formation of nitrosyl thiosulphate [O<sub>3</sub>SSNO]<sup>-</sup>, although this has not been isolated and even in solution decomposition is fairly rapid. The equilibrium constant for its formation  $K_{\text{XNO}}$  is  $1.66 \times 10^7$  dm<sup>6</sup> mol<sup>-2</sup> at 25 °C and the UV-visible absorption spectrum is very similar to that of other *S*-nitroso compounds<sup>85</sup>. The rate constant for its formation is very large and is believed to represent a diffusion controlled process. Thiosulphate ion does appear to catalyse nitrosation but, over the range studied

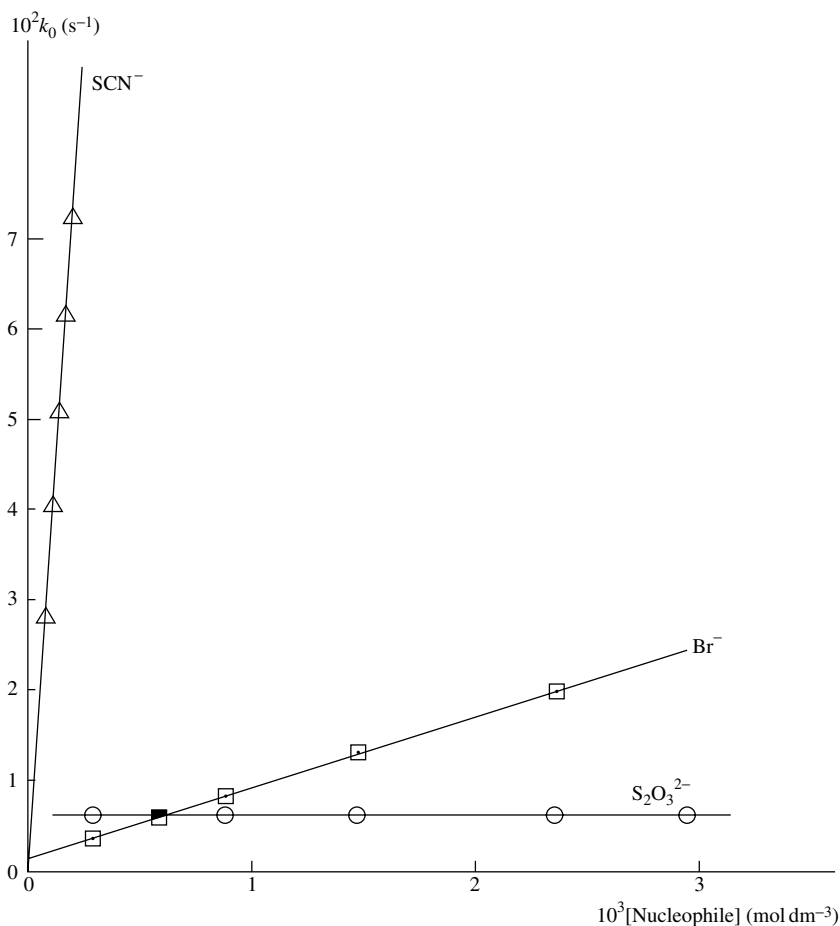


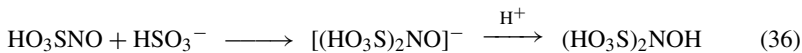
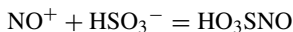
FIGURE 3. Catalytic effect of added  $\text{Br}^-$ ,  $\text{SCN}^-$  and  $\text{S}_2\text{O}_3^{2-}$  in the nitrosation of *N*-methylaniline

for the reaction of *N*-methylaniline, there is no kinetic dependence of the rate constant upon  $[\text{S}_2\text{O}_3^{2-}]$  (see Figure 3)<sup>86</sup>. This is because  $K_{\text{XNO}}$  is so large that under the experimental conditions  $\text{HNO}_2$  is fully converted to  $\text{O}_3\text{SSNO}^-$ . A kinetic analysis reveals that  $\text{O}_3\text{SSNO}^-$  is not a very effective nitrosating agent, being several orders of magnitude less reactive than  $\text{ONSCN}$ .

### 3. Nitrosyl bisulphite

It has been known since 1894 that bisulphite ion reacts with nitrous acid to give hydroxylamine disulphonate<sup>87</sup> (equation 36). It is believed that the nitrosyl bisulphite species is an intermediate which then nitrosates a further bisulphite ion. In this regard the reaction bears a striking resemblance to the nitrosation of sulphinic acids discussed earlier. This reaction has been important commercially for some time as the Raschig process<sup>88</sup> for the production of hydroxylamine, since the disulphonate is readily hydrolysed to give the

free hydroxylamine. The results suggest that HO<sub>3</sub>SNO is indeed a very reactive nitrosating species (just as the *S*-nitrososulphinates, see Section IV.B) but no kinetic studies have been reported on the possible catalytic activity of bisulphite ion in nitrosation reactions.



## V. REFERENCES

1. D. L. H. Williams, *Chem. Soc. Rev.*, **14**, 171 (1985).
2. L. R. Dix and D. L. H. Williams, *J. Chem. Soc., Perkin Trans. 2*, 109 (1984); P. A. Morris and D. L. H. Williams, *J. Chem. Soc., Perkin Trans. 2*, 513 (1988).
3. H. Lecher and W. Siefhen, *Chem. Ber.*, **59**, 1314, 2594 (1926).
4. H. S. Tasker and H. O. Jones, *J. Chem. Soc.*, **95**, 1910 (1909).
5. R. J. Phillips and H. Moor, *Spectrochim. Acta*, **17**, 1004 (1961); R.J. Phillips, *J. Mol. Spectrosc.*, **6**, 492 (1961).
6. S. Oae, Y. H. Kim, D. Fukushima and K. Shinhama, *J. Chem. Soc., Perkin Trans. 1*, 913 (1978).
7. J. Mason, *J. Chem. Soc. (A)*, 1587 (1969).
8. M. P. Doyle, J. W. Terpstra, R. A. Pickering and D. M. LePoire, *J. Org. Chem.*, **48**, 3379 (1983); S. A. Glover, A. Goosen, C. W. McClelland and F. R. Vogel, *S. Afr. J. Chem.*, **34**, 96 (1981).
9. H. M. S. Patel and D. L. H. Williams, *J. Chem. Soc., Perkin Trans. 2*, 37 (1990).
10. S. M. N. Y. F. Oh and D. L. H. Williams, *J. Chem. Soc., Perkin Trans. 2*, 755 (1989).
11. S. Oae and K. Shinhama, *Org. Prep. Proced. Int.*, **15**, 165 (1983).
12. H. Rheinboldt, *Chem. Ber.*, **59**, 1311 (1926).
13. G. Kresze and U. Uhlich, *Chem. Ber.*, **92**, 1048 (1959).
14. L. Field, R. V. Dilts, R. Ravichandran, P. G. Lenhart and G. E. Carnahan, *J. Chem. Soc., Chem. Commun.*, 249 (1978).
15. T. W. Hart, *Tetrahedron Lett.*, **26**, 2013 (1985).
16. B. Roy, A. du M. d'Hardemare and M. Fontecave, *J. Org. Chem.*, **59**, 7019 (1994).
17. H. A. Moynihan and S. M. Roberts, *J. Chem. Soc., Perkin Trans. 1*, 797 (1994).
18. J. Barrett, D. F. Debenham and J. Glauser, *J. Chem. Soc., Chem. Commun.*, 248 (1965).
19. S. Moncada, R. M. J. Palmer and E. A. Higgs, *Pharmacol. Rev.*, **43**, 109 (1991).
20. A. R. Butler and D. L. H. Williams, *Chem. Soc. Rev.*, 233 (1993).
21. P. L. Feldman, O. W. Griffith and D. J. Stuehr, *Chem. Eng. News*, **20**, 26 (1993).
22. M. Fontecave and J.-L. Pierre, *Bull. Soc. Chim. Fr.*, **131**, 620 (1994).
23. J. Barrett, L. J. Fitygibbones, J. Glauser, R. H. Still and P. N. W. Young, *Nature*, **211**, 848 (1966).
24. H. Rheinbolt and F. Mott, *J. Prakt. Chem.*, **133**, 328 (1932).
25. D. A. Wink, J. F. Darbyshire, R. W. Nims, J. E. Saavedra and P. C. Ford, *Chem. Res. Toxicol.*, **6**, 23 (1993).
26. S. C. Askew, D. J. Barnett, J. McAninly and D. L. H. Williams, *J. Chem. Soc., Perkin Trans. 2*, 741 (1995).
27. J. McAninly, D. L. H. Williams, S. C. Askew, A. R. Butler and C. Russell, *J. Chem. Soc., Chem. Commun.*, 1758 (1993).
28. I. M. Klotz, G. H. Czlerlinski and H. A. Friess, *J. Am. Chem. Soc.*, **80**, 2920 (1958).
29. F. J. Davis, B. C. Gilbert, R. O. C. Norman and M. C. R. Symons, *J. Chem. Soc., Perkin Trans. 2*, 1763 (1983).
30. B. Saville, *Analyst*, **83**, 670 (1958).
31. H. R. Swift and D. L. H. Williams, *J. Chem. Soc. Perkin Trans. 2*, (1996) to appear.
32. S. S. Al-Kaabi, D. L. H. Williams, R. Bonnett and S. L. Ooi, *J. Chem. Soc., Perkin Trans. 2*, 227 (1982).
33. H. Rheinboldt and F. Mott, *Chem. Ber.*, **65**, 1223 (1932).
34. Y. H. Kim, K. Shinhama, D. Fukushima and S. Oae, *Tetrahedron Lett.*, 1211 (1978).
35. J. W. Park, *Biochem. Biophys. Res. Commun.*, **152**, 916 (1988).
36. D. J. Meyer, H. Kramer, N. Ozer, B. Coles and B. Ketterer, *FEBS Lett.*, **345**, 177 (1994).
37. D. J. Barnett, A. Rios and D. L. H. Williams, *J. Chem. Soc., Perkin Trans. 2*, 1279 (1995).



38. W. R. Mathews and S. W. Kerr, *J. Pharmacol. Exp. Ther.*, **267**, 1529 (1993) and references cited therein.
39. J. Loscalzo, *J. Clin. Invest.*, **76**, 703 (1985); M. W. Radomski, D. D. Rees, A. Dutra and S. Moncada, *Br. J. Pharmacol.*, **107**, 745 (1992).
40. E. J. Langford, A. S. Brown, R. J. Wainwright, A. J. de Belder, M. R. Thomas, R. E. A. Smith, M. W. Radomski, J. F. Martin and S. Moncada, *Lancet*, **344**, 1458 (1994).
41. A. de Belder, C. Lees, J. Martin, S. Moncada and S. Campbell, *Lancet*, **345**, 124 (1995).
42. L. J. Ignarro, H. Lippiton, J. C. Edwards, W. H. Baricos, A. L. Hyman, P. J. Kadowitz and C. A. Gruetter, *J. Pharmacol. Exp. Ther.*, **218**, 739 (1981); G. M. Rubanyi, A. Johns, D. Wilcox, F. N. Bates and D. Harrison, *J. Cardiovasc. Pharmacol.*, **17**, S41 (1991).
43. J. S. Stamler, O. Jaraki, J. Osborne, D. I. Simon, J. Keaney, J. Vita, D. Singel, C. R. Valeri and J. Loscalzo, *Proc. Natl. Acad. Sci. U.S.A.*, **89**, 7674 (1992).
44. B. Gaston, J. Reilly, J. M. Drazen, J. Fackler, P. Ramdev, D. Arnelle, M. E. Mullins, D. J. Sugarbarker, C. Chee, D. J. Singel, J. Loscalzo and J. S. Stamler, *Proc. Natl. Acad. Sci. U.S.A.*, **90**, 10957 (1993).
45. D. I. Simon, J. S. Stamler, O. Jaraki, J. F. Keaney, J. A. Osborne, S. A. Francis, D. J. Singel and J. Loscalzo, *Arteriosclerosis Thrombos.*, **13**, 791 (1993).
46. P. R. Myers, R. L. Minor, R. Guerra, J. N. Bates and D. G. Harrison, *Nature*, **345**, 161 (1990).
47. J. A. Bauer and H.-L. Fung, *J. Pharmacol. Exp. Ther.*, **256**, 249 (1990).
48. E. A. Kowaluk and H. Fung, *J. Pharmacol. Exp. Ther.*, **256**, 1256 (1990).
49. D. R. Arnelle and J. S. Stamler, *Arch. Biochem. Biophys.*, **318**, 279 (1995).
50. M. P. Gordge, D. J. Meyer, J. Hotherhall, G. H. Neild, N. N. Payne and A. Noronha-Dutra, *Br. J. Pharmacol.*, **114**, 1083 (1995).
51. R. G. Pearson, H. Sobel and J. Songstad, *J. Am. Chem. Soc.*, **90**, 319 (1968).
52. A. E. Werner, *J. Chem. Soc.*, **101**, 2180 (1912); M. E. Coade and A. E. Werner, *J. Chem. Soc.*, **102**, 1221 (1913).
53. K. Al-Mallah, P. Collings and G. Stedman, *J. Chem. Soc., Dalton Trans.*, 2469 (1974).
54. P. Collings, K. Al-Mallah and G. Stedman, *J. Chem. Soc., Perkin Trans. 2*, 1734 (1975).
55. D. L. H. Williams, *J. Chem. Soc., Perkin Trans. 2*, 128 (1977).
56. M. J. Crookes and D. L. H. Williams, *J. Chem. Soc., Perkin Trans. 2*, 759 (1989).
57. J. R. Leis, M. E. Peña and A. M. Rios, *J. Chem. Soc., Perkin Trans. 2*, 587 (1995).
58. D. C. Sen, *J. Indian Chem. Soc.*, **12**, 751 (1935).
59. O. Touster, in *Organic Reactions* (Ed. R. Adams), **7**, Chap. 6, Wiley, New York, 1953, p. 327.
60. J. R. Leis, M. E. Peña, D. L. H. Williams and S. D. Mawson, *J. Chem. Soc., Perkin Trans. 2*, 157 (1988).
61. O. Foss, J. Johnsen and O. Tvedten, *Acta Chem. Scand.*, **12**, 1782 (1958).
62. R. L. Blankespoor, M. P. Doyle, D. M. Hedstrand, W. H. Tamblyn and D. A. Van Dyke, *J. Am. Chem. Soc.*, **103**, 7096 (1981).
63. P. Collings, M. Garley and G. Stedman, *J. Chem. Soc., Dalton Trans.*, 331 (1981).
64. K. A. Jorgensen and S. O. Lawesson, *Chem. Ser.*, **20**, 227 (1982); J. W. Lown and S. M. S. Chauhan, *J. Org. Chem.*, **48**, 507 (1983).
65. D. L. H. Williams, *Nitrosation*, Cambridge University Press, 1988, pp. 22–24 and references cited therein.
66. T. A. Meyer and D. L. H. Williams, *J. Chem. Soc., Perkin Trans. 2*, 361 (1981).
67. L. R. Dix and D. L. H. Williams, *J. Chem. Res. (S)*, 97 (1984).
68. M. Masui, C. Ueda, T. Yasuoka and H. Ohmori, *Chem. Pharm. Bull.*, **27**, 1274 (1979).
69. E. M. Harper and A. K. Macbeth, *Proc. Chem. Soc.*, **30**, 15 (1914); A. K. Macbeth and D. D. Pratt, *J. Chem. Soc.*, **119**, 354 (1921).
70. T. A. Meyer and D. L. H. Williams, *J. Chem. Soc., Chem. Commun.*, 1067 (1983).
71. J. W. Lown and S. M. S. Chauhan, *J. Org. Chem.*, **48**, 3901 (1983); T. Tahira, M. Tsuda, K. Wakabayashi, M. Nago and T. Sugimura, *Gann*, **75**, 889 (1984).
72. A. Castro, E. Iglesias, J. R. Leis, J. V. Tato, F. Meijide and M. E. Peña, *J. Chem. Soc., Perkin Trans. 2*, 651 (1987).
73. A. Coello, F. Meijide and J. V. Tato, *J. Chem. Soc., Perkin Trans. 2*, 1677 (1989).
74. T. Bryant and D. L. H. Williams, *J. Chem. Res. (S)*, 174 (1987).
75. G. Hallett and D. L. H. Williams, *J. Chem. Soc., Perkin Trans. 2*, 624 (1980).
76. S. Oae, K. Shinhama and Y. H. Kim, *Tetrahedron Lett.*, 3307 (1979).
77. C. S. Marvel and R. S. Johnson, *J. Org. Chem.*, **13**, 822 (1948); G. Kresze and W. Kort, *Chem. Ber.*, **94**, 2624 (1961).

78. S. Oae, K. Shinhama and Y. H. Kim, *Bull. Chem. Soc. Jpn.*, **53**, 1065 (1980).
79. T. Bryant and D. L. H. Williams, *J. Chem. Soc., Perkin Trans. 2*, 1083 (1985).
80. G. P. Quinton and D. L. H. Williams, *J. Chem. Res. (S)*, 209 (1987).
81. G. Stedman and P. A. E. Whincup, *J. Chem. Soc.*, 5796 (1963).
82. Reference 65, pp. 10–24.
83. K. A. Jorgensen and S. O. Lawesson, *J. Am. Chem. Soc.*, **106**, 4687 (1984).
84. J. O. Edwards, *Science*, **113**, 392 (1951).
85. M. S. Garley and G. Stedman, *J. Inorg. Nucl. Chem.*, **43**, 2863 (1981).
86. T. Bryant, D. L. H. Williams, M. H. H. Ali and G. Stedman, *J. Chem. Soc., Perkin Trans. 2*, 193 (1986).
87. E. Divers and T. Haga, *J. Chem. Soc.*, **65**, 523 (1894).
88. F. Raschig, *Z. Angew. Chem.*, **17**, 1398 (1904).

## CHAPTER 15

# Photochemistry of amines and amino compounds

TONG-ING HO

*Chemistry Department, National Taiwan University, Roosevelt Road Section 4,  
Taipei, Taiwan (ROC)*

*Fax: 886-2-363-6359; e-mail: HALL@CHEM50.CH.NTU.EDU.TW*

and

YUAN L. CHOW

*Department of Chemistry, Simon Fraser University, Burnaby,  
British Columbia V5A 1S6, Canada*

*Fax: (604)291-3765; e-mail: YCHOW@SFU.CA*

---

I. INTRODUCTION	684
II. PHOTOCHEMISTRY INVOLVING TERTIARY AMINES	685
A. With <i>trans</i> -Stilbene	685
B. With Styrenes	686
C. With $\alpha,\beta$ -Unsaturated Carbonyl Compounds	687
D. With Other Oxidants	692
E. Tertiary Amines as Donors in Intramolecular Charge Transfer Interaction	693
III. PHOTOCHEMISTRY WITH SECONDARY AMINES	698
A. With Excited State <i>trans</i> -Stilbene	698
B. With Excited Styrenes	700
C. With Other Excited Systems	702
IV. PHOTOCHEMISTRY INVOLVING PRIMARY AMINES AND AMMONIA	704
V. PHOTOCHEMISTRY OF IMINE AND IMINIUM SALTS	710
A. Photoinduced Electron Transfer Chemistry of Iminium Salts	710
B. The Aza-di- $\pi$ -methane Rearrangement	715
C. Photochemistry of Azirines	717
D. Stilbene-type Photocyclizations	717
E. Other Reactions of Imines	720

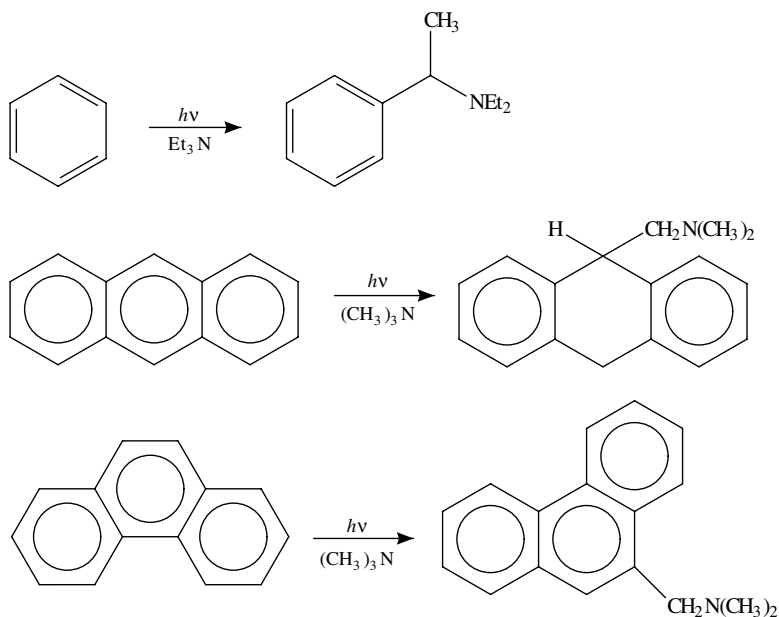
VI. PHOTOCHEMISTRY OF AMIDES AND IMIDES .....	722
A. Amides .....	722
B. Imides .....	730
VII. REFERENCES .....	740

## I. INTRODUCTION

Perhaps the most important reaction for the amine is their ability to donate electrons.

Since amines generally have low oxidation potentials, they are good electron donors in their ground state, and the donor ability is further enhanced by photoexcitation. The chemical consequence of this single electron transfer (SET) is the generation of the amine radical cations (aminium radicals) and an earlier review on the aminium radicals is available<sup>1</sup>.

The SET between amine and acceptor may be enhanced by photoexcitation and may lead to the formation of exciplexes<sup>2</sup> or molecular complex with charge transfer character<sup>3</sup>. The photochemistry between aromatic acceptors and amines via the exciplexes has been discussed earlier (Scheme 1)<sup>4</sup>.

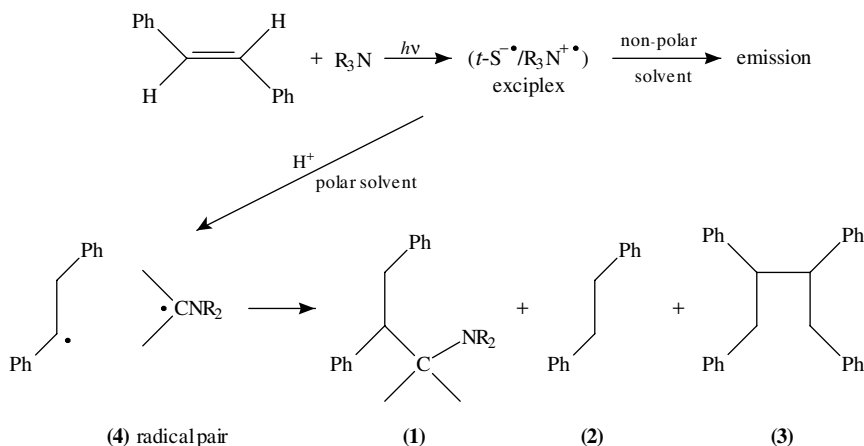


SCHEME 1

The importance of tertiary amines in the photochemically induced electron transfer reactions has also been addressed<sup>5</sup>. Direct irradiation of aromatic or aliphatic amines often leads to the scission of C–N, N–H or C–H bonds that lead to the subsequent chemical reactions by radical pathways<sup>6</sup>. In this section, photochemical reactions of amines reported since 1978 will be considered with emphasis on photoinduced electron transfer. Photochemical reactions of inorganic and organometallic compounds will not be included unless photochemistry of amine moieties is the primary interest.

## II. PHOTOCHEMISTRY INVOLVING TERTIARY AMINES

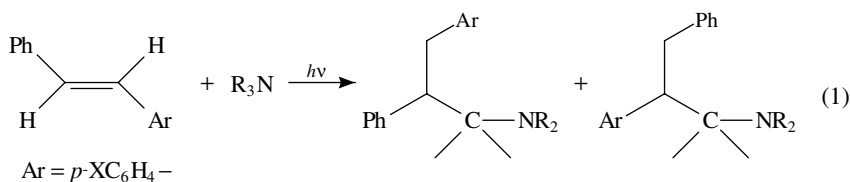
Tertiary amines are known to react with excited aromatic compounds such as benzene<sup>7</sup>, *trans*-stilbene<sup>8</sup>, naphthalene<sup>9</sup>, anthracene<sup>10</sup>, phenanthrene<sup>11</sup> and cyanoarenes<sup>12</sup>. The addition of an amine  $\alpha$ -C–H bond to the aromatic compounds is interpreted as the consequence of consecutive electron transfer and proton transfer<sup>13</sup> processes that involve several reactive intermediates including exciplexes<sup>2</sup> and contact ion radical pairs (CIRP)<sup>13–15</sup> from mechanistic considerations<sup>17–19</sup>. The photoreaction of *trans*-stilbene (*t*-S) and a tertiary amine can serve as a model<sup>16</sup> to illustrate the multistep process (Scheme 2).

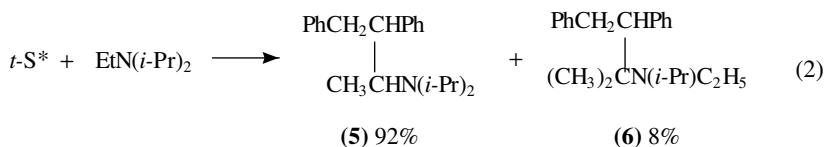


SCHEME 2

### A. With *trans*-Stilbene

Quenching of *t*-S\* by a tertiary aliphatic amine in non-polar solvents yields a fluorescent exciplex whose intensity and lifetime decreased with the increase of solvent polarity; preparatively, products **1**, **2** and **3** also increase concurrently. The results have been interpreted as the increasing participation of proton transfer with increasing solvent polarity within the exciplex to give radical pair **4**, which is the direct precursor for the observed chemical products. The random proton transfer from the aminium cations ( $R_3N^{+}$ ) to the stilbene anion radicals (*t*-S<sup>-•</sup>) practically determines the product pattern<sup>20</sup> (equation 1). However, the deprotonation of sterically hindered non-symmetrical tertiary amine cation radicals is regioselective<sup>13,21–23</sup> as shown in equation 2. Singlet *trans*-stilbene reacts with ethyldiisopropylamine by the mechanism to give **5** predominantly (equation 2). It also reacts with amines of structure  $Me_2NCH_2R$  ( $R = CH=CH_2$ ,  $CO_2Et$ ,  $C\equiv CCH_3$  and  $C\equiv CH$ ) in hexane solution to yield one single adduct  $PhCH_2CHPhCHRMe_2$  in each case without involving the methyl group reaction<sup>21</sup>.

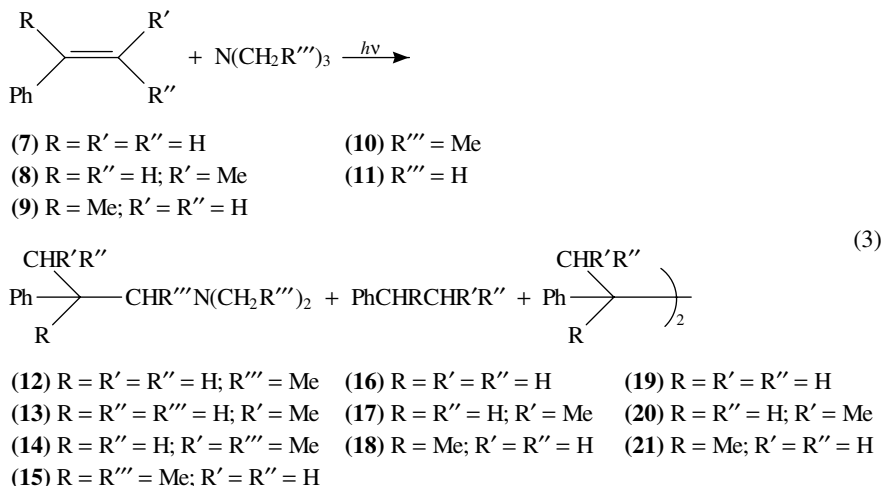




Photoinduced intramolecular interaction of *t*-S and tertiary amine moieties linked with a polymethylene chain has also been studied<sup>24</sup>. The photoexcitation of *trans*-stilbene in which a tertiary amine is attached to the *ortho* position with a (CH<sub>2</sub>)<sub>1-3</sub> linker leads to fluorescent exciplexes by intramolecular electron transfer, and results in no more than *trans-cis* isomerization. The failure to give adducts from the intramolecular exciplexes could arise from the unfavourable exciplex geometry to undergo the necessary bond formation.

## B. With Styrenes

Irradiation of styrenes in the presence of tertiary aliphatic amines resulted in the formation of adducts in fair to poor yield<sup>25</sup>. Excited styrene<sup>7</sup> reacted with triethylamine to yield diastereomeric adducts **12**, 1-phenylethane **16** and 2,3-diphenyl butane **19**<sup>26</sup> (equation 3).

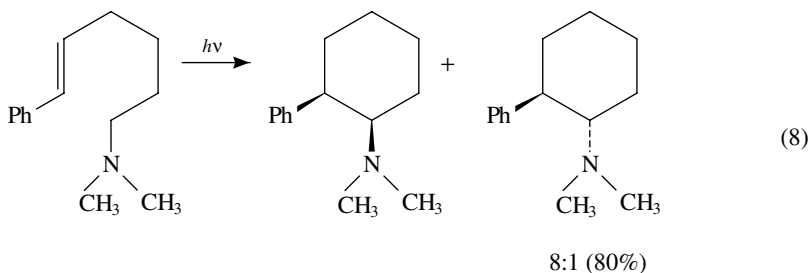
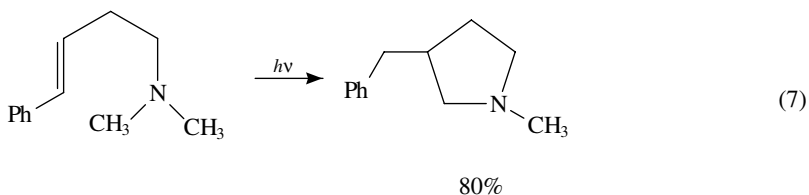
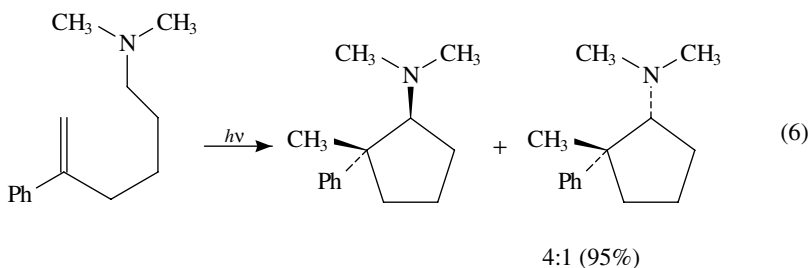
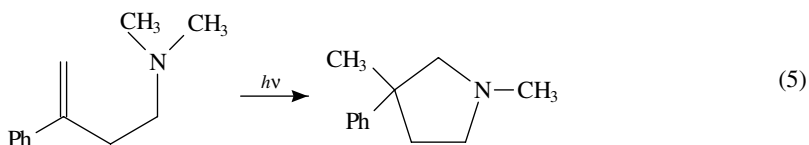
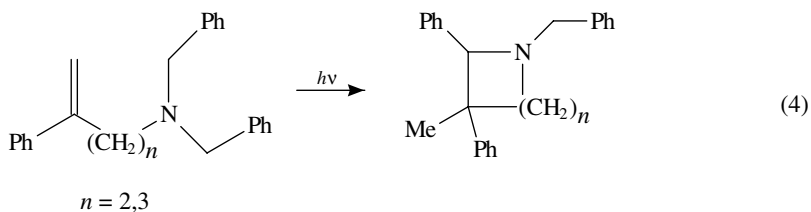


The total product quantum yield is higher in acetonitrile than in hexane solution (0.34 vs 0.07); the adduct yield is lower in acetonitrile (9% vs 28% of total product).

Irradiation of **8** with trimethylamine **11** yields the regiospecific adducts **13**, **17** and **20**<sup>27</sup>. The reaction of **8** with triethylamine **10** in either hexane or acetonitrile solution (>290 nm) results in the formation of a single adduct **14** (24% yield) accompanied by comparable amounts of **17** (15%) and also **20** (78%)<sup>28</sup> (equation 3). Regiospecific addition of triethylamine to  $\alpha$ -methylstyrene **9** is also observed to give **15** (32%), **18** (11%) and **21** (8%)<sup>26</sup> (equation 3).

Intramolecular photoaddition of tertiary amine and styrene moieties has been extensively studied by Aoyama<sup>29</sup> and Lewis' group<sup>28,30,31</sup> (equations 4–8). Equations 4 and 5 show that if the intramolecular additions result in the formation of a five- or six-membered ring, the product yields are excellent. Highly regioselective intramolecular proton transfer is proposed to occur via least motion pathways from the lowest energy

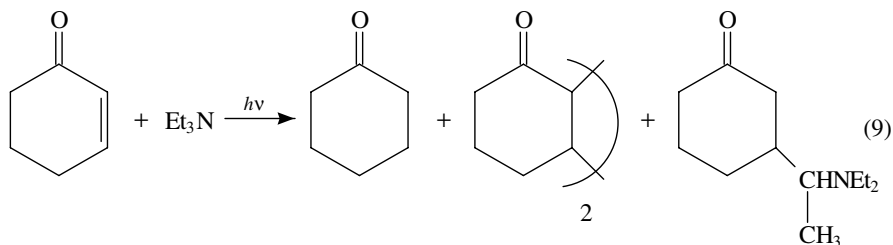
folded conformations of the singlet exciplex intermediates in non-polar solvents<sup>31</sup>.



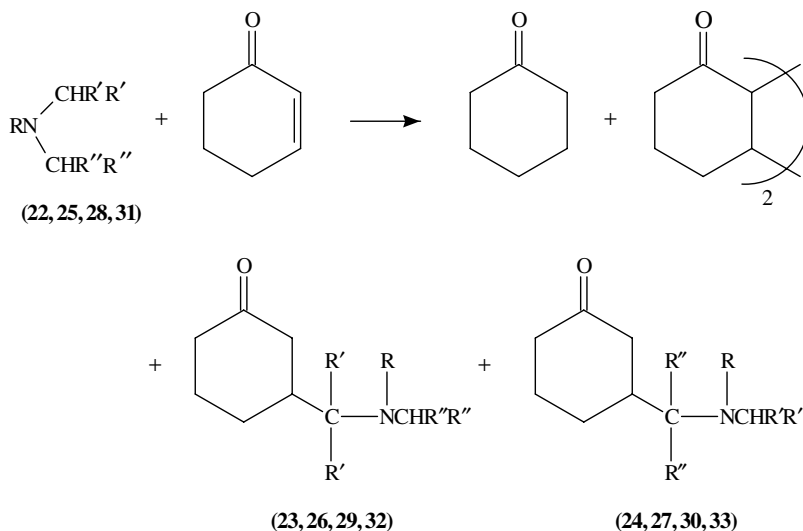
### C. With $\alpha,\beta$ -Unsaturated Carbonyl Compounds

Earlier reviews on the photochemistry of unsaturated ketones and amines are available<sup>39,40</sup>. The photoreactions of  $\alpha,\beta$ -unsaturated carbonyl compounds in the presence of amines have been reported to yield 1:1 amine adducts<sup>32,33</sup> as well as photoreduction

products (equation 9). The electron transfer from amine to the triplet enone leads to the formation of enone anion and aminium radical pair which has been demonstrated by CIDNP experiments<sup>34</sup>. Detailed studies by laser flash photolysis concerning the reaction mechanism between triplet enone and amines were carried out by Schuster and coworkers<sup>35-38</sup>



It is shown that the less substituted  $\alpha$ -C-H bond of several tertiary amines added across the olefin bond of 2-cyclohexenone (Scheme 3). In the radical ion pair the proton of the less substituted hydrogen is transferred to the  $\alpha$ -position of enones that leads to a predominance of products **23**, **26**, **29** and **32** (about 95% yield).



**22, 23, 24:** R=CH(CH<sub>3</sub>)<sub>2</sub>; R' = H; R'' = CH<sub>3</sub>

**25, 26, 27:** R=CH(CH<sub>3</sub>)<sub>2</sub>; R' = H and CH<sub>3</sub>; R'' = CH<sub>3</sub>

**28, 29, 30:** R=CH<sub>3</sub>; R' = H and C<sub>3</sub>H<sub>7</sub>; R'' = H

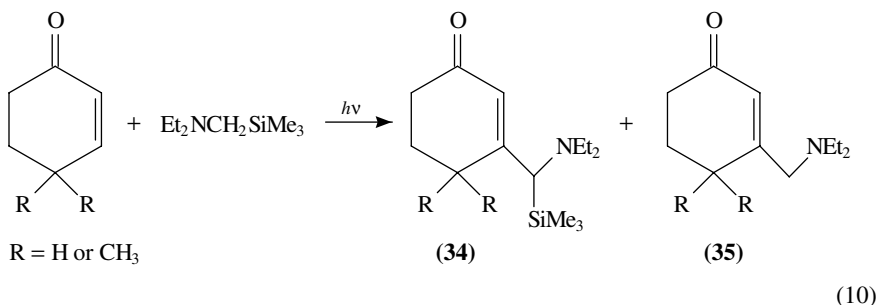
**31, 32, 33:** R=CH<sub>3</sub>; R' = H; R'' = CH<sub>3</sub>

SCHEME 3

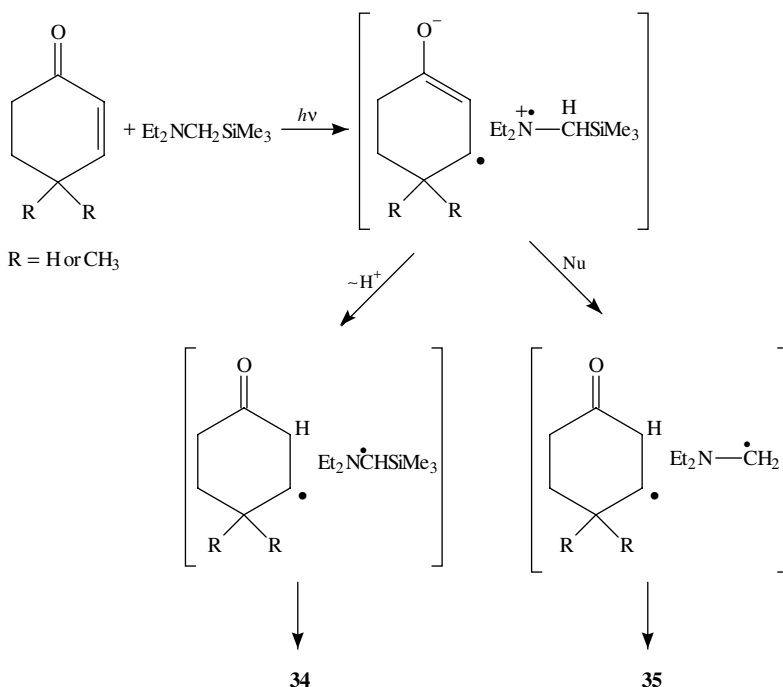
The effect of an  $\alpha$ -silyl group attached to tertiary amine on 2-cyclohexenone photochemistry has been clarified by Mariano's group<sup>42,43</sup>, who illustrates the importance of



anions in the proton transfer processes (equation 10).

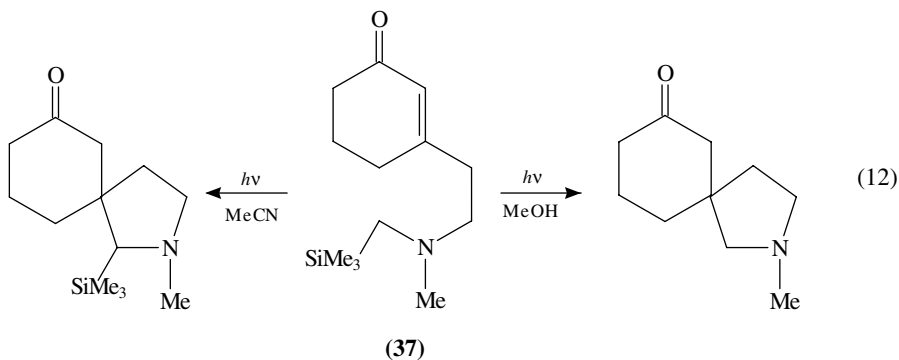
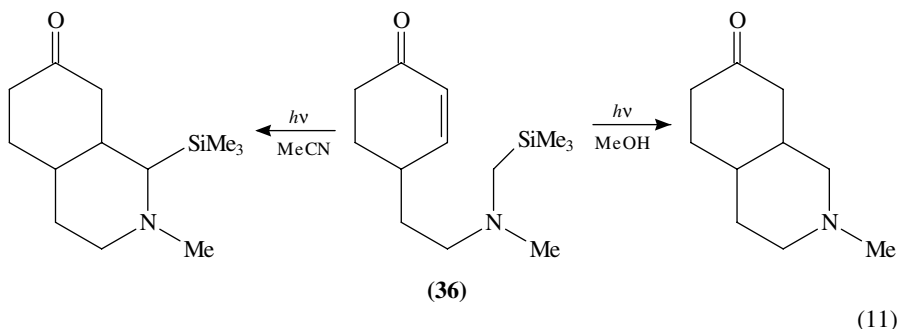


Product **34** predominates in the polar aprotic solvent (acetonitrile), while in the polar protic solvent (methanol) products **35** are formed preferentially. The different products are caused by the relative rate of deprotonation against desilylation of the aminium radical, that is in turn governed by the action of enone anion radical in acetonitrile as opposed to that of nucleophilic attack by methanol. In an aprotic, less silophilic solvent (acetonitrile), where the enone anion radical should be a strong base, the proton transfer is favoured and leads to the formation of product **34**. In aprotic solvents or when a lithium cation is present, the enone anion radical basicity is reduced by hydrogen bonding or coordination by lithium cation, and the major product is the desilylated **35** (Scheme 4).

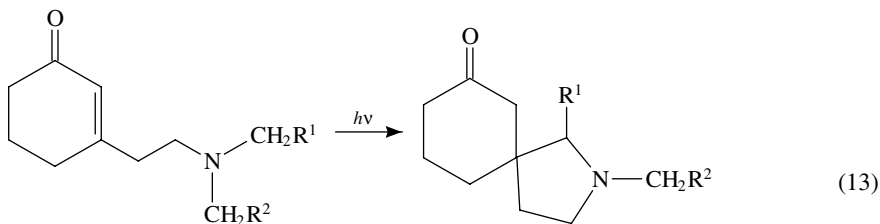


SCHEME 4

The solvent-controlled differential reactivity was also applied to the intramolecular photoaddition of **36** and **37** (equations 11 and 12)<sup>45,46</sup>.



Substituent effects on the  $\beta$ -(aminoethyl)cyclohexenone photochemistry were carried out to study the relative kinetic acidities of the tertiary aminium radical<sup>47</sup>. The ease of the methylene hydrogen to be removed as  $H^+$  increased in the order of  $X = \text{alkyl} < \text{Si}(\text{CH}_3)_3 < \text{C}\equiv\text{CH}$  (equation 13).



**(38)**  $R^1 = \text{H}$ ,  $R^2 = \text{CH}_3$

**(39)**  $R^1 = \text{H}$ ,  $R^2 = \text{Si}(\text{CH}_3)_3$

**(40)**  $R^1 = \text{H}$ ,  $R^2 = \text{C}\equiv\text{CH}$

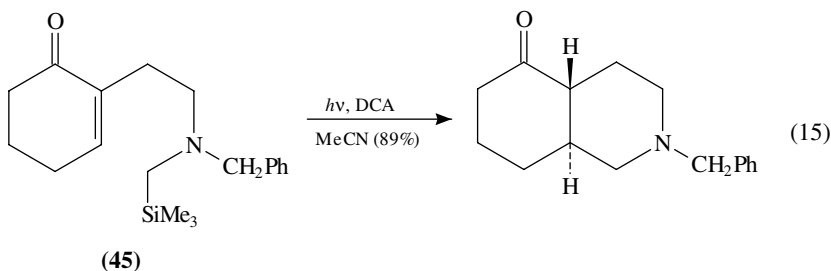
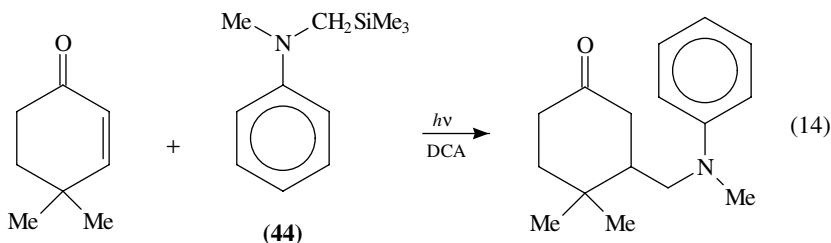
**(41)**  $R^1 = \text{CH}_3$ ,  $R^2 = \text{H}$  (34% in  $\text{CH}_3\text{CN}$ )

**(42)**  $R^1 = \text{Si}(\text{CH}_3)_3$ ,  $R^2 = \text{H}$  (76% in  $\text{CH}_3\text{CN}$ )

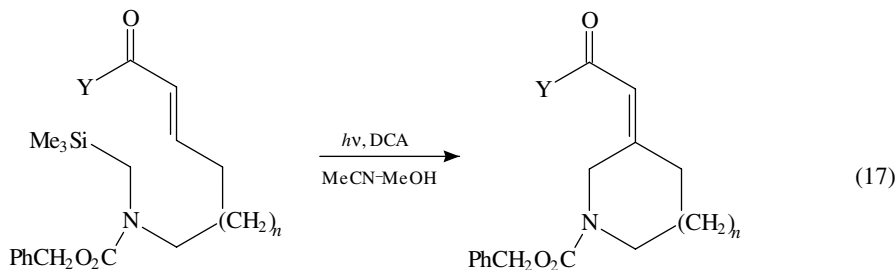
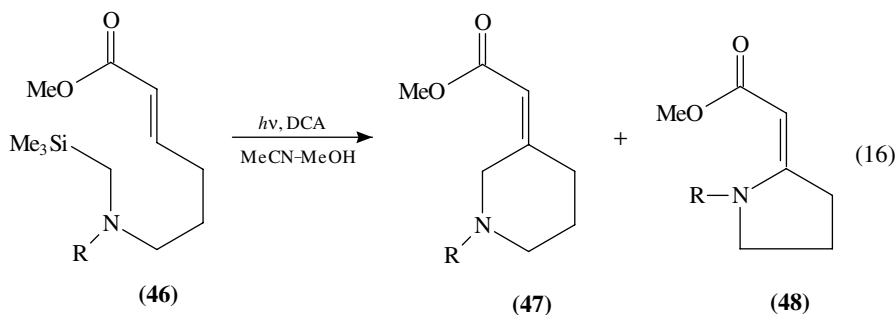
**(43)**  $R^1 = \text{C}\equiv\text{CH}$ ,  $R^2 = \text{H}$  (79% in  $\text{MeOH}$ )

The photosensitized electron transfer by 9,10-dicyanoanthracene (DCA) has been shown to initiate the addition of the  $\alpha$ -silyl amine **44** to 4,4-dimethylcyclohexenone<sup>47</sup> (equation 14). Intramolecular addition of  $\alpha$ -silyl amine **45** was also shown to be feasible<sup>45,46</sup> (equation 15). The primary step is electron transfer to give the aminium

radical ( $44^{+\bullet}$ ) and (DCA $^{-\bullet}$ ) anion radical; it is interpreted to be followed by the attack of  $44^{\bullet}$  on the enone after desilylation.



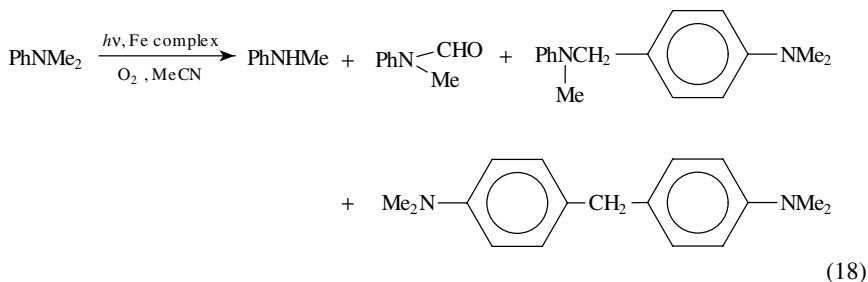
In the DCA-sensitized reaction of silyl amino esters **46** (equation 16) the formation of pyrrolidines **48** must be obtained through a desilylmethylation. This process can be prevented by attaching an electron-withdrawing group to the amine that obviously reduces its oxidation potential (equation 17)<sup>48</sup>.



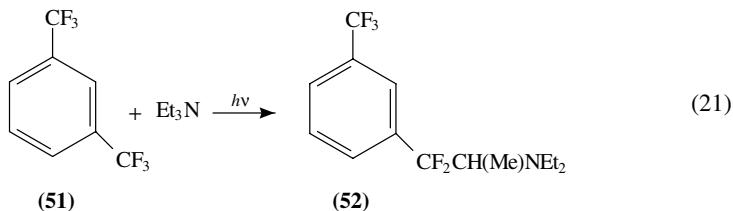
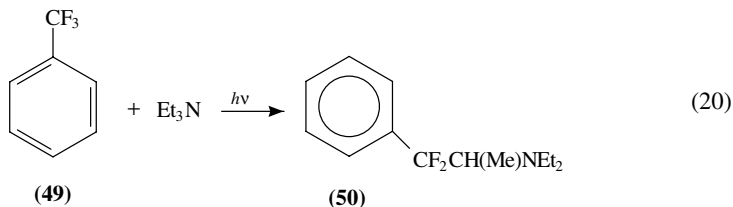
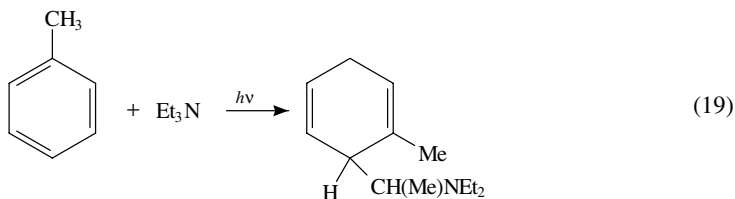
Y = Me, OMe  
n = 0, 1

### D. With Other Oxidants

By introducing a proper light-absorbing system, amines can be photoexcited to react with a ground state acceptor. For example, *N,N*-dimethylaniline is photooxidized by molecular oxygen in the presence of iron complex catalysts in acetonitrile to give a mixture of *N*-methylformanilide, 4,4'-methylenebis(*N,N'*-dimethylaniline) and *N*-methylaniline (equation 18)<sup>49</sup>. The amine *N*-dealkylation is usually used as a model for enzymatic and cytochrome P-450 oxidation reactions. The potential relationships between the photochemistry of flavin oxidation of amines and monoamine oxidases (MAO) has also been considered<sup>50</sup>. Anthraquinone fluorescence quenching by electron transfer from amines<sup>51</sup> and amine oxidation by triplet carbonyl compounds<sup>52</sup> were also studied to clarify electron transfer and deprotonation process.

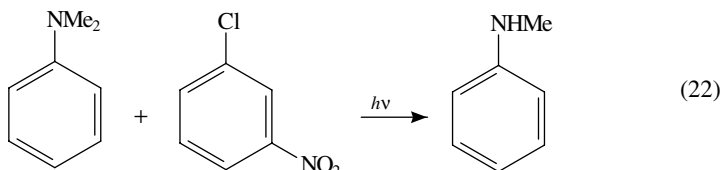


Substituent effects on benzene photochemistry in the presence of amines are described<sup>53</sup> in equations 19–21. The  $\alpha$ -C–H of an amine is shown to add photolytically to the 2,5-positions of toluene (equation 19). In contrast, trifluoro-substituted benzene was excited to react with trimethylamine to give **50** and **52** by a side-chain substitution. This chemistry arose from facile defluorination of the anion radicals of **49** and **51**.



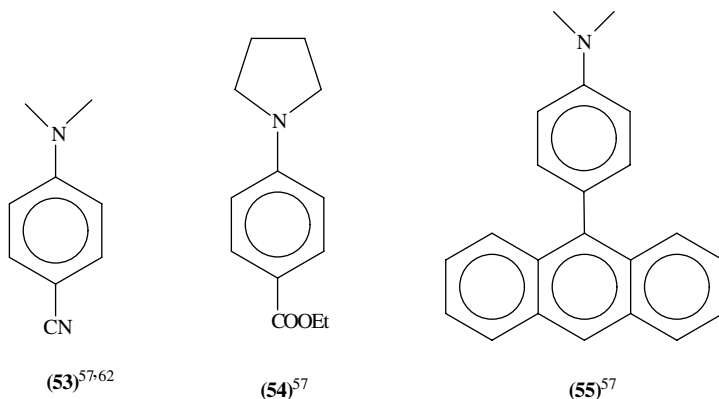
The electron transfer reaction of excited benzophenone and trialkylamines has been applied to design photochemical cells<sup>54</sup>.

*N,N*-Dimethylaniline is demethylated by excited 3-nitrochlorobenzene<sup>55</sup> (equation 22) in which the latter acts as the electron acceptor; subsequent proton transfer and hydrolysis complete the sequence.

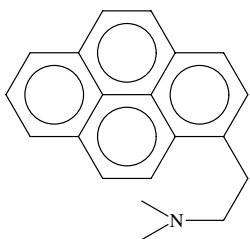
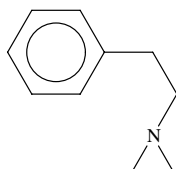
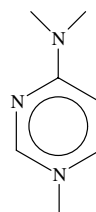
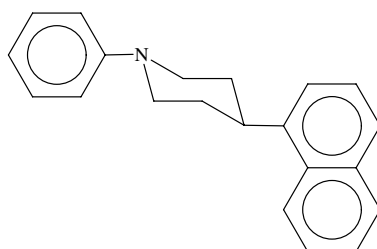
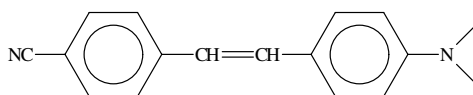
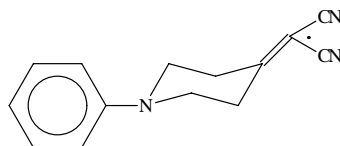
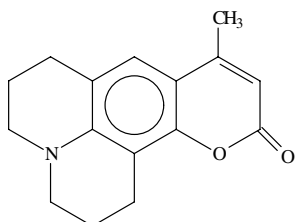
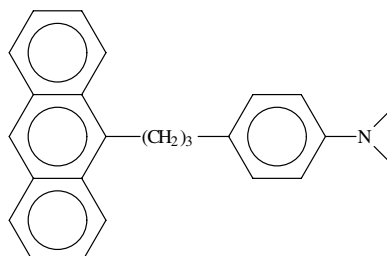


### E. Tertiary Amines as Donors in Intramolecular Charge Transfer Interaction

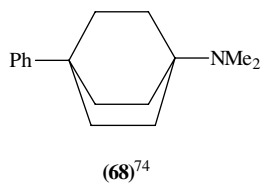
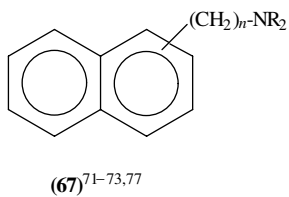
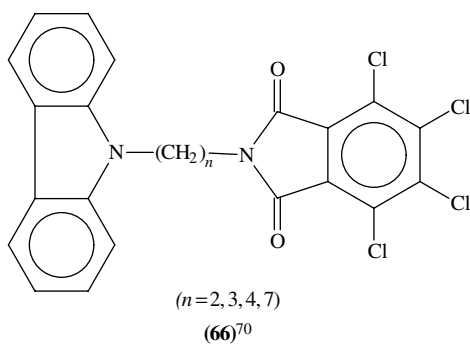
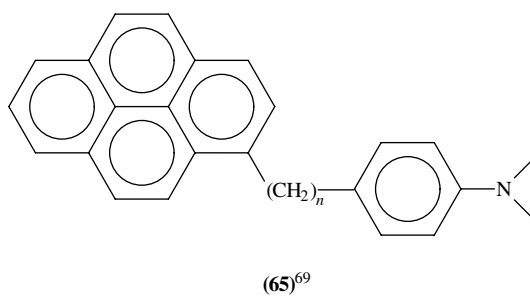
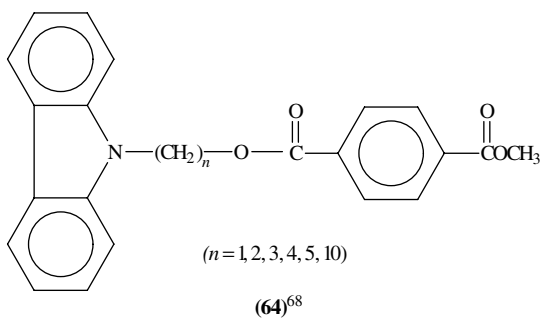
The photophysical aspects of inter- and intramolecular charge transfer interaction between benzenoid chromophores and tertiary amines continues to attract attention<sup>56</sup> with the aim of clarifying the intermediates, e.g. exciplexes or radical ion pairs. There are many intramolecular charge transfer systems published in which tertiary amines are used as donors in the intramolecular charge transfer (ICT), twist intramolecular charge transfer (TICT) and in intramolecular exciplex formation. Typical examples are summarized in Scheme 5. For example, the emission states for compounds **56** ( $\lambda_{\text{max}} = 586$  nm, emission maxima in acetonitrile), **57** ( $\lambda_{\text{max}} = 297$ , toluene), **65**, **67**, **74** (for  $n = 2$ ,  $\lambda_{\text{max}} = 369$  nm, 524 nm in DMSO), **76** ( $\lambda_{\text{max}} = 458$  nm in ethyl acetate,  $\lambda_{\text{max}} = 486$  nm in  $\text{CH}_3\text{CN}$ ) and **83** are classified as intramolecular exciplex systems, since the excitation is primarily on the donor or acceptor and the precursor states for exciplexes are locally excited states. The emission states for compounds **53** ( $\lambda_{\text{max}} = 351$  nm, 489 nm,  $\text{CH}_3\text{CN}$ ), **54**, **55**, **58**, **62**, **73** ( $\lambda_{\text{max}} = 486$  nm,  $\text{CHCl}_3$ ;  $\lambda_{\text{max}} = 508$  nm in DMSO), **75** ( $\lambda_{\text{max}} = 412$  nm, 430 nm, in methylcyclohexane) are classified as TICT states because there is mesomeric interaction in the ground state and excitation will cause a twist movement accompanied by the charge transfer. Compound **53** exhibits two fluorescence bands, the normal **b** band and the long-wave **a** band. The **a** band appears only in polar solvents; it grows with the polarity of the solvent and shifts strongly to the red. Compound **77**, in which the amine is immobilized



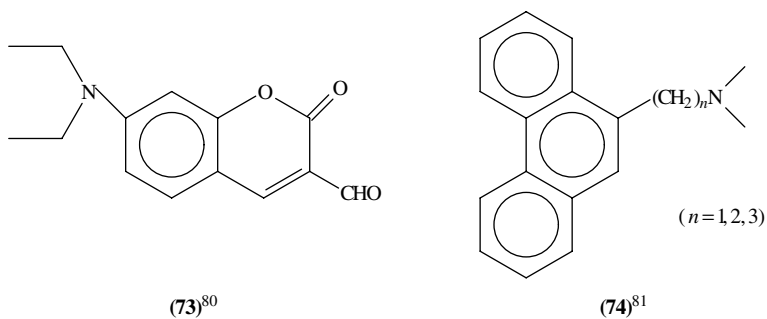
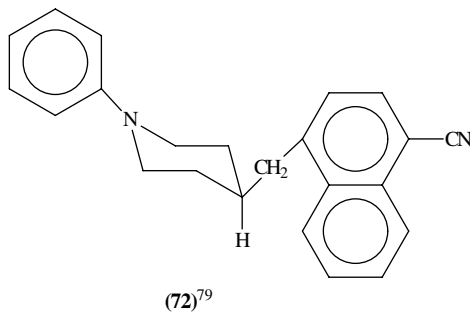
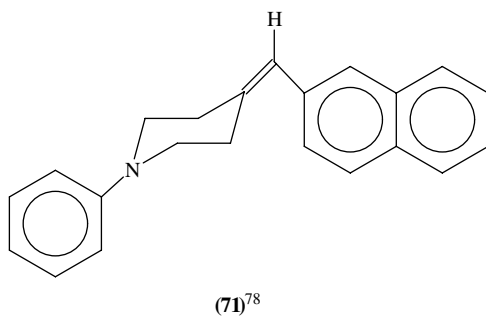
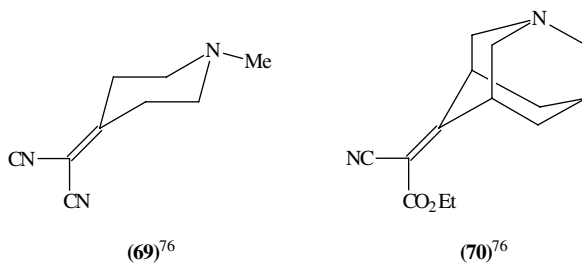
SCHEME 5

**(56)**<sup>58</sup>**(57)**<sup>59</sup>**(58)**<sup>60</sup>**(59)**<sup>61-64</sup>**(60)**<sup>63</sup>**(61)**<sup>65</sup>**(62)**<sup>66</sup>**(63)**<sup>67,75</sup>

SCHEME 5 (continued)

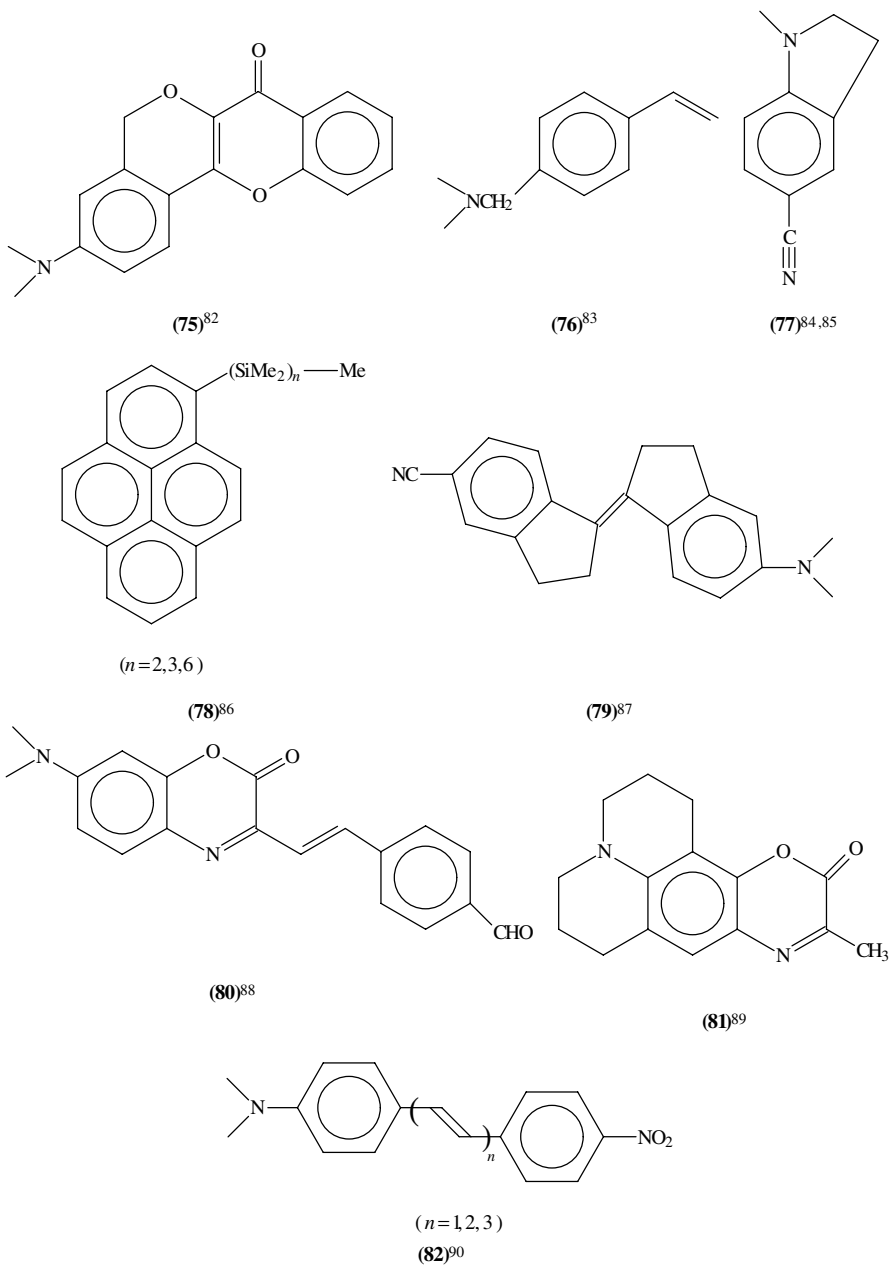


SCHEME 5 (continued)

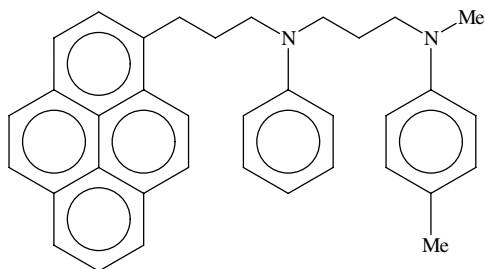


SCHEME 5 (continued)





SCHEME 5 (continued)

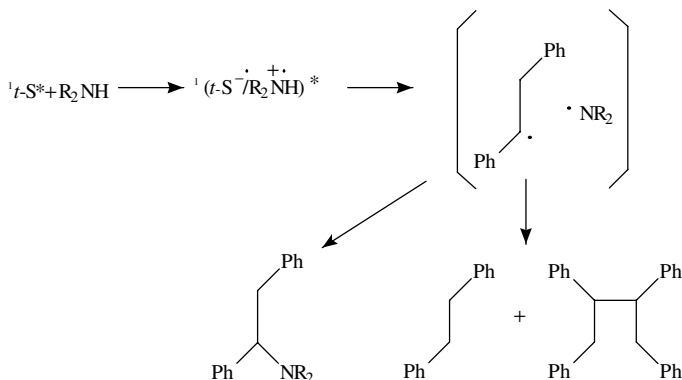
(83)<sup>98</sup>

SCHEME 5 (continued)

in a five-membered ring, emits the **b** band only. For most compounds, the intramolecular electron transfer is involved in the photoexcitation process even though the extent of electron transfer might not be one hundred percent.

### III. PHOTOCHEMISTRY WITH SECONDARY AMINES

The intermolecular photochemical reactions of aryl olefins<sup>25,91</sup> and arenes<sup>92,93</sup> with secondary aliphatic amines result in the addition of an N–H bond to the arenes. The products of the reduction and reductive dimerization of the aryl olefins are also observed. The mechanism<sup>8</sup> proposed for the stilbene-secondary amine addition (Scheme 6) involves electron transfer quenching of singlet stilbene (*t*-S) by a ground-state amine to form a singlet exciplex which undergoes N–H transfer to form a radical pair; this may either combine, disproportionate or diffuse apart<sup>22</sup>. The absence of exciplex fluorescence from singlet stilbene and other arenes with secondary amines may be due to rapid N–H transfer which occurs in both non-polar and polar solvents<sup>94–96</sup>.

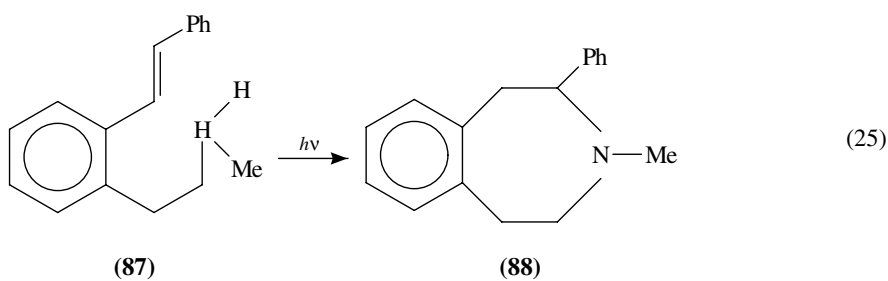
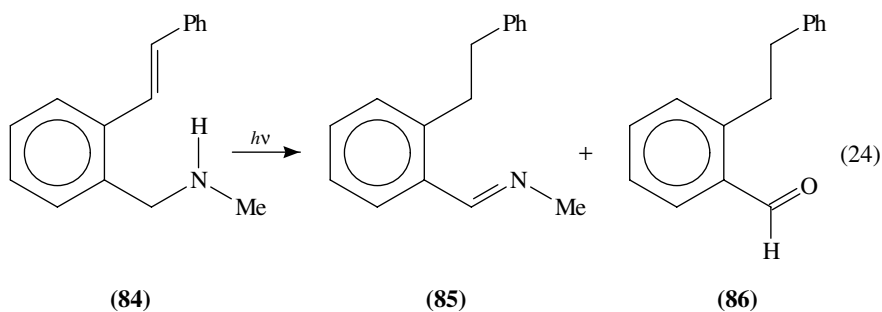
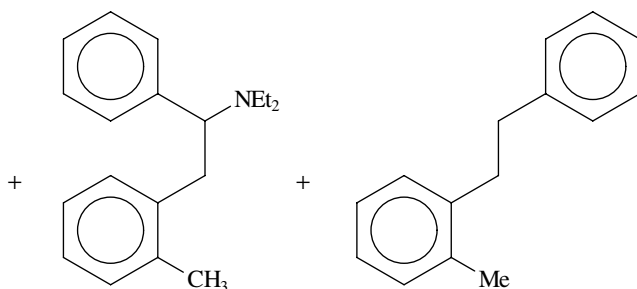
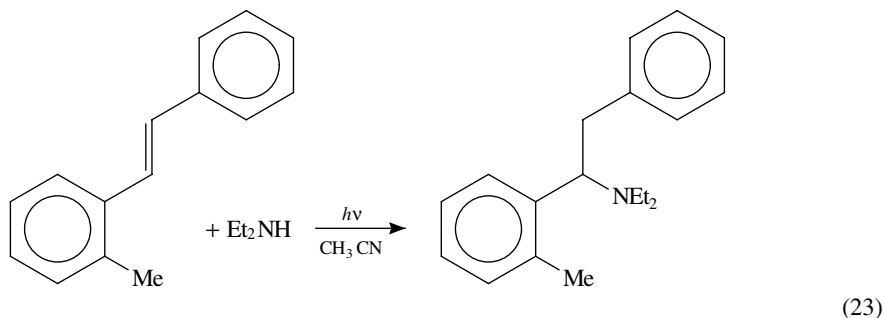


SCHEME 6

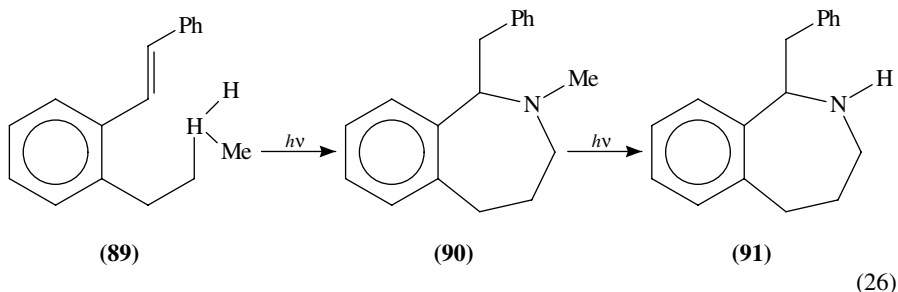
#### A. With Excited State *trans*-Stilbene

Irradiation of *o*-methyl-*trans*-stilbene with diethylamine in acetonitrile solution results in the formation of two regioisomeric adducts in a 1:1 ratio, together with comparable

amounts of reduced stilbene<sup>24</sup> (equation 23). Recent focus is on the intramolecular photochemistry of secondary (aminoalkyl) stilbenes<sup>24,28,97</sup>. Irradiation of *trans*-2-[(*N*-methylamino)methyl] stilbene **84** results in the slow formation of several products (equation 24). The major product can be converted to the aldehyde **86** (27% isolated yield). Irradiation of *trans*-2-[2-(*N*-methylamino)-ethyl] stilbene **87** results in the formation of *N*-methyl-2-phenyltetrahydro-3-benzazepine **88** as the only significant product (equation 25).

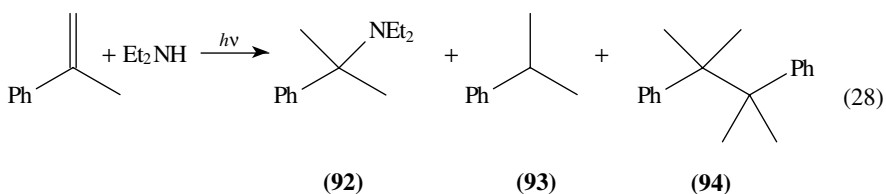
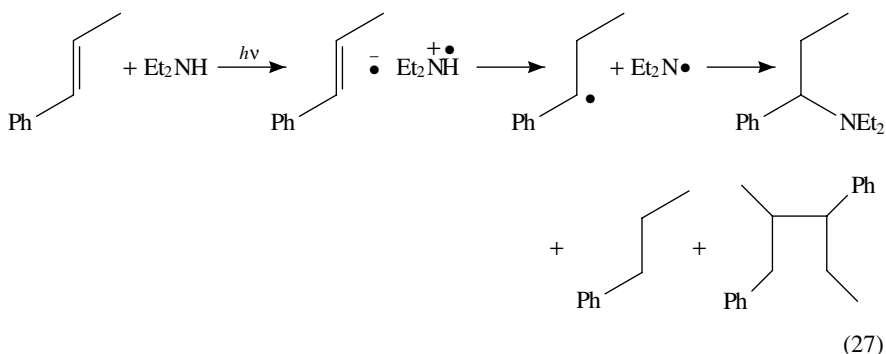


Irradiation *trans*-2-[3-(*N*-methylamino)propyl] stilbene **89** results in the formation of *N*-methyl-1-benzyltetrahydro-2-benzazepine **90** as the only significant primary photoproduct (equation 26), which in turn undergoes secondary photochemical *N*-demethylation. The final mixture contains **90** (38%) and **91** (25%) at high (>95%) conversion. Intramolecular photoadditions of these (equations 24–26) secondary (aminoalkyl)-stilbenes are highly regioselective processes<sup>24</sup>.

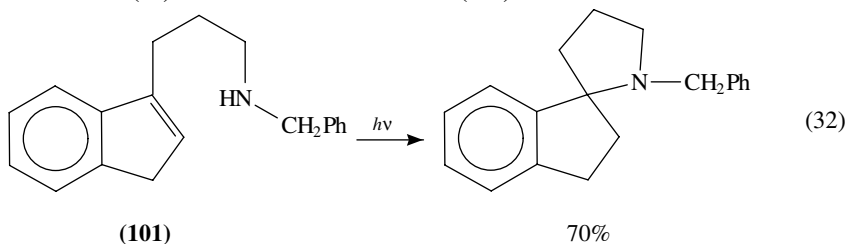
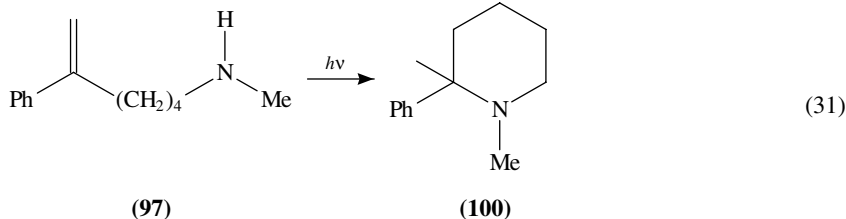
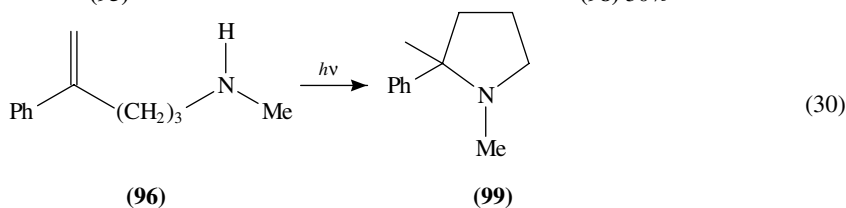
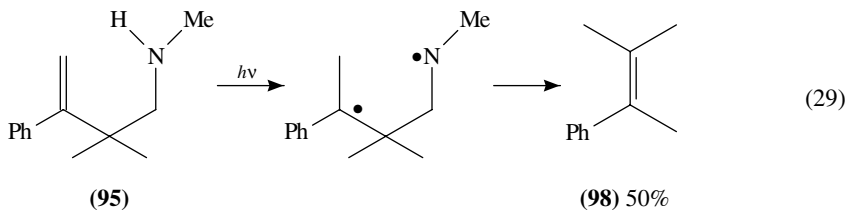


## B. With Excited Styrenes

Irradiation of styrenes in the presence of secondary aliphatic amines resulted in the regioselective addition of the N–H bond to the styrene<sup>25</sup>. The mechanism proposed for the formation of addition and reduction products from  $\beta$ -methylstyrene and diethylamine is outlined by equation 27<sup>99</sup>. Electron transfer quenching of singlet styrene by diethylamine followed by regioselective proton transfer to styrene  $\beta$ -C yields a radical pair which combines with the adducts. The escaped  $\alpha$ -styryl radical can disproportionate or combine. Irradiation of  $\alpha$ -methylstyrene with diethylamine in deoxygenated hexane solution results in the formation of the regioselective adduct **92** and the reduction products **93** and **94** in approximately equal amounts<sup>100</sup> (equation 28).

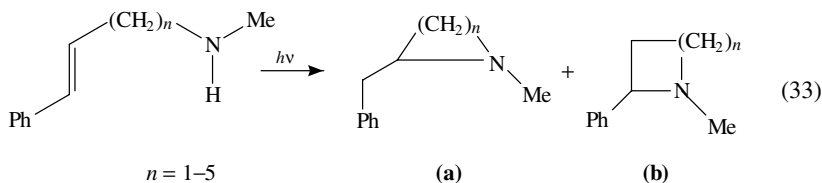


Intramolecular secondary aminostyrenes **95–97** were also studied<sup>100</sup>. *N*-2,2-Trimethyl-3-phenyl-3-buten-1-amine **95** was irradiated to obtain the elimination product **98** (equation 29). Irradiation of *N*-methyl-4-phenyl-4-penten-1-amine **96** results in a single product **99** in 80% yield by GC analysis (equation 30). Similarly, irradiation of *N*-methyl-5-phenyl-5-hexen-1-amine **97** results in the formation of a single product **100** in 70% yield (equation 31). The photochemistry of the (aminopropyl) indene **101** is also similar (equation 32).



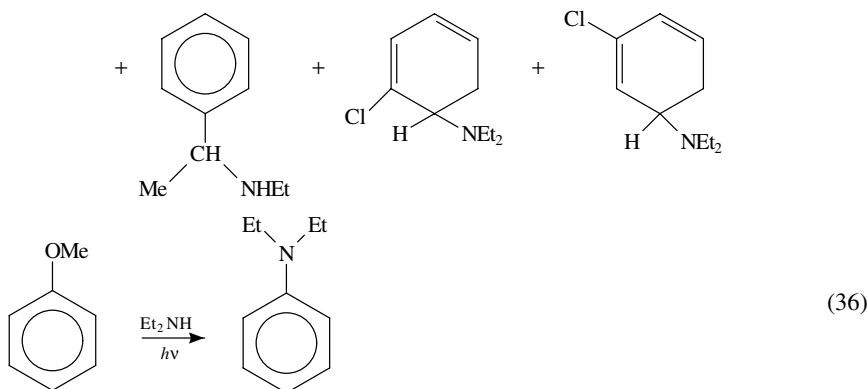
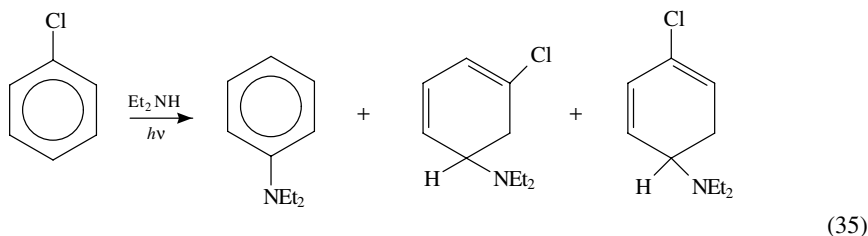
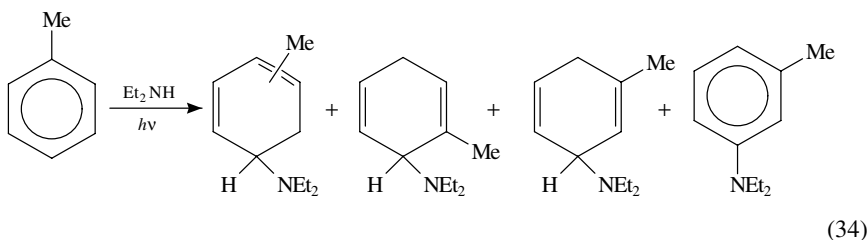
High yields of nitrogen heterocycles have been achieved<sup>28,99</sup> by irradiation of several  $\beta$ -[*N*-methylaminoalkyl] styrenes in which the chain length ( $n = 1$  to 5) (equation 33,  $n = 1-5$ ) determines the yield, quantum yield and ratio of regioisomeric adducts. The product of addition of nitrogen to the benzylic carbon (**b**) is exclusive for  $n = 3$ , and is predominant for  $n = 1,2$  or 5 (**b**:**a** > 10:1 in acetonitrile solution). However, **a** predominates for  $n = 4$  (**a**:**b** = 7:1 in acetonitrile). When  $n = 1$  or 2 the chain length may be too short to allow hydrogen transfer to the  $\beta$  end of the styrene double bond. When the chain is sufficiently long, the intramolecular exciplex would be expected to display chemistry similar to that of intermolecular systems. For intermediate chain lengths ( $n = 3$  or 4) the geometry of the exciplex, as determined by chain folding energies, may determine the regioselectivity of hydrogen transfer. The large isolated yield for  $n = 2-4$  (60–80%) is

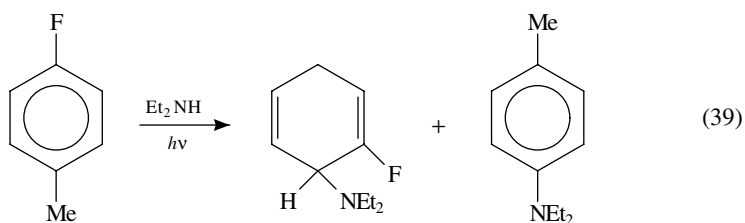
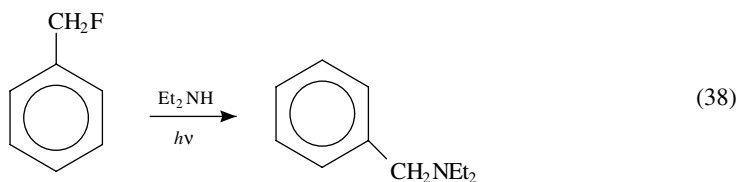
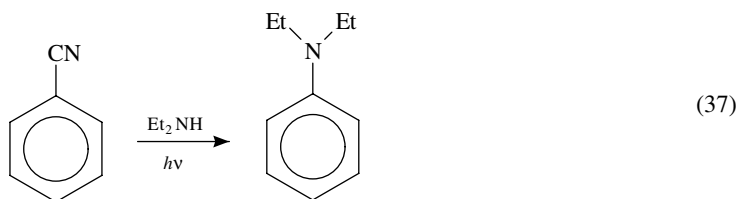
promising for the synthesis of macrocyclic naturally occurring alkaloids.



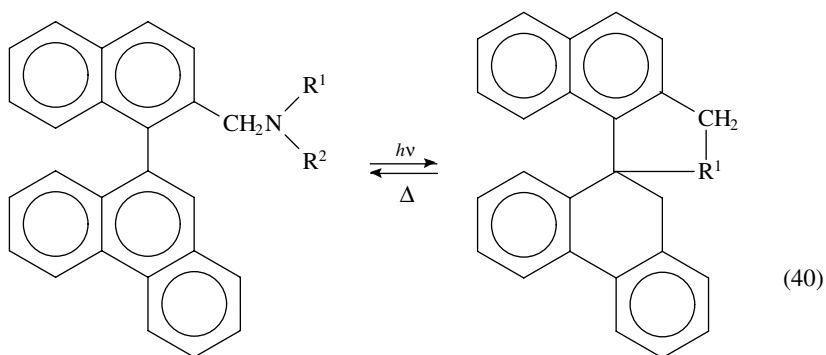
### C. With Other Excited Systems

The substituent effects on the photochemistry between benzene and secondary aliphatic amines<sup>53</sup> were studied. Irradiation of toluene or chlorobenzene with diethylamine results in the formation of mixtures of addition and substitution products (equations 34 and 35). Irradiation of anisole or benzonitrile with diethylamine gives the substitution product *N,N*-diethylaniline (equations 36 and 37). Irradiation of benzylfluoride with diethylamine results in a side-chain substitution (equation 38). The photoreaction of *p*-fluorotoluene with diethylamine gives both substitution and reduction products (equation 39).





The intramolecular photochemistry of 9-[2-(*N*-substituted aminomethyl)-1-naphthyl]phenanthrenes has also been studied<sup>101</sup> (equation 40). The pyrroline derivatives are obtained by the addition of the N–H to the C-9 carbon atom of phenanthrene ring. Reasonable yields for the highly regioselective products are obtained by irradiation in benzene solution.



(102)  $R^1 = C_6H_5$ ,  $R^2 = H$

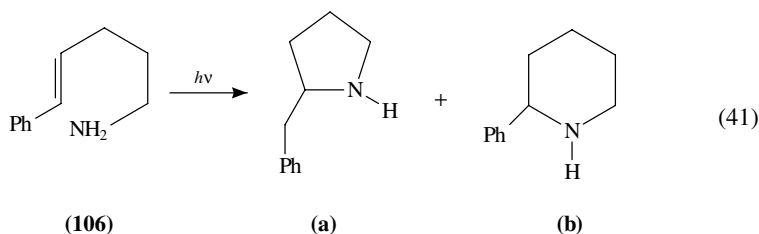
(103)  $R^1 = CH_3$ ,  $R^2 = H$

(104)  $R^1 = C_6H_{11}$ ,  $R^2 = H$

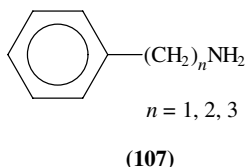
(105)  $R^1 = t-C_4H_9$ ,  $R^2 = H$

#### IV. PHOTOCHEMISTRY INVOLVING PRIMARY AMINES AND AMMONIA

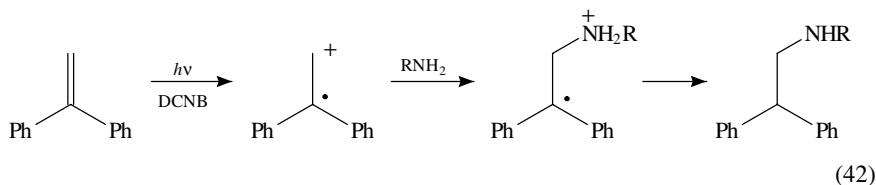
The intermolecular fluorescence quenching of the singlet *trans*-stilbene and primary aliphatic amines have been studied<sup>8</sup>. The free energy for electron transfer from ground state ethylamine to singlet stilbene was calculated to be endothermic (0.8 eV). Thus, neither electron transfer fluorescence quenching nor exciplex formation are observed for the ethylamine and stilbene system. The low observed rate constant for fluorescence quenching of styrene by butylamine is also due to the high oxidation potential of the primary amine<sup>99</sup>. Direct irradiation of stilbene<sup>8</sup> or styrene<sup>99</sup> with a primary amine does not result in any addition products, while irradiation of primary styrylamine **106** in acetonitrile solution results in both isomerization and intramolecular addition to yield a mixture of **a** and **b** adducts (equation 41). The ratio of **b/a** is about 1.4.



Intramolecular fluorescence quenching of phenylalkylamines **107** have been studied earlier<sup>102</sup> but no exciplex was observed. An exciplex is believed to be an intermediate in the intramolecular styrylamine **106** photoreaction<sup>99</sup>.

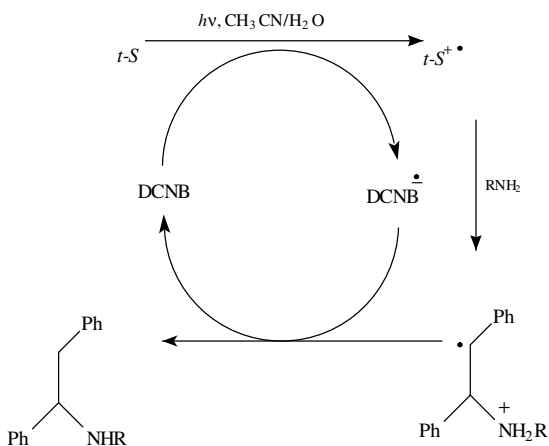


Photochemical addition of ammonia and primary amines to aryl olefins (equation 42) can be effected by irradiation in the presence of an electron acceptor such as dicyanobenzene (DCNB)<sup>103-106</sup>. The proposed mechanism for the sensitized addition to the stilbene system is shown in Scheme 7. Electron transfer quenching of DCNB\* by *t*-S (or vice versa) yields the *t*-S cation radical (*t*-S)<sup>+</sup>. Nucleophilic addition of ammonia or the primary amine to (*t*-S)<sup>+</sup> followed by proton and electron transfer steps yields the adduct and regenerates the electron transfer sensitizer. The reaction is a variation of the electron-transfer sensitized addition of nucleophiles to terminal arylelefins<sup>107,108</sup>.



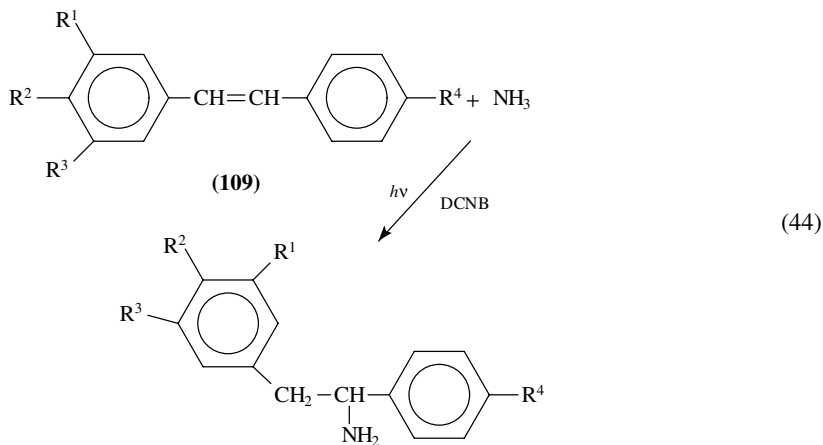
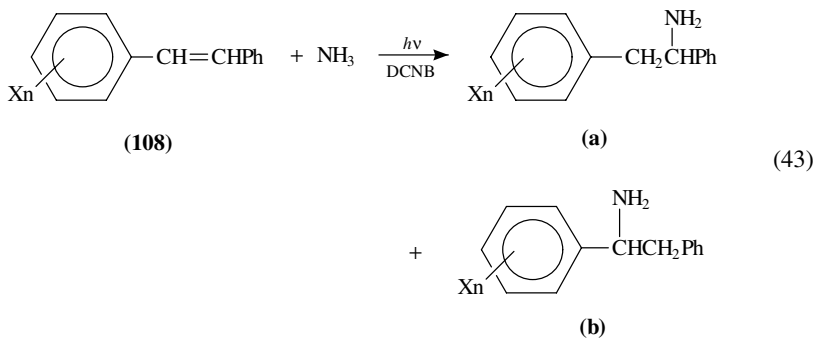
Irradiation of an equimolar mixture of *t*-S and DCNB in 9:1 acetonitrile–water solution containing ammonia results in the formation of 1,2-diphenylethylamine in 46% yield<sup>106</sup>.



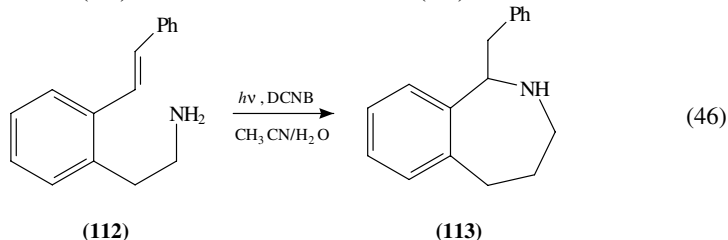
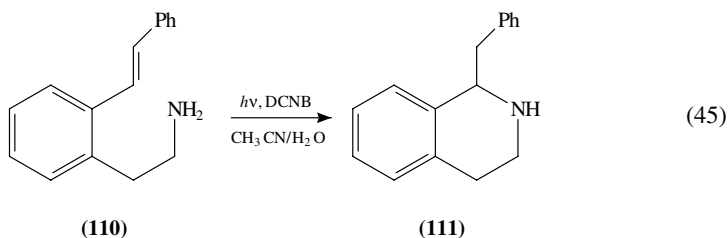


SCHEME 7

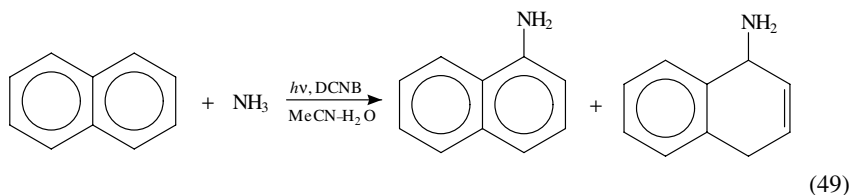
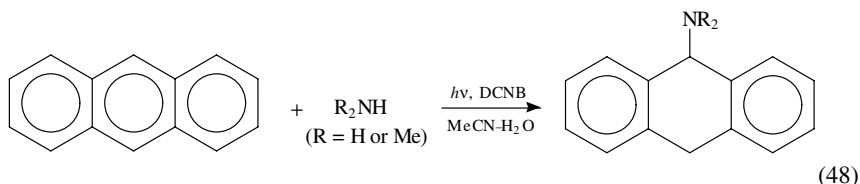
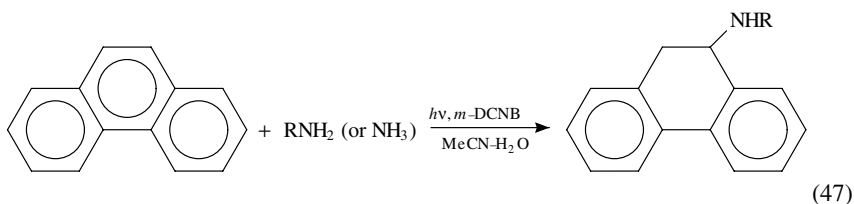
The regiochemistry for the substituted *t-S* with ammonia and DCNB was also studied (equation 43). When there is an alkoxy substituent on the *para* position, the reaction yields selectively 1-amino-2-aryl-1-phenylamine (equation 44).



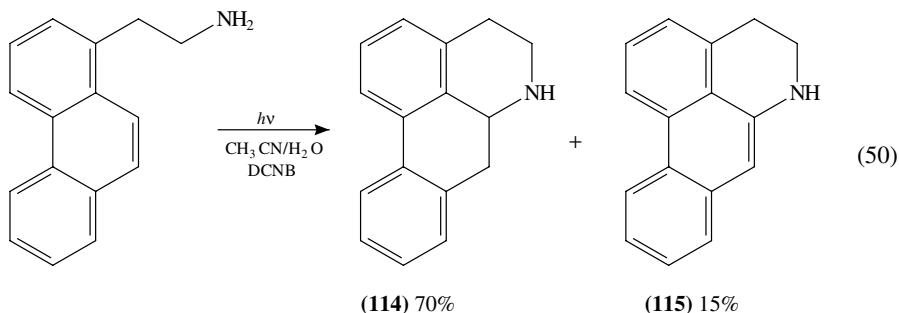
The photoamination of *t*-S having a methyl or chloro group in the *para* position or a methoxy group in the *meta* or *ortho* positions gave non-selective adducts. Irradiation of the primary aminoethyl and aminopropylstilbenes in acetonitrile–water solution in the presence of DCNB results in the formation of isoquinoline and benzazepine products in good preparative yields<sup>24,28</sup> (equations 45 and 46). The preparation of benzazepine represents an improvement in overall yield when compared to previously reported non-photochemical synthetic routes.



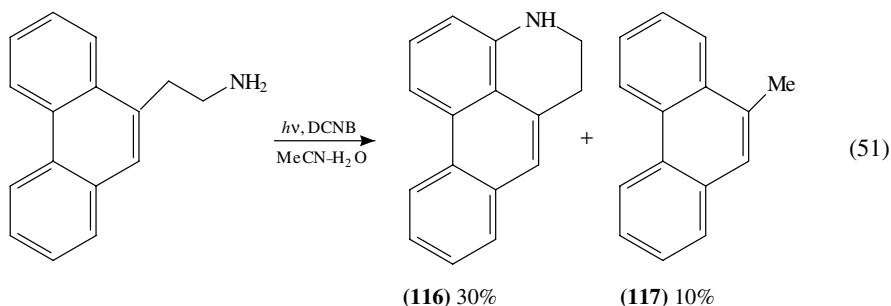
Photosensitized amination of several aromatic compounds including phenanthrene, anthracene, naphthalene with ammonia or primary amines has also been investigated<sup>106</sup> (equations 47–49).



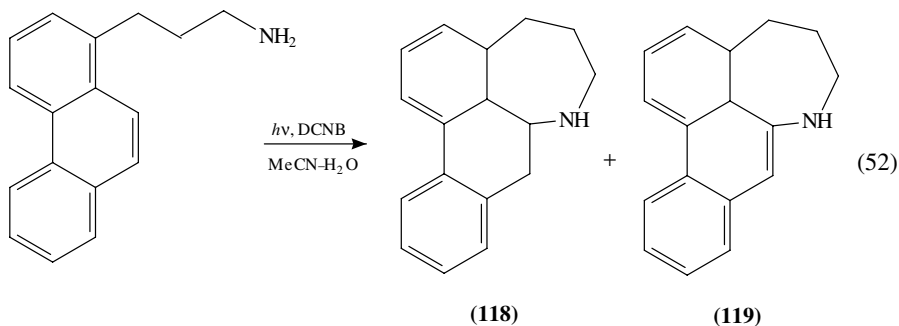
Recently, a photosensitized synthesis of phenanthrene heterocycles from 1- and 9-(aminoalkyl)phenanthrenes has been achieved<sup>109</sup>. Irradiation of 1-(2-aminoethyl)phenanthrene and *m*-DCNB in 9:1 acetonitrile water solution for 2 hours gives 70% of the aporphine **114** and 15% of the dehydroaporphine **115** with 87% conversion of starting material (equation 50).

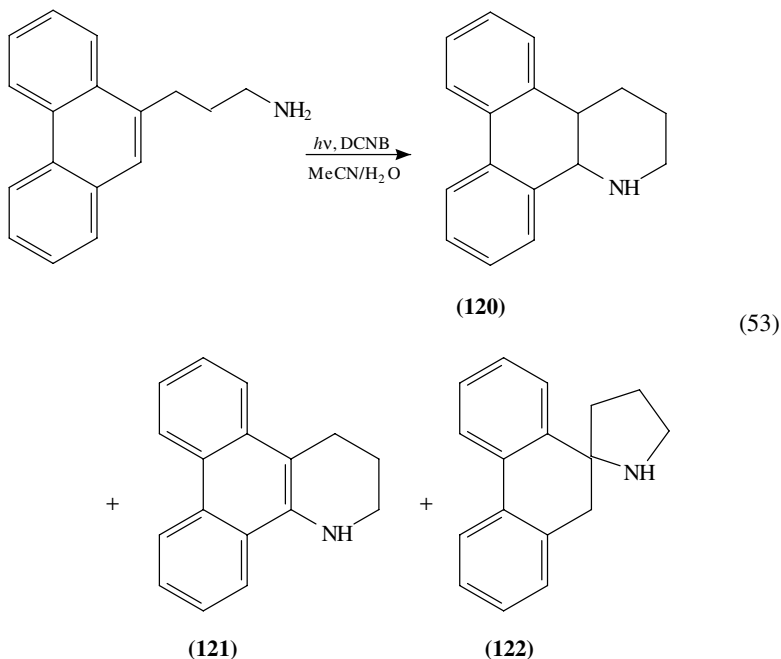


Irradiation of the 9-(2-aminoethyl)phenanthrene (equation 51) under the same conditions but for 70 hours produces phenanthro[1,10-*d,e*]piperidine **116** and 9-methylphenanthrene **117**.

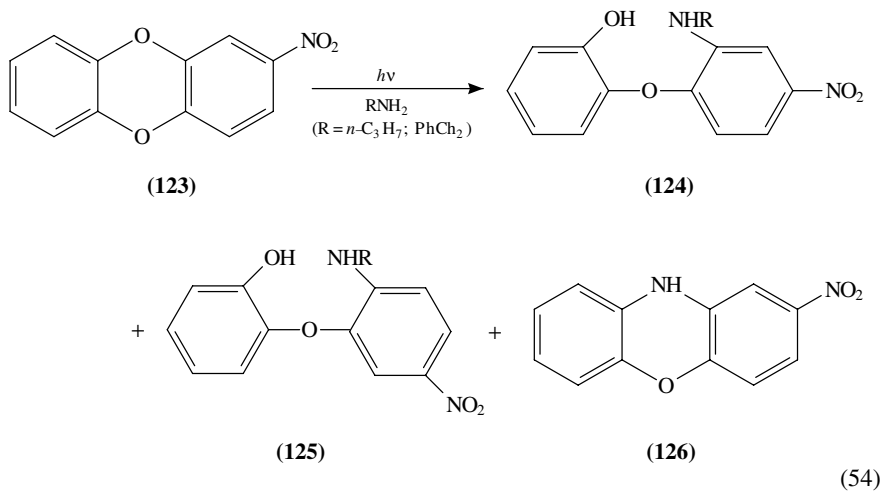


Irradiation of the 1-(3-aminopropyl)phenanthrene (equation 52) for 3 hours results in the formation of the hexahydrophenanthro[10, 1-*b,c*]azepine **118** (68%) and **119** (12%) with 81% conversion. Irradiation of 9-(3-aminopropyl)phenanthrene (equation 53) for 4 hours results in the formation of 9,10-dihydrophenanthrene[9,10-*b*]piperidine **120** (13%), phenanthro[9,10-*b*]piperidine **121** (22%) and 1-aza[5,6;7,8-dibenzo]spiro[4,5]decane **122** (4%).

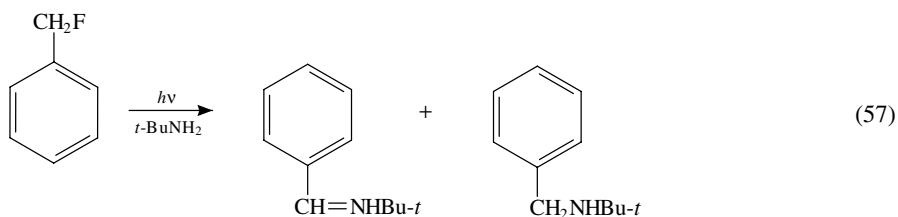
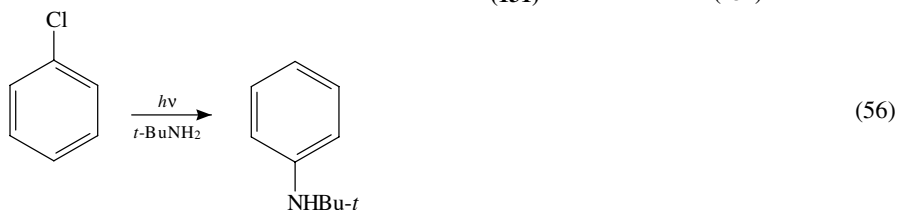
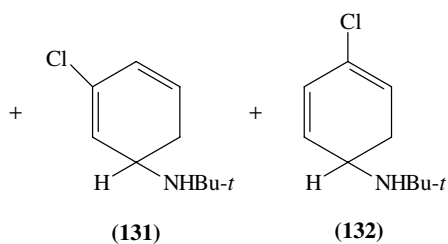
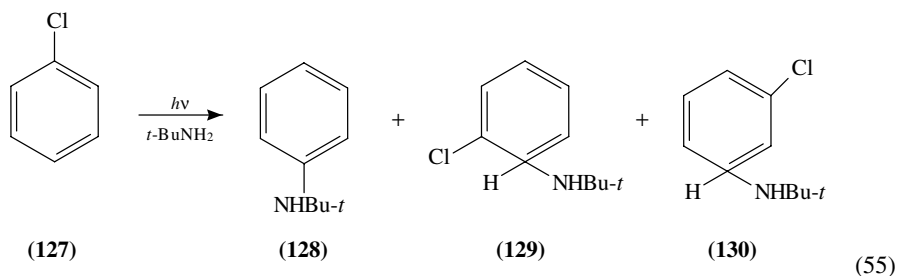




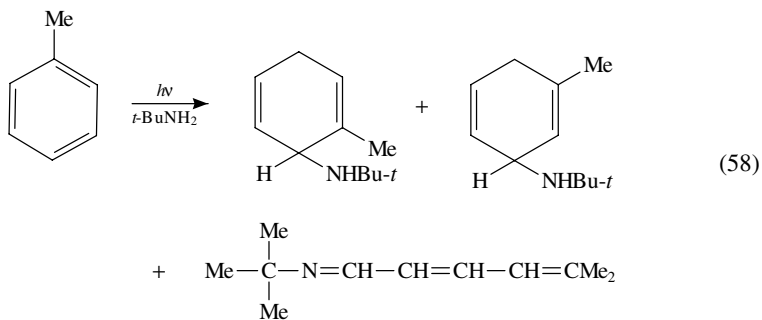
The triplet reaction of 2-nitrodibenzo[*b,e*][1,4]dioxin with primary amines (*n*-propylamine and benzylamine) was studied<sup>110</sup> in polar and apolar solvents. In polar solvents, the irradiation results in the formation of two isomeric compounds, (alkylamino)hydroxynitrodiphenyl ether and *N*-(alkylamino)-2-nitrophenoxazine (equation 54). In apolar solvents, only the nitrophenoxazine is obtained. In polar solvents, the exciplex formed between the 2-nitrodibenzo[*b,e*][1,4]dioxin triplet state and amines dissociates to the solvated radical ions, from which the diphenyl ether arises. 1-Nitrodibenzo[*b,e*][1,4]dioxin is stable even on prolonged irradiation.



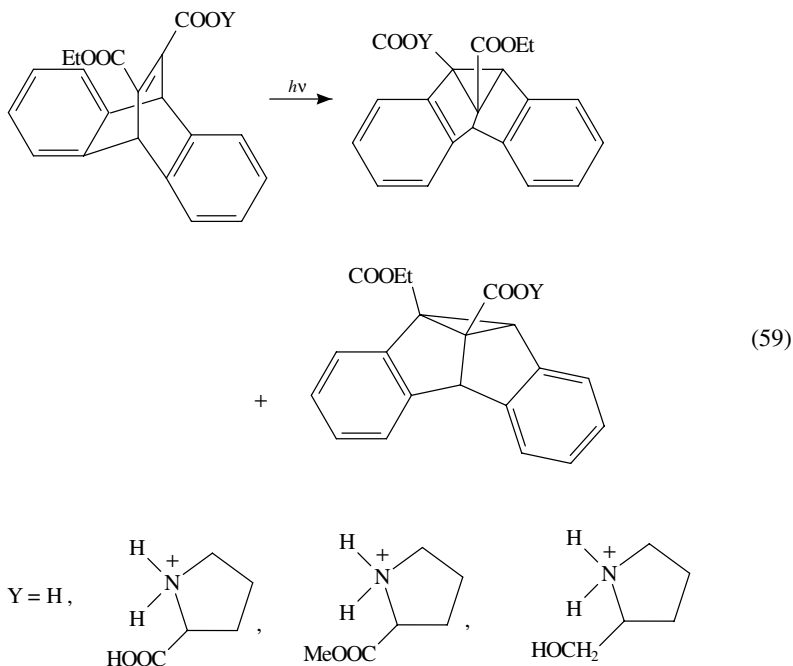
The photochemical reaction between substituted benzenes and *t*-butylamine gave a mixture of addition and substitution products<sup>53</sup> (equations 55–57).



In the case of toluene and *t*-butylamine (equation 58), a novel acyclic adduct is obtained.

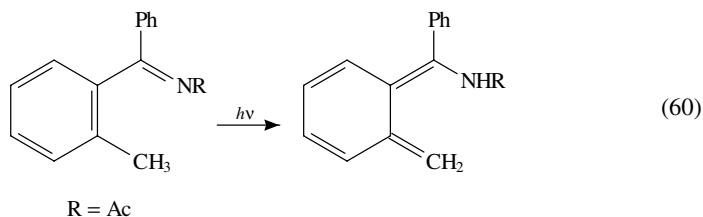


The solid state photochemistry of the salts of carboxylic acids with optically active primary amines has been studied<sup>111</sup>. Enantiomeric excesses ranging from 14–80% can be achieved (equation 59).



## V. PHOTOCHEMISTRY OF IMINE AND IMINIUM SALTS

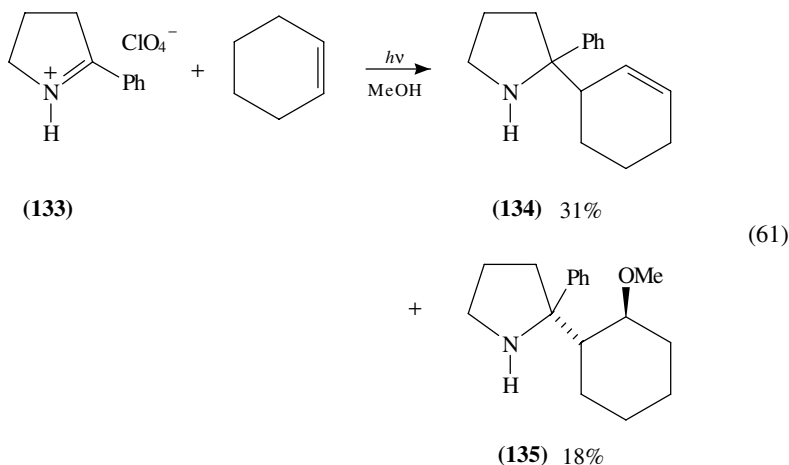
The photochemistry of imine chromophores shows similarity to the ethylenic or carbonyl group. For example, the imine double bond undergoes *syn-anti* photoisomerization<sup>112</sup>, photocyclization<sup>113</sup>, cycloaddition<sup>114</sup> and intramolecular hydrogen abstraction<sup>115</sup> (equation 60). Earlier reviews on the photochemistry of imine compounds are available<sup>116</sup>. More recent reviews on the photochemistry of imine and iminium salts are also available<sup>117,118</sup>.



### A. Photoinduced Electron Transfer Chemistry of Iminium Salts

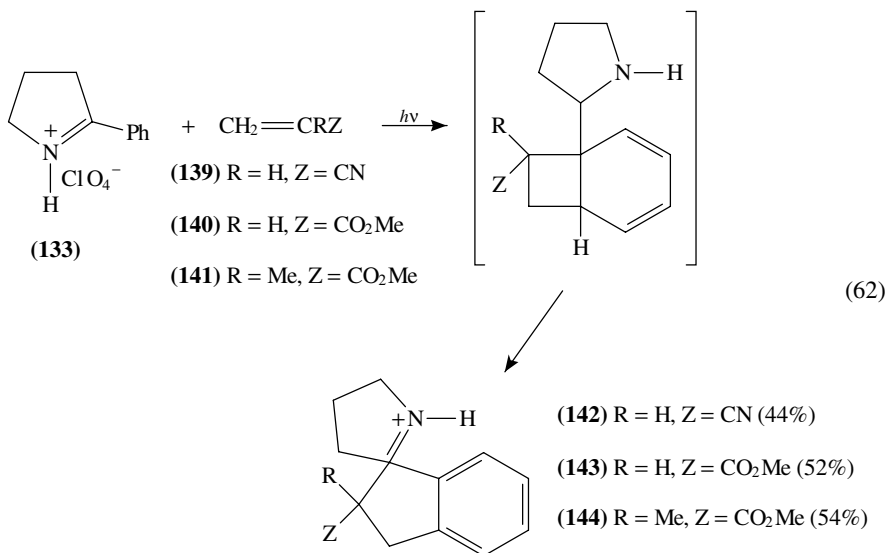
The energies calculated for the electron transfer from electron-rich olefins to excited conjugated iminium salts are energetically favourable<sup>118</sup>. Thus, electron-rich olefins are excellent fluorescence quenchers of 2-phenyl-1-pyrrolinium perchlorate **133**<sup>119</sup>. The

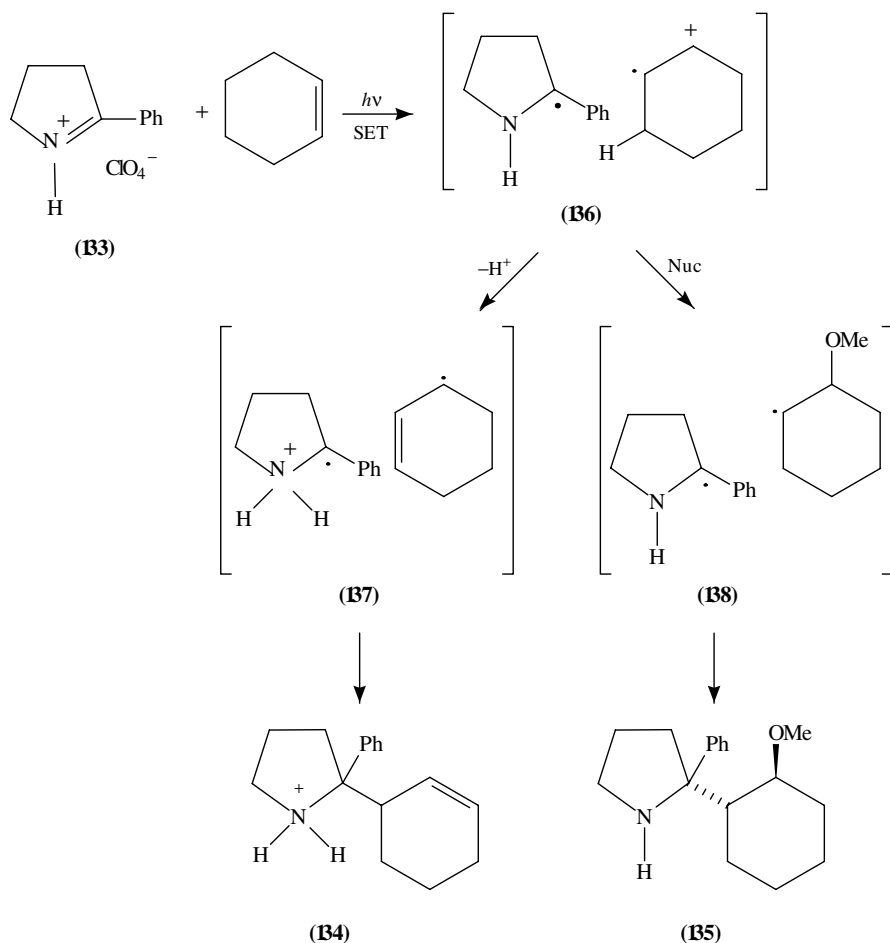
photochemistry between excited **133** and cyclohexene in methanol to obtain the addition product **134** and the methanol adduct **135** is illustrated in equation 61.



The mechanism for the photoreaction between **133** and cyclohexene can be summarized as in Scheme 8. The initiating electron transfer fluorescence quenching of **133** by cyclohexene resulted in the formation of an  $\alpha$ -amino radical-radical cation pair **136**. Proton transfer from the 2-position of the cyclohexene radical cation to the nitrogen atom of the  $\alpha$ -amino radical leads to another radical cation-radical pair **137**. Recombination of **137** at the radical site affords the adduct **134**, while nucleophilic attack at the cation radical of **136** leads to another radical pair **138** which is the precursor for the adduct **135**.

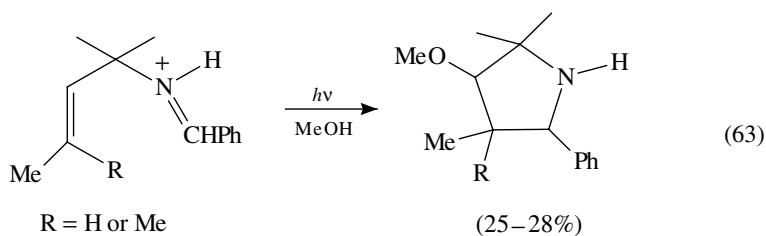
Electron-poor olefins with higher oxidation potentials may decrease the rate of electron transfer and other processes competing for deactivation of the iminium salt excited states may increase. Alternate reaction pathways involving olefin-arene 2 + 2 cycloaddition may take place in the photochemistry of **133** with electron-poor olefins (equation 62)<sup>120,121</sup>.



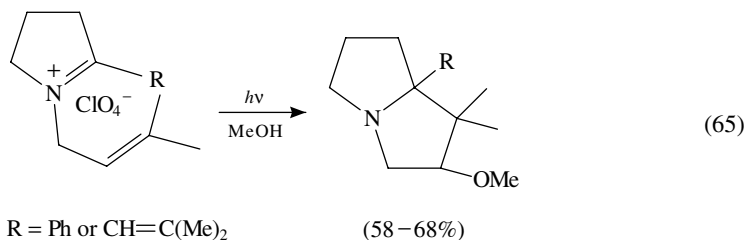
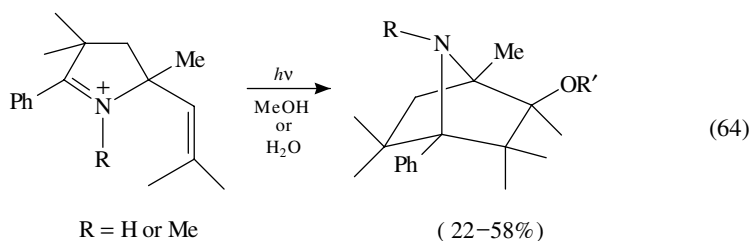


SCHEME 8

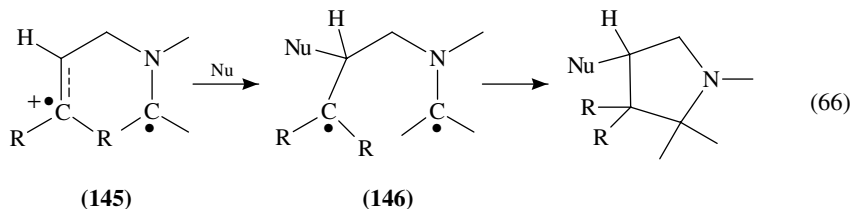
Intramolecular electron transfer initiated cyclization reaction of *N*-allyliminium salt systems may also generate 3-pyrrolidinyl ethers or alcohols in monocyclic and bridged or fused bicyclic systems (e.g. equations 63–65)<sup>122,123</sup>.



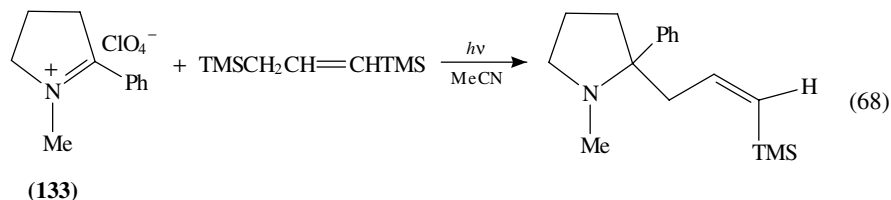
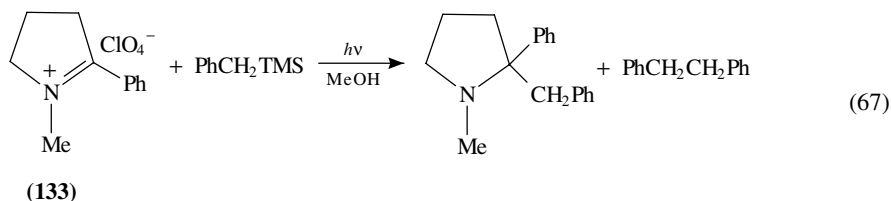




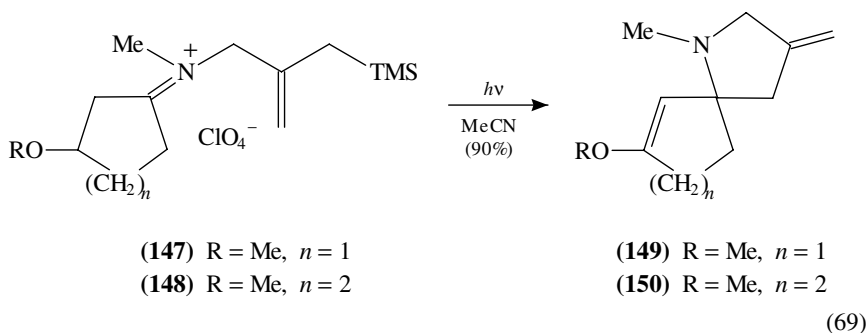
Selective generation of 2-aza-1,5-diradicals **146** through nucleophilic addition to the less substituted positions of the cation radicals **145** arising by intramolecular electron transfer was attributed to the cyclization regiochemistry (equation 66).



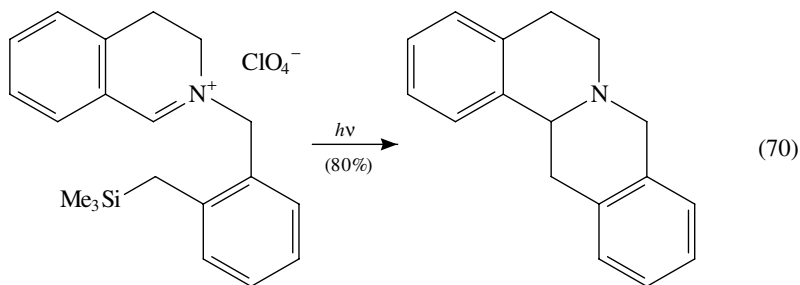
The efficient photoaddition reactions between pyrrolinium perchlorate (**133**) and benzyltrimethylsilane (equation 67) or the allylsilane (equation 68) are examples of the initial electron transfer induced desilylation processes.



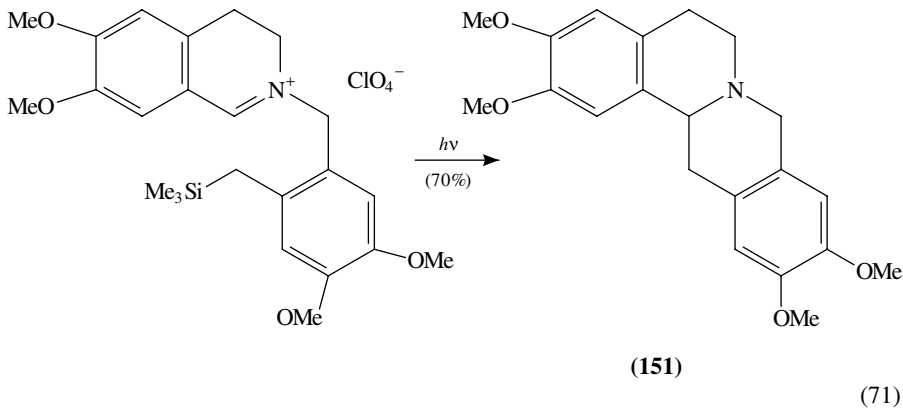
The allylsilane-iminium salt photochemistry has been found useful for the development of novel spirocyclization methodologies (equation 69)<sup>124,125</sup>.

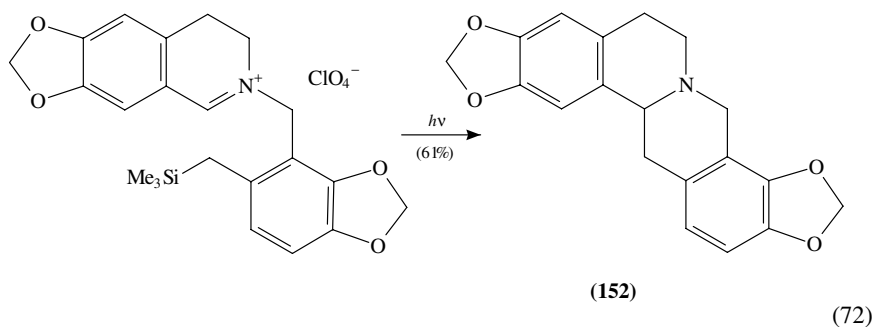


The iminium salt photoaddition reaction has been applied to the synthesis of N-heterocyclic systems (equation 70)<sup>126,127</sup>.



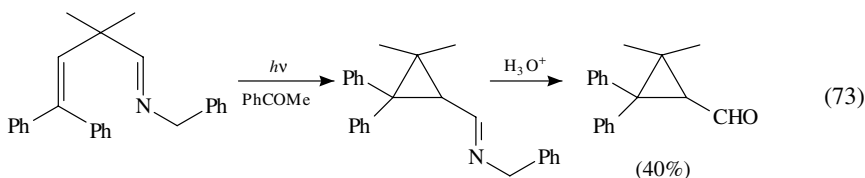
Total synthesis of the representative protoberberines, (+)-xylopinine **151** (equation 71) and (+)-stylopinine **152** (equation 72), have been achieved using silylarene-iminium salt photochemistry<sup>128</sup>. The photochemical routes appear to be superior to alternative ground-state methods involving dipolar cyclizations.



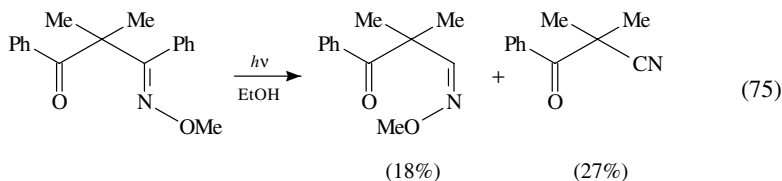
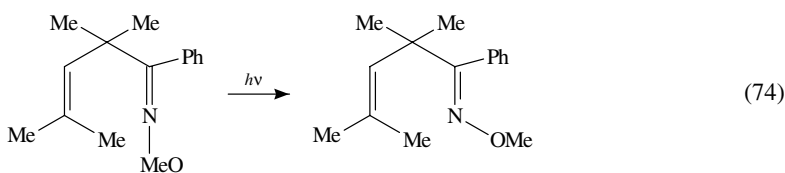


### B. The Aza-di- $\pi$ -methane Rearrangement

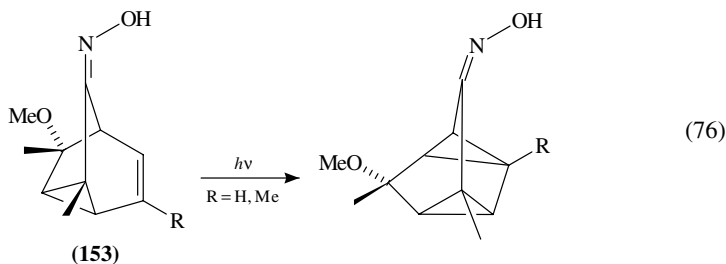
The extension of the di- $\pi$ -methane rearrangement from 1,4-dienes and  $\beta,\gamma$ -unsaturated ketones to the use of 1-aza-1,4-dienes has been achieved<sup>129</sup> (equation 73).



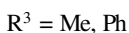
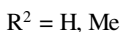
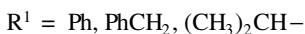
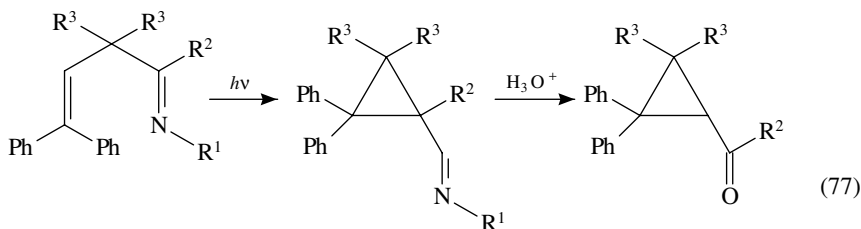
Acyclic  $\beta,\gamma$ -unsaturated oxime ethers are found to undergo both *cis-trans* isomerization and N–O bond fission<sup>130,132</sup> (equations 74 and 75).



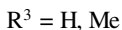
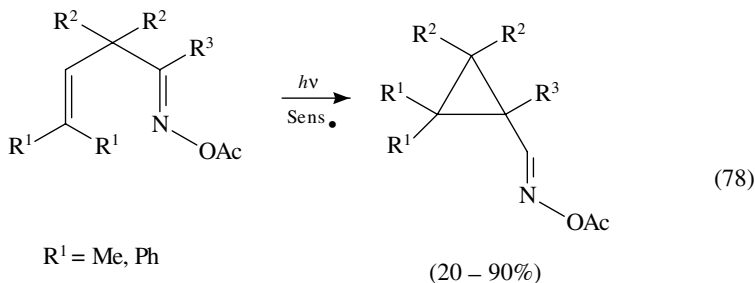
Cyclic  $\beta,\gamma$ -unsaturated oximes **153** did undergo aza-di- $\pi$ -methane rearrangement<sup>131</sup> (equation 76).



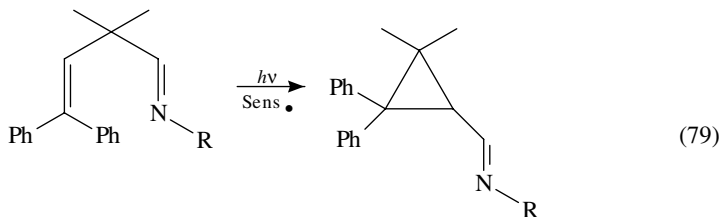
Various substituted  $\beta,\gamma$ -unsaturated imines (equation 77) did undergo aza-di- $\pi$ -methane rearrangements via triplet states<sup>132,133</sup>.



The introduction of an electron-withdrawing group such as acetyl at the oxime oxygen will decrease the intramolecular electron transfer reaction from the nitrogen lone pair and will enhance the aza-di- $\pi$ -methane rearrangement<sup>134-138</sup> (equation 78).

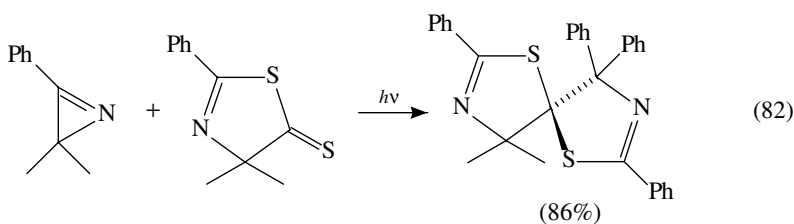
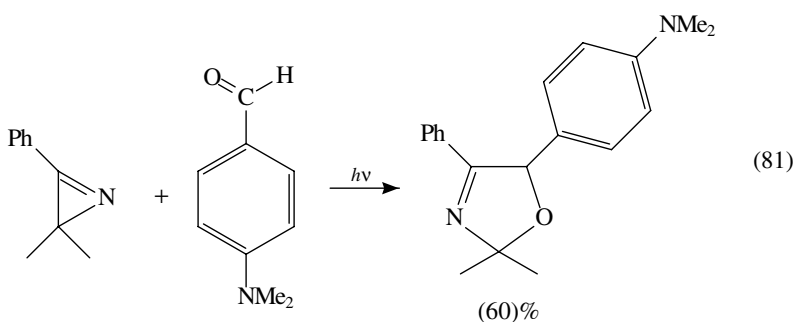
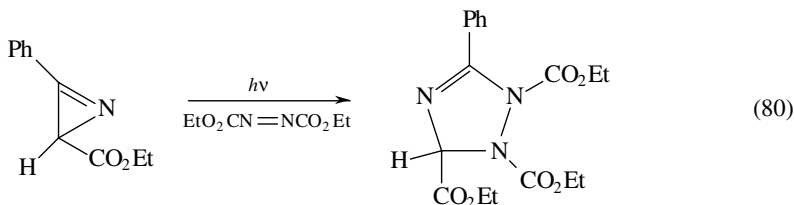


Other oxime ether derivatives, such as semicarbazones or benzoyl compounds, hydrazones undergo efficient aza-di- $\pi$ -methane rearrangement<sup>139</sup> (equation 79).



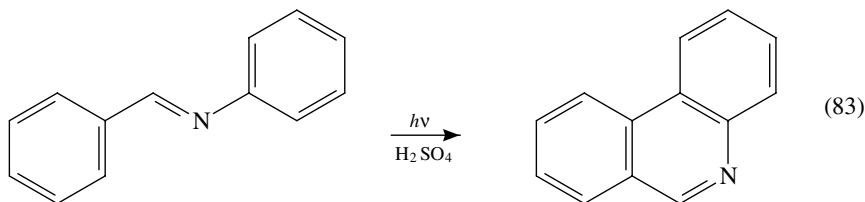
### C. Photochemistry of Azirines

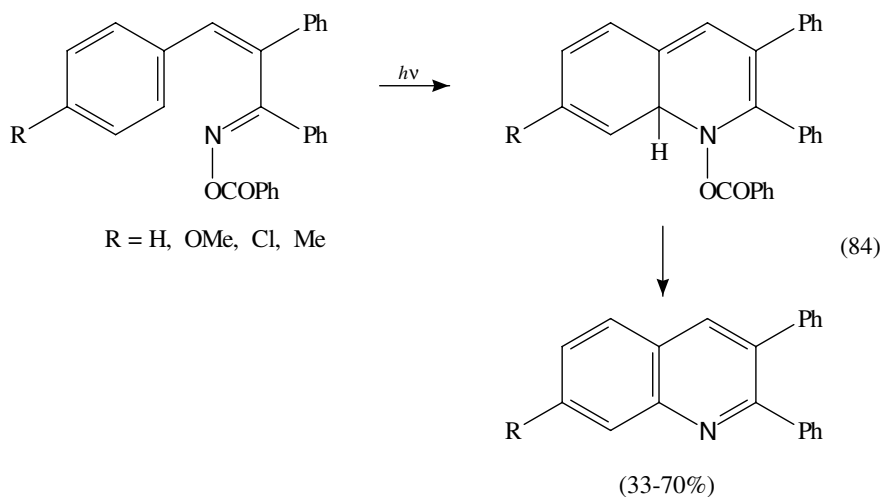
The irradiation of 2*H*-aryl azirines yields nitrile ylides which can be trapped by various dipolarophiles to form five-membered ring heterocycles<sup>116,140–142</sup> (equations 80–82).



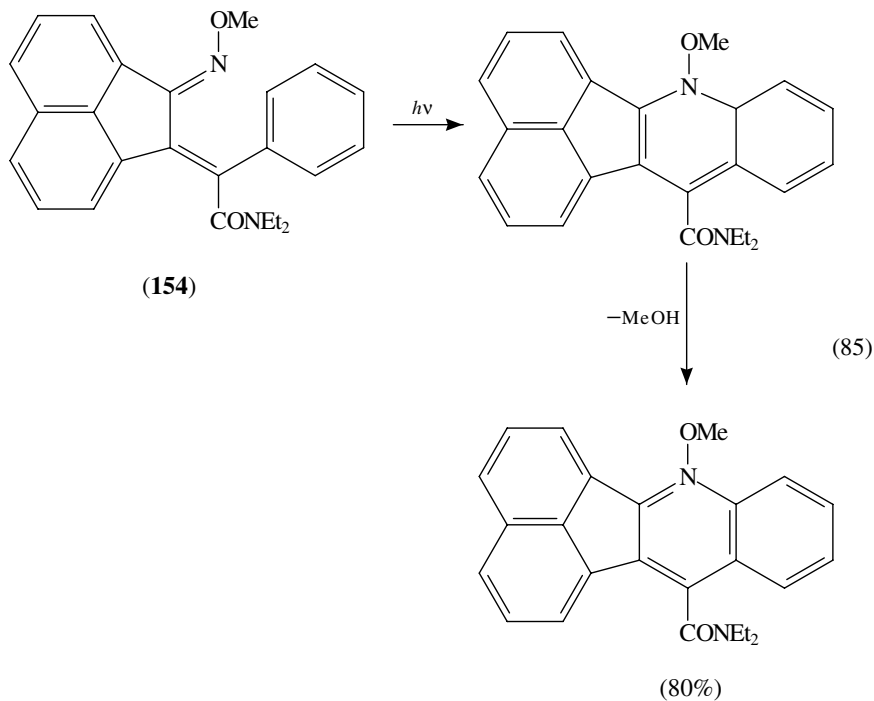
### D. Stilbene-type Photocyclizations

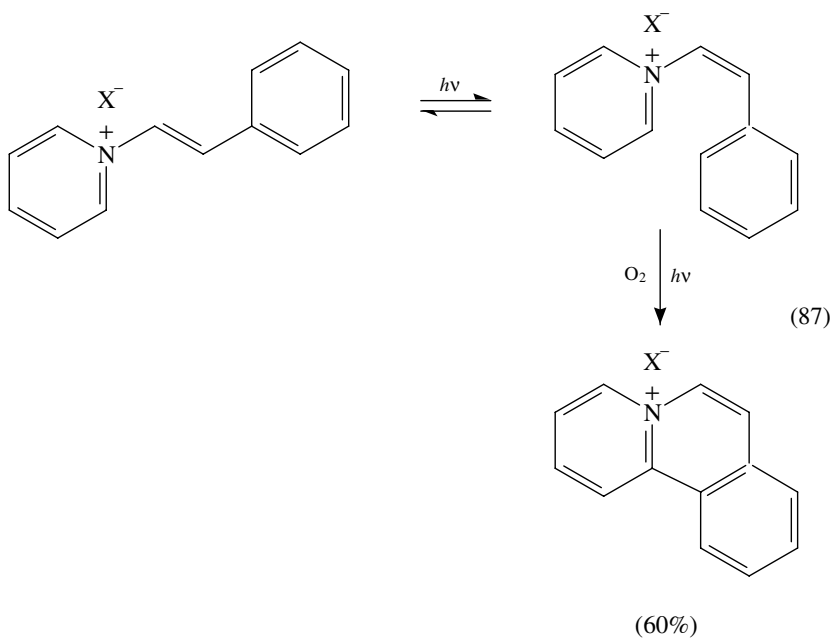
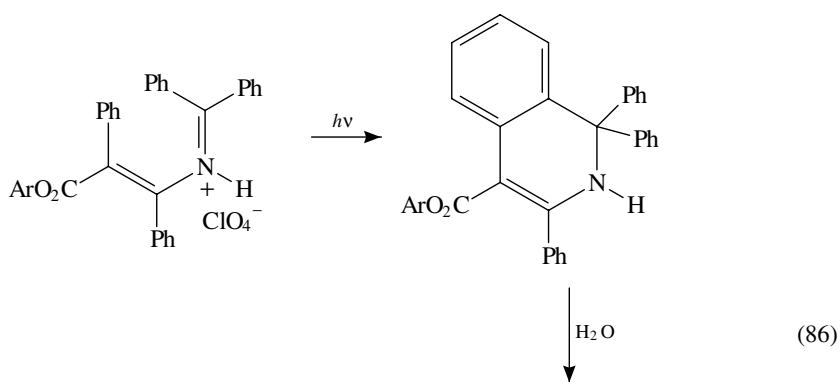
*N*-Phenylbenzylimines undergo stilbene-type photocyclizations (equation 83) to yield heterocyclic compounds<sup>143</sup>. The reactions usually take place via the iminium salt and need oxidants like oxygen or iodine. Six-electron electrocyclic reactions have been observed for 1-aza-1,3-dienes<sup>144</sup> (equation 84).

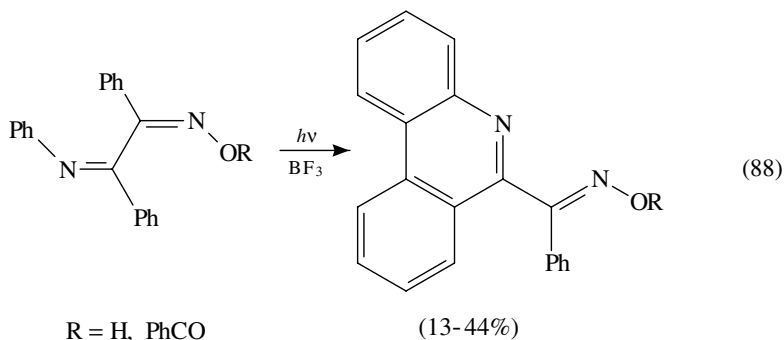




Similar reactions have also been observed for 1-azadiene **154**<sup>145</sup> (equation 85), 4-aryloxy-2-azabuta-1,3-dienes<sup>146</sup> (equation 86), 1-styrylpyridinium salts<sup>147</sup> (equation 87) and diaza-1,3-dienes<sup>148</sup> (equation 88).

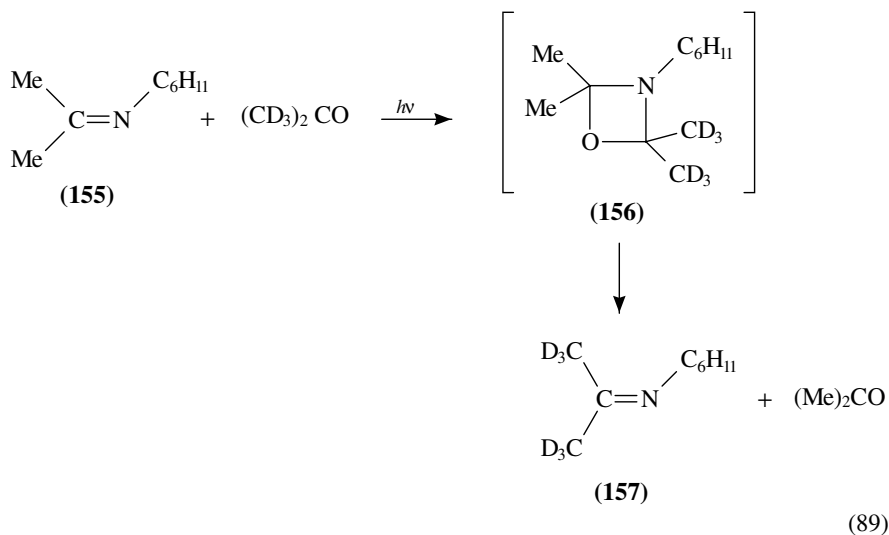




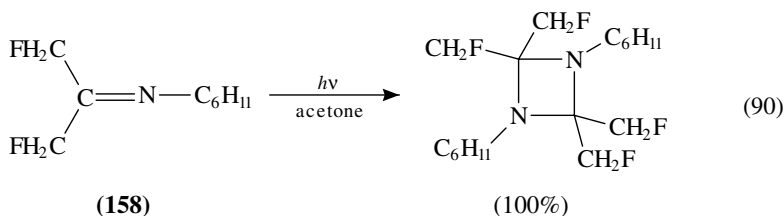


### E. Other Reactions of Imines

Unlike ketones and alkenes, aliphatic imines are reluctant to undergo photoinduced (2 + 2) cycloadditions. For example, the cyclohexanimines of acetone and its derivatives were studied<sup>149</sup>. Compound **155** undergoes photoaddition with deuterated acetone, but the oxazetidine **156** decomposes to acetone and hexa-deuterioimine **157** (equation 89).

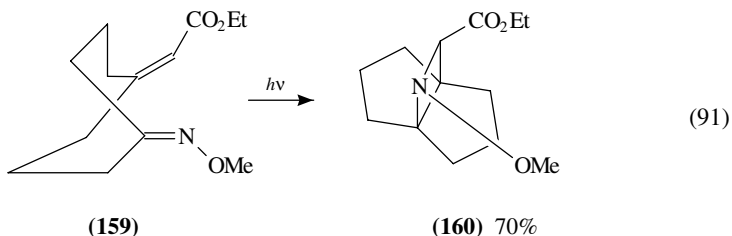


However, the cyclohexanimines of 1,3-difluoro-2-propane **158** do undergo photochemical 2 + 2 cycloaddition (equation 90).

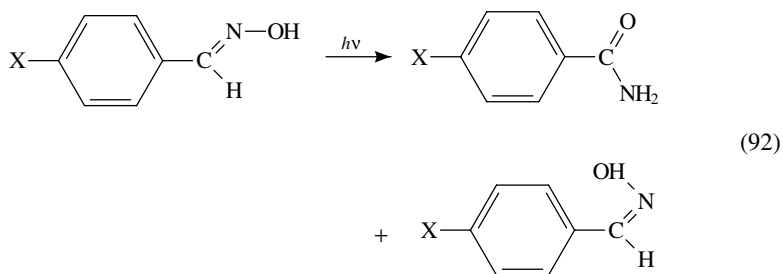




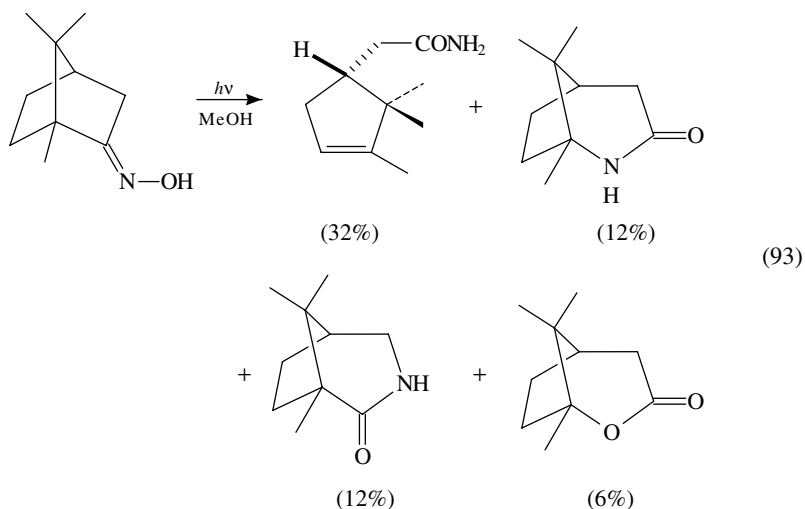
Intramolecular cycloaddition of an oxime ether **159** to yield an azapropellane **160** is also known<sup>150</sup> (equation 91).



Photochemical Beckman rearrangement of oximes results in the formation of carboxamides as the major product<sup>151</sup> (equation 92).

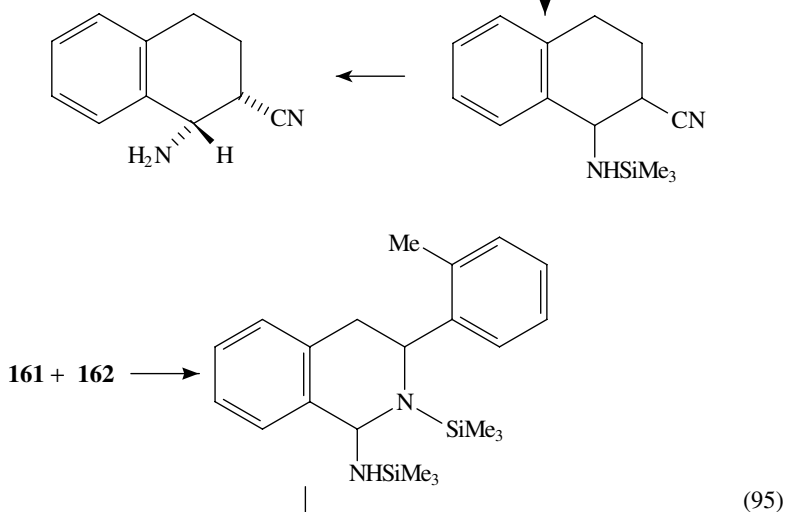
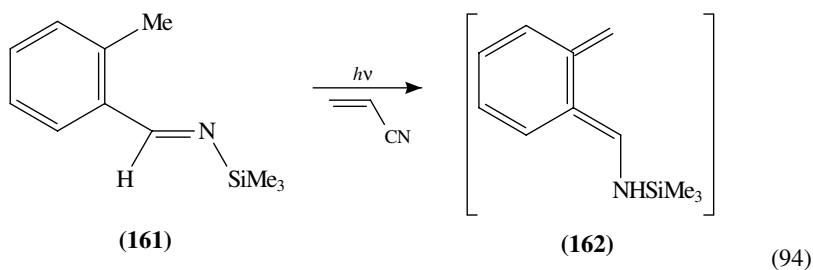


Recent studies with (+) fenchone or with (+) camphor (equation 93) indicated that 1:1 ratio of isomeric lactams is obtained<sup>152</sup>.



Photochemical hydrogen abstraction reaction for the silylimine **161** give an *o*-quinodimethane intermediate **162** which could be trapped with dimethyl fumarate, dimethyl maleate, *trans*-methyl cinnamate, methyl acrylate, acrylonitrile (equation 94)

and imine **161** itself<sup>152</sup> (equation 95).

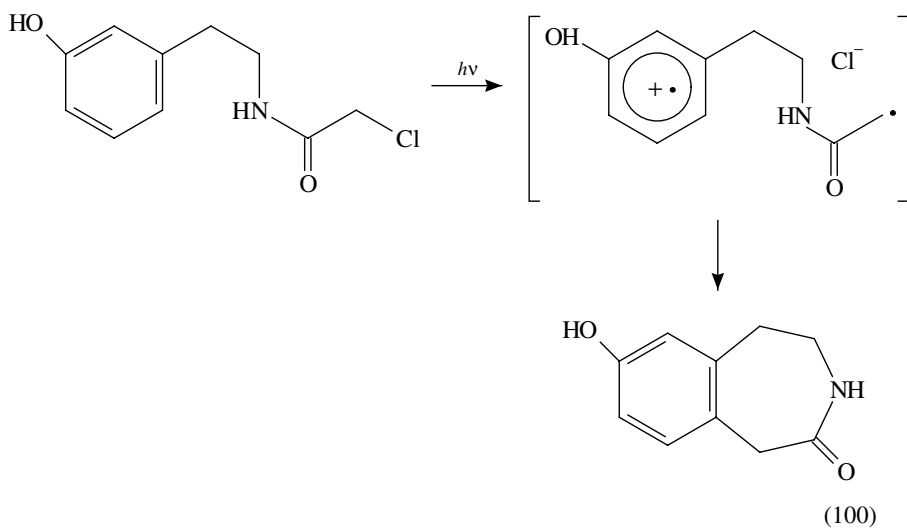
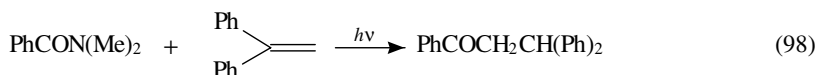
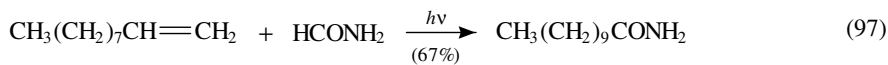
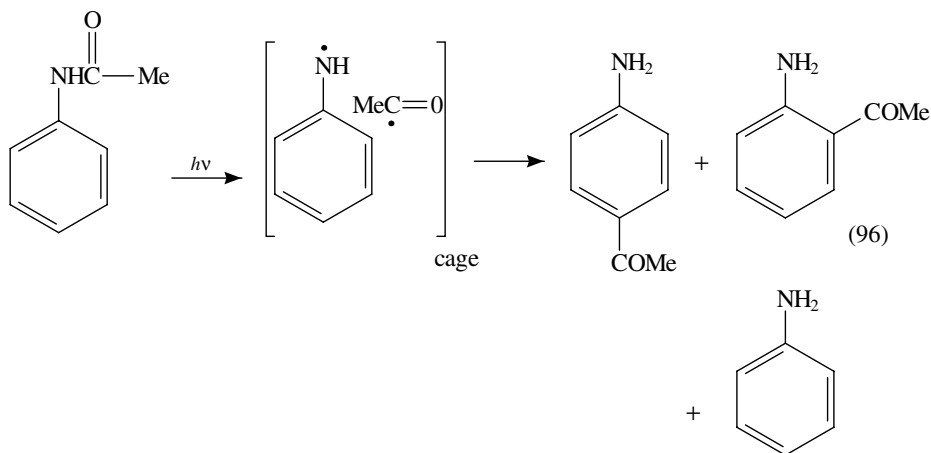


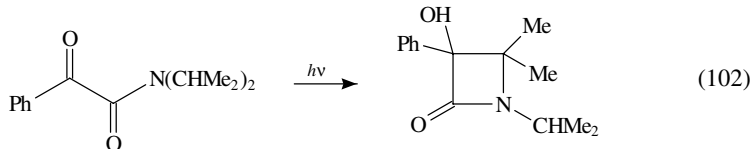
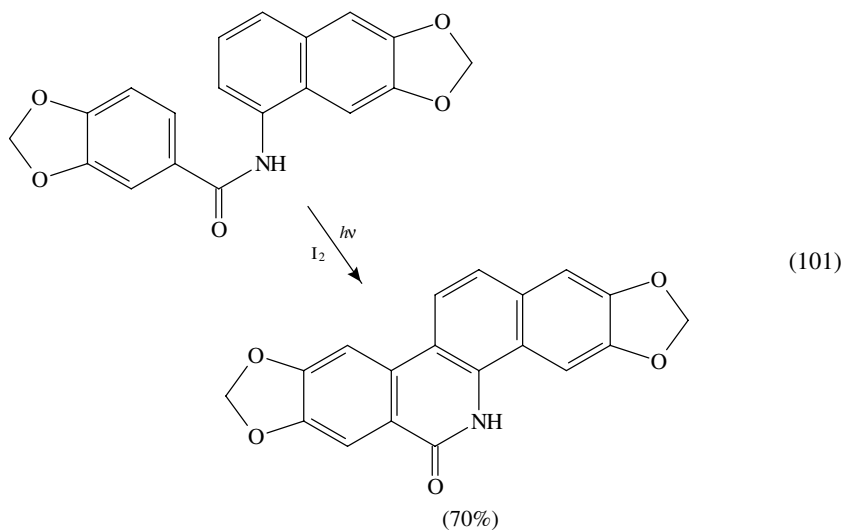
## VI. PHOTOCHEMISTRY OF AMIDES AND IMIDES

### A. Amides

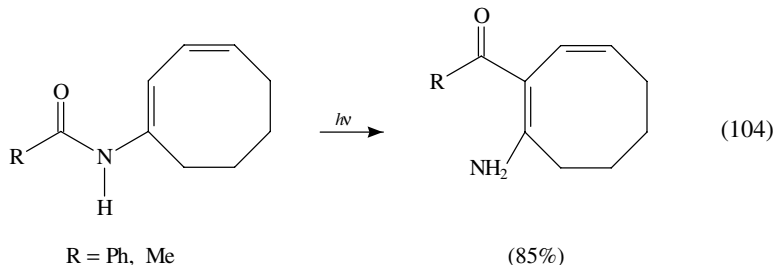
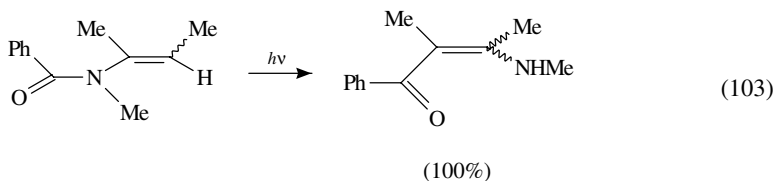
Photoreactions of the amide group include the Photo-Fries rearrangement<sup>153</sup> (equation 96), the photoaddition of formamide to a terminal alkene<sup>154</sup> (equation 97),  $\alpha$ -cleavage<sup>155</sup> (equation 98),  $\beta$ -cleavage<sup>156</sup> (equation 99), electron transfer initiated cyclization<sup>157</sup> (equation 100), stilbene-type oxidative cyclization<sup>158</sup> (equation 101) and

Norris-type hydrogen abstraction<sup>159</sup> (equation 102).

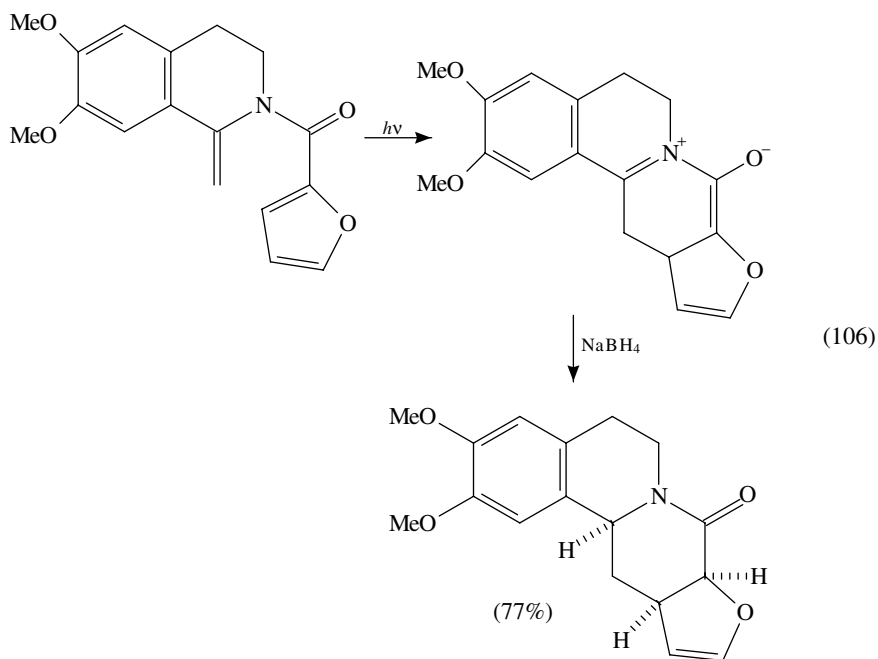
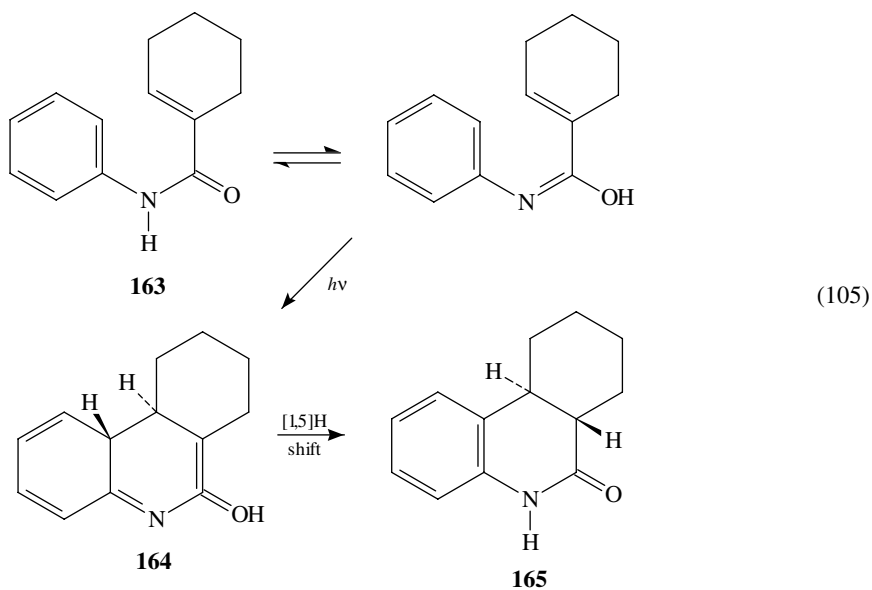


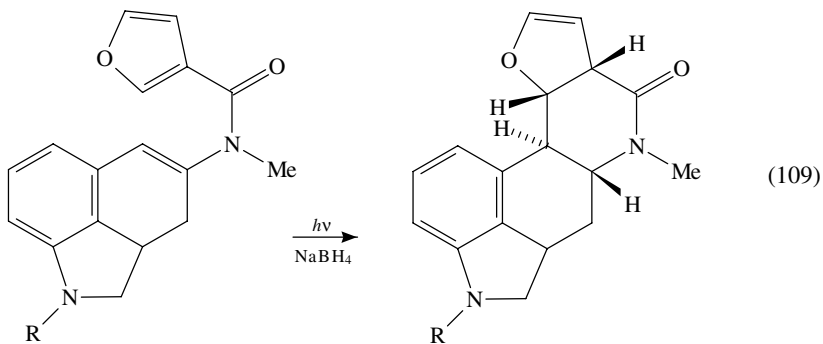
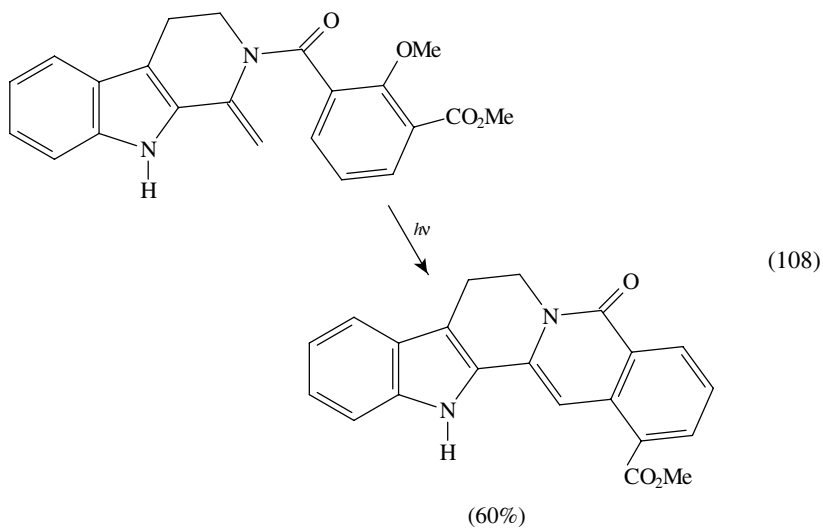
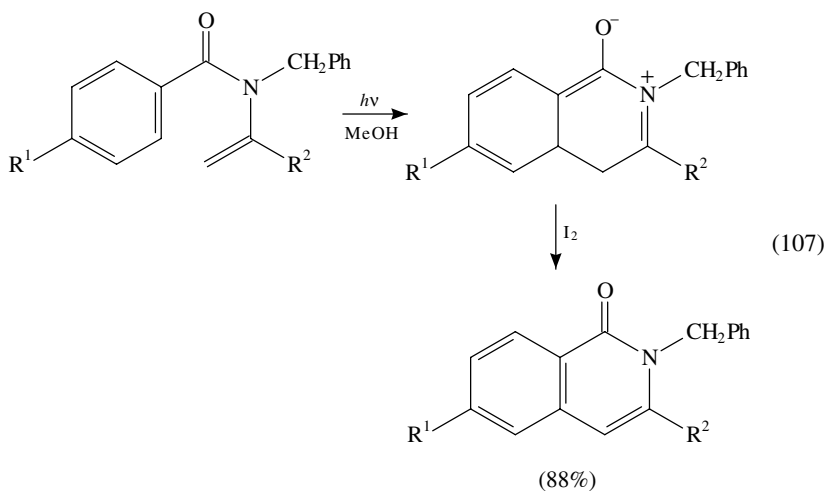


In addition, recent studies of amides include the 1,3-acyl migration of enamides to obtain the enamines through a photo-Fries like mechanism (equations 103<sup>160</sup> and 104<sup>161</sup>).

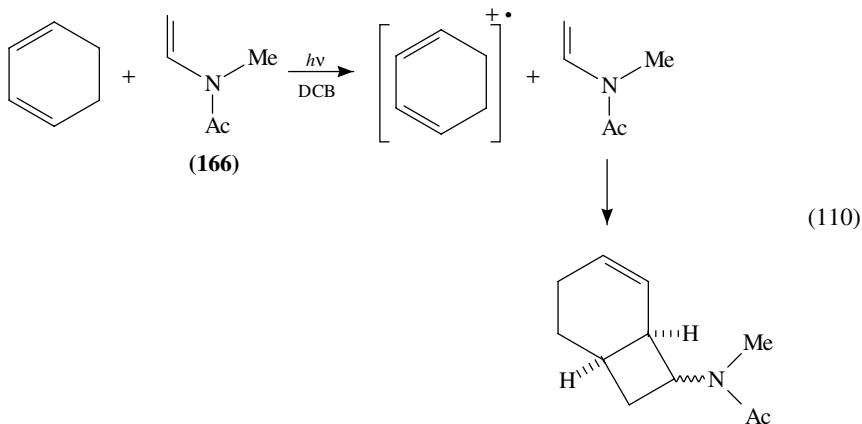


Enamides **163** undergo photochemical conrotatory six-electron electrocyclic reactions to yield the dihydro intermediate **164**, which in turn yields the *trans*-fused cyclic product **165** (equation 105) by a (1,5)-suprafacial hydrogen shift. Several natural product syntheses like that of benzyloquinoline and indole type alkaloids can be achieved by this type of photocyclization (equations 106<sup>163</sup>, 107<sup>164</sup>, 108<sup>165</sup> and 109<sup>166</sup>).

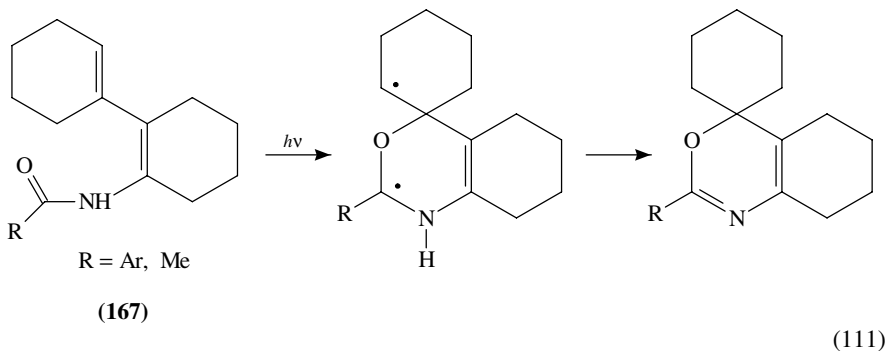




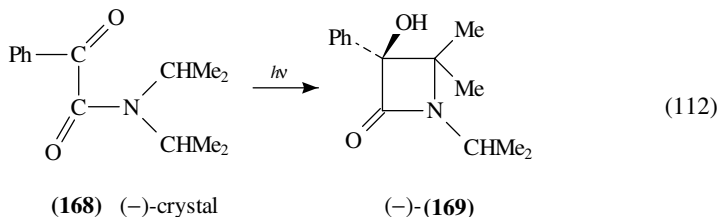
The enamide **166** reacts with the cation radical of cyclohexadiene, which is generated by sensitized electron transfer with the photoexcited dicyanobenzene (DCB), to generate a Diels-Alder type adduct (equation 110)<sup>167</sup>.



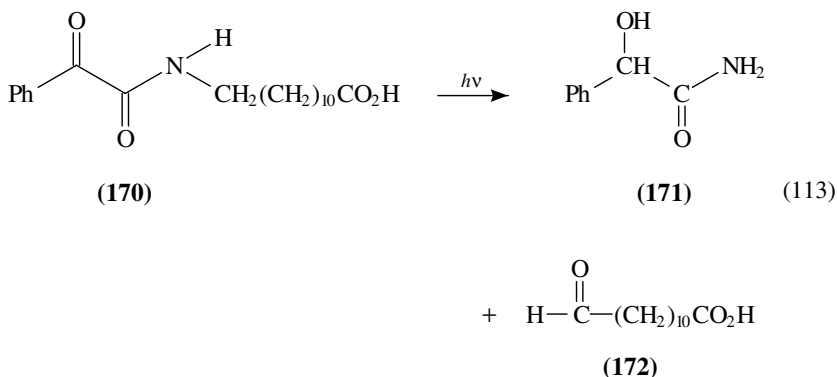
Dienamides such as **167** react by a different reaction pathway<sup>168</sup>, namely by addition of the amide oxygen to the alkene by a radical addition reaction (equation 111).



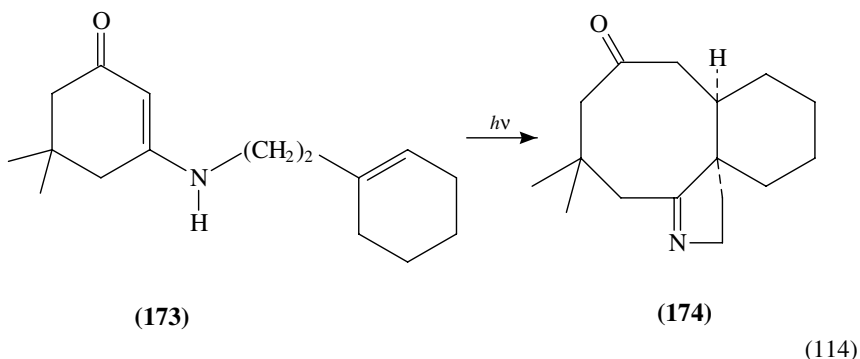
Chiral induction to obtain the  $\beta$ -lactam **169** by photolysis of the chiral crystal **168** in the solid state is possible (equation 112).



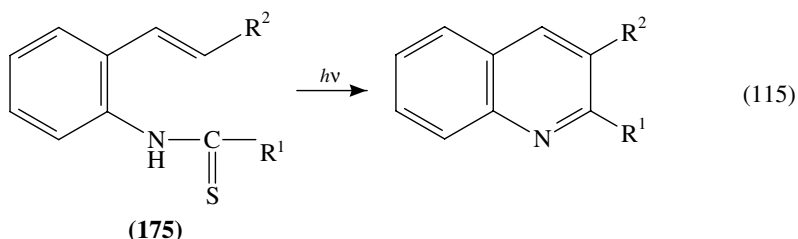
The photoreaction of *N*-(12-dodecanoic acid)-benzoylformamide **170** in solution and in  $\beta$ -cyclodextrin or carboxymethylamylose complexes indicated that major products are those of hydrolysis to mandelamide **171** and to the corresponding aldehyde **172** (equation 113)<sup>169</sup>.



The intramolecular photochemistry of the vinylogous amide **173** in *tert*-butyl alcohol yielded a retro-Mannich type reaction product **174** (equation 114)<sup>170</sup>.

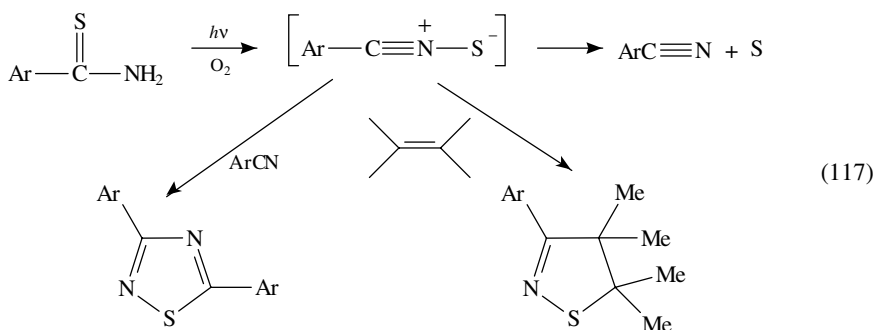
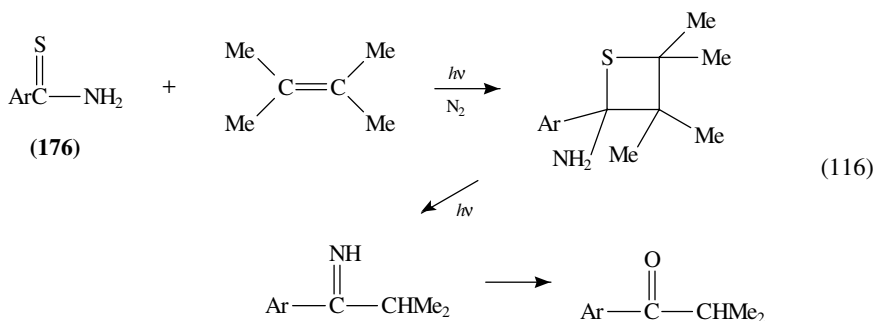


Compared to amides, the photochemistry of thioamides was less studied. The 2-substituted aryl thioamide **175** undergoes photocyclization to quinoline derivatives (equation 115)<sup>171</sup>.

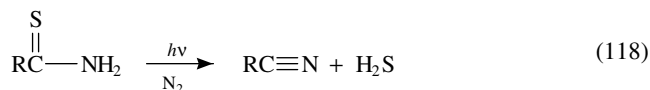


Thioamides **176** react photochemically with 2,3-dimethyl-2-butene in the absence of oxygen to give ketones (equation 116)<sup>172</sup>. In the absence of oxygen, the photoproducts of **176** include nitriles, 1,2,4-thiadiazole and isothiazoline (equation 117).

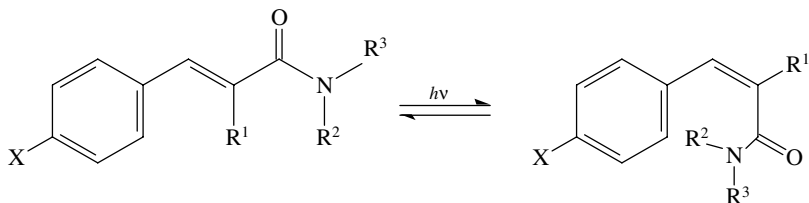




Primary thioamides undergo photochemical hydrogen sulphide extrusion in the absence of oxygen (equation 118)<sup>173</sup>.

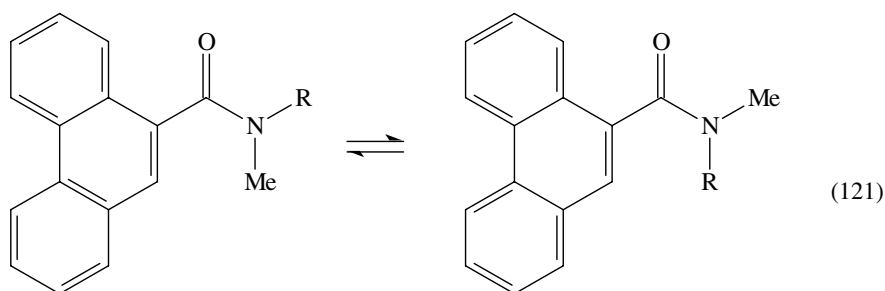
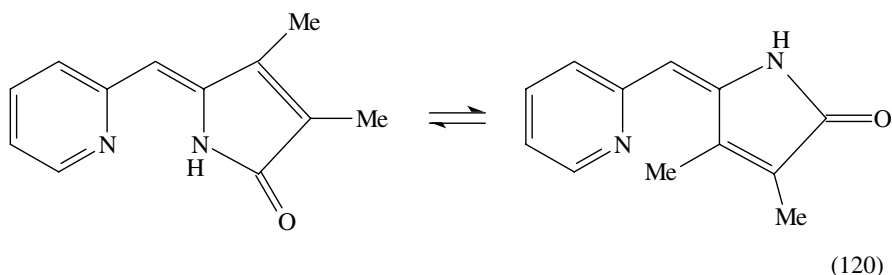


Finally the effects of conformation, hydrogen bonding and Lewis acids on the intramolecular electron transfer, spectroscopy and photochemistry of amides were recently studied<sup>174-176</sup> (equations 119-121).



X = H, CF<sub>3</sub>, OMe  
R<sub>1</sub>, R<sub>2</sub>, R<sub>3</sub> = H, Me

(119)

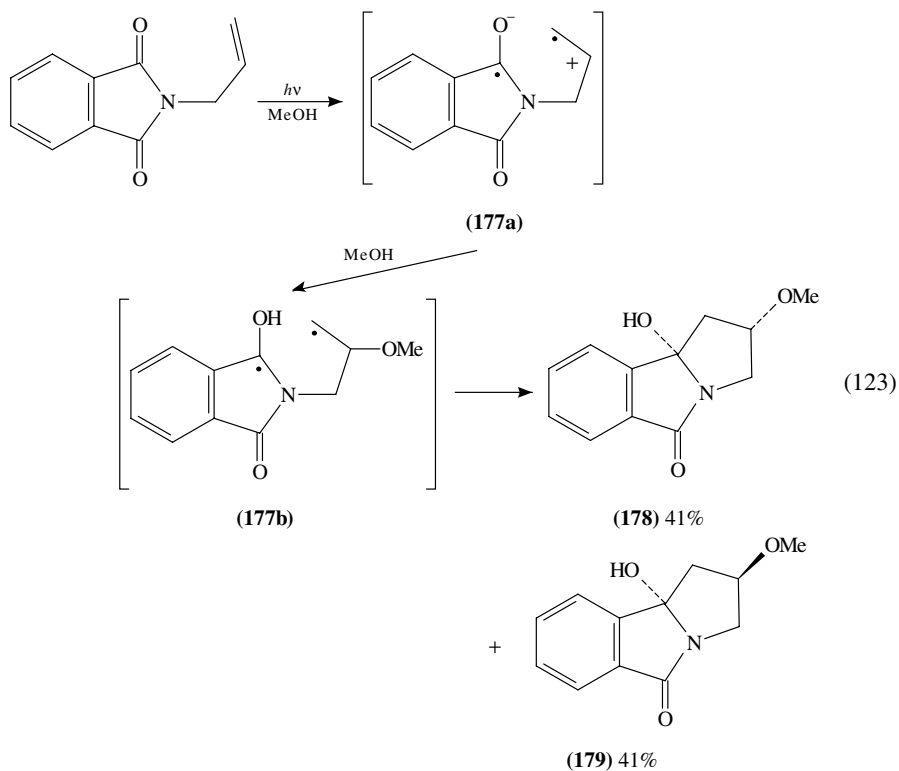
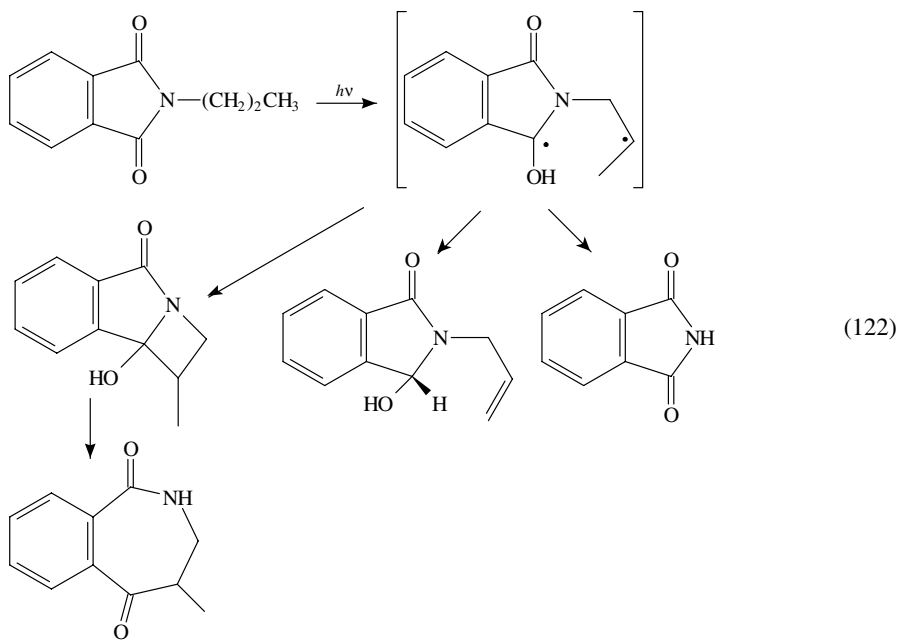


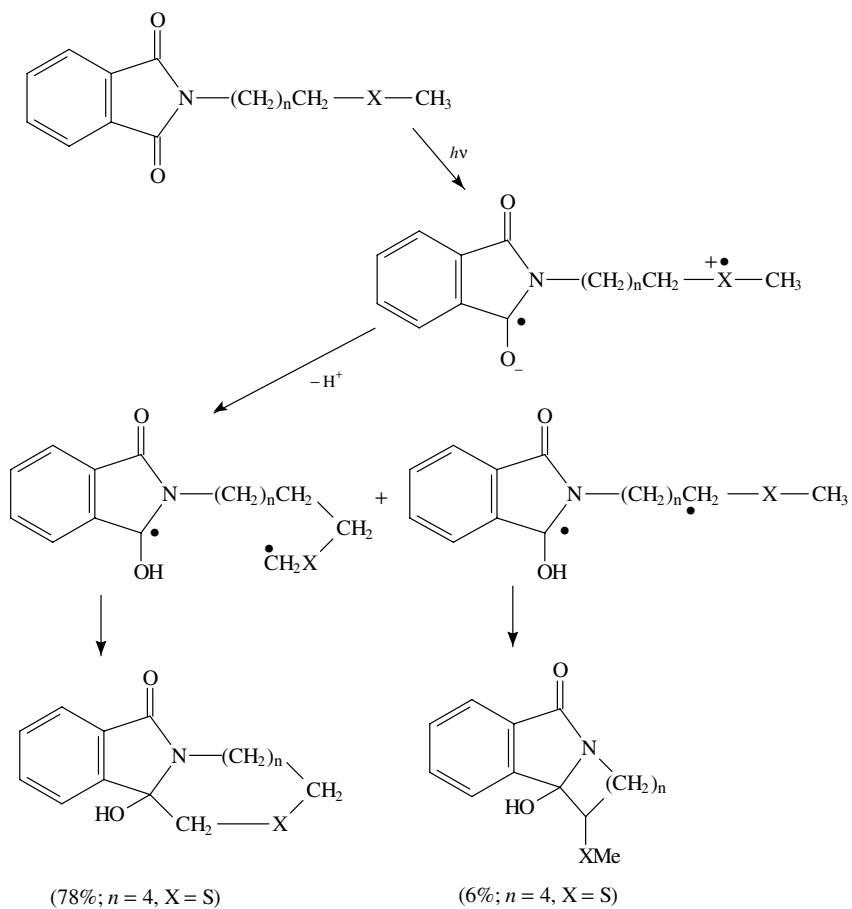
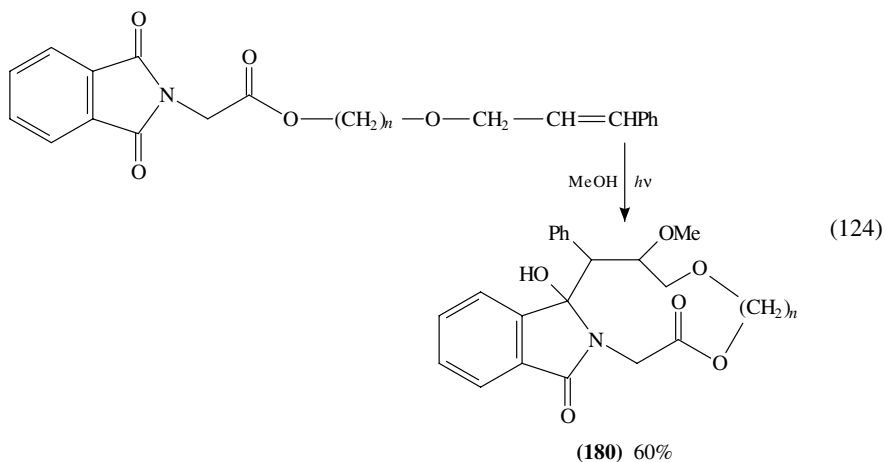
R = Me, C<sub>4</sub>H<sub>9</sub>, CH<sub>2</sub>CH<sub>2</sub>NMe<sub>2</sub>, CH<sub>2</sub>CH<sub>2</sub>CH<sub>2</sub>NMe<sub>2</sub>, CH<sub>2</sub>CH<sub>2</sub>NMePh

The first example of a counterthermodynamic one-way  $E \rightarrow Z$  photoisomerization based upon intramolecular hydrogen bonding was reported for the *N*-methyl-3-(2-pyridyl)-propanamide systems.

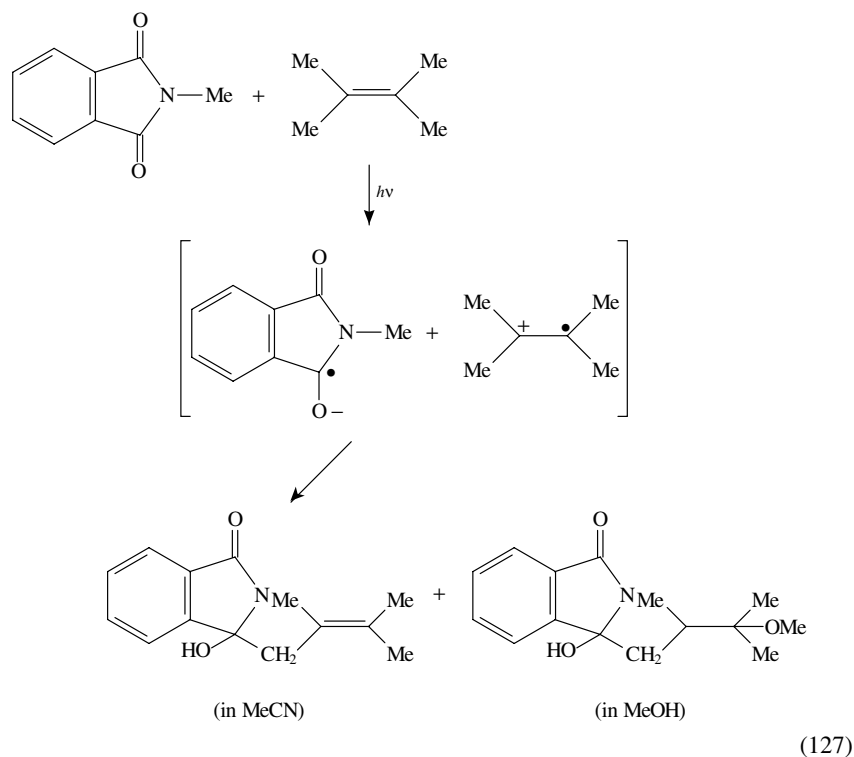
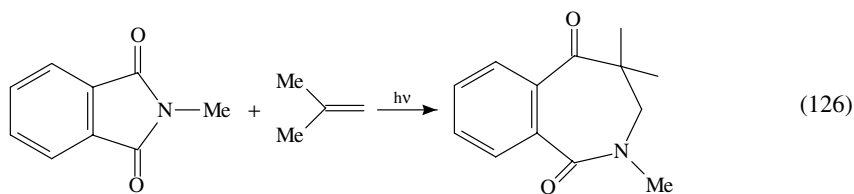
## B. Imides

There are several reviews available on the photochemistry of imides<sup>177</sup>. The photochemistry of *N*-alkylphthalimides (equation 122) has been extensively studied<sup>178</sup>. Photochemical cyclization,  $\beta$ -cleavage and hydrogen atom transfer reactions are caused by intramolecular  $\delta$ -H atom abstraction from the  $T_1$  ( $\pi\pi^*$ ) state of the phthalimide carbonyl group. The reaction is dependent on the solvent used. Benzazepinedione formation is observed in ethanol while  $\beta$ -cleavage and H-transfer occur in acetone and acetonitrile. Both intermolecular and intramolecular electron transfers are important pathways for imides<sup>179</sup>. For example<sup>180</sup>, irradiation of *N*-allylphthalimide in methanol results in intramolecular electron transfer to yield the radical ion pair **177a** followed by an anti-Markovnikov addition of the methanol to produce the biradical **177b**. The cyclized products **178** and **179** are derived from the biradical intermediate (equation 123). The macrocyclic compound **180** was also synthesized using this methodology<sup>180</sup> (equation 124). When a heteroatom such as nitrogen, oxygen or sulphur is introduced into the *N*-alkyl side chain of the phthalimide, photoinduced electron transfer to generate radical ion pairs becomes feasible<sup>181</sup>. Proton transfer from the methyl or methylene group adjacent to the heteroatom gives a diradical which will cyclize the products (equation 125). When the substituent is methylthio (MeS) rather than dimethylamino (NMe<sub>2</sub>), the chemical yield increases and medium to large rings containing 38 atoms can be achieved<sup>182</sup>.

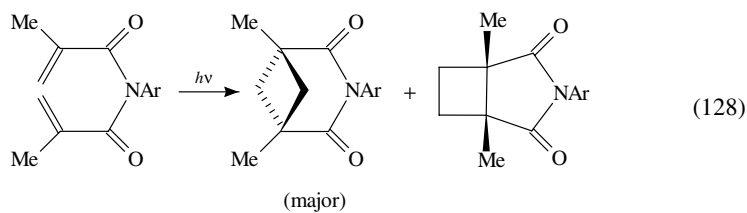




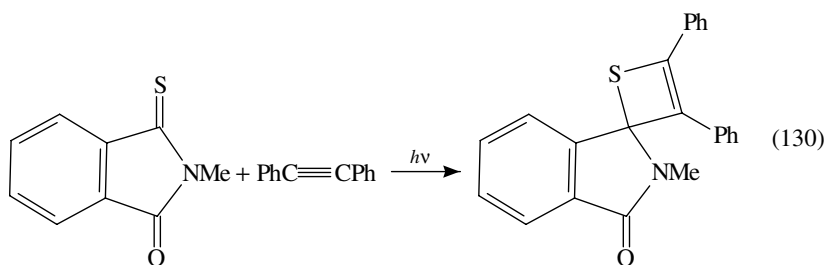
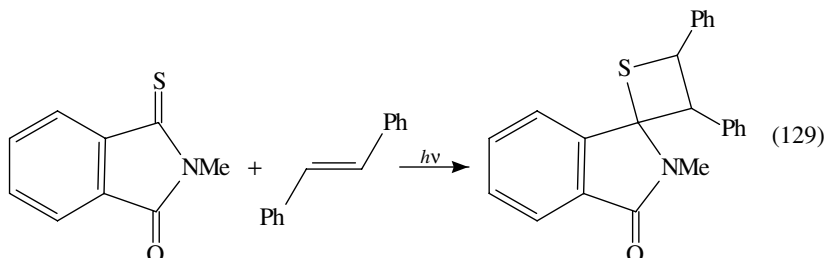
For the intermolecular interactions between *N*-methylphthalimide and alkenes, two reactions paths are possible<sup>183</sup>. The first is the regio- and stereocontrolled ( $2\pi+2\sigma$ ) cycloaddition of the alkene to the C–N bond to generate dihydrobenzazepinedione (equation 126), while the second is the electron transfer initiated addition (equation 127).



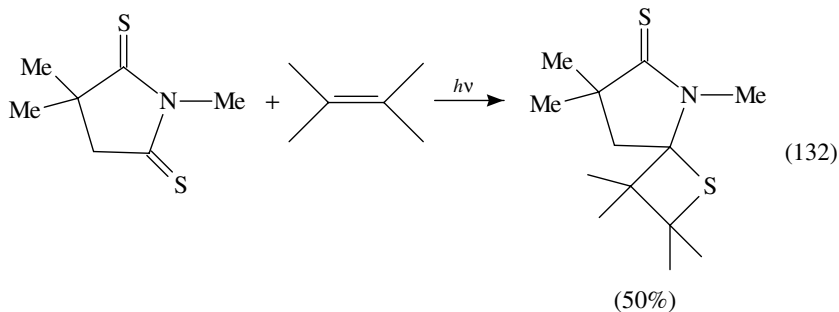
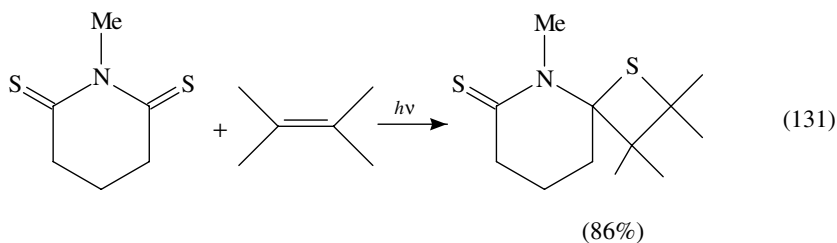
Intramolecular ( $2+2$ ) photocycloaddition is possible for the bis-methacryl-*N*-arylimide<sup>184</sup> (equation 128).

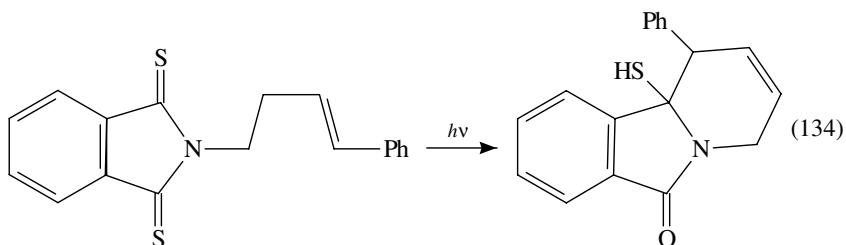
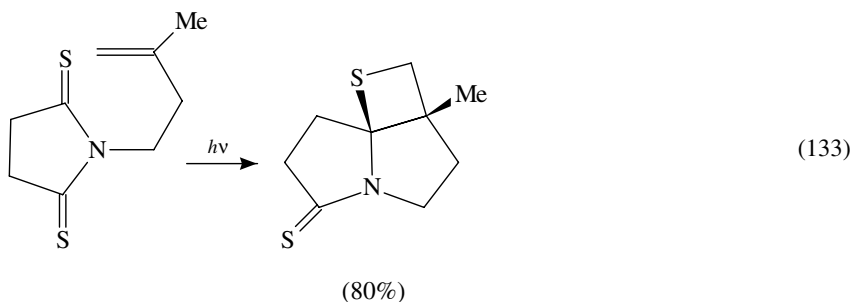


Both saturated or unsaturated thioimides and dithioimides behave like thioketones in their photocycloaddition reaction with alkenes (equation 129) and alkynes (equation 130)<sup>185</sup>.

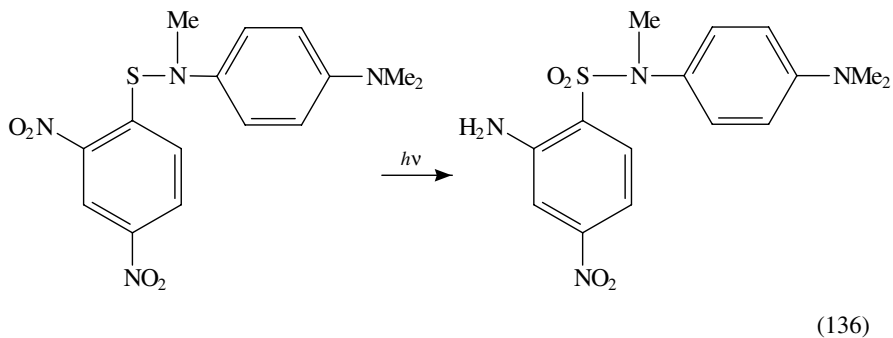
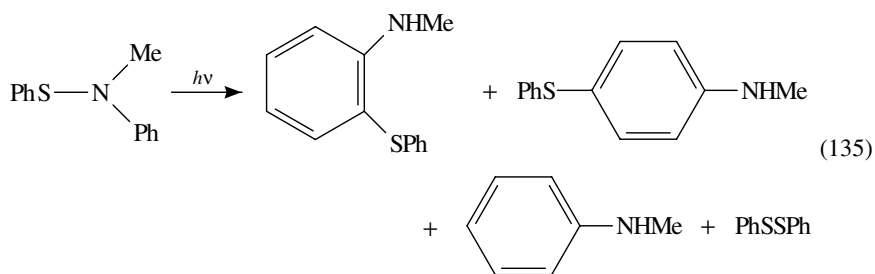


Dithioamides behave similarly<sup>186</sup> (equation 131) but, in the presence of steric hindrance in addition to the thiocarbonyl groups, the photoaddition will become regioselective<sup>187</sup> (equation 132). Intramolecular photocycloaddition will lead to the formation of strained polycyclic thietanes<sup>188</sup> (equation 133). Hydrogen abstraction by the thioamide functional group is also possible<sup>189</sup> (equation 134).

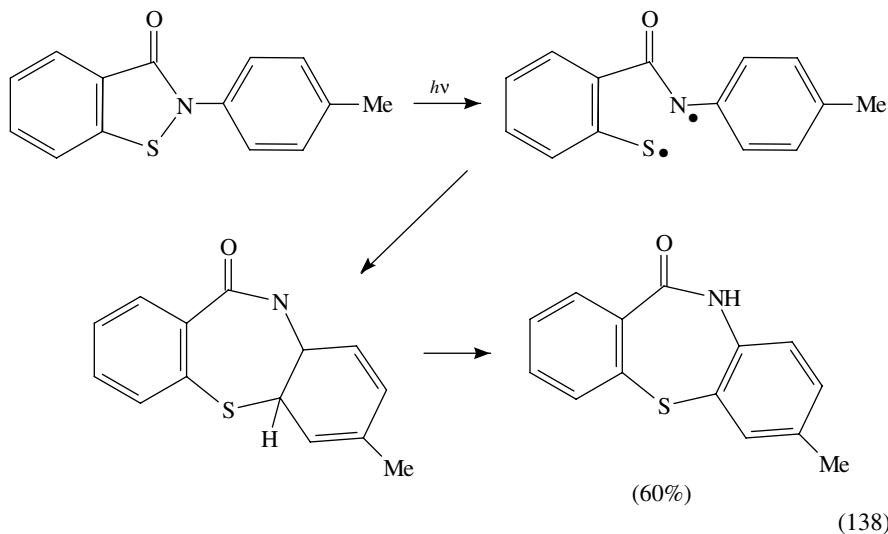
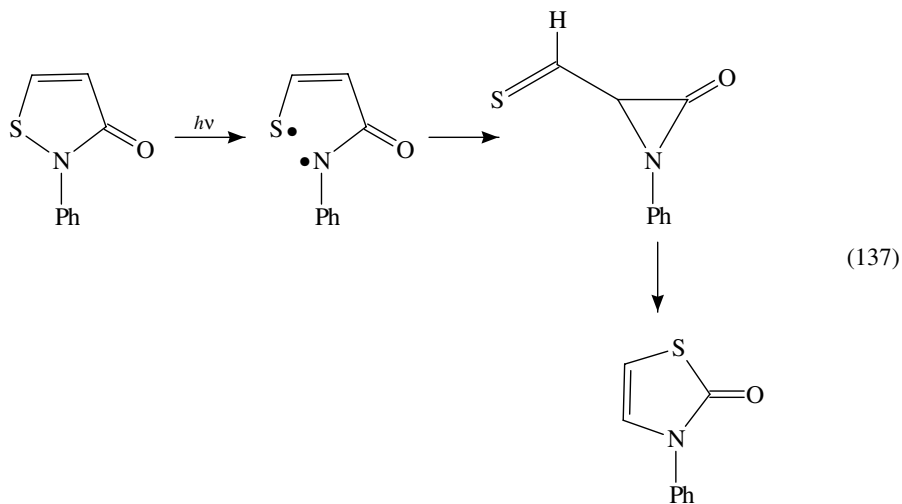




Sulphenamides<sup>190</sup> are photochemically active and undergo homolytic cleavage of the S–N bond. The products are derived from the sulphur- and nitrogen-centred free radicals (equation 135). Oxygen atom transfer from a neighbouring nitro group to the sulphur is also observed<sup>191</sup> (equation 136).

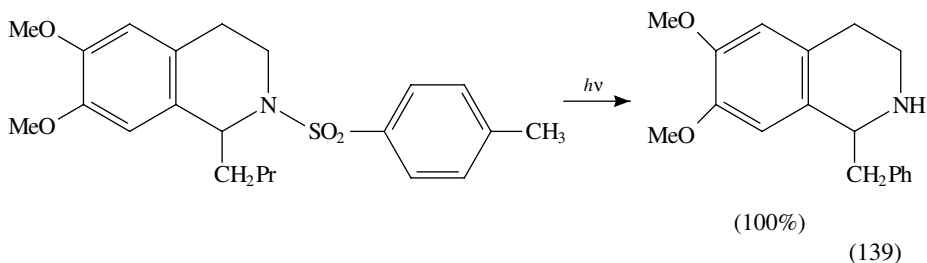


Similarly to the sulphenamides, the photochemistry of isothiazole is initiated by the fission of the weakest S–N bond<sup>192</sup> (equation 137 and 138).

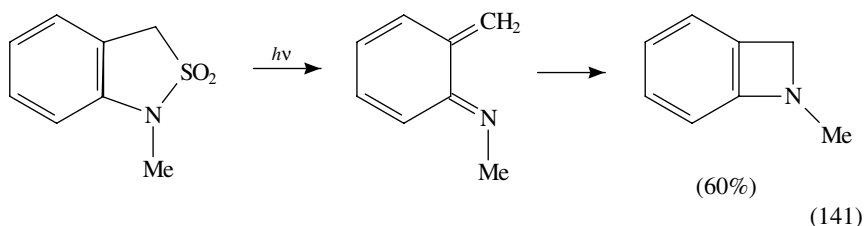
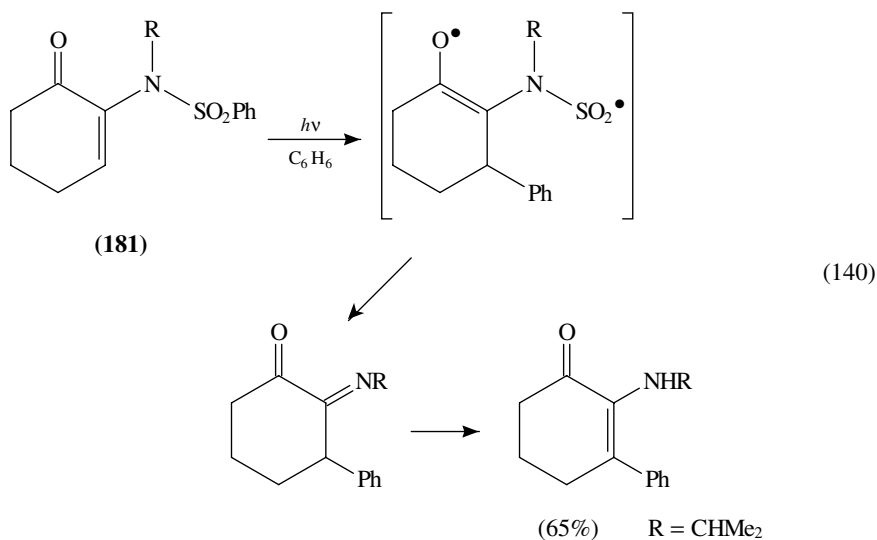


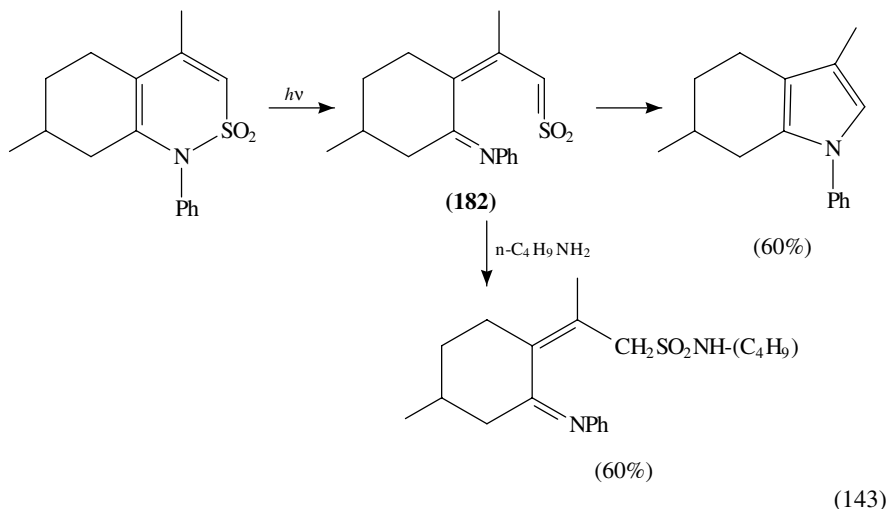
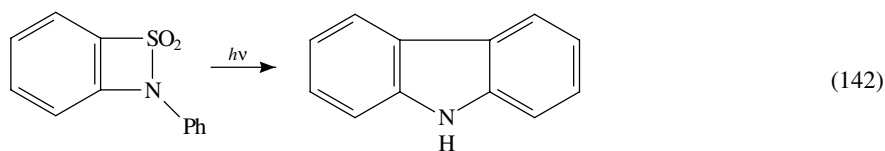
The photochemical deprotection of sulphonamides to free amines is synthetically useful<sup>193</sup>. This process is caused by electron transfer from an electron-donating sensitizer such as 1,2-dimethoxybenzene or 1,4-dimethoxybenzene and the presence of reductants like ammonia or hydrazine is also required<sup>194</sup> (equation 139).



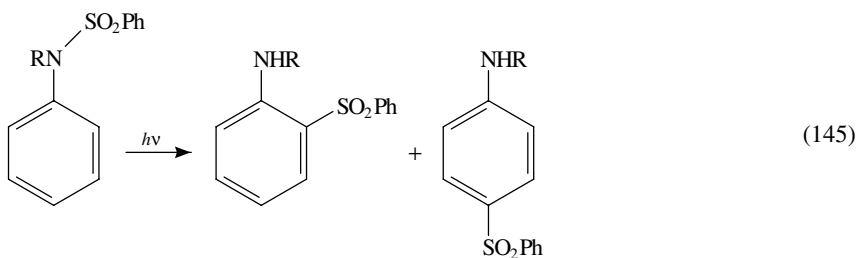
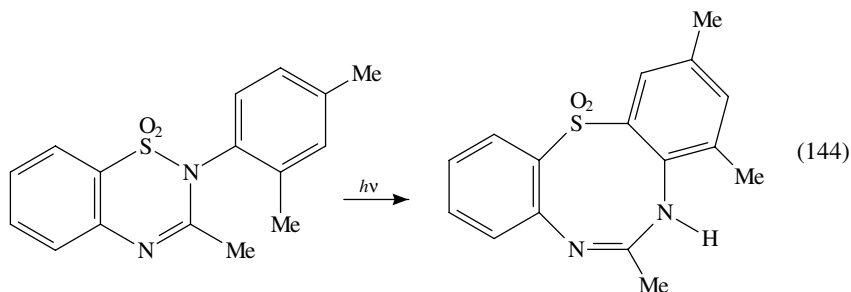


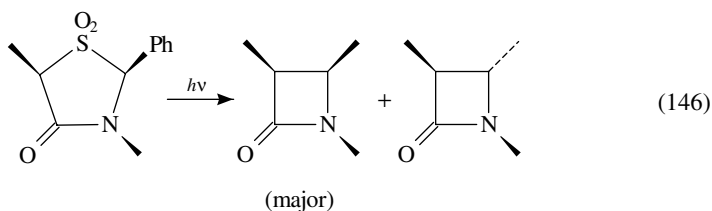
Extrusion of sulphur dioxide by a free radical mechanism can also lead to several ring-closing or ring-opening reactions. For example, intramolecular reaction of the enone **181** to the 3-substituted enone is accompanied by a phenyl shift<sup>195</sup> (equation 140). Free radical ring closure may lead to the formation of useful heterocycles such as azetidine<sup>196</sup> (equation 141) or carbazole<sup>197</sup> (equation 142). In the absence of an external nucleophile such as *n*-butylamine, photochemical ring closure of sultam **182** affords a pyrrole. Trapping of the N–S ruptured intermediate is also possible<sup>198</sup> (equation 143).



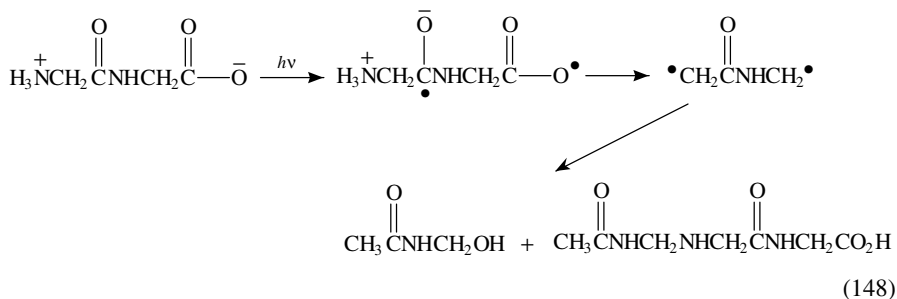
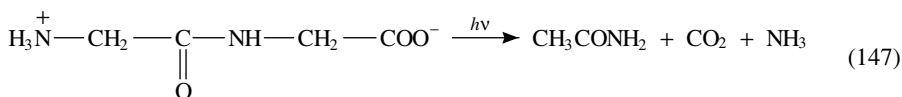


Ring expansion of the sulphonamide reaction<sup>199</sup> (equation 144) demonstrates the ability of a ruptured sulphur-centred free radical to undergo 1,3-Fries type migration<sup>200</sup> (equation 145). Sulphur dioxide extrusion may also provide a synthetic route to  $\beta$ -lactams<sup>201</sup> (equation 146).

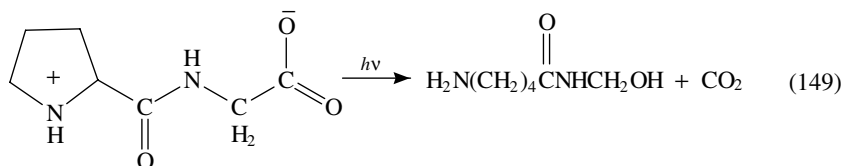




The amide functionality plays an important role in the physical and chemical properties of proteins and peptides, especially in their ability to be involved in the photoinduced electron transfer process. Polyamides and proteins are known to take part in the biological electron transport mechanism for oxidation–reduction and photosynthesis processes. Therefore studies of the photochemistry of proteins or peptides are very important. Irradiation (at 254 nm) of the simplest dipeptide, glycylglycine, in aqueous solution affords carbon dioxide, ammonia and acetamide in relatively high yields and quantum yield (0.44)<sup>202</sup> (equation 147). The reaction mechanism is thought to involve an electron transfer process. The isolation of intermediates such as *N*-hydroxymethylacetamide and *N*-glycylglycyl-methyl acetamide confirmed the electron-transfer initiated free radical processes<sup>203</sup> (equation 148).



Terminal deamination is also a major step in gamma ray reactions with aliphatic oligopeptides in aqueous solution<sup>204</sup>. This confirms that the amide group tends to react with the solvated electron. Ring opening of the pyrrolidine also occurs in the photolysis of pyrrolylglycine which is without a primary free amino group<sup>205</sup> (equation 149).



As for the photophysical aspects for the bio-mimic photoinduced electron transfer systems, studies on amides<sup>206</sup> and amino acid assemblies<sup>207</sup> have recently begun to be popular.

## VII. REFERENCES

1. Y. L. Chow, W. C. Danen, S. F. Nelsen and D. Rosenblatt, *Chem. Res.*, **78**, 243 (1978).
2. F. D. Lewis, *Acc. Chem. Res.*, **12**, 152 (1979).
3. R. S. Davidson, in *Molecular Association* (Ed. R. Foster), Academic Press, London, 1975.
4. A. Lablache-Combiere, *Bull. Soc. Chem. Fr.*, **12**, 4791 (1972).
5. (a) F. D. Lewis, A. Abini, A. Lablache-Combiere, P. S. Mariano and N. J. Pienta, in *Photoinduced Electron Transfer* (Eds. M. A. Fox and M. Chanan), Part C, Elsevier, New York, 1988.  
(b) F. D. Lewis, in *Advances in Electron Transfer Chemistry*.
6. A recent review on the photochemistry of aliphatic and aromatic amines is primarily focussed on the physical and spectroscopic aspects: A. N. Malkin and V. A. Kuz'min, *Russ. Chem. Rev.*, **54**, 1041 (1985).
7. D. Bryce-Smith, M. T. Clark, A. Gilbert, G. Klunkin and C. Manning, *J. Chem. Soc., Chem. Commun.*, 916 (1971)
8. F. D. Lewis and T. I. Ho, *J. Am. Chem. Soc.*, **99**, 7991 (1977).
9. J. A. Barltrop and R. J. Owers, *Chem. Commun.*, 1462 (1970).
10. R. S. Davidson, *Chem. Commun.*, 1450 (1969).
11. J. A. Barltrop, N. J. Bunce and A. Thomson, *J. Chem. Soc. (C)*, 1142 (1967).
12. M. Ohashi, K. Miyaki and K. Tsujimoto, *Bull. Chem. Soc. Jpn.*, **53**, 1683 (1980).
13. F. D. Lewis, *Acc. Chem. Res.*, **19**, 401 (1986).
14. T. I. Ho, K. Nozaki, A. Naito, S. Okazaki and H. Hanato, *J. Chem. Soc., Chem. Commun.*, 206 (1989).
15. C. R. Lin, C. N. Wang and T. I. Ho, *J. Org. Chem.*, **56**, 5025 (1991).
16. U. C. Yoon and P. S. Mariano, *Acc. Chem. Res.*, **25**, 233 (1992).
17. F. D. Lewis, *Adv. Photochem.*, **13**, 165 (1986).
18. F. D. Lewis and J. T. Simpson, *J. Phys. Chem.*, **83**, 2015 (1979).
19. W. Hub, S. Schneider, F. Dorr, J. D. Oxman and F. D. Lewis, *J. Am. Chem. Soc.*, **106**, 708 (1984).
20. J. C. Mai, Y. C. Lin and T. I. Ho, *J. Photochem. Photobiol.*, **A54**, 299 (1990).
21. F. D. Lewis, T. I. Ho and J. T. Simpson, *J. Am. Chem. Soc.*, **104**, 1924 (1982).
22. F. D. Lewis, T. I. Ho and J. T. Simpson, *J. Org. Chem.*, **46**, 1077 (1981).
23. F. D. Lewis and T. I. Ho, *J. Am. Chem. Soc.*, **102**, 1751 (1980).
24. F. D. Lewis, D. M. Bassani, E. L. Burch, B. E. Cohen, J. A. Engleman, G. D. Reddy, S. Schneider, W. Jaeger, P. Gedeck and M. Gahr, *J. Am. Chem. Soc.*, **117**, 660 (1995).
25. R. C. Cookson, S. M. de B. Costa and J. Hudec, *Chem. Commun.*, 753 (1969).
26. T. Susumu, S. Hida, S. Takamuku and H. Sakurai, *Nippon Kagaku Kaishi*, 152 (1984).
27. F. D. Lewis, G. D. Reddy and D. M. Bassani, *J. Photochem. Photobiol. A: Chem.*, **65**, 205 (1992).
28. F. D. Lewis, D. M. Bassani and G. D. Reddy, *Pure Appl. Chem.*, **64**, 1271 (1992).
29. H. Aoyama, Y. Arata and Y. Omote, *J. Chem. Soc., Chem. Commun.*, 1381 (1985).
30. F. D. Lewis, G. D. Reddy and D. M. Bassani, *J. Am. Chem. Soc.*, **115**, 6468 (1993).
31. F. D. Lewis, G. D. Reddy, D. M. Bassani, S. Schneider and M. Gahr, *J. Am. Chem. Soc.*, **116**, 597 (1994).
32. R. C. Cookson, J. Hudec and N. A. Mitza, *Chem. Commun.*, 824 (1967).
33. N. J. Pienta and J. E. McKimmey, *J. Am. Chem. Soc.*, **104**, 5501 (1982).
34. D. W. Smith and N. J. Pienta, *Tetrahedron Lett.*, **25**, 915 (1984).
35. D. I. Schuster, R. Bonneau, D. A. Dunn, J. M. Rao and J. Jousot-Dubien, *J. Am. Chem. Soc.*, **106**, 2706 (1984).
36. D. A. Dunn, D. I. Schuster and R. Bonneau, *J. Am. Chem. Soc.*, **107**, 2802 (1985).
37. D. I. Schuster and A. M. Insogna, *J. Org. Chem.*, **56**, 1879 (1991).
38. D. Weir, J. C. Scaicno and D. I. Schuster, *Can. J. Chem.*, **66**, 2595 (1988).
39. S. G. Cohen, A. Parola and G. H. Parsons, *Chem. Rev.*, **73**, 141 (1973).
40. P. J. Wagner, *Top. Curr. Chem.*, **66**, 1 (1976).
41. T. I. Ho, Y. L. Chow and H. C. Lee, *Proc. Natl. Sci. Council, Repub. China (A)* **10**, 212 (1986).
42. M. Zhang and P. S. Mariano, *J. Org. Chem.*, **56**, 1655 (1991).
43. U. C. Yoon, J. U. Kim, E. Hasegawa and P. S. Mariano, *J. Am. Chem. Soc.*, **109**, 4421 (1987).
44. E. Hasegawa, W. Xu, P. S. Mariano, U. C. Yoon and J. U. Kim, *J. Am. Chem. Soc.*, **110**, 8099 (1988).

45. W. Xu, Y. T. Jeon, E. Hasegawa, U. C. Yoon and P. S. Mariano, *J. Am. Chem. Soc.*, **111**, 413 (1989).
46. W. Xu, X. M. Zhang and P. S. Mariano, *J. Am. Chem. Soc.*, **113**, 8863 (1991).
47. W. Xu and P. S. Mariano, *J. Am. Chem. Soc.*, **113**, 1431 (1991).
48. Y. T. Jeon, C. P. Lee and P. S. Mariano, *J. Am. Chem. Soc.*, **113**, 8847 (1991).
49. S. Murata, M. Miura and M. Nomura, *J. Chem. Soc., Chem. Commun.*, 116 (1989).
50. J. M. Kim, I. S. Cho and P. S. Mariano, *J. Org. Chem.*, **56**, 4943 (1991).
51. I. Kawenoki, B. Keita, J. Kossanyi and L. Nadjo, *Bull. Soc. Chem. Fr.*, 104 (1982).
52. M. Goetz and I. Sartorius, *J. Am. Chem. Soc.*, **115**, 11123 (1993).
53. A. Gilbert, S. Krestonosich and D. L. Westover, *J. Chem. Soc., Perkin. Trans.* **1**, 295 (1981).
54. K. Chandrasekaran and D. G. Whitten, *J. Am. Chem. Soc.*, **103**, 7270 (1981).
55. D. Dopp and J. Heufer, *Tetrahedron Lett.*, **23**, 1553 (1982).
56. R. A. Beecroft, R. S. Davidson, D. Goodwin and J. E. Pratt, *Pure Appl. Chem.*, **54**, 1605 (1982).
57. M. Van der Auweraer, Z. R. Grabowski and W. Rettig, *J. Phys. Chem.*, **95**, 2083 (1991).
58. A. M. Swinnen, M. Van der Auweraer, F. C. De Schryver, N. Kakitani, T. Okada and N. Mataga, *J. Am. Chem. Soc.*, **109**, 321 (1987).
59. M. Van der Auweraer, A. Gilbert and F. C. De Schryver, *J. Am. Chem. Soc.*, **102**, 4001 (1980).
60. Z. R. Grabowski, *Pure Appl. Chem.*, **65**, 1751 (1993).
61. T. Scherer, R. J. Willems and J. W. Verhoeven, *Recl. Trav. Chim. Pays-Bas*, **110**, 95 (1991).
62. K. Hara, H. Suzuki and W. Rettig, *Chem. Phys. Lett.*, **145**, 269 (1988).
63. W. Rettig and W. Majenz, *Chem. Phys. Lett.*, **154**, 335 (1989).
64. J. W. Verhoeven, *Pure Appl. Chem.*, **62**, 1585 (1990).
65. R. M. Hermant, N. A. C. Bakker, T. Scherer, B. Krijnen and J. W. Verhoeven, *J. Am. Chem. Soc.*, **112**, 1214 (1990).
66. A. Nag, T. Chakraborty and K. Bhattacharyya, *J. Phys. Chem.*, **94**, 4023 (1990).
67. H. Shou, J. C. Alfano, N. A. Van Dantzig, D. H. Levy and N. C. Yang, *J. Chem. Phys.*, **95**, 711 (1991).
68. Y. Hatano, M. Yamamoto and Y. Nishijima, *J. Phys. Chem.*, **82**, 367 (1978).
69. M. Migita, M. Kawai, N. Mataga, Y. Sakata and S. Misumi, *Chem. Phys. Lett.*, **53**, 67 (1978).
70. J. H. Borkent, A. W. J. De Jong, J. W. Verhoeven and Th. J. De Boer, *Chem. Phys. Lett.*, **57**, 530 (1978).
71. F. C. De Schryver, N. Boens and J. Put, *Adv. Photochem.*, **10**, 359 (1977).
72. E. A. Chandross and H. T. Toomas, *Chem. Phys. Lett.*, **9**, 393 (1971).
73. R. S. Davidson and K. R. Tretheway, *J. Chem. Soc., Chem. Commun.*, 827 (1976).
74. R. S. Davidson, R. Bonneau, J. Joussot-Dubien and K. J. Toyne, *Chem. Phys. Lett.*, **63**, 269 (1979).
75. Y. Wang, M. K. Crawford and K. B. Eisenthal, *J. Phys. Chem.*, **84**, 2696 (1980).
76. P. Pasman, F. Rob and J. W. Verhoeven, *J. Am. Chem. Soc.*, **104**, 5127 (1982).
77. A. M. Swinnen, M. Van der Auweraer, F. C. De Schryver, C. Windels, R. Goedeweck, A. Vannerem and F. Meeus, *Chem. Phys. Lett.*, **95**, 467 (1983).
78. G. F. Mes, B. de Jong, H. J. Van Ramesdonk, J. W. Verhoeven, J. M. Warman, M. P. de Hass and L. E. W. Horsman-van den Dool, *J. Am. Chem. Soc.*, **106**, 6524 (1984).
79. B. Wegewijs, R. M. Hermant, J. W. Verhoeven, A. G. M. Kunst and R. P. H. Rettschnick, *Chem. Phys. Lett.*, **140**, 587 (1987).
80. B. Raju. B and T. S. Varadarajan, *J. Phys. Chem.*, **98**, 8903 (1994).
81. F. D. Lewis and B. E. Cohen, *J. Phys. Chem.*, **98**, 10591 (1994).
82. P. Wang and S. Wu, *J. Photochem. Photobiol. A: Chem.*, **76**, 27 (1993).
83. S. Schnieder, H. Rehabe, M. Gahr and W. Schusslbauer, *J. Photochem. Photobiol. A: Chem.*, **82**, 129 (1994).
84. U. Leinhos, W. Kuhnle and K. A. Zachariasse, *J. Phys. Chem.*, **95**, 2013 (1991).
85. W. Schuddeboom, S. A. Jonker, J. M. Warman, U. Leinhos, W. Kuhnle and K. A. Zachariasse, *J. Phys. Chem.*, **96**, 10809 (1992).
86. F. C. De Schryver, D. Declercq, S. Depaemelaere, E. Hermans, A. Onkelinx, J. W. Verhoeven and J. Gelan, *J. Photochem. Photobiol. A: Chem.*, **82**, 171 (1994).
87. R. Lapouyade, K. Czeschka, W. Majenz, W. Rettig, E. Gilbert and C. Rulliere, *J. Phys. Chem.*, **96**, 9643 (1992).
88. S. Frey-Forgues, M. T. Le Bris, J. C. Mialocq, J. Pouget, W. Reetig and B. Valeur, *J. Phys. Chem.*, **96**, 701 (1992).

89. A. Declémy and C. Rullière, *Chem. Phys. Lett.*, **146**, 1 (1988).
90. D. M. Shin and D. G. Whitten, *J. Phys. Chem.*, **92**, 2945 (1988).
91. M. Kawanisi and K. Matsunaga, *J. Chem. Soc., Chem. Commun.*, 313 (1972).
92. M. Bellas, D. Bryce-Smith and A. Gilbert, *Chem. Commun.*, 862 (1967).
93. P. Grandclaude and A. Lablance-Combié, *Chem. Commun.*, 892 (1971).
94. T. Okada, I. Karaki and M. Matage, *J. Am. Chem. Soc.*, **104**, 7191 (1982).
95. F. D. Lewis, B. E. Zebrowski and P. E. Correa, *J. Am. Chem. Soc.*, **106**, 187 (1984).
96. F. D. Lewis and P. E. Correa, *J. Am. Chem. Soc.*, **106**, 194 (1984).
97. F. D. Lewis and G. D. Reddy, *Tetrahedron Lett.*, **33**, 4294 (1992).
98. N. C. Yang, D. W. Minsek, D. C. Johnson, J. R. Larson, J. W. Petrich, R. Gerald, III and M. R. Wasielewski, *Tetrahedron*, **45**, 4669 (1989).
99. F. D. Lewis, G. D. Reddy, S. Schneider and M. Gahr, *J. Am. Chem. Soc.*, **113**, 3498 (1991).
100. F. D. Lewis, D. M. Bassani and G. D. Reddy, *J. Org. Chem.*, **58**, 6390 (1993).
101. A. Sugimoto, R. Sumida, N. Tamai, H. Inoue and Y. Otsuji, *Bull. Chem. Soc. Jpn.*, **54**, 3500 (1981).
102. H. Shizuka, M. Nakamura and T. Morita, *J. Phys. Chem.*, **83**, 2019 (1979).
103. M. Yasuda, J. Kubo and K. Shima, *Heterocycles*, **31**, 1007 (1990).
104. T. Yamashita, K. Shiomi, M. Yasuda and K. Shima, *Bull. Chem. Soc. Jpn.*, **64**, 366 (1991).
105. M. Yasuda, T. Isami, J. Kudo, M. Mizutani, T. Yamashita and K. Shima, *J. Org. Chem.*, **57**, 1351 (1992).
106. M. Yasuda, T. Yamashita, K. Shima and C. Pac., *J. Org. Chem.*, **52**, 753 (1987).
107. F. D. Lewis, in *Photoinduced electron Transfer* (Eds. M. Chanon and M. A. Fox), Elsevier, Amsterdam, 1988.
108. A. J. Maroulis, Y. Shigemitsu and D. R. Arnold, *J. Am. Chem. Soc.*, **100**, 535 (1978).
109. F. D. Lewis, G. D. Reddy and B. E. Cohen, *Tetrahedron Lett.*, **35**, 535 (1994).
110. M. A. Leoni, G. F. Bettinetti, G. Minoli and A. Albin, *J. Org. Chem.*, **45**, 2331 (1980).
111. A. D. Gudmundsdottir and J. R. Scheffer, *Tetrahedron Lett.*, **31**, 6807 (1990).
112. D. G. Anderson and G. Wettermark, *J. Am. Chem. Soc.*, **87**, 1433 (1965).
113. E. V. Blackburn and C. J. Timmons, *Quart. Rev.*, **23**, 482 (1969).
114. T. H. Koch and K. H. Howard, *J. Am. Chem. Soc.*, **97**, 7288 (1975).
115. K. R. Huffmann, M. Loy and E. F. Ullman, *J. Am. Chem. Soc.*, **87**, 5417 (1965).
116. (a) A. Padwa, *Chem. Rev.*, **77**, 37 (1977).  
(b) A. C. Pratt, *Chem. Soc. Rev.*, **6**, 63 (1977).
117. (a) P. S. Mariano, *Org. Photochem.*, **9**, 1 (1987).  
(b) P. S. Mariano, *Acc. Chem. Res.*, **16**, 130 (1983).
118. W. Horspool and D. Armesto, '*Organic Photochemistry*', Ellis Horwood, Chichester; Prentice Hall, New York, 1992.
119. P. S. Mariano, J. L. Stavinoha, G. Pepe and E. F. Meyers, *J. Am. Chem. Soc.*, **100**, 7114 (1978).
120. P. S. Mariano and A. Leone, *Tetrahedron Lett.*, 4581 (1980).
121. P. S. Mariano, J. L. Stavinoha and R. Swanson, *J. Am. Chem. Soc.*, **99**, 6781 (1977).
122. J. L. Stavinoha, P. S. Mariano, A. Leone-Bay, R. Swanson and C. Bracken, *J. Am. Chem. Soc.*, **103**, 3148 (1981).
123. K. Ohga and P. S. Mariano, *J. Am. Chem. Soc.*, **104**, 617 (1982).
124. T. Tiner-Harding, J. W. Ullrich, F. T. Chiu, S. F. Chem and P. S. Mariano, *J. Org. Chem.*, **47**, 3360 (1982).
125. S.-F. Chen, J. W. Ullrich and P. S. Mariano, *J. Am. Chem. Soc.*, **105**, 6160 (1983).
126. I. S. Cho, C. L. Tu and P. S. Mariano, *J. Am. Chem. Soc.*, **112**, 3594 (1990).
127. K. Ohga, U. C. Yoon and P. S. Mariano, *J. Org. Chem.*, **49**, 213 (1984).
128. G. Dai-Ho and P. S. Mariano, *J. Org. Chem.*, **53**, 5113 (1988).
129. D. Armesto, J. A. F. Martin, R. Perez-Ossorio and W. H. Horspool, *Tetrahedron Lett.*, **23**, 2149 (1982).
130. (a) A. C. Pratt and Q. Abdul-Majid, *J. Chem. Soc., Perkin Trans. 1*, 359 (1987).  
(b) A. C. Pratt and Q. Abdul-Majid, *J. Chem. Soc., Perkin Trans. 1*, 1691 (1986).
131. M. Nitta, I. Kashara and T. K. Kobayashi, *Bull. Chem. Soc. Jpn.*, **54**, 1275 (1981).
132. D. Armesto, F. Langa, J. A. F. Martin, R. Perez-Ossorio and W. M. Horspool, *J. Chem. Soc., Perkin Trans. 1*, 743 (1987).
133. D. Armesto, W. M. Horspool, J. A. F. Martin and R. Perez-Ossorio, *J. Chem. Res. (S)*, 46 (1986).
134. D. Armesto, W. M. Horspool and F. Langa, *J. Chem. Soc., Chem. Commun.*, 1874 (1987).

135. D. Armesto, W. M. Horspool, F. Langa and A. Ramos, *J. Chem. Soc., Perkin Trans. I*, 223 (1991).
136. D. Armesto, A. R. Agarrabeitia, W. M. Horspool and M. G. Gallego, *J. Chem. Soc., Chem. Commun.*, 934 (1990).
137. D. Armesto, M. G. Gallego and W. M. Horspool, *Tetrahedron Lett.*, **31**, 2475 (1990).
138. D. Armesto, M. G. Gallego and W. M. Horspool, *Tetrahedron Lett.*, **46**, 6185 (1990).
139. D. Armesto, W. M. Horspool, M. J. Mancheno and M. J. Oritz, *J. Chem. Soc., Perkin Trans. I*, 2348 (1990).
140. A. Hassner and B. Fischer, *Tetrahedron*, **45**, 3535 (1989).
141. K. H. Pfoertner, K. Bernauer, F. Kaufmann and E. Lorch, *Helv. Chim. Acta*, **68**, 584 (1985).
142. T. Buchel, R. Prewo, J. H. Bieri and H. Heimgartner, *Helv. Chim. Acta*, **67**, 534 (1984).
143. (a) M. P. Cava and R. H. Schlessinger, *Tetrahedron Lett.*, 2109 (1964).  
(b) G. M. Badger, C. P. Joshua and G. E. Lewis, *Tetrahedron Lett.*, 3711 (1964).
144. D. Armesto, M. G. Gallego and W. M. Horspool, *J. Chem. Soc., Perkin Trans. I*, 1623 (1989).
145. V. H. M. Elferink and H. J. T. Bos, *J. Chem. Soc., Chem. Commun.*, 882 (1985).
146. D. Armesto, M. G. Gallego, M. J. Ortiz, So Romano and W. M. Horspool, *J. Chem. Soc., Perkin Trans. I*, 1343 (1989).
147. S. Arai, T. Takeuchi, M. Ishikawa, M. Yamazari and M. Hida, *J. Chem. Soc., Perkin Trans. I*, 481 (1987).
148. D. Armesto, W. M. Horspool, M. Apoitá, M. G. Gallego and A. Ramos, *J. Chem. Soc., Perkin Trans. I*, 2035 (1989).
149. P. Margaretha, *Helv. Chim. Acta*, **65**, 290 (1982).
150. E. Malamidou-Xenikaki and D. N. Nicolaides, *Tetrahedron*, **42**, 5081 (1986).
151. Y. Ogata, K. Takagi and M. Mizuno, *J. Org. Chem.*, **47**, 3684 (1982).
152. S. V. Kessar, T. Singh and A. K. Singh Mankotia, *J. Chem. Soc., Chem. Commun.*, 1692 (1989).
153. (a) M. Fischer, *Chem. Ber.*, **102**, 342 (1969).  
(b) H. Shizuka, *Bull. Chem. Soc. Jpn.*, **42**, 52 (1969).  
(c) J. Stumpe, A. Melhorn and K. Schwellick, *J. Photochem.*, **8**, 1 (1978).  
(d) M. Z. A. Badr, M. M. Aly and F. F. Abdel-Latif, *J. Org. Chem.*, **44**, 3244 (1979).  
(e) H. J. Hageman, *Recl. Trav. Chim. Pays-Bas*, **91**, 1447 (1972).  
(f) D. Elad, D. V. Rao and V. I. Steuberg, *J. Org. Chem.*, **30**, 3252 (1965).  
(g) R. Chenevert and R. Plante, *Can. J. Chem.*, **61**, 1092 (1983).  
(h) M. M. Abdel-Malik and P. de Mayo, *Can. J. Chem.*, **62**, 1275 (1984).
154. (a) D. Flad and J. Rokach, *J. Org. Chem.*, **29**, 1885 (1964).  
(b) D. Flad, *Tetrahedron Lett.*, 77 (1963).
155. Y. Katsuhara, R. Tsujii, K. Hard, Y. Shigemitsu and Y. Odaira, *Tetrahedron Lett.*, 453 (1974).
156. (a) J. D. Coyle and D. H. Kingston, *Tetrahedron Lett.*, 4525 (1976).  
(b) J. D. Coyle, *Chem. Rev.*, **78**, 97 (1978).
157. (a) R. J. Sundberg, *Org. Photochem.*, **6**, 121 (1983).  
(b) S. Naruto, O. Yonemitsu, N. Kataoka and K. Kimura, *J. Am. Chem. Soc.*, **93**, 4053 (1971).  
(c) Y. Okuno and O. Yonemitsu, *Tetrahedron Lett.*, 1169 (1974).
158. (a) K. Shimada, M. Sako, K. Hirota and Y. Maki, *Tetrahedron Lett.*, **28**, 207 (1987).  
(b) S. V. Kessar, G. Singh and P. Balakrishnan, *Tetrahedron Lett.*, 2269 (1974).
159. (a) H. Aoyama, T. Hasegawa and Y. Omote, *J. Am. Chem. Soc.*, **101**, 5343 (1979).  
(b) F. Toda, M. Yagi and S. Soda, *J. Chem. Soc. Chem. Commun.*, 1413 (1987).  
(c) A. Sekine, K. Hori, Y. Ohashi, M. Yagi and F. Toda, *J. Am. Chem. Soc.*, **111**, 697 (1989).  
(d) F. Toda and H. Miyamoto, *J. Chem. Soc., Perkin Trans. I*, 1129 (1993).
160. A. L. Campbell and G. R. Lenz, *Synthesis*, 421 (1987).
161. C. Bochu, A. Couture, P. Grandelaudon and A. Lablache-Combié, *J. Chem. Soc., Chem. Commun.*, 839 (1986).
162. (a) P. G. Cleveland and O. L. Chapman, *J. Chem. Soc., Chem. Commun.*, 1064 (1967).  
(b) I. Ninomiya, S. Yamamuchi, T. Kiguchi, A. Shinohara and T. Naito, *J. Chem. Soc., Perkin Trans. I*, 1747 (1974).  
(c) G. R. Lenz, *Synthesis*, 489 (1978).  
(d) I. Ninomiya and T. Naito, *Heterocycles*, **15**, 1433 (1981).  
(e) I. Ninomiya and T. Naito, in *The Alkaloids* (Ed. A. Brossi), Vol. 22, Academic Press, New York, 1983.  
(f) J. D. Winkler, R. D. Scott and P. G. Willard, *J. Am. Chem. Soc.*, **112**, 8971 (1990).

163. T. Naito, N. Kojima, O. Miyata and I. Ninomiya, *J. Chem. Soc., Chem. Commun.*, **1611** (1985).
164. A. Couture and P. Grandclaoudon, *Synthesis*, 576 (1986).
165. T. Naito, E. Doi, O. Miyata and I. Ninomiya, *Heterocycles*, **24**, 903 (1986).
166. (a) T. Naito, Y. Tada, Y. Nishiguchi and I. Ninomiya, *J. Chem. Soc., Perkin Trans. 1*, 487 (1985).  
(b) I. Ninomiya, C. Hashimoto, T. Kiguchi and T. Naito, *J. Chem. Soc., Perkin Trans. 1*, 941 (1985).  
(c) T. Naito, Y. Hirata, O. Miyata and I. Ninomiya, *J. Chem. Soc., Perkin Trans. 1*, 2219 (1988).  
(d) I. Ninomiya and T. Naito, *Photochemical Synthesis*, Academic Press, New York, 1989, 176.
167. N. L. Bauld, B. Harirchian, D. W. Reynold and J. C. White, *J. Am. Chem. Soc.*, **110**, 8111 (1988).
168. C. Bochu, A. Couture, P. Grandclaoudon and A. Lablache-Combiere, *Tetrahedron*, **44**, 1959 (1988).
169. W. G. Richard, C. A. Chesta and D. G. Whitten, *Photochem. Photobiol.*, **54**, 557 (1991).
170. F. M. Schell and P. M. Cook, *J. Org. Chem.*, **49**, 4067 (1984).
171. (a) P. de Mayo, L. K. Sydnes and G. Wenska, *J. Chem. Soc., Chem. Commun.*, 499 (1979).  
(b) P. de Mayo, L. K. Sydnes and G. Wenska, *J. Org. Chem.*, **45**, 1549 (1980).
172. M. Machida, K. Oda and Y. Kanaoka, *Tetrahedron Lett.*, **25**, 409 (1984).
173. G. Crank and A. Mursyidi, *J. Photochem. Photobiol. A: Chem.*, **53**, 301 (1990).
174. F. D. Lewis, J. E. Elbert, A. L. Uthagrove and P. D. Hale, *J. Org. Chem.*, **56**, 553 (1991).
175. (a) F. D. Lewis, C. L. Stern and B. A. Yoon, *J. Am. Chem. Soc.*, **114**, 3131 (1992).  
(b) F. D. Lewis and B. A. Yoon, *J. Am. Chem. Soc.*, **59**, 2537 (1994).
176. (a) F. D. Lewis, S. V. Barancyk and E. L. Burch, *J. Am. Chem. Soc.*, **114**, 3866 (1992).  
(b) F. D. Lewis and E. L. Burch, *J. Am. Chem. Soc.*, **116**, 1159 (1994).
177. (a) J. D. Coyle, in *Synthetic Organic Photochemistry* (Ed. W. M. Horspool), Plenum Press, New York, 1984, p. 259.  
(b) Y. Kanaoka, *Acc. Chem. Res.*, **11**, 407 (1978).  
(c) H. P. Mazzocchi, *Org. Photochem.*, **5**, 421 (1981).
178. Y. Kanaoka, Y. Migita, K. Koyama, Y. Sato, H. Nakai and T. Mizoguchi, *Tetrahedron Lett.*, 1193 (1973).
179. J. D. Coyle, *Pure Appl. Chem.*, **60**, 941 (1988).
180. (a) K. Maruyama, Y. Kubo, M. Machida, K. Oda, Y. Kanaoka and K. Fukuyama, *J. Org. Chem.*, **43**, 2303 (1978).  
(b) K. Maruyama and Y. Kubo, *J. Am. Chem. Soc.*, **100**, 7772 (1978).
181. (a) M. Machida, H. Kakechi and Y. Kanaoka, *Heterocycles*, **7**, 273 (1977).  
(b) Y. Sato, H. Nakai, T. Mizoguchi and Y. Kanaoka, *Tetrahedron Lett.*, 1889 (1976).  
(c) Y. Sato, H. Nakai, T. Mizoguchi, Y. Hatanaka and Y. Kanaoka, *J. Am. Chem. Soc.*, **98**, 2349 (1976).  
(d) C. R. King and H. L. Ammon, *Tetrahedron Lett.*, **28**, 2473 (1987).  
(e) J. D. Coyle and L. R. B. Bryant, *J. Chem. Soc., Perkin Trans. 1*, 2857 (1983).  
(f) M. Machida, S. Oyadomari, H. Takechi, K. Ohno and Y. Kanaoka, *Heterocycles*, **19**, 2057 (1982).
182. (a) M. Machida, H. Takechi and Y. Kanaoka, *Chem. Pharm. Bull.*, **30**, 1579 (1982).  
(b) M. Wada, H. Nakai, K. Aoe, K. Kotera, Y. Sato, Y. Hatanaka and Y. Kanaoka, *Tetrahedron*, **39**, 1273 (1983).
183. (a) C. Somich, P. H. Mazzochi and H. L. Ammon, *J. Org. Chem.*, **52**, 3614 (1987).  
(b) K. Maruyama, T. Ogana, Y. Kubo and T. Araki, *J. Chem. Soc., Perkin Trans. 1*, 2025 (1985).  
(c) M. Machida, K. Oda and Y. Kanaoka, *Tetrahedron*, **41**, 4995 (1985).  
(d) P. H. Mazzochi and G. Fritz, *J. Am. Chem. Soc.*, **108**, 5362 (1986).  
(e) P. H. Mazzochi, S. Minamikawa and P. Wilson, *J. Org. Chem.*, **50**, 2681 (1985).
184. A. Alder, N. Buchler and D. Bellus, *Helv. Chim. Acta*, **65**, 2405 (1982).
185. (a) J. D. Coyle, P. A. Rapley, J. Kamphuis and H. J. T. Bos, *J. Chem. Soc., Perkin Trans. 1*, 2173 (1986).  
(b) J. D. Coyle and P. A. Rapley, *J. Chem. Soc., Perkin Trans. 1*, 2273 (1986).
186. K. Oda, M. Machida and Y. Kanaoka, *Synthesis*, 768 (1986).
187. M. Machida, K. Oda and Y. Kanaoka, *Chem. Pharm. Bull.*, **33**, 3552 (1985).
188. (a) K. Oda, M. Machida, K. Aoe, Y. Nishikata, Y. Sato and Y. Kanaoka, *Chem. Pharm. Bull.*, **34**, 1411 (1986).  
(b) M. Machida, K. Oda, E. Yoshida and Y. Kanaoka, *Tetrahedron*, **42**, 4619 (1986).
189. J. D. Coyle and P. A. Rapley, *J. Chem. Res. (S)*, 142 (1986).



190. (a) R. F. Bayfield and E. R. Cole, *Phosphorus and Sulfur*, **1**, 19 (1976).  
(b) Y. Miura, H. Asada and M. Kinoshita, *Bull. Chem. Soc. Jpn.*, **50**, 1855 (1977).  
(c) T. Anda, M. Nojima and N. Tokura, *J. Chem. Soc., Perkin. Trans. 1*, 2227 (1977).
191. D. H. R. Barton, T. Nakano and P. G. Sammes, *J. Chem. Soc., (S)*, 322 (1968).
192. (a) J. Rokach and P. Hammel, *J. Chem. Soc., Chem. Commun.*, 786 (1979).  
(b) N. Kamigata, S. Hashimoto, S. Fujie and M. Kobayashi, *J. Chem. Soc., Chem. Commun.*, 765 (1983).  
(c) N. Kamigata, H. Iizuka and M. Kobayashi, *Bull. Chem. Soc. Jpn.*, **59**, 1601 (1986).  
(d) N. Kamigata, H. Iizuka and M. Kobayashi, *Heterocycles*, **24**, 919 (1986).
193. V. N. R. Pillai, *Org. Photochem.*, **9**, 225 (1987).
194. (a) T. Hamada, A. Nishida and O. Yonemitsu, *J. Am. Chem. Soc.*, **108**, 140 (1986).  
(b) T. Hamada, A. Nishida, Y. Matsumoto and O. Yonemitsu, *J. Am. Chem. Soc.*, **102**, 3978 (1980).  
(c) K. Oda, T. Ohnuma and Y. Ban, *J. Org. Chem.*, **49**, 953 (1984).
195. (a) J. Cossy and J. P. Pete, *Tetrahedron*, **37**, 2287 (1981).  
(b) J. C. Arnould, J. Cossy and J. P. Pete, *Tetrahedron Lett.*, 3919 (1976).  
(c) J. C. Arnould, J. Cossy and J. P. Pete, *Tetrahedron*, **36**, 1585 (1980).
196. M. Lancaster and D. J. H. Smith, *J. Chem. Soc., Chem. Commun.*, 471 (1980).
197. M. S. Ao and E. M. Burgess, *J. Am. Chem. Soc.*, **93**, 5298 (1971).
198. T. Durst and J. F. King, *Can. J. Chem.*, **44**, 1869 (1966).
199. C. V. Kumar, K. R. Gopidas, K. Bhattacharyya, P. K. Das and M. V. George, *J. Org. Chem.*, **51**, 1967 (1986).
200. (a) B. Weiss, H. Durr and H. J. Hass, *Angew. Chem., Int. Ed. Engl.*, **19**, 648 (1980).  
(b) A. Chakrabarti, G. K. Biswas and D. P. Chakraborty, *Tetrahedron*, **46**, 5059 (1989).
201. M. R. Johnson, M. J. Fazio, L. D. Ward and L. R. Sousa, *J. Org. Chem.*, **48**, 494 (1983).
202. D. Birch, J. D. Coyle, R. R. Hill, G. E. Jeffs and D. Randall, *J. Chem. Soc., Chem. Commun.*, 796 (1984).
203. D. Birch, J. D. Coyle, R. R. Hill and G. E. Jeffs, *J. Chem. Soc., Chem. Commun.*, 293 (1986).
204. F. Moriya, K. Makino, N. Suzuki, S. Rokushika and H. Hatano, *J. Am. Chem. Soc.*, **104**, 830 (1982).
205. J. D. Coyle, R. R. Hill and G. E. Jeffs, *Tetrahedron Lett.*, **28**, 2529 (1987).
206. J. -Y. Liu and J. R. Bolton, *J. Phys. Chem.*, **96**, 1718 (1992).
207. S. L. Mecklenburg, B. M. Peck, J. R. Schoonover, D. G. McCafferty, C. G. Wall, B. W. Erickson and T. J. Meyer, *J. Am. Chem. Soc.*, **115**, 5479 (1993).

## CHAPTER 16

# Photochemistry of nitro and nitroso compounds

TONG-ING HO

*Department of Chemistry, National Taiwan University, Roosevelt Road Section 4, Taipei, Taiwan (ROC)*

*Fax: 886-2-363-6359; e-mail: HALL@CHEM50.CH.NTU.EDU.TW*

and

YUAN L. CHOW

*Department of Chemistry, Simon Fraser University, Burnaby, British Columbia, Canada V5A 1S6*

*Fax: (604)-291-3765; e-mail: YCHOW@SFU.CA*

---

I. INTRODUCTION	748
II. PHOTOCHEMISTRY OF AROMATIC NITRO COMPOUNDS	748
A. Photoreduction	748
B. Photosubstitution	753
1. Intermolecular reactions	753
2. Intramolecular reactions (photo-Smiles rearrangements)	758
C. Photorearrangements	760
1. Intramolecular redox reactions	760
a. <i>o</i> -Alkylnitrobenzenes	760
b. <i>o</i> -Benzyl derivatives	764
c. Nitrobenzenes with <i>ortho</i> C=X bonds and their derivatives	770
d. Nitrobenzenes with <i>ortho</i> heteroatom substituents and their derivatives	773
2. Nitro-nitrite rearrangement	776
D. Photoaddition and Coupling	776
E. Photoisomerization	778
F. Heterocyclic Compounds Containing Nitro Groups	780
G. Photoretro-Aldol Type Reactions and Photodecarboxylation to Generate Nitroaromatic Anions	782
H. Photoredox Reactions in Aqueous Solutions	785
I. Photodissociation	787
J. Photonitration	789

III. PHOTOCHEMISTRY OF NITRO-OLEFINS .....	792
IV. PHOTOCHEMISTRY OF ALIPHATIC NITRO COMPOUNDS .....	795
A. Simple Nitroalkanes .....	795
B. <i>aci</i> -Nitronates .....	795
C. Geminally Substituted Nitroalkanes .....	798
V. PHOTOCHEMISTRY OF C-NITROSO COMPOUNDS .....	803
A. Simple Nitrosoalkanes .....	803
B. Geminally Substituted Nitroalkanes .....	803
C. Aromatic Nitroso Compounds .....	806
D. Other C-Nitroso Compounds .....	807
VI. PHOTOCHEMISTRY OF ALKYL NITRITES .....	810
VII. PHOTOCHEMISTRY OF <i>N</i> -NITRO AND <i>N</i> -NITROSO COMPOUNDS .....	810
A. Nitrosamines .....	810
1. Photolysis mechanisms .....	810
2. Photo addition .....	812
3. Sensitized nitrosamine photoreaction by dual proton and energy transfer .....	814
B. Nitramines .....	816
C. Nitrosamides .....	816
VIII. REFERENCES .....	817

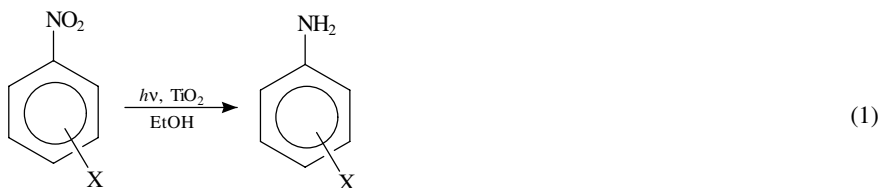
## I. INTRODUCTION

Since the last review in the preceding volume published in 1982 by Chow on the photochemistry of nitro and nitroso compounds covering references up to 1979, there has accumulated significant amounts of data to require a follow-up review on this subject. This chapter is organized similarly to the last review, according to types of functional groups, i.e. the nitro and nitroso groups attached to carbon, oxygen and nitrogen. Both the synthetic and mechanistic research activities have expanded drastically in the last 15 years, and we focus our attentions more on the synthetic aspects unless it is required to do otherwise.

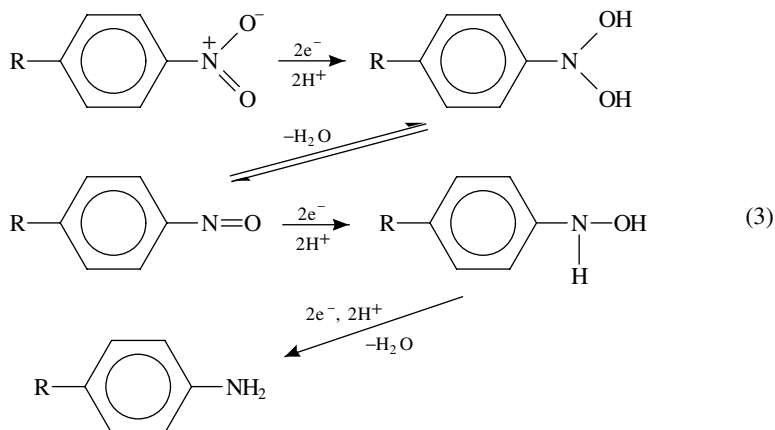
## II. PHOTOCHEMISTRY OF AROMATIC NITRO COMPOUNDS

### A. Photoreduction

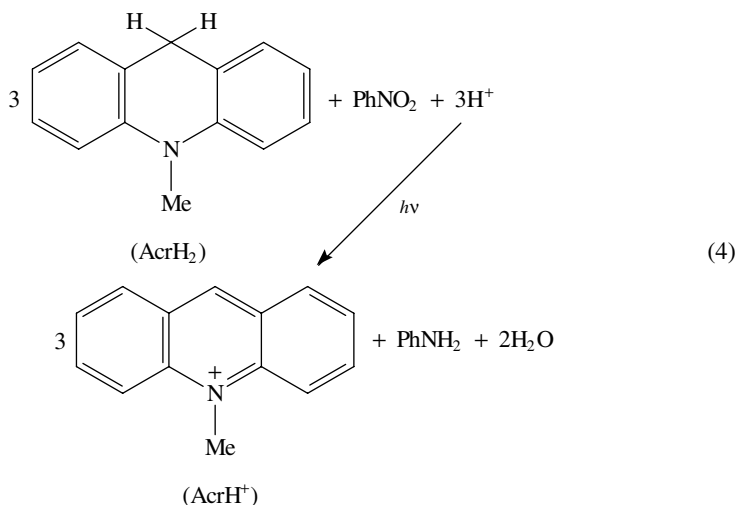
The photoreduction of aromatic nitro compounds to the amino compounds can be carried out on the surface of semiconductor particles such as titanium oxide<sup>1</sup> with H-atom donors (equation 1). At a shorter duration of the photoinduced reduction of *p*-nitroacetophenone, the hydroxylamine intermediate can be obtained in about 30% yield. The reaction mechanism proposed is based on the photoexcitation of TiO<sub>2</sub> to generate an electron and a positive hole (equations 2 and 3). Aliphatic nitro compounds such as 12-nitrododecanoic acid can be reduced to 12-amino dodecanoic acid in 90% yield by this method.



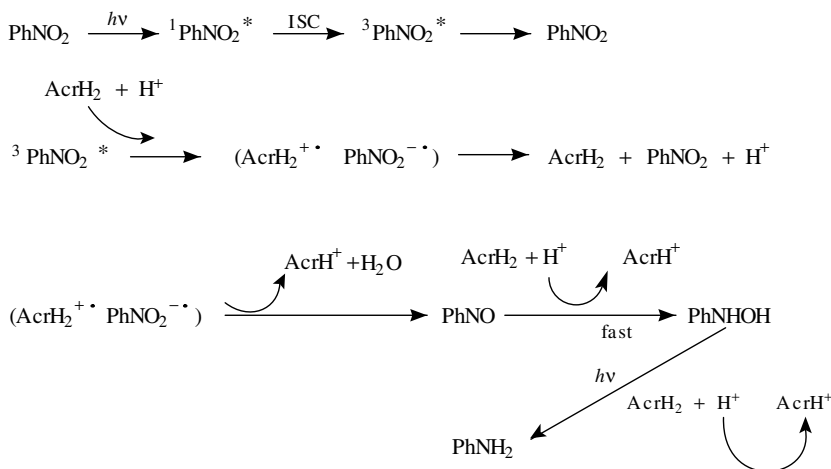
X = H, *p*-CHO, *p*-COCH<sub>3</sub>, *p*-CN, *p*-CH<sub>3</sub>, *p*-CH<sub>3</sub>O, *m*-CH=CH<sub>2</sub>, *m*-COCH<sub>3</sub> (80–90%)



The photoreduction of nitrobenzene derivatives by 10-methyl-9,10-dihydroacridine (AcrH<sub>2</sub>) occurs by a consecutive six-electron reduction process in the presence of perchloric acid to yield aniline derivatives and the 10-methyl acridinium ion<sup>2</sup> (equation 4). In comparison, thermal reduction of these nitrobenzene by AcrH<sub>2</sub> under comparable conditions yields hydroxylamine or aniline depending on the substituent<sup>3</sup>. The photochemical reduction proceeds by electron transfer from AcrH<sub>2</sub> to the n,π\* triplet excited state of nitrobenzenes to give, after secondary processes, nitrosobenzene as the first product. Subsequently nitrosobenzene is reduced in an acid-catalysed thermal reduction by AcrH<sub>2</sub> to hydroxylaminobenzene and in the subsequent photoreduction of the hydroxylaminobenzene to aniline (Scheme 1).

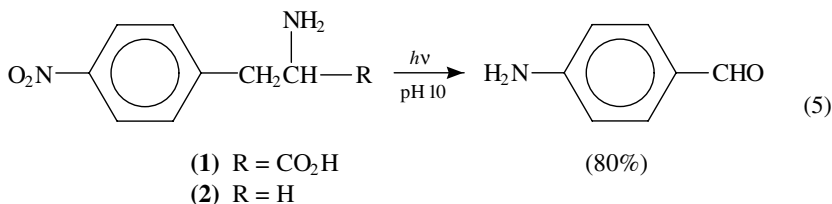


Intramolecular redox reactions for bichromophoric compounds containing nitro and amino (or amino acid) groups have also been examined. For example<sup>4</sup>, irreversible



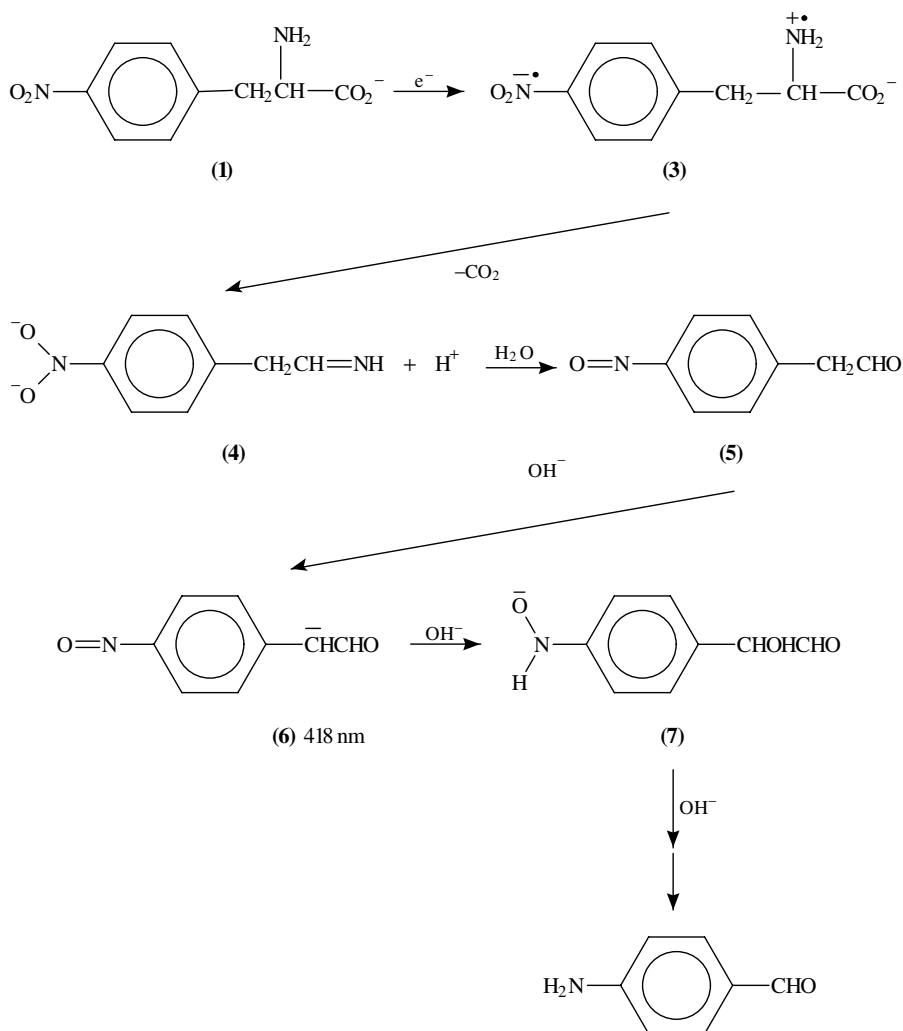
SCHEME 1

intramolecular electron transfer from the aliphatic amine moiety to the photoexcited nitrophenyl group in *p*-nitrophenylalanine **1** and *p*-nitrophenylethyl amine **2** is more efficient for the former giving *p*-aminobenzaldehyde in 80%. The presence of an  $\alpha$ -carboxyl group facilitates electron transfer (equation 5). The proposed reaction mechanism is summarized in Scheme 2, in which intramolecular electron transfer from the amino group to the excited-state nitrophenyl moiety initiates the process to afford the internal radical ion pair **3**. Decarboxylation and electron reorganization gives imine **4**, which is hydrolysed to *p*-nitrosophenyl acetaldehyde **5**. In basic medium, **5** undergoes deprotonation to **6** ( $\lambda_{\text{max}} = 418$ ) which slowly decomposes to *p*-aminobenzaldehyde.



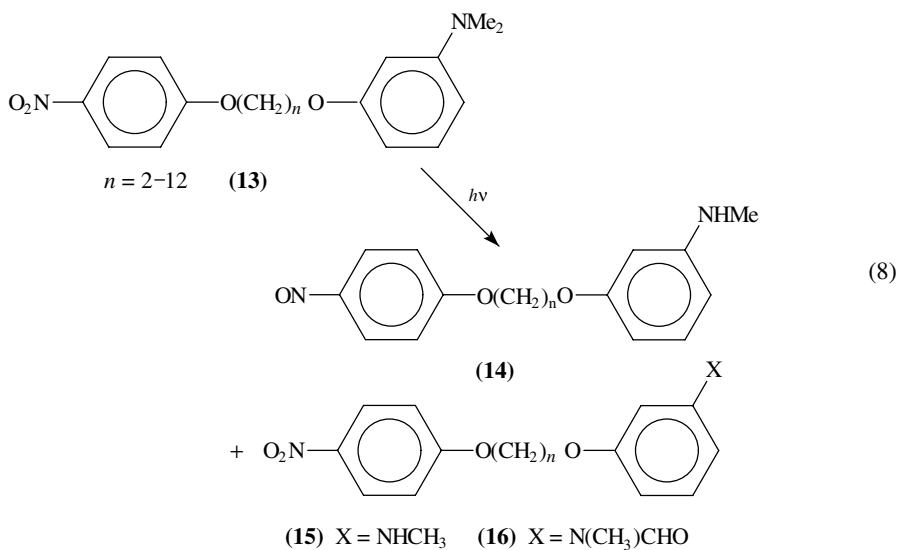
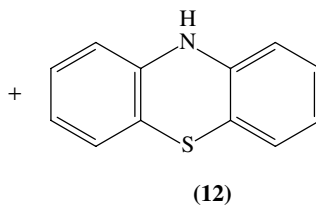
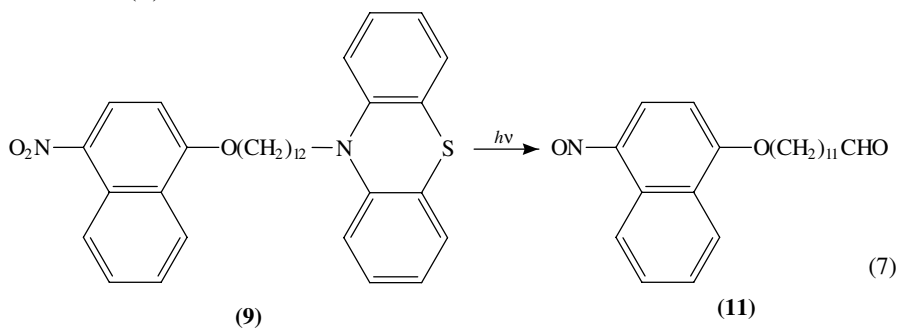
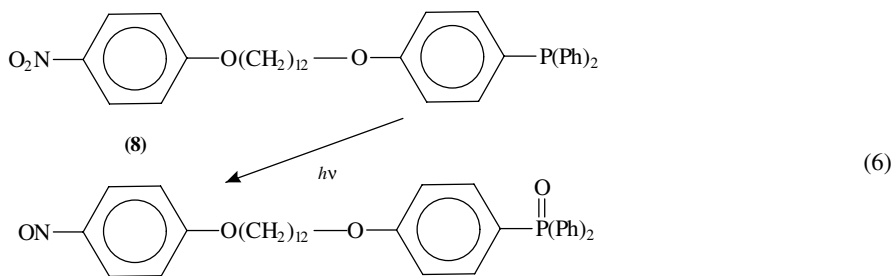
Both CIDNP and ESR techniques were used to study the mechanism for the photoreduction of 4-cyano-1-nitrobenzene in 2-propanol<sup>5</sup>. Evidence was obtained for hydrogen abstractions by triplet excited nitrobenzene moieties and for the existence of  $\text{Ar}\dot{\text{N}}\text{HO}$ ,  $\text{Ar}\dot{\text{N}}\text{O}_2\text{H}$  and hydroxyl amines. Time-resolved ESR experiments have also been carried out to elucidate the initial process in the photochemical reduction of aromatic nitro compounds<sup>6</sup>. CIDEP (chemically induced dynamic electron polarization) effects were observed for nitrobenzene anion radicals in the presence of triethylamine and the triplet mechanism was confirmed.

Laser flash photolysis was also applied to study the anion radicals of *trans*-isomers of 4-nitro, 4,4'-dinitro- and 4-nitro-4'-methoxystilbenes, that are generated by triplet state quenching with 1,4-diazabicyclo[2.2.2]octane (DABCO) in polar solvents at room temperature<sup>7</sup>. The study shows that electron transfer competes against the *trans*  $\rightarrow$  *cis*



SCHEME 2

isomerization and that the radical ions decay by back electron transfer to the ground state. Magnetic field effects have been observed for the intramolecular photoredox reaction of the bichromophoric compounds **8** and **9**, that contain an electron donor and a nitro-aromatic moiety as excited electron acceptors<sup>8</sup>. Irradiation of **8** and **9** will, by intramolecular redox reactions, afford **10** and **11** respectively (equations 6 and 7). The nitroso-aromatic products are characterized as cage products derived from a triplet biradical intermediate which originates from the triplet state nitroarene. Therefore, when an external magnetic field (0.64 tesla) is applied the cage nitroso product decreases by 8–9%. Similar observations have been made for the compounds containing tertiary amine and nitro-aromatic moieties connected by an alkyl chain **13**<sup>9</sup> (equation 8).

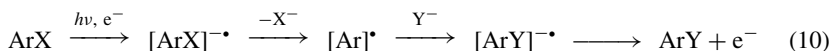
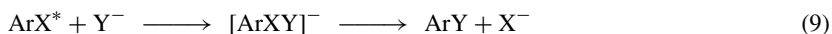


Time-resolved fluorescence studies were also carried out on a series of zinc(II) complexes of *meso*-tetraphenylporphyrins covalently linked to 1,3-dinitrobenzene and 1,3,5-trinitrobenzene as acceptors to study the photoinduced electron transfer process, which is the initial process for the photosynthesis<sup>10</sup>.

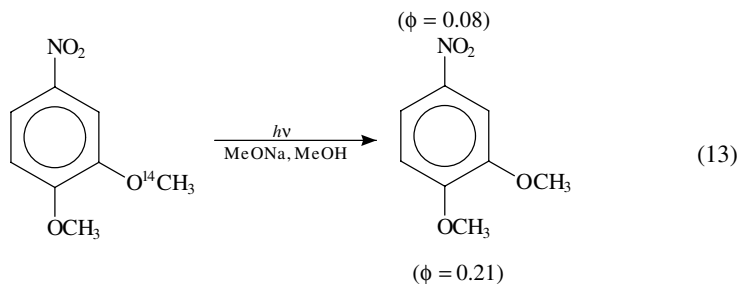
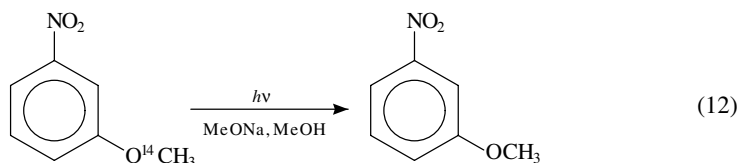
## B. Photosubstitution

### 1. Intermolecular reactions

Nucleophilic substitution is the widely accepted reaction route for the photosubstitution of aromatic nitro compounds. There are three possible mechanisms<sup>11,12</sup>, namely (i) direct displacement ( $S_N2Ar^*$ ) (equation 9), (ii) electron transfer from the nucleophile to the excited aromatic substrate ( $S_{R-N}1Ar^*$ ) (equation 10) and (iii) electron transfer from the excited aromatic compound to an appropriate electron acceptor, followed by attack of the nucleophile on the resultant aromatic radical cation ( $S_{R+N}1Ar^*$ ) (equation 11). Substituent effects are important criteria for probing the reaction mechanisms. While the  $S_{R-N}1Ar^*$  mechanism, which requires no substituent activation, is insensitive to substituent effects, both the  $S_N2Ar^*$  and the  $S_{R+N}1Ar^*$  mechanisms show strong and opposite substituent effects.

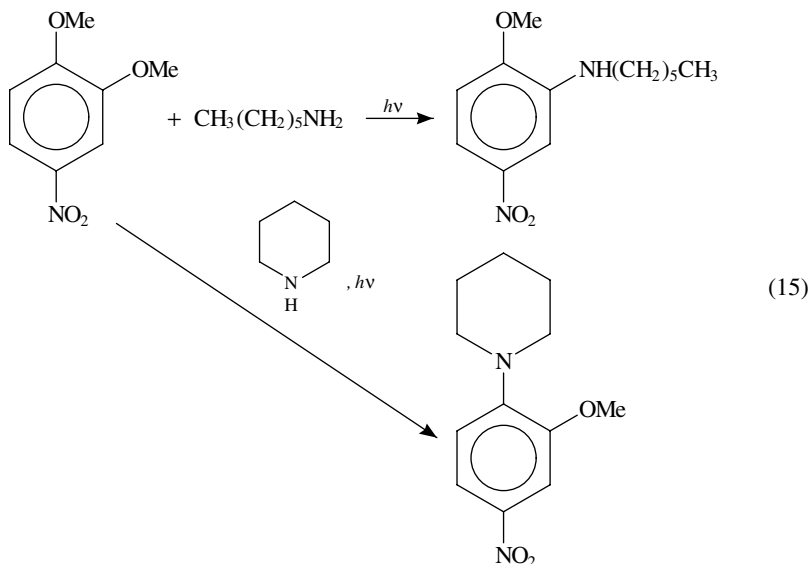
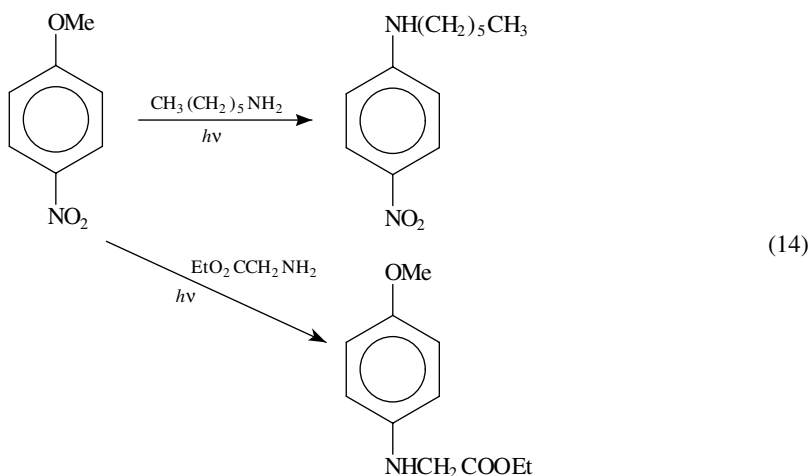


When *o*-, *m*- and *p*-nitroanisole with <sup>14</sup>C-labelled at the methoxy group were irradiated under identical conditions in methanol in the presence of sodium methoxide, only *m*-nitroanisole underwent methoxy exchange, with the limiting quantum yield ( $\phi = 0.08$ ) (equation 12)<sup>11</sup>. Both the *meta* activation and labelled isotope experiments support a  $\sigma$  complex intermediate and indicate an  $S_N2^3Ar^*$  mechanism (direct substitution in the triplet state) for this reaction (equation 12) and for 4-nitroveratroles (equation 13). Further evidence from quenching and lifetime experiments also support a direct displacement  $S_N2Ar^*$  mechanism for the photosubstitution reaction of nitroaryl ethers with hydroxide ions<sup>13</sup>.

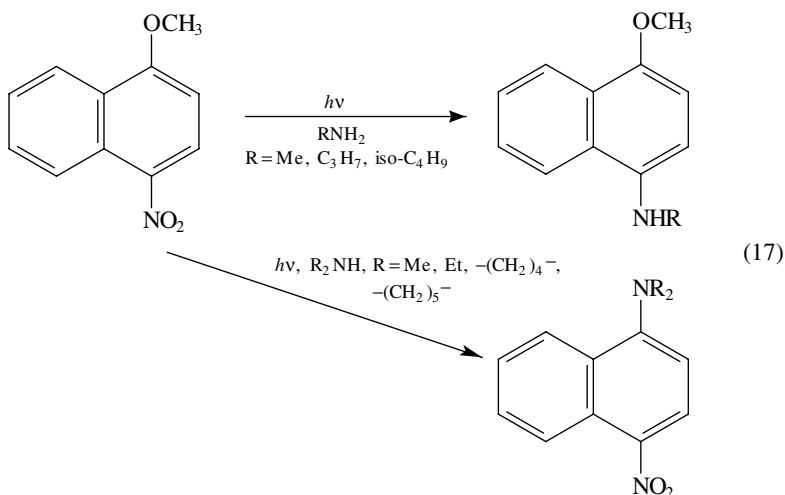
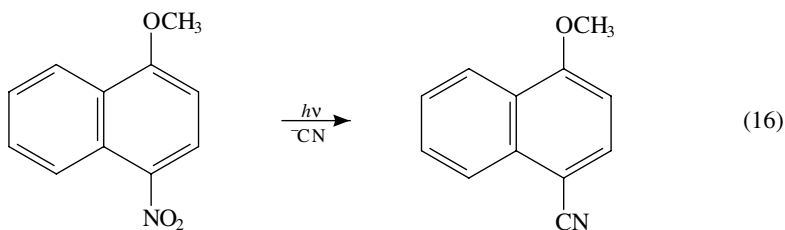




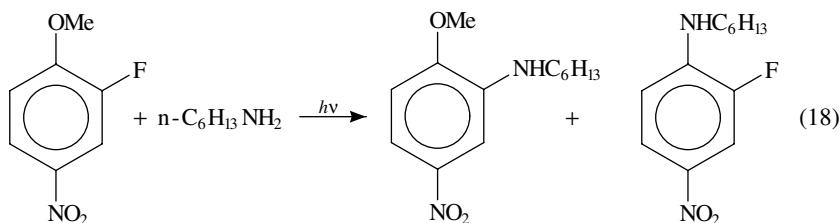
Regioselectivity in nucleophilic aromatic substitution reactions is also of interest. 4-Nitroanisole reacts with *n*-hexylamine and ethyl glycinate, to give regioselective methoxy and nitro group photosubstitution (equation 14), respectively<sup>14</sup>. Mechanistic evidence<sup>15</sup> indicated that the latter is produced through a  $S_N2^3Ar^*$  reaction pathway whereas the former arises from a radical ion pair via electron transfer from the amine to the 4-nitroanisole triplet excited state ( $S_{R-N}1Ar^*$  mechanism). The regioselectivity for the photosubstitution of 4-nitroveratrole with amines (equation 15) is dependent on the ionization potential of the amine used. Both laser flash<sup>16</sup> and steady-state photolyses<sup>17</sup> have shown that amines with high ionization potential follow the  $S_N2Ar^*$  pathway, but amines with low ionization potential follow the  $S_{R-N}1Ar^*$  mechanism.



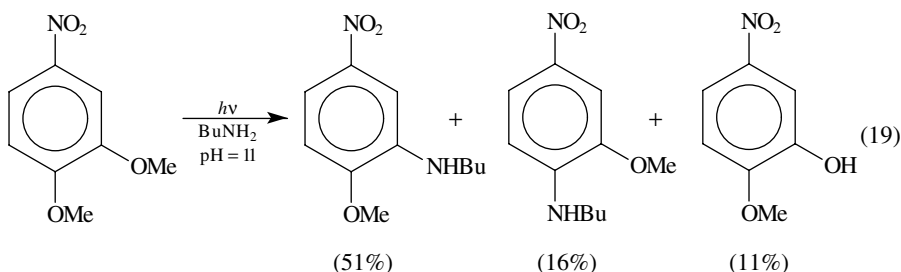
The theory of 'merging resonance stabilization' was proposed to explain the difference in the regioselective displacement of 1-methoxy-4-nitronaphthalene by cyanide and methylamine<sup>18</sup> (equation 16). The replacement of a nitro group by an electron-withdrawing cyano group must contribute to stabilize the transition states. The proposal's usefulness has become limited since the replacement of the methoxy group by methylamin is shown to occur under non-photolytic conditions. Time-resolved transient spectroscopy was applied to study the mechanism of the nucleophilic substitution for 1-methoxy-4-nitronaphthalene with amines<sup>19</sup>. These studies indicated that primary amines cause the replacement of the nitro group whereas secondary amines displace the methoxy substituent (equation 17). The spectroscopic evidence shows the existence of the anion radical of 1-methoxy-1,4-nitronaphthalene in the secondary amine reactions, that give higher yields than the primary amine reactions. It was concluded that the reaction with secondary amines is an electron-transfer process ( $S_{R-N}1^3Ar^*$ ), and that with primary amines is simply an  $S_N2^3Ar^*$  process.



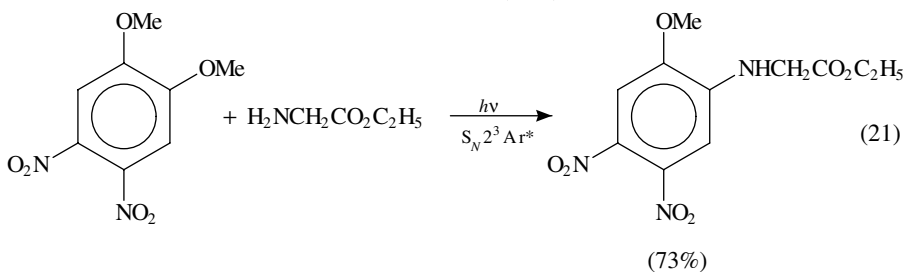
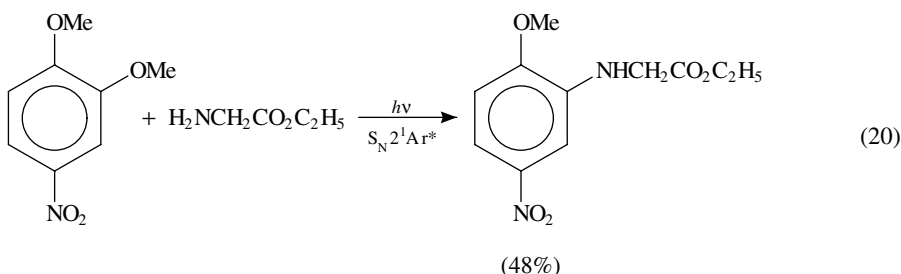
Dual mechanistic pathways are often implied for divergent products in nucleophilic aromatic photosubstitutions. For example, the photoreaction of 2-fluoro-4-nitroanisole with *n*-hexylamine gives rise to higher yield from the fluoride than from methoxy substitutions<sup>20</sup> (equation 18); the former major process is ascribed to an  $S_N2^3Ar^*$  mechanism occurring from the  $\pi-\pi^*$  triplet excited state, whereas the latter minor process has an  $S_{R-N}1^3Ar^*$  mechanism involving the  $n-\pi^*$  triplet excited state.



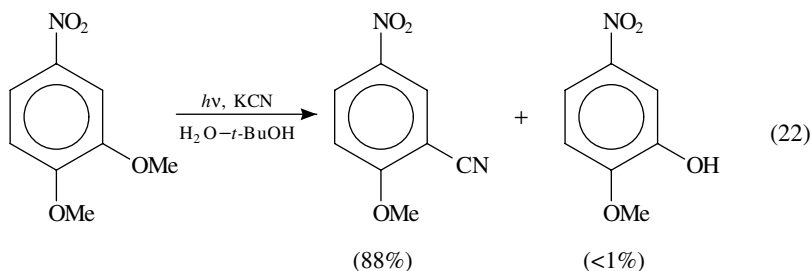
The pH dependence of the regioselectivity for the nucleophilic photosubstitution of 3,4-dimethoxy-1-nitrobenzene by *n*-butylamine gives<sup>21</sup> 2-methoxy-5-nitro-*N*-butylaniline as the major product at pH = 11 (equation 19). At pH = 12, the ratio of the major product to 2-methoxy-4-nitro-*N*-butylaniline increases to 12:1; the increased selectivity is caused by hydroxide ion, which can either promote exciplex formation or act as a base catalyst in deprotonation steps following the  $\sigma$ -complex formation<sup>22</sup>.



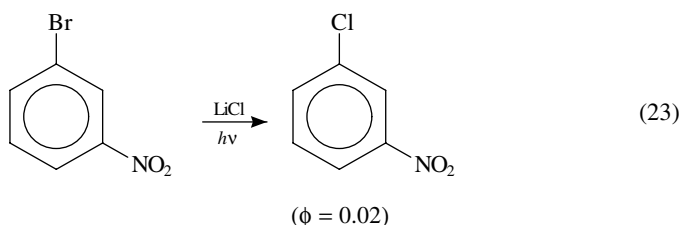
Mechanistic studies also indicate that 4-nitroveratrole (equation 20) and 4,5-dinitroveratrole (equation 21) undergo both singlet and triplet nucleophilic aromatic substitution with ethyl glycinate<sup>23</sup>. An electron transfer process competes against the nucleophilic aromatic photosubstitution for singlet excited 4-nitroveratrole, causing a decreased product yield in equation 20.



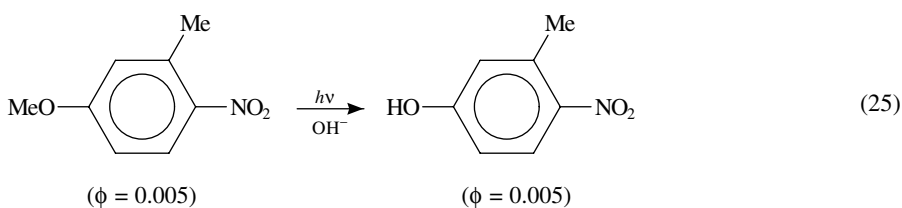
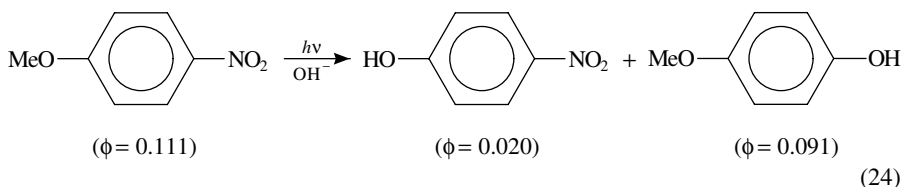
Second-order kinetics have been confirmed in the photocyanation of 3,4-dimethoxy-1-nitrobenzene with potassium cyanide<sup>24</sup> (equation 22), that has lead to the assignment of the  $S_N2^3Ar^*$  mechanism; this shows an interesting contrast to the  $S_N1Ar^*$  photocyanation of 2-nitrofurane to give 2-cyanofurane as judged by the quantum yield independent of the cyanide concentration<sup>25</sup>.

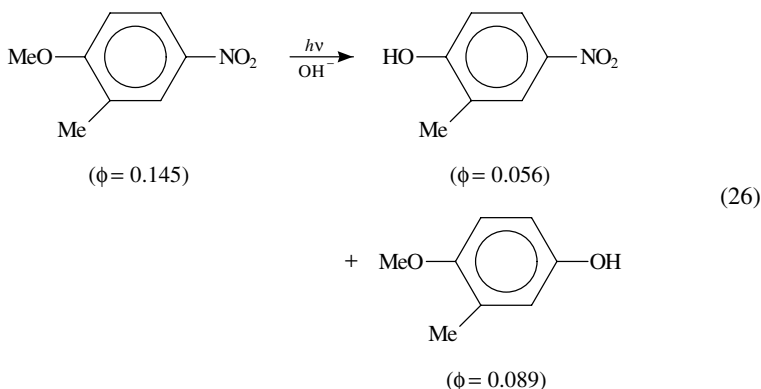


The protonation of the triplet  $\pi\pi^*$  state of 3-bromonitrobenzene is shown to be responsible for the acid-catalysed promotion of halogen exchange which follows a  $S_N2^3Ar^*$  mechanism<sup>26</sup> (equation 23). Cationic micellar effects on the nucleophilic aromatic substitution of nitroaryl ethers by bromide and hydroxide ions have also been studied<sup>27</sup>. The quantum efficiency is dependent on the chain length of the micelle. The involvement of counter ion exchanges at the surface of ionic micelles is proposed to influence the composition of the Stern-layer.

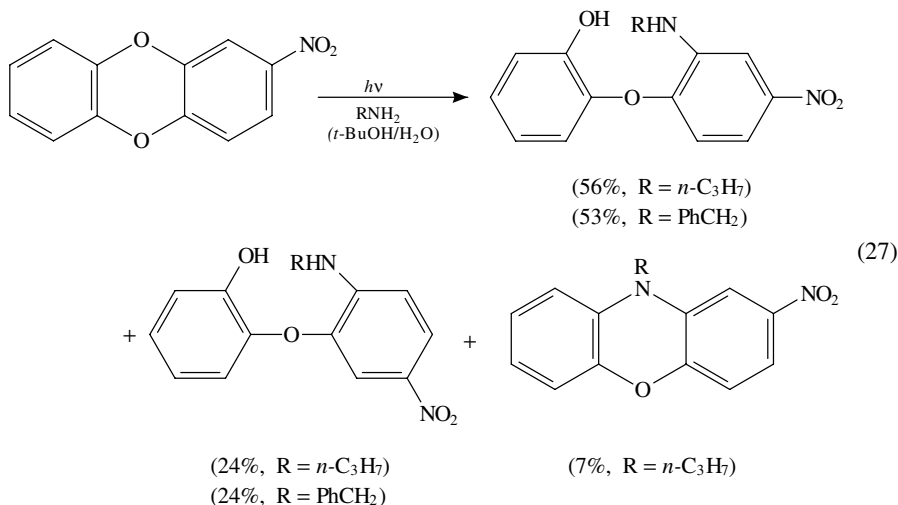


The effect of an *o*-methyl substituent on the photosubstitution of *o*- and *p*-nitroanisole by hydroxide ions<sup>28</sup> (equations 24–26) can be ascribed to both electronic and steric effects that determine the reactivity and selectivity.





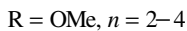
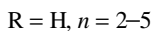
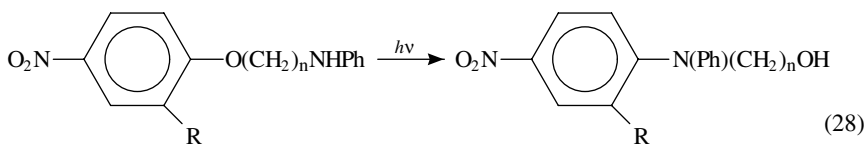
Triplet exciplexes have been proposed to explain photolysis of 2-nitrodibenzo[*b,e*]- (1,4)dioxin in the presence of primary amines<sup>29</sup> (equation 27). In polar solvents the exciplex dissociates to the solvated radical ions from which the diphenyl ethers formed; in apolar solvents only the nitrophenoxazine is obtained. In contrast, 1-nitrodibenzo[*b,e*] (1,4) dioxin is photostable in the presence of amines.



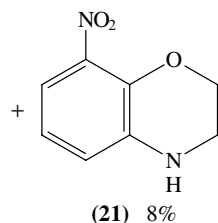
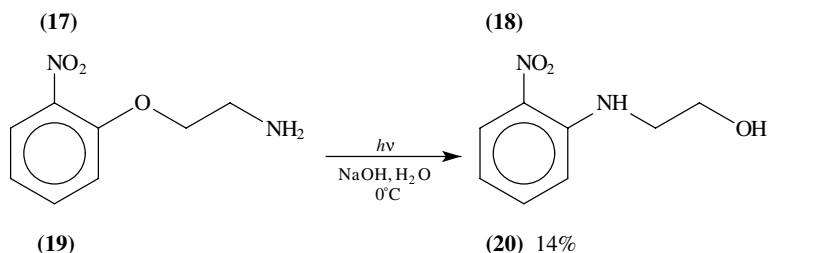
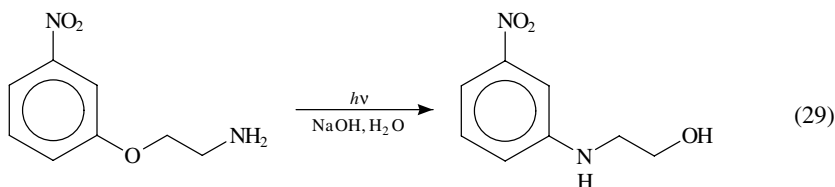
The nucleophilic aromatic substitutions of 2-fluoro-4-nitroanisole with amines have been shown to be useful as biochemical photoprobes<sup>30</sup>. Nitrophenyl ethers such as 4-nitroveratrole and 3- or 4-nitroanisole have also been explored as possible photoaffinity labels<sup>31</sup>.

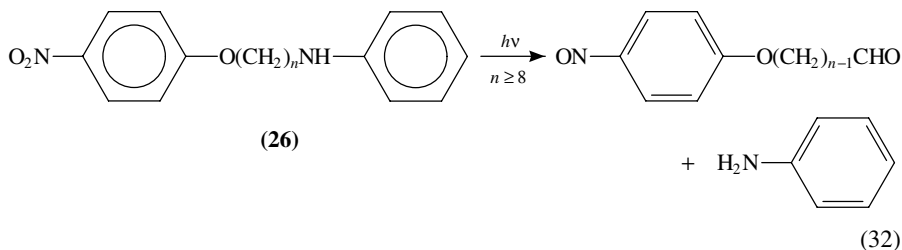
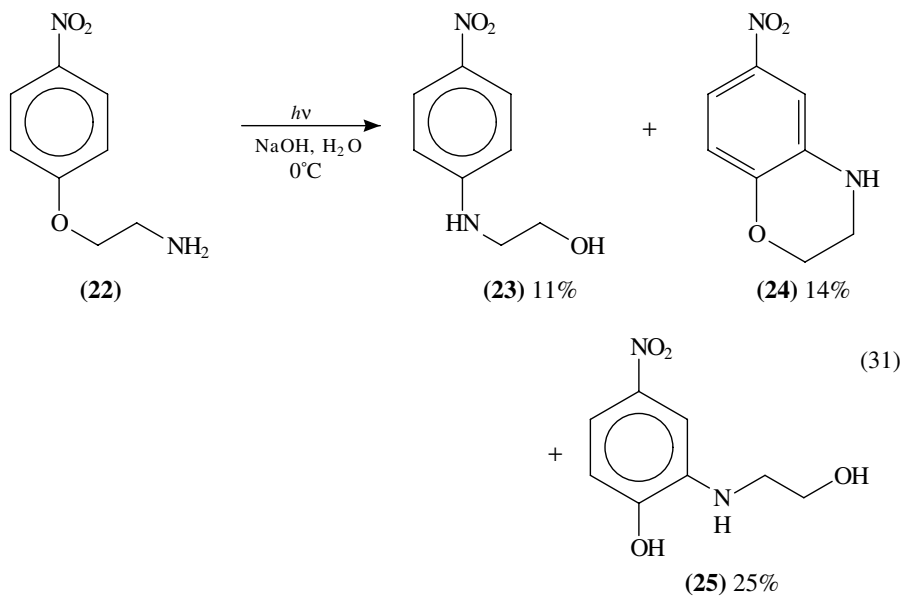
## 2. Intramolecular reactions (photo-Smiles rearrangements)

Excited-state intramolecular nucleophilic aromatic substitutions are known as photo-Smiles rearrangements. Earlier, these were reported for 2,4-dinitrophenyl ethers and *s*-triazinyl ethers<sup>32</sup>. The exploratory<sup>33</sup> and mechanistic<sup>34</sup> studies on photo-Smiles rearrangements of *p*-(nitrophenoxy)- $\omega$ -anilinoalkanes were carried out (equation 28).



Directive effects of the nitro group in photo-Smiles rearrangements have been systematically studied using a series  $\beta$ -(nitrophenoxy)ethylamines **17**, **19** and **22** as models<sup>35</sup>; the *meta* isomer **17** is photolysed to give the N,O-inverted product **18** cleanly in 75% (equation 29). However, photolysis of *ortho* (**19**) and *para* (**22**) isomers gave various by-products (such as **21**, **24** and **25**) in addition to the photo-Smiles rearrangement compounds **20** and **23** (equations 30 and 31). Predictably, both **19** and **22** are thermally rearranged in aqueous basic solution to give **20** and **23** cleanly. Apparently, excited nitrophenylic ether moieties preferentially undergo intramolecular nucleophilic attack by the amine group, wherein the *m*-nitro group can facilitate the collapse of the transition state to the product. Interestingly, the chain length has definite effects on the photochemical pattern of the nitro arene (acceptor) and amine (donor) moieties<sup>36</sup> of the chain terminal. While nitrophenyl ethers with  $n = 2-6$  (see equation 28) undergo photo-Smiles rearrangement, the higher ( $n \geq 8$ ) homologues show an intramolecular photoredox reaction (equation 32). Interestingly compound **26** with  $n = 7$  exhibits neither photo-Smiles rearrangement nor intramolecular photoredox reactions. The photochemistry of *N*-( $\omega$ -(4-nitro 1-naphthoxy)alkyl) anilines **27** shows exactly the same chain-length control on the product pattern to give **28** for  $n \leq 6$ , and **29-31** and aniline for  $n \geq 8$ .

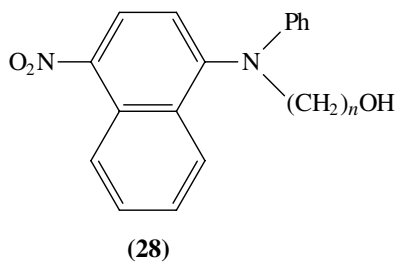
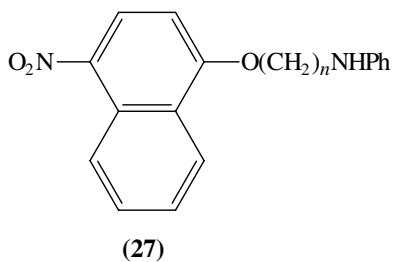


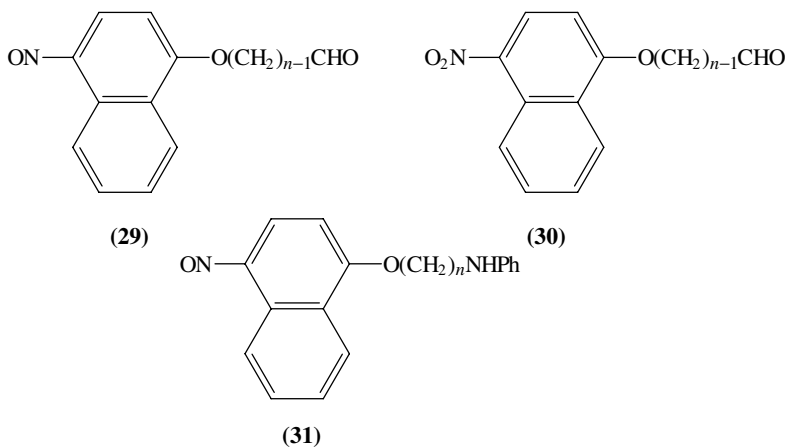


## C. Photorearrangements

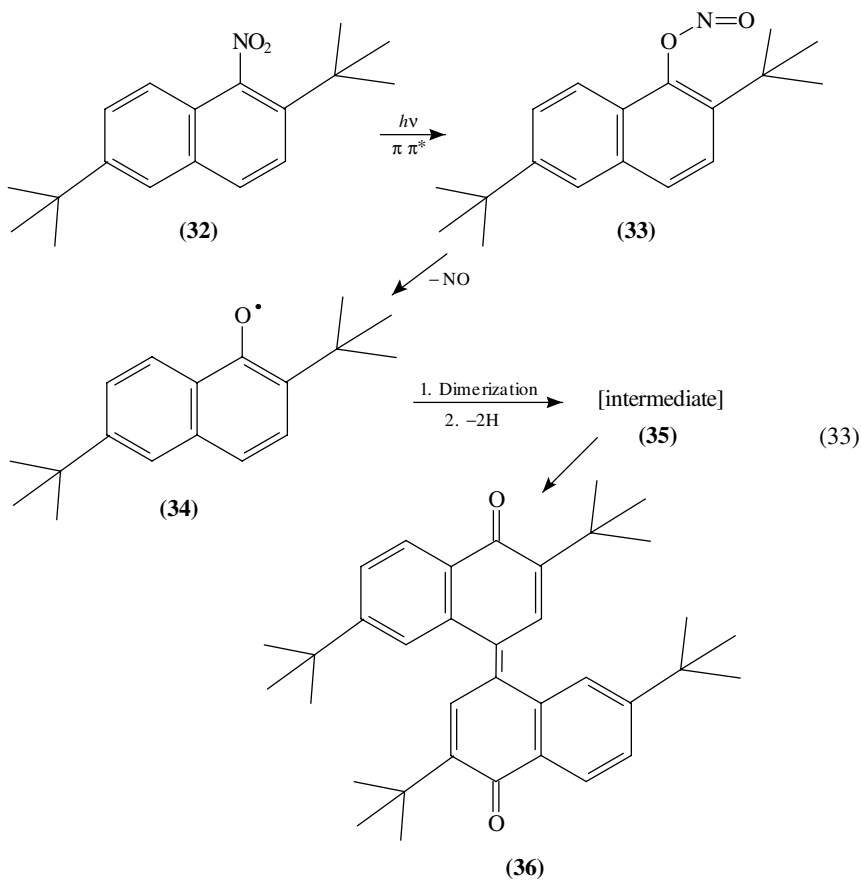
### 1. Intramolecular redox reactions

*a. o-Alkylnitrobenzenes.* The photochemical investigation of 2,6-di-tert-butyl-1-nitronaphthalene **32** was continued by Dopp and Wong<sup>37</sup> to give binaphthylidene



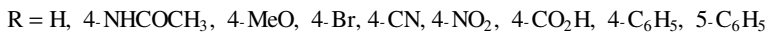
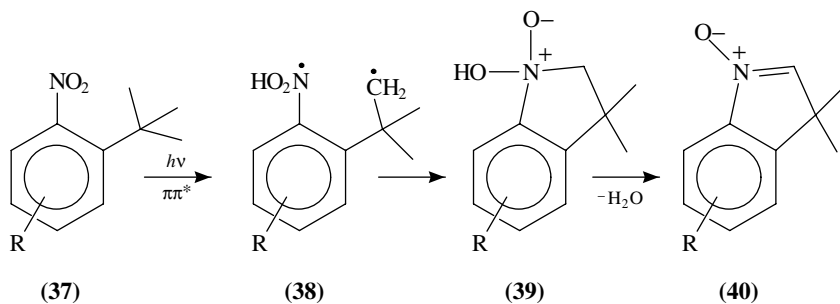


quinone 36 (equation 33) as the only isolable product.



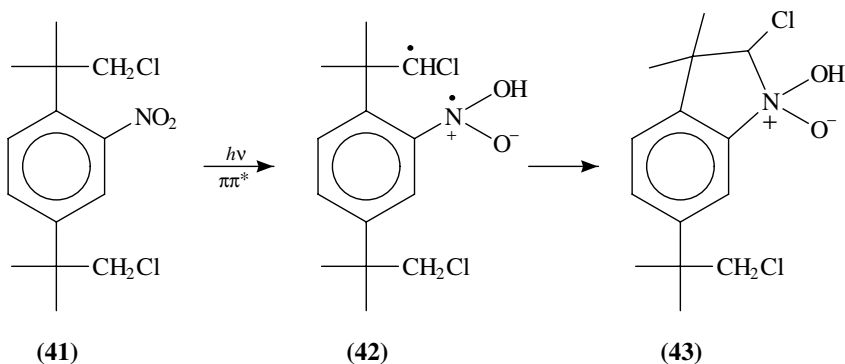


It is proposed that **32** reacts from its  $\pi\pi^*$  excited state by the nitro-to-nitrite (**33**) inversion followed by nitrite homolysis, when the naphthoxy radical must diffuse away from the cages to obtain the dimerization intermediate **35**. However, the source of oxidizing agents is not identified. In comparison, *o*-nitro-*tert*-butylbenzenes **37** are excited to undergo intramolecular H-atom transfer and cyclization to give indol-*N*-oxides **40** (equation 34)<sup>38</sup>. The discrepancy may arise from the nature of the excited state, e.g. that of **37** may react from its  $n\pi^*$  state.

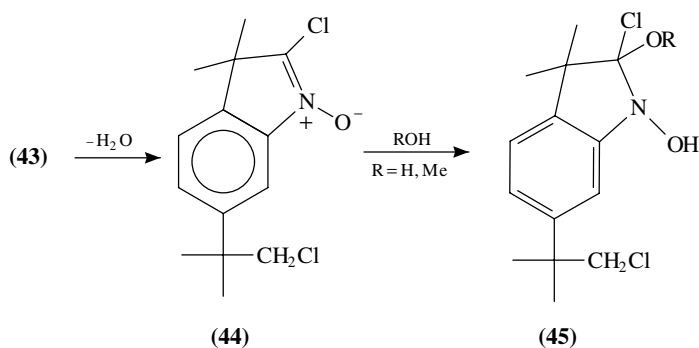


(34)

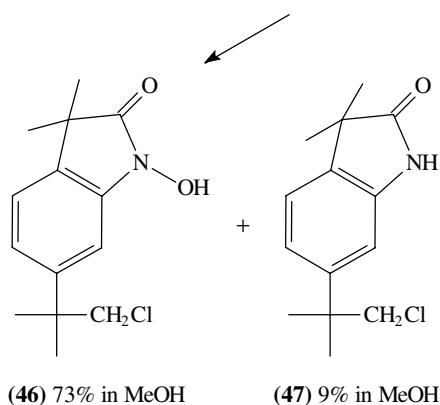
Photolysis of 1,4-bis-(2-chloro-1,1-dimethylethyl)-2-nitrobenzene **41** in solution and in the solid state<sup>39</sup> preferentially causes intramolecular hydrogen abstraction from the adjacent chloromethyl group instead of the methyl group, leading to the formation of indole 1-oxide **44** as the primary product. This is hydrolysed subsequently to afford the hydroxamic acid **46** and also the lactam **47** (equation 35). The molecular geometry and packing from the X-ray crystallographic structure of **41** have provided the rationale for the intramolecular hydrogen abstraction efficiency that, in turn, provides the basis of the structure–reactivity relationship. Such correlation is extended to 1-*t*-butyl-3,5-dimethyl-2,4,6-trinitrobenzene, 1-*t*-butyl-3,4,5-trimethyl-2,6-dinitrobenzene and 1-*t*-butyl-4-acetyl-3,5-dimethyl-2,6-dinitrobenzene<sup>40</sup>.



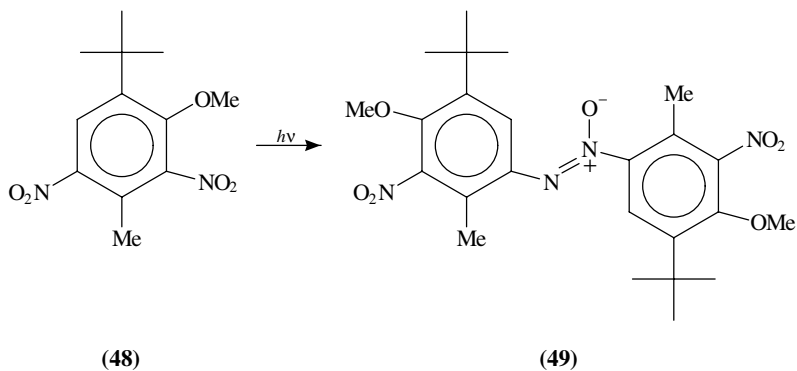
(35)

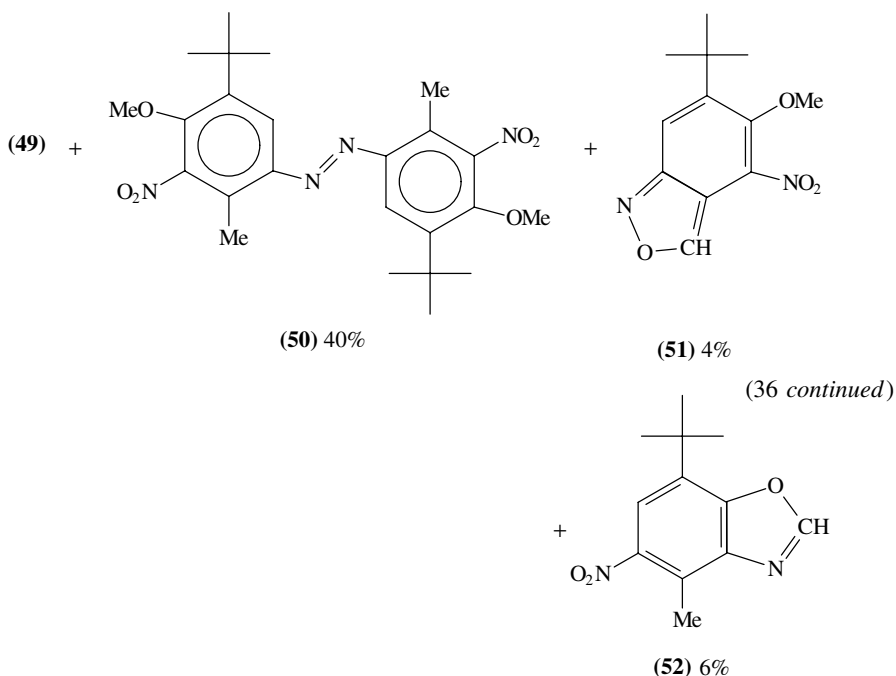


(35 continued)

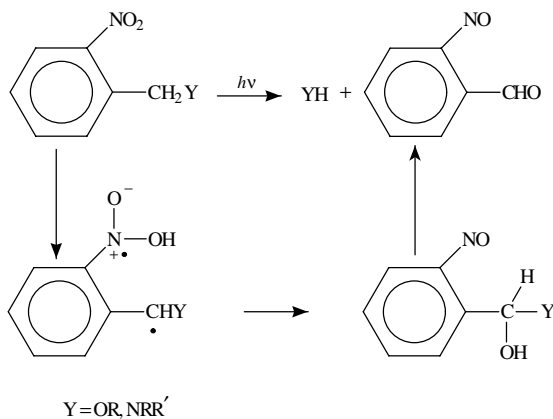


The light-induced yellowing of musk ambrette **48** is simulated<sup>41</sup> by photolysis of **48** in 0.1 N methanolic sodium hydroxide solution to give the azobenzene **50** (through the intermediacy of azoxybenzene) and by-products **51** and **52**, by intramolecular photocyclization (equation 36).



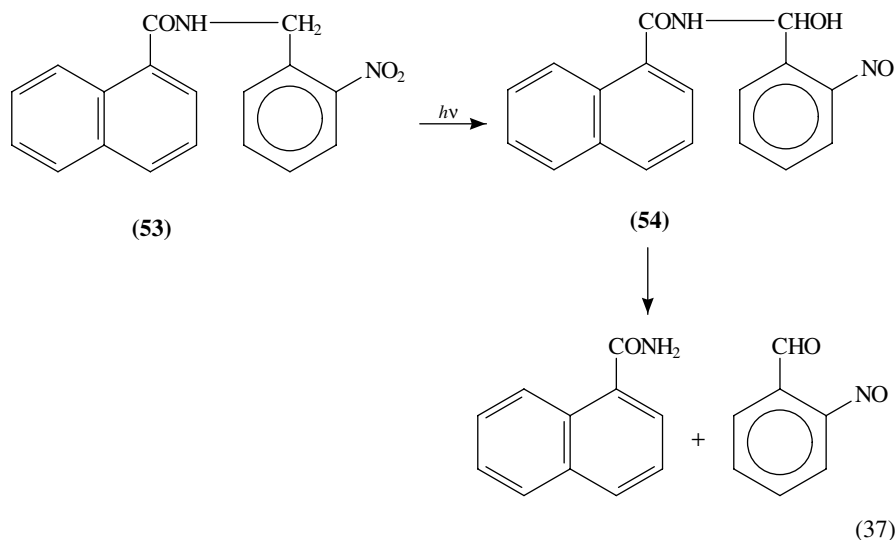


*b. o-Benzyl derivatives.* The photochemistry of *o*-nitrobenzyl derivatives carrying a well-placed heteroatom (see Scheme 3) has been reviewed thoroughly as a strategy in photoremovable protecting groups<sup>42</sup>. When alkyl *o*-nitrobenzyl ethers were irradiated, they were converted into *o*-nitrosobenzaldehyde releasing the alcohol intact as shown (Scheme 3); *o*-nitrobenzyl ethers have been used to protect hydroxyl groups during the chemical modifications of carbohydrates and their portions in nucleosides and oligoribo nucleotides. *N*-(2-nitrobenzyl)-1-naphthamide **53** is photolysed at  $-78^\circ\text{C}$  to

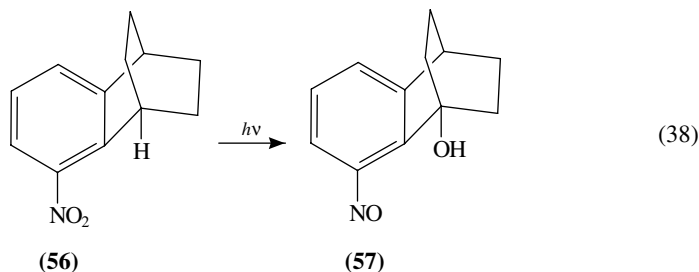


SCHEME 3

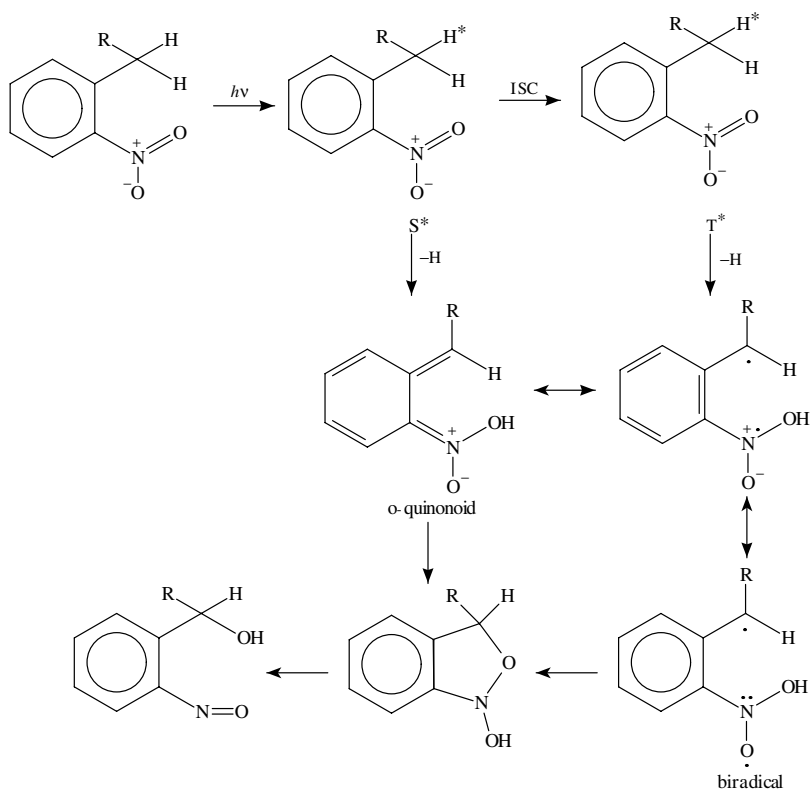
give *N*-( $\alpha$ -hydroxy-2-nitrosobenzyl)-1-naphthamide **54** (equation 37)<sup>43</sup> as identifiable intermediate, which is decomposed slowly at room temperature to 1-naphthamide and 2-nitrosobenzaldehyde.



The derivatives of the *o*-benzyl nitro group have been investigated by picosecond transient spectroscopy to examine the intermediates from the intramolecular hydrogen atom abstraction<sup>44</sup>. While the *o*-quinonoid intermediates are formed from both the singlet and triplet excited state *o*-nitrobenzyl ethers, observed transient absorption at 460 nm from excitation of *o*-nitrobenzyl *p*-cyanophenyl ether has been assigned to the biradical intermediate (see Scheme 4)<sup>45</sup>. Both 5-nitro-1,2,3,4-tetrahydro-1,4-methanonaphthalene **55** and 5-nitro-1,2,3,4-tetrahydro-1,4-ethanonaphthalens **56** incorporate structural contrasts that prohibit the contribution from the *o*-quinonoid structure. Picosecond spectroscopy of the excited nitro-arenes gives<sup>46</sup> transients with lifetimes of 770 ps and 410 ps that are assigned to the triplet excited state of **55** and **56**, respectively. As photolysis of **56** affords nitrosoalcohol **57** (equation 38), the operation of the biradical route must provide the access to the product (Scheme 4).

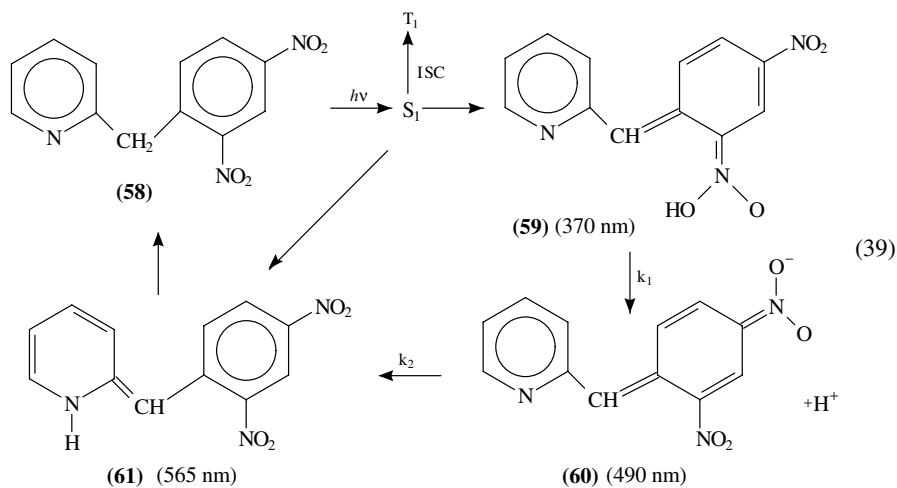


Recently, time-resolved resonance Raman spectroscopic studies<sup>47</sup> of the excitation of 2-(2',4'-dinitrobenzyl)-pyridine **58** and 4-(2',4'-dinitrobenzyl)pyridine have shown that three transient intermediates are involved: they are aci-nitro acid **59**, aci-nitro anion **60** and N-H



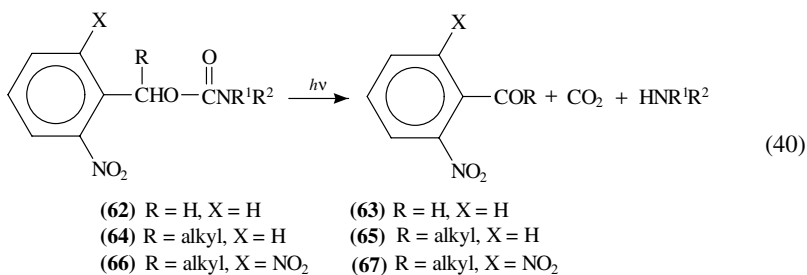
SCHEME 4

quinoid tautomer **61**, the transient  $\lambda_{\max}$  is shown in parentheses (equation 39).

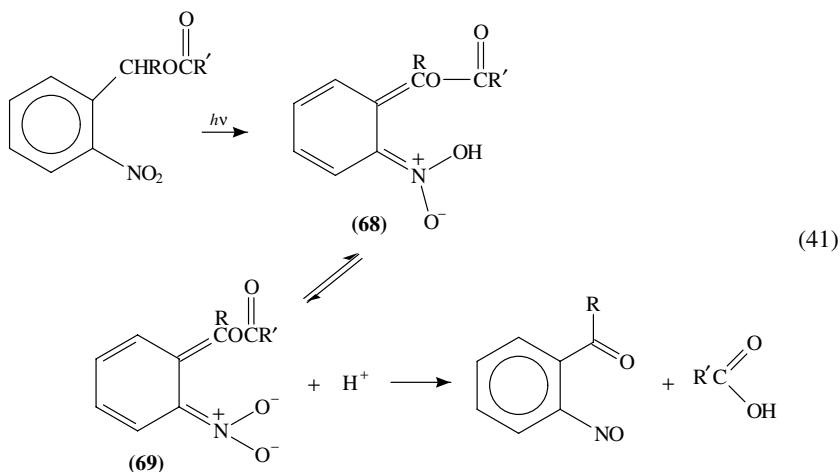


*o*-Nitrobenzyl photorearrangements have been applied to the area of photocatalysis, microlithography and biosensors. For example, the photolytic generation of acid has been developed as a potential candidate for radiation-sensitive materials for microelectronics and coating industry<sup>48</sup>. The systems of photogenerated acids from *o*-nitrobenzyl carboxylates<sup>49</sup> and sulphonates<sup>50</sup> have been applied as novel photoactive resists. The acid photogenerators based on the 2-nitrobenzyl rearrangement have been reviewed<sup>51</sup>.

Explorative studies of applying *o*-nitrobenzyl photochemistry to generate amines and diamines were reported, that is, to use the *o*-nitrobenzyloxy group as a masking group which can be photolytically detached<sup>52</sup>. The quantum efficiencies of the photodecomposition of *o*-nitrobenzyl carbamates **62** and **64** (equation 40) have been studied in solution and in the solid state<sup>52</sup>. The 2,6-dinitrobenzyl carbamates undergo photodecomposition most efficiently with quantum yields as high as 0.62 for **66**, R<sup>1</sup> and R<sup>2</sup> = cyclohexyl; the photosensitivities are controlled by a complex combination of both steric and electronic effects.

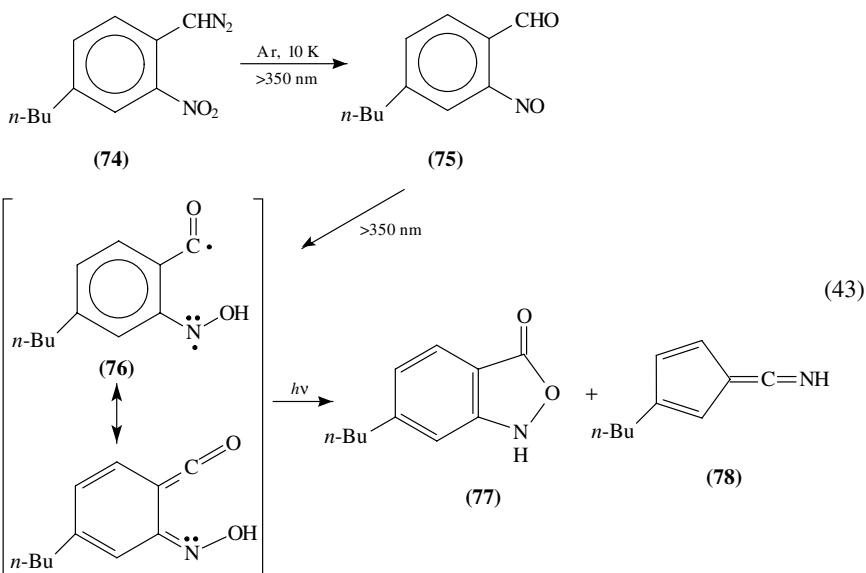
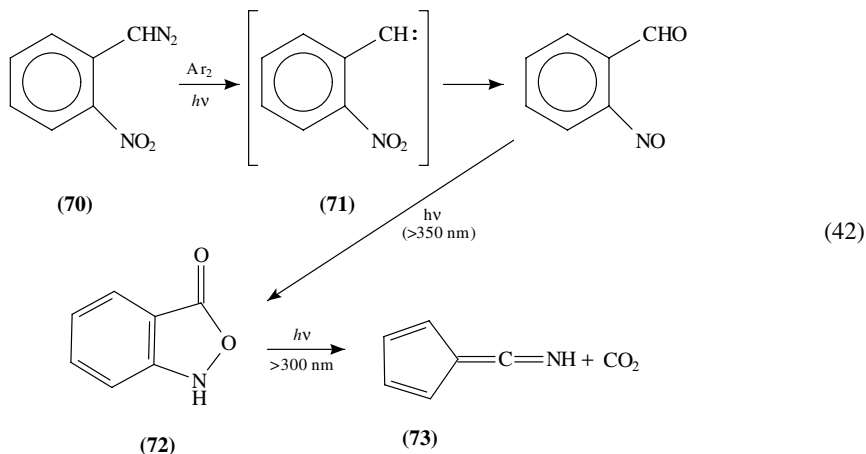


Time-resolved resonance Raman spectroscopy has been used to study the photorearrangement of *o*-nitrobenzyl esters in polar and protic solvents<sup>53</sup>; in acetonitrile, the only primary photoproduct is nitronic acid **68** with a lifetime of 80 microsecond, while in methanol the nitronic acid exists in equilibrium with the nitronate anion **69**, giving a lifetime of 100 microseconds (equation 41).

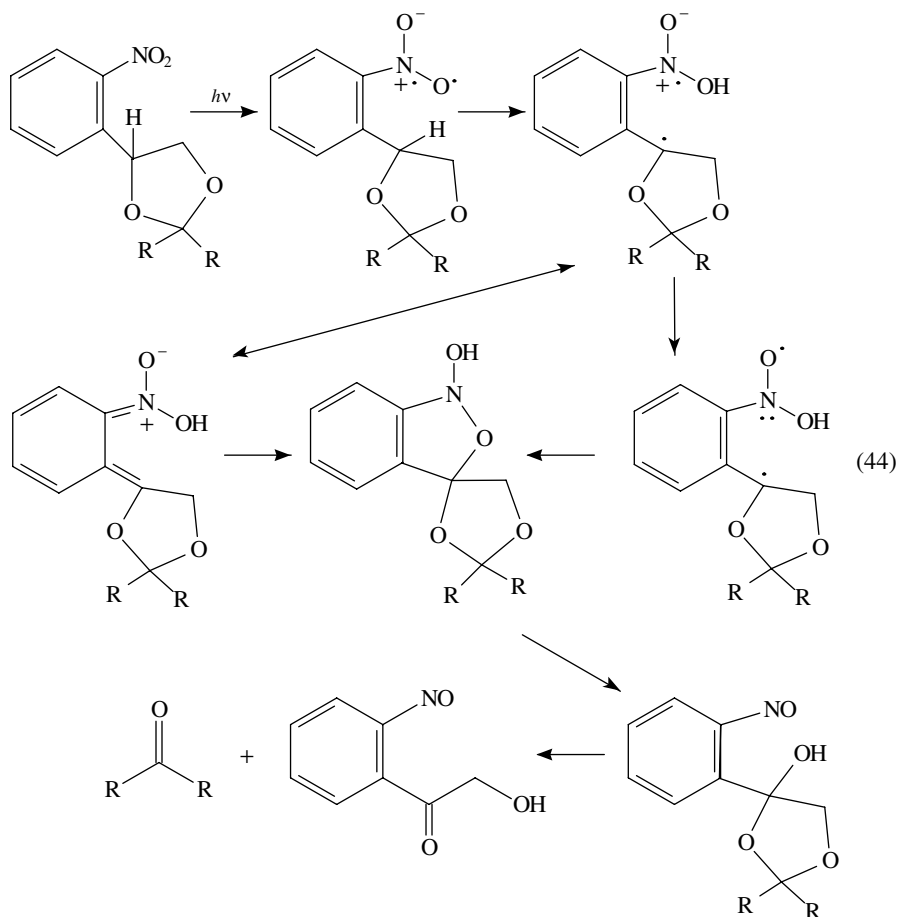


Photochemistry of (2-nitrophenyl)diazomethane **70** has been studied by excitation at 350 nm in argon matrix isolation system<sup>54</sup>. That shows that at 10 K, 2-nitrosobenzaldehyde is formed by intramolecular oxygen migration from (2-nitrophenyl) carbene

**71.** Further irradiation ( $\lambda > 350$  nm) of 2-nitrosobenzaldehyde causes secondary reactions to give a mixture of 2,1-benzisoxazol-3(1*H*)-one **72** and carbonylcyclopentadiene imine **73** along with carbon dioxide (equation 42). It was shown that oxazolone **72** undergoes decarboxylation to give **73** upon photolysis with shorter-wavelength light ( $\lambda > 300$  nm) but not with longer-wavelength light ( $\lambda > 350$  nm). Irradiation ( $\lambda > 350$  nm) of (4-*n*-butyl-2-nitrophenyl)diazomethane (**74**) in argon matrix at 10 K results in the formation of the oxazolone **77** and imine **78** that may be derived from intermediate **76** upon further irradiation (equation 43). Photoexcited nitrosobenzaldehyde **75** must undergo H-atom transfer to give intermediate **76**, which could spontaneously cyclize from either diradicaloid or ketenoid forms to give oxazolone **77**. However, it requires deep-seated rearrangements and corresponding energy to reach the ketimine stage; the nitrene and carbene species have been proposed to mediate the changes.

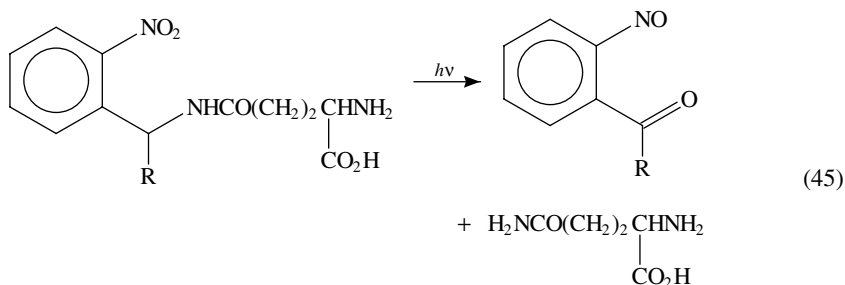


The application of *o*-nitrophenylethylene glycol as a photolabile protective group of aldehydes and ketones was further discussed<sup>55</sup>. The deprotection of 1,3-dioxolane group can be carried out by photolysis at 350 nm in an inert solvent such as benzene, giving fair to high yields. The isolation and characterization of *o*-nitroso- $\alpha$ -hydroxyacetophenone demonstrates a mechanistic link with the known photorearrangement of *o*-nitrobenzaldehyde to *o*-nitrosobenzoic acid. The scope and limitation are also discussed mainly on the basis of its stability to bases and acids (equation 44).

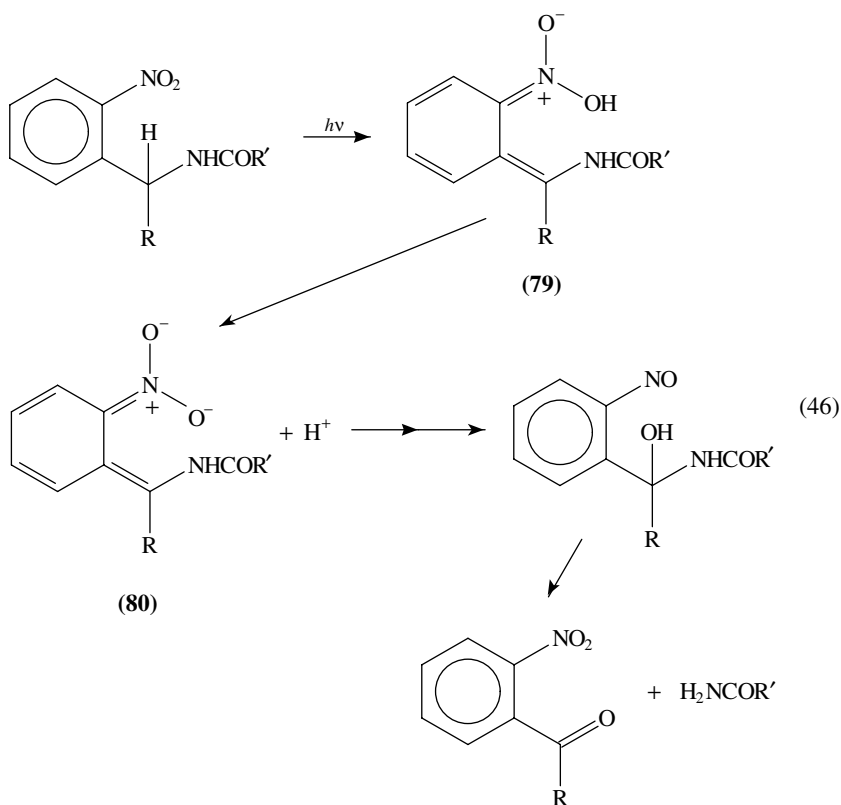


A series of *o*-nitrobenzyl derivatives derived from glutamine, asparagine, glycinamide and  $\gamma$ -aminobutyramide linked through the amide nitrogen are photolysed to release free amides according to the common mechanism shown in equation 46<sup>56</sup>. The quantum yield for the release of glutamine (equation 45) from the  $\alpha$ -methyl derivative is 0.13 and that from the carboxy derivative is 0.24. The mechanism involved the aci-nitro anion intermediate **80** (equation 46); the half-lives for the  $\alpha$ -methyl,  $\alpha$ -carboxyl and  $\alpha$ -H derivatives of glutamine at pH 7.5 are 360, 720 and 1800 microseconds respectively.

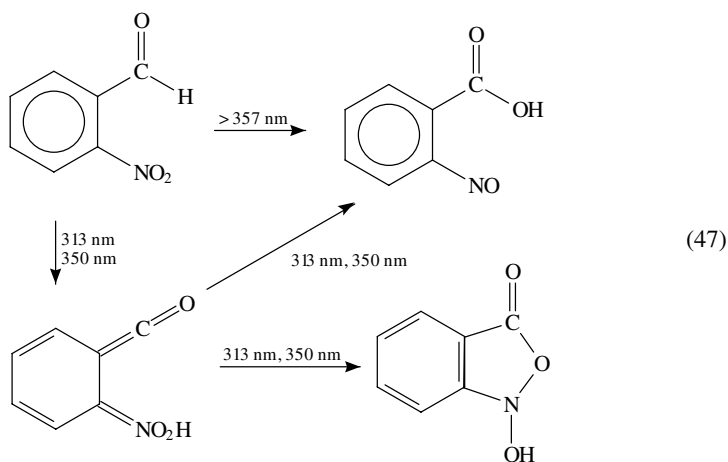




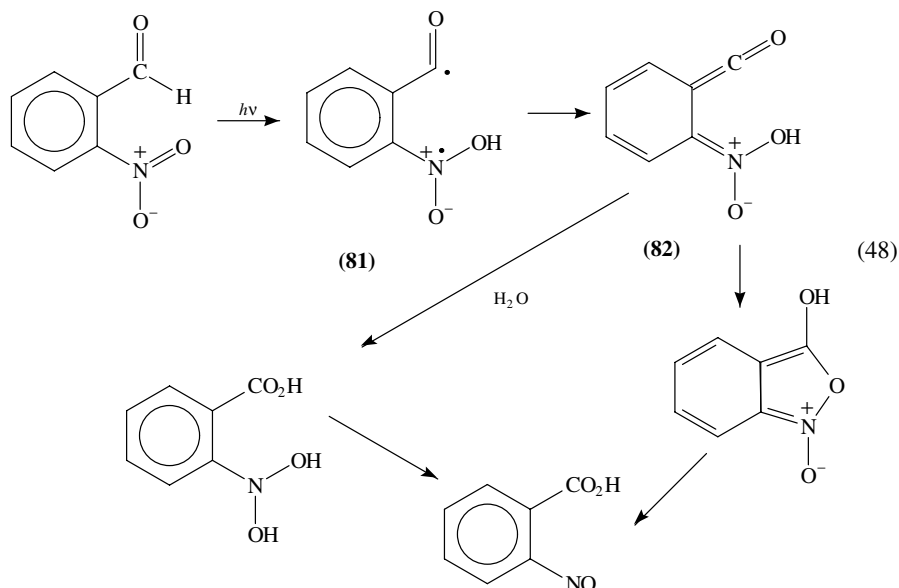
R = H, CH<sub>3</sub>, CO<sub>2</sub>H



*c. Nitrobenzenes with ortho C=X bonds and their derivatives.* Mechanistic studies on the photochemistry of *o*-nitrobenzaldehyde by the matrix-isolation technique have provided evidence for the existence of a ketene intermediate<sup>57</sup> on excitation at 313 or 350 nm (equation 47); the ketene is the precursor of the *o*-nitrosobenzoic acid and of the *N*-hydroxybenzoxazolone. Excitation at 357 nm leads to the exclusive formation of the former acid.

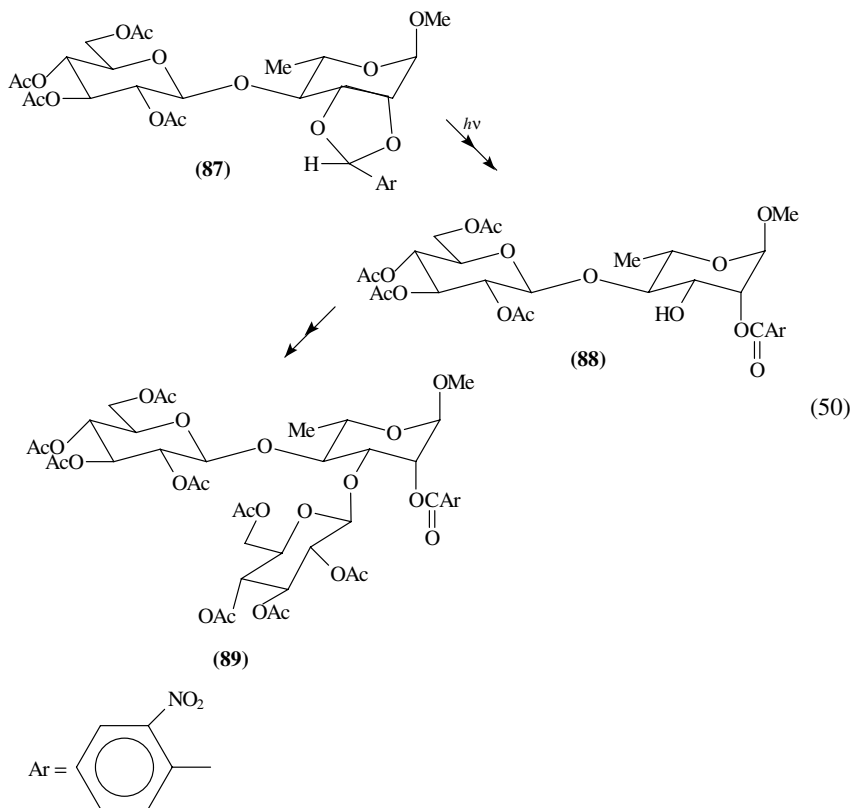
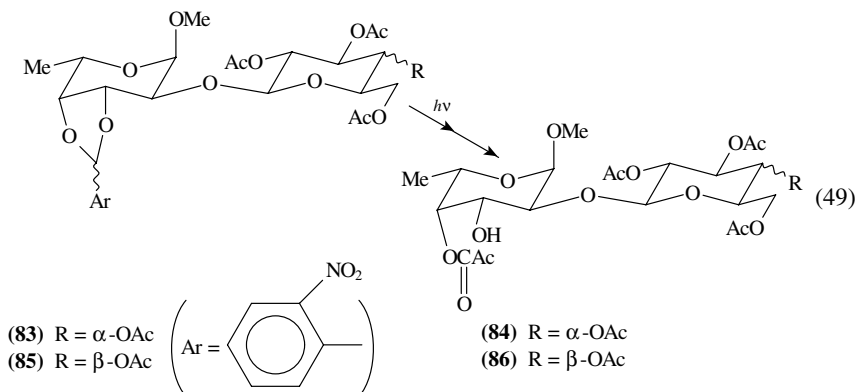


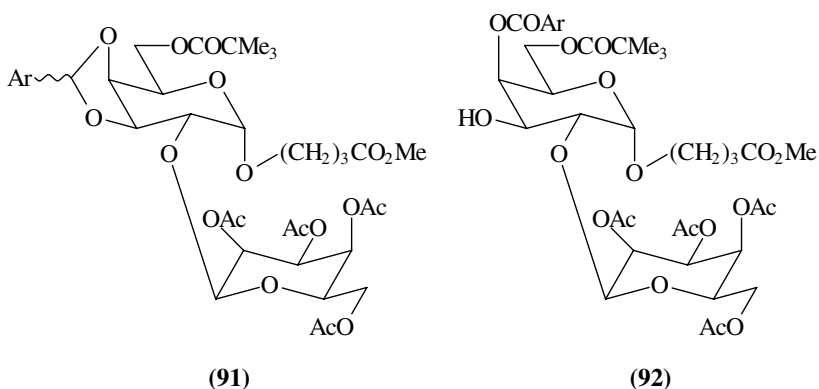
This photoreaction has been investigated by laser flash photolysis<sup>58</sup> and quantum yield measurements that identify the triplet state ( $\tau = 6$  nanoseconds) as the reactive species, and show intermediate **82** is sensitive to hydroxylic molecules, but the logical precursor biradical intermediate **81** could not be detected owing to a short lifetime (equation 48).



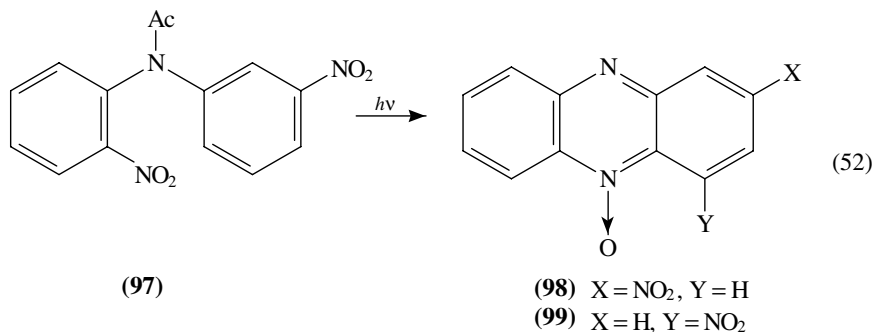
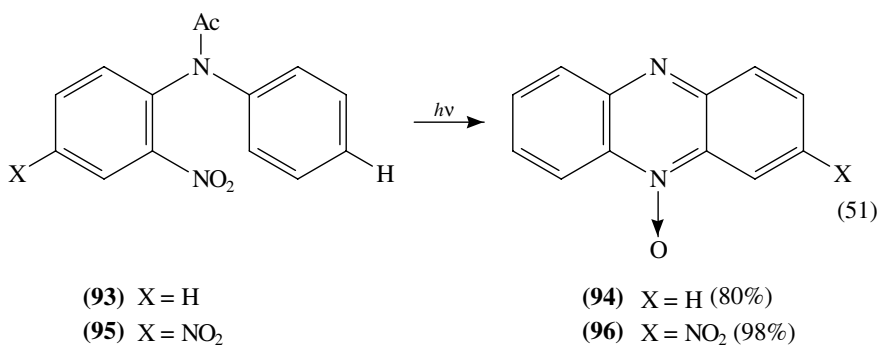
Application of similar photochemistry in the carbohydrate domain has been reported by Collins and coworkers who demonstrated that *O*-(2-nitrobenzylidene) sugars **83** and **85** can be sequentially decoupled by photolysis and oxidation to give hydroxy-*O*-2-nitrobenzoyl derivatives (**84** and **86**) that are specifically partially protected sugars<sup>59</sup> (equation 49). In both cases, the first-stage photolysis specifically deprotects the C-3 equatorial OH group. Such a blocking-deblocking sequence including the key-photoreaction step is

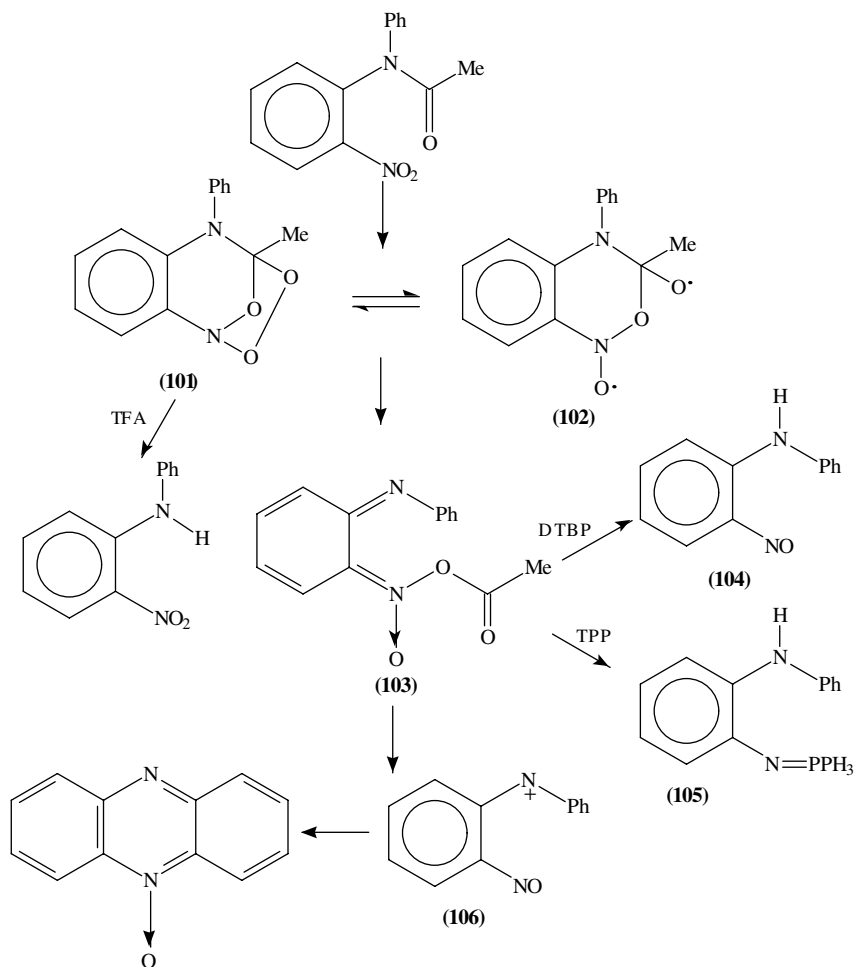
applied to transform **87** to **88**, during which the C-3 equatorial OH group is bared for the specific glycosylation<sup>60</sup> to afford **89** (equation 50); this corresponds to the fully esterified methyl-3,4-di-*O*-( $\beta$ -*O*-glucopyranosyl)- $\alpha$ -L-rhamnopyranoside (**90**, not shown). In a similar fashion, the fully protected  $\beta$ -galactosyl- $\alpha$ -galactoside derivative **91** is photolysed and oxidized to give the corresponding intermediate of **92** carrying the C-3 OH group<sup>61</sup>.



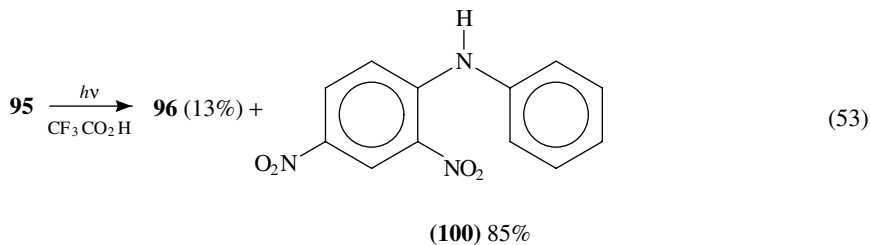


*d. Nitrobenzenes with ortho heteroatom substituents and their derivatives.* The photocyclization of *N*-acyl-2-nitrodiphenylamines is an efficient reaction to give phenazine *N*-oxides as shown<sup>62</sup> in equation 51. Irradiation of compound **97** gives *N*-oxides **98** and **99** in equal amounts (equation 52). When compound **95** is photolysed in the presence of trifluoroacetic acid, the acetyl group is eliminated efficiently to give **100** predominantly (equation 53); the acyl group must end up as the mixed anhydride. The overall reaction pattern involving equations 51–53 is summarized in Scheme 5, in which the key intermediate **103** can be trapped by 2,6-di-*tert*-butylphenol (DTBP) and triphenyl phosphine (TPP) to afford **104** and **105**, respectively.

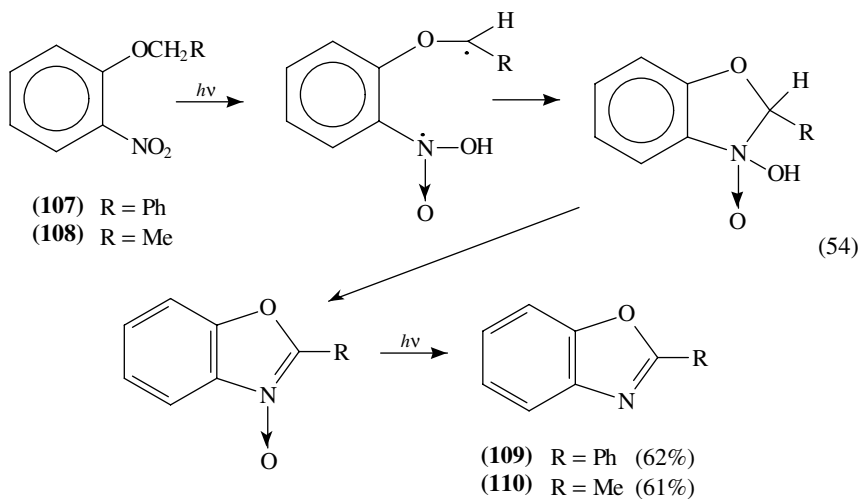




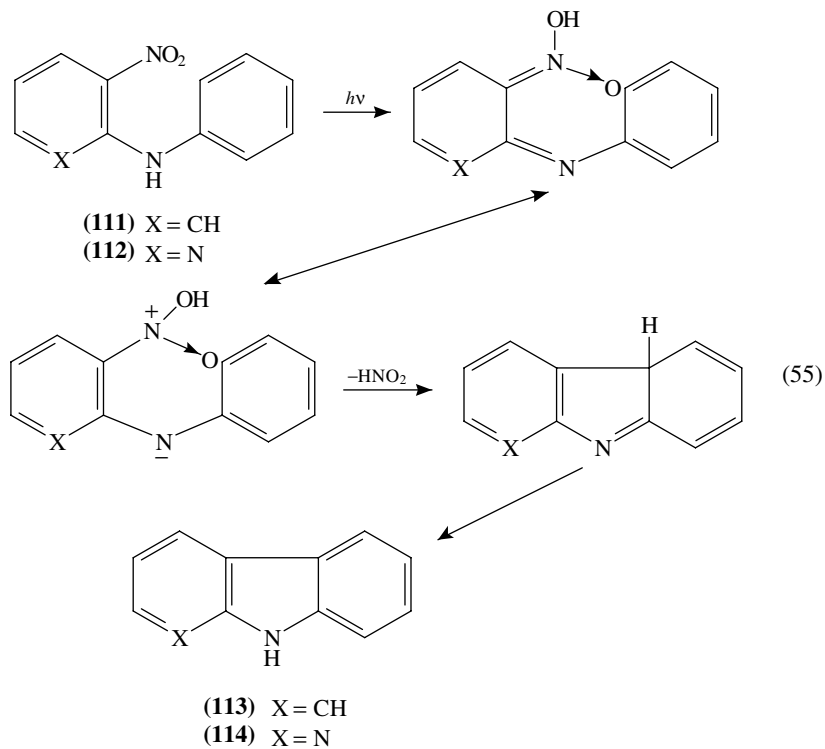
SCHEME 5



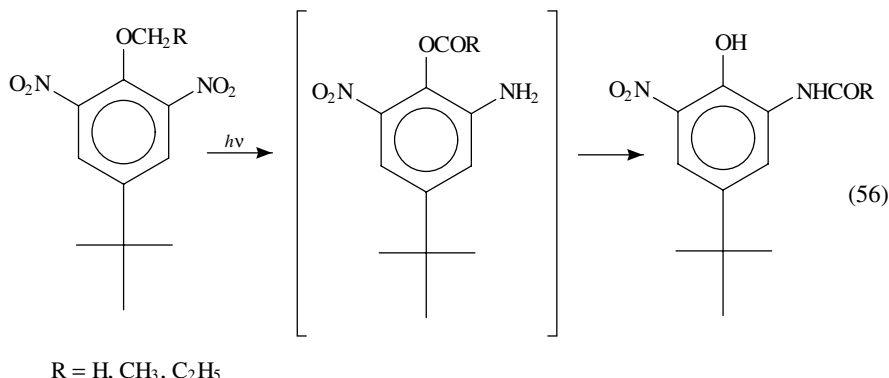
Excitation of *o*-nitrophenyl alkyl ethers (**107** and **108**) causes the intramolecular hydrogen abstraction from the  $n\pi^*$  triplet state of the nitro group to give benzoxazoles **109** and **110** respectively<sup>63</sup> according to the mechanism in equation 54.



Excitation of *o*-nitrodiphenylamine (**111**) and 3-nitro-2-phenylaminopyridine (**112**)<sup>64</sup> causes the common intramolecular hydrogen abstraction, as the initial step, but subsequent steps involve the elimination of  $\text{HNO}_2$  and cyclization to give carbazole and  $\alpha$ -carboline (**113** and **114**) in equation 55.

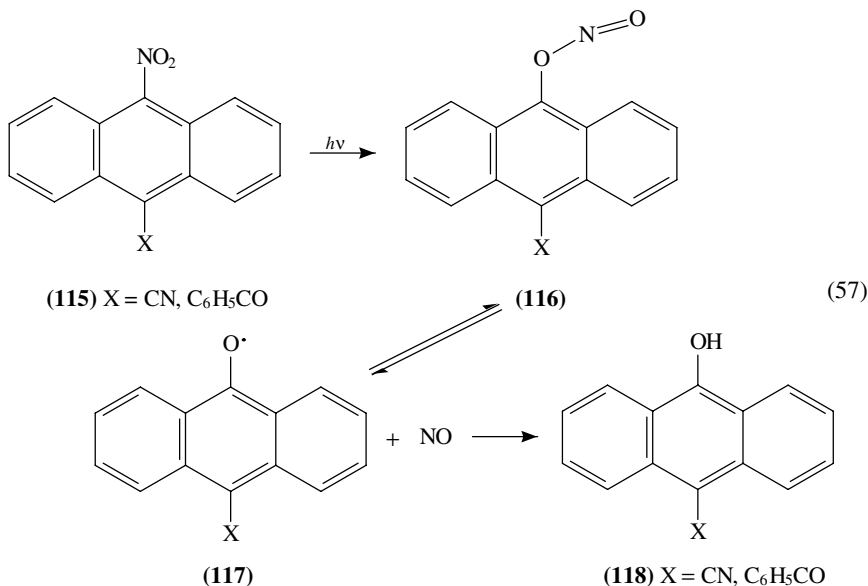


Irradiation of 1-alkoxy-4-*t*-butyl-2,6-dinitrobenzenes apparently gives aniline the aniline intermediates that undergo acyl migration to give the more stable anilide (equation 56)<sup>65</sup>.



## 2. Nitro-nitrite rearrangement

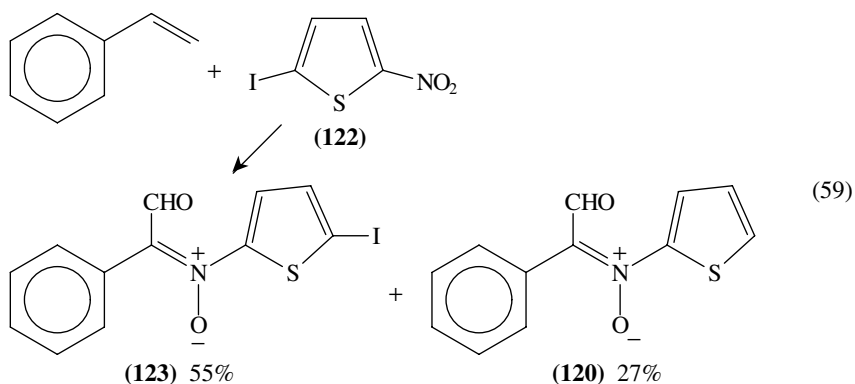
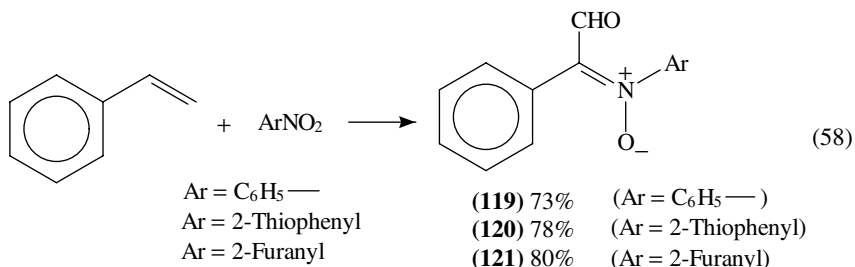
Derivatives of 9-nitroanthracens **115** undergo the nitro-nitrite rearrangement from their triplet  $n,\pi^*$  state to 9-anthrol derivatives **118** as shown<sup>66</sup> in equation 57; nitrite photolysis is well known and ESR spectra for the anthryloxy radical **117** can be recorded at room temperature.



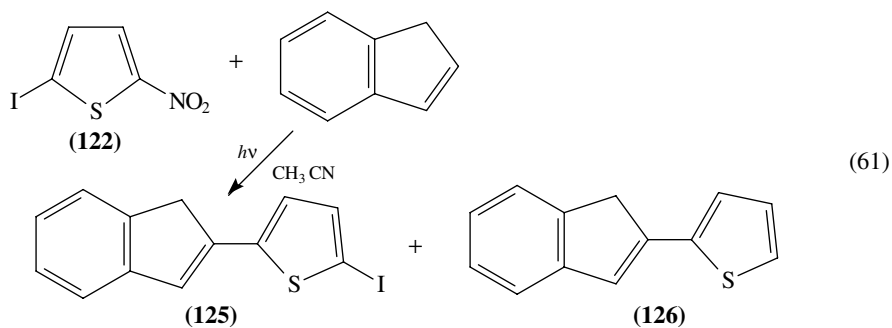
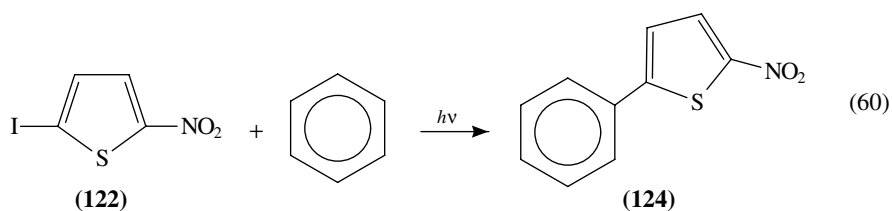
## D. Photoaddition and Coupling

Irradiation of a mixture of styrene and a nitroarene, such as nitrobenzene, 2-nitrothiophene or 2-nitrofuran, in acetonitrile gives the corresponding nitron in high

yields<sup>67</sup> (equations 58 and 59).

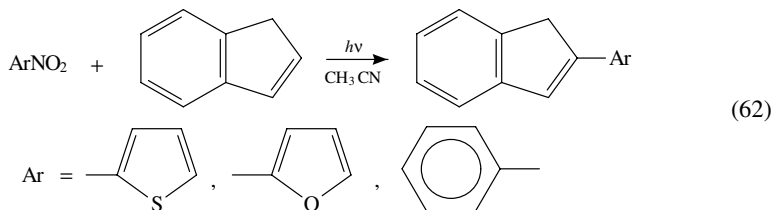


Irradiation of 2-iodo-5-nitrothiophene (**122**) in the presence of benzene or indene gives, instead of addition, the coupling products<sup>68</sup> **124** and **125** (equations 60 and 61). The latter photoreaction also gave a minor amount of the secondary product **126** through reduction of the C–I bond<sup>69</sup> in **125**.



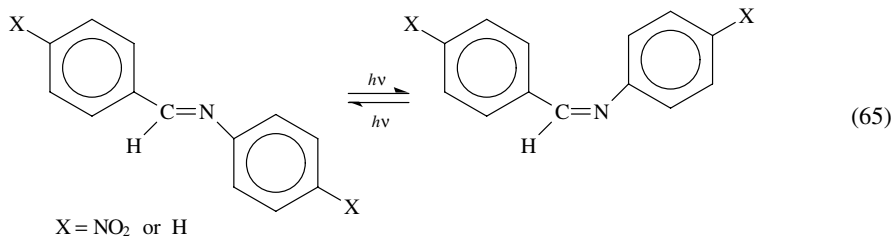
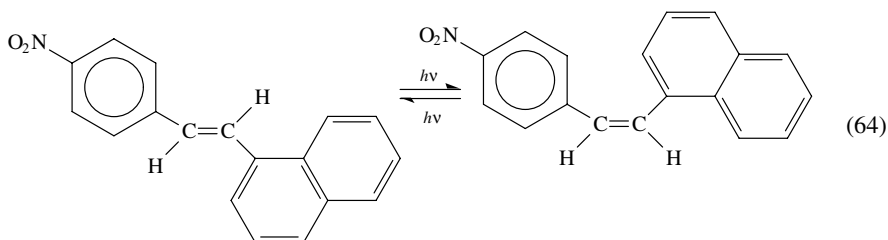
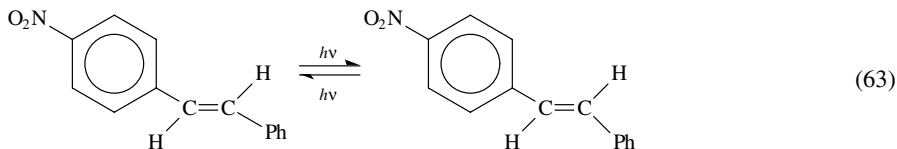


Interestingly, the photoreaction of indene with nitroarenes gives good yields of coupling products as shown in equation 62 (66% from 2-nitrothiophene and 52% from 2-nitrofuran). Nitrobenzene gives the reduction product. Strangely there is no reaction for *p*-nitrotoluene with indene.

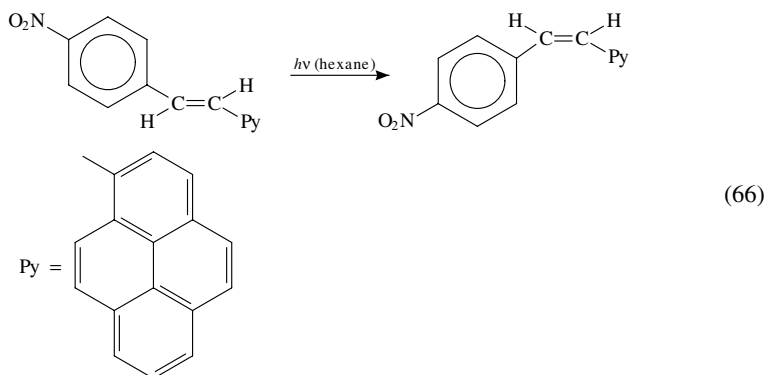


### E. Photoisomerization

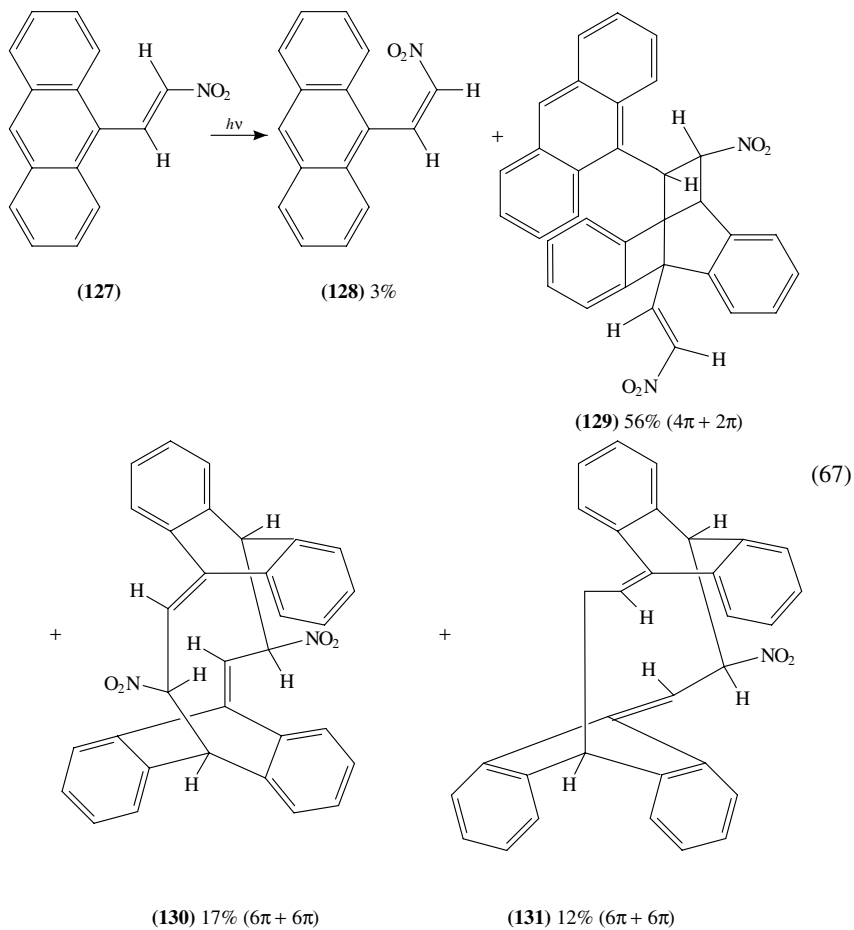
The effects of nitro substituents on the *cis-trans* isomerization of stilbenes has been reviewed<sup>70</sup> (equation 63). The *trans-to-cis* isomerization occurs from a triplet excited state, whereas the reverse *cis-to-trans* isomerization occurs through a main route which bypasses the triplet state. A nitro substituent usually causes a significant enhancement of the quantum yield of the intersystem crossing. Nitro substituent effects on the photoisomerization of *trans*-styrylnaphthalene<sup>71</sup> (equation 64), *trans*-azobenzenes<sup>72</sup> and 4-nitrodiphenylazomethines<sup>73</sup> (equation 65) have been studied for their mechanisms.



The presence of a nitro substituent can enhance the intramolecular charge transfer in the excited state dramatically, so that the normal *trans-to-cis* isomerization of 1-[2(4-nitrophenyl)ethenyl]pyrene in cyclohexane is completely suppressed<sup>74</sup> in polar solvents such as acetonitrile (equation 66).



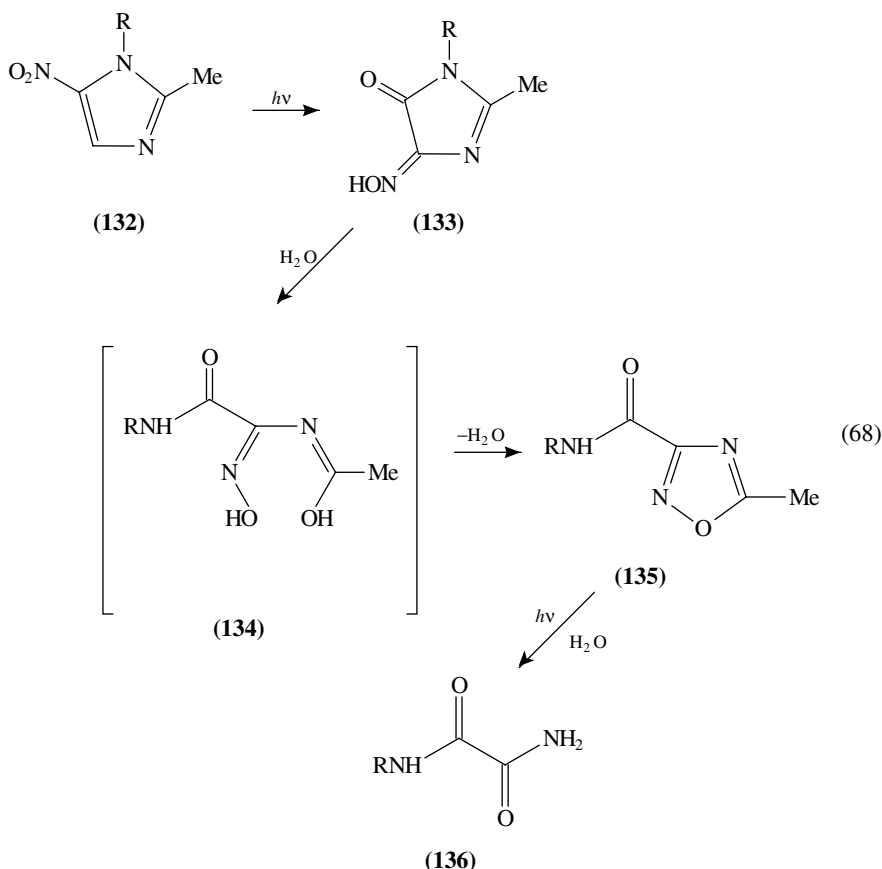
Upon irradiation ( $>400$  nm), 1-(9-anthryl)-2-nitroethylene **127** undergoes  $4\pi + 2\pi$  and  $6\pi + 6\pi$  as well as isomerization reactions<sup>75</sup> (equation 67).



## F. Heterocyclic Compounds Containing Nitro Groups

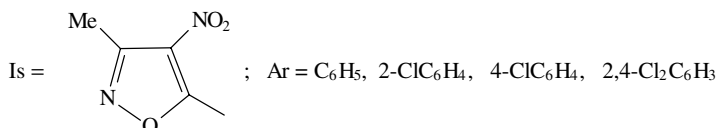
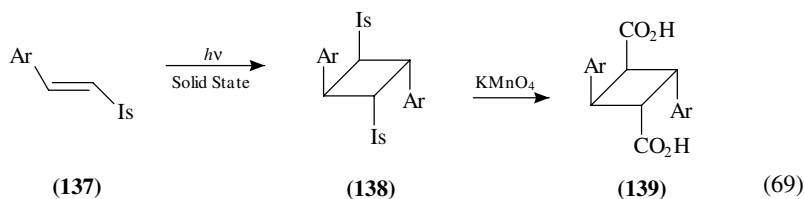
Nanosecond laser flash photolysis was applied to study excited-state 2-nitrothiophene in polar and non-polar solvents<sup>76</sup>: the transient absorption at  $545 \pm 5$  nm was assigned to its lowest triplet state. The rate constants of the interaction of this triplet excited state, with a number of substrates such as cyanide and hydroxide ions, have been determined<sup>77</sup>. Similarly, the transient absorption at  $490 \pm 5$  nm was assigned to the lowest triplet excited state of 5-nitro-2-furoic acid<sup>78</sup>, and that at  $500 \pm 5$  nm to that of *N*-(*n*-butyl)-5-nitro-2-furamide<sup>79</sup>.

The photolysis of 2-methyl-5-nitro-1*H*-imidazoles **132** in a water-containing solvent<sup>80</sup> gives oxime **133**, which is in turn hydrolysed to **134** followed by a dehydrative cyclization to the 1,2,4-oxadiazole **135**. Light-induced hydrolysis of **135** gives **136** (equation 68).



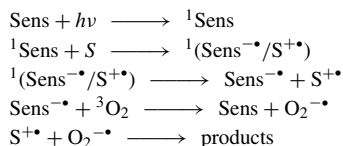
The solvent effects on the relative stabilities of 4-nitroimidazole and 5-nitroimidazole exhibit interesting patterns<sup>81</sup>. In the excited state the 5-nitro isomer is more stable than the 4-nitro isomer in aprotic solvents, while the stability order is reversed in the ground state.

The photodimerization of 3-methyl-4-nitro-5-styrylisoxazoles **137** has been studied in the solid state<sup>82</sup>. Truxillic acids **139** are prepared by the oxidation of the photodimers **138** (equation 69).

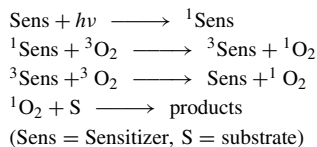


Nitroimidazoles (such as metronidazole and misonidazole) can enhance the porphyrin sensitized Type I photooxidations<sup>83</sup>; that is, electron transfer from the sensitizer to the oxygen molecule is facilitated to give more of the superoxide ion (Scheme 6). The Type II mechanism operates by energy transfer from the sensitizer to afford the singlet oxygen<sup>84</sup>.

## Type I

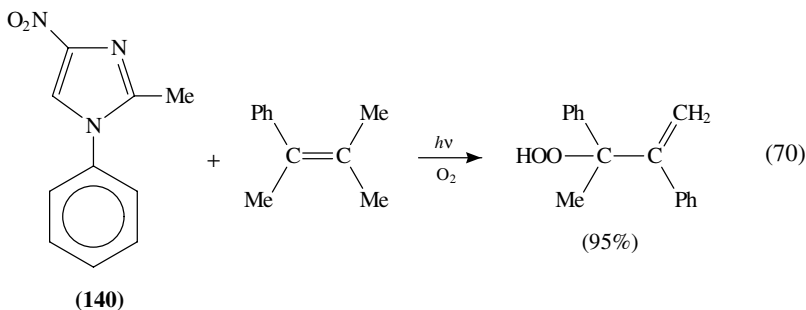


## Type II



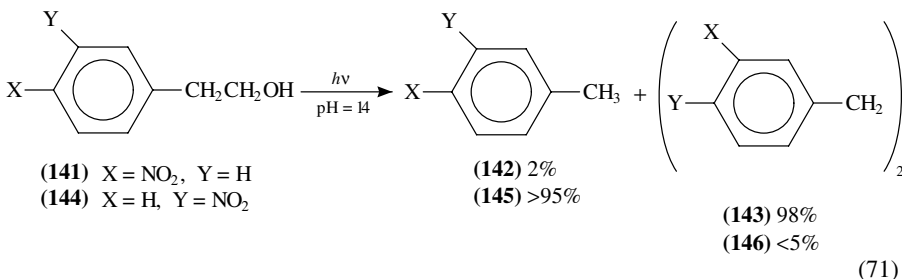
SCHEME 6

Whereas several 1-aryl-4-nitroimidazoles are found to be good sensitizers for superoxide ion formations<sup>85</sup> (Type I photooxidation), only 1-phenyl-2-methyl-4-nitroimidazole **140** is a photosensitizer for singlet oxygen, i.e. by energy transfer of type II photooxidation (equation 70).

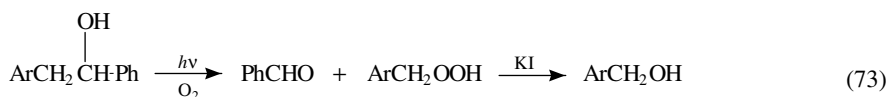
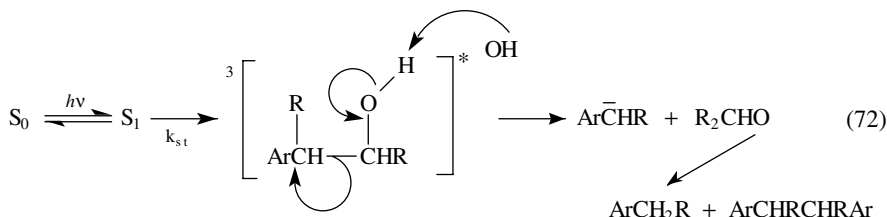


### G. Photoretro-Aldol Type Reactions and Photodecarboxylation to Generate Nitroaromatic Anions

Photolysis of *p*- or *m*-nitro phenylethyl alcohols **141** and **142** in aqueous solution causes retro-aldol type reactions, where the quantum efficiencies are pH dependent<sup>86-89</sup>. In these compounds the nitro group is placed so that no intramolecular hydrogen abstraction can occur and the excited state must follow an alternative route. The *m*- or *p*-position of the nitro group controls the product pattern as shown in equation 71; while the *p*-nitro group promotes biphenyl formation, the *m*-nitro group gives predominantly *m*-nitrotoluene at pH = 14. Photolysis of **144** at pH 7-14 does not change the product pattern significantly. Photolysis of **141** at pH = 12 changes the **142/143** ratio to 20/80. However, the expected formaldehyde product was not isolated.

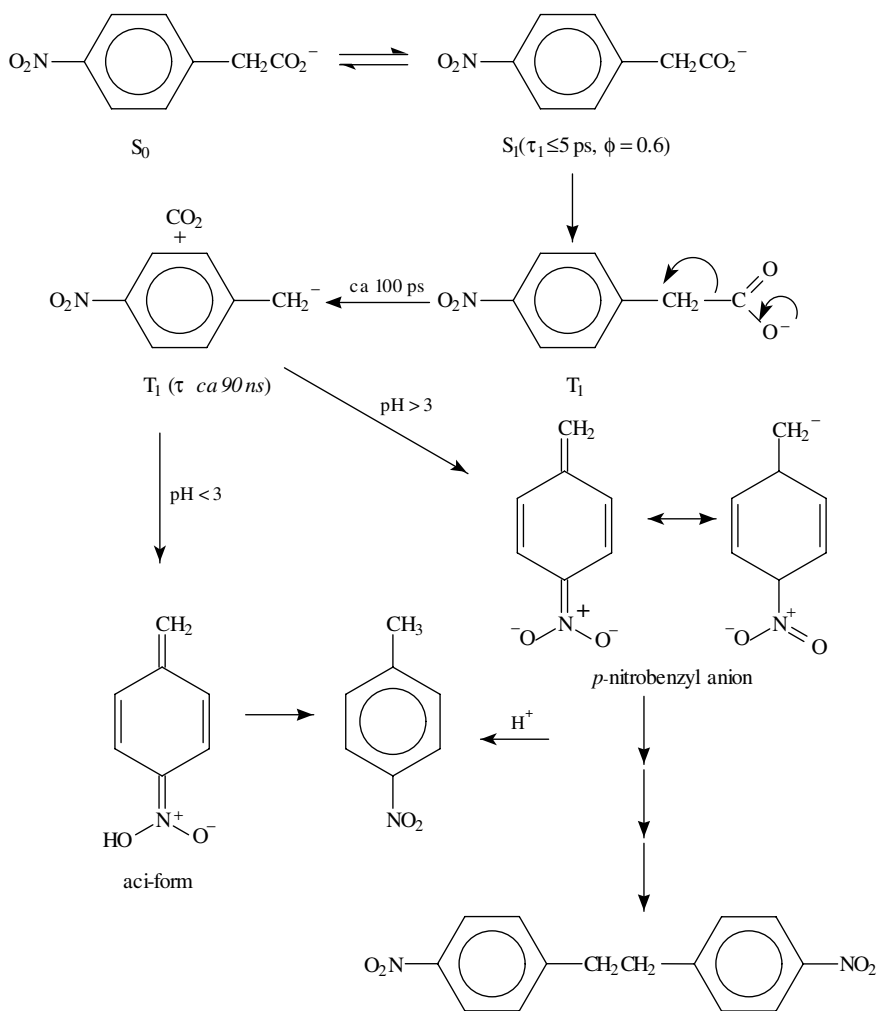


The photo-retro-aldol type reaction is general for appropriately substituted nitroaromatic compounds with a *p*- or *m*-nitrobenzyl carbanion moiety as the photolabile leaving group. Its mechanism is shown in equation 72, in which the reactive triplet nitrophenylethyl alcohol undergoes retro-aldol cleavage assisted by solvent water (or hydroxide ion) as the deprotonating base in the primary photoprocess. The photogenerated carbanion subsequently reacts to give the observed products (ArCH<sub>2</sub>R and ArCHR-CHRAr) in de-aerated solution. The photogenerated nitrobenzyl anion can transfer one electron to a suitable electron acceptor (including the original nitrobenzyl derivatives) to generate the anion radical, which can be observed by electron paramagnetic resonance (EPR) spectroscopy<sup>87,88,90</sup>. The dimerization products (**143,146**) are derived from the nitrobenzyl radical. The yield of **146** is small owing to the fact that the *m*-nitrobenzyl anion is reluctant to give up its electron to form an *m*-nitrobenzyl free radical. The EPR experiment consistently shows very weak signals for the *m*-nitrobenzyl system. In aerated solution, the photogenerated carbanion reacts with oxygen by similar electron transfer to give hydroperoxides as the products (equation 73).



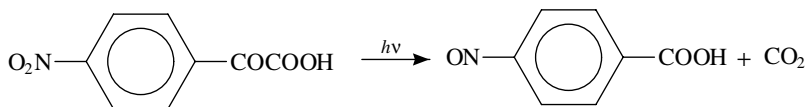
Ar = 3- and 4-NO<sub>2</sub>C<sub>6</sub>H<sub>4</sub>





SCHEME 7

derived from the excited-state decarboxylation and rearrangement.

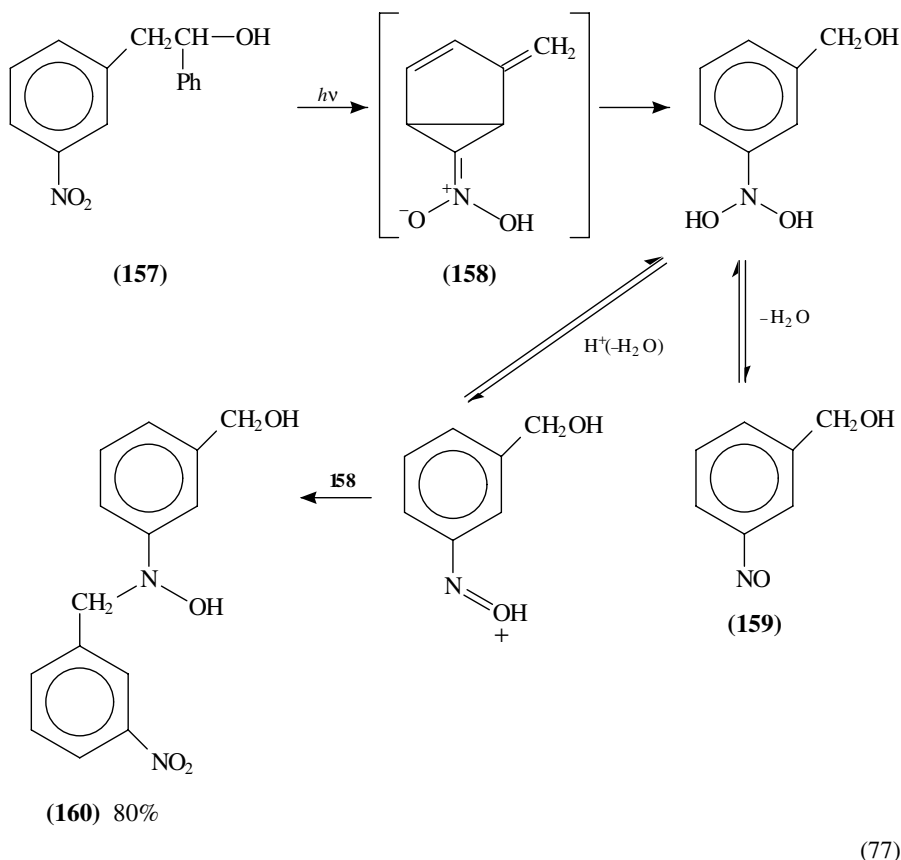


(156)

(76)

Evidence for the trapping of a non-Kekule intermediate in *m*-nitro participation was obtained in a photo-retro-aldol type reaction<sup>94</sup>. Photolysis of **157** in aqueous acid solution

( $\text{H}_2\text{SO}_4$ ,  $H_0 = -1.65$ ) leads to the formation of 3-(*N*-3'-nitrobenzyl-*N*-hydroxyamino)benzyl alcohol **160** in a high yield (equation 77).

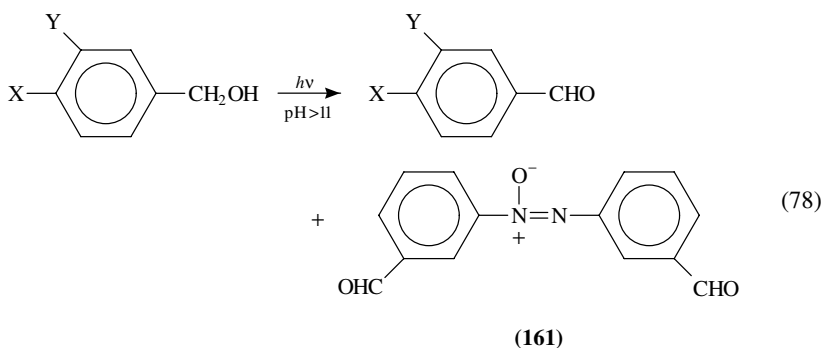


The intermediacy of nitrobenzyl carbanions in such photolysis is general, and also has been found in the photooxygenation of a series of nitrobenzyl derivatives including 2-methoxy-(*m*- and *p*-nitrobenzyl) ethanols<sup>95</sup>.

## H. Photoredox Reactions in Aqueous Solutions

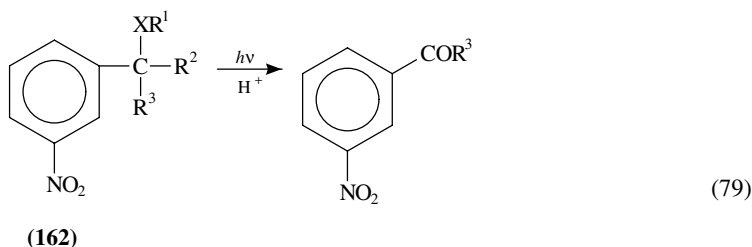
The photoredox reaction of *o*-nitrobenzyl compounds is mediated by intramolecular hydrogen abstraction and subsequent redox oxygen transfer following excitation in various solvents, and even in the solid state, due to the proximity of the two functional groups. Such reactions do not appear to involve catalysis by either external acids or bases. Similar photoredox reactions of *m*- and *p*-nitrobenzyl derivatives also take place, but only in aqueous solution and are subject to catalysis<sup>96,97</sup>. Irradiation of *p*-nitrobenzyl alcohol gives *p*-nitrosobenzaldehyde as the only product, in a reaction which is strongly catalysed by hydroxide ion<sup>97</sup> (equation 78). *m*-Nitrobenzyl alcohol gives *m*-nitrosobenzaldehyde as the major product by hydrogen ion catalysis<sup>98</sup> (equation 78); the azoxy compound **161** is also obtained in this case.





X, Y = H or NO<sub>2</sub>

This new type of photoredox reaction of *p*- and *m*-nitro-substituted aromatic derivatives is not observed in organic solvents, and is<sup>99,100</sup> extended to *m*-nitrobenzyl derivatives **162** containing alcohol, alkyl ether, ester or amine functions; these compounds undergo photooxidation to produce *m*-nitrobenzaldehyde (or *m*-nitroacetophenone) as the major isolable product<sup>100</sup> (equation 79).

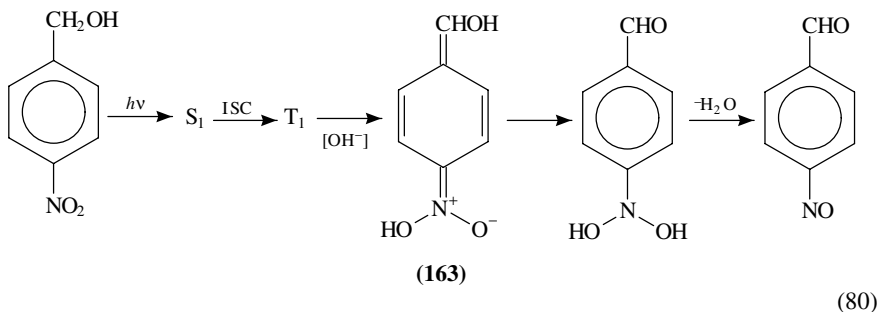


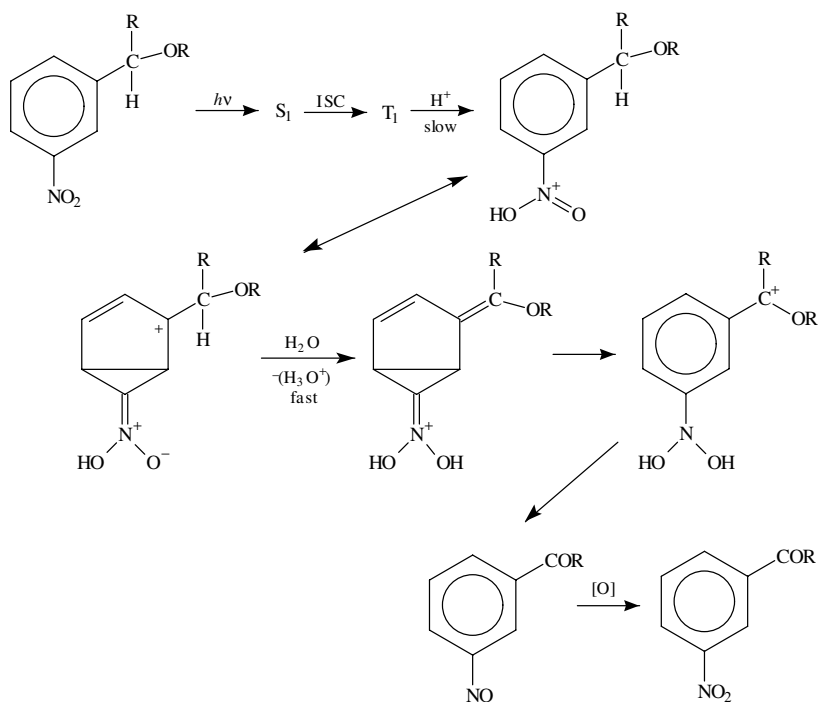
XR<sup>1</sup> = OH, OMe, OEt, OCOMe, NH<sub>2</sub>, OCH<sub>2</sub>Ph, OPh, H

R<sup>2</sup> = H, CH<sub>2</sub>OH, Me, CH<sub>2</sub>CO<sub>2</sub>Et, CH<sub>2</sub>OPh, OMe, COCH<sub>3</sub>

R<sup>3</sup> = H, Me, CH<sub>2</sub>OH

A general reaction mechanism for *m*-nitrobenzyl derivative is proposed (Scheme 8) which involves a non-Kekule intermediate<sup>100</sup>. The mechanism for the *p*-nitrobenzyl alcohol involves the highly polarized intermediate **163**, which is consistent with the observed strong solvent effect and base catalysis of the reaction (equation 80).

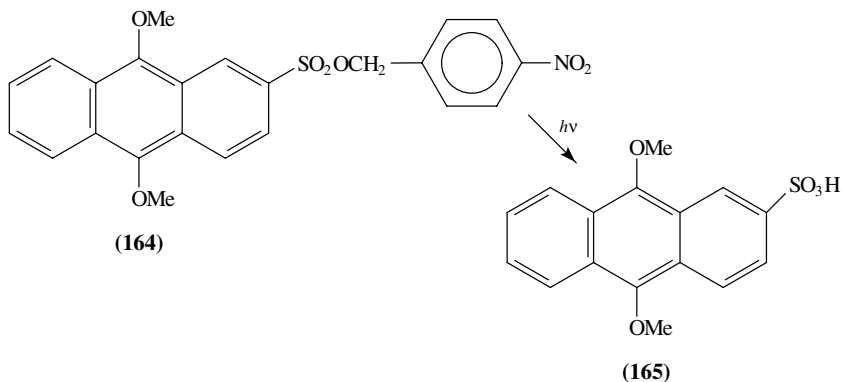




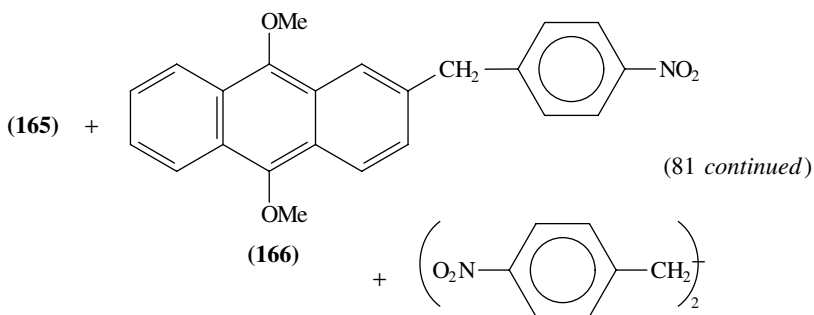
SCHEME 8

### I. Photodissociation

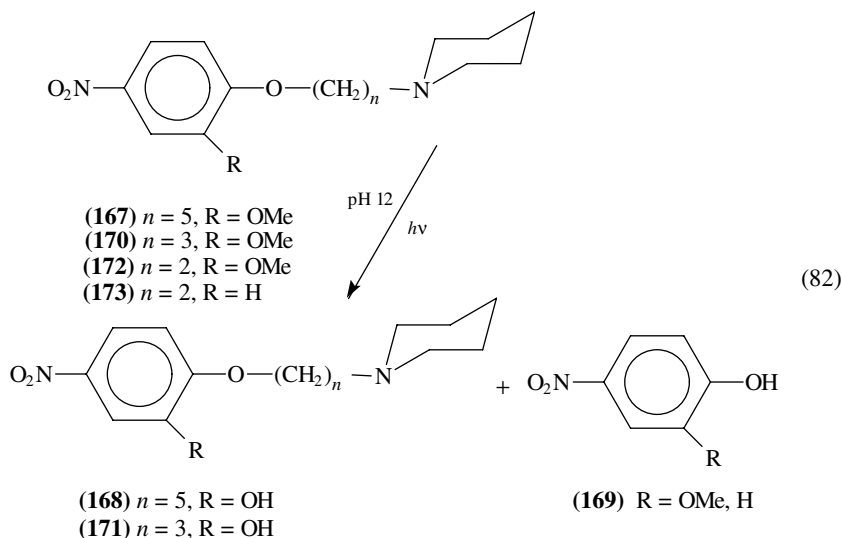
A new type of photodissociation for *p*-nitrobenzyl 9,10-dimethoxyanthracene-2-sulphonate **164** has been reported to give 9,10-dimethoxy-anthracene-2-sulphonic acid **165**, 9,10-dimethoxy-2-(*p*-nitrobenzyl)-anthracene **166** and *p,p'*-dinitrobenzyl<sup>101</sup> (equation 81). It is suggested to occur from excited intramolecular electron transfer followed by radical ion decompositions and recombinations.



(81)

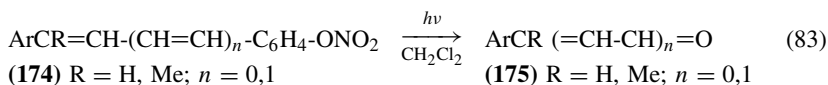


Topologically controlled intramolecular coulombic interactions have been applied to study the photochemical cleavage reactions of a series of 4-nitrophenyl ethers linked through a methylene chain to a tertiary amine (e.g. **167**, **170**, **172** and **173**). The product distribution is controlled by the chain length<sup>102,103</sup>. The photoproduct pattern in aqueous basic media (pH = 12) is shown in equation 82, where the usual *meta*-substituted photoproduct **168** is the highest at  $n = 5$  and decreased to *ca* 10% for  $n = 3$  and to nil for  $n = 2$ . In contrast, 2-methoxy-4-nitrophenol, the *p*-substituted photoproduct, increases from a trace amount for  $n = 5$  to quantitative yield for  $n = 2$ . The latter agrees with the clean photolyses of **173**. As shown, the photocleavage of the *p*-alkyl ether linkage occurs preferentially for the substrate containing a short (two or three methylene units) link between donor and acceptor; this may arise from unusual stabilization of the intramolecular charge transfer state and constitute a new type of photocleavage reaction.



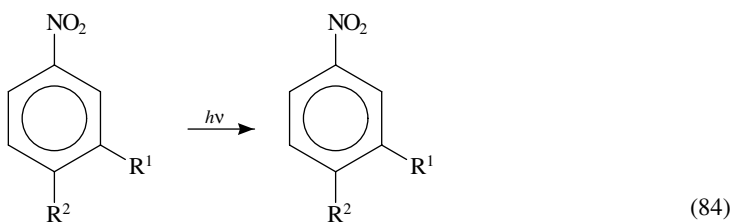
New photochemical cleavage reactions of *ortho*-substituted C=C double bonds were reported by introducing a 2-nitrophenyl group to the double bond<sup>104</sup>. Photolysis of 1-(2-nitrophenyl)-1-alkenes **174** in methylene chloride solution without oxygen affords aryl

and  $\alpha,\beta$ -unsaturated aldehyde in 30–80% yields (equation 83).



Ar = Ph, *p*-ClC<sub>6</sub>H<sub>4</sub>, *p*-MeC<sub>6</sub>H<sub>4</sub>, 1-C<sub>10</sub>H<sub>7</sub>, 2-C<sub>10</sub>H<sub>7</sub>

Photolysis of 4- and 3-nitrophenyl acetates (**176** → **177**; **178** → **179**) in neutral aqueous solution leads to the corresponding phenols with quantum yields 0.002 and 0.006<sup>105</sup> (equation 84). A greater difference in the photoreactivity (quantum yields of 0.002 and 0.129, respectively) is shown between 2-methoxy-4-nitrophenyl acetate **180** and 2-methoxy-5-nitrophenyl acetate **182**. The nitro substituent clearly exhibits a *meta*-activating effect in the hydrolysis of phenyl acetates.



(176) R<sup>1</sup> = H, R<sup>2</sup> = OCOCH<sub>3</sub>

(177) R<sup>1</sup> = H, R<sup>2</sup> = OH

(178) R<sup>1</sup> = OCOCH<sub>3</sub>, R<sup>2</sup> = H

(179) R<sup>1</sup> = OH, R<sup>2</sup> = H

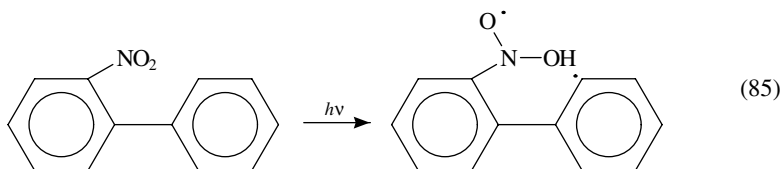
(180) R<sup>1</sup> = OMe, R<sup>2</sup> = OCOCH<sub>3</sub>

(181) R<sup>1</sup> = OMe, R<sup>2</sup> = OH

(182) R<sup>1</sup> = OCOCH<sub>3</sub>, R<sup>2</sup> = OMe

(183) R<sup>1</sup> = OH, R<sup>2</sup> = OMe

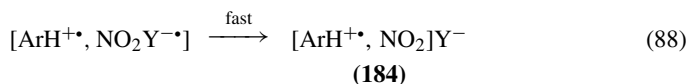
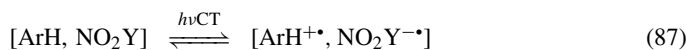
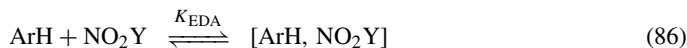
A new triplet diradical is detected by ESR from the photolysis of 2-nitrobiphenyl<sup>106</sup> (equation 85). The spectrum shows a temperature dependence which implies that the observed triplet state is a ground state.



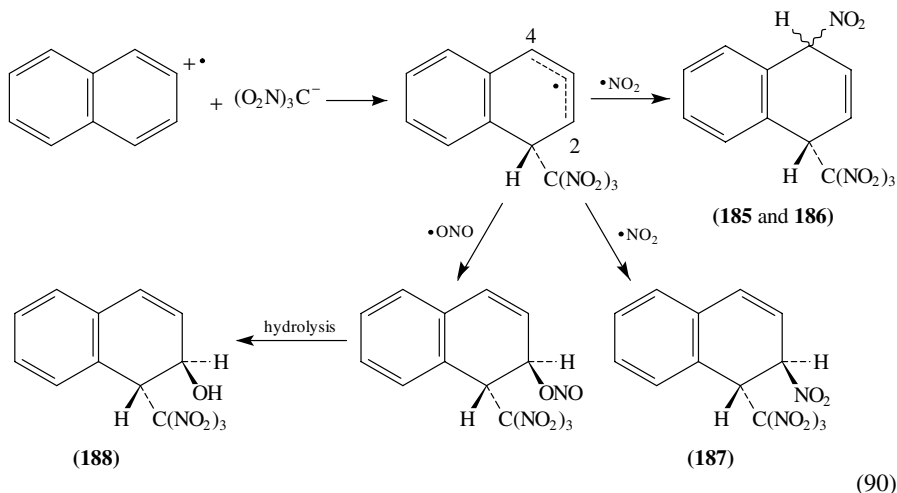
## J. Photonitration

The nitration reagents (NO<sub>2</sub>Y) for electrophilic aromatic nitration span a wide range and contain anions Y such as nitric acid (Y = OH<sup>-</sup>), acetyl nitrate (Y = OAc<sup>-</sup>), dinitrogen pentoxide (Y = NO<sub>3</sub><sup>-</sup>), nitryl chloride (Y = Cl<sup>-</sup>), *N*-nitropyridinium (Y = pyridine) and tetranitromethane [Y = C(NO<sub>2</sub>)<sub>3</sub><sup>-</sup>]. All reagents contain electron-deficient species which can serve as effective electron acceptors and form electron donor-acceptor (EDA) complexes with electron-rich donors including aromatic hydrocarbons<sup>107</sup> (ArH, equation 86). Excitation of the EDA complexes by irradiation of the charge-transfer (CT) absorption band results in full electron transfer (equation 87) to form radical ion

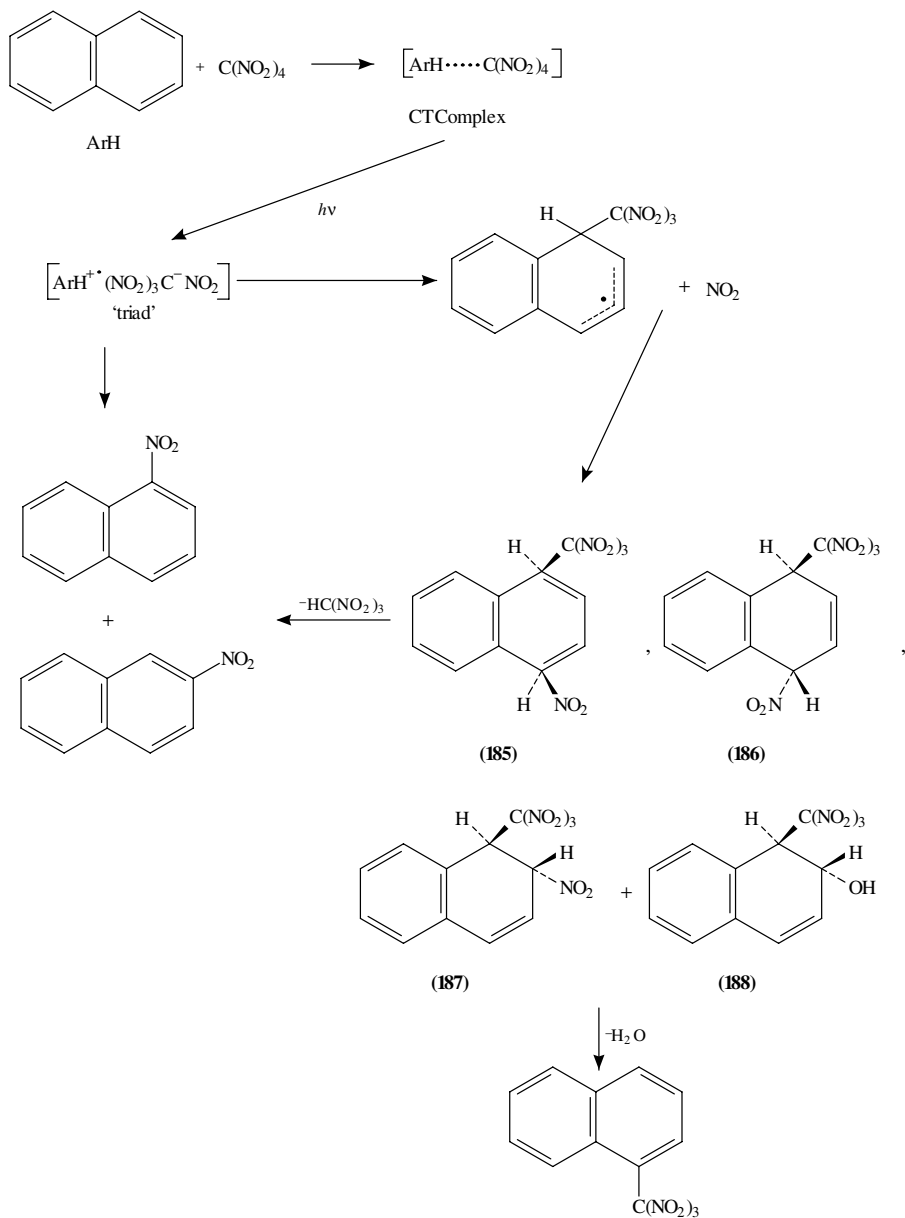
pairs. Subsequent fragmentation to **184** (equation 88) and radical recombination gives the nitration products (equation 89). This photoinduced inner-sphere electron transfer provides a new method of photonitration<sup>107</sup> and is a topic of current interest<sup>108</sup>. The EDA complexes of tetranitromethane (the electron acceptor) with arenes can be photolysed to cause the nitration of the arenes such as anisole<sup>109</sup>, anthracene<sup>110</sup>, naphthalene<sup>111</sup>, fluorene<sup>112</sup>, benzene<sup>113</sup>, dibenzofuran<sup>114</sup> and others. The photonitration of naphthalene with tetranitromethane is summarized in Scheme 9<sup>108</sup>.



When the naphthalene and tetranitromethane charge-transfer complex is photolysed in dichloromethane or acetonitrile at a low temperature, the nitro-trinitromethyl adducts **185**, **186**, **187** and hydroxy-trinitromethyl adduct **188** together accounted for 85–95% of the product mixture; the remaining products are 1- and 2-nitronaphthalene. The adduct **188** is a secondary product formed by hydrolysis of the corresponding nitrite during photolysis. Adducts **185**, **186** and **187** are all unstable and easily undergo elimination to give mainly 1-nitronaphthalene, with 2-nitronaphthalene as minor product. In Scheme 9, the formation of the radical ion pair is followed by fast fragmentation of the tetranitromethane radical anion to give a 'triad'. The initial chemical process is assumed to come from the trinitromethanide attack on naphthalene cation radical followed by the radical recombination (see equation 90).

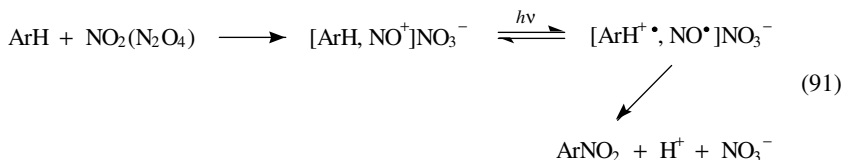


In the nitration of arenes with  $\text{N}_2\text{O}_4$ , the red-coloured transient arises from the metastable precursor complex  $[\text{ArH}, \text{NO}^+]\text{NO}_3^-$  which is formed in the prior



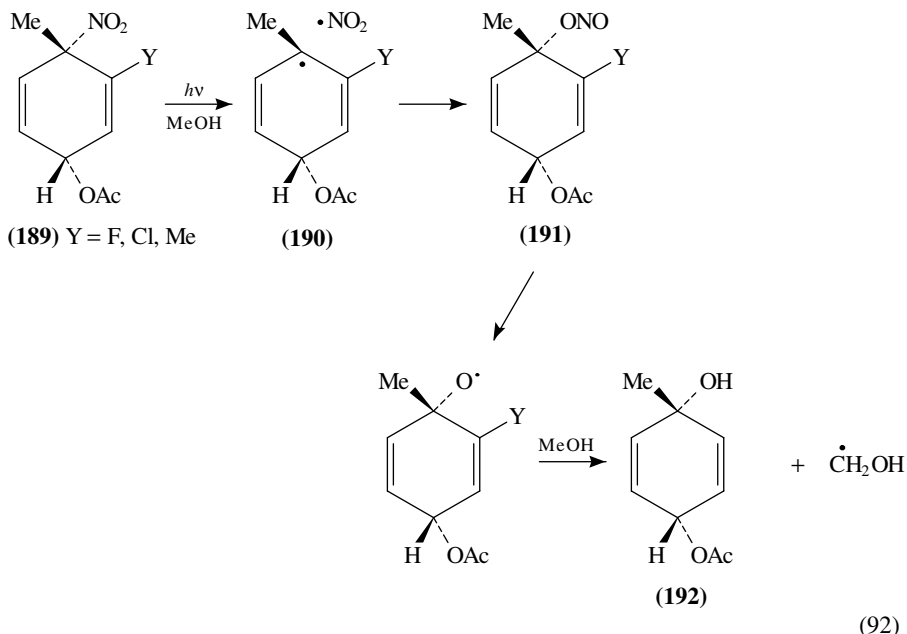
SCHEME 9

disproportionation of nitrogen dioxide induced by the aromatic donor<sup>115</sup> (equation 91). Irradiation at this charge-transfer absorption band at a low temperature results directly in aromatic nitration, which has been shown with 1,3,5-trimethylbenzene, toluene and others.

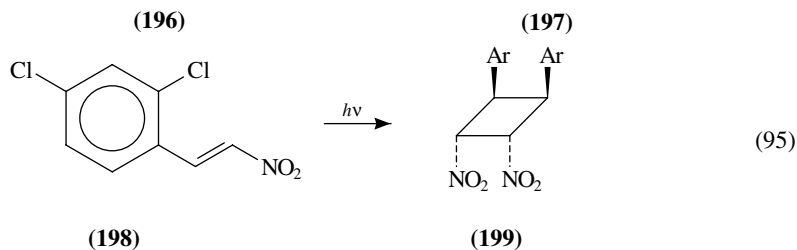
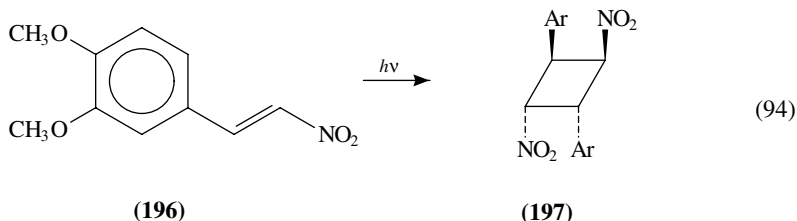
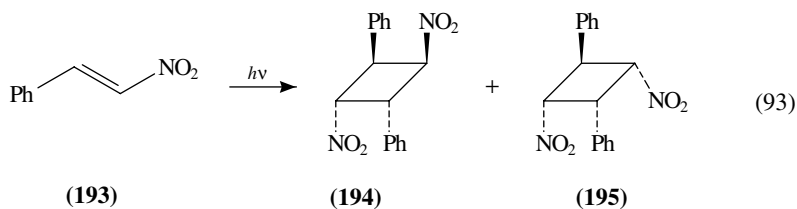


### III. PHOTOCHEMISTRY OF NITRO-OLEFINS

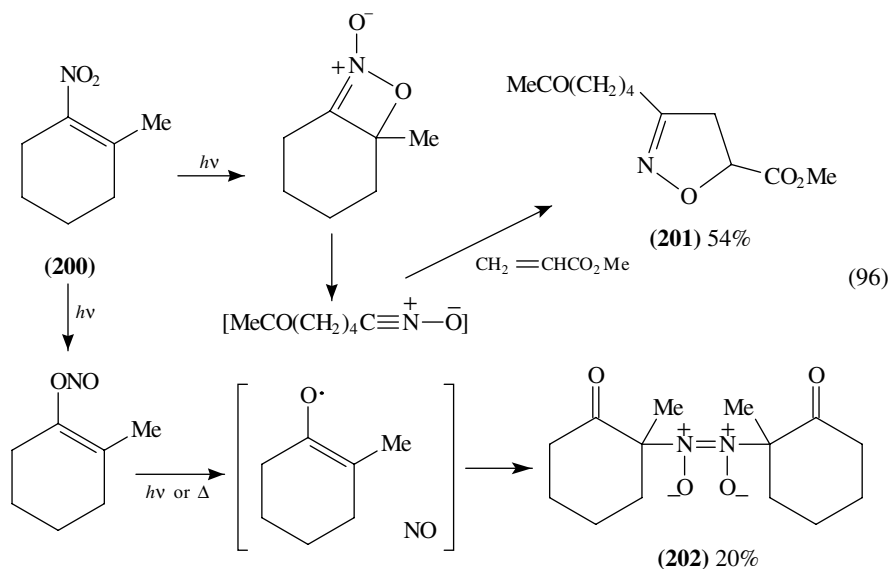
Photolysis of 4-nitro-2,5-cyclohexadienyl acetates in methanol gives 4-hydroxy-2,5-cyclohexadienyl acetates stereospecifically<sup>116</sup> although the mechanism (equation 92) involves the scission of the C–N bond (and therefore, the possible loss of chirality) to form the cyclohexadienyl radical and nitrogen dioxide pair in a solvent cage **190**. A recombination at the oxygen site ( $\text{NO}_2$ ) gives the corresponding nitrite **191**, which is then further photolysed to give the alcohol **192** via the alkoxy radical. The clean retention of stereochemistry in nitrite **191** implies that the radical pair **190** in the cage maintains a tight relation on the same face.



The crystalline state of **193** was irradiated with sunlight at 5 °C (equation 93) to afford the cyclobutanes **194** and **195** in a 3:1 ratio<sup>117</sup>. Compound **195** obviously arose from the dimerization of the *cis*-isomer of **193**. The disordered crystal structure of **193** permits isomerization of **193** to the *cis*-isomer which photolytically reacted with **193** to give **195**. Interestingly, the crystalline state of compound **196** and **198** was photolysed to **197** and **198**, respectively (equations 94 and 95), but  $\beta$ -nitro-*p*-methylstyrene was photostable.

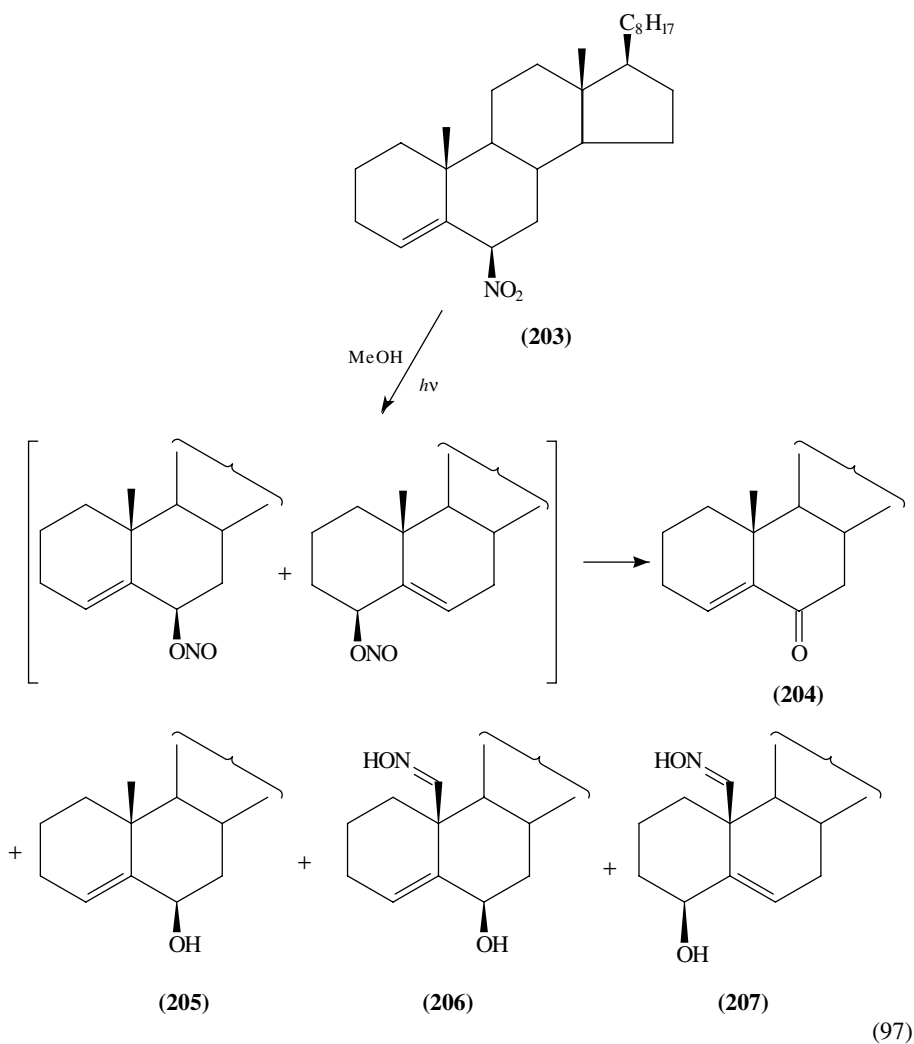


Irradiation of 1-methyl-2-nitrocyclohexene **200** in benzene in the presence of methyl acrylate showed a dual pathway to give both isoxazoline **201** (54%) and the C-nitroso dimer **202** (22%)<sup>118</sup> (equation 96). The isoxazoline **201** arose from an excited-state intramolecular cyclization and scission to give a nitrile N-oxide which is trapped by the acrylate. Concurrently, the photoinduced nitro–nitrite inversion also occurs competitively to give the C-nitroso compound which is isolated as the dimer **202**.





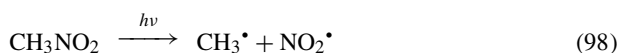
The functionalization of an unactivated but strategically located carbon can be initiated by intramolecular alkoxy radical hydrogen abstraction that can be induced by nitrite photolysis. Thus photolysis of 6 $\beta$ -nitrocholest-4-ene **203** in methanol under nitrogen causes the nitro-to-nitrite conversion in the first step, followed by the secondary nitrite photochemical transformation to afford cholest-4-en-6-one **204** (7%) cholest-4-en-6 $\beta$ -ol **205** (11%), and compounds **206** (24%) and **207** (7%)<sup>119</sup> (equation 97). While a number of products is obtained, it is significant that  $\beta$ -nitro configuration is stereospecifically retained in the nitrite intermediate, as can be judged from the  $\beta$ -alcoholic configuration. A small amount of leakage to 4 $\beta$ -nitrite (and 4 $\beta$ -OH product **207**) indicates a possibility of, but not the necessity of, the dissociative mechanism proposed in the nitro–nitrite conversion in equation 92, although it must be mentioned that a C–N bond homolysis is generally accepted in photoexcitation of nitroalkanes (see Section IV.A).



#### IV. PHOTOCHEMISTRY OF ALIPHATIC NITRO COMPOUNDS

##### A. Simple Nitroalkanes

The primary photochemical reaction for nitromethane in the gas phase is well supported by experiments to be the dissociation of the C–N bond (equation 98). The picosecond laser-induced fluorescence technique has shown that the ground state NO<sub>2</sub> radical is formed in <5 ps with a quantum yield of 0.7 in 264-nm photolysis of nitromethane at low pressure<sup>120</sup>. The quantum yield of NO<sub>2</sub> varies little with wavelength, but the small yields of the excited state NO<sub>2</sub> radical increase significantly at 238 nm. In a crossed laser–molecular beam study of nitromethane, it was found that excitation of nitromethane at 266 nm did not yield dissociation products under collision-free conditions<sup>121</sup>.

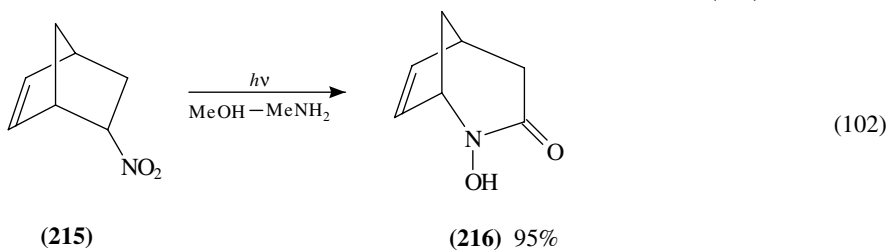
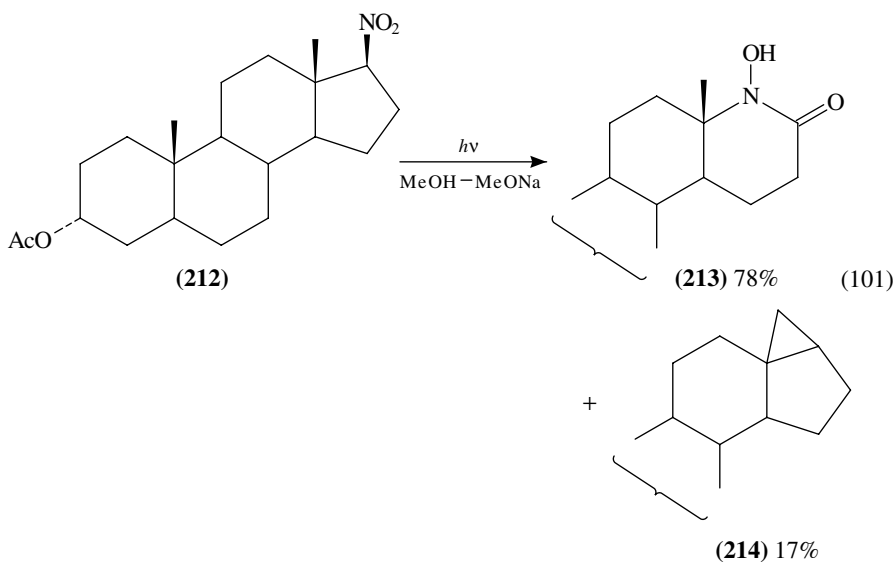
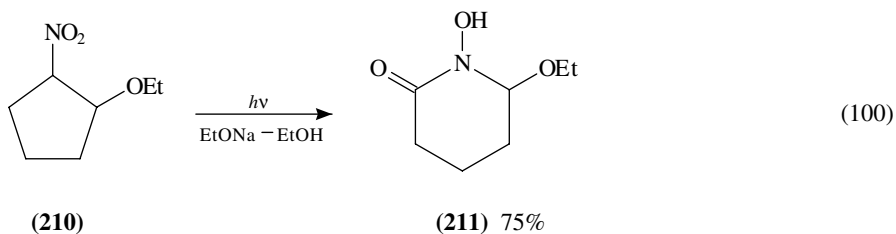
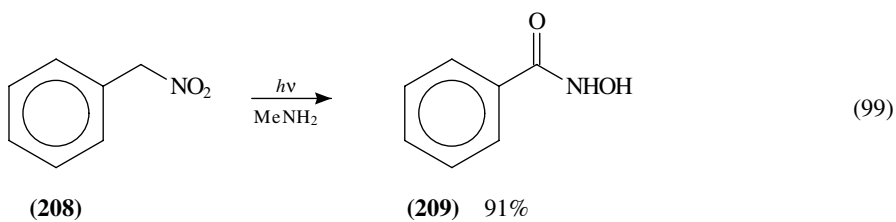


Two independent and complementary techniques, product emission spectroscopy and molecular beam photofragment translational energy spectroscopy, have been applied to confirm the C–N cleavage as the primary process at 193 nm in the ( $\pi\pi^*$ ) excitation<sup>122</sup>. The majority of the NO<sub>2</sub> radical produced is in the vibrationally excited <sup>2</sup>B<sub>2</sub> state, and unimolecular dissociation to NO + O is revealed by molecular beam studies. Several products (OH, HONO and NO<sub>2</sub>) were detected under one-photon and collision-free photoexcitation (222, 249 and 308 nm) of 2-nitropropane<sup>123</sup>. The collision-free photolysis at 282 nm for nitroethane, 1-nitropropane, 2-nitropropane and *tert*-nitrobutane has indicated that the OH radical is formed in the primary process<sup>124</sup>. The participation of a five-membered ring intermediate in the process is supported by relative yield data and by the observation that CH<sub>3</sub>CD<sub>2</sub>NO<sub>2</sub> yields OH exclusively and no OD. No OH formation from nitromethane is observed. In marked contrast to the nitromethane photodissociation, no evidence is found for simple C–N bond fission for nitromethyl radical ( $\bullet\text{CH}_2\text{NO}_2$ ) which was studied using a fast beam photofragment translation spectrometer<sup>125</sup>.

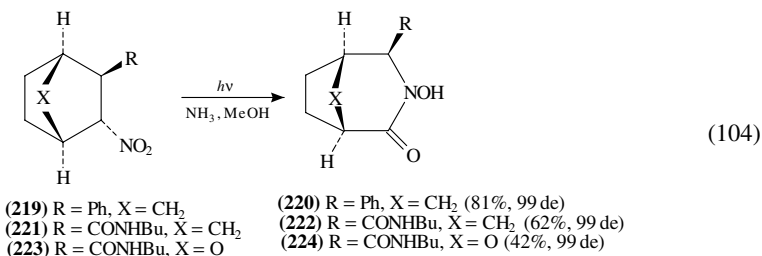
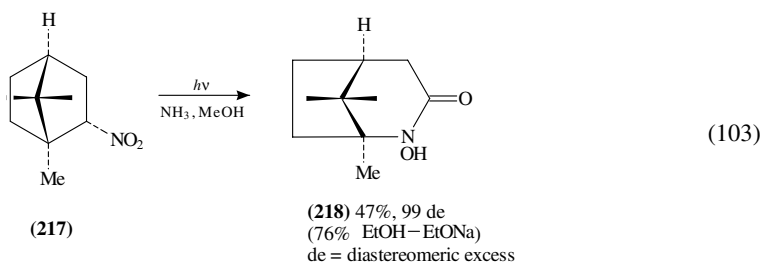
Nitromethane was photolysed in solid argon at 14 K to give *syn*- and *anti*-CH<sub>3</sub>ONO<sup>126</sup> as identified by IR absorptions. On prolonged photolysis, nitromethanol, CO, NO, HNCO and the hydrogen-bonded complexes H<sub>2</sub>CO···HNO and H<sub>2</sub>O–HNCO were detected by infrared absorption. When the enhanced role of cage recombinations is taken into account, the proposed mechanism in argon matrix is compatible with that determined from gas-phase studies of the photolysis of nitromethane. When nitromethane was exposed to ionizing irradiation in a solid matrix and studied by ESR, the primary process was electron ejection<sup>127</sup>. This is frequently followed by specific electron capture, so radical species are trapped in the rigid matrix. In dilute solutions of CD<sub>3</sub>OD such a captive yields nitromethane radical anions, and in that of CFC<sub>3</sub> nitromethane radical cations. In marked contrast, the exposure of nitromethane liquid to gamma rays at 77 K gives mainly CH<sub>3</sub> and NO<sub>2</sub> radicals.

##### B. aci-Nitronates

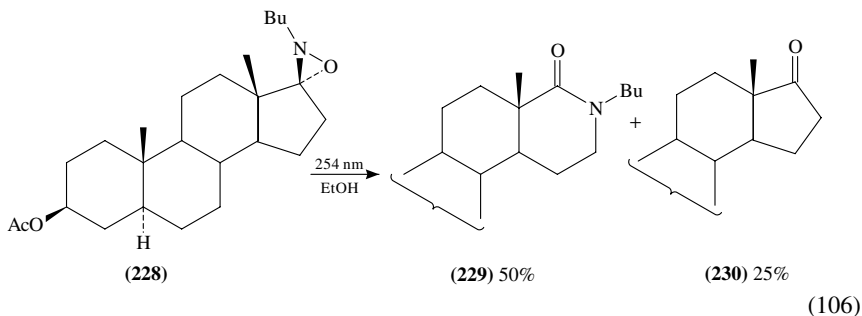
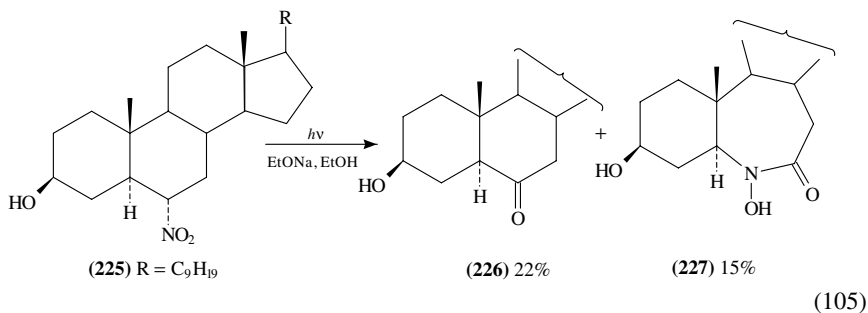
Further studies on the photochemistry of aci-nitronate anion have revealed that the reaction occurs from the  $\pi\pi^*$  triplet excited states causing an oxygen migration to give hydroxamic acids<sup>128,129</sup>. The photorearrangement gives regiospecific products with the retention of the configuration at the migratory terminus in high yields (equations 99–102).

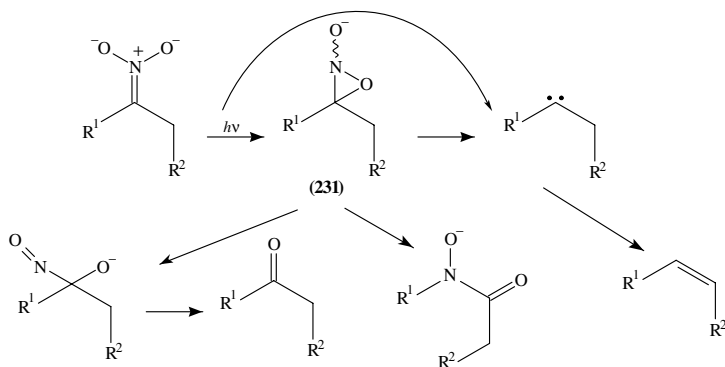


Correlative studies revealed that the faster the rate of nitronate formation, the higher the yields of the hydroxamic acids<sup>130</sup> (equations 103 and 104).



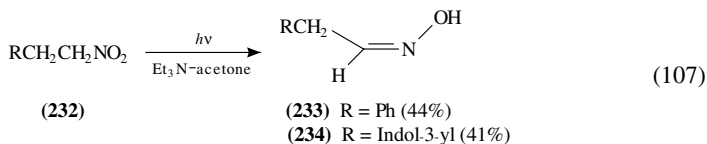
Photolysis of nitro-steroids **225** yields the aci-nitronate at 254 nm<sup>131</sup>. This in turn gives various products, among them are ketone **226** and hydroxamic acid **227** (equation 105) which could be formed from the intermediate anions of the *N*-hydroxyoxaziridines, with a possible participation of *gem*-hydroxynitroso transient (or its anion; see Scheme 10). For comparison, *N*-butyl spiro-oxaziridine **228** in ethanol is photolysed at 254 nm (equation 106) to give *N*-butyl lactam **229** (50%) and the ketone **230** (25%). The former process is a well-known photoprocess of oxaziridine<sup>131</sup>.





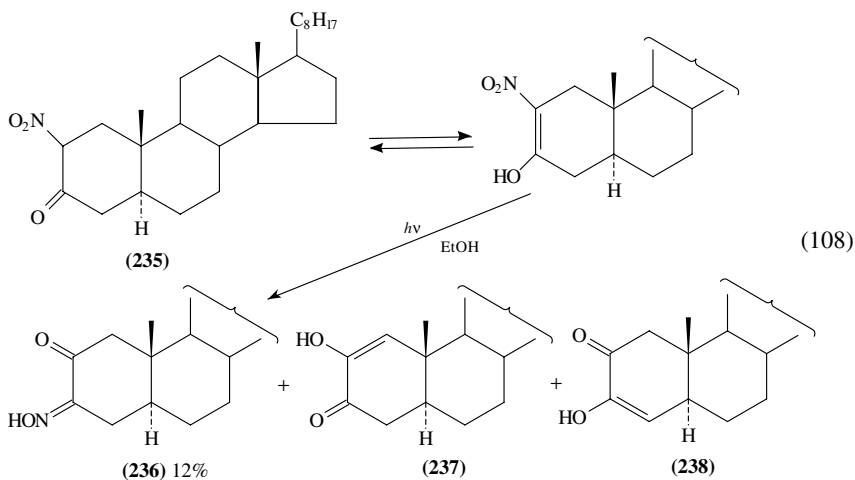
SCHEME 10

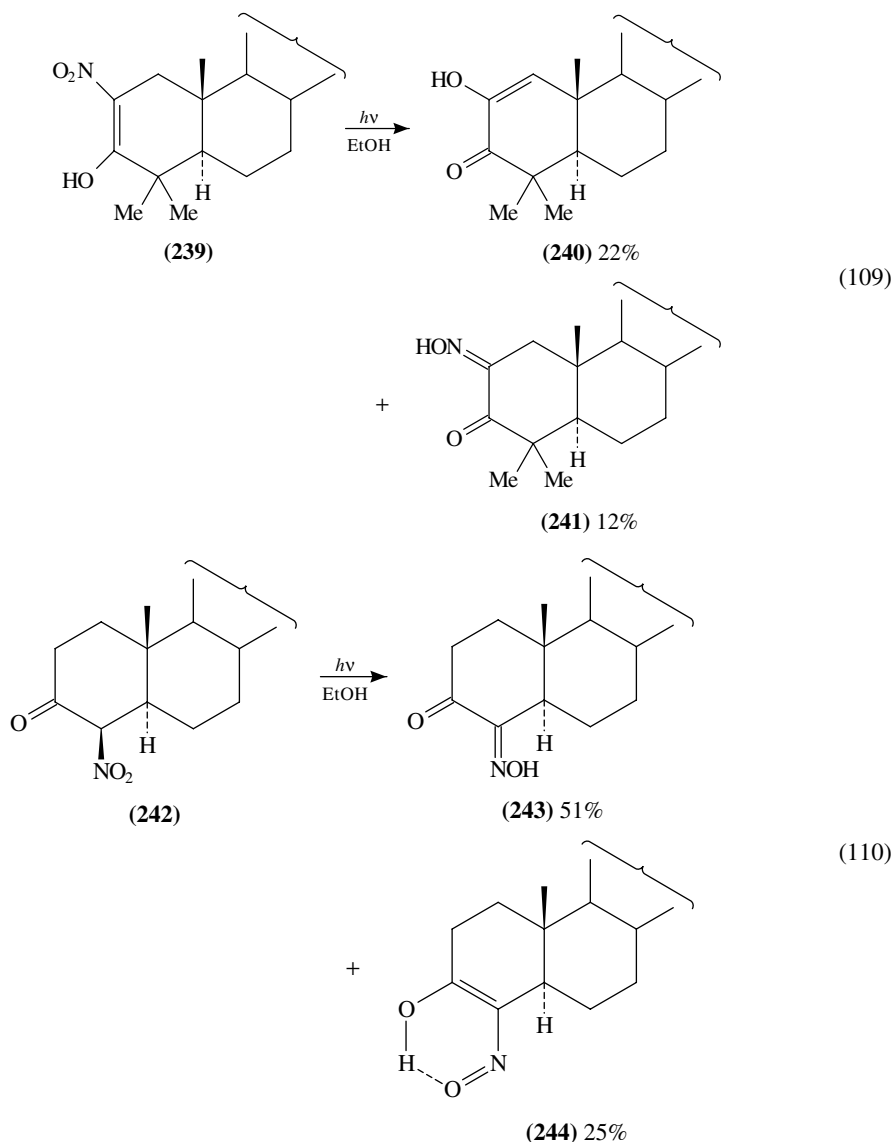
Aliphatic nitro compounds can be photolytically converted into oximes in acetone in the presence of triethylamine in moderate yields (30–74%)<sup>132</sup>, as shown by the examples in equation 107.



### C. Geminally Substituted Nitroalkanes

Both 2-nitro steroids **235** and **239** exist as the enols in ethanol, and are photolysed to give the corresponding  $\alpha$ -diketones **237** and **238** (23% in 1:1 ratio)<sup>133</sup> (equation 108) and **240** (equation 109), but different monoxime **236** and **241**, respectively. On the contrary, 4-nitroketone **242** exists in the keto form, and is photolysed to give the  $\alpha$ -oximino ketone **243** and its tautomer **244** without the diketones (equation 110).

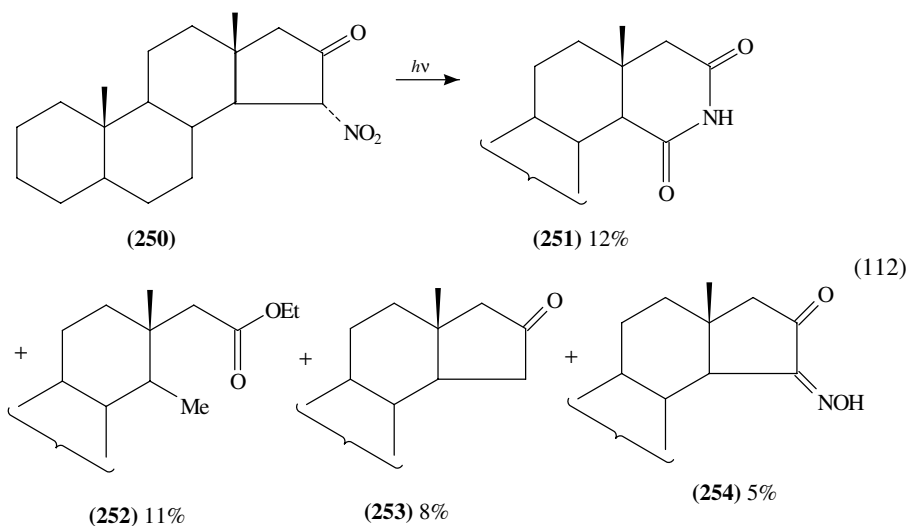
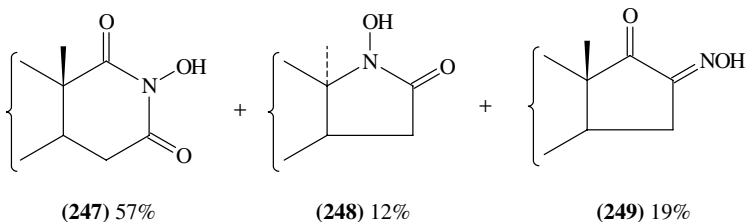
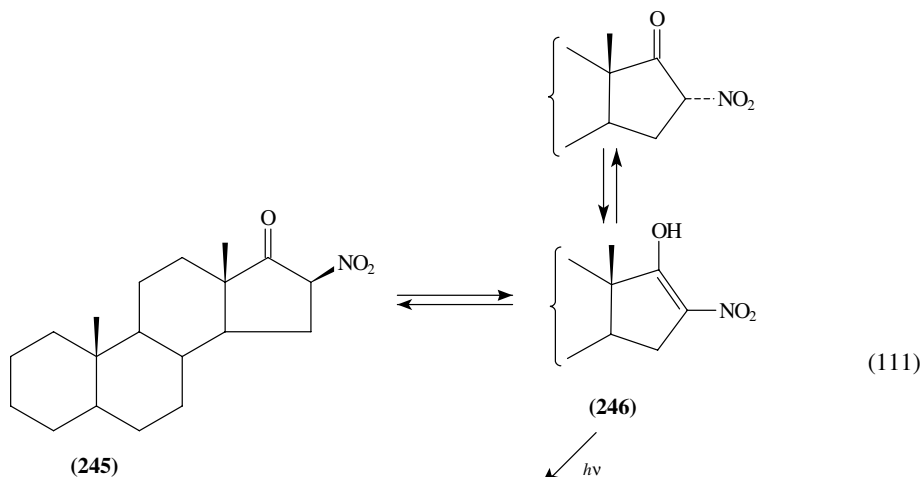


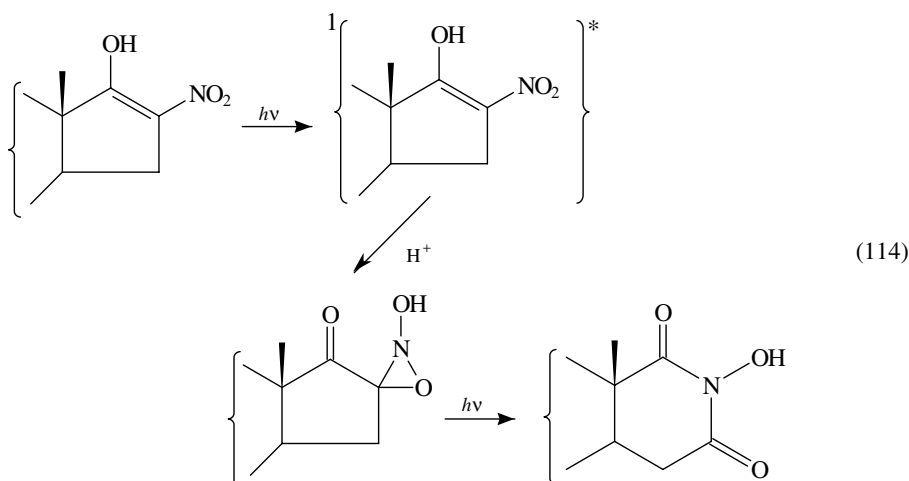
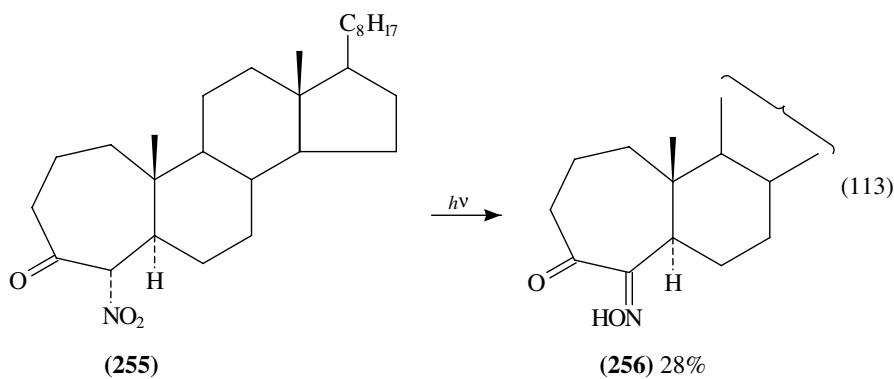


It is proposed that  $\alpha$ -hydroxyimino ketones are derived from a reaction pathway initiated from the hydrogen abstraction by the  $n\pi^*$  triplet-excited nitro group of the keto form, while  $\alpha$ -diketones are formed from the nitro–nitrite photorearrangement of the enol forms<sup>133</sup>.

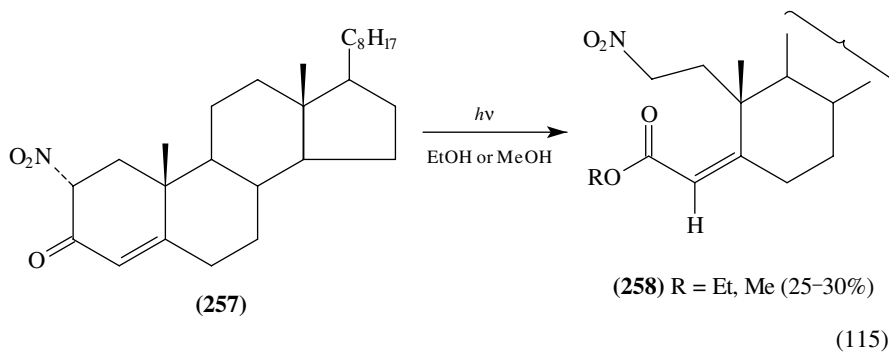
Photochemistry of the  $\alpha$ -nitroketones located in a steroidal ring has been studied<sup>134</sup>. The photoreaction of **245** (enol form) gives the corresponding cyclic *N*-hydroxy imide **247** (57–61%) (equation 111), whereas **250** (exclusively in the keto form) gives a cyclic imide which is formed from the  $\alpha$ -oximinoketone **254** by light-promoted Beckmann rearrangement<sup>134</sup> (equation 112). The mechanism of the formation of the *N*-hydroxy imide

**247** (see equation 111) can be visualized in analogy to that observed in the nitronate rearrangement (e.g. Scheme 10); it is noteworthy that **245** reacts from its singlet excited enol (equation 114). Photoreactions of the seven-membered-ring  $\alpha$ -nitrosteroidal ketone **255** in ethanol gave the corresponding  $\alpha$ -hydroxyimino ketones in a low yield<sup>134</sup> (equation 113).

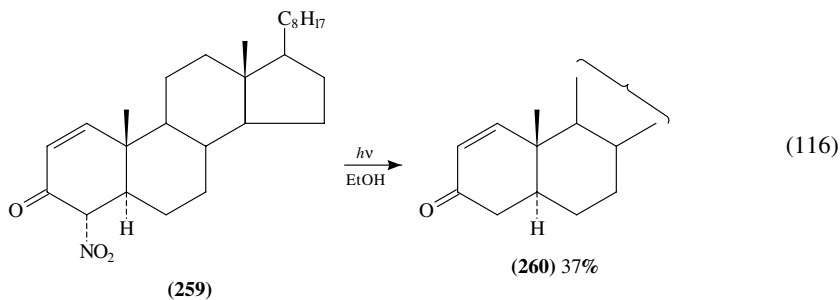




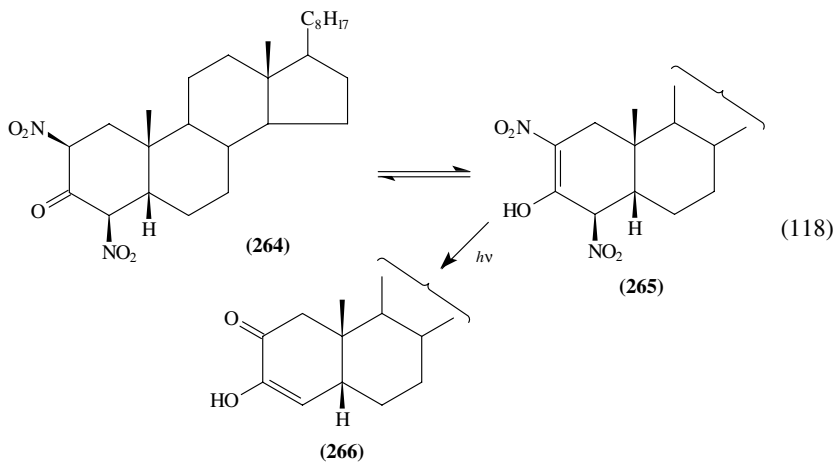
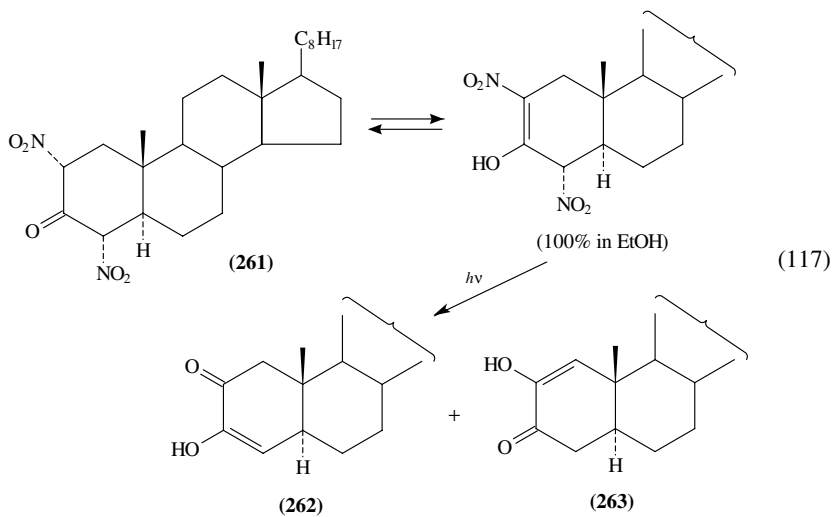
Photolysis of six-membered steroidal  $\alpha$ -nitro enones<sup>135</sup> **257** in protic solvents results in an unexpected  $\alpha$ -cleavage of the carbonyl group to give 3-alkoxy-2-nitro-2,3-secocholest-4-en-3-one **258** (equation 115) while irradiation of **259** gives the parent cholest-1-en-3-one **260** which is obtained by exchange of the nitro group with a hydrogen atom (equation 116).







In ethanol 2,4-dinitro-5 $\alpha$ -cholestan-3-one, **261**, exists entirely as the enol, which is irradiated to give a mixture of diosphenols, **262**, and its isomer, **263**, in 55% yield (equation 117)<sup>136</sup>. Similarly, photolysis of an equilibrium mixture of **264** and **265** gives **266** in 48% yield (equation 118).



The mechanism for this efficient removal of the two nitro groups to give an  $\alpha$ -diketone can be written in various ways with reference to existing proposals for allied compounds. It is noteworthy that it should specifically involve the homolysis of the C–N bond of the 4-nitro group, which is assumed to occur in the initial stage upon excitation.

## V. PHOTOCHEMISTRY OF C-NITROSO COMPOUNDS

### A. Simple Nitrosoalkanes

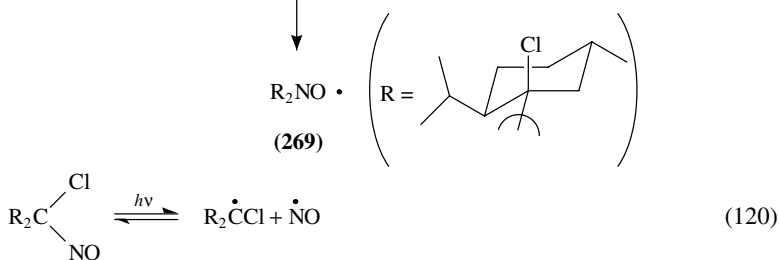
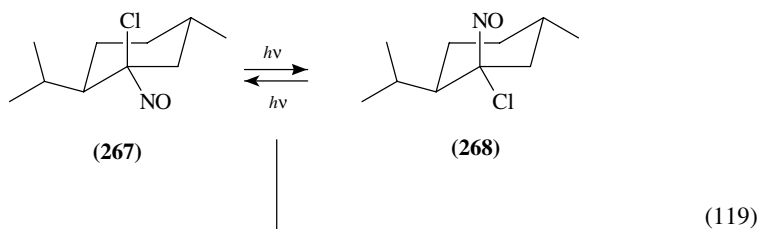
Both the molecular potential energy<sup>137</sup> and the photodissociation<sup>138</sup> of nitrosomethane were studied by *ab initio* SCF-CI techniques. There are geometry changes induced by the excitation and  $n\pi^*$  transition of nitrosomethane; the single excited-state surface has an energy barrier along the dissociation coordinate<sup>138</sup>. The first triplet state is not a dissociate state.

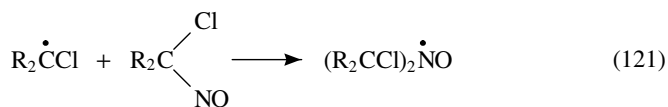
The photoelectron spectra of nitrosomethane, 2-methyl-2-nitrosopropane and perhalogeno nitrosomethanes has been re-examined and re-assigned on the basis of *ab initio* SCF-CI calculations<sup>139</sup>. Photoionization quantum yields<sup>140</sup> have been measured for 2-methyl-2-nitrosopropane at wavelengths 147, 123, 105 and 107 nm. The results show that photoionization at energies up to 1.5 eV above threshold is of low probability. The data have been compared with those of recent photoelectron spectroscopy.

Since the primary photochemical process for nitrosoalkane involves the homolytic dissociation of the C–N bond to generate free radicals<sup>141</sup>, recent studies on the photochemistry of nitrosoalkanes pay more attention to radical reactions and to the methods of detection, such as spin trapping studies coupled with ESR techniques<sup>142</sup>.

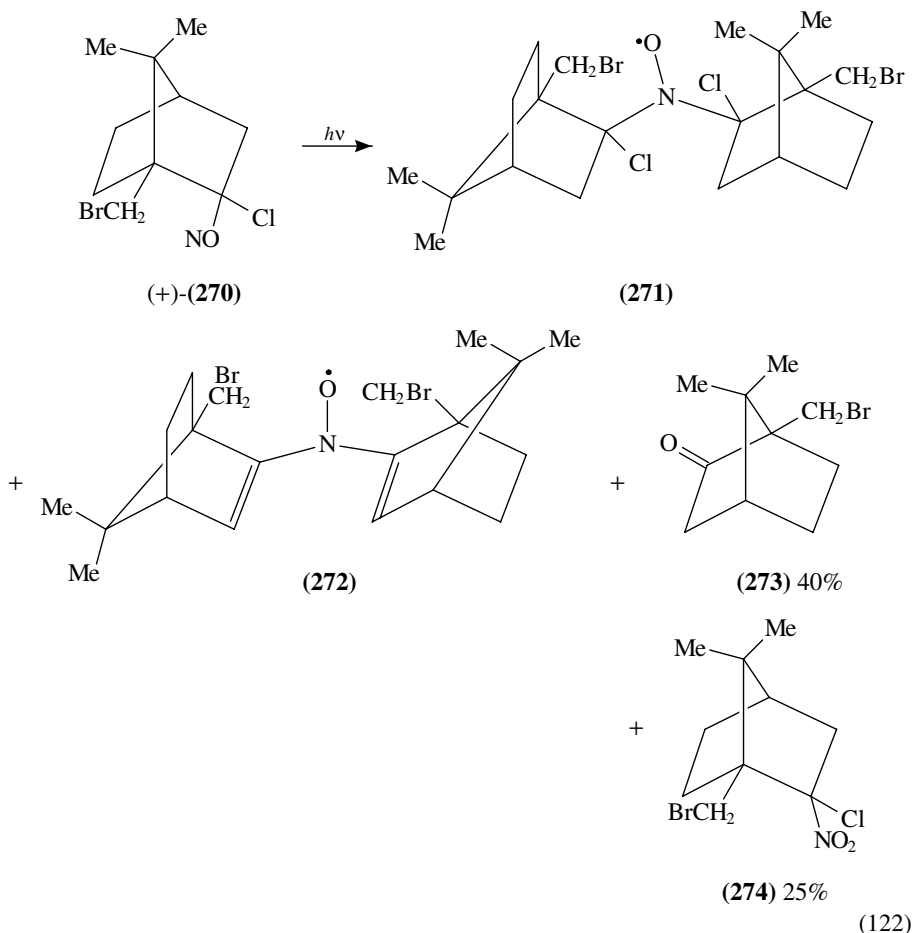
### B. Geminally Substituted Nitroalkanes

The diastereomeric 2-chloro-2-nitroso-*p*-menthane and 3-chloro-3-nitroso-*p*-menthane (**267**) epimerize during photolysis<sup>143</sup> (equation 119) and can concurrently give the nitroxide **269** as detected by ESR spectrometry, which confirms the mechanism for the photolysis of geminally substituted nitroso compounds (equations 120 and 121).



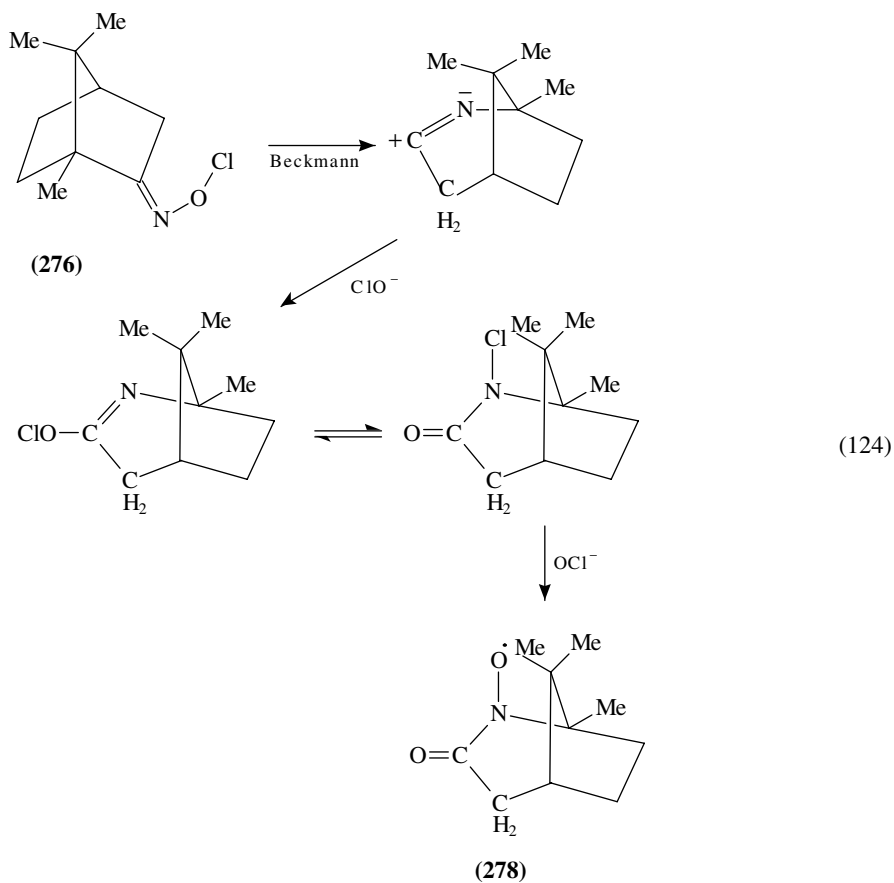
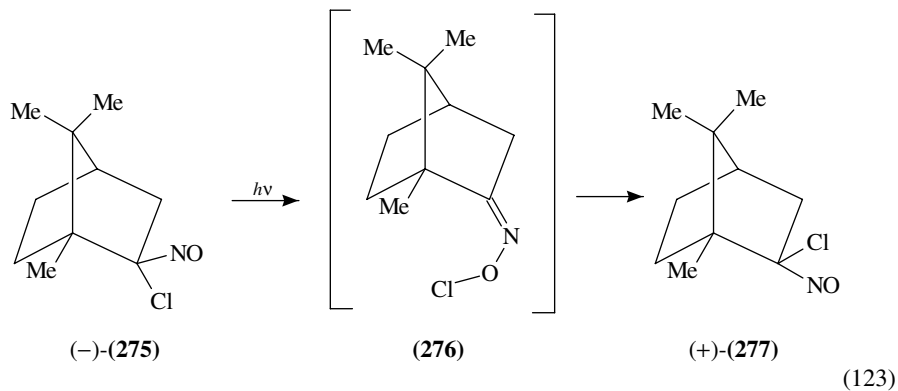


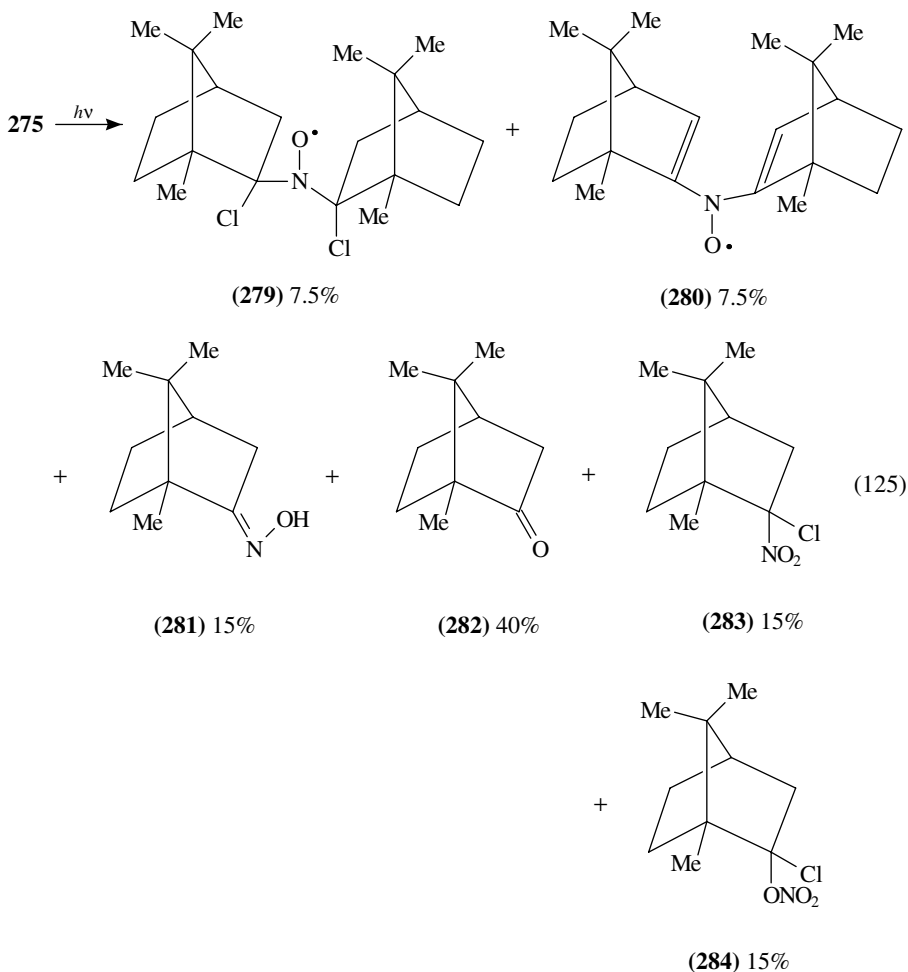
Photolysis of the blue solid (+)-10-bromo-2-chloro-2-nitrosocamphane (**270**) with red light produces two nitroxide radicals **271** and **272** and 10-bromo camphor **273**, 10-bromo-2-chloro-2-nitro camphane **274** in addition to some minor products (equation 122). A complex reaction mechanism has been proposed<sup>144</sup>.



Solid-state photochemistry of (–)-2-chloro-2-nitrosocamphane **275** was studied<sup>145</sup> by irradiation of the blue-crystal with red light to invert the configuration at C(2) (equation 123). This also causes a photochemically initiated Beckmann rearrangement to form chloroxime **276** to give nitroxide radical **278** (equation 124). The intermediate chloro oxime **276** is proposed to arise from the  $n\pi^*$  excitation and is believed to be the common intermediate for the photo-epimerization and Beckmann rearrangement. Extended

irradiation produces two additional nitroxides **279** and **280**, and camphor oxime **281**, camphor **282**, 2-chloro-2-nitro camphane **283** as well as 2-chloro-2-nitratocamphane **284** (equation 125).



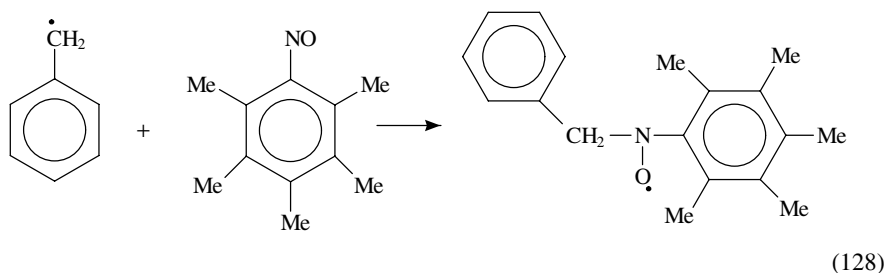
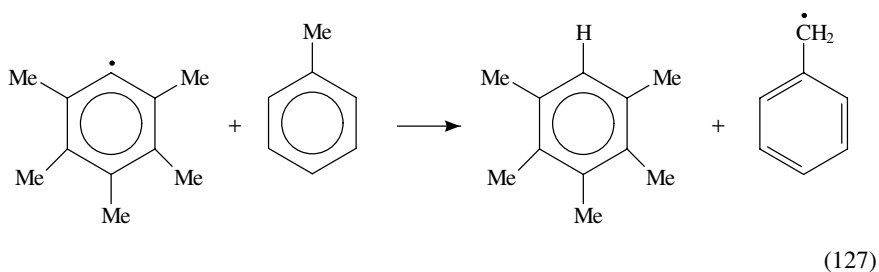
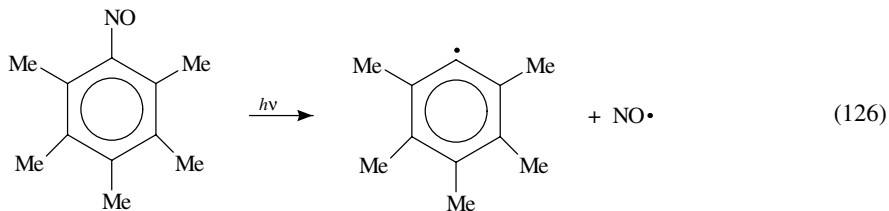


### C. Aromatic Nitroso Compounds

Nitrosobenzene was studied by NMR and UV absorption spectra at low temperature<sup>146</sup>. Nitrosobenzene crystallizes as its dimer in the *cis*- and *trans*-azodioxy forms, but in dilute solution at room temperature it exists only in the monomeric form. At low temperature ( $-60^{\circ}\text{C}$ ), the dilute solutions of the dimers could be obtained because the thermal equilibrium favours the dimer. The only photochemistry observed at  $< -60^{\circ}\text{C}$  is a very efficient photodissociation of dimer to monomer, that takes place with a quantum yield close to unity even at  $-170^{\circ}\text{C}$ . The rotational state distribution of NO produced by dissociation of nitrosobenzene at 225-nm excitation was studied by resonance-enhanced multiphoton ionization. The possible coupling between the parent bending vibration and the fragment rotation was explored.

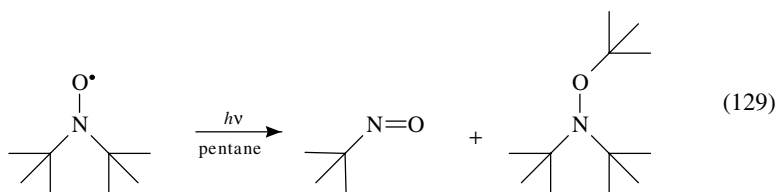
The homolysis of the C–NO bond and nitroxide formation<sup>147</sup> have been studied using a series of sterically hindered aromatic nitroso compounds such as pentamethyl nitrosobenzene, 2,3,5,6-tetramethylnitrosobenzene, 2,4,6-trimethylnitrosobenzene and

2,4,6-tri-*tert*-butyl nitrosobenzene. They are photolysed in ( $330 \text{ nm} < \lambda < 500 \text{ nm}$ ) solvent, such as toluene, *n*-heptane, cyclohexane, *p*-xylene and diethyl ether<sup>148</sup>, to give intense ESR signals of nitroxides. The latter are formed by hydrogen abstraction from the solvent and subsequent spin trapping (equations 126–128).



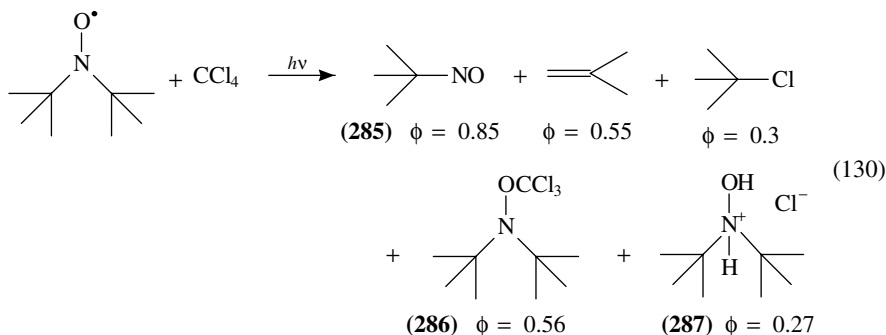
#### D. Other C-Nitroso Compounds

The photochemistry of di-*tert*-butyl nitroxide was studied<sup>149</sup>. When di-*tert*-butylnitroxide (DTBN) is excited at 254 nm to the  $\pi\pi^*$  state in pentane solution, it is cleaved to *tert*-butyl radical and 2-methyl-2-nitrosopropane (with quantum yield of 0.21). The *tert*-butyl radical is scavenged by DTBN to give di-*tert*-butyl-*tert*-butoxyamine<sup>150</sup> (equation 129).

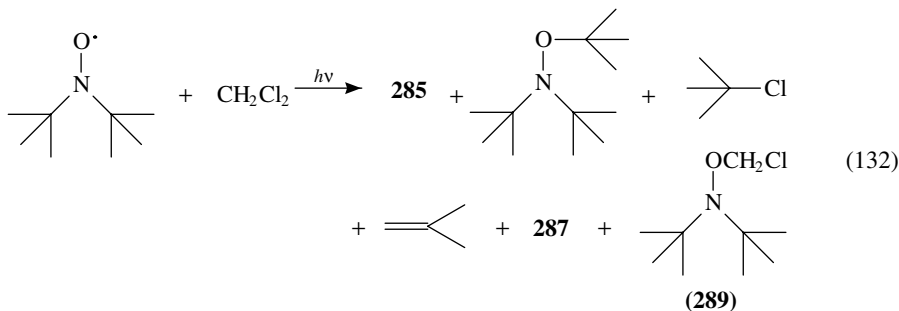
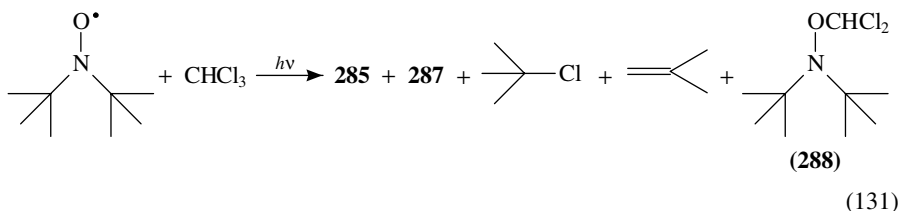


A solution containing DTBN and carbon tetrachloride was irradiated at 313 nm or 366 nm, when charge-transfer absorption, resulted in the efficient destruction of

DTBN with a quantum yield of 1.7. The products of the photoreaction are 2-methyl-2-nitrosopropane **285**, isobutylene, *tert*-butyl chloride, di-*tert*-butyltrichloromethoxyamine **286** and di-*tert*-butylhydroxylammonium chloride **287** (equation 130).

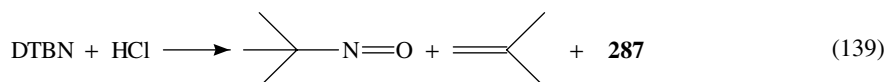
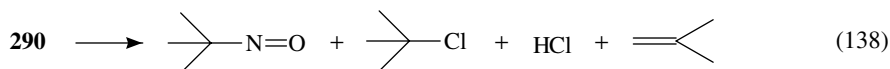
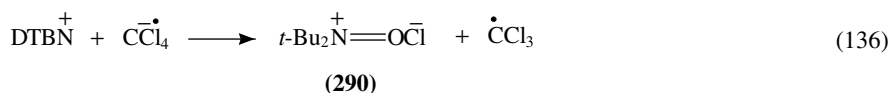
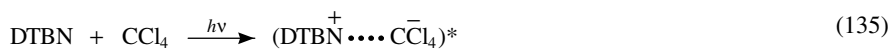
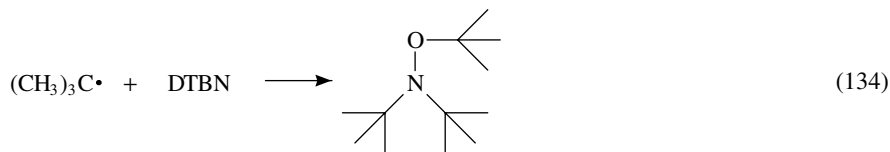
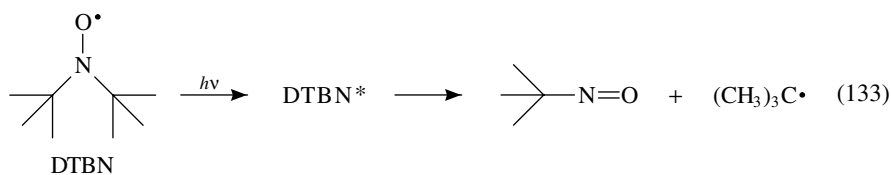


Irradiation at the DTBN–chloroform charge-transfer absorption yields<sup>151</sup> **285** ( $\phi = 1.01$ ), **287** ( $\phi = 0.6$ ), *tert*-butyl chloride ( $\phi = 0.06$ ), isobutylene ( $\phi = 0.99$ ) and di-*tert*-butyl (dichloromethoxy) amine **288** ( $\phi = 0.56$ ) (equation 131). Also<sup>151</sup>, irradiation of DTBN at 300 nm in methylene chloride gives 2-methyl-2-nitrosopropane and di-*tert*-butyl-*tert*-butoxyamine ( $\phi = 0.014$ ) products characteristic of the locally excited ( $\pi\pi^*$ ) state, and also 2-methyl-2-nitrosopropane ( $\phi = 0.11$ ), **287** ( $\phi = 0.047$ ), *tert*-butyl chloride ( $\phi = 0.004$ ), isobutylene ( $\phi = 0.093$ ) and di-*tert*-butyl (chloromethoxy) amine **289** ( $\phi = 0.05$ ) (equation 132) from the DTBN–CH<sub>2</sub>Cl<sub>2</sub> charge-transfer state.

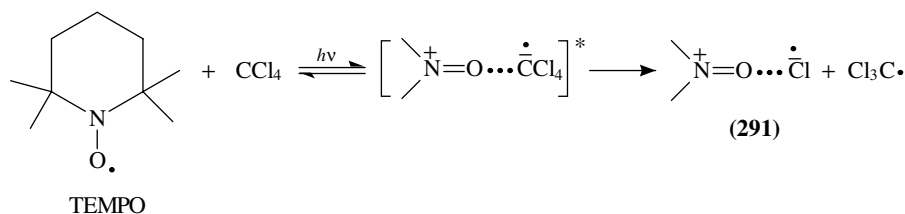


Mechanistically, the reaction in pentane with up to 35% methylene chloride is proposed to occur via  $\alpha$ -cleavage (equations 133 and 134). Other reactions in chloroform, carbon tetrachloride and 65% methylene chloride are proposed to occur by electron transfer to the chlorocarbon with initial formation of di-*tert*-butylloxammonium chloride **290** and

$\text{Cl}_n\text{CH}_{3-n}$  radical (equations 135–139).



Laser flash photolysis at wavelengths within the charge-transfer absorption bands of 2,2,6,6-tetramethylpiperidine-*N*-oxyl (TEMPO) and carbon tetrachloride yields the oxoammonium chloride of TEMPO **291** ( $\lambda_{\text{max}} = 460$  nm) and the trichloromethyl radical in an essentially instantaneous ( $\leq 18$  ps) process<sup>152</sup>. The primary photochemical reaction is an electron transfer from TEMPO to carbon tetrachloride followed by immediate decomposition of the carbon tetrachloride anion radical to chloride and trichloromethyl radical (equation 140). The laser flash photolysis of TEMPO and of other nitroxides in a variety of halogenated solvents have confirmed the generality of these photoreactions<sup>152</sup>.

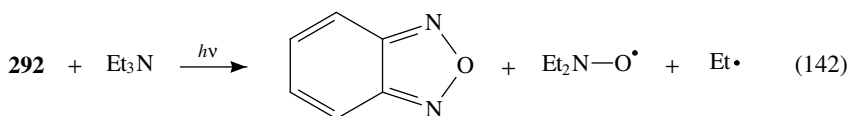
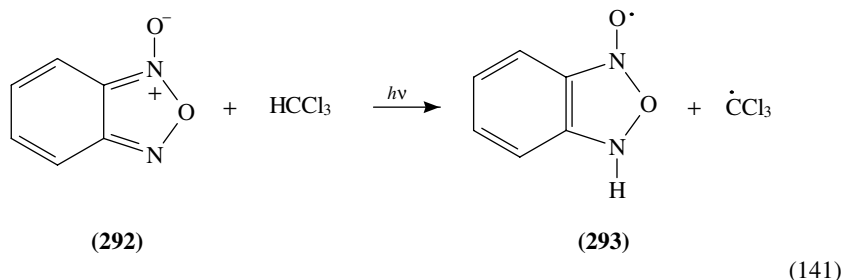


(140)

Photolysis of benzofurazan *N*-oxide **292** in chloroform generates the nitroxyl radical **393**<sup>153</sup> (equation 141), which is formed due to hydrogen abstraction from the solvent



by the lowest triplet state of **292**. The photoreaction of **292** in triethylamine provides the diethylnitroxyl radical derived from triethylamine through oxygen transfer (equation 142). ESR spectroscopy<sup>154</sup> indicated involvement of an exciplex<sup>155</sup>.



The stable nitroxyl radicals can be used for quenching the singlet excited naphthalene through an electron exchange mechanism<sup>156</sup>.

## VI. PHOTOCHEMISTRY OF ALKYL NITRITES

The photolysis of methyl nitrite at low temperature in an argon matrix was studied<sup>157</sup>. The products include formaldehyde, and nitroxyl HNO which also reacts to form N<sub>2</sub>O and water. The 355-nm photodissociation of gaseous methyl nitrite has been studied by monitoring the nascent NO product using a two-photon laser-induced fluorescence technique<sup>158</sup>.

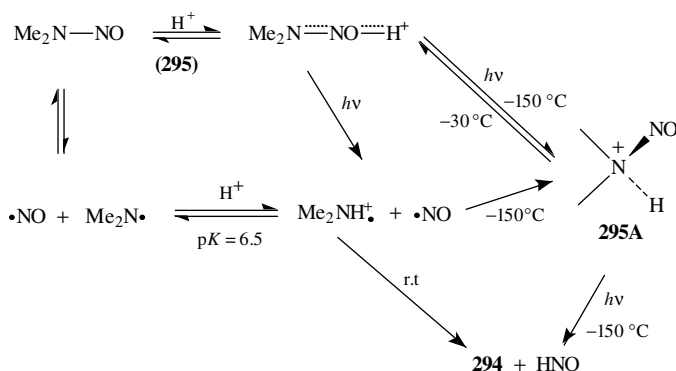
## VII. PHOTOCHEMISTRY OF *N*-NITRO AND *N*-NITROSO COMPOUNDS

### A. Nitrosamines

Since the last review in this series, a number of reports has been published to clarify the primary photoprocess and to show the application of aminium radical reactions in syntheses.

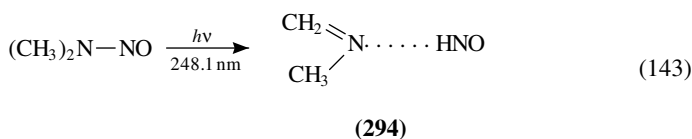
#### 1. Photolysis mechanisms

In the gas phase, *N*-nitrosodimethylamine (NND) is photolysed at the S<sub>0</sub>-S<sub>1</sub> (n,π\*) transition band at 363.5 nm, to cause N-N bond scission with ϕ of unity<sup>159,160</sup>; the recombination of the two radicals is equally efficient to give NND leaving no photoproducts at all (Scheme 11). This is in good agreement with the photolysis in neutral solution where no chemical reaction is observed<sup>174</sup>. Photolysis at the S<sub>0</sub>-S<sub>2</sub> (p,p\*) transition band at 248.1 nm, however, causes elimination of HNO, and subsequent secondary reaction to give *N*-methyl methyleneimine<sup>160</sup> (equation 143); similar photoreactions have been observed on irradiation with a low-pressure mercury lamp in cyclohexane to give slowly the timer of the imine<sup>174</sup>. In low-temperature inert matrices, such irradiation give hydrogen-bonded complex **294** which can be detected by IR spectroscopy<sup>161</sup> (equation 143). These reactions have been reviewed<sup>162</sup>. The fast singlet



SCHEME 11

excited-state dissociation is probably the reason why no fluorescence has been detected from nitrosamines.



In solution photochemistry in the presence of acids, the primary process is also the same except that both NND and the aminyl radical are protonated; the recombination of the aminium radical and NO to give **295A** is too slow to compete with bond scissions<sup>174</sup> (Scheme 11). The failure of oxygen to quench nitrosamine photoreactions in either solution (see below) or gas phases under various conditions must also mean a very short lifetime of singlet excited nitrosamines, in agreement with the fast dissociation<sup>159,160</sup>.

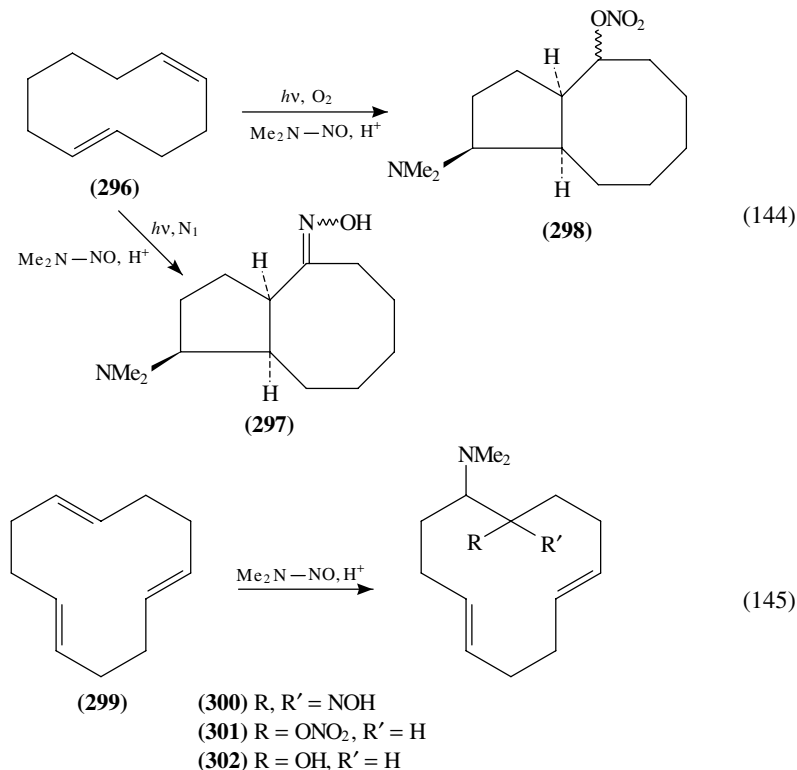
The molecular structure of nitrosamines is well described using NND and *N*-nitrosopiperidine (NNP) as the model. Their singlet and triplet excited states are well defined<sup>163</sup>. The triplet state can be generated by excitation at the  $S_0-T_1$  ( $n,\pi^*$ ) transition at 450 nm, but not from the singlet excited state owing to its fast photodissociation. The triplet state does not show any chemical reactivity. A resonance stabilized nitrosamine in acidic solution is associated with a proton (or proton donor)<sup>164</sup>; this species is photolysed at the 342-nm band ( $n,\pi^*$  transition) to give aminium and nitric oxide radicals by a chain mechanism in methanol in either the presence or absence of an olefin at room temperature<sup>163</sup>. Summarizing all available evidence, the primary photoreaction of a nitrosamine (NND) is shown in Scheme 11. It is most interesting to note that while the recombination of  $\text{Me}_2\text{N}^+\text{H}\cdot$  and  $\cdot\text{NO}$  is extremely fast, that of an aminium radical (e.g.  $\text{Me}_2\text{NH}^+\cdot$ ) with  $\cdot\text{NO}$  to give **295A** is slow, as shown by the lifetime of the piperidinium radical ( $>100$  microsecond) in water<sup>164</sup>. A competing reaction for the latter pair is the slow elimination according to equation 143. Also, estimations from flash photolysis show that these rates are slower than the hydrogen abstraction of  $\text{Me}_2\text{NH}^+$  from methanol<sup>163</sup>, that is  $<10^{-4} \text{ M}^{-1} \text{ s}^{-1}$ . Supported by simple INDO closed-shell calculation, this suggests that the *N*-protonated species **295A** possesses much higher energy than the *O*-protonated species **295** owing to absence of resonance in the former.

The low-temperature photolysis at  $-150^\circ\text{C}$  in an ethanol-methanol mixture containing trifluoroacetic acid (0.01 M) adds another dimension to nitrosamine chemistry<sup>163</sup>; irradiation at 313 nm under these conditions gives a new species showing absorption at 391,

375 and 362 nm, which reverted to **295** partially on warming to  $-30^{\circ}\text{C}$ . The absorption peaks suggest that the new species must be **295A**, which is photolabile at  $-150^{\circ}\text{C}$ , presumably undergoing an elimination similar to that shown in equation 143. Thus, while in the photolysis in the presence of an acid at room temperature the  $n,\pi^*$  excitation with a single photon causes the direct formation of an aminium radical and subsequent reactions, that at  $<-150^{\circ}\text{C}$  must be a biphotonic process to give chemical changes.

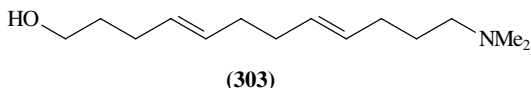
## 2. Photoaddition

Owing to the high electrophilic reactivity of aminium radicals, photolysis of nitrosamines under nitrogen in an acidic solution in the presence of an olefin results in the addition of a dialkylamino group and nitric oxide across the double bond. These C-nitroso compounds may form the dimers and are generally isolated as the tautomerized oxime if it is possible. Under oxygen, the photoreaction is not quenched but diverted to the formation of the corresponding nitrates instead of C-nitroso compounds; this arises from oxidation of nitric oxide to nitrogen trioxide during the photolysis. The reaction pattern has been described previously<sup>174</sup>, and applications of this photoaddition under oxidative and non-oxidative conditions to a variety of olefins have since been reported<sup>165-168</sup>. Some examples with subsequent modifications are shown in equations 144 and 145 to demonstrate its versatility.

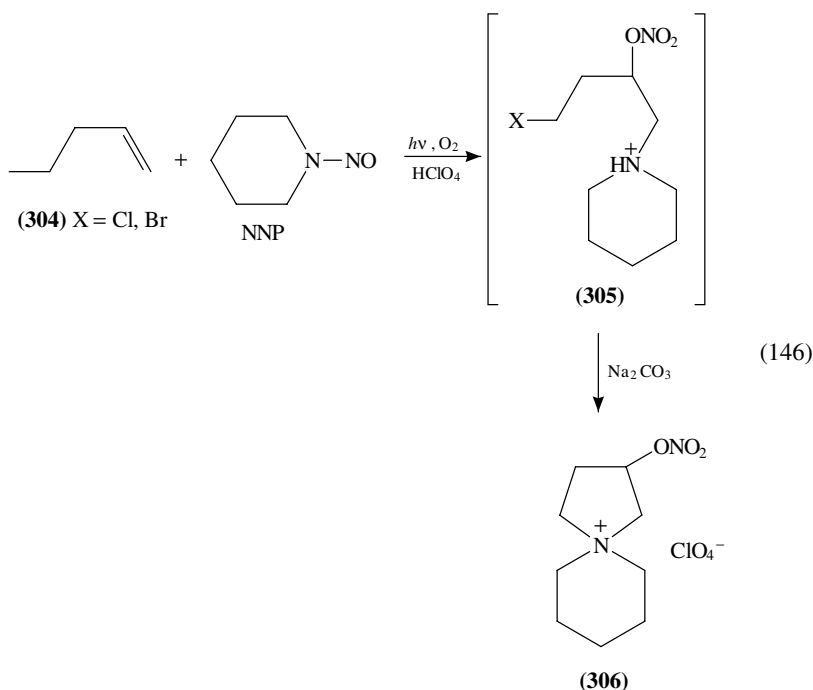


The non-oxidative photoaddition of NND to *cis,trans*-cyclodecadiene<sup>168</sup> (**296**) and *trans,trans,trans*-cyclododecatriene<sup>166,168</sup> (**299**) give the expected oximes **297** and **300**

in 85 and 76% yields, respectively, the former as a mixture of *syn*- and *anti*-oximes, but the latter is the *syn*-isomer. Under oxygen, the oxidative addition gives the expected nitrate isomers **298** and **301** in high yields and small amounts of the corresponding alcohols and ketones in both cases. Upon LAH reduction, the former gives  $\alpha$ - and  $\beta$ -alcohols<sup>168</sup> in 65 and 13% (equation 144), respectively, while the latter **301** gives the open-chain amino-alcohol **303** as the major product in addition to minor yields of **302**<sup>166</sup> (equation 145). The LAH promoted cleavage of **301** has been explained with a reasonable mechanism<sup>169</sup>.

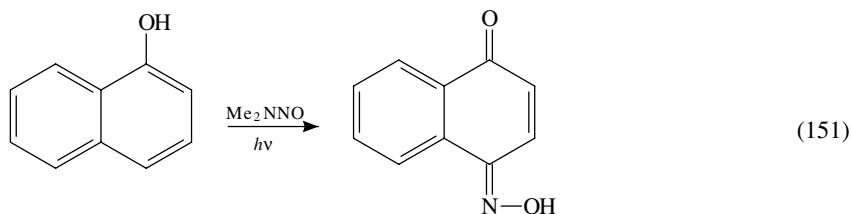


The oxidative photoaddition of NNP to 3-butenyl chloride and bromide in the presence of perchloric acid gave 2-nitrate-5-azoniaspiro [4,5] decane perchlorate (**306**) in 38 and 46% yield, respectively<sup>165</sup> (equation 146). The yield of the salt is obviously much higher, but it is difficult to extract from aqueous solution. The oxidative photoaddition to 3-butenol and its acetate gives 72–80% of the expected product **305**, while that to various benzoate esters gives about 26–33% and that to *p*-toluenesulphonate gives no product.

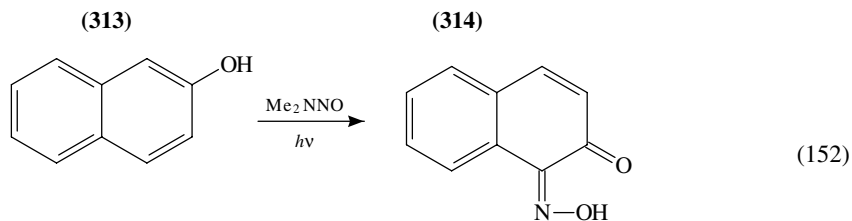


Several examples of aromatic hydrocarbon sensitized additions of NNP to the same arenes were demonstrated to occur if an acid is present; this is in contrast to the failure of benzophenone to sensitize the photoreactions. Irradiation of anthracene in the presence of NNP and hydrochloric acid gives **308** in 70% yield and a small amount of **309** derived from the acid-catalysed elimination of piperidinium ion and addition of ethanol<sup>165</sup> (equation 147). Anthracene possesses  $E_s = 76.3 \text{ kcal mol}^{-1}$ ,  $\phi_f = 0.27$  and  $\tau_s = 5 \text{ ns}$ , and can sensitize NNP ( $E_s = 75 \text{ kcal mol}^{-1}$ ) readily to its singlet excited





(151)



(152)

(313)

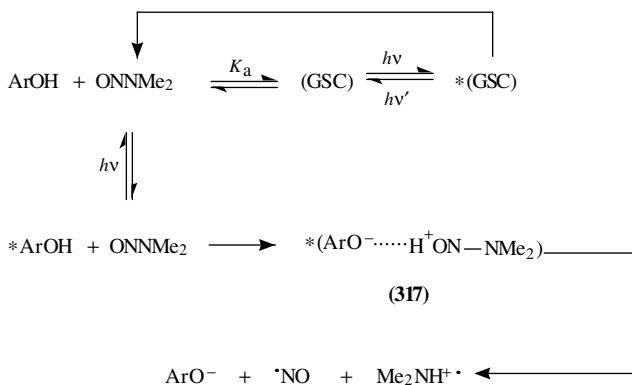
(314)

(315)

(316)

The crucial requirement of excited-state proton transfer (ESPT) is suggested by the failure of 1-naphthyl methyl ether to undergo self-nitrosation under similar photolysis conditions. The ESPT is further established by quenching of the photonitrosation as well as 1-naphthol fluorescence by general bases, such as water and triethylamine, with comparable quenching rate constants and quantum yield. ESPT shows the significance in relation to the requirement of acid in photolysis of nitrosamines; and acid association is a photolabile species.

Further studies of the self-nitrosation of 1-naphthol with NND reveal a high degree of stereospecificity in ESPT and the implication of at least two exciplexes in the excited state<sup>171</sup>. In dioxane, 1-NpOH and NND form ground state complexes showing  $\lambda_{\text{max}}$  at 380–450 nm with the association constant  $K_a = 7$ . Excitation of GSC (e.g. at 370 nm) shows weak exciplex fluorescence peaking at 480 nm, but gives no self-nitrosation product **312**. On the contrary, excitation of 1-NpOH at 300 nm in the presence of NND causes the self-nitrosation according to equations 149 and 151. Fluorescence of 1-NpOH is quenched by NND without showing new exciplex emission, although an exciplex **317** must be assumed to rationalize ESPT and energy transfer (Scheme 12), and to connect



SCHEME 12

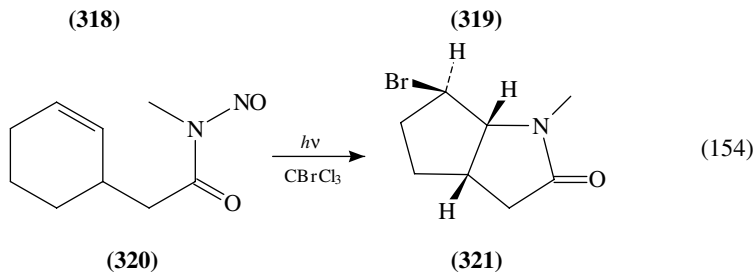
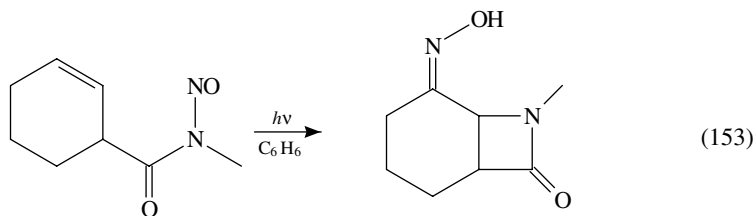
with the mechanism in equation 149. The exciplex **317** from the dynamic diffusion-controlled process and excited GSC do not interconvert to each other. The latter does not undergo ESPT, most probably owing to its geometry. It is deduced that exciplex **317** has a favourable geometry for ESPT.

## B. Nitramines

Nitramines are known to photodissociate from their  $\pi, \pi^*$  state to give aminyl and nitric oxide radicals; in the presence of an acid the aminyl radicals are protonated to give aminium radicals, which can initiate addition to olefins. As a synthetic reaction, photolysis of nitramines in the presence of acids can be conveniently run under oxygen to give oxidative addition similar to those shown in equation 145; indeed *N*-nitrodimethylamine is photolysed with triene **299** under such conditions to give a mixture of **301** and **302**, similar to results observed in the oxidative nitrosamine photoaddition<sup>169</sup>. To simplify the isolation, the crude products are reduced with LAH to form the open-chain amino alcohol **303**. Some other oxidative photoadditions of *N*-nitro dimethylamine to other olefins are reported. As the photoreaction has to use a Corex filter and product yields are no better than those shown by nitrosamines, further investigations were scarcely carried out.

## C. Nitrosamides

Many intramolecular photoadditions of *N*-nitrosamides were published recently<sup>172</sup>. Nitrosamides are photolysed to give amidyl and nitric oxide radicals, but thermalized to undergo the diazo ester rearrangement. In contrast to intermolecular reactivities, alkenyl amidyl radicals preferentially add intramolecularly to the inside double bond rather than abstract a C-5 hydrogen atom<sup>162</sup>. An interesting entry to  $\beta$ -lactam synthesis is the photolysis of **318** to give **319** in 59% (equation 153). Nitrosamide **320** is photolysed in  $\text{CBrCl}_3$ , which also act as a radical trapping agent, to give the bromoamide **321** in 89% (equation 154).



Owing to their importance in toxicology and as carcinogens, nitroamides must be considered seriously. The study of several *N*-nitroso-*N*-acetyl amino acids has been reported

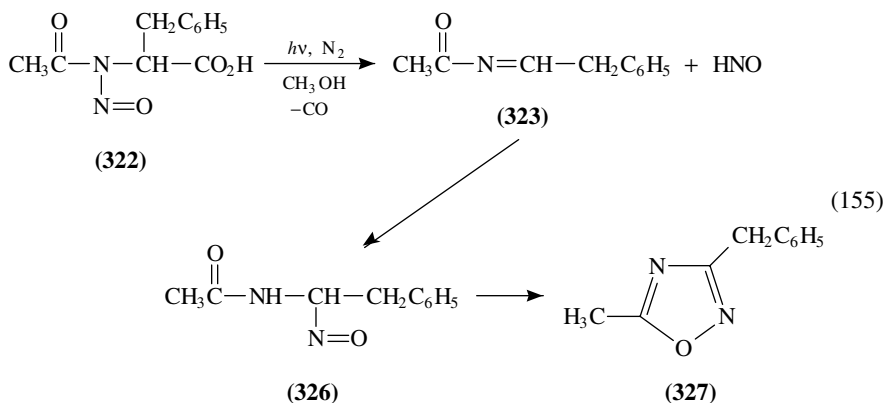


(324)



(325)

to give unusual results<sup>173</sup>. Photolysis of the nitrosamide **322** derived from phenylalanine in methanol under nitrogen at near 0°C gave both **324** and **325** in excellent yields in addition to a small amount of **327**. These products are derived from **323** (equation 155), which is formed by decarboxylative elimination of HNO from excited state **322**. Indeed MeOH is eliminated from **324** to give **325** during chromatography. Similar photolysis of **322** in acetonitrile in the presence of triethylamine gives 68% of oxadiazole **327**, which is formed from **323** through the intermediacy of **326**. The photoreaction must be run at a low temperature to avoid thermal reactions. The nitrosamides from other amino acids also show a similar reaction pattern if the thermal decompositions are suppressed<sup>173</sup>.



### VIII. REFERENCES

1. F. Mahdavi, T. C. Burton and Y. Li, *J. Org. Chem.*, **58**, 744 (1993).
2. S. Fukuzumi and Y. Tokuda, *Bull. Chem. Soc. Jpn.*, **65**, 831 (1992).
3. (a) S. Fukuzumi, M. Chiba and T. Tanaka, *J. Chem. Soc., Chem. Commun.*, 941 (1989).  
(b) S. Fukuzumi, M. Chiba and T. Tanaka, *J. Chem. Soc., Perkin Trans. 2*, 1393 (1991).
4. C. K. Lee and P. Wan, *J. Photochem. Photobiol. A: Chem.*, **76**, 39 (1993).
5. N. Levy and M. D. Cohen, *J. Chem. Soc., Perkin Trans. 2*, 553 (1979).
6. K. Akiyama, Y. Ikegami, T. Ikenoue and S. Tero-Kubota, *Bull. Chem. Soc. Jpn.*, **59**, 3269 (1986).
7. H. Gerner and D. Schulte-Frohlinde, *Chem. Phys. Lett.*, **124**, 321 (1986).
8. M. Hiramatsu, R. Nakagaki, Y. Tanimoto, K. Mutai, H. Takada and S. Nagakura, *Chem. Phys. Lett.*, **142**, 413 (1987).
9. Y. Ishii, H. Tukada, R. Nakagaki and K. Mutai, *Chem. Lett.*, 1559 (1990).
10. B. G. Maiya, S. Doraiswamy, N. Periasamy, B. Venkataraman and V. Krishnan, *J. Photochem. Photobiol. A: Chem.*, **81**, 139 (1994).
11. H. C. H. A. van Riel, G. Lodder and E. Havinga, *J. Am. Chem. Soc.*, **103**, 7257 (1981).
12. E. Havinga and J. Cornelisse, *Pure Appl. Chem.*, **47**, 1 (1976).
13. J. B. S. Boniha, A. C. Tedesco, L. C. Nogueira, M. T. R. S. Diamantino and J. C. Carreiro, *Tetrahedron*, **49**, 3053 (1993).
14. J. Cerrello, M. Figueredo, J. Marquet, M. Moreno-Manas, J. Bertran and J. M. Lluch, *Tetrahedron Lett.*, **25**, 4147 (1984).
15. A. Cantos, J. Marquet, M. Moreno-Manas, A. Gonzalez-Lafont, J. M. Lluch and J. Bertran, *J. Org. Chem.*, **55**, 3303 (1990).



16. A. M. J. Van Eijk, A. H. Huizer, C. A. G. O. Varma and J. Marquet, *J. Am. Chem. Soc.*, **111**, 88 (1989).
17. (a) A. Cantos, J. Marquet and M. Moreno-Manas, *Tetrahedron Lett.*, **28**, 4191 (1988).  
(b) A. Cantos, J. Marquet, M. Moreno-Manas and A. Castello, *Tetrahedron*, **44**, 2607 (1988).
18. E. Havingna and J. Cornelisse, *Pure Appl. Chem.*, **47**, 1 (1976).
19. N. J. Bunce, S. R. Cater, J. C. Scaiano and L. J. Johnston, *J. Org. Chem.*, **52**, 4214 (1987).
20. R. Pleixats and J. Marquet, *Tetrahedron*, **46**, 1343 (1990).
21. P. Kuzmic, L. Pavlickova, J. Velek and M. Soucek, *Collect. Czech. Chem. Commun.*, **51**, 1665 (1986).
22. G. G. Wubbels and D. W. Celander, *J. Am. Chem. Soc.*, **103**, 7669 (1981).
23. J. Marquet, A. Cantos, M. Moreno-Manas, E. Cayon and I. Gallardo, *Tetrahedron*, **48**, 1333 (1992).
24. P. Kuzmic and M. Soucek, *Collect. Czech. Chem. Commun.*, **51**, 358 (1986).
25. M. B. Groen and E. Havinga, *Mol. Photochem.*, **6**, 9 (1974).
26. G. G. Wubbels, D. P. Susens and E. B. Coughlin, *J. Am. Chem. Soc.*, **110**, 2538 (1988).
27. A. C. Tedesco, R. M. Z. G. Naal, J. C. Carreiro and J. B. S. Bonilha, *Tetrahedron*, **50**, 3071 (1994).
28. M. Sawaura and T. Mukai, *Bull. Chem. Soc. Jpn.*, **54**, 3213 (1981).
29. M. A. Leoni, G. F. Bettinetti, G. Minoli and A. Abini, *J. Org. Chem.*, **45**, 2331 (1980).
30. R. Pleixats, M. Figueredo, J. Marquet, M. Moreno-Manas and A. Cantos, *Tetrahedron*, **45**, 7826 (1989).
31. J. Cervello, M. Figueredo, J. Marquet, M. Moreno-Manas, J. Bertran and J. M. Lluch, *Tetrahedron Lett.*, **25**, 4147 (1984).
32. (a) K. Matsui, N. Maeno and S. Suzuki, *Tetrahedron Lett.*, 1467 (1970).  
(b) H. Shizuka, N. Maeno and K. Matsui, *Mol. Photochem.*, **4**, 335 (1972).
33. (a) K. Mutai, S. Kanno and K. Kobayashi, *Tetrahedron Lett.*, 1273 (1978).  
(b) K. Mutai, S. Kanno and K. Kobayashi, *Chem. Lett.*, 931 (1978).
34. (a) K. Yokoyama, R. Nokagaki, J. Nakamura, K. Mutai and S. Nagakura, *Bull. Chem. Soc. Jpn.*, **53**, 2472 (1980).  
(b) K. Mutai and K. Kobayashi, *Bull. Chem. Soc. Jpn.*, **54**, 462 (1981).  
(c) K. Yokoyama, J. Nakamura, K. Mutai and S. Nagakura, *Bull. Chem. Soc. Jpn.*, **55**, 317 (1982).  
(d) K. Mutai, K. Yokoyama, S. Kanno and K. Kobayashi, *Bull. Chem. Soc. Jpn.*, **55**, 1112 (1982).  
(e) K. Mutai, K. Kobayashi and K. Yokoyama, *Tetrahedron*, **40**, 1755 (1984).
35. (a) G. G. Wubbels, A. M. Halverson and J. D. Oxman, *J. Am. Chem. Soc.*, **102**, 4848 (1980).  
(b) G. G. Wubbels, A. M. Halverson, J. D. Oxman and V. H. De Bruyn, *J. Org. Chem.*, **50**, 4499 (1985).
36. (a) R. Nakagaki, M. Hiramatsu, K. Mutai and S. Nagakura, *Chem. Phys. Lett.*, **121**, 262 (1985).  
(b) R. Nakagaki, K. Mutai and S. Nagakura, *Chem. Phys. Lett.*, **154**, 581 (1989).  
(c) K. Mutai, H. Tukada and R. Nakagaki, *J. Org. Chem.*, **56**, 4896 (1991).
37. D. Dopp and C. C. Wong, *Chem. Ber.*, **121**, 2045 (1988).
38. (a) D. Dopp and E. Brugger, *Justus Liebigs Ann. Chem.*, 554 (1979).  
(b) D. Dopp and E. Brugger, *Justus Liebigs Ann. Chem.*, 1965 (1979).
39. K. Padmanabhan, K. Venkatesan, V. Ramamurthy, R. Schmidt and D. Dopp, *J. Chem. Soc., Perkin Trans. 2*, 1153 (1987).
40. K. Padmanabhan, D. Dopp, K. Venkatesan and V. Ramamurthy, *J. Chem. Soc., Perkin Trans. 2*, 897 (1986).
41. D. Dopp, U. Arfsten-Romberg, W. Bolz, W. Van Hoof and H. Kosfeld, *Chem. Ber.*, **112**, 3946 (1979).
42. R. Binkley and T. W. Flechtner, in *Synthetic Organic Photochemistry* (Ed. W. M. Horspool), Plenum Press, New York, 1984, pp. 375–423.
43. J. R. Peyser and T. W. Flechtner, *J. Org. Chem.*, **52**, 4645 (1987).
44. R. W. Yip, D. K. Sharma, R. Giasson and D. Gravel, *J. Phys. Chem.*, **89**, 5328 (1985).
45. R. W. Yip, Y. X. Wen, D. Gravel, R. Giasson and D. K. Sharma, *J. Phys. Chem.*, **95**, 6078 (1991).
46. D. Gravel, R. Giasson, D. Blanchet, R. W. Yip and D. K. Sharma, *Can. J. Chem.*, **69**, 1193 (1991).
47. H. Kimura, K. Sakata and H. Takahashi, *J. Mol. Struct.*, **1–4**, 293 (1993).

48. (a) C. G. Willson, in *Introduction to Microlithography*, ACS Symposium Series 219, **87**, American Chemical Society; Washington DC, 1983.  
(b) A. Reiser, *Photoreactive Polymers*, Wiley, New York, 1989.
49. C. W. Wilkins, Jr., E. Reichmanis and E. A. Chandross *J. Electrochem. Soc.*, **129**, 2552 (1982).
50. (a) F. M. Houlihan, A. Shugard, R. Gooden and E. Reichmanis, *Macromolecules*, **21**, 2001 (1988).  
(b) T. X. Neenan, F. M. Houlihan, E. Reichmanis, J. M. Kometani, B. J. Bachman and L. F. Thompson, *Macromolecules*, **23**, 145 (1990).
51. F. M. Houlihan, T. X. Neenan, E. Reichmanis, J. M. Kometani, L. F. Thompson, T. Chin and O. Nalamasu, *J. Photopolym. Sci. Technol.*, **3**, 259 (1990).
52. (a) M. R. Winkle and K. A. Graziano, *J. Photopolym. Sci. Technol.*, **3**, 419 (1990).  
(b) J. F. Cameron and J. M. J. Frechet, *J. Am. Chem. Soc.*, **113**, 4303 (1991).
53. S. Schneider, M. Fink, R. Bug and H. Schupp, *J. Photochem. Photobiol. A: Chem.*, **55**, 329 (1991).
54. H. Tomioka, N. Ichikawa and K. Komatsu, *J. Am. Chem. Soc.*, **114**, 8045 (1992).
55. D. Gravel, J. Herbert and D. Thoraval, *Can. J. Chem.*, **61**, 400 (1983).
56. D. Ramesh, R. Wieboldt, A. P. Billington, B. K. Carpenter and G. P. Hess, *J. Org. Chem.*, **58**, 4599 (1993).
57. S. Kuberski and J. Gebicki, *J. Mol. Struct.*, **275**, 105 (1992).
58. M. V. George and J. C. Scaiano, *J. Phys. Chem.*, **84**, 492 (1980).
59. P. M. Collins and V. R. N. Munasinghe, *J. Chem. Soc., Perkin Trans. I*, 921 (1983).
60. P. M. Collins and V. R. N. Munasinghe, *J. Chem. Soc., Perkin Trans. I*, 1879 (1983).
61. P. M. Collins and H. Eder, *J. Chem. Soc., Perkin Trans. I*, 927 (1983).
62. E. Fasani, S. Pietra and A. Albini, *Heterocycles*, **33**, 573 (1992).
63. S. Oguchi and H. Torizuka, *Bull. Chem. Soc. Jpn.*, **53** 2425 (1980).
64. R. Gawinecki, W. Boszczyk, D. Rasala and T. Bak, *J. Photochem. Photobiol. A: Chem.*, **71**, 133 (1993).
65. H. Obara, J. Onodera and M. Hattori, *Chem. Lett.*, 421 (1982).
66. K. Hamanoue, M. Amano, M. Kimoto, Y. Kajiwara, T. Nakayama and H. Teranishi, *J. Am. Chem. Soc.*, **106**, 5993 (1984).
67. M. D'Auria, *J. Photochem. Photobiol. A: Chem.*, **79**, 67 (1994).
68. R. Antonioletti, M. D'Auria, F. D'Onofrio, G. Piancatelli and A. Scettri, *J. Chem. Soc., Perkin Trans. I*, 1755 (1986).
69. M. D'Auria, *Tetrahedron Lett.*, **35**, 633 (1994).
70. (a) D. Schulte-Frohlinde and H. Corner, *Pure Appl. Chem.*, **51**, 279 (1979).  
(b) J. Saltiel and J. L. Charlton, in *Rearrangement in Ground and Excited States*, (Ed. P. de Mayo), Vol. 3, Academic Press, New York, 1980, 25.  
(c) H. Gruen and H. Gerner, *J. Phys. Chem.*, **93**, 7144 (1989).
71. H. Gerner, F. Elisei, U. Mazzucato and G. Galiazzi, *J. Photochem. Photobiol. A: Chem.*, **43**, 139 (1988).
72. H. Gerner, H. Gruen and D. Schulte-Frohlinde, *J. Phys. Chem.*, **84**, 3031 (1980).
73. H. Gerner and E. Fischer, *J. Photochem. Photobiol. A: Chem.*, **57**, 235 (1991).
74. Y. Kikuchi, H. Okamoto, T. Arai and K. Tokumaru, *Chem. Lett.*, 1811 (1993).
75. H.-D. Becker, H. Sorensen and K. Sandros, *J. Org. Chem.*, **51**, 3223 (1986).
76. L. J. A. Martins and T. J. Kemp, *J. Chem. Soc., Faraday Trans. I*, **78**, 519 (1982).
77. L. J. A. Martins, *J. Chem. Soc., Faraday Trans. I*, **78**, 533 (1982).
78. T. J. Kemp and L. J. A. Martins, *J. Chem. Soc., Faraday Trans. I*, **77**, 1425 (1981).
79. L. J. A. Martins and T. J. Kemp, *J. Chem. Soc., Faraday Trans. I*, **80**, 2509 (1984).
80. K.-H. Pfoertner and J. J. Daly, *Helv. Chim. Acta*, **70**, 171 (1987).
81. J. Catalan, P. Perez and J. Elguero, *New J. Chem.*, **16**, 511 (1992).
82. A. Baracchi, S. Chimichi, F. De Sio, D. Donati, R. Nesi, P. Sarti-Fantoni and T. Torroba, *Heterocycles*, **24**, 2863 (1986).
83. M. Bazin and R. Santus, *Photochem Photobiol.*, **43**, 235 (1986).
84. C. S. Foote, *Photochem. Photobiol.*, **54**, 659 (1991).
85. M. D'Auria, F. D'Onofrio, J. Suwinski and K. Swierezek, *Tetrahedron*, **49**, 3899 (1993).
86. P. Wan and S. Muralidharan, *Can. J. Chem.*, **64**, 1949 (1986).
87. S. Muralidharan and P. Wan, *J. Chem. Soc., Chem. Commun.*, 1142 (1987).
88. S. Muralidharan and P. Wan, *J. Photochem. Photobiol. A: Chem.*, **57**, 191 (1991).

89. P. Wan and S. Muralidharan, *J. Am. Chem. Soc.*, **110**, 4336 (1988).
90. B. B. Craig and M. Dale Pace, *J. Chem. Soc., Chem. Commun.*, 1144 (1987).
91. B. B. Craig and S. J. Atherton, *J. Chem. Soc., Perkin Trans. 2*, 1929 (1988).
92. B. B. Craig, R. G. Weiss and S. J. Atherton, *J. Phys. Chem.*, **91**, 5906 (1987).
93. H. Gorner, L. J. Currell and H. J. Kuhn, *J. Phys. Chem.*, **95**, 5518 (1991).
94. S. Muralidharan, K. A. Beveridge and P. Wan, *J. Chem. Soc., Chem. Commun.*, 1426 (1989).
95. P. Wan, S. Muralidharan, I. McAuley and C. A. Babbage, *Can. J. Chem.*, **65**, 1775 (1987).
96. P. Wan and K. Yates, *J. Chem. Soc., Chem. Commun.*, 1023 (1981).
97. (a) P. Wan and K. Yates, *J. Org. Chem.*, **48**, 138 (1983).  
(b) G. G. Wubbels, T. F. Kalhern, D. E. Johnson and D. Campbell, *J. Org. Chem.*, **47**, 4664 (1982).
98. P. Wan and K. Yates, *J. Org. Chem.*, **50**, 2881 (1985).
99. P. Wan and K. Yates, *Can. J. Chem.*, **64**, 2076 (1986).
100. K. Pafizadeh and K. Yates, *J. Org. Chem.*, **51**, 2777 (1986).
101. T. Yamaoka, H. Adachi, K. Matsumoto, H. Watanabe and T. Shiroasaki, *J. Chem. Soc., Perkin Trans. 2*, 1709 (1990).
102. E. Cayon, J. Marquet, J. M. Lluch and X. Martin, *J. Am. Chem. Soc.*, **113**, 8970 (1991).
103. J. Cornelisse and E. Havingna, *Chem. Rev.*, **75**, 353 (1975).
104. H. Frey, *Synlett*, 215 (1990).
105. P. Kuzmic, L. Pavlickova and M. Soucek, *Collect. Czech. Chem. Commun.*, **51**, 1293 (1986).
106. K. Tanigaki, M. Yagi and J. Higuchi, *Chem. Phys. Lett.*, **153**, 57 (1988).
107. J. K. Kochi, *Acc. Chem. Res.*, **25**, 39 (1992) and references cited therein.
108. L. Ebersson, M. P. Hartshorn, F. Radner and J. Svensson, *J. Chem. Soc., Perkin Trans. 2*, 1719 (1994) and references cited therein.
109. (a) S. Sankararaman, W. A. Haney and J. K. Kochi, *J. Am. Chem. Soc.*, **109**, 5253 and 7824 (1987).  
(b) L. Ebersson, M. P. Hartshorn and J. O. Svensson, *Acta. Chem. Scand.*, **47**, 925 (1993).
110. J. M. Masnovi and J. K. Kochi, *J. Org. Chem.*, **50**, 5245 (1985).
111. (a) S. Sankararaman and J. K. Kochi, *J. Chem. Soc., Perkin Trans. 2*, 1 (1991).  
(b) L. Ebersson, M. P. Hartshorn and F. Radner, *J. Chem. Soc., Perkin Trans. 2*, 1799 (1992).  
(c) L. Ebersson, M. P. Hartshorn and F. Radner, *J. Chem. Soc., Perkin Trans. 2*, 1793 (1992).  
(d) E. K. Kim, M. Bockman and J. K. Kochi, *J. Chem. Soc., Perkin Trans. 2*, 1879 (1992).
112. L. Ebersson, M. P. Hartshorn, F. Radner and W. T. Robinson, *Acta. Chem. Scand.*, **47**, 410 (1993).
113. L. Ebersson and M. P. Hartshorn, *J. Chem. Soc., Chem. Commun.*, 1564 (1992).
114. L. Ebersson, M. P. Hartshorn, F. Radner, M. Merchan and B. O. Roos, *Acta Chem. Scand.*, **47**, 176 (1993).
115. E. Bosch and J. K. Kochi, *J. Org. Chem.*, **59**, 3314 (1994).
116. A. Fischer and P. N. Ibrahim, *Tetrahedron*, **46**, 2737 (1990).
117. G. R. Desiraju and V. R. Pedireddi, *J. Chem. Soc., Chem. Commun.*, 1112 (1989).
118. R. D. Grant and J. T. Pinhey, *Aust. J. Chem.*, **37**, 1231 (1984).
119. H. Sugimoto, K. Takakuwa and K. Orito, *Chem. Lett.*, 1357 (1982).
120. P. E. Schoen, M. J. Marrone, J. M. Schnur and L. S. Goldberg, *Chem. Phys. Lett.*, **90**, 272 (1982).
121. H. S. Kwok, G. Z. He, R. K. Sparks and Y. T. Lee, *Int. J. Chem. Kinet.*, **13**, 1125 (1981).
122. L. J. Butler, D. Krajnovich and Y. T. Lee, *J. Chem. Phys.*, **79**, 1708 (1983).
123. G. Radhakrishnan, T. Parr and C. Wittig, *Chem. Phys. Lett.*, **111**, 25 (1984).
124. G. D. Greenblatt, H. Zuckermann and Y. Haas, *Chem. Phys. Lett.*, **134**, 593 (1987).
125. D. R. Cyr, D. J. Leahy, D. L. Osborn, R. E. Continetti and D. M. Neumark, *J. Chem. Phys.*, **99**, 8751 (1993).
126. M. E. Jacox, *J. Phys. Chem.*, **88**, 3373 (1984).
127. M. C. R. Symons, *Faraday Discuss. Chem. Soc.*, **86**, 99 (1988).
128. K. Yamada, T. Kanekiyo, S. Tanaka, K. Naruchi and M. Yamamoto, *J. Am. Chem. Soc.*, **103**, 7003 (1981).
129. K. Yamada, S. Tanaka, K. Naruchi and M. Yamamoto, *J. Org. Chem.*, **47**, 5283 (1982).
130. K. Yamada, K. Kishikawa and M. Yamamoto, *J. Org. Chem.*, **52**, 2327 (1987).
131. G. J. Edge, S. H. Iman and B. A. Marples, *J. Chem. Soc., Perkin Trans. 1*, 2319 (1984).
132. H. Takechi and M. Machida, *Synthesis*, 206 (1989).

133. H. Suginome, Y. Kurokawa and K. Orito, *Bull. Chem. Soc. Jpn.*, **61**, 4005 (1988).
134. H. Suginome and Y. Kurokawa, *J. Org. Chem.*, **54**, 5945 (1989).
135. H. Suginome and Y. Kurokawa, *Bull. Chem. Soc. Jpn.*, **62**, 1343 (1989).
136. H. Suginome and Y. Kurokawa, *Bull. Chem. Soc. Jpn.*, **62**, 1107 (1989).
137. N. P. Ernsting and J. Pfab, *Chem. Phys. Lett.*, **67**, 538 (1979).
138. R. Cimiriaglia, M. Persico and J. Tomasi, *J. Am. Chem. Soc.*, **107**, 1617 (1985).
139. N. P. Ernsting, J. Pfab, J. C. Green and J. Romelt, *J. Chem. Soc., Faraday Trans. 2*, **76**, 844 (1980).
140. C. A. F. Johnson, *J. Chem. Soc., Faraday Trans. 2*, **77**, 2147 (1981).
141. D. Forrest, B. G. Gowenlock and J. Pfab, *J. Chem. Soc., Perkin Trans. 2*, 576 (1979).
142. K. Makino, *J. Phys. Chem.*, **84**, 1012 (1984).
143. T. Bosch, G. Kresze and W. Hub, *Justus Liebigs Ann. Chem.*, 905 (1979).
144. N. N. Majeed and A. L. Porte, *J. Chem. Soc., Perkin Trans. 2*, 1139 (1987).
145. N. N. Majeed, G. S. Mac Dougall, A. L. Porte and I. H. Sadler, *J. Chem. Soc., Perkin Trans. 2*, 1027 (1988).
146. M. Azoulay and E. Fischer, *J. Chem. Soc., Perkin Trans. 2*, 637 (1982).
147. C. Chatgililoglu and K. U. Ingold, *J. Am. Chem. Soc.*, **103**, 4833 (1981).
148. D. Rehorek and E. G. Janzen, *J. Photochem.*, **35**, 251 (1986).
149. (a) F. Genoud, *Mol. Phys.*, **43**, 1465 (1981).  
(b) D. R. Anderson, J. K. Keute, H. L. Chapel and T. H. Koch, *J. Am. Chem. Soc.*, **101**, 1904 (1979).
150. D. R. Anderson and T. H. Koch, *Tetrahedron Lett.*, 3015 (1977).
151. J. S. Keute, D. R. Anderson and T. H. Koch, *J. Am. Chem. Soc.*, **103**, 5434 (1981).
152. J. Chateaufneuf, J. Luszyk and K. U. Ingold, *J. Org. Chem.*, **55** 1061 (1990).
153. S. K. Lin, *J. Photochem. Photobiol. A: Chem.*, **45**, 243 (1988).
154. S. K. Lin and L. B. Feng, *Chem. Phys. Lett.*, **128**, 319 (1986).
155. S. K. Lin and L. B. Feng, *Spectrosc. Lett.*, **19**, 883 (1986).
156. S. A. Green, D. J. Simpson, G. Zhou, P. S. Ho and N. V. Blough, *J. Am. Chem. Soc.*, **112**, 7337 (1990).
157. R. P. Muller, P. Russegger and J. R. Huber, *Chem. Phys. Lett.*, **70**, 281 (1982).
158. F. Lahmani, C. Lardeux and D. Solgadi, *Chem. Phys. Lett.*, **102**, 523 (1983).
159. G. Geiger, H. Stafast, U. Bruhlmann and J. R. Huber, *Chem. Phys. Lett.*, **79**, 521 (1981).
160. G. Geiger and J. R. Huber, *Helv. Chim. Acta*, **64**, 989 (1981).
161. R. P. Muller, S. Murata and J. R. Huber, *Chem. Phys.*, **66**, 237 (1982).
162. R. P. Muller and J. R. Huber, *Rev. Chem. Inter.*, **5**, 423 (1984).
163. Y. L. Chow, Z. Z. Wu, M. P. Lau and R. W. Yip, *J. Am. Chem. Soc.*, **107**, 8196 (1985).
164. W. S. Layne, H. H. Jaffe and H. Zimmer, *J. Am. Chem. Soc.*, **85**, 1816 (1963).
165. Y. L. Chow, C. J. Colon, D. W. L. Chang, K. S. Pillay, R. L. Lockhart and T. Tezuka, *Acta Chem. Scand.*, **B 36**, 623 (1982).
166. Y. L. Chow, H. Richard and Y. Sakaino, *Synthesis*, 818 (1980).
167. Y. L. Chow and Z. Z. Wu, *Recl. Trav. Chim. Pays-Bas*, **105**, 312 (1986).
168. Y. L. Chow, H. Richard and R. W. Lockhart, *J. Chem. Soc., Perkin Trans. 1*, 1419 (1982).
169. Y. L. Chow, and H. Richard, *J. Chem. Soc., Perkin Trans. 1*, 1405 (1982).
170. Y. L. Chow and Z. Z. Wu, *J. Am. Chem. Soc.*, **109**, 2560 (1987); **107**, 3338 (1985).
171. Y. L. Chow, Z. Z. Wu, M. L. W. Thewalt and T. W. Steiner, *J. Am. Chem. Soc.*, **110**, 5543 (1988).
172. Y. L. Chow and R. A. Perry, *Can. J. Chem.*, **63**, 2203 (1985).
173. Y. L. Chow and J. S. Polo, *J. Chem. Soc., Perkin Trans. 2*, 727 (1986).
174. Y. L. Chow, *Acc. Chem. Res.*, **6**, 354 (1973).

## CHAPTER 17

# Radiation chemistry of amines, nitro and nitroso compounds

WILLIAM M. HORSPOOL

*Department of Chemistry, The University of Dundee, Dundee DD1 4HN, Scotland*  
*Fax: +44 (0)382 34 5517; e-mail: W.M.HORSPOOL@DJMDEE.AC.UK*

---

I. INTRODUCTION	823
II. RADIOLYSIS OF AMINES	824
A. Radiolysis of Aliphatic Amines	824
B. Radiolysis of Aromatic Amines	826
III. RADIOLYSIS OF AMINO ACIDS	828
IV. RADIOLYSIS OF NITRO AND NITROSO COMPOUNDS	832
A. Aliphatic Nitro Compounds	832
B. Aromatic Nitro Compounds	832
C. Nitroso Compounds	834
V. REFERENCES	835

---

### I. INTRODUCTION

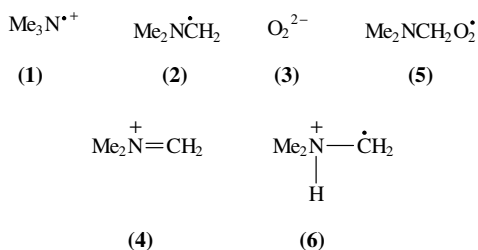
A detailed review<sup>1</sup> of this area was published thirteen years ago as part of this series. Within that article a comprehensive coverage of the various methods for irradiating compounds was given. This included energy absorption, early events, dosimetry and reaction kinetics including free-radical reactions, radical scavenging and pulse radiolysis. That review suggested that the radiation chemistry of the species covered by this review was becoming an increasingly important area of study. There are indeed many citations dealing with radiation-induced reactions where amines, nitro and nitroso compounds are used as secondary reagents. More often than not the radiation process is utilized to produce a primary oxidant that then reacts with the substrate under discussion. The radiation process in these instances is not directly reacting on the amine or nitro compound. Thus a reviewer has many problems to wrestle with regarding inclusion or omission of articles. This review of the area has tried to provide a flavour of what is happening currently but is by no means exhaustive for the reasons given above.

## II. RADIOLYSIS OF AMINES

### A. Radiolysis of Aliphatic Amines

Some studies have focused on the generation of the corresponding radical cations of methylamine, dimethylamine and *N*-methylpiperidine<sup>2,3</sup> by  $\gamma$ -irradiation at low temperature. The radical cation of *t*-BuNH<sub>2</sub> can be formed ( $k = 3.4 \times 10^6 \text{ M}^{-1} \text{ s}^{-1}$ ) by oxidation with DMSO·Cl<sup>4</sup>.

Trimethylamine has been subjected to radiolysis studies. Thus the trimethylamine radical cation **1** can be produced by  $\gamma$ -irradiation (<sup>60</sup>Co source) at 77 K in trichlorofluoromethane. This technique utilizes the facile generation of the radical cation of the trichlorofluoromethane. This radical cation then transfers an electron from the substrate to produce the radical cation of the amine. The EPR spectra of the radical cations were recorded. The cations produced under these conditions can be trapped indefinitely and do not undergo proton loss to give the radical **2**<sup>5</sup>. In a pulse radiolysis examination in basic aqueous solutions saturated with N<sub>2</sub>O and O<sub>2</sub> two radicals **2** and **3** are seen in a ratio of 9:1. The radical **1** reacts readily with oxygen ( $k = 3.5 \times 10^9 \text{ M}^{-1} \text{ s}^{-1}$ ) to yield the iminium ion **4**. The electron transfer to yield **4** is preferred to the path that would yield the peroxy radical **5** followed by fission to **4**. Trapping of **4** by hydroxide and hydrolysis of the hydroxymethyl dimethylamine accounts for the principal products, dimethylamine and formaldehyde, of the reaction<sup>6</sup>. However, further study showed that the formation of a nitrogen-centred radical was the important first step. Thus attack by the hydroxy radical on the amine affords the radical cation **1** and hydroxide. The former species can be transformed into each of the others by hydrolytic processes yielding the alkyl radical **2** or, on protonation, the conjugate acid **6**. The radical cation **1** is the stable species in acid<sup>7</sup>. This reaction has also been discussed in a review article<sup>8</sup>.

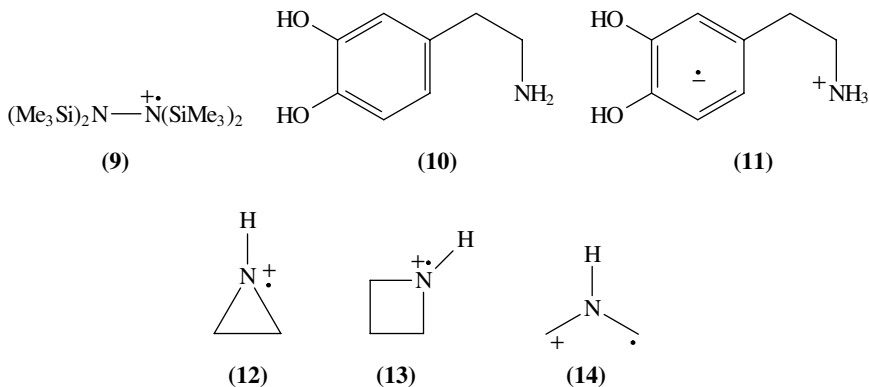


Triethylamine can also be converted into the corresponding radical cation by  $\gamma$ -irradiation at low temperature in trichlorofluoromethane<sup>5</sup> or by oxidation with the carbonate radical CO<sub>3</sub><sup>•-</sup> produced by pulse radiolysis. The radical cation of triethylamine has also been studied using time-resolved fluorescence detected magnetic resonance (FDMR). This work showed that the rate of formation of the radical cation was the same in *n*-hexane or in cyclohexane<sup>10</sup>. Triethylamine has, of course, been used in many studies as a sacrificial electron donor. This is a common use in photochemical systems as well as in pulse radiolysis. A typical example of this is the use of triethylamine as an electron donor in the photoreduction of carbon dioxide to formic acid in non-aqueous polar solvents using oligo(*p*-phenylenes) as the photocatalyst<sup>11</sup>, or the formation of hydrogen from water<sup>12</sup>. The sacrificial use of triethylamine is also seen in the pulse radiolysis generation of captive electrons in glasses at low temperature. The glasses are ethanol/triethylamine and radiolysis brings about the ejection of an electron from the triethylamine thus producing the corresponding radical cation<sup>13</sup>. Other studies have examined the temperature dependence of electron trapping in such glasses<sup>14,15</sup>.

Silicon derivatives of these simple amines have also been studied using  $\gamma$ -irradiation in  $\text{CFCl}_3$  solution at 77 K. The radical cations **7** and **8** are formed in each of the cases. The EPR study showed that the singly filled MO of the radical cation was delocalized and extended into the silyl groups. The hydrazine derivative **9** also affords a radical cation within which a twisted geometry exists with the two nitrogen tensors at an angle of  $24^\circ$ <sup>16</sup>.

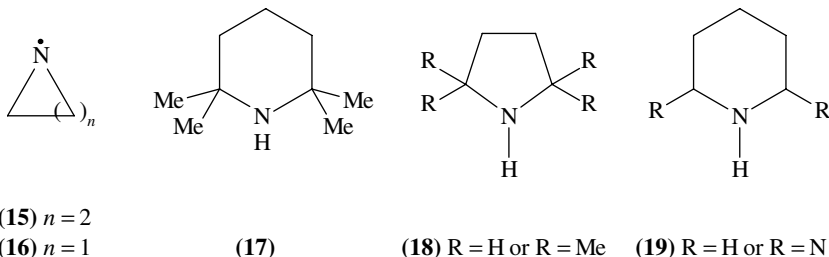
$(\text{Me}_3\text{Si})_n\overset{+}{\text{N}}\overset{\bullet}{\text{R}}_m$	$n$	$m$	R	$(\text{Me}_2\text{SiH})_2\overset{+}{\text{N}}\overset{\bullet}{\text{H}}$
(7)	1	2	Me	(8)
	2	1	Me	
	3	0	—	
	2	1	H	

Dopamine (**10**) has also been the subject of some study. Maity and coworkers<sup>17</sup> have studied the pulse radiolysis or  $\gamma$ -irradiation induced reduction of the protonated form. In this instance the addition of an electron affords the radical anion **11** with a bimolecular rate constant for the reaction of  $2.5 \times 10^8 \text{ M}^{-1} \text{ s}^{-1}$ .

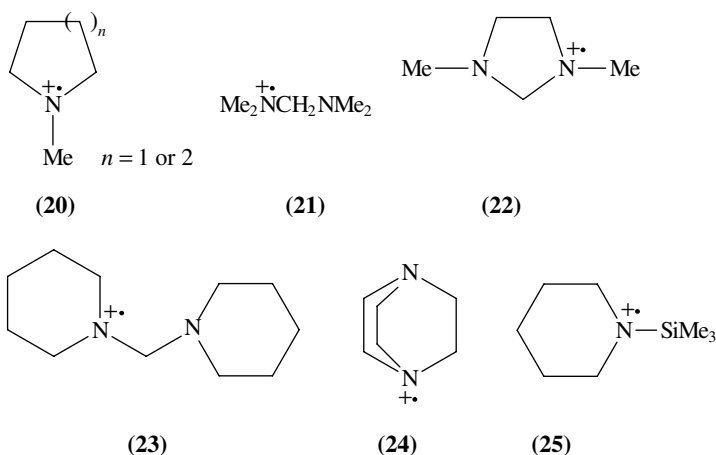


The cyclic amines, aziridine and azetidine, can be converted to their radical cations **12** and **13**, respectively, by  $\gamma$ -irradiation at 77 K in trichlorofluoromethane<sup>18</sup>. In the case of the aziridine radical cation there is evidence that it opens to afford **14**. There is a slight solvent dependency in the reaction of these systems and when the radical cation **13** of azetidine is irradiated in a matrix of  $\text{CFCl}_2\text{CF}_2\text{Cl}$  the radical cation converts into the neutral radical **15**. With aziridine in the same matrix the radical **16** is obtained without the generation of the radical cation. Hindered secondary amines such as 2,2,6,6-tetramethylpiperidine are of interest as antioxidants. However,  $\gamma$ -irradiation (at  $25^\circ\text{C}$  with  $72 \text{ rad min}^{-1}$ ) of well oxygenated dilute solutions of the piperidine **17** in 2,4-dimethylpentane has shown that these amines are not primary antioxidants<sup>19-22</sup>. Studies have also examined the use of secondary amines for the protection of polymers against damage from  $\gamma$ -radiation<sup>23</sup>. The stabilizers undergo oxidative transformations in the process. Hindered amine stabilizers, in combination with trivalent phosphorus melt processing stabilizers, are the stabilizers of choice. These are better than phenolic stabilizers since there is less discolouration of the polymer. Specifically polypropylene can also be protected against  $\gamma$ -initiated oxidation<sup>24</sup>.

FDMR has also been used to detect the transient radical cations formed from secondary amines by pulse radiolysis. As mentioned earlier this technique has been used to study a variety of systems such as the radical cation of triethylamine. The radical cations of diethylamine, *n*-propyl amine and *t*-butylamine, have also been studied<sup>25</sup>. The results have shown that the FDMR signal is enhanced with increasing alkyl substitution of the amine as in the pyrrolidines (**18**) and the piperidines (**19**)<sup>25</sup>.



$\gamma$ -Irradiation at 77 K in trichlorofluoromethane of cyclic tertiary amines also affords radical cations that can be trapped indefinitely. In these systems there apparently is no reaction between the radical cations and free amine. The EPR spectra of the radical cations were recorded. The cations produced under these conditions can be trapped indefinitely and do not undergo proton loss to give the corresponding carbon-centred radical. Several systems (**20**–**24**) were examined in this way and all were found to be stable. In the bis amine (**22**,  $n = 1$ ) evidence was obtained from the EPR study that there was weak N–N interaction<sup>4</sup>. The influence of silicon in **25** was also examined<sup>16</sup>.



## B. Radiolysis of Aromatic Amines

Triphenylamine (TPA), *N,N,N',N'*-tetramethyl-*p*-phenylenediamine (TMPD) and dimethylaniline (DMA) have been popular substrates for reaction under pulse radiolysis conditions. One of the earlier reports dealt with the formation of the radical cation of TMPD by reaction ( $k = 3 \times 10^8 \text{ M}^{-1} \text{ s}^{-1}$ ) with the peroxy radical derived from oxidation of methylene chloride ( $\text{CHCl}_2\text{O}_2$ ) by pulse radiolysis<sup>26</sup>. DMA is also oxidized to its radical cation by the same reagent ( $k = 2.5 \times 10^7 \text{ M}^{-1} \text{ s}^{-1}$ ). Since then it has been



TABLE 1. Absolute rate constants for reaction of peroxy radicals ( $\text{RO}_2^\bullet$ ) with TPMD

R	$k$ ( $\text{M}^{-1} \text{s}^{-1}$ )
Me	$4.3 \times 10^7$
Et	$3.3 \times 10^7$
Bu	$2.9 \times 10^7$
<i>i</i> -Pr	$9.2 \times 10^6$
<i>t</i> -Bu	$1.1 \times 10^6$
$\text{ClCH}_2$	$4.2 \times 10^8$
$\text{Cl}_2\text{CH}$	$7.4 \times 10^8$
$\text{Cl}_3\text{C}$	$1.7 \times 10^9$

demonstrated that a variety of oxidants can be used to convert TPMD into the radical cation  $\text{TPMD}^{\bullet+}$ . The absolute rate constants for the formation of this species by reaction with alkyl and haloalkylperoxy radicals ( $\text{RO}_2^\bullet$ ) have been determined<sup>27,28</sup> (Table 1).

Similar oxidation of amines occurs with pulse radiolysis of an aerated DMSO solution containing 5%  $\text{CCl}_4$  where the reactant species is  $\text{DMSO}\cdot\text{Cl}$ . The effective production of the radical cations was concentration dependent but reached a plateau at  $0.39 \mu\text{mol/J}$ .  $\gamma$ -Radiolysis gave a higher plateau value of  $0.42 \mu\text{mol/J}^4$ . Amines have also been oxidized by the use of sulphate radical anion obtained by pulse radiolysis in 95% acetonitrile solution. The rate constants were in the range of  $10^7$ – $10^9 \text{ mol}^{-1} \text{ s}^{-1}$  for the formation of the radical cation. Apparently these values are lower than those obtained from other solvent systems such as water<sup>29</sup>. A publication has collated data re absolute rate constants for the reaction of peroxy radicals with organic solvents<sup>30</sup>. The same amine substrates TPA and TPMD can also be converted into their radical cations ( $k = 10^{10} \text{ M}^{-1} \text{ s}^{-1}$ ) by the use of bromine atoms generated by pulse radiolysis<sup>31</sup>.

TPMD ( $k = 5.2 \times 10^8 \text{ M}^{-1} \text{ s}^{-1}$ ), *p*-diaminobenzene ( $k = 5 \times 10^7 \text{ M}^{-1} \text{ s}^{-1}$ ) and diphenylamine ( $k = 1 \times 10^7 \text{ M}^{-1} \text{ s}^{-1}$ ) can all be readily converted into the corresponding radical cation by oxidation with pulse radiolysis generated  $\text{SO}_3^{\bullet-}$ . With higher redox potential amines such as aniline and *N,N*-dimethylaniline the oxidation to the radical cation fails<sup>32</sup>. Rate constants have also been measured for conversion of the same amines into their radical cations by reaction with  $\text{SO}_4^{\bullet-}$ <sup>33</sup>.

Indoles can be also be converted into their radical cations by the use of  $\text{ClO}_2^\bullet$  as the oxidant produced by pulse radiolysis. From the reactivity of the resultant cation it was possible to establish the one-electron reduction potential of the indole in question. Typical results from this are illustrated in Table 2<sup>34</sup>. As can be seen, the one-electron reduction potential is influenced by alkyl substitution.

A measure of the one-electron reduction potential of tryptophan at pH 7 has shown it to be 0.093 V more positive than the tyrosine radical<sup>35</sup>. Further details on tryptophan and peptides, within which this moiety is present, have also been obtained using pulse-radiolysis-generated  $\text{N}_3^\bullet$ . This oxidant converts tryptophan into its radical cation with a second-order rate constant of  $3 \times 10^9 \text{ M}^{-1} \text{ s}^{-1}$ <sup>36</sup>. Interestingly the indolyl radical cation is capable of oxidizing tyrosine to the phenoxy radical<sup>37</sup>. Using this result and  $\text{N}_3^\bullet$  as the oxidant it has been possible to examine the through-bond electron transfer in peptides where the tryptophan unit is separated by an insulator from a tyrosine. Again the formation of the radical cation of the tryptophan was the first event<sup>38</sup>. Other studies<sup>39</sup> have shown that the redox potential of the tryptophan unit is only slightly lowered from the value for tryptophan ( $E_m = 1.05 \text{ V}$  at pH 7) when it is incorporated into peptides<sup>40</sup>. The

TABLE 2. One-electron reduction potentials of some indoles

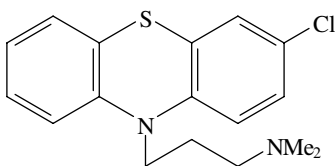
Indole	$E^\circ$ (V)
Indole	1.24
<i>N</i> -Methylindole	1.23
2-Methylindole	1.10
3-Methylindole	1.07
2,3-Dimethylindole	0.93
Tryptophan	1.24

TABLE 3. Absolute rate constants for the reaction of chloroalkylperoxy radicals with chlorpromazine

Radical	Solvent	Rate constant ( $M^{-1} s^{-1}$ )
$CCl_3O_2^\bullet$	$H_2O/i\text{-PrOH}/CCl_4$ ratio 90:10:0.06	$5.2 \times 10^8$
$CHCl_2O_2^\bullet$	$H_2O/i\text{-PrOH}/CHCl_3$ ratio 90:10:0.1	$3.7 \times 10^8$
$CHClO_2^\bullet$	$H_2O/i\text{-PrOH}/CHCl_3$ ratio 9:81:10	$3.4 \times 10^6$
$CH_2ClO_2^\bullet$	$H_2O/i\text{-PrOH}/CH_2Cl_2$ ratio 90:10:0.5	$2.8 \times 10^7$
$CH_2ClO_2^\bullet$	$H_2O/i\text{-PrOH}/CH_2Cl_2$ ratio 66:33:1	$1.7 \times 10^6$

reduction potential determinations of biochemically important free radicals have been reviewed<sup>41</sup>.

Other important aromatic amines such as chlorpromazine (**26**) have also been subjected to oxidation studies using oxidants produced by pulse radiolysis. Typical among these is the use of chloroalkylperoxyl radicals formed by pulse radiolysis in a variety of solvents. These oxidants yield the corresponding radical cation. The rate constants (Table 3) for these reactions were determined<sup>42</sup>. Other studies have determined the reactivity between chlorpromazine and  $Br_2^{\bullet-}$  in  $H_2O/DMSO$  in varying proportions. The rate constants for the formation of the radical cation of chlorpromazine were similar in value to those obtained from the peroxy radical reactions<sup>4</sup>.



(26)

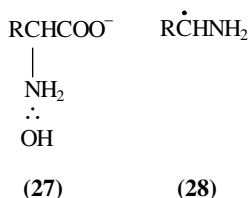
### III. RADIOLYSIS OF AMINO ACIDS

An excellent, fairly recent, review of this subject was published in 1987 as part of a text book dealing with radiation biology<sup>43</sup>. Since that time several advances have been reported. Much of the work reported in earlier reviews draws on material published in the 1960s and 1970s and, of course, most of this was reviewed (up to 1982) in the earlier volume<sup>1</sup> in this series. As with the other studies reviewed in this chapter, much of the work deals with the radiolytic generation of an oxidizing species that subsequently reacts with the substrate, in this section with amino acids. Typical of this is the description by Mönig and coworkers<sup>44</sup> of the reaction of hydroxy radicals, generated by  $\gamma$ -irradiation,

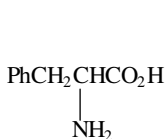
TABLE 4. Efficiency of decarboxylation of amino acids at pH 10.1 by hydroxy radicals

Amino acid	G(CO <sub>2</sub> ) CO <sub>2</sub> yield versus radiation dose
Glycine	4.0
$\alpha$ -Alanine	5.2
Valine	3.6
Leucine	3.9
Serine	4.5
<i>N,N</i> -Dimethylglycine	5.4

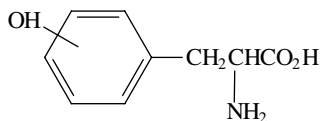
with amino acids. This brings about an efficient decarboxylation of the acid provided that the reaction is carried out in basic aqueous solution. Under these conditions the lone pair of electrons on the nitrogen is not protonated and it is at this site that the hydroxy radical attacks via a three-electron bonded system as illustrated in **27**. This intermediate collapses to hydroxide, carbon dioxide and the strongly reducing carbon-centred radical **28**. The detailed study (some examples are shown in Table 4) showed that decarboxylation occurs only when the amino and the carboxyl groups are on the same carbon. Furthermore, the yield of carbon dioxide amounts to 60–100% of the hydroxy radicals present.



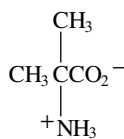
The introduction of phenyl groups affords another reaction path via the aryl group. Thus a typical example is that of phenylalanine (**29**) that can be hydroxylated radiolytically at the aryl group<sup>45</sup>. Another study has examined the reaction of pulse-radiolysis-generated hydroxyl radicals with the same substrate. Hydroxy radical attack in this instance leads to the formation of hydroxycyclohexadienyl radicals that can be oxidized to tyrosines (**30**). The attack by the hydroxy radical is quite random, however, although the *meta* position appears to be disfavoured. With sulphate radicals decarboxylation is again an important process along with tyrosine formation<sup>46</sup>. Apparently, sulphate radical attack generates a radical cation which either reacts with water to afford tyrosines or undergoes intramolecular electron transfer that results in decarboxylation. Conversion of the carboxylate into the corresponding radical occurs by electron transfer in situations where the  $\alpha$ -amino group is protonated. These processes have been studied using Fe(VI) and Fe(V) employing pulse radiolysis. The rate constants for the reaction of Fe(VI) with the carboxylates is in the range of  $10\text{--}10^3 \text{ M}^{-1} \text{ s}^{-1}$  while those for the reaction of Fe(V) are orders of magnitude greater<sup>47</sup>. Other studies with metal ions have examined the decarboxylation and deamination of 2-methylalanine **31**. This pulse study identified that the reaction of the carbon-centred radical **32** with  $\text{Cu}^{2+}$  or  $\text{Cu}^+$  formed a transient. In the case of  $\text{Cu}^{2+}$  the transient is suggested as **33**, with a copper-carbon  $\sigma$  bond. This decomposes by a  $\beta$ -carboxyl elimination reaction yielding  $\text{Cu}^+$ , carbon dioxide and the salt **34** that hydrolysed into acetone. This mechanism is thought to describe a new pathway for biological damage induced by free radicals<sup>48</sup>. The yield of radiation-induced radical formation in short peptides has also been measured and compared with the amino acids present<sup>49</sup>.



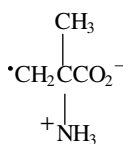
(29)



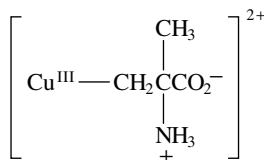
(30)



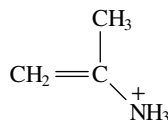
(31)



(32)

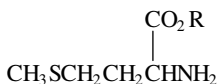


(33)



(34)

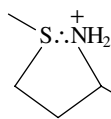
Methionine (**35**) also undergoes decarboxylation affording the radical **36** by attack of hydroxy radicals at  $\text{pH} \geq 3$ <sup>50</sup>. In this system the hydroxy radical attacks at sulphur in the first instance. This transient, with a three-electron S—O bond, is converted into the transient **37** and it is from this, the five-membered transition state, that decarboxylation takes place. The free acid is essential since no decarboxylation occurs with the ester **38**. A study of the transients in such systems has been carried out in frozen aqueous solutions at 77 K<sup>51</sup>. With *S*-methylcysteine (**39**) there is no interaction between the sulphur and the nitrogen. The transient formed on hydroxy radical oxidation was proposed as **40** and no decarboxylation takes place<sup>52</sup>. In the constrained methionine derivative **41** decarboxylation induced by hydroxy radicals is pH dependent<sup>53</sup>. Again the oxidation takes place at the sulphur. However, the intermediate **42** has a constant lifetime in the pH range 2.5–8. At higher pH the key intermediate is **43** and it is this that undergoes decarboxylation into the radical **44**.



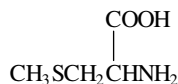
(35) R = H



(36)

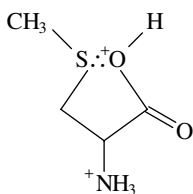


(37)

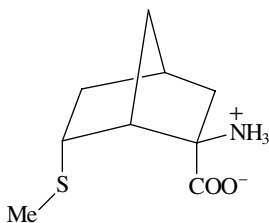


(39)

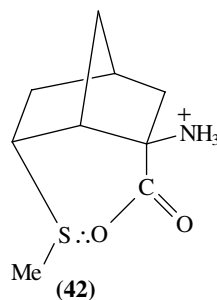
(38) R = Et



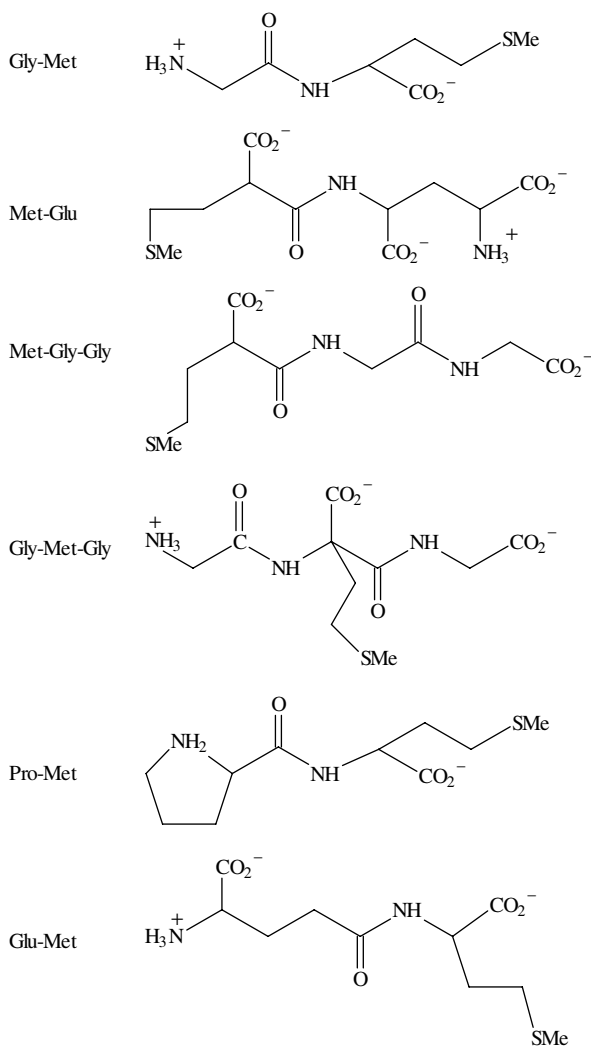
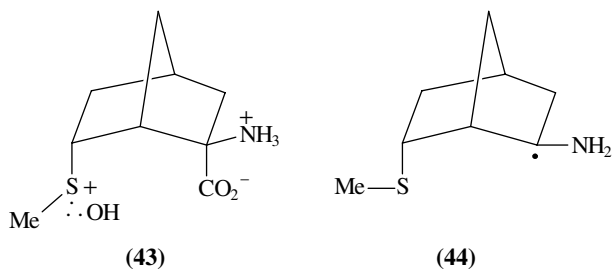
(40)



(41)



(42)



SCHEME 1

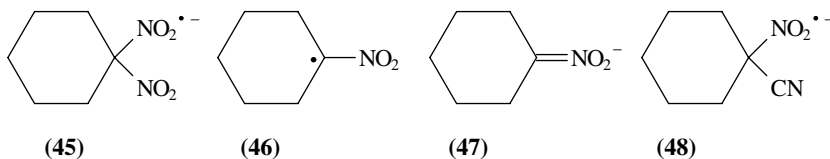
Other studies have examined the effect of pulse-generated hydroxy radicals on short peptides containing the methionine unit. Transients involving S–N interaction have been detected in *L*-methionyl-*L*-methionine<sup>54</sup>. In  $\gamma$ -glutamylmethionine and the *S*-alkylglutathione derivatives decarboxylation is also observed. However, the decarboxylation is thought to proceed by two different routes involving either (i) electron transfer between the oxidized sulphur and the carboxyl group on the terminal C-atom when both reactants are within the same peptide unit or (ii) interaction between a hydroxy radical adduct and a protonated amino group sited  $\alpha$  to a carboxyl group. This results in a process referred to as N-terminal decarboxylation<sup>55</sup>. The influence of peptide sequence has also been studied<sup>56</sup>. Mechanistically the decarboxylation, when it occurs, is the same in these systems as in the shorter peptides or in methionine itself and involves electron transfer from the methionine carboxylate function to the oxidized sulphur function. The effect of the make-up of the peptide is seen with the following systems: Met-Gly, Met-Glu, Met-Gly-Gly, Gly-Met-Gly and Pro-Met where decarboxylation does not occur. However, 80% decarboxylation occurs with  $\gamma$ -Glu-Met (Scheme 1)<sup>56</sup>.

Amino acids and proteins have also been shown to undergo oxidation when exposed to oxygen free radicals generated by  $\gamma$ -irradiation. This treatment results in the formation of hydroperoxide groups in, e.g., bovine serum albumin (BSA) or lysozyme. Common amino acids such as glutamate, isoleucine, leucine, lysine, proline and valine also undergo this peroxidation with similar efficiency<sup>57</sup>. The oxidation of BSA has also been studied using a variety of pulse-radiolysis-generated oxidants such as  $\text{Br}_2^{\cdot-}$ <sup>58</sup>. Other research has examined the reaction of hydroxy radicals, generated by <sup>60</sup>Co irradiation, with proteins either under an atmosphere of  $\text{N}_2\text{O}$  or of oxygen<sup>59–62</sup>.

#### IV. RADIOLYSIS OF NITRO AND NITROSO COMPOUNDS

##### A. Aliphatic Nitro Compounds

Pulse-radiolysis-induced electron transfer to nitro groups has been studied in some detail. Thus 1,1-dinitrocyclohexane undergoes conversion to the corresponding radical anion **45** on radiolysis in *t*-BuOH/ $\text{H}_2\text{O}$  (20:80) at pH 7. This species collapses to the radical **46** with loss of nitrite<sup>63</sup>. The products of the reaction result from the subsequent reactions of the radical **46** or of the nitronate **47** formed by addition of another electron to the radical. A later pulse-radiolysis study has examined<sup>64</sup> the reactivity of 2,2-dinitropropane and 1,1-dinitrocyclopentane and has shown that a similar reaction path is followed as that for 1,1-dinitrocyclohexane. However, the loss of nitrite from the radical anions of 2,2-dinitropropane and 1,1-dinitrocyclopentane was shown to be faster than that for 1,1-dinitrocyclohexane. The radical cation of 1-cyano-1-nitrocyclohexane (**48**), formed by radiolysis, also decomposes rapidly by elimination of nitrite. The subsequent cyanocyclohexyl radical undergoes hydrogen abstraction reactions from solvent<sup>64</sup>.

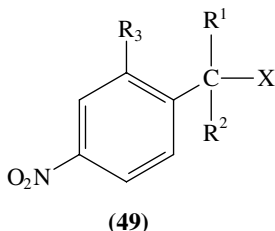


##### B. Aromatic Nitro Compounds

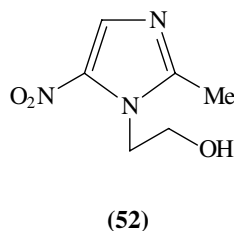
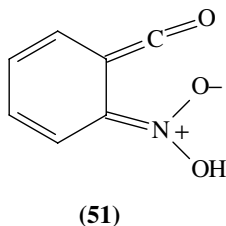
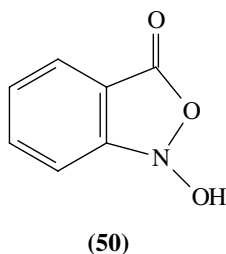
Aromatic nitro compounds are also prone to undergo one-electron reduction on pulse radiolysis. The behaviour of the radical cation so formed is dependent upon the type of

substituent attached to the aromatic ring. For example, a study has examined temperature effects on the loss of halide from the radical anions of the benzyl derivatives **(49)**<sup>65</sup>. X-radiation has also been used to induce transformations in aryl nitro derivatives isolated in argon matrices. Ionization under these conditions leads to radical cations that undergo intramolecular hydrogen transfer. The neutral products detected as a result of this are *o*-nitrosobenzoic acid and the isoxazolone **(50)**. Both of these are produced by reaction of the ketene **(51)** initially formed by the hydrogen transfer<sup>66</sup>. Other studies have examined the  $\gamma$ -radiolysis of nitrobenzene/carbon tetrachloride/water systems. The volatile products formed in these are dependent upon the composition of the reaction mixture. In the presence of high concentrations of carbon tetrachloride chlorobenzene is formed<sup>67</sup>.

	R <sup>1</sup>	R <sup>2</sup>	R <sup>3</sup>	X
	H	H	H	Cl
	H	Me	H	Cl
	H	Et	H	Cl
	Me	Bu'	H	Cl
	Me	H	H	Br
	Bu'	H	H	Br
	Me	H	Me	Br
	Bu'	H	Me	Br

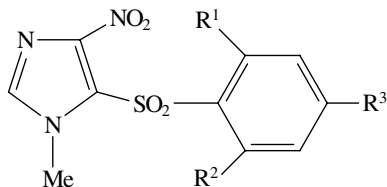


Considerable interest has been reported in the radiolytic reactions of radiosensitizing nitroimidazoles such as *Metronidazole*, 2-methyl-5-nitro-1*H*-imidazole-1-ethanol **(52)**. Again loss of the nitro function as nitrite appears to be one of the principal events. The formation of nitrite from  $\gamma$ -irradiation of the Ni(II) complex of the imidazole **52** arises by hydroxy radical attack to form the radical anion. This either eliminates nitrite or undergoes a four-electron reduction to a hydroxylamino derivative<sup>68,69</sup>.



Several studies have reported the influence of nitroimidazole derivatives on biological systems. Thus the influence of *Misonidazole*, 1-(2-nitro-1-imidazolyl)-3-methoxy-propan-2-ol, on strand breaking in calf thymus DNA under ionizing radiation conditions has been assessed<sup>70</sup>. Pulse-radiolysis studies of nitroheterocyclic compounds have examined

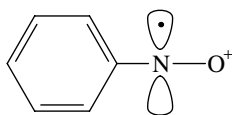
the interaction of the nitro radical with various cellular extracts and purified enzymes<sup>71</sup> and copper oxidases<sup>72</sup>. The imidazole derivatives (**53**) have also been tested as radiation sensitizers of hypoxic carcinoma cells<sup>73</sup>.



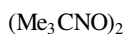
	R <sup>1</sup>	R <sup>2</sup>	R <sup>3</sup>
(53)	Me	Me	OCH <sub>2</sub> CO <sub>2</sub> H
	Cl	Me	H
	Cl	Cl	H
	Cl	CO <sub>2</sub> H	Cl

### C. Nitroso Compounds

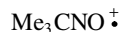
Radiation-induced electron transfer to nitroso compounds has also been studied. This technique, using electron expulsion from trichlorofluoromethane, provided data that the radical cation **54** is formed from nitrosobenzene at 77 K. Analysis of the EPR spectrum indicates that the singly occupied MO lies in the plane of the benzene ring and has high 2s character<sup>74</sup>. Irradiation of the dimer **55** under the same conditions shows that a trace of the monomeric radical cation **56** is produced<sup>74</sup>.



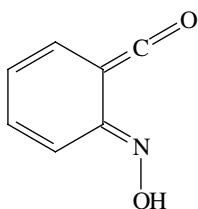
(54)



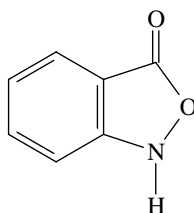
(55)



(56)



(57)



(58)

X-radiation of *o*-nitrosobenzaldehyde also brings about intramolecular hydrogen transfer to yield the ketene **57**. Cyclization within this affords **58**<sup>66</sup>.



## V. REFERENCES

1. C. L. Greenstock, 'Radiation chemistry of amines, nitro and nitroso compounds' in *Supplement F: The Chemistry of Amino, Nitroso and Nitro Compounds and their Derivatives, Part I* (Ed. S. Patai), Wiley, Chichester, 1982, p. 291.
2. V. N. Belevsky, O. In Quan, S. I. Belopushkin and V. I. Feldman, *Dokl. Akad. SSSR*, **281**, 869 (1985).
3. V. N. Belevsky, S. I. Belopushkin and V. I. Feldman, *J. Radioanal. Nucl. Chem. Lett.*, **107**, 67 (1986).
4. M. Kumar and P. Neta, *J. Phys. Chem.*, **96**, 3350 (1992).
5. G. W. Eastland, D. N. R. Rao and M. C. R. Symons, *J. Chem. Soc., Perkin Trans. 2*, 1551 (1984).
6. S. Das, M. N. Schuchmann, H. -P. Schuchmann and C. von Sonntag, *Chem. Ber.*, **120**, 319 (1987).
7. S. Das and C. von Sonntag, *Z. Naturforsch. B., Org. Chem.*, **41B**, 505 (1986).
8. C. von Sonntag and H. -P. Schuchmann *Angew. Chem., Int. Ed. Engl.*, **30**, 1229 (1991).
9. R. E. Huie, L. C. T. Shoute and P. Neta, *Int. J. Chem. Kinet.*, **23**, 541 (1991).
10. S. M. Lefkowitz and A. D. Trifunac, *J. Phys. Chem.*, **88**, 77 (1984).
11. S. Matsuoka, T. Kohzuki, C. Pac, A. Ishida, S. Takamuku and M. Kusaba, *J. Phys. Chem.*, **96**, 4443 37 (1992).
12. S. Matsuoka, H. Fujii, T. Yamada, C. Pac, A. Ishida, S. Takamuku, M. Kusaba, N. Nakashima, S. Yanagida, K. Hashimoto and T. Sakata, *J. Phys. Chem.*, **95**, 5802 (1991).
13. J. Piekarskagolebiowska, C. Z. Stradowski and M. Szadkowskanicz, *J. Photochem. Photobiol. A, Chem.*, **49**, 325 (1989).
14. J. Piekarskagolebiowska and J. Kroh, *Bull. Pol. Acad. Sci., Chem.*, **39**, 369 (1991).
15. J. Kroh, *Isotopenpraxis*, **26**, 461 (1990).
16. C. J. Rhodes, *J. Chem. Soc., Perkin Trans. 2*, 235 (1992).
17. D. K. Maity, H. Mohan and J. P. Mittal, *J. Chem. Soc., Perkin Trans. 2*, 919 (1994).
18. X. -Z. Qin and F. Williams, *J. Phys. Chem.*, **90**, 2292 (1986).
19. C. Crouzet and J. Marchal, *Radiat. Phys. Chem.*, **40**, 359 (1992).
20. C. Crouzet and J. Marchal, *Radiat. Phys. Chem.*, **40**, 233 (1992).
21. C. Crouzet and J. Marchal, *Radiat. Phys. Chem.*, **41**, 851 (1993).
22. C. Crouzet, *Radiat. Phys. Chem.*, **40**, 233 (1992).
23. P. P. Klemchuk, *Radiat. Phys. Chem.*, **41**, 165 (1993).
24. S. Falicki, D. J. Carlsson, J. M. Cooke and D. J. Gosciniak, *Polym. Degrad. Stab.*, **38**, 265 (1992).
25. D. W. Werst and A. D. Trifunac, *J. Phys. Chem.*, **95**, 1268 (1991).
26. Z. B. Alfassi, S. Mosseri and P. Neta, *J. Phys. Chem.*, **93**, 1380 (1989).
27. P. Neta, R. E. Huie, S. Mosseri, L. V. Shastri, J. P. Mittal, P. Maruthamuthu and S. Steenken, *J. Phys. Chem.*, **93**, 4099 (1989).
28. P. Neta, R. E. Huie, P. Maruthamuthu and S. Steenken, *J. Phys. Chem.*, **93**, 7654 (1989).
29. S. Padmaja, Z. B. Alfassi, P. Neta and R. E. Huie, *Int. J. Chem. Kinet.*, **25**, 193 (1993).
30. P. Neta, R. E. Huie and A. B. Ross, *J. Phys. Chem., Ref. Data*, **19**, 413 (1990).
31. L. C. T. Shoute and P. Neta, *J. Phys. Chem.*, **94**, 2447 (1990).
32. P. Neta and R. E. Huie, *J. Phys. Chem.*, **89**, 1783 (1985).
33. S. Padmaja, Z. B. Alfassi, P. Neta and R. E. Huie, *Int. J. Chem. Kinet.*, **25**, 193 (1993).
34. G. Merényi, J. Lind and X. Shen, *J. Phys. Chem.*, **92**, 134 (1988).
35. J. Butler, E. J. Land, W. A. Prutz and A. J. Swallow, *J. Chem. Soc., Chem. Commun.*, 348 (1986).
36. S. V. Jovanovic, A. Harriman and M. G. Simic, *J. Chem. Phys.*, **90**, 1935 (1986).
37. M. Faraggi, M. R. DeFelippis and M. H. Klapper, *J. Am. Chem. Soc.*, **111**, 5141 (1989).
38. M. R. DeFelippis, M. Faraggi and M. H. Klapper, *J. Am. Chem. Soc.*, **112**, 5640 (1990).
39. M. DeFelippis, C. P. Murthy, M. Faraggi and M. H. Klapper, *Biochemistry*, **28**, 4847 (1989).
40. M. R. DeFelippis, C. P. Murthy, F. Broitman, D. Weinraub, M. Farragi and M. H. Klapper, *J. Phys. Chem.*, **95**, 3416 (1991).
41. M. Faraggi and M. H. Klapper, *J. Chim. Phys.-Phys.-Chim. Biol.*, **90**, 711 (1993).
42. Z. B. Alfassi, R. E. Huie, M. Kumar and P. Neta, *J. Phys. Chem.*, **96**, 767 (1992).
43. C. von Sonntag, *The Chemical Basis of Radiation Biology*, Taylor and Francis, London, New York and Philadelphia, 1987, pp. 393-428.
44. J. Mönig, R. Chapman and K. -D. Asmus, *J. Phys. Chem.*, **89**, 3139 (1985).

45. C. Wiezorek, *Radiat. Res.*, **100**, 235 (1984).
46. D. G. Wang, H. -P. Schuchmann and C. von Sonntag, *Z. Naturforsch. B, Org. Chem.*, **48**, 761 (1993).
47. V. K. Sharma and B. H. J. Bielski, *Inorg. Chem.*, **30**, 4306 (1991).
48. S. Goldstein, G. Czapski, H. Cohen and D. Meyerstein, *Inorg. Chem.*, **31**, 2439 (1992).
49. C. Wiezorek, *Int. J. Radiat. Biol.*, **45**, 93 (1984).
50. K. -O. Hiller and K. -D. Asmus, *J. Phys. Chem.*, **87**, 3682 (1983).
51. M. H. Champagne, M. W. Mullins, A. O. Colson and M. D. Sevilla, *J. Phys. Chem.*, **95**, 6487 (1991).
52. K. -D. Asmus, M. Göbl, K. -O. Hiller, S. Mahling and J. Mönig, *J. Chem. Soc., Perkin Trans. 2*, 641 (1985).
53. L. K. Steffen, *J. Am. Chem. Soc.*, **113**, 2141 (1991).
54. K. Bobrowski and J. Holcman, *J. Phys. Chem.*, **93**, 6381 (1989).
55. K. Bobrowski, C. Schöneich, J. Holcman and K. -D. Asmus, *J. Chem. Soc., Perkin Trans. 2*, 975 (1991).
56. K. Bobrowski, C. Schöneich, J. Holcman and K. -D. Asmus, *J. Chem. Soc., Perkin Trans. 2*, 353 (1991).
57. S. Gebicki and J. M. Gebicki, *Biochem. J.*, **289**, 743 (1993).
58. S. K. Kapoor and C. Gopinathan, *J. Radioanal. Nucl. Chem.*, **171**, 443 (1993).
59. K. J. A. Davies, M. E. Delsignoret and S. W. Lin, *J. Biol. Chem.*, **262**, 9902 (1987).
60. K. J. A. Davies, S. W. Lin and R. E. Pacifici, *J. Biol. Chem.*, **262**, 9914 (1987).
61. K. J. A. Davies and M. E. Delsignoret, *J. Biol. Chem.*, **262**, 9908 (1987).
62. K. J. A. Davies, *J. Biol. Chem.*, **262**, 9895 (1987).
63. J. C. Ruhl, D. H. Evans, P. Hapiot and P. Neta, *J. Am. Chem. Soc.*, **113**, 5188 (1991).
64. J. C. Ruhl, D. H. Evans and P. Neta, *J. Electroanal. Chem.*, **340**, 257 (1992).
65. M. Meot-ner, P. Neta, R. K. Norris, and K. Wilson, *J. Phys. Chem.*, **90**, 168 (1986).
66. J. Michalak, J. Gebicki and T. Bally, *J. Chem. Soc., Perkin Trans. 2*, 1321 (1993).
67. J. Kuruc and M. K. Sahoo, *J. Radioanal. Nucl. Chem.*, **173**, 395 (1993).
68. M. B. Roy, P. C. Mandal and S. N. Bhattacharyya, *J. Chem. Soc., Dalton Trans.*, 2485 (1993).
69. T. Kagiya, H. Ide, S. Nishimoto and T. Wada, *Int. J. Radiat. Biol.*, **44**, 505 (1983).
70. G. W. Buchko and M. Weinfeld, *Biochemistry*, **32**, 2186 (1993).
71. N. Lougmani, A. Guissani, Y. Henry and B. Hickel, *J. Chim. Phys. Phys.-Chim. Biol.*, **90**, 931 (1993).
72. N. Lougmani, A. Guissani, Y. Henry and B. Hickel, *J. Chim. Phys.-Phys.-Chim. Biol.*, **90**, 943 (1993).
73. R. A. Egolf and N. D. Heindel, *J. Heterocycl. Chem.*, **28**, 577 (1991).
74. H. Chandra, D. J. Keeble and M. C. R. Symons, *J. Chem. Soc., Faraday Trans. 1*, **84**, 609 (1988).

## CHAPTER 18

# The electrochemistry of nitro, nitroso, and related compounds

ALBERT J. FRY

Wesleyan University, Middletown, Connecticut, USA  
Fax: (860)685-2211; e-mail: AFRY@WESLEYAN.EDU

---

I. INTRODUCTION .....	837
II. GENERAL CONSIDERATIONS .....	838
A. Mechanism of Electrochemical Reduction .....	838
1. Dependence of proton activity of medium .....	838
2. Other medium effects .....	843
III. SUBSTITUTED NITROAROMATICS .....	845
IV. AROMATIC DINITRO COMPOUNDS .....	847
V. ALIPHATIC NITRO COMPOUNDS .....	849
VI. RELATED PROCESSES .....	851
A. Nitro Compounds as Electrogenated Bases .....	851
B. Nitro Compounds as Protecting Groups .....	852
VII. NITROSO COMPOUNDS .....	854
VIII. ACKNOWLEDGMENTS .....	854
IX. REFERENCES .....	854

---

### I. INTRODUCTION

Nitro compounds have been popular subjects for investigation from the earliest days of organic electrochemistry. The reasons for this are not hard to find: they are available in profusion, are easily reduced without affecting other functional groups, and a variety of products can be produced, depending upon the exact nature of the experimental conditions. Studies on the electrochemical reduction of nitro compounds have produced important insights into the mechanistic pathways available to organic compounds generally. The electrochemical reduction of a given nitro compound may take a considerably different course when variables such as the pH, electrolysis potential or nature of the solvent are varied. This has made the study of their reduction mechanisms a popular and challenging research topic. Nitroso compounds are much less common than nitro compounds and have been studied far less. Nevertheless, their status as putative intermediates in the

electrochemical reductions of nitro compounds has led to a number of studies of their behavior.

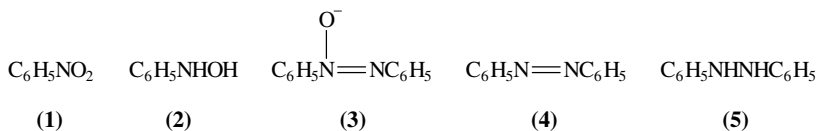
## II. GENERAL CONSIDERATIONS

### A. Mechanism of Electrochemical Reduction

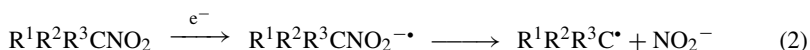
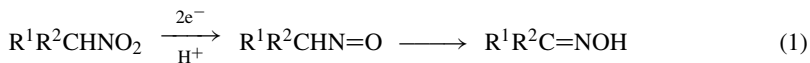
It will be helpful at this point to review a few well-known features of the electrochemical behavior of nitro and nitroso compounds. The reader is referred to a previous review in this series for more detail on this point<sup>1</sup>. The primary fact of which one must be aware of is that the electrochemistry of nitro compounds is exclusively cathodic: the high oxidation level of nitrogen in the nitro group means that while they are easily reduced, they generally cannot be oxidized. As a matter of fact, nitrobenzene and nitromethane have been used as solvents for electrochemical oxidations because of their stability under anodic conditions<sup>2</sup>. Nitroso compounds are readily both oxidized and reduced, although the literature on these substances is much more sparse.

#### 1. Dependence of proton activity of medium

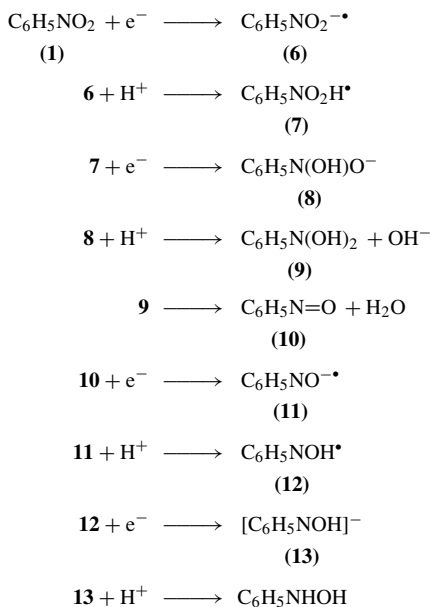
Aryl nitro compounds are by far the most common such substances, and nitrobenzene (**1**) is the best known of these. Nitrobenzene exhibits a single four-electron voltammetric wave at pH 5 or above; a second two-electron wave is observed at more negative potentials at pH 4 or lower. The products of the electrochemical reduction of nitrobenzene in aqueous organic media were established a century ago in the classic work of Haber<sup>3</sup>. Reduction at room temperature in weakly acidic media (roughly pH 5 to 7) consumes four electrons per mole of **1** and affords phenylhydroxylamine (**2**); reduction under more powerfully reducing conditions (pH  $\leq$  4 and more negative potentials) affords aniline by reductive cleavage of the N—O bond of **2**. If the reaction is carried out under more vigorous conditions (stronger acid, higher temperatures), the product is *p*-aminophenol, formed by acid-catalyzed rearrangement of **2** (the so-called Wallach rearrangement). Zuman has summarized the dependence of the ultimate fate of the arylhydroxylamine (that is, whether it is isolated or undergoes further transformation) on experimental conditions<sup>4</sup>. In contrast to these multi-electron processes in protic media, **1** exhibits a one-electron wave followed by a second three-electron wave at more negative potentials. Controlled-potential electrolysis at relatively positive potentials affords a very stable radical anion in media of low proton availability (aprotic solvents or even aqueous alkali). Reduction in liquid ammonia as solvent affords not only the radical anion but also the corresponding nitrobenzene dianion, at more negative potentials<sup>5</sup>. Similar behavior is observed in highly purified dimethylformamide<sup>6</sup>. Preparative scale electrolysis in alkaline media usually affords azoxy compounds (**3**), although the corresponding azo compounds (**4**) and hydrazo compounds (**5**) have been isolated from some electrolyses. The reasons for the diversity of products under alkaline conditions is still not fully clear. Azoxy compounds are reduced to azo compounds relatively easily, hence it would appear unlikely that **3** could ever be isolated from such electrolyses, but it appears that part of the reason is the fact that azoxy compounds often precipitate from solution, protecting them against further reduction<sup>7</sup>. In general these substances are produced by consecutive electrochemical reduction of **3** to **4** and finally to **5**.



Aliphatic nitro compounds exhibit rather different behavior from nitroaromatic compounds. Secondary and primary nitro compounds tend to produce oximes because the intermediate nitroso compound quickly tautomerizes to the oxime (equation 1). Under aprotic conditions the radical anions of primary and secondary nitro compounds are relatively stable; those derived from tertiary nitro compounds, on the other hand, eject nitrite ion relatively readily (equation 2)<sup>8</sup>.



Nitrogen in a nitro group is in the highest oxidation state which the element can exhibit while still bound to carbon. Under powerfully reducing conditions the nitro group can be reduced to an amino group, in which nitrogen exhibits its lowest oxidation state. A number of species of intermediate oxidation level are possible between these two extremes. The electrochemical reduction of nitro compounds does in fact give rise to a number of such intermediates. Some of these can be directly identified, while the existence of others can sometimes only be inferred. Furthermore, a variety of paths may interconnect the various intermediates, starting materials and products of the electrochemical reduction of a given nitro compound, depending on the particular experimental conditions being employed. Different nitro compounds may react by different paths under identical experimental conditions, and a given compound may give rise to *the same product by several different paths under different experimental conditions*. Consider the electrochemical reduction of nitrobenzene (**1**) to phenylhydroxylamine (**2**) in a weakly acidic protic medium. This process involves overall uptake of four electrons by **1**. As we shall see, this can occur by a variety of mechanisms, of which only one possibility is shown in Scheme 1. This scheme

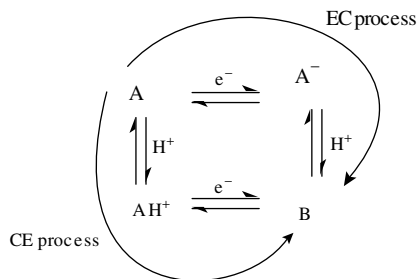


SCHEME 1

differs in one significant detail from the mechanism of reduction of **1** presented in the previous<sup>1</sup> review in this series: it is now known that cleavage of the N–O bond involves dehydration of an intermediate *N,N*-dihydroxy compound (**9**). Previously it had been suggested that nitrosobenzene (**10**) was formed by loss of hydroxide ion from intermediate **7**. In essence, Scheme 1 describes the gradual decrease in the oxidation level of nitrogen as electrons are successively added to **1**. Four electrons are added overall, but since this would build up an unacceptably high charge on **1** if no other change were to take place, the organic species responds by addition of protons at each stage to maintain its structure near neutrality. Scheme 1 works well to rationalize the known conversion of **1** to **2** in weak acid. However, it greatly misrepresents the complexity of the reactions taking place. For example, nitrosobenzene (**10**) is easier to reduce than **1**, hence it does not build up in solution but rather is reduced immediately upon formation. But, if nitrosobenzene is easier to reduce than nitrobenzene, this means that *the nitrobenzene radical anion (6) is itself thermodynamically capable of reducing 10 to its radical anion 11*. One therefore really ought to add to Scheme 1 another line representing electron transfer from **6** to **10** to produce **11** and regenerate **1**. Thus, there are two ways in which the reduction of **10** to **11** can take place, depending on whether electron transfer to **10** takes place from the electrode or from **6**, respectively. Because the reactant and the various intermediates are produced and react in a narrow zone (the *reaction layer*) close to the electrode surface, homogeneous solution electron exchange between **6** and **10** certainly does take place; in fact, it is probably the primary path for formation of **11**<sup>9</sup>. Likewise, we should also note that **6** and **11** may undergo homogeneous solution electron exchange with other intermediates in the redox chain<sup>10</sup>. One must also appreciate that in general the mechanism and even the products of reduction of any given nitro compound will be sensitive to reaction conditions, in particular pH and electrolysis potential. Often it is not readily apparent what the actual electroactive species is in a particular conversion. [An *electroactive species* is a chemical entity undergoing electron exchange from or to the electrode.] For example, one might legitimately inquire whether the actual electroactive material in the reduction of **10** is **10** itself or whether it is its conjugate acid, which being positively charged ought to be considerably easier to reduce than **10**. This question is of particular mechanistic relevance for understanding electrolyses carried out in relatively strongly acidic solution, especially when one appreciates that a component of the medium, e.g. the protonated form of a compound, may be the electroactive substance even when it is present at very low equilibrium concentration<sup>11</sup>. It is clear that working out the mechanism of the electrochemical reduction of nitro compounds represents a very challenging problem indeed. There has been a great deal of previous work in this area, largely summarized in previous reviews<sup>1,7b,12</sup>.

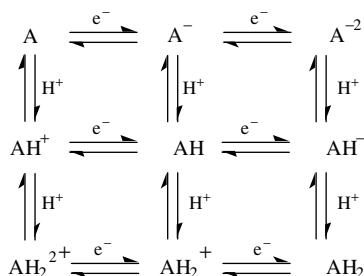
The electrochemical reduction of nitrosobenzene (**10**) to phenylhydroxylamine (**2**) and nitrobenzene (**1**) to the *N,N*-dihydroxy compound (**9**) can be used to illustrate another point. Complex organic electrochemical processes typically involve a series of individual reactions each of which is one of two types: (a) so-called 'E', or electron transfer steps (either homogeneous —to or from another component of the medium depending on whether one is discussing oxidations or reductions, respectively— or heterogeneous —to or from the electrode) and (b) 'C' steps, i.e. chemical conversions (all reactions other than electron transfer). The conversion of **10** to **2** formally involves addition of the elements of hydrogen or, more specifically, two electrons and two protons, to **10**. A major aim of mechanistic studies on organic electrode processes is the determination of the particular sequence of electron transfers and chemical steps involved in the overall reaction. For the conversion of **1** to **9** or **10** to **2**, all combinations of two E steps and two C steps must *a priori* be considered as possible<sup>13</sup>. Scheme 1 shows one possible way in which each of these conversions might take place, i.e. by alternate addition of electrons and protons to either **1** or **10**. In the commonly used terminology of mechanistic electrochemistry, these

are so-called 'ECEC' processes. The term ECEC is therefore a shorthand method for describing the sequence in which the electron transfer and protonation steps take place. If one includes all possible permutations of two proton and two electron transfers, there are six distinct mechanistic possibilities for the conversion of **1** to **9** and **10** to **2** ( $4!/2!2!$ ), or twelve if one recognizes that the second electron transfer could be either homogeneous or heterogeneous. Some of these sequences are highly improbable on chemical grounds. We may expect, for example, that the mechanism of reduction of **1** and **10** in acid will probably not be EECC, because the species produced by the first electron transfer are likely to be strong bases and would surely react with a proton before the second electron transfer could take place. Likewise, it is unlikely that conversion of **1** to **9** (or **10** to **2**) proceeds via a CCEE mechanism; this would imply that the electroactive species is doubly protonated nitrobenzene, whereas it is known that **1** and **10** are not strong bases. Even if such chemically unreasonable steps were to be omitted, it is clear that the number of discrete paths by which **1** might in principle be converted into **2** is very large. It would be very cumbersome to present all of the likely paths in a format similar to that of Scheme 1, i.e. as a series of chemical reactions written in text form. It turns out to be much more convenient to represent the various possible mechanistic paths in graphical form. This is done in the following way. Consider an electrochemical reaction involving the conversion of a substance A to a product B and requiring one electron transfer and one chemical step. There are two possible mechanisms (EC or CE) for this process, depending on the order in which the two steps occur. We can represent this as a so-called 'square' mechanism, represented as in Scheme 2. The EC path is represented by the top and right-hand equations while the CE process is represented by the left-hand and bottom reactions.



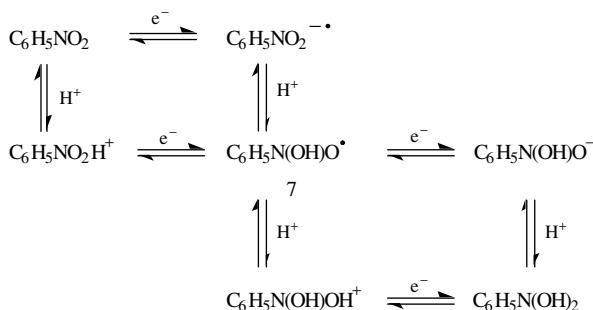
SCHEME 2. Simplest (four-component) square mechanism

This type of representation is readily extended to cover more complex cases. A one-electron, two-proton reduction can be described by a so-called 'ladder' scheme<sup>14</sup>, whereas a two-electron, one-proton process can be described by a 'fence' scheme<sup>15</sup>. Reactions involving uptake of the elements of H<sub>2</sub> are relatively common in organic electrochemistry; in fact, we have already encountered the conversion of **1** to **9** and **10** to **2**, which are examples of this type of process (see Scheme 1). Such processes may be represented by a nine-component square (Scheme 3). A number of features are common to schemes such as Schemes 2 and 3. All species in a given vertical column are in the same oxidation state but differ in their degree of protonation. Conversely, all species in a given horizontal row correspond to the same degree of protonation but are in different oxidation states. Each path which may be traced between any one species on the diagram and any other corresponds to a distinct electrochemical mechanism. The ECEC mechanism ( $A \rightarrow A^- \rightarrow AH \rightarrow AH^- \rightarrow AH_2$ ) which was mentioned previously as a mechanistic path from **1** to **9** and **10** to **2** can be seen from Scheme 3 to be only one of a number of paths by which this conversion might take place.



SCHEME 3. Nine-component square mechanism

As mentioned earlier, reduction of nitro compounds to hydroxylamines is now known to involve a sequence involving initial two-electron, two-proton conversion to an *N,N*-dihydroxy compound (**9**), dehydration of **9** to the corresponding nitroso compound (**10**) and finally a second two-electron, two-proton reduction of **10**. We may now recognize that two nine-component square schemes, separated by the intervening dehydration of **9** to **10**, are required to represent all possible mechanistic paths for this process in acidic media. In point of fact, however, the doubly protonated nitro and nitroso compounds, which correspond to the lower left-hand corner of Scheme 3, are improbable intermediates in these reactions, because **1** and **10** are weak bases and their doubly protonated forms will therefore be present in vanishingly small amounts even in strong acid. Likewise, the nitrobenzene and nitrobenzene dianions (corresponding to the top right-hand corners of Scheme 3) are equally improbable intermediates because they would be formed via intermediate monoanions, which would be very short-lived in acidic solution. For this reason, the top right and bottom left corners of Scheme 3 are sometimes omitted when describing the reduction of nitro compounds in acid, leaving a seven-component diagram consisting of two four-component square mechanisms sharing a single corner (Scheme 4). The common intermediate between the two four-component squares in Scheme 4 is the RN(OH)O-radical (**7**).



SCHEME 4

One of the advantages of electrochemical methods over more conventional chemical methods is the fact that the actual electron transfer process can be carried out at an electrode with a far greater degree of control than with a solution reactant. By careful application of the appropriate electrochemical techniques, it is possible to define the sequence of chemical and electron transfer steps in a given electrochemical process with



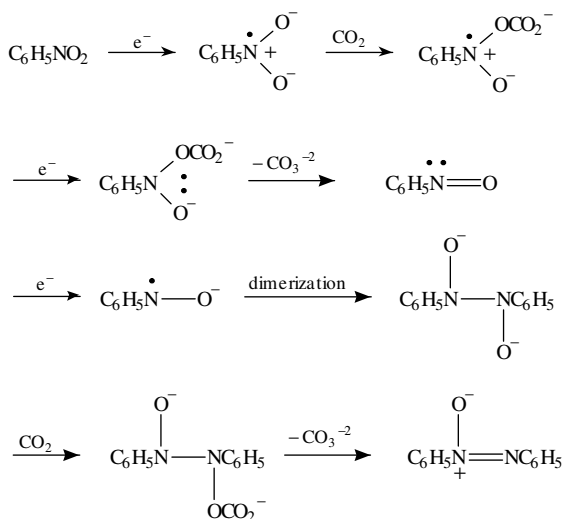
a high degree of specificity. Laviron has shown by such methods that the rate-determining step in the formation of the *N,N*-dihydroxy compound (**9**) is conversion of the radical  $\text{ArN(OH)O}\cdot$  to **9**. Using standard voltammetric techniques, he was able to conclude that the global mechanism for the reduction of  $\text{ArNO}_2$  to  $\text{ArN(OH)}_2$  changes from ECCE at  $\text{pH} = 0$  to ECEC at  $\text{pH} = 5$  (C is a protonation step) with the change in mechanism taking place at about  $\text{pH} = 3$ <sup>16</sup>. With 4-nitrobenzophenone the rate of dehydration of the *N,N*-dihydroxy compound controls the rate of the first reduction step in strongly acidic media ( $H_0 = -2$ )<sup>17</sup>. The sequence of steps involved changes through CECE, ECCE and finally ECEC as the acidity of the medium increases from  $H_0 = -5$  to  $\text{pH} 10$ , and is EE at  $\text{pH} > 10$ . Dehydration of **9** is sometimes slow enough that the nitroso compound can be observed as a transient intermediate during electrolysis, for example at low temperature<sup>18</sup> or with certain special structural types such as *p*-dinitrobenzene<sup>18</sup> and the nitropyridines<sup>19</sup>.

Information obtained by voltammetric studies and preparative scale electrolyses can often be used to understand the course of reactions carried out with chemical reductants or oxidants. Nitro compounds provide an excellent illustration of this point. Organic chemists have known for many years that aryl nitro compounds can be reduced to a variety of compounds, depending on experimental conditions. For example, reduction to the corresponding aniline is often carried out using metallic tin or iron (strong reducing agents) and hydrochloric acid; this is consistent with the voltammetric data, which indicate that conversion of the hydroxylamine to the amine requires a relatively negative potential and a rather strongly acidic medium. Similarly, reduction of nitrobenzene (**1**) to azobenzene (**4**) is typically carried out using a strong reductant, for example metallic zinc, in alkaline medium<sup>20</sup>; we have seen that dimeric derivatives are formed only under basic conditions and that the initial dimer is normally the azoxy compound (**3**), which is reduced further to the azo compound. Finally, reduction of the nitro compound under basic conditions with a mild reductant affords the azoxy compound, which can likewise be obtained by electrochemical reduction in base under mild conditions.

## 2. Other medium effects

From the discussions up to this point it should be clear that reduction of nitrobenzene in acidic media affords phenylhydroxylamine, whereas reduction in basic media affords azoxy compounds and/or their secondary electrolysis products, azo or hydrazo compounds. Ohkubo recently made the very interesting observation that azoxybenzene is the major product (together with some azobenzene and a trace of hydrazobenzene) when the solvent for electrochemical reduction of nitrobenzene (acetonitrile) is saturated with carbon dioxide<sup>21</sup>. The authors suggested that carbon dioxide emulates the effect of a proton in this reaction. This cannot be the entire answer, since addition of phenol to the medium instead of carbon dioxide results in formation of phenylhydroxylamine, not azoxybenzene<sup>22</sup>. Carbon dioxide probably acylates the electrochemically-generated nitrobenzene radical anion, paving the way for N–O bond breakage by loss of carbonate ion and providing an alternate route to azoxybenzene to that shown in Scheme 1. A possible mechanism is presented in Scheme 5.

Thus far the solvent systems we have discussed are typical protic organic media, such as, for example, water–ethanol mixtures containing an added supporting electrolyte. These solvents are presumably quite homogeneous on a microscopic level. However, a number of solvents have been developed in recent years which are heterogeneous on a microscopic scale. Micellar media are one example of such solvents. The electrochemical reduction of nitrobenzene in aqueous solutions containing polyoxyethylene lauryl ether, a substance known to produce neutral micelles, produces azobenzene (**4**) even at  $\text{pH}$  somewhat less than 7<sup>23</sup>. This is apparently the first case of formation of a dimeric product from electrolysis of nitrobenzene (**1**) in acidic media. Another striking example of this phenomenon



SCHEME 5

was recently observed during electrochemical reduction of **1** in a so-called 'microemulsion' consisting of 34% didodecylammonium bromide (DDAB), 51% hexane and 15% 5M aqueous HCl<sup>24</sup>. Constant-current electrochemical reduction of **1** in this solvent affords a mixture of azobenzene and azoxybenzene! [Recall that these products are usually found only in electrolyses of nitrobenzene in alkaline media.] Although microemulsions are thermodynamically stable and homogeneous on a macroscopic scale (for example, they do not scatter light), they are undoubtedly quite heterogeneous at the molecular level<sup>25</sup>. Nitrobenzene is presumably concentrated in the hydrocarbon phase in both of these media and therefore its local concentration is undoubtedly higher than its nominal concentration. As was also recognized by Blount<sup>23</sup>, this would favor dimerization, a bimolecular process.

As noted at the outset, electrochemistry normally occurs in a thin layer of solution near the electrode surface. Electrochemical reactions frequently occur via adsorbed reactants and/or intermediates. Whether adsorption effects are observed in a given situation depends not only on the structure of the electroactive substance but also on the nature of the solvent and, very importantly, the composition of the electrode. Adsorption effects fall into a variety of categories: reduction of a substance may become either easier or harder, some transformations may be totally inhibited and chemical reactions in adsorbed films may proceed at rates different than in homogeneous solution. For example, deposition of small amounts of palladium on a gold surface results in an electrode in which the 4-electron wave of some nitro compounds is shifted to more negative potentials and aniline formation is totally inhibited, but 3-nitro-1,2,4-triazole is *easier* to reduce than at pure gold, and the overall rate of reduction is controlled by the rate of dehydration of the ArN(OH)<sub>2</sub> intermediate<sup>26</sup>. Under similar conditions 2- and 4-nitroimidazole are reduced by parallel pathways: (a) electron transfer from the electrode to afford the ArN(OH)<sub>2</sub> intermediate and (b) electrocatalytically by adsorbed hydrogen (see below)<sup>27</sup>.

Reductions at noble metal electrodes in acidic protic media often form adsorbed hydrogen, which is the actual reductant. For example, reduction of nitrobenzene at a Pd/C electrode in acetic acid-methanol mixtures affords aniline via adsorbed hydrogen<sup>28</sup>. This reaction is more closely related to catalytic hydrogenation of nitro groups than to the

electrochemical process. The same might be said of electrochemical reductions of nitro compounds using Devarda copper<sup>29</sup>, Raney nickel<sup>30,31</sup> or Ti/TiO<sub>2</sub><sup>32</sup> electrodes. Pintauro found that nitrobenzene could be reduced to aniline at Raney nickel when sodium tosylate is the supporting electrolyte, but that reduction went all the way to cyclohexylamine (!) when the supporting electrolyte is tetraethylammonium tosylate<sup>31</sup>.

### III. SUBSTITUTED NITROAROMATICS

Laviron has studied an especially interesting class of nitro compounds containing a second basic site, e.g. 4-nitropyridine (**14**)<sup>33</sup>. Even two-dimensional representations such as those encountered earlier (Schemes 2–4) are inadequate to represent this mechanistically very complex situation. Laviron showed, however, that the electrochemical conversion of **14** to the corresponding ArN(OH)<sub>2</sub> species can be satisfactorily explained in terms of a modified so-called 'bi-cubic' diagram (Figure 1). Note that the each of the front and rear planes of the bi-cubic model consists of a seven-component reaction diagram analogous to that of

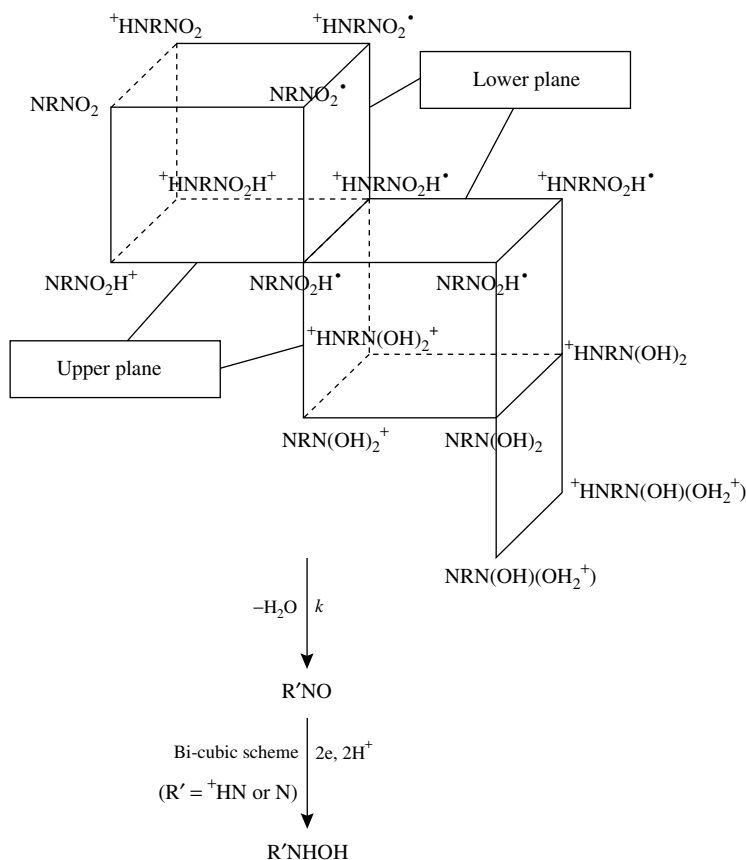
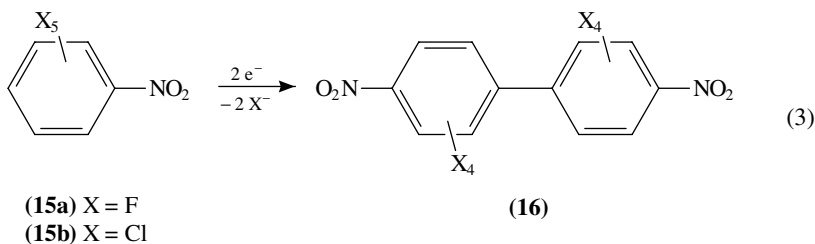


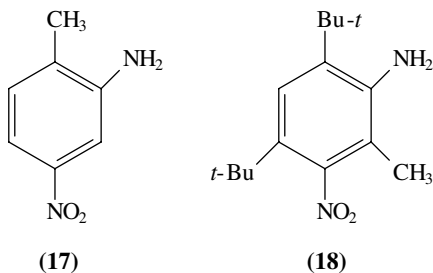
FIGURE 1. Bi-cubic mechanism for reduction of nitropyridines. Reproduced by permission of Elsevier Science SA from Reference 33

Scheme 4. The compounds and intermediates on the 'rear' plane of the bicubic system (farthest from the reader) are protonated on the pyridine nitrogen atom; those on the 'front' plane (nearest the reader) are not. Laviron's work has shown that the reduction of **14** and its corresponding N-oxide<sup>34</sup>, and indeed probably most aryl nitro compounds, proceeds by an ECEC sequence leading to the neutral *N,N*-dihydroxy [ArN(OH)<sub>2</sub>] intermediate at all proton concentrations from H<sub>0</sub> = -6 to pH 9.6. This substance then loses water to form the nitroso compound, which then undergoes a second sequence leading to the arylhydroxylamine.

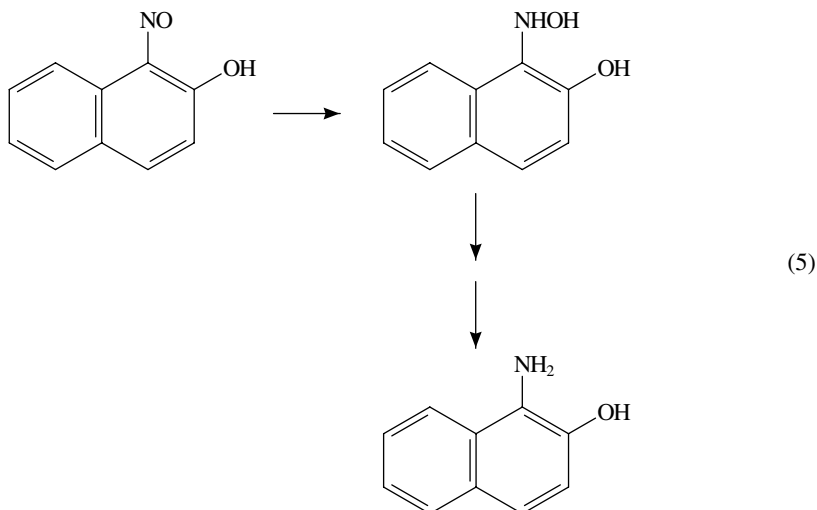
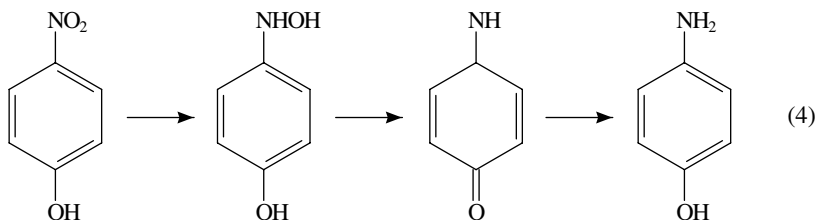
Pentahalogenobenzenes (**15**) undergo electrochemical coupling to the corresponding octahalobiphenyls (**16**, equation 3)<sup>35</sup>. There is an interesting mechanistic dichotomy between the fluorine and chlorine compounds (**15a** and **15b**, respectively). The radical anion of **15a** couples, then the resulting dimeric dianion ejects two fluoride ions to afford **16**; in contrast, the radical anion of **15b** ejects chloride ion to afford a neutral radical, which then dimerizes to **16**.



It was noted at the outset (Section II.A.1 that reduction of nitro compounds in basic media generally affords dimeric products (azoxy, azo or hydrazo compounds). It has been found, however, that reduction in 1N NaOH of nitroarenes bearing electron-supplying groups, especially hydroxy and alkoxy groups, affords amines in good yields<sup>36</sup>. This is presumably because the intermediate hydroxylamine dehydrates readily to a quinoid substance, which then undergoes facile reduction to the amine (equation 4). Similar conversion to the amine was observed with a naphthalenic nitrosophenol (equation 5)<sup>37</sup>. *p*-Nitrodiphenylamine is reduced all the way to the amine via dehydration of the intermediate hydroxylamine; however, reduction of the corresponding *N*-acylated compound stops at the hydroxylamine, which undergoes dehydration much less readily<sup>36b</sup>. In a related vein, it was reported that whereas 2-methyl-5-nitroaniline (**17**) exhibits a four-electron wave followed by a two-electron voltammetric wave in acidic medium, the closely related substance 4,6-di-*t*-butyl-2-methyl-3-nitroaniline (**18**) exhibits a single six-electron wave at the same pH. This suggests that the intermediate hydroxylamine from **18** is reduced to the corresponding amine faster than that from **17**. The authors ascribed this difference to the larger number of alkyl groups in **18** causing the hydroxylamine formed from it to be more basic than that from **17**<sup>38</sup>. It seems more likely that the increased basicity arises because



the steric bulk of the *t*-butyl group in **18** forces the hydroxyl group of the hydroxylamino group out of the aromatic plane, thus reducing the degree of resonance interaction of the nitrogen with the benzene ring and making it easier to cleave the N–O bond.

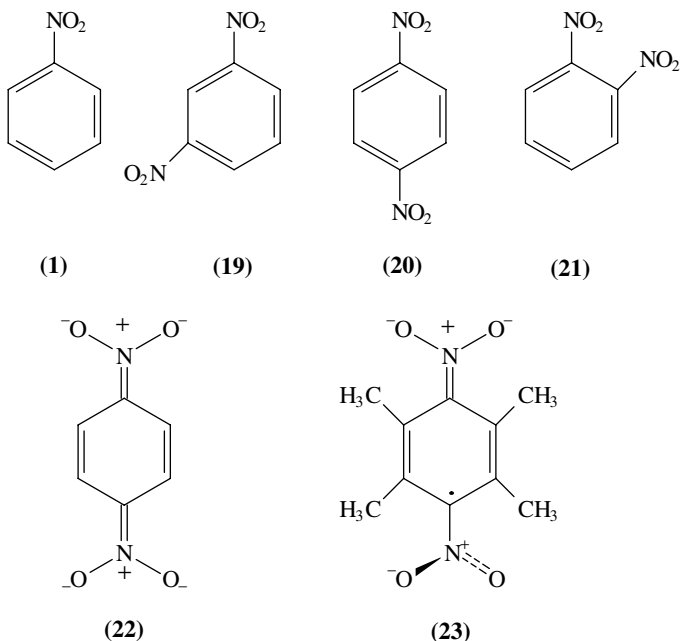


#### IV. AROMATIC DINITRO COMPOUNDS

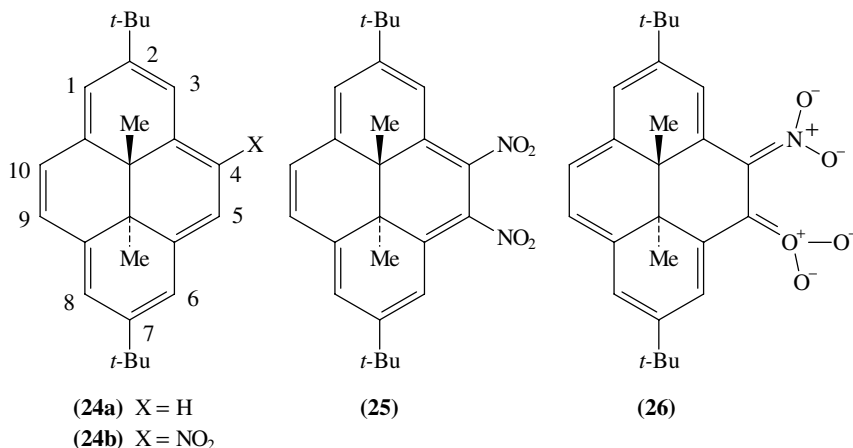
The behavior of dinitro compounds is of both synthetic and mechanistic interest. There is obvious synthetic value to selective reduction of a dinitro compound since the product has two readily differentiated groups for subsequent elaboration. One is also interested in the effect which one of the groups has on the other, and how this may change as one group is altered electrochemically. The observed effects depend on the nature of the structural relation between the two groups.

It is necessary at this point to review the behavior of analogous benzenoid species. As mentioned previously nitrobenzene (**1**) undergoes one-electron reduction to a stable radical anion in aprotic media<sup>39</sup>. The first polarographic reduction wave of *meta*-dinitrobenzene (**19**) is 0.25 V positive of that of **1**. This substantial shift ( $1 \text{ V} = 23.06 \text{ kcal mol}^{-1}$ ) is due to the effect of the second inductively electron-withdrawing nitro group on the reduction potential of the first. The second reduction potential of **19**, on the other hand, is *negative* of the reduction potential of **1**. This is presumably because in the radical anion formed at the first step the first nitro group now bears a negative charge<sup>40</sup> and hence is inductively electron-supplying. *Para*- and *ortho*-dinitrobenzenes (**20** and **21**), however, exhibit markedly different behavior. The first reduction potential of **20** is even more positive than that of **19**, even though the second nitro group in **20** is further away

from the first than in **19** and should exert less of an inductive effect. Furthermore, the second reduction potential of **20** is *positive* of that of the reduction potential of neutral nitrobenzene, even though in the case of **20** one is reducing a species already carrying a negative charge. *ortho*-Dinitrobenzene (**21**) behaves similarly, although the effects are less dramatic. The anomalous voltammetric behavior of **20** and **21** (and other aromatic compounds bearing unsaturated groups *para* or *ortho* to each other)<sup>41</sup> has been ascribed<sup>7,9</sup> to quinoidal contributions such as **22** to the structure of the dianions and corresponding monoanion radicals, thus providing a means of charge localization and stabilization in such species (presumably the effect is not as great in **21** because the two nitro groups are twisted somewhat out of planarity). The unusual ESR spectrum of the radical anion of **20** was also ascribed to a quinoidal contribution to the structure<sup>7</sup>. Parker has obtained further evidence for the formation of quinoidal dianions from **20** and **21**<sup>42</sup> and quantum mechanical calculations (MP2, SCF) show that related monoanions also prefer a quinoid-type structure<sup>43</sup>. On the other hand, it has been found that the radical anion of 1,4-dinitroindurene prefers a structure in which one nitro is perpendicular and the other is parallel to the plane of the ring<sup>44</sup>. The resonance stabilization of the quinoidal form is outweighed by the steric repulsions which arise if the nitro groups are both in the plane of the ring. The molecule apparently adopts a compromise in which only one nitro group is in the plane of the ring, thus preserving some stabilization in the semiquinoidal structure **23**.



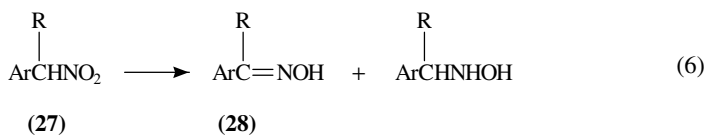
These concepts were recently applied to an understanding of the electrochemical reduction of the mono and dinitro derivatives of the nonbenzenoid hydrocarbon **24a**<sup>45</sup>. Compound **24b** exhibits a single one-electron wave at  $-1.08$  V, while dinitro compound **25** exhibits two one-electron waves at  $-0.88$  and  $-1.05$  V<sup>46</sup>. This behavior is quite similar to that exhibited by *ortho*-dinitrobenzene (**21**); it appears therefore that **25** is reduced to a dianion in which the quinoidal structure **26** is an important contributor to the resonance hybrid. The quinoidal structure **11** could be produced from **25** even though the



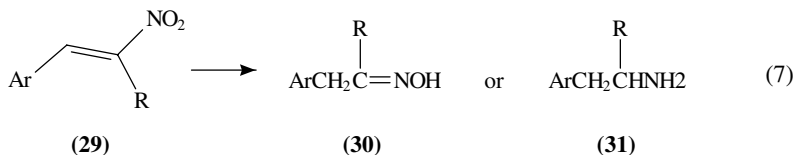
two nitro groups are twisted out of the plane of the aromatic ring because overlap is still largely preserved between the adjacent ring carbon and nitrogen pi-orbitals in the twisted structure<sup>47</sup>. Quantum mechanical calculations on **25** and its dianion were used to support these conclusions<sup>47</sup>.

## V. ALIPHATIC NITRO COMPOUNDS

Electrochemical reduction of benzylic nitro compounds (**27**) in an ethanolic aqueous acetic acid buffer (35:65) affords a mixture of the corresponding oxime and hydroxylamine (equation 6)<sup>48</sup>. The hydroxylamine can subsequently be oxidized back to the oxime (**28**) (via the intermediate nitroso compound); conversions as high as 90% can be obtained.

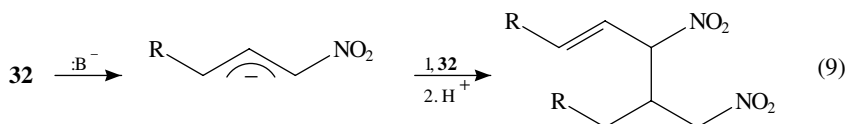
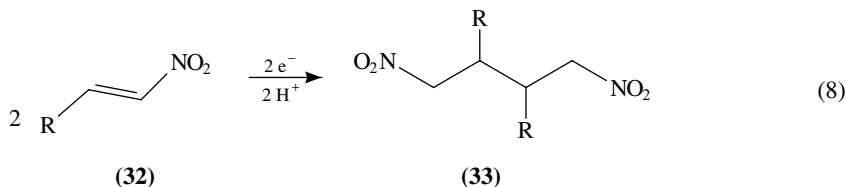


Reduction of  $\alpha,\beta$ -unsaturated nitro compounds (**29**) affords the corresponding oximes (**30**) in high yields when electrolysis is carried out at  $-0.4$  V (vs SCE) at a mercury or graphite electrode in aqueous isopropanol containing  $0.1$  M H<sub>2</sub>SO<sub>4</sub> (equation 7)<sup>49</sup>. Reduction at  $-1.1$  V affords the secondary amine (**31**) in fair yields. Isolated double bonds elsewhere in the molecule are not affected.

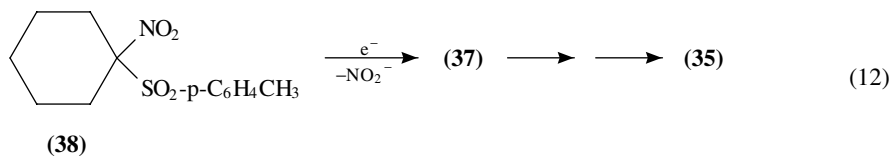
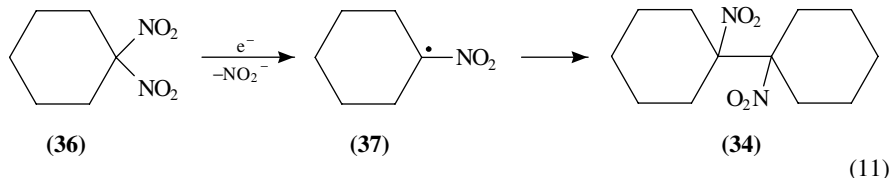
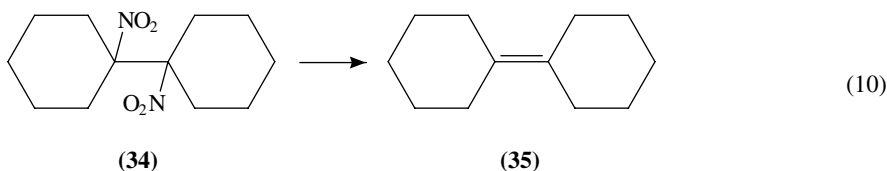


Electrochemical reduction of the  $\alpha,\beta$ -unsaturated nitro compounds **32** in acetonitrile containing tetraethylammonium tosylate affords the corresponding hydrodimer in 37%

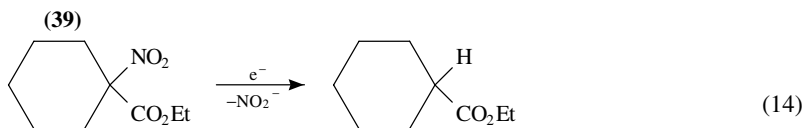
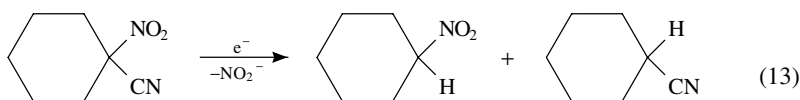
yield (equation 8)<sup>50</sup>. An alternate route more often observed in the electrolysis was deprotonation of **32** by an electrogenerated base<sup>51</sup> to afford a conjugated carbanion which attacks the starting material in a Michael-type reaction (equation 9).



1,2-Dinitro compounds are reduced to alkenes with elimination of two equivalents of nitrite ion (e.g. **34** to **35** equation 10)<sup>52</sup>. More surprising, perhaps, is the reductive electrochemical coupling of 1,1-dinitro compounds such as 1,1-dinitrocyclohexane (**36**) to the corresponding dimeric vicinal dinitro compounds (**34**, equation 11). The process is initiated by reduction of **36** to a radical anion, which ejects nitrite ion to produce the  $\alpha$ -nitrocyclohexyl radical (**37**), coupling of which leads to **34**<sup>8b,52</sup>. What happens in the reduction of compounds **38**–**40**, each of which bears an electronegative group bound to the carbon bearing the nitro group, depends upon the nature of the group<sup>8b</sup>. Compound **38** affords alkene **35**; toluenesulfonate ion is ejected from the initial radical anion to produce radical **37**, which reacts as shown above to afford **34** and ultimately **35** (equation 12). Reduction of **39** affords a mixture of nitrocyclohexane and cyanocyclohexane (equation 13); nitro ester **40**, on the other hand, affords ester **41** (equation 14). Whether it is the nitro group or the hetero atom group which is lost upon reduction apparently depends on both the relative electronegativity of X and the electrolysis potential.





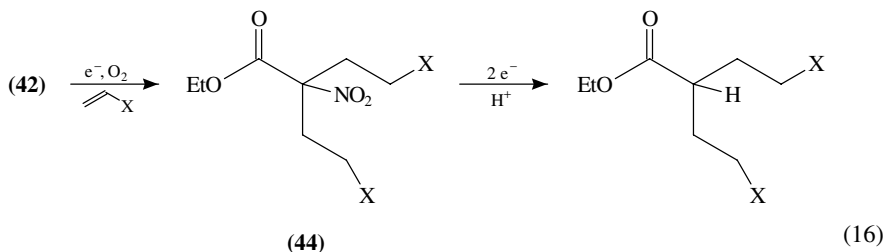
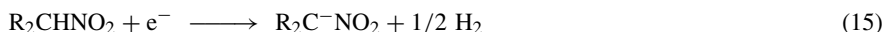


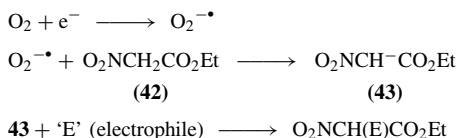
Cobalt(III) macrobicyclic polyamine complexes normally exhibit electrochemical behavior analogous to that of nitroarenes, in that electrolysis at pH 0 or 4 affords hydroxylamines, and azoxy compounds at high pH<sup>53,54</sup>. Their behavior in dry aprotic solvents resembles that of tertiary nitro compounds<sup>8</sup> in that reduction affords a radical anion which ejects nitrite ion to afford a tertiary radical. The final product contains a hydrogen atom at the site originally occupied by the nitro group. The same reductive removal of a tertiary nitro group and replacement with hydrogen is observed upon reduction of a nitro derivative of the alkaloid vincristine<sup>55</sup>.

## VI. RELATED PROCESSES

### A. Nitro Compounds as Electrogenerated Bases

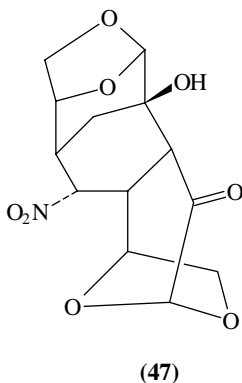
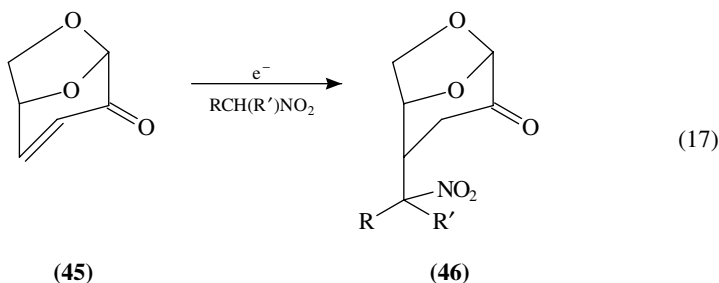
Reduction of many organic weak acid compounds results in formation of the corresponding carbanions (equation 15). The alkylation of such species represents an attractive synthetic application<sup>56</sup>. Niyazymbetov and Evans have explored the chemistry of ethyl nitroacetate (**42**)<sup>57</sup>. As it happens, reductive cleavage of the  $\alpha$ -nitro group occurs when **42** is reduced directly, but this problem was circumvented by using electrogenerated superoxide ion to deprotonate **42** (Scheme 6). (This is readily done: one simply exposes the electrolysis solution to the atmosphere during electrolysis; oxygen diffuses into the solvent and is immediately reduced to superoxide). The anion **43** is alkylated in high yield if the electrolysis is carried out in acetonitrile containing a tetraalkylammonium salt as supporting electrolyte; under these conditions ion-pairing is minimized and the carbanion is highly reactive. One can even effect dialkylation of **42** under these conditions. Anion **43** also reacts readily with Michael acceptors to afford the corresponding adducts in good yields. It is also possible to carry out alkylation and Michael addition in a single pot. Double Michael addition can be carried out also to produce adducts of type **44**. Since these are tertiary nitro compounds, they are readily reductively denitrated (equation 16)<sup>58</sup>. The nitro group is used temporarily to effect formation of the two carbon-carbon bonds, and is then removed.





SCHEME 6

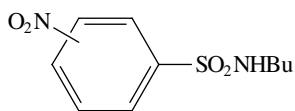
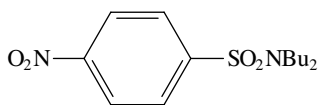
Secondary nitro compounds can be converted into carbanions in similar fashion. Interesting highly functionalized adducts (**46**) were prepared by addition to levoglucosene (**45**) (equation 17)<sup>59</sup>. Mixtures of diastereomeric adducts were generally formed<sup>60</sup>. The adduct from nitromethane undergoes double Michael addition followed by aldol condensation to afford the novel adduct **47**.



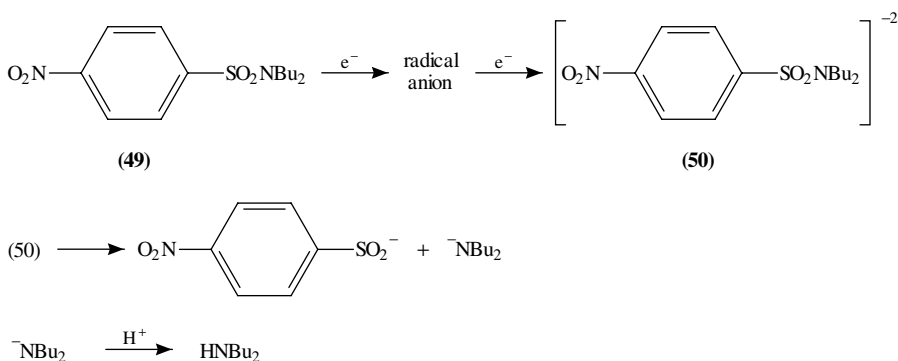
## B. Nitro Compounds as Protecting Groups

The extreme ease of electrochemical reduction of nitro compounds suggests that they might usefully serve as protecting groups. Torii has shown that alcohols can be protected as their *p*-nitrobenzyl ethers. The group is removed by a two-step sequence involving catalytic reduction to the corresponding amine, followed by electrochemical *oxidation* of the amine, which is accompanied by hydrolysis of the intermediate Schiff base<sup>61</sup>.

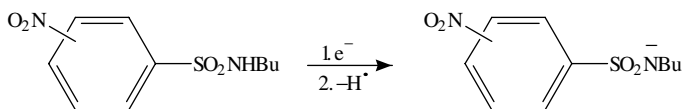
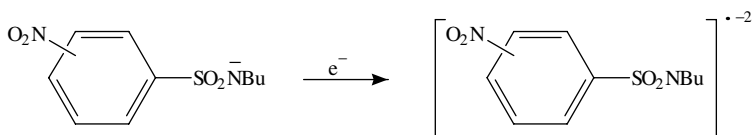
The electrochemical behavior of a series of nitrobenzenesulfonamides (**48** and **49**) were examined by cyclic voltammetry and other techniques in connection with the use of such arenosulfonyl groups as protecting groups for amines. Interestingly, the behavior of the 2-nitro derivative **48a** and the *N,N*-dialkyl 4-nitro derivative **49** differed from that of the 3-nitro and 4-nitro monosulfonamides **48b** and **48c**<sup>62</sup>. *Ortho*-derivative **48a** and **49**

**(48a)** X = 2-NO<sub>2</sub>**(48b)** X = 3-NO<sub>2</sub>**(48c)** X = 4-NO<sub>2</sub>**(49)**

are reduced to radical anions which are rather stable; they are however reduced at more negative potentials to dianions, which readily fragment with cleavage of the S–N bond and ejection of the nitrobenzenesulfinate anion (this is exemplified for **49** in Scheme 7). The free amines are isolated in good yields (>70%). The initial radical anions from **48b** and **48c** fragment relatively readily with loss of a hydrogen atom to form a species which can be reduced further to a rather stable dianion (Scheme 8). Since the latter species does not undergo spontaneous cleavage of the S–N bond at a useful rate, electrochemistry is therefore not useful for removal of the arenesulfonyl group with compounds such as **48b** and **48c**. The question naturally arises why different behavior should be exhibited by



SCHEME 7

**(48b)** X = 3-NO<sub>2</sub>**(48c)** X = 4-NO<sub>2</sub>**(51)**

SCHEME 8

compounds as similar as **48a** and, say, **48b**. In effect, the question is: why does dianion **50** fragment while dianion **51** does not? The difference between the two is quite possibly the fact that dianion **50** has two electrons in an antibonding pi-orbital, whereas **51**, which is a dianion *radical*, has only one electron in an antibonding pi-orbital. Furthermore, **51** can accommodate part of its negative charge on the relatively nonbasic sulfonamide nitrogen atom, while **50** has a doubly negative charge in its pi-system; these effects provide for a powerful driving force for cleavage of **50** which is absent from **51**.

On occasion such reductive deprotection processes can be quite selective. Electrochemical reduction of *N,N'*-di-*p*-toluenesulfonyl-*N-t*-butoxycarbonyl derivatives of aliphatic and aromatic diamines selectively removed the *p*-toluenesulfonyl group attached to a primary amine site<sup>63</sup>. Yields on the mono-protected products are fair to high; selective deprotection of the corresponding *N,N'*-dibenzoyl derivatives occurred in yields  $\geq 92\%$ .

## VII. NITROSO COMPOUNDS

As can be seen from the preceding discussion, the existence of nitroso compounds as intermediates in the electrochemical reduction of nitro compounds is mostly inferential: nitroso compounds are easier to reduce than nitro compounds. Hence, they should be reduced as quickly as they are formed and would not be expected to be isolable. However, nitroso compounds have occasionally been isolated in unusual structural cases<sup>54</sup> and the nitrosobenzene radical anion has been identified by ESR spectroscopy in at least one instance<sup>64</sup>. It is possible to prepare nitroso compounds by a two-step sequence: one reduces the nitro compound electrochemically to the hydroxylamine, then electrochemically oxidizes the hydroxylamine to the nitroso compound<sup>65</sup>.

It has been suggested on thermochemical grounds that the radical cations of at least some nitroso compounds should be short-lived species. Such calculations suggest in fact that the C–N bond dissociation energy of the radical cation of 2-nitroso-2-methylpropane should be close to zero<sup>66</sup>. Direct electrochemical oxidation and reduction afford radical cations and radical anions, respectively, the ESR spectra of which have been characterized in a number of cases<sup>67</sup>. Voltammetric studies have shown that the cationic micelle-forming surfactant cetyltrimethylammonium bromide inhibits the reduction of *p*-nitroso-*N,N*-dimethylaniline to the corresponding arylhydroxylamine<sup>68</sup>.

One possibility, the ECEC path, i.e. alternating electron transfer and protonation steps, for the mechanism of reduction of nitrosobenzene to phenylhydroxylamine was discussed in Section II.A.1. It is pointed out there that this conversion might take place by a number of different paths. Laviron explored this question<sup>69</sup>. He found that the mechanism is CECE in acidic media and ECEC in basic media and ECCE at intermediate pH.

## VIII. ACKNOWLEDGMENTS

Professors Dennis Evans and Petr Zuman kindly provided material in advance of publication. Financial support was provided by the National Science Foundation (Grant #CHE-9413128).

## IX. REFERENCES

1. A. J. Fry, in *The Chemistry of Functional Groups, Supplement F: The Chemistry of Amino, Nitroso and Nitro compounds* (Ed. S. Patai), Wiley, Chichester, 1982, pp. 319–337.
2. A. J. Fry, 'Solvents and Supporting Electrolytes', in *Laboratory Techniques in Electroanalytical Chemistry*, 2nd ed. (Eds. P. T. Kissinger and W. R. Heineman), Marcel Dekker, New York, in press.
3. F. Haber, *Z. Elektrochem.*, **4**, 506 (1989).

4. (a) P. Zuman, in *Electroorganic Synthesis* (Eds. R. D. Little and N. L. Weinberg), Marcel Dekker, New York, 1991, p. 137.  
(b) P. Zuman, Z. Fijalek, D. Dumanovic and D. Suznjevic, *Electroanalysis*, **4**, 783 (1992).
5. W. M. Smith and A. J. Bard, *J. Am. Chem. Soc.*, **97**, 5203 (1975).
6. B. S. Jensen and V. D. Parker, *J. Chem. Soc., Chem. Commun.*, 367 (1974).
7. (a) A. Darchen and C. Moinet, *J. Electroanal. Chem.*, **68**, 173 (1976).  
(b) F. D. Popp and H. P. Schultz, *Chem. Rev.*, **62**, 19 (1962).
8. (a) J. C. Rühl, D. H. Evans, P. Hapiot and P. Neta, *J. Am. Chem. Soc.*, **113**, 5188 (1991).  
(b) J. C. Rühl, D. H. Evans and P. Neta, *J. Electroanal. Chem.*, **340**, 257 (1992).  
(c) H. Wang and O. Hammerich, *Acta Chem. Scand.*, **46**, 563 (1992).
9. C. M. Amatore and J. M. Savéant, *J. Electroanal. Chem.*, **86**, 227 (1978).
10. (a) B. Kastening, *Electrochim. Acta*, **9**, 241 (1964).  
(b) B. Kastening, *Coll. Czech. Chem. Commun.*, **30**, 4033 (1965).  
(c) B. Kastening, *Z. Anal. Chem.*, **224**, 196 (1967).  
(d) B. Kastening, *Ber. Bunsenges. Phys. Chem.*, **72**, 27 (1968).
11. L. Meites, *Polarographic Techniques*, 2nd ed., Wiley-Interscience, New York, 1965, p. 176.
12. (a) H. Lund, in *Organic Electrochemistry* (Eds. H. Lund and M. M. Baizer), 3rd ed., Marcel Dekker, New York, 1991, pp. 401–432.  
(b) W. Kemula and T. M. Krygowski, in *Encyclopedia of Electrochemistry of the Elements* (Eds. A. J. Bard and H. Lund), Vol. 13; Chap. 2, Marcel Dekker, New York, 1979.  
(c) B. Kastening, in *Progress in Polarography* (Eds. P. Zuman and L. Meites), Vol. 3, Wiley-Interscience, New York, 1972, pp. 259–267.
13. A. J. Fry, R. D. Little and J. Leonetti, *J. Org. Chem.*, **59**, 5017 (1944).
14. E. Laviron, *J. Electroanal. Chem.*, **124**, 9 (1981).
15. E. Laviron, *J. Electroanal. Chem.*, **146**, 1 (1981)
16. E. Laviron and L. Roullier, *J. Electroanal. Chem.*, **288**, 165 (1990).
17. E. Laviron, R. Meunier-Prest and R. Lacasse, *J. Electroanal. Chem.*, **375**, 263 (1994).
18. A. Darchen and C. Moinet, *J. Electroanal. Chem.*, **78**, 81 (1977).
19. A. Darchen and C. Moinet, *J. Chem. Soc., Chem. Commun.*, 487 (1976).
20. (a) C. D. Gutsche and D. J. Pasto, *Fundamentals of Organic Chemistry*, Prentice-Hall, Englewood Cliffs, N.J., 1975, p. 714.  
(b) G. M. Loudon, *Organic Chemistry*, Addison-Wesley, Reading, Mass., 1984, p. 1198.
21. T. Ohba, H. Ishida, T. Yamaguchi, T. Horiuchi and K. Ohkubo, *J. Chem. Soc., Chem. Commun.*, 263 (1994).
22. D. H. Geske and A. H. Maki, *J. Am. Chem. Soc.*, **82**, 2671 (1960).
23. G. L. McIntire, D. M. Chiappardi, R. L. Casselberry and H. N. Blount, *J. Phys. Chem.*, **86**, 2632 (1982).
24. C. -W. Lee and A. J. Fry, unpublished research.
25. (a) J. F. Rusling, *Acc. Chem. Res.*, **24**, 75 (1991)  
(b) M. Bourrel and R. S. Schecter, *Microemulsions and Related Systems*, Marcel Dekker, New York, 1988.  
(c) I. D. Robb (Ed.), *Microemulsions*, Plenum Press, New York, 1982.
26. G. Kokkinidis, A. Papoutsis and G. Papanastasiou, *J. Electroanal. Chem.*, **359**, 253 (1993).
27. A. Papoutsis and G. Kokkinidis, *J. Electroanal. Chem.*, **371**, 231 (1994).
28. S. J. C. Cleghorn and D. Pletcher, *Electrochim. Acta*, **38**, 425 (1993).
29. G. Belot, S. Desjardins and J. Lessard, *Tetrahedron Lett.*, **25**, 5347 (1984).
30. P. Delair, A. Cyr and J. Lessard, in *Electroorganic Synthesis* (Eds: R. D. Little and N. L. Weinberg), Marcel Dekker, New York, 1991, p. 129.
31. P. N. Pinturo and J. R. Boutha, *J. Appl. Electrochem.*, **21**, 799 (1991).
32. (a) C. Ravichandran, M. Noel and P. N. Anantharaman, *J. Appl. Electrochem.*, **24**, 965 (1994).  
(b) C. Ravichandran, D. Vasudevan and P. N. Anantharaman, *J. Appl. Electrochem.*, **22**, 1192 (1992).
33. E. Laviron, R. Meunier-Prest, A. Vallat, L. Roullier and R. Lacasse, *J. Electroanal. Chem.*, **341**, 227 (1992).
34. R. Lacasse and R. Meunier-Prest, *J. Electroanal. Chem.*, **359**, 223 (1993).
35. C. P. Andrieux, A. Batlle, M. Espín, I. Gallardo, Z. Jiang and J. Marquet, *Tetrahedron*, **50**, 6913 (1994).
36. (a) K. J. Stutts, C. L. Scortichini and C. M. Repucci, *J. Org. Chem.*, **54**, 3740 (1989).

- (b) M. Ciureanu, *Rev. Roum. Chim.*, **38**, 807 (1993).  
(c) M. M. Ellaithy and P. Zuman, *J. Pharm. Sci.*, **81**, 191 (1992).
37. D. Vasudevan and P. N. Anantharaman, *J. Appl. Electrochem.*, **24**, 559 (1994).  
38. A. Ion-Carastoiu, F. -G. Banica and M. Moraru, *Rev. Roum. Chim.*, **38**, 287 (1993).  
39. A. H. Maki and D. H. Geske, *J. Chem. Phys.*, **33**, 825 (1960).  
40. The negative charge in nitroarene radical anions is localized on the nitro group:  
(a) W. Kemula and R. Sioda, *J. Electroanal. Chem.*, **7**, 233 (1964).  
(b) A. H. Maki D. H. Geske, *J. Am. Chem. Soc.*, **83**, 1853 (1961).
41. (a) Y. Kargin, O. Manousek and P. Zuman, *J. Electroanal. Chem.*, **12**, 443 (1966).  
(b) P. Zuman, O. Manousek and S. K. Vig, *J. Electroanal. Chem.*, **19**, 147 (1968).  
42. H. Wang and V. D. Parker, *Acta Chem. Scand.*, **48**, 933 (1994).  
43. S. Irle, T. M. Krygowski, J. E. Niu and W. H. E. Schwarz, *J. Org. Chem.*, **60**, 6744 (1995).  
44. S. Mahmood, B. J. Tabner and V. A. Tabner, *J. Chem. Soc., Faraday Trans.*, 3253 (1990).  
45. T. Yamato, K. Fujita, H. Kamimura, M. Tashiro, A. J. Fry, J. Simon and J. Ochterski, *Tetrahedron*, **51**, 9851 (1995).  
46. Potentials were measured relative to 0.1 M Ag/AgNO<sub>3</sub> and converted to S.C.E.  
47. Orbital overlap is proportional to  $\cos^2 \theta$ , where  $\theta$  is the dihedral angle between the two orbitals. Since  $\theta = 16.1^\circ$  in **25**,  $\cos^2 \theta = 0.92$ , hence little overlap is lost by the twist of the nitro groups out of planarity.  
48. F. Miralles-Roch, A. Tallec and R. Tardivel, *Electrochim. Acta*, **38**, 2379 (1993).  
49. M. Wessling and H. J. Schäfer, *Chem. Ber.*, **124**, 2303 (1991).  
50. R. D. Little, M. Schwabe and W. Russu, in *Novel Trends in Electro-organic Synthesis* (Ed. S. Torii), Kodansha, Tokyo, 1995, p. 123.  
51. A. J. Fry, *Synthetic Organic Electrochemistry*, 2nd ed., Wiley, New York, 1989, p. 308.  
52. (a) D. H. Evans and J. C. Rühl, in *Electroorganic Synthesis* (Eds. R. D. Little and N. L. Weinberg), Marcel Dekker, New York, 1991, p. 3.  
(b) W. J. Bowyer and D. H. Evans, *J. Org. Chem.*, **53**, 5234 (1988).  
53. A. M. Bond, G. A. Lawrence, P. A. Lay and A. M. Sargeson, *Inorg. Chem.*, **22**, 2010 (1983).  
54. P. A. Lay and A. M. Sargeson, *Inorg. Chem.*, **29**, 2762 (1990).  
55. L. Szabo, C. Szantay, E. G. Baitz and M. Mak, *Tetrahedron Lett.*, **36**, 5265 (1995).  
56. M. E. Niyazymbetov and D. H. Evans, *Tetrahedron*, **49**, 9627 (1993).  
57. M. E. Niyazymbetov and D. H. Evans, *J. Org. Chem.*, **58**, 779 (1993).  
58. M. E. Niyazymbetov and D. H. Evans, *Denki Kagaku*, **62**, 1139 (1994).  
59. A. L. Laikhter, M. E. Niyazymbetov, D. H. Evans, A. V. Samet and V. V. Semenov, *Tetrahedron Lett.*, **34**, 4465 (1993).  
60. Private communication from D. H. Evans and M. E. Niyazymbetov.  
61. K. Fukase, H. Tanaka, S. Torii and S. Kusumoto, *Tetrahedron Lett.*, **31**, 389 (1990).  
62. M. V. B. Zanoni and N. R. Stradiotto, *J. Electroanal. Chem.*, **312**, 141 (1991).  
63. L. Grehn, L. S. Maia, L. S. Monteiro, M. I. Montenegro and U. Ragnarsson, *J. Chem. Res. (S)*, 144 (1991).  
64. C. Nishihara and M. Kaise, *J. Electroanal. Chem.*, **149**, 287 (1983).  
65. (a) P. Zuman and C. Karakus, *Denki Kagaku*, **62**, 1306 (1994); P. Zuman and B. Shah, *Chem. Rev.*, **94**, 1621 (1994).  
66. M. L. Greer, H. Sarker, M. E. Mendicino and S. C. Blackstock, *J. Am. Chem. Soc.*, **117**, 10460 (1995).  
67. G. Gronchi and P. Tordo, *Res. Chem. Intermed.*, **19**, 733 (1993).  
68. N. C. Sarada, I. A. K. Reddy and K. M. Rao, *J. Indian Chem. Soc.*, **71**, 729 (1994).  
69. E. Laviron, A. Vallat and R. Meunier-Prest, *J. Electroanal. Chem.*, **379**, 427 (1994).

## CHAPTER 19

# Rearrangement reactions involving the amino, nitro and nitroso groups

D. LYN H. WILLIAMS

*Chemistry Department, University of Durham, Durham, U.K.*

*Fax: (191)-386-1127; e-mail: D.L.H.WILLIAMS@DURHAM.AC.UK*

---

I. INTRODUCTION	857
II. REARRANGEMENT OF HYDRAZOBENZENES (THE BENZIDINE REARRANGEMENT)	858
III. REARRANGEMENT OF AZOXYBENZENES (THE WALLACH REARRANGEMENT)	865
IV. REARRANGEMENT INVOLVING PHENYLHYDROXYLAMINES	867
A. The Bamberger Rearrangement	867
B. Other Rearrangements	871
V. REARRANGEMENT OF <i>N</i> -HALO COMPOUNDS	873
VI. REARRANGEMENT INVOLVING NITRO GROUPS	876
A. The Nitramine Rearrangement	876
B. Rearrangement of Nitro Aromatics	879
C. Other Rearrangements	882
VII. REARRANGEMENT INVOLVING NITROSO GROUPS	883
A. The Fischer–Hepp Rearrangement	883
B. Other Rearrangements	885
VIII. REFERENCES	888

---

### I. INTRODUCTION

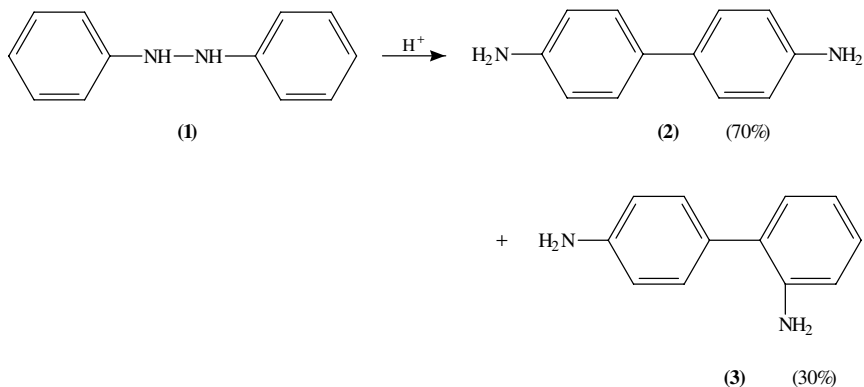
Rearrangement reactions have greatly interested chemists for a long time (a) from the synthetic viewpoint as routes to new compounds and (b) from the mechanistic viewpoint, in order to discover how these reactions occur. This chapter is intended to update previous chapters in this series. No attempt has been made to be comprehensive in the treatment, and the effort has centred on new developments, particularly of understanding mechanisms, rather than on reporting additional examples of reaction types already known. Rearrangement reactions are constantly being reviewed; the most complete account is in

that chapter devoted to rearrangements covering the literature each year in the *Organic Reaction Mechanisms* series<sup>1</sup>. A short account aimed at undergraduates has appeared within the Oxford Primer series<sup>2</sup>.

Two major new developments have occurred since the subject was last covered in this series and have been instrumental in being able to give definitive answers to mechanistic questions, which hitherto relied to some degree on speculation. The first is the ability to measure, with the necessary accuracy of measurement, heavy-atom kinetic isotope effects. Kinetic isotope effects (KIE) involving <sup>1</sup>H and <sup>2</sup>H isotopes have always played an important part in establishing reaction mechanisms, and such KIE values have been easy to measure experimentally, because of their relatively large magnitude. Isotope effects for bond breaking and making involving C, N and O isotopes particularly are now measurable and have been applied to the study of rearrangement reactions, particularly by Shine and his group at Texas Tech University. These studies have enabled chemists to decide in a rearrangement reaction whether bond breaking and bond making are synchronous processes, or whether the former precedes the latter resulting in at least a two-stage process with intermediate formation. The other technique is the application of the CIDNP effect, particularly by Ridd and coworkers. Enhancement of NMR signals is frequently an indication that radical pairs or radical ion-radical pairs are involved as intermediates. This ability to establish the nature of the intermediates clearly is a major tool in reaction mechanism studies.

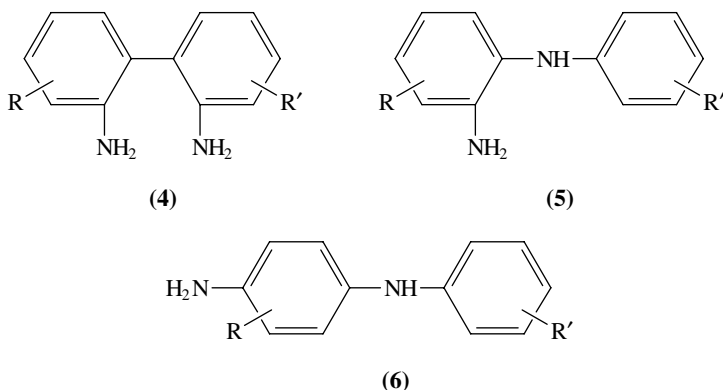
## II. REARRANGEMENT OF HYDRAZOBENZENES (THE BENZIDINE REARRANGEMENT)

This is one of the most well-known (and unusual) rearrangement reactions involving amino groups and has probably received the most attention mechanistically speaking of all rearrangement reactions. It is set out formally in Scheme 1. The reaction is most well-known under conditions of acid catalysis, although thermal and photochemical reaction pathways are also known. In acid solution hydrazobenzene **1** (more properly known as *N,N'*-diphenylhydrazine) rearranges to give 4,4'-diaminobiphenyl **2** usually in about 70% yield together with 2,4'-diaminobiphenyl **3** (*ca* 30%). The common name for **2** is benzidine (after which the rearrangement is generally known) and for **3** diphenylene. Three other products have been detected usually with substituted hydrazobenzenes, and often in low yield. These are the 2,2'-diaminobiaryl **4**, much more common from the reaction of hydrazonaphthalenes and the two arylaminoanilines **5** and **6** generally referred to as the *ortho*- and *para*-semidines, respectively. Often, products of disproportionation ArNH<sub>2</sub> and



SCHEME 1





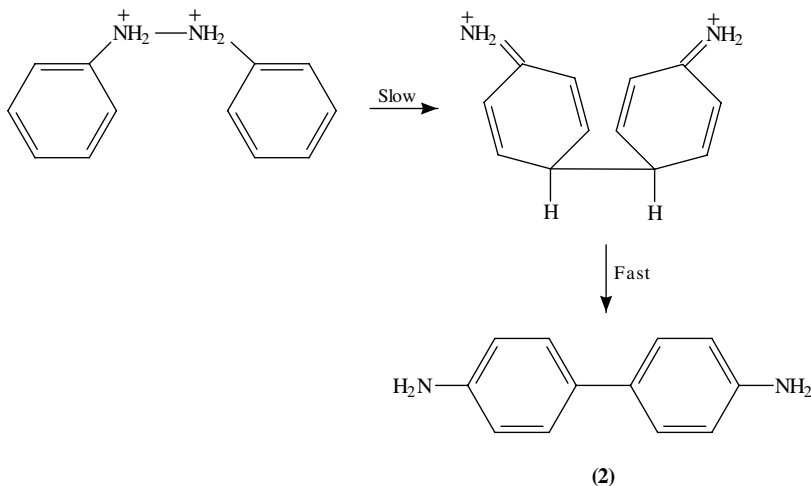
$\text{ArN}=\text{NAr}$  are also formed. Reaction occurs for a whole range of R and R' substituents, often leading to a large spread of products if both 4- and 4'-positions are substituted. In some cases (for R =  $\text{SO}_3\text{H}$ ,  $\text{CO}_2\text{H}$ ) the substituent group R can be displaced. The reaction also can occur when there are N-substituents. Interestingly there is a recent report<sup>3</sup> that when the rearrangement of **1** takes place in the presence of a rhodium(I) catalyst, the *ortho*-semidine product **5** is formed exclusively. Clearly the stereochemistry of the system when the catalyst is bound must be ideally set up for this product formation.

The rearrangement was reviewed in this series in 1968<sup>4</sup> and 1975<sup>5</sup> and there have been many other important reviews<sup>6-8</sup>. Interestingly from a historical viewpoint is the account of the very early history of the benzidine rearrangement which includes the possible contributions from the chemist/musician Borodin<sup>9</sup>. Reaction is clearly intramolecular as shown by a range of experiments where no cross-over products were observed, and also by isotopic labelling experiments. Kinetic measurements showed that reaction was first-order in the hydrazo compound and both a first- and second-order dependence upon the acidity occurred depending on the reactant structure and the acidity of the medium. Various mechanisms have been postulated, but two emerged as the most likely contenders during the 1960s and 1970s. These were the  $\pi$ -complex mechanism put forward and argued by Dewar<sup>10</sup>, and later the Polar Transition State mechanism advocated by Banthorpe, Hughes and Ingold<sup>11</sup>. Both mechanisms eventually attempted to incorporate reaction pathways via the monoprotonated reactant  $\text{ArNH}^+\text{NH}_2\text{Ar}$  and also via the diprotonated reactant  $\text{ArNH}_2^+\text{NH}_2^+\text{Ar}$ .

A major breakthrough in the mechanistic investigation of this and many other rearrangements occurred when it became possible to measure, within the accuracy required, heavy-atom kinetic isotope effects, i.e. those involving bond breaking and making of bonds to elements other than hydrogen. In particular for the benzidine rearrangement, the ability to measure these KIE for  $^{14}\text{N}$ - $^{14}\text{N}/^{15}\text{N}$ - $^{15}\text{N}$  for bond breaking, and the carbon isotope effects (for  $^{12}\text{C}/^{13}\text{C}$  and  $^{12}\text{C}/^{14}\text{C}$ ) for bond making, has meant that for the first time definitive reaction pathways have been firmly established. This has been due to the pioneering work of Shine and his group, begun in 1976. Heavy atom KIE are necessarily small (typically 1%–5%) so it is not possible to obtain meaningful values by kinetic measurements of the isotopically substituted materials. All of the data were obtained by competition methods<sup>12</sup>, using isotope-ratio mass spectrometry, whole-molecule-ion mass spectrometry and scintillation counting procedures. Details of the methods are given in the literature<sup>13-15</sup>. An account of the results obtained up to 1989 has been given by Shine<sup>16</sup>.

This also includes an excellent summary of earlier work, particularly on the position at various times of the  $\pi$ -complex theory.

The results obtained by the Shine group<sup>17</sup> for the reaction of hydrazobenzene itself are given in Table 1. The main point of note is that for the bond-making process the KIE values are *different* for the formation of **2** and **3**. There is a KIE of the expected magnitude on *N,N* bond breaking (although they are not the same) for both **2** and **3** formation. However, for C–C bond formation (using both the <sup>13</sup>C and <sup>14</sup>C isotopes) **2** formation shows the expected KIE for a rate-limiting process whereas for **3** formation there is no measurable KIE. The clear conclusion is that rearrangement of **1** to **2** is a concerted process whereas that for **3** formation is not, the rate-limiting step being N–N bond fission. There is no deuterium KIE for C–H bond breaking from the 4- and 4'-positions (other than a small inverse secondary effect), so this final proton loss must occur *after* the rate-limiting step. There is, as expected, no KIE for the 2,2',6,6'-<sup>13</sup>C labelled material. Rearrangement to give **2** is clearly a concerted process and can be classified as an allowed [5,5]-sigmatropic rearrangement, to form the quinonoid intermediate from which rapid proton transfer to the solvent occurs to give the final product (Scheme 2). This idea was in fact suggested as a possibility some twelve years earlier by Schmid<sup>18</sup> following elegant isotope work on the Claisen rearrangement. It is also in effect a part of the Polar Transition State mechanism.



SCHEME 2

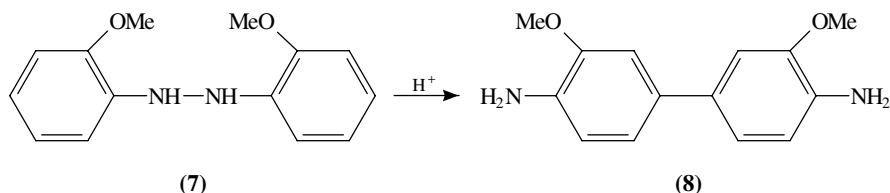
TABLE 1. Values of the KIE for the acid catalysed rearrangement of **1** to give **2** and **3**

Label	Formation of <b>2</b>	Formation of <b>3</b>
<sup>15</sup> N, <sup>15</sup> N'	1.0222	1.0633
4,4'- <sup>13</sup> C	1.0209	1.0006
4- <sup>14</sup> C	1.0284	1.0011
2,2',6,6'- <sup>13</sup> C	0.9945	0.9953
4,4'- <sup>2</sup> H		0.962 <sup>a</sup>

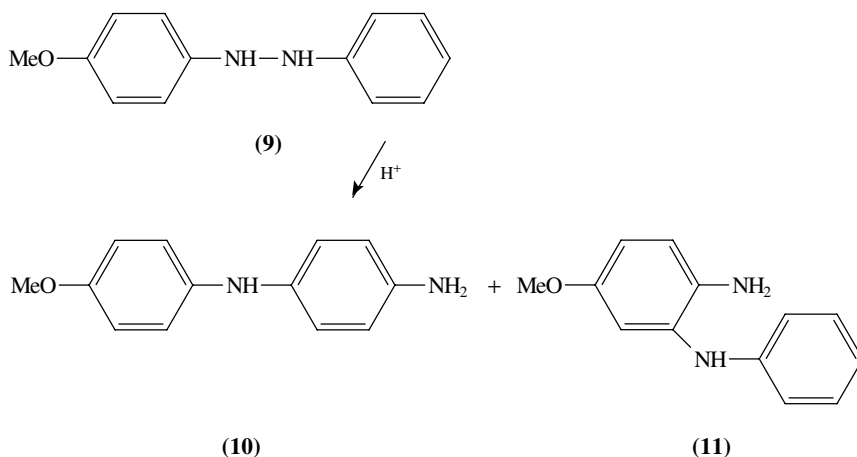
<sup>a</sup>Measured for the disappearance of **1**.

Rearrangement to the diphenylene product **3**, formally a forbidden [3,5] shift, must take place by a different mechanism in parallel to **2** formation. Previous mechanistic suggestions have attempted to explain the formation of both products within the same mechanistic framework. It is now apparent that **3** is formed by rate-limiting N-N bond fission to give an intermediate from which the product is formed. The nature of this intermediate is not yet known, but it has been suggested<sup>16</sup> that it could be a  $\pi$ -complex.

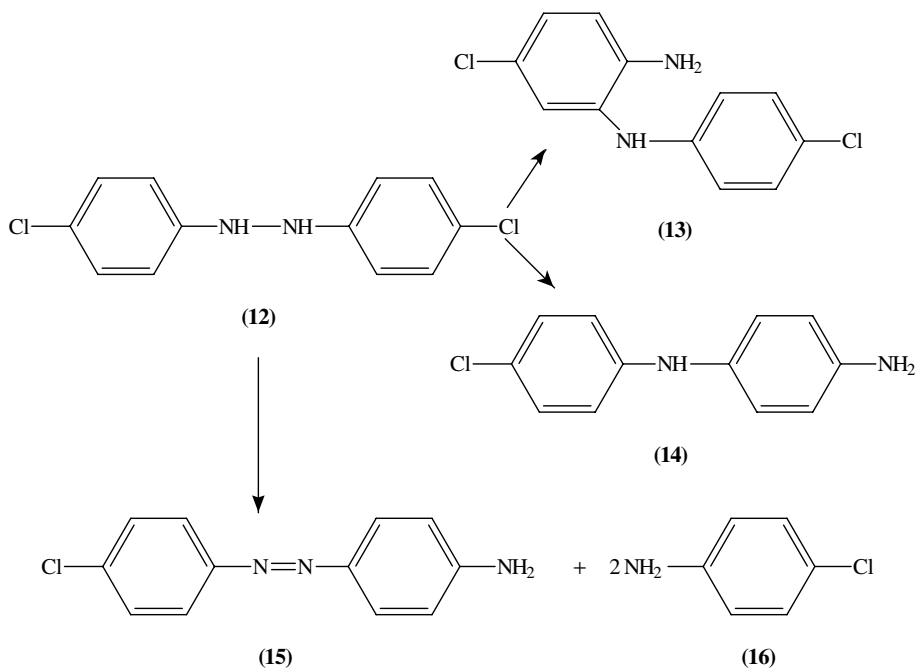
The reaction of hydrazobenzene (**1**) refers to reaction via the doubly protonated form. The mechanism for the rearrangement via a mono protonated form was examined<sup>17</sup> using 2,2'-dimethoxyhydrazobenzene (**7**). Again the KIE results for formation of the benzidine derivative **8** show that reaction is also concerted. It appears that there is no major difference between the one- and two-proton reactions.



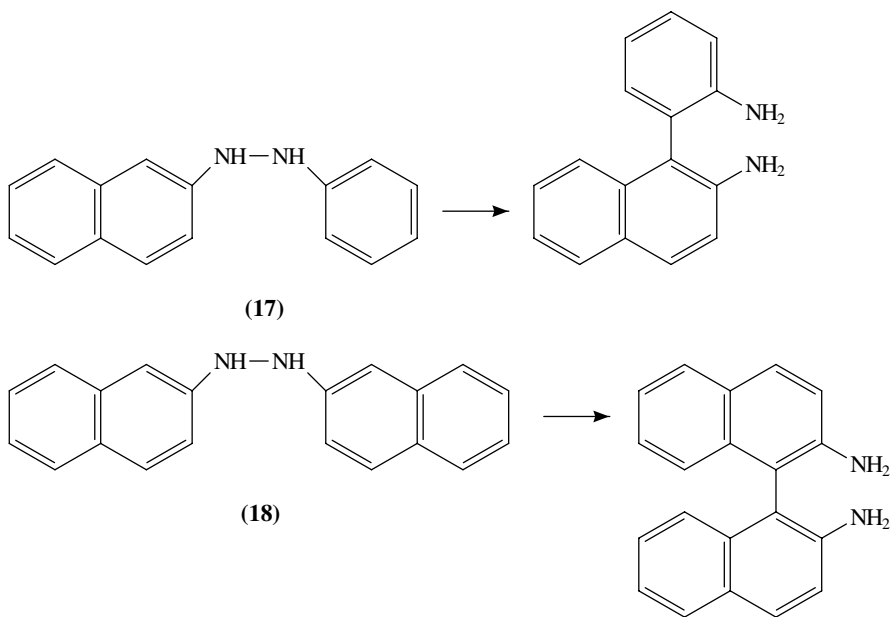
Reactions leading to the semidine products have also been examined by the heavy-atom KIE method<sup>19</sup>. The reaction of **9** gives both **10** and **11**. As expected, a KIE on N-N bond breaking was found for both products. For formation of **10** there was also a carbon KIE indicative of concertedness. The *para*-semidine rearrangement is then a [1,5]-sigmatropic shift. It was not possible to obtain the corresponding values for the formation of **11** (the *ortho*-semidine rearrangement). In an attempt to examine *ortho*-semidine formation the reaction of the 4,4'-dichlorohydrazobenzene (**12**) was studied<sup>20</sup>. This reaction gives the *ortho*- (**13**) and the *para*- (**14**) semidines as well as a significant amount of the products of disproportionation **15** and **16** (Scheme 3). The formation of **14** is accompanied by loss of chlorine. There was no carbon KIE for bond formation for the formation of *both* semidine products **13** and **14** but the expected nitrogen KIE for both, so that in this case neither rearrangement product is formed in a concerted process.



Details of the mechanism of the *ortho*-benzidine rearrangement were examined using the two hydrazonaphthalene derivatives **17** and **18**<sup>17,21</sup>. Both showed nitrogen and carbon



SCHEME 3



isotope effects showing the reactions to be concerted and can be regarded as [3,3]-sigmatropic shifts.

One other set of experimental results has been reported giving the results of heavy-atom KIE experiments in the benzidine rearrangement<sup>22</sup>. A feature of pericyclic reactions (including sigmatropic rearrangements) is that the motion of *all* the atoms involved are coupled. It follows that kinetic isotope effects should be found for atoms not directly involved in bond breaking or making, so that conventional secondary effects should be much greater than those normally encountered for the reactions. This has been tested in the reaction of hydrazobenzene itself using both carbon isotopes at the 1- and 1'-positions using 1-<sup>14</sup>C and 1,1'-<sup>13</sup>C<sub>2</sub> labelled reactants. As predicted, there was a small but significant KIE for the reaction leading to the benzidine product (**2**) but no measurable KIE on the reaction leading to diphenylene (**3**). This is entirely consistent with the earlier findings and interpretation that **2** is formed in a concerted process whereas **3** is not but requires the formation of an intermediate. This paper<sup>22</sup> also reports the results of the repetition of earlier experiments using **1** for 4,4'-<sup>13</sup>C<sub>2</sub>, 4-<sup>14</sup>C and <sup>15</sup>N, <sup>15</sup>N' labelled compounds. The results are somewhat different from those reported earlier, but it is argued that the more recent results are likely to be the more reliable given the better scintillation counting and mass spectrometric facilities available.

As mentioned earlier, products of disproportionation often accompany the rearrangement products. This reaction is also acid-catalysed and it is a reasonable assumption that reaction proceeds via the protonated species. Experiments with the 4,4'-diiodohydrazobenzene (**19**) showed that there were significant nitrogen *and para*-carbon kinetic isotope effects<sup>23</sup>. This implies that disproportionation must take place after C—C bonding has occurred, i.e. that the intermediate must be the quinonoid form **20** (and cannot, for example, be a  $\pi$ -complex), which is then believed to react with another reactant molecule to give the disproportionation products (Scheme 4).

As a result of these heavy-atom KIE experiments the principal features of the benzidine rearrangements have now been firmly established. The two main products arise from two parallel reactions one of which is concerted and the other is not. Other concerted processes have been identified and all of the concerted processes can be readily classified in the terminology of sigmatropic rearrangements within the general class of pericyclic reactions.

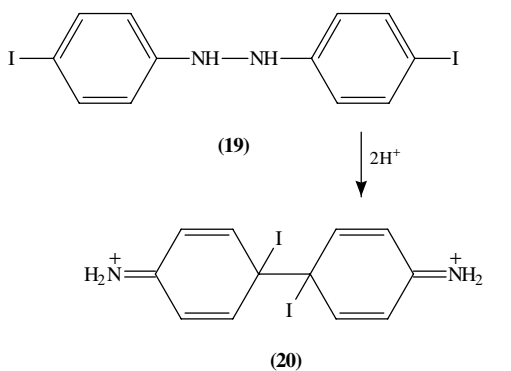
The benzidine rearrangements can also be brought about thermally, but very few mechanistic studies have been carried out. One set of heavy-atom KIE measurements has been made in the reaction of 2,2'-hydrazonaphthalene (**18**)<sup>21</sup>. Substantial nitrogen (1.0611 for the [<sup>15</sup>N, <sup>15</sup>N']) and carbon (1.0182 for the [1,1'-<sup>13</sup>C<sub>2</sub>]) KIE values were obtained showing that, just as for the acid catalysed reaction, this is a [3,3]-sigmatropic rearrangement, this time presumably of the non-protonated reactant.

There continue to be a few examples reported where rearrangement has been used synthetically to develop new products sometimes important in the industrial world. Monomers for polyamides and polyimides (which are used for making moisture sensitive films, fibres and mouldings) have been synthesized<sup>24</sup> by the reduction of a nitro compound, followed by a benzidine rearrangement of the resulting hydrazobenzene derivative as outlined in Scheme 5.

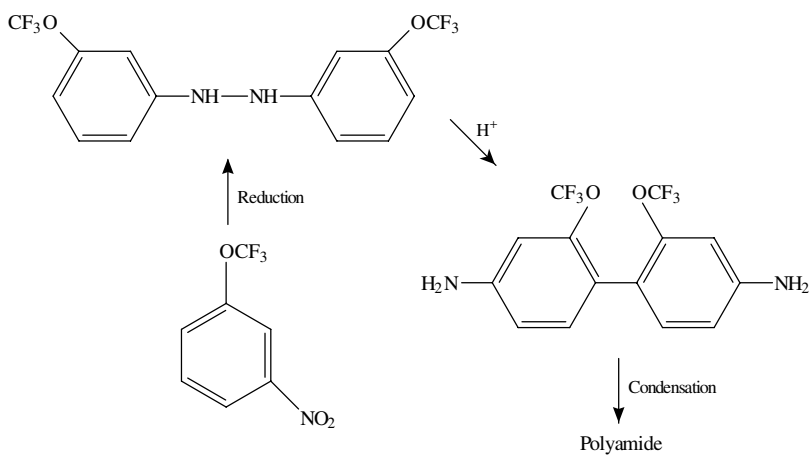
Similarly, a number of 2-(2-arylhydrazino) tropones undergo the benzidine rearrangement when treated with HCl in EtOH to give 2-amino-5-(4-aminoaryl)tropones, which can be hydrolysed to the corresponding 5-aryl-tropolones. This is a useful route to a synthesis for open B ring colchine analogues<sup>25</sup>.

### Quinamine Rearrangement

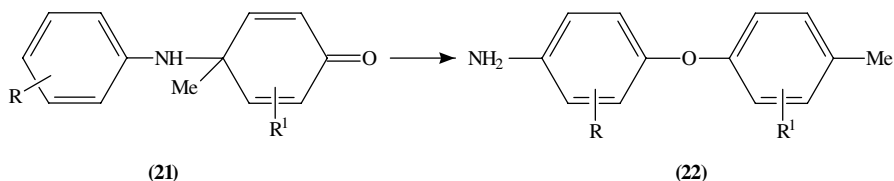
4-(Arylamino)-cyclohexadienones (**21**) rearrange in acid solution (often in alcohol or acetic acid solvents) to give 4-(aryloxy)-anilines (**22**) (Scheme 6). In some ways this



SCHEME 4



SCHEME 5

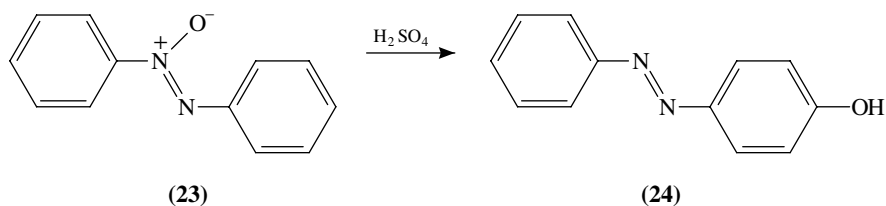


SCHEME 6

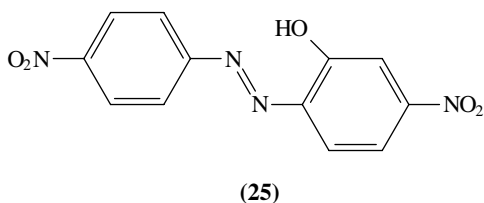
reaction bears a formal resemblance to the benzidine rearrangement. Kinetic measurements have quantified acid catalysis and the lack of crossover products has shown the reaction to be intramolecular<sup>26</sup>. There remained the question of whether rearrangement was concerted or not and this has been addressed by Boduszek and Shine<sup>27</sup>, who measured the KIE for the [<sup>18</sup>O], [<sup>15</sup>N] and [4-<sup>14</sup>C] (at the *para* position of the aniline ring) isotopes. The values obtained,  $k^{16}\text{O}/k^{18}\text{O}$  1.0399,  $k^{14}\text{N}/k^{15}\text{N}$  1.0089 and  $k^{12}\text{C}/k^{14}\text{C}$  1.0501, confirmed that the rearrangement is concerted and is a [5,5]-sigmatropic shift. Other minor products are formed resulting from another concerted [3,3]-sigmatropic change.

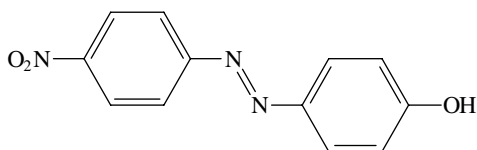
### III. REARRANGEMENT OF AZOXYBENZENES (THE WALLACH REARRANGEMENT)

In some way formally similar to the benzidine rearrangement is the Wallach rearrangement of azoxybenzene **23** to give 4-hydroxyazobenzene **24** in concentrated (typically 95%)  $\text{H}_2\text{SO}_4$ . The 2-hydroxy isomer is sometimes formed in low yield with some substituted azoxybenzenes, and it is the main product in the photochemically induced reaction. Much of what is known about the reaction has been covered in earlier review articles<sup>28-30</sup>. This contribution will report work published since 1981.

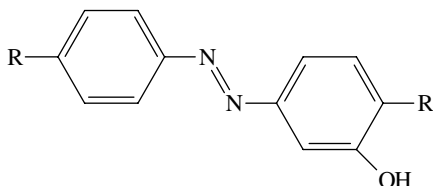


With 4,4'-substituted azoxybenzenes a range of different products has been reported. For example, with electron-withdrawing groups such as  $\text{NO}_2$ ,  $\text{COCH}_3$ ,  $\text{CO}_2\text{H}$  reaction gives the 'normal' 2-hydroxy isomer (**25**) plus the 4'-hydroxy product **26** believed to be formed by *ipso*-attack by water from the solvent and expulsion of the nitro group<sup>31</sup>. Another example of *ipso*-attack at the 4'-position, this time followed by rearrangement, occurs in the reaction of 4,4'-dialkylazoxybenzene when the products are **27** and **28**, believed to be

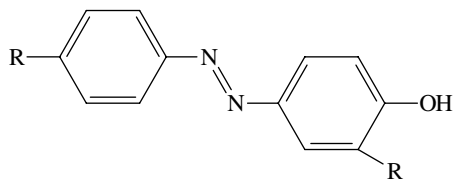




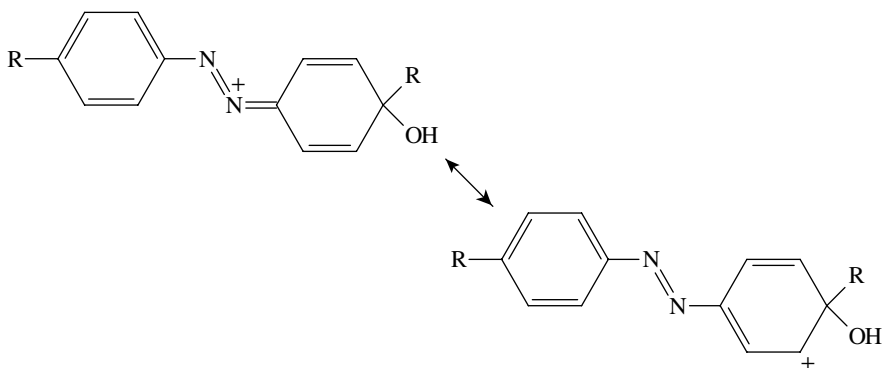
(26)



(27)



(28)



(29)

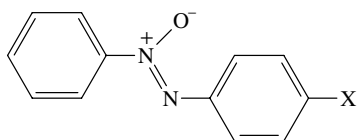
generated from the intermediate **29**<sup>32</sup>. When the 4- and 4'-substituents are halogens, then the major product is that of reduction, the 4,4'-dihaloazobenzene<sup>33</sup>.

Interconversion of the isomers **30** and **31** occurs in the reactant during the rearrangement, involving an intermediate which is suggested as the bridged ion **32**. This change occurs for X = Me and NO<sub>2</sub> but strangely not when X = Br<sup>34</sup>. A remarkable difference in reactivity exists between two such isomers in phenylazopyridine<sup>35</sup>. The  $\alpha$  isomer (**33**) is virtually inert towards rearrangement in 95–100% H<sub>2</sub>SO<sub>4</sub> whilst the  $\beta$  isomer (**34**) reacts 'normally' to give 4-(4'-hydroxyphenylazo) pyridine-*N*-oxide. The reactivity difference is so great, that from mixtures of **33** and **34** pure samples of **33** can be obtained when all **34** has rearranged.

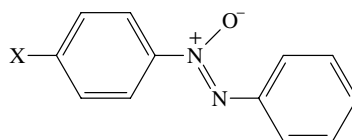
The Wallach rearrangement has been reported for perfluoro derivatives<sup>36</sup>. Reactions are much slower, as expected, and in sulphuric acid the octafluoro compound **35** gave no rearrangement product, but in chlorosulphuric acid rearrangement did occur to give the 4-chlorosulphonate ester.

Mechanistically speaking there have been no recent advances. What is known is that, at least for 4-OH formation, the reaction is intermolecular, requires two proton transfers at some stage and that a symmetrical intermediate is involved (often described as

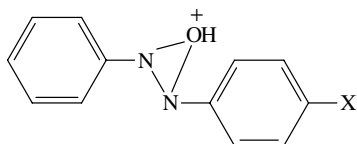




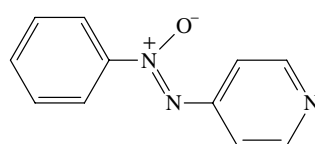
(30)



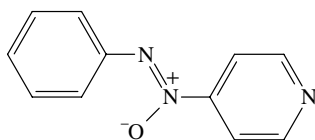
(31)



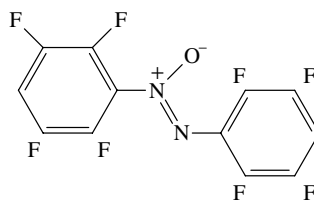
(32)



(33)

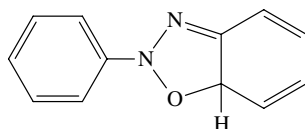


(34)



(35)

Ar-N<sup>+</sup>≡N<sup>+</sup>-Ar). A number of possible reaction mechanisms have been suggested at different times and, at this time, the position is not settled. No heavy-atom KIE work has been reported for the acid catalysed reaction, but such experiments have been carried out for the photochemical reaction<sup>37</sup> which gives the 2-hydroxy product and which is known to be intramolecular. There is an absence of a KIE when [<sup>15</sup>N,<sup>15</sup>N'] material is used, which at least reveals that if the proposed intermediate **36** is involved, then the rate-limiting step must be its formation and not its subsequent reaction since N-O bond fission cannot be part of the slow step.

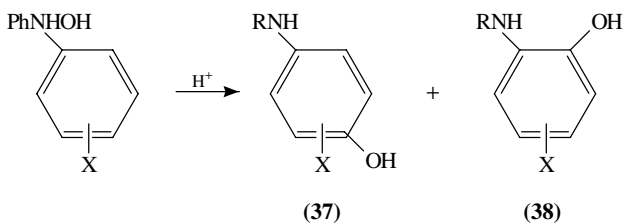


(36)

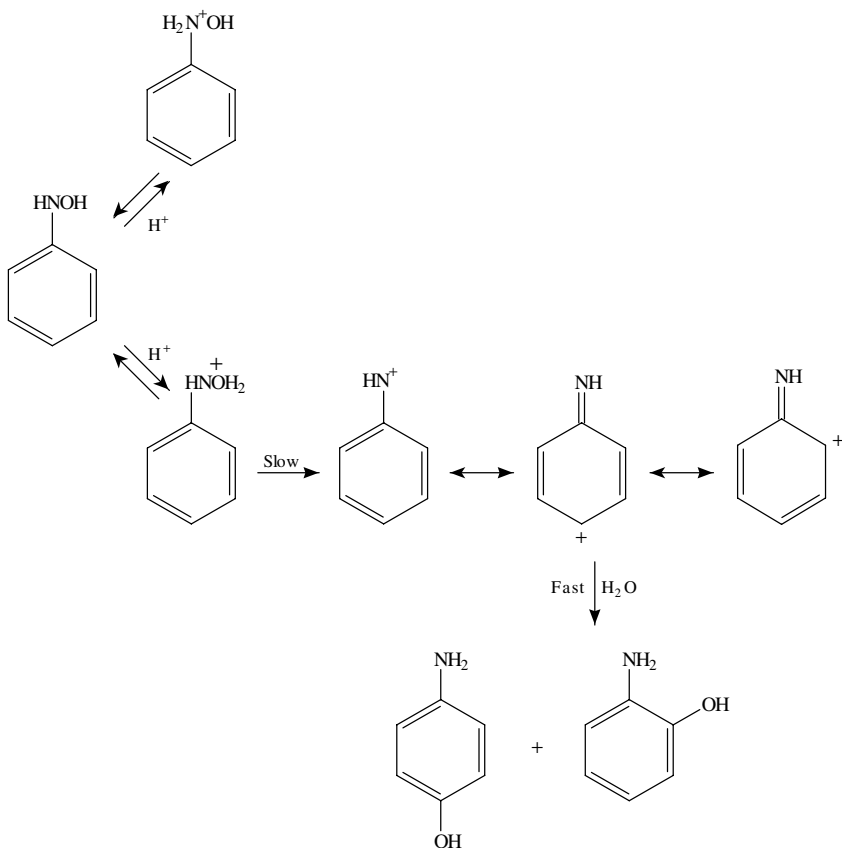
#### IV. REARRANGEMENT INVOLVING PHENYLHYDROXYLAMINES

##### A. The Bamberger Rearrangement

This is the best known rearrangement reaction of phenylhydroxylamines and is an acid catalysed reaction leading principally to the formation of 4-amino phenols **37**, although a little of the 2-isomers **38** are also sometimes formed. Reaction proceeds quite smoothly in relatively dilute acid at room temperature. Reaction is quite general for a range of R and X substituents. Much of the early work was carried out by Bamberger<sup>38</sup> and the position up to 1967 has been very well reviewed<sup>39</sup>.



In the presence of alcohols, the corresponding ethers are formed and added nucleophiles such as chloride ion<sup>40</sup> or azide ion<sup>41</sup> lead to the chloro- and azido-amine products, respectively. Rate constants are independent of the concentration of added nucleophile. Labelled <sup>18</sup>O from the solvent is incorporated in the product<sup>42</sup>. All the evidence points to a reaction mechanism where water is lost from the O-protonated reactant to give a nitrenium ion–iminium ion intermediate which is rapidly trapped by a nucleophile (H<sub>2</sub>O in this case) to give the final product. This is shown in Scheme 7. Protonation at N- is likely to be more extensive, but there is no pathway to products from the N-protonated intermediate.



SCHEME 7

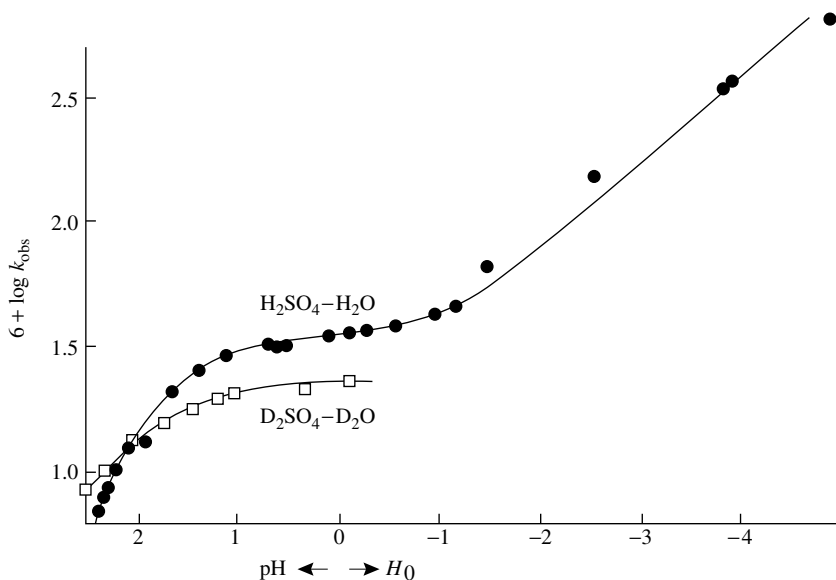


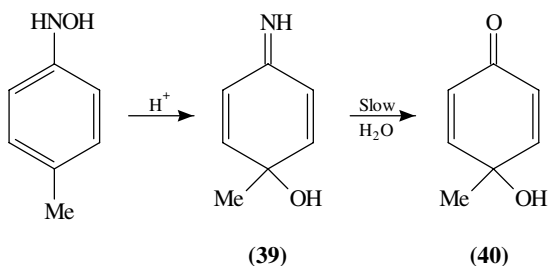
FIGURE 1. Plot of  $\log k_{\text{obs}}$  vs  $H_0$  or pH for the rearrangement of *N*-phenylhydroxylamine in  $\text{H}_2\text{SO}_4\text{-H}_2\text{O}$  and in  $\text{D}_2\text{SO}_4\text{-D}_2\text{O}$ . Reproduced by permission of the Royal Society of Chemistry from Reference 44

More recent mechanistic studies<sup>43,44</sup> have confirmed the general mechanistic framework. Acid catalysis is found at acidities up to *ca* pH 1, then there is an acid region where the rate constant is acid-independent, then at higher acidities acid catalysis occurs again. This is shown in Figure 1.

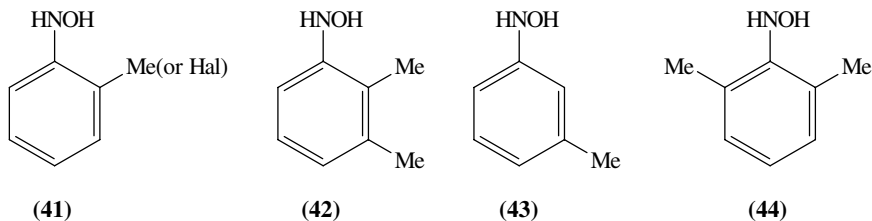
The plateau region corresponds to effectively complete N-protonation. The  $\text{p}K_{\text{a}}$  value measured spectrophotometrically (1.90) agreed with that derived from the kinetic measurements. Similar good agreement was obtained for the *N*-Et and 4-Me reactants and also for the unsubstituted phenylhydroxylamine in  $\text{D}_2\text{O}$ . The measured solvent KIE was also in agreement with the mechanism in Scheme 7. Acid catalysis at high acidity is believed to arise from another reaction pathway involving the doubly protonated species  $\text{Ph-NH}_2^+\text{OH}_2^+$  for which there is support from polarographic measurements at high acidity<sup>45</sup>.

Kinetic experiments using 3-ring substituted derivatives<sup>43</sup> gave a good  $\log k$  vs  $\sigma_m$  correlation yielding a  $\rho$  value of  $-3.2$ , confirming N–O bond fission in the sense leading to positive charge increase on the nitrogen atom in the transition state.

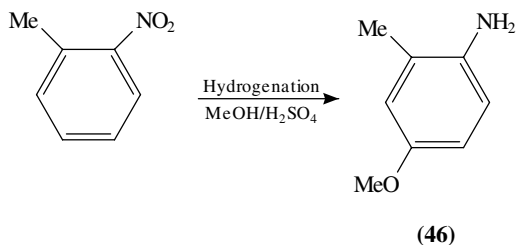
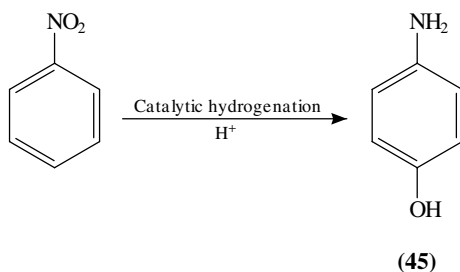
*N*-Ethyl substitution had very little effect on the measured rate constant, whereas a 4-methyl substituent increased the rate constant by a factor of *ca* 100. In this case the initial product (identified by Bamberger) is the iminocyclohexadienol **39**, which slowly hydrolyses to the quinone **40**. These substituent effects suggest that in the transition state the developing positive charge is located mostly at the 4-position (stabilized by the 4-Me substituent) and very little on the nitrogen atom (no stabilization by a *N*-Et substituent), so that the intermediate is more properly described by the iminium ion. This is supported by an earlier observation<sup>46</sup> that whilst full incorporation of  $^{18}\text{O}$  from the solvent  $\text{H}_2^{18}\text{O}$  occurs in the product, there is no detectable  $^{18}\text{O}$  incorporation into the reactant phenylhydroxylamine.



Further kinetic experiments with some sterically hindered phenylhydroxylamines gave results<sup>47</sup> which suggest that under certain circumstances steric acceleration occurs, attributable to the buttressing effect of neighbouring 3-substituents. Thus the rate constants for the reactions of **41** and **42** are respectively greater than are those for **43** and **44**.



The rearrangement reaction continues to be of synthetic utility, often involved in industrial processes. Patent references (e.g. Reference 48) refer to the formation of 4-amino phenols. Often the reactant nitro compound is reduced (to the hydroxylamine) in an acid environment so that the two-stage reaction can be accomplished as a one-pot synthesis. 4-Amino phenol itself **45** can be made in high yield directly from nitrobenzene<sup>49</sup> and the 4-methoxy aniline derivative **46** similarly from 2-methylnitrobenzene by hydrogenation in MeOH/H<sub>2</sub>SO<sub>4</sub><sup>50</sup>.



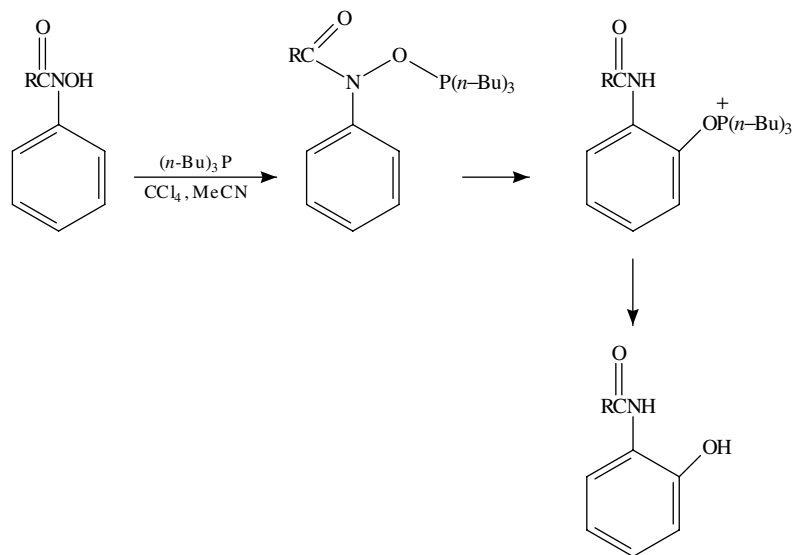
At low acidities oxidation of phenylhydroxylamine occurs yielding azoxybenzene and other products. This competing reaction can be eliminated by working anaerobically and can also be much reduced by working at high acidities, suggesting that the oxidation occurs via the free base form of phenylhydroxylamine.

An unusual kinetic result has been reported<sup>51</sup> when phenylhydroxylamine reacted anaerobically with bisulphite anion. The product distribution was as expected, i.e. both 2- and 4-aminophenol and the 2- and 4-aminobenzenesulphonates were formed. Kinetic measurements showed a first-order dependence upon [bisulphite], in contrast to the earlier work with  $\text{Cl}^-$  and later with  $\text{N}_3^-$ . The authors propose a mechanism involving direct attack by the nucleophile at the 2- and 4-positions as the rate-limiting step, followed by proton transfers and solvent attack to form the sulphonate products.

There has been considerable interest in the chemistry of hydroxylamines, since it is believed<sup>52</sup> that the carcinogenicity of some arylamines results from the formation of the *N*-hydroxy species, which in turn generate nitrenium ions that react in a conventional electrophilic sense with nucleic acids.

## B. Other Rearrangements

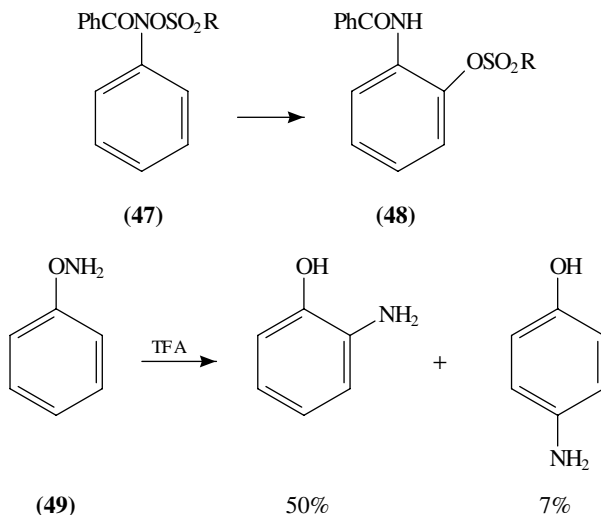
A different mechanism probably operates for the reaction of *N*-hydroxy-*N*-phenylamides in the presence of  $(n\text{-Bu})_3\text{P}$ ,  $\text{CCl}_4$  and MeCN, with the 2-isomer in the product<sup>53</sup> suggestive of some intramolecular pathway as outlined in Scheme 8.



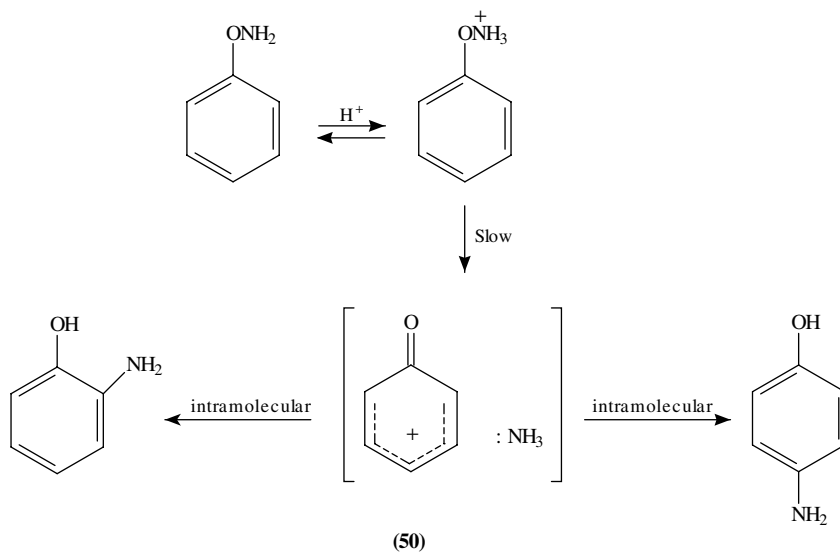
SCHEME 8

*O*-Substituted phenylhydroxylamines also undergo rearrangement to give the 2-isomers. For example *O*-(arenesulphonyl) phenylhydroxylamines **47** readily form the 2-sulphonyl derivatives **48**. Experiments with  $^{18}\text{O}$ -labelled compounds led to the suggestion<sup>54</sup> of a mechanism involving an ion pair which has only a very short lifetime.

Heating *O*-phenylhydroxylamine **49** gave 2-aminophenol, though not in very high yield<sup>55</sup>. A detailed mechanistic investigation of this reaction in trifluoroacetic acid has



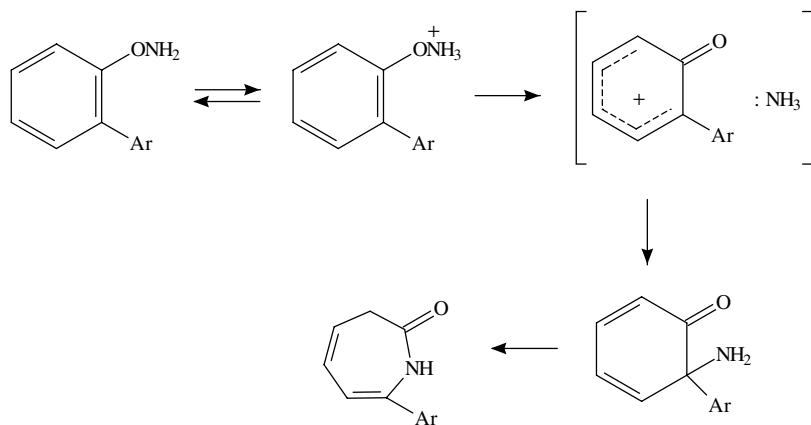
been carried out<sup>56</sup>. A little of the 4-isomer is formed, but the predominance of the 2-isomer suggests that this reaction is very different from the Bamberger rearrangement. Cross-coupling experiments with <sup>15</sup>N labelled compounds showed that the 2-isomer is formed in an intramolecular process and that the formation of the 4-isomer has both intramolecular and intermolecular reaction pathways. Substituent effects in the aromatic ring gave a large negative  $\rho$  value ( $-7.8$ ) from a Hammett plot using  $\sigma^+$  values, indicating that a positive charge is being generated on the oxygen atom (delocalized into the ring to a considerable degree) in the transition state. The suggested mechanism outlined in Scheme 9 involves N-protonation followed by the formation of a tight phenoxonium



SCHEME 9

ion-ammonia pair (**50**) which can collapse to give the products. Reaction of the solvent (TFA) with the ion pair gives a solvent separated ion pair from which it is possible to rationalize the formation of the two minor by-products, catechol and hydroquinone.

A synthetic application of this reaction has been reported<sup>57</sup> when the rearrangement of 2-aryl-*O*-phenylhydroxylamines is followed by a ring enlargement to give an aryldihydroazepinone (Scheme 10). The 2-aryl-2-phenyl intermediate was also trapped out as the *N*-trifluoroacetamide.

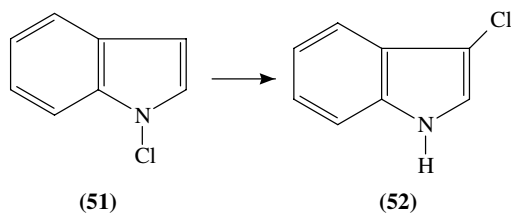


SCHEME 10

## V. REARRANGEMENT OF *N*-HALO COMPOUNDS

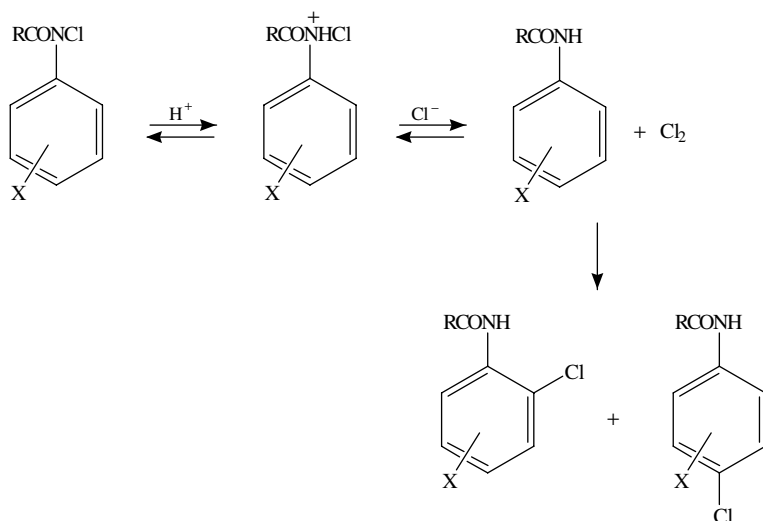
The Orton rearrangement of *N*-chloroanilides is well known and the reaction mechanism, at least for reaction in aqueous acid solution, is well understood. The position is set out in Scheme 11. Protonation of the nitrogen atom is followed by nucleophilic attack by the chloride ion, generating chlorine which reacts with the anilide in a conventional electrophilic substitution reaction. The reaction is well documented and the reaction mechanism is well understood<sup>58</sup>. Only a few recent developments have been reported. A good correlation between  $\log k$  and  $\sigma$  has been obtained<sup>59</sup> for reactions of 4-X reactants, giving a  $\rho$  value of 0.79. This small value is consistent with the conflicting electronic demands of the two stages, the *N*-protonation and nucleophilic attack by chloride ion. Rearrangement occurs with *N*-chlorobenzanilide with acid catalysis and chlorine does not migrate to the aromatic ring of the benzyl group<sup>60</sup>. That part of the reaction leading to de-chlorination has been studied separately<sup>61</sup> using triethylamine as the nucleophile and pathways involving the protonated and non-protonated *N*-chloroacetanilide have been identified.

Rearrangements of *N*-chloro compounds in heterocyclic systems have been studied. *N*-Chloroindole **51** gives<sup>62</sup> the 3-chloro isomer **52**. With pyrrole (**53**) there are two



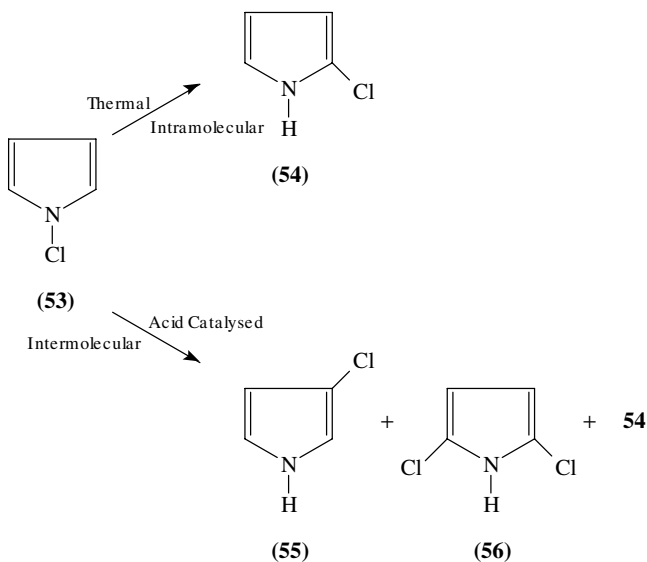
(51)

(52)

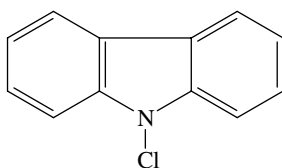


SCHEME 11

pathways<sup>63</sup>, one thermal which is believed to be intramolecular giving the 2-chloro compound **54**, and an acid-catalysed component leading to the 3-chloro (**55**) and 2,5-dichloro (**56**) products. The reaction of *N*-chlorocarbazole (**57**) gave a variety of products<sup>64</sup>, the 3- and 1-chloro compounds and the 3,6- and 1,6-dichlorocarbazoles as well as carbazole itself. Reaction takes place in refluxing methanol and an intermolecular mechanism is argued on the basis of the product distribution. In the presence of added base only the carbazole product of de-chlorination is observed. This is taken to support the idea that the rearrangement reaction is acid-catalysed.

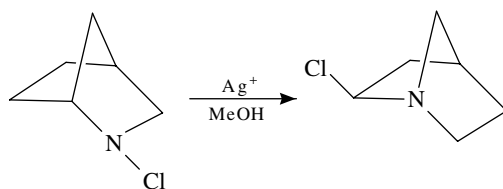






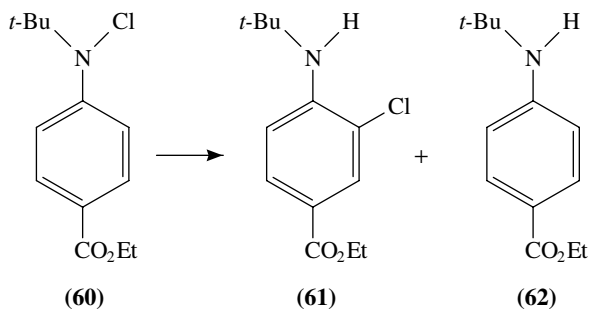
(57)

A quite different mechanism for rearrangement of *N*-chloro compounds occurs when reaction is carried out in the presence of silver ion. This reaction has been studied by Gassman as part of a quest to identify nitrenium ion intermediates in reactions. The work up to 1970 is covered in a review article<sup>65</sup>. Rearrangement of the 2-azabicyclo [2.2.1]-heptane derivative **58** occurs readily in a silver ion catalysed process to give the 1-aza derivative **59**. Kinetic measurements indicated that heterolytic cleavage had occurred, giving the nitrenium ion and chloride ion. The former then undergoes a skeletal rearrangement typical of these bicyclic systems. Later<sup>66</sup> the reaction of *N*-chloroaniline derivatives were studied, again in MeOH and silver ion assisted. With electron-donating ring substituents the final products are those derived by solvent attack at the ring 2- and 4-positions of the nitrenium ion–iminium ion intermediate, but with electron-attracting substituents the corresponding 2- and 4-chloro substitution products are formed. For example, the reaction of **60** gave the 2-chloro isomer **61** (58% yield) together with the de-chlorinated product **62** (26% yield). All of these fit Scheme 12 with the formation of a nitrenium ion followed by nucleophilic attack at the 2- and 4-ring positions. It appears quite unusual that the chloro products are formed in the presence of silver ion, and the authors propose that a tight ion-pair (**63**) is formed from which attack by chloride ion can occur. Kinetic measurements of substituted *N*-chloroanilines in the thermal reaction<sup>67</sup> gave a good correlation of  $\log k$  with  $\sigma^+$ , giving a large negative  $\rho$  value ( $-6.35$ ) consistent with the generation of a positive charge on nitrogen, which can be delocalized into the aromatic ring.



(58)

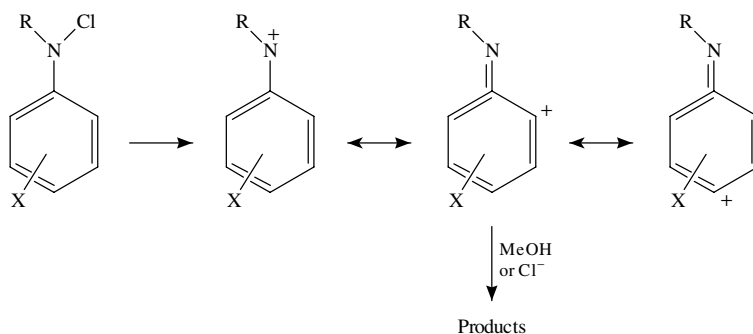
(59)



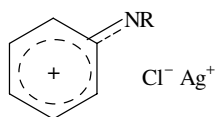
(60)

(61)

(62)



SCHEME 12

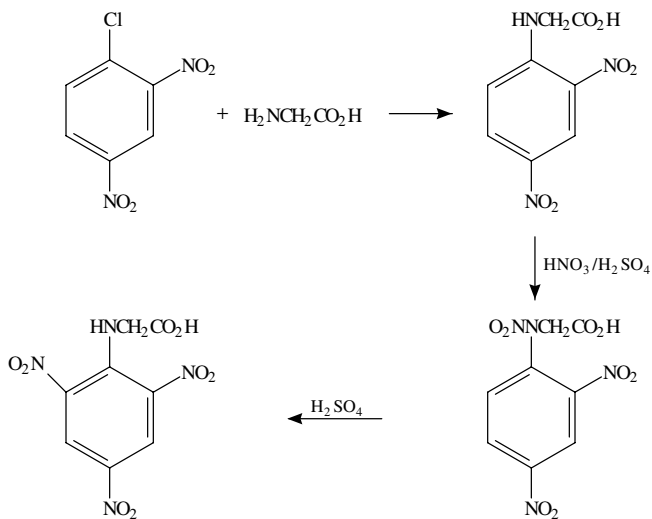


(63)

## VI. REARRANGEMENT INVOLVING NITRO GROUPS

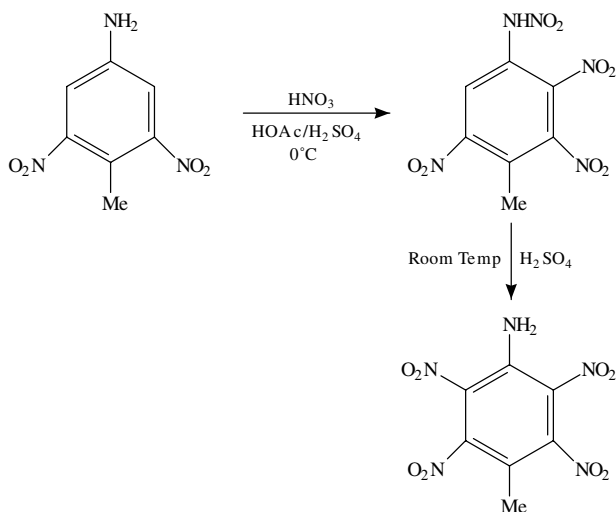
### A. The Nitramine Rearrangement

The acid-catalysed rearrangement of *N*-nitroaniline derivatives continues to provide convenient synthetic routes to some nitro compounds which are difficult to obtain by other methods. A recent example<sup>68</sup> is given in Scheme 13, where the introduction of the third nitro group into the aromatic ring is brought about by rearrangement of the



SCHEME 13

*N*-nitro glycine derivative. Another example<sup>69</sup> to obtain a tetranitro compound is given in Scheme 14. Here the product was then used to generate polynitrodiazophenols.

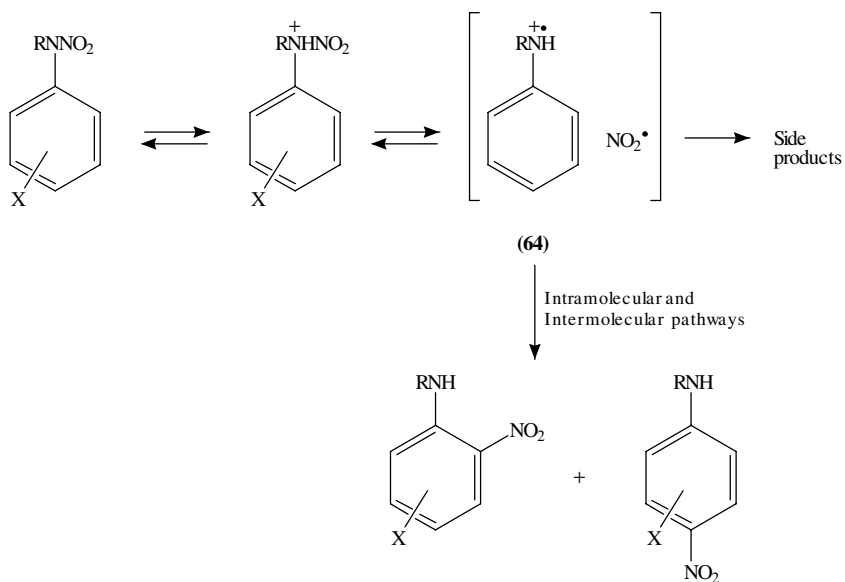


SCHEME 14

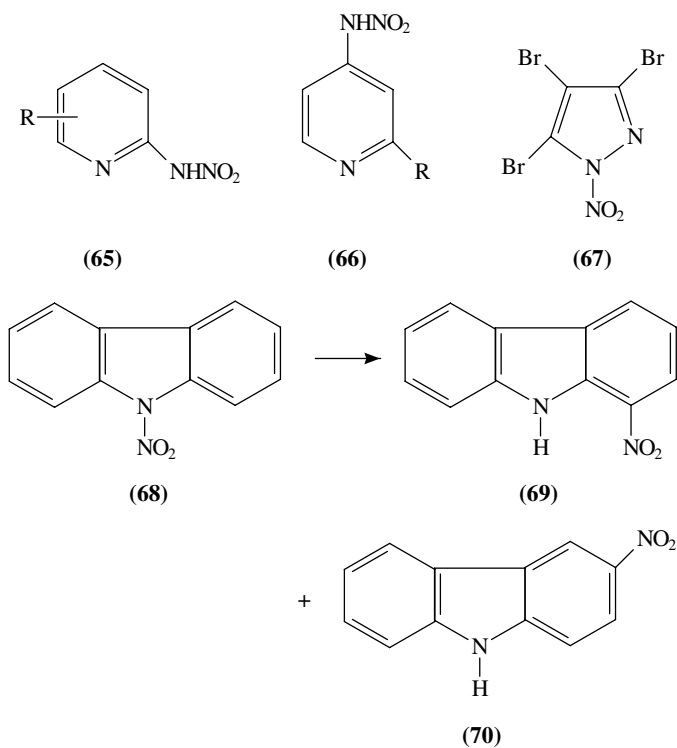
In the 1960s and 1970s there was something of a controversy regarding the mechanism of the nitramine rearrangement, and arguments were presented in favour of a 'cartwheel' mechanism and one involving the formation of radical pair intermediates. Now, two pieces of work, using modern techniques not available earlier, have produced conclusive evidence in support of the mechanism first put forward by White and coworkers<sup>70</sup> (Scheme 15), in which the reactant is protonated at the amino nitrogen atom and N–N bond fission occurs homolytically to give a radical–radical ion pair **64**. This intermediate can react within the solvent cage intramolecularly at the two positions of highest unpaired-electron density (i.e. the 2- and 4-positions) to give the observed products. This is the major pathway. Separation of the fragments of **64** allows reaction to occur also intermolecularly. This mechanism also can account for the formation of some of the minor products detected, e.g. the unsubstituted aniline formed by reduction of the radical cation.

Ridd and coworkers<sup>71</sup> have now shown unequivocally that radical pairs are indeed involved in this rearrangement by observation of strong enhancement of <sup>15</sup>N NMR signals in both the reactant and product, when reaction was carried out with <sup>15</sup>N-labelled nitro groups in both *N*-methyl-*N*-nitroaniline and also in *N*-methyl-*N*-nitro-2,5-dichloro (and dibromo) aniline.

Further, Shine and coworkers<sup>72</sup> have applied their heavy-atom kinetic isotope effect technique (widely applied in investigations into the mechanism of the benzidine rearrangement discussed in Section II of this chapter) to the nitramine rearrangement. Substantial nitrogen KIE values were recorded (for the formation of both 2- and 4-nitro products) when [<sup>15</sup>NO<sub>2</sub>] labelled *N*-methyl-*N*-nitroaniline underwent rearrangement, whereas there was no ring carbon KIE (in both products) for the reaction of both [2-<sup>14</sup>C] and [4-<sup>14</sup>C] labelled materials. This means that N–N bond fission and N–C bond formation cannot occur in a single synchronous process as is proposed in the 'cartwheel' mechanism<sup>73</sup>. On the other hand, the results are wholly consistent with the radical pair mechanism (Scheme 15), in which N–N bond fission is the rate-limiting step.



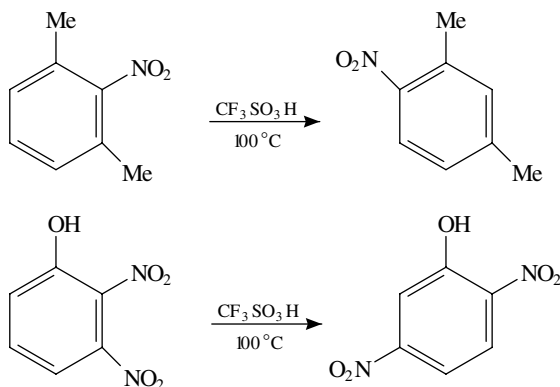
SCHEME 15



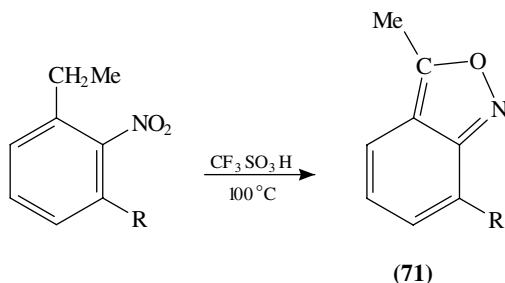
The nitramine rearrangement is also well known in heterocyclic systems. Fairly recent examples reported include the reaction of the pyridine derivatives<sup>74</sup> **65** and **66**, and the tribromo-1-nitro-1*H*-pyrazole **67**, which results in bromine displacement by the nitro group<sup>75</sup>. Reaction is also known for *N*-nitroindazoles, *N*-nitrotriazoles and *N*-nitroimidazoles. *N*-Nitrocarbazole **68** rearranges to give the 1-nitro (**69**) and 3-nitro (**70**) products<sup>76</sup>. Many of these reactions also take place thermally in organic solvents and also photochemically. The latter reactions are discussed elsewhere in this volume.

## B. Rearrangement of Nitro Aromatics

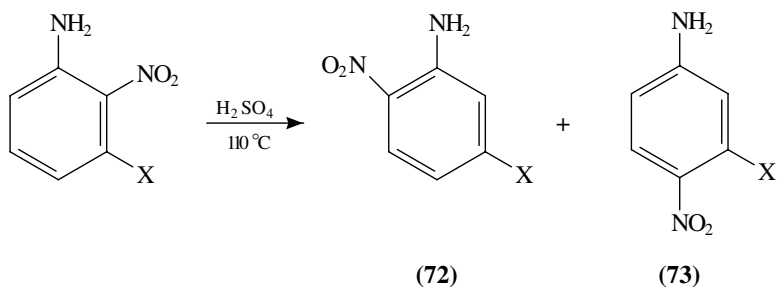
It has long been known that nitro-substituted aromatic compounds undergo positional rearrangements of nitro groups within the aromatic ring when treated with strong acids (usually H<sub>2</sub>SO<sub>4</sub>) at high temperatures. Normally the reactions are quite slow, yields are low and the reactions are not suitable for synthesis. Now the use of trifluoromethanesulphonic acid (triflic acid CF<sub>3</sub>SO<sub>3</sub>H) has enabled reactions to proceed much more rapidly and the yields can often be quantitative. Normally in these reactions, a 1,3-migration of the nitro group occurs. Some examples<sup>77-79</sup> are given below:



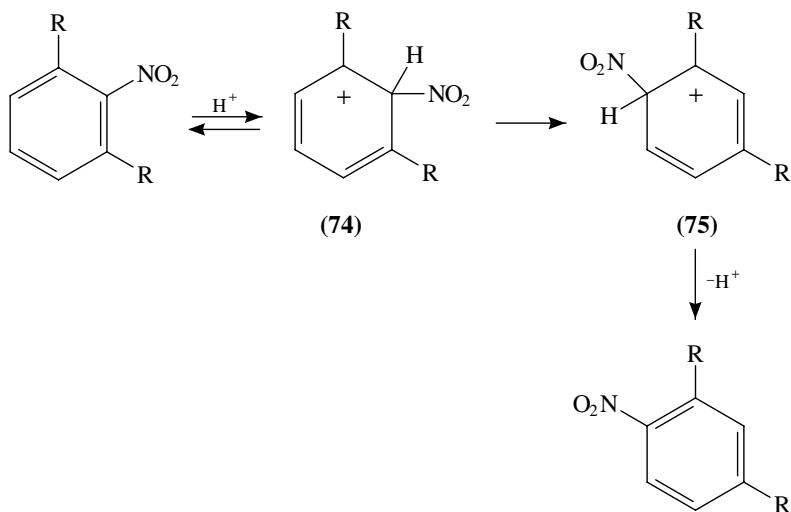
In some cases<sup>80</sup> where the nitro group is *ortho* to an ethyl group, there is a competing reaction which leads, via cyclization probably involving the nitronic acid form of the nitro group, to the corresponding anthranil **71**.



Substituted 2-nitroanilines also rearrange in concentrated sulphuric acid at 110°C to give both products of rearrangement **72** and **73**, where again 1,3-nitro group migration occurs<sup>81</sup>.

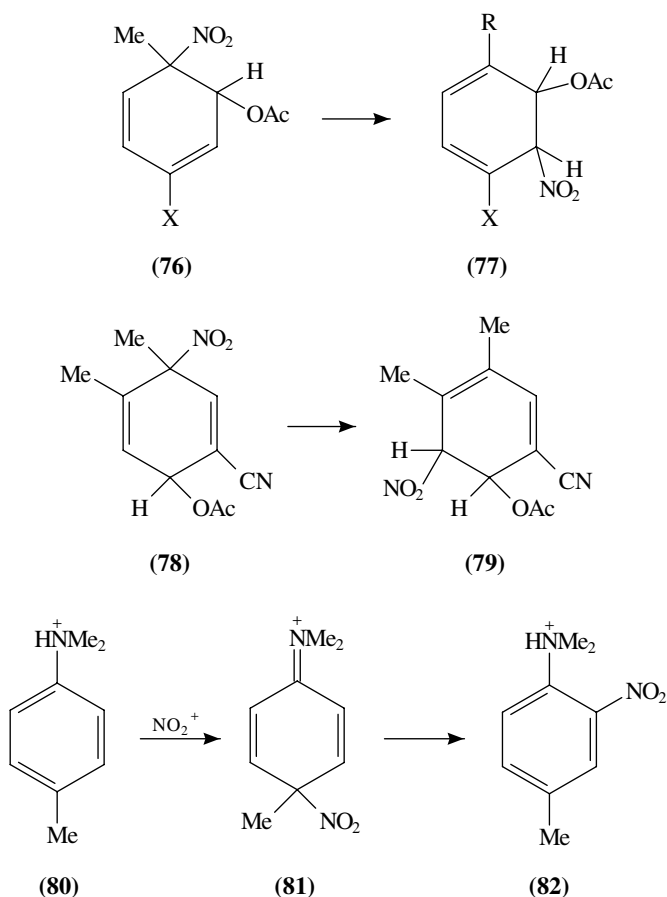


Labelling experiments using both  $^{15}\text{N}$  and  $^2\text{H}$  indicate that the rearrangement is intramolecular. Reactions are also acid-catalysed and are believed to occur via the Wheland intermediates **74** and **75**. The most likely interpretation is that the rearrangement occurs within the Wheland intermediate by a direct 1,3-shift rather than by consecutive 1,2-shifts, and that the process can be regarded as a typical [1,5]-sigmatropic rearrangement.

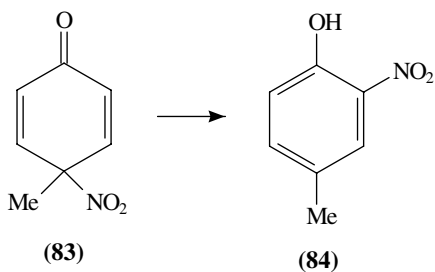


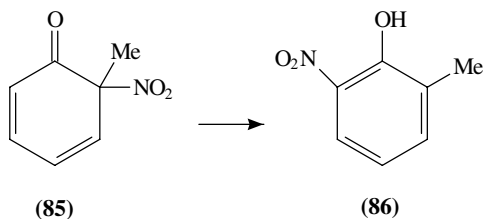
Nitro group rearrangements have also been postulated during aromatic nitration reactions, particularly those associated with reaction pathways involving *ipso* attack by the reagent ( $\text{NO}_2^+$  or  $\text{NO}_2$ ). This topic is more fully discussed elsewhere in this volume and so just a few examples will be presented here.

The nitronium acetate adducts **76** and **78**, made by nitration with nitric acid in acetic anhydride, both undergo the nitro group rearrangements shown, to give **77** and **79** respectively<sup>82</sup>. The former can be regarded as a [1,5]- and the latter as a [1,3]-sigmatropic shift. Similarly a 1,3-shift of the nitro group occurs in the nitration of aromatic amines. The nitration of **80** gives the *ipso* adduct **81** in quite high concentrations, detected and characterized by NMR measurements<sup>83</sup>. This then reacts by rearrangement to give (after proton loss) the 2-nitro product **82**. Similar reactions are common in the nitration of phenols and aromatic ethers<sup>84</sup>.



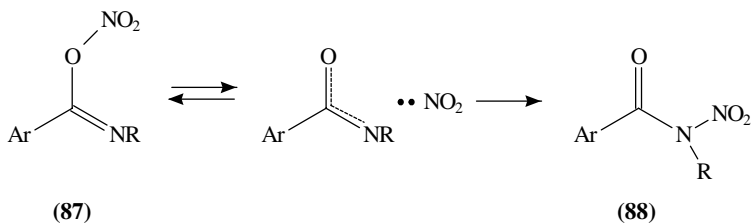
Some insight into the mechanism of these 1,3-NO<sub>2</sub> group shifts has been obtained from measurements of the <sup>15</sup>N CIDNP effect<sup>85</sup>. There appear to be two mechanisms. During the reaction of **83** to give **84** there is a strong enhancement of <sup>15</sup>N nuclear polarization indicative of reaction via a radical pair, whereas for the reaction of the isomer **85** to give **86** there is no such enhancement, indicative of a mechanism which does not involve a radical pair.



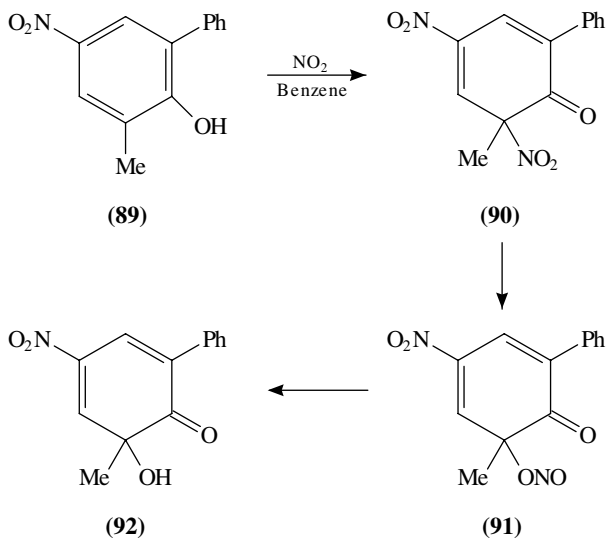


### C. Other Rearrangements

A 1,3-nitro group rearrangement from O to N has been reported<sup>86</sup>. This occurs in the reaction of an imidate, **87** (generated from the chloro compound and silver nitrate in acetonitrile), which gives an *N*-nitroamide (**88**). Reaction is believed to be intramolecular involving a radical pair following O–N homolytic bond fission.



A number of reactions of compounds containing the nitro group are postulated to occur by an isomerization to give the nitrite form  $-\text{NO}_2 \rightarrow -\text{ONO}$ , which is often followed by O–N homolytic bond fission releasing nitric oxide. The reaction has been extensively examined theoretically, for example in nitromethane. Calculations have led to values for the barrier height and characteristics of the transition state have been established (see, for example, Reference 87). The question of the nitro–nitrite rearrangement within the





reaction of nitramide decomposition has been examined in a number of photochemical processes (which will not be discussed here) and thermal reactions. For example, in the pyrolysis of  $\text{Me}_2\text{NNO}_2$ <sup>88</sup> two pathways have been established, one involving N–N bond breaking and the other involving  $-\text{NO}_2 \rightarrow -\text{ONO}$  rearrangement.

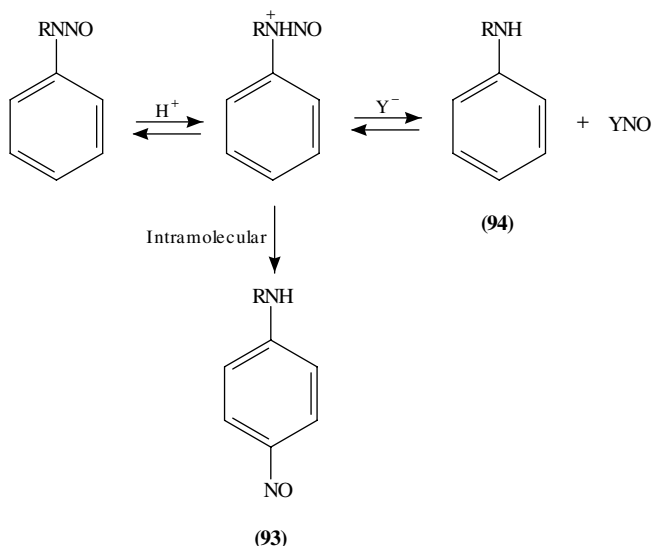
Another area in which  $-\text{NO}_2 \rightarrow -\text{ONO}$  rearrangement has been postulated is within aromatic nitration, again principally when *ipso* attack has occurred, in order to explain the formation of phenolic products. One example<sup>89</sup> comes from the nitration of aromatic systems by  $\text{N}_2\text{O}_4/\text{NO}_2$  typically in benzene solution. This involves reaction of a nitrophenol derivative (**89**) to give the *ipso* adduct (**90**), rearrangement of the nitro group to the nitrite (**91**) followed by hydrolysis to give the  $-\text{OH}$  product **92** (which in this system then reacts further with  $\text{NO}_2$ ).

Nitrites are also believed to be intermediates in nitration reactions where nitronium ion is the nitrating agent. Hydroxy compounds analogous to **92** are often products from the nitration of alkyl phenols<sup>90</sup>. Apart from the observation of hydroxy products there is convincing NMR evidence for the existence of the nitrite intermediates<sup>91</sup> and there is also spectroscopic evidence for their existence during the photochemical nitration of 1,4,5,8-tetramethylnaphthalene using tetranitromethane as the nitrating agent<sup>92</sup>.

## VII. REARRANGEMENT INVOLVING NITROSO GROUPS

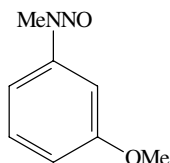
### A. The Fischer–Hepp Rearrangement

The case for an intramolecular mechanism for the rearrangement which takes place in parallel with a reversible denitrosation (Scheme 16) was presented in an earlier volume in this series<sup>93</sup>. Denitrosation is brought about by nucleophilic attack by  $\text{Y}^-$  at the nitroso nitrogen atom forming the secondary amine and a free nitrosating agent  $\text{YNO}$ . Generally  $\text{Y}^-$  is a halide ion or, in their absence, the solvent, water or ethanol. The crucial experiments which supported this mechanistic framework were those carried out in the presence of a ‘nitrite trap’ (such as sulphamic acid, hydrazine, hydrazoic acid, urea etc.), which



SCHEME 16

removes YNO and ensures the effective irreversibility of the denitrosation process. Under those circumstances when there is sufficient 'nitrite trap' present, a constant product ratio [93]/[94] was obtained as the concentration of the 'nitrite trap' was increased further. The ratio decreased as the concentration of  $[Y^-]$  was increased and also as  $Y^-$  was made more nucleophilic (e.g.  $Cl^- \rightarrow Br^-$ ). These results are entirely consistent with the mechanism in Scheme 16, but cannot be accommodated by the earlier suggestion that 93 is formed by direct C-nitrosation of 94 by YNO. If that were the case, then the product ratio [93]/[94] should decrease towards zero as the concentration of the 'nitrite trap' is increased. Further experimental results have now been presented<sup>94</sup> using 3-methoxy-*N*-nitrosoaniline (95) which gives a much higher [93]/[94] ratio than does *N*-methyl-*N*-nitrosoaniline (because of the activating effect of the OMe substituent). Table 2 shows the constancy of the % rearrangement product and of the rate constant (which will be the sum of the rate constants for denitrosation and rearrangement) over a range of different 'nitrite traps' and different concentrations. Table 3 shows the decreasing % rearrangement as the concentration of  $Br^-$  is increased; at 0.600 *M*  $Br^-$ , reaction is almost quantitatively that of denitrosation. Where it can be easily measured the rate constant increases with increasing  $[Br^-]$  concentration, since the  $[Br^-]$  term is included in the first-order rate constant for denitrosation. Similarly for different nucleophiles at the same concentration, % rearrangement decreases sharply as the nucleophilicity of  $Y^-$  increases. Similar results were obtained for reactions in HCl/EtOH and  $H_2SO_4$ /EtOH solutions using thiourea as the nucleophile and the solvent as the 'nitrite trap' (giving ethyl nitrite).



(95)

Some workers<sup>95</sup> continue to regard the rearrangement as being intermolecular, using the evidence of the formation of 94 and products derived from YNO. This makes the common error that the detection of an intermediate does not necessarily mean that the intermediate is on the pathway to the product under consideration.

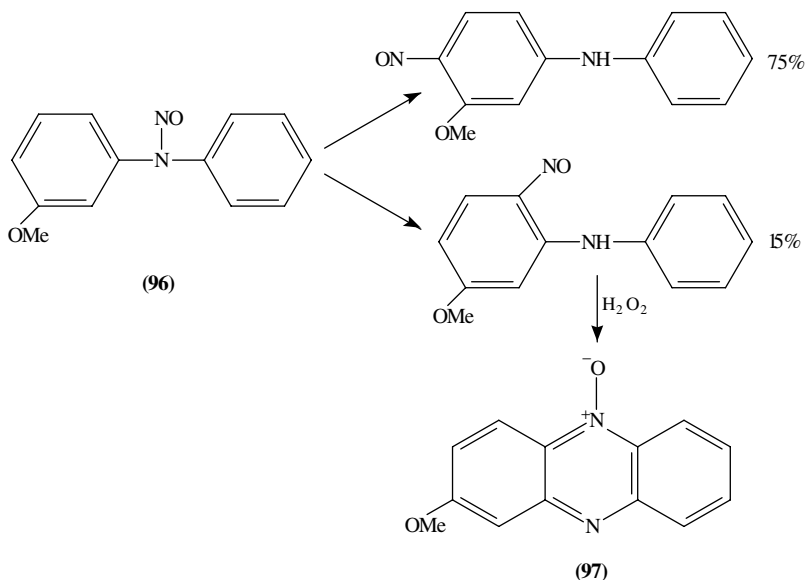
The Fischer-Hepp rearrangement generally gives only the 4-isomer and, apart from examples in the naphthyl series, the 2-isomer has rarely been identified. Now the 2-isomer has been characterized<sup>96</sup> as the minor product from the reaction of the diphenylamine derivative 96. The 2-nitroso product gives the cyclized product 97 on treatment with hydrogen peroxide (Scheme 17).

TABLE 2. Variation of the rate constant and % rearrangement with added 'nitrite traps' for the reaction of 95 in 3.5 *M*  $H_2SO_4$

Nitrite trap	% Rearrangement	$10^3 k_0$ ( $s^{-1}$ )
$HN_3$ $1 \times 10^{-3}$ <i>M</i>	84	3.10
$HN_3$ $5 \times 10^{-3}$ <i>M</i>	85	3.22
+ $NH_3NH_2$ $1 \times 10^{-3}$ <i>M</i>	85	3.25
+ $NH_3NH_2$ $5 \times 10^{-3}$ <i>M</i>	85	3.39
$NH_2SO_3H$ $1 \times 10^{-3}$ <i>M</i>	84	3.33
$NH_2SO_3H$ $5 \times 10^{-3}$ <i>M</i>	84	3.48

TABLE 3. Rearrangement yields and rate constants for the reaction of **95** (in 3.5 M H<sub>2</sub>SO<sub>4</sub> and 5 × 10<sup>-3</sup> M HN<sub>3</sub>) in the presence of added nucleophiles

Nucleophile	% Rearrangement	10 <sup>3</sup> k <sub>0</sub> (s <sup>-1</sup> )
H <sub>2</sub> O	80	3.27
0.077 M Cl <sup>-</sup>	73	3.51
0.077 M Br <sup>-</sup>	16	—
0.077 M SCN <sup>-</sup>	0	—
0.077 M SC(NH <sub>2</sub> ) <sub>2</sub>	0	—
0.004 M Br <sup>-</sup>	65	3.86
0.008 M Br <sup>-</sup>	56	4.14
0.016 M Br <sup>-</sup>	36	6.60
0.032 M Br <sup>-</sup>	29	9.40
0.077 M Br <sup>-</sup>	16	—
0.100 M Br <sup>-</sup>	11	—
0.600 M Br <sup>-</sup>	ca 2	—



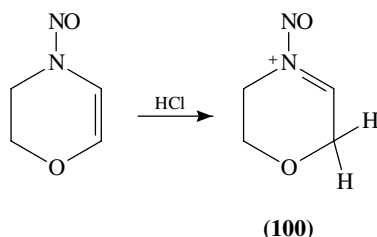
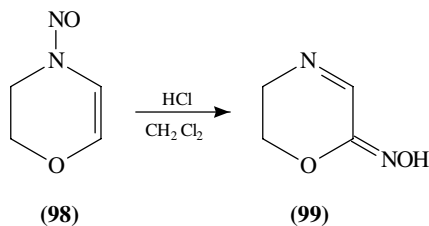
SCHEME 17

No evidence has been forthcoming on the nature of the intramolecular shift of the NO group to the 4-position (generally) in the aromatic ring. It would be helpful to have KIE values such as those obtained for the benzidine rearrangement as a first step in order to see if rearrangement is a concerted process.

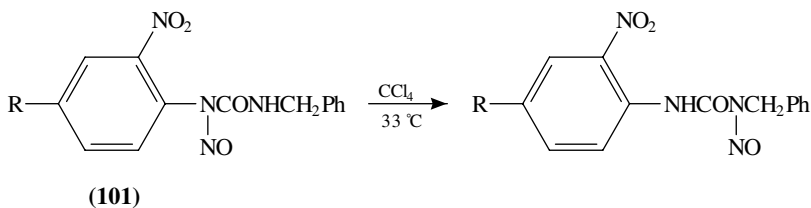
## B. Other Rearrangements

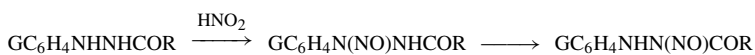
Quite different from the Fischer-Hepp rearrangement is the reaction of *N*-nitrosodehydromorpholine **98** which, in methylene chloride containing HCl, gives at room temperature 1-azo-4-oxa-3-oximinocyclohexene **99**, which ring-opens on treatment

with aqueous acid<sup>97</sup>. This is believed to be an intermolecular process, based on the results of cross-over experiments using  $^{15}\text{NO}$  and ring deuterium labelling. The suggested mechanism involves C-protonation and that this ion **100** acts as a nitrosating agent reacting with the nitrosomorpholine derivative at the ring alkene position leading eventually to the oxime product **99**. A similar rearrangement of *N*-nitrosodehydropiperidine to give also the 3-oximino derivative was reported earlier<sup>98</sup>, but was not subjected to a mechanistic investigation.

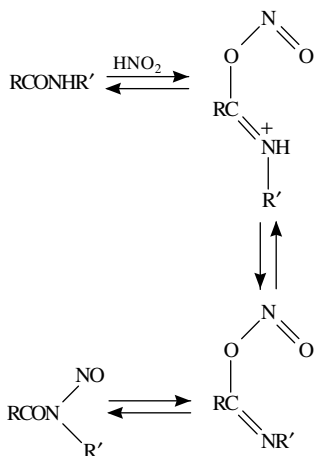


Examples continue to be reported of 1,2- and 1,3-rearrangements of the nitroso group in acyclic systems, showing that this is a widespread process. Scheme 18 shows the reaction of hydrazine derivatives (where G is an electron-withdrawing group). Evidence has been presented<sup>99</sup> which suggests that the 1-nitroso compound is first formed, but that subsequently this rearranges to the more thermodynamically stable 2-nitroso isomer. A 1,3-shift has been reported for a nitrosourea **101** in  $\text{CCl}_4$ <sup>100</sup>. Kinetic evidence based on the nature and slopes of Bronsted plots and the application of Eigen theory<sup>101,102</sup> suggests that in the nitrosation of amides, ureas and carbamates by nitrous acid, the NO group becomes attached first of all to the oxygen atom of the carbonyl group, and after proton loss the nitroso group undergoes a 1,3-rearrangement to give the final *N*-nitrosoamide product (Scheme 19). It is known that other electrophilic reagents (e.g.  $\text{H}^+$  and alkylating agents) attack the oxygen atom in amides preferentially. A similar rearrangement has been proposed (Scheme 20) for the mechanism of the nitrosation of tryptophan at low acidities<sup>103</sup>. The evidence comes from the observation that at these acidities reaction rates are independent of the acidity and also are independent of added nucleophiles and

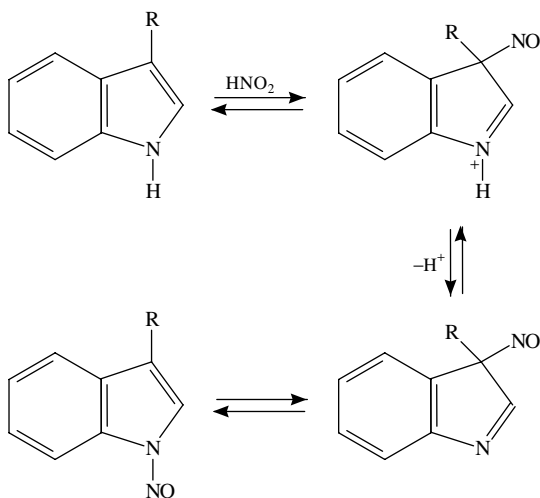




SCHEME 18



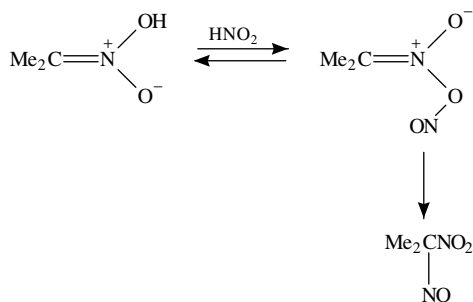
SCHEME 19



SCHEME 20

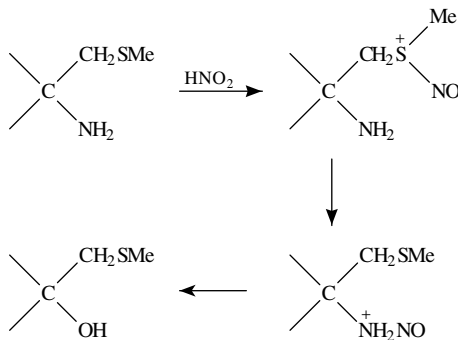
buffers. Under these conditions the nitroso group rearrangement is the rate-limiting step. There is also evidence<sup>104</sup> that the nitrosation of nitronic acids to give nitroso introalkanes (pseudonitroles) or nitro oximes (nitrolic acids) also occurs by initial attack at an oxygen atom followed by an O to C rearrangement of the NO group (Scheme 21).

Nitrosation at one site in a molecule (usually the most nucleophilic site) followed by NO rearrangement to give the final stable nitroso compound seems to be quite widespread.



SCHEME 21

Final examples of this report rearrangements from S to N. The diazotisation of amino acids containing the SR group appears to involve initial nitrosation at the very nucleophilic sulphur site, followed by a 1,4-rearrangement of the NO group, finally to give the alcohol product of deamination (Scheme 22)<sup>105</sup>. Again the evidence here is kinetic, the reaction being *ca* 100 times faster than the corresponding reaction in the absence of the sulphur group. Similar S to N rearrangements have been proposed in the nitrosation reactions of thioproline<sup>106</sup> and thiomorpholine<sup>107</sup>.



SCHEME 22

A large number of NO group rearrangements can also be brought about photochemically. These are not within the scope of this chapter and are discussed elsewhere in this volume.

### VIII. REFERENCES

1. A. W. Murray, in *Organic Reaction Mechanisms* (Eds. A. C. Knappe and W. E. Watts), Wiley, Chichester, 1993, pp. 437–559 and earlier volumes.
2. L. M. Harwood, *Polar Rearrangements*, Oxford University Press, Oxford, 1992.
3. C. J. Davies, B. T. Heaton and C. Jacob, *J. Chem. Soc., Chem. Commun.*, 1177 (1995).
4. D. V. Banthorpe, in *The Chemistry of the Amino Group* (Ed. S. Patai), Wiley-Interscience, London, 1968, pp. 642–649.
5. R. A. Cox and E. Buncl, in *The Chemistry of the Hydrazo, Azo and Azoxy Groups* (Ed. S. Patai), Wiley, London, 1975, pp. 775–805.
6. H. J. Shine, in *Aromatic Rearrangements*, Elsevier, New York, 1967, pp. 126–179.

7. D. V. Banthorpe, *Top, Carbocyclic Chem.*, **1**, 1 (1969); *Chem. Rev.*, **70**, 295 (1970).
8. M. J. S. Dewar, in *Molecular Rearrangements*, Part 1 (Ed. P. de Mayo), Interscience, New York, 1963, pp. 295–344.
9. H. J. Shine, *J. Chem. Educ.*, **66**, 793 (1989).
10. M. J. S. Dewar, *The Electronic Theory of Organic Chemistry*, Oxford University Press, Oxford, 1949, pp. 233–240.
11. D. V. Banthorpe, E. D. Hughes and C. K. Ingold, *J. Chem. Soc.*, 2864 (1964).
12. L. Melander and W. H. Saunders, *Reaction Rates of Isotopic Molecules*, Wiley-Interscience, New York, 1980, p. 124.
13. S. M. Husain, J. McKenna and J. M. McKenna, *J. Chem. Res. (S)*, 280 (1980); J. McKenna, J. M. McKenna and P. S. Taylor, *J. Chem. Res. (S)*, 281 (1980).
14. P. Paneth, *Talanta*, **34**, 877 (1987); *Isot. Org. Chem.*, 41 (1992).
15. H. Kwart and J. Stanulonis, *J. Am. Chem. Soc.*, **98**, 4009 (1976); H. J. Shine, *Isot. Org. Chem.*, 1 (1992).
16. H. J. Shine, *J. Phys. Org. Chem.*, **2**, 491 (1989).
17. H. J. Shine, H. Zmuda, K. H. Park, H. Kwart, A. G. Horgan and M. Breichbiel, *J. Am. Chem. Soc.*, **104**, 2501 (1982); L. Kupezyk-Subotkowska, H. J. Shine, W. Subotkowski and J. Zygmunt, *Gazz. Chim. Ital.*, **117**, 513 (1987).
18. G. Fräter and H. Schmid, *Helv. Chim. Acta*, **53**, 269 (1970).
19. H. J. Shine, H. Zmuda, H. Kwart, A. G. Horgan and M. Brechbiel, *J. Am. Chem. Soc.*, **104**, 5181 (1982).
20. E. S. Rhee and H. J. Shine, *J. Am. Chem. Soc.*, **108**, 1000 (1986); **109**, 5052 (1987); *J. Org. Chem.*, **52**, 5633 (1987).
21. H. J. Shine, E. Gruszecka, W. Subotkowski, M. L. Brownawell and J. San Filippo, *J. Am. Chem. Soc.*, **107**, 3218 (1985).
22. W. Subotkowski, L. Kupezyk-Subotkowska and H. J. Shine, *J. Am. Chem. Soc.*, **115**, 5073 (1993).
23. H. J. Shine, J. Habdas, H. Kwart, M. Breichbiel, A. G. Horgan and J. San Filippo, *J. Am. Chem. Soc.*, **105**, 2823 (1983).
24. B. C. Auman and A. E. Feiring, U.S. Patent, US 5 175 367; *Chem. Abstr.*, **119**, 9319 (1993).
25. T. Nozoe, K. Takase, H. Saito, H. Yamamoto and K. Imafuku, *Chem. Lett.*, 1577 (1986).
26. B. Miller, in *Mechanisms of Molecular Migrations* (Ed. B. Thyagarajan), Interscience, New York, 1968, p. 306.
27. B. Boduszek and H. J. Shine, *J. Am. Chem. Soc.*, **110**, 3247 (1988).
28. H. J. Shine, *Aromatic Rearrangements*, Elsevier, Amsterdam, 1967, pp. 272–284.
29. E. Buncl, *Acc. Chem. Res.*, **8**, 132 (1975).
30. D. L. H. Williams and E. Buncl, in *Isotopes in Organic Chemistry*, Vol. 5 (Eds. E. Buncl and C. C. Lee), Elsevier, Amsterdam, 1980, pp. 184–197.
31. I. Shimaō and S. Oae, *Bull. Chem. Soc. Jpn.*, **56**, 643 (1983).
32. I. Shimaō and S. Matsumura, *Bull. Chem. Soc. Jpn.*, **49**, 2294 (1976).
33. I. Shimaō, K. Fujimori and S. Oae, *Bull. Chem. Soc. Jpn.*, **55**, 546 (1982).
34. J. Yamamoto, H. Aimi, Y. Masuda, T. Sumida, M. Umezū and T. Matuura, *J. Chem. Soc., Perkin Trans. 2*, 1565 (1982).
35. E. Buncl, S. R. Kuem, M. Cygler, K. I. Varaghese and G. I. Birnbaum, *Can. J. Chem.*, **62**, 1628 (1984).
36. G. G. Furin, O. I. Andreevskaya, A. I. Rezvukhin and G. G. Yakobson, *J. Fluorine Chem.*, **28**, 1 (1985).
37. H. J. Shine, W. Subotkowski and E. Gruszecka, *Can. J. Chem.*, **64**, 1108 (1986).
38. E. Bamberger, *Chem. Ber.*, **27**, 1347, 1548 (1894) and later papers.
39. H. J. Shine, *Aromatic Rearrangements*, Elsevier, Amsterdam, 1967, pp. 182–190.
40. H. E. Heller, E. D. Hughes and C. K. Ingold, *Nature*, **168**, 909 (1951).
41. J. C. Fishbein and R. A. McClelland, *J. Am. Chem. Soc.*, **109**, 2824 (1987).
42. S. Okazaki and M. Okumura, unpublished work, cited by S. Oae, T. Fukumoto and M. Yamagami, *Bull. Chem. Soc. Jpn.*, **34**, 1873 (1961); **36**, 601 (1963).
43. T. Sone, Y. Tokuda, T. Sakai, S. Shinkai and O. Manabe, *J. Chem. Soc., Perkin Trans. 2*, 298 (1981).
44. G. Kohnstam, W. A. Petch and D. L. H. Williams, *J. Chem. Soc., Perkin Trans. 2*, 423 (1984).
45. M. Heyrovsky, S. Vavricka, L. Holleck and B. Katening, *J. Electroanal. Chem. Interfacial Electrochem.*, **26**, 399 (1970).

46. I. I. Kukhtenko, *Russ. J. Org. Chem. (Engl. Transl.)*, **7**, 324 (1971).
47. T. Sone, K. Hamamoto, Y. Seiji, S. Shinkai and O. Manabe, *J. Chem. Soc., Perkin Trans. 2*, 1596 (1981).
48. H. Landsheidt, A. Klausener and H. U. Blank, Eur. Pat-Appl. EP 569, 792; *Chem. Abstr.*, **120**, 163725 (1994).
49. L. Cerveny and J. Toman, *Chem. Prum.*, **42**, 85 (1992); *Chem. Abstr.*, **117**, 236179 (1992).
50. K. Miura, T. Kuvihara, K. Yanagida, Jpn. Kokai Tokkyo Koho JP 04 149, 160; *Chem. Abstr.*, **117**, 170969 (1992).
51. L. A. Sternson, A. S. Dixit and A. R. Becker, *J. Org. Chem.*, **48**, 57 (1983).
52. E. C. Miller, *Cancer Res.*, **38**, 1479 (1978).
53. Y. Kikugawa and K. Mitsui, *Chem. Lett.*, 1369 (1993).
54. D. Gutshke and A. Heesing, *Chem. Ber.*, **106**, 2379 (1973).
55. M. A. Carter and B. Robinson, *Chem. Ind.*, 304 (1974).
56. N. Haga, Y. Endo, K. Kataoka, K. Yamaguchi and K. Shudo, *J. Am. Chem. Soc.*, **114**, 9795 (1992).
57. Y. Endo, K. Kataoka, N. Haga and K. Shudo, *Tetrahedron Lett.*, **33**, 3339 (1992).
58. H. J. Shine, *Aromatic Rearrangements*, Elsevier, Amsterdam, 1967, pp. 221–230.
59. R. Onoda and H. Kawaguchi, *Kagaku Kyoiky*, **29**, 220 (1981); *Chem. Abstr.*, **95**, 203032 (1981).
60. M. D. Patwardhan, A. S. Mishra, S. S. Ghai and A. K. Mishra, *J. Indian Chem. Soc.*, **58**, 1084 (1981).
61. G. R. Underwood and P. E. Dietze, *J. Org. Chem.*, **49**, 5225 (1984).
62. M. De Rosa and J. L. Alonso Triana, *J. Org. Chem.*, **43**, 2639 (1978).
63. M. De Rosa, *J. Org. Chem.*, **47**, 1008 (1982).
64. M. De Rosa, A. Quesada and D. J. Dodsworth, *J. Org. Chem.*, **52**, 173 (1987).
65. P. G. Gassman, *Acc. Chem. Res.*, **3**, 26 (1970).
66. P. G. Gassman, G. A. Campbell and R. C. Frederick, *J. Am. Chem. Soc.*, **94**, 3884 (1972).
67. P. G. Gassman and G. A. Campbell, *J. Am. Chem. Soc.*, **94**, 3891 (1972).
68. K. U. B. Rao, R. K. Bhongle and S. Yoganarasimhan, *Org. Prep. Proced. Int.*, **22**, 113 (1990).
69. R. L. Atkins and W. S. Wilson, *J. Org. Chem.*, **51**, 2572 (1986).
70. W. N. White, J. R. Klink, D. Lazdins, C. Hathaway, J. T. Golden and H. S. White, *J. Am. Chem. Soc.*, **83**, 2024 (1961) and later papers.
71. J. H. Ridd and J. P. B. Sandall, *J. Chem. Soc., Chem. Commun.*, 261 (1982); A. M. A. Abu-Namous, J. H. Ridd and J. P. B. Sandall, *Can. J. Chem.*, **64**, 1124 (1986).
72. H. J. Shine, J. Zymunt, M. L. Brownawell and J. S. Filippo, *J. Am. Chem. Soc.*, **106**, 3610 (1984).
73. S. Brownstein, C. A. Bunton and E. D. Hughes, *J. Chem. Soc.*, 4354 (1958).
74. L. W. Deady, O. L. Korytsky and J. E. Rowe, *Aust. J. Chem.*, **35**, 2025 (1982).
75. J. P. H. Juffermans and C. L. Habraken, *J. Org. Chem.*, **51**, 4656 (1986).
76. J. B. Kyziol and Z. Daszkiewicz, *Tetrahedron*, **40**, 1857 (1984).
77. P. Barrow, J. V. Bullen, A. Dent, T. Murphy, J. H. Ridd and O. Sabek, *J. Chem. Soc., Chem. Commun.*, 1649 (1986).
78. J. V. Bullen, J. H. Ridd and O. Sabek, *J. Chem. Soc., Perkin Trans. 2*, 1681 (1990).
79. J. V. Bullen and J. H. Ridd, *J. Chem. Soc., Perkin Trans. 2*, 1675 (1990).
80. J. V. Bullen, J. H. Ridd, and O. Sabek, *Gazz. Chim. Ital.*, **120**, 291 (1990).
81. J. T. Murphy and J. H. Ridd, *J. Chem. Soc., Perkin Trans. 2*, 1767 (1987).
82. G. S. Bapat, A. Fischer, G. N. Henderson and S. Raymahasay, *J. Chem. Soc., Chem. Commun.*, 119 (1983).
83. F. Al-Omran, K. Fujiwara, J. C. Giffney, J. H. Ridd and S. R. Robinson, *J. Chem. Soc., Perkin Trans. 2*, 518 (1981).
84. C. Bloomfield, A. K. Manglik, R. B. Moodie, K. Schofield and G. D. Tobin, *J. Chem. Soc., Perkin Trans. 2*, 75 (1983).
85. J. H. Ridd, J. P. B. Sandall and S. Trevellick, *J. Chem. Soc., Chem. Commun.*, 1195 (1988).
86. E. Carvalho, J. Iley and E. Rosa, *J. Chem. Soc., Chem. Commun.*, 1249 (1988).
87. R. P. Saxon and M. Yoshimine, *Can. J. Chem.*, **70**, 572 (1992).
88. E. S. Nigenda, D. F. McMillen and D. M. Golden, *J. Phys. Chem.*, **93**, 1124 (1989).
89. M. P. Hartshorn, W. T. Robinson, J. Vaughan and J. M. White, *Aust. J. Chem.*, **38**, 575 (1985) and earlier papers for other examples.
90. M. P. Hartshorn, H. T. Ing, K. E. Richards, K. H. Sulston and J. Vaughan, *Aust. J. Chem.*, **35**, 1635 (1982).



19. Rearrangement reactions involving the amino, nitro and nitroso groups 891

91. M. R. Amin, L. Dekker, D. B. Hibbert, J. H. Ridd and J. P. B. Sandall, *J. Chem. Soc., Chem. Commun.*, 658 (1986).
92. L. Ebersson, J. L. Calvert, M. P. Hartshorn and W. T. Robinson, *Acta Chem. Scand.*, **47**, 1025 (1993).
93. D. L. H. Williams, in *The Chemistry of Amino, Nitroso and Nitro Compounds and Their Derivatives*, Supplement F (Ed. S. Patai), Wiley, Chichester, 1982, pp. 133–140.
94. D. L. H. Williams, *J. Chem. Soc., Perkin Trans. 2*, 801 (1982).
95. L. P. Nikitenkova, S. D. Karaktov, Y. A. Strepikheev and I. I. Naumova, *Zh. Obshch. Khim.*, **54**, 1375 (1984); *Chem. Abstr.*, **101**, 110052 (1984).
96. S. P. Titova, A. K. Arinch and M. V. Gorelik, *Zh. Org. Khim.*, **22**, 1562 (1986); *Chem. Abstr.*, **107**, 39293 (1987).
97. R. N. Loepky and H. Xiong, *J. Org. Chem.*, **60**, 5526 (1995).
98. R. E. Lyle, W. E. Krueger and V. E. Gunn, *J. Org. Chem.*, **48**, 3574 (1983).
99. J. C. Kim and S. H. Han, *Bull. Korean Chem. Soc.*, **15**, 173 (1994).
100. M. Tanno, S. Sueyoshi and S. Kamiga, *Chem. Pharm. Bull.*, **38**, 49 (1990).
101. A. Castro, E. Iglesias, J. R. Leis, M. E. Pena and J. V. Tato, *J. Chem. Soc., Perkin Trans. 2*, 1725 (1986).
102. A. Castro, M. Gonzalez, F. Meijide and M. Mosquera, *J. Chem. Soc., Perkin Trans. 2*, 2021 (1988).
103. A. Castro, E. Iglesias, J. R. Leis, M. E. Pena, J. V. Tato and D. L. H. Williams, *J. Chem. Soc., Perkin Trans. 2*, 1165 (1986).
104. E. Iglesias and D. L. H. Williams, *J. Chem. Soc., Perkin Trans. 2*, 1035 (1988).
105. T. A. Meyer and D. L. H. Williams, *J. Chem. Soc., Chem. Commun.*, 1067 (1983).
106. T. Tahira, M. Tsuda, K. Wakabayashi, M. Nugao and T. Sugimura, *Gann*, **75**, 889 (1984); A. Castro, E. Iglesias, J. R. Leis, J. V. Tato, F. Meijide and M. E. Pena, *J. Chem. Soc., Perkin Trans. 2*, 651 (1987).
107. A. Coello, F. Meijide and J. V. Tato, *J. Chem. Soc., Perkin Trans. 2*, 1677 (1989).

## CHAPTER 20

# The synthesis and uses of isotopically labelled amino and quaternary ammonium salts

KENNETH C. WESTAWAY

*Department of Chemistry, Laurentian University, Sudbury, Ontario,  
Canada P3E 2C6*

*Fax: 705-675-4844; e-mail: KWESTAWA@NICKEL.LAURENTIAN.CA*

---

I. INTRODUCTION	893
II. THE THEORY OF KINETIC ISOTOPE EFFECTS	894
A. Heavy-atom Kinetic Isotope Effects	894
B. Primary Hydrogen–Deuterium Kinetic Isotope Effects	895
C. Secondary Alpha Hydrogen–Deuterium Kinetic Isotope Effects	896
III. USING KINETIC ISOTOPE EFFECTS TO ELUCIDATE THE MECHANISM OF BENZIDINE-TYPE REARRANGEMENTS OF AMINES	897
IV. USING KINETIC ISOTOPE EFFECTS TO MODEL THE $S_N2$ TRANSITION STATES FOR REACTIONS INVOLVING QUATERNARY AMMONIUM SALTS	932
A. The Menshutkin Reaction	932
B. The $S_N2$ Reactions of Quaternary Ammonium Salts	938
V. REFERENCES	946

---

### I. INTRODUCTION

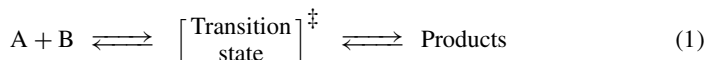
This topic has been reviewed in 'The Chemistry of the Functional Groups' series published in 1982<sup>1</sup>. It is not the purpose of this chapter to provide a complete literature review. Rather, this chapter will discuss some of the new methods of measuring and interpreting kinetic isotope effects that have been used to determine the mechanisms of the reactions of amines and amine derivatives.

## II. THE THEORY OF KINETIC ISOTOPE EFFECTS

### A. Heavy-atom Kinetic Isotope Effects

Several monographs<sup>2-5</sup> have detailed discussions dealing with heavy-atom and primary and secondary hydrogen-deuterium kinetic isotope effects. The monograph by Melander and Saunders<sup>5</sup> covers the entire area particularly well. For this reason, only a brief summary of the theory of kinetic isotope effects as well as their important uses in the determination of reaction mechanism and transition-state geometry will be presented.

The Bigeleisen treatment<sup>6-8</sup>, based on Eyring and coworkers' absolute rate theory<sup>9</sup>, assumes that there is a single potential energy surface along which the reaction takes place, and that there is a potential energy barrier separating the reactants from the products. The reaction occurs along the path over the lowest part of the barrier with the transition state at the top of the barrier, i.e. it lies at the energy maximum along the reaction coordinate but at an energy minimum in all other directions. The transition state is assumed to be in equilibrium with the reactants and products and to have all the properties of a stable molecule, except that one vibrational degree of freedom has been converted into motion along the reaction coordinate.



The kinetic isotope effect for this reaction is:

$$\frac{k_1}{k_2} = \frac{\kappa_1}{\kappa_2} \cdot \frac{Q_1^{\ddagger}}{Q_2^{\ddagger}} \cdot \frac{Q_{A2}}{Q_{A1}} \cdot \frac{Q_{B2}}{Q_{B1}} \quad (2)$$

where the subscripts 1 and 2 refer to the molecules containing the lighter and heavier isotopes, respectively, and the  $Q$ s are the complete partition functions for reactants A and B. Setting  $\kappa_1 = \kappa_2$  and applying the harmonic approximation to all nonlinear gas molecules leads to an expression for  $Q_2/Q_1$  (equation 3), where  $S_1$  and  $S_2$  are the symmetry numbers of the respective molecules, the  $M$ s are the molecular weights, the  $I$ s are the moments of inertia about the three principal axes of the  $n$ -atom molecules, and the  $\nu$ s are the fundamental vibrational frequencies of the molecules in wave numbers.

$$\frac{Q_2}{Q_1} = \frac{S_1}{S_2} \left( \frac{I_{A2}I_{B2}I_{C2}}{I_{A1}I_{B1}I_{C1}} \right)^{1/2} \left( \frac{M_2}{M_1} \right)^{3/2} \prod_i^{3n-6} \left[ \frac{(\nu_{1i} - \nu_{2i})hc}{2kT} \right] \left[ \frac{1 - \exp(-hc\nu_{1i}/kT)}{1 - \exp(-hc\nu_{2i}/kT)} \right] \quad (3)$$

Using various approximations, a solution to the isotopic rate ratio equation can be obtained. It is found that the isotope rate ratio,  $k_1/k_2$ , is dependent on the force constant changes which occur in going from the reactants to the transition state. Consequently, if C-X bond rupture (where the isotopically labelled atom X can be halogen, sulfur, nitrogen, etc.) has not progressed at the transition state of the rate-determining step of the overall reaction, there is no change in the force constants involving the isotopic atom and the isotope rate ratio,  $k_1/k_2$ , will be equal to one. An isotope rate ratio greater than one will be observed if there is a decrease in the force constants at the transition state of the slow step. The greater the decrease in the force constant, the larger the magnitude of the isotope effect.

The observation of a heavy-atom isotope effect, therefore, allows one to determine whether C-X bond weakening (a decrease in force constant) has occurred when the reactant is converted into the transition state of the rate-determining step. Calculations by

Saunders<sup>10</sup> and by Sims and coworkers<sup>11</sup> have shown that the magnitude of the leaving-group heavy-atom isotope effect varies linearly with the extent of C–X bond rupture in the transition state for concerted elimination reactions and for nucleophilic substitution reactions, respectively. Since the magnitude of the isotope effect is directly related to the amount of C–X bond rupture in the transition state, these isotope effects provide detailed information about the structure of the transition state.

### B. Primary Hydrogen–Deuterium Kinetic Isotope Effects

Although the zero-point energy differences between the isotopic molecules' vibrations are not the only contribution to the isotope effect, they are, however, often the dominant term. This is particularly true for hydrogen–deuterium kinetic isotope effects where the zero-point energy difference is large, and also for large molecules where isotopic substitution does not effect the mass and moment-of-inertia term significantly. It is usual to assume that the stretching modes are the most important in determining these isotope effects. This is based on the two assumptions: (i) that the bending vibrations are generally of a lower frequency and therefore have smaller zero-point energy differences for isotopic molecules, and (ii) the bending motions in the transition state will be similar to those in the substrates.

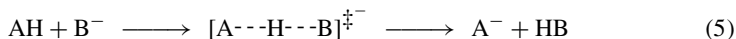
Applying these approximations to the rupture of a single C–H bond in a unimolecular process leads to equation 4,

$$\frac{k_H}{k_D} = \exp \left[ \left( \frac{hc}{2kT} \right) (\nu_H - \nu_D) \right] \quad (4)$$

where  $\nu_H$  and  $\nu_D$  are the ground-state symmetric stretching frequencies for the C–H and C–D bonds, respectively. Substitution of the appropriate frequencies into equation 4 gives an isotope effect of approximately seven at 25°C.

For reactions involving a proton transfer from one molecule to another, however, the situation is more complex. Westheimer<sup>12</sup> and Melander<sup>2</sup> independently pointed out that, because bond formation and bond breaking are occurring concurrently, new stretching vibrations in the transition state which are not present in the reactants must be considered.

They considered the reaction:



where  $[A \cdots H \cdots B]$  is a linear transition state. If this transition state is regarded as a linear molecule, there are two independent stretching vibrational modes which may be illustrated as follows:



Neither of these vibrations corresponds to stretching vibrations of AH or BH. The 'antisymmetric' vibrational mode represents translational motion in the transition state and has an imaginary force constant. The 'symmetric' transition-state vibration has a real force constant but the vibration may or may not involve motion of the central H(D) atom<sup>2,12,13</sup>. If the motion is truly symmetric, the central atom will be motionless in the vibration and the frequency of the vibration will not depend on the mass of this atom, i.e. the vibrational frequency will be the same for both isotopically substituted transition states. It is apparent that under such circumstances there will be no zero-point energy difference

between the deuterium- and hydrogen-substituted compounds for the symmetric vibration in the transition state. Hence, an isotope effect of seven at room temperature is expected since the difference in activation energy is the difference between the zero-point energies of the symmetric stretching vibrations of the initial states, i.e.  $1/2(h\nu_H - h\nu_D)$ .

In instances where bond breaking and bond making at the transition state are not equal, bond breaking is either more or less advanced than bond formation, and the 'symmetric' vibration will not be truly symmetric. In these cases, the frequency will have some dependence on the mass of the central atom, there will be a zero-point energy difference for the vibrations of the isotopically substituted molecules at the transition state and  $k_H/k_D$  will have values smaller than seven.

It may be concluded that for reactions where the proton is less or more than one-half transferred in the transition state, i.e. the A–H and H–B force constants are unequal, the primary hydrogen–deuterium kinetic isotope effect will be less than the maximum of seven. The maximum isotope effect will be observed only when the proton is exactly half-way between A and B in the transition state. This relationship is also found for carbon kinetic isotope effects where the isotopically labelled carbon is transferred between two atoms in the reaction<sup>10,11</sup>. This makes interpreting carbon isotope effects difficult.

### C. Secondary Alpha Hydrogen–Deuterium Kinetic Isotope Effects

In the preceding sections, the bond to the isotopic atom is broken or formed in the rate-determining step of the reaction. In these cases, the change in rate is referred to as a primary kinetic isotope effect. Isotopic substitution at other sites in the molecule has much smaller effects on the rate. These small isotope effects are collectively referred to as secondary kinetic isotope effects.

As with primary isotope effects, the origin of secondary isotope effects is considered to be mainly due to changes in force constants upon going from reactants to the transition state. For the most part, secondary isotope effects depend on the change in zero-point energy (ZPE). Smaller force constants for the isotopic nuclei in the transition state than in the reactant lead to an isotope effect greater than one (Figure 1a). When the force constants are greater in the transition state than in the reactant, on the other hand, an isotope effect of less than one is observed (Figure 1b).

Secondary alpha hydrogen–deuterium kinetic isotope effects are determined when hydrogen is replaced by deuterium at the  $\alpha$ - or reacting carbon. The generally accepted view originally proposed by Streitwieser and coworkers<sup>14</sup> is that the alpha deuterium kinetic isotope effects are primarily determined by the changes in the out-of-plane bending vibrations in going from the reactants to the transition state. Solvolysis reactions proceeding via a carbocation are expected to give large normal isotope effects,  $(k_H/k_D)_\alpha$ . The maximum  $(k_H/k_D)_\alpha$  expected per deuterium for various leaving groups are 1.22 for fluoride, 1.15 for chloride, 1.13 for bromide, 1.09 for iodide, 1.19 for ammonia and 1.22 for benzenesulfonate<sup>15,16</sup>.

Smaller alpha deuterium isotope effects are observed for reactions proceeding via the  $S_N2$  mechanism. This is due to steric interference by the leaving group and/or the incoming nucleophile with the out-of-plane bending vibrations of the  $C_\alpha$ –H bonds. This leads to an increased force constant at the  $S_N2$  transition state, **1** (see Figure 1b), where Nu is the nucleophile and LG is the leaving group in the  $S_N2$  reaction.

In fact, small or inverse isotope effects,  $(k_H/k_D)_\alpha\text{-D} = 0.95\text{--}1.04$ , are observed for the  $S_N2$  reactions of primary substrates<sup>17</sup>. Recently, Wolfe and Kim<sup>18</sup> pointed out that the changes in the stretching vibrations played the major role in determining the magnitude of these isotope effects. However, a more recent study by Poirier, Wang and Westaway<sup>19</sup>

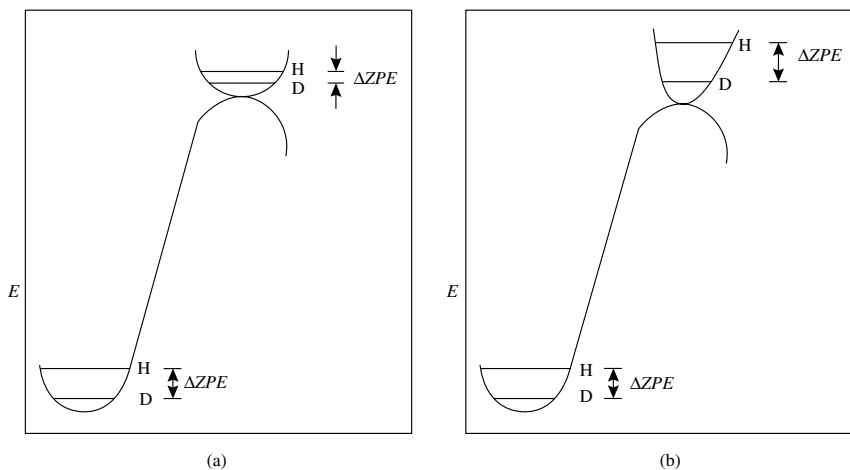
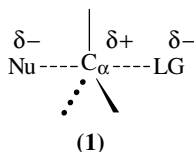


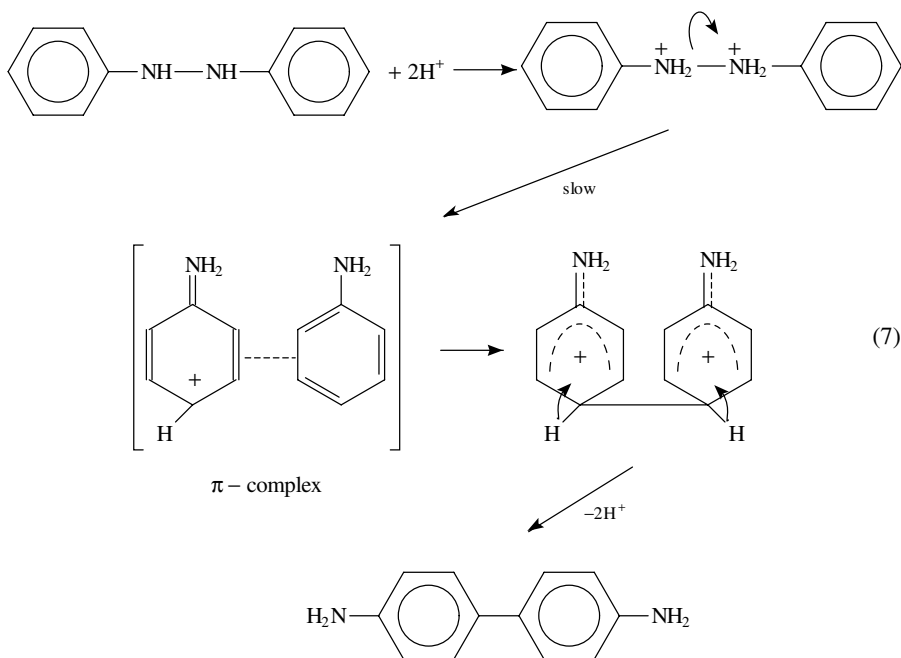
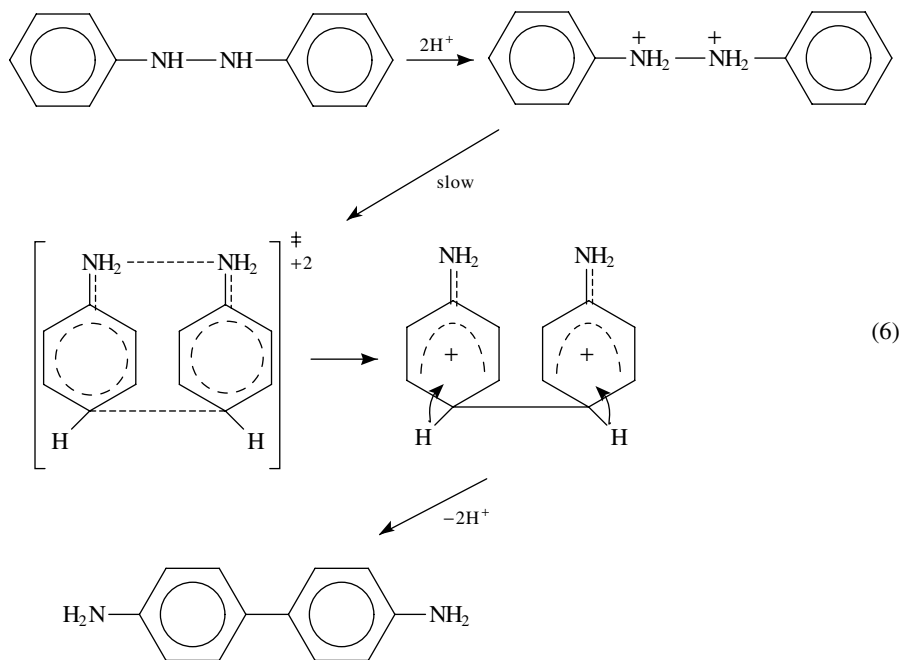
FIGURE 1. (a) A reaction where  $\Delta ZPE_{(\text{reactant})}$  is greater than  $\Delta ZPE_{(\text{transition state})}$  and  $(k_{\text{H}}/k_{\text{D}})_{\alpha} > 1.0$ . (b) A reaction where  $\Delta ZPE_{(\text{reactant})}$  is less than  $\Delta ZPE_{(\text{transition state})}$  and  $(k_{\text{H}}/k_{\text{D}})_{\alpha} < 1.0$

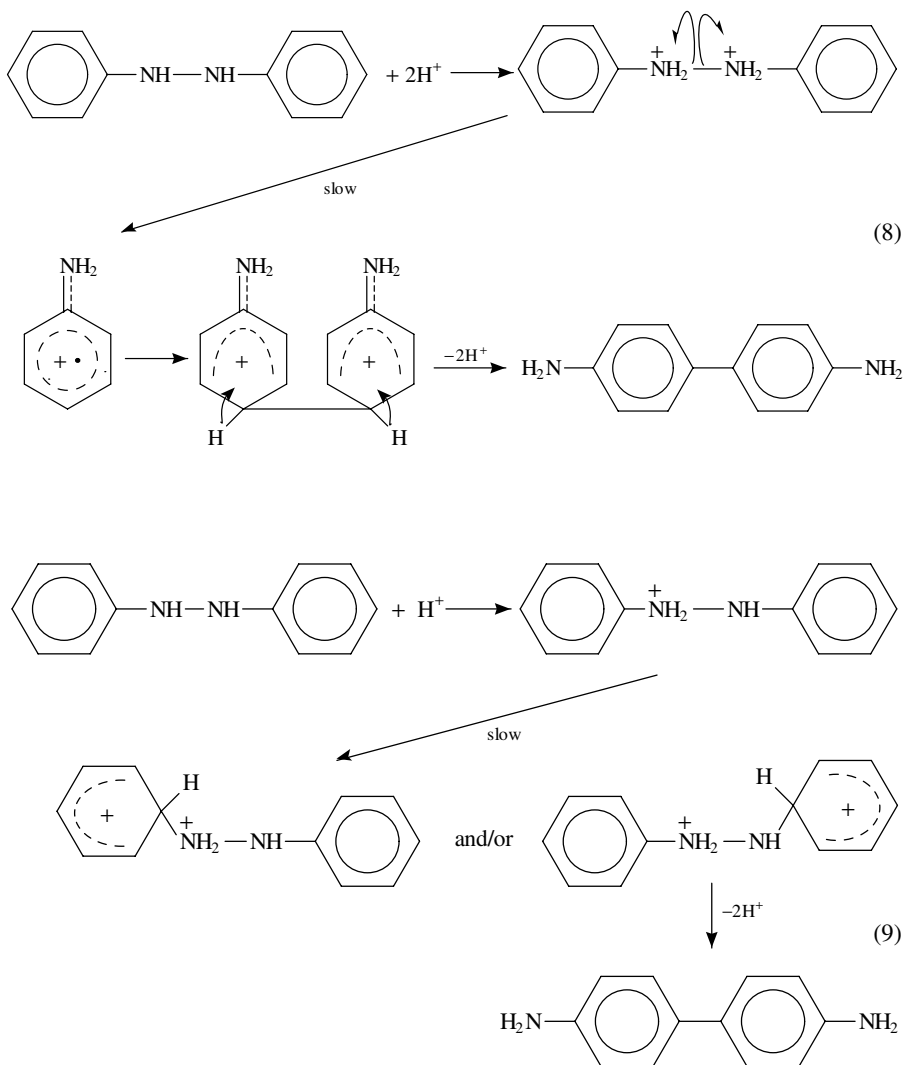


showed that the magnitude of these isotope effects for reactions with a particular leaving group is determined by the nucleophile-leaving group distance in the  $S_{\text{N}}2$  transition state, i.e. the changes in the out-of-plane bending vibrations as the reactant is converted into the transition state.

### III. USING KINETIC ISOTOPE EFFECTS TO ELUCIDATE THE MECHANISM OF BENZIDINE-TYPE REARRANGEMENTS OF AMINES

Shine and coworkers have used heavy-atom kinetic isotope effects to determine the mechanism of several electrophilic aromatic substitution reactions. The particular reactions of interest are the collection of reactions known as 'benzidine rearrangements'. The four mechanisms that have been proposed for these rearrangements are shown in equations 6–9 using the benzidine rearrangement of hydrazobenzene as the model. One possibility is the concerted rearrangement via polar transition states that was proposed by Ingold, Hughes and Banthorpe<sup>20</sup> (equation 6). A second possibility proposed by Dewar<sup>21</sup> is a non-concerted reaction via  $\pi$ -complexes (equation 7). A third possibility is that the reaction proceeds via a pair of radical cation intermediates within a solvent cage<sup>22</sup> (equation 8) and the final possibility is a rate-determining proton transfer to the benzene ring (equation 9). It is not known whether the rearrangement is concerted with the addition of the ring proton or proceeds via several fast steps after the rate-determining proton transfer to the benzene ring. It is also not known whether the proton adds to the benzene ring bearing the protonated nitrogen<sup>22</sup>.

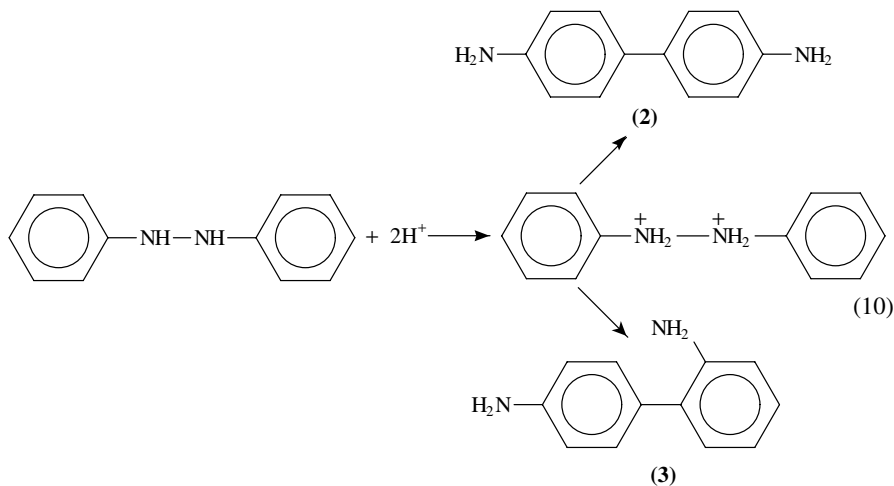




Shine and coworkers have used an extensive set of kinetic isotope effects to determine the mechanism of the benzidine rearrangement (equation 10). The major product of the rearrangement, 4,4'-diaminobiphenyl, or benzidine (**2**), accounts for 70% of the product, while 4,2'-diaminobiphenyl or diphenylene (**3**) accounts for the rest. The reaction is second order in sulfuric acid, so the diprotonated hydrazobenzene is obviously an intermediate in this reaction. A large nitrogen isotope effect of 1.0222<sup>23,24</sup> indicated that N–N bond rupture occurred in the rate-determining step of the reaction. It is worth noting that these isotope effects were measured by comparing the isotopic composition of the products formed from mixtures of the unlabelled and the labelled compound containing two <sup>15</sup>N isotopes per molecule, by whole-molecule isotope ratio mass spectrometry. This technique involves isolating the product from the reaction and analyzing it by mass spectrometry. In



these experiments, the isotopic ratio of the molecule (the ratio of the labelled to unlabelled molecules) was determined by measuring the isotopic composition of the molecule several thousand times. Typically, between 15,000 and 30,000 scans were used to determine the isotopic composition of the product. This very large number of scans was required because the heavy-atom isotope effects Shine and his coworkers measured were very small.



Whole-molecule isotope ratio mass spectrometry was also used to measure the secondary hydrogen–deuterium kinetic isotope effect of 0.962 found for the formation of benzidine from mixtures of the undeuterated and 4,4'-dideuterohydrazobenzene. This isotope effect illustrated that the bonding to these hydrogens was altered in the rate-determining step of the reaction. Model calculations indicated that the hydrogen–deuterium isotope effect would have been normal if the reaction had proceeded via the  $\pi$ -complex mechanism. Finally, a  $k^{12}/k^{14}$  of 1.050 found for the formation of benzidine when the label was at C-4 of the hydrazobenzene, demonstrated that the C-4 carbon was also altered in the rate-determining step of the reaction. The nitrogen heavy-atom kinetic isotope effect of 1.0222 indicated that the N–N bond is also breaking in the slow step of the reaction. Thus, finding a significant nitrogen, secondary hydrogen–deuterium and carbon (C-4) kinetic isotope effect led the authors to conclude that the benzidine rearrangement of hydrazobenzene to benzidine occurs by the concerted mechanism shown in equation 6.

The nitrogen kinetic isotope effect of 1.063 for the formation of diphenylene confirmed that rupture of the N–N bond was also involved in the rate-determining step of this reaction. However, the magnitude of the nitrogen isotope effect found in the formation of the diphenylene is very different from the isotope effect of 1.022 found for the formation of benzidine. This clearly indicates that this reaction proceeds via a very different transition state than that for the formation of benzidine and it was concluded that it probably occurred via the  $\pi$ -complex mechanism (equation 7). This conclusion is supported by the very small (effectively zero) carbon isotope effects found for the formation of diphenylene<sup>22</sup>. In fact, a  $k^{12}/k^{13}$  of 1.0000 was found by whole-molecule isotope ratio mass spectrometry and a  $k^{12}/k^{14}$  of 1.0011 was obtained when a scintillation counter technique was used. This lack of a carbon isotope effect indicates clearly that carbon–carbon bond formation does not occur in the rate-determining step of the reaction that forms diphenylene. Since N–N bond rupture does occur in the slow step of the reaction to form diphenylene, but carbon–carbon bond formation does not, it is obvious that diphenylene is not formed by a concerted

mechanism but must involve the formation of an intermediate, and it was concluded that it occurred via the  $\pi$ -complex mechanism (equation 7). Further confirmation of the  $\pi$ -complex mechanism was provided by the calculated isotope effects for the  $\pi$ -complex mechanism. The calculated nitrogen kinetic isotope effect for the formation of diphenylene by the dissociative  $\pi$ -complex mechanism was 1.055, in excellent agreement with the 1.063 found experimentally. A rationale for the different mechanisms for the formation of benzidine and diphenylene was presented. The formation of benzidine is concerted because it occurs via an allowed [5,5] suprafacial sigmatropic shift whereas the concerted formation of diphenylene would occur via a forbidden [3,5] suprafacial reaction.

The above results were interpreted in terms of the concerted mechanism shown in Scheme 1, although the authors state that one cannot determine whether the rings are bent (Figure 2) or planar in the transition state of the concerted reaction.

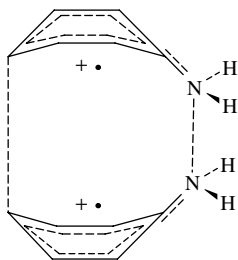
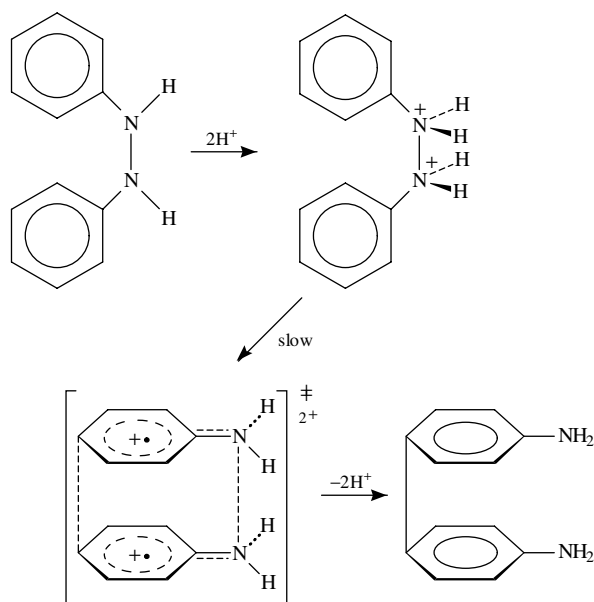
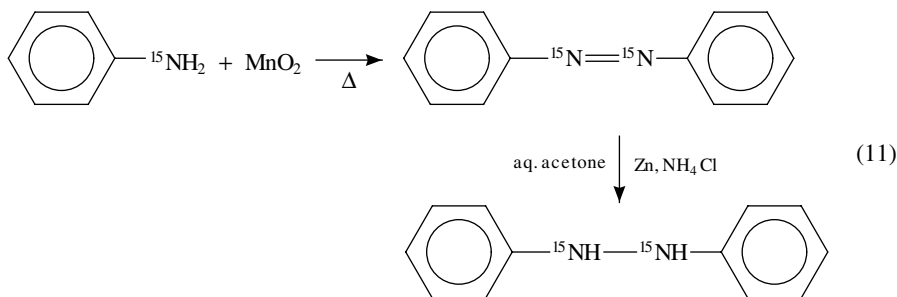
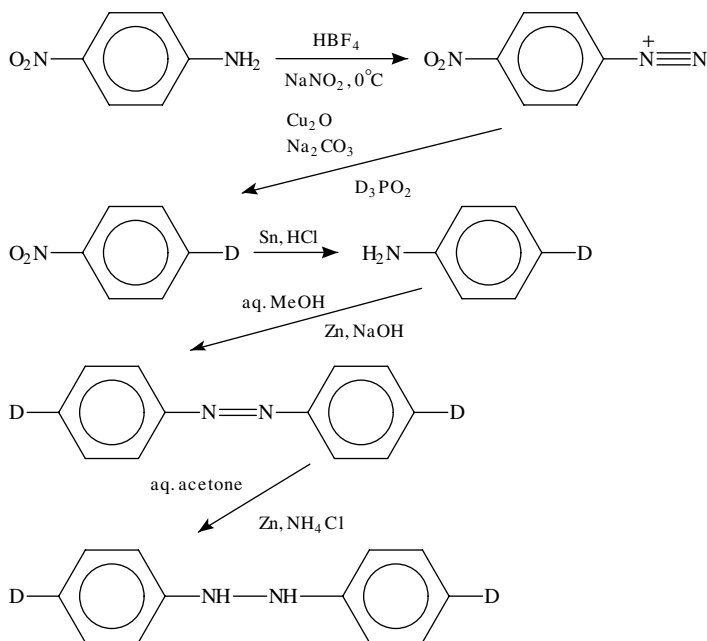


FIGURE 2. The possible bent configuration of the benzene rings for the concerted formation of benzidine

The labelled substrates required for this study were synthesized as follows. The hydrazobenzene doubly labelled with nitrogen-15 was prepared from the commercially available  $^{15}\text{N}$ -labelled aniline (equation 11).



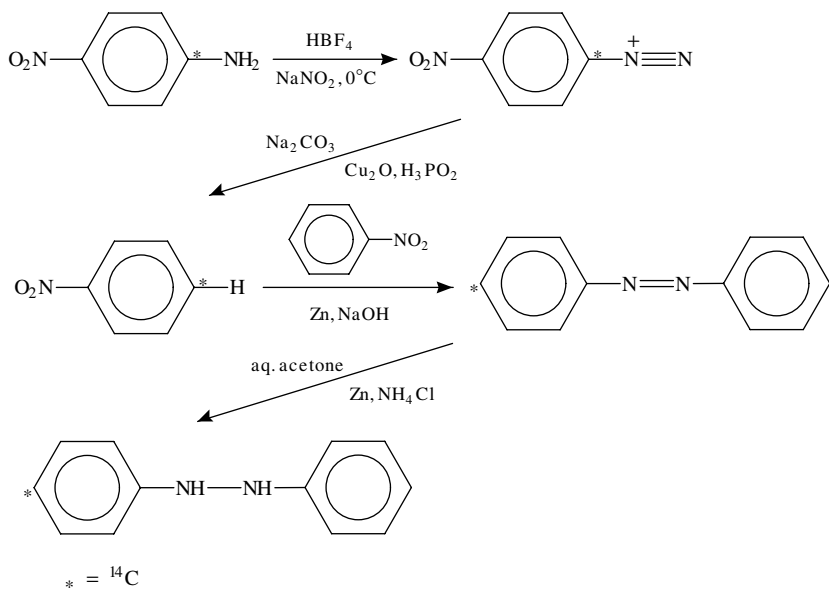
The 4,4'-dideuteroazobenzene was prepared with 97%  $\text{d}_2$  by the sequence of reactions shown in Scheme 2.



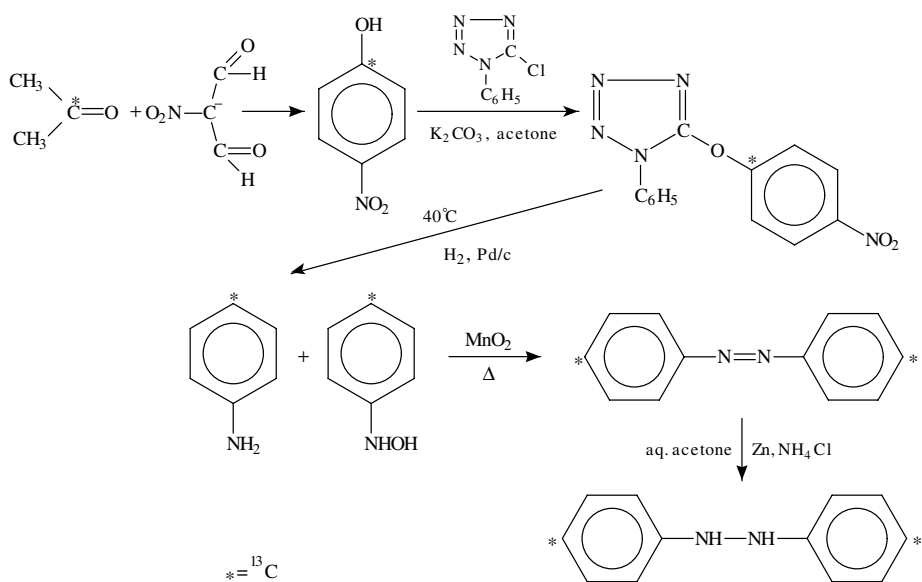
SCHEME 2

The  $^{14}\text{C}$ -labelled compound was prepared from the  $^{14}\text{C}$  nitrobenzene that was obtained by converting the commercially available 4-nitroaniline-1- $^{14}\text{C}$  into the diazonium tetrafluoroborate and reducing it with hypophosphous acid (Scheme 3)<sup>25</sup>.

The 4,4'- $^{13}\text{C}_2$  azobenzene was prepared from the commercially available  $^{13}\text{C}$ -labelled acetone by the sequence of reactions shown in Scheme 4.

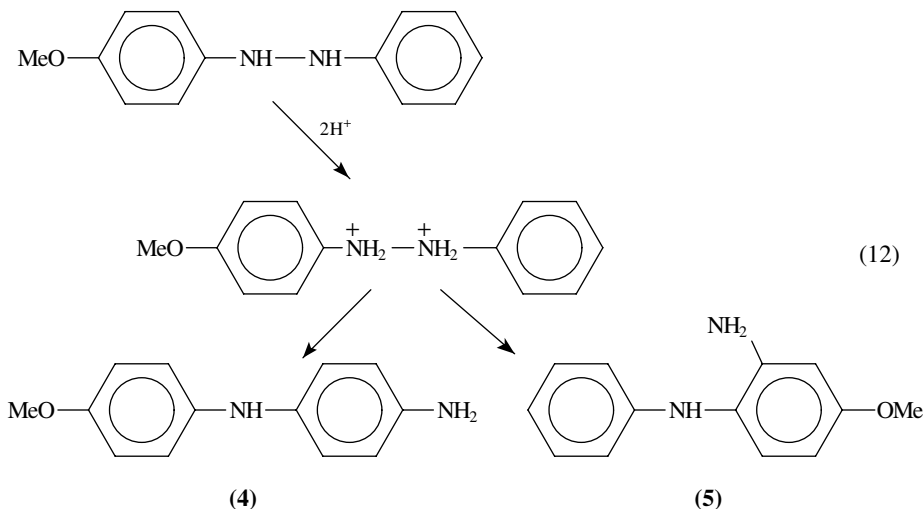


SCHEME 3



SCHEME 4

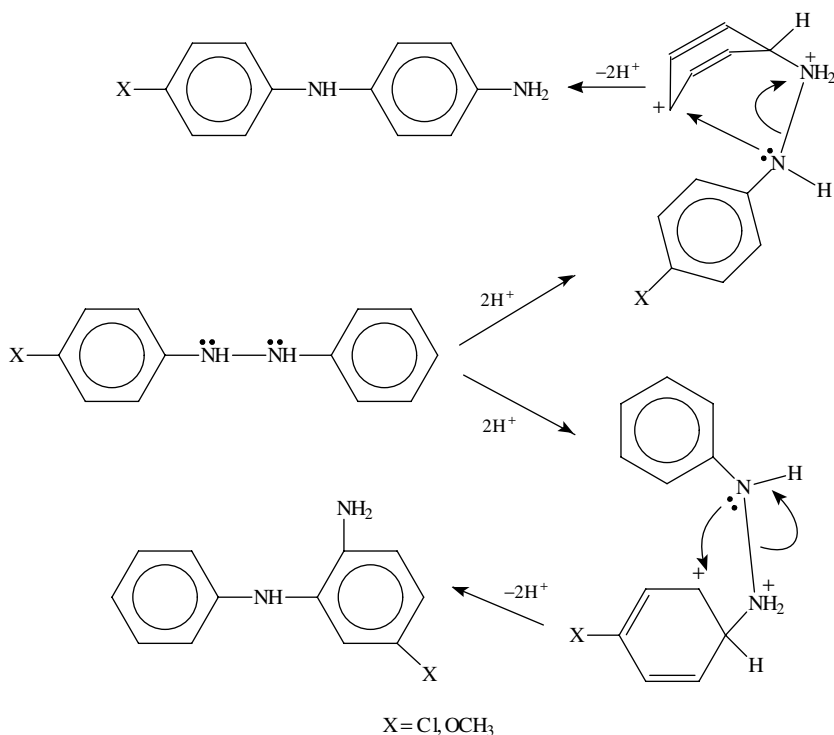
The next benzidine-type rearrangement studied by Shine and coworkers was the *p*-semidine rearrangement of 4-methoxyhydrazobenzene<sup>26</sup>. In this reaction, 4-methoxyhydrazobenzene rearranges in acidic medium to form *p*-semidine (**4**) and an *o*-semidine (**5**); see equation 12.



These rearrangements are especially interesting because one of the nitrogens from the hydrazo group attacks the *ortho*- or the *para*-position of the activated benzene ring. Thus, an intramolecular, concerted mechanism seems even more unlikely in these rearrangements. Heesing and Schinke have shown, using substrates labelled with <sup>15</sup>N at both nitrogens, that both the 4-methoxy- and the 4-chlorohydrazobenzene rearrange in an intramolecular reaction<sup>27,28</sup>. Some of these rearrangements involve a single proton while others require two protons. In the two-proton transfer reactions, the second proton is thought to add to the *ipso* position of the benzene ring producing a bent cyclohexadienyl-like configuration that brings the *para*-position of the benzene ring close to the unprotonated nitrogen of the hydrazo linkage (Scheme 5). The formation of the *o*-semidine is also thought to involve *ipso* protonation of the benzene ring (Scheme 5).

In the one-proton rearrangement, it is generally accepted that the protonation must occur at the nitrogen of the hydrazo group. Shine and coworkers synthesized 4-methoxyhydrazobenzene labelled with nitrogen-15 at both nitrogens and another sample labelled with carbon-14 at the 4-position of the unsubstituted benzene ring. The synthesis of the nitrogen-15 labelled substrate began with the commercially available <sup>15</sup>N-aniline (Scheme 6) while the carbon-14 labelled substrate was synthesized from 4-<sup>14</sup>C-nitrobenzene that had been prepared earlier in Shine's laboratory (Scheme 7).

The products from the rearrangement in 60% aqueous dioxane under oxygen-free argon at 0 °C at a pH of 4.43 were benzoylated, separated and analyzed by whole-molecule isotope ratio mass spectrometry. The nitrogen isotope effect for the formation of both the 4-amino-4'-methoxysemibenzidine (**4**) and 2-amino-3-methoxysemibenzidine (**5**) were 1.029 and 1.074, respectively. The carbon-12/carbon-14 isotope effect for the formation of the 4-amino-4'-methoxysemibenzidine was 1.039. The nitrogen and carbon isotope effects found for the formation of the 4-amino-4'-methoxysemibenzidine indicate that the nitrogen–nitrogen bond is breaking and that the nitrogen–carbon bond is forming in the slow step of the reaction forming the 4-amino-4'-methoxysemibenzidine. Obviously,

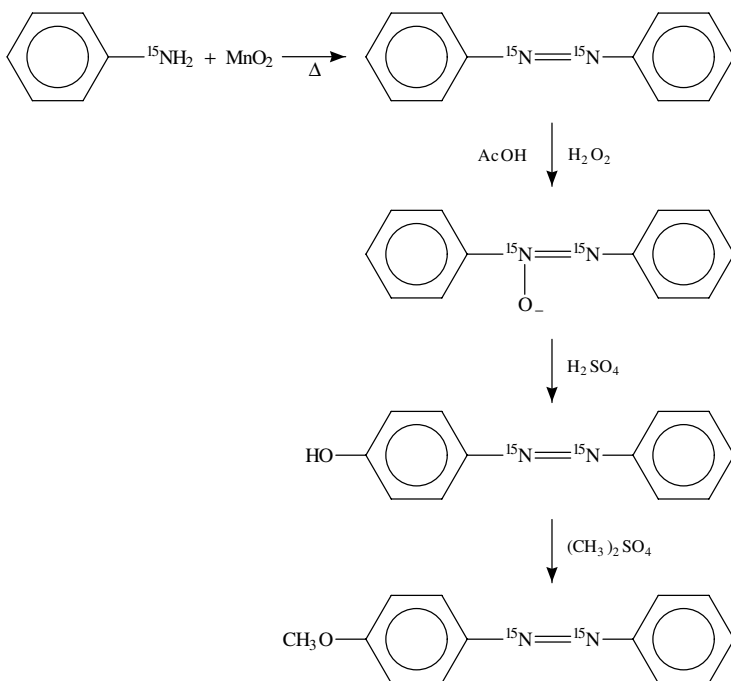


SCHEME 5

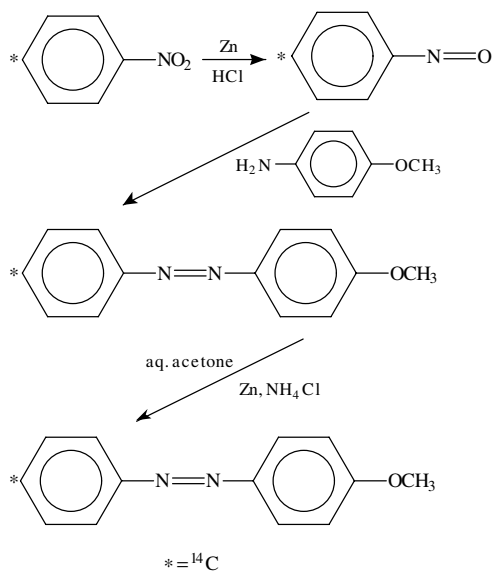
this is only consistent with a concerted mechanism for the formation of 4-amino-4'-methoxysemibenzidine. It is worth noting that the magnitude of these isotope effects are almost identical to those found in the concerted benzidine rearrangement (1.029 and 1.022 for the nitrogen isotope effects and 1.039 and 1.028 for the carbon isotope effects, respectively).

The much larger nitrogen isotope effect of 1.074 found for the formation of the 2-amino-3-methoxysemibenzidine suggests that this reaction occurs by a different mechanism. Thus, the authors concluded that the 2-amino-3-methoxysemibenzidine formed in a two-step mechanism with the nitrogen–nitrogen bond rupture rate-determining. The nitrogen isotope effect in this reaction is similar to the isotope effect of 1.063 found for the two-step benzidine rearrangement. Finally, it is worth noting that the observed kinetic isotope effects were in good agreement with those calculated for the concerted and two-step rearrangements.

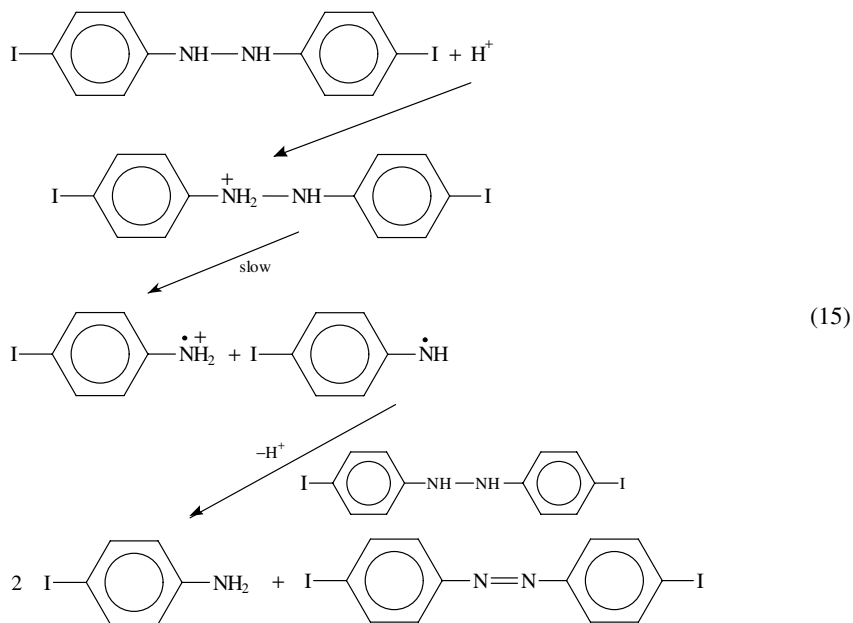
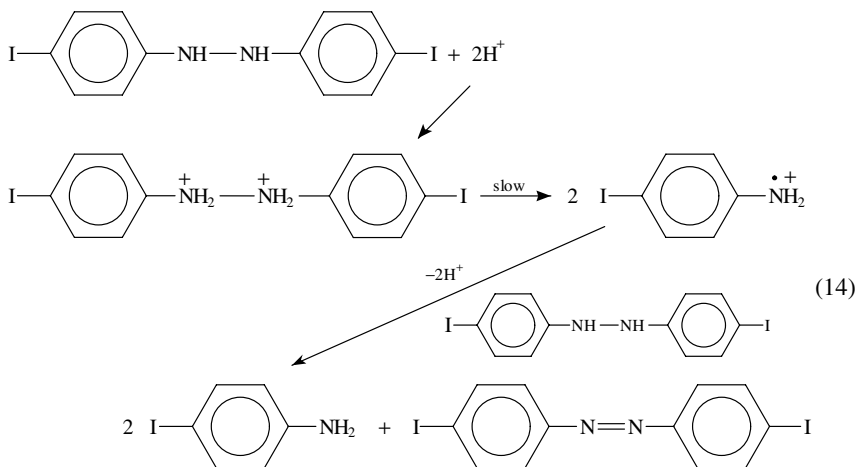
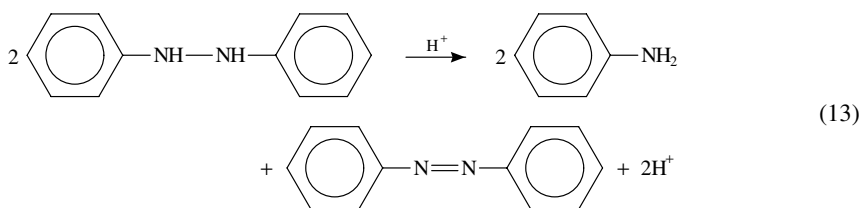
Disproportionation (equation 13) is one of the side reactions that can occur in benzidine rearrangements. Shine and coworkers measured the nitrogen and carbon kinetic isotope effects for the disproportionation reaction of 4,4'-diiodohydrazobenzene, which only yielded disproportionation products, at 25 °C in 70% aqueous dioxane that was 0.376 M in perchloric acid<sup>29</sup>. The reaction was first order in hydrazobenzene and it has been assumed that an intermediate was involved in the disproportionation reaction. This intermediate must be one of: a radical ion<sup>30</sup> (equations 14 and 15), a  $\pi$ -complex<sup>31</sup> (equation 16) or a quinonoid structure<sup>32</sup> (equation 17).



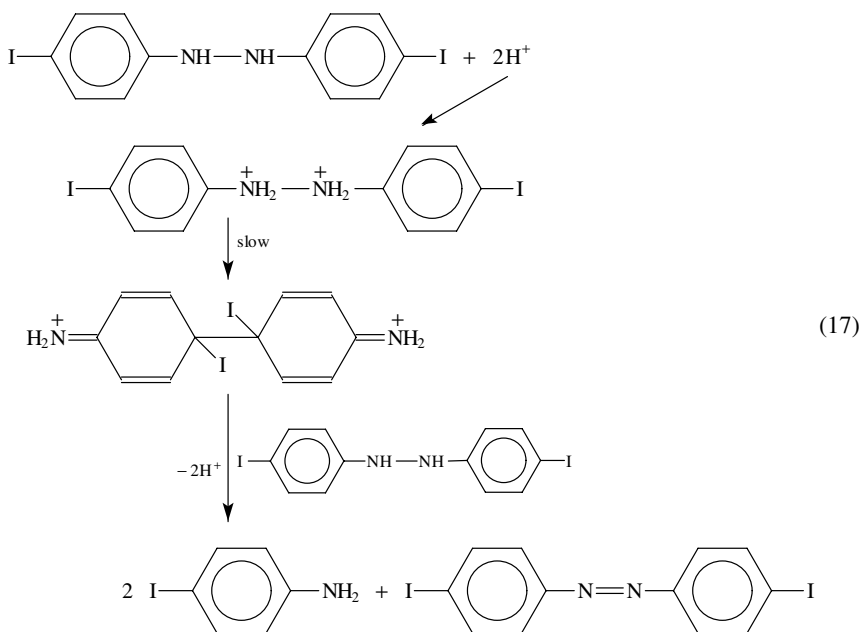
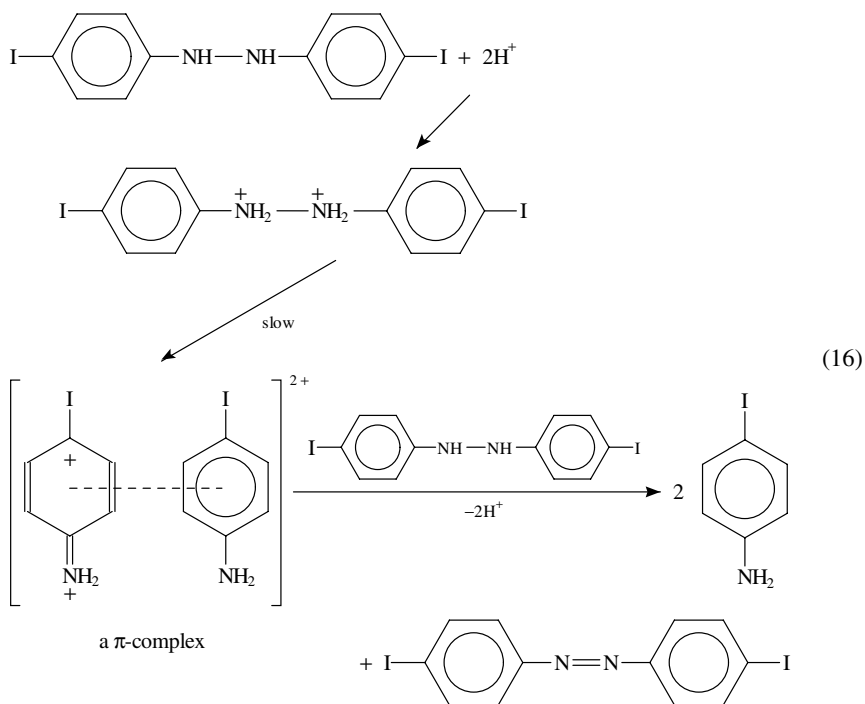
SCHEME 6



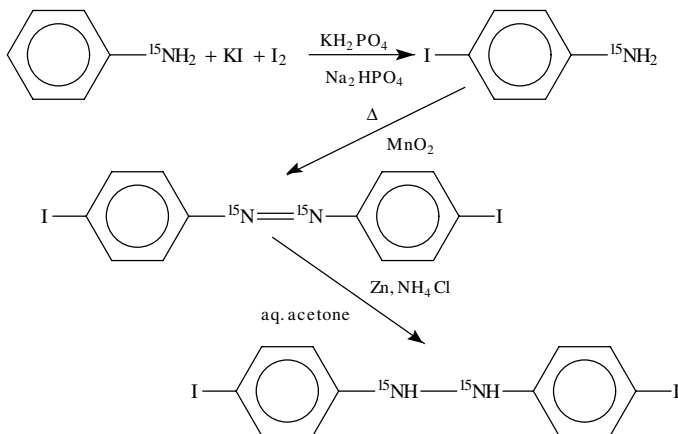
SCHEME 7





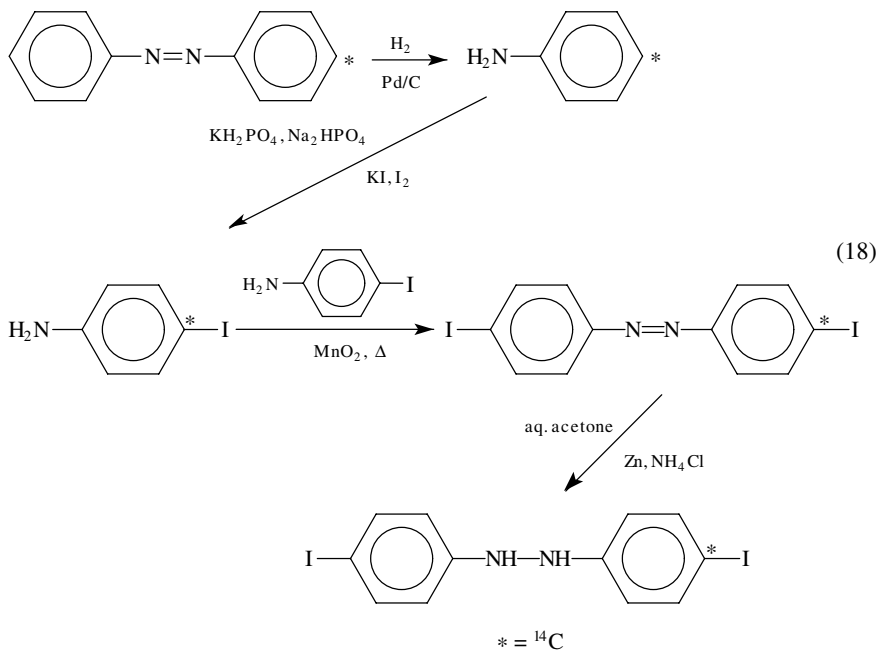


4,4'-Diiodohydrazobenzene labelled at both nitrogens with nitrogen-15 was synthesized from the commercially available  $^{15}\text{N}$ -aniline (Scheme 8), and another sample, with carbon-13 at the 4-position of both rings, was synthesized from  $[1-^{13}\text{C}]$ -4-nitrophenol that was available in Shine's laboratory (Scheme 9).

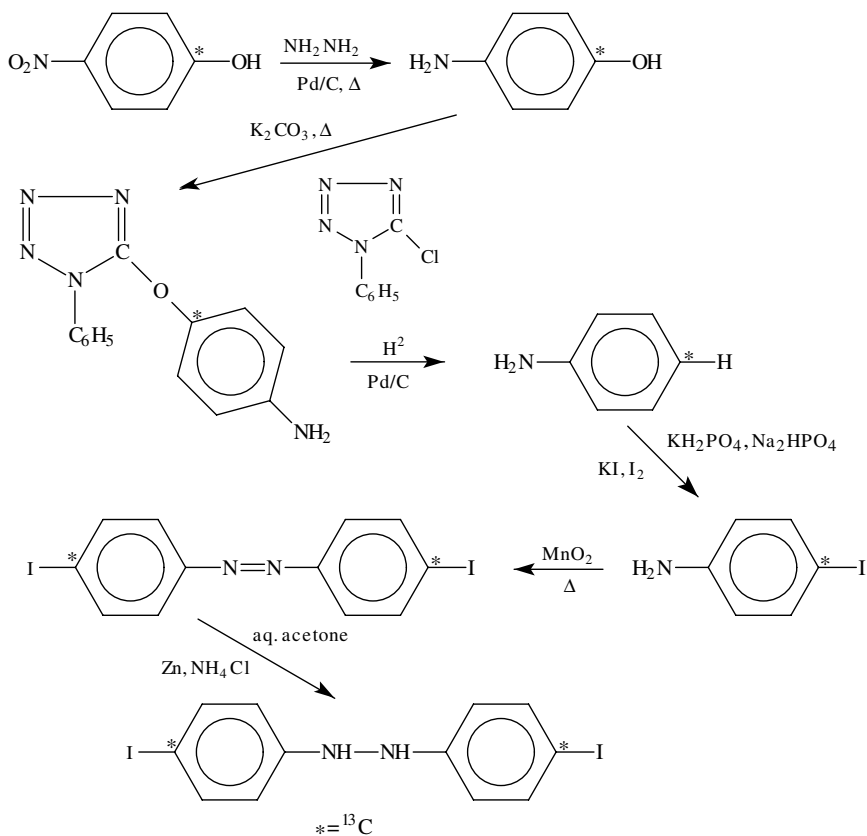


SCHEME 8

Some 4,4'-diiodohydrazobenzene labelled with carbon-14 at one of the 4-positions of the phenyl rings was prepared from  $[4-^{14}\text{C}]$ azobenzene that had been synthesized previously in Shine's laboratory (equation 18).



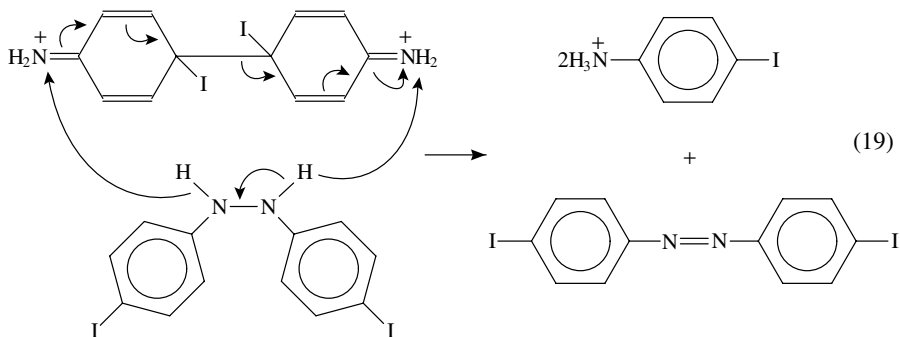
(18)



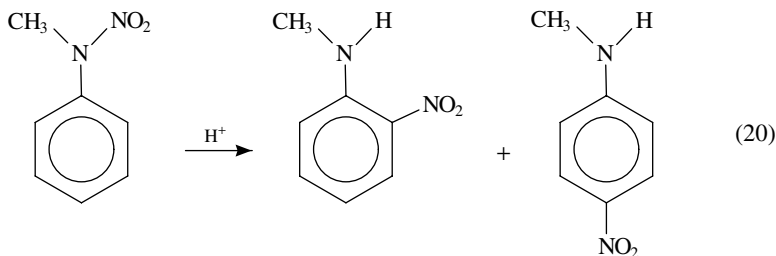
SCHEME 9

The nitrogen and carbon kinetic isotope effects were determined for the disproportionation reactions in 70% aqueous dioxane that was 0.376 M in perchloric acid. A nitrogen isotope effect of 1.037, a carbon-13 kinetic isotope effect of 1.023 and a carbon-14 isotope effect of 1.045 were observed for the disproportionation reaction forming 4,4'-diiodoazobenzene. The excellent agreement between the carbon-13 and carbon-14 isotope effects (the carbon-14 isotope effect should be 1.044 or 1.9 times the magnitude of the carbon-13 isotope effect<sup>33</sup>) which were measured by whole-molecule isotope ratio mass spectrometry and by scintillation counting, respectively, confirmed that the large carbon isotope effects were correct. Since the reaction is first order in substrate, these isotope effects demonstrated that an intermediate was formed and that nitrogen–nitrogen bond rupture and the formation of the 4,4' carbon–carbon bond both occurred in the rate-determining step of the decomposition of this intermediate. These results obviously rule out the radical ion and the  $\pi$ -complex mechanisms because they only involve nitrogen–nitrogen bond rupture in the rate-determining step of the reaction. Thus, the disproportionation reaction, like the benzidine rearrangement, is thought to proceed via a quinonoid intermediate that is formed in the slow step of the reaction. The quinonoid intermediate is then oxidized in a fast step by another hydrazobenzene

molecule (equation 19).



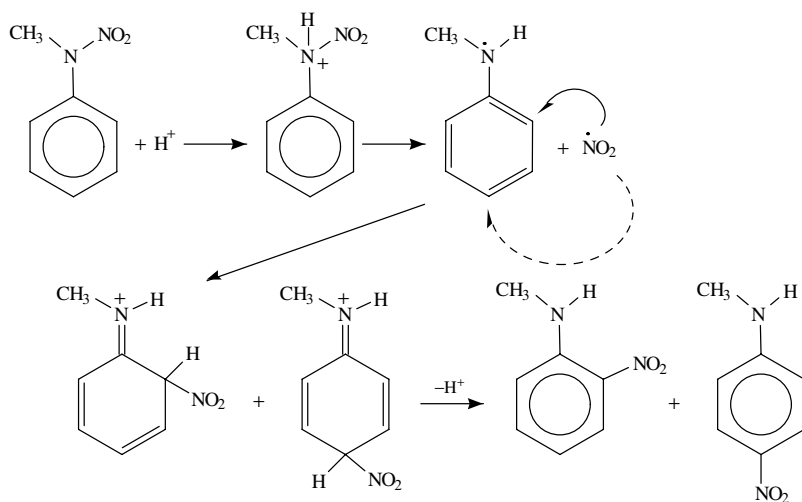
The next reaction of this type investigated by Shine and coworkers was the nitramine rearrangement<sup>34</sup> (equation 20).



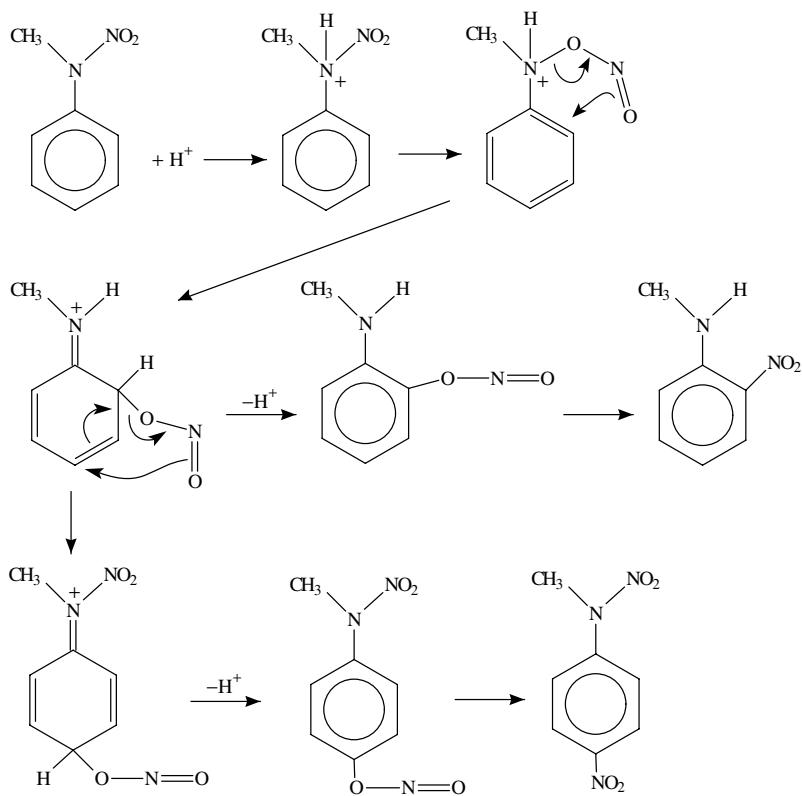
The rearrangements are first order in substrate and in acid and are mainly intramolecular in nature, although a small intermolecular component has been identified. Shine and coworkers investigated this reaction to try to prove that the process occurred by the nonconcerted (the favored) pathway (Scheme 10) rather than the concerted pathway (Scheme 11).

The *N*-methyl-*N*-[<sup>15</sup>N]nitroaniline, the *N*-methyl-*N*-nitro-[4-<sup>14</sup>C]aniline and the *N*-methyl-*N*-nitro-[2-<sup>14</sup>C]aniline required for this study were prepared using the reactions shown in Schemes 12–14.

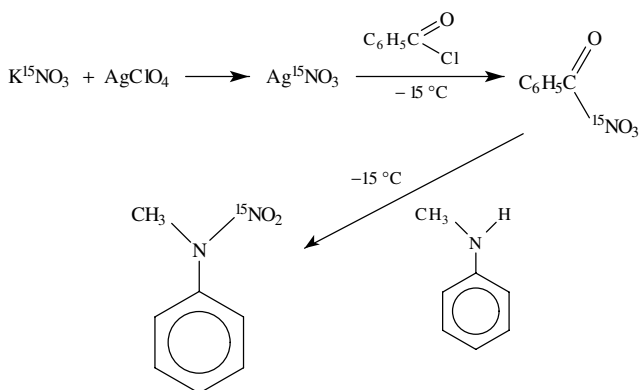
The nitrogen isotope effects were determined by whole-molecule isotope ratio mass spectrometry on the 2-nitro and the 4-nitro-*N*-methylanilines recovered from the reaction in 0.205 M hydrochloric acid at 30 °C. The large nitrogen isotope effects of 1.045 and 1.039 observed for the formation of the 2-nitro and the 4-nitro-*N*-methylanilines, respectively, clearly demonstrate that nitrogen–nitrogen bond cleavage occurs in the rate-determining step for the formation of both products. Although the carbon isotope effects were determined under conditions where a small amount of intermolecular reaction occurred, the isotope effects are effectively those for the intramolecular rearrangements. The carbon-12/carbon-14 isotope effects for the formation of both the 2-nitro- and the 4-nitro-*N*-methylanilines are, within experimental error, zero, i.e. they were 1.006 and 1.005 for the formation of the 2-nitro- and the 4-nitro-*N*-methylanilines, respectively, when the substrate was the *N*-methyl-*N*-nitro-[2-<sup>14</sup>C]aniline, and 1.008 and 1.005 for the formation of the 2-nitro- and the 4-nitro-*N*-methylanilines, respectively, when the substrate was the *N*-methyl-*N*-nitro-[4-<sup>14</sup>C]aniline. The absence of a carbon isotope effect clearly indicates that there is no carbon–carbon bond formation in the rate-determining step of either of the nitramine rearrangements. Clearly, neither of the nitramine rearrangements



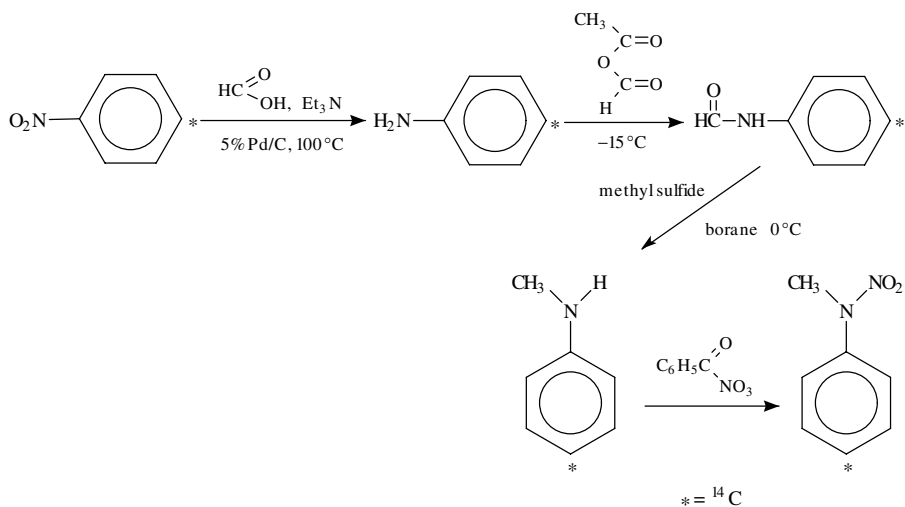
SCHEME 10



SCHEME 11

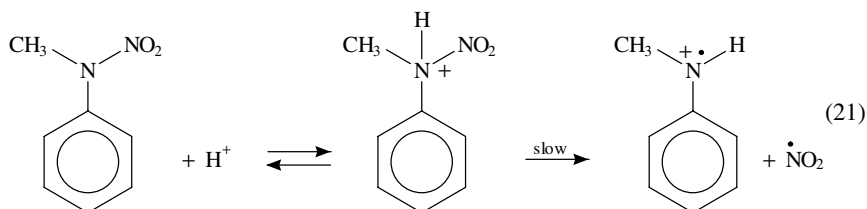


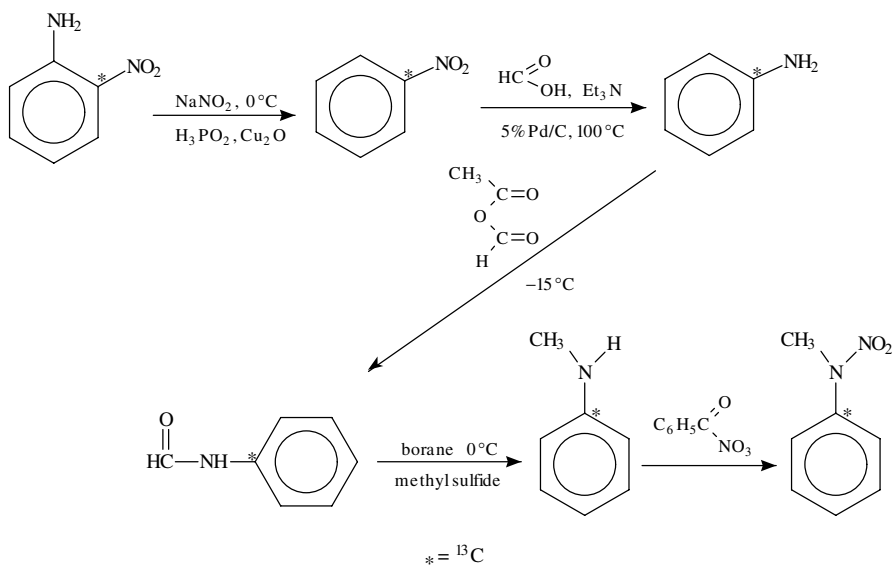
SCHEME 12



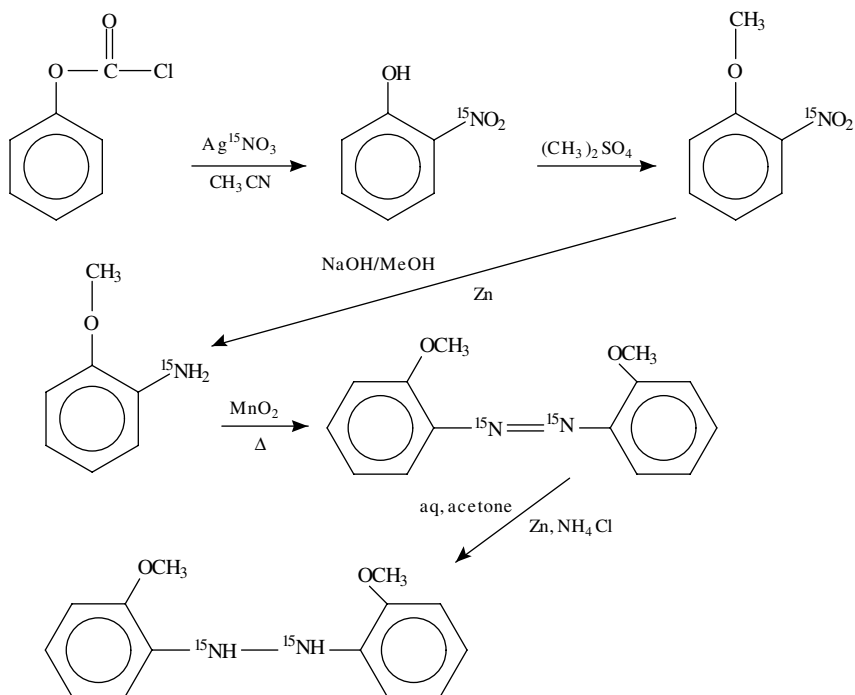
SCHEME 13

is concerted, and the authors concluded that both reactions occur via a radical mechanism where nitrogen–nitrogen bond rupture of the intermediate formed by protonation of the substrate is rate-determining (equation 21).





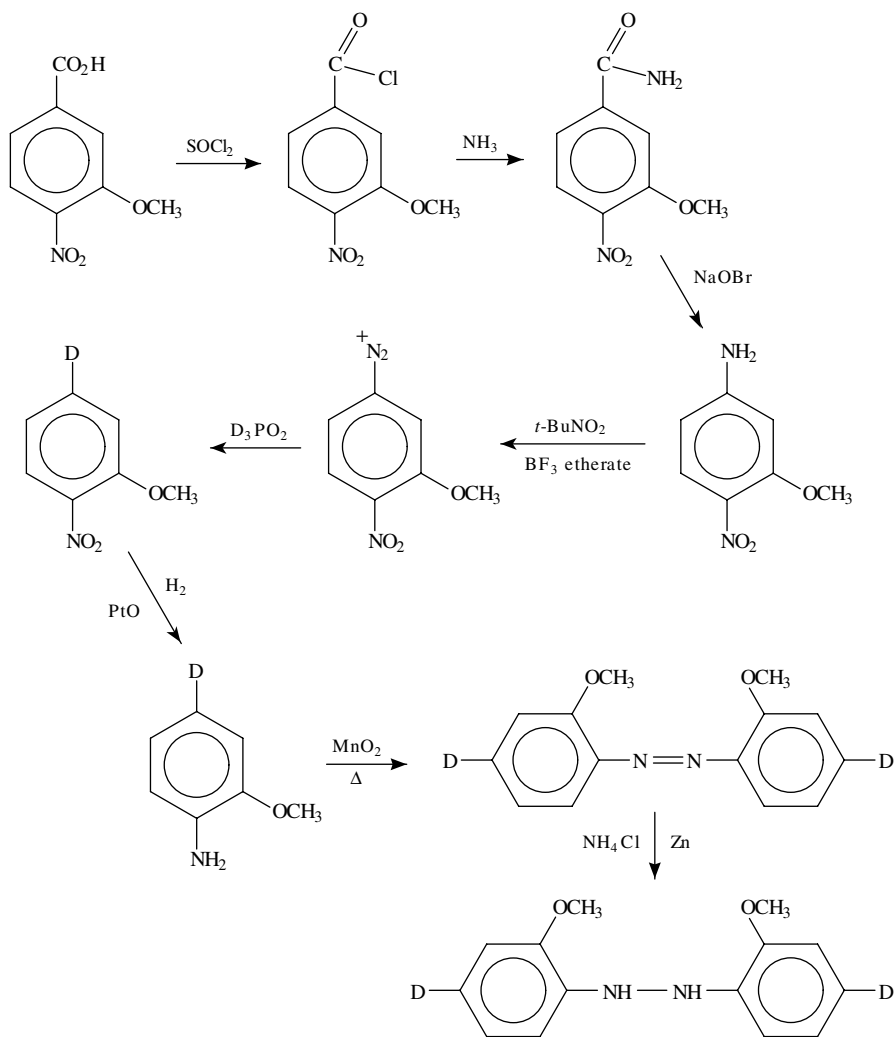
SCHEME 14



SCHEME 15

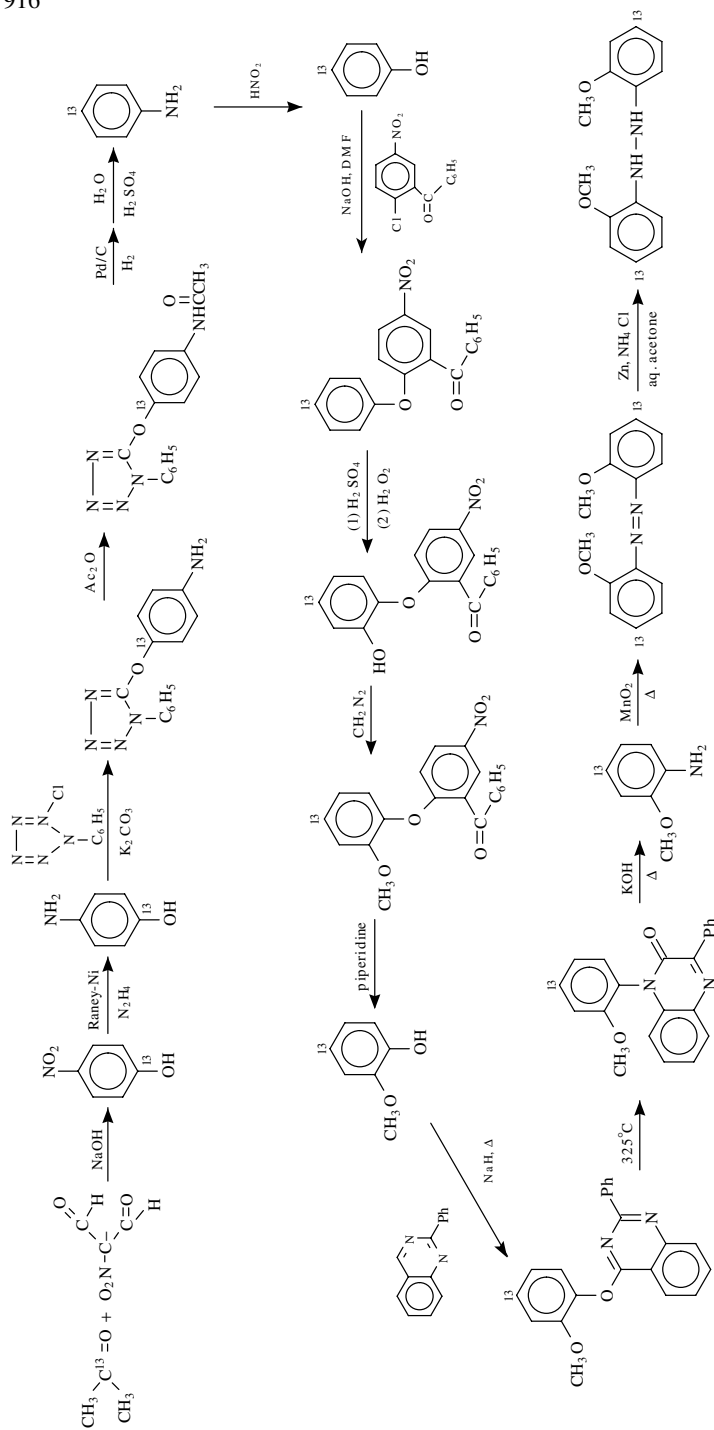
Confirmation of the radical mechanism was provided by Ridd and Sandall<sup>35</sup>, who detected radical cations by nitrogen-15 NMR of the reaction mixture for the nitramine rearrangement of 2,6-dibromo-*N*-nitroaniline and of *N*-methyl-*N*-nitroaniline labelled with nitrogen-15 in the nitro group. The results did not allow the authors to indicate whether the products were formed within the solvent cage or from separated radicals.

Shine and coworkers<sup>36</sup> also investigated the mechanism of the one-proton benzidine rearrangement of 2,2'-dimethoxyhydrazobenzene. The doubly labelled 2,2'-dimethoxy-[<sup>15</sup>N, <sup>15</sup>N]hydrazobenzene, the 2,2'-dimethoxy-[4,4'<sup>2</sup>H<sub>2</sub>]hydrazobenzene and the 2,2'-dimethoxy-[4,4'<sup>13</sup>C<sub>2</sub>]hydrazobenzene required for this study were synthesized using the reactions in Schemes 15, 16 and 17, respectively.



SCHEME 16





SCHEME 17

Then, the nitrogen, the carbon and the deuterium kinetic isotope effects for these one-proton benzidine rearrangements (equation 22) were measured in buffered 60% aqueous dioxane at 0 °C. The 2,2'-dimethoxybenzidine formed in the reaction was isolated and converted into its bis(trifluoroacetyl) derivative and analyzed by whole-molecule isotope ratio mass spectrometry. The nitrogen kinetic isotope effect was  $1.029 \pm 0.005$ , the carbon-13 kinetic isotope effect was  $1.029 \pm 0.005$  and the secondary hydrogen–deuterium kinetic isotope effect was  $0.93 \pm 0.03$ . The substantial nitrogen and carbon isotope effects indicate that the nitrogen–nitrogen bond is breaking as the carbon–carbon bond is forming in the rate-determining step of the reaction. Thus, the rearrangement is a concerted reaction. The inverse secondary hydrogen–deuterium kinetic isotope effect also confirms that the rearrangement is concerted. An inverse isotope effect is observed because carbon–carbon bond formation changes the hybridization of the 4 and 4' carbon atoms of the benzene rings from  $sp^2$ - to  $sp^3$ -like in the transition state. Thus, the one-proton transfer benzidine reaction occurs by a pre-equilibrium proton transfer to nitrogen followed by a rate-determining concerted rearrangement. Finally, it is worth noting that all three of the isotope effects in this reaction are almost identical to those found for the two-proton benzidine rearrangement (Table 1). This suggests that the transition states for the one-proton and two-proton benzidine rearrangements are very similar. The authors suggest that the transition states have two bent cyclohexadiene-like rings. This brings the two reacting carbons close enough to react (Figure 3).

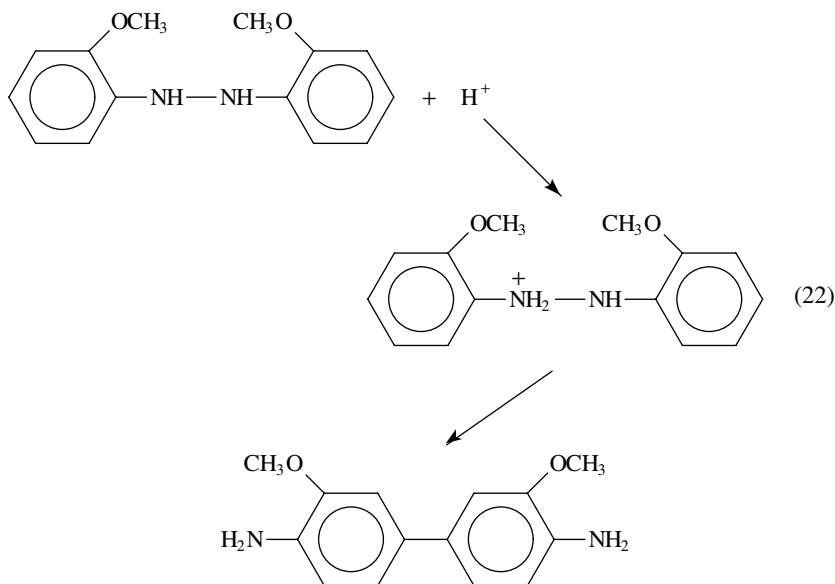


TABLE 1. The nitrogen, carbon-13 and secondary hydrogen–deuterium kinetic isotope effects found for the one- and two-proton benzidine rearrangements

Rearrangement	$k^{14}/k^{15}$	$k^{12}/k^{13}$	$k_H/k_D$
One-proton	1.029	1.029	0.93
Two-proton	1.022	1.021	0.94

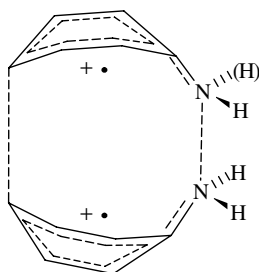
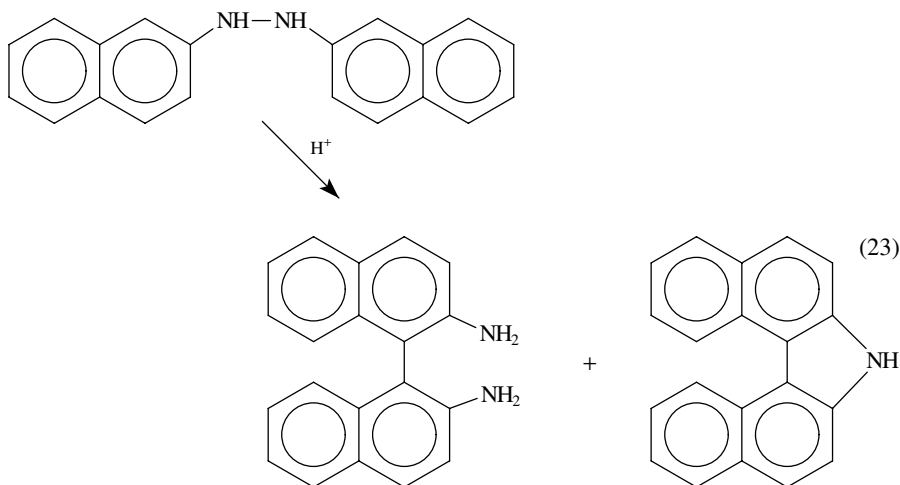


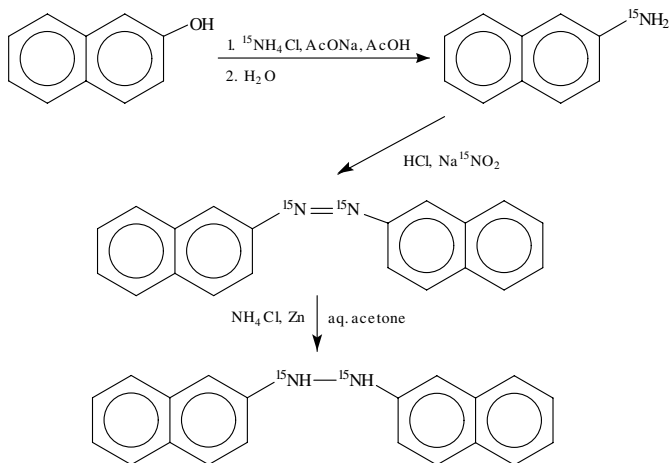
FIGURE 3. The transition state for the one- and two-proton benzidine rearrangement

The thermal rearrangement of 2,2'-hydrazonaphthalene has also been investigated by Shine and coworkers<sup>37</sup>. This reaction was of interest because these compounds undergo (i) a high yield of the *ortho,ortho'*-rearrangement with virtually no disproportionation in the normal acid-catalyzed reaction, and (ii) a clean thermal *ortho,ortho'*-rearrangement (equation 23). In fact, it is believed that the carbazole product is formed from the diamine produced in the rearrangement reaction, so the kinetic isotope effects used to elucidate the mechanism of this reaction are determined only by the rearrangement reaction.

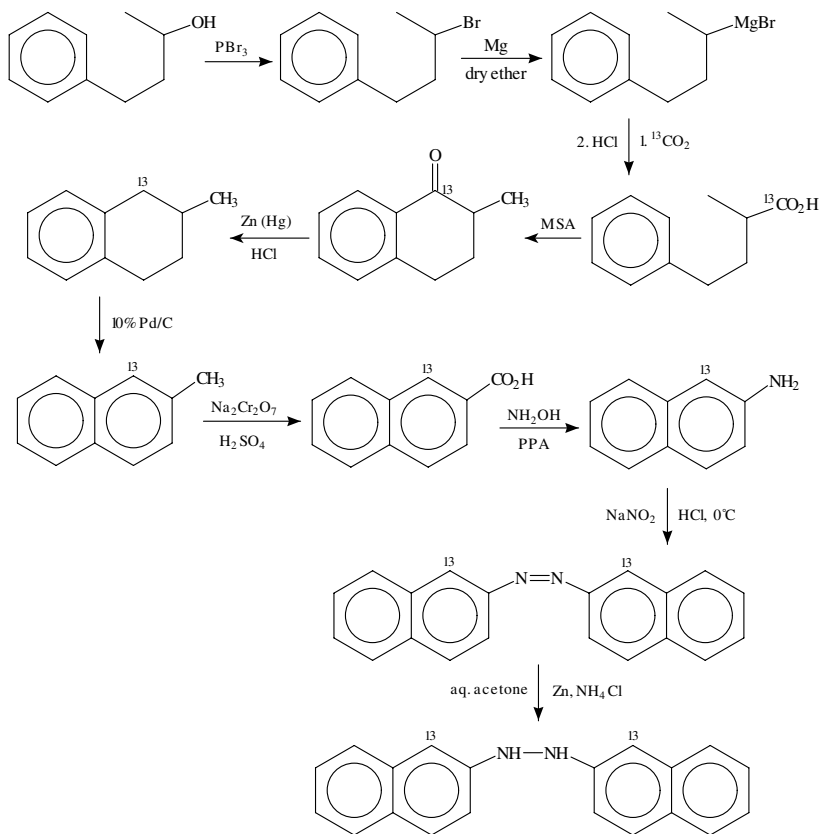


The 2,2'-hydrazonaphthalene doubly labelled with nitrogen-15 for the nitrogen isotope effect experiments and the [1,1'-<sup>13</sup>C<sub>2</sub>]-2,2'-hydrazonaphthalene required for measuring the carbon isotope effect were synthesized by the reaction sequence shown in Schemes 18 and 19.

The normal acid-catalyzed reaction was carried out at 0 °C in 70% aqueous dioxane that was  $1 \times 10^{-3}$  M in perchloric acid while the thermal rearrangement was carried out in 95% ethanol at 80 °C. The nitrogen and carbon-13 kinetic isotope effects found in these two rearrangements are presented in Table 2. The large nitrogen and significant carbon-13 kinetic isotope effects for both reactions indicate that both the acid-catalyzed and the thermal rearrangements are concerted. The larger nitrogen isotope effect for the acid-catalyzed reaction indicates that the transition state for the acid-catalyzed reaction has more



SCHEME 18



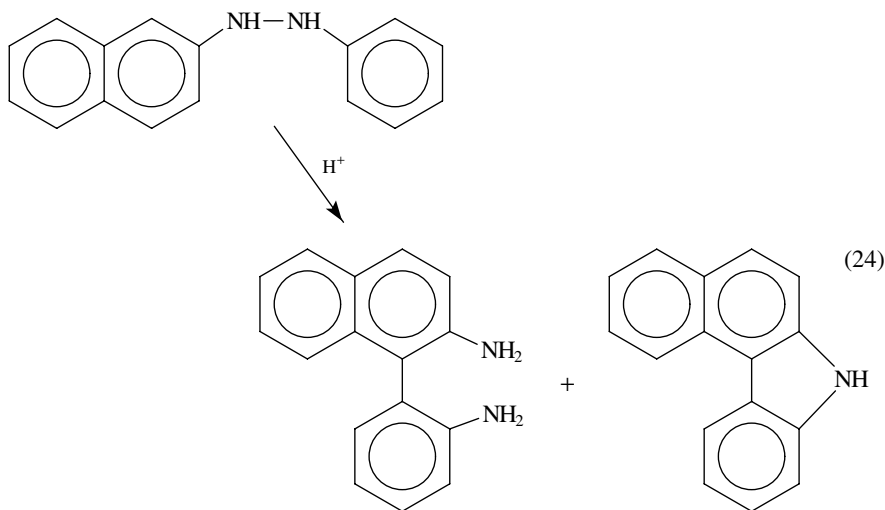
SCHEME 19

TABLE 2. The nitrogen and carbon-13 kinetic isotope effects for the acid-catalyzed and for the thermal benzidine rearrangement of 2,2'-hydrazonaphthalene in 70% aqueous dioxane at 0 °C and in 95% ethanol at 80 °C, respectively

Reaction	$k^{14}/k^{15}$	$k^{12}/k^{13}$
Acid-catalyzed	$1.090 \pm 0.004$	$1.0086 \pm 0.0004$
Thermal	$1.0611 \pm 0.0001$	$1.0182 \pm 0.0001$

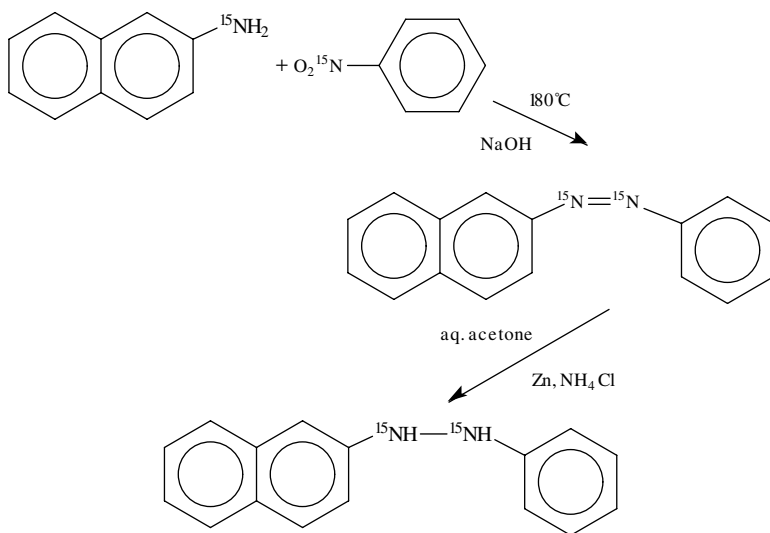
nitrogen–nitrogen bond rupture than the transition state for the thermal rearrangement. Unfortunately, the small carbon isotope effect is consistent with a transition state with either very little or almost complete carbon–carbon bond formation. Measuring the secondary hydrogen–deuterium kinetic isotope effect for this reaction would probably differentiate between these two possibilities.

Nitrogen, carbon-13 and carbon-14 kinetic isotope effects have been determined<sup>38</sup> for the analogous acid-catalyzed *ortho,ortho'*-rearrangement of the *N*-2-naphthyl-*N'*-phenylhydrazine (equation 24). The labelled compounds required for this study were prepared by the sequence of reactions shown in Schemes 20–22.

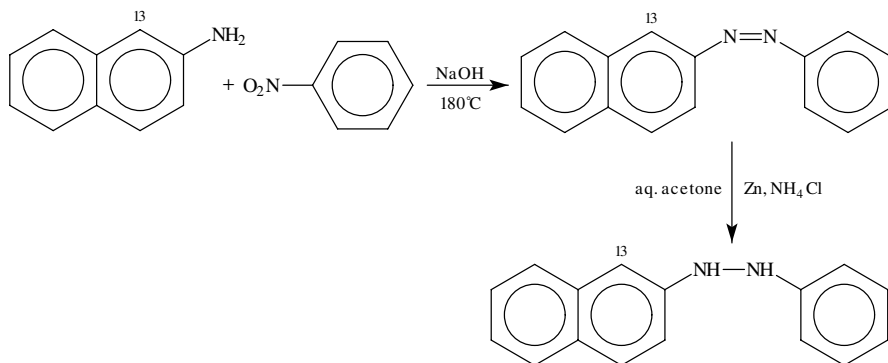


The isotope effects in Table 3 were measured at 0 °C in 60% aqueous dioxane that was 0.1 M in perchloric acid. The nitrogen isotope effect was determined for both the doubly labelled nitrogen-15 substrate and using the nitrogen gas from a sample with the natural abundance of nitrogen in the starting material. The doubly labelled nitrogen isotope effect was determined by whole-molecule isotope ratio mass spectrometry while that for the unlabelled substrate was measured by converting the nitrogen into nitrogen gas and determining the isotopic composition by isotope ratio mass spectrometry. The carbon-13 isotope effect was obtained by isotope ratio mass spectrometry on CO<sub>2</sub> while the carbon-14 isotope effect was measured by a scintillation counting technique.

The nitrogen kinetic isotope effect of 1.0197 found using the substrate with the natural abundance of nitrogen isotopes corresponds to an isotope effect of 1.04 for the reaction of the doubly labelled compound. Thus, the nitrogen isotope effects found using two different analytical techniques to measure the isotope effect are in excellent agreement.



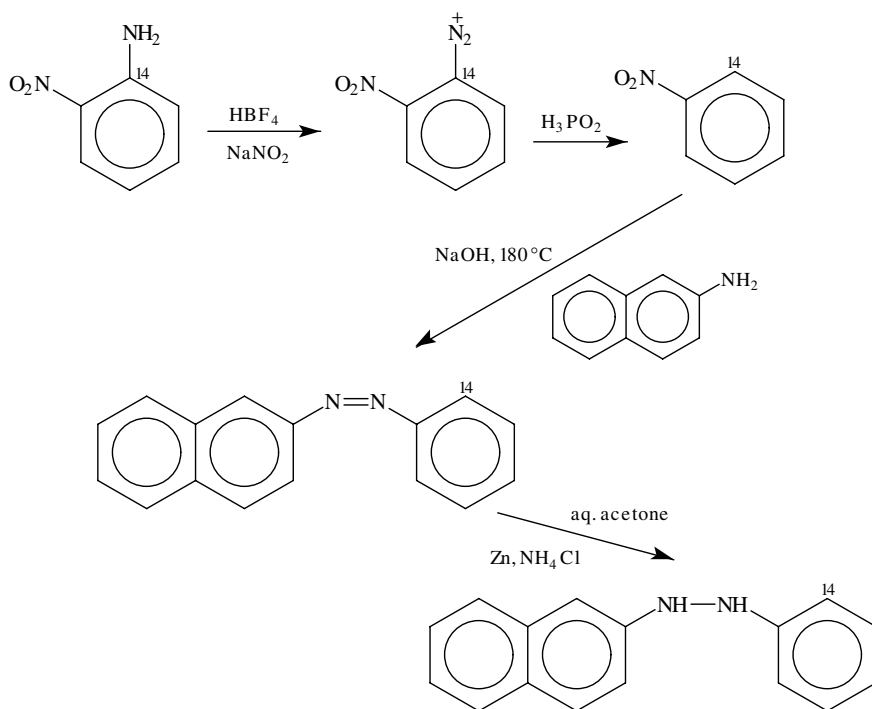
SCHEME 20



SCHEME 21

TABLE 3. The nitrogen, the carbon-13 and carbon-14 kinetic isotope effects found for the acid-catalyzed *ortho,ortho'*-rearrangement of *N*-naphthyl-*N*-phenylhydrazine in 60% aqueous dioxane at 0°C

Isotope effect	$k_L/k_H$
$^{15}\text{N}-^{15}\text{N}$	$1.043 \pm 0.005$
$^{15}\text{N}-\text{N}$	$1.0197 \pm 0.0009$
$^{13}\text{C}$	$1.0042 \pm 0.0001$
$^{14}\text{C}$	$1.0142 \pm 0.0005$



SCHEME 22

The carbon-13 kinetic isotope effect of 1.0074 estimated<sup>33</sup> for this rearrangement using the equation

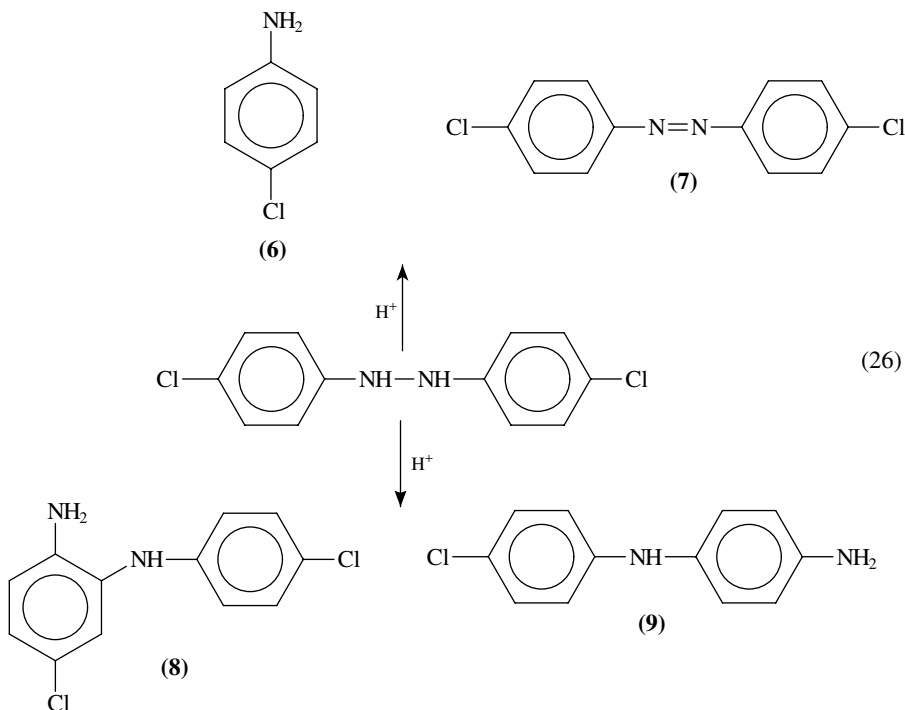
$$\log(k^{12}/k^{14})/\log(k^{12}/k^{13}) = 1.9 \quad (25)$$

is in reasonable agreement with the observed value of 1.0042. This agreement is satisfactory when one considers that (i) the two isotope effects are very small and that (ii) the carbon isotope effect indicates what is happening at the two carbons that are forming the new carbon-carbon bond in the transition state.

The nitrogen, carbon-13 and carbon-14 isotope effects clearly indicate that the rearrangement is concerted. However, the large nitrogen isotope effect accompanied by the small carbon isotope effects indicates that the transition state is unsymmetrical. It is worth noting that an unsymmetrical transition state with substantial nitrogen-nitrogen bond rupture and a small carbon isotope effect was also found for the acid-catalyzed *ortho,ortho'*-rearrangement of the closely related 2,2'-hydrazonaphthalene (*vide supra*). The nitrogen isotope effect for the 2,2'-hydrazonaphthalene rearrangement is approximately twice that for the *N*-naphthyl-*N*-phenylhydrazine rearrangement whereas the carbon-13 kinetic isotope effects are almost identical. The greater amount of nitrogen-nitrogen bond rupture in the transition state of the 2,2'-hydrazonaphthalene reaction has been attributed to the fact that the 2,2'-hydrazonaphthalene rearrangement is a two-proton reaction whereas the *N*-naphthyl-*N*-phenylhydrazine rearrangement requires only one proton. Another possibility is that nitrogen-nitrogen bond rupture has to be more advanced in the 2,2'-hydrazonaphthalene rearrangement so that the two large

naphthalene rings will be close enough to form the new carbon-carbon bond in the transition state.

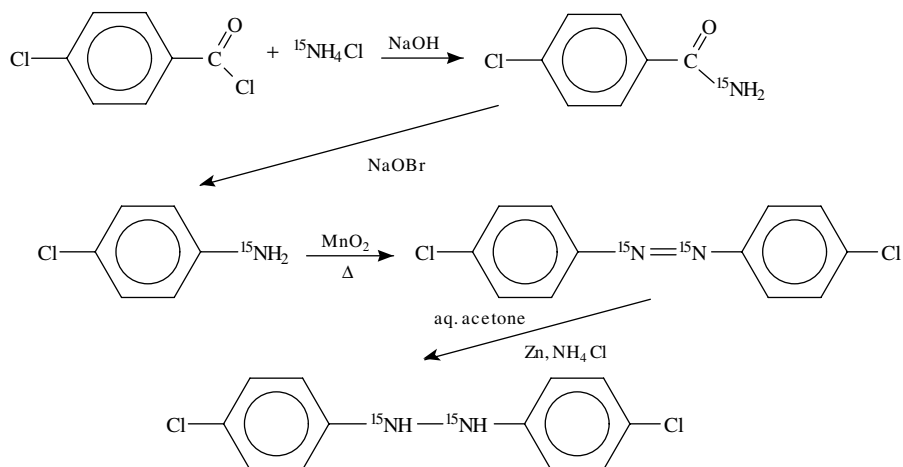
Rhee and Shine<sup>39</sup> used an impressive combination of nitrogen and carbon kinetic isotope effects to demonstrate that a quinonoidal-type intermediate is formed in the rate-determining step of the acid-catalyzed disproportionation reaction of 4,4'-dichlorohydrazobenzene (equation 26). When the reaction was carried out at 0 °C in 60% aqueous dioxane that was 0.5 M in perchloric acid and 0.5 M in lithium perchlorate, extensive product analyses indicated that the major pathway was the disproportionation reaction. In fact, the disproportionation reaction accounted for approximately 72% of the product (compounds **6** and **7**) while approximately 13% went to the *ortho*-semidine (**8**) and approximately 15% was consumed in the *para*-semidine (**9**) rearrangement.



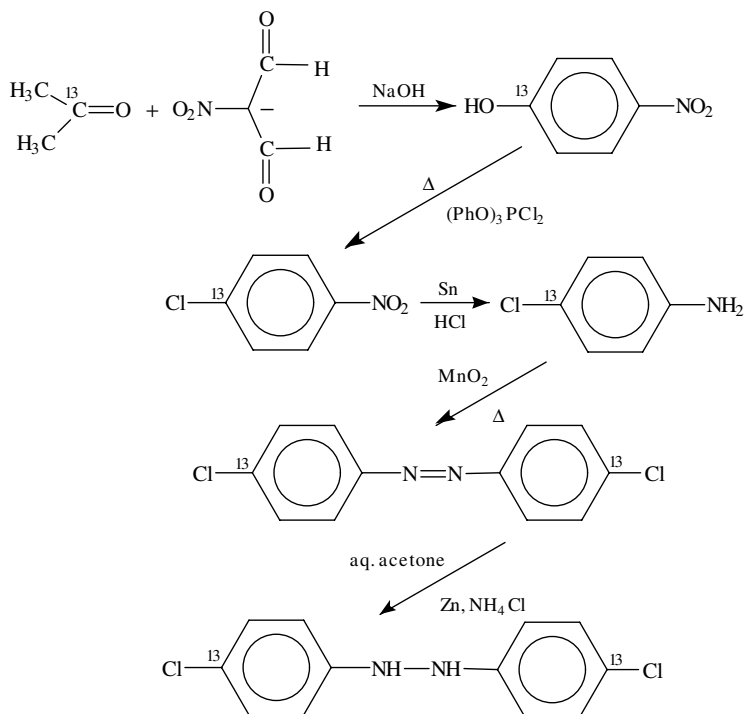
The doubly nitrogen-15 labelled substrate required for determining the nitrogen isotope effect for this reaction was obtained by the reactions shown in Scheme 23<sup>40</sup>. The series of reactions used in the synthesis of the [4,4'-<sup>13</sup>C<sub>2</sub>]-4,4'-dichlorohydrazobenzene is shown in Scheme 24<sup>40</sup>, and the preparation of the [2-<sup>14</sup>C]- and the [4-<sup>14</sup>C]-4,4'-dichlorohydrazobenzene are described in Schemes 25 and 26.

The reaction was second order in acid and first order in substrate, so both rearrangements and the disproportionation reaction proceed via the doubly-protonated hydrazobenzene intermediate formed in a rapid pre-equilibrium step. The nitrogen and carbon-13 kinetic isotope effects were measured to learn whether the slow step of each reaction was concerted or stepwise. The nitrogen and carbon-13 kinetic isotope effects were measured using whole-molecule isotope ratio mass spectrometry of the trifluoroacetyl derivatives of the amine products and by isotope ratio mass spectrometry on the nitrogen and carbon dioxide gases produced from the products. The carbon-12/carbon-14 isotope

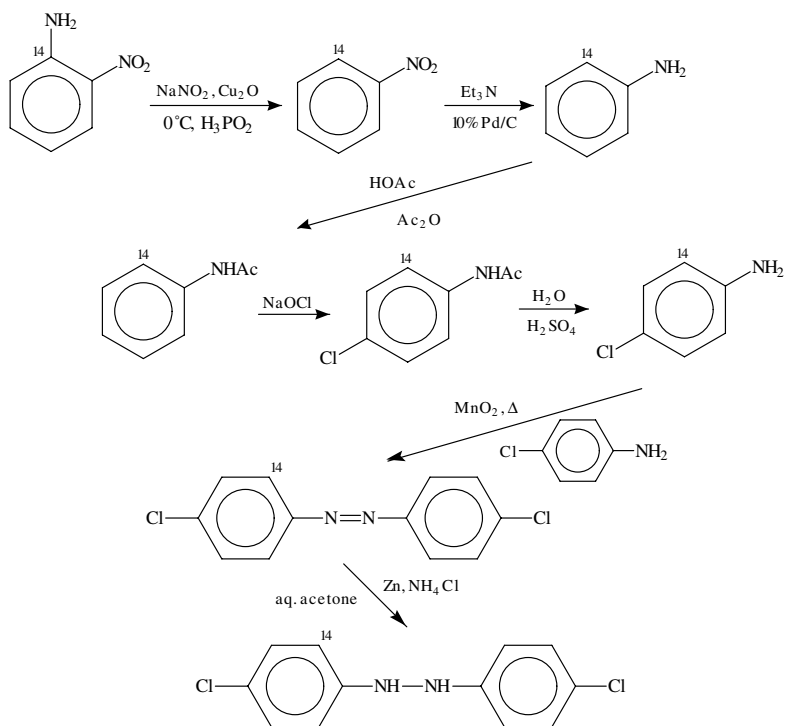




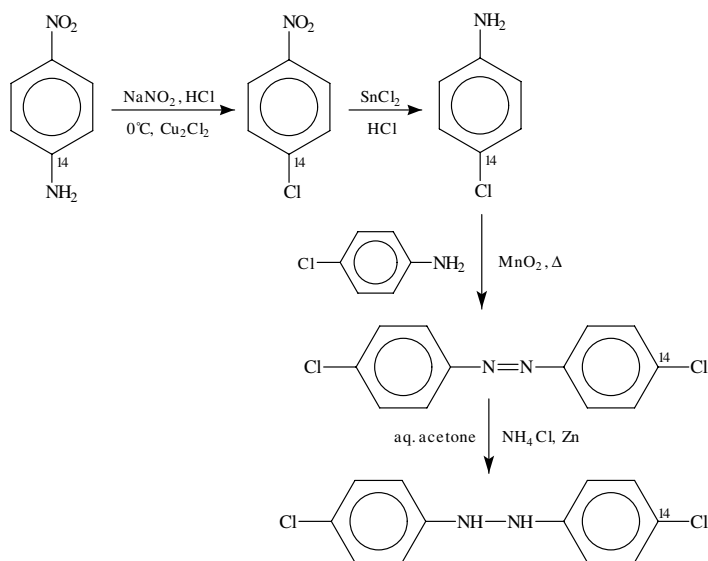
SCHEME 23



SCHEME 24



SCHEME 25



SCHEME 26

effects were determined by scintillation counting on the trifluoroacetyl derivatives of the products. The isotope effects for the formation of all three products are presented in Table 4.

The nitrogen isotope effects measured by whole-molecule isotope ratio mass spectrometry and by isotope ratio mass spectrometry are in excellent agreement, i.e. the  $^{15}\text{N}$ - $^{15}\text{N}$  kinetic isotope effect should be twice the  $^{15}\text{N}$  kinetic isotope effect for the formation of the disproportionation product and the *para*-semidine. The large nitrogen isotope effects indicate that there is substantial nitrogen-nitrogen bond rupture in the transition state of the rate-determining step for the formation of all three products. However, all of the carbon isotope effects are, within experimental error, unity and the obvious conclusion is that there is no concomitant carbon-carbon bond formation in the transition states of any of these reactions. The authors believe this simple explanation is correct for the formation of the *ortho*-semidine which would occur via an unacceptable concerted 1,3-sigmatropic shift that contravenes orbital-symmetry requirements. However, they are less willing to accept the obvious interpretation for the *para*-semidine reaction. The authors suggest that the lack of a carbon isotope effect in the formation of the *para*-semidine (**9**) might be observed because of the cancellation of two isotope effects. This seemed possible because the formation of **9** could arise by an allowed concerted 1,5-sigmatropic shift. Finally, the disproportionation reaction is thought to proceed by a multistep mechanism where the formation of the 4,4'-quinonoidal intermediate **10** (equation 27) is the slow step of the reaction. The *para*-semidine and the disproportionation products are then formed by a rapid oxidation of **10** by a second molecule of starting material (equations 28 and 29), respectively.

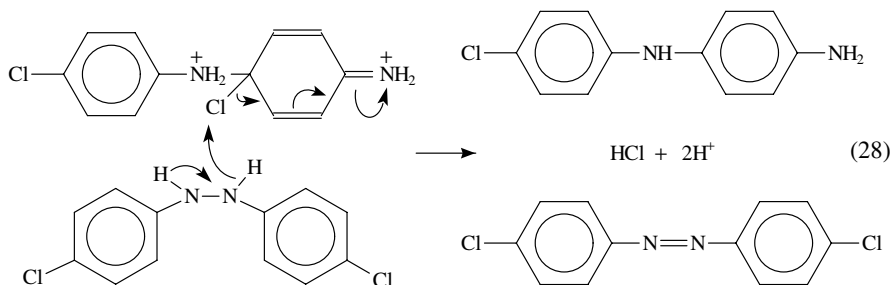
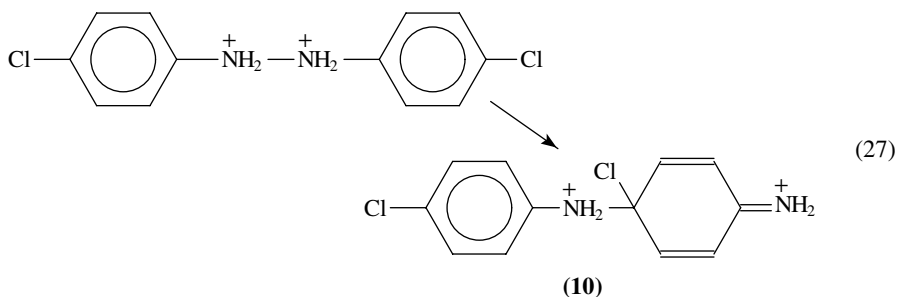


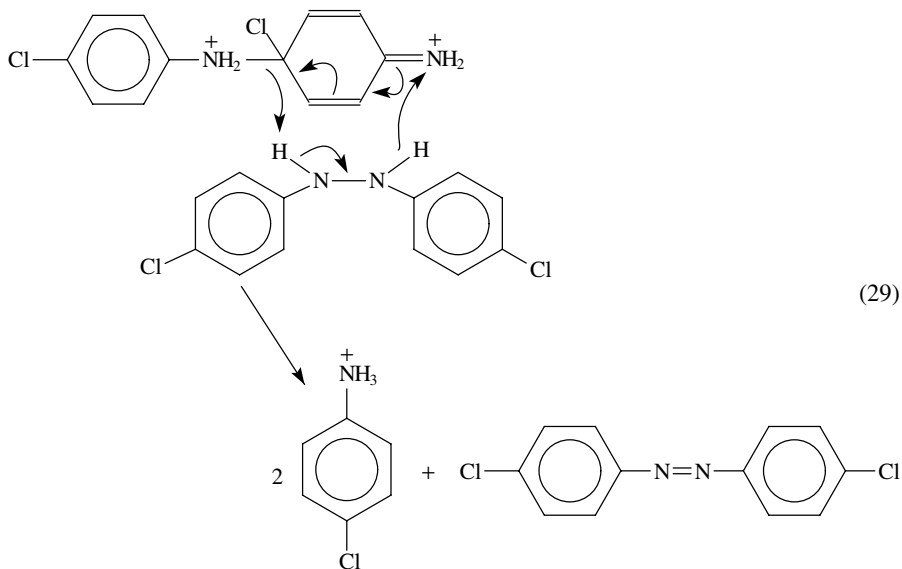
TABLE 4. The nitrogen, carbon-13 and carbon-14 kinetic isotope effects found for the acid-catalyzed formation of the disproportionation product, the *ortho*-semidine and the *para*-semidine at 0 °C in 60% aqueous dioxane that was 0.5 M in perchloric acid and 0.5 M in lithium perchlorate

Reaction	Isotope effect					
	$^{15}\text{N}-^{15}\text{N}^a$	$^{15}\text{N}^b$	$(^{15}\text{N})^2_{\text{calc}}$	$4,4'-^{13}\text{C}_2^b$	$2-^{14}\text{C}^c$	$4-^{14}\text{C}^c$
Disproportionation	1.026 ± 0.003	1.014 ± 0.0015	1.028	1.002 ± 0.002	1.000 ± 0.001	0.997 ± 0.002
<i>o</i> -Semidine	—	1.0155 ± 0.0003	—	0.9993 ± 0.0009	1.000 ± 0.002	1.003 ± 0.004
<i>p</i> -Semidine	1.028 ± 0.007	1.0162 ± 0.0005	1.033	0.997 ± 0.003	—	1.001 ± 0.003

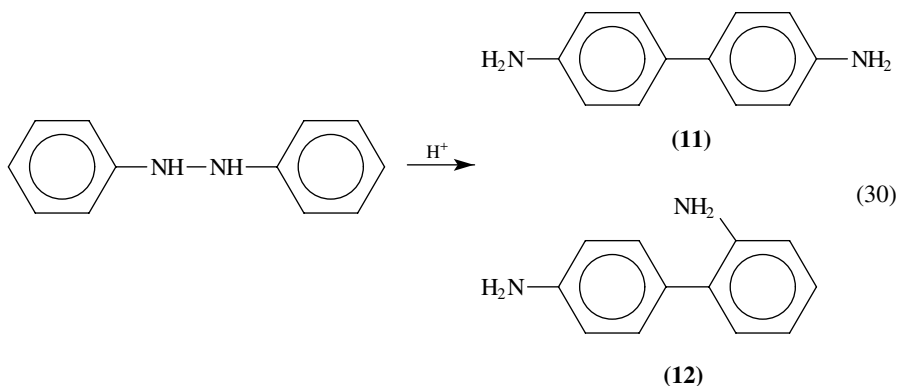
<sup>a</sup>These  $^{15}\text{N}-^{15}\text{N}$  kinetic isotope effects were measured by whole-molecule isotope ratio mass spectrometry.

<sup>b</sup>These  $^{15}\text{N}$  and  $^{12}\text{C}/^{13}\text{C}$  kinetic isotope effects were determined by isotope ratio mass spectrometry.

<sup>c</sup>These  $^{12}\text{C}/^{14}\text{C}$  kinetic isotope effects were determined by scintillation counting.



The most recent addition to Shine's extensive study of the benzidine-type rearrangements<sup>41</sup> involved remeasuring the nitrogen and the carbon-13 and carbon-14 kinetic isotope effects at the 4- and at the 4'-carbons as well as determining the carbon-13 and carbon-14 isotope effects at the 1- and at the 1'-carbons in the benzidine rearrangement of hydrazobenzene (equation 30). The reaction, which was carried out in 75% aqueous ethanol that was 0.1 M in hydrochloric acid and 0.3 M in lithium chloride at 0°C, gave an 86% yield of benzidine (**11**) and a 14% yield of diphenylene (**12**). The kinetic isotope effects found for the formation of benzidine and diphenylene under these reaction conditions are presented in Table 5.



The significant nitrogen, carbon-13 and carbon-14 kinetic isotope effects at the 4- and at the 4 and 4'-positions for the formation of benzidine (**11**) indicate that benzidine is formed in a concerted reaction. The small, but real, carbon-13 and carbon-14 kinetic

TABLE 5. The nitrogen, carbon-13 and carbon-14 kinetic isotope effects found for the acid-catalyzed benzidine rearrangement of hydrazobenzene in 75% aqueous ethanol that was 0.1 M in hydrochloric acid and 0.3 M in lithium chloride at 0 °C

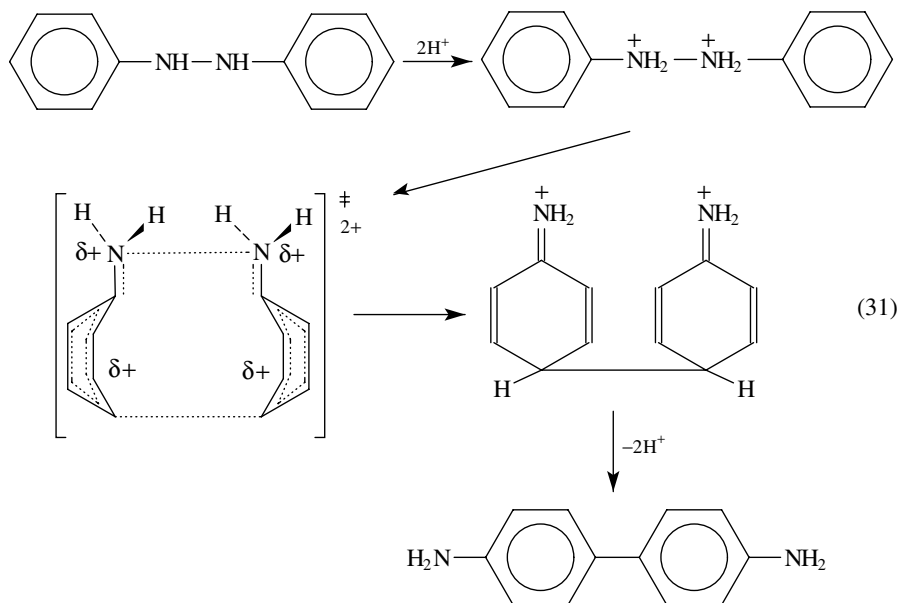
Substrate <sup>a</sup>	Isotope effect	Benzidine	Diphenylene
<sup>15</sup> N, <sup>15</sup> N'	$k^{14}/k^{15}$	$1.0410 \pm 0.0009^b$	$1.0367 \pm 0.0009^b$
4,4'- <sup>13</sup> C <sub>2</sub>	$k^{12}/k^{13}$	$1.0127 \pm 0.0011^b$	$1.001 \pm 0.001^b$
4- <sup>14</sup> C	$k^{12}/k^{14}$	$1.0121 \pm 0.0008^c$	$1.001 \pm 0.001^c$
1,1'- <sup>13</sup> C <sub>2</sub>	$k^{12}/k^{13}$	$1.0035 \pm 0.0010^b$	$1.000 \pm 0.003^b$
1- <sup>14</sup> C	$k^{12}/k^{14}$	$1.0051 \pm 0.0017^c$	$0.999 \pm 0.002^c$

<sup>a</sup>The preparation of these labelled substrates has been described previously.

<sup>b</sup>The nitrogen and carbon-13 kinetic isotope effects found using the <sup>15</sup>N-<sup>15</sup>N, the 1,1'-<sup>13</sup>C<sub>2</sub> and the 4,4'-<sup>13</sup>C<sub>2</sub> substrates were measured by whole-molecule isotope ratio mass spectrometry on the bis-(trifluoroacetyl) derivative.

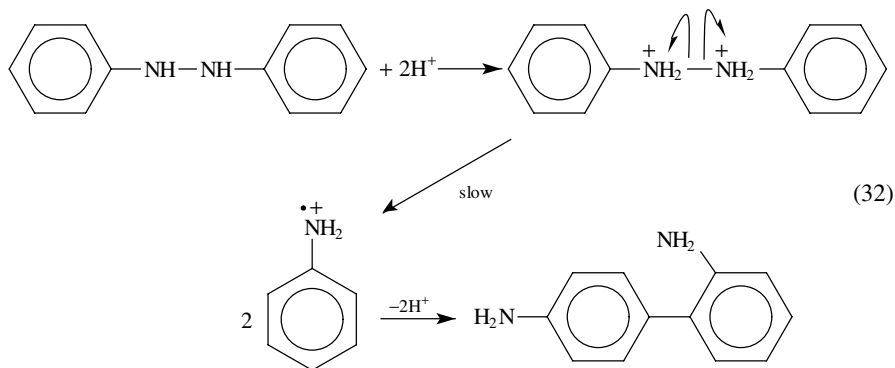
<sup>c</sup>The carbon-12/carbon-14 kinetic isotope effects found using the 1-<sup>14</sup>C and the 4-<sup>14</sup>C substrates were determined by scintillation counting on the bis-(trifluoroacetyl) derivative.

isotope effects found at the 1- and the 1- and 1'-positions in the formation of benzidine also suggest a concerted mechanism for the formation of benzidine. The reasonably large nitrogen isotope effect and small carbon isotope effects indicate that nitrogen–nitrogen bond rupture is well advanced compared to carbon–carbon bond formation, i.e. both the nitrogen–nitrogen and the carbon–carbon bonds are long and weak in the transition state of the rearrangement reaction forming benzidine (equation 31).



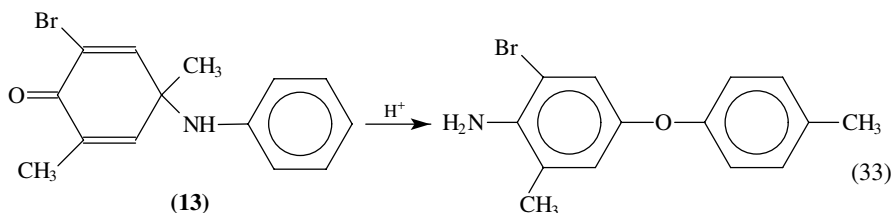
The absence of both carbon-13 and carbon-14 kinetic isotope effects at the 1-, the 1- and the 1'-, the 4- and the 4- and 4'-carbons in the formation of diphenylene (**12**) confirms beyond any doubt that this compound is formed in a two-step rearrangement. Thus, the nitrogen–nitrogen bond ruptures in the slow step of the reaction and then the product is

formed in a fast intramolecular step (equation 32).



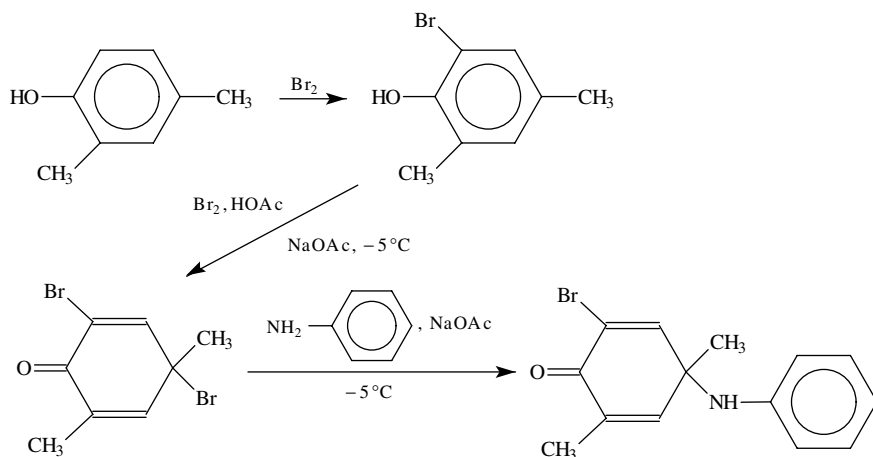
Finally, it is interesting that the nitrogen isotope effects for the formation of benzidine and diphenylene are almost identical. This suggests that both reactions have almost the same amount of nitrogen-nitrogen bond rupture in the transition state of the rate-determining step.

Boduszek and Shine<sup>42</sup> studied the acid-catalyzed quinamine rearrangement of the quinamine, 6-bromo-2,4-dimethyl-4-(phenylamino)cyclohexa-1,4-dienone (**13**), to 4'-amino-6-bromo-2,4-dimethyldiphenyl ether (equation 33). This study involved synthesizing the quinamine **13** (Scheme 27) labelled at (i) the nitrogen with nitrogen-15, (ii) the *para*-position of the phenyl ring with carbon-14, (iii) the *ortho* position of the phenyl ring with carbon-14 and (iv) the carbonyl oxygen with oxygen-18.



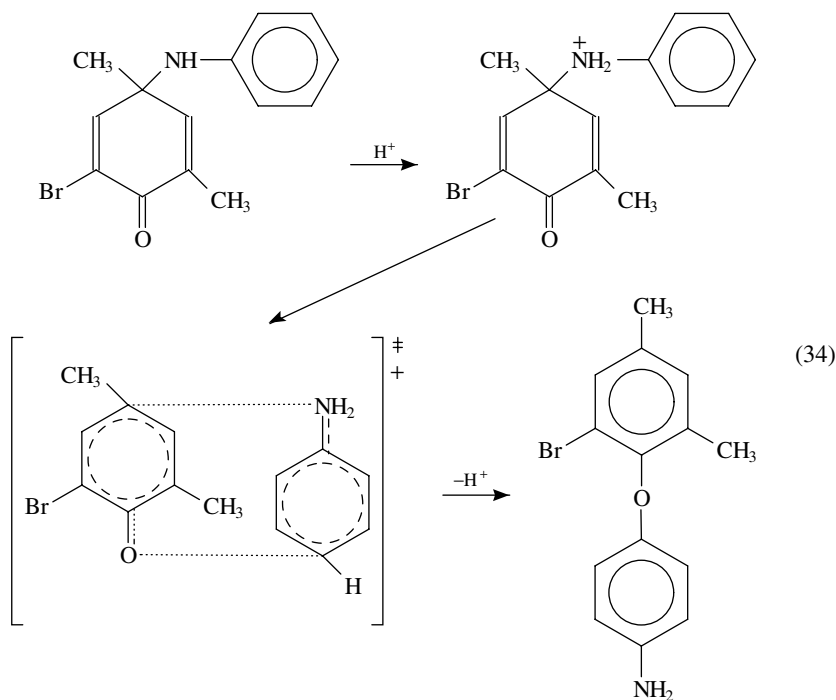
The labelled substrates required for this study were obtained by substituting (i) the commercially available  $^{15}\text{N}$ -aniline, (ii) the  $[4\text{-}^{14}\text{C}]$ aniline prepared by deaminating the commercially available 4-nitro $[1\text{-}^{14}\text{C}]$ aniline and reducing the nitro group with tin and HCl, (iii) the  $[2\text{-}^{14}\text{C}]$ aniline formed by reducing the commercially available  $[2\text{-}^{14}\text{C}]$ nitrobenzene with tin and HCl and (iv) the 2,4-dimethyl $[^{18}\text{O}]$ phenol, respectively, in the synthesis described in Scheme 27. The 2,4-dimethyl $[^{18}\text{O}]$ phenol was synthesized by diazotizing 2,4-dimethylaniline with sodium nitrite and fluoroboric acid and treating the diazonium salt with oxygen-18 labelled water.

Miller<sup>43</sup> showed that the quinamine rearrangement was intramolecular and that the reaction was first order in both the quinamine and acid. The isotope effects found for this quinamine rearrangement were measured in 83.3% aqueous methanol at 25 °C. The nitrogen isotope effect of 1.0089, the oxygen-18 isotope effect of 1.0399 and the carbon-14 isotope effect of 1.0501 at carbon-4 of the phenyl ring, found for this quinamine rearrangement, show that the nitrogen-carbon-1 bond is breaking and that the carbon-4-oxygen bond is forming in the transition state of the rate-determining step of this reaction. This clearly indicates that the quinamine rearrangement is concerted. However, the nitrogen



SCHEME 27

kinetic isotope effect is much smaller than either the oxygen-18 or the carbon-14 isotope effect at carbon-4 of the phenyl ring. This suggests the slow step of the quinamine rearrangement involves a [5,5]sigmatropic shift via an unsymmetrical transition state with only a slight amount of carbon–nitrogen bond rupture but extensive carbon–oxygen bond formation (equation 34).





Finally, although a very small inverse  $k^{12}/k^{14}$  isotope effect of  $0.990 \pm 0.008$  was found when the substrate with carbon-14 at the 2-position of the phenyl ring was used, the authors concluded that there was no carbon-14 isotope effect in the quinamine rearrangement to the phenyl ether. This was expected because no bond forms at carbon-2 in the transition state of the concerted [5,5]sigmatropic rearrangement. The authors attributed this very small inverse isotope effect of 0.990 to a large  $k^{12}/k^{14} = 1.07$  that was observed for the formation of a side product. The faster reaction of carbon-12 in forming the side product would enrich the unreacted substrate in carbon-14 and lead to the inverse isotope effect.

#### IV. USING KINETIC ISOTOPE EFFECTS TO MODEL THE $S_N2$ TRANSITION STATES FOR REACTIONS INVOLVING QUATERNARY AMMONIUM SALTS

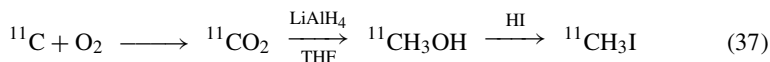
##### A. The Menshutkin Reaction

Matsson and coworkers have measured the carbon-11/carbon-14 kinetic isotope effects for several Menshutkin reactions (equation 35) in an attempt to model the  $S_N2$  transition state for this important class of organic reaction. These isotope effects are unusual because they are based on the artificially-made radioactive carbon-11 isotope. The radioactive carbon-11 isotope is produced in a cyclotron or linear accelerator by bombarding nitrogen-14 atoms with between 18- and 30-MeV protons (equation 36).



The  $^{11}\text{C}$  decays with a half-life of 20.34 minutes, to  $^{11}\text{B}$ , by emitting a positron that can be detected in a scintillation counter. In spite of the difficulties in producing the carbon-11 isotope, preparing the labelled substrate and carrying out the reaction in a very short time, these carbon-11/carbon-14 kinetic isotope effects are a very useful addition to the arsenal of tools available to the physical organic chemist. This is because the difference in mass between the carbon isotopes is three in a mass of only eleven. As a result, these isotope effects can be as large as 25%, which is in the range of some of the larger secondary hydrogen-deuterium kinetic isotope effects. This means that these extremely large heavy-atom kinetic isotope effects should be capable of detecting very small changes in the structure of  $S_N2$  transition states.

The first report of this new type of kinetic isotope effect in a Menshutkin reaction was published by Matsson and coworkers in 1987<sup>44</sup>. In this study, the alpha carbon  $k^{11}/k^{14}$  kinetic isotope effect was measured for the Menshutkin reaction between *N,N*-dimethyl-*para*-toluidine and labelled methyl iodide in methanol at 30 °C (equation 35). The carbon-11 labelled methyl iodide required for this study was prepared from the  $^{11}\text{C}$  atoms produced in the cyclotron in three steps<sup>45</sup> (equation 37).



The carbon-14 labelled methyl iodide used to measure the  $k^{11}/k^{14}$  was commercially available.

The very large carbon-11/carbon-14 isotope effect of  $1.202 \pm 0.008$  is almost twice the magnitude of the carbon-12/carbon-14 isotope effect of  $1.12 \pm 0.01$  measured for the same reaction at  $48.5^\circ\text{C}$ . This clearly illustrates the usefulness of this new type of very large heavy-atom isotope effect. A comparison of these two isotope effects is possible using the Swain–Schaad equation<sup>33</sup>. If one estimates the value of the  $k^{11}/k^{14}$  isotope effect using the Swain–Schaad equation<sup>33</sup> and the  $k^{12}/k^{14} = 1.12$ , the  $k^{11}/k^{14}$  isotope effect should be 1.21. Given that the Swain–Schaad equation is only approximate, the agreement with the observed  $k^{11}/k^{14} = 1.0202$  is excellent and it is safe to conclude that the Menshutkin reaction has a very large alpha carbon isotope effect and a fairly symmetrical transition state. Matsson and coworkers also used BEBOVIB IV calculations to model the transition state for this reaction<sup>46</sup>. The calculations and their observed  $k^{11}/k^{14} = 1.0202$  suggested that the transition state is early with a nitrogen–alpha carbon bond order of approximately 0.3 and an alpha carbon–iodide bond order of approximately 0.7.

It is worth noting that Yamataka and coworkers<sup>47</sup> also found large (near the theoretical maximum) alpha carbon kinetic isotope effects for the Menshutkin reactions between 3,5-disubstituted pyridines and methyl iodide (equation 38, Table 6).

Although the alpha carbon kinetic isotope effects increase slightly as more electron-withdrawing substituents are added to the nucleophile, they are all large and effectively constant for a wide range of nucleophiles. For example, the isotope effect only changes by 0.013 when the rate constant decreases 340 times, i.e. the rate of the reaction with 3,5-dimethylpyridine is 340 times larger than the rate of the reaction with 3,5-dichloropyridine. This suggests that the transition state for the Menshutkin reaction is not very susceptible to changes in the structure of the reactants.

Other types of kinetic isotope effects have been measured in an attempt to determine the structure of the transition states of Menshutkin reactions. For example, Bourns and Hayes<sup>1</sup> and Kurz and coworkers<sup>48,49</sup> found very small incoming nucleophile nitrogen kinetic isotope effects in Menshutkin reactions (Table 7). These very small isotope effects, which are only slightly larger than the error of the measurements, are not affected significantly by a change in the leaving group, the solvent or even the substrate. It is important to note, however, that these very small incoming nucleophile nitrogen kinetic isotope effects indicate that the transition state is early with only a small amount of nitrogen–alpha carbon bond formation. In fact, BEBOVIB IV calculations suggest that the nitrogen–alpha carbon bond order in these transition states is between 0.2 and 0.3. This is in excellent agreement with the results from Matsson's BEBOVIB IV calculations<sup>46</sup>.

Other workers have concluded that the transition state for the Menshutkin reaction is late with more nitrogen–alpha carbon bond formation than alpha carbon–leaving group bond rupture. For instance, Harris and coworkers<sup>51</sup> found that the secondary alpha deuterium kinetic isotope effects (Table 8) decreased when a poorer nucleophile was used in the  $S_N2$  reactions between 3,5-disubstituted pyridines and methyl iodide in 2-nitropropane at  $25^\circ\text{C}$  (equation 38, Table 8).

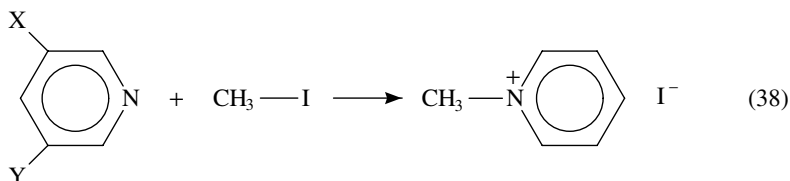


TABLE 6. The alpha carbon-12-carbon-13 kinetic isotope effects for the Menshutkin reaction between 3,5-disubstituted pyridines and methyl iodide in 2-nitropropane at 25 °C

3-X	5-Y	$(k^{12}/k^{13})_{\alpha}$
CH <sub>3</sub>	CH <sub>3</sub>	1.063 ± 0.004
CH <sub>3</sub>	H	1.062 ± 0.002
H	H	1.066 ± 0.005
Cl	H	1.074 ± 0.002
Cl	Cl	1.076 ± 0.016

TABLE 7. The incoming nucleophile nitrogen kinetic isotope effects in Menshutkin reactions with various amines in several solvents

Nucleophile (amine)	Substrate	Solvent	$k^{14}/k^{15}^a$
4-Methylpyridine	CH <sub>3</sub> OMs	H <sub>2</sub> O	0.9969
	CH <sub>3</sub> OTf	MeCN	0.9937
Pyridine	CH <sub>3</sub> OMs	H <sub>2</sub> O	0.9971
	CH <sub>3</sub> OTs	H <sub>2</sub> O	0.9978
	CH <sub>3</sub> OTf	H <sub>2</sub> O	0.9965
	CH <sub>3</sub> OTs	H <sub>2</sub> O	0.9978
	CH <sub>3</sub> OTf	H <sub>2</sub> O	0.9965
	CH <sub>3</sub> OTs	H <sub>2</sub> O	0.9978
	CH <sub>3</sub> OTf	H <sub>2</sub> O	0.9965
	CH <sub>3</sub> OTf	MeCN	0.9946
	CH <sub>3</sub> OTf	DCE	0.9942
	CH <sub>3</sub> Cl	H <sub>2</sub> O	0.9960
	CH <sub>3</sub> Br	H <sub>2</sub> O	0.9972
	CH <sub>3</sub> I	H <sub>2</sub> O	0.9950
	CH <sub>3</sub> Th <sup>+</sup>	H <sub>2</sub> O	0.9976
CH <sub>3</sub> Th <sup>+</sup>	MeCN	0.9964	
3-Acetylpyridine	CH <sub>3</sub> OMs	H <sub>2</sub> O	0.9972
	CH <sub>3</sub> OBBr	H <sub>2</sub> O	0.9972
2,6-Dimethylpyridine	CH <sub>3</sub> OMs	H <sub>2</sub> O	0.9978
	CH <sub>3</sub> OTs	H <sub>2</sub> O	0.9977
	CH <sub>3</sub> OTf	MeCN	0.9941
Quinuclidine	CH <sub>3</sub> OMs	H <sub>2</sub> O	1.0002 <sup>b</sup>
	CH <sub>3</sub> OMs	MeCN	0.9962 <sup>b</sup>
<i>N,N</i> -Dimethyl-4-toluidine	CH <sub>3</sub> OMs	MeCN (wet)	1.0024 <sup>b</sup>
	CH <sub>3</sub> OMs	MeCN	1.0027 <sup>b</sup>
	BzOBs	Me <sub>2</sub> C=O	1.0028 <sup>c</sup>
Et <sub>3</sub> N	CH <sub>3</sub> I	Benzene	1.0009 <sup>d</sup>
	CH <sub>3</sub> CH <sub>2</sub> I	Benzene	1.0015 <sup>d</sup>
Me <sub>3</sub> N	CH <sub>3</sub> CH <sub>2</sub> Br	Benzene	0.9991 <sup>d</sup>

<sup>a</sup>Reference 48.<sup>b</sup>Reference 49.<sup>c</sup>Reference 50.<sup>d</sup>Reference 1.

TABLE 8. The secondary alpha hydrogen–deuterium kinetic isotope effects for the Menshutkin reaction between 3,5-disubstituted pyridines and methyl iodide in 2-nitropropane at 25 °C

3-X	5-Y	$(k_H/k_D)_{\alpha}$
CH <sub>3</sub>	CH <sub>3</sub>	0.908
CH <sub>3</sub>	H	0.851
H	H	0.850
Cl	H	0.835
Cl	Cl	0.810

The important observation is that all of the isotope effects are large and inverse. Thus, the transition states in these reactions must obviously be very crowded, i.e. the  $C_\alpha-H(D)$  out-of-plane bending vibrations in the transition state must be high energy<sup>19</sup>. As a result, these workers concluded that nitrogen–alpha carbon bond formation is more advanced than alpha carbon–iodine bond rupture in the transition state. It is interesting, however, that these authors also concluded that the  $N-C_\alpha$  bond formation is approximately 30% complete in the transition state.

In another study, Paneth and O'Leary<sup>52</sup> measured the incoming nucleophile nitrogen and the secondary alpha hydrogen–deuterium kinetic isotope effects for the Menshutkin reaction between *N,N*-dimethyl-*para*-toluidine and methyl iodide in methanol at 25 °C. They found a very small nitrogen kinetic isotope effect of  $1.0019 \pm 0.001$  in good agreement with the isotope effects reported by Kurz and coworkers<sup>48,49</sup>. The secondary alpha deuterium kinetic isotope effect for this reaction was  $0.83 \pm 0.04$ , in good agreement with the isotope effects reported by Harris and coworkers<sup>51</sup>. This indicated that the transition state was symmetrical or slightly late with nitrogen–alpha carbon bond formation advanced with respect to alpha carbon–iodide bond rupture.

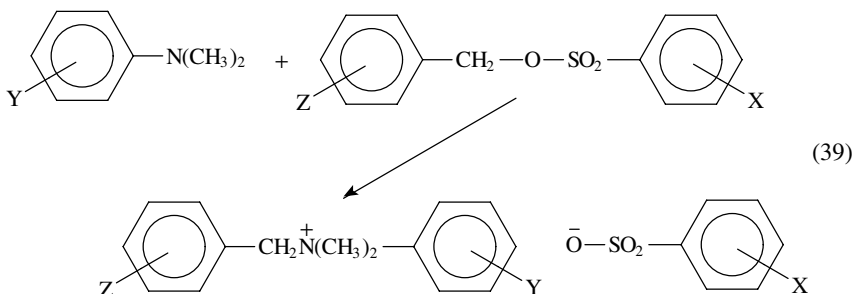
Ando, Tanabe and Yamataka<sup>53</sup> measured both the carbon-12/carbon-14 and the secondary alpha hydrogen–tritium kinetic isotope effects for the Menshutkin reactions between substituted *N,N*-dimethylanilines and substituted benzyl benzenesulfonates in acetone at 35 °C (equation 39). They found large carbon-12/carbon-14 isotope effects and small secondary alpha tritium isotope effects for these reactions (Table 9). The carbon-12/carbon-14 isotope effects for these reactions are all large, i.e. they are near the theoretical maximum for these isotope effects. Thus, these isotope effects agree, in general, with the large  $k^{11}/k^{14}$  isotope effect reported by Matsson and coworkers (*vide supra*). It is important to note that the carbon isotope effects go through a maximum when the leaving group is changed in the reactions between benzyl *para*-substituted benzenesulfonates and *N,N*-dimethyl-*para*-toluidine. This was the first illustration that alpha carbon kinetic isotope effects in  $S_N2$

TABLE 9. The carbon-12/carbon-14 and secondary alpha hydrogen–tritium kinetic isotope effects for the  $S_N2$  reactions between Y-substituted *N,N*-dimethylanilines and Z-substituted benzyl X-substituted benzenesulfonates in acetone at 35 °C<sup>a</sup>

Y	X	Z = <i>m</i> -Br		Z = H	
		$k^{12}/k^{14}$	$(k_H/k_T)_\alpha$	$k^{12}/k^{14}$	$(k_H/k_T)_\alpha$
<i>p</i> -CH <sub>3</sub> O	<i>p</i> -Cl	1.130	1.033	1.142	1.061
<i>p</i> -CH <sub>3</sub> O	H			1.140	
<i>p</i> -CH <sub>3</sub> O	<i>p</i> -CH <sub>3</sub>			1.148	
<i>p</i> -CH <sub>3</sub>	<i>m</i> -NO <sub>2</sub>	1.151	1.041	1.119	1.056
<i>p</i> -CH <sub>3</sub>	<i>p</i> -Cl	1.148	1.026	1.149	1.055
<i>p</i> -CH <sub>3</sub>	H	1.137	1.030	1.162	1.043
<i>p</i> -CH <sub>3</sub>	<i>p</i> -CH <sub>3</sub>	1.141	1.031	1.156	1.033
<i>p</i> -CH <sub>3</sub>	<i>p</i> -CH <sub>3</sub> O	1.141		1.147	1.035
H	<i>m</i> -NO <sub>2</sub>			1.158	
H	<i>p</i> -Cl			1.143	1.042
H	H			1.135	
<i>m</i> -CH <sub>3</sub>	<i>p</i> -Cl	1.129			
<i>p</i> -Br	<i>p</i> -Cl	1.117	1.033	1.139	1.048
<i>m</i> -NO <sub>2</sub>	<i>m</i> -NO <sub>2</sub>			1.127	

<sup>a</sup>The errors in the  $k^{12}/k^{14}$  are between  $\pm 0.003$  and  $\pm 0.005$  while those for the  $(k_H/k_T)_\alpha$  range from  $\pm 0.008$  to  $\pm 0.012$ .

reactions pass through a maximum as the theoretical calculations suggested<sup>10,11</sup>.



The secondary alpha tritium isotope effects, on the other hand, are small. Benzyl substrates have looser  $S_N2$  transition states than methyl substrates (*vide infra*) and thus these reactions would be expected to have slightly larger isotope effects than methyl substrates. Thus, these tritium isotope effects are in general agreement with those found by Paneth and O'Leary<sup>52</sup> and by Harris and coworkers<sup>51</sup> in other Menshutkin reactions (*vide supra*). It is worth noting that the tritium isotope effects are smaller for the *meta*-bromobenzyl benzenesulfonates than for the benzyl benzenesulfonates. This is expected because the transition state is invariably tighter with a shorter nucleophile-leaving group distance, when a more electron-withdrawing substituent is on the phenyl ring on the alpha carbon. Finally, although the transition states in these Menshutkin reactions appear to be slightly looser than those found for the methyl substrates in other studies, these isotope effects are consistent with a transition state with significant nitrogen-alpha carbon bond formation and less alpha carbon-oxygen bond rupture.

The newest type of isotope effect that has been used to characterize the transition state of the Menshutkin reaction is a secondary incoming nucleophile hydrogen-deuterium kinetic isotope effect<sup>54</sup>. These isotope effects involve using primary amines labelled with deuterium at the nitrogen as the nucleophile (equation 40). In fact, Lee and collaborators<sup>54</sup> measured both the secondary alpha hydrogen-deuterium and the secondary hydrogen-deuterium incoming nucleophile kinetic isotope effects for four different Menshutkin reactions (Table 10). The secondary alpha deuterium isotope effects for the benzyl benzenesulfonate reactions are fairly large and normal, indicating that these reactions have a loose transition state with long nucleophile-alpha carbon and alpha carbon-leaving group bonds. The methyl and ethyl substrate reactions, on the other hand, have inverse secondary alpha deuterium isotope effects like those found in the other Menshutkin reactions (*vide supra*). These inverse isotope effects indicate that these reactions have tight transition states with short nucleophile-alpha carbon and alpha carbon-leaving group bonds.

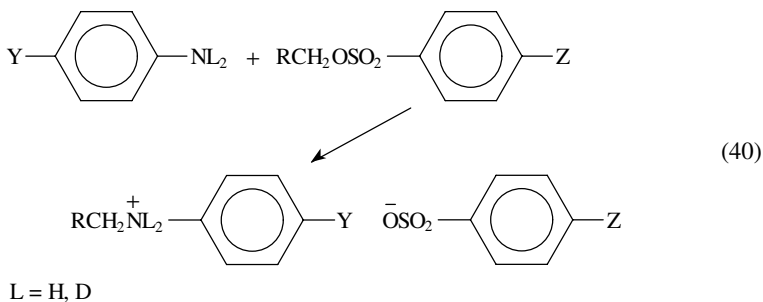


TABLE 10. The secondary alpha deuterium and secondary incoming nucleophile deuterium kinetic isotope effects found for the  $S_N2$  reactions between *para*-substituted anilines and benzylamines with benzyl, methyl and ethyl *para*-substituted benzenesulfonates in acetonitrile at 30 °C

Substituent on the nucleophile	<i>para</i> -Substituent on the leaving group	$(k_H/k_D)_\alpha$	$(k_H/k_D)_{\text{Nucl}}^a$
Benzyl <i>para</i> -substituted benzenesulfonates with <i>para</i> -substituted anilines			
<i>m</i> -NO <sub>2</sub>	CH <sub>3</sub>	1.089 ± 0.005	0.973
<i>p</i> -CH <sub>3</sub> O	CH <sub>3</sub>	1.096 ± 0.009	0.955
<i>m</i> -NO <sub>2</sub>	NO <sub>2</sub>	1.095 ± 0.010	0.951
<i>p</i> -CH <sub>3</sub> O	NO <sub>2</sub>	1.102 ± 0.010	0.898
Benzyl <i>para</i> -substituted benzenesulfonates with <i>para</i> -substituted benzylamines			
<i>m</i> -NO <sub>2</sub>	CH <sub>3</sub>	—	0.966
<i>p</i> -CH <sub>3</sub> O	CH <sub>3</sub>	—	0.952
<i>m</i> -NO <sub>2</sub>	NO <sub>2</sub>	—	0.953
<i>p</i> -CH <sub>3</sub> O	NO <sub>2</sub>	—	0.940
Methyl <i>para</i> -substituted benzenesulfonates with <i>para</i> -substituted anilines			
<i>m</i> -NO <sub>2</sub>	CH <sub>3</sub>	0.971 ± 0.009	0.963 ± 0.009 <sup>b</sup>
<i>p</i> -CH <sub>3</sub> O	CH <sub>3</sub>	0.990 ± 0.008	0.978 ± 0.008 <sup>b</sup>
<i>m</i> -NO <sub>2</sub>	NO <sub>2</sub>	0.974 ± 0.007	0.968 ± 0.009 <sup>b</sup>
<i>p</i> -CH <sub>3</sub> O	NO <sub>2</sub>	0.993 ± 0.007	0.984 ± 0.007 <sup>b</sup>
Ethyl <i>para</i> -substituted benzenesulfonates with <i>para</i> -substituted anilines			
<i>m</i> -NO <sub>2</sub>	CH <sub>3</sub>	0.963 ± 0.009	0.851 <sup>b</sup>
<i>p</i> -CH <sub>3</sub> O	CH <sub>3</sub>	0.978 ± 0.008	0.862 <sup>b</sup>
<i>m</i> -NO <sub>2</sub>	NO <sub>2</sub>	0.968 ± 0.009	0.858 <sup>b</sup>
<i>p</i> -CH <sub>3</sub> O	NO <sub>2</sub>	0.984 ± 0.007	0.869 <sup>b</sup>

<sup>a</sup>The authors did not give error limits for most of these isotope effects. They imply that the error is less than 1%.

<sup>b</sup>At 65 °C.

The secondary incoming nucleophile deuterium kinetic isotope effects are all inverse. This is because both the N–H(D) bending and stretching vibrations become higher in energy in the transition state as the steric crowding increases (the nitrogen–alpha carbon bond forms). Obviously, when the nitrogen–alpha carbon bond formation is more complete in the transition state, the steric crowding around the N–H(D) bonds will be greater and the isotope effect will be more inverse. Thus, these new isotope effects are useful because they indicate the degree of nitrogen–alpha carbon bond formation in the transition state.

The authors concluded that the transition states for the Menshutkin reactions of the benzyl substrates were early (reactant-like) with nitrogen–alpha carbon bond formation lagging behind alpha carbon–oxygen bond rupture. The transition states for the Menshutkin reactions with the methyl and ethyl substrates, on the other hand, are tight (product-like) with nitrogen–alpha carbon bond formation greater than alpha carbon–oxygen bond rupture.

Finally, it is worth noting that the substituent effects are different on the two types of Menshutkin reactions as well. For the benzyl substrates, changing to a better nucleophile, i.e. changing the substituent on the nucleophile from the *meta*-nitro to a *para*-methoxy substituent, leads to a later, more product-like transition state with more inverse secondary incoming nucleophile deuterium kinetic isotope effects. However, the same change in nucleophile in the reactions with the methyl and ethyl substrates leads to an earlier transition state and less inverse secondary incoming nucleophile deuterium kinetic isotope effects.

TABLE 11. The carbon-11/carbon-14 kinetic isotope effects for the  $S_N2$  reactions between several amine nucleophiles and the labelled methyl iodide in dimethoxyethane or acetonitrile at 15 °C and 30 °C, respectively

Nucleophile	Solvent	Temperature	$k^{11}/k^{14}$	$pK_a$
$(CH_3CH_2)_3N$	DME	15.00	$1.221 \pm 0.006$	10.65
Quinuclidine	DME	15.00	$1.220 \pm 0.005$	10.95
2,6-Lutidine	acetonitrile	30.00	$1.220 \pm 0.009$	6.77
2,4-Lutidine	acetonitrile	30.00	$1.189 \pm 0.012$	6.72

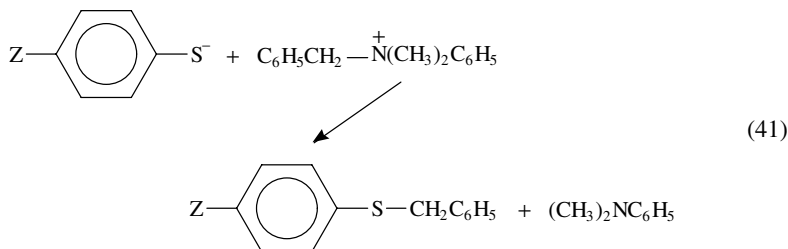
Finally, Persson, Berg and Matsson<sup>55</sup> measured the  $k^{11}/k^{14}$  isotope effects for the  $S_N2$  reactions between several amine nucleophiles and labelled methyl iodide in dimethoxyethane or acetonitrile at 15 °C and 30 °C, respectively, to determine how sterically crowded nucleophiles affected the structure of the transition state of a Menshutkin reaction. The results in Table 11 show that the  $k^{11}/k^{14}$  isotope effects for these reactions are large. In fact, they are all near the theoretical maximum value for these isotope effects. Secondly, the isotope effect for the reaction with the more sterically hindered amine, 2,6-lutidine, is larger than that for the less sterically hindered 2,4-lutidine. It is worth noting that 2,6-lutidine and 2,4-lutidine have almost the same  $pK_a$ , so there is little or no electronic effect in these reactions. Le Noble and Miller<sup>56</sup> found a larger chlorine leaving group isotope effect ( $k^{35}/k^{37} = 1.0038 \pm 0.0003$ ) for the 2,6-lutidine–methyl chloride reaction than for the corresponding pyridine reaction ( $k^{35}/k^{37} = 1.00355 \pm 0.00008$ ) in bromobenzene at 100 °C. Thus, it appears that the carbon–chlorine bond rupture is more advanced in the reaction with the more sterically crowded nucleophile, although the difference could be due to the fact that 2,6-lutidine is also a better nucleophile than pyridine. Also, the nitrogen incoming nucleophile kinetic isotope effects measured by Kurz and coworkers<sup>48,49</sup> and by Bourns and Hayes<sup>1</sup> (see above) indicated that nitrogen–alpha carbon bond formation is not well advanced in the transition state. These isotope effects suggest that the transition state for the reaction with the more sterically hindered nucleophile is loose with longer nitrogen–alpha carbon and alpha carbon–chlorine bonds. Finally, theoretical calculations also suggested a looser transition state should be found when a more sterically crowded nucleophile was used in this reaction, and the authors concluded that the transition state for these reactions were early but that the reaction, with the more sterically crowded nucleophile and the larger alpha carbon  $k^{11}/k^{14}$  isotope effect, was looser.

Unfortunately, the same trend in the  $k^{11}/k^{14}$  isotope effects is not observed in the triethylamine/quinuclidine reactions with methyl iodide, although it is possible that the identical isotope effects may be due to the cancellation of two effects, a steric effect and an electronic effect, i.e. triethylamine is both a stronger base and a more sterically crowded nucleophile. It is interesting that the chlorine leaving group kinetic isotope effects are also different for these two reactions. Swain and Hershey<sup>57</sup> found a larger chlorine leaving group isotope effect in the reaction of the less sterically hindered nucleophile, quinuclidine ( $k^{35}/k^{37} = 1.0071 \pm 0.0001$ ), than for the corresponding triethylamine–methyl chloride reaction ( $k^{35}/k^{37} = 1.00640 \pm 0.00009$ ).

## B. The $S_N2$ Reactions of Quaternary Ammonium Salts

Westaway and coworkers have measured the secondary alpha deuterium and nitrogen leaving group kinetic isotope effects for the  $S_N2$  reactions between thiophenoxide ions and benzyltrimethylphenylammonium ion to learn how ion-pairing, a change in solvent or substituents in the nucleophile, the substrate and the leaving group affect the structure of  $S_N2$  transition states.

In one study to determine how a change in nucleophile affected the structure of the  $S_N2$  transition state, the secondary alpha deuterium and nitrogen leaving group kinetic isotope effects for the  $S_N2$  reactions between several *para*-substituted thiophenoxide ions and benzyldimethylphenylammonium ion (equation 41) were measured at 0°C in DMF containing a high concentration of sodium nitrate to keep the ionic strength constant, so accurate rate constants could be determined<sup>58</sup>. Surprisingly, the nitrogen leaving group and the secondary alpha deuterium kinetic isotope effects for these reactions (Table 12) were identical. Two explanations for the identical secondary alpha deuterium and nitrogen kinetic isotope effects are possible. One possibility is that the transition states do not change when the substituent on the nucleophile is altered. This suggestion seems highly unlikely, however, because no one has observed this behavior in any study, and it is unreasonable to conclude that a change in nucleophile, which changes the rate constant by a factor of 6.4, would not alter the energy (structure) of the transition state, thereby causing a change in the isotope effects. The second, more likely, possibility is that the change in nucleophile changes the transition state but that the changes that occur in transition state structure do not cause a change in the isotope effect. If one assumes that the nitrogen leaving group kinetic isotope effects can be interpreted in the usual fashion, i.e. that the magnitude of the isotope effect increases with the percent  $C_{\alpha}-N$  bond rupture in the  $S_N2$  transition state<sup>10</sup>, then all three reactions have identical amounts of  $C_{\alpha}-N$  bond rupture in the transition state. If this is the case, interpreting the secondary alpha hydrogen–deuterium isotope effects is not straightforward. If a  $S_N2$  transition state were unsymmetrical and the bond to one of the nucleophiles was very long, the magnitude of the isotope effect would be determined by the length of the shorter reacting bond, because the second nucleophile in the  $S_N2$  transition state is too far away to affect the  $C_{\alpha}-H(D)$  out-of-plane bending vibrations that determine the magnitude of the isotope effect<sup>19</sup> (Figure 4).



The nitrogen (leaving group) kinetic isotope effects indicate that there is no change in the amount of  $C_{\alpha}-N$  bond rupture in the  $S_N2$  transition state when the substituent in the

TABLE 12. The nitrogen (leaving group) and secondary alpha hydrogen–deuterium kinetic isotope effects for the  $S_N2$  reactions between several *para*-substituted sodium thiophenoxide and benzyldimethylphenylammonium nitrate in DMF at 0°C

<i>para</i> -Substituent on the thiophenoxide ion	$k^{14}/k^{15}$	$(k_H/k_D)_{\alpha}$
CH <sub>3</sub> O	1.0162 ± 0.0007 <sup>a</sup>	1.221 ± 0.012 <sup>b</sup>
H	1.0166 ± 0.0004	1.215 ± 0.011
Cl	1.0166 ± 0.0005	1.215 ± 0.013

<sup>a</sup>The standard deviations of the mean of at least four separate experiments.

<sup>b</sup>The error in the isotope effect =  $1/k_D[(\Delta k_H)^2 + (k_H/k_D)^2 \times (\Delta k_D)^2]^{1/2}$  where  $\Delta k_H$  and  $\Delta k_D$  are the standard deviations for the rate constants for the undeuterated and deuterated substrates, respectively.



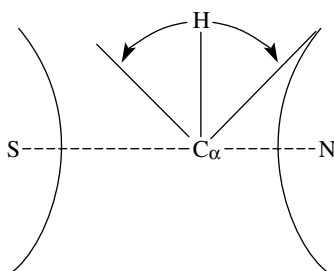


FIGURE 4. Showing how the magnitude of a secondary alpha hydrogen–deuterium kinetic isotope effect can be determined by the length of the shorter reacting bond rather than by the nucleophile–leaving group distance in an unsymmetrical  $S_N2$  transition state

nucleophile is altered. Moreover, the amount of  $C_\alpha$ –N bond rupture in the  $S_N2$  transition state is not large because the nitrogen isotope effect is only approximately one-third of the theoretical maximum nitrogen leaving group kinetic isotope effect of 1.044<sup>59</sup>. Also, the nitrogen isotope effects found when thiophenoxide ion was the nucleophile in these reactions ( $k^{14}/k^{15} = 1.0166 \pm 0.0004$ ) is significantly smaller than the  $1.0200 \pm 0.0007$  found for the same reaction in DMF at an ionic strength of 0.64 (Table 13)<sup>60</sup>. Thus, it appears that  $C_\alpha$ –N bond rupture is not well advanced in these transition states (the transition states are reactant-like).

The secondary alpha hydrogen–deuterium kinetic isotope effects for these reactions, on the other hand, are very large, indicating the transition states are very loose with long S–N distances. Since the  $C_\alpha$ –N bonds are short, the S– $C_\alpha$  bonds must be very long in these transition states. This conclusion is warranted because the secondary alpha hydrogen–deuterium kinetic isotope effects found for the reaction with thiophenoxide ion in this study [ $(k_H/k_D)_\alpha = 1.22 \pm 0.01$ ] is the largest that has been found for an  $S_N2$  reaction of a quaternary ammonium ion. Moreover, the  $(k_H/k_D)_\alpha$  of  $1.22 \pm 0.01$  found in this study is significantly larger than that [ $(k_H/k_D)_\alpha = 1.179 \pm 0.007^1$ ] found for the same reaction at an ionic strength of 0.640 (Table 13). The Hammett  $\rho = -1.62 \pm 0.01$  in the reaction where  $(k_H/k_D)_\alpha = 1.22$ , whereas a larger Hammett  $\rho$  value of  $-1.76 \pm 0.19$  was found in the reaction with  $(k_H/k_D)_\alpha = 1.179$ . Since a larger  $\rho$  value is observed when the change in charge on going from the reactants to the transition state is larger, i.e. when there is more nucleophile–alpha carbon bond formation in the transition state, the reaction with the larger  $(k_H/k_D)_\alpha$  must have the longer S– $C_\alpha$  transition state bond.

TABLE 13. The secondary alpha hydrogen–deuterium and primary nitrogen kinetic isotope effects for the  $S_N2$  reaction between sodium thiophenoxide and benzyldimethylphenylammonium nitrate at different ionic strengths in DMF at 0 °C

Ionic strength	$(k_H/k_D)_\alpha$	$k^{14}/k^{15}$	Hammett $\rho$
0.904	$1.215 \pm 0.011^a$	$1.0166 \pm 0.0004^b$	$-1.62 \pm 0.01^c$
0.64	$1.179 \pm 0.007^a$	$1.0200 \pm 0.0007^b$	$-1.79 \pm 0.19^c$

<sup>a</sup>The error in the isotope effect =  $1/k_D[(\Delta k_H)^2 + (k_H/k_D)^2 \times (\Delta k_D)^2]^{1/2}$  where  $\Delta k_H$  and  $\Delta k_D$  are the standard deviations for the rate constants for the undeuterated and deuterated substrates, respectively.

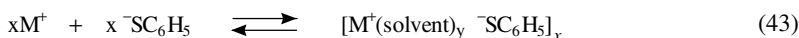
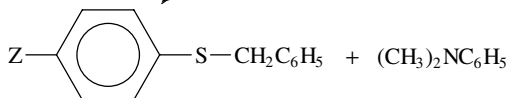
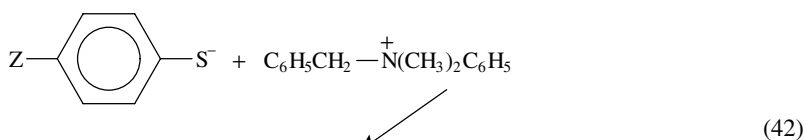
<sup>b</sup>The standard deviation of the mean of five different measurements.

<sup>c</sup>The correlation coefficients for the Hammett  $\rho$  plots found by changing the *para*-substituent in the nucleophile are 1.000 for the reaction at an ionic strength of 0.904 and 0.994 for the reaction at an ionic strength of 0.64.

The most reasonable explanation for the constant nitrogen and secondary alpha deuterium kinetic isotope effects found in these reactions is that changing the substituent in the nucleophile does not affect the amount of  $C_{\alpha}-N$  bond rupture in the transition state but changes the length of the  $S-C_{\alpha}$  transition state bond significantly. However, these changes in the length of the  $S-C_{\alpha}$  transition state bond occur too far from the alpha carbon to affect the  $C_{\alpha}-H$  out-of-plane bending vibrations (the magnitude of the secondary alpha hydrogen-deuterium kinetic isotope effect). As a result, the magnitude of the secondary alpha deuterium kinetic isotope effect is only determined by what happens to the shorter  $C_{\alpha}-N$  bond when the substituent is changed and, since the  $C_{\alpha}-N$  bond does not change when the substituent in the nucleophile is altered, the magnitude of the secondary alpha deuterium kinetic isotope effect does not change when the substituent on the nucleophile is altered.

These conclusions are interesting because they are consistent with the predictions of the 'Bond Strength Hypothesis'<sup>61</sup> which suggests that 'there will be a significant change in the weaker reacting bond but little or no change in the stronger reacting bond in an  $S_N2$  transition state when a substituent in the nucleophile, the substrate, or the leaving group is altered in an  $S_N2$  reaction'. Since the carbon-sulfur bond is weaker than the carbon-nitrogen bond in these  $S_N2$  reactions<sup>61</sup>, the 'Bond Strength Hypothesis' would predict that adding an electron-withdrawing group to the nucleophile should not affect the alpha carbon-leaving group ( $C_{\alpha}-N$ ) bond significantly but should lead to a significant change in the length of the weaker  $S-C_{\alpha}$  bond. It is interesting that these are the exact changes suggested on the basis of the isotope effects. Finally, another interesting conclusion is that the shortest bond in these  $S_N2$  transition states is the strongest bond, i.e. the stronger  $C_{\alpha}-N$  bond is the shorter reacting bond and the weaker  $S-C_{\alpha}$  bond is longer in the transition state.

The nucleophile in the  $S_N2$  reactions between benzyldimethylphenylammonium nitrate and sodium *para*-substituted thiophenoxides in methanol at 20°C (equation 42) can exist as a free thiophenoxide ion or as a solvent-separated ion-pair complex (equation 43)<sup>62,63</sup>. The secondary alpha deuterium and primary leaving group nitrogen kinetic isotope effects for these  $S_N2$  reactions were determined to learn how a substituent on the nucleophile affects the structure of the  $S_N2$  transition state for the free ion and ion-pair reactions<sup>64</sup>.



The secondary alpha deuterium kinetic isotope effects for both the ion pair and the free ion reactions (Table 14) decrease when a more electron-withdrawing *para*-substituent is on the nucleophile. Since the magnitude of the secondary alpha deuterium kinetic isotope effect is directly related to the  $S-N$  distance in the  $S_N2$  transition state<sup>19</sup>, adding a more electron-withdrawing substituent to the nucleophile leads to a transition state with a shorter  $S-N$  distance. The primary leaving group nitrogen kinetic isotope effects for the free ion and the ion-pair reactions (Table 14), on the other hand, increase very slightly when a more electron-withdrawing substituent is added to the nucleophile. Therefore, the

TABLE 14. The secondary alpha deuterium kinetic isotope effects and primary leaving group nitrogen kinetic isotope effects for the free ion and ion-pair  $S_N2$  reactions between benzyldimethylphenylammonium nitrate and *para*-substituted thiophenoxide ions in methanol at 20 °C

<i>para</i> -Substituent	$(k_H/k_D)_\alpha$	$k^{14}/k^{15}$
The nucleophile is the free thiophenoxide ion		
CH <sub>3</sub> O <sup>-</sup>	1.271 ± 0.013 <sup>a</sup>	1.0162 ± 0.0005 <sup>b</sup>
H <sup>-</sup>	1.222 ± 0.013	1.0166 ± 0.0008
Cl <sup>-</sup>	1.121 ± 0.014	1.0169 ± 0.0005
The nucleophile is a solvent-separated ion-pair complex		
CH <sub>3</sub> O <sup>-</sup>	1.216 ± 0.012 <sup>a</sup>	1.0161 ± 0.0005 <sup>b</sup>
H <sup>-</sup>	1.207 ± 0.008	1.0162 ± 0.0010
Cl <sup>-</sup>	1.150 ± 0.009	1.0166 ± 0.0003

<sup>a</sup>The error in the isotope effect is  $1/k_D[\Delta k_H]^2 + (k_H/k_D)^2 \times (\Delta k_D)^2]^{1/2}$ , where  $\Delta k_H$  and  $\Delta k_D$  are the standard deviations for the rate constants for the reactions of the undeuterated and deuterated substrates, respectively.

<sup>b</sup>Standard deviation for the average kinetic isotope effect.

$C_\alpha$ --N transition state bond length increases slightly as a more electron-withdrawing substituent is added to the nucleophile. The relative length of the S<sup>-</sup>-- $C_\alpha$  transition state bond can be deduced from the primary nitrogen and the secondary alpha deuterium kinetic isotope effects. When a more electron-withdrawing substituent is added to the nucleophile, the  $C_\alpha$ --N transition state bond increases slightly while the S<sup>-</sup>--N distance shortens. Therefore, the S<sup>-</sup>-- $C_\alpha$  transition state bond must be much shorter when a more electron-withdrawing substituent is added to the nucleophile in both the free ion and the ion-pair reactions. The relative transition state structures are shown in Figure 5 using the free ion as the nucleophile.

The earlier transition states, found when a more electron-donating substituent is added to the nucleophile, may be found because a better nucleophile would not have to come as close to the alpha carbon to distort the  $C_\alpha$ --N<sup>+</sup> bond and cause reaction.

The greater change in the S<sup>-</sup>-- $C_\alpha$  bond with substituent can be understood in terms of the Bond Strength Hypothesis<sup>61</sup>. The S-- $C_\alpha$  bond is weaker than the  $C_\alpha$ --N<sup>+</sup> bond and the Bond Strength Hypothesis predicts that the greatest change will occur in the weaker

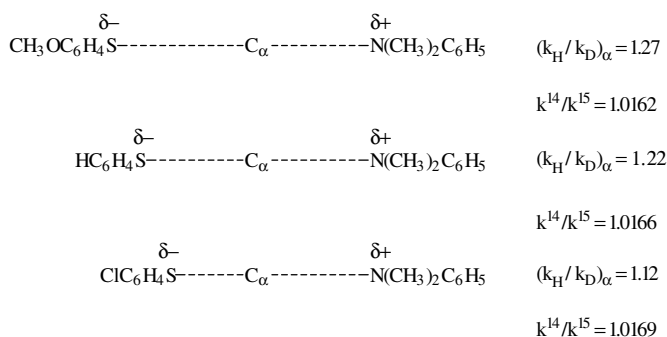


FIGURE 5. The relative transition state structures for the  $S_N2$  reactions between benzyldimethylphenylammonium ion and free *para*-substituted thiophenoxide ions in methanol at 20 °C

S $\alpha$ -C $\alpha$  bond and that there will be little or no change in the stronger C $\alpha$ -N bond when the *para*-substituent on the nucleophile changes.

A second observation is that the substituent effect is greater in the free ion reactions than in the ion-pair reactions, i.e. the  $(k_H/k_D)_\alpha$  (Table 14) changes by 15% in the free ion reactions but by only 7% in the ion-pair reactions. The corresponding change in the  $k^{14}/k^{15}$  is 0.0007 in the free ion reaction but only 0.0005 in the ion-pair reactions. A possible explanation for this is that the change in charge on the nucleophilic sulfur atom with substituent is greater in the free ions than in the ion-pairs. A CNDO/2 calculation<sup>64</sup> shows that the decrease in charge on the sulfur of the free ion is 0.0208 but is only 0.0171 for the ion-pair when the *para*-substituent is changed. Since the substituent effect on the negative charge on the sulfur atom is 22% greater for the free ion, it is not surprising that the substituent effect is greater in the free ion reactions.

Finally, the changes in transition state structure found in this study can be used to test the theories for predicting the substituent effects on the transition state structure. Unfortunately, Thornton's Reacting Bond Rule<sup>65</sup>, the More O'Ferrall-Jencks Energy Surface Method<sup>66,67</sup> and the Pross-Shaik Method<sup>68</sup> all fail to predict the change in transition state structure that was found in this study. Only the Bell, Evans and Polanyi Principle<sup>69</sup>, which predicts an earlier transition state when a better nucleophile is used, and the Bond Strength Hypothesis<sup>61</sup>, which predicts there will be a significant change in the weaker S $\alpha$ -C $\alpha$  reacting bond and little or no change in the stronger C $\alpha$ -N reacting bond when the *para*-substituent in the nucleophile is changed, are consistent with the experimental results.

The secondary alpha deuterium and primary leaving group nitrogen kinetic isotope effects for the free ion and ion-pair reactions in Table 15 show how ion pairing affects the structure of the transition state for the S<sub>N</sub>2 reactions between benzyldimethylphenylammonium nitrate and sodium *para*-substituted thiophenoxides in methanol at 20 °C. The

TABLE 15. The secondary alpha deuterium and primary leaving group nitrogen kinetic isotope effects and the Hammett  $\rho$  values for the ion-pair and free ion S<sub>N</sub>2 reactions between benzyldimethylphenylammonium nitrate and sodium *para*-substituted thiophenoxides in methanol at 20 °C

<i>para</i> -Substituent	Free ion	Ion-pair
	$k^{14}/k^{15}$	$k^{14}/k^{15}$
CH <sub>3</sub> O	1.0162 ± 0.0005 <sup>a</sup>	1.0161 ± 0.0005 <sup>a</sup>
H	1.0166 ± 0.0008	1.0162 ± 0.0010
Cl	1.0169 ± 0.0005	1.0166 ± 0.0003
	$(k_H/k_D)_\alpha$	$(k_H/k_D)_\alpha$
CH <sub>3</sub> O	1.271 ± 0.013 <sup>b</sup>	1.216 ± 0.012 <sup>b</sup>
CH <sub>3</sub>	1.237 ± 0.008	1.213 ± 0.013
H	1.222 ± 0.013	1.207 ± 0.008
Cl	1.121 ± 0.014	1.150 ± 0.009
$\rho^c$	-0.85 ± 0.14 <sup>d</sup>	-0.84 ± 0.11 <sup>d</sup>

<sup>a</sup>Standard deviation for the average kinetic isotope effect.

<sup>b</sup>The error in the isotope effect is  $1/k_D[(\Delta k_H)^2 + (k_H/k_D)^2 \times (\Delta k_D)^2]^{1/2}$ , where  $\Delta k_H$  and  $\Delta k_D$  are the standard deviations for the rate constants for the reactions of the undeuterated and deuterated substrates, respectively.

<sup>c</sup>The Hammett  $\rho$  values were obtained by changing the *para*-substituent in the nucleophile.

<sup>d</sup>The standard error of coefficient of the  $\rho$  value.

primary nitrogen leaving group kinetic isotope effects for the free ion and the ion-pair reactions (Table 15) are identical within the experimental error of the method. Although the incoming nucleophile sulfur kinetic isotope effects have not been measured, one can deduce how the S--C $\alpha$  bond changes with ion pairing by combining the information provided by the secondary alpha deuterium and the primary nitrogen kinetic isotope effects. The magnitude of the secondary alpha deuterium kinetic isotope effect is determined by the S--N distance in the S<sub>N</sub>2 transition state<sup>19</sup> and, since the nitrogen isotope effects show that the C $\alpha$ --N transition state bond is not changed by ion pairing, the change in the secondary alpha deuterium kinetic isotope effect caused by ion pairing must be due to a change in the S--C $\alpha$  transition state bond. Therefore, the secondary alpha deuterium kinetic isotope effects indicate that the free ion S--C $\alpha$  bond is significantly longer than the ion-pair S--C $\alpha$  bond when the nucleophile is the *p*-methoxythiophenoxide ion, is longer than the ion-pair S--C $\alpha$  bond when the nucleophile is the *p*-methylthiophenoxide ion, is slightly longer than the ion-pair S--C $\alpha$  bond when the nucleophile is thiophenoxide ion but is shorter than the ion-pair S--C $\alpha$  bond in the *p*-chlorothiophenoxide ion reaction. Finally, the identical Hammett  $\rho$  values, found by changing the *para*-substituent on the nucleophile for the free ion and ion-pair S<sub>N</sub>2 reactions (Table 15), indicate that the change in charge on the nucleophilic sulfur atom in going to the transition state is identical for the free ion and ion-pair reactions, and therefore, that the S--C $\alpha$  transition state bond is not altered significantly when the nucleophile changes from a free ion to an ion-pair. The identical  $\rho$  values for the free ion and ion-pair reactions may be observed because, *on average*, the S--C $\alpha$  bond for the free ion reaction is identical to the S--C $\alpha$  bond in the ion-pair reactions.

One explanation for the longer S--C $\alpha$  bond in the free ion transition state is that the sodium ion reduces the electron density on the sulfur atom<sup>64</sup>, making it a poorer nucleophile. This would lead to a more product-like transition state (*vide supra*). Unfortunately, this is not true for the *p*-chlorothiophenoxide ion reaction which has a shorter S--C $\alpha$  bond in the free ion transition state. Two other observations are obvious when one considers how ion-pairing affects the structure of the S<sub>N</sub>2 transition state. First, the major change in bonding occurs in the weaker S--C $\alpha$  bond and there is little or no change in the stronger C $\alpha$ --N reacting bond as the Bond Strength Hypothesis<sup>61</sup> predicts. The final observation is that the greatest change in transition state structure is found in the reaction with the best nucleophile, and the effect of ion-pairing becomes smaller as a more electron-withdrawing substituent is added to the nucleophile. This probably occurs because the decrease in the electron density on the sulfur atom, that occurs when a more electron-withdrawing substituent is added to the nucleophile, reduces the strength of the ionic bond between the solvent-separated sodium ion and the sulfur anion of the *para*-substituted thiophenoxide ion significantly. This means that the difference between the electron density on the sulfur atom of a free ion nucleophile and an ion-pair nucleophile will be smaller when a more electron-withdrawing substituent is on the nucleophile. As a result, the difference between the free ion and the ion-pair secondary alpha deuterium kinetic isotope effects should be smaller when a more electron-withdrawing group is added to the nucleophile. This trend is found when the nucleophile is the *p*-methoxythiophenoxide ion, the *p*-methylthiophenoxide ion and the thiophenoxide ion. Unfortunately, the effect of ion-pairing on the transition state for the *p*-chlorothiophenoxide ion reaction does not fit this trend.

The secondary alpha deuterium and primary leaving group nitrogen kinetic isotope effects (Table 16) were determined for the ion-pair S<sub>N</sub>2 reactions between sodium thiophenoxide and benzyldimethylphenylammonium nitrate in DMF at 0 °C<sup>60</sup> and in methanol at 20 °C<sup>64</sup> to learn how a change in solvent affects the structure of the S<sub>N</sub>2 transition state.

Unfortunately, the isotope effects were measured at different temperatures. Applying an average temperature dependence of 0.008 per 20 °C to the secondary alpha deuterium

TABLE 16. The secondary alpha deuterium and primary leaving group nitrogen kinetic isotope effects for the ion-pair  $S_N2$  reactions between sodium thiophenoxide and benzyldimethylphenylammonium nitrate in DMF at 0 °C and in methanol at 20 °C

Solvent	Temp (°C)	$(k_H/k_D)_\alpha$	$k^{14}/k^{15}$	Hammett $\rho$ value <sup>d</sup>
Methanol	20	$1.215 \pm 0.012^b$	$1.0162 \pm 0.0010^c$	$-0.84 \pm 0.11^d$
DMF	0	$1.179 \pm 0.010$	$1.0200 \pm 0.0007$	$-1.70 \pm 0.05$
DMF	20	$1.17^e$	$\geq 1.019^e$	

<sup>a</sup>The Hammett  $\rho$  value was obtained by changing the *para*-substituent on the nucleophile.

<sup>b</sup>The error in the isotope effect is  $1/k_D[(\Delta k_H)^2 + (k_H/k_D)^2 \times (\Delta k_D)^2]^{1/2}$ , where  $\Delta k_H$  and  $\Delta k_D$  are the standard deviations for the rate constants for the reactions of the undeuterated and deuterated substrates, respectively.

<sup>c</sup>Standard deviation of the average kinetic isotope effect.

<sup>d</sup>The standard error of coefficient of the  $\rho$  value.

<sup>e</sup>The kinetic isotope effects are estimated at 20 °C.

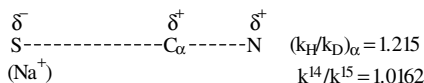
kinetic isotope effect of 1.179 found at 0 °C in DMF<sup>70,71</sup> suggests that this kinetic isotope effect would be approximately 1.17 at 20 °C. The temperature dependence of a nitrogen isotope effect would appear to be small<sup>1</sup>, i.e. a change of 20 °C would change the isotope effect by less than one percent. Thus, the nitrogen isotope effect for the reaction in DMF would be  $\geq 1.019$  at 20 °C.

The larger secondary alpha deuterium kinetic isotope effect of 1.215 in methanol indicates that the S---N transition state distance is greater in methanol than it is in DMF. The primary leaving group nitrogen kinetic isotope effect, on the other hand, is smaller in methanol than in DMF, indicating that the C<sub>α</sub>---N transition state bond is considerably shorter in methanol than in DMF. Because the transition state in methanol has a longer S---N distance but a shorter C<sub>α</sub>---N bond, the S---C<sub>α</sub> bond must be much longer in methanol than in DMF. Therefore, an earlier transition state with a much longer S---C<sub>α</sub> and a shorter C<sub>α</sub>---N bond is found in methanol (Figure 6).

The Hammett  $\rho$  values found by changing the *para*-substituent on the nucleophile in DMF and methanol (Table 16) support this conclusion. The larger  $\rho$  value in DMF indicates that the change in charge on the nucleophilic sulfur atom is greater on going from the reactant to the transition state in DMF. Therefore, the S---C<sub>α</sub> transition state bond is shorter in DMF than in methanol.

The earlier transition state in methanol can be rationalized as follows. The  $S_N2$  transition state for this reaction will primarily be solvated at the sulfur atom because the partial

In methanol:



In DMF:

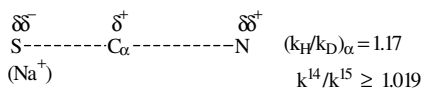


FIGURE 6. The relative transition state structures for the ion-pair  $S_N2$  reactions between sodium thiophenoxide and benzyldimethylphenylammonium nitrate in DMF and in methanol

positive charges on the alpha carbon and on the nitrogen atom are sterically hindered to solvation. The second assumption is that the structure of the transition state will depend on its stability in that solvent, i.e. that the transition state that is the most stable in each solvent will be found. An early transition state would be more stable than a product-like transition state in methanol, because solvation of the sulfur atom by hydrogen bonding would lower the energy of an early transition state where there is a greater negative charge on the sulfur atom, i.e. the solvent stabilizes an earlier transition state more than a late transition state. As a result, a transition state with a longer and weaker S---C $\alpha$  transition state bond would be expected in methanol. In DMF, a late, less ionic (dipolar) transition state which would be more strongly solvated by DMF, is expected.

Finally, the secondary alpha deuterium and primary leaving group nitrogen kinetic isotope effects for the ion-pair S<sub>N</sub>2 reactions between sodium thiophenoxide and benzylidimethylphenylammonium nitrate were measured at two different ionic strengths in DMF at 0 °C (Table 17)<sup>58</sup>. The larger secondary alpha deuterium and the smaller nitrogen leaving group kinetic isotope effect found in the high ionic strength reaction indicate that the S---N distance in the transition state is greater and that the C $\alpha$ ---N bond is shorter in the reaction at a high ionic strength. This means that the S---C $\alpha$  bond is longer in the transition state for the high ionic strength reaction. The earlier, more ionic, transition state is probably found at the high ionic strength because the more ionic transition state will be more stable (more highly solvated) in the more ionic solvent. The important observation, however, is that inert salts that are used to increase the ionic strength in reactions so that accurate rate constants can be measured, change the structure of the transition state markedly.

TABLE 17. The secondary alpha deuterium and primary leaving group nitrogen kinetic isotope effects and the relative transition state structures for the ion-pair S<sub>N</sub>2 reactions between sodium thiophenoxide and benzylidimethylphenylammonium nitrate in DMF at different ionic strengths at 0 °C

Ionic strength	(k <sub>H</sub> /k <sub>D</sub> ) $\alpha$	k <sup>14</sup> /k <sup>15</sup>	Relative transition state structure
0.640	1.179 ± 0.010 <sup>a</sup>	1.0200 ± 0.0007 <sup>b</sup>	$\delta\delta^-$ $\delta\delta^+$ S---C-----N $\delta^-$ $\delta^+$
0.904	1.215 ± 0.011 <sup>a</sup>	1.0166 ± 0.0004 <sup>b</sup>	S-----C---N

<sup>a</sup>The error in the isotope effect is  $1/k_D[\Delta k_H]^2 + (k_H/k_D)^2 \times (\Delta k_D)^2$ ]<sup>1/2</sup>, where  $\Delta k_H$  and  $\Delta k_D$  are the standard deviations for the rate constants for the reactions of the undeuterated and deuterated substrates, respectively.

<sup>b</sup>The standard deviation for the average kinetic isotope effect.

## V. REFERENCES

1. P. J. Smith and K. C. Westaway, in *The Chemistry of the Functional Groups, Supplement F: The Chemistry of Amino, Nitroso and Nitro Compounds and Their Derivatives* (Ed. S. Patai), Wiley, London, 1982, pp. 1261–1312.
2. L. Melander, *Isotope Effects on Reaction Rates*, Ronald Press, New York, 1960.
3. E. Caldin and V. Gold (Eds.), *Proton Transfer Reactions*, Chapman and Hall, London, 1975.
4. W. W. Cleland, M. H. O'Leary and D. B. Northrup (Eds.), *Isotope Effects in Enzyme-catalyzed Reactions*, University Park Press, Baltimore, 1977.
5. L. Melander and W. H. Saunders, Jr., *Reaction Rates of Isotopic Molecules*, Wiley-Interscience, New York, 1980.
6. J. Bigeleisen, *Proceedings of the International Symposium on Isotope Separation*, North-Holland, Amsterdam, 1958.

7. J. Bigeleisen and M. Wolfsberg, *Adv. Chem. Phys.*, **1**, 15 (1958).
8. J. Bigeleisen, *J. Chem. Phys.*, **17**, 675 (1949).
9. S. Glasstone, K. J. Laidler and H. Eyring, *The Theory of Rate Processes*, McGraw-Hill, New York, 1941.
10. W. H. Saunders, Jr., *Chem. Scr.*, **8**, 27 (1975).
11. L. B. Sims, A. Fry, L. T. Netherton, J. C. Wilson, K. D. Reppond and W. S. Cook, *J. Am. Chem. Soc.*, **94**, 1364 (1972).
12. F. H. Westheimer, *Chem. Rev.*, **61**, 265 (1961).
13. R. A. More O'Ferrall, *J. Chem. Soc. (B)*, 785 (1970).
14. A. Streitwieser, Jr., R. H. Jagow, R. C. Fahey and S. Suzuki, *J. Am. Chem. Soc.*, **80**, 2326 (1958).
15. K. C. Westaway and S. F. Ali, *Can. J. Chem.*, **57**, 1089 (1979).
16. S. R. Hartshorn and V. J. Shiner, Jr., *J. Am. Chem. Soc.*, **94**, 9002 (1972).
17. H. Humski, V. Sendjarevic and V. J. Shiner, Jr., *J. Am. Chem. Soc.*, **96**, 6187 (1974).
18. S. Wolfe and C. -K. Kim, *J. Am. Chem. Soc.*, **113**, 8056 (1991).
19. R. A. Poirier, Y. Wang and K. C. Westaway, *J. Am. Chem. Soc.*, **116**, 2526 (1994).
20. C. K. Ingold, E. D. Hughes and D. V. Banthorpe, *J. Chem. Soc.*, 2864 (1964).
21. M. J. S. Dewar and A. Marchand, *Annu. Rev. Phys. Chem.*, **16**, 338 (1965).
22. H. J. Shine, H. Zmuda, K. H. Park, H. Kwart, A. G. Horgan and M. Brechbiel, *J. Am. Chem. Soc.*, **104**, 2501 (1982).
23. H. J. Shine, H. Zmuda, K. H. Park, H. Kwart, A. G. Horgan, C. Collins and B. E. Maxwell, *J. Am. Chem. Soc.*, **103**, 955 (1981).
24. H. J. Shine, G. N. Henderson, A. Cu and P. Schmid, *J. Am. Chem. Soc.*, **99**, 3719 (1977).
25. S. H. Korzeniewski, L. Blum and G. W. Gokel, *J. Org. Chem.*, **42**, 1469 (1977).
26. H. J. Shine, H. Zmuda, H. Kwart, A. G. Horgan and M. Brechbiel, *J. Am. Chem. Soc.*, **104**, 5181 (1982).
27. A. Heising and U. Schinke, *Chem. Ber.*, **105**, 3838 (1972).
28. A. Heising and U. Schinke, *Chem. Ber.*, **110**, 3819 (1977).
29. H. J. Shine, J. Habdas, H. Kwart, M. Brechbiel, A. G. Horgan and J. San Filippo, Jr., *J. Am. Chem. Soc.*, **105**, 2823 (1983).
30. G. S. Hammond and J. S. Clovis, *J. Org. Chem.*, **28**, 3283 (1963).
31. M. J. S. Dewar, *The Electronic Theory of Organic Chemistry*, Oxford University Press, Oxford, 1949, p. 239.
32. D. V. Banthorpe and J. G. Winter, *J. Chem. Soc., Perkin Trans. 2*, 868 (1972).
33. C. G. Swain, E. C. Stivers, J. F. Reuwer, Jr. and L. J. Schaad, *J. Am. Chem. Soc.*, **80**, 5885 (1958).
34. H. J. Shine, J. Zygumt, M. L. Brownawell, and J. San Filippo, Jr., *J. Am. Chem. Soc.*, **106**, 3610 (1984).
35. J. H. Ridd and J. P. B. Sandall, *J. Chem. Soc., Chem. Commun.*, 261, (1982).
36. H. J. Shine, K. H. Park, M. L. Brownawell and J. San Filippo, Jr., *J. Am. Chem. Soc.*, **106**, 7077 (1984).
37. H. J. Shine, E. Gruszecka, W. Subotkowski, M. Brownawell and J. San Filippo, Jr., *J. Am. Chem. Soc.*, **107**, 3218 (1985).
38. H. J. Shine, L. K. Subotkowski and W. Subotkowski, *J. Am. Chem. Soc.*, **107**, 6674 (1985).
39. E. S. Rhee and H. J. Shine, *J. Am. Chem. Soc.*, **108**, 1000 (1986).
40. H. J. Shine and E. S. Rhee, *J. Labelled Compd. Radiopharm.*, **21**, 569 (1984).
41. W. Subotkowski, L. K. Subotkowski and H. J. Shine, *J. Am. Chem. Soc.*, **115**, 5073 (1993).
42. B. Boduszek and H. J. Shine, *J. Am. Chem. Soc.*, **110**, 3247 (1988).
43. B. Miller, *J. Am. Chem. Soc.*, **86**, 1127 (1964).
44. B. S. Axelsson, B. Langstrom and O. Matsson, *J. Am. Chem. Soc.*, **109**, 7233 (1987).
45. B. Langstrom, G. Antoni, P. Gullberg, C. Halldin, P. Malmberg, K. Nagren, A. Rimland and H. Svard, *J. Nucl. Med.*, **28**, 1037 (1987).
46. B. S. Axelsson, O. Matsson and B. Langstrom, *J. Phys. Org. Chem.*, **4**, 77 (1991).
47. T. Ando, T. Kimura and H. Yamataka, in *Nucleophilicity* (Eds. J. M. Harris and S. P. McManus) Chap. 7, American Chemical Society, Washington, DC, 1987, p. 108
48. J. L. Kurz, M. W. Daniels, K. S. Cook and M. M. Nasr, *J. Phys. Chem.*, **90**, 5357 (1986).
49. J. L. Kurz, J. E. Pantano, D. R. Wright and M. M. Nasr, *J. Phys. Chem.*, **90**, 5360 (1986).
50. T. Ando, H. Yamataka and E. Wada, *Isr. J. Chem.*, **26**, 354 (1985).
51. J. M. Harris, M. S. Paley and T. W. Prasthofer, *J. Am. Chem. Soc.*, **103**, 5915 (1981).
52. P. Paneth and M. H. O'Leary, *J. Am. Chem. Soc.*, **113**, 1691 (1991).



53. T. Ando, H. Tanabe and H. Yamataka, *J. Am. Chem. Soc.*, **106**, 2084 (1984).
54. I. Lee, H. J. Koh, B. -S. Lee, D. S. Sohn and B. C. Lee, *J. Chem. Soc., Perkin Trans. 2*, 1741 (1991).
55. J. Persson, U. Berg and O. Matsson, *J. Org. Chem.*, **60**, 5037 (1995).
56. W. J. Le Noble and A. R. Miller, *J. Org. Chem.*, **44**, 889 (1979).
57. C. G. Swain and N. D. Hershey, *J. Am. Chem. Soc.*, **94**, 1901 (1972).
58. V. T. Pham, M.Sc. Dissertation, Laurentian University, Sudbury, Ont., Canada, 1993.
59. A. Maccoll, *Annu. Rep. A. Chem. Soc., (London)*, **71**, 77 (1974).
60. K. C. Westaway and S. F. Ali, *Can. J. Chem.*, **57**, 1354 (1979).
61. K. C. Westaway, *Can. J. Chem.*, **71**, 2084 (1993).
62. Z. G. Lai and K. C. Westaway, *Can. J. Chem.*, **67**, 21 (1989).
63. K. C. Westaway and Z. G. Lai, *Can. J. Chem.*, **66**, 1263 (1988).
64. W. Jiang, M.Sc. Dissertation, Laurentian University, Sudbury, Ont., Canada, 1996.
65. E. R. Thornton, *J. Am. Chem. Soc.*, **89**, 2915 (1967).
66. R. A. More O'Ferrall, *J. Chem. Soc. (B)*, 274 (1970).
67. W. P. Jencks, *Chem. Rev.*, **72**, 705 (1972).
68. A. Pross and S. S. Shaik, *J. Am. Chem. Soc.*, **103**, 3702 (1981).
69. M. J. Dewar and R. C. Dougherty, *The PMO Theory of Organic Chemistry*, Plenum Press, New York, 1975, pp. 219, 220.
70. V. J. Shiner, Jr., W. Dowd, R. D. Fisher, S. R. Hartshorn, M. A. Kessik, L. Milakofsky and M. W. Rapp., *J. Am. Chem. Soc.*, **91**, 4838 (1969).
71. K. M. Koshy and R. E. Robertson, *J. Am. Chem. Soc.*, **96**, 914 (1974).

## CHAPTER 21

# Displacement and *ipso*-substitution in nitration

J. P. B. SANDALL

Department of Chemistry, University of Exeter, Stocker Road, Exeter EX4 4QD, UK  
 Fax: (+44) 1392 263434; e-mail: J.P.B. Sandall@exeter.ac.uk

I. INTRODUCTION .....	949
II. FORMATION OF <i>ipso</i> -ADDUCTS .....	950
III. FURTHER REACTIONS OF <i>ipso</i> -INTERMEDIATES AND ADDUCTS .....	957
A. Solvolysis of Adducts .....	957
B. Further Addition to the <i>ipso</i> -Species .....	961
IV. REARRANGEMENT OF <i>ipso</i> -SUBSTITUTED GROUPS .....	964
V. DISPLACEMENT OF <i>ipso</i> -SUBSTITUTED GROUPS .....	969
VI. CONCLUSION .....	970
VII. REFERENCES .....	970

## I. INTRODUCTION

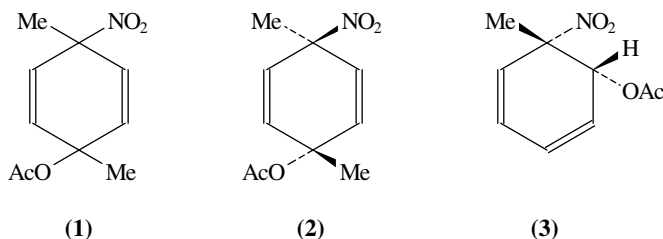
This review covers the literature from about 1980, the year of publication of Schofield's<sup>1</sup> book on nitration which includes a chapter on *ipso*-attack in nitration. The use of the term *ipso* dates back to 1971 when Perrin and Skinner<sup>2</sup> applied it to systems undergoing attack at a substituted position in an aromatic ring. This process has always been regarded as unusual in electrophilic processes such as nitration, since the requirement of a positively charged leaving group results much more often in loss of a proton than loss of a less stable positively charged species. However, this view is partly a consequence of seeing the nitration reaction only as a method of introducing the nitro group; when one considers all the possible reactions that might result from attack at an *ipso*-position, then it is clear that the process is of considerable importance. In nucleophilic substitution of course *ipso*-substitution is the norm, since the reversed polarity of the reaction results in loss of a stable negatively charged substituent (e.g. halide ion) much more commonly than a hydride ion, although this latter process can be competitive in special circumstances. Another reason for the greater attention paid to reaction at an *ipso*-position recently is that modern analytical techniques enable the characterization of less stable or transient

species, or compounds only present in small amounts, leading to a much fuller description of complicated mechanisms.

The general consequences of *ipso*-attack in a nitration reaction may be briefly outlined. Usually the aromatic substrate will have two substituent groups, one of which, not necessarily the more electron releasing, will direct an incoming electrophile to attack at a substituted position; thus, for example, 1,4-dimethylbenzene will react with nitronium ion, in a sufficiently acidic medium, to generate the 1,4-dimethyl-1-nitro-benzeneonium ion. For 4-chloroanisole, the dominant *ipso*-products will arise from attack at the position bearing halogen. This positively charged species may react to form a more stable species in several ways, for example by losing a proton from a suitable position, e.g. formation of 4-methyl-4-nitro-cyclohexa-2,5-dienone (often called an *ipso*-intermediate) from 4-methylphenol as starting material. Alternatively it may be stabilized by capture of a negatively charged species usually derived from the solvent, e.g. acetate ion from acetic acid, usually called an *ipso*-adduct. The *ipso*-species formed by either of these routes may dissociate again (possibly homolytically, generating nitrogen dioxide); either the *ipso*-substituent or the nitro group may rearrange (conceivably either homo- or heterolytically) resulting in either nuclear or side-chain substitution or it may undergo solvolysis. Other reactions include further addition to its carbon-carbon double bonds. Finally, a suitable substituent, e.g. iodo, may simply be displaced by the incoming electrophile. It must also be remembered that the substrates suitable for *ipso*-attack are often among the most reactive; this frequently gives rise to the possibility of nitrous acid catalysed nitration as a further complication or even direct reaction with nitrogen dioxide. Examples illustrating all these types of behaviour have been recently investigated.

## II. FORMATION OF *ipso*-ADDUCTS

Major work in this field has been carried out by Fischer, Henderson and their coworkers<sup>3-12</sup>. The behaviour of 1,4-dimethylbenzene on nitration may be taken as a typical example<sup>4</sup>. This substrate, when nitrated in acetic anhydride, gives rise to a diastereomeric pair of adducts involving the formal addition of nitronium acetate across the 1,4-positions (1). In earlier work, attempts were made to assign the configuration of such adducts by using proton NMR shift reagents, but with only limited success. However, relative configurations of the acetates, and dienols derived from these, had been obtained. Myhre and coworkers<sup>13</sup> had attacked a similar problem by synthesizing 1,4-dialkyl-4-nitrocyclohexadienols by addition of methyl lithium to a 4-alkyl-4-nitrocyclohexadienone. This reaction is somewhat stereoselective, and one would expect the predominant isomer to have (*Z*) configuration, since addition *trans* to the nitro group is preferred. This is the isomer which (as acetate) is formed in smaller amount in the nitration process. Fischer and coworkers prepared the two diastereoisomeric 1,4-dimethyl-4-nitrocyclohexa-2,5-dienyl acetates and separated them by low temperature chromatography (overall yield 90%, ratio approximately 7:3). The acetates were stereospecifically reduced to the corresponding dienols (aluminium hydride) and these, again stereospecifically, were methylated to give the ethers. The 2,6-dideuterio-1,4-dimethyl-4-nitrocyclohexadienols were prepared using the method of Myhre and coworkers, separated, and the <sup>13</sup>C NMR spectra assigned for both isomers of the alcohol, the ether and the acetate. Comparison with the spectra of the isomeric acetates derived from direct nitration allowed the assignment of the major isomer to the (*E*) configuration (2). Sufficiently good crystals of the (*E*)-1,4-dimethyl-4-nitrocyclohexa-2,5-dienol were obtained to carry out an X-ray structure analysis; the cyclohexadiene ring is almost flat with the methyl groups *trans* as expected. It may be noted that the stereochemistry of these acetates and ethers is wrongly assigned in an earlier paper by Shosenji and coworkers<sup>14</sup>.



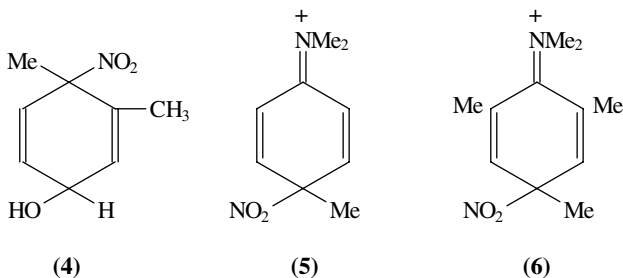
Whilst aromatic compounds substituted 1,4- with alkyl groups will give mainly 1,4-*ipso*-adducts by nitration at low temperatures, a complication arises with many other substituents, e.g. a halogeno group *para* to alkyl. This is the possible formation of 1,2-adducts (3), as well as the normal 1,4-addition observed with 1,4-dialkylbenzenes (except when one group is *t*-butyl). Thus nitration of 4-fluoromethylbenzene in acetic anhydride at low temperature<sup>10</sup> gives the expected pair of diastereomeric 1,4-nitronium acetate adducts, but in addition the *cis*-1,2-adduct is observed. In this case the ratio of 1,4-addition to 1,2-addition is about 10:1. However, replacement of the 4-fluoro-substituent by 4-chloro or 4-bromo results in only formation of the 1,2-adduct being observed, with the nitro and acetate groups again being *cis* to each other. In both cases, the NO<sub>2</sub> group is attached to the activated *ipso*-methyl position and *not* the *ipso*-halogen position. This behaviour may be rationalized by the relative activations of the *ipso* and unsubstituted positions towards the electrophile using simple additivity of the partial rate factors for the appropriate monosubstituted benzenes including the rate factors for the *ipso* positions. The nitro and acetate groups in these 1,2-adducts are always *cis*; the authors conclude that the addition is stereoselective, being in all cases *syn* addition. This was confirmed by an X-ray crystal structure determination in the case of the 4-bromo product. Presumably the *ipso*-intermediate carbocation does not escape from the substrate/nitronium acetate encounter pair. The authors also comment on the interesting regioselectivity mentioned above: with both 1,4-dimethylbenzene and 4-fluoromethylbenzene the addition is effectively 1,4; for the other 4-substituents investigated (chloro, bromo, methoxy) addition is almost completely 1,2. This similarity in behaviour for fluoro and methyl does not parallel either the inductive or resonance (or total) electronic effects of the substituents on an electrophilic process.

In an attempt to investigate further this regioselectivity, the group of Fischer and Henderson<sup>11</sup> looked at the nitration of a series of 2- and 3-substituted 4-methylanisoles and phenols. The product distribution by and large followed the expected pattern calculated from the partial rate factors for halogen and nitro substituents on the observed ratios of attack on 4-methoxymethylbenzene. The largest deviations from the expected regioselectivity occurred with a nitro group in the 2-position: it was expected that this should slightly increase *ipso*-attack; in fact it significantly decreased it, possibly due to steric effects. However, an examination of the relative amount of capture of the presumed 4-methoxy *ipso*-cation at the 2-, 4- and 6-positions showed some interesting anomalies. The extent of 4-capture versus 2/6 is again not related to the electronic effects of the substituents in the 3-position, nor is the fact that selectivity between the 2- and 6-positions reversed by exchanging a 3-chloro for a 3-nitro substituent easily explained. Although the grouping of fluoro and methyl substituent effects referred to above suggests the possibility of a radical process, the marked sensitivity of the reactions to substituent effects generally would seem to preclude this.

Whereas capture of the *ipso*-cation by acetate in acetic acid solution continues to be one of the best methods of isolating such adducts, its capture by water is, of course, of great importance during normal nitration in aqueous acid. For example, in 60% H<sub>2</sub>SO<sub>4</sub> 1,2-dimethylbenzene gives no less than 33% of mono- and di-nitro-3,4-dimethyl phenols<sup>15</sup>.

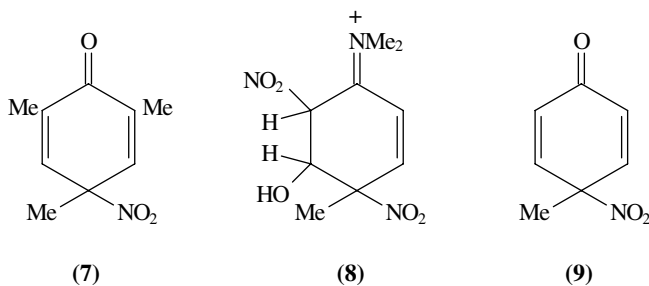
The general process is one of loss of nitrous acid from the adduct (4); in highly substituted aromatics the initially formed adduct may well also rearrange either by hydroxyl or other group migration.

The second major route to *ipso*-species formation may be formulated as loss of a proton (generally from a hydroxyl or amino group) from the initially formed cation. For example, in the nitration of 2,6-dichloro-4-methylphenol, the major initial product was shown to be 4-methyl-4-nitro-2,6-dichlorocyclohexa-2,5-dienone<sup>16</sup> as early as 1900. A more recent example, investigated by Ridd and coworkers<sup>17</sup>, is of formation of *ipso*-intermediates during the nitration of *N,N*-dimethyl-*p*-toluidine and some related compounds. The authors showed that the major product from the toluidine itself (2-nitro-*N,N*-dimethyl-*p*-toluidine, 78%) was formed in two stages; the intermediate was clearly demonstrated by both <sup>1</sup>H and <sup>13</sup>C NMR to be the *ipso*-adduct (5). The marked upfield shifts of the 4-methyl group protons (0.3 ppm) and the methyl carbon itself (38 ppm) are completely in accordance with the change from sp<sup>2</sup> to sp<sup>3</sup> hybridization at this position. The spectrum of the corresponding 4-ethyl-*N,N*-dimethylaniline also showed the same phenomenon as did *N,N*-2,4,6-pentamethylaniline where the alternative possibility of an *ortho ipso*-intermediate was shown to be absent. The solvent used was a typical nitrating mixture (HNO<sub>3</sub> in 70% H<sub>2</sub>SO<sub>4</sub>) and the intermediates had half-lives up to several hours at 0 °C. The clean separation of the <sup>1</sup>H NMR peaks for the 4-methyl group in starting amine, intermediate and the final product enabled a kinetic study to be carried out on the formation of both intermediate and product. This showed that formation of the intermediate was an autocatalytic reaction, inhibited by hydrazine and strongly catalysed by traces of nitrous acid. It is clear therefore that the intermediate is formed not by nitronium ion attack at the 4-position, but by a process involving catalytic quantities of nitrous acid, which can be formed by side-reactions. This kinetic behaviour parallels exactly that of *N,N*-dimethylaniline<sup>18</sup> which, under the same conditions, gives almost exclusively *N,N,N,N*-tetramethylbenzidines by dimerization of the cation radical PhNMe<sub>2</sub><sup>•+</sup> which is formed by electron transfer to the NO<sup>+</sup> ion. The possible alternative mechanism, nitrosation at the 4-position followed by oxidation, was rejected on the grounds that benzidine formation could not be explained. Further confirmation of the oxidizing function of nitrous acid (NO<sup>+</sup> at this acidity) is given by the observation during the reaction of the ESR spectrum of an organic free radical shown by simulation to be the *N,N*-4-trimethylanilinium cation radical. Although the authors noted at the time that the observation of the radical did not prove it was on the reaction path, later work showed that the intermediate and final nitro product exhibited a CIDNP effect which confirmed the postulated mechanism. Formation of the *ipso*-product by NO<sub>2</sub><sup>+</sup> attack also occurs at appropriate acidities. The rearrangement step will be considered later.



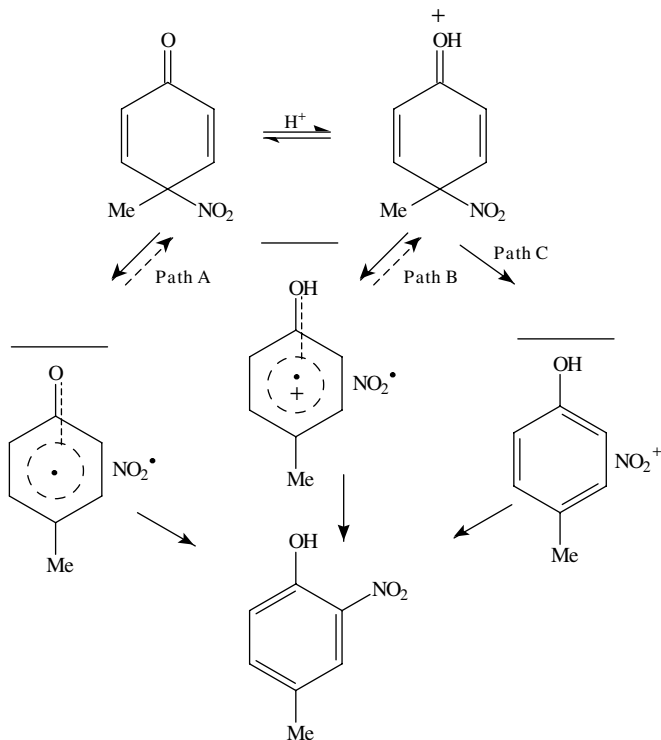
The example outlined above is a particularly clean reaction; most *ipso*-attacks in amines and phenols are rarely as simple as this. Two other substrates might be used as examples

at this point: *N,N*-2,4,6-pentamethylaniline and *N,N*-2,4-tetramethyl-6-nitroaniline<sup>19</sup>. At 0°C in 70% HNO<sub>3</sub> the former compound undergoes *ipso*-attack at the 4-position to form initially the relatively stable intermediate (6). This can be crystallized out of solution as a hexafluorophosphate, or, if the acid solution is somewhat diluted (40%), it can capture water to generate the 2,4,6-trimethyl-4-nitrocyclohexa-2,5-dienone (7) by the slow displacement of the dimethylamino group. On the other hand, substitution of the 6-methyl group by 6-nitro leads to a completely different final product. Here the analogous *ipso*-intermediate is seen only as a transitory species; the major product (8) may be formulated as arising by the formal addition of one molecule of water across the 5,6 double bond in the *ipso*-intermediate corresponding to 6.



The nitration of 4-methylphenol provides an interesting example of how the existence of a reasonably stable *ipso*-intermediate (9) modifies the nitration process and also is markedly affected by the exact reaction conditions. Coombes and coworkers<sup>20</sup> investigated products and kinetics for this reaction using HNO<sub>3</sub> in 60–80% H<sub>2</sub>SO<sub>4</sub>. The amount of the expected product, 2-nitro-4-methylphenol, although approaching 100% at high acidities, was much less at lower acidities unless a more efficient nitrous acid trap (sulphanilic acid) was used than the sulphamic acid, which was the trap required for the kinetic studies. The results of the kinetic study showed that the *ipso*-intermediate (9) was formed by a process first order with respect to nitric acid, and that it decomposed by an overall first order process at a rate (although dependent on overall acidity) independent of nitric acid concentration. In the presence of nitrous acid catalysis, presumably, a much greater fraction of the reaction went by the *ipso*-intermediate route—other reactions of this species would reduce the yield of the final nitro product.

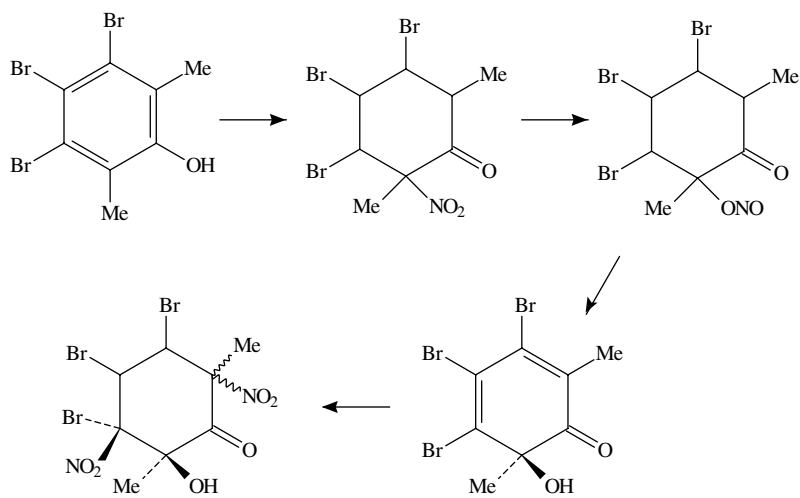
This reaction was subsequently investigated<sup>21</sup> in acetic anhydride as solvent, using nitronium acetate as the nitrating agent. Under these conditions nitrous acid catalysed nitration is the almost exclusive route to both the *ipso*-intermediate (30%) and the 2-nitro-4-methylbenzene (70%). The temperature at which the *ipso*-compound was formed was sufficiently low to preclude its rearrangement to the final nitro product. Both <sup>15</sup>N and <sup>13</sup>C CIDNP effects were seen. A strong emission signal in the <sup>15</sup>NMR spectrum corresponding to the *ipso*-nitro compound (9) was observed, as were an enhanced <sup>13</sup>C NMR absorption signal for C-4 and an emission signal for C-1. The starting material also showed a CIDNP effect in its <sup>13</sup>C spectrum, the reverse of that for the intermediate, i.e. the C-4 signal in emission and the C-1 signal in enhanced absorption. In order to interpret these effects, Kaptein's rules<sup>22</sup> were applied, using the known *g* values for NO<sub>2</sub> and the 4-methylphenoxy radical; the signs of the necessary hyperfine coupling constants were derived for C-1 and C-4 from semi-empirical molecular orbital calculations. The agreement between the observed phase of all the polarized signals and that deduced from the mechanism (Scheme 1) is complete. Thus, the results are only consistent with a mechanism in which the polarization of the *ipso*-intermediate arises from diffusion



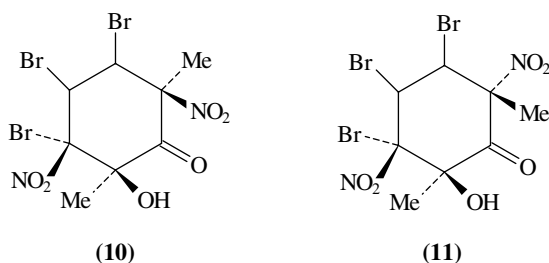
SCHEME 1

together with the 4-methylphenoxy radical and  $\text{NO}_2$ , *not* by direct electron transfer to the nitronium ions, *nor* from the radical pair generated by electron transfer to the nitronium ion. Also, the not inconsiderable polarization found in the substrate shows that there must be a significant probability of escape from the radical pair (Path A, Scheme 1) and that the initial oxidation step must also be reversible. This reversibility in the primary oxidation step had already been deduced from a kinetic study<sup>23</sup> under quite different conditions, i.e. for nitrous acid catalysed nitration in aqueous nitric acid. The subsequent rearrangements (Paths B and C) will be dealt with later.

Formation of *ipso*-intermediates by reaction of aromatic compounds with nitrogen dioxide is, of course, limited to the more reactive substrates such as phenols. Hartshorn's group<sup>24-33</sup>, also recently in conjunction with Ebersohn<sup>34-39</sup>, having investigated the reactions of *ipso*-compounds formed from many different substituted phenols using mainly fuming nitric acid as nitrating agent, wished to determine whether nitrogen dioxide would give a similar pattern of reactivity<sup>27</sup>. In a typical experiment, a suspension of 3,4,5-tribromo-2,6-dimethylphenol was suspended in cyclohexane, the solvent deoxygenated by a flow of nitrogen, and pure nitrogen dioxide was bubbled through the stirred suspension. A detailed study of the reaction has demonstrated the occurrence of the appropriate 4-nitrocyclohexa-2,5-dienone, as well as a product, 6-hydroxy-2,6-dimethyl-3,4,5-tribromocyclohexa-2,5-dienone, which further reacted with  $\text{NO}_2$  to generate two isomeric dinitro ketones (**10**, *cis*- 56%; **11**, *trans*- 31%). The possible sequence of reactions is illustrated in Scheme 2. Several points of interest arise here: some will have to be



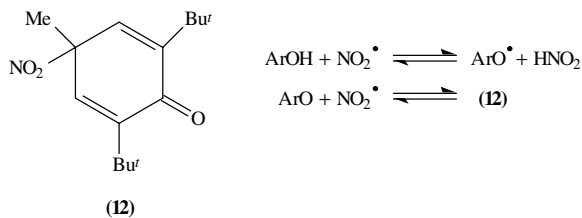
SCHEME 2



deferred to a later moment when we consider the rearrangements of *ipso*-intermediates. The suggested route to the formation of the *ipso*-intermediate, hydrogen atom abstraction from the hydroxy group of the phenol by  $\text{NO}_2$ , to generate the corresponding phenoxy radical which then combines with a further molecule of  $\text{NO}_2$ , is reminiscent of the radical process which occurs in nitrous acid catalysed nitration (*vide supra*). That this completely homolytic process, carried out in a non-polar solvent such as cyclohexane, should generate the same final products, **10** and **11**, in the same ratio (**10**, 54%; **11**, 30%) as the reaction in fuming nitric acid, is remarkable.

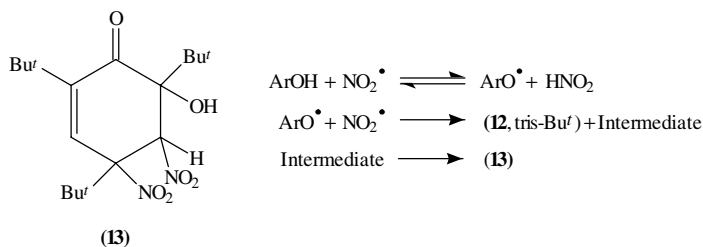
Confirmation of this mechanism, first proposed by Brunton and coworkers<sup>40</sup>, for the generation of the *ipso*-intermediates from phenols by  $\text{NO}_2$  has been produced by Coombes and collaborators<sup>41,42</sup>. They examined the kinetics of the reactions of phenol, 4-methylphenol and some 2,4,6-trialkylphenols with  $\text{NO}_2$  in cyclohexane. For example, the reaction of 2,6-di-*t*-butyl-4-methylphenol with  $\text{NO}_2$  forms the corresponding 2,6-di-*t*-butyl-4-methyl-4-nitro-cyclohexa-2,5-dienone (**12**) with a second order dependence of rate on the concentration of  $\text{NO}_2$ ; this is in accordance with the mechanism outlined in Scheme 3. On the other hand, the same reaction of 2,4,6-trimethylphenol is independent of the concentration of  $\text{NO}_2$ . This behaviour is only explicable if in the latter case the formation of the *ipso*-intermediate occurs by a rate limiting process from some other, rapidly formed, intermediate. In order to investigate this process further, 2,4,6-tri-*t*-butylphenol





SCHEME 3

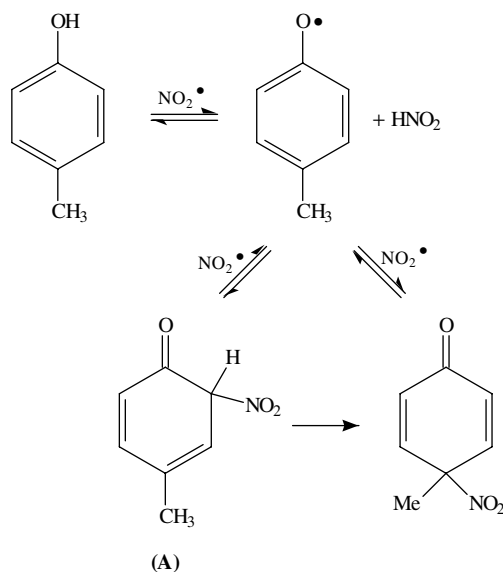
was reacted with  $\text{NO}_2$ ; it generated a small quantity of 2,6-di-*t*-butyl-*p*-benzoquinone (3%), the expected *ipso*-intermediate (67%) and a compound (22%) shown by spectroscopic data to have structure **13**. This same compound can be formed in 42% yield using  $\text{NO}_2$  in carbon tetrachloride solution but not apparently in benzene<sup>28</sup>. A kinetic study on the rate of formation of these compounds, together with data for the rate of reaction of  $\text{NO}_2$  with the 2,4,6-tri-*t*-butylphenoxy radical<sup>43</sup>, was completely consistent with Scheme 4, with the radical lying on the reaction path. It was suggested that the intermediate in this scheme may be identified with the *ipso*-intermediate generated by addition of  $\text{NO}_2$  at the 2- rather than the 4-position; this intermediate could be observed at low temperatures in deuteriochloroform; it isomerized to the 4-*ipso*-product as the temperature was raised. In the case of the more bulky *t*-butyl groups, the rate of isomerization becomes relatively fast.



SCHEME 4

Coombes and coworkers<sup>42</sup> have also investigated the reaction of 4-methylphenol with  $\text{NO}_2$  in cyclohexane as solvent. The reaction at room temperature give 32% 4-methyl-4-nitrocyclohexa-2,5-dienone and 68% 4-methyl-2-nitrophenol. This may be compared with the 30% and 70% respectively reported above for the nitrous acid catalysed process in acetic acid; again a fascinating similarity. The kinetics could only be explained in terms of a second intermediate, **A** in Scheme 5; such intermediates have been observed previously in the nitration of 2,5-dimethylphenol. In confirmation of this, a primary kinetic isotope effect was observed in the nitration of phenol itself at a relatively low  $\text{NO}_2$  concentration; and the product ratio of *ortho*- to *para*-substitution was shown to be almost identical to that for the nitrous acid catalysed nitration mechanism. Clearly, the product determining stage for both this  $\text{NO}_2$  attack and for the nitrous acid catalysed process is the addition reaction of the phenoxy and  $\text{NO}_2$  radicals. In fact, the observed product ratio is close to that predicted by relative magnitudes of the calculated (VAMP<sup>44</sup>, V.5.01, AM1 and PM3) annihilated spin densities (32, 36, 32) of the phenoxy radical at the 2-, 4- and 6-positions.

In general, it would appear that the process of *ipso*-intermediate formation of the more reactive substrates such as phenols and amines is dominated by nitrous acid catalysed



SCHEME 5

nitration, unless specific precautions are taken for this to be eliminated, and that this radical process also gives higher yields of the intermediates when the necessary substituent groups are in the 1,4-positions. In the case of dialkylbenzenes and halogenoalkylbenzenes, the classical Ingold mechanism appears more probable, although it is unlikely that the incipient *ipso*-carbocation escapes from the encounter pair in solvents such as acetic anhydride at low temperatures.

### III. FURTHER REACTIONS OF *ipso*-INTERMEDIATES AND ADDUCTS

#### A. Solvolysis of Adducts

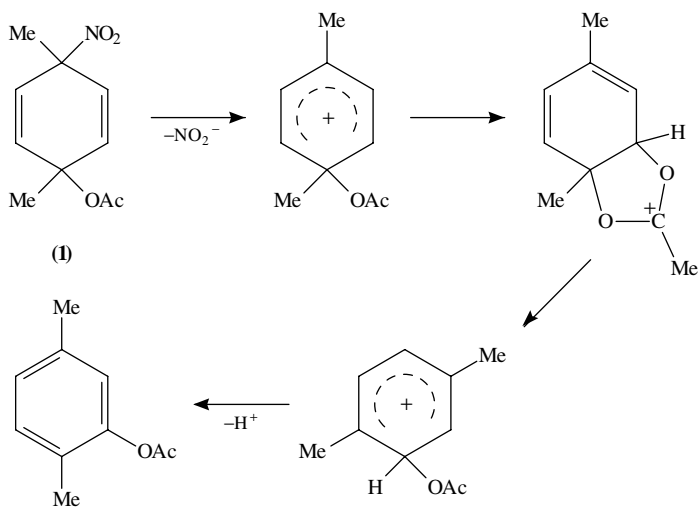
In this section we will emphasize the solvolytic behaviour of the *ipso*-adduct, although discussion of rearrangements cannot be avoided, since the latter are concurrent, competing reactions. Again, to some extent, the behaviour of the adducts arising from the nitration of 1,4-dimethylbenzene may be used as a general example. Several groups have investigated the solvolysis of 1,4-dimethyl-4-nitrocyclohexa-2,5-dienyl acetate (**1**, **14**) and its corresponding dienol. Myhre and collaborators<sup>45</sup> examined both products and kinetics in aqueous ethanol as solvent, comparing product formation for these systems with that in 50%–80% aqueous sulphuric acid. The *E* and *Z* isomers of both ester and alcohol were prepared and characterized as outlined above and subjected to solvolytic elimination in aqueous ethanol (40%–75%). Both isomeric acetates generated 2,5-dimethylphenyl acetate in at least 99.5% yield; no detectable amounts of the corresponding 2,4-isomer were found. The decomposition was first order in adduct, the *E* isomer being more reactive (by a factor of about 3). In acid solution, the products were, depending on the acid strength, a mixture of 2,5-dimethylnitrobenzene and the side-chain substitution product, *p*-tolualdehyde. Thus in greater than 77% acid, the nitro compound was obtained in quantitative yield, whereas in 64% acid, while the total yield was still quantitative, it comprised 72% nitro compound and 26% aldehyde. At still lower acid concentrations, the yield of nitro compound fell off drastically, with no further increase in aldehyde production, although other side-chain

substituted compounds were observed. The kinetics in these solutions were too fast to measure by conventional techniques.

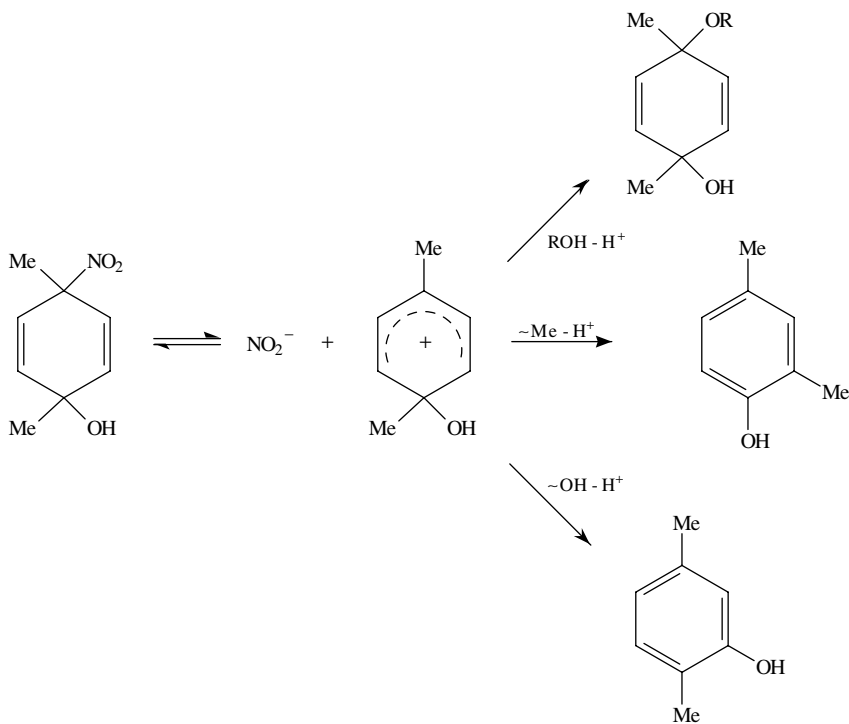
The results in aqueous ethanol were discussed in terms of Scheme 6. The rate limiting process is the rate of the solvolytic elimination of nitrous acid which depends on the ionizing power of the solvent; no primary isotope effect was observed. The migration of the acetate group had previously been shown to be intramolecular and involving a 1,2-shift<sup>46</sup>, although work with pseudocumene<sup>47</sup> has shown the possibility of a 1,3-shift of the acetoxyl group in dilute acid. The bridged cation is suggested on the basis of the known stability of such structures. The kinetic data for the aqueous alcoholic solvolysis of the dienol are more difficult to interpret since the reaction is more complex, producing about 30% 2,4-dimethylphenol, 50% 1,4-dimethylcyclohexadiene-1,4-diol together with smaller quantities of other species. The results were however thought to be consistent with Scheme 7, where the methyl group migrates more easily than the hydroxyl group. Possible routes to the variety of products obtained in acid solution are also outlined in this work.

A thorough re-examination of the products of solvolysis in aqueous organic solvents of the acetate (**14**) and its corresponding dienol and methyl ether was carried out by Fischer, Henderson and Smyth<sup>9</sup>. In order to maximize the solvolysis of the nitro group, 50% aqueous methanol was used. For up to 10 half-lives for the initial solvolysis, the products from the nitro dienol consisted of mainly methoxy dienol (**15**) and dienediol (**16**) together with the two phenols **17** and **18** (Scheme 8). At very long reaction times, the initially formed dienes were aromatized forming dimethylphenols and anisoles. In the presence of base, the rearomatization was suppressed; in trifluoroacetic acid, the dienediol gave close to 100% of the phenol (**17**). All the products were accounted for in terms of the reactions of the substituted 1,4-dimethyl-4-nitro-2,5-cyclohexadienyl cation, which can undergo 1,2- or 1,4-nucleophilic addition generating new cyclohexadienes. It is also suggested that the cation can also undergo competing rearrangements of the methyl group with the acetyl, hydroxyl or methoxyl substituents. Finally, the cation may lose a proton from the methyl side-chain to generate a triene, which in turn will undergo side-chain substitution via a benzylic cation. The variation in product yields with reaction conditions could be rationalized on this basis.

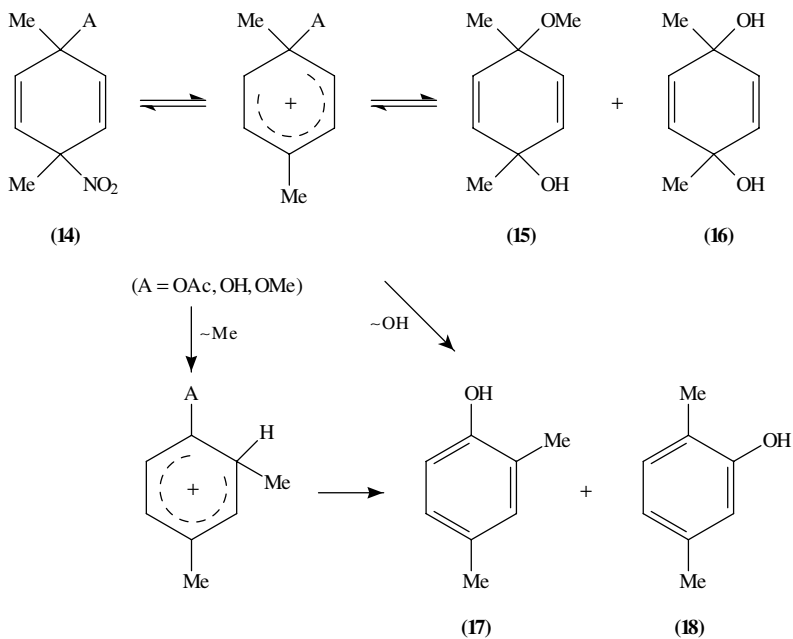
Further light has been thrown on the mechanism of solvolysis of *ipso*-adducts in aqueous acid solution by kinetic studies<sup>48,49</sup>. In order that the reactions should proceed at a measurable rate, substrates with more electron withdrawing groups than alkyl had to be used. The authors examined the kinetics and products of aqueous sulphuric acid solvolyses of 2-cyano-3,4-dimethyl-4-nitro-cyclohexa-2,5-dienyl acetate (**19**) and 5-chloro-2-methyl-2-nitrocyclohexa-3,5-dienyl acetate (**20**, a 1,2-adduct). When **20** was heated in acetic acid<sup>50</sup>, 2,3-dimethylbenzotrile and 2,3-dimethyl-5-nitrobenzotrile were formed and it was suggested that the nitro group migration was, somewhat unusually, an intramolecular 1,3-migration — more often these are 1,2-shifts. Moodie and coworkers<sup>48,49</sup> therefore investigated both kinetics and products in aqueous acid solution in the hope of clarifying these points. Their general mechanism is set out in Scheme 9, where the primary process is considered to be a competition between the elimination of nitrous acid (*E1*) to generate the Wheland type intermediate (**21**) that is the precursor of the aromatic ester, and the acid catalysed hydrolysis of the acetate group ( $A_{Al}1$ ) to form the *ipso*-cation (**22**). The cation underwent extensive capture by water particularly at low acidities and a 1,2-rearrangement of the nitro group, rather than the 1,3-shift, observed on heating. These rearrangements will be discussed later. A very similar picture was obtained for the *ipso*-adduct **20**: competing acid-catalysed elimination of nitrous acid and ester solvolysis. The *ipso*-cation generated by this solvolysis is identical to that obtained by attack on 4-chloromethylbenzene; no less than 59% of primary attack by nitronium ion takes place at C-1 in this compound.



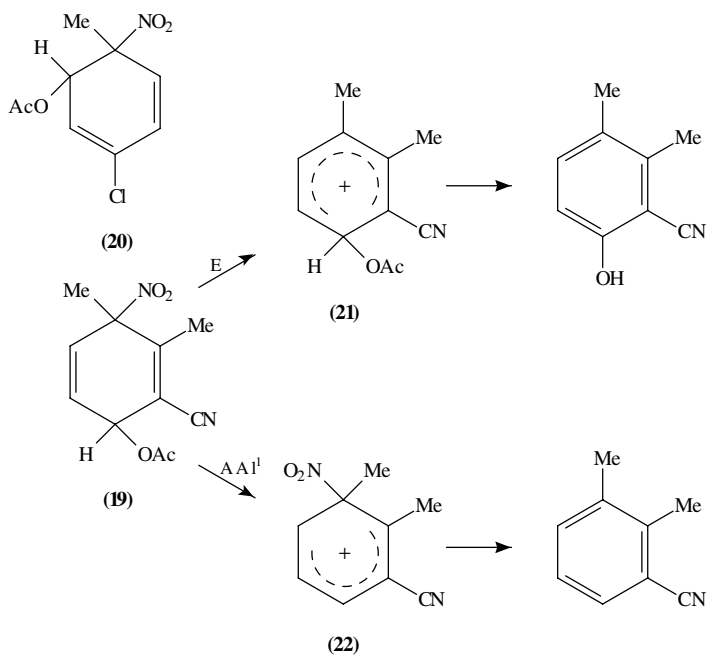
SCHEME 6



SCHEME 7



SCHEME 8

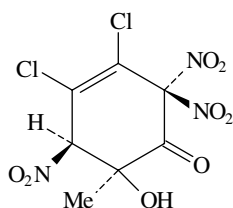


SCHEME 9

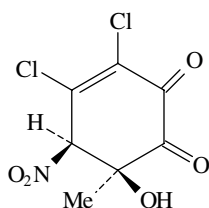
It is clear that these solvolytic reactions of *ipso*-adducts are markedly dependent on reaction conditions: strongly acidic conditions and electron withdrawing substituents will favour a heterolytic process; lower acidity, higher temperatures and electron releasing substituents probably favour homolytic processes. With so many factors involved, each substrate under each set of conditions gives rise to its own particular behaviour.

## B. Further Addition to the *ipso*-Species

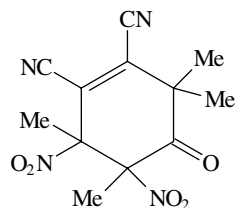
This aspect of the behaviour of *ipso*-species has been extensively investigated by Hartshorn's group. Again, it is impossible to review in any detail all the substrates that have been examined; a few examples will however illustrate the principle processes observed. A typical substrate, 4,5-dichloro-2-methylphenol<sup>24</sup>, on treatment with concentrated nitric acid gives 2,2,5-trinitro-3,4-dichloro-6-methylcyclohex-3-enone (**23**). An exactly analogous compound was observed and completely characterized by X-ray crystallography from the nitration of 4,6-dibromo-2,5-dimethylphenol. The IR, and <sup>1</sup>H and <sup>13</sup>C NMR spectra were fully in accord with this structure; the relative stereochemistry at C5 and C6 was assumed by analogy with that known for the dibromo analogue. Nitration of 4,5-dichloro-2-methyl-6-nitrophenol gave the identical compound. Further evidence for the structure comes from the behaviour of this adduct on heating in tetrachloroethylene:



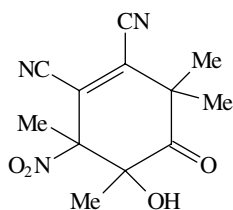
(23)



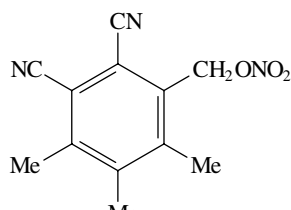
(24)



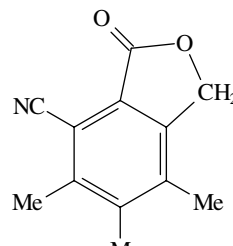
(25)



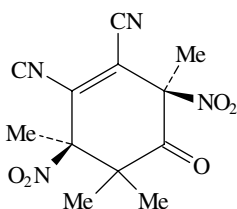
(26)



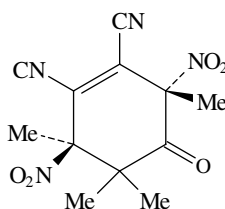
(27)



(28)

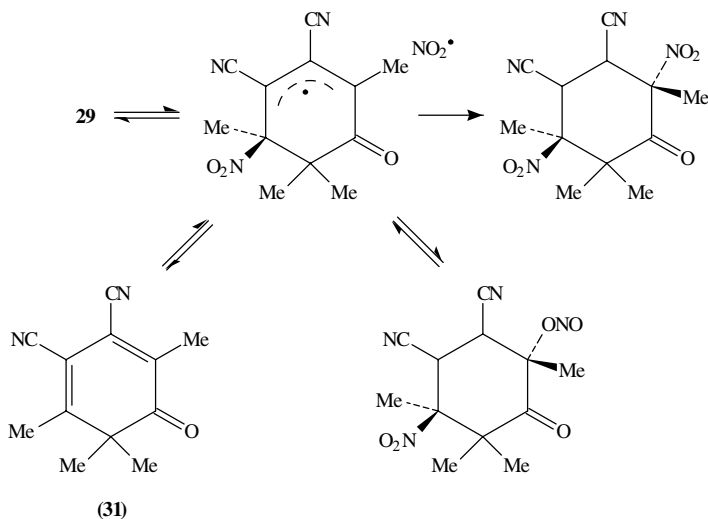


(29)



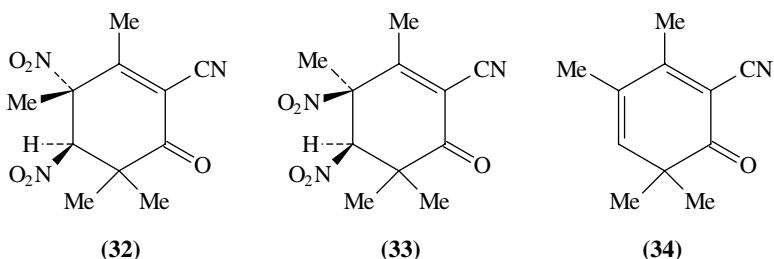
(30)

the  $\alpha$ -diketone (**24**) is formed with evolution of nitrogen dioxide. This type of addition reaction to the first generated *ipso*-intermediate is quite general and not restricted to phenols: another example may be found in the nitration of 3,4,5,6-tetramethylbenzene-1,2-dicarbonitrile. This substrate was first investigated by Suzuki's group<sup>51</sup> who reported the formation of several compounds (**25**, **26**, **27** and **28**) on nitration in fuming nitric acid. The structures given for **25** and **26** are not analogous to that, for instance, given above (**23**). This led Hartshorn and coworkers<sup>30</sup> to repeat the reaction; they identified two isomeric dinitroketones (**29**, **30**) and the two corresponding isomeric hydroxy nitro ketones, in addition to the compounds **37** and **38**. It will be noted that in this case, all the products have undergone a methyl group migration; the tendency of an *ipso*-substituted alkyl group to undergo a displacement will be discussed in the next section. The elimination of nitrogen dioxide from the *trans* dinitro ketone by refluxing in petroleum ether gives the cyclohexa-2,4-dienone (**31**); regeneration of the cyclohex-3-enones by treatment with nitrogen dioxide gives an approximately equimolar mixture of the *cis* and *trans* isomers, **29** and **30**. Likewise, the *cis* dinitroketone rearranges to the *trans* at 20°C in chloroform. These rearrangements, and the formation of the hydroxy ketones, were considered to take place via a radical pair intermediate (Scheme 10), the hydroxyl groups arising from hydrolysis of the nitrito ketones.



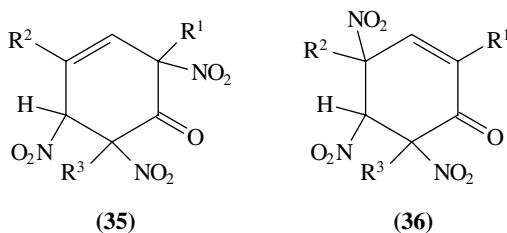
SCHEME 10

The effects of a quite small change in structure of the substrate may be illustrated by the behaviour of the 2,3,5,6-tetramethylbenzonitrile<sup>30</sup>. Here, on treatment with fuming nitric acid, the 6-nitro compound is formed as expected; two other products are the addition compounds **32** and **33**, again the *cis* and *trans* isomers. Again both compounds can be generated by direct addition of nitrogen dioxide to the 2-cyano-3,4,6-tetramethylcyclohexa-2,5-dienone (**34**). However, the *cis* dinitroketone dissolves on heating in chloroform to give solely the *trans* dinitroketone: clearly in this case a mechanism involving homolytic loss of nitrogen dioxide is most unlikely—such a process would surely lead to loss of some nitrogen dioxide and formation of **34**. In order to explain the retention of the  $\text{NO}_2$  moiety during reflux in chloroform, the authors suggest hetero- rather than homolytic cleavage of the C4- $\text{NO}_2$  bond. Thus the rearrangement in this isomer takes place via

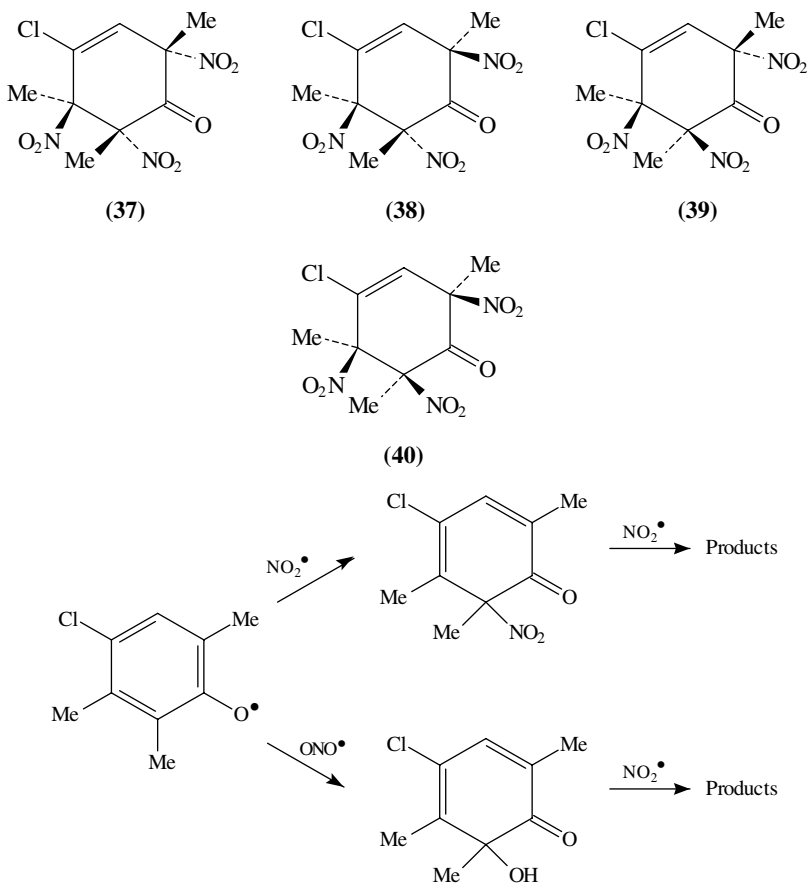


an ion pair formed from a nitronium ion and a resonance-stabilized carbanion. Recombination of the two ions with inversion at C-4 gives the required isomer. This difference in behaviour from compounds **29** and **30** above is marked; the extra stabilization of the carbanion is suggested to arise from the  $\beta$ -keto nitrile structure which is noted for the ability to stabilize a carbanionic centre at the  $\alpha$ -carbon atom—this structural feature is absent in **30**. Presumably this outweighs the extra stability which may arise in **30** from the second electron withdrawing cyano group. The reaction was also carried out in the presence of mesitylene; no nitromesitylene was formed, demonstrating that the nitronium ion does not escape from the ion pair.

If a more reactive polyalkylphenol is used as substrate, then nitrogen dioxide becomes a useful reagent for the generation and subsequent addition reactions of the *ipso*-intermediates. Thus reaction of 2,4,6-trialkylphenols<sup>31</sup> with nitrogen dioxide generates first the 4-alkyl-4-nitro-2,5-cyclohexadienone which can rearrange to the corresponding 6-nitro compound. Further reaction of this latter compound is by either 1,2- or 1,4-addition of two moles of nitrogen dioxide to form the isomeric trinitro compounds **35** and **36**, the final product depending on the sizes of the alkyl groups at C-2 and C-4. Hydroxyketones are also among the products when 4-chloro-2,3,6-trimethylphenol<sup>33</sup> is used. In order to characterize these, a reaction was first carried out with nitric acid in acetic acid which favours formation of these compounds relative to the trinitro adducts; four hydroxy ketones were characterized by X-ray crystallography. When the same substrate was reacted with nitrogen dioxide in benzene, in addition to the hydroxy ketones, four isomeric trinitroketones (**37**–**40**) were isolated and characterized. These compounds accounted for some 60% of the products and hydroxy ketones for 12%. Comparison of the behaviour of this substrate with that of 3-chloro-2,4,6-trimethylphenol and 2,3,4,6-tetramethylphenol enabled a comparison of the effect of the 3-substituent to be carried out. Essentially the reaction can be explained in terms of the recombination of the phenoxy and  $\text{NO}_2$  radicals to form either nitro or nitrito compounds, the latter giving rise to hydroxy ketones, the former to nitroketones (Scheme 11), both these species capable of further addition of  $\text{NO}_2$ . For 3-methyl substituted phenols, the pattern of attack was that arising from formation of an *ipso*-intermediate at the 6-position; for the 3-chloro-substituted phenol, attack must have been at the 2-position. As well as this change in the regiochemistry of the addition, the chloro substituent promotes the formation of





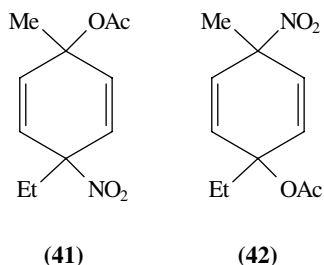


SCHEME 11

hydroxy ketones, either by favouring radical recombination via ONO, or by facilitating the hydrolysis.

#### IV. REARRANGEMENT OF *ipso*-SUBSTITUTED GROUPS

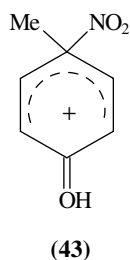
The migration of *ipso*-substituted groups, whether those attacked (e.g. alkyl) or those attacking (such as nitro or acetoxy), is a fertile ground for investigation. The behaviour of a typical *ipso*-adduct may be conveniently illustrated by the behaviour of the cyclohexadiene adducts arising from the nitration of 4-ethyltoluene in acetic anhydride<sup>5</sup>. Here all four possible adducts, the diastereoisomeric pairs of the 4-ethyl-1-methyl-4-nitro- and 1-ethyl-4-methyl-4-nitrocyclohexa-2,5-dienyl acetates, were obtained (**41**, **42**) and separated. The authors formulated the migration steps as occurring via the cyclohexadienyl cation. All possible rearrangement products can be realized under appropriate conditions; that is methyl, ethyl, acetoxy and nitro groups were all observed to migrate. In strongly acidified methanol, the formation of the nitrocyclohexadienyl cation is favoured; in methanol itself, or, better, aqueous methanol, the acetoxy-cyclohexadienyl cation is produced. The reaction



is further complicated by capture of the methoxy group also being of importance, not to mention migrations into the side-chain. However, Fischer and Henderson were able to establish that, for example in the 4-acetoxy-4-alkylcyclohexadienyl cation, 1,2-migration of acetoxy is faster than alkyl migration, but 1,2-alkyl migration is faster than that of hydroxyl or methoxyl in the corresponding cations. Nitro group migration appears always to take preference over other possibilities.

Much more detailed mechanistic studies have been carried out on the *ipso*-intermediates, 4-methyl-4-nitrocyclohexa-2,5-dienones (substituted 2-methyl, 3-methyl and 2-nitro), formed by nitration of the corresponding phenols. Here, only nitro group migration is important, and that only from the 4- to the 2-(6-)position. The first careful mechanistic study of such systems was carried out by Barnes and Myhre<sup>52</sup> who examined the behaviour on rearrangement of the 4-methyl-, 3,4-dimethyl- and 3,4,5-trimethylcyclohexa-2,5-dienones in both non-polar organic, aqueous and aqueous-acid solvents. In contrast to the 4-alkyl-4-nitro adducts discussed above, a 1,3-shift of the nitro group rather than a 1,2-shift was observed in all solvents. The reaction was faster in non-polar organic solvents than in water and kinetically first order in *ipso*-intermediate: the rate of formation of the product 2-nitro compound was equal to the rate of disappearance of the intermediate. The activation entropy was small and positive and radical scavengers lowered the yield of nitro product. Methyl groups substituted in the 3- and 5-positions slowed the reaction down. <sup>15</sup>N labelling of the nitro group demonstrated substantial but incomplete scrambling of the label. All these facts were held to be consistent with a radical dissociation-recombination process, with extensive loss of NO<sub>2</sub> from the solvent cage. An acid-catalysed route for the rearrangement was also found.

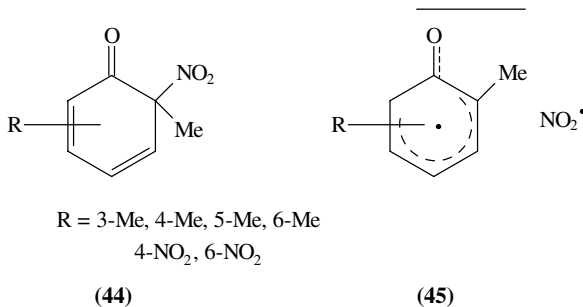
The work of Coombes and coworkers<sup>20</sup> on the formation of the 4-methyl-4-nitro intermediate has already been discussed above. Here the solvent was aqueous sulphuric acid with acid concentration ranging from 55% to 90%. The final product, 4-methyl-2-nitrophenol, was formed by the expected two routes: about 40% via the *ipso*-intermediate and 60% directly. Their kinetic studies enabled the acidity dependence of the *ipso*-rearrangement to be examined; they argued that this dependence demonstrated that the rate-limiting stage of the conversion involved the protonated *ipso*-intermediate (43). They



argued that, unlike the reaction in less acidic media, already established as a radical process, the catalysed process involved a rate-limiting reversion to the nitronium ion/phenol encounter pair, followed by heterolytic fission of the C–N bond and fast formation of product. They pointed out that if this acid catalysed process were homolytic, then effectively one must assume that electron transfer from phenol to nitronium ion must take place during encounter pair formation, an earlier suggestion by Perrin<sup>53</sup>. Later, some evidence that this acid catalysed process did *not* involve dissociation to the nitronium ion was produced by Myhre<sup>54</sup>.

In an attempt to clarify these processes further<sup>55</sup>, the rearrangement of the 4-methyl-4-nitrocyclohexa-2,5-dienone was followed *in situ* in an NMR spectrometer, to establish the presence of CIDNP effects. The formation of this *ipso* species has already been discussed; under the conditions of these experiments it is formed essentially by the nitrous acid catalysed radical nitration process, to the extent of approximately 70%, the major side-product being the 4-methyl-2-nitrophenyl acetate (the phenolic product of the rearrangement is acetylated rapidly in the acetic anhydride solvent). The nitrocyclohexadienone also reverts to 4-methylphenyl acetate during this period to the extent of 20%. The reactions are shown in Scheme 1. The rearrangement was followed by <sup>1</sup>H NMR; it gave first order kinetics and no sign of any <sup>1</sup>H nuclear polarization. Both the uncatalysed and acid-catalysed processes could be distinguished under these conditions; about 4% added sulphuric acid was required to give a reaction proceeding through the catalysed route to the extent of 90%. Substituent effects on this first order rate were also obtained: a 2-methyl substituent increased the rate by 20%, 3-methyl decreased it by about a factor of two and a 2-nitro group increased it by a factor of approximately 20. There was no marked difference between the substituent effect on the catalysed and uncatalysed processes. <sup>15</sup>N NMR spectra were then taken during the rearrangement, again under both acid catalysed and non-acid catalysed conditions. The various enhancement factors for the nitrogen nucleus in both reactant and product could be extracted mathematically for all possible routes illustrated in Scheme 1. This showed unambiguously that both the acid catalysed route and the simple thermal rearrangement *both* give rise to CIDNP effects and both must take place by homolytic dissociation of the C–N bond. This is also in accord with the substituent effects mentioned above. It is also clear from these studies that there is a significant return to the initial cyclohexadienone from the radical pair. Although the results require the acid catalysed rearrangement to have a homolytic component, obviously some contribution from a heterolytic process (Path C, Scheme 1) cannot be ruled out.

As we have noted so frequently before, it is important not to extrapolate too far in attempting to deduce a mechanism—even when only small structural changes in substrate are involved. The rearrangement of the nitro group in the *ipso*-intermediates derived from some 2-methylphenol provides an interesting example<sup>56</sup>. Here the intermediates, variously substituted 2-methyl-2-nitrocyclohexa-3,5-dienones (**44**), rearrange rapidly and regiospecifically to the corresponding 6-nitro-2-methylphenols unless the 6-position is

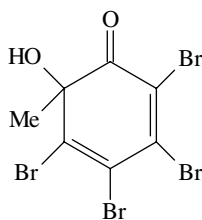


blocked. The same regioselectivity is found in the nitro group rearrangements of substituted 2-nitrophenols in trifluoromethanesulphonic acid<sup>57</sup>, where the rearrangement occurs via the Wheland intermediate. By analogy with the rearrangement of the 4-methyl-4-nitrocyclohexa-2,5-dienones outlined above, one would expect a homolytic mechanism, but a radical pair process involving NO<sub>2</sub> is not normally expected to be regioselective. Such radical pairs as **45**, when generated either by rearrangement of an *ipso*-intermediate or by nitrous acid catalysed nitration, result in attachment of NO<sub>2</sub> at both *ortho* and *para* positions as would be expected from the very similar spin densities at these sites. Previous workers investigating these substrates had noted the regioselectivity and suggested two possible explanations: either a homolytic process involving the transient formation of phenyl nitrate<sup>20</sup> or a 1,5 sigmatropic shift<sup>58</sup>. By generating the <sup>15</sup>N labelled *ipso*-intermediate and following the <sup>15</sup>N NMR spectrum during its rearrangement, it was shown that no CIDNP effect was observable *unless* the 6-position was blocked, in which case rearrangement takes place to the 4-position *with* a CIDNP effect. Both the regioselective 2-6 rearrangement and the clearly homolytic 2-4 rearrangement undergo acid catalysis to much the same extent. It seems that it is most unlikely that completely different mechanisms apply to these two rearrangements: in each case then the first step must involve homolysis of the C-N bond. Extensive semi-empirical calculations failed to detect a transition state for a 1,5 sigmatropic process; the NO<sub>2</sub> group always appears to move away from the 6-position as the C-N bond is stretched. The explanation for the absence of a CIDNP effect, and the marked regioselectivity for the 2-6 rearrangement, must presumably be sought elsewhere. The calculations mentioned above suggested that the barrier to movement of the NO<sub>2</sub> towards the 4-position is greater than that for movement towards the oxygen atom of the phenoxy radical. Perhaps then no escape from the radical pair undergoing the 2-6 shift takes place because of stabilizing interactions between the phenoxy oxygen atom and the NO<sub>2</sub> nitrogen atom as previously suggested by Coombes and collaborators<sup>20</sup>. It is worth emphasizing that although the presence of a CIDNP effect can be diagnostic of the presence of a radical pair on the reaction path<sup>59</sup>, the absence of such effects does not preclude a homolytic reaction. It is also necessary for some escape from the radical pair to take place, for there to be a reasonable electron spin density on the nucleus under observation and for the relaxation time of that nucleus to be sufficiently long. It is for these reasons that the observation of <sup>15</sup>N CIDNP effects in nitration processes involving NO<sub>2</sub> is easier than with other nuclei in the system.

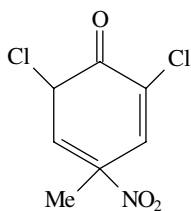
If the *ipso*-position attacked during nitration is already substituted by a nitro group, then the consequences of such a process will not be recognized unless the attacking nitrating agent or the original group is labelled (most conveniently with <sup>15</sup>N). Thus *ipso*-attack at the 4-position in 4-nitrophenol was investigated<sup>60</sup> and shown to occur to the extent of 20%. The conditions used involved nitric acid in trifluoroacetic acid in the presence of nitrous acid catalysed nitration, so it is not unexpected that the formation of the *ipso*-intermediate should be a free radical process. The rearrangement of the nitro group to the 2-position was also shown to be a homolytic process, involving the NO<sub>2</sub>-4-nitrophenoxy radical pair. This was demonstrated by <sup>15</sup>N labelling of the 4-nitrophenol and treating this with unlabelled nitric acid; the migrating nitro group in the 2-position showed a CIDNP effect of the appropriate phase. Another interesting aspect of this reaction, although not directly relevant to *ipso*-attack, is that the 2,4-dinitrophenol which is produced directly, even in conditions when nitrous acid catalysed nitration is prevented, also forms by a homolytic process. The authors suggest that this is possibly via nitronium attack on the phenolic oxygen atom to generate phenyl nitrate, which can then undergo a rearrangement akin to the nitramine rearrangement which is typically a homolytic process. It seems unlikely that this observation of a CIDNP effect arises from direct electron transfer from phenol to nitronium ion, since no such effect is observed with mesitylene, which is expected to be just as easily oxidized.

The exchange of nitro groups is not restricted to that at the 4-position relative to the hydroxyl group. Konior and coworkers<sup>61</sup> have nitrated both 2,6-dinitrophenol and picric acid with <sup>15</sup>N labelled nitric acid in acetic anhydride. The product from both nitrations (picric acid) showed the presence of the label in all three positions of the nitro group; indeed, in the picric acid derived from the dinitrophenol, the nitro group in the 4-position was also labelled <sup>14</sup>N. No precautions were taken to eliminate nitrous acid catalysed nitration so that it is possible that both formation of the *ipso*-intermediates and their rearrangement proceed via a radical pair. However, as pointed out by Moodie<sup>62</sup>, increasing the number of electron withdrawing substituents in the ring may well increase the extent of heterolysis as opposed to homolysis during the apparently very similar nitramine rearrangement; for example, significant heterolysis occurs during the rearrangement of *N*-2,4-trinitroaniline to picramide.

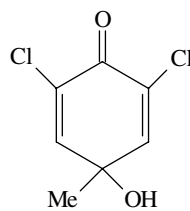
Yet another way in which an *ipso* nitro group may rearrange is to generate a nitrito compound. Thus when 2,3,4,5-tetrabromo-6-methylphenol is nitrated in fuming nitric acid, Hartshorn's group<sup>26</sup> noted the formation of the product 2,3,4,5-tetrabromo-6-methyl-6-hydroxycyclohexa-2,4-dienone (**46**). They suggested that this is produced via the corresponding 6-nitrito intermediate, which could not be isolated since it is hydrolysed during the work-up of the reaction products. Such hydroxy compounds are frequently observed on nitration of alkyl phenols. Confirmation of the existence of these nitrito *ipso*-intermediates and their facile hydrolysis to the corresponding hydroxy compounds has been gained from analysis of the <sup>1</sup>H and <sup>15</sup>N NMR spectra obtained<sup>63</sup> during the nitrous acid catalysed nitration of 2,6-dichloro-4-methylphenol. Four products were characterized by NMR: **47**–**50**. The 4-nitro-4-methyl *ipso*-intermediate could be isolated from the nitration; when dissolved in wet chloroform two other compounds are formed in the first five minutes with the disappearance of about half the starting material. One of these is the hydroxy compound **48**, the other is clearly an *ipso*-intermediate. When <sup>15</sup>N labelled starting material is used, only two signals are observed; one for the starting material and one at very low field ( $\delta$  600 p.p.m.) typical of nitrites. Further evidence for the nature of this compound and for its equilibrium with the nitro intermediate was obtained by treating the hydroxy compound with nitrous acid dissolved in chloroform and again



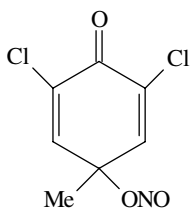
(46)



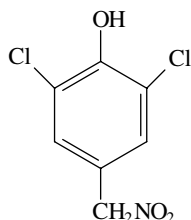
(47)



(48)



(49)



(50)

following the reaction with  $^1\text{H}$  NMR. As expected, the spectra of both the nitrito and nitro compounds are observed. The equilibrium can therefore be approached from either side. The reaction mixture is unstable, losing oxides of nitrogen; after several hours the major product visible has a spectrum corresponding to the aryl nitromethane **50**. More recently Ebersohn, Hartshorn and coworkers<sup>36</sup> have observed such nitrito compounds spectroscopically, during the photochemical nitration of 1,4,5,8-tetramethylnaphthalene with tetranitromethane. These were observed during the first hour of the reaction, subsequently disappearing.

## V. DISPLACEMENT OF *ipso*-SUBSTITUTED GROUPS

Many examples may be found in the literature<sup>1</sup> of the displacement of substituents other than hydrogen during nitration with concurrent formation of aromatic nitro compounds. Often these displacements are from highly activated substrates, and one frequently suspects that the dominating mechanism of formation of the final nitro product is nitrous acid catalysed nitration, the product-determining stage being attack of  $\text{NO}_2$  radical rather than nitronium ion on the *ipso*-position. An interesting use of *ipso*-displacement of a *tert*-butyl group by nitro is exemplified by the approach of Verboom and collaborators<sup>64</sup> to the functionalizing of calixarenes. Calix[4]arenes are often functionalized at the upper rim by nitration of free positions *para* to the hydroxyl group on the lower rim or by *ipso* nitration of *p*-sulphonate groups. Thus nitration of tetra-*t*-butyl-tetramethoxycalix[4]arene, where the *t*-butyl groups are *para* to the methoxyl groups, resulted in a good yield of the corresponding tetra-nitro compound. Dialkylated calix[4]arenes reacted much more quickly than the tetra-alkylated species to give regiospecific products where nitro-*de-t*-butylation occurs *para* to hydroxyl not methoxyl; this product, under more forcing conditions, then gives the expected tetra-nitro derivative. In this way, by control of the oxygenated function at the lower rim, a variety of usefully functionalized calixarenes may be prepared.

Another interesting system that has been investigated by Yamato and coworkers<sup>65</sup> comprises a series of 1,*n*-bis(5-*t*-butyl-2-methoxy-3-methylphenyl)alkanes where *n* ranges from 1 to 4, together with the corresponding biphenyl. Even in the absence of the 3-methyl group, the *para*-directing influence of the methoxyl group was sufficient to give significant amounts (13%) of the mono-5-nitro compound (*n* = 2). With the 3-methyl substituent blocking the other activated position, both mono- and di-nitro-*de-t*-butylation occurred with yields ranging up to 93%. The authors suggest that the high yields may be explained by one aromatic ring stabilizing the other arenonium ring arising from the *ipso*-attack of the nitronium ion.

Displacement of groups undergoing *ipso*-attack in indoles under both nitrating conditions and nitrosating conditions has been investigated by Colonna, Greci and Poloni<sup>66</sup>. Indoles are reactive species to electrophilic attack which occurs mainly at the 3-position. If this position is substituted by the  $\text{N}_2\text{C}_6\text{H}_5$ ,  $\text{CH}_2\text{OH}$ ,  $\text{COCH}_3$  or  $\text{CHO}$  groups, all could be displaced by treatment with 70% nitric acid mixed with twice its volume of acetic acid, to give the corresponding 3-nitro compound, often in addition to the 3,4- and 3,6-dinitro species. They failed to isolate any *ipso*-adduct, but deduced its presence from the deep colour observed on addition of the nitric/acetic acid solution. The reaction of the same substrates with sodium nitrite in acetic acid also gave the 3-nitro compounds; since the authentic 3-nitroso derivative could be oxidized by nitrous acid through to the corresponding 3-nitro compound, they deduced that the mechanism was one involving the 3-nitroso compound as an intermediate. However, the 3-nitrosoindole gives both the 3-nitro- and 3,5-dinitroindoles under these conditions; this was ascribed to the possibility of the *ipso*-cation undergoing both direct nitration in the 5-position as well as nitro-*de*-nitrosation. When carrying out the reactions in the cavity of an ESR spectrometer, a signal

ascribed to the NO<sub>2</sub> radical was sometimes observed. In these cases an electron transfer mechanism to generate the substrate cation radical, followed by radical pair collapse, was suggested. A sequence of leaving abilities of the various groups in the 3-position, based on yields and reaction times, is also given. In a later paper<sup>67</sup>, this work is extended to 4-substituted *N,N*-dimethylanilines and indolizines: further confirmation of the radical process was obtained.

As a final example in this section, we may consider the *ipso*-displacement of the nitro group itself. Liu and Zhao<sup>68</sup> have investigated the substitution of the nitro group in a series of 4-nitrobenzoate esters by the phenylthiolate anion. Here the process again involves radical species, but now it is the radical anions of the nitro compounds which are observed as well as the thiophenoxy radical which could be trapped.

## VI. CONCLUSION

Of necessity, only a few of the many papers published in this area have been examined in detail in this review. Clearly, the area of aromatic nitration is still full of surprises<sup>38</sup> and *ipso*-attack of nitrating species on substituted aromatics is proving useful in elucidating many of the subtle mechanistic details<sup>37</sup>.

## VII. REFERENCES

1. K. Schofield, in *Aromatic Nitration* (Ed. K. Schofield), Chap. 10, Cambridge University Press, 1980, pp. 171–235.
2. C. L. Perrin and G. A. Skinner, *J. Am. Chem. Soc.*, **93**, 3389 (1971).
3. A. Fischer, D. R. A. Leonard and R. Roderer, *Can. J. Chem.*, **57**, 2527 (1979).
4. A. Fischer, G. N. Henderson, T. A. Smyth, F. W. B. Einstein and R. E. Cobbleddick, *Can. J. Chem.*, **59**, 584 (1981).
5. A. Fischer and G. N. Henderson, *Can. J. Chem.*, **59**, 2314 (1981).
6. G. S. Bapat, A. Fischer, G. N. Henderson and S. Raymahasay, *J. Chem. Soc., Chem. Commun.*, 119 (1983).
7. G. G. Cross, A. Fischer, G. N. Henderson and T. A. Smyth, *Can. J. Chem.*, **62**, 1446 (1984).
8. A. Fischer, G. N. Henderson and L. M. Iyer, *Can. J. Chem.*, **63**, 2390 (1985).
9. A. Fischer, G. N. Henderson and T. A. Smyth, *Can. J. Chem.*, **64**, 1093 (1986).
10. A. Fischer, D. L. Fyles, G. N. Henderson and S. R. Mahasay, *Can. J. Chem.*, **64**, 1764 (1986).
11. A. Fischer, D. L. Fyles, G. N. Henderson and S. Raymahasay, *Can. J. Chem.*, **65**, 1233 (1987).
12. R. G. Clewley, A. Fischer and G. N. Henderson, *Can. J. Chem.*, **67**, 1472 (1989).
13. C. E. Barnes, K. S. Feldman, M. W. Johnson, H. W. Lee and P. C. Myhre, *J. Org. Chem.*, **44**, 3925 (1979).
14. H. Shosenji, A. Nagayoshi, T. Takemoto and K. Yamada, *J. Chem. Soc., Chem. Commun.*, 770 (1979).
15. P. C. Myhre, *J. Am. Chem. Soc.*, **94**, 7921 (1972).
16. Th. Zincke, *J. Prakt. Chem.*, **61**, 561 (1900).
17. F. Al-Omran, K. Fujiwara, J. C. Giffney, J. H. Ridd and S. R. Robinson, *J. Chem. Soc., Perkin Trans. 2*, 518 (1981).
18. J. C. Giffney and J. H. Ridd, *J. Chem. Soc., Perkin Trans. 2*, 618 (1979).
19. P. Helsby and J. H. Ridd, *J. Chem. Soc., Perkin Trans. 2*, 311 (1983).
20. R. G. Coombes, J. G. Golding and P. Hadjigeorgiou, *J. Chem. Soc., Perkin Trans. 2*, 1451 (1979).
21. J. H. Ridd, S. Trevellick and J. P. B. Sandall, *J. Chem. Soc., Perkin Trans. 2*, 573 (1992).
22. R. Kaptein, *J. Chem. Soc., Chem. Commun.*, 732 (1971).
23. M. Ali and J. H. Ridd, *J. Chem. Soc., Perkin Trans. 2*, 327 (1981).
24. M. P. Hartshorn, H. T. Ing, K. E. Richards, R. S. Thompson and J. Vaughan, *Aust. J. Chem.*, **35**, 221 (1982).
25. M. J. Gray, M. P. Hartshorn, K. E. Richards, W. T. Robinson, K. H. Sutton, R. S. Thompson and J. Vaughan, *Aust. J. Chem.*, **35**, 1237 (1982).

26. M. P. Hartshorn, H. T. Ing, K. E. Richards, K. H. Sutton and J. Vaughan, *Aust. J. Chem.*, **35**, 1635 (1982).
27. M. P. Hartshorn, R. J. Martyn, W. T. Robinson, K. H. Sutton, J. Vaughan and J. M. White, *Aust. J. Chem.*, **36**, 1589 (1983).
28. M. P. Hartshorn, W. T. Robinson, K. H. Sutton and J. Vaughan, *Aust. J. Chem.*, **38**, 161 (1985).
29. M. J. Gray, M. P. Hartshorn and J. Vaughan, *Aust. J. Chem.*, **39**, 59 (1986).
30. M. P. Hartshorn, J. M. Readman, W. T. Robinson, C. W. Sies and G. J. Wright, *Aust. J. Chem.*, **41**, 373 (1988).
31. J. W. Blunt, M. P. Hartshorn, R. G. Jensen, A. G. Waller and G. J. Wright, *Aust. J. Chem.*, **42**, 675 (1989).
32. M. P. Hartshorn, M. C. Judd, R. W. Vannoort and G. J. Wright, *Aust. J. Chem.*, **42**, 689 (1989).
33. J. L. Calvert, M. P. Hartshorn, W. T. Robinson and G. J. Wright, *Aust. J. Chem.*, **46**, 1629 (1993).
34. L. Ebersson, M. P. Hartshorn and F. Radner, *J. Chem. Soc., Perkin Trans 2*, 1799 (1992).
35. J. L. Calvert, L. Ebersson, M. P. Hartshorn, R. G. A. R. MacLagan and W. T. Robinson *Aust. J. Chem.*, **47**, 1211 (1993).
36. L. Ebersson, J. L. Calvert, M. P. Hartshorn and W. T. Robinson, *Acta Chem. Scand.*, **47**, 1025 (1993).
37. L. Ebersson, M. P. Hartshorn, F. Radner and J. O. Svensson, *J. Chem. Soc., Perkin Trans 2*, 1719 (1994).
38. L. Ebersson, M. P. Hartshorn and F. Radner, *Acta Chem. Scand.*, **48**, 937 (1994).
39. C. P. Butts, L. Ebersson, G. J. Foulds, K. L. Fulton, M. P. Hartshorn and W. T. Robinson, *Acta Chem. Scand.*, **49**, 76 (1995).
40. G. Brunton, H. W. Cruse, K. M. Riches and A. Whittle, *Tetrahedron Lett.*, **20**, 1093 (1979).
41. R. G. Coombes, A. W. Diggle and S. P. Kempell, *Tetrahedron Lett.*, **34**, 8557 (1993).
42. R. G. Coombes, A. W. Diggle and S. P. Kempell, *Tetrahedron Lett.*, **35**, 6373 (1994).
43. C. D. Cook and R. C. Woodworth, *J. Am. Chem. Soc.*, **75**, 6242 (1953).
44. G. Rauhut, J. Chandrasekhar, A. Alex, T. Steinke and T. Clark, Centrum für Computer-Chemie der Universität Erlangen-Nurnberg, 1993.
45. J. T. Geppert, M. W. Johnson, P. C. Myhre and S. P. Woods, *J. Am. Chem. Soc.*, **103**, 2057 (1981).
46. A. Fischer and J. N. Ramsay, *Can. J. Chem.*, **52**, 3960 (1974).
47. H. W. Gibbs, R. B. Moodie and K. Schofield, *J. Chem. Soc., Perkin Trans. 2*, 1145 (1978).
48. C. Bloomfield, R. B. Moodie and K. Schofield, *J. Chem. Soc., Perkin Trans. 2*, 1003 (1983).
49. C. Bloomfield, R. B. Moodie and K. Schofield, *J. Chem. Soc., Perkin Trans. 2*, 1793 (1983).
50. A. Fischer and C. C. Greig, *Can. J. Chem.*, **52**, 1231 (1974).
51. H. Suzuki, A. Inoue, M. Koge and T. Hanafusa, *Bull. Chem. Soc., Jpn.*, **51**, 1172 (1978).
52. C. E. Barnes and P. C. Myhre, *J. Am. Chem. Soc.*, **100**, 973 (1978).
53. C. L. Perrin, *J. Am. Chem. Soc.*, **99**, 5516 (1977).
54. P. C. Myhre, Report 1985, ARO-17572.1-CH-H; cf. Gov. Rep. Announce Index (U.S.), **85(24)**, Abstr. No. 555-257, 1985.
55. J. H. Ridd, S. Trevellick and J. P. B. Sandall, *J. Chem. Soc., Perkin Trans. 2*, 1535 (1992).
56. J. H. Ridd, S. Trevellick and J. P. B. Sandall, *J. Chem. Soc., Perkin Trans. 2*, 1073 (1993).
57. J. V. Bullen and J. H. Ridd, *J. Chem. Soc., Perkin Trans. 2*, 1675 (1990).
58. A. Fischer and G. N. Henderson, *Tetrahedron Lett.*, **21**, 4661 (1980).
59. J. H. Ridd and J. P. B. Sandall, *J. Chem. Soc., Chem. Commun.*, 402 (1981).
60. A. H. Clemens, J. H. Ridd and J. P. B. Sandall, *J. Chem. Soc., Perkin Trans. 2*, 1667 (1984).
61. R. J. Konior, R. I. Walter, U. L. Bologa, M. T. Capriogu, N. Negoita and A. T. Balaban, *Polish J. Chem.*, **68**, 2451 (1994).
62. R. B. Moodie, in *Aromatic Nitration* (Ed. K. Schofield), Chap. 15, Cambridge University Press, 1980.
63. M. R. Amin, L. Dekker, D. B. Hibbert, J. H. Ridd and J. P. B. Sandall, *J. Chem. Soc., Chem. Commun.*, 658 (1986).
64. W. Verboom, A. Durie, R. J. M. Egberink, Z. Asfari and D. N. Reinhoudt, *J. Org. Chem.*, **57**, 1313 (1982).
65. T. Yamato, H. Kamimura, K. Noda and M. Tashiro, *J. Chem. Res. (S)*, 424 (1994).
66. M. Colonna, L. Greci and M. Poloni, *J. Chem. Soc., Perkin Trans. 2*, 628 (1981).
67. M. Colonna, L. Greci and M. Poloni, *J. Chem. Soc., Perkin Trans. 2*, 165 (1984).
68. Y. -C. Liu and W. -Y. Zhao, *Acta Chimica Sinica*, **49**, 615 (1991).



## CHAPTER 22

# Nitric oxide from arginine: a biological surprise

ALAN H. MEHLER

*Department of Biochemistry and Molecular Biology, Howard University,  
Washington, DC, USA*

---

I. ABBREVIATIONS .....	974
II. ABBREVIATIONS AND DESIGNATIONS USED IN BIOCHEMISTRY .....	974
III. INTRODUCTION .....	974
A. Early Reports on NO .....	974
B. Mechanism of NO Formation .....	975
C. Content of Folate and the Origin of Oxygen .....	976
IV. INDIVIDUAL NOS .....	976
A. bNOS cDNA .....	976
B. eNOS cDNA .....	977
C. iNOS cDNA .....	978
V. LOCALIZATION OF THE HUMAN GENE .....	978
A. bNOS in the Human Gene .....	978
B. eNOS in the Human Gene .....	979
C. iNOS in the Human Gene .....	979
D. Three Genes come from Three Chromosomes .....	980
VI. FORMATION OF NO AND CITRULLINE .....	980
VII. COMPLEXITIES OF NOS .....	983
A. Role of BH <sub>4</sub> .....	983
B. Iron in NOS .....	983
C. Subunits and Dimers .....	987
D. Complications of Many Cofactors .....	989
E. Inhibitors of NOS .....	990
F. Factors for Growth of NOS .....	991
VIII. PHYSIOLOGICAL FUNCTIONS OF NOS .....	992
IX. CONCLUSIONS .....	993
X. REFERENCES .....	993

---

## I. ABBREVIATIONS

bNOS	brain nitric oxide synthase
BH <sub>4</sub>	tetrahydrobiopterin, tetrahydrofolate
cDNA	complementary DNA
cGMP	3',5'-cyclic phosphate of guanylic acid
EDRF	endothelial-derived relaxing factor
eNOS	endothelium nitric oxide synthase
FAD	flavin adenine dinucleotide
FMN	flavin mononucleotide
iNOS	inducible nitric oxide synthase
NADPH	nicotinamide adenine diphosphate phosphate reduced
L-NAME	N <sup>G</sup> -nitro-L-arginine methyl ester
NO	nitric oxide
NOS	nitric oxide synthase

## II. ABBREVIATIONS AND DESIGNATIONS USED IN BIOCHEMISTRY

Biochemists started more than 50 years ago to name familiar molecules by abbreviations. They have not been dissuaded by the change in terminology nor the alterations in names. Therefore, the current list of short-hand abbreviations that are used now takes several pages. The sort of names used in this chapter is quite varied and is illustrated below.

For distance along nucleotide length, the dimension is kilobases, kb. The nomenclature for the weight of proteins is one of several possibilities. The one used is Kilodaltons, Kd. The position of genes upon a chromosome is given by either p, for the shorter portion from the centromere, or q, for the longer portion. Within the p or q, the distance is given as staining bands with the Giemsa stain, as for example 7q35–7q36 represents the 7th chromosome, position 35–36 of the distance away from the centrosome. The designation qter represents the terminal portion of the chromosome.

DEAE is the abbreviation for DiEthyl Amino Ethyl, the binding group of a substitution on cellulose. SDS/PAGE is a technique for naming the material used for electrophoresis in which SDS represents sodium dodecyl sulfate solution that is used with PolyAcrylimide Gel Electrophoresis (PAGE).

TATA and CCAAT are the names where, in general, the polymerase binds to DNA, but these factors are sometimes missing. The other binding sites for the many factors that activate the polymerase, Sp1, AP-1, etc., have many diverse meanings. SOD is superoxide dismutase. The abbreviations as part of the names such as N<sup>G</sup>- or N<sup>ω</sup>- for the L-NAME indicate the nitrogen atoms listed as either the guanido nitrogen (G) or the terminal nitrogen ( $\omega$ ) (two ways for listing the same nitrogen atoms).

## III. INTRODUCTION

### A. Early Reports on NO

The discovery that a biological catalyst was nitric oxide (NO) was a surprising event. This finding was in part due to the persistence of Furchgott<sup>1</sup>, who discovered in 1987 that what he called EDRF (endothelium-derived relaxing factor) was probably this molecule and Ignarro<sup>2</sup>, who determined in the same year that EDRF and NO had the same half-life and were released in the same order by various treatments of arterial or venous substrates; cGMP was induced and the materials were bound by hemoglobin. These two findings were reported in a symposium organized by Vanhoutte<sup>3</sup> and were the first findings

that a new era was dawning. Inspired by this discovery, Moncada and collaborators in the Wellcome Research Laboratories<sup>4</sup> tried a group of physical approaches that also favored the existence of nitric oxide as the material proposed by Furchgott and by Ignarro. It should be emphasized that all of the experiments reported by 1988 were pharmacological and were of primary interest to pharmacologists. However, from that time until the present (1995), many papers have involved biochemists, physicians and other scientists and the number of papers on the subject of nitric oxide has reached over 1000 in 1994.

The first paper by Furchgott on EDRF was published in 1980<sup>5</sup>. This work showed that acetylcholine was effective in producing the effect of a relaxation of rabbit thoracic aorta only if endothelial cells were still present and that these were easily removed. It is necessary to recall that the endothelial cells are only a single layer on the internal surface of a much larger muscle layer. However, the single layer of endothelial cells comprises the essential components for producing the active principle. The production of NO was not completely unexpected. Some 10 years prior to Furchgott and to Ignarro's discovery, in a review by Murad's group<sup>6</sup>, the efficiency of NO was shown upon cGMP and the inhibition by hemoglobin was also demonstrated. However, the technical tools necessary for determining the source and even the identity of this compound were not available. This was true even though Keilin and Hartree had shown that catalase formed NO back in 1954<sup>7</sup>.

While the statements that EDRF was really NO were still in progress, Moncada and collaborators started studies that gave further evidence that the active ingredient was in fact the simple gas. In a series of papers in 1987, Radomski, Palmer and Moncada showed that material released from endothelial cells and NO were similar in their passage through a cascade and decomposed at similar rates<sup>8,9</sup>. A parallel study showed that platelets<sup>10</sup> and vascular smooth muscle were effected in the same way by both EDRF and NO<sup>11,12</sup>. The activation by superoxide dismutase (SOD) and inhibition by hemoglobin (Hb) were similar for both of these<sup>11,12</sup>. In these experiments, the concentration of NO was determined by chemiluminescence following the reaction with ozone<sup>11</sup>.

It should be noted that many of the data of Moncada were confirmations of the data of others. Thus, the work of Furchgott showed that Hb inhibited EDRF action<sup>12-16</sup>. The laboratory of Murad had very early shown the effects of many nitro compounds, including NO, on the stimulation of cyclic guanylic acid (cGMP)<sup>17,18</sup> and Craven and DeRubertis<sup>19</sup> had shown that NO along with a number of related compounds was capable of stimulating cGMP and that nitrohemoglobin had a similar effect. Gruetter and coworkers<sup>20</sup> and Mellion and collaborators<sup>20-22</sup> reported that NO is a good inhibitor of platelet aggregation based on work of Needleman's group<sup>23,24</sup>. Ignarro<sup>25-28</sup> found NO was liberated from nitrosothiols and activated guanylate cyclase, elevated the vascular and platelet level of cGMP, caused vascular smooth muscle relaxation, inhibition of platelet aggregation and hypotension in anesthetized animals.

## B. Mechanism of NO Formation

By the year 1987, there was intense excitement about the biosynthesis of NO. The discovery that the active molecule was derived from arginine was strange enough. This was first shown by Hibbs and coworkers<sup>29</sup>, who showed that mouse macrophages required L-arginine for cytotoxic activated macrophages (CAM) and also for inhibition of aconitase and uptake of [3]-thymidine into DNA. The reaction was also given by L-homoarginine and some derivatives of L-arginine and N-monomethyl arginine (N<sup>G</sup>MMA) was particularly inhibitory. Shortly after, the same group<sup>30</sup> showed that arginine was converted to citrulline.

Iyengar and coworkers<sup>31</sup> found that the oxidation of L-arginine led to citrulline, actually before Hibbs and collaborators<sup>30</sup>. At this point in time, Palmer's group<sup>11</sup> showed that NO was indeed formed from the guanido nitrogen of arginine. This led to a series of confirmations; the first was Ignarro and collaborators<sup>32</sup>, who demonstrated that NO was the same as EDRF. Then in 1988 Marletta and coworkers<sup>33</sup> showed that nitric oxide was formed and that NO<sub>2</sub> and NO<sub>3</sub> were formed from it. In their reaction L-arginine Mg<sup>++</sup> and NADPH were required. The enzyme was soluble in mouse macrophage, the RAW 264.7 cells. Later in 1988, Hibbs and collaborators<sup>34</sup> showed that mouse macrophages formed NO from arginine and that NO was the precursor of NO<sub>3</sub>. This was confirmed in 1989 by Stuehr's group<sup>35</sup>, who showed that the production of NO from L-arginine was responsible for CAM and that the process was inhibited by N<sup>G</sup>, N<sup>G</sup>-dimethyl-L-arginine.

### C. Content of Folate and the Origin of Oxygen

The complexity of NO-synthase was emphasized by Tayeh and Marletta<sup>36</sup> and Kwon, Nathan and Stuehr<sup>37</sup>, who isolated dihydro- and tetrahydrofolate as the endogenous compounds that stimulated the oxidation from 20–30% to 100%. Kwon and coworkers<sup>38</sup> followed this finding with mass spectrometric data, which showed that the oxygen of citrulline formed from arginine contains the oxygen of air. Leone's group<sup>39</sup> demonstrated that both the citrulline and NO oxygen are derived from molecular O<sub>2</sub> by showing that both methylate citrulline and nitrosomorpholine contained the isotope of the oxygen gas. This was found to be true for the three types of NO synthetase (see below) except for the NO from brain, which was not recovered as a morpholine derivative.

## IV. INDIVIDUAL NOS

### A. bNOS cDNA

The presence of NO in mammalian brain was first proposed by pharmacologists. Using cerebellar cells, Garthwaite and collaborators<sup>40</sup> determined that EDRF was produced by *N*-methyl-D-aspartate (NMDA) and that NO was the probable nature of the EDRF. While this work was under way, Knowles and coworkers<sup>41</sup> demonstrated the synthesis of NO and citrulline in a crude synaptosomal cytosol from rat forebrains. This work established that NADPH was required, that a number of simple arginine derivatives were effective, that hemoglobin was inhibitory and that L-methylarginine prevented the activity. Within months of the work of Knowles, Bredt and Snyder<sup>42</sup> purified an enzyme from cerebella of 10-day-old rats that synthesized NO. The technique involved the formation of citrulline, since this compound can be easily determined. This work was continued and Bredt and Snyder<sup>43</sup> within a few months of their previous study had purified the brain NOS. This work was dependent upon a couple of factors: first, the requirement of calmodulin for the enzyme and, second, the elution of the enzyme from 2',5'-ADP agarose with NADPH. The use of calmodulin is important for the role of calcium as an activator of the enzyme. The first elution gave a six-fold purification on DEAE. The second step, 2',5'-ADP agarose, allowed the bulk of the protein to be eliminated with 0.5 M NaCl followed by elimination of NO synthase with 10 mM NADPH.

The isolation of NOS led to the cloning and expression of the cDNA for this enzyme. NOS was purified as before and tryptic fragments were isolated. Bredt's group<sup>44</sup> then continued to isolate the cDNA by a complex method. The two larger peptides (17 and 18 amino acids) were formed, then a 599-bp product was synthesized from the two of these. This 599-bp product was then used to screen 10<sup>6</sup> cDNA clones and three clones

had an open reading frame of 4,287 bases. This corresponded to a molecular mass of about ~160K and incorporated all of the 21 peptides given by trypsin.

The cDNA was inserted into human kidney cells with cytomegalus virus and gave a single Coomassie blue stain, which produced citrulline from arginine, produced nitrite from arginine and produced NO, which gave increased endogenous cGMP synthesis. The cDNA showed a 10.5 Kb band in total cerebellar RNA, which indicates that over half the mRNA is not expressed. NOS RNA was not expressed in kidney, liver, skeletal muscle, stomach or heart. The largest amounts were present in cerebellum, then less so in olfactory bulb, colliculi, hippocampus and cerebral cortex. Comparing the structure with those in Gene Bank, this was found to resemble cytochrome P-450. The amino acids from the C-terminal portion, 641 amino acids, have a homology with the cytochrome P450; there is a 36% identity and 58% close homology. The fact that both enzymes use both FMN and FAD suggests that there is a mechanism for transferring between them.

This finding was confirmed by Mayer and coworkers<sup>45</sup>. Using pork cerebellum, they employed similar purification to obtain a 45-fold enzyme. The factors responsible for activation were the same as those for rat: NADPH, Ca<sup>++</sup> plus calmodulin, FAD and, in an unknown way, BH<sub>4</sub>. The molecular weight was also 160,000 kDa. A similar purification from rat cerebellum was made by Schmidt and collaborators<sup>46</sup>, who also obtained similar values although they claimed four major factors were given by SDS/PAGE. The difference might have been attributable to the use of generic cerebella by the latter workers.

## B. eNOS cDNA

The success of Bredt's group<sup>44</sup> in cloning NOS from cerebellum raised questions about the similar cloning of endothelial cell NOS, largely because these two have roughly identical properties. In 1988, Palmer and Moncada<sup>47</sup> and Schmidt and coworkers<sup>48</sup> independently found that endothelial cells formed NO from L-arginine. Pollock's group<sup>49</sup> purified the enzyme from bovine aorta. The preparation was 95% insoluble but was converted to a form that was soluble on treatment with 3-[(3-cholamidopropyl) dimethylammonio]-propane sulfate (CHAPS). The soluble form with CHAPS was used. The purified enzyme required BH<sub>4</sub> for maximum activity, Ca<sup>++</sup> and calmodulin and NADPH for any activity. Arginine was converted to citrulline, NO<sub>3</sub> was created and the preparation had EDRF activity. The molecular weight was 135 kDa.

The cDNA responsible for the aortic protein from bovine source was purified by four groups simultaneously, namely by Janssen's group<sup>50</sup>, by Sessa's group<sup>51</sup>, by Lamas and coworkers<sup>52</sup> and by Nishida's group<sup>53</sup>. All four derived the same sequence of bases. Those include methionine, which is in a consensus sequence for initiation<sup>54</sup>. Also included are a calmodulin site, an FMN site, a pyrophosphate and an FAD site for the dinucleotide and the NADPH sites for ribose and adenine. The three cDNAs made NO according to different assays, including NADPH diaphorase, a cyclic GMP assay, interfered with by NAME, synthesis of citrulline from arginine and NO synthase in COS cells. The fact that this 135 kDa protein was associated with the cell structure was pointed out by the authors as due to a myristyl site, which was not found in the brain cDNA. The report of Nishida showed a sheer stress in the cDNA.

Endothelial NOS was found to be associated with cell membranes and this property was associated with the finding that the cDNA contained the structure for binding myristic acid<sup>55</sup>. Busconi and Michel<sup>56</sup> used bovine aortic endothelial cells to demonstrate that the myristoylated protein was found. When the second amino acid, glycine, was converted to alanine, the addition of myristic acid was prevented and the enzyme remained soluble. Sessa and coworkers<sup>51</sup> carried out the same experiments simultaneously and found the same results. However, in both cases the enzyme was not purified, although the protein

was found to include myristic acid. The protein was shown to be modified by Liu and Sessa<sup>57</sup>. They found the endothelial NOS was indeed myristylated, that the myristic acid was not modified during the binding and that the binding is an amide linkage. Of course, the N-terminal methionine is lost during the preparation of the enzyme for myristoylation.

### C. iNOS cDNA

Macrophages were among the first cells found to produce NO<sup>29</sup>. On purification, the macrophages from various animals were found to be similar to the neural<sup>43</sup> and endothelial cells<sup>47,49</sup> in that they contained an enzyme that decomposed arginine to citrulline and NO<sup>31,39</sup>. The enzyme used NADPH for the reaction<sup>39</sup>; molecular oxygen was the source of the oxygen included in the products<sup>38,39</sup> and the enzyme was only partially active in the absence of BH<sub>4</sub><sup>36,37</sup>. The major difference between the enzymes was the complete lack of effect of Ca<sup>++</sup> and the independence of the activity upon calmodulin<sup>58,59</sup>. Another difference was the inducibility of the macrophage enzyme<sup>60-62</sup>. Both interferon- $\gamma$  and lipopolysaccharide were required for maximum expression of activity<sup>63</sup> and, contrary to the short half-life of the neuronal enzyme (seconds), the half-life of the macrophage was hours<sup>64</sup>.

The lack of calmodulin in the macrophage enzyme was explained by the work of Cho and coworkers<sup>65</sup>, who reported that the purified enzyme contained calmodulin bound through noncovalent bonds. This followed the report by Stuehr's group<sup>58</sup> that the macrophage enzyme was purified from RAW 264.7 cells derived from mice and that this enzyme had, in addition to the features above, both FAD and FMN. This work strengthened the report of Yui and collaborators<sup>66</sup>, which described the enzyme from rat macrophages but did not find evidence for calmodulin or flavins. A similar report from Hevel and coworkers<sup>67</sup> described the purification from mouse macrophages of an enzyme that contained 1 FMN and 1 FAD; this also oxidized arginine to citrulline and NO better in the presence of BH<sub>4</sub>.

At this stage of discovery, the encouragement was set for cloning of the macrophage enzyme. This was carried out independently by three groups, Lyons and coworkers<sup>68</sup>, Xie and collaborators<sup>63</sup> and Lowenstein's group<sup>69</sup>. The first group<sup>68</sup> showed the gene contained FMN, FAD and NADPH, the second group<sup>63</sup> showed in addition the calmodulin binding site. Lowenstein's group<sup>69</sup> confirmed the findings of Xie and coworkers and showed the picture of spleen cells with both red pulp and, less, in white pulp. All three teams showed the molecular weight of 130,000.

## V. LOCALIZATION OF THE HUMAN GENE

### A. bNOS in the Human Gene

The localization of bNOS to the human genome was accomplished by Kishimoto and coworkers<sup>70</sup>. These investigators used a rat cerebellar cDNA to obtain a human cDNA from Clontech. This cDNA was hybridized to Southern blots containing DNA from a battery of human-rodent somatic cell DNA. Since the blots had been shown to be selective, the authors showed that the cDNA hybridized to chromosome 12. By using restriction nucleases EcoRI and Hind III the assignment was made to 12 q14-qter. One or two copies were indicated *in vivo* but reducing the hybrid conditions showed more bands. It is necessary to conduct further studies to see whether the other cDNA are derived from this or another clone.

A more complete analysis of human neuronal NOS gene was made by Hall's group<sup>71</sup>. It is a gene of 29 exons; a flanking region of over 1500 bp was determined 5- and several

poly (A) are found as far as nt 6632: A region for heme in exon 6, Ca<sup>++</sup>/calmodulin in exons 13 and 14, FMN in exon 18, FAD in exons 21, 22 and 23 and NADPH in exons 25, 26 and 27. Although promoters have yet to be determined *in vivo*, diversity is suggested by the occurrence of AP-2, TEF-1/MCBF, CREB/ATF/cFOS, NRF-1, Ets, NF-1 and NF- $\kappa$ B in the 5-region.

### B. eNOS in the Human Gene

Janssens and coworkers<sup>50</sup> cloned the cDNA for endothelial NOS from human tissues. The cDNA contained the FMN, FAD and NADPH sequences attributed to these cofactors. The enzyme was Ca<sup>++</sup>-dependent and this was blocked by L-NAME. More than 95% of the enzyme sedimented in the particulate fraction. The enzyme made cGMP in reporter cells, corresponding to NO synthesis, and this was antagonized by L-NAME. These properties of cDNA from human endothelial NOS were basically confirmed with several differences noted by Marsden's group<sup>72</sup> in the process of isolating and characterizing the human gene and locating it in 7q35–7q36. The gene was isolated from human clones in a bacteriophage library. This gene lacks the TATA box but includes a CCAAT box, Sp1 sites, GATA sites and reverse sites; AP-1 site, AP-2 site, physical stress elements and heavy metal sequences were found. Steroid binding sites were lacking. The consensus sequence for RNA polymerase III was found. The chromosome map was determined with human-rodent pairs at 7q32–7qter and was done more accurately with the FISH determination with metaphase chromosomes. This latter analysis showed that the gene was 7q35–36. The same authors also obtained a more precise location of the human bNOS as 12q24.2. This gene also contained the calmodulin/calcium site and the FMN, FAD and NADPH binding sites.

Zhang and coworkers<sup>73</sup> confirmed the work in eNOS of Marsden's group<sup>72</sup> with about 10 differences in the 5'-region, none of which was a promoter box. They found the number of promoters and Sp1 and GATA sites were effective. There is a likelihood of several others participating also. Busconi and Michel<sup>74</sup> tested eNOS for membrane targeting and found that only the myristyl portion of the molecule, not the polybasic region, is responsible for membrane association. Venema and collaborators<sup>75</sup> grew the eNOS in baculovirus. They found less than theoretical FAD and FMN and hope to find conditions for putting these flavins in the enzyme in proper quantities.

### C. iNOS in the Human Gene

A human gene for hepatic inducible NOS was isolated in 1993 by Geller and coworkers<sup>76</sup>. Hepatocytes were isolated from an operative wedge resection, which were over 98% pure. The cells were stimulated with cytokines TNF- $\alpha$ , IL-1 and IFN- $\gamma$ . The purified cDNA, in addition to FMN, FAD and NADPH factors, also contained a calmodulin site. This site retained some activity in the presence of calcium inhibitors. There are also phosphorylation sites at 232, 576 and 890 residues.

In a paper completing the series, Xu's group<sup>77</sup> confirmed the structure of human endothelial NOS as occupying 7q35–36 and found the gene for human inducible NOS as being on chromosome 17. This was a short paper that made the point that each of human genes for NOS, brain, endothelial are inducible, as a separate product of similar but related genes. A more complete paper by Chartrain and coworkers<sup>78</sup> isolated the gene from human foreskin fibroblasts. The gene was shown to reside on chromosome 17 cen-q11.2. A comparison of hepatic cDNA for NOS with the gene sequence showed 99.7% identity and the 0.3% difference is attributed to polymorphism, since the sources differed.

**D. Three Genes come from Three Chromosomes**

In the few years since NOS was shown to be an ubiquitous enzyme, the enzyme had been purified, the mRNA was identified and the gene had been isolated and mapped to human chromosomes. The findings were the sort predicted from the beginning: the three types of NOS were indeed different from each other and were represented by three closely related, but distinct, genes occurring on three chromosomes in man. The three genes are large structures and it is possible that many introns will be responsible for types of one or more of the types. It should be noted, however, that only one gene exists of each type.

**VI. FORMATION OF NO AND CITRULLINE**

The formation of citrulline from arginine led Hibbs and collaborators<sup>34</sup> to postulate that the reaction known to occur in microorganisms was also found in eukaryotes. They proposed that the reactions shown in Figure 1 occurred. The reaction was specific for L-arginine and was also given by L-homoarginine but by no other guanidino compounds. A short time later, Iyengar's group<sup>31</sup> showed that the mixture of NO<sub>2</sub>/NO<sub>3</sub> was derived from the guanidino groups of L-arginine and that, since citrulline was probably a product, only a single N contributed. Since NO<sub>3</sub> is not derived from NO<sub>2</sub>, the synthesis of these compounds is conjectural. They wrote the reaction as shown in Figure 2.

Palmer and Moncada<sup>79</sup> found a similar reaction in porcine aortic endothelium but were reluctant to designate the same reaction as Hibbs and coworkers<sup>39</sup> because they thought there was little point in reducing the nitrogen to ammonia before oxidizing it. They found NNMA to be a powerful inhibitor.

Kwon, Nathan and Stuehr<sup>37</sup> found tetrahydrofolic acid (BH<sub>4</sub>) to serve as a cofactor for the production of NO from mouse macrophages. This compound had been established

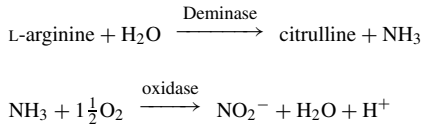


FIGURE 1

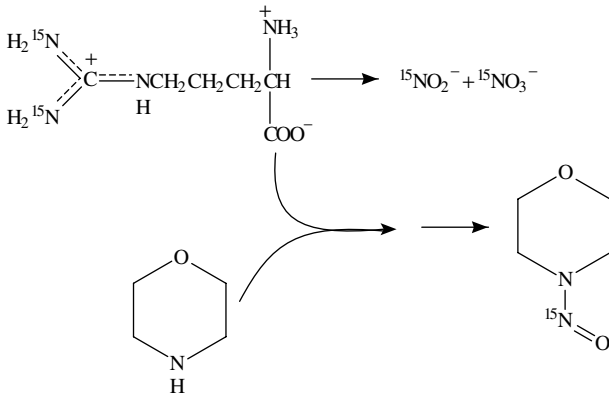


FIGURE 2



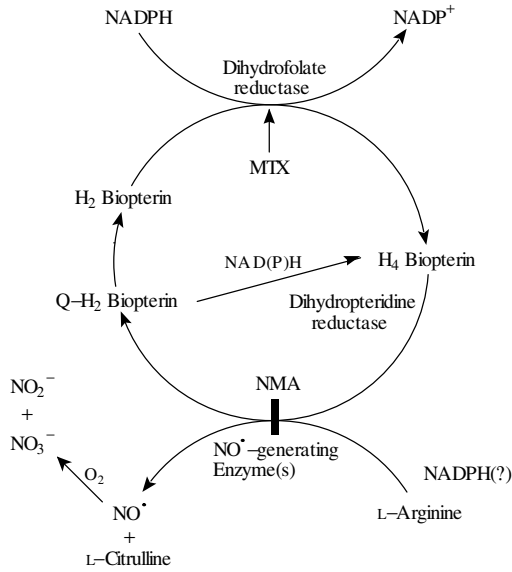


FIGURE 3

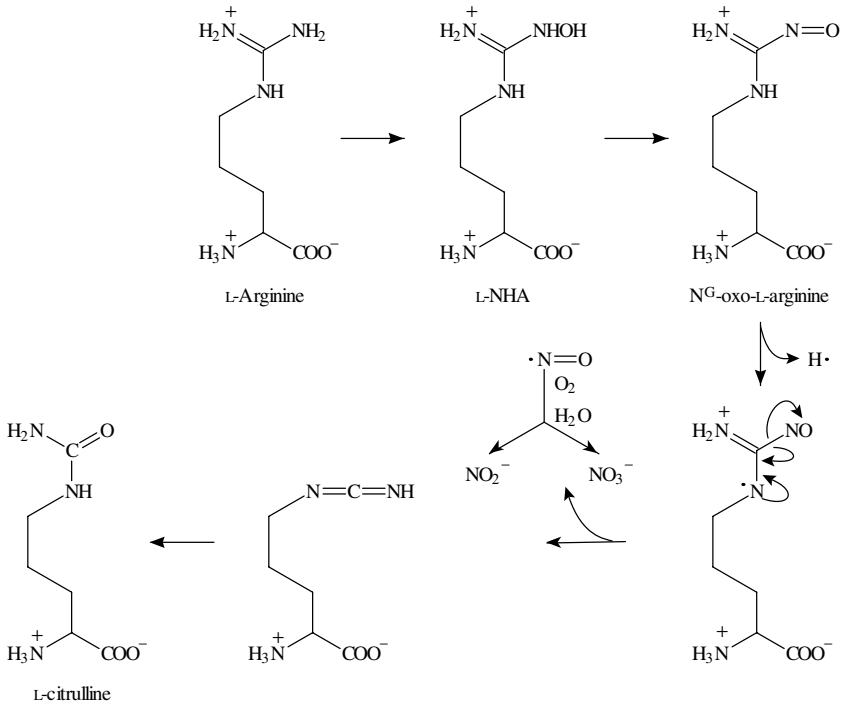


FIGURE 4

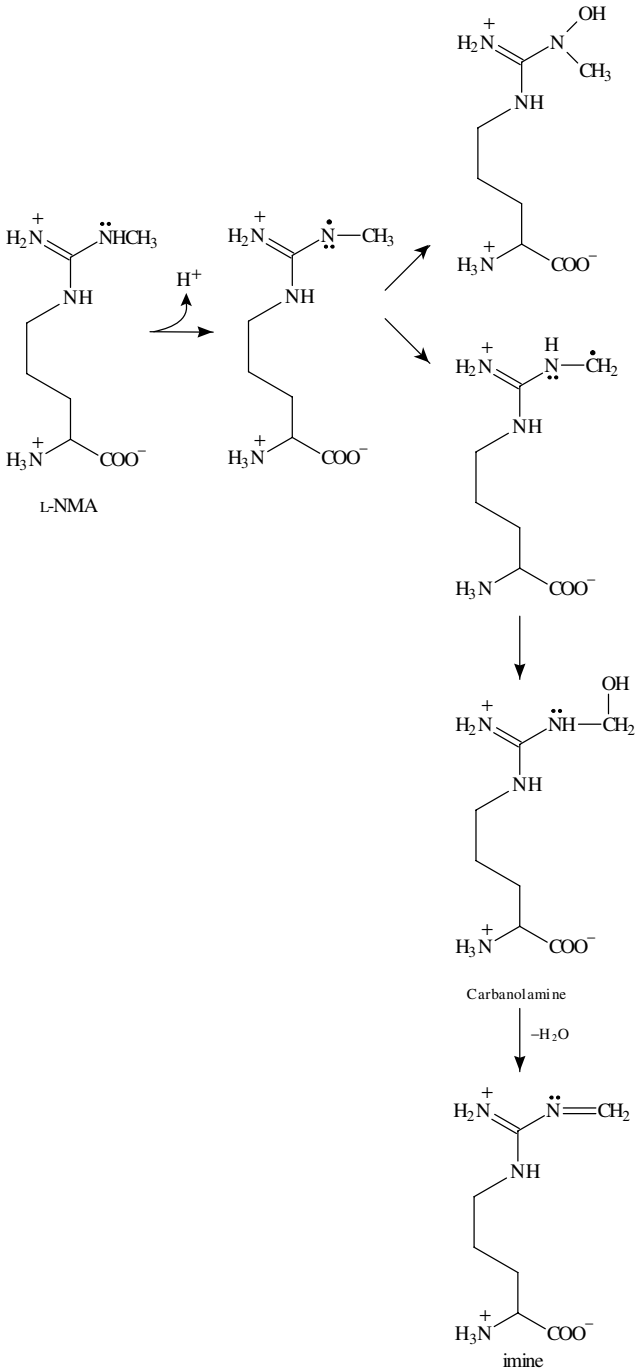


FIGURE 5

as the cofactor for phenylalanine hydroxylation to tyrosine<sup>80</sup> as well as tyrosine and tryptophan hydroxylation<sup>81</sup>. Kwon and coworkers<sup>37</sup> not only found that the production of NO was stimulated, but found that a reduction of the pterin could be accomplished if FAD and GSH were added. Therefore, they included in their article the picture shown in Figure 3 to illustrate the reaction.

Actually, Tayeh and Marletta<sup>36</sup> had also found BH<sub>4</sub> to be a cofactor for mouse macrophages one month previously but had emphasized the NO synthesis. In the picture that they had included, the first hydroxylated arginine was shown as *N*-hydroxyl-L-arginine although this compound had not yet been published. The reactions leading to NO and citrulline are shown in Figure 4.

The synthesis of *N*<sup>G</sup>-hydroxy-L-arginine was published by Pufahl and Marletta<sup>82</sup>. This compound was shown to be a substrate for the production of nitrite and nitrate, for the production of NO and for the synthesis of citrulline. When <sup>15</sup>N-NHA was used as substrate, the NO<sub>2</sub><sup>-</sup>/NO<sub>3</sub><sup>-</sup> produced were found to contain undiluted <sup>15</sup>N. Therefore, they concluded that the *N*<sup>G</sup>-hydroxy-L-arginine is a true substrate in NO synthesis.

Hibbs and coworkers<sup>34</sup> had reported that the *N*<sup>G</sup>-methyl-L-arginine was a potent inhibitor of macrophage nitrite generation. This was subsequently studied by Olken and collaborators<sup>83</sup>. They found that *N*<sup>G</sup>-methyl-L-arginine is indeed an inhibitor with a *K*<sub>i</sub> approximately equal to the *K*<sub>m</sub> of arginine (4–2 μM for the methyl compound and 7.4 μM for arginine). Two of the mechanisms of the inhibitor are illustrated in Figure 5. They also included a third mechanism of a peroxide formation. The lower case given, in which a Michael acceptor is shown, seems unlikely since the authors state that this should give formaldehyde and L-arginine, which should overcome the inhibition.

## V. COMPLEXITIES OF NOS

### A. Role of BH<sub>4</sub>

The role of BH<sub>4</sub> was made contentious by the finding that it is not recycled in the brain NOS. Giovannelli's group<sup>84</sup> used the enzyme prepared according to Bredt and Snyder<sup>43</sup> and showed that the protein responded to BH<sub>4</sub>. The results of Giovannelli's group<sup>84</sup> showed that the BH<sub>4</sub> acts in very low concentration (<1.0 mμ) and that it does not have to be reactivated during the catalysis. Each BH<sub>4</sub> molecule is responsible for >15 moles of product. They conclude that the function may be allosteric or it may serve to maintain some groups in a reduced state required for activity.

The above conclusion<sup>84</sup> was negated by the findings of Hevel and Marletta<sup>85</sup>. These authors used mouse macrophages to study the effect of BH<sub>4</sub> on NOS. With the purification used in the past, they found only a small portion of the BH<sub>4</sub> relative to other cofactors and in this case they found a considerable activation on adding more BH<sub>4</sub> to the reaction. However, when 5 × M BH<sub>4</sub> was added to the solutions used for preparation of the enzyme, they found essentially a 1:1 ratio of BH<sub>4</sub> to the enzyme and no effect of adding more BH<sub>4</sub>. They concluded that BH<sub>4</sub> is used in an oxidative reaction of the macrophage NOS. Of course, a possibility as to the difference between the results of Giovannelli's' group<sup>89</sup> and of Hevel and Marletta<sup>85</sup> is the use of bNOS and iNOS, respectively.

### B. Iron in NOS

Iron was first found in NO synthase by Mayer and coworkers<sup>86</sup>. Probably because the amount of enzyme obtained from brain was small, they reported the iron as non-heme. The next year, however, the iron was reported by White and Marletta<sup>87</sup> as heme iron. The heme was identified at a mixture of high-spin and low-spin states with a shoulder at

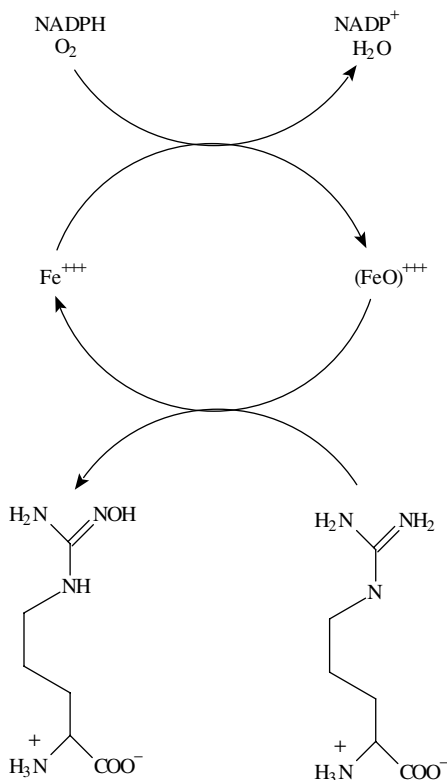


FIGURE 6

406 nm, previously shown by Nardi and Fulco<sup>88</sup> to be due to FMN and FAD bound to the enzyme. White and Marletta<sup>87</sup> proposed that the iron might work as a carrier of oxygen and be responsible for the formation of *N*<sup>G</sup>-hydroxy-L-arginine. They also demonstrated that the porphyrin was protoporphyrin IX and presented the CO spectrum. The work was with mouse macrophage NOS and a partially purified bNOS was said to have similar properties. This is shown in Figure 6.

In an article published independently at the same time, Stuehr and Ikeda-Saito<sup>89</sup> used the purified bNOS and iNOS to reach the same conclusions. While the paper was under review, the authors mention that White and Marletta had reported earlier that the iron was a heme and was used as an oxidant. Using the same type of study, they found that the iron porphyrin and its CO derivative had the expected properties and proposed that the iron is penta-coordinated, with a cysteine thiolate as the fifth coordinate. A third publication confirmed the results when McMillan and coworkers<sup>90</sup> used bNOS grown in human kidney cells. These workers obtained similar data for the light absorption of the enzyme and its CO spectrum. They also speculate on very similar sequences in the three types of purified enzyme that might be the porphyrin binding site.

Mayer and collaborators<sup>45</sup> also found biopterin in NOS and found iron, which they claimed was non-heme. The biopterin they postulated was reduced by NADPH. Therefore, they proposed the mechanism shown in Figure 7 to account for the overall reaction.

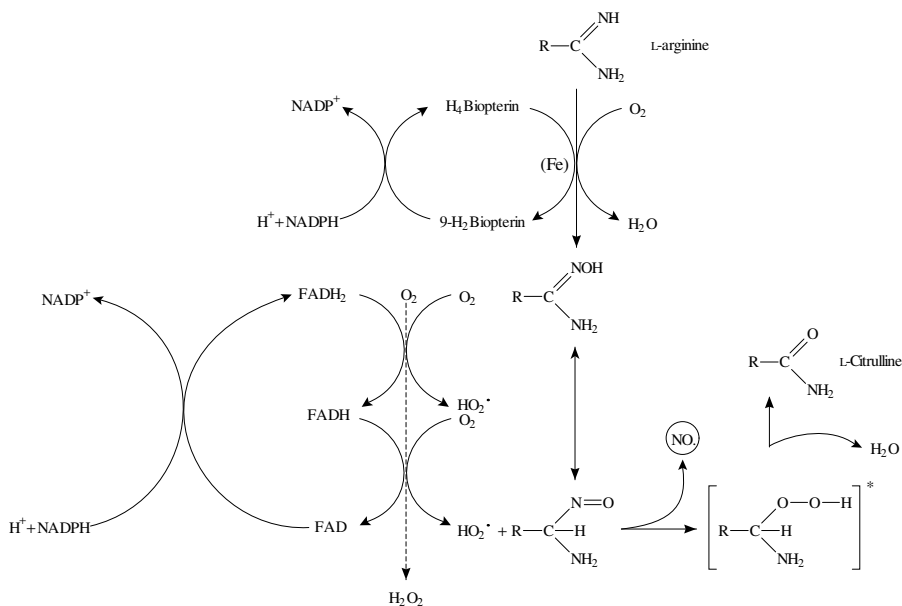


FIGURE 7

Stuehr and coworkers<sup>91</sup> synthesized  $N^G$ -hydroxy-L-arginine and suggested the scheme shown in Figure 8 to make up the action of NOS.

Using bNOS, Klatts' group<sup>92</sup> determined that the  $BH_4$  gave five times the rate of NADPH and that Fe was part of the enzyme. Without deciding where the  $BH_4$  reacted, they proposed the scheme shown in Figure 9.

Pufahl and Marletta<sup>82</sup>, with the  $N^G$ -hydroxy-L-arginine that they had synthesized, gave the outline of the scheme presented in Figure 10.

Using a spectrophotometric method, McMillan and Masters<sup>93</sup> obtained evidence that bNOS contained a heme group that reacted with L-arginine and with  $N^G$ -hydroxy-L-arginine (an intermediate) and  $N^G$ -methyl-L-arginine (an inhibitor). They therefore concluded that the heme was an oxygen donor.

In a minireview, Marletta<sup>94</sup> postulated the series of reactions in Figure 11. The reactions show the details of the iron porphyrin reaction and are concerned with the formation of NO.

In a review without references, Feldman and coworkers<sup>95</sup> proposed a very similar scheme to Marletta<sup>94</sup> but with the nitrogen of hydroxyarginine assuming an iminoxyl radical that is converted to NO. Korth's group<sup>96</sup> accept the scheme published by Marletta<sup>94</sup> but proposed that the  $N^G$ -hydroxy-L-arginine must be oxidized according to the mechanism of Figure 12. This sequence of reactions argues against the participation of the iminoxyl radical of NOH as the reductant because it is likely to lose a proton more rapidly, and therefore reactions A, B, F, G, H and I are proposed.

Using a purified bNOS, Campos and collaborators<sup>97</sup> studied the hydroxylation of L-arginine by the enzyme minus NADPH. They found 0.16 mole of NOH per mol of NOS. The presence of reducing agents in the purified bNOS was measured as much less than the NOH formed. Possible reagents that could have been responsible are flavin and  $BH_4$ .

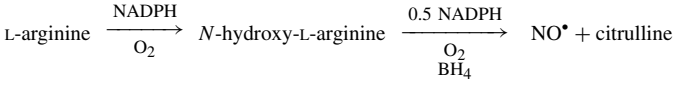


FIGURE 8

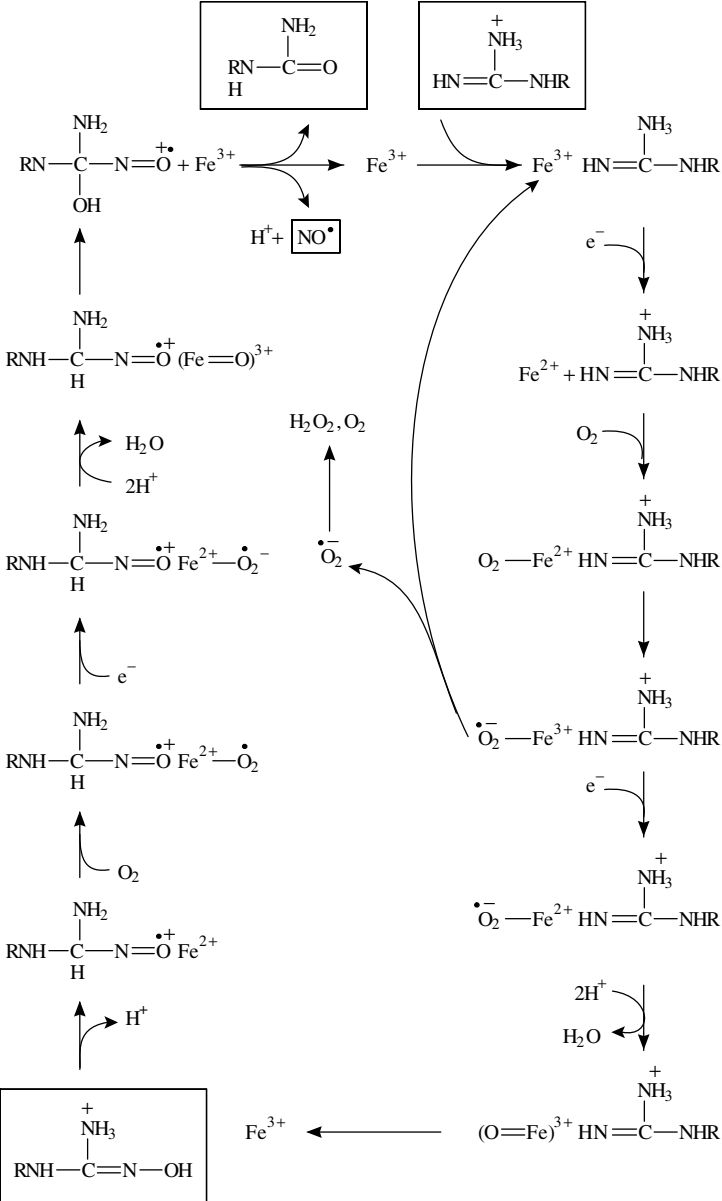


FIGURE 9

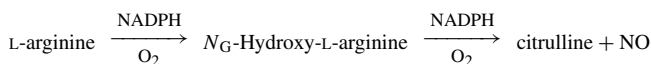


FIGURE 10

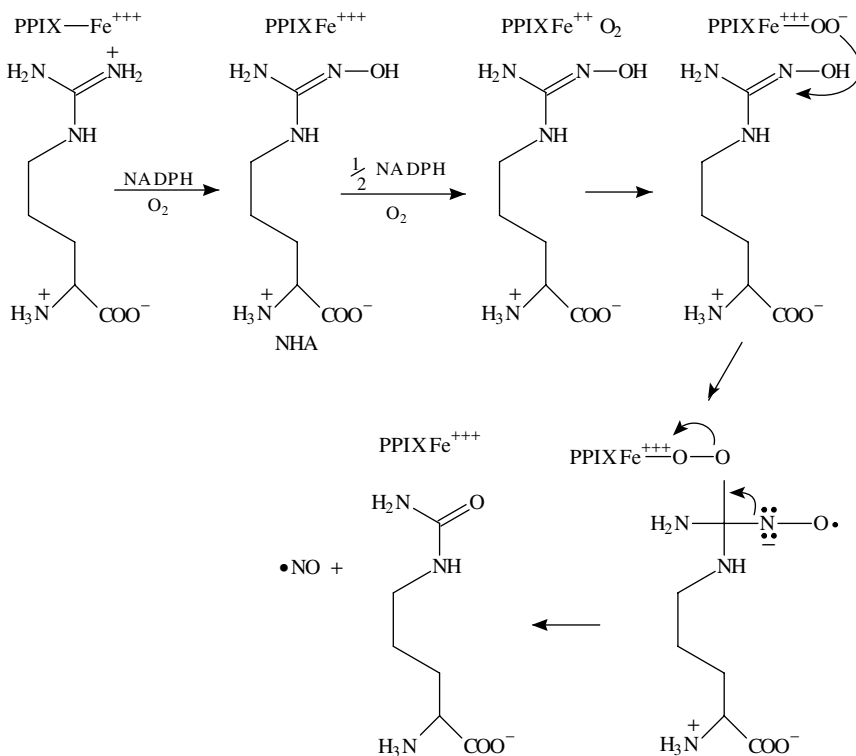


FIGURE 11

### C. Subunits and Dimers

Although the first purification of bNOS was a monomer, it is now clear that the enzyme in all cases is effective as a dimer. A purified macrophage iNOS was used by Baek and coworkers<sup>98</sup> to separate the holoenzyme from the monomers. The subunits do not have NOS activity but do have the ability to oxidize reduced triphosphopyridine nucleotide with either ferricyanide, cytochrome c or dichlorophenolindophenol. When all of the missing factors are present, but not when any is missing, the authors find recombination, as shown in Figure 13.

Ghosh and Stuehr<sup>99</sup> found the two subunits combined in a head-to-head fashion. They consider that the two tails could be free or could be somehow bound.

Raman spectra were performed by Wang's group<sup>100</sup>. They found the heme to have a 5-coordinate high spin configuration. The fifth ligand was an axial bond to the thiolate, which was confirmed by the Fe-C-O bending mode at 562 cm<sup>-1</sup>.

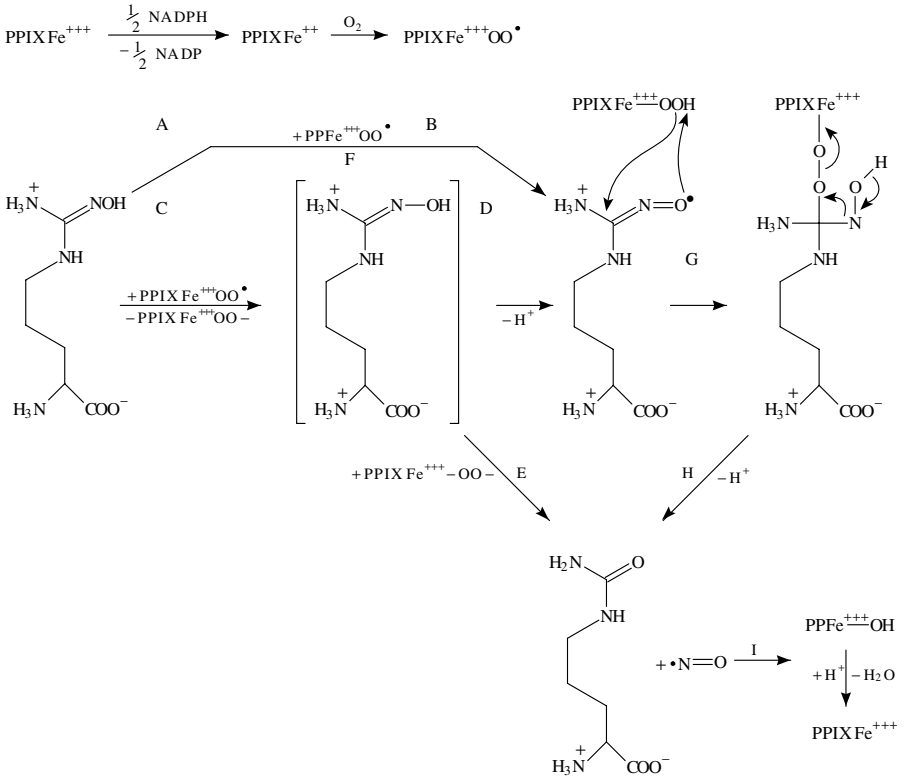


FIGURE 12

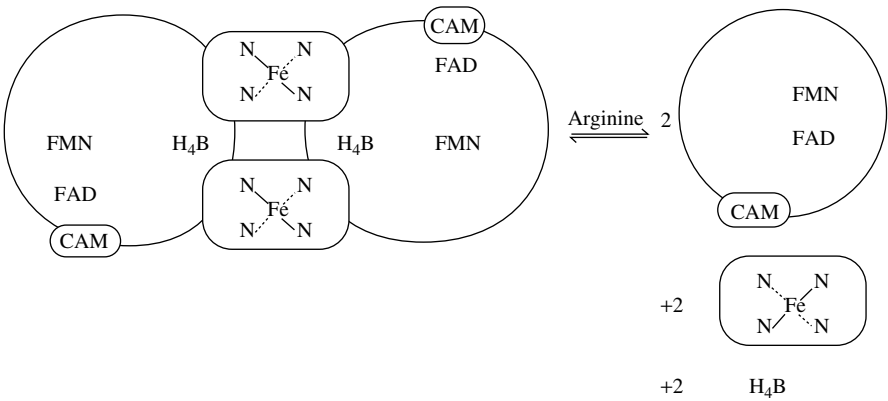


FIGURE 13



The activity of bNOS is firmly bound to the amino acids that comprise the enzyme and is able to withstand separation of the two halves by tryptic cleavage. Sheta and collaborators<sup>101</sup> separated *ca* 79 and *ca* 89 fractions from bNOS and found that one fraction (*ca* 79) had the heme and the other (*ca* 89) had the flavin and was able to reduce cytochrome *c*. When the two domains of the enzyme were held together with calmodulin, the appearance of the two domains was prevented. The finding of retained activity of the two halves was confirmed by McMillan and Masters<sup>102</sup>, who produced the heme component and the flavin-binding component with and without the calmodulin site as proteins produced in *E. coli*. The workers showed the heme had spectral properties of NOS and that the fifth ligand was Cys<sup>415</sup> by changing this to histidine in a site-specific mutation: the mutant did not bind heme. Chen and coworkers<sup>103</sup> prepared mutants of the eNOS and grew them in COS-1 and baculovirus cells. Alanine instead of cysteine in positions 235 and 441 retained the heme and NOS activity of the enzyme, but these changes at cysteine 99 and 241 gave no NOS activity. The authors picked Cys<sup>184</sup> as being responsible, because the peaks with CO were missing whereas the Cys<sup>99</sup> still gave the CO change. At the same time that Chen's group<sup>103</sup> reported the above, Richards and Marletta<sup>104</sup> reported the findings with neural NOS and the C415H mutant. Heme at  $7 \times M$  gave a 7-fold greater activity and there was about a 50% increase with BH<sub>4</sub> in the assay. The C415H mutation gave no NOS activity and the enzyme was devoid of heme. The flavin spectra in the region 450 to 500 nm were normal. This was the first evidence that the Cys 415 binds the heme.

#### D. Complications of Many Cofactors

By resonance Raman methods, Wang and coworkers<sup>105</sup> showed NO bound to both ferric and ferrous heme of bNOS. Hurshman and Marletta<sup>106</sup> used iNOS and spectrophotometric methods to show similar reactions, although the physiological effects will depend on the effects of arginine and oxygen *in vivo*.

Using neuronal NOS, Matsuoka and collaborators<sup>107</sup> observed that arginine apparently reacted with the heme to reduce the rate of CN or CO reacting. The reaction of L-arginine

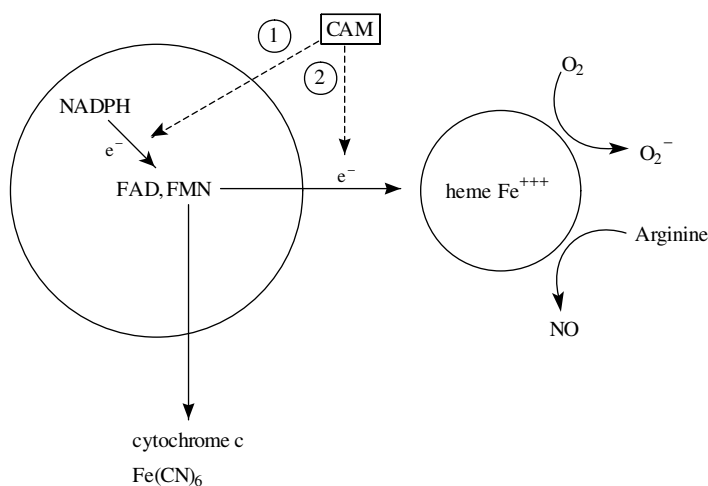


FIGURE 14

is shown to take place with the iron instead of the H<sub>2</sub>O. Calmodulin does not affect the iron but permits electrons to flow from the flavins.

NO in the concentrations formed by NOS from brain were shown by Griscavage and coworkers<sup>108</sup> to inhibit the synthase about 1,000× more than CN<sup>-</sup>. This effect was attributed to binding to the ferric heme and could be reversed by BH<sub>4</sub> but not by other reducing agents. Mayer's group<sup>109</sup> used a Clark-type nitric oxide electrode to follow the reaction of bNOS and found also a strong inhibition by BH<sub>4</sub>. They conclude that BH<sub>4</sub> reacts with SOD to peroxyxynitrite.

Abu-Soud and coworkers<sup>110</sup> were able to remove heme and BH<sub>4</sub> from NOS by dialysis with 2 M urea. The remaining enzyme retained the ability to reduce ferricyanide and cytochrome c. The reduction of cytochrome c was about 9× in the presence of calmodulin. The two sites of calmodulin for influencing the reaction are shown in Figure 14.

Hobbs and coworkers<sup>111</sup> used a specific chemiluminescent reaction to measure NO. With this they determined that the reaction measured by citrulline formation was not affected by SOD but that NO was increased.

**E. Inhibitors of NOS**

A further study by Olken and collaborators<sup>112</sup> describes inactivation of mouse iNOS by N<sup>G</sup>-methyl-L-arginine. The inactivation occurs only in the presence of oxygen. Only a small amount of <sup>3</sup>H or <sup>14</sup>C label from the labeled methyl group of N<sup>G</sup>-methyl-L-arginine

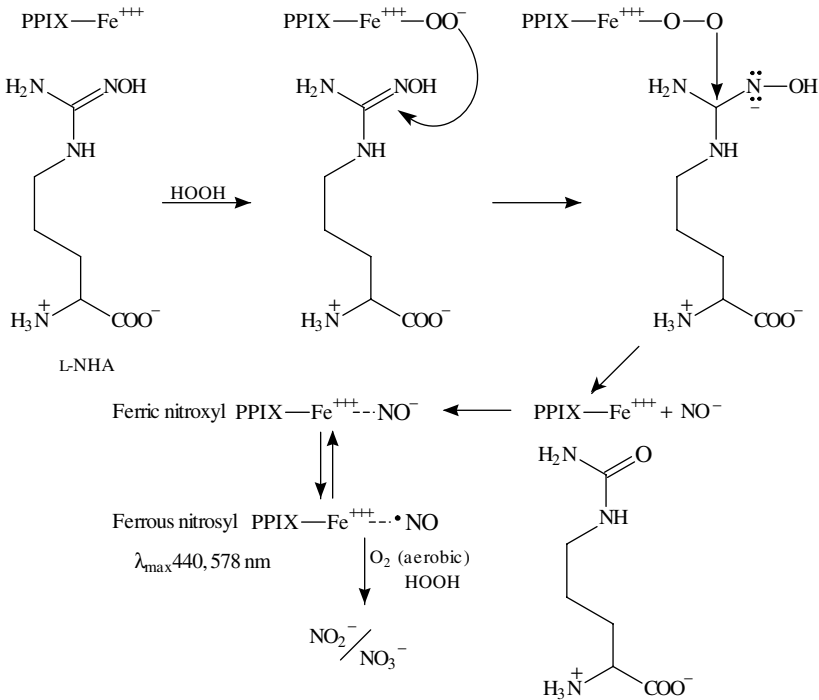


FIGURE 15

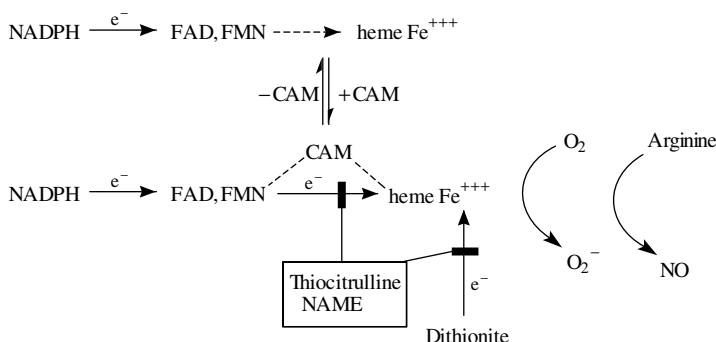


FIGURE 16

was included, showing that the reaction is varied. A large amount of the heme was lost in inactivation. Simultaneous studies by Abu-Soud group<sup>113</sup> with three inhibitors, *N*<sup>ω</sup>-methyl-L-arginine, *N*<sup>ω</sup>-nitro-L-arginine methyl ester and thiocitrulline, affected both neuronal and macrophage NOS. Whereas the *N*<sup>ω</sup>-methyl-L-arginine was similar to L-arginine in that it did not prevent the reduction of heme, both *N*<sup>ω</sup>-nitro-L-arginine and thiocitrulline did. The inhibition by both of these compounds seems to block at two points, shown in Figure 15.

A variety of L-arginine-based inhibitors was tested by Komori and coworkers<sup>114</sup>. They found *N*<sup>G</sup>-methoxy-L-arginine as well as *N*<sup>G</sup>-hydroxy-L-arginine and L-arginine itself to oxidize NADPH. The mechanism of the effects remain to be determined.

The ability of murine macrophage NOS to use peroxides in place of oxygen was studied by Pufahl and collaborators<sup>115</sup>. Cumene hydroperoxide and *tert*-butylhydroperoxide were inactive but hydrogen peroxide supported product formation. Interestingly, L-arginine was not used but *N*<sup>G</sup>-hydroxy-L-arginine was a substrate. The authors proposed the mechanism for the hydrogen peroxide in Figure 16.

Several specific inhibitors of NO synthetases have been found. The species of all three human NOS was found by Garvey's group<sup>116</sup> to be inhibited by isothioureas, with ethylthiourea the most powerful. Furfine and coworkers<sup>117</sup> found *S*-methyl-L-thiocitrulline and *S*-ethyl-L-thiocitrulline were effective vs neuro NOS in human, but there seems to be difficulty in *in vivo* studies. Narayanan's group<sup>118</sup> reported on several *S*-alkyl-L-thiocitrullines from rat with nNOS and iNOS. The methyl compound is most potent and is reversible. Another type of inhibitor was found by Wolff and Griben<sup>119</sup> to be imidazole and its phenyl derivatives and<sup>120</sup> also substituted nitroindazole, especially the 7-nitroindazole. Wolff and Lubeskie<sup>121</sup> reported that aminoguanidine is a mechanism-based inhibitor of the three types of NOS.

## F. Factors for Growth of NOS

Hartneck and coworkers<sup>122</sup> grew rat bNOS in baculovirus. Calcasi and collaborators<sup>124</sup> found that the bNOS gives a burst of superoxide when stimulated by *N*-methyl-D-aspartate. This is arachadonic-independent and is suppressed by L-arginine or *N*<sup>G</sup>-nitro-L-arginine. The superoxide gives cell death.

Xie's group<sup>123</sup> measured two closely linked but separable promoters for iNOS. Lowenstein and coworkers<sup>125</sup> reported that bacterial lipopolysaccharide (LPS) promotes iNOS

and that IFN- $\gamma$  does not by itself but with LPS gives a big stimulation. This was confirmed by Weisz and coworkers<sup>126</sup>. Balligand's group<sup>127</sup> detected the iNOS in single myocytes. Two distinct pathways for generating expression of iNOS in rat cells were demonstrated by Kunz and coworkers<sup>128</sup>. Xie and collaborators<sup>129</sup> reported that NF- $\kappa$ B is essential for LPS induction of iNOS in the mouse. They found two NF- $\kappa$ B, one in the 5'-region, NF- $\kappa$ B $\alpha$ , and one in the downstream location, NF- $\kappa$ B $\beta$ . The downstream NF- $\kappa$ B $\beta$  is responsible for the induction of LPS. Chu's group<sup>130</sup> described a large series of human iNOS that varied in the initial codons, many lacking the first exon.

Xie and coworkers<sup>131</sup> cloned the NOS from RAW264.7 cells and found two sets of cDNA. The smaller set was 22 amino acids shorter. They found that this cDNA did not produce NOS. By removing amino acids, they found Phe reduced the level to 41%, removing the Ile<sup>1121</sup> further reduced the level to 95% and further removal lost all NOS activity. This is the first example of the importance of the -COO region.

The eNOS has been purified from many tissues. Human NOS was purified from placenta by Garvey collaborators<sup>132</sup>. Balligand's group<sup>133</sup> found rat eNOS in myocytes and showed it to be responsible for cholinergic and  $\beta$ -adrenergic regulation and muscular contraction. The eNOS of guinea pigs was shown to be dependent on sex hormones by Weiner and coworkers<sup>134</sup>. This was the first evidence that the eNOS was inducible. A human colon adenocarcinoma was found by Jenkins and collaborators<sup>135</sup> to be stimulated by eNOS.

Schmidt's group<sup>136</sup> reported that two of the arginine derivatives inhibit NOS,  $N^G$ -methyl-L-arginine and  $N^G$ -nitro-L-arginine, and are taken up by cationic amino acid transporter and neutral amino acid transporter of macrophages. The same authors<sup>137</sup> found that peroxynitrite produces the same change in hemoglobin as NO, but that it does not interfere with the Clark-type determination of NO. Peroxynitrite was also found to be the compound that inactivates aconitase. In a couple of papers published together in *J. Biol. Chem.*, Hausladen and Fridovich<sup>138</sup> and Castro's group<sup>139</sup> reported that this iron-containing enzyme is not inhibited by NO but is inhibited by peroxynitrite. Hecker and coworkers<sup>140</sup> described an adduct of  $N^G$ -hydroxyl-L-arginine with NO as the product made by IL-1 $\beta$  in rat muscle that yields NO immediately with NOS.

### VIII. PHYSIOLOGICAL FUNCTIONS OF NOS

The two most surprising aspects of NO are the large number of alterations of metabolism controlled by a simple gas and the most extensive list of diseases that may be caused by either an increase or decrease in the concentration of the molecule. The second function, the clinical function of NO, has occupied the attention of both the preclinical and clinical investigators and is responsible for the growth in the literature. To attempt to cover the clinical literature is far beyond the scope of this review but the outlines of the subject cannot be ignored. The scope of this branch of the literature is expanding while this chapter is being written, and the impact of NO on medicine is just arriving.

The early studies on NOS in macrophages suggested to the authors that the synthesis of NO was responsible for the killing of tumor cells and certain pathogens<sup>28</sup>. It is now clear that the application of nitroglycerin and related compounds is due to the release of NO<sup>141</sup> and that eNOS carries out this function *in vivo*. However, NO also is responsible for killing neuronal cells. Zhang and coworkers<sup>142</sup> have determined that NO was capable of damaging the DNA of sensitive cells and, by activating poly (ADP-ribose) synthetase, kill the cells by energy depletion.

The finding of a brain NOS<sup>42,43</sup> led to speculation that various neurological disorders were due to this molecule. Therefore, it was of great significance when Huang and collaborators<sup>143</sup> produced a strain of mice completely lacking bNOS. These mice had

only minor lack of the enzyme: homozygous mutant animals have stomachs with 1.5–3× the stomachs of littermates and pyloric stenosis. They grow normally and breed at normal levels. Their brains appear normal. Except for the NOS, they appear to have the usual enzymes and the mutant mice seem to have the expected functions. Vasodilation of vascular penile beds does not depend upon the bNOS and the animals mate normally.

Prior to knockout mice, a number of neural functions were ascribed to NO function. The fact that these have not appeared does not mean that the functions do not exist but that more than one function can apply. Thus, in penile tissue of rats NOS nerves are prominent<sup>144</sup> and electrical stimulation produced penile erection<sup>145,146</sup>. Normal mating of knockout mice suggests that this function can take place without NO participation, but this leaves the NO function to be assigned to an auxiliary role, perhaps to play a more important role when the alternative neuroexciter is deficient. Similarly, Huntington and Alzheimer diseases might occur when two different neurotransmitters are deficient.

The second mice to undergo a deficiency of iNOS were produced by MacMicking's group<sup>147</sup>. These animals were again, like the bNOS, grossly normal. When tested against certain toxic elements (Listeria, lymphoma cells), the iNOS were more susceptible, showing that the NO produced had an effect but was not the difference that some of the experimenters had anticipated. Testing against septic shock, the drop in arterial pressure was only 15% in 2 hours with LPS and the animals survived whereas wild-type mice lost 64% of the arterial pressure and all died. However, the death due to killed *Propionobacterium acne*, a granuloma-forming bacterium, was the same for mutant and wild-type mice. In this case it is clear that the NO does not deal with all of the functions of live bacteria and that iNOS can affect only those properties protected against by NO.

The third eNOS has very recently been knocked out in mice in work that has yet to be published by P. L. Huang. Although he cannot give the data of the paper, he indicates that the animals are fertile and that they have higher blood pressure than their littermates. Since this form of NOS is primarily concerned with blood pressure, this is the feature that is emphasized in the preliminary paper.

Within the past two years, NOS has been shown in a variety of invertebrates, from slime molds<sup>148</sup> through molluscs<sup>149</sup>. The exact function of NO in invertebrates is still unknown and is part of the puzzle of the purpose of this material in biology. According to Nathan and Xie<sup>150</sup>, it is quite within the scope of biology for some modifications to be met on purification of the invertebrate enzymes. The nomenclature of the mammalian enzymes studied in the present situations is suggested by these authors to be mathematical in place of alphabetical. Thus bNOS, or ncNOS, would be referred to as I, iNOS would be called II and eNOS, or ecNOS, would be called III.

## IX. CONCLUSIONS

From 1987 until now only a few years have passed, but in that time a new physiological mediator has been found, NO. In this short time the three enzymes that individually mediate this reaction in mammals have been characterized and the occurrence of similar enzymes in invertebrates have been determined. It is not only new, but surprising, that this physiological agent is a gas that is formed in one cell and spreads its function to nearby cells, but that its function is limited by oxidation. In the case of brain, Verma and coworkers<sup>151</sup> have recently suggested that carbon monoxide may be a similar activator of cGMP. The period of surprises is not yet over.

## X. REFERENCES

1. R. F. Furchgott, in *Vasodilatation: Vascular Smooth Muscle, Peptides, Autonomic Nerves and Endothelium* (Ed. P. M. Vanhoutte), pp. 401–414. Raven Press, New York, 1988.

2. L. J. Ignarro, G. M. Buga, K. S. Wood, R. E. Byrns and G. Chardhuri, *Proc. Natl. Acad. Sci. USA*, **84**, 9265 (1987).
3. P. M. Vanhoutte, in *Vasodilatation: Vascular Smooth Muscle, Peptides, Autonomic Nerves and Endothelium* (Ed. P. M. Vanhoutte), Raven Press, New York, 1988.
4. S. Moncada, R. M. J. Palmer, and E. A. Higgs, *Pharmacol. Rev.*, **43**, 109 (1991).
5. R. F. Furchgott and J. V. Zawadzki, *Nature*, **288**, 373 (1980).
6. F. Murad, C. Mittal, W. P. Arnold, S. Katsudi and H. Kimura, *Adv. Cyclic Nucleotide Res.*, **9**, 145 (1978).
7. D. Keilin and E. F. Hartree, *Nature*, **173**, 720 (1954).
8. M. W. Radomski, R. M. J. Palmer and S. Moncada, *Br. J. Pharmacol.*, **92**, 639 (1987).
9. M. W. Radomski, R. M. J. Palmer and S. Moncada, *Lancet ii*, 1057 (1987).
10. M. W. Radomski, R. M. J. Palmer and S. Moncada, *Br. J. Pharmacol.*, **92**, 181 (1987).
11. R. M. J. Palmer, A. G. Ferrige and S. Moncada, *Nature*, **327**, 524 (1987).
12. P. J. A. Hutchinson, R. M. J. Palmer and S. Moncada, *Eur. J. Pharmacol.*, **141**, 145 (1987).
13. R. F. Furchgott, P. D. Cleary, J. V. Zawadzki and D. Jothionandan, *J. Cardiovasc. Pharmacol.*, **6**, Suppl. 2, S336 (1984).
14. R. F. Furchgott, W. Martin, D. Jothionandan and G. M. Villari, Proc. IHPHAR 9th Int. Cong. Pharm., Vol. 1 (Eds. W. Paton, G. Mitchell and P. Turner), London, pp. 149–157
15. W. Martin, G. M. Villari, D. Jothionandan and R. F. Furchgott, *J. Pharmacol. Exp. Ther.*, **232**, 708 (1985).
16. W. Martin, G. M. Villari, D. Jothionandan and R. F. Furchgott, *J. Pharmacol. Exp. Ther.*, **233**, 679 (1985).
17. S. Katsudi, W. Arnold, C. Mittal and F. Murad, *J. Cyclic Nucleotide Res.*, **3**, 23 (1977).
18. W. P. Arnold, C. Mittal, S. Katsudi and F. Murad, *Proc. Natl. Acad. Sci., USA*, **79**, 3203 (1977).
19. P. A. Craven and F. R. DeRubertis, *J. Biol. Chem.*, **253**, 8433 (1978).
20. C. A. Gruetter, B. K. Barry, D. B. McNamara, P. J. Kadowitz and L. J. Ignarro, *J. Pharmacol. Exp. Ther.*, **212**, 469 (1980).
21. B. T. Mellion, L. J. Ignarro, E. H. Ohlstein, E. G. Pontecorvo, A. Hyman and P. J. Kadowitz, *Blood*, **57**, 946 (1981).
22. B. T. Mellion, L. J. Ignarro, C. B. Meyers, E. H. Ohlstein, B. A. Ballot, A. L. Hyman and P. J. Kadowitz, *Mol. Pharmacol.*, **23**, 653 (1983).
23. P. Needleman and E. M. Johnson, *J. Pharmacol. Exp. Ther.*, **184**, 709 (1973).
24. P. Needleman, B. Jakschik and E. M. Johnson, *J. Pharmacol. Exp. Ther.*, **187**, 324 (1973).
25. L. J. Ignarro, H. Lipton, J. C. Edwards, W. H. Baricos, A. L. Hyman, P. J. Kadowitz and C. A. Gruetter, *J. Pharmacol. Exp. Ther.*, **218**, 739 (1981).
26. L. J. Ignarro, J. C. Edwards, D. Y. Gruetter, B. K. Barry and C. A. Gruetter, *FEBS Lett.*, **110**, 275 (1980).
27. L. J. Ignarro, B. K. Barry, D. Y. Gruetter, J. C. Edwards, E. H. Ohlstein, C. A. Gruetter and W. H. Baricos, *Biochem. Biophys. Res. Commun.*, **94**, 93 (1980).
28. L. J. Ignarro and C. A. Gruetter, *Biochem. Biophys. Acta*, **631**, 221 (1980).
29. J. B. Hibbs, Jr., Z. Vavrin and R. R. Taintor, *Immunology*, **138**, 550 (1987).
30. J. B. Hibbs, Jr., R. R. Taintor, Z. Vavrin and E. M. Racklin, *Biochem. Biophys. Res. Commun.*, **157**, 87 (1988).
31. R. Iyengar, D. J. Stuehr and M. A. Marletta, *Proc. Natl. Acad. Sci. USA*, **84**, 6369 (1987).
32. L. J. Ignarro, R. E. Byrns, G. Buga and K. S. Wood, *Circ. Res.*, **61**, 866 (1987).
33. M. A. Marletta, P. S. Yoon, R. Iyengar, C. D. Leaf and J. S. Wishnok, *Biochemistry*, **24**, 8706 (1988).
34. J. B. Hibbs, Jr., R. R. Taintor and Z. Vavrin, *Science*, **235**, 473 (1987).
35. D. J. Stuehr, S. S. Gross, I. Sakuma, R. Levi and C. F. Nathan, *J. Exp. Med.*, **169**, 1011 (1989).
36. M. A. Tayeh and M. A. Marletta, *J. Biol. Chem.*, **264**, 19654 (1989).
37. N. S. Kwon, C. F. Nathan and D. J. Stuehr, *J. Biol. Chem.*, **264**, 20496 (1989).
38. N. S. Kwon, C. F. Nathan, F. Gilkar, O. W. Griffith, D. E. Matthew and D. J. Stuehr, *J. Biol. Chem.*, **265**, 13442 (1990).
39. A. M. Leone, R. M. J. Palmer, R. G. Knowles, P. L. Francis, D. S. Ashton and S. Moncada, *J. Biol. Chem.*, **266**, 23790 (1991).
40. J. Garthwaite, S. J. Charles and R. Chess-William, *Nature*, **336**, 385 (1988).
41. R. G. Knowles, M. Palacios, R. M. J. Palmer and S. Moncada, *Proc. Natl. Acad. Sci. USA*, **86**, 5159 (1989).

42. D. S. Bredt and S. H. Snyder, *Proc. Natl. Acad. Sci. USA*, **86**, 9030 (1989).
43. D. S. Bredt and S. H. Snyder, *Proc. Natl. Acad. Sci. USA*, **87**, 682 (1990).
44. D. S. Bredt, P. M. Hwang, C. E. Glatt, C. Lowenstein, R. R. Reed and S. H. Snyder, *Nature*, **351**, 714 (1991).
45. B. Mayer, M. John and E. Böhme, *FEBS Lett.*, **277**, 215 (1990).
46. H. H. H. W. Schmidt, J. S. Pollock, M. Nakane, L. D. Gorsky, U. Förstermann and F. Murad, *Proc. Natl. Acad. Sci. USA*, **88**, 365 (1991).
47. R. M. J. Palmer, D. D. Rees, D. S. Ashton and S. Moncada, *Biochem. Biophys. Res. Commun.*, **153**, 1251 (1988).
48. H. H. H. W. Schmidt, H. Nau, W. Wittfoht, J. Gerlack, K. -E. Prescher, N. M. Klein, F. Niroomand and E. Böhme, *Eur. J. Pharmacol.*, **154**, 213 (1988).
49. J. S. Pollock, U. Förstermann, J. A. Mitchell, T. O. Warner, H. H. H. W. Schmidt, M. Nakane and F. Murad, *Proc. Natl. Acad. Sci. USA*, **88**, 10480 (1992).
50. S. P. Janssens, A. Shimorichi, T. Quartermous, D. B. Bloch and K. D. Bloch, *J. Biol. Chem.*, **267**, 14519 (1992).
51. W. C. Sessa, J. K. Harrison, C. M. Barber, D. Zeng, M. E. Durieux, D. D. D'Angelo, K. R. Lynch and M. J. Peach, *J. Biol. Chem.*, **267**, 15274 (1992).
52. S. Lamas, P. A. Marsden, G. K. Lu, P. Tempst and T. Michel, *Proc. Natl. Acad. Sci. USA*, **89**, 6348 (1992).
53. K. Nishida, D. G. Harrison, J. P. Navas, A. A. Fisher, S. P. Dockery, M. Uematsu, R. M. Nerem, R. W. Alexander and T. J. Murphy, *J. Clin. Invest.*, **90**, 2092 (1992).
54. M. Kozak, *Cell*, **44**, 283 (1986).
55. K. M. Boje and H. -L. Fung, *J. Pharmacol. Exp. Ther.*, **253**, 20 (1990).
56. L. Busconi and T. Michel, *J. Biol. Chem.*, **268**, 8410 (1993).
57. J. Liu and W. C. Sessa, *J. Biol. Chem.*, **269**, 11691 (1994).
58. D. J. Stuehr, H. J. Cho, N. S. Kwon, M. Weise and C. F. Nathan, *Proc. Natl. Acad. Sci. USA*, **88**, 7773 (1991).
59. Y. Yui, R. Hattori, K. Kosuga, H. Eizawa and C. Kawai, *J. Biol. Chem.*, **266**, 12544 (1991).
60. L. J. Ignarro, *Annu. Rev. Pharmacol. Toxicol.*, **30**, 535 (1990).
61. C. F. Nathan and J. B. Hibbs Jr., *Curr. Opin. Immunol.*, **3**, 65 (1991).
62. S. Moncada, R. M. J. Palmer and E. A. Higgs, *Pharmacol. Rev.*, **43**, 109 (1991).
63. Q. -W. Xie, H. J. Cho, J. Calaycay, R. A. Mumford, K. M. Swiderek, T. D. Lee, A. Ding, T. Troso, and C. Nathan, *Science*, **256**, 225 (1992).
64. C. F. Nathan and D. J. Stuehr, *J. Natl. Cancer Inst.*, **82**, 726 (1990).
65. H. J. Cho, Q. -W. Xie, J. Calaycay, R. A. Mumford, K. M. Swiderek, T. D. Lee and C. Nathan, *J. Exp. Med.*, **176**, 599 (1992).
66. Y. Yui, R. Hattori, K. Kosuga, H. Eizawa, K. Hiki, S. Ohkawa, K. Ohnishi, S. Terao and C. Kawai, *J. Biol. Chem.*, **266**, 3369 (1991).
67. J. M. Hevel, K. A. White and M. A. Marletta, *J. Biol. Chem.*, **266**, 22789 (1991).
68. C. R. Lyons, G. J. Orloff and J. M. Cunningham, *J. Biol. Chem.*, **267**, 6370 (1992).
69. C. R. Lowenstein, C. S. Glatt, D. S. Bredt and S. H. Snyder, *Proc. Natl. Acad. Sci. USA*, **89**, 6711 (1992).
70. J. Kishimoto, N. Spurr, M. Liao, L. Lizhi, P. Emson and W. Xu, *Genomics*, **14**, 802 (1992).
71. A. V. Hall, H. Antoniou, Y. Wang, A. V. Cheung, A. M. Arbus, S. L. Olson, W. C. Lu, C. -L. Kau and P. A. Marsden, *J. Biol. Chem.*, **269**, 33082 (1994).
72. P. A. Marsden, K. T. Schappert, H. S. Chen, M. Flowers, C. L. Sundell, J. Wilcox, S. Lamas and T. Michel, *FEBS Lett.*, **307**, 287 (1992).
73. R. Zhang, W. Min and W. C. Sessa, *J. Biol. Chem.*, **270**, 15320 (1995).
74. L. Busconi and T. Michel, *J. Biol. Chem.*, **269**, 25016 (1994).
75. R. C. Venema, H. S. Sayegh, J. F. Arnal and D. G. Harrison, *J. Biol. Chem.*, **270**, 14705 (1995).
76. D. A. Geller, C. J. Lowenstein, R. A. Shapiro, A. K. Nussler, M. DiSilvio, S. C. Wang, D. K. Nakayama, R. L. Simmons, S. H. Snyder and T. R. Billiar, *Proc. Natl. Acad. Sci. USA*, **90**, 3491 (1993).
77. W. Xu, I. G. Charles, S. Moncada, P. Gorman, D. Sheer, L. Liu and P. Emson, *Genomics*, **21**, 419 (1994).
78. N. A. Chartrain, D. A. Geller, P. P. Koty, N. F. Sitrin, A. K. Nussler, E. P. Hoffman, T. R. Billar, N. I. Hutchison and J. S. Mudgett, *J. Biol. Chem.*, **269**, 6765 (1994).
79. R. M. J. Palmer and S. Moncada, *Biochem. Biophys. Res. Commun.*, **158**, 348 (1989).

80. S. Kaufman, in *Methods in Enzymology* (Ed. S. Kaufman), Academic Press, Orlando, 1987, pp. 3–27.
81. H. Fujisawa and S. Okuno, in *Methods in Enzymology* (Ed. S. Kaufman), Academic Press, Orlando, 1987, pp. 63–71, 83–87.
82. R. A. Pufahl and M. A. Marletta, *Biochem. Biophys. Res. Commun.*, **193**, 963 (1993).
83. N. M. Olken, K. M. Rusche, M. K. Richards and M. A. Marletta, *Biochem. Biophys. Res. Commun.*, **177**, 828 (1991).
84. J. Giovanelli, K. L. Campos and S. Kaufman, *Biochem. Biophys. Res. Commun.*, **88**, 7091 (1991).
85. J. M. Hevel and M. A. Marletta, *Biochemistry*, **31**, 7160 (1992).
86. B. Mayer, M. John, B. Heinzl, E. R. Werner, H. Wachter, G. Schultz and E. Böhme, *FEBS Lett.*, **288**, 187 (1991).
87. K. A. White and M. A. Marletta, *Biochemistry*, **31**, 6627 (1992).
88. L. O. Nardi and A. J. Fulco, *J. Biol. Chem.*, **261**, 7160 (1986).
89. D. J. Stuehr and M. Ikeda-Saito, *J. Biol. Chem.*, **267**, 20547 (1992).
90. K. McMillan, D. S. Bredt, D. J. Hirsch, S. H. Snyder, J. E. Clark and B. S. S. Masters, *Proc. Natl. Acad. Sci. USA*, **89**, 11141 (1992).
91. D. J. Stuehr, N. S. Kwon, C. F. Nathan, O. W. Griffith, P. L. Feldman and J. Wiseman, *J. Biol. Chem.*, **266**, 6259 (1991).
92. P. Klatt, K. Schmidt, G. Uray and B. Mayer, *J. Biol. Chem.*, **268**, 14781 (1993).
93. K. McMillan and B. S. S. Masters, *Biochemistry*, **32**, 9875 (1993).
94. M. A. Marletta, *J. Biol. Chem.*, **268**, 12231 (1993).
95. P. L. Feldman, O. W. Griffith and D. J. Stuehr, *Chem. Eng. News*, Dec. 20, 26–38 (1993).
96. H. G. Korth, R. Sustmann, C. Thater, A. R. Butler and K. V. Ingold, *J. Biol. Chem.*, **269**, 17776 (1994).
97. K. J. Campos, J. Giovanelli and S. Kaufman, *J. Biol. Chem.*, **270**, 1721 (1995).
98. K. J. Baek, B. A. Theil, S. Lucas and D. J. Stuehr, *J. Biol. Chem.*, **268**, 21120 (1993).
99. D. K. Ghosh and D. J. Stuehr, *Biochemistry*, **34**, 801 (1995).
100. J. Wang, D. J. Stuehr, M. Ikeda-Saito and D. L. Rousseau, *J. Biol. Chem.*, **268**, 22255 (1993).
101. E. A. Sheta, K. McMillan and B. S. S. Masters, *J. Biol. Chem.*, **269**, 15147 (1994).
102. K. McMillan and B. S. S. Masters, *Biochemistry*, **34**, 3686 (1995).
103. P.-F. Chen, A. L. Tsai and K. K. Wu, *J. Biol. Chem.*, **269**, 25062 (1994).
104. M. K. Richards and M. A. Marletta, *Biochemistry*, **33**, 14723 (1994).
105. J. Wang, D. L. Rousseau, H. M. Abu-Soud and D. J. Stuehr, *Proc. Natl. Acad. Sci. USA*, **91**, 10512 (1994).
106. A. C. Hurshman and M. A. Marletta, *Biochemistry*, **34**, 5627 (1995).
107. A. Matsuoka, D. J. Stuehr, J. S. Olson, P. Clark and M. Ikeda-Saito, *J. Biol. Chem.*, **269**, 20335 (1994).
108. J. M. Griscavage, J. M. Fukuto, Y. Komori and L. J. Ignarro, *J. Biol. Chem.*, **269**, 21644 (1994).
109. B. Mayer, P. Klatt, E. R. Werner and K. Schmidt, *J. Biol. Chem.*, **270**, 655 (1995).
110. H. M. Abu-Soud, L. L. Yoho and D. J. Stuehr, *J. Biol. Chem.*, **269**, 32047 (1994).
111. A. J. Hobbs, J. M. Fukuto and L. J. Ignarro, *Proc. Natl. Acad. Sci. USA*, **91**, 10992 (1994).
112. H. M. Olken, Y. Osawa and M. A. Marletta, *Biochemistry*, **33**, 14784 (1994).
113. H. M. Abu-Soud, P. L. Feldman, P. Clark and D. J. Stuehr, *J. Biol. Chem.*, **269**, 32318 (1994).
114. Y. Komori, G. C. Wallace and J. M. Fukuto, *Arch. Biochem. Biophys.*, **315**, 213 (1994).
115. R. A. Pufahl, J. S. Wishnok and M. A. Marletta, *Biochemistry*, **34**, 1930 (1995).
116. E. P. Garvey, J. A. Oplinger, G. J. Tanoury, P. A. Sherman, M. Fowler, S. Marshall, M. F. Harmon, J. E. Paith and E. S. Furfine, *J. Biol. Chem.*, **269**, 26669 (1994).
117. E. S. Furfine, M. F. Harmon, J. E. Paith, R. G. Knowles, M. Salter, R. J. Kiff, C. Duffy, R. Hazelwood, J. G. Oplinger and E. P. Garvey, *J. Biol. Chem.*, **269**, 26677 (1994).
118. K. Narayanan, L. Speck, K. McMillan, R. G. Kilbourn, M. A. Hayward, B. S. S. Masters and O. W. Griffith, *J. Biol. Chem.*, **270**, 11103 (1995).
119. D. J. Wolff and B. J. Griben, *Arch. Biochem. Biophys.*, **311**, 293 (1994).
120. D. J. Wolff and B. J. Griben, *Arch. Biochem. Biophys.*, **311**, 300 (1994).
121. D. J. Wolff and A. Lubeskie, *Arch. Biochem. Biophys.*, **316**, 290 (1994).
122. C. Hartneck, P. Klatt, K. Schmidt and B. Mayer, *Biochem. J.*, **304**, 683 (1994).
123. J. Xie, P. Roddy, T. K. Rife, F. Murad and A. P. Young, *Proc. Natl. Acad. Sci. USA*, **92**, 1242 (1995).
124. M. Calcasi, M. Lafon-Cazal, S. Pietri and J. Backaert, *J. Biol. Chem.*, **269**, 12589 (1994).



125. C. J. Lowenstein, E. W. Alley, T. Raval, A. M. Snowman, S. H. Snyder, S. W. Russell and W. J. Murphy, *Proc. Natl. Acad. Sci. USA*, **90**, 9730 (1993).
126. A. Weisz, S. Oguchi, L. Cicatiello and H. Esumi, *J. Biol. Chem.*, **269**, 8324 (1994).
127. J. L. Balligand, D. Ungureanu-Longrois, W. W. Simmons, D. Pimental, T. A. Malinski, M. Kapturczuk, Z. Taha, C. J. Lowenstein, A. J. Davidoff, R. A. Kelly, T. W. Smith and T. Michel, *J. Biol. Chem.*, **269**, 27580 (1994).
128. D. Kunz, H. Muhl, G. Walker and J. P. Pfeilschifter, *Proc. Natl. Acad. Sci. USA*, **91**, 5387 (1994).
129. Q. -W. Xie, Y. Kashiwabara and C. Nathan, *J. Biol. Chem.*, **269**, 4705 (1994).
130. S. C. Chu, H. P. Wu, T. C. Banks, N. T. Eissa and J. Moss, *J. Biol. Chem.*, **270**, 10625 (1995).
131. Q. -W. Xie, H. Cho, Y. Kashiwabara, M. Baum, J. H. Wiedner, K. Elliston, R. Mumford and C. Nathan, *J. Biol. Chem.*, **269**, 28500 (1994).
132. E. P. Garvey, J. V. Tuttle, K. Covington, B. M. Merrill, E. R. Wood, S. A. Baylis and I. E. Charles, *Arch. Biochem. Biophys.*, **311**, 235 (1994).
133. J. L. Balligand, L. Kobzik, X. Han, D. M. Kaye, L. Belhassen, D. S. O'Hara, R. A. Kelly, T. W. Smith and T. Michel, *J. Biol. Chem.*, **270**, 14582 (1995).
134. C. P. Weiner, I. Lizasoain, S. A. Baylis, R. G. Knowles, I. A. Charles and S. Moncada, *Proc. Natl. Acad. Sci. USA*, **91**, 5212 (1994).
135. D. C. Jenkins, I. G. Charles, L. L. Thomsen, D. W. Moss, L. S. Holmes, S. A. Baylis, P. Rhodes, K. Westmore, P. C. Emson and S. Moncada, *Proc. Natl. Acad. Sci. USA*, **92**, 4392 (1995).
136. K. Schmidt, P. Klatt and B. Mayer, *Biochem. J.*, **301**, 313 (1994).
137. K. Schmidt, P. Klatt and B. Mayer, *Biochem. J.*, **301**, 645 (1994).
138. A. Hausladen and I. Fridovich, *J. Biol. Chem.*, **269**, 29405 (1994).
139. L. Castro, M. Rodriguez and R. Radi, *J. Biol. Chem.*, **269**, 29409 (1994).
140. M. Hecker, M. Boese, V. A. Schini-Kerth, A. Mülsch and R. Busse, *Proc. Natl. Acad. Sci. USA*, **92**, 4671 (1995).
141. M. Fulisch, *J. Cardiovasc. Pharmacol.*, **17**, Suppl. 3:S25 (1991).
142. J. Zhang, V. L. Dawson, T. M. Dawson and S. H. Snyder, *Science*, **263**, 687 (1992).
143. P. L. Huang, T. M. Dawson, D. S. Bredt, S. H. Snyder and M. C. Fishman, *Cell*, **75**, 1273 (1993).
144. L. J. Ignarro, P. A. Bush, G. M. Buga, K. S. Wood, J. M. Fukoto and J. Raifer, *Biochem. Biophys. Res. Commun.*, **170**, 843 (1990).
145. F. Holmquist, H. Hedlund and K. E. Anderson, *Acta physiol. Scand.*, **141**, 441 (1991).
146. N. Kim, K. M. Azazdoi, I. Goldstein and I. Saenz de Tejada, *J. Clin. Invest.*, **88**, 112 (1991).
147. J. D. MacMicking, C. Nathan, G. Hom, N. Chartrain, D. S. Fletcher, M. Trumbauer, K. Stevens, Q. -W. Xie, K. Sokol, N. Hutchinson, H. Chen and J. S. Mudgett, *Cell*, **81**, 641 (1995).
148. G. Werner-Felmayer, G. Golderer, E. R. Werner, P. Gröbner and H. Wachter, *Biochem. J.*, **304**, 105 (1994).
149. A. Gelperin, *Nature*, **369**, 61 (1994).
150. C. Nathan and Q. -W. Xie, *Cell*, **78**, 915 (1994).
151. A. Verma, D. J. Hirsch, C. E. Glatt, G. V. Ronnett and S. H. Snyder, *Science*, **295**, 381 (1993).

## CHAPTER 23

# Reactions of nitrosoarenes with SH groups

P. EYER and D. GALLEMANN

*Walther-Straub-Institut für Pharmakologie und Toxikologie, Ludwig-Maximilians-Universität München, Nußbaumstr. 26, D-80336 München, Germany*  
Fax: (089)-51452-224

---

I. INTRODUCTION AND HISTORICAL REMARKS . . . . .	1000
II. REACTION PRODUCTS AND PATHWAYS . . . . .	1001
A. Overview . . . . .	1001
B. Formation of the Semimercaptal Intermediate . . . . .	1001
1. Structural elucidation . . . . .	1001
2. Kinetic aspects of semimercaptal formation . . . . .	1003
C. Formation of the <i>N</i> -Hydroxyarylamine and its Secondary Products . . . . .	1007
1. <i>N</i> -Hydroxyarylamine . . . . .	1007
2. The bifurcation at the semimercaptal stage . . . . .	1007
3. Secondary products . . . . .	1009
D. The Sulfenamide Cation Descendants . . . . .	1009
1. The sulfinamide . . . . .	1009
a. Identification . . . . .	1009
b. Formation mechanism and kinetics . . . . .	1010
2. Sulfenamide and arylamine . . . . .	1011
a. Formation and identification . . . . .	1011
b. Remarks on the formation mechanism . . . . .	1012
3. Thio ether . . . . .	1014
4. <i>N</i> -Sulfenylquinonimines and resultant products . . . . .	1015
a. Monocyclic products . . . . .	1015
b. Bicyclic products . . . . .	1016
c. <i>N</i> -Sulfenylquinonimine formation from nitrosophenols and nitrosoanilines . . . . .	1018
E. Formation of <i>N</i> -Hydroxysulfonamide . . . . .	1019
F. Reaction Pathways Involving Radical Intermediates . . . . .	1019
III. BIOLOGICAL SIGNIFICANCE . . . . .	1020
A. Introduction . . . . .	1020
B. Monocyclic Nitrosoaromatics . . . . .	1022

1. Nitrosobenzene generated from nitrobenzene and aniline . . . . .	1022
2. Nitroso-procainamide from procainamide . . . . .	1023
3. 3-Nitrosobenzamide . . . . .	1023
4. Nitroso derivatives of chloramphenicol . . . . .	1024
5. Nitroso derivatives of chloroanilines . . . . .	1026
6. Nitroso derivatives of sulfonamide drugs . . . . .	1026
7. Nitroso derivatives of dinitrobenzenes . . . . .	1028
8. 4-Nitrosophenetol from 4-phenetidine . . . . .	1029
9. 4-Nitroso- <i>N,N</i> -dimethylaniline . . . . .	1029
C. Polycyclic Nitrosoaromatics . . . . .	1030
1. 4-Nitrosobiphenyl from 4-aminobiphenyl . . . . .	1030
2. 2-Nitrosofluorene from 2-acetamidofluorene . . . . .	1031
D. Heterocyclic Nitrosoaromatics . . . . .	1031
1. Nitrosoimidazoles from nitroimidazoles . . . . .	1031
2. Heterocyclic <i>N</i> -oxygenated compounds derived from food mutagens . . . . .	1033
IV. REFERENCES . . . . .	1035

## I. INTRODUCTION AND HISTORICAL REMARKS

The reaction of the aromatic nitroso group with thiols was unknown in organic chemistry until the sixties of this century. Thus, in 1969 Furuya and coworkers attempted to investigate the mechanism of thio etherification of 4-nitrosophenol in more detail when they reacted it with ethylmercaptan<sup>1</sup>. The products they observed, however, most probably resulted from the interaction of the nitroso group with the thiol. This gap in organochemical knowledge is quite amazing since reactions of nitrosoarenes with thiols are exothermic and kinetically uninhibited at ambient temperature. Furthermore, these reactions obviously parallel the semiacetal formation of carbonyls reacting with alcohols. Moreover, similar reactions of nitrosoaromatics with active hydrogen compounds are well known<sup>2,3</sup>. Thus, a semiacetal-like product was identified in 1901 by Bamberger and Rising<sup>4</sup> while reacting nitrosobenzene with 4-toluenesulfinic acid. However, until the late seventies there are only a few papers superficially dealing with the interaction of nitrosoarenes with thiols.

To our knowledge, this reaction was first mentioned by Smentowski in 1963<sup>5</sup>. He investigated the reaction of nitrosobenzene with 2-naphthylthiol and reported the thiol disulfide and the corresponding azo(xy)aromatics to be the main products. A variety of products have been observed by several groups: thiol disulfide<sup>5,6</sup>, azo(xy)aromatics<sup>5-7</sup>, arylamines<sup>6,8</sup>, an adduct of nitrosoarene with thiol which could be hydrolyzed to the corresponding arylamine by acid or alkali treatment<sup>9-11</sup> and a thio ether<sup>8,12</sup>. Despite this mysterious medley of different products emerging from the reaction of nitrosoaromatics with thiols, no detailed investigation was undertaken to illuminate the obviously complex reactions until toxicologists took an interest in that topic. This interest arose when it became clear that nitrosoarenes and the *N*-hydroxyarylamines are biological reactive intermediates that are involved in toxic, allergic, mutagenic and carcinogenic effects. Hence, interactions with cellular thiols, predominantly with glutathione (GSH) and protein SH groups, were considered to be important for the detoxication of nitrosoarenes. In 1977, Neumann and coworkers<sup>11</sup> were the first to present a hypothetical scheme illustrating how a labile nitrosoarene/thiol adduct<sup>9-11</sup> may liberate the arylamine.

In 1958, Kiese and coworkers for the first time detected nitrosobenzene in the blood of dogs after aniline administration, and it was his group who discovered *N*-oxygenation and the site of action *in vivo*<sup>13-16</sup>. Finally, Kiese initiated<sup>17</sup> and extended the research in the metabolic fate of nitrosobenzene in erythrocytes<sup>10</sup> and encouraged one of the authors

to participate in this field<sup>18,19</sup>. Hence, we greatly took the opportunity to maintain this tradition by collecting the pertinent data and presenting a comprehensive review on chemical reactions of the aromatic nitroso group with thiols. Detailed investigations in well defined chemical systems revealed these reactions to be very complex, and a lot of items remain in the dark until today. Since scientists of chemical toxicology are expected to be among the most interested readers of this chapter, the biological significance of these reactions is presented in more detail, too.

## II. REACTION PRODUCTS AND PATHWAYS

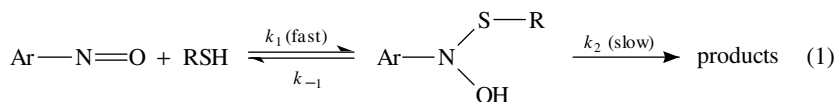
### A. Overview

Scheme 1 summarizes the main reaction pathways proposed for the interaction of nitrosoarenes with thiols in aqueous, neutral solvents as deduced from product patterns and kinetic data. Accordingly, the first reaction step is the formation of an addition product (1), termed 'semimercaptal'. This labile intermediate is cleaved by a second thiol molecule yielding the corresponding *N*-hydroxyarylamine (2). Alternatively, the semimercaptal N–O bond may be broken with formation of an electrophilic sulfenamide cation (3). Both reaction pathways compete for each other, depending on aryl substituent(s), pH of the reaction medium, and concentration and  $pK_a$  of the thiol. The ramification of the reaction pathway at the sulfenamide cation stage is even more complex since the positive charge is delocalized through the aromatic system, depending on the aryl substituent(s). Generally, three electrophilic centers (the sulfur atom and the *o*- and *p*-position of the aromatic ring) can react with various nucleophiles (excess thiol, solvent H<sub>2</sub>O and the reaction product arylamine 8), giving rise to a variety of intermediates and end products such as sulfinamides (4), sulfenamides (5 and 6), thio ethers (7), arylamines (8) and *N*-sulfenylquinonimines (9 and 10). Again, the preference of a distinct pathway depends on the aryl substituent(s) and the thiol concentration. Beside the pathways summarized in Scheme 1, a few additional reaction possibilities are reviewed in Sections II.E and II.F.

### B. Formation of the Semimercaptal Intermediate

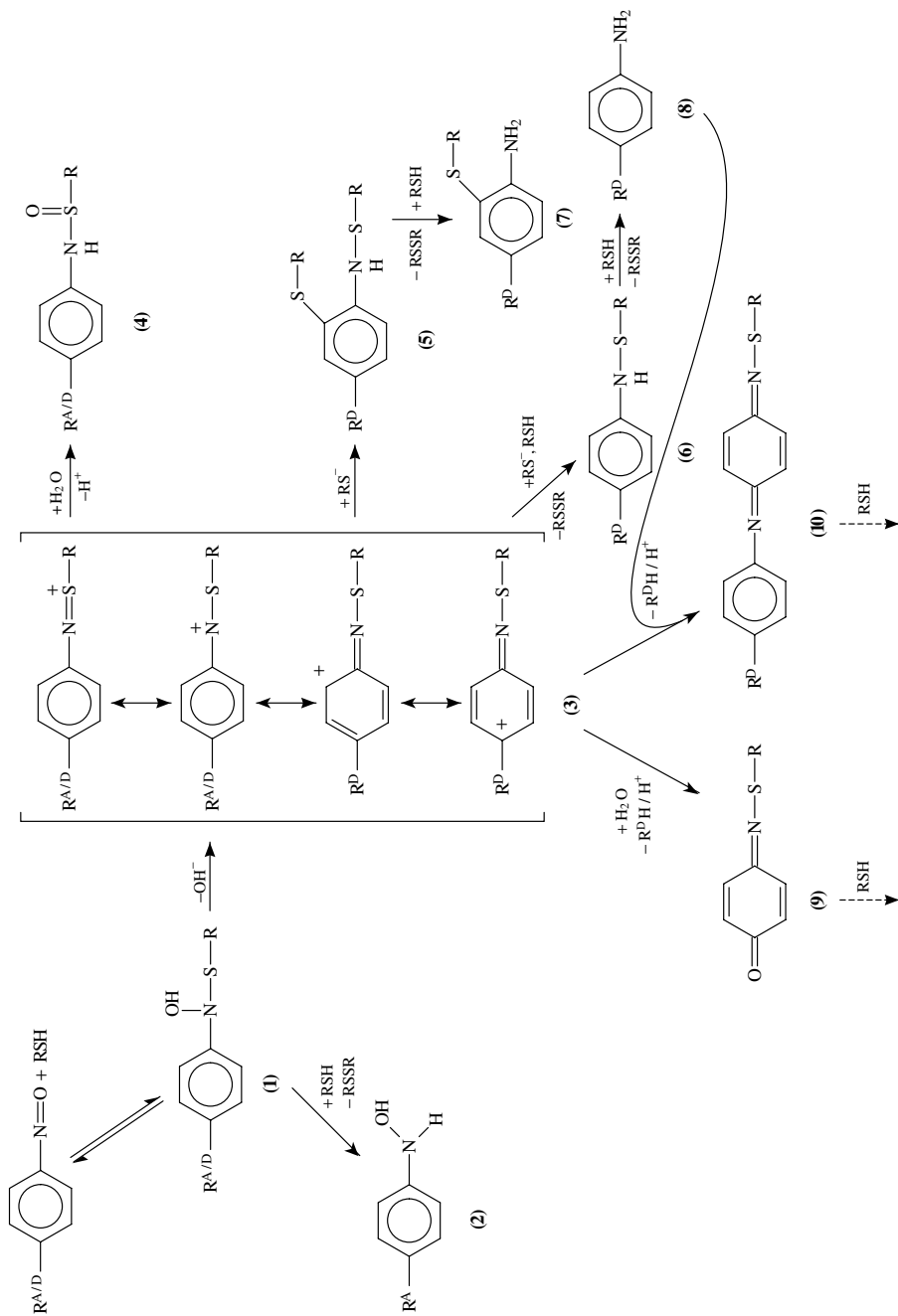
#### 1. Structural elucidation

According to the different electronegativity of nitrogen and oxygen, the nitroso group is polarized in analogy to the homologous carbonyl group<sup>†</sup>. Similar to alcohols reacting with carbonyls, the addition of thiols to nitrosoarenes yields a semiacetal-like *N*-hydroxysulfenamide which was first postulated by Youssefyeh<sup>21</sup>.



The family of the *N*-hydroxysulfenamides has been commonly termed 'semimercaptal'<sup>22–31</sup>, despite the potential confusion with carbonyl/thiol adducts (see, for example, Reference 32). With few exceptions, semimercaptals are very unstable and give various

<sup>†</sup> Molecular orbital calculations on the electrostatic potential of the aromatic nitroso group revealed an uneven charge distribution at the nitroso-nitrogen, enabling both electrophilic and nucleophilic attack<sup>20</sup>. Accordingly, the major negative region is located at the outside of the C<sub>(Ar)</sub>–N=O angle within the molecular plane, reflecting the nitrogen lone electron pair. A significant build-up of a positive potential was calculated to be inside the C<sub>(Ar)</sub>–N=O angle below and above the molecular plane.



SCHEME 1. Main reaction pathways during interaction of nitrosoarenes with thiols ( $\text{R}^{\text{A}}$  denotes electron acceptor substituent and  $\text{R}^{\text{D}}$  electron donor substituent)

products depending on the nature of their aryl substituent(s). Therefore, this family has only been hypothesized for about ten years<sup>11,18,21–23,25,33–37</sup> before it could be isolated in substance. In our laboratory, Klehr reacted nitrosobenzene with 1-thioglycerol in methanol at  $-40^{\circ}\text{C}$  and confirmed the proposed structure by  $^{13}\text{C}$ -NMR, FAB-MS and UV spectroscopy<sup>24,38</sup>. In the meantime some other semimercaptals have been proved structurally<sup>29,38,39</sup>.

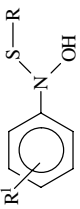
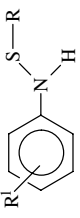
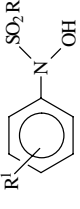
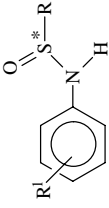
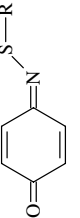
Semimercaptals (**1**) exhibit a variety of spectroscopic characteristics. The most typical property is a strong FAB-MS signal at  $m/z = [\text{M}+\text{H}-18]^+$  (positive ion mode), thereby enabling a clear distinction from the isomeric sulfinamide (**4**)<sup>24,29,38,39</sup>. Obviously, the *N*-hydroxy group is particularly prone to proton impact and subsequent loss of water. Further discrimination from the sulfinamide is given by the absence of an IR absorption at  $\nu = 1060\text{ cm}^{-1}$  which is typical for the S=O double bond<sup>29</sup>. The semimercaptal exhibits maximum UV absorption in the region of 255–270 nm<sup>18,24,30,38,40</sup>. The  $^{13}\text{C}$ -NMR chemical shift of the *ipso* carbon atom of *N*-hydroxy-*N*-(1-thioglycerol-*S*-yl)-aniline was found to be similar to that of *N*-hydroxyaniline (152 ppm). The signal of the aliphatic carbon atom vicinal to the sulfur atom (37 ppm) appeared between the corresponding signals of the parent thiol and the sulfenamide, indicating a relatively weak electron withdrawal at the sulfur atom<sup>24,38</sup> (Table 1). Characteristic  $^1\text{H}$ -NMR signals<sup>29</sup> of semimercaptals, containing N–S conjugated cysteinyl residues, are summarized in Table 1. On separation by reversed-phase HPLC, semimercaptals are eluted subsequent to the respective sulfin- and sulfenamides<sup>24,38</sup>.

## 2. Kinetic aspects of semimercaptal formation

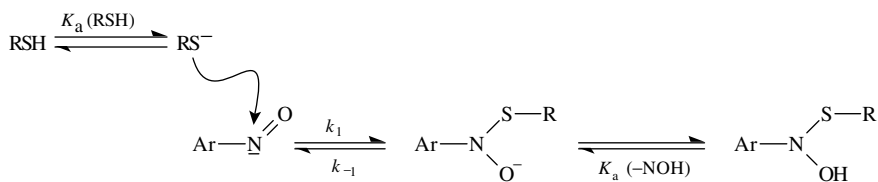
The formation of the semimercaptal has been shown to be reversible<sup>18,22,30,36,38,40</sup>. First indications came from a simple observation: nitrosobenzene<sup>18,38</sup> and nitrosochloramphenicol<sup>22</sup>, respectively, having reacted with GSH to complete disappearance of their characteristic UV absorption, could be recovered from the reaction mixture by extraction with ether. During reaction of various nitrosoarenes with thiols, no isosbestic points were detected between the UV spectra of the nitrosoarenes and their end products, indicating formation of a labile intermediate<sup>18,22,38,40</sup>. Correspondingly, absorbance of most nitrosoarenes decreased biphasically when reacted with excess thiol<sup>18,22,30,36,40</sup>. A rapid initial fall in optical density—reflecting the establishment of the semimercaptal equilibrium—was followed by a slower decrease due to consecutive reactions of the semimercaptal with concomitant readjustment of the preceding equilibrium (see equation 1). Similarly, the rapid build-up and the slower decrease of the semimercaptal can be observed in the region around 260 nm<sup>18,30</sup> (the maximum absorbance of the semimercaptals).

Forward and reverse reaction rates have been shown to increase with rise in pH<sup>18,30,38</sup>, but no indications for general acid or base catalysis were found<sup>30</sup>. Therefore, the thiolate anion is assumed to be the nucleophile ultimately reacting during the forward reaction (Scheme 2). This conclusion is corroborated by the rate constants of semimercaptal formation with various thiols (Table 2). The marked differences in reactivities at pH 7.4 are obviously largely due to the different degree of dissociation, except for *t*-butylthiol, hemoglobin cysteine ( $\beta$  93) SH groups (Hb–SH) and thiophenol. (With *t*-butylthiolate and Hb–S<sup>-46–48</sup>, steric hindrance may cause the low reaction rates. The low reactivity of phenylthiolate is attributed to resonance stabilization of the negative charge, as indicated by the Hammett reaction constant for dissociation of substituted thiophenols  $\rho \approx 2^{49}$ ). In the back reaction, the N–S cleavage of the semimercaptal anion ( $\text{p}K_{\text{a}}$  estimated as  $\approx 10^{30}$ ) is suggested to be the rate-determining step (Scheme 2). Forward and

TABLE 1. Comparison of characteristic properties of N-S conjugates emerging during the reaction of nitrosoarenes with alkanethiols<sup>a</sup>

Reversed-phase HPLC <sup>b</sup>		$R_t$	$>$		$R_t$	$\approx$		$R_t$	$>$		$R_t^c$	$>$		$R_t$
Neutral hydrolysis	Ar-NH-SO-R	ArNH <sub>2</sub> + RSSR + RSO <sub>2</sub> H <sup>d</sup>		ArNO + RSO <sub>2</sub> H			ArNH <sub>2</sub> + RSO <sub>2</sub> H			ArNH <sub>2</sub> + RSO <sub>2</sub> H			ArNH <sub>2</sub> + RSO <sub>2</sub> H	
Acidic hydrolysis	ArNH <sub>2</sub> + RSO <sub>2</sub> H	ArNH <sub>2</sub> + RSSR + RSO <sub>2</sub> H <sup>d</sup>		ArNO + RSO <sub>2</sub> H			ArNH <sub>2</sub> + RSO <sub>2</sub> H			ArNH <sub>2</sub> + RSO <sub>2</sub> H			ArNH <sub>2</sub> + RSO <sub>2</sub> H	
Alkaline hydrolysis	ArNH <sub>2</sub> <sup>24</sup>	ArNH <sub>2</sub> + RSSR		ArNO + RSO <sub>2</sub> H			ArNH <sub>2</sub> + RSSR			ArNH <sub>2</sub> + RSSR			ArNH <sub>2</sub> + RSSR	
Reaction with RSH	Ar-NHOH + RSSR	ArNH <sub>2</sub> + RSSR		ArNH <sub>2</sub> + RSSR			ArNH <sub>2</sub> + RSSR			ArNH <sub>2</sub> + RSSR			ArNH <sub>2</sub> + RSSR	
UV/VIS <sup>e</sup>														
$\lambda_{\max 1}$ (nm)	255–270	244–255 <sup>f</sup>		$\approx$ 250			230–245 <sup>f, g</sup>			412				
$\lambda_{\max 2}$ (nm)		280–304 <sup>f</sup>					271–288 <sup>f</sup>							
$\epsilon_{21}/\epsilon_{32}$		5–7					8–14							
IR: $\nu$ (cm <sup>-1</sup> )	$\nu_{\text{S=O}}$ not existing	$\nu_{\text{S=O}}$ not existing		$\nu_{\text{SO}_2} \approx 1165/1360$			$\nu_{\text{S=O}} \approx 1060$							
FAB-MS	[M + H] <sup>+</sup> , [M + H - H <sub>2</sub> O] <sup>+</sup>	[M + H] <sup>+</sup> , [M + H - SR] <sup>+</sup>		[M + H] <sup>+</sup> , [M + H - O] <sup>+</sup>			[M + H] <sup>+</sup> , [M + H - ArNH] <sup>+</sup>			[M + H] <sup>+</sup> , [M + H - SR] <sup>+</sup>				
<sup>13</sup> C-NMR <sup>h</sup>	C <sub>Aryl</sub> -N-S: 152	C <sub>Aryl</sub> -N-S: 149		C <sub>Aryl</sub> -N-S: 139–142			C <sub>Aryl</sub> -N-S: 139–142							
$\delta$ (ppm)	N-S-C <sub>Alkyl</sub> : 37	N-S-C <sub>Alkyl</sub> : 42		N-S-C <sub>Alkyl</sub> : 42			N-S-C <sub>Alkyl</sub> : 56–58 <sup>i</sup>							
<sup>1</sup> H-NMR <sup>j</sup>	cys $\beta_1$ : 3.0	cys $\beta_1$ : 2.7–3.0		cys $\beta_{1/2}$ : 4.8			cys $\beta_1$ : 3.4–3.6 <sup>i</sup>			cys $\beta_1$ : 3.64				
$\delta$ (ppm)	cys $\beta_2$ : 3.4	cys $\beta_2$ : 3.1–3.2					cys $\beta_2$ : 3.6–3.7 <sup>i</sup>			cys $\beta_2$ : 3.87				

<sup>a</sup>For references compare the respective text parts.<sup>b</sup>Retention times ( $R_t$ ) compared according to<sup>24,26,38,43,45</sup>.<sup>c</sup>With chiral thiols, double peaks may be obtained at high chromatographic resolution.<sup>d</sup>Originally, RSOH will result which disproportionates according to equation 7.<sup>e</sup>In MeOH/H<sub>2</sub>O.<sup>f</sup>Corresponding sulfen- and sulfonamides exhibit about 15 nm difference in their absorption maxima;  $\pi$ -donor substituted sulfen- and sulfonamides reveal a slight bathochromic shift<sup>38</sup>.<sup>g</sup>For the probable glutathione sulfonamide of the polycyclic 3-nitroso-1-methyl-5H-pyridolo[4,3-*b*]indole, the UV maximum was reported at 262 nm<sup>41</sup>.<sup>h</sup>Data of derivatives from nitrosobenzene reacted with 1-thioglycerol, 2-thioethanol and cysteamine (in CD<sub>3</sub>OD). The corresponding signal of the original thiols are located at  $\approx 27$  ppm<sup>24,42</sup>.<sup>i</sup>With chiral thiols, signals are doubly splitted.<sup>j</sup>Data of derivatives containing N-S conjugated cysteinyl residues (in CD<sub>3</sub>OD, D<sub>2</sub>O or mixtures of both). The corresponding signals of GSH, for example, are located at cys  $\beta_1$ : 2.88  $\pm$  0.04 ppm and cys  $\beta_2$ : 2.93  $\pm$  0.03 ppm in D<sub>2</sub>O<sup>35,44</sup>.



SCHEME 2. Mechanism of semimercaptal formation (from Kazanis and McClelland<sup>30</sup>, with modification)

TABLE 2. Second-order rate constants of the semimercaptal formation for various thiols reacting with nitrosobenzene (conditions unless otherwise specified: pH 7.4, 37 °C, nitrogen)

Thiol	$k_{1, \text{obs}}^a$ ( $\text{M}^{-1}\text{s}^{-1}$ )	$\text{p}K_a$ (SH)	$k_{1, \text{thiolate}}^b$ ( $\text{M}^{-1}\text{s}^{-1}$ )	Reference
Cysteine	$12 \times 10^3$	8.6	$2.0 \times 10^5$	36
Cysteamine	$12 \times 10^3$	8.3 <sup>49</sup>	$1.0 \times 10^5$	25
Glutathione	$5 \times 10^3$	8.8	$1.2 \times 10^5$	25
1,2-Ethanedithiol	$4.5 \times 10^3$	9.1 <sup>49</sup>	$2.2 \times 10^5$	38
1-Thioglycerol	$1.7 \times 10^3$	9.5 <sup>49</sup>	$2.1 \times 10^5$	38
Benzylthiol	$1.5 \times 10^3$	9.4 <sup>49</sup>	$1.5 \times 10^5$	36
Thioethyleneglycol	$1.3 \times 10^3$	9.6	$2.1 \times 10^5$	25
Thiophenol	32	6.5	40	25
Hb-SH	5.5 <sup>c</sup>	$>11^{51}$	$>2.2 \times 10^4$	40
<i>t</i> -Butylthiol	4	11.1 <sup>49</sup>	$2.0 \times 10^3$	25

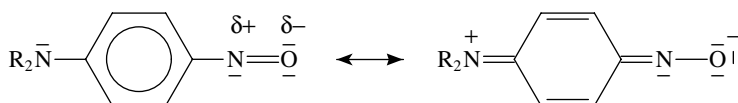
<sup>a</sup> $k_{1, \text{obs}} = -d[\text{nitrosobenzene}]/dt \cdot [\text{nitrosobenzene}]^{-1} \cdot [\text{RSH}]^{-1}$ .

<sup>b</sup> $k_{1, \text{thiolate}} = -d[\text{nitrosobenzene}]/dt \cdot [\text{nitrosobenzene}]^{-1} \cdot [\text{RS}^-]^{-1}$ .

<sup>c</sup>pH 7.4, 25 °C, carbon monoxide.

reverse reaction are affected by pH in the same manner so that the equilibrium itself is unimpaired<sup>†</sup>.

The semimercaptal formation rates of substituted nitrosobenzenes reacting with GSH<sup>25,30,36</sup> and Hb-SH<sup>27,40</sup>, respectively, have been shown to obey a Hammett correlation. As far as  $\pi$ -electron donors are not considered, a good fit is achieved using Hammett  $\sigma$  constants [ $\rho(k_1^{\text{GSH}}) = +1.9^{30}$ ]. However, inclusion of definite  $\pi$ -electron donor substituents such as *o*- or *p*-alkoxy or dialkylamino groups require the Hammett  $\sigma^+$  scale<sup>25,27,36,40</sup> [ $\rho^+(k_1^{\text{GSH}}) = +2.1$ ,  $\rho^+(k_1^{\text{Hb-SH}}) = +1.7^{27}$ ] (Figure 1). These substituents significantly slow down the semimercaptal formation rates, presumably as  $\pi$ -electron donation results in a second resonance structure (**11**) disabling the nitroso-thiol interaction:



(11)

<sup>†</sup> A similar mechanism of addition was presumed for the reaction of nitrosobenzene with  $\text{OH}^-$ . However, the resulting adduct is not protonated at the pH of reaction, but additionally deprotonated to the dianion, giving rise to a completely different product pattern<sup>3,50</sup>.



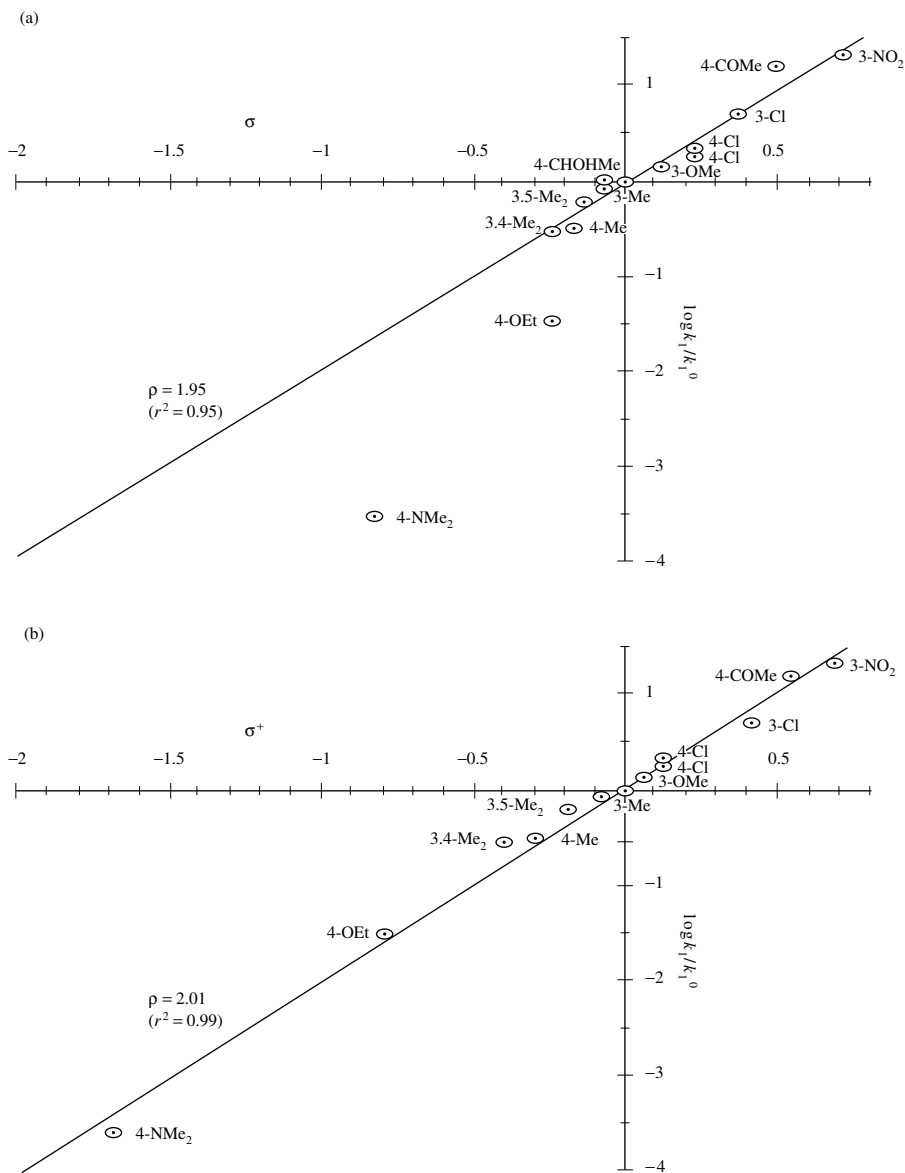


FIGURE 1. Hammett plots [ $\sigma$  (a) and  $\sigma^+$  (b), respectively] for the formation of semimercaptals from GSH and substituted nitrosobenzenes.  $\log k_1/k_1^0$  values were calculated from the rate constants reported for pH 7.4, 37°C<sup>18,22,36</sup> and pH 7.49, 25°C, ionic strength 1 M<sup>30</sup>. Correction for pH is unnecessary as  $k_1$  and  $k_1^0$  are affected in the same manner. Correction for the different temperatures has been revealed to be insignificant. (The Hammett parameter  $\rho$  appears to vary with  $1/T$  while  $\sigma$  seems to be independent of temperature<sup>54</sup>. Hence,  $\log k_1/k_1^0$  has been assumed to correlate with  $1/T$ .) For want of  $\sigma$  for the complex nitroschloramphenicol substituent (**20**),  $\sigma$  of 4-CHOHMe was used<sup>55</sup>

This resonance effect is a well-known phenomenon of  $\pi$ -donor substituted nitrosoarenes, and the batho- and hyperchromic UV shifts<sup>40,52</sup>, increased dipole moments<sup>2,52</sup> and molecular geometry<sup>20,53</sup> have been attributed to it. In addition, molecular orbital calculations have shown a significant decrease of the positive electrostatic potential at the nitrogen atom of the nitroso group in the presence of  $\pi$ -donating substituents<sup>20</sup> (see footnote in Section II.B.1).

Reverse reaction rates and equilibrium constants of the semimercaptal formation have been shown to fit a Hammett correlation ( $\sigma$ -scale), too<sup>30</sup>. Since an investigation of the latter kinetic parameters has not been possible for nitrosoarenes bearing  $\pi$ -donating substituents (because of the kinetic instability of such semimercaptals, see Section II.D), the fit cannot be proved on the  $\sigma^+$ -scale. The Hammett reaction constants were reported to be  $\rho(k_{-1}^{\text{GSH}}) = -1.4$  and  $\rho(K_1^{\text{GSH}}) = +3.2$ <sup>30</sup>. Thus, electron acceptor groups give rise to rapid establishment of the equilibrium while electron donor groups distinctly slow down this reaction. The relatively high and positive  $\rho$ -value of the equilibrium constant ( $K_1$ ) reflects the strong dependence of the semimercaptal equilibrium on the nature of the aryl substituent(s).

## C. Formation of the *N*-Hydroxyarylamine and its Secondary Products

### 1. *N*-Hydroxyarylamine

The formation of *N*-hydroxyarylamines (**2**) has been reported for a variety of nitrosoarenes reacting with thiols<sup>18,24,33,36,38,41,43</sup>. In the case of electron acceptor substituted nitrosoarenes, *N*-hydroxyarylamines are usually the main end products<sup>22,25,28,29,36,41</sup>. In contrast,  $\pi$ -donor substituted nitrosobenzenes have not been observed to form *N*-hydroxyarylamines<sup>25,36,38,39,56</sup>. Similarly, *N*-hydroxy derivative formation could not be detected during the reaction of the electron-rich 1-methyl-2-nitrosoimidazole with GSH<sup>57</sup>. Thus, the electronic effects of the aryl residue play a crucial role not only for the initial reaction rates, but also for the further reaction pathways. In addition, *N*-hydroxyarylamine formation is substantially affected by the thiol concentration and the pH of the solvent. At an educt stoichiometry of 1:1, *N*-hydroxyarylamines were hardly detected<sup>3,18,22,29,38,43</sup>. From this point of stoichiometry, increasing thiol proportions were found to result in increasing yields of the *N*-hydroxyarylamines<sup>18,22,28,29,36,38,43</sup>. In the case of electron acceptor substituted nitrosoarenes, stoichiometric amounts of thiol disulfide are formed<sup>18,22,36</sup>. Thus, the *N*-hydroxyarylamines have been presumed to be formed from the labile semimercaptal by thiolytic cleavage of the N–S bond<sup>18,22,24,25,28,29,33,36</sup> (see Scheme 1).

### 2. The bifurcation at the semimercaptal stage

Some detailed work has been done to investigate the dependence of branching ratios at the semimercaptal step on thiol concentration, pH, and the nature of the aryl substituent(s). Thus, Eyer and coworkers<sup>18,22,25,36</sup> determined product ratios of the stable end products, *N*-hydroxyarylamine (**2**) and sulfinamide (**4**), while Kazanis and McClelland<sup>30</sup> conducted kinetic investigations. Not included in all these studies were  $\pi$ -donor substituted nitrosoarenes, as their semimercaptals form a variety of additional products<sup>36</sup> (see Scheme 1). Furthermore, as already mentioned in Section II.B.2, the establishment of the semimercaptal equilibrium is distinctly slowed down by these substituents. Besides, consecutive reactions are accelerated, thereby obscuring the biphasic reaction kinetics. Thus, a sufficient kinetic distinction between (fast) semimercaptal formation and (slower) subsequent reactions is not feasible (see equation 1). This effect is

also displayed by sterically hindered thiols as *t*-butylthiol since kinetics of the initial step are drastically slowed down<sup>38</sup> (cf Table 2). [Reaction kinetics of nitrosoarenes with +I-groups can be corrected for incomplete establishment of the semimercaptal equilibrium as shown by Kazanis and McClelland<sup>30</sup>].

Observation of the slow kinetic component at the maximum absorption of the semimercaptals revealed a pseudo first-order decrease, consisting of a thiol-dependent and a thiol-independent component<sup>30</sup>:

$$k_2(\text{slow}) = k_2^{\text{RSH}} \cdot [\text{RSH}] + k_2(\text{rearr}) \quad (2)$$

The first term obviously reflects the thiol-dependent *N*-hydroxyarylamine formation while the second term stands for the rearrangement to the sulfinamide (see Scheme 1). Correspondingly, product ratios were found to correlate with thiol concentrations in the following manner<sup>22,25</sup>:

$$\frac{[N\text{-hydroxyarylamine}]}{[\text{sulfinamide}]} = \frac{(K_1 \cdot [\text{NOAr}] \cdot [\text{RSH}]) \cdot k_2^{\text{RSH}} \cdot [\text{RSH}]}{(K_1 \cdot [\text{NOAr}] \cdot [\text{RSH}]) \cdot k_2(\text{rearr})} = p \cdot [\text{RSH}];$$

$$p = \frac{k_2^{\text{RSH}}}{k_2(\text{rearr})} \quad (3)$$

At constant pH, the parameter *p* is dependent on the electronic effects of the nitrosoarene substituent(s). Using only definite acceptor substituted nitrosoarenes, a Hammett correlation on the  $\sigma$  scale was obtained<sup>25</sup>. Separate investigation of  $k_2^{\text{RSH}}$  and  $k_2(\text{rearr})$  for a wider selection of nitrosoarenes reacting with GSH revealed reasonable correlation with Hammett  $\sigma$  constants only for  $k_2^{\text{RSH}}$  ( $\rho = +1.4$ ). However,  $k_2(\text{rearr})$  was found to fit better on the Hammett  $\sigma^+$  scale ( $\rho^+ = -3.5$ )<sup>30</sup> [for further discussion of  $k_2(\text{rearr})$  see Section II.D.1.b].

Substantial dependence of the bifurcation ratio *p* on pH, buffer concentration and temperature was noticed, too<sup>18,25,30,33</sup>. For the thiol-dependent reaction, a linear correlation of  $\log k_2^{\text{RSH}}$  with pH was obtained (slope = 0.9), indicating the thiolate to be the reacting species<sup>30</sup>. A similar dependence of  $k_2^{\text{RSH}}$  on the thiol  $\text{p}K_a$  is to be expected, but, except for a few indications<sup>33</sup>, detailed data are lacking hitherto. General acid-base catalysis could be excluded, and a distinct negative entropy of activation was found. Thus, the detailed mechanism of *N*-hydroxyarylamine formation seems to proceed via a nucleophilic attack of the thiolate anion at the semimercaptal sulfur atom, forming a properly orientated transition state. The subsequent displacement of the *N*-hydroxyarylamine anion is probably not assisted by proton transfer, as indicated by the absence of buffer catalysis and the positive  $\rho$  Hammett value<sup>30</sup> (Scheme 3).



SCHEME 3. Mechanism of *N*-hydroxyarylamine formation (from Kazanis and McClelland<sup>30</sup>, with modification)

Recently, some doubts have appeared on this widely accepted mechanism, because sulfenamides, but not *N*-hydroxyarylamines, were found upon addition of thiols to *isolated* semimercaptals (from nitrosobenzene and 4-chloronitrosobenzene reacted with 1-thioglycerol or 2-thioethanol)<sup>27,38</sup>. During the direct reaction of the nitrosoarenes with excess thiols, however, *N*-hydroxyarylamines were formed as the main products<sup>27,38</sup>. On the other hand, semimercaptals from 3- and 4-nitronitrosobenzene reacting with *N*-acetylcysteine methyl ester or GSH were reported to be thiolitically cleaved as expected<sup>29</sup>. These contrasting observations have remained without any well-founded explanation hitherto. Possibly, there exists an additional pathway, e.g. via radicals, leading from the nitrosoarene to the *N*-hydroxyarylamine, as discussed below in Section II.F.

### 3. Secondary products

Azo- and azoxyarenes have been repeatedly observed during reactions of nitrosoarenes with thiols<sup>5-7,11,29,33,35,36,38</sup>. The latter family presumably emerges from the interaction of the *N*-hydroxyarylamine with unreacted nitrosoarene, a reaction proceeding even in neutral solutions<sup>2,6,58</sup>. The formation of azoarenes may be due to condensation of the end-product arylamine with still unreacted nitrosoarene<sup>59</sup>.

## D. The Sulfenamide Cation Descendants

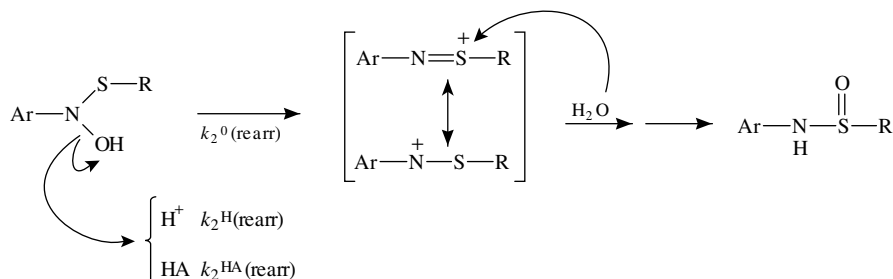
### 1. The sulfinamide

*a. Identification.* In the reaction of a great variety of nitrosoarenes with alkanethiols, formation of a stable adduct has been repeatedly observed. This adduct was identified as *N*-aryl-*S*-alkylsulfenamide (**4**) due to a lot of characteristics. Radioactive experiments<sup>26,35</sup> as well as <sup>1</sup>H-NMR spectra<sup>18,35,43</sup> revealed a 1:1 adduct of nitrosoarene and thiol. N—S bond formation was indicated as ring substitution was excluded by <sup>1</sup>H-NMR data and hydrolysis experiments: On acidification<sup>9,10,18,22,28,35,38,41,60,61</sup> and alkalization<sup>11,24,33,43</sup> the adduct liberated the corresponding arylamine and the sulfinic acid<sup>18,33,60,62</sup>. In neutral aqueous solutions and in the presence of excess thiol, the adduct remained stable<sup>35,38</sup>. Only the glutathione sulfinamides of the heterocyclic 3-nitroso-1-methyl-5*H*-pyrido[4,3-*b*]indole<sup>41</sup> and 2-nitroso-6-methyldipyrido[1,2-*a*:3',2'-*d*]imidazole<sup>43</sup> were observed to decay slowly at neutral conditions. Elemental analysis<sup>24,38</sup> and FAB-MS spectra<sup>24,35,37,38,43,60</sup> displayed the same mass as the respective semimercaptal, but no fragmentation corresponding to the loss of water was observed (see Table 1). IR spectra<sup>18,24,35,38,43</sup> exhibited a broad intense peak at  $\nu \approx 1060 \text{ cm}^{-1}$  indicative of a sulfoxide stretching vibration. Characteristic UV<sup>9,24,38,40,41,43,61</sup>, <sup>13</sup>C-NMR<sup>24,38</sup> and <sup>1</sup>H-NMR data<sup>35,43,63</sup> are summarized in Table 1.

Among all products formed during reactions of nitrosoarenes with thiols, the sulfinamides display one special characteristic. Because of the stereostable pyramidal conformation at the sulfur atom, two enantiomeric forms are possible<sup>64-66</sup>. (Sulfenamides contain a stereogenic S—N axis which, however, is stereolabile; therefore, enantiomers are not observable in many cases<sup>67</sup>. Most likely, this holds true for semimercaptals and *N*-hydroxyarylamines as well.) Therefore, nitrosoarenes reacting with optically active thiols—as, for example, the physiological substrates L-cysteine or GSH (L-glutamyl-L-cysteinylglycine)—will result in diastereomeric sulfinamides, provided the chirality of the thiol does not control the formation ratio<sup>24,38,61</sup>. In fact, doubling of NMR signals has been observed with sulfinamides containing chiral thiols<sup>24,35,38,43,61</sup>. Because of the relatively high inversion barrier of the stereogenic sulfur center<sup>65,66</sup>, the diastereomers are stable enough to allow isolation. Thus, distinct sulfinamides are eluted as double peaks,

as observed with GSH<sup>26,68</sup>, L-cysteinyl-L-prolinyl-L-tyrosine<sup>61</sup>, L-cysteinyl-glycine<sup>63</sup> and 1-thioglycerol<sup>38</sup> by high-resolution HPLC. In contrast, sulfinamides from achiral thiols displayed one single HPLC peak<sup>63</sup>.

*b. Formation mechanism and kinetics.* Exclusive formation of sulfinamides was observed during decomposition of isolated semimercaptals in aqueous solutions<sup>24,38</sup>. Some efforts have been undertaken to elucidate the mechanism leading from the semimercaptal to the isomeric sulfinamide in more detail. Using 1-thioglycerol<sup>38</sup> and GSH<sup>30</sup>, the respective *N*-(thiol-*S*-yl)aniline-*S*-oxides have been synthesized in <sup>18</sup>O-enriched water as solvent. Investigation of the products by FAB-MS revealed the sulfinamide molecular peak to be shifted to 2 higher mass units, indicating the incorporation of one <sup>18</sup>O-isotope. Therefore, the rearrangement was suggested to proceed by N–O bond fission of the semimercaptal (Scheme 4). The liberated sulfenamide cation will partly allocate its positive charge to the more electropositive sulfur atom, and addition of a water molecule with subsequent proton rearrangement will result in the sulfinamide.



SCHEME 4. Mechanism of the semimercaptal-sulfinamide rearrangement (from Kazanis and McClelland<sup>30</sup>, with modification)

A couple of additional findings support the intermediate occurrence of a sulfenamide cation. Thus, the isolated semimercaptal shows a prolonged lifetime in solvents of reduced polarity<sup>24,38</sup> since the transition state cation is less stabilized by solvation. Kinetic investigations at different pH values and buffer concentrations revealed a general acid catalysis. Both decreased pH<sup>18,22,25,30</sup> and increased buffer concentrations<sup>30</sup> have been found to accelerate the N–O bond cleavage (see Scheme 4), thereby raising the sulfinamide portion. Thus, the rate constant for the rearrangement reaction has been separated into three terms, reflecting the different types of N–O cleavage<sup>30</sup>:

$$k_2(\text{rearr}) = k_2^0(\text{rearr}) + k_2^{\text{H}}(\text{rearr})[\text{H}^+] + k_2^{\text{HA}}(\text{rearr})[\text{HA}] \quad (4)$$

The first term considers an unassisted cleavage of the hydroxide ion while terms two and three imply catalysis by  $\text{H}^+$  and buffer acids, respectively. At physiological pH, the uncatalyzed pathway will account for the main part of the reaction, as deduced from the individual kinetic constants reported for *N*-(glutathion-*S*-yl)-aniline-*S*-oxide formation<sup>30</sup>. The proton-catalyzed reaction path contributes only at pH below 6, and catalysis by  $\text{H}_2\text{PO}_4^-$  is relevant from about 10 mM upwards. Under physiological conditions, the high concentrations of buffering protein amino acid residues (histidine:  $\text{p}K_{\text{a}} \approx 6.5$ <sup>69</sup>, terminal  $\alpha$ -amino groups:  $\text{p}K_{\text{a}} \approx 8.0$ <sup>69</sup>) and carbonic acid ( $\text{p}K_{\text{a}} = 6.4$ <sup>70</sup>) will also contribute to the latter term. Kinetic constants for these buffers, however, are lacking hitherto.

A Brønsted plot for the sulfinamide rearrangement of *N*-(glutathion-*S*-yl)-*N*-hydroxyaniline revealed a slope  $\sigma$  of 0.6, indicating that the proton is not fully transferred to the hydroxy group in the transition state<sup>30</sup>. The developing positive charge is obviously highly delocalized, thereby enabling the hydroxide anion to leave without catalysis. In addition to the neighboring sulfur atom, the aromatic ring provides a large system for delocalization. A Hammett correlation for the sulfinamide rearrangement revealed a reasonable fit only for  $\sigma^+$  constant and a reaction constant of  $\rho^+ = -3.5$ <sup>30</sup>. These findings once more corroborate a substantial build-up of a positive charge in the transition state and a significant stabilizing contribution of the (substituted) benzene ring. Accordingly, a couple of metabolites could be attributed to ring-localized nucleophilic addition reactions to the sulfenamide cation (see below). For comparison with the analogous Bamberger reaction of *N*-phenylhydroxylamine and *N*-imidazoylehydroxylamines the account of Kazanis and McClelland<sup>30</sup> is recommended.

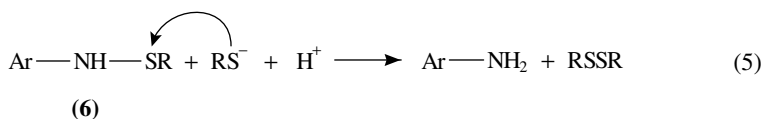
The significant inverse correlation of sulfinamide formation with thiol concentration<sup>18,22,24,25,28-30,33,35,36,38</sup> has already been discussed in Section II.C.2. Accordingly, the rearrangement pathway from the semimercaptal to the sulfinamide is favored at low thiol concentrations at the expense of *N*-hydroxyarylamine formation (see equation 2). In the case of bulky thiols as *t*-butylthiol<sup>38</sup> or Hb-SH<sup>40</sup> the sulfinamide is the main product since reduction by a second thiol is sterically hindered.

The reaction of nitrosoarenes with alkanethiols may provide a new and simple synthetic route to *N*-aryl-*S*-alkylsulfinamides which has not been mentioned hitherto<sup>62</sup>. Nitrosoarenes are frequently accessible by simple redox reactions of the commercially available arylamines or nitroarenes<sup>2,71</sup>. High yields of the desired sulfinamide may be achieved by adjusting stoichiometry, pH and solvent polarity. With aryl thiols, however, this method may not be applicable because of the very sluggish reaction (see Table 2). Whether such a synthetic route can be extended to alkylnitroso compounds remains to be established.

## 2. Sulfenamide and arylamine

*a. Formation and identification.* During reaction of various electron-rich nitrosoarenes with physiological thiols, several indications of a further, metastable adduct arose which liberated the corresponding arylamine on prolonged incubation<sup>33,35,72</sup>. Again, radioactive experiments<sup>26,35</sup> and <sup>1</sup>H-NMR data<sup>24,35,72</sup> revealed a 1:1 adduct without ring substitution. MS spectra<sup>24,35,72</sup> and elemental analysis<sup>24</sup> indicated a product containing one oxygen atom less than the sulfinamide, and IR spectroscopy<sup>24,35,38</sup> proved the sulfoxide structure to be absent. Correspondingly, <sup>1</sup>H-NMR<sup>35,72</sup>, <sup>13</sup>C-NMR<sup>24,38</sup> and UV data<sup>24,38,72</sup> indicated a lower electron withdrawal of the sulfenyl sulfur compared to the sulfinamide (see Table 1). According to these spectroscopic characteristics and the chemical behavior described below, this family was identified as *N*-aryl-*S*-alkylsulfenamides (6).

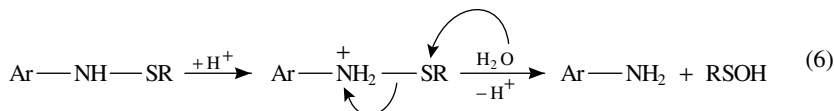
The instability of *N*-aryl-*S*-alkylsulfenamides observed in the reaction mixture was shown to be due to hydrolysis and a more rapid reaction with nucleophiles. In the presence of millimolar concentrations of GSH isolated sulfenamides yielded the arylamine and the thiol disulfide within a few minutes<sup>35,72</sup>.



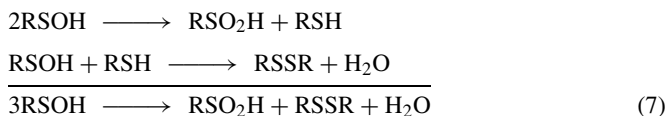
Klehr argued against this thiolytic cleavage of sulfenamides, as he did not observe accelerated aniline formation from Ph-NH-SR in the presence of 1-thioglycerol<sup>24,38</sup>. However,

this negative result was probably due to the distinct higher  $pK_a$  and, therefore, lower reactivity of 1-thioglycerol (see Table 2). In fact, thiolytic cleavage of aromatic sulfenamides does not always proceed spontaneously and requires proton catalysis<sup>73</sup>.

Moderate instability of various isolated *N*-aryl-*S*-alkylsulfenamides towards hydrolysis was observed<sup>24,35,72</sup> with formation of one equivalent arylamine and 2/3 equivalent thiol disulfide<sup>38</sup>. This decomposition may be rationalized by protonation of the sulfenamide nitrogen atom and subsequent sulfenylation of a solvent molecule<sup>24,35,38</sup>.



The sulfenic acids formed thereby are known to be highly unstable and were presumed to disproportionate to 2/3 thiol disulfide equivalent and 1/3 sulfinic acid<sup>38,74-77</sup>.

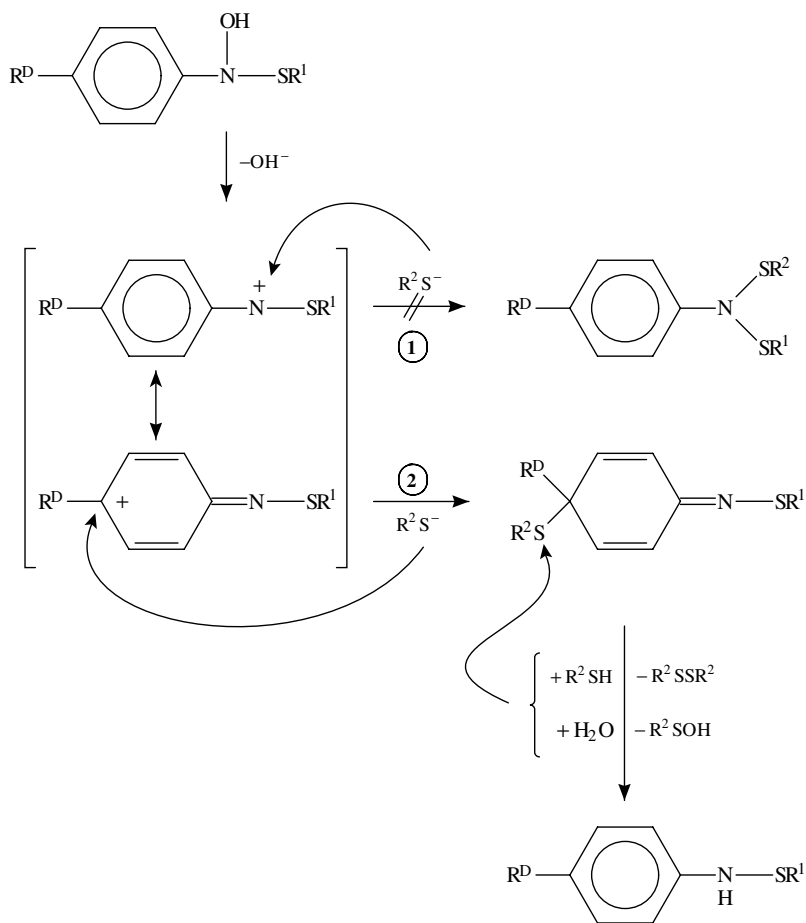


The proposed mechanism of sulfenamide hydrolysis is consistent with various findings on the reactivity of sulfenamides. Thus, protonation of sulfenamides is widely suggested to occur at the nitrogen atom, both from theoretical calculations<sup>78</sup> and from experimental results<sup>79-82</sup>. Accordingly, the reaction of sulfenamides with electrophiles involves the coordination of the electrophile with the nitrogen atom and subsequent nucleophilic attack on the sulfur atom<sup>83</sup>. This mechanism of hydrolysis could also explain the apparent high instability of the sulfenamide of 2-nitroso-6-methyldipyrido[1,2-*a*:3',2'-*d*]imidazole<sup>37,43</sup> (see Section II.E): The electron-rich heterocyclic *N*-aryl substituent may drastically raise the  $pK_a$  of the sulfenamide nitrogen atom as observed with donor substituted sulfenanilides<sup>80</sup>. Despite all these indications, the postulated reverse hydrolysis mechanism of proton-assisted cleavage of the thiol with liberation of a nitrenium ion<sup>35</sup> may not be totally excluded. The sulfenamide *N*-(glutathion-*S*-yl)-2-amino-1-methyl-6-phenylimidazo[4,5-*b*]pyridine was observed to hydrolyze spontaneously with formation of the 5-hydroxyarylamine<sup>84</sup>. This reaction might be rationalized by addition of water to the highly resonance-stabilized nitrenium ion<sup>85</sup>.

*b. Remarks on the formation mechanism.* Klehr observed the formation of sulfenamides from isolated semimercaptals in the presence of excess thiol<sup>24,38</sup>. Thus, reduction of the semimercaptal does not only lead to *N*-hydroxyarylamines (see Section II.C), but also to the sulfenamides (Scheme 1). Formation of the latter product or the subsequent arylamine has been reported for a variety of electron-rich nitrosoarenes<sup>24,26,33,35,37-39,43,72</sup>, but has hardly been observed in the case of acceptor substituted nitrosoarenes at neutral conditions<sup>29,36,38</sup>. Nevertheless, in an acidic milieu formation of 3-nitroaniline was reported to be a main pathway during the reaction of 3-nitrosanitrobenzene with GSH<sup>29</sup> (the probable intermediate sulfenamide will rapidly hydrolyze at the pH of reaction). These data suggest the sulfenamides to emerge from thiol-mediated reduction of the sulfenamide cation which is preferentially formed from electron-rich nitrosoarenes and/or at low pH (see Section II.D.1). Accordingly, high concentrations<sup>35,38</sup> and low  $pK_a$ <sup>33</sup> of the thiol favored the sulfenamide-arylamine pathway at the expense of the sulfinamide route.

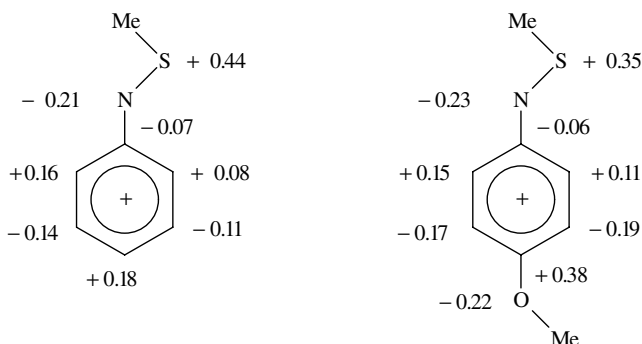
The occurrence of an intermediate *N,N*-bis(thiol-*S*-yl)-arylamine (full mercaptal) has been repeatedly surmised to be involved in the semimercaptal reduction<sup>25,29,33,37</sup>

(Scheme 5, pathway 1). Analogously, thioacetal/-ketal formation is known to proceed from the unstable hemithioacetals/-ketals of carbonyls<sup>58</sup>. However, this kind of a 1:2 adduct has not been observed hitherto during reactions of nitrosoarenes with thiols<sup>37</sup>. In addition, reaction of the isolated semimercaptal  $\text{Ph-N(OH)-SR}^1$  with different thiols  $\text{R}^2\text{SH}$  never did yield  $\text{Ph-NH-SR}^2$  but always  $\text{Ph-NH-SR}^1$ <sup>24,38</sup> (Scheme 5). Molecular orbital calculations on the semiempirical level (MNDO) conducted for the *N*-(methylthiol-*S*-yl)-4-anisidine cation and *N*-(methylthiol-*S*-yl)-aniline cation revealed a significant negative total charge density at the nitrogen atom (Scheme 6). Conceivably, this is due to the high electronegativity of nitrogen compared to its neighboring atoms in the sulfenamide cation. Therefore, a significant contribution of the  $\text{N}^+$ -localized resonance structure (Scheme 5) is not to be expected, and a thiolate may not react to give the full mercaptal. Accordingly, full mercaptal formation was achieved just the other way by sulfenylation of sulfenamides<sup>79</sup>. Taken together, these indications argue against the occurrence of a full mercaptal in the semimercaptal-sulfenamide reaction path.



Scheme 5. Mechanism of the semimercaptal-sulfenamide reduction





SCHEME 6. Charge distribution in two different sulfenamide cations (total charge densities as revealed by MNDO calculation; H. -U. Wagner in Reference 56)

Kazanis and McClelland, in their outstanding work<sup>30</sup>, have proposed a detailed mechanism of semimercaptal reduction (Scheme 5, pathway 2). Accordingly, a thiolate may add to the *p*-position of the sulfenamide cation, resulting in an unstable *ipso*-adduct. Attack of a second thiolate with elimination of thiol disulfide will restore aromaticity in the sulfenamide. This thiolytic cleavage of the *ipso*-adduct implicates a 1:1 stoichiometry in the formation of sulfenamide and thiol disulfide. However, the initial sulfenamide formation during the reaction of 4-nitrosophenetol with GSH (0.1 and 0.5 mM, respectively, pH 7.4, 37 °C, argon atmosphere) was accompanied by formation of only about 1/5 equivalent glutathione disulfide (GSSG)<sup>56</sup>. Therefore, an alternative route of hydrolytic cleavage of the *ipso*-adduct has been proposed (see Scheme 5)<sup>24,56</sup>, as already mentioned for sulfenamide decomposition. In summary, the *ipso*-adduct mechanism reflects plausibly the events occurring during semimercaptal reduction.

According to this mechanistic conception,  $\pi$ -donor substituted nitrosoarenes exhibit a strong correlation between sulfenamide and arylamine yield, respectively, and the thiol concentration employed<sup>38,56</sup>. In the case of nitrosobenzene and 4-chloronitrosobenzene, however, the 1-thioglycerol proportion (1:2 and 1:25, respectively) had virtually no effect on the sulfinamide/sulfenamide ratio at pH 6–9<sup>38</sup>. As to our understanding, this effect lacks any reasonable explanation.

### 3. Thio ether

Formation of some other products during reaction of the donor substituted 4-nitrosophenetol and *N,N*-dimethyl-4-nitrosoaniline with GSH has been implicated<sup>26,36</sup>. In fact, a stable glutathione conjugate was isolated from reaction mixtures of 4-nitrosophenetol and GSH in low yields<sup>68</sup>. FAB-MS analysis revealed the same molecular mass as the corresponding sulfenamide, but the UV spectrum was distinctly different, and acidic milieu did not decompose this compound. UV data,  $pK_a$  value and <sup>1</sup>H-NMR spectra indicated this product to be 4-ethoxy-2-(glutathion-*S*-yl)-aniline<sup>68</sup>. The formation of this adduct is consistent with the postulated intermediate occurrence of a resonance-stabilized sulfenamide cation which is prone to nucleophilic ring addition of thiolate (see Scheme 1). The resulting 4-ethoxy-2-*N*-bis-(glutathion-*S*-yl)-aniline (**5**) has now been isolated and structurally confirmed by FAB-MS, <sup>1</sup>H-NMR and chemical reactivity<sup>45</sup>. As already mentioned above, the sulfenamide group is sensitive to thiolytic and hydrolytic cleavage, yielding the stable arylamine thio ether (**7**). A similar mechanism was proposed

for the formation of the main product 2-amino-5-(glutathion-*S*-yl)-1-methylimidazole during reaction of 1-methyl-2-nitrosoimidazole with large excess of GSH<sup>57</sup>.

Formation of ring-substituted arylamine thio ethers occurs also by proton-catalyzed thermal rearrangement of the corresponding sulfenamides<sup>73,82,83</sup>. This alternative pathway may not completely be excluded in thio ether formation from nitrosoarenes, but it seems unlikely since these thio ethers were produced at neutral pH and low temperatures<sup>68</sup>. The discovery of the *bis*-conjugate additionally favors the pathway of nucleophilic ring addition of thiolate to the sulfenamide cation.

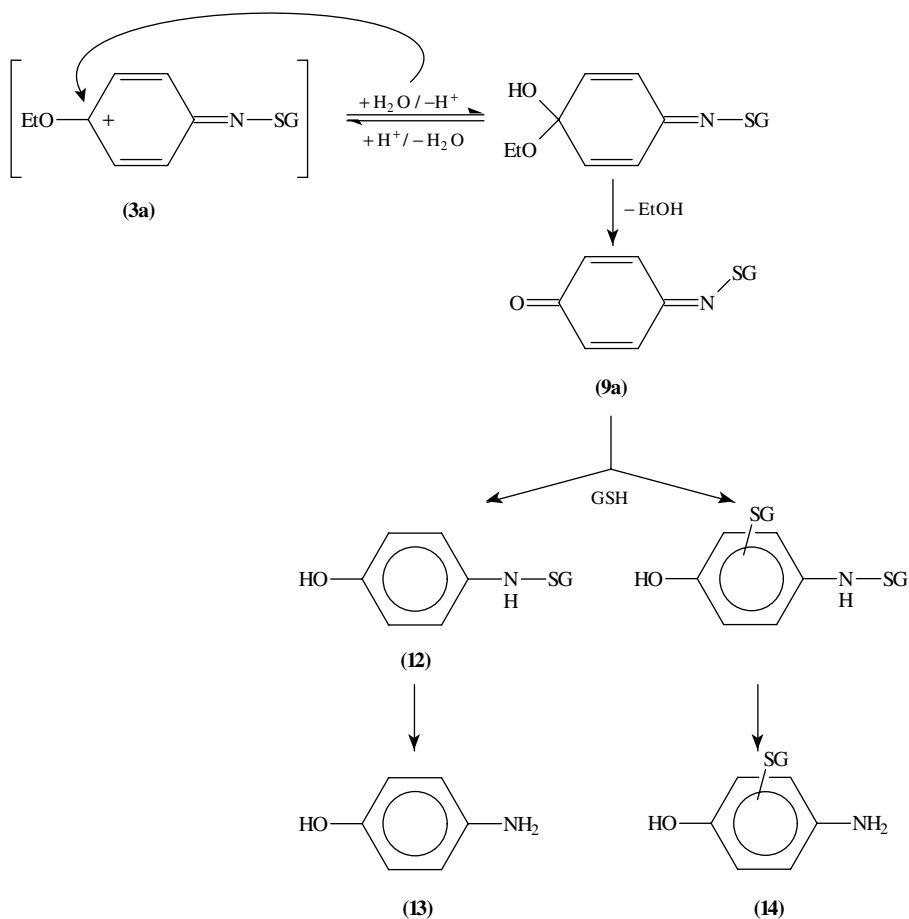
Hitherto, thio ether formation has clearly been proved only in the case of the  $\pi$ -donor substituted 4-nitrosophenetol and the electron-rich 1-methyl-2-nitrosoimidazole. The low yields of this adduct (about 2% at 1:1- and about 10% at 1:5-stoichiometry for 4-nitrosophenetol reacting with GSH<sup>56</sup>) may be the reason for its rare discovery. However, other nitrosoarenes should yield this family, too. Semiempirical molecular orbital calculations (MNDO) indicate a similar positive charge at the *o*-position of the *N*-(methylthiol-*S*-yl)-aniline cation and -4-anisole cation as well (Scheme 6). Furthermore, formation of 1-(glutathion-*S*-yl)-2-naphthylamine was reported to occur in mixtures of 2-nitrosophthalene and GSH<sup>12</sup>.

#### 4. *N*-Sulfenylquinonimines and resultant products

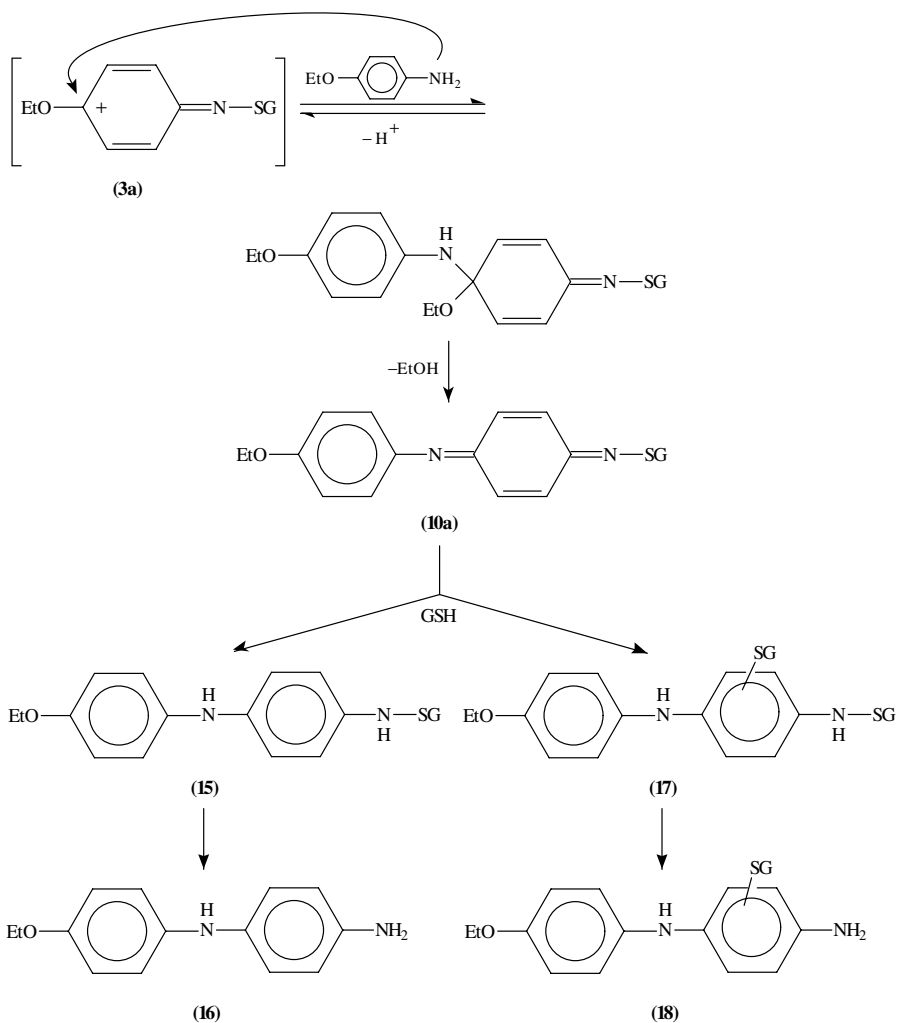
Formation of several colored products during reaction of nitrosoarenes with thiols has been repeatedly observed<sup>12,26,68</sup>. Two different orange-colored conjugates were found during HPLC separation of mixtures of 4-nitrosophenetol and GSH. The UV spectra were indicative of a quinoid structure, and further studies revealed these adducts to be a monocyclic and a bicyclic conjugate. In both cases the reactive quinoid structure gives rise to formation of secondary, stable end products.

*a. Monocyclic products.* An identical monocyclic conjugate was formed, both from 4-nitrosophenetol reacting with GSH as well as from 4-nitrosoanisole and 4-nitrosophenol, indicating an exchange of the *p*-substituent by an identical group. Accordingly, the signals of the *p*-substituent were lost in the <sup>1</sup>H-NMR spectrum. Characteristically, 4 different aromatic signals, each splitted into a double doublet by *o*- and *m*-coupling, were observed. These findings are consistent with the structure of *N*-(glutathion-*S*-yl)-4-benzoquinonimine (Scheme 7, **9a**) because the hindered rotation around the imino bond<sup>86</sup> causes magnetic inequivalence of the quinoid protons. FAB-MS analysis corroborated the proposed structure. The *isolated* conjugate reacted with excess GSH with formation of various products. Mild reduction yielded the corresponding sulfenamide **12** followed by formation of 4-aminophenol (**13**) while addition to the quinoid system resulted in thio ethers of 4-aminophenol (**14**). However, these secondary products have not been observed directly in reaction mixtures of 4-nitrosophenetol and GSH, presumably because of the low yield of the quinonimine derivative (**9a**) (maximum 5% of theory)<sup>45</sup>.

Under mechanistic aspects, discovery of the quinonimine derivative was not unexpected. The sulfenamide cation of 4-nitrosophenetol (**3a**) gives rise not only to ring addition of GSH but of other nucleophiles, too. Especially the *p*-position seems to be prone to nucleophilic attack since this aromatic carbon atom obtains additional positive charge by the  $-I$ -effect of the adjacent oxygen atom as revealed by semiempirical molecular orbital calculations (see Scheme 6). The ethoxy group is known to be quite a good leaving group<sup>58</sup>. Thus, addition of H<sub>2</sub>O with concomitant loss of a proton may produce an unstable *ipso*-adduct which is prone to release either hydroxide or ethoxide, presumably with proton assistance (Scheme 7). A similar reaction pathway has already been described for the *N*-(thiophenol-*S*-yl)-4-anisidine cation<sup>87</sup>.

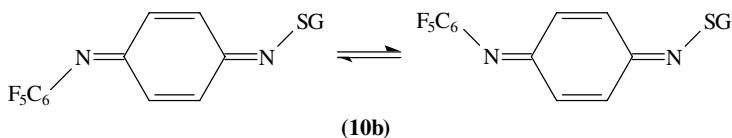
SCHEME 7. Formation of *N*-(glutathion-*S*-yl)-4-benzoquinonimine and subsequent reactions

*b. Bicyclic products.* In analogy to the monocyclic quinonimine derivative, reaction of the main end-product 4-phenetidide (see Scheme 1) with the sulfenamium cation (**3a**) produces *N*-(4'-ethoxyphenyl)-*N'*-(glutathion-*S*-yl)-4-benzoquinone diimine (Scheme 8, **10a**). The corresponding 2-thioethanol and *t*-butylthiol derivatives exhibited MS spectra corroborating the presumed structure<sup>68</sup>. <sup>1</sup>H-NMR spectra of the three derivatives, however, were not sufficiently meaningful since the aromatic signals of 8 protons overlapped mutually<sup>68</sup>. Therefore, the pentafluorophenyl derivative **10b** was synthesized<sup>56</sup>. (As pentafluoroaniline hardly reacted with the sulfenamium cation **3a**, because of the low nucleophilic amino nitrogen, another route was pursued: 4-nitrosophenetol was reacted with pentafluoroaniline under acid catalysis<sup>3,88</sup>, giving pentafluoro-4'-nitrosodiphenylamine in low yield. Transformation with GSH delivered the desired benzoquinone diimine derivative **10b**.) Chemical behavior of the 4-ethoxyphenyl (**10a**) and the pentafluorophenyl (**10b**) derivatives was similar, and FAB-MS analysis revealed the expected mass. The <sup>1</sup>H-NMR spectrum exhibited 8 aromatic double doublets with a relative intensity of 0.5 proton



SCHEME 8. Formation of *N*-(4'-ethoxyphenyl)-*N'*-(glutathion-*S*-yl)-4-benzoquinone diimine and subsequent reactions

each, reflecting the *E-Z* isomerism of *N,N'*-disubstituted quinone diimines<sup>56</sup>. Further confirmation of the proposed structure of **10a** came from chemical reactivity as described elsewhere<sup>68</sup>.

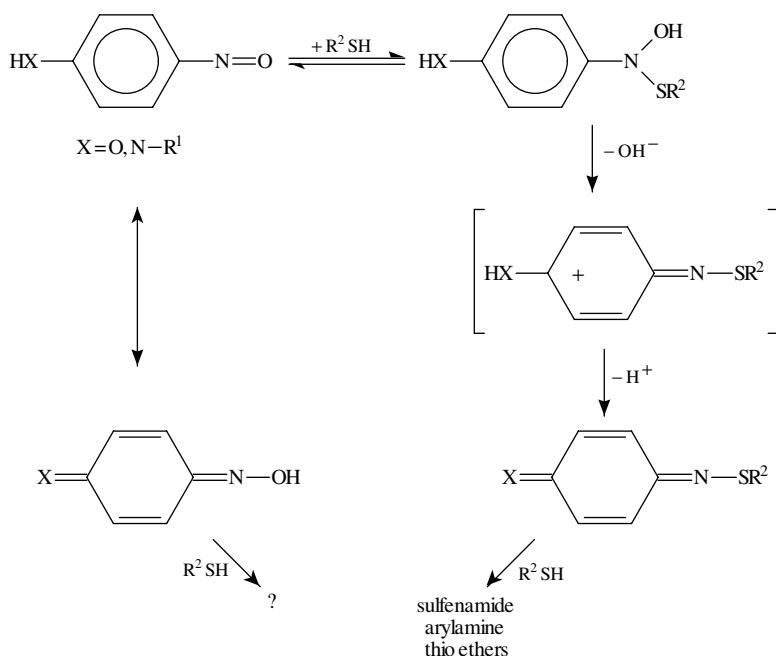


The bicyclic quinone diimine **10a** exhibits the same product pattern in the reaction with excess GSH as the monocyclic quinonimine **9a**. Reduction results in slow formation of

4-amino-4'-ethoxydiphenylamine (**16**) with intermediate occurrence of a metastable compound, probably the corresponding sulfenamide **15**. Besides, ring addition of various thiols ultimately resulted in the formation of 4-amino-4'-ethoxy-2-(thiol-*S*-yl)-diphenylamine (**18**), presumably via the corresponding sulfenamide **17**<sup>68</sup> (Scheme 8).

The quinone diimine **10a** was discovered in incubates of 4-nitrosophenetol with about 2.5-fold excess of GSH. At higher GSH concentrations, this product was hardly formed because 4-nitrosophenetol and hence the sulfenamide cation (**3a**) had completely reacted before significant amounts of 4-phenetidine were formed (see Scheme 1)<sup>56</sup>. However, when GSH was slowly generated by an enzymic reaction in the presence of 4-nitrosophenetol, quinone diimine yields increased markedly<sup>56</sup>. Similarly, high yields of the quinone diimine **10a** were obtained when authentic 4-phenetidine was present from the beginning in the mixtures of 4-nitrosophenetol and GSH. This path may provide a new and simple synthetic route for distinct *N*-sulfenylquinonimines which has not been mentioned hitherto<sup>86</sup>. In fact, a variety of *N*-sulfenylquinone diimine derivatives were obtained during reaction of 4-nitrosophenetol with other primary arylamines and other thiols. Because of the weaker nucleophilicity of acceptor substituted anilines and alkylamines, these amines presumably can hardly compete with the other nucleophiles for the sulfenamide cation<sup>56</sup>.

*c. N-Sulfenylquinonimine formation from nitrosophenols and nitrosoanilines.* Because of the ionizable proton of the aryl substituent, nitrosophenols and -anilines presumably will display a somewhat different metabolic pattern (Scheme 9). The semimercaptals of these  $\pi$ -donor substituted nitrosoarenes will almost exclusively yield the sulfenamide cation which is prone to simple and rapid stabilization: Dissociation of the proton at the substituent oxygen and nitrogen results in the corresponding *N*-sulfenylquinone mono- and



SCHEME 9. Tentative pathways of nitrosophenols and nitrosoanilines reacting with thiols

diimine, respectively. In fact, during the reaction of 4-ethoxy-4'-nitrosodiphenylamine and pentafluoro-4'-nitrosodiphenylamine with equivalent amounts of GSH the quinone diimines **10a**<sup>68</sup> and **10b**<sup>56</sup> were the main products. However, in the reaction of 4-nitrosophenol with varying proportions of GSH, the quinonimine **9a** was formed only as a minor product<sup>45</sup>. Most probably, the quinoid resonance structure of the parent nitrosoarene decelerates the rate of the nitroso/thiol interaction<sup>36</sup> (see Section II.B.2) and gives rise to further nucleophilic reaction centers besides the nitroso group. These pathways, however, remain to be elucidated in detail.

### E. Formation of *N*-Hydroxysulfonamide

Recently, a new product was discovered during reaction of the polycyclic 2-nitroso-6-methyldipyrido[1,2-*a*:3',2'-*d*]imidazole with GSH and cysteine, respectively<sup>43</sup>. Structural elucidation by UV/Vis, <sup>1</sup>H-NMR, IR and FAB-MS and the stability towards hydrolysis<sup>71</sup> (see Table 1) revealed an *N*-hydroxysulfonamide. The authors suggested it to be formed by addition of the nitrosoarene to sulfinic acid, emerging by hydrolysis of the metastable sulfinamide. In fact, nitrosoarenes are known to react with aryl-<sup>3,4,7,71,89</sup> as well as with alkylsulfinic acids<sup>7,90</sup> to form stable *N*-hydroxysulfonamides. However, the glutathione sulfinamide decay in neutral solution probably proceeded too slowly to deliver the large amounts of glutathione sulfinic acid required within a few minutes. In addition, a sulfinamide was not observed during the reaction with cysteine. Both thiols, however, formed large amounts of the corresponding arylamine. Its precursor sulfenamide was detected immediately after the reaction start by FAB-MS<sup>37</sup>, but it was not observed 10 min later by HPLC, despite the low thiol proportions employed<sup>43</sup>. Therefore, the sulfenamide is probably the unstable ancestor of the sulfinic acid (see equations 6 and 7). Transferred to other nitrosoarenes, formation of an *N*-hydroxysulfonamide is only to be expected from electron-rich nitrosoarenes forming the sulfenamide, provided the sulfenamide exhibits a particularly marked instability towards hydrolysis (see Section II.D.2).

### F. Reaction Pathways Involving Radical Intermediates

Formation of hydronitroxide radicals during nonenzymic reduction of nitrosobenzene, 2-nitroso-1-naphthol and 2-nitroso-1-naphthol-4-sulfonic acid with reducing agents such as NADH, GSH, cysteine, *N*-acetylcysteine and other thiols has been observed by ESR spectroscopy<sup>5,91,92</sup>. The reaction was carried out with 5 mM nitrosoarene and 5 mM thiol in 0.1 M phosphate buffer, pH 7.4, under either air or nitrogen. Radical formation did not depend on atmospheric oxygen. Interestingly, in the presence of higher concentrations of the reducing agents, e.g. 10 mM thiol, no ESR signal was detected. These data have been interpreted as being indicative of a one-electron reduction of nitrosoarenes leading to the hydronitroxide radical as the initial reaction product, followed by reduction of the radical to the hydroxylamine with excess thiols<sup>91-93</sup>.



Formation of phenylhydronitroxide radicals, DMPO (5,5-dimethyl-1-pyrroline-*N*-oxide)/glutathiyyl and DMPO/hemoglobin thiyyl free radical adducts has been detected in erythrocytes of rats *in vivo* after administration of nitrosobenzene and phenylhydroxylamine, respectively<sup>92,94</sup>. The data, however, could also be interpreted in a different way:





In fact, neutral, partially aqueous solutions containing nitrosobenzene and phenylhydroxylamine yielded phenylnitroxide radicals<sup>95</sup>. However, excess thiol will reduce the nitrosoarene completely, thereby excluding the comproportionation reaction 11. Reaction 9 is thermodynamically highly unfavored, and formation of thiyl radicals could be only demonstrated in the presence of high concentrations of the spin trapping agent DMPO, e.g. at 100 mM<sup>92</sup>. Since the yields of spin adducts of thiyl radicals were much higher when phenylhydroxylamine instead of nitrosobenzene was reacted with GSH in buffer or with red cells, it was proposed that the species responsible for the oxidation of the thiols to produce the thiyl free radicals *in vivo* and *in vitro* was the phenylhydronitroxide radical generated in the reaction of phenylhydroxylamine with oxyhemoglobin<sup>92</sup>. Hence, the radical pathway of reaction 8 appears less likely, and the radicals detected stem probably from the reaction chain 10, 11, 9.

### III. BIOLOGICAL SIGNIFICANCE

#### A. Introduction

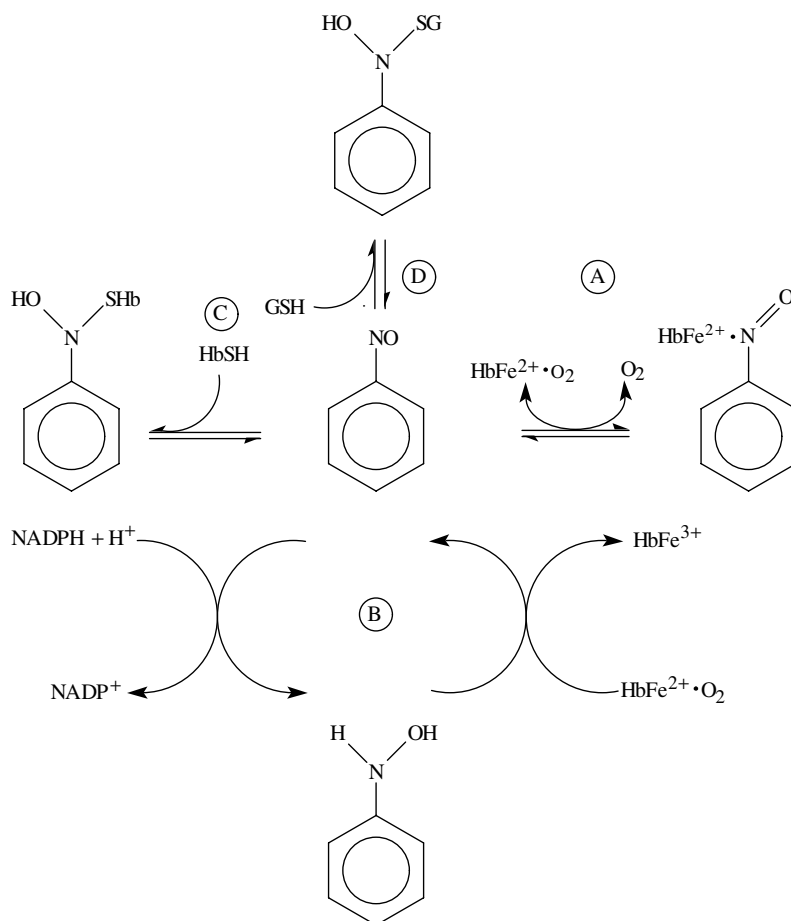
Overt external exposure of living organisms to nitrosoarenes is a rare event, and chemists are usually aware of the hazard potential of *C*-nitroso compounds. Nonetheless, we are daily exposed to nitrosoarenes that are generated within our cells.

To maintain a proper milieu intérieur, our body is faced with eliminating efficiently the useless or harmful ballast of foreign compounds incorporated daily. Since lipophilic xenobiotics are usually not excreted by the kidneys, higher organisms have evolved a variety of metabolic reactions to produce more hydrophilic derivatives that are easily eliminated by the renal route. The liver is the central organ to fulfill this task, but other organs may share it, too. In doing so, the organism runs some risk because reactive intermediates can be formed which may injure the cells where they arise, or — if sufficiently stable — some distant sensitive organs they reach while travelling through the body.

Aromatic amines and nitroaromatics are typical representatives of lipophilic compounds undergoing extensive metabolism. These substances are widely used in industrial manufacturing of dyes, pesticides, plastics and ammunition, constitute significant environmental pollutants, which are also produced in cigarette smoke, and are constituent moieties of various drugs. Finally, a variety of heterocyclic aromatic amines with a remarkably mutagenic potential are prepared daily in our kitchen while cooking or frying food. Irrespective of their origin, all these compounds have to be considered as being potentially responsible for allergic, toxic, mutagenic and carcinogenic effects. Of the various metabolic pathways involved, *N*-oxygenation and nitroreduction are generally accepted as being the most important toxication reactions that occur in the body of mammals (for reviews see References 16 and 96–99).

The reactive intermediate oxidation states of this class of compounds, namely, the *N*-hydroxyarylamines and nitrosoarenes, are in rapid metabolic equilibrium. The nitrosoarenes are readily reduced to the corresponding *N*-hydroxyarylamines, both enzymically and nonenzymically, and the *N*-hydroxyarylamines are quickly re-oxidized by autoxidation and, particularly effective, by oxyhemoglobin<sup>17,19,34,100</sup>.

Scheme 10 depicts the most important reactions of *N*-oxygenated arylamines as detected in red blood cells<sup>27</sup>. The most important elimination reaction of *N*-hydroxyarylamines in blood is the co-oxidation with oxyhemoglobin under formation of the nitroso compound. Depending on substituents, the nitrosoarenes can (A) reversibly bind to the hemoglobin iron like gaseous ligands<sup>40</sup>, are (B) enzymically reduced to the parent *N*-hydroxyarylamines by methemoglobin reductase (NADPH) thereby sustaining the

SCHEME 10. Reaction pathways of *N*-oxygenated arylamines in erythrocytes

catalytic cycle (Kiese cycle<sup>17,101</sup>) of methemoglobin formation, or (C, D) undergo addition reactions with thiols. Of these, the reactive cysteine residues in hemoglobin (in human hemoglobin only cys 93 of the  $\beta$ -chain) (C) and the abundant reduced glutathione (GSH) (D) are of primary importance.

For the last years, covalent binding of nitrosoarenes to hemoglobin SH groups with formation of a sulfinamide that can be hydrolyzed *in vitro* has attracted particular interest<sup>102,103</sup>. Biomonitoring of hemoglobin-bound residues has been proposed as a suitable approach to control exposure to, and toxication of, potential carcinogenic arylamines and nitrosoarenes in persons at risk<sup>104–108</sup>.

Although hemoglobin adducts of aromatic amines and nitrosoarenes appear to be good dosimeters for the biologically effective dose of a carcinogen delivered as *N*-hydroxy or nitroso compound and to correlate with target tissue DNA adduct formation<sup>109</sup>, several factors probably intervene to limit the quality of such a correlation<sup>108</sup>. In this context also nongenotoxic actions on tissue-specific tumor formation by arylamines or nitrosoarenes



have to be considered<sup>110</sup>. As recently shown in isolated liver mitochondria, the initiating and promoting hepatocarcinogen 2-acetylaminofluorene starts, after transformation into 2-nitrosofluorene, a redox cycle, thereby disturbing the intramitochondrial thiol status. The mitochondrial insult due to thiol depletion and calcium release may lead to cell death, entailing stimulation of cell proliferation that may amplify the altered clone with the genotoxic hit<sup>111</sup>. Hence, cellular actions of *N*-hydroxyarylamines other than on DNA should gain more interest in carcinogenicity studies.

This overture highlights only some aspects which, in the opinion of the authors, shed light on the biological, mostly toxicological implications related to the reactions of nitrosoarenes with thiols. The following part presents more in-depth information on selected topics that may exemplify some general principles of reaction pathways occurring under physiological conditions. It covers by no means all of the pertinent literature. Particular emphasis has been put on substituent effects that govern distinct reaction pathways with cellular thiols.

## B. Monocyclic Nitrosoaromatics

### 1. Nitrosobenzene generated from nitrobenzene and aniline

The capacity of aniline and, to a less extent, nitrobenzene to produce hemolysis, methemoglobin and denaturated hemoglobin (Heinz bodies) following poisoning is well known and has been linked to the hepatic biotransformation of these substances into proximate toxic compounds such as phenylhydroxylamine<sup>14,16,101,112</sup>. This derivative, entering red blood cells within the liver, reacts very fast ( $k = 2 \times 10^3 \text{ M}^{-1} \text{ s}^{-1}$ ) with oxyhemoglobin to yield ferrihemoglobin and nitrosobenzene (Scheme 10, reaction B)<sup>100</sup>. The latter, being a better ligand for the ferrous iron of hemoglobin than dissolved molecular oxygen<sup>40</sup>, is rapidly sequestered from further reactions (Scheme 10, reaction A) and thus can escape the liver via red blood cells<sup>34,113</sup>.

Nitrosobenzene itself hardly produces any ferrihemoglobin in solutions of purified oxyhemoglobin but gives rise to many equivalents of ferrihemoglobin in red cells under normal metabolic conditions. In doing so, nitrosobenzene has to be reduced to phenylhydroxylamine, which in turn is co-oxidized with oxyhemoglobin to yield ultimately nitrosobenzene and ferrihemoglobin (Scheme 10, reaction B). Since reactive reduced oxygen species, expectedly superoxide and hydrogen peroxide derived thereof, did not influence ferrihemoglobin formation<sup>100</sup>, the co-oxidation process was suggested to be more complex, including formation of phenylhydronitroxide radicals and compound I- and II-type hemoglobin intermediates<sup>92,114,115</sup>.

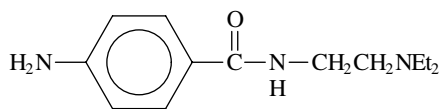
Formation of free phenylhydronitroxide radicals was observed in live mice immediately after injection of nitrosobenzene<sup>116</sup> and in blood *in vitro* upon addition of nitrosobenzene<sup>117</sup>. The intermediate phenylhydronitroxide radical arising from the co-oxidation of phenylhydroxylamine and oxyhemoglobin<sup>92</sup> is reduced by thiols, yielding thiyl radicals that were detected as DMPO (5,5-dimethyl-1-pyrroline-*N*-oxide)/glutathiyl free radical adducts and DMPO/hemoglobin thiyl free radical adducts (for reaction details see Section II.F). These adducts were observed in rat and human blood *in vitro*, and in rats *in vivo* after administration of aniline, phenylhydroxylamine, nitrosobenzene and nitrobenzene, respectively<sup>92</sup>. Conceivably, these thiyl radicals may react with oxygen under formation of reactive oxygen species or with adjacent amino acid residues, thus explaining hemoglobin denaturation and membrane damage that underly Heinz body formation, hemolysis and reduced life span<sup>112</sup>. Of course, impaired antioxidative capacity such as in glucose-6-phosphate dehydrogenase deficiency will enhance the susceptibility of red cells towards nitrosoaromatics, whether formed from arylamines or nitroarenes<sup>118</sup>.

When nitrosobenzene was incubated with human red cells, GSSG was formed together with glutathione adducts which, upon acid treatment, liberated aniline and glutathione sulfenic acid. In addition, nitrosobenzene was bound to the globin moiety (Scheme 10, reaction C). Acid hydrolysis liberated aniline (about 70%) and stoichiometric amounts of cysteic acid (after total hydrolysis of the globin), indicating formation of a sulfenamide<sup>19</sup>. It should be mentioned, however, that some radioactive material from [U-<sup>14</sup>C]-labelled nitrosobenzene remained bound to the globin moiety even after extensive acid hydrolysis<sup>10,19</sup>. The nature of these adducts remains still to be elucidated. Conceivably, a sulfenamide cation may have added to nucleophilic sites under formation of stable adducts (see Section II.D.3).

Collectively, the data from *in vitro* and *in vivo* experiments confirm the reactions of nitrosobenzene with thiols as observed in mere chemical systems.

## 2. Nitroso-procainamide from procainamide

Procainamide [**19**; 4-amino-*N*-(2-diethylaminoethyl)benzamide], used as an antiarrhythmic drug, is associated with the highest incidence of drug-induced *Lupus erythematoses* and with agranulocytosis (4% incidence)<sup>119</sup>. Procainamide is metabolized by rat and human microsomes and by leucocytes to yield *N*-hydroxy-procainamide<sup>120</sup>. In the presence of oxygen the [<sup>14</sup>C]-label of *N*-hydroxy-procainamide was found to be bound to proteins, which was prevented by ascorbic acid, NADPH and GSH. In the reaction with GSH a compound was isolated that liberated parent procainamide and glutathione sulfenic acid and exhibited a molecular mass consistent with a glutathione sulfenamide. Besides, a labile compound was detected that regenerated procainamide in the presence of GSH and, therefore, was tentatively assigned as a sulfenamide<sup>60</sup>. In addition, nitroso-procainamide reacted with cysteine and GSH under physiological conditions with formation of *N*-hydroxy-procainamide and stoichiometric amounts of the disulfides. Nitroso-procainamide also was found to bind irreversibly to mouse hemoglobin<sup>121</sup>.



(19)

Binding of *N*-hydroxy-procainamide (in the presence of oxygen) to histone proteins of white blood cells was markedly reduced by ascorbic acid, but the material bound was not liberated by acid treatment<sup>120,122</sup>. Hence, it was suggested by the authors that nitroso-procainamide may have reacted with something other than sulfhydryl groups, particularly since histone proteins contain very few sulfhydryl groups<sup>60,120,122</sup>.

Binding of nitroso-procainamide to histone proteins may perturb chromatin structure or catabolism, resulting in immunogenic forms of DNA-free histones. In fact, all sera of patients ( $n = 24$ ) with procainamide-induced *Lupus* showed IgG and IgM antibody activity against various histone components of chromatin (chromosome subunits)<sup>122</sup>. The nature of the procainamide adduct to histone proteins still awaits elucidation.

## 3. 3-Nitrosobenzamide

3-Nitrosobenzamide and 6-nitroso-1,2-benzopyrone are among the most active *C*-nitroso compounds that inactivate the eukariotic nuclear protein poly(ADP-ribose) polymerase at

one zinc finger site, thereby completely suppressing the proliferation of leukemic and other malignant human cells. The cellular event elicited by these *C*-nitroso compounds consists of apoptosis due to DNA degradation by the nuclear calcium/magnesium-dependent endonuclease<sup>123</sup>. The most probable mechanism underlying the destabilization of zinc coordination to poly(ADP-ribose) polymerase was related to the oxidation of the cysteine ligands in the zinc finger peptide by the *C*-nitroso compounds<sup>124</sup>.

3-Nitrosobenzamide gained even more interest when it was found that the compound inhibited acute infection of cultured human lymphocytes by human immunodeficiency virus type 1. The retroviral nucleocapsid protein of HIV-1 contains two domains, each of which binds zinc stoichiometrically with three cysteine thiols and one histidine imidazole group. These zinc complexes and the protein folding that they stabilize are essential for viral genome recognition during budding, genomic RNA packaging, and early events in viral infection. Since these zinc finger sequences are completely conserved and essential for viral replication they appeared as a prime target for antiviral chemotherapy. Treatment of HIV-1 with 3-nitrosobenzamide resulted in a loss of zinc from the virion, as well as from synthetic HIV-1 zinc finger polypeptide, coincidental with viral inactivation<sup>125,126</sup>.

The mechanism of zinc deprivation by 3-nitrosobenzamide was elucidated most recently. When the reconstituted nucleocapsid protein p7 of HIV-1 (15  $\mu$ M) was incubated with 3-nitrosobenzamide (300  $\mu$ M) at pH 7.5, three disulfide bonds per protein molecule were formed while 3-nitrosobenzamide was reduced to the hydroxylamine. Molecular masses of p7 adducts augmented by one or two 3-nitrosobenzamide residues were observed by electrospray ionization MS, consistent with covalent bond formation between cysteine sulfur and the nitroso nitrogen atom<sup>127</sup>.

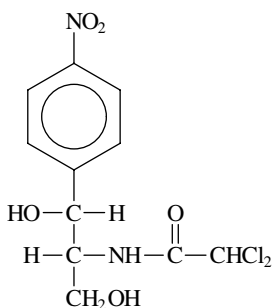
These findings point to intermediate semimercaptal formation of 3-nitrosobenzamide with one of the three cysteine residues per domain followed by intramolecular thiolytic cleavage by an adjacent cysteine residue of the triad that normally forms the ligand for the zinc atom. The carboxamide substituent *meta* to the nitroso group ( $\sigma_m = +0.28^{55}$ ) should favor hydroxylamine formation by thiolytic cleavage at the expense of the sulfinamide pathway. In addition, intramolecular reactions with a properly orientated second thiol group will greatly facilitate the observed reaction. Nevertheless, sulfinamide formation should equally result in loss of zinc binding capacity, and the observed masses would be consistent with a sulfinamide structure, too. Possibly, quantitative data will be provided in future to foster the proposed<sup>127</sup> mechanism.

#### 4. Nitroso derivatives of chloramphenicol

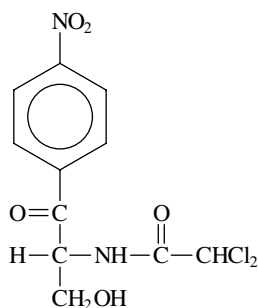
Chloramphenicol [20; CAP; D-(–)-*threo*-1-(*p*-nitrophenyl)-2-(dichloroacetamido)-1,3-propanediol] is an important antibiotic due to its broad activity against a number of clinically relevant microbial pathogens and its ability to penetrate easily the blood–brain barrier. Besides human application, CAP became widely and routinely used in veterinary practice and is used in Europe in most animal productions including fish<sup>128</sup>.

However, the use of CAP was soon restricted after its association with bone marrow depression and aplastic anemia. The underlying biochemical lesion is still obscure, and adequate animal models are lacking. Since thiamphenicol, a CAP analogue where the nitro function has been replaced by a MeSO<sub>2</sub>-group, has never been associated with aplastic anemia, Yunis and coworkers suggested that the *p*-nitro group of CAP may be involved in the development of aplastic anemia<sup>129,130</sup>.

When the nitroso analogue became available<sup>131</sup> this hypothesis was tested experimentally. Nitroso-CAP has proved to be considerably more toxic to cultured human bone marrow cells than CAP and to irreversibly inhibit DNA synthesis as well as the growth of



(20)



(21)

pluripotential hematopoietic stem cells. Moreover, 500-times more [ $^{14}\text{C}$ ]-labelled nitroso-CAP was irreversibly bound to viable bone marrow cells than [ $^{14}\text{C}$ ]-labelled CAP<sup>132</sup>. From all these data it seemed reasonable to suspect nitroso-CAP as the most probable candidate responsible for the bone marrow cell injury.

Although nitroso-CAP was not detected *in vivo*, there is ample evidence for nitro reduction of CAP<sup>133,134</sup>. Nitroso-CAP reacts very rapidly with GSH in chemical systems with formation of a semimercaptal-type intermediate ( $k = 5.5 \times 10^3 \text{ M}^{-1} \text{ s}^{-1}$ , pH 7.4, 37 °C) which gives rise to a sulfinamide<sup>22</sup>. Nitroso-CAP is rapidly eliminated from human blood *in vitro*, 90% in less than 15 s. Only 5% is covalently bound to plasma proteins, mainly albumin, the remainder being metabolized in red cells by the very rapid adduct formation with GSH. Preferentially, the sulfinamide but also *N*-hydroxy-CAP rapidly give rise to amino-CAP in the blood<sup>23</sup>. It is thus conceivable that part of amino-CAP observed in the blood after CAP administration may have originated from intermediate nitroso-CAP as suggested most recently<sup>134</sup>. In any event, nitroso-CAP, whether formed by microorganisms in the intestine or produced in the liver, will be degraded in blood before reaching the bone marrow<sup>23,130,135</sup>.

Interestingly, another CAP metabolite emerged as a favorite proximate toxic candidate, dehydroCAP (21)<sup>135</sup>. This compound is fairly stable in blood and can readily reach the bone marrow cells. DehydroCAP itself inhibits myeloid colony growth<sup>136,137</sup>. Perhaps the most important aspect of dehydroCAP is that, in contrast to CAP, it is readily reduced by human bone marrow homogenate even under aerobic conditions<sup>130,138</sup>. One can assume that the 4-nitrosopropiophenone derivative will react with GSH in a similar way as 4-nitrosoacetophenone to give quite exclusively the hydroxylamine and GSSG<sup>25,36</sup>, thereby inducing a marked oxidative stress. Further investigations will show whether this metabolic pathway is indeed responsible for the CAP-induced aplastic anemia.

New aspects of CAP exposure and toxicity arose when residues of CAP metabolites were detected in kidney, liver and muscles of chickens that had received oral doses of CAP 12 days before being slaughtered<sup>139</sup>. Of these, nitroso-CAP, dehydroCAP and dehydroCAP base [1-(*p*-nitrophenyl)-2-amino-3-hydroxypropanone] appear of particular toxicological importance. The results, however, should be confirmed since it is quite unexpected that a reactive compound such as nitroso-CAP can be detected in organs 12 days after dosing with CAP.

Finally, a toxicological impact is given by the fact that CAP readily decomposes in aqueous solution when exposed to sunlight UV or tungsten light<sup>140</sup>. Decomposition of CAP has also been observed *in vivo* when CAP-dosed rats were exposed to UV-A light. Of the degradation products detected, *p*-nitrosobenzoic acid appears to be most relevant because it induces methemoglobinemia and inhibits DNA synthesis in rat bone marrow

cells. Moreover, covalent binding of [ring- $^3\text{H}$ ]-CAP to tissue of ears and skin of the back of rats was several times higher when the animals were exposed to light compared with controls kept in the dark<sup>141</sup>. The influence of UV-A on covalent binding of xenobiotics to endogenous material in the skin is considered an important aspect of the occurrence of photoallergic effects<sup>141</sup>.

Since *p*-nitrosobenzoic acid has been shown to have a half-life of some 4 min in rat blood, this intermediate, once formed in the capillaries of the irradiated skin, may meet the requirement of sufficient stability to reach sensitive targets as the bone marrow while travelling through the blood<sup>141</sup>. The reactivity of *p*-nitrosobenzoic acid with thiols appears not to have been tested hitherto. From the known Hammett constant ( $\sigma_p = +0.45^{55}$ ) one may deduce that the compound will show a reactivity in between the reactivities of nitrosobenzene and *p*-nitrosoacetophenone.

Taken together, CAP may yield different nitroso derivatives through widely varying pathways. Depending on the substituent, sulfinamides may be formed that deplete cellular thiols and give rise to haptization of macromolecules, thereby inducing antigenicity. Thiol-mediated reduction of the nitroso compounds, yielding autoxidizable hydroxylamines, may induce oxidative stress with formation of reactive oxygen species that could well be responsible for DNA toxicity.

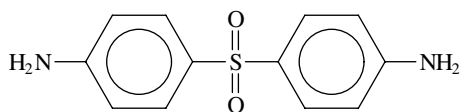
### 5. Nitroso derivatives of chloroanilines

Propanil (3,4-dichloropropionanilide) is an important arylamide herbicide that is used in rice, barley, oat and wheat fields. The 3,4-dichloroaniline moiety is also found in the *N*-substituted phenylureas linuron, diuron and neburon. Hence, exposure to 3,4-dichloroaniline derivatives will be common and has been associated with methemoglobinemia in humans<sup>142</sup>.

*N*-Hydroxy-3,4-dichloroaniline has been identified as microsomal metabolite and detected in the blood of propanil-treated rats. Its amount appeared sufficient to account for the hemolytic activity of the parent compound and to be largely responsible for the methemoglobinemia observed<sup>143</sup>. Interestingly, 3,4-dichloroaniline itself has been shown to produce ferrihemoglobin in bovine red cells *in vitro* with formation of 3,4-dichloronitrosobenzene<sup>144</sup>, confirming the peroxidative activity of oxyhemoglobin leading to *N*-oxygenation<sup>145</sup>. Moreover, intraperitoneal administration of 3,4-dichloronitrosobenzene to rats produced ferrihemoglobin over much longer periods than an equivalent dose of nitrosobenzene<sup>146</sup>. This finding is consistent with the behavior of 3,4-dichloronitrosobenzene in the reaction with GSH. At the usual GSH concentration found in red cells, i.e. 2 mM, about 90% of the nitroso compound forms the hydroxylamine that can re-enter the Kiese cycle while side reactions leading to the sulfinamide are small<sup>25</sup>. Nevertheless, binding of 3,4-dichloroaniline to hemoglobin of rats was observed<sup>143,147</sup>.

### 6. Nitroso derivatives of sulfonamide drugs

Dapsone (**22**; 4,4'-diaminodiphenyl sulfone) is an established antileprotic and anti-inflammatory drug that is also effective in the therapy of *Pneumocystis carinii* pneumonia



(22)

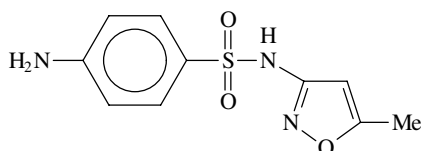
and against chloroquine-resistant *Plasmodium falciparum*<sup>148</sup>. Its use is often limited by its dose-dependent toxicity, such as methemoglobinemia and hemolysis. It is also responsible for occasional life-threatening disorders such as agranulocytosis<sup>149</sup>.

The toxicity of dapson is due to the cytochrome P-450-catalyzed oxygenation leading to *N*-hydroxydapson. This major metabolite enters red cells and is co-oxidized with oxyhemoglobin to generate a nitroso derivative and methemoglobin<sup>148</sup>.

GSH levels of red cells were diminished upon incubation with *N*-hydroxydapson only when glucose was absent, or in glucose-6-phosphate dehydrogenase-deficient red cells<sup>150</sup>. On the other hand, oxidation of purified hemoglobin was greatly enhanced by GSH<sup>151</sup>. Prior depletion of GSH by diethylmaleate led to a fall in both methemoglobin and dapson formation compared with untreated cells<sup>148</sup>. Hence, it was suggested by the authors that GSH, rather than NADPH methemoglobin reductase, was chiefly responsible for the process of methemoglobin generation and parent amine formation from *N*-hydroxydapson in human red cells.

Two GSH-dependent pathways were proposed: reduction of the nitroso derivative by GSH to yield the hydroxylamine together with GSSG, and adduct formation to yield a labile sulfenamide that ultimately gives rise to dapson<sup>152</sup>. The latter pathway appears less likely, considering the electron-withdrawing sulfonamide substituent with a Hammett  $\sigma_p$  constant of +0.58<sup>55</sup>. Rather, the nitroso derivative of dapson is suggested to react in a similar way as 4-nitrosoacetophenone ( $\sigma_p = +0.55$ <sup>55</sup>) which has been shown to yield nearly exclusively the *N*-hydroxy derivative and GSSG<sup>25,36</sup>. Two other routes for the GSH-mediated amine formation are conceivable. The enhanced formation of *N*-hydroxydapson facilitates its enzymic reduction to the amine<sup>16,17</sup>. In addition, the amine could be formed by enzymic cleavage of the sulfenamide as detected for nitrosobenzene<sup>19</sup>.

Sulfamethoxazole [23; *N*<sup>1</sup>-(5-methylisoxazol-3-yl)sulfanilamide] is a clinically important sulfonamide that is mainly used together with trimethoprim in fixed combination (cotrimoxazole). The use of this sulfonamide has been associated with a variety of idiosyncratic reactions, including fever, lymphadenopathy, skin rash, hepatitis, nephritis and blood dyscrasias<sup>153</sup>. The incidence of these reactions is in the range of 1:5000 in the normal population but is much more common in patients with AIDS<sup>154</sup>. Sulfamethoxazole is metabolized to the *N*-hydroxy derivative by cytochrome P-450 and peroxidases, e.g. of white blood cells. Under physiological conditions the *N*-hydroxy derivative appears to be rapidly and spontaneously oxidized to yield the nitroso compound that is more reactive and more toxic than the *N*-hydroxy precursor<sup>155</sup>. When 1 mM GSH was added to 50  $\mu$ M nitroso-sulfamethoxazole quantitative formation of *N*-hydroxy-sulfamethoxazole was observed. At much lower concentrations of GSH, e.g. 100  $\mu$ M, significant quantities of a sulfenamide were formed together with a short-lived intermediate which was tentatively assigned as a semimercaptal<sup>28</sup>.

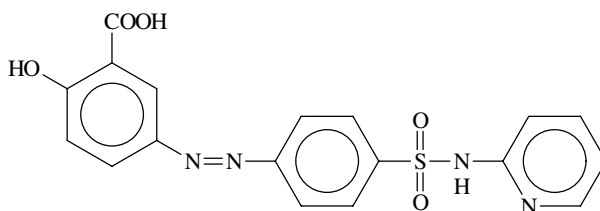


(23)

These data, e.g. predominant thiolytic cleavage of the semimercaptal at physiological GSH concentrations, is in line with the expected behavior in considering the positive Hammett constant of the sulfonamide substituent ( $\sigma_p = +0.58$ <sup>55</sup>). It is to be expected that cells with lowered GSH content or impaired enzymic capacity to reduce GSSG will be

more susceptible towards conjugate formation and thus depletion of GSH. Such a vicious cycle may underly cellular toxicity of HIV<sub>III-B</sub>-infected lymphocytes and hypersensitivity reactions<sup>154</sup>.

Sulfasalazine [24; 4-hydroxy-4'-(2-pyridylsulfamoyl)azobenzene-3-carboxylic acid] is commonly used for the treatment of inflammatory bowel disease. The drug consists of two moieties, sulfapyridine [*N*<sup>1</sup>-(2-pyridyl)sulfanilamide] and 5-aminosalicylic acid, which are linked by an azo bond. Sulfasalazine is hardly absorbed in the intestine and reaches the colon unchanged where bacteria cleave the azo link, liberating sulfapyridine which is absorbed, while 5-aminosalicylic acid is thought to exert its antiinflammatory effects locally. The moiety responsible for its toxicity is considered to be sulfapyridine which can be metabolized to yield *N*-hydroxy-sulfapyridine (for review see Reference 156). A wide range of adverse effects of sulfapyridine has been reported, including leucopenia, intravascular hemolysis, particularly in glucose-6-phosphate dehydrogenase deficient patients, and methemoglobinemia in up to 40% of the patients.



(24)

*N*-Hydroxy-sulfapyridine was shown *in vitro* to produce ferrihemoglobin and to be cytotoxic to mononuclear leucocytes. Co-incubation with ascorbic acid, GSH, or *N*-acetylcysteine did abolish cytotoxicity but did not inhibit ferrihemoglobin formation<sup>156</sup>, indicating that the nitroso derivative may be the ultimate cytotoxic agent for leucocytes while in red cells the Kiese cycle<sup>16,101</sup> may be still operating. These data are suggestive that nitroso-sulfapyridine is mainly reduced to the *N*-hydroxy derivative at high concentrations of GSH as found in human red cells.

### 7. Nitroso derivatives of dinitrobenzenes

1,3-Dinitrobenzene is an intermediate employed in chemical syntheses of a large number of compounds used in the dye, explosives and plastics industry. The compound is known to induce methemoglobinemia and to cause testicular toxicity with the Sertoli cell being the major target. Nitro reduction was observed in erythrocytes, in rat Sertoli-germ cell cocultures and in rat testicular subcellular fractions, and it was shown that 3-nitrosodinitrobenzene was formed that was considerably more toxic. Testicular toxicity was enhanced when the intracellular thiol levels were reduced by pretreatment with diethylmaleate. In turn, pretreatment with cysteamine or ascorbate reduced the toxicity of 1,3-dinitrobenzene and 3-nitrosodinitrobenzene.

These findings suggest that formation of 3-nitrosodinitrobenzene and the corresponding hydroxylamine may elicit a futile redox cycle, using up reduced cofactors such as GSH and NADPH in the Sertoli cell (for literature see Reference 157). The strong electron-withdrawing properties of the nitro group ( $\sigma_m = +0.7$ ;  $\sigma_p = +0.8^{55}$ ) are in line with this view. Accordingly, the semimercaptal will be stabilized<sup>29,157</sup> and the hydroxylamine pathway will be favored.

From this it becomes clear that low molecular thiols will not lead to eventual detoxication of these nitrosodinitroaromatics but will sustain a redox cycle that may be

detrimental. The reported beneficial effects of added thiols on the testicular toxicity of 3-nitrosobenzene thus remain to be explained. One can speculate that stable protein adducts of a semimercaptal structure may be cleaved by low molecular thiols, followed by restitution of the protein sulfhydryl by another low molecular thiol. Similarly enigmatic is the fact that only 1,3-dinitrobenzene, but not 1,2- or 1,4-dinitrobenzenes, elicit the observed testicular toxicity<sup>157</sup>.

#### 8. 4-Nitrosophenetol from 4-phenetidine

4-Phenetidine (4-ethoxyaniline) is one of the metabolites of the previously widely used analgesic/antipyretic drug phenacetin which has been accused to cause methemoglobinemia, particularly in infants, and serious kidney lesions following long-term treatment. In addition, phenacetin has been made responsible for an increased rate of cancer in the urinary tract. Hence, phenacetin has been displaced from analgesic formulations in most countries. Neither phenacetin nor 4-phenetidine is toxic *per se*, but the latter is a suitable substrate for several drug metabolizing enzymes, such as cytochrome P-450s, peroxidases and prostaglandin synthase (for literature see Reference 158), and even for oxyhemoglobin<sup>144</sup>.

*N*-Hydroxy-4-phenetidine and its autoxidation product 4-nitrosophenetol formed during cytochrome P-450 oxidation of 4-phenetidine were attributed to the methemoglobinemia and hemolysis observed<sup>159-162</sup>. The mechanism of ferrihemoglobin formation, however, is much more complicated than considered formerly<sup>163-165</sup>. Moreover, *N*-hydroxy-4-phenetidine binds to DNA<sup>72</sup> and is directly mutagenic<sup>166,167</sup>, whereas 4-nitrosophenetol did not react with DNA<sup>72</sup> but binds covalently to proteins, predominantly to sulfhydryl groups<sup>40,168</sup>.

The reaction of 4-nitrosophenetol with thiols is extremely complex as deduced in Section II. Formation of the semimercaptal<sup>39</sup>, the sulfinamide<sup>36</sup> and the sulfenamide<sup>72</sup> have been described. Formation of GSSG was clearly observed (0.44 mM) when 4-nitrosophenetol (1 mM) was allowed to react with GSH (2 mM) under physiological conditions<sup>36</sup>. On the other hand, GSSG hardly increased when isolated rat hepatocytes were exposed to 0.2 mM 4-nitrosophenetol while GSH had dropped markedly and resulted in cell death<sup>158</sup>. Similarly, total GSH of isolated perfused rat livers was depleted by 4-nitrosophenetol with a small increase in GSSG and mixed glutathione/protein disulfides. The bile flow of the livers was significantly inhibited and the excretion mechanism for GSSG impaired<sup>169</sup>. These results suggested that glutathione adducts might be formed that compete with the GSSG excretion mechanism<sup>25</sup>. Interestingly, transport systems of glutathione conjugates in human red cells were similarly inhibited by metabolites of 4-nitrosophenetol<sup>170</sup>. Possible candidates for this inhibitory action are two thioethers, 4-ethoxy-2-(glutathion-*S*-yl)-aniline (**7**) and 4-amino-4'-ethoxy-2-(glutathion-*S*-yl)-diphenylamine (**17**)<sup>68</sup>.

When 4-nitrosophenetol reacted with human red cells formation of acid-stable hemoglobin adducts was observed. The amount of these adducts was markedly increased when the reduction of GSSG was inhibited. These findings suggest GSH-mediated formation of the sulfenamide cation that is not consumed by further GSH-mediated reactions but is available for ring addition reactions<sup>56</sup>.

#### 9. 4-Nitroso-*N,N*-dimethylaniline

4-Nitroso-*N,N*-dimethylaniline has been reported to be bactericidal and mutagenic to *Salmonella typhimurium* TA 100 tester strains. In addition, this compound has proved to



be carcinogenic to male mice and rats<sup>171</sup>. 4-Nitrosodimethylaniline was shown to be cytotoxic to isolated rat hepatocytes and to deplete cellular GSH. Pretreatment with diethylmaleate, which reduced hepatocyte GSH by 85%, enhanced 4-nitrosodimethylaniline toxicity<sup>172,173</sup>.

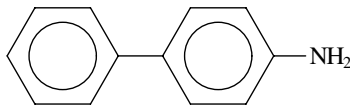
The reaction of 4-nitrosodimethylaniline with GSH is quite slow and leads to formation of *N,N*-dimethyl-*p*-phenylenediamine and 2 molecules GSSG together with hitherto unknown glutathione conjugates<sup>36</sup>. The disappearance of 4-nitrosodimethylaniline in the presence of GSH was clearly enhanced by glutathione *S*-transferase. No attempts have been reported on isolation of such a reaction product<sup>172</sup>. Formation of quite stable glutathione *S*-conjugates derived from 4-nitrosodimethylaniline have already been suggested to explain the inhibitory effect on biliary GSSG excretion<sup>25</sup>. It should be noted that the *N,N*-dimethyl-*p*-quinone diiminium cation, which is easily formed during autoxidation of *N,N*-dimethyl-*p*-phenylenediamine, also reacts rapidly with GSH with formation of a typical Michael addition product<sup>174</sup>.

These data show that 4-nitrosodimethylaniline can deplete GSH in the liver by multiple reactions that are not exclusively related to the nitroso function, and it appears that the slow reactivity towards thiols correlates with the strongly negative Hammett constant ( $\sigma_p^+ = -1.7^{55}$ ).

## C. Polycyclic Nitrosoaromatics

### 1. 4-Nitrosobiphenyl from 4-aminobiphenyl

4-Aminobiphenyl (**25**) is a carcinogenic aromatic amine detected in cigarette mainstream and sidestream smoke and found to increase the risk of smokers for bladder cancer. In addition, 4-aminobiphenyl induces methemoglobinemia in various animal species. A prerequisite for these toxic actions appears to be *N*-hydroxylation<sup>175</sup>. The extent of covalent binding of radiolabelled 4-aminobiphenyl to rat hemoglobin was extraordinarily high and amounted to 5% of the dose<sup>103</sup>. This high binding index was correlated with an exceptionally high rate of *N*-oxygenation of 4-aminobiphenyl by rat liver microsomes<sup>176</sup>.



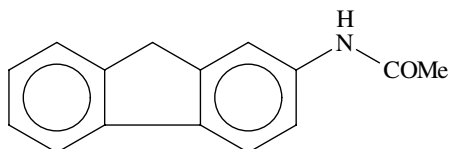
(25)

The fate of *N*-hydroxy-4-aminobiphenyl in rat erythrocytes *in vitro* was studied in more detail<sup>177</sup>. It was found that both *N*-hydroxy-4-aminobiphenyl and 4-nitrosobiphenyl had rapidly disappeared while ferrihemoglobin formation still proceeded. Acid treatment of the hemolysate liberated only one third of the expected 4-aminobiphenyl, indicating a binding type different from a sulfonamide linkage. 3-Hydroxy-4-aminobiphenyl was considered a probable ferrihemoglobin-forming candidate which, after oxidation to an *o*-quinonimine, may form an acid-stable conjugate with hemoglobin<sup>146</sup>.

Upon reaction of 4-nitrosobiphenyl with thiols, its negative Hammett constant ( $\sigma_p^+ = -0.18^{55}$ ) is expected to facilitate formation of a sulfenamide cation that may delocalize its positive charge partly to  $C_{(3)}$ ,  $C_{(2')}$  and  $C_{(4')}$ . Hence formation of aminophenols and acid-stable hemoglobin adducts would be conceivable.

## 2. 2-Nitrosofluorene from 2-acetamidofluorene

2-Acetamidofluorene (**26**), which was initially intended to be used as an insecticide<sup>178</sup>, is one of the most extensively studied chemical carcinogens. This aromatic amide as well as its amine and nitro derivatives induce tumors in a wide variety of sites, including liver, urinary bladder, mammary gland, intestine and forestomach. The initial activation involves the formation of *N*-hydroxy intermediates<sup>179,180</sup>.



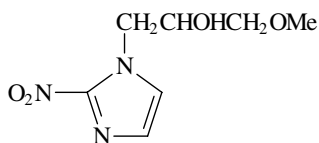
(26)

The observation that 2-nitrosofluorene, under physiological conditions, readily reacts with GSH to yield a water-soluble product that liberated 2-aminofluorene upon mild acid treatment is probably the first report in the literature pointing to sulfinamide formation. At that time, however, no further attempts were made to identify this compound<sup>9</sup>. Formation of two glutathione conjugates from 2-nitrosofluorene was reported later on<sup>35</sup>. These authors succeeded in isolation and identification of *N*-(glutathion-*S*-yl)-2-aminofluorene-*S*-oxide (sulfinamide) and *N*-(glutathion-*S*-yl)-2-aminofluorene (sulfenamide). These conjugates made up >90% of the 2-nitrosofluorene applied (10 mM GSH, pH 7), indicating that hydroxylamine formation is a minor pathway if at all. This behavior can be expected, considering the strong  $\pi$ -donor character of the fluorenyl moiety<sup>30</sup> ( $\sigma_p^+ = -0.48^{55}$ ).

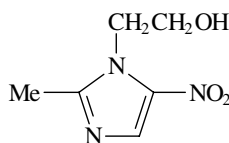
## D. Heterocyclic Nitrosoaromatics

### 1. Nitrosoimidazoles from nitroimidazoles

Misonidazole [**27**; 1-methoxy-3-(2-nitroimidazol-1-yl)-2-propanol] and the model compound 1-methyl-2-nitroimidazole have been used as radiosensitizers in the treatment of certain types of human tumors. One important property of these compounds is that they are more toxic to hypoxic cells than to aerobic cells, indicating that reductive metabolism of the drug is involved in the toxicity. Results of a number of studies suggest that intracellular thiols play a significant role in the hypoxic cell toxicity, and it was found that reduction products formed stable thio ethers with GSH (for literature see References 181–183). The reaction mechanism of thio ether formation has not been fully established. It has been suggested that the 4-electron reduction product was involved in thio ether formation<sup>181,184,185</sup>, and that the hydroxylamine rather than the nitroso derivative was the reactant. On the other hand, an intermediate nitroso derivative is expected to give a sulfenamide cation (see Scheme 1) which easily allows thio ether formation.



(27)



(28)

An extensive proposal of the underlying reaction mechanisms has been presented by McClelland's group<sup>57,186,187</sup>.

Unlike phenylhydroxylamine, these hydroxylamines do not exhibit an acid-catalyzed N–O cleavage as in the Bamberger rearrangement. In contrast, N–O cleavage becomes predominant at neutral pH when the imidazole nitrogen is no longer protonated. The resulting nitrenium ion is considerably stabilized since the positive charge is highly delocalized into the imidazole system under predominant formation of an imminium ion. Nucleophilic attack of GSH to the resonance contributing carbenium ion at the C<sub>(5)</sub> atom easily explains formation of a stable thio ether<sup>30,187</sup>. Noyce<sup>188</sup> has determined  $\sigma^+$  constants defining the accelerating effect of heterocyclic ring systems in reactions that result in the formation of a carbenium ion center adjacent to the ring. The  $\sigma^+$  values so obtained were  $-0.82$  for the 1-methyl-2-imidazole and  $-1.02$  for the 1-methyl-5-imidazole group<sup>188</sup>. It has been predicted that *N*-hydroxy-4-anisole ( $\sigma^+ = -0.78^{55}$ ) should have a reactivity similar to that of 2-(hydroxylamino)-1-methylimidazole, thereby undergoing a neutral Bamberger rearrangement<sup>187</sup>. In fact, the structural analogue *N*-hydroxy-4-phenetidine quickly yielded high amounts of 4-aminophenol when kept in phosphate buffer at pH 7.4 under argon<sup>189</sup>.

When 1-methyl-2-nitrosoimidazole became available<sup>190</sup> it was found that addition of excess GSH to solutions of 1-methyl-2-nitrosoimidazole led to a rapid loss of the characteristic absorbance at 360 nm within a few seconds. Preliminary experiments suggested that formation of GSSG and the hydroxylamine was followed by formation of stable thio ethers. It should be noted, however, that detection of free hydroxylamine was unsuccessful<sup>57</sup>. In cell-free systems 1-methyl-2-nitrosoimidazole reacted with excess GSH to form adducts in a 1:3 stoichiometric reaction<sup>191</sup>.

1-Methyl-2-nitrosoimidazole was by two orders of magnitude more toxic to CHO cells than the nitro and hydroxylamine compound. Circumstantial evidence suggested that GSH might reduce cytotoxicity<sup>190</sup>. Similar observations were reported with HT-29 human colon cancer cells. Depletion of cellular GSH with buthionine sulfoximine before incubation with the nitrosoimidazole resulted in enhanced susceptibility<sup>192</sup>. Since the DNA damage by the nitrosoimidazole in HT-29 colon cancer cells was probably not a result of a direct interaction of the nitroso compound, a possible activating effect of GSH to yield the ultimate electrophile was discussed<sup>193</sup>. Interestingly, mixtures of the nitrosoimidazole with GSH gave rise to DNA strand breaks in the plasmid assay<sup>194</sup>. These data suggest that 1-methyl-2-nitrosoimidazole is responsible for the cytotoxicity elicited by 1-methyl-nitroimidazole<sup>191</sup>. Whether the hydroxylamine-derived nitrenium/carbenium ion and/or the nitroso-derived sulfenamide cation are responsible for the DNA effects remains to be elucidated.

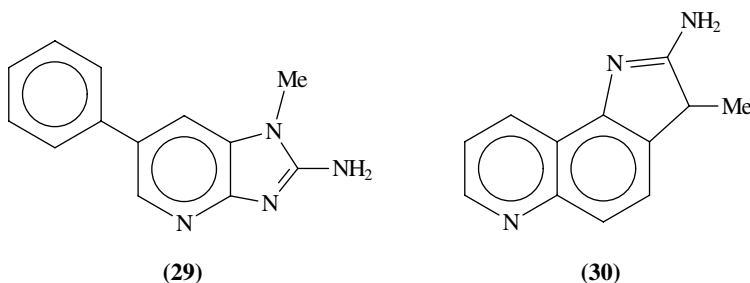
Metronidazole [28; 1-(2-hydroxyethyl)-2-methyl-5-nitroimidazole] and other 1-alkyl-5-nitroimidazoles are important antibiotics for the treatment of anaerobic bacterial and protozoal infections. Evidence suggests that their activity is due to inhibition of the DNA function and that reduction of the nitro group is required for the antiparasitic activity of the drugs<sup>195</sup>. They are also bacterial mutagens and rodent tumorigens (for literature see Reference 196). The 2-electron reduction model compound 1-methyl-4-phenyl-5-nitrosoimidazole was found to have properties consistent with the biologically active form of a 5-nitroimidazole and to bind to DNA, but at a rate too slow to account for its bactericidal effect. In the presence of physiological concentrations of thiols such as cysteine and GSH, however, binding to lambda-phage DNA and polynucleotides was enhanced by 2–3 orders of magnitude, which was quantitatively sufficient to account for its bactericidal effect<sup>197</sup>. The authors concluded that a semimercaptal-like intermediate might yield a highly reactive cation that binds to DNA. These data suggest that

the nitrosoimidazole might still be a penultimate reactive intermediate in the bioactivation of nitroimidazoles which by interaction with thiols would give the ultimate reactive species that binds to DNA. Whether a semimercaptal-type intermediate is formed, which upon loss of the hydroxyl group may produce a sulfenamide cation, or whether a neutral Bamberger rearrangement of the hydroxylamine species occurs, has to await further investigations.

## 2. Heterocyclic N-oxygenated compounds derived from food mutagens

In the past 15 years, analyses of pyrolyzed amino acids and proteins<sup>198</sup> and of cooked protein-containing foods<sup>199</sup> have led to the discovery of several classes of highly mutagenic heterocyclic aromatic amines. The most common class of mutagens in foods in the Western diet appears to be aminoimidazoazaarenes, characterized by having 1 or 2 heterocyclic rings fused to an aminoimidazo ring. This class of compounds was also obtained in model reactions by heating creatin(in)e (from muscle) together with an amino acid.

2-Amino-1-methyl-6-phenylimidazo[4,5-*b*]pyridine (**29**; PhIP), usually the most abundant product of food-derived mutagens, is formed by heating creatine and phenylalanine at 200 °C<sup>200</sup>. This compound is modestly mutagenic in the Ames test, but is a potent carcinogen in rats and mice, causing breast and colon cancers.



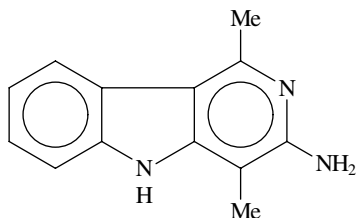
PhIP is a hydrophobic procarcinogen that is inactive *per se*, but is metabolized *in vivo* to highly reactive electrophiles that bind covalently to DNA (for literature see Reference 201). The initial bioactivation step responsible for PhIP-DNA adduct formation appears to be the *N*-oxidation of PhIP to form *N*-hydroxy-PhIP which undergoes further activation to yield *N*-acetoxy, *N*-sulfonyloxy and *N*-glucuronide derivatives. Using isolated rat hepatocytes it was shown that pretreatment of the hepatocytes with 1-bromoheptane and buthionine sulfoximine, depleting GSH and preventing its re-synthesis, respectively, resulted in a 15-fold increase in the formation of PhIP-DNA adducts, as well as in a high level of unscheduled DNA synthesis<sup>202,203</sup>. These data suggest that GSH may either intervene in DNA binding of reactive metabolites, e.g. by reaction with the putative nitrenium ion, or inhibit formation of the activated *N*-hydroxy conjugate. Interestingly, formation of an unstable *N*-(glutathion-*S*-yl)-PhIP (sulfenamide) was observed on reacting *N*-acetoxy-PhIP with GSH. The conjugate disappeared upon further purification to yield the stable end-product 5-hydroxy-PhIP<sup>84</sup>. These data suggest that the intermediate sulfenamide may lead to a nitrenium ion which is in resonance with a highly electrophilic carbenium form<sup>85</sup>. In this pathway GSH provides a metastable conjugate but not a detoxification product. No details on possible reaction pathways have been presented hitherto.

2-Amino-3-methylimidazo[4,5-*f*]quinoline (**30**; IQ) is formed at modest yields by heating creatinine together with an amino acid (glycine, serine, phenylalanine) at 200 °C<sup>200</sup>.

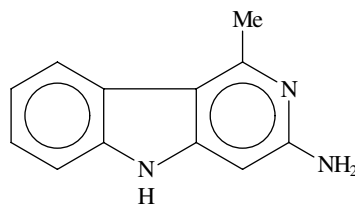
This compound requires metabolic activation by liver microsomes to yield highly mutagenic derivatives in the Ames test<sup>204</sup>. In addition, IQ is a multipotent animal carcinogen that is metabolized by prostaglandin-H synthase<sup>205</sup> and the hepatic cytochrome P-450 system<sup>204</sup>.

Blood protein binding of IQ was found in rats dosed intragastrally with the labelled compound. The same adducts, though in much higher yields, were found when purified rat serum albumin was exposed either to *N*-hydroxy-IQ or incubated with parent IQ in the presence of a microsomal system. A tripeptide was isolated which contained *N*-(cystein-*S*-yl)-IQ-*S*-oxide (sulfinamide) that easily liberated IQ on acidification. Pretreatment of albumin with *p*-chloromercuribenzoate reduced covalent binding drastically<sup>61</sup>. The authors concluded that the reactant most likely to yield this structure is 2-nitroso-3-methylimidazo[4,5-*f*]quinoline, which is probably formed by autooxidation of *N*-hydroxy-IQ.

The 3-amino-1-methyl-5*H*-pyrido[4,3-*b*]indole derivatives (**31**; Trp-P-1) and (**32**; Trp-P-2) were found as tryptophane pyrolysates in broiled fish and meat and in pyrolysates of protein and amino acids by Sugimura and coworkers<sup>198</sup>. These mutagens are heterocyclic amines and exhibit mutagenicity in the Ames test supplemented with S-9 mix<sup>198</sup>. The pyridoindole derivatives Trp-P-1 and Trp-P-2 are *N*-hydroxylated at the exocyclic amino group to form proximate reactive compounds.

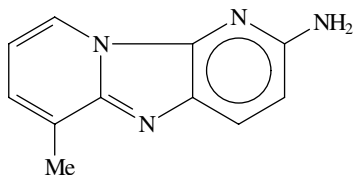


(31)

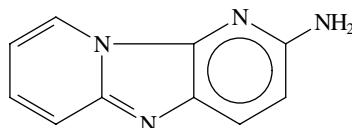


(32)

Thiols, particularly GSH, modify the mutagenic activity and covalent binding to DNA by at least two mechanisms. The first one involves glutathione *S*-transferase which, in the case of *N*-hydroxy-Trp-P-2, produced a stable *C*-conjugate and two labile *N*-conjugates, one of which decomposed into Trp-P-2 while the other liberated the parent *N*-hydroxy-Trp-P-2. This latter conjugate was found to be outstandingly mutagenic<sup>41,204</sup>. The second pathway starts with the nitroso derivative leading to the putative sulfenamide and sulfinamide<sup>41</sup>. Alternatively, both labile compounds could also be stereoisomeric sulfinamides, particularly since they showed nearly identical UV maxima.



(33)



(34)

The 2-amino-dipyrido[1,2-*a*:3',2'-*d*]imidazoles (**33**; Glu-P-1) and (**34**; Glu-P-2) were first isolated from glutamic acid pyrolysates. As observed with Trp-P-1 and Trp-P-2,

mutagenic activity was shown after microsomal *N*-oxygenation at the exocyclic amino group to yield the reactive *N*-hydroxy and nitroso derivatives<sup>204</sup>. Most interestingly, upon reaction of nitroso-Glu-P-1 with GSH also an *N*-hydroxysulfonamide was apparently formed besides sulfinamide, sulfenamide and arylamine<sup>37,43</sup> (see Section II.E).

#### IV. REFERENCES

1. Y. Furuya, I. Urasaki, K. Itoho and A. Takashima, *Bull. Chem. Soc. Jpn.*, **42**, 1922 (1969).
2. J. H. Boyer, in *The Chemistry of the Nitro and Nitroso Groups* (Ed. H. Feuer), Interscience Publishers, New York, 1969, p. 215.
3. P. Zuman and B. Shah, *Chem. Rev.*, **94**, 1621 (1994).
4. E. Bamberger and A. Rising, *Chem. Ber.*, **34**, 228 (1901).
5. F. J. Smentowski, *J. Am. Chem. Soc.*, **85**, 3036 (1963).
6. E. Gülbaran, *Finish Chem. J.*, **37**, 229 (1964).
7. E. Y. Belyaev, L. M. Gornostaev and G. A. Suboch, *Khim. Tekhnol. Polim.*, **4**, 60 (1975).
8. E. Boyland, P. L. Grover and D. Manson, *Ann. Rep. Brit. Emp. Cancer Campaign*, **44**, 2 (1966).
9. P. D. Lotlikar, E. C. Miller, J. A. Miller and A. Margreth, *Cancer Res.*, **25**, 1743 (1965).
10. M. Kiese and K. Taeger, *Naunyn-Schmiedeberg's Arch. Pharmacol.*, **292**, 59 (1976).
11. H. -G. Neumann, M. Metzler and W. Töpner, *Arch. Toxicol.*, **39**, 21 (1977).
12. D. Manson, *J. Chem. Soc., Perkin Trans. 1*, 192 (1974).
13. M. Kiese, *Angew. Chem.*, **70**, 93 (1958).
14. M. Kiese, *Naunyn-Schmiedeberg's Arch. Exp. Pathol. Pharmacol.*, **235**, 354 (1959).
15. M. Kiese and H. Uehleke, *Naunyn-Schmiedeberg's Arch. Exp. Path. Pharmacol.*, **242**, 117 (1961).
16. M. Kiese, *Pharmacol. Rev.*, **18**, 1091 (1966).
17. M. Kiese, D. Reinwein and H. D. Waller, *Arch. Exp. Path. Pharmacol.*, **210**, 393 (1950).
18. P. Eyer, *Chem.-Biol. Interact.*, **24**, 227 (1979).
19. P. Eyer and E. Lierheimer, *Xenobiotica*, **10**, 517 (1980).
20. P. Politzer and R. Bar-Adon, *J. Phys. Chem.*, **91**, 2069 (1987).
21. R. D. Youssefyeh, *J. Chem. Soc., Perkin Trans. 1*, 1857 (1975).
22. P. Eyer and M. Schneller, *Biochem. Pharmacol.*, **32**, 1029 (1983).
23. P. Eyer, E. Lierheimer and M. Schneller, *Biochem. Pharmacol.*, **33**, 2299 (1984).
24. H. Klehr, P. Eyer and W. Schäfer, *Biol. Chem. Hoppe-Seyler*, **366**, 755 (1985).
25. P. Eyer, in *Biological Oxidation of Nitrogen in Organic Molecules: Chemistry, Toxicology and Pharmacology* (Eds. J. W. Gorrod and L. A. Damani), Horwood, Chichester, 1985, p. 386.
26. H. Klehr, P. Eyer and W. Schäfer, *Biol. Chem. Hoppe-Seyler*, **368**, 895 (1987).
27. P. Eyer, *Xenobiotica*, **18**, 1327 (1988).
28. A. E. Cribb, M. Miller, J. S. Leeder, J. Hill and S. P. Spielberg, *Drug Metab. Dispos.*, **19**, 900 (1991).
29. M. K. Ellis, S. Hill, P. Matthew and D. Foster, *Chem.-Biol. Interact.*, **82**, 151 (1992).
30. S. Kazanis and R. A. McClelland, *J. Am. Chem. Soc.*, **114**, 3052 (1992).
31. P. Eyer, *Environ. Health Perspect.*, **102** (Suppl. 6), 123 (1994).
32. H. P. T. Ammon, C. J. Estler and F. Heim, *Biochem. Pharmacol.*, **16**, 769 (1967).
33. B. Dölle, W. Töpner and H. -G. Neumann, *Xenobiotica*, **10**, 527 (1980).
34. P. Eyer, H. Kampffmeyer, H. Maister and E. Rösch-Oehme, *Xenobiotica*, **10**, 499 (1980).
35. G. J. Mulder, L. E. Unruh, F. E. Evans, B. Ketterer and F. F. Kadlubar, *Chem.-Biol. Interact.*, **39**, 111 (1982).
36. C. Diepold, P. Eyer, H. Kampffmeyer and K. Reinhardt, in *Biological Reactive Intermediates—II. Chemical Mechanisms and Biological Effects* (Eds. R. Snyder, D. V. Parke, J. J. Kocsis, D. J. Jollow, C. G. Gibson and C. M. Witmer), Plenum Press, New York, 1982, p. 1173.
37. K. Saito and R. Kato, *Biochem. Biophys. Res. Commun.*, **124**, 1 (1984).
38. H. Klehr, PhD Thesis, Ludwig-Maximilians-Universität München, 1988.
39. H. Klehr and P. Eyer, *Naunyn-Schmiedeberg's Arch. Pharmacol.*, **335** (Suppl.), R 12 (1987).
40. P. Eyer and M. Ascherl, *Biol. Chem. Hoppe-Seyler*, **368**, 285 (1987).
41. K. Saito, Y. Yamazoe, T. Kamataki and R. Kato, *Carcinogenesis*, **4**, 1551 (1983).
42. H. -O. Kalinowski, S. Berger and S. Braun, <sup>13</sup>C-NMR-Spektroskopie, Thieme Verlag, Stuttgart, 1984.

43. A. Umemoto, S. Grivas, Z. Yamaizumi, S. Sato and T. Sugimura, *Chem.-Biol. Interact.*, **68**, 57 (1988).
44. D. L. Rabenstein and D. A. Keire, in *Glutathione. Chemical, Biochemical, and Medical Aspects*, Vol. A (Eds. D. Dolphin, O. Avramovic and R. Poulson), Wiley, New York, 1989, p. 67.
45. D. Galleman, A. Speckmann and P. Eyer, in preparation.
46. R. E. Benesch and R. Benesch, *Biochemistry*, **1**, 735 (1962).
47. G. Geraci and L. J. Parkhurst, *Biochemistry*, **12**, 3414 (1973).
48. Y. M. Torchinsky, *Sulfur in Proteins*, Pergamon Press, Oxford, 1977, p. 133.
49. M. R. Crampton, in *The Chemistry of the Thiol Group*, Vol. 2 (Ed. S. Patai), Wiley, London, 1974, p. 379.
50. P. Zuman and Z. Fijalek, *J. Org. Chem.*, **56**, 5486 (1991).
51. L. H. Bothelo and F. R. N. Gurd, in *Practical Handbook of Biochemistry and Molecular Biology* (Ed. G. D. Fasman), CRC Press, Boca Raton, 1992, p. 359.
52. B. G. Gowenlock and W. Lüttke, *Quart. Rev.*, **12**, 321 (1958).
53. M. Raban and J. Greenblatt, in *The Chemistry of Amino, Nitroso and Nitro Compounds and their Derivatives* (Ed. S. Patai), Wiley, Chichester, 1982, p. 53.
54. C. D. Johnson, *The Hammett Equation*, Cambridge University Press, London, 1973.
55. C. Hansch, A. Leo and R. W. Taft, *Chem. Rev.*, **91**, 165 (1991).
56. D. Galleman, PhD Thesis, Ludwig-Maximilians-Universität München, 1993.
57. S. F. Farah, PhD Thesis, University of Toronto, 1991.
58. J. March, *Advanced Organic Chemistry: Reactions, Mechanisms, and Structure*, 2nd ed., McGraw-Hill, Tokyo, 1977.
59. R. A. Yunes, A. J. Terenzani and L. do Amaral, *J. Am. Chem. Soc.*, **97**, 368 (1975).
60. J. P. Uetrecht, *J. Pharmacol. Exp. Ther.*, **232**, 420 (1985).
61. R. J. Turesky, P. L. Skipper and S. R. Tannenbaum, *Carcinogenesis*, **8**, 1537 (1987).
62. J. G. Tillett, in *The Chemistry of Sulphinic Acids, Esters and their Derivatives* (Ed. S. Patai), Wiley, Chichester, 1990, p. 603.
63. D. Galleman, A. Speckmann and P. Eyer, unpublished result.
64. R. M. Moriarty, *J. Org. Chem.*, **30**, 600 (1965).
65. R. E. Booms and D. J. Cram, *J. Am. Chem. Soc.*, **94**, 5438 (1972).
66. E. L. Eliel and S. H. Wilen, *Stereochemistry of Organic Compounds*, Wiley, New York, 1994, p. 430.
67. D. Kost and M. Raban, in *The Chemistry of Sulphinic Acids and their Derivatives* (Ed. S. Patai), Wiley, Chichester, 1990, p. 23.
68. D. Galleman and P. Eyer, *Environ. Health Perspect.*, **102** (Suppl. 6), 137 (1994).
69. L. Stryer, *Biochemie*, 4th ed., Spektrum der Wissenschaft, Heidelberg, 1990.
70. R. C. Weast, *Handbook of Chemistry and Physics*, 54th ed., CRC Press, Cleveland, 1973.
71. S. Darchen and C. Moinet, *J. Chem. Soc., Chem. Commun.*, 820 (1976).
72. G. J. Mulder, F. F. Kadlubar, J. B. Mays and J. A. Hinson, *Mol. Pharmacol.*, **26**, 342 (1984).
73. G. Capozzi, G. Modena and L. Pasquato, in *The Chemistry of Sulphinic Acids and their Derivatives* (Ed. S. Patai), Wiley, Chichester, 1990, p. 403.
74. R. Cecil and J. R. McPhee, *Biochem. J.*, **66**, 538 (1957).
75. W. S. Allison, *Acc. Chem. Res.*, **9**, 293 (1976).
76. J. R. Prohaska, *Biochim. Biophys. Acta*, **611**, 87 (1980).
77. L.v. den Brock, L. Delbressine and H. Ottenheim, in *The Chemistry of Sulphinic Acids and their Derivatives* (Ed. S. Patai), Wiley, Chichester, 1990, p. 701.
78. A. Bagno, S. J. Eustace, L. Johansson and G. Scorrano, *J. Org. Chem.*, **59**, 232 (1994).
79. L. Benati, P. C. Montevecchi and P. Spagnolo, *J. Chem. Soc., Perkin Trans. 1*, 2261 (1985).
80. R. F. Bayfield and E. R. Cole, *Phosphorus Sulfur Silicon*, **45**, 237 (1989).
81. P. de Maria, in *The Chemistry of Sulphinic Acids and their Derivatives* (Ed. S. Patai), Wiley, Chichester, 1990, p. 293.
82. S. Braverman, in *The Chemistry of Sulphinic Acids and their Derivatives* (Ed. S. Patai), Wiley, Chichester, 1990, p. 311.
83. L. Craine and M. Raban, *Chem. Rev.*, **89**, 689 (1989).
84. R. Reistad, H. Frandsen, S. Grivas and J. Alexander, *Carcinogenesis*, **15**, 2547 (1994).
85. J. H. N. Meerman, F. A. Beland, B. Ketterer, S. K. S. Srari, A. P. Bruins and G. J. Mulder, *Chem.-Biol. Interact.*, **39**, 149 (1982).
86. P. K. Claus, in *The Chemistry of Sulphinic Acids and their Derivatives* (Ed. S. Patai), Wiley, Chichester, 1990, p. 723.

87. H. Sayo, in *The Chemistry of Sulphinic Acids and their Derivatives* (Ed. S. Patai), Wiley, Chichester, 1990, p. 571.
88. J. T. Hays, H. L. Young and H. H. Espy, *J. Org. Chem.*, **32**, 158 (1967).
89. T. Okuyama, in *The Chemistry of Sulphinic Acids, Esters and their Derivatives* (Ed. S. Patai), Wiley, Chichester, 1990, p. 639.
90. A. F. Finch, *Theilheimer's Synthetic Methods of Organic Chemistry*, Vol. 49, Karger, Basel, 1995, p. 110.
91. N. Takahashi, V. Fischer, J. Schreiber and R. P. Mason, *Free Rad. Res. Commun.*, **4**, 351 (1988).
92. K. R. Maples, P. Eyer and R. P. Mason, *Mol. Pharmacol.*, **37**, 311 (1990).
93. M. C. R. Symons, W. R. Bowman and P. F. Taylor, *Tetrahedron Lett.*, **31**, 3221 (1990).
94. T. P. Bradshaw, D. C. McMillan, R. K. Crouch and D. J. Jollow, *Free Rad. Biol. Med.*, **18**, 279 (1995).
95. G. A. Russell, E. J. Geels, F. J. Smentowski, K. Y. Chang, J. Reynolds and G. Kaupp, *J. Am. Chem. Soc.*, **89**, 3821 (1967).
96. J. H. Weisburger and E. K. Weisburger, *Pharmacol. Rev.*, **25**, 1 (1973).
97. D. E. Rickert, *Toxicity of Nitroaromatic Compounds*, Hemisphere Publ. Corp., Washington, 1985.
98. D. E. Rickert, *Drug Metab. Rev.*, **18**, 23 (1987).
99. J. A. Miller, *Drug Metab. Rev.*, **26**, 1 (1994).
100. P. Eyer, H. Hertle, M. Kiese and G. Klein, *Mol. Pharmacol.*, **11**, 326 (1975).
101. M. Kiese, *Methemoglobinemia: A Comprehensive Treatise*, CRC Press, Cleveland, 1974.
102. E. Wieland and H. -G. Neumann, *Arch. Toxicol.*, **40**, 17 (1978).
103. L. C. Green, P. L. Skipper, R. J. Turesky, M. S. Bryant and S. R. Tannenbaum, *Cancer Res.*, **44**, 4254 (1984).
104. P. B. Farmer, H. -G. Neumann and D. Henschler, *Arch. Toxicol.*, **60**, 251 (1987).
105. H. -G. Neumann, *IARC Sci. Publ.*, **89**, 157 (1988).
106. G. Sabbioni, *Environ. Health Perspect.*, **102** (Suppl. 6), 61 (1994).
107. G. Sabbioni, *Chem. Res. Toxicol.*, **7**, 267 (1994).
108. P. L. Skipper and S. R. Tannenbaum, *Environ. Health Perspect.*, **102** (Suppl. 6), 17 (1994).
109. F. F. Kadlubar, *Nature*, **360**, 189 (1992).
110. H. -G. Neumann, in *Metabolic Aspects of Cell Toxicity* (Ed. P. Eyer), B. I. Wissenschaftsverlag, Mannheim, 1994, p. 109.
111. H. -G. Neumann, S. Ambs and A. Bitsch, *Environ. Health Perspect.*, **102** (Suppl. 6), 173 (1994).
112. J. H. Harrison and D. J. Jollow, *J. Pharm. Exp. Ther.*, **238**, 1045 (1986).
113. P. Eyer, *Arch. Toxicol.*, **6** (Suppl.), 3 (1983).
114. P. Eyer, in *Metabolic Aspects of Cell Toxicity* (Ed. P. Eyer), B. I. Wissenschaftsverlag, Mannheim, 1994, p. 149.
115. K. Stolze and H. Nohl, *Biochem. Pharmacol.*, **49**, 1261 (1995).
116. H. Fujii, B. Zhao, J. Koscielniak and L. J. Berliner, *Magn. Reson. Med.*, **31**, 77 (1994).
117. H. Fujii, J. Koscielniak, K. Kakinuma and L. J. Berliner, *Free Rad. Res.*, **21**, 235 (1994).
118. E. Beutler, *Pharmacol. Rev.*, **21**, 73 (1969).
119. J. Uetrecht and B. Sokoluk, *Am. Soc. Pharm. Exp. Ther.*, **20**, 120 (1992).
120. J. P. Uetrecht, *Drug Metab. Rev.*, **24**, 299 (1992).
121. J. F. Wheeler, C. E. Lunte, H. Zimmer and W. R. Heineman, *J. Pharm. Biomed. Anal.*, **8**, 143 (1990).
122. R. L. Rubin, *Clin. Biochem.*, **25**, 223 (1992).
123. W. G. Rice, C. D. Hillyer, B. Harten, C. A. Schaeffer, M. Dorminy, D. A. Lackey, E. Kirsten, J. Mendeleyev, K. G. Buki, A. Hakam and E. Kun, *Proc. Natl. Acad. Sci. USA*, **89**, 7703 (1992).
124. K. G. Buki, P. I. Bauer, J. Mendeleyev, A. Hakam and E. Kun, *FEBS Lett.*, **290**, 181 (1991).
125. W. G. Rice, C. A. Schaeffer, L. Graham, M. Bu, J. S. McDougal, S. L. Orloff, F. Villinger, M. Young, S. Oroszlan, M. P. Fesen, Y. Pommier, J. Mendeleyev and E. Kun, *Proc. Natl. Acad. Sci. USA*, **90**, 9721 (1993).
126. W. G. Rice, C. A. Schaeffer, B. Harten, F. Villinger, T. L. South, M. F. Summers, L. E. Henderson, J. W. Bess, L. O. Arthur, J. S. McDougal, S. L. Orloff, J. Mendeleyev and E. Kun, *Nature*, **361**, 473 (1993).
127. X. Yu, Y. Hathout, C. Fenselau, R. C. Sowder, L. E. Hendereson, W. G. Rice, J. Mendeleyev and E. Kun, *Chem. Res. Toxicol.*, **8**, 586 (1995).
128. G. Bories and J. -P. Cravedi, *Drug Metab. Rev.*, **26**, 767 (1994).
129. A. A. Yunis, A. M. Miller, Z. Salem, M. D. Corbett and G. K. Arimura, *J. Lab. Clin. Med.*, **96**, 36 (1980).



130. A. A. Yunis, *Ann. Rev. Pharmacol. Toxicol.*, **28**, 83 (1988).
131. M. D. Corbett and B. R. Chipko, *Antimicrob. Agents Chemother.*, **13**, 193 (1978).
132. B. L. Gross, R. V. Branchflower, T. R. Burke, D. E. Lees and L. R. Pohl, *Toxicol. Appl. Pharmacol.*, **64**, 557 (1982).
133. M. Ascherl, P. Eyer and H. Kampffmeyer, *Biochem. Pharmacol.*, **34**, 3755 (1985).
134. D. E. Holt, R. Hurley and D. Harvey, *J. Antimicrob. Chemother.*, **35**, 115 (1995).
135. W. H. Abou-Khalil, A. A. Yunis and S. Abou-Khalil, *Pharmacology*, **36**, 272 (1988).
136. J. J. Jimenez, G. K. Arimura, W. H. Abou-Khalil, M. Isildar and A. A. Yunis, *Blood*, **70**, 1180 (1987).
137. C. Lafarge-Frayssinet, S. Robbana-Barnat, C. Frayssinet, L. Toucas and F. Decloitre, *Mutation Res.*, **320**, 207 (1994).
138. M. Isildar, W. H. Abou-Khalil, J. J. Jimenez, S. Abou-Khalil and A. A. Yunis, *Toxicol. Appl. Pharmacol.*, **94**, 305 (1988).
139. A. Anadon, P. Bringas, M. R. Martinez-Larranaga and M. J. Diaz, *J. Vet. Pharmacol. Ther.*, **17**, 52 (1994).
140. I. K. Shih, *J. Pharm. Sci.*, **60**, 1889 (1971).
141. H. de Vries, P. J. Hemelaar, A. C. M. Gevers and G. M. J. Beyersbergen van Henegouwen, *Photochem. Photobiol.*, **60**, 249 (1994).
142. D. C. McMillan, T. P. Bradshaw, J. A. Hinson and D. J. Jollow, *Toxicol. Appl. Pharmacol.*, **110**, 70 (1991).
143. D. C. McMillan, T. A. McRae and J. A. Hinson, *Toxicol. Appl. Pharmacol.*, **105**, 503 (1990).
144. W. Lenk and H. Sterzl, *Xenobiotica*, **7**, 581 (1984).
145. I. Golly and P. Hlavica, *Biochim. Biophys. Acta*, **760**, 69 (1983).
146. S. Karreth and W. Lenk, *Xenobiotica*, **21**, 971 (1991).
147. G. Birner and H. -G. Neumann, *Arch. Toxicol.*, **62**, 110 (1988).
148. M. D. Coleman and M. D. Tingle, *Drug Dev. Res.*, **25**, 1 (1992).
149. W. R. Graham, *Int. J. Dermatol.*, **14**, 494 (1975).
150. G. L. Scott and M. R. Rasbridge, *Br. J. Haematol.*, **24**, 307 (1973).
151. P. A. Kramer, B. E. Glader and T. -K. Li, *Biochem. Pharmacol.*, **21**, 1265 (1972).
152. M. D. Coleman and D. P. Jacobus, *Biochem. Pharmacol.*, **45**, 1027 (1993).
153. G. L. Mandell and M. A. Sande, in *Goodman and Gilman's The Pharmacological Basis of Therapeutics*, 8th ed. (Eds. A. Goodman Gilman, T. W. Rall, A. S. Nies and P. Taylor), Pergamon Press, New York, 1990.
154. M. J. Rieder, R. Krause, I. A. Bird and G. A. Dekaban, *J. Acquired Immunol. Defic. Syndr. Hum. Retrovir.*, **8**, 134 (1995).
155. S. P. Spielberg, J. S. Leeder, A. E. Cribb and H. -M. Dosch, *Eur. J. Clin. Pharmacol.*, **36**, A 173 (1989).
156. M. Pirmohamed, M. D. Coleman, F. Hussain, A. M. Breckenridge and B. K. Park, *Br. J. Clin. Pharmacol.*, **32**, 303 (1991).
157. M. K. Ellis and P. M. D. Foster, *Toxicol. Lett.*, **62**, 201 (1992).
158. T. Lindqvist, P. Moldéus and B. Lindeke, *Pharmacol. Toxicol.*, **69**, 117 (1991).
159. H. Baader, S. Girgis, M. Kiese, H. Menzel and L. Skrobot, *Naunyn-Schmiedeberg's Arch. Exp. Path. Pharmacol.*, **241**, 317 (1961).
160. H. Uehleke, *Naunyn-Schmiedeberg's Arch. Pharmacol.*, **264**, 434 (1969).
161. T. Fischbach and W. Lenk, *Xenobiotica*, **15**, 915 (1985).
162. C. B. Jensen and D. J. Jollow, *Toxicol. Appl. Pharmacol.*, **111**, 1 (1991).
163. D. Galleman and P. Eyer, *Biol. Chem. Hoppe-Seyler*, **374**, 37 (1993).
164. D. Galleman and P. Eyer, *Biol. Chem. Hoppe-Seyler*, **374**, 752 (1993).
165. D. Galleman and P. Eyer, *ISSX Proceedings*, **4**, 115 (1993).
166. K. Shudo, T. Ohta, Y. Orihara, T. Okamoto, M. Nagao, Y. Takahashi and T. Sugimura, *Mutation Res.*, **58**, 367 (1978).
167. P. J. Wirth, P. Alewood, I. Calder and S. S. Thorgeirsson, *Carcinogenesis*, **3**, 167 (1982).
168. J. A. Hinson and J. B. Mays, *J. Pharmacol. Exp. Ther.*, **238**, 106 (1986).
169. P. Eyer and H. Kampffmeyer, *Chem.-Biol. Interact.*, **42**, 209 (1982).
170. D. Galleman and P. Eyer, *Biol. Chem. Hoppe-Seyler*, **374**, 51 (1993).
171. C. M. Goodall, C. M. Moore and O. B. Stephens, *Xenobiotica*, **16**, 587 (1986).
172. J. M. Silva and P. J. O'Brien, *Prog. Pharmacol. Clin. Pharmacol.*, **8**, 301 (1991).
173. J. M. Silva, S. D. Jatoe and P. J. O'Brien, *Prog. Pharmacol. Clin. Pharmacol.*, **8**, 289 (1991).

174. C. Störle and P. Eyer, *Chem.-Biol. Interact.*, **83**, 271 (1992).
175. S. Karreth and W. Lenk, *Xenobiotica*, **21**, 417 (1991).
176. J. Suzuki, S. -I. Meguro, O. Morita, S. Hirayama and S. Suzuki, *Biochem. Pharmacol.*, **38**, 3511 (1989).
177. R. Heilmair, S. Karreth and W. Lenk, *Xenobiotica*, **21**, 805 (1991).
178. R. H. Wilson, F. DeEds and A. J. Cox, *Cancer Res.*, **1**, 595 (1941).
179. J. W. Cramer, J. A. Miller and E. C. Miller, *J. Biol. Chem.*, **235**, 250 (1960).
180. F. A. Beland and F. F. Kadlubar, in *Chemical Carcinogenesis and Mutagenesis. Handbook of Experimental Pharmacology*, Vol. 94/I (Eds. C. S. Cooper and P. L. Grover), Springer-Verlag, Berlin, 1990, p. 267.
181. A. J. Varghese, *Biochem. Biophys. Res. Commun.*, **112**, 1013 (1983).
182. J. E. Biaglow, M. E. Varnes, L. Roizen-Towle, E. P. Clark, E. R. Epp, M. B. Astor and E. J. Hall, *Biochem. Pharmacol.*, **35**, 77 (1986).
183. G. L. Kedderis and G. T. Miwa, *Drug Metab. Rev.*, **19**, 33 (1988).
184. A. J. Varghese and G. F. Whitmore, *Int. J. Radiat. Oncol. Biol. Phys.*, **10**, 1341 (1984).
185. A. J. Varghese and G. F. Whitmore, *Chem.-Biol. Interact.*, **56**, 269 (1985).
186. R. A. McClelland, R. Panicucci and A. M. Rauth, *J. Am. Chem. Soc.*, **109**, 4308 (1987).
187. J. L. Bolton and R. A. McClelland, *J. Am. Chem. Soc.*, **111**, 8172 (1989).
188. D. S. Noyce and G. T. Stowe, *J. Org. Chem.*, **38**, 3762 (1973).
189. P. Eyer and M. Ascherl, unpublished results (1984).
190. M. B. Noss, R. Panicucci, R. A. McClelland and A. M. Rauth, *Biochem. Pharmacol.*, **37**, 2585 (1988).
191. C. B. Brezden, R. A. McClelland and M. A. Rauth, *Biochem. Pharmacol.*, **48**, 361 (1994).
192. R. T. Mulcahy, J. J. Gipp, G. A. Ublacker, R. Panicucci and R. A. McClelland, *Biochem. Pharmacol.*, **38**, 1667 (1989).
193. J. J. Gipp, R. A. McClelland and R. T. Mulcahy, *Biochem. Pharmacol.*, **42** (Suppl.), 127 (1991).
194. L. R. Berube, S. Farah, R. A. McClelland and A. M. Rauth, *Biochem. Pharmacol.*, **42**, 2153 (1991).
195. D. I. Edwards, *Biochem. Pharmacol.*, **35**, 53 (1986).
196. P. Goldman, R. L. Koch, T. -C. Yeung, E. J. T. Chrystal, B. B. Beaulie, M. A. McLafferty and G. Sudlow, *Biochem. Pharmacol.*, **35**, 43 (1986).
197. W. J. Ehlhardt and P. Goldman, *Biochem. Pharmacol.*, **38**, 1175 (1989).
198. T. Sugimura, S. Sato and K. Wakabayashi, in *Chemical Induction of Cancer*, Vol. IIIC (Eds. Y. -T. Lai, J. C. Arcos and M. F. Argus), Academic Press, San Diego, 1988, p. 681.
199. J. S. Felton, M. G. Knize, N. H. Shen, P. R. Lewis, B. D. Andresen, J. Happe and F. T. Hatch, *Carcinogenesis*, **7**, 1081 (1986).
200. J. S. Felton and M. G. Knize, in *Chemical Carcinogenesis and Mutagenesis. Handbook of Experimental Pharmacology*, Vol. 94/I (Eds. C. S. Cooper and P. L. Grover), Springer-Verlag, Berlin, 1990, p. 471.
201. G. A. Marsch, E. N. Goldman, E. Fultz, N. H. Shen and K. W. Turteltaub, *Chem. Res. Toxicol.*, **8**, 659 (1995).
202. K. R. Kaderlik, R. F. Minchin, G. J. Mulder, K. F. Ilett, M. Daugaard-Jenson, C. H. Teitel and F. F. Kadlubar, *Carcinogenesis*, **15**, 1703 (1994).
203. K. R. Kaderlik, G. J. Mulder, J. G. Shaddock, D. A. Casciano, C. H. Teitel and F. F. Kadlubar, *Carcinogenesis*, **15**, 1711 (1994).
204. R. Kato, *Crit. Rev. Toxicol.*, **16**, 307 (1986).
205. E. Wolz, D. Wild and G. H. Degen, *Arch. Toxicol.*, **69**, 171 (1995).

## CHAPTER 24

# Analytical aspects of amino, quaternary ammonium, nitro, nitroso and related functional groups

JACOB ZABICKY and SHMUEL BITTNER

*Institutes for Applied Research and Department of Chemistry,  
Ben-Gurion University of the Negev, Beer-Sheva, Israel*

*Fax: 927-7-472969, 972-7-472943; e-mail: zabicky@bgumail.bgu.ac.il  
bittner@bgumail.bgu.ac.il*

---

I. ABBREVIATIONS	1042
II. INTRODUCTION	1044
III. ELEMENTAL ANALYSIS	1045
A. Automatic Organic Elemental Analysis (CHNOS)	1045
1. General	1045
2. Nitrogen	1045
3. Oxygen	1046
B. Digestion Methods	1046
C. Nitrogen Responsive Detectors for GC	1047
D. Stable Isotope Analysis	1048
IV. AMINES	1049
A. General	1049
B. Isotope Analysis	1059
C. Gas Chromatography	1060
D. Liquid Chromatography	1067
1. General	1067
2. Underivatized analytes	1068
3. Pre-column and post-column derivatization	1076
a. Reaction with dicarboxaldehydes	1077
b. Oxazole derivatives	1080
c. <i>N</i> -Acylation and <i>N</i> -sulfonation	1080
d. Reaction with isothiocyanates	1084

e. <i>N</i> -Arylation	1085
f. Schiff bases	1085
g. Miscellaneous reactions	1086
4. Chiral purity	1089
5. Fossil dating	1092
E. Electrophoresis	1093
F. Spectrophotometric Methods	1096
G. Enzymatic Biosensors	1102
H. Miscellaneous Methods	1105
I. Derivatization	1109
V. QUATERNARY AMMONIUM COMPOUNDS	1114
A. Chromatography	1116
B. Miscellaneous Methods	1118
VI. NITRO COMPOUNDS	1122
A. General	1122
B. Aromatic Nitro Compounds	1125
1. General	1125
2. Monocyclic arenes	1127
3. Polycyclic aromatic hydrocarbons (PAH)	1129
4. Phenols	1133
a. HPLC and GC without derivatization	1133
b. HPLC and GC with precolumn derivatization	1134
c. Miscellaneous methods	1134
5. Aromatic amines	1135
6. Miscellaneous aromatic compounds	1137
C. Nitrofurans	1139
D. Miscellaneous Heterocyclic Compounds	1140
E. Aliphatic Compounds	1141
F. Nitrates	1142
G. Nitramines	1142
VII. NITROSO COMPOUNDS	1143
A. General	1143
B. Nitrosoarenes	1143
C. Nitrosamines	1144
1. Gas chromatography	1144
2. Liquid chromatography	1146
3. Miscellaneous methods	1148
D. Tobacco	1150
VIII. HYDROXYLAMINES	1151
A. Quantitative Analysis	1151
B. Structural Analysis	1152
C. Derivatization	1152
IX. AMINO-OXYLS	1153
X. REFERENCES	1154

### I. ABBREVIATIONS

AAS	atomic absorption spectroscopy
AED	atomic emission detector(ion)
AFID	alkali FID
AOAC	Association of Official Analytical Chemists

CE	capillary electrophoresis
CI-MS	chemical ionization MS
CLD	chemiluminescence detector(ion)
CLND	chemiluminescence nitrogen detector(ion)
CMC	critical concentration for micelle formation
CZE	capillary zone electrophoresis
DON	dissolved organic nitrogen
DSC	differential scanning calorimetry
DTA	differential thermal analysis
ECD	electron capture detector(ion)
EI-MS	electron impact MS
ELCD	electrolytic conductivity detector(ion)
ELISA	enzyme-linked immunosorbed assay
ELS	evaporative light scattering
EPA	Environmental Protection Agency (USA)
FAB	fast atom bombardment
FASD	flameless alkali-sensitized detector(ion)
FIA	flow injection analysis
FID	flame ionization detector(ion)
FLD	fluorescence detector(ion)
FPD	flame photometric detector(ion)
GC-...	gas chromatography combined with special detectors
GCE	glassy carbon electrode
HPTLC	high-performance TLC
ICP	inductively coupled plasma
IEC	ion-exchange chromatography
LIF	laser-induced fluorescence
LLE	liquid-liquid extraction
LOD	limit(s) of detection
LOQ	limit(s) of quantation
MEKC	micellar electrokinetic chromatography
MSTS	mainstream tobacco smoke
NAA	nitroso amino acids
NDIR	nondispersive infrared
NICI-MS	negative ion chemical ionization MS
NIOSH	National Institute for Occupational Safety and Health (USA)
NOC	nitroso organic compounds (nitrosamines)
NPD	nitrogen-phosphorus detector(ion)
OFID	oxygen FID
OSHA	Occupational Safety and Health Administration (USA)
PAH	polycyclic aromatic hydrocarbon(s)
PON	particular organic nitrogen
PSP-MS	plasma-spray MS (discharge-assisted TSP-MS)
RIA	radioimmunoassay
RID	refractive index detector(ion)
RP-...	reversed-phase combined with other items
RSD	relative standard deviation

RTECS	Registry of Toxic Effects of Chemical Substances (NIOSH/OSHA)
SCE	standard calomel electrode
SFE	supercritical fluid extraction
SIM	selected-ion monitoring mode of MS
SIMS	secondary ion MS
SNR	signal-to-noise ratio
SPE	solid-phase extraction
SPME	solid-phase microextraction
SSTS	sidestream tobacco smoke
TCD	thermal conductivity detector(ion)
TDN	total dissolved nitrogen
TEA	thermal energy analyzer
TGA	thermogravimetric analysis
TOF	time of flight
TSD	thermionic specific detector(ion)
TSNA	tobacco-specific <i>N</i> -nitrosamines
TSP-MS	thermospray MS
USP	US Pharmacopea
UVD	UVV photometric detector(ion)
UVV	ultraviolet-visible
VNOC	volatile NOC
XPS	X-ray photoelectron spectroscopy
XRD	X-ray diffractometry

## II. INTRODUCTION

The present chapter deals with amino, nitro and nitroso groups, quaternary ammonium compounds, and with several minor related functional groups. Analytical aspects concerning these functional groups were reviewed in the past to various extents<sup>1-3</sup>. The present chapter will deal with certain general aspects and especially with advancements that took place in the last few years.

The technological importance of organic compounds containing amino and nitro groups is outstanding, both as chemical intermediates and as products that are used in other manufacturing industries, agriculture and medicine. They have found application as drugs, dyestuffs, pesticides, explosives, additives, modifiers and others. Manufacture of these chemicals requires development of analytical methods for process and quality control. Examples of such compounds that have found industrial application are listed in various tables below.

Automatization of all stages of the analytical process is a trend that can be discerned in the development of modern analytical methods for chemical manufacture, to various extents depending on reliability and cost-benefit considerations. Among the elements of reliability one counts conformity of the accuracy and precision of the method to the specifications of the manufacturing process, stability of the analytical system and closeness to real-time analysis. The latter is a requirement for feedback into automatic process-control systems. Since the investment in equipment for automatic online analysis may be high, this is frequently replaced by monitoring a property that is easy and inexpensive to measure and correlating that property with the analyte of interest. Such compromise is usually accompanied by a collection of samples that are sent to the analytical laboratory for determination, possibly at a lower cost.

A different approach is required in biological research, pharmacology, forensic investigations, occupational hygiene and environmental protection. Often one confronts samples that are difficult to deal with because of their small size, instability, the low concentration

of analyte or the nature of the matrix. Many advances of modern analysis are concerned with pushing down the limits of detection and quantation (LOD, LOQ) using smaller and smaller samples, frequently in the  $\mu\text{M}$  or  $\text{nM}$  range, with only picomoles or even femtomoles of analyte. These advancements are the result of improved selectivity of reagents and media, development of sensors with increased sensitivity that are backed-up by reliable electronic system and optimization of the analytical methodology. Some advances are concerned with making the analytical equipment cheaper, easier to handle and more time efficient (see, for example, Reference 4).

It should be pointed out that the LOD and LOQ concepts are used rather loosely in the literature and are sometimes interchanged. Furthermore, LOD are given in extensive as well as intensive terms (e.g.  $\mu\text{mol}$  vs  $\text{nM/mL}$ ). Except for cases where sample size was reported and a lower limit concentration could be discerned, extensive LOD are given as reported.

The present chapter is subdivided according to the nature of the various analytical methods, emphasizing the importance of chromatography including the various detection methods. Structural analysis is treated only briefly here and is left mostly to other chapters dealing with spectral properties.

### III. ELEMENTAL ANALYSIS

Compounds bearing the functional groups of the present chapter are usually analyzed for the characteristic N heteroatom and less frequently for O. In this section some recent advances in the analysis of these heteroatoms are presented. A critical review appeared of the analysis of the nutrient elements C, N, P and Si, and their speciation in environmental waters, including sample collection and preservation, sample preparation and methods for end analysis<sup>5</sup>.

#### A. Automatic Organic Elemental Analysis (CHNOS)

##### 1. General

A recent brief review showed the working principles of various automatic analyzers<sup>6</sup>. A modified account of N and O analysis will be presented here. Today there exist in the market instruments that perform organic elemental analyses in a few minutes. The ease and speed of such analyses enable the use of such instruments for routine analysis. Although some operational details vary from model to model and between one manufacturer and another, all these instruments can be considered as exalted versions of the classical Pregl determination of C and H by conversion to  $\text{CO}_2$  and  $\text{H}_2\text{O}$ , together with Dumas' method for N by conversion to  $\text{N}_2$ , the calorimetric bomb method for S by conversion to  $\text{SO}_2$  and  $\text{SO}_3$  and Schultzes' method for O by conversion to CO. This is combined with modern electronic control, effective catalysts and instrumental measuring methods such as IR detectors and GC analyzers.

A method for rapid organic C and N analysis in natural particulate materials consists of eliminating carbonates with HCl solution and determining these elements in an automatic analyzer<sup>7</sup>.

##### 2. Nitrogen

Instruments are available for determination of N alone, CHN, CNS and CHNS. N determination in one of the CHN models involves removal of all nonnitrogenous combustion products, including halogens and various oxides, reduction of N oxides to  $\text{N}_2$ , removal of excess oxygen, dilution with helium and measurement with a thermal conductivity

detector (TCD)<sup>8</sup>. In a simultaneous CHNS analyzer the combustion gases are reduced to a mixture of N<sub>2</sub>, CO<sub>2</sub>, H<sub>2</sub>O and SO<sub>2</sub>, carried in a helium stream and determined by GC-TCD<sup>9</sup>.

Automatic Dumas determinations of N in plant tissue were consistently higher than the corresponding Kjeldahl determination in a comparative study. A correlation between both results was proposed<sup>10</sup>. Significantly higher values were also obtained from a LECO FP-428 nitrogen analyzer when comparing the results with those of the Kjeldahl method for the determination of N in various oil-bearing seeds. The automatic analyzer was adopted for routine analysis of these materials<sup>11</sup>. The same instrument was fitted with a liquid injector for determination of total N in milk. The intense production of steam resulted in poor N recoveries. This was improved by slow injection and filling the combustion tube with CeO<sub>2</sub>. Results were about 6.7% higher than by the Kjeldahl method<sup>12</sup>.

A dual-channel analyzer for the determination of N in water was developed, based on chemiluminescence detectors (CLD). One channel is for total dissolved N (TDN) and the other for N<sub>ox</sub> (e.g. NO<sub>2</sub><sup>-</sup>, NO<sub>3</sub><sup>-</sup>). The difference between the two channels is taken as organic N. Total N analysis of waste waters takes 2–4 min, in manual or automatic mode; operational range: 10 ppb to 200 ppm N as N<sub>ox</sub>, 60 ppb to 200 ppm total N and 90 ppb to 200 ppm organic N<sup>13</sup>.

### 3. Oxygen

Oxygen elemental analyzers are usually sold as adaptation kits for the CHN analyzers. In one commercial model all the oxygen-containing compounds are converted to CO, which is measured with a nondispersive infrared (NDIR) photometer<sup>8</sup>. A recent development in GC is the oxygen flame ionization detector (OFID), incorporating a reactor in which the C of organic matter is retained and O appears ultimately as methane and is measured by FID. The OFID exhibits over 10<sup>5</sup> O-to-C selectivity<sup>14</sup>.

## B. Digestion Methods

Nitrogen in forest soil extracts and surface waters may belong dominantly to the so-called dissolved organic nitrogen (DON), which is difficult to measure by the Kjeldahl method. An accurate, fast, simple and inexpensive alternative is based on persulfate oxidation followed by conductometric measurement of the nitrate ion<sup>15</sup>. Nitrogen in sediments can be determined by persulfate oxidation in a strongly alkaline environment in a bomb at high temperature and pressure. End analysis of the resulting nitrates is by ion-exchange chromatography (IEC)<sup>16</sup>.

Determination of DON and dissolved organic phosphorus was carried out in a flow injection analysis (FIA) system by oxidation promoted by UV light, successively in acid and alkaline media. At the 2–40 μM level, recovery was 60–100% for spiked deionized water and 40–80% for seawater<sup>17</sup>. A method for TDN in water is based on photooxidation of inorganic and organic nitrogen with alkaline peroxodisulfate. The nitrate formed is reduced by Cd to nitrite. The latter participates in diazotation and coupling reactions, followed by spectrophotometric determination at 540 nm. The FIA method is relatively fast and inexpensive; LOD 0.03 mg N/L with linearity up to 3 mg/L<sup>18</sup>. The alkaline peroxodisulfate digestion of TDN in a bomb may yield nitrate as the sole product. End analysis can be by ion chromatography. The method showed a recovery higher than 90%, relative standard deviation (RSD) 4.62% for urea and ammonium chloride and 3.62% for natural water samples<sup>19</sup>. Determination of total particulate organic nitrogen (PON) and phosphorus is based on the standard persulfate digestion method at 120 °C, yielding nitrate and phosphate for end analysis. The modification is efficient for cell cultures and natural



seawater and is suitable for routine analysis in shipboard laboratories<sup>20</sup>. PON was determined by persulfate oxidation using 0.2  $\mu\text{m}$  Teflon membrane filters. The results obtained for seawater were 20–90% higher than those obtained with the coarser glass fiber filters, so it was concluded that submicron particles contribute significantly to PON<sup>21</sup>. Possible interferences in the analysis of TDN in seawater by the persulfate oxidation stem from the presence of bromide ions. These are eliminated by reducing the bromate ion product to bromide, oxidizing to bromine and expelling the latter from the solution<sup>22</sup>.

A review of the Kjeldahl method has appeared<sup>23</sup>. A Cu catalyst was investigated instead of the standard Hg catalyst for the Kjeldahl determination of N in meat products, according to AOAC Method 928.08<sup>24</sup>. Microwave drying was demonstrated for rice leaves and did not affect the N analysis<sup>25</sup>. The presence of organic nitrogen interferes with the determination of ammonium ions in organic fertilizers when ammonia is distilled off from suspensions alkalized with NaOH. No such interference was noted when MgO was used as the base. The specific ammonium electrode was found to be unsatisfactory for the end analysis of ammonia. The residue left after distilling off ammonia could be used for Kjeldahl determination of organic N<sup>26</sup>.

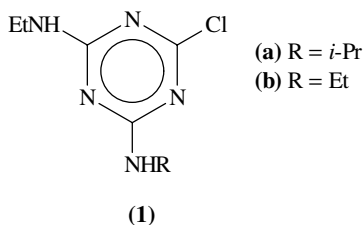
Total nitrogen determinations in barley and malt gave slightly higher results by the Dumas than by the Kjeldahl method. The Dumas method was adopted as the reference method by the Analysis Committee of the Institute of Brewing<sup>27</sup>. Comparison of the results obtained by the Kjeldahl method with those of automatic N analyzers is mentioned in Section III.A.2 above.

Pyrochemiluminescence was adopted by AOAC International, as a method for determination of total N in urine. The reaction of ozone with the products of oxidative pyrolysis is measured with a CLD; average recovery of total N in urine in a collaborative study of twelve laboratories was 99.9% with RSD ranging from 3.66 to 9.57%<sup>28</sup>.

### C. Nitrogen Responsive Detectors for GC

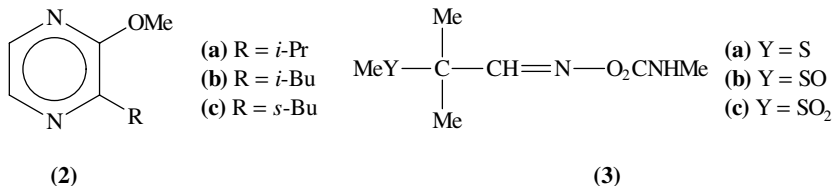
Gas chromatography is ideally suited for identification and determination of individual compounds, but samples with overlapping and coincidental peaks may confuse the analysis. Combinations such as GC-MS or GC-FTIR are now commonplace; however, these instruments may be unwieldy for most routine analyses. In such cases element-specific detectors may be of help, as they greatly simplify complex chromatograms. These detectors have been reviewed<sup>6,29,30</sup> including ones that respond specifically to nitrogen-containing species: Alkali flame ionization detector (AFID)<sup>31–33</sup>, flameless alkali-sensitized detector (FASD)<sup>34–38</sup>, chemiluminescence detector (CLD)<sup>39–42</sup>, electrolytic conductivity detector (ELCD)<sup>43,44</sup> and electron capture detector (ECD)<sup>45–49</sup>. A nitrogen-specific chemiluminescence detector (CLND) is based on total conversion of N to NO, which undergoes a chemiluminescent reaction with ozone. This was applied to the analysis of nitrosamines, pesticide residues, food flavoring compounds, pharmaceuticals and petroleum distillates<sup>50</sup>. A new thermionic ionization chemiluminescence-measuring device is sensitive to S, N and P. In this detector sulfur-containing compounds produce SO and the chemiluminescence produced on mixing this species with O<sub>3</sub> is measured. Independent response channels lead to chromatograms for the S channel and for the NP channel<sup>51</sup>. Recent examples of GC analysis using specific response detectors for N are mentioned also in Sections IV.C and VI.A.

Atrazine (**1a**) was determined in freeze-dried water samples containing simazine (**1b**) by GC combined with a nitrogen-phosphorus detector (NPD). This method and direct rapid-magnetic particle-based enzyme-linked immunosorbed assay (ELISA) gave comparable results at levels between 0.1 to 5  $\mu\text{g/L}$  of water. A clean-up step before ELISA was advantageous<sup>52</sup>. Organophosphorus and nitrogen-containing pesticides,



e.g. simazine (**1b**), in ground and drinking water were determined after concentration by solid-phase extraction (SPE) and elution with an organic solvent. Recovery was 75–90% from 1–2.5 L samples containing 0.1–5  $\mu\text{g/L}$  of analytes. GC-NPD and GC-MS in selected-ion monitoring (SIM) mode were compared, the latter being more sensitive; LOD 0.08–0.60  $\mu\text{g/L}$  vs 0.03–0.13  $\mu\text{g/L}$ , respectively<sup>53</sup>.

2-Methoxy-3-alkylpyrazines (**2**) were determined in carrots by combining a selective stripping method with GC-NPD. Concentrations of **2a** as low as 0.029 ng/g were measured<sup>54</sup>. Traces of aldicarb (**3a**) and its metabolites (**3b–c**) were determined in oranges by extraction with aqueous solvents, partitioning with dichloromethane and a combination of reversed phase (RP) HPLC, using a gradient mobile phase, GC-NPD and GC combined with a flame photometric detector (FPD); LOD 0.4, 0.8 and 0.4 ppb for **3a**, **b** and **c**, respectively<sup>55</sup>.



Nitrogen-containing components of gasoline were determined by simulated distillation (a GC procedure) using a CLND<sup>56</sup>. The effect of SPE was studied on analytical reproducibility in the determination of thirteen drugs by GC-NPD in whole blood. Reproducibility was good as long as limiting factors such as volatility or chromatographic behavior did not interfere<sup>57</sup>. A study was made of the effectiveness of SPE with a C<sub>18</sub> adsorbent for P- and N-containing pesticides, using GC-NPD for the end analysis. Recoveries varied from 0 to 91%, depending on the physicochemical properties of the analyte<sup>58</sup>.

#### D. Stable Isotope Analysis

A comparative study was made between determinations of the <sup>15</sup>N content of plant and soil samples, using the methods of the International Atomic Energy Agency Laboratories, based on MS, a novel automatic N analyzer coupled to a mass spectrometer and a microprocessor-controlled emission spectrometer. Although the latter instrument is fast, its precision may be insufficient to determine <sup>15</sup>N in soil<sup>59</sup>.

Enrichment of the <sup>15</sup>N content has become part of various powerful research techniques. For example, uniform labeling with <sup>15</sup>N was used for sequence-specific assignments and secondary structure determination of certain proteins by NMR<sup>60</sup> and tracing of complicated processes including the increase of DON in soil<sup>61,62</sup>.

An inexpensive piston-action ball mill for the rapid preparation of plant and soil material for automated <sup>15</sup>N and <sup>13</sup>C analysis enables one to process 150 samples per hour to

particle sizes that are at least 50% under 105  $\mu\text{m}$ . This allows a precision better than 1% for the determination of  $^{15}\text{N}$  isotope enrichment in an automated, continuous flow, N and C isotope-ratio mass spectrometer<sup>63</sup>. A method for purification of nanomole quantities of N prior to determination of the isotope ratio was described, based on the absorption of various impurities on calcium oxide and copper at high temperature<sup>64</sup>. Problems arose with ammonia diffusion techniques for concentration of low N-content samples, before  $^{15}\text{N}$  analysis, such as nonquantitative recovery and isotopic fractionation, to which no solutions were found. Therefore, evaluation of the ammonia diffusion technique for representative sample types and use of standard curves are recommended for overcoming such problems<sup>65</sup>.

Some elemental analysis methods involve conversion to  $\text{N}_2$  and a direct method that does not require standards was developed based on the (2,0) band of the second positive system emitted by the  $\text{N}_2$  molecule in a high-frequency discharge. The band heads of  $^{14}\text{N}^{14}\text{N}$  and  $^{14}\text{N}^{15}\text{N}$  molecules were resolved in a monochromator and the peak intensities measured; RSD <4% in the  $^{15}\text{N}$  concentration range of 0.36 to 24%<sup>66</sup>. The precision of these molecular spectroscopy measurements has been limited by the variability of the spectral background. Imaging of the isotopic bandhead region with a diode array allowed making corrections for the spectral background and increasing the analytical precision<sup>67</sup>.

A study was made of the effects of derivatization on the  $^{13}\text{C}$  analysis of amino acid enantiomers. Conventional isotope ratio MS and GC-isotope ratio MS were used. The latter method requires volatilization of the analytes, which was accomplished by introducing *O*-isopropyl and *N*-trifluoroacetyl groups, causing a change in the  $^{13}\text{C}$  analysis of the original analytes. It was proposed to use a set of known standards for such analyses, which are applied in geological studies<sup>68</sup>.

## IV. AMINES

### A. General

Amines, including the amino acids, peptides and proteins, are mentioned in this Section. Tables 1–3 list primary, secondary and tertiary amines of industrial relevance. Compounds

TABLE 1. Examples of environmental, occupational and quality control protocols for industrial primary amines

Compound and CAS registry number <sup>a</sup>	Safety <sup>b</sup>	Spectra <sup>c</sup>	Various protocols <sup>d</sup>
<i>Amino group attached to saturated aliphatic carbon</i>			
1-Adamantanamine [768-94-5]	117D	I(3)409D, N(1)276C	YD1925000, USP
L-Alanine [56-41-7]	83D	I(1)571B	USP
Amikacin <sup>e</sup>			USP
2-Aminoethanol [141-43-5]	1547B	I(3)423D, N(1)291B	KJ5775000
2-(2-Aminoethylamino)ethanol [111-41-1] <sup>f</sup>	168B	I(3)437D, N(1)304C	KJ6300000
1-(2-Aminoethyl)piperazine [140-31-8] <sup>f</sup>	172B	I(3)437D, N(1)330C	TK8050000
2-Amino-2-ethyl-1,3-propanediol [115-70-8]		I(1)348B	
2-Aminoheptane [123-82-0]	177C	I(3)374A, N(1)490C	MQ5425000, USP
6-Aminohexanoic acid [60-32-2]	149B	I(1)578D, N(1)247C	MO6300000, USP

(continued overleaf)

TABLE 1. (continued)

Compound and CAS registry number <sup>a</sup>	Safety <sup>b</sup>	Spectra <sup>c</sup>	Various protocols <sup>d</sup>
2-Amino-2-methyl-1-propanol [124-68-5]	194B	I(3)425D, N(1)294B	UA5950000
1-Amino-2-propanol [78-96-6]	215D	I(3)425A, N(1)293B	UA5775000
Amphetamine sulfate [60-13-9] ( <b>28</b> )			SI1750000, USP
Amphotericin B [1397-89-3]			BU2625000, USP
Ampicillin [69-53-4]	247A		XH8350000, USP
L-Arginine [74-79-3] ( <b>8</b> )	302D	I(1)786A, N(1)658B	CF1934200, USP
Bacampicillin hydrochloride [37661-08-8]			SH8490000, USP
<i>n</i> -Butylamine [109-73-9]	302D	I(3)364D, N(1)239B	EO2975000
<i>s</i> -Butylamine [13952-84-6; 33966-50-6] <sup>g</sup>	615B	I(3)368B, N(1)243A	EO3325000
<i>t</i> -Butylamine [65-64-9]	615C	I(3)369B, N(1)244A	EO3330000
Capreomycin sulfate [1405-37-4] <sup>e</sup>			USP
( <i>R</i> )-(+)-Cycloserine [68-41-7]		I(1)810D, N(1)678C	NY2975000, USP
Cyclohexylamine [108-91-8]	970C	I(3)402A, N(1)270C	GX0700000
L-Cysteine hydrochloride monohydrate [7048-09-6] ( <b>115</b> )	1000C	I(1)592A, N(1)499B	HA2275000, USP
Diethylenetriamine [111-40-0] <sup>e,f</sup>	1207D	I(1)396A, N(1)266B	IE1225000
L-DOPA [59-92-7]		I(2)257B	AY5600000, USP
Dopamine [62-31-7] ( <b>19b</b> )		I(1)1294A, N(1)1098B	UX1092000, USP
Doxorubicin hydrochloride [25316-40-9]	1499A		Q19295900, USP
Ethylamine [75-04-7]	1569C	I(3)364B, N(1)237D	KH2100000
Ethylenediamine [107-15-3] <sup>e</sup>	1604B	I(3)374D, N(1)248A	KH8575000, USP
L-Glutamic acid [56-86-0] ( <b>34b</b> )	1776A	I(1)590A, N(1)497B	LZ9700000
Glycine [56-40-6]	1786D	I(1)563A, N(1)481A	MB7600000, USP
Histamine phosphate [51-74-1] ( <b>6</b> )	1877C		NI5425000, USP
L-Histidine [71-00-1]	1877D	I(2)621D, N(2)493B	MS3070000, USP
L-Isoleucine [73-32-5]	2024A	I(1)575D, N(1)489C	NR4705000, USP
Isopropylamine [75-31-0]	2031B	I(3)368A, N(1)242C	NT8400000
Kanamycin sulfate [133-92-6; 25389-94-0] <sup>e</sup>			NZ3225000, USP
L-Leucine [61-90-5]	2116D	I(1)575B, N(1)489B	OH2850000, USP
L-Lysine monohydrochloride [657-27-2] ( <b>144</b> ) <sup>e</sup>	2172B	I(1)588B, N(1)495B	OL5650000, USP
L-Methionine [63-68-3]	2232D	I(1)594C, N(1)501B	PD0457000, USP
Methylamine [74-89-5]	2283D	I(3)363D	PF6300000
$\alpha$ -Methyl-L-DOPA [41372-08-1]		I(2)258D	AY5950000, USP
Natamycin [7681-93-8]	2838C		TK3325000, USP
( $\pm$ )-Norephedrine hydrochloride [154-41-6] ( <b>79</b> )	2624C	I(1)1273A, N(1)1079D	DN4200000, USP
D-Penicillamine [52-67-5]	2689b	I(1)592C, N(1)500A	YV9425000, USP
DL-Phenylalanine [150-30-1]	2755D	I(2)250C, N(2)248B	
L-Phenylalanine [63-91-2] ( <b>45</b> )	2756B	I(2)251A, N(2)248C	AY7535000, USP
2-Phenylethylamine [64-04-0] ( <b>33</b> )	2741C	I(3)1164C, N(1)1075C	SG8750000
Pimaricin [7681-93-8] <sup>g</sup>	2838C		TK3325000
Primaquine phosphate ( <b>148</b> ) [63-45-6] <sup>f</sup>	2942C	I(2)864B, N(2)741A	VA9660000, USP

TABLE 1. (continued)

Compound and CAS registry number <sup>a</sup>	Safety <sup>b</sup>	Spectra <sup>c</sup>	Various protocols <sup>d</sup>
<i>n</i> -Propylamine [107-10-8]	2961D	I(3)364C, N(1)238D	UH9100000, EPA
L-Serine [56-45-1]	3085C	I(1)580B	USP
Tetraethylenepentamine [112-57-2] <sup>e,f</sup>	3261B	I(3)398D, N(1)268A	KH8585000
D-Thyroxine [51-49-0]	3349C	I(2)254A	USP
L-Thyroxine [51-48-9]	3349B	I(2)254B	YP2833500, USP
Triethylenetetramine [112-24-3] <sup>e,f</sup>	3431D	I(3)498B, N(1)267C	YE6650000
(+)-3,3',5-Triiodo-L-thyronine sodium salt [55-06-1]	3467B	I(2)253D	USP
L-Tyrosine [60-18-4] ( <b>46</b> )	3565B	I(2)255D, N(2)254B	YP2275600, USP
<i>Amino group attached to carbon-carbon double bond</i>			
2-Amino-3-chloro-1, 4-naphthoquinone [2797-51-5] <sup>g</sup>	154C	I(2)81A, N(2)87A	QL7350000
Mitomycin C [50-07-7]	2470B	I(2)1068A	CN0700000, USP
<i>Amino group attached to aromatic carbon</i>			
Acclonifen [74070-46-5] <sup>g</sup>			
Acrisorcin [7527-91-5]			USP
Amiloride hydrochloride [17440-83-4] <sup>e</sup>			USP
2-Aminobenzoic acid [119-92-3]	282B	I(2)189A, N(2)186B	CB2450000
2-Aminobenzoic acid methyl ester [134-20-3] ( <b>165</b> )	2295A	I(3)1371A, N(2)284A	CB3325000
4-Aminobenzoic acid [150-13-0]	138B	I(2)198C, N(2)195B	DG1400000, USP
4-Aminobenzoic acid <i>n</i> -butyl ester [94-25-7]			DG1530000, USP
4-Aminobenzoic acid ethyl ester [94-09-7] ( <b>165</b> )	1571A	I(3)1372B, N(2)287D	DG2450000, USP
4-Aminobiphenyl [92-67-1]	143D	I(3)1157B,	DU8925000, EPA
2-Amino-4-chlorophenol [95-85-2]	789A	I(1)1228A, N(1)1038A	SJ5700000
DL-Aminogluthethimide [125-84-8]	149B	I(2)404A,	MA4026950, USP
4-Aminohippuric acid [61-78-9]		I(2)378B, N(2)355A	USP
1-Aminonaphthalene [134-32-7]	196D	N(1)1058B	QM1400000, EPA
2-Aminonaphthalene [91-59-8]	197A		QM2100000, EPA
2-Aminophenol [95-55-6]	206C	I(3)1115D, N(1)997B	SJ4950000
4-Aminophenol [123-30-8]	207A	I(1)1210B, N(1)1013A	SJ5075000
4-Aminosalicylic acid [65-49-6]	225A	I(2)219C, N(2)215C	VO1225000, USP
Amprolium			USP
Anileridine [144-14-9] <sup>f</sup>			USP
Aniline [62-53-3]	270A	I(3)1109A, N(1)987A	BW6650000, EPA
Asulam [2302-17-2] <sup>g</sup>			
Atrazine [1912-24-9] ( <b>1a</b> ) <sup>e,g</sup>			
Basic fuchsin [569-61-9; 632-99-5] <sup>e</sup>	338C, 339A	I(2)963B, U126, 129	CX9850000, CX9850100, USP
Benzidine [92-87-5] ( <b>32</b> ) <sup>e</sup>			DC9625000, EPA
Chloramben [133-90-4] <sup>g</sup>			
2-Chloroaniline [107-47-8]	732D	I(3)1114C, N(1)995A	BX0525000

(continued overleaf)

TABLE 1. (continued)

Compound and CAS registry number <sup>a</sup>	Safety <sup>b</sup>	Spectra <sup>c</sup>	Various protocols <sup>d</sup>
4-Chloroaniline [107-47-8]	733B	I(3)1126C, N(1)1010A	BX0700000, EPA
3-Chloro-4-fluoroaniline [367-21-5]	782A	I(3)1137A, N(1)1025D	EPA
3-Chloro-4-methylaniline [95-74-9]	797C	I(3)1138C, N(1)1026B	XU5111000, EPA
2-Chloro-4-nitroaniline [121-87-9]	815D	I(3)1365D, N(1)1168D	BX1400000
4-Chloro-2-nitroaniline [89-63-4]	816B	I(3)1211A, N(1)1169A	BX1575000
Dapsone [80-08-0]	212A	I(2)490B, N(2)815C	GA0875000, USP
1,2-Diaminobenzene [95-54-5] <sup>e</sup>	2773A	I(1)1154A, N(1)1045C	SS7875000
1,3-Diaminobenzene [106-50-3] <sup>e</sup>	2773B	I(1)1154D, N(1)1048A	SS7700000
1,4-Diaminobenzene [106-50-3] <sup>e</sup>	2773C	I(1)1242B, N(1)1051B	SS8050000, EPA
2,4-Diaminotoluene [95-80-7] <sup>e</sup>	1059C	I(3)1155B, N(1)1049A	XS9625000, EPA
3,4-Dichloroaniline [95-76-1]	1112C	I(3)1139D, N(1)1029A	BX2625000
3,3'-Dichlorobenzidine [91-94-1] <sup>e</sup>			DD0525000, EPA
2,6-Dichloro-4-nitroaniline [99-30-9] <sup>g</sup>			
2,6-Diethylaniline [579-66-8]	1196C	I(3)1131C, N(1)1019A	BX3500000, EPA
2,4-Dimethylaniline [95-68-1]	1348C	I(3)1135B	ZE8925000
2,6-Dimethylaniline [87-62-7]	1349A	I(3)1131A, N(1)1018C	ZE9275000, EPA
Dinitramine [29091-05-2] <sup>f, g</sup>			
Fluroxypyr [69377-81-7] <sup>g</sup>			
Methotrexate [59-05-2] <sup>e, f</sup>	129C	I(2)896D	MA1225000, USP
2-Methoxy-5-methylaniline [120-71-8]	2252C	I(3)1144A, N(1)1033B	BZ6720000
2-Methylaniline [95-53-4]	3371C	I(3)1112D, N(1)992D	XU2975000, EPA
4-Methylaniline [106-49-0]	3372D	I(3)1121B, N(1)1005B	XU3150000
2-Methyl-5-nitroaniline [99-55-8]	2388C	I(1)1364B, N(1)1167C	XU8225000, EPA
2-Nitroaniline [88-74-4]	2549C	I(3)1185C, N(1)1134D	BY6650000, EPA
3-Nitroaniline [99-09-2]	2550A	I(3)1189B, N(1)1139A	BY6825000, EPA
4-Nitroaniline [100-01-6]	2550C	I(3)1193C, N(1)1144C	BY7000000, EPA
Procainamide hydrochloride [614-39-1] <sup>f</sup>	2942D	I(2)373B, N(2)350C	CV2295000, USP
Procaine hydrochloride [51-05-8] <sup>f</sup>	2943B	I(2)303D, N(2)349D	DG2275000, USP
Sulfadiazine [68-35-9] ( <b>111</b> )	3195A		WP1925000, USP
Sulfamethazine [57-68-1]		I(2)836C	WO9275000, USP
Sulfathiazole [72-14-0]	3322B		WP2360000, USP
Triamterene [396-01-0] <sup>e</sup>	3389C		UO3470000, USP

TABLE 1. (continued)

Compound and CAS registry number <sup>a</sup>	Safety <sup>b</sup>	Spectra <sup>c</sup>	Various protocols <sup>d</sup>
2,4,5-Trichloroaniline [636-30-6]	3407A	I(3)1152B, N(1)1043A	XU8225000, EPA
3-Trifluoromethylaniline [98-16-8]	141A	I(3)1114B, N(1)994B	XU9210000, EPA

<sup>a</sup>Nomenclature may vary from source to source. See also Reference 69.

<sup>b</sup>Entry number in Reference 70.

<sup>c</sup>Codes beginning with I,N and U denote FTIR spectra in Reference 71, NMR spectra in Reference 72 and UVV spectra in Reference 73, respectively.

<sup>d</sup>A code of two letters followed by seven digits is a reference to *Registry of Toxic Effects of Chemical Substances* (RTECS) of National Institute for Occupational Safety and Health/Occupational Safety and Health Administration (NIOSH/OSHA). Standard samples are commercially available for most compounds with reference to protocols of the US Environmental Protection Agency (EPA) and the *US Pharmacopeia* (USP)<sup>74</sup>.

<sup>e</sup>The compound has two or more amino groups of the same type.

<sup>f</sup>The compound has several types of amino groups.

<sup>g</sup>A pesticide, see Reference 75.

TABLE 2. Examples of environmental, occupational and quality control protocols for industrial secondary amines

Compound and CAS registry number <sup>a</sup>	Safety <sup>b</sup>	Spectra <sup>c</sup>	Various protocols <sup>d</sup>
<i>Amino group attached to two saturated aliphatic carbons</i>			
2-(2-Aminoethylamino)ethanol [111-41-1] <sup>f</sup>	168B	I(3)466B, N(1)304C	KJ6300000
1-(2-Aminoethyl)piperazine [140-31-8] <sup>f</sup>	172B	I(3)437D, N(1)330C	TK8050000
Desipramine hydrochloride [58-28-6] <sup>f</sup>			USP
Dicyclohexylamine [101-83-7]	1177C	I(3)402D, N(1)272C	HY4025000
Diethanolamine [111-42-2]	1183D	I(3)431B, N(1)297D	KL2975000
Diethylenetriamine [111-40-0] <sup>f</sup>	1207D	I(1)396A, N(1)266B	IE1225000
Dobutamine hydrochloride [49745-95-1]			USP
(1 <i>R</i> ,2 <i>S</i> )-(-)-Ephedrine [299-42-3] ( <b>30</b> )	1513A	I(1)1277C, N(1)1078C	KB0700000, USP
( <i>R</i> )-(-)-Epinephrine [51-43-4] ( <b>21b</b> )	1518C	I(1)1296A, N(1)1099C	DO2625000, USP
Iminodiacetic acid [142-73-4]	1976A	I(1)564B, N(1)483B	AI2975000
(±)-Isoproterenol hydrochloride [949-36-0] ( <b>21c</b> )	2043D	I(1)1296B, N(1)1099D	DO1930000, USP
(±)-Ketamine hydrochloride [1867-66-9]			GW1400000, USP
Mitomycin C [50-07-7] <sup>f</sup>	2470B	I(2)1068A	CN0700000, USP
Morpholine [110-91-8]	2477C	I(3)472A, N(1)335C	QD6475000
Oxamniquine [21738-42-1] <sup>f</sup>			USP
( <i>R</i> )-(-)-Phenylephrine hydrochloride [61-76-7] ( <b>51</b> )	2776D	I(1)1286A,	DO7525000, USP
Piperazine [57-47-6] <sup>e</sup>	2843D	I(3)463B, N(1)326A	TK7800000, USP
Piperazine dihydrochloride [142-64-3] <sup>e</sup>	2844C		TL4025000
Piperazine hexahydrate [142-63-2] <sup>e</sup>	2844A	I(1)371B, N(1)326B	TM0850000

(continued overleaf)

TABLE 2. (continued)

Compound and CAS registry number <sup>a</sup>	Safety <sup>b</sup>	Spectra <sup>c</sup>	Various protocols <sup>d</sup>
L-Proline [147-85-3]	2946A	I(1)583C	TW3584000, USP
(±)-Propranolol hydrochloride [3506-09-0]	2961A	I(1)1300D, N(1)1104B	UB7526000, USP
(1 <i>S</i> ,2 <i>S</i> )-(+)-Pseudoephedrine hydrochloride [345-78-8] ( <b>180a</b> )	2983D		UL5950000, USP
Sarcosine [107-97-1]	3070A	I(1)570A	VQ2897000
Tetraethylenepentamine [112-57-2] <sup>e,f</sup>	3261B	I(3)398D, N(1)268A	KH8585000
Triethylenetetramine [112-24-3] <sup>e,f</sup>	3431D	I(3)498B, N(1)267C	YE6650000
<i>Amino group attached to one saturated aliphatic carbon and one carbon-carbon double bond</i>			
Flurtamone [96525-23-4] <sup>g</sup>			USP
<i>Amino group attached to one saturated aliphatic carbon and one aromatic carbon</i>			
Benzonate [104-31-4]			USP
Butralin [33629-47-9] <sup>g</sup>			
Chloroquine [54-05-7]			VB2360000, USP
Cyanazine [21725-46-2] <sup>e,g</sup>			UG1490000
Desmetryn [1014-69-3] <sup>e,g</sup>			
Dinitramine [29091-05-2] <sup>f,g</sup>			
Ethoxyquin [91-53-2] <sup>g</sup>			
<i>N</i> -Ethyl- <i>m</i> -toluidine [102-27-2]	1660B	I(3)1117C, N(1)999D	XU6400000
<i>N</i> -Ethyl- <i>o</i> -toluidine [94-68-8]		I(3)1113A	XU6440000
Hydroflumethazide [135-09-1]			USP
Oxamniquine [21738-42-1] <sup>f</sup>			USP
Pendimetalin [40487-42-1] <sup>g</sup>			
Primaquine phosphate [63-45-6] ( <b>148</b> ) <sup>f</sup>	2942C	I(2)864B, N(2)741A	VA9660000, USP
Quinacrine hydrochloride hydrate [6151-30-0] <sup>f</sup>	3020C	I(2)877A, N(2)751D	AR7875000, USP
<i>Amino group attached to one aromatic carbon and one carbon-carbon double bond</i>			
Bromocriptine mesylate [22260-51-1] <sup>f</sup>			KE8250000, USP
Reserpine [50-55-5] <sup>f</sup>	3039C	I(2)1069C, N(2)945A	ZG0350000, USP
Vinblastine sulfate [143-67-9]( <b>102b</b> ) <sup>f</sup>	3598B		YY8400000, USP
<i>Amino group attached to two aromatic carbons</i>			
Amodiaquine [86-42-0] ( <b>146</b> ) <sup>f</sup>			USP
Carbazole [86-74-8]	681B	I(2)679C	FE3150000, EPA
Diphenylamine [122-39-4] <sup>g</sup>			JJ7800000, EPA
Fluazinam [79622-59-6] <sup>g</sup>			

<sup>a</sup>Nomenclature may vary from source to source. See also Reference 69.

<sup>b</sup>Entry number in Reference 70.

<sup>c</sup>Codes beginning with I, N and U denote FTIR spectra in Reference 71, NMR spectra in Reference 72 and UVV spectra in Reference 73, respectively.

<sup>d</sup>A code of two letters followed by seven digits is a reference to RTECS of NIOSH/OSHA. Standard samples are commercially available for compounds with reference to protocols of EPA and USP<sup>74</sup>.

<sup>e</sup>The compound has two or more amino groups of the same type.

<sup>f</sup>The compound has several types of amino groups.

<sup>g</sup>A pesticide, see Reference 75.



TABLE 3. Examples of environmental, occupational and quality control protocols for industrial tertiary amines

Compound and CAS registry number <sup>a</sup>	Safety <sup>b</sup>	Spectra <sup>c</sup>	Various protocols <sup>d</sup>
<i>Amino group attached to three saturated aliphatic carbons</i>			
Acetophenazine maleate [5714-00-1] <sup>e,f</sup>			OB4180000, USP
Alphaprodine hydrochloride [14405-05-1; 49638-24-6]			TN7101000, USP
1-(2-Aminoethyl)piperazine [140-31-8]	172B	I(3)437D, N(1)330C	TK8050000
Aminotriptyline hydrochloride [549-18-8]			USP
Amodiaquine [86-42-0] <b>(146)</b> <sup>f</sup>			USP
Anileridine [144-14-9] <sup>f</sup>			USP
Apomorphine hydrochloride hemihydrate [41372-20-7] <b>(54)</b>			CE0700000, HQ1750000, USP
Atropine sulfate monohydrate [5908-99-6] <b>(159)</b>	320A	I(2)286B, N(2)274B	CK2455000, USP
Azatadine maleate [3978-86-7]			DE8025500, USP
Bensultap [17606-31-4] <sup>g</sup>			
Benztropine mesylate [132-17-2]	277B	I(1)381D	YM3150000, USP
Benzyl dimethylamine [103-83-3]	1357B	I(3)1167D, N(1)1067D	DP4500000
Bromocriptine mesylate [22260-51-1] <sup>f</sup>			KE8250000, USP
Bromodiphenhydramine hydrochloride [1808-12-4]			USP
Bromopheniramine maleate [980-71-2]			US4025000, USP
Bupivacaine hydrochloride [18010-40-7] <b>(11)</b>			TK6060000, USP
Buspirone [33386-08-2; 36505-88-7] <b>(27)</b> <sup>f</sup>			USP
Butorphanol tartrate [58786-99-5]			USP
Cartap [15263-53-3] <sup>g</sup>			
Chlorcyclizine hydrochloride [1620-21-9; 4362-31-3] <sup>e</sup>			TL2200000, USP
Chlorphenoxamine hydrochloride [562-09-4]			KR3155000, USP
Chlorpromazine hydrochloride [69-09-0] <sup>e</sup>	871A		SO1750000, USP
Chlortetracycline hydrochloride [64-72-2] <sup>e</sup>	871B		QI7800000, USP
Clindamycin hydrochloride [21462-39-5]			GF2275000, USP
Clomiphene citrate [50-41-9]			YE0875000, USP
Cocaine [50-36-2] <b>(23a)</b>			YM2800000, USP
Codein [76-57-3]			QD0893000, USP
Cyclizine [82-92-8] <sup>e</sup>			USP
Cyclomethycaine sulfate [50978-10-4]			USP
Cyproheptadine hydrochloride sesquihydrate [41354-29-4]	999C		TM7050000, USP
Dibucaine hydrochloride [61-12-1]	1095C		GD3325000, USP

(continued overleaf)

TABLE 3. (continued)

Compound and CAS registry number <sup>a</sup>	Safety <sup>b</sup>	Spectra <sup>c</sup>	Various protocols <sup>d</sup>
2-( <i>N,N</i> -Diethylamino)ethanol [100-37-8]	1208D	I(3)432B, N(1)299B	KK5075000
Diethylenetriaminepentaacetic acid [67-43-6] <sup>e</sup>	1208A	I(1)543C	MB8205000
Diphenhydramine hydrochloride [147-24-0]	1450A		KR7000000, USP
Diphenylpyraline hydrochloride [132-18-3]	1461A		TM7823600, USP
Dodemorph [1593-77-7] <sup>g</sup>			
Erythromycin [114-07-8]		I(1)703B	KF4375000, USP
Ethopropazine hydrochloride [1094-08-2] <sup>f</sup>	1551B		SO5002000, USP
Ethylenediaminetetraacetic acid [60-00-4] <sup>e</sup>			AH4025000, USP
Ethylenediaminetetraacetic acid, calcium disodium salt hydrate [23411-34-9] <sup>e</sup>	1605D		EV7700000, USP
Fenpropidin [67306-00-7] <sup>g</sup>			
Fenpropimorph [67564-91-4] <sup>g</sup>			
Flupropadin [81613-59-4] <sup>g</sup>			
Haloperidol [52-86-8]			EU1575000, USP
Hexamethylenetetramine [100-97-0] <sup>e</sup>	1852B	I(2)471D, N(2)332D	MN4725000, USP
<i>D,L</i> -Homatropine hydrobromide [51-56-9]	1882B	I(2)286A, N(2)274C	YM5602000, USP
Morphine sulfate [64-31-3] ( <b>55</b> )			QC8750000, USP
Naloxone hydrochloride dihydrate [51481-60-8]			QD2275000, USP
( <i>S</i> )-(-)-Nicotine [54-11-5] <sup>g</sup>	2541A	I(3)1537B, N(2)647B	QS5250000
Noscapine [128-62-1]			RD2625000, USP
Pargyline hydrochloride [306-07-0]	2423C	I(2)948C, N(2)964A	DP6650000, USP
Physostigmine [57-47-6] <sup>f</sup>	1533B	I(2)1065C, N(2)392D	TJ2100000, USP
Procainamide hydrochloride [614-39-1] <sup>f</sup>	2942D	I(2)373B, N(2)350C	CV2295000, USP
Procaine hydrochloride [51-05-8] <sup>f</sup>	2943B	I(2)303D, N(2)349D	DG2275000, USP
Promethazine hydrochloride [58-33-3] <sup>f</sup>	2948C		SO8225000, USP
Propamocarb hydrochloride [25606-41-1] <sup>g</sup>			
Quinacrine hydrochloride hydrate [6151-30-0] <sup>f</sup>	3020C	I(2)877A, N(2)751D	AR7875000, USP
Quinidine sulfate [6591-63-5]	3023A	I(2)866A,	VA6950000, USP
Quinine sulfate [6119-70-6] ( <b>160</b> )	3023D	I(2)865C,	VA8440000, USP
Reserpine [50-55-5]	3039C	I(2)1069C, N(2)945A	ZG0350000, USP
Scopolamine hydrobromide [114-49-8]	3073B	I(2)286C, N(2)274D	YM4550000, USP
Strychnine [57-29-9] <sup>g</sup>	3180C	I(2)1066B, N(2)942D	WL2275000
Tetracycline hydrochloride [64-75-5]	3252B	I(2)421C	QI9100000, USP
Thioridazine hydrochloride [130-61-0] <sup>f</sup>	3337C	I(1)1316D	SP2275000, USP

TABLE 3. (continued)

Compound and CAS registry number <sup>a</sup>	Safety <sup>b</sup>	Spectra <sup>c</sup>	Various protocols <sup>d</sup>
Tridemorph [81412-43-3] <sup>g</sup>			
Triethanolamine [102-71-6]	3426B	I(3)434C, N(1)301D	KL9275000
Tubocurarine chloride pentahydrate [41354-45-4] ( <b>205</b> ) <sup>f</sup>	3556D		YO5100000, USP
Vinblastine sulfate [143-67-9] ( <b>102b</b> ) <sup>e,f</sup>	3598B		YY8400000, USP
<i>Amino group attached to one carbon-carbon double bond and two saturated aliphatic carbons</i>			
Mitomycin C [50-07-7] <sup>f</sup>	2470B	I(2)1068A	CN0700000, USP
<i>Amino group attached to two carbon-carbon double bonds and one saturated aliphatic carbon</i>			
Propyliodone [587-61-1]			USP
<i>Amino group attached to one aromatic carbon, one carbon-carbon double bond and one saturated aliphatic carbon</i>			
Nalidixic acid [389-08-2]	2485D	I(2)889B, N(2)763B	QN2885000, USP
Oxolinic acid [14698-29-4] <sup>g</sup>			J15075000
<i>Amino group attached to one aromatic carbon and two carbon-carbon double bonds</i>			
Pyrvinium pamoate [3546-41-6] <sup>f</sup>	3018C	I(2)873C	VC3543500, USP
<i>Amino group attached to one aromatic carbon and two saturated aliphatic carbons</i>			
Ametrin [834-12-8] <sup>e,g</sup>			EPA
Benfluralin [1861-40-1] <sup>g</sup>			EPA
Buspirone [33386-08-2; 36505-88-7] ( <b>27</b> ) <sup>f</sup>			USP
Crystal violet [548-62-9] <sup>e</sup>	929B	I(2)1029D, U239	BO9000000, USP
<i>N,N</i> -Diethylaniline [91-66-7]	1196B	I(3)1111C, N(1)991B	BX3400000
3-(Dimethylamino)phenol [99-07-0]	1341D	I(3)1120C, N(1)1004B	SL1050000, USP
<i>N,N</i> -Dimethylaniline [121-69-7]	1347D	I(3)1111A, N(1)990D	BX4725000, EPA
Dipyridamole [58-32-2] <sup>e</sup>	1472B		KK7450000, USP
Ethalfuralin [55283-68-6] <sup>g</sup>			EPA
Isopropalin [33820-53-0] <sup>g</sup>			EPA
Methotrexate [59-05-2] <sup>f</sup>	129C	I(2)896D	MA1225000, USP
Methylene blue [7220-79-3] <sup>e</sup>	2344C	I(2)887D, U448	SO5600000, USP
Methyl yellow [60-11-7]	2464D	U472	BX7350000, USP
Oryzalin [19044-88-3] <sup>g</sup>			
Physostigmine [57-47-6] <sup>f</sup>	1533B	I(2)1065C, N(2)392D	TJ2100000, USP
Profluralin [26399-36-0] <sup>g</sup>			EPA
Propachlor [1918-16-7] <sup>g</sup>			
Pyrvinium pamoate [3546-41-6] <sup>f</sup>	3018C	I(2)873C	VC3543500, USP
Vinblastine sulfate [143-67-9] ( <b>102b</b> ) <sup>f</sup>	3598B		YY8400000, USP
<i>Amino group attached to two aromatic carbons and one saturated aliphatic carbon</i>			
Acetophenazine maleate [5714-00-1] <sup>f</sup>			OB4180000, USP
Antazoline phosphate			USP
Bromethaline [63333-35-7] <sup>g</sup>			
Desipramine hydrochloride [58-28-6] <sup>f</sup>			USP
Ethopropazine hydrochloride [1094-08-2] <sup>f</sup>	1551B		SO5002000, USP

(continued overleaf)

TABLE 3. (continued)

Compound and CAS registry number <sup>a</sup>	Safety <sup>b</sup>	Spectra <sup>c</sup>	Various protocols <sup>d</sup>
Promethazine hydrochloride [58-33-3] <sup>f</sup>	2948C		SO8225000, USP
Thioridazine hydrochloride [130-61-0] <sup>f</sup>	3337C	I(1)1316D	SP2275000, USP

<sup>a</sup>Nomenclature may vary from source to source. See also Reference 69.

<sup>b</sup>Entry number in Reference 70.

<sup>c</sup>Codes beginning with I, N and U denote FTIR spectra in Reference 71, NMR spectra in Reference 72 and UVV spectra in Reference 73, respectively.

<sup>d</sup>A code of two letters followed by seven digits is a reference to RTECS of NIOSH/OSHA. Standard samples are commercially available for compounds with reference to protocols of EPA and USP<sup>74</sup>.

<sup>e</sup>The compound has two or more amino groups of the same type.

<sup>f</sup>The compound has several types of amino groups.

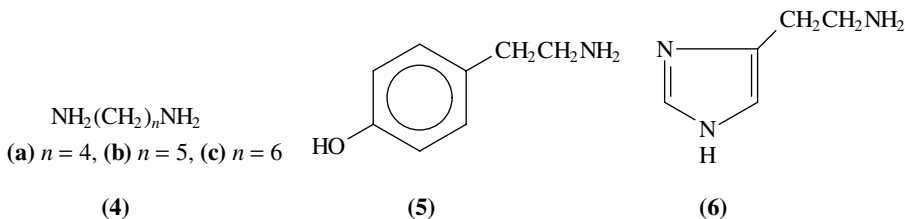
<sup>g</sup>A pesticide, see Reference 75.

containing the amino group are important intermediates in the manufacture of organic chemicals. Many of the pharmaceuticals listed in these tables stem from biological systems, possibly with some minor chemical modification. Some amines, including amino acids, are also traced in environmental samples to assess ecologic interaction of living organisms and pollution by industrial chemicals.

Nanomolar concentrations of low molecular weight amines and organic acids dissolved in seawater can be preconcentrated up to 1000-fold by diffusion across hydrophobic membranes and collecting in HCl or NaOH solutions, respectively. Of a set of 25 amines investigated, excepting pyrrole, all showed practically quantitative trapping efficiency<sup>76</sup>.

A comparative study was carried out between diffusive (passive) and pumping (active) sampling of airborne contaminants, including factors such as retention volumes, uptake rate, concentration, recovery by thermal desorption and sampling efficiency. Diffusive sampling gave precise and accurate results according to NIOSH standards ( $\pm 25\%$  accuracy), and the method is sensitive enough to measure benzene, aniline and nitrobenzene at concentrations as low as 0.1 mg/m<sup>3</sup>. Diffusive sampling has practical advantages and is cost effective<sup>77</sup>.

Interlaboratory studies were carried out on the precision characteristics of the analytical methods used for determination of certain biogenic amines in fish and fish products, as required by German law. These included putrescine (**4a**), cadaverine (**4b**), tyramine (**5**) and histamine (**6**)<sup>78</sup>.



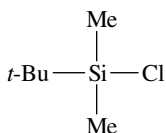
## B. Isotope Analysis

In Section III.D various methods were mentioned for determination of the  $^{15}\text{N}$  to  $^{14}\text{N}$  isotope ratio. Some applications to amines that appeared in the recent literature are presented here. Isotope dilution with a known aliquot of labelled compound allows solving some of the problems related to nonquantitative recovery yields of analyte in the analytical processing of a sample. However, the possibility of isotopic fractionation has to be taken into consideration.

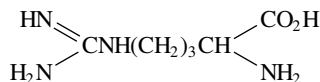
Isotopic analysis of amino acids containing natural abundance levels of  $^{15}\text{N}$  was performed by derivatization, GC separation, on-line combustion and direct analysis of the combustion products by isotope-ratio MS. The  $\text{N}_2$  gas showed RSD better than 0.1‰ for samples larger than 400 pmol and better than 0.5‰ for samples larger than 25 pmol. After on-column injection of 2 nmol of each amino acid and delivery of 20% of the combustion products to the mass spectrometer, accuracy was 0.04‰ and RSD 0.23‰<sup>79</sup>.

Nitrogen uptake studies in plants can be made based on  $^{15}\text{N}$  labelling, taking advantage of developments in MS and automated on-line separation.  $^{15}\text{N}$  can be precisely analyzed in samples of plant extract containing as little as 5–50  $\mu\text{g}$  of N, with isotope enrichment close to the natural abundance level, and then be ascribed to N pools in the plant, such as nitrate, amino acids and soluble protein<sup>80</sup>. Individual amino acids can be determined out of mixtures in the natural  $^{13}\text{C}$  abundance range by addition of  $^{13}\text{C}$ -labelled amino acid, derivatization to the *N*-acetyl propyl ester, GC separation, combustion and determination of  $\Delta^{13}\text{C}$ . Up to nine amino acids could be determined in 200  $\mu\text{g}$  of a mixture. The global  $\Delta^{13}\text{C}$  of casein calculated from individual amino acids differed by less than 1.5‰ from the directly determined value<sup>81</sup>.

Characteristic line pairs of the following isotopically enriched amino acids were investigated by MS-SIM: [ $\alpha$ - $^{15}\text{N}$ ] and [ $\epsilon$ - $^{15}\text{N}$ ]lysine, [ $1$ - $^{13}\text{C}$ ] and [ $^{15}\text{N}$ ]alanine and leucine, and [ $1$ - $^{13}\text{C}$ ], [ $2$ - $^{13}\text{C}$ ], [ $3$ - $^{13}\text{C}$ ] and [ $4$ - $^{13}\text{C}$ ]aspartic acid. Enrichments from 0.14 to 36% were determined with high precision<sup>82</sup>. A method of high precision and accuracy for determining  $^{15}\text{N}$  enrichment of eighteen common plasma amino acids and urea was proposed, based on derivatization with *t*-butyldimethylsilyl chloride (**7**) followed by a single GC analysis combined with electron impact (EI) MS-SIM detection. The monitored ions contained all the N atoms of the original compounds, except for arginine (**8**) that lost one of the guanidino nitrogens. The method was applied to human metabolism studies<sup>83</sup>.



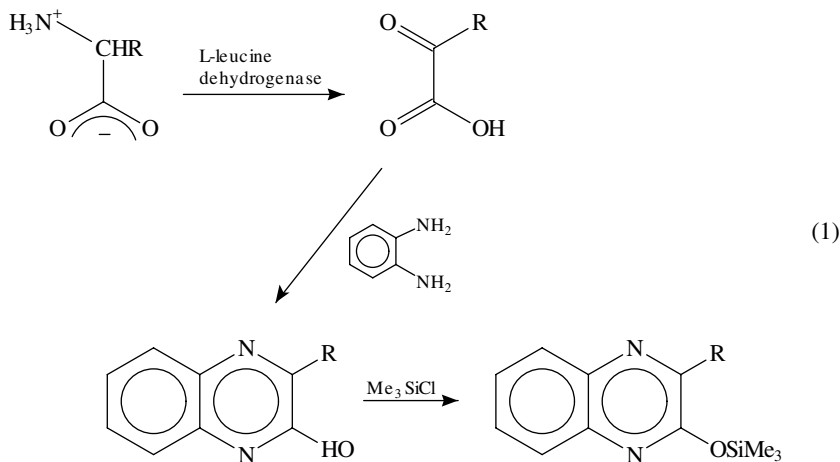
(7)



(8)

A sensitive method for determination of branched-chain L-amino acids is based on labelling individual species with  $^{13}\text{C}$  or  $^2\text{H}$ , isolating the amino acid by IEC and applying the derivatization scheme depicted in reaction 1. The L-amino acid is converted

enzymatically to the corresponding  $\alpha$ -keto acid which, on reaction with *o*-phenylenediamine, yields a branched chain quinoxalinol. After SPE and *O*-trimethylsilylation the isotope enrichment is determined by GC using chemical ionization (CI) MS-SIM with ammonia and monitoring the  $[MH]^+$  and  $[MH + 1]^+$  ions<sup>84</sup>.



Determination of the  $^{15}\text{NH}_4^+:(^{15}\text{NH}_4^+ + ^{14}\text{NH}_4^+)$  ratio in samples enriched with  $^{15}\text{NH}_4^+$  can be performed by IEC with post-column derivatization according to reaction 7 (Section IV.D.3.a) and fluorescence measurement. The working principle is based on the slightly longer (1.2%) retention time of  $^{15}\text{NH}_4^+$ . This is insufficient for peak resolution, but causes a slight retardation to the emergence of the peak maximum, that can be correlated with the concentration of the heavier isotope in the 25–75% range<sup>85</sup>.

The problem of indigeneity assessment of organic matter in fossils can be solved by determining  $\Delta^{13}\text{C}$  and  $\Delta^{15}\text{N}$  for the enantiomers of each amino acid. These values should be the same for all amino acids in the fossil sample in indigenous organic matter, while a divergence points to contamination of the sample. The technique involves LC-MS for  $\Delta^{15}\text{N}$ , combustion of the eluted amino acids and determination of the  $^{13}\text{C}$  content<sup>86</sup>. See also Section IV.D.5.

GC-MS analysis of the organic matter in hot water extracts from the Murchinson meteorite showed substantial enrichment of the heavier isotopes of the 'organic' elements over the terrestrial values:  $\Delta^2\text{H} +1221\%$ ,  $\Delta^{13}\text{C} +22\%$  and  $\Delta^{15}\text{N} +93\%$ . However, a lower value was found for ammonia —  $\Delta^{15}\text{N} +69\%$ . The total amino acids separated from the extracts had  $\Delta^{15}\text{N} +94\%$ . The  $\Delta^{15}\text{N}$  values of the soluble organic compounds found in the meteorite are consistent with their formation, or formation of their precursors, by interstellar chemistry<sup>87,88</sup>.

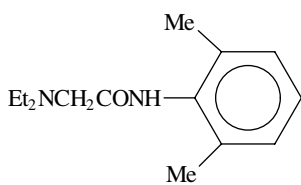
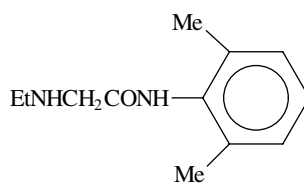
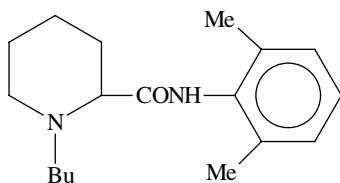
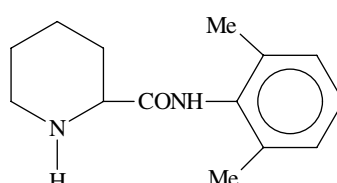
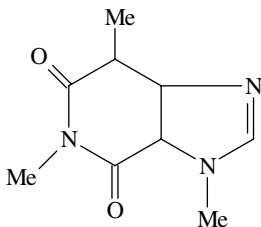
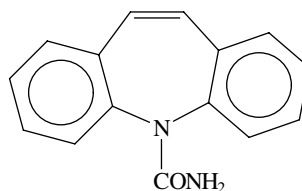
### C. Gas Chromatography

Innumerable applications of chromatographic methods to the analysis of amines appeared in the recent literature concerning biogenic amines, drugs and their metabolites, pesticides and industrial intermediates; however, due to the nonvolatile nature of many amines, application of the LC methods in Section IV.D became preponderant.

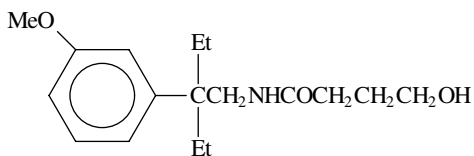
In Section III.C various detectors were mentioned that respond selectively to nitrogen-containing compounds; some applications to amines follow. A nonlinear calibration curve

for the NPD was proposed as to be more suitable than a linear one, when this detector is applied to the GC determination of amino acids<sup>89</sup>.

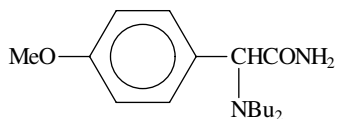
A collaborative validation study of EPA method 507 was conducted for the GC-NPD analysis of traces of forty-five pesticides containing N and P in reagent water and finished drinking waters. The results were processed with an EPA computer program to assess recovery, precision and effect of the water type. Method 507 was found to be acceptable for the tested analytes, except for merphos, that decomposed in the injection port of the gas chromatograph. Several pesticides exhibited statistically significant matrix effects for finished drinking water<sup>90</sup>. Lidocaine (**9**) and bupivacaine (**11**) and their main metabolites resulting from dealkylation of the amino group (**10** and **12**) in plasma were determined by liquid-liquid extraction (LLE) followed by GC-NPD, using a capillary column; LOD was as low as 15  $\mu\text{g/L}$  for the four compounds studied. Simultaneous ingestion of caffeine (**13**) or carbamazepine (**14**) interfered with the determination of **10** and **12**, respectively<sup>91</sup>.

**(9)****(10)****(11)****(12)****(13)****(14)**

Embutramide (**15**), a general anesthetic, was determined in biological matrices after extraction and GC-NPD, using ambucetamide (**16**) as internal standard; LOD 40  $\mu\text{g/L}$ , linearity from 0.1 to 3 ppm, with recovery of about 80% from blood of dogs that underwent euthanasia with formulation T61<sup>92</sup>.

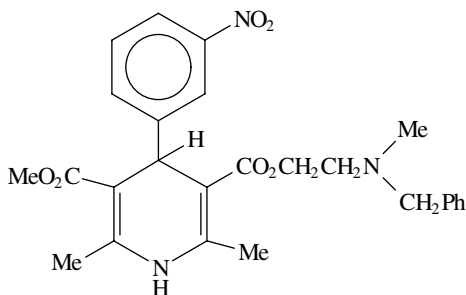


(15)



(16)

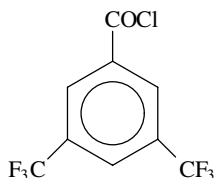
The calcium antagonist nicardipine (**17**) and its pyridine metabolite M-5 were determined in plasma after LLE and concentration. End analysis was by capillary GC-NPD with temperature gradient; LOD 0.5  $\mu\text{g/L}$  for both compounds<sup>93</sup>. See also reaction 27 in Section IV.H for electrochemical processes undergone by similar compounds.



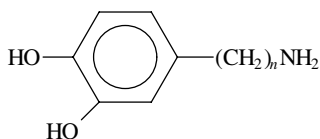
(17)

The sensitivity of FID and ECD toward perfluoroacyl derivatives of amino, hydroxy and mercapto compounds was investigated. Thus, the FID signal of the perfluorovaleryl derivative of a compound increased with the size of the alkyl substituent, but was reduced as compared with the signal of an analogous hydrocarbon. The sensitivity of ECD toward the derivatives varied within two orders of magnitude, depending on the size of the alkyl substituents<sup>94</sup>.

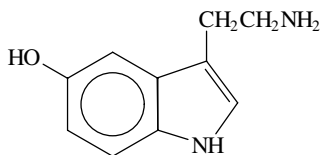
Determination of biogenic amines in aqueous medium was based on a scheme consisting of derivatization with 3,5-bis(trifluoromethyl)benzoyl chloride (**18**), LLE, hydrolysis of phenolic esters present in the extract, silylation of the free hydroxy groups and GC combined with negative ion chemical ionization (NICI) MS. It happened that the molecular ion carried more than 60% of the ionic current, making the method highly specific, with potential LOD below the picogram level. This method revealed that the principal amines in bovine retina are dopamine (**19b**), tyramine (**5**) and serotonin (**20**)<sup>95</sup>, and in the



(18)

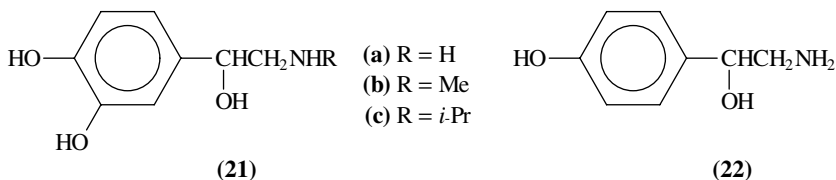
(a)  $n = 1$ , (b)  $n = 2$ 

(19)



(20)

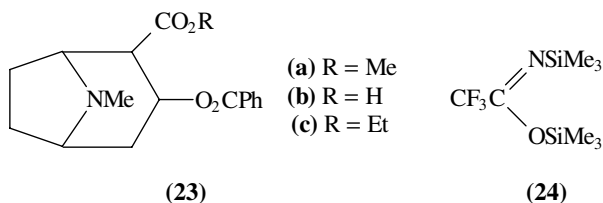




thoracic nervous system of a locust species are the same ones in addition to norepinephrine (**21a**) and octopamine (**22**)<sup>96</sup>.

The presence of hexamethylenediamine (**4c**) in hydrolyzed human urine is indicative of exposure to hexamethylene diisocyanate. The diamine was determined after derivatization with heptafluorobutyric anhydride followed by GC-CI-MS, using ammonia as the ionizing reagent and deuterated hexamethylenediamine as internal standard; LOD 0.5  $\mu\text{g/L}$  urine<sup>97</sup>.

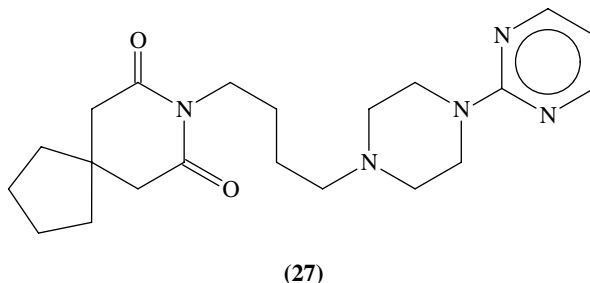
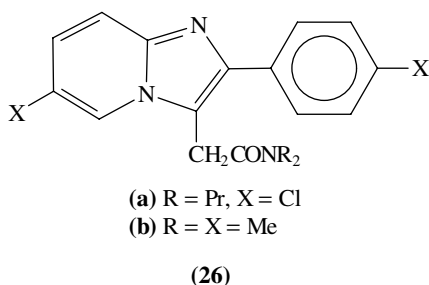
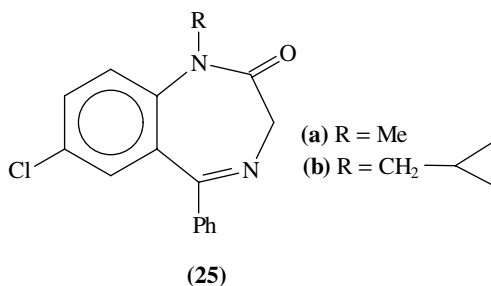
A screening program was proposed for the analysis of cocaine (**23a**) and its metabolite benzoyl ecgonine (**23b**) in the meconium of newborn infants, of mothers suspect of cocaine use during pregnancy. The method consists of SPE from a methanolic extract of the meconium, silylation of **23b** with *N,O*-bis(trimethylsilyl)trifluoroacetamide (**24**) and analysis by GC-MS. The method was sensitive to less than 0.25 ppm of **23a** and 0.5 ppm of **23b** in the meconium, and is preferable for screening to the more involved fluorescence polarization immunoassay determination of these compounds<sup>98</sup>. See also the beginning of Section IV.D.2 for an alternative analysis of cocaine.



Attention should be paid to the appearance of spurious peaks in the fragmentation patterns of amines determined by GC-MS, when the analytes came into contact with methanol or ethanol as solvents. Thus, for example, Schiff bases may be formed on condensation of a primary amine with traces of formaldehyde or acetaldehyde present in the solvent. Although the peaks of such product may be unresolved in the chromatogram, they may appear as ions with mass increments of +12 or +26 in the mass spectrogram, complicating the identification of the analyte, as was the case with some amphetamine drugs<sup>99</sup>.

Simultaneous screening and determination of benzodiazepines (e.g. diazepam, **25a**) and other anxiolytic drugs in plasma were carried out on 1 mL samples by SPE onto a C<sub>8</sub> RP-sorbent, reextraction with AcOH/MeOH and GC-NPD-ECD analysis with twin columns, using prazepam (**25b**) as internal standard. Application of SPE instead of the usual LLE proved to be of advantage in the case of imidazopyridine drugs (e.g. alpidem—**26a** and zolpidem—**26b**). The LOQ of the method allowed toxicological and pharmacological determinations, except for buspirone (**27**) that allowed determinations only at toxic blood levels<sup>100</sup>.

Volatile amines from C<sub>1</sub> to C<sub>6</sub> and ammonia were separated on a PoraPLOT column, with or without a temperature gradient, depending on volatility. The method is applicable to determination of the purity of manufactured amines. Trace analysis of these amines can be performed by capillary GC-FID and of ammonia by GC-ELCD<sup>101</sup>.

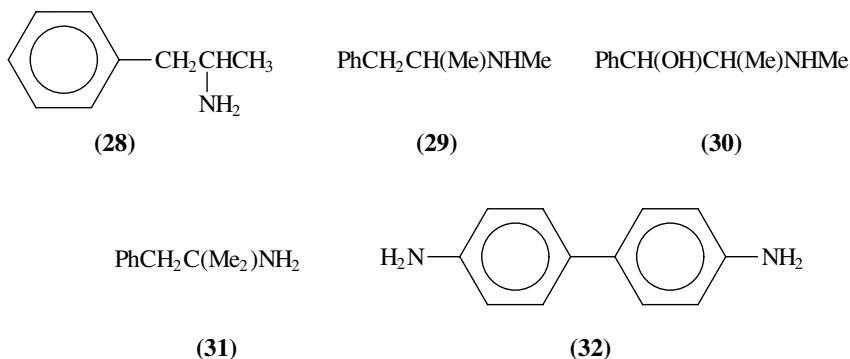


Determination of the lower tertiary aliphatic amines in environmental samples, such as river water and bottom sediments, may be performed easily and with good selectivity by distillation of the amines followed by headspace GC-MS; LOD in  $\mu\text{g/L}$  for 40 mL samples were 1.25 for Me<sub>3</sub>N, 0.25 for Et<sub>3</sub>N, 0.125 for AlI<sub>3</sub>N, 0.25 for Pr<sub>3</sub>N and 0.125 for Bu<sub>3</sub>N, with recovery over 70% and standard deviation of the recoveries below 12% ( $n = 5$ )<sup>102</sup>. A method for determination of volatile methylamines in urine, proposed as an aid for detection of the fish odor syndrome, is based on headspace GC analysis<sup>103</sup>. Volatile amines dissolved in water or sediments were determined by preconcentration in a Cavett diffusion flask, by adding strong alkali and cyclopropylamine as internal standard to the water or the solution in the pores of the sediment. The evolved amines were collected in a small volume of HCl. After neutralizing the acid, the amines were determined by GC-NPD, using cyclobutylamine as internal standard; LOD 7.3, 54.0 and 703 ng/L of MeNH<sub>2</sub>, Me<sub>2</sub>NH and Me<sub>3</sub>N, respectively, for 5  $\mu\text{L}$  injection; linear range  $1 \times 10^{-6}$  to  $7 \times 10^{-4}$  M<sup>104</sup>.

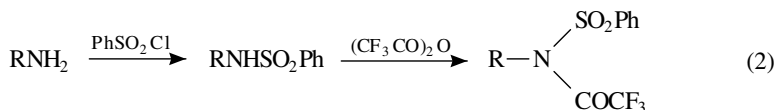
Acetic anhydride is a useful GC pre-column derivatizing reagent for amines, phenols and alcohols. In the presence of aqueous base only amines and phenols are derivatized, but

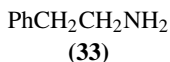
under anhydrous conditions also alcohols undergo acetylation. The acetylated derivatives are useful for GC and GC-MS analysis of biogenic amines, antidepressants, antipsychotics and some of their metabolites<sup>105</sup>.

A comparison was made between variations of the full scan GC ion-trap MS method for detection of amphetamine (**28**) and similar drugs in urine. Thus, the fragmentation patterns obtained by methane-CI-MS of underivatized methamphetamine (**29**), ephedrine (**30**), pseudoephedrine (**30**) and phentermine (**31**) have more characteristic peaks that help making positive identifications, than those obtained by EI-MS of the *N*-(heptafluorobutyl) or *N*-( $\gamma$ -(ethoxycarbonyl)hexafluorobutyl) derivatives; LOD 2.4 and 2.6  $\mu\text{g/L}$  of **28** and **29** for CI-MS vs 0.7 and 1.4  $\mu\text{g/L}$  for EI-MS, respectively; also LOQ are slightly higher for CI-MS than EI-MS<sup>106</sup>. A polymeric reagent was proposed for derivatizing primary and secondary amines, consisting of a polystyrene matrix with attached pentafluorobenzoyl groups via anhydride moieties. Analysis of amines at picogram levels was by capillary GC with thermionic specific detection (TSD) on N mode or ECD<sup>107</sup> or with NICI-MS-SIM; LOD 1  $\mu\text{g}$  BuNH<sub>2</sub>/L for 2  $\mu\text{L}$  injection, with linearity in the 5–250  $\mu\text{g/L}$  range<sup>108</sup>. Detection of benzidine (**32**) and its conjugates in urine can be performed after hydrolysis of the conjugates, LLE, adding benzidine-*d*<sub>8</sub> as internal standard, derivatizing with pentafluoropropionic anhydride and end analysis by GC-NICI-MS-SIM; LOD 0.5  $\mu\text{g/L}$  urine; linearity between 2 and 200  $\mu\text{g/L}$ . This test was applied for toxicological monitoring of workers in polyurethane manufacture<sup>109</sup>.

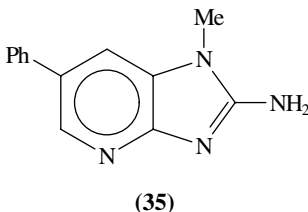
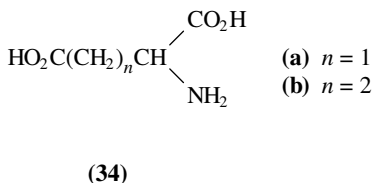


A sensitive method for primary amines is shown in reaction 2, leading to the corresponding *N*-benzenesulfonyl-*N*-trifluoroacetyl derivatives. These can be determined by GC-ECD using SE-30 columns; LOD 1–5 pg, which is about 200 times more sensitive than GC-FID. The method was applied for determination of phenethylamine (**33**) in urine<sup>110</sup>. This analysis was performed also by LLE into *n*-pentane, derivatization to the benzenesulfonamide and GC-FPD using a capillary column; recoveries of aliphatic primary amines in urine were 91–107%, RSD 0.2–4.5%<sup>111,112</sup>. Amines in environmental waters and sediments were determined after LLE with dichloromethane, derivatization with benzenesulfonyl chloride and GC-SIM-MS; LOD 0.02–2  $\mu\text{g/L}$  of water and 0.5–50 ng/g of sediment<sup>113</sup>.



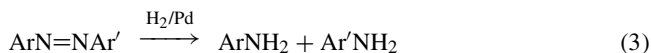


More extensive derivatization schemes than reaction 2 are necessary for GC analysis of amino acids. A method was proposed for detection of amino acids and dipeptides at the femtomol level. After LLE the analytes were *N*-alkylated with pentafluorobenzyl bromide, *N*-acylated with heptafluorobutyric anhydride and esterified with *N,O*-bis(trimethylsilyl)trifluoroacetamide (24). Of the twenty amino acids studied, only glutamic acid (34b) and arginine (8) could not be detected by this scheme. Dipeptides with neutral side groups were more easy to derivatize. End analysis was by GC-NICI-MS. Recoveries of phenylalanine, lysine and threonine were 76, 55 and 34% respectively; LOD was less than 150 fg for MS-SIM at signal-to-noise ratio (SNR) 80. The method was applied to urine samples<sup>114</sup>. A sensitive and specific method for detecting the carcinogen 2-amino-1-methyl-6-phenylimidazo[4,5,*b*]pyridine (35) adducted to DNA in living tissues consists of alkaline hydrolysis of the tissue, LLE, production of the bis(pentafluorobenzyl) derivative and GC-MS combined with ECD; LOD 0.03 fmol of 35/ $\mu\text{g}$  DNA (1 adduct/ $10^8$  nucleotides). Evidence for the adduct was found in samples of human colon but not of human pancreas or urinary bladder<sup>115</sup>.



Amines, aminoalcohols and amino acids in aqueous medium can be derivatized before GC analysis by treatment with alkyl chloroformates<sup>116</sup>. A method proposed for protein amino acids uses ethyl chloroformate which, under optimal conditions, reacts within a few seconds with all the reactive moieties of the molecule. Amino acid GC analysis is finished within five minutes in a capillary column, including pre-column derivatization time. Arginine (8) fails to react to completion and is not eluted from the column<sup>117,118</sup>. Of the alkyl chloroformates investigated for derivatization of amino acids, isobutyl chloroformate gave the most sensitive derivatives for determination by GC-FID and GC-MS<sup>119</sup>. A procedure proposed for protein and nonprotein amino acids consists of pre-column isobutyloxycarbonylation of amino, alcohol and mercapto groups with isobutyl chloroformate, SPE, producing the *t*-butyldimethylsilyl ester with *t*-butylchlorodimethylsilane (7) and end analysis by GC-MS. Temperature-programmed retention indexes for DB-5 and DB-17 capillary columns were determined. The method was applied to determination of amino acids in almond, walnut and sunflower seeds<sup>120</sup>. The analytical and synthetic applications of reagent 7 were reviewed<sup>121,122</sup>.

Azo dyes extracted from waste sludges can be identified by GC-MS after  $\text{H}_2/\text{Pd}$  cleavage to aromatic amines according to reaction 3, in a microreactor mounted on the injector<sup>123</sup>.



The offensive odor emitted by fish meal processing plants is due mainly to aliphatic amines. The degree of environmental damage can be measured from a correlation between

an odor organoleptic test and the results of GC fitted with a semiconductor sensor, with trimethylamine serving as reference compound<sup>124</sup>.

A combination of column adsorption chromatography on basic alumina and GC of the eluate served for characterization of the trace fraction of nitrogen-containing compounds in hydroprocessed naphtha. These were subdivided into groups of four types, namely pyridines, pyrroles (the most abundant), anilines and indoles<sup>125</sup>.

## D. Liquid Chromatography

### 1. General

Intense research activity is taking place at all times on LC separation of biologically active amines in general and amino acids in particular. All aspects of the analytical problem are focused in these studies, such as sampling, nature of sample, pre- and post-column treatment with well established and new reagents, separating phases, carrying liquids and their composition gradients, and detection methods.

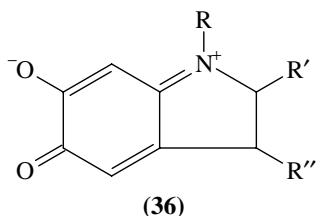
Various important LC methods for amino acid, peptide and protein analysis were reviewed and evaluated<sup>126,127</sup>. A review of HPLC methods for the analysis of selected biogenic amines in foods appeared, including methods for extraction and for elimination of interfering compounds<sup>128</sup>.

A study comprising five laboratories was carried out on the accuracy and precision of protein amino acid analysis. An important conclusion reached was that it is necessary to examine both accuracy and precision to achieve maximum improvement in either<sup>129</sup>. A commercially available single-cell protein, Pruteen, was proposed as reference material for the determination of amino acids and other substances in food. This recommendation was the result of a five-year-long study on the stability of this particular protein<sup>130</sup>.

Some recovery problems encountered during hydrolytic extraction of amino acids from environmental samples were discussed. A way was proposed for compensating for differential losses of neutral, acidic and basic amino acids, consisting of adding various nonprotein amino acids before the hydrolysis, that act as charge-matched recovery standards<sup>131</sup>.

The stability under long-term storage of biogenic amines dissolved in Krebs-Ringer-Henleit saline solution, usually employed for studying the release of such compounds, was examined by LC with electrochemical detection, with 3,4-dihydroxybenzylamine (**19a**) serving as reference compound. Although every amine shows a peculiar behavior, all are affected by temperature, pH of the solution and length of storage. Catecholamines such as dopamine (**19b**), epinephrine (**21b**) and norepinephrine (**21a**) were stable for weeks in acidic solution under refrigeration, while indolamines such as serotonin (**20**) underwent fast degradation under the same conditions. At room temperature and pH 7.81, marked reductions in the concentration of the catecholamines were observed, but not of serotonin. Under freezing, at pH 1.96, the catecholamines remained intact and serotonin disappeared after two weeks<sup>132</sup>. At the low concentrations required for detection by thermal lens spectrometry, catecholamines can undergo immediate oxidative cyclization with hexacyanoferrate ions to aminochromes (**36**), at pH 7. These are intensely colored quinonoid dyes. At higher concentrations a lower pH is required to avoid polymerization of the dyes, and the process becomes slower and inadequate for HPLC detection; LOD *ca* 1  $\mu\text{g/L}$  in urine<sup>133</sup>. See Section IV.D.3.g for an alternative application of aminochromes to the analysis of catecholamines.

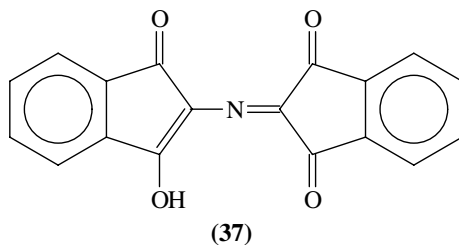
A universal eluent system was proposed for analysis of amino acids in biological fluids by IEC on the cation exchange resin Ostion LG ANB<sup>134</sup>. A study was carried out on the effect of the carrier pH on RP-HPLC of amines, using a C<sub>8</sub> column and octyl sulfate as ion pairing reagent. Optimal results were obtained for the analysis of catecholamines



in urine by a pre-column cleanup with alumina and chromatography with the mobile phase at pH 5.4<sup>135</sup>.

A comparative study of the analysis of aliphatic amines by GC-FID, GC-TSD and HPLC with refractive index detector (RID), using isopropylamine as internal standard, gave good results in all cases. Determination of trimethylamine oxide by HPLC with a pulsed amperometric detector was problematic<sup>136</sup>.

A study involving twenty-six laboratories was carried out to assess the quality of amino acid analysis, using samples of urine and lyophilized plasma. Coefficients of variation ranged from 13% for glycine to 65% for methionine. Automated IEC followed by ninhydrin detection (37) seemed to perform better than other methods; however, there was no clearly superior method and no analyzer clearly outperformed the others. This seems to point to the importance of personal proficiency and expertise in the performance of such analyses<sup>137</sup>.



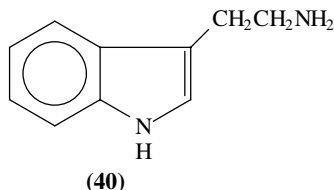
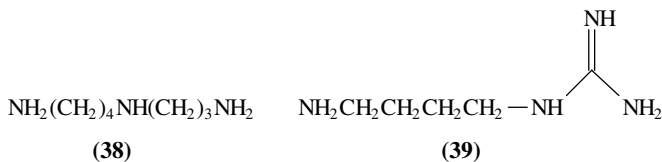
A general approach was described to the analysis of traces of nitrogen- and phosphorus-containing pesticides in environmental samples, using on-line and off-line SPE, followed by LC with TSP-MS-SIM detection. The assignments of various pesticides were reconfirmed by a variety of MS techniques<sup>138</sup>. Preconcentration of traces of thirty-four pesticides and various transformation products was performed on-line by SPE on extraction disks or a packed column, followed by LC-TSP-MS-SIM of the positive ions  $[M + H]^+$  and either  $[M + NH_4]^+$  or  $[M + CH_3CN]^+$  or the negative ions  $[M - H]^-$  and  $[M + HCO_2]^-$ ; LOD 0.01–0.4  $\mu\text{g/L}$  for 100 mL samples, depending on the analyte and mode of operation. The method was applied to determination of trace levels of pesticides in river waters<sup>139</sup>.

## 2. Underivatized analytes

The standard urine immunoassay for detection of cocaine (23a) abuse during the gestation period of newborn babies was frequently found to yield negative results in cases where positive results were shown by extraction of meconium with a solvent, followed by HPLC. The drug and metabolites such as norcocaine (23b) and cocaethylene (23c) were detected<sup>140</sup>. See Section IV.C for an alternative analysis of cocaine.

Results of high-performance silica gel, cellulose and RP-bonded silica gel for eighteen amino acids were compared with previous reports on IEC, RP-LC and paper chromatography. Determination was by scanning densitometry of the product (presumably **37**) obtained after applying ninhydrin<sup>141,142</sup>. Determination of amino acids in pig plasma by IEC and detection by the ninhydrin method is influenced by the protein and lipophilic compounds present, causing lower resolution. This is avoided on addition of sulfosalicylic acid followed by SPE. An increase was observed in the results for threonine, asparagine, glutamic acid, glutamine, glycine, alanine, valine and lysine, whereas those for phenylalanine and tryptophane showed a decrease with this modification<sup>143</sup>.

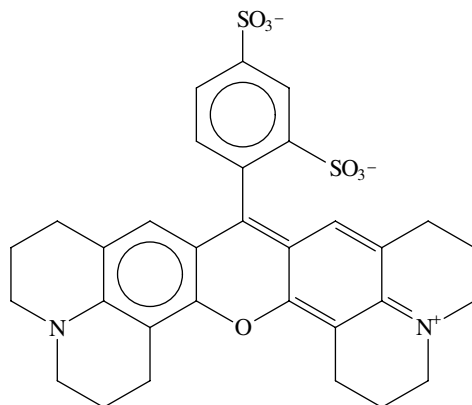
IEC was applied to determine biogenic polyamines such as putrescine (**4a**), cadaverine (**4b**), tyramine (**5**), histamine (**6**), spermidine (**38**), agmatine (**39**) and tryptamine (**40**), contained in aqueous trichloroacetic extracts of leafy vegetables, such as cabbage and lettuce. A cation exchange column loaded with potassium ions and a special buffer were used. Spermidine (**38**) was the major amine detected in this group (7–15  $\mu\text{g/g}$  fresh weight)<sup>144</sup>.



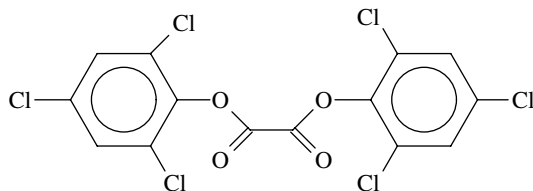
Underivatized amino acids were analyzed in a FIA system including a high-performance IEC column and a CLD cell. The chemiluminescence generated on a GCE was measured when Ru(II) ions in the carrier solution were oxidized to Ru(III) and reacted *in situ* with the amino acid. LOD ranged from 100 fmol for proline to 22 pmol for serine (SNR 6)<sup>145</sup>.

A study of fifty-five aliphatic, aromatic and heterocyclic amines showed that twenty-eight of them could be detected in a FIA system at concentrations in the range of  $1.0 \times 10^{-10}$  to  $4.0 \times 10^{-6}$  M (SNR 3, 20  $\mu\text{L}$  injection), without derivatization, by HPLC-CLD, taking profit of the chemiluminescence produced in the presence of aryl oxalate and sulforhodamine 101 (**41**). The method was applied to the determination of histamine (**6**) in fish<sup>146</sup>. See reaction 24 in Section IV.G.

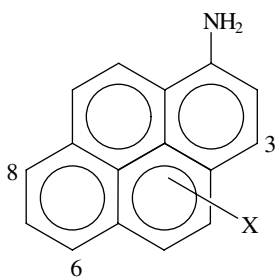
HPLC on a Cosmosil 5 C<sub>18</sub> column, using a perchloric acid–acetonitrile eluent (pH 7.6), followed by CLD in the presence of hydrogen peroxide and bis(2,4,6-trichlorophenyl) oxalate (**42**), was applied to the determination of 1-aminopyrene (**43a**) and various diaminopyrenes (**43b–d**). Ascorbic acid was added to avoid oxidative degradation of the aminopyrenes in the presence of metals; LOD in the sub-fmol range (SNR 3)<sup>147</sup>. A fast (less than 10 min) HPLC-ELCD method was proposed for determination of dopamine (**19b**) and its metabolites in microdialysates, using packed fused silica capillary columns; LOD 0.05  $\mu\text{g/L}$  of dopamine in a 2  $\mu\text{L}$  sample, RSD 3% ( $n = 10$ )<sup>148</sup>.



(41)

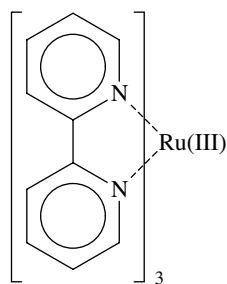


(42)



(43)

- (a) X = H
- (b) X = 3-NH<sub>2</sub>
- (c) X = 6-NH<sub>2</sub>
- (d) X = 8-NH<sub>2</sub>



(44)

Tris(2,2'-bipyridine)ruthenium(III) complex ions (**44**) produce a chemiluminescence in the presence of amino acids in a FIA system. Amino acids containing secondary amino groups have the strongest response; LOD 20 pmol for proline to 50 nmol for asparagine<sup>149</sup>.

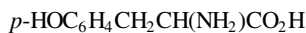
Nitrogen-containing compounds are easily detected by CLND, without pre- or post-column derivatization. Thus, peptide mapping by RP-HPLC using CLND gave the correct results as for the chain size, against the results of UV-visible (UVV) detection (UVD), which were biased by the presence of strong UV chromophores<sup>150</sup>.

A method for determination of the aromatic amino acid phenylalanine (**45**), tyrosine (**46**) and tryptophan (**47**) content of peptides at low microgram levels is based on size-exclusion HPLC combined with UVD using a diode array, and data processing of the

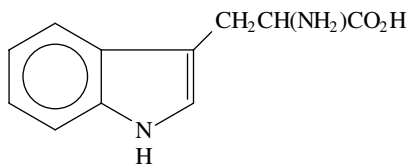




(45)



(46)



(47)

spectra to yield the second-order derivative. Comparison of the derivative spectra with those of standards consisting of the aromatic amino acids and their heterodipeptides, using spectral features such as amplitude and wavelength of primary and secondary minima and intersection with the abscissa, helps corroborating and quantifying their presence<sup>151</sup>.

The series of regioisomeric amines **48–50**, methamphetamine (**29**) and phentermine (**31**), can be identified in forensic screening analyses by RP-HPLC-UV (254/280 nm dual accessory) using a C<sub>18</sub> stationary phase and a mobile phase buffered at pH 3.0. The capacity factors and retention times increase in the order **48** < **49** < **29** < **31** < **50**. Other methods for identifying these compounds failed; for example, the base peak in MS is  $m/z = 58$  for all five compounds, corresponding to a loss of a benzyl group from the molecular peak; also their IR and UVV spectra are too similar to be useful for this purpose<sup>152</sup>.



(48)



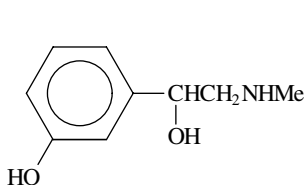
(49)



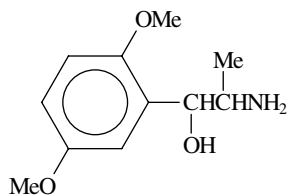
(50)

Analysis of a wide range of amines, in dialysate aliquotes taken from experimental animals, was carried out by isocratic HPLC with detection on a series of eight coulometric electrodes, measuring from 0 to 0.490 V with increments of 0.070 V. A parallel analysis was carried out after pre-column derivatization according to reaction 7 (Section IV.D.3.a), isocratic elution on a different column and measurement with a series of four electrodes set at 0.250, 0.450, 0.550 and 0.650 V. Compounds were identified by retention time and electrochemical profile along the arrays. Analyses were complete within 25 min. Among the compounds examined were isoproterenol (**21c**), phenylephrine (**51**), methoxamine (**52**), hydralazine (**53**), apomorphine (**54**), morphine (**55**) and its 3-glucuronide metabolite; for these compounds LOD 0.215–10.65  $\mu\text{g/L}$ , at SNR 3, with linearity in the 0.5–500  $\mu\text{g/L}$  range. For amino acids LOD *ca* 0.75  $\mu\text{g/L}$ , at SNR 3, with linearity in the 0.25–20  $\mu\text{g/L}$  range<sup>153</sup>.

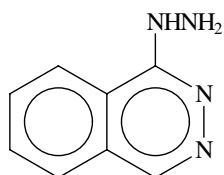
RP-HPLC determination of trace impurities of the toxic 4-aminopyridine in the central system-stimulating drug 3,4-diaminopyridine can be performed on condition that the impurity has a lower retention time. This was accomplished on applying ion pairing with dodecanesulfonate to maximize selectivity; LOD 50 ppm of the impurity in the drug<sup>154</sup>.



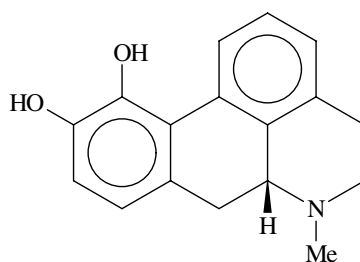
(51)



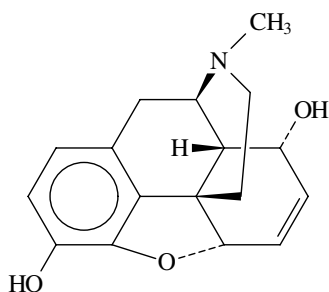
(52)



(53)



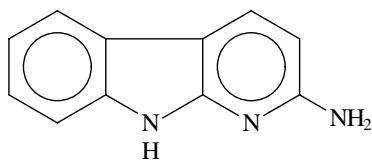
(54)



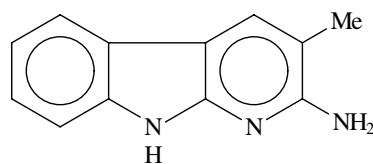
(55)

Methods were described for HPLC determination of the mutagenic and carcinogenic  $\alpha$ -carbolines (**56,57**),  $\gamma$ -carbolines (**58,59**)<sup>155-160</sup>, and other products of amino acid pyrolysis found in cigarette smoke, diesel exhaust and cooked foods and phenazines (**60, 61**) present as impurities of certain pesticides<sup>161</sup>. These compounds were also determined in human plasma, urine and bile<sup>161,162</sup>.

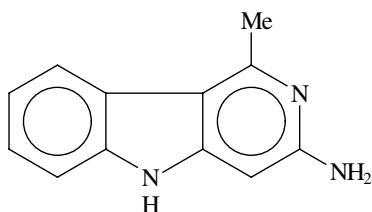
The use in consumer products of azo dyes that yield carcinogenic amines under reductive conditions is illegal in Germany. Detection of such carcinogenic amines in textiles is problematic, and a method was proposed combining TLC, automatic multiple development



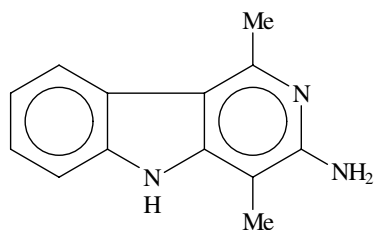
(56)



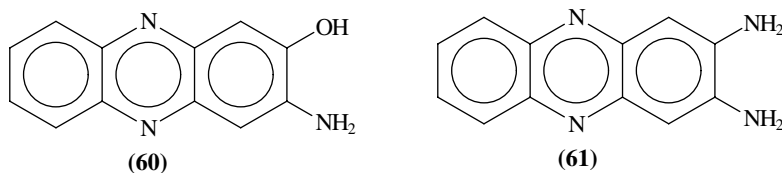
(57)



(58)



(59)

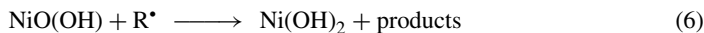
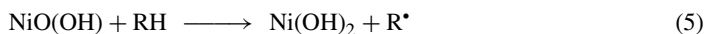


and assessment by means of a scanner<sup>163</sup>. Azo dyes present in sludges can be determined after extraction with dichloromethane, reduction with sodium hydrosulfide or tin(II) chloride and HPLC-MS<sup>164</sup>. See also discussion of reaction 3 in Section IV.C.

A sensitive HPLC method used coulometric detection for the simultaneous determination of catecholamines, indoleamines and related metabolites. Oxidative and redox modes were applied to the various analytes, using arrays containing one to four coulometric working electrodes<sup>165</sup>. Pulsed amperometric detection following HPLC of the underivatized amino acid is sensitive but has a limited range of linear response. Application of ELCD before amperometric detection extends the dynamic range of amino acid determination<sup>166</sup>. Pulsed amperometric detection after IEC was found to be more sensitive (0.01–1.2  $\mu\text{M}$ ) than ninhydrin derivatization with UVD (4.5–55.0  $\mu\text{M}$ )<sup>167</sup>.

Determination of the amino saccharides glucosamine, mannosamine and galactosamine in microbial polymers, chitin, animal waste, sewage, plant residues and soil was performed by HPLC using a strong ion-exchange column, an alkaline eluent and a pulsed amperometric detector. The latter was superior to RID. More than 3% of the total nitrogen in alfalfa and 20% in straw stems from amino saccharides<sup>168</sup>.

A glassy carbon electrode (GCE) modified by electrodeposition of Ru(III,IV) oxides was used for the amperometric determination of cystine, cysteine, methionine, glutathione and glutathione disulfide after HPLC using a strong cation exchange column. Unmodified electrodes are unfit for analysis of these compounds. For methionine, sensitivity was  $20 \pm 0.3 \text{ nA}/\mu\text{M}/\text{cm}^2$ ; linearity over the range of 0.6–180  $\mu\text{M}$  at pH 2, 7.5  $\mu\text{L}$  sample, 1 mL/min flow<sup>169,170</sup>. A constant potential amperometric detector was used in a FIA system for the determination of carbohydrates and amino acids. The working electrode is an Eastman-AQ electrode chemically modified by Ni(II) ions. The mechanism shown in reactions 4–6 was proposed, where reaction 5 is rate limiting<sup>171</sup>.



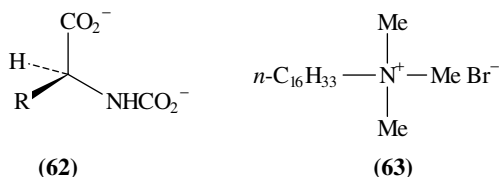
A comparison was made between Ag, Au, Co, Cu, Ni and Pt electrodes for constant-potential amperometric detection of carbohydrates, amino acids and related compounds in FIA systems. Cu electrodes showed the best performance as for their range of linear response, LOD, stability and long life<sup>172</sup>. Two electro-oxidation processes of amino acids at a Cu electrode are possible, depending on the applied potential and the conditions of the solution: In neutral or slightly basic solution, at very low potentials measured against an Ag/AgCl electrode, the process is related to complex formation between the amino acid and Cu(II) ions. In a strongly alkaline solutions, at 0.4–0.8 V the process involves electrocatalytic oxidation. The latter process is better for constant-potential amperometric detection of underivatized amino acids and peptides in FIA chromatographic systems; LOD 1–10 pmol for most amino acids and simple peptides<sup>173</sup>.

Nitrogen-containing analytes in a FIA system, e.g. amino acids, as they emerge from the LC column, are introduced into a pyrolysis oven under argon atmosphere. The products

are converted to nitrate by potassium peroxodisulfate, and determined with malachite green using a UVD at 650 nm<sup>174</sup>.

Determination of iodo amino acids by HPLC with inductively coupled plasma (ICP)-MS detection had LOD 35–130 pg of I, which is about one order of magnitude lower than with UVD usually applied for these compounds<sup>175</sup>. Amino acids and peptides containing sulfur, such as cysteine, cystine, methionine and glutathione, can be determined after HPLC separation by pulsed electrochemical detection, using gold electrodes<sup>176</sup>.

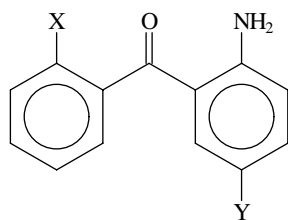
It is usually a very difficult task to introduce chemical modifications in the solid phase filling the chromatographic column. On the other hand, the possibilities of modifying the carrying fluid used for elution are practically unlimited. This includes solvent composition in isocratic and gradient regimes, buffers and other additives. For RP-HPLC on C<sub>18</sub> columns, ion interaction reagents such as octylammonium salicylate or orthophosphate are used to modify the properties of the absorbing surface, improving the resolution of many mixtures. Thus, trace levels of aromatic amines can be determined without derivatization. Applying this method to the analysis of a commercial brown hair dye revealed the presence of more than 7000 ppm of *p*-phenylenediamine<sup>177,178</sup>. The same two ion interaction reagents were applied to the RP-HPLC-UVD determination of the food-related biogenic amines tyramine (**5**), histamine (**6**), 2-phenethylamine (**33**) and tryptamine (**40**). The elution sequence was different for both additives; LOD 400 ppb for **5** ( $\lambda$  230 or 280 nm), 900 ppb for **6** ( $\lambda$  230 nm), 500 ppb for **33** ( $\lambda$  254 nm) and 20 ppb for **40** ( $\lambda$  280 nm)<sup>179</sup>. RP-HPLC using alkylammonium salicylates as ion interaction reagents is effective in the separation of amines from inorganic analytes such as nitrite and nitrate ions. However, care should be taken that alkylamine analytes should be of shorter chain-length than the ion interaction reagent. By this method 0.50 ppm of *p*-phenylenediamine and 0.20 ppm of nitrate could be determined in seawater<sup>180</sup>. RP-ion pair chromatography of amino acids was performed using 1-naphthylamine as ion-interaction reagent with sodium heptanesulfonate as hydrophobic counterion, to enhance the capacity ratio of the column for all amino acids tested<sup>181</sup>. Amino acids and peptides yield under physiological conditions carbamates of structure **62**, which are presumed to be neurotoxic agents. A correlation was found between the propensity of these compounds to undergo such transformation and their RP-LC behavior in the presence of cetrимide (**63**), a cationic surfactant that makes the separation technique sensitive to the negative charge on **62**<sup>182</sup>.



Determination of halogenated 2-aminobenzophenones (**64a–c**), which are metabolites of psychotropic drugs, was performed by HPLC with amperometric detection (GCE vs Ag/AgCl); LOQ 750 ng of metabolite/L of biological fluid (urine or serum), with recovery better than 97%<sup>183</sup>.

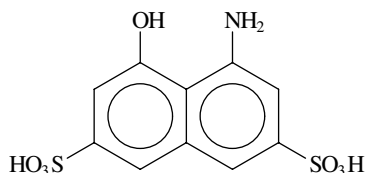
The impurities of H-acid (**65**), an intermediate for various synthetic dyes, include Koch's acid (**66**), omega acid (**67**), chromotropic acid (**68**) etc. They were determined by RP-HPLC-UVD at  $\lambda$  235 nm, using as mobile phase a 0.3 M aqueous solution of sodium sulfate<sup>184</sup>.

The chemiluminescence of the reaction of hydrogen peroxide with luminol (**69**) is catalyzed by metalloporphyrins **70a** and **70b**. This chemiluminescence is quenched by

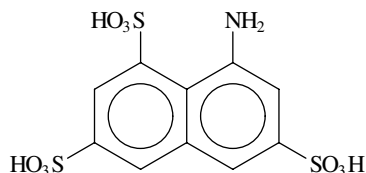


- (a)  $X = Y = \text{Cl}$   
 (b)  $X = \text{H}, Y = \text{Cl}$   
 (c)  $X = \text{F}, Y = \text{Br}$

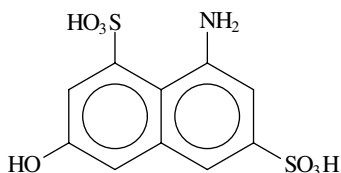
(64)



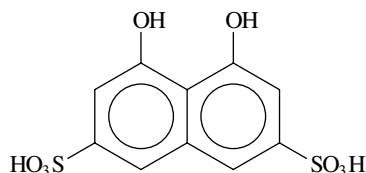
(65)



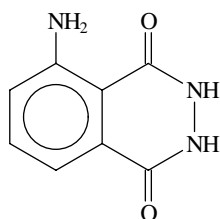
(66)



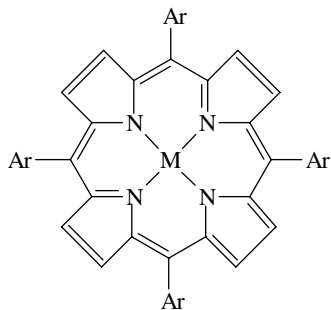
(67)



(68)



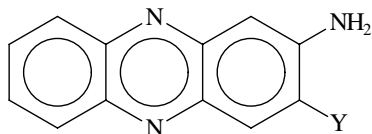
(69)

(a)  $M = \text{Fe}, \text{Ar} = \text{---} \text{C}_6\text{H}_4 \text{---} \text{N}^+ \text{---} \text{Me}$ (b)  $M = \text{Mn}, \text{Ar} = \text{---} \text{C}_6\text{H}_4 \text{---} \text{SO}_3^-$ 

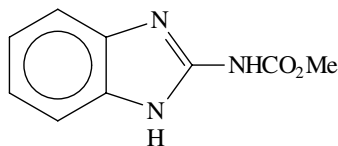
(70)

the presence of amines that form complexes with the metal ions and reduce the catalytic effect of the porphyrine complexes. This abatement is the working principle of a method proposed for determination of amino acids in a FIA system following LC<sup>185</sup>.

The mutagenic aminophenazines **71** are present as impurities of carbendazim (**72**) fungicides and its formulations. They were determined by HPLC-UVD (diode array), using 0.02% sulfuric acid in MeOH, and measuring at 270 and 453 nm<sup>186</sup>.



(71) Y = NH<sub>2</sub>, OH



(72)

The neutral nitrogen-containing components in diesel oil were selectively retained by an alumina HPLC column and were eluted by a gradient mobile phase of hexane-dioxan. Identification and determination was carried out by a combination of MS and UV diode array detectors, showing that these components were mainly alkylcarbazoles and alkylindoles<sup>187</sup>.

Aromatic and sulfur-containing amino acids were separated by HPLC, and subjected to post-column UV irradiation before electrochemical detection with GCE vs AgCl/Ag electrodes. The analytes showed different behavior during lamp off and on periods. Thus, for example, tyrosine (**46**) and tryptophan (**47**) showed inherent electrochemical response at +0.80 V, but none at +0.60 V; however, on turning on the UV lamp they showed sensitive response at both potentials<sup>126</sup>.

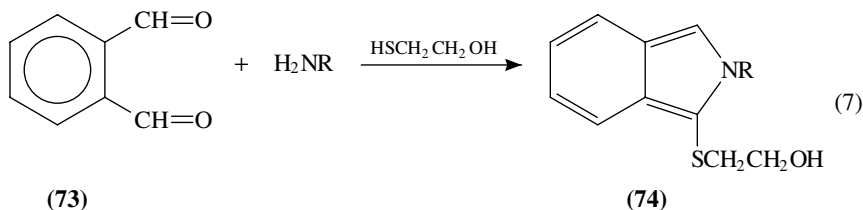
### 3. Pre-column and post-column derivatization

Pre-column derivatization procedures fulfil several important analytical functions. However, some problems are involved such as separation of the analytes from the matrix with the inherent recovery problems; modification of the analyte to improve chromatographic resolution with the inherent problems of functional specificity, derivatization yields of individual analytes, stability of the derivative and the necessity of removing excess reagents. Although automatization of pre-column treatment is now commonplace, this is not usually a requirement. Post-column derivatization is performed mainly for labelling the analyte to better fit the installed detector and is frequently applied in FIA systems. This requires fast and effective reactions with minimum excess reagent or a means for removal of excess to avoid interferences. Additional targets may also be sought in post-column derivatization, such as modification of retention times in a second chromatographic cycle.

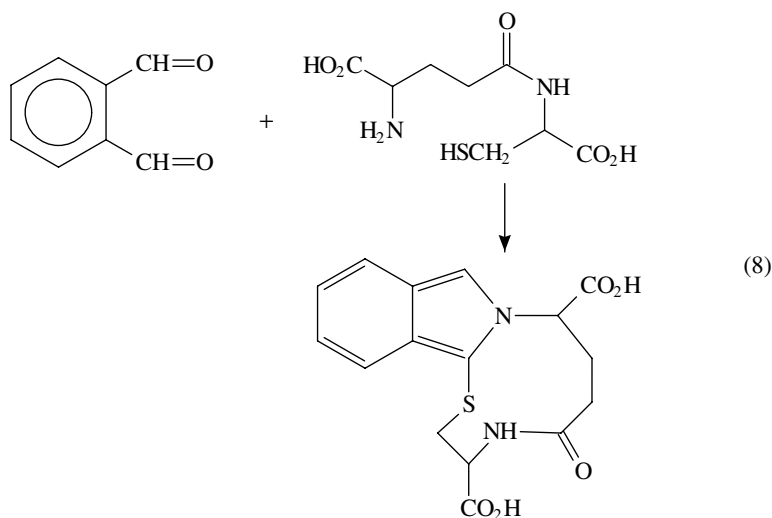
A comparative study was made of the RP-HPLC analysis of free amino acids in physiological concentrations in biological fluids, with pre-column derivatization by one of the four major reagents: *o*-phthalaldehyde (**73**) in the presence of 2-mercaptoethanol, 9-fluorenylmethyl chloroformate (**90**), dansyl chloride (**92**) and phenyl isothiocyanate (**97**, R = Ph) (these reagents are discussed separately below). Duration of the analysis was 13–40 min. Sensitivity with the latter reagent was inferior to the other three; however, its use is convenient in clinical analysis, where sample availability is rarely a problem. The derivatives of **73** were unstable and required automatized derivatization lines. Only **92** allowed reliable quantation of cystine. All four HPLC methods compared favorably with the conventional ion-exchange amino acid analysis<sup>188</sup>.

Some examples of derivatization used in LC are shown here and in Sections IV.D.4 and IV.E.

*a. Reaction with dicarboxaldehydes.* Primary amines react with *o*-phthalaldehyde (**73**) in the presence of 2-mercaptoethanol, as shown in reaction 7, yielding fluorescent isoindole products (**74**)<sup>189,190</sup>. This reaction affords a very frequently used pre-column and post-column derivatizing scheme.



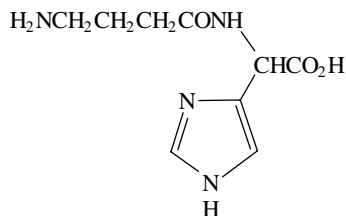
Some problems and solutions involved in the automatization of pre-column derivatization of amino acids applying reaction 7 to biological samples were discussed<sup>191</sup>. Solid media and conditions were examined for enrichment by SPE of the lower aliphatic amines in aqueous solution, prior to HPLC with fluorometric detection of the *o*-phthalaldehyde derivative. The best medium was the weak cation exchanger Spheron C 1000, and desorption with methanolic perchloric acid. Concentration limits for the determination were in the nM range, with enrichment factor of 240 in the preconcentration step<sup>192</sup>. The problem of the stability under laser-induced fluorescence (LIF) of the fluorescent species **74**, derived from amino acids and peptides in biological samples, in the concentration range of  $10^{-12}$  to  $10^{-15}$  M was addressed<sup>193</sup>. *N*-Acetylcysteine was proposed as replacement for 2-mercaptoethanol, to avoid its unpleasant odor<sup>194</sup>;  $\gamma$ -glutamylcysteine provided its own mercapto group, as shown in reaction 8<sup>193</sup>. See also references to reaction 7 in Section IV.D.4.



A study of residual analysis of thirty pesticides and their transformation products was based on SPE on-line with HPLC-UV-D or post-column derivatization with *o*-phthalaldehyde (**73**) and fluorescence detection (FLD), according to EPA method 531.1 and others. The method allowed determination of many pesticides in river and well waters at 0.01 to 0.5  $\mu\text{g/L}$  levels<sup>195</sup>. An automatized procedure was proposed for determination

of amino acids in plasma based on pre-column derivatization with this reagent that was claimed to be fast and stable for long series of analyses; the coefficient of variation was <3% for most of the thirty physiological amino acids tested<sup>196</sup>.

Biogenic amines such as  $\gamma$ -aminobutyric acid, spermidine (**38**), spermine (**75**) and hexamethylenediamine (**4c**) were determined by pre-column derivatization according to reaction 7, gradient elution LC and amperometric detection at +650 mV, using GCE vs Ag/AgCl electrodes. On column detection limits are at the low picomole range<sup>197</sup>. A method was evaluated for determination of amines in wine, such as polymethylene diamines (**4a–c**), tryptamine (**40**) and 2-phenethylamine (**33**), based on pre-column derivatization with *o*-phthalaldehyde (**73**), RP-HPLC with gradient elution and coulometric detection with an array of sixteen electrodes at increasing potentials<sup>198</sup>. The same derivatization served for determination of biogenic amines in wine by RP-HPLC-FLD on a C<sub>18</sub> column;  $\lambda_{\text{ex}}$  356 nm,  $\lambda_{\text{fl}}$  445 nm, recovery 84.0–108.3%, RSD 3.0–8.2%<sup>199</sup>. Amino acids in cultured cells were determined by RP-HPLC-FLD;  $\lambda_{\text{ex}}$  330 nm,  $\lambda_{\text{fl}}$  450 nm, LOD 0.5 pmol, linearity in the 1–800 pmol range<sup>200</sup>. Determination of  $\gamma$ -aminobutyric acid in cerebrospinal fluid requires special care, because of its relatively low concentration as compared to other amino acids and the possibility of distorting results on degradation of homocarnosine (**76**). A procedure was proposed consisting of deproteinization with sulfosalicylic acid, separation by IEC, post-column derivatization according to reaction 7 and FLD measurement<sup>201</sup>. A method for determination of  $\epsilon$ -aminocaproic acid in body fluids consists of deproteinization with zinc sulfate, addition of D-valine as internal standard, derivatization according to reaction 7 and HPLC-FLD using a mobile phase containing 2.5 mM of the Cu(II) complex of L-proline. As low as 50  $\mu\text{g/L}$  of the analyte could be detected, using 100  $\mu\text{L}$  samples of urine or plasma<sup>202</sup>.

**(75)****(76)**

Fast determinations of amino acids in plasma, cerebrospinal fluid and other media were based on reaction 7 and RP-HPLC. In one of them, taking 17 min per run, including times for derivatization and column re-equilibration, recovery of amino acids spiked into plasma was 96–106%, except for tryptophan (**47**, 89%). The method had within run precision of 1.8–6.4%, between run precision of 2.1–7.2% and was linear in the 5–800  $\mu\text{M}$  range for all amino acids<sup>203</sup>. RP-HPLC with electrochemical detection, using a multistep polarity gradient, resolved the derivatives of twenty-three amino acids and physiological dipeptides in less than 25 min<sup>204,205</sup>. A fast variation claimed runs of less than 5 min for simultaneous determination of the neurotransmitter amino acids glycine, aspartic (**34a**), glutamic (**34b**), taurine (**77**) and  $\gamma$ -aminobutyric acid in brain tissue; LOD 2.5 pmol for all five amino acids<sup>206</sup>. A modification allowed improved resolution and sensitivity and shorter performance times. This was applied to determination of sixteen amino acids in plasma and cerebrospinal fluid<sup>207</sup>.

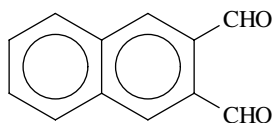
**(77)**



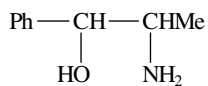
Amino acids and other nitrogen-containing compounds affect chlorine consumption in the treatment of drinking water. Such amino acids from three French rivers were determined in the raw samples and, after each treatment step in a plant, by pre-column derivatization by reaction 7 and HPLC-FLD. The main compounds detected were glycine, serine, alanine, aspartic acid, glutamic acid, threonine and valine. The global amino acid content was 20–90  $\mu\text{g N/L}$ , causing a consumption of 0.4–1  $\text{mg Cl}_2/\text{L}$ <sup>208</sup>. Use of a basic citrate buffer for the pre-column derivatization step of amino acids in seawater avoids precipitation of Ca and Mg hydroxides<sup>209</sup>.

Post-column application of reaction 7 was used to bind the  $\epsilon$ -amino groups of lysine residues in a hemoregulatory peptide, for determination by HPLC-FLD; LOD 1 ng, LOQ 20  $\mu\text{g/L}$  for 0.25 mL plasma samples; response was linear for 20–4000  $\mu\text{g/L}$  of plasma<sup>210</sup>. Reaction 7 was also applied to amino acids in seawater in a FIA system. Determination of ammonia vs primary amines could be accomplished in the system by a buffer change from pH 7 to pH 10.5, respectively<sup>211</sup>. A fast method for determination of biogenic amines is important for assessing the freshness of sea food and its possible allergenic and toxic effects. The simultaneous detection of histamine (**6**), agmatine (**39**) and other polyamines poses a difficult problem. A method for determination of these compounds uses sodium hexanesulfonate as ion pairing agent in RP-HPLC and post-column derivatization with *o*-phthalaldehyde (**73**)<sup>212</sup>. Perchloric acid extraction, RP-HPLC-UVD (diode array) using post-column derivatization by reaction 7 was applied in the determination of the biogenic amines putrescine (**4a**), cadaverine (**4b**), tyramine (**5**), histamine (**6**) and phenethylamine (**33**) in meat products; LOD 0.5 mg/kg with 96–113% recoveries<sup>213</sup>. Biogenic amines **4a**, **4b**, **5**, **6**, **33**, serotonin (**20**), tryptamine (**40**), spermidine (**38**), spermine (**75**) and agmatine (**39**) were determined simultaneously in beer after microfiltration, RP-HPLC, post-column derivatization with **73** and FLD; LOD 0.30–0.40 mg/L except for **20** and **75**, which were slightly higher. Linearity, precision, sensitivity and recovery were satisfactory, and the interference from amino acids and other amines was assessed<sup>214</sup>. The effect of SPE was studied on the determination of thirty pesticides and their transformation products was based on derivatization by reaction 7, using UVD or FLD (EPA method 531.1). The method was used for analysis of river waters of Spain and France<sup>195</sup>.

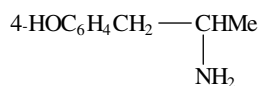
A variant of reagent **73**, naphthalene-2,3-dicarboxaldehyde (**78**), was used for determination of amino acids in tobacco<sup>215</sup>. Analytes containing more than one primary amino group show a much diminished quantum efficiency, which can be corrected by coordinated deposition of the LC effluent on a TLC plate and performing a second fluorometric measurement of the immobilized derivatives<sup>216</sup>. An HPLC-CLD method was proposed, based on measurement of the chemiluminescence emitted by the pre-column **78**-derivatives of the analytes in the presence of a diaryl oxalate (**42**) and hydrogen peroxide, for determination of ultratrace amounts of amphetamine (**28**), norephedrine (**79**) and *p*-hydroxyamphetamine (**80**) in urine, using phenethylamine (**33**) as internal standard; LOD 0.1–1.5  $\times 10^{-15}$  mol<sup>217</sup>. See discussion of reaction 24 in Section IV.G.



(78)



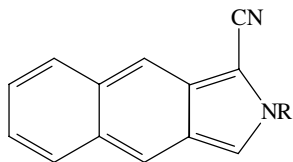
(79)



(80)

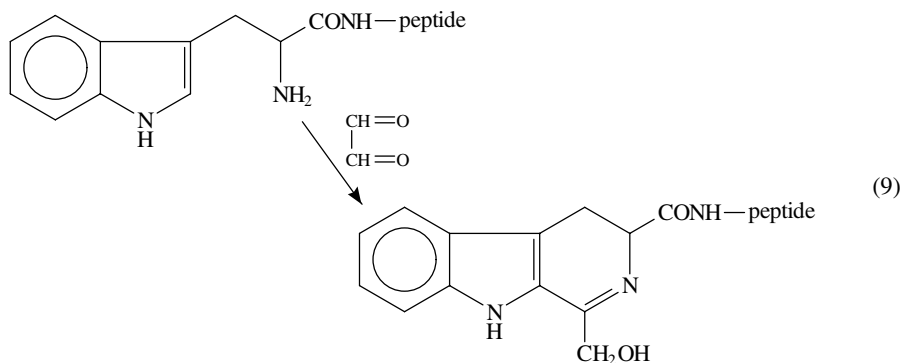
The painstaking procedures and special instrumentation required for manipulating nanoliter range volumes were described for the determination of amino acids in single cells<sup>218</sup> and the amino acid analysis of subnanogram amounts of protein<sup>219</sup>. The amino acid extract

of a single cell was derivatized with **78** in the presence of cyanide ions, leading to products of probable structure **81**, which were both fluorescent and electroreactive. Separation was by open tubular microbore LC and the derivatives were measured electrochemically<sup>218</sup>. Using norleucine as internal standard, and the various amino acids contained in the hydrolyzate of a 5 nL sample of protein solution were determined by the method just described<sup>219</sup>. A high-sensitivity LIF-based detector for HPLC was developed incorporating a HeCd laser, which responds specifically to amines derivatized with **78** in the presence of cyanide ions; LOD *ca*  $10^{-12}$  M<sup>220</sup>.



(81)

Peptides containing a tryptophan residue at the *N*-end can be determined by pre-column derivatization with glyoxal and RP-HPLC-FLD, as shown in reaction 9, giving single fluorescent peaks; LOD 0.55–3.82 nM (SNR 3) for 100  $\mu$ L injection volume<sup>221</sup>.

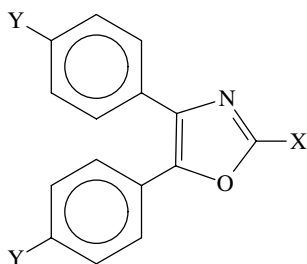


(9)

See also reaction 15 in Section IV.E.

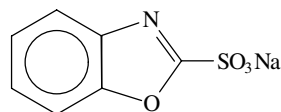
*b. Oxazole derivatives.* Various oxazole-based reagents have been proposed for tagging amines and thiols. For example, 2-fluoro-4,5-diphenyloxazole (**82a**) and 2-chloro-4,5-bis(*p*-*N,N*-dimethylaminosulfonylphenyl)oxazole (**82b**) for pre-column derivatization of amino acids followed by HPLC-FLD; LOD for the **82a** derivatives of thirteen amino acids is in the 19–64 fmol range (SNR 2). Amino acids with thiol substituents had LOD of one order of magnitude lower. Chemiluminescence with hydrogen peroxide/oxalate esters also afforded very sensitive determinations<sup>222,223</sup>. Sodium benzoxazole-2-sulfonate (**83**) itself is not fluorescent, but with amines and amino acids the derivatives exhibit an intense blue fluorescence<sup>224</sup>.

*c. N-Acylation and N-sulfonation.* By pre-column benzoylation in biological fluids, the hydroxy groups of sugars become esterified and neutral amino acids are converted to the corresponding 5-benzoyloxy-2-phenyloxazoles (**84**). No protein precipitation takes place and no pyridine or drying are required. Determination by HPLC-MS has LOD *ca* 1 pmol (SNR 2)<sup>225</sup>. Benzoylation followed by RP-HPLC on a C<sub>18</sub> column detects biogenic amines in fish, including putrescine (**4a**), cadaverine (**4b**), phenethylamine (**33**), spermidine (**38**),



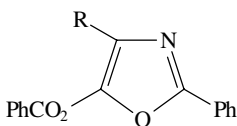
- (a) X = F; Y = H  
 (b) X = Cl; Y = SO<sub>2</sub>NMe<sub>2</sub>

(82)

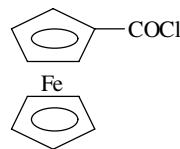


(83)

spermine (**75**), histamine (**6**), tyramine (**5**) and agmatine (**39**)<sup>226</sup>. Mixtures of industrial polyvalent amines (**85**) were determined by RP-HPLC-UVD after derivatization with benzoyl chloride or *m*-toluyl chloride<sup>227,228</sup>. Ferrocenecarboxylic acid chloride (**86**) was used for tagging primary and secondary amines, amino acids and peptides. End analysis was by LC with electrochemical detection for electro-oxidation of ferrocene; LOD 500 fmol<sup>229</sup>.

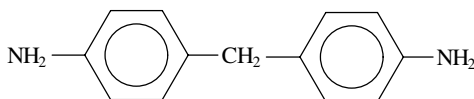


(84)

(85)  $n = 1-5$ 

(86)

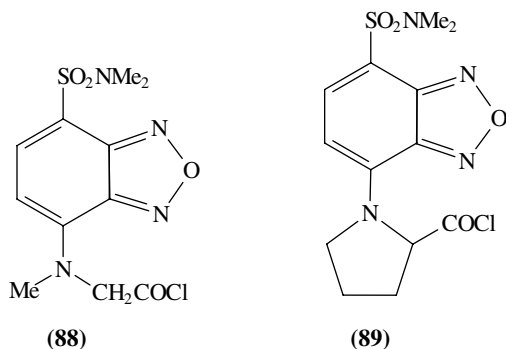
Compound **87** in acid-hydrolyzed urine serves as a tracer for occupational exposure to the corresponding diisocyanate. It was derivatized with pentafluoropropionic anhydride and determined by LC using TSP-MS and plasmaspray (PSP) MS (discharge-assisted TSP-MS). The  $[\text{M} - 2](-)$  ion was measured; instrumental LOD 0.1 pg/ $\mu\text{L}$ ; LOD about 0.2  $\mu\text{g/L}$  urine, RSD 10% for 0.5  $\mu\text{g/L}$ <sup>230</sup>. Another determination of **87** in urine is with isobutyl chloroformate<sup>231</sup>.



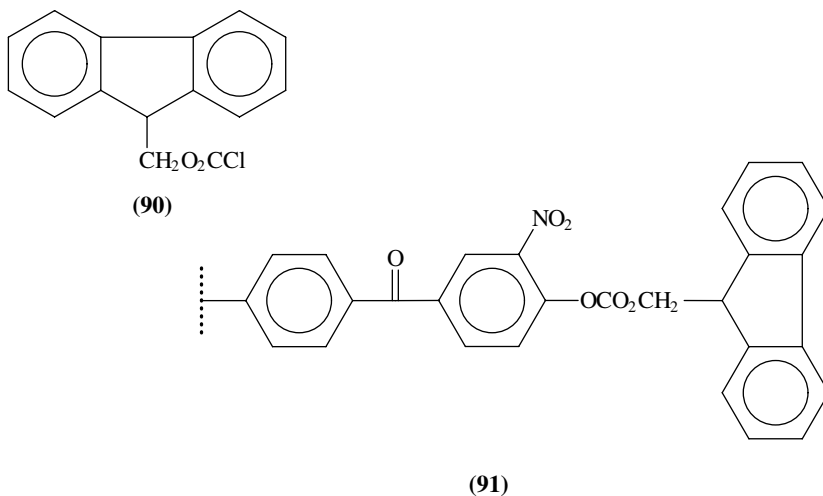
(87)

A determination of traces of low ( $\text{C}_1$  to  $\text{C}_4$ ) aliphatic amines in the atmosphere consists of passing air through an absorber containing phosphorous acid, derivatizing with *m*-toluyl chloride and end analysis by HPLC-UVD; LOD 1–5 pmol of amine, corresponding to concentrations lower than 0.1  $\mu\text{g/m}^3$  of air, in a 300 L sample<sup>232</sup>.

Various benzoxadiazole reagents have been proposed for fluorescent labelling of alcohols, phenols, thiols and amines. Reagent **88** was used for derivatization of various substrates, including aliphatic and aromatic amines<sup>233,234</sup>. Derivatization of alcohols and amines with reagent **89** affords fluorescent labeling of these compounds, when excitation and fluorescence were essentially the same for all alcohols and amines tested with both reagents. Using LIF ( $\text{Ar}^+$  emission at 488 nm) improves the sensitivity of the method (LOD 2–10 fmol) as compared with a conventional Xe lamp (LOD 10–500 fmol). See also Section IV.D.4 for other benzoxadiazole reagents.

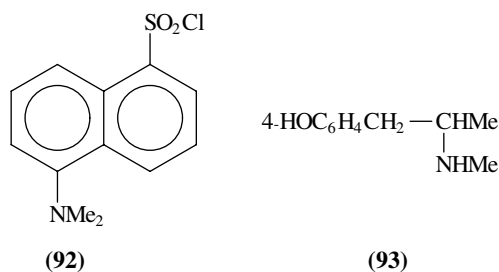


9-Fluorenylmethyl chloroformate (**90**) yields with primary and secondary amines the corresponding 9-fluorenylmethyl carbamates. Primary and secondary biogenic amines and amino acids can be derivatized with **90** in a fully automated pre-column system and determined by LC with spectrophotometric detection<sup>235</sup>. This method was applied to food analysis<sup>236</sup>. In one automatic system reaction time was 45 s allowing good determinations of amino acids at <10 pmol levels<sup>237,238</sup>. Derivatization with **90** enabled the separation and determination of twenty-seven free amino acids in extracts from green coffee with a recovery of 99.8%<sup>239</sup>. A complete amino acid analysis of collagen can be performed within 35 min by derivatization with **90** and RP-HPLC-FLD. The response is linear over the range 1–800 pmol. The method allows complete analysis on a 100 ng sample of collagen, corresponding to 1 pmol of protein chain<sup>240</sup>. A protocol was proposed for identification of protein binders used in art (e.g. casein, glue, egg), based on derivatization with **90** and HPLC-FLD of certain amino acids<sup>241</sup>. A pre-column automatic derivatization method for the amino acids in plasma was proposed, involving reaction 7 for the primary ones, followed by derivatization with reagent **90** for the secondary ones<sup>242</sup>. A polymeric reagent (**91**) was synthesized that attaches the same tabbing to primary and secondary amines as does **90**. Aliphatic amines in the air of various industrial environments were collected by adsorption on silica gel



(ca 100 L of air), desorbed with dilute acid and determined by injection of a 5–10  $\mu\text{L}$  sample into a reactor containing **91**, on-line with HPLC-FLD<sup>243</sup>. Reactive polymers were synthesized for tagging amines with 9-fluorenylmethoxycarbonyl, 4-nitrobenzoyl and acetylsalicyl groups. The reactive polymers were combined into a mixed bed reactor for on-line pre-column derivatization in HPLC analysis of amines. The objective of multiple pre-column tagging was to aid identification of unknown analytes in a complex matrix. The method was demonstrated for amphetamine (**28**) in human urine with acceptable accuracy and precision<sup>244</sup>.

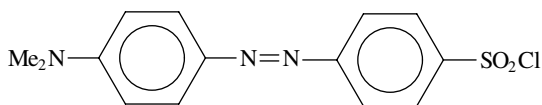
Nineteen biogenic amines in wine were determined by derivatization with dansyl chloride (**92**), SPE and HPLC-UVD. Linearity was observed for amine concentrations in the 0.5–20 ppm range; LOD 50–150  $\mu\text{g/L}$  (SNR 3), which is typical of dansyl derivatives. Addition of standard amines showed recoveries better than 85% for ethanolamine, phenethylamine (**33**), putrescine (**4a**), cadaverine (**4b**), tyramine (**5**) and histamine (**6**)<sup>245,246</sup>. The dansyl derivatives of the latter five biogenic amines, tryptamine (**40**), spermidine (**38**) and spermine (**75**) were separated by TLC on silica gel plates. None of the twelve solvent systems studied could resolve the mixture; however, application of two-dimensional TLC did, using extraction with acetonitrile and spectrofluorometry. The method was applied for analysis of fish and dry sausage samples<sup>247</sup>, and also for analysis of biogenic amines in fermented olives<sup>248</sup>. After post-column addition of tris(2,2'-bipyridyl)ruthenium(II) complex (**44**) and electrochemical oxidation in a flow cell to Ru(III), this ion reacts with the dansyl derivatives *in situ* and the chemiluminescence of the reaction can be measured<sup>249</sup>. An HPLC-CLD method based on measurement of the chemiluminescence emitted by the pre-column dansyl derivatives of the analytes in the presence of bis(2,4,6-trichlorophenyl) oxalate (**42**) and hydrogen peroxide was proposed for determination of ultratrace amounts of methamphetamine (**29**), amphetamine (**28**), norephedrine (**79**), *p*-hydroxymethamphetamine (**93**) and *p*-hydroxyamphetamine (**80**) in urine, using phenethylamine (**33**) as internal standard; LOD  $1\text{--}3 \times 10^{-14}$  mol<sup>217</sup>. A simplified automated procedure for pre-column derivatization of amino acids with **92** was proposed<sup>250</sup>.



A good correlation between experimental retention times and calculated selectivities and molecular connectivities was found using the PRISMA model for seventeen dansylated biogenic amines present in foodstuffs and animal fodder<sup>251</sup>.

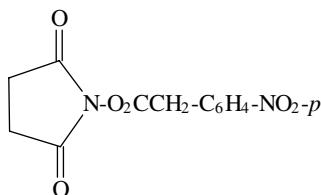
Derivatization with dansyl chloride (**94**) was applied for the separation of primary amino acids in physiological samples, prior to determination of their specific radioactivity. The derivatization is easy to perform and the derivatives are stable<sup>252</sup>.

*N*-Acylation can be performed with esters of *N*-hydroxysuccinimide; *N*-succinimidyl 4-nitrophenylacetate (**95**) was used to derivatize the primary and secondary amines conferring bad odor to water<sup>253</sup>. Derivatization of amines with the ester of *N*-hydroxysuccinimide with *N*-(quinolin-6-yl)carbamic acid (**96**) gives excellent yields of

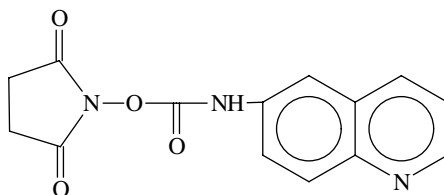


(94)

unsymmetric ureas. The selective fluorescence of the derivatives allows direct injection of the reaction mixture with no interference of the excess reagent; LOD from 40 fmol for phenylalanine to 800 fmol for cystine, linear response in the 2.5–200  $\mu\text{M}$  range. Good amino acid analyses could be obtained from protein hydrolysates containing as little as 30 ng of sample<sup>254</sup>. By derivatization with reagent **96** nineteen amino acids were separated in 35 min with resolution of at least 1.6, seventeen of which showed linearity at concentrations of 25–500  $\mu\text{M}$ <sup>255</sup>. A study of the long-term repeatability and consistency of amino acid analyses showed that derivatization with **96** was superior to that with phenyl isothiocyanate (reaction 11)<sup>256</sup>. See also Section IV.E for other acylating reagents derived from *N*-hydroxysuccinimide (**134**, **135**).

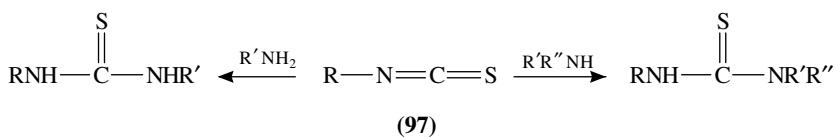


(95)



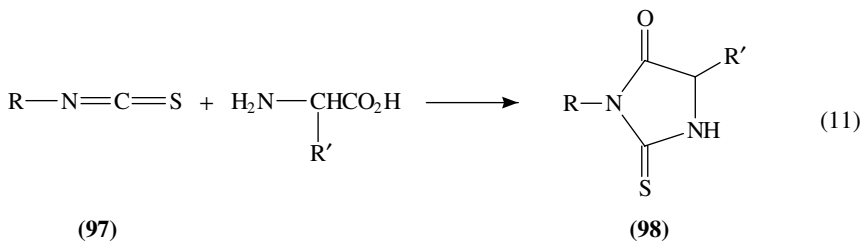
(96)

*d. Reaction with isothiocyanates.* Primary and secondary amines in general react with isothiocyanates (**97**) to yield the corresponding thioureas, as in reaction 10; however,  $\alpha$ -amino acids can undergo further cyclization to the corresponding thiohydantoin (**98**), the classical Edman reaction 11.



(97)

(10)



(97)

(98)

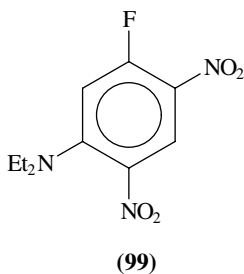
(11)

Derivatization with phenyl isothiocyanate (**97**, R = Ph) followed by HPLC was compared with IEC followed by the ninhydrin reaction for over ninety compounds. The former method was favored for speed, sensitivity and equipment versatility<sup>257</sup>. Phenylthiocarbonyl derivatives of amino sugars and amino sugar alcohols (reaction 10) were

resolved by RP-HPLC<sup>258</sup>. Twenty-two protein amino acids underwent derivatization with butyl isothiocyanate (**97**, R = Bu) and were determined by RP-HPLC-UVD; RSD of the molar response relative to the methionine peak was less than 5% for all except cysteine; asparagine and serine were not resolved from one another<sup>259</sup>. RP-HPLC on a C<sub>18</sub> column with a multistep linear gradient of two solutions was investigated for the phenyl isothiocyanate derivatives of twenty-six amino acids<sup>260</sup>, and also for determination of amino acids in deprotenized blood<sup>261</sup>. Modifications were proposed to make it faster, for the analysis of nutritionally important amino acids in serum and internal organs<sup>262</sup>. It was claimed that RP-HPLC of the phenyl isothiocyanate derivatives of plasma and urine amino acids, followed by electrochemical detection, virtually eliminates interferences of other components in the sample and enables the determination of secondary amino acids<sup>263</sup>. Methods based on derivatization with phenyl isothiocyanate were proposed for determination of free amino acids in wine and must<sup>264</sup> and infant food<sup>265,266</sup>. The derivatives obtained on treatment of amino acids with 4-nitrophenyl isothiocyanate are stable and suitable for subsequent HPLC-UVD analysis<sup>267</sup>.

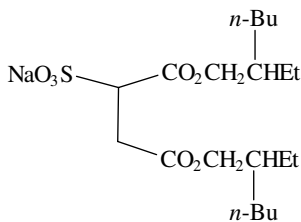
A study was made of RP-HPLC with constant-potential (1.2 V vs SCE) and pulsed-potential amperometric detection using platinum or gold electrodes, of the derivatives of the common amino acids, obtained from phenyl and methyl isothiocyanates. All the thiohydantoins (**98**) were oxidized at both electrodes; LOD was less than 0.2 μM for lysine and glycine, for 50 μL injection<sup>268</sup>.

*e. N-Arylation.* A comparative study was carried out for the analysis of amino acids in serum by pre-column derivatization with *o*-phthalaldehyde (**73**) and *N,N*-diethyl-2,4-dinitro-5-fluoroaniline (**99**) followed by HPLC, and IEC followed detection by the ninhydrin method (**37**) in an amino acid analyzer. Good agreement was found for the three methods, but pre-column derivatization was more sensitive and faster. Good resolution was found for thirty amino acids with **73** and thirty-eight with **99**<sup>269</sup>. See also reagents **127** in Section IV.D.4.

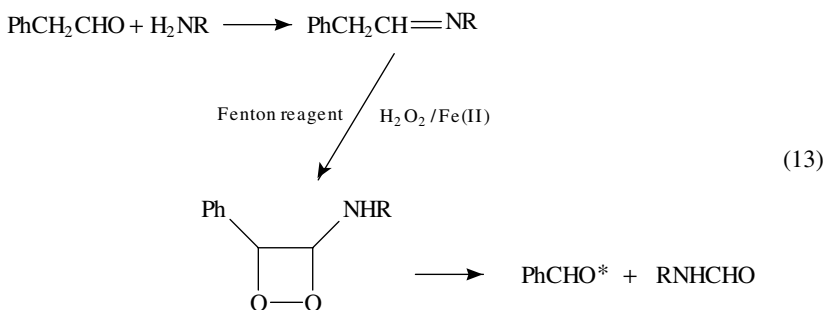


*f. Schiff bases.* Measurement of the chemiluminescence of Schiff base formation (reaction 12) can be applied for determination of primary amines, by post-column derivatization in a FIA system. Sodium bis(2-ethylhexyl) sulfosuccinate (**100**) is also added to form reversed micelles to accelerate the reaction<sup>270</sup>. The chemiluminescence of the oxidation of Schiff bases with the Fenton reagent in a FIA system was proposed; LOD  $1.5 \times 10^{-8}$  M for hexylamine and  $1.4 \times 10^{-7}$  for alanine, with linear behavior in the  $10^{-5}$ – $10^{-3}$  M range. The mechanism depicted in reaction 13 was tentatively proposed, where PhCHO\* is a benzaldehyde molecule in a triplet state<sup>271</sup>.

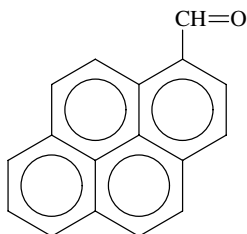




(100)



1-Pyrenecarboxaldehyde (**101**) was used for derivatization of primary aromatic amines to the corresponding Schiff bases, for their determination by HPLC-FLD; LOD 1–2 pmol<sup>272</sup>.



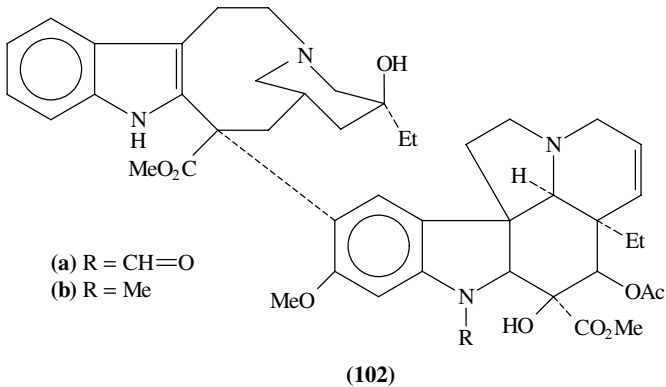
(101)

*g. Miscellaneous reactions.* Catecholamines were oxidized to aminochromes (**36**) with hexacyanoferrate(III) ion and the products were separated on a C<sub>18</sub> column using a micellar mobile phase containing sodium dodecylsulfonate. Detection was by thermal lens spectrophotometry, using the 488 nm line of an Ar<sup>+</sup> laser; LOD *ca* 4 μg/L. The method was applied for determination of unconjugated catecholamines in urine, using isoproterenol (**21c**) as internal standard<sup>273</sup>.

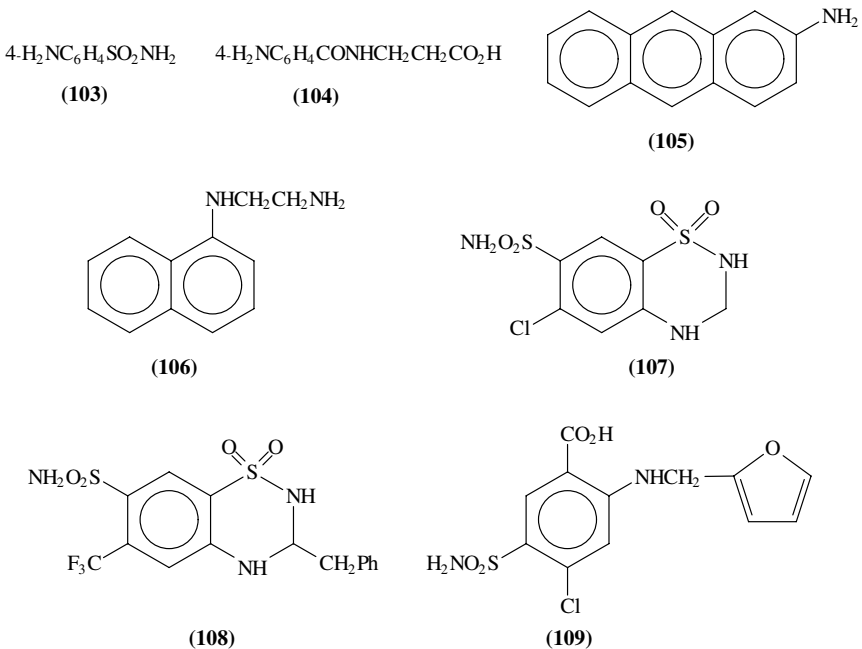
The PRISMA model<sup>274</sup> and factorial experimental design were applied in the development of a one-dimensional overpressured layered chromatography separation method for the anti-neoplastic bis-indole alkaloids vincristine (**102a**), vinblastine (**102b**) and some derivatives<sup>275</sup>.

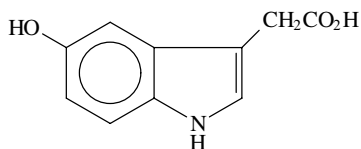
Diazotization and formation of diazo dyes affords a general approach to pre-column derivatization, to be followed by direct phase or RP-HPLC with UVD or FLD. Thus,



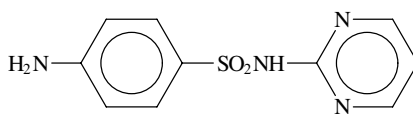


sulfanylamide (**103**), *p*-aminobenzoyl- $\beta$ -alanine (**104**) and *p*-aminobenzoic acid served as model compounds for diazotization and coupling with 2-aminoanthracene (**105**). The method was applied for determination of *p*-aminobenzoic acid in urine. The method was unsuitable for 4-hydroxy or alkyl derivatives of aniline<sup>276</sup>. Modifications of the Bratton–Marshall method<sup>277</sup> were proposed for precolumn derivatization, by which primary aromatic amines are diazotized and coupled with *N*-(1-naphthyl)ethylenediamine (**106**). The diuretics hydrochlorothiazide (**107**), bendroflumethazide (**108**) and furosemide (**109**) were determined in urine after hydrolysis, diazotization and coupling with **106**, with *p*-aminobenzoic acid serving as model compound. Substituted indoles such as 5-hydroxyindole-3-acetic acid (**110**) and tryptophan (**47**) underwent *N*-nitrosation and interfered with the determination. End analysis was by HPLC with UVD or thermal lens spectrophotometry, using a micellar carrier; LOD for the diuretics was *ca* 5 nM for the





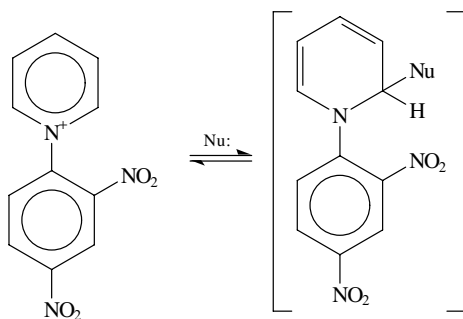
(110)



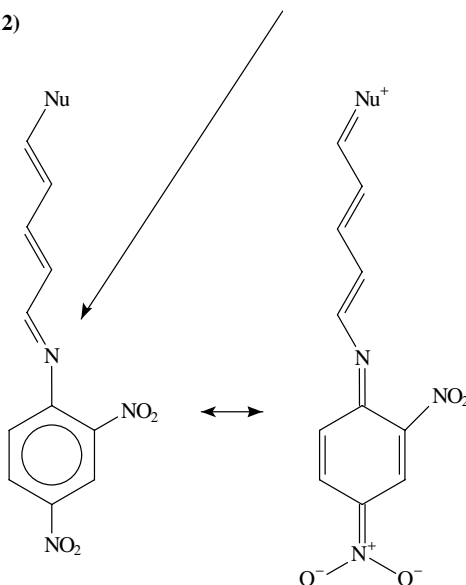
(111)

latter detector, which was 20–50-fold more sensitive than UVD<sup>278</sup>. The necessity of preparing fresh solutions of unstable nitrite is avoided in a FIA system where nitrate is reduced to nitrite *in situ* by Cd/Cu, followed by diazotization and coupling with reagent **106**. This was applied to fast analysis of sulfadiazine (**111**), with a throughput of 72/h. UVD measurements at 542 nm were linear in the 0.5–50 ppm range<sup>279</sup>.

1-(2,4-Dinitrophenyl)pyridinium chloride (**112**) is a versatile display reagent after planar chromatography (e.g. TLC and paper chromatography), revealing as colored areas on a yellow background. The reagent can be applied for detection of nucleophilic analytes such as primary and secondary amines, thiols, thiolactones and carboxylic acids, as shown in reaction 14<sup>280</sup>.



(112)

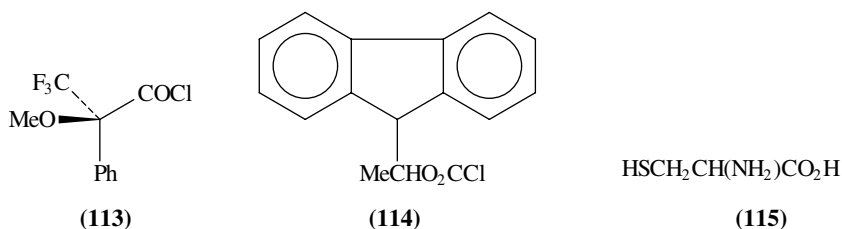


(14)

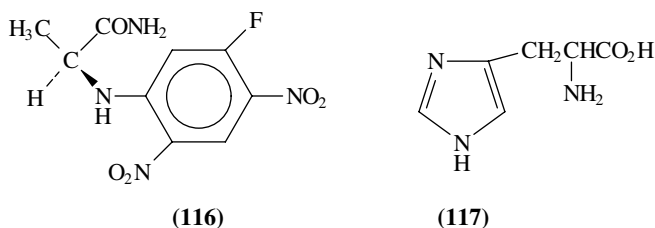
## 4. Chiral purity

See Section IV.I for alternative methods of chiral resolution. Partial chemical hydrolysis of proteins and peptides with hot 6 M HCl, followed by enzymatic hydrolysis with pronase, leucine aminopeptidase and peptidyl D-amino acid hydrolase, avoids racemization of the amino acids<sup>281</sup>. The problems arising from optical rotation measurements of chiral purity were reviewed. Important considerations are the nonideal dependence of optical rotation on concentration and the effect of chiral impurities<sup>282</sup>.

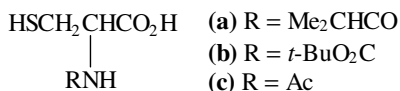
Determination of chiral purity using chromatographic methods has been reviewed<sup>283</sup>. The feasibility of using a circular dichroism spectrophotometer as LC detector for chromophore-bearing chiral molecules was critically examined. Using UVD in tandem with such spectrophotometer may be of advantage<sup>284</sup>. The sensibility of the chromatographic detectors and the good yields usually attained with derivatizing reagents make it possible to analyze small samples containing low concentrations of chiral amines, such as biological fluids and environmental samples. Usually, methods are based on precolumn derivatization with a chiral reagent, for example *S*(+)-Mosher's acid chloride (**113**)<sup>285,286</sup>, followed by destruction of excess reagent, chromatographic resolution and detection of the diastereoisomers. Derivatization of amino acids with the (+) form of 1-(9-fluorenyl)ethyl chloroformate (**114**) affords diastereoisomers that can be resolved and determined by RP-ion pair HPLC. Of the nineteen amino acids investigated tyrosine (**46**), tryptophan (**47**) and cysteine (**115**) could not be detected due to their weak reaction with the derivatizing reagent. The method was applied to the study of amino acids in the nervous system of crustaceans<sup>287</sup>.



The enantiomeric purity of protected amino acids used in peptide synthesis can be determined by pre-column partial deprotection followed by derivatization with Marfey's reagent (**116**). The Marfey diastereoisomers can be easily resolved and determined by RP-HPLC using an ODS-Hypersil column<sup>288</sup>. Fifteen amino acids collected from mammalian tissues were derivatized with Marfey's reagent and subjected to two-dimensional TLC. Each individual spot (enantiomeric mixture of a diastereoisomer) was then resolved by RP-HPLC. Except for tyrosine (**46**) and histidine (**117**), subnanomole quantities of enantiomers could be analyzed<sup>289,290</sup>.

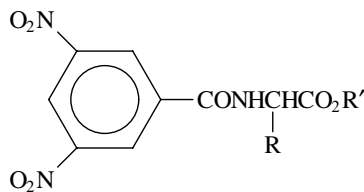


A fully automated derivatization system for determination of enantiomeric purity of amino acids is based on derivatization with *o*-phthalaldehyde (**73**) in the presence of the chiral thiol *N*-isobutyryl-L-cysteine (**118a**) or its D enantiomer (see reaction 7). The diastereoisomeric isoindole derivatives of forty-one amino acids were separated on a C<sub>18</sub> RP-column. The fluorescence allowed detection of 1–2 pmol of an amino acid enantiomer; linearity was good in the 25–1000 pmol range<sup>291</sup>. Derivatization by reaction 7, using *N*-*t*-butyloxycarbonyl-L-cysteine (**118b**) as mercaptol, was applied to enantiomeric analysis of the free amino acids in brain tissue, revealing the presence of a large amount of free D-serine (0.22 μmol/g, 25% of the free serine found) while D-alanine and D-aspartate are present at trace levels<sup>292</sup>. Similarly, thiosugars were proposed as chiral thiol reagents for pre-column derivatization of enantiomeric mixtures of 2-amino-1-alcohols. The reaction takes place within 1 min and resolution by RP-HPLC with fluorescence detection is efficient; LOD is less than 1 μM for 10 μL injection<sup>293</sup>.

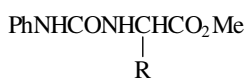


(118)

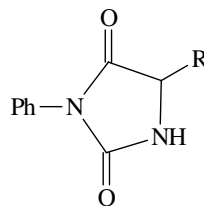
A comparative study was carried out of the effectiveness of three commercially available chiral columns and nonchiral derivatives of amino acids such as *N*-(3,5-dinitrobenzoyl) esters (**119**), phenylurea esters (**120**), hydantoin (**121**) and thiohydantoin (**98**). Although good separations were obtained, no column was universally effective<sup>294</sup>.



(119)



(120)



(121)

Derivatization of secondary amino acids with 9-fluorenylmethyl chloroformate (**90**), followed by HPLC using a modified cyclodextrin-bonded phase and a nonaqueous polar mobile phase, served to determine enantiomeric impurities which were in some cases as low as 1 ppm of the main enantiomer. The derivatizing group served both as a tracer and as a means for avoiding further racemization of imino acids<sup>295</sup>. The enantiomeric purity of esters of amino acids derivatized with reagent **90** could be separated on Chiralcel-OD with large separation factors (1.5–2.2). FLD had LOD below 0.05% down to the ppm range. Inversion of the elution order was observed for certain proline and tryptophan enantiomers<sup>296</sup>.

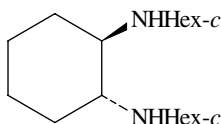
The chiral reagent **122** was proposed for derivatization of enantiomeric mixtures of amino acids. Good HPLC separations were obtained for the diastereoisomer derivatives of a series of amino acids, including some unusual  $\alpha$ -amino acids with long or bulky side chains, aryl and hetaryl groups, and  $\beta$ -substituted  $\beta$ -amino acids<sup>297</sup>.

Nonchiral columns can be used with nonchiral derivatization for better detectability of the analytes, using chiral modifiers of the carrier solvent. For example, RP-HPLC resolution of dansylated (**92**) D,L-amino acids using L-phenylalanine–Cu(II) complex



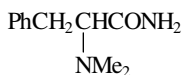
(122)

as chiral modifier<sup>298</sup>. The Cu(II) complex of (*R,R*)(-)-*N,N'*-dicyclohexyl-*trans*-1,2-cyclohexanediamine (**123**) was also proposed as chiral modifier. This was applied to the RP-HPLC resolution of free or dansylated amino acids and to further assist the separation of diastereoisomers<sup>299</sup>.



(123)

The concept of two-dimensional chromatography was applied to LC in columns for determination of enantiomeric composition of complex mixtures of amino acids, as occurring in biological fluids and foods. The first run performed was IEC with LiCl–Li citrate buffer. Each eluted peak corresponding to an amino acid was reinjected into an RP-C<sub>18</sub> column and eluted with an aqueous solution containing chiral Cu(II) complexes with various derivatives of L-phenylalanine (**124–126**), which undergo partial ligand exchange with the amino acid enantiomers and perform chiral discrimination. Advantages of the method are that only the chiral mixtures of interest are separated and each one of these can be treated with a different chiral reagent. Detection was by fluorometry, after post-column derivatization with 4-chloro-7-nitrobenz-2,1,3-oxadiazole (**127a**) for proline and hydroxyproline and, according to reaction 7, for the other amino acids. It was possible to detect chiral impurities as low as 0.1% in the nM concentration range<sup>300</sup>. Pre-column derivatization of amino acids with 4-fluoro-7-nitro-2,1,3-benzoxadiazole (**127b**) followed by HPLC-FLD ( $\lambda_{\text{ex}}$  470 nm,  $\lambda_{\text{fl}}$  530 nm) showed separation factors of 1.27 and 1.17 for the derivatives of the enantiomers of phenylalanine and leucine, respectively; LOD *ca* 30 fmol<sup>301</sup>; phenylcarbamylated  $\beta$ -cyclodextrin stationary phases were also used<sup>301,303</sup>. The fluorogenic benzoxadiazolyl isothiocyanate Edman reagents (**128**) were proposed for pre-column derivatization of amino acids, followed by HPLC-FLD. No racemization took place on derivatization<sup>304</sup>. Pre-column derivatization of alcohols and amines with the chiral proline derivative reagent **129** affords fluorescent labeling of these compounds for LC-FLD. Excitation at about 450 nm and fluorescence at about 560 nm were essentially the same for all alcohols and amines tested; instrumental LOD (SNR 2) and detection using a conventional Xe lamp was 10–500 fmol, and 2–10 fmol with LIF, using the Ar<sup>+</sup> emission at 488 nm<sup>234</sup>. See other benzoxadiazole reagents above (**88**, **89**).



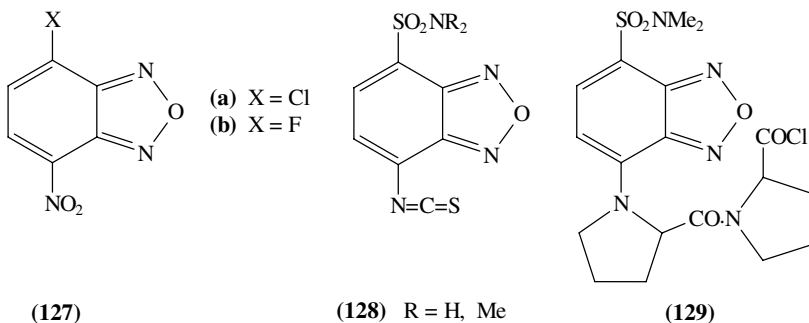
(124)



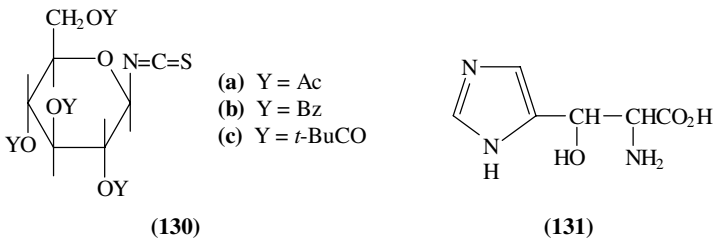
(125)



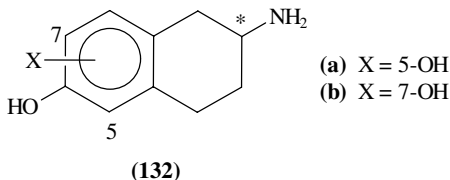
(126)



The enantiomeric composition of the amino acids of a pyoverdine hydrolyzate was determined by RP-HPLC of their derivatives with  $\beta$ -D-glucopyranosyl isothiocyanate tetraacetate (**130a**). However, the L-configuration of *threo*- $\beta$ -hydroxyhistidine (**131**), a rare amino acid, was established with amino acid oxidases<sup>305</sup>. Derivatization with the tetrabenzoate analogue (**130b**) gave excellent resolution in the RP-HPLC of a variety of enantiomeric amino acids and  $\beta$ -adrenergic blockers on a standard C<sub>18</sub> column, while the tetrapivalate analogue (**130c**) gave unsatisfactory results<sup>306</sup>. Derivatization with reagent **130a** followed by RP-HPLC was proposed for determination of the enantiomers of cyclic imino acids and  $\beta$ -substituted  $\beta$ -alanines<sup>307</sup>.



HPLC, using a Crownpack CR column containing an 18-crown-6-type chiral crown ether, served to separate and resolve the enantiomers of 5,6-dihydroxy-2-aminotetraline (**132a**) and 6,7-dihydroxy-2-aminotetraline (**132b**) at pH 2.0; LOQ for enantiomeric impurities was <0.1%<sup>308</sup>.



### 5. Fossil dating

A dating technique for fossils is based on the measurement of the D:L ratio of amino acids extracted from the fossil sample. The hypothesis is that over very long periods

epimerization takes place, and the enantiomeric ratio can be correlated with age. This has some advantages over  $^{14}\text{C}$  radioisotope dating, as several easily resolved tracers (amino acids) are available for mutual reconfirmation or discovery of unusual features. The rate of racemization is affected by temperature, pH, catalysts etc., but these factors can be eliminated by correlating D:L ratios in fossils of a locality with  $^{14}\text{C}$  dating. This was done for about one-hundred known fossil specimens collected in Hungary, and the calibration curves were applied to estimate the age of specimens, based on two to three amino acids<sup>309</sup>. See also end of Section IV.B.

Besides providing a dating tool for samples older than the limit of radiocarbon dating ( $4\text{--}5 \times 10^4$  year), enantiomer ratio can be applied to dating of recent samples, where the  $^{14}\text{C}$  method is also insensitive. Thus, the rate of epimerization of aspartic acid allows dating of deposits less than 350 years old<sup>310</sup>. Assessment of indigeneity of fossil samples can be carried out by analyzing the soluble organic matter. Each peptide is separated and submitted to amino acid analysis and differentiation using multivariate statistics. Besides dating, also the molecular phylogeny of the fossils can be asserted<sup>311</sup>. Determination of the 'I/A' ratio (L-isoleucine to D-alloisoleucine) requires very small samples, e.g. snail shells were individually analyzed and shown to belong to a mixed-aged deposit, aided by  $^{14}\text{C}$  dating<sup>312</sup>.

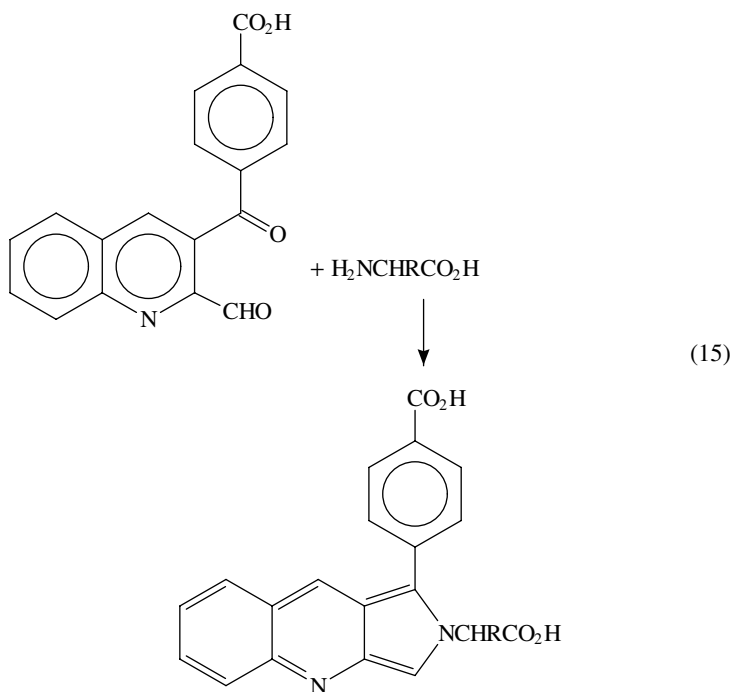
The effect of temperature on the rate of racemization of amino acids in fossils was investigated and the implications of the findings on fossil dating were analyzed<sup>313</sup>. The high rate of conversion of L-aspartic acid into its D-isomer, observed in uncontaminated bone samples taken from catacombs in Rome (IV century BC) was attributed to collagen decomposition due to the humidity of the catacombs<sup>314</sup>.

## E. Electrophoresis

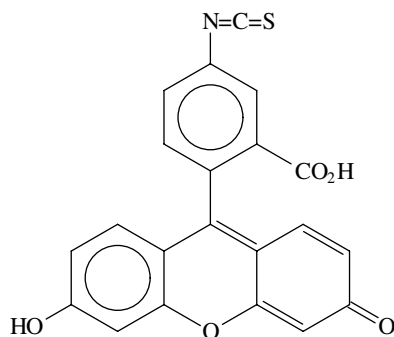
Refractive index may afford a sensitive universal detection method for capillary electrophoresis (CE). An important part of the setup is a refractive index matching fluid in which the capillary is submerged. The method was tested for a saccharide mixture including *N*-acetylglucosamine and *N*-acetylgalactosamine<sup>315</sup>. An intensity-modulated 257 nm pump laser-induced refractive index changes inside a 25  $\mu\text{m}$  bore capillary used in CE. These changes were monitored with the aid of a probe laser beam oscillating at 663 nm. This RID was demonstrated for dansyl (**92**) derivatives of amino acids: total sample 350 pg, with detection volume  $<10$  pL<sup>316</sup>.

The effectiveness of nine background electrolytes, providing both buffering action and background absorbance, was assessed for CE separation of twenty common amino acids. *p*-Aminosalicylic acid and *p*-(*N,N*-dimethylamino)benzoic acid were the best<sup>317</sup>. Low molecular weight amines can be separated and determined by CE using an electrolytic system based on Cu(II)<sup>318</sup>. Potential-amperometric detection of amino acids and peptides separated by CE was carried out by electro-oxidation at a Cu electrode in alkaline medium. The method was applied to determination of amino acids in urine, L-aspartyl-L-phenylalanine methyl ester (aspartame) in soft beverages and pentapeptides from a solid-phase synthesis process<sup>319</sup>.

Primary amines are derivatized readily and quantitatively as illustrated in reaction 15. CE and detection by LIF had LOD in the low attomol ( $1 \times 10^{-18}$ ) range for amino acids and amino sugars<sup>320,321</sup>.



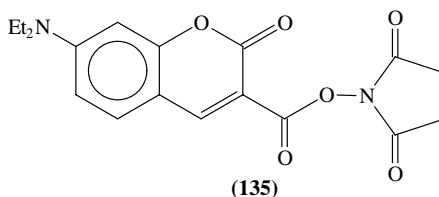
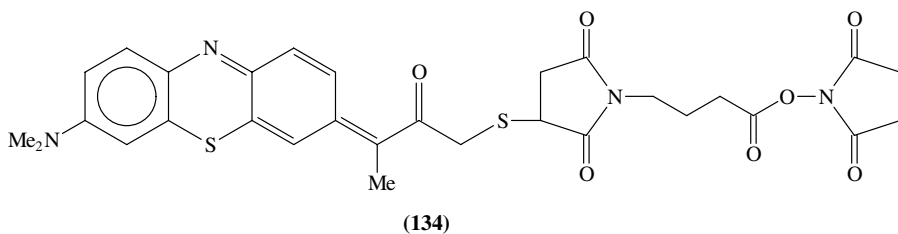
Amino acids derivatized with 9-fluorenylmethyl chloroformate (**90**) were separated by CE and determined by LIF with a pulsed laser; LOD 0.5 nM (SNR 2)<sup>322</sup>. A sensitive technique for amino acids is capillary zone electrophoresis (CZE) combined with LIF of their fluorescein isothiocyanate (**133**) derivatives. Not all amino acids give good resolution. LOD for proline and arginine were 0.3 and 0.5 nM, respectively<sup>323</sup>.



(133)

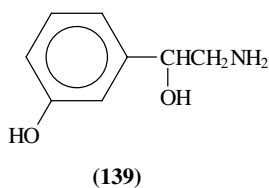
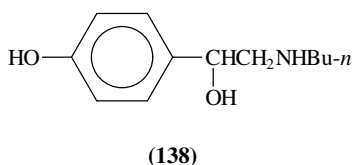
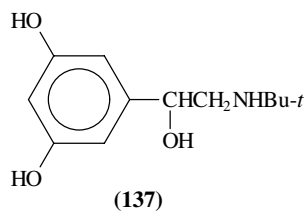
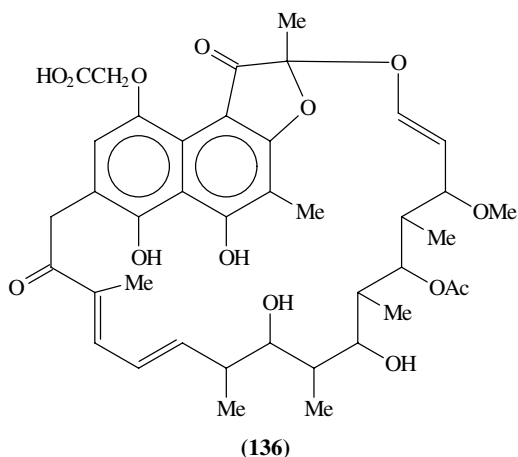
The chiral purity of amino acids at large enantiomeric excess can be determined automatically by derivatization with 4-fluoro-7-nitro-2,1,3-benzoxadiazole (**127b**) followed by CE with cyclodextrin chiral selectors and detection of the LIF excitation at 488 nm. LOD 140 ppm of L-phenylalanine in D-phenylalanine<sup>324</sup>.





Pre-column derivatization with either **134** or **135** followed by CZE and LIF detection was proposed for amino acids. The amino group of the analyte displaces the succinyloxy moiety of the reagent yielding a carboxamide<sup>325</sup>. See also Section IV.D.3.c for other acylating reagents derived from *N*-hydroxysuccinimide (**95** and **96**).

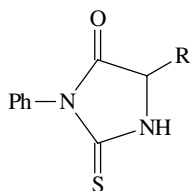
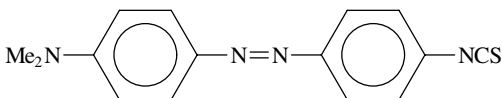
Rifamycin B (**136**), a macrocyclic antibiotic of the ansamycin class, associates enantioselectively with amino alcohols. As **136** bears a carboxyl group, it can be used as a host molecule to resolve enantiomeric mixtures by CE. This was applied to analyze a variety of drugs, including terbutalin (**137**), bamethan (**138**), norphenylephrine (**139**),



isoproterenol (**21c**), epinephrine (**21b**), norepinephrine (**21a**), pseudoephedrine (**30**) and octopamine (**22**)<sup>326</sup>.

Micellar techniques can increase the concentration of a component in the disperse phase and the ionic mobility due to lower specific surface for a given specific charge. Pre-column derivatization with **90** was followed by micellar electrokinetic chromatography (MEKC) and LIF detection. Combined derivatization with **73** and **90**, to attach fluorescent markers to primary and secondary amino acids in biological samples, was investigated<sup>327</sup>. Derivatization with **78** in the presence of cyanide afforded fluorescent derivatives of amino acids that were separated by MEKC; LOD of 0.9 amol (attomol,  $10^{-18}$  mol) at SNR 2, using LIF, at 200  $\mu$ M concentrations, with injections of *ca* 2.5 nL<sup>328</sup>. The analysis of thirty dansyl (**92**) derivatized amino acids by MEKC was investigated. Sodium dodecylsulfate micelles were used for neutral and acidic amino acids, attaining separation efficiency between 210,000 and 343,000 theoretical plates; LOD was 3–6 fmol, RSD 0.09–0.70% for migration times and 0.85–3.41% for peak area. Sodium cholate micelles were used for basic amino acids. The method was demonstrated for determination of amino acid composition in foodstuffs and skin<sup>329</sup>.

Applicability of CZE to the Edman phenylthiohydantoin derivatives of amino acids (**140**) is limited because the neutral amino acids cannot be resolved by this method and by the reduced thickness of the sample requiring relatively high concentrations of the fluorescent material for detection. These limitations may be overcome by a micellar technique that confers mobility to neutral **140** species and by application of thermotropic detection that allows one to detect a few tens of fmol of the derivative, obtained after injecting *ca* 0.5 nL, at a concentration of *ca* 1  $\mu$ M<sup>330</sup>.

**(140)****(141)**

The thiohydantoin derivatives of amino acids obtained from 4-(4-dimethylaminophenylazo)phenyl isothiocyanate (**141**) and fluorescein isothiocyanate (**133**) can be separated by CZE. Lowering the absolute detection limits of thiohydantoin derivatives of the amino acids is a basic requirement for the development of highly sensitive protein sequencer based on Edman-like processes. Thus, the absolute LOD of thiohydantoin derivatives are at present of the order of  $10^{-16}$  mol for **141** and  $10^{-21}$  mol for **133**<sup>331</sup>.

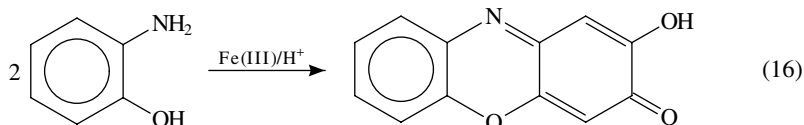
The basic material in seeds that is extractable with trichloroacetic acid solutions is ascribed to nonprotein nitrogen when the acid is in the 0.4–1.0 M concentration range. Gel electrophoresis on a sodium dodecylsulfate polyacrylamide medium pointed to the presence of 12 kDa polypeptides in soybean meal and 7, 10, 12 and 28 kDa in almond meal<sup>332</sup>.

## F. Spectrophotometric Methods

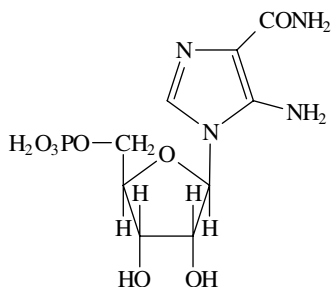
Aromatic amines can be determined by measuring the difference of their UVV absorption spectra, taken at identical concentrations but different pH of the solution. Also, standard mixtures and samples of the amines isolated from coke processing products were tested; LOD 0.1–1 ppm. The procedure is potentially useful for waste waters and industrial effluents, where techniques such as GC and nonaqueous titrations may prove difficult to apply<sup>333</sup>. A determination of certain metabolites symptomatic of pancreatitis

consists of basic hydrolysis of urine, followed by spectrofluorimetric determination of *p*-aminobenzoic acid and *p*-aminosalicylic acid<sup>334</sup>.

*o*-Aminophenol undergoes oxidative dimerization followed by hydrolysis, yielding the intensely colored 2-hydroxy-3*H*-phenoxazin-3-one, as shown in reaction 16. Halogen-substituted *o*-aminophenols in urine were determined by the same reaction<sup>335</sup>.

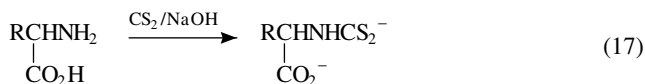


Modifications of the Bratton–Marshall method mentioned in Section IV.D.3.g can be used for sensitive spectrophotometric detection and determination of primary aromatic and heterocyclic amines. Thus, a simple spectrophotometric determination of the cardio-protective agent acadesine (**142**) was developed, to measure concentrations of the drug in plasma during intravenous infusion to patients undergoing coronary artery bypass graft surgery<sup>336</sup>.

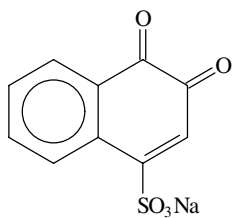


(142)

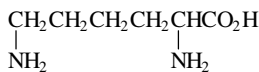
Amino acids can be determined according to reaction 17. The resulting dithiocarbamates have two specific absorption bands at  $\lambda_{\max}$  255 and 285 nm. Lysine and cysteine have almost double the molar absorbance because of reaction of the additional  $\text{NH}_2$  and  $\text{SH}$  group, respectively<sup>337</sup>. The kinetics of this reaction can be used for the determination of secondary amines, by measuring the absorbance of the  $\text{Cu(II)}$  complex with the *N,N*-dialkyldithiocarbamate, at  $\lambda_{\max}$  440, in a stop-flow cell. The products of primary amines are unstable. The reaction rate of *n*-alkylamines is faster than that of isoalkylamines. Micelle formation by addition of Triton X-100 improved the method<sup>338</sup>.



A spectrophotometric method for determination of primary and secondary amines requires development for each particular compound, determining the kinetics of reaction of the amine with sodium 1,2-naphthoquinone-4-sulfonate (**143**) and the UVV absorption spectrum of the product, under a set of fixed conditions. The procedure was applied to determination of ephedrine (**30**) and amphetamine (**28**) in pharmaceutical samples<sup>339</sup>. Reagent **143** in a FIA system was used for the fast determination of lysine (**144**) in commercial feed samples by multivariate calibration techniques, without need of chromatographic separation<sup>340</sup>.



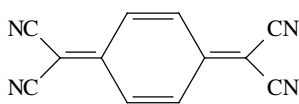
(143)



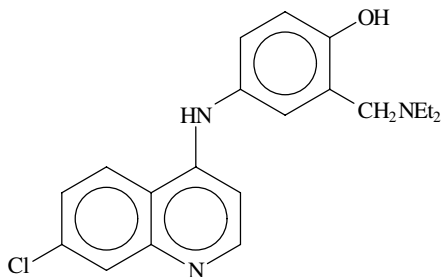
(144)

Reaction 7 (Section IV.D.3.a) was applied for the automatic kinetic-fluorometric determination of primary amine pharmaceuticals, using *N*-acetylcysteine (**118c**) as thiol and a stop-flow technique for data acquisition<sup>194</sup>. A FIA system was designed for determining the total free amino acids in seawater, based on reaction 7 and measurement of LIF ( $\lambda_{\text{ex}}$  337 nm,  $\lambda_{\text{fl}}$  455 nm) using a diode array. The signals of dissolved ammonia and urea are weak. Possible interference by ammonia can be eliminated by the time-resolved fluorescence technique, because the fluorescent lifetime of the ammonia derivative is 9 ns vs 21 ns for that of all the amino acid derivatives. Linearity was observed in the 1–500 nM range of alanine equivalent. The method is suitable for real-time analyses in on-board laboratories<sup>341</sup>. The results from this FIA method compared well with HPLC determination of the free amino acids. Only in the case when ammonia concentration strongly overbalanced that of the free amino acids (ratio  $\gg$  10) did the FIA method fail<sup>342</sup>.

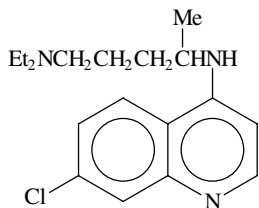
The electron acceptor 7,7,8,8-tetracyanoquinodimethane (TCNQ, **145**) is capable of abstracting one electron from a donor molecule, yielding deeply colored solutions of a



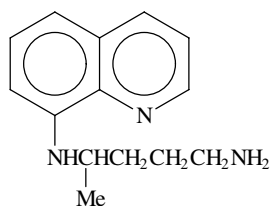
(145)



(146)



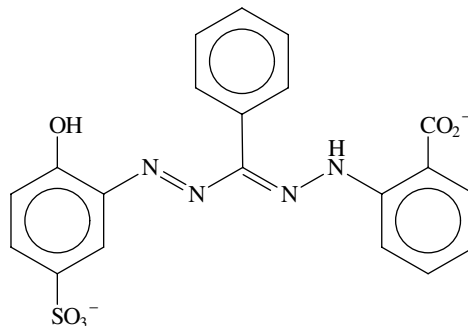
(147)



(148)

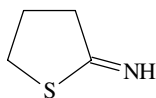
stable radical anion that can be measured spectrophotometrically. This was applied to the determination of the antimalarial drugs amodiaquin (**146**) hydrochloride, chlorodiaquin (**147**) phosphate and primaquin (**148**) phosphate in pharmaceutical formulations<sup>343</sup>.

A solution containing an amino acid is passed through a polymeric bed containing Cu(II) ions, forming a complex which is further reacted with zincon (**149**) and the blue color measured at 600 nm in a FIA system. This was applied for fast determination of amino acids in pharmaceutical formulations<sup>344</sup>.

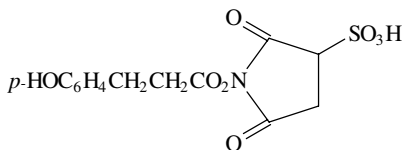


(149)

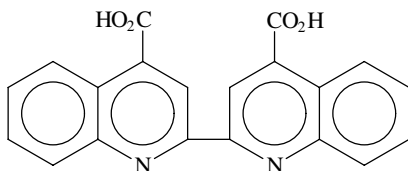
A sensitive method for the spectrophotometric determination of primary or secondary amino functions attached to a solid support consists of derivatizing with either 2-iminothiolane (**150**, Traut's reagent) or sulfosuccinimidyl 3-(4-hydroxyphenyl)propionate (**151**). The products contain one mercapto or phenolic OH group attached to each amino site, which are capable of reducing Cu(II) to Cu(I) in alkaline medium. Thus, the derivatized sample is incubated with the so-called 2,2'-biconchonic acid copper protein reagent, containing **152** and Cu(II) ions, yielding an intensely colored chelate complex with Cu(I) ions<sup>345</sup>. Derivatization with **150** and 5,5-dithiobis(2-nitrobenzoic acid) (**153**, Ellman's reagent) as the chelating agent was also recommended for determination of primary amino groups attached to the surface of solid supports<sup>346</sup>.



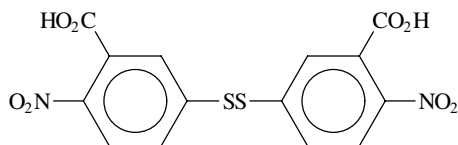
(150)



(151)

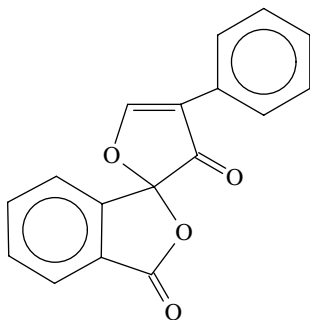


(152)



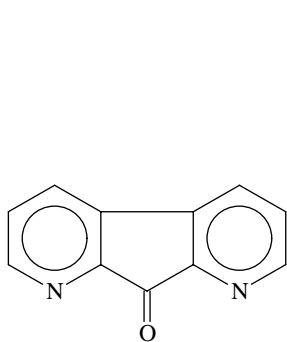
(153)

The lysine and hydroxylysine sites of gelatin were determined by combining their free amino groups with fluorescamine (**154**) and measuring the induced photoluminescence<sup>347</sup>. Primary amino groups covalently attached to the surface of glass were determined by derivatization with the same reagent and measurement of the fluorescence<sup>348</sup>.

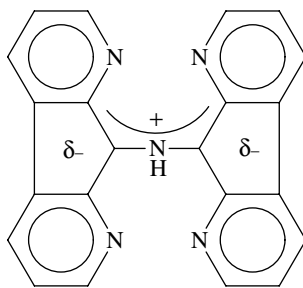


(154)

Latent fingerprints on paper have been revealed by combining the amino acids present with reagents such as ninhydrin (see **37**), dansyl chloride (**92**), fluorescamine (**154**), 4-chloro-7-nitrobenzofurazan (**127a**) and *o*-phthalaldehyde (see reaction 7). To avoid some problems encountered with these reagents it was proposed to use 1,8-diazafluorenone (**155**), leading to the formation of highly fluorescent ylides (**156**)<sup>349</sup>.



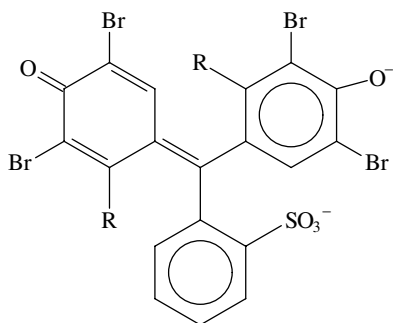
(155)



(156)

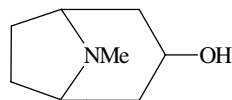
Amines form ion associates of the type [dye (amine H<sup>+</sup>)] or [dye (amine H<sup>+</sup>)<sub>2</sub>] with sulfonphthalein-type dyes, such as bromophenol blue (**157a**) or bromocresol green (**157b**). Spectrophotometry using these ion associates may give wrong results if the amines were once dissolved in halogenated solvents, due to quaternization between the amine and the solvent. This was demonstrated for a series of amines such as ephedrine (**30**), tropine (**158**), atropine (**159**), quinine (**160**) and ajmaline (**161**), and a series of solvents such as CH<sub>2</sub>Cl<sub>2</sub>, CHCl<sub>3</sub>, CCl<sub>4</sub> and ClCH<sub>2</sub>CH<sub>2</sub>Cl<sup>350</sup>.

A series of calixarenes bearing azo groups, such as **162a-c**, are potential detectors of aliphatic primary amines, as they showed bathochromic shifts of 37–100 nm from  $\lambda_{\text{max}}$  382 with these compounds. No shift was shown in the presence of aniline or *p*-nitroaniline<sup>351</sup>.

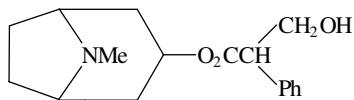


(157)

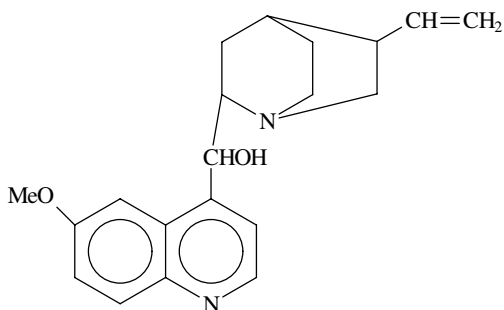
(a) R = H  
(b) R = Me



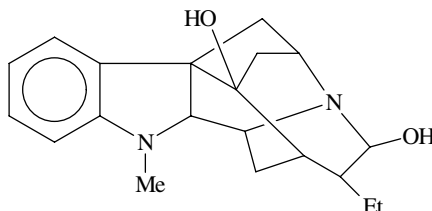
(158)



(159)



(160)



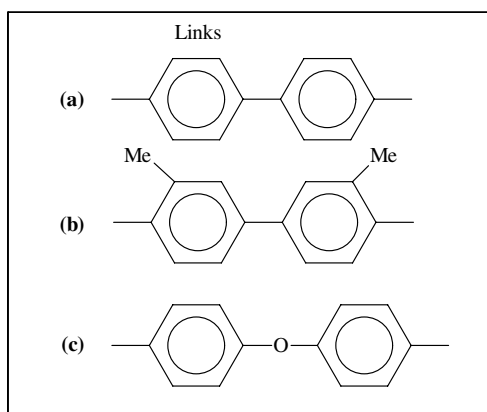
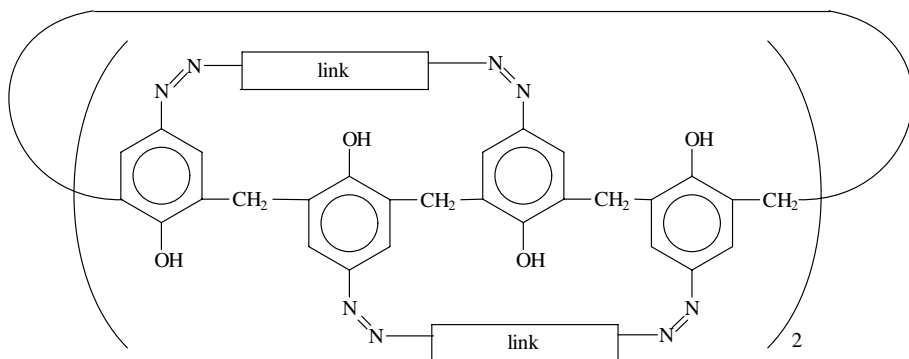
(161)

Primary amines form fluorescent Schiff base complexes in the presence of salicylaldehyde (**163**) and Be(II) ions, that can be measured in a FIA-FLD system. The reaction is fast, allowing up to 30 determinations per hour. Analytical range: MeNH<sub>2</sub>  $6 \times 10^{-6}$  to  $6 \times 10^{-3}$  M, RSD 3%; EtNH<sub>2</sub>, *n*-PrNH<sub>2</sub> and *n*-BuNH<sub>2</sub>  $3 \times 10^{-5}$  to  $8 \times 10^{-3}$  M. Secondary and tertiary amines do not react. This was applied to the determination of traces of MeNH<sub>2</sub> (0.007–0.008%) in commercial Me<sub>2</sub>NH<sup>352</sup>.

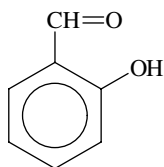
A fast and sensitive method for determination of 4-aminoantipyrine (**164**) consists of coupling this compound with diazotized *p*-nitroaniline in a FIA system and measuring spectrophotometrically at 380 nm. About 50 determinations per hour could be carried out; LOD was 0.05 ppm (SNR 3), RSD 0.61% for 4 ppm and 0.27% for 50 ppm, with linearity up to 50 ppm<sup>353</sup>.

Surface-enhanced Raman scattering using a silver-coated alumina support selectively enhanced the spectrum of *p*-aminobenzoic acid. This allowed the determination of this compound at low ppm levels in vitamin B complex<sup>354,355</sup>.

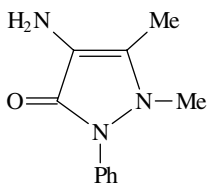
LIF excitation spectra were recorded for alkyl aminobenzoates (**165**) under free jet conditions. The partially resolved band contours were different for the various compounds



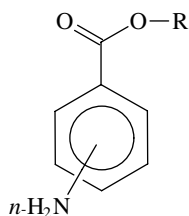
(162)



(163)



(164)



(165)

R = Me, Et  
n = 3,4

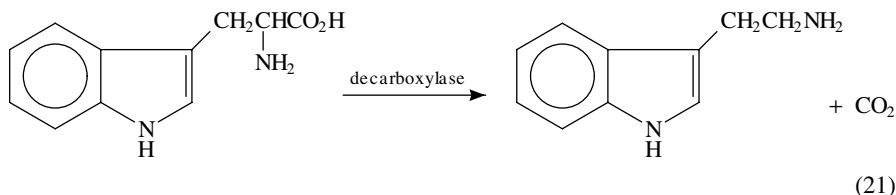
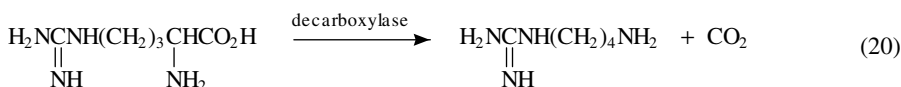
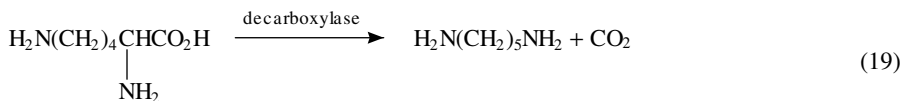
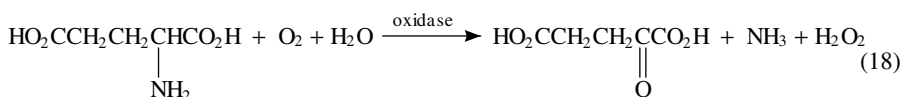
and could be assigned to conformers of the molecule. Differences in band contour were ascribed to changes in hybridization caused by the conformational structure<sup>356</sup>.

### G. Enzymatic Biosensors

Amperometric biosensors incorporating certain enzymes on the electrode for the determination of D- and L-amino acids were investigated. The parameters included enzyme immobilization procedure, composition of the immobilizing matrix, amount of enzyme,



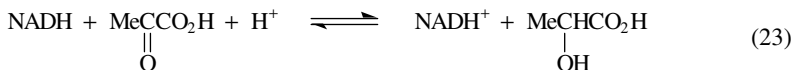
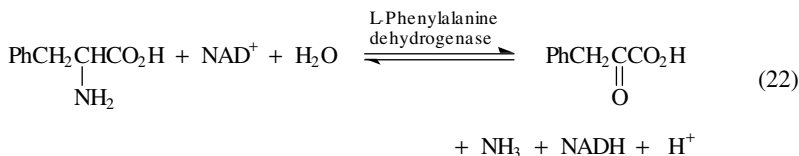
pH, flow rate and injection volume. The immobilized enzymatic system consisted of a D- or an L-amino acid oxidase producing hydrogen peroxide, and hydrogen peroxide reductase. The efficiency of the electrocatalytic reduction of hydrogen peroxide starts to increase from +600 mV towards negative potentials, and levels off at -100 mV, measured against a Ag/AgCl electrode. The 20 most common L-amino acids could be detected<sup>357</sup>. Specific amperometric amino acid sensors were based on a Clark oxygen electrode, with specific or nonspecific enzymes immobilized on the gas-permeable membrane. L-Glutamic acid was determined using L-glutamate oxidase, by measuring the oxygen consumption of reaction 18. For L-lysine, L-arginine and L-histidine the corresponding decarboxylases catalyzed reactions 19–21. The liberated carbon dioxide was consumed by autotrophic bacteria leading to oxygen consumption that was measured in the detector<sup>358</sup>.



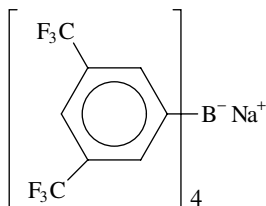
Polyaniline-modified electrodes allow electrometric determination of hydrogen peroxide produced in aminooxidase systems, without interference of electroreactive amino acids, such as cysteine, histidine, methionine, tyrosine and tryptophan<sup>359</sup>.

An interdigitated array of microelectrodes in a small volume helped to significantly reduce the LOD of electrochemically reversible redox materials<sup>360,361</sup>. This was applied to the determination of *p*-aminophenol by small volume immunoassay, by sandwiching layers of a supported enzyme with the microelectrodes. A steady-state signal was obtained for the array, showing a linear relationship between the concentration and the limiting current over the range of 1–1000  $\mu\text{M}$ . Less than 1 min detection time was required for 2–10  $\mu\text{L}$  samples<sup>362</sup>.

A biosensor was designed where a dehydrogenase and an enlarged coenzyme are confined behind an ultrafiltration membrane. The amino acid is determined indirectly, by measuring the fluorescence of the reduced coenzyme ( $\lambda_{\text{ex}}$  360 nm,  $\lambda_{\text{fl}}$  460 nm) produced in reaction 22, with the aid of an optical fiber. The coenzyme is regenerated with pyruvate in a subsequent step, as shown in reaction 23. This biosensor was proposed for determination of L-alanine and L-phenylalanine for monitoring of various metabolic diseases and for dietary management<sup>363</sup>.

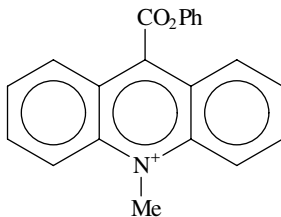


Amino acids may be determined by measuring the amines obtained after the action of a carboxylase with a specific electrode for amines, which is based on a poly(vinyl chloride) membrane containing sodium tetrakis[3,5-bis(trifluoromethyl)phenyl]borate (**166**) as ion exchanger and tricresyl phosphate as solvent mediator. LOD was 20 and 50  $\mu\text{M}$  for tyroxine and phenylalanine, determined as tyramine (**5**) and phenethylamine (**33**), respectively<sup>364</sup>.



(166)

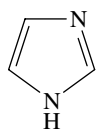
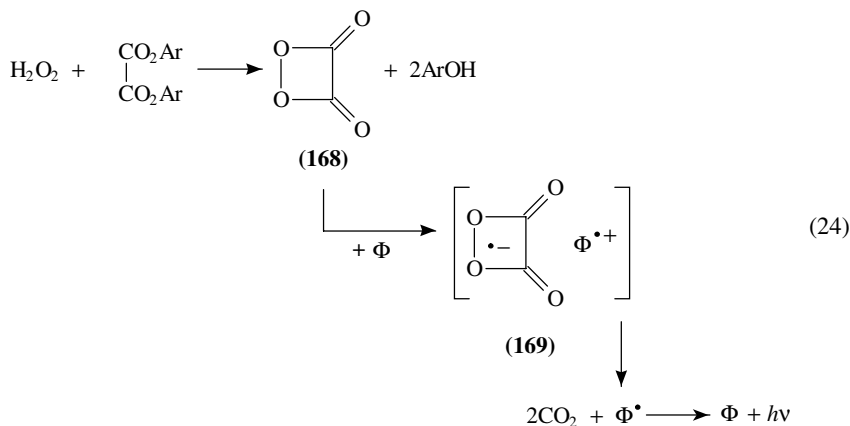
The hydrogen peroxide produced in a FIA system coupled with a bioreactor containing an amino acid peroxidase can be determined by the chemiluminescence it produces in the presence of phenyl 10-methylacridinium-9-carboxylate (**167**). Thus, for example, a throughput of 200 samples of glutamate per hour was achieved with LOD 0.5  $\mu\text{M}$  (SNR 3)<sup>365</sup>. Hydrogen peroxide, generated on degradation of amino acids by L-amino acid oxidase immobilized in a reactor, can be determined by measuring the chemiluminescence in the presence of luminol (**69**) and hexacyanoferrate ions. The method was applied to the determination of free amino acids in cheese, with a throughput of 40 samples per hour<sup>366</sup>. This method was preferable to derivatization procedures with either trinitrobenzenesulfonic acid or by applying reaction 7<sup>367</sup>.



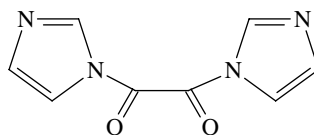
(167)

A sensitive method of determination of  $\text{H}_2\text{O}_2$  is by the so-called peroxalate reaction luminescence (reaction 24) by which hydrogen peroxide reacts with an aryl oxalate

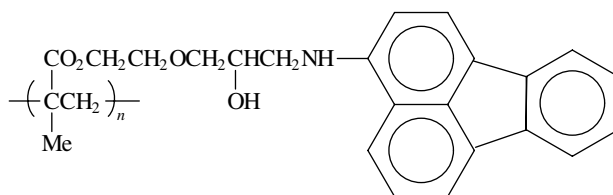
forming 1,2-dioxetanedione (**168**); this reacts with a fluorophore  $\Phi$ , leading to an excited state (**169**), that eventually returns to the ground state emitting a photon<sup>368</sup>. The effectiveness of the method depends on the readiness by which **169** is formed and the nature of the fluorophore. For example, 2,4,6-trichlorophenyl oxalate (**42**) catalyzed by imidazole (**170**) is frequently used. The method was reviewed<sup>369</sup>. A modification claimed to be 10 times more sensitive uses 1,1'-oxalyldiimidazole (**171**) as reagent and an immobilized form of 3-aminofluoranthene (**172**); LOD 10 nm of  $\text{H}_2\text{O}_2$  in water, for 0.5 pmol (50  $\mu\text{L}$ ) injection<sup>370</sup>.



(170)



(171)

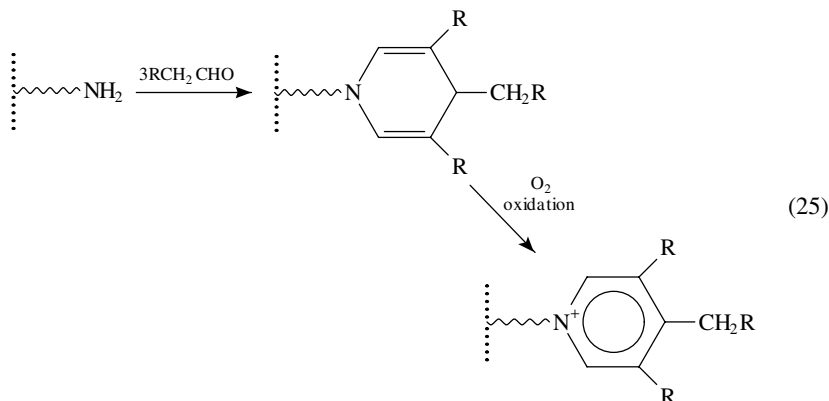


(172)

## H. Miscellaneous Methods

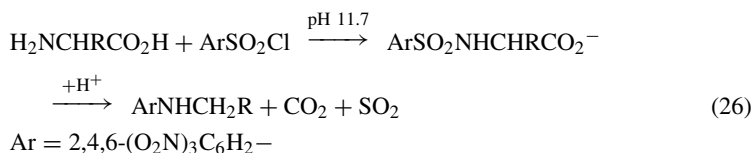
Carbon paste and graphite epoxy electrodes modified with  $\text{RuO}_2$  can be used for detection of amino acids and peptides in FIA systems. Optimal conditions are in strongly alkaline solutions at +0.45 V vs  $\text{Ag}/\text{AgCl}$  electrode, with a fast and linear response. Carbon paste electrodes can be modified also with  $\text{Co}_3\text{O}_4$ <sup>371</sup>. Colorimetric methods for the determination of amino groups attached to a solid support may give erroneous values

due to nonspecific adsorption of chromophores on the solid surface. An amperometric determination of primary amino groups was based on derivatization with glutaraldehyde followed by oxidation of the resulting dienamine (reaction 25). The amino group concentration is proportional to the oxygen consumption, that is monitored by a Clark oxygen electrode; RSD is 3.2% for AH-Sepharose 4B<sup>372</sup>.



Amino acids enhance the oxidation peak of Cu(0) obtained with a carbon paste electrode incorporating Cu(II) cyclohexylbutyrate. The increased current is proportional to the amino acid concentration at trace levels in the  $\mu\text{M}$  range<sup>373</sup>. The behavior of such electrodes was investigated for cysteine (**115**). On scanning potentials in the positive direction, the amino acid is accumulated on the electrode as the Cu(I) complex at +0.90 V vs a standard calomel electrode (SCE), in acetate buffer at pH 4.5; linear range is  $2 \times 10^{-9}$  to  $1 \times 10^{-7}$  M, 1 min accumulation, RSD 3% ( $n = 5$ )<sup>374,375</sup>.

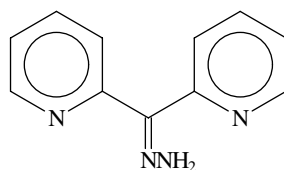
Amino acids can be determined in a two-step process (reaction 26). The  $\text{SO}_2$  produced can be determined by measuring the  $\text{S}_2$  emission of an  $\text{N}_2\text{-H}_2$  flame in a molecular emission cavity. Carbon was found to be better than iron for building the cavity<sup>376</sup>.



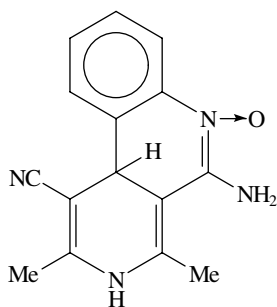
Radioimmunoassay (RIA) may sometimes be the method of choice for certain amines. Thus an  $^{125}\text{I}$  RIA method was developed for the specific detection of D-amphetamine (**28**) and D-methamphetamine (**29**) in urine, with LOD of approximately  $25 \mu\text{g/L}$ . The method was compared with GC-MS and other commercially available amphetamine assays. Other drugs gave erroneous positive identification as **28** with the latter methods, whereas the results of RIA were negative<sup>377</sup>.

Amino acids accelerate and proteins retard the rate of Cu(II)-catalyzed oxidation of di-2-pyridyl ketone hydrazone (**173**) yielding fluorescent compounds. This has been applied for the analysis of amino acids and proteins<sup>378</sup>.

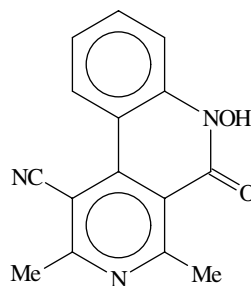
1,4-Dihydropyridines and their *N*-alkyl derivatives undergo anodic oxidation in basic medium to the corresponding pyridines (reaction 27). The process may be complicated by the presence of other moieties; for example, a nitro group may reductively condense



(173)

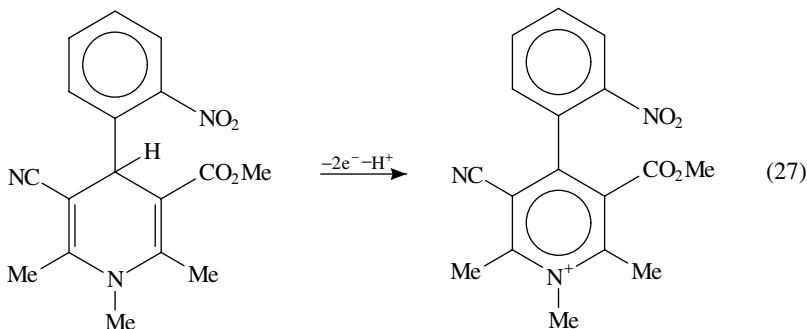


(174)



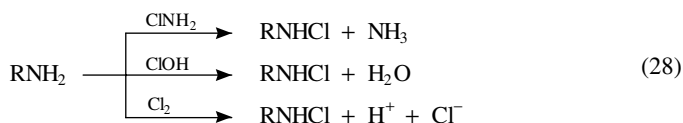
(175)

with nearby cyano or ester functions to yield products such as **174** and **175**<sup>379–382</sup>.



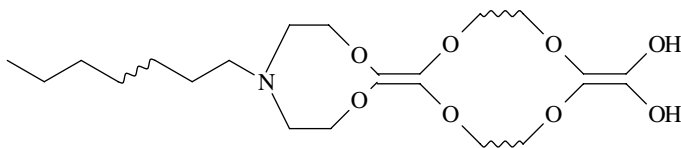
(27)

The fate of dissolved amines during disinfection of water by chlorination was determined by membrane injection MS. Aliphatic amines undergo *N*-chlorination to exhaustion of the N–H atoms by one of the tentatively proposed paths shown in reaction 28. Aromatic amines undergo mainly ring substitution; however, the possible intervention of *N*-Cl intermediates is not excluded. At pH 10.6 aniline chlorination is much slower than that of *n*-butylamine<sup>383</sup>.

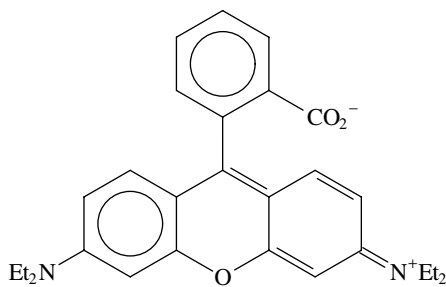


Nonionic surfactants of general structure **176**, used in off-shore drilling (e.g. Nonidet AT 85), are toxic and slowly biodegradable. They can be determined in an FIA system by

measuring the chemiluminescence produced on oxidation of the tertiary amino group by sodium hypochlorite at *ca* pH 11, in the presence of rhodamine B (**177**) as sensitizer. Only tertiary amines, including Me<sub>3</sub>N, Et<sub>3</sub>N and Pr<sub>3</sub>N, show chemiluminescence; however, the simpler amines can be distinguished by their faster kinetics; LOD *ca* 5 ppm of **176**<sup>384</sup>.



(176)

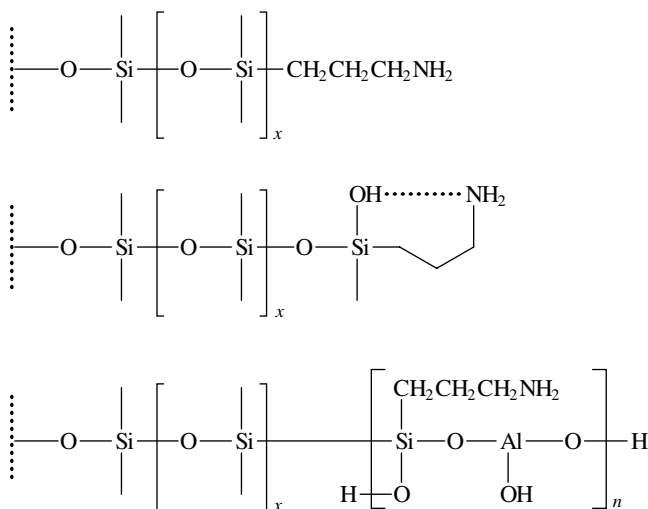


(177)

Primary amino groups covalently attached to the surface of glass were determined by derivatization with <sup>14</sup>C-labelled acetyl chloride and measurement of the radioactivity<sup>348</sup>. The interaction of hydrolyzed (3-aminopropyl)triethoxysilane with E-glass results in the formation of a thin coating about 6 nm thick. Investigation of this film by time of flight-secondary ion MS (TOF-SIMS)<sup>385,386</sup> and by X-ray photoelectron spectroscopy (XPS)<sup>387</sup> led to the conclusion that the film consists of three main structures as depicted in **178**, where the open bonds on silicon atoms represent oxygen bridges to other silicon atoms.

The structure of the two-dimensional molecular aggregates formed at the air-water interface of aqueous solutions of amino acids carries precise enantioselective information that influences the direction of growth of glycine crystals at that interface. Thus, solutions of valine, leucine, phenylalanine, norleucine, isoleucine or 2-aminooctanoic acid of *S*-configuration induce fast growth of the (010) face of glycine crystals at the air-water interface, while that of the 010 phase is induced in the presence of those of *R*-configuration. Hexafluorovaline, neopentylglycine and *t*-butylglycine fail to show this induction<sup>388</sup>. Amino acid enantiomers in association with the NaCl-H<sub>2</sub>O eutectic were investigated by differential scanning calorimetry (DSC) and NMR. Thus, a solution of amino acid in 0.1 M NaCl was heated in the DSC apparatus at a rate of 1 °C/min, starting at -60 °C, and the <sup>1</sup>H NMR spectrum was recorded at -20 °C. The combined DSC and NMR results showed that the L and D forms of the amino acids could be differentiated, based on the singlet and doublet bands<sup>389</sup>.

The bonding forms of nitrogen in several Australian coals were determined by XPS and predominantly assigned to pyrrolic and pyridinic forms. Amino forms appear to be absent<sup>390</sup>.



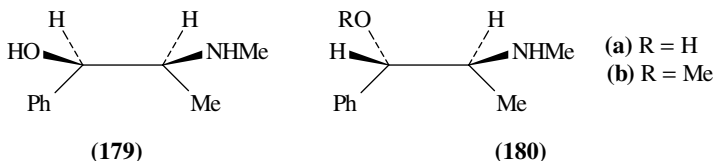
(178)

### I. Derivatization

Amines are converted quantitatively to dithiocarbamates (reaction 29), that can be determined by nonaqueous titration with Ce(IV); accuracy 0.8%, RSD 0.7%<sup>391</sup>.



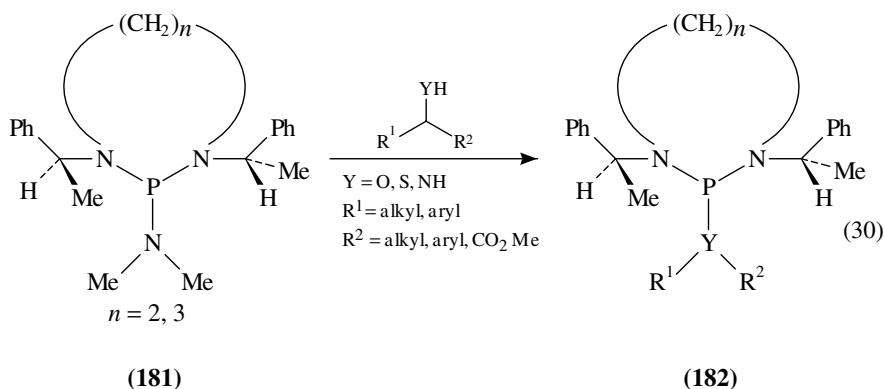
Despite the high sensitivity of the methods for chiral resolution described in Section IV.D.4, more direct methods are afforded by NMR spectroscopy, especially for the products of synthesis. Ephedrine (**179**), pseudoephedrine (**180a**) and its Me ether (**180b**) yield stable epimeric  $\text{N} \rightarrow \text{BH}_3$  adducts on treatment with borane. The configuration of the nitrogen moiety was established by NMR, taking into account the conformational analysis of the molecule<sup>392</sup>.



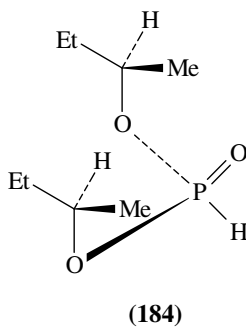
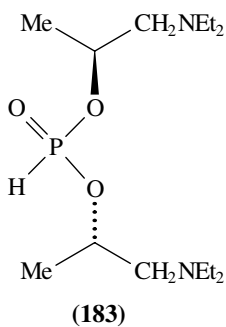
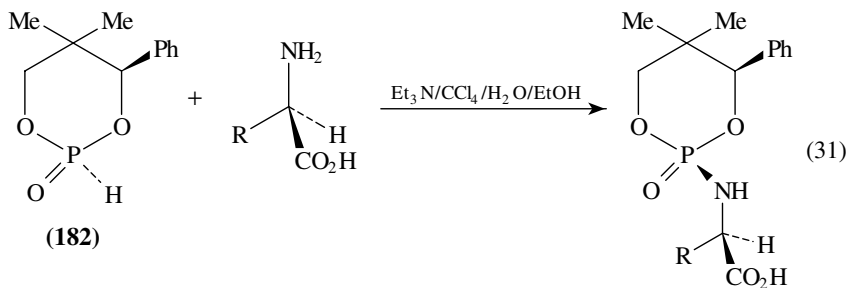
(179)

(180)

Various chiral derivatization reagents containing phosphorus have been proposed for determination of enantiomer excess. Measurement of <sup>31</sup>P NMR has the advantage of large peak separation. Reaction 30 takes place quantitatively with alcohols, thiols and amines in the NMR tube, at room temperature, in C<sub>6</sub>D<sub>6</sub> or CDCl<sub>3</sub> solution. Reagents **181** have C<sub>2</sub> symmetry and yield diastereoisomers **182**, with excellent <sup>31</sup>P NMR peak separation for accurate integration and determination of enantiomer excess. Other spectra such as <sup>1</sup>H NMR can also be taken, but they may be too complex for enantiomer analysis<sup>393</sup>.

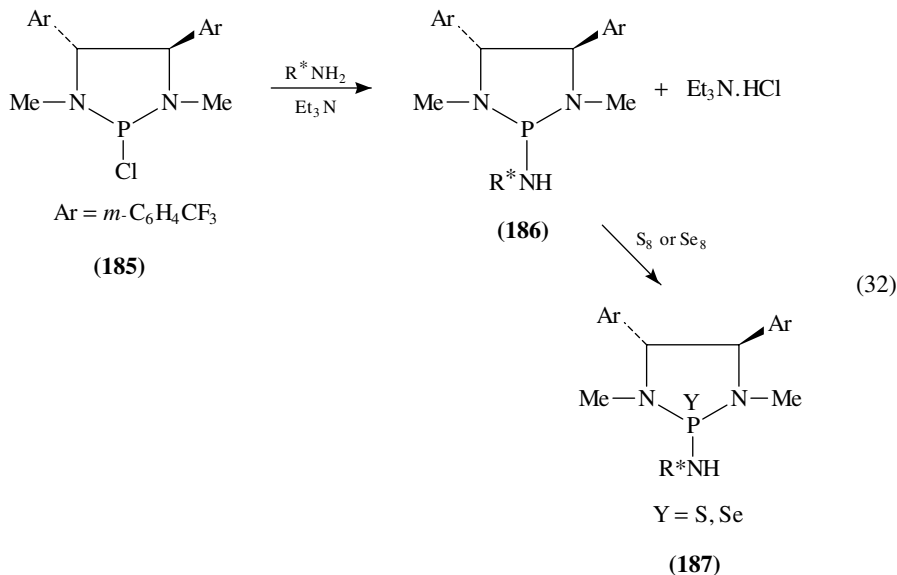


(*S*)-2*H*-2-Oxo-5,5-dimethyl-4(*R*)-phenyl-1,3,2-dioxaphosphorinane (182) and unprotected amino acids are easily combined in aqueous solutions, as illustrated in reaction 31. The resulting phosphamide shows well separated  $^{31}\text{P}$  NMR signals of the diastereoisomers, allowing accurate enantiomer excess determination. Diastereomeric amide derivatives of chiral phosphorinane 183 and unprotected amino acids are similarly useful. The diastereomeric shift depends strongly on pH, pointing to the influence of ionic charge on the diastereomeric shift dispersion<sup>394,395</sup>. Also (*S,S*)-*O,O*-di-*s*-butyl phosphonate (184) has been proposed for unprotected amino acids<sup>396</sup>.

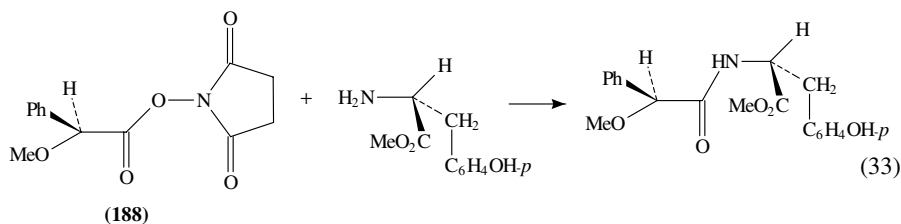


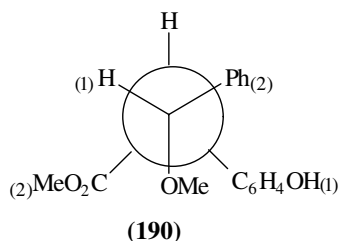
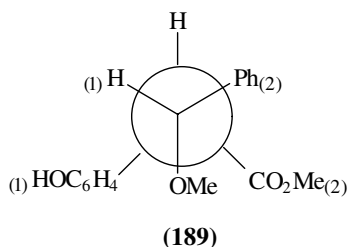


Additional NMR information may be useful in difficult enantiomer analyses of alcohols, thiols, and primary and secondary amines. Reaction 32 illustrates the process for a chiral primary amine,  $R^*NH_2$ , undergoing N-substitution with chiral reagent **185**. Besides the  $^{31}P$  NMR spectra of the diastereoisomers **186**, also  $^1H$ ,  $^{13}C$  and  $^{19}F$  spectra may be taken. Addition of sulfur or selenium to the NMR tube will afford diastereoisomers **187**, for which the corresponding spectra can also be taken<sup>397</sup>.

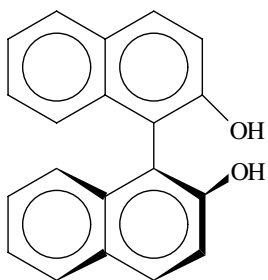
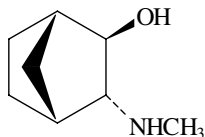
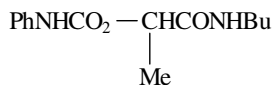


NMR assignment of configuration served for development of a method claimed to be of great reliability for establishing the absolute configuration of amines with an asymmetric center in the  $\alpha$  position, for which no reference compound is needed. The first step consists of derivatizing the amine with a chiral reagent, for example *N*-[(*S*)-2-methoxy-2-phenylacetoxy]succinimide (**188**), as shown in reaction 33 for the methyl ester of (*R*)-tyrosine. The substituents on each one of the asymmetric carbons are designated as follows: If a substituent is an H-bonding donor it is designated as (1); otherwise, the smallest substituent is designated as (1). The largest of the two remaining groups is given designation (2). When drawing the Newman projections with the undesigned groups in *anti* conformation, the diastereomer with both groups of designation (1) on the same side will be the one with the longest retention time when analyzed by HPLC on a silica column. This is the case of derivative **189** of (*R*)-tyrosine vs **190** of the (*S*) epimer<sup>398</sup>.





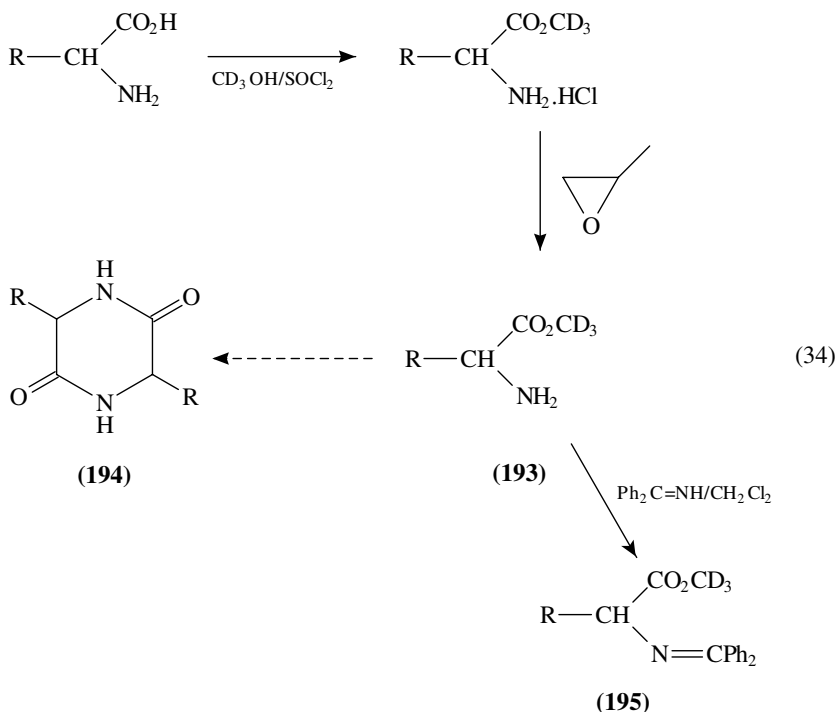
(*S*)-1,1'-Binaphthyl-2,2'-diol (**191**) was proposed as a chemical shift reagent for assessing the chiral purity of amino alcohols. It gave a split of about 0.3 ppm for the N—CH<sub>3</sub> signal of the enantiomer of compound **192** and smaller splits for other configurations<sup>399</sup>.

**(191)****(192)****(193)**

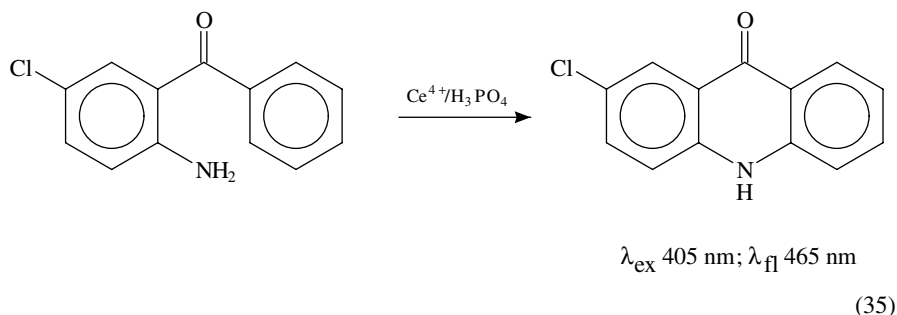
(*S*)-*N*-*n*-Butyl-2-(phenylcarbamoyloxy)propionamide (**193**) was used as chiral solvating agent in the NMR determination of the enantiomer composition of the *N*-(3,4-dinitrobenzoyl) derivative of amino acid ethyl esters<sup>400</sup>.

A general approach for the determination of the absolute configuration of a chiral carbon consists of attaching to it a labile chiral unit and a dissymmetric chromophore and measuring the optical rotation at the sodium D line. This has been successfully applied to amino acids<sup>401</sup>.

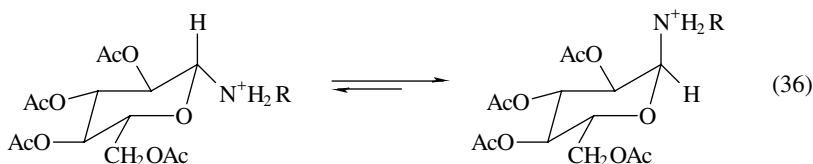
Some synthetic polypeptides form lyotropic cholesteric liquid crystals when dissolved in organic solvents. That is the case of poly( $\gamma$ -benzyl *L*-glutamate) in methylene dichloride. This system can be used as a chiral solvent to distinguish enantiomers by <sup>2</sup>H NMR. In such chiral solvents the averaged ordering parameters are different for each enantiomer. The quadrupolar splitting of CD<sub>3</sub> signals,  $\Delta\nu_Q$ , is very sensitive to this differential ordering. Determination of enantiomer excess of amino acids requires the scheme shown in reaction 34: The amino acid is esterified with deuterated methanol in the presence of thionyl chloride; the acidity of the reaction mixture is removed with propylene oxide yielding the  $\alpha$ -amino ester **193** that, in principle, can be dissolved in the liquid crystal submitted to <sup>2</sup>H NMR analysis. However, these esters tend to dimerize and yield the corresponding 2,5-diketopiperazines (**194**). Hence a Schiff base (**195**) is produced by treatment of **193** with benzophenoneimine and used for dissolution in the liquid crystal<sup>402</sup>.



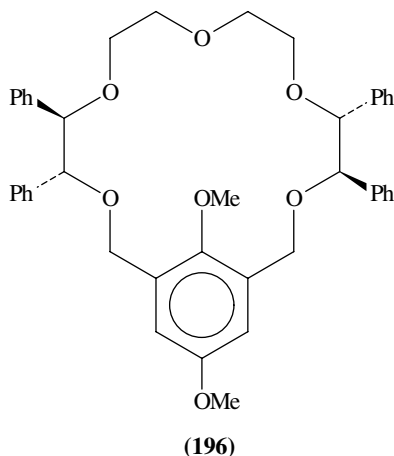
2-Amino-5-chlorobenzophenone, an impurity of chlordiazepoxide, can be determined by spectrofluorometry after oxidative cyclization (reaction 35). Chlordiazepoxide does not react<sup>403</sup>.



An NMR study on the conformation of glucopyranosylammonium compounds showed that the general tendency of many electronegative substituents at C<sub>(1)</sub> to adopt an axial conformation was prevalent in this case too, as depicted in equilibrium 36 for R groups of various sizes. These results disclaim the importance of the so-called 'reverse anomeric effect'<sup>404</sup>.

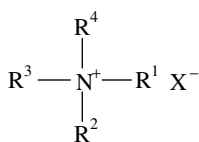


Enantioselective reagents for ammonium ions include, for example, a mixture containing a host chiral crown ether such as **196**, possessing four (*R*) centers and symbolized as M, a host achiral crown ether of similar functionality, symbolized as R, and a salt of a guest chiral amine, symbolized as A, which is analyzed by fast atom bombardment MS (FAB-MS), and the relative peak intensity of the equilibrium complexes  $I(MA)/I(RA)$  is measured and correlated with the chirality of the guest molecule. Many host and guest molecules have been investigated<sup>405</sup>.



## V. QUATERNARY AMMONIUM COMPOUNDS

The simultaneous ionic and covalent character of quaternary ammonium compounds (**197a**) is central to most of their applications. *N*-Quaternized heteroaromatic compounds possess many of the properties of **197a**, and will be mentioned occasionally in this chapter. In Table 4 are listed some quaternary ammonium compounds that have found industrial application. Many analytical methods make use of this class of compounds both as essential reagents or as accessories; however, in the present chapter quaternary ammonium compounds will appear only as analytes.



(a)  $\text{R}^1 \dots \text{R}^4 = \text{alkyl, aryl}$

(b)  $\text{R}^1 = \text{C}_8\text{H}_{17} \text{ to } \text{C}_{18}\text{H}_{37}$ ;  $\text{R}^2 = \text{R}^3 = \text{Me}$ ;  $\text{R}^4 = \text{PhCH}_2$ ;  $\text{X} = \text{Cl}$

(c)  $\text{R}^1 = \text{C}_{16}\text{H}_{33}$ ;  $\text{R}^2, \text{R}^3, \text{R}^4 = \text{Me}$ ;  $\text{X} = \text{Br}$

(197)

TABLE 4. Examples of environmental, occupational and quality control protocols for industrial quaternary ammonium compounds

Compound and CAS registry number <sup>a</sup>	Safety <sup>b</sup>	Spectra <sup>c</sup>	Various protocols <sup>d</sup>
<i>Quaternary N attached to four saturated aliphatic carbons</i>			
Acetylcholine chloride [60-31-1]	35D	I(1)678C	FZ9800000, USP
Benzalkonium chloride [8001-54-5] (197b)	347A	I(1)1322A, N(1)1122D	BO3150000
Bephenium hydroxynaphthoate [3818-50-6]			USP
Betaine hydrochloride [590-46-5]	409A	I(1)588C, N(1)496B	BP3136000, USP
Betanechol chloride [590-63-6]			USP
Carbachol [51-83-2]	680B	I(1)773D, N(1)649C	GA0875000, USP
Chlormequat chloride [999-81-5] <sup>g</sup>			
Choline chloride [67-48-1]	876C	I(1)395D, N(1)347D	KH2975000, USP
Clidinium bromide [3485-62-9] 1,1-Dimethylpiperidinium chloride [24307-26-4] <sup>g</sup>			
Diphemanyl methylsulfate [62-97-5]			TN5075000, USP
Echothiophate iodide [513-10-0]			USP
Glycopyrrolate [596-51-0]			UY4455000, USP
Hexafluorenium bromide [317-52-2] <sup>e</sup>			BQ8225000, USP
Isopropamide iodide [71-81-8]			USP
Mepenzolate bromide [76-90-4]			USP
Methantheline bromide [53-46-3]			USP
Methscopolamine bromide [155-41-9]			YM3675000, USP
Methylbenzethonium chloride [25155-18-4]	2296A		CP1300000, USP
Metocurine iodide [7601-55-0] <sup>e</sup>			USP
Piproctanyl bromide [56717-11-4] <sup>g</sup>			TN4426000
Propantheline bromide [50-34-0] (213)			USP
Succinylcholine chloride [71-27-2]			GA2360000, USP
Tubocurarine chloride pentahydrate [41354-45-4] (205) <sup>f</sup>	3556D		YO5100000, USP
<i>Quaternary N attached to one aromatic carbon and three saturated aliphatic carbons</i>			
Demecarium bromide [56-94-0] <sup>e</sup>			USP
Dimethylethyl(3-hydroxyphenyl)- ammonium chloride [116-38-1]			USP
Neostigmine bromide [114-80-7] (212)	2528B		BR3150000, USP

<sup>a</sup>Nomenclature may vary from source to source. See also Reference 69.

<sup>b</sup>Entry number in Reference 70.

<sup>c</sup>Codes beginning with I and N denote FTIR spectra in Reference 71 and NMR spectra in Reference 72, respectively.

<sup>d</sup>A code of two letters followed by seven digits is a reference to RTECS of NIOSH/OSHA. Standard samples are commercially available for compounds with reference to USP protocols<sup>74</sup>.

<sup>e</sup>The compound has two or more quaternary ammonium groups of the same type.

<sup>f</sup>The compound has several types of quaternary ammonium and amino functional group.

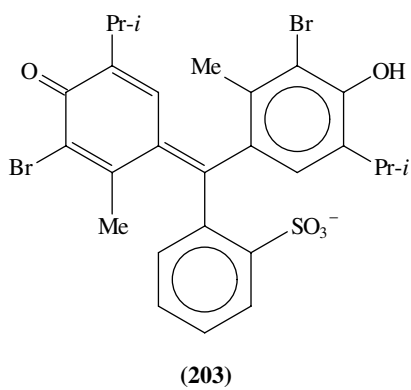
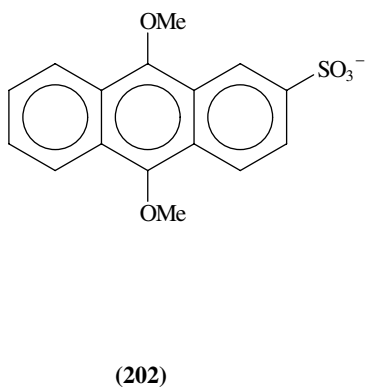
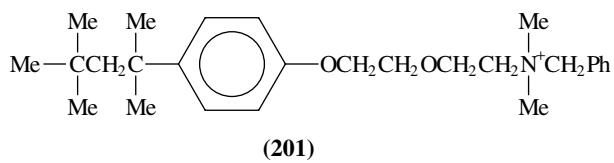
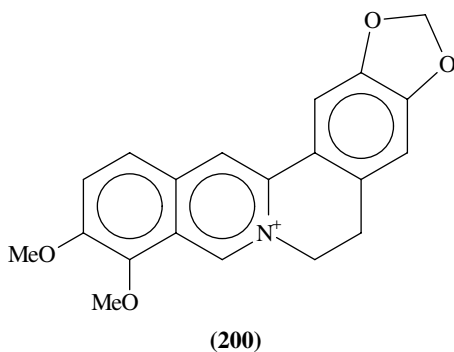
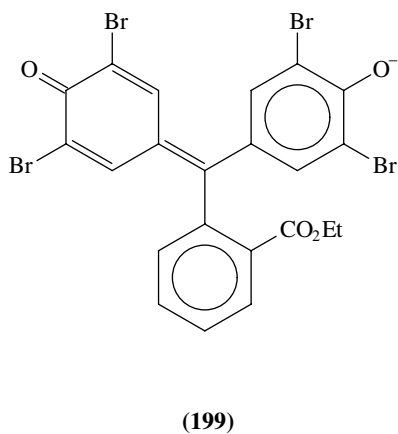
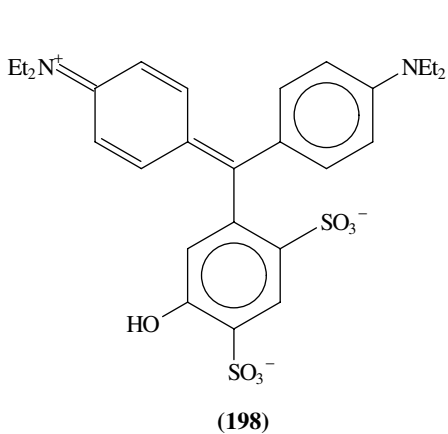
<sup>g</sup>A pesticide, see Reference 75.

## A. Chromatography

A method for extraction, purification and preconcentration of dialkyldimethylammonium compounds and other detergents before determining their concentration in sewage water and activated sludge was described. It consists of a series of LLE and LC operations, the details of which are dependent of the original matrix, and end analysis was by HPLC-ELCD<sup>406</sup>.

A general approach to the analysis of aqueous solutions of quaternary ammonium compounds containing large alkyl groups consists of extracting with an organic solvent, applying a separation method and determining the specific components with an adequate sensor. Sometimes an anionic reagent, for example a chromophore, is added to the aqueous medium and the ammonium cation becomes paired to it in the extraction. This approach was used for the determination of quaternary ammonium compounds present in milk, after extraction by the Mojonnier method for fat in milk, RP-LC and detection with diode array at 217–280 nm<sup>407</sup>. An interlaboratory study was carried out for the determination of di(hardened tallow)dimethylammonium surfactants in sludges, sediments, soil and aqueous environmental samples, down to ppb concentrations. The method consisted of HPLC-ELCD; LOD in environmental liquids and solids 2.5 µg/L and 0.5 µg/g, respectively, intralaboratory RSD ≤7% and recovery ≥90%. The method is highly specific as opposed to the nonspecific colorimetric one based on ion pairing to disulfine blue (**198**). The method can be extended to other surfactants<sup>408</sup>. The various homologues of benzalkonium chloride (**197b**) in ophthalmic and nasal preparations can be determined by RP-HPLC on a C<sub>8</sub> column and UVD with a diode array, measuring at 260 nm<sup>409</sup>. The HPLC-UVD procedure is quite simple and adequate for such preparations, and does not suffer from common interferences; recovery of 100.2 ± 1.2% (*n* = 10)<sup>410–412</sup>. A fast FIA-based spectrophotometric method was proposed for determination of benzalkonium chloride (**197b**) and *N*-cetylpyridinium chloride, consisting of ion-pair extraction and association of the cations with the anion of tetrabromophenolphthalein ethyl ester (**199**). The interference caused by ordinary amines on association with **199** disappears on heating to 45 °C, when the color of these associates fades away<sup>413</sup>. The associates of **199** with berberine (**200**) and benzethonium (**201**) at pH 11 have a blue color. This was applied to the determination of these quaternary bases, measuring at 610 nm, batchwise or in an FIA system<sup>414</sup>. A screening method for the presence of ditallowdimethylammonium ions in environmental waters consists of SPE, normal HPLC and post-column pairing with the fluorescent anion 9,10-dimethoxyanthracene-2-sulfonate (**202**) (λ<sub>ex</sub> 384 nm, λ<sub>fl</sub> 452 nm); LOQ 5 µg/L with 21 ± 3% recovery<sup>415</sup>. A special FIA system was designed for determination of quaternary ammonium compounds, in which segments of solution containing the quaternary ammonium cation paired with a chromophoric anion are alternated with a segment of insoluble solvent. The ion pair becomes adsorbed and preconcentrated on a part of the conduit loaded with immobilized adsorbent, and it is subsequently desorbed by extraction with the organic solvent and measured in a suitable detector. LOD < 10<sup>-7</sup> M for tetrabutyl ammonium paired with bromothymol blue (**203**)<sup>416</sup>.

Samples containing quaternary ammonium compounds with a wide range of molecular weights gave unsatisfactory results by HPLC coupled with various detectors (RID, ELCD, UVD). In such cases evaporative light scattering (ELS) may be of advantage. This consists of nebulizing the effluent of the LC column, drying the solvent and carrying the cloud of fine solid particles past a light source. The light scattered by the cloud is detected with a photomultiplier. The method was applied for determination of low levels of alkyltrimethylammonium and methyltrialkylammonium in dialkyldimethylammonium products, using a bonded polyphenol silica gel column with gradient elution<sup>417</sup>.



The use of ion pairing agents, such as sodium benzenesulfonate, may be helpful in the analysis of complex mixtures of quaternary ammonium compounds, as they modify their retention times<sup>418</sup>.

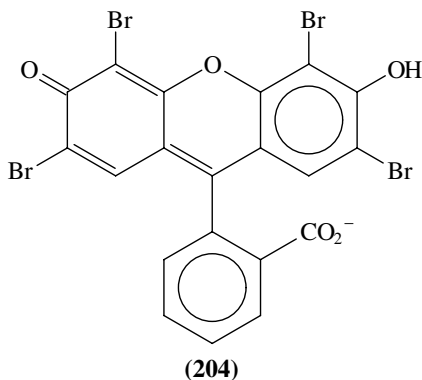
The use of suppressors in ion chromatography of quaternary ammonium compounds can be of advantage. These are ion exchange membranes that introduce hydroxide ions instead of the counterion present in the analyte. This simplifies the mixture and enhances the electrolytic conductivity of the sample. The effluent of the suppressor may be nebulized and subjected to field-assisted evaporation, yielding a cloud of ions suspended in the gas phase, which can be introduced into an MS analyzer designed for work at atmospheric pressure. Both the molecular weight and the structure of the quaternary cations can be determined by this method<sup>419</sup>.

A TLC method for determination of quaternary ammonium antiseptics was proposed, using silanized silica plates in combination with triiodide ions and UVV densitometry at 400 nm. The method was applied to cetylpyridinium chloride, cetrimide (**197c**) and the isomers of benzalkonium chloride (**197b**)<sup>420</sup>.

The determination of alkyl and alkylbenzyl quaternary ammonium compounds may be complicated by the polarity of the compound, its tendency to form micelles when the alkyl groups have 12 or more carbon atoms and lack of chromophores. Addition of tetrahydrofuran as organic modifier to the solvent precluded micelle formation and allowed the separation of a mixture of alkylbenzyl and alkylbenzylethyl quaternary ammonium compounds by CZE. Indirect determination of these compounds is achieved on addition of cationic chromophores to the buffer, using a standard UVD<sup>421</sup>. The indirect methods of detection for CE have been reviewed<sup>422</sup>.

## B. Miscellaneous Methods

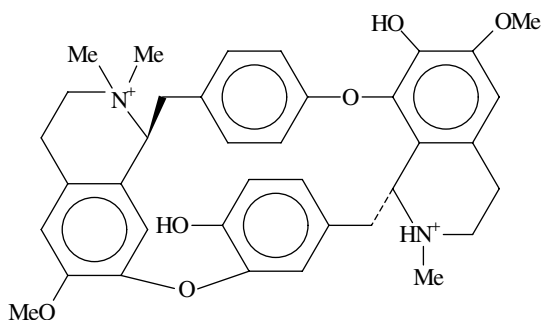
Cetylpyridinium chloride, cetrimide (**197c**) and benzalkonium chloride (**197b**) were determined at 534 nm by ion-pair formation with eosin Y (**204**) in the presence of Triton X-100. Standard curves were linear over the ranges 0.2–3.0, 0.3–3.0 and 0.7–15.0 mg/L, respectively<sup>423</sup>. The extraction behavior of quaternary ammonium cations (**197**) paired with bromophenol blue (**157a**) was studied for various surfactants. Thus, the ion pairs formed with **197** possessing either small or large carbon chains at high concentration of **157a**, after addition of one proton, gave yellow chloroform extracts of 1:1 composition. At high concentrations of **157a** one ammonium cation became associated with two molecules of the dye and the extract had a more intense color, that could be measured with higher sensitivity<sup>424</sup>.



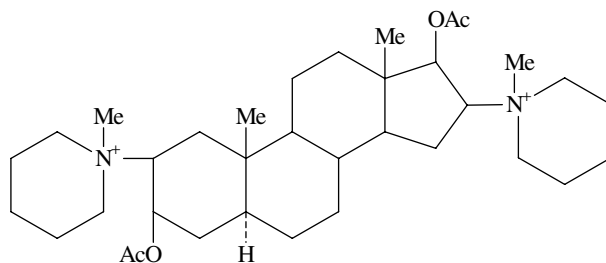


Alternatively, cetrimide (**197c**) and cetylpyridinium chloride were determined in industrial and consumer products, by indirect adsorptive stripping voltametry on a dropping mercury electrode<sup>425</sup>. A rapid method for benzalkonium chloride (**197b**) in pharmaceutical preparations was based on LLE of the picrate into chloroform in an FIA system and determination of the anion<sup>426</sup>.

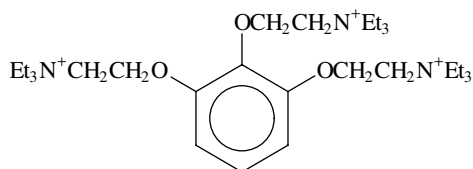
Development of ion selective electrodes for various muscle relaxation drugs was investigated. Thus, tubocurarine (**205**), pancuronium (**206**), gallamine (**207**) and succinylcholine (**208**), paired with either tetraphenylborate (**209**) or dipicrylamine (**210**) anions, were dispersed in a poly(vinyl chloride) membrane adhered to a Ag/AgCl electrode; LOD was *ca*  $10^{-6}$  M at physiological pH values. Electrodes containing the **205** cation or the **210** anion were sensitive to pH, due to the presence of amine moieties capable of attaching or detaching protons, while the others could be used over a wide pH range. The response was linear over 2–3 orders of magnitude. Selectivity varied according to the electrode and the analyte; for example, the electrode containing pancuronium tetraphenylborate (**206** paired with **209**) had selectivity  $10^{-0.3}$  towards **205** and  $10^{-1.8}$  towards **207**<sup>427</sup>.



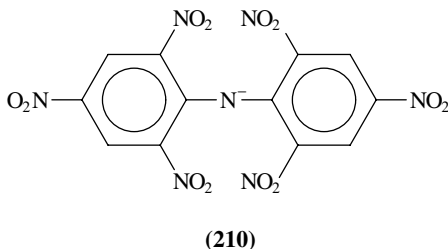
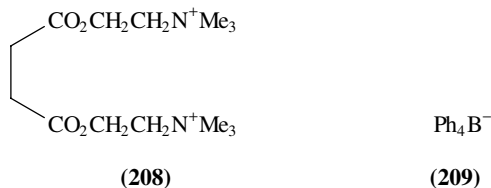
(205)



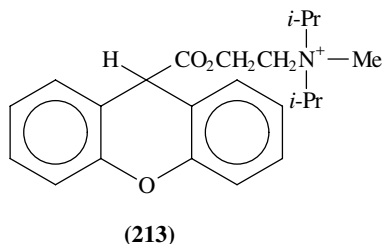
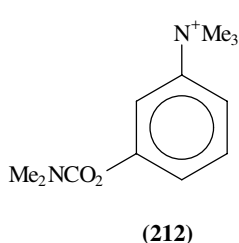
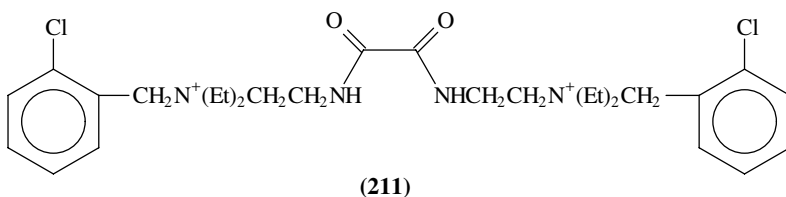
(206)



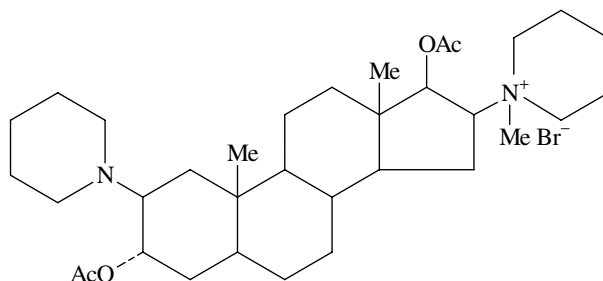
(207)



A fast and accurate screening test was proposed for nine quaternary ammonium drugs in urine, including pancuronium (**206**), ambenonium (**211**), benzethonium (**201**), neostigmine (**212**) and propantheline (**213**). The drugs were extracted as the triiodide ( $\text{I}_3^-$ ) into dichloromethane and analyzed by direct inlet EI-MS; LOD was 20–150  $\mu\text{g/L}$  for all the analytes<sup>428</sup>. Analysis of the neuromuscular blocking agents pancuronium bromide (**206**) and vecuronium bromide (**214**) in plasma or urine was performed by CI-MS, placing samples of an extract on the moving belt and monitoring the single metastable transition corresponding to elimination of acetic acid from the  $m/z$  543 ion. The method is sensitive to concentrations below 5  $\mu\text{g/L}$ <sup>429</sup>.

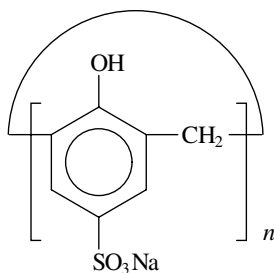


The induced circular dichroism and Cotton effect have been investigated for quaternary ammonium ions with N anchored on an asymmetric C, when hosted in calix[ $n$ ]arene molecules (**215**,  $n = 4, 6, 8$ )<sup>430</sup>.

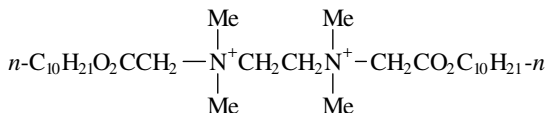


(214)

Field desorption MS proved to be the most effective MS technique for the detection and determination of bis(quaternary ammonium) molecules, such as the antibiotic drug ethonium (216)<sup>431,432</sup>.



(215)

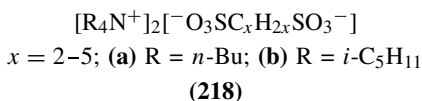
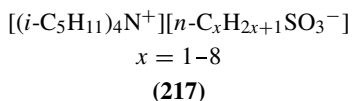


(216)

The critical concentration for micelle formation (CMC) has been determined by various methods, including the use of membrane electrodes that are selective to specific ionic surfactants. Unfortunately, it is difficult to find materials suitable for producing the selective membranes. An alternative method is based on the drastic change in the mobility of the species occurring on micelle formation. This affects the liquid junction potential generated at the interface between two solutions of different concentration. The method was applied for determination of the CMC of alkylammonium nitrates of various chain lengths<sup>433</sup>. The structure of the air–water interface layer of an aqueous solution of C<sub>18</sub>H<sub>37</sub>NMe<sub>3</sub>Br, at the CMC ( $3.1 \times 10^{-4}$  M at 33 °C), was investigated by surface tension and neutron reflectivity. The possible sources of systematic error in the neutron reflectivity measurements were taken into account for the improvement of analysis<sup>434</sup>. The effect of various factors on the aggregation number *N* of alkyltrimethylammonium micells was studied by small-angle neutron scattering. Thus, *N* was found to increase with concentration and chain length of the alkyl group, and to vary as follows for the various counter ions: OH<sup>-</sup> ≪ Cl<sup>-</sup> < MeSO<sub>4</sub><sup>-</sup> < Br<sup>-</sup> < NO<sub>3</sub><sup>-</sup><sup>435</sup>. The shape and thickness of the monolayer of cetrinide (197c) formed at the air–water interface was determined by neutron reflection. The total thickness of the monolayer was estimated to be  $2.1 \pm 0.2$  nm, of which 1.0 nm is immersed in water; six water molecules are associated with each molecule of surfactant<sup>436</sup>. Similar studies were performed for various C<sub>10</sub> to C<sub>18</sub> alkyltrimethylammonium surfactants. Interpretation of the neutron reflection results included an estimate

of the molecular cross-section at the air–liquid interface, surface roughness, molecular shape and chain orientation<sup>437</sup>.

The hydration numbers  $N$  of the quaternary ammonium alkanesulfonates (**217**) and alkylidene- $\alpha,\omega$ -disulfonates (**218**) were determined from the melting points of their saturated aqueous solutions. Both the  $N$  values and the melting points were fairly high (**217**:  $N \approx 37$ , mp 13–19 °C; **218a**:  $N \approx 52$ , mp 1–10 °C; **218b**:  $N \approx 76$ , mp 13–18 °C). The water molecules probably assume a clathrate structure<sup>438</sup>.



The apparent standard rate constant  $k_s$  for the transfer of tertiary and quaternary alkylammonium ions between water and nitrobenzene increased slightly when the ionic radius was increased from  $\text{Me}_3\text{HN}^+$  to  $\text{Et}_4\text{N}^+$  and then it decreased with further increase of the ionic radius until  $\text{Pr}_4\text{N}^+$ . The dependence of  $k_s$  on the ionic radius suggests that with small ions the processes of desolvation and resolvation are involved in the rate-determining step, while the effect of hydrodynamic drag is the prevalent one with the larger ions<sup>439</sup>.

The stability of the gel phase and the transitions of coagel and gel phases to liquid crystal in the dioctadecyldimethylammonium bromide–water system were determined by differential scanning calorimetry (DSC)<sup>440</sup>.

## VI. NITRO COMPOUNDS

### A. General

The present section is organized following roughly the nature of the structural frame supporting the nitro groups (arene, hetaryl or alkyl C, N and O atoms) and the presence of other functional groups that may contribute additional analytical methods (phenols, anilines, etc.). Nitro compounds are important intermediates and end products of the chemical industry with a wide range of applications in organic synthesis, manufacturing industries, medicine, agriculture and engineering (civil and military). Table 5 lists nitro

TABLE 5. Examples of environmental, occupational and quality control protocols for industrial nitro compounds

Compound and CAS registry number <sup>a</sup>	Safety <sup>b</sup>	Spectra <sup>c</sup>	Various protocols <sup>d</sup>
<i>Nitro group attached to saturated aliphatic carbon</i>			
2-Bromo-2-nitro-propane-1,3-diol [52-51-7] <sup>g</sup>	558B	I(1)403C, N(1)355A	TY3385000
Chloropicrin [76-06-2] <sup>g</sup>			PB6300000
Nitroethane [79-24-3]	2571D	I(3)482A, N(1)352C	KI5600000
Nitromethane [75-52-5]	2576D	I(3)481C, N(1)351D	PA9800000
1-Nitropropane [108-03-2]	2593D	I(3)482B	TZ5075000
Tris(hydroxymethyl)nitro-methane [126-11-4]	3532C	I(1)403A, N(1)354D	TY7350000
<i>Nitro group attached to carbon–carbon double bond</i>			
Metronidazole [443-48-1] ( <b>268a</b> )	2467A	I(2)619B, N(2)490C	NI5600000, USP
Nitrofurantoin [67-20-9] ( <b>263</b> )	2574C		MU2800000, USP

TABLE 5. (continued)

Compound and CAS registry number <sup>a</sup>	Safety <sup>b</sup>	Spectra <sup>c</sup>	Various protocols <sup>d</sup>
Nitrofurazone [59-87-0] (261)	2573D		LT7700000, USP
Nitromersol [133-58-4] <sup>e</sup>			USP
<i>Nitro group attached to aromatic carbon</i>			
Acifluorfen [50594-66-6] <sup>g</sup>			
Aclonifen [74070-46-5] <sup>g</sup>			
Benfluralin [1861-40-1] <sup>e,g</sup>			EPA
Bifenox [12680-11-4] <sup>g</sup>			
Bromethaline [63333-35-7] <sup>e,g</sup>			
Bromofenixim [13181-17-4] <sup>e,g</sup>			
Butralin [33629-47-9] <sup>e,g</sup>			
2- <i>s</i> -Butyl-4,6-dinitrophenol [88-85-7] <sup>e,g</sup>			SJ9800000
Chloramphenicol [56-75-7]	722C	I(2)362D, N(2)340B	AB6825000, USP
Chlometoxyfen [32861-85-1] <sup>g</sup>			
Chlornitrofen [1836-77-7] <sup>g</sup>			
1-Chloro-2,4-dinitrobenzene [97-00-7] <sup>e</sup>	769A	I(3)1212D, N(1)1173D	CZ0525000
2-Chloro-4-nitroaniline [121-87-9]	815D	I(3)1365D, N(1)1168D	BX1400000
4-Chloro-2-nitroaniline [89-63-4]	816B	I(3)1211A, N(1)1169A	BX1575000
1-Chloro-2-nitrobenzene [88-73-3]	818D	I(3)1183D, N(1)1133B	CZ0875000
2,6-Dichloro-4-nitroaniline [99-30-9] <sup>g</sup>			
1,3-Dimethyl-2-nitrobenzene [81-20-9]	2609B	I(3)1194D, N(1)1146B	ZE4686000, EPA
Dinitramine [29091-05-2] <sup>e,g</sup>			
1,2-Dinitrobenzene [528-29-0] <sup>e</sup>	1430C	I(3)1186B, N(1)1135D	CZ7450000, EPA
1,3-Dinitrobenzene [99-65-0] <sup>e</sup>	1430D	I(3)1189D, N(1)1139D	CZ7350000, EPA
1,4-Dinitrobenzene [100-25-4] <sup>e</sup>	1431B	I(3)1194B, N(1)1146A	CZ7525000, EPA
4,6-Dinitro- <i>o</i> -cresol [534-52-1] <sup>e,g</sup>	1436C	I(1)1375D, N(1)1182A	GO9625000, EPA
2,4-Dinitrophenol [51-28-5] <sup>e</sup>	1439D	I(1)1370C, N(1)1174C	SL2800000, EPA
2,4-Dinitrotoluene [121-14-2] <sup>e</sup> (220)	1442C	I(3)1211D, N(1)1172B	XT1575000, EPA
2,6-Dinitrotoluene [606-20-2] <sup>e</sup>	1442D	I(3)1197D, N(1)1150C	XT1925000, EPA
Dodemorph [1593-77-7] <sup>g</sup>			AE0610000*
EPN [2104-64-5] <sup>g</sup>			TB1925000
Ethalfuralin [55283-68-6] <sup>e,g</sup>			XU6200000, EPA
Fluazinam [79622-59-6] <sup>e,g</sup>			
Fluoroglycofen [77501-60-1] <sup>g</sup>			
Isopropalin [33820-53-0] <sup>e,g</sup>			EPA
2-Methyl-5-nitroaniline [99-55-8]	2388C	I(1)1364B, N(1)1167C	XU8225000, EPA
4-Methyl-2-nitrophenol [119-33-5]	2394B	I(3)1208A, N(1)1164B	GP2800000
Niclosamide [50-65-7] <sup>g</sup>			
Nifedipine [21829-25-4]			USP
5-Nitroacenaphthene [602-87-9] (235)			AB1060000, MISA <sup>f</sup>

(continued overleaf)

TABLE 5. (continued)

Compound and CAS registry number <sup>a</sup>	Safety <sup>b</sup>	Spectra <sup>c</sup>	Various protocols <sup>d</sup>
2-Nitroaniline [88-74-4]	2549C	I(3)1185C, N(1)1134D	BY6650000, EPA
3-Nitroaniline [99-09-2]	2550A	I(3)1189B, N(1)1139A	BY6825000, EPA
4-Nitroaniline [100-01-6]	2550C	I(3)1193C, N(1)1144C	BY7000000, EPA
2-Nitroanisole [91-23-6]		I(3)1184C, N(1)1134C	BZ8790000
Nitrobenzene [98-95-3]	2554A	I(3)1182B, N(1)1131B	DA6475000, EPA
Nitropentachlorobenzene [82-68-8] <sup>g</sup>	2695D	I(1)1382D	DA6650000, EPA
2-Nitrophenol [88-75-5]	2581B	I(3)1184D, N(1)1134B	SM2100000, EPA
4-Nitrophenol [100-02-7]	2582B	I(3)1192D, N(1)1144A	SM2275000, EPA
4-Nitroquinoline <i>N</i> -oxide [56-57-5]	2597B	I(2)919A, N(2)779D	VC2100000, EPA
1-Nitro-2,3,5,6-tetrachlorobenzene [117-18-0] <sup>g</sup>	3248C	I(3)1217D, N(1)1186D	DC1750000
2-Nitrotoluene [88-72-2]	2606B	I(3)1182C, N(1)1131C	XT3150000
3-Nitrotoluene [99-08-1]	2606C	I(3)1186C, N(1)1136A	XT2975000
4-Nitrotoluene [99-99-0]	2606D	I(3)1190A, N(1)1140A	XT3325000
Oryzalin [19044-88-3] <sup>e,s</sup>			
Oxamniquine [21738-42-1]			VC0340000, USP
Pendimetalin [40487-42-1] <sup>e,g</sup>			
Picric acid [88-89-1] <sup>e</sup>	2836B	I(1)1378D, N(1)1182B	TJ8750000
Profluralin [26399-36-0] <sup>e,g</sup>			XU5785000, EPA
Tetril [479-45-8] <sup>e</sup>			BY6300000, EPA
Trifluralin [1582-09-8] <sup>e,g</sup>			XU9275000, EPA
1,3,5-Trinitrobenzene [99-35-4] <sup>e</sup>			DC3850000, EPA
2,4,6-Trinitrotoluene [118-96-7] <sup>e</sup> (221)			XU0175000, EPA
<i>Organic nitrates</i>			
Erythritol tetranitrate [7297-25-8] <sup>e</sup>			USP
Nitroglycerin [55-63-0] (273) <sup>e</sup>			QX2100000, USP
Pentaerythritol tetranitrate [78-11-5] (274) <sup>e</sup>			RZ2620000, USP
Pyroxylin [9004-70-0] <sup>e</sup>			UX8650000, USP
<i>Nitramines</i>			
HMX [2691-41-0] (275) <sup>e</sup>			EPA
RDX [121-82-4] (276) <sup>e</sup>			EPA
Tetril [479-45-8]			BY6300000, EPA

<sup>a</sup>Nomenclature may vary from source to source. See also Reference 69.

<sup>b</sup>Entry number in Reference 70.

<sup>c</sup>Codes beginning with I and N denote FTIR spectra in Reference 71, NMR spectra in Reference 72, respectively.

<sup>d</sup>A code of two letters followed by seven digits is a reference to RTECS of NIOSH/OSHA; a\* denotes a protocol for a different derivative of the same main compound. Standard samples are commercially available for compounds with reference to protocols of EPA and USP<sup>74</sup>.

<sup>e</sup>The compound has two or more nitro groups of the same type.

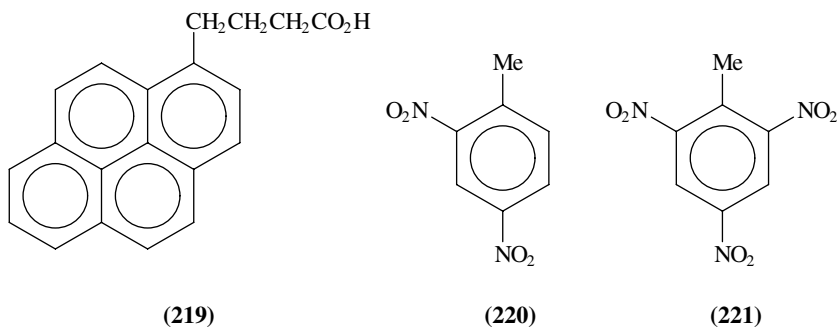
<sup>f</sup>Included among other pollutants listed by EPA in the Municipal Industrial Strategy for Abatement regulations of the Ontario Ministry of the Environment.

<sup>g</sup>A pesticide, see Reference 75.

compounds of commercial relevance possessing C–NO<sub>2</sub>, O–NO<sub>2</sub> and N–NO<sub>2</sub> bonds with reference to environmental and occupational protocols.

A review appeared on the determination of nitroalkanes, polynitroalkanes, nitroalkenes, aromatic nitro and polynitro compounds, heterocyclic nitro derivatives and inactive compounds after nitration, by polarography, voltammetry and HPLC with electrochemical detection<sup>441</sup>.

Fluorescent cellulose triacetate membranes were prepared by incorporation of pyrenebutyric acid (**219**), and were applied to *in situ* detection of ground water contamination by explosives, based on fluorescence quenching by the nitro groups; LOD 2 mg/L of DNT (**220**) and TNT (**221**) and 10 mg/L for RDX (**276**); the response follows the Stern–Volmer law for DNT and TNT<sup>442</sup>.



The nitrogen camera is an instrument based on detection of  $\gamma$ -rays in the multiscalar mode, after irradiation of a target pixel by a beam from a 50 MeV electron racetrak microtron. An image consisting of 180  $2 \times 2$  cm<sup>2</sup> pixels can be produced in about 7 s. This technique is capable of imaging nitrogen concentrations with surface densities and amounts typical of concealed conventional explosives. The sole interfering signal from <sup>13</sup>C can be disentangled<sup>443</sup>.

A novel technique for sensing trace vapors of nitro compounds is based on photolysis of the target molecule using a laser operating at 226 nm. The same beam can be used to detect the characteristic NO fragment formed from a rapid predissociation of NO<sub>2</sub>, by resonance-enhanced multiphoton ionization and by LIF using the  $A^2\Sigma^+ - X^2\Pi(0,0)$  transition. The analytical utility of this technique was demonstrated on a number of compounds, including TNT (**221**), RDX (**276**), dimethylnitramine, nitromethane and nitrobenzene, employing molecular beam sampling<sup>444</sup>.

## B. Aromatic Nitro Compounds

### 1. General

A comparison of active (using pumps) and passive (relying on diffusion) sampling techniques for the determination of nitrobenzene, benzene and aniline in air was mentioned in Section IV.A<sup>77</sup>. Several LLE methods for nitroaromatic compounds dissolved in water were evaluated. High recoveries were achieved with discontinuous or continuous extraction with dichloromethane, adsorption on a 1:1:1 mixture of Amberlite XAD-2, -4 and -8 resins and elution with dichloromethane<sup>445</sup>.

Polynitroaromatic compounds are used as explosives. They are toxic and might cause liver damage, methemoglobinemia and uncoupling of the oxidative phosphorylation process. Trace analyses of polynitroaromatic residues in groundwater, surface water, rainwater

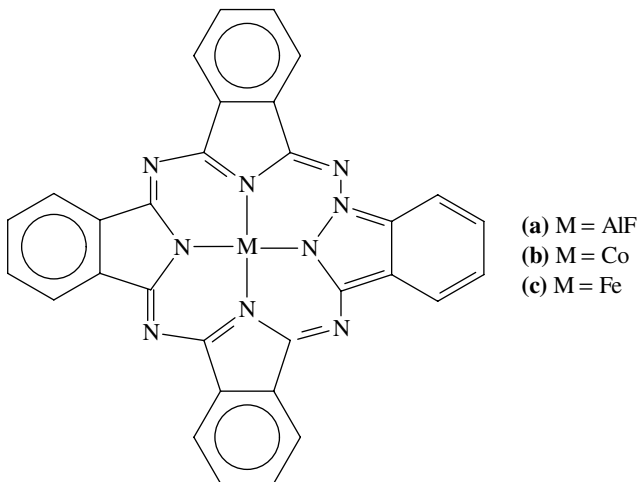
runoff, soil and sediments are important because these compounds become absorbed through the skin<sup>446</sup>.

It is possible to quantify individual nitroaromatic compounds present in commercial nitroglycerine-based explosives without prior separation, by using 500 MHz <sup>1</sup>H NMR. Patterns within the quantitative data provide a good degree of sample batch characterization<sup>447</sup>.

Mutagenicity tests and gas chromatographic analyses of motor oils exposed to NO<sub>2</sub> indicated the presence of many mutagenic nitroaromatic compounds. Comparison of motor oil nitrated with NO<sub>2</sub> and used automobile oil show similar behavior<sup>448</sup>.

A new dual-electrode electrochemical detector for LC was designed utilizing two series of generator/detector electrodes, having a larger electrode area and higher electrolytic efficiency and sensitivity, as compared with the commercial ones. Analytes are reduced at the upstream electrode and the products are then detected by oxidation at the downstream electrode. This eliminates the influence of dissolved oxygen and trace amounts of heavy metals in the mobile phase and sample, and exhaustive removal of dissolved oxygen before injection is not required. The method can be easily automated<sup>449</sup>.

A semiconductor sensor-based instrument was described for determination of the composition and concentrations of vapors of organic nitro compounds and nitrogen dioxide in the atmosphere. Four organic semiconductor sensors [e.g. aluminum phthalocyanine fluoride (**222a**)] were tested in conjunction with platinized platinum preconcentrators; sensitivity is to ppm levels of nitrobenzene<sup>450</sup>.



(222)

LOD and LOQ were measured to assess the sensitivity of the FID, ECD and TSD detectors for GC analysis of various nitroaromatic compounds. A parallel connection of the three detectors at the end of a single narrow-bore capillary column enabled direct comparison of the chromatograms. Structural effects on the response were evaluated and detection mechanisms were discussed. Recommendations were made for identification purposes and for analysis of environmental samples of nitro- and chloro-nitro-benzenes in a wide range of concentrations<sup>451</sup>.



## 2. Monocyclic arenes

This section also includes nitrated monocyclic arenes with halogen atoms directly attached to the benzene ring.

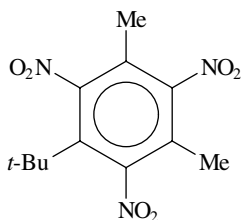
Sampling on Tenax TA followed by thermal desorption and GC affords a simple method for the determination of nitrobenzene in the workplace air. Recoveries were quantitative in the mass range 0.04–10  $\mu\text{g}$ <sup>452</sup>.

A selective procedure for attomole detection of nitrobenzene and *o*-nitrotoluene vapors at sub-ppm levels has been developed using resonance-enhanced multiphoton ionization MS. The TOF-MS spectra of these nitroaromatic molecules show a prominent  $\text{NO}^+$  ion signal ( $m/z$  30) together with a characteristic pattern of hydrocarbon fragment ions. In the wavelength range studied, 224–260 nm, generation of  $\text{NO}^+$  is strongly dependent on the laser wavelength, with maximum intensity at 226.3 nm. At this particular wavelength  $\text{NO}^+$  ion signals have been detected with  $<1$  amol ( $<10^{-18}$  mol) of nitrobenzene vapor present in the laser beam<sup>453</sup>. The same analytes were detected in trace concentrations in gas mixtures at atmospheric pressure in a simple unity-gain ionization chamber. They could be distinguished by observing their different laser-induced MS and the wavelength dependence of their fragmentation<sup>454</sup>.

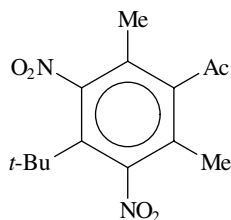
Nitrobenzene, 2,4-dinitrotoluene and 2,6-dinitrotoluene were determined in water by GC-EC or GC-CLD thermal energy analyzer (TEA) and by EI-MS, CI-MS and NICI-MS<sup>455</sup>, after solid-phase microextraction (SPME) with polydimethylsiloxane coated fiber. SPME is a technique to concentrate organic compounds dissolved in an aqueous matrix by adsorption on a solid stationary phase immobilized on a fused silica fiber. The analytes were thermally desorbed directly into the GC injector; LOD was 9  $\mu\text{g/L}$  for nitrobenzene and 15  $\mu\text{g/L}$  for the dinitrotoluenes<sup>456</sup>.

The recently reviewed EPA method 8330 uses RP-HPLC-UVD for determination of polynitroaromatics and other explosives at ppb concentration levels<sup>446</sup>. Very low concentrations of TNT (**221**), DNT (**220**) and some nitramines (Section VI.G) in water were determined by isothermal equilibrium adsorption on a porous film, color development with *o*-toluidine and Griess' reagent and colorimetric measurements using diffuse reflected light<sup>457</sup>. Nitroaromatics and nitramines have been determined in drinking water by GC-ECD, using a DB-1301 wide-bore fused-silica capillary column, at low concentration levels never previously achieved; LOD was 0.003  $\mu\text{g/L}$  for 2,6-dinitrotoluene, 0.04  $\mu\text{g/L}$  for DNT and 0.06  $\mu\text{g/L}$  for TNT<sup>458</sup>. Mononitrotoluenes, dinitrotoluenes, TNT and nitrotoluidines have been found in concentrations ranging from 0.1 to 20  $\mu\text{g/L}$  in brooks and ponds in former ammunition production areas in Germany. The method consisted of SPE with Amberlite XAD 2/4/8, elution with dichloromethane and RP-HPLC-UVD with a photodiode array at their optimum wavelength; LOD was *ca* 50 ng/L with 85–105% recoveries, depending on the compound<sup>445</sup>. Good separations were achieved with methanol–water gradient and a methanol–water gradient containing 2% of THF, with different elution orders for nitrated benzenes, nitrated toluenes and nitrated toluidines<sup>459</sup>.

A method with LOQ at ppt levels was developed based on LLE followed by GC-AFID for the determination of trace concentrations of nitrobenzene, 1-chloro-2-nitrobenzene and synthetic fragrances such as musk xylene (**223**) and musk ketone (**224**). The method was applied to study the distribution of these compounds in environmental samples of North Sea waters<sup>460</sup>. GC with atomic emission detection (AED) has been successfully applied to the determination of nitro musks in human adipose tissues, at ppb concentration levels. A clean-up procedure for nonpolar substances and element-specific detection with AED enabled for the first time target screening analysis for lipophilic nitro aromatic compounds. The lack of sensitivity of AED was compensated by higher concentrations of the extracts



(223)

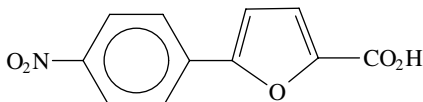


(224)

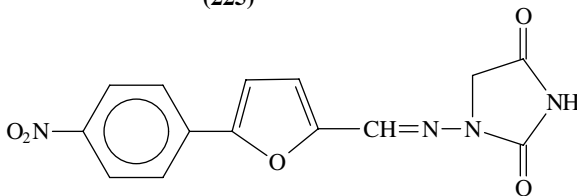
and injection of larger sample volumes, performed with cold programmed temperature vaporization in the solvent split mode<sup>461</sup>.

A sensitive ELISA procedure was developed for the determination of TNT (**221**) and other nitroaromatic compounds. TNT can be detected within the range of 0.02–20 ng/L in water samples<sup>462</sup>. A simplified immunofiltration prepacked portable device for field screening tests of TNT in water and soil was also developed. A quantitative color response to concentrations of TNT in the range 1–30 ng/L in water and 50–1000 pg/g in soil was demonstrated<sup>463</sup>.

A sensitive HPLC method for the determination of 5-(4-nitrophenyl)-2-furoic acid (**225**), a dantrolene (**226**) metabolite, in blood plasma and urine was developed<sup>464</sup>.



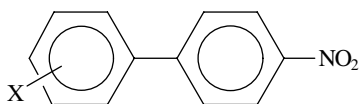
(225)



(226)

Adsorptive stripping square-wave polarography and differential-pulse polarography methods were developed for the determination of 4-nitrophenyl (**227a**). The best adsorption conditions on a hanging mercury dropping electrode in aqueous solution with Britton–Robinson buffer were pH 3, accumulation potential of –10 mV (vs Ag/AgCl electrode) and accumulation time of 100 s<sup>465</sup>. Optimum conditions were found for the determination of **227a** by fast scan differential pulse voltammetry at a hanging mercury drop electrode in the concentration range  $1 \times 10^{-5}$  to  $2 \times 10^{-7}$  M. A further increase in sensitivity was attained by adsorptive accumulation of this substance on the surface of the working electrode<sup>466</sup>.

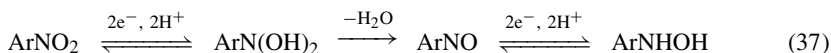
The mechanism of the global 4-electron electrochemical reduction of aromatic nitro compounds to hydroxylamines in aqueous medium shown in reaction 37 was investigated by polarography and cyclic voltametry. The nitro group is converted first to a dihydroxylamine, that on dehydration yields a nitroso group; the latter is further reduced to a



(a) X = H; (b) X = 4'-NO<sub>2</sub>

(227)

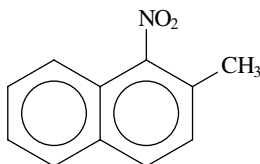
hydroxylamino group. The mechanism proposed for the process consists of a 9-membered square scheme involving protonations and electron transfer steps for each one of the equilibria shown in reaction 37<sup>467-471</sup>. The electrochemical processes may be complicated to some extent by the presence of other moieties; for example, a nitro group may reductively condense with nearby cyano or ester functions to yield products such as **174** and **175**, as discussed in Section IV.H.



### 3. Polycyclic aromatic hydrocarbons (PAH)

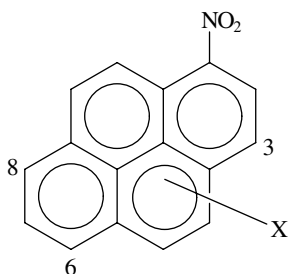
Nitro-substituted PAH have received increased attention as an important class of environmental pollutants. They have been detected in an ample variety of sources, including automobile exhaust fumes, wood and cigarette smoke, kerosene heater flue, emissions of coal-driven power stations and grilled meat. These subjects have been reviewed<sup>472,473</sup>.

The effect of solvent polarity on the injection conditions for the determination of nitro-PAH by capillary GC with splitless injection was investigated; LOD was 129 pg of 2-methyl-1-nitronaphthalene (**228**), at SNR 2, RSD 1.8–6.7% when measuring by peak area using FID<sup>474</sup>.



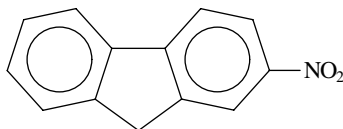
(228)

Mutagens in the semivolatile phase of airborne particulate matter of diesel and gasoline engine emissions were investigated using chemical and biological assays. Various modifications of a method for determination of nitro-PAH, such as 1-nitropyrene (**229a**) and 2-nitrofluorene (**230**), were described, consisting mainly of a reduction step followed by derivatization and chromatographic end analysis. In one instance the nitro group was reduced to an amino group by Zn or sodium hydrosulfide, derivatized with heptafluorobutyric anhydride and determined by GC-MS. The method was used for air samples collected in workplaces associated with the use of diesel engines, chassis dynamometer studies and others<sup>475</sup>. An HPLC-FLD method was developed, including an on-line reduction step for the determination of **229a** and its nitroso analog. Chemical reduction on a zinc column was more efficient than electrochemical reduction LOD 20–30 fmol for SNR 3<sup>476</sup>. The method was applied to the determination of **229a** at low pg levels in a variety of matrices:



(229)

- (a) X = H  
 (b) X = 3-NO<sub>2</sub>  
 (c) X = 6-NO<sub>2</sub>  
 (d) X = 8-NO<sub>2</sub>

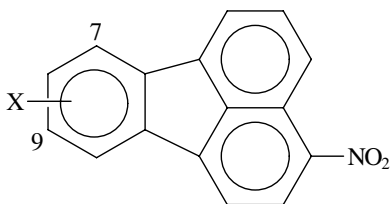


(230)

The incubation mixture of a mutagenicity test using *Salmonella typhimurium* YG1021<sup>476</sup>, extracts from diesel particulate emissions<sup>477</sup> and leaves of roadside trees<sup>478</sup>. Nitropyrenes **229a–d** found in sooty emissions of diesel and gasoline emissions were determined by HPLC-CLD, after conversion to the corresponding amines **43a–d** by refluxing samples in the presence of sodium hydrosulfide<sup>147</sup>.

A sensitive method was developed for determination of nitropyrenes **229a–d** in airborne particulates and in emission particulates from diesel and gasoline engine vehicles by on-line reduction and RP-HPLC-CLD. Chemiluminescence was according to reaction 24 (Section IV.G) using the oxalate **42**. Urban air showed matutine and vespertine peaks; concentrations were higher in autumn and winter than in spring and summer. Mean concentrations of **229a–d**:  $0.70 \pm 0.28$  pmol/m<sup>3</sup>;  $2.19 \pm 0.81$  fmol/m<sup>3</sup>;  $4.03 \pm 1.52$  fmol/m<sup>3</sup>;  $3.63 \pm 1.40$  fmol/m<sup>3</sup>, respectively<sup>479–481</sup>.

Nitro-PAH were determined by capillary GC-MC, after reduction to amines and conversion to pentafluoropropionamides. This made it possible to prove the presence of **229a**, **230** and 3-nitrofluoranthene (**231a**) in most samples of airborne particular matter taken in Upper Silesia<sup>482</sup>.

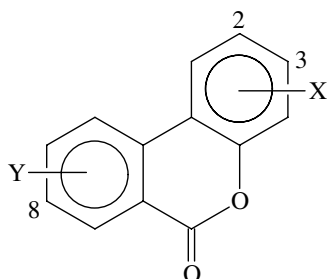


(231)

- (a) X = H  
 (b) X = 7-NO<sub>2</sub>  
 (c) X = 9-NO<sub>2</sub>

Nitro-PAH were determined in air particulate matter by RP-HPLC with reductive electrochemical detection; sensitivity of 3–0.3 ng injected<sup>483</sup>.

6*H*-Dibenzo[*b,d*]pyran-6-one (**232a**) and its nitro derivatives at positions 2, 3, 4 and 8 (**232b–e**) were characterized by their <sup>1</sup>H-NMR spectra, mass spectra and GC retention indexes, to allow their analysis in ambient samples<sup>484</sup>. The 2-nitro isomer (**232b**) was found to be a significant contributor of ambient air particle and gas-phase mutagenicity, as assayed with a microsuspension modification of the standard Ames *Salmonella* plate, incorporating test strain *Salmonella typhimurium* TA98 without activation. Both **232b** and **232d** were quantified in diesel particulate emissions and in ambient air samples collected in

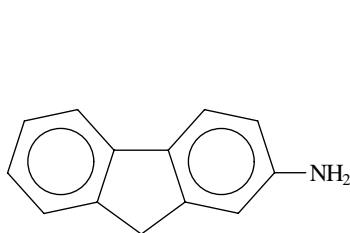


- (a) X = Y = H  
 (b) X = 2-NO<sub>2</sub>, Y = H  
 (c) X = 3-NO<sub>2</sub>, Y = H  
 (d) X = 4-NO<sub>2</sub>, Y = H  
 (e) X = H, Y = 8-NO<sub>2</sub>

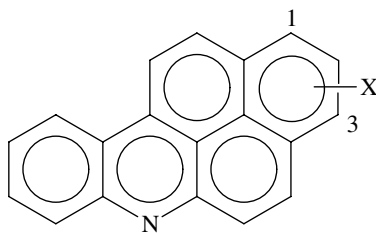
(232)

southern California and in Washington, DC. It was concluded that nitrobenzopyranones are formed in the atmosphere<sup>485</sup>.

A sensitive method for the detection of mutagenic nitroarenes is based on a new strain of *Salmonella typhimurium*, developed by genetic engineering. Acetyl-CoA:*N*-hydroxyarylamine *O*-acetyl transferase is an enzyme involved in the intracellular metabolic activation of arylhydroxylamines derived from mutagenic nitroarenes and aromatic amines. This strain has high *O*-acetyl transferase activity and was extremely sensitive to the mutagenic action of **229a**, **230**, **229d**, Glu-P-1, 2-aminofluorene (**233**) and 2-aminoanthracene (**105**)<sup>486</sup>. Biological and chemical assays were recently performed on mutagens in the semivolatile phase of airborne particulate matter of diesel and gasoline engine emission<sup>476</sup>. Several new nitroazabenzopyrenes were detected and found to be mutagenic using *Salmonella typhimurium* TA98, including 1- and 3-nitro-6-azabenzopyrenes (**234**) and their corresponding *N*-oxides. The compounds were detected by HPLC-MS in the semivolatile phase of airborne particulate matter (0.3–1.2 ng/g) and in diesel and gasoline engine emissions (2.2–7.7 ng/g)<sup>487</sup>.



(233)

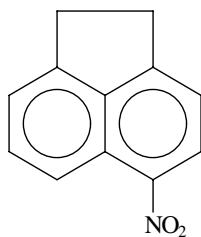


(234)

- (a) X = 1-NO<sub>2</sub>  
 (b) X = 3-NO<sub>2</sub>

A sensitive umu test system for the detection of mutagenic nitroarenes has been developed, using a new strain of *Salmonella typhimurium* NM1011 with a high nitroreductase activity. This enables one to monitor the genotoxic activity of various nitroarene compounds by measuring the  $\beta$ -galactosidase activity of the cells. It had nitrofurazone-reductase activity about 3 times higher than the parent strain and was highly sensitive to 1-nitropyrene (**229a**), 2-nitrofluorene (**230**), 1-nitronaphthalene, 2-nitronaphthalene, *m*-dinitrobenzene, 4,4'-dinitrobiphenyl (**227b**), the nitrofluoranthenes **231a–c**, 5-nitroacenaphthene (**235**) and 2,4-dinitrotoluene<sup>488</sup>.

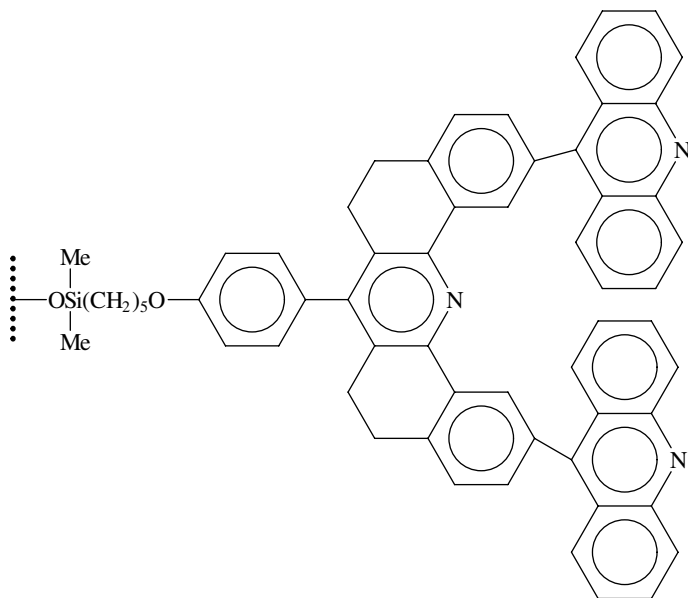
Immunoassay was used for determination of metabolites of nitroarenes and PAH in the urine of occupational patients exposed to diesel exhaust. It was found that the urinary



(235)

excretion of metabolites was significantly enhanced in diesel mechanics as compared to that of office clerks<sup>489</sup>.

The trapping efficiency of solid-phase adsorbents was compared for 4-nitrobiphenyl (**227a**), 2-nitrofluorene (**230**) and others. XAD-4 was the best adsorbent for aromatic compounds, followed by supercritical fluid extraction (SFE) with carbon dioxide, resulting in 60–92% recoveries<sup>490</sup>. Synthetic hosts with improved binding affinities for nitro substituted PAHs guests were synthesized. The hosts were covalently linked to silica gel (e.g. **236**) to produce modified chemically bonded stationary phases. These hosts contain aromatic binding clefts and were used for HPLC analysis of nitro-PAH<sup>491</sup>.

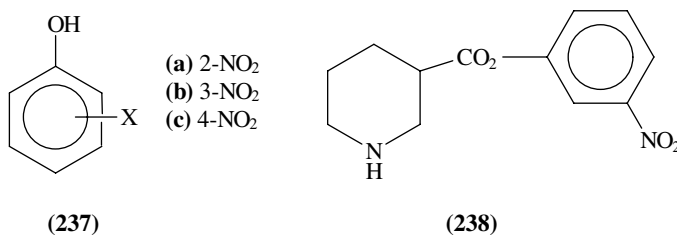


(236)

The structure of some phenolic metabolites of 3-nitrofluoranthene (**231a**) and its 2-nitro isomer have been analyzed by one-dimensional and two-dimensional <sup>1</sup>H NMR at 500 MHz. Chemical shifts suggest that the nitro group is not strictly coplanar with the aromatic ring system in solution and that metabolism at a distant site can alter the conformation about the C–N bond of the nitro group<sup>492</sup>.

#### 4. Phenols

*a. HPLC and GC without derivatization.* The three mononitrophenols (**237**) can be determined in distilled and drinking water by HPLC with amperometric detection using a gold electrode<sup>493</sup>. *p*-Nitrophenol (**237c**) as urinary metabolite was determined by RP-HPLC using a C<sub>18</sub> column in isocratic mode. The method is rapid, economical and easily automated, and has excellent reproducibility and specificity<sup>494</sup>. A similar method was used to analyze **237c** and its glucoside conjugates generated in perfused rat liver, bile or blood preparations<sup>495</sup>. **237c** and its glucurono- or sulfo-conjugates were analyzed by the same technique, using UVD<sup>496</sup>. *m*-Nitrophenol (**237b**), a metabolite of the anticonvulsant nipecotic acid *m*-nitrophenyl ester (**238**) in mouse blood and brain tissue, was determined by HPLC<sup>497</sup>.



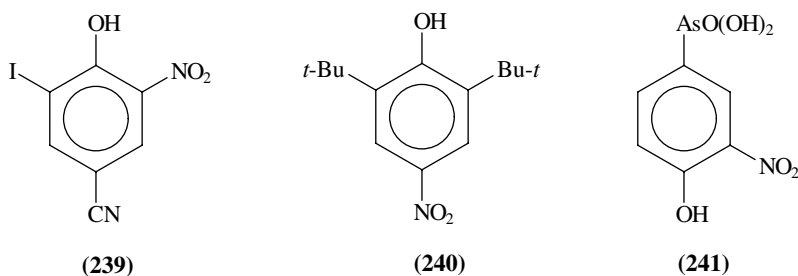
*p*-Nitrophenol, dinitrophenols and nitrocresols in sub- $\mu\text{g/L}$  concentrations were identified in rain water by isocratic HPLC-UVD with photodiode array. The detector allowed identification and determination of individual nitrophenols at their optimum wavelength by comparison with those of reference compounds<sup>498</sup>. RP-HPLC and multicomponent UVV spectroscopy were used to analyze mono- and dinitrophenols formed during irradiation of nitrobenzene with <sup>60</sup>Co  $\gamma$ -rays in aqueous media. Linear multiparametric regression analysis allowed one to calculate the concentrations of nitrobenzene, nitrophenols and dinitrophenols in water, HNO<sub>3</sub> and KOH solutions<sup>499</sup>.

Electrokinetic detection is a technique that uses the charge acquired by a liquid flowing along a solid surface, and is considerably selective towards ionizing solutes. It was applied to determination of nitrophenols eluted from both unmodified and chemically modified silica gel with *n*-heptane-acetone (90:10). The sensitivities are one order of magnitude higher than those attained using photometric detection<sup>500</sup>.

Nitrophenols in fog and atmospheric particles were determined by GC of the underivatized compounds and their corresponding acetate esters. Four fused-silica columns were used with three alternative detection modes, namely mass-selective detection, nitrogen-specific detection and ECD. GC-ECD of the acetate derivatives gave the best results<sup>501</sup>. A capillary GC-UVD method was developed for the determination of small amounts of nitrophenols present in the environment. The method was compared with HPLC-UVD from the point of view of selectivity and sensitivity. LOD for GC were about one-tenth of those for HPLC<sup>502</sup>.

Nitrocresols in air sample extracts were evaluated by GC using matrix-isolation infrared spectrometry. The IR spectra of the nitrocresols were recorded in argon matrix, xenon matrix, in the vapor phase and in dilute CCl<sub>4</sub>. The spectra of the nitrocresols that do not undergo intramolecular hydrogen bonding exhibited split OH stretching bands. Factors that might cause the band splitting are aggregation, solute-matrix interactions and isolation of conformers. The presence of the split OH absorption bands did not preclude the use of the same technique to identify several nitrocresols produced by photooxidation of toluene and NO<sub>x</sub><sup>503</sup>.

Nitroxylin (fasciolicide) (**239**) residues were determined in cow milk by RP-HPLC using dual-electrode coulometric detection; LOD was  $0.7 \mu\text{g/L}$ , average recoveries of 92–97% ( $n = 5$ ) from milk samples spiked with  $0.01\text{--}0.1 \text{ mg/L}$  of **239**<sup>504</sup>. 2,6-Di-*t*-butyl-4-nitrophenol (**240**), a potentially powerful uncoupler of ATP-generating oxidative phosphorylation, has been physically and spectroscopically characterized using GC-MS, X-ray crystallography (XRD), DSC, TGA, Fourier-transform IR (FTIR) spectrophotometry, UVV spectrophotometry, and  $^1\text{H}$  and  $^{13}\text{C}$  FT-NMR<sup>505</sup>. A simple and fast method for the growth promoter roxarsone (**241**) in tissues of swine liver, kidney and muscle involves a microwave assisted LLE followed by HPLC; LOD  $0.25 \mu\text{g/g}$ <sup>506</sup>. Another method for **241** is based on LLE followed by RP-HPLC with ICP-MS detection. This was applied to determination of **241** in tissue from chicken fed on a diet supplemented with this compound<sup>507</sup>.



*b. HPLC and GC with precolumn derivatization.* Methylation, acetylation, silylation and dansylation are the commonly used techniques to derivatize nitrophenols. Thus, mononitrophenols and nitrocresols were determined in rain precipitations by GC-NPD and GC-MS, following LLE and methylation with diazomethane<sup>508</sup>. A sensitive GC-MS method was developed for the analysis of nitrophenols in polluted waters at  $0.1\text{--}0.25 \mu\text{g/L}$  concentration, involving extraction and derivatization<sup>509</sup>.

Nitrophenolic compounds were analyzed by GC-MS-SIM, after trimethylsilylation by the flash heater derivatization procedure, which is suitable for nitrophenols not easily derivatized by the conventional methods. The method is suitable for identification of complex mixtures and for quantitative analysis in the nanogram range<sup>510</sup>.

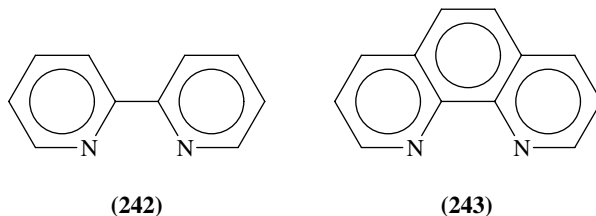
Nitrophenols at sub-ppm levels can be determined after a two-phase dansylation using dansyl chloride (**92**). LC is carried out with a methanol–water gradient followed by photolysis of the eluted derivatives. The strongly quenching electronegative nitrophenol fragments are photochemically removed from the derivatives, while the resulting dansyl hydride and dansyl methoxide products are sensitively detected by peroxy-oxalate chemiluminescence. Chemical excitation is carried out by post-column addition of 2-nitrophenyl oxalate and hydrogen peroxide dissolved in acetonitrile; LOD is *ca*  $0.01\text{--}0.1 \mu\text{g/L}$ <sup>511</sup>.

*c. Miscellaneous methods.* Various variables were studied and optimized for the determination of a mixture of nitrophenols **237** by differential pulse voltammetry, using a carbon paste electrode modified with 50% (w/w) of C<sub>18</sub>; LOD was  $2 \mu\text{g/L}$  of **237a**,  $5 \mu\text{g/L}$  of **237b** and  $4.3 \mu\text{g/L}$  of **237c**. The method was applied to samples of a small lake that gathers rain water<sup>512</sup>.

Simultaneous determination of *o*- and *p*-nitrophenol was achieved in a FIA system based on extraction of ion pairs using tetrabutylammonium as counter ion at pH 7.4. Detection was with a diode-array at 260 nm for **237a** and 410 nm for **237c**; LOD was  $0.03 \text{ mg/L}$ , RSD 0.15% ( $n = 8$ ) at  $6 \text{ mg/L}$  for both isomers; the calibration graphs were



linear from 0.1 to 12 mg/L<sup>513</sup>. An indirect determination of nitrophenols consists of extraction of ionic associates of the analytes with complexes of Cu(II) with bipyridyl (**242**) or phenanthroline (**243**), followed by atomic absorption spectroscopy (AAS) determination of Cu. It was possible to determine several tenths to hundredths of ppm of nitrophenols. Extractable associates with these complexes are formed by phenols possessing two substituents or by higher molecular weight phenols such as naphthol or hydroxyquinoline. Monosubstituted phenols fail to form ionic associates of this kind<sup>514</sup>.

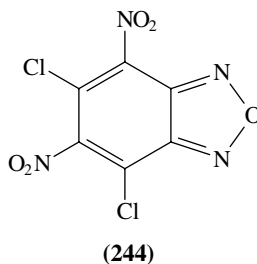


Analysis of *p*-nitrophenol in soil can be accomplished by supercritical fluid extraction (SFE) with carbon dioxide, giving recoveries equivalent to LLE with AcOEt. Quantitation of the recovered compounds by ELISA agreed well with the GC analysis. Extraction and analysis by SFE-ELISA results in greater sample throughput allowing for rapid screening of a large number of environmental samples<sup>515</sup>.

The electrochemical behavior of the components of a commercial plant growth stimulator (Svion) was studied. This included determination of *o*-nitrophenol, *p*-nitrophenol, 2-methoxy-5-nitrophenol and 2,4-dinitrophenol by differential pulse voltammetry at a hanging mercury drop electrode. The optimum conditions were established for their quantitation over the  $1 \times 10^{-7}$  to  $1 \times 10^{-5}$  M range<sup>516</sup>.

### 5. Aromatic amines

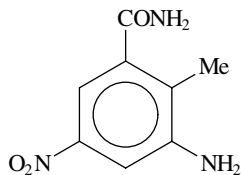
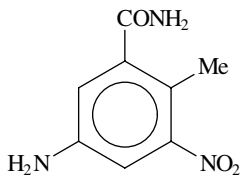
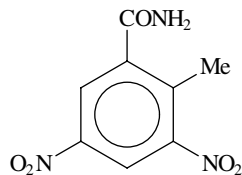
The photometric determination of mixtures of aniline, *p*-nitroaniline and *o*-nitroaniline was described. Distribution coefficients and separation efficiency of these compounds by LLE in various solvents were compared<sup>517</sup>. Substituted nitroanilines such as 2-chloro-4-nitroaniline and 2,4-dinitroaniline are intermediates in the manufacture of the dye D&C Red No. 36 and were identified as impurities by RP-LC<sup>518</sup>. A spectrophotometric method was developed for the determination of aniline and *m*-nitroaniline in a mixture of aniline and nitroaniline isomers by derivatization with 5,7-dichloro-4,6-dinitrobenzofuroxan (**244**). The relative error of the determination is <5%<sup>519</sup>. See also Section IV.D.3.b for similar derivatives.



Nitrotoluidines and nitrotoluenes, in concentrations ranging from 0.1 to 20  $\mu\text{g/L}$ , have been found in brooks and ponds in former ammunition production areas in Germany, by

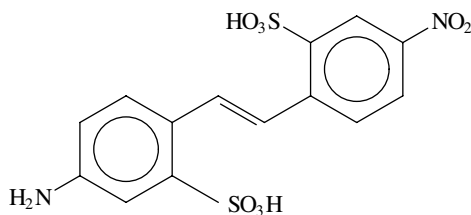
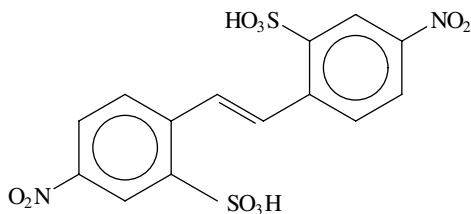
SPE with Amberlite XAD 2/4/8 mixture, elution with dichloromethane and RP-HPLC-UVD with a photodiode-array at their optimum wavelength; LOD is *ca* 50 ng/L with 85–105% recoveries, depending on the compound<sup>445</sup>.

3-Amino-5-nitro-*o*-toluamide (**245**) and 5-amino-3-nitro-*o*-toluamide (**246**), the principal metabolites in the tissues of chickens fed a diet containing the anticoccidial agent Zoalene (**247**), were shown to deplete in frozen liver tissues stored up to 1 year at  $-20^{\circ}\text{C}$ . Both  $\alpha$ - and  $\beta$ -anomers of the conjugate were observed by LC of tissue extracts<sup>520</sup>.

**(245)****(246)****(247)**

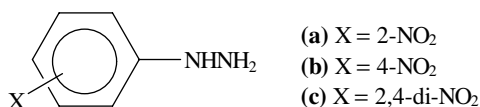
*p*-Nitroaniline has potential application in optical disk coating. Its surface-enhanced Raman scattering properties were recorded and vibrational assignments were made for the molecule in the IR ( $500\text{--}1800\text{ cm}^{-1}$ ) and Raman ( $200\text{--}1800\text{ cm}^{-1}$ ) frequency regions. The Raman enhancement factor was estimated to be of the order of  $10^6$ , and the limit of optical detection was estimated to be 30 fg ( $30 \times 10^{-15}\text{ g}$ )<sup>521</sup>. The UVV luminescence spectra of *p*-nitroaniline were analyzed taking into account dipolar interactions and H-bond complexes, conferring on the molecule a twisted conformation in the ground state, due to the rotation of the  $\text{NH}_2$  group around the  $\text{C}\text{--}\text{NH}_2$  bond<sup>522</sup>.

HPLC and GC methods were used for analysis of water-soluble nitro-substituted aromatic sulfonic acids<sup>523</sup>. For example, 4-amino-4'-nitrostilbene-2,2'-disulfonic acid (**248**)

**(248)****(249)**

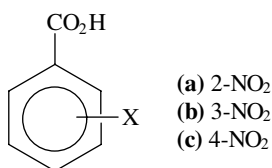
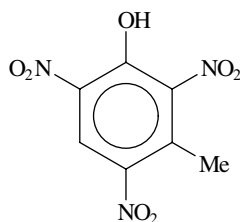
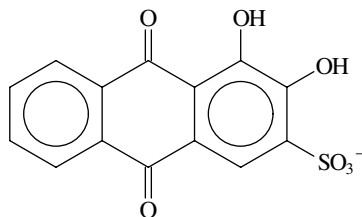
and 4,4'-dinitrostilbene-2,2'-disulfonic acid (**249**) were separated by RP-HPLC on a Bondapak column packed with 10  $\mu\text{m}$   $\text{C}_{18}$  stationary phase. The mobile phase was a 55:45 mixture by volume of 0.15 M aq ammonium sulfate and acetonitrile<sup>524</sup>.

A general approach to the analysis of multicomponent analytes bearing chromophores was demonstrated with a mixture of nitrophenylhydrazines (**250**). In a FIA system the mixture was preconcentrated by SPE on  $\text{C}_{18}$  bonded silica, followed by desorption with a buffer and detection by UVV on a diode array. The spectrum, resolved for three components, had RSD 1.43% for 11 samples containing  $2 \times 10^{-5}$  M of **250c**. The method allowed up to 40 samplings per hour<sup>527</sup>.

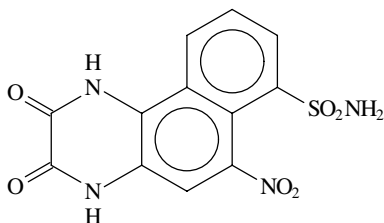
**(250)**

#### 6. Miscellaneous aromatic compounds

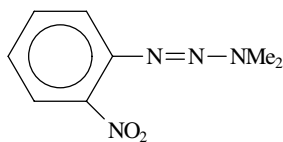
4-Nitrobenzoic acid (**251c**) was determined in samples containing 2- and 4-nitrotoluene and trinitro-*m*-cresol (**252**) as impurities, by peak chromatography on untreated FN-3 paper. The mobile phase was water or water-acetone solution. The detection reagent was alizarin Red S (**253**)<sup>525</sup>. An equivalent method was used to determine 3-nitrobenzoic acid (**251b**) using a lumomagneson solution for the development of the peak<sup>526</sup>.

**(251)****(252)****(253)**

A rapid, sensitive and selective HPLC-UVD method for the determination of the neuroprotectant 1,2,3,4-tetrahydro-2,3-dioxo-6-nitrobenzo[*f*]quinoxaline-7-sulfonamide (**254**) in rat plasma has been established<sup>528</sup>.



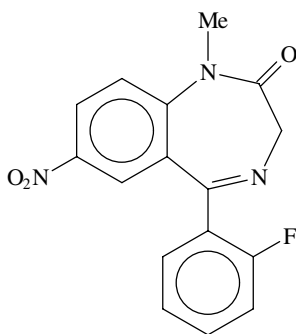
(254)



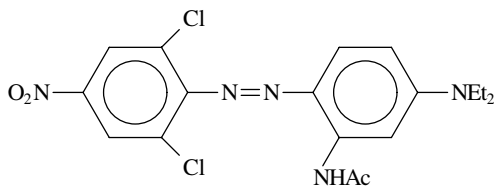
(255)

The polarographic behavior of 1-(2-nitrophenyl)-3,3-dimethyltriazene (**255**) in a mixed aqueous-methanolic solvent was investigated by test polarography, differential pulse polarography and fast scan differential pulse voltammetry at a hanging mercury drop electrode<sup>529</sup>.

The adsorption behavior of the psychotropic drug flunitrazepam (**256**) at the hanging mercury drop electrode was studied by staircase voltammetry and by adsorptive stripping differential pulse voltammetry. **256** can be determined down to nanomolar levels by using adsorptive preconcentration prior to the differential pulse voltammetry scan. The method was applied to determination of **256** in human urine<sup>530</sup>.



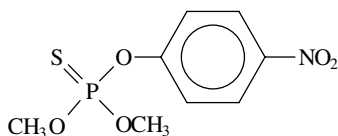
(256)



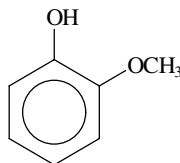
(257)

Optimal conditions were found for analysis of the azo dye 2,6-dichloro-4-nitro-2'-(acetylamino)-4'-(diethylamino)azobenzene (**257**) by various polarographic reduction methods and a mechanism was proposed for the process<sup>531</sup>.

A spectrophotometric determination of parathion-methyl (**258**) in soil and various vegetables is based on reduction of the nitro group to an amino group with zinc/HCl, diazotization and coupling with guaiacol (**259**) to form a yellow-colored azo dye in alkaline medium<sup>532</sup>.



(258)

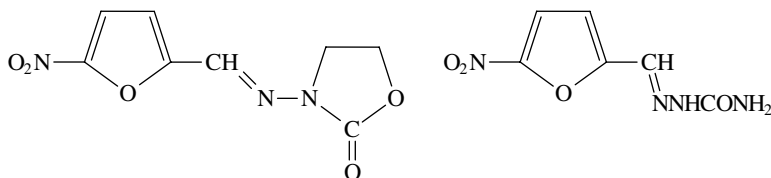


(259)

### C. Nitrofurans

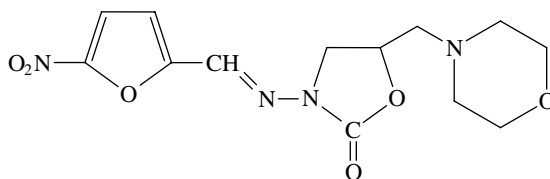
A variety of methods were developed for the identification and determination of the antimicrobial nitrofurans. They include LC, colorimetric and polarographic methods. Nitrofurans could be determined in animal tissues by extraction with acetonitrile, SPE and LC-UVD<sup>533</sup>. An LC-UVD method was statistically validated for the determination of nitrofuran drug residues in poultry<sup>534</sup>.

HPLC methods were modified for the determination of nitrofurans in different tissues<sup>535</sup>. A specific and sensitive HPTLC method was developed for the identification and determination of the furazolidone (**260**), nitrofurazone (**261**), furaltadone (**262**) and nitrofurantoin (**263**) in eggs and milk. The procedure includes extraction of the drug residues with acetonitrile and liquid-liquid partitioning for clean-up. The pre-chromatographic photoreaction of the nitrofurans takes place *in situ* on the HPTLC plate in the presence of pyridine, leading to fluorescent, ionic products<sup>536</sup>. See reaction 14 in Section IV.D.3.g for analogous processes of color development. Compounds **260**, **261** and **263** were determined in various matrices: In formulations, feed and milk by RP-HPLC-UVD<sup>537</sup> or using a high-speed C<sub>18</sub> 3 × 3 column<sup>538</sup>, and in animal tissues by RP-LC on a ODS Hypersil column<sup>539</sup>; in foods of animal origin by extraction with acetonitrile, followed by TLC or HPLC<sup>540</sup>. **260** and **261** were determined in shrimp muscle tissue by LC<sup>541</sup>. **263** was determined in plasma of rabbits by RP-HPLC, using acetanilide as internal standard<sup>542</sup>. LC was used to determine residues of **261** in chicken raised to maturity on a diet fortified with 0.0055% of this drug<sup>543</sup>. A differential pulse polarographic method is described for the determination of **261** in its pharmaceutical formulations using addition of standard<sup>544</sup>. Zero-crossing first derivative spectrophotometry was applied to the determination of **263**

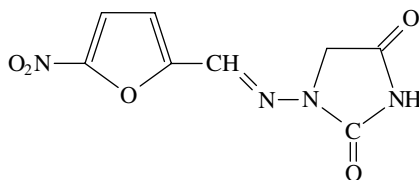


(260)

(261)



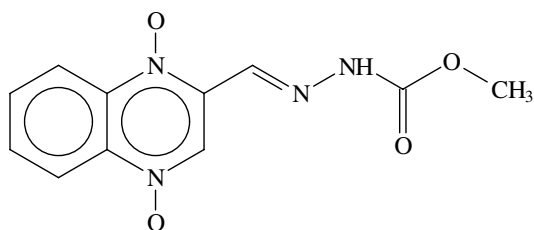
(262)



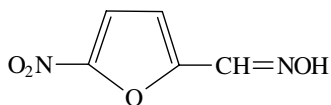
(263)

in tablets<sup>545</sup> while for **260**, **262** and **263** in formulations and in feeds first and second derivatives of the UVV absorption spectra were used<sup>546</sup>.

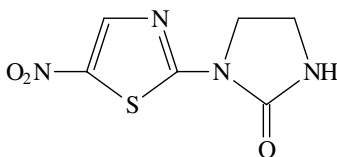
A combination of TLC separation followed by quantitative determination by HPLC of **260–263** and carbadox (**264**) was developed<sup>547</sup>. The simultaneous determination of **260** and nifuroxime (**265**) in vaginal suppositories by RP-HPLC-UVD was described<sup>548</sup>. A simple RP-HPLC-UVD assay has been developed for the determination of **260**, **261**, **263**, **265** and niridazole (**266**), in pure form and in pharmaceutical preparations, using a Lichrosorb RP-18 column with methanol–water buffer pH 3 eluent and detection at 365, 375, 367, 368 and 340 nm, respectively. Recoveries from bulk drugs were quantitative<sup>549</sup>. A simple colorimetric method for the determination of nitrazepam (**267**), **265**, **266**, **260**, **261** and **263** was described, based on the orange to purple discoloration appearing when these nitro compounds react with tetrabutylammonium hydroxide in DMF<sup>550</sup>.



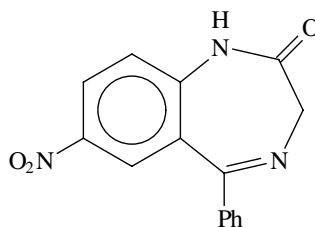
(264)



(265)



(266)

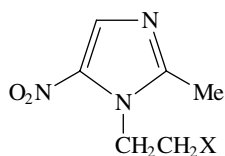


(267)

#### D. Miscellaneous Heterocyclic Compounds

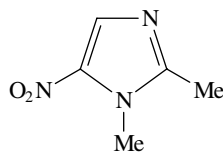
An IR spectrophotometric method (alkali halide matrix) was elaborated for the fast detection and determination of concentration changes of nitroimidazoles, caused by their photolability in the solid state. Even small changes could be directly recognized, based on the appearance of a new band at 1600–1800  $\text{cm}^{-1}$ , which is absent in the initial compounds. A decrease in the content of the initial compound could be determined quantitatively by measurement of absorbance at analytical wavelengths, i.e. in the ranges 1665–1430, 1300–1100 and 730–990  $\text{cm}^{-1}$ . The method was tested using seven derivatives of 4- and 5-nitroimidazole including compounds applied in therapy, such as metronidazole (**268a**) and ornidazole (**268b**)<sup>551</sup>.

A series of monoclonal antibodies were generated that can bind dimetridazole (**269**) and other nitroimidazole drugs used in veterinary medicine. An extraction procedure was developed for these nitroimidazoles that is compatible with a competition ELISA method, based on binding of these antibodies to the drugs. As little as 1 ng of **269** could be detected in turkey muscle by this method<sup>552</sup>.



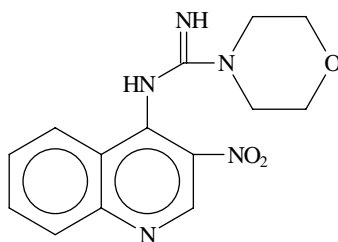
(268)

(a) X = OH  
(b) X = Cl



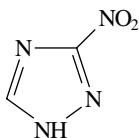
(269)

An HPLC-UVD method was developed for the determination of the radiosensitizing agent *N*-(3-nitro-4-quinoline)morpholino-4-carboxamide (EGIS-4136, **270**) in plasma, using an internal standard and measuring at 330 nm. The assay was validated with respect to linearity, sensitivity, accuracy, precision, stability and recovery. The method was applied to pharmacokinetic studies in male rats, monitoring **270** concentrations in the range of 5–10  $\mu\text{g/L}$ <sup>553</sup>.

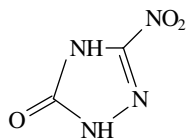


(270)

3-Nitro-1,2,4-triazole (**271**) was determined by solvent peak paper chromatography in the presence of impurities<sup>554</sup>. The crystallography, morphology, kinetics and mechanism of the thermal decomposition of 3-nitro-1,2,4-triazol-5-one (**272**) have been studied, applying DTA, DSC, TGA, IR spectroscopy, XRD and hot-stage microscopy. Cleavage of the C–NO<sub>2</sub> bond with rupture of the adjacent C–N bond appears to be the primary step in the thermolysis of **272**. The evolved gases were analyzed by IR spectroscopy<sup>555</sup>.



(271)



(272)

## E. Aliphatic Compounds

The RP-HPLC retention times of nitroalkanes (e.g. MeNO<sub>2</sub>, EtNO<sub>2</sub>, *n*-PrNO<sub>2</sub>, *i*-PrNO<sub>2</sub>, *c*-HexNO<sub>2</sub>), their nitronates and their nitronic acid degradation products (including alkyl oximes, nitrooximes and pseudonitroles) were determined using a Nova-Pak C<sub>18</sub> radial column<sup>556</sup>.

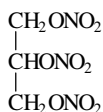
3-Nitropropanoyl esters of glucose from the roots of *Lotus pendunculatus* Cav. were determined by analysis of nitrate released on alkaline hydrolysis. This method was validated for quantitation of both total nitro compounds in ethanolic extracts and for individual components from TLC separations<sup>557</sup>.

Low levels of nitrogen dioxide react with the polyunsaturated fatty acids under anaerobic conditions to give allylic nitro and allylic nitrite derivatives of methyl linoleate and methyl linolenate. These were identified by NICI-MS<sup>558</sup>.

## F. Nitrates

In Table 5 are listed some industrial organic nitrates and protocols containing analytical methods.

A method for the spectrophotometric analysis of nitroglycerin (**273**) in gaseous effluents was developed. The compound is absorbed in an alkaline solution and converted with hydrogen peroxide to nitrite ions. These can be analyzed spectrophotometrically by reacting with a mixture of sulfanylamide (**103**) and phosphoric acid (diazotization), coupling with *N*-(1-naphthyl)ethylenediamine (**106**) and measuring the absorption at 540 nm<sup>559</sup>. The determination of nitrite ions is a modification of the Bratton–Marshall method (see Section IV.D.3.g).



(273)

A rapid and sensitive capillary GC-ECD method was used to evaluate the nitroglycerin (**273**) content in human blood serum; LOD was 50 ng/L. Significant amounts of the active metabolites 1,2- and 1,3-dinitroglycerine could be demonstrated<sup>560</sup>. A major problem in the analysis of **273** and its metabolites is due to adsorption of the nitro compounds on the glassware used during sample preparation or injection. The adsorption problem was overcome by the use of triethylamine, resulting in a simpler sample preparation and accurate results. Coupling this technique to a capillary GC-ECD method gave high precision in the determination of **273** and its metabolites in plasma at low nanomolar level; LOD was *ca* 0.2 nM in plasma<sup>561</sup>. A similar, specific capillary GC-ECD method for the simultaneous determination of **273** and its di- and mononitrate metabolites included an extraction step; LOD was 0.4 μg/L plasma, with recoveries >76% for **273** and the mononitrates and >95% for the dinitrates. The assay was applied to pharmacological studies<sup>562</sup>.

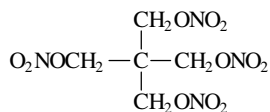
A combination of FTIR and TGA is very effective for the quantitative and qualitative analysis of gunpowder<sup>563</sup>.

Four nitrosamines, seven nitramines, three nitroesters and the explosives Semtex 10 and Composition B have been investigated by TGA. Linear dependence was confirmed between the position of the TGA onsets, as defined in the sense of Perkin-Elmer's TGA-7 standard program, and the samples' weights. The slope of this dependence is closely related to the thermal reactivity and molecular structure. The intercept values of the dependence correlate with the autoignition temperatures and with the critical temperatures of the studied compounds, without any clear influence from molecular structure. Results show that Semtex 10 exhibits approximately the same thermostability as its active component pentaerythryl tetranitrate (PETN, **274**). Results also show that TGA data for Composition B do not correlate with analogous data for pure nitramines<sup>564</sup>.

## G. Nitramines

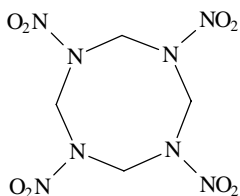
In Table 5 are listed some industrial nitramines and protocols containing analytical methods. Nitramines are used as explosives and propellants, they are toxic and might cause



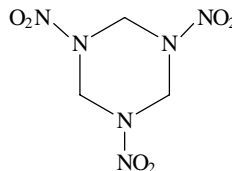


(274)

liver damage, methemoglobinemia and uncoupling of the oxidative phosphorylation process. Trace analysis of nitramine residues in groundwater, surface water, rainwater runoff, soil and sediment matrices are important because these compounds become absorbed through the skin<sup>446</sup>. Very low concentrations of HMX (**275**), RDX (**276**) and some nitroaromatics (see Section VI.A) in water were determined by isothermal equilibrium adsorption, on a porous film, color development with *o*-toluidine and Griess reagent and colorimetric measurements using diffuse reflected light<sup>457</sup>. Nitramines and nitroaromatics have been determined in drinking water, at low concentration levels never previously achieved, by GC-ECD using a DB-1301 wide-bore fused-silica capillary column<sup>458</sup>.



(275)



(276)

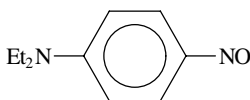
## VI. NITROSO COMPOUNDS

### A. General

Interest in nitroso compounds as intermediates for organic synthesis has faded due mainly to their potential toxic effects. Table 6, shows that activity in this field is centered mainly on occupational and environmental pollution subjects. An ample review appeared recently on *N*-nitroso compounds, including chemical, biochemical and analytical aspects<sup>566</sup>.

### B. Nitrosoarenes

A cathodic stripping voltammetric method was developed for the determination of 4-nitroso-*N,N*-diethylaniline (**277**), using a GCE coated with a cation-exchanger membrane film. The preconcentration step involved a series of electron transfers and dehydration steps by an ECE mechanism, leading to a reduced product that couples with a second molecule of **277** subsequently introduced to the film. This condensation product is reduced at a lower potential than **277**. The resulting differential pulse stripping current is directly proportional to the solution concentration over the range 5–810 nM<sup>567</sup>.



(277)

TABLE 6. Examples of environmental and occupational protocols for nitroso compounds of industrial significance

Compound and CAS registry number <sup>a</sup>	Safety <sup>b</sup>	Spectra <sup>c</sup>	Various protocols <sup>d</sup>
<i>N</i> -Nitrosodi- <i>n</i> -butylamine [56375-33-8]			EO5730000, EPA
<i>N</i> -Nitrosodiethylamine [55-18-5]			IA3500000, EPA
<i>N</i> -Nitrosodimethylamine [62-75-9] ( <b>278a</b> )	2599B		IQ0525000, EPA
<i>N</i> -Nitrosodiphenylamine [86-30-6] ( <b>278c</b> )			JK0175000, EPA
<i>N</i> -Nitrosodi- <i>n</i> -propylamine [621-64-7] ( <b>278d</b> )			JL9700000, EPA
<i>N</i> -Nitrosoethylmethylamine [10595-95-6]			KR9200000, EPA
<i>N</i> -Nitrosomorpholine [59-89-2]			QR7525000, EPA
<i>N</i> -Nitrosopiperidine [100-75-4] ( <b>298</b> )			TN2100000, EPA
<i>N</i> -Nitrosopyrrolidine [930-55-2] ( <b>280</b> )	2603D	I(3)481B, N(1)355D	UY1575000, EPA

<sup>a</sup>Nomenclature may vary from source to source. See also Reference 69.

<sup>b</sup>Entry number in Reference 70.

<sup>c</sup>Codes beginning with I and N denote FTIR spectra in Reference 71 and NMR spectra in Reference 72, respectively.

<sup>d</sup>A code of two letters followed by seven digits is a reference to RTECS of NIOSH/OSHA. Standard samples are commercially available for most compounds with reference to EPA protocols.

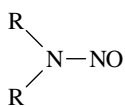
The mechanism of electrochemical reduction of nitrosobenzene to phenylhydroxylamine in aqueous medium has been examined in the pH range from 0.4 to 13, by polarographic and cyclic voltametry. The two-electron process has been explained in terms of a nine-membered square scheme involving protonations and electron transfer steps<sup>565</sup>. This process is part of the overall reduction of nitrobenzene to phenylhydroxylamine, shown in reaction 37 (Section VI.B.2). Nitrosobenzene undergoes spontaneous reaction at pH > 13, yielding azoxybenzene<sup>471</sup>.

### C. Nitrosamines

A review appeared, discussing the determination of nitrosamines in cosmetics and cosmetic raw materials, including analytical procedures and LOD<sup>568</sup>. The nitrosamines connected with tobacco are discussed in Section VI.D below.

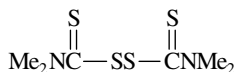
#### 1. Gas chromatography

Various gas chromatographic techniques combined with plentiful detection methods were used to separate and quantify volatile *N*-nitrosamines. Preconcentration methods were usually applied for separating these compounds. Thus, a method was developed for determination of *N*-nitrosodimethylamine (**278a**) in minced fish or frankfurters, based on SPE followed by GC-CLD-TEA; RSD was 0.56 to 2.25%<sup>569</sup>. This method has been adopted by AOAC. A similar GC method using NPD was described for the determination of **278a** in fish products<sup>570</sup>. Steam distillation can also be used to isolate volatile



- (a) R = Me  
 (b) R = CH<sub>2</sub>Ph  
 (c) R = Ph  
 (d) R = Pr

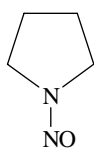
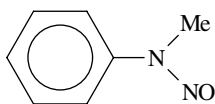
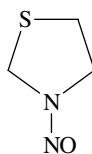
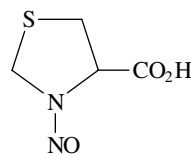
(278)



(279)

components and was applied to separate the **278a** found as impurity in thiram (**279**) formulations, followed by SPE and determination by GC-MS-SIM<sup>571</sup>.

The nitrosamines on the EPA list (see Table 6) were determined in samples of ground-water and drinking water at the sub-ppb level (0.1 ppb). The method consisted of either LLE with methylene chloride or SPE on a series of two adsorbents (C<sub>8</sub> and an activated C cartridge), followed by capillary GC-NPD<sup>572</sup>. Of all foods, nitrite-cured meats have been investigated most thoroughly for the presence of nitrosamines, many of which are carcinogens. Thus, varying levels (1–48 ppb) of *N*-nitrosodimethylamine (**278a**), *N*-nitrosopyrrolidine (**280**) and *N*-nitroso-*N*-methylaniline (**281**) were detected in Icelandic smoked mutton using GC-CI-MS. Low levels of *N*-nitrosothiazolidine (**282**, 0.6–2.4 ppb) and *N*-nitrosothiazolidine-4-carboxylic acid (**283**, 56–475 ppb) were also present. It was suggested that the formation of all the above nitrosoamines can be minimized by changing or modifying the method of smoking<sup>573</sup>.

**(280)****(281)****(282)****(283)**

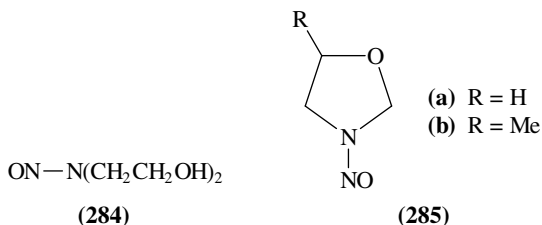
A GC-tandem CI-MS method, using a quadrupole ion storage mass spectrometer, has been developed for the determination of *N*-nitrosodimethylamine (**278a**) in complex environmental matrices. No interference from chlorobenzene, ethylbenzene and the xylenes was detected; LOD was in the subpicogram range<sup>574</sup>. An alternative method for **278a** involves preconcentration by SPE, extraction with CH<sub>2</sub>Cl<sub>2</sub> and GC-MS, using isotope dilution with hexadeuterated **278a**. LOD 1.0 ppt in water, accuracy of 6% at 10 ppt<sup>575</sup>. **278a** was also determined in drinking water and fruit drinks by GC using both TEA and MS-SIM detection; LOD was 15 pg/g in drinking water and 1 pg/g in fruit drinks<sup>576</sup>.

Volatile nitroso compounds were determined in hams processed in elastic rubber nettings by SPE and GC-CLD<sup>577</sup>. By a similar method *N*-nitrosodibenzylamine (**278b**), a semivolatile nitrosamine, was determined in these products by SPE followed by GC interfaced to a nitrosamine-specific TEA-CLD detector; the coefficient of variation was 10.6% at the 2.1 ppb level<sup>578</sup>. The nitrosamines detected in ham most likely originate from the amine precursors in rubber and from the nitrite commonly used in the meat curing process.

A method involving SPE was developed for the determination of ten *N*-nitroso amino acids in cured meat products. These compounds were derivatized with diazomethane followed by *O*-acylation of hydroxyl groups with acetic anhydride-pyridine reagent. The methyl esters and their acylated derivatives were separated by GC on a DB-5 fused silica capillary column and quantified with a TEA-CLD specific for the nitric oxide derived from the thermal denitrosation of nitrosamines; recovery exceeded 75% at the 10 ppb level<sup>579</sup>.

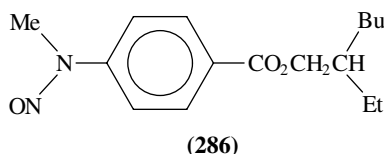
*N*-Nitrosodiethanolamine (**284**), *N*-nitroso-1,3-oxazolidine (**285a**) and *N*-nitroso-5-methyl-1,3-oxazolidine (**285b**) were detected in metalworking fluids in Canada, using GC-ECD. **284** was derivatized with trifluoroacetic acid anhydride, while **285a** and **285b** were converted to their corresponding nitramine analogs by oxidation with pertrifluoroacetic acid before analysis; LOD was 1.2–5 ng<sup>580</sup>.

A laboratory-assembled supercritical fluid extractor was designed for the efficient recovery of volatile nitrosamines from frankfurters. The nitrosamines were separated and detected using a GC-TEA-CLD. Recovery of 10 volatile aliphatic and alicyclic nitrosamines from frankfurters spiked at the 20 ppb level was 84.3–104.8% with RSD 2.34–6.13%<sup>581</sup>.

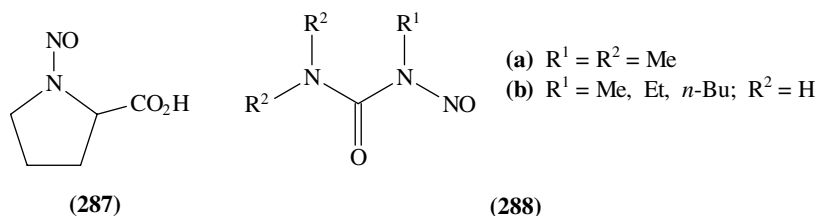


## 2. Liquid chromatography

Computer simulation was applied for the development and optimization of a gradient chromatography method for the analysis of nitrosamines<sup>582</sup>. Interest in the analysis of nonvolatile *N*-nitrosamines has recently been renewed due to the development of novel interfaces to TEA or CLD after RP-HPLC. An interface was devised, incorporating a thermospray vaporizer, a counter flow gas diffusion cell to reduce the LC effluent to a dry aerosol and a single-stage momentum separator to form a particle beam of the nonvolatile analyte. This interface was used in the HPLC-TEA analysis of the nonvolatile *N*-nitrosodiethanolamine (**284**) and 2-ethylhexyl *N*-nitroso-*N*-methyl-*p*-aminobenzoate (**286**). These results are comparable to other LC-TEA interfacing methods; however, several advantages are ease of application, ruggedness and MS compatibility. Full scan EI-MS identification of the *N*-nitrosamine contaminants in cosmetics was used for confirming the TEA detection data<sup>583</sup>. Traces of **284** in triethanolamine, up to 10  $\mu\text{g/L}$ , were determined by HPLC-UV/D, using a strongly acidic cation exchanger PRPX200 column and aqueous  $\text{HClO}_4$  as eluent of high optical transparency, measuring at  $\lambda_{\text{max}}$  235 nm. The method takes advantage of difference in  $\text{p}K_a$  values of the amine matrix and the nitroso impurity<sup>584</sup>.



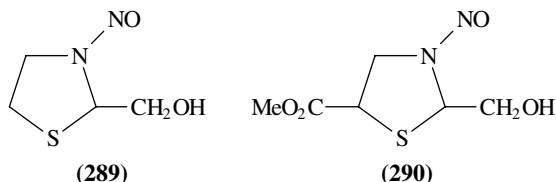
Using TEA-CLD it was possible to determine rapidly total *N*-nitroso compounds and nitrite in fresh human gastric juice; LOD 1.0 pmol, RSD 1–6%<sup>585</sup>. Mixtures of volatile and nonvolatile *N*-nitroso compounds, including *N*-nitrosodipeptides, were determined by HPLC-TEA, using a water/acetonitrile gradient mobile phase; RSD was 3.0 and 5.1%, for 80–90 ng injections of *N*-nitrosoproline (**287**) and *N*-nitrosotrimethylurea (**288a**), respectively<sup>586</sup>.



A method for analysis of *N*-nitroso-*N*-alkylureas (**288b**) has been developed by forming fluorescent derivatives with sodium sulfide, taurine (**77**) and *o*-phthalaldehyde (**73**)

and separating by RP-HPLC. The method was applied to the determination of **288b** in blood<sup>587</sup>.

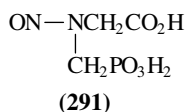
2-(Hydroxymethyl)-*N*-nitrosothiazolidine (**289**) and 2-(hydroxymethyl)-*N*-nitrosothiazolidine-4-carboxylic acid methyl ester (**290**) were determined in cured smoked meats by HPLC-TEA<sup>588</sup>.



Various nonvolatile nitrosamines were analyzed using HPLC-UV photolysis-CLD. This was applied for determination of *N*-nitrosamides in dried squid<sup>589</sup> and *N*-nitrosodiphenylamine (**278c**) in treated apples<sup>590</sup>.

An improved HPLC-photohydrolysis-colorimetry method was validated for twenty-eight reference nitrosamines. These were separated by HPLC and photolytically cleaved by UV radiation. The resulting nitric oxide was oxidized and hydrolyzed to nitrite ions, which were derivatized into an azo dye with Griess' reagent and measured spectrophotometrically. The method was applied to separate and detect hitherto unknown nonvolatile nitrosamines in biological fluids and food extracts<sup>591</sup>.

Two conformers of *N*-nitrosoglyphosate (**291**) were separated by HPLC. NMR, spectrophotometric and electroanalytical measurements indicate that these conformers are always present in equilibrium, with slow interconversion<sup>592</sup>.

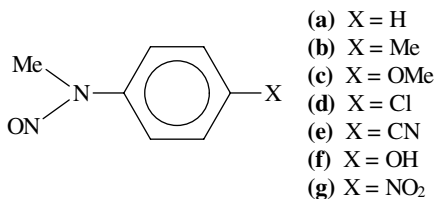


Microconcentrations of carcinogenic *N*-nitrosamines were determined in various rubber articles (tubing, stoppers, hoses, seals, etc.) for medical and food uses by extraction followed by HPLC-FLD<sup>593</sup>. *N*-Nitrosodiphenylamine (**278c**) present in diphenylamine formulations was determined by LC-TEA on a Zorbax CN column<sup>594</sup>.

Ce(IV) in acidic medium is a suitable post-column reagent in the LC-amperometric determination of nonvolatile nitrosamines such as nitrosoourea, nitrosoguanidine, nitrosoourea and nitrosoamino acids. The behavior of the Ce(IV)-Ce(III) couple with a rotating disk electrode approaches the operational conditions of a 'channel-thin layer' cell with solid electrodes, frequently used as detector for LC. Gold was found to be the most suitable electrode. The reaction between Ce(IV) and  $\text{NO}_2^-$ , the product of nitrosamine decomposition in warm acidic solution, was considered<sup>595</sup>. An improved LC-amperometric determination of nonvolatile nitrosamines was proposed, using an online detector system based on the Ce(IV) reagent in acidic medium. A two-line flow manifold coupled with a flow-through voltammetric detector equipped with twin gold electrodes, for both mono- and bi-amperometric detection modes, was evaluated. Mono- and bi-amperometric measurements allowed determination of linear dynamic ranges, sensitivities and LOD of nitrite under different experimental conditions of composition, liquid carrier and temperature of the reactor<sup>596</sup>. The use of iodide reagent in acidic medium was introduced for the LC-amperometric determination of nonvolatile nitrosamines. A two-line flow-injection manifold was used, coupled with a voltammetric flow-through

detector. A peak current signal was obtained for the nitrite–iodide reaction. The method has high sensitivity and LOD of about  $1 \times 10^{-8}$  M, which is better than with the Ce(IV) reagent<sup>597</sup>.

Optimized conditions were found for the separation of *p*-substituted *N*-nitroso-*N*-methylanilines (**292**), using RP-HPLC with a C<sub>18</sub> chemically bonded stationary phase. Four detection techniques were studied: Direct UV photometry, polarography on a hanging Hg electrode, anodic voltammetry on a glassy carbon fiber array electrode and indirect anodic voltammetry after photolytic denitrosation of the analytes. UV photometry is the most universal with LOD around  $10^{-6}$  M. Polarography exhibits the poorest sensitivity (LOD *ca*  $10^{-5}$  M) but can be used for selective detection of the *p*-nitro derivative **292g**. Direct voltammetric detection is selective for the oxidizable derivatives, and the LOD attained are lower than those obtained by UV photometry for **292f**. When the analytes are photolytically denitrosated to yield oxidizable derivatives, the LOD of voltammetric detection of **292a**, **292b**, **292d** and **292g** are an order of magnitude lower than those of UV photometry<sup>598</sup>.



(292)

The diffusion-limited electrochemical oxidation of *N*-nitrosamines in an aqueous pH 1.5 buffer was demonstrated at a GCE coated with a film of mixed valence ruthenium oxides, stabilized by cyano crosslinks. This electrode was used in a potentiostatic amperometric detector for FIA and HPLC, to allow the determination of representative *N*-nitrosamines (**278a**, **278c** and **278d**); for **278c**, LOD was 10 nM and RSD 2% at 0.80  $\mu$ M ( $n = 5$ )<sup>599</sup>.

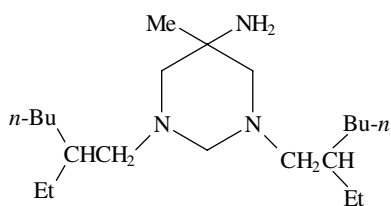
### 3. Miscellaneous methods

Hexetidine (**293**) and hexedine (**294**), common ‘formaldehyde releasing’ antimicrobial agents and drug constituents, can undergo nitrosation in the pH range 1–4.8. The major nitrosamine product, ‘HEXNO’ (**295**), can be characterized and analyzed using common spectroscopic methods. Rapid formation of **295** from **293** and **294** supports the hypothesis that tertiary geminal diamines produce nitrosamines rapidly, by a mechanism involving cleavage of a nitrosammonium ion with the assistance of the neighboring nitrogen atom<sup>600</sup>.

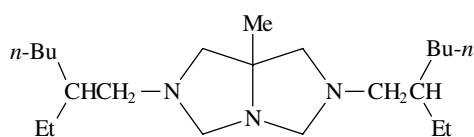
A linear correlation was found between the absorbance and the concentration (12.5–100 mg/L) of sixteen antineoplastic nitrosoureas, belonging to 4 distinct chemical classes, in the presence of ceftizoxime (**296**) in acidic media ( $\lambda_{\max}$  500 nm)<sup>601</sup>.

Sodium iodide in trifluoroacetic anhydride reacts with nitrosamines and releases iodine. This was used for selective detection of nitrosamines after TLC separation<sup>602,603</sup>.

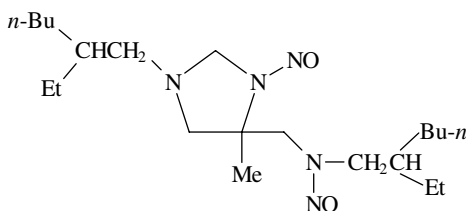
Denitrosation of *N*-nitrosamines to yield secondary amines affords an alternative way for detecting *N*-nitrosamines. Treatment with a hydrogen bromide–acetic acid mixture and reacting the resulting amines with 4-(2-phthalimidyl)benzoyl chloride (**297**) gives fluorescent amides. *N*-Nitrosodialkylamines such as **278a**, **278d**, **278e**, **280** and *N*-nitrosopiperidine (**298**) were used as model compounds<sup>604</sup>.



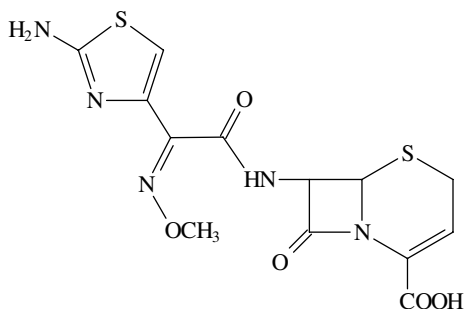
(293)



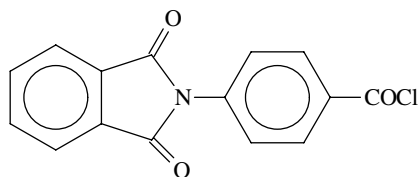
(294)



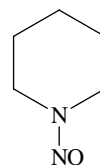
(295)



(296)



(297)



(298)

Quantification of total *N*-nitroso compounds in urine and gastric juice is achieved by combining photolytic denitrosation with TEA. Nitrite interference is effectively eliminated with sulfamic acid ( $\text{H}_2\text{NSO}_3\text{H}$ )<sup>605</sup>.

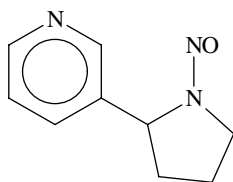
*S*-Nitroso derivatives of the biological thiols—glutathione, cysteine (**115**) and homocysteine—have been considered as bioactive intermediates in the metabolism of organic nitrates and the endothelium-derived relaxing factor with properties of nitric oxide. A simple, rapid and reproducible method for separating these thiols from their

*S*-nitrosated and disulfide derivatives using CZE was developed. *S*-Nitroso thiols were selectively detected at 320 nm<sup>606</sup>.

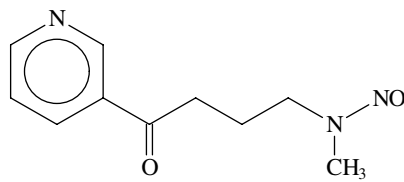
#### D. Tobacco

Tobacco smoke and *N*-nitrosation are the focus of intense research activity. Workers in the field use the following concepts: Tobacco-specific *N*-nitrosamines (TSNA); mainstream tobacco smoke (MSTS), smoke inhaled in a puff; sidestream tobacco smoke (SSTS), smoke evolved by smoldering cigarettes between puffs; nitroso organic compounds (NOC), referring especially to *N*-nitrosamines; volatile NOC (VNOC) and *N*-nitroso amino acids (NAA).

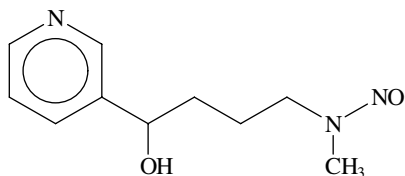
Nicotine and the minor tobacco alkaloids yield TSNA during tobacco processing and smoking<sup>607,608</sup>. TSNA increase cancer risk in the upper digestive tract of tobacco chewers and in the lung of smokers, especially pulmonary adenocarcinoma<sup>609</sup>. Chemical analysis led to the identification of seven TSNA in smokeless tobacco ( $\leq 25 \mu\text{g/g}$ ) and in MSTS of cigarettes ( $1.3 \mu\text{g TSNA/cigarette}$ ). Indoor air polluted by tobacco smoke may contain up to 24 pg TSNA/L. The three TSNA *N'*-nitrosornicotine (**299**), 4-(methylnitrosamino)-1-(3-pyridyl)-1-butanone (**300**) and 4-(methylnitrosamino)-1-(3-pyridyl)-1-butanol (**301**) are powerful carcinogens for mice, rats and hamsters. Studies revealed also artifactual formation of VNOC and TSNA during trapping of MSTS and SSTS by the method of Hoffman<sup>610</sup>. Comparative analysis of *N*-nitrosamines in smoke from cigarettes that heat but do not burn (the test cigarette) and in various reference cigarettes was performed. Concentrations of both VNOC and TSNA in both MSTS and SSTS from the test cigarette were substantially lower than in the reference cigarettes<sup>611</sup>. An experiment was carried out in which five male nonsmokers were exposed to SSTS generated by a machine smoking reference cigarettes, for 180 minutes, on two occasions six months apart. Twenty-four-hour urine samples were collected before and after exposure. The urine samples were analyzed for **301** and its glucuronide, which are metabolites of the powerful lung carcinogen **300**. The urinary excretion of the metabolites increased significantly after exposure to SSTS in all the men. It was concluded that nonsmokers exposed to SSTS take up and metabolize a lung carcinogen, providing experimental support for the contention that environmental tobacco smoke may cause lung cancer<sup>612</sup>.



(299)



(300)

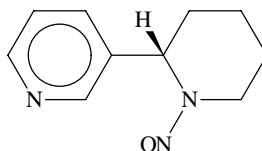


(301)



The carcinogenic activity of snuff and other smokeless tobacco products is also attributed to the presence of VNOC and especially to TSNA. The effects of aging and storage on the levels of TSNA, NAA and VNOC in commercial moist snuff was studied. VNOC were analyzed by the method of Brunnemann<sup>613,614</sup>, consisting of extraction with citrate buffer containing ascorbic acid, LLE and GC-TEA. NAA and TSNA were similarly separated and derivatized with bis(trimethylsilyl)trifluoroacetamide (**24**). The silylated compounds were analyzed by GC-TEA and GC-EI-MS. It was found that none of these compounds increased significantly during storage at 4 °C. However, at ambient room temperature and at 37 °C, the levels of NOC and nitrite of the snuff increased significantly after 4 weeks storage. TSNA rose from 6.24 to 18.7 ppm, NAA from 3.13 to 16.3 ppm and VNOC from 0.02 to 0.2 ppm. This study also led to the identification and quantitative determination of **301** in moist snuff<sup>614</sup>. A relationship between intragastric *N*-nitrosation, gastric pH and nitrite was also established. Thus, fasting gastric juice samples were analyzed for total NOC and nitrite concentrations. The results confirmed that both acid-catalyzed and biologically-catalyzed *N*-nitrosation occur in the human stomach, and that both are markedly affected by factors other than intragastric pH and nitrite concentration<sup>615</sup>.

A method was developed to assess TSNA in indoor air polluted with tobacco smoke. Collection was followed by enrichment, concentration and desorption, and analysis by capillary GC-TEA. The concentration of *N'*-nitrosonornicotine (**299**) was 0–23 pg/L, that of *N'*-nitrosoanatabine (**302**) was 0–9 pg/L and that of **300** 1–29 pg/L. Thus, nonsmokers can be exposed to highly carcinogenic TSNA<sup>616</sup>.



(302)

A new approach to the analysis of the carcinogenic TSNA in moist snuff tobacco is based on SFE with methanol-modified carbon dioxide. Extracted TSNA are trapped across a glass cartridge filled with Tenax GR, from which they are subsequently released by thermal desorption and analyzed by capillary GC-TEA; LOD was <2 ng/g. The technique is fast, reproducible, highly selective and sensitive<sup>617</sup>. SFE with carbon dioxide was also used in the analysis of TSNA in smokeless tobacco. It revealed the presence of higher levels of 4-(methylnitrosamino)-1-(3-pyridyl)-1-butanone (**300**) than had been determined earlier by conventional methods<sup>618</sup>.

## VIII. HYDROXYLAMINES

### A. Quantitative Analysis

Hydroxylamine and its *N*-monosubstituted, *N,N*-disubstituted and *O*-substituted derivatives were separated by LC using as detector a GCE, modified with a polymeric coating containing cobalt phthalocyanine (**222b**). The analytes required potentials higher than +1 V for the unmodified GCE vs Ag/AgCl, while the modified electrode gave substantial anodic currents in the +0.25–0.55 V range. Oxidations involved a transfer between 1.2 to 1.6 electrons, depending on the particular hydroxylamine derivative analyzed and the conditions of reaction. The products included oximes, azoxy compounds and dimeric species. The detection could be made selective for hydroxylamine and its *N*-monosubstituted derivatives by operating at +0.20 V<sup>619</sup>.

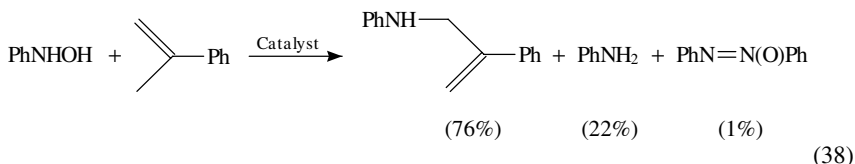
Hydroxylamine, *N*-methylhydroxylamine and *N,N*-dimethylhydroxylamine were determined by ion chromatography. Amperometric detection using a GCE showed best sensitivity and selectivity, with injections of nanomole amounts<sup>620</sup>.

## B. Structural Analysis

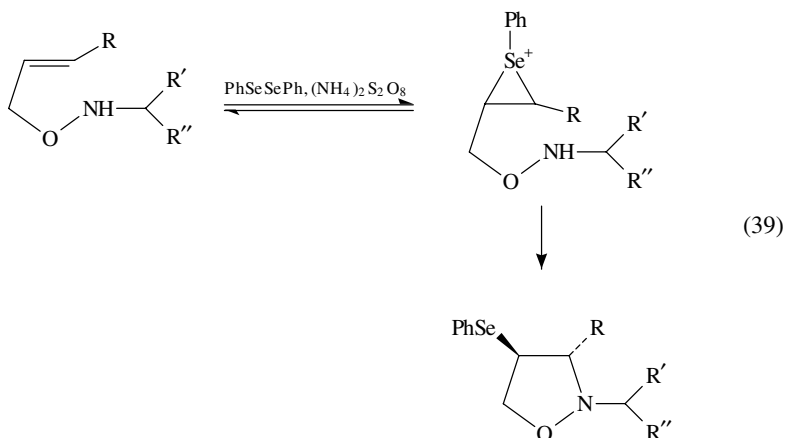
The conformation energy and inversion barriers around the N(sp<sup>3</sup>)-O single bond, calculated by *ab initio* and semiempirical methods, showed a simple twofold character of the conformations, without any appreciable population of the *cis* conformer. Rotation is generally favored over inversion for hydroxylamine and its methylated derivatives<sup>621</sup>. Various authors have conducted calculations on the conformations of hydroxylamine and its *N*- and *O*-substituted derivatives. Calicheamicin is a glycosidic antibiotic of very complex structure. Its antitumor activity is due to its capacity of producing an adduct with DNA, followed by breaking-up of the nucleic acid chain and death of the cell. The complexing capacity of calicheamicin is added to the shape of the molecule. The contribution of the conformations of the hydroxylamino moiety to the molecular shape was analyzed<sup>622</sup>.

## C. Derivatization

Reaction 38 shows that hydroxylamines can cause amination at allylic positions. Fe(II) phthalocyanine (**222c**) was the most effective catalyst. Other catalysts and substrates were also investigated<sup>623</sup>. Complexes of Mo(VI) were less effective than **222c** as catalysts for amination processes of this type<sup>624</sup>.

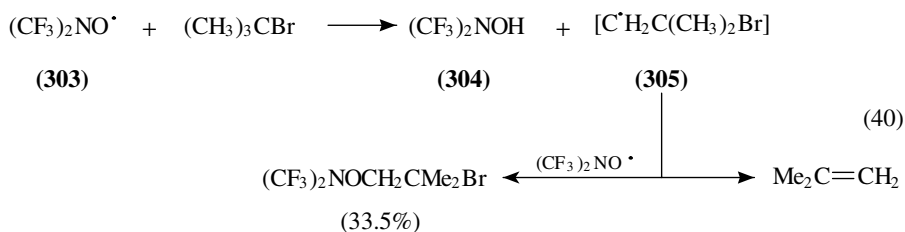


*O*-Allylhydroxylamines undergo a selenium-induced cyclization to isoxazolidines, as shown in reaction 39<sup>625</sup>.

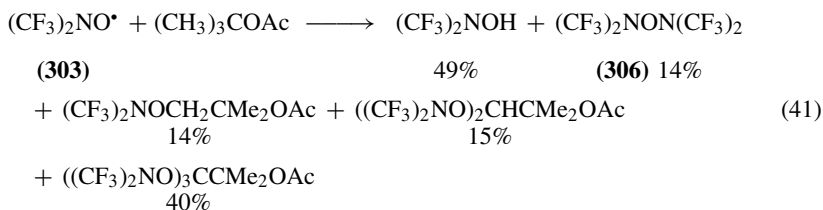


## IX. AMINO-OXYLS

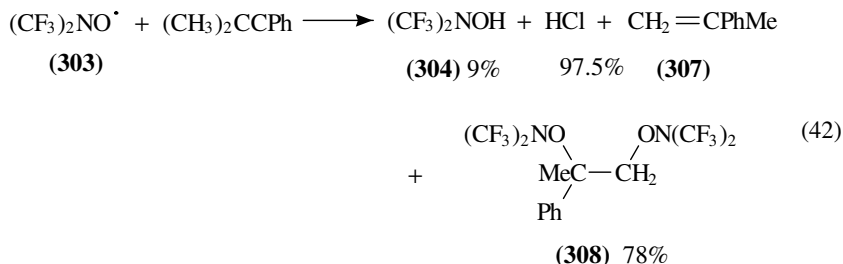
Bis(trifluoromethyl)amino-oxyl (**303**) is a relatively stable free radical species that can be scavenged by organic molecules. Due to the reasonable yields of the products, the following reactions may have analytical value, both for tagging organic molecules and for exploring the properties of other amino-oxyls. Reaction 40 illustrates with *t*-butyl bromide the basic processes undergone by **303** when let to warm up from  $-196^\circ\text{C}$  to room temperature, in the presence of organic compounds. The first step is abstraction of a hydrogen atom yielding the corresponding hydroxylamine (**304**) and an intermediate free radical (**305** for example). The latter may yield an olefin or react with a molecule of the amino-oxyl<sup>626</sup>.



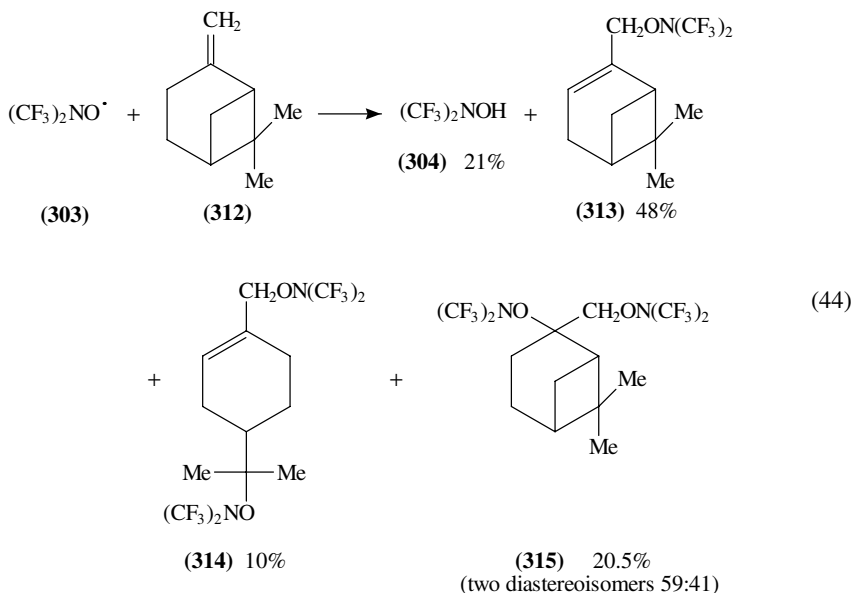
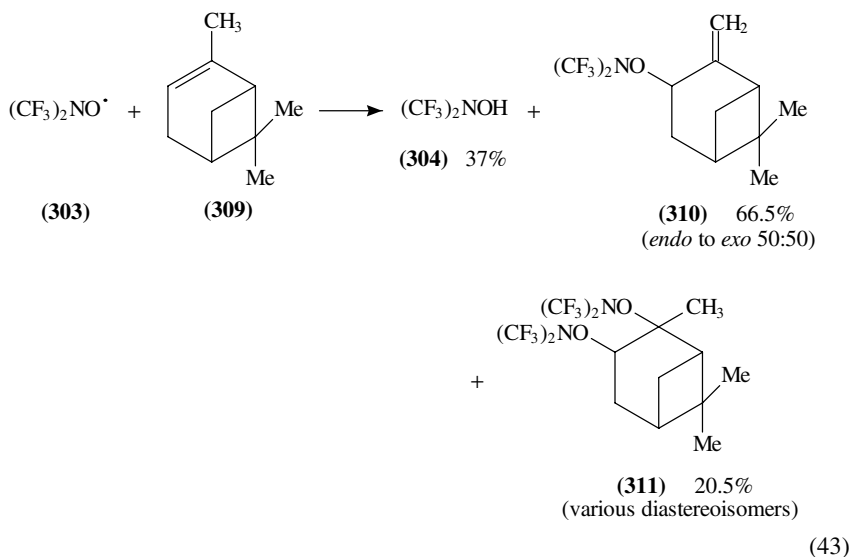
In the case of *t*-butyl acetate, shown in reaction 41, three successive geminal hydrogen abstractions and insertions of **303** take place; a product of reductive dimerization (**306**) is also formed in small yield<sup>626</sup>.



The 2:1 adduct **308** obtained from **303** with 2-chloro-2-phenylpropane (reaction 42) is probably derived from the addition of **303** to  $\alpha$ -methylstyrene (**307**)<sup>626</sup>.



Olefinic compounds such as  $\alpha$ -pinene (**309**) and  $\beta$ -pinene (**312**) undergo hydrogen abstraction followed by rearrangement and amino-oxyl insertion (**310**, **313**) and addition reactions (**311**, **314**, **315**), as shown in reactions 43 and 44<sup>627</sup>. Other olefinic compounds such as norbornadiene, cyclo-octene and cyclo-octa-1,5-diene gave analogous results<sup>628</sup>.



## X. REFERENCES

1. J. Zabicky, in *The Chemistry of the Amino Group* (Ed. S. Patai), Wiley, London, 1968, p. 79.
2. C. N. R. Rao, in *The Chemistry of the Nitro and Nitroso Groups* (Ed. H. Feuer), Interscience, Wiley, New York, 1969, p. 79.
3. C. N. R. Rao and K. R. Bhaskar, in *The Chemistry of the Nitro and Nitroso Groups* (Ed. H. Feuer), Interscience-Wiley, New York, 1969, p. 137.
4. G. K. Sims, T. R. Ellsworth and R. L. Mulvaney, *Commun. Soil Sci. Plant Anal.*, **26**, 303 (1995).

5. K. Robards, I. D. McKelvie, R. L. Benson, P. J. Worsfold, N. J. Blundell and H. Casey, *Anal. Chim. Acta*, **287**, 147 (1994).
6. J. Zabicky, in *The Chemistry of Sulphenic Acids and Their Derivatives* (Ed. S. Patai), Wiley, Chichester, 1990, p. 90.
7. J. Nieuwenhuize, Y. E. M. Maas and J. J. Middelburg, *Marine Chem.*, **45**, 217 (1994).
8. *Elemental Analyzer CHN-O-Rapid. Operating Instructions*, W. C. Heraeus GmbH, Hanau, Germany, 1986.
9. B. Colombo, M. Baccant and J. Teobald, *Int. Labmate*, **13** [7] (1988).
10. E. H. Simonne, H. A. Mills, J. B. Jones, D. A. Smittle and C. G. Hussey, *Commun. Soil Sci. Plant Anal.*, **25**, 943 (1994).
11. J. K. Daun and D. R. DeClercq, *J. Am. Oil Chem. Soc.*, **71**, 1069 (1994).
12. E. Jacob, C. Sievert, S. Sommer and Z. Puhan, *Z. Lebensmit.-Untersuch. Forsch.*, **200**, 239 (1995).
13. J. Martin, Y. Takahashi and M. Datta, *Am. Lab.*, **27**, 49 (1995).
14. F. P. Di Sanzo, *J. Chromatogr. Sci.*, **28**, 73 (1990).
15. Z. S. Yu, R. R. Northup and R. A. Dahlgren, *Commun. Soil Sci. Plant Anal.*, **25**, 3161 (1994).
16. M. C. de Vargas, H. L. de Medina, E. Villalobos, E. Gutiérrez and R. Mazurek, *Analyst*, **120**, 761 (1995).
17. Y. Collos and F. Mornet, *Marine Biol. (Berlin)*, **116**, 685 (1993); *Biol. Abstr.*, **96**, 97716 (1993).
18. I. D. McKelvie, M. Mitri, B. T. Hart, I. C. Hamilton and A. D. Stuart, *Anal. Chim. Acta*, **293**, 155 (1994).
19. H. L. de Medina, M. C. de Vargas, J. Marín and D. Pirela, *J. Chromatogr. A*, **671**, 287 (1994).
20. M. Pojopay and P. Raimbault, *Mar. Ecol. Prog. Ser.*, **105**, 203 (1994).
21. P. S. Libby and P. A. Wheeler, *Marine Chem.*, **48**, 31 (1994).
22. H. Namiki, K. Hanaue and E. Nakamura, *Bunseki Kagaku*, **43**, 953 (1994).
23. H. A. McKenzie, *Trac Trends Anal. Chem.*, **13**, 138 (1994).
24. C. G. Price, N. B. Webb, W. J. Smith, H. M. Marks and A. M. Yoffe, *J. Ass. Off. Agr. Chem. Int.*, **77**, 1542 (1994).
25. S. B. Peng, M. R. C. Laza, F. V. García and K. G. Cassman, *J. Plant Nutr.*, **17**, 209 (1994).
26. S. G. Sommer, V. Kjellerup and O. Kristjansen, *Acta Agric. Scand., Sect. B—Soil Plant Sci.*, **42**, 146 (1992).
27. G. K. Buckee, *J. Inst. Brewing*, **100**, 57 (1994).
28. K. A. Boehm and P. F. Ross, *J. Ass. Off. Agr. Chem. Int.*, **78**, 301 (1995).
29. M. Dressler, *Selective Gas Chromatography Detectors*, Elsevier, Amsterdam, 1986.
30. H. H. Hill and D. G. McMinn (Eds.), *Detection for Capillary Chromatography*, Wiley, New York, 1992.
31. K. O. Gerhardt and W. A. Aue, *J. Chromatogr.*, **52**, 47 (1970).
32. M. Butler and A. Darbre, *J. Chromatogr.*, **101**, 51 (1974).
33. N. Mellor, *J. Chromatogr.*, **123**, 396 (1976).
34. K. Oláh, A. Zóke and Z. Vajta, *J. Chromatogr. Sci.*, **17**, 497 (1979).
35. P. L. Patterson, R. A. Gatten and C. Ortiveros, *J. Chromatogr. Sci.*, **20**, 97 (1982).
36. P. L. Patterson, *Chromatographia*, **16**, 107 (1982).
37. W. R. West and M. L. Lee, *J. High Resolut. Chromatogr., Chromatogr. Commun.*, **9**, 161 (1986).
38. P. L. Patterson, *J. Chromatogr. Sci.*, **24**, 41 (1986).
39. H. V. Drushel, *Anal. Chem.*, **49**, 932 (1977).
40. N. Kashihira, K. Makino, K. Kirita and Y. Watanabe, *J. Chromatogr.*, **239**, 617 (1982).
41. D. P. Rounbehler, S. J. Bradley, B. C. Challis, D. H. Fine and E. A. Walker, *Chromatographia*, **16**, 354 (1982).
42. R. S. Hutte, R. E. Sievers and J. W. Birks, *J. Chromatogr. Sci.*, **24**, 499 (1986).
43. B. E. Pape and M. A. Ribick, *J. Chromatogr.*, **136**, 127 (1977).
44. R. J. Anderson and R. C. Hall, *Am. Lab.*, **12**, 108 (1980).
45. E. D. Pellizzari, *J. Chromatogr.*, **98**, 323 (1974).
46. S. O. Farwell, D. R. Gage and R. A. Kagel, *J. Chromatogr. Sci.*, **19**, 358 (1981).
47. Z. Witkiewicz and E. Stryszak, *Chem. Anal. (Warsaw)*, **30**, 491 (1985).
48. Z. Witkiewicz and E. Stryszak, *Chem. Anal. (Warsaw)*, **30**, 683 (1985).
49. M. B. Wise, M. V. Buchanan, S. K. Parks and J. W. Haas, *Rev. Sci. Instrum.*, **57**, 3075 (1986).
50. L. O. Courthaudon and E. M. Fujinari, *LC-GC*, **9**, 732 (1991).
51. T. B. Ryerson, R. M. Barkley and R. E. Sievers, *J. Chromatogr. A*, **670**, 117 (1994).

52. J. Gascon and D. Barcelo, *Chromatographia*, **38**, 633 (1994).
53. M. Psathaki, E. Manoussaridou and E. G. Stephanou, *J. Chromatogr. A*, **667**, 241 (1994).
54. E. D. Lund, *J. Ass. Off. Agr. Chem. Int.*, **77**, 416 (1994).
55. C. Albelda, Y. Pico, G. Font and J. Manes, *J. Ass. Off. Agr. Chem. Int.*, **77**, 74 (1994).
56. R. J. Young and E. M. Fujinari, *Am. Lab.*, **26** [15], 38 (1994).
57. P. G. M. Zweipfenning, A. H. C. M. Wilderink, P. Horsthius, J. P. Franke and R. A. de Zeeuw, *J. Chromatogr. A*, **674**, 87 (1994).
58. C. de la Colina, A. P. Heras, G. D. Cancela and F. S. Rosero, *J. Chromatogr. A*, **655**, 127 (1993).
59. E. T. Craswell and D. L. Eskew, *Soil Sci. Soc. Am. J.*, **55**, 750 (1991).
60. X. Jia, J. M. Reisman, V. L. Hsu, E. P. Geiduschek, J. Parello and D. R. Kearns, *Biochemistry*, **33**, 8842 (1994).
61. N. S. Saghir, F. P. Mungwari, R. L. Mulvaney and F. Azam, *Commun. Soil Sci. Plant Anal.*, **24**, 2747 (1993).
62. S. N. Stein, L. Li, R. L. Mulvaney and F. W. Simmons, *Commun. Soil Sci. Plant Anal.*, **24**, 2765 (1993).
63. M. A. Rondon and R. J. Thomas, *Commun. Soil Sci. Plant Anal.*, **25**, 435 (1994).
64. S. R. Boyd, A. Rejou-Michel and M. Javoy, *Anal. Chem.*, **66**, 1396 (1994).
65. J. A. Lory and M. P. Russelle, *Soil Sci. Soc. Am. J.*, **58**, 1400 (1994).
66. M. Singh, R. Venkatasubramanian, T. K. Balasubramanian and V. V. Athalye, *Anal. Lett.*, **27**, 2369 (1994).
67. F. Lipschultz, *Appl. Spectrosc.*, **47**, 2093 (1993).
68. J. A. Silber, M. H. Engel, S. A. Macko and E. J. Jumeau, *Anal. Chem.*, **63**, 370 (1991).
69. N. I. Sax, *Dangerous Properties of Industrial Materials*, 6th edn., Van Nostrand Reinhold, New York, 1984.
70. R. E. Lenga (Ed.), *The Sigma-Aldrich Library of Chemical Safety Data*, 2nd edn., Sigma-Aldrich, Milwaukee, WI, 1988.
71. C. J. Pouchert, *The Aldrich Library of FT-IR Spectra*, Aldrich Chemical, Milwaukee, WI, 1985–1989.
72. C. J. Pouchert, *The Aldrich Library of NMR Spectra*, 2nd edn., Aldrich Chemical, Milwaukee, WI, 1985–1989.
73. F. J. Green, *The Sigma-Aldrich Handbook of Stains, Dyes and Indicators*, Aldrich, Milwaukee, WI, 1990.
74. *The United States Pharmacopeia*, 23rd edn., United States Pharmacopeia Convention, Inc., Rockville, MD, 1995.
75. C. R. Worthing (Ed.), *The Pesticide Manual*, British Crop Protection Council, 1991.
76. X. H. Yang, C. Lee and M. I. Scranton, *Anal. Chem.*, **65**, 572 (1993).
77. S. F. Patil and S. T. Lonkar, *J. Chromatogr. A*, **688**, 189 (1994).
78. U. Feier and P. H. Goetsch, *Arch. Lebensmit. Hyg.*, **44**, 134 (1993).
79. D. A. Merritt and J. M. Hayes, *J. Am. Soc. Mass Spectrom.*, **5**, 387 (1994).
80. W. E. Robe, H. Griffiths, D. Sleep and C. Quarmby, *Plant Cell Environ.*, **17**, 1073 (1994).
81. H. Demmelmair and H. L. Schmidt, *Isotopenpraxis*, **29**, 237 (1993).
82. T. A. Lee, D. I. Frost, G. E. Wilson and J. K. Hardy, *Anal. Biochem.*, **197**, 321 (1991).
83. B. W. Patterson, F. Carraro and R. R. Wolfe, *Biol. Mass Spectrom.*, **22**, 518 (1993).
84. U. Matthiesen and P. Schadewaldt, *Isotopenpraxis*, **30**, 219 (1994).
85. W. S. Gardner, L. R. Herche, P. A. St. John and S. P. Seitzinger, *Anal. Chem.*, **63**, 1838 (1991).
86. M. H. Engel, G. A. Goodfriend, Y. R. Qian and S. A. Macko, *Proc. Natl. Acad. Sci. USA*, **91**, 10475 (1994).
87. S. Pizzarello, R. V. Krishnamurthy, S. Epstein and J. R. Cronin, *Geochim. Cosmochim. Acta*, **55**, 905 (1991).
88. S. Pizzarello, X. Feng, S. Epstein and J. R. Cronin, *Geochim. Cosmochim. Acta*, **58**, 5579 (1994).
89. M. F. Philpott and M. J. van der Merwe, *Chromatographia*, **31**, 500 (1991).
90. K. W. Edgell, E. L. Jenkins and V. López-Ávila, *J. Assoc. Off. Anal. Chem.*, **74**, 295 (1991).
91. A. M. Lorec, B. Bruguerolle, L. Attolini and X. Roucoules, *Therap. Drug Monit.*, **16**, 592 (1994).
92. J. Z. Huo, J. Van Boecklaer, W. E. Lambert and A. P. De Leenheer, *J. Chromatogr. B, Biomed. Appl.*, **661**, 69 (1994).
93. M. T. Rosseel and R. A. Lefebvre, *J. Chromatogr. A*, **668**, 475 (1994).
94. O. A. Osipova, V. E. Kirichenko and K. I. Pashkevich, *J. Anal. Chem.*, **49**, 646 (1994).

95. R. G. MacFarlane, S. C. MacLeod, J. M. Midgley and D. G. Watson, *J. Neurochem.*, **53**, 1731 (1989); *Biol. Abstr.*, **89**, 28999 (1990).
96. R. G. MacFarlane, J. M. Midgley, D. G. Watson and P. D. Evans, *Insect Biochem.*, **20**, 305 (1990); *Biol. Abstr.*, **90**, 63690 (1990).
97. M. Dalene, G. Skarping and T. Brorson, *J. Chromatogr.*, **516**, 405 (1990).
98. G. D. Clark, I. B. Rosenzweig, V. A. Raisys, C. M. Callahan, T. M. Grant and A. P. Streissguth, *J. Anal. Toxicol.*, **16**, 261 (1992).
99. C. R. Clark, J. Deruiter and F. T. Noggle, *J. Chromatogr. Sci.*, **30**, 399 (1992).
100. Y. Gaillard, J. P. Gay-Montchamp and M. Ollagnier, *J. Chromatogr. B, Biomed. Appl.*, **622**, 197 (1993).
101. M. Mohnke, B. Schmidt, R. Schmidt, J. C. Buijten and P. Mussche, *J. Chromatogr. A*, **667**, 334 (1994).
102. T. Tsukioka, H. Ozawa and T. Murakami, *J. Chromatogr.*, **642**, 395 (1993).
103. A. Q. Zhang, S. C. Mitchell, R. Ayes and R. L. Smith, *J. Chromatogr., Biomed. Appl.*, **584**, 141 (1992).
104. M. K. Abdil-Rashid, J. P. Riley, M. F. Fitzsimons and G. A. Wolff, *Anal. Chim. Acta*, **252**, 223 (1991).
105. G. B. Baker, R. T. Coutts and A. Holt, *J. Pharmacol. Toxicol. Meth.*, **31**, 141 (1994).
106. A. H. B. Wu, T. A. Onigbinde, S. S. Wong and K. G. Johnson, *J. Anal. Toxicol.*, **16**, 137 (1992).
107. K. Jedrzejczak and V. S. Gajnd, *Fresenius J. Anal. Chem.*, **344**, 133 (1992).
108. K. Jedrzejczak and V. S. Gajnd, *Analyst*, **118**, 1383 (1993).
109. K. Jedrzejczak and V. S. Gajnd, *Fresenius J. Anal. Chem.*, **347**, 136 (1993).
110. Y. Miyamoto, H. Kataoka, S. Ohruai and M. Makita, *Bunseki Kagaku*, **43**, 1113 (1994).
111. H. Kataoka, S. Ohruai, Y. Miyamoto and M. Makita, *J. Chromatogr., Biomed. Appl.*, **578**, 120 (1992).
112. H. Kataoka, S. Ohruai, Y. Miyamoto and M. Makita, *Biomed. Chromatogr.*, **6**, 251 (1992).
113. A. Terashi, Y. Hanada, A. Kido and R. Shinohara, *J. Chromatogr.*, **503**, 369 (1990).
114. C. D. Márquez, S. T. Weintraub and P. C. Smith, *J. Chromatogr. B, Biomed. Appl.*, **658**, 213 (1994).
115. M. D. Friesen, K. Kaderlik, D. X. Lin, L. Garren, H. Bartsch, N. P. Lang and F. F. Kadlubar, *Chem. Res. Toxicol.*, **7**, 733 (1994).
116. P. Husek, Z. H. Huang and C. C. Sweeley, *Anal. Chim. Acta*, **259**, 185 (1992).
117. P. Husek and C. C. Sweeley, *J. High Resolut. Chromatogr.*, **14**, 751 (1991).
118. P. Husek, *J. Chromatogr.*, **552**, 289 (1991).
119. J. Wang, Z. H. Huang, D. A. Gage and J. T. Watson, *J. Chromatogr. A*, **663**, 71 (1994).
120. C. H. Oh, J. H. Kim, K. R. Kim, D. M. Brownson and T. J. Mabry, *J. Chromatogr. A*, **669**, 125 (1994).
121. M. Lalonde and T. H. Chan, *Synthesis*, 817 (1985).
122. G. van Look, *Silylating Agents*, Fluka Chemie, Buchs, 1988.
123. R. F. Straub, R. D. Voyksner and J. T. Keever, *Anal. Chem.*, **65**, 2131 (1993).
124. H. Kameyama, R. Shimada, S. Nakagome, M. Watanabe and T. Takeyama, *Bunseki Kagaku*, **43**, 1071 (1994).
125. T. Yoshida, P. D. Chantal and H. Sawatzky, *Energy Fuels*, **5**, 299 (1991); *Chem. Abstr.*, **114**, 127690 (1991).
126. L. Dou and I. S. Krull, *Anal. Chem.*, **62**, 2599 (1990).
127. R. S. Ersser and J. F. Davey, *Med. Lab. Sci.*, **48**, 59 (1991).
128. W. J. Hurst, *J. Liq. Chromatogr.*, **13**, 1 (1990).
129. R. L. Davies, D. R. Baigent, M. S. Levitt, Y. Mollah, C. J. Rayner and A. B. Frensham, *J. Sci. Food Agric.*, **59**, 423 (1992); *Biol. Abstr.*, **95**, 549 (1993).
130. A. Aziz and F. Abu-Dagga, *J. Assoc. Off. Anal. Chem.*, **74**, 104 (1991).
131. G. L. Cowie and J. I. Hedges, *Marine Chem.*, **37**, 223 (1992).
132. D. L. Palazzolo and S. K. Quadri, *J. Chromatogr.*, **518**, 258 (1990).
133. R. M. V. Camanas, J. M. S. Mallols, E. F. S. Alfonso and G. R. Ramos, *Anal. Lett.*, **25**, 1425 (1992).
134. R. Pospisil and D. Valik, *Clin. Chim. Acta*, **200**, 49 (1991).
135. P. Husek and J. Malikova, *J. Liq. Chromatogr.*, **13**, 3351 (1990).
136. A. Marzo, N. Monti, M. Ripamonti, S. Muck and E. Arrigoni-Martelli, *J. Chromatogr.*, **507**, 241 (1990).

137. J. M. Rattenbury and J. C. Townsend, *Clin. Chem.*, **36**, 217 (1990).
138. D. Volmer and K. Levsen, *J. Am. Soc. Mass Spectrom.*, **5**, 655 (1994).
139. S. Chiron, S. Dupas, P. Scribe and D. Barceló, *J. Chromatogr. A*, **665**, 295 (1994).
140. S. Browne, C. Moore, A. Negrusz, I. Tebbett, R. Covert and A. Dusick, *J. Forensic Sci.*, **39**, 1515 (1994).
141. E. Norfolk, S. H. Khan, B. Fried and J. Sherma, *J. Liq. Chromatogr.*, **17**, 1317 (1994).
142. L. Sentier, J. Marchal, J. Boudrant and P. Germain, *J. Chromatogr.*, **547**, 531 (1991).
143. L. H. de Jonge and M. Breuer, *J. Chromatogr. B, Biomed. Appl.*, **652**, 90 (1994).
144. L. Simon-Sarkadi and W. H. Holzapfel, *Z. Lebensmit.-Untersuch. Forsch.*, **198**, 230 (1994).
145. W. A. Jackson and D. R. Bobbit, *Anal. Chim. Acta*, **285**, 309 (1994).
146. M. Katayama, H. Takeuchi and H. Taniguchi, *Anal. Chim. Acta*, **281**, 111 (1993).
147. K. Hayakawa, R. Kitamura, M. Butoh, N. Imazumi and M. Miyazaki, *Anal. Sci.*, **7**, 573 (1991).
148. V. F. Ruban, *J. Chromatogr., Biomed. Appl.*, **619**, 111 (1993).
149. L. He, K. A. Cox and N. D. Danielson, *Anal. Lett.*, **23**, 195 (1990).
150. E. M. Fujinari and J. D. Manes, *J. Chromatogr. A*, **676**, 113 (1994).
151. D. E. H. Palladino and K. A. Cohen, *J. Chromatogr. Sci.*, **29**, 91 (1991).
152. F. T. Noggle, C. R. Clark, K. H. Bouhedir and J. Deruiter, *J. Chromatogr. Sci.*, **29**, 31 (1991).
153. I. N. Ackworth, J. Yu, E. Ryan, K. C. Garipey, P. Gamache, K. Hull and T. Maher, *J. Liq. Chromatogr.*, **17**, 685 (1994).
154. J. A. Perry and M. Chang, *J. Pharm. Sci.*, **79**, 437 (1990).
155. S. Manabe, O. Wada and Y. Kanai, *J. Chromatogr., Biomed. Appl.*, **529**, 125 (1990).
156. S. Manabe and O. Wada, *Environ. Pollut.*, **64**, 121 (1990).
157. S. Manabe and O. Wada, *Environ. Mol. Mutagenesis*, **15**, 229 (1990); *Biol. Abstr.*, **90**, 64818 (1990).
158. Y. Kanai, O. Wada and S. Manabe, *Carcinogenesis (London)*, **11**, 1001 (1990). *Biol. Abstr.*, **90**, 52707 (1990).
159. S. Manabe, S. Izumikawa, K. Asakuno, O. Wada and Y. Kanai, *Environ. Pollution*, **70**, 255 (1991).
160. S. Manabe and O. Wada, *J. Toxicolog. Sci.*, **16** (suppl. 1), 63 (1991).
161. B. Koppen, *J. Chromatogr.*, **623**, 168 (1992).
162. S. Manabe, M. Suzuki, E. Kusano, O. Wada and Y. Asano, *Clin. Nephrol.*, **37**, 28 (1992); *Biol. Abstr.*, **93**, 101551 (1992).
163. P. Kralicek, *Chimia*, **49**, 22 (1995).
164. R. D. Voixner, R. F. Straub, J. T. Keever, H. S. Freeman and W. N. Hsu, *Environ. Sci. Technol.*, **27**, 1665 (1993).
165. H. Takeda, T. Matsumiya and T. Shibuya, *J. Chromatogr.*, **515**, 265 (1990).
166. L. E. Welch, W. W. Lacourse, D. A. Mead, Jr. and D. C. Johnson, *Talanta*, **37**, 377 (1990).
167. D. A. Martens and W. T. Frankenberger, *J. Liq. Chromatogr.*, **15**, 423 (1992).
168. D. A. Martens and W. T. Frankenberger, Jr., *Talanta*, **38**, 245 (1991).
169. J. A. Cox and E. Dabek-Zlotorzynska, *Electroanalysis*, **3**, 239 (1991).
170. J. A. Cox and E. Dabek-Zlotorzynska, *J. Chromatogr.*, **543**, 226 (1991).
171. E. Wang and A. Liu, *J. Electroanal. Chem.*, **319**, 217 (1991).
172. P. F. Luo, F. Z. Zhang and R. P. Baldwin, *Anal. Chim. Acta*, **244**, 169 (1991).
173. P. F. Luo, F. Z. Zhang and R. P. Baldwin, *Anal. Chem.*, **63**, 1702 (1991).
174. J. L. Burguera, M. Burguera, M. de la Guardia and A. Salvador, *Anal. Chim. Acta*, **261**, 23 (1992).
175. K. Takatera and T. Watanabe, *Anal. Chem.*, **65**, 759 (1993).
176. P. J. Vandenberg and D. C. Johnson, *Anal. Chem.*, **65**, 2713 (1993).
177. M. C. Gennaro, P. L. Bertolo and E. Marengo, *J. Chromatogr.*, **518**, 149 (1990).
178. M. C. Gennaro and P. L. Bertolo, *J. Liq. Chromatogr.*, **13**, 2059 (1990).
179. M. C. Gennaro and C. Abrigo, *Chromatographia*, **31**, 381 (1991).
180. M. C. Gennaro and P. L. Bertolo, *J. Chromatogr.*, **509**, 147 (1990).
181. M. Eslami, P. Hashemi and M. N. Sarbolouki, *J. Chromatogr. Sci.*, **31**, 480 (1993).
182. J. G. Chen, M. Sandberg and S. G. Weber, *J. Am. Chem. Soc.*, **115**, 7343 (1993).
183. F. J. Rodríguez, R. M. Jiménez and R. M. Alonso, *J. Chromatogr., Biomed. Appl.*, **578**, 146 (1992).
184. C. D. Gaitonde and P. V. Pathak, *J. Chromatogr.*, **514**, 330 (1990).
185. Y. X. Ci, J. K. Tie, Q. W. Wang and W. B. Chang, *Anal. Chim. Acta*, **269**, 109 (1992).



186. J. C. Van Damme, B. de Dickel and M. Galoux, *J. Chromatogr.*, **518**, 375 (1990).
187. J. Mao, C. R. Pacheco, D. D. Traficante and W. Rosen, *J. Chromatogr. A*, **684**, 103 (1994).
188. P. Furst, L. Pollack, T. A. Graser, H. Godel and P. Stehle, *J. Chromatogr.*, **499**, 557 (1990).
189. M. Roth, *Anal. Chem.*, **43**, 880 (1971).
190. S. S. Simons, Jr. and D. F. Johson, *J. Am Chem. Soc.*, **98**, 7098 (1976).
191. K. A. Krok and S. S. Seaver, *Biotechniques*, **10**, 664 (1991); *Biol. Abstr.*, **92**, 24692 (1991).
192. P. Jandera, K. Ventura, R. Hladonikova and J. Chracek, *J. Liq. Chromatogr.*, **17**, 69 (1994).
193. O. Orwar, M. Sanberg, I. Jacobson, M. Sundahl and S. Folestad, *Anal. Chem.*, **66**, 4471 (1994).
194. P. Izquierdo, P. Pavón, A. Gómez Hens and D. Pérez Bendito, *Fresenius J. Anal. Chem.*, **349**, 820 (1994).
195. S. Chirón, A. Fernández-Alba and D. Barceló, *Environ. Sci. Technol.*, **27**, 2352 (1993).
196. H. M. H. Van Eijk, D. R. Rooyackers and N. E. P. Deutz, *J. Chromatogr. B, Biomed. Appl.*, **620**, 143 (1993).
197. P. G. Zambonin, A. Guerrieri, T. Rotunno and F. Palmisano, *Anal. Chim. Acta*, **251**, 101 (1991).
198. G. Achilli, G. P. Cellerino and G. M. Deril, *J. Chromatogr. A*, **661**, 201 (1994).
199. C. Tricard, J. M. Cazabeil and H. M. Salagoity, *Analysis*, **19**, M53 (1991).
200. S. Palmero, M. De Marchis, M. Prati and E. Fugassa, *Anal. Biochem.*, **202**, 152 (1992).
201. H. A. Carchon, J. Jaeken, E. Jansen and E. Eggermont, *Clin. Chim. Acta*, **201**, 83 (1991).
202. S. Lam, *Biomed. Chromatogr.*, **4**, 175 (1990).
203. T. Teerlink, P. A. M. van Leeuwen and A. Houdijk, *Clin. Chem.*, **40**, 245 (1994).
204. L. Canevari, R. Vieira, M. Aldegunde and F. Dagani, *Anal. Biochem.*, **205**, 137 (1992).
205. L. Canevari, R. Vieira, M. Aldegunde and F. Dagani, *Pharmacol. Res.*, **25**, Suppl. 1, 137 (1992).
206. S. Murai, H. Saito, E. Abe, Y. Masuda and T. Itoh, *J. Neural Trans., Gen. Sect.*, **87**, 145 (1992); *Biol. Abstr.*, **93**, 137026 (1992).
207. D. J. Begley, A. Reichel and A. Ermisch, *J. Chromatogr. B, Biomed. Appl.*, **657**, 185 (1994).
208. F. D. Berne, B. Penais, N. Merlet, B. Cauchi and B. Legube, *Environ. Technol.*, **15**, 901 (1994).
209. A. Wenck, L. Mintrop and J. C. Duinker, *Marine Chem.*, **33**, 1 (1991).
210. V. K. Boppana and C. Millerstein, *J. Chromatogr. A*, **676**, 161 (1994).
211. W. S. Gardner and P. A. St.-John, *Anal. Chem.*, **63**, 537 (1991).
212. S. Susuki, K. Kobayashi, J. Noda, T. Suzuki and K. Takama, *J. Chromatogr.*, **508**, 225 (1990).
213. B. Straub, M. Schollenberger, M. Kicherer, B. Luckas and P. W. Hammes, *Z. Lebensmit.-Untersuch. Forsch.*, **197**, 230 (1993); *Biol. Abstr.*, **96**, 122987 (1993).
214. M. L. Izquierdo-Pulido, M. C. Vidal-Carou and A. Marine-Font, *J. Ass. Off. Agr. Chem. Int.*, **76**, 1027 (1993).
215. S. S. Yang and I. Smetana, *Chromatographia*, **37**, 593 (1993).
216. K. Desilva, J. Strojek and T. Kuwana, *Anal. Sci.*, **10**, 573 (1994).
217. K. Hayakawa, Y. Miyoshi, H. K. Y. Matsushima, N. Takayama, S. Tanaka and M. Miyazaki, *Biol. Pharm. Bull.*, **16**, 817 (1993); *Biol. Abstr.*, **96**, 84546 (1993).
218. M. D. Oates, B. R. Cooper and J. W. Jorgenson, *Anal. Chem.*, **62**, 1573 (1990).
219. M. D. Oates and J. W. Jorgenson, *Anal. Chem.*, **62**, 1577 (1990).
220. J. M. Bostick, J. W. Stojek, T. Metcalf and T. Kuwana, *Appl. Spectrosc.*, **46**, 1532 (1992).
221. M. Kai, E. Kojima, Y. Okura and M. Iwasaki, *J. Chromatogr. A*, **653**, 235 (1993).
222. T. Toyo'oka, H. P. Chokshi, R. G. Carlson, R. S. Givens and S. M. Lunte, *Analyst*, **118**, 257 (1993).
223. T. Toyo'oka, H. P. Chokshi, R. S. Givens, R. G. Carlson, S. M. Lunte and T. Kuwana, *Biomed. Chromatogr.*, **7**, 208 (1993).
224. O. R. Idowu and G. O. Adewiyu, *J. Liq. Chromatogr.*, **16**, 2501 (1993).
225. J. Oehlke, M. Brudel and I. E. Blasig, *J. Chromatogr. B, Biomed. Appl.*, **655**, 105 (1994).
226. G. C. Yen and C. L. Hsieh, *J. Food Sci.*, **56**, 158 (1991).
227. K. D. Duong, H. Kolodziejczyk, D. D. Blanco-Gomis and R. Rosset, *Analysis*, **19**, 103 (1991).
228. K. D. Duong, H. Kolodziejczyk and R. Rosset, *Analysis*, **19**, 154 (1991).
229. R. L. Cox, T. W. Schneider and M. D. Koppang, *Anal. Chim. Acta*, **262**, 145 (1992).
230. G. Sharping, M. Dalene and P. Brunmark, *Chromatographia*, **39**, 619 (1994).
231. A. Tiljander, G. Scarping and M. Dalene, *J. Liq. Chromatogr.*, **13**, 803 (1990).
232. M. Possanzini and V. Di Palo, *Chromatographia*, **29**, 151 (1990).
233. K. Imai, T. Fukushima and H. Yokosu, *Biomed. Chromatogr.*, **8**, 107 (1994).
234. T. Toyo'oka, Y. M. Liu, N. Hanioka, H. Jino and M. Ando, *Anal. Chim. Acta*, **285**, 343 (1994).
235. J. Kirschbaum, B. Luckas and W. D. Beinert, *Am. Lab.*, **26**, C28 (1994).

236. J. Kirschbaum, B. Luckas and W. D. Beinert, *Deut. Lebensmit. Rund.*, **90**, 224 (1994).
237. B. Gustavsson and I. Betner, *J. Chromatogr.*, **507**, 67 (1990).
238. M. F. Malmér and L. A. Schroeder, *J. Chromatogr.*, **514**, 227 (1990).
239. U. Arnold, E. Ludwig, R. Kuhn and U. Moschwitzer, *Z. Lebensmit.-Untersuch. Forsch.*, **199**, 22 (1994).
240. E. J. Miller, A. J. Narkates and M. A. Niemann, *Anal. Biochem.*, **190**, 92 (1990).
241. C. M. Grywacz, *J. Chromatogr. A*, **676**, 177 (1994).
242. H. G. Worthen and H. Liu, *J. Liq. Chromatogr.*, **15**, 3323 (1992).
243. C. X. Gao, I. S. Krull and T. Trainor, *J. Chromatogr. Sci.*, **28**, 102 (1990).
244. C. X. Gao, D. Schmalzing and I. S. Krull, *Biomed. Chromatogr.*, **5**, 23 (1991).
245. A. Ibe, K. Saito, M. Nakazato, Y. Kikuchi, K. Fujinuma and T. Nishima, *J. Assoc. Off. Anal. Chem.*, **74**, 695 (1991).
246. O. Busto, Y. Valero, J. Guasch and F. Borrull, *Chromatographia*, **38**, 571 (1994).
247. A. R. Shalaby, *Food Chem.*, **49**, 305 (1994).
248. D. Homero Méndez and A. Garrido Fernández, *Analyst*, **119**, 2037 (1994).
249. W. Y. Lee and T. A. Nieman, *J. Chromatogr. A*, **659**, 111 (1994).
250. M. Simmaco, D. de Biase, D. Barra and F. Borsa, *J. Chromatogr.*, **504**, 129 (1990).
251. H. Vuorela, P. Lehtonen and R. Hiltunen, *J. Liq. Chromatogr.*, **14**, 3181 (1991).
252. D. Drnevich and T. C. Varty, *J. Chromatogr. B, Biomed. Appl.*, **613**, 137 (1993).
253. Y. Hwang, T. Matsuo, K. Hanaki and N. Suzuki, *Water Res.*, **29**, 711 (1995).
254. S. A. Cohen and D. P. Michaud, *Anal. Biochem.*, **211**, 279 (1993).
255. H. J. Liu, *J. Chromatogr. A*, **670**, 59 (1994).
256. D. J. Strydom and S. A. Cohen, *Anal. Biochem.*, **222**, 19 (1994).
257. J. F. Davey and R. S. Ersser, *J. Chromatogr., Biomed. Appl.*, **528**, 9 (1990).
258. K. R. Anumula and P. B. Taylor, *Anal. Biochem.*, **197**, 113 (1991).
259. K. L. Woo and S. H. Lee, *J. Chromatogr. A*, **667**, 105 (1994).
260. M. Hariharan, S. Naga and T. van Noord, *J. Chromatogr. B, Biomed. Appl.*, **621**, 15 (1993).
261. G. Buzzigoli, L. Lanzone, D. Ciociaro, S. Frascerra, M. Carri, A. Scandroglio, R. Coldani and E. Ferrannini, *J. Chromatogr.*, **507**, 85 (1990).
262. G. Sarwar and H. G. Botting, *J. Assoc. Off. Anal. Chem.*, **73**, 470 (1990).
263. R. A. Sherwood, A. C. Titheradge and D. A. Richards, *J. Chromatogr., Biomed. Appl.*, **528**, 293 (1990).
264. M. Puigdeu and S. Buxaderas, *J. Chromatogr. A*, **685**, 21 (1994).
265. N. Astephen and T. Wheat, *Am. Lab.*, **25** [2], 24 (1993).
266. M. L. Alonso, A. I. Alvarez and J. Zapico, *J. Liq. Chromatogr.*, **17**, 4019 (1994).
267. S. A. Cohen, *J. Chromatogr.*, **512**, 283 (1990).
268. L. E. Welch and D. C. Johnson, *J. Liq. Chromatogr.*, **13**, 1387 (1990).
269. I. Fermo, E. de Vecchi, L. Diomede and R. Paroni, *J. Chromatogr., Biomed. Appl.*, **534**, 23 (1990).
270. J. Hayashi, M. Yamada and T. Hobo, *Anal. Chim. Acta*, **259**, 67 (1992).
271. J. Hayashi, M. Yamada and T. Hobo, *Anal. Chim. Acta*, **247**, 27 (1991).
272. K. Adachi and N. Ichinose, *Fresenius J. Anal. Chem.*, **338**, 265 (1990).
273. J. M. S. Mallols, R. M. V. Camanas and G. Ramis Ramos, *Chromatographia*, **38**, 365 (1994).
274. K. Dallenbach-Toelke, S. Nyireddy, B. Meier and O. Stricher, *J. Chromatogr.*, **365**, 63 (1986).
275. A. Nagy-Turák and Z. Végh, *J. Chromatogr. A*, **668**, 501 (1994).
276. T. Hayashi, U. Amino, G. Uchida and M. Sato, *J. Chromatogr. B, Biomed. Appl.*, **665**, 209 (1995).
277. A. C. Bratton, E. K. Marshall, Jr., D. Babbitt and A. R. Hendrickson, *J. Biol. Chem.*, **128**, 537 (1939).
278. J. S. Esteve-Romero, E. F. Sino-Alfonso, M. C. García-Álvarez-Coque and G. Ramis-Ramos, *Talanta*, **40**, 1711 (1993).
279. A. M. Romero, C. G. Benito and J. M. Calatayud, *Anal. Chim. Acta*, **308**, 451 (1995).
280. P. W. Grosvenor and D. O. Gray, *J. Chromatogr.*, **504**, 456 (1990).
281. A. d'Aniello, L. Petrucelli, C. Gardner and G. Fisher, *Anal. Biochem.*, **213**, 290 (1993).
282. D. Parker, *Chem. Rev.*, **91**, 1441 (1991).
283. S. G. Allenmark, *Chromatographic Enantioseparations: Methods and Applications*, Ellis Horwood Chichester, 1988.
284. J. Zukowski, Y. Tang, A. Berthod and D. W. Armstrong, *Anal. Chim. Acta*, **258**, 83 (1992).
285. J. A. Dale, D. L. Dull and H. S. Mosher, *J. Org. Chem.*, **34**, 2543 (1969).

286. J. A. Dale and H. S. Mosher, *J. Am. Chem. Soc.*, **95**, 512 (1973).
287. E. Okuma and H. Abe, *J. Chromatogr. B, Biomed. Appl.*, **660**, 243 (1994).
288. G. Szokan, S. Hadfi, K. Krizsan, A. Liembeck, I. Krecz, M. Almas and C. Somlai, *J. Liq. Chromatogr.*, **17**, 2759 (1994).
289. Y. Nagata, K. Yamamoto and T. Shimojo, *J. Chromatogr., Biomed. Appl.*, **575**, 147 (1992).
290. Y. Nagata, K. Yamamoto, T. Shimojo, R. Konno, Y. Yasumura and T. Akino, *Biochem. Biophys. Acta*, **1115**, 208 (1992).
291. H. Bruckner, S. Haasmann, M. Langer, T. Westhauser, R. Wittner and H. Godel, *J. Chromatogr. A*, **666**, 259 (1994).
292. A. Hashimoto, T. Nishikawa, T. Oka, K. Takahashi and T. Hayashi, *J. Chromatogr., Biomed. Appl.*, **582**, 41 (1992).
293. A. Jgorov, T. Trnska and J. Stuchlik, *J. Chromatogr.*, **558**, 311 (1991).
294. E. Aziz, J. S. Davies, G. Llewellyn, S. Szajda, R. S. Ward and K. R. N. Rao, *J. Chromatogr. Sci.*, **29**, 419 (1991).
295. J. Zukowski, M. Pawlowska and D. W. Armstrong, *J. Chromatogr.*, **623**, 33 (1992).
296. C. Spondlin and E. Kusters, *Chromatographia*, **38**, 325 (1994).
297. T. Yamada, S. Nonomura, H. Fujiwara, T. Miyazawa and S. Kuwata, *J. Chromatogr.*, **515**, 475 (1990).
298. V. Carunchio, A. M. Girelli, A. Messina and M. Sinibaldi, *Chirality*, **2**, 194 (1990).
299. F. Federici, A. M. Girelli, A. Messina, I. Nicoletti and M. Sinibaldi, *Anal. Lett.*, **23**, 1565 (1990).
300. A. Dossena, G. Galaverna, R. Corradini and R. Marchelli, *J. Chromatogr. A*, **653**, 229 (1993).
301. K. Imai, T. Fukushima and S. Uzu, *Biomed. Chromatogr.*, **7**, 177 (1993).
302. K. Imai, T. Fukushima and S. Uzu, *Biomed. Chromatogr.*, **7**, 177 (1993).
303. T. Fukushima, M. Kato, T. Santa and K. Imai, *Analyst*, **120**, 381 (1995).
304. K. Imai, K. Nakashima and S. Akiyama, *Biomed. Chromatogr.*, **7**, 56 (1993).
305. D. K. Hancock and D. J. Reeder, *J. Chromatogr.*, **646**, 335 (1993).
306. M. Lobell and M. P. Schneider, *J. Chromatogr.*, **633**, 287 (1993).
307. T. Miyazawa, H. Iwanaga, T. Yamada and S. Kuwata, *Anal. Lett.*, **26**, 367 (1993).
308. P. Castelnovo, *Chirality*, **5**, 181 (1993).
309. J. Csapo, Z. Csapokiss, S. Nemethy, S. Folestad, A. Tivesten and T. G. Martin, *Amino Acids*, **7**, 317 (1994).
310. G. A. Goodfriend, *Nature (London)*, **357**, 399 (1992).
311. D. Walton and G. B. Curry, *Lethaia*, **27**, 179 (1994).
312. G. A. Goodfriend, *Radiocarbon*, **31**, 1041 (1989).
313. G. A. Goodfriend and V. R. Meyer, *Geochim. Cosmochim. Acta*, **55**, 3355 (1991).
314. A. Messina, I. Nicoletti, M. Sinibaldi and G. Vigliano, *Ann. Chim.*, **80**, 379 (1990).
315. A. E. Bruno, B. Krattiger, F. Maystre and H. M. Widmer, *Anal. Chem.*, **63**, 2689 (1991).
316. A. E. Bruno, A. Paulus and D. J. Bornhop, *Appl. Spectrosc.*, **45**, 462 (1991).
317. Y. H. Lee and T. I. Lin, *J. Chromatogr. A*, **680**, 287 (1994).
318. J. M. Riviello and M. P. Harrold, *J. Chromatogr. A*, **652**, 385 (1993).
319. J. N. Ye and R. P. Baldwin, *Anal. Chem.*, **66**, 2669 (1994).
320. J. P. Liu, Y. Z. Hsieh, D. Wiesler and M. Novotny, *Anal. Chem.*, **63**, 408 (1991).
321. J. P. Liu, O. Shirota and M. Novotny, *Anal. Chem.*, **63**, 413 (1991).
322. K. C. Chan, G. M. Janini, G. M. Muschik and H. J. Issaq, *J. Chromatogr. A*, **653**, 93 (1993).
323. J. Mattusch and K. Dittrich, *J. Chromatogr. A*, **680**, 279 (1994).
324. H. Ruyters and S. Van der Wal, *J. Liq. Chromatogr.*, **17**, 1883 (1994).
325. T. Hagashijima, T. Fuchigami, T. Imasaka and N. Ishibashi, *Anal. Chem.*, **64**, 711 (1992).
326. D. W. Armstrong, K. Rundlett and G. L. Reid III, *Anal. Chem.*, **66**, 1690 (1994).
327. K. C. Chan, G. M. Janini, G. M. Muschik and H. J. Issaq, *J. Chromatogr. B, Biomed. Appl.*, **622**, 269 (1993).
328. T. Ueda, F. Kitamura, R. Mitchell, T. Metcalf, T. Kuwana and A. Nakamoto, *Anal. Chem.*, **63**, 2979 (1991).
329. S. Michaelsen, P. Moller and H. Sorensen, *J. Chromatogr. A*, **680**, 299 (1994).
330. K. C. Waldron and N. J. Dovichi, *Anal. Chem.*, **64**, 1396 (1992).
331. K. C. Waldron, S. Wu, C. W. Earle, H. R. Harke and N. J. Dovichi, *Electrophoresis*, **11**, 777 (1990).
332. W. J. Wolf, *Cereal Chem.*, **72**, 115 (1995).
333. A. Labudzinska and A. Gorczynska, *Analyst*, **119**, 1195 (1994).

334. P. W. Pemberton, P. Gagjee, C. Chaloner, J. M. Breganza and R. W. Lobley, *Clin. Chim. Acta*, **199**, 253 (1991).
335. N. H. P. Cnubben, B. Blaauboer, S. Juyn, J. Vervoort and I. M. C. M. Rietjens, *Anal. Biochem.*, **220**, 165 (1994).
336. J. M. Fujitaki, T. M. Sandoval, L. A. Lembach and R. Dixon, *J. Biochem. Biophys. Meth.*, **29**, 143 (1994).
337. A. W. M. Lee, W. H. Chan and M. F. Ho, *Anal. Chim. Acta*, **246**, 443 (1991).
338. S. Tagashira, Y. Sasaki, K. Hayashi and G. Fukuhara, *Anal. Chim. Acta*, **244**, 239 (1991).
339. A. S. Cabeza, P. C. Falco and C. M. Legua, *Anal. Lett.*, **27**, 1095 (1994).
340. J. Saurina and S. Hernández-Cassou, *Anal. Chim. Acta*, **281**, 593 (1993).
341. M. R. Wing, E. J. Stromvall and S. H. Lieberman, *Marine Chem.*, **29**, 325 (1990).
342. D. Delmas, M. G. Frikha and E. A. S. Linley, *Marine Chem.*, **29**, 145 (1990).
343. A. M. El-Brashi, *Anal. Lett.*, **26**, 2595 (1993).
344. L. L. Zamora and J. M. Calatayud, *Anal. Chim. Acta*, **281**, 601 (1993).
345. S. E. Kakabakos, P. E. Tyllianakis, G. P. Evangelatos and D. S. Ithakissios, *Biomaterials*, **15**, 289 (1994).
346. P. E. Tyllianakis, S. E. Kakabakos, G. P. Evangelatos and D. S. Ithakissios, *Appl. Biochem. Biotechnol.*, **38**, 15 (1993).
347. S. H. Ehrlich, *J. Imag. Sci. Technol.*, **38**, 447 (1994).
348. L. Locascio-Brown, A. L. Plant, R. A. Durst and M. W. Brizgys, *Anal. Chim. Acta*, **228**, 107 (1990).
349. R. Grigg, T. Mongkolaussvaratana and C. A. Pounds, *Tetrahedron Lett.*, **31**, 7215 (1990).
350. A. H. Gainza, R. I. Konyeaso and R. A. Asenjo, *J. Pharm. Sci.*, **83**, 226 (1994).
351. H. M. Chawla and K. Srinivas, *J. Chem. Soc., Chem. Commun.*, 2593 (1994).
352. I. Aoki, A. Takahashi and K. Watanabe, *Anal. Sci.*, **8**, 323 (1992).
353. A. M. Alwehaid, *Analyst*, **115**, 1419 (1990).
354. V. A. Narayanan, J. M. Bello and T. Vo Dinh, *J. Raman. Spectrosc.*, **22**, 327 (1991).
355. V. A. Narayanan, J. M. Bello, D. L. Stokes and T. Vo Dinh, *Analysis*, **19**, 307 (1991).
356. J. McCombie, P. A. Hepworth, T. F. Palmer, J. P. Simons and M. J. Walker, *Chem. Phys. Lett.*, **206**, 37 (1993).
357. V. Kacaniklic, K. Johansson, G. Marko-Varga, L. Gorton, G. Jonsson-Pettersson and E. Csoregi, *Electroanalysis*, **6**, 381 (1994).
358. H. Susuki, E. Tamiya and I. Karube, *Electroanalysis*, **6**, 299 (1994).
359. J. C. Cooper, M. Hammerle, W. Schuhmann and H. L. Schmidt, *Biosensors Bioelectronics*, **8**, 65 (1993).
360. O. Niwa, M. Morita and H. Tabei, *Anal. Chem.*, **62**, 447 (1990).
361. O. Niwa, M. Morita and H. Tabei, *Electroanalysis*, **3**, 163 (1991).
362. O. Niwa, Y. Xu, H. B. Halsall and W. R. Heineman, *Anal. Chem.*, **65**, 1559 (1993).
363. S. J. Lee, T. Scheper and A. F. Bückmann, *Biosensors Bioelectronics*, **9**, 29 (1994).
364. T. Katsu, T. Kayamoto and Y. Fujita, *Anal. Chim. Acta*, **239**, 23 (1990).
365. M. S. Kaltenbach and M. A. Arnold, *Mikrochim. Acta*, **108**, 205 (1992).
366. R. Puchades, L. Lemieux and R. E. Simard, *J. Food Sci.*, **54**, 885 (1989).
367. L. Lemieux, R. Puchades and R. E. Simard, *J. Food Sci.*, **55**, 1552 (1990).
368. M. M. Rauhut, L. J. Bollyky, B. G. Roberts, M. Loy, R. H. Whitman, A. V. Iannotta, A. M. Semsel and R. A. Clarke, *J. Am. Chem. Soc.*, **89**, 6515 (1967).
369. P. J. M. Kwackman and U. A. T. Brinkman, *Anal. Chim. Acta*, **266**, 175 (1992).
370. M. Stigbrand, E. Pontén and K. Irgum, *Anal. Chem.*, **66**, 1766 (1994).
371. J. Wang and Y. H. Lin, *Electroanalysis*, **6**, 125 (1994).
372. H. Ukeda, Y. Nakazono, K. Matsumoto and Y. Osajima, *Biotechnol. Bioeng.*, **38**, 948 (1991).
373. K. Sugawara, S. Tanaka and M. Taga, *Bioelectrochem. Bioenergetics*, **31**, 229 (1993).
374. K. Sugawara, S. Tanaka and M. Taga, *J. Electroanal. Chem. Interfacial Electrochem.*, **316**, 305 (1991).
375. K. Sugawara, S. Tanaka and M. Taga, *Bioelectrochem. Bioenergetics*, **26**, 469 (1991).
376. Z. Al Zamil, S. M. Sultan and Y. A. Hassan, *Anal. Chim. Acta*, **239**, 161 (1990).
377. C. Ward, A. J. McNally, D. Rusyniak and S. J. Salamone, *J. Forensic Sci.*, **39**, 1486 (1994).
378. H. Mori, K. Sakai, K. Yamashina, S. Hirata and K. Horie, *Bull. Chem. Soc. Jpn.*, **64**, 3634 (1991).
379. J. Y. David, J. P. Hurvois and A. Tallec, *Tetrahedron*, **51**, 3181 (1995).
380. R. Hazard, J. P. Hurvois, C. Moinet, A. Tallec, J. L. Burgot and G. Eon-Burgot, *Electrochim. Acta*, **36**, 1135 (1991).

381. J. P. Hurvois, A. Tallec and L. Toupet, *Bull. Soc. Chim. Fr.*, **129**, 406 (1992).
382. J. P. Hurvois, C. Moinet and A. Tallec, *Electrochim. Acta*, **38**, 1775 (1993).
383. T. Kotiaho, M. J. Hayward and R. G. Cooks, *Anal. Chem.*, **63**, 1794 (1991).
384. J. S. Lancaster, P. J. Worsfold and A. Lynes, *Anal. Chim. Acta*, **239**, 189 (1990).
385. D. Wang, F. R. Jones and P. Denison, *J. Mater. Sci.*, **27**, 36 (1992).
386. D. Wang, F. R. Jones and P. Denison, *J. Adhes. Sci. Technol.*, **6**, 79 (1992).
387. D. Wang and F. R. Jones, *J. Mater. Sci.*, **28**, 2481 (1993).
388. I. Weissbuch, F. Frolow, L. Addadi, M. Lahav and L. Leiserowitz, *J. Am. Chem. Soc.*, **112**, 7718 (1990).
389. S. Fujiwara and Y. Nishimoto, *Anal. Sci.*, **6**, 907 (1990).
390. A. N. Bickley, *Fuel Proc. Technol.*, **38**, 165 (1994).
391. D. K. Sharma and R. D. Sharma, *Talanta*, **38**, 665 (1991).
392. H. Tlahuext, F. Santiesteban, E. García-Báez and R. Contreras, *Tetrahedron, Asymmetry*, **5**, 1579 (1994).
393. R. Hulst, N. Koen de Vries and B. L. Feringa, *Tetrahedron, Asymmetry*, **5**, 699 (1994).
394. R. Hulst, N. Koen de Vries and B. L. Feringa, *Tetrahedron*, **50**, 11721 (1994).
395. R. Hulst, R. W. J. Zijlstra, N. Koen de Vries and B. L. Feringa, *Tetrahedron, Asymmetry*, **5**, 1701 (1994).
396. R. Hulst., N. K. de Vries and B. L. Feringa, *Angew. Chem., Int. Ed. Engl.*, **31**, 1092 (1992).
397. A. Alexakis, J. C. Frutos, S. Mutti and P. Mangeney, *J. Org. Chem.*, **59**, 3326 (1994).
398. P. A. Husain, J. Debnath and S. W. May, *Anal. Chem.*, **65**, 1456 (1993).
399. M. Michalik and C. Dobler, *Tetrahedron*, **46**, 7739 (1990).
400. D. Pini, G. Uccello-Barretta, C. Rosini and P. Salvadori, *Chirality*, **3**, 174 (1991).
401. C. Moulin and M. Raban, *Analysis*, **18**, 399 (1990).
402. I. Canet, A. Meddour, J. Courtieu, J. I. Canet and J. Salaun, *J. Am. Chem. Soc.*, **116**, 2155 (1994).
403. L. Szekelehid, A. Lapat and I. Horniak, *Anal. Chim. Acta*, **227**, 309 (1989).
404. C. L. Perrin and K. B. Armstrong, *J. Am. Chem. Soc.*, **115**, 6825 (1993).
405. M. Sawada, Y. Okumura, M. Shizuma, Y. Takai, Y. Hidaka, H. Yamada, T. Tanaka, T. Kaneda, K. Hirose, S. Misumi and S. Takahashi, *J. Am. Chem. Soc.*, **115**, 7381 (1993).
406. K. Levsen, M. Emmrich and S. Behnert, *Fresenius J. Anal. Chem.*, **346**, 732 (1993).
407. M. Villadao and W. E. Sandine, *J. Dairy Sci.*, **77**, 1509 (1994).
408. P. Gerike, H. Klotz, J. G. A. Kooijman, E. Matthijs and J. Waters, *Water Res.*, **28**, 147 (1994).
409. G. Santoni, A. Medica, P. Gratteri, S. Furlanetto and S. Pinzauti, *Farmaco*, **49**, 751 (1994).
410. R. B. Miller, C. Chen and C. H. Sherwood, *J. Liq. Chromatogr.*, **16**, 3801 (1993).
411. G. Parhizkari, G. Delker, R. B. Miller and C. Chen, *Chromatographia*, **40**, 155 (1995).
412. G. Parhizkari, R. B. Miller and C. Chen, *J. Liq. Chromatogr.*, **18**, 553 (1995).
413. T. Sakai, *Analyst*, **117**, 211 (1992).
414. T. Sakai, *Analyst*, **116**, 187 (1991).
415. S. M. Gort, E. A. Hogendoorn, R. A. Baumann and P. Van Zoonen, *Int. J. Environ. Anal. Chem.*, **53**, 289 (1993).
416. C. C. Lindgren and P. K. Dasgupta, *Talanta*, **39**, 101 (1992).
417. A. J. Wilkes, G. Valraven and J. M. Talbot, *J. Am. Oil Chem. Soc.*, **69**, 609 (1992).
418. T. Suortti and H. Sirviö, *J. Chromatogr.*, **507**, 421 (1990).
419. J. J. Conboy, J. D. Henion, M. W. Martin and J. A. Zweigenbaum, *Anal. Chem.*, **62**, 800 (1990).
420. J. Paesen, I. Quintens, G. Thoithi, E. Roets, G. Reybrouck and J. Hoogmartens, *J. Chromatogr. A*, **677**, 377 (1994).
421. C. S. Weiss, J. S. Hazlett, M. H. Datta and M. H. Danzer, *J. Chromatogr.*, **608**, 325 (1992).
422. E. S. Yeung and W. G. Kuhr, *Anal. Chem.*, **63**, 275A (1991).
423. L. J. Schep, D. S. Jones, I. Tucker and M. G. Shepherd, *Int. J. Pharm.*, **113**, 263 (1995).
424. K. Yamamoto, *Anal. Chim. Acta*, **302**, 75 (1995).
425. S. B. Adeloju and S. J. Shaw, *Electroanalysis*, **6**, 645 (1994).
426. J. J. Halvax, G. Wiese, J. A. Arp, J. M. P. Vermeer, W. P. Van Bennekom and A. Bult, *J. Pharmacol. Biomed. Anal.*, **8**, 243 (1990).
427. R. Aubeck, C. Brauchle and N. Hampp, *Anal. Chim. Acta*, **238**, 405 (1990).
428. M. Nisikawa, M. Tatsuno, S. Suzuki and H. Tsuchihashi, *Forensic Sci. Int.*, **51**, 131 (1991).
429. T. R. Baker, P. Vouros, D. Rindgen and J. A. J. Martin, *Biomed. Environ. Mass Spectrom.*, **19**, 69 (1990).
430. T. Morozumi and S. Shinkai, *J. Chem. Soc., Chem. Commun.*, 1219 (1994).

431. L. F. Sukhodub, M. V. Kosevich, V. S. Shelkovskii and Y. L. Volyanskii, *Antibiot. Khimioter.*, **34**, 823 (1989); *Biol. Abstr.*, **90**, 12539 (1990).
432. L. F. Sukhodub, M. V. Kosevich, V. S. Shelkovskii, O. A. Boryak, Y. L. Volyanskii, V. I. Moleva and T. A. Chumachenko, *Antibiot. Khimioter.*, **35**, 10 (1990); *Biol. Abstr.*, **90**, 72976 (1990).
433. A. Yamauchi, M. Inoue, H. Ohgi and T. Mito, *Bull. Chem. Soc. Jpn.*, **66**, 1361 (1993).
434. J. R. Lu, E. A. Simister, R. K. Thomas and J. Penfold, *J. Phys. Chem.*, **97**, 6024 (1993).
435. S. Berr, R. R. M. Jones and J. S. Johnson, *J. Phys. Chem.*, **96**, 5611 (1992).
436. J. R. Lu, M. Hromadova, E. Simister, R. K. Thomas and J. Penfold, *Physica B*, **198**, 120 (1994).
437. D. J. Lyttle, J. R. Lu, T. J. Su, R. K. Thomas and J. Penfold, *Langmuir*, **11**, 1001 (1995).
438. H. Nakayama, M. Yamanobe and K. Baba, *Bull. Chem. Soc. Jpn.*, **64**, 3023 (1991).
439. T. Kakiuchi, M. Kotani and M. Senda, *J. Electroanal. Chem.*, **296**, 517 (1990).
440. M. Kodama, T. Kunitake and S. Seki, *J. Phys. Chem.*, **94**, 1550 (1990).
441. J. Barek and I. Svagrova, *Chem. Listy*, **84**, 1042 (1990).
442. C. Jian and W. R. Seitz, *Anal. Chim. Acta*, **237**, 265 (1990).
443. W. P. Trower, *Nucl. Instrum. Methods Phys. Res.*, **B79**, 589 (1993).
444. G. W. Lemire, J. B. Simeonsson and R. C. Sausa, *Anal. Chem.*, **65**, 529 (1993).
445. J. Feltes and K. Levsen, *J. High Resolut. Chromatogr.*, **12**, 613 (1989).
446. D. Henderson, S. Cole and E. Doughty, *Reporter*, **14**, 12, (1995).
447. D. T. Burns and R. J. Lewis, *Anal. Chim. Acta*, **300**, 221, (1995).
448. A. B. J. Naughton and N. D. Jespersen, *Anal. Chim. Acta*, **251**, 95 (1991).
449. Y. Lin and R. Zhang, *Electroanalysis*, **6**, 1126 (1994).
450. A. Wilson, M. Tamizi and J. D. Wright, *Sensors and Actuators B—Chemical*, **19**, 511 (1994).
451. G. Castello, A. Bonincontro and G. Damato, *Ann. Chim.*, **84**, 431 (1994).
452. S. F. Patil and S. T. Lonkar, *J. Chromatogr.*, **600**, 344 (1992).
453. A. Clark, K. W. D. Ledingham, A. Marshall, J. Sander and R. P. Singhal, *Analyst*, **118**, 601 (1993).
454. A. Marshall, A. Clark, R. M. Deas, C. Kosmidis, K. W. D. Ledingham, W. Peng and R. P. Singhal, *Analyst*, **119**, 1719 (1994).
455. J. Feltes, K. Levsen, D. Volmer and M. Spiekermann, *J. Chromatogr.*, **518**, 21 (1990).
456. J. Y. Horig and S. D. Huang, *J. Chromatogr.*, **678**, 313 (1994).
457. S. Stevanovic and M. Mitrovic, *J. Environ. Anal. Chem.*, **40**, 69 (1990).
458. M. Hable, C. Stern, C. Asowata and K. Williams, *J. Chromatogr. Sci.*, **29**, 131 (1991).
459. M. Emmrich, M. Kaiser, H. Rueden and S. Sollinger, *J. Chromatogr.*, **645**, 89 (1993).
460. R. Gatermann, H. Huehnerfuss, G. Rimkus, M. Wolf and S. Franke, *Marine Pollution Bull.*, **30**, 221 (1995).
461. M. Linkerhaegner, H. J. Stan and G. Rimkus, *J. High Resolut. Chromatogr.*, **17**, 821 (1994).
462. C. Keuchel, L. Weil and R. Niessner, *Anal. Sci.*, **8**, 9 (1992).
463. C. Keuchel and R. Niessner, *J. Anal. Chem.*, **350**, 538 (1994).
464. E. W. Wuis, M. G. A. Janssen, T. B. Vree and E. Van der Kleijn, *J. Chromatogr.*, **526**, 575 (1990).
465. P. Hernández, F. Galán-Estella and L. Hernández, *Anal. Chim. Acta*, **271**, 17 (1993).
466. J. Barek, G. Makik and J. Zima, *Collect. Czech. Chem. Commun.*, **56**, 595 (1991).
467. R. Meunier-Prest and E. Laviron, *J. Electroanal. Chem.*, **328**, 33 (1992).
468. E. Laviron, R. Meunier-Prest, A. Vallat, R. Roullier and R. Lacasse, *J. Electroanal. Chem.*, **341**, 227 (1992).
469. R. Lacasse, R. Meunier-Prest, E. Laviron and A. Vallat, *J. Electroanal. Chem.*, **359**, 223 (1993).
470. E. Laviron, R. Meunier-Prest and R. Lacasse, *J. Electroanal. Chem.*, **375**, 263 (1994).
471. E. Laviron, A. Vallat and R. Meunier-Prest, *J. Electroanal. Chem.*, **379**, 427 (1994).
472. P. P. Fu, *Drug Met. Rev.*, **22**, 209, (1990).
473. H. Tokiwa and Y. Ohnishi, *CRC Crit. Rev. Toxicol.*, **17**, 23, (1986).
474. M. T. Galceran and E. Moyano, *J. Chromatogr.*, **607**, 287 (1992).
475. P. J. T. Scheepers, D. D. Velders, M. H. J. Martens, J. Noordhoek and R. P. Bos, *J. Chromatogr.*, **677**, 107 (1994).
476. K. Hayakawa, N. Terai, K. Suzuki, P. G. Dinning, M. Yamada and M. Miyazaki, *Biomed. Chromatogr.*, **7**, 262 (1993).
477. E. Veigl, W. Posch, W. Lindner and P. Tritthart, *Chromatographia*, **38**, 199 (1994).
478. D. Nakajima, T. Teshima, M. Ochiai, M. Tabata, J. Suzuki and S. Suzuki, *Bull. Environ. Contamin. Toxicol.*, **53**, 888 (1994).

479. K. Hayakawa, M. Butoh and M. Miyazaki, *Anal. Chim. Acta*, **266**, 251 (1992).
480. H. Li and R. Westerholm, *J. Chromatogr.*, **664**, 177 (1994).
481. K. Hayakawa, T. Murahashi, M. Butoh and M. Miyazaki, *Environ. Sci. Technol.*, **20**, 928, (1995).
482. L. Warzecha, *Chem. Anal. (Warsaw)*, **38**, 303 (1993).
483. M. T. Galceran and E. Moyano, *Talanta*, **40**, 615 (1993).
484. D. Helmig and J. Arey, *Int. J. Environ. Anal. Chem.*, **49**, 207 (1992).
485. D. Helmig, J. Lopez Cancio, J. Arey, W. P. Harger and R. Atkinson, *Environ. Sci. Technol.*, **26**, 2207 (1992).
486. M. Watanabe, M. J. Ishidate and T. Nohmi, *Mutat. Res.*, **234**, 337 (1990).
487. N. Sera, K. Fukuhara, N. Miyata and H. Tokiwa, *Mutagenesis*, **9**, 47 (1994).
488. Y. Oda, T. Shimada, M. Watanabe, M. J. R. Ishidate and T. Nohmi, *Mutat. Res.*, **272**, 91 (1992).
489. P. T. J. Scheepers, H. J. T. M. Thuis, M. H. J. Martens and R. P. Bos, *Toxicol. Lett.*, **72**, 191, (1994).
490. J. M. Wong, N. Y. Kado, P. A. Kuzmicky, H. S. Ning, J. E. Woodrow, D. P. H. Hsieh and J. N. Seiber, *Anal. Chem.*, **63**, 1644 (1991).
491. S. C. Zimmerman, K. W. Saionz and Z. Zeng, *Proc. Natl. Acad. Sci. USA*, **90**, 1190 (1993).
492. F. E. Evans, J. Deck and P. C. Howard, *Chem. Res. Toxicol.*, **7**, 352 (1994).
493. V. F. Ruban, *Zh. Anal. Khim.*, **47**, 2042 (1992).
494. A. Astier, *J. Chromatogr. B*, **573**, 318, (1992).
495. M. E. Morris and S. B. Hansel, *J. Chromatogr. Biomed. Appl.*, **532**, 285 (1990).
496. A. Brega, P. Prandini, C. Amaglio and E. Pafumi, *J. Chromatogr.*, **535**, 311 (1990).
497. M. Nassereddine-Sebaei, A. M. Crider, R. T. Carroll and C. N. Hinko, *J. Pharm. Sci.*, **82**, 39 (1993).
498. H. B. Bohm, J. Feltes, D. Volmer and K. Levsen, *J. Chromatogr.*, **478**, 399 (1989).
499. J. Kuruc, M. K. Saho, J. Locaj and M. Hutta, *J. Radioanal. Nuc. Chem. Art.*, **183**, 99 (1994).
500. R. Vespalec and J. Neca, *J. Chromatogr.*, **541**, 257 (1991).
501. R. Herterich, *J. Chromatogr.*, **549**, 313 (1991).
502. Z. Voznakova and E. Tesarova, *Chem. Listy*, **88**, 393 (1994).
503. J. W. Childers, D. F. Smith, N. K. Wilson, and R. K. Barbour, *Appl. Spectrosc.*, **49**, 2886 (1995).
504. A. K. Takeba, M. Matsumoto and H. Nakazawa, *J. Chromatogr.*, **596**, 67 (1992).
505. J. A. Rivera-Nevares, J. F. Wyman, D. L. Vonminden, N. Lacy, M. L. Chabinyc, A. V. Fratinden and D. A. Macys, *Environ. Toxicol. Chem.*, **14**, 251 (1995).
506. L. G. Croteau, M. H. Akhtar, J. M. R. Belanger and J. R. J. Pare, *J. Liq. Chromatogr.*, **17**, 2971 (1994).
507. J. R. Dean, L. Ebdon, M. E. Foulkes, H. M. Crews and R. C. Massey, *J. Anal. Atom. Spectrom.*, **9**, 615 (1994).
508. K. Nick and H. F. Schoeler, *Fresenius J. Anal. Chem.*, **343**, 304 (1992).
509. A. Geissler and H. F. Scholer, *Water Res.*, **28**, 2047 (1994).
510. T. Kim, J. Hong, J. Rhee and K. Kim, *Bull. Korean Chem. Soc.*, **14**, 529 (1993).
511. P. J. M. Kwakman, D. A. Kamminga, U. A. T. Brinkman and G. J. De Jong, *J. Chromatogr.*, **553**, 345 (1991).
512. L. Hernández, P. Hernández and J. Vicente, *Fresenius J. Anal. Chem.*, **345**, 712 (1993).
513. M. E. León-González, L. V. Pérez-Arribas, M. J. Santos-Delgado and L. M. Polo-Diez, *Anal. Chim. Acta* **258**, 269, (1992).
514. V. Stuzka and J. Soucek, *Collect. Czech. Chem. Commun.*, **59**, 2227 (1994).
515. J. M. Wong, Q. X. Li, B. D. Hammock and J. N. Seiber, *J. Agric. Chem.*, **39**, 1802 (1991).
516. J. Barek, H. Ebertova, V. Mejstrik and J. Zima, *Collect. Czech. Chem. Commun.*, **59**, 1761 (1994).
517. Y. I. Korenman and G. M. Smolskii, *Zh. Anal. Khim.*, **47**, 1251 (1992).
518. A. L. Scher and N. C. Adamo, *J. Ass. Off. Agr. Chem. Int.*, **76**, 287 (1993).
519. J. B. Simeonsson, W. G. Lemire and R. C. Sausa, *Appl. Spectrosc.*, **47**, 1907 (1993).
520. O. W. Parkes, *J. Ass. Off. Agr. Chem. Int.*, **76**, 698 (1993).
521. Y. S. Li, D. T. Vo, D. L. Stokes and Y. Wang, *Appl. Spectrosc.*, **49**, 1354 (1992).
522. A. Boucetta, B. Benali, A. Kadiri, F. Ghailane, C. Cazeau du Broca and G. Nouchi, *Spectrochim. Acta*, **50**, 2249 (1994).
523. T. O. Crowley and R. A. Larson, *J. Chromatogr. Sci.* **32**, 57, (1994).
524. S. Husain, R. Narsimha, S. N. Alvi and R. N. Rao, *J. High Resol. Chromatogr.*, **15**, 562 (1992).
525. A. A. Mokhov, L. B. Leont'eva and V. V. Bardin, *Izv. Vyssh. Uchebn. Zaved., Khim. Tekhnol.*, **32**, 116 (1989).

526. L. B. Leont'eva, I. V. Tselinskii, E. S. Boichinova and I. V. Krauklish, *Russ. J. Appl. Chem.*, **66**, 1303 (1993).
527. B. Fernández-Band, F. Lázaro, M. D. L. de Castro and M. Valcárcel, *Anal. Chim. Acta*, **229**, 177 (1990).
528. L. Nordholm, *J. Chromatogr. Biomed. Appl.*, **568**, 481 (1991).
529. J. Barek, D. Drevinkova and J. Zima, *Collect. Czech. Chem. Commun.*, **58**, 2021 (1993).
530. E. Bermejo, A. Zapardiel, J. A. Pérez, A. Huerta and L. Hernández, *Talanta*, **40**, 1649 (1993).
531. J. Barek, D. Civisova, A. Ghosh and J. Zima, *Collect. Czech. Chem. Commun.*, **55**, 379 (1990).
532. P. Shivhare, J. Raju and V. K. Gupta, *Microchem. J.*, **42**, 283 (1990).
533. A. Posynia, S. Semeniuk, J. Niedzielska and J. Zmudzki, *Chem. Anal. (Warsaw)*, **39**, 289 (1994).
534. L. Kumar, J. R. Toothill and K. B. Ho, *J. Ass. Off. Agr. Chem. Int.*, **77**, 591 (1994).
535. P. Kruzik, M. Weister, J. Damoser and I. Helsberg, *Tier. Monats.*, **77**, 141 (1990).
536. A. M. Echterhoff and M. Petz, *Deut. Lebensmit.-Rundschau*, **90**, 341 (1994).
537. I. Kaniou, G. Zachariadis, G. Kalligas, H. Tsoukali and J. Stratis, *J. Liq. Chromatogr.*, **17**, 1385 (1994).
538. T. G. Dias, L. L. Martínez, M. M. Galera and F. Salinas, *J. Liq. Chromatogr.*, **17**, 457 (1994).
539. H. S. Rupp, R. K. Munns, A. R. Long and S. M. Plakas, *J. Ass. Off. Agr. Chem. Int.*, **77**, 344 (1994).
540. A. Posyniak, A. Kozak and S. Semeniuk, *Chem. Anal. (Warsaw)*, **36**, 197 (1991).
541. S. H. Rupp, R. K. Munns and A. R. Long, *J. Ass. Off. Agr. Chem. Int.*, **76**, 1235 (1993).
542. T. K. Mandal and L. N. Ace, *J. Clin. Pharm. Ther.*, **18**, 347 (1993).
543. O. W. Parks and L. F. Kubena, *J. Ass. Off. Agr. Chem. Int.*, **75**, 261 (1992).
544. C. S. Reddy and S. J. Reddy, *Electroanal. (N. Y.)*, **4**, 595 (1992).
545. M. I. Walsh, A. M. Elbrashy, M. S. Eldin, M. A. Abuirjeie and M. A. E. Sultan, *Pharmazie*, **49**, 696 (1994).
546. T. G. Díaz, L. L. Martínez and F. Salinas, *Analisis*, **22**, 202 (1994).
547. I. Kaniou, G. Zachariadis, G. Kalligas, H. Tsoukali and J. Stratis, *J. Liq. Chromatogr.*, **17**, 1385 (1994).
548. S. M. Hassan, F. A. Ibrahim and M. M. Hefnawy, *Anal. Lett.*, **23**, 599 (1990).
549. S. M. Hassan, F. A. Ibrahim, M. S. El-Din and M. M. Hefnawy, *Chromatography*, **30**, 176 (1990).
550. M. I. Walsh, A. M. El-Brashy and M. A. Sultan, *Anal. Lett.*, **26**, 499 (1993).
551. B. Marciniak and A. Bugaj, *Chem. Anal. (Warsaw)*, **39**, 705 (1994).
552. L. H. Stanker, C. McKeown, B. E. Watkins, M. Vanderlaan, R. Ellis and J. Rajan, *J. Agric. Food Chem.*, **41**, 1332 (1993).
553. S. Benko and J. Lengyel, *J. Chromatogr.*, **520**, 379 (1990).
554. L. B. Leont'eva, I. V. Tselinskii, E. S. Boichinova and I. V. Krauklish, *Izv. Vyssh. Uchebn. Zaved., Khim. Khim. Tekhnol.*, **36**, 17 (1993).
555. K. V. Prabhakaran, S. R. Naidu and E. M. Kurian, *Thermochim. Acta*, **241**, 199 (1994).
556. A. J. Shaw and A. Gescher, *J. Chromatogr.*, **505**, 402 (1990).
557. D. R. Greenwood, *J. Sci. Food Agric.*, **52**, 499 (1990).
558. A. A. Gallon and W. A. Pryor, *Lipids*, **28**, 125 (1993).
559. N. Z. Muradov, *Environ. Sci. Technol.*, **28**, 388 (1994).
560. J. J. Janssens, M. I. Selala, F. F. Daelemans, S. W. Andries and P. J. C. Schepens, *J. Pharm. Biomed. Anal.*, **7**, 1631 (1989).
561. M. Jorgensen, M. P. Andersen and S. H. Hansen, *J. Chromatogr., Biomed. Appl.*, **577**, 167 (1992).
562. C. Han, M. Gumbleton, D. T. W. Lau and L. Z. Benet, *J. Chromatogr., Biomed. Appl.*, **579**, 237 (1992).
563. D. J. Johnson and D. A. C. Compton, *Am. Lab.*, **23**, 37 (1991).
564. S. Zeman, *Thermochim. Acta*, **230**, 191 (1993).
565. E. Laviron and R. Roullier, *J. Electroanal. Chem.*, **288**, 165 (1990).
566. R. N. Loepky and C. J. Michejda, *ACS Symp. Ser.*, **553** (1994).
567. W. Gorski and J. A. Cox, *Anal. Chem.*, **64**, 2706 (1992).
568. K. Ikeda and K. G. Migliorese, *J. Soc. Cosmet. Chem.*, **41**, 283 (1990).
569. J. W. Pensabene, W. Fiddler and J. G. Phillips, *J. Assoc. Off. Anal. Chem.*, **73**, 947 (1990).
570. K. Takatsuki and T. Kikuchi, *J. Chromatogr.*, **508**, 357 (1990).
571. Y. Y. Wigfield and M. D. Lacroix, *Bull. Environ. Contam. Toxicol.*, **49**, 827 (1992).
572. M. E. L. R. De Queiroz, K. Wuchner, R. Grob and J. Mathieu, *Analisis*, **20**, 12 (1992).



573. N. Sen, P. A. Baddoo, D. Weber and T. Helgason, *J. Agric. Food Chem.*, **38**, 1007 (1990).
574. J. B. Plomley, C. J. Koestler and R. E. March, *Anal. Chem.*, **66**, 4437 (1994).
575. V. Y. Taguchi, S. D. W. Jenkins, D. T. Wang, J. P. F. P. Paimentier and F. J. Reiner, *Can. J. Appl. Spectrosc.*, **39**, 87 (1994).
576. N. P. Sen, P. A. Baddoo, D. Weber and M. Boyle, *Int. J. Environ. Anal. Chem.*, **56**, 149 (1994).
577. J. W. Pensabene, W. Fiddler and R. A. Gates, *J. Ass. Off. Agr. Chem. Inter.*, **75**, 438 (1992).
578. J. W. Pensabene and W. Fiddler, *J. Ass. Off. Anal. Chem. Int.*, **77**, 981 (1994).
579. J. W. Pensabene and W. Fiddler, *J. Ass. Off. Anal. Chem. Int.*, **73**, 226 (1990).
580. S. Fadlallah, S. F. Cooper, M. Fournier, D. Drolet and G. Perrault, *J. Chromatogr. Sci.*, **28**, 517 (1990).
581. R. J. Maxwell, J. W. Pensabene and W. Fiddler, *J. Chromatogr. Sci.*, **31**, 212 (1993).
582. M. Matyska and T. Kossowski, *Chem. Anal. (Warsaw)*, **39**, 431 (1994).
583. S. M. Billedeau, T. M. Heinze, J. G. Wilkes and H. C. Thompson, *J. Chromatogr. A.*, **688**, 55, (1994).
584. B. Buechele, L. Hofmann and J. Lang, *Fresenius J. Anal. Chem.*, **336**, 328 (1990).
585. G. Xu and P. I. Reed, *Analyst*, **118**, 877 (1993).
586. D. C. Havery, *J. Anal. Toxicol.*, **14**, 181 (1990).
587. A. Sano, M. Ohashi, M. Kodama and S. Takitani, *J. Chromatogr., Biomed. Appl.* **621**, 157 (1994).
588. N. P. Sen, P. A. Baddoo, S. W. Seaman and D. Weber, *J. Agric. Food Chem.*, **40**, 221 (1992).
589. S. H. Kim and J. H. Hotchkiss, *ACS Symp. Ser.*, **553**, 355 (1994).
590. T. J. Lillard and J. H. Hotchkiss, *ACS Symp. Ser.*, **553**, 358 (1994).
591. B. Pignatelli, C. Malaveille, P. Thuillier, A. Hautefeuille and H. Bartsch, *ACS Symp. Ser.*, **553**, 102 (1994).
592. P. Pastore, I. Lavagnini, A. Boaretto and F. Magno, *Anal. Chim. Acta*, **230**, 29 (1990).
593. Ya. L. Kostyukovskii, D. B. Melamed and O. V. Tauts, *Zh. Anal. Khim.*, **44**, 1895 (1989).
594. Y. Y. Wigfield and C. C. McLenaghan, *Bull. Environ. Contam. Toxicol.*, **45**, 853 (1990).
595. G. A. Sacchetto, P. Pastore and G. F. M. Fiorani, *Anal. Chim. Acta*, **258**, 99 (1992).
596. G. Favaro, G. A. Sacchetto, P. Pastore and M. Fiorani, *Anal. Chim. Acta*, **273**, 457 (1993).
597. G. A. Sacchetto, G. Favaro, P. Pastore and M. Fiorani, *Anal. Chim. Acta*, **294**, 251 (1994).
598. J. Barek, P. T. Hai, V. Pacakova, K. Stulik, I. Svagrova and J. Zima, *Fresenius J. Anal. Chem.*, **350**, 678 (1994).
599. W. Gorski and J. A. Cox, *Anal. Chem.*, **66**, 2771 (1994).
600. J. Y. Bae, P. Mende, G. Shevlin, B. Spiegelhalter, R. Preussmann and R. N. Loeppky, *Chem. Res. Toxicol.*, **7**, 868 (1994).
601. J. V. Uri, N. Burdash and D. A. Farina, *Acta Chim. Hung.*, **129**, 865 (1992).
602. A. Kotynski, Z. H. Kudzin and R. Skowronski, *J. Chromatogr.*, **516**, 467 (1990).
603. A. Kotynski and Z. H. Kudzin, *J. Chromatogr.*, **663**, 127 (1994).
604. M. Zheng, C. Fu and H. Xu, *Analyst*, **118**, 269 (1993).
605. G. M. Janini, S. D. Fox, M. L. Citro, G. M. Muschik and H. J. Issaq, *Anal. Instrum.*, **21**, 1 (1993).
606. J. S. Stamler and J. Loscalzo, *Anal. Chem.*, **64**, 779 (1992).
607. M. V. Djordjevic, J. G. Fan, J. Krzeminski, K. D. Brunnemann and D. Hoffmann, *ACS Symp. Ser.*, **553**, 367 (1994).
608. K. D. Brunnemann and D. Hoffman, *ACS Symp. Ser.*, **553**, 369 (1994).
609. D. Hoffmann, K. D. Brunnemann, B. Prokopczyk and M. V. Djordjevic, *J. Toxicol. Environ. Health*, **41**, 1 (1994).
610. K. D. Brunnemann, J. C. Scott and D. Hoffman, *Carcinogenesis*, **3**, 693, (1982)
611. W. S. Caldwell and J. M. Conner, *J. Assoc. Off. Anal. Chem.*, **73**, 783 (1990).
612. S. S. Hecht, S. G. Carmella, S. E. Murphy, S. Akerkar, K. D. Brunnemann and D. Hoffmann, *New England J. Med.*, **329**, 1543 (1993).
613. K. D. Brunnemann, L. Yu and D. Hoffman, *Cancer Res.*, **37**, 3218 (1977)
614. M. V. Djordjevic, J. Fan, L. P. Bush, K. D. Brunnemann and D. Hoffmann, *J. Agric. Food Chem.*, **41**, 1790 (1993).
615. G. P. Xu and P. I. Reed, *Carcinogenesis*, **14**, 2547 (1994).
616. K. D. Brunnemann, J. E. Cox and D. Hoffmann, *Carcinogenesis*, **13**, 2415 (1992).
617. B. Prokopczyk, D. Hoffmann, J. E. Cox, M. V. Djordjevic and K. D. Brunnemann, *Chem. Res. Toxicol.*, **5**, 336 (1992).
618. B. Prokopczyk, M. Wu, J. E. Cox and D. Hoffmann, *Carcinogenesis*, **13**, 863 (1992).

619. X. H. Qi and R. P. Baldwin, *Electroanalysis*, **6**, 353 (1994).
620. A. M. Prokai and R. K. Ravichandran, *J. Chromatogr. A*, **667**, 298 (1994).
621. J. M. J. Tronchet and I. Komaromi, *J. Comput. Chem.*, **15**, 1091 (1994).
622. S. Walker, D. Gange, V. Gupta and D. Kahne, *J. Am. Chem. Soc.*, **116**, 3197 (1994).
623. M. Johansson and K. Jørgenson, *J. Org. Chem.*, **59**, 214 (1994).
624. R. S. Srivastava and K. M. Nicholas, *J. Org. Chem.*, **59**, 5365 (1994).
625. M. Tiecco, L. Testaferri, M. Tingoli and C. Santi, *Tetrahedron Lett.*, **36**, 163 (1995).
626. G. D. Connelly and A. E. Tipping, *J. Fluorine Chem.*, **68**, 83 (1994).
627. G. D. Connelly and A. E. Tipping, *J. Fluorine Chem.*, **68**, 103 (1994).
628. G. D. Connelly and A. E. Tipping, *J. Fluorine Chem.*, **71**, 85 (1995).

## CHAPTER 25

# Environmental aspects of compounds containing nitro, nitroso and amino groups

H. K. CHAGGER and A. WILLIAMS

*Department of Fuel and Energy, University of Leeds, Leeds, LS2 9JT, UK*  
*Fax: +44 113 244 0572; e-mail: FUEAW@LEEDS.AC.UK*

---

I. ABBREVIATIONS	1170
II. INTRODUCTION	1171
III. ENVIRONMENTAL EXPOSURE	1173
A. Nitro Compounds	1173
B. Nitroso Compounds	1182
1. Leather and tanning	1183
2. Rubber industry	1184
3. Metal and machining	1185
IV. ENVIRONMENTAL EXPOSURE TO PREFORMED NITROSAMINES	1186
A. Sunscreens and Cosmetics	1186
B. Pharmaceutical Products	1186
C. Agricultural Products	1186
D. Packing Materials	1187
E. Foods and Beverages	1187
F. Endogenous Formation	1189
V. AMINES	1196
A. Hydrazine	1196
B. Azo Dyes	1197
VI. CONTROL AND LEGISLATION	1197
VII. REFERENCES	1212

---

### I. ABBREVIATIONS

BCG	Bacillus Calmette-Guerin
BCNU	bischloroethyl-nitrosourea
CCNU	1-chloroethyl-3-cyclohexyl-1-nitrosourea

C-PAH	C-polyaromatic hydrocarbons
DNA	deoxyribonucleic acid
EPA	environmental Protection Agency
HO <sub>2</sub> NO <sub>2</sub>	peroxy nitric acid
HNO <sub>2</sub>	nitric acid
LPS	lipopolysaccharide
N/C	nitrogen/Carbon
NCO	isocyanate radical
NDBA	<i>N</i> -nitrosodibutylamine
NDEA	<i>N</i> -nitrosodiethylamine
NDELA	<i>N</i> -nitrosodiethanolamine
NDMA	<i>N</i> -nitrosodimethylamine
NDPhA	<i>N</i> -nitrosodiphenylamine
NEMA	<i>N</i> -nitrosoethylmethylamine
NHMTCA	<i>N</i> -nitroso-2-hydroxymethylthiazolidine-4-carboxylic acid
NHMTHZ	<i>N</i> -nitroso-2-hydroxymethylthiazolidine
NH <sub>2</sub> O	oxyamine radical
NHPRO	<i>N</i> -nitroso-4-hydroxyproline
NHPYR	<i>N</i> -nitroso-3-hydroxypyrrolidine
Nitro-PAH	nitro-polyaromatic hydrocarbons
NMAMBA	<i>N</i> -nitroso- <i>N</i> -(1-methylacetyl)-3-methylbutylamine
NMAMPA	<i>N</i> -nitroso- <i>N</i> -(1-methylacetyl)-2-methylpropylamine
NMOCA	<i>N</i> -nitroso-5-methylloxazolidine-carboxylic acid
NMOR	<i>N</i> -nitrosomorpholine
NMPABOA	2-ethylhexyl 4-( <i>N,N</i> -dimethylamino) benzoate (Padimate O)
NMPPhA	<i>N</i> -nitrosomethylphenylamine
NMPZ	<i>N</i> -nitrosomethylphenylamine
NOC	<i>N</i> -nitroso compounds
NO	nitric oxide
NO <sub>2</sub>	nitrogen dioxide
NO <sub>3</sub> <sup>*</sup>	nitrate radical
NO <sub>2</sub> <sup>*</sup>	nitrite radical
N <sub>2</sub> O <sub>3</sub>	nitrogen trioxide
NO <sub>x</sub>	mixture of oxides of nitrogen like nitric oxide and nitrogen dioxide
N <sub>2</sub> O	nitrous oxide
N <sub>2</sub> O <sub>3</sub>	nitrogen pentaoxide
NOCA	<i>N</i> -nitrosooxazolidine-4-carboxylic acid
NPAH	polyaromatic compounds containing nitrogen
NPIP	<i>N</i> -nitrosopiperidine
NPRO	<i>N</i> -nitrosoproline
NPYR	<i>N</i> -nitrosopyrrolidine
NSAR	<i>N</i> -nitrososarcosine
NTCA	<i>N</i> -nitrosothiazolidine-4-carboxylic acid
NTHZ	<i>N</i> -nitrosothiazolidine
PAH	polynuclear aromatic hydrocarbons
PAC	polynuclear aromatic compounds
PAN	peroxy acetyl nitrate
PANH	nitrogen containing polyaromatic hydrocarbons
RNO <sub>3</sub>	alkyl nitrate
VOC	volatile organic compounds

## II. INTRODUCTION

The nitro, amino and nitroso derivatives of organic compounds constitute a large and varied group of compounds which are used widely in industry but can also be formed in the atmosphere by chemical reactions. This series is characterized chemically by substitution of an amino group ( $\text{NH}_2$ ) or nitro group ( $\text{NO}_2$ ) for a hydrogen atom of an organic (usually aromatic) compound. Nitroso compounds can be placed into two categories, the N-nitroso and the C-nitroso compounds. The N-nitroso compounds result from typical free radical reactions or by the reaction of secondary amines with nitrous acid. The C-nitroso compounds can be derived from aliphatic compounds by free radical reactions, or from aromatic compounds when, e.g., nitrosation of the aromatic ring of a tertiary amine occurs at either the *para* or the *ortho* position. Beside these routes,  $\text{NO}_x$ , which is present in the atmosphere as a result of combustion processes, reacts with volatile organic compounds (VOC) to give rise to various organic NO and  $\text{NO}_2$  compounds. Ammonia in the atmosphere plays a very minor role, although high levels of ammonia or hydrazine in the work place can produce some very toxic compounds.

The nitro compounds which are products of direct nitration can undergo subsequent reduction yielding amines; these amines can be converted into more versatile class of organic compounds as shown in Figure 1. This sequence provides a route to formation of dozens of aromatic compounds.

The amino, nitro and nitroso compounds are often used in bulk as intermediates in synthesis of dyes, pharmaceuticals, antioxidants and accelerators for the rubber industry and are also produced during the manufacture of different industrial commodity foods beverages and agricultural products. The nitrosamine production seems to be an unsolved problem, although there has been a reduction in concentration of nitrates in cured meats and other products over the decades. Several new nitrosamines have been identified in tobacco products, while cosmetic and personal care products have been found to be contaminated with nitrosodiethanolamine. Increased use of diesel fuel because of its higher efficiency has led to problems due to emission of high polyaromatic compounds (PAC) which react with either the nitrogen present in the fuel or in the lubricating oil, with NO and  $\text{NO}_2$  being formed and in term forming nitro-PAH. These nitro-PAH have been found to be even more potent than their parent PAH in terms of mutagenicity and carcinogenicity (Table 1).

Legislation and control have been implemented on concentration levels of  $\text{NO}_x$  arising from industries and combustion processes in developed nations (USA, Canada, Europe). Still nitroso compounds are formed invariably as intermediates either during manufacturing cycles or in the atmosphere. Exposure from most compounds occurs during handling of the chemicals, inhalation and ingestion are also becoming prominent routes for exposure. There is sufficient evidence to indicate that the large majority (90%) of these compounds

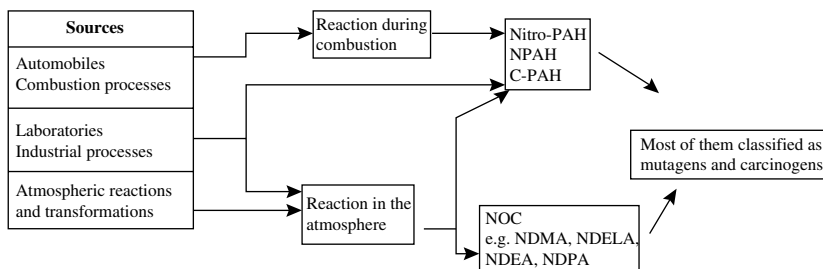


FIGURE 1. Formation and reduction of nitro compounds

TABLE 1. Structure, sources and effects of nitrogen-containing organic compounds<sup>1,2</sup>

Structure	Sources	Effects
Nitro ( $-\text{NO}_2$ ) Aliphatic ( $-\text{C}-\text{NO}_2$ ) Examples: Nitromethane, nitroethane, nitropropane etc.	Solvents for cellulose esters, resins, oils, fats, waxes, dyes, vasodilators in medicine, industrial and military explosives	Cause toxic narcosis, liver damage, depressive effect on central nervous system; industrially 30 ppm can cause nausea, vomiting, diarrhea, irritation of the respiratory system, dizziness. Repeated exposure causes cyanosis and may act as potential carcinogens
Nitro-PAH, Nitrophenols	Combustion processes, atmospheric reactions, diesel engines	Mutagenic and carcinogenic
C-nitroso compounds ( $\text{C}-\text{N}=\text{O}$ )	Combustion products, atmospheric reactions	Mutagenic and carcinogenic
Nitrogen Oxides Nitric oxide (NO)	Fossil fuel combustion systems, biomass burning	Cause bronchitis, pneumonia and lung infections, asthma Photochemical smog, acid rain
Amines Hydrazine	Aniline Tobacco plants, polymerization catalysts, pharmaceutical products, corrosion inhibitor in boiler water, propellant fuels	Production of $\text{NO}_2$
Nitroso ( $\text{N}-\text{N}=\text{O}$ ) (NOC)	Pesticides, industrial waste, drying of foods in combustion gases, e.g. brewing industry, soup mixes, tea, spices, powdered formulations, soy protein isolates, cereal products, dairy products and cured meat products etc. Explosives, dyes, pigments, insecticides, textiles, plastics, resins, elastomers, pharmaceuticals, fuel additives, plant-growth regulators, rubber accelerators and antioxidants Azo dyes, used in textiles, leather, printing, paper making, drugs and food industry	Some substances were considered to induce cancer of oesophagus, stomach and nasopharynx  Skin irritants, cause cyanosis and methaemoglobinemia  Mutagenic and carcinogenic

represent a serious health hazard, and are known for their toxic, mutagenic and carcinogenic effects. The simplest of these toxic compounds are aniline, hydrazine and mononitrobenzene. In most cases the symptoms appear over a period of time usually many years. This causes difficulties in assessing the carcinogenicity of these chemicals and the implication of regulatory activities in order to minimize the exposure to these chemicals. The Occupational Safety and Health Administration in many countries divides these chemicals into three classes, namely potential suspected carcinogens where there is good scientific evidence of human carcinogenesis; suspected carcinogens where there is suggestive evidence of carcinogenicity in man, and experimental carcinogens. Some countries have totally banned the production and use of the first category of these chemicals, and in other cases the production and use are controlled by legislation. A list of some chemical carcinogens is given in Table 2.

TABLE 2. Different categories and possible control of chemical carcinogens<sup>3</sup>

Chemicals	Control
<i>Human carcinogens</i>	
2-Naphthylamine	Importation and use in manufacture of these are prohibited by legislation, e.g. in the U.K., except if present at less than 1% in another material
Benzidine	
4-Aminobiphenyl	
4-Nitrobiphenyl	
1-Naphthylamine	Use of this is controlled by legislation, e.g. in the U.K.
Acrylonitrile	Threshold limit values (TLV) awaiting reassignment when new data becomes available; no exposure permitted
<i>Suspected human carcinogens</i>	
<i>Assigned maximum operating levels (TLV)</i>	
3-Amino-1,2,4-triazole	0.5 ppm (1 mg $\mu^{-3}$ )
1,1-Dimethylhydrazine	
2-Chloroaniline	0.2 ppm (0.35 mg $\mu^{-3}$ )
Methylhydrazine	
2-Nitropropane	25 ppm (90 mg $\mu^{-3}$ )
<i>Experimental carcinogens</i>	
2-Acetylaminofluorene	
Diazomethane	
4-Dimethylaminoazobenzene	
Ethyl diazoacetate	
Ethylenethiourea	
Ethyl <i>N</i> -nitroso carbamate	

In general carcinogenic activity has also been observed in certain structural classes<sup>3</sup>:

- Biological alkylating agents, bis(chloroethyl)amines, ethyleneimines
- Polycyclic hydrocarbons or heterocycles, mono- and di-benzanthracenes, -pyrenes, -acridines
- Aromatic amines, two rings or more, naphthylamines, amino- (or nitro-), acetylaminofluorene
- Nitroso compounds, nitrosoamines, nitrosoamides
- Azo compounds and hydrazines, azo alkanes, azo aromatics, aminoazobenzenes, diazonium salts, diazomethane, hydrazine and its methyl derivatives

This review does not deal specifically with all the categories mentioned above, but takes into account compounds which are formed at the work place and result in direct exposure and preformed nitroso compounds. The latter are formed from amines or contain high concentrations of amino compounds. The contamination may arise as a result of contaminated starting material, in particular amines or from the formation of NOC during the manufacturing cycle.

### III. ENVIRONMENTAL EXPOSURE

#### A. Nitro Compounds

A variety of nitrogen oxides (NO<sub>x</sub>) such as nitric oxide (NO) and nitrogen dioxide (NO<sub>2</sub>) as well as nitrous oxide (N<sub>2</sub>O) are present in the atmosphere. The sources of these oxides are biological actions and organic decomposition in the soil and in the ocean

(mainly  $N_2O$ ) or from activities through combustion. The combustion generated  $NO_x$  mainly consists of  $NO$  initially but is rapidly converted into  $NO_2$  in the atmosphere. These oxides react with the VOCs in the atmosphere leading to the formation of photochemical oxidants and of smog, when as part of the reaction sequence the hydrocarbon radicals also produce  $RNO$  and  $RNO_2$ .

The major route of formation of these nitro compounds is via the reaction of VOCs with the  $NO_x$  arising from hot flue gases, such as automobile exhaust gases and gas streams used for drying food stuffs, etc. In these combustion systems the aliphatics can react with nitro compounds or arenes to produce nitro-PAH and nitroarenes. Some of the  $NO_x$  produced are thus converted into C-nitroso compounds. The interactions and reaction chemistry of these compounds is complex and difficult to interpret.

During combustion processes the molecular nitrogen in the combustion air and the fuel nitrogen that may be present in the fuel is converted into nitric oxide and some nitrogen dioxide<sup>4</sup> when  $NO$  and residual  $O_2$  are cooled together. The  $NO$  formation is also controlled by (1) thermal  $NO$ , (2) prompt  $NO$  and (3)  $N_2O$  to  $NO$  routes<sup>5-7</sup>.

The amount of prompt  $NO$  produced in combustion systems is relatively small compared with the total  $NO_x$  formation. However, prompt  $NO_x$  is still formed at low temperatures and is one of the features in producing ultra-low  $NO_x$  burners. The nitric oxide reacts with other species in the atmosphere to give various other nitrogen oxides, namely  $NO_2$  and nitrogen pollutants.

Figure 2 shows the nitric oxide cycle resulting in the emission of  $NO_x$  and pollutants arising from it at atmospheric temperatures<sup>8</sup>.

Apart from  $NO_x$ , ammonia also occurs in the atmosphere which is largely formed by the natural ecosystem. In industrial regions it can undergo a series of reactions to produce ammonium sulphate aerosol in presence of sulphuric acid, or alternatively form  $NH_2$ ,  $N_2O$  and  $NO$ . These species are responsible for the destruction of ozone in the troposphere<sup>9</sup>.

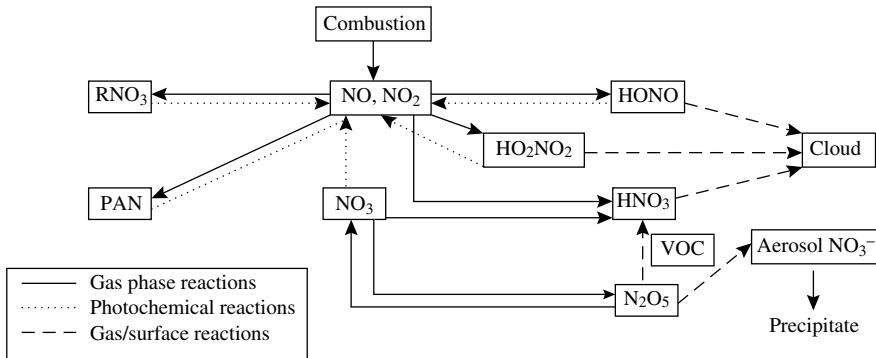
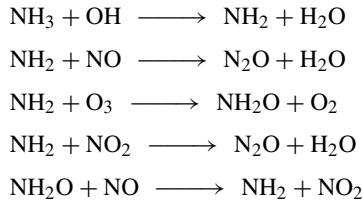


FIGURE 2. Nitric oxide cycle and pollutants



The  $\text{NH}_2\text{O}$  formed in the series of chain reactions is anticipated to be a short-lived intermediate which could interact with polyaromatic hydrocarbons (PAH) in atmosphere to give nitroarenes or nitro-PAH.

A typical fuel combustion process in air produces 50–1000 ppm of  $\text{NO}_x$  in flue gases. The level of  $\text{NO}_x$  occurring during combustion can be reduced considerably by using low or ultra-low  $\text{NO}_x$  burners and such burners have also been produced for food drying. These burners consist of fuel-lean pre-mixed flames burning in a stream of ducted dilutionary air. In such flames, formation of  $\text{NO}_x$  occurs partly via the thermal  $\text{NO}_x$  route and nitrous oxide route. These burners are fuel-lean and hence produce insignificant levels of PAH ( $0.2 \mu\text{g}/\mu^3$ ) and almost no  $\text{NO}_x$  in case of some burners<sup>10,11</sup>. Low temperature catalytic combustion of lean natural gas mixtures is another method of eliminating  $\text{NO}_x$  and PAH generated during combustion. Low cost and highly active nickel-cobalt or iron-based catalysts have a great potential in this field<sup>12,13</sup>. Application of reburn process, i.e. staging of the fuel to react with  $\text{NO}$  formed in the flame with hydrocarbon radicals,  $\text{CH}_i$ , and converting it to molecular nitrogen thereby reduce the  $\text{NO}_x$  concentration levels<sup>14</sup>. Gas turbines are being used to generate electric power because of their effect on energy conservation and low cost of installation. Gas turbine combustors are now designed to use low  $\text{NO}_x$  burners and typical emissions at full load are around 15–25 ppm only<sup>15</sup>. These techniques not only resolve the problem of  $\text{NO}_x$  and PAH, but also that of nitroso compounds which are formed during the combustion process or are formed atmospherically.

Besides nitrogen oxides, PAH are also formed due to incomplete combustion or pyrolysis of organic matter in the combustion systems at high temperatures<sup>16–19</sup>. Figure 3

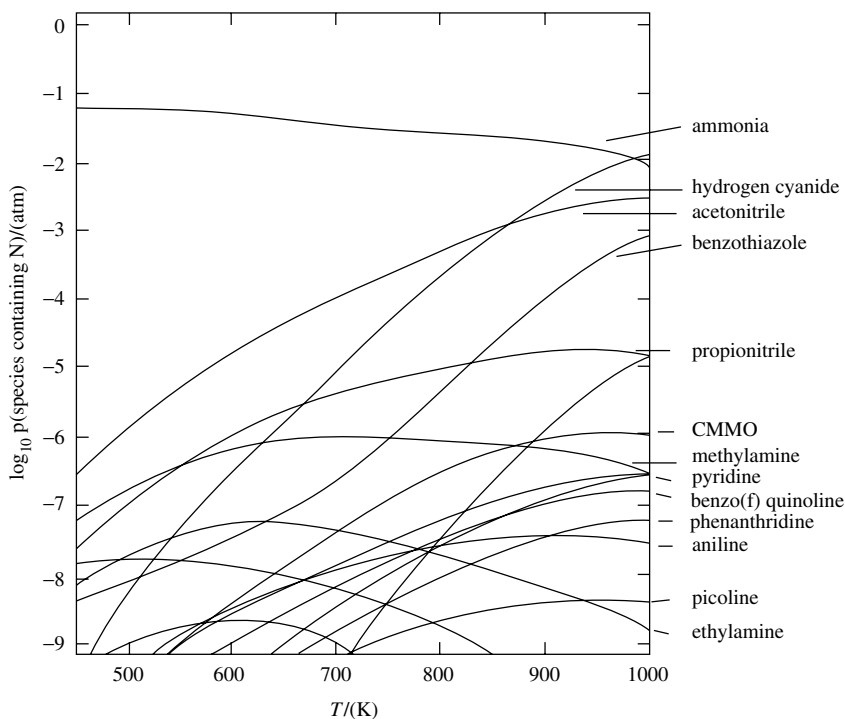


FIGURE 3. Variation of nitrogenous species with temperature

illustrates that most nitrogen compounds and nitro-PAH are formed at high temperatures and are produced directly or indirectly during high-temperature combustion processes<sup>20</sup>. This raises questions regarding the mode of formation of N-nitroso and C-nitroso compounds, as to whether they are formed in the high combustion region or in the other cooling regions involving reaction products at the same time undergoing a quenching process.

Numerous forms of PAH have also been identified in the exhausts from diesel-powered vehicles. Soot generated from combustion processes generally contains about 0.1 mol% of N/C, but the nitrogen content in case of soot deposits in engines is ten times higher than particles found in flames or atmosphere. It was found that the nitrogen-containing PAH (PANH) originated by the reaction of nitrogen oxides ( $\text{NO}_x$ ) with PAH in the hot exhaust gases<sup>21</sup>. These PANH can dissociate to give rise to  $\text{NO}_x$  or act as a precursor in the formation of the nitro-PAH which are potent mutagens<sup>22</sup>. The unburnt fuel which is between 0.2–1.0% was found to act as a source for the formation of NPAH. Experiments involving the addition of PAH, e.g. pyrene and phenanthrene, to aliphatic fuels was found to increase the emission levels of the PAH and NPAH corresponding to the concentration of its parent PAH. Hence, the variability of PAC components in diesel fuels can significantly affect the PAH concentrations<sup>23</sup>. Most commonly found PAH are: naphthalene, fluorene and phenanthrene and their alkyl substituted homologues<sup>24</sup>. The PAH are distributed in both the gaseous phase and particle phase in the atmosphere. Some of the two to four ring PAH are present in the gaseous phase depending upon their vapour pressure<sup>25,26</sup>. The nitration of the parent aromatic molecule, as a result of either combustion or atmospheric reaction, results in formation of nitro-PAH or nitroarenes<sup>27,28</sup> as shown in Figure 4.

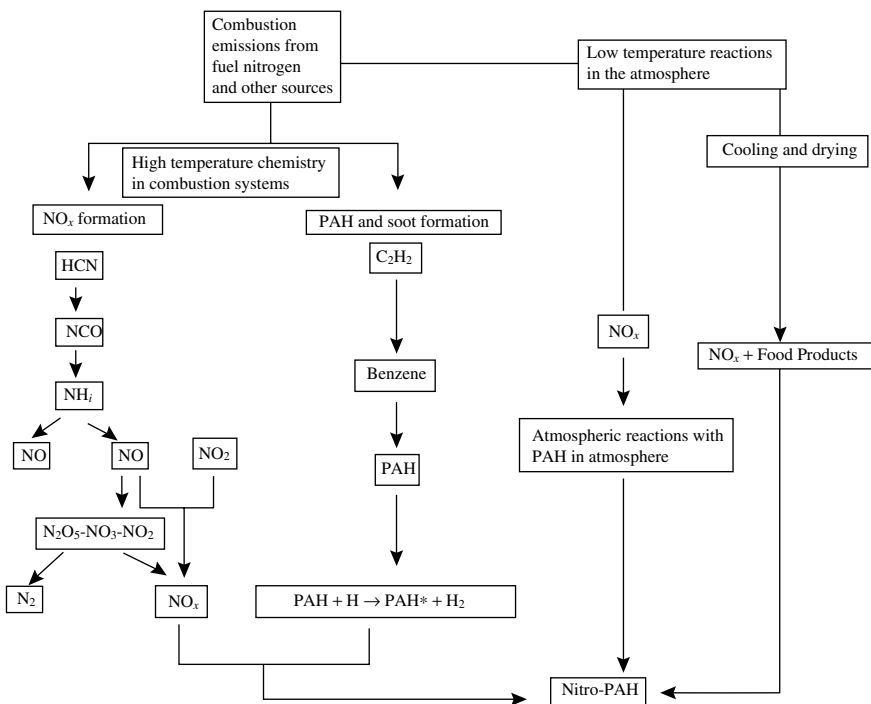


FIGURE 4. Formation of nitro-PAH by association of  $\text{NO}_x$  and PAH compounds

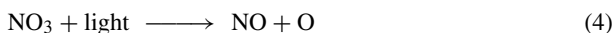
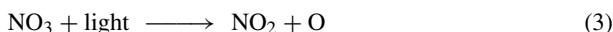
Although simpler nitroarenes have been used for decades as industrial chemicals (e.g. nitrobenzene and nitrotoluene) and pharmaceutical chemicals (e.g. nitrofurantoin), their carcinogenic effects have only come to light in the last two decades. Nitroarenes have also been identified in photocopy toners<sup>29,30</sup>, diesel exhaust particles<sup>31,32</sup>, kerosene heater emissions<sup>33,34</sup> and ambient air. Specific nitroarenes are formed by different mechanisms. Direct combustion appears to emit nitroarenes formed by direct electrophilic nitration (e.g. 1-nitropyrene, 3-nitrofluoranthene)<sup>35,36</sup>, whereas atmospheric reactions involve multi-step reaction of OH radicals in the presence of NO<sub>x</sub> resulting in different nitroarene isomers. Atmospheric nitroarenes are largely in the vapour phase while the direct nitrated nitroarenes of similar volatility are found in particle extracts distributed between the gas/vapour phase<sup>37,38</sup>.

### Atmospheric reactions

Most of the experimental work on PAH has been conducted on 4 or 6-ring compounds. The PAH undergoes photolysis and reacts with OH and NO<sub>3</sub> radicals, N<sub>2</sub>O<sub>5</sub> and ozone. As the ambient atmosphere contains oxides of nitrogen and OH radicals, it was proposed that the gas-phase reactions of PAH with OH occurred in daytime and with N<sub>2</sub>O<sub>5</sub> at night. N<sub>2</sub>O<sub>5</sub> is generated in the atmosphere from the reaction between NO<sub>2</sub> with O<sub>3</sub> to form NO<sub>3</sub> radicals. NO<sub>3</sub> then reacts with NO<sub>2</sub> to give N<sub>2</sub>O<sub>5</sub> as shown in reactions 1 and 2.



In the presence of sunlight the NO<sub>3</sub> reacts rapidly with NO to yield NO<sub>2</sub> and it is photolysed via reactions 3 and 4.



Hence, the potential for NO<sub>3</sub> and N<sub>2</sub>O<sub>5</sub> existing in the atmosphere depends upon simultaneous existence of O<sub>3</sub> and NO<sub>2</sub> in the absence of nitric oxide and sunlight. The reaction mechanism for the formation of a typical PAH is illustrated in Figure 5. The basic steps involve (i) addition of OH at the site of highest electron density, (ii) addition of NO<sub>2</sub> to OH-PAH adduct and (iii) loss of water to form nitroarene as shown below in Figure 7. It was suggested that this mechanism could proceed partly or fully in gas phase, followed by condensation of the products, i.e. nitro-PAH on the surface of the particles<sup>39</sup>.

Nitroarenes were formed under laboratory conditions when PAH reacted with gas-phase OH radical (in presence of NO<sub>x</sub>) and N<sub>2</sub>O<sub>5</sub><sup>40-45</sup>. The atmospheric nitroarene formation rate depends upon the concentration of the individual species N<sub>2</sub>O<sub>5</sub>-NO<sub>3</sub>-NO<sub>2</sub>. An analogous reaction sequence occurs when PAH reacts in N<sub>2</sub>O<sub>5</sub>-NO<sub>3</sub>-NO<sub>2</sub> systems<sup>46</sup>. Naphthalene reacts with NO<sub>3</sub> radical forms NO<sub>3</sub>-naphthalene adduct, which dissociates or reacts with NO<sub>2</sub> to form nitronaphthalene and other products as shown in Figure 6.

Table 3 shows the atmospheric lifetime for eleven PAH with respect to gas-phase reaction with OH and NO<sub>3</sub> radicals, O<sub>3</sub> and N<sub>2</sub>O<sub>5</sub>. This was calculated from the estimated and calculated rate constants. It is evident that most of the nitroarenes formed under ambient atmospheric conditions were produced by reaction of PAH with OH. The PAH reaction with NO<sub>3</sub> radical was also considered as an important step because it resulted in the formation of nitroarenes from the N<sub>2</sub>O<sub>5</sub> reaction with gas-phase PAH.

However, it should be noted that the amount of nitrated (NO<sub>2</sub> and NO) compounds in diesel exhaust can be correlated with a number of experimental variables. The key

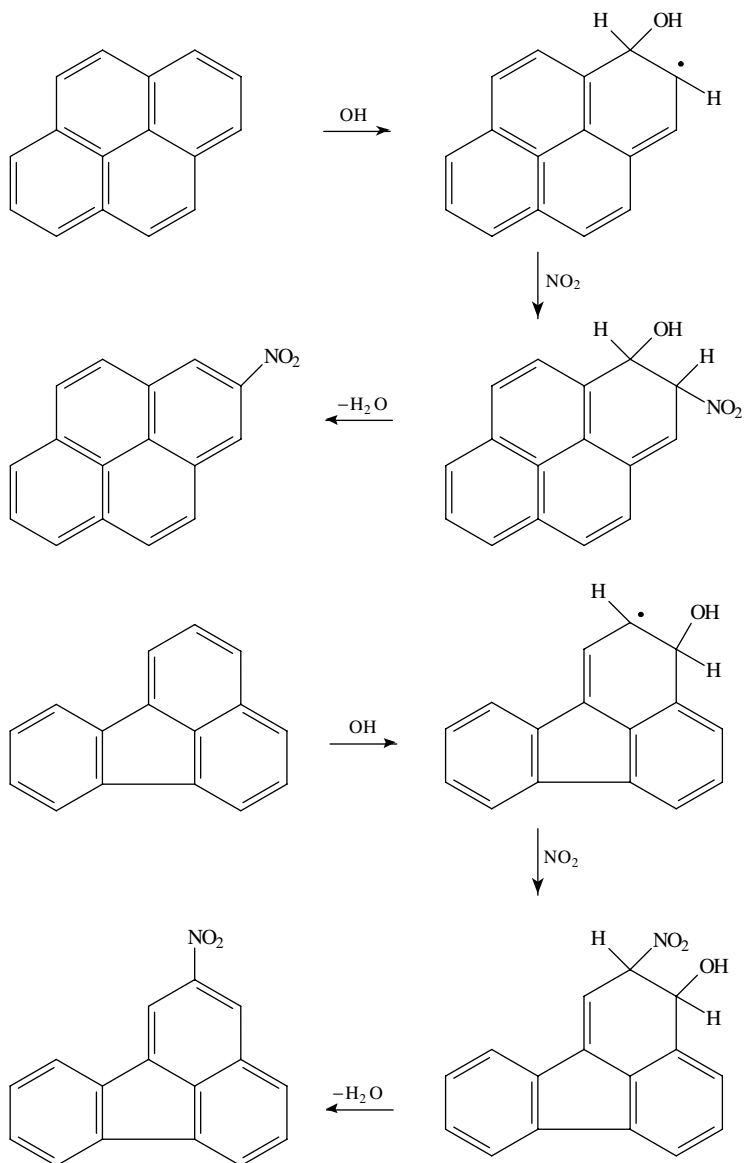
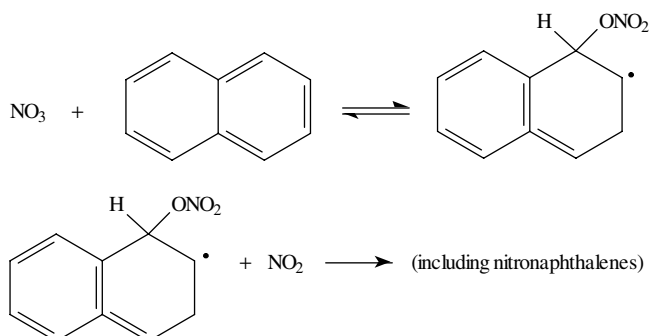


FIGURE 5. Gas-phase reactions of PAH with OH radicals and NO<sub>2</sub>

issue still to be resolved is whether these compounds are formed in the combustion regions (i.e. combustion chambers) or are formed by secondary reaction products in the exhaust soot deposits. Some experimentalist have not found any nitrated products in diesel exhausts<sup>48</sup>. However, dinitro compounds like 1,3-dinitropyrene, 1,6-dinitropyrene and 1,8-dinitropyrene have been identified in the diesel exhaust by other authors<sup>49</sup>.

FIGURE 6. Reaction sequence for PAH reaction with  $\text{N}_2\text{O}_5$ - $\text{NO}_3$ - $\text{NO}_2$  systemTABLE 3. Calculated atmospheric lifetimes of PAH due to gas-phase reactions with OH and  $\text{NO}_3$  radicals,  $\text{O}_3$  and  $\text{N}_2\text{O}_5$ <sup>47</sup>

PAH	Lifetime due to reaction with			
	OH <sup>a</sup>	$\text{NO}_3$ <sup>b</sup>	$\text{N}_2\text{O}_5$ <sup>c</sup>	$\text{O}_3$ <sup>d</sup>
Naphthalene	8.6 h	—	83 days	>80 days
1-Methylnaphthalene	3.5 h	—	35 days	>125 days
2-Methylnaphthalene	3.6 h	—	28 days	>40 days
Acenaphthylene	1.7 h	13 min	—	~43 min
Acenaphthene	1.8 h	2.5 h	21 days	>30 days
Biphenyl	2.1 days	—	>16 yr	>80 days
Phenanthrene	6.0 h	—	—	—
Anthracene	1.4 h	—	—	—
Fluoranthene	3.7 h	—	64 days	—
Pyrene	3.7 h	—	21 days	—
Acephenanthrylene	1.8 h	2.5 h	21 days	>30 days

<sup>a</sup>For a 12-h daytime OH radical concentration of  $1.5 \times 10^6$  molecules  $\text{cm}^{-3}$ .

<sup>b</sup>For a 12-h nighttime  $\text{NO}_3$  radical concentration of  $2.4 \times 10^8$  molecules  $\text{cm}^{-3}$ .

<sup>c</sup>For a 12-h nighttime  $\text{N}_2\text{O}_5$  radical concentration of  $2.0 \times 10^{10}$  molecules  $\text{cm}^{-3}$ .

<sup>d</sup>For a 24-h daytime  $\text{O}_3$  radical concentration of  $7 \times 10^{11}$  molecules  $\text{cm}^{-3}$ .

The soot particles emitted from the diesel and petrol exhaust were found to be very stable over a period of hours. These PAH could undergo nitrosation with nitrogen oxides also produced in the combustion process to give rise to nitroarenes. Diesel particles obtained from a car engine were reacted with  $\text{N}_2\text{O}_5$  and their rate constant was determined. The rate of reaction for the degradation of particulate PAH on atmospheric soot in presence of gas-phase  $\text{N}_2\text{O}_5$  was given by the expression<sup>50</sup>:

$$r = k_{\text{spec}}[\text{PAH}]_{\text{mass}}[\text{O}]$$

where  $r$  is the rate of reaction in moles/unit time and  $k_{\text{spec}}$  is the specific composite constant unique to the particle size distribution;  $[\text{PAH}]_{\text{mass}}$  denotes the surface coverage and  $[\text{O}]$  is the concentration (mass/volume) of the gas oxidant (i.e.  $\text{N}_2\text{O}_5$ ). The rate constants for  $\text{N}_2\text{O}_5$  on atmospheric soot particles were found to be in the range from  $5 \times 10^{-18}$  to  $3 \times 10^{-18}$   $\text{cm}^{-1}$  molecule<sup>-1</sup> s<sup>-1</sup>.

Similarly, the rate constants for gas-phase PAH and  $N_2O_5$  were determined from the following expression:

$$\text{rate} = k_g [N_2O_5] [\text{PAH}]$$

where the rate equals the gas-phase rate constant  $k_g$  multiplied by the vapour-phase concentrations of  $[N_2O_5]$  and  $[\text{PAH}]$ . The rate constants reported for  $N_2O_5$  with methyl-naphthalenes are in the range of  $1.4 \times 10^{-17}$  to  $5.7 \times 10^{-17} \text{ cm}^3 \text{ molecule}^{-1} \text{ s}^{-1}$ . It was also estimated that nearly 95% of gaseous PAH would react with  $N_2O_5$  to give nitro-PAH.

Most PAH are carcinogenic in nature. The biological effects can be put into two categories; effects on health and effects on the ecosystem. Both can be acute or on a long term basis. The different biological responses can be related to each other since the same substance can give rise to several reactions in the organism or in the ecosystem. Nitro-PAH are considered to be even more potent carcinogens than their parent molecules. Hence, nitro-PAH can be classified as possible etiologic agents. Present data do not demonstrate a convincing association between exposure of nitro-PAH found in the petrol and diesel exhaust to that of lung cancer incidence. However, inhalation studies of structures analogous to that of benzo[*a*]pyrene (1,6-dinitropyrene, 6-nitrochrysene) have shown these to be tumorigenic to rodent lung<sup>51</sup>. The structures are shown in Figure 7. However, an epidemiologic study of motor exhaust-related occupation has suggested a possible risk for bladder cancer. Both 2-nitronaphthalene and 4-nitrobiphenyl have been attributed to induce bladder tumours, although bioassay data are limited<sup>52</sup>.

Application of oxygen enrichers in diesel engines, which are made of an assembly of a large number of hollow fibers, has been shown to emit low levels of soot and  $NO_x$ . The oxygen enrichers can dissolve oxygen from the atmospheric air and this technique can keep a balance between the air/fuel ratio. The exhaust gas containing the polyaromatics is recycled into the engine and subsequently oxidized into leading to low emissions of soot and  $NO_x$ .

Table 4 gives a list of nitro-PAH arising directly from combustion measured in different cities of the world. This is presented as air concentration and as nitro-PAH levels in soot.

Nitrated phenols were identified in fog water in north-eastern Bavaria<sup>54</sup>. Phenols are emitted mainly through combustion processes<sup>55</sup> or evaporation from the waste water and are very reactive in the atmosphere. The nitrated phenols are formed by atmospheric photochemical reactions of aromatic compounds such as benzene, toluene and cresols with OH-radicals and nitrogen oxides<sup>56-59</sup>. Figure 8 shows the structure of nitrophenols identified in the fog. Some of these nitrophenols are included by the Environmental Protection Agency (EPA) list as pollutants, although hardly any data are available regarding their

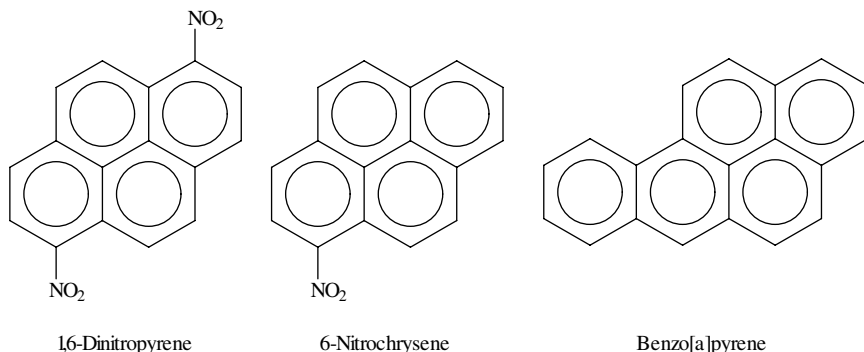


FIGURE 7. Nitroarene structures analogous to that of benzo(*a*)pyrene

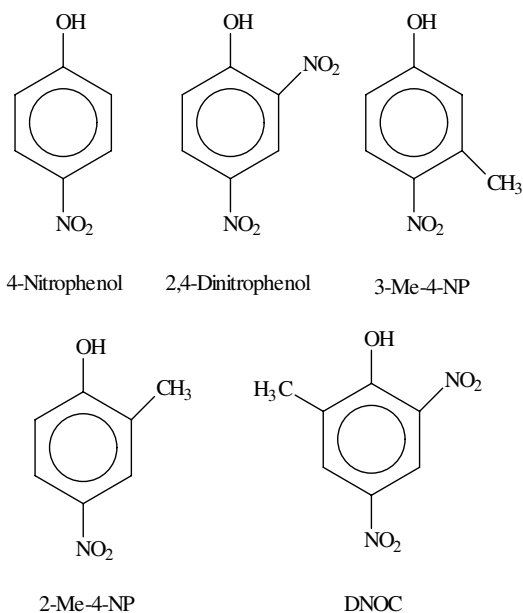


FIGURE 8. Nitrophenols identified in the fog

TABLE 4. Occurrence of nitroarenes<sup>53</sup>

Chemical (mutagenicity)	Location/Source	ng/m <sup>3</sup> air	μg/g extract from soot
3-Nitrotoluene	Ambient air Boise, ID U.S.		0.1–0.6
1-Nitronaphthalene	Diesel particles		0.3–0.7
	Ambient air Los Angeles, CA	2–3	
3-Nitrobiphenyl	Boise, ID	0.03–0.4	
	Ambient air Los Angeles, CA	0.03–0.1	
	Boise, ID	0.6–6.0	
2-Nitrofluorene	Diesel emissions		71–186
	Air particles Tokyo, Japan	ND–22	ND–0.3
	China	0.03–0.7	
	Germany	0.2–5	
9-Nitroanthracene	Diesel		5–94
	Ambient air Los Angeles, CA	0.05–0.1	
	Boise, ID	0.04–1.5	
	Columbus, OH		
	Outdoors	0.01–0.1	
	Indoors	0.04–1.3	

(continued overleaf)

TABLE 4. (continued)

Chemical (mutagenicity)	Location/Source	ng/m <sup>3</sup> air	μg/g extract from soot
1-Nitropyrene	Diesel particles		100–200
	Gasoline particles		2.5
	Air particles		
	Detroit, MI	0.2–0.6	
	Tokyo, Japan	0.2–1.6	
	Boise, ID	0.06–0.1	
	Los Angeles, CA	0.03–0.04	
	Columbus, OH		
	Outdoors		0.01–0.05
	Indoors		0.005–0.1
2-Nitrofluoranthene	Air particles		
	Boise, ID	0.07–0.2	
	Los Angeles, LA	0.3–0.4	
	Columbus, OH		
	Outdoors	0.03–0.2	
	Indoors	0.01–0.2	
	Air particles		
3-Nitrofluoranthene	Boise, ID	0.07–0.2	
	Los Angeles, LA	0.3–0.4	
	Columbus, OH		
	Outdoor	0.03–0.2	
	Indoors	0.01–0.2	
3-Nitrofluoranthene	Diesel particles	0.9–7.0	
	6-Nitrobenzo( <i>a</i> )pyrene		
Diesel particles	ND–50		
	Gasoline particles	0.2–33	
Air particles			
	Michigan, U.S.	0.9–2.5	0.04–0.3
1,3-Dinitropyrene	Diesel particles		ND–1.6
	Kerosene heater		0.5
Air particles			
	Tokyo, Japan		0.005
	Diesel particles	ND–1.2	
1,6-Dinitropyrene	Air particles		
	Michigan, U.S.	0.004–0.05	0.1–4.4
	Tokyo, Japan	0.005–0.1	0.3–8.7
1,8-Dinitropyrene	Diesel particles		
	Air particles		ND–3.4
	Michigan US	0.04–3.8	0.002–0.5

concentrations and fluxes. Nitrophenols have been suggested to be possible contributors to forest decline<sup>60</sup>.

## B. Nitroso Compounds

For the past three decades, active research has been carried out on N-nitroso compounds (NOC) and related compounds. The impact of NOC and nitrogen oxides regarding their effect on human health and safety aspects is well documented in the literature<sup>61–63</sup>. Exposure to nitrogenous chemicals, pollutants and their precursors is mainly via ingestion; however, in some cases inhalation is the major route of exposure.

The nitroso compounds can be formed by reaction with organic compounds present in the atmosphere and include two categories namely N-nitroso and C-nitroso compounds.



The former are formed by the reaction of aromatic amines and  $\text{NO}_x$  in the atmosphere whereas the latter are formed during combustion processes. N-nitroso compounds have been studied extensively and some of them are discussed below.

The N-nitroso compounds are substances that have a characteristic linkage of a secondary nitrogen atom to the nitroso group,  $\text{N}=\text{O}$ . These compounds can be formed by interaction of nitrosable substrates with nitrosating agents as illustrated in Figure 9.

Nitrosamines, which are the amides of nitrous acid, are more stable and are derived from secondary amines with nitrous acid. N-nitrosamides are substances which have a carbonyl group attached to a nitrogen-bearing NO group, e.g. N-nitrosamides, N-nitrosocarbamates and N-nitrosoureas; see Figure 10.

NOC are widely distributed in the human environment and their largest exposures occur in certain work environments. However, very little data are available on the occupational exposure of NOC. The general situation for occupational exposure to NOC is summarized later in Table 5.

### 1. Leather and tanning

In the leather and tanning industry dimethylamine sulphate is used in depilation processes. Under alkaline conditions, dimethylamine is released into the atmosphere and it reacts with nitrogen oxides produced from exhaust emissions, to give

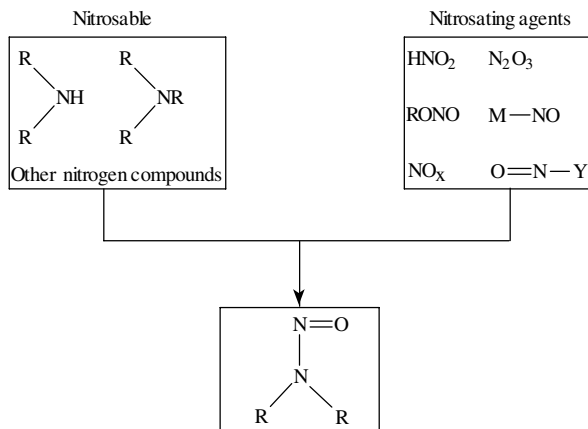


FIGURE 9. Routes leading to formation of nitrosamines

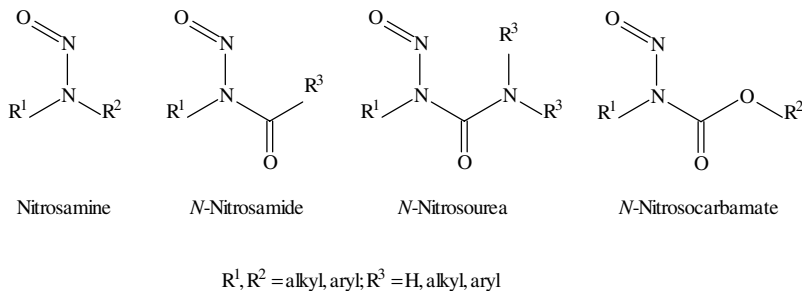


FIGURE 10. Structure of N-nitrosamines and N-nitrosamides

*N*-nitrosodimethylamine (NDMA). *N*-Nitrosomorpholine (NMOR) is also produced in this process, but the origin of this pollutant is unknown. Samples collected from different tanneries showed airborne nitrosamine contamination ranging from 0.05–47  $\mu\text{g}/\text{m}^3$  NDMA (mean 3.4  $\mu\text{g}/\text{m}^3$ ) and 0.05–2.0  $\mu\text{g}/\text{m}^3$  NMOR (mean 0.2  $\mu\text{g}/\text{m}^3$ )<sup>64</sup>. Studies have indicated the possible risk of nasal cancer to workers exposed to NDMA at a daily exposure level of 440  $\mu\text{g}$  NDMA/person/day and 20  $\mu\text{g}$  NMOR/person/day<sup>65</sup>. Animals exposed to long-term inhalation of NDMA were found to have formed malignant tumours of mainly the liver and kidney<sup>66</sup>.

## 2. Rubber industry

The formation of nitroamines occurs due to the use of certain vulcanisation accelerators such as thiuams, dithiocarbamates and sulphenamides. These agents are nitrosated during the vulcanisation process. The origin of the NOC is primarily due to the adsorption of  $\text{NO}_x$  on the large surface of inorganic rubber additives, e.g. zinc oxide and carbon black or nitrosating rubber chemicals. Figure 11 shows the nitrosation reactions of typical accelerators<sup>67</sup>.

The extent of formation of these NOC depends upon the presence of nitrogen oxides present in the atmosphere during the manufacturing cycle. The major contaminants are NDMA, *N*-nitrosodiethylamine (NDEA), *N*-nitrosopyrrolidine (NPYR), NMOR, *N*-nitrosodiphenylamine (NDPhA), *N*-nitrosopiperidine (NPIP) and *N*-nitrosodibutylamine (NDBA)<sup>68</sup>. NMOR was found in the hot process areas; NDMA occurred in tube production areas in which NDPhA was being used as retarder and tetramethylthiuram disulphide as an accelerator. Figure 12 shows a proposed reaction scheme of formation of NOC in the rubber industry and subsequent exposure<sup>67</sup>.

The nitrosamine formation can be controlled by meeting the following regulations<sup>69</sup>:

- Block or reduce nitrogen oxide species, have adequate ventilation
- Degrade nitrosamine
- Use amine-free accelerators by changing compounds

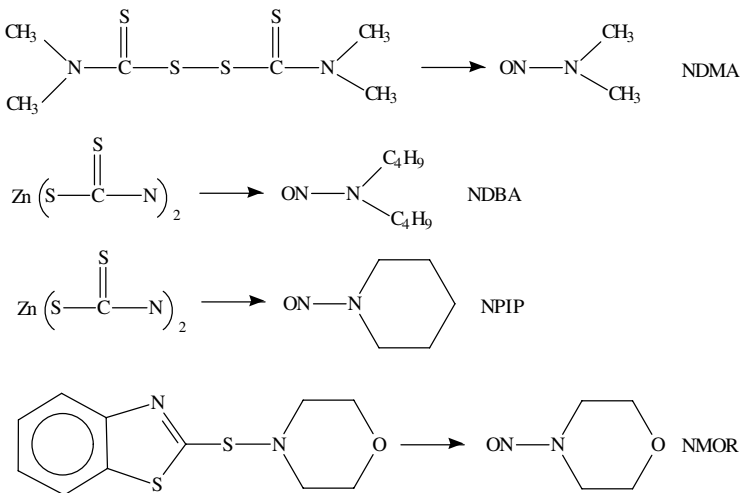


FIGURE 11. Formation of different NOC from their corresponding accelerators

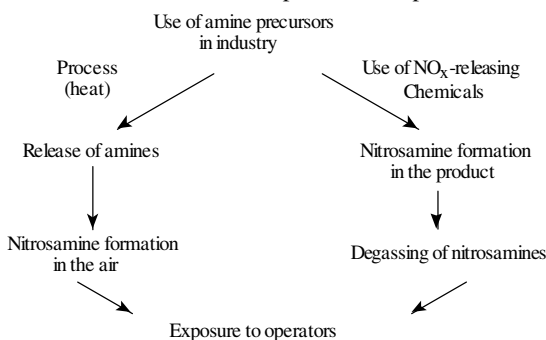


FIGURE 12. Proposed reaction mechanism of formation and exposure

### 3. Metal and machining

One of the major pollutants in this industry is *N*-nitrosodiethanolamine (NDELA) arising from cutting fluids. The simultaneous use of diethanolamine or triethanolamine cutting fluids with nitrite as an anticorrosion (antioxidative) agent in the formulation results in NDELA production. Workers come into direct contact due to inhalation of oil mists as they handle the products directly. The demonstration of dermal penetration of NDELA has been shown in both humans and animals. NDELA in laboratory animals has been shown to induce cancer in different organs like liver, kidneys, nasal cavity and papilloma of trachea<sup>70,71</sup>. Workers staying in rooms with  $1 \mu\text{g}/\text{m}^3$  revealed two times more DNA damage in mononuclear blood cells than those staying in an environment with less than  $50 \text{ ng}/\text{m}^3$ . However, no significant correlation was obtained between the extent of DNA damage and the extent of skin contact or the concentration of NDELA found in the cutting fluids<sup>72</sup>.

Table 5 gives the exposure level of different *N*-nitrosamines analogously arising as pollutants from various chemical industries<sup>73</sup>.

TABLE 5. Occupational exposure to *N*-nitroso compounds

Industry/occupation	<i>N</i> -Nitrosamine	Exposure levels
Metal working industry	<i>N</i> -nitrosodiethanolamine (NDELA)	>50
	<i>N</i> -nitrosodiethanolamine (NDELA)	>50
Metal foundries (core-making)	<i>N</i> -nitrosodimethylamine (NDMA)	>5
	<i>N</i> -nitrosodiethylamine (NDEA)	>5
Leather tanneries	<i>N</i> -nitrosodimethylamine (NDMA)	>50
Rubber and tyre industry	<i>N</i> -nitrosodimethylamine (NDMA)	>50
	<i>N</i> -nitrosodiethylamine (NDEA)	>5
	<i>N</i> -nitrosodibutylamine (NDBA)	>5
	<i>N</i> -nitrosomorpholine (NMOR)	>50
	<i>N</i> -nitrosomethylphenylamine (NMPPhA)	>50
Chemical industries		
Rocket fuel industry	<i>N</i> -nitrosodimethylamine (NDMA)	>50
Dye manufacture	<i>N</i> -nitrosodimethylamine (NDMA)	<5
	<i>N</i> -nitrosodiethylamine (NDEA)	<5
Detergents and surfactants	<i>N</i> -nitrosodimethylamine (NDMA)	<5
Amine and pesticide production	<i>N</i> -mononitrosopiperazine (NMPZ)	<5
Fish processing industry	<i>N</i> -nitrosodimethylamine (NDMA)	<5
Warehouse and sale rooms (especially for rubber products)	<i>N</i> -nitrosodimethylamine (NDMA)	>5
	<i>N</i> -nitrosomorpholine (NMOR)	>5

#### IV. ENVIRONMENTAL EXPOSURE TO PREFORMED NITROSAMINES

The presence of non-volatile NOC, i.e. preformed nitrosamines, has been reported in various cosmetics, pharmaceutical products, foods, beverages and dairy products.

##### A. Sunscreens and Cosmetics

Nitrosamine contamination of cosmetic products and toiletries may result through formulation with nitrosamine contaminated amines or via formulation by contact with nitrosating agents or bactericides. Market surveys have detected up to 45 ppm nitrosodiethanolamide and 21 ppm 2-ethylhexyl 4-(*N*-methyl-*N*-nitrosamino) benzoate in several sunscreens and cosmetic products. Oxides of nitrogen can also act as potential nitrosating agents in cosmetics. The extent of exposure depends upon the frequency of usage, degree of absorption through the skin and nitrosamine stability on exposure to UV. Products like sunscreens, after being applied to skin, leave a non-aqueous layer as the water from the emulsion evaporates. Oxides of nitrogen can readily be absorbed into a non-polar matrix and nitrosate amines to produce nitrosamines<sup>74</sup>. However, the stability of nitrosamine can be questioned as it decomposes in the presence of UV light<sup>75</sup>. Hence, more research needs to be carried out where human exposure to NMPABOA and its decomposition in sunlight is concerned, although the carcinogenicity of NMPABOA is uncertain. The products can also undergo nitrosation over a period of time depending on conditions like its storage and temperature. A sunscreen product containing 2-ethylhexyl 4-(*N,N*-dimethylamino) benzoate (Padimate O) purchased in 1987 was free of nitrosamine contamination. The same product was found to contain 8 ppm nitrosamine derivatives in the year 1990. Hence, seasonal products such as sunscreen, not sold by the end of the summer, may be affected by nitrosamine levels in products depending on their storage conditions.

##### B. Pharmaceutical Products

Several pharmaceutical products undergo nitrosation and form nitrosamines during synthesis and storage *in vivo* under gastric conditions in human beings. Investigations have reported the development of tumours in test animals when they were exposed to long-term concurrent nitrite and drug feeding<sup>76,77</sup>. This in turn has caused some governments to impose legislation for the removal of nitrosamines from these products before the sale. Aminophenazone, a precursor to NDMA, was shown to induce sarcoma in liver and lung and hence has been removed from some pharmaceutical markets.

The production of hydrazine and hydrazones by reduction of nitrosamines is another route for NOC production. Piperazine also leads to production of NOC and its use as an antihelminthic has decreased considerably in most developed countries, though not in the case of developing countries due to its low cost.

Two *N*-nitrosoureas, Bischloroethyl-nitrosourea (BCNU) and 1-chloroethyl-3-cyclohexyl-1-nitrosourea (CCNU), have been used as anticancer agents in clinics but their mechanism and their toxicities have yet to be determined<sup>78</sup>.

##### C. Agricultural Products

There are several routes for nitrosamine contamination in pesticides: use of contaminated chemicals during synthesis, side reactions, use of nitrite as a preservative and corrosion inhibitor of metal containers and by reactions with environmental nitrosating agents. Over 300 formulations were shown to be contaminated with nitrosamines; however, the main contamination was confined to 2,6-dinitroaniline herbicides, dimethylamino salts of phenoxyalkanoic acid herbicide, diethanolamine and triethanolamine salts of acid

pesticide, quaternary ammonium compounds and morpholine derivatives<sup>79</sup>. Presence of NDPA in herbicide trifluralin was reported due to nitrosation of the respective amine used during synthesis.

Accumulation of agricultural chemicals in soils may lead to formation of nitrosamines. The herbicides atrazine and butralin were found to form nitrosamines only in the presence of high levels of nitrite. Active uptake of NDMA and NDEA by wheat and barley has been published; however, no conclusive evidence has been reported<sup>80</sup>.

#### D. Packing materials

Migration of nitrosamines into consumer products can occur via direct contact of materials such as waxed containers, elastic and rubber etc.<sup>81</sup>. Morpholine is used extensively as an industrial solvent for wax formulations. The wax formulations are used for coating fruits and vegetables to prevent moisture loss and increase shelf-life of the products. Paper and cardboard packed with morpholine was also found to give rise to NDMA, as these packaging materials were found to be contaminated with NDMA as well. Besides this, rubber products also provided a migratory source for both nitrosamines and nitrosable amine precursors, as trace levels of NDEA and *N*-nitrosodibutylamine (NDBA) have been reported in cured meats with amine-based accelerators in the rubber nettings<sup>82</sup>.

#### E. Foods and beverages

NOC constitute a large category of genotoxic chemical carcinogens occurring in human diet and are known to induce cancer in experimental animals. Nitrosamines are generally found in foods since they are more stable than nitrosamides. Some NOC precursors do not act directly but must be converted to other nitrosation species.

Human exposure to nitrates is via exposure to food and drinking water. The nitrates in food may be present naturally or as an additive introduced for various technological reasons. Nitrite is added to foods for preservation, but is reactive in foods, whereas nitrate is quite unreactive.

Vegetables are also a prime source of nitrate, and variations in their nitrate levels occur due to conditions employed during the cultivation and storage processes. The nitrate concentration in surface water has increased due to increased use of artificial fertilizers, changes in land use and disposal of waste from intensive farming. Nitrate is readily converted in mammalian systems through bacterial and mammalian enzymes to nitrite which can react with amines, amides and amino acids to form NOC.

Critical analysis has shown that most dietary components contaminated with NOC can be classified into different categories as follows<sup>83</sup>:

- In foodstuff preserved by addition of nitrate/nitrite (namely cured meat produce and cheeses) both methods of preservation introduce nitrosating species into the food matrix.
- In foodstuffs preserved by smoking (such as fish and meat products) oxides of nitrogen present in the smoke act as nitrosating agents.
- Nitrosated amino acids during cooking yield corresponding volatile nitrosamines: *N*-nitrosoproline (NPRO), *N*-nitroso-4-hydroxyproline (NHPRO) and *N*-nitrososarcosine (NSAR), respectively.
- Concentration of different *N*-nitrosamines in nitrite-cured meat products is further increased following smoking processes.
- Foodstuffs subject to drying by combustion gases (containing oxides of nitrogen) such as malt for production of beer and whiskey, low-fat dried milk products and spices.

- Pickled and salt-preserved foods, in particular plant-based products (pickled vegetables) in which microbial reduction of nitrate to nitrite occurs. Foodstuffs stored under humid conditions favouring fungal contamination, particularly the growth of *Fusarium moniliforme*.
- Migration and formation of nitrosamines from food contact materials.

The last source of NOC that has been a major source for health concern of infants is usage of rubber pacifiers and baby feeding bottles fitted with rubber nipples. NOC present in the rubber formulations can migrate into baby foods and drinks and into meat packed in rubber nettings.

Various NOC can be found in food processing operations. The most commonly known contributors to dietary volatile and non-volatile N-nitrosamines are nitrite cured meats, particularly fried bacon and beer. Several reviews cover the occurrence and formation of NOC in foods and beverages<sup>84-86</sup>.

The contamination in beer with NOC was first reported in Germany in 1979<sup>87</sup>. The contamination of beer occurs during the kilning (drying) process of malt<sup>88</sup> and fermentation<sup>89</sup>, which leads to the occurrence of NDMS and NPYR. The nitrogen oxides were identified as a source of nitrosamine formation in the beer, formed by nitrosation of the alkaloids present in the malt<sup>90</sup>.

Since NDMA is a potent carcinogen it could pose serious health implications, as beer is widely used in Western Europe. A recent study which involved 14 German beers could detect only two compounds, NDMA ( $0.17 \pm 0.18$  mg/kg) and NPYR ( $1.5 \pm 1.01$  mg/kg), in very low concentrations. Continuous efforts by the brewing industry and change in brewing technology has resulted in a significant reduction in the NDMA contamination by 1-5% over the years. See Table 6 for details. Hence it can be concluded that for moderate beer drinkers, current levels of NDMA are unlikely to represent a significant health risk, and NPYR was shown to be non-carcinogenic<sup>92</sup>.

TABLE 6. Reduction of *N*-nitrosodimethylamine (NDMA) in beer and some representative current data<sup>91,85</sup>

Country	Year	NDMA ( $\mu\text{g}/\text{kg}$ )	
		mean	range
FRG	1977/78	2.7	0-68
	1980	0.28	0-9.2
	1981	0.44	0-7.0
	1989	0.16	0-1.7
	1990	0.17	0-0.6
USA	1980	5.9	0-14
	1988	0.26	0.03-0.99
Canada	1978	1.4	0.60-4.9
	1982	0.31	0-1.9
USA & Canada	1989	0.07	0-0.58
Netherlands	1979	2.0	0-7.4
	1980	0.2	0-1.2
Italy	1982	0.4	0-0.79
	1986	0.3	0-0.71
	1988	0.2	0-6.5
Poland	1989	0.2	0-0.3
China	1981	2.1	0-6.5
	1987	0.5	0-6
Japan			0-<5
UK			0.9-23

Over the last two decades there has been a net decrease in both nitrate and nitrite in cured meats and foods. In cured meat products it is generally accepted that the formaldehyde present in the wood smoke is involved in the formation of *N*-Nitrosothiazolidine (NTHZ) and *N*-Nitrosothiazolidine-4 carboxylic acid (NTCA). Bacon represents a unique case as uncooked bacon is generally free of nitrosamines, but high levels of nitrosamines are formed during cooking. The conditions leading to formation of nitrosamines in bacon have been widely studied and the presence of NTCA in raw and fried bacon has been reported<sup>93-97</sup>. It has been suggested that the thermal process results in transformation of NTCA into NTHZ during the frying process<sup>98</sup>.

Over 300 NOC have been shown to be carcinogenic to more than one animal species. Table 7 shows some compounds present in the diet, their occurrence and their carcinogenicity<sup>99</sup>.

## F. Endogenous Formation

There is sufficient evidence to indicate that the NOC compounds represent a serious potential health hazard, although the magnitude of this hazard remains to be established. Exposure to nitroso compounds and their precursors is mainly via ingestion. However, in some cases inhalation may become the major route of exposure. Figure 13 illustrates the total exposure of NOC compounds on humans occurring via both exogenous and endogenous routes<sup>100</sup>.

Nitric oxide is formed endogenously in the body by many types of cells for the purpose of intercellular communication (brain, cardiovascular system), or as a part of the immune or inflammatory response (macrophages, endothelial cells). The chemistry of nitric oxide formation in the body is very complex both in terms of chemical species and in the number of parallel and consecutive reactions. Damage to DNA in mammalian cells is caused by at least two major pathways: one arising from the reaction of NO with molecular oxygen and the other by reaction of NO with superoxides. The first route gives  $N_2O_3$ , which can either (1) nitrosate secondary amines to form carcinogenic or mutagenic *N*-nitrosamines or (2) nitrosate primary amines on DNA bases. The latter reaction results in deaminated bases from adenine, cytosine, 5-methylcytosine and guanine. NOC have been shown to produce cancer in humans, particularly when exposure starts early in life and persists over a long period<sup>101</sup>. Figure 14 shows endogeneous NOC synthesis in the human body<sup>102</sup>. The NOC production is brought about by bacterial enzymes which catalyse nitrosation from

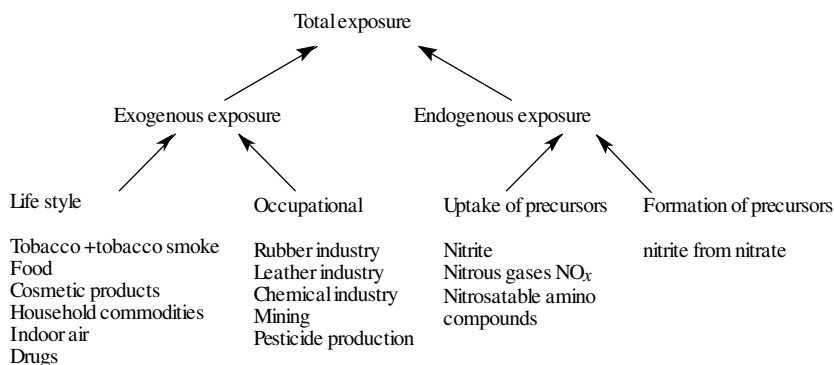
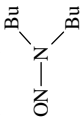
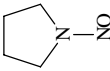
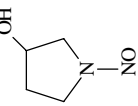
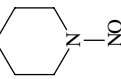


FIGURE 13. NOC and total exposure

TABLE 7. *N*-Nitroso compounds in the diet, carcinogenicity and occurrence<sup>99</sup>

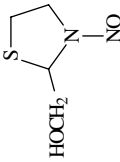
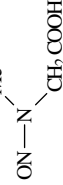
<i>N</i> -Nitroso compound	Carcinogenicity (following oral administration)			Major dietary source ( $\mu\text{g}/\text{kg}$ )	
	Species	Organotropy	Foodstuff	Range	Mean
<i>N</i> -Nitrosodimethylamine (NDMA) <chem>CN(C)N=O</chem>	Rat	Liver, kidney, (lung)	Cured meats	1.0–5.0	4.0
	Mouse	Liver, kidney, lung	Fried bacon	<2.3	
	Hamster	Liver, (glandular stomach)	Marine products:		
	Guinea pig	Liver	Dried fish (Japan)	3.0–39	8.6
	Rabbit	Liver, lung	Dried fish (Greenland)	8.6–38	43.9
Mink	Liver	Dried shrimps (China)	5.4–132		
<i>N</i> -Nitrosoethylmethylamine (NEMA) <chem>CN(C)N=O</chem>			Broiled squid (China)	<300	
			Millet flour and grain products (China)	0.1–1.3	0.5
			Dairy and cheese products	1–6	
			Dried milk products	<7.0	
			Edible oils and fats	<1.0	
			Pickled/fermented vegetables	<5.0	
			Beer	<0.5	0.2
			Alcoholic beverages (whisky)	<2.0	1.0
			Pickled/fermented vegetables (China)	<5.0	
	<i>N</i> -Nitrosodiethylamine (NDEA) <chem>CN(CC)N=O</chem>	Rat	Liver, nasal cavity, (oesophagus)		
Hamster		Liver, nasal cavity, trachea			
			Cured meats (packed in rubber nettings) Salami	<2.4	
<i>N</i> -Nitrosodimethylamine (NDEA) <chem>CN(CC)N=O</chem>	Rat	Liver, kidney, (oesophagus)			
	Mouse	Liver, lung, oesophagus, forestomach			
	Hamster	Trachea, lung, nasal cavity, (oesophagus, forestomach, liver)		<3.9	0.6
		Millet flour and grain products (China)	0.1–0.5	0.22	

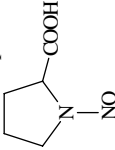
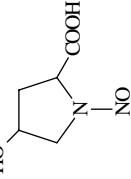
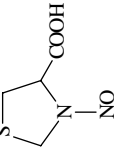


<i>N</i> -Nitrosodibutylamine (NDBA)		Rabbit, cat Guinea pig, dog, monkey	Liver, oesophagus Liver	Dried cuttlefish	<4.5	1.4
<i>N</i> -Nitrosopyrrolidine (NPY)		Rat	Liver, urinary bladder, (oesophagus, pharynx) Fore stomach, liver, oesophagus, urinary bladder, (lung) Respiratory tract, lung, urinary bladder Liver, urinary bladder Liver, nasal cavity, (vagina, testis) Lung	Cured meats (packed in rubber nettings) Smoked chicken Dried fish (Japan)	1–56 <5.3 <3.1	10.2
<i>N</i> -Nitroso-3-hydroxy- pyrrolidine (NHPYR)		Mouse		Cured meats Fried bacon Pickled vegetables Mixed spices Dried chillies Broiled squid	1.0–5.0 <130 <96 <10 <6.0 2.4–13	1.8 17 3.1
<i>N</i> -Nitrosopiperidine (NPIP)		Rat	Liver, oesophagus, upper respiratory and digestive tracts, nasal cavity Fore stomach, liver, lung Liver, upper respiratory and digestive tracts	Cured meats Fried bacon	<20 <9.2	2.2
		Mouse Hamster		Peppered salami Pepper Mixed spices Pickled vegetables	<30 <300 0.6–3.5 <14	5.8

(continued overleaf)

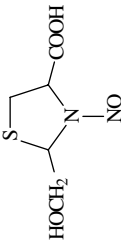
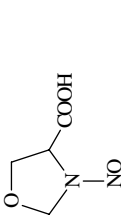
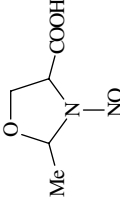
TABLE 7. (continued)

N-Nitroso compound	Carcinogenicity (following oral administration)			Major dietary source ( $\mu\text{g}/\text{kg}$ )	
	Species	Organotropy	Foodstuff	Range	Mean
N-Nitrosothiazolidine (NTHZ)	Rat	Non-carcinogenic	Cured meats Fried bacon Smoked fish Smoked oyster	<32 <30 <6 <109	8.9
					
N-Nitroso-2-hydroxymethylthiazolidine (NHMTTHZ)		No data available	Cured meats Smoked ham	Occasionally <2.8	
N-Nitrosomorpholine (NMOR)	Rat Mouse Hamster	Liver, (kidney, ovary) Liver, lung Liver, upper respiratory tract, colon	Packaging contamination of: Fats/margarine Dairy products	1.7-3.8 <3.2	
N-Nitrosocarcosine (NSAR)	Rat Mouse	Oesophagus Lung, nasal cavity, (small intestine)	Cured meats Pickled vegetables Brewing malt	<410 <36 Occasionally	
					

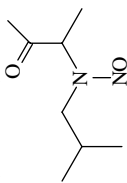
<i>N</i> -Nitrosoproline (NPRO)		Rat Mouse	Non-carcinogenic Non-carcinogenic	Cured meats Preserved fish Broiled squid Dried vegetables Dried chillies Brewing malt Beer	20-580 <89 <94 <24 <132 <113 1-6 10-560	140      1.7
<i>N</i> -Nitroso-4-hydroxyproline (NHPRO)		Rat Mouse	Non-carcinogenic Non-carcinogenic	Cured meats	10-560	1.7
<i>N</i> -Nitrosothiazolidine-4-carboxylic acid (NTCA)			No data available	Cured meats Fried bacon Smoked poultry Smoked fish Smoked oyster Smoked cheese	<1620 <14,000 <1240 <1600 <167 5-24	85  67
<i>N</i> -Nitroso-2-methylthiazolidine-4-carboxylic acid (NMTCA)			No data available	Cured meats Smoked poultry	<28 <98	

(continued overleaf)

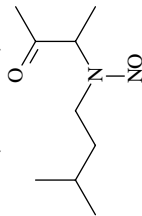
TABLE 7. (continued)

<i>N</i> -Nitroso compound	Species	Carcinogenicity (following oral administration)	Foodstuff	Concentration	
				Major dietary source ( $\mu\text{g}/\text{kg}$ )	Mean
<i>N</i> -Nitroso-2-hydroxymethyl-thiazolidine-4-carboxylic acid (NHMTCA)		No data available	Cured meats Smoked cheese Smoked poultry	<2100 <1628 <462	
<i>N</i> -Nitrosooxazolidine-4-carboxylic acid (NOCA)		No data available	Cured meats	40-70	
<i>N</i> -Nitroso-5-methyloxazolidine-4-carboxylic acid (NMOCA)		No data available	Cured meats	30-120	

*N*-Nitroso-*N*-(1-methylacetyl)-2-methylpropylamine (NMAMPA)



*N*-Nitroso-*N*-(1-methylacetyl)-3-methylbutylamine (NMAMBA)



Mice

Forestomach  
(tested by feeding with amine + nitrite)

Moldy millet and wheat flour

< 1.2

No data available

Millet flour and grain products (China)

0.1 – 1.3

0.2

Reproduced with permission from Reference 83.

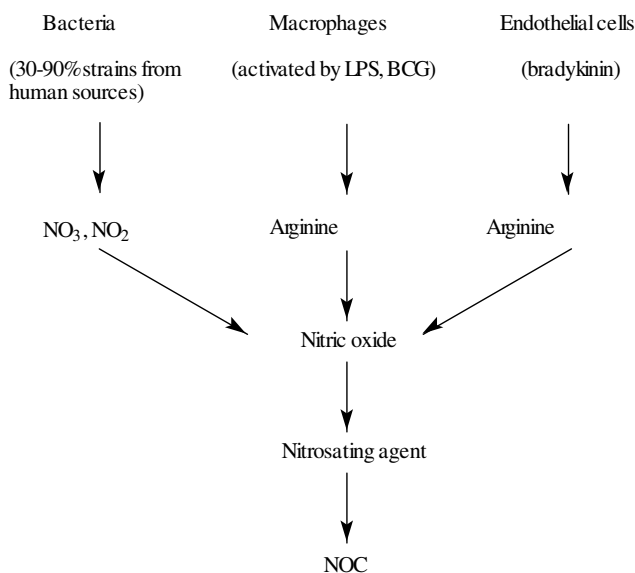


FIGURE 14. Proposed scheme of formation of NOC by bacterial activated macrophages and endothelial cells through intermediate nitric oxide

nitrate or nitrite, probably through formation of nitric oxide at natural pH. Activated macrophages use arginine as a source to produce nitric oxide. Once generated, nitric oxide can be oxidized to nitrosating agents that form NOC readily in the presence of amines. A similar reaction is thought to occur also in endothelial cells.

## V. AMINES

Several amino compounds are being used extensively in industrial processes. Most of these compounds are manufactured, except hydrazine. Azo dyes are produced by diazotization of aromatic amines and currently there are at least 3000 azo dyes in use. These dyes are used widely in textiles, leather, printing, paper making, drug and food industries. In the past three decades many food, drug and cosmetic colours have been banned from commercial use as food colourants. This section gives a brief account of adverse effects caused by the use of various amino compounds.

### A. Hydrazine

The only known natural source of hydrazine is found in tobacco plants and it may also occur as an intermediate in biological nitrogen fixation. Alkaline solutions of hydrazine in water can be subject to autooxidation by dissolved oxygen, leading to increased hardness and high pH. Decomposition of hydrazine and the increase of pH just below 7 have adverse effects on the marine life ecology. Frog spawn showed teratogenic effects, the embryos of fathead minnows showed deformities and the rainbow trout had poor fitting jaws, pronounced mouth gap and absence of body movement. In air, hydrazine can be oxidized by ozone and hydroxyl radicals. Hydrazine can also be co-metabolised to nitrogen gas by the nitrifying bacterium *Nitrosomonas*. Germination of seeds of brush squash, peanut and

corn was inhibited upon exposure to hydrazine and led to wilting and subsequently death of the plant<sup>2</sup>.

NOC might be generated by aerial oxidation of the hydrazines. Experimental studies on oxidation of 1,1-dimethylhydrazine which is not a mutagen and *N*-aminopiperidine which is a mutagen indicated that the oxides of both hydrazide samples were mutagenic<sup>103</sup>.

## B. Azo Dyes

These dyes are used extensively and can be divided into four different categories: azo dyes containing a nitro group, azo dyes containing benzeneamines and related chemicals, azo dyes containing a benzidine group and miscellaneous azo dyes. This section will not lay too much emphasis on the subject of azo dyes as several reviews exist on this topic<sup>104,105</sup>. Some of the dyes are not mutagenic but become mutagenic through intestinal microflora mechanism for mammalian azo reduction and chemical reduction. It is also possible that the carcinogenesis occurs due to formation of aromatic amines, formed by enzymatic cleavage of azo bonds with subsequent N-ring hydroxylation and N-acetylation of aromatic amines. Table 8 gives a list of dyes which were shown to be carcinogenic and mutagenic to animals and humans<sup>106</sup>. The + sign indicates that metabolic activation was required and the – sign shows cases where no activation was required, i.e. which are direct mutagens.

## VI. CONTROL AND LEGISLATION

Most of the pollution of nitroso and other nitrogen related compounds occurs mainly through anthropogenic sources, the largest contributor being combustion. Hence, legislation and control is basically oriented around controlling the amount of dry NO<sub>x</sub> input into the atmosphere. The estimated global NO<sub>x</sub> arising from anthropogenic sources is of the order 100 × 10<sup>6</sup> t/a, and it is increasing every year. By the year 2020 the expected NO<sub>x</sub> level is calculated to go up by a factor of 15%. In developed countries like Canada, USA, Europe and Japan limits and guidelines have been specified for the NO/NO<sub>2</sub> concentration levels. Amongst the developing countries China is one of the biggest NO<sub>x</sub> contributors; the total emission is around 6.77 Tg nitrogen per year<sup>107</sup>. The NO<sub>x</sub> level is in the developing countries are quite high due to lack of legislative and strategic policies. In order to control the increasing levels of NO<sub>x</sub> these countries need to implement specified levels of NO<sub>x</sub> concentrations that should be emitted into the atmosphere. To date, several reviews exist on the control technologies of NO<sub>x</sub><sup>6</sup>, the issue is to reduce the formation of nitroso and nitro compounds which are formed inadvertently in industrial processes or in the atmosphere. In case of the rubber industry, new accelerators are being tested which are relatively safe as they do not form carcinogenic nitrosamines<sup>108</sup>. Some of the straight-chain accelerators do not produce detectable amounts of environmentally undesirable *N*-nitrosoamines. The main source of NDMA and other nitrosamines occurs in food and beverages when direct fire is employed. This has been controlled by reducing the nitrate concentration in the foods and by employing ultra-low NO<sub>x</sub> burners. The formation of nitroso compounds in cosmetic products can be reduced by elimination of secondary amines as cosmetic ingredients, reduction of the levels of secondary amines and nitrite in the raw products, and avoiding contamination of cosmetics and raw materials with oxides of nitrogen. The federal government in the USA is imposing and amending regulations to reduce the discharge of nitroso compounds into the atmosphere. Besides this, smoking contributes to a high level of indoor pollution, hence most offices and work places are being designated as non-smoking zones in order to cut down the nitroso levels.

TABLE 8. Mutagenic azo dyes: chemical structures and requirements for metabolic activation<sup>106</sup>

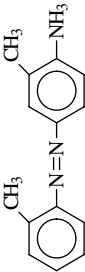
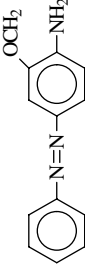
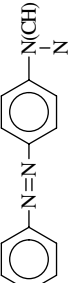
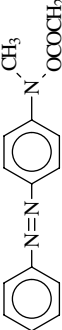
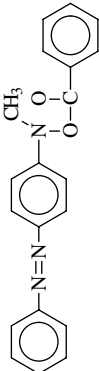
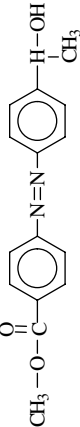

Common name	Chemical structure	Metabolic activation <sup>a</sup>
Azo Dyes Containing Nitro Groups		
Alizarin Yellow G G		-
Acid Alizarin Yellow R		-
Red GTL (C.J. Basic Red 18)		±
Orasol Navy Blue 2RB		±
Azo Dyes Containing Benzeneamines and Related Compounds		
Chrysoidin (C.I. Index 11270)		+



Sudan IV	+	
Guiba Black D (C.I. Direct Black 17)	±	
Methyl Red	+	
Methyl Orange	+	
<i>N,N</i> -Dimethyl-4- aminoazobenzene	+	
<i>N</i> -Methyl-4- aminoazobenzene	+	
4-Aminoazobenzene	+	
2-Methyl- <i>N,N</i> - dimethyl-4- aminoazobenzene	+	

(continued overleaf)

TABLE 8. (continued)

Common name	Chemical structure	Metabolic activation <sup>a</sup>
<i>O</i> -Aminoazotoluene		+
3-Methoxy-4-aminoazobenzene		+
<i>N</i> -Hydroxy-4-aminoazobenzene		+
<i>N</i> -Acetoxy- <i>N</i> -methyl-4-aminoazobenzene		-
<i>N</i> -Benzoyloxy- <i>N</i> -methyl-4-aminoazobenzene		-
4'-Methoxycarbonyl- <i>N</i> -hydroxy- <i>N</i> -methyl-4-aminoazobenzene		±
4'-Methoxycarbonyl- <i>N</i> -methyl-4-aminoazobenzene		±

4'-Methoxycarbonyl- <i>N</i> -benzoyloxy- <i>N</i> -methyl-4-aminoazobenzene		±
<i>N</i> -Hydroxyl- <i>N</i> -methyl-4-aminoazobenzene		±
<i>N</i> -Methyl- <i>N</i> -hydroxy-4-aminoazobenzene		±
3'-Methyl- <i>N,N</i> -dimethyl-4-aminoazobenzene		+
3'-Methyl- <i>N</i> -methyl-4-aminoazobenzene		+
3'-Methyl-4-aminoazobenzene		+
3'-Methyl- <i>N</i> -methyl-4-aminoazobenzene		+

(continued overleaf)

TABLE 8. (continued)

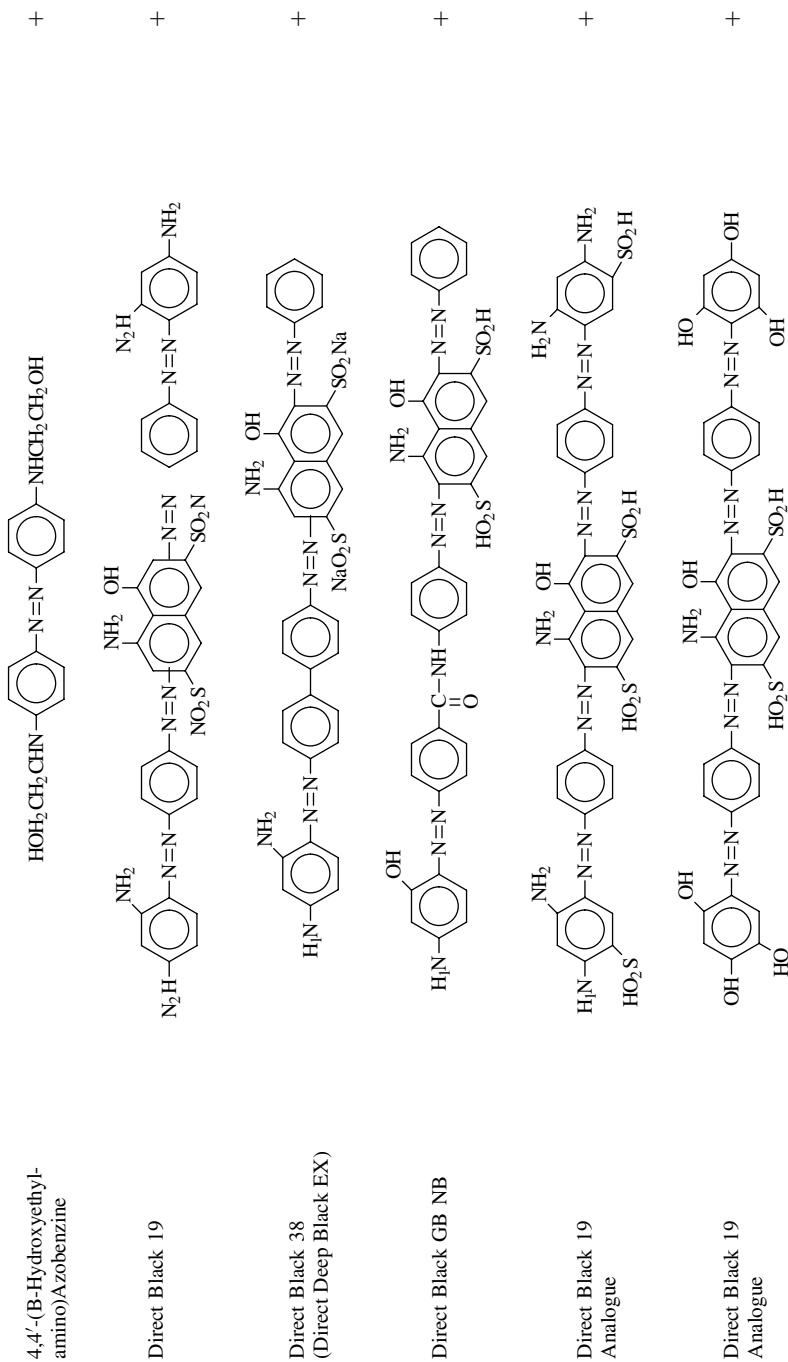
Common name	Chemical structure	Metabolic activation <sup>a</sup>
3'-Methyl- <i>N</i> -acetyl-4-aminoazobenzene		+
3'-Hydroxymethyl- <i>N,N</i> -dimethyl-4-aminoazobenzene		+
3'-Hydroxymethyl- <i>N</i> -methyl-4-aminoazobenzene		+
3'-Hydroxymethyl-4-aminoazobenzene		+
3'-Formyl- <i>N,N</i> -dimethyl-4-aminoazobenzene		+
3'-Carboxylic <i>N,N</i> -dimethyl-4-aminoazobenzene		+

3'-Carboxylic- N-methyl-4- aminoazobenzene	+	
3'-Methyl-4'-hydroxyl- N,N'-dimethyl-4- -aminoazobenzene	+	
3,3'-Bischloromethyl-4- aminoazobenzene	-	
3'-Acetoxymethane- N,N'-dimethyl-4- aminoazobenzene	+	
2'-Methyl-N,N'- dimethyl-4- aminoazobenzene	+	
2',3'-Hydroxylmethyl- N,N'-dimethyl-4- aminoazobenzene	+	
4'-Methyl-N,N'- dimethyl-4- aminoazobenzene	+	

(continued overleaf)

TABLE 8. (continued)

Common name	Chemical structure	Metabolic activation <sup>a</sup>
4'-Hydroxymethyl- <i>N,N</i> -dimethyl-4-aminoazobenzene		+
6-Dimethylaminophenyl-azobenzthiazole (6BT)		+
5-Dimethylamino-phenylazoindoline (5I)		+
Chrysoidin Y (C.I. Index 11325)		+
Bismark Brown Y (C.I. Index 21000)		+
Bismark Brown R (C.I. Index 21010)		+
4,4'-Diaminoazobenzene		+

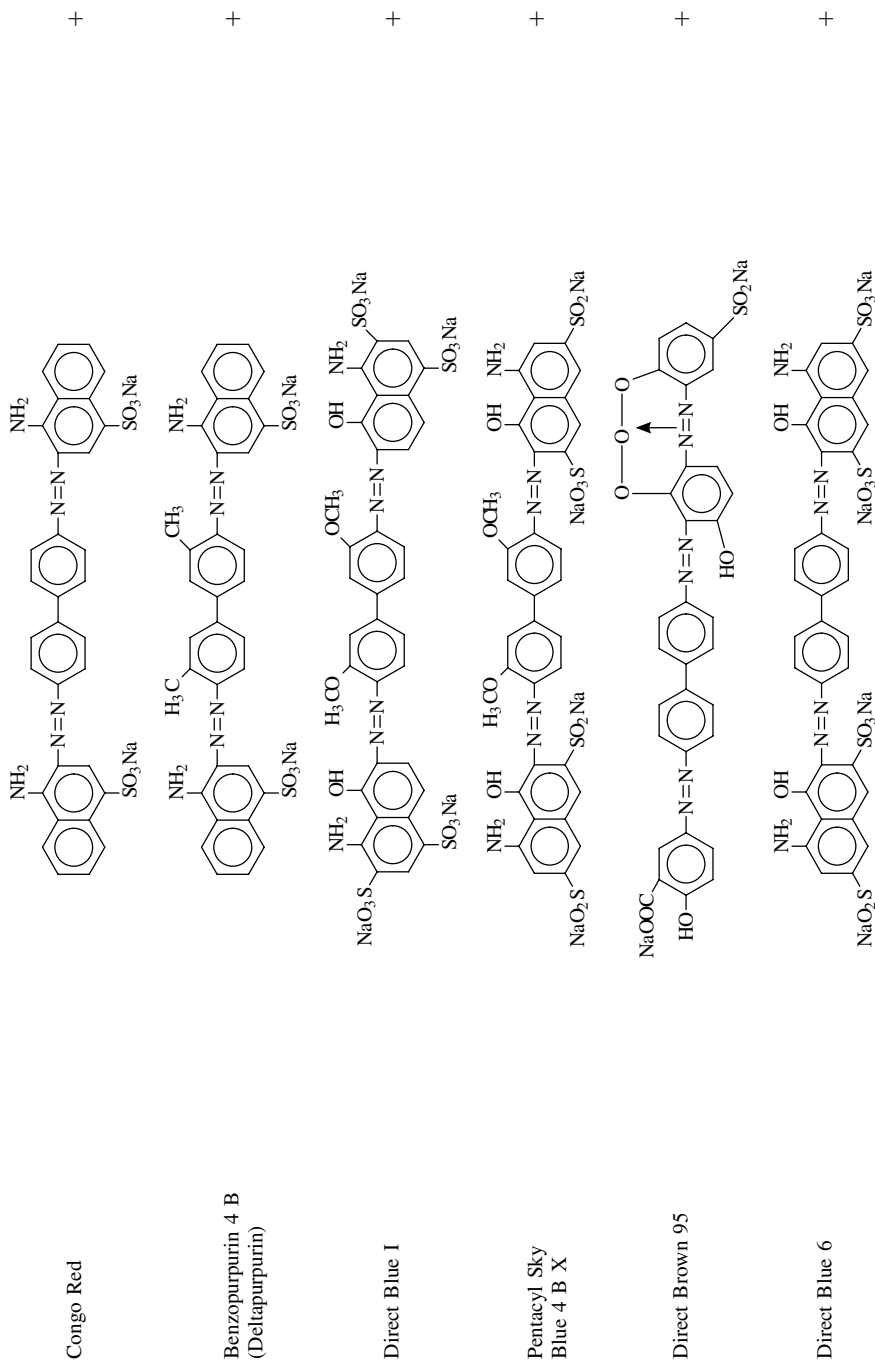


(continued overleaf)

TABLE 8. (continued)

Common name	Chemical structure	Metabolic activation <sup>a</sup>
Direct Black 19 Analogue		+
Direct Black 19 Analogue		+
Azo Dyes Containing the Benzidine Group		
Brown 5 R (C.I. Acid Orange 45)		±
Trypan Blue (Direct Blue 14)		+
Evan's Blue		+



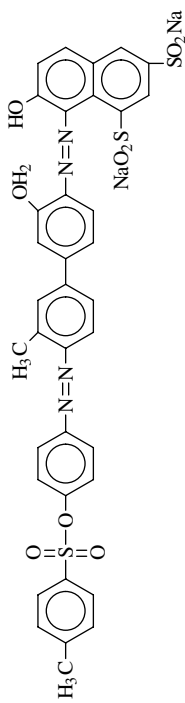


(continued overleaf)

TABLE 8. (continued)

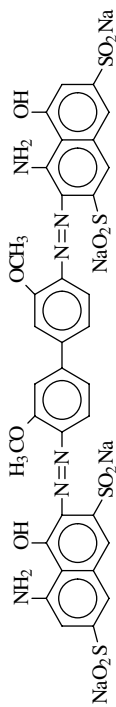
Common name	Chemical structure	Metabolic activation <sup>a</sup>
Direct Brown 1:2		+
Direct Brown 31		+
Acid Red 85		+
Direct Red 2		+
Direct Blue 53		+

Acid Red 114



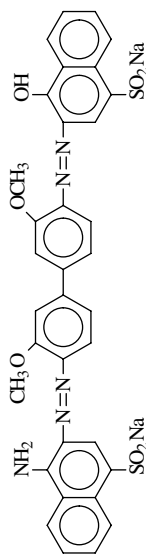
+

Direct Blue 15



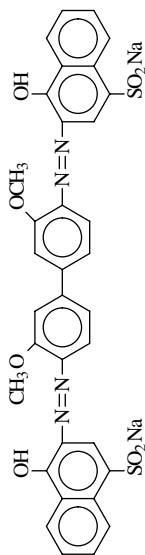
+

Direct Violet 32



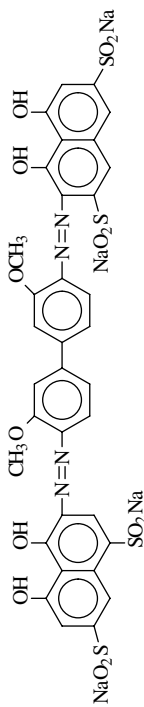
+

Direct Blue 8



+

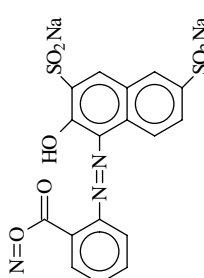
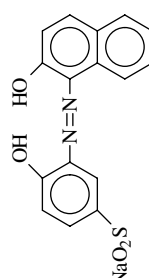
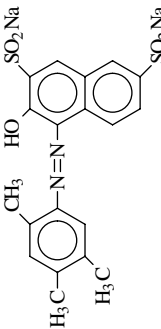
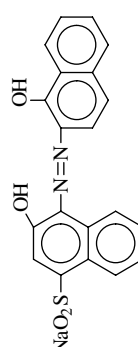
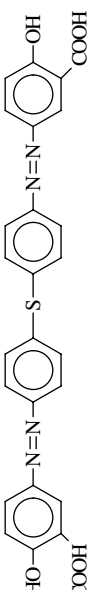
Direct Blue 10



+

TABLE 8. (continued)

Common name	Chemical structure	Metabolic activation <sup>a</sup>
Direct Blue 25		+
Direct Orange 6		+
Direct Red 39		+
Direct Red 46		+
Miscellaneous Azo Dyes		
Sudan 2		+

Acid Alizarin Red B		+
Acid Alizarin Violet N		+
Ponceau 3R (Acid Dye, C.I.16155)		+
Eriochrome Blue Black B		+
Thiodiphenyl-4,4'- diazo-bis-salicylic Acid		±

<sup>a</sup>+, metabolic activation required; -, no metabolic activation is required, i.e. a direct mutagen. Reproduced with permission from Reference 106.

## VII. REFERENCES

1. Luigi Parmeggiani, *Encyclopedia of Occupational Health and Safety*, Vol. 2, Geneva, 1983 p. 1449.
2. Hydrazine, *Envt. Health Criteria* 68, WHO, Geneva, 1987.
3. L. Bretherilk (Ed.), *Hazards in Chemical Laboratory*, Royal Society of Chemistry, London, 1981.
4. J. A. Miller, M. C. Branch, W. J. McLean, D. W. Chandler, M. D. Smooke and R. J. Kee, *20th Int. Symp. Combustion*, The Combustion Institute, 1984, p. 673.
5. J. A. Miller and C. T. Bowman, *Prog. Energy Combust. Sci.*, **15**, 287 (1989).
6. A. Clarke and A. Williams, *Energy and Environ.*, **3**, 280 (1992).
7. A. Williams, M. Pourkashanian, P. Bysh and J. Norman, *Fuel*, **73**, 1006 (1994).
8. Private communication.
9. F. J. Dentener and P. J. Crutzen, *J. Atmos. Chem.*, **19**, 3 (1994).
10. V. Dupont, M. Porkashanian and A. Williams, *J. Inst. Energy*, **66**, 20 (1993).
11. P. O'Nions and M. M. Vahadati, *3rd International Conf. on Combustion Technologies for a Clean Environment*, Centro cultural de Belem, Lisbon, Portugal, 1995.
12. D. Klvana, J. Chaouki, C. Guy and J. Kirchnerova, *3rd International Conf. on Combustion Technologies for a Clean Environment*, Centro cultural de Belem, Lisbon, Portugal, 1995.
13. V. A. Self, P. A. Sermon, P. Kumaraswamy and M. S. Vong, *3rd International Conf. on Combustion Technologies for a Clean Environment*, Centro cultural de Belem, Lisbon, Portugal, 1995.
14. J. O. L. Wendt, *Proceedings of the 2nd International Conf. on Combustion Technologies for a Clean Environment*, Portugal, 1993.
15. H. Maghon, A. Kreutzer and H. Termuehlen, *Proc. Am. Power Conf.*, **60** (1988).
16. A. Ciajolo, R. Barbella, M. Mattiello and A. D'Alessio, *19th Int. Symp. Comb. Technion—Israel Institute of Technology, Haifa, Israel*, The Combustion Institute, Pittsburgh, PA, 1982, p. 1369.
17. G. Prado, A. Garo, A. Ko and A. Sarofim, *20th Int. Symp. Combustion*, University of Michigan, Ann Arbor, MI, The Combustion Institute, Pittsburgh, PA, 1985, p. 989.
18. M. Toqan, W. F. Farmayan, J. M. Beer, J. B. Howard and J. D. Teare, *20th Int. Symp. Combustion*, University of Michigan, Ann Arbor, MI, The Combustion Institute, Pittsburgh PA, 1984, p. 1075.
19. K. Nikolaou, P. Masclet and G. Mouviar, *Sci. Total Environ.*, **32**, 103 (1984).
20. D. Thompson, *3rd International Conf. on Combustion Technologies for a Clean Environment*, Centro cultural de Belem, Lisbon, Portugal, 1995, p. 20.
21. D. Schuetzle, *Environ. Health Perspectives*, **47**, 65 (1983).
22. T. C. Pederson and J. S. Siak, *J. Appl. Toxicol.*, **1**, 54 (1981).
23. P. T. Williams, K. D. Bartle and G. E. Andrews, *Fuel*, **65**, 1150 (1986).
24. R. Atkinson, and S. M. Aschmann, *Int. J. Chem. Kinet.*, **20**, 513 (1988).
25. R. W. Coutant, L. Brown, J. C. Chuang, R. M. Riggan and R. G. Lewis, *Atmos. Environ.*, **22**, 403 (1988).
26. M. P. Ligocki and J. F. Pankow, *Environ. Sci. Technol.*, **23**, 75 (1989).
27. J. N. Pitts Jr., K. A. Van Cauwenberghe, D. Grosjean, J. P. Schmid, D. R. Fitz, W. L. Belser, Jr., G. B. Knudson and P. M. Hynds, *Science*, **202**, 515 (1978).
28. J. N. Pitts, Jr., *Phil. Trans. R. Soc. London A*, **A290**, 551 (1979).
29. G. Lofroth, E. Hefner, I. Alfhelm and M. Moller, *Science*, **209**, 1037 (1980).
30. H. S. Rosenkranz, E. C. McCoy, D. R. Sanders, M. Butler, D. K. Kiriazides and R. Mermelstein, *Science*, **209**, 1039 (1980).
31. D. Schuetzle, F. S. C. Lee, T. J. Prater and S. B. Tejada, *Int. J. Environ. Anal. Chem.*, **9**, 93 (1981).
32. J. Lewtas, *Fundamentals and Applied Toxicol.*, **10**, 571 (1988).
33. T. Tokiwa, R. Nakagawa and K. Horikawa, *Mutation Res.*, **157**, 39 (1985).
34. G. W. Traynor, M. G. Apte, H. A. Sokol, J. C. Chang and J. L. Mumford, *Proc. of the 79th Air Pollution Control Association Annual Meeting*, Minneapolis, 1986.
35. J. Arey, B. Zielinska, R. Atkinson and A. M. Winer, *Atmos. Environ.*, **21**, 1437 (1987).
36. M. C. Paputa-Peck, R. S. Marano, D. Scheutzle, T. L. Riley, C. V. Hampton, T. J. Prater, L. M. Skewes, T. E. Jensen, P. H. Reuhle, L. C. Bosch and W. P. Duncan, *Anal. Chem.*, **55**, 1946 (1983).
37. H. Tokiwa and Y. Ohnishi, *CRC Crit. Rev. Toxicol.*, **17**, 23 (1986).
38. M. G. Nishioka and J. Lewtas, *Atmos. Environ.*, **26**, 2077 (1992).
39. J. N. Pitts Jr., *Atmos. Environ.*, **21**, 2531 (1987).

40. J. Arey, B. Zielinska, R. Atkinson, A. M. Winer, T. Ramdahl and J. N. Pitts Jr., *Atmos. Environ.*, **20**, 2339 (1986).
41. R. Atkinson, J. Arey, B. Zielinska and S. M. Aschmann, *Environ. Sci. Technol.*, **21**, 1014 (1987).
42. B. Zielinska, J. Arey, R. Atkinson and P. A. McElroy, *Environ. Sci. Technol.*, **22**, 1044 (1988).
43. B. Zielinska, J. Arey, R. Atkinson and P. A. McElroy, *Environ. Sci. Technol.*, **23**, 723 (1989).
44. E. S. C. Kwok, R. Atkinson and J. Arey, *Int. J. Chem. Kinet.*, **26**, 511 (1994).
45. R. Atkinson, E. C. Tuazon, I. Bridier and J. Arey, *Int. J. Chem. Kinet.*, **26**, 605 (1994).
46. R. Atkinson, J. Arey, B. Zielinska and S. M. Aschmann, *Int. J. Chem. Kinet.*, **22**, 999 (1990).
47. B. Zielinska, J. Arey and R. Atkinson, *Env. Sci. Res.*, **40**, 73 (1990).
48. P. T. Williams, Private communication, 1995.
49. R. Crebelli, L. Conti, B. Crochi, A. Carere, C. Bertoli and N. D. Giacomo, *Mutat. Res.*, **346**, 167 (1995).
50. R. C. Kamens, J. Guo, Z. Guo and S. R. McDow, *Atmos. Environ.*, **24A**(5), 1161 (1990).
51. T. Maeda, K. Izumi, H. Otsuka, Y. Manabe, T. Kinouchi and Y. Ohnishi, *J. Natl. Cancer Inst.*, **76**, 693 (1986).
52. D. T. Silverman, R. N. Hoover, T. J. Manson and G. M. Swanson, *Cancer Res.*, **46**, 2113 (1986).
53. J. Lewtas and M. Nishioka, *Environ. Sci. Res.*, **40**, 61 (1989).
54. H. Richartz, A. Reischl, F. Traunter, and O. Hutzinger, *Atmos. Environ.*, **24**, 3067 (1990).
55. P. Romeliotis, W. Liebald and K. K. Unger, *Int. J. Environ. Anal. Chem.*, **9**, 27 (1981).
56. D. Grosjean, *Environ. Sci. Technol.*, **19**, 968 (1985).
57. K. Nojima and S. Kanno, *Chemosphere*, **6**, 371 (1977).
58. J. A. Leone and J. H. Seinfeld, *Int. J. Environ. Anal. Chem. Kinet.*, **16**, 159 (1984).
59. J. A. Leone, R. C. Flagan, D. Grosjean and J. H. Seinfeld, *Int. J. Chem. Kinet.*, **17**, 177 (1983).
60. F. Trautner, A. Reischl and O. Hutzinger, *Umweltchem. Okotox.*, **3**, 10 (1989).
61. S. Preston-Martin and P. Correa, *Cancer Res.*, **8**, 459 (1989).
62. I. K. O'Neill, J. Chen and H. Bartsch, *IARC Scientific Publication No. 105*, International Agency for Research on Cancer (WHO), Lyon, (1991).
63. M. J. Hill (Ed.), *Nitrosamine, Toxicology and Microbiology*, Ellis Horwood, Chichester, (1988).
64. J. M. Fajen, D. P. Rounbehler and D. H. Fine, 'N-Nitroso compounds: occurrence and biological effects', *IARC Scientific Publications No. 41*, International Agency for Research on Cancer, Lyon, 1982, p. 223.
65. D. H. Fine, *Oncology*, **37**, 199 (1980).
66. G. E. Moiseev and V. V. Benemansky, *Voprosy Onkologii*, **26**, 107 (1975).
67. B. Spiegelhalder and C. D. Wacker, in *ACS Symp. Ser.*, **553**, (Eds. R. N. Loeppky and C. J. Michejda, Washington, DC, (1994), p. 43.
68. D. P. Rounbehler and J. M. Fajen, 'N-nitroso compounds in factory environment', *Report, NIOSH Contract No. 210-77-0100*, National Institute for Occupational Safety and Health, Cincinnati, OH, 1982.
69. D. G. Lloyd and G. Monsanto, *Rubber World*, **210**, 25 (1994).
70. R. Preussmann, H. Habs and D. Schmahl, *Cancer Res.*, **42**, 5167 (1982).
71. H. Zerban, R. Preussmann and P. Bannasch, *Carcinogenesis*, **9**, 607 (1988).
72. J. Fuchs, J. Burg, J. G. Hengstler, U. Bolm-Audorff and F. Oesch, *Mutat. Res.* **342**, 95 (1995).
73. A. R. Tricker, B. Spiegelhalder and R. Preussmann, *Cancer Survey*, **8**, 251 (1989).
74. J. B. Powell, *J. Soc. Cosmet. Chem.*, **38**, 29 (1987).
75. R. C. Doerr and W. J. Fiddler, *Chromatography*, **140**, 284 (1977).
76. W. Lijinsky and H. W. Taylor, *Food Cosmet. Toxicol.*, **15**, 269 (1977).
77. W. Lijinsky, *Drug Dev. Eval.*, 93 (1990).
78. R. N. Loeppky, *Nitrosamines and Related N-nitroso Compounds*, (Eds. R. N. Loeppky and C. J. Michejda, ACS Symp. Series 553, American Chemical Society, Washington, DC, 1994, p. 1.
79. G. Zweig, S. Selim, R. Hummel, A. Mittelman, D. P. Wright, C. Law and E. Regezman, 'N-nitroso compounds: Analysis, Formation and Occurrence', *IARC Publication No. 31*, International Agency for Research on Cancer, Lyon, 1980, p. 555.
80. J. Dressel, *Z. Lebensm.-Unter. Forsch.*, **163**, 11 (1976).
81. N. P. Sen, in *ACS Symp. Ser.*, **365**, (Ed. J. H. Hotchkiss), American Chemical Society, Washington, DC, 1988, p. 146.
82. N. P. Sen, P. A. Baddoo, D. Weber and S. W. Seaman, *J. Food Sci.*, **53**, 731 (1988).
83. A. R. Tricker and R. Preussmann, *Mutat. Res.*, **259**, 277 (1991).
84. J. H. Hotchkiss, *Cancer Surveys*, **8**(2), 295 (1989).

85. A. R. Tricker and S. J. Kubacki, *Food Additives and Contaminants*, **9**(1), 39 (1992).
86. A. D. Gangolli, P. A. Brandt van den, V. J. Feron, C. Janzowsky, J. H. Koeman, G. J. A. Speijers, B. Spiegelhalter, R. Walker and J. S. Wishnok, *Eur. J. Pharmacol. Environ. Toxicol., Pharmacol. Section*, **292**, 1 (1994).
87. B. Spiegelhalter, G. Eisenbrand and R. Preussmann, *Food Chem. Toxicol.*, **17**, 29 (1979).
88. B. Spiegelhalter, G. Eisenbrand and R. Preussmann, *Oncology*, **37**, 211 (1980).
89. J. Calderbank, and J. R. M. Hammond, *J. Inst. Brew.*, **95**, 277 (1989).
90. M. M. Mangino and R. A. Scalan, *J. Agric. Food Chem.*, **33**, 699 (1985).
91. A. R. Tricker and R. Preussmann, *J. Cancer Res. Clin. Oncol.*, **117**, 130 (1991).
92. R. Preussmann and B. Steward, 'N-Nitroso carcinogens', in *Chemical Carcinogenesis* (Ed. C. D. Searle), American Chemical Society, Washington, DC, 1984, p. 643.
93. H. C. Grice, D. J. Clegg, D. C. Eargle, M. Tein-Lo, E. J. Middleton, E. Sandi, P. M. Scott, N. P. Sen, B. L. Smith and J. R. Withey, in *Carcinogenesis in Industry and Environment* (Ed. Sontag), J. M. Marcel Dekker, New York, 1981.
94. J. W. Pensabene, and W. Fidler, *J. Food Sci.*, **48**, 1870 (1983).
95. A. K. Mandagere, J. I. Gray, D. J. Skrypec, A. M. Booren and A. M. Pearson, *J. Food Sci.*, **49**, 658 (1984).
96. N. P. Sen, L. Tessier, S. W. Seaman and P. A. Baddoo, *J. Agric. Food Chem.*, **33**, 264 (1985).
97. J. W. Pensabene and W. Fiddler, *J. Assoc. Off. Anal. Chem.*, **68**, 1077 (1985).
98. N. P. Sen, P. A. Baddoo and S. W. Seaman, *J. Food Sci.*, **51**, 821 (1986).
99. A. R. Tricker and R. Preussmann, *Mutat. Res.*, **259**, 277 (1991).
100. D. H. Fine, D. Lieb and F. Ruffe, *J. Chromatography*, **107**, 351 (1975).
101. S. R. Tannenbaum, S. Tamir, T. de Rojas-Walker and J. S. Wishnok, in '*Nitrosamines and Related N-nitroso Compounds*' (Eds. R. N. Loeppey and C. J. Michejda), ACS Symp. Ser., **553**, American Chemical Society, Washington, DC, (1994), p. 120.
102. H. Bartsch, International Agency for Research on Cancer, *IARC Scientific Publication No. 105*, Lyon, (1991).
103. G. Lynn, E. B. Sansone and A. W. Andrews, *Environ. Molecular Mutagenesis*, **17**, 59 (1991).
104. 'The Evaluation of the Carcinogenic Risk of Chemicals to Humans', *IARC Scientific Publication No. 29*, International Agency for Research on Cancer (WHO), Lyon, 1982.
105. C. P. Hartman, G. E. Fulk and A. W. Andrews, *Mutat. Res.*, **44**, 9 (1978).
106. K. T. Chung, and C. E. Cerniglia, *Mutat. Res.*, **277**, 201 (1992).
107. J. Dignon, *Atmos. Environ.*, **26A**, 1157 (1992).
108. R. W. Layer and D. W. Chasar, Eur. Pat. Appl. (Patent No. 591632 A2 940413).



## CHAPTER 26

# $S_NAr$ reactions of amines in aprotic solvents

NORMA S. NUDELMAN

*Universidad de Buenos Aires, Facultad de Ciencias Exactas y Naturales, Ciudad  
Universitaria, 1428 Buenos Aires, Argentina*

*Fax: 541-782 0529; e-mail: nudelman@quimor.qo.fcen.uba.ar*

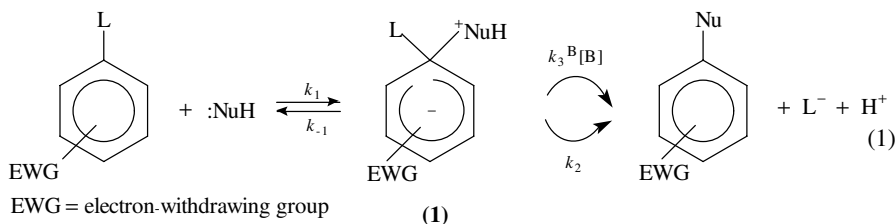
---

I. INTRODUCTION	1216
II. SYSTEMS SHOWING CLASSICAL KINETICS	1218
A. The Specific Base–General Acid (SB–GA) Mechanism	1218
B. Medium Effects	1220
1. Mono-solvent parameters	1220
2. Hydrogen-bonding scales	1222
3. Mixed solvents	1225
C. The Influence of the Nucleophile	1228
1. Basicity	1228
2. Nucleophilicity and polarizability	1232
3. Steric effects	1235
4. Gas-phase basicity scales	1237
5. Solvation effects on relative basicities	1238
D. The Influence of the Substrate	1240
1. Steric and conformational effects	1240
2. <i>o</i> - vs <i>p</i> -Activation	1241
3. The field effect	1243
4. The nitro nucleofuge	1244
E. Molecular Complexes	1245
F. Electrophilic Catalysis	1250
G. Aromatic Nucleophilic Substitution with Amines in which the Nucleofuge is a Sulphur Derivative	1253
H. Aromatic Nucleophilic Substitution with Amines under High Pressure	1256
III. SYSTEMS SHOWING ‘ANOMALOUS’ KINETICS	1261
A. Fourth-order Kinetics	1261
B. The Eight-membered Cyclic Transition state	1264
C. Aggregation of the Nucleophile	1265
D. The ‘Dimer Nucleophile’ Mechanism	1267

E. Specific Solvent Effects	1272
F. Catalysis by Methanol	1273
G. Catalysis by Hydrogen-bond Acceptor (HBA) Additives	1275
H. The Homo- and Hetero-conjugate Mechanisms	1276
I. The Substrate-Catalyst Molecular Complex	1278
J. The 'Desolvative Encounter Mechanism'	1281
K. Conformational Effects	1282
L. Isotope Effects	1285
M. Further Treatment of Kinetic Results	1286
1. 'Inversion Plots'	1286
2. Evaluation of the equilibrium constants	1289
3. The dichotomy of amine effects in aromatic nucleophilic substitution (ANS) in aprotic solvents	1290
IV. CONCLUDING REMARKS	1294
V. ACKNOWLEDGEMENTS	1294
VI. REFERENCES	1295

## I. INTRODUCTION

For neutral nucleophiles (e.g. amines, alcohols, water) there is much evidence that the addition-elimination mechanism depicted in equation 1 fits very well most of the intermolecular and intramolecular nucleophilic displacements involving nitro-activated aromatic substrates<sup>1</sup>.



Some of the most important evidence for the two-step mechanism comes from studies of base catalysis, in this regard, reactions involving primary and secondary amines have played a central role<sup>1-5</sup>. The initially formed  $\sigma$ -adduct, **1**, is zwitterionic and contains an acidic proton, which can be removed by a base which may be the nucleophile itself. Conversion of **1** to products can then occur via the uncatalysed  $k_2$  pathway or via the base-catalysed  $k_3^B$  pathway. The influence of Brønsted base catalysis, the experimental observation of 1,1- and 1,3- $\sigma$ -adducts, the sensitivity of the system to medium effects, are some experimental evidence of the mechanism depicted in equation 1.

Assuming for simplicity that only a particular base B is an effective catalyst in equation 1, application of the steady-state approximation derives in equation 2 the expression of the second-order rate constant,  $k_A$ , at a given concentration of B.

$$\frac{\text{rate}}{[\text{Ar-L}][\text{R}^1\text{R}^2\text{NH}]} = k_A = \frac{k_1 k_2 + k_1 k_3^B [\text{B}]}{k_{-1} + k_2 + k_3^B [\text{B}]} \quad (2)$$

Three main situations of interest with respect to the reaction shown in equation 1 were earlier considered in equation 2<sup>2b</sup>.

(a)  $k_2 + k_3^B [\text{B}] \gg k_{-1}$ . In this case, no base catalysis is possible: equation 2 simplifies to  $k_A = k_1$  and the formation of the intermediate is rate-limiting.

(b)  $k_2 + k_3^B[B] \ll k_{-1}$ . This situation corresponds to a rapid formation of the intermediate **1** followed by its rate-determining decomposition. In this case, equation 2 reduces to equation 3, which predicts base catalysis with a *linear* dependence of  $k_A$  on  $[B]$ :

$$k_A = \frac{k_1 k_2}{k_{-1}} + \frac{k_1 k_3^B [B]}{k_{-1}} \quad (3)$$

(c)  $k_2 + k_3^B[B] \approx k_{-1}$ . In this intermediate situation, equation 2 indicates that base catalysis should be observed with a *curvilinear* dependence of  $k_A$  on  $[B]$ . At low  $[B]$ , the plot of  $k_A$  vs  $[B]$  should be a straight line which will change to a plateau at high  $[B]$ , where formation of the intermediate becomes rate-limiting. A *downward* curvature is expected on these grounds. Numerous kinetic studies devoted to the reactions shown in equation 1 have demonstrated the validity of equations 2 and 3<sup>2-10</sup>.

The isolation and/or NMR spectroscopic characterization of  $\sigma$ -complexes, as that shown by **1**, have received considerable attention over the past two decades, because of the relationship between the formation of such adducts and that of the metastable cyclohexadienyl intermediates postulated in the  $S_NAr$  mechanism. The detailed structures of these adducts are now well known, and their reactions, the kinetics and thermodynamics of their formation and decomposition, as well as their spectral properties have been investigated in detail<sup>5,11,12</sup>. Although these studies constitute an important contribution to the understanding of the intermediates involved in  $S_NAr$ , they will not be discussed in this chapter since they have been recently reviewed; furthermore, most of the  $\sigma$ -adducts were formed by the addition of anionic nucleophiles<sup>1a,5,11</sup>.

Many recent investigations have been also carried out in the field of heterocyclic compounds. As a result of the replacement of a ring carbon atom in an arene system by a more electronegative atom, the greater electron density on that atom and the concomitant reduction in electron density on the remaining carbon atoms make these substrates prone to suffer nucleophilic attack. A <sup>1</sup>H and <sup>13</sup>C NMR study of substituted nitropyridines and nitrobenzenes, and of their  $S_NAr$  products obtained with amines, demonstrated that the electronic *aza* and *nitro* group effects are comparable if conjugation of the nitro group is not hindered<sup>12</sup>. Many  $S_NAr$  reactions with nitro-activated heterocyclic compounds have been reported; however, a peculiar feature of *aza-aromatic* systems is that nucleophilic displacements of common leaving groups, as well as of hydrogen, can occur through multistep sequences involving ring opening-reclosure (RORC) of the heterocyclic system<sup>13</sup>. These reactions are commonly referred to as  $S_N(ANRORC)$  because they are promoted by initial addition of the nucleophile (AN) at an activated unsubstituted carbon<sup>1a,13</sup>. Evidence has been provided that this mechanism can operate to a large extent in the substitution of halonitropyridines by strong nucleophiles like OH<sup>-</sup> in water/DMSO mixtures rich in DMSO, or with amide ions in ammonia<sup>14-16</sup>. The identification of the open intermediates<sup>16</sup> constitutes a strong indication to suggest that the conversion of 2-halo-5-nitropyridines into the corresponding 2-hydroxypyridines occurs via the  $S_N(ANRORC)$ -type process rather than via the anticipated  $S_NAr$  mechanism. The feasibility of nucleophilic substitutions at the 4- or 7-position in condensed heterocycles such as nitrobenzofurazans has been also recently proved, and the finding of  $\sigma$ -adducts of the type found in trinitrobenzene analogues gives strong support to the operation of similar mechanisms<sup>17</sup>. Nevertheless, the observation of by-products indicates that nucleophilic attack also occurs at the annelated moiety with destruction of the heterocyclic system.

Numerous kinetic studies devoted to  $S_NAr$  reactions with amines indicate that the occurrence and efficiency of base catalysis depend on the identity of the amine, the nucleofugue, the base and the solvent. In general, base catalysis is more often observed with secondary than with primary amines, with poor leaving groups and in the less polar solvents; one

of the three described kinetic situations is observed. Nevertheless, it will be shown in the forthcoming discussion that a new situation has been recently discovered: for several systems an *upward* curvature has been found in the plot of  $k_A$  vs [B], which corresponds to a *parabolic* dependence of  $k_A$  on [B], and a *fourth-order* kinetic law. Several alternative mechanisms have been proposed to account for this new kinetic finding.

Most of the more relevant findings related to  $S_NAr$  reactions in the last decade have been observed in aprotic solvents, and the factors that have been studied with amines in aprotic solvents will be discussed. The first part will deal with works where some of the three kinetic situations described above have been found. In the second part, the systems where 'anomalous' kinetics have been observed will be discussed.

## II. SYSTEMS SHOWING CLASSICAL KINETICS

### A. The Specific Base-General Acid (SB-GA) Mechanism

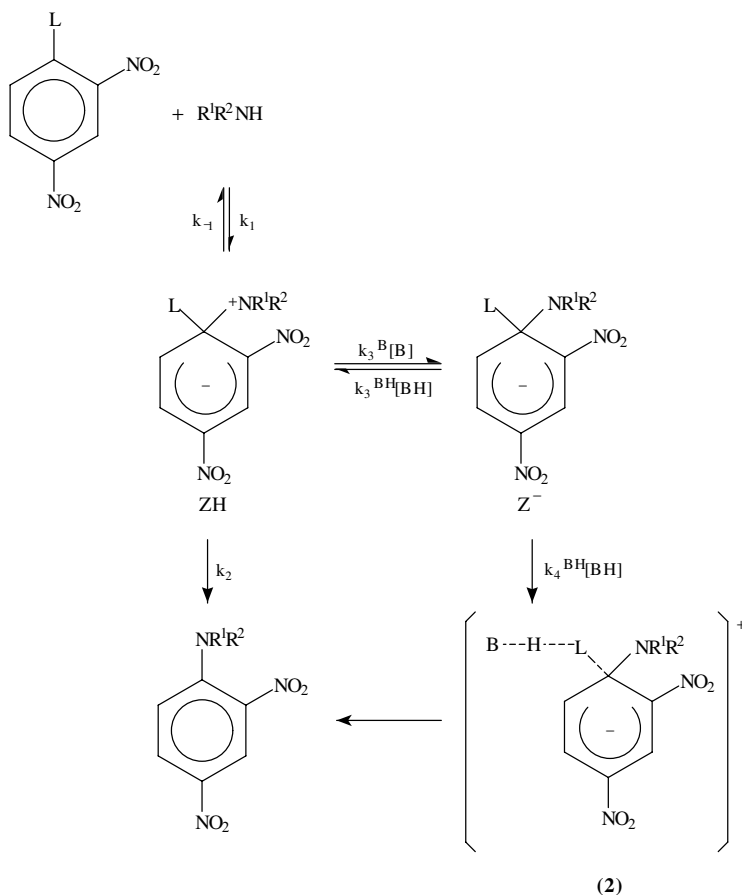
For reactions in which the decomposition of the zwitterionic intermediate, ZH, is, at least partially, rate-limiting, two major mechanisms are now widely accepted. These are known as the specific base-general acid (SB-GA) and the rate-limiting proton transfer (RLPT) mechanisms and are shown in Scheme 1<sup>1a</sup>.

In the rate-limiting proton transfer mechanism, the initially formed ZH undergoes rate-limiting, base-induced deprotonation followed by rapid uncatalysed or acid-catalysed leaving-group departure from the anionic intermediate,  $Z^-$ . This mechanism was initially proposed by Bunnett and Randall<sup>2d</sup> and then thoroughly studied by Bernasconi and coworkers<sup>3,18</sup> who demonstrate that diffusion-controlled proton transfer steps can be overall rate-determining in multistep processes where the species undergoing deprotonation is present in a highly unfavourable equilibrium, or where reversion of this species is extremely rapid. This situation is clearly found for  $S_NAr$  in protic solvents and this mechanism has been well established in those cases. On the contrary, for aprotic solvents the situation is still unclear.

The SB-GA mechanism consists of a rapid equilibrium deprotonation of the ZH intermediate, followed by rate-limiting, general acid-catalysed leaving-group departure from the anionic  $\sigma$ -complex  $Z^-$  via the concerted transition state, **2**. The derived expression for this mechanism is equation 4, where  $k_4^{BH}$  is the rate coefficient for acid-catalyzed expulsion of L from  $Z^-$  and  $K_3$  is the equilibrium constant for the reaction  $ZH \rightleftharpoons Z^- + BH$ .

$$k_A = \frac{k_1 k_2 + k_1 k_4^{BH} K_3 [B]}{k_{-1} + k_2 + k_4^{BH} [B]} \quad (4)$$

The SB-GA mechanism was earlier established by Orvick and Bunnett<sup>19</sup> for the reaction of 2,4-dinitro-1-naphthyl ethyl ether with *n*-butylamine and *t*-butylamine in DMSO, and it has been recently reported for the reactions of 2,4,6-trinitroanisole, 2,4,6-trinitrophenetole and methyl-4-methoxy-3,5-dinitrobenzoate with *n*-butylamine, and for the reactions of 2,4-dinitro-1-ethylnaphthyl ether with piperidine and pyrrolidine<sup>20-24</sup>. While the rate constants ( $k_1$  for formation of the zwitterionic intermediates) are consistent with the expected trend, i.e. pyrrolidine is more reactive than piperidine by a factor of 2.5, the results obtained for the decomposition of the intermediates were rather amazing. The rate constant  $k_4$  for the decomposition of the pyrrolidine adduct,  $Z^-$ , is about 11,000 times greater than that for the piperidine analogue<sup>20-24</sup>. Similarly, the general acid-catalysed decomposition of the pyrrolidine intermediate, ZH, is considerably faster than that of the piperidine analogue. Sekiguchi and coworkers<sup>21a</sup> have recently produced evidence that base catalysis in the substitution reaction of *n*-butylamine with



SCHEME 1

1-pyrrolidino-2,4-dinitronaphthalene also involves rate-limiting deprotonation of the zwitterionic intermediate.

All the available information indicates that the most plausible interpretation of these huge differences between systems apparently so similar, is in terms of *stereoelectronic* or *conformational* factors that result in destabilization of the transition states for general acid-catalysed expulsion of the leaving group in the piperidine system relative to pyrrolidine<sup>20,21</sup>. Interestingly, the sensitivity of the efficiency of the acid catalysis of the leaving-group departure to structural factors is in itself a criterion for the validity of the SB-GA mechanism<sup>1</sup>. This mechanism has been also observed in other dipolar aprotic solvents like acetone or acetonitrile<sup>25,26</sup>; in the latter, catalysis by  $Cl^-$  has been observed<sup>26</sup>.

In non-polar aprotic solvents, however, the SB-GA mechanism is more difficult to accept because of the known inability of these solvents to stabilize ionic species. The following discussion will consider the different proposals as well as several aspects that have been recently studied.

## B. Medium Effects

Changes in reactivity due to transfer from protic to dipolar aprotic solvents were early recognized in  $S_NAr$  reactions and some novel aspects have been recently studied<sup>11,27</sup>. Reactions carried out in the presence of crown ethers<sup>28,29</sup>, micellar surfactants and related modified micelles<sup>30–32</sup>, or under conditions of phase transfer catalysis (PTC)<sup>29,33–35</sup>, have been recently reported, as well as the effect of molten dodecyltributylphosphonium salts on  $S_NAr$  reactions by halide ions<sup>36</sup>. Since most of these studies refer to anionic nucleophiles, they will not be discussed in this chapter.

### 1. Mono-solvent parameters

Many different approaches have been reported in the last decade toward a better understanding of the medium factors that influence reaction rates. Fundamental studies have been devoted to probe the reaction at a microscopic level in order to obtain information on the nature of several specific solvent–solute interactions on  $S_NAr$  and to attempt a description of these effects quantitatively. Recent works have shown the wide applicability of a single parameter scale such as the  $E_T(30)$  Dimroth and Reichardt<sup>37</sup>, as well as other multi-parameter equations.

In this respect, the solvatochromic approach developed by Kamlet, Taft and coworkers<sup>38</sup> which defines four parameters:  $\pi^*$ ,  $\alpha$ ,  $\beta$  and  $\delta$  (with the addition of others when the need arose), to evaluate the different solvent effects, was highly successful in describing the solvent effects on the rates of reactions, as well as in NMR chemical shifts, IR, UV and fluorescence spectra, solvent–water partition coefficients etc.<sup>38</sup>. In addition to the polarity/polarizability of the solvent, measured by the solvatochromic parameter  $\pi^*$ , the aptitude to donate a hydrogen atom to form a hydrogen bond, measured by  $\alpha$ , or its tendency to provide a pair of electrons to such a bond,  $\beta$ , and the cavity effect (or Hildebrand solubility parameter),  $\delta$ , are integrated in a multi-parametric equation to rationalize the solvent effects.

The number of terms in the equation used to correlate the studied property (XYZ) depends on the significance of the solute–solvent interactions. When the property studied refers to a single solute in multiple solvents, the general equation is usually expressed as equation 5<sup>39</sup>:

$$XYZ = XYZ_0 + s\pi^* + \alpha\alpha + b\beta + d\delta \quad (5)$$

This solvatochromic solvent effect equation has been probably the most widely used one in the analysis of solvent effects<sup>40</sup> and it has been applied to literally hundreds of processes in solution and for the correlation of all kinds of solvents effects<sup>39–43</sup>.

Application of these single- and multi-parameter analyses in  $S_NAr$  will be referred to in many aspects discussed below. The importance of the hydrogen bond interactions has been also considered in other approaches which attempted to explain the solvent effects in these reactions<sup>43,44</sup>. Thus, two solvatochromic indicators for hydrogen bond donation and acceptance have been recently reintroduced, and the respective scales have been determined for 17 solvents<sup>45</sup>. H-bonding scales will be discussed in the next section. In some cases, the solvent hydrogen-bond basicity,  $\beta$ , has been identified with the solvent nucleophilicity, but Bentley<sup>46</sup> has recently pointed out that it is only an assumption. Nevertheless, there is a reasonable connection between the nucleophilic solvent parameter  $Y^+$  of Kevill and Anderson<sup>47</sup> and the solvent  $\beta$  values<sup>38a</sup>.

In  $S_NAr$  involving amines as the nucleophiles, abundant recent studies afford evidence of the importance of the nature of the solvent in determining whether the formation or the decomposition of the zwitterionic intermediate will be the rate-determining step<sup>1,3b,20</sup>.

Furthermore, in many cases, changes in the mechanism have also been observed and they will be discussed in a later section. Nevertheless, by selecting a system that exhibited the *same rate-determining step* in a variety of solvents it would be possible to assess how the rate of a given process may be affected by a solvent transfer. Such is the case of the reaction of 1-chloro-2,4-dinitrobenzene with piperidine, where the rate dependence with amine concentration has been studied in 12 aprotic solvents<sup>48a</sup> as well as in 10 protic solvents<sup>48b</sup>. It was found that the reaction does not exhibit base catalysis in any of the solvents studied; that is, addition of piperidine is rate-limiting in all the cases<sup>48</sup>.

It is shown in Table 1 that for aprotic solvents, the rates increase with increasing solvent polarity, as a result of increased stabilization of the transition state leading to the zwitterionic intermediate. Many solvent parameters were tested and the best correlation was observed with the Dimroth-Reichardt  $E_T(30)$  values<sup>37</sup>. The observation of a satisfactory correlation between reactivity and the  $E_T$  parameter in hydrogen bond acceptor aprotic solvents suggests that strong intramolecular hydrogen bonding between the ammonio proton and the *ortho*-nitro group is responsible for the stabilization of the ZH and of the corresponding transition state in these solvents<sup>48a</sup>. On the other hand, and in spite of increased polarity, the reactivity in hydroxylic solvents (Table 2) is slower than in any of the aprotic solvents studied and no correlation exists with  $E_T$  values<sup>48b</sup>. In this instance, the reactivity is inversely proportional to the hydrogen bond donating ability of the solvent as measured by the  $\alpha$ -hydrogen bond donor solvent parameter<sup>38</sup>. The fact that the rates are correlated by the hydrogen bond donicity of the hydroxylic solvent supports the view that the relatively low rates of substitution are the result of a strong solvation of the amine molecules<sup>48b</sup>. A similar effect will be also found in reactions discussed in Section III.

When the decomposition of the zwitterionic intermediate is rate-determining, the effect of the solvent is crucial since it may produce changes in the mechanisms and in the rate-determining step. A recent study of the kinetics of the reactions of 1-chloro-, 1-fluoro- and 1-phenoxy-2,4-dinitrobenzene with piperidine, *n*-butylamine and benzylamine in ethyl acetate and THF indicated that these reactions resemble those in dipolar aprotic solvents when primary amines are the nucleophiles (i.e. that shown in equation 1, with

TABLE 1. Reaction of 1-fluoro-2,4-dinitrobenzene (DNFB) with piperidine in aprotic solvents at 15 °C<sup>48a</sup> second-order overall rate coefficients<sup>a</sup>

Solvent	$E_T(30)$	10 <sup>3</sup> [Piperidine] (M)							
		0.625	1.25	2.50	5.00	7.50	10.0	12.5	15.0
Toluene	33.9			1.38	2.55	3.58	4.48	5.41	6.19
Benzene	34.5			2.34	3.70	5.09	6.45		
Dioxane	36.0		2.06	2.57	3.42	4.11	5.05	5.83	6.67
Trichloroethane	36.2	2.48	3.28	5.35	8.48	11.7	15.0	17.5	20.7
Tetrahydrofuran	37.4	2.94	4.59	7.83	13.3	18.0	22.3	26.5	30.6
Chlorobenzene	37.5	4.23	5.22	8.42	13.7	18.4	22.4	24.7	28.0
Ethyl acetate	38.1	3.48	6.34	9.55	15.6	20.3	25.0	28.7	32.3
Chloroform	39.1		18.9	19.5	20.0	20.2	20.4	20.6	
Dichloromethane	41.1			39.7	42.4	45.3	47.4		
Acetone	42.2	24.8	31.6	44.3	64.9	79.5			
Acetonitrile	46.0		87.9	99.4	110	114	116		
Nitromethane	46.3		163	172	192				

<sup>a</sup>[DNFB] = 5 × 10<sup>5</sup>M;  $k_A$  in 1 mmol<sup>-1</sup> s<sup>-1</sup>.

TABLE 2. Second-order reaction rate coefficients,  $k_A$ , at 15, 25 and 40 °C, and activation parameters for the reactions  $10^{-4}$  M of 1-chloro-2,4-dinitrobenzene with piperidine in hydroxylic solvents<sup>48b</sup>

Solvent	$10^2 k_A$ (mol <sup>-1</sup> s <sup>-1</sup> )			$\Delta H^\ddagger$ (kJ mol <sup>-1</sup> )	$\Delta S^\ddagger$ (JK <sup>-1</sup> mol <sup>-1</sup> )	$E_T(30)^a$	$\alpha^b$	$\delta_{SA}^c$	$\beta^d$
	15 °C	25 °C	40 °C						
Methanol	0.801	1.41	2.80	39.0	151.7	55.5	0.98	3.0	0.62
Ethanol		1.80				51.9	0.83	2.1	0.77
2-Methylpropan-1-ol	1.05	1.90	4.61	41.9	145.3	49.0			
Propan-1-ol	1.03	1.92	4.76	43.5	140.3	50.7	0.77	1.8	
Propan-2-ol	1.40	2.51	6.25	42.7	141.1	48.6	0.70	1.5	0.92
Butan-2-ol	1.48	2.57	6.04	39.9	150.3	47.1			
Benzyl alcohol	0.494	1.02	2.84	49.8	123.5	50.8	0.60		0.56
2-Phenoxyethanol	0.836	1.68	4.53	48.1	125.6	52.0			
2-Methoxyethanol	2.34	4.01	9.09	38.4	151.6	52.3			
Diethylene glycol	3.00	5.50	13.0	41.5	138.2	53.8			

<sup>a</sup>Reference 37.<sup>b</sup>Reference 38a<sup>c</sup>Reference 38b<sup>d</sup>Reference 39 $\alpha$  = H-bond acidity;  $\beta$  = H-bond basicity;  $\delta$  = cavity effect.

a molecule of the solvent replacing that of base) and those in aprotic solvents when the nucleophile is a secondary amine.

$S_NAr$  reactions of nitroaromatics such as 1-chloro-2,4-dinitrobenzene and 2,4,6-trinitroanisole with amines are accelerated in micelles or microemulsions<sup>49</sup>. As with anionic nucleophiles, the rate enhancement is mainly the effect of a high local concentration of both reactants<sup>1a,31</sup>.

## 2. Hydrogen-bonding scales

One of the most comprehensive hydrogen-bonding scales is due to Abraham and his coworkers<sup>50</sup>, who have derived the general solvation equation 6<sup>51</sup>

$$\log SP = c + rR_2 + s\pi_2^{*H} + a\Sigma\alpha_2^H + b\Sigma\beta_2^H + \nu V_x \quad (6)$$

where SP is some solvent property of a series of solutes in a given system and the explanatory variables, or descriptors, are solute properties as follows:  $R_2$  is an excess molar refraction,  $\pi_2^{*H}$  is the solute dipolarity/polarizability, and  $\Sigma\alpha_2^H$  and  $\Sigma\beta_2^H$  represent the solute overall hydrogen-bond acidity and basicity, respectively.

Thus, water-octanol partition coefficients ( $\log P_{oct}$ ) were shown to follow equation 7:

$$\log P_{oct} = 0.088 + 0.562R_2 - 1.054\pi_2^{*H} + 0.034\Sigma\alpha_2^H - 3.460\Sigma\beta_2^H + 3.814V_x \quad (7)$$

Table 3 presents the parameters for an extensive set of solutes. The treatment has been successfully applied to the correlation of the reversed-phase HPLC capacity factors<sup>52,53</sup>. For a molecule with multiple hydrogen bonding sites, it has been found that additivity can be applied<sup>54-56</sup>. This additivity assumption has been successfully used in quantitative structure-activity relationships (QSAR), in many reactions and particularly in drug design<sup>57-59</sup>. Some abnormalities observed by Abraham<sup>54</sup> with pyridines and alkylpyridines in tetrachloromethane have been recently revisited, and the treatment has also been applied to other heterocycles employing 1,1,1-trichloroethane as solvent<sup>60</sup>.



TABLE 3. Solutes and their descriptors used in the regression equations<sup>72</sup>. Reprinted with permission from Reference 72. Copyright (1994) American Chemical Society

Solute	$R_2$	$\pi_2^H$	$\Sigma\alpha_2^H$	$\Sigma\beta_2^H$	$\Sigma\beta_2^0$	$V_x$
Benzene	0.610	0.52	0.00	0.14	0.14	0.7164
Toluene	0.601	0.52	0.00	0.14	0.14	0.8573
Ethylbenzene	0.613	0.51	0.00	0.15	0.15	0.9982
<i>o</i> -Xylene	0.663	0.56	0.00	0.16	0.16	0.9982
<i>m</i> -Xylene	0.623	0.52	0.00	0.16	0.16	0.9982
<i>p</i> -Xylene	0.613	0.52	0.00	0.16	0.16	0.9982
<i>n</i> -Propylbenzene	0.604	0.50	0.00	0.15	0.15	1.1391
Isopropylbenzene	0.602	0.49	0.00	0.16	0.16	1.1391
<i>n</i> -Butylbenzene	0.600	0.51	0.00	0.15	0.15	1.2800
Isobutylbenzene	0.580	0.47	0.00	0.15	0.15	1.2800
<i>s</i> -Butylbenzene	0.603	0.48	0.00	0.16	0.16	1.2800
<i>t</i> -Butylbenzene	0.619	0.49	0.00	0.16	0.16	1.2800
<i>trans</i> - $\beta$ -Methylstyrene	0.913	0.72	0.00	0.18	0.18	1.0961
Allylbenzene	0.717	0.60	0.00	0.22	0.22	1.0961
Biphenyl	1.360	0.99	0.00	0.22	0.22	1.3242
2-Methylbiphenyl	1.331	0.88	0.00	0.23	0.23	1.4650
3-Methylbiphenyl	1.371	0.95	0.00	0.23	0.23	1.4650
4-Methylbiphenyl	1.380	0.98	0.00	0.23	0.23	1.4650
Naphthalene	1.340	0.92	0.00	0.20	0.20	1.0854
Fluorobenzene	0.477	0.57	0.00	0.10	0.10	0.7341
Chlorobenzene	0.718	0.65	0.00	0.07	0.07	0.8388
2-Chlorotoluene	0.762	0.65	0.00	0.07	0.07	0.9797
3-Chlorotoluene	0.736	0.67	0.00	0.07	0.07	0.9797
4-Chlorotoluene	0.705	0.67	0.00	0.07	0.07	0.9797
Benzyl chloride	0.821	0.82	0.00	0.33	0.33	0.9797
2-Chloroethylbenzene	0.801	0.90	0.00	0.25	0.25	1.1206
1-Chloro-3-phenylpropane	0.794	0.90	0.00	0.24	0.24	1.2615
Bromobenzene	0.882	0.73	0.00	0.09	0.09	0.8914
2-Bromotoluene	0.923	0.72	0.00	0.09	0.09	1.0320
3-Bromotoluene	0.896	0.75	0.00	0.09	0.09	1.0320
4-Bromotoluene	0.879	0.74	0.00	0.09	0.09	1.0320
Benzyl bromide	1.014	0.98	0.00	0.20	0.20	1.0320
2-Bromo-1-phenylethane	0.974	0.94	0.00	0.30	0.30	1.1732
1-Bromo-3-phenylpropane	1.078	1.00	0.00	0.27	0.27	1.3030
Methyl phenyl ether	0.708	0.75	0.00	0.29	0.29	0.9160
2-Methylanisole	0.725	0.75	0.00	0.30	0.30	1.0569
3-Methylanisole	0.709	0.78	0.00	0.30	0.30	1.0569
Benzaldehyde	0.820	1.00	0.00	0.39	0.39	0.8730
2-Methylbenzaldehyde	0.870	0.96	0.00	0.40	0.40	1.0140
3-Methylbenzaldehyde	0.840	0.97	0.00	0.42	0.42	1.0140
4-Methylbenzaldehyde	0.862	1.00	0.00	0.42	0.42	1.0140
Acetophenone	0.818	1.01	0.00	0.48	0.48	1.0139
3-Methylacetophenone	0.806	1.00	0.00	0.49	0.49	1.1550
4-Methylacetophenone	0.842	1.00	0.00	0.51	0.51	1.1550
Ethylphenylketone	0.804	0.95	0.00	0.51	0.51	1.1550
<i>n</i> -Propyl phenyl ketone	0.797	0.95	0.00	0.50	0.50	1.2960
<i>n</i> -Butyl phenyl ketone	0.795	0.95	0.00	0.50	0.50	1.4370
<i>n</i> -Pentyl phenyl ketone	0.719	0.95	0.00	0.50	0.50	1.5780
<i>n</i> -Hexyl phenyl ketone	0.720	0.95	0.00	0.50	0.50	1.7190
Methyl benzoate	0.733	0.85	0.00	0.46	0.46	1.0726
Ethyl benzoate	0.689	0.85	0.00	0.46	0.46	1.2135

(continued overleaf)

TABLE 3. (continued)

Solute	$R_2$	$\pi_2^H$	$\Sigma\alpha_2^H$	$\Sigma\beta_2^H$	$\Sigma\beta_2^0$	$V_x$
Methyl 2-methylbenzoate	0.772	0.87	0.00	0.43	0.43	1.2135
Methyl 3-methylbenzoate	0.754	0.88	0.00	0.47	0.47	1.2135
Methyl 4-methylbenzoate	0.730	0.88	0.00	0.47	0.47	1.2135
Phenyl acetate	0.661	1.13	0.00	0.54	0.54	1.0730
Benzyl acetate	0.798	1.06	0.00	0.65	0.65	1.2135
Methyl phenylacetate	0.703	1.13	0.00	0.58	0.58	1.2135
Ethyl phenylacetate	0.660	1.01	0.00	0.57	0.57	1.3544
Methyl 3-phenylpropanoate	0.687	1.21	0.00	0.59	0.59	1.3544
Ethyl 3-phenylpropanoate	0.654	1.20	0.00	0.62	0.62	1.4953
Methyl 4-phenylbutanoate	0.693	1.29	0.00	0.59	0.59	1.4953
Dimethyl phthalate	0.780	1.41	0.00	0.88	0.88	1.4288
Benzonitrile	0.742	1.11	0.00	0.33	0.33	0.8711
2-Methylbenzonitrile	0.780	1.06	0.00	0.31	0.31	1.0120
3-Methylbenzonitrile	0.762	1.08	0.00	0.34	0.34	1.0120
4-Methylbenzonitrile	0.740	1.10	0.00	0.34	0.34	1.0120
Phenylacetoneitrile	0.751	1.15	0.00	0.45	0.45	1.0120
3-Phenylpropanonitrile	0.771	1.35	0.00	0.51	0.51	1.1529
4-Phenylbutanonitrile	0.759	1.38	0.00	0.51	0.51	1.2938
Aniline	0.955	0.96	0.26	0.41	0.50	0.8162
<i>o</i> -Toluidine	0.966	0.92	0.23	0.45	0.59	0.9570
<i>m</i> -Toluidine	0.946	0.95	0.23	0.45	0.55	0.9570
<i>p</i> -Toluidine	0.923	0.95	0.23	0.45	0.52	0.9570
2-Bromoaniline	1.070	0.98	0.31	0.31	0.39	0.9910
3-Bromoaniline	1.128	1.19	0.31	0.30	0.34	0.9910
2-Nitroaniline	1.180	1.37	0.30	0.36	0.36	0.9910
3-Nitroaniline	1.200	1.71	0.40	0.35	0.35	0.9910
4-Nitroaniline	1.220	1.91	0.42	0.38	0.38	0.9910
<i>N</i> -Ethylaniline	0.945	0.85	0.17	0.43	0.51	1.0980
Nitrobenzene	0.871	1.11	0.00	0.28	0.28	0.8910
2-Nitrotoluene	0.866	1.11	0.00	0.27	0.27	1.0320
3-Nitrotoluene	0.874	1.10	0.00	0.25	0.25	1.0320
4-Nitrotoluene	0.870	1.11	0.00	0.28	0.28	1.0320
Benzamide	0.990	1.50	0.49	0.67	0.67	0.9728
3-Methylbenzamide	0.990	1.50	0.49	0.63	0.63	1.1137
<i>N</i> -Methylbenzamide	0.950	1.44	0.35	0.73	0.73	1.1137
<i>N,N</i> -Dimethylbenzamide	0.950	1.40	0.00	0.98	0.98	1.2546
Phenylacetamide	0.950	1.60	0.52	0.79	0.79	1.1137
3-Phenylpropanamide	0.940	1.65	0.52	0.80	0.80	1.2546
Acetanilide	0.870	1.40	0.50	0.67	0.67	1.1133
Phenol	0.805	0.89	0.60	0.30	0.30	0.7751
<i>o</i> -Cresol	0.840	0.86	0.52	0.30	0.30	0.9160
<i>m</i> -Cresol	0.822	0.88	0.57	0.34	0.34	0.9160
<i>p</i> -Cresol	0.820	0.87	0.57	0.31	0.31	0.9160
2,4-Dimethylphenol	0.843	0.80	0.53	0.39	0.39	1.0569
2,5-Dimethylphenol	0.840	0.79	0.54	0.37	0.37	1.0569
4- <i>t</i> -Butylphenol	0.810	0.89	0.56	0.41	0.41	1.3387
2-Isopropyl-5-methylphenol	0.822	0.79	0.52	0.44	0.44	1.3387
2-Phenylphenol	1.550	1.40	0.56	0.49	0.49	1.3829
3-Phenylphenol	1.560	1.41	0.59	0.45	0.45	1.3829
4-Phenylphenol	1.560	1.41	0.59	0.45	0.45	1.3829
2-Chlorophenol	0.853	0.88	0.32	0.31	0.31	0.8975
3-Chlorophenol	0.909	1.06	0.69	0.15	0.15	0.8975
4-Chlorophenol	0.915	1.08	0.67	0.20	0.20	0.8975
2-Bromophenol	1.037	0.90	0.35	0.31	0.31	0.9501

TABLE 3. (continued)

Solute	$R_2$	$\pi_2^H$	$\Sigma\alpha_2^H$	$\Sigma\beta_2^H$	$\Sigma\beta_2^0$	$V_x$
3-Bromophenol	1.060	1.15	0.70	0.16	0.16	0.9501
4-Bromophenol	1.080	1.17	0.67	0.20	0.20	0.9501
2-Bromo-4-methylphenol	1.040	0.90	0.35	0.31	0.31	1.0910
2-Methoxyphenol	0.837	0.91	0.22	0.52	0.52	0.9747
3-Methoxyphenol	0.879	1.17	0.59	0.39	0.39	0.9747
4-Methoxyphenol	0.900	1.17	0.57	0.48	0.48	0.9747
2-Hydroxybenzaldehyde	0.962	1.15	0.11	0.31	0.31	0.9317
3-Hydroxybenzaldehyde	0.990	1.38	0.74	0.40	0.40	0.9317
4-Hydroxybenzaldehyde	1.010	1.01	0.77	0.44	0.44	0.9317
2-Cyanophenol	0.920	1.33	0.74	0.33	0.33	0.9298
3-Cyanophenol	0.930	1.55	0.77	0.28	0.28	0.9298
4-Cyanophenol	0.940	1.63	0.79	0.29	0.29	0.9298
2-Aminophenol	1.110	1.10	0.60	0.66	0.66	0.8749
3-Aminophenol	1.130	1.15	0.65	0.79	0.79	0.8749
4-Aminophenol	1.150	1.20	0.65	0.83	0.83	0.8749
2-Nitrophenol	1.015	1.05	0.05	0.37	0.37	0.9493
3-Nitrophenol	1.050	1.57	0.79	0.23	0.23	0.9493
4-Nitrophenol	1.070	1.72	0.82	0.26	0.26	0.9493
Catechol	0.970	1.07	0.85	0.52	0.52	0.8340
Resorcinol	0.980	1.00	1.10	0.58	0.58	0.8340
Hydroquinone	1.000	1.00	1.16	0.60	0.60	0.8340
Methylparaben	0.900	1.37	0.69	0.45	0.45	1.1313
<i>n</i> -Propylparaben	0.860	1.35	0.69	0.45	0.45	1.4131
Methyl 3-hydroxybenzoate	0.905	1.40	0.66	0.45	0.45	1.1313
2-Hydroxybenzamide	1.140	1.50	0.59	0.52	0.52	1.0315
Benzyl alcohol	0.803	0.87	0.33	0.56	0.56	0.9160
3-Nitrobenzyl alcohol	1.064	1.35	0.44	0.64	0.64	1.0902
4-Nitrobenzyl alcohol	1.064	1.39	0.44	0.62	0.62	1.0902
2-Phenylethanol	0.811	0.91	0.30	0.64	0.64	1.0569
3-Phenylpropanol	0.821	0.90	0.30	0.67	0.67	1.1978
2-Phenylpropan-2-ol	0.848	0.85	0.32	0.65	0.65	1.1978
4-Phenylbutanol	0.811	0.90	0.33	0.70	0.70	1.3387
5-Phenylpentanol	0.804	0.90	0.33	0.72	0.72	1.4796
1-Phenylpropan-1-ol	0.775	0.83	0.30	0.66	0.66	1.1978
2-Phenylpropan-1-ol	0.810	0.90	0.30	0.64	0.64	1.1978
1-Phenylpropan-2-ol	0.787	0.90	0.30	0.72	0.72	1.1978
Benzenesulphonamide	1.130	1.55	0.55	0.80	0.80	1.0971

### 3. Mixed solvents

The study of solute-solvent and solvent-solvent interactions in mixed solvents has been gaining significance in recent years<sup>61-64</sup>, because of the increasing application of these solvents. Casassas and collaborators<sup>67</sup> have used the Kamlet-Taft multiparametric equation for the correlation of dissociation constants of acids in 1, 4-dioxane-water mixtures. They found that when the main solvent is retained the property does not involve significant changes in the cavity volumes and, in those cases, the  $pK$  in binary solvents can be described by equation 8:

$$pK = pK_0 + s(\pi^* + d\delta) + a\alpha + b\beta \quad (8)$$

Bosch, Roses and coworkers<sup>62,65,66</sup> have used the dissociation of electrolytes in binary solvents of low permittivity using 2-methylpropanol or propan-2-ol as the main solvent

to evaluate the parameter(s) describing the preferential solvation. The authors observed that equation 8 is applicable and could evaluate the variations in parameters as a function of the mole fraction ( $x$ ) of the cosolvent. They found that for a non-polarizable main solvent polarizability effects can be considered to be proportional to the mole fraction of polarizable cosolvent (equation 9):

$$\delta_{\text{mixture}} = x_{\text{main solvent}} \delta_{\text{main solvent}} + x_{\text{cosolvent}} \delta_{\text{cosolvent}} = x_{\text{cosolvent}} \delta_{\text{cosolvent}} \quad (9)$$

The results are given in Table 4. By statistical treatment of the coefficients, it was found that the  $b$  coefficient is not significant in most cases and equation 8 can be further simplified to equation 10:

$$\Delta pK = s(\pi^* + d\delta) + a\alpha \quad (10)$$

The applicability of the equation to predict  $pK$  values was confirmed by the good fits obtained for experimental and predicted values. A graphical example is given in Figure 1 for the dissociation constants of picric acid in binary mixtures<sup>62</sup>.

Recently<sup>68,69</sup> Abraham and coworkers have applied equation 6 to the correlation of several physico-chemical and biological phenomena in binary systems. These include solvent-water partition coefficients<sup>70,71</sup>, HPLC capacity factors<sup>53,72</sup> and the distribution

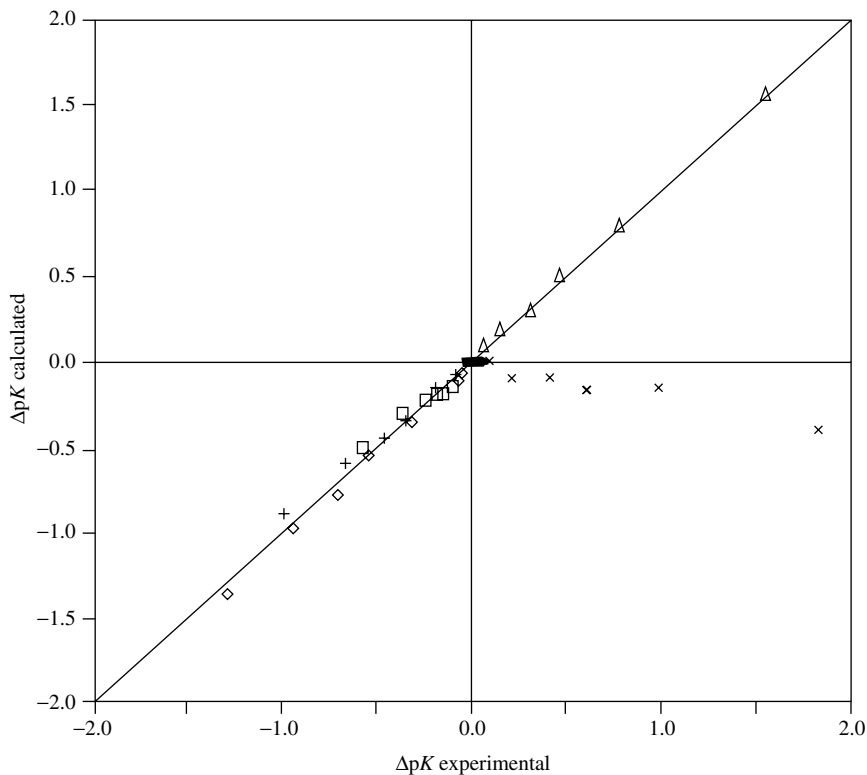


FIGURE 1. Dissociation constants of picric acid in binary mixtures<sup>62</sup>. Reprinted with permission from Reference 62. Copyright (1994) American Chemical Society

TABLE 4. Variation in  $\pi^*$ ,  $\alpha$  and  $\beta$  solvatochromic parameters in 2-methylpropan-2-ol by addition of cosolvents<sup>62</sup>. Reprinted with permission from Reference 62. Copyright (1994) American Chemical Society

Cosolvent	$v^a$	$x^a$	$\Delta\pi^*$	$\Delta\alpha$	$\Delta\beta$	$\Delta\delta$
<i>n</i> -Hexane	0.00200	0.00146	0.000	-0.001	-0.003	0.000
	0.00398	0.00292	0.000	-0.001	-0.003	0.000
	0.00794	0.00581	-0.005	0.001	0.000	0.000
	0.01961	0.01441	-0.009	0.000	-0.002	0.000
	0.03846	0.02841	-0.014	-0.003	-0.007	0.000
	0.05660	0.04202	-0.023	-0.002	-0.007	0.000
	0.09091	0.06812	-0.037	-0.003	-0.012	0.000
	0.12281	0.09284	-0.051	-0.002	-0.014	0.000
	0.13793	0.10472	-0.060	0.000	-0.014	0.000
	0.16667	0.12755	-0.074	0.003	-0.019	0.000
Benzene	0.00200	0.00214	0.000	0.000	-0.003	0.002
	0.00398	0.00427	0.000	0.000	-0.005	0.004
	0.00794	0.00851	0.000	0.000	-0.010	0.009
	0.01961	0.02100	0.005	-0.004	-0.031	0.021
	0.03846	0.04113	0.005	-0.005	-0.051	0.041
	0.05660	0.06046	0.009	-0.009	-0.077	0.060
	0.09091	0.09686	0.009	-0.012	-0.110	0.097
	0.12281	0.13054	0.014	-0.018	-0.144	0.131
	0.13793	0.14646	0.019	-0.023	-0.162	0.146
	0.16667	0.17661	0.023	-0.030	-0.190	0.177
Propan-2-ol	0.00200	0.00249	0.000	0.002	0.000	0.000
	0.00398	0.00496	0.000	0.004	0.000	0.000
	0.00794	0.00987	0.000	0.007	0.000	0.000
	0.01961	0.02432	0.005	0.014	-0.003	0.000
	0.03846	0.04748	0.005	0.029	0.000	0.000
	0.05660	0.06957	0.005	0.042	0.002	0.000
	0.09091	0.11081	0.005	0.065	0.005	0.000
	0.12281	0.14854	0.009	0.080	0.002	0.000
	0.13793	0.16624	0.009	0.088	0.005	0.000
	0.16667	0.19950	0.009	0.103	0.007	0.000
Ethanol	0.00200	0.00326	0.000	0.007	-0.013	0.000
	0.00398	0.00649	0.000	0.012	-0.015	0.000
	0.00794	0.01290	0.000	0.023	-0.020	0.000
	0.01961	0.03164	0.000	0.050	-0.023	0.000
	0.03846	0.06133	0.005	0.084	-0.028	0.000
	0.05660	0.08926	0.005	0.115	-0.028	0.000
	0.09091	0.14041	0.005	0.163	-0.028	0.000
	0.12281	0.18612	0.005	0.200	-0.031	0.000
	0.13793	0.20720	0.009	0.211	-0.036	0.000
	0.16667	0.24625	0.009	0.236	-0.036	0.000
Methanol	0.00200	0.00469	0.000	0.020	0.000	0.000
	0.00398	0.00933	0.000	0.036	-0.003	0.000
	0.00794	0.01849	0.000	0.063	-0.003	0.000
	0.01961	0.04498	0.000	0.120	-0.008	0.000
	0.03846	0.08609	0.000	0.183	-0.015	0.000
	0.05660	0.12381	0.005	0.225	-0.028	0.000
	0.09091	0.19061	0.005	0.292	-0.041	0.000
	0.12281	0.24795	0.009	0.337	-0.059	0.000
	0.13793	0.27368	0.009	0.358	-0.064	0.000
	0.16667	0.32019	0.009	0.393	-0.074	0.000

<sup>a</sup> $v$  = Volume fraction of cosolvent;  $x$  = mole fraction of cosolvent.

of solutes between blood and brain<sup>73</sup>. It was shown in a recent publication<sup>74</sup> that for a series of alcohols, the  $a$  coefficient is effectively zero, so that all the alcohol phases have the same basicity as bulk water, no matter what their water content is. This would indicate that the alcohols have similar hydrogen-bond basicity to water, contrary to results of solvatochromic measurements; the anomaly is assumed to be due to the strong dependence of the  $\beta$  values on the indicator used in the solvatochromic determinations<sup>75</sup>. It is suggested that the partition equations are more useful to represent the real interactions with the solvatochromic method<sup>74</sup>.

### C. The Influence of the Nucleophile

The basicity, nucleophilicity, polarizability and steric requirements of the nucleophile have been recently shown to affect the  $S_NAr$  reactions with amines.

#### 1. Basicity

The effect of basicity is clearly shown by the dependence of the rates of reactions of structurally related nucleophiles<sup>76,77</sup>. Bordwell<sup>76</sup> has pointed out that Brønsted plots reported in the literature for reactions in which bond formation to the nucleophile is rate-limiting have slopes  $\beta_{Nu}$  that range for the most part between 0.5–0.7, as shown in Table 5;  $\beta_{Nu}$  measures the sensitivity of the rates to changes in the basicity of the nucleophile. Its size appears to be associated with the extent of charge transfer in the transition state for the rate-limiting step, and it can be used to describe the position of the transition state along the reaction coordinate.

In single-electron-transfer reactions from carbanions where charge transfer is essentially complete,  $\beta_{Nu}$  is near-unity, while for  $S_N2$  reactions  $\beta_{Nu}$  ranges from 0.2 to 0.5. In  $S_NAr$  processes, where the size of  $\beta_{Nu}$  is determined by the bonding between the

TABLE 5. Brønsted  $\beta_{Nu}$  values for  $S_NAr$  reactions with thianion, amine, and oxanion families in hydroxylic solvents<sup>76</sup>. Reprinted with permission from Reference 76. Copyright (1986) American Chemical Society

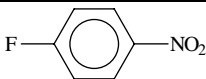
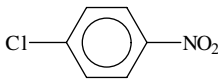
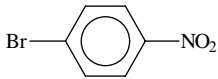
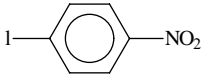
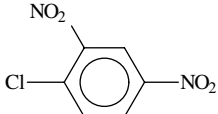
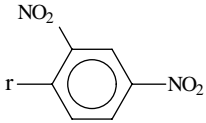
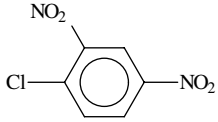
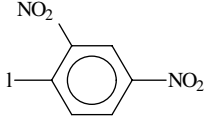
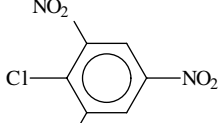
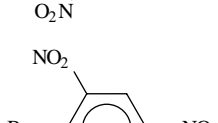
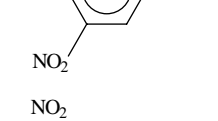
Nu family	Substrate	Solvent	$\beta_{Nu}$	Reference
ArS <sup>-</sup>		MeOH, 50 °C	0.52	<i>a</i>
ArS <sup>-</sup>		MeOH, 50 °C	0.48	<i>a</i>
ArS <sup>-</sup>		MeOH, 50 °C	0.55	<i>a</i>
ArS <sup>-</sup>		MeOH, 50 °C	0.55	<i>a</i>
ArO <sup>-</sup>		MeOH	0.91	<i>b</i>

TABLE 5. (continued)

Nu family	Substrate	Solvent	$\beta_{\text{Nu}}$	Reference
Amines		water	0.42	<i>c</i>
Amines		water	0.52	<i>c</i>
Amines		water	0.45	<i>c</i>
Amines		water	0.64	<i>c</i>
2-NpCOO <sup>-</sup>		80% MeOH/water	0.56	<i>d</i>
ArO <sup>-</sup>		75% EtOH/water	0.67	<i>e</i>

<sup>a</sup>G. Bartoli, L. DiNunno, L. Forlani, and P. E. Todesco, *Int. J. Sulphur Chem., Part C* **6** 77 (1971).

<sup>b</sup>G. D. Leahy, M. Liveris, J. Miller and A.J. Parker, *Aust. J. Chem.*, **9**, 382 (1956).

<sup>c</sup>J. E. Dixon and T.C. Bruice, *J. Am. Chem. Soc.*, **94**, 2052 (1972).

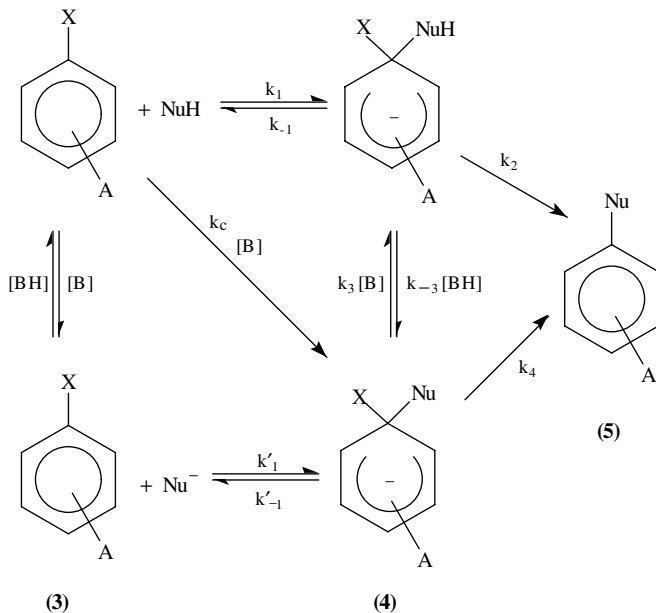
<sup>d</sup>P. A. Nadar and C. Gnanasekaran, *J. Chem. Soc., Perkin Trans. 2*, 671 (1978).

<sup>e</sup>J. J. Ryan and A. A. Hummfray, *J. Chem. Soc. (B)*, 1300 (1967).

nucleophile and a partially positively charged sp<sup>2</sup> carbon atom,  $\beta_{\text{Nu}}$  is large but not near-unity. The observation that it increases when more nitro groups are added to the electrophile (e.g.  $\beta_{\text{Nu}}$  for amines reacting with picryl chloride is 0.12 unit larger than for 1-chloro-2,4-dinitrobenzene) is consistent with the expected extent of charge transfer in the transition state.

Connected with the determination of Brønsted plots, some mathematical treatments have been recently developed attempting to yield structural information on the transition state.

These treatments have been also applied to  $S_NAr$ . For example, for a neutral nucleophile, all the classical pathways identified at present are represented by the general reaction mechanism shown by Scheme 2. A concerted mechanism, indicated by the diagonal path in Scheme 2, had not been discussed until lately, but was observed, among other systems, in the hydrolysis of 1-chloro-2,4,6-trinitrobenzene and 1-picrylimidazole. The study was then extended to other related substrates and structure–reactivity relationships could be obtained<sup>78</sup>.



SCHEME 2

The Brønsted  $\beta$  values for substituted phenyl ethers, 0.39 to 0.52, are in the range expected for concerted reactions, but indicate a transition state with less proton transfer than in the case of 3-methylimidazolium chloride derivatives, ( $\beta = 0.60$ – $0.65$ ). The structure–reactivity parameters were interpreted on the basis of the mathematical method developed by Jencks and More O'Ferrall. The tridimensional energy maps are shown in Figure 2, where proton transfer is represented along the  $x$ -axis and C–O bond formation along the  $y$ -axis. The position of the transition state along the reaction coordinate is shown in Figure 3 (the third dimension is omitted for clarity). The reaction coordinate shows more degree of proton transfer than C–O bond formation. The change in the nucleofugue from imidazole to OPh produces some stabilization in state II and a greater decrease in the energy of state IV. This produces a shift along the reaction coordinate toward I (arrow 1) and a little shift to II (arrow 2) by a perpendicular Thornton effect. The result of the two changes (arrow 3) indicates a lower degree of proton transfer and a small increase in the C–O bond formation<sup>78</sup>.

Recently, the same group<sup>79</sup> have reported the kinetic study of the reaction of 1-pyrrolidino-2,4-dinitrobenzene, 1-piperidino-2,4-dinitrobenzene and 1-morpholino-2,4-dinitrobenzene with NaOH in the presence of the amine leaving group and proposed the formation of  $\sigma$ -complexes, which were found to react faster than the original substrates.



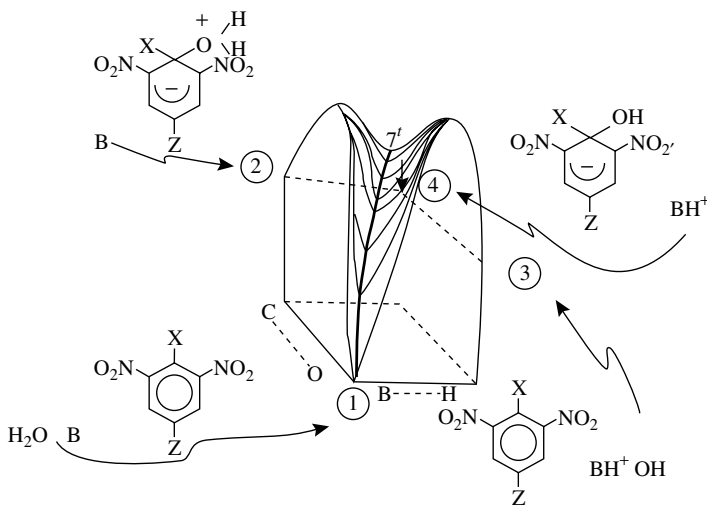


FIGURE 2. Tridimensional reaction coordinate diagram for the hydrolysis of 1-X-4-Z-2,6-dinitrobenzene. The  $x$ -axis represents the proton transfer reaction and the  $y$ -axis, the C–O bond formation<sup>78</sup>. Reproduced by permission of the Indian Journal of Technology

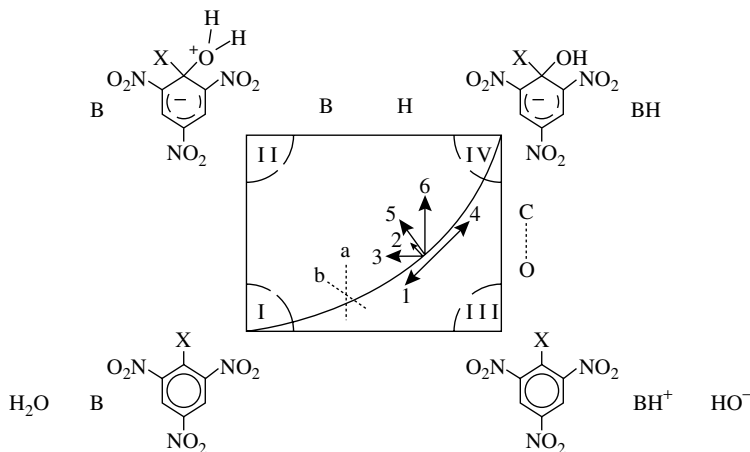


FIGURE 3. Structure–reactivity Jencks–More O’Ferral diagram for the hydrolysis of 1-X-2,4,6-trinitrobenzenes: (a) vertical level line as a consequence of  $-\partial\beta/\partial pK_{BH} = p_x = 0$ ; (b) level line clockwise rotated from the horizontal as a consequence of  $-(-\partial\beta_{XH}/-\partial pK_{XH}) = p_y = \text{negative}$ ; (c) reaction coordinate with an angle higher than 45 degrees with the vertical as the line that bisects the two level lines. Effect of change in the X substituent by better withdrawing groups, arrows 1, 2 and 3. Effect of change in the base (B) by other with lower  $pK_{BH}$ , arrows 4, 5 and 6<sup>78</sup>. Reproduced by permission of the Indian Journal of Technology

## 2. Nucleophilicity and polarizability

The *nucleophilicity* of the amine is another factor affecting reactivity, and changes in it have been sometimes responsible for the observed scattering in the Brønsted plots. The Ritchie equation<sup>80</sup> (equation 11) has been applied to a variety of reactions in which nucleophilic addition to, or combination with, an electrophilic center is rate-limiting.

$$\log k = \log k_0 + N_+ \quad (11)$$

Here  $k$  is the rate constant for reaction of an electrophile with a given nucleophile in a given solvent,  $k_0$  corresponds to the reaction of the same electrophile with water (in water) and  $N_+$  is a parameter characteristic of the given nucleophile in the given solvent, but independent of the electrophile<sup>80</sup>. Ritchie's ideas imply that the transition states are characterized by rather large separations of the nucleophile and electrophile moieties. For  $S_NAr$  reactions involving rate-determining nucleophilic addition, this would mean that bond formation and charge transfer have made little progress in the transition states. These conclusions are in disagreement with those reached on the basis of the  $\beta_{Nu}$  values obtained from Brønsted plots<sup>76</sup>. A possible explanation of this conflicting situation is in terms of imbalanced transition states, with desolvation of the nucleophile being ahead of bond formation and charge transfer in the transition state<sup>1a</sup>.

A recent study of the reactions of 2,4-dinitrochlorobenzene and of picryl chloride with a series of nucleophiles that are presented in Table 6 shows that a plot (not shown) of  $\log k$  against the  $pK_a$  values of all the nucleophiles is badly scattered<sup>77</sup>. Differences of up to  $10^8$  are observed for bases with similar  $pK_a$  values. Part of this scatter is due to deviations that result because different families of nucleophiles (with different nucleophilic atoms) give rise to different Brønsted correlation lines. Thus, for the reactions of picryl chloride good correlations are observed for a family of oxyanions ( $\beta = 0.38$ , plot not shown), primary and secondary amines (Figure 4,  $\beta = 0.52$ ) and quinuclidines (Figure 4,  $\beta = 0.66$ ).

On the other hand, the correlation with the  $N_+$  parameter shown in Figure 4 for the same reaction is a good one, with a slope of  $0.79 \pm 0.11$ . The rate constants in this correlation span a range of almost  $10^5$  in reactivities. For the reaction of 2,4-dinitrochlorobenzene a slope of  $0.95 \pm 0.13$  is observed in Figure 5. The correlation spans a reactivity range of almost  $10^7$ . Despite these overall good correlations, there are significant changes in relative nucleophilic reactivities, which the authors attributed mainly to steric effects<sup>77</sup>. For example, secondary amines such as piperidine and morpholine are relatively more reactive than less hindered primary amines in reactions with 2,4-dinitrochlorobenzene. Notwithstanding, it will be shown below that other effects have been also found to be responsible for these changes. Steric effects cannot account for the slope of less than one observed for the reactions of picryl chloride, because the slope is not significantly different ( $0.82 \pm 0.11$ ) when the points for the more hindered secondary amines are omitted from the plot<sup>77</sup>. The slopes less than one observed for these reactions (Figure 5) mean that picryl chloride shows a lower selectivity toward nucleophilic attack than does 2,4-dinitrochlorobenzene, in accordance with the reactivity-selectivity principle and with relative nucleophilic reactivities that are substrate-dependent<sup>77</sup>. Nevertheless, in other cases, it has been found that nucleophilic additions to halonitroarenes do not follow the reactivity-selectivity principle<sup>7</sup>.

The nitro group is highly polarizable and electrostatic repulsion between this group and the incoming nucleophile should *decrease* the rate when the nitro group is located in the *ortho*-position. Nevertheless, *polarizability* effects of the nucleophile may be *rate-enhancing* because of the operation of London forces, as shown earlier with the reactions with thiophenoxide ions<sup>81</sup>. Although no studies of these effects have been conducted in

TABLE 6. Second-order rate constants for nucleophilic aromatic substitution reactions of 2,4-dinitrochlorobenzene and picryl chloride<sup>d77</sup>. Reprinted with permission from Reference 77. Copyright (1992) American Chemical Society

	Nucleophile (N+) <sup>b</sup>	log <i>h</i> M <sup>-1</sup> 8 <sup>-1</sup> PC <sup>e</sup>	DNCB <sup>d</sup>
1	NH <sub>2</sub> CH <sub>2</sub> CH <sub>2</sub> NH <sub>2</sub> (5.37)	0.412	
2	NH <sub>2</sub> CH <sub>2</sub> CH <sub>2</sub> NH <sub>3</sub> <sup>4</sup> (3.91)	-0.821	
3	CF <sub>3</sub> CH <sub>2</sub> NH <sub>2</sub> (2.89)	-1.91	-5.58
4	NH <sub>2</sub> NHCONH <sub>2</sub> (3.17)	-1.10	-5.15
5	Morpholine (5.25)	0.23	-2.48 <sup>e</sup>
6	Piperidine (6.11)	1.05	-1.39
7	HO <sup>-</sup> (4.75)	-0.155 <sup>l</sup>	-3.91 <sup>e</sup>
8	Morpholine <sup>2</sup> (5.8) <sup>h</sup>	0.131	-2.59 <sup>e</sup>
9	Piperidine <sup>g</sup> (6.6) <sup>h</sup>	1.06	-2.00 <sup>e</sup>
10	CH <sub>3</sub> ONH <sub>2</sub> (3.88)	-1.06	-5.35 <sup>e</sup>
11	Phenoxide (5.6)		-3.00 <sup>e</sup>
12	HOO <sup>-</sup> (8.08)		-0.64 <sup>e</sup>
13	<sup>-</sup> SCH <sub>2</sub> CO <sub>2</sub> <sup>-</sup> (8.7) <sup>l</sup>	3.00 <sup>h</sup>	0.57 <sup>e</sup>
14	CH <sub>3</sub> O <sup>-</sup> (7.68)		-1.50 <sup>e</sup>
15	Thiophenoxide <sup>g</sup> (10.51)		-1.30 <sup>e</sup>
16	NH <sub>2</sub> CH <sub>2</sub> CONHCH <sub>2</sub> CO <sub>2</sub> <sup>-</sup> (4.48)	-0.194 <sup>l</sup>	-4.20 <sup>e</sup>
17	NH <sub>2</sub> CH <sub>2</sub> CO <sub>2</sub> <sup>-</sup> (5.22)		-3.40 <sup>e</sup>
18	NH <sub>2</sub> NH <sub>2</sub> (5.66)	0.959 <sup>l</sup>	-2.80 <sup>e</sup>
19	Quinuclidinol (5.50)	-1.31	
20	3-Quinuclidinol	-3.22	
21	DABCO (5.30)	-4.01 <sup>j</sup>	
21	3-Quinuclidine	-4.96	
22	CH <sub>3</sub> COO <sup>-</sup> (>2.95)	-4.41	
23	H <sub>2</sub> O (0)	-7.19 <sup>l,m</sup>	
24	CO <sub>3</sub> <sup>2-</sup>	-2.62 <sup>l</sup>	
25	HCO <sub>3</sub> <sup>-</sup>	-3.84 <sup>l</sup>	
26	PO <sub>4</sub> <sup>3-</sup>	-2.06 <sup>l</sup>	
27	Borate	-4.70 <sup>l</sup>	

<sup>a</sup>At 25 °C in aqueous solution.<sup>b</sup>From C. D. Ritchie, *J. Am. Chem. Soc.* **97**, 1170 (1975) unless noted otherwise.<sup>c</sup>PC is picryl chloride.<sup>d</sup>DNCB is 2,4-dinitrochlorobenzene.<sup>e</sup>Data from Reference 80c.<sup>f</sup>R. H. Rossi and E. B. Vargas, *J. Org. Chem.*, **44**, 4100 (1979).<sup>g</sup>In methanol at 25 °C.<sup>h</sup>Data from M. R. Crampton and J. A. Stevens, *J. Chem. Soc., Perkin Trans. 2*, 1097 (1990).<sup>i</sup>Data from J. E. Dixon and T. C. Bruce, *J. Am. Chem. Soc.*, **94**, 2052 (1972). Rate constants corrected from 30 to 25 °C using the Arrhenius equation, assuming an activation energy of 10 kcal mol<sup>-1</sup>.<sup>j</sup>log *k* = -4.01 from work reported in R. H. Rossi and E. B. Vargas, *J. Org. Chem.*, **44**, 4100 (1979).<sup>k</sup>Values of N+ for morpholine and piperidine in methanol solution were obtained by taking the average value of N+ determined by fitting the rate constants for the reactions of these nucleophiles with 2,4-dinitrofluorobenzene, 2,4-dinitrochlorobenzene, 2,4-dinitroiodobenzene and 2,4-dinitroiodobenzene, to plots of log *k* against N+ (using the data reported in Reference 80c). Data for the reactions of these substrates with azide ion were excluded from the correlation lines for the purpose of calculating these N+ values.<sup>l</sup>Based on data from Reference 80c.<sup>m</sup>In units of S<sup>-1</sup>.

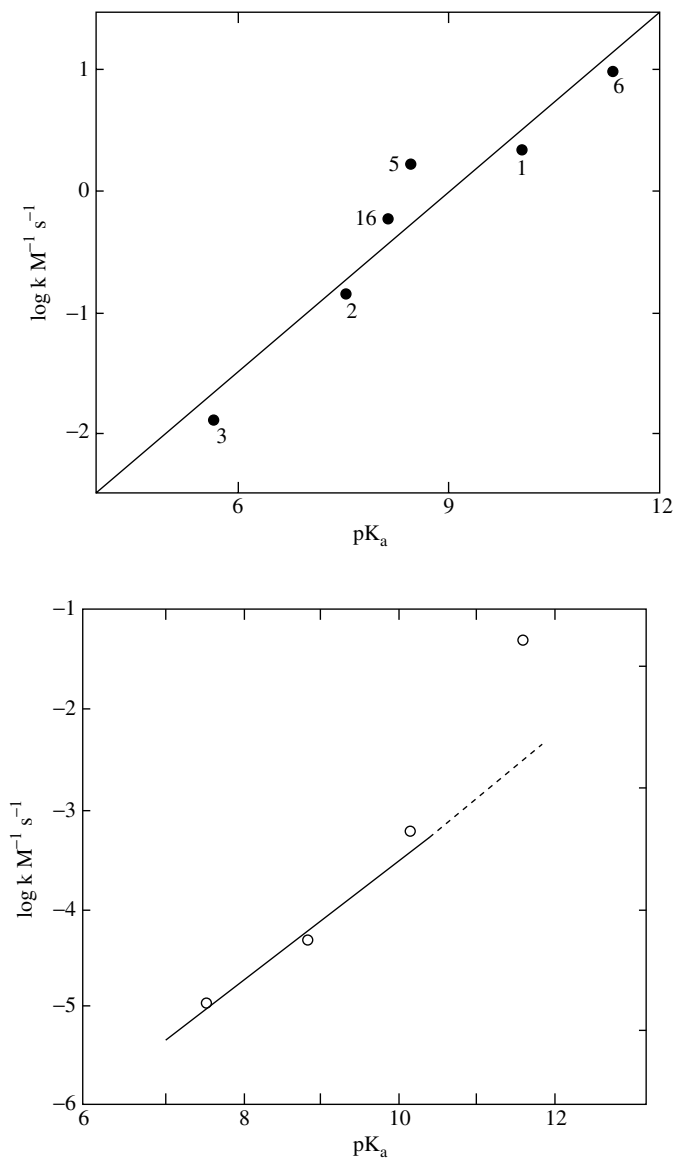


FIGURE 4. (Top) plot of  $\log k$  for the reactions of primary and secondary amine nucleophiles with picryl chloride against their  $\text{pK}_a$  values in aqueous solution at  $25^\circ\text{C}$ . (Bottom) plot of  $\log k$  for the reactions of a series of substituted quinuclidine ions with picryl chloride against the  $\text{pK}_a$  values of the nucleophiles. In aqueous solution at  $25^\circ\text{C}$ <sup>77</sup>. Reprinted with permission from Reference 77. Copyright (1992) American Chemical Society

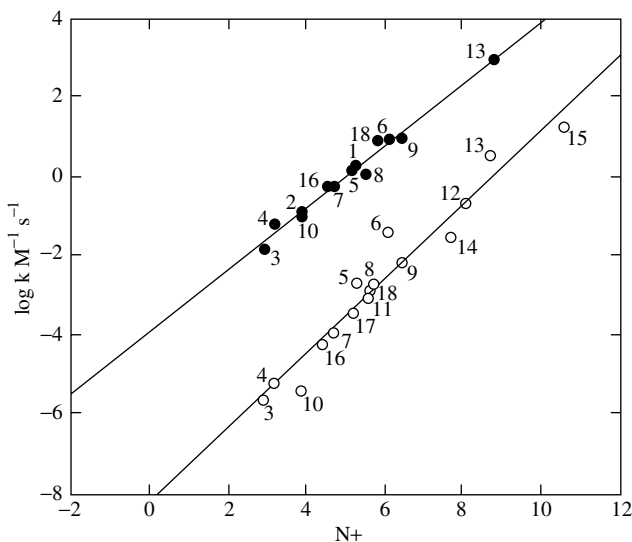


FIGURE 5. Plot of  $\log k$  for the reactions of nucleophiles with 2,4-dinitrochlorobenzene and picryl chloride against the  $N+$  parameter. In aqueous or methanol solutions at  $25^\circ\text{C}$ <sup>77</sup>. Numbers 1–18 are defined in Table 6. Reprinted with permission from Reference 77. Copyright (1992) American Chemical Society

the reactions with amines, it is expected that highly polarizable amines would react faster than other amines of similar basicity, since the polarizability effect has been considered in  $S_NAr$  reactions<sup>76,81</sup>.

### 3. Steric effects

*Steric effects* in the nucleophile have been long known to affect the reactivity in  $S_NAr$  reactions, mainly due to the steric hindrance to the entrance of the nucleophile in the formation of the zwitterionic intermediate<sup>1</sup>. In the case of amines, branching in the nucleophile was shown to decrease the rate of reaction with nitrohalobenzenes and the result was interpreted as due to a decrease in the rate of formation of the zwitterionic intermediate<sup>4</sup>, and a similar result was observed in the reaction of 1,2-dinitrobenzene<sup>9</sup>. Table 7 shows the  $S_NAr$  of several substrates with *n*- and *s*-butylamine. It can be observed that *s*-BuNH<sub>2</sub> exerts an important decrease in reactivity with respect to *n*-BuNH<sub>2</sub> for every substrate. The  $\alpha$ -branching of the amines decreases the  $k_2/k_{-1}$  values, probably by increasing  $k_{-1}$  via steric hindrance, and retardation is present despite the electronic effect of the methyl group. On the other hand, it will be shown that  $\alpha$ -branching of the amines reduces  $k_3/k_{-1}$  by reducing the rate of proton transfer ( $k_3$ ).

It has been recently reported that, contrary to previous assumptions, primary steric effects due to a branching in the amine do not produce a large decrease in the reaction rate when the first step is rate-determining<sup>82</sup>. In  $S_NAr$  reactions of amines with fluoronitrobenzene, it is generally accepted that the second step of the mechanism depicted in Scheme 1 is rate-determining; base catalysis is frequently found and the observed rate constants obey equation 2. Nevertheless, the reaction of *o*-fluoronitrobenzene with *n*- and *iso*-propylamine in toluene and in DMSO are only slightly sensitive to the nucleophile concentration. The

TABLE 7. Experimental and literature kinetic constants for  $S_NAr$  reactions of  $Bu''NH_2$  and  $Bu'NH_2$  with several substrates<sup>9</sup>

Substrate	Solvent	$Bu''NH_2$		$Bu'NH_2$		$k_0$ ( $dm^3 mol^{-1} s^{-1}$ )	$k'$ ( $dm^3 mol^{-1} s^{-1}$ )	$k_0$ ( $dm^3 mol^{-1} s^{-1}$ )	$k'$ ( $dm^3 mol^{-1} s^{-1}$ )	$k''$ ( $dm^3 mol^{-1} s^{-1}$ )	$k'''$ ( $dm^3 mol^{-1} s^{-1}$ )	Reference
		$k_0$ ( $dm^3 mol^{-1} s^{-1}$ )	$k'$ ( $dm^3 mol^{-1} s^{-1}$ )	$k_0$ ( $dm^3 mol^{-1} s^{-1}$ )	$k'$ ( $dm^3 mol^{-1} s^{-1}$ )							
1,2-DNB	Hexane <sup>d</sup>	$0.54 \times 10^{-4}$	$6.10 \times 10^{-4}$	$0.31 \times 10^{-4}$	$0.23 \times 10^{-4}$							107
1,2-DNB	Benzene <sup>b</sup>	$3.09 \times 10^{-5}$	$3.76 \times 10^{-4}$	$0.28 \times 10^{-5}$	$0.41 \times 10^{-5}$							9
1-F-2,4-DNB	Benzene <sup>c</sup>	0.16	35.8	0.023	1.36							111
6-NO <sub>2</sub> -2-Cl-benzothiazole	Benzene <sup>c</sup>	$5.47 \times 10^{-5}$	$1.11 \times 10^{-3}$	$3.0 \times 10^{-6}$	$5.28 \times 10^{-5}$							160
6-NO <sub>2</sub> -2-Br-benzothiazole	Benzene <sup>c</sup>	$5.13 \times 10^{-5}$	$1.04 \times 10^{-3}$	$1.0 \times 10^{-6}$	$5.02 \times 10^{-5}$							160
6-NO <sub>2</sub> -2-F-benzothiazole	Benzene <sup>c</sup>	$1.20 \times 10^{-2}$	2.98	$3.41 \times 10^{-3}$	$1.90 \times 10^{-1}$							159

<sup>a</sup> $T$  37 °C.<sup>b</sup> $T$  27 °C.<sup>c</sup> $T$  25 °C.

mild acceleration observed conforms to the mathematical form of equation 12;  $k'$  and  $k''$  become the terms  $k_1k_2/k_{-1}$  and  $k_1k_3/k_{-1}$ , respectively, when the effect is due to authentic base catalysis, as is the case of the reactions with *p*-fluoronitrobenzene.

$$k_A = k' + k''[B] \quad (12)$$

Examining the results of the reactions of *o*- and *p*-fluoronitrobenzene with *n*-propylamine and isopropylamine in toluene and in DMSO, the observed very low  $k'':k'$  ratio for the reactions of *o*-fluoronitrobenzene clearly shows that decomposition of the intermediate  $\sigma$ -complex is not a slow step. Efficient activation in this reaction requires coplanarity of the *o*-nitro group (the nitro-oxygen atoms support a strong negative charge as shown by theoretical calculations)<sup>83a,b</sup> and the result is interpreted as due to the strong hydrogen bond formed between the ammonium hydrogen and the oxygen atoms, which loosens the N–H bond (calculations show that a real hydrogen transfer occurs in the vacuum)<sup>83a</sup>. It was observed that *branching* in the amine *does not* produce a highly significant decrease in the rate (see also Table 28).

The reaction of *p*-fluoronitrobenzene with *n*-propylamine, on the contrary, proceeds almost exclusively by the base-catalysed step. Very interestingly, this reaction exhibits a 100-fold decrease in rate when compared with the reaction with *n*-propylamine in toluene. It is obvious that primary steric effects cannot be greater than those in *o*-fluoronitrobenzene: interestingly, it was found that the large diminution in the rate is due to the great slowness of the base-catalysed step<sup>82</sup>. Therefore, when comparing reactivities in reactions with fluorine substrates, steric effects of the nucleophile must be examined at different amine concentrations; it is almost certain that primary steric effects should be low, but stereoelectronic effects on the hydrogen abstraction in the intermediate complex are expected to be important: the *o:p* ratio for isopropylamine in toluene is *ca* 10<sup>4</sup>. Although it may be argued that branching in the amine reduces the  $k_3/k_{-1}$  values not only by reducing the rate of proton transfer ( $k_3$ ) but also by increasing the rate of decomposition of the zwitterionic intermediate to reactants ( $k_{-1}$ ) because of steric congestion, this effect was shown to be not very important with the reactions of *o*-fluoronitrobenzene (see Table 28) and also with the reactions of *p*-fluoronitrobenzene in DMSO<sup>82</sup>. It was observed that  $k_{n\text{-propylamine}}/k_{iso\text{-propylamine}}$  changes from 100 in toluene to almost 1 in DMSO where the first step is rate-determining.

Consistently with these arguments, analysis of the data in Table 7 indicates that stronger influence of steric effects is exerted on  $k''$  (related to  $k_3$ ) than on  $k'$  (related to  $k_2$ ). It is also observed that the ratios of  $k'$  seem to depend on the substrate, while the ratios of  $k''$  for the same reactions are higher (stronger retardation effects) and similar, despite the nucleofuge<sup>9</sup>. There is evidence<sup>21</sup> for unfavourable stereoelectronic conformational effects when the transition step contains piperidine groups and it has been also recently reported that a change from primary amines to piperidine results in a reduction in the rate of proton transfer<sup>24</sup>.

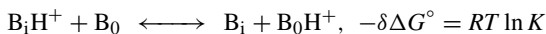
Section III will show the importance of amine aggregates in  $S_NAr$  reactions in aprotic solvents when the second step is rate-determining: it is obvious that branching of the amine will diminish the formation of the aggregates that help the proton transfer and the nucleofuge departure from the  $\sigma$ -complex.

#### 4. Gas-phase basicity scales

The advent of techniques that enable the study of fast reactions in the gas phase, such as ion cyclotron resonance (ICR) spectrometry, Fourier-transform ion cyclotron resonance spectrometry (FT-ICR) and high pressure mass spectrometry (HPMS), allowed the measurement of the gas-phase proton affinities for strong bases<sup>84–86</sup> as well as for

low-basicity compounds<sup>87-91</sup>. These data are useful as a reference for further estimations of the specific solute-solvent interactions when the compounds are used in solution, especially in solvents of low permittivity (i.e. low dielectric constant).

Recent measurements for the following gas-phase proton transfer equilibria:



where  $B_0$  is the reference base, have been made by ICR, FT-ICR<sup>87,88</sup> and HPMS<sup>91,92</sup>, covering a wide interval between 41 kcal mol<sup>-1</sup> and 318.2 kcal mol<sup>-1</sup><sup>87</sup>.

*Superbases.* Measurements of the basicity of very strong bases have been carried out in the gas phase, extending the gas-phase basicity scale for organic compounds up to PA = 1050 kJ mol<sup>-1</sup><sup>84-86</sup>, and a basicity scale for these superbases has been recently proposed<sup>86,87,93</sup>. Raczynska and coworkers, studied a series of amidines<sup>84,85</sup> and guanidines<sup>86</sup> using the gas-phase values for Pr<sub>3</sub><sup>n</sup>N and Bu<sub>3</sub><sup>n</sup>N<sup>85</sup> as the starting points in the basicity scale. A quantitative comparison based on the Taft and Topsom analysis<sup>94</sup> was conducted for alkyl substituents, for which the relative basicities ( $\delta_R$ GB) obey equation 13:

$$\delta_R \text{GB} = \rho_a \sigma_a + c \quad (13)$$

where  $\rho_a$  is the reaction constant for the polarizability effect and  $\sigma_a$  is the directional polarizability parameter of Taft and coworkers<sup>94,95</sup>. An interesting intramolecular stabilization has been observed with the amidinium and guanidinium ions, that will be discussed in Section III. M, because of its connection with the 'dimer' mechanism.

*Weak bases.* Several basicity scales have been suggested, such as the HPMS<sup>91</sup> and the FT-ICR<sup>87,88</sup> basicity scales. Most of the investigations have been centred on compounds which are usually more basic than water, but Table 8 shows the recently measured relative basicities ( $\delta\Delta G^0$ ) and the basicity relative to ammonia,  $-\delta\Delta G^0(\text{NH}_3)$  of very low-basicity compounds, determined by FT-ICR<sup>87</sup>.

The FT-ICR gas-phase basicity scale for the weak bases<sup>87,93</sup> can be compared with the results obtained by McMahon and coworkers<sup>91,92</sup> using ICR and HPMS spectrometric techniques. Satisfactory agreement was found with the existing ICR data, but some variances were observed with the HMPS results.

### 5. Solvation effects on relative basicities

The overall importance of the medium on the reaction rates has been shown previously, but the nature and extent of solute-solvent interactions can alter tremendously various properties of the nucleophile; the variations are usually satisfactorily correlated by some of the several quantitative structure-activity relationships (QSAR) that have been discussed<sup>37,38,51,96</sup>. The term quantitative structure-property relationship (QSPR) has been recently proposed for cases where a specific property, such as the basicity, is examined<sup>97</sup>.

The QSAR technique, widely developed by Kamlet, Taft and coworkers<sup>38,98</sup> for the prediction of specific solute-solvent interactions, has been used to predict the different solute-solvent contributions to property variations of compounds. The influence of solvent on the relative basicity of dipolar trimethylamines has been recently studied: a descriptor was developed to describe a unique solute-solvent interaction involving dipolar amines<sup>99</sup>.



TABLE 8. Directly measured relative basicities  $\delta\Delta G^\circ$  and the basicity relative to ammonia,  $\delta\Delta G^\circ(\text{NH}_3)^{a,b,87a}$ . Reprinted with permission from Reference 87a. Copyright (1994) American Chemical Society

	Directly measured $\delta\Delta G^\circ$	$\delta\Delta G^\circ(\text{NH}_3)$
(CF <sub>3</sub> ) <sub>2</sub> CHOCH <sub>3</sub>		33.4
H <sub>2</sub> S		33.9°
CF <sub>3</sub> COOH	0.9	33.8°
CF <sub>3</sub> SSCF <sub>3</sub>	0.3	34.1
CF <sub>3</sub> COOCH <sub>2</sub> CF <sub>3</sub>	1.5	34.2
(CF <sub>3</sub> CH <sub>2</sub> ) <sub>2</sub> O	0.7	34.8
CF <sub>3</sub> CH <sub>2</sub> OH	0.6	35.4°
(F <sub>2</sub> CH <sub>2</sub> )CO	1.2	36.1
(CN) <sub>2</sub> C=C(CN) <sub>2</sub>	0.7	37.4
H <sub>2</sub> O	2.0	37.5°
CF <sub>3</sub> CN	2.1	39.1
(CF <sub>3</sub> ) <sub>2</sub> CHOH	1.7	39.9
CF <sub>3</sub> COCl	0.8	40.1
CF <sub>3</sub> CHO	0.2	40.3
C <sub>2</sub> H <sub>4</sub>	0.2	40.5°
(CN) <sub>2</sub>	0.2	40.5°
FCN	2.4	41.2
(CF <sub>3</sub> ) <sub>3</sub> COH	1.7	41.7
CF <sub>3</sub> C=CH	1.5	42.2
FSO <sub>2</sub> Cl	0.5	42.5
F <sub>2</sub> NH	1.0	43.0
SO <sub>2</sub>	1.2	43.0°
COS	0.4	43.4
(CF <sub>3</sub> ) <sub>2</sub> CO	0.5	43.7
F <sub>2</sub> CO	1.3	45.0
(CF <sub>3</sub> ) <sub>2</sub> O	0.2	45.2
SO <sub>2</sub> F <sub>2</sub>	0.9	46.0

<sup>a</sup>All quantities are given in kcal mol<sup>-1</sup>.

<sup>b</sup> $\delta\Delta G^\circ(\text{NH}_3) = \Delta G^\circ(\text{NH}_3) - \Delta G^\circ(\text{base})$ .

<sup>c</sup>See also S. G. Lias, J. E. Bartmess, J. F. Liebman, J. L. Holmes, R. D. Levin and G. W. Mallard, *J. Phys. Chem. Ref. Data*, **17**, Suppl. 1 (1988).

It was found that a better representation of non-specific interactions between solvents and the monosubstituted dipolar trimethylammonium ions is gained from the product of  $\pi^*$  and the solvent dipole moment ( $\mu$ ). The obtained results were compared with the gas-phase basicity and the solvent attenuation factors (SAF) were calculated<sup>99</sup>.

The multiparametric equation 14 has been also applied to estimate solvent effects on the relative basicities ( $\delta\Delta G$ ) of propylamines<sup>97</sup>:

$$\delta\Delta G = s\pi^* + a\alpha + b\beta + \delta\Delta G_0 \quad (14)$$

where the intercept, i.e.  $\delta\Delta G_0$ , represents the relative basicity in the absence of solvents.

TABLE 9. Solvent solvatochromic parameters<sup>a</sup> and the relative basicities ( $\delta\Delta G$ ) of propylamines in the gas phase and various solvents (values are in kcal mol<sup>-1</sup> at 298 K and relative to diethylamine)<sup>97</sup>. Reprinted with permission from Reference 97. Copyright (1995) American Chemical Society

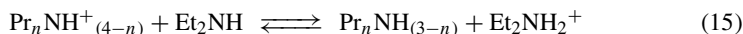
Solvent <sup>b</sup>	$\pi^*$	$\alpha$	$\beta$	PrNH <sub>2</sub>	Pr <sub>2</sub> NH	Pr <sub>3</sub> N
(Gas) <sup>c</sup>	-1.1	—	—	6.8	-2.3	-8.7
AQ	1.09	1.17	0.18	0.61	-0.03	0.44
MeOH	0.60	0.98	0.62	0.47	0.29	1.39
EtOH	0.54	0.86	0.77	0.38	0.23	1.56
2-PrOH	0.46	0.78	0.90	0.56	0.31	1.11
EG	0.92	0.92	0.52	0.48	0.40	2.11
DMSO	1.00	0.00	0.76	0.30	1.02	2.61
AN	0.76	0.15	0.31	1.24	0.00	0.83
NB	1.01	0.00	0.39	0.75	0.29	1.11
NM	0.85	0.23	0.37	1.00	0.00	0.88

<sup>a</sup>From Reference 101.

<sup>b</sup>(Gas), gas phase; AQ, water; MeOH, methanol; EtOH, ethanol; 2-PrOH, propan-2-ol; EG, ethylene glycol; DMSO, dimethyl sulphoxide; AN, acetonitrile; NB, nitrobenzene; NM, nitromethane.

<sup>c</sup>Gas-phase basicity values are taken from D. H. Aue and M. T. Bowers, in *Gas Phase Ion Chemistry* (Ed. M. T. Bowers), Vol. 2, Academic Press, London, 1979.

Table 9 shows the basicity variations of propylamines in the gas phase and in different solvents, relative to diethylamine; the equilibrium is given by equation 15.



Propylamines with positive basicity values are less basic than diethylamines, and propylamines with negative values are more basic than diethylamines. The expected order Pr<sub>3</sub>N > Pr<sub>2</sub>NH > PrNH<sub>2</sub> is observed in the gas phase, while in solution the basicity trend shown in Table 9 indicates that dipropylamine is the most basic amine in all the solvents used, except in DMSO, where propylamine is the most basic amine. Analysis of the different solute–solvent interactions carried out by the correlation coefficients found for equation 14 shows that the *dipolarity–polarizability term* ( $\pi^*$ ) has an important contribution (the coefficient changes from -2.4 for PrNH<sub>2</sub> to +3.9 for Pr<sub>3</sub>N), possibly due to the different interactions in the ammonium ions. It has been shown that alkyl substituents which are polarizable<sup>98</sup> do contribute to the reduction of the positive character of the ammonium ions, although this contribution is highly attenuated in solution<sup>100</sup>. The *solvent basicity* ( $\beta$ ) is also important because the number of acidic sites differs for the different types of ammonium ions. Propylammonium ion has three acidic hydrogens at which individual specific solute–solvent interactions take place. On the other hand, tripropylammonium ions depend strongly on this specific interaction for the dispersal of the charge into the solvent. This is shown by the *b* values, that change from -2.3 to +4.3. Thus, for the basicity of propylamines in solution, solute–solvent interactions of the ammonium ions with the dipolar basic solvents seem to play the greatest role in the determination of the relative basicities. This observation is consistent with that made for the basicity of substituted ethylamines, in which it was shown that their basicities are very sensitive to the polar, acidic and basic nature of the medium<sup>101</sup>.

## D. The Influence of the Substrate

### 1. Steric and conformational effects

The relative importance of *steric effects* in the substrate on the rates of S<sub>N</sub>Ar reactions with amines in aprotic solvents was studied earlier and it was shown that the rates

of reaction of 2-nitro-6-alkyl chlorobenzenes with piperidine in benzene could be satisfactorily correlated with the  $\sigma$ -Hammett substituents<sup>102</sup>. Correlations including steric parameters did not significantly improve the linear regression coefficient. This means that substitution in both sites of the reaction centre does not produce severe steric congestion that would affect the rates unless very bulky substituents were present. Thus, in the case of the reactions of 2-nitro-6-alkyl chlorobenzenes with piperidine in benzene only the bulkiest substituent, the 6-methyl group, was out of the straight line<sup>102</sup>.

Similar results were then found for piperidino-debromination of various nitro-activated five-membered ring heterocycles<sup>103</sup>. The existence of such linear Hammett plots for *ortho*-substituted substrates was interpreted as a peculiar feature of five-membered ring heterocycles, where steric effects of substituents *ortho* to the site of the nucleophilic attack are minimized<sup>1a</sup>.

It was recently shown that also the reactions of 2-nitro-6-alkyl anisoles with amines in aprotic solvents are not strongly influenced by steric effects<sup>104</sup>. On the contrary, it was observed that even the 6-methyl-2-nitroanisole reacts with cyclohexylamine about 15-fold faster than the 4-methyl-2-nitroanisole. The absence of primary steric effects and even the increase in rate can be understood by considering some *substrate conformational features*. When one of the *ortho* positions is not substituted, the methoxy group may be coplanar with the ring, but when both *ortho* positions are substituted, rotation of the methoxy group was predicted. The loss of coplanarity would result in a decrease of resonance stabilization, as can be seen in Figure 6; this was proposed as the reason that makes the 6-substituted compound more reactive<sup>104</sup>. Further crystallographic studies of related anisoles and phenetoles confirmed that the alkoxide group is almost perpendicular to the aromatic ring<sup>105</sup>. Thus, an X-ray determination of the structures of both 2,6- and 2,4-dinitroanisole revealed that when methoxy is *ortho*-substituted on one side alone, the methoxy group makes only a very small angle ( $5^\circ$ ) with the ring, whereas when there are two nitro groups adjacent to methoxy, the methoxy group makes a large angle with the ring ( $79^\circ$ ), as shown in Figure 7<sup>105</sup>.

Taft and coworkers<sup>106a</sup>, have recently reviewed the substituent and structural effects in a comprehensive analysis of substituents constants<sup>106a</sup>, followed by a survey of structural effects in organic chemistry<sup>106b</sup>.

## 2. *o*- vs *p*-Activation

For  $S_NAr$  reactions with amines, the presence of a nitro group in a position *ortho* to the nucleofuge plays an important role. In spite of the steric effects which will tend to decrease the reactivity of *o*-nitroaromatics, and the fact that the rate-enhancing effect of the resonance stabilization of the transition state will be more important from the *para* position, a  $k^o/k^p$  ratio greater than unity is usually found in the reactions of nitroaromatics

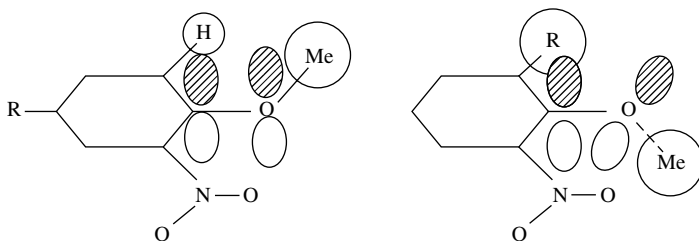


FIGURE 6. Orbital interactions in 4-R- and 6-R-2-nitroanisoles<sup>104</sup>

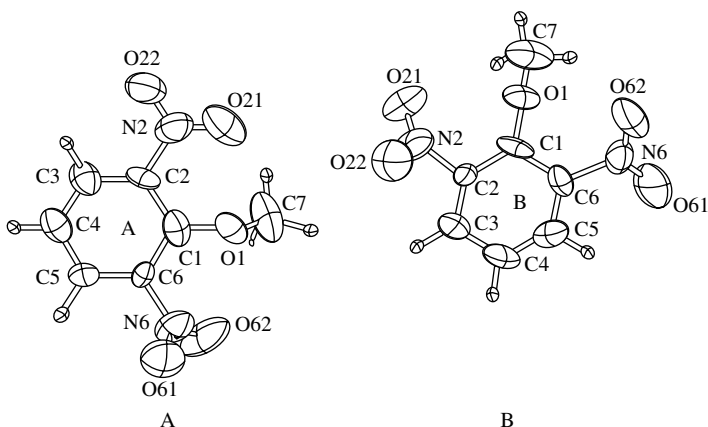
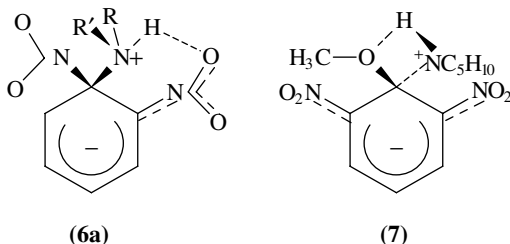


FIGURE 7. ORTEP plot of 2,6-dinitroanisole<sup>105</sup>. Reproduced by permission of the International Union of Crystallography

with amines. This ratio is always greater for reactions carried out in aprotic solvents than those in protic solvents<sup>1b,2c,107</sup>.

This *inversion in reactivity* has received considerable attention, and recent studies have contributed to a better understanding of the transition states and intermediates in the  $S_NAr$  reactions with amines. Several explanations have been proposed for the greater reactivity of the *o*-nitro derivatives with amines. The first, which is applicable to most of the systems, is an enhanced stabilization of the zwitterionic intermediate through intramolecular hydrogen bonding between the ammonio proton and the *ortho*-nitro group (a phenomenon visualized in structure **6a** and earlier called ‘built-in solvation’)<sup>2c</sup>. Although this proposal has been criticized, independent evidence that such intramolecular hydrogen bonding indeed occurs has been obtained from a proton transfer study, that suggests a hydrogen bond of about 9.6 kJ mol<sup>-1</sup> for a 2,4,6-trinitrobenzene derivative in aqueous solution<sup>108</sup>. No doubt that in a less polar solvent, and with a smaller number of nitro groups sharing the negative charge, this hydrogen bond will be appreciable stronger.



Besides the increased reactivity, formation of species like **6a** may also produce a *change in the rate-determining step* in substitutions of *ortho*-derivatives when compared with the *para*-isomers. For example, it has been recently demonstrated that the formation of **1** (L = F; R<sup>1</sup> = *n*-C<sub>3</sub>H<sub>7</sub>, *i*-C<sub>3</sub>H<sub>7</sub>; R<sup>2</sup> = H) is rate-limiting in the reaction of *n*-propylamine and isopropylamine with *o*-fluoronitrobenzene in toluene, while it is the decomposition of the corresponding zwitterionic intermediate that is rate-determining in the same reactions

with *p*-fluoronitrobenzene<sup>82</sup>. Such differences in the mechanisms of the reactions must be kept in mind in the analysis of the activation of  $S_NAr$  reactions with *ortho*- and *para*-nitro groups<sup>1a</sup>.

### 3. The field effect

For dinitro-substituted substrates, it has been recently shown that activation in 2,4-dinitrophenyl substrates is mainly due to the mesomeric effect of the 4-nitro group, thus reducing the electron density at the reaction site<sup>83</sup>. However, another important feature of highly polarizable groups, such as a nitro group in the *ortho* position, has been considered to be the *field effect*<sup>107</sup>.

This effect has been reported in the reactions of 2,4- and 2,6-dinitroanisole (DNA) with cyclohexylamine in benzene<sup>107</sup>. Both substrates have an *ortho*-nitro group and the stabilization of the zwitterionic intermediate through hydrogen bonding with the ammonium proton will be similar in both cases. Nevertheless, in spite of increased steric hindrance in the di-*ortho*-derivative and of the expected greater resonance stabilization of the intermediate by a *para*- than by an *ortho*-nitro group, and hence an overall higher energy of the transition states of the substitution of 2,6-DNA when compared with its 2,4-isomer, the inverse effect is observed. The accepted mechanism for the uncatalysed step involves a transfer from an ammonium proton to the nucleofuge in concert with the departure of the leaving group, as shown by complex 7. When there are two *o*-nitro groups, the quaternary ammonium proton can be hydrogen-bonded to one or the other; formation of this intermediate is favoured by the twisting of the methoxy group, giving a more favourable 'looser' transition state.

In the reactions of the same substrates with piperidine,  $S_N2$  reactions are observed together with  $S_NAr$ . The  $S_NAr$  reaction of 2,6- is 10 times faster than that of the 2,4-, while the  $S_N2$  reaction is  $10^3$  times faster<sup>107</sup>. The spectacular inversion in reactivity was interpreted as due to a favourable field effect by the *ortho*-nitro group. It was proposed that the methoxy group in 2,6-DNA would adopt a *conformation* perpendicular to the ring plane and the greater reactivity of 2,6- over 2,4-DNA would be due to a favourable field effect, as in the previous reaction with cyclohexylamine<sup>107</sup>. To confirm this assumption, the  $S_N2$  reaction with *N*-methylpiperidine in benzene was also studied. As expected on the grounds of the *favourable field effect*, the 2,6-DNA was nearly 300 faster than the 2,4-DNA<sup>107</sup>.

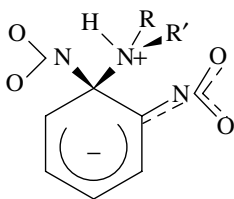
$S_NAr$  with other 6-R-2-nitroanisoles (R = alkyl) were also studied and the results compared with the 4-R-2-nitroanisoles<sup>83a</sup>. It was found in all cases that 6-R reacted faster than the 4-R consistent with the absence of primary steric effects due to the proposed twisting of the di-*ortho*-substituted anisoles. However, the more striking result was the spectacular reactivity of the 6-bromo- and the 6-nitro-isomer, in spite of the electronic and steric effects; e.g. in the reaction with cyclohexylamine in benzene 6-Br is almost  $10^4$  more reactive than the 4-R<sup>83a</sup>. It was proposed that the methoxy group in the di-*ortho*-substituted anisoles is twisted out of the plane of the aromatic ring by the presence of substituents on each side, which facilitates the replacement of methoxy by an amine group. When both substituents are electron-withdrawing groups, the favourable *field effect* exerted through the space is superimposed on the twisting of the nucleofuge, and both are responsible for the spectacular increase in rate of the 2,6-dinitroanisole when compared with the 2,4-dinitro isomer. Thus, in the case of the DNA with piperidine, the  $S_NAr$  reaction with 6-NO<sub>2</sub> is nearly 10 times that of the 4-, while the  $S_N2$  is nearly  $10^4$  times faster than the 4-NO<sub>2</sub><sup>83a</sup>.

A similar twisting was expected to occur with the phenoxy ether to explain the greater reactivity of the 2,6-isomer in recent studies of the reactions of 2,4-dinitro and 2,6-dinitrophenyl phenyl ethers with *n*-butylamine<sup>109</sup>. Nevertheless, in this case, the authors

assume that the twisting of the phenyl moiety in the 2,6-substrate will increase the electron density on the oxygen atoms of 'at least one of the nitro groups in the  $\sigma$ -complex, leading to stronger *ortho*-nitro hydrogen bonding of the ammonio hydrogen atoms and to a greater propensity to a reaction third order in nucleophile concentration'<sup>109</sup>. When a methyl group is introduced at the 6-position of the 2,4-dinitrophenyl ether, the curvilinear upward kinetic form which is observed was also attributed to the increase in basicity of the ethereal oxygen atom. Notwithstanding, the unexpected increased reactivity of the 6-position in all these systems is well explained in terms of the field effect in all the cases. On the contrary, the changes in the kinetic law, giving rise to a third-order dependence on the nucleophile concentration, require a more comprehensive mechanistic explanation, as will be discussed in Section III.

#### 4. The nitro nucleofuge

When the *leaving* group is the *nitro group*, the reactions with amines in aprotic solvents show a behaviour different from  $S_NAr$  reactions with other nucleofuges, such as halogens or alkoxy groups, since an intramolecular hydrogen bond may be expected between the *leaving nitro group* and the ammonium H of the nucleophiles. This effect was observed in the reactions of 1,2-dinitrobenzene with butylamine and piperidine, in several aprotic solvents<sup>110</sup>. In solvents such as ethyl acetate, THF, acetonitrile, DMF and DMSO (called solvent set A), neither reaction is base-catalysed and the formation of the intermediate is rate-determining ( $k_A = k_1$ ). The sequence and range of reactivity for butylamine and piperidine are similar in these solvents. This is unexpected, considering that from the overall rate constants observed in  $S_NAr$  reactions, in which the formation of the  $\sigma$ -adduct is rate-determining, butylamine is usually an order of magnitude less reactive than piperidine<sup>1</sup>. Besides the intramolecular hydrogen bond with the *o*-nitro group, similar to that depicted in complex **6a**, another intramolecular hydrogen bond was postulated for 1,2-dinitrobenzene (DNB) (or other substrates where nitro is the nucleofuge) such as that depicted in the intermediate **6b**.



(6b)

If this structure makes a major contribution to the stability of the transition state, the usual reactivity and solvent effects found for other nucleofuges with these amines will not be the same in these cases. A structure such as **6b** was earlier proposed for rationalizing the unexpected fast expulsion of the nitro group in the reactions of 1,2-DNB and 1,2,4-trinitrobenzene with piperidine in benzene<sup>111</sup>. This proposal was fully confirmed by the study of the reactions in several aprotic solvents. The reactions of 1,2-DNB with butylamine (BA) (Table 10) and piperidine in the set of solvents A could be correlated with the Kamlet-Taft<sup>38</sup> solvatochromic equation, when the  $\beta$  parameter, which measures the solvent hydrogen-bond acceptor capability, was included in the correlations. The calculated equations as well as the whole ( $F$ ) and partial ( $F_1$ ,  $F_2$ ) confidence levels showed the weight of the  $\beta$  parameter<sup>110</sup>.

TABLE 10. Rate constants of reactions between 1,2-DNB and BA in aprotic solvents at various temperatures<sup>a,110</sup>. Reprinted with permission from Reference 110. Copyright (1989) American Chemical Society

Solvent	Parameter	Values							
Chloroform <sup>b</sup>	[BA] (M)	0.10	0.20	0.30	0.40	0.50	0.60	0.70	
	$10^4 k_A$ (mol <sup>-1</sup> dm <sup>3</sup> s <sup>-1</sup> )	0.11	0.15	0.18	0.18	0.20	0.22	0.23	
Ethyl acetate <sup>c</sup>	[BA] (M)	0.20	0.28 <sup>d</sup>	0.28 <sup>e</sup>	0.30	0.40	0.49	0.50	0.60
	$10^4 k_\psi$ (s <sup>-1</sup> )	0.32	0.29	0.92	0.52	0.86	1.01	0.95	1.19
	$10^4 k_A$ (mol <sup>-1</sup> dm <sup>3</sup> s <sup>-1</sup> )	1.97	$(r = 0.9979)$						
THF <sup>c</sup>	[BA] (M)	0.10	0.11	0.20	0.30	0.40	0.50	0.60	0.30 <sup>d</sup> 0.30 <sup>e</sup>
	$10^4 k_\psi$ (s <sup>-1</sup> )	0.31	0.34	0.67	1.07	1.28	1.73	1.89	0.61 1.56
	$10^4 k_A$ (mol <sup>-1</sup> dm <sup>3</sup> s <sup>-1</sup> )	3.29	$(r = 0.9989)$						
ACN <sup>c</sup>	[BA] (M)	0.10	0.20	0.30	0.40	0.46	0.50	0.55	0.40 <sup>f</sup> 0.40 <sup>g</sup>
	$10^4 k_\psi$ (s <sup>-1</sup> )	0.23	0.45	0.63	0.81	0.91	1.12	1.29	0.52 1.56
	$10^4 k_A$ (mol <sup>-1</sup> dm <sup>3</sup> s <sup>-1</sup> )	0.22	$(r = 0.9979)$						
DMF <sup>c</sup>	[BA] (M)	0.20	0.30	0.40	0.50	0.60	0.40 <sup>d</sup>	0.40 <sup>e</sup>	
	$10^4 k_\psi$ (s <sup>-1</sup> )	0.16	0.24	0.34	0.39	0.52	0.29	0.55	
	$10^4 k_A$ (mol <sup>-1</sup> dm <sup>3</sup> s <sup>-1</sup> )	0.83	$(r = 0.9990)$						
DMSO <sup>c</sup>	[BA] (M)	0.10	0.20	0.30	0.40	0.50	0.30 <sup>h</sup>	0.30 <sup>i</sup>	
	$10^4 k_\psi$ (s <sup>-1</sup> )	0.24	0.35	0.64	0.77	0.90	0.84	1.16	
	$10^4 k_A$ (mol <sup>-1</sup> dm <sup>3</sup> s <sup>-1</sup> )	18.89	$(r = 0.9972)$						
Diisopropyl ether <sup>b</sup>	[BA] (M)	0.20	0.30	0.40	0.50	0.60			
	$10^4 k_A$ (mol <sup>-1</sup> dm <sup>3</sup> s <sup>-1</sup> )	0.43	0.52	0.73	0.86	0.91			
Toluene <sup>b</sup>	[BA] (M)	0.10	0.20	0.30	0.40	0.50	0.70		
	$10^4 k_A$ (mol <sup>-1</sup> dm <sup>3</sup> s <sup>-1</sup> )	0.38	0.51	0.63	0.71	0.81	1.00		
Chlorobenzene <sup>b</sup>	[BA] (M)	0.26	0.38	0.51	0.64	0.77	1.00	1.02	
	$10^4 k_A$ (mol <sup>-1</sup> dm <sup>3</sup> s <sup>-1</sup> )	0.73	0.93	1.10	1.31	1.47	1.51	1.90	

<sup>a</sup>[1,2-DNB]  $\approx 10^{-4}$  M.<sup>b</sup>Reactions at  $27.0 \pm 0.1$  °C unless stated otherwise.<sup>c</sup>Reactions at  $27.5 \pm 0.1$  °C unless stated otherwise.<sup>d</sup> $17.0 \pm 0.1$  °C.<sup>e</sup> $37.0 \pm 0.1$  °C.<sup>f</sup> $16.3 \pm 0.1$  °C.<sup>g</sup> $36.3 \pm 0.1$  °C.<sup>h</sup> $34.5 \pm 0.1$  °C.<sup>i</sup> $42.0 \pm 0.1$  °C.

In non-polar solvents such as benzene, toluene, chlorobenzene and diisopropyl ether (called solvent set B), a mild acceleration is observed, and the reactions are slower than in hexane. A molecular complex (see below) is proposed to explain the results for the reactions in solvent set B.

## E. Molecular Complexes

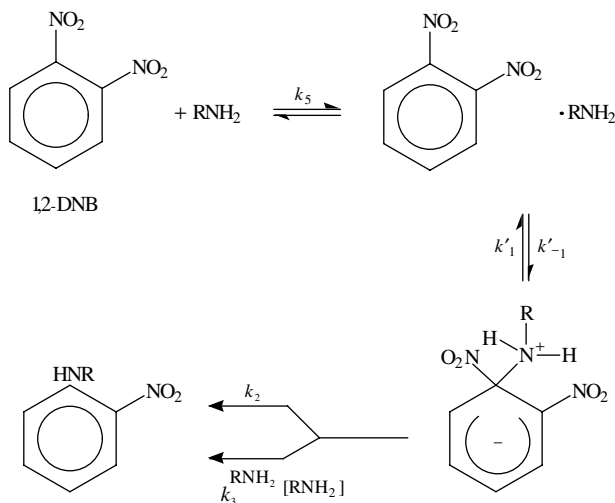
It is now well established that molecular complexes may play a catalytic role in chemical transformations<sup>112,113</sup>, and their influence in the  $S_NAr$  reactions with amines is the subject of intense research activity at present<sup>8,10,110,113-117</sup>. Although there is no total acceptance that these complexes are real intermediates on the reaction path, increasing evidence is being accumulated regarding their role in the substitution reactions. The curve-crossing (configuration mixing) model<sup>118-120</sup> has proved very useful in providing a

qualitative insight into the origin of activation barriers in reactions between nucleophiles and electrophiles, and of the contribution of *donor-acceptor pairs* in the reaction pathway. It has been recently shown that the differences between charge-transfer transition energies calculated for donor-acceptor pairs at infinite separation and values determined experimentally for the charge-transfer complex geometry vary according to the charge type of the pairs and within a group of fixed charge type<sup>121</sup>. Intramolecular charge-transfer (ICT) interactions in aromatic amines are considered and have been recently studied in hydroxylic solvents in their connections with hydrogen-bond-induced rehybridization of trivalent nitrogen atoms.

Most of the experimental studies concerning the formation of *electron donor-acceptor* (EDA) complexes between nitroaromatics and amines have been reported by Silber and coworkers<sup>9,115-117</sup>. On the basis that 1,2-DNB forms stronger EDA complexes with aliphatic amines in hexane than 1,3- or 1,4-DNB<sup>116a</sup> the authors proposed the catalytic effect of EDA complexes in the reactions with aliphatic primary<sup>116b</sup> and secondary<sup>117</sup> amines, as shown in Scheme 3. Although the kinetic behaviour would be also consistent with a classical base-catalysed decomposition of the  $\sigma$ -complex as in Scheme 1, preference is given to Scheme 3 based on the observation of absorbances attributed to EDA complexes between substrate and reactants at zero reaction time. In the case of secondary amines, such as, e.g. piperidine, the behaviour of the rate coefficients with the amine (Am) concentration could be best explained in terms of the formation of the [1,2-dinitrobenzene piperidine] complex. Application of the stationary-state hypothesis to the mechanism of Scheme 3 given equation 16, where  $k_A$  is the observed second-order rate constant.

$$k_A = \frac{k_1 k_2 + k_1 K_s k_3^B [\text{Am}]}{(k_{-1} + k_2 + k_3^B [\text{Am}])(1 + K_s [\text{Am}])} \quad (16)$$

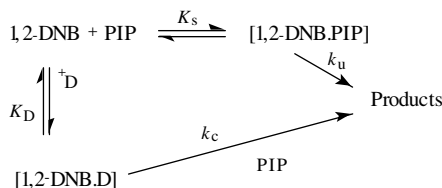
$$k_A = \frac{k_1 k_2 K_s}{k_{-1}} + \frac{k_1 K_s k_3^B [\text{Am}]}{k_{-1}} \quad (17)$$



SCHEME 3



For  $K_s [\text{Am}] \gg 1$  and  $k_2 + k_3 [\text{Am}] \ll k_{-1}$ , a linear response to the nucleophile concentration, such as that depicted in equation 8, is obtained. This behaviour is characteristic of most base-catalysed reactions. On the other hand, whereas all the studied reactions were base-catalysed in *n*-hexane, only mild acceleration was observed in benzene<sup>9</sup>. Also, the reactions seem to be inhibited in benzene and other electron-donor solvents, and Silber and coworkers attributed this effect to a preferential solvation exerted through EDA complex formation with the aromatic substrate, as shown in Scheme 4<sup>9</sup>.



SCHEME 4

These studies have been recently extended to the reaction of *n*-butylamine (*n*-BA) and piperidine (PIP) with other aromatic substrates, such as 1-chloro-2,4-dinitrobenzene (CDNB) and 4-chloro-3-nitrotrifluoromethylbenzene (CNTFB) in hexane, benzene, mesitylene and binary mixtures of hexane with the aromatic solvents, and the results are consistent with Scheme 4 which includes the proposal of a preferential solvation with the donor solvent, D<sup>115</sup>. As expected, a decrease in rate was observed in the reactions with butylamine with increasing amounts of the donor solvent, which was attributed to the formation of the EDA complex with the solvent. The result is expressed by equation 18 which, in the limiting case where  $K_s \ll K_D$ , reduces to equation 19.

$$k_\psi = \frac{(K_s k_u + k_c K_D [\text{D}]) [\text{Am}]}{1 + K_s [\text{Am}] + K_D [\text{D}]} \quad (18)$$

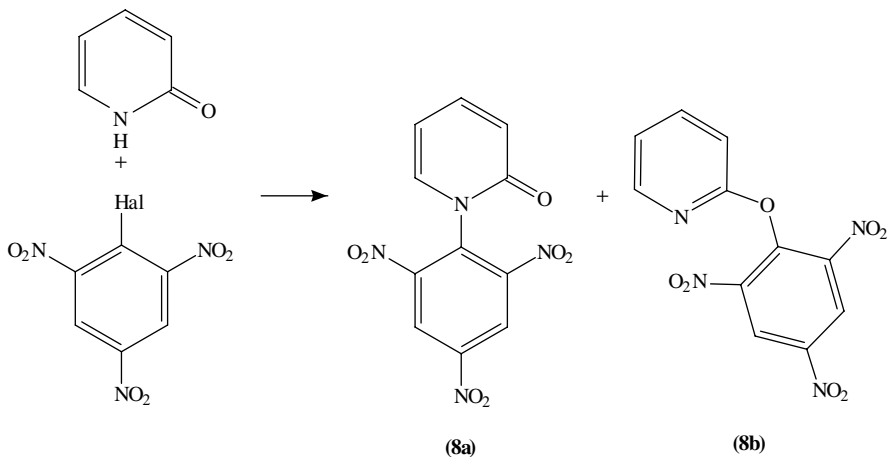
$$k_\psi = \frac{(K_s k_u + k_c K_D [\text{D}]) [\text{Am}]}{1 + K_D [\text{D}]} \quad (19)$$

By fitting equation 19 with the experimental data, the values of  $K_D$  were obtained for the following systems: CDNB–benzene =  $0.76 \pm 0.02$ , CNTFB–benzene =  $0.26 \pm 0.02$ , CDNB–mesitylene =  $0.96 \pm 0.02$  and CNTFB–mesitylene =  $0.48 \pm 0.02 \text{ mol}^{-1}$ . It can be observed that  $K_D$  increases with increasing donor strength of the aromatic solvents<sup>115</sup>. For the reactions with piperidine, on the contrary, an increase in rate was observed with increased molar fractions of the donor solvent. This result was interpreted as a conventional solvent effect since, in this case,  $K_S \cong K_D$ .

The  $S_NAr$  reactions with amines in chloroform show a peculiar behaviour and the rates cannot usually be correlated with reactions in other solvents. It has been observed in the reaction of 2,4-dinitrochlorobenzene with piperidine<sup>48c</sup> and in the reaction of 1,2-DNB with butylamine<sup>115</sup> that chloroform exerts a special solvent effect due to its known hydrogen-bond donor ability. Thus, an association between the solvent and the nucleophile can be postulated as a side-reaction to the  $S_NAr$ <sup>115</sup>. Associations of chloroform with amines are known<sup>122</sup> and the assumption of a partial association between piperidine or butylamine and chloroform as the cause of the downward curvature in the plots of  $k_A$  vs [amine] seems plausible.

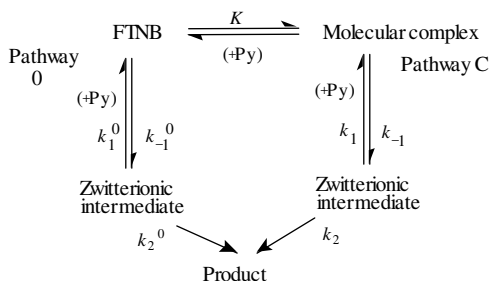
Forlani and coworkers<sup>123</sup> studied the reactions of 1-halogeno-2,4,6-trinitrobenzene with 2-hydroxypiperidine in aprotic solvents: the reaction provides two isomeric products as

shown in Scheme 5. For X = Cl, in THF at 45 °C the reaction afforded compound **8a** in 68% relative yield, and 32% of compound **8b**. In the presence of 2-hydroxypyridine compound **7** is quantitatively converted into compound **8b**. The authors studied the kinetics of the reaction of 2,4-dinitrofluorobenzene in THF, toluene and chlorobenzene in excess of 2-hydroxypyridine, and the data are gathered in Table 11, which also includes data of the reaction of 2,4-dinitrochlorobenzene in chlorobenzene.



SCHEME 5

It can be observed that  $k_{\text{obs}}$  increases with increasing initial concentration of 2-hydroxypyridine. The authors interpret the increase in rate as due to the formation of a molecular complex as shown in Scheme 6; the equilibrium constant  $K$  for the formation of the complex was estimated in each case and the values are shown in Table 12. Some observations on these results are discussed in Section III.



SCHEME 6

Other interesting data in these reactions concern the H/D isotopic effect of the nucleophile/catalyst, for example when  $[2\text{-hydroxypyridine}] = [2\text{-O}^2\text{H}] = 0.08$ ,  $k_{\text{obs H}}/k_{\text{obs D}} = 1.5$ . Since a very poor H/D effect is usual in  $S_N\text{Ar}$  reactions with neutral nucleophiles (amines) in apolar solvents<sup>1c</sup>, the authors conclude that the unusually high H/D effect should be due to a difference in the  $K_{\text{H}}/K_{\text{D}} = 1.75$  of the molecular complex. Nevertheless, the same effect could be explained on the basis of an autoassociation of

TABLE 11. Kinetic data for reactions between FTNB (2,4,6-fluorotrinitrobenzene) and Py in chlorobenzene (unless otherwise indicated)<sup>123</sup>

$T = 45\text{ }^\circ\text{C}; [\text{FTNB}]_0 = 6.5 \times 10^{-4} \text{ mol dm}^{-3}$					
$10^2 [\text{Py}]_0 \text{ (mol dm}^{-3}\text{)}$	3.09	4.63	6.18	7.72	
$10^2 k_{\text{obs}} \text{ (dm}^3 \text{ mol}^{-1} \text{ s}^{-1}\text{)}$	3.50	4.94	6.52	7.56	
$T = 35\text{ }^\circ\text{C}; [\text{FTNB}]_0 = 6.5 \times 10^{-4} \text{ mol dm}^{-3}$					
$10^2 [\text{Py}]_0 \text{ (mol dm}^{-3}\text{)}$	3.10	4.65	5.27	6.20	
$10^2 k_{\text{obs}} \text{ (dm}^3 \text{ mol}^{-1} \text{ s}^{-1}\text{)}$	2.80	4.04	4.52	5.01	
$T = 25\text{ }^\circ\text{C}; [\text{FTNB}]_0 = 5.5 \times 10^{-4} \text{ mol dm}^{-3}$					
$10^2 [\text{Py}]_0 \text{ (mol dm}^{-3}\text{)}$	1.41	1.88	2.35	3.15	4.73
$10^2 k_{\text{obs}} \text{ (dm}^3 \text{ mol}^{-1} \text{ s}^{-1}\text{)}$	0.944	1.27	1.45	2.05	2.68
$10^2 [\text{Py}]_0 \text{ (mol dm}^{-3}\text{)}$	6.30	7.96	9.02	10.6	
$10^2 k_{\text{obs}} \text{ (dm}^3 \text{ mol}^{-1} \text{ s}^{-1}\text{)}$	3.43	4.51	5.08	5.75	
$T = 25\text{ }^\circ\text{C}; [\text{FTNB}]_0 = 2.9 \times 10^{-4} \text{ mol dm}^{-3}$					
$10^2 [\text{H-Py}]_0 \text{ (mol dm}^{-3}\text{)}$	3.64	4.86	6.07	8.03	9.45
$10^2 k_{\text{obs}} \text{ (dm}^3 \text{ mol}^{-1} \text{ s}^{-1}\text{)}$	1.46	1.96	2.30	2.94	3.50
$T = 25\text{ }^\circ\text{C}; [\text{FTNB}]_0 = 2.9 \times 10^{-4} \text{ mol dm}^{-3} \text{ }^a$					
$10^2 [\text{Py}]_0 \text{ (mol dm}^{-3}\text{)}$	1.57	2.24	3.14	3.85	4.71
$10^2 k_{\text{obs}} \text{ (dm}^3 \text{ mol}^{-1} \text{ s}^{-1}\text{)}$	3.50	4.54	5.77	6.29	7.66
$T = 25\text{ }^\circ\text{C}; [\text{FTNB}]_0 = 3.7 \times 10^{-4} \text{ mol dm}^{-3} \text{ }^b$					
$10^2 [\text{Py}]_0 \text{ (mol dm}^{-3}\text{)}$	1.80	3.61	5.40	6.05	7.20
$10^3 k_{\text{obs}} \text{ (dm}^3 \text{ mol}^{-1} \text{ s}^{-1}\text{)}$	2.44	4.71	6.66	8.44	9.88
$10^2 [\text{Py}]_0 \text{ (mol dm}^{-3}\text{)}$	8.23	9.09			
$10^3 k_{\text{obs}} \text{ (dm}^3 \text{ mol}^{-1} \text{ s}^{-1}\text{)}$	11.1	12.0			
$T = 45\text{ }^\circ\text{C}; [\text{CTNB}]_0 = 3.5 \times 10^{-4} \text{ mol dm}^{-3} \text{ }^c$					
$10[\text{Py}]_0 \text{ (mol dm}^{-3}\text{)}$	1.73	2.05	3.11	3.22	
$10^5 k_{\text{obs}} \text{ (dm}^3 \text{ mol}^{-1} \text{ s}^{-1}\text{)}$	1.59	1.78	2.25	2.30	

<sup>a</sup>In THF.<sup>b</sup>In toluene.<sup>c</sup>In chlorobenzene.TABLE 12.  $k_c$  and  $K$  values<sup>a</sup> (see text) for reactions between FTNB (2,4,6-fluorotrinitrobenzene) and Py<sup>123</sup>

$T \text{ (}^\circ\text{C)}$	$k_c \text{ (dm}^3 \text{ mol}^{-1} \text{ s}^{-1}\text{)}$	$K \text{ (dm}^3 \text{ mol}^{-1}\text{)}$	$n^b$	$R^c$
25 <sup>d</sup>	0.21 ± 0.05	3.5 ± 0.9	9	0.9982
35 <sup>d</sup>	0.29 ± 0.06	3.6 ± 0.8	4	0.9991
45 <sup>d</sup>	0.48 ± 0.2	3.0 ± 1	4	0.9976
25 <sup>d,e</sup>	0.23 ± 0.06	2.0 ± 0.06	5	0.9986
25 <sup>f</sup>	0.17 ± 0.02	17 ± 2	5	0.9976
25 <sup>g</sup>	(0.4) <sup>i</sup>	(0.34) <sup>j</sup>	7	0.9994
45 <sup>d,h</sup>	(4.7 ± 0.1) × 10 <sup>-5</sup>	2.9 ± 0.1	4	0.9999

<sup>a</sup>Errors are calculated from standard deviations.<sup>b</sup>Number of points.<sup>c</sup>Correlation coefficient.<sup>d</sup>In chlorobenzene.<sup>e</sup>Monodeuteropyridone.<sup>f</sup>In THF.<sup>g</sup>In toluene.<sup>h</sup>1-Chloro-2,4,6-trinitrobenzene.<sup>i</sup>Indicative value: error is higher than value.<sup>j</sup>Indicative value:  $1/k_c K = 7.4 \pm 0.2$ .

TABLE 13. Apparent stability constants of molecular complexes between 2-hydroxypyridine and some aromatic nitro derivatives in benzene-*d*<sub>6</sub> at 25 °C<sup>125</sup>. Reproduced by permission of società chimica Italiana from Reference 125

Nitro derivative	K (mol <sup>-1</sup> ) <sup>a</sup>	<i>n</i> <sup>b</sup>	<i>R</i> <sup>c</sup>
DNB <sup>d</sup>	0.12 ± 0.01	4	0.996
CNB <sup>e</sup>	0.36 ± 0.02	5	0.999
CDNB <sup>f</sup>	0.22 ± 0.03	5	0.979
CTNB <sup>g</sup>	0.31 ± 0.02	5	0.992
OFNB <sup>h</sup>	0.19 ± 0.01	6	0.995
PFNB <sup>i</sup>	0.51 ± 0.04	5	0.993
FDNB <sup>l</sup>	0.42 ± 0.03	5	0.992
PFNB <sup>i,m</sup>	0.15 ± 0.01	5	0.994
FDNB <sup>l,m</sup>	0.25 ± 0.02	5	0.991

<sup>a</sup>Errors are standard deviations.

<sup>b</sup>Number of points.

<sup>c</sup>Correlation coefficient.

<sup>d</sup>1,3-Dinitrobenzene.

<sup>e</sup>1-Chloro-4-nitro-benzene.

<sup>f</sup>1-Chloro-2,4-dinitrobenzene.

<sup>g</sup>1-Chloro-2,4,6-trinitrobenzene.

<sup>h</sup>1-Fluoro-2-nitrobenzene.

<sup>i</sup>1-Fluoro-4-nitrobenzene.

<sup>l</sup>1-Fluoro-2,4-dinitrobenzene.

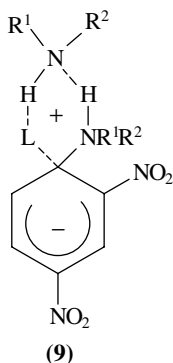
<sup>m</sup>Monodeutero-2-hydroxypyridine.

the nucleophile, since the tendency of 2-hydroxypyridine to form dimeric species is very well known<sup>124</sup>.

The study of molecular complexation was then extended to other aromatic nitro derivatives<sup>125</sup>. Although, as was described before, one of the more frequent methods of studying the formation of molecular complexes is by UV-visible spectrophotometry, the author did not observe detectable differences in the UV-visible absorbance spectra between the 2-hydroxypyridine–1-fluoro-2,4-dinitrobenzene (FDNB) mixtures and the sum of their separate components. The author observed that the signals of the <sup>1</sup>H NMR spectra of FDNB in apolar solvents were shifted downward by the addition of 2-hydroxypyridine: from solutions where [2-hydroxypyridine] ≪ [FDNB] he calculated the apparent stability constants, which are shown in Table 13.

## F. Electrophilic Catalysis

When expulsion of the nucleofuge is rate-determining, stabilization of the transition state for the leaving group departure is important especially in solvents of low permittivity. Because of the anionic nature of the nucleofuge in the zwitterionic intermediate, acid catalysis has been sought since early times but the results were rather controversial<sup>1</sup>. Capon and Rees<sup>126</sup> suggested that in aprotic solvents the catalysed reaction proceeded via a cyclic intermediate such as shown by **9**. On the other hand, Orvick and Bunnett<sup>19</sup> were able to measure separately the rates of formation and decomposition to products of the intermediate (the conjugate base corresponding to **2** in Scheme 1) formed in the reaction of 2,4-dinitro-1-naphthyl ethyl ether with butylamine in DMSO. The decomposition of the intermediate was found to be first-order in *n*-butylammonium ion, but independent of the free amine concentration, and this was an important piece of evidence of the SB-GA.



Recently, Hirst and collaborators<sup>127</sup> have carried out a more comprehensive search for electrophilic catalysis in  $S_NAr$  reactions with primary and secondary amines in dipolar aprotic solvents. Thus, the effects of lithium, trialkylammonium and tetraalkylammonium ions on the reactions of piperidine with 2,4-dinitroanisole and of morpholine with 2,4-dinitrophenyl phenyl ether were investigated in DMSO. Although the reaction between 1-fluoro-4-nitrobenzene and trimethylamine in DMSO had been previously found to be catalysed by trimethylammonium and lithium ions<sup>127</sup>, no evidence for electrophilic catalysis was found in the present systems. In the case of lithium ions, expulsion of the methoxy or phenoxy groups was not catalysed by this ion. When the putative catalysts are trialkylammonium ions, the lack of catalysis could be due to an unfavourable equilibrium between the ions and piperidine in the case of the methoxide expulsion, as was observed by Nudelman and Palleros<sup>104</sup> for the reactions of piperidine with 2,4- and 2,6-dinitroanisole in benzene. But in the phenyl ether–morpholine system, this is not the case, and although catalysis of the ejection of the phenoxy group has never been demonstrated experimentally, the premise that it does occur is the basis of the SB-GA mechanism<sup>19</sup>.

The lack of catalysis could be due to steric effects. Crampton and Routledge<sup>24</sup> have shown that steric effects operate in the ejection of the leaving group when the nucleophile is piperidine and the catalyst is its conjugate acid. Similarly, reductions in the rate constants for proton transfers from the zwitterionic intermediates to amines to less than expected for diffusion-controlled reactions have been attributed to steric effects. Additionally, Hirst and coworkers<sup>128</sup> have tentatively proposed a contribution of ‘proximity’ effects. In the system studied by Orvick and Bunnett<sup>19</sup> the conjugate acid of the base that removes the proton from the intermediate is generated in the immediate vicinity of the nucleofuge and hence has an advantage over other catalysts in solution. Nevertheless, the effect of HBA additives was investigated with regard to the homo–heteroconjugate mechanism (see below) and electrophilic catalysis was found.

Recently, Forlani<sup>129</sup> studied the reactions of fluoro dinitrobenzene (FDNB) with several amines in the presence of some compounds that have been found to catalyse the reaction. The plots of  $k_{\text{obs}}$  vs [catalyst] show a linear dependence at low catalyst concentration and then a downward curvature. This behaviour has been previously observed in several related cases: the usual interpretation is that the  $k_{\text{obs}}$  increases on increasing the [catalyst] value until it reaches a maximum when  $k_{-1} = k_1 + k_2$  [catalyst].

The deviation from linearity was explained by including a third term due to the catalyst in the rate law equation (equation 20) and the results are given in Table 14.

$$k_{\text{obs}} = A + B [\text{catalyst}] + C [\text{catalyst}]^2 \quad (20)$$

TABLE 14. *A*, *B* and *C* values (see text) for reactions between FDNB and amines in the presence of various catalysts at 25 °C (errors are standard deviations)<sup>129</sup>. Reproduced by permission of Società Chimica italiana from Reference 129

Amine <sup>a</sup>	S <sup>b</sup>	Catalyst <sup>c</sup>	<i>A</i> <sup>d</sup>	<i>B</i> <sup>e</sup>	− <i>C</i> <sup>f</sup>	<i>n</i> <sup>g</sup>	<i>r</i> <sup>h</sup>
Pip	Bz	1	1.29 ± 0.1	960 ± 30	(1.9 ± 0.1) × 10 <sup>4</sup>	6	0.999
Pip	Bz	2	1.40 ± 0.3	460 ± 100	(1.9 ± 1) × 10 <sup>4</sup>	5	0.978
Pip	Bz	5	1.90 ± 0.5	1070 ± 200	(3.6 ± 1) × 10 <sup>4</sup>	9	0.979
Pip	Bz	6	1.28 ± 0.3	730 ± 100	(2.6 ± 1) × 10 <sup>4</sup>	6	0.989
Pip	D	1	2.29 ± 0.2	320 ± 20	(1.6 ± 0.1) × 10 <sup>3</sup>	9	0.989
Pip	Ch	1	23.5 ± 0.6	900 ± 300	(5.7 ± 2) × 10 <sup>4</sup>	5	0.949
Pip	Ch	8	23.0 ± 0.3	250 ± 40	(6.3 ± 0.9) × 10 <sup>4</sup>	4	0.992
Bu	Bz	1	0.21 ± 0.01	5.8 ± 0.7	20 ± 7	8	0.992
Bu	Bz	9	0.26 ± 0.05	13 ± 2	39 ± 13	7	0.993
Bu	Bz	10	0.23 ± 0.04	13 ± 2	49 ± 14	6	0.995
Bu	Bz	11	0.22 ± 0.2	9 ± 1	26 ± 8	6	0.997
<i>t</i> -Bu	Bz	1	(1.89 ± 0.04) × 10 <sup>−3</sup>	(6.5 ± 0.6) × 10 <sup>−2</sup>	1.1 ± 0.1	6	0.995

<sup>a</sup>Pip = piperidine; Bu = *n*-butylamine; *t*-Bu = *t*-butylamine.

<sup>b</sup>Solvent: Bz = benzene; Ch = chloroform; D = *p*-dioxan.

<sup>c</sup>Numbers refer to the original publication.

<sup>d</sup>In s<sup>−1</sup> M<sup>−1</sup>.

<sup>e</sup>In s<sup>−1</sup> M<sup>−2</sup>.

<sup>f</sup>In s<sup>−1</sup> M<sup>−3</sup>.

<sup>g</sup>Number of points.

<sup>h</sup>Correlation coefficient.

TABLE 15. Dissection of experimental data (*k*<sub>2</sub> and *K* values, see text) for reactions between FDNB and amines in the presence of various catalysts at 25 °C<sup>129</sup>. Reproduced by permission of Società Chimica Italiana from Reference 129

Amine <sup>a</sup>	S <sup>b</sup>	Catalyst <sup>c</sup>	<i>k</i> <sub>2</sub> <sup>d</sup>	<i>K</i> <sup>e</sup>	<i>r</i> <sup>f</sup>
Pip	Bz	1	12	141	0.999
Pip	Bz	2	4.2	515	0.978
Pip	Bz	5	14	153	0.992
Pip	Bz	6	9.0	145	0.996
Pip	Bz	7	8.0	183	0.998
Pip	D	1	35	13	0.998
Pip	Ch	1	27	1120	0.999
Pip	Ch	8	27	362	0.949
Bu	Bz	1	0.80	16	0.995
Bu	Bz	9	2.0	13	0.998
Bu	Bz	10	1.2	31	0.986
Bu	Bz	11	1.1	19	0.994
<i>t</i> -Bu	Bz	1	4.1 × 10 <sup>−3</sup>	26	0.983

<sup>a</sup>Pip = piperidine (p*K*<sub>a</sub> = 11.06); Bu = *n*-butylamine (p*K*<sub>a</sub> = 10.59); *t*-Bu = *t*-butylamine (p*K*<sub>a</sub> = 10.8).

<sup>b</sup>Solvent: Bz = benzene; Ch = chloroform; D = *p*-dioxan.

<sup>c</sup>Numbers refer to the original publication.

<sup>d</sup>In s<sup>−1</sup> M<sup>−1</sup>.

<sup>e</sup>In M<sup>−1</sup>.

<sup>f</sup>Correlation coefficient.

Nevertheless, it can be observed that the significant values are in *B*, and these show a strong influence of the amine used. The author<sup>129</sup> interpreted the results through a mechanism involving a molecular complex substrate, and calculated the values of *k*<sub>2</sub> and of the equilibrium constant *K*, shown in Table 15. Again, the significant values depend on the nucleophilic power of the amine. If such a molecular complex between

the substrate and the catalyst would exist (the author suggests an interaction between the amido group and the fluorine atom or the nitro group), it should be possible to detect it since, in this case, it would not react as it occurs with other previously studied catalysts. Nevertheless, the author was unable to detect any interaction between the catalyst and FDNB.

The downward curvature observed in this and other systems could be easily explained in terms of a 'mixed aggregate' between the catalyst and the nucleophile. A hydrogen-bond donation to the amide catalyst would render the amine a better nucleophile, up to a value of 'saturation', after which increasing amounts of catalysts should have no further effect. The results in Table 15 can be easily explained in the same terms, where *K* measures the equilibrium of the association between the amine and the catalyst.

### G. Aromatic Nucleophilic Substitution with Amines in which the Nucleofuge is a Sulphur Derivative

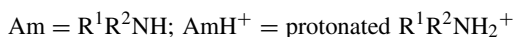
*Ethyl 2,4,6-trinitrophenyl sulphide.* Crampton's group<sup>130,131</sup> has recently studied the reaction of amines with activated substrates where the nucleofuge has a sulphur atom attached to the reaction centre. Thus, in the reactions of ethyl 2,4,6-trinitrophenyl sulphide with butylamine and with pyrrolidine in DMSO, substitution occurs without the accumulation of intermediates on the reaction pathway<sup>130</sup>. With *n*-butylamine a first-order dependence on amine was observed indicating that nucleophilic attack, *k*<sub>1</sub>, was rate-determining, whereas with pyrrolidine a squared dependence on amine was observed. The authors argued that base catalysis in this reaction was likely to involve rate-limiting proton transfer from the zwitterionic intermediate, based on the failure to observe an intermediate on the lower kinetic barrier expected for loss of an alkylthio relative to an alkoxy group<sup>132</sup>, and on the unlikelihood of general acid catalysis involving proton transfer to a sulphur atom.

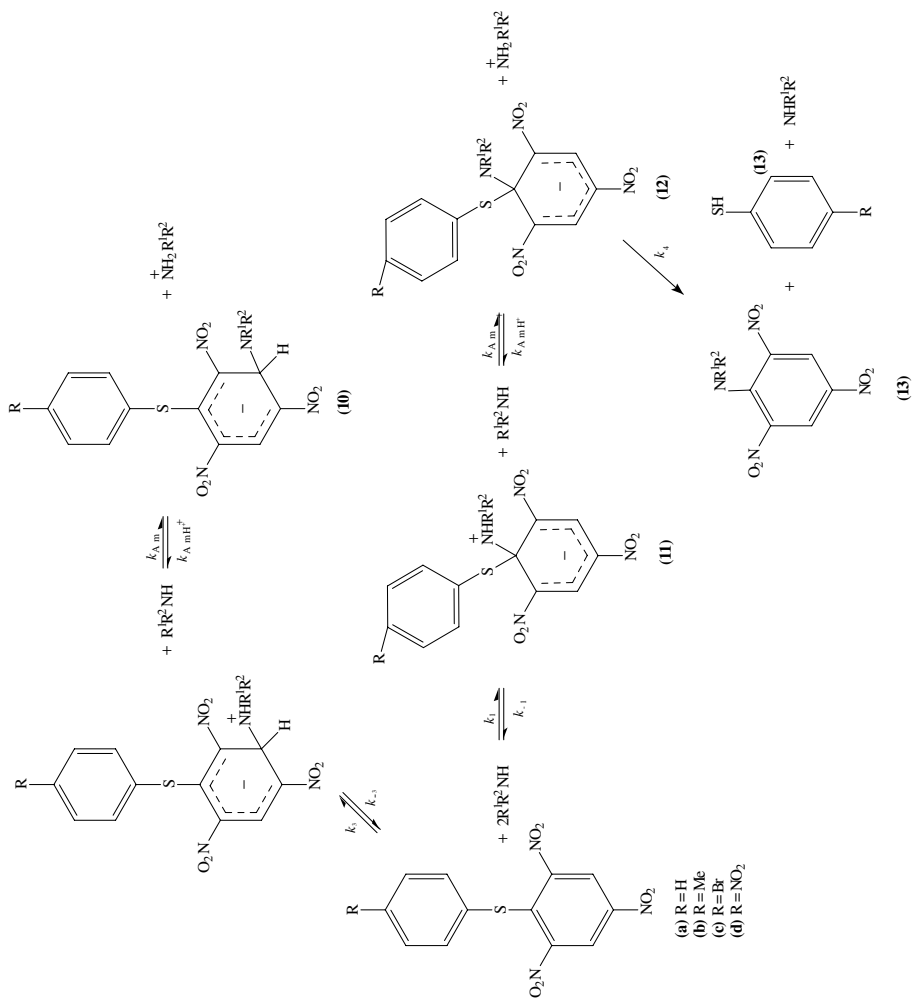
*4'-Substituted Phenyl 2,4,6-trinitrophenyl sulphides.* By UV-VIS measurements of the reactions of 4'-substituted phenyl 2,4,6-trinitrophenyl sulphides with amines in DMSO, Crampton's group<sup>131</sup> showed the presence of two well-separated processes which were interpreted by Scheme 7<sup>129</sup>. In each case a rapid reversible equilibrium was established leading to the 3-adduct (**10**). They also observed a second, much slower process resulting in formation of the N-substituted picamide derivatives, **13**. The final spectra were identical to those of the independently prepared products, **13**. Chamberlain and Crampton<sup>133</sup> showed that the reaction products are in rapid equilibrium with anions derived from them by amine addition at the 3-position and/or loss of a side-chain proton, but they did not find evidence for the accumulation of spectroscopically observable concentrations of intermediates such as **12**.

By application of the steady-state treatment to Scheme 7, the authors calculate the general rate expression for reaction at the 3-position to produce adducts **10** (*k*<sub>fast</sub>), and the rate expression for product formation (*k*<sub>slow</sub>), respectively (equations 21 and 22).

$$k_{\text{fast}} = \frac{k_3 k_{\text{Am}} [\text{Am}]^2 + k_3 k_{\text{AmH}^+} [\text{AmH}^+]}{k_{-3} + k_{\text{Am}} [\text{Am}]} \quad (21)$$

$$k_{\text{slow}} = \frac{k_1 k_{\text{Am}} [\text{Am}]^2}{(k_{-1} + k_{\text{Am}} [\text{Am}])} + \left( 1 + K_{c,3} \frac{[\text{Am}]^2 - 1}{[\text{AmH}^+]} \right) \quad (22)$$





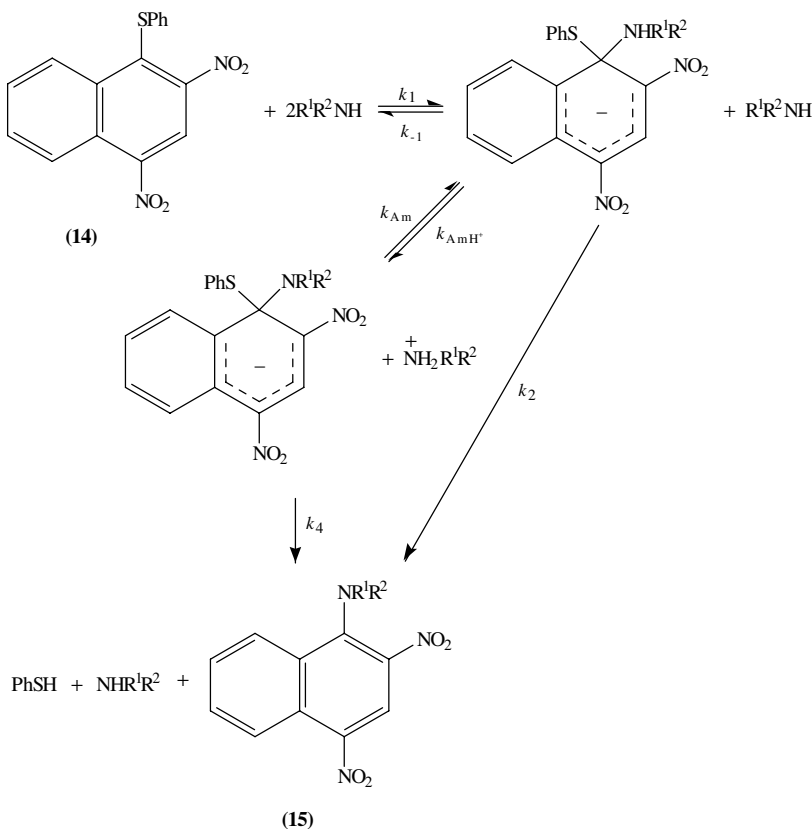
SCHEME 7



The above equations could be further simplified by limiting conditions and the authors found that, in the reactions with pyrrolidine, the values for  $k_{fast}$  showed that in the formation of the 3-adduct **10**, the proton transfer is partially rate-limiting, whereas the  $k_{slow}$  relating to the displacement of the phenylthio group showed a squared dependence on the pyrrolidine concentration: this is compatible with the proton transfer being the rate-determining step in the substitution. On the other hand, the values of  $k_{fast}$  and  $k_{slow}$  increase linearly with the amine concentration for the reactions with butylamine, indicating that nucleophilic attack is rate-determining.

A Hammett plot of the values of  $K_{c,3}$  for these reactions has a slope,  $\rho$ , of 1.2: the authors<sup>133</sup> recognize that in view of the remoteness of the substituents from the reaction centre, this value is surprisingly large and indicates that the phenylthio groups play a significant role in delocalizing the negative charge in the adduct. For comparison, Crampton and coworkers<sup>134</sup> have previously determined the  $\rho$  for the related process of hydroxide addition at the 3-position and found a value of 0.98

*Phenyl 2,4-dinitronaphthyl sulphide, 14.* Chamberlain and Crampton<sup>130</sup> showed by UV-VIS determinations of the reactions of phenyl 2,4-dinitronaphthyl sulphide **14** with amines in DMSO that the reactions proceed through the formation of a single intermediate (Scheme 8) resulting in the quantitative formation of the product, **15**. In the reactions with



*n*-butylamine  $k_{\text{obs}}$  increases linearly with [butylamine], whereas in the reactions with pyrrolidine the plot of  $k_{\text{obs}}/[\text{pyrrolidine}]$  versus [pyrrolidine] passes through the origin, and curves with decreasing slope as [pyrrolidine] is increased. That the plot passes through the origin indicates that the uncatalysed pathway,  $k_2$ , is unimportant, while the curvature indicates that the proton transfer step,  $k_{\text{Am}}$ , is partially rate-limiting.

*Phenyl 2,6-dinitro-4-trifluoromethylphenyl sulphide*. Chamberlain and Crampton<sup>130</sup> studied also the reaction of phenyl 2,6-dinitro-4-trifluoromethylphenyl sulphide with amines in DMSO. They observed a single rate process with butylamine giving the expected substituted product; again, the observed rate constant increased with [butylamine]. In the reaction with pyrrolidine a rapid reaction giving the 3-pyrrolidino adduct was observed, which could be suppressed by addition of pyrrolidinium perchlorate. Under these conditions the expected 1-substituted product was formed.

It can be concluded that in the reactions of amines with activated substrates derived from substituted arylthio-derivatives in DMSO, the reactions with pyrrolidine are faster than with butylamine. The rate-determining step in the formation of 3-adducts changes from nucleophilic attack with *n*-butylamine to proton transfer, partially rate-limiting with pyrrolidine and fully rate-determining with piperidine. Crampton and coworkers found that the major factor is the change in  $k_{\text{Am}}$  with the changing nature of the amine. Although the proton transfer step leading to adducts **10** is thermodynamically favoured, values of the rate constants are very much lower than those expected for diffusion-controlled reactions. This reflects steric hindrance to the approach of the reagents, which becomes increasingly severe as the amine is changed from *n*-butylamine to pyrrolidine to piperidine.

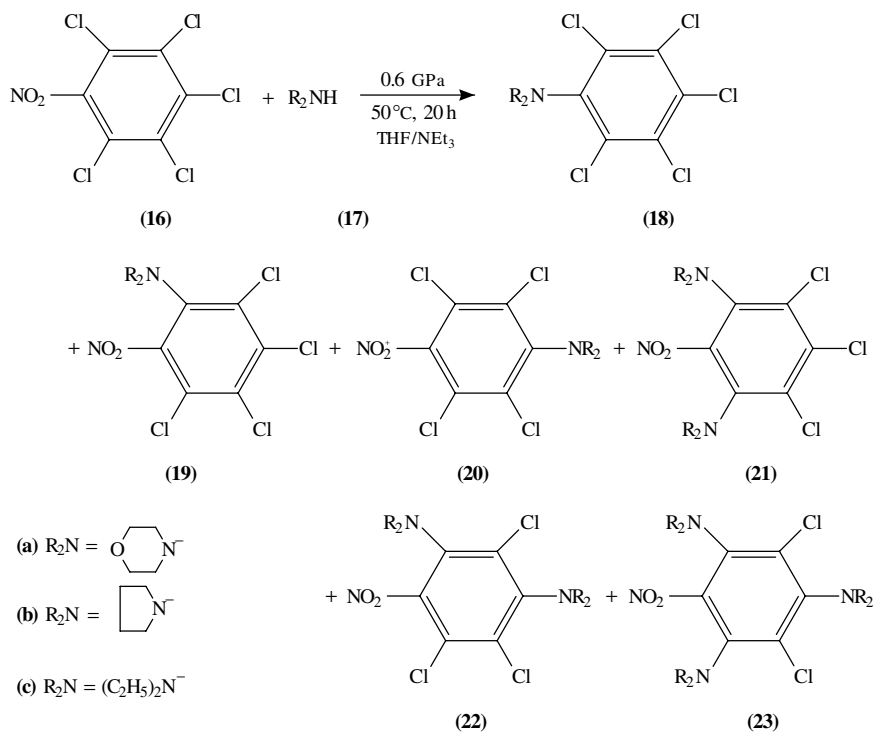
For reactions at the 1-position, with butylamine as the nucleophile, nucleophilic attack is rate-determining, whereas when pyrrolidine is the nucleophile the reactions are base-catalysed, and the values of  $K_1k_{\text{Am}}$  show a small dependence on the nature of the 4'-substituent. The relatively small decrease on changing the 1-substituent from SPH to SET is compatible with the interpretation that, in the reactions with pyrrolidine, proton transfer from the zwitterionic intermediate to amine is rate-limiting. The authors also discussed why the alternative explanation of base catalysis in terms of the SB-GA mechanism is less preferred; a greater sensitivity on the nature of the leaving group should be expected if this mechanism were operating. Acid-catalysed expulsion of the nucleofuge is also unlikely in view of the  $\text{p}K_{\text{a}}$  values of the group involved.

## H. Aromatic Nucleophilic Substitution with Amines under High Pressure

Several studies have recently appeared on the acceleration of  $\text{S}_{\text{N}}\text{Ar}$  reactions by high pressure<sup>135–139</sup>. Iyata and coworkers<sup>135,136</sup> studied the  $\text{S}_{\text{N}}\text{Ar}$  reaction of mono-, di-, tri- and pentachloronitrobenzenes with various amines under high pressure.

In particular, when pentachloronitrobenzene (**16**) is heated at 50 °C for 20 h with 6.0 molar equivalent of morpholine at 0.60 GPa in tetrahydrofuran (THF) solution in the presence of 5.0 molar equivalent of triethylamine, several products were isolated and are shown in Scheme 9.

Table 16 shows the results of the same reaction under different pressures between atmospheric pressure ( $10^{-4}$  GPa) to 0.78 GPa. At atmospheric pressure, nitro-group-substitution product, **18a**, and *o*-mono- and *p*-monosubstitution products **19a** and **20a** were obtained in a total yield of 7.4% recovering 92% of the starting pentachloride **16**. When the pressure was raised, the yields of these monosubstitution products increased; at higher pressures di- and trisubstitution products appeared and this trend continued in the reactions under pressures above 0.60 GPa, affording higher yields of the trisubstitution product **23a**. These results indicate that the second substitution occurred at the pressure



SCHEME 9

TABLE 16. Pressure effect of the  $S_NAr$  reaction of pentachloronitrobenzene with morpholine<sup>a,136</sup>. Reprinted by permission of The Chemical Society of Japan

Run	Pressure (GPa)	Yield (%) <sup>b</sup>						Total yield (%)	18/Total yield	Recovered 16 (%)
		18	19	20	21	22	23			
1	1/10000	0.6	6.0	0.9	0	0	0	7.5	0.080	92.2
2	0.10	1.0	18.6	4.0	0	0	0	23.6	0.042	75.8
3	0.20	1.7	40.0	9.0	0.4	0.4	0	51.5	0.038	47.1
4	0.30	2.6	65.4	14.2	4.4	3.4	0	90.0	0.029	8.3
5	0.40	2.6	63.5	14.9	6.0	4.4	0	91.4	0.028	4.6
6	0.50	2.9	50.0	7.9	18.6	14.6	0	94.0	0.030	0
7	0.60	2.6	19.3	1.2	40.2	25.8	3.7	92.6	0.028	0
8	0.78	3.2	3.0	0.6	52.9	24.0	12.1	95.8	0.033	0

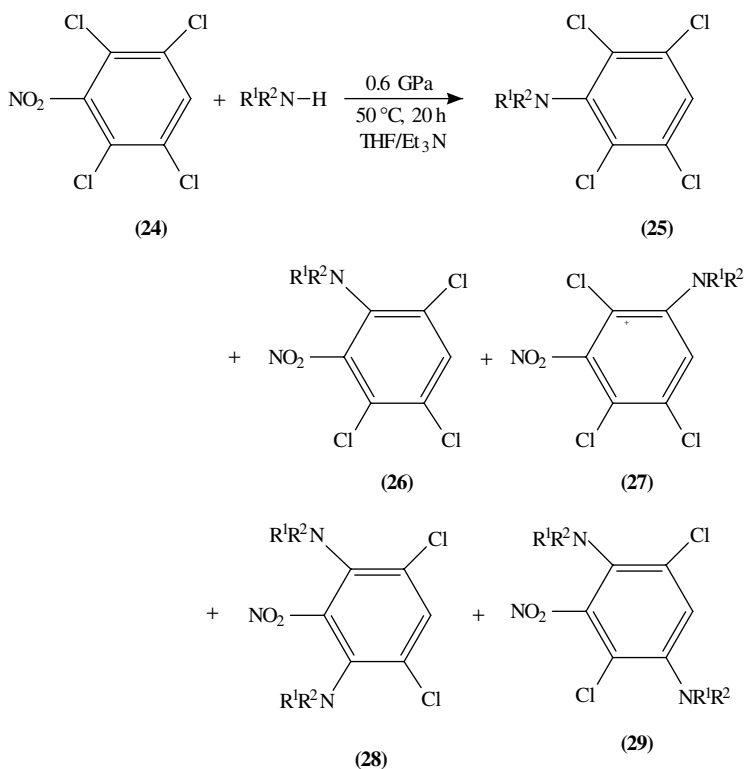
<sup>a</sup>The reactions were carried out under the following conditions using 1.0 mmol of **16** and 6.0 mmol of **17**; 50 °C, 20 h, in THF.

<sup>b</sup>Determined by HPLC.

over 0.20 GPa and that the third substitution does not proceed below 0.60 GPa, according to what is expected on the basis of the reduced activation of the corresponding reaction centre. By comparing the results observed on changing the amount of morpholine from 1.0 to 15.0 molar equivalent relative to **16**, it is again confirmed that the di- and trisubstitution reactions are slower than the mono substitution.

The reactions of **16** with pyrrolidine and diethylamine were studied at 0.60 GPa in a similar way described above, with or without triethylamine, as shown in Table 17. It can be observed that even with 10.0 molar equivalent of diethylamine only mono-substitution products **18c**, **19c** and **20c** were obtained, whereas pyrrolidine yielded the trisubstitution product **23b** in higher yield than did morpholine. The authors explained these results on the basis of the bulkiness of the amines<sup>135</sup>.

The effect of steric hindrance was further studied by comparing the reactivity of primary and secondary amines of different steric requirements with 2,3,5,6-tetrachloronitrobenzene, **24** (Scheme 10)<sup>140</sup>. It is shown in Table 18 that open-chain amines give higher yield of the nitro-substitution products.



SCHEME 10

The reactivity and regioselectivity in the first and second substitutions steps were studied by Iбата's group<sup>141</sup> in the reactions of **24** with 6.0 molar equivalent of morpholine and pyrrolidine, monitoring the kinetics of formation of the reaction products by <sup>1</sup>H NMR measurements. In the reactions with morpholine (Figure 8), the yields of **25a**, **26a** and **27a** increased monotonously during the initial 20 h, while **1** decreases monotonously to zero recovery. The amount of **26a** decreases slowly after 20 h: this indicates that the second attack of morpholine proceeds slowly to give **28a** and **29a**, in contrast to no attack on **27a**.

The reaction of pyrrolidine is faster than that of morpholine<sup>142</sup> and almost all **16** was consumed in the first 10 h (Figure 9). An interesting feature in this reaction is that the

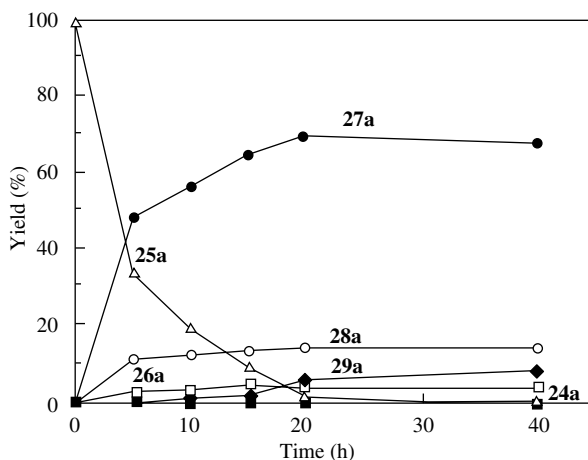
TABLE 17. Reaction of pentachloronitrobenzene with secondary amines under high pressure<sup>a,b</sup>

Run	Amine <b>17</b>	Amount of HNR <sub>2</sub> (mmol)	Amount of NEt <sub>3</sub> (mmol)	Pressure (GPa)	Yield (%) <sup>b</sup>					Total yield (%)	18/Total yield	Recovered (%)	
					<b>18</b>	<b>19</b>	<b>20</b>	<b>21</b>	<b>22</b>				<b>23</b>
1		1.0	5.0	0.60	2.4	57.2	15.6	1.2	2.5	0	78.9	0.030	19.3
2		2.0	5.0	0.60	2.5	62.8	15.6	6.8	6.1	0	93.8	0.027	0
3		3.0	5.0	0.60	2.4	50.3	10.0	16.2	12.7	0.4	92.0	0.026	0
4		4.0	5.0	0.60	2.4	35.7	5.3	26.4	19.7	1.5	91.0	0.026	0
5		5.0	5.0	0.60	2.5	28.4	3.6	32.7	22.8	2.4	92.4	0.027	0
6		6.0	5.0	0.60	2.6	19.3	1.2	40.2	25.8	3.7	92.8	0.028	0
7		10.0	5.0	0.60	2.4	11.9	0.5	44.4	25.2	6.1	90.5	0.027	0
8		15.0	5.0	0.60	3.0	2.5	0.2	46.0	23.1	14.3	89.4	0.033	0
9		1.0	5.0	0.78	2.3	53.7	15.7	3.8	3.0	0	78.0	0.029	0
10		2.0	5.0	0.78	2.4	42.0	9.3	20.1	14.8	0.8	89.4	0.027	0
11		3.0	5.0	0.78	2.9	24.2	3.1	34.6	23.5	2.5	90.8	0.032	0
12		4.0	5.0	0.78	3.3	10.5	1.4	45.2	24.7	6.4	91.5	0.036	0
13		5.0	5.0	0.78	3.2	4.1	0.6	50.9	24.8	10.2	93.8	0.034	0
14		6.0	5.0	0.78	3.2	3.0	0.6	52.9	24.0	12.1	95.8	0.033	0
15		10.0	5.0	0.78	3.2	0.5	0.2	50.9	16.1	23.8	94.7	0.034	0
16		15.0	5.0	0.78	3.0	0	0	46.0	11.7	30.4	91.1	0.033	0
17		6.0	0	0.60	3.1	26.6	3.5	34.0	21.4	4.0	92.6	0.033	0
18		10.0	0	0.60	3.6	0	0	50.0	20.4	24.1	94.5	0.038	0
19		1.0	5.0	0.60	18.2	48.8	17.0	2.4	3.0	0	89.4	0.200	0
20		6.0	0	0.60	34.1	1.5	0	20.0	3.2	29.8	88.6	0.380	0
21		10.0	0	0.60	40.7	0	0	8.5	0	40.6	89.8	0.450	0
22		1.0	5.0	0.60	0	40.4	11.8	0	0	0	52.2	0.000	38.5
23		6.0	0	0.60	1.9	62.5	8.5	0	0	0	72.9	0.026	19.3
24		10.0	0	0.60	3.7	73.8	12.4	0	0	0	89.9	0.041	2.4

<sup>a</sup>The reactions were carried out under the following conditions using 1.0 mmol of **17**; 50 °C, 20 h, in THF.<sup>b</sup>Determined by HPLC for Run 1 – 16. Isolated by column chromatography for Run 17–24.

TABLE 18. Yields of the reaction of 2,3,5,6-tetrachloronitrobenzene (**24**) with amines<sup>140</sup>

Amine	Yield (%)				Total yield (%)	Recovered <b>24</b> (%)	Ratio <b>25</b> /total yield
	<b>25</b>	<b>26</b>	<b>27</b>	<b>28</b>			
Morpholine	1.6	30.2	6.7	0	38.5	58.6	0.042
Piperidine	5.3	72.2	10.4	0	87.9	8.1	0.060
Pyrrolidine	38.0	42.1	8.6	0.6	89.3	1.9	0.426
Diethylamine	0	7.1	0	0	7.1	87.1	0
Aniline	0	0	0	0	0	100	—
Benzylamine	64.7	14.3	0	0	79.0	8.0	0.819
Butylamine	82.8	15.7	0	0	98.5	1.1	0.841
<i>iso</i> -Butylamine	48.2	17.7	3.4	0.9	70.2	14.4	0.687
<i>sec</i> -Butylamine	40.3	19.1	6.6	1.7	67.7	16.1	0.595
<i>t</i> -Butylamine	7.3	12.4	0	0	19.7	74.2	0.371

FIGURE 8. Monitoring of products in the reaction of **16** with morpholine<sup>141</sup>

high yield (45%) of the nitro group substitution product **25c** was observed at the early stage of the reaction (5 h), and it remained constant within experimental error after 10 h. The yields of *ortho*-mono-**26c** became maximum at 5 h and, after that, **26c** decreased gradually with the increase of disubstitution products **28c** and **29c** until all **26c** was consumed completely in 20 h. This means that the second attack of pyrrolidine onto **26c** gives disubstitution products **28c** and **7c**. On the contrary, the decrease in the yield of **27c** is found to be slower than that of **26c**.

Taking into account that the nucleophilicities of morpholine and pyrrolidine do not show a big difference, the authors explained the difference of the regioselectivity between these amines by the bulkiness of the amine, since similar effects of bulkiness on the regioselectivity were observed in the reactions of **24** with several butylamines (Table 18).

By comparing CPK models of the Meisenheimer intermediates which should be formed in each case, steric hindrance for substitution of the nitro group (intermediate **30**) should be larger than for substitution of any of the chlorine atoms (intermediates **31**, **32**). This is in accordance with the observed results where bulkiness of the butylamine leads to a diminution of the corresponding nitro-substitution product. Nevertheless, as we have

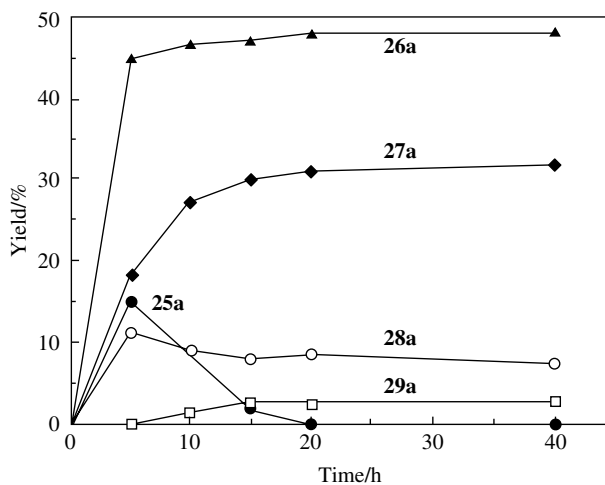
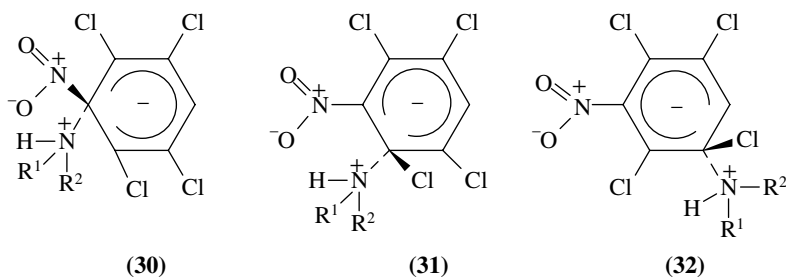


FIGURE 9. Monitoring of products in the reaction of **16** with pyrrolidine<sup>141</sup>

explained before, pyrrolidine exhibits an unusual high  $S_NAr$  reactivity and it seems that this will also be the effect here, since the steric requirements between both cyclic amines are not extremely different.



### III. SYSTEMS SHOWING 'ANOMALOUS' KINETICS

#### A. Fourth-order Kinetics

The classical two-step base-catalysed  $S_NAr$  reaction with amines, B, follows the third-order kinetic law given by equation 2. As noted in Section II, this equation predicts a straight line in the plot of  $k_A$  vs  $[B]$  or a downward curvature. But several  $S_NAr$  reactions with amines in aprotic solvents studied in the last decade exhibit an *upward* curvature, as is shown in Figure 10 for the reactions of 2,4-dinitroanisole with *n*-butylamine and the  $S_NAr$  reaction of 2,6-dinitroanisole with *n*-butylamine in benzene<sup>143</sup>. In these systems, if  $k_A/[B]$  is plotted vs  $[B]$ , straight lines are obtained and a downward curvature may be observed in some cases (as shown in Figure 11 for the reaction of 2,4-dinitroanisole with butylamine in benzene at 60 °C), which demonstrates that a new kinetic law is obeyed

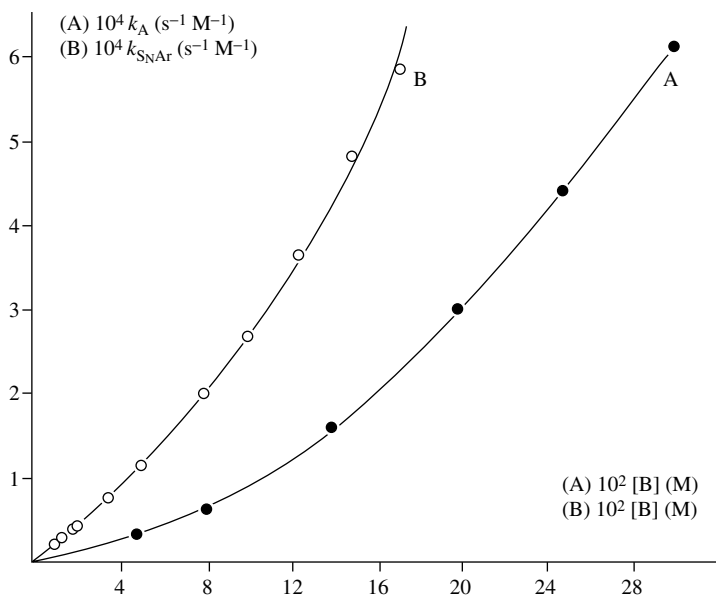


FIGURE 10. (A) Reaction of 2,4-dinitroanisole with *n*-butylamine at 100 °C. (B) Reaction of 2,6-dinitroanisole with *n*-butylamine at 45 °C<sup>144</sup>. Reprinted with permission from Reference 144. Copyright (1983) American Chemical Society

showing *third-order* dependence on the amine (equation 23).

$$k_A = k[B]^2 + k'[B]^3 \quad (23)$$

To the best of our knowledge, the first report of this *fourth-order kinetics* was published in 1980, for the reactions of 2,4- and 2,6-dinitroanisole with butylamine in benzene<sup>143b</sup>, and afterwards several other systems were studied in the same laboratory, some of which are shown in Table 19<sup>144</sup>. An early observation in these systems was that they frequently exhibited negative energies of activation; it can be observed in Figure 11 that for low [B], the rates at 60 °C are higher than those at 80 and 100 °C. Both results, the third-order dependence on [B] added to the observation of negative enthalpies of activation (characteristic of the existence of pre-equilibrium in the reaction coordinate), were considered evidence of the aggregation of the nucleophile, and that the reaction could proceed by attack of a *dimer* of the amine (B:B) superimposed on the classical mechanism by the monomer<sup>144</sup>. Amine aggregations are known to be affected by temperature<sup>145,146</sup>, inversely so that very low and even overall negative enthalpies of activation are observed where a pre-equilibrium, such as  $(2B \rightleftharpoons B:B)$ , exists<sup>144</sup>.

Although these peculiar kinetics had never been observed before, a careful search in the literature revealed that some 'anomalous' results ambiguously ascribed by the authors to 'unspecific solvent effects'<sup>103,147</sup>, were indeed due to the fact that these *S<sub>N</sub>Ar* reactions exhibit a fourth-order kinetic law<sup>144</sup>. Some of them are shown in Table 20. Shortly afterwards, some other authors reported third-order dependence in amine in *S<sub>N</sub>Ar* reactions in aprotic solvents<sup>148-152</sup>. Several alternative mechanisms have been suggested to rationalize this kinetic finding and many studies in the last years have attempted to



TABLE 19. Aromatic nucleophilic substitution in non-polar aprotic solvents. Third-order in amine kinetic law<sup>144</sup>. Reprinted with permission from Reference 144. Copyright (1983) American Chemical Society

Substrate, S	Amine, B	[B]	Solvent	Temp. (°C)	Reference
2,4-Dinitroanisole	cyclohexylamine	0.06–0.51	cyclohexane	60; 80; 100 <sup>c</sup>	144a
		0.05–0.61	benzene	60; 80; 100 <sup>c</sup>	144a
2,6-Dinitroanisole	<i>n</i> -butylamine	0.05–0.34	benzene	60; 80; 100 <sup>c</sup>	144b
	cyclohexylamine	0.03–0.46	benzene	27; 35; 45	144a
		0.03–1.25	cyclohexane	35; 45; 55	144a
		0.10–0.50	benzene:MeOH <sup>a</sup>	45	175
		0.30–0.70	toluene	35	180
	0.10–0.70	toluene-DMSO <sup>b</sup>	35	180	
	<i>n</i> -butylamine	0.01–0.17	benzene	27; 35; 45	174
2,4-Dinitrofluorobenzene	<i>o</i> -anisidine	0.01–0.82	benzene	35; 50; 60	172
	<i>o</i> -anisidine-pyridine	0.10–0.82			
			0.00–0.06	benzene	60
<i>p</i> -Fluoronitrobenzene	<i>n</i> -propylamine	0.1–1.5	toluene	60; 80; 100	82
3,5-Dinitro-2-methoxy-pyridine	cyclohexylamine	0.01–0.10	toluene	35	12
3,5-Dinitro-2-methoxy-pyridine	benzylamine	0.02–0.12	toluene	35	12

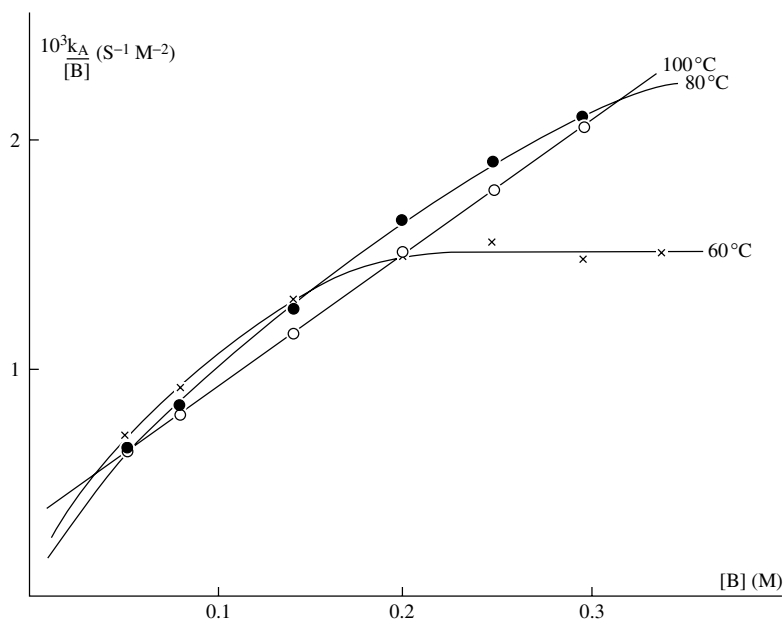
<sup>a</sup>Up to 30% MeOH,<sup>b</sup>Up to 2% DMSO,<sup>c</sup>Overall negative activation energies were observed.FIGURE 11. Reaction of 2,4-dinitroanisole with butylamine in benzene<sup>144</sup>. Reprinted with permission from Reference 144. Copyright (1983) American Chemical Society

TABLE 20. Reported 'anomalous' aromatic nucleophilic substitutions<sup>n144</sup>. Reprinted with permission from Reference 144. Copyright (1983) American Chemical Society

Substrate, S	Amine, B	[B]	Solvent	Temp. (°C)	Reference
2,4-Dinitrofluorobenzene	<i>p</i> -anisidine	0.05–0.29	benzene	25	147c
	aniline	0.05–0.30	toluene	40	147b
	morpholine	0.002–0.20	benzene	25	147c
2,3-Dinitronaphtalene	piperidine	0.02–3.0	benzene	22; 50; 60	160
2-Methoxy-3-nitrothiophene	piperidine	0.10–2.04	benzene	20	103
2-Phenoxy-1,3,5-triazine	piperidine	0.03–0.330	iso-octane	23; 71	147a
1-Fluoro-4-nitronaphtalene	<i>n</i> -butylamine	0.03–0.30	benzene	25	18
1-Fluoro-4,5-dinitronaphtalene	<i>n</i> -butylamine	0.01–0.24	benzene	25	103
2-Nitrophenyl 2,4,6-trinitro-phenyl ether	aniline	0.02–0.08	benzene	5, 15, 25, 35	151
3-Nitrophenylether	aniline	0.18–0.25	benzene	5, 15, 25, 35	151
4-Nitrophenylether	aniline	0.18–0.25	benzene	5, 15, 25, 35	151
bis-2,4-Dinitrophenyl ether	morpholine	0.10–0.60	benzene	30	148
phenyl 2,4,6-Trinitrophenyl ether	aniline	0.03–0.06	benzene	15; 25; 30	150

<sup>n</sup>Treatment of the reported data shows third-order in amine kinetic laws.

elucidate the factors involved in these reactions. Hirst<sup>153</sup> has recently reviewed some of the evidence of the mechanisms proposed in this controversial subject.

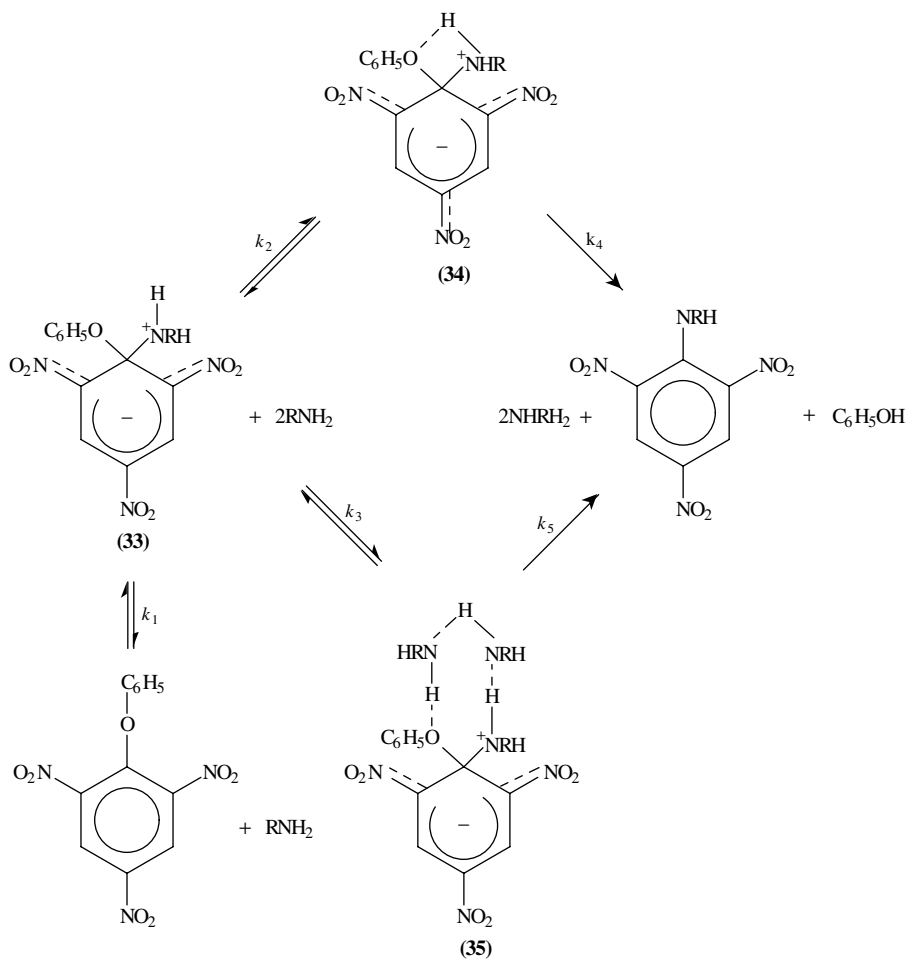
## B. The Eight-membered Cyclic Transition State

In the reactions of anilines with picryl phenyl ethers in benzene, Banjoko's group<sup>150,154,155</sup> observed that the second-order rate constant,  $k_A$ , exhibits a linear dependence on the square of the nucleophile concentration (equation 24).

$$k_A = k_0 + k'[\text{amine}]^2 \quad (24)$$

Banjoko has interpreted the third-order term in the amine concentration as due to a reaction proceeding through an eight-membered ring formed through a network of the inter-hydrogen bonding between two aniline molecules and the zwitterionic intermediate as shown in Scheme 11. In these reactions, the authors found that  $k_A$  showed little change with temperature in the range 5–35°C,  $k_0$  is almost invariant with temperature, and  $k'$  has negative activation energy for anilines containing electron-releasing substituents. The kinetic form also depends on the substitution in the nucleofuge. Thus, for unsubstituted or nitro-substituted leaving groups a third-order dependence is observed, whereas for leaving groups containing 2,4-, 3,4- and 2,5-dinitro groups in amine a second-order, and for the 2,6-dinitrophenoxy groups a first-order, kinetic law was obtained. The results were explained as a change in the transition state: from eight- to six- to four-membered rings, containing three, two or one molecules of aniline, respectively. Why an eight-membered transition state would be more effective in removing the nucleofuge than a six-membered one was not explained. Considering that formation of the cyclic intermediate requires the encounter of intermediate **33** with two amine molecules (aggregates are not considered) to form the highly ordered transition state **35**, a highly negative entropy of activation would be expected, but the observed values are within the usual ranges.

Addition of methanol to the reaction of aniline with picryl ether in benzene resulted in a continuous curvilinear increase of  $k_A$  over the entire range of solvent composition from pure benzene to pure methanol<sup>155</sup>. The order in aniline changes from three in benzene to



SCHEME 11

two in pure methanol. The expression in equation 25, where B = amine, holds over the range 0–0.6% methanol.

$$k_A = k_0 + k^B[B]^2 + k^{\text{MeOH}} [\text{MeOH}] \quad (25)$$

The authors presume that the observed effect is due to acid catalysis by methanol, but no catalysis by phenol was observed. Pietra and Vitali<sup>111</sup> have shown earlier that phenol catalyses the reaction of 1-fluoro-2,4-dinitrobenzene with piperidine in benzene.

### C. Aggregation of the Nucleophile

The mechanisms of chemical reactions are concerned largely with the sequence in which reactants are assembled and dispersed in relation to the bond-making and bond-breaking steps<sup>156</sup>. This is specially important for reactions in aprotic solvents in which

solvation is not as clear as in the network encountered in protic solvents. It is well known<sup>112,114,145,146,157</sup> that amines may undergo *auto-association* in aprotic media giving rise to aggregates of various stoichiometry. The dominating aggregate is a dimer with typical formation constant  $K \cong 0.1 \text{ M}^{-1}$  (the value for cyclohexylamine in cyclohexane)<sup>145</sup>. The structure of the aggregates has been studied in some cases and found to be non-cyclic oligomers<sup>146</sup>.

Amine aggregates are known<sup>145,157</sup> to be affected inversely by temperature, hence in  $S_NAr$  rates, then, overall negative energies of activation can be observed in reactions where a pre-equilibrium, such as  $(2B \rightleftharpoons B:B)$ , exists. It has been proved in many reactions in solution that aggregates can react without previous dissociation. One of the earlier reports is on the butylaminolysis of *p*-nitrophenyl acetate in chlorobenzene<sup>158</sup>, more recent ones are about the butylaminolysis of 2-hydroxy-5-nitro- $\alpha$ -toluene sulphonic acid sultone in acetonitrile and toluene<sup>159</sup>, the butylaminolysis of several nitro-substituted 4-nitrophenyl benzoates and cinamates<sup>114</sup> and on the rearrangement of the *Z-p*-nitrophenylhydrazone of 3-benzoyl-5-phenyl-1,2,4-oxadiazole into 4-benzoylamino-2-*p*-nitrophenyl-5-phenyl-1,2,3-triazole in benzene<sup>152</sup>. Curiously, in this last reaction, the authors 'have excluded the possibility that the amine behaves as a *dimer* because in other reactions catalysed by aliphatic secondary amines (e.g.  $S_NAr$ ) this kind of dependence on amine concentration is not usually observed'<sup>152,160</sup>. They described the effect as 'catalysis of catalysis', a term that was also used in the observed effect by two molecules of piperidine in the reaction of 1,2-dinitrobenzene in *n*-hexane<sup>115</sup>. Notwithstanding, it has been recently shown that for  $S_NAr$  reactions in non-polar solvents, auto-association of amines is very important because of the low permittivity of the media and the consequent range of electrostatic forces and the importance of hydrogen bonding. These types of interactions form the basis of the so-called 'dimer nucleophile' mechanism<sup>10,143,144</sup>.

It had been previously suggested<sup>114a,163,164</sup> that amine dimers should be *more nucleophilic* than the free amine, since the formation of the hydrogen bond would increase the electronic density on the nitrogen atom which partially donates its hydrogen. In fact, theoretical calculations by the PCILO method<sup>165</sup> showed that the dimers of aliphatic amines are linear, stabilized with respect to the monomer ( $\Delta E_{ca}$ , 4–5 kcal mol<sup>-1</sup>) and the examination of the electron density shows a 0.022 electron transfer. *Ab initio* theoretical calculations<sup>166</sup> carried out on ammonia dimers indicate a 0.0136 electron density increase. NMR studies<sup>169</sup> of butylamine in benzene show also that aggregation increases the amine nitrogen electron density<sup>167,168</sup>.

Besides self-association, the nucleophile can also aggregate to any other hydrogen-bond acceptor present in the media, forming *mixed aggregate*; this effect is particularly important in solvents of low permittivity<sup>10</sup>. Tertiary non-nucleophilic amines added as catalysts are prone to form these mixed aggregates, and various authors have recently shown their formation in  $S_NAr$  reactions with amines in non-polar solvents. Thus, Hirst and coworkers<sup>162</sup> have recognized the importance of these interactions to stabilize the protonated amine in the reactions of 1-chloro- and 1-fluoro-2,4-dinitrobenzenes with morpholine in benzene, forming what they called the *hetero-conjugates of the conjugate acid* of the nucleophile. (See Section III.I.) Frena and coworkers<sup>152,160</sup> described as 'catalysis of catalysis' the effect that requires association of a pair of amines, and this term was also used in the observed effect of pyridine in the reaction of piperidine with 1,2-dinitrobenzene in *n*-hexane<sup>115</sup>. In this reaction, taking into account that there are no significant changes of  $k_A$  with [Py] when the constant concentration of piperidine is high, the authors concluded that piperidine is a better catalyst than the mixed aggregate [piperidine-pyridine].

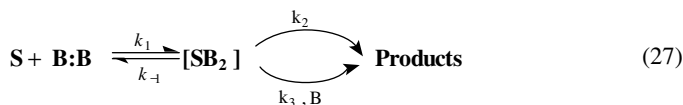
*Aggregation with the co-solvent* may also be very important in  $S_NAr$  reactions with amines in binary solvents, when the non-polar solvent is mixed with small amounts of a co-solvent that has hydrogen-bond donor or hydrogen-bond acceptor capabilities. Thus, aggregation of amines with protic solvents is very well known, and aggregation with DMSO<sup>144,161</sup> and with other hydrogen-bond acceptor additives<sup>162</sup> has also been shown.

*Ab initio* theoretical calculations show a three times stronger interaction for the *solvated nucleophile*  $CH_3OH \cdots NH_3$  than for the *ammonia dimer*<sup>167</sup>. *Ab initio* calculations<sup>168</sup> on the hydrogen-bonding ability of pyridine bases with water showed a 0.03 charge transfer from the pyridine to the water molecule and the dimers are again linear, the stabilization energy being  $4.7 \text{ kcal mol}^{-1}$ . The operation of all these mixed aggregates will be discussed below in connection with the 'dimer nucleophile' mechanism<sup>169</sup>.

#### D. The 'Dimer Nucleophile' Mechanism

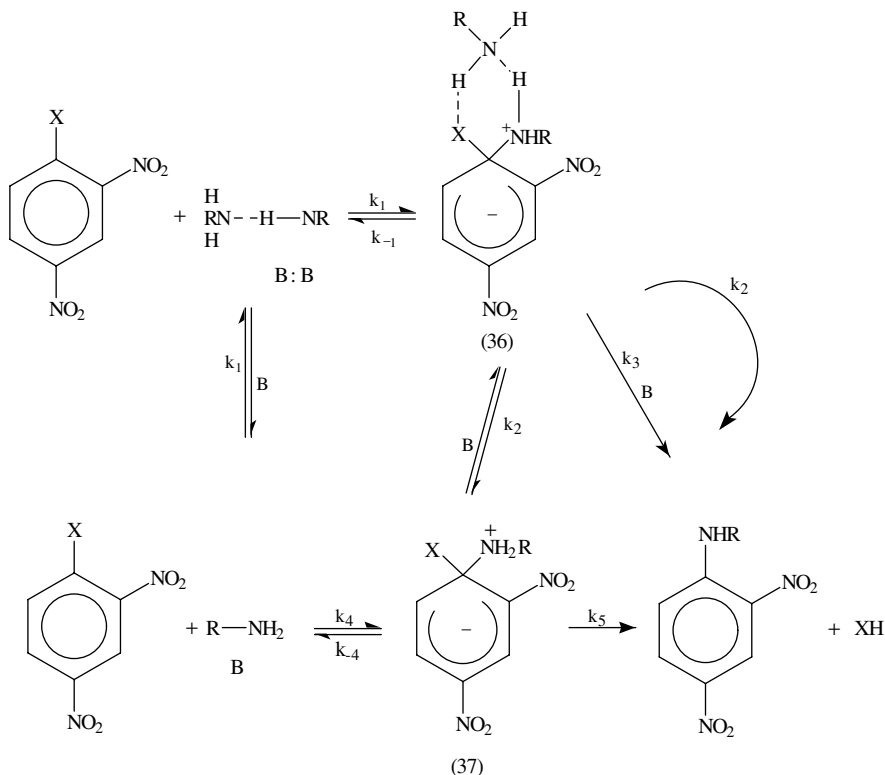
Taking into account the self-aggregation of the amine that prevails in non-polar aprotic solvents, Nudelman and Palleros<sup>144</sup> proposed that the observed third-order in amine could be due to a mechanism involving attack of the *dimer of the nucleophile* superimposed on the classical reaction with the monomer, as shown in Scheme 12. A cyclic intermediate, **36**, similar to **9** proposed by Capon and Rees<sup>126</sup>, is formed straightforwardly in the addition step through the *dimer* of the amine. The proposed mechanism does not preclude attack by the monomer which directly would form intermediate **37**, as reported for the two-step mechanism shown by equation 1. The intermediate **36** formed in the first step is in mobile equilibrium with the second classical intermediate **37**, and either of them can react to form ultimate products, by spontaneous or base-catalysed decomposition. The whole reacting system is depicted in Scheme 12. A cyclic transition state was also proposed by Banjoko and Otiono<sup>170</sup> but for the second step (decomposition of the intermediate complex, **37**).

Application of the steady-state treatment to the whole mechanism gives an expression involving the seven specific rate constants for each step, the association equilibrium constant for the nucleophile,  $K_1$ , and the constant for the equilibrium between intermediates **36** and **37**,  $K_2$ . The complete expression and the different limit situations that were evaluated are derived in Reference 144. A simplified reacting scheme, where only attack for the *dimer* is considered, is shown by equations 26 and 27. The dimer of the nucleophile (**B:B**), equation 26, attacks the substrate, **S**, forming the intermediate, **SB<sub>2</sub>**, and a third molecule of amine assists the decomposition step (equation 27). Both transition states in Scheme 12 are highly zwitterionic and the extra amine molecule should help to stabilize the developing charges in these non-polar solvents and to assist the departure of the nucleofuge (probably as suggested by Hirst, see below). The derived expression for  $k_A$  in this simplified reacting scheme is equation 28.



$$k_A = \frac{k_1 k_2 K [B] + k_1 k_3 K [B]^2}{k_{-1} + k_2 + k_3 [B]} \quad (28)$$

Here  $K = [B:B]/[B]_0^2$  stands for the amine auto-association constant. Usually, in the reactions with amines with poor nucleofuges the second step is rate-determining, the inequality



SCHEME 12

$k_{-1} \gg (k_2 + k_3[B])$  holds and equation 28 can be further simplified to equation 29, which predicts a linear dependence of  $k_A/[B]$  vs  $[B]$ .

$$\frac{k_A}{[B]} = \frac{k_1 k_2 K}{k_{-1}} + \frac{k_1 k_3 K [B]}{k_{-1}} \quad (29)$$

$$k_A/[B] = k_1 K \quad (30)$$

If  $k_{-1} \cong (k_2 + k_3[B])$ , at high  $[B]$ , equation 28 may be transformed into equation 30, which is responsible for the plateau observed in some cases in the plot of  $k_A/[B]$  vs  $[B]$  (e.g. the reaction of 2,4-dinitroanisole with butylamine in benzene at 60 °C, Figure 11)<sup>143a</sup>. The first report of this mechanism was published in 1980<sup>143b</sup> for the reactions of 2,4- and 2,6-dinitroanisole with butylamine in benzene, and afterwards several other systems were studied some of which are shown in Table 19. That association of the nucleophile, at relatively high  $[B]$ , in  $S_NAr$  reactions should increase its nucleophilicity was suggested earlier<sup>163a,171</sup>; the original proposal here is the operation of the *dimer* of the amine as an entity, according to the experimental evidence.

The reactions shown in Table 19 exhibit a very small overall energy of activation, and in some cases [e.g. the reaction of 2,4-dinitroanisole with butylamine in benzene (Figure 11), and with cyclohexylamine in cyclohexane and in benzene (not shown)<sup>144</sup>] negative activation energies are observed. Since the equilibrium association constant,  $K_1$ ,

diminishes with increasing temperature, this is a reasonable explanation for the apparently surprising 'inverse' temperature effect. The rate-determining step is preceded by a fast equilibrium, whereby the expected increase in rate for the slow step with increasing temperature would be compensated by a shift of the preceding equilibrium towards the monomer. Similar small or even negative overall energies of activation were observed by Banjoko and Ezeani<sup>150</sup> for the reactions of dinitrophenyl phenyl ethers with aniline and substituted anilines in benzene.

In the cyclic intermediate proposed in Scheme 12, the second molecule of amine acts as a proton donor to the leaving group as well as a proton acceptor from the positively charged nitrogen of the zwitterion, thus stabilizing the dipolar transition state that otherwise should be quite unstable in benzene. The third molecule of amine would assist the decomposition of the zwitterionic intermediate to the products, forming the acid conjugate of the dimer through concerted detachment of the proton from the intermediate. This 'protonated dimer' catalyses the nucleofuge departure in the non-polar solvents<sup>10</sup>.

If this interpretation is correct, catalysis by *mixed aggregates* should be also observed since, as was mentioned above, amines form such aggregates in non-polar aprotic media. Overwhelming evidence of the participation of these aggregates in the kinetic law has been accumulated in recent years. One of the first systems where this effect was considered is the reaction of 2,4-dinitrofluorobenzene with *o*-anisidine in benzene<sup>172</sup>. A quadratic dependence of  $k_A$  with [B] was observed and interpreted as due to a hydrogen-bonded dimer operating as the main nucleophile in a mechanism similar to that shown in Scheme 12. When the reaction is run in the presence of a hydrogen-bond acceptor (HBA) such as pyridine, a new *mixed associated nucleophile*, **B:P**, is present in the system as depicted in Scheme 13. Three competing nucleophilic reactions are shown: attack by the dimer (measured by  $k_1$ ), by the monomer (determined by  $k_4$ ) and by the **B:P** complex (measured by  $k_7$ ). An equilibrium between the three possible tetrahedral intermediates (**36,37,38**) is established (measured by the equilibrium constants  $K_2$ ,  $K_3$  and  $K_4$ ),  $k_{-4}$  being greater than  $k'_{-1}$  and  $k'_{-7}$  as discussed earlier. The whole kinetic expression for  $k_A$  as well as the simplification that can apply to limit situations are fully discussed in Reference 172; the general expression for  $k_A$  can be reduced to equation 31, which can be written in the condensed form of equation 32.

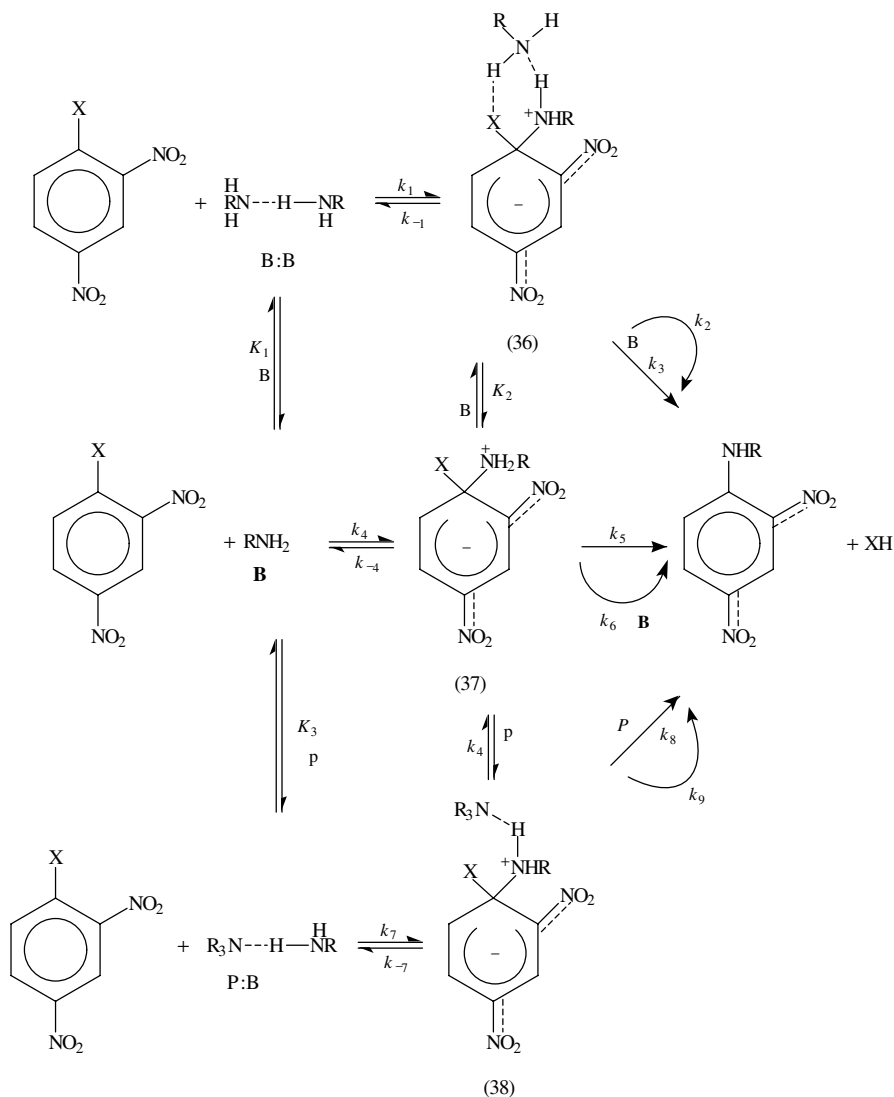
$$k_A = (k_3k_4 + k_1k_5K_1) [B] + k_1k_3K_1[B]^2 + (k_1k_8K_1 + k_7k_3K_3)[B][P] + (k_5k_7K_3 + k_4k_8)[P]/k_4 \quad (31)$$

$$k_A = k_\alpha[B] + k_\beta[B]^2 + k_\gamma[B][P] + k_\delta[P] \quad (32)$$

Several experiments were carried out to test equation 32 and the four constants could be evaluated; the determined values are shown in equation 33<sup>172</sup>. It can be observed that catalysis by a *HBA-nucleophile* complex is more important than for the nucleophile itself, as expected on the basis of the 'dimer nucleophile'.

$$k_A = 10^{-4}(0.152 [B] + 0.780 [B]^2 + 9.22[B][P] + 13.5[P]) \quad (33)$$

Experiments carried out in the range [B] = 0.025–0.1 M, in the presence of pyridine, [P] = 0.037 and 0.062 M, showed that equation 31 holds in the whole range of [B] studied, i.e. 0.02–0.8 M. At low [B] the points for  $k_A$  vs [B] approach a straight line of slope  $5.0 \times 10^{-5} \text{ s}^{-1} \text{ M}^{-2}$  and intercept  $3.8 \times 10^{-5} \text{ s}^{-1} \text{ M}^{-1}$  (for [P] = 0.037 M). If equation 32 holds, the slope of  $k_A$  vs [B] at the origin is a measure of  $k_\alpha + k_\gamma [P]$ . This term was measured and found to be  $4.4 \times 10^{-5} \text{ s}^{-1} \text{ M}^{-1}$ , which agrees fairly well with the value of  $5.9 \times 10^{-5} \text{ s}^{-1} \text{ M}^{-1}$  found for the runs at low [B], showing that equation 32 holds in the whole range of [B] studied<sup>172</sup>.



SCHEME 13

From the magnitude of the calculated constants it is possible to estimate a higher limit for the value of the uncatalysed term in equation 31; since  $k_7 [P]$  is between 2 and  $8 \times 10^{-5} \text{ s}^{-1} \text{ M}^{-1}$ , the uncatalysed term should be  $< 6 \times 10^{-7} \text{ s}^{-1} \text{ M}^{-1}$ . For measurements of this term it would be necessary to work at very low  $[B]$  and also at very low  $[P]$ , but then the reactions would become too slow to be measured.

In terms of the 'dimer mechanism' a term in  $[P]^2$  would also be expected in special systems according to the reacting scheme shown in Scheme 13. Actually, one molecule of pyridine would act forming the *mixed associate nucleophile*, and the second molecule



could operate in the base-catalysed decomposition of the intermediate **38**. In the reactions of 2,4-dinitrofluorobenzene with *o*-anisidine in benzene, the  $[P]$  was relatively low ( $[P] < 0.07$  M) and the term  $[P]^2$  becomes negligible when compared with the catalytic terms  $[B]:[P]$  and  $[P]$  and a linear dependence of  $k_A$  on  $[P]$  is observed. Nevertheless, with a less basic nucleophile such as morpholine, M, it was found in the reaction with 2,4-dinitrofluorobenzene (DNF) in benzene that the dependence of  $k_A$  on  $[P]$  departs from the line (upward curvature), and this was considered to be a medium effect due to the relatively high  $[P]$  used (up to 0.5 M)<sup>147c</sup>. Nevertheless, if the data are treated as if a 1:1 complex between morpholine and pyridine is formed, the empirical equation 34 can be formulated for the overall-rate second-order rate coefficient which shows a quadratic dependence of  $k_A$  on  $[P]$ .

$$k_A = k_0 + k_M[M] + k_P[P] + k_{P:M}[P]^2 \quad (34)$$

If the terms independent of  $[P]$  are divided by  $[P]$  and the quotient plotted against  $[P]$ , a straight line is obtained, which demonstrates the validity of equation 34 and the existence of a non-negligible term in  $[P]^2$  for this case. Further studies of the reactions of DNF with aniline in toluene also showed a quadratic dependence of the rate with [pyridine] (Figure 12).

In other systems, similar kinetic laws were observed when studying the effect of added pyridine, although differentiation with the 'dimer nucleophile' mechanism is made in the interpretation of the experimental results (see below). Rationalizations of the involved phenomena are based on the strong hydrogen-bond interactions between the nucleophile and the pyridine, and on the catalytic effect of a third amine molecule in the decomposition of the zwitterionic intermediate in non-polar solvents.

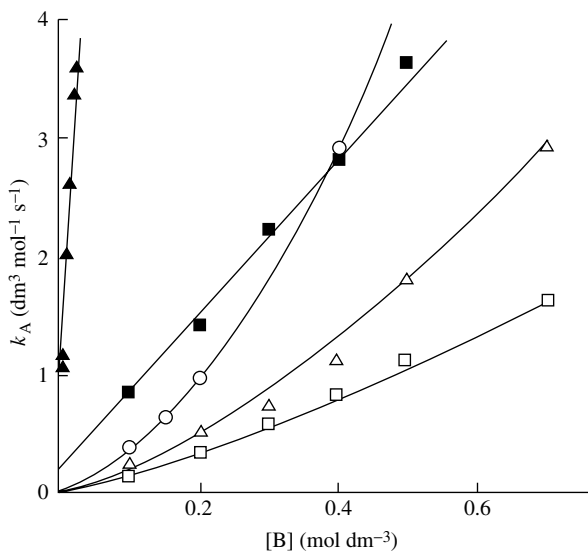


FIGURE 12. Reaction rates,  $k_A(f)$ , of DNF (2,4-dinitrofluorobenzene) with aniline in  $\blacktriangle$  acetonitrile ( $\times 10^4$ );  $\blacksquare$  ethyl acetate ( $\times 10^4$ );  $\triangle$  chloroform ( $\times 10^7$ ) and  $\square$  toluene ( $\times 10^7$ ) as a function of [aniline];  $\circ$  in toluene ( $5 \times 10^4$ ) as a function of [pyridine]<sup>190</sup>

### E. Specific Solvent Effects

The quadratic dependence of  $k_A$  on  $[B]$  is a peculiar phenomenon observed in aprotic solvents. The mechanisms proposed to explain the results should consider the strong hydrogen-bond interactions that are expected to stabilize the highly ionic intermediates in the poorly solvating media. Thus changes in the reaction media will have a strong influence on the rates and on the kinetics. Interactions between alcohols and amines are known to be stronger than among amines themselves, and it has been demonstrated that nitro-to-nitrogen proton transfers are intrinsically slower than nitro-to-oxygen proton transfers<sup>173</sup>. It is therefore of critical importance to determine the effect of adding defined amounts of a protic solvent to the reaction media to test the validity of the 'dimer nucleophile' mechanism.

A special system where classical solvent effects should be negligible is, e.g., the reaction of 2,6-dinitroanisole with cyclohexylamine. Indeed, at 45 °C and  $[B] = 0.4$  M, the  $k_A$  has almost the same values in benzene and in methanol ( $5.27$  and  $5.82 \times 10^{-4} \text{ M}^{-1} \text{ s}^{-1}$ , respectively)<sup>174</sup>. If no special effects were operating, the reaction rate should increase slightly and steadily on addition of methanol to benzene in the reaction media; this should be expected since the zwitterionic transition states should be stabilized by the more polar solvent. However, a spectacular effect was observed, namely the reaction rate decreases abruptly on small additions of methanol to benzene, reaches a minimum at nearly 25% of methanol and then begins to increase up to the given value in pure methanol (Figure 13a)<sup>175</sup>.

The huge decrease in rate was interpreted as the result of competition between the auto-association of the amine and the amine-methanol aggregates, where the hydroxylic solvent acts as proton donor:  $\text{ROH} \cdots \text{NH}_2\text{R}$ , thereby *decreasing* the nucleophilicity of the amine. Higher oligomers with more than one ROH molecule are also possible<sup>176</sup>. In spite of the rate decrease, the *third order* in amine rate dependence is observed up to 25% methanol:75% benzene, i.e. the binary mixture where the minimum region is observed.

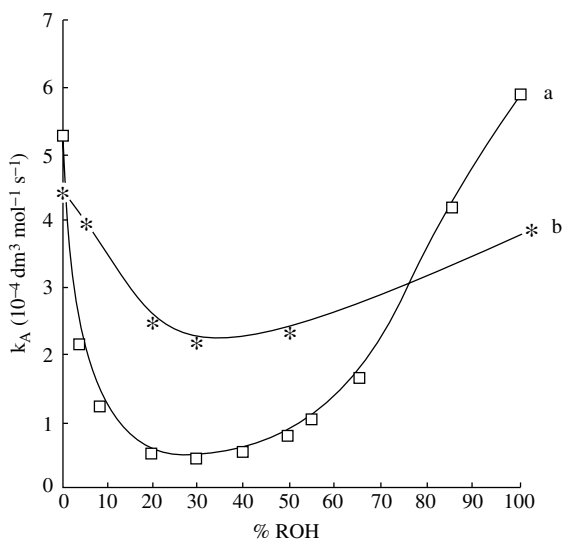


FIGURE 13. Overall second-order rate coefficients,  $k_A$ , for the reaction of 2,6-dinitroanisole with cyclohexylamine in binary solvents: □, benzene-methanol; \*, toluene-octanol<sup>175</sup>.

Linearization of the amine profiles ( $k_A/[B]$  vs  $[B]$ ) shows decreasing slopes for 0–25% methanol, consistently what would be expected on the basis of the mechanism depicted in Scheme 12. The continuous diminution of the slope with increasing methanol percentage shows the continuous diminution in the auto-association constant of the amine,  $K$ , to be practically nil at 25% methanol<sup>175</sup>. For higher methanol content in the mixed solvent, the classical mechanism is observed.

## F. Catalysis by Methanol

The above interpretation of specific solvent effects on the ‘dimer nucleophile mechanism’ has been recently criticised, however, by Banjoko and Bayeroju<sup>155</sup> in a paper which they called “strong evidence against the ‘dimer’ mechanism”. Their contention was that the observed decrease in rate is due to a special feature in the reaction of 2,6-dinitroanisole (2,6-DNA) with cyclohexylamine in benzene<sup>175</sup>. Since they did not observe similar behaviour in the reaction of phenyl 2,4,6-trinitrophenyl ether with aniline in benzene-methanol<sup>155</sup> they proposed that the retarding effect observed in the reaction of 2,6-DNA with cyclohexylamine is the result of the reaction being reversible. According to their suggestions, since methanol is formed as a product arising from the nucleofuge departure, additions of small amounts of methanol to the solvent would result in a decrease in rate as expected by Le Chatelier’s principle. This argument, obviously, does not take into account the rising portion of the curve, and the fact that the reaction produces quantitatively *N*-(2,6-dinitrophenyl) cyclohexylamine even in pure methanol. Moreover, the authors even suggest that all reactions of amines with substrates having methoxy nucleofuges are likely to be reversible.

Although this argument could be refuted by the observation of the ‘dimer nucleophile’ in other systems<sup>10</sup>, it was of interest to examine the effect of addition of a hydrogen-bond donor (HBD) co-solvent different from methanol, to the reaction of a substrate where the nucleofuge is methoxide, such as the reaction of 2,6-DNA with cyclohexylamine in toluene–octanol binary mixtures<sup>177</sup>. As regards octanol: (a) it would not compete with the product (methanol) in case of a reversible reaction; (b) its dipolarity ( $\pi^* = 0.37$ ) is between that of toluene and methanol<sup>178</sup>; (c) its hydrogen-bond donor ability ( $\alpha = 0.30$ )<sup>179</sup> is greater than that of toluene or cyclohexylamine ( $\alpha = 0$  for both) but smaller than that of methanol ( $\alpha = 0.69$ )<sup>179</sup>.

In the reactions of 2,6-DNA with cyclohexylamine ( $[B] = 0.264$  M) in toluene and in octanol at 35, 45 and 60 °C, it was observed that at 35 °C the reaction is slightly faster in toluene than in octanol, whereas at 45 and 60 °C the inverse is observed<sup>177</sup>. These results show, once more, the difficulties of studying related reaction rates at a single temperature. A very low enthalpy of activation is observed for the reactions in toluene consistently with the operation of the ‘dimer’ nucleophile mechanism. The reaction in octanol shows a higher enthalpy of activation and also a slightly higher entropy of activation<sup>177</sup>.

To add new experimental evidence to the argument of competition between self- and mixed aggregates, the reaction was studied in toluene–octanol mixtures at the same base concentration that was used in studies in toluene–methanol, i.e.  $[B] = 0.4$  M. A continuous increase in rate on addition of increasing amounts of octanol to toluene would be expected on the basis of Banjoko and Bayeroju’s arguments<sup>155</sup>. On the contrary, a *decrease* in rate is observed on small additions of octanol (Figure 13b), up to nearly 30% of octanol where the valley of the curve is reached; then it begins to increase up to the value in pure octanol. As expected, on the basis of a special effect of a medium hydrogen-bond donor co-solvent that competes with the amine itself for aggregation, the reaction in the toluene–octanol system exhibits a similar, albeit smaller, dependence on the protic solvent content than that observed in the toluene–methanol system<sup>104</sup>.

It was observed that in pure toluene  $k_A$  exhibits a curvilinear dependence with  $[B]$ . A similar response is found in the binary solvents, the curvature being smaller on increasing the octanol content. The plot of  $k_A/[B]$  versus  $[B]$  (Figure 14) in pure toluene is a straight line (equation 30), which indicates the parabolic dependence of  $k_A$  on  $[B]$ , consistent with equation 29. Similar behaviour is observed in the plot of  $k_A/[B]$  versus  $[B]$  for the reactions carried out in 5, 20, 30 and 50% octanol–toluene binary solvents. It can be observed in Figure 14 that the slope decreases sharply on passing from pure toluene to 5% octanol; then the decrease is smaller. A small decrease is also observed in the intercepts of the plots up to 30% octanol (Table 21) and then the intercepts increase in pure octanol. In fact, the intercept is greater than the slope in pure octanol, since in this solvent  $k_3$  is almost negligible, consistently with the entire concept of the ‘dimer’ mechanism. In their paper against this mechanism, Banjoko and Bayeroju<sup>155</sup> argued that the intercepts should decrease on adding increasing amounts of methanol to toluene, and the fact that the figure in Reference 144 did not show significant changes from 4–30% methanol, in their opinion: ‘casts serious doubt on the validity of equation 31 and hence on the dimer mechanism on which it is based’. It can be observed in Table 21 that the values of the intercepts change slightly in the present study, and also in the reactions in benzene–methanol mixtures: they decrease from 6.06 to  $1.04 \times 10^{-4} \text{ L mol}^{-1} \text{ s}^{-1}$  on going from pure benzene to 4% methanol–benzene.

Furthermore, although the intercepts ( $k_1 k_2 K / k_{-1}$ ) and the slope ( $k_1 k_3 K / k_{-1}$ ) are equally influenced by the dimerization constant  $K$  in equation 28, this does not imply that they should show the same effect on changing the solvent. According to the ‘dimer mechanism’, it could be expected that the ‘base catalysed’ decomposition of the transition state  $\text{SB}_2$ , measured by  $k_3$ , should be more depressed by small additions of protic solvents than the ‘spontaneous’ decomposition measured by  $k_2$ . Indeed, the overwhelming evidence on the classical base catalysis by amines shows that usually  $k_3$  is more important in aprotic than in protic solvents<sup>1</sup>.

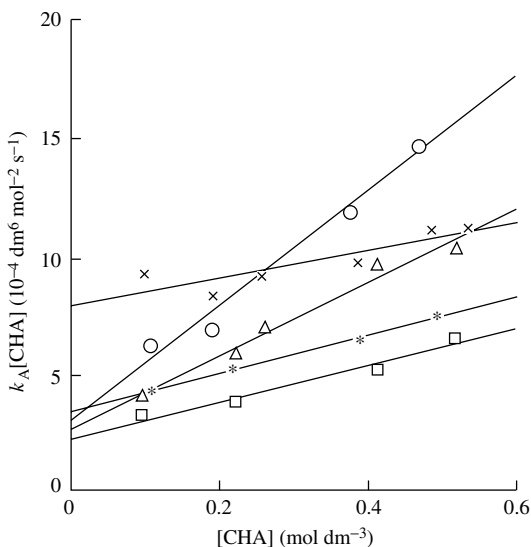


FIGURE 14. Overall second-order rate coefficients over cyclohexylamine (CHA) concentration,  $k_A/[B]$ , for the reaction of 2,6-dinitroanisole with cyclohexylamine in:  $\circ$ , toluene; and  $\Delta$ , 5;  $*$ , 20;  $\square$ , 30;  $\times$ , 100% octanol–toluene binary solvents, as a function of  $[B]$ <sup>177</sup>

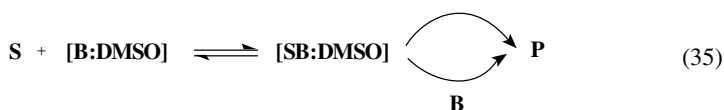
TABLE 21. Reaction of 2,6-dinitroanisole (DNA) with cyclohexylamine (CHA) in toluene–octanol binary solvents, at 35 °C<sup>a177</sup>

% Octanol	[CHA] (mol dm <sup>-3</sup> )	k <sub>A</sub> (10 <sup>-4</sup> dm <sup>3</sup> mol <sup>-1</sup> s <sup>-1</sup> )	k <sub>A</sub> /[CHA] (10 <sup>-4</sup> dm <sup>6</sup> mol <sup>-2</sup> s <sup>-1</sup> )	k <sub>1</sub> k <sub>3</sub> K/k <sub>-1</sub> (10 <sup>-4</sup> dm <sup>9</sup> mol <sup>-3</sup> s <sup>-1</sup> )	k <sub>1</sub> k <sub>2</sub> K/k <sub>-1</sub> (10 <sup>-4</sup> dm <sup>6</sup> mol <sup>-2</sup> s <sup>-1</sup> )
0	0.109	0.67	6.14		
	0.188	1.27	6.84		
	0.264	2.53	9.58	24 ± 2	3.1 ± 0.5
	0.376	4.39	11.78		
	0.470	6.76	14.51		
5	0.096	0.38	3.98		
	0.223	1.28	5.76		
	0.260	1.77	6.81	15 ± 1	2.6 ± 0.4
	0.415	3.93	9.48		
	0.518	5.28	10.19		
10	0.264	1.29	4.89		
15	0.264	1.08	4.10		
20	0.109	0.45	4.17		
	0.218	1.13	5.19		
	0.393	2.46	6.26	8 ± 1	3.3 ± 0.2
	0.492	3.66	7.44		
30	0.096	0.30	3.07		
	0.223	0.85	3.79		
	0.415	2.13	5.13	8 ± 1	2.2 ± 0.2
	0.518	3.28	6.34		
50	0.264	1.05	3.98		
	0.415	2.05	4.94	9 ± 1	1.3 ± 0.2
	0.518	3.35	6.45		
100	0.109	0.92	9.20		
	0.194	1.61	8.30		
	0.260	2.37	9.11	8 ± 1	6.8 ± 0.2
	0.388	3.76	9.69		
	0.485	5.36	11.05		
	0.530	5.90	11.13		

<sup>a</sup>[DNA] = 20 × 10<sup>-4</sup> mol dm<sup>-3</sup>.

### G. Catalysis by Hydrogen-bond Acceptor (HBA) Additives

If the ‘dimer mechanism’ interpretation is correct, addition of a *HBA* co-solvent, e.g. dimethyl sulphoxide (DMSO) ( $\beta$  value = 0.76)<sup>178</sup>, in catalytic amounts should *increase* the reaction rate by forming a mixed aggregate  $\text{RNH}_2 \cdots \text{OS}(\text{CH}_3)_2$  (B:DMSO), equation 35, where the amine acts now as a HBD, and therefore this mixed aggregation should increase its nucleophilicity. DMSO has been shown to increase the nitrogen electron density of primary and secondary amines<sup>161</sup>.



The reaction rate of 2,6-dinitroanisole with cyclohexylamine in toluene increases rapidly with small additions of DMSO up to 0.5%; then the increase with [DMSO] is slower<sup>108</sup>.

Studies of the amine concentration rate dependence show that the reactions are strictly *third-order* in amine for DMSO <2%. For DMSO constants >10% the reactions show the classical behaviour usually found in base-catalysed  $S_NAr^{180}$ . The specific solvent effects observed for small additions of the HBD co-solvent are consistent with the formation of the mixed aggregate, and a linear correlation was found between  $k_A$  and [DMSO], shown by equation 36, which expresses that the third-order term is more affected by the small additions of DMSO than the fourth-order term. Equation 36 is valid for [DMSO] <2% (0.282 M).

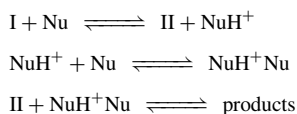
$$k_A = k_0(k_\alpha + k_\beta[\text{DMSO}]) [\text{B}] + k_D[\text{B}]^2 \quad (36)$$

Although the catalytic effect of the aggregation of the nucleophile with DMSO could also operate in the second step, the above interpretation is preferred since it also explains the early reported 'anomalous' catalytic effect of small additions of DMSO (<0.2 M) observed when the first step is rate-determining (i.e. reaction of 2,4-dinitrochlorobenzene with piperidine in benzene)<sup>181</sup>.

Similar rate accelerations due to the addition of small amounts of DMSO were found in the reactions of 1,2-dinitrobenzene with butylamine in benzene. While the reaction is almost insensitive to other additives, the accelerations observed upon addition of DMSO to benzene exceed expectations based only on considerations of the polarity of the medium<sup>9</sup>. Catalysis by other *HBA* additives was recently studied by Hirst and coworkers<sup>162</sup> in connection with the 'homo-/hetero-conjugate mechanism'.

## H. The Homo- and Hetero-conjugate Mechanisms

Hirst and coworkers proposed in 1977<sup>182</sup> that in the reactions of 2,4,6-trinitrophenyl phenyl ether with aniline in benzene, aggregates can be formed between the nucleophile and its conjugate acid, which can be formulated as  $\text{NuHNu}^+$ , and the reaction would take place within aggregates by SB-GA. They explained<sup>148</sup> the upward curving plots as being due to electrophilic catalysis of the expulsion of the leaving group by homo- and hetero-conjugates of the conjugate acid, as shown in Scheme 14, where I and II refer to the intermediates in equation 1 and Scheme 1, and Nu is the nucleophile.



SCHEME 14

Accelerations of the rates due to an additive P are explained as *electrophilic catalysis* by the heteroconjugate  $\text{NuH}^+\text{P}$ , while a second-order term in the concentration of P can be obtained if the relative basicities of Nu and P are such that P can compete with Nu for removal of the proton from I followed by electrophilic catalysis by the homoconjugate  $\text{PH}^+\text{P}$ .

Support for this mechanism has been obtained from the study of the effect of twelve hydrogen-bond acceptors on the reactions of 1-chloro- and 1-fluoro-2,4-dinitrobenzenes with morpholine in benzene<sup>162</sup>. The reaction of 1-chloro-2,4-dinitrobenzene is not catalysed by either morpholine or DABCO, i.e.  $k_A = k_1$ ; the first stage of the reaction is rate-determining and the various additives have no effect on the rate constant. On the other hand, Table 22 shows that the reaction of the fluoro-substrate is highly sensitive to the presence of the various additives and it is base-catalysed while for ten additives there was a linear dependence of  $k_A$  on either their concentration, [P], or on the square

TABLE 22. Effect of some additives  $P$  on the reaction of 1-fluoro-2,4-dinitrobenzene with morpholine in benzene at 30 °C. Values of  $k''$  ( $\text{mol}^2 \text{ l}^{-2} \text{ s}^{-1}$ ) in the equation  $k_A = k' + k'' [P]$  and other relevant data<sup>162</sup>

$P$	Anisole	DMA	MeCN	THF	Cyclo- hexanone	Nitro- benzene	Pyridine	4-Mepy	DABCO	Me <sub>2</sub> SO	pyNO	HMPA
$k''$			$3.09 \times 10^{-2}$	$2.94 \times 10^{-2}$	$6.69 \times 10^{-2}$	$1.07 \times 10^{-1}$	$1.87 \times 10^{-1}$	$5.61 \times 10^{-1}$	3.26	3.89	6.94	25.1
$pK_{\text{HB}}$	0.02 <sup>a</sup>	0.45 <sup>b</sup>	0.90 <sup>b</sup>	1.26 <sup>a</sup>	1.32 <sup>b</sup>	0.73 <sup>a</sup>	1.88 <sup>a</sup>	2.03 <sup>a</sup>	2.20 <sup>b</sup>	2.53 <sup>a</sup>	2.76 <sup>a</sup>	3.56 <sup>a</sup>
$pK_a$	-6.51	5.07 <sup>d</sup>	-10.13 <sup>e</sup>	-2.1 <sup>e</sup>	-6.8	-11.26	5.22	6.00	8.60	0 <sup>e</sup>	0.79	
$E_{235}^f$	4.33		37.5	7.58	18.3 <sup>g</sup>	34.8	12.4 <sup>h</sup>			46.7		30.0 <sup>g</sup>

<sup>a</sup>Reference<sup>162</sup>.

<sup>b</sup>L. Jores, J. Mitsky and R. W. Taft, *J. Am. Chem. Soc.*, **94**, 3438 (1972).

<sup>c</sup>D. D. Perrin, *Dissociation Constants of Organic Bases in Aqueous Solution*, I.U.P.A.C.-Butterworths, London, 1965.

<sup>d</sup>M. M. Fickling, A. Fischer, B. R. Munn, J. Packer and J. Vaughan, *J. Am. Chem. Soc.*, **81**, 4226 (1959).

<sup>e</sup>E. M. Arnett, *Prog. Phys. Org. Chem.*, **1**, 223 (1963).

<sup>f</sup>Dielectric constant; see 'Organic Solvents', in *Techniques of Organic Chemistry* (Eds. J. A. Riddich and W. B. Bunger), Vol. II, 3rd edn., Wiley-Interscience, New York, 1970.

<sup>g</sup>At 20 °C.

<sup>h</sup>At 21 °C.

of their concentration,  $[P]^2$ . An approximately linear correlation was found between the logarithms of the factors which measure the dependence on  $[P]$  and the hydrogen-bonding parameter,  $\beta^{179}$ . The authors correlate the slopes with the former  $pK_{HB}$  'Taft parameter', which is now called the hydrogen-bonding parameter,  $\beta^{179}$ . The acceptors, P, consisted of a variety of substances ranging from acetonitrile through nitrobenzene and pyridine N-oxide to hexamethylphosphoric triamide, and covered a range of  $pK_{HB}$  values from 0.90 to 3.56. Anisole and dimethylaniline with very low  $pK_{HB}$  values of 0.02 and 0.45 did not produce accelerations.

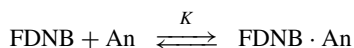
The effect is interpreted as evidence of the operation of the homo-/hetero-conjugate mechanism. The authors presume that for the mechanism given by equation 1, for additives P which are much less basic than the nucleophile N, electrophilic catalysis also occurs both with the hetero-conjugate  $N^+HP$  formed between the conjugate acid of the nucleophile, N, and P, as well as with the homo-conjugate  $Nu^+HNu$ . For more basic additives, *electrophilic catalysis* is possible by the species  $PH^+$  and its homo-conjugate  $PHP^+$ <sup>153,162,182</sup>.

The interpretation of formation of *homo- (or hetero-) conjugated acid*  $BH^+B$  by proton transfer from the intermediate and the electrophilically catalysed departure of the nucleofuge due to this aggregate is common to this and to the 'dimer mechanism' and they can be formulated as essentially the same, and as reflecting different parts of a spectrum of methods for the formation of the second intermediate<sup>153</sup>. For a given nucleophile, dimer formation increases with increase of concentration, hence the relative importance that reaction via a dimer should increase with increasing nucleophile concentration.

## I. The Substrate-Catalyst Molecular Complex

That the formation of molecular complexes (especially EDA complexes) can catalyse the decomposition of the  $\sigma$ -adduct has been discussed in Section II.E. Another possibility is that the substrate and catalyst (nucleophile or added base) form a complex which is then attacked by a *new* molecule of the nucleophile: in this context catalysis need no longer be associated with proton removal. Thus, Ryzhakov and collaborators<sup>183</sup> have recently shown that the N-oxides of 4-chloropyridine and 4-chloroquinoline act as  $\pi$ -donors toward tetracyanoethylene and that the reactions of these substrates with pyridine and quinoline are strongly catalysed by the  $\pi$ -acceptor. Similarly, the formation of a Meisenheimer complex between 1,3,5-trinitrobenzene and 1,8-diazabicyclo[5,4,0]undec-7-ene in toluene has been assumed to take place via an *association complex* to explain the observed second-order in tertiary amine<sup>184</sup>.

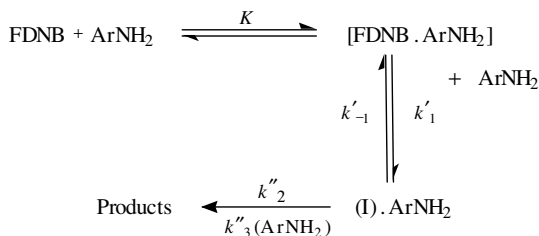
A new assumption to be discussed in this section is that the *fourth-order* kinetics in  $S_NAr$  by amines in aprotic solvents is due to the formation of the *substrate-catalyst molecular complex*. Since 1982, Forlani and coworkers<sup>149</sup> have advocated a model in which the third order in amine is an effect of the substrate-nucleophile interaction on a rapidly established equilibrium preceding the substitution process, as is shown in Scheme 15 for the reaction of 4-fluoro-2,4-dinitrobenzene (FDNB) with aniline (An), where  $K$  measures the equilibrium constant for:



If, for the sake of simplicity, it is assumed that the reaction proceeds only via the molecular complex, according to Scheme 15 the relation between  $k_A$  and  $[An]$  is shown by equation 37.

$$(k_A/[An])(1 + K[An]) = (k'_1/k'_{-1})Kk''_2 + (k'_1/k'_{-1})Kk''_3[An] \quad (37)$$





SCHEME 15

Scheme 15 could be a reaction pathway parallel to the classical reaction (equation 1), and it was postulated to explain the third order in amine observed in the reactions of FDNB and aromatic amines in benzene and in chloroform<sup>184</sup>. The  $K$  values were calculated from the absorbances of the reaction mixture extrapolated to zero reaction time, in a wavelength range in which the starting materials do not show an appreciable absorbance value. Good agreement was observed between the values of  $K$  for the FDNB/aniline complex in chloroform by U.V. and <sup>1</sup>H-NMR spectroscopy, as well as for the  $K$  obtained kinetically (based on Scheme 15) and spectroscopically.

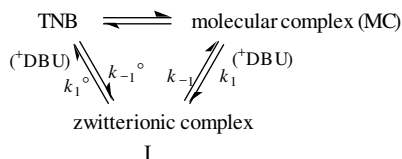
Catalysis by DABCO in the reactions of FDNB with piperidine, *t*-butylamine, aniline, *p*-anisidine and *m*-anisidine (usually interpreted as base catalysis as in Section II) was also assumed to occur by the formation of a complex between DABCO and the substrate<sup>149b</sup>. The high (negative)  $\rho$ -value of  $-4.88$  was deemed inappropriate for the usually accepted mechanism of the base-catalysed step (reaction 1). For the reactions with *p*-chloroaniline, *m*- and *p*-anisidines and toluidines in benzene in the presence of DABCO a  $\rho$ -value of  $-2.86$  was found for the observed catalysis by DABCO ( $k_3^{\text{DABCO}}$ ). The results were taken to imply that the transition state of the step catalysed by DABCO and that of the step catalysed by the nucleophile have similar requirements, and in both the nucleophilic (or basicity) power of the nucleophile is involved. This conclusion is in disagreement with the usual interpretation of the base-catalysed step.

The reaction of FDNB with aniline, first studied in toluene and in chloroform, was then extended to other solvents: in the reactions with aromatic amines, the order changes from two in solvents of considerably donicity (THF, dioxane) to three in solvents of low donicity (benzene, carbon tetrachloride), and is explained as arising from competition between the solvent and amine for complex formation with the substrate<sup>185</sup>. (Molecular complexes formed within benzene and 1,2-DNB were discussed in Section II.E.) In the presence of a constant initial concentration of triethylamine (TEA) approximately of the same magnitude as that of the nucleophile, the reactions of FDNB with both aniline and *p*-chloroaniline in benzene are no longer catalysed by the nucleophile, while catalysis is observed when the reagent is *p*-anisidine<sup>185</sup>. This is interpreted as evidence of the substrate-catalyst association. Considering that the  $K$  value for FDNB-TEA ( $0.47 \pm 0.17$ ) is higher than that between FDNB and aniline (0.062) and *p*-chloroaniline (0.02) the insensitivity to catalysis by the nucleophile is assumed to be due to a 'saturation' phenomenon (complete formation of the molecular complex FDNB-TEA) that precedes the attack of the nucleophile. Since the association constant of TEA and *p*-anisidine (0.67) is of the same order of magnitude than FDNB-TEA, catalysis of the reaction by the nucleophile still takes place in the presence of TEA.

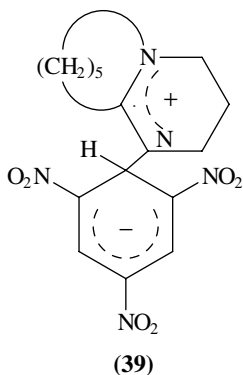
Nevertheless, when other solvents were studied, no total consistency is observed between the magnitude of the equilibrium constants and the experimental order in

amine. Thus, while the reactions in chloroform ( $K = 0.37 \pm 0.9$ ) and in chlorobenzene ( $K = 0.27 \pm 0.1$ ) are third-order in amine, the reaction in 1,4-dioxane ( $K = 0.81 \pm 0.7$ ) is second-order in amine<sup>186</sup>. These peculiarities were not explained. The reactions of FDBN with substituted 2-aminothiazoles in benzene are not catalysed by the nucleophile (they do not form molecular complexes), however the reactions are catalysed by DABCO, 2-hydroxypyridine and  $\alpha$ -valerolactam. Forlani has shown that  $\alpha$ -valerolactam forms a hydrogen-bonded complex with the substrate and similar complexes are formed between 2-hydroxypyridine and aromatic nitro derivatives<sup>187</sup>.

The reaction of 1,3,5-trinitrobenzene (TNB) and 1,8-diazabicyclo[5.4.0]undec-7-ene (DBU) in toluene<sup>184</sup> was also proposed to proceed by the mechanism shown in Scheme 16. The visible spectrum, recorded immediately after mixing appropriate solutions of TNB and DBU in toluene, shows a feeble absorbance maximum at 505 nm, which changes to a stable maximum at 468 nm, after variable reaction times. The first maximum was attributed to a molecular complex between TNB and DBU, and the second maximum at the Meisenheimer complex, **39**, although NMR structural determinations were not possible, because of the low solubility of the complex in toluene.



SCHEME 16

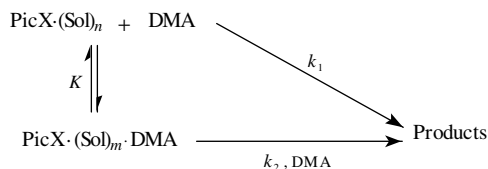


Under the experimental conditions  $[\text{TNT}] \gg [\text{DBU}]_0$ , the rate of formation of the second maximum (468 nm) is slow and the authors could make a quantitative evaluation of the first interaction attributed to the formation of a *molecular complex* (MC). The low reactivity under these conditions was interpreted as due to the fact that the MC has very little tendency to rearrange to the zwitterionic complex, since the amount of DBU complexed by TNB would be unavailable for the nucleophilic attack. Since in this system the base-catalysed step for departure of HL does not exist, the small increase in  $k_{\text{obs}}$  values with the  $[\text{DBU}]$  was interpreted as evidence of the mechanism shown in Scheme 16. Similarly, the increase in  $k_A$  with  $[\text{amine}]$  observed in the reactions of FDNB with butylamine in

toluene, usually considered base-catalysed, was recently reinvestigated<sup>188</sup> and interpreted as produced by the formation of a substrate-amine molecular complex, which with another amine molecule rearranges to the Meisenheimer complex as shown in Scheme 16. Nevertheless, several conceptual problems are associated with this alternative interpretation. One of the major conflicts between this mechanism and that described in Section II.E is the requirement of an additional molecule of amine, associated with the assumption that the molecular complex cannot evolve to the intermediate.

### J. The 'Desolvative Encounter Mechanism'

Hayami and Sugiyama<sup>189</sup> have recently found that picryl fluoride in acetonitrile follows second-order kinetics with saturation behaviour, while essentially no Brønsted base catalysis was observed, as would be suspected from the 'rate-limiting nucleophilic' addition of the nucleophilic amines. Interestingly, picryl chloride was more reactive than picryl fluoride in the presence of a low concentration of the amine nucleophile 2,4-dimethoxyaniline (DMA). The diminished reactivity of picryl fluoride is proposed to stem from the unfavourable encounter complex formation and also from the unfavourable first-order reaction in the complex. The reaction shown in Scheme 17 is proposed as the 'desolvative encounter mechanism'. It is suggested that in acetonitrile, strongly solvated picryl fluoride,  $[\text{Pic}(\text{Sol})_n]$ , is only slightly desolvated on encounter with the first molecule of the nucleophile, so that the solvation is still tight, preventing it from nucleophilic attack by the nucleophilic partner in the complex. However, the participation of a second molecule of the nucleophile would result in a more profound desolvation allowing a productive attack, and would allow the faster reaction in the  $k_2$  step for the picryl fluoride (3150, at 298 °C) than picryl chloride (5.2), thus showing a reactivity order parallel to the intrinsic reactivity of these substrates.

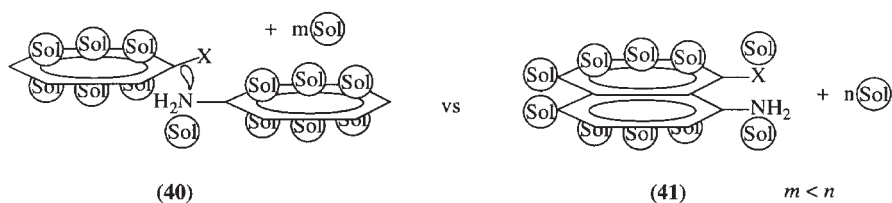


SCHEME 17

The calculated equilibrium constants for the 'encounter complex' are given in Table 23<sup>189</sup>. The  $K$  value for the complex between 2,4-dimethoxyaniline and picryl chloride is higher than that for picryl fluoride, and this is proposed to be responsible for the higher rate observed for the chloro-substituted compound. The calculated equilibrium constants for the 'encounter complex' are different from those for the 'charge-transfer (or EDA) complex formation', as shown in Table 23. If the charge-transfer complex were formed through the 'encounter or association complex', the equilibrium constant for the charge-transfer complex formation should be larger than that of the encounter complex. Since this is not the case, the authors proposed that the desolvation for the encounter should be much lighter than that required for the charge-transfer peripheral desolvation in the former interaction against the double facile desolvation in the latter ( $m < n$ , in complexes **40** and **41**). The authors propose that the two interactions constitute different association (reaction) channels and that the charge-transfer complex would not lead to any action of the nucleophile on the substrate<sup>189</sup>.

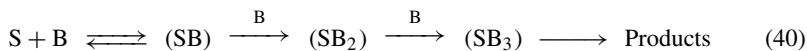
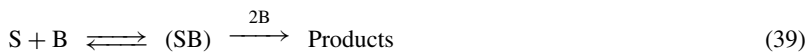
TABLE 23. Encounter and charge transfer associations (in Acetonitrile at 298 K)<sup>189</sup>

Acceptor	Donor	$K^{CT}$	$K^{Encounter}$
PicF	<i>N,N</i> -dimethylaniline	ca 0.5	
PicF	<i>N,N</i> -dimethyl- <i>p</i> -toluidine	ca 0.7	80
PicF	2,4-dimethylaniline		14.4
PicCl	2,4-dimethylaniline		77.7
TNB	<i>N,N</i> -dimethylaniline	0.42	
TNB	<i>N,N</i> -dimethyl- <i>p</i> -toluidine	0.43	
TNB	2,4-dimethylaniline	0.59	
TNB	<i>N,N</i> -dimethyl dimethylaniline	0.67	



### K. Conformational Effects

Most of the novel mechanisms hitherto presented were based on the observation of overall fourth-order kinetics (third-order in amine). Nevertheless, this result gives an account only of how many molecules are involved in the rate-determining step. It cannot distinguish, e.g., between three mechanisms that could be depicted as equations 38–40.



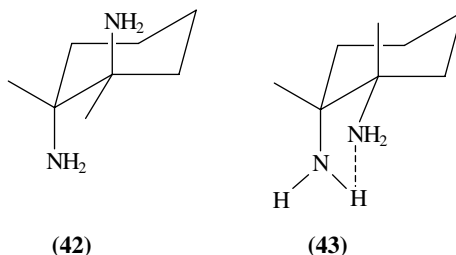
To strengthen the point that a *dimer nucleophile* mechanism could be responsible for the observed third-order dependence on amine and some other peculiar features, some of them already described, a nucleophile was chosen in which *intramolecular N–H...N* hydrogen bonding could exist. With such a nucleophile, the reaction with the intramolecularly H-bonded nucleophile should be faster than with the non-H-bonded molecule; and, furthermore, a third-order rate dependence in amine should not be observed for systems (substrate and solvent) where this kinetic behaviour has been found in  $S_NAr$  reactions with related amines<sup>143,144</sup>. The plot of the rate of reaction of FDNB with cyclohexylamine in toluene against [B] exhibits a slight upward curvature, typical of a third-order dependence on [B]<sup>190</sup>. On the contrary, the reactions of *trans*-1,2-diaminocyclohexane, **42**, shows a linear dependence of  $k_A$  on [B]: it is known that diaxial interactions in this type of amines prevent self-association<sup>190</sup> and the kinetic behaviour is that usually found in the classical base-catalysed rate-determining decomposition of the zwitterionic intermediate. However, a more interesting result, expected within the *dimer nucleophile* mechanism, is the more

TABLE 24. Reaction of 1-fluoro-2,4-dinitrobenzene (FDNB) with cyclohexylamine, and with 1,2-diaminocyclohexane (DACH) in toluene at 5 °C<sup>a190</sup>

Cyclohexylamine		1,2-DACH			<i>cis</i> - and <i>trans</i> -1,2-DACH	
[B] (mol dm <sup>-3</sup> )	$k_A$ (dm <sup>3</sup> mol <sup>-1</sup> s <sup>-1</sup> )	[B] (mol dm <sup>-3</sup> )	$k_A$ (dm <sup>3</sup> mol <sup>-1</sup> s <sup>-1</sup> )		[B] (mol dm <sup>-3</sup> )	$k_A$ (dm <sup>3</sup> mol <sup>-1</sup> s <sup>-1</sup> )
			<i>trans</i>	<i>cis</i>		
0.0234	0.044	0.000218	0.181	0.399	0.00756	0.338
0.127	0.067	0.00733	0.206	0.440	0.0407	0.425
0.236	0.102	0.0118	0.223	0.466	0.0535	0.516
0.365	0.142	0.0719	0.342	0.810	0.0774	0.590
0.539	0.239	0.107	0.451	1.01	0.111	0.749

<sup>a</sup>[FDNB]  $2.05 \times 10^6$  mol dm<sup>-3</sup>; error in  $k_A < 2\%$ .

than twofold *increase* in rate with the *cis*-isomer, in spite of enhanced steric hindrance. Intramolecular hydrogen bonding between both amine groups in the *cis*-configuration, **43**, increases the nucleophilicity of the hydrogen-bonded donor amine, thereby increasing the rate<sup>190</sup> (Table 24).



Consistent with this interpretation is the effect of addition of small amounts of a hydrogen-bond donor solvent. The rate behaviour is compared with that found before in the reaction of the same substrate with piperidine in benzene–ethanol mixtures. It is shown that the reaction with piperidine is base-catalysed ( $k_3/k_2 = 1230$ ), no self-association of the nucleophile in benzene is observed and when small amounts of ethanol are added an important *increase* in rate is observed. On the other hand, an important *decrease* in the rate of reaction with the *cis*- and *trans*-1,2-diaminocyclohexane mixture was observed on addition of small amounts of methanol. The rate decreases up to 50% toluene–50% methanol and then a two-fold increase in rate takes place on going to pure methanol. The sharp decrease in rate is interpreted as partially due to the rupture of the intramolecular hydrogen bonding between both *cis*-amino groups, by competition with external hydrogen bonding with the good HBD methanol ( $\alpha = 0.93$ )<sup>178</sup>.

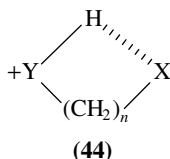
The data allowed calculation of the rate ratio shown in Table 25<sup>190</sup>. The  $k_3/k_2$  quotients for both nucleophiles are almost equal; the more than two-fold increase in rate observed for the *cis*-isomer should then be due to a similar increase in  $k_1$  or a decrease in  $k_{-1}$ . It is reasonable to expect that  $k_{-1}$  would be similar for the two amines (or even bigger for the *cis*-isomer due to the greater steric effects); thus the increase in rate observed with the *cis*-1,2-diaminocyclohexane should be due to an increase in  $k_1$ . The  $k_{-1}$  values were calculated in both cases by standard procedures and it was found that the value is *five times* greater for the *cis*-isomer (Table 25). This enhanced rate in the first step is

TABLE 25. Reaction of 1-fluoro-2,4-dinitrobenzene with 1,2-diaminocyclohexanes in toluene at 5 °C, with rate coefficients quotient<sup>190</sup>.

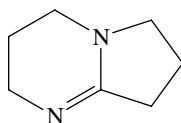
	1,2-DACH	<i>cis</i> -1,2-DACH	<i>cis/trans</i>
$k_1 k_3 / k_{-1}$	2.4	5.7	65
$k_1 k_2 / k_{-1}$	0.19	0.40	2.1
$k_3 / k_2$	12.9	14.3	1.1
$k_1$	0.413	2.08	5.0

fully consistent with the proposal of an 'intramolecularly self-associated nucleophile' in solvents of low permittivity<sup>190</sup>.

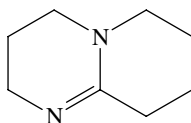
This proposal finds good support in the gas-phase basicities (GB)<sup>68</sup> of various polyfunctionalized amines recently determined. An intramolecular stabilization of protonated polyfunctional groups, also called 'internal solvation', has been observed in the gas phase with the amidinium and guanidinium cations<sup>86,191,192</sup>. This effect is due to cyclization by internal hydrogen bonding between the protonated functional group (Y) and a hydrogen-bond donor group (X), **44**. Studies of substituent effects on the basicity of amidines and guanidines in solution<sup>193</sup> have shown that the amino nitrogen is the preferred site of protonation in solution, similarly as in the gas phase. Thus, the  $pK_a$  values can be directly compared with the GB values: good regression values are obtained for the plots of  $pK_a$  vs GB; in the alkyl systems the polarizability (*P*) effect seems to be the most important parameter, whereas for aromatic systems other terms are also contributing.



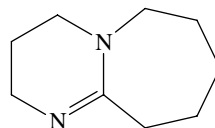
The bicyclic amidines 1,5-diazabicyclo[4,3,0]non-5-ene (DBN, **45**), 1,5-diazabicyclo[4,4,0]dec-6-ene (DBD, **46**) and 1,5-diazabicyclo[5,4,0]undec-7-ene (DBU, **47**) are widely used in ANS as base catalysts, because they exhibit high basicity and low nucleophilicity; the GB values are 993.9, 999.6 and 1002.9, respectively<sup>86</sup>. It is interesting that the proton affinity (PA) of DBN (1025.7)<sup>86</sup> derived from the experimental GB measurements is very similar to the recently reported PA of arginine (1025.9)<sup>194</sup>. Raczynska and coworkers<sup>86</sup> suggested that the strong GB of arginine may be due to the 'internal solvation' of the guanidinium cation, **48**. In histamine, **49**, an important biogenic molecule, Raczynska and coworkers<sup>86</sup> have demonstrated the existence of



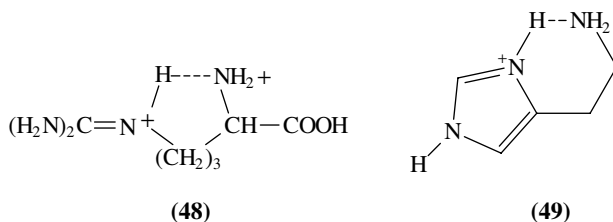
DBN  
(45)



DBD  
(46)



DBU  
(47)



'internal solvation', favoured by the alkylamino chain separated by three carbon atoms from the imidazole nitrogen.

In the gas phase, the imidazole 'sp<sup>2</sup>' nitrogen atom is the preferred site of protonation. (GB for histamine is 949 kJ mol<sup>-1</sup>, for 4-methylimidazole 915 kJ mol<sup>-1</sup> and for PhCH<sub>2</sub>CH<sub>2</sub>NH<sub>2</sub> 895 kJ mol<sup>-1</sup>.) In aqueous solution PhCH<sub>2</sub>CH<sub>2</sub>NH<sub>2</sub> is more basic than 4-methylimidazole by 2.3 pK<sub>a</sub> units (13 kJ mol<sup>-1</sup>). This reversal is due to a better solvation of -NH<sub>3</sub><sup>+</sup> compared with =NH<sup>+</sup>, but in the gas phase, and likely in aprotic solvents, the energetically preferred imidazole nitrogen protonation is further favoured by 'internal solvation'. This change in histamine cation structure on going from aqueous media to gas phase has recently been considered in theoretical calculations<sup>195,196</sup>. Similarly for the case of the  $\alpha$ -amino acid histidine, a recent semi-empirical calculation<sup>197</sup> gives the structure with an intramolecular H-bond C=O...H-N(Im) as the most stable conformation of protonated histidine.

Arginine is another example of an  $\alpha$ -amino acid in which guanidine and amine functions are separated by a chain of four carbon atoms. Raczyńska and coworkers<sup>86</sup> suggested that the strong gas-phase basicity of arginine (comparable to the GB of DBN) may be due to the 'internal solvation' of the guanidinium cation, **48**.

These authors conclude that 'the problem of internal solvation is still an experimental and theoretical challenge'; GB measurements for this type of molecules of low volatility are not always in good agreement<sup>194</sup>. Molecular orbital calculations may help to solve the difficult experimental problems, but they have to take into account conformational isomerisms and the prototropic tautomerisms of the amidine and guanidine moieties. In light of the above discussion, the proton affinities deduced from the experimental GB values should be based on accurate estimations of the 'entropy of cyclization'<sup>86</sup>.

The accurate determination of gas-phase basicities and gas-phase acidities opened the way to analyses of the effect of solvation on proton acidities, and on hydrogen-bond acidities and basicities, as well as on substituents effects.

## L. Isotope Effects

Forlani and coworkers<sup>184</sup> determined that the magnitude of  $k_A$  was found to increase linearly with nucleophile concentration for the reaction of picryl fluoride with 2-hydroxypyridine in chlorobenzene, and  $k_A^H/k_A^D = 1.5$  for mono-deutero-2-hydroxypyridine was observed<sup>184</sup>. Since isotope effects are usually small in  $S_NAr$  in apolar solvents<sup>1</sup> the authors attributed the isotope effect to the formation of a *substrate-catalyst* molecular complex. They obtained a value of  $k_A^H/k_A^D = 1.75$  for the ratio of the association constants,  $k_H/k_D$ . When the substrate was picryl chloride, the slight increase of  $k_A$  with nucleophile concentration was interpreted in terms of Scheme 6 giving a value of  $K = 2.9 \pm 1$  identical with that for the fluoro-substrate ( $3.0 \pm 1$ ).

Taking into account, for instance, the slight differences in  $K$  observed for 1-fluoro-2,4,6-trinitrobenzene and 1-chloro-2,4,6-trinitrobenzene in Table 13, it is difficult to explain such a difference in  $K_H/K_D$ . Nevertheless, a H/D isotopic effect of 1.5 could be easily explained

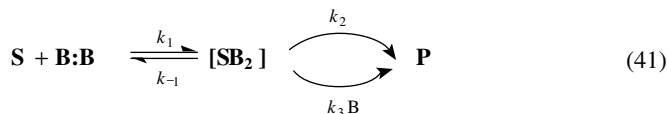
on the basis of the auto-association of 2-hydroxypyridine, involving hydrogen bonding, since the tendency of 2-hydroxypyridine to form dimeric species is very well known<sup>124</sup>. Another alternative explanation for the observed H/D isotopic effect is the ability of 2-hydroxypyridine to act as a 'bifunctional' catalyst: as mentioned in Section II.F, 2-hydroxypyridine is able to both base-catalyse proton abstraction and acid-catalyse the nucleofuge departure. Either of these two explanations seems to be more satisfactory to account for the observed H/D isotopic effect than the weak rationale based on the molecular complexes.

Clearly, these isotope effects could also be explained on the basis of the 'dimer nucleophile' or 'homo/heteroconjugate' mechanisms.

## M. Further Treatment of Kinetic Results

### 1. 'Inversion Plots'

Several alternative mechanisms have been described here that have been reported to explain the 'anomalous' kinetic results, such as the observed *fourth-order kinetics*. Further treatment of the different equations may help to understand the scope of the different proposals. In a simplified form for the *dimer mechanism*, only attack by the dimer nucleophile can be considered, as shown by equation 41.



It was shown that the derived expression for  $k_A$  is equation 28. (Section III.D). If  $k_{-1} \cong (k_2 + k_3[\text{B}])$ , at high  $[\text{B}]$  equation 28 may be transformed into equation 30, which is responsible for the *plateau* observed in some cases [e.g. the reactions of 2,4-dinitroanisole with cyclohexylamine in benzene (Figure 11) and in cyclohexane (not shown)]<sup>143,144</sup> and it was also observed in the reactions with *n*-butylamine in benzene at 60 °C (the reactions at 80 °C show a slight curvature, tending to a farther asymptotic behaviour). In all the  $S_N\text{Ar}$  systems studied by other authors, in which fourth-order kinetics were found, the observation of a similar plateau in the plots of  $k_A/[\text{B}]$  vs  $[\text{B}]$  was not reported.

Inversion of equation 28 (Section III.D) gives expression 42, which allows some estimation of the different  $k$  values involved:

$$\frac{[\text{B}]}{k_A} = \frac{1}{k_1K} + \frac{k_{-1}}{k_1k_2K + k_1k_3K[\text{B}]} \quad (42)$$

Taking into account that the uncatalysed decomposition is slower than the base-catalysed one, equation 42 can be simplified to equation 43:

$$\frac{[\text{B}]}{k_A} = \frac{1}{k_1K} + \frac{k_{-1}}{k_1k_3K[\text{B}]} \quad (43)$$

A plot of  $[\text{B}]/k_A$  vs  $[\text{B}]^{-1}$  should be linear, except where the conditions that allow the simplification to equation 43 are not fulfilled. Such a plot is presented as line A in Figure 15 for the reaction of 2,4-dinitroanisole (DNA) with cyclohexylamine (CHA) in cyclohexane, and as line B in Figure 15 for the reactions with *n*-butylamine (BA) in benzene, both at 80 °C. Each is satisfactorily linear, and they allow evaluation of the different  $k$  values. Estimations of the  $k_1k_3K/k_{-1}$  values for this and other reactions are given in Table 26<sup>144</sup>. The reactions at 80 °C exhibit useful behaviour for evaluation of the



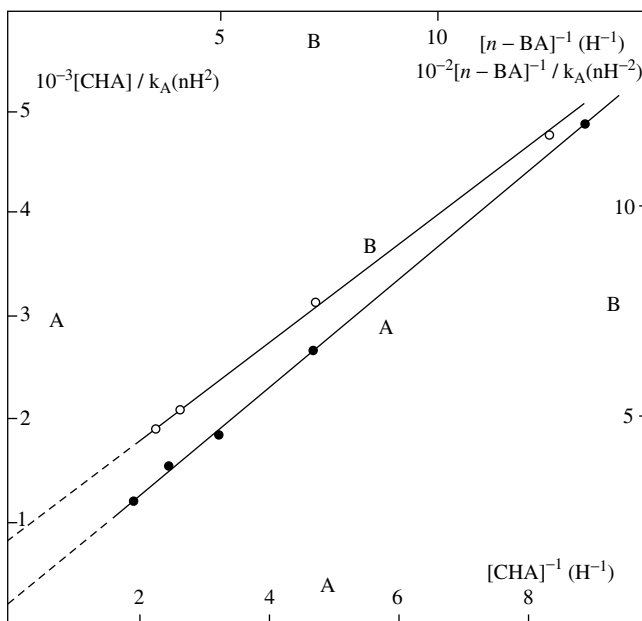


FIGURE 15. Inversion plot: A, reaction of 2,4-dinitroanisole with cyclohexylamine at 80 °C (●); B, reaction of 2,4-dinitroanisole with *n*-butylamine (*n*-BA) in benzene at 80 °C (○, data from Reference 143a)<sup>144</sup>. Reprinted with permission from Reference 144. Copyright (1983) American Chemical Society

TABLE 26. Rate coefficient relationships for S<sub>N</sub>Ar reactions of dinitroanisole (DNA)<sup>199</sup>

Amine	Substrate	Solvent	Temp (°C)	$10^4 k_3 k_4 / k_{-4} K_2^a$	$10^3 k_1 k_3 K_1 / k_{-4} K_2^a$	$10^3 k_1 k_2 K_1 / k_{-4} K_2^b$	$k_1 K_1 / k_4$
Cyclohexylamine	2,4-DNA	benzene	100	0.602	0.781		13 <sup>c</sup>
			80	<0.34	>0.86	1.26	>37 <sup>d</sup>
			60	<0.13	>1.0	1.81	>140 <sup>d</sup>
		cyclohexane <sup>e</sup>	100	0	1.73		∞
			80	0	1.81	1.89	∞
			60	0	>2.65	4.0	∞
<i>n</i> -Butylamine	2,6-DNA	benzene	45	6.06	1.78		2.9 <sup>c</sup>
			35	4.57	2.00		4.4 <sup>c</sup>
			27	3.78	2.04		5.4 <sup>c</sup>
	2,4-DNA <sup>f</sup>	benzene	100	3.61	5.78		16 <sup>c</sup>
			80	<3.2	>6.8	12.9	>40 <sup>d</sup>
			60	<4.0	>6.6	22.7	>57 <sup>d</sup>
2,6-DNA <sup>f</sup>	benzene	45	19.0	9.5		5.0 <sup>c</sup>	
		35	15.0	10.9		7.3 <sup>c</sup>	
		27	13.0	12.3		9.5 <sup>c</sup>	

<sup>a</sup>From Equation 28.

<sup>b</sup>From the inverted slope of Equation 43.

<sup>c</sup>From the quotient between the slope and the intercept of Equation 28.

<sup>d</sup>From the quotient between the inverted slope of Equation 43 and the intercept of Equation 28.

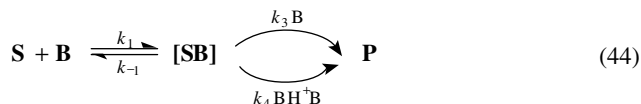
<sup>e</sup>Cyclohexane/benzene ratio of 99:1.

<sup>f</sup>Data from Reference 144.

same expression from the plot of  $k_A/[B]$  vs  $[B]$ . Indeed, at low  $[B]$  equation 28 can be simplified to equation 29, and the slope of the plot of  $k_A/[B]$  vs  $[B]$  agrees satisfactorily with the values obtained from the inversion plot. These results can be interpreted as evidence that equation 28 holds and that the simplification to equation 29 is justified<sup>10</sup>. The intercepts allow an estimation of the order of magnitude of  $k_1k_2K/k_{-1}$  and, from both quotients, the ratio  $k_3/k_2$  can be reckoned (Table 26). The quotients increase with decreasing temperature in accord with the increased association constant.

In the reaction of DNA with CHA and with BA in benzene, the slopes of the curves at the origin are not zero. For the last case, the rate of the reaction allows several kinetic measurements at low  $[B]$  and exact evaluation of the slope at the origin of  $k_A$  vs  $[B]$  for a range of  $[B] = 0-0.03$  M. At 45 °C a value of  $2.2 \times 10^{-3} \text{ M}^{-2} \text{ s}^{-1}$  is obtained which agrees satisfactorily with the value  $k_1k_2K/k_{-1} = 1.9 \times 10^{-3} \text{ M}^{-2} \text{ s}^{-1}$  obtained from the intercept of the plot of  $k_A/[B]$  vs  $[B]$  constructed with the data obtained at higher  $[B]$ . The values for the reaction at 35 and 27 °C are  $1.6 \times 10^{-3}$  and  $1.4 \times 10^{-3} \text{ s}^{-1} \text{ M}^{-2}$ , respectively, which agree satisfactorily with the data obtained at higher  $[B]$ . Similar agreement was found for the other systems gathered in Table 16. The satisfactory agreement between the quotients obtained from both sets of data obtained under different conditions indicates that the assumptions made are correct and the whole treatment justified.

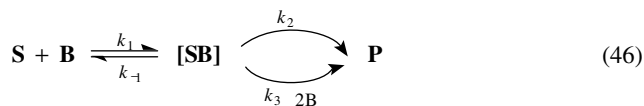
Hirst's proposal for the fourth-order kinetics implies an electrophilic catalysis of the second step by the homoconjugate acid of the nucleophile,  $\text{BH}^+\text{B}$  (where B stands for the nucleophile). The simplified equation would be



which requires that the catalyst acts in the second step, and the derived expression is given by equation 45:

$$k_A = \frac{k_1k_2 + k_1k_3K[\text{B}] + k_1k_4K[\text{B}]^2}{k_{-1} + k_2 + k_3[\text{B}] + k_4K[\text{B}]^2} \quad (45)$$

On the other hand, the eight-membered cyclic transition state mechanism proposes that two molecules of the nucleophile intervene in the decomposition of the zwitterionic intermediate. It can be described in condensed form by equation 46, and the derived kinetic expression is equation 47.



$$k_A = \frac{k_1k_2 + k_1k_3[\text{B}]^2}{k_{-1} + k_2 + k_3[\text{B}]} \quad (47)$$

Equation 45 and 47 as well as equation 28 account for the quadratic dependence of  $k_A$  with  $[B]$ , with a zero intercept if the uncatalysed decomposition is assumed to be negligible. However, the peculiar kinetic behaviour observed in some systems (which has just been described) can only be explained by equation 28. Hirst<sup>148</sup> and Banjoko<sup>170</sup>

have not reported the observation of a plateau in the plots of  $k_A/[B]$  vs  $[B]$  in the reactions studied, therefore their respective mechanisms can account satisfactorily for their results. However, only the *dimer nucleophile* mechanism can account for the observation of the 'inversion plots', i.e. a linear plot of  $[B]/k_A$  vs  $[B]^{-1}$ , agreement between the several  $k$  values evaluated under different reaction conditions and a rather large range of  $[B]$ .

The other alternative mechanisms discussed here, which are based on the formation of different types of complexes with the substrate, failed to accommodate additional observations, such as the conformational effects. Indeed, if any difference would be expected between the *cis*- and *trans*-1,2-diaminocyclohexane in forming complexes with the substrate, that would be in favour of an *increase* in rate for the reaction with the *trans*-isomer, contrarily to the experimental observation.

## 2. Evaluation of the equilibrium constants

One of the major difficulties in Forlani's proposal of the molecular complex substrate-catalyst mechanism, to explain the fourth-order kinetics, is the assumption that this complex needs an additional molecule of amine to decompose to products. The formation of molecular complexes between dinitrohalobenzenes and certain amines (especially aromatic amines) has been widely studied, and their involvement in  $S_NAr$  reaction has been discussed in Section II.E. The equilibrium constants for the formation of those complexes were calculated in several cases, and they were included in the kinetic expressions when pertinent. But in all cases, the complex was assumed to be in the reaction pathway, and no need of an additional amine molecule was invoked by the several authors who studied those reactions.

In some of Forlani's works, such as the reactions of 1-halogeno-2,4,6-trinitrobenzene with 2-hydroxypyridine<sup>123,125</sup>, a substrate-catalyst molecular complex was assumed, but the kinetic law showed the regular *second order in amine*. Rather interestingly in this scheme, the authors assume that the molecular complex can lead to the formation of products following a second order in nucleophile kinetics, while in the reactions with amines it was presumed that the complex was not on the reaction coordinate, and that an *additional* molecule of amine was required (the authors needed to include this additional molecule to account for the *third* order in amine rate law).

In the mechanisms involving molecular complexes discussed in Section II.E, several authors were able to calculate the equilibrium association constants, in reactions showing classical kinetics. On the other hand, Forlani and coworkers, in the reactions discussed in Section III.I, assume that the complexes intervene in determining the *third* order in amine kinetic law, and make calculations of some  $K$ ; some results were presented in Table 13. Several features arise from this Table:

(a) The effect of adding a nitro group at the *ortho*-position *diminishes* the association constant when compared with *p*-chloronitrobenzene, but adding another nitro group at the other *ortho*-position *increases*  $K$ , comparatively to CDNB. The author concludes that this probably arises from a balance of the interaction of the additional nitro group and the steric hindrance of the nitro group in the *ortho*-position to the halogen atom, but the steric hindrance should be more noticeable in CTNB and the observed effect is the inverse.

(b) The data for the monodeutero-2-hydroxypyridine ( $K_H/K_D = 1.7$  for FDNB and 3.4 for 1-fluoro-4-nitrobenzene) is interpreted as a clear indication that a major interaction is the hydrogen bond involving the halogen atom (or the nitro group), but it is not so clear, then, why the  $K_H/K_D$  for the 1-fluoro-4-nitrobenzene is twice the value for FDNB.

(c) The large differences between  $K$  values for FDNB in THF ( $17 \text{ dm}^3 \text{ mol}^{-1}$ ) and in chlorobenzene ( $3.5 \text{ dm}^3 \text{ mol}^{-1}$ ) or toluene (0.34), shown in Table 12, are also unexplained.

Taking into account these apparent inconsistencies between the values, which are rather higher than the stated errors given as standard deviations, results in suspicions as regarding the whole way of calculating of the stability constants.

### 3. The dichotomy of amine effects in aromatic nucleophilic substitution (ANS) in aprotic solvents

In the preceding sections throughout this chapter, several aspects of the influence of the nucleophile on the rates of the different reaction steps and/or mechanisms involved in ANS with amines have been discussed. One of the most outstanding features and most widely studied phenomena is the observation or the absence of base catalysis and, somewhat related with this subject, is the occurrence of a first, second or third order in amine kinetic law.

Hirst and coworkers<sup>198</sup> have recently examined the dichotomy of primary and secondary amine effects in ANS in the reactions of 2-trifluoromethyl- and 2-cyano-4-nitrofluorobenzenes with piperidine, *n*-butylamine, morpholine and benzylamine in acetonitrile and benzene (see Table 27). The substituents in the 2-position were chosen on the basis of their different steric requirements: the cyano group is linear and much smaller than either the nitro or the trifluoromethyl groups. For the reaction of 2-cyano-4-nitro-fluorobenzene with benzylamine the  $k_3/k_2$  value is 1.9, and for the trifluoromethyl substrate the values of the ratio are: 6.0 (*n*-butylamine), 14.9 (piperidine) and 1.2 (benzylamine)<sup>198</sup>. According to Bunnett's criteria these low values do not represent true base catalysis, and the authors take the measured  $k_A$  values as being those for the formation of the intermediate. The ratio of the rate constants for piperidine and butylamine ( $k_A^{\text{Pip}}/k_A^{\text{Bu}}$ ) are 15.5 and 4.5 for the *ortho*-nitro and -cyano substrates, respectively, whereas when the *ortho* group is the trifluoromethyl the ratio is 0.2, i.e. the secondary amine is *less* reactive than the primary one. This is interpreted as evidence of the operation of a primary steric effect: as we have demonstrated in an early study on the effect of 2-R substituents in ANS reactions with piperidine in benzene<sup>102</sup>, this kind of effect should only be observed with an *ortho*-substituent of steric requirements similar to or greater than a methyl group.

The reactions of the three substrates with morpholine showed base catalysis, and when the nucleophile is benzylamine, plots of the second-order rate constants against the nucleophile concentration have an upward curvature<sup>197</sup>. Similar behaviour exhibits the reaction of 2,4-dinitrophenyl phenyl ether with piperidine in acetonitrile<sup>182</sup> while the corresponding reaction with *n*-butylamine is not catalysed<sup>182</sup>, thus providing further examples of the dichotomy of amine effects<sup>198,199</sup>. Taking into account that the dichotomy is also observed when the *ortho*-group is cyano, for which it has been demonstrated that there is little or no hydrogen bonding between it and the ammonio group of the  $\sigma$ -complex, the authors conclude that the effects must be steric, although these would not arise from differential steric compressions between primary and secondary amines, but from stereoelectronic effects<sup>198</sup>. The existence of stereoelectronic effects in ANS have been previously proposed by Bunnett<sup>20b,c</sup> and Hasegawa<sup>22</sup> for reactions involving *ortho*-nitro groups. Bunnett and Cartano<sup>20a</sup> ascribed the very large difference in rates between piperidine and pyrrolidine to stereoelectronic inhibition of the detachment of the nucleofuge when piperidine is the nucleophile.

Since morpholine and piperidine are stereochemically similar but exhibit different  $pK_a$  values, the difference between their rates in the reactions of the fluoro-substrates in acetonitrile could be also due to a change in mechanism, whereby proton transfer from the intermediate **1** in equation 1 becomes rate-limiting when the reagent is morpholine. The change from an uncatalysed to a base-catalysed reaction with decrease in basicity of the nucleophile is well known in ANS for both primary and secondary amines<sup>1,200</sup>.

TABLE 27. Rate constants (dm<sup>3</sup> mol<sup>-1</sup> s<sup>-1</sup>) for the reactions of 2-cyano- and 2-trifluoromethyl-4-nitrofluorobenzenes and 2-cyano-4-nitrophenylphenyl ether with some amines in aprotic solvents at 30 °C<sup>198</sup>

Solvent	Substrate	Nucleophile	$c(\text{mol dm}^{-3})$	$k_A$	$k''/k'^a$
Acetonitrile	2-Trifluoromethyl-4-nitrofluorobenzene	Piperidine	$5.0 \times 10^{-2}$	$1.48 \times 10^{-3}$	14.9
			$6.0 \times 10^{-2}$	$1.60 \times 10^{-3}$	
			$8.0 \times 10^{-2}$	$1.85 \times 10^{-3}$	
			$10 \times 10^{-2}$	$2.11 \times 10^{-3}$	
		<i>n</i> -Butylamine	$1.0 \times 10^{-2}$	$4.29 \times 10^{-3}$	6.0
			$1.5 \times 10^{-2}$	$4.41 \times 10^{-3}$	
			$1.6 \times 10^{-2}$	$4.58 \times 10^{-3}$	
			$2.0 \times 10^{-2}$	$4.53 \times 10^{-2}$	
			$2.5 \times 10^{-2}$	$4.68 \times 10^{-3}$	
			Morpholine	$5.0 \times 10^{-2}$	
		$10 \times 10^{-2}$		$3.61 \times 10^{-5}$	
		$15 \times 10^{-2}$		$4.86 \times 10^{-5}$	
		$20 \times 10^{-2}$		$5.85 \times 10^{-5}$	
		$25 \times 10^{-2}$		$6.84 \times 10^{-5}$	
		$30 \times 10^{-2}$		$7.77 \times 10^{-5}$	
		$40 \times 10^{-2}$		$9.53 \times 10^{-5}$	
		Benzylamine	$50 \times 10^{-2}$	$10.8 \times 10^{-5}$	1.2
			$4.0 \times 10^{-2}$	$3.95 \times 10^{-4}$	
			$6.0 \times 10^{-2}$	$3.88 \times 10^{-4}$	
			$8.0 \times 10^{-2}$	$3.98 \times 10^{-4}$	
	$10 \times 10^{-2}$		$4.04 \times 10^{-4}$		
	$15 \times 10^{-2}$		$4.45 \times 10^{-4}$		
	2-Cyano-4-nitrofluorobenzene	Piperidine	$8.0 \times 10^{-4}$	$4.55 \times 10^{-1}$	
			$10.0 \times 10^{-4}$	$4.60 \times 10^{-1}$	
			$12.0 \times 10^{-4}$	$4.60 \times 10^{-1}$	
			$14.0 \times 10^{-4}$	$4.70 \times 10^{-1}$	
			$100 \times 10^{-4}$	$4.30 \times 10^{-1}$	
		<i>n</i> -Butylamine	$4.0 \times 10^{-3}$	$9.95 \times 10^{-2}$	
			$6.0 \times 10^{-3}$	$10.9 \times 10^{-2}$	
			$8.0 \times 10^{-3}$	$10.4 \times 10^{-2}$	
			$10.0 \times 10^{-3}$	$9.53 \times 10^{-2}$	
			$20.0 \times 10^{-3}$	$10.0 \times 10^{-2}$	
		Morpholine	$8.0 \times 10^{-3}$	$3.46 \times 10^{-3}$	
			$10.0 \times 10^{-3}$	$3.88 \times 10^{-3}$	
			$20.0 \times 10^{-3}$	$4.87 \times 10^{-3}$	
			$40.0 \times 10^{-3}$	$7.03 \times 10^{-3}$	
			$60.0 \times 10^{-3}$	$9.45 \times 10^{-3}$	
			$80.0 \times 10^{-3}$	$11.8 \times 10^{-3}$	
			$100 \times 10^{-3}$	$13.3 \times 10^{-3}$	
		Benzylamine	$150 \times 10^{-3}$	$17.7 \times 10^{-3}$	1.9
$4.0 \times 10^{-2}$			$1.72 \times 10^{-2}$		
$6.0 \times 10^{-2}$			$1.73 \times 10^{-2}$		
$8.0 \times 10^{-2}$	$1.83 \times 10^{-2}$				
$10.0 \times 10^{-2}$	$1.90 \times 10^{-2}$				

(continued overleaf)

TABLE 27. (continued)

Solvent	Substrate	Nucleophile	$c(\text{mol dm}^{-3})$	$k_A$	$k''/k'^a$	
Dimethylsulphoxide <sup>b</sup>	Morpholine		$4.0 \times 10^{-4}$	1.47		
			$6.0 \times 10^{-4}$	1.56		
			$8.0 \times 10^{-4}$	1.50		
			$10.0 \times 10^{-4}$	1.54		
			$12.0 \times 10^{-4}$	1.31		
			$14.0 \times 10^{-4}$	1.46		
			$20.0 \times 10^{-4}$	1.52		
	Benzylamine		$1.0 \times 10^{-3}$	$3.40 \times 10^{-1}$		
			$2.0 \times 10^{-3}$	$3.25 \times 10^{-1}$		
			$2.5 \times 10^{-3}$	$3.30 \times 10^{-1}$		
			$5.0 \times 10^{-3}$	$3.36 \times 10^{-1}$		
			$10.0 \times 10^{-3}$	$3.47 \times 10^{-1}$		
	Benzene	Piperidine		$6.0 \times 10^{-3}$	$0.867 \times 10^{-2}$	$1.05 \times 10^3$
			$8.0 \times 10^{-3}$	$1.12 \times 10^{-2}$		
			$10.0 \times 10^{-3}$	$1.30 \times 10^{-2}$		
			$20.0 \times 10^{-3}$	$2.57 \times 10^{-2}$		
			$30.0 \times 10^{-3}$	$3.80 \times 10^{-2}$		
<i>n</i> -Butylamine			$4.0 \times 10^{-2}$	$0.86 \times 10^{-3}$	408	
			$6.0 \times 10^{-2}$	$1.26 \times 10^{-3}$		
			$8.0 \times 10^{-2}$	$1.70 \times 10^{-3}$		
			$10.0 \times 10^{-2}$	$2.06 \times 10^{-3}$		
			$20.0 \times 10^{-2}$	$4.11 \times 10^{-3}$		
Morpholine			$5.0 \times 10^{-2}$	$1.57 \times 10^{-3}$	233	
			$6.0 \times 10^{-2}$	$1.90 \times 10^{-3}$		
			$8.0 \times 10^{-2}$	$2.45 \times 10^{-3}$		
			$10.0 \times 10^{-2}$	$3.01 \times 10^{-3}$		
			$12.0 \times 10^{-2}$	$3.64 \times 10^{-3}$		
Benzylamine			$1.0 \times 10^{-1}$	$3.09 \times 10^{-4}$		
			$2.0 \times 10^{-1}$	$6.50 \times 10^{-4}$		
			$3.0 \times 10^{-1}$	$10.3 \times 10^{-4}$		
			$4.0 \times 10^{-1}$	$14.1 \times 10^{-4}$		
			$5.0 \times 10^{-1}$	$19.1 \times 10^{-4}$		
2-Cyano-4-nitrophenyl phenyl ether	Piperidine		$3.0 \times 10^{-1}$	$2.11 \times 10^{-5}$		
			$4.0 \times 10^{-1}$	$3.25 \times 10^{-5}$		
			$5.0 \times 10^{-1}$	$4.36 \times 10^{-5}$		
			$6.0 \times 10^{-1}$	$5.55 \times 10^{-5}$		
			$7.0 \times 10^{-1}$	$5.97 \times 10^{-5}$		
			$8.0 \times 10^{-1}$	$7.06 \times 10^{-5}$		
	<i>n</i> -Butylamine		$2.0 \times 10^{-1}$	$0.835 \times 10^{-6}$		$\infty$
			$3.0 \times 10^{-1}$	$1.24 \times 10^{-6}$		
			$4.0 \times 10^{-1}$	$1.44 \times 10^{-6}$		
			$5.0 \times 10^{-1}$	$2.14 \times 10^{-6}$		
Acetonitrile	Piperidine		$5.0 \times 10^{-2}$	$3.00 \times 10^{-5}$	123	
			$7.5 \times 10^{-2}$	$3.88 \times 10^{-5}$		
			$10.0 \times 10^{-2}$	$5.50 \times 10^{-5}$		
			$20.0 \times 10^{-2}$	$11.2 \times 10^{-5}$		
			$25.0 \times 10^{-2}$	$13.1 \times 10^{-5}$		
			$30.0 \times 10^{-2}$	$15.1 \times 10^{-5}$		

TABLE 27. (continued)

Solvent	Substrate	Nucleophile	$c$ (mol dm <sup>-3</sup> )	$k_A$	$k''/k^a$
		<i>n</i> -Butylamine	$1.0 \times 10^{-1}$	$0.975 \times 10^{-5}$	5.4
			$2.0 \times 10^{-1}$	$1.42 \times 10^{-5}$	
			$3.0 \times 10^{-1}$	$1.72 \times 10^{-5}$	
			$4.0 \times 10^{-1}$	$2.03 \times 10^{-5}$	
			$5.0 \times 10^{-1}$	$2.46 \times 10^{-5}$	
			$6.0 \times 10^{-1}$	$2.77 \times 10^{-5}$	

<sup>a</sup>See the text.<sup>b</sup>At 29 °C.TABLE 28. Calculated values for reactions of *o*- and *p*-fluoronitrobenzene<sup>a,82</sup>

	<i>n</i> -C <sub>3</sub> H <sub>7</sub> NH <sub>2</sub>		<i>iso</i> -C <sub>3</sub> H <sub>7</sub> NH <sub>2</sub>	
	Toluene	DMSO	Toluene	DMSO
<i>o</i> -Fluoronitrobenzene				
$10^6 k_A$ (l mol <sup>-1</sup> s <sup>-1</sup> )	24	3130	5.4	643
$10^6 k''$	12.9		6.04	
$10^6 k'$	22.6		4.77	
$k''/k'$	0.57		1.27	
$\Delta H^\ddagger$ (kcal mol <sup>-1</sup> )	10.6	9.5	11.1	10
$-\Delta S^\ddagger$ (cal K <sup>-1</sup> mol <sup>-1</sup> )	46	55	48	42
<i>p</i> -Fluoronitrobenzene				
$10^6 k_A$ (l mol <sup>-1</sup> s <sup>-1</sup> )	0.054	205 <sup>b</sup>	0.0005	400 <sup>b</sup>
$10^6 k_3 k_1/k_{-1}$	0.75		0.06 <sup>c</sup>	
$10^6 k_2 k_1/k_{-1}$			0.01 <sup>c</sup>	
$k_3/k_2$	$\infty$		5 <sub>c</sub>	
$\Delta H^\ddagger$ (kcal mol <sup>-1</sup> )	7.4		9	
$-\Delta S^\ddagger$ (cal K <sup>-1</sup> mol <sup>-1</sup> )	69		65	

<sup>a</sup>At 45 °C, [Amine] 0.1M.<sup>b</sup>Data at 50 °C from Reference 181.<sup>c</sup>Only the order of magnitude is accurate. See text.

Other clear-cut evidence that the dichotomy between primary and secondary amines cannot be due to differential steric compression in the  $\sigma$ -complexes formed in these reactions has been afforded by Nudelman and Cerdeira<sup>82</sup> in their study of the reactions of *o*- and *p*-fluoronitrobenzenes with two *primary* amines: *n*- and *iso*-propylamine in toluene (Table 28). For the reactions with *o*-fluoronitrobenzene the ratio  $k_A^{n\text{-Pr}}/k_A^{i\text{-Pr}}$  is 4.4, whereas for the reactions with *p*-fluoronitrobenzene  $k_A^{n\text{-Pr}}/k_A^{i\text{-Pr}}$  is 108. The high decrease in the rate of reaction of *i*-propylamine with *p*-fluoronitrobenzene cannot be obviously due to primary steric effects of the isopropylamine, since they should be more noticeable with the *o*-substrate. We have examined the effect of the amine on the concentration reaction rates and demonstrated that for the *o*-substrate only a slight effect is observed, whereas the reactions of *p*-fluoronitrobenzene with *n*-propylamine proceed only through the catalysed pathway ( $k_3/k_2 = \infty$ ) with the branched amine  $k_3$  and  $k_2$  are of the same order of magnitude. This clearly demonstrates that the huge decrease in rate on passing from *n*- to *iso*-propylamine is due to a retarding effect in the base-catalysed decomposition of the  $\sigma$ -complex.

Crampton<sup>24</sup> has also demonstrated that for Meisenheimer complex formation, increased crowding at the reaction site caused by change from primary amines to piperidine results in rate reduction of proton transfer from the complex to the amine catalyst, and Hirst<sup>199</sup>

has interpreted similar results as due to steric inhibition to the electrophilic catalysis of the expulsion of the nucleofuge; the authors expect that the  $k_3/k_2$  values should be lower for secondary than for the corresponding primary amines, *except* where hydrogen bonding can take place between a group *ortho* to the reaction site and the ammonio hydrogen of the intermediate.

Nevertheless, the results observed for the reactions of *o*- and *p*-fluoronitrobenzenes with propylamines demonstrate that: (a) the dichotomy is not only observed when comparing primary with secondary amines; (b) the origin is not due to primary steric effects; (c) when there is *no ortho*-nitro group the decrease in rate for the bulky amine is greater; (d) the diminution in rate is due to an inhibition effect in the base-catalysed decomposition.

All these observations, together with the finding that in the reactions of *p*-fluoronitrobenzene with *n*-propylamine in toluene the plot of  $k_A$  against *n*-propylamine exhibits a negative intercept, typical of a third order in amine kinetic law, are consistent with the operation of amine aggregates ('dimers' or 'mixed aggregates') in solvents of low permittivity. In the *absence* of an *ortho*-nitro group that could assist the reaction through H-bonding, and it being clear that fluorocarbon compounds are very poor hydrogen-bond acceptors<sup>201</sup>, the only effective way for stabilizing the  $\sigma$ -complex is through hydrogen bonding with the amine, as observed in the intermediate formed with the 'dimer' nucleophile, followed by the amine catalysed decomposition. Branching in the amine hinders aggregation in the nucleophile as well as in the intermediate: this interpretation is confirmed by the solvent effects. As discussed in Section DMSO is a good hydrogen-bond acceptor, forms 'mixed aggregates' with the amines and consistently with the whole mechanism, the reactions in DMSO are very much faster: the reaction rates with *n*-propylamine and *iso*-propylamine are of the same order of magnitude, the reaction rate with this amine being almost twice the value of *n*-propylamine, as expected for a better nucleophile in the absence of steric effects.

#### IV. CONCLUDING REMARKS

The  $S_NAr$  reactions with amines in aprotic solvents pose various difficulties, related to the inability of those solvents to stabilize ionic species, as has been discussed. Several alternative mechanisms have been proposed for these reactions, specially connected with the finding of 'anomalous' kinetics, some of them controversial. Although we believe the case is not closed, certain features of the reactions in aprotic solvents can be considered well settled. Those are: the existence of *aggregates* of the nucleophile and their influence on the kinetic expressions, the formation of *complexes* between the nucleophile and the substrate (although their participation in the kinetic law is not completely clear); the accelerating effect of *HBA additives*; the formation of 'mixed aggregates'; and the homo- and hetero-conjugate acid complexes. In this respect, we agree with Hirst and coworkers<sup>109,162</sup> that the interpretation of formation of *homo- (or hetero-) conjugated acid BH<sup>+</sup>B* by proton transfer from the intermediate and the electrophilically catalysed departure of the nucleofuge due to this aggregate is common to this and to the 'dimer mechanism' and they can be formulated as essentially the same, and as reflecting different parts of a spectrum of methods for the formation of the second intermediate, the relative importance of which depends not only on the entities employed, but on their concentrations as well. Nevertheless, there are some experimental findings such as the conformational effects and the 'inversion plots', that are only explained by the 'dimer nucleophile' mechanisms.

#### V. ACKNOWLEDGEMENTS

The author is deeply indebted to her coworkers in this area, whose names appear in the references. Enlightening discussions with Prof. J. F. Bunnett on many occasions



throughout almost two decades devoted to the study of S<sub>N</sub>Ar reactions are heartily acknowledged.

## VI. REFERENCES

- For recent reviews see:
  - F. Terrier, 'Nucleophilic aromatic displacement: The influence of the nitro group', in *Organic Nitro Chemistry Series* (Ed. H. Ferrer), VCH Publishers, New York, 1991.
  - N. S. Nudelman, *An. Acad. Nac. Ciencias Exactas (Buenos Aires)*, **32**, 109, (1980).
  - C. F. Bernasconi, *MTP Int. Rev. Sci., Org. Chem. Ser. 1*, **3**, 33, (1973).
  - J. F. Bunnett and J. J. Randall, *J. Am. Chem. Soc.*, **80**, 6020 (1958).
- J. F. Bunnett and R. J. Garst, *J. Am. Chem. Soc.*, **87**, 3875 (1965).
  - J. F. Bunnett and R. J. Garst, *J. Am. Chem. Soc.*, **87**, 3879 (1965).
  - J. F. Bunnett and R. J. Morath, *J. Am. Chem. Soc.*, **77**, 5051 (1955).
- C. F. Bernasconi, *Acc. Chem. Res.*, **11**, 147 (1978).
  - C. F. Bernasconi, *Chimia*, **324**, 1 (1980).
- N. S. Nudelman and J. A. Brioux *An. Asoc. Quim. Arg.*, 207 (1978).
  - N. S. Nudelman and J. A. Brioux, *An. Asoc. Quim. Arg.*, 217 (1978).
- F. Terrier, *Chem. Rev.*, **82**, 77 (1982).
- R. Bacaloglu, A. Blasko, C. A. Bunton, E. Dorwin, F. Ortega and C. Zucco, *J. Am. Chem. Soc.*, **113**, 238 (1991) and references cited therein.
  - R. Bacaloglu, C. A. Bunton and F. Ortega, *J. Am. Chem. Soc.*, **111**, 1041 (1989).
  - R. Bacaloglu, C. A. Bunton and F. Ortega, *J. Am. Chem. Soc.*, **110**, 3503 (1988).
- J. I. Hayami, S. Otani, F. Yamaguchi and Y. Nishikawa, *Chem. Lett.*, 739 (1987).
- L. Forlani, M. Sintoni and P. E. Todesco, *J. Chem. Res. (S)*, **66**, 344 (1986).
- S. M. Chiacchiera, J. O. Singh, J. D. Anunziata and J. J. Silber, *J. Chem. Soc., Perkin Trans. 2*, 1585 (1988).
- N. S. Nudelman, *J. Phys. Org. Chem.*, **2**, 1 (1989) and references cited therein.
- E. Buncel, M. R. Crampton, M. J. Strauss and F. Terrier. In *Electron-Deficient Aromatic- and Heteroaromatic-Base Interactions*, Elsevier, Amsterdam, 1984.
  - G. A. Artamkina, M. P. Egorov and I. P. Beletskaya, *Chem. Rev.*, **82**, 427 (1982).
- N. S. Nudelman and S. B. Cerdeira, *Magn. Reson. Chem.*, **24**, 1098 (1986).
- D. A. De Bie, B. Geurtsen, I. E. Berg and H. C. Van der Plas, *J. Org. Chem.*, **51**, 3209 (1986).
  - H. C. Van der Plas, M. Wozniak and H. J. Van der Haak, *Adv. Heterocycl. Chem.*, **33**, 96 (1983).
- K. Bowden, S. Prasanna and R. J. Ranson, *J. Chem. Soc., Perkin Trans. 2*, 181 (1987).
- F. Bazzani, P. Mencarelli and F. Stegel, *J. Org. Chem.*, **49**, 2375 (1984).
  - A. Annulli, P. Mencarelli and F. Stegel, *J. Org. Chem.*, **49**, 4065 (1984).
- J. D. Reinheimer, N. Sourbais, R. L. Lavallee and D. Goodwin and G. L. Gould, *Can. J. Chem.*, **62**, 1120 (1984).
- F. Terrier, A. P. Chatrouse, P. Soudais and M. Hlaibi, *J. Org. Chem.*, **49**, 4176 (1984).
- C. F. Bernasconi and R. H. de Rossi, *J. Org. Chem.*, **41**, 44 (1976).
- J. A. Orvick and J. F. Bunnett, *J. Am. Chem. Soc.*, **92**, 2417 (1970).
- J. F. Bunnett and A. V. Cartaño, *J. Am. Chem. Soc.*, **103**, 4861 (1981).
  - J. F. Bunnett, S. Sekiguchi and L. A. Smith, *J. Am. Chem. Soc.*, **103**, 4865 (1981).
  - S. Sekiguchi and J. F. Bunnett, *J. Am. Chem. Soc.*, **103**, 4871 (1981).
- S. Sekiguchi, M. Hosokawa, T. Suzuki and M. Sato, *J. Chem. Soc., Perkin Trans. 2*, 1111 (1993).
  - H. Fujinuma, M. Hosokawa, T. Suzuki, M. Sato and S. Sekiguchi, *Bull. Chem. Soc. Jpn.*, **62**, 1969 (1989).
- Y. Hasegawa, *Bull. Chem. Soc. Jpn.*, **56**, 1314 (1983).
  - Y. Hasegawa, *J. Org. Chem.*, **50**, 649 (1985).
- Y. Hasegawa, *J. Chem. Soc., Perkin Trans. 2*, 547 (1984).
- M. R. Crampton and P. J. Routledge, *J. Chem. Soc., Perkin Trans. 2*, 573 (1984).
- R. H. de Rossi and R. A. Rossi, *J. Org. Chem.*, **39**, 3486 (1974).
- T. O. Bamkole, J. Hirst and G. Hussain, *J. Chem. Soc., Perkin Trans. 2*, 681 (1984).
- E. R. de Vargas and R. H. de Rossi, *J. Org. Chem.*, **49**, 3978 (1984).
- F. Del Cima, G. Biggi and F. Pietra, *J. Chem. Soc., Perkin Trans. 2*, 559 (1983).

29. (a) C. Paradisi and G. Scorrano, in *Nucleophilicity* (Eds. J. M. Harris and S. P. Mc Manus), ACS Advances in Chemistry Series, No 215, American Chemical Society: Washington, DC, 1987, p. 339.  
(b) V. Arca, C. Paradisi and G. Scorrano, *J. Org. Chem.*, **55**, 3617 (1990).  
(c) C. Paradisi, U. Quintilli and G. Scorrano, *J. Org. Chem.*, **48**, 3022 (1983).
30. (a) C. A. Bunton, J. R. Moffatt and J. Spillane, *J. Chem. Soc., Perkin Trans. 2*, 1799 (1986).  
(b) V. Athanassakis, C. A. Bunton and F. de Buzzaccarini, *J. Phys. Chem.*, **86**, 5002 (1982).
31. (a) T. J. Broxton, J. R. Christie and A. J. Dole, *J. Phys. Org. Chem.*, **7**, 442 (1994).  
(b) T. J. Broxton, J. R. Christie and D. Theodoridis, *J. Phys. Org. Chem.*, **6**, 535 (1993).
32. (a) A. Cipicani, R. Germani, G. Savelli, C. A. Bunton, M. Mhala and J. R. Moffatt, *J. Chem. Soc., Perkin Trans. 2*, 541 (1987).  
(b) A. Cipicani, M. C. Fracasini, R. Germani, G. Savelli and C. A. Bunton, *J. Chem. Soc., Perkin Trans. 2*, 547 (1987).
33. E. N. Durantini, S. M. Chiacchiera and J. J. Silber, *J. Org. Chem.*, **58**, 7115 (1993).
34. M. Gislser and H. Zollinger, *Angew. Chem., Int. Ed. Engl.*, **20**, 203 (1981).
35. F. Schmidtchen, *Chem. Ber.*, **117**, 725, 1287 (1984).
36. S. E. Fry and N. J. Pienta, *J. Am. Chem. Soc.*, **107**, 6399 (1985).
37. C. F. Reichardt, *Solvents and Solvent Effects in Organic Chemistry*, 2nd ed., VCH, Weinheim, 1988.
38. (a) M. J. Kamlet, J. L. Abboud, M. Abraham and R. W. Taft, *J. Org. Chem.*, **48**, 2877 (1983).  
(b) J. L. Abboud, M. J. Kamlet and R. W. Taft, *Prog. Phys. Org. Chem.*, **13**, 485 (1981).
39. M. J. Kamlet and R. W. Taft, *Acta Chem. Scand. Ser. B*, **39**, 611 (1985).
40. M. H. Abraham, *J. Phys. Org. Chem.*, 1994, **7**, 655 (1994).
41. (a) M. J. Kamlet, J. -L. M. Abboud, M. H. Abraham and R. W. Taft, *J. Org. Chem.*, **48**, 2877 (1983).  
(b) R. W. Taft, J. -L. M. Abboud, M. J. Kamlet and M. H. Abraham, *J. Solution Chem.*, **14**, 153 (1983).
42. M. H. Abraham, P. L. Grelier, J. -L. M. Abboud, R. M. Doherty and R. W. Taft, *Can. J. Chem.*, **66**, 153 (1988).
43. S. Supan *J. Photochem. Photobiol.*, **A50**, 293 (1990).
44. R. Nakagaki, I. Aoyama, K. Shimizu and M. Akagi *J. Phys. Org. Chem.*, **6**, 261 (1993).
45. (a) Y. Migron and Y. Marcus, *J. Phys. Org. Chem.*, **4**, 310 (1991).  
(b) Y. Migron and Y. Marcus, *J. Phys. Chem.*, **95**, 400 (1991).
46. T. W. Bentley, *Am. Chem. Soc. Ser.*, **215**, 255 (1987).
47. D. N. Kevill and S. W. Anderson, *J. Am. Chem. Soc.*, **108**, 1579 (1986).
48. (a) P. M. E. Mancini, R. D. Martinez, L. R. Vottero and N. S. Nudelman, *J. Chem. Soc., Perkin Trans. 2*, 1133 (1984).  
(b) R. D. Martinez, P. M. E. Mancini, L. R. Vottero and N. S. Nudelman, *J. Chem. Soc., Perkin Trans. 2*, 1427 (1986).  
(c) N. S. Nudelman, R. D. Martinez, P. M. E. Mancini and L. R. Vottero, *An. Soc. Cient. Arg.*, **211**, 27 (1981).
49. (a) J. Lelievre, O. Haddad-Fahed and R. Gaboriaud, *J. Phys. Chem.*, **84**, 449 (1987).  
(b) J. Lelievre, O. Haddad-Fahed and R. Gaboriaud, *J. Chem. Soc., Faraday Trans. 1*, **82**, 2301 (1986).
50. M. H. Abraham, P. L. Grelier, D. V. Prior, J. J. Morris and P. J. Taylor, *J. Chem. Soc., Perkin Trans. 2*, 521 (1990).
51. M. H. Abraham, P. L. Grelier, D. V. Prior, R. W. Taft, J. J. Morris, P. J. Taylor, C. Laurence, M. Berthelot, R. M. Doherty, M. J. Kamlet, J. -L. M. Abboud, K. Sraidi and G. Guiheneuf, *J. Am. Chem. Soc.*, **110**, 8534 (1988).
52. M. H. Abraham and M. Roses, *J. Phys. Org. Chem.*, **7**, 672 (1994).
53. K. G. Millar and C. F. Poole, *J. High Resolut. Chromatogr.*, **17**, 125 (1994).
54. M. H. Abraham, *J. Phys. Org. Chem.*, **6**, 660 (1993).
55. M. H. Abraham, *Pure Appl. Chem.*, **65**, 2503 (1993).
56. M. H. Abraham, H. S. Chadha, G. S. Whiting and R. C. Mitchell, *J. Pharm. Sci.*, **83**, 1085 (1994).
57. D. E. Leahy, J. J. Morris, P. J. Taylor and A. R. Wait, *J. Chem. Phys.*, **89**, 1597 (1992).
58. D. E. Leahy, J. J. Morris, P. J. Taylor and A. R. Wait, *J. Chem. Soc., Perkin Trans. 2*, (a) 705, (b) 723 (1992).

59. M. H. Abraham, H. S. Chadha and R. C. Mitchell, *J. Pharm. Sci.*, **83**, 1257 (1994).
60. D. E. Leahy, J. J. Morris, P. J. Taylor and A. R. Wait, *J. Phys. Org. Chem.*, **7**, 743 (1994).
61. Y. Marcus, *Ion Solvation*, Wiley, New York, 1995.
62. E. Bosch, F. Rived and M. Roses, *J. Phys. Org. Chem.*, **7**, 696 (1994).
63. Y. Marcus, *J. Solution Chem.*, **20**, 929 (1991).
64. Y. Migron and Y. Marcus, *J. Chem. Soc., Faraday Trans.*, **87**, 1339 (1991).
65. E. Bosch, C. Rafols and M. Roses, *Anal. Chem.*, **62**, 102 (1990).
66. M. Roses, F. Rived and E. Bosch, *J. Chem. Soc., Faraday Trans.*, **89**, 1723 (1993).
67. E. Casassas, G. Fonrodona, A. de Juan and R. Tauler, *Chemometr. Intell. Lab. Syst.*, **12**, 29 (1991).
68. M. H. Abraham, *Chem. Soc. Rev.*, **22**, 73 (1993).
69. M. H. Abraham, *Pure Appl. Chem.*, **65**, 2503 (1993).
70. M. H. Abraham, *J. Phys. Org. Chem.*, **6**, 660 (1993).
71. M. H. Abraham, H. S. Chadha, G. S. Whiting and R. C. Mitchell, *J. Pharm. Sci.*, **83**, 1085 (1994).
72. M. H. Abraham and M. Roses, *J. Phys. Org. Chem.*, **7**, 672 (1994).
73. M. H. Abraham, H. S. Chadha and R. C. Mitchell, *J. Pharm. Sci.*, **83**, 1257 (1994).
74. M. H. Abraham, H. S. Chadha, J. P. Dixon and A. J. Leo, *J. Phys. Org. Chem.*, **7**, 712 (1994).
75. R. M. C. Goncalves, A. M. N. Simoes, L. M. P. C. Albuquerque, M. Roses, C. Rafols and E. Bosch, *J. Chem. Res.*, (M) 1380; (S) 214 (1993).
76. F. G. Bordwell and D. L. Hughes, *J. Am. Chem. Soc.*, **108**, 5991 (1986).
77. J. R. Gandler, I. U. Setiarahardjo, C. Tufon and C. Chen, *J. Org. Chem.*, **57**, 4169 (1992).
78. A. V. Veglia and R. H. de Rossi, *Indian J. Technol.*, **30**, 397 (1992).
79. E. B. de Vargas, M. V. Remedi and R. H. de Rossi, *J. Phys. Org. Chem.*, **8**, 113 (1995).
80. (a) C. D. Ritchie, *Acc. Chem. Res.*, **5**, 348 (1972).  
(b) C. D. Ritchie and P. O. I. Virtanen, *J. Am. Chem. Soc.*, **95**, 1882 (1973).  
(c) C. D. Ritchie and M. Sawada, *J. Am. Chem. Soc.*, **99**, 3754 (1977).
81. J. F. Bunnett and N. S. Nudelman *J. Org. Chem.*, **34**, 2038 (1969) and references cited therein.
82. N. S. Nudelman and S. Cerdeira, *J. Chem. Soc., Perkin Trans. 2*, 695 (1986).
83. (a) N. S. Nudelman and P. Mac Cormack, *J. Chem. Soc., Perkin Trans. 2*, 227 (1987).  
(b) N. S. Nudelman and P. Mac Cormack, *Tetrahedron*, **40**, 4227 (1984).
84. E. D. Raczynska, P. C. Maria and M. Decouzon, in *Proceedings of the 12th International Mass Spectrometry Conference*, 1991.
85. M. Decouzon, J. F. Gal, P. C. Maria and E. D. Raczynska, *Rapid Commun. Mass Spectrom.*, **7**, 599 (1993).
86. E. D. Raczynska, P. C. Maria, J. F. Gal and M. Decouzon, *J. Phys. Org. Chem.*, **7**, 725 (1994).
87. (a) I. A. Koppel, F. Anvia and R. W. Taft, *J. Phys. Org. Chem.*, **7**, 717 (1994).  
(b) M. Berthelot, M. Helbert, C. Laurence, J. -Y. LeQuestel, F. Anvia and R. W. Taft, *J. Chem. Soc., Perkin Trans. 2*, 625 (1993).
88. R. W. Taft and R. D. Topsom, *Prog. Phys. Org. Chem.*, **16**, 1 (1987).
89. I. A. Koppel, U. H. Molder and R. J. Pikkver, in *Electron and Proton Affinities of Molecules*, 1991, pp. 5–112. USSR Academy of Sciences Press, Ufa
90. M. Meot-Ner (Mautner) and L. W. Sieck, *J. Am. Chem. Soc.*, **113**, 4448 (1991).
91. J. E. Szulejiko and T. B. McMahon, *J. Mass. Spectrom, Ion Processes*, **109**, 279 (1991).
92. J. E. Szulejiko and T. B. McMahon, *J. Am. Chem. Soc.*, **115**, 7839 (1993).
93. I. A. Koppel, R. W. Taft, F. Anvia, S.-Z. Zhu, L. Q. Hu, K. S. Sung, D. D. DesMarteau, L. M. Yagupolskii, Yu. L. Yagupolskii, N. V. Ignat'ev, N. V. Kondratenko, A. Y. Volkonskii, V. M. Vlasov, R. Notario and P. C. Maria, *J. Am. Chem. Soc.*, **116**, 3047 (1994).
94. R. W. Taft and R. D. Topsom, *Prog. Phys. Org. Chem.*, **16**, 1 (1987).
95. C. Hansh, A. Leo and R. W. Taft, *Chem. Rev.*, **91**, 165 (1991).
96. S. Gupta, *Chem. Rev.*, **87**, 1183 (1987).
97. A. D. Headley, S. D. Straness, E. T. Cheung and P. L. Malone, *J. Phys. Org. Chem.*, **8**, 26 (1995).
98. R. W. Taft, *Prog. Phys. Org. Chem.*, **16**, 120 (1987).
99. A. D. Headley and M. E. McMurray, *J. Phys. Org. Chem.*, **7**, 63 (1994).
100. A. D. Headley, *J. Phys. Org. Chem.*, **4**, 3688 (1991).
101. V. O. Chechik and V. A. Bobylev, *Zh. Onshch, Khim.*, 1993, **63**, 1502
102. N. S. Nudelman *J. Org. Chem.*, **30**, 3356 (1965).

103. (a) G. Consiglio, R. Notto and D. Spinelli *J. Chem. Soc., Perkin Trans. 2*, 222 (1979).  
(b) D. M. Brewis, N. B. Chapman, J. S. Paine, J. Shorter and D. J. Wright, *J. Chem. Soc. Perkin Trans. 2*, 1787 (1974).  
(c) G. Becker, C. F. Bernasconi and H. Zollinger, *Helv. Chim. Acta*, **49**, 10 (1966).
104. (a) N. S. Nudelman and D. Palleros, *J. Chem. Soc., Perkin Trans. 2*, 805 (1985).  
(b) D. Palleros and N. S. Nudelman *An. Soc. Cient. Arg.*, **43**, 3 (1986).
105. (a) S. C. Nyburg, C. H. Faerman, L. Prasad, D. Palleros and N. S. Nudelman *Acta Crystallogr.*, **C43**, 686 (1987).  
(b) N. S. Nudelman and D. Garrido, *J. Chem. Soc., Perkin Trans. 2*, 1256 (1976).
106. (a) C. Hansch, A. Leo and R. W. Taft, *Chem. Rev.*, **91**, 165 (1991).  
(b) R. W. Taft, *J. Chim. Phys.*, **89**, 1557 (1992).
107. N. S. Nudelman and D. Palleros *J. Chem. Soc., Perkin Trans. 2*, 995 (1981).
108. C. F. Bernasconi, *J. Phys. Chem.* **75**, 3636 (1971).
109. T. A. Emokpae, P. U. Uwakwe and J. Hirst, *J. Chem. Soc., Perkin Trans. 2*, 509 (1991).
110. S. M. Chiacchiera, R. I. Cattana, J. O. Singh, J. D. Anunziata and J. J. Silber, *J. Phys. Org. Chem.*, **2**, 631 (1989).
111. F. Pietra and D. Vitali, *J. Chem. Soc., Perkin Trans. 2*, 385 (1972).
112. G. A. Jeffrey and W. Saenger, *Hydrogen Bonding in Biological Molecules*, Springer-Verlag, Berlin-Heidelberg, 1991.
113. K. Tamaru and M. Ichikama, *Catalysis by Electron-Donor-Acceptor Complexes*, Wiley, New York, 1975.
114. (a) O. B. Nagy, *Bull. Soc. Chim. Belg.*, **94**, 11 (1985).  
(b) O. B. Nagy, M. Wa Muanda and J. B. Nagy, *J. Chem. Phys.*, **83**, 1961 (1979).
115. (a) E. Durantini, L. Zingaretti, J. D. Anunziata, and J. J. Silber, *J. Phys. Org. Chem.*, **5**, 557 (1992).  
(b) L. Giacomelli, R. Cattana, J. D. Anunziata, J. J. Silber, M. Hedrera, S. Salerno and I. Perillo, *J. Phys. Org. Chem.*, **7**, 162 (1994).
116. (a) J. O. Singh, J. D. Anunziata and J. J. Silber, *Can J. Chem.*, **63**, 903 (1985).  
(b) S. M. Chiacchiera, J. O. Singh, J. D. Anunziata and J. J. Silber, *J. Chem. Soc., Perkin Trans. 2*, 987 (1987).
117. R. I. Cattana, J. O. Singh, J. D. Anunziata and J. J. Silber, *J. Chem. Soc., Perkin Trans. 2*, 79 (1987).
118. (a) S. S. Shaik *Pure Appl. Chem.*, **63**, 195 (1991).  
(b) S. S. Shaik *J. Org. Chem.*, **52**, 1563 (1987).
119. A. Pross, *Acc. Chem. Res.*, **18**, 212 (1985).
120. (a) S. S. Shaik, in *New Theoretical Concepts for Understanding Organic Reactions* (Eds. J. Bertran and J. G. Csizmadia), ed. p. 165. Kluwer, Dordrecht, 1989.  
(b) S. S. Shaik *J. Am. Chem. Soc.*, **106**, 1227 (1984).
121. D. Bethell and V. D. Parker, *J. Phys. Org. Chem.*, **5**, 317 (1992).
122. E. Sinsheimer and A. M. Keuhnelian, *Anal. Chem.*, **44**, 89 (1974).
123. L. Forlani, G. Guastadisegni and L. Raffellini, *J. Chem. Res. (S)*, 392 (1989).
124. M. H. Krackov, C. M. Lee and H. G. Mautner, *J. Am. Chem. Soc.*, **99**, 4090 (1977).
125. L. Forlani, *Gazz. Chim. Ital.*, **121**, 475 (1991).
126. B. Capon and C. W. Rees, *An. Rep. Prog. Chem.*, **60**, 279 (1963).
127. J. Hirst, G. Hussain and I. Onyido, *J. Chem. Soc., Perkin Trans. 2*, 397 (1986).
128. D. Ayediran, T. O. Bamkole and J. Hirst, *J. Chem. Soc., Perkin Trans. 2*, 1013 (1974).
129. L. Forlani, *Gazz. Chim. Ital.*, **122**, 349 (1992).
130. R. Chamberlain and M. R. Crampton, *J. Chem. Soc., Perkin Trans. 2*, 75 (1993).
131. R. Chamberlain and M. R. Crampton, *J. Chem. Soc., Perkin Trans. 2*, 425 (1994).
132. M. R. Crampton and J. A. Stevens, *J. Chem. Soc., Perkin Trans. 2*, 925 (1989).
133. R. Chamberlain and M. R. Crampton, *J. Chem. Res. (S)*, 106; (M), 811 (1993).
134. R. Chamberlain, M. R. Crampton and R. L. Knight, *J. Chem. Res. (S)*, 444; (M), 2986 (1993).
135. T. Ibata and X. Zou, *High Pressure Research*, **11**, 81 (1992).
136. T. Ibata, Y. Isogami and J. Toyoda, *Chem. Lett.*, 1187 (1987); T. Ibata, Y. Isogami and J. Toyoda, *Bull. Chem. Soc. Jpn.*, **64**, 42 (1991).
137. K. Matsumoto, T. Uchida, T. Okamoto and S. Hashimoto, *Chem. Express*, **2**, 551 (1987).
138. S. Hashimoto, S. Otani, T. Okamoto and K. Matsumoto, *Heterocycles*, **27**, 319 (1988); K. Matsumoto, T. Uryu and M. Munakata, *Chem. Express*, **3**, 739 (1988).

139. K. Matsumoto, S. Hashimoto, H. Minatogawa, M. Munakata and S. Otani, *Chem. Express*, **5**, 473 (1990).
140. T. Ibata, X. Zou and T. Demura, *Tetrahedron Lett.*, **34**, 5613 (1993).
141. T. Ibata, X. Zou and T. Demura, *Bull Chem. Soc. Jpn.*, **67**, 196 (1994).
142. T. Ibata, Y. Isogami and J. Toyoda, *Chem. Lett.*, 1187 (1987); *Bull Chem. Soc. Jpn.*, **64**, 42 (1991).
143. (a) N. S. Nudelman and D. Palleros, *Acta Sud. Am. Quím.*, **1**, 125 (1981).  
(b) D. Palleros and N. S. Nudelman, Proceedings IInd Phys. Org. Chem. Symposium, Cordoba, 1980; p. 33.
144. N. S. Nudelman and D. Palleros, *J. Org. Chem.*, **48**, 1607 (1983).
145. L. Abello, M. Kern, C. Caseres and G. Pannetier, *Bull Soc. Chim. France*, 94 (1970).
146. J. C. Shug and W. M. Chang *J. Phys. Chem.*, **75**, 938 (1971).
147. (a) G. Illuminati, F. La Torre, G. Liggieri, G. Sleiter and F. Stegal *J. Am. Chem. Soc.*, **97**, 1851 (1975).  
(b) D. M. Brein, *J. Chem. Soc., Perkin Trans. 2*, 1787 (1974).  
(c) G. Becker, C. F. Bernasconi and H. Zollinger, *Helv. Chim. Acta*, **49**, 10 (1966).
148. (a) T. O. Bamkole, J. Hirst and J. Onyido, *J. Chem. Soc., Perkin Trans. 2*, 889 (1982).  
(b) E. T. Akinyele, I. Onyido and J. Hirst, *J. Phys. Org. Chem.*, **3**, 41 (1990).
149. (a) L. Forlani and C. Cimarelli, *J. Chem. Res. (S)*, 62 (1982).  
(b) L. Forlani and C. Cimarelli, *J. Chem. Res. (S)*, 258 (1982).  
(c) L. Forlani, *Gazz. Chim. Ital.*, **112**, 205 (1982).
150. O. Banjoko and C. Ezeani, *J. Chem. Soc., Perkin Trans. 2*, 1357 (1982).
151. G. Guanti, G. Petrillo and S. Thea, *Tetrahedron*, **38**, 505 (1982).
152. V. Frenna, N. Vivona, A. Caronia, G. Consiglio and D. Spinelli, *J. Chem. Soc., Perkin Trans. 2*, 1203 (1983).
153. J. Hirst, *J. Phys. Org. Chem.*, **7**, 68 (1994).
154. O. Banjoko and C. Ezeani, *J. Chem. Soc., Perkin Trans. 2*, 531 (1986).
155. O. Banjoko and I. A. Bayeroju, *J. Chem. Soc., Perkin Trans. 2*, 1853 (1988).
156. W. P. Jencks, *Chem. Soc. Rev.*, **10**, 345 (1981).
157. A. Wolff and G. Gamer, *J. Phys. Chem.*, **76**, 871 (1972).
158. J. M. Menger and J. H. Smith, *J. Am. Chem. Soc.*, **91**, 4211 (1969).
159. F. Ciuffarin, M. Isola and P. Leoni, *J. Org. Chem.*, **46**, 3064 (1981).
160. V. Frena, N. Vivona, G. Consiglio and D. Spinelli, *J. Chem. Soc. Perkin Trans. 2*, 1865 (1985).
161. A. Reyes and R. M. Scott, *J. Phys. Chem.*, **84**, 3600 (1980).
162. J. Hirst, G. N. Onuoha and I. Onyido *J. Chem. Soc. Perkin Trans. 2*, 971 (1988).
163. (a) C. F. Bernasconi and H. Zollinger, *Helv. Chim. Acta*, **49**, 2570 (1966).  
(b) C. F. Bernasconi, M. Kaufmann and H. Zollinger, *Helv. Chim. Acta*, **49**, 2563 (1966).
164. S. D. Ross, *Tetrahedron*, **25**, 4427 (1969).
165. R. Cetina, M. Rubio and M. A. Mora *Rev. Latinoam. Quím.*, **10**, 50 (1979).
166. (a) P. A. Kollman and L. C. Allen, *J. Am. Chem. Soc.*, **93**, 4991 (1971).  
(b) J. E. del Bene, *J. Am. Chem. Soc.*, **95**, 5460 (1973).
167. (a) F. Ratkonis and T. Salamon, *Acta Chim. Acad. Sci. Hung.*, **94**, 93 (1977).  
(b) M. K. D. Choudhury and H. B. Mathur, *Indian J. Chem., A*, **14**, 735 (1976).
168. J. del Bene, *J. Am. Chem. Soc.*, **102**, 5191 (1980).
169. L. Farah, G. Giles, D. Wilson, A. Ohno and R. M. Scott, *J. Phys. Chem.*, **83**, 2455 (1979).
170. O. Banjoko and P. Otiono, *J. Chem. Soc., Perkin Trans. 2*, 399 (1981).
171. J. F. Bunnett and R. H. Garst, *J. Org. Chem.*, **33**, 2320 (1968).
172. N. S. Nudelman and D. Palleros, *J. Org. Chem.*, **48**, 1612 (1983).
173. A. J. Kresge and M. F. Powell, *J. Am. Chem. Soc.*, **103**, 972 (1981).
174. D. Palleros and N. S. Nudelman *Acta Sud Am. Quím.*, **3**, 49 (1984).
175. N. S. Nudelman and D. Palleros *J. Chem. Soc. Perkin Trans. 2*, 1277 (1984).
176. G. Visandul, V. S. Kutz and V. D. Pokhodenko, *Zh. Obshch. Khim.*, **43**, 180 (1972).
177. N. S. Nudelman, M. Marder and A. Gurevich, *J. Chem. Soc., Perkin Trans. 2*, 229 (1993).
178. J. M. Harris, S. P. McManus, M. R. Sedaghat-herati, N. Neamati-Mazraey, R. M. Doherty, R. W. Taft and M. H. Abraham, *Am. Chem. Soc. Ser.*, **215**, 247 (1987).
179. R. W. Taft, T. Gramstad and M. J. Kamlet, *J. Org. Chem.*, **47**, 4557 (1982).
180. D. Palleros and N. S. Nudelman, *J. Chem. Soc., Perkin Trans. 2*, 479 (1985).
181. H. Suhr, *Ber. Bunsenges. Phys. Chem.*, **67**, 893 (1963).

182. D. Ayediran, T. O. Bamkole, J. Hirst and I. Onyido, *J. Chem. Soc., Perkin Trans. 2*, 597 (1977).
183. A. V. Ryzhakov, V. V. Vapirov and L. L. Rodina, *J. Org. Chem. USSR. (Engl. Transl.)*, **27**, 825 (1991).
184. (a) L. Forlani and C. Cimorelli, *J. Phys. Org. Chem.*, **2**, 653 (1989).  
(b) L. Forlani, G. Guastadisegni and L. Raffellini, *J. Chem. Res. (S)*, 392 (1989).
185. L. Forlani, *J. Chem. Res. (S)*, 260 (1984).
186. L. Forlani and M. Sintoni, *J. Chem. Soc., Perkin Trans. 2*, 1959 (1988).
187. L. Forlani, *Gazz. Chim. Ital.*, **121**, 475 (1991).
188. L. Forlani and M. Bosi, *J. Phys. Org. Chem.*, **5**, 429 (1992).
189. J. Hayami and N. Sugiyama, Proceedings Vth. KISPOC, Japan, 1993, p. 031.
190. N. S. Nudelman and J. Montserrat, *J. Chem. Soc., Perkin Trans. 2*, 1990, 1073 (1990).
191. H. E. Audier, G. Bouchoux, D. Thilmann, *Analysis*, **20**, 20s (1992).
192. G. Bouchoux, S. Jezequel and F. Penaud Berruyer, *Org. Mass. Spectrom*, **28**, 421 (1993).
193. J. Oszczapowicz, in *The Chemistry of Amidines and Imidates* (Eds. S. Patai and Z. Rappoport), Vol. 2, Chap. 12, Wiley, Chichester, 1991 and references cited therein.
194. (a) Z. Wu and C. Fenselau, *Rapid Commun. Mass Spectrom.*, **4**, 403 (1992).  
(b) G. S. Gorman, J. P. Speir, C. A. Turner and I. J. Amster, *J. Am. Chem. Soc.*, **114**, 3986 (1992).
195. O. Tapia, R. Cardenas, Y. G. Smeyers, A. Hernandez.Laguna and F. J. RandeZ, *Int. J. Quantum Chem.*, **38**, 727 (1990).
196. A. Hernandez.Laguna, J. L. M. Abboud, R. Notario, H. Homan and Y. G. Smeyers, *J. Am. Chem. Soc.*, **115**, 1450 (1993).
197. A. A. Bliznyuk, H. F. Schaefer III and I. J. Amster, *J. Am. Chem. Soc.*, **115**, 5149 (1993).
198. R. E. Akpojivi, T. A. Emokpae and J. Hirst, *J. Chem. Soc., Perkin Trans. 2*, 443 (1994).
199. T. A. Emokpae, P. U. Uwakwe and J. Hirst, *J. Chem. Soc., Perkin Trans. 2*, 125 (1993).
200. T. A. Emokpae, J. Hirst and P. U. Uwakwe, *J. Chem. Soc., Perkin Trans. 2*, 2191 (1990).
201. F. Hibbert and J. Emsley, *Adv. Phys. Org. Chem.*, **26**, 255 (1990).

## Author index

This author index is designed to enable the reader to locate an author's name and work with the aid of the reference numbers appearing in the text. The page numbers are printed in normal type in ascending numerical order, followed by the reference numbers in parentheses. The numbers in *italics* refer to the pages on which the references are actually listed.

- Aakermark, B. 568 (188), 620  
Aakeröy, C.B. 428 (29), 471  
Abbotto, A. 398 (109a, 110, 111), 420, 509 (195), 530  
Abboud, J.L. 433 (80), 439 (129), 443 (158), 472–474, 1220–1222, 1238, 1244 (38a, 38b), 1296  
Abboud, J.-L.M. 381 (16a–c, 17d, 18, 20b), 387 (53), 408 (165b, 168), 417, 418, 421, 428 (42), 471, 524 (253, 254), 531, 1220 (41a, 41b, 42), 1222, 1238 (51), 1285 (196), 1296, 1300  
Abdel-Latif, F.F. 722 (153d), 743  
Abdel-Magid, A. 113, 114 (43), 154  
Abdel-Magid, A.F. 563 (156), 620  
Abdel-Malik, M.M. 722 (153h), 743  
Abdil-Rashid, M.K. 1064 (104), 1157  
Abdulla, R.F. 442 (147), 473  
Abdul-Majid, Q. 715 (130a, 130b), 742  
Abe, E. 1078 (206), 1159  
Abe, H. 1089 (287), 1161  
Abe, M. 654 (151), 662  
Abello, L. 434 (85, 91), 472, 1262, 1266 (145), 1299  
Abernathy, C.L. 348 (30a), 373  
Abernethy, C.L. 361, 362, 367, 371 (84), 377  
Abeywickrema, A.N. 655 (160), 662  
Abia, L. 644 (96), 661  
Abini, A. 684 (5), 740, 758 (29), 818  
Abou-Khalil, S. 1025 (135, 138), 1038  
Abou-Khalil, W.H. 1025 (135, 136, 138), 1038  
Abowitz, G. 435 (99), 472  
Abraham, M. 1220 (38a, 40), 1221, 1222, 1238, 1244 (38a), 1296  
Abraham, M.H. 381 (16a–c, 17a–e, 19, 20a–c), 386 (45a, 45b), 387 (53), 395 (81), 417–419, 427 (26), 428 (40–42), 429 (26), 433 (80), 471, 472, 1220 (41a, 41b, 42), 1222 (50–52, 54–56, 59), 1223 (72), 1226 (68–72), 1228 (73, 74), 1238 (51), 1273, 1275, 1283 (178), 1296, 1297, 1299  
Abraham, R.J. 301, 302 (16), 332  
Abramovitch, R.A. 640 (67), 660  
Abrigo, C. 1074 (179), 1158  
Abu-Dagga, F. 1067 (130), 1157  
Abuirjeie, M.A. 1140 (545), 1166  
Abu-Namous, A.M.A. 877 (71), 890  
Abu-Soud, H.M. 989 (105), 990 (110), 991 (113), 996  
Ace, L.N. 1139 (542), 1166  
Achari, B. 598 (377), 624  
Achiba, Y. 161, 163, 171–173, 193, 197 (21), 202  
Achilli, G. 1078 (198), 1159  
Ackworth, I.N. 1071 (153), 1158  
Acree, W.E.Jr. 338 (5), 357 (67), 358 (71–73), 372, 376  
Adachi, H. 787 (101), 820  
Adachi, K. 1086 (272), 1160  
Adachi, T. 551 (89a, 89b, 90, 91), 618  
Adamo, N.C. 1135 (518), 1165  
Adams, J.E. 163 (29), 202  
Addadi, L. 1108 (388), 1163  
Adeloju, S.B. 1119 (425), 1163  
Adewiyu, G.O. 1080 (224), 1159  
Agafonov, V. 453 (206), 475  
Agarrabeitia, A.R. 716 (136), 743  
Agren, H. 171 (76), 203

- Ahlbrecht, H. 603 (392), 624  
 Ahuja, S. 106 (14), 153  
 Aiello, E. 630 (15), 633 (27), 659  
 Aimi, H. 866 (34), 889  
 Ainscow, T.A. 97 (66), 103  
 Akabori, S. 536 (21), 537 (22), 617  
 Akagi, M. 432, 443 (72), 472, 1220 (44), 1296  
 Akerkar, S. 1150 (612), 1167  
 Akermark, B. 542 (54), 617  
 Akhtar, M.H. 1134 (506), 1165  
 Akihiro Yoshino (88), 334  
 Akikusa, N. 592 (332), 623  
 Akino, T. 1089 (290), 1161  
 Akinyele, E.T. 1262, 1264, 1276, 1288 (148b), 1299  
 Akio Kuwae 320 (84), 334  
 Akiyama, F. 654 (151), 662  
 Akiyama, I. 188 (115–117), 204  
 Akiyama, K. 750 (6), 817  
 Akiyama, S. 1091 (304), 1161  
 Akkok, S. 216 (63c), 245  
 Akopyan, Z.A. 363 (89), 377  
 Akpojivi, R.E. 1290, 1291 (198), 1300  
 Akritopoulou, I. 566 (181), 620  
 Akutsu, Y. 77 (127–129), 78 (128, 129), 79 (129), 84  
 Alagona, G. 3 (2a), 81  
 Alanzo, V. 398 (110), 420  
 Albanese, D. 616 (462, 463), 626  
 Albelda, C. 1048 (55), 1156  
 Albert, A. 381 (3), 416  
 Alberty, W.J. 409 (176), 421  
 Albinati, A. 94 (36), 102  
 Albini, A. 773 (62), 819  
 Albuquerque, L.M.P.C. 1228 (75), 1297  
 Aldegunde, M. 1078 (204, 205), 1159  
 Alder, A. 733 (184), 744  
 Alder, R.W. 66 (111, 112), 67 (111), 84, 166, 168 (52), 176 (88), 179 (52, 88, 93), 181 (96), 184 (52, 98, 105), 185 (52), 202, 203, 435 (102), 472  
 Aleman, R. 216, 218 (65), 245  
 Alessi, D.M. 124 (74), 155, 427 (22), 471  
 Alewood, P. 1029 (167), 1038  
 Alex, A. 956 (44), 971  
 Alexakis, A. 126, 127 (80), 155, 546 (73), 618, 1111 (397), 1163  
 Alexander, J. 1012, 1033 (84), 1036  
 Alexander, R.W. 977 (53), 995  
 Alfano, J.C. 694 (67), 741  
 Alfassi, Z.B. 826 (26), 827 (29, 33), 828 (42), 835  
 Alfheim, I. 1177 (29), 1212  
 Alfonso, E.F.S. 1067 (133), 1157  
 Algrim, D. 415 (205), 422  
 Algrim, D.J. 400 (127), 420  
 Ali, M. 954 (23), 970  
 Ali, M.H.H. 679 (86), 682  
 Ali, S.F. 896 (15), 940, 944 (60), 947, 948  
 Aliev, A.E. 322 (102), 334  
 Alison, C.E. 220 (95), 246  
 Al-Kaabbi, S.S. 448 (190), 474, 672 (32), 680  
 Al-Khalil, S.I. 611 (445), 612 (449), 626  
 Allan, J. 485 (47), 526  
 Allen, A.D. 510 (203), 530  
 Allen, F.H. 37 (56), 82  
 Allen, L.C. 1266 (166a), 1299  
 Allen, R.L.M. 628, 629, 636 (5), 659  
 Allenmark, S.G. 1089 (283), 1160  
 Alley, E.W. 991 (125), 997  
 Allinger, N.L. 3 (1a, 3a–d, 4a), 4 (1a, 4a, 5, 6, 43, 44), 5 (1a, 3a–d, 8), 6 (5), 7 (5, 6), 8 (5), 9 (5, 6), 10, 11 (5), 12 (5, 6), 15 (26a), 16 (5, 8, 26a), 20 (4a), 21 (4a, 6, 30b, 31), 22 (8, 31), 23 (5, 6, 30b), 24 (6, 30b, 34, 35), 25 (6), 26 (6, 30b), 27 (3a–d, 4a, 6, 30a, 30b), 28 (30b), 29 (1a, 30b, 42, 43), 30, 31 (43), 32 (31, 43), 33, 35 (44), 38 (6), 41 (5), 57 (30a, 86), 59 (98, 102), 61 (5, 6), 62, 64, 65 (108), 68 (114), 81–84  
 Allison, W.S. 1012 (75), 1036  
 Al-Mallah, K. 674 (53), 675 (54), 677 (53), 681  
 Almas, M. 1089 (288), 1161  
 Almerico, A.M. 630 (15), 633 (27), 659  
 Almond, H.R.Jr. 73 (124), 84  
 Al-Omran, F. 880 (83), 890, 952 (17), 970  
 Alonso, M.L. 1085 (266), 1160  
 Alonso, R.M. 1074 (183), 1158  
 Alonso Triana, J.L. 873 (62), 890  
 Alper, H. 595 (357), 624  
 Altenbach, H.-J. 165, 166, 182 (47), 202  
 Alti, G.de 192 (131), 204  
 Altona, C. 3–5 (1d), 15, 17 (25a, 25b), 29 (1d), 57 (92), 81, 83  
 Alty, A.C. 636 (34), 659  
 Alvarez, A.I. 1085 (266), 1160  
 Alvi, S.N. 1137 (524), 1165  
 Alwehaid, A.M. 1101 (353), 1162  
 Aly, M.M. 722 (153d), 743  
 Al Zamil, Z. 1106 (376), 1162  
 Amaglio, C. 1133 (496), 1165  
 Amano, M. 776 (66), 819  
 Amaral, L.do 1009 (59), 1036  
 Amatatsu, Y. 34 (46), 82  
 Amatore, C.M. 840, 848 (9), 855  
 Ambrosetti, R. 443 (155), 474  
 Ambros, S. 1022 (111), 1037  
 Amin, M. 509 (191), 530  
 Amin, M.R. 883 (91), 891, 968 (63), 971  
 Amino, U. 1087 (276), 1160  
 Ammon, H.L. 80 (135), 84, 91 (24), 93 (22–24), 99 (23, 24), 100 (95), 102, 103, 730 (181d), 733 (183a), 744



- Ammon, H.P.T. 1001 (32), 1035  
 Amri, H. 597 (371), 624  
 Amrollah-Madjadabadi, A. 607 (416), 625  
 Amster, I.J. 390 (71), 419, 1284 (194b), 1285 (194b, 197), 1290 (197), 1300  
 An, X.-W. 346 (19), 373  
 Anadon, A. 1025 (139), 1038  
 Ananthan, S. 605 (410), 625  
 Anantharamaiah, G.M. 119 (60), 154  
 Anantharaman, P.N. 845 (32a, 32b), 846 (37), 855, 856  
 Anda, T. 735 (190c), 745  
 Anders, E. 398 (108), 420  
 Andersen, K.K. 491, 503, 504, 515, 517 (96, 97), 527  
 Anderson, M.P. 1142 (561), 1166  
 Anderson, B.A. 119, 120 (59), 154  
 Anderson, D.A. 610 (437), 615 (460), 625, 626  
 Anderson, D.G. 710 (112), 742  
 Anderson, D.R. 807 (149b, 150), 808 (151), 821  
 Anderson, J.E. 43 (66), 50 (66, 74), 52 (74), 83  
 Anderson, K.E. 993 (145), 997  
 Anderson, L. 447 (180), 474  
 Anderson, L.O. 315 (63), 333  
 Anderson, M. 594 (347, 348), 623  
 Anderson, R.F. 329 (117), 334  
 Anderson, R.J. 1047 (44), 1155  
 Anderson, S.W. 1220 (234), 1296  
 Anderson, W.D. 60 (103d), 84  
 Andersson, P.G. 120 (61), 154  
 Ando, I. 322, 323 (96), 334  
 Ando, M. 1081, 1091 (234), 1159  
 Ando, T. 933 (47), 934 (50), 935 (53), 947, 948  
 Andose, J.D. 3–5, 29 (1c), 81, 356 (60), 375  
 Andraos, J. 658 (175), 663  
 Andrae, S. 553 (105), 618  
 Andreevskaya, O.I. 866 (36), 889  
 Andreoli, P. 549 (81), 618  
 Andresen, B.D. 1033 (199), 1039  
 Andrews, A.W. 1197 (103, 105), 1214  
 Andrews, G.E. 1176 (23), 1212  
 Andries, S.W. 1142 (560), 1166  
 Andrieux, C.P. 846 (35), 855  
 Andrussov, K. 491, 500 (107a), 527  
 Anet, F.A.L. 74 (125), 84, 353 (49), 375  
 Anghoni, L. 57 (89), 83  
 Aniello, A.d' 1089 (281), 1160  
 Annese, M. 426 (14), 470  
 Annulli, A. 1217 (15b), 1295  
 Anoniou, H. 978 (71), 995  
 Antipova, I.V. 347 (25), 373  
 Antoni, G. 932 (45), 947  
 Anulewicz, R. 454 (210), 475  
 Anumula, K.R. 1085 (258), 1160  
 Anunziata, J. 433 (81), 472  
 Anunziata, J.D. 440 (139–141), 463 (254), 464 (255), 467 (271), 473, 476, 1217, 1235–1237 (9), 1244 (110), 1245 (110, 115a, 115b, 116a, 116b, 117), 1246 (9, 115a, 115b, 116a, 116b, 117), 1247 (9, 115a, 115b), 1266 (115a, 115b), 1276 (9), 1295, 1298  
 Anvia, F. 308, 309 (42), 333, 384 (29), 407 (161b), 408 (167b), 417, 421, 524 (254), 531, 1238 (87a, 87b, 93), 1239 (87a), 1297  
 Ao, M.S. 737 (197), 745  
 Aoe, K. 730 (182b), 734 (188a), 744  
 Aoki, E. 587 (297), 622  
 Aoki, I. 1101 (352), 1162  
 Aoki, S. 537 (22), 617  
 Aoyama, H. 686 (29), 722 (159a), 740, 743  
 Aoyama, I. 432, 443 (72), 472, 1220 (44), 1296  
 Aoyama, T. 538 (34), 617  
 Aparicio, D. 573 (203), 620  
 Apasov, E.T. 609 (432), 625  
 Aped, P. 14 (22a, 22b), 15, 16 (22a, 22b, 26b, 26c), 17 (22a, 22b), 18 (22b), 19 (22a, 22b), 20 (22a, 27–29), 21 (22a), 43, 54 (67), 81–83  
 Apeloig, Y. 15, 16 (26b), 82, 161, 173 (19), 202, 208 (10), 244  
 Apoita, M. 718 (148), 743  
 Apte, M.G. 1177 (34), 1212  
 Arai, S. 718 (147), 743  
 Arai, T. 438 (125, 126), 473, 778 (74), 819  
 Arakawa, R. 260 (53), 292  
 Araki, T. 733 (183b), 744  
 Arata, Y. 396 (93), 419, 686 (29), 740  
 Arbus, A.M. 978 (71), 995  
 Arca, V. 1220 (29b), 1296  
 Archibald, T.G. 97 (60, 61), 101 (61), 103, 537 (25), 606 (414), 617, 625  
 Archinal, A.E. 130 (91), 155  
 Arcoria, A. 434 (88), 472  
 Arey, J. 1130 (484), 1131 (485), 1165, 1177 (35, 40–46), 1179 (47), 1212, 1213  
 Arfsten-Romberg, U. 763 (41), 818  
 Argay, G.Y. 94 (34), 102  
 Arimura, G.K. 1024 (129), 1025 (136), 1037, 1038  
 Arinch, A.K. 884 (96), 891  
 Armesto, D. 710 (118), 715 (129, 132), 716 (132–139), 717 (144), 718 (146, 148), 742, 743  
 Armstrong, D.R. 396 (92), 419  
 Armstrong, D.W. 1089 (284), 1090 (295), 1095 (326), 1160, 1161  
 Armstrong, H.E. 481 (12, 15), 484 (37), 525, 526  
 Armstrong, K.B. 1113 (404), 1163

- Arnal, J.F. 979 (75), 995  
 Arnaut, L.G. 409 (179), 422  
 Arnelle, D. 673 (44), 681  
 Arnelle, D.R. 674 (49), 681  
 Arnett, E.M. 381 (7), 397 (102), 400 (125),  
 410 (7), 411 (185), 416, 420, 422, 436 (116,  
 117), 473  
 Arnold, D.R. 704 (108), 742  
 Arnold, M.A. 1104 (365), 1162  
 Arnold, U. 1082 (239), 1160  
 Arnold, W. 975 (17, 18), 994  
 Arnold, W.P. 975 (6), 994  
 Arnould, J.C. 737 (195b, 195c), 745  
 Arp, J.A. 1119 (426), 1163  
 Arrigoni-Martelli, E. 1068 (136), 1157  
 Arrowsmith, R.J. 66, 67 (111), 84, 166, 168  
 (52), 179 (52, 93), 181 (96), 184, 185 (52),  
 202, 203  
 Artamkina, G.A. 457 (230), 475, 1217, 1220  
 (11b), 1295  
 Arthur, L.O. 1024 (126), 1037  
 Artonioletti, R. 777 (68), 819  
 Arumugasamy, N. 441 (143), 473  
 Arvanaghi, M. 510 (204), 530  
 Asada, H. 735 (190b), 745  
 Asada, K. 535 (11), 616  
 Asakuno, K. 1072 (159), 1158  
 Asano, Y. 1072 (162), 1158  
 Ascherl, M. 1003, 1005, 1007, 1009, 1011,  
 1020, 1022 (40), 1025 (133), 1029 (40),  
 1032 (189), 1035, 1038, 1039  
 Aschmann, S.M. 1176 (24), 1177 (41, 46),  
 1212, 1213  
 Asenjo, R.A. 1100 (350), 1162  
 Asensio, G. 568 (189), 620  
 Asfari, Z. 969 (64), 971  
 Ashfaqzaman, S. 93 (14), 102  
 Ashman, W.P. 6 (10), 81  
 Ashton, D.S. 976 (39), 977 (47), 978 (39, 47),  
 980 (39), 994, 995  
 Askew, S.C. 669 (26), 670 (26, 27), 680  
 Aslam, M.H. 501 (143, 144), 502 (143, 144,  
 146), 503, 520 (143, 144), 529  
 Asmus, K.-D. 828 (44), 830 (50, 52), 832 (55,  
 56), 835, 836  
 Aso, Y. 583 (276), 622  
 Asowata, C. 1127, 1143 (458), 1164  
 Ast, T. 250 (1), 291  
 Astephen, N. 1085 (265), 1160  
 Astier, A. 1133 (494), 1165  
 Astor, M.B. 1031 (182), 1039  
 Astorga, C. 592 (337), 623  
 Athalye, V.V. 1049 (66), 1156  
 Athanassakis, V. 1220 (30b), 1296  
 Atherton, S.J. 783 (91, 92), 820  
 Atkins, R.K. 544 (66), 617  
 Atkins, R.L. 877 (69), 890  
 Atkinson, E.R. 653 (143, 144), 662  
 Atkinson, R. 1131 (485), 1165, 1176 (24),  
 1177 (35, 40–46), 1179 (47), 1212, 1213  
 Attina, M. 232 (141), 247  
 Attolini, L. 1061 (91), 1156  
 Atwell, G.J. 329, 330 (111), 334  
 Aubeck, R. 1119 (427), 1163  
 Audier, H.E. 212 (43, 46–50), 216 (48–50, 58,  
 60, 61), 218 (85), 222 (43, 46–50, 58), 228  
 (130), 233 (145), 238 (130), 244–247, 1284  
 (191), 1300  
 Aue, D.H. 164 (33, 34), 165 (44), 166 (44,  
 50), 178 (34), 202, 232 (140), 236 (167,  
 168), 247, 386 (48a, 48b), 418  
 Aue, W.A. 1047 (31), 1155  
 Auman, B.C. 863 (24), 889  
 Aurrocochea, J.M. 546 (76), 554 (115a), 618,  
 619  
 Ausloos, P. 211 (37), 244  
 Auzou, G. 589 (308), 623  
 Avakyan, V.G. 413 (199), 422  
 Awen, B.Z.E. 611 (441), 625  
 Axelsson, B.S. 932 (44), 933 (46), 947  
 Axenrod, T. 281 (93), 293, 317 (67, 69), 318  
 (78), 333, 334  
 Ay, M. 552, 553 (103), 618  
 Ayediran, D. 1251 (128), 1276, 1278, 1290  
 (182), 1298, 1300  
 Ayesh, R. 1064 (103), 1157  
 Azam, F. 1048 (61), 1156  
 Azami, T. 262 (58), 292  
 Azazdoi, K.M. 993 (146), 997  
 Aziz, A. 1067 (130), 1157  
 Aziz, E. 1090 (294), 1161  
 Azoulay, M. 447 (178), 474, 806 (146), 821  
 Azzaro, M. 381 (13), 416  
 Baader, H. 1029 (159), 1038  
 Baar, B.L.M.van 215 (56), 216 (63c), 245  
 Baba, A. 543 (64), 617  
 Baba, K. 1122 (438), 1164  
 Babbage, C.A. 785 (95), 820  
 Babbitt, D. 1087 (277), 1160  
 Bacaloglu, R. 1217 (6a–c), 1295  
 Baccant, M. 1046 (9), 1155  
 Bachman, B.J. 767 (50b), 819  
 Bachman, G.B. 639 (61), 660  
 Bachovchin, W.W. 322 (103), 334  
 Bachrach, S.M. 80 (136b), 84  
 Backaert, J. 991 (124), 996  
 Backström, M. 171 (76), 203  
 Baddoo, P.A. 1145 (573, 576), 1147 (588),  
 1166, 1167, 1187 (82), 1189 (96, 98), 1214  
 Bader, R.F.W. 648 (115), 661  
 Badet, B. 592 (335), 623  
 Badger, G.M. 717 (143b), 743  
 Badr, M.Z.A. 722 (153d), 743

- Bae, J.Y. 1148 (600), *1167*  
 Baek, K.J. 987 (98), *996*  
 Baer, H.H. 482, 483, 507 (22), *525*  
 Baer, T. 234 (152), *247*, *259* (42), *262* (57), *292*  
 Bagno, A. 381 (5b), 405 (153), *416*, *421*, *657* (169), *662*, *1012* (78), *1036*  
 Bahsas, A. 570 (195), *620*  
 Baig, T. 588 (303), *623*  
 Baigent, D.R. 1067 (129), *1157*  
 Baik, W. 534 (5), *616*  
 Bailey, G.F. 151, *152* (160), *157*  
 Baitz, E.G. 851 (55), *856*  
 Bak, T. 286 (103), *293*, *775* (64), *819*  
 Baker, A.D. 160 (1, 2, 5, 15), 161, 163 (1), *171*, *175* (70), *201*, *203*  
 Baker, C. 160, 161, 163 (1), *201*  
 Baker, G.B. 1065 (105), *1157*  
 Baker, J.W. 485 (51), *526*  
 Baker, R.J. 433 (79), *472*  
 Baker, R.W. 143 (131), *156*  
 Baker, T.R. 1119 (429), *1163*  
 Baker, V.J. 57 (89), *83*  
 Bakker, N.A.C. 694 (65), *741*  
 Bakshi, R.K. 111 (37), *154*  
 Balaban, A.T. 968 (61), *971*  
 Balakrishnan, P. 313, 314 (58), *333*  
 Balakrishnan, P. 325, 326, 329 (110), *334*, *722* (158b), *743*  
 Balasubramanian, K.K. 270 (82), *293*  
 Balasubramanian, T. 270 (82), *293*  
 Balasubramanian, T.K. 1049 (66), *1156*  
 Balasubramanian, T.M. 590 (322), *623*  
 Baldeschwieler, J.D. 235 (162), *247*  
 Baldwin, J. 442 (148), *473*  
 Baldwin, M.A. 266 (70–72), *267* (71), *293*  
 Baldwin, R.P. 1073 (172, 173), 1093 (319), *1151* (619), *1158*, *1161*, *1167*  
 Ballard, R.E. 160 (6), 188 (120), *201*, *204*  
 Ballesteros, E. 408 (168), *421*  
 Balligand, J.L. 992 (127, 133), *997*  
 Ballini, R. 607 (415), 608 (423), 610 (436), *625*  
 Ballot, B.A. 975 (22), *994*  
 Bally, T. 833, 834 (66), *836*  
 Balon, M. 409 (169a, 169b), *421*  
 Bamberger, E. 639 (55), *660*, *867* (38), *889*, *1000*, *1019* (4), *1035*  
 Bamkole, T.O. 1219 (26), 1251 (128), *1262*, *1264* (148a), *1276* (148a, 182), *1278* (182), *1288* (148a), *1290* (182), *1295*, *1298–1300*  
 Ban, Y. 736 (194c), *745*  
 Banbury, F.A. 396 (92), *419*  
 Banerjee, A. 96, 97 (57), *103*  
 Banica, F.-G. 846 (38), *856*  
 Banjoko, O. 467 (272, 273), *476*, *1262* (150), *1264* (150, 154, 155), *1267* (170), *1269* (150), *1273*, *1274* (155), *1288* (170), *1299*  
 Banks, R.E. 303, 308 (37), *333*, *636* (34), *659*  
 Banks, T.C. 992 (130), *997*  
 Bannasch, P. 1185 (71), *1213*  
 Banthorpe, D.V. 859 (4, 7, 11), *888*, *889*, *897* (20), *905* (32), *947*  
 Bao, W. 557 (125), *619*  
 Bapat, G.S. 880 (82), *890*, *950* (6), *970*  
 Baracchi, A. 780 (82), *819*  
 Bar-Adon, R. 1001, 1007, 1008 (20), *1035*  
 Baranczyk, S.V. 729 (176a), *744*  
 Baranne-Lafont, J. 580 (252b), *621*  
 Baranski, A. 561 (142), *619*  
 Barany, G. 564 (167), *620*  
 Barbella, R. 1175 (16), *1212*  
 Barber, C.M. 977 (51), *995*  
 Barber, M. 234 (157), *247*  
 Barbetti, J.F. 563 (164), *620*  
 Barboni, L. 608 (426b), *625*  
 Barbour, R.K. 1133 (503), *1165*  
 Barbucci, R. 389 (60), 390 (62), *418*  
 Barceló, D. 1047 (52), 1068 (139), 1078, 1079 (195), *1156*, *1158*, *1159*  
 Barchiesi, E. 398 (106, 112), *420*  
 Barcza, L. 431 (61, 62), *471*  
 Barczynski, P. 430 (54), *471*  
 Bard, A.J. 838 (5), *855*  
 Bardin, V.V. 1137 (525), *1165*  
 Bardoli, R.S. 234 (157), *247*  
 Barek, J. 1125 (441), 1128 (466), 1135 (516), *1138* (529, 531), *1148* (598), *1164–1167*  
 Bares, J.E. 398 (115), 410 (182), *420*, *422*  
 Bargar, T.M. 577 (219), *621*  
 Bar-Haim, A. 607 (417), *625*  
 Baricos, W.H. 673 (42), *681*, *975* (25, 27), *994*  
 Barker, J. 348 (30b), *373*  
 Barkley, R.M. 1047 (51), *1155*  
 Barltrop, J.A. 685 (9, 11), *740*  
 Barluenga, J. 396 (88), *419*, *568* (189), *576* (213), *620*, *621*  
 Barnes, C.E. 950 (13), 965 (52), *970*, *971*  
 Barnes, D. 536 (16), *617*  
 Barnes, D.M. 119, 120 (59), *154*  
 Barnett, D.J. 669, 670 (26), *672* (37), *680*  
 Barney, C.L. 563 (157), *577* (219), *620*, *621*  
 Baron, V. 494, 507 (121), *528*  
 Barone, V. 389 (60), 390 (62), *418*  
 Barra, D. 1083 (250), *1160*  
 Barra, M. 658 (175), *663*  
 Barrett, A.G.M. 604 (399), *625*  
 Barrett, J. 669 (18, 23), *680*  
 Barrio, J.R. 652 (139, 140), 653 (140), 656 (165), *662*  
 Barron, D. 152 (161), *157*  
 Barron, L.D. 150 (157), 151 (158), 152 (163–166), 153 (165, 166, 168), *157*

- Barrow, P. 879 (77), 890  
 Barrow, R.P. 240 (186), 248  
 Barry, B.K. 975 (20, 26, 27), 994  
 Barry, J.E. 430 (55), 440 (55, 137), 471, 473  
 Bartell, L.S. 3–5, 29 (1e), 81  
 Barth, T. 436 (113), 473  
 Bartle, K.D. 1176 (23), 1212  
 Bartmess, J.E. 235, 236 (166), 247, 255 (24),  
 292, 382, 385 (22), 398 (115), 410 (182),  
 411 (193), 417, 420, 422  
 Bartoli, G. 608 (425, 426a, 426b), 625  
 Barton, D. 414 (200), 422  
 Barton, D.H.R. 538 (36, 37), 548 (80), 584  
 (278, 279), 615 (461), 617, 618, 622, 626,  
 735 (191), 745  
 Bartoszak, E. 436 (114), 473  
 Bartsch, H. 1066 (115), 1147 (591), 1157,  
 1167, 1182 (62), 1189 (102), 1213, 1214  
 Baruah, J.B. 569 (190), 620  
 Basil, A. 133 (97), 155  
 Bass, V.-M. 175 (82), 203  
 Bassani, D.M. 686 (24, 27, 28, 30, 31), 687  
 (31), 699 (24, 28), 700 (24, 100), 701 (28,  
 100), 706 (24, 28), 740, 742  
 Bates, F.N. 673 (42), 681  
 Bates, J.N. 673 (46), 681  
 Bates, W.W. 426 (16), 470  
 Batlle, A. 846 (35), 855  
 Batt, L. 339, 340 (8), 357 (8, 68), 360 (8),  
 372, 376  
 Battaglia, L.P. 445 (164), 474  
 Battioni, P. 572 (202), 620  
 Battiste, D.R. 192 (133), 204  
 Batts, R.D. 310 (45), 333  
 Baudy-Floc'h, M. 544 (69), 618  
 Bauer, J.A. 673 (47), 681  
 Bauer, L. 405, 407 (149), 421  
 Bauer, P.I. 1024 (124), 1037  
 Bauld, N.L. 727 (167), 744  
 Baum, K. 97 (60, 61), 101 (61), 103, 537 (25),  
 606 (414), 617, 625  
 Baum, M. 992 (131), 997  
 Baumann, K. 582 (269), 622  
 Baumann, R.A. 1116 (415), 1163  
 Baumann, V. 603 (392), 624  
 Baumgaertel, H. 164, 166, 168 (32), 202  
 Baumstark, A.L. 71 (120), 84, 313, 314 (58),  
 333  
 Bausch, M.J. 400 (129), 420  
 Bayeroju, I.A. 1264, 1273, 1274 (155), 1299  
 Bayfield, R.F. 735 (190a), 745, 1012 (80),  
 1036  
 Baylis, S.A. 992 (132, 134, 135), 997  
 Bayliss, N.S. 641 (71, 75), 655 (71), 660  
 Bazin, M. 781 (83), 819  
 Bazzani, F. 1217 (15a), 1295  
 Beagley, B. 7 (12), 81  
 Bean, G.P. 408 (167a), 421  
 Beaten, A. 388 (58), 418  
 Beauchamp, A.L. 100 (88), 103  
 Beauchamp, J.L. 178, 188 (92), 192 (132),  
 203, 204, 235, 236 (165), 247, 353 (46),  
 375  
 Beaulie, B.B. 1032 (196), 1039  
 Beck, K. 186 (110), 204  
 Becker, A.R. 871 (51), 890  
 Becker, E.D. 302 (20), 317 (67), 332, 333  
 Becker, G. 396 (91b), 419, 1241 (103c), 1262,  
 1264 (103c, 147c), 1298, 1299  
 Becker, H.-D. 779 (75), 819  
 Becker, H.G.O. 649 (119), 661  
 Beckhaus, H.-D. 184, 186 (106), 204  
 Beckwith, A.L.J. 655 (160–163), 662  
 Beckwith, K.R.Jr. 579 (229), 621  
 Bedford, C.D. 606 (412), 625  
 Bedi, G. 572 (202), 620  
 Beecroft, R.A. 693 (56), 741  
 Beer, J.M. 1175 (18), 1212  
 Begley, D.J. 1079 (207), 1159  
 Behnert, S. 1116 (406), 1163  
 Beinert, W.D. 1082 (235, 236), 1159, 1160  
 Bekki, K. 165, 166 (23), 202  
 Bekkum, H.van 489, 490 (83), 527  
 Bélaadi, S. 357 (69), 376  
 Beland, F.A. 1012 (85), 1031 (180), 1033 (85),  
 1036, 1039  
 Belanger, J.M.R. 1134 (506), 1165  
 BelBruno, J.J. 226 (117), 246  
 Belder, A.J.de 673 (40, 41), 681  
 Beletskaya, I.P. 457 (230), 475, 1217, 1220  
 (11b), 1295  
 Belevsky, V.N. 824 (2, 3), 835  
 Belhassen, L. 992 (133), 997  
 Bell, H.M. 638 (49), 660  
 Bell, R.A. 88, 90 (8), 102  
 Bell, R.P. 508 (186), 529  
 Bellanato, J. 453 (204), 475  
 Bellard, S. 37 (56), 82  
 Bellas, M. 698 (92), 742  
 Bello, J.M. 1101 (354, 355), 1162  
 Bellobono, I.R. 447 (187), 448 (188), 474  
 Bellucci, G. 443 (155), 474  
 Bellus, D. 733 (184), 744  
 Belmont, M.R. 97 (66), 103  
 Belopushkin, S.I. 824 (2, 3), 835  
 Belostotskii, A.M. 43, 54 (67), 55, 56 (79), 83  
 Belot, G. 845 (29), 855  
 Belsler, W.L.Jr. 1176 (27), 1212  
 Beltrame, P.L. 448 (188), 474  
 Belyaev, E.Y. 636 (35), 659, 1000, 1009, 1019  
 (7), 1035  
 Belyaev, E.Yu. 515 (231), 530  
 Benali, B. 1136 (522), 1165  
 Benati, L. 1012, 1013 (79), 1036

- Ben Ayed, T. 597 (371), 624  
 Benbrook, C.H. 648 (110), 661  
 Bencini, A. 391 (64–66), 396 (101), 418–420  
 Bencivenni, L. 435 (100), 472  
 Bender, C. 29 (42), 82  
 Bene, J.E.del 1266 (166b, 168), 1267 (168), 1299  
 Ben-Efraim, D.A. 589 (313), 623  
 Benemansky, V.V. 1184 (66), 1213  
 Benesch, R. 1003 (46), 1036  
 Benesch, R.E. 1003 (46), 1036  
 Benet, L.Z. 1142 (562), 1166  
 Benito, C.G. 1088 (279), 1160  
 Benko, S. 1141 (553), 1166  
 Bennani, Y.L. 125 (77), 155  
 Benneche, T. 579 (234), 621  
 Bennet, R.A. 257 (36), 292  
 Benson, R.L. 1045 (5), 1155  
 Benson, S.C. 130 (89), 155  
 Benson, S.W. 221 (108), 246, 343 (16), 354 (53), 372, 375  
 Benson, W.R. 240 (186), 248  
 Bente, P.F.III 209 (27), 244  
 Benthem, R.A.T.M.van 568 (187), 620  
 Bentley, T.W. 1220 (46), 1296  
 Beranova, S. 240–242 (189), 248  
 Beresford, K.J.M. 569 (192), 620  
 Berestovitskaya, V.M. 604 (401), 625  
 Berg, I.E. 1217 (13a), 1295  
 Berg, U. 432 (71), 472, 938 (55), 948  
 Bergander, K. 396 (87), 419  
 Berger, S. 1004 (42), 1035  
 Bergmann, H. 188, 189 (125, 127), 191, 192 (125), 204  
 Berkowitz, J. 160 (7), 201, 360 (78), 376, 382 (23), 417  
 Berliner, L.J. 1022 (116, 117), 1037  
 Bermejo, E. 1138 (530), 1166  
 Bernasconi, C.F. 409 (176, 178), 410 (184), 415 (204), 416 (211), 421, 422, 465, 466 (263), 476, 508 (187), 529, 1216 (1c, 3a, 3b), 1217 (3a, 3b), 1218 (3a, 3b, 18), 1219 (1c), 1220 (1c, 3b), 1235 (1c), 1241 (103c), 1242 (108), 1244, 1248, 1250 (1c), 1262 (103c, 147c), 1264 (18, 103c, 147c), 1266 (163a, 163b), 1268 (163a), 1274 (1c), 1275 (108), 1290 (1c), 1295, 1298, 1299  
 Bernauer, K. 717 (141), 743  
 Berndt, A. 291 (119), 294  
 Berne, F.D. 1079 (208), 1159  
 Bernheim, M. 552 (104), 618  
 Bernstein, M.A. 550 (86a), 574 (206), 618, 621  
 Bernstein, M.D. 563 (154), 619  
 Bernstein, M.P. 396 (91e, 94), 419  
 Berova, N. 139 (116, 117), 141 (116, 117, 119), 142 (121), 143 (126–130), 156  
 Berr, S. 1119 (435), 1164  
 Berrier, C. 609 (433), 625  
 Bersier, P. 634 (29), 659  
 Berthelot, M. 381 (17d, 17e), 395 (82–84), 417, 419, 451 (195), 474, 505 (158), 524 (254), 529, 531, 1222 (51), 1238 (51, 87b), 1296, 1297  
 Berthod, A. 1089 (284), 1160  
 Bertolasi, V. 96 (51), 103, 426 (15), 435 (103), 470, 472  
 Bertoli, C. 1178 (49), 1213  
 Bertolo, P.L. 1074 (177, 178, 180), 1158  
 Bertonnello, R. 175 (83), 203  
 Bertran, J. 754 (14, 15), 758 (31), 817, 818  
 Bertrand, G. 592 (334, 338), 623  
 Bertrand, M. 252, 253, 262 (11), 291  
 Berube, L.R. 1032 (194), 1039  
 Bess, J.W. 1024 (126), 1037  
 Besse, J. 650 (124), 661  
 Bestmann, H.J. 553 (108a, 108b), 618  
 Bethell, D. 1246 (121), 1298  
 Betner, I. 1082 (237), 1160  
 Betschart, C. 564 (169), 620  
 Betteridge, D. 160 (2), 192 (134), 201, 204  
 Bettinetti, G.F. 708 (110), 742, 758 (29), 818  
 Beugelmans, R. 607 (416), 625  
 Beutler, E. 1022 (118), 1037  
 Beveridge, K.A. 784 (94), 820  
 Bey, P. 576 (218), 621  
 Beyerman, H.C. 130, 131 (92), 155  
 Beyersbergen van Henegouwen, G.M.J. 1026 (141), 1038  
 Beynon, J.H. 206, 207 (2a, 2f), 217 (77), 233 (2a, 2f, 146), 243, 245, 247, 250 (1), 251 (4), 252 (11), 253 (10, 11), 262 (11), 264 (63), 265 (67, 69), 266 (73), 267 (76), 291, 293  
 Bhaskar, K.R. 1044 (3), 1154  
 Bhattacharjee, S.K. 93 (22, 23), 99 (23), 102  
 Bhattacharyya, K. 694 (66), 738 (199), 741, 745  
 Bhattacharyya, S. 562 (151), 563 (161), 619, 620  
 Bhattacharyya, S.N. 833 (68), 836  
 Bhongle, R.K. 876 (68), 890  
 Bhuyan, P.J. 569 (193), 620  
 Biaglow, J.E. 1031 (182), 1039  
 Bianchi, A. 391 (63–66), 396 (101), 418–420  
 Bianchini, R. 443 (155), 474  
 Biase, D.de 1083 (250), 1160  
 Biasutti, M.A. 440 (141), 473  
 Bickley, A.N. 1108 (390), 1163  
 Bida, G.T. 652, 653 (140), 656 (165), 662  
 Biedrzycka, Z. 310, 311 (50), 333  
 Biekofsky, R.R. 438 (127), 473  
 Bielski, B.H.J. 829 (47), 836  
 Biemann, K. 206, 207, 233 (2b), 243

- Bieniek, A. 560 (136), 619  
 Bieri, G. 166, 169 (51), 202  
 Bieri, J.H. 717 (142), 743  
 Bigeleisen, J. 894 (6–8), 946, 947  
 Bigelow, S.S. 97, 101 (61), 103, 606 (414), 625  
 Bigg, D.C.H. 592 (334, 338), 623  
 Biggi, G. 1220 (28), 1295  
 Biles, C. 584 (287), 622  
 Billar, T.R. 979 (78), 995  
 Billedeau, S.M. 1146 (583), 1167  
 Billeter, M. 60 (103b), 83  
 Billiar, T.R. 979 (76), 995  
 Billii, L. 549 (81), 618  
 Billington, A.P. 769 (56), 819  
 Billups, W.E. 589 (312), 623  
 Bilodeau, M.T. 119, 120 (59), 154  
 Binkley, J.S. 407 (163), 421  
 Binkley, R. 764 (42), 818  
 Binsch, G. 317 (70), 333  
 Biradha, K. 452 (199), 475  
 Birch, D. 739 (202, 203), 745  
 Bird, I.A. 1027, 1028 (154), 1038  
 Birkall, T. 400 (124a), 420  
 Birks, J.W. 1047 (42), 1155  
 Birnbaum, G.I. 453 (205), 475, 866 (35), 889  
 Birnbaum, S.M. 107 (26), 154  
 Birner, G. 1026 (147), 1038  
 Bischof, P. 184 (102), 203  
 Bischoff, L. 566 (178), 620  
 Bishop, S.W. 650 (128), 661  
 Biswas, G.K. 738 (200b), 745  
 Biswas, S.S. 578 (225), 621  
 Bitsch, A. 1022 (111), 1037  
 Bjerrum, N. 483 (30), 526  
 Bjornholm, T. 212 (41, 42), 213 (42), 214, 216 (41, 42), 225 (42), 244  
 Blaauboer, B. 1097 (335), 1162  
 Black, T.M. 148 (147), 152 (147, 164), 157  
 Blackburn, E.V. 710 (113), 742  
 Blackstock, S.C. 440 (142), 473, 854 (66), 856  
 Blair, L.K. 442 (148, 150), 473  
 Blaive, B. 4, 13 (16), 81  
 Blanchet, D. 765 (46), 818  
 Blanco-Gomis, D.D. 1081 (227), 1159  
 Blangey, L. 628, 634 (4), 658  
 Blank, D.H. 595 (354), 624  
 Blank, H.U. 870 (48), 890  
 Blankespoor, R.L. 675 (62), 681  
 Blasig, I.E. 1080 (225), 1159  
 Blasko, A. 1217 (6a), 1295  
 Bliznyuk, A.A. 1285, 1290 (197), 1300  
 Bloch, D.B. 977, 979 (50), 995  
 Bloch, K.D. 977, 979 (50), 995  
 Bloomfield, C. 880 (84), 890, 958 (48, 49), 971  
 Blough, N.V. 810 (156), 821  
 Blount, H.N. 843, 844 (23), 855  
 Blum, L. 902 (25), 947  
 Blum, W. 268, 269 (79), 293  
 Blundell, N.J. 1045 (5), 1155  
 Blunt, J.W. 954, 963 (31), 971  
 Boaretto, A. 1147 (592), 1167  
 Bobbit, D.R. 1069 (145), 1158  
 Bobrowski, K. 832 (54–56), 836  
 Bobylev, V.A. 1240 (101), 1297  
 Bocelli, G. 100 (91), 103  
 Boche, G. 396 (99, 100), 413, 414 (197), 420, 422, 551 (95), 552 (104), 618  
 Bochu, C. 724 (161), 727 (168), 743, 744  
 Bock, C.W. 452 (201), 475  
 Bock, H. 160 (11), 163 (27), 164 (27, 32, 35, 38, 43), 165 (27, 38), 166 (27, 32, 38, 43), 167 (35), 168 (27, 32, 38), 188, 189 (127), 201, 202, 204  
 Bockman, M. 790 (111d), 820  
 Bockman, T.M. 455 (216), 475  
 Bodenhausen, G. 297 (11), 332  
 Bodor, N. 170 (65), 203  
 Boduszek, B. 865 (27), 889, 930 (42), 947  
 Boegesoe, K.P. 62, 63 (109), 84  
 Boehm, K.A. 1047 (28), 1155  
 Boens, N. 695 (71), 741  
 Boer, Th.J.de 262, 263 (59), 292, 484 (34), 526  
 Boese, M. 992 (140), 997  
 Boese, R. 165, 166 (49), 168 (61), 202, 398 (108), 420  
 Boeyens, J.C.A. 58 (96, 97), 83, 453 (207, 208), 475  
 Boga, C. 564 (168), 620  
 Bogaard, M.P. 151 (158), 157  
 Boggs, J.E. 25 (39, 40), 82  
 Bohlmann, F. 425 (6), 470  
 Bohm, H.B. 1133 (498), 1165  
 Böhm, S. 348 (28), 373  
 Bohme, D.K. 178 (91), 203, 235 (160), 247, 380, 383, 390 (2), 416  
 Böhme, E. 977 (45, 48), 983 (86), 984 (45), 995, 996  
 Bohme, H. 443 (154), 474  
 Böhn, K.H. 413, 414 (197), 422  
 Boichinova, E.S. 1137 (526), 1141 (554), 1166  
 Boivin, J. 613 (451), 626  
 Boje, K.M. 977 (55), 995  
 Bojensen, G. 390 (69, 72), 419  
 Bojić, V.D. 563 (160), 620  
 Bokii, N.G. 636 (39), 659  
 Bolin, G. 573 (204), 620  
 Bollyky, L.J. 1105 (368), 1162  
 Bolm-Audorff, U. 1185 (72), 1213  
 Bologa, U.L. 968 (61), 971  
 Bolton, J.L. 1032 (187), 1039  
 Bolton, J.R. 739 (206), 745

- Bolz, W. 763 (41), 818  
 Bon, E. 592 (334, 338), 623  
 Bonamartini, A.C. 426 (14), 470  
 Bond, A.M. 851 (53), 856  
 Bondi, A. 78 (132), 84  
 Bonham, G.A. 405 (151a), 421  
 Bonilha, J.B.S. 753, 757 (13, 27), 817, 818  
 Bonincontro, A. 1126 (451), 1164  
 Bonnat, M. 536 (19), 617  
 Bonneau, P.R. 46, 47 (71), 83  
 Bonneau, R. 688 (35, 36), 695 (74), 740, 741  
 Bonnet, J.J. 654 (149), 662  
 Bonnett, R. 317 (65), 333, 672 (32), 680  
 Booms, R.E. 1009 (65), 1036  
 Boone, C.D.G. 90, 93 (19), 102  
 Booren, A.M. 1189 (95), 1214  
 Boothby, C.St.J. 181 (96), 203  
 Boppana, V.K. 1079 (210), 1159  
 Borah, H.N. 608 (427), 625  
 Borch, R.F. 563 (154), 619  
 Borchers, F. 240 (184), 248  
 Bordwell, F.G. 308 (41), 333, 381 (6a, 6b), 387 (52b), 398 (115), 400 (127, 129), 401 (133), 402 (131–133, 139), 403 (137, 140, 141), 404 (143, 144), 407 (159), 409 (6b), 410 (182, 183), 413 (198), 415 (205), 416, 418, 420–422, 436 (116, 117), 473, 505 (163), 508 (183), 529, 1228, 1232, 1235 (76), 1297  
 Bories, G. 1024 (128), 1037  
 Borisenko, K.B. 452 (201, 202), 475  
 Borkent, J.H. 695 (70), 741  
 Bornhop, D.J. 1093 (316), 1161  
 Borossay, J. 164 (37), 202  
 Borrull, F. 1083 (246), 1160  
 Bors, D.A. 399 (117, 118), 420  
 Borsa, F. 1083 (250), 1160  
 Boryak, O.A. 1119 (432), 1164  
 Bos, H.J.T. 718 (145), 734 (185a), 743, 744  
 Bos, R.P. 1129 (475), 1132 (489), 1164, 1165  
 Bosch, E. 792 (115), 820, 1225 (62, 65, 66), 1226, 1227 (62), 1228 (75), 1297  
 Bosch, L.C. 1177 (36), 1212  
 Bosch, T. 803 (143), 821  
 Bosco, M. 608 (426a), 625  
 Bosi, M. 464, 467, 468 (259), 476, 1281 (188), 1300  
 Bosma, N.L. 234, 238, 240–243 (158), 247  
 Bosnich, B. 151 (159), 157  
 Bostick, J.M. 1080 (220), 1159  
 Boszczyk, W. 775 (64), 819  
 Bothelo, L.H. 1005 (51), 1036  
 Bott, K. 639 (63), 660  
 Bottaro, J.C. 605 (405), 606 (412), 625  
 Botting, H.G. 1085 (262), 1160  
 Boubaker, T. 416 (212), 422, 509 (188), 529  
 Boucetta, A. 1136 (522), 1165  
 Bouchoux, G. 216 (61), 231 (134), 232 (142), 245, 247, 260 (47, 48), 292, 1284 (191, 192), 1300  
 Boudrant, J. 1069 (142), 1158  
 Bougeard, D. 457 (227), 475  
 Bouhedir, K.H. 1071 (152), 1158  
 Bouma, W. 208 (8), 244  
 Bouma, W.J. 208 (12, 13, 19), 209 (22, 25), 210 (19), 211 (13, 19), 214 (12, 52), 215 (55), 235 (19), 244, 245  
 Bouquant, J. 590 (315), 623  
 Bourasseau, S. 78, 79 (133), 84  
 Bourie, J.R. 457 (227), 475  
 Bourn, A.J.R. 319 (81), 334  
 Bourrel, M. 844 (25b), 855  
 Boutha, J.R. 845 (31), 855  
 Bovill, M.J. 60 (103c), 84  
 Bowden, K. 509 (192), 530, 1217 (14), 1295  
 Bowen, D. 217 (74, 75), 218, 221 (75), 245  
 Bowen, R.D. 216 (63e, 66, 67), 218 (87, 88), 220, 221 (99), 223 (113), 224 (88), 225 (116), 226 (118, 121), 227 (118, 126, 127, 129), 228, 229 (118, 127, 129), 230 (127, 132), 231 (136, 138, 139), 232 (138, 144), 236, 237 (174), 238 (118, 174, 178), 239 (178), 241 (118, 132), 245–248, 284, 285 (101), 293  
 Bowers, M.T. 164 (33, 34), 165 (44), 166 (44, 50), 178 (34), 202, 232 (140), 236 (167, 168), 247, 386 (48a, 48b), 418  
 Bowley, H.J. 266 (72), 293  
 Bowman, C.T. 1174 (5), 1212  
 Bowman, W.R. 601 (384a, 384b), 611 (444, 445), 612 (446–450), 624–626, 1019 (93), 1037  
 Bowyer, W.J. 850 (52b), 856  
 Boyd, A.A. 360 (80), 377  
 Boyd, D.B. 3–5, 29 (1b), 81, 442 (147), 473  
 Boyd, M. 329 (111, 117), 330 (111), 334  
 Boyd, P.D.W. 329, 330 (111), 334  
 Boyd, R.J. 411 (190, 191), 422  
 Boyd, R.K. 253 (10), 291  
 Boyd, S.R. 1049 (64), 1156  
 Boyer, J.H. 606 (413), 625, 1000, 1007, 1009, 1011 (2), 1035  
 Boykin, D.W. 71 (120), 84, 297 (8), 313, 314 (58), 315 (64), 325, 326, 329 (110), 332–334  
 Boyland, E. 1000 (8), 1035  
 Boyle, M. 1145 (576), 1167  
 Boyle, P.H. 412, 413 (196), 422  
 Bozhkova, N. 139, 141 (116, 117), 143 (126), 156  
 Bracken, C. 712 (122), 742  
 Bracuti, A.J. 87, 88 (7), 102

- Bradamante, S. 397 (104, 105), 398 (106, 109a, 109b, 110–112), 400 (105), 420  
 Bradamante, S. 509 (193–195), 530  
 Bradfield, A.E. 486 (61, 62, 64), 526  
 Bradley, R.B. 317 (67), 333  
 Bradley, S.J. 1047 (41), 1155  
 Bradshaw, T.P. 1019 (94), 1026 (142), 1037, 1038  
 Braga, M. 184 (100), 203  
 Bragheti, M. 99 (79), 103  
 Brahmi, R. 609 (433), 625  
 Brammer, R. 171 (76), 203  
 Bramwell, M.R. 330 (126), 335  
 Branca, J.C. 410 (183), 413 (198), 422  
 Branch, G.E.K. 499 (139), 515 (229), 520 (139), 528, 530  
 Branch, M.C. 1174 (4), 1212  
 Branchflower, R.V. 1025 (132), 1038  
 Brandsen, J. 99 (86), 103  
 Brandt, P.A.van den 1188 (86), 1214  
 Bratton, A.C. 1087 (277), 1160  
 Brauchle, C. 1119 (427), 1163  
 Brauman, J.I. 220 (105), 246, 385 (34a, 34b), 398 (113a), 401 (136), 417, 420  
 Braun, S. 1004 (42), 1035  
 Braverman, S. 1012, 1015 (82), 1036  
 Bravo, C. 644 (92), 660  
 Bray, D.D. 94 (35), 102  
 Brechbiel, M. 897 (22), 904 (26), 905 (29), 947  
 Breckenridge, A.M. 1028 (156), 1038  
 Brede, O. 649 (119), 661  
 Bredig, G. 483 (29), 526  
 Bredt, D.S. 976 (42–44), 977 (44), 978 (43, 69), 983 (43), 984 (90), 992 (42, 43, 143), 995–997  
 Brega, A. 1133 (496), 1165  
 Breganza, J.M. 1097 (334), 1162  
 Breichbiel, M. 860 (17), 861 (17, 19), 863 (23), 889  
 Breindhal, T. 390 (72), 419  
 Breitmaier, E. 302, 303 (22), 332  
 Brel, V.K. 607 (419), 625  
 Bremser, W. 310 (47), 333  
 Brennan, J.G. 43 (68), 83  
 Brent, D.A. 290 (118), 294  
 Bresse, M. 398 (116), 420  
 Breuer, E. 552 (100a), 565 (172), 618, 620  
 Breuer, M. 1069 (143), 1158  
 Brevis, D.M. 1262, 1264 (147b), 1299  
 Brewis, D.M. 434 (85), 472, 511 (211, 212), 530, 1241, 1262, 1264 (103b), 1298  
 Brewster, J.H. 106 (9), 137 (108), 153, 156  
 Brezden, C.B. 1032 (191), 1039  
 Brice, M.D. 37 (56), 82  
 Bridier, I. 1177 (45), 1213  
 Brien, D.J. 166 (53), 202  
 Brioux, J.A. 1216, 1217, 1235 (4a, 4b), 1295  
 Brieua, R. 592 (336), 623  
 Briggs, A.J. 99 (84), 103  
 Briggs, J.M. 320 (91), 331 (128), 334, 335  
 Brinck, T. 408, 409 (170), 421  
 Bringas, P. 1025 (139), 1038  
 Brink, C.P. 407 (158b, 158c), 421  
 Brinkman, U.A.T. 1105 (369), 1134 (511), 1162, 1165  
 Brintzinger, H.H. 115 (49), 154  
 Brito-Palma, F.M.S. 57 (89), 83  
 Britton, D. 98 (73), 103  
 Brizgys, M.W. 1100 (348), 1162  
 Brock, C.P. 442 (150), 473  
 Brock, L.v.den 1012 (77), 1036  
 Brodalla, D. 86, 88 (4), 102  
 Broitman, F. 827 (40), 835  
 Bromidge, S.M. 589 (310), 623  
 Bromilow, J. 303 (26, 27), 310, 311 (44), 332, 333, 504, 505 (155), 529  
 Brooke, D.N. 416 (213), 422  
 Brooke, G.M. 635 (30), 659  
 Brorson, T. 1063 (97), 1157  
 Broucier, S. 106 (6), 153  
 Brouwer, A.M. 446 (171, 173), 474  
 Brown, A.S. 392 (73), 419, 673 (40), 681  
 Brown, B.E. 88, 90 (8), 102  
 Brown, C.J. 90, 93 (18), 96, 97 (57), 102, 103  
 Brown, D.S. 612 (448, 450), 626  
 Brown, H.C. 114 (46), 117 (54), 118, 119 (55), 154, 488, 489 (82), 527, 552 (100a, 100b), 565 (172, 176), 618, 620  
 Brown, J.H. 48 (72), 49 (73), 83  
 Brown, L. 1176 (25), 1212  
 Brown, P.S. 590 (322), 623  
 Brown, R.S. 171, 174, 184, 188 (67), 203  
 Brownawell, M.L. 861, 863 (21), 877 (72), 889, 890, 911 (34), 915 (36), 918, 920 (37), 947  
 Browne, S. 1068 (140), 1158  
 Brownell, R.M. 497 (133), 528  
 Brownlee, R.T.C. 303 (26, 27), 310, 311 (44), 312 (56), 313 (56, 57), 314, 315 (57), 332, 333, 490 (92), 491, 503 (99), 504 (92, 154, 155), 505 (155), 515, 518 (154), 521, 522 (92), 527, 529, 642 (83), 660  
 Brownson, D.M. 1066 (120), 1157  
 Brownstein, S. 877 (73), 890  
 Broxton, T.J. 1220, 1222 (31a, 31b), 1296  
 Bruckner, H. 1090 (291), 1161  
 Bruckner, S. 53 (77), 83  
 Brudel, M. 1080 (225), 1159  
 Brugger, E. 762 (38a, 38b), 818  
 Bruguerolle, B. 1061 (91), 1156  
 Bruhlmann, U. 810, 811 (159), 821  
 Bruce, T.C. 535 (12), 616  
 Bruins, A.P. 1012, 1033 (85), 1036



- Brundle, C.R. 160 (1, 5), 161, 163 (1), 201  
 Bruneau, C. 591 (327), 598 (374), 623, 624  
 Brunet, J.-J. 587 (299), 588 (302a, 302b), 622, 623  
 Bruni, P. 441 (146), 473  
 Brunmark, P. 1081 (230), 1159  
 Brunnemann, K.D. 1150 (607–610, 612), 1151 (613, 614, 616, 617), 1167  
 Bruno, A.E. 1093 (315, 316), 1161  
 Brunton, G. 955 (40), 971  
 Bryant, G.L.Jr. 590 (317), 623  
 Bryant, L.R.B. 730 (181e), 744  
 Bryant, M.S. 1021, 1030 (103), 1037  
 Bryant, T. 677 (74), 678 (79), 679 (86), 681, 682  
 Bryce, M.R. 456 (222), 475, 594 (347, 348), 623  
 Bryce-Smith, D. 685, 686 (7), 698 (92), 740, 742  
 Brycki, B.E. 560 (136), 619  
 Bryker, W.J. 640 (68), 660  
 Brynmor Jones 486 (61–63), 526  
 Brzezinski, B. 435 (108–112), 472, 473  
 Brzezinski, J. 593 (343), 623  
 Bu, M. 1024 (125), 1037  
 Buchachenko, A.L. 649 (118), 661  
 Buchanan, M.V. 1047 (49), 1155  
 Buchel, T. 717 (142), 743  
 Buchko, G.W. 833 (70), 836  
 Buchler, N. 733 (184), 744  
 Buchner, E. 654 (146), 662  
 Buchwald, S.L. 115 (47, 48, 51), 116 (51, 52), 117 (48, 52), 154, 546 (74a, 74b), 577 (220), 584 (282), 618, 621, 622  
 Buck, H.M. 648 (112), 661  
 Buckee, G.K. 1047 (27), 1155  
 Buckingham, A.D. 6 (9), 81, 150 (157), 151 (158), 157  
 Buckingham, J. 106, 113 (5), 153  
 Buckley, T.J. 211 (38), 244  
 Bückmann, A.F. 1103 (363), 1162  
 Buděšínský, M. 522 (240, 241), 531  
 Budzikiewicz, H. 206, 207, 233 (2c, 2e), 243  
 Buechele, B. 1146 (584), 1167  
 Bug, R. 767 (53), 819  
 Buga, G. 976 (32), 994  
 Buga, G.M. 974 (2), 993 (144), 994, 997  
 Bugaj, A. 1140 (551), 1166  
 Buglass, J. 405 (150a), 421  
 Buijten, J.C. 1063 (101), 1157  
 Buist, G.J. 381 (20b), 417, 428 (42), 471  
 Buki, K.G. 1024 (123, 124), 1037  
 Bullen, J.V. 879 (77–80), 890, 967 (57), 971  
 Bult, A. 1119 (426), 1163  
 Bulusu, S. 281 (92, 93), 293, 317 (69), 318 (78), 333, 334  
 Bunce, N.J. 685 (11), 740, 755 (19), 818  
 Bunzel, E. 411 (189), 414 (202), 422, 457 (231, 235), 475, 476, 512 (215, 216), 530, 859 (5), 865 (29, 30), 866 (35), 888, 889, 1217, 1220 (11a), 1295  
 Bunes, L. 582 (263), 622  
 Bunker, C.E. 441 (145), 473  
 Bunnell, R.D. 410 (184), 422  
 Bunnnett, J.F. 457 (233), 466 (266, 268), 475, 476, 611 (443), 625, 1216 (1d, 2a–c), 1217 (2a–c), 1218 (19, 20a–c), 1219, 1220 (1d, 20a–c), 1232 (81), 1235 (1d, 81), 1242 (2c), 1244 (1d), 1250 (1d, 19), 1251 (19), 1268 (171), 1274 (1d), 1278 (2a–c), 1290 (1d, 20a–c), 1295, 1297, 1299  
 Bunt, R.C. 590 (316), 623  
 Bunton, C.A. 510 (196), 530, 877 (73), 890, 1217 (6a–c), 1220 (30a, 30b, 32a, 32b), 1295, 1296  
 Burch, E.L. 686, 699, 700, 706 (24), 729 (176a, 176b), 740, 744  
 Burdash, N. 1148 (601), 1167  
 Burden, A.G. 501–503, 520 (143), 529  
 Burg, J. 1185 (72), 1213  
 Burgar, M.I. 312 (53), 333  
 Bürger, H. 164–166, 168 (38), 202  
 Burgers, P.C. 208 (7, 11), 209 (11), 214 (11, 51), 215 (7, 56), 233 (148, 149), 234 (148), 244, 245, 247, 254 (23), 255 (23, 27), 292  
 Burgess, E.M. 737 (197), 745  
 Burgot, J.L. 1107 (380), 1162  
 Burguera, J.L. 1074 (174), 1158  
 Burguera, M. 1074 (174), 1158  
 Burke, P.O. 405 (147, 148), 421  
 Burke, T.R. 1025 (132), 1038  
 Burkert, U. 3–5 (1a), 24 (35), 29 (1a), 81, 82  
 Burkle, W. 121 (68), 122, 123 (69), 155  
 Burns, C.A. 612 (450), 626  
 Burns, D.T. 1126 (447), 1164  
 Burri, P. 648 (110), 661  
 Burrow, P.D. 173 (77), 203  
 Burrows, E.P. 137 (109, 112), 138 (109), 156  
 Burton, T.C. 748 (1), 817  
 Busch, K.L. 251, 253, 254 (5), 291  
 Buschek, J.M. 184, 187 (104), 203  
 Busconi, L. 977 (56), 979 (74), 995  
 Bush, L.P. 1151 (614), 1167  
 Bush, P.A. 993 (144), 997  
 Bushweller, C.H. 46 (70, 71), 47 (71), 48 (72), 49 (73), 83  
 Buss, V. 139 (113), 141 (120), 156  
 Busse, R. 992 (140), 997  
 Bussolari, J. 576 (216), 621  
 Busto, O. 1083 (246), 1160  
 Butcher, A.R. 264, 266 (64), 293  
 Butcher, M. 268 (78), 293  
 Butin, K.P. 444 (161), 474

- Butler, A.R. 628, 640, 644 (1), 658, 669 (20), 670 (27), 680, 985 (96), 996
- Butler, J. 827 (35), 835
- Butler, L.J. 795 (122), 820
- Butler, M. 1047 (32), 1155, 1177 (30), 1212
- Butler, R.N. 630 (14), 632 (21), 636 (14), 646 (102), 659, 661
- Butoh, M. 1069 (147), 1130 (147, 479, 481), 1158, 1165
- Butts, C.P. 456 (220), 475, 954 (39), 971
- Buvári, A. 431 (62), 471
- Buxaderas, S. 1085 (264), 1160
- Buys, H.R. 15, 17 (25b), 81
- Buzby, J.H. 579 (237), 621
- Buzzaccarini, F.de 1220 (30b), 1296
- Buzzigoli, G. 1085 (261), 1160
- Byrn, S.R. 91, 93 (21), 102
- Byrns, R.E. 974 (2), 976 (32), 994
- Bysh, P. 1174 (7), 1212
- Cabeza, A.S. 1097 (339), 1162
- Cacace, F. 232 (141), 247
- Cadogan, J.I.G. 647 (105), 650 (127), 661
- Cady, H.H. 329 (112), 334
- Cai, G. 139, 141 (116), 143 (126), 156
- Cai, P. 130 (89), 155
- Caia, V. 99 (79), 103
- Cainelli, G. 549 (81), 618
- Calabrese, J.C. 90, 93 (13), 102, 587 (301), 623
- Calatayud, J.M. 1088 (279), 1099 (344), 1160, 1162
- Calaycay, J. 978 (63, 65), 995
- Calcasi, M. 991 (124), 996
- Calder, I. 1029 (167), 1038
- Calderbank, J. 1188 (89), 1214
- Caldin, E. 894 (3), 946
- Caldwell, W.S. 1150 (611), 1167
- Callaghan, P.T. 330 (119), 335
- Callahan, C.M. 1063 (98), 1157
- Calvert, J.L. 883 (92), 891, 954 (33, 35, 36), 969 (36), 971
- Calvin, M. 515 (229), 530
- Camanas, R.M.V. 1067 (133), 1086 (273), 1157, 1160
- Cambon, A. 540 (45), 617
- Camerman, A. 96 (48), 102
- Camerman, N. 96 (48), 102
- Cameron, D. 390 (70), 419
- Cameron, J.F. 767 (52b), 819
- Cameron, M. 447 (180), 474
- Caminati, W. 25 (39), 71 (121), 82, 84
- Campbell, A.L. 724 (160), 743
- Campbell, D. 785 (97b), 820
- Campbell, G.A. 875 (66, 67), 890
- Campbell, S. 178, 188 (92), 203, 673 (41), 681
- Campos, K.J. 985 (97), 996
- Campos, K.L. 983 (84), 996
- Campos, P.J. 576 (213), 621
- Canal, G. 576 (213), 621
- Canas, M. 545 (70), 618
- Cancela, G.D. 1048 (58), 1156
- Canet, I. 1112 (402), 1163
- Canet, J.I. 1112 (402), 1163
- Canevari, L. 1078 (204, 205), 1159
- Cantos, A. 754 (15, 17a, 17b), 756 (23), 758 (30), 817, 818
- Cao, J.A. 231 (137), 247
- Capdevielle, P. 580 (241, 252a, 252b), 590 (321), 621, 623
- Capon, B. 1250, 1267 (126), 1298
- Caporusso, A.M. 575 (211), 621
- Capozzi, G. 1012, 1015 (73), 1036
- Capriogu, M.T. 968 (61), 971
- Caprioli, R.M. 233 (146), 247, 251 (4), 291
- Caranoni, C. 94 (37), 102
- Carballeira, L. 15, 16 (26e), 55–57 (82), 82, 83
- Carboni, B. 566 (177), 620
- Carchon, H.A. 1078 (201), 1159
- Cardenas, R. 1285 (195), 1300
- Carere, A. 1178 (49), 1213
- Carey, J. 107 (20), 153
- Carfagna, C. 398 (112), 420
- Carlsen, L. 251 (6), 253, 254 (15), 255 (15, 29), 259 (44–46), 260 (15, 50), 262 (55), 263, 264 (61), 290 (45), 291, 292
- Carlson, R. 563 (165), 583 (272), 620, 622
- Carlson, R.G. 1080 (222, 223), 1159
- Carlson, T.A. 160 (3), 201
- Carlsson, A. 62 (107), 84
- Carlsson, D.J. 825 (24), 835
- Carlstrom, D. 89, 90 (9), 102
- Carmella, S.G. 1150 (612), 1167
- Carmona, C. 409 (169a, 169b), 421
- Carnahan, G.E. 668–670, 672 (14), 680
- Carney, T.E. 234 (152), 247
- Carnovale, F. 166 (60), 202
- Caronia, A. 1262, 1266 (152), 1299
- Carpenter, A.J. 595 (351), 624
- Carpenter, B.K. 769 (56), 819
- Carpenter, J.G.D. 57 (86), 83
- Carper, W.R. 281 (94), 293
- Carpino, P.A. 575 (209), 621
- Carr, P.W. 381 (21), 417, 428 (43), 471
- Carraro, F. 1059 (83), 1156
- Carrasco, R. 584 (283), 622
- Carreira, L.A. 8 (13), 81
- Carreiro, J.C. 753 (13), 757 (27), 817, 818
- Carrell, H.L. 452 (199), 475
- Carreyre, H. 609 (433), 625
- Carri, M. 1085 (261), 1160
- Carroll, R.T. 1133 (497), 1165
- Carson, K.G. 563 (156), 620
- Cartaño, A.V. 1218–1220, 1290 (20a), 1295

- Cartano, V. 457 (233), 475  
 Carter, D.M. 266, 267 (71), 293  
 Carter, M.A. 871 (55), 890  
 Carter, R.E. 408, 409 (170), 421  
 Cartwright, B.A. 37 (56), 82  
 Carunchio, V. 1091 (298), 1161  
 Carvalho, E. 606 (411), 625, 882 (86), 890  
 Carver, D.R. 575 (210), 621  
 Casado, J. 643, 645 (88), 660  
 Casalnuovo, H.L. 587 (301), 623  
 Casara, P. 576 (218), 621  
 Casarini, A. 551 (93), 618  
 Casarini, D. 43 (66), 50 (66, 74), 52 (74), 83  
 Casassas, E. 1225 (67), 1297  
 Casciano, D.A. 1033 (203), 1039  
 Case, D.A. 3 (2a, 2b), 81  
 Casella, L. 137 (111), 156  
 Caseres, C. 1262, 1266 (145), 1299  
 Casewit, C.J. 38–40 (58, 59), 82  
 Casey, H. 1045 (5), 1155  
 Caspar, J.V. 441 (144), 473  
 Casselberry, R.L. 843, 844 (23), 855  
 Cassman, K.G. 1047 (25), 1155  
 Casson, A. 66, 67 (111), 84, 166, 168, 179, 184, 185 (52), 202  
 Castellato, F. 456 (225), 475  
 Castellino, F.J. 564 (167), 620  
 Castello, G. 1126 (451), 1164  
 Castelnovo, P. 1092 (308), 1161  
 Castenmiller, W.A.M. 648 (112), 661  
 Castleman, A.W.Jr. 262 (54), 292, 385 (41), 418  
 Castro, A. 643 (88), 644 (92, 96), 645 (88, 98), 660, 661, 677 (72), 681, 886 (101–103), 888 (106), 891  
 Castro, L. 992 (139), 997  
 Castro, M.D.L.de 1137 (527), 1166  
 Catalan, J. 407 (161b), 408 (165a, 165b, 166, 167b), 421, 524 (253), 531, 780 (81), 819  
 Cataliotti, R.S. 99 (79), 103  
 Cater, S.R. 755 (19), 818  
 Cattana, R. 433 (81), 472, 1245–1247, 1266 (115b), 1298  
 Cattana, R.I. 1244 (110), 1245 (110, 117), 1246 (117), 1298  
 Cauchi, B. 1079 (208), 1159  
 Caufield, C. 41 (63), 82  
 Cautletti, C. 165–167 (24), 202  
 Cava, M.P. 717 (143a), 743  
 Cavoli, P. 94 (36), 102  
 Cayon, E. 756 (23), 788 (102), 818, 820  
 Cazabeil, J.M. 1078 (199), 1159  
 Cazeau du Broca, C. 1136 (522), 1165  
 Ceasar, G.P. 175 (84), 203  
 Cecil, R. 1012 (74), 1036  
 Celander, D.W. 756 (22), 818  
 Cellerino, G.P. 1078 (198), 1159  
 Cellota, R.J. 257 (36), 292  
 Cense, J.M. 453 (206), 475  
 Ceolin, R. 453 (206), 475  
 Cerdeira, S. 1235, 1237, 1243, 1263, 1293 (82), 1297  
 Cerdeira, S.B. 1217, 1263 (12), 1295  
 Cerioni, G. 53 (77), 70 (119), 83, 84, 315 (62), 333  
 Cerniglia, C.E. 1197, 1198 (106), 1214  
 Cernigliaro, G.J. 658 (175), 663  
 Cerny, A. 633 (26), 659  
 Cerny, R.L. 208 (16), 211 (36), 244  
 Cerrello, J. 754 (14), 817  
 Cerreta, F. 591 (325), 623  
 Cert, A. 283, 284 (100), 293  
 Cervello, J. 758 (31), 818  
 Cerveny, L. 870 (49), 890  
 Cervinka, O. 112, 113 (41), 154  
 Cetina, R. 434 (90), 472, 1266 (165), 1299  
 Chaabouni, R. 566 (180), 567 (183), 620  
 Chabiny, M.L. 1134 (505), 1165  
 Chadha, H.S. 1222 (56, 59), 1226 (71), 1228 (73, 74), 1296, 1297  
 Chadikun, F. 254, 288 (22), 292  
 Chadwick, D.J. 60 (103c), 84  
 Chadwick, I. 456 (223), 475  
 Chaffin, J.D.E. 612 (448), 626  
 Chakrabarti, A. 738 (200b), 745  
 Chakrabarty, T. 694 (66), 741  
 Chakraborty, D.P. 738 (200b), 745  
 Challis, B.C. 593 (344), 623, 628, 640, 644 (1), 658, 1047 (41), 1155  
 Chaloner, C. 1097 (334), 1162  
 Chamberlain, R. 1253 (130, 131, 133), 1255 (130, 133, 134), 1256 (130), 1298  
 Chamberlin, R.A. 457 (234), 476  
 Chambers, R.D. 435 (107), 472, 651 (134), 662  
 Chamchaang, W. 545 (71), 618  
 Champagne, M.H. 830 (51), 836  
 Chan, K.C. 1094 (322), 1096 (327), 1161  
 Chan, T.H. 1066 (121), 1157  
 Chan, W.H. 1097 (337), 1162  
 Chan, Y.M. 110 (34), 154  
 Chandler, D.W. 1174 (4), 1212  
 Chandra, H. 834 (74), 836  
 Chandrakumar, N. 396 (87), 419  
 Chandramouly, T. 148 (144), 156  
 Chandrasekaran, K. 693 (54), 741  
 Chandrasekaran, S. 608 (421), 625  
 Chandrasekhar, J. 386 (46), 418, 956 (44), 971  
 Chandross, E.A. 695 (72), 741, 767 (49), 819  
 Chanet-Ray, J. 598 (373), 624  
 Chang, C.J. 581 (259), 622  
 Chang, D.W.L. 812–814 (165), 821  
 Chang, G. 41 (63), 82

- Chang, H. 596 (369), 624  
 Chang, J.C. 1177 (34), 1212  
 Chang, K.-C. 100 (94), 103  
 Chang, K.Y. 1020 (95), 1037  
 Chang, M. 1072 (154), 1158  
 Chang, W.B. 1076 (185), 1158  
 Chang, W.M. 434 (86), 472, 1262, 1266 (146),  
 1299  
 Chantal, P.D. 1067 (125), 1157  
 Chantry, D. 96 (50), 103  
 Chao, J. 431 (67), 472  
 Chao, O. 434 (90), 472  
 Chaouki, J. 1175 (12), 1212  
 Chapel, H.L. 807 (149b), 821  
 Chapleo, C.B. 584 (284), 622  
 Chaplinski, V. 164, 165 (36), 168 (61), 202  
 Chapman, N.B. 434 (85), 472, 501 (143, 144),  
 502 (143, 144, 148), 503 (143, 144, 149),  
 511 (208, 210–212), 520 (143, 144), 529,  
 530, 1241, 1262, 1264 (103b), 1298  
 Chapman, O.L. 353 (49), 375, 724 (162a), 743  
 Chapman, R. 828 (44), 835  
 Chardhuri, G. 974 (2), 994  
 Chardin, A. 395 (84), 419  
 Charles, I.A. 992 (134), 997  
 Charles, I.E. 992 (132), 997  
 Charles, I.G. 979 (77), 992 (135), 995, 997  
 Charles, S.J. 976 (40), 994  
 Charlton, J.L. 778 (70b), 819  
 Charton, B. 524 (256), 531  
 Charton, B.I. 499 (140), 528  
 Charton, M. 490 (95), 492 (109–111), 493  
 (109, 112, 113), 498 (95), 499 (140–142),  
 501 (95, 143, 144), 502, 503 (143, 144),  
 504, 512 (109), 514 (109, 112), 517, 518  
 (109), 520 (109, 143, 144), 521 (95), 522  
 (249), 524 (109, 255, 256), 525 (257),  
 527–529, 531, 642 (85), 660  
 Chartrain, N. 993 (147), 997  
 Chartrain, N.A. 979 (78), 995  
 Chasar, D.W. 1197 (108), 1214  
 Chastel, R. 349 (32), 374  
 Chateaufneuf, J. 809 (152), 821  
 Chatgililoglu, C. 806 (147), 821  
 Chatrouse, A.P. 1217 (17), 1295  
 Chatrouse, A.P. 415 (207, 209, 210), 422  
 Chatterjee, A. 562 (151), 619  
 Chatterjee, S.K. 536 (20), 617  
 Chaudhury, D.K. 511 (210), 530  
 Chauhan, S.M.S. 675 (64), 677 (71), 681  
 Chauvin, R. 564 (166), 620  
 Chawla, H.M. 1100 (351), 1162  
 Che, R. 77–79 (129), 84  
 Chechik, V.O. 1240 (101), 1297  
 Chee, C. 673 (44), 681  
 Cheetham, A.K. 86 (3), 102  
 Cheikh, R.B. 567 (183), 620  
 Chekhuta, V.G. 348 (31), 373  
 Chen, C. 1116 (410–412), 1163, 1228,  
 1232–1235, 1239 (77), 1297  
 Chen, C.-K. 560 (137), 619  
 Chen, F.-M. 137 (109, 112), 138 (109), 156  
 Chen, H. 993 (147), 997  
 Chen, H.G. 580 (244), 621  
 Chen, H.S. 979 (72), 995  
 Chen, J. 1182 (62), 1213  
 Chen, J.G. 1074 (182), 1158  
 Chen, J.S. 427 (19), 470  
 Chen, K. 4 (44), 21, 22, 32 (31), 33, 35 (44),  
 82  
 Chen, K.-L. 605 (410), 625  
 Chen, P.-F. 989 (103), 996  
 Chen, S.-F. 714 (124, 125), 742  
 Chen, S.-H. 567 (182), 620  
 Chen, S.-J. 592 (330), 623  
 Chen, S.-T. 592 (330), 623  
 Chen, S.-Y. 592 (330), 623  
 Chen, Y.J. 609 (430), 625  
 Chen, Z. 433 (79), 472  
 Chenevert, R. 722 (153g), 743  
 Cheng, C.H. 447 (185), 474  
 Cheng, J.-F. 120, 142 (62), 154  
 Cheng, J.-P. 401, 402 (133, 139), 420  
 Cheng, M.Y. 96 (45), 102  
 Cherkasov, A.R. 506 (175), 529  
 Cherkasov, R.A. 506 (175), 529  
 Chernov, A.N. 592 (339), 623  
 Chernovitz, A.C. 150 (154), 157  
 Chesick, J.P. 90 (10), 102  
 Chesney, A. 594 (347), 623  
 Chess-William, R. 976 (40), 994  
 Chesta, C.A. 727 (169), 744  
 Cheung, A.V. 978 (71), 995  
 Cheung, E.T. 1238, 1240 (97), 1297  
 Chiacchera, S.M. 467 (271), 476  
 Chiacchiera, S.M. 1217 (9), 1220 (33),  
 1235–1237 (9), 1244 (110), 1245 (110,  
 116b), 1246 (9, 116b), 1247, 1276 (9),  
 1295, 1296, 1298  
 Chiang, Y. 658 (175), 663  
 Chiappardi, D.M. 843, 844 (23), 855  
 Chiara, J.L. 453 (204), 475  
 Chiavari, G. 563 (162), 620  
 Chiba, M. 749 (3a, 3b), 817  
 Chickos, J.S. 338 (4, 6), 346 (21), 347 (24),  
 352 (41, 44), 355 (57), 356 (59),  
 372–375  
 Childers, J.W. 1133 (503), 1165  
 Chimichi, S. 780 (82), 819  
 Chin, D. 430 (50), 471  
 Chin, T. 767 (51), 819  
 Chin, W.S. 193, 194 (143, 144), 195, 196  
 (143), 197 (143, 144), 198, 199 (144), 200  
 (150, 151), 204

- Chini, M. 544 (65, 68), 617  
 Chio, C. 3 (2a), 81  
 Chipko, B.R. 1024 (131), 1038  
 Chirico, R.D. 346 (20), 350, (35, 37), 373, 374  
 Chirón, S. 1068 (139), 1078, 1079 (195), 1158, 1159  
 Chiu, F.T. 714 (124), 742  
 Cho, B.T. 114 (46), 154  
 Cho, H. 992 (131), 997  
 Cho, H.J. 978 (58, 63, 65), 995  
 Cho, I.S. 692 (50), 714 (126), 741, 742  
 Choi, C. 563 (155), 620  
 Choi, C.S. 86, 88 (5), 102  
 Choi, H. 108 (27), 154  
 Choi, J. 534 (2), 537 (30), 616, 617  
 Chokshi, H.P. 1080 (222, 223), 1159  
 Choudary, B.M. 596 (360), 624  
 Choudhury, M.K.D. 1266, 1267 (167b), 1299  
 Chow, Y.L. 684 (1), (41), 740, 810 (174), 811 (163, 174), 812 (165–168, 174), 813 (165, 166, 168, 169), 814, (165, 170), 815 (171), 816 (169, 172), 817 (173), 821  
 Chowdary, A. 357 (67), 376  
 Chowdhury, S. 256 (34, 35), 258 (38), 292, 385 (37a, 40), 418  
 Choy, G.S.-C. 648 (113), 661  
 Choy, N. 108 (27), 154  
 Chracek, J. 1077 (192), 1159  
 Christ, H.A. 312 (51), 316, 317 (66), 333  
 Christensen, J.B. 212, 222–225 (44), 244  
 Christie, J.R. 219 (91), 220 (104), 236 (171), 246, 248, 1220, 1222 (31a, 31b), 1296  
 Chronister, C.W. 445 (166), 474  
 Chrystal, E.J.T. 1032 (196), 1039  
 Chu, S.C. 992 (130), 997  
 Chuang, J.C. 1176 (25), 1212  
 Chuang, T.H. 581 (259), 622  
 Chuchani, G. 483 (32), 526  
 Chucho, J. 590 (315), 623  
 Chudek, J.A. 456 (224), 475  
 Chumachenko, T.A. 1119 (432), 1164  
 Chung, K.T. 1197, 1198 (106), 1214  
 Chupka, W.A. 217 (76), 245  
 Ci, Y.X. 1076 (185), 1158  
 Cijajolo, A. 1175 (16), 1212  
 Cicatiello, L. 992 (126), 997  
 Cimarelli, C. 459, 464, 468 (245), 476, 1262 (149a, 149b), 1278 (149a, 149b, 184a), 1279 (149b, 184a), 1280, 1285 (184a), 1299, 1300  
 Cimiraglia, R. 803 (138), 821  
 Cini, R. 57 (93), 83  
 Ciociaro, D. 1085 (261), 1160  
 Ciommer, B. 208 (9, 10), 244  
 Cioslowski, J. 411 (194, 195), 412 (194), 422  
 Cipiciani, A. 1220 (32a, 32b), 1296  
 Cirrincione, G. 630 (15), 633 (27), 659  
 Citra, M. 150 (152), 157  
 Citro, M.L. 1149 (605), 1167  
 Citterio, A. 655 (157), 662  
 Ciuffarin, E. 398 (113a, 113b), 420  
 Ciuffarin, F. 1236, 1266 (159), 1299  
 Ciureanu, M. 846 (36b), 856  
 Civiso, D. 1138 (531), 1166  
 Claramunt, R.M. 407 (161b), 421  
 Clark, A. 1127 (453, 454), 1164  
 Clark, C.R. 1063 (99), 1071 (152), 1157, 1158  
 Clark, D.N. 601 (384a, 384b), 624  
 Clark, D.T. 310 (48), 333  
 Clark, E.P. 1031 (182), 1039  
 Clark, G.D. 1063 (98), 1157  
 Clark, J.E. 984 (90), 996  
 Clark, M. 36–38, 42 (52), 82  
 Clark, M.T. 685, 686 (7), 740  
 Clark, P. 989 (107), 991 (113), 996  
 Clark, T. 956 (44), 971  
 Clarke, A. 1174 (6), 1212  
 Clarke, C.T. 542 (52), 617  
 Clarke, R.A. 1105 (368), 1162  
 Claus, P.K. 1015, 1018 (86), 1036  
 Clavijo, E. 431 (66), 472  
 Clay, R.M. 355, 356 (58), 375  
 Cleary, P.D. 975 (13), 994  
 Clegg, D.J. 1189 (93), 1214  
 Clegg, W. 396 (90), 419  
 Cleghorn, S.J.C. 844 (28), 855  
 Cleland, W.W. 894 (4), 946  
 Clemens, A.H. 967 (60), 971  
 Clennan, E.L. 56 (80c), 83  
 Cleveland, P.G. 724 (162a), 743  
 Clewley, R.G. 950 (12), 970  
 Clifford, P. 220, 221 (99), 246  
 Closset, J.L. 100 (90), 103  
 Clovis, J.S. 905 (30), 947  
 Cnubben, N.H.P. 1097 (335), 1162  
 Coade, M.E. 674 (52), 681  
 Cobbleddick, R.E. 329 (116), 334, 950 (4), 970  
 Coburn, M.D. 370 (100–102), 378  
 Cockerill, A.F. 509 (192), 530  
 Cocksey, B.J. 168 (62), 202  
 Coello, A. 677 (73), 681, 888 (107), 891  
 Cohen, B.E. 686 (24), 696 (81), 699, 700, 706 (24), 707 (109), 740–742  
 Cohen, H. 829 (48), 836  
 Cohen, K.A. 1071 (151), 1158  
 Cohen, L.A. 497, 516 (134), 528  
 Cohen, M.D. 436 (119, 120), 473, 750 (5), 817  
 Cohen, M.P. 537 (25), 617  
 Cohen, N. 345 (17), 372  
 Cohen, S.A. 1084 (254, 256), 1085 (267), 1160  
 Cohen, S.G. 687 (39), 740  
 Cohen, T. 653 (145), 656 (164), 662  
 Coitino, E.L. 453 (206), 475

- Colbourne, D. 166 (56), 202  
 Colburn, A.W. 227–229 (129), 231 (136), 246, 247  
 Coldani, R. 1085 (261), 1160  
 Cole, E.R. 735 (190a), 745, 1012 (80), 1036  
 Cole, N.W. 219 (91), 246  
 Cole, S. 1126, 1127, 1143 (446), 1164  
 Cole, T.E. 118, 119 (55), 154  
 Coleman, M.D. 1027 (148, 152), 1028 (156), 1038  
 Coleman, R.S. 595 (351), 624  
 Coles, B. 672 (36), 680  
 Colina, C.de la 1048 (58), 1156  
 Coll, J.C. 347 (27), 373  
 Collet, A. 106 (12), 153, 553 (106), 618  
 Collie, J.N. 485 (48), 526  
 Collina, G. 459 (241), 476  
 Collings, P. 674 (53), 675 (54, 63), 677 (53), 681  
 Collins, C. 899 (23), 947  
 Collins, P.M. 771 (59), 772 (60, 61), 819  
 Collins, S. 115 (50), 154  
 Collos, Y. 1046 (17), 1155  
 Collum, D.B. 396 (85, 86a, 86b, 89, 91a, 91e, 94, 97), 419  
 Collyer, S.M. 384 (30c), 417  
 Colombo, B. 1046 (9), 1155  
 Colomina, M. 357 (70), 376  
 Colon, C.J. 812–814 (165), 821  
 Colon, D.F. 137 (107), 155  
 Colon, M. 130 (89), 155  
 Colonna, F.P. 165, 166, 178 (46), 191, 199 (130), 202, 204  
 Colonna, M. 191, 199 (130), 204, 969 (66), 970 (67), 971  
 Colpitts, T.L. 564 (167), 620  
 Colson, A.O. 830 (51), 836  
 Colton, R.J. 191 (129), 192, 193, 200, 201 (136), 204  
 Colucci, W.J. 70 (117a, 117b), 84  
 Colwell, K.S. 38–40 (58, 59), 82  
 Commenges, G. 588 (302b), 623  
 Compton, D.A.C. 1142 (563), 1166  
 Comuzzi, C. 405 (153), 421  
 Conboy, J.J. 1118 (419), 1163  
 Connell, R.D. 542 (54), 568 (188), 617, 620  
 Connelli, G.D. 1153 (626–628), 1168  
 Conner, J.M. 1150 (611), 1167  
 Conser, K.R. 119 (58), 154  
 Consiglio, G. 100 (92), 103, 388 (56), 418, 1236 (160), 1241 (103a), 1262 (103a, 152), 1264 (103a), 1266 (152, 160), 1298, 1299  
 Constant, D. 165, 166, 182 (47), 202  
 Conti, C. 441 (146), 473  
 Conti, F. 390 (62), 418  
 Conti, L. 1178 (49), 1213  
 Contineanu, I. 353 (50), 375  
 Continetti, R.E. 795 (125), 820  
 Contreras, R. 1109 (392), 1163  
 Contreras, R.H. 319, 320 (82), 334, 438 (127), 473  
 Convery, M.A. 412, 413 (196), 422  
 Cook, C.D. 956 (43), 971  
 Cook, K.S. 933, 935, 938 (48), 947  
 Cook, P.M. 728 (170), 744  
 Cook, W.S. 895, 896, 936 (11), 947  
 Cooke, J.M. 825 (24), 835  
 Cooke, P.W. 461 (252), 476  
 Cooks, R.G. 209 (29), 217 (77), 233 (146), 234 (156), 238 (176, 179, 181), 244, 245, 247, 248, 251 (4), 252, 253, 262 (11), 291, 390 (70), 419, 1107 (383), 1163  
 Cookson, R.C. 686 (25), 688 (32), 698, 700 (25), 740  
 Cooley, J.H. 581 (260), 622  
 Coombes, R.G. 953 (20), 955 (41, 42), 956 (42), 965, 967 (20), 970, 971  
 Coon, C.L. 362 (90), 363 (90, 91), 377  
 Cooper, A.B. 550 (84), 618  
 Cooper, B.R. 1079, 1080 (218), 1159  
 Cooper, J.C. 1103 (359), 1162  
 Cooper, S.F. 1145 (580), 1167  
 Copin, A. 100 (90), 103  
 Corbett, M.D. 1024 (129, 131), 1037, 1038  
 Corey, D.E. 124 (74), 155, 427 (22), 471  
 Corey, E.J. 111 (37), 154, 539 (42), 617  
 Cornelisse, J. 753 (12), 754 (18), 788 (103), 817, 818, 820  
 Cornforth, F.J. 398 (115), 410 (182), 420, 422  
 Corradi, A.B. 445 (164), 474  
 Corradini, R. 1091 (300), 1161  
 Correa, P. 1182 (61), 1213  
 Correa, P.E. 698 (95, 96), 742  
 Corriou, R.J.P. 573 (204), 620  
 Cossy, J. 590 (318), 591 (328), 623, 737 (195a–c), 745  
 Costa, S.M.de B. 686, 698, 700 (25), 740  
 Cotsaris, E. 445 (169), 474  
 Coughlin, E.B. 757 (26), 818  
 Coulter, D.R. 444 (162), 474  
 Courthaudon, L.O. 1047 (50), 1155  
 Courtieu, J. 1112 (402), 1163  
 Courtois, G. 576 (214), 621  
 Courtot-Coupez, J. 400 (126), 420  
 Coustard, J.M. 609 (433), 625  
 Coutant, R.W. 1176 (25), 1212  
 Coutts, R.T. 1065 (105), 1157  
 Couture, A. 724 (161, 164), 727 (168), 743, 744  
 Couture, Y. 450 (193), 474  
 Covert, R. 1068 (140), 1158  
 Covington, K. 992 (132), 997  
 Cowie, G.L. 1067 (131), 1157  
 Cowling, S.A. 171, 174 (72), 203

- Cowperthwaite, M. 369 (96), 378  
 Cox, A.J. 1031 (178), 1039  
 Cox, J.A. 1073 (169, 170), 1143 (567), 1148 (599), 1158, 1166, 1167  
 Cox, J.D. 218, 225 (82), 245, 339 (10), 372  
 Cox, J.E. 1151 (616–618), 1167  
 Cox, K.A. 1070 (149), 1158  
 Cox, R.A. 381 (5a), 400 (123), 416, 420, 641 (76), 660, 859 (5), 888  
 Cox, R.H. 302 (21), 332  
 Cox, R.L. 1081 (229), 1159  
 Coyle, J.D. 722 (156a, 156b), 730 (177a, 179, 181e), 734 (185a, 185b, 189), 739 (202, 203, 205), 743–745  
 Coynev, E.C. 655 (156), 662  
 Crabb, T.A. 15, 17 (24a), 81  
 Cradock, S. 164 (39), 202  
 Cragghine, I. 396 (92, 96), 419  
 Craig, B.B. 782 (90), 783 (90–92), 820  
 Craig, J.C. 130 (92), 131 (92–94), 132 (93–95), 155  
 Craik, D.J. 303 (27), 310, 311 (44), 312 (56), 313 (56, 57), 314, 315 (57), 332, 333, 491, 503 (99), 527  
 Craine, L. 1012, 1015 (83), 1036  
 Cram, D.J. 508 (185), 529, 1009 (65), 1036  
 Cramer, J.W. 1031 (179), 1039  
 Cramer, R.D.III 36–38, 42 (52), 82  
 Cramer, R.E. 96 (45), 102  
 Crampton, M.R. 416 (213), 422, 457 (231, 234), 475, 476, 1003, 1005 (49), 1036, 1217 (11a), 1218 (24), 1220 (11a), 1237, 1251 (24), 1253 (130–133), 1255 (130, 133, 134), 1256 (130), 1293 (24), 1295, 1298  
 Crandall, J.K. 579 (235), 621  
 Crank, G. 729 (173), 744  
 Craswell, E.T. 1048 (59), 1156  
 Cravedi, J.-P. 1024 (128), 1037  
 Craven, P.A. 975 (19), 994  
 Crawford, K.S.K. 338, 339, 342–346 (1), 371  
 Crawford, M.C. 446 (174), 474  
 Crawford, M.K. 694 (75), 741  
 Crawford, P.C. 370 (104), 378  
 Crebelli, R. 1178 (49), 1213  
 Cremer, D. 24 (37), 82  
 Crestini, C. 560 (135), 619  
 Crews, H.M. 1134 (507), 1165  
 Cribb, A.E. 1001, 1007, 1009, 1011 (28), 1027 (28, 155), 1035, 1038  
 Crider, A.M. 1133 (497), 1165  
 Crisma, M. 142 (124), 156  
 Crochi, B. 1178 (49), 1213  
 Crombie, R.A. 288, 289 (108), 293  
 Cronin, J.R. 1060 (87, 88), 1156  
 Crookes, M.J. 675 (56), 681  
 Crosby, D. 612 (450), 626  
 Cross, G.G. 950 (7), 970  
 Crossley, M.L. 648 (110), 661  
 Croteau, L.G. 1134 (506), 1165  
 Crotti, P. 544 (65, 68), 545 (72), 617, 618  
 Crouch, R.K. 1019 (94), 1037  
 Crouzet, C. 825 (19–22), 835  
 Crow, F.W. 281 (94), 293  
 Crowfoot Hodgkin, D. 96 (50), 103  
 Crowley, T.O. 1136 (523), 1165  
 Cruickshank, F.R. 354 (53), 375  
 Crumbliss, A.L. 407 (158a–c), 421  
 Crum Brown, A. 484 (38), 526  
 Cruse, H.W. 955 (40), 971  
 Crutzen, P.J. 1174 (8, 9), 1212  
 Csapo, J. 1093 (309), 1161  
 Csapokiss, Z. 1093 (309), 1161  
 Csizmadia, I.G. 236, 238 (173), 248  
 Csoregi, E. 1103 (357), 1162  
 Cu, A. 899 (24), 947  
 Cuevas, G. 15, 17 (23e), 81  
 Cullimore, P.A. 348 (30b), 373  
 Cum, G. 226 (120), 246  
 Cunkle, G.T. 56 (80b), 83  
 Cunningham, A.J. 235 (159), 247  
 Cunningham, J.M. 978 (68), 995  
 Currell, L.J. 783 (93), 820  
 Curry, G.B. 1093 (311), 1161  
 Curtis, D.Y. 447 (179), 474  
 Curtiss, L.A. 208 (4), 244, 355 (55), 375, 384 (28a, 28b), 417  
 Curzon, E. 297 (9), 332  
 Cuscela, M. 578 (224), 621  
 Cygler, M. 53, 54 (78), 83, 866 (35), 889  
 Cyr, A. 845 (30), 855  
 Cyr, D.R. 795 (125), 820  
 Czapski, G. 829 (48), 836  
 Czerlinski, G.H. 670 (28), 680  
 Czeschka, K. 697 (87), 741  
 Dabek-Zlotorzynska, E. 1073 (169, 170), 1158  
 Daelemans, F.F. 1142 (560), 1166  
 Dagani, F. 1078 (204, 205), 1159  
 Dahlgren, R.A. 1046 (15), 1155  
 Dahn, H. 315 (61), 316 (61, 66), 317 (66), 333  
 Dai, M. 431 (67), 472  
 Dai, S. 232 (143), 247  
 Dai, W. 547 (77), 618  
 Dai-Ho, G. 714 (128), 742  
 Dais, P. 510 (199), 530  
 Dakabu, M. 234 (151), 247  
 Dale, J.A. 124 (76), 125 (76, 78), 155, 1089 (285, 286), 1160, 1161  
 Dalene, M. 1063 (97), 1081 (230, 231), 1157, 1159  
 Dale Pace, M. 782, 783 (90), 820  
 D'Alessio, A. 1175 (16), 1212  
 Dalinger, I.L. 550 (85), 618  
 Dalla Croce, P. 539 (39), 617

- Dallenbach-Toelke, K. 1086 (274), *1160*  
Dalpozzo, R. 608 (425, 426a, 426b), *625*  
Daly, J.J. 780 (80), *819*  
Damato, G. 1126 (451), *1164*  
Damewood, J.R. 60 (103d), *84*  
Dammel, R. 164 (32, 38), 165 (38), 166, 168 (32, 38), *202*  
Damoser, J. 1139 (535), *1166*  
Damour, D. 576 (217), *621*  
Danby, C.J. 168 (62), *202*  
Danehey, C.T.Jr. 46, 47 (71), *83*  
Danen, W.C. 684 (1), *740*  
D'Angelo, D.D. 977 (51), *995*  
Daniels, M.W. 933, 935, 938 (48), *947*  
Danielson, N.D. 1070 (149), *1158*  
Danis, P.O. 208, 210–212, 215 (17), *244*  
Dannenbergh, J.J. 435 (97), 439 (130), *472, 473*  
Danovich, D. 161, 173 (19), *202*  
Danzer, M.H. 1118 (421), *1163*  
Dapporto, P. 396 (101), *420*  
Darbre, A. 1047 (32), *1155*  
Darbyshire, J.F. 669 (25), *680*  
Darchen, A. 447 (182, 184), *474, 838 (7a), 843 (18, 19), 848 (7a), 855*  
Darchen, S. 1011, 1019 (71), *1036*  
Darcy, M.G. 579 (237, 238), *621*  
Das, K.G. 289 (115), *294*  
Das, P.K. 738 (199), *745*  
Das, P.R. 259, 262 (43), *292*  
Das, S. 824 (6, 7), *835*  
Dasgupta, P.K. 1116 (416), *1163*  
Dashevskii, V.G. 363 (89), *377*  
Dassbjerg, K. 651 (136), *662*  
Daszkiewicz, Z. 593 (346), 623, 878 (76), *890*  
Date, M. 649 (120), *661*  
Date, T. 396 (93), *419*  
Datta, M. 1046 (13), *1155*  
Datta, M.H. 1118 (421), *1163*  
Dattolo, G. 630 (15), 633 (27), *659*  
Daugaard-Jenson, M. 1033 (202), *1039*  
Daun, J.K. 1046 (11), *1155*  
D'Auria, M. 777 (67–69), 781 (85), *819*  
Davalli, S. 50, 52, 53 (75), *83*  
Davey, J.F. 1067 (127), 1084 (257), *1157, 1160*  
David, J.Y. 1107 (379), *1162*  
Davidoff, A.J. 992 (127), *997*  
Davidson, E.R. 173 (79), *203*  
Davidson, M.G. 396 (92, 96), *419*  
Davidson, R.S. 684 (3), 685 (10), 693 (56), 695 (73, 74), *740, 741*  
Davidson, W.R. 165, 166 (44), 202, 232 (140), *247*  
Davies, C.J. 859 (3), *888*  
Davies, I.W. 598 (376), *624*  
Davies, J.S. 106 (2), 153, 1090 (294), *1161*  
Davies, J.W. 56 (80e), *83*  
Davies, K.J.A. 832 (59–62), *836*  
Davies, M. 426 (16), *470*  
Davies, M.M. 430 (56), *471*  
Davies, R.L. 1067 (129), *1157*  
Davies, S.R. 456 (222), *475*  
Davis, A.P. 412, 413 (196), *422*  
Davis, B. 239 (183), *248*  
Davis, F.J. 670 (29), *680*  
Davis, G.T. 491, 503, 504, 515, 517 (96, 97), *527*  
Davis, L.P. 192 (133), *204*  
Dawes, J.M. 209 (25), *244*  
Dawson, T.M. 992 (142, 143), *997*  
Dawson, V.L. 992 (142), *997*  
Day, R.J. 238 (176), *248*  
Deadwyler, G.H. 71 (120), *84*  
Deady, L.W. 878 (74), *890*  
Deakynne, C.A. 385 (43b, 43c), *418*  
Dean, J.R. 1134 (507), *1165*  
Deas, R.M. 1127 (454), *1164*  
Debenham, D.F. 669 (18), *680*  
De Bie, D.A. 1217 (13a), *1295*  
Debies, T. 171, 174 (71), *203*  
Debies, T.P. 188 (121), *204*  
Debnath, J. 1111 (398), *1163*  
DeBoer, J.E. 639 (60), *660*  
De Boer, Th.J. 695 (70), *741*  
De Bruyn, V.H. 759 (35b), *818*  
Deccouzon, M. 407 (160), *421*  
Dechat, T. 582 (269), *622*  
Deck, J. 1132 (492), *1165*  
Declémy, A. 697 (89), *741*  
Declercq, D. 697 (86), *741*  
DeClercq, D.R. 1046 (11), *1155*  
Decloitre, F. 1025 (137), *1038*  
Decouzon, M. 348 (28), 373, 406 (154), *421, 459 (244), 476, 499, 522 (138), 528, 1237, 1238 (84–86), 1284, 1285 (86), 1297*  
Dedeva, P. 192 (131), *204*  
Deeb, T.M. 599 (381), *624*  
Deeba, M. 538 (38), *617*  
DeEds, F. 1031 (178), *1039*  
Defelippis, M.R. 827 (37–40), *835*  
Defrees, D.D. 384 (27), *417*  
Dega-Szafran, Z. 430 (54), 431 (59), 436 (114), *471, 473*  
Degen, G.H. 1034 (205), *1039*  
De Jong, A.W.J. 695 (70), *741*  
De Jong, G.J. 1134 (511), *1165*  
Dekaban, G.A. 1027, 1028 (154), *1038*  
DeKimpe, N. 569 (191), 586 (296), *620, 622*  
Dekker, L. 883 (91), *891, 968 (63), 971*  
Delair, P. 845 (30), *855*  
Delbressine, L. 1012 (77), *1036*  
Del Cima, F. 1220 (28), *1295*  
De Leenheer, A.P. 1061 (92), *1156*  
De Leeuw, F.A.A.M. 57 (92), *83*



- Delfini, M. 390 (62), 418  
 Delgado-Cobos, P. 283, 284 (100), 293  
 Delhalle, J. 218 (81), 245  
 Delker, G. 1116 (411), 1163  
 Dellaria, J.F. 650 (128), 654 (148), 657 (168), 661, 662  
 Dellaria, J.F.Jr. 574 (208), 621  
 Dell'Erba, C. 100 (93), 103  
 Delmas, D. 1098 (342), 1162  
 Delpeyroux, D. 4, 13 (16), 81  
 Delsignoret, M.E. 832 (59, 61), 836  
 De Marchis, M. 1078 (200), 1159  
 Dembech, P. 551 (93), 618  
 De Mendoza, J. 537 (23), 617  
 Demers, J.P. 595 (353), 624  
 Demko, D.M. 595 (353), 624  
 Demmelmair, H. 1059 (81), 1156  
 Dempsey, B. 381 (4b), 416, 491, 500 (107b), 527  
 Demura, T. 601 (385), 624, 1258, 1260 (140, 141), 1261 (141), 1299  
 Demuth, R. 188, 189, 191, 192 (125), 204  
 Dem'yanovich, V.M. 139 (115, 115), 156  
 Deng, Z. 153 (167), 157  
 Denhez, J.-P. 212 (43, 46, 48–50), 216 (48–50), 222 (43, 46, 48–50), 233 (145), 244, 245, 247  
 De Nicola, A. 583 (274), 622  
 Denison, P. 1108 (385, 386), 1163  
 Denisov, E.T. 401 (135), 420  
 Denner, L. 453 (207, 208), 475  
 Denny, W.A. 329 (111, 117), 330 (111), 334  
 Dent, A. 879 (77), 890  
 Dentener, F.J. 1174 (8, 9), 1212  
 Depaemelaere, S. 697 (86), 741  
 De Paz, J.L.G. 407 (161b), 408 (166, 167b), 421  
 De Pietro, S. 455 (212), 475  
 Depke, G. 268 (77, 79), 269 (79), 293  
 De Proft, W. 388 (58), 418  
 DePuy, C.H. 408 (167a), 421  
 De Queiroz, M.E.L.R. 1145 (572), 1166  
 Derguini, F. 141 (119), 142 (121), 156  
 Deril, G.M. 1078 (198), 1159  
 Derissen, J.L. 90, 93 (19), 102  
 De Roos, F.L. 217 (78), 245  
 De Rosa, M. 873 (62), 874 (63, 64), 890  
 Derrick, P.J. 208 (14), 212 (44), 214, 215 (14), 217 (79), 218 (84), 219 (89–91), 220 (90, 93–95, 104), 221 (84), 222 (44), 223 (44, 93), 224, 225 (44, 115), 227–229 (93, 129), 231 (136), 236 (171), 244–248  
 DeRubertis, F.R. 975 (19), 994  
 Deruiter, J. 1063 (99), 1071 (152), 1157, 1158  
 De Schryver, F.C. 694 (58, 59), 695 (71, 77), 697 (86), 741  
 Desclaux, R. 360 (80), 377  
 Deselaers, K. 646 (101), 661  
 Deshpande, S.R. 285 (102), 293  
 Desilva, K. 1079 (216), 1159  
 De Sio, F. 780 (82), 819  
 Desiraju, G.R. 427 (28), 452 (197–200), 471, 475, 792 (117), 820  
 Desjardins, S. 845 (29), 855  
 Deslongchamps, P. 15, 17 (23c), 81  
 DesMarteau, D.D. 602 (389), 624, 1238 (93), 1297  
 Detter, L.D. 234 (156), 247  
 Deutsch, J. 592 (329), 623  
 Deutz, N.E.P. 1078 (196), 1159  
 De Vos, M.-J. 535 (12), 616  
 Dewar, M.J. 943 (69), 948  
 Dewar, M.J.S. 161 (18), 170 (65), 173 (18), 202, 203, 859 (8, 10), 889, 897 (21), 905 (31), 947  
 Dhaneshwar, N.N. 93, 96, 98 (25, 56), 102, 103  
 D'Hondt, L. 586 (296), 622  
 Diamantino, M.T.R.S. 753 (13), 817  
 Días, T.G. 1139 (538), 1166  
 Diaz, M.J. 1025 (139), 1038  
 Díaz, T.G. 1140 (546), 1166  
 Di Bugno, C. 143 (125), 156  
 Dickel, B.de 1076 (186), 1159  
 Dickinson, C. 97 (65), 103, 329 (114), 334  
 Diehl, P. 312 (51), 316, 317 (66), 321 (94), 333, 334  
 Diem, M. 150 (153), 157  
 Diener, H. 631 (18), 644 (93), 659, 660  
 Diepold, C. 1003, 1005–1007, 1009, 1011, 1012, 1014, 1019, 1027, 1029, 1030 (36), 1035  
 Diestad, A.M.L. 236 (172), 248  
 Diestad, E.L. 236 (172), 248  
 Dieterich, D.A. 447 (179), 474  
 Dietrich, B. 390 (67), 419  
 Dietrich, C.O. 572 (200), 620  
 Dietz, A.G. 656 (164), 662  
 Dietze, P.E. 873 (61), 890  
 DiFuria, F. 405 (150b), 421  
 Diggle, A.W. 955 (41, 42), 956 (42), 971  
 Dignon, J. 1197 (107), 1214  
 Di Grazia, M. 286, 287 (105), 293  
 Dijkstra, G. 208 (6), 244  
 Dillard, J.G. 208, 210, 217, 237 (18), 244  
 Dillow, G.W. 257 (37), 258 (37, 38), 292, 385 (37b), 418  
 Dilts, R.V. 668–670, 672 (14), 680  
 Dimroth, K. 425 (6), 470  
 Ding, A. 978 (63), 995  
 Dinges, W. 571 (199), 620  
 Dingle, R. 641 (75), 660  
 Dinning, P.G. 1129–1131 (476), 1164  
 Diomede, L. 1085 (269), 1160

- Di Palo, V. 1081 (232), *1159*  
 Dippy, J.F.J. 493 (115), *528*  
 Di Renzo, F. 98 (77), *103*  
 Dirx, I.P. 484 (34), *526*  
 Di Sanzo, F.P. 1046 (14), *1155*  
 DiSilvio, M. 979 (76), *995*  
 Distefano, G. 164 (37), 165, 166 (46), 173 (78), 175 (83), 178 (46), 191, 199 (130), *202–204*  
 Dittmar, G. 657 (171), *662*  
 Dittrich, K. 1094 (323), *1161*  
 Divers, E. 679 (87), *682*  
 Dix, L.R. 666 (2), 676 (67), *680, 681*  
 Dixit, A.S. 871 (51), *890*  
 Dixneuf, P.H. 591 (327), 595 (359a, 359b), *598 (374), 623, 624*  
 Dixon, D.A. 90, 93 (13), *102, 384 (26), 417*  
 Dixon, J.P. 1228 (74), *1297*  
 Dixon, R. 1097 (336), *1162*  
 Djerassi, C. 106 (7), *153, 227 (124), 246, 267 (75), 293*  
 Djerassi, K. 206, 207, 233 (2c, 2e), *243*  
 Djordjevic, M.V. 1150 (607, 609), 1151 (614, 617), *1167*  
 Dobler, C. 130 (90), *155, 1112 (399), 1163*  
 Dobratz, P.M. 370 (104), *378*  
 Dobson, C.M. 322 (103), *334*  
 Dockery, S.P. 977 (53), *995*  
 Dodd, J.A. 385 (34a), *417*  
 Dodsworth, D.J. 874 (64), *890*  
 Doerr, R.C. 1186 (75), *1213*  
 Doh, C.H. 543 (61), *617*  
 Doherty, R.M. 381 (16b, 16c, 17d, 20b), 387 (53), *417, 418, 428 (42), 471, 1220 (42), 1222, 1238 (51), 1273, 1275, 1283 (178), 1296, 1299*  
 Doi, E. 724 (165), *744*  
 Doiron, C.E. 384 (30a), *417*  
 Dole, A.J. 1220, 1222 (31a), *1296*  
 Dolle, A. 98 (74), *103*  
 Dölle, B. 1003, 1007–1009, 1011, 1012 (33), *1035*  
 Domalski, E.S. 338 (2d, 3, 5), 361 (2d), *372*  
 Domanski, A. 593 (346), *623*  
 Dombrovskii, A.V. 654 (147), *662*  
 Domelsmith, L.N. 163, 164, 166, 179, 180 (28), *202*  
 Domenicano, A. 98 (77), *103, 435 (100), 472*  
 Domingue, R.P. 43 (68), *83*  
 Donati, D. 780 (82), *819*  
 Donchi, K.F. 212 (44), 218 (84), 219 (90), 220 (90, 104), 221 (84), 222–225 (44), 236 (171), *244–246, 248*  
 Donnelly, D.M.X. 584 (279), *622*  
 D'Onofrio, F. 777 (68), 781 (85), *819*  
 Dopp, D. 693 (55), *741, 759 (36), 762 (38a, 38b, 39, 40), 763 (41), 818*  
 Doraiswamy, S. 753 (10), *817*  
 Dorey, R.C. 281 (94), *923*  
 Dorff, P. 576 (216), *621*  
 Dorie, J. 300 (15), 317 (77), *332, 334*  
 Dörler, G. 639 (54), *660*  
 Dorminy, M. 1024 (123), *1037*  
 Dorofeeva, O.V. 8 (14a, 14b), 24 (14a, 14b, 37), *81, 82*  
 Dorr, F. 685 (19), *740*  
 Dörre, R. 273, 274 (84), *293*  
 Dorwin, E. 1217 (6a), *1295*  
 Dosch, H.-M. 1027 (155), *1038*  
 Dossena, A. 1091 (300), *1161*  
 Dou, L. 1067, 1076 (126), *1157*  
 Doubleday, A. 37 (56), *82*  
 Dougherty, D. 188 (114), *204*  
 Dougherty, R.C. 943 (69), *948*  
 Doughty, E. 1126, 1127, 1143 (446), *1164*  
 Douglas, J.E. 165, 166 (44), *202*  
 Doussot, J. 537 (31), *617*  
 Dovichi, N.J. 1096 (330, 331), *1161*  
 Dowd, W. 945 (70), *948*  
 Doyle, M.P. 639 (60), 640 (68), 650 (128), 654 (148), 657 (168), *660–662, 667 (8), 675 (62), 680, 681*  
 Drago, R.S. 445 (166, 167), *474*  
 Draxl, K. 208, 210, 217, 237 (18), *244*  
 Drazen, J.M. 673 (44), *681*  
 Dressel, J. 1187 (80), *1213*  
 Dressler, M. 1047 (29), *1155*  
 Drevinkova, D. 1138 (529), *1166*  
 Drew, M.G.B. 59 (100, 101), 60 (101), 83, 453 (209), *475*  
 Drewello, T. 211 (40), *244, 251 (6), 253–255, 260 (15), 291, 292*  
 Drewlies, R. 547 (79), *618*  
 Drewniak, M. 546 (76), *618*  
 Drnevich, D. 1083 (252), *1160*  
 Drolet, D. 1145 (580), *1167*  
 Drucker, G.E. 398 (115), 410 (182), *420, 422*  
 Drummond, D.F. 384 (30b), *417*  
 Drushel, H.V. 1047 (39), *1155*  
 Du, S. 557 (124, 125), *619*  
 Du, Z. 80 (135), *84*  
 Duarte, M. 88, 90 (8), *102*  
 Duce, P.P. 381 (17a–c), *417, 428 (41), 471*  
 Duckworth, C.A. 590 (322), *623*  
 Dudek, V. 112, 113 (41), *154*  
 Duffy, C. 991 (117), *996*  
 Duinker, J.C. 1079 (209), *1159*  
 Duisenberg, A.J.M. 91, 93 (20), *102*  
 Dull, D.L. 124, 125 (76), *155, 1089 (285), 1160*  
 Dumanovic, D. 447 (183), *474, 838 (4b), 855*  
 Duncan, W.P. 1177 (36), *1212*  
 Dungthai, S. 318 (78), *334*  
 Dunham, R.C. 35 (50), *82*

- Dunitz, J.D. 60 (104), 84, 90 (11), 96 (49),  
102
- Dunkin, D.B. 235 (161), 247
- Dunn, D.A. 688 (35, 36), 740
- Dunn, T.J. 570 (196), 620
- Duong, K.D. 1081 (227, 228), 1159
- Dupas, S. 1068 (139), 1158
- Dupont, V. 1175 (10), 1212
- Durant, F. 100 (90), 103
- Durantini, E. 463 (254), 476, 1245–1247, 1266  
(115a), 1298
- Durantini, E.N. 1220 (33), 1296
- Durie, A. 969 (64), 971
- Durieux, M.E. 977 (51), 995
- Durr, H. 738 (200a), 745
- Durst, H.D. 563 (154), 619
- Durst, R.A. 1100 (348), 1162
- Durst, T. 411 (189), 414 (202), 422, 737 (198),  
745
- Dusick, A. 1068 (140), 1158
- Dutra, A. 673 (39), 681
- Duttachowdhury, S.K. 562 (151), 619
- Dutuit, O. 262 (57), 292
- Dzharimova, E.S. 353 (50), 375
- Dziembowska, T. 436 (120), 473
- Eargle, D.C. 1189 (93), 1214
- Earle, C.W. 1096 (331), 1161
- Eastland, G.W. 824 (5), 835
- Eastwood, G.B.M. 290 (117), 294
- Eaton, P.E. 604, 605 (404), 625
- Ebdon, L. 1134 (507), 1165
- Ebersson, L. 455 (218), 456 (220), 475, 790  
(108, 109b, 111b, 111c, 112–114), 820, 883  
(92), 891, 954 (34–39), 969 (36), 970 (37,  
38), 971
- Ebertova, H. 1135 (516), 1165
- Ebsworth, E.A.V. 164 (39), 202
- Echavarren, A. 392 (77), 419
- Echavarren, A.M. 537 (23), 617
- Echterhoff, A.M. 1139 (536), 1166
- Eder, H. 772 (61), 819
- Edge, G.J. 797 (131), 820
- Edgecombe, K.E. 411 (190, 191), 422
- Edgell, K.W. 1061 (90), 1156
- Edwards, D.I. 1032 (195), 1039
- Edwards, J.C. 673 (42), 681, 975 (25–27), 994
- Edwards, J.O. 466 (265), 476, 678 (84), 682
- Edwards, M.L. 543 (58), 617
- Efremov, D.A. 604 (401), 625
- Egawa, T. 616 (465), 626
- Egberink, R.J.M. 969 (64), 971
- Egdell, R. 188, 191 (128), 204
- Egger, N. 588 (306), 623
- Eggermont, E. 1078 (201), 1159
- Eggimann, T. 148, 149, 152 (149, 150), 157
- Eggimann, W. 457 (235), 476
- Egolf, R.A. 834 (73), 836
- Egorov, M.P. 457 (230), 475, 1217, 1220  
(11b), 1295
- Egsgaard, H. 212, 222–225 (44), 244, 251 (6),  
253, 254 (15), 255 (15, 29), 259 (44–46),  
260 (15, 50), 262 (55), 263, 264 (61), 290  
(45), 291, 292
- Eguchi, M. 543 (57), 617
- Ehlhardt, W.J. 1032 (197), 1039
- Ehrenberg, M. 90, 93 (18), 102
- Ehrenson, S. 490 (90–92), 491 (90), 498 (91),  
503 (90), 504 (92), 521 (91, 92), 522 (92),  
527, 642 (83), 660
- Ehrlich, S.H. 1100 (347), 1162
- Eigen, M. 435 (105), 472
- Einhorn, C. 594 (349), 624
- Einhorn, J. 583 (274), 594 (349), 622, 624
- Einstein, F.W.B. 329 (116), 334, 950 (4), 970
- Eisch, J.J. 554 (111), 618
- Eisenbrand, G. 1188 (87, 88), 1214
- Eisenthal, K.B. 446 (174), 474, 694 (75),  
741
- Eissa, N.T. 992 (130), 997
- Eizawa, H. 978 (59, 66), 995
- Elad, D. 722 (153f), 743
- ELAmin, B. 119 (60), 154
- Eland, J.H.D. 160 (9), 168 (62), 201, 202
- Elbel, S. 188, 189, 191, 192 (125), 204, 260  
(50), 292
- Elbert, J.E. 729 (174), 744
- El-Brashy, A.M. 1099 (343), 1140 (545, 550),  
1162, 1166
- El-Din, M.S. 1140 (545, 549), 1166
- Elégant, L. 381 (13), 416
- Elferink, V.H.M. 718 (145), 743
- El Gaid, M.M. 597 (371), 624
- Elguero, J. 407 (161b), 408 (165a, 165b, 166,  
167b, 168), 421, 435 (106), 472, 524 (253),  
531, 780 (81), 819
- Elias, A.J. 584 (289), 622
- Eliel, E.L. 1009 (66), 1036
- Eliet, E.L. 297 (10), 332
- Elisei, F. 778 (71), 819
- El Kaaim, L. 613 (451), 626
- El-Kholy, A.E. 439 (134), 473
- Ellaithy, M.M. 846 (36c), 856
- Elleneweig, A. 15, 16 (26b), 82
- Ellerbrock, R. 192 (138), 204
- Elliott, J.D. 542 (52), 617
- Elliott, R.C. 654 (148), 662
- Ellis, A.F. 57 (90a), 83
- Ellis, M.K. 1001, 1003, 1007, 1009, 1011,  
1012 (29), 1028 (29, 157), 1029 (157),  
1035, 1038
- Ellis, R. 1140 (552), 1166
- Ellison, G.B. 360 (78), 376, 382 (23), 417

- Elliston, K. 992 (131), 997  
 Ellsworth, T.R. 1045 (4), 1154  
 Elofson, R.M. 653 (141), 662  
 Elquero, J. 426 (13), 470, 631 (17), 659  
 Emmrich, M. 1116 (406), 1127 (459), 1163, 1164  
 Emokpae, T.A. 1243, 1244 (109), 1287 (199), 1290 (198–200), 1291 (198), 1293 (199), 1294 (109), 1298, 1300  
 Emsley, J. 428 (36), 471, 1294 (201), 1300  
 Emsley, J.W. 320 (89), 321 (92), 334  
 Emson, P. 978 (70), 979 (77), 995  
 Emson, P.C. 992 (135), 997  
 Emster, K.van 654 (146), 662  
 Enders, D. 586 (295), 622  
 Endo, Y. 872 (56), 873 (57), 890  
 Engel, A. 628 (6), 659  
 Engel, M.H. 1049 (68), 1060 (86), 1156  
 Engel, P.S. 649 (119), 655 (159), 661, 662  
 Engleman, J.A. 686, 699, 700, 706 (24), 740  
 Engler, E.M. 3–5, 29 (1c), 81, 356 (60), 375  
 Enholm, E.J. 550 (83), 618  
 Enikolopyan, N.S. 352 (43), 374  
 Entrena, A. 60, 62 (105), 84  
 Entwistle, D.A. 589 (310), 623  
 Eon-Burgot, G. 1107 (380), 1162  
 Epp, E.R. 1031 (182), 1039  
 Eppers, O. 396 (87), 419  
 Epstein, S. 1060 (87, 88), 1156  
 Erdik, E. 552, 553 (103), 618  
 Erickson, B.W. 739 (207), 745  
 Ermisch, A. 1079 (207), 1159  
 Ernst, R.R. 297 (11), 332  
 Ernst, T.D. 551 (88), 618  
 Ernsting, N.P. 188–191 (126), 204, 803 (137, 139), 821  
 Errser, R.S. 1084 (257), 1160  
 Ershov, V.V. 637, 639 (44), 660  
 Ersser, R.S. 1067 (127), 1157  
 Ertl, P. 499, 522 (138), 528  
 Eschenmoser, A. 427 (20), 470  
 Eskew, D.L. 1048 (59), 1156  
 Eslami, M. 1074 (181), 1158  
 Espín, M. 846 (35), 855  
 Espinosa, A. 60, 62 (105), 84  
 Espy, H.H. 1016 (88), 1037  
 Essefar, M. 408 (168), 421  
 Esteve-Romero, J.S. 1088 (278), 1160  
 Estler, C.J. 1001 (32), 1035  
 Esumi, H. 992 (126), 997  
 Eter, M.C. 98 (68, 73), 103, 428 (39), 433 (78), 471, 472  
 Eustace, S.J. 1012 (78), 1036  
 Evain, E.J. 581 (260), 622  
 Evangelatos, G.P. 1099 (345, 346), 1162  
 Evans, D.A. 119 (56, 59), 120 (59), 154  
 Evans, D.H. 832 (63, 64), 836, 839 (8a, 8b), 850 (8b, 52a, 52b), 851 (8a, 8b, 56–58), 852 (59, 60), 855, 856  
 Evans, F.E. 1003, 1004, 1009, 1011, 1012, 1031 (35), 1035, 1132 (492), 1165  
 Evans, J.C. 35 (49), 82  
 Evans, P.D. 1063 (96), 1157  
 Evans, W.H. 338 (3, 5), 372  
 Even, U. 426 (11), 470  
 Evrard, G. 100 (90), 103  
 Ewbank, J.D. 24 (36), 56 (85), 82, 83  
 Ewing, D.F. 302 (23), 303 (23, 24), 332, 491, 503, 504 (98), 527  
 Exner, O. 348 (28), 373, 405 (149), 406 (154), 407 (149, 160), 421, 487 (69, 74, 77), 488 (74, 78), 490 (77, 94), 494 (122, 123), 495 (77), 496 (78, 128), 499 (138), 514, 515, 517, 518 (78), 519 (78, 237), 521 (78, 94), 522 (77, 138, 240–243), 526–528, 531  
 Eyer, P. 1001 (18, 19, 22–27, 31), 1003 (18, 22–25, 34, 36, 39, 40), 1004 (24, 26, 45), 1005 (25, 27, 36, 40), 1006 (18, 22, 36), 1007 (18, 22, 24, 25, 36, 39, 40), 1008 (18, 25), 1009 (18, 22, 24, 26, 27, 36, 40, 63), 1010 (18, 22, 24–26, 63, 68), 1011 (18, 22, 24–26, 36, 40), 1012 (24–26, 36, 39), 1013 (24), 1014 (24, 26, 36, 45, 68), 1015 (26, 45, 68), 1016–1018 (68), 1019 (36, 45, 68, 92), 1020 (19, 27, 34, 40, 92, 100), 1022 (34, 40, 92, 100, 113, 114), 1023 (19), 1025 (22, 23, 133), 1026 (25), 1027 (19, 25, 36), 1029 (25, 36, 39, 40, 68, 163–165, 169, 170), 1030 (25, 36, 174), 1032 (189), 1035–1039  
 Eyring, H. 894 (9), 947  
 Ezeani, C. 467 (272, 273), 476, 1262 (150), 1264 (150, 154), 1269 (150), 1299  
 Faber, D.H. 3–5, 29 (1d), 81  
 Fabiano, E. 538 (35), 617  
 Fabrizio, E.C.R.de 643 (86), 660  
 Fackler, J. 673 (44), 681  
 Fadlallah, S. 1145 (580), 1167  
 Faerman, C.H. 1241, 1242 (105a), 1298  
 Fahey, R.C. 896 (14), 947  
 Fail, J. 96 (46), 102  
 Fajen, J.M. 1184 (64, 68), 1213  
 Falco, P.C. 1097 (339), 1162  
 Falicki, S. 825 (24), 835  
 Fan, E. 428, 430 (35), 471  
 Fan, J. 1151 (614), 1167  
 Fan, J.G. 1150 (607), 1167  
 Fananas, F.J. 396 (88), 419  
 Fang, J.M. 581 (259), 622  
 Faraggi, M. 827 (37–40), 828 (41), 835  
 Farah, L. 1267 (169), 1299  
 Farah, S. 1032 (194), 1039  
 Farah, S.F. 1007, 1015, 1032 (57), 1036

- Farina, D.A. 1148 (601), *1167*  
 Farkas, E. 406 (155), *421*  
 Farmayan, W.F. 1175 (18), *1212*  
 Farmer, M.L. 589 (312), *623*  
 Farmer, P.B. 1021 (104), *1037*  
 Farnell, L.F. 331 (128), *335*  
 Farrel, P.G. 416 (212), *422, 456 (225), 475*  
 Farrell, N. 329 (116), *334*  
 Farrell, P.G. 415 (203, 207–210), *422, 509 (188, 189), 529, 530*  
 Farwell, S.O. 1047 (46), *1155*  
 Fasani, E. 773 (62), *819*  
 Fateyev, O.V. 413 (199), *422*  
 Faul, M.M. 119 (56, 59), 120 (59), *154*  
 Faulkner, T.R. 147 (139), *156*  
 Favaro, G. 1147 (596), 1148 (597), *1167*  
 Favero, L. 544 (68), 545 (72), *617, 618*  
 Fawcett, F.S. 515, 519 (230), *530*  
 Fazio, M.J. 738 (201), *745*  
 Federici, F. 1091 (299), *1161*  
 Fedotov, M.A. 306, 311, 313 (38), 315 (59), *333*  
 Fehsenfeld, F.C. 235 (161), *247*  
 Feier, U. 1058 (78), *1156*  
 Feiring, A.E. 863 (24), *889*  
 Feldman, K.S. 950 (13), *970*  
 Feldman, P.L. 669 (21), *680, 985 (91, 95), 991 (113), 996*  
 Feldman, V.I. 824 (2, 3), *835*  
 Feltes, J. 1125 (445), 1127 (445, 455), 1133 (498), 1136 (445), *1164, 1165*  
 Feltkamp, H. 37, 38, 41 (55), *82*  
 Felton, J.S. 1033 (199, 200), *1039*  
 Feng, L.B. 810 (154, 155), *821*  
 Feng, R. 208, 210–212, 215 (17), *244*  
 Feng, X. 1060 (88), *1156*  
 Fenselau, C. 227 (124), *246, 1024 (127), 1037, 1284, 1285 (194a), 1300*  
 Ferguson, D.M. 59 (102), *83*  
 Ferguson, E.E. 262 (54), *292*  
 Ferguson, I.J. 57 (89), *83*  
 Feringa, B.L. 125 (79), 127 (81), 128 (85), *155, 585 (291), 622, 1110 (393–396), 1163*  
 Fermo, I. 1085 (269), *1160*  
 Fernández, B. 15, 16 (26e), *82*  
 Fernandez, I. 615 (461), *626*  
 Fernandez, S. 592 (333), *623*  
 Fernández-Alba, A. 1078, 1079 (195), *1159*  
 Fernández-Band, B. 1137 (527), *1166*  
 Feron, V.J. 1188 (86), *1214*  
 Ferraccioli, R. 398 (112), *420*  
 Ferrannini, E. 1085 (261), *1160*  
 Ferrao, M.L.C.C.H. 349 (32, 33), *374*  
 Ferretti, V. 426 (15), 435 (103), *470, 472*  
 Ferrige, A.G. 975, 976 (11), *994*  
 Ferris, D.C. 445 (166), *474*  
 Ferruti, R. 390 (62), *418*  
 Fesen, M.P. 1024 (125), *1037*  
 Fetterolf, D.D. 238 (180), *248*  
 Fetzer, S. 188 (119), *204*  
 Feuer, H. 534 (1b, 1c), 604 (400), *616, 625*  
 Fiat, D. 312 (53), *333*  
 Fickling, M.M. 516 (233), *530*  
 Fiddler, W. 1144 (569), 1145 (577–579, 581), *1166, 1167, 1189 (94, 97), 1214*  
 Fiddler, W.J. 1186 (75), *1213*  
 Field, F.H. 208, 210, 217 (18), 234 (154), 237 (18), *244, 247*  
 Field, K.W. 552 (102), *618*  
 Field, L. 668–670, 672 (14), *680*  
 Fields, E.K. 265 (68), *293*  
 Fierz-David, H.E. 628, 634 (4), *658*  
 Figueredo, M. 754 (14), *817*  
 Figuredo, G. 758 (30, 31), *818*  
 Fijalek, Z. 447 (183, 186), *474, 838 (4b), 855, 1005 (50), 1036*  
 Fiksdahl, A. 109 (32), *154*  
 Filippini, G. 433 (73), *472*  
 Filippo, J.S. 877 (72), *890*  
 Finch, A. 366, 369, 370 (98), *378*  
 Finch, A.F. 1019 (90), *1037*  
 Fine, D.H. 1047 (41), *1155, 1184 (64, 65), 1189 (100), 1213, 1214*  
 Finet, J.P. 538 (36), 584 (278, 279), *617, 622*  
 Fingas, M. 255 (25), *292*  
 Fink, M. 767 (53), *819*  
 Finkam, M. 586 (295), *622*  
 Finkelstein, M. 430 (55), 440 (55, 137), *471, 473*  
 Finley, K.T. 358 (76), *376*  
 Fiorani, G.F.M. 1147 (595, 596), 1148 (597), *1167*  
 Fischbach, T. 1029 (161), *1038*  
 Fischer, A. 510 (205), 516 (233), *530, 792 (116), 820, 880 (82), 890, 950 (3–12), 951 (10, 11), 958 (9, 46, 50), 964 (5), 967 (58), 970, 971*  
 Fischer, B. 717 (140), *743*  
 Fischer, E. 447 (178), *474, 778 (73), 806 (146), 819, 821*  
 Fischer, H. 95 (43), *102*  
 Fischer, M. 240 (185), *248, 722 (153a), 743*  
 Fischer, V. 1019 (91), *1037*  
 Fischer, W. 512 (219), *530*  
 Fish, L.L. 407 (158c), *421*  
 Fishbein, J. 645 (100), *661*  
 Fishbein, J.C. 868 (41), *889*  
 Fisher, A.A. 977 (53), *995*  
 Fisher, G. 1089 (281), *1160*  
 Fisher, G.B. 536 (18), *617*  
 Fisher, R.D. 945 (70), *948*  
 Fisher, T.A. 658 (175), *663*  
 Fishman, M.C. 992 (143), *997*  
 Fishwick, B.R. 636 (34), *659*

- Fiftygibbones, L.J. 669 (23), 680  
 Fitz, D.R. 1176 (27), 1212  
 Fitzner, J.N. 575 (209), 621  
 Fitzpatrick, J. 629 (12), 659  
 Fitzpatrick, P.A. 108 (29), 154  
 Fitzsimons, M.F. 1064 (104), 1157  
 Flad, D. 722 (154a, 154b), 743  
 Flagan, R.C. 1180 (59), 1213  
 Flament, J.P. 232 (142), 247  
 Flammang, R. 232 (142), 247, 274, 275 (85), 293  
 Flammang-Barbieux, M. 274, 275 (85), 293  
 Flavian, S. 436 (119), 473  
 Flechtner, T.W. 764 (42), 765 (43), 818  
 Fleischman, S.H. 46 (70), 83  
 Fleischmann, E.D. 411, 412 (194), 422  
 Fleming, I. 220, 232 (101), 246, 642 (81), 660  
 Fleming Mattox, T. 444 (163), 474  
 Fletcher, D.S. 993 (147), 997  
 Flippen-Anderson, J.L. 97 (60, 61), 101 (61), 103, 606 (414), 625  
 Floegel, R. 315, 316 (61), 333  
 Flôrencio, H. 251 (6), 253–255, 260 (15), 291, 292  
 Flowers, M. 979 (72), 995  
 Flürscheim, B. 484, 485 (41), 526  
 Foces-Foces, C. 435 (106), 472  
 Fogel, P. 415 (209), 422  
 Fokkens, R.H. 220 (94), 231 (135), 246, 247, 260, 263 (51), 292  
 Folestad, S. 1077 (193), 1093 (309), 1159, 1161  
 Foley, S.A. 100 (94), 103  
 Fonrodona, G. 1225 (67), 1297  
 Font, G. 1048 (55), 1156  
 Fontana, L.P. 133 (102, 105), 134–136 (105), 148 (144, 146), 155–157  
 Fontcave, M. 669 (16, 22), 680  
 Foote, C.S. 781 (84), 819  
 Forbes, D.C. 550 (83), 618  
 Forbes, E.J. 635 (30), 659  
 Ford, G.P. 491, 503 (101), 527  
 Ford, M.E. 538 (38), 617  
 Ford, P.C. 669 (25), 680  
 Forlani, L. 426 (14), 445 (164), 454 (211), 455 (211, 212), 459 (240, 241, 245), 462 (253), 463 (253, 257, 258), 464 (245, 258–262), 465 (264), 466 (253, 260), 467 (259, 270), 468 (245, 259), 470, 474–476, 1217, 1245 (8), 1247, 1249 (123), 1250 (125), 1251–1253 (129), 1262 (149a–c), 1278 (149a–c, 184a, 184b), 1279 (149b, 184a, 184b, 185), 1280 (184a, 184b, 186, 187), 1281 (188), 1285 (184a, 184b), 1289 (123, 125), 1295, 1298–1300  
 Formaggio, F. 142 (124), 156  
 Formosinho, S.J. 409 (180, 181), 422  
 Fornarini, S. 232 (141), 247  
 Forrest, D. 803 (141), 821  
 Forsberg, J.H. 590 (322), 623  
 Forst, W. 221 (106), 246  
 Förstermann, U. 977 (46), 995  
 Foss, O. 675 (61), 681  
 Foster, D. 1001, 1003, 1007, 1009, 1011, 1012, 1028 (29), 1035  
 Foster, P.M.D. 1028, 1029 (157), 1038  
 Foster, R. 456 (224), 475  
 Foster, R.F. 220 (105), 246, 439–441, 460, 462 (132), 473  
 Förstermann, U. 977, 978 (49), 995  
 Fouad, F.M. 415 (210), 422  
 Foubelo, F. 396 (88), 419  
 Foulds, G.J. 456 (220), 475, 954 (39), 971  
 Foulkes, M.E. 1134 (507), 1165  
 Fournier, J. 598 (374), 624  
 Fournier, M. 1145 (580), 1167  
 Fowler, M. 991 (116), 996  
 Fox, D. 384 (28a), 417  
 Fox, I.R. 491, 503, 504, 515, 517 (96, 97), 527  
 Fox, S.D. 1149 (605), 1167  
 Fracasini, M.C. 1220 (32b), 1296  
 Fraefel, A. 251 (9), 291  
 Fraisse, D. 289 (115), 294  
 Francis, J.T. 220, 221 (99), 246  
 Francis, P.L. 976, 978, 980 (39), 994  
 Francis, S.A. 673 (45), 681  
 Francke, J.P. 1048 (57), 1156  
 Francotte, E. 106 (15), 153  
 Frandsen, H. 1012, 1033 (84), 1036  
 Franke, S. 1127 (460), 1164  
 Frankenbach, G.M. 98 (73), 103  
 Frankenberger, W.T. 1073 (167, 168), 1158  
 Frankhauser, J.E. 575 (209), 621  
 Frank-Kamenetskaya, O.V. 94, 100 (32), 102  
 Franklin, J.L. 208, 210, 217, 237 (18), 244  
 Franklin, N.C. 37, 38, 41 (55), 82  
 Frascerra, S. 1085 (261), 1160  
 Fraser, R.R. 128 (84), 155, 312 (55), 333, 398 (116), 399 (121), 420  
 Fräter, G. 860 (18), 889  
 Fratinden, A.V. 1134 (505), 1165  
 Frayssinet, C. 1025 (137), 1038  
 Frazier, J. 544 (66), 617  
 Frechet, J.M.J. 584 (280), 622, 767 (52b), 819  
 Frederick, R.C. 875 (66), 890  
 Freedman, H.H. 580 (242), 621  
 Freedman, T.B. 148 (146), 150 (152), 154–156), 153 (167), 157  
 Freeman, H.S. 1073 (164), 1158  
 Freeman, R. 297 (13), 332  
 Freemantle, M. 107 (23), 154  
 Frena, V. 1236, 1266 (160), 1299  
 Frenking, G. 208 (10), 234 (150), 244, 247, 396 (100), 420

- Frenna, V. 388 (56), 418, 1262, 1266 (152), 1299  
 Frensham, A.B. 1067 (129), 1157  
 Frey, H. 788 (104), 820  
 Frey-Forgues, S. 697 (88), 741  
 Fridovich, I. 992 (138), 997  
 Fried, B. 1069 (141), 1158  
 Fried, H.E. 403 (140), 407 (159), 421  
 Friedrich, I.E. 402 (130), 420  
 Frierson, M.R. 5, 16, 22 (8), 81  
 Friesen, M.D. 1066 (115), 1157  
 Friess, H.A. 670 (28), 680  
 Frigo, T.B. 56 (80a), 83  
 Frikha, M.G. 1098 (342), 1162  
 Fripiat, J.C. 100 (90), 103  
 Fritz, G. 733 (183d), 744  
 Fritzsche, C.J. 481 (10), 525  
 Frolow, F. 1108 (388), 1163  
 Fronza, G. 321 (93), 334  
 Fronzoni, G. 192 (131), 204  
 Frost, D.C. 166 (56), 202, 290 (116), 294  
 Frost, D.I. 1059 (82), 1156  
 Frund, R. 321 (95), 334  
 Frutos, J.C. 126, 127 (80), 155, 1111 (397), 1163  
 Fruttero, R. 324 (104), 334  
 Fry, A. 895, 896, 936 (11), 947  
 Fry, A.J. 838 (1, 2), 840 (1, 13), 844 (24), 848 (45), 850 (51), 854–856  
 Fry, S.E. 1220 (36), 1296  
 Fu, C. 1148 (604), 1167  
 Fu, P.P. 1129 (472), 1164  
 Fu, S.-C.J. 107 (26), 154  
 Fuchigami, T. 1095 (325), 1161  
 Fuchs, B. 14 (22a, 22b), 15, 16 (22a, 22b, 26b-d), 17 (22a, 22b), 18 (22b), 19 (22a, 22b), 20 (22a, 27–29), 21 (22a), 81, 82  
 Fuchs, J. 1185 (72), 1213  
 Fugassa, E. 1078 (200), 1159  
 Fujie, S. 736 (192b), 745  
 Fujii, H. 452 (196), 475, 824 (12), 835, 1022 (116, 117), 1037  
 Fujii, M. 650 (126), 661  
 Fujii, S. 552 (101), 618  
 Fujimori, K. 866 (33), 889  
 Fujinari, E.M. 1047 (50), 1048 (56), 1070 (150), 1155, 1156, 1158  
 Fujinuma, H. 1218, 1219, 1237 (21b), 1295  
 Fujinuma, K. 1083 (245), 1160  
 Fujio, M. 387 (52a), 418, 496, 505 (131), 524 (254), 528, 531  
 Fujisawa, H. 983 (81), 996  
 Fujita, H. 598 (375), 624  
 Fujita, K. 848 (45), 856  
 Fujita, T. 306 (34), 333, 506 (173), 529  
 Fujita, Y. 1104 (364), 1162  
 Fujitaki, J.M. 1097 (336), 1162  
 Fujiwara, H. 1090 (297), 1161  
 Fujiwara, K. 880 (83), 890, 952 (17), 970  
 Fujiwara, M. 543 (64), 617  
 Fujiwara, S. 1108 (389), 1163  
 Fujiwara, Y. 654 (151), 662  
 Fujiyama, Y. 604 (395), 624  
 Fukase, K. 852 (61), 856  
 Fukoto, J.M. 993 (144), 997  
 Fukuda, E.K. 436 (117), 473  
 Fukuhara, G. 1097 (338), 1162  
 Fukuhara, K. 1131 (487), 1165  
 Fukuhara, T. 651 (132, 133), 656 (166), 657 (132), 661, 662  
 Fukui, K. 220, 232 (100), 246  
 Fukumoto, T. 868 (42), 889  
 Fukushima, D. 666, 667, 670 (6), 672 (6, 34), 680  
 Fukushima, K. 57 (88), 83  
 Fukushima, T. 1081 (233), 1091 (301–303), 1159, 1161  
 Fukuto, J.M. 990 (108, 111), 991 (114), 996  
 Fukuyo, M. 502 (147), 529  
 Fukuzumi, S. 749 (2, 3a, 3b), 817  
 Fulco, A.J. 984 (88), 996  
 Fulisch, M. 992 (141), 997  
 Fulk, G.E. 1197 (105), 1214  
 Fuller, D.J. 396 (86b, 89, 91e), 419  
 Fuller, J.C. 536 (18), 617  
 Fulton, K.L. 456 (220), 475, 954 (39), 971  
 Fultz, E. 1033 (201), 1039  
 Fung, H. 673 (48), 681  
 Fung, H.-L. 673 (47), 681, 977 (55), 995  
 Furchgott, R.F. 974 (1), 975 (5, 13–16), 993, 994  
 Furfine, E.S. 991 (116, 117), 996  
 Furguson, E.E. 235 (161), 247  
 Furin, G.G. 306, 311, 313 (38), 315 (59), (86), 333, 334, 866 (36), 889  
 Furlanetto, S. 1116 (409), 1163  
 Furlong, J.J.P. 396 (98), 419  
 Furst, P. 1076 (188), 1159  
 Furukawa, J. 358 (73), 376  
 Furukawa, M. 551 (94), 618  
 Furuya, Y. 1000 (1), 1035  
 Fuß, W. 164, 166 (43), 202  
 Futrell, J.H. 220 (103), 246  
 Fyles, D.L. 950, 951 (10, 11), 970  
 Gabe, E.J. 93, 100 (26), 102, 453 (205), 475  
 Gaboriaud, R. 1222 (49a, 49b), 1296  
 Gadallah, F.F. 653 (141), 662  
 Gaffield, W. 144 (132), 156  
 Gage, D.A. 1066 (119), 1157  
 Gage, D.R. 1047 (46), 1155  
 Gagjee, P. 1097 (334), 1162

- Gahr, M. 686 (24, 31), 687 (31), 697 (83), 699 (24), 700 (24, 99), 701, 704 (99), 706 (24), 740–742
- Gaillard, Y. 1063 (100), 1157
- Gaind, V.S. 1065 (107–109), 1157
- Gainza, A.H. 1100 (350), 1162
- Gaitonde, C.D. 1074 (184), 1158
- Gal, J.-F. 348 (28), 373, 381 (13, 19, 20b), 384 (33b), 387 (51, 55), 406 (154), 407 (160), 416–418, 421, 499 (138), 505 (158), 522 (138), 524 (254), 528, 529, 531
- Gal, J.F. 428 (42), 459 (244), 471, 476, 1237, 1238 (85, 86), 1284, 1285 (86), 1297
- Galán, A. 392 (77), 419, 537 (23), 584 (284), 617, 622
- Galán-Estella, F. 1128 (465), 1164
- Galasso, V. 186, 187 (109), 204
- Galaverna, G. 1091 (300), 1161
- Galaverna, N.S. 440 (140), 473
- Galceran, M.T. 1129 (474), 1130 (483), 1164, 1165
- Gal'chenko, G.L. 347 (25), 373
- Galera, M.M. 1139 (538), 1166
- Galezowski, W. 460 (249), 476
- Galianoroth, A.S. 396 (86b), 419
- Galiazzo, G. 778 (71), 819
- Galkin, V.I. 506 (175), 529
- Gallagher, T. 598 (376), 624
- Gallardo, I. 756 (23), 818, 846 (35), 855
- Gallas, J.K. 556 (121), 619
- Galle, J.E. 587 (300), 622
- Gallego, M.G. 716 (136–138), 717 (144), 718 (146, 148), 743
- Galleman, D. 1004 (45), 1007 (56), 1009 (63), 1010 (63, 68), 1014, 1015 (45, 56, 68), 1016 (56, 68), 1017 (68), 1018 (56, 68), 1019 (45, 56, 68), 1029 (56, 68, 163–165, 170), 1036, 1038
- Galli, C. 165–167 (24), 202, 649, 651 (116, 117), 653 (117), 661
- Gallo, M.A. 60, 62 (105), 84
- Gallo, R. 4, 13 (16), 81
- Gallon, A.A. 1142 (558), 1166
- Galloway, W.J. 510 (205), 530
- Galoux, M. 1076 (186), 1159
- Gamache, P. 1071 (153), 1158
- Gamba, A. 398 (107), 420
- Gamer, G. 434 (92), 472, 1266 (157), 1299
- Gan, T.-H. 166 (60), 202
- Gandler, J.R. 508 (187), 529, 1228, 1232–1235, 1239 (77), 1297
- Gandour, R.D. 70 (117a, 117b), 84
- Ganem, B. 604 (397), 625
- Gange, D. 1152 (622), 1168
- Gangolli, A.D. 1188 (86), 1214
- Ganguly, S. 543 (60), 617
- Gannett, P.M. 56 (80b), 83
- Gao, C.X. 1083 (243, 244), 1160
- Garbow, J.R. 322 (99), 334
- García, E. 94 (33), 102
- García, F.V. 1047 (25), 1155
- García, J. 573 (203), 620
- García-Álvarez-Coque, M.C. 1088 (278), 1160
- García-Báez, E. 1109 (392), 1163
- García-España, E. 391 396, (64–66, 101), 418, 419, 420
- Gard, J.-C. 450 (193), 474
- Gardiner, T.M. 217 (79), 245
- Gardner, C. 1089 (281), 1160
- Gardner, P.J. 366, 369, 370 (98), 378
- Gardner, W.S. 1060 (85), 1079 (211), 1156, 1159
- Gargano, P. 165–167 (24), 202
- Gargaro, A.R. 152 (165, 166), 153 (165, 166, 168), 157
- Gargiulo, D. 139 (116, 117), 141 (116, 117, 119), 142 (121), 156
- Garipey, K.C. 1071 (153), 1158
- Garito, A.F. 94 (30), 102
- Garley, M. 675 (63), 681
- Garley, M.S. 678 (85), 682
- Garner, W.E. 348 (30a), 361, 362, 367, 371 (84), 373, 377
- Garo, A. 1175 (17), 1212
- Garren, L. 1066 (115), 1157
- Garrido, D. 1241, 1242 (105b), 1298
- Garrido Fernández, A. 1083 (248), 1160
- Garst, R.H. 1268 (171), 1299
- Garst, R.J. 1216, 1217, 1278 (2a, 2b), 1295
- Garthwaite, J. 976 (40), 994
- Garvey, E.P. 991 (116, 117), 992 (132), 996, 997
- Gasco, A. 324 (104), 334
- Gascon, J. 1047 (52), 1156
- Gase, M.B. 587 (298), 622
- Gassman, P.G. 510 (200, 201), 530, 875 (65–67), 890
- Gaston, B. 673 (44), 681
- Gatermann, R. 1127 (460), 1164
- Gates, R.A. 1145 (577), 1167
- Gatten, R.A. 1047 (35), 1155
- Gatti, C. 398 (107), 420
- Gauthier, S. 584 (280), 622
- Gautier-Luneau, I. 437 (122), 473
- Gavezzotti, A. 433 (73), 472
- Gawinecki, R. 454 (210), 475, 775 (64), 819
- Gawinecky, R. 286 (103), 293
- Gay-Montchamp, J.P. 1063 (100), 1157
- Gebicki, J. 770 (57), 819, 833, 834 (66), 836
- Gebicki, J.M. 832 (57), 836
- Gebicki, S. 832 (57), 836
- Gebreyesus, T. 267 (75), 293



- Gedanken, A. 133 (97, 101), 149 (151), 155, 157
- Gedeck, P. 686, 699, 700, 706 (24), 740
- Gee, K.R. 537 (33), 617
- Geels, E.J. 1020 (95), 1037
- Geerlings, P. 388 (58), 418
- Geib, S.J. 428, 430 (35), 471
- Geiduschek, E.P. 1048 (60), 1156
- Geiger, G. 810, 811 (159, 160), 821
- Geissler, A. 1134 (509), 1165
- Gelan, J. 697 (86), 741
- Gella, I.M. 132, 133 (96), 155
- Geller, D.A. 979 (76, 78), 995
- Gelperin, A. 993 (149), 997
- Genet, J.P. 551 (92), 566 (178), 618, 620
- Genin, M.J. 584 (287), 622
- Gennaro, M.C. 1074 (177–180), 1158
- Genoud, F. 807 (149a), 821
- Gentric, E. 381 (18), 417
- George, C. 97 (60, 61), 101 (61), 103, 606 (414), 625
- George, M. 231 (137), 247, 276, 279 (86, 87), 280 (90), 293
- George, M.V. 738 (199), 745, 771 (58), 819
- Geppert, J.T. 957 (45), 971
- Geraci, G. 1003 (47), 1036
- Gerald, R.III 698 (98), 742
- Gerba, S. 655 (162), 662
- Gerger, W. 426 (9), 470
- Gerhardt, K.O. 1047 (31), 1155
- Geri, R. 575 (211), 621
- Géribaldi, S. 387 (51), 418
- Gerike, P. 1116 (408), 1163
- Gerlack, J. 977 (48), 995
- Germain, P. 1069 (142), 1158
- Germani, R. 1220 (32a, 32b), 1296
- Gernstein, J. 407 (157b), 421
- Gerth, D.B. 649 (119), 661
- Gescher, A. 1141 (556), 1166
- Geseke, D.H. 184 (101), 203
- Geske, D.H. 843 (22), 847 (39, 40b), 855, 856
- Geurtsen, B. 1217 (13a), 1295
- Gevers, A.C.M. 1026 (141), 1038
- Ghai, S.S. 873 (60), 890
- Ghailane, F. 1136 (522), 1165
- Ghosh, A. 1138 (531), 1166
- Ghosh, A.C. 608 (427), 625
- Ghosh, D.K. 987 (99), 996
- Ghosh, K.K. 405 (151b), 421
- Ghosh, P.K. 160 (8), 201
- Giacomelli, L. 433 (81), 472, 1245–1247, 1266 (115b), 1298
- Giacomellio, P. 232 (141), 247
- Giacomo, N.D. 1178 (49), 1213
- Giammaruco, M. 570 (194), 620
- Giasson, R. 765 (44–46), 818
- Gibbs, D.E. 536 (16), 617
- Gibbs, H.W. 958 (47), 971
- Gibson, B. 457 (234), 476
- Gibson, H.H. 640 (67), 660
- Gibson, H.W. 584 (286), 622
- Gibson, J. 484 (38), 526
- Gierlich, H.H. 240 (184), 248
- Gies, H. 628 (10), 659
- Giffney, J.C. 880 (83), 890, 952 (17, 18), 970
- Gil, V.M.S. 320 (83), 334
- Gilabert, D.M. 580 (245), 621
- Gilabert, E. 697 (87), 741
- Gilardi, R. 97 (60, 61), 101 (61), 103, 606 (414), 625
- Gilbert, A. 685, 686 (7), 692 (53), 694 (59), 698 (92), 702, 709 (53), 740–742
- Gilbert, B.C. 670 (29), 680
- Gilbert, J.R. 509 (192), 530
- Gilchrist, A.B. 329 (116), 334
- Gilchrist, J.H. 396 (86b, 89, 91e), 419
- Giles, G. 1267 (169), 1299
- Gilkar, F. 976, 978 (38), 994
- Gillaspy, M.L. 168 (61), 202
- Gilli, G. 96 (51), 103, 426 (15), 435 (103), 470, 472
- Gilli, P. 426 (15), 435 (103), 470, 472
- Gillies, D.G. 297 (4), 332
- Gillis, R.G. 289 (112), 293
- Gilman, J.P. 255 (30), 262 (30, 56), 292
- Gilmore, J. 266, 267 (71), 293
- Ginsberg, A. 636 (33), 646 (101), 659, 661
- Giorgi, G. 57 (93), 83
- Giorgi, R. 143 (125), 156
- Giorgini, E. 441 (146), 473
- Giovanelli, J. 983 (84), 985 (97), 996
- Gipp, J.J. 1032 (192, 193), 1039
- Girelli, A. 456 (225), 475
- Girelli, A.M. 1091 (298, 299), 1161
- Girgis, S. 1029 (159), 1038
- Gisler, M. 1220 (34), 1296
- Gittins, V.M. 57 (87), 83
- Giumanini, A.G. 53 (77), 71 (121), 83, 84, 173 (78), 203, 563 (162, 163), 583 (270a, 270b), 620, 622
- Giuo, J. 1179 (50), 1213
- Giuo, Z. 1179 (50), 1213
- Giusti, M. 391 (64, 65), 418, 419
- Givens, R.S. 1080 (222, 223), 1159
- Giziewicz, J. 453 (205), 475
- Glader, B.E. 1027 (151), 1038
- Glaeske, K.W. 578 (222), 621
- Glasyb, J.S. 106 (3), 153
- Glaser, R. 648 (113, 114), 661
- Glasstone, S. 487 (68), 526, 894 (9), 947
- Glatt, C.E. 976, 977 (44), 993 (151), 995, 997
- Glatt, C.S. 978 (69), 995
- Glauser, J. 669 (18, 23), 680
- Gledhill, A.P. 650 (129), 661

- Gleich, A. 393, 394 (78), 419  
 Gleiter, R. 174, 175 (81), 184, 185 (108), 199 (148), 203, 204  
 Glenn, R. 99 (80), 103  
 Glick, R.E. 490, 491, 503 (90), 527  
 Glish, G.L. 238 (179), 248, 251, 253, 254 (5), 264, 269, 270 (66), 291, 293  
 Glover, S.A. 667 (8), 680  
 Glowka, M.L. 98 (75), 103  
 Göbel, I. 164, 167 (35), 202  
 Göbl, M. 830 (52), 836  
 Goddard, W.A.III 37 (55), 38 (55, 58), 39, 40 (58), 41 (55), 82  
 Godel, H. 1076 (188), 1090 (291), 1159, 1161  
 Godfrey, A.G. 604 (397), 625  
 Godovikova, T.I. 628 (8), 659  
 Goedeweck, R. 695 (77), 741  
 Goerdeler, J. 636 (32, 33), 646 (101), 659, 661  
 Goetsch, P.H. 1058 (78), 1156  
 Goetz, M. 692 (52), 741  
 Gokel, G.W. 902 (25), 947  
 Gold, V. 894 (3), 946  
 Goldberg, I. 15, 16 (26b, 26c), 82  
 Goldberg, L.S. 795 (120), 820  
 Golden, D.M. 354 (53), 375, 401 (134), 420, 883 (88), 890  
 Golden, J.T. 877 (70), 890  
 Golderer, G. 993 (148), 997  
 Golding, B.T. 297 (9), 332, 538 (35), 617  
 Golding, J.G. 953, 965, 967 (20), 970  
 Goldman, E.N. 1033 (201), 1039  
 Goldman, P. 1032 (196, 197), 1039  
 Gol'dshtein, I.P. 381 (9), 416  
 Goldstein, I. 993 (146), 997  
 Goldstein, J. 589 (310), 623  
 Goldstein, P. 435 (99), 472  
 Goldstein, S. 829 (48), 836  
 Goldwhite, H. 165, 166 (44), 202  
 Golly, I. 1026 (145), 1038  
 Gomes, A. 505 (156), 529  
 Gomez, J.A. 60, 62 (105), 84  
 Gómez Hens, A. 1077, 1098 (194), 1159  
 Gomez-Sanchez, A. 453 (204), 475  
 Goncalves, R.M.C. 1228 (75), 1297  
 Gonzales, M. 886 (102), 891  
 González, G. 431 (66), 456 (223), 472, 475  
 Gonzalez, R. 396 (88), 419  
 Gonzalez-Lafont, A. 754 (15), 817  
 Goodall, C.M. 1030 (171), 1038  
 Gooden, R. 767 (50a), 819  
 Goodfriend, G.A. 1060 (86), 1093 (310, 312, 313), 1156, 1161  
 Goodwin, D. 693 (56), 741, 1217 (16), 1295  
 Goosen, A. 667 (8), 680  
 Gopidas, K.R. 738 (199), 745  
 Gopinathan, C. 832 (58), 836  
 Goralski, C.T. 536 (18), 617  
 Gorczynska, A. 1096 (333), 1161  
 Gorden, R. 211 (37), 244  
 Gordge, M.P. 674 (50), 681  
 Gordillo, B. 297 (10), 332  
 Gordon, D.M. 430 (50), 471  
 Gorelik, M.V. 631 (19, 20), 659, 884 (96), 891  
 Gorman, G.S. 390 (71), 419, 1284, 1285 (194b), 1300  
 Gorman, P. 979 (77), 995  
 Gorner, H. 750 (7), 778 (70a, 70c, 71–73), 783 (93), 817, 819, 820  
 Gornostaev, L.M. 1000, 1009, 1019 (7), 1035  
 Gors, B. 141 (120), 156  
 Gorski, W. 1143 (567), 1148 (599), 1166, 1167  
 Gorsky, L.D. 977 (46), 995  
 Gort, S.M. 1116 (415), 1163  
 Gorton, L. 1103 (357), 1162  
 Gosciniak, D.J. 825 (24), 835  
 Goss, F.R. 486 (57), 526  
 Gotchiguian, P. 234 (153), 247  
 Goti, A. 580 (249), 621  
 Gotor, V. 592 (333, 336, 337), 623  
 Gottardi, W. 581 (256), 622  
 Gottlieb, H.E. 43, 54 (67), 55, 56 (79), 83  
 Götz, R. 434 (84, 89), 472  
 Gouali, M. 358 (75), 376  
 Goudgaon, N.M. 565 (171), 620  
 Gouesnard, J.P. 297 (6), 300 (15), 332  
 Gougoutas, J.Z. 651 (137), 652 (138), 662  
 Gould, G.L. 1217 (16), 1295  
 Goulding, B.T. 208 (5), 244  
 Govoni, P. 447 (187), 474  
 Gowenlock, B.G. 188, 191 (128), 204, 354 (53), 375, 447 (176, 180), 474, 803 (141), 821, 1007 (52), 1036  
 Graaf, B.van de 519 (236), 531  
 Graboski, G.G. 604 (399), 625  
 Grabowski, S.J. 99 (85), 103  
 Grabowski, Z.R. 693 (57), 694 (60), 741  
 Grady, G.L. 46 (70, 71), 47 (71), 83  
 Graham, L. 1024 (125), 1037  
 Graham, M. 444 (162), 474  
 Graham, W.R. 1027 (149), 1038  
 Grambal, F. 392 (75), 419  
 Gramstad, T. 431 (63–65), 471, 472, 1273, 1278 (179), 1299  
 Grandclaudon, P. 698 (93), 724 (161, 164), 727 (168), 742, 743, 744  
 Grandinetti, F. 165–167 (24), 202  
 Granozzi, G. 175 (83), 203  
 Grant, R.D. 793 (118), 820  
 Grant, T.M. 1063 (98), 1157  
 Graser, T.A. 1076 (188), 1159  
 Gratteri, P. 1116 (409), 1163

- Gravel, D. 765 (44–46), 769 (55), 818, 819  
 Gray, D.O. 1088 (280), 1160  
 Gray, E.J. 633 (23), 659  
 Gray, J.I. 1189 (95), 1214  
 Gray, M.J. 954 (25, 29), 970, 971  
 Graziano, K.A. 767 (52a), 819  
 Grech, E. 322, 323 (96), 334, 435 (108–112), 436 (120), 472, 473  
 Greci, L. 191, 199 (130), 204, 969 (66), 970 (67), 971  
 Greck, C. 551 (92), 566 (178), 618, 620  
 Greef, J.van der 218 (86), 246  
 Green, F.J. 1053, 1054, 1058, 1115, 1124, 1144 (73), 1156  
 Green, J.C. 164, 165, 175 (31), 188 (126, 128), 189, 190 (126), 191 (126, 128), 202, 204, 803 (139), 821  
 Green, L.C. 1021, 1030 (103), 1037  
 Green, M.M. 209 (23), 244  
 Green, S.A. 810 (156), 821  
 Greenberg, A. 345 (18), 361 (86), 373, 377  
 Greenblatt, G.D. 795 (124), 820  
 Greenblatt, J. 1007 (53), 1036  
 Greene, E.F. 466 (265), 476  
 Greenhalgh, C. 457 (234), 476  
 Greenlee, R.B. 589 (312), 623  
 Greenstein, J.P. 107 (25, 26), 154  
 Greenstock, C.L. 823 (1), 835  
 Greenwood, D.R. 1141 (557), 1166  
 Greer, M.L. 854 (66), 856  
 Grefenstein, L. 400 (128), 420  
 Grehn, L. 540 (46), 541 (46, 51), 542 (53), 617, 854 (63), 856  
 Greig, C.C. 958 (50), 971  
 Grelier, P.L. 1220 (42), 1222 (50, 51), 1238 (51), 1296  
 Grellier, P.L. 381 (17b-e, 19, 20b, 20c), 395 (81), 417, 419, 428 (41, 42), 471  
 Griben, B.J. 991 (119, 120), 996  
 Grice, H.C. 1189 (93), 1214  
 Grieco, P.A. 570 (195), 620  
 Grierson, L. 579 (239), 621  
 Griffin, R.G. 322 (103), 325, 326 (108), 334  
 Griffith, O.W. 669 (21), 680, 976, 978 (38), 985 (91, 95), 991 (118), 994, 996  
 Griffiths, H. 1059 (80), 1156  
 Grigg, R. 1100 (349), 1162  
 Grillot, G.F. 554 (110), 618  
 Grimaldi, J. 598 (378), 624  
 Grimmett, M.R. 100 (94), 103  
 Grimsrud, E.P. 385 (37a), 418  
 Griscavage, J.M. 990 (108), 996  
 Grivas, S. 1004, 1007, 1009 (43), 1012 (43, 84), 1019 (43), 1033 (84), 1035 (43), 1036  
 Grob, C.A. 179 (94), 203, 512 (217–222), 530  
 Grob, R. 1145 (572), 1166  
 Gröbner, P. 993 (148), 997  
 Groen, M.B. 757 (25), 818  
 Gronchi, G. 854 (67), 856  
 Gronert, S. 399 (119), 420  
 Groombridge, C.J. 324 (104), 334  
 Gros, C. 106 (6), 153  
 Grosjean, D. 1176 (27), 1180 (56, 59), 1212, 1213  
 Grosjean, F. 546 (73), 618  
 Grosjean, M. 106 (8), 153  
 Gross, A.W. 539 (42), 617  
 Gross, B.L. 1025 (132), 1038  
 Gross, J.H. 227–229 (128), 230, 231 (133), 246, 247  
 Gross, M.L. 208 (16), 211 (35, 36, 39), 217 (78), 222, 223 (112), 244–246, 595 (354), 624  
 Gross, S.S. 976 (35), 994  
 Grosvenor, P.W. 1088 (280), 1160  
 Grover, P.L. 1000 (8), 1035  
 Gruen, H. 778 (70), 819  
 Gruetter, C.A. 673 (42), 681, 975 (20, 25–28), 992 (28), 994  
 Gruetter, D.Y. 975 (26, 27), 994  
 Grunwald, E. 409 (175), 421, 424 (2, 4), 470  
 Gruszecka, E. 861, 863 (21), 867 (37), 889, 918, 920 (37), 947  
 Grutmacher, H.-F. 216 (63f), 245  
 Grywacz, C.M. 1082 (241), 1160  
 Gu, J. 535 (9), 616  
 Guan, Y. 562 (153), 619  
 Guanti, G. 100 (93), 103, 1262, 1264 (151), 1299  
 Guardado, P. 409 (169a, 169b), 421  
 Guardia, M.de la 1074 (174), 1158  
 Guasch, J. 1083 (246), 1160  
 Guastadisegni, G. 1247, 1249 (123), 1278–1280, 1285 (184b), 1289 (123), 1298, 1300  
 Gudmundsdottir, A.D. 710 (111), 742  
 Gudriniece, E. 437 (124), 473  
 Guennouni, F. 540 (45), 617  
 Guerra, M. 50, 53 (76), 83  
 Guerra, R. 673 (46), 681  
 Guerrieri, A. 1078 (197), 1159  
 Guerro, S.A. 175 (83), 203  
 Guida, W.C. 41 (63), 82  
 Guihéneuf, G. 381 (17d, 18), 417, 1222, 1238 (51), 1296  
 Guilhem, J. 592 (335), 623  
 Guillaumet, G. 596 (366), 624  
 Guindi, L.H.M. 616 (464), 626  
 Guiry, P.J. 584 (279), 622  
 Guissani, A. 834 (71, 72), 836  
 Gülbaran, E. 1000, 1009 (6), 1035  
 Gülec, B. 644 (93), 660  
 Gullberg, P. 932 (45), 947  
 Gullion, T. 322 (97, 98), 334

- Gullotti, M. 137 (111), 156  
 Gumbleton, M. 1142 (562), 1166  
 Gundertofte, K. 41, 42 (60), 82  
 Gunn, V.E. 886 (98), 891  
 Gunther, H. 25, 38 (38), 82, 396 (87), 419  
 Guo, Q. 232 (143), 247  
 Gupta, O.D. 593 (345), 623  
 Gupta, S. 1238 (96), 1297  
 Gupta, V. 1152 (622), 1168  
 Gupta, V.K. 1138 (532), 1166  
 Guram, A.S. 584 (282), 622  
 Gurd, F.R.N. 1005 (51), 1036  
 Gurevich, A. 1273–1275 (177), 1299  
 Gurka, D. 381, 395 (14a, 14b), 416  
 Gur'yanova, E.N. 381 (9), 416  
 Gustavsson, B. 1082 (237), 1160  
 Güsten, H. 176 (87), 199 (147), 203, 204  
 Guthrie, J.P. 348 (30b), 373  
 Gutiérrez, E. 1046 (16), 1155  
 Gutman, D. 360 (78), 376, 382 (23), 417  
 Gutmann, V. 381 (12a–c), 416, 424 (3), 425 (3, 8), 426 (9), 431 (3), 470  
 Gutsche, C.D. 843 (20a), 855  
 Gutshke, D. 871 (54), 890  
 Guy, A. 537 (31), 563 (164), 617, 620  
 Guy, C. 1175 (12), 1212  
 Guy, L. 553 (106), 618
- Haammerum, S. 224, 225 (115), 246  
 Haas, J.W. 1047 (49), 1155  
 Haas, Y. 795 (124), 820  
 Haase, A. 330 (122), 335  
 Haasmann, S. 1090 (291), 1161  
 Habdas, J. 905 (29), 947  
 Haber, F. 838 (3), 854  
 Hable, M. 1127, 1143 (458), 1164  
 Habraken, C.L. 878 (75), 890  
 Habs, H. 1185 (70), 1213  
 Hachisuka, C. 565 (175), 620  
 Hacksell, U. 62 (107), 84  
 Hada, W.A. 168 (61), 202  
 Hadayatullah, M. 578 (226), 621  
 Haddad-Fahed, O. 1222 (49a, 49b), 1296  
 Hadfi, S. 1089 (288), 1161  
 Hadjigeorgiou, P. 953, 965, 967 (20), 970  
 Hadrick, G.R. 369, 370 (99), 378  
 Hadzi, D.D. 62 (106), 84  
 Haga, N. 872 (56), 873 (57), 890  
 Haga, T. 679 (87), 682  
 Hagashijima, T. 1095 (325), 1161  
 Hageman, H.J. 722 (153e), 743  
 Hague, D.N. 390 (61), 418  
 Hahn, J.-T. 534 (5), 616  
 Hai, P.T. 1148 (598), 1167  
 Haink, H.J. 163 (29), 202  
 Haisa, M. 93 (15, 16), 98 (16), 102  
 Haiza, M.A. 130 (89), 155
- Hajicek, J. 566 (178), 620  
 Hakam, A. 1024 (123, 124), 1037  
 Haken, J.K. 434 (95), 472  
 Hale, P.D. 729 (174), 744  
 Halim, H. 208 (9), 220, 221, 232 (97), 244, 246  
 Hall, A.V. 978 (71), 995  
 Hall, E.J. 1031 (182), 1037  
 Hall, J.L. 257 (36), 292  
 Hall, L.D. 330 (118), 335  
 Hall, R.C. 1047 (44), 1155  
 Hall, W.E. 175 (84), 203  
 Halldin, C. 932 (45), 947  
 Halle, J.-C. 512 (216), 530  
 Hallett, G. 448 (190), 474, 677 (75), 681  
 Halsall, H.B. 1103 (362), 1162  
 Halvax, J.J. 1119 (426), 1163  
 Halverson, A.M. 759 (35a, 35b), 818  
 Hamada, K. 34 (46), 82  
 Hamada, T. 736 (194a, 194b), 745  
 Hamada, Y. 24 (32), 82  
 Hamaguchi, M. 457 (235), 476  
 Hamamoto, I. 605 (409b), 614 (452–454, 456, 457), 615 (458), 625, 626  
 Hamamoto, K. 870 (47), 890  
 Hamanoue, K. 776 (66), 819  
 Hamasuna, S. 562 (150), 619  
 Hamazone, I. 308, 309 (39), 333  
 Hambley, T.W. 58 (94), 83, 97, 98, 101 (67), 103  
 Hamelin, J. 589 (311), 623  
 Hamer, G.K. 505 (156), 529  
 Hamilton, A.D. 428, 430 (35), 471  
 Hamilton, I.C. 1046 (18), 1155  
 Hammel, P. 736 (192a), 745  
 Hammerich, O. 839, 851 (8c), 855  
 Hammerle, M. 1103 (359), 1162  
 Hammerum, S. 208 (14, 15), 209 (26), 212 (26, 41, 42, 44, 45), 213 (15, 26, 42), 214 (14, 15, 41, 42), 215 (14), 216 (41, 42, 59, 63d), 218 (45, 84, 85), 219 (89, 92), 220 (93–95), 221 (26, 84, 107), 222 (44, 45, 59), 223 (44, 93), 224 (44), 225 (42, 44), 227–229 (93), 244–246  
 Hammes, P.W. 1079 (213), 1159  
 Hammett, L.P. 483 (28), 487 (72, 73), 493 (28, 116), 525, 527, 528, 644, 647 (95), 660  
 Hammick, D.L.I. 484 (40), 526  
 Hammock, B.D. 1135 (515), 1165  
 Hammond, G.S. 905 (30), 947  
 Hammond, J.R.M. 1188 (89), 1214  
 Hammons, J.H. 398 (113a, 113b), 420  
 Hampel, F. 397 (103), 420  
 Hampp, N. 1119 (427), 1163  
 Hampson, N.A. 581 (255), 622  
 Hampton, C.V. 1177 (36), 1212  
 Han, B.H. 534 (3), 616

- Han, C. 1142 (562), *1166*  
 Han, C.-C. 385 (34a, 34b), *417*  
 Han, J.L. 534 (5), *616*  
 Han, S.H. 886 (99), *891*  
 Han, X. 992 (133), *997*  
 Han, Y. 540 (47), *617*  
 Hanada, Y. 1065 (113), *1157*  
 Hanafusa, T. 962 (51), *971*  
 Hanaki, K. 1083 (253), *1160*  
 Hanato, H. 685 (14), *740*  
 Hanaue, K. 1047 (22), *1155*  
 Hanazaki, Y. 534 (7), *616*  
 Hancock, D.K. 1092 (305), *1161*  
 Hancock, R.D. 58 (95–97), *83*  
 Hand, O.W. 234 (156), *247*  
 Handrick, G.R. 338, 361, 362, 364 (2b), *372*  
 Haney, W.A. 455 (215), *475*, 790 (109a), *820*  
 Hanioka, N. 1081, 1091 (234), *1159*  
 Hannigan, T.J. 404 (145), 405 (148), *421*  
 Hansch, C. 303 (29), 332, 494 (118), 504 (150), 514 (118, 150), 515, 517, 518 (150), 522 (150, 251), 528, 529, *531*, 1006, 1024, 1026–1028, 1030–1032 (55), *1036*, 1241 (106a), *1298*  
 Hansch, C.G. 522 (245), *531*  
 Hansel, S.B. 1133 (495), *1165*  
 Hansen, H.-J. 152 (162), *157*  
 Hansen, I. 603 (393), *624*  
 Hansen, S.H. 1142 (561), *1166*  
 Hansh, C. 1238 (95), *1297*  
 Hansson, L. 583 (272), *622*  
 Hantzsck, A.R. 482 (24), *525*  
 Hapiot, P. 832 (63), 836, 839, 851 (8a), *855*  
 Happe, J. 1033 (199), *1039*  
 Happer, D.A.R. 505 (157), *529*  
 Hara, K. 693, 694 (62), *741*  
 Harada, K. 650 (124a), 651 (133), *661*  
 Harada, N. 140 (118), 141 (118, 119), 142 (121, 122), *156*  
 Harada, Y. 193, 194, 197–199 (144), *204*  
 Harasek, M. 582 (269), *622*  
 Harbison, G.S. 325, 326 (108), *334*  
 Hard, K. 722 (155), *743*  
 Hardemare, A. du M.d' 669 (16), *680*  
 Harden, A. 120 (61), *154*  
 Hardy, J.K. 1059 (82), *1156*  
 Harger, W.P. 1131 (485), *1165*  
 Hargittai, I. 8, 24 (14a), *81*, 452 (201), *475*  
 Hargittai, K.B. 452 (202), *475*  
 Hariharan, M. 1085 (260), *1160*  
 Harirchian, B. 727 (167), *744*  
 Harke, H.R. 1096 (331), *1161*  
 Harlow, R.L. 543 (63), *617*  
 Harmon, M.F. 991 (116, 117), *996*  
 Harms, K. 396 (99, 100), *420*  
 Harper, E.M. 676 (69), *681*  
 Harper, T. 96 (50), *103*  
 Harrelson, J.A. 403 (141), *421*  
 Harriman, A. 827 (36), *835*  
 Harrington, G.W. 94 (41), *102*  
 Harris, F.M. 266 (73), *293*  
 Harris, J.M. 933, 935, 936 (51), *947*, 1273, 1275, 1283 (178), *1299*  
 Harris, K.D.M. 322 (102), *334*  
 Harris, P.A. 556 (119), 557 (126, 127), *619*  
 Harris, R.K. 57 (90b), 83, 297 (14), *332*  
 Harrison, A.G. 216 (62), 226 (121), 234 (155, 158), 236 (173, 174), 237 (174), 238 (158, 173, 174, 178), 239 (178), 240–243 (158), 245–248, 254 (22), 287 (106), 288 (22, 106, 108), 289 (108, 113), 292–294  
 Harrison, A.T. 396 (86b, 89, 91e), *419*  
 Harrison, D. 673 (42), *681*  
 Harrison, D.G. 673 (46), *681*, 977 (53), 979 (75), *995*  
 Harrison, J. 536 (18), *617*  
 Harrison, J.H. 1022 (112), *1037*  
 Harrison, J.K. 977 (51), *995*  
 Harrold, M.P. 1093 (318), *1161*  
 Hart, B.T. 1046 (18), *1155*  
 Hart, T.W. 668 (15), *680*  
 Hart, W.J. van der 289 (114), *294*  
 Harten, B. 1024 (123, 126), *1037*  
 Hartman, C.P. 1197 (105), *1214*  
 Hartneck, C. 991 (122), *996*  
 Hartree, E.F. 975 (7), *994*  
 Hartshorn, M.P. 455 (218), 456 (220), *475*, 790 (108, 109b, 111b, 111c, 112–114), 820, 883 (89, 90, 92), *890*, *891*, 954 (24–39), 956 (28), 961 (24), 962 (30), 963 (31), 968 (26), 969 (36), 970 (37, 38), *970*, *971*  
 Hartshorn, S.R. 896 (16), 945 (70), *947*, *948*  
 Hartstock, F.W. 595 (357), *624*  
 Harvey, D. 1025 (134), *1038*  
 Harvey, T.M. 289 (109), *293*  
 Harwood, L.M. 858 (2), *888*  
 Hasanuddin, S.K. 192 (134), *204*  
 Hasegawa, E. 688 (43), 690 (45), (44), *740*  
 Hasegawa, T. 722 (159a), *743*  
 Hasegawa, Y. 596 (361a, 361b), *624*, 1218 (22a, 22b, 23), 1290 (22a, 22b), *1295*  
 Hashemi, P. 1074 (181), *1158*  
 Hashida, Y. 648 (107), *661*  
 Hashimoto, A. 1090 (292), *1161*  
 Hashimoto, C. 724 (166b), *744*  
 Hashimoto, K. 824 (12), *835*  
 Hashimoto, M. 165, 166 (23), *202*  
 Hashimoto, S. 736 (192b), *745*, 1256 (137–139), *1298*, *1299*  
 Hashmall, J.A. 184 (102), *203*  
 Hass, H.J. 738 (200a), *745*  
 Hass, M.P. de 696 (78), *741*  
 Hassan, S.M. 1140 (548, 549), *1166*  
 Hassan, Y.A. 1106 (376), *1162*

- Hassel, O. 442 (149, 152), 473  
 Hassner, A. 43, 54 (67), 55, 56 (79), 83, 717 (140), 743  
 Hassnoot, C.A.G. 57 (92), 83  
 Hatanaka, Y. 730 (181c, 182b), 744  
 Hatano, H. 739 (204), 745  
 Hatano, Y. 695 (68), 741  
 Hatch, F.T. 1033 (199), 1039  
 Hatem, J. 598 (378), 624  
 Hathaway, B.J. 329 (113), 334  
 Hathaway, C. 877 (70), 890  
 Hathout, Y. 1024 (127), 1037  
 Hattori, M. 776 (65), 819  
 Hattori, R. 978 (59, 66), 995  
 Haugen, G.R. 354 (53), 375  
 Haumann, T. 168 (61), 202  
 Hauske, J.R. 576 (216), 621  
 Hausladen, A. 992 (138), 997  
 Hautefeuille, A. 1147 (591), 1167  
 Havery, D.C. 1146 (586), 1167  
 Haviga, E. 15, 17 (25b), 81, 753 (11, 12), 757 (25), 817, 818  
 Havingna, E. 754 (18), 788 (103), 818, 820  
 Havlas, Z. 164, 167 (35), 202  
 Haw, J.F. 414 (201), 422  
 Hawkes, G.E. 324 (104), 334  
 Hawkins, C.J. 58 (94), 83  
 Hawkins, J.M. 72 (123), 84  
 Hayakawa, K. 1069 (147), 1079, 1083 (217), 1129 (476), 1130 (147, 476, 479, 481), 1131 (476), 1158, 1159, 1164, 1165  
 Hayakawa, S. 551 (91), 618  
 Hayami, J. 467, 468 (274), 476, 1281, 1282 (189), 1300  
 Hayami, J.I. 1217 (7), 1295  
 Hayashi, J. 1085 (270, 271), 1160  
 Hayashi, K. 614 (455), 615 (459), 626, 1097 (338), 1162  
 Hayashi, M. 602 (390), 624  
 Hayashi, T. 1087 (276), 1090 (292), 1160, 1161  
 Hayes, J.M. 1059 (79), 1156  
 Hays, J.T. 1016 (88), 1037  
 Hayward, M.A. 991 (118), 996  
 Hayward, M.J. 1107 (383), 1163  
 Hazard, R. 1107 (380), 1162  
 Hazelwood, R. 991 (117), 996  
 Hazlett, J.S. 1118 (421), 1163  
 He, G.Z. 795 (121), 820  
 He, H. 437 (121), 473  
 He, L. 1070 (149), 1158  
 He, R.X. 396 (87), 419  
 Head, A.J. 366, 369, 370 (98), 378  
 Head-Gordon, M. 384 (28a), 417  
 Headley, A.D. 388 (57), 389 (59), 418, 523 (252), 524 (254), 531, 1238 (97, 99), 1239 (99), 1240 (97, 100), 1297  
 Healy, H.F. 161, 173 (18), 202  
 Heany, H. 585 (290), 622  
 Hearing, E.D. 338 (2d, 3, 5), 361 (2d), 372  
 Heaton, B.T. 859 (3), 888  
 Heaton, J.N. 594 (347, 348), 623  
 Hecht, L. 152 (164–166), 153 (165, 166, 168), 157  
 Hecht, S.S. 1150 (612), 1167  
 Hecker, M. 992 (140), 997  
 Hedberg, K. 436 (118), 473  
 Hedberg, L. 436 (118), 473  
 Hedges, J.I. 1067 (131), 1157  
 Hedlund, H. 993 (145), 997  
 Hedrera, M. 433 (81), 472, 1245–1247, 1266 (115b), 1298  
 Hedstrand, D.M. 675 (62), 681  
 Heema, W. 208 (6), 244  
 Heesing, A. 871 (54), 890, 904 (27, 28), 947  
 Heffron, P.J. 117 (53), 154  
 Hefnawy, M.M. 1140 (548, 549), 1166  
 Hefner, E. 1177 (29), 1212  
 Hegarty, A.F. 329 (113), 334, 642 (78), 660  
 Hegedus, L.S. 605, 614 (409a), 625  
 Hegyes, P. 564 (167), 620  
 Hehre, W.J. 34 (48), 82, 208 (4), 244, 303 (25), 332, 510 (207), 523 (252), 530, 531  
 Heilbronner, E. 66, 67 (111), 84, 160 (12), 166 (51, 52), 168 (52), 169 (51), 170 (12), 179 (52, 94), 181 (96), 184 (52, 102, 103, 105), 185 (52), 201–203  
 Heilmair, R. 1030 (177), 1039  
 Heim, F. 1001 (32), 1035  
 Heimbach, H. 238 (177), 248  
 Heimgartner, H. 717 (142), 743  
 Heindel, N.D. 834 (73), 836  
 Heineman, W.R. 1023 (121), 1037, 1103 (362), 1162  
 Heinis, T. 256 (35), 292, 385 (34d), 417  
 Heinrich, G. 199 (147), 204  
 Heinrich, N. 211 (40), 216 (63c), 244, 245  
 Heinze, J. 164, 165 (36), 202  
 Heinze, T.M. 1146 (583), 1167  
 Heinzl, B. 983 (86), 996  
 Helbert, M. 395 (83), 419, 505 (158), 529, 1238 (87b), 1297  
 Helgaker, T. 236 (172), 248  
 Helgason, T. 1145 (573), 1166  
 Heller, H.E. 868 (40), 889  
 Helmig, D. 1130 (484), 1131 (485), 1165  
 Helquist, P. 542 (54), 568 (188), 617, 620  
 Helsing, I. 1139 (535), 1166  
 Helsby, P. 953 (19), 970  
 Hemalatha, J. 269 (80), 293  
 Hemelaar, P.J. 1026 (141), 1038  
 Hemsworth, R.S. 235 (160), 247  
 Henderson, D. 1126, 1127, 1143 (446), 1164  
 Henderson, D.A. 565 (170), 620

- Henderson, D.O. 148 (146), 157  
 Henderson, E. 1024 (126, 127), 1037  
 Henderson, G.N. 880 (82), 890, 899 (24), 947, 950 (4–12), 951 (10, 11), 958 (9), 964 (5), 967 (58), 970, 971  
 Henderson, K.W. 396 (90), 419  
 Henderson, W.G. 524 (254), 531  
 Hendricks, L. 217 (77), 245  
 Hendrickson, A.R. 1087 (277), 1160  
 Hendrickson, T. 41 (63), 82  
 Hengstler, J.G. 1185 (72), 1213  
 Henion, J.D. 1118 (419), 1163  
 Hennion, B. 457 (227), 475  
 Henriët-Bernard, C. 598 (378), 624  
 Henry, L. 482 (26), 525  
 Henry, Y. 834 (71, 72), 836  
 Henschler, D. 1021 (104), 1037  
 Henshall, J.L. 97 (66), 103  
 Heppener, M. 445 (169), 474  
 Hepworth, P.A. 1102 (356), 1162  
 Heras, A.P. 1048 (58), 1156  
 Herbert, C.G. 265 (67), 293  
 Herbert, J. 769 (55), 819  
 Herbstein, F.H. 98, 101 (76), 103  
 Herche, L.R. 1060 (85), 1156  
 Hercouët, A. 536 (19), 617  
 Hermans, E. 697 (86), 741  
 Hermant, R.M. 694 (65), 696 (79), 741  
 Hernández, L. 1128 (465), 1134 (512), 1138 (530), 1164–1166  
 Hernández, P. 1128 (465), 1134 (512), 1164, 1165  
 Hernández-Cassou, S. 96 (46), 102, 1097 (340), 1162  
 Hernandez-Laguna, A. 1285 (195, 196), 1300  
 Herron, J.T. 208, 210, 217, 237 (18), 244  
 Hershey, N.D. 938 (57), 948  
 Hertel, M. 639 (65), 660  
 Herterich, R. 1133 (501), 1165  
 Hertle, H. 1020, 1022 (100), 1037  
 Herzfeld, J. 322 (103), 325, 326 (108), 334  
 Herzshuh, R. 273, 274 (84), 293  
 Hess, B.A.Jr. 148 (145, 146), 157  
 Hess, G.P. 769 (56), 819  
 Hesse, D.G. 338 (4), 347 (24), 355 (57), 356 (59), 372, 373, 375  
 Heufer, J. 693 (55), 741  
 Heuser, N. 139 (113), 156  
 Hevel, J.M. 978 (67), 983 (85), 995, 996  
 Hevesi, L. 218 (81), 245  
 Heydkamp, W.R. 552 (100a), 565 (172), 618, 620  
 Heyrovsky, M. 869 (45), 889  
 Heywood, P.J. 57 (87), 83  
 Hibbert, D.B. 883 (91), 891, 968 (63), 971  
 Hibbert, F. 381 (8), 416, 435 (104), 472, 1294 (201), 1300  
 Hibbs, J.B.Jr. 975 (29, 30), 976 (30, 34), 978 (29, 61), 980, 983 (34), 994, 995  
 Hiberny, C. 443 (159), 474  
 Hicckel, B. 834 (71, 72), 836  
 Hida, M. 718 (147), 743  
 Hida, S. 686 (26), 740  
 Hidaka, Y. 1114 (405), 1163  
 Hidalgo, J. 409 (169a, 169b), 421  
 Hiemstra, H. 568 (187), 620  
 Higgs, E.A. 669 (19), 680, 975 (4), 978 (62), 994, 995  
 Higgs, H. 37 (56), 82  
 Higuchi, D. 551 (90, 91), 618  
 Higuchi, J. 789 (106), 820  
 Hikasa, M. 561 (148), 619  
 Hiki, K. 978 (66), 995  
 Hilinski, E.F. 455 (213), 475  
 Hill, H.H. 1047 (30), 1155  
 Hill, J. 1001, 1007, 1009, 1011, 1027 (28), 1035  
 Hill, M.J. 1182 (63), 1213  
 Hill, R.A. 106, 113 (5), 153  
 Hill, R.R. 739 (202, 203, 205), 745  
 Hill, S. 1001, 1003, 1007, 1009, 1011, 1012, 1028 (29), 1035  
 Hiller, K.-O. 830 (50, 52), 836  
 Hillyer, C.D. 1024 (123), 1037  
 Hiltunen, R. 1083 (251), 1160  
 Hindawey, A.M. 439 (134), 473  
 Hindawi, S.K. 260, 263 (51), 292  
 Hinko, C.N. 1133 (497), 1165  
 Hinman, M.M. 119 (56), 154  
 Hino, T. 565 (174), 620  
 Hinson, J.A. 1011, 1012 (72), 1026 (142, 143), 1029 (72, 168), 1036, 1038  
 Hintz, P.J. 187 (112), 204  
 Hiramatsu, M. 751 (8), 759 (36a), 817, 818  
 Hirao, A. 111 (36), 154  
 Hirashima, T. 596 (365), 624  
 Hirata, S. 1106 (378), 1162  
 Hirata, Y. 724 (166c), 744  
 Hirayama, S. 1030 (176), 1039  
 Hirokawa, S. 96, 97 (59), 103  
 Hirose, Y. 458 (238), 476  
 Hirose, K. 1114 (405), 1163  
 Hirota, K. 722 (158a), 743  
 Hirsch, D.J. 984 (90), 993 (151), 996, 997  
 Hirsch, M.S. 445 (166), 474  
 Hirschberg, Y. 436 (120), 473  
 Hirschfeld, F.L. 87, 88 (6), 102  
 Hirst, J. 1219 (26), 1243, 1244 (109), 1251 (127, 128), 1262 (148a, 148b), 1264 (148a, 148b, 153), 1266, 1267 (162), 1276 (148a, 148b, 162, 182), 1277 (162), 1278 (153, 162, 182), 1287 (199), 1288 (148a, 148b), 1290 (182, 198–200), 1291 (198), 1293 (199), 1294 (109, 162), 1295, 1298–1300

- Hishikura, H. 458 (238), 476  
 Hiskey, M.A. 370 (100, 101), 378  
 Hitchings, G.J. 604 (394), 624  
 Hladonikova, R. 1077 (192), 1159  
 Hlaibi, M. 1217 (17), 1295  
 Hlavica, P. 1026 (145), 1038  
 Ho, J. 645 (100), 661  
 Ho, K.B. 1139 (534), 1166  
 Ho, L.Y. 447 (185), 474  
 Ho, M.F. 1097 (337), 1162  
 Ho, P.S. 810 (156), 821  
 Ho, T.I. 685 (8, 14, 15, 20–23), 698 (8, 22), 704 (8), (41), 740  
 Hobbs, A.J. 990 (111), 996  
 Hobbs, M.E. 426 (16), 470  
 Hobo, T. 1085 (270, 271), 1160  
 Hobson, J.D. 581 (261), 622  
 Hobza, P. 426 (10, 12), 428 (30), 431 (12), 434 (83), 470–472  
 Hochstrasser, R.M. 441 (144), 473  
 Hoefnagel, A.J. 494, 495 (117, 124, 125), 498 (125), 519 (124, 125, 236), 520 (239), 522 (248), 528, 531  
 Hoefnagel, M.A. 520 (239), 531  
 Hoeve, W.ten 539 (40), 617  
 Hoffman, E.P. 979 (78), 995  
 Hoffman, M.K. 217 (78), 245  
 Hoffman, R.V. 580 (250), 621, 634 (28), 659  
 Hoffmann, D. 1150 (607–610, 612), 1151 (613, 614, 616–618), 1167  
 Hoffmann, H.M.R. 229 (131), 247  
 Hoffmann, R. 184 (99), 203  
 Hofman, H.J. 262, 263 (59), 292  
 Hofmann, L. 1146 (584), 1167  
 Hog, J.H. 171 (68), 203  
 Hogendoorn, E.A. 1116 (415), 1163  
 Hohi Lee 320 (84), 334  
 Hojo, M. 498 (137), 528  
 Holbrook, K.A. 505 (161), 529  
 Holcman, J. 832 (54–56), 836  
 Holden, J.R. 80 (135), 84, 93 (22), 97 (65), 102, 103, 329 (114), 334  
 Holleck, L. 869 (45), 889  
 Holleman, A.F. 484 (42), 526  
 Holleyhead, R. 317 (65), 333  
 Holmes, E.L. 485 (54, 55), 526  
 Holmes, J.L. 208 (7, 11), 209 (11, 33), 214 (11, 51), 215 (7, 56), 217 (72), 231 (137), 233 (148, 149), 234 (148, 151), 235, 236 (166), 237 (175), 244, 245, 247, 248, 251 (8), 254 (19), 255 (24–28), 260–262 (52), 291, 292  
 Holmes, L.S. 992 (135), 997  
 Holmquist, F. 993 (145), 997  
 Holt, A. 1065 (105), 1157  
 Holt, D.E. 1025 (134), 1038  
 Holub, D.P. 550 (83), 618  
 Holzapfel, W.H. 1069 (144), 1158  
 Holzwarth, G. 147 (139), 156  
 Hom, G. 993 (147), 997  
 Homan, H. 1285 (196), 1300  
 Homero Méndez, D. 1083 (248), 1160  
 Hon, Y.-S. 539 (41), 617  
 Honegger, E. 179 (94), 184 (105), 203  
 Hong, J. 1134 (510), 1165  
 Hong, Y. 115 (50), 154  
 Hoof, R. 99 (86), 103  
 Hoogmartens, J. 1118 (420), 1163  
 Hooper, R.M. 97 (66), 103  
 Hoover, D.J. 168 (61), 202  
 Hoover, R.N. 1180 (52), 1213  
 Hop, C.E.C.A. 234 (151), 247, 260–262 (52), 292  
 Hope, H. 87, 88 (6), 102, 442 (152), 473  
 Hopfel, D. 330 (122), 335  
 Hopfinger, A.J. 13 (19), 81  
 Hopkins, P.B. 575 (209), 621  
 Hopkins, T.E. 583 (273), 622  
 Hoppilliard, Y. 216 (61), 232 (142), 245, 247  
 Horan, C.J. 648 (113, 114), 661  
 Horeld, G. 639 (56), 660  
 Horgan, A.G. 860 (17), 861 (17, 19), 863 (23), 889, 897 (22), 899 (23), 904 (26), 905 (29), 947  
 Hori, K. 722 (159c), 743  
 Hori, T. 572 (200, 201), 620  
 Hori, Y. 597 (370), 624  
 Horie, K. 1106 (378), 1162  
 Horie, T. 458 (236), 476  
 Horikawa, K. 1177 (33), 1212  
 Horiuchi, T. 843 (21), 855  
 Horn, J.Y. 1127 (456), 1164  
 Horniak, I. 1113 (403), 1163  
 Hornung, V. 184 (102), 203  
 Horsman-van den Dool, L.E.W. 696 (78), 741  
 Horspool, W. 710 (118), 742  
 Horspool, W.H. 715 (129), 742  
 Horspool, W.M. 715 (132), 716 (132–139), 717 (144), 718 (146, 148), 742, 743  
 Horstius, P. 1048 (57), 1156  
 Hortmann, A.G. 560 (137), 619  
 Horton, D. 15, 17 (23b), 81, 106 (4), 153  
 Hoshino, N. 437 (122), 473  
 Hoshino-Miyajima, N. 437 (123), 473  
 Hosken, G.D. 412, 413 (196), 422  
 Hosokawa, M. 458 (236), 476, 1218, 1219, 1237 (21a, 21b), 1295  
 Hosomi, A. 541 (50), 617  
 Hosseini, M.W. 390 (67), 419  
 Hosseini, S. 352 (41), 374  
 Hotchkiss, J.H. 1147 (589, 590), 1167, 1188 (84), 1214  
 Hothersall, J. 674 (50), 681



- Houdijk, A. 1078 (203), *1159*
- Houk, K.N. 72 (122a, 122b, 123), *84*, 163, 164, 166 (28), 169 (63), 179, 180 (28), 199 (145), *202–204*, 655 (161), *662*
- Houle, F.A. 192 (132), *204*
- Houlihan, F.M. 767 (50a, 50b, 51), *819*
- Houriet, R. 179 (94), *203*, 218 (81), *245*
- Hovey, J.K. 385 (34d), *417*
- Hovinen, J. 645 (100), *661*
- Howard, A.E. 60 (103b), *83*
- Howard, J.B. 1175 (18), *1212*
- Howard, K.H. 710 (114), *742*
- Howard, P.C. 1132 (492), *1165*
- Howard-Lock, H.E. 88, 90 (8), *102*
- Howe, G.P. 569 (192), *620*
- Howe, I. 209 (27), 221 (109), 227 (122), *244*, *246*
- Hrabie, J.A. 448 (189), *474*
- Hrcnciar, P. 313, 314 (58), *333*
- Hromadova, M. 1119 (436), *1164*
- Hsieh, C.L. 1081 (226), *1159*
- Hsieh, D.P.H. 1132 (490), *1165*
- Hsieh, T. 255 (30), 262 (30, 56), *292*
- Hsieh, Y.Z. 1093 (320), *1161*
- Hsu, E.C. 147 (139), *156*
- Hsu, V.L. 1048 (60), *1156*
- Hsu, W.N. 1073 (164), *1158*
- Hu, H. 540 (47), 580 (243), *617*, *621*
- Hu, J. 346 (19), *373*
- Hu, L.Q. 1238 (93), *1297*
- Hu, N.X. 583 (276), *622*
- Hu, R. 346 (19), *373*
- Hu, X. 535 (9, 10), *616*
- Hu, Y. 580 (243), *621*
- Hua, S.-T. 100 (94), *103*
- Huang, C.-G. 658 (175), *663*
- Huang, H.H. 97 (64, 67), 98, 101 (67), *103*, 193, 194 (143, 144), 195, 196 (143), 197 (143, 144), 198, 199 (144), 200 (150, 151), *204*
- Huang, P.L. 992 (143), *997*
- Huang, S.D. 1127 (456), *1164*
- Huang, X. 583 (277), *622*
- Huang, Y. 450 (193), *474*, 589 (309), *623*
- Huang, Z.H. 1066 (116, 119), *1157*
- Hub, W. 685 (19), *740*, 803 (143), *821*
- Hübel, M. 547 (79), *618*
- Huber, C.P. 329 (115), *334*
- Huber, E.W. 563 (157), *620*
- Huber, H. 66, 67 (111), *84*, 166, 168, 179, 184, 185 (52), *202*
- Huber, J.E. 108 (29), *154*
- Huber, J.R. 163 (29), 202, 810 (157, 159–162), 811 (159, 160), 816 (162), *821*
- Hubler, K. 396 (91b), *419*
- Hübner, H. 484 (35), *526*
- Huch, V. 396 (91d), *419*
- Hudec, J. 686 (25), 688 (32), 698, 700 (25), *740*
- Hudlicky, M. 638 (49), *660*
- Hudson, C.E. 216 (64, 65), 217 (80), 218 (65), *245*
- Hudson, K. 405 (150a), *421*
- Huehnerfuss, H. 1127 (460), *1164*
- Huerta, A. 1138 (530), *1166*
- Huffmann, K.R. 710 (115), *742*
- Hug, W. 151 (160), 152 (160, 162), *157*
- Hugel, H.M. 303 (27), *332*
- Hughes, D.L. 403 (140), 407 (159), 410 (183), 413 (198), *421*, *422*, 1228, 1232, 1235 (76), *1297*
- Hughes, E.D. 645 (97), *661*, 859 (11), 868 (40), 877 (73), 889, 890, 897 (20), *947*
- Huh, K.T. 543 (61), *617*
- Huie, R.E. 824 (9), 827 (27–30, 32, 33), 828 (42), *835*
- Huisgen, R. 426 (16), *470*, 639 (56), *660*
- Huizer, A.H. 754 (16), *818*
- Hulett, L. 329 (113), *334*
- Hull, K. 1071 (153), *1158*
- Hulst, R. 125 (79), 128 (85), *155*, 1110 (393–396), *1163*
- Hummel, R. 1187 (79), *1213*
- Hummelink, T. 37 (56), *82*
- Hummelink-Peters, B.G. 37 (56), *82*
- Humski, H. 896 (17), *947*
- Hünig, S. 186 (110), *204*
- Hunt, D.F. 289 (109), *293*
- Hunt, S. 512 (216), *530*
- Hunter, C.A. 430 (46), *471*
- Hunter, J. 59 (100), *83*
- Huo, J.Z. 1061 (92), *1156*
- Hurley, R. 1025 (134), *1038*
- Hurshman, A.C. 989 (106), *996*
- Hurst, W.J. 1067 (128), *1157*
- Hursthouse, M.B. 97 (66), *103*, 456 (222), *475*
- Hurtaud, D. 544 (69), *618*
- Hurvois, J.P. 1107 (379–382), *1162*, *1163*
- Husain, P.A. 1111 (398), *1163*
- Husain, S. 1137 (524), *1165*
- Husain, S.M. 859 (13), *889*
- Huse, G. 461 (252), *476*
- Husek, P. 1066 (116–118), 1068 (135), *1157*
- Hush, N.S. 445 (169), *474*
- Husinec, S. 585 (294), *622*
- Hussain, F. 1028 (156), *1038*
- Hussain, G. 1219 (26), 1251 (127), *1295*, *1298*
- Hussey, C.G. 1046 (10), *1155*
- Hutchings, G.J. 556 (122), *619*
- Hutchins, R.O. 113, 114 (43), *154*, 541 (49), *617*
- Hutchinson, N. 993 (147), *997*
- Hutchinson, N.I. 979 (78), *995*
- Hutchinson, P.J.A. 975 (12), *994*

- Hutchinson, R.E.J. 504, 515, 518 (154), 529  
 Hutta, M. 1133 (499), 1165  
 Hutte, R.S. 1047 (42), 1155  
 Huttner, G. 115 (49), 154  
 Hutzinger, O. 1180 (54), 1182 (60), 1213  
 Hvistendahl, G. 226 (121), 227 (123), 236  
 (123, 169, 170), 239 (182), 246, 248  
 Hvoslef, J. 95, 96 (44), 102  
 Hwang, P.M. 976, 977 (44), 995  
 Hwang, Y. 1083 (253), 1160  
 Hwu, J.R. 534 (6), 605 (410), 610 (437), 615  
 (460), 616, 625, 626  
 Hyman, A. 975 (21, 22), 994  
 Hyman, A.L. 673 (42), 681, 975 (25), 994  
 Hynds, P.M. 1176 (27), 1212
- Iannotta, A.V. 1105 (368), 1162  
 Iбата, T. 601 (385), 624, 1256 (135, 136),  
 1257 (136), 1258 (135, 140–142), 1259  
 (135), 1260 (140, 141), 1261 (141), 1298,  
 1299  
 Ibe, A. 1083 (245), 1160  
 Ibers, J. 24 (33), 82  
 Ibers, J.A. 654 (149), 662  
 Ibrahim, F.A. 1140 (548, 549), 1166  
 Ibrahim, P.N. 792 (116), 820  
 Ichikama, M. 1245 (113), 1298  
 Ichikawa, N. 767 (54), 819  
 Ichinose, N. 1086 (272), 1160  
 Ide, H. 833 (69), 836  
 Ideomoto, T. 657 (172), 662  
 Idowu, O.R. 1080 (224), 1159  
 Iffland, D.C. 628 (9), 659  
 Iglesias, A. 453 (206), 475  
 Iglesias, E. 643 (88), 644 (92, 96), 645 (88,  
 98), 660, 661, 677 (72), 681, 886 (101,  
 103), 887 (104), 888 (106), 891  
 Ignarro, L.J. 673 (42), 681, 974 (2), 975  
 (20–22, 25–28), 976 (32), 978 (60), 990  
 (108, 111), 992 (28), 993 (144),  
 994–997  
 Ignat'ev, N.V. 1238 (93), 1297  
 Ignatov, S.M. 553 (107), 618  
 Ihara, M. 580 (251), 621  
 Iizuki, H. 736 (192c, 192d), 745  
 Ikeda, M. 552 (98, 101), 618  
 Ikeda, S. 161, 163, 164 (22), 202  
 Ikeda-Saito, M. 984 (89), 989 (107), 996  
 Ikedo-Saito, M. 987 (100), 996  
 Ikegami, Y. 750 (6), 817  
 Ikemoto, N. 139, 141 (116, 117), 156  
 Ikenaga, K. 655 (154), 662  
 Ikenoue, T. 750 (6), 817  
 Ilczyszyn, M. 430 (57), 471  
 Ilett, K.F. 1033 (202), 1039  
 Iley, J. 606 (411), 625, 882 (86), 890  
 Il'ina, I.G. 444 (161), 474  
 Illingworth, W.S. 484 (40), 526  
 Illuminati, G. 1262, 1264 (147a), 1299  
 Imada, M. 543 (64), 617  
 Imada, Y. 535 (8), 576 (212), 593 (341), 616,  
 621, 623  
 Imafuku, K. 863 (25), 889  
 Imai, K. 1081 (233), 1091 (301–304), 1159,  
 1161  
 Imai, T. 112 (40), 154  
 Imai, Y. 590 (320), 623  
 Imam, M.R. 5, 16, 22 (8), 81  
 Iman, M.R. 27, 57 (30a), 82  
 Iman, S.H. 797 (131), 820  
 Imanaka, T. 534 (4), 616  
 Imasaka, T. 1095 (325), 1161  
 Imazumi, N. 1069, 1130 (147), 1158  
 Inaba, M. 541 (50), 617  
 Inabe, T. 437 (122, 123), 473  
 Inagaki, T. 563 (159), 620  
 Ing, H.R. 486 (56), 526  
 Ing, H.T. 883 (90), 890, 954 (24, 26), 961  
 (24), 968 (26), 970, 971  
 Ingemann, S. 216 (59), 219 (92), 220 (93–95),  
 222 (59), 223, 227–229 (93), 245, 246, 354  
 (54), 375  
 Ingold, C.K. 485 (50–52, 54, 55), 486 (57–60),  
 515 (50), 526, 859 (11), 868 (40), 889, 897  
 (20), 947  
 Ingold, E.H. 485 (52), 526  
 Ingold, K.U. 806 (147), 809 (152), 821  
 Ingold, K.V. 985 (96), 996  
 Inoue, A. 962 (51), 971  
 Inoue, H. 703 (101), 742  
 Inoue, M. 1119 (433), 1164  
 Inoue, N. 552 (100b), 618  
 Inoue, T. 596 (368), 624  
 Inoue, Y. 650, 652 (130), 661  
 In Quan, O. 824 (2), 835  
 Insogna, A.M. 688 (37), 740  
 Ioffe, S.L. 448 (192), 474, 608 (424), 625  
 Ion-Carastoian, A. 846 (38), 856  
 Ippoliti, J.T. 56 (80a), 83  
 Irgum, K. 1105 (370), 1162  
 Irion, M.P. 262 (54), 292  
 Irle, S. 848 (43), 856  
 Irsch, G. 165, 166, 192 (45), 202  
 Irving, K. 453 (206), 475  
 Isami, T. 561 (147), 619, 704 (105), 742  
 Ishibashi, N. 1095 (325), 1161  
 Ishida, A. 824 (11, 12), 835  
 Ishida, H. 843 (21), 855  
 Ishida, T. 647 (104), 661  
 Ishidate, M.J. 1131 (486), 1165  
 Ishidate, M.J.R. 1131 (488), 1165  
 Ishii, K. 123 (72), 155, 561 (148), 619  
 Ishii, S. 595 (355, 358), 624

- Ishii, Y. 654 (149), 662, 751 (9), 817  
 Ishikawa, M. 718 (147), 743  
 Ishimoto, M. 596 (361b), 624  
 Isildar, M. 1025 (136, 138), 1038  
 Isogami, Y. 1256, 1257 (136), 1258 (142),  
     1298, 1299  
 Isola, M. 1236, 1266 (159), 1299  
 Issa, R.M. 439 (134), 473  
 Issaq, H.J. 1094 (322), 1096 (327), 1149 (605),  
     1161, 1167  
 Ithakissios, D.S. 1099 (345, 346), 1162  
 Ito, K. 111 (36), 154, 536 (14), 565 (175),  
     617, 620  
 Ito, T. 654 (149), 662  
 Ito, Y. 602 (390), 624  
 Itoh, M. 565 (176), 620  
 Itoh, T. 1078 (206), 1159  
 Itoho, K. 1000 (1), 1035  
 Itou, K. 551 (89b), 618  
 Itsuno, S. 111 (36), 154, 536 (14), 565 (175),  
     617, 620  
 Ivanov, P.M. 57 (91), 83  
 Ivanova, E.V. 444 (161), 474  
 Ivanović, M.D. 563 (160), 620  
 Iwamoto, H. 635 (31), 659  
 Iwamura, H. 312 (52), 333, 407 (156), 421  
 Iwanaga, H. 1092 (307), 1161  
 Iwanicka, I. 98 (75), 103  
 Iwasaki, M. 1080 (221), 1159  
 Iwasaki, T. 438 (125), 473  
 Iwashita, T. 139, 141 (117), 156  
 Iwata, J. 442 (151), 473  
 Iwata, S. 161, 163, 171–173 (21), 193, 197  
     (21, 142), 202, 204  
 Iyengar, R. 976 (31, 33), 978, 980 (31), 994  
 Iyer, L.M. 950 (8), 970  
 Izquierdo, P. 1077, 1098 (194), 1159  
 Izquierdo-Pulido, M.L. 1079 (214), 1159  
 Izumi, K. 1180 (51), 1213  
 Izumikawa, S. 1072 (159), 1158  
 Izumiya, N. 107 (26), 154  
  
 Jachak, M. 588 (307), 623  
 Jackson, R.A. 655 (163), 662  
 Jackson, S.W. 612 (448), 626  
 Jackson, W.A. 1069 (145), 1158  
 Jacob, C. 859 (3), 888  
 Jacob, E. 1046 (12), 1155  
 Jacob, G.S. 325 (109), 334  
 Jacobs, P.A. 580 (240), 621  
 Jacobsen, E.N. 119 (57, 58), 154  
 Jacobson, I. 1077 (193), 1159  
 Jacobus, D.P. 1027 (152), 1038  
 Jacox, M.E. 795 (126), 820  
 Jacques, J. 106 (6, 12), 153  
 Jacquesy, J.C. 609 (433), 625  
 Jaeger, R. 547 (79), 618  
 Jaeger, W. 686, 699, 700, 706 (24), 740  
 Jaeken, J. 1078 (201), 1159  
 Jaffé, H.H. 488 (80), 527, 811 (164), 821  
 Jagow, R.H. 896 (14), 947  
 Jaime, C. 5 (7), 81  
 Jakobson, G.G. (86), 334  
 Jakschik, B. 975 (24), 994  
 Janarthanan, N. 596 (367), 624  
 Jandra, P. 1077 (192), 1159  
 Jang, D.G. 534 (3), 616  
 Janini, G.M. 1094 (322), 1096 (327), 1149  
     (605), 1161, 1167  
 Janousek, Z. 403 (138a, 138b), 420  
 Jansen, E. 1078 (201), 1159  
 Janssen, M.G.A. 1128 (464), 1164  
 Janssens, J.J. 1142 (560), 1166  
 Janssens, S.P. 977, 979 (50), 995  
 Janzen, E.G. 807 (148), 821  
 Janzowsky, C. 1188 (86), 1214  
 Jaraki, O. 673 (43, 45), 681  
 Jarczewski, A. 435 (112), 460 (248, 249), 473,  
     476, 509 (190), 530  
 Jarema, M.A. 130 (91), 155  
 Jaskólski, M. 436 (114), 473  
 Jason, M.E. 68 (113), 84  
 Jaszberenyi, J.C. 548 (80), 618  
 Jatoo, S.D. 1030 (173), 1038  
 Jaunin, A. 63 (110b), 84  
 Javoy, M. 1049 (64), 1156  
 Jedrzejczak, K. 1065 (107–109), 1157  
 Jeffrey, G.A. 427 (27), 471, 1245, 1266 (112),  
     1298  
 Jeffs, G.E. 739 (202, 203, 205), 745  
 Jegorov, A. 1090 (293), 1161  
 Jenck, J. 588 (303), 623  
 Jencks, W.P. 431 (68), 432 (71), 466 (267),  
     472, 476, 943 (67), 948, 1265 (156),  
     1299  
 Jenkins, D.C. 992 (135), 997  
 Jenkins, E.L. 1061 (90), 1156  
 Jenkins, S.D.W. 1145 (575), 1167  
 Jenks, W.P. 407 (157b), 409 (177), 421, 422  
 Jennings, K.R. 284, 285 (101), 293  
 Jennings, W.B. 170 (65), 203  
 Jensen, B.S. 838 (6), 855  
 Jensen, C.B. 1029 (162), 1038  
 Jensen, R.G. 954, 963 (31), 971  
 Jensen, R.K. 57 (90a), 83  
 Jensen, T.E. 1177 (36), 1212  
 Jensen, W.B. 381 (10), 416  
 Jeon, Y.T. 690 (45), 691 (48), 740, 741  
 Jespersen, N.D. 1126 (448), 1164  
 Jeyaraman, R. 579 (228a), 621  
 Jezequel, S. 1284 (192), 1300  
 Ji, G.-Z. 404 (143, 144), 421  
 Ji, G.-Z.J. 401, 402 (133), 420  
 Jia, X. 1048 (60), 1156

- Jian, C. 1125 (442), *1164*  
 Jiang, J. 557 (127), 559 (133, 134), *619*  
 Jiang, W. 941, 943, 944 (64), *948*  
 Jiang, X. 608 (422), *625*  
 Jiang, Z. 846 (35), *855*  
 Jimenez, J.J. 1025 (138), *1038*  
 Jiménez, P. 357 (70), *376*  
 Jiménez, R.M. 1074 (183), *1158*  
 Jiminez, J.J. 1025 (136), *1038*  
 Jiminez, P. 408 (168), *421*  
 Jinfeng Cai 506 (168, 169), *529*  
 Jino, H. 1081, 1091 (234), *1159*  
 Jochims, H.W. 164, 166, 168 (32), *202*  
 Johannsen, M. 571 (198), *620*  
 Johannsson, M. 1152 (623), *1168*  
 Johansen, C. 109 (32), *154*  
 Johansson, A.M. 62 (107), *84*  
 Johansson, K. 1103 (357), *1162*  
 Johansson, L. 1012 (78), *1036*  
 John, M. 977 (45), 983 (86), 984 (45), *995, 996*  
 Johns, A. 673 (42), *681*  
 Johnsen, J. 675 (61), *681*  
 Johnson, B.L. 317 (65), *333*  
 Johnson, C.A.F. 803 (140), *821*  
 Johnson, C.D. 510 (206), *530, 1006 (54), 1036*  
 Johnson, D.C. 698 (98), *742, 1073 (166), 1074 (176), 1085 (268), 1158, 1160*  
 Johnson, D.E. 785 (97b), *820*  
 Johnson, D.J. 1142 (563), *1166*  
 Johnson, E.M. 975 (24), *994*  
 Johnson, J. 651 (137), *662*  
 Johnson, J.S. 1119 (435), *1164*  
 Johnson, K.G. 1065 (106), *1157*  
 Johnson, L.F. 96 (53), *103*  
 Johnson, M.R. 738 (201), *745*  
 Johnson, M.W. 950 (13), 957 (45), *970, 971*  
 Johnson, R. 98 (68), *103, 433 (78), 472*  
 Johnson, R.L. 290 (118), *294*  
 Johnson, R.S. 677 (77), *681*  
 Johnson, T.A. 538 (38), *617*  
 Johnson, W.C.Jr. 133 (102), *155*  
 Johnson, W.H. 339 (9, 12), 341, 342 (12), *372*  
 Johnston, D. 411 (185), *422*  
 Johnston, L.J. 755 (19), *818*  
 Johnstone, R.A.W. 171, 174 (72), *203, 206, 207, 233 (2g), 243*  
 Johson, D.F. 1077 (190), *1159*  
 Jollow, D.J. 1019 (94), 1022 (112), *1026 (142), 1029 (162), 1037, 1038*  
 Jolly, W.L. 400 (124a), *420*  
 Jones, C. 384 (28b), *417*  
 Jones, D.S. 1118 (423), *1163*  
 Jones, F.R. 1108 (385–387), *1163*  
 Jones, H.O. 666, 668 (4), *680*  
 Jones, J. 188 (120), *204*  
 Jones, J.B. 1046 (10), *1155*  
 Jones, J.H. 542 (52), *617*  
 Jones, J.R. 508, 509 (184), 512 (216), *529, 530*  
 Jones, N.D. 442 (147), *473*  
 Jones, P.G. 98 (74), 99 (80, 84), *103*  
 Jones, R.R.M. 1119 (435), *1164*  
 Jones, W. 437 (121), *473*  
 Jones, W.M. 497, 516 (134), *528*  
 Jong, B.de 696 (78), *741*  
 Jonge, C.R.H.I.de 637, 639 (44), *660*  
 Jonge, L.H.de 1069 (143), *1158*  
 Jonker, S.A. 697 (85), *741*  
 Jonsson-Pettersson, G. 1103 (357), *1162*  
 Jordan, K.D. 173 (77), *203*  
 Jorgensen, F.S. 171, 174, 184, 188 (67), *203*  
 Jørgensen, K.A. 571 (198), 620, 642 (79), *660, 675 (64), 678 (83), 681, 682*  
 Jorgensen, M. 1142 (561), *1166*  
 Jorgensen, W.L. 386 (46), *418*  
 Jorgenson, J.W. 1079, 1080 (218, 219), *1159*  
 Jørgenson, K. 1152 (623), *1168*  
 Joris, L. 381, 395 (14b), *416*  
 Jortner, J. 426 (11), *470*  
 Joshua, C.P. 717 (143b), *743*  
 Joswiak, A. 554 (115b), *619*  
 Jothionandan, D. 975 (13–16), *994*  
 Jousot-Dubien, J. 688 (35), 695 (74), *740, 741*  
 Jovanovic, S.V. 827 (36), *835*  
 Joyeux, M. 456 (226), *475*  
 Juan, A.de 1225 (67), *1297*  
 Juaristi, E. 15, 17 (23e), *81, 398 (113c), 420, 583 (275), 622*  
 Judd, M.C. 954 (32), *971*  
 Juffermans, J.P.H. 878 (75), *890*  
 Julin, S. 576 (216), *621*  
 Jumeau, E.J. 1049 (68), *1156*  
 Jund, K. 576 (218), *621*  
 Junek, H. 588 (307), *623*  
 Jung, M. 121 (66), *155*  
 Jung, M.E. 604 (396), *625*  
 Jungk, S.J. 70 (117a), *84*  
 Juranic, I. 585 (294), *622*  
 Juršić, B. 581 (253), *622*  
 Juyn, S. 1097 (335), *1162*  
 Kabachnik, M.I. 519 (238), *531*  
 Kabalka, G.W. 565 (170, 171, 173), 566 (179a, 179b), 616 (464), *620, 626*  
 Kacaniklic, V. 1103 (357), *1162*  
 Kachanov, A.V. 133 (99, 100), 146 (136), *155, 156*  
 Kachurin, O.I. 348 (31), *373*  
 Kaddachi, M.T. 581 (258), *622*  
 Kadeřábek, V. 438 (128), *473*  
 Kaderlik, K. 1066 (115), *1157*

- Kaderlik, K.R. 1033 (202, 203), *1039*  
 Kadiri, A. 1136 (522), *1165*  
 Kadlubar, F.F. 1003, 1004, 1009 (35), 1011, 1012 (35, 72), 1021 (109), 1029 (72), 1031 (35, 180), 1033 (202, 203), *1035–1037*, *1039*, 1066 (115), *1157*  
 Kado, N.Y. 1132 (490), *1165*  
 Kadorkina, G.K. 133 (98, 99), 146 (136), *155*, *156*  
 Kadota, H. 561 (148), *619*  
 Kadowitz, P.J. 673 (42), *681*, 975 (20–22, 25), *994*  
 Kagel, R.A. 1047 (46), *1155*  
 Kagiya, T. 833 (69), *836*  
 Kahne, D. 1152 (622), *1168*  
 Kai, M. 1080 (221), *1159*  
 Kai, Y. 96 (49), *102*, 614 (455), 615 (459), *626*  
 Kaim, W. 163–166, 168 (27), *202*  
 Kaise, M. 854 (64), *856*  
 Kaiser, M. 1127 (459), *1164*  
 Kaji, A. 605 (409b), 609 (435), 610 (439), 611 (440), 614 (452–454, 456, 457), 615 (458), *625*, *626*  
 Kajiwara, Y. 776 (66), *819*  
 Kakabakos, S.E. 1099 (345, 346), *1162*  
 Kakechi, H. 730 (181a), *744*  
 Kakihana, M. 614 (452, 455), *626*  
 Kakikawa, T. 565 (174), *620*  
 Kakimoto, M. 590 (320), *623*  
 Kakinuma, K. 1022 (117), *1037*  
 Kakitani, N. 694 (58), *741*  
 Kakiuchi, T. 1122 (439), *1164*  
 Kalatzis, E. 633 (24, 25), 643 (86, 87), 644 (25, 90, 91), *659*, *660*  
 Kalbalka, G.W. 284, 285 (101), *293*  
 Kalck, P. 588 (303), *623*  
 Kalhern, T.F. 785 (97b), *820*  
 Kalinin, A.V. 609 (432), *625*  
 Kalinowski, H.O. 96 (49), *102*, 1004 (42), *1035*  
 Kalligas, G. 1139 (537), 1140 (547), *1166*  
 Kallury, R.K.M.R. 269 (80), 287, 288 (106), *293*  
 Kálmán, A. 93 (27), 94 (34), 98 (27), 100 (27, 89), *102*, *103*  
 Kaltenbach, M.S. 1104 (365), *1162*  
 Kamal, A. 108 (30), *154*  
 Kamataki, T. 1004, 1007, 1009, 1034 (41), *1035*  
 Kamath, H.V. 271, 273 (83), *293*  
 Kambe, N. 563 (159), 596 (368), *620*, *624*  
 Kamens, R.C. 1179 (50), *1213*  
 Kametani, T. 580 (251), *621*  
 Kameyama, H. 1067 (124), *1157*  
 Kamiga, S. 886 (100), *891*  
 Kamigata, N. 736 (192b–d), *745*  
 Kamimura, A. 605 (409b), 610 (438), 611 (440), *625*  
 Kamimura, H. 848 (45), 856, 969 (65), *971*  
 Kamlet, J. 381 (18), *417*  
 Kamlet, M.J. 308 (39), 309 (39, 43), 333, 381 (15a, 15b, 16a–d, 17d, 20b), 387 (53), *416–418*, 428 (42), 433 (80), 439 (129), 443 (157, 158), *471–474*, 1220 (38a, 38b, 39, 41a, 41b), 1221 (38a, 38b), 1222 (38a, 38b, 39, 51), 1238 (38a, 38b, 51), 1244 (38a, 38b), 1273, 1278 (179), *1296*, *1299*  
 Kamlett, M.J. 453 (203), *475*  
 Kammerer, C. 652, 653 (140), *662*  
 Kamminga, D.A. 1134 (511), *1165*  
 Kamoonpuri, S.I.M. 461 (251), *476*  
 Kampar, V.E. 636 (43), *659*  
 Kampe, K.-D. 588 (306), *623*  
 Kampffmeyer, H. 1003 (34, 36), 1005–1007, 1009, 1011, 1012, 1014, 1019 (36), 1020, 1022 (34), 1025 (133), 1027 (36), 1029 (36, 169), 1030 (36), *1035*, *1038*  
 Kamphuis, J. 142 (124), *156*, 734 (185a), *744*  
 Kanagasabapathy, V.M. 510 (203), *530*  
 Kanai, Y. 1072 (155, 158, 159), *1158*  
 Kanaoka, Y. 728 (172), 730 (178, 180a, 181a–c, 181f, 182a, 182b), 733 (183c), 734 (186, 187, 188a, 188b), *744*  
 Kanaoko, Y. 730 (177b), *744*  
 Kanazawa, Y. 551 (94), *618*  
 Kaneda, K. 534 (4), *616*, 654 (151), *662*  
 Kaneda, T. 1114 (405), *1163*  
 Kanekiyo, T. 795 (128), *820*  
 Kaneko, Y. 585 (293), *622*  
 Kaniou, I. 1139 (537), 1140 (547), *1166*  
 Kanjia, D.M. 303, 308 (37), *333*  
 Kanno, S. 758 (33a, 33b, 34d), *818*, 1180 (57), *1213*  
 Kanters, J.A. 4, 14 (20), *81*, 99 (86), *103*  
 Kanth, J.V.B. 536 (17), 582 (266), 584 (281), *617*, *622*  
 Kao, J. 13 (18), *81*  
 Kaplan, J. 599 (380), *624*  
 Kaplan, L. 221 (110), *246*  
 Kaplan, S. 637 (45), *660*  
 Kapon, M. 98, 101 (76), *103*  
 Kapoor, S.K. 832 (58), *836*  
 Kaptein, R. 953 (22), *970*  
 Kapturczuk, M. 992 (127), *997*  
 Karaki, I. 698 (94), *742*  
 Karaktov, S.D. 884 (95), *891*  
 Karakus, C. 854 (65), *856*  
 Kargin, Y. 848 (41a), *856*  
 Karkowski, F.M. 57 (86), *83*  
 Karlen, A. 62 (107), *84*  
 Karni, M. 15, 16 (26b), 82, 208 (10), *244*  
 Karrer, P. 483 (31), *526*

- Karreth, S. 1026 (146), 1030 (146, 175, 177),  
*1038, 1039*
- Karube, I. 1103 (358), *1162*
- Karyakin, N.V. 353 (50), *375*
- Kashara, I. 715 (131), *742*
- Kashihira, N. 1047 (40), *1155*
- Kashino, S. 93 (15, 16), 98 (16), *102*
- Kashiwabara, Y. 992 (129, 131), *997*
- Kass, S.R. 408 (167a), *421*
- Kastening, B. 840 (10a–d, 12c), *855*
- Kasukhin, L.F. 649 (118), *661*
- Kataoka, H. 1065 (110–112), *1157*
- Kataoka, K. 872 (56), 873 (57), *890*
- Kataoka, N. 722 (157b), *743*
- Kataoka, Y. 571 (197), *620*
- Katayama, A. 657 (172), *662*
- Katayama, M. 1069 (146), *1158*
- Katening, B. 869 (45), *889*
- Kato, M. 616 (465), 626, 1091 (303), *1161*
- Kato, R. 1003 (37), 1004, 1007 (41), 1009 (37,  
41), 1012, 1013, 1019 (37), 1034 (41, 204),  
1035 (37, 204), *1035, 1039*
- Kato, S. 193, 194, 197–199 (144), *204, 546*  
(75), 574 (205), *618, 620*
- Katoh, M. 312 (52), *333*
- Katritzky, A.R. 15, 17 (24a), 57 (89), *81, 83,*  
*426* (13), *470, 491, 503* (100, 101), *504,*  
*515, 518* (154), *527, 529, 546* (76), *554*  
(112–114, 115a–c), *555* (115c, 116, 117),  
*556* (118–123), *557* (126, 127), *558*  
(128–132), *559* (133, 134), *560* (136), *593*  
(343), *604* (394), *607* (418), *618, 619,*  
*623–625*
- Katritzky, A.R. 409 (171), *421*
- Katrusiak, A. 4, 13, 69 (17), *81, 145* (135),  
*156*
- Katsu, T. 1104 (364), *1162*
- Katsudi, S. 975 (6, 17, 18), *994*
- Katsuhara, Y. 722 (155), *743*
- Katsumata, S. 161, 163, 171–173 (21), 193,  
197 (21, 142), *202, 204*
- Katsumi, M. 142 (123), *156*
- Katzenellenbogen, J.A. 547 (77), *618*
- Kau, C.-L. 978 (71), *995*
- Kaufman, M.J. 399 (117, 118), *420*
- Kaufman, S. 983 (80, 84), 985 (97), *996*
- Kaufmann, F. 717 (141), *743*
- Kaufmann, G. 657 (171), *662*
- Kaufmann, M. 1266 (163b), *1299*
- Kauppp, G. 1020 (95), *1037*
- Kavarnos, G.J. 446 (170), *474*
- Kawada, Y. 312 (52), *333*
- Kawaguchi, H. 873 (59), *890*
- Kawai, C. 978 (59, 66), *995*
- Kawai, M. 142 (123), *156, 695* (69), *741*
- Kawanisi, M. 698 (91), *741*
- Kawano, C. 650 (126), *661*
- Kawasaki, H. 396 (93), *419*
- Kawase, M. 592 (331), *623*
- Kawashima, T. 93, 98 (16), *102*
- Kawate, T. 565 (174), *620*
- Kawazura, H. 654 (149), *662*
- Kawenoki, I. 692 (51), *741*
- Kayamoto, T. 1104 (364), *1162*
- Kaye, D.M. 992 (133), *997*
- Kazanis, S. 1001, 1003, 1005–1008, 1010,  
1011, 1014, 1031, 1032 (30), *1035*
- Kazerouni, M.R. 436 (118), *473*
- Kazitsyna, L.A. 636 (40), 638 (48), *659, 660*
- Kazuhisa Iwasawa (88), *334*
- Keana, J.F.W. 537 (33), *617*
- Keaney, J. 673 (43), *681*
- Keaney, J.F. 673 (45), *681*
- Kearns, D.R. 1048 (60), *1156*
- Kebarle, P. 235 (159), *247, 256* (34, 35), *257*  
(37), *258* (37, 38), *288* (107), *292, 293, 384*  
(32), *385* (34c, 34d, 37a, 37b, 40), *392* (73),  
*417–419*
- Kedderis, G.L. 1031 (183), *1039*
- Kee, R.J. 1174 (4), *1212*
- Keeble, D.J. 834 (74), *836*
- Keefer, L.K. 448 (189), *474*
- Keenan, G. 355, 356 (58), *375*
- Keesee, R.G. 385 (41), *418*
- Keever, J.T. 1066 (123), 1073 (164), *1157,*  
*1158*
- Keffer, L.K. 144 (132), *156*
- Keiderling, T.A. 147, 148 (140, 141), *156*
- Keilin, D. 975 (7), *994*
- Keinan, E. 568 (186), *620*
- Keire, D.A. 1004 (44), *1036*
- Keita, B. 692 (51), *741*
- Kellogg, R.M. 127 (81), *155*
- Kelly, D.P. 303 (27), *332*
- Kelly, F.W. 505 (160), *529*
- Kelly, R.A. 992 (127, 133), *997*
- Kemp, T.J. 780 (76, 78, 79), *819*
- Kempzell, S.P. 955 (41, 42), 956 (42), *971*
- Kemula, W. 840 (12b), 847 (40a), 855, *856*
- Kende, A.S. 609 (434), *625*
- Kennard, O. 37 (56), 82, 433 (74–77), 453  
(205), *472, 475*
- Kenne, L. 62 (107), *84*
- Kennedy, R.M. 112 (40), *154*
- Kensuke Takashi (88), *334*
- Kenyon, G.L. 165, 166 (44), *202*
- Keough, T. 234 (156), *247*
- Kern, M. 434 (91), 472, 1262, 1266 (145),  
*1299*
- Kerr, S.W. 673 (38), *681*
- Kervagoret, J. 613 (451), *626*
- Kessar, S.V. 721 (152), 722 (152, 158b), *743*
- Kessel, C.R. 166 (53), *202*
- Kessik, M.A. 945 (70), *948*

- Ketterer, B. 672 (36), 680, 1003, 1004, 1009, 1011 (35), 1012 (35, 85), 1031 (35), 1033 (85), 1035, 1036
- Keuchel, C. 1128 (462, 463), 1164
- Keuhnelian, A.M. 434 (96), 472, 1247 (122), 1298
- Keumi, T. 650, 652 (130), 661
- Keute, J.K. 807 (149b), 808 (151), 821
- Kevill, D.N. 1220 (47), 1296
- Khamisi, J. 538 (36), 584 (278), 617, 622
- Khan, S.H. 1069 (141), 1158
- Kharasch, M.S. 338 (2a), 354 (51), 358 (74), 359, 361 (2a), 372, 375, 376
- Kheir, A.A. 414 (201), 422
- Khetrapal, C.L. 317, 320, 321 (90), 334
- Khmel'nitzki, L.I. 628 (8), 659
- Kicherer, M. 1079 (213), 1159
- Kido, A. 1065 (113), 1157
- Kienle, R.H. 648 (110), 661
- Kiese, M. 1000 (10, 13–17), 1009 (10), 1020 (16, 17, 100), 1021 (17, 101), 1022 (14, 16, 100, 101), 1023 (10), 1027 (16, 17), 1028 (16, 101), 1029 (159), 1035, 1037, 1038
- Kiff, R.J. 991 (117), 996
- Kiguchi, T. 724 (162b, 166b), 743, 744
- Kikuchi, T. 651, 657 (132), 661, 1144 (570), 1166
- Kikuchi, Y. 778 (74), 819, 1083 (245), 1160
- Kikugawa, Y. 592 (331, 332), 623, 871 (53), 890
- Kikukawa, K. 654 (150, 152), 655 (153–155), 657 (170, 172), 662
- Kilbourn, R.G. 991 (118), 996
- Kim, B.H. 534 (5), 616
- Kim, C.-K. 896, 935, 941 (18), 947
- Kim, E.G. 563 (155), 620
- Kim, E.K. 455 (216), 475, 790 (111d), 820
- Kim, J.C. 886 (99), 891
- Kim, J.H. 1066 (120), 1157
- Kim, J.M. 692 (50), 741
- Kim, J.U. 688 (43), (44), 740
- Kim, K. 1134 (510), 1165
- Kim, K.H. 506 (174), 522 (245), 529, 531
- Kim, K.R. 1066 (120), 1157
- Kim, K.-W. 118, 119 (55), 154
- Kim, N. 993 (146), 997
- Kim, S. 596 (369), 602 (386), 624
- Kim, S.C. 108 (27), 154
- Kim, S.H. 1147 (589), 1167
- Kim, T. 1134 (510), 1165
- Kim, Y.H. 654 (148), 662, 666, 667, 670 (6), 672 (6, 34), 677 (76), 678 (78), 680–682
- Kim, Y.J. 396 (86b), 419
- Kimoto, M. 776 (66), 819
- Kimura, E. 390, 391 (68), 419
- Kimura, H. 765 (47), 818, 975 (6), 994
- Kimura, K. 161, 163, 171–173 (21), 193, 197 (21, 142), 202, 204, 722 (157b), 743
- Kimura, M. 585 (292), 622
- Kimura, T. 933 (47), 947
- Kinchesh, P. 330 (123, 124, 127), 331 (127), 332 (130, 131), 335
- King, C.R. 730 (181d), 744
- King, J.A.Jr. 590 (317), 623
- King, J.F. 737 (198), 745
- King, M.M. 318 (78), 334
- Kingston, D.H. 722 (156a), 743
- Kingston, E.E. 266 (73), 293
- Kinoshita, M. 735 (190b), 745
- Kinouchi, T. 1180 (51), 1213
- Kinsley, S.A. 590 (322), 623
- Kint, S. 151, 152 (160), 157
- Kira, M. 163–166, 168 (27), 202
- Kirby, A.J. 15, 17 (23a), 81, 98 (74), 99 (80, 84), 103, 351 (38), 374
- Kirby, S.P. 218 (83), 245, 338, 361 (2), 371, 410 (188), 422
- Kirchmeier, R.L. 593 (345), 623
- Kirchnerova, J. 1175 (12), 1212
- Kiriazides, D.K. 1177 (30), 1212
- Kirichenko, V.E. 1062 (94), 1156
- Kirilenko, A.G. 547 (78), 618
- Kirita, K. 1047 (40), 1155
- Kirschbaum, J. 1082 (235, 236), 1159, 1160
- Kirst, H.A. 535 (13), 616
- Kirsten, E. 1024 (123), 1037
- Kiseki, Y. 655 (153), 662
- Kishi, H. 258 (38), 292
- Kishikawa, K. 796 (130), 820
- Kishimoto, J. 978 (70), 995
- Kiss, A. 431 (61), 471
- Kiss, T. 406 (155), 421
- Kitaguchi, H. 108 (29), 154
- Kitajima, H. 650, 652 (130), 661
- Kitamura, F. 1096 (328), 1161
- Kitamura, R. 1069, 1130 (147), 1158
- Kjellerup, V. 1047 (26), 1155
- Klabunde, K.J. 591 (324), 623
- Klapper, M.H. 827 (37–40), 828 (41), 835
- Klar, G. 96 (58), 103
- Klasinc, L. 176 (87), 180 (95), 188 (122, 123), 199 (147), 200 (149), 203, 204
- Klatt, P. 985 (92), 990 (109), 991 (122), 992 (136, 137), 996, 997
- Klausener, A. 870 (48), 890
- Klebe, G. 413, 414 (197), 422
- Kleemiss, W. 551 (95), 618
- Klehr, H. 1001 (24, 26), 1003 (24, 38, 39), 1004 (24, 26, 38), 1005 (38), 1007 (24, 38, 39), 1008 (38), 1009–1011 (24, 26, 38), 1012 (24, 26, 38, 39), 1013 (24, 38), 1014 (24, 26, 38), 1015 (26), 1029 (39), 1035
- Klein, G. 1020, 1022 (100), 1037
- Klein, M. 139 (113), 156

- Klein, N.M. 977 (48), 995  
 Klemchuk, P.P. 825 (23), 835  
 Klessinger, M. 171, 174, 184, 188 (66), 203  
 Klibanov, A.M. 108 (29), 154  
 Kliner, D.A.V. 416 (211), 422  
 Klingebiel, U. 396 (91f), 419  
 Klink, J.R. 877 (70), 890  
 Klinowski, J. 437 (121), 473  
 Klopman, G. 642 (80), 660  
 Klose, W. 268 (77, 79), 269 (79), 293  
 Klotz, H. 1116 (408), 1163  
 Klotz, I.M. 670 (28), 680  
 Klötzer, W. 639 (54), 660  
 Kluft, E. 220 (95), 246  
 Klunkin, G. 685, 686 (7), 740  
 Klvana, D. 1175 (12), 1212  
 Klyne, W. 106, 113 (5), 153  
 Knicker, H. 321 (95), 334  
 Knight, R.L. 1255 (134), 1298  
 Knipe, A.C. 507, 512 (181), 529  
 Knipmeyer, S.E. 346 (20), 350 (35), 373, 374  
 Knize, M.G. 1033 (199, 200), 1039  
 Knochel, P. 96 (49), 102, 580 (244), 621  
 Knöpfel, N. 160 (13), 201  
 Knowles, R.G. 976 (39, 41), 978, 980 (39),  
 991 (117), 992 (134), 994, 996, 997  
 Knudson, G.B. 1176 (27), 1212  
 Ko, A. 1175 (17), 1212  
 Kobayashi, A. 551 (91), 618  
 Kobayashi, H. 635 (31), 659  
 Kobayashi, K. 169 (64), 203, 758 (33a, 33b,  
 34b, 34d, 34e), 818, 1079 (212), 1159  
 Kobayashi, M. 184, 185 (108), 204, 736  
 (192b–d), 745  
 Kobayashi, T. 169 (64), 171 (73), 192 (135),  
 193, 197 (140), 203, 204  
 Kobayashi, T.K. 715 (131), 742  
 Kobzik, L. 992 (133), 997  
 Koch, R.L. 1032 (196), 1039  
 Koch, T.H. 710 (114), 742, 807 (149b, 150),  
 808 (151), 821  
 Koch, W. 209 (31), 234 (150), 244, 247  
 Kochi, J.K. 439 (133), 440 (142), 455  
 (213–216), 456 (221), 473, 475, 789 (107),  
 790 (107, 109a, 110, 111a, 111d), 792  
 (115), 820  
 Kocian, , O. 396 (96), 419  
 Kocjan, D. 62 (106), 84  
 Kocovsky, P. 574 (207), 621  
 Kodama, M. 390, 391 (68), 419, 1122 (440),  
 1147 (587), 1164, 1167  
 Kodera, Y. 535 (8), 616  
 Koeman, J.H. 1188 (86), 1214  
 Koен de Vries, N. 125 (79), 128 (85), 155,  
 1110 (393–396), 1163  
 Koestler, C.J. 1145 (574), 1167  
 Koetzle, T.F. 94 (39), 102  
 Koga, K. 396 (93), 419  
 Koga, Y. 34, 35 (45), 82  
 Koge, M. 962 (51), 971  
 Koh, H.J. 936 (54), 948  
 Koh, J.S. 108 (27), 154  
 Koh, L.L. 97 (64), 103  
 Kohnstam, G. 448 (191), 474, 869 (44), 889  
 Kohra, S. 541 (50), 585 (292), 617, 622  
 Kohzuki, T. 824 (11), 835  
 Koike, A. 649 (120), 661  
 Kojima, E. 1080 (221), 1159  
 Kojima, N. 724 (163), 743  
 Kojima, S. 459 (244), 476  
 Kojima, T. 7 (11), 81  
 Kok, R.A. 27, 57 (30a), 82  
 Kokars, V.R. 636 (43), 659  
 Kokkinidis, G. 844 (26, 27), 855  
 Kol, M. 579 (230, 231), 621  
 Kolbe, H. 482 (20), 525  
 Koller, S. 636 (42), 659  
 Kollman, P.A. 3 (2a, 2b), 60 (103a, 103b), 81,  
 83, 165, 166 (44), 202, 1266 (166a), 1299  
 Kolodziejczyk, H. 1081 (227, 228), 1159  
 Kolster, K. 141 (120), 156  
 Koltypin, Y. 133 (101), 155  
 Koltypin, Yu. 149 (151), 157  
 Komaki, T. 308, 309 (42), 333  
 Komaromi, I. 1152 (621), 1168  
 Komatsu, K. 767 (54), 819  
 Kometani, J.M. 767 (50b, 51), 819  
 Komissarov, V.N. 576 (215), 621  
 Komiya, Y. 591 (326), 623  
 Komori, Y. 990 (108), 991 (114), 996  
 Kondo, S. 34, 35 (45), 82  
 Kondratenko, N.V. 1238 (93), 1297  
 Konior, R.J. 968 (61), 971  
 Könnecke, A. 273, 274 (84), 293  
 Konno, R. 1089 (290), 1161  
 Kono, K. 657 (172), 662  
 Konyeaso, R.I. 1100 (350), 1162  
 Kooijman, H. 4, 14 (20), 81  
 Kooijman, J.G.A. 1116 (408), 1163  
 Koopmans, T. 160, 163, 190 (17), 201  
 Kopf, J. 96 (58), 103, 396 (95), 419  
 Koppang, M.D. 1081 (229), 1159  
 Koppel, A. 384 (29), 417  
 Koppel, I. 235, 236 (165), 247, 524 (254), 531  
 Koppel, I.A. 1238 (87a, 89, 93), 1239 (87a),  
 1297  
 Koppen, B. 1072 (161), 1158  
 Korenman, Y.I. 1135 (517), 1165  
 Korn, S.R. 435 (107), 472  
 Kornblum, N. 611 (442), 625, 628 (9), 650  
 (125), 659, 661  
 Korneev, V.A. 133 (100), 155  
 Kornfield, R. 209 (27), 244  
 Kort, W. 677 (77), 681



- Korth, H.G. 985 (96), 996  
 Kortüm, G. 491, 500 (107a), 527  
 Korytsky, O.L. 878 (74), 890  
 Korzeniowski, S.H. 902 (25), 947  
 Koscielniak, J. 1022 (116, 117), 1037  
 Kosevich, M.V. 1119 (431, 432), 1164  
 Kosfeld, H. 763 (41), 818  
 Koshy, K.M. 945 (71), 948  
 Kosmidis, C. 1127 (454), 1164  
 Kosower, E.N. 424 (5), 470  
 Kossanyi, J. 692 (51), 741  
 Kosse, P. 396 (91d), 419  
 Kossowski, T. 1146 (582), 1167  
 Kost, D. 1009 (67), 1036  
 Kostyanovskii, R.G. 553 (107), 618  
 Kostyanovsky, R.G. 132 (96), 133 (96, 98–100), 146 (136), 155, 156  
 Kostyukovskii, Ya.L. 1147 (593), 1167  
 Kosuga, K. 978 (59, 66), 995  
 Kotake, M. 123 (71), 155  
 Kotani, M. 1122 (439), 1164  
 Kotera, K. 730 (182b), 744  
 Kothandaraman, H. 441 (143), 473  
 Kotiaho, T. 1107 (383), 1163  
 Koty, P.P. 979 (78), 995  
 Kotynek, O. 112, 113 (41), 154  
 Kotynski, A. 1148 (602, 603), 1167  
 Kovac, B. 66, 67 (111), 84, 166, 168 (52), 176 (87), 179, 184, 185 (52), 202, 203  
 Kovacic, P. 552 (102), 618  
 Kowaluk, E.A. 673 (48), 681  
 Kowski, K. 163 (26), 164, 165 (26, 36), 166, 170, 172, 175, 189, 192, 195, 201 (26), 202  
 Koyama, K. 551 (89b), 618, 730 (178), 744  
 Kozak, A. 1139 (540), 1166  
 Kozak, M. 977 (54), 995  
 Koziara, A. 537 (32), 540 (44), 542 (55), 617  
 Kozina, M.P. 347 (25), 373  
 Koziol, A.E. 554 (115a), 619  
 Koziol, B. 459 (242), 476  
 Koziol, J. 439 (135), 440 (136), 473  
 Krabbenhoft, H.O. 224 (114), 246  
 Krackov, M.H. 1250 (124), 1298  
 Kracov, M.H. 426 (17), 470  
 Krajnovich, D. 795 (122), 820  
 Kralicek, P. 1073 (163), 1158  
 Kramer, H. 672 (36), 680  
 Kramer, M.P. 591 (324), 623  
 Kramer, P.A. 1027 (151), 1038  
 Krane, J. 74 (125), 84  
 Krattiger, B. 1093 (315), 1161  
 Krauklish, I.V. 1137 (526), 1141 (554), 1166  
 Krause, R. 1027, 1028 (154), 1038  
 Krause, W. 443 (154), 474  
 Krecz, I. 1089 (288), 1161  
 Krenmayr, P. 642 (77), 660  
 Krepelka, J. 633 (26), 659  
 Kresge, A.J. 409 (176), 421, 658 (175), 663, 1272 (173), 1299  
 Krestonosich, S. 692, 702, 709 (53), 741  
 Kresze, G. 668 (13), 677 (77), 680, 681, 803 (143), 821  
 Kreutzer, A. 1175 (15), 1212  
 Kricheldorf, H.R. 324 (107), 325 (106), 334  
 Krieger, C. 95 (43), 102, 436 (113), 473  
 Kriessmann, U. 588 (307), 623  
 Krijnen, B. 694 (65), 741  
 Krishnamohan Sharma, C.V. 452 (197, 198), 475  
 Krishnamurthy, R.V. 1060 (87), 1156  
 Krishnamurthy, V.V. 510 (204), 530  
 Krishnan, A.M. 606 (413), 625  
 Krishnan, R. 407 (163), 421  
 Krishnan, V. 753 (10), 817  
 Krishnani, K.K. 405 (151b), 421  
 Kristjansen, O. 1047 (26), 1155  
 Kristóf, E. 386 (45a), 418  
 Krizsan, K. 1089 (288), 1161  
 Krogh Andersen, E. 93 (29), 98 (70), 102, 103  
 Kroh, J. 824 (14, 15), 835  
 Krok, K.A. 1077 (191), 1159  
 Krolikiewicz, K. 603 (391), 624  
 Krom, J.A. 399 (120), 420  
 Kroon, J. 4, 14 (20), 81, 99 (86), 103  
 Kroschwitz, J.I. 310 (47), 333  
 Krueger, W.E. 886 (98), 891  
 Kruger, C. 139 (113), 156  
 Kruger, G.J. 97 (62), 103  
 Krull, I.S. 1067, 1076 (126), 1083 (243, 244), 1157, 1160  
 Kruse, C.G. 539 (40), 617  
 Kruzik, P. 1139 (535), 1166  
 Krygowski, T.M. 98 (69), 99 (85), 103, 444 (160), 454 (210), 474, 475, 522 (243), 531, 840 (12b), 848 (43), 855, 856  
 Krzeminski, J. 1150 (607), 1167  
 Ku, H. 652 (139, 140), 653 (140), 662  
 Kuang, J. 4, 29–32 (43), 82  
 Kubacki, S.J. 1188 (85), 1214  
 Kubena, L.F. 1139 (543), 1166  
 Kuberski, S. 770 (57), 819  
 Kubo, J. 704 (103, 105), 742  
 Kubo, Y. 730 (180a, 180b), 733 (183b), 744  
 Kubota, M. 94 (31), 99 (83), 102, 103  
 Kuchitsu, K. 24 (32), 56 (84a, 84b), 82, 83  
 Kuck, D. 208 (14), 212 (41, 42), 213 (42), 214 (14, 41, 42), 215 (14), 216 (41, 42), 225 (42), 244  
 Kuckowski, R.L. 431 (69), 472  
 Kudo, K. 596 (362), 624  
 Kudo, T. 608 (428, 429), 625  
 Kudzin, Z.H. 1148 (602, 603), 1167  
 Kuem, S.R. 866 (35), 889  
 Kuhn, H.J. 783 (93), 820

- Kuhn, R. 1082 (239), *1160*  
 Kuhn, S.J. 448 (191), *474*  
 Kuhnle, W. 697 (84, 85), *741*  
 Kuhr, W.G. 1118 (422), *1163*  
 Kukhar, V.P. 547 (78), *618*  
 Kukhtenko, I.I. 869 (46), *890*  
 Kulhánek, J. 507 (178, 179), *529*  
 Kulkarni, P.S. 271, 273 (83), *293*  
 Kulkarni, S.N. 271, 273 (83), *293*  
 Kumakura, S. 98 (72), *103*  
 Kumar, A. 580 (250), *621*  
 Kumar, A.C. 317, 320, 321 (90), *334*  
 Kumar, B.S.A. 322 (101), *334*  
 Kumar, C.V. 738 (199), *745*  
 Kumar, L. 1139 (534), *1166*  
 Kumar, M. 824, 826, 827 (4), 828 (4, 42),  
   835  
 Kumar, M.U. 600 (382), *624*  
 Kumar, N. 143 (130), *156*  
 Kumaraswamy, P. 1175 (13), *1212*  
 Kumińska, M. 392 (76), *419*  
 Kun, E. 1024 (123–127), *1037*  
 Kunitake, T. 1122 (440), *1164*  
 Kunst, A.G.M. 696 (79), *741*  
 Kuntz, B.A. 115 (50), *154*  
 Kuntz, I. 463, 465, 466 (256), *476*  
 Kunz, D. 992 (128), *997*  
 Kuokkanen, T. 648 (111), 649 (123), *661*  
 Kupezyk-Subotkowska, L. 860, 861 (17), 863  
   (22), *889*  
 Kupletsкая, N.B. 638 (48), *660*  
 Kurahashi, M. 502 (147), *529*  
 Kurian, E.M. 1141 (555), *1166*  
 Kuroishi, Y. 98 (72), *103*  
 Kurokawa, Y. 798 (133), 799 (133, 134), 800  
   (134), 801 (135), 802 (136), *821*  
 Kurono, S. 647 (104), *661*  
 Kurtz, A.N. 589 (312), *623*  
 Kuruc, J. 833 (67), 836, 1133 (499), *1165*  
 Kurz, J.L. 933 (48, 49), 934 (49), 935, 938  
   (48, 49), *947*  
 Kurzweil, P.R. 68 (113), *84*  
 Kusaba, M. 824 (11, 12), *835*  
 Kusano, E. 1072 (162), *1158*  
 Kusters, E. 1090 (296), *1161*  
 Kusumoto, S. 852 (61), *856*  
 Kuthan, J. 184, 185 (108), *204*  
 Kutz, V.S. 1272 (176), *1299*  
 Kuvihara, T. 870 (50), *890*  
 Kuwahara, H. 534 (4), *616*  
 Kuwana, T. 1079 (216), 1080 (220, 223), 1096  
   (328), *1159, 1161*  
 Kuwata, S. 1090 (297), 1092 (307), *1161*  
 Kuzmenko, V.V. 552 (97), *618*  
 Kuzmic, P. 756 (21), 757 (24), 789 (105), *818,*  
   820  
 Kuzmicky, P.A. 1132 (490), *1165*  
 Kuzmierkiewicz, W. 554 (115a), *619*  
 Kuz'min, V.A. 684 (6), *740*  
 Kuznetsova, O.P. 352 (43), *374*  
 Kwackman, P.J.M. 1105 (369), *1162*  
 Kwakman, P.J.M. 1134 (511), *1165*  
 Kwart, H. 859 (15), 860 (17), 861 (17, 19),  
   863 (23), 889, 897 (22), 899 (23), 904 (26),  
   905 (29), *947*  
 Kwiatkowski, S. 96 (49), *102*  
 Kwok, E.S.C. 1177 (44), *1213*  
 Kwok, H.S. 795 (121), *820*  
 Kwon, N.S. 976 (37, 38), 978 (37, 38, 58),  
   980, 983 (37), 985 (91), *994–996*  
 Kydd, R.A. 35 (50), *82*  
 Kyziol, J.B. 593 (346), 623, 878 (76), *890*  
  
 Labanowski, J.K. 29 (42), *82*  
 Lablache-Combier, A. 684 (4, 5), 698 (93),  
   724 (161), 727 (168), *740, 742, 743, 744*  
 Labudzinska, A. 1096 (333), *1161*  
 Lacasse, R. 843 (17), 845 (33), 846 (34), 855,  
   1129 (468–470), *1164*  
 Lacey, M.J. 267 (74), *293*  
 Lacey, M.P. 234 (156), *247*  
 Lachkar, A. 395 (83), *419*  
 Lackey, D.A. 1024 (123), *1037*  
 Lacourse, W.W. 1073 (166), *1158*  
 Lacroix, M.D. 1145 (571), *1166*  
 Lacy, N. 1134 (505), *1165*  
 Ladell, J. 435 (99), *472*  
 Laderoute, K. 216 (62), *245*  
 Ladure, P. 453 (206), *475*  
 Lady, J.H. 434 (89, 93, 94), *472*  
 Lafarge-Frayssinet, C. 1025 (137), *1038*  
 Laffitte, M. 349 (32), *374*  
 Lafon-Cazal, M. 991 (124), *996*  
 Lagowski, L.L. 400 (124b), *420*  
 Lahav, M. 1108 (388), *1163*  
 Lahbabi, N. 598 (373), *624*  
 Lahmani, F. 810 (158), *821*  
 Lai, Z.G. 941 (62, 63), *948*  
 Laidig, K.E. 403 (142), *421*  
 Laidler, K.J. 78 (131), 84, 894 (9), *947*  
 Laikhter, A.L. 852 (59), *856*  
 Lakomý, J. 519 (237), *531*  
 Lalonde, M. 1066 (121), *1157*  
 Lam, J.N. 593 (343), *623*  
 Lam, S. 1078 (202), *1159*  
 Lam, Y.L. 97 (64, 67), 98, 101 (67), *103*  
 Lam, Y.-T. 217 (70), *245*  
 Lamas, S. 977 (52), 979 (72), *995*  
 Lambe, T.M. 646 (102), *661*  
 Lambert, C. 397 (103), *420*  
 Lambert, J.B. 317 (70), *333*  
 Lambert, W.E. 1061 (92), *1156*  
 Lamont, R.B. 598 (376), *624*

- Lancaster, J.S. 1108 (384), *1163*  
 Lancaster, M. 737 (196), *745*  
 Land, E.J. 827 (35), *835*  
 Landeck, H. 434 (84, 89), *472*  
 Landells, R.G.M. 648 (107), *661*  
 Landini, D. 616 (462, 463), *626*  
 Landor, S.R. 109 (33), 110 (33–35), 113 (33, 42), *154*  
 Landsheidt, H. 870 (48), *890*  
 Lang, H. 558 (129), *619*  
 Lang, J. 1146 (584), *1167*  
 Lang, N.P. 1066 (115), *1157*  
 Langa, F. 715 (132), 716 (132, 134, 135), *742*  
 Langenaeker, W. 388 (58), *418*  
 Langer, M. 1090 (291), *1161*  
 Langford, E.J. 673 (40), *681*  
 Langlotz, I. 396 (99, 100), *420*  
 Langstrom, B. 932 (44, 45), 933 (46), *947*  
 Lank, W. 1030 (177), *1039*  
 Lanzone, L. 1085 (261), *1160*  
 Lapat, A. 1113 (403), *1163*  
 Lapidus, A.L. 596 (360), *624*  
 Lapierre, J.C. 639 (59), *660*  
 Lapouyade, R. 446 (172), *474, 697 (87), 741*  
 Lapworth, A. 483, 507 (27), *525*  
 Lardeux, C. 810 (158), *821*  
 Lardicci, L. 575 (211), *621*  
 Larka, E.A. 265 (67), 267 (76), *293*  
 Larock, R.C. 657 (173), *663*  
 La Rosa, C. 539 (39), *617*  
 Larsen, E. 212, 222–225 (44), *244*  
 Larsen, I.K. 100 (87), *103*  
 Larsen, N.W. 171 (68), *203*  
 Larson, J.R. 698 (98), *742*  
 Larson, J.W. 385 (35a–e, 38a–c, 39a, 39b), *418*  
 Larson, R.A. 1136 (523), *1165*  
 Larsson, S. 184 (100), *203*  
 Larsson, U. 583 (272), *622*  
 Laschever, M. 289 (111), *293*  
 Lasia, A. 450 (193), *474*  
 Latajka, Z. 27 (41), *82*  
 Lathan, W.A. 208 (4), *244*  
 Latif, M. 558 (130), *619*  
 La Torre, F. 1262, 1264 (147a), *1299*  
 Lattes, A. 587 (298), *622*  
 Lau, D.T.W. 1142 (562), *1166*  
 Lau, M.P. 811 (163), *821*  
 Lau, W.M. 290 (116), *294*  
 Lau, Y.H. 288 (107), *293*  
 Lau, Y.K. 392 (73), *419*  
 Lauderdale, W.J. 77 (130), *84*  
 Lauransan, J. 381 (18), *417*  
 Laurence, C. 381 (17d, 17e), 395 (82–84), *417, 419, 451 (195), 474, 505 (158, 159), 529, 1222 (51), 1238 (51, 87b), 1296, 1297*  
 Laurent, A. 566 (180), 567 (183), *620*  
 Lauterbur, P.C. 317 (75), *334*  
 Lavagnini, I. 1147 (592), *1167*  
 Lavallee, R.L. 1217 (16), *1295*  
 Lavigne, A. 580 (252a, 252b), *621*  
 Laviron, E. 841 (14, 15), 843 (16, 17), 845 (33), 854 (69), 855, 856, 1129 (467–471), 1143 (565), 1144 (471), *1164, 1166*  
 Law, C. 1187 (79), *1213*  
 Law, K.Y. 637 (45), 639 (53), *660*  
 Lawesson, S.O. 642 (79), *660, 675 (64), 678 (83), 681, 682*  
 Lawler, H.J. 653 (144), *662*  
 Lawrance, G.A. 851 (53), *856*  
 Lawson, J.P. 575 (210), *621*  
 Lay, P.A. 851 (53, 54), 854 (54), *856*  
 Layer, R.W. 1197 (108), *1214*  
 Layne, W.S. 811 (164), *821*  
 Laza, M.R.C. 1047 (25), *1155*  
 Lázaro, F. 1137 (527), *1166*  
 Lazdins, D. 877 (70), *890*  
 Lazzari, D. 551 (93), *618*  
 Leaf, C.D. 976 (33), *994*  
 Leahy, D.E. 1222 (57, 58), *1296*  
 Leahy, D.J. 795 (125), *820*  
 Leardini, R. 655 (158), *662*  
 Leahy, D.E. 1222 (60), *1297*  
 Lebedev, Y.A. 352 (43), *374*  
 Leblanc, J.-P. 584 (286), *622*  
 Leblanc, Y. 550 (86a, 86b), 574 (206), *618, 621*  
 Leboutet, L. 576 (214), *621*  
 LeBreton, P.R. 188 (113, 115–119), *204*  
 Le Bris, M.T. 697 (88), *741*  
 Lecher, H. 666 (3), *680*  
 Lechevallier, A. 607 (416), *625*  
 LeClouerec, E. 563 (165), *620*  
 Lécotier, S. 591 (327), 595 (359a), *623, 624*  
 LeCorré, M. 536 (19), *617*  
 Lecoultrre, J. 179 (94), *203*  
 LeDemenez, M. 400 (126), *420*  
 Ledingham, K.W.D. 1127 (453, 454), *1164*  
 Lee, A.W.M. 1097 (337), *1162*  
 Lee, B.C. 936 (54), *948*  
 Lee, B.-S. 936 (54), *948*  
 Lee, C. 1058 (76), *1156*  
 Lee, C.K. 749 (4), *817*  
 Lee, C.M. 426 (17), *470, 1250 (124), 1298*  
 Lee, C.P. 691 (48), *741*  
 Lee, C.S. 108 (27), *154, 604 (403), 625*  
 Lee, C.-W. 844 (24), *855*  
 Lee, F.S.C. 1177 (31), *1212*  
 Lee, G.A. 580 (242), *621*  
 Lee, H.C. (41), *740*  
 Lee, H.H. 329 (117), *334*  
 Lee, H.J. 534 (2), *616*  
 Lee, H.W. 534 (2), *616, 950 (13), 970*  
 Lee, I. 936 (54), *948*

- Lee, J. 446 (175), 474  
 Lee, J.B. 581 (255), 622  
 Lee, J.R. 502 (148), 503 (149), 529  
 Lee, K.C. 534 (5), 616  
 Lee, K.-Y. 94 (33), 102, 369 (99), 370 (99–102), 378  
 Lee, L.K. 188 (116, 117), 204  
 Lee, M.L. 1047 (37), 1155  
 Lee, N.E. 577 (220), 621  
 Lee, N.H. 534 (5), 616  
 Lee, S.H. 1085 (259), 1160  
 Lee, S.J. 1103 (363), 1162  
 Lee, S.Y. 97 (64), 103  
 Lee, S.-Y.C. 130, 131 (92), 155  
 Lee, T.A. 1059 (82), 1156  
 Lee, T.D. 978 (63, 65), 995  
 Lee, T.H. 192, 193, 200, 201 (136), 204  
 Lee, T.V. 584 (284), 622  
 Lee, W.Y. 1083 (249), 1160  
 Lee, Y.H. 1093 (317), 1161  
 Lee, Y.T. 795 (121, 122), 820  
 Leeder, J.S. 1001, 1007, 1009, 1011 (28), 1027 (28, 155), 1035, 1038  
 Leeds, J.P. 535 (13), 616  
 Lees, C. 673 (41), 681  
 Lees, D.E. 1025 (132), 1038  
 Leeuwen, P.A.M.van 1078 (203), 1159  
 Lefebvre, R.A. 1062 (93), 1156  
 Lefkowitz, K.T. 509 (190), 530  
 Leffler, J.E. 424 (2), 470  
 Lefker, B.A. 168 (61), 202  
 Lefkowitz, S.M. 824 (10), 835  
 Legon, A.C. 428 (37, 38), 471  
 Legrand, M. 106 (8), 153  
 LeGrel, P. 544 (69), 618  
 Legua, C.M. 1097 (339), 1162  
 Legube, B. 1079 (208), 1159  
 Lehn, J.-M. 390 (67), 392 (77), 419, 428 (32, 33), 471  
 Lehtonen, P. 1083 (251), 1160  
 Leinhos, U. 697 (84, 85), 741  
 Leis, J.R. 644 (96), 661, 675 (57, 60), 677 (72), 681, 886 (101, 103), 888 (106), 891  
 Leiserowitz, L. 1108 (388), 1163  
 Leister, D. 13 (18), 81  
 Lejon, T. 563 (165), 620  
 Lelievre, J. 415 (203, 207, 209), 416 (212), 422, 1222 (49a, 49b), 1296  
 Lelj, F. 321 (93), 334  
 Lemaire, M. 537 (31), 617  
 Lembach, L.A. 1097 (336), 1162  
 LeMelle, J. 303, 305 (31), 333  
 Lemieux, L. 1104 (366, 367), 1162  
 Lemire, G.W. 1125 (444), 1164  
 Lemire, W.G. 1135 (519), 1165  
 Lemor, A. 537 (31), 617  
 Lenga, R.E. 1053, 1054, 1058, 1115, 1124, 1144 (70), 1156  
 Lengyel, J. 1141 (553), 1166  
 Lenhart, P.G. 668–670, 672 (14), 680  
 Lenk, W. 1026 (144, 146), 1029 (144, 161), 1030 (146, 175), 1038, 1039  
 Le Noble, W.J. 938 (56), 948  
 Lenz, G.R. 724 (160, 162c), 743  
 Leo, A. 303 (29), 332, 504, 514, 515, 517, 518 (150), 522 (150, 245), 529, 531, 1006, 1024, 1026–1028, 1030–1032 (55), 1036, 1238 (95), 1241 (106a), 1297, 1298  
 Leo, A.J. 494, 514 (118), 528, 1228 (74), 1297  
 Leonard, D.R.A. 950 (3), 970  
 Leonard, J.M. 6 (10), 81  
 Leonard, N.J. 347 (27), 373  
 Leone, A. 711 (120), 742  
 Leone, A.M. 976, 978, 980 (39), 994  
 Leone, J.A. 1180 (58, 59), 1213  
 Leone-Bay, A. 712 (122), 742  
 Leonetti, J. 840 (13), 855  
 Leon-González, M.E. 1135 (513), 1165  
 Leoni, M.A. 708 (110), 742, 758 (29), 818  
 Leoni, P. 1236, 1266 (159), 1299  
 Leont'eva, L.B. 1137 (525, 526), 1141 (554), 1165, 1166  
 Le Page, Y. 93, 100 (26), 102  
 LePoire, D.M. 667 (8), 680  
 Lepom, P. 273, 274 (84), 293  
 Le Questel, J.-Y. 395 (83), 419, 1238 (87b), 1297  
 Leriverend, C. 591 (325), 623  
 Lerner, R.D. 216, 218 (65), 245  
 Leroy, G. 410 (187a, 187b), 422  
 Leska, B. 459 (243), 460 (248), 476  
 Lessard, J. 450 (193), 474, 845 (29, 30), 855  
 Lessen, T.A. 595 (353), 624  
 Lester, G.R. 233 (146), 247, 251 (4), 264 (63), 291, 293  
 Létard, J.-F. 446 (172), 474  
 Lett, R.G. 57 (90a), 83  
 Leutwyler, S. 426 (11), 470  
 Lever, O.W.Jr. 290 (118), 294  
 Levi, R. 976 (35), 994  
 Levin, I. 251, 254, 262 (7), 291  
 Levin, R.D. 235, 236 (166), 247, 255 (24), 258 (39), 292, 383, 384 (24a), 407 (161a), 417, 421  
 Levine, H.B. 369 (95), 378  
 Levitt, M.S. 1067 (129), 1157  
 Levsen, K. 206 (1), 209 (28), 226 (119), 233 (147), 238 (177), 240 (184), 243, 244, 246–248, 250 (2), 251 (3), 253 (3, 12), 259, 261 (3), 291, 1068 (138), 1116 (406), 1125 (445), 1127 (445, 455), 1133 (498), 1136 (445), 1158, 1163–1165  
 Levy, A.B. 565 (176), 620  
 Levy, D.H. 694 (67), 741

- Levy, G.C. 297, 300, 301 (2), 302 (19), 303 (30), 308 (35), 310 (46), 312, 313 (56), 318 (80), 332–334  
 Levy, N. 482, 483 (23), 525, 750 (5), 817  
 Lewarchik, R.J. 653 (145), 662  
 Lewin, R.O. 436 (115), 473  
 Lewis, D.W. 128 (82, 83), 129 (82), 155  
 Lewis, E.S. 409 (172), 421  
 Lewis, F.D. 684 (2, 5), 685 (2, 8, 13, 17–19, 21–23), 686 (24, 27, 28, 30, 31), 687 (31), 696 (81), 698 (8, 22, 95, 96), 699 (24, 28, 97), 700 (24, 99, 100), 701 (28, 99, 100), 704 (8, 99, 107), 706 (24, 28), 707 (109), 729 (174, 175a, 175b, 176a, 176b), 740–742, 744  
 Lewis, G.E. 648 (107), 661, 717 (143b), 743  
 Lewis, I.C. 489 (87, 88), 490 (90), 491 (90, 96, 97), 493 (87), 503 (90, 96, 97), 504 (87, 96, 97), 515 (96, 97), 517 (87, 96, 97), 527  
 Lewis, J.F. 96, 97 (57), 103  
 Lewis, P.R. 1033 (199), 1039  
 Lewis, R.G. 1176 (25), 1212  
 Lewis, R.J. 1126 (447), 1164  
 Lewkowicz, E. 396 (98), 419  
 Lewtas, J. 1177 (32, 38), 1181 (53), 1212, 1213  
 Leyden, D.E. 302 (21), 332  
 Leyrer, U. 123 (70), 155  
 Li, C.N. 609 (430), 625  
 Li, G. 562 (152), 619  
 Li, H. 431 (67), 472, 1130 (480), 1165  
 Li, J. 381 (21), 417, 428 (43), 471, 562 (152), 619  
 Li, K. 188 (116, 117), 204  
 Li, L. 1048 (62), 1156  
 Li, Q.X. 1135 (515), 1165  
 Li, S. 68 (114), 84  
 Li, S.-S. 4, 14 (21), 81  
 Li, T.-K. 1027 (151), 1038  
 Li, W.-K. 411 (192), 422  
 Li, Y.S. 1136 (521), 1165  
 Li, Z. 119 (57, 58), 154  
 Liang, Y. 565 (171), 620  
 Liao, M. 978 (70), 995  
 Lias, S.G. 211 (38), 235, 236 (166), 244, 247, 255 (24), 258 (39), 292, 383 (24a, 24b), 384 (24a, 24b, 26), 407 (161a), 417, 421, 436 (115), 473  
 Libby, P.S. 1047 (21), 1155  
 Libman, J.F. 407 (161a), 421  
 Lichtenberger, D.L. 178, 188 (92), 203  
 Lichter, R.L. 297, 300, 301 (2), 302 (19), 303 (30, 31), 305 (31, 32), 308 (35, 36), 310 (46), 317 (76), 318 (80), 332–334  
 Lide, D.R.Jr. 45 (69), 83  
 Lieb, D. 1189 (100), 1214  
 Liebold, W. 1180 (55), 1213  
 Lieberman, S.H. 1098 (341), 1162  
 Liebig, J. 482 (17), 525  
 Liebman, J.F. 235, 236 (166), 247, 255 (24), 258 (39), 292, 338 (1, 4), 339 (1, 7), 342 (1, 14), 343 (1, 15), 344–346 (1), 347 (24), 348 (29), 354 (54), 355 (57), 356 (59, 61, 62), 357 (70), 360 (14), 361 (83, 86), 365 (92), 371–373, 375–378, 383, 384 (24a), 417, 436 (115), 473  
 Liedle, S. 164, 167 (35), 202  
 Liembeck, A. 1089 (288), 1161  
 Lien, E.J. 522 (245), 531  
 Liepmann, E. 273, 274 (84), 293  
 Lierheimer, E. 1001 (19, 23), 1003 (23), 1020, 1023 (19), 1025 (23), 1027 (19), 1035  
 Lifshitz, C. 234 (153), 247, 251, 254, 262 (7), 291  
 Liggieri, G. 1262, 1264 (147a), 1299  
 Ligocki, M.P. 1176 (26), 1212  
 Lii, J.-H. 3, 4, 20 (4a), 21 (4a, 30b), 23, 24, 26 (30b), 27 (4a, 30b), 28, 29 (30b), 62, 64, 65 (108), 81, 82, 84  
 Lijinsky, W. 1186 (76, 77), 1213  
 Liljefors, T. 62, 63 (109), 84  
 Lillard, T.J. 1147 (590), 1167  
 Lillocci, C. 165–167 (24), 202  
 Lilse, J.B. 208 (4), 244  
 Lilzefors, T. 41, 42 (60), 82  
 Lin, C.R. 685 (15), 740  
 Lin, C.-T. 91, 93 (21), 102  
 Lin, D.X. 1066 (115), 1157  
 Lin, J. 188 (115–117), 204  
 Lin, S.K. 809 (153), 810 (154, 155), 821  
 Lin, S.W. 832 (59, 60), 836  
 Lin, T.I. 1093 (317), 1161  
 Lin, T.S. 453 (205), 475  
 Lin, Y. 1126 (449), 1164  
 Lin, Y.C. 685 (20), 740  
 Lin, Y.H. 1105 (371), 1162  
 Lind, J. 827 (34), 835  
 Linda, P. 426 (13), 470  
 Lindeke, B. 1029 (158), 1038  
 Lindgren, C.C. 1116 (416), 1163  
 Lindner, W. 1130 (477), 1164  
 Lindon, J.C. 320 (89), 334  
 Lindqvist, T. 1029 (158), 1038  
 Lindsey, J.S. 428 (34), 471  
 Lingafelter, E.C. 636 (38), 659  
 Linkerhaegner, M. 1128 (461), 1164  
 Linley, E.A.S. 1098 (342), 1162  
 Lin-Zhi Chen 274, 275 (85), 293  
 Lipczynska-Kochany, E. 407 (156), 421  
 Lipina, E.S. 604 (401), 625  
 Lipkowitz, K.B. 3–5, 29 (1b), 81, 312 (54), 333  
 Lippton, H. 673 (42), 681, 975 (25), 994  
 Lipschultz, F. 1049 (67), 1156

- Lipscomb, G.F. 94 (30), 102  
 Lipton, M. 41 (63), 82  
 Lisini, A. 192 (131), 204  
 Liška, J. 507 (180), 529  
 Liskamp, R. 41 (63), 82  
 Lister, D.G. 171 (68), 203  
 Liszi, J. 386 (45a, 45b), 418  
 Little, R.D. 840 (13), 850 (50), 855, 856  
 Littler, J.S. 646 (103), 661  
 Liu, A. 1073 (171), 1158  
 Liu, G.K. 590 (322), 623  
 Liu, H. 1082 (242), 1160  
 Liu, H.J. 1084 (255), 1160  
 Liu, J. 978 (57), 995  
 Liu, J.P. 1093 (320, 321), 1161  
 Liu, J.-Y. 739 (206), 745  
 Liu, L. 979 (77), 995  
 Liu, Y.-C. (68), 971  
 Liu, Y.M. 1081, 1091 (234), 1159  
 Livant, P. 164, 165, 168 (40), 202  
 Livett, M.K. 166 (55), 202  
 Lizasoain, I. 992 (134), 997  
 Lizhi, L. 978 (70), 995  
 Llamas-Saiz, A.L. 435 (106), 472  
 Lledos, A. 453 (206), 475  
 Llewellyn, G. 1090 (294), 1161  
 Llobera, A. 585 (294), 622  
 Lloyd, D.G. 1184 (69), 1213  
 Lluich, J.M. 754 (14, 15), 758 (31), 788 (102),  
 817, 818, 820  
 Lo, L.-C. 143 (128), 156  
 Lobanov, D.I. 519 (238), 531  
 Lobell, M. 1092 (306), 1161  
 Loblely, R.W. 1097 (334), 1162  
 Locaj, J. 1133 (499), 1165  
 Locascio-Brown, L. 1100 (348), 1162  
 Lock, C.J. 88, 90 (8), 102  
 Locke, M.J. 386 (44), 418  
 Lockhart, R.L. 812–814 (165), 821  
 Lockhart, R.W. 812, 813 (168), 821  
 Lodder, G. 753 (11), 817  
 Loepky, R.N. 107 (24), 154, 886 (97), 891,  
 1143 (566), 1148 (600), 1166, 1167, 1186  
 (78), 1213  
 Loewenthal, E. 427 (20), 470  
 Lofroth, G. 1177 (29), 1212  
 Loftus, P. 301, 302 (16), 332  
 Lomzakova, V.I. 631 (19), 659  
 Loncharich, R.J. 72 (123), 84  
 Long, A.R. 1139 (539, 541), 1166  
 Long, Q.-H. 554 (115b), 558 (132), 619  
 Longevialle, P. 216 (63g), 245  
 Longmore, R.W. 655 (163), 662  
 Lonkar, S.T. 1058 (77), 1127 (452), 1156,  
 1164  
 Look, G.van 1066 (122), 1157  
 Lopes, A.J.M. 349 (32, 33), 374  
 Lopez, C. 407 (161b), 421  
 Lopez, V.O. 303 (26), 332, 504, 505 (155),  
 529  
 López-Ávila, V. 1061 (90), 1156  
 Lopez Cancio, J. 1131 (485), 1165  
 Lorand, J.P. 440 (142), 473  
 Lorch, E. 717 (141), 743  
 Lord, R.C. 8 (13), 81  
 Lorec, A.M. 1061 (91), 1156  
 Lorentzen, R.J. 137 (108), 156  
 Lorenzen, N.P. 396 (95), 419  
 Lorr, S. 355, 356 (58), 375  
 Lory, J.A. 1049 (65), 1156  
 Loscalzo, J. 673 (39, 43–45), 681, 1150 (606),  
 1167  
 Lossing, F.P. 208 (7, 11), 209, 214 (11), 215  
 (7), 217 (70–72), 237 (175), 244, 245, 248,  
 255 (25–28), 292  
 Lothrop, W.C. 338, 361, 362, 364 (2b),  
 372  
 Lotlikar, P.D. 1000, 1009, 1031 (9), 1035  
 Lou, J. 607 (420), 625  
 Lou, W. 607 (420), 625  
 Loudon, A.G. 217 (79), 245  
 Loudon, G.M. 552 (99), 618, 843 (20b), 855  
 Lougmani, N. 834 (71, 72), 836  
 Lovey, R.G. 550 (84), 618  
 Lowe, J.P. 36, 38, 41 (54), 82  
 Lowe, P. 96 (54), 103  
 Lowe-Ma, C.K. 96 (53), 103  
 Lowenstein, C. 976, 977 (44), 995  
 Lowenstein, C.J. 979 (76), 991 (125), 992  
 (127), 995, 997  
 Lowenstein, C.R. 978 (69), 995  
 Lown, J.W. 675 (64), 677 (71), 681  
 Lowry, M.K. 552 (102), 618  
 Lowry, T.M. 146 (138), 156  
 Loy, M. 710 (115), 742, 1105 (368), 1162  
 Lu, G.K. 977 (52), 995  
 Lu, J. 348 (30b), 373  
 Lu, J.R. 1119 (434, 436), 1122 (437), 1164  
 Lu, L. 539 (41), 617  
 Lu, S.M. 583 (277), 622  
 Lu, W.C. 978 (71), 995  
 Lu, Y. 1151 (613), 1167  
 Lubben, M. 585 (291), 622  
 Lubberts, P.T. 639 (53), 660  
 Lubeskie, A. 991 (121), 996  
 Lucas, S. 987 (98), 996  
 Luche, J.-L. 583 (274), 594 (349), 622,  
 624  
 Lucht, B.L. 396 (86a, 91a), 419  
 Luckas, B. 1079 (213), 1082 (235, 236), 1159,  
 1160  
 Luçon, M. 451 (195), 474, 505 (158), 529  
 Ludemann, H.D. 321 (95), 334  
 Ludwig, E. 1082 (239), 1160

- Ludwig, M. 494 (120, 121), 507 (120, 121, 178, 179), 522 (242), 528, 529, 531  
 Lue, P. 554 (115b), 555 (117), 558 (132), 562 (152), 619  
 Luijten, W.C.M.M. 282 (96–99), 283 (98, 99), 289 (114), 293, 294  
 Lumme, P. 640 (69), 660  
 Lunazzi, L. 43 (66), 50 (66, 74–76), 52 (74, 75), 53 (75, 76), 83  
 Lund, E.D. 1048 (54), 1156  
 Lund, H. 651 (136), 662, 840 (12a), 855  
 Lundin, R.E. 144 (132), 156  
 Lundstedt, T. 563 (165), 620  
 Luneau, I. 437 (123), 473  
 Lunn, G. 1197 (103), 1214  
 Lunte, C.E. 1023 (121), 1037  
 Lunte, S.M. 1080 (222, 223), 1159  
 Luo, P.F. 1073 (172, 173), 1158  
 Lupton, E.C. 522 (244), 531  
 Luszyk, J. 809 (152), 821  
 Luteyn, J.M. 539 (40), 617  
 Lüttke, W. 188 (124), 204, 1007 (52), 1036  
 Lyapkaio, I.M. 448 (192), 474  
 Lyapkaio, I.M. 608 (424), 625  
 Lyle, R.E. 886 (98), 891  
 Lynch, B.M. 199 (145), 204  
 Lynch, K.R. 977 (51), 995  
 Lynch, R.D. 137 (112), 156  
 Lynch, T.-Y. 403 (137, 140, 141), 407 (159), 420, 421  
 Lynes, A. 1108 (384), 1163  
 Lyons, C.R. 978 (68), 995  
 Lyttle, D.J. 1122 (437), 1164
- Ma, B. 441 (145), 473  
 Ma, Y. 571 (199), 620  
 Maas, W.P. 211 (40), 244  
 Maas, Y.E.M. 1045 (7), 1155  
 Maat, L. 130, 131 (92), 155  
 Mabry, T.J. 1066 (120), 1157  
 Macbeth, A.K. 676 (69), 681  
 Maccarone, E. 434 (88), 472  
 Macchia, F. 544 (65, 68), 545 (72), 617, 618  
 Macciantelli, D. 50 (75, 76), 52 (75), 53 (75, 76), 83  
 Maccoll, A. 210 (34), 216 (66), 217 (70, 74, 75), 218 (75, 88), 221 (75), 223 (113), 224 (88), 244–246, 940 (59), 948  
 MacCormack, P. 1237 (83a, 83b), 1243 (83a), 1297  
 Macdonald, C.G. 267 (74), 293  
 MacDonald, K.I. 581 (255), 622  
 MacDougall, G.S. 804 (145), 821  
 MacFarlane, R.G. 1063 (95, 96), 1157  
 Macháčková, O. 638 (52), 660  
 Macheleid, J. 640 (66), 660  
 Machida, M. 609 (431), 625, 728 (172), 730 (180a, 181a, 181f, 182a), 733 (183c), 734 (186, 187, 188a, 188b), 744, 798 (132), 820  
 Maciel, G.E. 330 (121), 335  
 MacIntyre, D.W. 505 (156), 510 (199), 529, 530  
 Macko, S.A. 1049 (68), 1060 (86), 1156  
 MacLagan, R.G.A.R. 954 (35), 971  
 MacLeod, S.C. 1063 (95), 1157  
 MacMicking, J.D. 993 (147), 997  
 Macys, D.A. 1134 (505), 1165  
 Mader, C.L. 369 (95), 378  
 Maeda, K. 593 (342), 623  
 Maeda, T. 1180 (51), 1213  
 Maemura, K. 655 (153), 662  
 Maeno, N. 758 (32a, 32b), 818  
 Magagnoli, C. 50, 53 (76), 83  
 Maghon, H. 1175 (15), 1212  
 Magno, F. 1147 (592), 1167  
 Mahalakshmi, P. 286 (104), 293  
 Mahdavi, F. 748 (1), 817  
 Mahe, R. 595 (359a), 624  
 Maher, T. 1071 (153), 1158  
 Mahler, G.S. 124 (74), 155, 427 (22), 471  
 Mahling, S. 830 (52), 836  
 Mahmood, S. 848 (44), 856  
 Mahy, J.P. 572 (202), 620  
 Mai, J.C. 685 (20), 740  
 Mai, K. 584 (285a, 285b), 622  
 Maia, L.S. 854 (63), 856  
 Maier, J.P. 164, 165, 171, 174 (42), 175 (42, 85), 176, 178 (86), 202, 203  
 Maier, N. 603 (393), 624  
 Maier, U. 426 (9), 470  
 Mair, F.S. 396 (92, 96), 419  
 Maister, H. 1003, 1020, 1022 (34), 1035  
 Maiti, S.N. 537 (26, 28), 617  
 Maity, D.K. 825 (17), 835  
 Maiya, B.G. 753 (10), 817  
 Majdi, H.S. 366, 369, 370 (98), 378  
 Majeed, N.N. 804 (144, 145), 821  
 Majenz, W. 694 (63), 697 (87), 741  
 Majer, J. 438 (128), 473  
 Mak, M. 851 (55), 856  
 Makarski, V.V. 94, 100 (32), 102  
 Makhamatkhanov, M.M. 519 (238), 531  
 Maki, A.H. 843 (22), 847 (39, 40b), 855, 856  
 Maki, Y. 722 (158a), 743  
 Makik, G. 1128 (466), 1164  
 Makino, K. 739 (204), 745, 803 (142), 821, 1047 (40), 1155  
 Makita, M. 1065 (110–112), 1157  
 Malamidou-Xenikaki, E. 721 (150), 743  
 Malaraski, Z. 435 (108–111), 472  
 Maléndez, E. 631 (17), 659  
 Malfroot, T. 582 (264), 622  
 Malik, A.A. 537 (25), 617  
 Malikova, J. 1068 (135), 1157

- Malinski, T.A. 992 (127), 997  
 Malkin, A.N. 684 (6), 740  
 Mallard, G.W. 338, 339, 342–346 (1), 371  
 Mallard, W.G. 235, 236 (166), 247, 255 (24),  
 292, 348 (29), 361 (83), 373, 377  
 Mallart, S. 551 (92), 618  
 Mallols, J.M.S. 1067 (133), 1086 (273), 1157,  
 1160  
 Malmborg, P. 932 (45), 947  
 Malmer, M.F. 1082 (238), 1160  
 Malone, P.L. 1238, 1240 (97), 1297  
 Malpass, J.R. 56 (80e), 83  
 Malpezzi, L. 53 (77), 83  
 Mamaveille, C. 1147 (591), 1167  
 Mammen, M. 430 (50), 471  
 Manabe, O. 448 (191), 474, 869 (43), 870  
 (47), 889, 890  
 Manabe, S. 1072 (155–160, 162), 1158  
 Manabe, Y. 1180 (51), 1213  
 Mancheno, M.J. 716 (139), 743  
 Mancini, P.M.E. 1221 (48a–c), 1222 (48b),  
 1247 (48c), 1296  
 Mandagere, A.K. 1189 (95), 1214  
 Mandal, P.C. 833 (68), 836  
 Mandal, S.B. 598 (377), 624  
 Mandal, T.K. 1139 (542), 1166  
 Mandel, M. 96 (45), 102  
 Mandelbaum, A. 208 (10), 244  
 Mandell, G.L. 1027 (153), 1038  
 Manderville, R.A. 512 (215), 530  
 Manes, J. 1048 (55), 1156  
 Manes, J.D. 1070 (150), 1158  
 Manescalchi, F. 564 (168), 620  
 Mangani, S. 391 (65), 419  
 Mangeney, P. 126, 127 (80), 155, 546 (73),  
 618, 1111 (397), 1163  
 Mangino, M.M. 1188 (90), 1214  
 Manglik, A.K. 880 (84), 890  
 Mann, B.E. 297 (14), 332  
 Mann, B.R. 516 (233), 530  
 Mann, D.E. 45 (69), 83  
 Manning, C. 685, 686 (7), 740  
 Manousek, O. 848 (41a, 41b), 856  
 Manoussaridou, E. 1048 (53), 1156  
 Mansfield, P. 330 (120), 335  
 Manson, D. 1000 (8, 12), 1015 (12), 1035  
 Manson, T.J. 1180 (52), 1213  
 Mansour, T.S. 398 (116), 399 (121), 420  
 Mansuy, D. 572 (202), 620  
 Mao, J. 1076 (187), 1159  
 Maples, K.R. 1019, 1020, 1022 (92), 1037  
 Maquestiau, A. 232 (142), 247, 274, 275 (85),  
 293  
 Maquin, F. 209 (31), 244  
 Marano, R.S. 1177 (36), 1212  
 Marcantoni, E. 608 (425, 426a, 426b), 625  
 Marcantonio, R.P. 43 (68), 83  
 March, J. 653 (142), 662, 1009, 1013, 1015  
 (58), 1036  
 March, R.E. 254, 288 (22), 292, 1145 (574),  
 1167  
 Marchal, J. 825 (19–21), 835, 1069 (142),  
 1158  
 Marchand, A. 897 (21), 947  
 Marchand, A.P. 604 (402), 625  
 Marchelli, R. 1091 (300), 1161  
 Marchesini, A. 397 (104), 420  
 Marchetti, F. 143 (125), 156  
 Marchidan, D.I. 353 (50), 375  
 Marciniac, B. 1140 (551), 1166  
 Marcon, M.G. 94 (36), 102  
 Marcucci, J.L. 540 (43), 617  
 Marcus, Y. 1220 (45a, 45b), 1225 (61, 63, 64),  
 1296, 1297  
 Marder, M. 1273–1275 (177), 1299  
 Marengo, E. 1074 (177), 1158  
 Margaretha, P. 720 (149), 743  
 Margolin, A. 410 (182), 422  
 Margolin, Z. 398 (115), 420, 436 (116), 473  
 Margreth, A. 1000, 1009, 1031 (9), 1035  
 Maria, P.-C. 348 (28), 373, 381 (13, 19, 20b),  
 387 (51, 55), 406 (154), 416–418, 421, 499,  
 522 (138), 528  
 Maria, P.C. 407 (160), 421, 428 (42), 459  
 (244), 471, 476, 1237 (84–86), 1238  
 (84–86, 93), 1284, 1285 (86), 1297  
 Maria, P.de 1012 (81), 1036  
 Mariano, P.S. 684 (5), 685 (16), 688 (42, 43),  
 690 (45–47), 691 (48), 692 (50), 710 (117a,  
 117b, 119), 711 (120, 121), 712 (122, 123),  
 714 (124–128), (44), 740–742  
 Marjanucci, E. 465 (264), 476  
 Marín, J. 1046 (19), 1155  
 Marine-Font, A. 1079 (214), 1159  
 Marini, E. 551 (93), 618  
 Markov, V.I. 132, 133 (96), 155  
 Marko-Varga, G. 1103 (357), 1162  
 Markovits, G.Y. 641 (70), 660  
 Markowicz, T. 53, 54 (78), 83  
 Marks, H.M. 1047 (24), 1155  
 Marks, M.J. 137 (112), 156  
 Marletta, M.A. 976 (31, 33, 36), 978 (31, 36,  
 67), 980 (31), 983 (36, 82, 83, 85, 87),  
 984 (87), 985 (82, 94), 989 (104, 106), 990  
 (112), 991 (115), 994–996  
 Marmon, R.J. 601 (384a, 384b), 624  
 Maron, A. 505 (156), 529  
 Maroulis, A.J. 704 (108), 742  
 Marples, B.A. 797 (131), 820  
 Marquardt, D.J. 599 (380), 624  
 Marquet, B. 566 (180), 620  
 Marquet, J. 754 (14–16, 17a, 17b), 755 (20),  
 756 (23), 758 (30, 31), 788 (102), 817, 818,  
 820, 846 (35), 855



- Márquez, C.D. 1066 (114), *1157*  
Marr, H.E.III 97 (62), *103*  
Marriott, S. 506 (164–167), 510 (167, 199),  
*529, 530*  
Marrone, M.J. 795 (120), *820*  
Marrosu, G. 191, 199 (130), *204*  
Marrs, D. 59 (100), *83*  
Marsch, G.A. 1033 (201), *1039*  
Marsch, M. 396 (99, 100), 413, 414 (197),  
*420, 422*  
Marschner, F. 171, 174 (74), *203*  
Marsden, P.A. 977 (52), 978 (71), 979 (72),  
*995*  
Marsden, R.J.B. 487 (67), *526*  
Marsella, J.A. 543 (62), *617*  
Marsh, R.E. 444 (162), *474*  
Marshall, A. 1127 (453, 454), *1164*  
Marshall, A.G. 235 (164), *247*  
Marshall, E.K.Jr. 1087 (277), *1160*  
Marshall, S. 991 (116), *996*  
Marstokk, K.M. 56 (83), *83*  
Martelli, G. 549 (81), *618*  
Martens, D.A. 1073 (167, 168), *1158*  
Martens, M.H.J. 1129 (475), 1132 (489), *1164,*  
*1165*  
Martin, G. 317 (77), *334*  
Martin, G.J. 297 (6), 303 (28), *332*  
Martin, H.-D. 165, 166 (47), 178 (90), 182  
(47), 202, *203*  
Martin, H.D. 184 (107), *204*  
Martin, J. 673 (41), *681*, 1046 (13), *1155*  
Martin, J.A.F. 715 (129, 132), 716 (132, 133),  
*742*  
Martin, J.A.J. 1119 (429), *1163*  
Martin, J.F. 673 (40), *681*  
Martin, M.L. 297 (6), 303 (28), *332*  
Martin, M.W. 1118 (419), *1163*  
Martin, T.G. 1093 (309), *1161*  
Martin, W. 975 (14–16), *994*  
Martin, X. 788 (102), *820*  
Martin, Y.C. 506 (174), *529*  
Martinelli, G. 576 (216), *621*  
Martinez, A. 408 (167b), *421*  
Martínez, L.L. 1139 (538), 1140 (546), *1166*  
Martinez, R.D. 1221 (48a–c), 1222 (48b), 1247  
(48c), *1296*  
Martinez-Carrera, S. 435 (98), *472*  
Martinez-Fresneda, P. 566 (177), *620*  
Martinez-Larranaga, M.R. 1025 (139), *1038*  
Martinho Simões, J.A. 342 (14), 343 (15), 360  
(14), *372*  
Martins, L.J.A. 780 (76–79), *819*  
Martins Costa, M.T.C. 456 (226), *475*  
Martyn, R.J. 954 (27), *971*  
Martynov, I.V. 607 (419), *625*  
Martz, J.T. 582 (264), *622*  
Maruha, J. 94 (38), *102*
- Maruthamuthu, P. 827 (27, 28), *835*  
Maruyama, K. 730 (180a, 180b), 733 (183b),  
*744*  
Maruyama, R. 597 (370), *624*  
Maruyama, Y. 437 (122, 123), *473*  
Marvel, C.S. 677 (77), *681*  
Maryanoff, B.E. 73 (124), *84*  
Maryanoff, C.A. 563 (156), *620*  
Marzabadi, M.R. 560 (137), *619*  
Marzin, C. 426 (13), *470*  
Marzluff, E.M. 178, 188 (92), *203*  
Marzo, A. 1068 (136), *1157*  
Masamune, S. 112 (40), *154*  
Mascal, M. 427 (18), *470*  
Maschmeier, C.P. 603 (393), *624*  
Masclat, P. 1175 (19), *1212*  
Mashima, M. 505 (163), *529*  
Masi, D. 57 (93), *83*  
Maskill, H. 648 (111), *661*  
Maslen, E.N. 95 (42), *102*  
Masnovi, J. 433 (79), *472*  
Masnovi, J.M. 455 (213–215), 456 (221), *475,*  
*790 (110), 820*  
Mason, J. 297 (3), 303, 308 (37), 315 (63),  
*332, 333, 666, 669 (7), 680*  
Mason, R.P. 1019 (91, 92), 1020, 1022 (92),  
*1037*  
Massey, R.C. 1134 (507), *1165*  
Masters, B.S.S. 984 (90), 985 (93), 989 (101,  
102), 991 (118), *996*  
Mastrokalos, C. 633, 644 (25), *659*  
Mastryukov, V.S. 8 (14a, 14b), 24 (14a, 14b,  
37), *81, 82*  
Masuda, H. 111 (36), *154*  
Masuda, S. 193, 194, 197–199 (144), *204, 649*  
(120), *661*  
Masuda, Y. 866 (34), 889, 1078 (206), *1159*  
Masui, M. 676 (68), *681*  
Mataga, N. 694 (58), 695 (69), *741*  
Matage, M. 698 (94), *742*  
Matcham, G.W. 108, 109 (31), *154*  
Mateos, J.L. 434 (90), *472*  
Mathews, R.J. 268 (78), *293*  
Mathews, W.R. 673 (38), *681*  
Mathews, W.S. 410 (182), *422*  
Mathias, J.P. 430 (50–53), *471*  
Mathieu, J. 1145 (572), *1166*  
Mathur, H.B. 1266, 1267 (167b), *1299*  
Mathur, H.M. 285 (102), *293*  
Matiskella, J.D. 582 (262), *622*  
Matiushin, Y.N. 362, 363 (90), *377*  
Matschiner, H. 603 (393), *624*  
Matsson, O. 932 (44), 933 (46), 938 (55), *947,*  
*948*  
Matsubara, S. 597 (372), *624*  
Matsuda, H. 543 (64), 590 (319), 596 (361a,  
361b), *617, 623, 624*

- Matsuda, T. 654 (150, 152), 655 (153–155), 657 (170, 172), 662
- Matsui, A. 164, 170 (30), 202, 638 (50), 660
- Matsui, K. 758 (32a, 32b), 818
- Matsui, T. 565 (174), 620
- Matsumiya, T. 1073 (165), 1158
- Matsumoto, K. 787 (101), 820, 1106 (372), 1162, 1256 (137–139), 1298, 1299
- Matsumoto, M. 1134 (504), 1165
- Matsumoto, Y. 736 (194b), 745
- Matsumura, G. 96 (47), 102
- Matsumura, S. 866 (32), 889
- Matsunaga, K. 698 (91), 741
- Matsuo, T. 1083 (253), 1160
- Matsuoka, A. 989 (107), 996
- Matsuoka, S. 824 (11, 12), 835
- Matsushima, H.K.Y. 1079, 1083 (217), 1159
- Matsushita, A. 651 (133), 661
- Matsushita, T. 215 (54), 245
- Matsuyoshi, H. 596 (362), 624
- Matteoli, E. 386 (45b), 418
- Matthew, D.E. 976, 978 (38), 994
- Matthew, P. 1001, 1003, 1007, 1009, 1011, 1012, 1028 (29), 1035
- Matthews, D.P. 577 (219), 621
- Matthews, W.S. 398 (115), 420
- Matthiesen, U. 1060 (84), 1156
- Matthijs, E. 1116 (408), 1163
- Mattiello, M. 1175 (16), 1212
- Mattusch, J. 1094 (323), 1161
- Matuura, T. 866 (34), 889
- Matvienko, N.M. 348 (31), 373
- Matyska, M. 1146 (582), 1167
- Maumy, M. 580 (241, 252a, 252b), 590 (321), 621, 623
- Maurer, J. 648 (109), 661
- Maurin, J. 98 (69), 103, 444 (160), 474
- Maurin, R. 598 (378), 624
- Mautner, H.G. 426 (17), 470, 1250 (124), 1298
- Maverick, D. 60 (104), 84
- Mawson, S.D. 675 (60), 681
- Maxwell, B.E. 899 (23), 947
- Maxwell, R.J. 1145 (581), 1167
- May, D.P. 171, 175 (70), 203
- May, S.W. 1111 (398), 1163
- Mayence, A. 556 (120), 558 (131), 619
- Mayer, B. 165, 166 (47), 178 (90), 182 (47), 184 (107), 202–204, 977 (45), 983 (86), 984 (45), 985 (92), 990 (109), 991 (122), 992 (136, 137), 995–997
- Mayer, N. 552 (104), 618
- Mayo, E.C. 497 (133), 528
- Mayo, P.de 722 (153h), 728 (171a, 171b), 743, 744
- Mayo, S.L. 37, 38, 40 (57), 82
- Mays, J.B. 1011, 1012 (72), 1029 (72, 168), 1036, 1038
- Maystre, F. 1093 (315), 1161
- Mazurek, R. 1046 (16), 1155
- Mazzocchi, H.P. 730 (177c), 744
- Mazzochi, P.H. 733 (183a, 183d, 183e), 744
- Mazzucato, U. 778 (71), 819
- McAdoo, D.J. 216 (63b, 63h, 64, 65), 217 (80), 218 (65), 245
- McAlduff, E.J. 199 (145), 204
- McAninly, J. 669 (26), 670 (26, 27), 680
- McAuley, I. 785 (95), 820
- McCafferty, D.G. 739 (207), 745
- McCallum, G.J. 410 (182), 422
- McCallum, R.J. 398 (115), 410 (182), 420, 422
- McCarthy, J.R. 543 (58), 563 (157), 577 (219), 617, 620, 621
- McClellan, A.L. 427 (24), 471
- McClelland, C.W. 667 (8), 680
- McClelland, R.A. 868 (41), 889, 1001, 1003, 1005–1008, 1010, 1011, 1014, 1031 (30), 1032 (30), 186, 187, 190–194), 1035, 1039
- McCluskey, J.G. 581 (261), 622
- McCollum, G.J. 398 (115), 420
- McCollum, G.W. 565 (173), 620
- McCombie, J. 1102 (356), 1162
- McCormack, M.T. 329 (113), 334
- McCoy, E.C. 1177 (30), 1212
- McCreary, M.D. 128 (83), 155
- McCrudden, K. 648 (111), 661
- McCullough, K. 447 (176), 474
- McDermott, S.D. 405 (147, 148), 421
- McDougal, J.S. 1024 (125, 126), 1037
- McDougall, G.J. 58 (95–97), 83
- McDow, S.R. 1179 (50), 1213
- McDowell, C.A. 166 (56), 202, 290 (116), 294
- McElroy, P.A. 1177 (42, 43), 1213
- McEwen, A.B. 184 (105), 203
- McEwen, I.J. 447 (180), 474
- McEwen, H.K. 400 (122), 420
- McFarlane, H.C.E. 297 (7), 332
- McFarlane, W. 297 (7), 332
- McGhee, W.D. 595 (356), 596 (364), 624
- McGill, C.K. 560 (138), 619
- McGill, R.A. 381 (20b), 417, 428 (42), 471
- McGlynn, S.P. 188 (114), 200 (149), 204
- McIntire, G.L. 843, 844 (23), 855
- McIntyre, J.S. 448 (191), 474
- McIver, R.T. 308 (41), 333, 496 (131), 505 (131, 163), 528, 529
- McIver, R.T.Jr. 235, 236 (165), 247, 382 (22), 384 (33b), 385 (22), 386 (44), 387 (52a, 52b), 411 (193), 417, 418, 422, 436 (117), 473
- McKee, M.L. 164, 165, 168 (40), 202, 255 (32, 33), 292, 410 (186), 422
- McKelvey, G.N. 594 (347), 623
- McKelvie, I.D. 1045 (5), 1046 (18), 1155
- McKenna, J. 859 (13), 889

- McKenna, J.M. 859 (13), 889  
McKenzie, H.A. 1047 (23), 1155  
Mckeown, C. 1140 (552), 1166  
McKimmey, J.E. 688 (33), 740  
McKinney, T.M. 184 (101), 203  
McLafferty, F.W. 206, 207 (3), 208 (17), 209 (27, 30), 210 (17), 211 (17, 35), 212, 215 (17), 217 (68), 219 (3, 68), 226 (3, 68, 119), 229, 233 (3), 243–246, 253 (13, 14), 254 (16, 20), 292  
McLafferty, M.A. 1032 (196), 1039  
McLean, A.D. 384 (27), 417  
McLean, W.J. 1174 (4), 1212  
McLenaghan, C.C. 1147 (594), 1167  
McLeod, J.K. 208 (8), 244  
McLuckey, S. 251, 253, 254 (5), 291  
McLuckey, S.A. 264, 269, 270 (66), 293, 390 (70), 419  
McLuckley, S.A. 238 (179, 181), 248  
McMahon, A.W. 254, 288 (22), 292  
McMahon, T.B. 384 (25b, 25c, 30a–c), 385 (34c, 34d, 35a–e, 38a–c, 39a, 39b), 417, 418, 1238 (91, 92), 1297  
McManus, S.P. 1273, 1275, 1283 (178), 1299  
McMillan, D.C. 1019 (94), 1026 (142, 143), 1037, 1038  
McMillan, K. 984 (90), 985 (93), 989 (101, 102), 991 (118), 996  
McMillen, D.F. 401 (134), 420, 883 (88), 890  
McMinn, D.G. 1047 (30), 1155  
McMurray, M.E. 1238, 1239 (99), 1297  
McMurry, M.E. 389 (59), 418  
McNally, A.J. 1106 (377), 1162  
McNamara, D.B. 975 (20), 994  
McNulty, J.F. 554 (111), 618  
McPhail, A.T. 397 (102), 420  
McPhee, J.R. 1012 (74), 1036  
McRae, T.A. 1026 (143), 1038  
McWherter, C.A. 322 (99), 334  
Mead, D.A.Jr. 1073 (166), 1158  
Mead, P.T. 220 (104), 246  
Means, G.E. 119 (60), 154  
Mechin, B. 317 (77), 334  
Mecklenburg, S.L. 739 (207), 745  
Meddour, A. 1112 (402), 1163  
Mederer, K. 553 (108b), 618  
Medica, A. 1116 (409), 1163  
Medina, H.L.de 1046 (16, 19), 1155  
Medwid, A.R. 7 (12), 81  
Meeks, J. 188 (114), 204  
Meerman, J.H.N. 1012, 1033 (85), 1036  
Meerwein, H. 654 (146), 657 (171), 662  
Meeus, F. 695 (77), 741  
Meguro, S.-I. 1030 (176), 1039  
Mehdi, S. 98 (71), 103  
Mehnert, R. 649 (119), 661  
Meier, B. 1086 (274), 1160  
Meier, C. 551 (95), 618  
Meijere, A.de 164, 165 (36), 168 (61), 202  
Meijide, F. 677 (72, 73), 681, 886 (102), 888 (106, 107), 891  
Meijs, G.F. 655 (160), 662  
Meisels, G.G. 255 (30), 259 (43), 262 (30, 43, 56), 292  
Meites, L. 840 (11), 855  
Mejstrik, V. 1135 (516), 1165  
Melamed, D.B. 1147 (593), 1167  
Melandrer, L. 859 (12), 889, 894 (2, 5), 895 (2), 946  
Melhorn, A. 722 (153c), 743  
Mellion, B.T. 975 (21, 22), 994  
Mellor, N. 1047 (33), 1155  
Mel'nikov, E.B. 636 (35), 659  
Memory, J.D. 302 (18), 332  
Mencarelli, P. 1217 (15a, 15b), 1295  
Mende, P. 1148 (600), 1167  
Mendelejev, J. 1024 (123–127), 1037  
Mendicino, M.E. 854 (66), 856  
Mendoza, J.de 392 (77), 419  
Mendoza, J.S. 609 (434), 625  
Menendez, E. 592 (333), 623  
Menendez, M. 408 (165a), 421  
Menger, J.M. 1266 (158), 1299  
Menzel, H. 1029 (159), 1038  
Meot-Ner, M. 384 (25a), 385 (36, 42, 43a–c), 417, 418, 429 (44), 471, 833 (65), 836, 1238 (90), 1297  
Merchan, M. 455 (218), 475, 790 (114), 820  
Merényi, G. 827 (34), 835  
Merényi, R. 403 (138a, 138b), 420  
Merlet, N. 1079 (208), 1159  
Merlino, S. 93 (28), 102  
Mermelstein, R. 1177 (30), 1212  
Merrill, B.M. 992 (132), 997  
Merritt, D.A. 1059 (79), 1156  
Merwe, M.J.van der 1061 (89), 1156  
Mes, G.F. 696 (78), 741  
Messina, A. 1091 (298, 299), 1093 (314), 1161  
Messinger, J. 139 (113), 156  
Mestdagh, H. 240 (188), 248  
Metcalf, T. 1080 (220), 1096 (328), 1159, 1161  
Metzler, M. 1000, 1003, 1009 (11), 1035  
Metzner, P. 591 (325), 623  
Meunier-Prest, R. 843 (17), 845 (33), 846 (34), 854 (69), 855, 856, 1129 (467–471), 1144 (471), 1164  
Meurs, F.van 100 (89), 103  
Meyer, D.J. 672 (36), 674 (50), 680, 681  
Meyer, G.-J. 649 (122), 661  
Meyer, M. 407 (162), 421  
Meyer, R. 35 (51), 82  
Meyer, T.A. 448 (190), 474, 629 (12), 659, 676 (66, 70), 677 (66), 681, 888 (105), 891

- Meyer, T.J. 739 (207), 745  
 Meyer, V. 482 (18, 19), 525  
 Meyer, V.R. 1093 (313), 1161  
 Meyers, A.I. 575 (210), 621  
 Meyers, C.B. 975 (22), 994  
 Meyers, E.F. 710 (119), 742  
 Meyerson, S. 265 (68), 293  
 Meyerstein, D. 829 (48), 836  
 Mezzina, E. 464 (262), 476  
 Mhala, M. 1220 (32a), 1296  
 Mialocq, J.C. 697 (88), 741  
 Micetich, R.G. 537 (26), 617  
 Michael, J.P. 453 (207, 208), 475  
 Michaelsen, S. 1096 (329), 1161  
 Michalak, J. 833, 834 (66), 836  
 Michalik, M. 130 (90), 155, 1112 (399), 1163  
 Michalowicz, W. 639 (61), 660  
 Michalska, D.F. 148 (142), 156  
 Michaud, D.P. 1084 (254), 1160  
 Micejda, C.J. 107 (24), 154, 1143 (566), 1166  
 Micejda, J.A. 173 (77), 203  
 Michel, A. 100 (90), 103  
 Michel, T. 977 (52, 56), 979 (72, 74), 992 (127, 133), 995, 997  
 Micheloni, M. 389 (60), 391 (63–66), 396 (101), 418–420  
 Michels, J.J. 568 (187), 620  
 Michurin, A.A. 592 (339), 623  
 Mićović, I.V. 563 (160), 620  
 Middelburg, J.J. 1045 (7), 1155  
 Middleton, E.J. 1189 (93), 1214  
 Midgley, J.M. 1063 (95, 96), 1157  
 Midland, M.M. 565 (176), 620  
 Middleton, S. 268 (78), 293  
 Miginiac, L. 576 (214, 217), 621  
 Migita, M. 695 (69), 741  
 Migita, Y. 730 (178), 744  
 Migliorese, K.G. 1144 (568), 1166  
 Migron, Y. 1220 (45a, 45b), 1225 (64), 1296, 1297  
 Mikulcik, P. 393, 394 (78), 419  
 Milakofsky, L. 945 (70), 948  
 Milewska, M.J. 4, 13 (17), 69 (17, 116), 81, 84, 145 (135), 156  
 Millar, K.G. 1222, 1226 (53), 1296  
 Millefiori, A. 199 (146), 204  
 Millefiori, S. 199 (146), 204  
 Millen, D.J. 428 (38), 471  
 Miller, A. 75 (126), 84  
 Miller, A.M. 1024 (129), 1037  
 Miller, A.R. 938 (56), 948  
 Miller, B. 865 (26), 889, 930 (43), 947  
 Miller, B.J. 110 (35), 154  
 Miller, D.L. 222, 223 (112), 246  
 Miller, E.C. 871 (52), 890, 1000, 1009 (9), 1031 (9, 179), 1035, 1039  
 Miller, E.J. 1082 (240), 1160  
 Miller, J. 510 (197), 511 (209, 213, 214), 515 (213), 516 (197, 213, 232), 530  
 Miller, J.A. 1000, 1009 (9), 1020 (99), 1031 (9, 179), 1035, 1037, 1039, 1174 (4, 5), 1212  
 Miller, J.L. 590 (322), 623  
 Miller, J.S. 90, 93 (13), 102  
 Miller, M. 1001, 1007, 1009, 1011, 1027 (28), 1035  
 Miller, M.J. 552 (99), 618  
 Miller, R.B. 1116 (410–412), 1163  
 Millerstein, C. 1079 (210), 1159  
 Milliet, A. 212 (46–50), 216 (48–50, 61), 222 (46–50), 233 (145), 244, 245, 247  
 Mills, H.A. 1046 (10), 1155  
 Mills, J.E. 590 (323), 623  
 Milne, G.A. 317 (67), 333  
 Milner, D.J. 651 (131), 661  
 Milstein, D. 587 (301), 623  
 Min, W. 979 (73), 995  
 Minamikawa, J. 552 (98, 101), 618  
 Minamikawa, S. 733 (183e), 744  
 Minatogawa, H. 1256 (139), 1299  
 Minchin, R.F. 1033 (202), 1039  
 Ming Miao, F. 96 (54), 103  
 Ming Miao, F. 96 (46, 50), 102, 103  
 Minkwitz, J. 164, 166, 168 (32), 202  
 Minoli, G. 708 (110), 742, 758 (29), 818  
 Minor, R.L. 673 (46), 681  
 Minsek, D.W. 445 (168), 474, 698 (98), 742  
 Mintrop, L. 1079 (209), 1159  
 Miralles-Roch, F. 849 (48), 856  
 Miroshnichenko, E.A. 352 (43), 374  
 Miser, J.R. 656 (164), 662  
 Mishani, E. 607 (417), 625  
 Mishima, M. 308 (39, 41), 309 (39), 333, 387 (52b), 418, 524 (254), 531  
 Mishra, A.K. 873 (60), 890  
 Mishra, A.S. 873 (60), 890  
 Mishra, P. 594 (350), 624  
 Miskowski, V.M. 444 (162), 474  
 Mison, P. 567 (183), 620  
 Missavage, R.J. 347 (27), 373  
 Misumi, S. 695 (69), 741, 1114 (405), 1163  
 Mitani, K. 193, 197 (142), 204  
 Mitani, T. 437 (122, 123), 473  
 Mitchell, D. 284, 285 (101), 293  
 Mitchell, D.J. 15, 17 (24b), 81  
 Mitchell, H. 550 (86b), 618  
 Mitchell, J.A. 977, 978 (49), 995  
 Mitchell, R. 1096 (328), 1161  
 Mitchell, R.C. 1222 (56, 59), 1226 (71), 1228 (73), 1296, 1297  
 Mitchell, S.C. 1064 (103), 1157  
 Mito, T. 1119 (433), 1164  
 Mitri, M. 1046 (18), 1155  
 Mitrovic, M. 1127, 1143 (457), 1164

- Mitscherlich, E. 481 (7), 525  
 Mitsui, H. 579 (232), 621  
 Mitsui, K. 592 (331, 332), 623, 871 (53), 890  
 Mitsunobu, O. 543 (56, 57), 602 (388), 617, 624  
 Mittal, C. 975 (6, 17, 18), 994  
 Mittal, J.P. 441 (144), 473, 825 (17), 827 (27), 835  
 Mittelbach, M. 588 (307), 623  
 Mittelman, A. 1187 (79), 1213  
 Mitza, N.A. 688 (32), 740  
 Miura, K. 870 (50), 890  
 Miura, M. 582 (268), 622, 692 (49), 741  
 Miura, Y. 735 (190b), 745  
 Miwa, G.T. 1031 (183), 1039  
 Miyaguchi, N. 582 (267), 622  
 Miyaki, K. 685 (12), 740  
 Miyamoto, H. 722 (159d), 743  
 Miyamoto, Y. 1065 (110–112), 1157  
 Miyashi, T. 452 (196), 475  
 Miyashita, M. 593 (340), 611 (441), 623, 625  
 Miyata, N. 96 (47), 102, 1131 (487), 1165  
 Miyata, O. 724 (163, 165, 166c), 743, 744  
 Miyazaki, H. 654 (151), 662  
 Miyazaki, K. 111 (36), 154  
 Miyazaki, M. 1069 (147), 1079, 1083 (217), 1129 (476), 1130 (147, 476, 479, 481), 1131 (476), 1158, 1159, 1164, 1165  
 Miyazawa, T. 1090 (297), 1092 (307), 1161  
 Miyoshi, N. 563 (159), 620  
 Miyoshi, Y. 1079, 1083 (217), 1159  
 Mizoguchi, T. 730 (178, 181b, 181c), 744  
 Mizokami, T. 656 (166), 662  
 Mizukami, H. 593 (342), 623  
 Mizuno, M. 721 (151), 743  
 Mizuno, T. 596 (365), 624  
 Mizutani, M. 704 (105), 742  
 Mlekuz, M. 595 (357), 624  
 Mlynarik, V. (87), 334  
 Mochizuki, A. 590 (320), 623  
 Modelli, A. 173 (78), 203  
 Modena, G. 405 (150b), 421, 1012, 1015 (73), 1036  
 Moens, L. 586 (296), 622  
 Moffatt, J.R. 1220 (30a, 32a), 1296  
 Mogami, T. 596 (368), 624  
 Moghe, P.P. 578 (225), 621  
 Mohamadi, F. 41 (63), 82  
 Mohammad, A. 461 (250), 476  
 Mohan, H. 825 (17), 835  
 Mohan, L. 579 (228a, 228b), 621  
 Mohnke, M. 1063 (101), 1157  
 Moinet, C. 447 (182, 184), 474, 838 (7a), 843 (18, 19), 848 (7a), 855, 1011, 1019 (71), 1036, 1107 (380, 382), 1162, 1163  
 Moiseev, G.E. 1184 (66), 1213  
 Moiseeva, A.A. 444 (161), 474  
 Mok, C.Y. 193, 194 (143, 144), 195, 196 (143), 197 (143, 144), 198, 199 (144), 200 (150, 151), 204  
 Mokhov, A.A. 1137 (525), 1165  
 Molder, U.H. 1238 (89), 1297  
 Moldéus, P. 1029 (158), 1038  
 Molenaar-Langeveld, T.A. 231 (135), 247  
 Moleva, V.I. 1119 (432), 1164  
 Molher, L.K. 405 (151a), 421  
 Molina, G.A. 650 (127), 661  
 Mollah, Y. 1067 (129), 1157  
 Mollendal, H. 56 (83), 83  
 Moller, M. 1177 (29), 1212  
 Moller, P. 1096 (329), 1161  
 Moltzen, E.K. 591 (324), 623  
 Momchilova, T.G. 57 (91), 83  
 Mommers, A.A. 233 (148, 149), 234 (148), 247  
 Moncada, S. 669 (19), 673 (39–41), 680, 681, 975 (4, 8–12), 976 (11, 39, 41), 977 (47), 978 (39, 47, 62), 979 (77), 980 (39, 79), 992 (134, 135), 994, 995, 997  
 Mondelli, R. 321 (93), 334  
 Mongkolaussvaratana, T. 1100 (349), 1162  
 Mönig, J. 828 (44), 830 (52), 835, 836  
 Monsanto, G. 1184 (69), 1213  
 Monshouwer, J.C. 494, 495, 519 (124), 528  
 Monte, M.J.S. 357 (67), 376  
 Monteiro, L.S. 854 (63), 856  
 Montenegro, M.I. 854 (63), 856  
 Montevecchi, P.C. 1012, 1013 (79), 1036  
 Montgomery, R.L. 342 (13), 372  
 Monti, N. 1068 (136), 1157  
 Montserrat, J. 1271, 1282–1284 (190), 1300  
 Montserrat, J.M. 469 (279), 477  
 Montzka, T.A. 582 (262), 622  
 Monzyk, B. 407 (158a), 421  
 Mooberry, E.A. 770 (117b), 84  
 Moodie, R.B. 880 (84), 890, 958 (47–49), 968 (62), 971  
 Moor, H. 666 (5), 680  
 Moore, C. 1068 (140), 1158  
 Moore, C.M. 1030 (171), 1038  
 Moore, D.W. 96 (53), 103  
 Moore, L.L. 544 (66), 617  
 Moormann, A.E. 563 (158), 579 (229), 620, 621  
 Mootz, D. 86, 88 (4), 102  
 Mora, M.A. 1266 (165), 1299  
 Morales, E.Q. 143 (128), 156  
 Moraru, M. 846 (38), 856  
 Morath, R.J. 1216, 1217, 1242, 1278 (2c), 1295  
 Moreau, J.J.E. 573 (204), 620  
 Moreland, W.T. 491 (102), 527  
 Moreno-Manas, M. 754 (14, 15, 17a, 17b), 756 (23), 758 (30, 31), 817, 818

- More O'Ferrall, R.A. 381 (5b), 416, 895 (13), 943 (66), 947, 948
- Moreton, A.D. 390 (61), 418
- Morgan, K.M. 355 (56), 375
- Morgan, T.G. 266 (73), 293
- Mori, A. 649 (120), 661
- Mori, H. 1106 (378), 1162
- Mori, M. 578 (223), 621
- Mori, S. 538 (34), 596 (362), 617, 624
- Moriarty, R.M. 583 (273), 622, 1009 (64), 1036
- Moriarty, T.C. 400 (125), 420
- Morimoto, T. 553 (109), 618
- Morin, N. 240 (188), 248
- Morishima, I. 165, 166 (23), 202
- Morita, M. 1103 (360, 361), 1162
- Morita, O. 1030 (176), 1039
- Morita, T. 704 (102), 742
- Moriya, F. 739 (204), 745
- Moriyama, M. 438 (126), 473
- Mornet, F. 1046 (17), 1155
- Morosin, B. 636 (38), 659
- Morozumi, T. 1119 (430), 1163
- Morris, D.G. 395 (84), 419, 451 (195), 474, 505 (158), 529
- Morris, G.E. 595 (357), 624
- Morris, J.J. 381 (17a–e, 19, 20b, 20c), 395 (81), 417, 419, 428 (41, 42), 471, 1222 (50, 51, 57, 58, 60), 1238 (51), 1296, 1297
- Morris, M.E. 1133 (495), 1165
- Morris, M.L. 588 (305), 623
- Morris, P.A. 666 (2), 680
- Morris, P.G. 330 (120), 335
- Morrison, J.D. 121 (63, 64), 154, 155
- Morse, M.D. 90 (10), 102
- Morton, A.G. 216 (63a), 245
- Morton, T.H. 228, 238 (130), 246
- Morton, T.ZH. 216 (63h), 245
- Moschwitzer, U. 1082 (239), 1160
- Moscowitz, A. 147 (139), 156
- Mosher, H.S. 114 (45), 121 (63), 124 (76), 125 (76, 78), 147 (139), 154–156, 1089 (285, 286), 1160, 1161
- Moskovits, M. 151 (159), 157
- Moskowitz, D. 509 (189), 530
- Mosquera, M. 886 (102), 891
- Mosquera, R.A. 55–57 (82), 83
- Moss, D.W. 992 (135), 997
- Moss, J. 992 (130), 997
- Moss, R.E. 56 (80e), 83, 184 (105), 203
- Mosseri, S. 826 (26), 827 (27), 835
- Mostad, A. 636 (41), 659
- Motevalli, M. 456 (222), 475
- Motherwell, W.D.S. 37 (56), 82
- Motoc, I. 29 (42), 82
- Motokawa, H. 597 (370), 624
- Mott, F. 669 (24), 672 (33), 680
- Moulin, C. 1112 (401), 1163
- Moussounga, J. 590 (315), 623
- Mouviar, G. 1175 (19), 1212
- Mower, H.F. 96 (45), 102
- Moyano, A. 545 (70), 618
- Moyano, E. 1129 (474), 1130 (483), 1164, 1165
- Moyes, W. 171, 172, 174, 175 (75), 193, 197–199 (141), 203, 204
- Moynihan, H.A. 669, 673 (17), 680
- Muanda, M.wa 468 (275), 476
- Muck, S. 1068 (136), 1157
- Mudgett, J.S. 979 (78), 993 (147), 995, 997
- Mueller, R. 297 (5), 332
- Mugnier, Y. 450 (193), 474
- Mugnoli, A. 100 (92, 93), 103
- Muhl, H. 992 (128), 997
- Mukai, T. 757 (28), 818
- Mukaiyama, T. 593 (340), 602 (387), 623, 624
- Mukherjee, T. 441 (144), 473
- Mulcahy, R.T. 1032 (192, 193), 1039
- Mulder, G.J. 1003, 1004, 1009 (35), 1011 (35, 72), 1012 (35, 72, 85), 1029 (72), 1031 (35), 1033 (85, 202, 203), 1035, 1036, 1039
- Muller, D. 324 (107), 325 (106), 334
- Müller, G. 393, 394 (78), 419
- Müller, M. 165, 166, 182 (47), 202
- Müller, P. 580 (245), 621
- Muller, R.P. 810 (157, 161, 162), 816 (162), 821
- Mullin, A.S. 416 (211), 422
- Mullins, M.E. 673 (44), 681
- Mullins, M.W. 830 (51), 836
- Mülsch, A. 992 (140), 997
- Mulvaney, R.L. 1045 (4), 1048 (61, 62), 1154, 1156
- Mulvey, R.E. 396 (90), 419
- Mumford, J.L. 1177 (34), 1212
- Mumford, R. 992 (131), 997
- Mumford, R.A. 978 (63, 65), 995
- Munakata, M. 1256 (138, 139), 1298, 1299
- Munasinghe, V.R.N. 771 (59), 772 (60), 819
- Munchausen, L.L. 163, 164, 166, 179, 180 (28), 202
- Mungwari, F.P. 1048 (61), 1156
- Munns, R.K. 1139 (539, 541), 1166
- Munowitz, M. 322 (103), 334
- Munowitz, M.G. 325, 326 (108), 334
- Munoz, M.A. 409 (169a, 169b), 421
- Munson, M.S.B. 234 (154), 247
- Murad, F. 975 (6, 17, 18), 977 (46, 49), 978 (49), 991 (123), 994–996
- Muradov, N.Z. 1142 (559), 1166
- Murahashi, S. 579 (232, 236), 582 (265, 267), 593 (341), 621–623
- Murahashi, S.-I. 535 (8), 576 (212), 580 (246), 616, 621

- Murahashi, T. 1130 (481), *1165*  
 Murai, S. 1078 (206), *1159*  
 Murai, T. 574 (205), *620*  
 Murai, Y. 587 (297), *622*  
 Murakami, M. 602 (390), *624*  
 Murakami, T. 1064 (102), *1157*  
 Muralidharan, S. 782 (86–89), 783 (88, 89),  
 784 (94), 785 (95), *819, 820*  
 Murata, S. 358 (73), 376, 582 (268), 622, 692  
 (49), *741, 810 (161), 821*  
 Murata, Y. 506 (173), *529*  
 Murer, P. 583 (275), *622*  
 Murphy, D.M. 653 (143), *662*  
 Murphy, S.E. 1150 (612), *1167*  
 Murphy, T. 879 (77), *890*  
 Murphy, T.J. 977 (53), *995*  
 Murphy, W.J. 991 (125), *997*  
 Murphy, W.S. 552 (100a), 565 (172), *618, 620*  
 Murray, A.W. 858 (1), *888*  
 Murray, B.A. 412, 413 (196), *422*  
 Murray, J.S. 408, 409 (170), *421*  
 Murray, R.W. 579 (228a, 228b, 233a, 233b),  
*621*  
 Mursyidi, A. 729 (173), *744*  
 Murthy, C.P. 827 (39, 40), *835*  
 Murthy, J.T. 879 (81), *890*  
 Muschik, G.M. 1094 (322), 1096 (327), 1149  
 (605), *1161, 1167*  
 Musiani, M. 563 (162), *620*  
 Mussche, P. 1063 (101), *1157*  
 Musso, H. 3–5, 29 (1g), *81*  
 Musumarra, G. 434 (88), *472*  
 Muszkat, K.A. 184 (103), *203*  
 Mutai, K. 169 (64), 203, 751 (8, 9), 758 (33a,  
 33b, 34a–e), 759 (36a–c), *817, 818*  
 Mutti, S. 126, 127 (80), *155, 1111 (397), 1163*  
 Myers, P.R. 673 (46), *681*  
 Myhre, P.C. 950 (13), 951 (15), 957 (45), 965  
 (52), 966 (54), *970, 971*
- Naal, R.M.Z.G. 757 (27), *818*  
 Nabeshima, T. 605 (406), *625*  
 Nabi, S.A. 461 (250), *476*  
 Nadjo, L. 692 (51), *741*  
 Nafie, L.A. 147 (140), 148 (140, 146), 150  
 (152, 154–156), 153 (167), *156, 157*  
 Nafti, A. 567 (183), *620*  
 Nag, A. 694 (66), *741*  
 Naga, S. 1085 (260), *1160*  
 Nagai, U. 142 (123), *156*  
 Nagakura, S. 171 (73), 193, 197 (140), 203,  
 204, 751 (8), 758 (34a, 34c), 759 (36a,  
 36b), *817, 818*  
 Nagao, M. 1029 (166), *1038*  
 Nagase, S. 409 (174), *421*  
 Nagashima, U. 437 (122), *473*  
 Nagata, Y. 1089 (289, 290), *1161*  
 Nagayoshi, A. 950 (14), *970*  
 Nagira, K. 654 (152), 657 (170), *662*  
 Nago, M. 677 (71), *681*  
 Nagren, K. 932 (45), *947*  
 Nagy, A. 164, 165, 175 (31), *202*  
 Nagy, J.B. 468 (275), *476, 1245, 1266 (114b),*  
*1298*  
 Nagy, O.B. 468 (275), *476, 1245, 1266 (114a,*  
*114b), 1298*  
 Nagy-Felsobuki, E. 166 (55, 57–59), 202, 510  
 199, *530*  
 Nagy-Turák, A. 1086 (275), *1160*  
 Naidu, B.N. 578 (222), *621*  
 Naidu, S.R. 1141 (555), *1166*  
 Naik, S.N. 96 (56), *103*  
 Naito, A. 685 (14), *740*  
 Naito, T. 724 (162b, 162d, 162e, 163, 165,  
 166a–d), *743, 744*  
 Nakagaki, R. 432, 443 (72), *472, 751 (8, 9),*  
*759 (36a–c), 817, 818, 1220 (44), 1296*  
 Nakagawa, M. 565 (174), *620*  
 Nakagawa, R. 1177 (33), *1212*  
 Nakagome, S. 1067 (124), *1157*  
 Nakahama, S. 111 (36), *154*  
 Nakai, H. 324 (105), 334, 730 (178, 181b,  
 181c, 182b), *744*  
 Nakaitani, D. 522 (245), *531*  
 Nakaji, D.Y. 355 (56), *375*  
 Nakajima, D. 1130 (478), *1164*  
 Nakamoto, A. 1096 (328), *1161*  
 Nakamura, E. 1047 (22), *1155*  
 Nakamura, I. 576 (212), *621*  
 Nakamura, J. 758 (34a, 34c), *818*  
 Nakamura, M. 704 (102), *742*  
 Nakamura, N. 123 (71), *155*  
 Nakamura, T. 614 (455), *626*  
 Nakane, M. 977 (46, 49), 978 (49), *995*  
 Nakanishi, K. 139 (116, 117), 140 (118), 141  
 (116–119), 142 (121, 122), 143 (126), *156*  
 Nakano, M. 111 (36), *154*  
 Nakano, S. 561 (147), *619*  
 Nakano, T. 590 (319), 623, 735 (191), *745*  
 Nakashima, K. 1091 (304), *1161*  
 Nakashima, N. 824 (12), *835*  
 Nakato, T. 582 (267), *622*  
 Nakausa, R. 649 (120), *661*  
 Nakayama, D.K. 979 (76), *995*  
 Nakayama, H. 595 (358), *624, 1122 (438),*  
*1164*  
 Nakayama, T. 776 (66), *819*  
 Nakazato, M. 1083 (245), *1160*  
 Nakazawa, H. 1134 (504), *1165*  
 Nakazono, Y. 1106 (372), *1162*  
 Nalamasu, O. 767 (51), *819*  
 Nallaiah, C. 578 (227a, 227b), *621*  
 Namiki, H. 1047 (22), *1155*

- Nanni, D. 655 (158), 662  
 Naota, T. 580 (246), 582 (265, 267), 621, 622  
 Narang, R.S. 94 (30), 102  
 Narang, S.C. 510 (204), 530  
 Narayanan, K. 991 (118), 996  
 Narayanan, V.A. 1101 (354, 355), 1162  
 Nardi, L.O. 984 (88), 996  
 Narkates, A.J. 1082 (240), 1160  
 Narsimha, R. 1137 (524), 1165  
 Naruchi, K. 795 (128, 129), 820  
 Naruto, S. 722 (157b), 743  
 Nasr, M.M. 933 (48, 49), 934 (49), 935, 938 (48, 49), 947  
 Nass, R. 164, 166, 168 (32), 202  
 Nassereddine-Sebaei, M. 1133 (497), 1165  
 Nathan, C. 978 (63, 65), 992 (129, 131), 993 (147, 150), 995, 997  
 Nathan, C.F. 976 (35, 37, 38), 978 (37, 38, 58, 61, 64), 980, 983 (37), 985 (91), 994–996  
 Nau, H. 977 (48), 995  
 Naughton, A.B.J. 1126 (448), 1164  
 Nauman, R.V. 192 (133), 204  
 Naumann, W. 649 (119), 661  
 Naumova, I.I. 884 (95), 891  
 Navas, J.P. 977 (53), 995  
 Naylor, R.D. 218 (83), 245, 338, 361 (2), 371, 410 (188), 422  
 Neamati-Mazraey, N. 1273, 1275, 1283 (178), 1299  
 Nebenzhal, L.L. 398 (113c), 420  
 Neca, J. 1133 (500), 1165  
 Needleman, P. 975 (24), 994  
 Neenan, T.X. 767 (50b, 51), 819  
 Neergaard, J.R. 137, 138 (109), 148 (142), 156  
 Neeter, R. 220 (102), 246  
 Nefedov, V.I. 160 (10), 201  
 Negoita, N. 968 (61), 971  
 Negrebetsky, V. 437 (124), 473  
 Negrusz, A. 1068 (140), 1158  
 Neibecker, D. 587 (299), 588 (302a, 302b), 622, 623  
 Neiland, O.Y. 636 (43), 659  
 Neild, G.H. 674 (50), 681  
 Nelsen, S.F. 56 (80a–d), 83, 164 (41), 166 (53), 169 (41), 184 (104), 187 (104, 112), 202–204, 684 (1), 740  
 Nelson, G.L. 302 (19), 332  
 Nelson, J. 59 (100), 83  
 Nemeryuk, M.P. 633 (26), 659  
 Nemethy, S. 1093 (309), 1161  
 Nerem, R.M. 977 (53), 995  
 Neset, S.M. 579 (234), 621  
 Nesi, R. 780 (82), 819  
 Nesmeyanov, A.N. 657 (173), 663  
 Nesterova, Y.M. 636 (40), 659  
 Neta, P. 824 (4, 9), 826 (4, 26), 827 (4, 27–33), 828 (4, 42), 832 (63, 64), 833 (65), 835, 836, 839 (8a, 8b), 850 (8b), 851 (8a, 8b), 855  
 Netherton, L.T. 895, 896, 936 (11), 947  
 Neuenschwander, K. 143 (130), 156  
 Neugebauer, F.A. 95 (43), 102, 436 (113), 473  
 Neumann, H.-G. 1000 (11), 1003 (11, 33), 1007, 1008 (33), 1009 (11, 33), 1011, 1012 33, 1021 (102–105), 1022 (110, 111), 1026 (147), 1030 (103), 1035, 1037, 1038  
 Neumann, W.L. 570 (196), 620  
 Neumark, D.M. 795 (125), 820  
 Neveux, M. 591 (327), 623  
 Newcomb, M. 599 (380, 381), 600 (382, 383), 624  
 Newman, L. 641 (70), 660  
 Newman, P. 106 (13), 153  
 Nguyen, A. 346 (20), 350 (35), 373, 374  
 Nguyen, D.T. 3 (2b), 81  
 Nguyen, K.C. 580 (252b), 621  
 Nguyen, M.T. 642 (78), 660  
 Nguyen, N.V. 97, 101 (61), 103, 606 (414), 625  
 Nguyen, T. 640 (67), 660  
 Nguyen Quy Dao 456 (226), 457 (227), 475  
 Ni, J.X. 416 (211), 422  
 Nibbering, N.M.M. 211 (40), 216 (59), 218 (86), 220 (94, 95, 102), 222 (59), 231 (135), 244–247, 260 (51), 262 (58, 59), 263 (51, 59), 292, 354 (54), 375  
 Nicholas, K.M. 567 (184), 571 (199), 620, 1152 (624), 1168  
 Nichols, M.A. 396 (91c), 397 (102), 419, 420  
 Nick, K. 1134 (508), 1165  
 Niclas, H.J. 592 (329), 623  
 Nicol, G. 385 (34d), 417  
 Nicolaidis, D.N. 721 (150), 743  
 Nicolet, P. 381 (20b), 417, 428 (42), 471  
 Nicoletti, I. 1093 (314), 1161  
 Nicoletti, R. 560 (135), 619  
 Niedercorn, F. 587 (299), 622  
 Niedzielska, J. 1139 (533), 1166  
 Nielsen, A.T. 604 (400), 625  
 Nieman, T.A. 1083 (249), 1160  
 Niemann, M.A. 1082 (240), 1160  
 Niemczyk, M.P. 445 (168), 474  
 Niessner, R. 1128 (462, 463), 1164  
 Nieuwenhuize, J. 1045 (7), 1155  
 Nigenda, E.S. 883 (88), 890  
 Niketic, S.R. 3–5, 29 (1f), 81  
 Nikiforov, G.A. 637, 639 (44), 660  
 Nikitenkova, L.P. 884 (95), 891  
 Nikolaou, K. 1175 (19), 1212  
 Nilsson, J.L.G. 62 (107), 84  
 Nims, R.W. 669 (25), 680  
 Ning, H.S. 1132 (490), 1165  
 Ninomiya, I. 724 (162b, 162d, 162e, 163, 165, 166a–d), 743, 744



- Niroomand, F. 977 (48), 995  
 Nishida, A. 736 (194a, 194b), 745  
 Nishida, K. 977 (53), 995  
 Nishiguchi, H. 551 (89a, 89b), 618  
 Nishiguchi, I. 596 (365), 624  
 Nishiguchi, Y. 724 (166a), 744  
 Nishihara, C. 854 (64), 856  
 Nishijima, Y. 695 (68), 741  
 Nishikata, Y. 734 (188a), 744  
 Nishikawa, T. 1090 (292), 1161  
 Nishikawa, Y. 467, 468 (274), 476, 1217 (7),  
 1295  
 Nishima, T. 1083 (245), 1160  
 Nishimoto, K. 215 (53, 54), 245  
 Nishimoto, S. 833 (69), 836  
 Nishimoto, Y. 1108 (389), 1163  
 Nishimura, K. 593 (341), 623  
 Nishimura, T. 259, 262 (43), 292  
 Nishimura, Y. 650 (126), 661  
 Nishioka, M. 1181 (53), 1213  
 Nishioka, M.G. 1177 (38), 1213  
 Nishioka, T. 306 (34), 333  
 Nishizawa, K. 392 (73), 419  
 Nishizawa, M. 113 (44), 154  
 Nisikawa, M. 1119 (428), 1163  
 Nitta, M. 598 (375), 624, 715 (131), 742  
 Niu, J.E. 848 (43), 856  
 Niwa, O. 1103 (360–362), 1162  
 Niwa, Y. 259 (41), 292  
 Niyazymbetov, M.E. 851 (56–58), 852 (59,  
 60), 856  
 Nobes, R.H. 208 (12, 13), 211 (13), 214 (12,  
 52), 215 (55), 244, 245  
 Noble, G. 557 (126), 619  
 Noda, J. 1079 (212), 1159  
 Noda, K. 969 (65), 971  
 Noel, M. 845 (32a), 855  
 Noelting, E. 484 (36), 526  
 Nogami, T. 647 (104), 661  
 Noggle, F.T. 1063 (99), 1071 (152), 1157,  
 1158  
 Nogueira, L.C. 753 (13), 817  
 Nohl, H. 1022 (115), 1037  
 Nohmi, T. 1131 (486, 488), 1165  
 Nojima, K. 1180 (57), 1213  
 Nojima, M. 735 (190c), 745  
 Nokagaki, R. 758 (34a), 818  
 Nomura, M. 582 (268), 622, 692 (49), 741  
 Nomura, R. 590 (319), 596 (361a, 361b), 623,  
 624  
 Nonomura, S. 1090 (297), 1161  
 Noord, T.van 1085 (260), 1160  
 Noordhoek, J. 1129 (475), 1164  
 Nordenson, S. 95, 96 (44), 102  
 Nordgren, J. 171 (76), 203  
 Nordholm, L. 1137 (528), 1166  
 Nordling, C. 171 (76), 203  
 Norfolk, E. 1069 (141), 1158  
 Norishima, I. 164, 170 (30), 202  
 Norman, J. 1174 (7), 1212  
 Norman, R.O.C. 670 (29), 680  
 Normant, J. 546 (73), 618  
 Noronha-Dutra, A. 674 (50), 681  
 Norrby, P.-O. 41, 42 (60), 82  
 Norris, A.R. 457 (235), 476  
 Norris, R.K. 833 (65), 836  
 Norskov-Lauritsen, L. 15, 16 (26a), 81  
 Northrup, D.B. 894 (4), 946  
 Northup, R.R. 1046 (15), 1155  
 Nose, A. 608 (428, 429), 625  
 Noss, M.B. 1032 (190), 1039  
 Noszal, B. 407 (164), 421  
 Notario, R. 1238 (93), 1285 (196), 1297, 1300  
 Noto, R. 100 (92), 103  
 Notto, R. 1241, 1262, 1264 (103a), 1298  
 Nouchi, G. 1136 (522), 1165  
 Novak, M. 405 (151a), 421  
 Novi, M. 100 (93), 103  
 Novotny, M. 1093 (320, 321), 1161  
 Nowak, K. 561 (144), 619  
 Nowek, A. 440 (136), 473  
 Nowick, J.S. 427 (19), 470  
 Nowicka-Scheibe, J. 435 (112), 473  
 Noyce, D.S. 1032 (188), 1039  
 Noyori, R. 106 (18), 113 (44), 120 (18), 153,  
 154  
 Nozaki, K. 685 (14), 740  
 Nozière, B. 360 (80), 377  
 Nozoe, T. 863 (25), 889  
 Nsunda, K.M. 218 (81), 245  
 Nudelman, N.E.S. 396 (99), 420  
 Nudelman, N.S. 396 (98), 419, 434 (87), 469  
 (276–279), 472, 477, 1216 (1b, 4a, 4b),  
 1217 (4a, 4b, 10, 12), 1219, 1220 (1b),  
 1221 (48a–c), 1222 (48b), 1232 (81), 1235  
 (1b, 4a, 4b, 81, 82), 1236 (107), 1237 (82,  
 83a, 83b), 1241 (102, 104a, 104b, 105a,  
 105b), 1242 (1b, 105a, 105b, 107), 1243  
 (82, 83a, 107), 1244 (1b), 1245 (10), 1247  
 (48c), 1250 (1b), 1251 (104a, 104b), 1261  
 (143a, 143b), 1262 (144), 1263 (12, 82,  
 144, 172, 174, 175, 180), 1266 (10, 143a,  
 143b, 144), 1267 (144), 1268 (143a, 143b,  
 144), 1269 (10, 172), 1271 (190), 1272  
 (174, 175), 1273 (10, 104a, 104b, 175, 177,  
 180), 1274 (1b, 177), 1275 (177), 1276  
 180, 1282 (143a, 143b, 144, 190), 1283,  
 1284 (190), 1286 (143a, 143b, 144), 1287  
 (144), 1288 (10), 1290 (1b, 102), 1293 (82),  
 1295–1300  
 Nugao, M. 888 (106), 891  
 Nugent, W.A. 543 (63), 617  
 Nussbaum, P. 582 (269), 622  
 Nussler, A.K. 979 (76, 78), 995

- Nyburg, S.C. 1241, 1242 (105a), 1298  
 Nyireddy, S. 1086 (274), 1160
- Oae, S. 535 (11), 616, 654 (148), 662, 666 (6), 667, 670 (6, 11), 672 (6, 34), 677 (76), 678 (11, 78), 680–682, 865 (31), 866 (33), 868 (42), 889
- Oancea, D. 411 (185), 422
- Oates, M.D. 1079, 1080 (218, 219), 1159
- Obara, H. 776 (65), 819
- Oberhammer, H. 25 (38–40), 38 (38), 82, 164, 167 (35), 202
- O'Brien, P.J. 1030 (172, 173), 1038
- Occupati, G. 57 (90c), 83
- Ochiai, M. 1130 (478), 1164
- Ochterski, J. 848 (45), 856
- O'Connell, A.M. 95 (42), 102
- Oda, D. 605 (408), 614 (455), 615 (459), 616 (465), 625, 626
- Oda, K. 728 (172), 730 (180a), 733 (183c), 734 (186, 187, 188a, 188b), 736 (194c), 744, 745
- Oda, Y. 1131 (488), 1165
- Odaira, Y. 722 (155), 743
- Odaka, H. 571 (197), 620
- Odingo, J. 139, 141 (116, 117), 143 (126), 156
- Odintsov, V.V. 362, 363 (90), 377
- Odiot, S. 303 (28), 332
- Oehlke, J. 1080 (225), 1159
- Oesch, F. 1185 (72), 1213
- Oevering, H. 445 (169), 474
- Ogana, T. 733 (183b), 744
- Ogata, K. 585 (292), 622
- Ogata, S. 590 (320), 623
- Ogata, Y. 721 (151), 743
- Ogawa, A. 563 (159), 596 (368), 620, 624
- Oguchi, S. 774 (63), 819, 992 (126), 997
- Ogura, F. 583 (276), 622
- Oh, C.H. 1066 (120), 1157
- Oh, S.M.N.Y.F. 667 (10), 680
- Ohanessian, G. 443 (159), 474
- Ohannesian, L. 448 (189), 474
- O'Hara, D.S. 992 (133), 997
- Ohashi, M. 240 (186), 248, 587 (297), 622, 647 (104), 661, 685 (12), 740, 1147 (587), 1167
- Ohashi, Y. 722 (159c), 743
- Ohba, S. 93 (17), 94 (31), 99 (83), 102, 103
- Ohba, T. 843 (21), 855
- Ohfuno, Y. 595 (352), 624
- Ohga, K. 712 (123), 714 (127), 742
- Ohgi, H. 1119 (433), 1164
- Ohkawa, S. 978 (66), 995
- Ohkubo, K. 843 (21), 855
- Ohlstein, E.H. 975 (21, 22, 27), 994
- Ohmori, H. 676 (68), 681
- Ohnishi, K. 978 (66), 995
- Ohnishi, Y. 1129 (473), 1164, 1177 (37), 1180 (51), 1212, 1213
- Ohno, A. 650 (126), 661, 1267 (169), 1299
- Ohno, K. 730 (181f), 744
- Ohnsorge, U.F.W. 131, 132 (93), 155
- Ohnuma, T. 736 (194c), 745
- Ohruai, S. 1065 (110–112), 1157
- Ohsawa, T. 580 (251), 621
- Ohta, H. 591 (326), 623
- Ohta, T. 1029 (166), 1038
- Oitkelinx, A. 697 (86), 741
- Oka, T. 1090 (292), 1161
- Okada, T. 694 (58), 698 (94), 741, 742
- Okamoto, H. 437 (122), 473, 546 (75), 618, 778 (74), 819
- Okamoto, I. 123 (72), 155
- Okamoto, K. 96, 97 (59), 103
- Okamoto, T. 1029 (166), 1038, 1256 (137, 138), 1298
- Okamoto, Y. 488, 489 (82), 527
- Okamura, K. 396 (93), 419
- Okaniwa, K. 437 (122), 473
- Okawara, T. 551 (94), 618
- Okay, G. 657 (167), 662
- Okazaki, M.E. 594 (350), 624
- Okazaki, S. 685 (14), 740, 868 (42), 889
- Oku, A. 638 (50), 660
- Okuma, E. 1089 (287), 1161
- Okuma, K. 591 (326), 623
- Okumura, M. 868 (42), 889
- Okumura, Y. 1114 (405), 1163
- Okuno, S. 983 (81), 996
- Okuno, Y. 722 (157c), 743
- Okura, Y. 1080 (221), 1159
- Okushi, T. 596 (365), 624
- Okuyama, T. 1019 (89), 1037
- Olafson, B.D. 37, 38, 40 (57), 82
- Olah, G.A. 510 (204), 530, 550 (87), 551 (88), 604 (403), 605 (407), 618, 625, 639 (59), 651 (134), 657 (169), 660, 662
- Oláh, K. 1047 (34), 1155
- Olbrich, F. 396 (95), 419
- Olbricht, T. 160 (13), 201
- O'Leary, M.H. 894 (4), 935, 936 (52), 946, 947
- Olefirowicz, E. 184 (105), 203
- Olivato, P.R. 175 (83), 203
- Olivella, S. 640 (67), 660
- Oliver, A.M. 445 (169), 474
- Oliver, S. 428 (42), 471
- Olken, H.M. 990 (112), 996
- Olken, N.M. 983 (83), 996
- Ollagnier, M. 1063 (100), 1157
- Ollis, W.D. 414 (200), 422
- Olliver, S. 381 (20b), 417

- Olmstead, W.N. 308 (41), 333, 387 (52b), 410 (183), 413 (198), 418, 422, 436 (116), 473, 505 (163), 529
- Olofson, R.A. 582 (263, 264), 622
- Olson, E.S. 638 (46), 660
- Olson, J.S. 989 (107), 996
- Olson, S.L. 978 (71), 995
- Omote, Y. 686 (29), 722 (159a), 740, 743
- O'Neal, H.E. 354 (53), 375
- Oneil, P.A. 396 (90), 419
- O'Neill, I.K. 1182 (62), 1213
- O'Neill, M.E. 629 (12), 659
- Onigbinde, T.A. 1065 (106), 1157
- O'Nions, P. 1175 (11), 1212
- Onkenhout, W. 289 (115), 294
- Ono, N. 458 (238), 476, 605 (409b), 610 (438, 439), 611 (440), 614 (452–454, 456, 457), 615 (458), 625, 626
- Onoda, R. 873 (59), 890
- Onodera, J. 776 (65), 819
- Onuoha, G.N. 1266, 1267, 1276–1278, 1294 (162), 1299
- Onyido, I. 1251 (127), 1266, 1267 (162), 1276 (162, 182), 1277 (162), 1278 (162, 182), 1290 (182), 1294 (162), 1298–1300
- Onyido, J. 1262, 1264, 1276, 1288 (148a, 148b), 1299
- Ooi, S.L. 672 (32), 680
- Oosterbeek, W. 522 (248), 531
- Opella, S.J. 322 (101), 334
- Oppenorth, H.-J. 629 (11), 659
- Opitz, A. 398 (108), 420
- Oplinger, J.A. 991 (116), 996
- Oplinger, J.G. 991 (117), 996
- Oppenheimer, N.J. 132 (95), 155
- Orbán, M. 431 (61), 471
- Orihara, Y. 1029 (166), 1038
- Orioli, P. 391 (65), 419
- Orito, K. 794 (119), 798, 799 (133), 820, 821
- Oritz, M.J. 716 (139), 743
- Orlek, B.S. 589 (310), 623
- Orloff, G.J. 978 (68), 995
- Orloff, S.L. 1024 (125, 126), 1037
- Orlova, Zh.I. 576 (215), 621
- Ornellas, D. 369 (95), 378
- Oroszlan, S. 1024 (125), 1037
- Orrel, K.G. 447 (177), 474
- Orrell, K.G. 315 (60), 333
- Ortega, F. 1217 (6a–c), 1295
- Ortiveros, C. 1047 (35), 1155
- Ortiz, M.J. 718 (146), 743
- Orton, K.J.P. 486 (61, 64), 526
- Orvick, J.A. 1218, 1250, 1251 (19), 1295
- Orwar, O. 1077 (193), 1159
- Osajima, Y. 1106 (372), 1162
- Osapay, K. 218 (81), 245
- Osawa, E. 3 (1g), 4 (1g, 15), 5 (1g, 7), 13 (15), 29 (1g), 77 (15), 81
- Osawa, H. 163–166, 168 (27), 202
- Osawa, Y. 990 (112), 996
- Osborn, D.L. 795 (125), 820
- Osborne, J. 673 (43), 681
- Osborne, J.A. 673 (45), 681
- Osipova, O.A. 1062 (94), 1156
- Osowska-Pacewicka, K. 537 (32), 540 (44), 617
- Ostwald, W. 493 (114), 528
- Osugi, J. 460 (246, 247), 476
- Oszczapowicz, J. 392 (74, 76), 419, 1284 (193), 1300
- Otani, S. 467, 468 (274), 476, 1217 (7), 1256 (138, 139), 1295, 1298, 1299
- Oth, J.F.M. 96 (49), 102
- Otiono, P. 1267, 1288 (170), 1299
- Otsubo, T. 583 (276), 622
- Otsuji, Y. 703 (101), 742
- Otsuka, H. 1180 (51), 1213
- Ottenheijm, H. 1012 (77), 1036
- Ouchabane, R. 581 (257), 622
- Ouihia, A. 592 (335), 623
- Ouyang, H. 381 (21), 417, 428 (43), 471
- Overchuk, N.A. 639 (59), 660
- Overman, L.E. 594 (350), 624
- Overstraeten, A. van 630 (16), 659
- Owers, R.J. 685 (9), 740
- Oxford, A.E. 485 (47), 526
- Oxman, J.D. 685 (19), 740, 759 (35a, 35b), 818
- Oyadomari, S. 730 (181f), 744
- Ozawa, H. 1064 (102), 1157
- Ozbalik, N. 538 (37), 617
- Ozer, N. 672 (36), 680
- Ozin, G.A. 151 (159), 157
- Pac, C. 561 (149), 619, 704, 706 (106), 742, 824 (11, 12), 835
- Pacakova, V. 1148 (598), 1167
- Pacheco, C.R. 1076 (187), 1159
- Pacifici, R.E. 832 (60), 836
- Packer, J. 516 (233), 530
- Paddon-Row, M.N. 445 (169), 474
- Padma, D.K. 584 (289), 622
- Padmaja, S. 827 (29, 33), 835
- Padmanabhan, K. 762 (39, 40), 818
- Padva, A. 188 (113), 204
- Padwa, A. 710, 717 (116a), 742
- Paesen, J. 1118 (420), 1163
- Pafizadeh, K. 786 (100), 820
- Pafumi, E. 1133 (496), 1165
- Pagani, G. 398 (107), 400 (128), 420
- Pagani, G.A. 397 (104, 105), 398 (109a, 109b, 110, 111), 400 (105), 420, 509 (193–195), 530
- Paimentier, J.P.F.P. 1145 (575), 1167

- Paine, J.S. 434 (85), 472, 511 (211, 212), 530, 1241, 1262, 1264 (103b), 1298
- Paith, J.E. 991 (116, 117), 996
- Pal, H. 441 (144), 473
- Palacios, F. 573 (203), 620
- Palacios, M. 976 (41), 994
- Palacios, S.M. 655 (162), 662
- Palazzolo, D.L. 1067 (132), 1157
- Pale-Grosdemange, C. 590 (318), 623
- Palenik, G.J. 554 (115a), 619
- Paley, M.S. 933, 935, 936 (51), 947
- Paliani, G. 99 (79), 103
- Palladino, D.E.H. 1071 (151), 1158
- Palleros, D. 469 (276–278), 477, 1236 (107), 1241 (104a, 104b, 105c), 1242 (105c, 107), 1243 (107), 1251 (104a, 104b), 1261 (143a, 143b), 1262 (144), 1263 (144, 172, 174, 175, 180), 1266 (143a, 143b, 144), 1267 (144), 1268 (143a, 143b, 144), 1269 (172), 1272 (174, 175), 1273 (104a, 104b, 175, 180), 1276 (180), 1282, 1286 (143a, 143b, 144), 1287 (144), 1298, 1299
- Pallos, G. 310 (45), 333
- Palm, V.A. 491, 500, 501 (107c), 508 (182), 510 (198), 528–530
- Palmer, J.A. 58 (94), 83
- Palmer, M.H. 171, 172, 174, 175 (75), 193, 197–199 (141), 203, 204
- Palmer, R.M.J. 669 (19), 680, 975 (4, 8–12), 976 (11, 39, 41), 977 (47), 978 (39, 47, 62), 980 (39, 79), 994, 995
- Palmer, T.F. 1102 (356), 1162
- Palmero, S. 1078 (200), 1159
- Palmisano, F. 1078 (197), 1159
- Pan, Y. 322 (98, 100), 334, 595 (356), 624
- Panczel, M. 259 (42), 292
- Pande, R. 405 (152a, 152b), 421
- Pandurangi, R.S. 148, 152 (148), 157
- Paneth, P. 859 (14), 889, 935, 936 (52), 947
- Panicucci, R. 1032 (186, 190, 192), 1039
- Pankayatselvan, R. 571 (199), 620
- Pankow, J.F. 1176 (26), 1212
- Panneerselvam, K. 452 (197, 199), 475
- Pannetier, G. 434 (85, 91), 472, 1262, 1266 (145), 1299
- Panshin, S.Y. 338 (4), 356 (59), 372, 375
- Pant, A.K. 93 (14), 102
- Pant, L.M. 93, 98 (25), 102
- Pantano, J.E. 933–935, 938 (49), 947
- Panunto, T.W. 98 (68), 103, 433 (78), 472
- Panunzio, M. 549 (81), 618
- Paoletti, P. 391 (63–66), 396 (101), 418–420
- Paoli, P. 396 (101), 420
- Papadopoulos, P. 644 (91), 660
- Papanastasiou, G. 844 (26), 855
- Pape, B.E. 1047 (43), 1155
- Papoutsis, A. 844 (26, 27), 855
- Pappalardo, S. 286, 287 (105), 293
- Paputa-Peck, M.C. 1177 (36), 1212
- Paradisi, C. 1220 (29a–c), 1296
- Pare, J.R.J. 1134 (506), 1165
- Parello, J. 1048 (60), 1156
- Parhizkari, G. 1116 (411, 412), 1163
- Park, B.K. 1028 (156), 1038
- Park, C. 108 (27), 154
- Park, J.W. 672 (35), 680
- Park, K.H. 860, 861 (17), 889, 897 (22), 899 (23), 915 (36), 947
- Park, M.K. 534 (3), 616
- Park, S.-U. 599 (380), 624
- Park, W.S. 114 (46), 154
- Párkányi, L. 93, 98, 100 (27), 102
- Parker, A.J. 511, 515, 516 (213), 530
- Parker, D. 124 (75), 130 (88), 155, 1089 (282), 1160
- Parker, J.K. 98 (74), 103
- Parker, V.D. 838 (6), 848 (42), 855, 856, 1246 (121), 1298
- Parkes, O.W. 1136 (520), 1165
- Parkhurst, L.J. 1003 (47), 1036
- Parkin, C. 581 (255), 622
- Parks, O.W. 1139 (543), 1166
- Parks, S.K. 1047 (49), 1155
- Parmeggiane, L. 1172 (1), 1212
- Parola, A. 687 (39), 740
- Paroni, R. 1085 (269), 1160
- Parr, T. 795 (123), 820
- Parris, K.D. 442 (150), 473
- Parsons, G.H. 687 (39), 740
- Partyka, R.A. 582 (262), 622
- Pasa-Tolic, L. 200 (149), 204
- Pascard, C. 592 (335), 623
- Pashkevich, K.I. 1062 (94), 1156
- Pasman, P. 696 (76), 741
- Pasquato, L. 1012, 1015 (73), 1036
- Pasto, D.J. 843 (20a), 855
- Pastore, P. 1147 (592, 595, 596), 1148 (597), 1167
- Patai, S. 534 (1a, 1d), 616
- Patel, H.M.S. 667 (9), 680
- Paterlini, M.G. 150 (154), 157
- Pathak, P.V. 1074 (184), 1158
- Patil, G. 584 (285a, 285b), 622
- Patil, S.F. 1058 (77), 1127 (452), 1156, 1164
- Patterson, B.W. 1059 (83), 1156
- Patterson, P.L. 1047 (35, 36, 38), 1155
- Patwardhan, M.D. 873 (60), 890
- Pau, C.-F. 523 (252), 531
- Paul, I.C. 347 (27), 373
- Paul, M. 405 (152b), 421
- Pauland, I.C. 447 (179), 474
- Pauling, L. 427 (23), 471
- Pauling, P.J. 143 (131), 156
- Paulins, J. 437 (124), 473

- Paulus, A. 1093 (316), *1161*  
 Pavlickova, L. 756 (21), 789 (105), *818, 820*  
 Pavón, P. 1077, 1098 (194), *1159*  
 Pawelke, G. 164–166, 168 (38), *202*  
 Pawlowska, M. 1090 (295), *1161*  
 Payne, N.N. 674 (50), *681*  
 Payzant, J.D. 235 (159), *247*  
 Peach, M.J. 977 (51), *995*  
 Peacock, V.E. 56 (80c), *83*  
 Pearlstein, R.A. 13 (19), *81*  
 Pearson, A.M. 1189 (95), *1214*  
 Pearson, R.G. 674 (51), *681*  
 Peat, I.R. 505 (156), *529*  
 Pechy, P. 315, 316 (61), *333*  
 Peck, B.M. 739 (207), *745*  
 Pedersen, S.F. 549 (82), *618*  
 Pederson, T.C. 1176 (22), *1212*  
 Pedireddi, V.R. 792 (117), *820*  
 Pedley, J.B. 218 (83), *245, 338 (2), 345 (17), 350 (35), 352 (44), 361 (2), 371, 372, 374, 410 (188), 422*  
 Peel, J.B. 163–165 (25), 166 (55, 57–60), *202*  
 Peerboom, R.A.L. 354 (54), *375*  
 Peet, K.M. 405 (151a), *421*  
 Peeters, D. 410 (187a, 187b), *422*  
 Peevey, R.M. 575 (209), *621*  
 Pelizza, F. 456 (225), *475*  
 Pellerite, M.J. 220 (105), *246*  
 Pellizzari, E.D. 1047 (45), *1155*  
 Pellon, R.F. 584 (283), *622*  
 Pemberton, P.W. 1097 (334), *1162*  
 Peña, M.E. 643 (88), 644 (92, 96), 645 (88, 98), *660, 661, 675 (57, 60), 677 (72), 681, 886 (101, 103), 888 (106), 891*  
 Penais, B. 1079 (208), *1159*  
 Penaud-Berruyer, F. 1284 (192), *1300*  
 Penfold, J. 1119 (434, 436), 1122 (437), *1164*  
 Peng, S. 188 (113, 115–117), *204*  
 Peng, S.B. 1047 (25), *1155*  
 Peng, W. 1127 (454), *1164*  
 Pensabene, J.W. 1144 (569), 1145 (577–579, 581), *1166, 1167, 1189 (94, 97), 1214*  
 Penso, M. 616 (462, 463), *626*  
 Penwell, P.E. 605 (405), *625*  
 Pepe, G. 710 (119), *742*  
 Pepe, J.P. 582 (263), *622*  
 Pepekin, V.I. 362, 363 (90), *377*  
 Pereira, W.E.Jr. 130, 131 (92), 132 (95), *155*  
 Perekalin, V.V. 604 (401), *625*  
 Peres, T. 251, 254, 262 (7), *291*  
 Pérez, J.A. 1138 (530), *1166*  
 Perez, P. 780 (81), *819*  
 Pérez-Arribas, L.V. 1135 (513), *1165*  
 Pérez Bendito, D. 1077, 1098 (194), *1159*  
 Pérez-Lanzac, M.T. 283, 284 (100), *293*  
 Perez-Ossorio, R. 715 (129, 132), 716 (132), *742*  
 Perez-Prieto, J. 568 (189), *620*  
 Periasamy, M. 536 (17), 582 (266), 584 (281), *617, 622*  
 Periasamy, N. 753 (10), *817*  
 Pericas, M.A. 545 (70), *618*  
 Perie, J.J. 587 (298), *622*  
 Perillo, I. 433 (81), 472, 1245–1247, 1266 (115b), *1298*  
 Perjessy, A. 313, 314 (58), *333*  
 Perkins, M.J. 579 (239), *621*  
 Perks, H.M. 339 (7), *372*  
 Perrault, G. 1145 (580), *1167*  
 Perrin, C.L. 949 (2), 966 (53), *970, 971, 1113 (404), 1163*  
 Perrin, D.D. 381 (4a), *416, 431 (60), 471*  
 Perry, J.A. 1072 (154), *1158*  
 Perry, J.W. 444 (162), *474*  
 Perry, R.A. 816 (172), *821*  
 Persico, M. 803 (138), *821*  
 Persson, J. 938 (55), *948*  
 Petasis, N.A. 566 (181), *620*  
 Petch, W.A. 448 (191), *474, 869 (44), 889*  
 Petcher, T.J. 63 (110a, 110b), *84*  
 Pete, J.P. 737 (195a–c), *745*  
 Peterson, M.R. 236, 238 (173), *248*  
 Petillo, P.A. 56 (80a), 83, 184 (105), *203*  
 Petrakis, L. 57 (90a), *83*  
 Petri, A. 143 (125), *156*  
 Petrich, J.W. 698 (98), *742*  
 Petrillo, G. 1262, 1264 (151), *1299*  
 Petrini, M. 608 (423, 425, 426b), 610 (436), *625*  
 Petris, G.de 289 (110), *293*  
 Petrov, E.S. 398 (114), *420*  
 Petrov, V.A. 602 (389), *624*  
 Petrova, M. 437 (124), *473*  
 Petruccelli, L. 1089 (281), *1160*  
 Petterson, L. 171 (76), *203*  
 Petterson, I. 41, 42 (60), *82*  
 Petty, J.T. 399 (120), *420*  
 Petz, M. 1139 (536), *1166*  
 Pevzner, M.S. 646 (102), *661*  
 Peyser, J.R. 765 (43), *818*  
 Pez, G.P. 587 (300), *622*  
 Pfab, J. 188 (126, 128), 189, 190 (126), 191 (126, 128), *204, 803 (137, 139, 141), 821*  
 Pfafferot, G. 25 (39, 40), *82*  
 Pfeil, E. 628 (10), *659*  
 Pfeilschifter, J.P. 992 (128), *997*  
 Pfoertner, K.H. 717 (141), *743, 780 (80), 819*  
 Pham, V.T. 939, 946 (58), *948*  
 Phelps, M.E. 652, 653 (140), 656 (165), *662*  
 Philipot, K. 588 (302a, 302b), *623*  
 Philippsborn, W.von 297 (5), 320 (83), *332, 334*  
 Phillips, J.G. 1144 (569), *1166*  
 Phillips, R.J. 666 (5), *680*

- Philpott, M.F. 1061 (89), *1156*  
 Piancatelli, G. 777 (68), *819*  
 Piatak, D.M. 563 (160), *620*  
 Pickard, S.T. 112, 133, 135, 136 (38), 137 (38),  
 107), 148 (147, 148), 152 (147, 148, 164),  
*154, 155, 157*  
 Pickering, M. 96 (52), *103*  
 Pickering, R.A. 667 (8), *680*  
 Pico, Y. 1048 (55), *1156*  
 Piekarskagolebiowska, J. 824 (13, 14), *835*  
 Pienta, N.J. 684 (5), 688 (33, 34), *740, 1220*  
 (36), *1296*  
 Pierpoint, C. 297 (9), *332*  
 Pierre, J.-L. 669 (22), *680*  
 Pietra, F. 467 (269), *476, 1220* (28), *1236,*  
*1244, 1265* (111), *1295, 1298*  
 Pietra, S. 773 (62), *819*  
 Pietri, S. 991 (124), *996*  
 Pignataro, S. 164 (37), *202*  
 Pignatelli, B. 1147 (591), *1167*  
 Pignato, S. 165, 166, 178 (46), *202*  
 Pihlaja, K. 353 (45), *375*  
 Pike, D.C. 348 (30b), *373*  
 Pikulik, I. 638 (47), *660*  
 Pikver, R.J. 1238 (89), *1297*  
 Pilarski, B. 554 (112), 557 (126), *619*  
 Pilati, T. 452 (197), *475*  
 Pilcher, G. 218, 225 (82), *245, 339* (10), *357*  
 (67), *358* (71–73), *372, 376*  
 Pilichowska, S. 540 (48), *617*  
 Pillai, V.N.R. 736 (193), *745*  
 Pillay, K.S. 812–814 (165), *821*  
 Pimental, D. 992 (127), *997*  
 Pimentel, G.C. 427 (24), *471*  
 Pinder, W.E. 131, 132 (94), *155*  
 Pineschi, M. 544 (68), 545 (72), *617, 618*  
 Pinhas, A.R. 545 (71), *618*  
 Pinhey, J.T. 793 (118), *820*  
 Pini, D. 143 (125), *156, 1112* (400), *1163*  
 Pinkse, F.A. 260, 263 (51), *292*  
 Pintauro, P.N. 845 (31), *855*  
 Pinzauti, S. 1116 (409), *1163*  
 Pirela, D. 1046 (19), *1155*  
 Pirkle, W.H. 121 (67), 123 (73), 124 (74), *130*  
 (86), *155, 427* (21, 22), *471*  
 Pirmohamed, M. 1028 (156), *1038*  
 Pirozhkov, S.D. 596 (360), *624*  
 Pitacco, G. 165, 166, 178 (46), *202*  
 Piteau, M. 582 (264), *622*  
 Pittman, C.U. 171 (69), *203*  
 Pitts, J.N.Jr. 1176 (27, 28), 1177 (39, 40),  
*1212, 1213*  
 Piveteau, E. 551 (92), *618*  
 Pizzarello, S. 1060 (87, 88), *1156*  
 Plakas, S.M. 1139 (539), *1166*  
 Plant, A.L. 1100 (348), *1162*  
 Plante, R. 722 (153g), *743*  
 Plapinger, R.E. 407 (157a), *421*  
 Platt, J.R. 135, 136 (106), *155*  
 Pleixats, R. 755 (20), 758 (30), *818*  
 Pletcher, D. 844 (28), *855*  
 Plomley, J.B. 1145 (574), *1167*  
 Ploug-Sørensen, G. 93 (29), 98 (70), *102,*  
*103*  
 Poch, M. 545 (70), *618*  
 Pochapsky, T.C. 121 (67), 123 (73), 124 (74),  
*155, 427* (21, 22), *471*  
 Poggi, G. 173 (78), *203*  
 Pohl, E. 396 (92, 96), *419*  
 Pohl, L.R. 1025 (132), *1038*  
 Poiana, M. 563 (163), *620*  
 Poirer, R.A. 236, 238 (173), *248*  
 Poirier, R.A. 896, 935, 941, 944 (19), *947*  
 Poitras, J. 100 (88), *103*  
 Pojopay, M. 1047 (20), *1155*  
 Pokhodenko, V.D. 1272 (176), *1299*  
 Pol, A.V. 578 (225), *621*  
 Polavarapu, P.L. 148 (142–148), 152 (147,  
 148, 164–166), 153 (165–167), *156, 157*  
 Politzer, P. 408, 409 (170), *421, 1001, 1007,*  
*1008* (20), *1035*  
 Polizzi, C. 575 (211), *621*  
 Pollack, L. 1076 (188), *1159*  
 Pollack, R.M. 361 (86), *377*  
 Pollock, J.S. 977 (46, 49), 978 (49), *995*  
 Polo, J.S. 817 (173), *821*  
 Polo-Diez, L.M. 1135 (513), *1165*  
 Poloni, M. 191, 199 (130), *204, 969* (66), *970*  
 (67), *971*  
 Polonski, T. 4, 13 (17), 69 (17, 116), 70 (118),  
*81, 84, 145* (134, 135), *156*  
 Polynova, T.N. 636 (39), *659*  
 Pommier, Y. 1024 (125), *1037*  
 Poncet, J. 589 (308), *623*  
 Ponomarchuk, M.P. 649 (118), *661*  
 Ponomarev, I.L. 353 (50), *375*  
 Pontecorvo, E.G. 975 (21), *994*  
 Pontén, E. 1105 (370), *1162*  
 Ponti, A. 398 (107), *420*  
 Poole, C.F. 121 (68), *155, 1222, 1226* (53),  
*1296*  
 Popik, V.V. 658 (175), *663*  
 Pople, J.A. 34 (48), 82, 208 (4), *244, 355* (55),  
*375, 384* (28a, 28b), *407* (163), *417, 421*  
 Popowski, E. 396 (91d), *419*  
 Popp, F.D. 838, 840, 848 (7b), *855*  
 Poppek, R. 163–166, 170, 172, 175 (26), 186  
 (110), 189, 192, 195, 201 (26), *202, 204*  
 Popper, K.R. 470 (280), *477*  
 Poradowska, H. 561 (144), *619*  
 Porai-Koshits, B.A. 636 (39, 40), *659*  
 Porkashanian, M. 1175 (10), *1212*  
 Pornet, J. 576 (217), *621*  
 Porta, F. 578 (224), *621*

- Portalone, G. 435 (100), 472  
 Porte, A.L. 804 (144, 145), 821  
 Porter, A.E.A. 585 (294), 622  
 Porter, C.J. 250 (1), 267 (76), 291, 293  
 Posch, W. 1130 (477), 1164  
 Pospisil, R. 1067 (134), 1157  
 Possanzini, M. 1081 (232), 1159  
 Postma, R. 215 (56), 245  
 Posynia, A. 1139 (533), 1166  
 Posyniak, A. 1139 (540), 1166  
 Potapov, V.M. 139 (114, 115), 156  
 Poteruca, J.J. 590 (322), 623  
 Potvin, P.G. 59 (99), 83  
 Pouchert, C.J. 1053, 1054, 1058, 1115, 1124, 1144 (71, 72), 1156  
 Pouet, M.-J. 512 (216), 530  
 Pouget, J. 697 (88), 741  
 Pounds, C.A. 1100 (349), 1162  
 Pourkashanian, M. 1174 (7), 1212  
 Powell, H.M. 461 (252), 476  
 Powell, J.B. 1186 (74), 1213  
 Powell, M.F. 1272 (173), 1299  
 Powlson, D.S. 330 (123), 335  
 Pozharskii, A.F. 552 (97), 618  
 Pozzi, G. 616 (463), 626  
 Prabhakaran, K.V. 1141 (555), 1166  
 Pradeep, T. 434 (82), 472  
 Prado, G. 1175 (17), 1212  
 Prados, P. 537 (23), 617  
 Prajapati, D. 569 (193), 608 (427), 620, 625  
 Prajer, K. 70 (118), 84, 145 (134), 156  
 Prakash, G.K. 651 (134), 662  
 Prakash, G.K.S. 510 (204), 530, 550 (87), 604 (403), 618, 625, 657 (169), 662  
 Prakash, I. 583 (273), 622  
 Prandini, P. 1133 (496), 1165  
 Prasad, A.S.B. 536 (17), 617  
 Prasad, L. 93, 100 (26), 102, 1241, 1242 (105a), 1298  
 Prasad, S.M. 91, 93, 99 (24), 102  
 Prasannan, S. 1217 (14), 1295  
 Prasthofer, T.W. 933, 935, 936 (51), 947  
 Prater, T.J. 289 (109), 293, 1177 (31, 36), 1212  
 Prati, M. 1078 (200), 1159  
 Pratt, A.C. 710 (116b), 715 (130a, 130b), 717 (116b), 742  
 Pratt, D.D. 676 (69), 681  
 Pratt, D.V. 575 (209), 621  
 Pratt, G.L. 290 (117), 294  
 Pratt, J.E. 693 (56), 741  
 Pregosin, P.S. 317 (67), 333  
 Prescher, K.-E. 977 (48), 995  
 Press, R.D. 436 (117), 473  
 Preston, S.B. 537 (25), 617  
 Preston-Martin, S. 1182 (61), 1213  
 Preussmann, R. 1148 (600), 1167, 1185 (70, 71, 73), 1187 (83), 1188 (87, 88, 91, 92), 1189, 1190 (99), 1213, 1214  
 Prewo, R. 717 (142), 743  
 Price, C.G. 1047 (24), 1155  
 Price, E. 491, 503, 504, 515, 517 (96, 97), 527  
 Priebs, B. 482 (25), 525  
 Priesner, C. 640 (66), 660  
 Prince, E.C. 303, 305 (31), 333  
 Prior, D.V. 381 (17b–e, 19, 20b, 20c), 395 (81), 417, 419, 428 (41, 42), 471, 1222 (50, 51), 1238 (51), 1296  
 Procter, G. 75 (126), 84, 569 (192), 620  
 Proctor, C.J. 267 (76), 293  
 Profeta, S. 3 (2a, 3c, 3d), 5, 27 (3c, 3d), 81  
 Profeta, S.Jr. 4, 6–12, 16, 23 (5), 24 (34, 35), 41, 61 (5), 81, 82  
 Prohaska, J.R. 1012 (76), 1036  
 Prokai, A.M. 1152 (620), 1168  
 Prokopczyk, B. 1150 (609), 1151 (617, 618), 1167  
 Prokschy, F. 186 (110), 204  
 Prosen, E.J. 339 (9, 12), 341, 342 (12), 372  
 Pross, A. 409 (173), 421, 510 (207), 530, 943 (68), 948, 1245 (119), 1298  
 Prout, K. 96 (46, 54), 102, 103  
 Prusoff, W.H. 453 (205), 475  
 Prutz, W.A. 827 (35), 835  
 Pryor, W.A. 1142 (558), 1166  
 Przybyl, J. 459 (243), 460 (248), 476  
 Psathaki, M. 1048 (53), 1156  
 Ptitsyna, D.A. 657 (173), 663  
 Puchades, R. 1104 (366, 367), 1162  
 Pufahl, R.A. 983, 985 (82), 991 (115), 996  
 Puhan, Z. 1046 (12), 1155  
 Puigdeu, M. 1085 (264), 1160  
 Pujol, M.D. 596 (366), 624  
 Pulley, S.R. 590 (316), 623  
 Pullman, A. 386 (47a–c), 418  
 Purgstaller, K. 551, 552 (96), 618  
 Puskas, I. 265 (68), 293  
 Put, J. 695 (71), 741  
 Pytela, O. 494 (120, 121), 507 (120, 121, 176–180), 528, 529  
 Qi, X.H. 1151 (619), 1167  
 Qian, J.H. 524 (254), 531  
 Qian, Y.R. 1060 (86), 1156  
 Qin, X.-Z. 825 (18), 835  
 Qu, X. 150 (152), 157  
 Qu, Y. 608 (422), 625  
 Quadri, S.K. 1067 (132), 1157  
 Quan, R.W. 119 (57), 154  
 Quarmby, C. 1059 (80), 1156  
 Quartermous, T. 977, 979 (50), 995  
 Quereshi, M. 461 (250), 476  
 Quereshi, P.M. 461 (250, 251), 476  
 Quesada, A. 874 (64), 890

- Quian, J.H. 407 (161b), 421  
 Quinn, J.M. 434 (95), 472  
 Quintens, I. 1118 (420), 1163  
 Quintilli, U. 1220 (29c), 1296  
 Quinton, G.P. 678 (80), 682  
 Quirk, R.P. 400 (125), 420  
 Quirós, M. 592 (336), 623
- Raabe, E. 139 (113), 156  
 Rabalais, J.W. 160, 161 (4), 171, 174 (71), 188 (121), 191 (129), 192 (136, 139), 193 (136), 194, 197 (139), 200, 201 (136), 201, 203, 204  
 Rabalias, J.W. 255, 256 (31), 292  
 Raban, M. 1007 (53), 1009 (67), 1012, 1015 (83), 1036, 1112 (401), 1163  
 Rabenstein, D.L. 407 (164), 421, 1004 (44), 1036  
 Raber, D.J. 59 (102), 83  
 Rabinovich, I.B. 353 (50), 375  
 Rachwai, S. 554 (113, 114), 555 (116), 619  
 Rachwal, B. 554 (113, 114), 555 (116), 619  
 Rachwal, S. 556 (118), 619  
 Racklin, E.M. 975, 976 (30), 994  
 Raczynska, E.D. 395 (82), 419, 459 (244), 476, 1237, 1238 (84–86), 1284, 1285 (86), 1297  
 Rademacher, P. 163 (26), 164 (26, 36), 165 (26, 36, 45, 48, 49), 166 (26, 45, 48, 49), 170 (26), 171 (66), 172 (26), 174 (66), 175 (26, 82), 181, 182 (48, 97), 184 (66, 106), 186 (106, 110), 188 (66), 189 (26), 192 (26, 45, 138), 195, 201 (26), 202–204  
 Radhakrishnan, G. 795 (123), 820  
 Radhamani, K.N. 584 (289), 622  
 Radi, R. 992 (139), 997  
 Radner, F. 455 (218), 475, 790 (108, 111b, 111c, 112, 114), 820, 954 (34, 37, 38), 970 (37, 38), 971  
 Radom, L. 34 (48), 82, 208 (5, 8, 12, 13, 19–21), 209 (22, 25), 210 (19), 211 (13, 19, 20), 214 (12, 21, 52), 215 (20, 55), 235 (19), 244, 245, 355 (55), 375, 384 (28c, 31), 417, 510 (207), 530  
 Radomski, M.W. 673 (39, 40), 681, 975 (8–10), 994  
 Rae, I.D. 438 (127), 473  
 Raffellini, L. 1247, 1249 (123), 1278–1280, 1285 (184b), 1289 (123), 1298, 1300  
 Rafols, C. 1225 (65), 1228 (75), 1297  
 Ragauskas, A.J. 312 (55), 333  
 Raghavachari, K. 384 (28a, 28b), 417  
 Ragnarsson, U. 540 (46), 541 (46, 51), 542 (53), 617, 854 (63), 856  
 Ragunathan, R. 150 (152), 157  
 Rahkamma, E.J. 320 (91), 334  
 Raifer, J. 993 (144), 997
- Raimbault, P. 1047 (20), 1155  
 Raisys, V.A. 1063 (98), 1157  
 Raithby, P.R. 396 (92, 96), 419  
 Rajadhyaksha, S.N. 579 (228b), 621  
 Rajan, J. 1140 (552), 1166  
 Rajput, S.K. 405 (151b), 421  
 Raju, B. 696 (80), 741  
 Raju, J. 1138 (532), 1166  
 Rakitin, O.A. 628 (8), 659  
 Rakova, G.V. 352 (43), 374  
 Rakshys, J.W. 381, 395 (14b), 416  
 Ramada, S.K. 596 (367), 624  
 Ramadas, K. 596 (363), 624  
 Ramaiah, P. 550 (87), 604 (403), 618, 625  
 RamaKrishna, N.V.S. 270 (81), 276, 277 (88, 89), 279 (89), 293  
 Ramamurthy, V. 762 (39, 40), 818  
 Ramana, D.V. 270 (81, 82), 276 (86–89), 277 (88, 89), 279 (86, 87, 89), 280 (90, 91), 286 (104), 293  
 Ramdahl, T. 1177 (40), 1213  
 Ramdev, P. 673 (44), 681  
 Ramesdonk, H.J.van 446 (171), 474  
 Ramesh, D. 769 (56), 819  
 Ramesh, M. 538 (37), 617  
 Ramette, R.W. 651 (135), 662  
 Ramis Ramos, G. 1086, 1088 (273, 278), 1160  
 Ramondo, F. 435 (100), 472  
 Ramón Leis, J. 644 (92), 645 (98), 660, 661  
 Ramos, A. 716 (135), 718 (148), 742, 743  
 Ramos, G.R. 1067 (133), 1157  
 Ramsay, J.N. 958 (46), 971  
 Randall, D. 739 (202), 745  
 Randall, E.W. 297 (4), 317 (65), 319 (81), 320 (91), 321 (92, 93), 324 (104), 330 (123–127), 331 (125, 127, 128), 332 (129–131), 332–335  
 Randall, J.J. 466 (268), 476, 1216, 1219, 1220, 1235, 1244, 1250, 1274, 1290 (1d), 1295  
 Randez, F.J. 1285 (195), 1300  
 Randrianoelina, B. 576 (217), 621  
 Ranson, R.J. 1217 (14), 1295  
 Rao, C.N.R. 174 (80), 188, 191 (128), 192 (137), 193 (80, 137), 200 (137), 203, 204, 301 (17), 332, 434 (82), 441 (144), 472, 473, 1044 (2, 3), 1154  
 Rao, D.N.R. 824 (5), 835  
 Rao, D.V. 722 (153f), 743  
 Rao, H.S.P. 537 (27), 617  
 Rao, J.M. 688 (35), 740  
 Rao, K.K. 596 (360), 624  
 Rao, K.M. 854 (68), 856  
 Rao, K.R.N. 1090 (294), 1161  
 Rao, K.U.B. 876 (68), 890  
 Rao, R.N. 1137 (524), 1165  
 Rao, S.J. 541 (49), 617



- Rapley, P.A. 734 (185a, 185b, 189), 744  
 Rapp, M.W. 945 (70), 948  
 Rappa, A. 560 (138), 619  
 Rappe, A.K. 38–40 (58, 59), 82  
 Rasala, D. 286 (103), 293, 454 (210), 475, 555 (117), 619, 775 (64), 819  
 Rasbridge, M.R. 1027 (150), 1038  
 Raschig, F. 679 (88), 682  
 Rasmussen, K. 3–5, 29 (1f), 55–57 (81), 81, 83  
 Rathke, M.W. 552 (100b), 618  
 Rathore, R. 608 (421), 625  
 Ratkonis, F. 1266, 1267 (167a), 1299  
 Rattenbury, J.M. 1068 (137), 1158  
 Raue, R. 657 (171), 662  
 Rauhut, G. 956 (44), 971  
 Rauhut, M.M. 1105 (368), 1162  
 Rauk, A. 133 (98–101), 146 (136, 137), 148 (147, 149, 150), 149 (149–151), 152 (147, 149, 150), 155–157  
 Rauth, A.M. 1032 (186, 190, 191, 194), 1039  
 Raval, T. 991 (125), 997  
 Ravenscroft, M.D. 648 (107, 108), 661  
 Ravichandran, C. 845 (32a, 32b), 855  
 Ravichandran, R. 668–670, 672 (14), 680  
 Ravichandran, R.K. 1152 (620), 1168  
 Raymahasay, S. 880 (82), 890, 950 (6, 10, 11), 951 (10, 11), 970  
 Rayner, C.J. 1067 (129), 1157  
 Read, D. 188 (120), 204  
 Readman, J.M. 954, 962 (30), 971  
 Rebolledo, F. 592 (336, 337), 623  
 Reboul, J.P. 94 (37), 102  
 Rechsteiner, B. 589 (311), 623  
 Reddy, A.V.N. 537 (28), 617  
 Reddy, C.K. 582 (266), 622  
 Reddy, C.S. 1139 (544), 1166  
 Reddy, G.D. 686 (24, 27, 28, 30, 31), 687 (31), 699 (24, 28, 97), 700 (24, 99, 100), 701 (28, 99, 100), 704 (99), 706 (24, 28), 740, 742  
 Reddy, I.A.K. 854 (68), 856  
 Reddy, J.S. 580 (240), 621  
 Reddy, S.J. 1139 (544), 1166  
 Redey, G.D. 707 (109), 742  
 Redmont, W. 636 (37), 659  
 Reed, P.I. 1146 (585), 1151 (615), 1167  
 Reed, R.R. 976, 977 (44), 995  
 Reeder, D.J. 1092 (305), 1161  
 Rees, C.W. 1250, 1267 (126), 1298  
 Rees, D.D. 673 (39), 681, 977, 978 (47), 995  
 Rees, D.I. 192 (134), 204  
 Reetig, W. 697 (88), 741  
 Reetz, M.T. 547 (79), 618  
 Regezman, E. 1187 (79), 1213  
 Reginato, G. 551 (93), 618  
 Rehaber, H. 697 (83), 741  
 Rehorek, D. 807 (148), 821  
 Reichardt, C. 381 (11), 416, 424 (1), 425 (6, 7), 470  
 Reichart, C.F. 1220–1222, 1238 (37), 1296  
 Reichel, A. 1079 (207), 1159  
 Reichmanis, E. 767 (49, 50a, 50b, 51), 819  
 Reid, G.L.III 1095 (326), 1161  
 Reilly, J. 673 (44), 681  
 Reilly, J.P. 173 (79), 203  
 Reimlinger, H. 630 (16), 659  
 Rein, T. 542 (54), 568 (188), 617, 620  
 Reiner, E.J. 236 (173, 174), 237 (174), 238 (173, 174, 178), 239 (178), 248  
 Reiner, F.J. 1145 (575), 1167  
 Reinhardt, K. 1003, 1005–1007, 1009, 1011, 1012, 1014, 1019, 1027, 1029, 1030 (36), 1035  
 Reinheimer, J.D. 1217 (16), 1295  
 Reinhoudt, D.N. 969 (64), 971  
 Reinwein, D. 1000, 1020, 1021, 1027 (17), 1035  
 Reischi, A. 1180 (54), 1213  
 Reischl, A. 1182 (60), 1213  
 Reiser, A. 767 (48b), 819  
 Reisman, J.M. 1048 (60), 1156  
 Reistad, R. 1012, 1033 (84), 1036  
 Reix, T. 579 (235), 621  
 Rejou-Michel, A. 1049 (64), 1156  
 Rejwan, M. 251, 254, 262 (7), 291  
 Rekis, A. 437 (124), 473  
 Remedi, M.V. 1230 (79), 1297  
 Rempe, M.E. 178, 188 (92), 203  
 René, L. 589 (308), 592 (335), 623  
 Reno, D.S. 124 (74), 155, 427 (22), 471  
 Rentzepis, P.M. 455 (213), 475  
 Reppond, K.D. 895, 896, 936 (11), 947  
 Repucci, C.M. 846 (36a), 855  
 Resnati, G. 547 (78), 618  
 Resvukhin, A.I. (86), 334  
 Rettig, W. 174, 175 (81), 203, 693 (57, 62), 694 (62, 63), 697 (87), 741  
 Retting, W. 446 (172), 474  
 Rettschnick, R.P.H. 696 (79), 741  
 Reuben, J. 432 (70), 472  
 Reuhle, P.H. 1177 (36), 1212  
 Reutov, O.A. 657 (173), 663  
 Reuwer, J.F.Jr. 910, 933 (33), 947  
 Reybrouck, G. 1118 (420), 1163  
 Reyes, A. 1267, 1275 (161), 1299  
 Reynold, D.W. 727 (167), 744  
 Reynolds, G.A. 655 (156), 662  
 Reynolds, J. 1020 (95), 1037  
 Reynolds, W.F. 505 (156), 510 (199), 522 (247), 529–531, 642 (82), 660  
 Rezvukhin, A.I. 306, 311, 313 (38), 315 (59), 333, 866 (36), 889

- Rhee, E.S. 861 (20), 889, 923 (39, 40), 947  
 Rhee, J. 1134 (510), 1165  
 Rheinboldt, H. 668 (12), 672 (33), 680  
 Rheinbolt, H. 669 (24), 680  
 Rhodes, C.J. 825, 826 (16), 835  
 Rhodes, P. 992 (135), 997  
 Ribeiro da Silva, M.A.V. 349 (32, 33), 374  
 Ribeiro da Silva, M.D.M.C. 357 (67), 376  
 Ribick, M.A. 1047 (43), 1155  
 Ricci, A. 551 (93), 618  
 Rice, S. 96 (45), 102  
 Rice, W.G. 1024 (123, 125–127), 1037  
 Rich, R. 512 (221), 530  
 Richard, C.S. 615 (461), 626  
 Richard, H. 812 (166, 168), 813 (166, 168, 169), 816 (169), 821  
 Richard, W.G. 727 (169), 744  
 Richards, D.A. 1085 (263), 1160  
 Richards, K.E. 883 (90), 890, 954 (24–26), 961 (24), 968 (26), 970, 971  
 Richards, M.K. 983 (83), 989 (104), 996  
 Richards, N.G.J. 41 (63), 82  
 Richardson, E.N. 486 (61), 526  
 Richardson, G.D. 612 (446, 447), 626  
 Richardson, J.H. 401 (136), 420  
 Richardson, R.D. 635 (30), 659  
 Richartz, H. 1180 (54), 1213  
 Riches, K.M. 955 (40), 971  
 Richter, A.F. 440 (138), 473  
 Richter, W.J. 268, 269 (79), 293  
 Rickard, G.J. 219 (91), 246  
 Rickert, D.E. 1020 (97, 98), 1037  
 Ridd, H.J. 915 (35), 947  
 Ridd, J.H. 641 (72), 643 (86, 87), 645 (97), 660, 661, 877 (71), 879 (77–81), 880 (83), 881 (85), 883 (91), 890, 891, 952 (17, 18), 953 (19, 21), 954 (23), 966 (55, 56), 967 (57, 59, 60), 968 (63), 970, 971  
 Ridyard, J.N.A. 171, 172, 174, 175 (75), 193, 197–199 (141), 203, 204  
 Rieder, M.J. 1027, 1028 (154), 1038  
 Rieker, A. 649 (120), 661  
 Riel, H.C.H.A. van 753 (11), 817  
 Riera, A. 545 (70), 618  
 Rietjens, I.M.C.M. 1097 (335), 1162  
 Rife, T.K. 991 (123), 996  
 Rigaudy, J. 581 (257, 258), 622  
 Riggan, R.M. 1176 (25), 1212  
 Říha, V. 507 (178), 529  
 Riley, D.P. 595 (356), 624  
 Riley, J.P. 1064 (104), 1157  
 Riley, T.L. 289 (109), 293, 1177 (36), 1212  
 Rimkus, G. 1127 (460), 1128 (461), 1164  
 Rimland, A. 932 (45), 947  
 Rinaldi, D. 456 (226), 475  
 Rindgen, D. 1119 (429), 1163  
 Ringdahl, B. 131 (93, 94), 132 (93–95), 144, 145 (133), 155, 156  
 Rios, A. 672 (37), 680  
 Rios, A.M. 675 (57), 681  
 Rios, M.A. 15, 16 (26e), 55–57 (82), 82, 83  
 Ripamonti, M. 1068 (136), 1157  
 Rising, A. 1000, 1019 (4), 1035  
 Ritchie, C.D. 1232 (80a–c), 1233 (80c), 1297  
 Ritchie, J.P. 80 (136a, 136b), 84  
 Rithner, C.D. 46 (70), 83  
 Ritieni, A. 539 (39), 617  
 Riva di Sanseverino, L. 98 (77), 103  
 Rived, F. 1225 (62, 66), 1226, 1227 (62), 1297  
 Rivera-Nevarés, J.A. 1134 (505), 1165  
 Riviello, J.M. 1093 (318), 1161  
 Rizzoli, C. 100 (91), 103, 426 (14), 470  
 Roa, M.V. 108 (30), 154  
 Rob, F. 696 (76), 741  
 Robards, K. 1045 (5), 1155  
 Robb, I.D. 844 (25c), 855  
 Robbana-Barnat, S. 1025 (137), 1038  
 Robe, W.E. 1059 (80), 1156  
 Robert, A. 544 (69), 618  
 Roberts, B.G. 1105 (368), 1162  
 Roberts, B.N. 317 (70), 333  
 Roberts, D.J. 317 (70), 333  
 Roberts, I. 510 (206), 530  
 Roberts, J.D. 310 (47, 48), (85), 333, 334, 491 (102), 527  
 Roberts, J.E. 325, 326 (108), 334  
 Roberts, S.M. 669, 673 (17), 680  
 Robertson, R. 370, 371 (103), 378  
 Robertson, R.E. 945 (71), 948  
 Robinson, B. 871 (55), 890  
 Robinson, G.N. 339, 340 (8), 357 (8, 68), 360 (8), 372, 376  
 Robinson, G.W. 446 (175), 474  
 Robinson, J.W. 160 (14), 201  
 Robinson, R. 485 (47, 49), 526  
 Robinson, S.R. 880 (83), 890, 952 (17), 970  
 Robinson, W.T. 456 (220), 475, 790 (112), 820, 883 (89, 92), 890, 891, 954 (27, 28, 30, 33, 35, 36, 39), 956 (28), 962 (30), 969 (36), 971  
 Rochin, G. 605 (407), 625  
 Roddy, P. 991 (123), 996  
 Roder, L. 584 (283), 622  
 Roderer, R. 950 (3), 970  
 Rodgers, A.S. 354 (53), 375  
 Rodgers, J.R. 37 (56), 82  
 Rodgers, M.T. 178, 188 (92), 203  
 Rodgers, S.L. 77 (130), 84  
 Rodier, N. 453 (206), 475  
 Rodina, L.L. 1278 (183), 1300  
 Rodriguez, F.J. 1074 (183), 1158  
 Rodriguez, M. 992 (139), 997  
 Roegler, M. 636 (32), 659  
 Roemming, C. 442 (149), 473

- Roets, E. 1118 (420), *1163*  
 Roger, A. 578 (226), *621*  
 Rogers, D.W. 356 (59), *375*  
 Rogers, R.N. 371 (105), *378*  
 Rogic, M.M. 570 (196), *620*  
 Roizen-Towle, L. 1031 (182), *1039*  
 Rojas-Walker, T.de 1189 (101), *1214*  
 Rojo, J. 537 (23), *617*  
 Rokach, J. 722 (154a), 736 (192a), *743, 745*  
 Rokushika, S. 739 (204), *745*  
 Rolando, C. 240 (188), *248*  
 Roller, R. 234 (153), *247*  
 Rollgen, F.W. 240 (184), *248*  
 Rolli, E. 179 (94), *203, 218 (81), 245*  
 Romani, M. 580 (249), *621*  
 Romano, So. 718 (146), *743*  
 Romeliotis, P. 1180 (55), *1213*  
 Römelt, J. 188–191 (126), *204, 803 (139), 821*  
 Romero, A.M. 1088 (279), *1160*  
 Romero, D.L. 584 (287), *622*  
 Romers, C. 15, 17 (25b), *81*  
 Romesberg, F.E. 396 (89, 91e, 97), *419*  
 Romm, I.P. 381 (9), *416*  
 Rømming, C. 636 (41), *659*  
 Rondon, M.A. 1049 (63), *1156*  
 Ronnett, G.V. 993 (151), *997*  
 Roos, B.O. 455 (218), *475, 790 (114), 820*  
 Rooyackers, D.R. 1078 (196), *1159*  
 Ropp, G.A. 655 (156), *662*  
 Rosa, E. 606 (411), *625, 882 (86), 890*  
 Rösch-Oehme, E. 1003, 1020, 1022 (34), *1035*  
 Rose, J.D. 482, 483 (23), *525*  
 Rosen, W. 1076 (187), *1159*  
 Rosenblatt, D. 684 (1), *740*  
 Rosenkranz, H.S. 1177 (30), *1212*  
 Rosenquist, N.R. 522 (246), *531*  
 Rosenstock, H.M. 208, 210, 217, 237 (18), *244*  
 Rosenzweig, I.B. 1063 (98), *1157*  
 Rosero, F.S. 1048 (58), *1156*  
 Roses, M. 1222 (52), 1223 (72), 1225 (62, 65, 66), 1226 (62, 72), 1227 (62), 1228 (75), *1296, 1297*  
 Rosini, C. 143 (125), *156, 1112 (400), 1163*  
 Rosini, G. 607 (415), 610 (436), *625*  
 Roskamp, E.J. 549 (82), *618*  
 Ross, A.B. 827 (30), *835*  
 Ross, J. 466 (265), *476*  
 Ross, P.F. 1047 (28), *1155*  
 Ross, S.D. 430 (55), 440 (55, 137), 463, 465, 466 (256), *471, 473, 476, 1266 (164), 1299*  
 Rosseel, M.T. 1062 (93), *1156*  
 Rosset, R. 1081 (227, 228), *1159*  
 Rossi, P. 563 (162), *620*  
 Rossi, R.A. 1219 (25), *1295*  
 Rossi, R.H.de 458 (237–239), *476, 1218 (18), 1219 (25), 1220 (27), 1230 (78, 79), 1231 (78), 1264 (18), 1295, 1297*  
 Rossini, F.D. 339 (9, 12), 341 (12), 342 (12, 13), *372*  
 Rössler, K. 649 (122), *661*  
 Roth, M. 1077 (189), *1159*  
 Rotunno, T. 1078 (197), *1159*  
 Roucoules, X. 1061 (91), *1156*  
 Roullier, L. 843 (16), 845 (33), *855*  
 Roullier, R. 1129 (468), 1143 (565), *1164, 1166*  
 Rounbehler, D.P. 1047 (41), *1155, 1184 (64, 68), 1213*  
 Roundhill, D.M. 543 (59, 60), *617*  
 Rousseau, D.L. 987 (100), 989 (105), *996*  
 Roussel, C. 381 (18), *417*  
 Rousselet, G. 590 (321), *623*  
 Routledge, P.J. 457 (234), *476, 1218, 1237, 1251, 1293 (24), 1295*  
 Roux, M.V. 357 (70), *376*  
 Rowe, J.E. 878 (74), *890*  
 Roy, B. 669 (16), *680*  
 Roy, M.B. 833 (68), *836*  
 Royer, G.P. 119 (60), *154*  
 Rozeboom, M.D. 169 (63), *203*  
 Rozen, S. 579 (230, 231), 607 (417), *621, 625*  
 Rózycka-Roszak, S. 431 (58), *471*  
 Ruban, V.F. 1069 (148), 1133 (493), *1158, 1165*  
 Rubanyi, G.M. 673 (42), *681*  
 Rubin, R.L. 1023 (122), *1037*  
 Rubio, M. 1266 (165), *1299*  
 Rütchardt, C. 184, 186 (106), *204, 604 (398), 625, 629 (11), 659*  
 Rudchenko, V.F. 553 (107), *618*  
 Rudd, K. 236 (172), *248*  
 Rudman, R. 97 (63), *103*  
 Rudolf, K. 72 (123), *84*  
 Rudolph, J.P. 400 (125), *420*  
 Rueden, H. 1127 (459), *1164*  
 Ruehl, E. 164, 166, 168 (32), *202*  
 Rufeh, F. 1189 (100), *1214*  
 Rühl, J.C. 832 (63, 64), *836, 839 (8a, 8b), 850 (8b, 52a), 851 (8a, 8b), 855, 856*  
 Rulliere, C. 697 (87, 89), *741*  
 Rumpf, B.A. 236 (171), *248*  
 Rundle, H.W. 235 (160), *247*  
 Rundlett, K. 1095 (326), *1161*  
 Runge, F. 481 (9), *525*  
 Rupp, H.S. 1139 (539, 541), *1166*  
 Rusche, K.M. 983 (83), *996*  
 Ruscic, B. 199 (147), *204*  
 Rusconi, L. 389 (60), *418*  
 Rusic, B. 180 (95), *203*  
 Rusling, J.F. 844 (25a), *855*  
 Russeger, P. 810 (157), *821*  
 Russell, C. 670 (27), *680*

- Russell, G.A. 1020 (95), *1037*  
 Russell, J.J. 215 (57), *245*  
 Russell, S.W. 991 (125), *997*  
 Russelle, M.P. 1049 (65), *1156*  
 Russell-Hill, D.A. 511 (208), *530*  
 Russu, W. 850 (50), *856*  
 Rusyniak, D. 1106 (377), *1162*  
 Rutherford, K.G. 636 (37), *659*  
 Ruttink, P.J.A. 215 (56), *245*  
 Ruyters, H. 1094 (324), *1161*  
 Ryan, E. 1071 (153), *1158*  
 Rybinov, V.I. 631 (20), *659*  
 Ryerson, T.B. 1047 (51), *1155*  
 Rylance, J. 96 (52), *103*  
 Ryzhakov, A.V. 1278 (183), *1300*  
 Rzepa, H.S. 215 (57), *245*
- Saavedra, J.E. 669 (25), *680*  
 Sabatini, A. 57 (93), *83*  
 Sabbah, R. 349 (32), 357 (69), 358 (75), *374, 376*  
 Sabbioni, G. 1021 (106, 107), *1037*  
 Sabek, O. 879 (77, 78, 80), *890*  
 Sabljic, A. 180 (95), *203*  
 Sacchetto, G.A. 1147 (595, 596), 1148 (597), *1167*  
 Sack, T.M. 208 (16), 211 (36), *244*  
 Saczewski, F. 607 (418), *625*  
 Sadec, M. 310, 311 (44), *333*  
 Sadeghi, M.M. 538 (35), *617*  
 Sadler, I.H. 804 (145), *821*  
 Saebo, S. 171 (69), *203*  
 Saegusa, K. 616 (465), *626*  
 Saenger, W. 1245, 1266 (112), *1298*  
 Saenz de Tejada, I. 993 (146), *997*  
 Safenova, T.S. 633 (26), *659*  
 Saghir, N.S. 1048 (61), *1156*  
 Saho, M.K. 1133 (499), *1165*  
 Sahoo, M.K. 833 (67), *836*  
 Sahu, D.P. 536 (20), *617*  
 Saionz, K.W. 1132 (491), *1165*  
 Saito, H. 863 (25), 889, 1078 (206), *1159*  
 Saito, K. 1003 (37), 1004, 1007 (41), 1009 (37, 41), 1012, 1013, 1019 (37), 1034 (41), 1035 (37), *1035, 1083 (245), 1160*  
 Saito, Y. 93 (17), *102*  
 Sakai, K. 1106 (378), *1162*  
 Sakai, S. 654 (149), *662*  
 Sakai, T. 448 (191), *474, 869 (43), 889, 1116 (413, 414), 1163*  
 Sakaino, Y. 812, 813 (166), *821*  
 Sakaïtani, M. 595 (352), *624*  
 Sakamoto, T. 592 (331, 332), *623*  
 Sakan, T. 123 (71), *155*  
 Sakata, K. 585 (293), *622, 765 (47), 818*  
 Sakata, T. 824 (12), *835*  
 Sakata, Y. 695 (69), *741*
- Sake Gowda, D.S. 97 (63), *103*  
 Sakito, Y. 112 (39), *154, 536 (15), 617*  
 Sakiyami, M. 358 (73), *376*  
 Sako, M. 722 (158a), *743*  
 Sakuma, I. 976 (35), *994*  
 Sakurai, H. 163–166, 168 (27), *202, 686 (26), 740*  
 Sakurai, Y. 536 (14), *617*  
 Saladino, R. 560 (135), *619*  
 Salagoity, H.M. 1078 (199), *1159*  
 Salamon, T. 1266, 1267 (167a), *1299*  
 Salamone, S.J. 1106 (377), *1162*  
 Salaun, J. 1112 (402), *1163*  
 Salem, Z. 1024 (129), *1037*  
 Salerno, A. 433 (81), *472*  
 Salerno, S. 1245–1247, 1266 (115b), *1298*  
 Salinas, F. 1139 (538), 1140 (546), *1166*  
 Sallin, K.J. 574 (208), *621*  
 Salter, M. 991 (117), *996*  
 Saltiel, J. 778 (70b), *819*  
 Saltzman, M.D. 484, 485 (44, 45), *526*  
 Salvador, A. 1074 (174), *1158*  
 Salvadori, P. 143 (125), *156, 1112 (400), 1163*  
 Samet, A.V. 852 (59), *856*  
 Sammes, P.G. 735 (191), *745*  
 Samojlova, Z.E. 132, 133 (96), *155*  
 Sample, S. 227 (124), *246*  
 Samuelson, A.G. 569 (190), *620*  
 Sana, M. 410 (187a, 187b), *422*  
 Sanberg, M. 1077 (193), *1159*  
 Sánchez, V.M. 592 (336), *623*  
 Sanchez-Cabezudo, M. 408 (166), *421*  
 Sandall, J.P.B. 877 (71), 881 (85), 883 (91), *890, 891, 915 (35), 947, 953 (21), 966 (55, 56), 967 (59, 60), 968 (63), 970, 971*  
 Sandberg, M. 1074 (182), *1158*  
 Sande, M.A. 1027 (153), *1038*  
 Sander, J. 1127 (453), *1164*  
 Sanders, D.R. 1177 (30), *1212*  
 Sandford, G. 435 (107), *472*  
 Sandhu, J.S. 569 (193), 608 (427), *620, 625*  
 Sandi, E. 1189 (93), *1214*  
 Sandine, W.E. 1116 (407), *1163*  
 Sandman, D.J. 440 (138), *473*  
 Sandoval, T.M. 1097 (336), *1162*  
 Sandros, K. 779 (75), *819*  
 San Filippo, J. 861 (21), 863 (21, 23), *889*  
 San Filippo, J.Jr. 905 (29), 911 (34), 915 (36), *918, 920 (37), 947*  
 Sankaraman, S. 455 (215, 216), 456 (221), *475, 790 (109a, 111a), 820*  
 Sano, A. 1147 (587), *1167*  
 Sano, T. 649 (120), *661*  
 Sansone, E.B. 1197 (103), *1214*  
 Santa, T. 1091 (303), *1161*  
 Santa Ana, M.A. 456 (223), *475*  
 Santamaria, J. 581 (257, 258), *622*

- Santi, C. 1152 (625), *1168*  
 Santiesteban, F. 1109 (392), *1163*  
 Santini, S. 99 (79), *103*  
 Santoni, G. 1116 (409), *1163*  
 Santos, M.A. 59, 60 (101), *83*  
 Santos-Delgado, M.J. 1135 (513), *1165*  
 Santus, R. 781 (83), *819*  
 Sarada, N.C. 854 (68), *856*  
 Sarbolouki, M.N. 1074 (181), *1158*  
 Sargeson, A.M. 851 (53, 54), 854 (54), *856*  
 Sarker, H. 854 (66), *856*  
 Sarma, J.C. 537 (29), *617*  
 Sarofim, A. 1175 (17), *1212*  
 Sarti-Fantoni, P. 780 (82), *819*  
 Sartori, F. 93 (28), *102*  
 Sartorius, I. 692 (52), *741*  
 Sarwar, G. 1085 (262), *1160*  
 Sasaki, M. 460 (246, 247), *476*  
 Sasaki, S. 651, 657 (132), *661*  
 Sasaki, Y. 595 (359b), 624, 1097 (338), *1162*  
 Sastry, K.A.R. 565 (173), *620*  
 Satapathy, S.N. 645 (100), *661*  
 Satish, A.V. 401, 402 (133), 403 (140), 407 (159), *420, 421*  
 Sato, D. 396 (93), *419*  
 Sato, H. 308, 309 (42), *333*  
 Sato, K. 587 (297), *622*  
 Sato, M. 605 (408), 625, 1087 (276), *1160, 1218, 1219, 1237 (21a, 21b), 1295*  
 Sato, S. 537 (22), *617, 1004, 1007, 1009, 1012, 1019 (43), 1033, 1034 (198), 1035 (43), 1036, 1039*  
 Sato, T. 112 (40), *154, 649 (120), 661*  
 Sato, Y. 730 (178, 181b, 181c, 182b), 734 (188a), *744*  
 Satoh, T. 585 (293), *622*  
 Satyamurthy, N. 652, 653 (140), 656 (165), *662*  
 Saunders, K.H. 628, 629, 636 (5), *659*  
 Saunders, M. 356 (59), *375*  
 Saunders, R.A. 206, 207, 233 (2f), *243, 265 (69), 293*  
 Saunders, W.H. 509 (191), *530, 859 (12), 889*  
 Saunders, W.H.Jr. 894 (5), 895, 896, 936, 939 (10), *946, 947*  
 Saupe, T. 176 (89), *203, 435 (101), 472*  
 Saurina, J. 1097 (340), *1162*  
 Sausa, R.C. 1125 (444), 1135 (519), *1164, 1165*  
 Savage, W.J. 164 (39), *202*  
 Savčiant, J.M. 840, 848 (9), *855*  
 Savelli, G. 1220 (32a, 32b), *1296*  
 Saville, B. 671 (30), *680*  
 Savoia, D. 564 (168), *620*  
 Sawaada, M. 1232, 1233 (80c), *1297*  
 Sawada, M. 489, 496 (86), 504 (153), 521 (86), *527, 529, 1114 (405), 1163*  
 Sawada, T. 651, 657 (132), *661*  
 Sawatzky, H. 1067 (125), *1157*  
 Sawaura, M. 757 (28), *818*  
 Sax, N.I. 1053, 1054, 1058, 1115, 1124, 1144 (69), *1156*  
 Saxon, R.P. 882 (87), *890*  
 Sayakhov, R.D. 506 (175), *529*  
 Sayegh, H.S. 979 (75), *995*  
 Sayo, H. 1015 (87), *1037*  
 Scaiano, J.C. 658 (175), 663, 755 (19), 771 (58), *818, 819*  
 Scaicno, J.C. 688 (38), *740*  
 Scalán, R.A. 1188 (90), *1214*  
 Scandroglio, A. 1085 (261), *1160*  
 Scettri, A. 777 (68), *819*  
 Schaad, L.J. 148 (145, 146), *157, 910, 933 (33), 947*  
 Schaal, R. 415 (206), *422*  
 Schadewaldt, P. 1060 (84), *1156*  
 Schaefer, H.F.III 1285, 1290 (197), *1300*  
 Schaefer, J. 322 (97, 98, 100), 325 (109), *334*  
 Schaefer, W.P. 444 (162), *474*  
 Schaeffer, C.A. 1024 (123, 125, 126), *1037*  
 Schäfer, H.J. 849 (49), *856*  
 Schafer, L. 5, 16, 22 (8), 24 (36), 56 (85), *81–83*  
 Schäfer, W. 199 (148), *204, 1001 (24, 26), 1003 (24), 1004 (24, 26), 1007 (24), 1009–1012 (24, 26), 1013 (24), 1014 (24, 26), 1015 (26), 1035*  
 Schaffrath, R.E. 554 (110), *618*  
 Schamp, N. 569 (191), *620*  
 Schanze, K.S. 444 (163), *474*  
 Schappert, K.T. 979 (72), *995*  
 Schechter, R.S. 844 (25b), *855*  
 Scheepers, P.J.T. 1129 (475), *1164*  
 Scheepers, P.T.J. 1132 (489), *1165*  
 Scheffer, J.R. 710 (111), *742*  
 Scheiner, S. 27 (41), *82*  
 Schell, F.M. 728 (170), *744*  
 Schep, L.J. 1118 (423), *1163*  
 Schepens, P.J.C. 1142 (560), *1166*  
 Schepert, T. 1103 (363), *1162*  
 Scher, A.L. 1135 (518), *1165*  
 Scherer, J.R. 151, 152 (160), *157*  
 Scherer, T. 446 (171, 173), *474, 694 (61, 65), 741*  
 Scheutzle, D. 1177 (36), *1212*  
 Schiesser, C.H. 655 (161), *662*  
 Schiff, H.I. 235 (160), *247*  
 Schijnadel, J.A.M.van 99 (86), *103*  
 Schini-Kerth, V.A. 992 (140), *997*  
 Schinke, U. 904 (27, 28), *947*  
 Schlageter, M.G. 512 (217, 218), *530*  
 Schleifer, L. 14–17, 19–21 (22a), *81*  
 Schlemper, H. 394 (80a), *419*  
 Schlessinger, R.H. 717 (143a), *743*

- Schleyer, P.v.R. 3–5, 29 (1c), 34 (48), 81, 82, 356 (60), 375, 381, 395 (14b), 397 (103), 416, 420
- Schmahl, D. 1185 (70), 1213
- Schmalzing, D. 1083 (244), 1160
- Schmeltekopf, A.L. 235 (161), 247
- Schmid, H. 642 (77), 644 (94), 660, 860 (18), 889
- Schmid, J.P. 1176 (27), 1212
- Schmid, P. 899 (24), 947
- Schmidt, B. 1063 (101), 1157
- Schmidt, D.G. 652, 653 (140), 662
- Schmidt, G.M. 436 (119, 120), 473
- Schmidt, H.H.H.W. 977 (46, 48, 49), 978 (49), 995
- Schmidt, H.L. 1059 (81), 1103 (359), 1156, 1162
- Schmidt, K. 985 (92), 990 (109), 991 (122), 992 (136, 137), 996, 997
- Schmidt, R. 762 (40), 818, 1063 (101), 1157
- Schmidt, W. 187 (111), 204
- Schmidtbase, D. 396 (91f), 419
- Schmidtchen, F. 1220 (35), 1296
- Schmidtchen, F.P. 393, 394 (78), 419
- Schmitt, R.J. 605 (405), 606 (412), 625
- Schmitt, W. 584 (288), 622
- Schmitz, E. 553 (105), 618
- Schmitz, L.R. 4, 7, 9, 12, 21, 23 (6), 24 (6, 34), 25–27 (6), 29 (42), 38, 61 (6), 81, 82
- Schmutz, J. 63 (110a), 84
- Schneider, H.R. 316, 317 (66), 333
- Schneider, M.P. 1092 (306), 1161
- Schneider, S. 685 (19), 686 (24, 31), 687 (31), 699 (24), 700 (24, 99), 701, 704 (99), 706 (24), 740, 742, 767 (53), 819
- Schneider, T.W. 1081 (229), 1159
- Schneller, M. 1001, 1003 (22, 23), 1006, 1007, 1009–1011 (22), 1025 (22, 23), 1035
- Schneider, S. 697 (83), 741
- Schnur, J.M. 795 (120), 820
- Schnur, R.C. 582 (263), 622
- Schoeler, H.F. 1134 (508), 1165
- Schoemaker, H.E. 142 (124), 156
- Schoen, P.E. 795 (120), 820
- Schofield, K. 880 (84), 890, 949 (1), 958 (47–49), 969 (1), 970, 971
- Scholer, H.F. 1134 (509), 1165
- Schollenberger, M. 1079 (213), 1159
- Schöneich, C. 832 (55, 56), 836
- Schoone, J.C. 90, 93 (19), 102
- Schoonover, J.R. 739 (207), 745
- Schorr, M. 584 (288), 622
- Schouten, A. 99 (86), 103
- Schreiber, J. 1019 (91), 1037
- Schrem, G. 25, 38 (38), 82
- Schröder, D. 262 (57), 292
- Schroeder, G. 435 (108, 112), 459 (242, 243), 460 (248), 472, 473, 476, 509 (190), 530
- Schroeder, L.A. 1082 (238), 1160
- Schuchmann, H.-P. 824 (6, 8), 829 (46), 835, 836
- Schuchmann, M.N. 824 (6), 835
- Schuddeboom, W. 697 (85), 741
- Schuetzle, D. 289 (109), 293, 1176 (21), 1177 (31), 1212
- Schug, J.C. 434 (86), 472
- Schuhmann, W. 1103 (359), 1162
- Schüle, U. 184, 186 (106), 204
- Schullery, S.E. 427 (25), 471
- Schulltz, H.P. 838, 840, 848 (7b), 855
- Schulman, J.M. 317 (71, 72), 333
- Schulte-Frohlinde, D. 750 (7), 778 (70a, 72), 817, 819
- Schultz, G. 983 (86), 996
- Schultze, O.W. 482 (24), 525
- Schumann, U. 396 (95), 419
- Schupp, H. 767 (53), 819
- Schurig, V. 121 (65, 66, 68), 122 (69), 123 (69, 70), 155
- Schusslbauer, W. 697 (83), 741
- Schuster, D.I. 688 (35–38), 740
- Schwabe, M. 850 (50), 856
- Schwalbe, C.H. 94 (39, 40), 102
- Schwan, A.L. 589 (314), 623
- Schwartz, M.A. 535 (9, 10), 616
- Schwartz, S.E. 641 (70), 660
- Schwarz, H. 206 (1), 208 (9, 10), 209 (24, 28, 31, 32), 211 (40), 216 (63c), 220 (96–98), 221 (97, 98), 232 (97, 98, 144), 234 (150), 243–247, 250 (2), 251 (6), 253 (12, 15), 254 (15, 17), 255 (15), 259 (46), 260 (15, 49), 262 (57), 264 (62), 268 (77, 79), 269 (79), 291–293
- Schwarz, W. 650 (124), 661
- Schwarz, W.H.E. 848 (43), 856
- Schweig, A. 160 (13), 201
- Schweizer, W.B. 60 (104), 84
- Schwesinger, R. 393 (79), 394 (80a, 80b), 419
- Schwetlick, K. 722 (153c), 743
- Schwinck, K.F. 178, 188 (92), 203
- Scopes, D.I.C. 598 (376), 624
- Scorrano, G. 381 (5b), 405 (153), 416, 421, 1012 (78), 1036, 1220 (29a–c), 1296
- Scottichini, C.L. 846 (36a), 855
- Scott, F.L. 632 (21), 646 (102), 659, 661
- Scott, G.L. 1027 (150), 1038
- Scott, J.A. 411 (193), 422
- Scott, J.C. 1150 (610), 1167
- Scott, P.M. 1189 (93), 1214
- Scott, R.D. 724 (162f), 743
- Scott, R.M. 427 (25), 471, 1267 (161, 169), 1275 (161), 1299
- Scranton, M.I. 1058 (76), 1156
- Scribe, P. 1068 (139), 1158

- Scrimin, P. 405 (150b), 421  
 Scriven, E.F.V. 537, 553 (24), 617  
 Scuseria, G.E. 319, 320 (82), 334  
 Sdmeier, J.L. 57 (90c), 83  
 Seaman, S.W. 1147 (588), 1167, 1187 (82),  
 1189 (96, 98), 1214  
 Seaver, S.S. 1077 (191), 1159  
 Sedaghat-herati, M.R. 1273, 1275, 1283 (178),  
 1299  
 Seddon, K.R. 428 (29), 471  
 Sedgwick, R.D. 234 (157), 247  
 Sedov, A.L. 633 (26), 659  
 Seebach, D. 96 (49), 102, 564 (169), 583  
 (275), 620, 622  
 Seebach, E. 405 (146), 421  
 Seeger, R. 407 (163), 421  
 Seel, F. 641 (74), 660  
 Seff, K. 96 (45), 102  
 Sēgalas, I. 100 (88), 103  
 Segre, A.L. 390 (62), 418  
 Seiber, J.N. 1132 (490), 1135 (515), 1165  
 Seibl, L. 251 (9), 291  
 Seiji, Y. 870 (47), 890  
 Seiler, P. 60 (104), 84  
 Seinfeld, J.H. 1180 (58, 59), 1213  
 Seitz, W.R. 1125 (442), 1164  
 Seitzinger, S.P. 1060 (85), 1156  
 Seki, S. 358 (73), 376, 1122 (440), 1164  
 Sekido, K. 96, 97 (59), 103  
 Sekiguchi, M. 651, 657 (132), 661  
 Sekiguchi, S. 457 (233), 458 (236, 238), 475,  
 476, 1218, 1219 (20b, 20c, 21a, 21b), 1220  
 (20b, 20c), 1237 (21a, 21b), 1290 (20b,  
 20c), 1295  
 Sekine, A. 722 (159c), 743  
 Sekiya, M. 553 (109), 618  
 Selala, M.I. 1142 (560), 1166  
 Selander, L. 171 (76), 203  
 Self, V.A. 1175 (13), 1212  
 Selim, S. 1187 (79), 1213  
 Selinger, A. 262 (54), 292  
 Sellers, P. 339 (11), 372  
 Semeniuk, S. 1139 (533, 540), 1166  
 Semenov, V.V. 852 (59), 856  
 Semsel, A.M. 1105 (368), 1162  
 Sen, D.C. 675 (58), 681  
 Sen, N. 1145 (573), 1166  
 Sen, N.P. 1145 (576), 1147 (588), 1167, 1187  
 (81, 82), 1189 (93, 96, 98), 1213, 1214  
 Senda, H. 94 (38), 102  
 Senda, M. 1122 (439), 1164  
 Senderowitz, H. 14 (22b), 15, 16 (22b, 26c,  
 26d), 17–19 (22b), 20 (27–29), 81, 82  
 Sendjarevic, V. 896 (17), 947  
 Senet, J.-P. 582 (264), 622  
 Sengupta, S. 536 (20), 617  
 Sen Hii, P. 442 (150), 473  
 Senning, A. 591 (324), 623  
 Senoh, S. 123 (71), 155  
 Sensior, R.J. 441 (144), 473  
 Sentier, L. 1069 (142), 1158  
 Sera, N. 1131 (487), 1165  
 Serjeant, E.P. 381 (3, 4b), 416, 491, 500  
 (107b), 519 (235), 527, 530  
 Sermon, P.A. 1175 (13), 1212  
 Serov, Y.V. 646 (102), 661  
 Servais, B. 434 (91), 472  
 Seshadri, R. 441 (144), 473  
 Sessa, W.C. 977 (51), 978 (57), 995  
 Sesse, W.C. 979 (73), 995  
 Sessions, R.B. 66, 67 (111), 84, 166, 168, 179  
 (52), 184 (52, 98, 105), 185 (52), 202, 203,  
 390 (67), 419  
 Setiarahardio, I.U. 1228, 1232–1235, 1239  
 (77), 1297  
 Seto, C.T. 430 (45, 49–52), 471  
 Ševčík, J. 392 (75), 419  
 Sevilla, M.D. 830 (51), 836  
 Seyedrezai, S.E. 402 (139), 420  
 Sgarabotto, P. 99 (79), 103, 426 (14), 445  
 (164), 470, 474  
 Shaddock, J.G. 1033 (203), 1039  
 Shah, B. 447, 450 (181), 474, 854 (65), 856,  
 1000, 1005, 1007, 1016, 1019 (3), 1035  
 Shaik, S. 161, 173 (19), 202  
 Shaik, S.S. 409 (173), 421, 943 (68), 948,  
 1245 (118a, 118b, 120a, 120b), 1298  
 Shalaby, A.R. 1083 (247), 1160  
 Shang, M. 601 (385), 624  
 Shao, J.-D. 264, 265 (65), 293  
 Shapiro, M.J. 130 (91), 155  
 Shapiro, R.A. 979 (76), 995  
 Sharipova, S.Kh. 139 (114, 115), 156  
 Sharma, C.V.K. 452 (199), 475  
 Sharma, D.K. 765 (44–46), 818, 1109 (391),  
 1163  
 Sharma, R.D. 1109 (391), 1163  
 Sharma, R.P. 537 (29), 617  
 Sharma, S. 99 (81), 103  
 Sharma, S.K. 564 (167), 620  
 Sharma, V.K. 829 (47), 836  
 Sharping, G. 1081 (230, 231), 1159  
 Sharples, R.E. 369 (95), 378  
 Sharpless, K.B. 125 (77), 155, 572 (200, 201),  
 620  
 Shastri, L.V. 827 (27), 835  
 Shatenshtein, A.I. 398 (114), 420  
 Shaw, A.J. 1141 (556), 1166  
 Shaw, D. 297 (12), 332  
 Shaw, F.R. 486 (58), 526  
 Shaw, M.J. 581 (255), 622  
 Shaw, R. 354 (53), 375  
 Shaw, S.J. 1119 (425), 1163  
 Shea, R.G. 575 (209), 621

- Sheer, D. 979 (77), 995  
 Sheldrick, G.M. 99 (80, 84), 103  
 Shelkovskii, V.S. 1119 (431, 432), 1164  
 Shen, N.H. 1033 (199, 201), 1039  
 Shen, X. 827 (34), 835  
 Shepherd, M.G. 1118 (423), 1163  
 Sheppard, W.A. 515, 519 (230), 530  
 Sheridan, R.S. 353 (49), 375  
 Sherma, J. 1069 (141), 1158  
 Sherman, P.A. 991 (116), 996  
 Sherwood, C.H. 1116 (410), 1163  
 Sherwood, R.A. 1085 (263), 1160  
 Sheta, E.A. 989 (101), 996  
 Shevedlev, S.A. 550 (85), 618  
 Shevlin, G. 1148 (600), 1167  
 Shevlin, P.B. 633 (22), 659  
 Shi, X. 554 (111), 618  
 Shiao, M.J. 534 (6), 616  
 Shibasaki, M. 578 (223), 621  
 Shibata, S. 111 (37), 154, 442 (151), 473  
 Shibata, T. 123 (72), 155  
 Shibuya, T. 1073 (165), 1158  
 Shigemitsu, Y. 704 (108), 722 (155), 742, 743  
 Shiina, I. 593 (340), 623  
 Shim, S.C. 543 (61), 617  
 Shima, K. 561 (146, 147, 149), 562 (150), 588 (304), 619, 623, 704 (103–106), 706 (106), 742  
 Shimada, A. 502 (147), 529  
 Shimada, I. 396 (93), 419  
 Shimada, K. 722 (158a), 743  
 Shimada, R. 1067 (124), 1157  
 Shimada, T. 1131 (488), 1165  
 Shimao, I. 865 (31), 866 (32, 33), 889  
 Shimizu, K. 432, 443 (72), 472, 536 (14), 617, 1220 (44), 1296  
 Shimojo, T. 1089 (289, 290), 1161  
 Shimoni, L. 452 (199), 475  
 Shimorichi, A. 977, 979 (50), 995  
 Shin, D.M. 697 (90), 741  
 Shine, H.J. 859 (6, 9, 15, 16), 860 (17), 861 (16, 17, 19–21), 863 (21–23), 865 (27, 28), 867 (37, 39), 873 (58), 877 (72), 888–890, 897 (22), 899 (23, 24), 904 (26), 905 (29), 911 (34), 915 (36), 918, 920 (37), 922 (38), 923 (39, 40), 928 (41), 930 (42), 947  
 Shiner, V.J.Jr. 896 (16, 17), 945 (70), 947, 948  
 Shinham, K. 654 (148), 662, 666 (6), 667, 670 (6, 11), 672 (6, 34), 677 (76), 678 (11, 78), 680–682  
 Shinkai, S. 448 (191), 474, 869 (43), 870 (47), 889, 890, 1119 (430), 1163  
 Shinohara, A. 724 (162b), 743  
 Shinohara, R. 1065 (113), 1157  
 Shioiri, T. 538 (34), 617  
 Shioji, K. 650 (126), 661  
 Shiomori, K. 562 (150), 619, 704 (104), 742  
 Shiota, T. 579 (232, 236), 621  
 Shiro, M. 324 (105), 334  
 Shiromaru, H. 193, 197 (142), 204  
 Shirosaki, T. 787 (101), 820  
 Shirota, O. 1093 (321), 1161  
 Shishulina, A.V. 592 (339), 623  
 Shivhare, P. 1138 (532), 1166  
 Shizuka, H. 704 (102), 722 (153b), 742, 743, 758 (32b), 818  
 Shizuma, M. 1114 (405), 1163  
 Shobana, N. 556 (119), 619  
 Shoichi Ide (88), 334  
 Shon, Y.S. 537 (30), 617  
 Short, R.L. 97 (66), 103  
 Shorter, J. 434 (85), 445 (165), 472, 474, 480 (1–6), 481 (1–3, 5, 6), 482, 483 (6), 484 (46), 485 (5, 46), 486 (5), 487 (70, 71, 75, 76), 488 (79, 81), 489 (75, 76, 84), 490 (76), 491 (103–105), 492 (108), 493 (79), 494 (119, 123), 496 (84, 127, 129, 130), 497 (132), 498 (104, 136), 501 (143, 144), 502 (143–145, 148), 503 (143, 144, 149), 505 (76), 511 (210–212), 512 (5, 6), 514 (5, 79), 515 (46), 517 (234), 519 (79, 234), 520 (143, 144), 522 (75, 76, 84), 523 (76), 525–530, 1241, 1262, 1264 (103b), 1298  
 Shosenji, H. 950 (14), 970  
 Shou, H. 694 (67), 741  
 Shoute, L.C.T. 824 (9), 827 (31), 835  
 Shpinell, Y.I. 636 (35), 659  
 Shreeve, J.M. 593 (345), 623  
 Shudo, K. 872 (56), 873 (57), 890, 1029 (166), 1038  
 Shuely, W.J. 381 (20b), 417, 428 (42), 471  
 Shug, J.C. 1262, 1266 (146), 1299  
 Shugard, A. 767 (50a), 819  
 Shustov, G.V. 133 (98–101), 146 (136, 137), 148, 149, 152 (149, 150), 155–157  
 Shutov, G.V. 149 (151), 157  
 Shuttleworth, L. 630 (13), 659  
 Siak, J.S. 1176 (22), 1212  
 Siam, K. 24 (36), 56 (85), 82, 83  
 Sibi, M.P. 303 (31), 305 (31, 32), 308 (36), 333  
 Sibi, M.S. 317 (76), 334  
 Sicinska, W. 310, 311 (50), 333  
 Sicking, W. 161 (20), 165, 166, 192 (45), 202  
 Sieck, L.W. 211 (37), 244, 384 (25a), 385 (36), 417, 418, 1238 (90), 1297  
 Sieffen, W. 666 (3), 680  
 Siegfried, B. 650 (128), 654 (148), 657 (168), 661, 662  
 Siepmann, T. 425 (6), 470  
 Sies, C.W. 954, 962 (30), 971  
 Sievers, R.E. 1047 (42, 51), 1155  
 Sievert, C. 1046 (12), 1155  
 Siew, P.-Y. 91, 93 (21), 102



- Sigsby, M.L. 238 (176), 248  
 Sik, V. 315 (60), 333  
 Silber, J.J. 433 (81), 440 (139–141), 463 (254), 464 (255), 467 (271), 472, 473, 476, 1217 (9), 1220 (33), 1235–1237 (9), 1244 (110), 1245 (110, 115a, 115b, 116a, 116b, 117), 1246 (9, 115a, 115b, 116a, 116b, 117), 1247 (9, 115a, 115b), 1266 (115a, 115b), 1276 (9), 1295, 1296, 1298  
 Silber, J.A. 1049 (68), 1156  
 Siling, S.A. 353 (50), 375  
 Silva, J.M. 1030 (172, 173), 1038  
 Silverman, D.T. 1180 (52), 1213  
 Silverman, G.S. 567 (184), 620  
 Silvestro, A. 506 (166, 167), 510 (167), 529  
 Silvestro, T. 506 (170), 529  
 Simanek, E.E. 430 (47, 49, 51–53), 471  
 Simard, R.E. 1104 (366, 367), 1162  
 Simeonsson, J.B. 1125 (444), 1135 (519), 1164, 1165  
 Simic, M.G. 827 (36), 835  
 Simister, E. 1119 (436), 1164  
 Simister, E.A. 1119 (434), 1164  
 Simmaco, M. 1083 (250), 1160  
 Simmons, F.W. 1048 (62), 1156  
 Simmons, R.L. 979 (76), 995  
 Simmons, W.W. 992 (127), 997  
 Simoes, A.M.N. 1228 (75), 1297  
 Simon, D.I. 673 (43, 45), 681  
 Simon, J. 848 (45), 856  
 Simonne, E.H. 1046 (10), 1155  
 Simons, J.P. 1102 (356), 1162  
 Simons, S.S.Jr. 1077 (190), 1159  
 Simon-Sarkadi, L. 1069 (144), 1158  
 Simpson, D.J. 810 (156), 821  
 Simpson, J. 100 (94), 103  
 Simpson, J.T. 685 (18, 21, 22), 698 (22), 740  
 Sims, G.K. 1045 (4), 1154  
 Sims, L.B. 895, 896, 936 (11), 947  
 Sindona, G. 226 (120), 246  
 Singaram, B. 118, 119 (55), 154, 536 (18), 617  
 Singel, D. 673 (43), 681  
 Singel, D.J. 673 (44, 45), 681  
 Singh, G. 639 (62), 660, 722 (158b), 743  
 Singh, J.O. 440 (139, 140), 464 (255), 467 (271), 473, 476, 1217, 1235–1237 (9), 1244 (110), 1245 (110, 116a, 116b, 117), 1246 (9, 116a, 116b, 117), 1247, 1276 (9), 1295, 1298  
 Singh, M. 579 (233a, 233b), 621, 1049 (66), 1156  
 Singh, M.P. 537 (26), 617  
 Singh, T. 721, 722 (152), 743  
 Singh, U.C. 3 (2a), 60 (103b), 81, 83  
 Singhal, R.P. 1127 (453, 454), 1164  
 Singh Mankotia, A.K. 721, 722 (152), 743  
 Sinibaldi, M. 1091 (298, 299), 1093 (314), 1161  
 Sinke, G.C. 338, 361 (2c), 363 (87), 372, 377  
 Sino-Alfonso, E.F. 1088 (278), 1160  
 Sinsheimer, E. 1247 (122), 1298  
 Sinsheimer, J.E. 434 (96), 472  
 Sinta, R. 658 (175), 663  
 Sintoni, M. 459 (240), 476, 1217, 1245 (8), 1295  
 Sintori, M. 1280 (186), 1300  
 Sioda, R. 847 (40a), 856  
 Sirois, M. 260–262 (52), 292  
 Sirviö, H. 1118 (418), 1163  
 Sitrin, N.F. 979 (78), 995  
 Siuzdak, G. 226 (117), 246  
 Siva, P. 537 (27), 617  
 Skaane, H. 236 (172), 248  
 Skancke, P.N. 188 (124), 204  
 Skarjune, R. 554 (115a), 619  
 Skarping, G. 1063 (97), 1157  
 Skewes, L.M. 1177 (36), 1212  
 Skiff, W.M. 38–40 (58), 82  
 Skih, I.K. 1025 (140), 1038  
 Skinner, G.A. 949 (2), 970  
 Skipper, P.L. 1009, 1010 (61), 1021 (103, 108), 1030 (103), 1034 (61), 1036, 1037  
 Skjold, A.C. 638 (51), 660  
 Skolimowski, J. 53, 54 (78), 83  
 Skowronski, R. 53, 54 (78), 83, 1148 (602), 1167  
 Skrabal, P. 644 (93), 660  
 Skrobot, L. 1029 (159), 1038  
 Skrypec, D.J. 1189 (95), 1214  
 Skvortsov, I.M. 347 (25), 373  
 Sladowska, H. 561 (145), 619  
 Slayden, S.W. 338, 339 (1), 342 (1, 14), 343 (1, 15), 344–346 (1), 348 (29), 360 (14), 361 (83), 371–373, 377  
 Sleep, D. 1059 (80), 1156  
 Sleiter, G. 1262, 1264 (147a), 1299  
 Sliwka, H.-R. 152 (162), 157  
 Small, L.E. 400 (125), 411 (185), 420, 422, 436 (116), 473  
 Small, R.W. 96 (52), 103  
 Small, R.W.H. 98 (78), 99 (82), 103  
 Smentowski, F.J. 1000, 1009, 1019 (5), 1020 (95), 1035, 1037  
 Smetana, I. 1079 (215), 1159  
 Smeyers, Y.G. 1285 (195, 196), 1300  
 Smirnov, K.S. 352 (43), 374  
 Smith, B.J. 355 (55), 375, 384 (28c, 31), 417  
 Smith, B.L. 1189 (93), 1214  
 Smith, D.F. 1133 (503), 1165  
 Smith, D.J.H. 595 (357), 624, 737 (196), 745  
 Smith, D.W. 688 (34), 740  
 Smith, G.A. 227 (125), 246  
 Smith, G.G. 505 (160), 529

- Smith, G.R. 441 (144), 473  
 Smith, H.E. 106, 107 (1), 112 (38), 130 (1),  
 133 (1, 38, 102–105, 110), 134 (103, 105),  
 135, 136 (38, 104, 105), 137 (1, 38, 104,  
 107–110, 112), 138 (109, 110), 139 (110),  
 148 (142–144, 146–148), 152 (147, 148,  
 164), 153–157  
 Smith, H.W. 96 (48), 102  
 Smith, J.C. 485 (47), 526  
 Smith, J.H. 1266 (158), 1299  
 Smith, J.W. 380, 390 (1), 416  
 Smith, L.A. 457 (233), 475  
 Smith, N.K. 350 (37), 374  
 Smith, P.C. 1066 (114), 1157  
 Smith, P.J. 893, 933, 934, 938, 945 (1), 946  
 Smith, R.D. 220 (103), 246  
 Smith, R.E.A. 673 (40), 681  
 Smith, R.F. 540 (43), 617  
 Smith, R.L. 1064 (103), 1157  
 Smith, S.C. 429 (44), 471  
 Smith, T.W. 992 (127, 133), 997  
 Smith, W.C. 442 (148), 473  
 Smith, W.J. 1047 (24), 1155  
 Smith, W.M. 838 (5), 855  
 Smittle, D.A. 1046 (10), 1155  
 Smolskii, G.M. 1135 (517), 1165  
 Smooke, M.D. 1174 (4), 1212  
 Smyth, T.A. 950 (4, 7, 9), 958 (9), 970  
 Snaith, R. 396 (92, 96), 419  
 Snorn, E.C.G. 494, 495, 519 (124), 528  
 Snow, M.R. 58 (94), 83  
 Snowman, A.M. 991 (125), 997  
 Snyder, J.K. 130 (89), 155  
 Snyder, S.H. 976 (42–44), 977 (44), 978 (43,  
 69), 979 (76), 983 (43), 984 (90), 991  
 (125), 992 (42, 43, 142, 143), 993 (151),  
 995–997  
 Sobczyk, L. 322, 323 (96), 334, 435  
 (108–111), 472  
 Sobel, H. 674 (51), 681  
 Soda, S. 722 (159b), 743  
 Soenger, W. 427 (27), 471  
 Sohn, D.S. 936 (54), 948  
 Sokol, H.A. 1177 (34), 1212  
 Sokol, K. 993 (147), 997  
 Sokoluk, B. 1023 (119), 1037  
 Sole, A. 640 (67), 660  
 Solgadi, D. 810 (158), 821  
 Sollinger, S. 1127 (459), 1164  
 Soloshonok, V.A. 547 (78), 618  
 Somfai, P. 120 (61), 154  
 Somich, C. 733 (183a), 744  
 Somlai, C. 1089 (288), 1161  
 Sommer, S. 1046 (12), 1155  
 Sommer, S.G. 1047 (26), 1155  
 Son, H.S. 563 (155), 620  
 Son, Y. 108 (27), 154  
 Sonawane, H.R. 578 (225), 621  
 Sone, T. 448 (191), 474, 588 (304), 623, 869  
 (43), 870 (47), 889, 890  
 Song, X. 173 (79), 203  
 Songstad, J. 674 (51), 681  
 Songster, M.F. 564 (167), 620  
 Sonntag, C.von 824 (6–8), 828 (43), 829 (46),  
 835, 836  
 Sono, S. 565 (176), 620  
 Sonoda, N. 563 (159), 596 (368), 620, 624  
 Sonoda, T. 635 (31), 659  
 Sonola, O.O. 109 (33), 110 (33, 34), 113 (33,  
 42), 154  
 Sorensen, H. 779 (75), 819, 1096 (329), 1161  
 Sorriso, S. 85 (1), 86 (1, 2), 88, 95 (1), 99  
 (79), 102, 103  
 Sosnovsky, G. 551, 552 (96), 618  
 Sotomatsu, T. 506 (173), 529  
 Soucek, J. 1135 (514), 1165  
 Soucek, M. 756 (21), 757 (24), 789 (105), 818,  
 820  
 Soudais, P. 1217 (17), 1295  
 Sourbais, N. 1217 (16), 1295  
 Sousa, L.R. 738 (201), 745  
 South, M.S. 577 (221), 621  
 South, T.L. 1024 (126), 1037  
 Sowder, R.C. 1024 (127), 1037  
 Sozzi, G. 212 (43, 48–50), 216 (48–50, 60),  
 222 (43, 48–50), 233 (145), 244, 245,  
 247  
 Spagnolo, P. 1012, 1013 (79), 1036  
 Spaltenstein, A. 575 (209), 621  
 Spanka, G. 165, 166 (48, 49), 181, 182 (48),  
 202  
 Sparfel, D. 580 (252b), 621  
 Sparks, R.K. 795 (121), 820  
 Spaziano, V.T. 590 (322), 623  
 Spear, R.J. 303 (27), 332  
 Speck, L. 991 (118), 996  
 Speckamp, W.N. 166, 187 (54), 202, 568  
 (187), 620  
 Speckmann, A. 1004 (45), 1009, 1010 (63),  
 1014, 1015, 1019 (45), 1036  
 Speijers, G.J.A. 1188 (86), 1214  
 Speir, J.P. 390 (71), 419, 1284, 1285 (194b),  
 1300  
 Spellmeyer, D.C. 72 (122b), 84, 386 (46), 418,  
 655 (161), 662  
 Spencer, N. 396 (96), 419  
 Speranza, M. 232 (141), 247  
 Spevak, P. 537 (28), 617  
 Spiegelhalter, B. 1148 (600), 1167, 1184 (67),  
 1188 (86–88), 1213, 1214  
 Spiegelhalter, J.G. 1185 (73), 1213  
 Spiekermann, M. 1127 (455), 1164  
 Spielberg, S.P. 1001, 1007, 1009, 1011 (28),  
 1027 (28, 155), 1035, 1038

- Spiers, M. 171, 172, 174, 175 (75), 193, 197–199 (141), 203, 204
- Spillane, J. 1220 (30a), 1296
- Spillane, W.J. 404 (145), 405 (147, 148), 421
- Spinelli, D. 100 (92), 103, 388 (56), 418, 1236 (160), 1241 (103a), 1262 (103a, 152), 1264 (103a), 1266 (152, 160), 1298, 1299
- Spiteller, G. 206, 207, 233 (2d), 243
- Splitter, J.S. 221 (111), 246
- Spondlin, C. 1090 (296), 1161
- Spragg, R.A. 57 (90b), 83
- Spunta, G. 549 (81), 618
- Spurr, N. 978 (70), 995
- Squillacote, M. 353 (49), 375
- Srai, S.K.S. 1012, 1033 (85), 1036
- Sraidi, K. 381 (17d, 18), 417, 1222, 1238 (51), 1296
- Srinivas, K. 1100 (351), 1162
- Srinivasan, N. 596 (363, 367), 624
- Srinivasan, R. 547 (77), 618
- Srivastava, A. 571 (199), 620
- Srivastava, R.S. 1152 (624), 1168
- Staab, H.A. 176 (89), 199 (148), 203, 204, 435 (101), 436 (113), 472, 473
- Stacey, M. 635 (30), 659
- Stacey, T.M. 411, 412 (194), 422
- Stafast, H. 810, 811 (159), 821
- Stahl, D. 209 (31), 244
- Stahl, N. 431 (68), 472
- Staley, R.H. 235, 236 (165), 247, 353 (46), 375, 384 (33a), 417
- Stålhandske, C. 90, 93 (12), 102
- Stamler, J.S. 673 (43–45), 674 (49), 681, 1150 (606), 1167
- St.Amour, T.E. 312 (53), 333
- Stan, H.J. 1128 (461), 1164
- Stanescu, L. 353 (50), 375
- Stanker, L.H. 1140 (552), 1166
- Stanoeva, E. 569 (191), 620
- Stanovnik, B. 639 (54), 660
- Stanulomis, J. 859 (15), 889
- Starkey, E.B. 636 (36), 659
- Starova, G.L. 94, 100 (32), 102
- Stavinoha, J.L. 710 (119), 711 (121), 712 (122), 742
- Stedman, G. 674 (53), 675 (54, 63), 677 (53), 678 (81, 85), 679 (86), 681, 682
- Steele, W.F. 350 (35), 374
- Steele, W.V. 346 (20), 350 (37), 355, 356 (58), 373–375
- Steenken, S. 827 (27, 28), 835
- Stefaniac, L. 297, 300 (1a, 1b), 301, 317 (1b), 332
- Stefaniak, L. 310 (49), 322, 323 (96), 333, 334
- Steffek, D.J. 56 (80b), 83
- Steffen, L.K. 830 (53), 836
- Stegel, F. 1217 (15a, 15b), 1262, 1264 (147a), 1295, 1299
- Stehle, P. 1076 (188), 1159
- Stein, S.N. 1048 (62), 1156
- Steinberg, G.M. 407 (157c), 421
- Steiner, B.W. 208, 210, 217, 237 (18), 244
- Steiner, T.W. 815 (171), 821
- Steinke, T. 956 (44), 971
- Stella, L. 403 (138a, 138b), 420, 599 (379), 624
- Stemerick, D.M. 543 (58), 617
- Stenhouse, I.A. 303, 308 (37), 333
- Stepanov, N.D. 646 (102), 661
- Stephanou, E.G. 1048 (53), 1156
- Stephens, O.B. 1030 (171), 1038
- Stephens, P.J. 147, 148 (140), 156
- Stephenson, D. 315 (60), 333, 447 (177), 474
- Stephenson, L.M. 401 (136), 420
- Štěrba, V. 638 (52), 660
- Stercho, Y.P. 113, 114 (43), 154
- Sterin, S. 553 (106), 618
- Sterling, D.I. 106 (17), 153
- Stern, C. 1127, 1143 (458), 1164
- Stern, C.L. 729 (175a), 744
- Sternson, L.A. 871 (51), 890
- Sterzl, H. 1026, 1029 (144), 1038
- Steuberg, V.I. 722 (153f), 743
- Stevanovic, S. 1127, 1143 (457), 1164
- Stevens, J.A. 1253 (132), 1298
- Stevens, K. 993 (147), 997
- Stevens, M.F.G. 633 (23), 659
- Stevenson, D.P. 259 (40), 292
- Stevenson, T.A. 345 (18), 361 (86), 373, 377
- Steward, B. 1188 (92), 1214
- Stewart, J.J.P. 161, 173 (18), 202
- Stewart, J.M. 97 (62), 103
- Stewart, R.J. 400 (123), 420
- Stiegman, A.E. 444 (162), 474
- Stigbrand, M. 1105 (370), 1162
- Still, R.H. 669 (23), 680
- Still, W.C. 41 (63), 82
- Stinecipher, M.M. 369, 370 (99), 378
- Stinson, S.C. 107 (19, 21), 153, 154
- Stirling, D.I. 108, 109 (31), 154
- Stivers, E.C. 910, 933 (33), 947
- St.John, P.A. 1060 (85), 1079 (211), 1156, 1159
- Stöcklin, G. 649 (122), 661
- Stoddart, J.F. 396 (96), 419
- Stojek, J.W. 1080 (220), 1159
- Stokes, D.L. 1101 (355), 1136 (521), 1162, 1165
- Stokkum, I.H.M.van 446 (171, 173), 474
- Stolze, K. 1022 (115), 1037
- Störle, C. 1030 (174), 1039
- Storm, C.B. 370 (100), 378
- Stothers, J.B. 312 (55), 333

- Stover, L.R. 638 (51), 660  
 Stowe, G.T. 1032 (188), 1039  
 Stradiotto, N.R. 852 (62), 856  
 Stradowski, C.Z. 824 (13), 835  
 Strakovs, A. 437 (124), 473  
 Strangeland, L.J. 431 (63), 471  
 Strarness, S.D. 1238, 1240 (97), 1297  
 Stratis, J. 1139 (537), 1140 (547), 1166  
 Straub, B. 1079 (213), 1159  
 Straub, R.F. 1066 (123), 1073 (164), 1157, 1158  
 Strauss, M.J. 457 (228, 231), 475, 1217, 1220 (11a), 1295  
 Strazzolini, P. 563 (163), 583 (270a, 270b), 620, 622  
 Streets, D.G. 175 (84), 203  
 Streissguth, A.P. 1063 (98), 1157  
 Streitwieser, A.J. 398 (113a-c), 399 (118-120), 420  
 Streitwieser, A.Jr. 399 (117), 420, 896 (14), 947  
 Strelenko, Y.A. 448 (192), 474  
 Strelenko, Yu.A. 609 (432), 625  
 Strepikheev, Y.A. 884 (95), 891  
 Stricher, O. 1086 (274), 1160  
 Strickland, S. 567 (184), 620  
 Strickler, P. 90 (11), 102  
 Strickson, J.A. 578 (227a, 227b), 621  
 Stridh, G. 339 (11), 372  
 Strijtveen, B. 127 (81), 155  
 Strojek, J. 1079 (216), 1159  
 Stromvall, E.J. 1098 (341), 1162  
 Struchkov, Yu.T. 363 (89), 377  
 Strydom, D.J. 1084 (256), 1160  
 Stryer, L. 1010 (69), 1036  
 Stryszak, E. 1047 (47, 48), 1155  
 Stuart, A.D. 1046 (18), 1155  
 Stuber, O. 482 (18), 525  
 Stublely, D. 96 (52), 103  
 Stuchlik, J. 1090 (293), 1161  
 Stuehr, D.J. 669 (21), 680, 976 (31, 35, 37, 38), 978 (31, 37, 38, 58, 64), 980 (31, 37), 983 (37), 984 (89), 985 (91, 95), 987 (98-100), 989 (105, 107), 990 (110), 991 (113), 994-996  
 Stulik, K. 1148 (598), 1167  
 Stull, D.R. 338 (2c), 352 (41), 361 (2c), 363 (87), 372, 374, 377  
 Stumpe, J. 722 (153c), 743  
 Sturgess, M.A. 588 (305), 623  
 Stutts, K.J. 846 (36a), 855  
 Stuzka, V. 1135 (514), 1165  
 Su, C.N. 147, 148 (141), 156  
 Su, T.J. 1122 (437), 1164  
 Suboch, G.A. 515 (231), 530, 1000, 1009, 1019 (7), 1035  
 Subong, A.P. 579 (237), 621  
 Subotkowski, L.K. 922 (38), 928 (41), 947  
 Subotkowski, W. 861 (21), 863 (21, 22), 867 (37), 889, 918, 920 (37), 922 (38), 928 (41), 947  
 Subramanian, G. 106 (16), 153  
 Suchan, V. 112, 113 (41), 154  
 Sudalai, A. 578 (225), 621  
 Sudha, M.S. 270 (82), 293  
 Sudlow, G. 1032 (196), 1039  
 Suehiro, T. 649 (120, 121), 661  
 Sueyoshi, S. 96 (47), 102, 886 (100), 891  
 Suezaki, H. 467, 468 (274), 476  
 Sugarbarker, D.J. 673 (44), 681  
 Sugawara, K. 1106 (373-375), 1162  
 Sugawara, T. 312 (52), 333  
 Sugihara, H. 609 (435), 625  
 Sugimoto, A. 703 (101), 742  
 Sugimoto, N. 460 (246, 247), 476  
 Sugimura, T. 677 (71), 681, 888 (106), 891, 1004, 1007, 1009, 1012, 1019 (43), 1029 (166), 1033, 1034 (198), 1035 (43), 1036, 1038, 1039  
 Suginome, H. 598 (375), 624, 794 (119), 798 (133), 799 (133, 134), 800 (134), 801 (135), 802 (136), 820, 821  
 Sugita, K. 650 (124a), 661  
 Sugita, N. 596 (362), 624  
 Sugiyama, N. 467, 468 (274), 476, 1281, 1282 (189), 1300  
 Suh, D. 216 (67), 245  
 Suhr, H. 1276, 1293 (181), 1299  
 Sukhodub, L.F. 1119 (431, 432), 1164  
 Sukumar, S. 330 (118), 335  
 Sultan, M.A. 1140 (550), 1166  
 Sultan, M.A.E. 1140 (545), 1166  
 Sultan, S.M. 1106 (376), 1162  
 Sulton, K.H. 883 (90), 890  
 Sülzle, D. 259 (46), 262 (57), 292  
 Sumida, R. 703 (101), 742  
 Sumida, T. 866 (34), 889  
 Summerhays, K.D. 510 (207), 530  
 Summers, M.F. 1024 (126), 1037  
 Sun, Ya.-P. 441 (145), 473  
 Sundahl, M. 1077 (193), 1159  
 Sundaram, N. 276, 279 (86, 87), 280 (90), 293  
 Sundberg, R.J. 722 (157a), 743  
 Sundell, C.L. 979 (72), 995  
 Sundell, S. 62 (107), 84  
 Sung, K.S. 1238 (93), 1297  
 Sunner, J. 384 (32), 417  
 Sunner, S. 339 (11), 372  
 Suortti, T. 1118 (418), 1163  
 Supan, S. 1220 (43), 1296  
 Süs, O. 658 (174), 663  
 Suschitzky, H. 639 (57), 660  
 Susens, D.P. 757 (26), 818  
 Susskind, S.M. 319, 320 (82), 334

- Sustmann, R. 161 (20), 202, 985 (96), 996  
 Susuki, H. 1103 (358), 1162  
 Susuki, S. 1079 (212), 1159  
 Susumu, T. 686 (26), 740  
 Sutherland, I.O. 60 (103c), 84  
 Sutton, D. 329 (116), 334  
 Sutton, K.H. 954 (25–28), 956 (28), 968 (26), 970, 971  
 Sutton, L.E. 487 (66), 526  
 Suwinski, J. 781 (85), 819  
 Suyama, T. 604 (395), 624  
 Suznjevic, D. 447 (183), 474, 838 (4b), 855  
 Suzukamo, G. 112 (39), 154, 536 (15), 617  
 Suzuki, A. 565 (176), 620, 651 (132), 656 (166), 657 (132), 661, 662  
 Suzuki, H. 693, 694 (62), 741, 962 (51), 971  
 Suzuki, I. 534 (7), 616  
 Suzuki, J. 1030 (176), 1039, 1130 (478), 1164  
 Suzuki, K. 582 (268), 622, 1129–1131 (476), 1164  
 Suzuki, M. 1072 (162), 1158  
 Suzuki, N. 739 (204), 745, 1083 (253), 1160  
 Suzuki, S. 758 (32a), 818, 896 (14), 947, 1030 (176), 1039, 1119 (428), 1130 (478), 1163, 1164  
 Suzuki, T. 452 (196), 458 (236), 475, 476, 1079 (212), 1159, 1218, 1219, 1237 (21a, 21b), 1295  
 Svagrova, I. 1125 (441), 1164  
 Svard, H. 932 (45), 947  
 Svec, W.A. 445 (168), 474  
 Svensson, J. 790 (108), 820  
 Svensson, J.O. 790 (109b), 820, 954, 970 (37), 971  
 Svensson, K. 62 (107), 84  
 Swain, C.G. 522 (244, 246, 250), 531, 910, 933 (33), 938 (57), 947, 948  
 Swain, M.S. 522 (246), 531  
 Swalen, J.D. 24 (33), 82  
 Swallow, A.J. 827 (35), 835  
 Swamy, R.A. 289 (115), 294  
 Swanson, G.M. 1180 (52), 1213  
 Swanson, R. 711 (121), 712 (122), 742  
 Swartzendruber, J.K. 442 (147), 473  
 Sweeley, C.C. 1066 (116, 117), 1157  
 Swern, D. 94 (41), 102  
 Swiderek, K.M. 978 (63, 65), 995  
 Swidler, R. 407 (157c), 421  
 Swierezek, K. 781 (85), 819  
 Swift, H.R. 672 (31), 680  
 Swinnen, A.M. 694 (58), 695 (77), 741  
 Sydnes, L.K. 728 (171a, 171b), 744  
 Symons, M.C.R. 612 (448, 449), 626, 670 (29), 680, 795 (127), 820, 824 (5), 834 (74), 835, 836, 1019 (93), 1037  
 Szabo, L. 851 (55), 856  
 Szadkowsknicze, M. 824 (13), 835  
 Szafran, M. 430 (54), 431 (59), 436 (114), 471, 473  
 Szajda, S. 1090 (294), 1161  
 Szantay, C. 851 (55), 856  
 Szarek, W.A. 15, 17 (23b), 81  
 Szarka, A.Z. 441 (144), 473  
 Szczesniak, M. 554 (115a), 619  
 Szekelhidi, L. 1113 (403), 1163  
 Szele, I. 648 (107, 109), 661  
 Szepes, L. 164 (31, 37), 165, 175 (31), 202  
 Szeverenyi, N.M. 330 (121), 335  
 Szoenyi, F. 540 (45), 617  
 Szokan, G. 1089 (288), 1161  
 Szpakiewicz, B. 561 (142, 143), 619  
 Szulejko, J.E. 384 (25b, 25c), 417, 1238 (91, 92), 1297  
 Szulejko, J.E. 233 (149), 247  
 Szulejko, J.W. 385 (38c), 418  
 Taagepera, M. 66, 67 (111), 84, 166, 168, 179, 184, 185 (52), 202, 235, 236 (165), 247, 407 (161b), 421, 510 (207), 524 (254), 530, 531  
 Tabata, M. 1130 (478), 1164  
 Tabei, H. 1103 (360, 361), 1162  
 Tabet, D. 357 (69), 376  
 Tabet, J.C. 216, 222 (58), 245  
 Tabner, B.J. 848 (44), 856  
 Tabner, V.A. 848 (44), 856  
 Tada, Y. 724 (166a), 744  
 Tadayoshi Yoshida (88), 334  
 Taddai, M. 570 (194), 620  
 Taeger, K. 1000, 1009, 1023 (10), 1035  
 Taft, R.W. 235, 236 (165), 247, 303 (25, 26, 29), 308 (39–42), 309 (39, 42, 43), 310, 311 (44), 332, 333, 381 (6b, 14a, 14b, 15a, 15b, 16a–d, 17d, 18, 20b), 384 (29, 33b), 386 (49, 50), 387 (51, 52a, 52b, 53), 395 (14a, 14b), 407 (161b), 408 (167b), 409 (6b), 416–418, 421, 428 (42), 433 (80), 439 (129), 443 (157, 158), 453 (203), 471–475, 489 (87–89), 490 (90, 92), 491 (89, 90, 96, 97, 106), 493 (87, 89), 496 (131), 503 (90, 96, 97, 106), 504 (87, 89, 92, 96, 97, 150–152, 155), 505 (131, 151, 155, 163), 509 (89), 510 (199, 207), 514 (150), 515 (96, 97, 150), 517 (87, 89, 96, 97, 150), 518 (150), 521 (92), 522 (92, 150, 151), 523 (151, 252), 524 (151, 253, 254), 527–531, 642 (83, 84), 660, 1006, 1024, 1026–1028, 1030–1032 (55), 1036, 1220 (38a, 38b, 39, 41a, 41b, 42), 1221 (38a, 38b), 1222 (38a, 38b, 39, 51), 1238 (38a, 38b, 51, 87a, 87b, 88, 93–95, 98), 1239 (87a), 1240 (98), 1241 (106a, 106b), 1244 (38a, 38b), 1273 (178, 179), 1275 (178), 1278 (179), 1283 (178), 1296–1299

- Taga, M. 1106 (373–375), 1162  
 Tagashira, S. 1097 (338), 1162  
 Taguchi, M. 649 (120), 661  
 Taguchi, V.Y. 1145 (575), 1167  
 Taha, Z. 992 (127), 997  
 Tahara, S. 77 (127), 84  
 Tahira, T. 677 (71), 681, 888 (106), 891  
 Tainor, R.R. 976, 980, 983 (34), 994  
 Taintor, R.R. 975 (29, 30), 976 (30), 978 (29), 994  
 Tajima, S. 218 (86), 246, 259 (41), 262 (58), 292  
 Takada, H. 751 (8), 817  
 Takagi, K. 7 (11), 81, 648 (108), 661, 721 (151), 743  
 Takahashi, A. 1101 (352), 1162  
 Takahashi, H. 765 (47), 818  
 Takahashi, K. 580 (251), 621, 1090 (292), 1161  
 Takahashi, M. 161, 163, 164 (22), 202  
 Takahashi, N. 1019 (91), 1037  
 Takahashi, S. 1114 (405), 1163  
 Takahashi, T. 553 (109), 618  
 Takahashi, Y. 654 (149), 662, 1029 (166), 1038, 1046 (13), 1155  
 Takai, K. 571 (197), 620  
 Takai, Y. 1114 (405), 1163  
 Takakuwa, K. 794 (119), 820  
 Takama, K. 1079 (212), 1159  
 Takamuku, S. 686 (26), 740, 824 (11, 12), 835  
 Takanohashi, Y. 536 (21), 537 (22), 617  
 Takao, N. 305 (33), 306 (34), 307 (33), 333  
 Takase, K. 863 (25), 889  
 Takashima, A. 1000 (1), 1035  
 Takasuka, M. 324 (105), 334  
 Takatera, K. 1074 (175), 1158  
 Takatsuki, K. 1144 (570), 1166  
 Takayama, N. 1079, 1083 (217), 1159  
 Takazawa, H. 93 (17), 102  
 Takeba, A.K. 1134 (504), 1165  
 Takechi, H. 730 (181f, 182a), 744, 798 (132), 820  
 Takeda, H. 1073 (165), 1158  
 Takeda, S. 437 (123), 473  
 Takeda, T. 580 (248), 621  
 Takemoto, T. 950 (14), 970  
 Takeuchi, H. 551 (89a, 89b, 90, 91), 618, 1069 (146), 1158  
 Takeuchi, T. 215 (53, 54), 245, 718 (147), 743  
 Takeuchi, Y. 305 (33), 306 (34), 307 (33), 333  
 Takeyama, T. 1067 (124), 1157  
 Taki, H. 580 (246), 621  
 Takitani, S. 1147 (587), 1167  
 Talberg, H.J. 96 (55), 103  
 Talbot, J.M. 1116 (417), 1163  
 Tallec, A. 849 (48), 856, 1107 (379–382), 1162, 1163  
 Talley, J.J. 510 (200), 530  
 Tamai, N. 703 (101), 742  
 Tamaru, K. 1245 (113), 1298  
 Tamatani, A. 582 (268), 622  
 Tamblyn, W.H. 675 (62), 681  
 Tamir, S. 1189 (101), 1214  
 Tamiya, E. 1103 (358), 1162  
 Tamiya, H. 592 (331), 623  
 Tamizi, M. 1126 (450), 1164  
 Tamura, K. 593 (342), 623  
 Tamura, M. 77 (127–129), 78 (128, 129), 79 (129), 84  
 Tamura, R. 605 (408, 409a, 409b), 610 (438), 614 (409a, 452, 455), 615 (459), 616 (465), 625, 626  
 Tamura, T. 112 (40), 154  
 Tamura, Y. 552 (98, 101), 618  
 Tanabe, H. 935 (53), 948  
 Tanabe, K. 4, 13, 77 (15), 81, 561 (147), 588 (304), 619, 623  
 Tanahashi, T. 551 (91), 618  
 Tanaka, H. 852 (61), 856  
 Tanaka, K. 609 (435), 625  
 Tanaka, N. 455 (217), 475  
 Tanaka, S. 795 (128, 129), 820, 1079, 1083 (217), 1106 (373–375), 1159, 1162  
 Tanaka, T. 749 (3a, 3b), 817, 1114 (405), 1163  
 Tandom, S.G. 405 (152a), 421  
 Tang, Y. 1089 (284), 1160  
 Tanigaki, K. 789 (106), 820  
 Taniguchi, H. 597 (370), 624, 1069 (146), 1158  
 Tanigushi, H. 654 (151), 662  
 Tanikaga, R. 609 (435), 625  
 Tanimoto, Y. 113 (44), 154, 751 (8), 817  
 Tanin, A. 505 (156), 529  
 Tannenbaum, S.R. 1009, 1010 (61), 1021 (103, 108), 1030 (103), 1034 (61), 1036, 1037, 1189 (101), 1214  
 Tanner, D. 106 (10), 120 (61), 153, 154  
 Tanno, M. 96 (47), 102, 886 (100), 891  
 Tanoury, G.J. 991 (116), 996  
 Tapia, O. 1285 (195), 1300  
 Tardivel, R. 849 (48), 856  
 Tarnawsky, I.W. 637 (45), 660  
 Tartakovskii, V.A. 448 (192), 474, 608 (424), 609 (432), 625  
 Tartakovsky, E. 15, 16 (26b, 26c), 82  
 Tasaki, K. 188 (119), 204  
 Tashiro, M. 848 (45), 856, 969 (65), 971  
 Tashiro, T. 649 (120), 661  
 Tasker, H.S. 666, 668 (4), 680  
 Tasnawskij, I.W. 639 (53), 660  
 Tatchell, A.R. 109 (33), 110 (33–35), 113 (33, 42), 154  
 Tatlow, J.C. 635 (30), 659

- Tato, J.V. 643, 645 (88), 660, 677 (72, 73), 681, 886 (101, 103), 888 (106, 107), 891
- Tatsumo, M. 1119 (428), 1163
- Tauler, R. 1225 (67), 1297
- Tauts, O.V. 1147 (593), 1167
- Tavale, S.S. 93 (25), 96 (56), 98 (25), 102, 103
- Tayeh, M.A. 976, 978, 983 (36), 994
- Taylor, H.W. 1186 (76), 1213
- Taylor, P. 381 (19), 417
- Taylor, P.B. 1085 (258), 1160
- Taylor, P.C. 594 (348), 623
- Taylor, P.F. 1019 (93), 1037
- Taylor, P.G. 510 (206), 530
- Taylor, P.J. 381 (17a–e, 20b, 20c), 395 (81), 417, 419, 428 (41, 42), 471, 1222 (50, 51, 57, 58, 60), 1238 (51), 1296, 1297
- Taylor, P.S. 859 (13), 889
- Taylor, R. 433 (74–77), 453 (205), 472, 475, 505 (162), 512 (223, 224), 513 (224–228), 529, 530
- Taylor, R.J. 130 (88), 155
- Teare, J.D. 1175 (18), 1212
- Tebbett, I. 1068 (140), 1158
- Tecklenburg, B. 396 (91f), 419
- Tedesco, A.C. 753 (13), 757 (27), 817, 818
- Teerlink, T. 1078 (203), 1159
- Tein-Lo, M. 1189 (93), 1214
- Teitel, C.H. 1033 (202, 203), 1039
- Tejada, S.B. 1177 (31), 1212
- Tejero, A. 546 (73), 618
- Temchenko, T.P. 646 (102), 661
- Tempst, P. 977 (52), 995
- Tenge, B.J. 575 (209), 621
- Tennant, G. 633 (23), 659
- Teobald, J. 1046 (9), 1155
- Terai, N. 1129–1131 (476), 1164
- Teranishi, H. 776 (66), 819
- Teranishi, S. 654 (151), 662
- Terao, N. 654 (152), 662
- Terao, S. 978 (66), 995
- Terashi, A. 1065 (113), 1157
- Terekhova, M.I. 398 (114), 420
- Terenzani, A.J. 1009 (59), 1036
- Terlouw, J.K. 208 (6, 7, 11), 209 (11, 32), 214 (11, 51), 215 (7, 56), 216 (63c, 67), 220, 221 (99), 233 (148, 149), 234 (148), 244–247, 251 (8), 254 (17, 18, 23), 255 (23), 291, 292
- Termuehlen, H. 1175 (15), 1212
- Tero-Kubota, S. 750 (6), 817
- Terpstra, J.W. 667 (8), 680
- Terrier, F. 415 (203, 207–210), 416 (212), 422, 457 (229, 231, 232), 475, 509 (188, 189), 512 (216), 529, 530, 1216 (1a, 5), 1217 (1a, 5, 11a, 17), 1218, 1219 (1a), 1220 (1a, 11a), 1222, 1232, 1235, 1241, 1243, 1244, 1250, 1274, 1290 (1a), 1295
- Tesarova, E. 1133 (502), 1165
- Teshima, T. 1130 (478), 1164
- Tessier, L. 1189 (96), 1214
- Testaferrri, L. 1152 (625), 1168
- Texier-Boullet, F. 589 (311), 623
- Tezuka, T. 812–814 (165), 821
- Thatcher, G.R.J. 15, 17 (23d), 81
- Thater, C. 985 (96), 996
- Thea, S. 1262, 1264 (151), 1299
- Theil, B.A. 987 (98), 996
- Thellend, A. 591 (328), 623
- Theodorakis, E.A. 548 (80), 618
- Theodoridis, D. 1220, 1222 (31b), 1296
- Thewalt, M.L.W. 815 (171), 821
- Thiecke, J.R.G. 539 (40), 617
- Thilmann, D. 1284 (191), 1300
- Thoithi, G. 1118 (420), 1163
- Thomas, C.B. 264, 266 (64), 293
- Thomas, D.K. 426 (16), 470
- Thomas, H.D. 4 (43), 21, 22 (31), 29–31 (43), 32 (31, 43), 82
- Thomas, K.E. 354 (53), 375
- Thomas, M.R. 673 (40), 681
- Thomas, R.J. 1049 (63), 1156
- Thomas, R.K. 1119 (434, 436), 1122 (437), 1164
- Thompson, A.R. 636 (34), 659
- Thompson, H.C. 1146 (583), 1167
- Thompson, L.F. 767 (50b, 51), 819
- Thompson, R.S. 954 (24, 25), 961 (24), 970
- Thomsen, L.L. 992 (135), 997
- Thomson, A. 685 (11), 740
- Thompson, D. 1176 (20), 1212
- Thoraval, D. 769 (55), 819
- Thorgeirsson, S.S. 1029 (167), 1038
- Thornton, E.R. 943 (65), 948
- Thorpe, T.E. 482 (21), 525
- Threadgill, M.D. 650 (129), 661
- Thuijl, J.van 282 (96–99), 283 (98, 99), 289 (114, 115), 293, 294
- Thuillier, P. 1147 (591), 1167
- Thuis, H.J.T.M. 1132 (489), 1165
- Tidwell, T.T. 504 (154), 510 (201–203), 515, 518 (154), 529, 530, 658 (176), 663
- Tie, J.K. 1076 (185), 1158
- Tiecco, M. 1152 (625), 1168
- Tiljander, A. 1081 (231), 1159
- Tillett, J.G. 405 (150a), 421, 1009, 1011 (62), 1036
- Timmons, C.J. 710 (113), 742
- Timofeeva, L.P. 347 (25), 373
- Tiner-Harding, T. 714 (124), 742
- Tingle, M.D. 1027 (148), 1038
- Tingoli, M. 1152 (625), 1168
- Tingue, P.S. 540 (43), 617
- Tipping, A.E. 408 (168), 421, 1153 (626–628), 1168

- Tišler, M. 639 (54), 660  
 Titheradge, A.C. 1085 (263), 1160  
 Titova, S.P. 631 (20), 659, 884 (96), 891  
 Tivesten, A. 1093 (309), 1161  
 Tlahuext, H. 1109 (392), 1163  
 Tobin, G.D. 880 (84), 890  
 Tobin, J.C. 646 (102), 661  
 Toda, F. 722 (159b-d), 743  
 Todesco, P.E. 455 (212), 459 (240), 465 (264),  
 467 (270), 475, 476, 1217, 1245 (8), 1295  
 Tokarskaya, O.A. 576 (215), 621  
 Tokiwa, H. 1129 (473), 1131 (487), 1164,  
 1165, 1177 (37), 1212  
 Tokiwa, T. 1177 (33), 1212  
 Tokles, M. 130 (89), 155  
 Tokuda, M. 598 (375), 624  
 Tokuda, Y. 448 (191), 474, 749 (2), 817, 869  
 (43), 889  
 Tokumaru, K. 438 (125, 126), 473, 778 (74),  
 819  
 Tokura, N. 735 (190c), 745  
 Tollari, S. 578 (224), 621  
 Toman, J. 870 (49), 890  
 Tomas Baer 264, 265 (65), 293  
 Tomasi, J. 803 (138), 821  
 Tomasik, P. 440 (136), 473  
 Tomer, K.B. 267 (75), 281 (94), 293  
 Tomilov, A.G. 352 (43), 374  
 Tominaga, Y. 585 (292), 622  
 Tominga, Y. 541 (50), 617  
 Tomino, I. 113 (44), 154  
 Tomioka, H. 767 (54), 819  
 Tomita, M. 93 (15), 102  
 Tommaselli, G.A. 434 (88), 472  
 Tompson, R.D. 308 (40), 333  
 Tondys, H. 561 (141), 619  
 Tong, L.K.J. 358 (76), 376  
 Toniolo, C. 142 (124), 156  
 Toole, G. 358 (71-73), 376  
 Toomas, H.T. 695 (72), 741  
 Toothill, J.R. 1139 (534), 1166  
 Topham, A. 265 (69), 293  
 Töpner, W. 1000 (11), 1003 (11, 33), 1007,  
 1008 (33), 1009 (11, 33), 1011, 1012 (33),  
 1035  
 Topsom, R.D. 303 (25), 332, 491, 503 (100,  
 101), 504 (151, 154), 505 (151), 506  
 (164-172), 510 (167, 172, 199, 207), 515,  
 518 (154), 522 (151, 247), 523 (151, 171,  
 252), 524 (151), 527, 529-531, 642 (82,  
 84), 660, 1238 (88, 94), 1297  
 Toqan, M. 1175 (18), 1212  
 Torchinsky, Y.M. 1003 (48), 1036  
 Tordo, P. 854 (67), 856  
 Torii, S. 852 (61), 856  
 Torino, J.Z. 653 (145), 662  
 Torizuka, H. 774 (63), 819  
 Torroba, T. 780 (82), 819  
 Tortajada, J. 232 (142), 247  
 Tortelli, V. 463 (257), 464 (261), 476  
 Tosi, C. 55-57 (81), 83  
 Tosi, G. 441 (146), 473  
 Töth, J. 100 (89), 103  
 Toucas, L. 1025 (137), 1038  
 Toupet, L. 1107 (381), 1163  
 Touster, O. 675 (59), 681  
 Tovar, C.A. 55-57 (82), 83  
 Tovbis, M.S. 515 (231), 530  
 Towns, R.L. 433 (79), 472  
 Townsend, J.C. 1068 (137), 1158  
 Toyne, K.J. 695 (74), 741  
 Toyoda, J. 1256, 1257 (136), 1258 (142),  
 1298, 1299  
 Toyō'oka, T. 1080 (222, 223), 1081, 1091  
 (234), 1159  
 Toyosaki, T. 596 (361a, 361b), 624  
 Traeger, J.C. 220 (104), 246  
 Traetteberg, M. 188 (124), 204  
 Traficante, D.D. 1076 (187), 1159  
 Trainor, T. 1083 (243), 1160  
 Traldi, P. 94 (36), 102  
 Traunter, F. 1180 (54), 1213  
 Trautner, F. 1182 (60), 1213  
 Traynor, G.W. 1177 (34), 1212  
 Trazza, A. 191, 199 (130), 204  
 Tretheway, K.R. 695 (73), 741  
 Trevellick, S. 881 (85), 890, 953 (21), 966 (55,  
 56), 970, 971  
 Tricard, C. 1078 (199), 1159  
 Tricker, A.R. 1185 (73), 1187 (83), 1188 (85,  
 91), 1189, 1190 (99), 1213, 1214  
 Trifunac, A.D. 824 (10), 826 (25), 835  
 Trimmer, R.W. 638 (51), 660  
 Trinajstić, N. 180 (95), 203  
 Tritthart, P. 1130 (477), 1164  
 Trivedi, G.K. 285 (102), 293  
 Trnska, T. 1090 (293), 1161  
 Tronchet, J.M.J. 1152 (621), 1168  
 Troso, T. 978 (63), 995  
 Trost, B.M. 568 (185, 186), 590 (316), 620,  
 623  
 Trower, W.P. 1125 (443), 1164  
 Trucks, G. 384 (28b), 417  
 Truesdale, L.K. 572 (200), 620  
 Trumbauer, M. 993 (147), 997  
 Tsai, A.L. 989 (103), 996  
 Tsai, H.-W. 567 (182), 620  
 Tsai, S.-C. 209 (27), 244  
 Tsang, W. 360 (78), 376  
 Tsankov, D. 133 (101), 149 (151), 155, 157  
 Tse, R. 392 (73), 419  
 Tselinskii, I.V. 1137 (526), 1141 (554), 1166  
 Tso, J. 208, 210-212, 215 (17), 244  
 Tsoukali, H. 1139 (537), 1140 (547), 1166



- Tsuboi, M. 24 (32), 34 (46), 82  
 Tsuchihashi, H. 1119 (428), 1163  
 Tsuchiya, T. 259 (41), 262 (58), 292  
 Tsuda, M. 647 (104), 661, 677 (71), 681, 888 (106), 891  
 Tsuda, T. 579 (232), 621  
 Tsuji, M. 614 (455), 626  
 Tsujii, R. 722 (155), 743  
 Tsujimoto, K. 685 (12), 740  
 Tsukioka, T. 1064 (102), 1157  
 Tsuno, Y. 489, 496 (85, 86), 504 (153), 521 (85, 86), 527, 529  
 Tsuzuki, S. 4, 13, 77 (15), 81  
 Tsvetkov, E.N. 519 (238), 531  
 Tu, C.L. 714 (126), 742  
 Tuazon, E.C. 1177 (45), 1213  
 Tubergen, M.J. 431 (69), 472  
 Tucker, I. 1118 (423), 1163  
 Tucker, S.A. 357 (67), 358 (71–73), 376  
 Tufon, C. 1228, 1232–1235, 1239 (77), 1297  
 Tukada, H. 751 (9), 817  
 Tumas, W. 220 (105), 246  
 Tummuvuori, J. 640 (69), 660  
 Tundo, A. 655 (158), 662  
 Tun Khin 317 (69, 73), 333  
 Turbanti, L. 143 (125), 156  
 Turcan, J. 639 (58), 660  
 Turecek, F. 206, 207 (3), 217 (69), 219, 226, 229, 233 (3), 243, 245, 254 (21), 292  
 Turesky, R.J. 1009, 1010 (61), 1021, 1030 (103), 1034 (61), 1036, 1037  
 Turnbull, K. 537, 553 (24), 617  
 Turner, C.A. 390 (71), 419, 1284, 1285 (194b), 1300  
 Turner, D.W. 160 (1, 16), 161, 163 (1), 164, 165 (42), 171 (42, 70), 174 (42), 175 (42, 70, 85), 201–203  
 Turner, E. 381 (20b), 417, 428 (42), 471  
 Turrión, C. 357 (70), 376  
 Turro, N.J. 446 (170), 474  
 Turska, E. 431 (58), 471  
 Turteltaub, K.W. 1033 (201), 1039  
 Tuttle, J.V. 992 (132), 997  
 Tutuya, S. 585 (292), 622  
 Tvedten, O. 675 (61), 681  
 Tverdokhlebov, S.V. 636 (35), 659  
 Twisleton, D.R. 456 (224), 475  
 Tyler, A.N. 234 (157), 247  
 Tyler, J.K. 171 (68), 203  
 Tyllianakis, P.E. 1099 (345, 346), 1162  
 Zeng, D. 97 (60), 103  
 Ublacker, G.A. 1032 (192), 1039  
 Uccella, N.A. 226 (120), 227 (122), 246  
 Uccello-Barretta, G. 1112 (400), 1163  
 Uchida, G. 1087 (276), 1160  
 Uchida, T. 1256 (137), 1298  
 Uchimaru, T. 4, 13, 77 (15), 81  
 Ueda, C. 676 (68), 681  
 Ueda, T. 1096 (328), 1161  
 Uehleke, H. 1000 (15), 1029 (160), 1035, 1038  
 Ueji, S. 524 (254), 531  
 Uematsu, M. 977 (53), 995  
 Uetrecht, J. 1023 (119, 120), 1037  
 Uetrecht, J.P. 1009, 1023 (60), 1036  
 Uffer, P.M. 356 (59), 375  
 Uggerud, E. 236 (170, 172), 248  
 Uhllich, U. 668 (13), 680  
 Ukai, T. 654 (149), 662  
 Ukeda, H. 1106 (372), 1162  
 Ukhin, L.Yu. 576 (215), 621  
 Ulivi, P. 570 (194), 620  
 Ullman, E.F. 710 (115), 742  
 Ullrich, J.W. 714 (124, 125), 742  
 Umeda, T. 650, 652 (130), 661  
 Umekawa, H. 655 (155), 662  
 Umemoto, A. 1004, 1007, 1009, 1012, 1019, 1035 (43), 1036  
 Umezu, M. 866 (34), 889  
 Underwood, G.R. 873 (61), 890  
 Undheim, K. 579 (234), 621  
 Uneyama, K. 593 (342), 623  
 Unger, K.K. 1180 (55), 1213  
 Unger, S.H. 522 (245, 246), 531  
 Ungureanu-Longrois, D. 992 (127), 997  
 Unruh, L.E. 1003, 1004, 1009, 1011, 1012, 1031 (35), 1035  
 Unterhalt, B. 405 (146), 421  
 Unverdorben, O. 481 (8), 525  
 Uozumi, Y. 578 (223), 621  
 Upadiheva, A.V. 636 (40), 659  
 Uppal, J.S. 384 (33a), 417  
 Uthagrove, A.L. 729 (174), 744  
 Urano, S. 188 (118), 204  
 Urasaki, I. 1000 (1), 1035  
 Uray, G. 985 (92), 996  
 Urban, J.J. 60 (103d), 84  
 Urbánczyk-Lipkowska, Z. 98 (68), 103, 433 (78), 472  
 Urbański, T. 484 (33), 526  
 Urbas, L. 482, 483, 507 (22), 525  
 Uri, J.V. 1148 (601), 1167  
 Urođi, L. 554 (112), 555 (117), 556 (120), 558 (130, 131), 559 (133, 134), 619  
 Uršić, S. 450 (194), 474  
 Uryu, T. 1256 (138), 1298  
 Utaka, M. 498 (137), 528  
 Utimoto, K. 571 (197), 597 (372), 620, 624  
 Utting, B.D. 6 (9), 81  
 Uvarova, L.V. 607 (419), 625  
 Uwakwe, P.U. 1287 (199), 1290 (199, 200), 1293 (199), 1300  
 Uzu, S. 1091 (301, 302), 1161

- Vacca, A. 57 (93), 83  
 Vahadati, M.M. 1175 (11), 1212  
 Vaid, B.K. 583 (273), 622  
 Vaid, R.K. 583 (273), 622  
 Vainiotalo, P. 353 (45), 375  
 Vajta, Z. 1047 (34), 1155  
 Valcárcel, M. 1137 (527), 1166  
 Valentin, E. 165, 166, 178 (46), 202  
 Valentine, D. 312 (53), 333  
 Valeri, C.R. 673 (43), 681  
 Valero, Y. 1083 (246), 1160  
 Valeur, B. 697 (88), 741  
 Valik, D. 1067 (134), 1157  
 Vallat, A. 845 (33), 854 (69), 855, 856, 1129 (468, 469, 471), 1144 (471), 1164  
 Valpiana, L. 634 (29), 659  
 Valraven, G. 1116 (417), 1163  
 VanAllen, J.A. 655 (156), 662  
 Van Alsenoy, C. 24 (36), 56 (85), 82, 83  
 Van Bennekom, W.P. 1119 (426), 1163  
 Van Boecxlaer, J. 1061 (92), 1156  
 Van Cauwenberghe, K.A. 1176 (27), 1212  
 Van Damme, J.C. 1076 (186), 1159  
 Van Dantzig, N.A. 694 (67), 741  
 Vandeberg, P.J. 1074 (176), 1158  
 Vanden Eynde, J.-J. 558 (128), 619  
 Van der Auweraer, M. 693 (57), 694 (58, 59), 695 (77), 741  
 Van der Haak, H.J. 1217 (13b), 1295  
 Van der Kleijn, E. 1128 (464), 1164  
 Vanderlaan, M. 1140 (552), 1166  
 Van der Plas, H.C. 561 (140a–c, 141, 145), 619  
 Van der Wal, S. 1094 (324), 1161  
 Van Dyke, D.A. 675 (62), 681  
 Van Eijk, A.M.J. 754 (16), 818  
 Van Eijk, H.M.H. 1078 (196), 1159  
 Vanhessche, K.P.M. 125 (77), 155  
 Van Hoof, W. 763 (41), 818  
 Vanhoutte, P.M. 974 (3), 994  
 Vanier, N.R. 398 (115), 420  
 Vankar, P.S. 608 (421), 625  
 Vannerem, A. 695 (77), 741  
 Vannoort, R.W. 954 (32), 971  
 Van Opdenbosch, N. 36–38, 42 (52), 82  
 Van Ramesdonk, H.J. 696 (78), 741  
 Van Sant, K. 577 (221), 621  
 Van Vechten, D. 356 (61, 62), 376  
 Van Veldhuizen, A. 561 (145), 619  
 Van Zoonen, P. 1116 (415), 1163  
 Vapirov, V.V. 1278 (183), 1300  
 Varadarajan, T.S. 696 (80), 741  
 Varaghese, K.I. 866 (35), 889  
 Varandas, A.J.C. 409 (180), 422  
 Vargas, E.B.de 458 (237–239), 476, 1230 (79), 1297  
 Vargas, E.R.de 1220 (27), 1295  
 Vargas, M.C.de 1046 (16, 19), 1155  
 Varghese, A.J. 1031 (181, 184, 185), 1039  
 Varghese, J.N. 95 (42), 102  
 Varlamov, S.V. 133 (99), 155  
 Varlamov, V.T. 401 (135), 420  
 Varma, C.A.G.O. 754 (16), 818  
 Varma, R.S. 284, 285 (101), 293, 565 (170), 616 (464), 620, 626  
 Varnes, M.E. 1031 (182), 1039  
 Varshney, R.K. 461 (251), 476  
 Varty, T.C. 1083 (252), 1160  
 Vasapollo, G. 595 (357), 624  
 Vasudevan, D. 845 (32b), 846 (37), 855, 856  
 Vaughan, J. 510 (205), 516 (233), 530, 883 (89, 90), 890, 954 (24–29), 956 (28), 961 (24), 968 (26), 970, 971  
 Vaultier, M. 566 (177), 620  
 Vavricka, S. 869 (45), 889  
 Vavrin, Z. 975 (29, 30), 976 (30, 34), 978 (29), 980, 983 (34), 994  
 Vazques, J.T. 143 (128), 156  
 Vecchi, C. 456 (225), 475  
 Vecchi, E.de 1085 (269), 1160  
 Večeřa, M. 494, 507 (120, 121), 528  
 Végh, Z. 1086 (275), 1160  
 Veglia, A.V. 458 (237), 476, 1230, 1231 (78), 1297  
 Veigl, E. 1130 (477), 1164  
 Veith, H.J. 227–229 (128), 230, 231 (133), 240 (185, 187), 246, 247, 248  
 Veith, M. 396 (91d), 419  
 Velders, D.D. 1129 (475), 1164  
 Velek, J. 756 (21), 818  
 Velluz, L. 106 (8), 153  
 Venanzi, T. 317 (71, 72), 333  
 Venayak, N.D. 303, 308 (37), 333  
 Ven der Plas, H.C. 1217 (13a, 13b), 1295  
 Venema, R.C. 979 (75), 995  
 Venkataraman, B. 753 (10), 817  
 Venkatasubramaniam, K.G. 381, 410 (7), 416, 436 (117), 473  
 Venkatasubramanian, R. 1049 (66), 1156  
 Venkatesan, K. 762 (39, 40), 818  
 Veno, S. 215 (54), 245  
 Ventura, K. 1077 (192), 1159  
 Ventura, O.N. 453 (206), 475  
 Veracine, C.A. 321 (93), 334  
 Verardo, G. 53 (77), 83, 563 (163), 583 (270a, 270b), 620, 622  
 Verbit, L. 117 (53), 154  
 Verboom, W. 969 (64), 971  
 Verdaguer, X. 545 (70), 618  
 Verhé, R. 569 (191), 620  
 Verhoeven, J.W. 166, 187 (54), 202, 263 (60), 292, 445 (169), 446 (173), 474, 694 (61, 64,

- 65), 695 (70), 696 (76, 78, 79), 697 (86),  
741
- Verin, I.A. 592 (339), 623
- Verkade, P.E. 489, 490 (83), 527
- Verlaque, J.H. 447 (177), 474
- Verma, A. 993 (151), 997
- Vermeer, J.M.P. 1119 (426), 1163
- Vernier, N.R. 410 (182), 415 (205), 422
- Veronese, A.C. 96 (51), 103
- Versichel, W. 433 (75–77), 472
- Vertal, L.E. 165, 166 (44), 202
- Vervoort, J. 1097 (335), 1162
- Verzijl, B.H.M. 91, 93 (20), 102
- Vespalec, R. 1133 (500), 1165
- Vessiere, R. 598 (373), 624
- Vevers, R.J.S. 633 (23), 659
- Vicente, J. 1134 (512), 1165
- Vidal, J. 553 (106), 618
- Vidal, M. 165, 166 (44), 202
- Vidal-Carou, M.C. 1079 (214), 1159
- Viehe, H.G. 403 (138a, 138b), 420, 630 (16),  
659
- Vieira, R. 1078 (204, 205), 1159
- Vig, S.K. 848 (41b), 856
- Vigliano, G. 1093 (314), 1161
- Villarrasa, J. 631 (17), 659
- Vilinger, F. 1024 (125, 126), 1037
- Vilkov, L.V. 8, 24 (14a, 14b), 81
- Villado, M. 1116 (407), 1163
- Villalobos, E. 1046 (16), 1155
- Villari, G.M. 975 (14–16), 994
- Villieras, J. 597 (371), 624
- Vincent, C. 428, 430 (35), 471
- Vinogradov, V.M. 550 (85), 618
- Vinogradova, S.V. 353 (50), 375
- Vinson, L.K. 435 (97), 439 (130), 472, 473
- Violeau, B. 609 (433), 625
- Virtanen, P.O.I. 1232 (80b), 1297
- Visandul, G. 1272 (176), 1299
- Viswanadham, S.K. 280 (91), 293
- Vita, J. 673 (43), 681
- Vitali, D. 467 (269), 476, 1236, 1244, 1265  
(111), 1298
- Vivona, N. 388 (56), 418, 1236 (160), 1262  
(152), 1266 (152, 160), 1299
- Vlasov, V.M. 1238 (93), 1297
- Vo, D.T. 1136 (521), 1165
- Vo Dinh, T. 1101 (354, 355), 1162
- Voelter, W. 302, 303 (22), 332
- Vogel, E. 165, 166, 182 (47), 202
- Vogel, F.R. 667 (8), 680
- Vogel, M. 588 (306), 623
- Vogel, W. 491, 500 (107a), 527
- Vögtle, F. 428 (31), 439 (131), 471, 473
- Vohra, S.K. 94 (41), 102
- Voixner, R.D. 1073 (164), 1158
- Volkonskii, A.Y. 1238 (93), 1297
- Volmer, D. 1068 (138), 1127 (455), 1133  
(498), 1158, 1164, 1165
- Volyanskii, Y.L. 1119 (431, 432), 1164
- Vona, M.L.D. 165–167 (24), 202
- Vong, M.S. 1175 (13), 1212
- Vonminder, D.L. 1134 (505), 1165
- Voogd, J. 91, 93 (20), 102
- Vorbrüggen, H. 560 (139), 603 (391), 619, 624
- Vorländer, D. 484 (39), 526
- Vottero, L.R. 1221 (48a–c), 1222 (48b), 1247  
(48c), 1296
- Vouk, M.V. 583 (271), 622
- Vouros, P. 1119 (429), 1163
- Vovna, V.I. 160 (10), 201
- Voyksner, R.D. 1066 (123), 1157
- Voznakova, Z. 1133 (502), 1165
- Vree, T.B. 1128 (464), 1164
- Vries, H.de 1026 (141), 1038
- Vsetecka, V. 494 (122), 528
- Vulpius, T. 236 (172), 248
- Vuorela, H. 1083 (251), 1160
- Wachter, H. 983 (86), 993 (148), 996, 997
- Wacker, C.D. 1184 (67), 1213
- Wada, E. 934 (50), 947
- Wada, F. 654 (152), 655 (153), 657 (170), 662
- Wada, M. 730 (182b), 744
- Wada, O. 1072 (155–160, 162), 1158
- Wada, T. 833 (69), 836
- Wade, F. 657 (172), 662
- Wagner, K. 552 (104), 618
- Wagner, K.-G. 639 (64, 65), 640 (66), 660
- Wagner, L. 353 (50), 375
- Wagner, P.J. 687 (40), 740
- Wagner, W. 238 (177), 248
- Wahl, G.H. 648 (110), 661
- Wainwright, R.J. 673 (40), 681
- Wait, A.R. 1222 (57, 58, 60), 1296, 1297
- Wakabayashi, K. 677 (71), 681, 888 (106),  
891, 1033, 1034 (198), 1039
- Walash, M.I. 1140 (545, 550), 1166
- Waldman, T.E. 596 (364), 624
- Waldmann, H. 106 (11), 153
- Waldmuller, D. 396 (91c), 419
- Waldner, A. 512 (220), 530
- Waldron, K.C. 1096 (330, 331), 1161
- Walker, E.A. 1047 (41), 1155
- Walker, G. 992 (128), 997
- Walker, M.J. 1102 (356), 1162
- Walker, R. 1188 (86), 1214
- Walker, S. 1152 (622), 1168
- Wall, C.G. 739 (207), 745
- Wallace, G.C. 991 (114), 996
- Waller, A.G. 954, 963 (31), 971
- Waller, H.D. 1000, 1020, 1021, 1027 (17),  
1035

- Walsh, R. 354 (53), 375  
 Walter, R.I. 968 (61), 971  
 Walters, T.R. 579 (238), 621  
 Walton, D. 1093 (311), 1161  
 Walton, R.A. 234 (156), 247  
 Waltz, H. 426 (16), 470  
 Wambsgans, A. 113, 114 (43), 154  
 Wa Muanda, M. 1245, 1266 (114b), 1298  
 Wan, P. 749 (4), 782 (86–89), 783 (88, 89),  
 784 (94), 785 (95, 96, 97a, 98), 786 (99),  
 817, 819, 820  
 Wanczek, K.P. 235 (163), 247  
 Wang, A.H.-J. 347 (27), 373  
 Wang, C.N. 685 (15), 740  
 Wang, D. 1108 (385–387), 1163  
 Wang, D.-A. 4, 14 (21), 81  
 Wang, D.G. 829 (46), 836  
 Wang, D.T. 1145 (575), 1167  
 Wang, E. 1073 (171), 1158  
 Wang, H. 839 (8c), 848 (42), 851 (8c), 855,  
 856  
 Wang, J. 557 (124, 125), 619, 987 (100), 989  
 (105), 996, 1066 (119), 1105 (371), 1157,  
 1162  
 Wang, J.T. 232 (143), 247  
 Wang, K.-T. 592 (330), 623  
 Wang, P. 697 (82), 741  
 Wang, Q. 550 (87), 618  
 Wang, Q.W. 1076 (185), 1158  
 Wang, R. 562 (153), 619  
 Wang, S. 346 (19), 373  
 Wang, S.C. 979 (76), 995  
 Wang, Y. 171 (69), 203, 431 (67), 441 (144),  
 446 (174), 472–474, 694 (75), 741, 896,  
 935, 941, 944 (19), 947, 978 (71), 995,  
 1136 (521), 1165  
 Wang, Z. 566 (179a, 179b), 620  
 Wangbo, M.H. 15, 17 (24b), 81  
 Ward, C. 1106 (377), 1162  
 Ward, L.D. 738 (201), 745  
 Ward, R.S. 1090 (294), 1161  
 Warkentin, J. 589 (314), 623  
 Warma, K.R. 552 (100b), 618  
 Warman, J.M. 696 (78), 697 (85), 741  
 Warner, T.O. 977, 978 (49), 995  
 Warzecha, L. 1130 (482), 1165  
 Wasielewski, M.R. 445 (168), 474, 698 (98),  
 742  
 Wasylishen, R.E. 317 (68), 333  
 Watanabe, H. 593 (342), 623, 787 (101), 820  
 Watanabe, I. 161, 163, 164 (22), 202  
 Watanabe, K. 1101 (352), 1162  
 Watanabe, M. 595 (355), 624, 1067 (124),  
 1131 (486, 488), 1157, 1165  
 Watanabe, S. 535 (8), 579 (232), 616, 621  
 Watanabe, T. 1074 (175), 1158  
 Watanabe, Y. 1047 (40), 1155  
 Waters, B.W. 297 (9), 332  
 Waters, J. 1116 (408), 1163  
 Waters, W.A. 484 (43), 526  
 Watkin, D. 60 (103c), 84  
 Watkins, B.E. 1140 (552), 1166  
 Watnick, C.M. 318 (78), 334  
 Watson, D.G. 37 (56), 82, 1063 (95, 96), 1157  
 Watson, H.B. 486, 487 (65), 498 (135), 526,  
 528  
 Watson, J.T. 1066 (119), 1157  
 Watts, D.W. 641 (71, 75), 655 (71), 660  
 Watts, W.E. 507, 512 (181), 529  
 Weast, R.C. 1010 (70), 1036  
 Weaver, M.A. 630 (13), 659  
 Webb, G.A. 297, 300 (1a–c), 301 (1b), 310  
 (49, 50), 311 (50), 317 (1b, 69, 73, 74), 318  
 (78, 79), 322, 323 (96), 332–334  
 Webb, H.M. 164 (33, 34), 165 (44), 166 (44,  
 50), 178 (34), 202, 236 (167, 168), 247, 386  
 (48a, 48b), 418  
 Webb, N.B. 1047 (24), 1155  
 Weber, D. 1145 (573, 576), 1147 (588), 1166,  
 1167  
 Weber, H.P. 63 (110a, 110b), 84  
 Weber, K.A. 600 (383), 624  
 Weber, R.U. 638 (47), 660  
 Weber, S.G. 1074 (182), 1158  
 Weger, H. 175 (82), 203  
 Wegewijs, B. 696 (79), 741  
 Wei, J. 541 (49), 617  
 Weiden, N. 99 (81), 103  
 Weidlein, J. 396 (91b), 419  
 Weigel, L.O. 544 (66), 617  
 Weigold, J.A. 438 (127), 473  
 Weil, K.G. 262 (54), 292  
 Weil, L. 1128 (462), 1164  
 Weiner, C.P. 992 (134), 997  
 Weiner, P. 3 (2a), 60 (103a), 81, 83  
 Weiner, S.J. 3 (2a, 2b), 81  
 Weinfeld, M. 833 (70), 836  
 Weinman, S. 15, 16 (26c), 82  
 Weinraub, D. 827 (40), 835  
 Weinreb, S.M. 595 (353), 624  
 Weintraub, S.T. 1066 (114), 1157  
 Weir, D. 688 (38), 740  
 Weisburger, E.K. 1020 (96), 1037  
 Weisburger, J.H. 1020 (96), 1037  
 Weise, M. 978 (58), 995  
 Weiske, T. 211 (40), 220 (96–98), 221, 232  
 (97, 98), 244, 246, 259 (46), 292  
 Weisman, G.R. 56 (80c, 80d), 83, 130 (87),  
 155, 184 (105), 203  
 Weiss, A. 99 (81), 103  
 Weiss, B. 648 (108), 661, 738 (200a), 745  
 Weiss, C.S. 1118 (421), 1163  
 Weiss, E. 396 (95), 419  
 Weiss, R. 639 (64, 65), 640 (66), 660

- Weiss, R.G. 783 (92), 820  
 Weissbuch, I. 1108 (388), 1163  
 Weister, M. 1139 (535), 1166  
 Weisz, A. 208 (10), 244, 992 (126), 997  
 Welch, L.E. 1073 (166), 1085 (268), 1158, 1160  
 Welch, W.M. 595 (354), 624  
 Wen, Y.X. 765 (45), 818  
 Wenck, A. 1079 (209), 1159  
 Wendt, J.O.L. 1175 (14), 1212  
 Wenska, G. 728 (171a, 171b), 744  
 Wentrup, C. 274, 275 (85), 293  
 Wenz, G.C. 313–315 (57), 333  
 Wepster, B.M. 489, 490 (83), 494, 495 (117, 124, 125), 498 (125), 519 (124, 125, 236), 520 (239), 522 (248), 527, 528, 531  
 Werner, A.E. 674 (52), 681  
 Werner, E.R. 983 (86), 990 (109), 993 (148), 996, 997  
 Werner, R.L. 434 (95), 472  
 Werner-Felmayer, G. 993 (148), 997  
 Wernick, D.L. 128 (83), 155  
 Werst, D.W. 826 (25), 835  
 Wesdemiotis, C. 208, 210–212, 215 (17), 240–242 (189), 244, 248, 254 (16), 292  
 Wessling, M. 849 (49), 856  
 West, F.G. 578 (222), 621  
 West, W.R. 1047 (37), 1155  
 Westaway, K.C. 893 (1), 896 (15), 933, 934, 938 (1), 940 (60), 941 (61–63), 942, 943 (61), 944 (60, 61), 945 (1), 946–948  
 Westaway, K.C.Jr. 896, 935, 941, 944 (19), 947  
 Westerholm, R. 1130 (480), 1165  
 Westhauser, T. 1090 (291), 1161  
 Westheimer, F.H. 895 (12), 947  
 Westmore, K. 992 (135), 997  
 Westover, D.L. 692, 702, 709 (53), 741  
 Westrum, E.F.Jr. 338, 361 (2c), 363 (87), 372, 377  
 Westwood, N.P.C. 166 (56), 202, 290 (116), 294  
 Wettermark, G. 710 (112), 742  
 Whalon, M.R. 43 (68), 46 (70), 83  
 Whang, Y. 403 (140), 421  
 Whang, Y.E. 407 (159), 421  
 Wheat, T. 1085 (265), 1160  
 Wheeler, J.F. 1023 (121), 1037  
 Wheeler, P.A. 1047 (21), 1155  
 Wheland, G.W. 443 (156), 474, 497 (133), 528  
 Whetsel, K.B. 434 (89, 93, 94), 472  
 Whincup, P.A.E. 678 (81), 682  
 White, H.S. 877 (70), 890  
 White, J.C. 727 (167), 744  
 White, J.G. 94 (35), 102  
 White, J.M. 184 (105), 203, 883 (89), 890, 954 (27), 971  
 White, K.A. 978 (67), 983, 984 (87), 995, 996  
 White, M.G. 192, 193, 200, 201 (136), 204  
 White, T.G. 63 (110a), 84  
 White, W.N. 877 (70), 890  
 Whiteford, R.A. 164 (39), 202  
 Whitesides, G.M. 108 (28), 128 (82, 83), 129 (82), 154, 155, 430 (45, 47–53), 471  
 Whiting, G.S. 1222 (56), 1226 (71), 1296, 1297  
 Whitman, R.H. 1105 (368), 1162  
 Whitmore, G.F. 1031 (184, 185), 1039  
 Whitten, D.G. 444 (163), 474, 693 (54), 697 (90), 727 (169), 741, 744  
 Whittle, A. 955 (40), 971  
 Wiberg, K.B. 355 (56), 375, 403 (142), 421  
 Wicks, G.E. 604, 605 (404), 625  
 Widdowson, D.A. 215 (57), 245  
 Widmer, H.M. 1093 (315), 1161  
 Wiebecke, M. 86, 88 (4), 102  
 Wieboldt, R. 769 (56), 819  
 Wieder, M.J. 317 (67, 69), 318 (78), 333, 334  
 Wiedner, J.H. 992 (131), 997  
 Wieland, E. 1021 (102), 1037  
 Wierenga, W. 639 (60), 660  
 Wiese, G. 1119 (426), 1163  
 Wieser, H. 133 (101), 148 (149, 150), 149 (149–151), 152 (149, 150), 155, 157  
 Wieser, K. 291 (119), 294  
 Wiesler, D. 1093 (320), 1161  
 Wiesler, W.T. 143 (129), 156  
 Wiezorek, C. 829 (45, 49), 836  
 Wigfield, Y.Y. 1145 (571), 1147 (594), 1166, 1167  
 Wikstrom, H. 62, 64, 65 (108), 84  
 Wilante, G. 410 (187a, 187b), 422  
 Wilcox, D. 673 (42), 681  
 Wilcox, J. 979 (72), 995  
 Wild, D. 1034 (205), 1039  
 Wild, F.R.W.P. 115 (49), 154  
 Wildemann, M. 175 (82), 203  
 Wilderink, A.H.C.M. 1048 (57), 1156  
 Wilen, S.H. 106 (12), 153, 1009 (66), 1036  
 Wilkes, A.J. 1116 (417), 1163  
 Wilkes, J.G. 1146 (583), 1167  
 Wilkie, R.J. 641 (75), 660  
 Wilkins, A. 98 (78), 99 (82), 103  
 Wilkins, C.W.Jr. 767 (49), 819  
 Willard, P.G. 724 (162f), 743  
 Willemse, R.J. 694 (61), 741  
 Willer, R.L. 96 (53), 103  
 Willett, G.D. 163–165 (25), 166 (55, 57), 202, 236 (171), 248  
 Willey, G.R. 453 (209), 475  
 William, D.Lyn H. 448 (190), 474  
 Williams, A. 1174 (6, 7), 1175 (10), 1212  
 Williams, A.E. 206, 207, 233 (2f), 243, 264 (63), 265 (69), 293

- Williams, D.H. 206, 207 (2c, 2e), 218 (87), 225 (116), 226 (121), 227 (122, 123, 125, 126), 232 (144), 233 (2c, 2e), 236 (123, 169), 239 (182, 183), 243, 246–248
- Williams, D.L.H. 448 (191), 474, 629 (12), 641, 644 (73), 659, 660, 666 (1, 2), 667 (9, 10), 669 (20, 26), 670 (26, 27), 672 (31, 32, 37), 675 (55, 56, 60, 65), 676 (66, 67, 70), 677 (66, 74, 75), 678 (79, 80, 82), 679 (86), 680–682, 865 (30), 869 (44), 883 (93), 884 (94), 886 (103), 887 (104), 888 (105), 889, 891
- Williams, F. 232 (143), 247
- Williams, G.J.B. 94 (39, 40), 102
- Williams, K. 1127, 1143 (458), 1164
- Williams, P.T. 1176 (23), 1178 (48), 1212, 1213
- Williams, S.C.R. 330 (123, 124, 127), 331 (127), 332 (130, 131), 335
- Williard, P.G. 396 (91c), 419
- Willisma, F. 825 (18), 835
- Willoughby, C.A. 115 (47, 48, 51), 116 (51, 52), 117 (48, 52), 154, 546 (74a, 74b), 618
- Willson, C.G. 767 (48a), 819
- Wilson, A. 1126 (450), 1164
- Wilson, C.A. 402 (139), 420
- Wilson, D. 1267 (169), 1299
- Wilson, G.E. 1059 (82), 1156
- Wilson, G.E.Jr. 325 (109), 334
- Wilson, I.S. 486 (57, 58), 526
- Wilson, J.C. 895, 896, 936 (11), 947
- Wilson, K. 833 (65), 836
- Wilson, N.K. 302 (18), 332, 1133 (503), 1165
- Wilson, P. 733 (183e), 744
- Wilson, R.H. 1031 (178), 1039
- Wilson, W.R. 329, 330 (111), 334
- Wilson, W.S. 877 (69), 890
- Windels, C. 695 (77), 741
- Winer, A.M. 1177 (35, 40), 1212, 1213
- Wing, M.R. 1098 (341), 1162
- Winitz, M. 107 (25), 154
- Wink, D.A. 669 (25), 680
- Winkle, M.R. 767 (52a), 819
- Winkler, J.D. 724 (162f), 743
- Winkler, R. 641 (74), 660
- Winstein, S. 424 (4), 470
- Winter, J.G. 905 (32), 947
- Wipff, G. 60 (103a), 83
- Wirth, P.J. 1029 (167), 1038
- Wirth, T. 604 (398), 625
- Wise, M.B. 1047 (49), 1155
- Wiseman, J. 985 (91), 996
- Wishnok, J.S. 976 (33), 991 (115), 994, 996, 1188 (86), 1189 (101), 1214
- Witanowski, M. 297, 300 (1a–c), 301 (1b), 310 (49, 50), 311 (50), 317 (1b), 318 (79), 332–334
- Withey, J.R. 1189 (93), 1214
- Witkiewicz, Z. 1047 (47, 48), 1155
- Wittel, K. 188 (114), 204
- Wittfoht, W. 977 (48), 995
- Wittig, C. 795 (123), 820
- Wittner, R. 1090 (291), 1161
- Woerpel, K.A. 119 (56), 154
- Wokaum, A. 297 (11), 332
- Wold, S. 522 (242), 531
- Wolf, J.L. 235, 236 (165), 247
- Wolf, M. 1127 (460), 1164
- Wolf, W.J. 1096 (332), 1161
- Wolfe, R.R. 1059 (83), 1156
- Wolfe, S. 14 (22a), 15 (22a, 24b), 16 (22a), 17 (22a, 24b), 19–21 (22a), 81, 896, 935, 941 (18), 947
- Wölfel, G. 553 (108a, 108b), 618
- Wolff, A. 1266 (157), 1299
- Wolff, D.J. 991 (119–121), 996
- Wolff, G.A. 1064 (104), 1157
- Wolff, H. 434 (84, 89, 92), 472
- Wolford, L.T. 606 (413), 625
- Wolfsberg, M. 894 (7), 947
- Wollmann, T.A. 112 (40), 154
- Wolz, E. 1034 (205), 1039
- Wong, C.C. 760 (37), 818
- Wong, C.-H. 108 (28), 154
- Wong, F.F. 534 (6), 616
- Wong, J.M. 1132 (490), 1135 (515), 1165
- Wong, M.H. 59 (99), 83
- Wong, S.S. 1065 (106), 1157
- Woo, K.L. 1085 (259), 1160
- Wood, E.R. 992 (132), 997
- Wood, K.S. 974 (2), 976 (32), 993 (144), 994, 997
- Woodrow, J.E. 1132 (490), 1165
- Woods, S.P. 957 (45), 971
- Woodworth, R.C. 956 (43), 971
- Worley, S.D. 164, 165, 168 (40), 170 (65), 202, 203
- Worrell, C. 166, 187 (54), 202
- Worsfold, P.J. 1045 (5), 1108 (384), 1155, 1163
- Worthen, H.G. 1082 (242), 1160
- Worthing, C.R. 1053, 1054, 1058, 1115, 1124 (75), 1156
- Wozniak, K. 437 (121), 473
- Wozniak, M. 561 (140c, 142–144), 619, 1217 (13b), 1295
- Wright, A.D. 231 (136, 138), 232 (138), 247
- Wright, D.J. 434 (85), 472, 511 (211), 530, 1241, 1262, 1264 (103b), 1298
- Wright, D.P. 1187 (79), 1213
- Wright, D.R. 933–935, 938 (49), 947
- Wright, G.J. 954 (30–33), 962 (30), 963 (31), 971
- Wright, J.D. 1126 (450), 1164

- Wu, A.-H. 657 (169), 662  
 Wu, A.H.B. 1065 (106), 1157  
 Wu, H.P. 992 (130), 997  
 Wu, J. 556 (118), 619  
 Wu, K.K. 989 (103), 996  
 Wu, M. 1151 (618), 1167  
 Wu, M.-J. 567 (182), 620  
 Wu, S. 697 (82), 741, 1096 (331), 1161  
 Wu, Y.-D. 72 (122a), 84  
 Wu, Y.M. 447 (185), 474  
 Wu, Z. 1284, 1285 (194a), 1300  
 Wu, Z.Z. 811 (163), 812 (167), 814 (170), 815 (171), 821  
 Wubbels, C.G. 785 (97b), 820  
 Wubbels, G.G. 756 (22), 757 (26), 759 (35a, 35b), 818  
 Wuchner, K. 1145 (572), 1166  
 Wuis, E.W. 1128 (464), 1164  
 Würthwein, E.-U. 165, 166, 192 (45), 202  
 Wurtz, C.A. 481 (14), 525  
 Wurtz, R. 434 (89), 472  
 Wyman, J.F. 1134 (505), 1165  
 Wynberg, H. 539 (40), 617  
 Wyn-Jones, E. 57 (87), 83  
  
 Xiao, H.-M. 4, 14 (21), 81  
 Xiao, L. 509 (188, 189), 529, 530  
 Xie, H.-Q. 415 (208), 416 (212), 422  
 Xie, J. 991 (123), 996  
 Xie, Q.-W. 978 (63, 65), 992 (129, 131), 993 (147, 150), 995, 997  
 Xiong, H. 886 (97), 891  
 Xu, C.D. 583 (277), 622  
 Xu, G. 1146 (585), 1167  
 Xu, G.P. 1151 (615), 1167  
 Xu, H. 557 (124), 619, 1148 (604), 1167  
 Xu, W. 690 (45–47), (44), 740, 741, 978 (70), 979 (77), 995  
 Xu, Y. 1103 (362), 1162  
  
 Yabroff, D.L. 499, 520 (139), 528  
 Yacobson, G.G. 315 (59), 333  
 Yagi, M. 722 (159b, 159c), 743, 789 (106), 820  
 Yagupolskii, L.M. 1238 (93), 1297  
 Yagupolskii, Yu.L. 1238 (93), 1297  
 Yakechi, H. 609 (431), 625  
 Yakobson, G.G. 306, 311, 313 (38), 333, 866 (36), 889  
 Yamada, H. 565 (174), 620, 1114 (405), 1163  
 Yamada, J. 544 (67), 617  
 Yamada, K. 795 (128, 129), 796 (130), 820, 950 (14), 970  
 Yamada, M. 543 (56), 617, 1085 (270, 271), 1129–1131 (476), 1160, 1164  
 Yamada, T. 824 (12), 835, 1090 (297), 1092 (307), 1161  
 Yamada, Y. 590 (319), 623  
 Yamagami, C. 305 (33), 306 (34), 307 (33), 333  
 Yamagami, M. 868 (42), 889  
 Yamaguchi, F. 467, 468 (274), 476, 1217 (7), 1295  
 Yamaguchi, J. 580 (248), 621  
 Yamaguchi, K. 96 (47), 102, 872 (56), 890  
 Yamaguchi, S. 114 (45), 154, 390, 391 (68), 419  
 Yamaguchi, T. 843 (21), 855  
 Yamaizumi, Z. 1004, 1007, 1009, 1012, 1019, 1035 (43), 1036  
 Yamakawa, K. 585 (293), 622  
 Yamamoto, H. 863 (25), 889  
 Yamamoto, J. 866 (34), 889  
 Yamamoto, K. 1089 (289, 290), 1118 (424), 1161, 1163  
 Yamamoto, M. 215 (53, 54), 245, 574 (205), 620, 695 (68), 741, 795 (128, 129), 796 (130), 820  
 Yamamoto, T. 616 (465), 626  
 Yamamoto, Y. 459 (244), 476, 544 (67), 617  
 Yamamuchi, S. 724 (162b), 743  
 Yamamuro, A. 112 (40), 154  
 Yamano, M. 561 (146), 619  
 Yamanobe, M. 1122 (438), 1164  
 Yamanouchi, K. 24 (32), 82  
 Yamaoka, T. 787 (101), 820  
 Yamasaki, T. 551 (94), 618  
 Yamashina, K. 1106 (378), 1162  
 Yamashita, T. 561 (146–149), 562 (150), 595 (355, 358), 619, 624, 704 (104–106), 706 (106), 742  
 Yamashita, Y. 452 (196), 475  
 Yamataka, H. 409 (174), 421, 933 (47), 934 (50), 935 (53), 947, 948  
 Yamato, T. 848 (45), 856, 969 (65), 971  
 Yamauchi, A. 1119 (433), 1164  
 Yamazaki, S. 580 (247), 581 (254), 621, 622  
 Yamazaki, T. 161, 163, 171–173, 193, 197 (21), 202  
 Yamazaki, Y. 581 (254), 622  
 Yamazari, M. 718 (147), 743  
 Yamazoe, Y. 1004, 1007, 1009, 1034 (41), 1035  
 Yan, D.-S. 567 (182), 620  
 Yan, J. 346 (19), 373  
 Yan, L. 4, 33, 35 (44), 82  
 Yanagida, K. 870 (50), 890  
 Yanagida, S. 824 (12), 835  
 Yanai, T. 610 (439), 611 (440), 614 (457), 625, 626  
 Yanez, M. 407 (161b), 408 (168), 421  
 Yang, C.C. 581 (259), 622

- Yang, D. 133 (101), 148 (147, 149, 150), 149 (149–151), 152 (147, 149, 150), 155, 157  
 Yang, M. 173 (79), 203  
 Yang, N.C. 445 (168), 474, 694 (67), 698 (98), 741, 742  
 Yang, S.S. 1079 (215), 1159  
 Yang, X. 188 (118, 119), 204  
 Yang, X.H. 1058 (76), 1156  
 Yang, Z.-Z. 184 (105), 203  
 Yannakopoulou, K. 554 (115a, 115c), 555 (115c, 117), 556 (121, 123), 558 (129), 619  
 Yano, Y. 605 (406), 625  
 Yarwood, J. 442 (153), 473  
 Yasuda, M. 561 (146, 147, 149), 562 (150), 588 (304), 619, 623, 704 (103–107), 706 (106), 742  
 Yasui, S. 650 (126), 661  
 Yasumura, Y. 1089 (290), 1161  
 Yasuoka, T. 676 (68), 681  
 Yates, B.F. 208 (19–21), 209 (22), 210 (19), 211 (19, 20), 214 (21), 215 (20), 235 (19), 244  
 Yates, K. 381 (5a), 416, 641 (76), 660, 785 (96, 97a, 98), 786 (99, 100), 820  
 Yavari, I. (85), 334  
 Ye, J.N. 1093 (319), 1161  
 Yeh, H.J.C. 317 (69), 318 (78), 333, 334  
 Yen, G.C. 1081 (226), 1159  
 Yeo, A.N.H. 239 (183), 248  
 Yeung, E.S. 1118 (422), 1163  
 Yeung, T.-C. 1032 (196), 1039  
 Yi, K.Y. 602 (386), 624  
 Yildirim, Y. 657 (167), 662  
 Yinon, J. 281 (92, 95), 289 (111), 293  
 Yip, R.W. 765 (44–46), 811 (163), 818, 821  
 Yoffe, A.M. 1047 (24), 1155  
 Yoganasimhan, S. 876 (68), 890  
 Yoho, L.L. 990 (110), 996  
 Yokosu, H. 1081 (233), 1159  
 Yokoyama, K. 758 (34a, 34c–e), 818  
 Yokoyama, T. 308, 309 (39, 42), 333, 439 (129), 443 (157), 473, 474  
 Yokozeki, A. 56 (84a, 84b), 83  
 Yoneda, N. 651 (132, 133), 656 (166), 657 (132), 661, 662  
 Yonemitsu, O. 722 (157b, 157c), 743  
 Yonemitsu, O. 736 (194a, 194b), 745  
 Yonemura, K. 582 (265), 622  
 Yoneyoshi, Y. 112 (39), 154, 536 (15), 617  
 Yoon, B.A. 729 (175a, 175b), 744  
 Yoon, H. 108 (27), 154  
 Yoon, N.M. 534 (2), 537 (30), 563 (155), 616, 617, 620  
 Yoon, P.S. 976 (33), 994  
 Yoon, U.C. 685 (16), 688 (43), 690 (45), 714 (127), (44), 740, 742  
 Yoshida, E. 734 (188b), 744  
 Yoshida, K. 561 (148), 605 (406), 619, 625  
 Yoshida, T. 77 (127), 84, 1067 (125), 1157  
 Yoshida, Y. 595 (355, 358), 624  
 Yoshida, Z. 498 (137), 528  
 Yoshihiro Kuroda 320 (84), 334  
 Yoshikawa, K. 164 (30), 165, 166 (23), 170 (30), 202  
 Yoshikoshi, A. 611 (441), 625  
 Yoshimine, M. 882 (87), 890  
 Yoshimizu, H. 322, 323 (96), 334  
 Yoshimura, A. 535 (11), 616  
 Yoshioka, H. 565 (173), 620  
 Yoshioka, M. 597 (372), 624  
 Yost, R.A. 238 (180), 248  
 Young, A.P. 991 (123), 996  
 Young, H.L. 1016 (88), 1037  
 Young, M. 1024 (125), 1037  
 Young, P.N.W. 669 (23), 680  
 Young, R.J. 1048 (56), 1156  
 Yousaf, T.I. 593 (344), 623  
 Youssefyeh, R.D. 1001, 1003 (21), 1035  
 Yssa, Y.M. 439 (134), 473  
 Yu, C. 188 (115–117), 204  
 Yu, G.-S. 153 (167), 157  
 Yu, J. 1071 (153), 1158  
 Yu, X. 1024 (127), 1037  
 Yu, Z.S. 1046 (15), 1155  
 Yuasa, M. 576 (212), 621  
 Yuh, Y.H. 3 (3c, 3d, 4a), 4 (4a), 5 (3c, 3d, 8), 16 (8), 20, 21 (4a), 22 (8), 27 (3c, 3d, 4a), 59 (102), 81, 83  
 Yui, Y. 978 (59, 66), 995  
 Yukawa, Y. 489, 496 (85, 86), 504 (153), 521 (85, 86), 527, 529  
 Yumoto, M. 544 (67, 67), 617  
 Yunes, R.A. 1009 (59), 1036  
 Yunis, A.A. 1024 (129, 130), 1025 (130, 135, 136, 138), 1037, 1038  
 Yus, M. 396 (88), 419  
  
 Zabicky, J. 1044 (1), 1045, 1047 (6), 1154, 1155  
 Zabrowski, D.L. 579 (229), 621  
 Zachariadis, G. 1139 (537), 1140 (547), 1166  
 Zacharias, D.E. 94 (41), 102, 452 (199), 475  
 Zachariasse, K.A. 697 (84, 85), 741  
 Zahradnik, R. 426 (10, 12), 428 (30), 431 (12), 434 (83), 470–472  
 Zaitsev, V.P. 139 (114, 115), 156  
 Zajac, W.W.Jr. 579 (237, 238), 621  
 Zaleta, M.A. 639 (60), 660  
 Zaltsgendler, I. 550 (86a), 618  
 Zamboni, R. 574 (206), 621  
 Zambonin, P.G. 1078 (197), 1159  
 Zamora, L.L. 1099 (344), 1162  
 Zanardi, G. 655 (158), 662  
 Zanaly, L. 164, 165, 175 (31), 202



- Zanoni, M.V.B. 852 (62), 856  
 Zapardiel, A. 1138 (530), 1166  
 Zapico, J. 1085 (266), 1160  
 Zard, S.Z. 613 (451), 615 (461), 626  
 Zavattarelli, F. 447 (187), 448 (188), 474  
 Zawadzki, J.V. 975 (5, 13), 994  
 Zawadzki, S. 537 (32), 540 (44), 617  
 Zebrowski, B.E. 698 (95), 742  
 Zeegers-Huyskens, T. 387, 388 (54), 418  
 Zeeuw, R.A.de 1048 (57), 1156  
 Zeitlin, A.L. 108, 109 (31), 154  
 Želazna, M. 459 (242), 476  
 Zelenetskii, A.N. 352 (43), 374  
 Zeman, S. 1142 (564), 1166  
 Zeng, D. 977 (51), 995  
 Zeng, Z. 1132 (491), 1165  
 Zerban, H. 1185 (71), 1213  
 Zerkowski, J.A. 430 (49), 471  
 Zhang, A.Q. 1064 (103), 1157  
 Zhang, F. 431 (67), 472  
 Zhang, F.Z. 1073 (172, 173), 1158  
 Zhang, J. 992 (142), 997  
 Zhang, M. 688 (42), 740  
 Zhang, R. 979 (73), 995, 1126 (449), 1164  
 Zhang, X.-M. 401 (133), 402 (131–133), 420, 690 (46), 740  
 Zhang, Y. 381 (21), 417, 428 (43), 471  
 Zhang, Z.-L. 346 (19), 373  
 Zhao, B. 1022 (116), 1037  
 Zhao, C. 608 (422), 625  
 Zhao, N. 143 (130), 156  
 Zhao, W.-Y. (68), 971  
 Zhao, X. 556 (122), 604 (394), 619, 624  
 Zheng, M. 1148 (604), 1167  
 Zhong-zhi, Y. 181 (96), 203  
 Zhou, G. 810 (156), 821  
 Zhou, O. 589 (309), 623  
 Zhou, P. 143 (129), 156  
 Zhou, W.-S. 120, 142 (62), 154  
 Zhou, X. 557 (124, 125), 562 (152), 619  
 Zhu, S.Z. 1238 (93), 1297  
 Zhu, X.-Y. 120, 142 (62), 154  
 Zibarev, A.V. 306, 311, 313 (38), 333  
 Zielinska, B. 1177 (35, 40–43, 46), 1179 (47), 1212, 1213  
 Zijlstra, R.W.J. 1110 (395), 1163  
 Zima, J. 1128 (466), 1135 (516), 1138 (529, 531), 1148 (598), 1164–1167  
 Zimmer, H. 639 (62), 660, 811 (164), 821, 1023 (121), 1037  
 Zimmerman, S.C. 1132 (491), 1165  
 Zimmermann, J. 655 (162), 662  
 Zincke, Th. 952 (16), 970  
 Zingaretti, L. 463 (254), 476, 1245–1247, 1266 (115a), 1298  
 Zinin, N.N. 481 (11), 525  
 Zipplies, M.F. 535 (12), 616  
 Zlatkis, A. 121 (68), 155  
 Zmuda, H. 860 (17), 861 (17, 19), 889, 897 (22), 899 (23), 904 (26), 947  
 Zmudzki, J. 1139 (533), 1166  
 Zoebisch, E.G. 161, 173 (18), 202  
 Zóke, A. 1047 (34), 1155  
 Zollinger, H. 628 (2, 3, 7), 631 (18), 636 (42), 637 (3, 7), 638 (47), 643 (89), 644 (7, 93), 646 (2, 7), 647 (2, 7, 106), 648 (107–110), 649 (3, 7), 650 (124), 651–654, 657 (7), 658–661, 1220 (34), 1241 (103c), 1262, 1264 (103c, 147c), 1266 (163a, 163b), 1268 (163a), 1296, 1298, 1299  
 Zou, X. 1256 (135), 1258 (135, 140, 141), 1259 (135), 1260 (140, 141), 1261 (141), 1298, 1299  
 Zsolnai, L. 115 (49), 154  
 Zubler, H. 634 (29), 659  
 Zucco, C. 1217 (6a), 1295  
 Zuckerman, J.J. 330, 331 (125), 335  
 Zuckermann, H. 795 (124), 820  
 Zuk, W.M. 148 (146), 150 (154, 156), 157  
 Zukowski, J. 1089 (284), 1090 (295), 1160, 1161  
 Zuman, P. 447 (181, 183, 186), 450 (181), 474, 838 (4a, 4b), 846 (36c), 848 (41a, 41b), 854 (65), 855, 856, 1000 (3), 1005 (3, 50), 1007, 1016, 1019 (3), 1035, 1036  
 Zummack, W. 216 (63c), 245  
 Zweifel, G. 117 (54), 154  
 Zweig, G. 1187 (79), 1213  
 Zweigenbaum, J.A. 1118 (419), 1163  
 Zweipfenning, P.G.M. 1048 (57), 1156  
 Zwierzak, A. 537 (32), 540 (44, 48), 617  
 Zwisler, W.H. 369 (96), 378  
 Zygumt, J. 860, 861 (17), 877 (72), 889, 890, 911 (34), 947

# Subject index

- Ab initio* calculations,  
 for ammonia dimers 27  
 for anilines 33, 34  
 for methylenediamines 17–19  
 for mixed aggregates 1267  
 for nitrosoalkane photoreactions 803  
 for propanediamines 57  
 for vinylamines 33, 34
- Acadesine, determination of 1097
- Acceptor number 425
- Acenaphthenes—*see* Nitroacenaphthenes
- Acetylenic amines, enthalpies of formation of 352
- N*-Acetyl-D,L-penicillamine, nitrosothiol derived from,  
 reactions of 670, 671  
 structure of 669  
 synthesis of 668
- Acidity,  
 gas-phase 382–385  
 hydrogen-bond 381  
 of amines 398–401  
 of ammonia 386  
 of carboxamides 403–405  
 of nitrogen acids 395
- Acridines—*see* Diaminoacridines, Dihydroacridines
- Activation, *ortho* vs *para* 1241–1243
- Activation energy, reverse 264
- Acyclic amines, MM2 parameterization of 6–8
- Acylamino group, activating effects of 486
- N*-Acylation, as pre-/post-column derivatization procedure 1080–1084
- N*-Acyl-2-nitrodiphenylamines, photocyclization of 773
- Acylnitroso compounds, cycloaddition of, MM2 study of 75, 76
- Adamantanes—*see* Azzadamantanes, Nitroadamantanes
- Adamantylamines, conformers of 50
- Addition–elimination mechanism, for  $S_NAr$  reactions 1216
- $\sigma$ -Adducts 1216, 1244
- 2',5'-ADP agarose 976
- $\beta$ -Adrenergic blockers 1092
- Adsorptive stripping square-wave polarography 1128
- Agmatine, analysis of 1069, 1079, 1081
- Agricultural products, nitrosamine contamination in 1186, 1187
- Ajmaline, analysis of 1100
- Alanines, determination of 1069, 1085, 1103, 1104
- $\beta$ -Alanines, chiral purity of 1092
- Alchemy III 42
- Alcohols, as amine precursors 542, 543
- Aldoximes, acidity of 404
- Alicyclic amines,  
 enthalpies of formation of 345–347, 352–355  
 structure of 88–90
- Aliphatic amines—*see also* Alicyclic amines  
 atmospheric, determination of 1081–1083  
 chlorination of 1107  
 diazotization of 628  
 enthalpies of formation for 10–12, 351, 352  
 IPs of 163–168  
 PE spectra of 163–170  
 radiolysis of 824–826  
 structure of 86–88
- Aliphatic nitro compounds,  
 electroreactions of 849–851  
 photoreactions of 795–803
- Aliphatic nitroso compounds, enthalpies of formation of 360, 361
- Alizarin Red S 1137

- Alkali flame ionization detection (AFID) 1047
- Alkaloids,  
  bis-indole—*see* Bis-indole alkaloids  
  interactions with receptors 180  
  PE spectra of 180, 181, 188  
  through-space interactions in 181
- Alkanediazonium ions 628
- Alkanes—*see also* Aminoalkanes, Cycloalkanes, Nitroalkanes, Nitrosoalkanes, Tetraazaalkanes  
  elimination of, in fragmentations 218, 221, 238–241
- Alkenediazonium ions 632
- Alkenes—*see also* Aminoalkenes, Nitroalkenes  
  amination of 117–119, 587, 588  
  aziridination of 119, 120  
  elimination of, in fragmentations 214, 218, 223–225, 227–231, 236, 237
- Alkenylamines, ionized, mass spectra of 231–233
- Alkenyl radicals, elimination of, in fragmentations 214, 218, 223–225
- Alkoxy radical hydrogen abstraction, intramolecular 794
- Alkylamines—*see also*  $\alpha$ -(Cyanoalkyl)amines, Cycloalkylamines, Hexylamines, Isopropylamines, Phenylalkylamines  
  basicity of 386, 388, 389  
  enthalpies of formation of 340  
  correlation of 343–345  
  ionized,  
    conventional structures for 207, 208  
    dostonic isomers of 208–217  
    mass spectra of 217–231  
    MM2 parameterization of 6–8  
    proton affinities for 235  
  protonated, mass spectra of 236–239, 241–243  
  radical cations of 824, 826
- Alkylammonium nitrates, CMC of 1119
- Alkylanilines—*see* 4-Cyano-*N,N*-dialkylanilines, *N,N*-Dimethylanilines, *N,N*-2,4,6-Pentamethylaniline
- Alkyl nitrites,  
  as nitrosating agents 666, 667  
  photoreactions of 810
- Alkylphenols—*see* Methylphenols, Trialkylphenols
- Alkyl radicals, elimination of, relative ease of 219, 220
- Allenic amines, synthesis of 577
- Allylic amines—*see also* Homoallylic amines  
  IPs of 163  
  synthesis of 541, 566–575
- N*-Allylminium salts, photocyclization of 712, 713
- Alpidem, determination of 1063
- AM1 80
- Ambenonium, analysis of 1119
- AMBER 3, 35, 36
- Amidates, basicity of 395
- Amides—*see also* Benzamides, Carboxamides, Cyanamides, Enamides, Nitramides, Nitrosamides, Phosphoramides, Sulphonamides, Thioamides, Toluamides  
  acidity of 403, 404  
  basicity of 395  
  chiral—*see* Chiral amides  
  metal—*see* Metal amides  
  PE spectra of 188  
  phosphonic—*see* Phosphonic amides  
  photoreactions of 722–730  
  reduction of 536, 537  
  synthesis of 590–594
- Amidines—*see also* Benzamidines  
  acidity of 403, 404  
  basicity of 392  
  reactions with nitromethanes 412
- Amidoximes, acidity of 404
- Animals, synthesis of 558
- Aminon, electrophilic 550–553  
  oxidative 560, 561  
  photochemical 561, 562
- Amine aggregates 1237, 1262, 1266, 1294
- Amines—*see also* Adamantylamines, Alkenylamines, Alkylamines, Amino compounds, Arylamines, Catecholamines, Diamines, Enamines, Fluorenylamines, Haloamines, Hydroxylamines, Indoleamines, Naphthylamines, Neopentylamines, Polyamines, Propargylamines, Silylamines, Tetramines, Triamines  
  acetylenic—*see* Acetylenic amines  
  acidity of 398–401  
  acyclic—*see* Acyclic amines  
  aliphatic—*see* Aliphatic amines  
  allenic—*see* Allenic amines  
  allylic—*see* Allylic amines  
  aromatic—*see* Aromatic amines  
  basicity of 66–68  
    correlation with hybridization of N atom 236  
    effect of alkyl substitution on 178  
    strain effects on 66–68  
  biogenic—*see* Biogenic amines  
  branching in, effect on  $S_NAr$  reactions of 1235, 1237, 1294  
  complexes of,  
    covalent 457–460  
    donor–acceptor 439–446, 460–465, 1246–1252  
    non-covalent 460–470  
  cyclic—*see* Cyclic amines

- dimerization of 434, 435, 1262, 1266  
heterocyclic—*see* Heterocyclic amines  
hydrogen bonding in 430–439  
nitranion salts of 397  
primary—*see* Primary amines  
reactivity of, solvent effects on 235  
secondary—*see* Secondary amines  
tertiary—*see* Tertiary amines  
vibrational frequencies in 23  
volatile—*see* Volatile amines
- Aminium radicals 812
- Amino acid peroxidases 1104
- Amino acids—*see also* Nitrosoamino acids
- CE separation of 1093, 1094  
chiral purity of 1089–1092, 1094  
derivatization of 1078–1080, 1082, 1084, 1085, 1096  
detection of 1066  
  amperometric 1073  
  in FIA systems 1105  
determination of,  
  spectrophotometric 1097  
  using enzymatic biosensors 1102–1104  
D:L ratio of 1092, 1093  
enantiomers of 1108  
FIA of 1098  
in drinking water 1079  
in single cells, determination of 1079  
isotope analysis of 1059  
LC of 1067–1070, 1074, 1076, 1079  
PE spectra of 188  
pyrolysis of 1072  
radiolysis of 828–832  
synthesis of 550  
tagging of 1081  
thiohydantoin derivatives of 1084, 1090, 1096
- $\alpha$ -Amino acids,  
  basicity of 386  
  proton affinities of 390  
  ROA spectra of 152, 153  
  VCD spectra of 150
- $\omega$ -Amino acid transaminases 108, 109
- Amino alcohols,  
  chiral—*see* Chiral aminopropanols  
  chiral purity of 1090, 1112  
  GC analysis of 1066  
  hydrogen bonding in 29  
  structure of 86  
  synthesis of 543–545
- Aminoalkanes,  
  chiral—*see* Chiral aminoalkanes  
  conformers of 46–49
- Aminoalkanoic acids 1108
- Aminoalkenes, transannular interactions in 181, 182
- Aminoalkyl-4-nitrobenzenes, CT interactions in 169
- Aminoalkylphenanthrenes, irradiation of 707, 708
- Aminoanthracenes, detection of 1131
- Aminoanthraquinones, diazotization of 634
- Aminoantipyrines, determination of 1101
- Aminobenzenes, structure of 90, 93
- Aminobenzoates, LIF excitation spectra of 1101
- Aminobenzoic acids,  
  determination of, in vitamin B complex 1101  
  structure of 90, 91, 93
- Aminobenzophenones, HPLC of 1074
- Aminobiphenyls,  
  enthalpies of formation of 350  
  formation of 1030
- $\epsilon$ -Aminocaproic acid, determination of 1078
- Aminochromes 1067, 1086
- Amino chromophore 130–133  
  singlet–triplet transition of 133
- Amino compounds—*see also* Amines, Amino acids, Amino alcohols, Amino esters, Amino ketones, Amino saccharides
- alkylation/arylation of 538–540, 583–587  
analysis of 1105–1109  
  electrophoretic 1093–1096  
  gas chromatographic 1060–1067  
  general 1049–1058  
  isotope 1059, 1060  
  liquid chromatographic 1067–1093  
  spectrophotometric 1096–1102  
  using enzymatic biosensors 1102–1105
- as aminating agents 587, 588
- carcinogenic 1173, 1196–1201  
  detection of 1072, 1073  
  chiroptical properties of 105–153  
  configuration of, absolute 1111  
  cyclization of 597–599  
  dealkylation of 581–583  
  derivatization of 1109–1114  
  pre-/post-column 1076–1088  
  dipole moments for 11, 12  
  environmental sources of 1171–1173, 1196, 1197
- MM2 parameterization of 6–11  
MM3 parameterization of 23–29
- NMR spectra of,  
  effect of alkyl groups on 300, 301  
  effect of aryl groups on 303–310  
  oxidation and dehydrogenation of 578–581  
  protection of 594, 595  
  radiolysis of 824–828  
  reactious of 601–604  
   $S_N$ Ar 1215–1295

Amino compounds (*cont.*)

- reactions of (*cont.*)
  - with formation of amides 590–594
  - with formation of aminyl radicals 599–601
  - with formation of carbamates 595–597
  - with formation of enamines 588–590
  - with formation of isocyanates 595–597
  - with formation of ureas 595–597
- structure of 86–95
- synthesis of 577, 578, 607–610
  - by alkylation/arylation of amines and azides 538–540
  - by electrophilic amination 550–553
  - by modifications of the Gabriel synthesis 540–542
  - by oxidative amination 560, 561
  - by photoamination 561, 562
  - by reduction 534–538
  - by reductive alkylation 562–564
  - from alcohols 542, 543
  - from aziridines 543, 545
  - from epoxides 543–545
  - from imines 545–550
  - from organoboranes 564–567
  - from oxetanes 543, 545
  - via  $\text{NC}^+$  synthons 553–560
- Aminocyclohexanes—*see* Diaminocyclohexanes
- 2-Amino-2-deoxygalactopyranosides, *p*-bromobenzoyl derivatives of, ECCD spectra of 143
- Amino esters, synthesis of 556
- Amino fluoranthenes 1105
- Amino fluorenes,
  - BDEs of 402
  - detection of 1131
  - formation of 1031
- Amino group—*see also* Acylamino group
  - electronic effects of 516–521
  - ortho* effect of 520
- Aminoindans, conformers of 64–66
- Amino ketones, transannular interactions in 182
- $\alpha$ -Amino ketones, synthesis of 577, 578
- Aminonaphthalenes—*see also* Diaminonaphthalenes
  - conformers of 52, 53
  - PE spectra of 176–178
- Aminonitrosobenzenes, enthalpies of formation of 358
- Aminonitrosilbenzenedisulphonic acids, separation of 1136, 1137
- Aminonitrotolamides, analysis of 1136
- Aminooxazoles, structure of 94
- Aminooxidases 1103
- Amino-oxyls, analysis of 1153, 1154

- Aminophenazines,
  - diazotization of 638
  - HPLC of 1076
- Aminophenols,
  - determination of 1103
  - diazotization of 637–639
  - electroformation of 838
  - structure of 93
- Aminopyrazines, structure of 94
- Aminopyrazolines, diazotization of 631
- Aminopyrenes, determination of 1069
- Aminopyridazines, synthesis of 561
- Aminopyridine oxides, diazotization of 633, 644
- Aminopyridines,
  - diazotization of 633, 644
  - HPLC of 1071
  - mass spectra of 234
  - structure of 94
- Aminopyrimidines, structure of 94
- Aminoquinolines, diazotization of 644
- Amino saccharides, determination of 1073
- Aminosalicyclic acids, structure of 91, 93
- Aminostannanes, arylation of 584
- Aminotetralines, resolution of 1092
- Aminotetrazines, structure of 95
- Aminotetrazoles,
  - diazotization of 633
  - structure of 94
- Aminothiadiazoles, structure of 94
- Aminothiazoles,
  - diazotization of 644
  - structure of 94
- Aminotriazines, structure of 95
- Aminotriazoles, structure of 94
- Aminyl radicals, formation of 599–601
- Ammonia,
  - acidity of 386, 395
  - dimerization of 27, 28
  - inversion barrier of 24
  - IP of 168
  - PE spectrum of 161–163
  - photoreactions of 704–706
- Ammonia–water complex, hydrogen bonding in 28, 29
- Ammonium compounds—*see* Quaternary ammonium compounds
- Amperometric biosensors 1102–1105
- Amphetamines,
  - detection of 1065, 1071, 1106
  - determination of 1079, 1083, 1097
  - PE spectra of 180
  - tagging of 1083
- Anilides—*see* *N*-Chloroanilides
- Anilines—*see also* Alkylanilines, *N*-Benzylideneanilines, Dihydroanilines, Haloanilines, Nitroanilines, (4-Nitro-

- phenacylanilines, Nitrosoanilines, *N*-Salicylideneanilines  
acidity of 395, 400, 401  
basicity of 390, 392  
charge-transfer complexes of 441  
conformers of 53  
determination of 1125, 1135  
electroformation of 844, 845  
enthalpies of formation of 35, 348, 349  
IPs of 163, 172–176  
mass spectra of 234  
MM2 parameterization of 14, 33–35  
MM3 parameterization of 33–35  
MOs of 171, 173  
NMR spectra of 303–310  
PE spectra of 171–176  
radiolysis of 826  
resonance energies of 348, 349  
structure of 93  
synthesis of 537, 538, 1023
- Anion binding 385
- Anisoles—*see* 4-Methylanisoles, Nitroanisoles
- Annellation processes 286, 287
- Anomeric effect 4  
force-field parameterization for 14–20  
reverse 1113
- Anthracenes—*see* Aminoanthracenes, Nitroanthracenes
- Anthraquinones—*see* Aminoanthraquinones
- Antimalarial drugs, determination of 1099
- Antipyrines—*see* Aminoantipyrines
- Anxiolytic drugs, determination of 1063
- Apomorphine, HPLC of 1071
- Arene-carboxylic halides, formation from diazonium salts 657
- Arenediazonium ions, structure of 648, 649
- Arenes—*see* Nitroarenes, Nitrosoarenes
- Arenesulphonyl halides, formation from diazonium salts 657
- Arenols—*see* Nitrosoarenes
- Arginines—*see also N*-Hydroxy-L-arginine, *N*-Methyl-L-arginine  
analysis of 1094, 1103  
as NO precursor 673, 975, 976, 980–983, 986, 987
- Argon matrix isolation systems 767
- Aromatic amines—*see also* Aromatic diamines  
chlorination of 1107  
PE spectra of 171–178  
radiolysis of 826–828  
structure of 90–95  
titration of 628, 629
- Aromatic diamines,  
diazotization of 635  
enthalpies of formation of 353, 354
- Aromatic dinitro compounds, electroreactions of 847–849
- Aromatic nitro compounds—*see also* Aromatic dinitro compounds, Nitroarenes, Polycyclic nitroaromatics  
analysis of 1125–1138  
gas chromatographic 1126, 1127, 1129, 1130  
liquid chromatographic 1128–1132  
carcinogenic 1171–1173, 1180  
electroreactions of 845–847  
explosive properties of 361, 366, 368–371  
mutagenic 1126, 1129–1131, 1171, 1172, 1181, 1182  
photoaddition and coupling of 776–778  
photodissociation of 787–789  
photoisomerization of 778, 779  
photorearrangement of 760–776  
photoreduction of 748–753  
photosubstitution of,  
intermolecular 753–758  
intramolecular 758–760  
rearrangement of 876–882  
resonance effects in 361, 362
- Aromatic nitroso compounds, photoreactions of 806, 807
- Arylamines—*see also* Benzylamines, *N*-Hydroxyarylamines, Phenylamines  
basicity of 235, 236  
enthalpies of formation of 348–350  
formation from nitrosoarenes and thiols 1011, 1023, 1030, 1031  
ionized, mass spectra of 233, 234
- Arylation, palladium-catalysed 654
- N*-Arylation, as pre-/post-column derivatization procedure 1085
- Aryl cations, as intermediates in dediazoniations 647, 648
- Arylmetallic compounds, as arylating agents 584
- Arylmethanes—*see* Nitroarylmethanes
- Asparagine 1069, 1085
- Aspartic acid, rate of epimerization of 1093
- Asymmetric synthesis,  
using chiral diimine-based catalysts 119, 120  
using chiral metal hydride reagents 109–119  
using enzymes 107–109
- Atrazine, determination of 1047
- Atropine 1100
- Autocatalytic kinetic behaviour 455
- Average dipole orientation (ADO) theory 258
- Azaadamantanes—*see also* Diazaadamantanes, Tetrazaadamantanes, Triazaadamantanes  
IPs of 166
- Aza-aromatic compounds,  $S_NAr$  reactions of 1217
- Azabicycloalkanes—*see also* Diazabicycloalkanes

- Azabicycloalkanes(*cont.*)  
chiral—*see* Chiral azabicycloalkanes  
conformers of 66  
IPs of 166, 168, 179  
proton affinities of 67, 68, 179
- Azacrown ethers, conformers of 60
- Aza-di- $\pi$ -methane rearrangement 715, 716
- Azamacycles, metal complexes of 396
- Azanorbmanes,  
IPs of 165  
PE spectra of 182
- Azatwistanes, IPs of 166
- Azepines—*see also* Benzazepines,  
Hexahydroazepines, Perhydroazepines  
IPs of 165, 166, 168
- Azetidines—*see also* *N*-Nitrosazetidines  
chiral—*see* Chiral azetidines  
enthalpies of formation of 346, 347  
IPs of 165, 166  
MM2 parameterization of 8  
proton affinities of 67  
radical cations of 825
- Azides,  
alkylation/arylation of 538, 540  
reduction of 537, 538
- Azidodediazotization 652
- Azines,  
nitranion salts of 398  
 $pK_a$  values of 409
- Aziridines—*see also* *N*-Nitrosaziridines  
as amine precursors 543, 545  
chiral—*see* Chiral aziridines  
IPs of 165, 166, 168  
proton affinities of 67  
radical cations of 825
- Azirines, photoreactions of 717
- Azobenzenes,  
electroformation of 843, 844  
PE spectra of 199
- Azo compounds—*see also* Azo dyes,  
Hydroxyazo compounds  
carcinogenicity of 1173
- Azo dyes,  
carcinogenicity of 1197–1211  
GC-MS of 1066  
HPLC-MS of 1073  
polarography of 1138
- Azoles—*see also* Isoxazoles, Nitroazoles,  
Pyrazoles, Thiazazoles, Thiazoles,  
Triazoles  
nitranion salts of 398  
 $pK_a$  values of 408
- Azoxybenzenes 1144  
rearrangement of 865–867
- Azoxy compounds, electroformation of 838, 844
- Bacillus megaterium*, in asymmetric synthesis 108
- Bacteria, autotrophic 1103
- Balz–Schiemann reaction 649, 651
- Bamberger rearrangement 867–871
- Bamethan 1095
- Base catalysis 1216, 1217, 1290  
dependences of rate constants on [B] 1217, 1218, 1274, 1288
- Basicity,  
gas-phase 382–385, 1237, 1238, 1284  
hydrogen-bond 381  
of alkylamines 386, 388, 389  
of amides 395  
of amides 392  
of amino acids 386  
of enamino ketones 387  
of guanidines 392–394  
of phosphinimines 394  
of pyridines 386
- Basis Set Superimposition Error 27, 28
- Bathocuproine sulphonate 674
- Beckmann rearrangement, photolytic 799
- Bend–bend energy, in MM3 force field 22
- Bending energy, in MM2 force field 5
- Benesi–Hildebrand treatment 462, 463
- Benzaldehydes—*see* Nitrosobenzaldehydes
- Benzalkonium salts, determination of 1116, 1118, 1119
- Benzamides—*see also* Fluorobenzamides  
PE spectra of 199
- Benzamidines, acidity of 404
- Benzazepines, synthesis of 706
- Benzene chirality rule 133, 135–137
- Benzene chromophore, effect of the amino group on 133
- Benzenediamines, enthalpies of formation of 353
- Benzene ring, electronic structure of, substituent effects on 174
- Benzenes—*see also* Aminobenzenes, Dimethylbenzenes, Fluoromethylbenzenes, Hydrazobenzenes, Nitrobenzenes, Nitrofluorobenzenes, Nitrosobenzenes  
NMR spectra of, effect of amino, nitro and nitroso groups on 301–303
- Benzene sector rule 133–135
- Benzenesulphonates, as ion-pairing agents 1118
- Benzethonium 1117  
analysis of 1116, 1119
- Benzidine,  
detection of 1065  
enthalpy of formation of 354

- Benzidine rearrangement 858–865  
  heavy-atom kinetic isotope effects on  
    859–861, 897–932  
  mechanisms of 859  
    elucidation of 897–932  
  thermal 863
- Benzoates—*see* Aminobenzoates
- Benzodiazepines, determination of 1063
- Benzoic acids—*see* Aminobenzoic acids,  
  Nitrobenzoic acids
- Benzophenones—*see* Aminobenzophenones,  
  Nitrobenzophenones
- Benzoquinone diimines, formation of  
  1016–1018
- Benzoquinuclidine, IPs of 174
- Benzotriazoles,  
  as amine precursors 554–559  
  synthesis of 635
- Benzoxadiazole reagents 1081, 1091
- N*-Benzoyl derivatives, ECCD spectra of 142,  
  143
- Benzylamines—*see also N*-Nitroso-  
  dibenzylamine, Tribenzylamine  
  PE spectra of 170
- N*-Benzylidencanilines, PE spectra of 199
- N*-Benzylidene derivatives, ECCD spectra of  
  139–142
- Berberine 1116, 1117
- Beverages, nitrosamine contamination in 1187,  
  1188
- Bicyclic diamines, through-bond interactions in  
  184
- Bicycloalkanes—*see also* Azabicycloalkanes  
  enthalpies of formation of 347
- Bicycloalkanones—*see* Nitrotetraazabicyclo-  
  alkanones
- Bicycloalkenes—*see also* Diazabicycloalkenes  
  transannular interactions in 181, 182
- Bicycloalkyls—*see* Dinitrobicycloalkyls
- Bifunctional catalysts 1286
- Biocatalysts, in asymmetric synthesis 108
- Biogenic amines,  
  derivatization of 1082, 1083  
  pre-column 1078  
  detection of 1080, 1081  
  determination of 1058, 1062, 1069, 1074,  
    1079  
  HPLC of 1067  
  stability of 1067
- Biopterins 981
- Biosensors 767
- Biphenyls—*see* Aminobiphenyls,  
  Nitrobiphenyls
- Bis(aminoalkyl)alkanediamines, enthalpies of  
  formation of 355
- Bisdiazonium ions, synthesis of 635
- Bis-indole alkaloids, separation of 1086
- Bohlmann bands 4
- Bohlmann effect 22
- Boltzmann distribution 72
- Bond dissociation energy 382  
  NH 400–403
- Born–Oppenheimer surface 3
- Bratton–Marshall method 1087  
  in spectrophotometric analysis 1097
- Bromonitrobenzenes, photoreactions of 757
- Bromophenol blue, as ion-pairing agent 1118
- Bromothymol blue, as ion-pairing agent 1116
- Brønsted acids, proton transfer from 289
- Brønsted plots 1228–1230
- Buckingham-type potential functions 6
- Buckminster fullerene, reactions with  
  diazonium salts 647
- Bupivacaine, determination of 1061
- Bupirone, determination of 1063
- t*-Butylglycine 1108
- Cadaverine, determination of 1058, 1069,  
  1079, 1081, 1083
- Caesium ion pairs 399
- Calicheamicin 1152
- Calixarenes 1119  
  as amine detectors 1100  
  nitration of 969
- Calmodulin 976–979, 989, 990
- Cambridge Structural Database 14
- Camphanes—*see* Nitrosocamphanes
- Candida antarctica* lipase 592
- Capillary electrophoresis 1093–1095
- Capillary zone electrophoresis 1094–1096
- Carbadox, analysis of 1140
- Carbamates—*see also* Dithiocarbamates  
  LC of 1074  
  synthesis of 595–597
- Carbazoles—*see N*-Chlorocarbazoles
- Carbendazim, impurities of 1076
- Carbenes, reactions with alkenes 647
- Carbolines, HPLC of 1072
- Carbon electrodes, glassy 1073
- Carbon paste electrodes 1105, 1106
- Carboxamides,  
  acidity of 403–405  
  basicity of 395  
  nitranion salts of 397
- Carboxylases 1104
- Carcinogenicity,  
  of amino compounds 1072, 1073, 1173,  
    1196–1211  
  of nitro compounds 1171–1173, 1180  
  of nitroso compounds 1145, 1172, 1173,  
    1186–1196  
  of snuff 1151  
  of tobacco smoke 1150



- Catalysis of catalysis 1266  
Catecholamines,  
  HPLC of 1073  
  oxidation of 1086  
CD curves, bisignate 140, 141  
Ceftizoxime 1148  
Cetrimide, determination of 1118, 1119  
Cetylpyridinium salts, determination of 1116, 1118, 1119  
CFF 55  
Charge-transfer complexes 426  
  of anilines 441  
  of cyclic amines 170  
Charge-transfer excited states 176  
Charge-transfer interactions 169, 170  
Charton,  
  extended Hammett equation 490, 499, 501, 524  
  LDR equation 524  
Chemical shift imaging 330–332  
Chemical shift reagents 1112  
Chemical shifts 297, 298  
  <sup>13</sup>C 302, 303  
  <sup>1</sup>H 301, 302  
  <sup>14</sup>N, substituent effects on 315–317  
  <sup>15</sup>N, substituent effects on 303–312, 315–317  
  <sup>17</sup>O,  
    relationship of aromatic nitro group  
    torsion angles with 325–330  
    substituent effects on 312–317  
Chemiluminescence—*see also*  
  Pyrochemiluminescence  
  of naphthalene-2,3-dicarboxaldehyde 1079  
  of ruthenium 1069, 1070, 1083  
  of Schiff bases 1085  
  of tertiary amines 1108  
  peroxy-luminol 1074, 1104  
  peroxy-oxalate 1080, 1104, 1105, 1130, 1134  
Chemiluminescence detection (CLD) 1047  
Chemiluminescence nitrogen detection (CLND) 1070  
Chichibabin reaction 560, 561  
Chiral alkylamines—*see also* Chiral  $\alpha$ -phenylalkylamines  
  synthesis of 108, 110–113, 116, 120  
Chiral amides, synthesis of 108  
Chiral aminoalkanes, synthesis of 114  
Chiral aminopropanols, VCD spectra of 150  
Chiral auxiliaries 111, 112, 124–130  
Chiral azabicycloalkanes,  
  ECD spectra of 132, 133  
  VCD spectra of 149  
Chiral azetidines, ECD spectra of 132  
Chiral aziridines,  
  ECD spectra of 132, 133  
  ROA spectra of 152  
  synthesis of 119, 120  
  VCD spectra of 148, 149, 152  
Chiral benzoyl compounds, ECCD spectra of 142  
Chiral borohydride reagents 117–119  
Chiral crown ethers 1114  
Chiral cyclohexylamines, synthesis of 118  
Chiral derivatization reagents 124–127, 1109  
Chiral diimine-based catalysts 119, 120  
Chiral halobenzamido-1-phenyl-1-cyclohexanols, ECCD spectra of 142, 143  
Chiral indans, VCD spectra of 148  
Chiral indolizidines, ECD spectra of 132  
Chiral lanthanide shift reagents 124, 128, 129  
Chiral metal hydride reagents 109–119  
Chiral *N*-nitrosamines, ECD spectra of 143–146  
Chiral *N*-nitrosazetidines, ECD spectra of 146  
Chiral *N*-nitrosopyrrolidines, ECD spectra of 145  
Chiral oxiranes,  
  ROA spectra of 152  
  VCD spectra of 148, 152  
Chiral perhydrobenzocycloalkanes, Cotton effects for 137  
Chiral  $\alpha$ -phenylalkylamines,  
  Cotton effects for 135, 136  
  ECD spectra of 133, 134  
  Raman circular intensity spectra of 151, 152  
  VCD spectra of 147  
Chiral phenylcarbinamines, Cotton effects for 135  
Chiral piperidines,  
  Cotton effects for 135, 136  
  ECD spectra of 130–132  
Chiral piperidinols, ECD spectra of 131, 132  
Chiral purity, determination of 1089–1092, 1094  
Chiral pyrrolidines,  
  Cotton effects for 135, 136  
  ECD spectra of 130–132  
Chiral quinuclidinols, ECCD spectra of 143  
Chiral resolution 1089–1092, 1109  
Chiral solvating agents 124, 129, 130  
Chiral stationary phases 121–124  
Chiral thiiranes,  
  ROA spectra of 152  
  VCD spectra of 148, 152  
Chiral titanium hydride complexes 114–117  
*N*-Chloroanilides, rearrangement of 873  
*N*-Chloroanilines, rearrangement of 875, 876  
*N*-Chlorocarbazoles, rearrangement of 874, 875  
*N*-Chloroindoles, rearrangement of 873, 874  
Chlorosulphodiazotiation 657  
Chlorpromazine, oxidation of 828

- Cholesteric liquid crystals 1112  
Chromes—*see* Aminochromes  
Chromophoric derivatives, for tertiary amino groups 143  
Chromotropic acid, HPLC of 1074  
CIDEP effect 750  
CIDNP effect 858, 881  
CIDNP spectroscopy,  
  in dediazoniations 649  
  in photoreduction of nitrobenzenes 750  
Cigarette smoke, polycyclic nitroaromatics in 1129  
Circular dichroism,  
  of *N*-nitrosopyrrolidines 69, 70  
  of quaternary ammonium compounds 1119  
Citrulline 975, 976  
  formation of 980–983, 986, 987  
Clark oxygen electrode 1103, 1106  
 $\alpha$ -Cleavage 206  
  of ionized alkenylamines 231  
  of ionized alkylamines 217, 219–221  
 $\sigma$ -Cleavage, of distonic ions 224  
Coal, determination of N in 1108  
Cocaethylene, detection of 1068  
Cocaine, analysis of 1063, 1068  
Codeine, PE spectrum of 180  
Coenzymes 1103  
Collisional activation spectroscopy 209, 253  
Collision-induced dissociation spectroscopy 209  
Collision-induced dissociative ionization (CID) spectroscopy 233, 234  
Combination rules 38  
Complexes,  
  charge-transfer—*see* Charge-transfer complexes  
  donor-acceptor—*see* Donor-acceptor complexes  
  encounter—*see* Encounter complexes  
 $\sigma$ -Complexes 1218  
  decomposition of 1237  
  isolation and characterization of 1217  
  of amines and nitro-activated aromatics 457–460  
  steric compression in 1293  
Composition B explosives, TGA of 1142  
Concerted mechanism, for  $S_NAr$  reactions 1230  
Conformational analysis 42  
  of biologically active compounds 62–66  
  of medium-size rings 60–62  
  of polyamines 55–60  
  of tertiary amines 43–55  
Conformational energies, for cyclic amines 9, 10  
Conproportionation 354  
Contaminants, airborne, sampling of 1058  
Copper(2+) ions,  
  as catalysts for *S*-nitrosothiol reactions in water 670, 671  
  in biological activity of *S*-nitrosothiols 674  
Correlation diagrams 173, 178  
Cosmetics, nitrosamine contamination in 1186  
Cosolvents, hydrogen-bond donor 1273, 1283  
Cotton effects 70  
  exciton coupled 141  
  rotational contributions to 135, 136  
Coupled oscillator mechanism 139  
Coupling reactions 1101  
Couplings,  
  one-bond  $^{15}\text{N}$ - $^{13}\text{C}$  317, 318  
  one-bond  $^{15}\text{N}$ - $^1\text{H}$  318–320  
Cresols—*see* Nitrocresols  
Critical energies 251  
Crossed laser-molecular beam studies, of nitromethane 795  
Cross-terms, in force fields 3  
Crown ethers—*see also* Azacrown ethers  
  chiral—*see* Chiral crown ethers  
  complexes with arenediazonium salts 637, 650  
  effect on  $S_NAr$  reactions 1220  
Cryptands, conformers of 59  
Cryptopine, through-space interactions in 181  
Cyanamides,  
  acidity of 395  
  nitranion salts of 397  
 $\alpha$ -(Cyanoalkyl)amines, synthesis of 560  
Cyanodediazoniatioin 652  
4-Cyano-*N,N*-dialkylanilines, spectra of 174  
2-Cyano-4-nitrophenyl ethers, reactions with amines 1291, 1292  
Cyclic amines,  
  CT complexes of 170  
  IPs of 165–170  
  MM2 parameterization of 8–10  
Cyclization—*see also* Photocyclization  
  of amines 597–599  
  of nitroalkanes 262–264  
  oxidative 1113  
Cycloadditions—*see also* Photocycloadditions  
  of acylnitroso compounds 75, 76  
Cycloalkanes—*see* Bicycloalkanes,  
  Cyclohexanes, Cyclopropanes,  
  Polyazacycloalkanes, Spirocycloalkanes  
Cycloalkylamines—*see also* Cyclohexylamines,  
  Cyclopropylamines  
  chiral—*see* Chiral cycloalkylamines  
  ionized, mass spectra of 233  
Cyclohexanes—*see* Amino cyclohexanes,  
  Diazacyclohexanes, Dinitrocyclohexanes  
Cyclohexanimines, photocycloadditions of 720  
Cyclohexenamines, structure of 88–90

- Cyclohexylamines,  
 acidity of 398  
 chiral—*see* Chiral cyclohexylamines
- Cyclophanes, PE spectra of 199
- Cyclopropanes, ionized 216
- Cyclopropylamines,  
 IPs of 168  
 structure of 89, 90
- Cysteines 1103, 1106—*see also* *S*-Methyl-  
 cysteine  
 detection of 1089  
 determination of 1073, 1074  
*S*-nitroso derivatives of 1149  
 radiolysis of 830  
 thiolate anion from 668
- Cysteine thiolate 984
- Cystine, determination of 1073, 1074
- Cytochrome P-450 977
- Dansyl derivatives,  
 of amino acids 1093, 1096, 1100  
 of biogenic amines 1083  
 of nitrophenols 1134
- Dantrolene metabolites, determination of 1128
- D&C Red No.36 1135
- Decalins—*see* Tetraazadecalins
- Decarboxylases, as catalysts 1103
- Decarboxylation—*see also*  
 Photodecarboxylation  
 of amino acids 829–832
- Dediazonation—*see also* Azidodediazonation,  
 Chlorosulphodediazonation, Cyano-  
 dediazonation, Halodediazonation,  
 Hydrodediazonation, Hydroxy-  
 dediazonation, Mercaptodediazonation,  
 Metallodediazonation  
 mechanisms of 646–650  
 photolytic 657, 658
- Degrees of freedom effect 219, 230
- Dehydrogenases 1103
- Denitrosation 884, 1148  
 photolytic 1149
- Density calculations 42, 78, 80
- Deprotection, reductive 854
- Derivatization 1109–1114  
 pre-/post-column 1076–1088
- Desolvative encounter mechanism, for  $S_NAr$   
 reactions 1281, 1282
- Diallyldiamines, synthesis of 570
- Diamines—*see also* Benzenediamines,  
 Bis(aminoalkyl)alkanediamines,  
 Diallyldiamines, Methylenediamines,  
 Phenylenediamines  
 aromatic—*see* Aromatic diamines  
 bicyclic—*see* Bicyclic diamines  
 conformational analysis of 55–57  
 enthalpies of formation of 340  
 PE spectra of 183–186  
 synthesis of,  
 from alcohols 543  
 from aziridines 545  
 from imines 545–548
- gem*-Diamine units 356
- Diaminoacridines, enthalpies of formation of  
 354
- Diaminocyclohexanes, structure of 90
- Diaminonaphthalenes, intramolecular hydrogen  
 bonding in 435, 436
- Diarylamines—*see* Diphenylamines,  
 Nitrodiarylamines
- Diazaadamantanes, PE spectra of 184–186
- Diazabicycloalkanes,  
 donor–acceptor complexes of 440, 441  
 enthalpies of formation of 353
- Diazabicycloalkenes,  $\sigma$ -complexes of 459
- 1,3-Diazacyclic compounds, MM2 para-  
 meterization of 19, 20
- Diazacyclohexanes, conformers of 57
- Diazenes—*see* Nitrodiazenes
- Diazenolates 645
- Diazenols 645
- Diazoates—*see* Diazenolates
- Diazo compounds,  
 as base catalysts 1284  
 infrared spectra of 631
- Diazohydroxides—*see* Diazenols
- Diazoketones 637  
 reactions of 658
- Diazonio group, M and I effects of 638
- Diazonium ions—*see also* Alkanediazonium  
 ions, Alkenediazonium ions, Arene-  
 diazonium ions, Bisdiazonium ions,  
 Fluorodiazonium ions  
 deprotonation of 631  
 formation of 628–646
- Diazo reprographic paper 657, 658
- Diazo tars 650
- Diazotization,  
 as pre-column derivatization procedure  
 1086–1088  
 in strong acids 630–636, 644, 646  
 mechanism and kinetics of 640–644  
 nucleophilic catalysis of 644–646  
 of aminophenols 637–639  
 of heteroaromatic amines 630–636, 644, 646  
 under anhydrous conditions 639, 640  
 with alkali nitrite 628–636  
 with nitrosonium salts 639  
 with nitrosyl halides 639
- Dibenzozate chirality rule 142
- Dicarboxaldehydes, in pre-/post-column  
 derivatization 1077–1080
- 4,5-Dichloro-2-methylphenol, nitration of 961
- 2,6-Dichloro-4-methylphenol, nitration of 952

- Dienamides, photoreactions of 727  
Dienamines, synthesis of 558, 559  
Diesel oil, nitrogen-containing components in 1076  
Differential-pulse polarography 1128  
Differential scanning calorimetry (DSC) 1108, 1122  
Differential thermal analysis 371  
Difluoroammonia, basicity of 384  
Digestion methods, for analysis of N 1046, 1047  
Dihedral driver 48  
Dihydroacridines, in photoreduction of nitroarenes 749, 750  
Dihydropyridines, oxidation of 1106  
Diketopiperazines 1112  
Dimerization energies, for ammonia 27  
Dimer nucleophile mechanism, for  $S_NAr$  reactions 1267–1275, 1278, 1282, 1286, 1289, 1294  
    specific solvent effects on 1272, 1273  
Dimethoxyethane, acidity of 398  
Dimethoxy-1-nitrobenzenes, photoreactions of 756, 757  
*N,N*-Dimethylanilines, nitration of 952  
Dimethylbenzenes, nitration of 950–952, 957  
Dimethyl sulphoxide, acidity of 398  
*N,N*-Dimethyltoluidines, nitration of 952  
Dimetridazole, analysis of 1140  
Dimroth–Reichardt  $E_T(30)$  values 1220, 1221  
Dinitroalkanes, radiolysis of 832  
Dinitroalkenes, structure of 97, 101  
Dinitroanilines, stability of 365  
Dinitroarenes, mass spectra of 281  
Dinitrobenzenes,  
    detection of 1131  
    electroreduction of 843, 847, 848  
    reactions with amines 1221, 1222, 1233, 1235, 1244, 1271, 1276–1279, 1282, 1283  
Dinitrobicycloalkyls, structure of 97, 98, 101  
Dinitrobiphenyls, detection of 1131  
Dinitro compounds, enthalpies of formation of 340  
Dinitrocyclohexanes, electrocoupling of 850  
Dinitroarenes, radical anions of 848  
Dinitrogen tetroxide, as nitrosating agent 666  
Dinitrogen trioxide,  
    as diazotization reagent 640, 641  
    as nitrosating agent 666  
Dinitroglycerines, analysis of 1142  
Dinitroglucosyls, MM2 parametrization of 13  
Dinitronaphthyl sulphides, reactions with amines 1255, 1256  
Dinitrophenols, analysis of 1133  
Dinitrophenyl ethers, reactions with amines 1290  
Dinitrophenyl sulphides, reactions with amines 1256  
Dinitropyrenes, atmospheric formation of 1178, 1180, 1182  
Dinitrosopiperazines, structure of 96, 97  
Dinitrotolucnes—*see also* DNT  
    detection of 1131  
    determination of 1127  
Dioxiranes, as oxidizing agents 579  
Dipeptides—*see also* *N*-Nitrosodipeptides  
    detection of 1066  
Diphenylamines—*see also*  
    Nitrodiphenylamines  
    acidity of 401  
Diphenylene, as hydrazobenzene rearrangement product 858  
Dipolarity–polarizability term 1240  
Dipole moments,  
    of amines 11, 12  
    of solvents 1239  
Di-2-pyridyl ketone hydrazone, oxidation of 1106  
Dissociation constants, correlation of 1225  
Dissociations—*see also* Photodissociations  
    unimolecular 251–253  
Distonic ions 208–217, 262  
    1,2-NH<sub>3</sub> migration in 215, 216  
    of alkenylamines 232  
    of cycloalkylamines 233  
    skeletal isomerization of 215  
Disulphine blue, as ion-pairing agent 1116  
Ditallowdimethylammonium ions, analysis of 1116  
Dithioamides, photoreactions of 734  
Dithiocarbamates, as amine derivatives 1109  
Dithioimides, photoreactions of 734  
Diuretics, determination of 1087  
DNT,  
    detection of 1125  
    determination of 1127  
Donor–acceptor complexes—*see also* Electron donor–acceptor complexes  
    of amines 439–446, 460–465  
Donor–acceptor interactions 427  
Donor number 425  
Dopamine,  
    determination of 1069  
    in bovine retina 1062  
    radiolysis of 825  
    stability of 1067  
Dopamine receptor agonists 63, 64  
DREIDING 37, 38  
Dual-channel analyser, for determination of N 1046  
Dual substituent parameter equation 490  
    for dediazoniations 647  
Dumas determination of N, automatic 1046

- Durenes—*see* Dinitrodurenes  
Dynamical theory 219
- Edman reaction 1084  
EFF 58  
EGIS-4136, determination of 1141  
Electrokinetic detection techniques 1133  
Electrolytes, dissociation of 1225  
Electrolytic conductivity detection (ELCD)  
1047, 1073  
Electron affinities 256–258, 382, 385  
Electron capture detection (ECD) 1047, 1062,  
1133  
Electron donor–acceptor (EDA) complexes—  
*see also* Donor–acceptor complexes  
as intermediates in *S<sub>N</sub>Ar* reactions  
1246–1252  
photoreactions of 789, 790  
Electronegativity effects, on bond lengths 5, 22  
Electronic circular dichroism (ECD) 130–146  
far-ultraviolet 133  
Electron spin resonance spectroscopy, in study  
of photoreduction of nitrobenzene 750  
Electron transfer,  
in dediazoniations 649  
single 1228  
Electron transmission spectroscopy 173  
Electrophilic nitrosation,  
catalysis of, by non-basic nucleophiles 666,  
675, 676  
of thiols 666–669  
Electrophoresis, of amino compounds  
1093–1096  
Electroreduction,  
mechanism of 838–845  
of aliphatic nitro compounds 849–851  
of aromatic nitro compounds 845–849  
of nitroso compounds 854  
Electrostatic energy, in MM2 force field 6  
Elemental analysis 1045–1049  
automatic organic 1045, 1046  
Ellman's reagent 1099  
Embutramide, determination of 1061, 1062  
Enamides—*see also* Dienamides  
photoreactions of 724–727  
Enamines—*see also* Dienamines  
ionized,  $\gamma$ -cleavage of 233  
MM2 parameterization of 14, 33–35  
MM3 parameterization of 33–35  
PE spectra of 181, 188  
synthesis of 588–590  
Enamino ketones,  
basicity of 387  
synthesis of 577  
Enantiomeric drugs 107  
Enantiomeric excess, estimation of 1109, 1110  
using chromatography 121–124  
using NMR spectroscopy 124–130  
Enantioselective reagents 1114  
Encounter complexes 1281, 1282  
Endothelium-derived relaxing factor (EDRF)  
673, 974–977  
Energy-resolved mass spectrometry 238, 239  
Engine emissions, mutagens in 1129–1131  
Enthalpies of activation,  
low 1273  
negative 1262  
Enthalpies of deprotonation, of nitroalkanes  
410  
Enthalpies of destabilization 362–364  
of explosives 371  
Enthalpies of formation 338  
correlation of, for alkyl nitrogen-containing  
compounds 339–343  
of acyclic amines 343–345  
of alicyclic amines 345–347  
of aliphatic amines, calculated 10–12  
of anilines, calculated 35  
of arylamines 348–350  
of explosives 369, 370  
of nitramines, calculated 78, 79  
of nitrites 340, 341  
of nitro compounds 361–368  
calculated 32, 77, 78  
of nitro [M—OH radical]<sup>+</sup> 265  
of nitroso compounds 357–361  
of polyamines 350–356  
Enthalpies of trimerization 354  
Enthalpies of vaporization, of nitrites 340  
Entropic bottlenecks 216  
Entropies of cyclization 1285  
Enzymatic biosensors 1102–1105  
Enzyme-linked immunosorbed assay (ELISA)  
1047, 1128, 1135, 1140  
Enzymes, as catalysts in asymmetric synthesis  
107–109  
Eosin Y 1118  
Ephedrate salts 397  
Ephedrines 1100, 1109  
detection of 1065  
determination of 1097  
Epinephrine 1095  
stability of 1067  
Epoxides, as amine precursors 543–545  
Ethanolamine 1083  
Ether/methylene exchange energy 343, 346  
Ethonium, analysis of 1119  
Evaporative light scattering 1116  
Exchange quantities, in homologous series  
343–345  
Exciton coupled circular dichroism (ECCD)  
139–143  
Exhaust fumes, polycyclic nitroaromatics in  
1129

- Exner, analysis of substituent effects 521, 522  
Explosives 361, 366, 368–371  
  detection of 1125  
  determination of 1126, 1127  
  enthalpies of formation of 369, 370  
  sensitivity of 370, 371  
  TGA of 1142
- Fast atom bombardment mass spectrometry (FAB-MS) 1114  
  of tetraalkylammonium ions 234
- Field desorption mass spectrometry, of bis(quaternary ammonium) compounds 1119
- Field effects 1243, 1244
- Fingerprints, detection of 1100
- Fischer–Hepp rearrangement 883–885
- Flame ionization detection (FID) 1062, 1068
- Flameless alkali-sensitized detection (FASD) 1047
- Flavin adenine dinucleotide (FAD) 977, 978, 984
- Flavin mononucleotide (FMN) 977, 978, 984
- Flowing afterglow method 235
- Flunitrazepam, analysis of 1138
- Fluoranthenes—*see* Aminofluoranthenes, Nitrofluoranthenes
- Fluorenes—*see also* Aminofluorenes, Nitrofluorenes  
  magnetic anisotropy of 68
- Fluorenones—*see* Polynitrofluorenones
- Fluorenylamines, synthesis of 547
- Fluorescamine 1100
- Fluorescence,  
  decay of 446  
  laser-induced 1077
- Fluorescence-detected magnetic resonance (FDMR) 824, 826
- Fluorescence quenching, by nitro groups 1125
- Fluorescence techniques, time-resolved 1098
- Fluorescent labelling 1081, 1091
- Fluoroanilines—*see also* Pentafluoroaniline  
  IPs of 174, 175
- Fluorobenzamides, intramolecular hydrogen bonding in 438
- Fluorodiazonium ions 649
- Fluoromethylbenzenes, nitration of 951
- Folates, in bioformation of NO 976
- Food and Drug Administration (FDA) 107
- Foodstuffs, nitrosamine contamination in 1144, 1145, 1187–1189
- Force fields 3  
  energetic comparison between 40–42  
  specific 5–40
- Fossils,  
  dating of 1092, 1093  
  indigeneity of 1060
- Franck–Condon factor 160
- Freeze-out temperatures 368, 369
- Furaladone, analysis of 1139
- Furans—*see* Nitrofurans
- Furazolidone, analysis of 1139
- Furoic acids—*see* Nitrophenylfuroic acids
- Gabriel synthesis, modifications of 540–542
- $\beta$ -Galactosidase activity 1131
- Gallamine, analysis of 1119
- Gamma rays, detection of 1125
- Gas chromatography,  
  headspace 1064  
  nitrogen responsive detectors for 1047, 1048  
  of amines 1060–1067  
  of nitroaromatics 1133–1136  
  of nitroglycerin 1142  
  of nitrosamines 1144–1146  
  thermionic specific detectors for 1068  
  using chiral stationary phases 121–123
- Gas chromatography–alkali flame ionization detection (GC-AFID) 1127
- Gas chromatography–atomic emission detection (GC-AED) 1127
- Gasoline, determination of 1048
- Gaussian metastable peaks 228, 230
- Gel electrophoresis 1096
- Glucopyranosylammonium compounds 1113
- Glutamic acid 1069, 1103
- Glutamine 1069
- Glutathiones,  
  determination of 1073, 1074  
  5-nitroso derivatives of 1149  
  radiolysis of 832
- Glyceryl trinitrate, *in vivo* synthesis of nitric oxide from 673
- Glycines 1069, 1085—*see also*  
  Neopentylglycine  
  crystals of 1108
- Gomberg–Bachmann reaction 647, 653
- Graphite epoxy electrodes 1105
- Guanidines—*see also* Nitrosoguanidines  
  acidity of 404  
  basicity of 392–394  
  structure of 86–88
- Guanylic acid, 3',5'-cyclic phosphate of (cGMP) 974, 975
- Haemoglobin,  
  inhibition by 975, 976  
  materials bound by 974
- Halide ions, as diazotization catalysts 644
- Hallucinogenic activity, correlation with IP values 179
- Haloalkylperoxyl radicals 827, 828
- Haloamines, IPs of 166, 168

- Haloanilines—*see* *N*-Chloroanilines,  
Fluoroanilines  
*N*-Haloaziridine chromophore, sector rule for  
133  
*N*-Halo compounds, rearrangement of  
873–876  
Halodediazotiation 649, 651–653  
2-Halo-5-nitropyridines, S(ANRORC) reactions  
of 1217  
Hammett correlations 1005, 1006, 1008  
Hammett equation 443, 462, 487–491  
multiparameter extensions of 489–491, 499,  
501, 524  
Hammett substituents 1241  
HBD acidity 381  
HBD basicity 381  
Heroin, PE spectrum of 180  
Heterocyclic amines,  
diazotization of 630–636, 644, 646  
structure of 94, 95  
Heterocyclic compounds,  
nitro-substituted, photoreactions of 780, 781  
 $S_NAr$  reactions of 1217  
Heterocyclic nitrosoarenes,  
effects in biological systems 1031  
adduct formation with DNA 1032, 1033  
mutagenicity 1032–1034  
reaction with glutathione 1031–1034  
reaction with protein SH groups 1034  
reactions with alkylthiols 1007, 1009, 1012,  
1015, 1019  
Hexafluorovaline 1108  
Hexahydroazepines, IPs of 165, 166, 168  
Hexahydrobenzazonines, reduction of, MM2  
study of 73–75  
Hexahydrotriazines, PE spectra of 186  
Hexamethylenediamines, in human urine 1063  
Hexanitrobenzene, steric interactions in 363  
Hexedine, analysis of 1148  
Hexetidine, analysis of 1148  
HEXNO 1148  
Hexylamines 1085  
High performance liquid chromatography—*see*  
HPLC  
Hildebrand solubility parameter 1220  
Histamine,  
C(2)-deprotonation of 407  
determination of 1058, 1069, 1074, 1079,  
1081  
derivatization of 1083  
Histidines 1089, 1103—*see also*  $\beta$ -Hydroxy-  
histidine  
protonation of 407  
HMX, analysis of 1143  
Homoallylic amines, synthesis of 570  
Homoconjugation 182  
Homocysteine, *S*-nitroso derivatives of 1149  
Homo-/hetero-conjugate mechanism, for  $S_NAr$   
reactions 1276–1278, 1294  
Homologous series, thermochemical properties  
of 339–343  
Homolytic bond energy 178  
HPLC 1067, 1071–1074, 1076, 1146, 1147  
of amines 1078–1083, 1085–1087,  
1089–1092  
of nitroaromatics 1127–1134, 1136, 1137  
of nitrofurans 1140  
of nitrosamines 1146–1148  
of quaternary ammonium compounds 1116  
size-exclusion 1070  
using chiral stationary phases 123  
HPLC-CLD 1147  
HPLC-RID 1068  
HPLC-TEA 1146, 1147  
HPLC-UVD 1076  
Hydralazine, HPLC of 1071  
Hydrazines—*see also* Nitrophenylhydrazines  
carcinogenicity of 1173  
environmental sources of 1196, 1197  
mutagenicity of 1196, 1197  
PE spectra of 188  
Hydrazobenzenes,  
electroformation of 838  
rearrangement of 858–865  
synthesis of,  
<sup>13</sup>C-labelled 902, 903, 910, 915, 916,  
918, 919, 921, 923, 924  
<sup>14</sup>C-labelled 902, 903, 906, 909, 922,  
923, 925  
<sup>2</sup>H-labelled 902, 915  
<sup>15</sup>N-labelled 902, 906, 909, 914, 915,  
918, 919, 921, 923, 924  
Hydride anion affinities 217  
Hydrodediazotiation 650  
Hydrogen-bond acceptors 1275, 1276,  
1294  
Hydrogen-bond acidity, solvation effects on  
1285  
Hydrogen-bond basicity, solvation effects on  
1285  
 $\alpha$ -Hydrogen-bond donor solvent parameter  
1221  
Hydrogen bonding 381, 424–428  
basicity scale of 451  
cationic 385  
in amines 428–439  
in nitro compounds 451–455  
in nitroso compounds 447–451  
intramolecular 15  
in  $S_NAr$  reactions 1221, 1282  
MM3 calculations for 27–29  
resonance-assisted 426  
strong 426, 428  
weak 428

- Hydrogen-bond interactions, in solvent effects on  $S_NAr$  reactions 1220
- Hydrogen-bond parameters 1278
- Hydrogen-bond scales, of solutes 1222–1225
- Hydrogen transfer 211, 212, 218, 227, 264–270
- double 223–225, 231
  - isotope effects on 228
  - ratio of  $\alpha$ -,  $\beta$ - and  $\gamma$ -, in protonated alkylamines 238
  - regioselectivity in 229
- Hydroxamic acids, as amphoteric systems 405
- N*-Hydroxy-L-arginine 985–987
- N*-Hydroxyarylamines,
- effects in biological systems 1020
  - adduct formation with DNA 1021, 1029
  - carcinogenicity 1020, 1029–1031
  - methemoglobinemia 1020–1022, 1025–1029
  - mutagenicity 1020, 1029
  - formation from nitrosoarenes and thiols 1007, 1023–1028, 1032
  - Hammett correlation for 1008
  - kinetics of 1007
- Hydroxyazo compounds, dimerization in 426, 432
- Hydroxydediazotiation 656, 657
- $\beta$ -Hydroxyhistidine, chiral purity of 1092
- Hydroxylamines—*see also* Phenylhydroxylamines
- analysis of 1151, 1152
  - as electrophilic aminating agents 551, 552
  - PE spectra of 188
  - reduction of 534, 535
  - synthesis of 607–610
- Hydroxypyridines, dimerization in 426
- N*-Hydroxysulphenamides 1001, 1024, 1027, 1029
- formation kinetics of 1003, 1005
  - Hammett correlation for 1005, 1006
  - identification of 1001
  - sulphinamide rearrangement of 1008, 1010
- N*-Hydroxysulphenamides 1019
- Image technology, photolytic dediazoniations in 657
- Imidazoles—*see also* Nitroimidazoles, Nitrosoimidazoles
- proton affinity of 407
  - protonation of N in 1285
- Imidazolidines, PE spectra of 186
- Imidazolines, PE spectra of 184
- Imides—*see also* Thioimides
- acidity of 395
  - photoreactions of 730–739
- Imines—*see also* Methanimines
- as amine precursors 545–550
  - photoreactions of 715–722
  - reduction of 112–117
- Iminium salts 208—*see also* *N*-Allyliminium salts
- photoreactions of, cyclization 712, 713
  - with nucleophiles 713
  - with olefins 710–712
  - with trimethylsilanes 713–715
- Imino acids, chiral purity of 1092
- Immonium ions 208
- mass spectra of 226–231, 238
- Immunoassay 1131, 1132
- Impact machine, Type 12 370
- Indans—*see* Aminoindans, Chiral indans
- Indazoles,  $pK_a$  values of 408
- Indoleamines, HPLC of 1073
- Indoles—*see also* *N*-Chloroindoles, Nitroindoles, Nitrosoindoles, Phenylindoles
- nitration of 969
  - radiolysis of 827, 828
- Infrared spectroscopy, matrix-isolation 1133
- of diazo compounds 631
- Interaction reagents 1074
- Intermediates,
- decomposition of, rate-determining 1217
  - formation of, rate-limiting 1217
- Intersecting State Model (ISM) 409
- Intrinsic bond energies (IBEs) 410
- Inversion energy 37
- Inversion plots 1286–1289, 1294
- Ion-cyclotron resonance 222, 235
- Ion exchange chromatography 1069, 1073
- Ionization energies 255, 256, 382
- of bicyclic amines 66
  - of diamines 66
- Ionization potentials 160
- and biological activity 179, 180
  - and proton affinities 178, 179
  - of aliphatic amines 163–168
  - of aromatic amines 172–178
  - of cyclic amines 165–170
  - of nitramines 201
  - of nitroalkanes 194–197
  - of nitroalkenes 200
  - of nitrobenzenes 197–199
  - of nitrosamines 192
  - of nitrosoalkanes 188–191
- Ion–molecule pairs, tight, in dediazoniations 648
- Ion–neutral complexes 216
- Ion pairing, with ammonium ions 1116, 1118
- Ion selective electrodes 1119
- Ips*o adducts,
- addition to 961–964



- Ips*o adducts (*cont.*)  
  formation of 950–957  
  solvolysis of 957–961
- Ips*o-substituted groups,  
  displacement of 969, 970  
  rearrangement of 964–969
- Isocyanates, synthesis of 595–597
- Isoleucine 1108
- Isopropylamines, conformers of 48, 49
- Isoproterenol 1086, 1095  
  HPLC of 1071
- Isoquinolines, synthesis of 706
- Isothiocyanates, in pre-/post-column  
  derivatization 1084, 1085, 1096
- Isotope analysis 1048, 1049  
  of amines 1059, 1060
- Isoxazoles—*see* 4-Nitro-5-styrylisoxazoles
- Isoxazolidines, formation of 1152
- Jahn–Teller effect 160, 161
- Jencks–More O’Ferral mathematical model  
  1230, 1231
- Julolidine, IPs of 174
- Kamlet–Taft multiparametric equation 1225,  
  1244
- Karplus equation 69, 70
- Kerosene, polycyclic nitroaromatics in 1129
- Ketoxime ethers, reduction of 109–112
- Ketoximes,  
  acidity of 404  
  reduction of 109–112
- Kidney amidase, in asymmetric synthesis 107
- Kinetic energy release, determination of 251
- Kinetic isotope effects,  
  alpha carbon 933  
  carbon-11 932–935, 938  
  carbon-13 900, 910, 917, 918,  
    920–923, 926–929, 933  
  carbon-14 900, 904, 905, 910, 911, 920–  
    923, 926–932, 935  
  chlorine 938  
  heavy-atom 858  
    measurement of 899, 900, 904, 910, 911,  
      920, 926  
    on benzidine rearrangement 859–861  
    on nitramine rearrangement 877  
    theory of 894, 895  
  nitrogen-15 899–901, 904, 905, 910, 911,  
    917, 918, 920–923, 926–930, 933–935,  
    938–946  
  oxygen-18 930, 931  
  primary hydrogen–deuterium 895, 896  
  secondary alpha hydrogen–deuterium 896,  
    897, 934–937, 939–946  
  secondary alpha hydrogen–tritium 935, 936  
  secondary hydrogen–deuterium 900, 917  
    secondary incoming nucleophile hydrogen–  
      deuterium 936, 937
- Kinetic laws,  
  for amines, in  $S_NAr$  reactions 1262, 1276,  
    1280, 1290, 1294  
  fourth-order 1218, 1261–1264, 1278, 1286,  
    1288  
  third-order 1261
- Kinetics, in  $S_NAr$  systems,  
  anomalous 1261–1294  
  classical 1218–1261
- Kjeldahl method, for determination of N 1046,  
  1047
- Koch’s acid 1074
- Koopmans’ theorem 160, 168
- Laser flash photolysis 771
- Leather/tanning industry, formation of nitroso  
  compounds in 1183, 1184
- Lennard–Jones expression 38
- Leucine 1108
- Leucine aminopeptidase 1089
- Leuckart reaction 563
- Lewis acids 381
- Lidocaine, determination of 1061
- LIF excitation spectroscopy 1101
- Linear free energy relationships 169
- Liquid chromatography—*see also* HPLC  
  of amines 1067–1093  
  of nitrosamines 1146–1148  
  of quaternary ammonium compounds 1116  
  two-dimensional 1091
- Lithium ion pairs 399
- London forces 1232
- Low-energy low-temperature spectroscopy 217,  
  224
- LSD, PE spectrum of 179, 180
- Luminescence spectroscopy 1136
- Luminol 1074, 1104
- LUMO energies 257, 258
- Lysine 1069, 1085, 1103  
  determination of 1097
- Macrocyclic effect 59
- MacroModel 4.0 41
- Magnetic anisotropy, of cycloalkanes 68, 69
- Magnetic field effects, in photoreduction of  
  nitroarenes 751, 752
- Mannich reaction 585
- Marfey’s reagent 1089
- Mass spectrometry,  
  energy-resolved 238, 239  
  FAB 234, 1114  
  field desorption 1119  
  high-pressure 256  
  NICI 1062  
  of alkenylamines 231–233

- of alkylamines,
    - ionized 217–231
    - protonated 236–239, 241–243
  - of arylamines 233, 234
  - of cycloalkylamines 233
  - of immonium ions 226–231, 238
  - of nitro compounds 250–290
  - of nitroso compounds 259, 290, 291
  - of tetraalkylammonium ions 240–243
  - tandem 259
  - under collision-free conditions 250
  - Matrix-isolation infrared spectroscopy 1133
  - Meat, grilled, polycyclic nitroaromatics in 1129
  - Meerwein reaction 647, 653–656
  - Meisenheimer complexes 457–460
    - formation of 1293
  - Membrane electrodes 1119
  - Menshutkin reaction 932–938
  - Mercaptodediazotiation 656, 657
  - Mercury(2+) ions, as catalysts for *S*-nitrosothiol reactions in water 671, 672
  - Mescaline, PE spectrum of 180
  - Metal amides, structure of 396–398
  - Metal cation binding 384
  - Metallo-dediazotiation 657
  - Metalloporphyrins 1074
  - Metal/machining industry, formation of nitroso compounds in 1185
  - Metastable ions 214, 251
  - Methadone, PE spectrum of 180
  - Methanimines, acidity of 404
  - Methemoglobinemia 1125, 1143
  - Methinè stretching vibrational frequencies 152
  - Methionines,
    - determination of 1073, 1074, 1085, 1103
    - radiolysis of 830, 832
  - Methoxamine, HPLC of 1071
  - Methoxy group, twisting of 1243
  - 4-Methylanisoles, nitration of 951
  - N*-Methyl-*L*-arginine 983
  - N*-Methyl-*D*-aspartate (NMDA) 976
  - S*-Methylcysteine 677
  - Methyl effect 342
  - Methylenediamines—*see also* Hexamethylenediamines
    - ab initio* calculations for 17–19
  - Methylene increment 339
  - Methylphenols, nitration of 953, 955, 956
  - Metronidazole, analysis of 1140
  - Micellar electrokinetic chromatography (MEKC) 1096
  - Micellar surfactants, effect on  $S_NAr$  reactions 1220, 1222
  - Micellar techniques 1096, 1097
  - Micelle formation, critical concentration for 1119
  - Michael addition 1030
    - MM2 model of 72, 73
  - Microemulsions,
    - as electroreduction media 844
    - effect on  $S_NAr$  reactions 1222
  - Microolithography 767
  - Microtrons 1125
  - Minimal effective brain level 179
  - Mixed aggregates 1266, 1267, 1273, 1276, 1294
  - MM1 42, 66–68
  - MM2 3, 5–20, 42
    - combined with spectroscopy 66–72
    - in calculation of enthalpies of formation 77, 78
    - in conformational analysis 44–53, 55–61, 63–66
    - in study of reaction mechanisms 72–76
  - parameterization,
    - of amines 6–11
    - of anilines 14, 33–35
    - of enamines 14, 33–35
    - of nitro compounds 14, 29–32
    - of nitrosamines, nitramines, nitrates and oximes 11, 13, 14
    - of *N*-nitrosopyrrolidines 145
  - PCModel implementation of 68
  - potential functions 5, 6
- MM2',
  - in calculation of enthalpies of formation 77–79
  - parameterization of nitro compounds 11, 13
- MM3 3, 20–40, 42
  - in conformational analysis 54–56, 61–63
- parameterization,
  - of amines 23–29
  - of anilines 33–35
  - of enamines 33–35
  - of nitro compounds 29–32
- potential functions 21–23
- MMP1 75
- MMX 68
- MNDO calculations, for nitroso compounds 14
- MO calculations,
  - for fragmentation of ionized arylamines 234
  - for internal solvation 1285
  - for protonated alkylamines 236, 238
- Molecular beam photofragment translational energy spectroscopy 795
- Molecular complexes,
  - as intermediates, in  $S_NAr$  reactions 1245–1252, 1289, 1294
  - substrate-catalyst 1278–1281
- Molecular density, MOLPAK-calculated 78, 80
- Molecular emission cavity 1106
- Molecular mechanics,
  - application of 42–80

- Molecular mechanics (*cont.*)  
  development of 3–42
- Molecular orbitals,  
  of aniline 171, 173  
  of benzene 173  
  of naphthalene 177  
  of nitrobenzene 198  
  of nitromethane 193, 194  
  of nitrosoalkanes 188, 190, 191
- Molecular reaction dynamics 236
- Molecular recognition 427
- Molecular spectroscopy 1049
- MOLPAK 78, 80
- Moments of inertia, for amines 24
- MOPAC 59
- Morphine,  
  HPLC of 1071  
  PE spectrum of 180
- Morpholines—*see also N-Nitrosodehydro-*  
  *morpholines*  
  IPs of 165
- Mosher's acid chloride 1089
- Mulliken population analysis 14
- Murchinson meteorite, isotope analysis of 1060
- Muscarinic agonists 14
- Musk ambrette, photo-induced yellowing of  
  763
- Musk ketone 1127
- Musk xylene 1127
- Mutagenicity,  
  of azo dyes 1197–1211  
  of hydrazines 1196, 1197  
  of nitro compounds 1171, 1172, 1181, 1182  
  of nitroso compounds 1172
- Myristic acid 977, 978
- Naphtha, analysis of 1067
- Naphthalenes—*see Aminonaphthalenes, Nitro-*  
  *naphthalenes, Styrylnaphthalenes, Tetra-*  
  *methylnaphthalenes*
- 1-Naphthalenesulphonic acid, as additive in  
  diazotization 635
- Naphthols, nitrosation of 815
- Naphthylamines, enthalpies of formation of  
  349, 350
- Negative ion chemical ionization (NICI) mass  
  spectrometry 1062
- Neocuproine 670, 674
- Neopentylamines, conformers of 50, 51
- Neopentylglycine 1108
- Neostigmine, analysis of 1119
- Neutralization–reionization techniques 209,  
  210, 254, 255
- Neutron reflectivity 1119
- Neutron scattering, small-angle 1119
- Newton–Raphson minimization algorithm 21
- Nicardipine, determination of 1062
- Nicotinamide adenine diphosphate phosphate  
  reduced (NADPH) 976–979, 984–987
- Nifuroxime, determination of 1140
- Ninhydrin detection 1068, 1069, 1085, 1100
- Niridazole, determination of 1140
- Nitramides,  
  nitranion salts of 397  
  use in NRMS study of nitrosamides 259
- Nitramine rearrangement 876–878, 911–914  
  radical pair mechanism for 877, 878
- Nitramines,  
  analysis of 1127, 1142, 1143  
  as propellants 1142  
  enthalpies of formation of 78, 79  
  industrial, protocols for 1124, 1142  
  MM2 parameterization of 11, 13  
  PE spectra of 200, 201  
  photoreactions of 816  
  synthesis of,  
    <sup>13</sup>C-labelled 914  
    <sup>14</sup>C-labelled 913  
    <sup>15</sup>N-labelled 913
- Nitranion salts 395, 397, 398
- Nitrates—*see also Tetrinitrates, Thionitrates*  
  analysis of 1142  
  enthalpies of formation of 340  
  industrial, protocols for 1124, 1142  
  MM2 parameterization of 11, 14
- Nitration—*see also Photonitration*  
  formation of *ipso* adducts in 950–957
- Nitrazepam, determination of 1140
- Nitrenium cations 551, 553
- Nitrenium ion–iminium ion intermediates, in  
  Bamberger rearrangement 868
- Nitric acid,  
  early reports on 974, 975  
  formation of 975, 976
- Nitric oxide,  
  formation of 980–983, 986, 987, 990  
  physiological action of 673
- Nitric oxide synthase (NOS) 976–978  
  factors for growth of 991, 992  
  inhibitors of 990, 991  
  iron in 983–987  
  physiological functions of 992, 993
- Nitriles,  
  nitration of 962, 963  
  reduction of 536, 537
- Nitrite ion, formation of 669
- Nitrite photolysis 794
- Nitrites,  
  enthalpies of formation of 340, 341  
  enthalpies of vaporization of 340  
  PE spectra of 192
- Nitrite traps 884
- Nitroaceneaphthenes, detection of 1131
- Nitroacetates, electroreactions of 851, 852

- Nitroadamantanes, mass spectra of 281
- Nitroalkenediols, structure of 97
- Nitroalkanes—*see also* Dinitroalkanes,  
Polynitroalkanes  
cyclization of 262–264  
determination of 1125, 1141  
geminally substituted, photoreactions of  
798–803  
mass spectra of 254, 255  
PE spectra of 192–197  
photoreactions of 795  
 $pK_a$  values of 409, 410  
structure of 97, 411–414  
thermodynamics of 410, 411
- Nitroalkenes—*see also* Dinitroalkenes  
determination of 1125  
PE spectra of 200  
reactions of 613–616  
photochemical 792–794
- Nitroanilines—*see also* Dinitroanilines,  
Pentanitroaniline, Tetranitroaniline,  
Trinitroaniline  
analysis of 1135, 1136  
diazotization of 634  
electroreduction of 846, 847  
enthalpies of destabilization of 364  
enthalpies of formation of 364  
nitration of 953  
structure of 98, 100
- N*-Nitroanilines, rearrangement of 876, 877
- p*-Nitroanilines,  
mass spectra of 252  
through conjugation in 443
- Nitroanisoles, reactions of,  
photochemical 753–758  
with amines 1241, 1243, 1272–1275, 1286,  
1287
- Nitroanthracenes, atmospheric formation of  
1181
- Nitroarenes—*see also* Aromatic nitro  
compounds, Dinitroarenes, Polynitro-  
arenes, Trinitroarenes  
atmospheric formation of 1177–1182  
carcinogenicity of 1171–1173
- N*-Nitro-L-arginine methyl ester (L-NAME)  
979
- Nitroarylmethanes, acidity of 414–416
- Nitroazabenzopyrenes, detection of 1131
- Nitroazoles, mass spectra of 281–284
- Nitrobenzaldehydes,  
mass spectra of 252  
photorearrangement of 770, 771
- Nitrobenzenes—*see also* Aminoalkyl-  
4-nitrobenzenes, Bromonitro-  
benzenes, Dimethoxy-1-nitrobenzenes,  
Dinitrobenzenes, Hexanitrobenzene,  
Pentahalogenitrobenzenes, Trinitrobenzenes  
determination of 1125–1127  
electroreduction of 838–840, 843–845  
enthalpies of destabilization of 363  
enthalpies of formation of 362  
mass spectra of 250, 259  
NMR spectra of 310–315  
PE spectra of 197–200  
photorearrangement of 760–764  
photoreduction of 748, 749  
structure of 98, 99
- Nitrobenzoic acids,  
analysis of 1137  
structure of 98, 99
- Nitrobenzophenones, electroreduction of 843
- Nitrobenzoquininoxaline sulphonamides, analysis  
of 1137
- Nitrobenzyl compounds,  
photorearrangement of 764–770  
radiolysis of 832, 833
- o*-(2-Nitrobenzylidene) sugars,  
photorearrangement of 771, 772
- o*-Nitrobenzyloxy group, as masking group 767
- Nitrobiphenyls 1132—*see also*  
Dinitrobiphenyls  
atmospheric formation of 1181  
carcinogenicity of 1173  
determination of 1128
- Nitrocarbon acids 507–509
- Nitrochromanes, mass spectra of 284, 285
- Nitrochromenes, mass spectra of 284, 285
- Nitro compounds,  
aliphatic—*see* Aliphatic nitro compounds  
analysis of 1122–1143  
aromatic—*see* Aromatic nitro compounds  
as explosives 368–371  
as protecting groups 852–854  
carcinogenicity of 1171–1173, 1180  
donor–acceptor complexes of 455, 456  
enthalpies of formation of 32, 340  
MM2/MM2'-calculated 77, 78  
environmental sources of 1171–1182  
hydrogen bonding in 451–455  
industrial, protocols for 1122–1124  
mass spectra of 250–290  
MM2 parameterization of 14, 29–32  
MM2' parameterization of 11, 13  
MM3 parameterization of 29–32  
mutagenicity of 1171, 1172, 1181, 1182  
NMR spectra of,  
effect of alkyl groups on 300, 301  
effect of aryl groups on 310–315  
radiolysis of 832–834  
reactions of 607–610, 613–616  
with nucleophiles 610–613  
reduction of 534  
structure of 97–101  
synthesis of 604–606

- Nitro compounds (*cont.*)  
tertiary—*see* Tertiary nitro compounds  
 $\alpha,\beta$ -unsaturated—*see*  $\alpha,\beta$ -Unsaturated nitro compounds
- Nitro-containing groups, substituent constants of 514, 515
- Nitrocresols, analysis of 1133
- Nitrocycloalkanes—*see also* Dinitrocycloalkanes  
radiolysis of 832
- Nitrocyclohexadienones, rearrangement of 965, 966
- Nitrocyclohexenes, photoreactions of 793
- Nitrodiarylamines—*see also* Nitrodiphenylamines  
mass spectra of 286, 287
- Nitrodiazenes, as intermediates 629
- Nitrodibenzodioxins, photoreactions of 758
- Nitrodibenzopyranones, analysis of 1130, 1131
- Nitrodiphenylamines—*see also* *N*-Acyl-2-nitrodiphenylamines  
electroreduction of 846  
photorearrangement of 775
- Nitro esters, TGA of 1142
- Nitrofluoranthenes,  
atmospheric formation of 1182  
detection of 1131  
determination of 1130  
metabolites of 1132
- Nitrofluorenes 1132  
atmospheric formation of 1181  
determination of 1129
- Nitrofluorobenzenes, reactions with amines 1291, 1292
- Nitrofurans, analysis of 1139, 1140
- Nitrofurantoin, analysis of 1139
- Nitrofurazone, analysis of 1139
- Nitrofuroic acid, photoreactions of 780
- Nitrogen,  
bridgehead 66  
dissolved organic (DON) 1046, 1048  
fixation of 578  
particulate organic (PON) 1046, 1047  
total dissolved (TDN) 1046
- Nitrogen acids 395–405
- Nitrogen analysers 1045, 1046
- Nitrogen camera 1125
- Nitrogen dioxide, detection of 1142
- Nitrogen inversion, molecular mechanics  
treatment of 21
- Nitrogen musks 1127
- Nitrogen oxides,  
atmospheric 1173–1177  
reactions of 1177–1180  
control of pollution by 1197
- Nitrogen–phosphorus detection (NPD) 1047
- Nitrogen proton affinities 66–68
- Nitrogen responsive detectors, for GC 1047, 1048
- Nitrogen-specific chemiluminescence detection (CLND) 1047
- Nitroglycerin, analysis of 1142
- Nitroglycerines 1126—*see also* Dinitroglycerines
- Nitro group,  
activating effects of 482  
directing effects of 484, 485, 759  
electronic effects,  
in acids of type PhGCOOH 494–496  
in alicyclic and aliphatic systems 491–493  
in aromatic systems 493, 494  
in phenol and anilinium ions 496, 497  
influence of,  
in carbanions 507–509  
in electrophilic aromatic substitution 512, 513  
in nucleophilic substitution 510–512  
*ortho* effect of 498–503  
substituent constants of,  
from ICR 505, 506  
from MO calculations 506, 507  
from NMR 503–505
- Nitroimidazoles,  
analysis of 1140  
influence on biological systems 833, 834  
mass spectra of 282–284  
photoreactions of 780, 781  
radiolysis of 833  
structure of 100
- Nitroindoles, structure of 100
- Nitromethane, mass spectra of 251, 253  
*aci*-Nitromethane 414  
generation of 254, 255
- Nitromethane radical cation, isomerization of 260
- Nitronaphthalenes,  
atmospheric formation of 1181  
detection of 1129, 1131  
photoreactions of 754, 755  
structure of 100
- Nitronaphthyl sulphides—*see* Dinitronaphthyl sulphides
- Nitronates,  
formation of 832  
structure of 413, 414  
*aci*-Nitronates, photoreactions of 795–798
- Nitrones, synthesis of 607–610
- Nitronic acids, nitrosation of 887
- Nitro/nitrite radical cations 262
- Nitro–nitrite rearrangement 762, 776, 794, 799, 882, 883
- Nitro/*aci*-nitro radical cations 259–261

- (4-Nitrophenyl)anilines, charge-transfer interactions in 442
- Nitrophenols—*see also* Dinitrophenols  
analysis of 1133–1135  
atmospheric formation of 1180–1182  
carcinogenicity of 1172  
rearrangement of 967  
structure of 99
- Nitrophenyl ethers—*see also* Dinitrophenyl ethers, Trinitrophenyl ethers  
photorearrangement of 774, 775
- Nitrophenylfuroic acids, determination of 1128
- Nitrophenylhydrazines, analysis of 1137
- Nitrophenylindoles, PE spectra of 199
- Nitrophenyl sulphides—*see* Dinitrophenyl sulphides, Trinitrophenyl sulphides
- Nitrophenyltriazenes, polarography of 1138
- Nitropyrazoles, mass spectra of 282
- Nitropyrenes—*see also* Dinitropyrenes  
atmospheric formation of 1182  
detection of 1131  
determination of 1129, 1130
- Nitropyridine *N*-oxide, intramolecular charge transfer in 456
- Nitropyridines—*see also* 2-Halo-5-nitropyridines  
electroreduction of 843, 845, 846
- Nitroreductase activity 1131
- Nitrosamides,  
mass spectra of 259  
photoreactions of 816, 817
- Nitrosamine chromophore, planar, sector rule for 145
- N*-Nitrosamines,  
as diazonium ion precursors 644–646  
as intermediates 630, 646  
carcinogenicity of 1145, 1186, 1190–1195  
chiral—*see* Chiral *N*-nitrosamines  
control of pollution by 1197  
denitrosation of 1148  
environmental exposure to 1186–1196  
formation of,  
endogenous 1189, 1196  
in diet 1187–1195  
industrial 1183–1187  
GC of 1144–1146  
hydrogen bonding in 448, 449  
LC of 1146–1148  
MM2 parameterization of 11, 13, 14  
NMR spectra of 70–72  
PE spectra of 192  
photoreactions of 810–816  
by dual proton and energy transfer 814–816  
mechanism of 810–812  
TGA of 1142  
tobacco-specific (TSNA) 1150, 1151
- Nitrosation, electrophilic—*see* Electrophilic nitrosation
- N*-Nitrosation, intragastric 1151
- N*-Nitrosazetidines, chiral—*see* Chiral *N*-nitrosazetidines
- N*-Nitrosaziridines, ECD spectra of 146
- Nitrosoacidium ion, as diazotization reagent 640–642
- Nitrosoalkanes,  
PE spectra of 188–191  
photoreactions of 803–806
- Nitrosoamino acids 1150, 1151  
determination of 1145, 1147
- Nitrosoanilines,  
detection of 1145  
determination of 1143  
rearrangement of 884, 885  
separation of 1148
- Nitrosoarenes,  
analysis of 1143, 1144  
effects in biological systems 1020  
allergic reactions 1023, 1026, 1027  
hemolysis 1022, 1027–1029  
reaction with glutathione 1021, 1023, 1025, 1027–1031  
reaction with protein SH groups 1021, 1023, 1024, 1026, 1029, 1030  
heterocyclic—*see* Heterocyclic nitrosoarenes  
reactions with alkylthiols 1001
- Nitrosoareneols, enthalpies of formation of 358, 359
- Nitrosobenzaldehydes,  
photoreactions of 768  
radiolysis of 834
- Nitrosobenzenes—*see also*  
Aminonitrosobenzenes  
electroreduction of 840, 1144  
enthalpies of formation of 357, 358  
PE spectra of 191  
photoreactions of 806, 807
- Nitrosocamphanes, photoreactions of 804–806
- Nitrosocaptopril, biological activity of 673
- Nitroso compounds—*see also* Acylnitroso compounds  
aliphatic—*see* Aliphatic nitroso compounds  
aromatic—*see* Aromatic nitroso compounds  
carcinogenicity of 1145, 1172, 1173, 1186, 1190–1195  
dimerization of 290  
electroreduction of 854  
environmental sources of 1171–1173, 1182–1196  
formation of,  
atmospheric 1182, 1183  
in leather/tanning industry 1183, 1184  
in metal/machining industry 1185  
in rubber industry 1184, 1185

- Nitroso compounds (*cont.*)  
hydrogen bonding in 447–451  
mass spectra of 259, 290, 291  
NMR spectra of,  
effect of alkyl groups on 300, 301  
effect of aryl groups on 315–317  
radiolysis of 834  
rearrangement of 883–888  
structure of 95–97
- C-Nitroso compounds, photoreactions of 803–810
- N-Nitrosodehydromorpholines, rearrangement of 885, 886
- N-Nitrosodehydropiperidines, rearrangement of 886
- N-Nitrosodibenzylamine, determination of 1145
- N-Nitrosodiethanolamine, analysis of 1145, 1146
- N-Nitrosodipeptides, determination of 1146
- Nitrosodiphenylamines,  
analysis of 1147  
structure of 96, 97
- Nitrosoglutathione,  
biological activity of 673  
reactions of 672
- N-Nitrosoglyphosphate, HPLC separation of conformers of 1147
- Nitroso group,  
electronic effects of 515, 516  
S to N migration of 677
- Nitrosoguanidines,  
determination of 1147  
structure of 95, 96
- Nitrosoimidazoles, reactions with thiols 1007, 1009, 1012, 1015, 1019
- Nitrosoindoles, reactions with thiols 1009
- Nitroso/nitro difference quantities 360
- Nitrosonium salts, as diazotization reagents 639–641, 651
- Nitroso organic compounds, volatile (VNOC) 1150, 1151
- Nitrosooxazolidines, detection of 1145
- Nitrosophenylindoles, PE spectra of 191
- N-Nitrosopiperidines, denitrosation of 1148
- N-Nitrosoprolines, determination of 1146
- N-Nitrosopyrrolidines,  
CD spectra of 69, 70  
chiral—see Chiral N-nitrosopyrrolidines  
detection of 1145
- S-Nitrososulphides 676, 677
- S-Nitrososulphinates 677, 678
- S-Nitrososulphonium ions 674, 675
- N-Nitrosothiazolidines, analysis of 1145, 1147
- S-Nitrosothiocarbonyl compounds,  
formation of 674, 675  
reactions of 675, 676
- S-Nitrosothiols,  
biological activity of 673, 674  
detection of 1150  
formation of 666–669  
oxidation of 672  
properties of 669  
reactions in water 669–672  
reduction of 672  
transnitrosation of 672
- Nitrosoureas,  
analysis of 1146–1148  
structure of 95, 96
- Nitrosourethane, determination of 1147
- Nitrosteroids, photoreactions of 797–803
- 4-Nitro-5-styrylisoxazoles, photodimerization of 780, 781
- Nitrosyl bisulphite 679, 680
- Nitrosyl halides,  
as diazotization reagents 639, 640  
as nitrosating agents 666  
PE spectra of 192
- Nitrosyl ion, solvation of 642
- Nitrosylsulphuric acid 630, 634, 635
- Nitrosyl thiocyanate 678
- Nitrosyl thiosulphate 678, 679
- Nitrotetraazabicycloalkanes, MM2 parameterization of 13
- Nitrothiazoles, reactions with nucleophiles 454, 455
- Nitrothiophenes,  
photoreactions of 780  
structure of 100
- Nitrotoluenes—see also Dinitrotoluenes, TNT  
analysis of 1127, 1135  
atmospheric formation of 1181  
enthalpies of destabilization of 366, 367  
enthalpies of formation of 366–368
- Nitrotoluidines, analysis of 1127, 1135
- Nitrotriazoles,  
analysis of 1141  
structure of 100
- Nitrous acid, as nitrosating agent 666
- Nitroxides, photoreactions of 807–809
- Nitroxynil, determination of 1134
- NO-probe electrode systems 669
- Norcocaine, detection of 1068
- Norephedrine, determination of 1079, 1083
- Norepinephrine 1095  
biologically occurring 1063  
stability of 1067
- Norleucine 1108
- Norphenylephrine 1095
- bNOS 985  
activity of 989  
physiological functions of 992, 993  
purified 984
- eNOS, physiological functions of 993

- iNOS,  
  physiological functions of 993  
  purified 984  
bNOS cDNA 976, 977  
  in the human gene 978, 979  
eNOS cDNA 977, 978  
  in the human gene 979  
iNOS cDNA 978  
  in the human gene 979  
NOS RNA 977  
Nuclear magnetic resonance spectroscopy  
  296–332  
  dynamic 43, 46, 48–50, 52, 54  
  effects of hydrogen bonding 299  
  effects of protonation 299  
  effects of proton exchange 299  
  in structure determinations in solution  
    317–330  
  of amino acid enantiomers 1108, 1109,  
    1112  
  of amino compounds 300, 301, 303–310  
  of anilines 303–310  
  of hydroxamic acids 405  
  of nitranion salts 397, 407  
  of nitro compounds 300, 301, 310–315  
  of nitroso compounds 70–72, 300, 301,  
    315–317  
  of substituted benzenes 301–303  
  <sup>31</sup>P 1109–1111  
  relaxation effects 299  
  shift standards 300  
  solid-state 321–325  
  two-dimensional 1132  
Nucleic bases, PE spectra of 188  
Nucleofuges,  
  nitro 1244, 1245  
  twisting of 1243  
Nucleophile,  
  aggregation of 1265–1267, 1272, 1283,  
    1294  
  mixed 1266, 1267  
  self- 1266  
  with conjugate acid 1276  
  influence on S<sub>N</sub>Ar reactions,  
    of basicity of 1228–1231, 1237–1240  
    of nucleophilicity of 1232–1235  
    of polarizability of 1232, 1235  
    of steric effects in 1235–1237  
Nucleophilic analytes, detection of 1088  
Nucleophilic aromatic substitution 461,  
  753–758—*see also* S<sub>N</sub>Ar reactions  
  desolvative association mechanism for 468  
  dimer mechanism for 469  
  kinetic features of 465–470  
  regioselectivity in 754–756  
  pH dependence of 756  
  SBGA mechanism for 466  
Octopamine 1095  
  biologically occurring 1063  
Omega acid, HPLC of 1074  
Organic cation binding 385  
Organoboranes, as amine precursors 564–567  
Organometallic binding 385  
Ornidazole, analysis of 1140  
ORTEP plots 1242  
*Ortho* effect 264–270  
  in anions 269, 270  
  of amino group 520  
  of nitro group 498–503  
  rearrangements due to 267–269  
Orton rearrangement 873  
Oxaziridines, as electrophilic aminating agents  
  553  
Oxazoles—*see also* Aminooxazoles  
  in pre-/post-column derivatization 1080  
Oxazolidines—*see* Nitrosooxazolidines  
Oxetanes, as amine precursors 543, 545  
Oxidases—*see* Aminooxidases  
Oxidation—*see also* Photooxidation  
  competing, of sulphur and carbon 276–281  
  remote,  
    of imines and ketenimines 273–276  
    of multiple carbon bonds 270–273  
Oximes,  
  MM2 parameterization of 11, 14  
  reduction of 535, 536  
  synthesis of 607–610  
Oxiranes—*see* Chiral oxiranes, Dioxiranes  
Oxonium ions 217  
Oxygen analysers 1046  
Oxygen flame ionization detection (OFID)  
  1046  
Oxyls—*see* Amino-oxyls  
Packing materials, nitrosamine contamination  
  in 1187  
Pancuronium, analysis of 1119  
Parathion-methyl, determination of 1138  
PCILO calculations 62  
PCK/ME procedure 80  
Peak shapes, of isomeric metastable ions 251  
Penning ionization electron spectra 194, 197  
Pentafluoroaniline, diazotization of 635  
Pentahalogenobenzenes, electrocoupling of 846  
*N,N*-2,4,6-Pentamethylaniline, nitration of 952,  
  953  
Pentanitroaniline, destabilization in 366  
PEPICO spectrometry 259  
Peptides—*see also* Dipeptides  
  detection of, in FIA systems 1105  
  LC of 1067  
  photoreactions of 739  
  tagging of 1081  
Peptidyl amino acid hydrolase 1089



- Perhydroazepines, conformers of 60–62
- Peroxalate reaction 1104
- Persulphate oxidation 1046, 1047
- Pesticides, analysis of 1061
- Pharmaceuticals, nitrosamine contamination in 1186
- Phase-transfer catalysis, of  $S_NAr$  reactions 1220
- Phenanthrenes—*see also* Aminoalkylphenanthrenes  
synthesis of 653
- Phenazines—*see also* Aminophenazines  
HPLC of 1072
- Phenethylamines 1079, 1081, 1083, 1104  
determination of 1074  
PE spectra of 179, 180
- Phenols—*see also* Alkylphenols, Aminophenols, Nitrophenols  
nitration of 955
- Phentermine, detection of 1065, 1071
- Phenylalanine 1069, 1070, 1091, 1108  
hydroxylation of 983
- Phenylalkylamines—*see* (*S*)-*N*-Salicylidene- $\alpha$ -phenylalkylamines
- Phenylamines—*see also* Diphenylamines, Triphenylamines  
enthalpies of formation of 350
- Phenylcyclohexylamines,  
enthalpies of formation of 353  
radiolysis of 826, 827
- Phenylephrine, HPLC of 1071
- Phenylhydronitroxide radicals 1019, 1022
- Phenylhydroxylamines,  
electroformation of 838–840  
rearrangements involving 867–873
- Phenylindoles—*see* Nitrophenylindoles,  
Nitrosophenylindoles
- Phosphinimines, basicity of 394
- Phosphoramides, nitranion salts of 397
- Phosphonic amides, diastereomeric 125
- Photocatalysis 767
- Photocyclization,  
of imines 717–720  
of iminium salts 712, 713  
of nitrodiphenylamines 773  
stilbene-type 717–720
- Photocycloadditions, of imines 720, 721
- Photodecarboxylation 782–784
- Photodissociations, of nitroarenes 787–789
- Photoelectric effect 160
- Photoelectron spectroscopy,  
in conformational analysis 174  
of aliphatic amines 163–170  
of alkaloids 180, 181, 188  
of amides 188  
of amino acids 188  
of aminoalkenes 181–183  
of aminoketones 182  
of ammonia 161–163  
of aromatic amines 171–178  
of azobenzenes 199  
of benzamides 199  
of *N*-benzylideneanilines 199  
of bicyclic amines 179  
of biological amines 179, 180  
of cyclophanes 199  
of diamines 183–186  
of enamines 181, 188  
of hydrazines 188  
of hydroxylamines 188  
of imidazolidines 186  
of imidazolines 184  
of morphine 180  
of nitramines 200, 201  
of nitrites 192  
of nitroalkanes 192–197  
of nitroalkenes 200  
of nitrobenzenes 197–200  
of nitrophenylindoles 199  
of nitrosamines 192  
of nitrosoalkanes 188–191  
of nitrosobenzenes 191  
of nitrosophenylindoles 191  
of nitrosyl halides 192  
of nitrosyl transition metal compounds 192  
of polyamines 186, 187  
with force field calculations 66  
zero kinetic energy 173
- Photo-Fries rearrangement 722
- Photogenerators, acid 767
- Photoisomerization, of nitroarenes 778, 779
- Photolabile protective groups 769
- Photon counts 151
- Photonitration 789–792
- Photooxidation, porphyrin-sensitized 781
- Photorearrangement, of nitroarenes 760–776
- Photoredox reactions 749, 750, 760–776, 785–787
- Photoreduction, of nitroarenes 748–753
- Photoretro-aldol type reactions 782–785
- Photo-Smiles rearrangement 758–760
- Photosubstitution, of nitroarenes 753–760
- Picosecond transient spectroscopy 765
- (*S*)- $\alpha$ -Pipicoline, ECD spectra of 130, 131
- Piperazines—*see also* Diketopiperazines,  
Dinitrosopiperazines  
conformers of 57  
enthalpies of formation of 352
- Piperidine helicity rule 131
- Piperidines—*see also* *N*-Nitrosodehydropiperidines, *N*-Nitrosopiperidines  
addition to nitrobenzenes 1221  
chiral—*see* Chiral piperidines  
conformers of 53, 54, 63

- enthalpies of formation of 346, 352
- IPs of 165, 166, 169
- MM2 parameterization of 9
- MM3 parameterization of 26
- radiolysis of 824–826
- synthesis of 539
- Piperidinols, chiral—*see* Chiral piperidinols
- Plasmaspray mass spectrometry 1081
- Platelet aggregation, inhibition of 673
- Polarizability parameters, directional 1238
- Polyamines,
  - conformational analysis of 55–60
  - enthalpies of formation of 350–356
  - PE spectra of 186, 187
  - protonation of, basicity constants of 390
- Polyaminophosphazene, basicity of 394
- Polyazacycloalkanes,
  - metal complexes of 396
  - protonation of, basicity constants of 390, 391
- Polycyclic nitroaromatics, analysis of 1129–1132
- Polynitroalkanes, determination of 1125
- Polynitroarenes 1125
- Polynitrofluorenones, donor–acceptor complexes of 441, 442
- Potential energy surface 4
- Potential energy wells 216
- Potential functions 3
- Primary amines,
  - complexes with Schiff bases 1101
  - derivatization of 1093, 1094
  - determination of 1065
    - amperometric 1106
  - enantiomer analysis of 1111
  - industrial, protocols for 1049–1053
  - interaction with glass 1108
  - photoreactions of,
    - with carboxylic acid salts 710
    - with nitrodibenzodioxins 708
    - with phenanthrene 706
    - with *trans*-stilbene 704, 705
    - with substituted benzenes 709
  - tagging of 1081–1083
- Principle of Nonperfect Synchronization (PNS) 409
- PRISMA model 1086
- Product emission spectroscopy 795
- Prolines 1090, 1091, 1094—*see also* *N*-Nitrosoproline, Thioproline
- Protease 1089
- Propantheline, analysis of 1119
- Propargylamines, synthesis of 556, 575, 576
- Proteins, LC of 1067
- Proton acidity, solvation effects on 1285
- Proton affinities 178, 179, 382
  - determination of 234–236
  - nitrogen 66–68
    - of  $\alpha$ -amino acids 390
- Proton-bridged complexes 238
- Proton sponges 176, 435, 436
- Proton transfer 381
  - excited-state 814–816
  - rate-limiting, mechanism for 1218
  - thermal equilibria for 235
- Protopine, through-space interactions in 181
- Protoporphyrin IX 984
- Prutein 1067
- Pschorr reaction 647, 653–656
- Pseudo- $\alpha$ -cleavage 212, 221–223
  - of ionized long-chain alkylamines 216
  - mechanism for 222
  - suppression by *N*-alkylation 223
- Pseudoephedrine 1095, 1109
- Pseudomonas aeruginosa*, in asymmetric synthesis 108
- Pseudomonas putida*, in asymmetric synthesis 108
- Psychotropic drugs, PE spectra of 179, 180
- Pulmonary adenocarcinoma 1150
- Pulsed-potential amperometric detection 1085
- Pulse radiolysis 824, 826
- Putrescine, analysis of 1058, 1069, 1079, 1080, 1083
- Pyrazines—*see also* Aminopyrazines
  - determination of 1048
- Pyrazoles—*see also* Nitropyrazoles
  - basicity of 407
  - $pK_a$  values of 408
- Pyrazolines—*see* Aminopyrazolines
- Pyrenes—*see* Aminopyrenes,
  - Nitroazabenzopyrenes, Nitropyrenes
- Pyridazines—*see* Aminopyridazines
- Pyridines—*see also* Aminopyridines,
  - Hydroxypyridines, Nitropyridines
  - acidity of 401
  - basicity of 386
  - IPs of 165
  - mass spectra of 234
  - nitranion salts of 398
- Pyrimidines—*see* Aminopyrimidines
- Pyrochemiluminescence 1047
- Pyrololes,
  - BDEs of 401
  - IPs of 165
- Pyrrolidines,
  - as intermediates 1218
  - chiral—*see* Chiral pyrrolidines
  - enthalpies of formation of 347
  - IPs of 165, 166
  - MM2 parameterization of 9
  - MM3 parameterization of 25, 26
  - radiolysis of 826
- Pyrrolizidines, enthalpies of formation of 347

- QCFF/PI calculations 62  
QCPE parameters 13  
Quadrant rules 133  
Quantum-mechanical calculations 4  
Quaternary ammonium compounds,  
  analysis of 1060, 1118–1122  
    chromatographic 1116–1118  
    hydration numbers of 1122  
    industrial, protocols for 1114, 1115  
    S<sub>N</sub>2 reactions of 938–946  
Quinamine rearrangement 863, 865, 930–932  
Quinamines, synthesis of,  
  <sup>14</sup>C-labelled 930  
  <sup>15</sup>N-labelled 930  
  <sup>18</sup>O-labelled 930  
Quinine 1100  
Quinoidal dianions 848  
Quinolines—*see* Aminoquinolines  
Quinone diazides 637  
  photolysis of 658  
*o*-Quinonoid intermediates 765  
Quinonoid resonance structures 365  
Quinuclidines,  
  donor–acceptor complexes of 440, 441  
  enthalpies of formation of 347  
  IPs of 169, 170, 179  
  proton affinities of 179  
Quinuclidinols, chiral—*see* Chiral  
  quinuclidinols
- Radical anions,  
  cleavage of 402  
  formation of 256–258  
Radical cations, formation of 255, 256  
Radicals, stability of, with respect to 1,2-H  
  shifts 221  
Radical stabilization energy 403  
Radioimmunoassay 1106  
Radiolysis,  
  of amines 824–828  
  of amino acids 828–832  
  of nitro compounds 832–834  
  of nitroso compounds 834  
Raman circular intensity differential 151  
Raman optical activity (ROA) 150–153  
Raman scattering 1101, 1136  
Raman spectroscopy 57  
  time-resolved resonance 765, 767  
Raschig process 679  
RDX, analysis of 1125, 1143  
Reactivity–selectivity principle 1232  
Redox reactions—*see also* Photoredox  
  reactions  
  intramolecular 749, 750, 760–776  
Regression analysis 340  
Resolution, kinetic 120
- Resonance effects, in aromatic nitro  
  compounds 361, 362  
Resonance-enhanced multiphoton ionization  
  1125, 1127  
Resonance stabilization, merging 754  
Retardation effects 1237  
Retro-aldol type reactions—*see* Photoretro-  
  aldol type reactions  
Rice–Ramsperger–Kassel–Marcus (RRKM)  
  theory 221  
Rifamycin B 1095  
Ring closure, electrocyclic 258  
Ring opening–reclosure (RORC) 1217  
Ritchie equation 1232  
Rotational barriers,  
  in tertiary amines 43  
  of nitro group 31, 32  
Roxarsone, determination of 1134  
RRKM/QET calculations 259  
Rubber industry, formation of nitroso  
  compounds in 1184, 1185
- Saddle points, first-order 62  
Salicylic acids—*see* Aminosalicylic acids  
Salicylidenamino chirality rule 137–139  
*N*-Salicylideneanilines, intramolecular  
  hydrogen bonding in 436, 437  
(*S*)-*N*-Salicylidene- $\alpha$ -phenylalkylamines,  
  Cotton effects for 137–139  
*Salmonella typhimurium* 1130, 1131  
Sampling, comparison of active/passive 1125  
Sandmeyer reaction 647, 649, 651–653  
S(ANRORC) reactions 1217  
S<sub>N</sub>Ar reactions 1215–1295  
  anomalous kinetics for 1261–1294  
  catalysis of,  
    by HBA additives 1275, 1276, 1294  
    by methanol 1273–1275  
    electrophilic 1250–1253, 1276, 1278,  
      1288, 1294  
    phasc-transfer 1220  
  change in rate-determining step in 1242,  
    1243  
  classical kinetics for 1218–1261  
  conformational effects on 1282–1285, 1294  
  dichotomy of amine effects on 1290–1294  
  equilibrium constants for 1289, 1290  
  high-pressure 1256–1261  
  influence of nucleophile on 1228–1240  
  influence of substrate on 1240–1245  
  inversion in reactivity of 1242  
  isotope effects on 1285, 1286  
  mechanisms for,  
    concerted 1230  
    desolvative encounter 1281, 1282  
    dimer nucleophile 1267–1275, 1278,  
      1282, 1286, 1289, 1294

- homo-/hetero-conjugate 1276–1278, 1294  
specific base–general acid (SBGA) 466, 1218, 1219  
  substrate–catalyst 1278–1281, 1289  
  medium effects on 1220–1228  
  molecular complex intermediates in 1245–1250  
  specific solvent effects on 1272, 1273  
  stereoelectronic effects on 1219, 1237  
  transition states of 1228, 1264, 1265, 1288
- Scavengers, of nitrous acid 629
- Schiff bases, in pre-/post-column derivatization 1085, 1086, 1101
- Seawater, analysis of amines in 1058
- Secondary amines,  
  enantiomer analysis of 1111  
  industrial, protocols for 1053, 1054  
  photoreactions of,  
    with excited-state *trans*-stilbene 698–700  
    with excited-state styrenes 700–702  
    with other excited systems 702, 703  
  tagging of 1081–1083
- Sector rules 70
- Selected ion flow tube (SIFT) technique 235
- Self-aggregates 1266, 1273, 1283
- Semiconductors, in photoreduction of nitro-arenes 748
- Semidines, as hydrazobenzene rearrangement products 858, 859
- Semimercaptals—*see* *N*-Hydroxysulphenamides
- Semtex 10, TGA of 1142
- Serine 1085
- Serotonin, stability of 1067
- Serotonine, biologically occurring 1063
- Sharpless reagent, modified 120
- [1,3]-Sigmatropic rearrangements 880
- [1,5]-Sigmatropic rearrangements 861, 879, 880
- [3,3]-Sigmatropic rearrangements 863
- [5,5]-Sigmatropic rearrangements 860
- Silylamines—*see also* Trimethylsilylamines  
  IPs of 168
- Simazine 1047, 1048
- Snuff, carcinogenicity of 1151
- Solid-phase extraction (SPE) 1136, 1145
- Solid-phase microextraction (SPME) 1127
- Solvation,  
  built-in 1242  
  internal 1284, 1285  
  preferential 1226
- Solvation effects, on relative basicities 1238–1240
- Solvatochromic parameters 1220  
  effect of cosolvents on 1227
- Solvent effects, on  $S_NAr$  reactions 1240, 1294  
  specific 1272, 1273  
  unspecific 1262
- Solvent hydrogen-bond basicity 1220, 1228
- Solvent nucleophilicity 1220
- Solvent parameters, for  $S_NAr$  reactions 1220–1222
- Solvents,  
  dipole moments of 1239  
  hydroxylic,  
    hydrogen-bond donicity of 1221  
    reactivity in 1221, 1222  
  interactions in 424  
  liquid crystal 320, 321  
  mixed 1225–1228  
  parameters for 424, 425  
  polarity of 425, 445
- Solvent–solute interactions, in  $S_NAr$  reactions 1220, 1225, 1238
- Solvent–solvent interactions 1225
- Solvent transfer 1221
- Specific base–general acid (SBGA)  
  mechanism, for  $S_NAr$  reactions 466, 1218, 1219
- Spectrophotometry,  
  of amino compounds 1096–1102  
  of nitroglycerin 1142  
  zero-crossing first derivative 1139
- Spectroscopic moments 135
- Spermidine, analysis of 1069, 1079, 1081, 1083
- Spermic, analysis of 1079, 1081, 1083
- Spin coupling constants, of cycloalkanes 166
- Spin-orbital effect 160
- Spin–spin couplings, indirect 298, 299
- Spirocycloalkanes, magnetic anisotropy of 68
- Square mechanism, for electroreactions 841, 842
- Stannanes—*see* Aminostannanes
- Stereoelectronic effects, on  $S_NAr$  reactions 1290
- Steric effects,  
  in aromatic nitro compounds 361, 362  
  on nucleophilic reactivities 1232, 1235–1237, 1290, 1294
- Steric energy, in MM2 force field 5
- Steric hindrance, of groups *ortho* to nitro groups 439
- Steric resonance inhibition 174
- Stilbenes, *cis*–*trans* isomerization of 778
- Stretching energies, in MM2 force field 5
- Structure–activity relationships, quantitative (QSAR) 1222, 1238
- Structure–property relationships, quantitative (QSPR) 1238
- Styrylnaphthalenes, *cis*–*trans* isomerization of 778
- Substrate, influence in  $S_NAr$  reactions,  
  of field effects in 1243, 1244

- Substrate, influence in  $S_NAr$  reactions (*cont.*)  
of steric/conformational effects in 1240, 1241
- Substrate-catalyst mechanism, for  $S_NAr$  reactions 1278-1281, 1289
- Subtilisin Carlsberg, as catalyst in asymmetric synthesis 108
- Succinylcholine, analysis of 1119
- Sulphadiazine, analysis of 1088
- Sulphamic acid, as nitrous acid scavenger 629
- Sulphamides, acidity of 404, 405
- Sulphanilic acid, diazotization of 629
- Sulphenamidic cation 1009, 1030, 1031  
MO calculations for 1014
- Sulphenamides 1011, 1029, 1031—*see also*  
*N*-Hydroxysulphenamides  
formation of 1012  
identification of 1011  
photoreactions of 735, 736
- N*-Sulphenylquinone imines 1015, 1016
- Sulphides, *S*-nitrosation of 676, 677
- Sulphinamides 1009, 1023, 1025, 1027, 1029-1031  
diastereomers of 1009  
formation kinetics of 1010  
identification of 1009, 1023
- Sulphinic acids, nitrosation of 678
- Sulphonamides—*see also N*-Hydroxy-sulphonamides  
acidity of 395  
nitranion salts of 397  
photoreactions of 736-738
- N*-Sulphonation, as pre-/post-column derivatization procedure 1080-1084
- Sulphonic acids—*see* Aminonitrostilbenedisulphonic acids, 1-Naphthalenesulphonic acid
- Sulphonphthalein-type dyes 1100
- Sulphonyl halides—*see* Arenesulphonyl halides
- Sulphonyl nitrites 677, 678
- Sunscreens, nitrosamine contamination in 1186
- Superbases 1238
- Supercritical fluid extraction (SFE) 1132, 1135
- Superoxide dismutase (SOD) 975
- Supramolecular chemistry 428
- Surfactants, nonionic 1107, 1108
- Survivor signals 210
- Swain, treatment of electronic effects 522
- Taft equations 489, 490, 522, 523
- Taft gas-phase substituent parameters 258
- Taft  $\sigma$ -values, of quinuclidines 169, 170
- Tautomerism 426  
in dimers 432  
in nitro radical cations 259-261  
keto-enol 260
- TEMPO, photoreactions of 809
- Terbutalin 1095
- Tertiary amines,  
aliphatic, determination of 1064  
as donors in intramolecular charge-transfer interaction 693-698  
chemiluminescence of 1108  
conformational analysis of 43-55  
industrial, protocols for 1055-1058  
photoreactions of,  
with other oxidants 692, 693  
with *trans*-stilbene 685, 686  
with styrenes 686, 687  
with  $\alpha,\beta$ -unsaturated carbonyls 687-691
- Tertiary nitro compounds,  
denitration of 851  
radical anions of 839
- Tetraalkylammonium ions,  
FAB spectra of 234  
mass spectra of 240, 241  
comparison with protonated amines 241-243
- Tetraazaadamantanes, enthalpies of formation of 356
- Tetraazaalkanes, complexes of, structure of 58, 59
- Tetraazacyclohexadecanes, MM2 parameterization of 10
- Tetraazacyclotetradecanes, enthalpies of formation of 356
- Tetraazadecalins, structure of 19, 20
- 2,3,4,5-Tetrabromo-6-methylphenol, nitration of 968
- Tetrabutylammonium ions, analysis of 1116
- Tetrahydrofolic acid 977, 985  
in formation of NO 980, 983
- Tetrahydrofuran, acidity of 398
- Tetralines—*see* Aminotetralines
- Tetramethylnaphthalenes, nitration of 969
- Tetramines,  
conformational analysis of 58, 59  
enthalpies of formation of 355, 356  
protonation of, basicity constants of 389, 390
- Tetranitrates, analysis of 1142
- Tetranitroaniline, destabilization in 366
- Tetranitromethane, donor-acceptor complexes of 455
- Tetrazines—*see* Aminotetrazines
- Tetrazoles—*see* Aminotetrazoles
- Thermal energy analyser-chemiluminescence detector (TEA-CLD) 1145
- Thermal energy analyser (TEA) 1144
- Thermal lens spectrophotometry 1087
- Thermochemistry, definition of 338
- Thermogravimetric analysis (TGA) 1142
- Thiadiazoles—*see* Aminothiadiazoles
- Thiazoles—*see* Aminothiazoles, Nitrothiazoles

- Thiazolidines—*see* *N*-Nitrosothiazolidines  
Thiiranes, chiral—*see* Chiral thiiranes  
Thin-layer chromatography,  
  of quaternary ammonium compounds 1118  
  two-dimensional 1089  
Thioamides—*see also* Dithioamides  
  acidity of 403, 404  
  photoreactions of 728, 729  
Thiocamphor, reactions of 675  
Thioethers 1014, 1029–1031  
  formation of 1014, 1016, 1017  
Thioglycolic acid, thiolate anion from,  
  reactions of 668  
Thiohydantoin derivatives, of amino acids  
  1084, 1090, 1096  
Thioimides—*see also* Dithioimides  
  photoreactions of 734  
Thiolate anions, reactions of 667, 668  
Thiomorpholines, nitrosation of 677, 888  
Thionitrates, formation of 672  
Thiophenes—*see* Nitrothiophenes  
Thioprolines, nitrosation of 677, 888  
Thioureas,  
  acidity of 404  
  reactions of 674, 675  
Thiyl radicals 1019, 1022  
Threonine 1069  
Through-bond interactions 66  
Through-space interactions 66  
Tiger computer code 369  
Time of flight mass spectrometry (TOF-MS)  
  1127  
Time of flight—secondary ion mass spec-  
  trometry (TOF-SIMS) 1108  
Titanium oxide, photoexcitation of 748  
TNT,  
  detection of 1125  
  determination of 1127, 1128  
Tobacco smoke,  
  mainstream (MSTS) 1150  
  sidestream (SSTS) 1150  
Toluamides—*see* Aminonitrotoluamides  
Toluenes—*see* Nitrotoluenes  
Toluidines—*see also* *N,N*-Dimethyltoluidines,  
  Nitrotoluidines  
  IPs of 174, 175  
Torsional energy, in MM2 force field 6  
Torsion-stretch energy, in MM3 force field  
  22  
Transannular interactions 181–183, 187  
Transition metal complexes, of nitroso  
  compounds, PE spectra of 192  
Transition moments 135, 139  
Transition states, of  $S_NAr$  reactions,  
  charge transfer in 1228  
  eight-membered cyclic 1264, 1265, 1288  
Translational energies 253  
Traut's reagent 1099  
Trialkylphenols, nitration of 955, 963  
Triamines,  
  conformational analysis of 57, 58  
  PE spectra of 186, 187  
1,3,5-Triamino-2,4,6-trinitrobenzene, stability  
  of 366  
Triazaadamantanes, PE spectra of 187  
Triazenes—*see also* Nitrophenyltriazenes  
  as precursors for diazonium ions 652, 653  
  hydrolysis of 656  
Triazines—*see also* Aminotriazines,  
  Hexahydrotriazines  
  enthalpies of formation of 354, 355  
Triazoles—*see also* Aminotriazoles, Benzo-  
  triazoles, Nitrotriazoles  
  thermodynamics of 408  
Tribenzylamine, conformers of 46  
3,4,5-Tribromo-2,6-dimethylphenol, nitration of  
  954, 955  
Tridimensional energy maps 1230, 1231  
Triflates, synthesis of 656, 657  
Trimethylsilylamines,  
  IPs of 168  
  radical cations of 825  
Trimethylsilyl derivatives, of nitrophenols  
  1134  
Trinitroaniline, stability of 365, 366  
Trinitroarenes, mass spectra of 281  
Trinitrobenzenes—*see also* 1,3,5-Triamino-  
  2,4,6-trinitrobenzene  
  reactions with amines 1248, 1249, 1280  
Trinitrophenyl ethers, reactions with amines  
  1273  
Trinitrophenyl sulphides, reactions with amines  
  1253–1255  
Triphenylamine, radiolysis of 826, 827  
Tripos 5.2 36, 37  
Tropine 1100  
Tryptamines,  
  derivatization of 1083  
  determination of 1069, 1074, 1079  
  PE spectra of 179, 180  
Tryptophan 1103  
  analysis of 1070, 1076, 1080, 1089, 1090  
  hydroxylation of 983  
Tryptophane 1069  
Tubocurarine, analysis of 1119  
Tyramine,  
  derivatization of 1083  
  determination of 1058, 1069, 1074, 1079,  
  1081  
  in bovine retina 1062  
Tyrosine,  
  analysis of 1070, 1076, 1089, 1103  
  configuration of 1111  
  hydroxylation of 983

- Tyrosine (*cont.*)  
  radical of 827  
Tyroxine 1104
- Ultrasonic relaxation spectroscopy 57  
Universal Force Field (UFF) 38–40  
Universal slope 339  
 $\alpha,\beta$ -Unsaturated nitro compounds, electro-  
  reduction of 849, 850  
Ureas—*see also* Nitrosoureas, Thioureas  
  acidity of 404  
  as nitrous acid scavengers 629  
  synthesis of 595–597  
Urethanes, PE spectra of 182  
Urotropine, PE spectrum of 187
- Valine 1069, 1108  
Van der Waals forces 426  
Vasodilation, control of 673  
VBFF 60  
VdW energy, in MM2 force field 6  
Vecuronium salts, analysis of 1119  
Vibrational circular dichroism (VCD) 146–150  
Vibrational frequencies, in amines 23  
Vibrational modes, totally symmetric 134  
Vibrational spectroscopy 21, 32, 35  
Vibronic borrowing 134  
Volatile amines, determination of 1063
- Wallach rearrangement 865–867  
Water, disinfection of 1107  
Wolff rearrangement 658  
Wood smoke, polycyclic nitroaromatics in  
  1129
- Ylides, fluorescent 1100  
Yukawa–Tsuno equation 451, 489
- Zeolite catalysts 538, 578  
Zero-point energies 220  
Zincon 1099  
Zolpidem, determination of 1063  
Zwitterionic intermediates,  
  hydrogen bonding in 1243  
  rate-limiting deprotonation of 1219  
  resonance stabilization of 1243

*Index compiled by P. Raven*